

HUGO GERNSBACK, Editor

RADIO CRAFT

In this issue -

German Radar Equipment
Radio Proximity Fuze

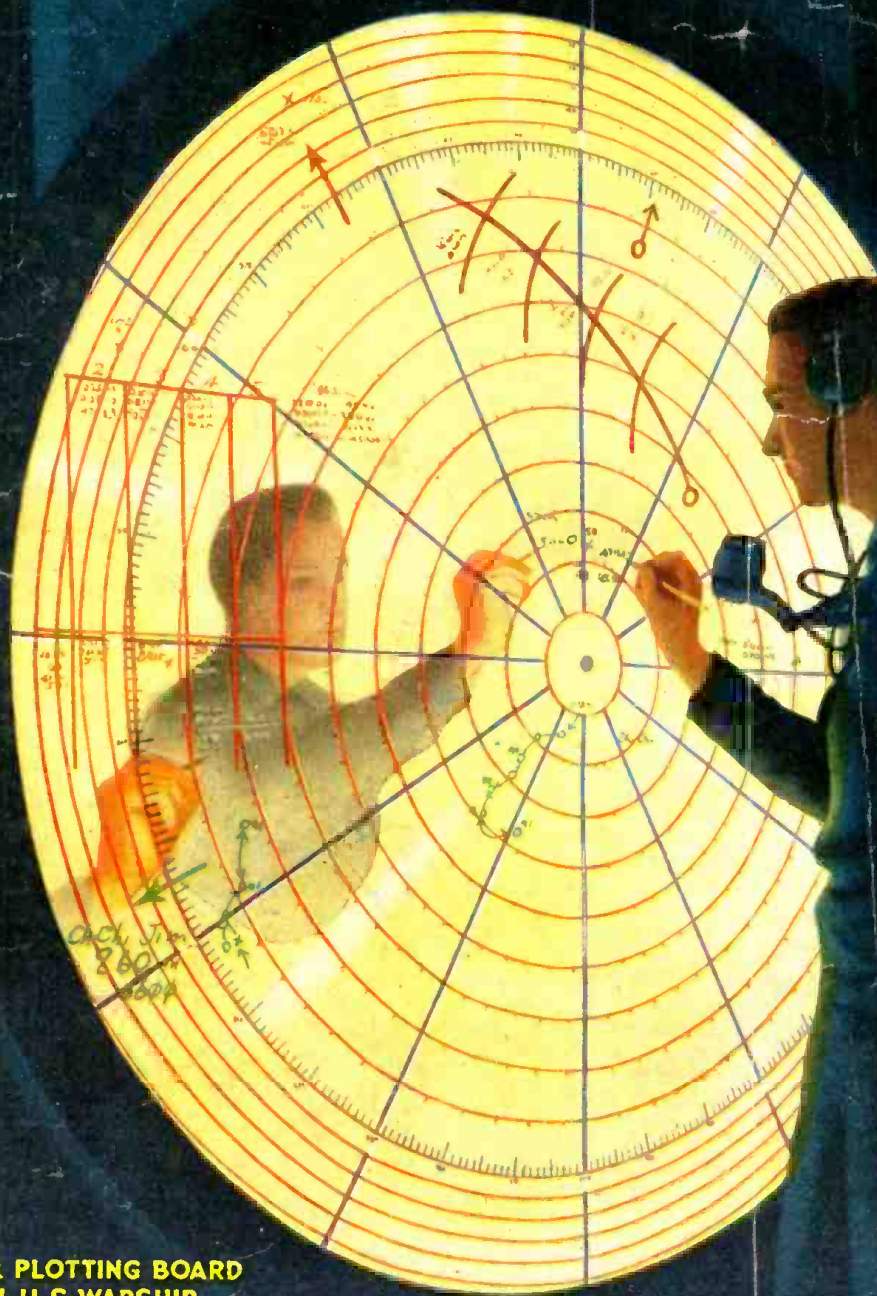

RADAR PLOTTING BOARD
ON U.S. WARSHIP
SEE PAGE 162

DEC

1945

25¢

CANADA 50¢

RADIO-ELECTRONICS IN ALL ITS PHASES



DUALS

with Lugs

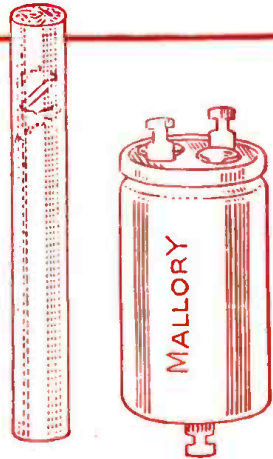

They're GOOD and SMALL

Smaller than a cigarette—*smaller, in fact, than some of the smallest cardboard capacitors made!* But aluminum-cased, hermetically sealed! Long-lived, dependable! That's the story of the new Mallory Duals.

Notice those lugs at top and bottom! They eliminate broken leads, difficult skinning operations . . . make handy anchors for other wiring.

Notice especially the bottom capacitor in the upper left-hand picture. That's the Mallory "TCS," each section of which is independent of the other. It will replace units of common negative, common positive or separate section construction—yet it's the *smallest* separate section unit ever made!

These Mallory Dual Capacitors are part of a *complete new line*, including pint-sized single units too. Get acquainted with the entire family! See them—buy them at your nearest Mallory distributor.

P. R. MALLORY & CO., Inc.
INDIANAPOLIS 6, INDIANA



*More than ever—
ALWAYS
INSIST ON*

P. R. MALLORY & CO. Inc.
MALLORY
APPROVED
PRECISION PRODUCTS

**VIBRATORS • VIBRAPACKS* • CONDENSERS
VOLUME CONTROLS • SWITCHES • RESISTORS
FILTERS • RECTIFIERS • POWER SUPPLIES**

ALSO MALLORY "TROPICAL"® DRY BATTERIES, ORIGINALLY DEVELOPED BY MALLORY FOR THE U. S. ARMY SIGNAL CORPS, NOT PRESENTLY AVAILABLE FOR CIVILIAN USE.

*Trademarks

A FREE LESSON SHOWED BILL HOW HE COULD MAKE GOOD PAY IN RADIO!

BILL, YOU'RE ALWAYS FOOLING WITH RADIO--OUR SET WON'T WORK--WILL YOU FIX IT?

I'LL TRY, MARY. I'LL SEE WHAT I CAN DO WITH IT TONIGHT



I CAN'T FIND OUT WHAT'S WRONG -- GUESS I'LL MAKE A FOOL OF MYSELF WITH MARY

HELLO, BILL-- GOT A TOUGH ONE TO FIX? LET ME HELP YOU

YES, JOE -- I'M STUMPED-- BUT SINCE WHEN ARE YOU A RADIO EXPERT?

I'VE BEEN STUDYING AT HOME WITH THE NATIONAL RADIO INSTITUTE. I JUST LANDED A SWELL RADIO JOB, TOO LISTEN FOR THE CLICKS AS I SHORT THE GRID CONNECTIONS... HERE'S YOUR TROUBLE IN THE FIRST I.F. STAGE-- I LEARNED THIS TEST BEFORE I EVEN STARTED THE COURSE, FROM A FREE LESSON THE N.R.I. SENT ME

SAY, I'VE SEEN THEIR ADS BUT I NEVER THOUGHT I COULD LEARN RADIO AT HOME I'LL MAIL A COUPON FOR A FREE LESSON RIGHT AWAY



I'M CONVINCED NOW THAT THE N.R.I. COURSE IS PRACTICAL AND THOROUGH. I'LL ENROLL NOW THEN I CAN MAKE EXTRA MONEY FIXING RADIOS IN SPARE TIME WHILE LEARNING

SOON I CAN HAVE MY OWN FULL-TIME RADIO REPAIR BUSINESS, OR BE READY FOR A GOOD JOB IN A BROADCASTING STATION AVIATION RADIO, POLICE RADIO OR SOME OTHER BUSY RADIO FIELD

YOU CERTAINLY KNOW RADIO. SOUNDS AS GOOD AS THE DAY I BOUGHT IT!

THANKS! I WAS JUST A TINKERER A FEW MONTHS AGO, BEFORE I STARTED THE N.R.I. COURSE-- BUT N.R.I.'S '50-50 METHOD' GIVES A FELLOW THE PRACTICAL KNOWLEDGE AND EXPERIENCE TO BE A SUCCESSFUL RADIO TECHNICIAN

OH, BILL-- I'M SO GLAD I ASKED YOU TO FIX OUR RADIO! IT GOT YOU STARTED THINKING ABOUT RADIO AS A CAREER, AND NOW YOU'RE GOING AHEAD SO FAST!

YES, OUR WORRIES ARE OVER I HAVE A GOOD JOB AND THERE'S A BRIGHT FUTURE FOR US IN RADIO



I will send you a Lesson on Radio Servicing Tips **FREE** TO SHOW HOW PRACTICAL IT IS TO TRAIN AT HOME FOR **GOOD JOBS IN RADIO**

I want to give every man who's interested in Radio, either professionally or as a hobby, a copy of my Lesson, "Radio Receiver Troubles—Their Cause and Remedy"—absolutely FREE! It's a valuable lesson. Study it—keep it—use it—without obligation! And with it I'll send my 64-page, illustrated book, "Win Rich Rewards in Radio," FREE. It describes many fascinating jobs in Radio, tells how N.R.I. trains you at home in spare time, how you get practical experience with SIX BIG KITS OF RADIO PARTS I send. This "Sample" Lesson will show you why the easy-to-grasp lessons of the N.R.I. Course have paved the way to good pay for hundreds of other men. I will send it to you without obligation... MAIL THE COUPON!



Future for Trained Men is Bright in Radio, Television, Electronics

The Radio Repair business is booming NOW. There is good money fixing Radios in your spare time or even full time business. And trained Radio Technicians also find wide-open opportunities in Police, Aviation and Marine Radio, in Broadcasting, Radio Manufacturing, Public Address work, etc. Think of the boom coming now that new Radios can be made! And think of even greater opportunities when Television and Electronics are available to the public! Get into Radio NOW.

Many Beginners Soon Make \$5, \$10
a Week EXTRA in Spare Time

The day you enroll I start sending EXTRA MONEY JOB SHEETS to help you

Our 31st Year of Training Men for Success In Radio

My Radio Course Includes Training in
TELEVISION • ELECTRONICS • FREQUENCY MODULATION

make EXTRA money fixing Radios in spare time while learning. You LEARN Radio principles from my easy-to-grasp Lessons—PRACTICE what you learn by building real Radio Circuits with the six kits of Radio parts I send—USE your knowledge to make extra money while getting ready for a good full time Radio job.

Find Out What N.R.I. Can Do for YOU

MAIL COUPON for Sample Lesson and FREE 64-page book. It's packed with facts about opportunities for you. Read the details about my Course. Read letters from men I trained, telling what they are doing, earning. Just MAIL COUPON in an envelope or paste it on a penny postal.—J. E. Smith, President, Dept. 5NX, National Radio Institute, Pioneer Home Study Radio School, Washington 9, D. C.

You Build These and Other Radio Circuits with 6 BIG KITS OF PARTS I SEND YOU!

By the time you've conducted 60 sets of Experiments with Radio Parts I supply, made hundreds of measurements and adjustments, you'll have valuable PRACTICAL Radio experience for a good full or part-time Radio job!



SUPERHETERODYNE CIRCUIT (right) Preselector, oscillator-mixer-first detector, i.f. stage, diode detector—a.v.c. stage, audio stage. Bring in local and distant stations on this circuit you build yourself!

MEASURING INSTRUMENT (above) you build early in Course. Use it in practical Radio work to make EXTRA money. Vacuum tube multimeter, measures A.C., D.C., and R.F. volts, D.C. currents, resistance, receiver output.

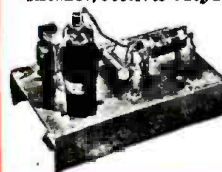

A. M. SIGNAL-GENERATOR (left) build it yourself! Provides amplitude-modulated signals for test and experimental purposes. Gives valuable practice!



GET BOTH 64 PAGE BOOK **FREE** SAMPLE LESSON

MR. J. E. SMITH, President, Dept. 5NX
NATIONAL RADIO INSTITUTE, Washington 9, D. C.
Mail me FREE, without obligation, Sample Lesson and 64-page book, "Win Rich Rewards in Radio." (No salesman will call. Please write plainly.)

Age.....
Name.....
Address.....
City.....Zone.....State.....14X1



... now, in a striking new
package for profitable service business

Key to the powerful N. U. merchandising plans that are now ready to go to work for service dealers—is the most striking package design in the radio parts field.

In this smart, modern, stream-line container, all N. U. branded products will be packaged—adding tremendously to their shelf-display and eye-appeal.

You can count on it—nothing has been left

undone to make the National Union family of products the most profitable of all for the service dealer. In engineering, in product performance, in sales policy, and in merchandising—the N. U. line is in a class by itself in meeting today's needs of the Service Dealer and Parts Distributor.

NATIONAL UNION RADIO CORPORATION
NEWARK 2, NEW JERSEY

NATIONAL UNION RADIO TUBES AND PARTS

Transmitting, Cathode Ray, Receiving, Special Purpose Tubes • Condensers • Volume Controls • Photo Electric Cells • Panel Lamps • Flashlight Bulbs



I'LL SHOW YOU HOW TO SUCCEED IN RADIO

Here's the right training for Big Post-War Pay!



F. L. Sprayberry, one of the country's foremost Radio Teachers.



A RADIO SERVICE BUSINESS OF YOUR OWN

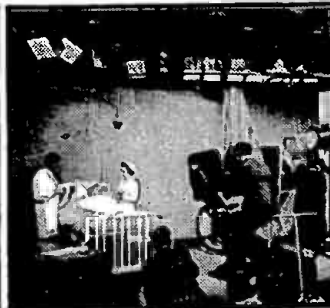

A GOOD JOB IN RADIO & TELEVISION BROADCASTING

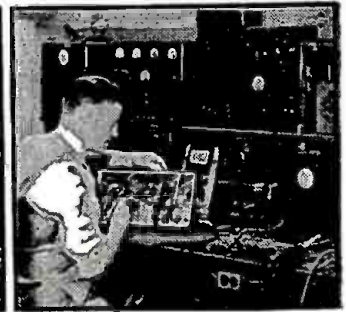

RADIO-ELECTRONIC SERVICE ENGINEER

BE A RADIO-ELECTRONICIAN



I SUPPLY A FULL RADIO SET for practical easy LEARNING

NOW! YOU CAN PREPARE AT HOME IN YOUR SPARE TIME FOR THE AMAZING OPPORTUNITIES AHEAD IN RADIO — ELECTRONICS — TELEVISION

The offer I make you here is the opportunity of a lifetime. It's your big chance to get ready for a wonderful future in the swiftly expanding field of Radio-Electronics INCLUDING Radio, Television, Frequency Modulation and Industrial Electronics. Be wise! NOW'S the time to start. Opportunities ahead are tremendous! No previous experience is necessary. The Sprayberry Course starts right at the beginning of Radio. You can't get lost. It gets the various subjects across in such a clear, simple way that you understand and remember. And, you can master my entire course

in your spare time. It will not interfere in any way with your present duties. Along with your Training, you will receive my famous BUSINESS BUILDERS which will show you how to make some nice profits while learning.

Prepares You for a Business of Your Own or Good Radio Job

My training will give you the broad, fundamental principles so necessary as a background, no matter which branch of Radio you wish to specialize in. I make it easy for you to learn Radio Set Repair and Installation Work. I teach you how to install and repair Electronic Equipment. In fact, you'll be a fully qualified RADIO-ELECTRONICIAN, equipped with the skill and knowledge to perform efficiently and to make a wonderful success of yourself.

Just Out! FREE!

"How to Read Radio Diagrams & Symbols" a valuable new book which explains in simple English how to read and understand any Radio Set Diagram. Provides the quick key to analyzing any Radio circuit. Includes translations of all Radio symbols. Send for this FREE book now, and along with it I will send you another big FREE book describing my Radio-Electronic training.



GET FREE BOOKS

SPRAYBERRY ACADEMY OF RADIO

F. L. Sprayberry, Pres.
Room 20125
Pueblo, Colorado

Please rush my FREE copies of "HOW TO MAKE MONEY IN RADIO, ELECTRONICS and TELEVISION," and "HOW TO READ RADIO DIAGRAMS and SYMBOLS."

Name Age

Address

City State

Tear off this coupon, mail in envelope or paste on penny postcard.

SPRAYBERRY TRAINING GIVES YOU BOTH TECHNICAL KNOWLEDGE • SKILLED HANDS

There's only one right way to learn Radio Electronics. You must get it through simplified lesson study combined with actual "shop" practice under the personal guidance of a qualified Radio Teacher. It's exactly this way that Sprayberry trains you... supplying real Radio parts for learn-by-doing experience right at home. Thus, you learn faster, your understanding is clear-cut, you acquire the practical "know how" essential to a good-paying Radio job or a Radio business of your own.

I'll Show You a New, Fast Way to Test Radio Sets Without Mfg. Equipment

The very same Radio Parts I supply with your Course for gaining pre-experience in Radio Repair work may be adapted through an exclusive Sprayberry wiring procedure to serve for complete, fast, accurate Radio Receiver troubleshooting. Thus, under Sprayberry meth-

ods, you do not have one cent of outlay for manufactured Test Equipment which is not only expensive but scarce.

Read What Graduate Says "One Job Nets About \$26.00"

"Since last week I fixed 7 radios, all good-paying jobs and right now I am working on an amplifier system. This job alone will net me about \$26.00. As long as my work keeps coming in this way, I have only one word to say and that is, 'Thanks to my Sprayberry training' and I am not afraid to boast about it."—ADRIEN BENJAMIN, North Grosvenordale, Conn.

DON'T PUT IT OFF!

Get the facts about my training—now! Take the first important step toward the money-making future of your dreams. All features are fully explained in my big, illustrated FREE Catalog which comes to you along with another valuable FREE book you'll be glad to own. Mail Coupon AT ONCE!

3 BIG STEPS AHEAD!

IT'S engineering that counts these days—and it's engineering that Sprague Electric Company gives you in fullest measure! From the smallest Sprague tubular or Atom replacement type to unique, giant capacitors developed for difficult war services, you'll find Sprague engineering leading the way in assuring such essential characteristics as greater dependability in smaller size, longer life, and outstanding electrical performance.

The three exclusive Sprague developments shown here are typical of many that have played a big part in helping Sprague become a FIVE TIME WINNER of the coveted Army-Navy "E" Award. And they're typical of the kind of engineering that goes into every Sprague Capacitor or Koolohm Resistor that leaves the plant!

See the Sprague Trading Post Advertisement on Page 154

Harry Walker
Sales Manager

SPRAGUE PRODUCTS COMPANY
North Adams, Mass.

(Jobbing Sales Organization for Products of the Sprague Electric Co.)

SPRAGUE



1 *VITAMIN Q. This unique impregnant is Sprague's answer to high-voltage, high-temperature problems. Although small in size, Vitamin Q Capacitors operate satisfactorily at thousands of volts at ambients as high as 105° C. Leakage resistance at room temperature is 20,000 megohms per microfarad—at least five times better than that of previous types!

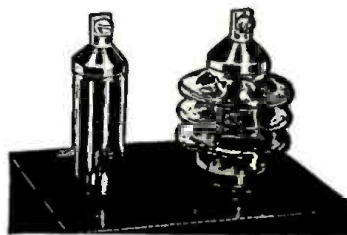

2 GLASS-TO-METAL SEALS
(Under this exclusive Sprague method, glass capacitor bushings are welded directly to the metal container. On certain Sprague Koolohm Resistor types, the units are encased in glass tubes which are then processed to the metal ends. The resulting seals are leak-proof, shock-proof, humidity-proof and fungus-proof!)

3 *CEROC 200
Much electrical equipment can now be designed for 200° C. continuous operation, thanks to Sprague CEROC 200, a Class C flexible ceramic insulation for wire. Smaller equipment can be designed to do bigger jobs.



Trademarks registered
U. S. Patent Office

**CAPACITORS FOR EVERY SERVICE,
AMATEUR, AND EXPERIMENTAL NEED**

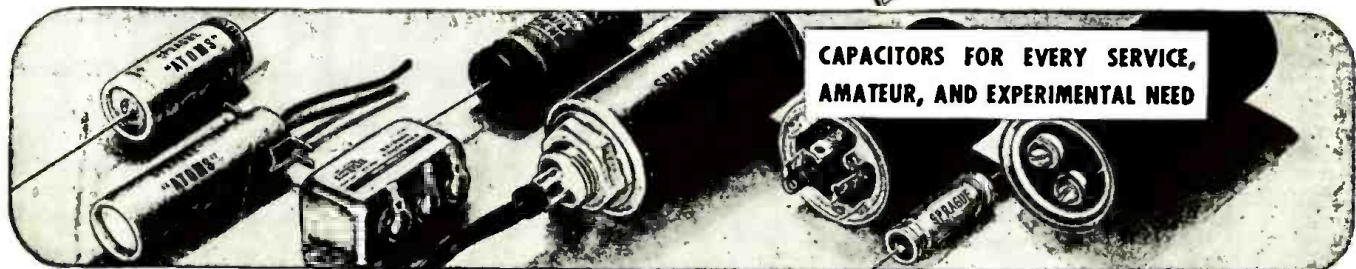

**FOR REAL JOB SECURITY
NOW AND IN THE FUTURE . . .**

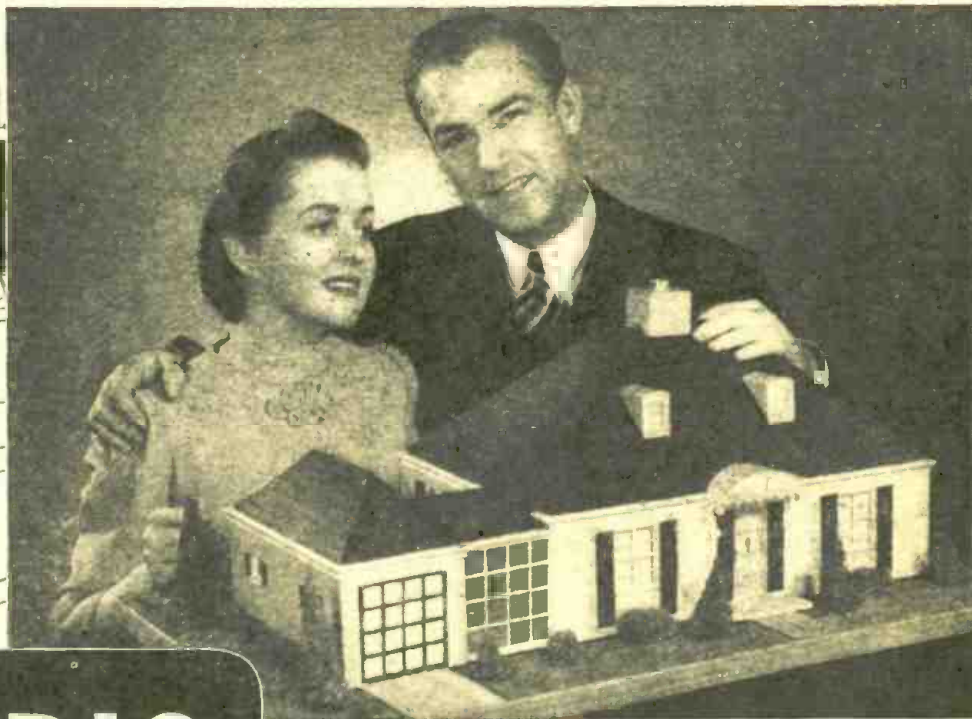

Learn **RADIO
ELECTRONICS**
AT HOME OR IN
OUR CHICAGO LABORATORIES

● Now that the war is over and civilian production is getting under way . . . choose a field that promises *real job security*. Radio, Electronics—and all the many applications and opportunities of each, are wide open to *trained men!* . . . in broadcasting, manufacturing, merchandising, installing and servicing Communications, Sound Pictures, Transportation, Aviation Radio, etc.

If you are even slightly mechanically minded . . . if you can follow clear, easy-to-understand instructions—you can learn all about Radio-Electronics and its many applications in Television, Radar, etc. DeForest's modern A-B-C Method makes it seem simple. The exclusive home training advantages of actual MOVIES and "Synchro-Graphic" Lesson

DeFOREST'S TRAINING, INC.
CHICAGO, ILL.

Texts, prepared under the personal supervision of Dr. Lee DeForest, the "Father of Radio," actually helps make learning *faster-easier* . . . and much more interesting than *ordinary* methods. You make 133 fascinating experiments with 8 Big Kits of Radio Parts and Assemblies, too—a practical "Shop Training" right in your own home. If you prefer, you can take the complete course in our modern Chicago Laboratories . . . in the heart of the Radio Industry.

SEND FOR FREE BOOKS FOR FURTHER INFORMATION

Use your *free time today* to store up *practical knowledge and experience* for *good pay and job security* tomorrow! Mail coupon *now* for complete information—get the big "Victory for You!" book and Equipment folder—see how easy it is for you to get started at once. No obligation.

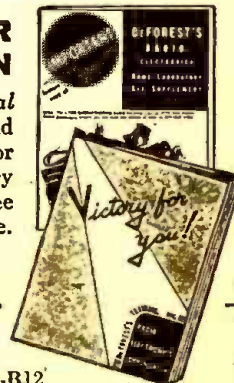

E. B. DeVry, President
DeFOREST'S TRAINING, INC.
2535-41 North Ashland Avenue, Dept. RC-B12
Chicago 14, Illinois, U.S.A.

Please send me your "VICTORY FOR YOU!"
BOOK and EQUIPMENT FOLDER

Name _____ Age _____

Address _____

City _____ Zone _____ State _____

If under 16, check here for special information.

If a veteran of World War II, check here.

RADIO CRAFT

AND POPULAR ELECTRONICS

Incorporating
SHORT WAVE CRAFT TELEVISION NEWS
RADIO & TELEVISION



HUGO GERNSBACK, Editor-in-Chief
FRED SHUNAMAN, Associate Editor
I. QUEEN, Editorial Associate
ELMER FULLER, Shortwave Editor
E. A. WITTEN, Technical Editor
A. PASCALE, Production Manager
G. ALIQUO, Circulation Manager
JOHN J. LAMSON, Advertising Director
ALFRED STERN, Promotion Manager

IN THE NEXT ISSUE

Electronic Transients
Reducing Hum Levels
A Capacity Bridge
Elements of Radar—II
All Wave Sig Generator

Published by Radercraft Publications, Inc.
Publication Office: 29 Worthington Street, Springfield 8, Mass.
Editorial and Advertising Offices: 25 West Broadway, Tel. RE2-9690, New York 7, N. Y.
Chicago Advertising Office: Radio-Craft, 308 W. Washington Street, Suite 1413, Chicago 6, Ill. Tel. Randolph 7363.
Cleveland Advertising Office: 405 Erie Bldg., Cleveland, Ohio. Burdette Phillips, Manager. Tel. Main 9645.
Los Angeles Advertising Office: 606 South Hill Street, Los Angeles 14, Calif. Ralph W. Harker, Manager.
San Francisco Advertising Office: 582 Market St., San Francisco 4, Calif. Ralph W. Harker, Manager. Tel. Garfield 2481.
New England Office: Bridgewater, Conn. W. D. Ward, Manager.
Michigan Advertising Office: 70 Highland Ave., Highland Park 3, Michigan. Harry R. Lipson, Manager.
RADIO-CRAFT is published monthly on the 25th of the month preceding that of date. Subscription rates: United States and possessions, Mexico, Central and South American countries, \$2.50 a year, \$4.00 for two years, \$6.00 for three years. Canada, \$3.00 a year, \$5.00 for two years, \$7.50 for three years. All other foreign countries, \$3.25 a year, \$5.50 for two years, \$8.25 for three years. Special rates for members of the Armed Forces in U. S., or those addressed by A.P.O. or F.P.O. mail. \$2.00. Entered at the post office at Springfield as second-class matter under the Act of March 3, 1879. All communications about subscriptions should be addressed to: Circulation Manager, Radio-Craft, 29 Worthington St., Springfield 3, Mass.

Notice of CHANGE of ADDRESS should reach us at least one month in advance. When ordering a change, please furnish an address stencil impression from a recent wrapper if you can. Address changes cannot be made without the old address as well as the new.

Foreign Agents

London—Atlas Publishing and Distributing Co., Ltd., 18 Bride Lane, Fleet St., London, E.C. 4.
Melbourne—McGill's Agency, 179 Elizabeth St., Australia.

Text and illustrations of this magazine are copyright and must not be reproduced without permission of the copyright owners. Copyright, 1945, Radercraft Publications, Inc.

Contents December, 1945 Volume XVII, No. 3

Editorial: War Radio for Peace.....	by Hugo Gernsback	157
Radio-Electronics Monthly Review.....		158

ELECTRONICS

Radio Fuze Fires Shells.....		160
Pulse-Time Modulation.....		161
U. S. Carrier Radar (Cover Feature).....	by E. A. Witten	162
New FM Bands.....	by Alan Jay	163
German Radar.....	by Jordan McQuay	164
Elements of Radar.....	by Jordan McQuay	169
Radio & Television Twin Crime Fighters.....		175

SERVICING

Postwar Radio Shop.....	by Gene Conklin	171
Power Output Stages.....	by Jack King	173
Electrification for the Old Set.....	by Gerald A. Chase	177
Measuring U.H.F.....	by Fred Simpson	193

CONSTRUCTION

Bicycle Radio With 4 Tubes.....	by Robert B. Essex	172
Acorn-Tube Radio for Ultra Highs.....	by Homer L. Davidson	174

SOUND

Recorder on Tape Has Voice Control.....	by J. M. Lee	167
Postwar Recorders Show New Ideas.....	by I. Queen	176

DEPARTMENTS

Radio-Electronic Circuits.....		179
World-Wide Station List.....	by Elmer R. Fuller	180
New Radio-Electronic Devices.....		186
The Question Box.....		190
Try This One!.....		192
New Radio Patents.....	by I. Queen	194
Book Reviews.....		199
Technotes.....		205
Communications.....		212
Why Not?.....		215

ON THE COVER

A Radar Plotting Board such as is to be seen in the Combat Information Center of a large American battleship is the subject of our cover this month. Keeping a constant check on the positions of both friendly and hostile aircraft, the Plotting Board is a valuable tool of naval radar strategy.



MAKE MORE MONEY

IN Radio TELEVISION & ELECTRONICS

GET THESE 2 BIG BOOKS

Now! FREE!

You men already in Radio know how great the demand is for trained, experienced servicemen, operators and technicians. You know how fast the field is growing and how important it is to keep up with developments — F.M. Receivers, Electronics and Television. You know, too, a fellow cannot learn too much about any industry for **REAL SUCCESS**. Whether you have experience or are merely **INTERESTED** in radio as an amateur, you must recognize the **WONDERFUL OPPORTUNITY** right within your grasp to cash in on your natural abilities. Make them pay dividends. Get into the **EXPERT RADIO SERVICE FIELD**. Be an F.M. and **TELEVISION specialist—OWN A BUSINESS OF YOUR OWN**, if you prefer. Fill out and mail the coupon below for all the details of our plan.

Here's Just a Few of the Interesting Facts you Learn with the **FREE MANUAL**.

1. Routine for diagnosing Radio Troubles.
2. Preliminary Inspection of Receivers.
3. How to Check Power Supply.
4. How to Identify Various Stages of Receiver.
5. How to Trace the Circuit and Prepare Skeleton Diagram.
6. How to Test and Measure Voltages.
7. How to Test Speaker in Audio Stages.
8. How to Test Detector, I.F., R.F., and Mixer Stages.
9. Complete Reference Table for Quickly Locating Receiver Troubles.

Get the Latest Inside Information—Short Cuts—Trade Secrets by

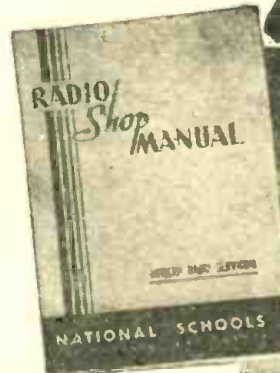

SHOP METHOD HOME TRAINING

FROM A REAL ESTABLISHED RESIDENT SCHOOL

Now the famous National Schools brings its exclusive Shop-Method of training right into your own home. You can learn the most up-to-date, approved projects, systems and circuits step by step in your spare time. This is the sound practical training you want and need—the development of experienced instructors working with thousands of students right in shops, NEW F.M. broadcast studios and experimental laboratories of **NATIONAL SCHOOLS**—one of the most advanced trade educational centers in the world.



LEARN BY DOING

Work with Real Experimental Equipment Furnished without Extra Cost as Part of Your National Training

Experience is the best teacher. You learn by experience with the exclusive National Shop-Method of Home Training. In the course of your study you actually build various types of receivers—a powerful superheterodyne, a signal generator, an audio oscillator and others—you make tests and conduct experiments that show you the why and how of things. You understand what makes the various elements of electronics operate because you actually see them work for you. Not only do you gain marvelous experience by this method of learning but you receive valuable equipment you will use on the job in the practice of your profession as an electronics expert. Mail the coupon and learn what this means to you.

National Trained Men Now Making the Best Money in History

The real value of National training shows up on the quick progress our men make on the job. Incomes that seemed fantastic only a short time ago are now being reported by National graduates. And this is only a sample of what the future holds for the **MAN WHO KNOWS RADIO, ELECTRONICS, F.M., TELEVISION** and allied subjects. National is proud of the progress its graduates are making all over the world. Read the facts—the actual proof in the books we send you **FREE**.

Send the Coupon and prove to yourself what YOU can do in **RADIO!**

Be Sure Of Your Success And Security After The War

Don't let your post-war ambitions lag. Don't let YOUR future depend on others. Build a career for yourself. Never in all history has the returning serviceman, or war worker been confronted with such a great future if he reaches out and grasps it NOW. Here is a new world opening before you. Get ready now while you are still in uniform—while you are on your war job. Then you can soon step into an essential, well paid position or, with little capital, **GET INTO BUSINESS FOR YOURSELF**. It isn't a bit too soon to start now. Radio men are vitally needed. Fill out and mail the coupon immediately and examine the **NATIONAL SHOP METHOD HOME TRAINING COURSE** carefully, without obligation.

FREE LESSON INCLUDED

Examine the exclusive National Shop Method of Home Training. See for yourself how sound and practical it is. Be convinced that you can learn Radio, Electronics, Television—quickly and easily in your spare time. You can't tell until you try. This trial is **ABSOLUTELY FREE**. Fill out the coupon immediately while you are thinking about it and drop it in the mail at once. Mail the coupon here for the books that tell you the complete story of the marvelous new system of training in Radio, Electronics and Television. Learn the facts of this exclusive shop-method of home training. See for yourself! **DECIDE FOR YOURSELF!** This is the **MODERN SYSTEM OF TRAINING**; it matches the rapid progress constantly being made in Radio, Television and Electronics. It is **TIME TESTED**, too. National Schools has been training men for more than a third of a century. It is the very same training that has helped thousands to more pay and greater opportunity. You owe it to yourself—your future—to read the book "Your Future in Radio, Electronics and Television"—**FREE** to you when you send in the coupon.

NATIONAL SCHOOLS

LOS ANGELES 37, CALIFORNIA EST. 1905



MAIL OPPORTUNITY COUPON FOR QUICK ACTION

National Schools, Dept. 12RC

(Mail in envelope or paste on penny post card)

4000 South Figueroa Street, Los Angeles 37, California.

Mail me **FREE** the two books mentioned in your ad, including a sample lesson of your course. I understand no salesman will call on me.

NAME

ADDRESS

CITY STATE

Include your zone number

The New Model CA-11 SIGNAL TRACER

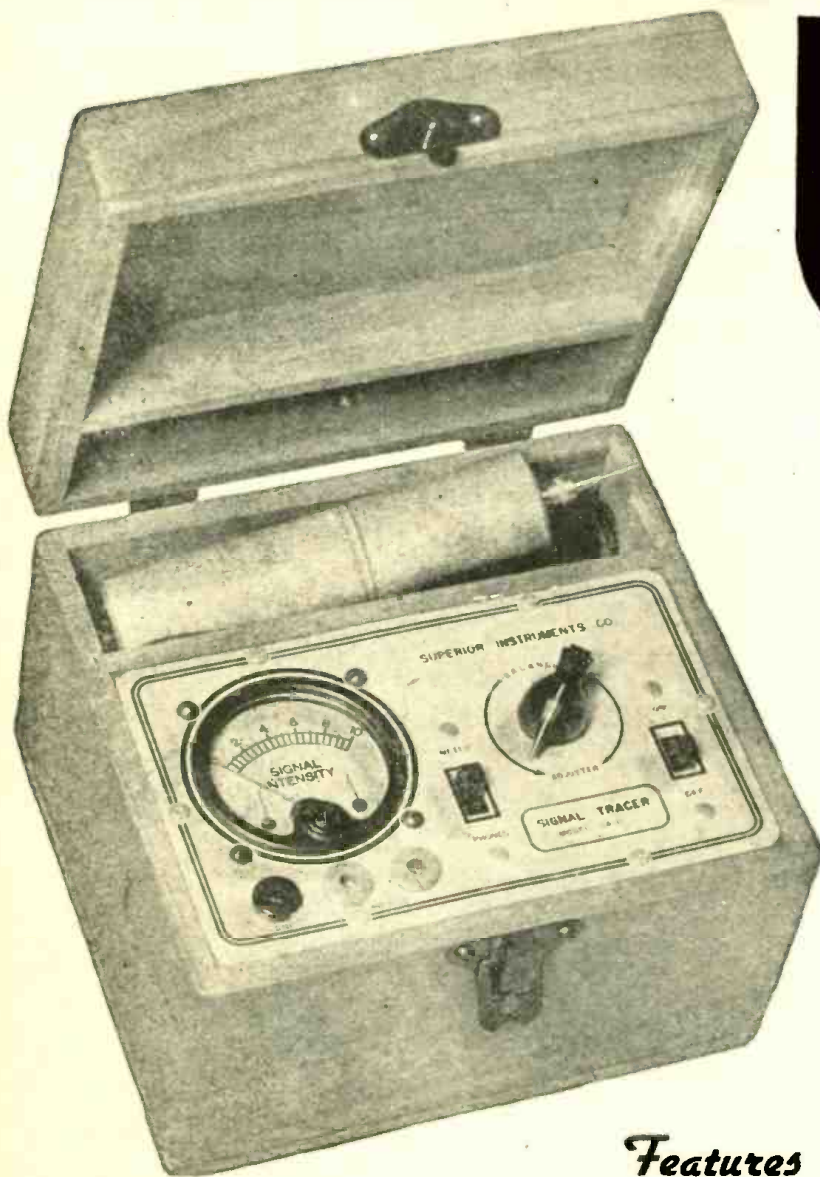

Simple to operate
... because it has only
ONE connecting cable—
NO tuning controls!

Introduced in 1939-1940 Signal Tracing, the "short-cut" method of Radio Servicing quickly became established as the accepted method of localizing the cause of trouble in defective radio receivers. Most of the pre-war testers (including ours) were bulky requiring a number of connections before the unit was "set for operation" and included a tuned amplifier which had to be "retuned" to compensate for signal shift. The new model CA-11 affords all the advantages offered by the pre-war models and only weighs 5 lbs. and measures 5" x 6" x 7". Always ready for immediate use without the necessity of connecting cables, this amazingly versatile unit has NO TUNING CONTROLS.

Essentially "Signal Tracing" means following the signal in a radio receiver and using the signal itself as a basis of measurement and as a means of locating the cause of trouble. In the CA-11 the Detector Probe is used to follow the signal from the antenna to the speaker—with relative signal intensity readings available on the scale of the meter which is calibrated to permit constant comparison of signal intensity as the probe is moved to follow the signal through the various stages.

Features

- ★ **SIMPLE TO OPERATE**—only 1 connecting cable—NO TUNING CONTROLS.
- ★ **COMPLETELY PORTABLE**—weighs 5 lbs. and measures 5"x6"x7".
- ★ **HIGHLY SENSITIVE**—uses an improved Vacuum Tube Voltmeter circuit. Tube and resistor-capacity network are built into the Detector Probe.
- ★ **Comparative Signal Intensity** readings are indicated directly on the meter as the Detector Probe is moved to follow the Signal from Antenna to Speaker.
- ★ Provision is made for insertion of phones.

Please place your order with your regular radio parts jobber. If your local jobber cannot supply you kindly write for a list of jobbers in your state who do distribute our instruments, or send your order directly to us.

The Model CA-11 comes housed in a beautiful hand-rubbed wooden cabinet. Complete with Probe, test leads and instructions. NET PRICE.....

\$18⁷⁵



SUPERIOR INSTRUMENTS CO.
DEPT. R 227 FULTON STREET NEW YORK 7, N. Y.

Men! Whether 16 or up to 40..

Get into

RADIO OR ELECTRICITY



ELECTRICITY—a corner of my A.C. Department. Students work on actual motors and controls.



RADIO-ELECTRONICS—students learning to use Oscillograph, important new electronic device.

2 GREAT FIELDS Each with a Great Future for YOU

ELECTRICITY and RADIO-ELECTRONICS stand out in today's postwar world. They offer countless good jobs with a real future, to men who are ready. COYNE has helped many hundreds of men to succeed in these two fields, through QUICK, PRACTICAL SHOP TRAINING. We also were one of the schools called upon by our Government when the war started, and we trained thousands of men for the armed services. Read the facts on this page, then mail coupon. See what it will mean when YOU are prepared for these great opportunities!

Learn in a few Weeks IN THE GREAT SHOPS OF COYNE IN CHICAGO

Student Finance Plan

We train you on real full-size Electrical or Radio equipment. RIGHT HERE IN THE COYNE SHOPS IN CHICAGO. You "learn-by-doing"—first the basic principles, then you are shown how to do each job, and THEN YOU DO IT YOURSELF. When you get out on the job, whether you've had practical experience or not, your Coyne training will give you the confidence and ability to do it RIGHT.

EARN WHILE LEARNING

If you are short of money I'll arrange to finance most of your tuition and you can pay it back in easy monthly payments after you graduate. We'll help you get a part-time job if you wish, so you can earn while learning. I also give Coyne Graduates my LIFETIME EMPLOYMENT SERVICE — no charge whatever, no matter how often you use this great feature.

MEN WITH PHYSICAL DISABILITIES—whether due to war or other causes—we also have facilities for you. Check coupon for particulars if you have a physical disability of any nature.

LOOK AT THE JOBS!

Electricity	Radio
Armature Expert	Radio Manufacturing
Aviation Electrician	Radio Receivers
Maintenance Engineer	Automobile Radio
Illuminating Expert	Public Address and
Power Plant Operator	Sound Systems
Automotive Electrician	Electronics Technician
Wiring Contractor	Frequency Modulation
Motor Tester	Television Servicing
Signal and Alarm Work	Radio Merchandising
	Your Own Business

INDUSTRIAL ELECTRONICS AND ELECTRIC REFRIGERATION

EXTRA TRAINING
NO-EXTRA COST

No Extra Cost
Extra training to help you get ready for the better jobs in these great fields... no additional tuition cost with either my Electrical or Radio Course, If You Act Now!

ELECTRICITY—Many Branches

Here at Coyne you learn A.C. and D.C. motors, wiring, signals, lighting, farm electricity, power plants, batteries, auto electricity, and dozens of other branches of Electricity—all in a few short weeks. No time wasted on subjects you won't need. It's JOB TRAINING based on 46 years' experience.

RADIO—Electronics—Television

This streamlined shop course includes Radio receivers, set-making, public address and sound systems, television, FM (frequency modulation), auto radio, and the other good-pay branches of Radio-Electronics. Many Coyne Radio graduates have a thriving, prosperous business of their own.



Pick Your Field—Get Book FREE

Some men prefer Electricity, others Radio-Electronics. Whichever interests you most, we will train you in a few short weeks at Coyne. I have a big, fully illustrated book on each course, and will send you the one you want, without the slightest cost or obligation. Simply check below, then mail coupon in envelope or paste on postcard. No salesman will call. Rush coupon now!



VETERANS!

This training is available to you in its entirety if you qualify under the G.I. Bill of Rights. Check the coupon now for special G.I. Bulletin.

COYNE ELECTRICAL SCHOOL

H. C. LEWIS, Pres. Founded 1899
500' So. Paulina Street, Dept. 95-78H CHICAGO 12, ILLINOIS

H. C. Lewis, Pres.
COYNE ELECTRICAL SCHOOL
500 S. Paulina St., Dept. 95-78H
Chicago 12, Ill.

Send me your BIG FREE BOOK—for the course checked below. Also full details of your Student Finance Plan. This does not obligate me in any way.

- ELECTRICITY RADIO-ELECTRONICS
 SEND SPECIAL G.I. BULLETIN
 SEND Physical Disability details.

NAME

ADDRESS

CITY STATE

SPRAGUE TRADING POST

A FREE Buy-Exchange-Sell Service for Radio Men

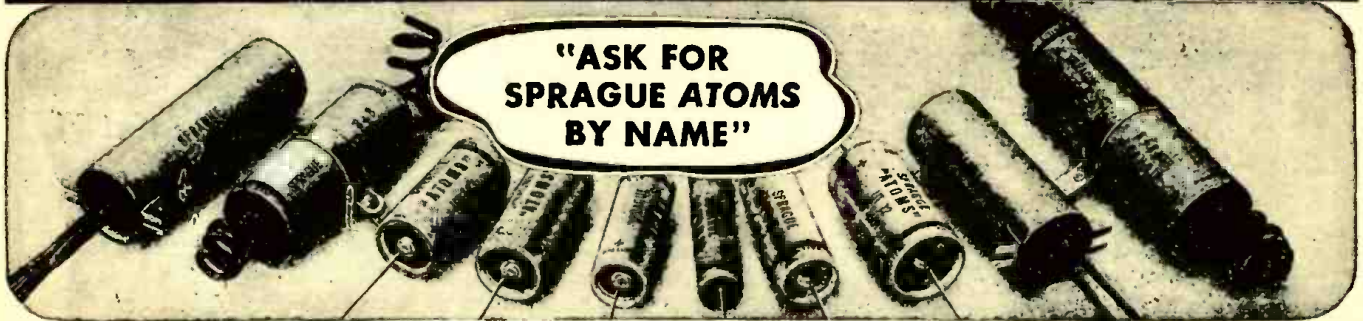

THE IDEAL REPLACEMENTS FOR ALL DRY ELECTROLYTIC CAPACITOR TYPES

FOR SALE—Triplet tube tester No. 1210 in case; perpetual tester No. 1179 like new; octal base tube checking adapter; Raco-Super clipper 3-550 meters and following tubes 37, 38, 12A7, 25Z3, 76, 31 and 30. Theodore E. Sargent, 618 Mount Hope St., North Attleboro, Mass.

WANTED—Radio tube tester and signal generator. Max Adler, 850 Bryant Ave., New York 69, N. Y. Apt. 4-C.

URGENTLY NEEDED—Small portable signal generator or station allocator. Will trade nearly all types of tubes. Maurice S. Uilman, 6th Bn. F.A.S. Ft. Sill, Okla.

FOR SALE—Weston tube checker, No. 682 and Supreme radio analyzer No. 91. Both very good condition, hardly used. Sgt. Jack Cohen, 5113 Pennway St., Philadelphia 24, Pa.

WANTED—Test equipment, typewriter, radios and electric fan. Will pay cash or trade new tubes. Edward Howell, Rt. 2, Dillon, S. C.

FOR SALE—Riders, Gernsback, and Cornes books; Philco RYL Model R tube tester, \$15; R-L electric 3 battery charger \$10. Edwin Larsson, Box 1237, Martinsburg, Ohio.

SELL OR TRADE—Test equipment, books and manuals. Send for list. Want short-wave receiver any condition. Will pay cash. Glenn Watt, Chanute, Kans.

FOR SALE—New signal tracer. Cash. Glen E. Cruzan, Osgood, Ind.

WANTED—Signal generator, good make; hard-to-get tubes; Rider Manuals. What have you? Smaid's Radio and Electric Service, 724 Meadow Ave., Rockdale, Joliet, Ill.

FOR SALE—Brand new SX-25 without speaker, \$75. S. Palmsel, 62 Main St., Fort Washington, N. Y.

WANTED—Superhot, 2½-5 meter. Will trade camera or cash. John Lubinsky, 3349 Fulton Road, Cleveland 9, Ohio.

FOR SALE—RCA Radio & phono, \$35. RCA radio, \$33. Want Riders Manuals 8 to 13. Theodore Lehr, 140-28, 247th St., Rosedale, L. I.

WANTED—Automatic record changer with three point record suspension. B. J. Huff, 12 W. Side Sq., Macomb, Ill.

FOR SALE—New Superior C.A.-10 signal tracer, \$15; 3-tube phono amplifier with tubes and speaker, \$15; two-tube phono oscillator, \$7. Will trade for good multi-tester or good set analyzer or what have you. Stephen Hodroski, Jr., Appy's Radio Service, 46 Lincoln Ave., Carteret, N. J.

WANTED—Record changer; can be amplifier, oscillator or plug-in type or with radio. Also phono motors, 501A, 7017 and 2526 tubes. Will trade scarce tubes or pay cash. V. R. Hein, 418 Gregory St., Rockford, Ill.

FOR SALE—New Supreme No. 540, 3" oscilloscope and Supreme 570 signal generator in fair condition. W. J. Schwallier, 514 9th St., Henderson, Ky.

WANTED—Hallcrafters S-20R Sky Champion. State condition. I. C. D. Byers, 900 E. Broadway, Hoboken, Va.

FOR SALE—Astatic JT-30 microphone with desk stand and cord \$9.11; Webster A-1 crystal pickup in original carton \$3.92. C. J. Clinton, 814 W. Third St., North Platte, Nebr.

FOR SALE—CA10 signal tracer, \$13.95; V-O-M 1.5 to 150 ma. on 3 scales, 0-15000 on four scales; 0-500,000 ohms on two scales, \$7.95; tube tester; R.C.P. No. 309, \$18. Joe Gamewell, Red Balling Springs, Route 3, Tenn.

SELL OR TRADE—Six-tube ac-dc broadcast receiver, \$45. Want signal generator or tube tester. Worth Wamick, 135 E. Palmer Ave., Camden, N. J.

WANTED—BC coils for HRO. Richard E. Weston, 759 E. 8th St., Hobart, Ind.

FOR SALE—Line cord, power transformer and filament transformer. S. Nelson, 6228 Angus Drive, Vancouver, B. C. Canada.

WANTED—RCA rack and panel 500-watt transmitter. William Garnett, Y.M.C.A., Mary St., Newport, R. I.

FOR SALE—Tubes, 30% off list, meter tested. Write for list. Howard B. Loomis, 4741 13th Ave., S. Minneapolis 7, Minn.

WANTED—Case for Triplet 1210A tube tester or complete tester; radio tubes and parts of all kinds. Johnson & Kent, 1124 Park Ave., Brenton, Wash.

FOR SALE—Jewell 199 tester \$25 and Zenith 35mm silent motion picture machine with 11 reels of film \$25. Charles W. Wood, Alton, Ind.

FOR SALE—Hallcrafters SX-24; DMRT-3 with portable power supply; code oscillator; Triplet No. 1219 tube tester and Paramount tenor banjo. I. H. DeGraw, 55 McKinley Ave., Dumont, N. J.

FOR SALE—National Co. radio parts such as type "B" dials, transformers, condensers, etc. M. L. Brownstein, 4653 Boudinot St., Philadelphia 20, Pa.

WANTED—Tube tester or other testing eqpt. Have gold-plated Holton cornet to trade. Bob Lien, General Delivery, Burlington, Wash.

WANTED—Back issues QST and No. 30 tube. Daniel Selder, 4258 S. Maplewood Ave., Chicago 32, Ill.

FOR SALE—Philco 2" oscilloscope with control circuit, 1832 vertical amp. to 1000kc and horizontal amp; new 902 tube, \$40 or will trade for camera. William Miller, 693 Union Ave., Providence, R. I.

URGENTLY NEEDED—Plans for "B" battery eliminator and 1D8GT tube. Leonard Kraus, 7233 Tapper Ave., Hammond, Ind.

WANTED—Five tube 1½" d-c battery radio with tubes, wide frequency coverage, with or without cabinet. L. C. Chapman, Rt. 1, Box 112, Columbus, Miss.

FOR SALE—2 Baron dynamic super giant 6" curled cylindrical horn; and RCA 14" and 1 Ampion master dynamic units; 1-wide range speaker, heavy duty. J. J. Bressler, 25 Dongan Place, New York 34, N. Y.

SELL OR TRADE—RCA test oscillator No. 139; Garrard record changer No. RC30 and Cinesograph 25-watt PM units and sound projectors. Bob Simmons, Radio Service, 622 Main St., Santa Paula, Calif.

FOR SALE—Superior signal generator No. 1230, \$25; Radio City multimeter, No. 419, \$28; Capacitor analyzer BR-44; \$25; abridged 1-5 Riders \$12 all practically new and G-E unitometer UM-3 needs oxide rectifier \$23. Edmond McGee, 41 Birch St., Worcester, Mass.

URGENTLY NEEDED—Riders manuals, any or all; 1L4C tube new or used. Robert E. Sunthelmer, 457 Wolcott Ave., Kent, Ohio.

FOR SALE—S20R Hallcrafters; new Astatic pickup; new mike stand; little used amplifiers; metal baffle horns, etc. Rensman, 1334 Marie Court, Sheboygan, Wis.

SELL OR TRADE—RCA communication receiver ART7; 10-tube FM receiver; 2-88 Astatic; 1-812 Astatic xtal pickups new, and ¼ size bass violon. Want recorder RCA or what have you; 30 watt amp. or phone & CW transmitter. Gerald Hess, Radio Service, 15 Park St., Moravia, N. Y.



5 TIMES HONORED BY DISTINGUISHED SERVICE CITATIONS

YOUR OWN AD RUN FREE!

For three wartime years, the Sprague Trading Post helped radio men sell, trade or buy needed materials. Now, with the advent of Peace, this free advertising service will continue as long as the need exists.

We'll gladly run your ad free in the first available issue of one of the 5 magazines in which the Trading Post appears. All we ask is that it be written clearly and concisely, that it be confined to radio materials, and that it fit in with the spirit of this service.

As always we know we can count on you to use Sprague Condensers and Koolohm Resistors—and to ask for them by name!

HARRY KALKER, Sales Manager

RC-125 SPRAGUE PRODUCTS CO., North Adams, Mass.

Jobbing Distributing Organization for Products of the Sprague Electric Co.



SPRAGUE CONDENSERS KOOLOHM RESISTORS

TM. REGISTERED U. S. PATENT OFFICE

Obviously, Sprague cannot assume any responsibility, or guarantee goods, services, etc., which might be exchanged through the above advertisements



old man Centralab
can supply you with plenty of
RADIOHM REPLACEMENTS

CENTRALAB Radiohms are always available on your jobber's shelves.

For more than twenty years Old Man Centralab has stood for **QUALITY** in volume Controls, and today more than ever before, the familiar blue and white carton is your guarantee of goodness. These are desperate days in the replacement business . . . which is all the more reason why it is gratifying to know that Centralab parts are as dependable as ever . . . so if you want to be doubly sure . . . **ALWAYS SPECIFY CENTRALAB.**

Centralab

Division of **GLOBE-UNION INC., Milwaukee**

Producers of: Variable Resistors • Selector Switches • Ceramic Capacitors,
Fixed and Variable • Steatite Insulators and Button-type Silver Mica Capacitors.

NEW TELEVISION camera tube of revolutionary design and sensitivity emerged from wartime secrecy last month for exhibition by the Radio Corporation of America. In a series of studio and remote pickups it not only transmitted scenes illuminated by candle and match light but performed the amazing feat of picking up scenes with infra-red rays in a blacked-out room.

"This new instrument, which is easily portable and suitable for use in every field of television, opens new vistas that challenge the imagination. It assures television of twenty-four-hour coverage, in daylight, twilight, or moonlight—in good weather and in bad.

Resembling a large tubular flashlight in size and appearance, the advanced development model of the Image Orthicon has an overall length of about 15 inches, with the shank about two inches in diameter. The head is about 3 inches in diameter and 3 inches long.

It has three main parts: An electron image section, which amplifies the photo-electric current; an improved Orthicon-type scanning section, smaller and simpler than those built before the war; and an electron multiplier section, the function of which is to magnify the relatively weak video signals before transmission.

The principle which makes the new tube super-sensitive to low light levels is similar to that which enables RCA's famous multiplier phototube to measure starlight. This principle, known as secondary electronic emission, involves the use of electrons emitted from a primary source as missiles to bombard a target or a series of targets, known as stages, or dynodes, from each of which two or more electrons are emitted for each electron striking it.

Light from the scene being televised is picked up by an optical lens system and focused on the photo-sensitive face of the tube, which emits electrons from each illuminated area in proportion to the intensity of the light striking the area.

Streams of electrons, accelerated by a positive voltage applied to a grid placed directly behind the photo-sensitive face and held on parallel courses by an electromagnetic field, flow from the back of the



Above—Image Orthicon. Below—Path of electron beam. Action is described in the text and all parts named in the drawing.

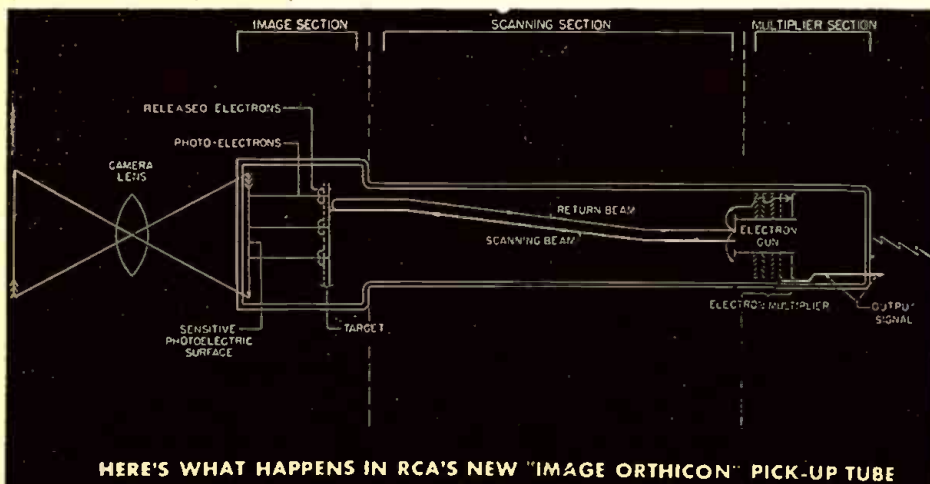

HERE'S WHAT HAPPENS IN RCA'S NEW "IMAGE ORTHICON" PICK-UP TUBE

Radio-Electronics

Items Interesting

photo-sensitive face to a target. Secondary emission of electrons from the target, caused by this bombardment, leaves on the target a pattern of varying positive charges which corresponds to the pattern of light from the scene being televised.

The back of the target is scanned by a beam of electrons generated by an electron gun in the base of the tube, but the electrons making up this beam are slowed down so that they will stop just short of the target and return to the base of the tube except when they approach a section of the target which carries a positive charge. When this occurs, the beam will deposit on the back of the target enough electrons to neutralize the charge, after which it will again fall short of the target and turn back until it again approaches a positively charged section.



Operating position, Presidential radio car.

COMMUNICATION with any part of the world was possible from the President's secret radio train, it was revealed last month by Lt. Col. Dewitt Greer, Commanding Officer of the White House Signal Detachment.

The car, called No. 1401, is a converted passenger-and-baggage coach. It was built to the order of President Roosevelt and from it he ran a large part of America's radio war activities. With the wire and radio telephone and telegraph equipment available, it was possible, from No. 1401, to:

1. Telephone to any house or to any radio-telephone equipped automobile or other vehicle in the United States.
2. Carry on a radio teletype conversation—in virtually unbreakable code—around the world at a rate of 100 words a minute.

3. Send and receive messages to and from ships at sea.

4. Send and receive telegraph code messages.

The newest of the numerous communications devices in the car is the radio teletype. An operator punches out a message on an ordinary teletype keyboard similar to that on a typewriter. The message progresses through a transmitter into a "scrambler" which puts it into a code difficult to break because of its lack of uniformity. The resulting jargon goes to a "descrambler" at the point of reception, then passes into a receiver and appears, readably, on a teletype receiver.

All this goes on while the coach is in motion. When the train goes through a tunnel which interferes with transmission the sending is automatically halted and upon a signal denoting the train has emerged from the tunnel the operator resumes sending.

RADAR in a national network to control all United States air traffic was envisioned last month by Dr. Milton G. White of the Radiation Laboratories, Massachusetts Institute of Technology. Not only would this network promote the safety of aviation but would also serve as a potential collector of military information in case of threatened plane or rocket-bomb invasion.

Such a nation-wide network would make it entirely possible, through a central information center, to know the whereabouts of every air-borne aircraft in the United States.

Under the plan proposed by Dr. White, the entire physical area of the United States would be swept by the searching microwave rays of up to 150 radar stations. It is estimated that about 150 stations would do the job nicely. Each radar station would scan the air for a radius of 200 miles and would slightly overlap the scanning patterns of the adjoining stations.

Thus any airplane rising from the ground anywhere in the United States would intercept the scanning beam of a radar station in its vicinity, and it would likewise never be out of range of some station along its route.



old man Centralab
can supply you with plenty of
RADIOHM REPLACEMENTS

CENTRALAB Radiohms are always available on your jobber's shelves.

For more than twenty years Old Man Centralab has stood for **QUALITY** in volume Controls, and today more than ever before, the familiar blue and white carton is your guarantee of goodness. These are desperate days in the replacement business . . . which is all the more reason why it is gratifying to know that Centralab parts are as dependable as ever . . . so if you want to be doubly sure . . . **ALWAYS SPECIFY CENTRALAB.**

Centralab

Division of **GLOBE-UNION INC., Milwaukee**

Producers of: Variable Resistors • Selector Switches • Ceramic Capacitors,
Fixed and Variable • Steatite Insulators and Button-type Silver Mica Capacitors.

ORDER YOUR NEW COMMUNICATIONS RECEIVER

NOW from ALLIED .. For Earliest Delivery

Available on Time-Payments
Trade-ins Accepted

BE ONE OF THE FIRST to own and enjoy one of these celebrated receivers. All models cover amateur, short-wave, and broadcast bands. War-proved features . . . plus latest engineering developments. Allied is a leader in the distribution of communications receivers. Place your order now for earliest delivery.



HALLICRAFTERS S-36A

Hallicrafters' most advanced development in very-high-frequency, high-fidelity receivers. Combines AM, FM, and CW reception. Frequency range 27.8 Mc. to 143 Mc. continuous in 3 bands. Covers old and new FM bands. RF stage with acorn tube. Push-pull high fidelity output stage. Four position tone control with bass boost. Sharp-broad selectivity switch. Dual purpose "S" and tuning meter. Oscillator compensated for frequency drift. Hermetically sealed transformers and reactors. Beat frequency oscillator, pitch variable from panel. Designed for service in any climate. Net. \$415

PM23 Speaker, Net. \$15.00

stage. Four position tone control with bass boost. Sharp-broad selectivity switch. Dual purpose "S" and tuning meter. Oscillator compensated for frequency drift. Hermetically sealed transformers and reactors. Beat frequency oscillator, pitch variable from panel. Designed for service in any climate. Net. \$415



HALLICRAFTERS SX-28A

Famous Super Sky-Rider. Frequency range 550 kc. to 42 Mc. continuous in 6 bands. Main tuning dial accurately calibrated in megacycles. Separate calibrated bandspread dial. Two r.f. stages. Lamb type 3 stage adjustable noise limiter.

PM23 Speaker, net. \$15.00

Six position i.f. and crystal filter selectivity switch. Oscillator temperature compensated for frequency drift. Inertia flywheel tuning and pre-loaded gear drive on main and bandspread dials. Push-pull 8 watt output stage. Net. \$223



ECHOPHONE EC-1A

Popular low-cost communications-type short-wave and broadcast receiver, with many new features. Covers entire tuning range from 550 kc. to 30 Mc. in 3 bands. For 115-125 volts AC-DC. Electrical bandspread on all bands with separate tuning control and dial. Dial calibrated in megacycles. Beat frequency oscillator

for CW reception. Automatic noise limiter. Built-in PM dynamic speaker. Headphones or speaker selected by panel switch. Housed in metal cabinet with gray wrinkle baked-on finish. Net. \$29.50

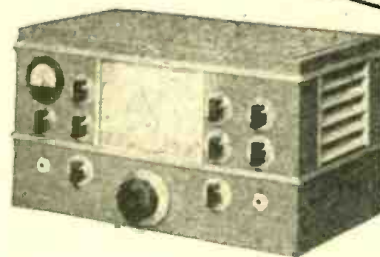

NATIONAL NC-2-40C

One of National's top receivers. 490 kc. to 30 Mc. range in 6 tuning bands. Definite, accurate calibration for all bands. Actual single dial control.

Stable high frequency circuits. Frequency drift reduction to a negligible value by temperature compensation. Automatic voltage stabilization. Wide range adjustable series-valve-noise limiter. Flexible crystal filter. Phonograph or high level microphone pick-up jack. Special r.f. coupling circuits maintain full sensitivity. Net. \$225

Speaker in matching cabinet, net. \$15.00



HAMMARLUND HQ-129X

Designed to meet the most critical demands of professional operators. Full range .54 to 31 Mc., accurately calibrated. 4 calibrated Ham bands and one arbitrary scale. Variable selectivity crystal filter. Low drift beat oscillator for code and

locating stations. Antenna compensator. Voltage regulation. Compensated oscillator to reduce drift during warm-up. Automatic noise limiter. Earphone jack. 3 i.f. amplifier stages. 2 audio stages. For phone or CW. Net. \$129

Speaker, net. \$10.50

Other well-known receivers such as:

- Hallicrafters SX-25 \$ 94.50
- Hallicrafters S-20R 60.00
- Hallicrafters S-22R 74.50
- Hallicrafters S-39 110.00
- National HRO 197.70
- PM23 Speaker 15.00

Net. F.O.B. Chicago
(All prices subject to possible change)

ALLIED RADIO

Everything in Radio and Electronics

833 W. Jackson Blvd. • Chicago 7, Illinois

SEND YOUR ORDER TODAY FOR EARLIEST DELIVERY

ALLIED RADIO CORP., L. M. Dezettel W95FW

833 West Jackson Blvd., Dept. 2-MM-5

Chicago 7, Illinois

Date _____

Please enter order for

Model _____

Enclosed \$ _____ Full Payment

Part Payment (Balance C.O.D.)

Please send full information on Communications Receivers and Time Payment Plan, without obligation.

Name _____

Address _____

City _____ Zone _____ State _____

RADIO-CRAFT for DECEMBER, 1945

War Radio for Peace

... Applications of radio inventions brought forth under pressure of war and for purposes of destruction will promote personal safety and industrial progress in the years of peace ...

HUGO GERNSBACK

SINCE 1941—beginning of World War II of the United States—radio developments in this country have advanced at a breath-taking pace, so much so that the advances today often sound fantastic. Advances in radar alone are often unbelievable even to technicians, and for security purposes, much still remains to be told.

There are still many other war inventions and devices in radio which cannot be released for some time to come. Many advances, components, processes, however, are now coming into use and will continue to be employed for peace purposes.

As an illustration of how far-reaching the application of war inventions in peacetime can be, let us consider one of the most recently released war secrets, the radio proximity fuze. This device is described in this issue of RADIO-CRAFT. In the head of an artillery shell there is a tiny radio set which sends out radio waves. These, striking an airplane or the ground, are reflected back to the shell. When the missile approaches the target within 70 feet (or other predetermined distance) a trigger in the fuze sets off the detonator and the shell explodes. Powered by battery or wind (on aircraft bombs) generator, the radio components are exceedingly small, the entire transmitter and receiver taking up not much more room than a large fist. It should be noted that the radio fuze is not radar, but parallels the principle to a certain degree.

Actually hundreds of thousands of these proximity radio fuzes were manufactured since 1943 and the experience gained in their manufacture not only gives us a number of new components that did not exist before the war, but the idea of the proximity fuze can be adapted for numerous peacetime uses.

The proximity fuze was a project under the supervision of the National Bureau of Standards, whose scientists developed the fuze for World War II. The Bureau is continuing its wartime applications and furthering the research. Secretary of War Patterson made known recently that the Army had in operation a program which is to develop new radio fuzes as well as other electronic weapons to make the United States invulnerable to attack.

The National Bureau of Standards also brought out

the fact that the work on new fuzes and developments along this line certainly would result in smaller hearing-aid devices, miniature radio receivers, handie-talkie sets, as well as many industrial electronic controls and devices.

Peacetime uses for the proximity fuze can easily be envisaged and only a few examples are given here.

Instead of blind persons using seeing-eye dogs, a compact little instrument can readily be designed whereby the blind person wearing a special hearing device will be able to walk through crowded streets without colliding with pedestrians, walls, or vehicles. Radio waves reflected back from such objects will make stronger or weaker sounds in the earpiece which can be readily interpreted by the blind man. Such a device can be manufactured cheaply. It has often been said by radar engineers that for collision prevention of trains, automobiles, etc., radar is not the best solution; the reason given usually is the great weight and complexity of radar apparatus as well as high cost, running into thousands of dollars.

The proximity fuze idea incorporated into trains, automobiles, and planes does not have these disadvantages. Bulk will be very small and cost will be reasonable. Certainly every airplane can afford to install such a proximity device so that accidents of the type that occurred this summer when an airplane collided with the Empire State Building, may never have to happen again.

Rear-end collisions between trains also should be a thing of the past, if trains adopt the same means. Even automobiles could have their brakes automatically set when the car approaches a vehicle or wall to within a certain distance. Many other uses of the proximity fuze can readily be worked out. You will see many during the next decade.

Radar instrumentalities also have paved the way for many peace uses which, strictly speaking, have nothing whatsoever to do with radar itself. For instance, the experience gained in mass-producing cathode-ray tubes as used in radar, is invaluable for television and other purposes. Where it is possible to install radar or near-radar instrumentalities, such as in ships, motor boats, etc., which have to be navigated in fog, such simplified installations will be a

(Continued on page 214)

Radio Thirty-Five Years Ago In Gernsback Publications

FROM the December 1910 issue of MODERN ELECTRICS:
Wireless on Airships, by A. C. Marlowe.
A Generator of Rapid Electrical Vibrations, by Dr. Alfred Gradenwitz.
A Universal Wireless Testing Set, by William Dubilier.
Calculating Transmitting Condenser Capacity, by I. H. Glickman.
Unique Potentiometer, by R. E. Baker.
New Frequency Transformer
Construction of a Sensitive Wireless Detector, by William H. Taber.
New Military Quenched Spark Set, by Oliver A. DeCelle.

HUGO GERNSBACK

Founder

Modern Electrics	1908
Electrical Experimenter	1913
Radio News	1919
Science & Invention	1920
Radio-Craft	1929
Short-Wave Craft	1930
Wireless Association of America	1906

Some of the larger libraries in the country still have copies of Modern Electrics on file for interested readers.

How To Make an Oscillation Transformer, by Ralph Weddel.
Construction of a Rotary Spark Gap, by Hallam Anderson.
Circular Potentiometer, by Fannon Beauchamp.
Hot Wire Meter, by R. W. Burger.
Neat Sending Condenser, by John C. Rector.
Simple (Transmitting) Key
Cheap Variable Condenser, by Bruce W. Young.
Wireless Helps, by R. C. Bodie.
Unique Sending Condenser, by John P. Hobart, Jr.

NEW TELEVISION camera tube of revolutionary design and sensitivity emerged from wartime secrecy last month for exhibition by the Radio Corporation of America. In a series of studio and remote pickups it not only transmitted scenes illuminated by candle and match light but performed the amazing feat of picking up scenes with infra-red rays in a blacked-out room.

"This new instrument, which is easily portable and suitable for use in every field of television, opens new vistas that challenge the imagination. It assures television of twenty-four-hour coverage, in daylight, twilight, or moonlight—in good weather and in bad.

Resembling a large tubular flashlight in size and appearance, the advanced development model of the Image Orthicon has an overall length of about 15 inches, with the shank about two inches in diameter. The head is about 3 inches in diameter and 3 inches long.

It has three main parts: An electron image section, which amplifies the photoelectric current; an improved Orthicon-type scanning section, smaller and simpler than those built before the war; and an electron multiplier section, the function of which is to magnify the relatively weak video signals before transmission.

The principle which makes the new tube super-sensitive to low light levels is similar to that which enables RCA's famous multiplier phototube to measure starlight. This principle, known as secondary electronic emission, involves the use of electrons emitted from a primary source as missiles to bombard a target or a series of targets, known as stages or dynodes, from each of which two or more electrons are emitted for each electron striking it.

Light from the scene being televised is picked up by an optical lens system and focused on the photo-sensitive face of the tube, which emits electrons from each illuminated area in proportion to the intensity of the light striking the area.

Streams of electrons, accelerated by a positive voltage applied to a grid placed directly behind the photo-sensitive face and held on parallel courses by an electromagnetic field, flow from the back of the

Radio-Electronics

Items Interesting

photo-sensitive face to a target. Secondary emission of electrons from the target, caused by this bombardment, leaves on the target a pattern of varying positive charges which corresponds to the pattern of light from the scene being televised.

The back of the target is scanned by a beam of electrons generated by an electron gun in the base of the tube, but the electrons making up this beam are slowed down so that they will stop just short of the target and return to the base of the tube except when they approach a section of the target which carries a positive charge. When this occurs, the beam will deposit on the back of the target enough electrons to neutralize the charge, after which it will again fall short of the target and turn back until it again approaches a positively charged section.

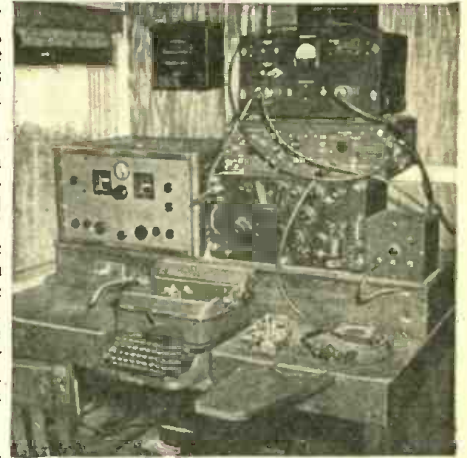

Operating position, Presidential radio car.

COMMUNICATION with any part of the world was possible from the President's secret radio train, it was revealed last month by Lt. Col. Dewitt Greer, Commanding Officer of the White House Signal Detachment.

The car, called No. 1401, is a converted passenger-and-baggage coach. It was built to the order of President Roosevelt and from it he ran a large part of America's radio war activities. With the wire and radio telephone and telegraph equipment available, it was possible, from No. 1401, to:

1. Telephone to any house or to any radio-telephone equipped automobile or other vehicle in the United States.
2. Carry on a radio teletype conversation—in virtually unbreakable code—around the world at a rate of 100 words a minute.

3. Send and receive messages to and from ships at sea.

4. Send and receive telegraph code messages.

The newest of the numerous communication devices in the car is the radio teletype. An operator punches out a message on an ordinary teletype keyboard similar to that on a typewriter. The message progresses through a transmitter into a "scrambler" which puts it into a code difficult to break because of its lack of uniformity. The resulting jargon goes to a "descrambler" at the point of reception, then passes into a receiver and appears, readably, on a teletype receiver.

All this goes on while the coach is in motion. When the train goes through a tunnel which interferes with transmission the sending is automatically halted and upon a signal denoting the train has emerged from the tunnel the operator resumes sending.

RADAR in a national network to control all United States air traffic was envisioned last month by Dr. Milton G. White of the Radiation Laboratories, Massachusetts Institute of Technology. Not only would this network promote the safety of aviation but would also serve as a potential collector of military information in case of threatened plane or rocket-bomb invasion.

Such a nation-wide network would make it entirely possible, through a central information center, to know the whereabouts of every air-borne aircraft in the United States.

Under the plan proposed by Dr. White, the entire physical area of the United States would be swept by the searching microwave rays of up to 150 radar stations. It is estimated that about 150 stations would do the job nicely. Each radar station would scan the air for a radius of 200 miles and would slightly overlap the scanning patterns of the adjoining stations.

Thus any airplane rising from the ground anywhere in the United States would intercept the scanning beam of a radar station in its vicinity, and it would likewise never be out of range of some station along its route.



Above—Image Orthicon. Below—Path of electron beam. Action is described in the text and all parts named in the drawing.

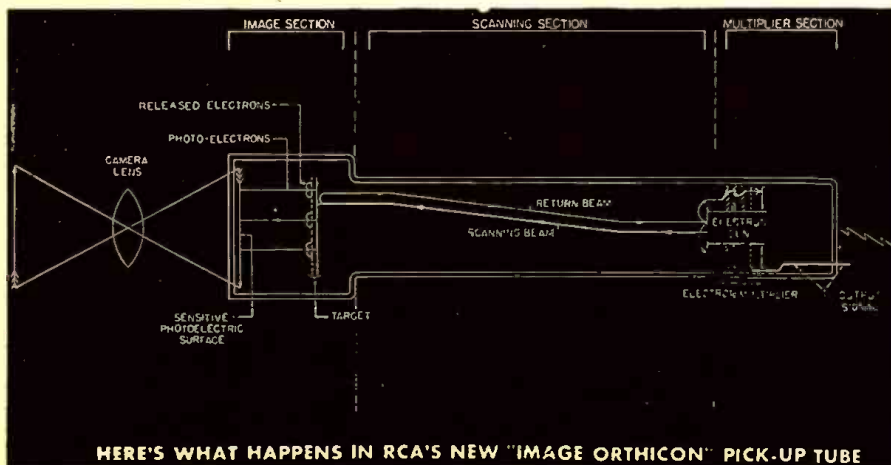

HERE'S WHAT HAPPENS IN RCA'S NEW "IMAGE ORTHICON" PICK-UP TUBE

Monthly Review

to the Technician

RADIO RELAYS will replace thousands of miles of telegraph lines in circuits between major American cities, Dr. C. B. Joliffe of RCA Laboratories stated last month. The new system, stated to be one of the most significant advances in communications in modern times, will be established through co-operation between RCA and Western Union, Microwave apparatus of recent design is being used.

With this type of radio relay system, it is possible not only to send telegraph messages in multiple numbers over one circuit simultaneously and with the speed of light, but to transmit telephone calls, commercial high-speed facsimile, radio-photos, and FM (frequency modulation) broadcast programs. In addition, it can be used to operate automatic typewriters and business machines at widely separated terminal points.

Tests conducted over an experimental circuit between New York and Philadelphia, have demonstrated that the radio relay system functions more efficiently than one using pole lines, without having the limitations or costly maintenance of wires.

Another important feature of the system is its ability to achieve high-power performance with low-power input. This is accomplished by use of new design antennas, equipped with parabolic reflectors, which transmit the signal in a narrow beam directly to the point desired without waste of power. The principle is the same as the familiar one used in controlling radar beams.

Radio relay stations in the system are automatic, unattended towers so perfectly designed that, despite the fact that they participate in the transmission and reception of every signal set in motion, their presence in the circuit causes no delay or interference.

It is reasonable to believe that besides the wide use such systems will eventually have in communications services in this country, including those for transport vehicles and aircraft, they will be especially well adapted to rehabilitate and expand communication services in various foreign lands.

FIFTEEN MILLION radios will be demanded by the public in the first full year following reconversion, according to a survey made public last month by General Electric. The release, which is actually a compilation of twenty surveys and estimates, states that this will represent a demand in dollars of more than 455,250,000.

Next greatest in number demanded, believes General Electric, will be electric clocks, 7,800,000 of which will be called for. In dollar value, the runner-up is expected to be vacuum cleaners, demand for which may run to 2,390,000, with a value of \$112,330,000.

Other types of appliances included are electric irons, toasters, clocks, automatic blankets, running to 35,400,000 items valued at \$320,302,000.

WIND-DRIVEN electric generators no larger than a pocket watch, designed to fit into the nose of an aerial bomb or rocket projectile were described last month by Major General Harry C. Ingles, Chief Signal Officer of the Army, as a major step in the perfection of the VT proximity fuse, which ranks with radar and the atomic bomb as one of the most decisive weapons of the war.

A major hurdle in development of the fuses was the problem of supplying electric power for the minute radio. This was tentatively solved by development of a tiny dry-cell battery which, although no larger than the cap of a fountain pen, supplied adequate voltage for the few seconds it had to function.

This power source worked well in laboratory and proving ground tests, but engineers realized it would be undependable in combat because the batteries would fail in the extreme cold of high altitudes at which modern bombers fly. The limited "shelf-life" of the batteries was another objection.

Under Signal Corps supervision, a development program was established at the National Bureau of Standards in Washington to perfect a generator to replace the batteries. A development model was completed in late 1943, utilizing a propeller recessed in the nose of the projectile as a windmill to drive a tiny generator.

Whirling at a rate of 100,000 revolutions per minute—50 times faster than the spin of an airplane propeller—the windmill supplies sufficient power to the generator to create a continuous radiation of radio waves from the bomb or projectile.

To prevent the proximity fuse from detonating the explosive upon receipt of wave echoes from the aircraft which

launched it or from other nearby planes, the connection between the fuse and the detonator is left open until after the projectile has been launched. The first few spins of the windmill turn a worm gear which closes the connection.

Use of the proximity fuse has been found to increase many-fold the effectiveness of aerial bombs, since it causes them to detonate in the air before striking the surface of the earth, and the damaging effect is not blanketed by the surrounding terrain as it would be in a ground explosion. Similarly, the arming of rocket projectiles with proximity fuses causes them to detonate whenever they pass near a suitable target, so a direct hit on the target is not necessary.

Rocket projectiles equipped with proximity fuses were also fitted with a self-destruction element so that they would detonate automatically before falling to the earth, in case they did not pass close enough to a suitable target for the proximity fuse. This device not only prevented damage and casualties when they fell to earth in friendly territory, but insured that the fuses would not fall intact into the hands of the enemy.

FILMS will furnish much valuable source material for television broadcast, will solve the problem of the small independent station and may be the practical way of achieving truly national networks, stated John Flory, film manufacturer, before the annual meeting of the Society of Motion Picture Engineers last month.

"Films bridge the gap in television broadcasts caused by set, costume changes, or mechanical difficulties," he said. "Since mobile tele units are still too cumbersome to operate, and exceedingly expensive, the motion picture camera will be made wide use of, because it is lighter and more flexible and more adapted to location work. "Until most television equipment now in use is improved," he added, "motion picture equipment will have to substitute if high quality broadcasting is to be maintained."

Furthermore, film is more sensitive to color, and accurate in reproducing color, while present cathode television tubes fail to do justice to red and other shades—a serious handicap when displaying fashions or packaged merchandise. "Film is the most practical way of achieving a national video network," Flory declared.

The windmill-like generator is only a couple of inches in diameter, but produces relatively large amounts of power due to the speed at which the bomb descends. Rotation is much faster than that of the aeroplane's propeller. Premature explosion is prevented by a time delay switch in the "windmill."



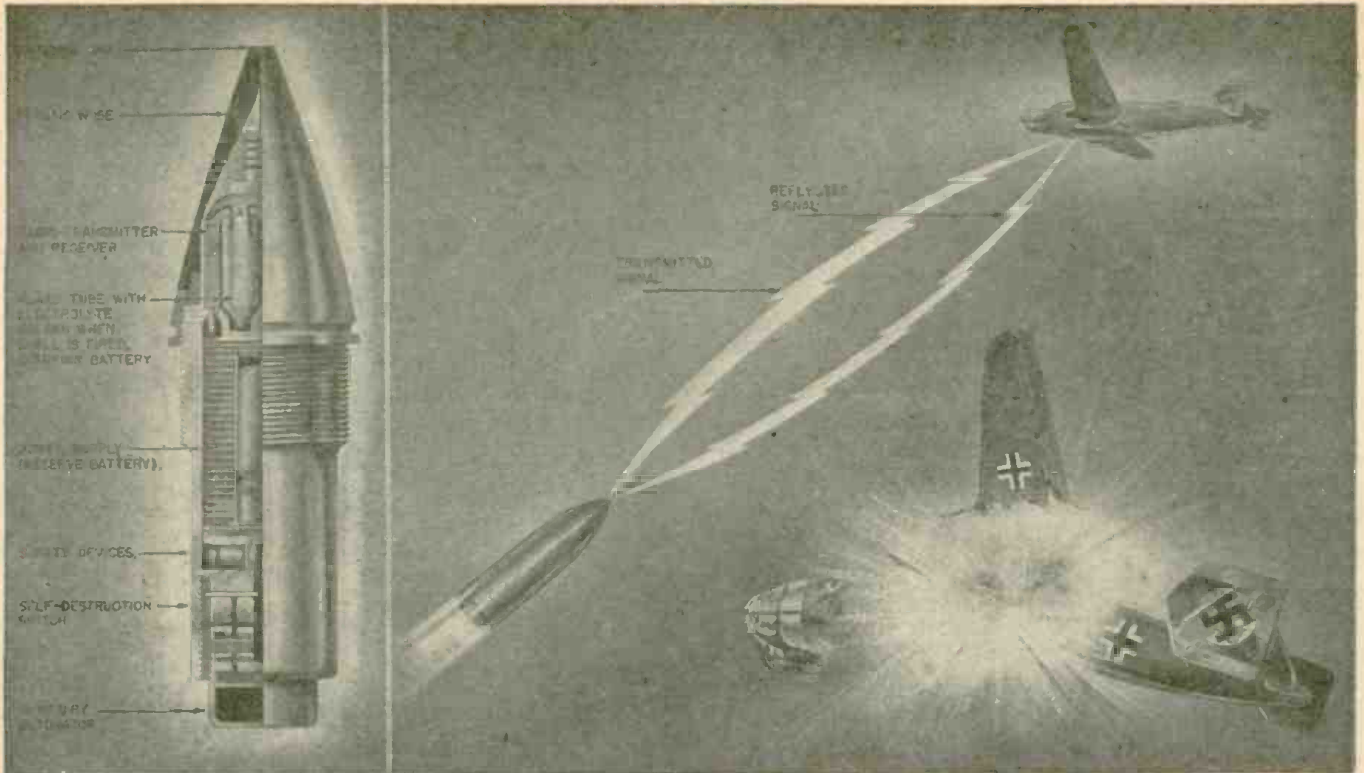

"Beat" between transmitted and reflected waves detonates primer when it reaches correct frequency. End: detail of the radio equipment.

Radio Fuze Fires Shells

A SECRET weapon no bigger than a pint milk bottle was one of the most potent factors in the U. S. Navy's fight against suicide bombers in the last desperate months of Jap resistance. This "artilleryman's dream" is a fuze which explodes a shell as soon as it comes close enough to an enemy target to inflict damage.

The development is officially known as

a *radio proximity fuze*, proximity fuze, influence fuze and VT (variable time) radio fuze. During its secret development period it was also variously called by such titles as "Project A," "Madame X," "Buck Rogers," and "Pozit."

The unit consists of an extremely rugged five-tube receiver and transmitter, so small that it fits in the nose of a three-inch shell. If a projectile outfitted with one of these

radio fuzes passes within seventy feet of a plane, impulses from its tiny transmitter are reflected back to explode the shell. The fuze works on the proximity principle; reflected waves from water, earth and—more particularly—metal objects, increase in intensity with the approach of the shell. When the waves reach a predetermined strength, the fuze operates and the charge is detonated.

An ideal fuze would explode the shell at the most favorable point to inflict maximum damage on the target. Contact and time fuzes are inaccurate, particularly with respect to fast-moving targets. The small target presented by an airplane, together with its isolation in space and its speed, practically forced consideration of a fuze which would detonate in the vicinity of an airplane.

CONSTRUCTION OF THE FUZE

The basic components of this radio proximity fuze are: 1—Miniature vacuum tubes of the hearing aid type but strong enough to stand the tremendous stresses of being shot from a gun; 2—A rugged miniature battery to provide electrical power, and 3—Safety devices to prevent operation of the fuze until it had travelled a safe distance from the gun.

The transmitter-oscillator generates an R.F. signal. When a target is approached, part of the radiated signal is reflected back to the fuze and an impulse is set up by the interaction of the radiated and returned signals. This impulse is amplified by an A.F. amplifier in the fuze and fed to a thyatron which serves as a switch to initiate detonation of the projectile, which is accomplished by an electrical detonator

(Continued on page 200)

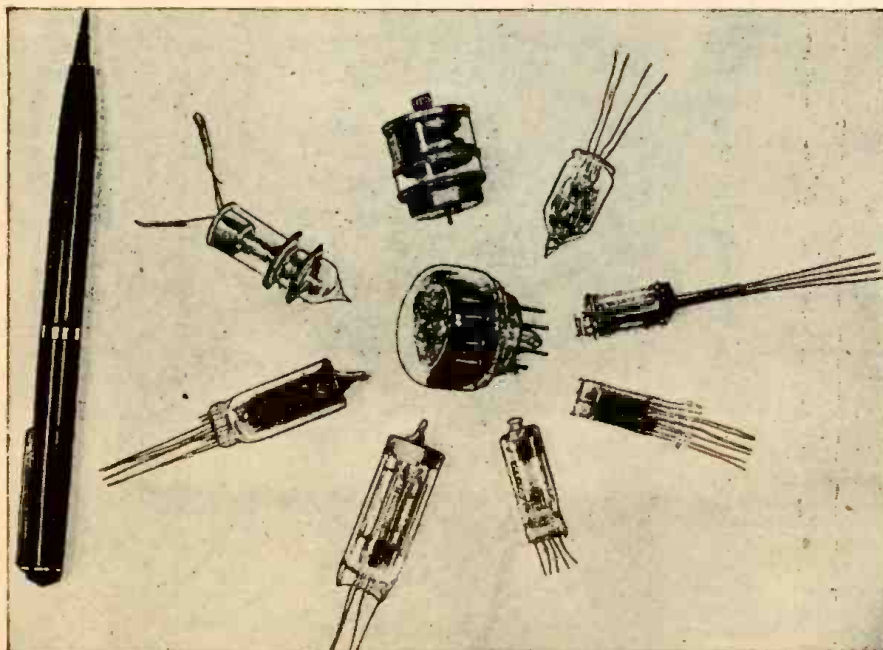
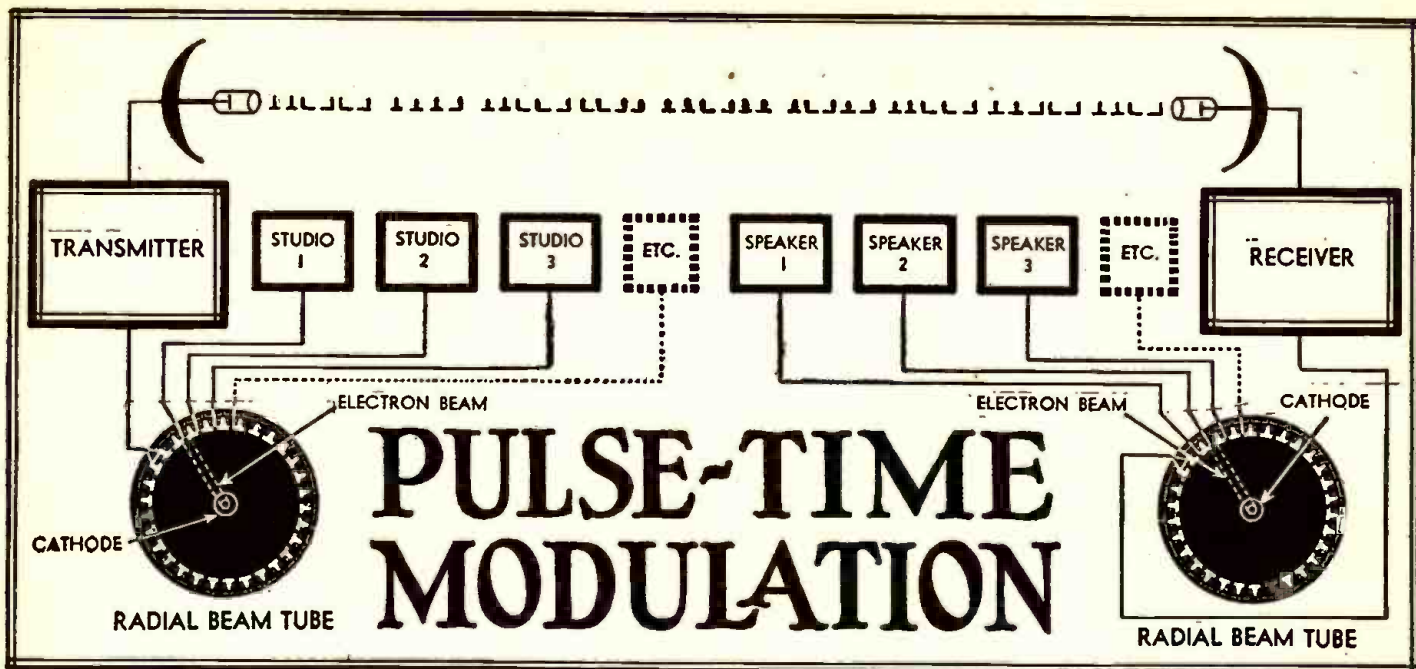

Fig. 1—A number of the special tubes employed in proximity fuzes. Smaller than hearing-aid apparatus, their ruggedness permits firing out of guns at accelerations of 20,000 G.



A BOMB can be dropped on a target by remote control from a point fifty miles distant. Forty-eight people can converse simultaneously by telephone over a single microwave carrier. Half-a-hundred different broadcasts can be sent simultaneously by telephone over one radio channel, with automatic "drop-offs" at principal broadcasting centers. Televisophone may now be a possibility—in color! These are the actualities of today and a portion of the possibilities of tomorrow, thanks to a new and revolutionary method of radio transmission.

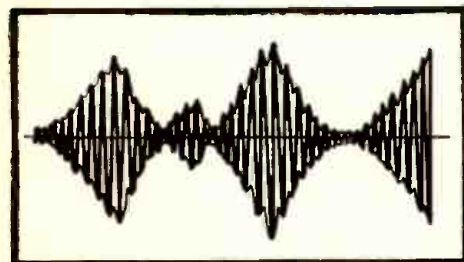

Fig. 1—An example of amplitude modulation.

The Pulse-Time modulation system, a development of the Federal Telephone and Radio Corporation, operating on microwave frequencies (1300-megacycles) is the answer to "how." The varying of an audio component with respect to a time base and the transmission of these variations in the form of pulses is the answer to "why." The advantages of this system in telephony as

compared to standard wire-telephony are numerous. In amplitude modulation, the electrical

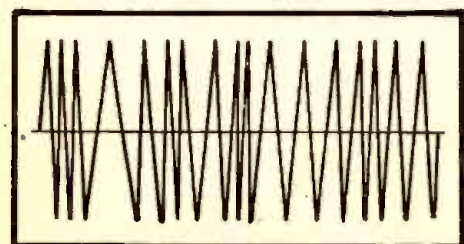

Fig. 2—FM signals have constant amplitude.

height of the wave is varied. The audio component (outside pattern or envelope) is superimposed on a carrier as in Fig. 1. The fine lines that make up the body of the AM wave in the figure constitute the R.F. carrier. At the receiver, the variations of this R.F. carrier are taken out and reproduced so that the signal that reaches your loudspeaker, and ultimately your ear, corresponds exactly to the original voice or music pattern.

In frequency modulation, the closeness or far-apartness of the individual components of the wave is varied. The "height" or amplitude remains constant throughout. Thus if the same voice or music is sent by an FM system, the wave varies as shown in Fig. 2. This then, is what is transmitted. At the receiver, the difference or distance between each successive wave and the one preceding it is "measured" and the variations from the average distance between waves are transformed into sound. This variation in frequency and constancy in amplitude are the distinguishing characteristics of FM as compared to AM.

The pulse-time method of modulation operates by emitting short pulses of high-frequency radio energy. These pulses are of constant amplitude, and are all of the same carrier frequency. Modulation is effected by transmitting a synchronizing, or "marker" pulse at fixed times, and following this pulse with the "signal" pulse at a variable time interval, the time interval being varied at a rate corresponding to the audio-frequency of the signal being broadcast.

Since the transmitted wave is intermittent (pulsed) and not continuous, it is easily possible to operate the transmitter and adjacent receiver at the same frequency. This is accomplished by including suitable time-delay circuits in the receiver, and by making it insensitive while the transmitter pulse is being emitted.

In single-channel operation one marker-pulse would be followed by a single signal-pulse, but since they are of very short duration—the marker pulse occupying an interval of the order of one micro-second, and the signal-pulse 0.5 micro-second—multi-channel operation is entirely feasible.

In the present arrangement a single marker-pulse is followed by the 24 signal-pulses for the 24 channels, the entire sequence being repeated at a rate of 8,000 pulses per second. Lacking an applied signal, the entire 25 pulses are evenly spaced in time. However, if a signal is applied to the channel No. 1, the No. 1 signal-pulse will occur slightly sooner or later in the first sequence cycle than its no-signal position, in relation to the fixed time position of the marker-pulse. During the next cycle its position will have again changed, while the other 23 signal-pulses, lacking applied signals, will retain their previous time position.

(Continued on page 197)

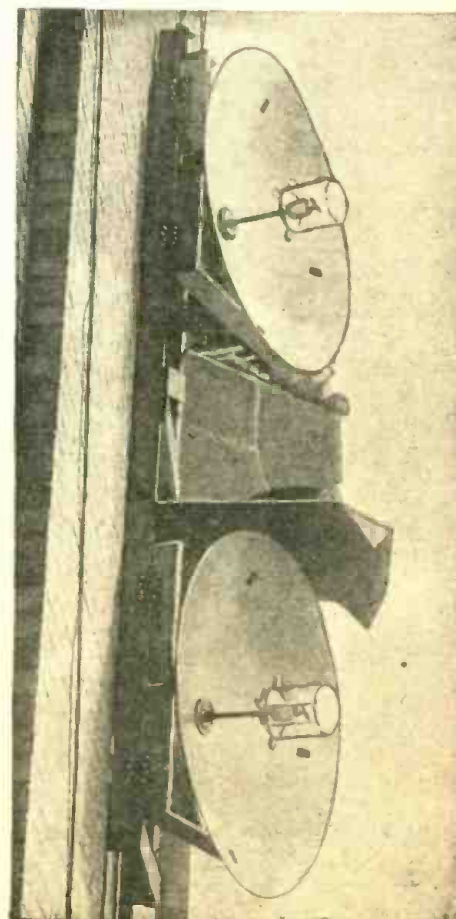

The 1200-mc. parabolic reflecting antenna.

COVER FEATURE:

U. S. CARRIER RADAR

ONE of the largest aircraft carriers afloat, the U.S.S. *Lake Champlain*, was recently in New York harbor, and radiomen were given an opportunity to see the hitherto secret radar and communications apparatus of the vessel. One of the newest of our carriers, the *Champlain*, uses types of radar apparatus not yet installed on older craft. If all the radar and radio equipment aboard were weighed at one time, it would tip the scales at more than twenty tons.

Radio installations aboard the new carrier consist primarily of seven radio "shacks" or operations stations. Radio 1 is the radio central control station where all

By E. A. WITTEN

tions suffer direct hits, one of these two widely separated positions will remain reasonably intact as long as the ship remains afloat. Radio 7 is the special VHF shack. All radio and radar equipment operating on VHF, UHF, and higher, is housed here.

Radio 1, the main control room and central, has a total of 21 receivers set to semi-fixed frequencies and contains a patchboard system connected by intercom throughout the ship. Loud-speakers are located in strategic positions and provision is made for a seaman to call in from a gun position or lookout spot and request a given frequen-

this unit is that it is subject to freak operation and sporadic reflections. Theoretically it is supposed to be limited to line-of-sight transmission but on occasions it has been heard 130 miles distant and on at least one occasion a signal was picked up at a distance of 620 miles. The TBS uses modulated continuous wave (A2) signals usually but can also be used as an A3 (voice transmission) set.

Such (by now) old friends as the A scope, the J scope, the B scope, the AA scope, and the PPI (plan position indicator) are in everyday operation here. The cover of this issue shows part of the CIC (Combat Information Center) or radar room with its plotting board of plexiglas. The board is illuminated through its cross section. Lights are placed along the edge of the board so that the rays permeate the material, giving even illumination from the inside out and reducing glare to an absolute minimum. The marking on the lower left of the board can be distinguished as "Chi Chi Jima 260 mi. 0600." This means that Chi Chi Jima was sighted or plotted at 0600 (6 A.M.) as being 260 miles from the carrier in the direction that the green line points. It is written on the border since the board is plotted for ten mile intervals. That is, each red circle on the board represents a distance of ten miles. This is an arbitrary figure, since each ring can be made to represent ten miles, ten yards or 100 miles if desired.

The operator standing in front of the board receives his information from the radar operators by phone. He marks his directions and information down accordingly in different colored pencils. For example, if a plane or a group of planes were sighted at 90 miles distance bearing 005 degrees a mark would be made signifying this "bogey" or unidentified flight, in colored pencil such as is marked near the 90 mile

(Continued on page 196)

STRIKE & PATROL STATUS BOARD

MISSION	CALL	FREQ.	VF	VBF	VT	VB	TTO	ETA	ETD	ETA	REMARKS
Ships Rabaul Harbor	Fairytale	16 Mc	16	16	8	12	0545	0730	0600	0900	3 cruisers sunk 2 "damaged"

Fig. 1—The board illustrated above keeps tab on missions under way and scores successes.

the message center work is handled and monitoring takes place twenty-four hours a day. Radio 2 is the main transmitter room where the large 500-watt transmitter and modulator units are housed. Radio 3 is in a similar transmitter shack. Radio 4 is the storeroom for parts and repair equipment. Radio 5 is the special emergency shack. This is fully equipped for any emergency or failure of equipment that might occur. It is located forward on the port side of the ship as contrasted with radio 6, an alternate emergency shack located aft on the starboard side. It is reasonably certain that even if all other radio installa-

tion or program. A receiver is tuned in to that station, a patchcord (similar to those in telephone switchboards) is plugged in, and the lonely seaman now has his favorite program to keep him company. The entire procedure from the time he calls down to the moment when he hears the first sound from the position loud-speaker, is about 35-40 seconds.

An interesting new communications system is the TBS (Talk-Between-Ships), a 60-80 megacycle transceiver for intership and ship-to-shore liaison operation. Its main function is as a command set between ships of the same fleet. The only disadvantage of

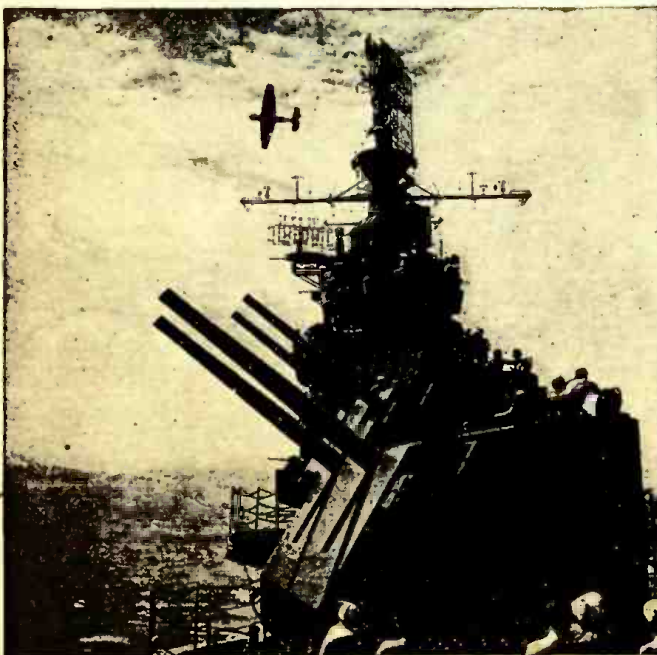

Photo 1—Antennas on a "flat-top" of the Essex type. The gun batteries are also controlled by radar units for accuracy. A General Motors "Avenger" is seen flying above.



Photo 2—An air of cold, quiet tension pervades the radar room of this Champlain-type carrier as death and destruction to enemy planes, ships and men are plotted out.

NEW FM BANDS

By ALAN JAY

OLD	
FM	42
TELE	50
AM	56
TELE	60
TELE	66
GOV'T	72
TELE	78
TELE	84
GOV'T	90
AERO	92
GOV'T	94
TELE	96
TELE	102
GOV'T	108
AMAT	112
MISC.	116
GOV'T	120

ON December first, FM stations start testing on the new high-frequency bands. From January first, operation will be in the "upstairs" portion of the spectrum. The new frequency allocations are: Educational; 88-92 Mc., Commercial Broadcasting; 92-106 Mc. (see chart). At that time, FCC published a report of the proposed allocations from 25,000 to 30,000,000 kilocycles. This report fixed the frequencies at the place they now occupy. Panel 2 and 5 of the Radio Technical Planning Board recommended that FM broadcasting be retained in its present place in the spectrum, i.e., in the 40 to 50 Mc. region. Those who opposed the recommendation believed that FM should be moved to a higher place in the spectrum to avoid skywave interference.

Before a decision could be reached as to FM's place in the radio spectrum, careful consideration had to be given to the propagation problems created by skywave interference of the "burst," "sporadic E" and "F2 layer" types.

The ionosphere's E layer reflects or refracts broadcast frequencies so that long distance reception is possible. The F layer (120 to 180 miles above sea level) reflects or refracts short waves that pass through the E layer (60 miles above sea level), thus making possible short-wave reception from distances of four and five thousand miles or greater (See Fig. 1). These layers vary in density and in height with changes in seasons, and time of day, and are subject to "magnetic storms." These layers respond in the same manner for higher frequencies with the added inconvenience of sudden and unpredictable changes. The height and the positions vary almost constantly, with the result that a radio wave passing through the E layer might at one moment be refracted back to earth at a given angle and then, because of the change taking place, be sent back at a different angle. Since it is this angle of reflection that governs the point at which the wave strikes the earth, the sporadic or sudden and intermittent effects have disastrous results on the FM signals.

A sporadic E layer transmission on 44.3 Mc. was received in the vicinity of Atlanta, Georgia, from a station in Paxton, Massachusetts, during 12 percent of the time in July, 1944, with sufficient intensity to cause interference at 50 microvolts/meter. Interference of this type was experienced for shorter periods at intervals throughout the entire year. Interference 12 percent of the time during even one month would not result in good FM service.

Sporadic E and F layer transmissions are rare indeed in the 100 Mc. region. Present experience supports the view that F layer transmissions would be negligible in the vicinity of 80 Mc. and that sporadic E would be approximately 1/100 as troublesome at 80 Mc. as at 40 Mc. The virtual disappearance of skywave interference above 80 Mc. solves the chief propagation difficulty for FM and eliminates the prin-

cipal obstacle in the way of permanent establishment of a new basic system of radio broadcast service.

The suggestion was made that zoning of stations within the limits of skip distance would be a means of avoiding skywave interference. Such a plan would be uneconomical since it would require a great many more frequencies. Moreover, a zoning plan would not be practicable because of the difficulty of predicting the areas of interference. A slight increase in tropospheric wave interference may be expected between 40 and 80 Mc. This effect may be negated by a somewhat greater geographical separation between co-channel stations. Thus the problem can be solved effectively by proper station allocation. Multipath distortion is not generally regarded as a difficulty which would seriously impair FM service either in its present band or in the suggested higher frequencies.

"Shadows" would be more pronounced at 100 Mc. than at 50 Mc. Reduced field intensities due to shadows in certain areas, should they occur, is not believed to be sufficiently serious to impair FM service.

Skywave transmissions would be negligible in the vicinity of 80 Mc. and would be practically non-existent beyond 100 Mc.

The channel width is of greater importance to this service than any other factor, including its position in the spectrum. At the present time, the Commission's rules prescribe a channel 200 Kc. wide. A reduction in channel width to 100 Kc. would cause a 6 db. loss in the ability of the FM receiver to discriminate against electrical noises and co-channel interference would be increased.

As a compensation for the lower quality of FM service resulting from halving the channel width, it is contended that the number of available channels could be doubled. However, this benefit does not follow, since the geographical separation of co-channel stations would have to be greater, particularly in the congested metropolitan areas where the need for channels is greatest. Additional objections to a 100 Kc. channel are based on the stringent requirements that such a change would impose upon the receiver design, particularly with respect to oscillator drift or receiver stability. Finally, in the event that multiplexing of facsimile with FM broadcasting should prove feasible, such multiplexing would be extremely difficult if not impossible if the channel width were reduced to 100 Kc.

Since it is possible that the FM band may ultimately extend from 78 to 108 Mc., it is probable that FM receiver manufacturers will build sets to encompass the entire range, minimizing obsolescence of receivers. Existing FM stations will not be required to move to new assignments in this band until new receivers are available and in the hands of the public.

480 to 920 Mc. has been made available for experimental television. 460 to 470 Mc. has been allocated to a new "Citizens' Radiocommunication Band." This service

(Continued on page 191)

NEW	
EXP. POLICE	42
TELE	44
AMAT	50
TELE	54
TELE	60
TELE	66
TELE	66
FIXED MOBILE	72
TELE	76
TELE	82
TELE	82
EDUC. FM	88
COMM FM	92
FACSIMILE	106
GOV'T	108
AIRPORT CONTROL	118
AERO MOBILE	122

GERMAN RADAR

RADIO-CRAFT takes great pride in presenting to our readers this authoritative article which for the first time shows in word and picture an extensive array of German radar equipment. It has never been published before.

By JORDAN McQUAY

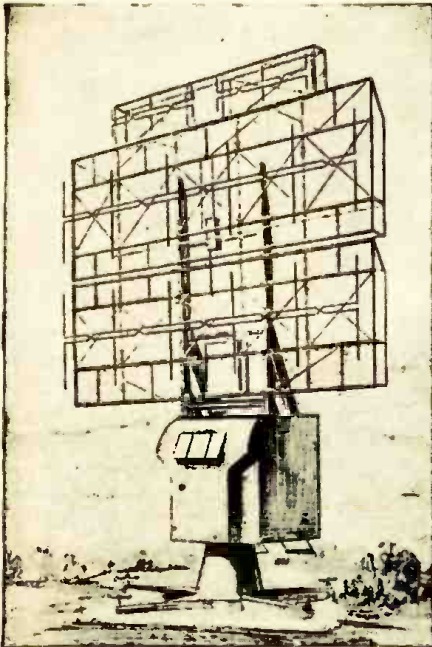

Fig. 1—LIMBER FREYA, a semi-portable radar.

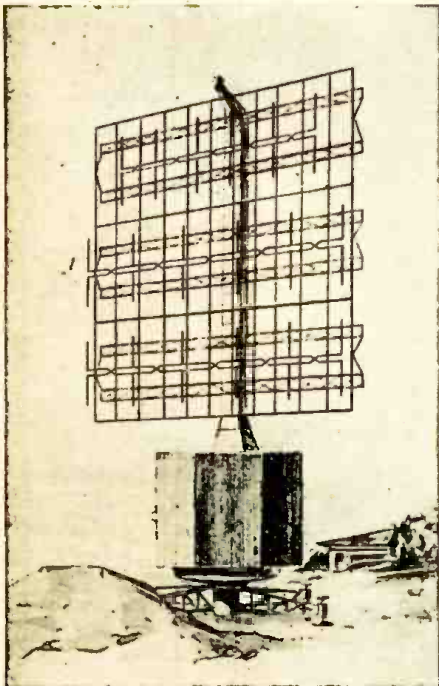
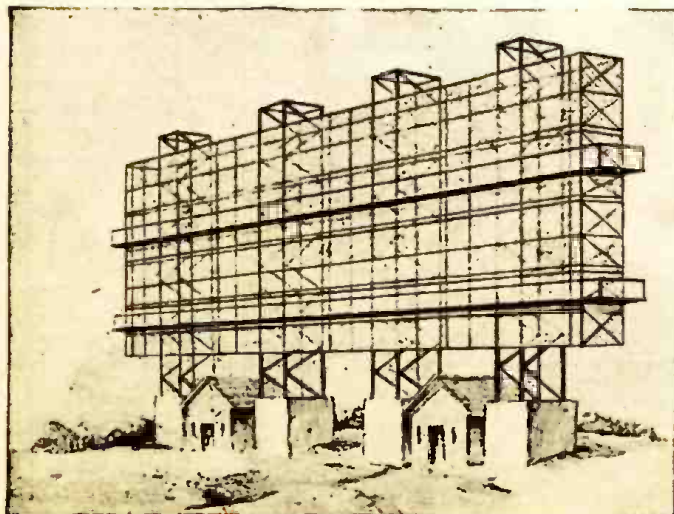

Fig. 2—POLE FREYA, transportable by plane.



THE cessation of hostilities in Europe permits revelation—for the first time—that German radar was used extensively against Allied forces and aircraft throughout the war.

Just as the Allies developed radar for defensive and offensive purposes, the Nazis also made use of their knowledge of the science of radiolocation. They developed and used many types of radar sets, the most important of which can now be described.

The immense practicability of radar in modern warfare was recognized by the Germans long before the first guns were fired in Europe.

A number of sets—then simply called *Dete*—were in operation along the borders of Germany early in 1939, months before the declaration of war. Nazi scientists worked frantically to extend the technical development of radar beyond that of any other country. And, at the time, they succeeded.

By the spring of 1940 there were several types of ground reporting stations in operation, and the nomenclature *Dete-Gerät* I, II, III, etc., was used to indicate the principal types of these sets. Late in 1940 the large number of early warning, airborne, gun-laying, and other kinds of radar equipment brought forth a more expressive word: *Funkmessgerät*—more often abbreviated, as *FuMG*.

It can now be told that at the start of the war between Germany and England, the Nazi scientists were months ahead of the British in radar development. This was natural, since Germany was intent on cre-

ating war and was preparing for it; whereas the English were not so belligerent.

But this scientific unbalance was rectified within a few short months after war began.

British and American scientists, experimenters, and technicians collaborated in the development of Allied radar equipment. Our sets were constructed by skilled, efficient personnel—not by slave labor. Our sets were better built, of better parts, and proved much more accurate in actual operation.

Soon the Allies outdistanced the Germans. And from that time we moved ahead consistently in greater and greater strides, developing and perfecting our systems of radar.

Even though they lagged behind, however, the Germans continued their scientific efforts in the field of radar research.

Until 1942-43—when the Nazis made a grave error.

They wantonly drafted many of their trained and experienced technicians, experimenters, and scientists, to fill suddenly vacated "positions" in combat branches of their army. It was the belief of the German general staff that they had adequate technical equipment to win the war and they considered further radar development to be useless.

Within a year after this fatal decision they were proven wrong. But it was then too late to turn back.

From that time, American and British radar, jointly, surpassed German equipment at every turn.

We used the magnetron u-h-f oscillator

FOR THE
FIRST TIME
IN ANY
RADIO
PUBLICATION

Figs. 3 and 4—Two early fixed installations, a HOARDING type, using vertically-polarized dipoles.

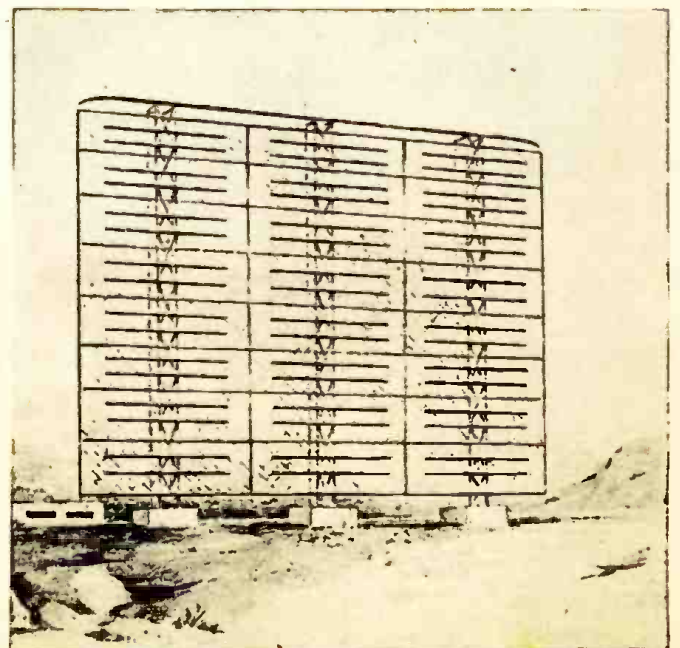

After a long apprenticeship with the Radio Corporation of America which included commercial (ship) operating, receiver design and development of vacuum tubes, Jordan McQuay worked for five years as Field Engineer for one of the country's leading radio networks.



Until only recently a Captain in the Army Signal Corps, he participated directly in the early development of radar both in this country and in England. One of the first Radar Officers in the Signal Corps, early in the war he was attached to the British Royal Air Force for radar duties that included development, installation, and operation of England's defensive and offensive radar systems. He was one of the few directly engaged in the development of centimeter radar equipment.

In 1943 he returned to this country, continuing his radar duties with the U. S. Army. During the past two years he has written and prepared Signal Corps technical manuals, instruction books, and other literature on radar, radio, and communications equipment.

as early as the spring of 1942, permitting our radar sets to operate at unheard-of frequencies far above 300 megacycles with a huge amount of output power. But try as they would, the Germans were never able to duplicate successfully this ingenious electronic mechanism. And until the day the war ended they were unable to operate their radar equipment—except in remote or inefficient instances — at wave lengths less than about a half meter.

This was but one of the many scientific advantages of our radar over German equipment. Other devices—still too secret to be described—also contributed to our technical superiority.

The Nazis made an attempt during the early years of the war to maintain a high quality of standardization. But during 1944 and 1945 the sets were built almost entirely by slave labor. The equipment, therefore, showed obvious signs of bad construction, as well as poor workmanship, and the wide use of substitute metals.

But the importance and effectiveness of Nazi radar against Allied forces, ships, and aircraft should neither be ignored nor minimized.

Their equipment reflects the work and technical philosophy of German science, and as such is of extreme interest. Some of the more important technical features of certain German sets have long ago been incorporated into our own apparatus—proving the merit of at least a few Nazi radar developments. But in general, their equipment had few technical advantages over British and American radar equipment.

The Germans' principal use of radar was in a defensive capacity: to warn of the approach of Allied Bombers, fighters, and other aircraft.

These ground stations were located at regular intervals around the perimeter of the Third Reich—including all conquered

territories—and in or near every strategic military, naval, and industrial area and installation. The equipment, in almost every case, was operated by personnel of the German Air Force (especially assigned to *Funkmessgerät* ground duty).

Radar sets used primarily for early warning fell into three distinct classes: the transportable *Freya*, the large fixed *Hoarding*, and the smaller fixed *Chimney*.

The main differences between the three classes of ground radar equipment were in their size and degree of portability.

There were numerous variations of these radar sets, but such varieties always bore marked physical and electrical characteristics which catalogued them immediately as belonging to one of the three basic classes of equipment.

Practically all of the sets used for early warning purposes operated at frequencies between 120 and 130 megacycles, at a nominal wave length of about $\frac{1}{2}$ meters.

"FREYA" EQUIPMENT

The *Freya* early warning radars were heavy, transportable ground sets. The equipment—manufactured by *Gema*—provided range and azimuth readings on approaching Allied aircraft up to distances of about 100 miles. It was also used to locate shipping, particularly along the English channel, at much shorter ranges.

An early model of the *Freya* was known as the Limber type (Fig. 1). Both the antenna array and operating cabin were constructed on a modified 88-mm antiaircraft gun mounting, which was provided with two detachable two-wheel "limbers" for ease in transportation.

The heart of the *Freya* equipment was the electronic timer, which included a master oscillator consisting of a very stable triode-connected pentode as an audio generator. This wave form was suitably shaped into a 2-microsecond pulse, which triggered the transmitter. The set normally operated at a frequency of about 125 megacycles with a peak power of 15 kilowatts.

The antenna consisted of two frames, each containing six full-wave vertical dipoles. The lower frame was used for transmitting the radar pulses, the upper frame for receiving reflected echoes from Allied targets.

The 125-megacycle echo signal passed through an R.F. amplifier stage, and was then mixed with a local 110-mc signal to create an intermediate frequency of only 15 mc for further amplification. After detection, the echo signal was fed to the indicator unit composed of two double-beam cathode ray oscilloscopes, giving range and azimuth data. There was no provision for height measurements with the *Freya* equipment.

A later model of the *Freya* (Fig. 2) was known as the Pole type. The mechanical mounting of this set differed from the Limber type so that the equipment could be packed and carried by air transport. Five Junkers 52 transports were required for the task.

The electrical characteristics and circuit functions of the Pole type *Freya* were very similar to the Limber type. Since this was a much later model, however, the Pole type *Freya* included many circuit refinements.

HOARDING EQUIPMENT

A huge, fixed antenna array characterized the largest of the German early warning equipment (Fig. 3) known as the *Hoarding*.

Designed and manufactured by *Gema* during 1942, a number of these stations were

(Continued on following page)

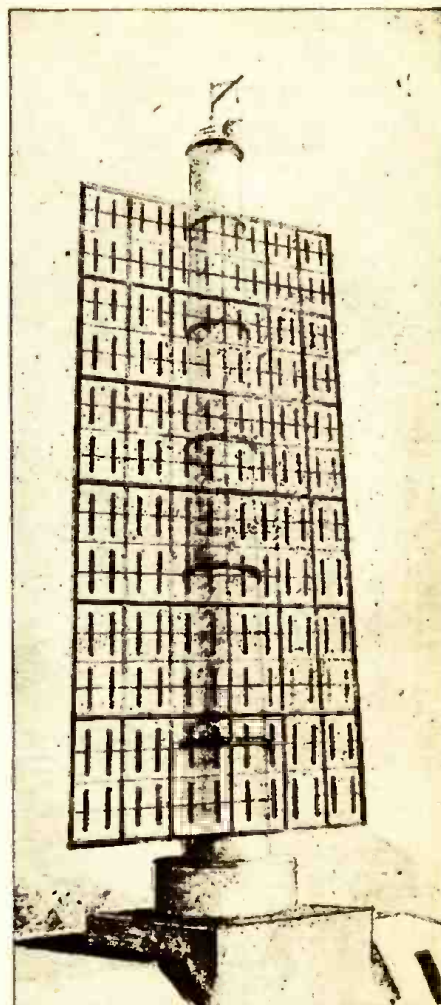

Fig. 5—The CYLINDER CHIMNEY was set up in Norway to report London-to-Stockholm planes, and for general aircraft detection.

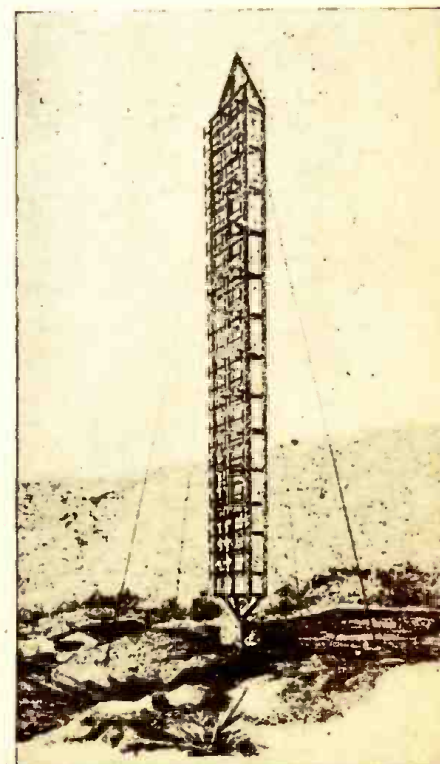

Fig. 6—GIRDER CHIMNEY, used in Mediterranean areas to detect aircraft at 180 miles.

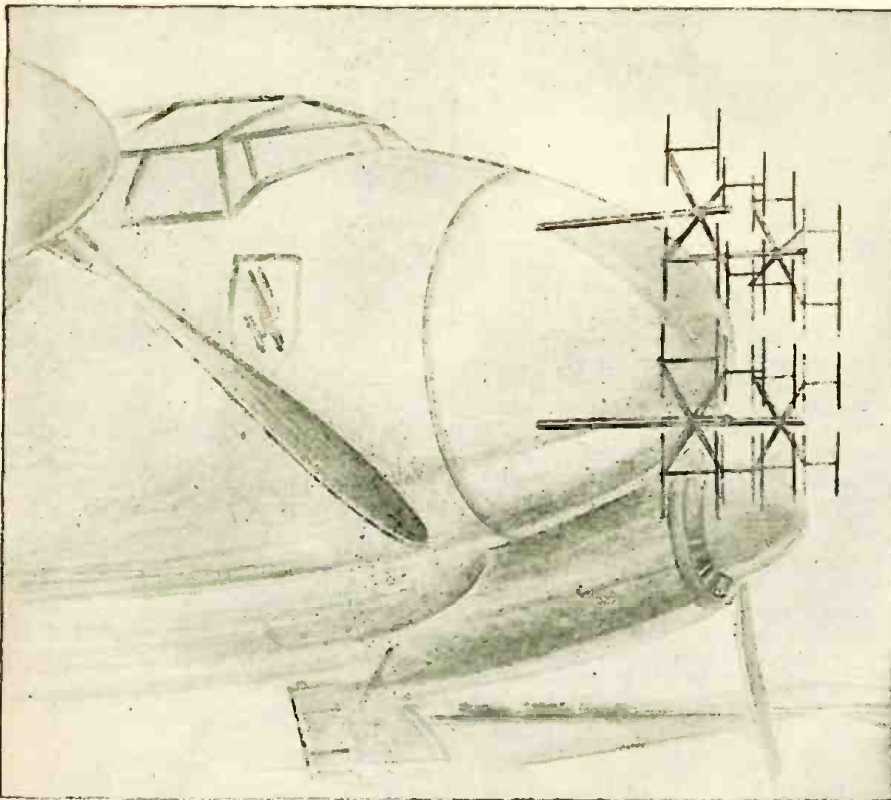

Fig. 7—The FuMG202, used by nightfighters, has an extensive antenna system for a plane.

installed along the northwestern coast of Europe for long range detection and location of Allied aircraft. The *Hoarding* operated up to ranges of 180 miles in all directions, giving range and azimuth information.

The antenna was capable of scanning over a considerable area by means of phase control—variable phased feeding of the full wave, vertically polarized dipoles. The array was similar to the *Freya* type, but very much larger.

The rest of the *Hoarding* equipment was housed in a concrete building generally buried underneath the fixed antenna. The transmitter, electronic timer, and receiving components were all similar to the *Freya* radar, and the *Hoarding* employed three

cathode ray oscilloscopes for data presentation. The transmitter could be operated at any of several frequencies between 115 and 145 megacycles, with a peak power of about 20 kilowatts.

A slightly smaller version of this set, known as the Small *Hoarding* (Fig. 4), had exactly the same technical operating characteristics as the larger set—the difference being largely in the arrangement of the antenna array. The equipment was housed in three concrete, partially buried buildings which also served as the foundation for the antenna array.

Neither the large nor small *Hoarding* were ever used in very great numbers, due to the shortage of certain materials and the difficulty in constructing such large radar sets.

"CHIMNEY" EQUIPMENT

A more commonly used early warning radar was known as the *Chimney*, of which there were two distinct types.

The *Cylinder Chimney* (Fig. 5) was used throughout northern Europe for intercepting Allied aircraft at long ranges up to 180 miles. The first model of the *Cylinder Chimney* was built in Norway and used to report the passage of fast courier planes between London and Stockholm.

The antenna—a rotatable, broadside array—consisted of about 144 vertically polarized, full-wave dipoles.

Fig. 9—Large SEETAKT, improved coast radar.

Fig. 10—WURZBURG, a parabolic-antenna type.

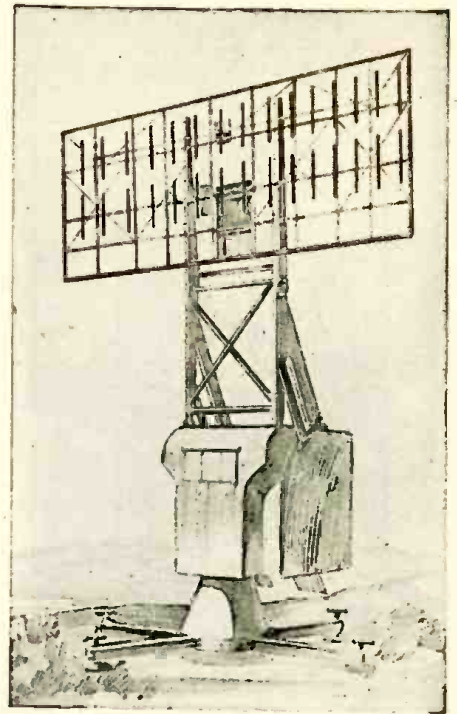

Fig. 8—SEETAKT, used for coastal defense.

The transmitter operated at any of several frequencies between 115 and 150 megacycles, with an output peak power of about 20 kilowatts. The equipment was, in general, very similar to the *Freya* radar.

The *Girder Chimney* (Fig. 6) was a slightly smaller set, used extensively in the Mediterranean for reporting aircraft at long ranges up to 185 miles. This antenna array was also rotatable, and consisted of 72 vertically polarized, full-wave dipoles. In other technical respects the *Cylinder* and *Girder Chimney* radars were similar.

RADAR FOR NIGHT FIGHTERS

The FuMG 202—best airborne radar set of the Nazis—was designed and manufactured by *Telefunken* for use by any of the three important German night fighters: the *Junkers 88*, the *Dornier 217*, or the infamous *Messerschmitt 110*.

The operating equipment was mounted forward in the cockpit and was accessible to the radio operator during flight. The antenna array was mounted directly on the detachable nose of the plane, as shown in Fig. 7. The same antenna was used for both transmitting and receiving.

(Continued on page 206)

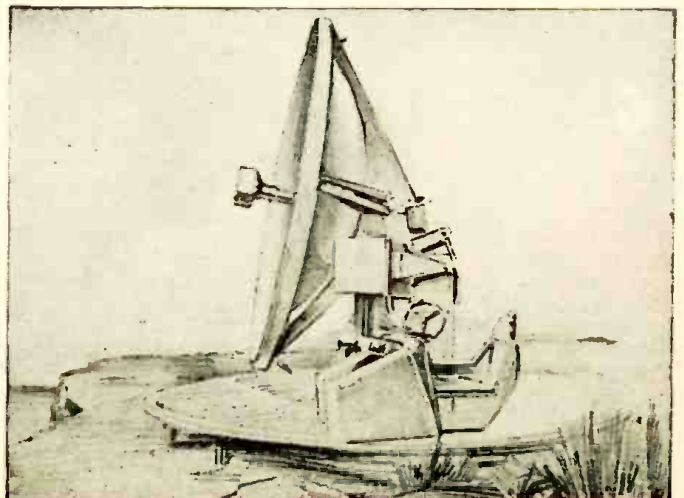
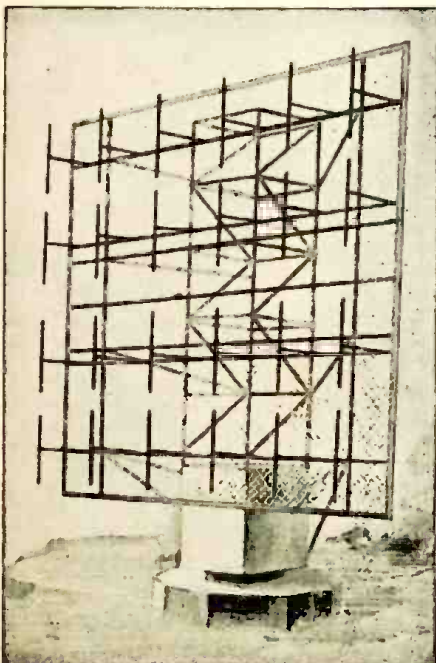

Recorder on Tape Has Voice Control

By J. M. LEE

THE *Hartron*, a battle recorder which successfully survived every known hazard of the war—from sea dunkings to air pockets and from Atlantic frost to Pacific heat—is now at work in control centers, radio stations, airports, railroads, police department, fire departments, and in many other civilian spots where recording speech and sound is essential.

A portable film recording and instantaneous playback unit, the *Hartron* was formerly known as the Recordgraph, a story on which appeared in the October, 1944 issue of *Radio-Craft*. It is a development of Frederick Hart & Company, Inc., of New York City. Recording procedure of the machine is similar to that of the usual disc recorder, except that sound grooves are embossed in parallel lines on a film belt rather than on a disc. The film belt, after recording is completed, is played back immediately without any processing.

In contrast to this mechanical process of recording sound on film, recording on wire is done with a unit that translates sound waves into fluctuations of a magnetic field, recording the fluctuations in the form of altered molecular patterns on a fine wire passed through the field. Still more complicated is the process of making a sound track on movie film, wherein the sound waves are transformed electrically into light rays by means of a light valve, and then photographed on the moving film.

The film recorder is completely self-contained in a carrying case about twice the size of a standard portable typewriter, and weighs less than fifty pounds. Figure 1 shows it opened and closed. The unit is made up of two main assemblies: the mechanical-electrical main frame assembly, and the amplifier. Operating on 110-volt, 50- to 60-cycle A.C., it requires a power input of 125 to 130 watts, and has a power

output of three watts. A rotary converter makes it adaptable to direct-current, or battery supply.

The mechanical portion of the recorder is driven by a 1/50-hp shaded pole single-phase motor.

A film magazine, mounted on the left end of the main frame, supports the film while recording and playing back. From this magazine

the film passes over a wiper and cleaner post assembly, which clears the under-side of the film; then passes under a film tension post which insures proper wrap on the recording drum. The recording drum consists of a stationary bed which supports the film during recording, and two rotating flanges which hold the film in place laterally.

A groove in the recording drum forms an air gap under the film which relieves the pressure of the recording needle, at the same time eliminating the possibility of needle breakage. (This "groove" made the film recorder practical in Marauder bombers, warships, landing crafts, and even in jeeps, where the machine was subject to jostlings and bouncings.)

The film itself is of noncombustible cellulose acetate, and having no emulsion, does not deteriorate with age. A fifty-foot film belt records a total of 115 sound tracks, providing one-and-one-half hours of continuous recording at the sixty-foot per minute track, speed. A special fifty-foot reverse-recording film, which permits recording on both surfaces, allows for three hours of recording at the sixty-foot speed.

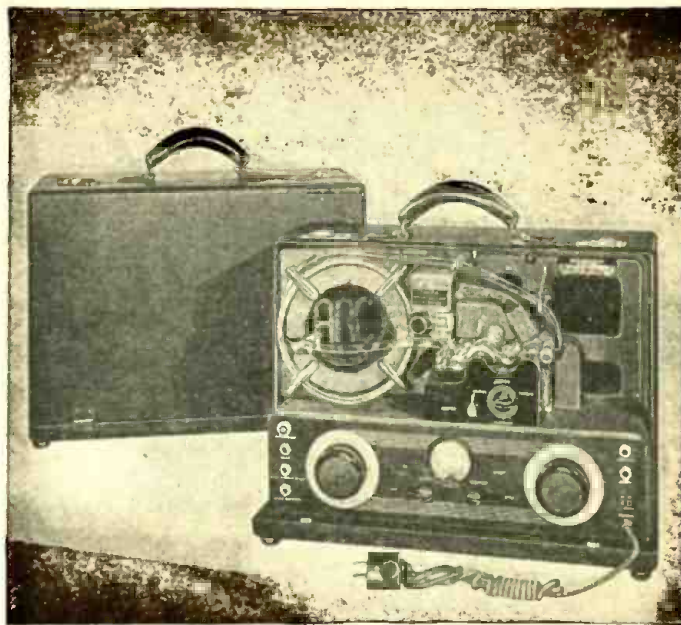

Front and rear views of the portable-type *Hartron* tape recorder.

On one side of the film is a series of notches which, through a switching mechanism on the machine, automatically moves the recording and playback needles across the film upon completion of each sound track. As the tracking cycle is completed, the trackage indicator (a counter located on the recording head bracket assembly) moves ahead one number, indexing the track. This index makes it possible to locate instantly any desired portion of the 115 sound tracks on the film should it be desired to play back any special portion.

Assembled and exploded views of the recording head are shown in Fig. 2-a. It is a balanced armature, magnetic type. Surrounding the armature, mounted on the inner pole piece (Fig. 2-d) are two coils (Fig. 2-d), connected in series, with a D.C. resistance of about 1½ ohms. The two leads from the coil are led back through the arm casting, through the plastic sleeving, and then through a hole in the main frame to the terminal strip. The magnets are shown at Fig 2-c.

Impedance of the recording head at 1,000
(Continued on following page)

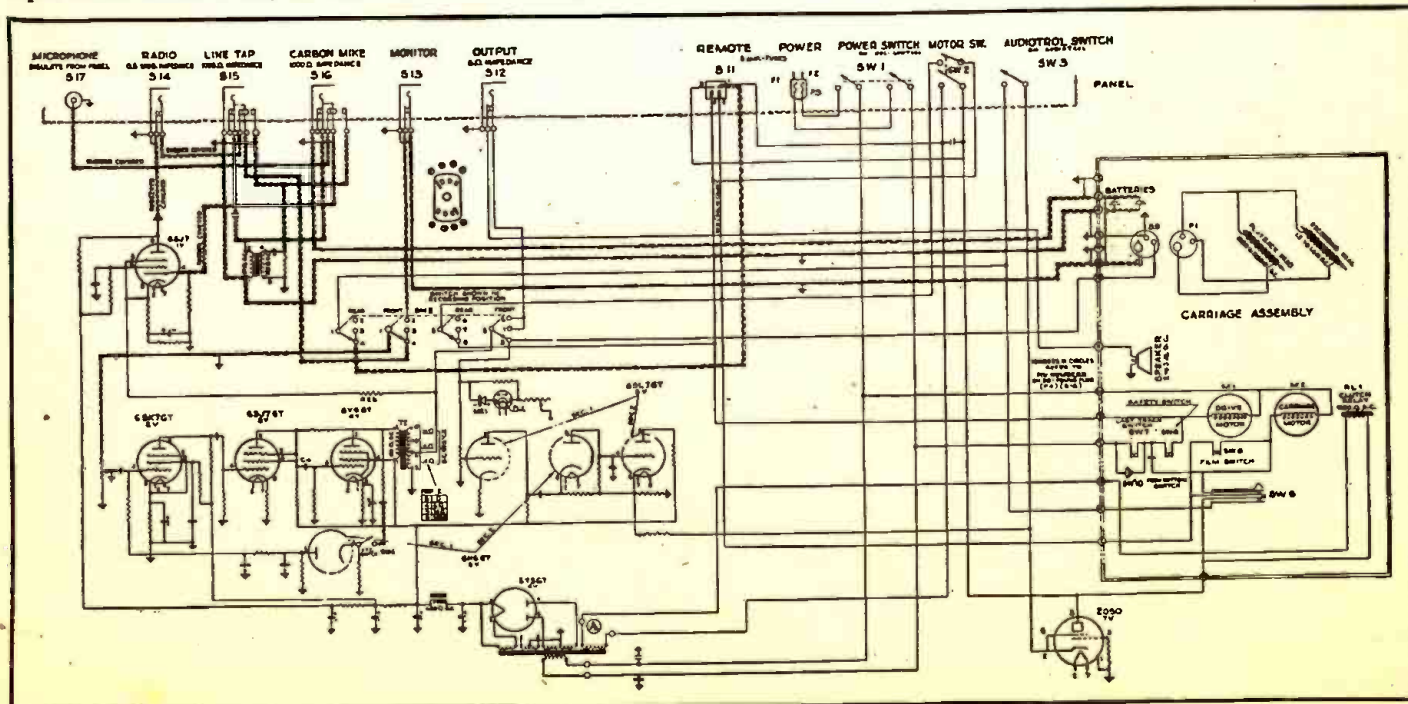

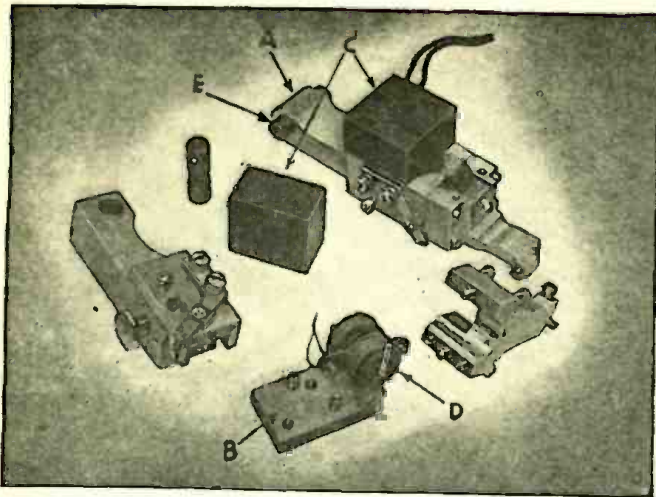

Fig. 2—Breakdown of recording head. Letters are explained in text.

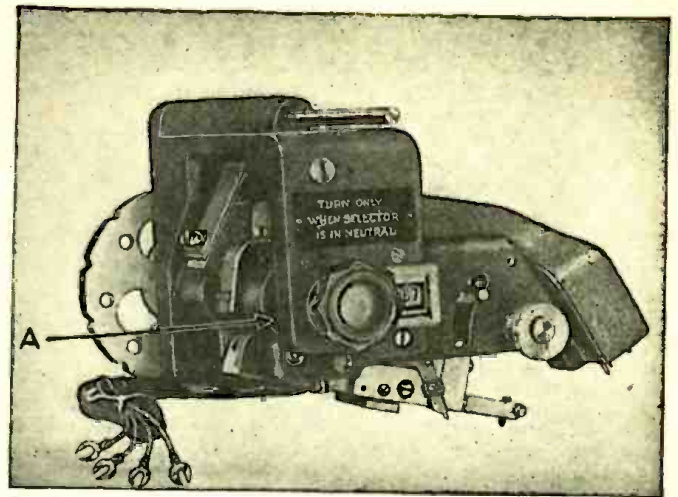

Fig. 3—The carriage assembly. Recording head is seen pivoted at A.

cycles is 6 ohms; frequency range is from 150 to 5,000 cps; and driving power required for maximum amplitude for recording is from 1/2 to 1 watt.

The recording head is pivot-mounted in a pocket in the carriage casting (Fig. 3-a). This mounting consists of a recording arm hinge pin (Fig. 2-c) which passes through a hole in the left end of the recording arm. Pivot pins are threaded into the carriage with their ball-shaped points bearing in the eccentric centers of the hinge pin. A spring in the carriage pocket exerts a downward pressure on the recording head, overcoming any vibration to which the recording arm may be subjected.

A sapphire-tipped needle is used in the recording head to reduce wear on the film, as a substantial pressure is exerted at the point of recording.

The playback head (Fig. 4-a) is of the high-impedance magnetic type, and has an impedance of 10,000 ohms at 1,000 cycles, a D.C. resistance of the coil of 2,000 ohms, and the same frequency range as the recording head.

The actual playback mechanism is mounted on an angular plate (Fig. 4-c) which fastens to an aluminum arm. This arm is pivoted on its left end in two directions through a block (Fig. 4-b) hinged on the same carriage which supports the recording arm. Directly under this hinge block is an adjustable compression spring which balances the weight of the playback, providing correct needlepoint pressure on film.

Two leads from the coil in the playback head are carried back along the inside edge

of the playback arm, and are connected through the same plastic sleeve and to the same terminal strip as the recording head connections. The playback needle, which is also sapphire tipped, may be adjusted by a vernier screw and wedge arm, permitting it to come down in the center of any track on any film recorded by the unit.

A trackage mechanism, mounted on the back of the main frame, drives a lead screw which, in turn, moves the carriage mounting the recording and playback heads. As mentioned above, the track embossed on the film is not a continuous spiral, but runs parallel to the sides of the film, angling over to a new track location only at each complete rotation of the recording film.

When the film switch (SW9) has been actuated by the passing of the notches in the film, the motor is energized. This causes the mechanism to operate, while simultaneously closing a spring leaf pile-up. Keeping the clutch relay energized during the period of the trackage cycle is the only purpose of this switch.

A microswitch (SW7), located above the trackage mechanism assembly, automatically cuts off the trackage mechanism and the drive motor upon reaching the last track, preventing damage to the recorder should the unit be running unattended. This microswitch, normally closed, is in the circuit of both the trackage mechanism and the main drive motor.

AMPLIFIER SECTION

The amplifier section combines the functions of an audio amplifier, audiotrol, and automatic volume control. Eight tubes are utilized, five in the straight audio amplifier circuits and three in the AVC and audiotrol. The amplifier has a power supply of 110- to 115-volts at 60-cycles a-c; a frequency response of from 150 to 10,000 cycles; an output impedance of 6 ohms; and an output of 3 watts.

The audiotrol, a special feature of the Recordgraph, is a device which automatically starts or stops the recording process upon receipt of impulses from voice or other audible signal, thereby eliminating the alternative of unmodulated film.

Three tubes make up the audiotrol circuit: A 6SL7GT (5V), 6H6GT (6V) and 2050 (7V). The signal from the recording-head circuit is fed to one section of tube 5V (acting as an a-c amplifier), the output of which is fed to one section of tube 6V. The latter rectifies the signal and applies it as negative bias to the second section of tube 5V (acting as a D.-C. amplifier), whose cathode is connected to that of tube 7V.

With no signal applied, the voltage on these cathodes is 15 volts positive because of the normal flow of current through the D.C. section of tube 5V to ground, through its 10,000-ohm cathode resistor R12. With the cathode of tube 7V at +15 volts and its grid at ground potential, the tube is sufficiently biased so that conduction will not occur.

CONTROLLED BY SIGNAL

When a signal is introduced, the increased negative bias on the D.C. section of tube 5V causes the plate current to decrease, thereby decreasing the cathode voltage. When the cathode voltage drops from 15 volts to below 3 or 4 volts, tube 7V becomes conductive, passing current to operate the clutch relay (RL1).

A 0.05-mfd capacitor (C11), which receives a charge from tube 6V upon application of a signal, is connected between the grid of the D.C. section of the audiotrol and ground. Upon stoppage of signal, this capacitor slowly discharges through a 20-megohm resistor (R35-R12) connected to it, slowly decreasing the negative bias on the grid of tube 5V and increasing positive voltage on the cathode.

When the cathode reaches approximately 6 volts, tube 7V will de-ionize or become nonconductive, and the clutch relay (RL1) will open. The amount of delay is dependent upon the amount of signal, since the greater the voltage change on C11, the longer it will take to discharge to a given value. Six seconds is a safe approximation of the time it will take to discharge.

Since the signal is obtained from the recording-head circuit, it reaches the audiotrol only when the 4-gang switch (SW5) is in "record" position. The 110 volts which pass through tube 7V to operate relay RL1 is obtained from a special winding on the power transformer (T1) which has a capacity of 10 watts. The current is taken from this point, through a section of the main amplifier switch (SW5), through the switch (SW3) on the audiotrol volume control (R6), to the cathode of tube 7V. When this tube is conducting, the current passes through it, and the plate is connected to pin No. 7 of 11-circuit socket S10-P2 for the operation of relay RL1. The return for this circuit is through pin No. 9 of the same socket and back to the terminal strip.

SW5, the main amplifier switch, controls the four input circuits: microphone, radio, line tap, and carbon mike. The latter three circuits consist of jacks with switches, and

(Continued on page 188)

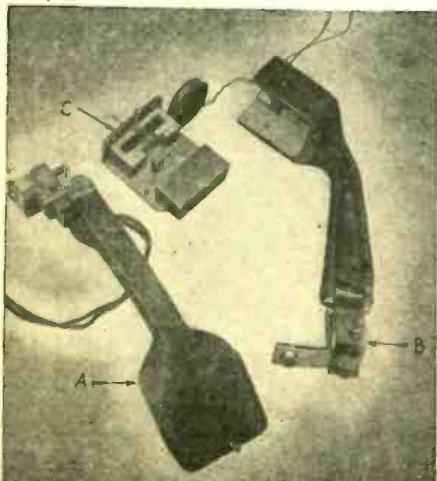

Fig. 4—Exploded view of the playback head.

Elements of RADAR

PART I—RADAR PULSES

By JORDAN McQUAY

RADAR—the science of radiolocation—is a development, not an invention. There's nothing fundamentally new about radar. It combines certain technical advancements in a number of scientific fields: physics, microwave radio, electronics, and television.

True, the circuits are complicated. Radar sets often are subdivided into twenty or thirty components, some using as many as 500 radio tubes. And all components must be synchronized to the millionth of a second.

But all types of radar equipment—regardless of size or tactical employment—operate on the same principle: the transmission of pulses and the reception of reflected echoes.

The key to an understanding of radar is the radar pulse. The elements of operation are simple.

Powerful u-h-f pulses are generated by a radio transmitter, and radiated by a highly directional antenna system. This pulsed microwave energy travels out into space within the confines of a narrow beam until it encounters an object or surface. Then the radar pulses are reflected or reradiated by the object. And some of these reflections return to the radar receiver in the form of echoes.

Since pulse modulation of the u-h-f transmitter occurs only for an extremely short duration—usually between 1 and 10 microseconds or millionths of a second—transmission of the initial radar pulse ends before reflected echoes from distant targets arrive at the receiver.

Passing through the receiver, echoes are detected and amplified, and are applied to the screen of a cathode ray tube or video indicator.

When all echoes have had time to return the radio transmitter is pulsed again.

The complete out-and-back cycle is repeated between 250 and 5000 times per second, and echoes from reflecting objects or surfaces are received with the same

With this issue *Radio-Craft* begins a new and important series—Elements of Radar. Unlike earlier treatments, which for security reasons could not be definite, these articles will present detailed technical information on Radar systems. Following the series, which will run three installments, the author will present a number of technical articles on the various components of Radar systems and their applications in television communications and industry.

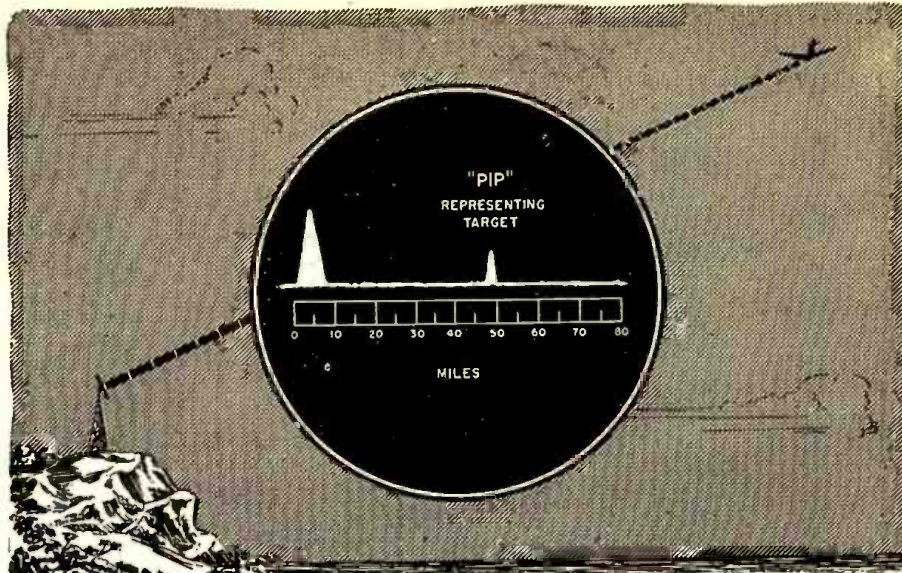

Fig. 1—Echoes from plane cause the pip at 50 miles. Large pip at zero is the "marker."

frequency. Echoes appear on the indicator screen as video signals—giving the range or distance to the object, or other directional data.

An object is bombarded constantly by the radar pulses. And if the object moves within the narrow beam of u-h-f energy, the echo "pip" on the screen will move accordingly.

Measurement of distance is the primary electronic function of a radar set. Since radio waves travel at the speed of light—186,000 miles per second—actual distance to a given object or target can be determined by an accurate measurement of the elapsed time between each transmitted radar pulse and the reception of its echo.

This time interval is extremely short and must be measured by electronic means.

For example, if a 1 microsecond pulse from a radar transmitter travels to a target 3270 yards away, the time required for the pulse to make the one-way journey would be 50 microseconds. Although there is considerable loss of energy, there is no loss of time when the radar pulse strikes a surface and is reflected. Thus, for an echo to return to the radar set would also require an equal amount of time. And the total time would be 100 microseconds.

This elapsed time is measured accurately by the cathode ray oscilloscope, and instantaneously translated into terms of distance along a time axis or scale.

The linear sweep of a scope is synchronized with the transmission of each radar pulse, so that successive echo "pips" are superimposed along the calibrated scale (Fig. 1). This gives a fairly steady and almost continuous pattern for easy visual observation.

Many types of indicator scales can be used in radar, calibrated for distance or for angular measurements. One of the simplest and most common types (Fig. 1) measures range or distance along a base line calibrated in miles.

If more than one object or target is present at varying distances within the narrow energy beam, an echo representing each target will appear on the scope.

Since the radar process of detection and location is almost instantaneous and used to search in all directions, any number of targets can be located by a single radar set.

Having detected a target and obtained its distance, the direction and location—in

terms of bearing or azimuth, and related angular elevation—can be determined by the physical position of the directional antenna system. Radar antenna systems are moveable, able to search the skies in any direction.

"An echo "pip" will usually appear on the scope when the antenna is pointing in the general direction of the target; but the "pip" appears strongly only when the antenna is exactly "on the target."

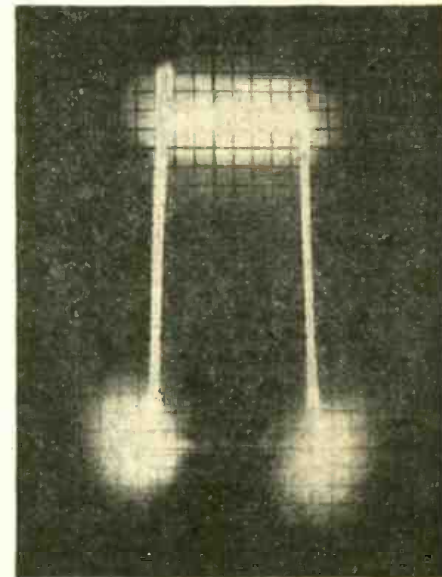

Fig. 2—Here of this story, the radar pulse photographed on the cathode-ray tube screen.

Where greater accuracy of angular direction measurement is required, two radar pulses are sent out simultaneously—one slightly different in angular orientation from the other. This results in two u-h-f beams slightly overlapping each other, and permits more accurate location of a target between the narrow, highly directional beams. The indicator scopes of such equipment portray two echoes along the base line, representing energy reception from two beams or lobes.

Thus radar supplies the three dimensions necessary to locate an object in space: range or distance, azimuth or bearing, and angle of elevation. Knowing these three things, it's a problem in high-school trigonometry to determine the actual height of the airplane target; but this computation is per-

(Continued on following page)

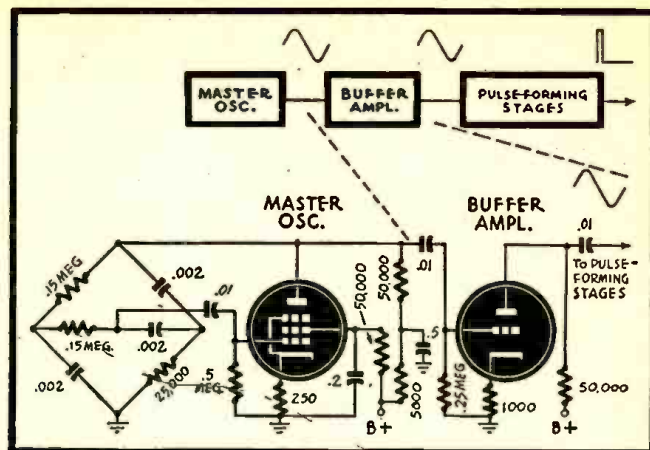
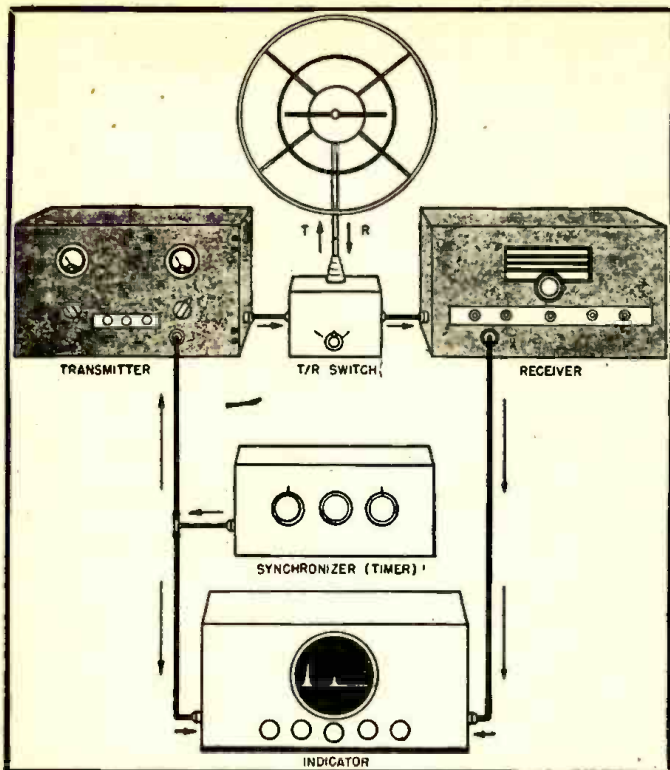

Fig. 3, left—Block diagram of typical radar equipment. Fig. 4, right—Oscillator for a radar synchronizer.

is also used as a "blocking signal." It is applied to the cathode ray tube during the radiation of energy by the u-h-f transmitter, and prevents overloading and damage to the sensitive indicator tube during the pulsing period.

Thus, the radar pulse from the synchronizer has an important responsibility in timing the functions of all components of a radar set. Let's examine this important pulse, which must be so accurately timed and precisely formed.

RADAR PULSE CHARACTERISTICS

The radar pulse has two important characteristics: its pulse recurrence frequency or p-r-f, and its length or duration. Both of these are established in the synchronizer.

Pulse recurrence frequency is usually between 250 and 5000 per second. In other words, pulses of u-h-f energy are radiated between 250 and 5000 times every second. Exact choice of a p-r-f is determined by several factors.

The highest possible value depends upon the desired maximum working range of the equipment. After transmission of a pulse, sufficient time must be allowed for reception of echoes from targets up to any established or desired distance. This distance is known as the "working range" of the equipment. If pulses are transmitted too frequently, returning echoes from long ranges may be "blotted out" by the following and much stronger R.F. pulses from the transmitter—and the echoes may never appear on the oscilloscope screen.

The lowest possible value of pulse recurrence frequency will depend upon the rotational speed of the antenna system. If the antenna moves at a high speed, relatively fewer R.F. pulses will strike a target. With antennas revolving 6 to 10 times each minute, a desirable repetition rate or p-r-f would be between 500 and 1000 per second.

The pulse recurrence frequency must be very stable if accurate range measurements over long distances is desired.

The second characteristic of the radar pulse—the length or duration of each pulse—is affected by and in turn affects the minimum range of the radar set.

The shortest range at which a target can be located is determined largely by the length or duration of the radar pulse. If an echo returns from a near-by target before the transmitter has stopped radiating, the echo will be "lost" within the strong transmitter "pip" at the start of the scope's base line.

For this reason, radar sets used to detect and locate targets at very close range—within one mile—use a pulse duration of only 1 or two microseconds.

If the location of near-by targets is unimportant, a long range radar set would be

(Continued on page 202)

formed electronically by certain circuits of the radar set.

Locating ships at sea is even easier because only range and bearing are required.

This, simplified, is the function of radar.

But more complex are considerations of: how the radar pulse is generated and transmitted, how the radar echoes are received and changed into visual signals, and how the electronic measurement of distance is achieved.

All of this is accomplished by an important wave form known as the radar pulse. (Fig. 2.)

THE BASIC RADAR SET

There are five basic components of a complete radar set: 1—a microwave transmitter, 2—an antenna system, 3—a microwave receiver, 4—an indicator or oscilloscope, and 5—a synchronizer or timing device.

While most radar sets are more complicated in function and arrangement, every type of pulse-modulated radar set can be represented by the block diagram shown in Fig. 3.

The synchronizer—sometimes called a timer—is the electronic heart of the set. In this component the radar pulse is created as a voltage waveform (Fig. 2), having a certain shape, a required frequency of recurrence or repetition, and a required length or duration.

These voltage pulses are used to modulate the u-h-f oscillator stage of the microwave transmitter. Thus, the R.F. output pulses

have the same pulse recurrence frequency and the same duration as the original voltage pulses created in the synchronizer.

Radar pulses travel outward into space according to the physical position of the antenna system.

If the pulses fail to strike an object or target, there will be no echo reflection. But when pulses do strike an object within the radiating beam, a weak echo returns to the radar set.

The transmitter always allows sufficient time for an echo to return before another pulse is radiated. Therefore, the transmitter and receiver function alternately. The same antenna system can be used for both transmitting and receiving, if a suitable device—known as a T/R switch—is provided to switch the antenna between transmitter and receiver at the precise moment.

The T/R switch is essentially an electronic device, capable of functioning up to 5000 times per second with no mechanical movement. It uses tuned sections of u-h-f transmission lines and tiny spark gaps to accomplish the precise switching requirements of radar.

After the received echo has been detected and amplified by the receiver—usually a superheterodyne—the echo signal appears as a wide-band or video signal, often containing frequencies and harmonics up to two megacycles. Thus the echo must be further amplified only by wide-band or video amplifiers, much in the manner of television video amplification—where distortion of complex wave shapes cannot be tolerated.

Finally, when the echo signal is at the proper level, it is applied to the indicator unit for visual inspection and measurement. This is usually caused by displacing the time base of any of several types of cathode ray oscilloscopes.

At the time the synchronizer applied the voltage pulse to the transmitter, a similar voltage pulse was also applied to the indicator component. This control pulse triggered the time base of the cathode ray oscilloscope, causing a repetition of the base line with every radiated u-h-f pulse from the transmitter.

The control pulse from the synchronizer

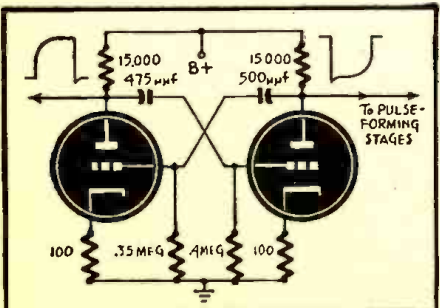

Fig. 5—Master oscillator, a multivibrator.

Postwar Radio Shop

Some postwar servicing ideas are more ambitious than practical. The article below is typical of much such thinking.

By GENE CONKLIN

WILLIAM REYNOLDS of Lowville, New York, is a returned war veteran who, like thousands of his compatriots, planned to set up a service establishment of his own. Because his method of procedure offers a guide to the establishment of a post-war radio shop it is well worth considering in detail.

According to Mr. Reynolds it is important that the veteran examine closely indeed his qualifications for the profession of radio servicing. If he was engaged in servicing prior to the outbreak of the war or acquired technical training therein while in the Signal Corps or other branch of the service, that is an excellent stepping stone toward the future. Yet he must not overlook the very salient fact that frequency modulation, television and electronics as well as communications equipment design will be pertinent in the "after the war" era. The veteran will do well to enroll with a recognized radio school and brush up on fundamentals, at the same time acquiring specialized knowledge along certain lines.

His financial position is likewise "of the essence." Mr. Reynolds estimates that it requires from \$500 at the very minimum to several thousand dollars to establish a service business and to carry it on until such time as his clientele expands sufficiently to guarantee a "month in and month out" revenue. If for example the veteran desires to rent a service site, the cost of redesigning this shop will be very apt to amount to several hundred dollars.

If a new service edifice be constructed from scratch, the initial outlay may well run into the thousand dollar bracket!

Is it best to rent a vacant shop or to design one to personal specifications? Again, and we quote Mr. Reynolds, "consider carefully whether or not the community justified the expense incurred in the hiring of a contractor, carpenter or both. By all means pay a personal visit to the local Chamber of Commerce. Their attitude will enable you to determine whether or not

the locality is an energetic and enterprising one. A Chamber of Commerce keenly alert to its responsibilities and offering encouragement to new commercial settlers is an indication that the community it represents is or will shortly become a flourishing one—always allowing for the geographical factors involved."

If for example the community is a county seat or is in close proximity to a number of smaller towns or hamlets too tiny to afford the services of a radioman, yet composed of a citizenry requiring radio repair work, then the serviceman may well consider the community more favorable.

The population of a community is another extremely pertinent consideration for the serviceman-to-be. In general the following table is applicable, allowing for minor discrepancies and exceptions which must be anticipated.

Inhabitants	Radio Service Shops
500-2000 can support.....	1
2000-5000.....	2-3
5,000 to 15,000.....	4-5
15,000 to 30,000.....	6
30,000 to 50,000.....	8
50,000 and over.....	more than 9

At this point, Mr. Reynolds advises the veteran to determine in advance upon a specialty "of the house." Perhaps the serviceman is deeply interested in industrial electronic apparatus, its installation and maintenance. He may be particularly engrossed with frequency modulation and television "service engineering" as related to hospital, factory, and school installations requiring static-free reception. With the increasing emphasis upon private aviation, a radio-shop at a local airport concentrating its attention upon the installation and repair of both private and commercial aircraft radio equipment may be found eminently practical and profitable as well.

The important thing is that the serviceman consider his competitors already established. Are they general practitioners?

Gene Conklin began writing for radio publications on short wave DX in 1934. During the past ten years has written number of articles for Radio News, Radio-Craft, Radio Retailing Today, and others. Was Editor of Short Wave Digest, a ham publication. In addition, has served as Short Wave Edi-



tor for Radio Mirror and White's Radio, Log, and has prepared considerable material for Hygrade Sylvania, R.C.A. and other manufacturing corporations. Specializes in material on the business side of radio servicing, and "believes whole-heartedly that a radio man must be first, last and always a business man."

Do one or more of them possess their own specialties, such as auto radio repair, short-wave and amateur radio repair, etc.? If you possess a specialty not already a fixture in the community you have a final and extremely valid reason for locating there.

Having determined the community, the question of the service shop location may not be lightly shelved. "Super market" executives have in almost every instance made a profoundly elaborate survey of traffic—both pedestrian and motor—which may be anticipated in virtually every section of a town or city. If you locate in close proximity to a "super market" you will more than likely find your service shop catering to a satisfactory consumer group.

It is not always necessary to establish yourself upon a Main Street or adjacent avenue. If there is a vacant site in a residential section and competitors are conveniently located elsewhere there is no reason why such a location could not be satisfactory to both serviceman and consumer. Consider the income level of home owners in your immediate vicinity. In general, as with a neighborhood drug outlet, your reg-

(Continued on page 210)



Left—J. G. Pough, service staff member. Right—Mr. Reynolds himself.

BICYCLE RADIO WITH 4 TUBES

By ROBERT B. ESSEX

ON MANY occasions, while cycling along our beautiful state roads, or resting after conquering an especially steep hill, I would have enjoyed the soft tones of some favorite orchestra. Last Spring, after four weeks of this wishful thinking, plus stimulus from another source, a tentative layout was drawn for a small economical battery set. The extra stimulus for this design came in the form of a request from a close friend owning a small sailboat. He too, wanted a small economical receiver which could be operated while sailing near his home.

After considering many circuits, the design shown in Fig. 1 was finally chosen.

The antenna system for bicycle operation consists of a revamped automobile "whip aerial" coupled to the antenna coil of the set by a small compression-type mica condenser. The receiver and whip antenna are shown mounted on the bicycle in the photograph. When used on board the sailboat, there were two possible antenna connections, both easily accessible. The wire stays supporting the mast were found to make an excellent antenna system. These may be used, or the brass guide rail screwed to the mast will also give excellent results.

The receiver is a superheterodyne using four tubes of the miniature type—1R5, osc; converter; 1T4, I.F. amp.; 1S5, det. 1st audio; 1S4 or 3S4, power amplifier. The first and second intermediate frequency transformers T1, T2, operate at 455 kilocycles and should be small in size. These are generally tuned by compression mica condensers. Iron slug tuning is also acceptable. The radio frequency antenna and oscillator coils, and the two-gang, cut-plate, variable condenser should be purchased as a kit. The purchaser should indicate that the desired range is 540 to 1620 kilocycles. The variable condenser purchased should have trimmers on the oscillator and R.F. sections. A small permanent-magnet speaker with a 5-inch cone and 6-8 ohm voice coil was chosen. This speaker will give wonderful reproduction when properly matched to the output tube. Matching is accomplished through the use of a small good quality output transformer,

capable of reflecting a 5000-ohm plate load to the 1S4 when its secondary winding is coupled to the 6-8 ohm voice coil. The volume control is the small one-megohm type with a double-pole single-throw switch attached at the rear. If the switch cannot be obtained as part of the small volume control, a separate double-pole single-throw switch will do as well. Naturally, sufficient room must be allotted for mounting the separate switch in the latter instance. All resistors are of the small 1/4-watt insulated variety. All condensers but one are rated at 150 volts. The exception is the .002 mfd. 400 volt plate by-pass condenser connected across the output tube. The antenna coupling condenser has a capacity range of 15-200 mmfds. and is of the mica compression type. The battery situation is no longer critical and therefore should not present a problem. The "A" supply consists of 2 or more of the regular large size flashlight cells connected in parallel. The brass caps are joined together in parallel connection and the zinc shells are wired similarly. The method of connection is shown in Fig. 2. Where sufficient room is available more than two cells should be used in parallel. The reason for this is that the annoyance of continual replacement is reduced and

Robert B. Essex was born August 22, 1919, in New York City, receiving his education in New York public and high schools and in an Electrical Engineering course in Cooper Union, later taking special courses in electronics at N.Y.U.



His record includes work for Air King Radio Corp. as assistant to the chief engineer; Radio Development and Research Co. as project engineer; Emerson Radio Corp. as an associate design engineer, and his present position with Lear, Inc., as a project engineer. He holds a Class-A amateur radio ticket and a First Class Radiotelephone license. Hobby: Radio-controlled model planes and automobiles.

the volume control turned to the full-on position. The set is now ready for alignment.

For alignment, a modulated signal generator having output frequencies of 455, 1620, 1400 and 540 kilocycles, is required. The "hot lead" of the signal generator should contain a series-isolating .1 mfd. con-

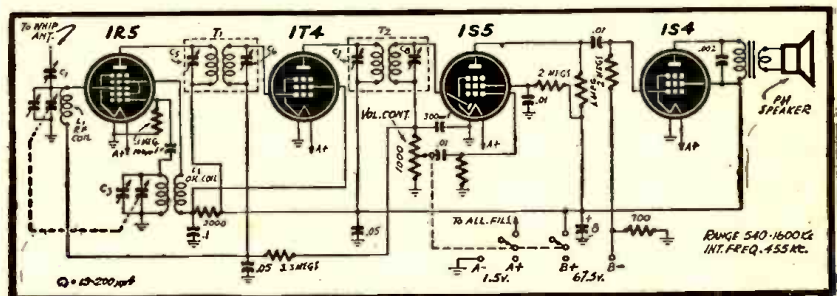

Fig. 1—A standard circuit and high-sensitivity coils are used for the bicycle receiver.

each individual cell will operate more efficiently. (Two cells however, will give satisfactory results.) The 67½-volt "B" supply may be the Eveready "Mini-Max" type or one of similar size and capacity. The builder is cautioned to exercise particular care in handling the "A" and "B" batteries, as a short circuit even of short duration will injure them permanently. For tuning it is suggested that a small pointer knob be used to indicate frequency. A small cardboard dial may be placed directly underneath and calibrated as the stations are received.

The author salvaged some of the parts for the set from the junk heap, but most of them, were bought in the local Ham and wholesale supply house. All tubes and the output transformer were borrowed for an indefinite period from a friend. The chassis was cut and revamped from an old 5-tube A.C.-D.C. receiver. Of course a few dull bits hampered progress but this was soon remedied and the unit was ready for testing a week after work had begun.

After all parts are mounted and the wiring completed, the soldered connections should be rechecked carefully. Where possible, the wires should be dressed down against the chassis. The batteries are then connected, the switch is snapped on, and

denser. The second intermediate frequency transformer T2, is first aligned by adjusting C7 and C8. A strong modulated 455 kilocycle signal, of approx. .01 volts, applied to the grid of the 1T4 tube. (pin No. 6). The capacitors are adjusted to obtain maximum output from the speaker. The next step is to apply approx. .001 volts of the modulated 455-kilocycle signal to the modulator grid of the 1R5 tube. (pin No. 6.) The first intermediate frequency transformer is now aligned by adjusting the capacitors C5, C6 for maximum output. With the generator lead still connected to the modulator grid of the 1R5, readjust capacitors C7 and C8 slightly for maximum output.

The generator output is then adjusted for medium output (approx. .001 volt) at 1620

(Continued on page 189)



Fig. 2—Three cells are preferred to two.

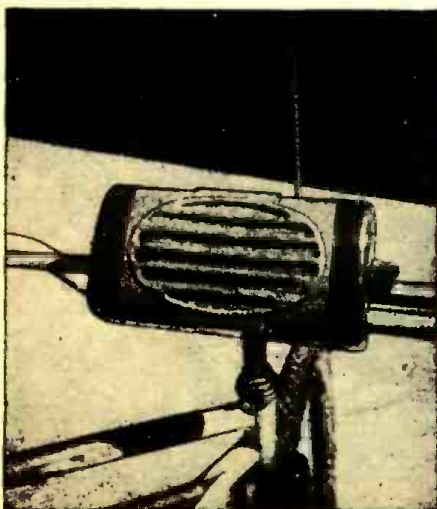

Appearance of the little radio is excellent.

POWER OUTPUT STAGES

Effects of plate and cathode voltage, filtering, load and plate impedances, are all important in servicing the output stage. Jack King describes the effects of each on power and fidelity.

By JACK KING

THE serviceman often gives only passing attention to the power output stage of a radio receiver or an audio frequency amplifier. Yet, the power output stage may be the most important to sound quality. An impedance mismatch there will show up as loss of fidelity and signal power. In making tube substitutions the necessity of proper impedance matching must therefore be kept in mind. For example, a 50L6 tube is very similar to the 25L6, differing only in the filament voltage and current rating. The 25L6 could be used in place of the 50L6, modifying the filament circuit. A new output transformer would not be required. The recommended plate load in the RCA tube manual is 2,000 ohms for a single-ended tube with a bias of

resistance would be used, since the values are not critical.

THE CATHODE BYPASS CONDENSER

The resistance of the cathode circuit is low, but to avoid degeneration we must bypass the resistor R2 with a low-impedance condenser. The impedance of the condenser may be made about 1/10th R2 at the lowest operating frequency of the stage. Suppose the output stage is to function down to 80 cycles. Then, Xc must equal 140 x .1 or 14 ohms. The reactance of the condenser is,

$$X_c = \frac{159,184}{fc} = 14 \text{ ohms}$$

Then,

$$C = \frac{159,184}{fX_c} = 142 \text{ mfd.}$$

(C is in microfarads, f in cycles per sec.)

If we use a lower limit of 160 cycles, the reactance of the condenser will be halved and will be 71 mfd. If we make the assumption that the reactance of C in shunt with R2 in Fig. 1 need only be half that of R2 or 70 ohms at the lowest operating frequency, and that frequency is 80 cycles, C may be about 28 mfd. A compromise is usually made and a 30- or 40-mfd. unit would be used in practical work.

If the condenser's resistance is negligible, the 70-ohm capacitive reactance in shunt with the 140-ohm cathode resistor will give a net impedance between the cathode and ground of,

$$Z = \frac{Z_1 Z_2}{Z_1 + Z_2} = \frac{70 \times 140}{70 + 140} = 46.6 \text{ ohms}$$

The rated power output of the tube is 2.2 watts maximum, for a 2,000-ohm load. The cathode-circuit impedance can be considered a part of that load. Then, the power available will be less due to cathode circuit degeneration, or:

$$P = 2.2 \times \frac{(2000 - 46)}{2000} \\ = 2.2 \times \frac{1954}{2000} = 2.1 \text{ watts}$$

From this, it can be seen that cathode circuit degeneration is low when the cathode resistor is bypassed. If the resistor is not bypassed,

$$P = 2.2 \times \frac{(2000 - 140)}{2000} = 2.04 \text{ watts}$$

PLATE CIRCUIT IMPEDANCES

In the first case, the resistance reflected into the plate circuit by the output transformer should be 1954 ohms and in the second case it should be 1860 ohms, or 2,000 minus 140. Assuming a voice coil impedance of 6.5 ohms (multiply 5 ohms D.C. resist-

ance of coil by 1.3 to obtain the approximate impedance the turns ratio on the output transformer can be calculated. The capacitive reactance of the .006 mfd. plate condenser at 400 cycles will be

$$X_c = \frac{159,184}{fc_{mfd}} = \frac{159,184}{400 \times .006} = 66320 \text{ ohms}$$

This value of shunt impedance across the primary would have a small effect at 400 cycles, since 66,320 ohms would be large in comparison with a plate load requirement of 1860 ohms. At 4,000 cycles, however, the reactance of the .006 mfd. condenser would be only 6632 ohms. The formula for the net impedance when the two impedances are in parallel is,

$$\frac{1}{1860} + \frac{1}{6632} = \frac{1}{Z_2} \\ Z_2 = 2631 \text{ ohms}$$

Therefore, to get a match at 4,000 cycles, the transformer would have to reflect into the primary circuit a resistance of about 2631 ohms. Actually, the voice coil impedance rises and becomes more inductive at high audio frequencies. A value of C across L1 can be determined experimentally to give best tonal quality, making the assumption that a 2,000-ohm load is required in the stage. The turns ratio is equal to the square root of the impedance ratio. Assuming a

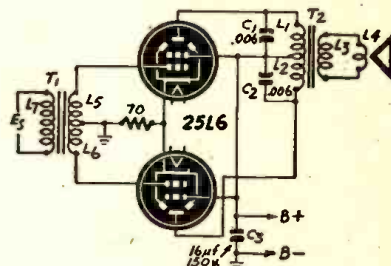

Fig. 2—Features of a push-pull output stage.

2000-ohm load and 5-ohm voice coil, 2000/5 equals 400 and the square root of 400 is 20, giving a turns ratio of 20 to 1.

VOICE COIL CONSIDERATIONS

Assuming the voice coil impedance is 1.3 x R, or 5 x 1.3 equals 6.5 ohms, the inductive reactance is the square root of the square of the total impedance minus the square of the resistance, or:

$$6.5^2 - 5^2 = X_L^2$$

$$X_L = \sqrt{6.5^2 - 5^2} = 4 \text{ ohms}$$

The inductive reactance at 400 cycles is:

$$6.28 \times 400 \times L = 2512L$$

$$L = \frac{4}{2512} = .0015 \text{ henr}$$

(Continued on page 207)

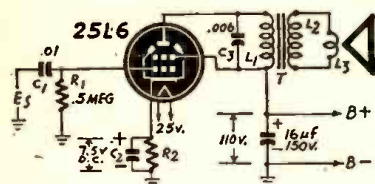

Fig. 1—A standard single-ended output stage.

—7.5 volts and a plate and screen voltage of 110. The total harmonic distortion is 10% with the 2,000 ohms plate load. Plate resistance of the tube is approximately 10,000 ohms. The plate load is made lower than the plate resistance, being equal to about 1/5th the plate Rp. A circuit diagram of a typical single-ended stage is shown in Fig. 1.

The cathode resistor R2 is used for biasing. Assuming that there is no input signal, electrons come from B-minus and pass up through R2 to the cathode of the tube, next passing from the cathode to the screen and plate. The electrons of the screen go to the B-plus source directly and the electrons from the plate pass through the primary resistance of transformer T, in L1, to B-plus. Electron flow in R2 results in the development of a voltage across it, equal to 7.5 volts. This voltage is equal to the cathode circuit resistance multiplied by the cathode current. The tube manufacturer states that minimum or no-signal screen current is 4 milliamperes and the no-signal plate current is 49 milliamperes. The maximum-signal plate current is stated as 50 milliamperes and the maximum-signal screen current is 11 ma. The total no-signal cathode current is then 49 plus 4 or 53 ma. and the total cathode current for maximum signal is 50 plus 11 or 61 ma.

The value of bias resistance required will be greater in ohms if we choose the low signal or zero signal values. To make certain that there is sufficient bias on the tube at low signal input levels, and zero signal input, we may use the minimum cathode current value in calculating the bias resistance. Then,

$$R = \frac{E}{I} = \frac{7.5}{.053} = 141.5 \text{ ohms}$$

In practical work, a 140-ohm or 150-ohm

Acorn-Tube Radio For Ultra Highs

By HOMER L. DAVIDSON

THE vacuum tubes used in this small ultra-high frequency receiver were two 955 triodes. These tubes have a great advantage over other tubes at high and ultra-high frequencies. They take up very little space, work efficiently at high frequencies, and have small capacitance losses. The 955 triode will work well up into the ultra-highs and even the microwave spectrum. In some cases they will oscillate up to 700 megacycles.

This small receiver operates from 100 to 130 megacycles, thus covering the recently-opened amateur band, and also serves to introduce the beginner to ultra-high-frequency receivers.

One of the triodes was used as a self-quenching super-regenerator. The other 955 triode amplifies this signal enough for headphone reception. In one instance a 4-inch P.M. speaker was connected and volume was surprisingly good on a local station.

DETAILS OF THE PANEL

The receiver is four inches long, three inches wide, and two and one half inches in depth. All the major parts are mounted upon the front panel. This panel can be constructed from polystyrene or lucite insulating material. The tubes were mounted directly upon this high frequency panel and with looped hook-up wire. The wires for the heater circuit, coming from the power supply, came first through the 1/4-inch lucite panel and back to the heaters of the tubes. With this method the tube was bonded to the lucite material.

First a piece of lucite material was procured and cut with a hacksaw to the correct front panel dimension. The hacksaw traces or rough edges can be finished down with a coarse file. For the two tube-socket holes use a circle-cutter or drill to make the hole just large enough so the tubes will fit into it snugly. This helps to secure them to the front panel. The four outside mounting holes along the corner edges were 3/16 inches in diameter. A 3/8-inch hole is drilled for the small variable tuning condenser so an insulated knob can turn the slotted shaft as shown in the drawing. Holes for the two headphone jacks were also 3/8 inches in diameter. All other small holes are drilled with a 1/8-inch drill.

The tuning condenser was mounted first and then the two small 955 triodes. Extreme care must be exercised when soldering to the prongs of these tubes. Don't let the iron rest too long upon the prong connections. Also don't let the solder or iron touch the insulating material. It burns very easily. To avoid damage place a sheet of paper underneath the connections when soldering. If the surface is marred and

scratched one can see it very plainly through the front of the panel.

The tops of the two triodes extend about one-half inch through the front panel. This does not detract from the appearance of the receiver and when the tubes are heated up it adds a little attraction. *There are no front dials.* A small round knob on a 1/4-inch fiber shaft with a screwdriver point accomplishes the necessary tuning. Two small red insulated phone jacks are also on the front panel.

WIRING THE RECEIVER

After all major components are mounted, the small resistors and condensers are soldered into position. A small 3-plate variable condenser was used to cover the band from 100 to 130 megacycles. This one was a mid-gut ceramic type. It has a screwdriver adjustment. The grid resistor and condenser were of the .1 megohm 1/2 watt type and .00005 mfd. ceramic, respectively.

The regeneration control was a potentiometer in the plate circuit of the first 955 triode. This control varied the plate voltage on the super-regenerator. Super-regeneration was smoothest when the plate supply was 180 volts D.C.

The amplifier was another 955 triode with cathode bias. The bias resistor was 1000 ohms, 1/2 watt. Enough by-passing was obtained with a .1 mfd. paper by-pass condenser. The plate connection was soldered directly to the red headphone jack.

Looking at the bottom of the tubes, the connections are numbered in the usual manner. At the bottom the two heaters are the outside prongs. The center prong is the cathode. The left tube prong at the top is the plate connection and the remaining one, to the right, is the control grid.

The inductance L1 is two turns of number 12 tinned copper wire. This coil is loosely coupled at one end of coil L2. Inductance L2 is wound with the same size wire of 4 turns. Both inductances are self-supporting and may be about one-half inch in diameter. The antenna coil L1 is soldered directly to the small 16-inch antenna. The antenna was constructed from regular automobile gas-line tubing.

CABINET CONSTRUCTION

The cabinet was made from thin sheet aluminum, its depth was 2 1/2 inches, length 4 inches and height 3 inches. This sheet metal butts up flush with the sides of the front panel. Four 8/32-inch bolts, one on each corner, secured the cabinet in place. One slot at the top was cut out with tin snips as was a 1/2-inch slot at the bottom for the power supply cable.

The cable from the power supply was a four-conductor type. Practically any

Homer L. Davidson was born Sept. 30, 1921, at Unionville, Mo., moving to Newton, Iowa, when five years old. He became interested in radio at 14 years of age and radio has been with him ever since. Before entering the Enlisted Reserve Corps he was an electrician and repairman. Also



went to E.S.M.D.T. Radio night school. He enlisted in the E.R.C. Signal Corp. Reserves at Omaha, Neb., and entered service Jan. 16, 1943. Attended ground Radar school at Camp Murphy, Fla., and later was transferred to Robins Field, Ga. Was a Sgt. instructor in Radar electronic operation, installation and maintenance. Installed and maintained Radar equipment on the east coast. Postwar plan — to experiment and work with radio and electronics for the next fifty years or so.

power supply furnishing 6.3 volts for the heaters and from 150 to 250 volts plate voltage is sufficient. This power supply contains filament and "B" (standby) switches.

To put the receiver into operation hook up the power supply and watch that the triode heaters light up. Plug in the earphones and rotate the regeneration control back and forth several times, noting whether super-regeneration fades in and out. Touch the small antenna and notice the cutting down of background noise. The receiver should oscillate over the whole band when the small tuning condenser is varied.

A high-frequency signal generator, modulated with a 400-cycle note, was used to

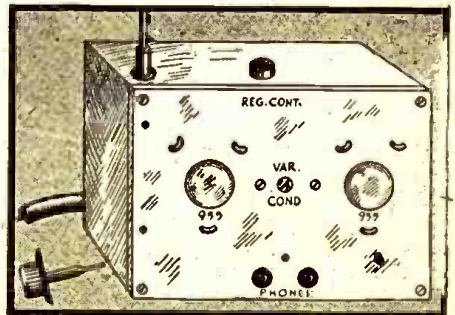

Set is tuned with the bakelite shaft, left.

calibrate the complete band. This was done by setting the signal generator a few feet away and picking the signal up in the receiver.

A certain amount of practice is necessary to operate a superregenerator. The hissing sound heard when the set is in its most sensitive condition will be recognized after a little experience is gained. Like an ordinary regenerator, too much regeneration reduces rather than increases volume. The hiss or rushing sound dies down or disappears when a station is tuned in, so it does not bother the listener or interfere with reception.

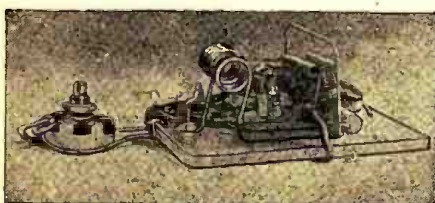

All parts are fastened to the lucite panel.

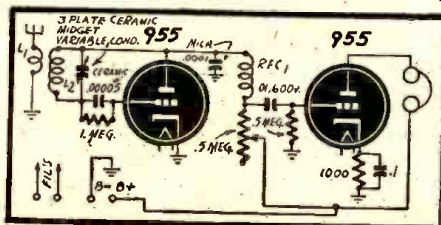

Schematic of the U.H.F. superregenerator.

Radio and Television Twin Crime Fighters

EVERY one is familiar with the use of radio in prowl cars and at police headquarters. Not so many, however, are familiar with many other uses of radio by the police, both at present and in the postwar period ahead.

Perhaps the most important device to be used in police circles will be the "Handie-Talkie," that compact transmitter and receiver which weighs slightly less than five pounds and can be held in the palm of one hand.

This unit possesses an earpiece at the top and a mouthpiece at the bottom and resembles a narrow cigar box in appearance. Using batteries with a life expectancy of 12½ hours the entire affair can be carried by patrolmen and plain-clothesmen for instantaneous communication with headquarters. Possessing a range of from two to five miles under favorable conditions, these units may be furnished doctors so that they may contact the police in an emergency and may be carried by payroll men who are habitually entrusted with large sums of money. These individuals may carry it on their person hidden underneath their clothing. In case of a holdup a slight pressure on the instrument will push a button and set the "Handie-Talkie" in operation. All such instruments would be connected directly with a central police station.

Television, too, will play its part in fighting crime at the end of the war. It will be possible to erect television trans-

mitters in police headquarters of one community and "televise" a lineup to another police headquarters in a city many miles distant. New York already uses television to transmit pictures of missing persons and wanted criminals to the various precincts. True, the range of a televised signal seldom exceeds 50 miles with full clarity, but by means of "booster" transmitters it may be possible for authorities in a half dozen metropolitan centers to observe, simultaneously a lineup of criminals.

Even more startling, from a crime-fighting viewpoint, is the development of portable television transmitters which may be installed in police cruisers. A tiny screen, located on the dashboard, allows cruising patrolmen to see as well as hear their dispatcher. And a television camera mounted on the running board will instantly televise holdups, traffic accidents and other occurrences back to police radio headquarters.

The American home will possess its quota of crime-prevention aids. The "listening ear" which has been used in many homes, even before the war, is nothing more or less than an intercommunication system which transmits all the sounds from the children's room to the parents' sleeping quarters and warns them of any unwelcome intruders or any sudden illness which might occur. This "ear" may be installed in the wall and requires very little attention from a service standpoint. Equally familiar to many householders is the "electric eye"



Patrolman calls station on Handie-Talkie.

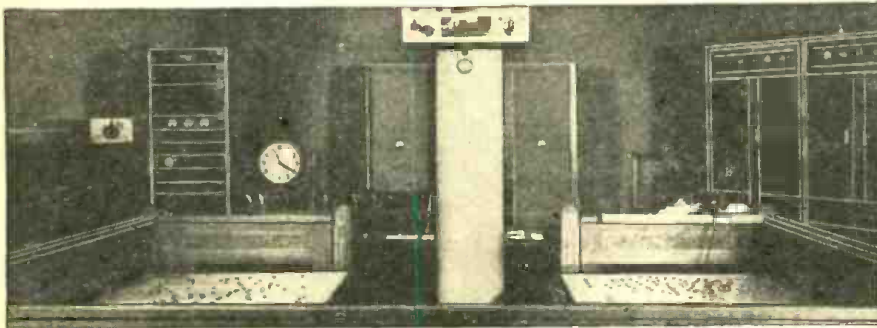

Top—Radio WEPG, New York City Police Dept. Bottom—WVRP, Douglas Aircraft, E. Chicago.



Top Photos—Courtesy New York City Police Dept.; bottom—Galvin Manufacturing Co.

which acts as a super-efficient burglar alarm. This device may be set so that when any individual even passes in front of a window or door after a certain hour of the night an alarm goes throughout the house.

In the police laboratory the baby electron microscope will shortly come into its own. This instrument can be used to examine minute bodies which may yield important information in cases where poison has been employed for criminal purposes. It can also be employed with profit by scientists who wish to examine strands of clothing to determine traces of blood or other stains and to determine texture of the material involved. The electron microscope possesses a magnifying intensity far greater than any comparable instrument available to crime laboratory technicians today.

Fantastic though it may seem, radar may well be employed by police prowl vehicles to scientifically aim their ammunition at fleeing criminals. Ofttimes in the heat of a chase between police and criminal, marksmanship is understandably a little off the beam no matter how skilled the police marksman may be. Through the use of radar an escaping criminal will have less than one chance in a thousand of making good his flight.

There is every indication that radio may be used educationally through the erection of a community police radio transmitter which will offer three or four hours daily of lectures on juvenile crime prevention, technique of finger-printing, tracking down of counterfeit money, and other subjects of interest to the civilian populace, including the prevention of traffic accidents and the offering of first aid to injured parties.

Radio will certainly have its legitimate place in the crime-prevention sun and will do its part to cause criminals to bitterly regret Marconi's brainchild.—E.A.C.

Postwar Recorders Show New Ideas

MUCH interest and enthusiasm is being shown in the wire recorders which will be available for general use shortly. It is reasonable to assume that they will become necessary accessories for the home, shop and office.

Recent issues of *Radio-Craft* have discussed wire recording from amateur and professional points of view. The January, 1945, issue described the technique of a home-built outfit. In March, 1945, the theory and design of modern recorders was discussed. Here we are concerned with present and future uses of these instruments and offer a preview of models either already in production or in the development stage. The use of recorders will be as widespread and handy for preserving sound events as cameras are for scenes.

Many recent and basic discoveries in wire recording are due to Marvin Camras of Chicago, who first worked with recorders while he was still a student of electrical engineering at Illinois Institute of Technology. His original experiments were prompted by his cousin, who liked to sing, and his first crude models were built for the purpose of recording such vocal music. After graduation Camras joined the Armour Research Foundation as associate physicist, and his work was developed and perfected there. The Foundation is the non-profit research organization of Illinois Tech.

Briefly, a wire recording instrument uses a steel wire which moves past an intense magnetic field which is varied in accordance with the desired sounds. The wire then becomes permanently magnetized. If the wire is now passed through a coil (usually the recording head also serves as the reproducing head) a corresponding audio voltage will be induced in the coil. This voltage is amplified so that the original sound is reproduced.

By I. QUEEN

The high fidelity of which the modern recorder is capable is due to introduction of a super-sonic voltage which is superimposed over the recording frequencies. The resultant magnetic bias eliminates distortion which is present otherwise due to non-linear response at very low magnetizing force.

Wire recorders are serving with the Marine Corps, the Army and a number of government agencies. During the war they were used for transmission of instructions and observations which could not be trusted to radio, as well as for troop entertainment and boosting military morale. A standard type is seen below. Its characteristics are listed in Table A.

The U.S. Dept. of Agriculture is using wire recorders for a series of interviews at agricultural experiment stations, to be rebroadcast on several farm radio programs, thus eliminating the necessity of personal appearance of the speakers. The Library of Congress uses an experimental machine and is exploring the possibility of re-recording on wire from the present disc records of American folk-lore music. Both National political party conventions of 1944 were permanently recorded on wire.

Wire recorders will be manufactured and distributed by many nationally known radio companies which have obtained licenses from the Foundation for the manufacture and sale of instruments covered by its basic patents. Among them are:

- Scott Radio Laboratories
- Automatic Electric
- General Electric
- Radiotechnic Laboratories
- Raytheon
- Stromberg Carlson
- Utah Radio Products

and others pending. Evidently radio and recording will be closely linked. This is fitting, for many interesting radio programs will be recorded and stored for future playback. Since the same wire can be used



Artist's conception of post-war adaptor unit, designed to be attached to existing radio receivers.

over and over again, there is nothing lost by recording many programs and keeping only a treasured few.

The features of wire recording not possessed by other methods are listed in Table B.

MODERN RECORDER DESIGN

Wire recorders for home and office will tend towards compactness and ease of operation. Many medium-priced radio and television receivers will be equipped with this accessory. Other models, small enough to fit a woman's handbag are being planned. A few designs are illustrated here.

- Important uses will be:
- Home radio-television receivers;
 - Recording and playing amateur and professional records;
 - Speech and music training;
 - Educational purposes
 - Office and remote dictation;
 - Court reporting;
 - Police calls and reports;
 - Church and industrial music.

One typical model is to have the following specifications:

- Dimensions—7¾ x 4 x 1¾ inches;
- Wire on spool—½ lb. of .003" wire;
- Recording time—2¼ hours at 1¼ ft./sec;
- Weight—3 pounds.

This instrument will be completely self-

(Continued on page 185)

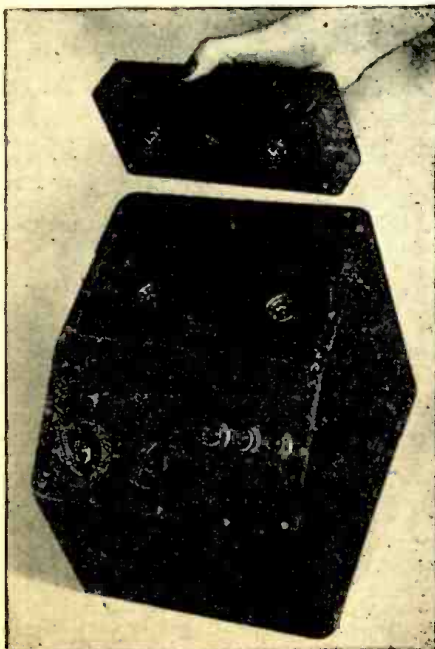

The original Model 50 wire recorder, used extensively during the war, appears at the right. Its ruggedness gave it a marked advantage over less sturdy types of recorders. At left is a magazine model, with the magazine shown lifted just clear of the sockets into which it fits.



Electrification For the Old Set

Now that transformers, tubes and other components are available, it becomes easier to convert old battery receivers.

By GERALD A. CHASE

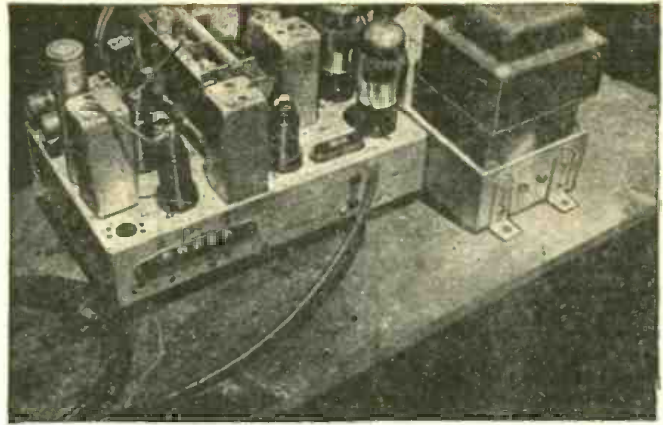

How power pack is added to the battery set.

THERE are many people these days who wish to purchase new radios and are unable to do so. Many of those in the market for new electric receivers are farmers who have just had electricity put in and are anxious to get away from the bother and expense of keeping their radios supplied with batteries. Since there are very few used sets for sale and absolutely no new ones, many of these people are turning to the next best thing, namely, having their battery receivers rebuilt to operate from the 110-120 V. power lines. When completed, these sets have all new tubes, new power supply, and new resistors and condensers. Sometimes it is also found necessary to replace such items as I.F. transformers, volume control, tone control and occasionally an output transformer. The R.F. section is always left intact unless it is defective. The result is, therefore, as near as it is possible to come to a new radio without actually building one. I have rebuilt several of these radios and I have found that the average four-tube battery set costs approximately twenty-five

dollars for labor and parts to rebuild. When finished the radio, of course, becomes a five tube A.C. set which is the equivalent of a four tube battery model. I always try to keep from making them into A.C.-D.C. receivers because of the extreme scarcity of these types of tubes. Sometimes, though, it is quite a problem to find room on the chassis for the power transformer. I use a Hammond 270 for the smaller sets and a Hammond 273 for the larger ones.

I recently purchased a five-tube Stewart-Warner battery radio model No. R-187 and converted it into an A.C. set using eight tubes. The set used two-volt tubes: a 1C6G-pentagrid converter, a 34 1st I.F., 34 2nd I.F., 1C6G 2nd det., a.v.c. tube and first audio, and a 33 in the output. The rebuilt version used the following line-up: 6A8 converter, two 6L7's in the I.F. stages, 85 (6V7G) 2nd det., a.v.c. and diode-biased 1st audio, 6SC7 "self-balancing" phase inverter, two 6F6G's in push-pull output, delivering in the neighborhood of ten watts; and finally a 5Y4G as the rectifier. The circuit, as the tubes imply, is a superhetero-

dyne, using two stages of intermediate frequency amplification, tuned to 370 kc. The set uses no R.F. stage but a pre-selector was incorporated ahead of the first detector to prevent images from occurring in the broadcast band. The short-wave band does have two-spot tuning but it is not very objectionable except to a critical listener.

The chassis of the radio was not large enough to accommodate the power supply as well as the receiver proper, so it was necessary to build it on a separate chassis and bolt it to the end of the other chassis. Two bolts through brackets fastened to the rear of the chassis held it in the cabinet. On the power supply chassis were mounted the power transformer, rated at 340-0-340 volts at 100 ma. for the high-voltage secondary, 5 volts at 2 amp. and 6.3 volts at 3 amp.; the 5Y4G rectifier tube; two 8 mfd. filter condensers; the output transformer, and the two filter chokes which I salvaged from an old T.R.F. radio. These chokes were good husky ones and since

(Continued on next page)

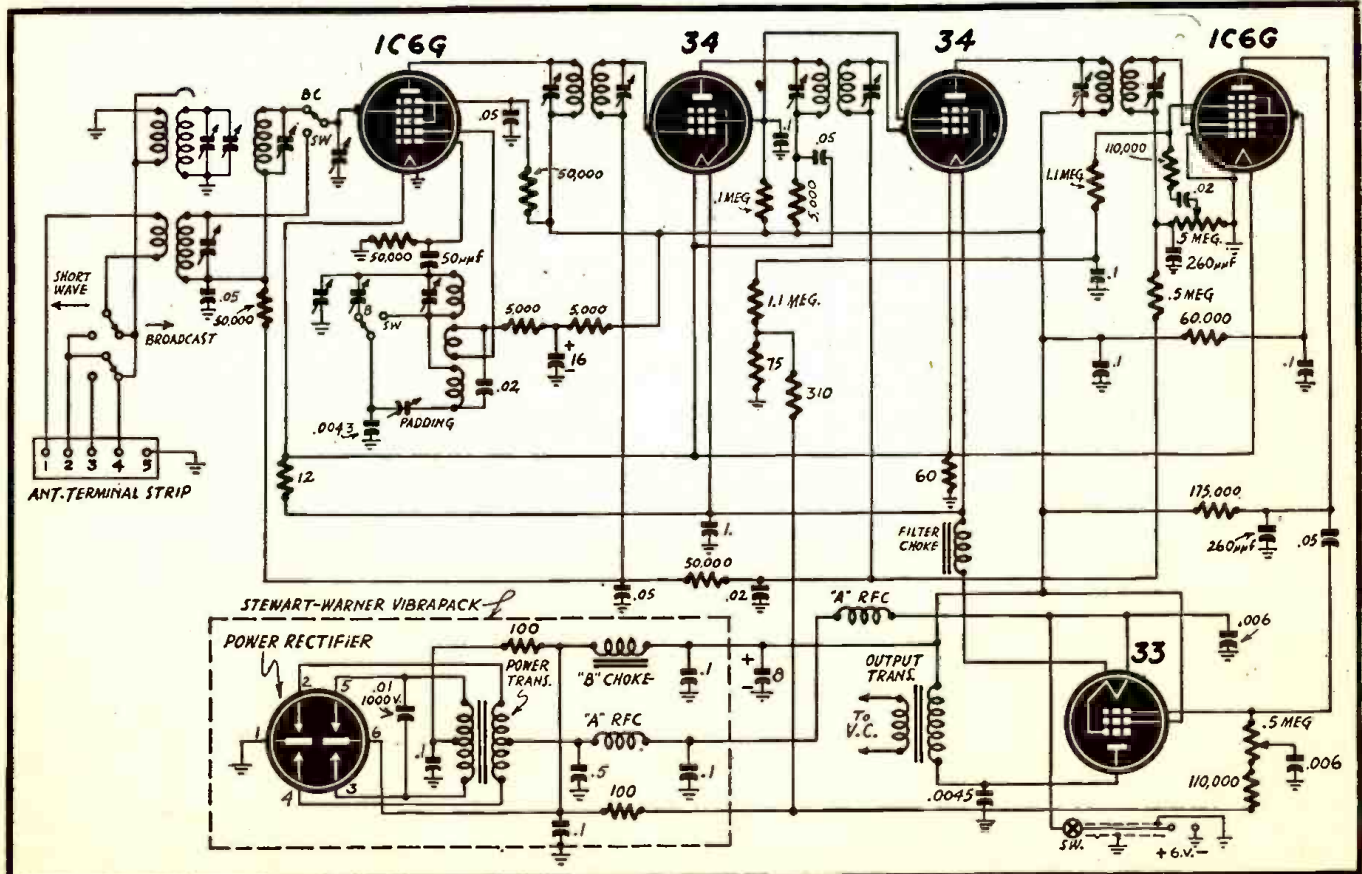

The Stewart-Warner set operated originally from a 6-volt Vibrapak, and used five dry-cell tubes of low power output and efficiency.

new ones were not obtainable at the time, I decided to use them. I kept the power transformer as far back on the chassis as possible to give it plenty of ventilation, and even after several hours of operation it becomes no more than slightly warm.

Two phone tip jacks were mounted on the back of the power supply chassis and two wires from the speaker voice coil plugged into them to connect with the output transformer secondary. Provision is also made for an extension speaker by mounting two more tip jacks on the back of the receiver chassis.

A phonograph input jack, also salvaged from the old Minerva, makes provision for a crystal pickup to be connected across the volume control. This arrangement gives good volume on most records but for greater volume it could be connected ahead of the 85.

When I first rebuilt the radio I used a 6J8G and two 6K7's in the converter and I.F. stages respectively. This arrangement did not work so well because of a tendency to oscillate in the first I.F. stage. I could stop this trouble by decreasing the gain of the tube, but this resulted in a very serious loss in sensitivity. The trouble cleared when I changed the tubes to a 6A8 and two 6L7's. Also, with a.v.c. bias applied to the two control grids of each 6L7, the action of the a.v.c. is somewhat better than when the 6K7's were used.

I experimented with a 6Q7 in place of the 85 but this made the set too sensitive to vibration and also produced more distortion. I had intended using a 6V7G instead of the 85 but with the tube shortage I had to use what I could get. The 6V7G is the octal equivalent of the 85 and would have made all of the tubes in the set of the octal type.

When using such tubes as the 6V7G, 85, 55, etc., as diode biased amplifiers it is usually necessary to use a plate load impedance of at least 20,000 ohms; in this case I used 100,000 ohms. The plate returns

ELECTRIFICATION FOR THE OLD SET

(Continued from previous page)

for the 85 and the 6SC7 are brought to the "B" plus through a filter circuit consisting of a 2,000-ohm resistor and two 8-mfd. electrolytic condensers. With this arrangement absolutely no hum is amplified by the tubes; even the wire running to the grid cap of the 85 does not need to be shielded despite the fairly high gain of the audio section.

The phase inverter is of the so-called "self-balancing" type. There are some, I suppose, who would choose one of the other types of inverter circuits but, personally, I think this one gives somewhat better performance than either of the other two types. My second choice would have been the cathode-loaded inverter; mainly, I think, because of my lack of experience with the tapped output type. The cathode-loaded circuit is simple and gives a very even drive to the two push-pull grids. It has the disadvantage of supplying very little if any gain to the radio. I wanted to obtain the greatest amount of amplification with the smallest number of tubes possible so I chose the self-balancing type, which contributes a fair amount of amplification while it performs the function of phase inverter. Several types of tubes are suitable for this sort of phase inverter service, such as the 6N7, 6C8G, 6F8G, 6SC7, etc. I chose the 6SC7 because of its low filament and plate currents and also because it was designed primarily for this type of service.

The output stage is quite conventional, using two 6F6G's in push-pull and delivering about ten watts. One thing often not included in the output stage is the network, consisting of a 13,000-ohm resistor in series with a .05 mfd., 600 volt. condenser, across the output transformer primary. It acts as a sort of automatic tone control, giving a flatter response curve. The

value for the resistor is found by multiplying the impedance of the transformer primary by 1.3. In this case the impedance was 10,000 ohms. This resistor should be rated at ten watts at least and should be mounted rigidly. This circuit improves fidelity considerably.

The original speaker was an eight-inch P.M. dynamic with a fairly heavy magnet. It sounded so well that I decided to use it rather than purchase a new one. I replaced the output transformer, which matched a single 33, with a Standard Radio Products universal No. 4195.

One of the main difficulties encountered in rebuilding a battery radio to operate on A.C. is the problem of lighting the dial. A little thought on the subject, however, will usually produce a solution. In this case the dial was a translucent one and was riveted to a stiff piece of aluminum which held it upright. It was necessary for me to carefully remove the dial and fasten it to another stiff piece of metal which I cut from a sheet of galvanized iron. I cut it slightly wider than the dial and then I cut a hole in it the same size as that part of the dial that showed from in front of the radio. The dial was then fastened to it by means of four small screws in place of the rivets that held it originally. The whole thing was then assembled and fastened to the chassis, and, using two pilot lights, it made a very nice looking job. The edge of the galvanized iron is apt to rust unless given a coat of aluminum paint.

Although there is room for improvement in any radio, I am well satisfied with the performance of this rebuilt receiver. It lacks little in the way of sensitivity and selectivity, and if a station can be heard at all it can usually be brought up to full speaker volume. The mixer noise in this set is probably greater than it would be if a stage of radio frequency amplification were used ahead of the converter stage. Even so it is noticeable only on the very weak stations.

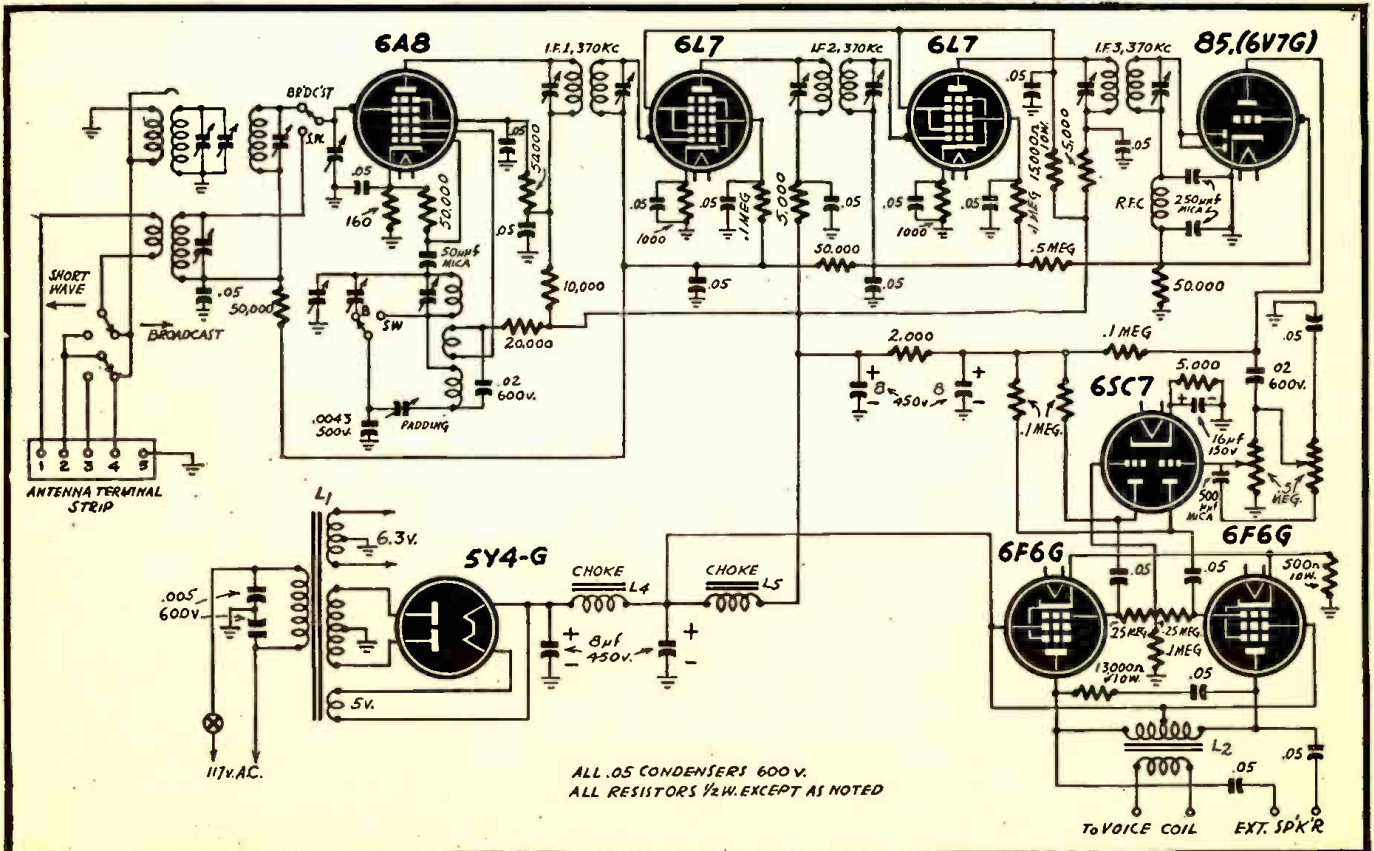

The original Type 33 output tube is replaced by a pair of 6F6-G's, driven by a phase-inverter, in this converted model of the S-W R-187.

Radio-Electronic Circuits

SAWTOOTH SWEEP

When I needed a sweep circuit for an Oscilloscope, I could get no Gas Triode (884, 885). But what I had on stock were plenty of gassy tubes, so for a while I tangled around with them to find a substitute for the thyatron. Some old 24 and 35 tubes with plenty of gas, connected as triodes, behaved almost like the 885 tube on frequencies up to 500 cycles, are easy to synchronize, to control, and are stable, giving the ideal sweep circuit for those who are not interested in higher frequencies.

None of these various gassy tubes will become stable on frequencies above 1000 cycles. They do oscillate even up to 10,000 cycles, may be synchronized to the incoming signal, but there is always a certain instability which makes the graph appear ragged on the screen of the cathode ray tube.

After plenty of trials with vacuum tube circuits, as multi-vibrators, RF oscillators with too high variable grid resistances, relaxation oscillators, and others, the simplest and most useful among the VT oscillators proved to be the Transitron oscillator. Its output wave is the one which most closely approximates the desired saw tooth form. The plate condenser charges and discharges rather linearly. Each cycle consists of 1/5 discharge time and 4/5

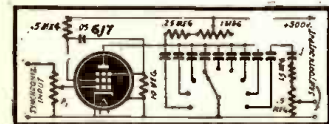

charging time. The wave has excellent sharp corners. Synchronization possibilities are excellent, needing about 0.01 volts on the control grid for stability of the observed wave, it being easy to synchronize signals over a range of 1 to 10.

Sweep frequencies from below 10 cycles up to 50,000 cycles are obtained, so that the wave-form of frequencies of 250,000 cycles can be observed. Output voltage of the oscillator is about 10 to 30 volts (peaks), the lower figure for the highest frequencies. With nine different condensers and a potentiometer of 1 megohm in the plate circuit the range from 10 to 50,000 cycles is covered with sufficient overlapping of ranges, with the highest capacity 0.25 and the lowest capacity .0001 μfd. The output of the oscillator must be loaded with a very high impedance load, a minimum of 2 megohms. —Haroldo Ellern, Sao Paulo, Brazil.

Radio-Craft welcomes new and original radio or electronic circuits. Hook-ups which show no advance on or advantages over previously published circuits are not interesting to us. Send in your latest hook-ups—Radio-Craft will extend a one-year subscription for each one accepted. Pencil diagrams—with short descriptions of the circuit—will be acceptable, but must be clearly drawn on a good-sized sheet of paper.

A 30-WATT HI-FI AMPLIFIER

Results have been most gratifying with this 30-watt, 47 db gain amplifier. With excellent filtering, there is practically no hum present. Shielded wire was used in wiring in the controls and the input circuit. Phase inversion makes an input transformer unnecessary. Inverse feedback is utilized, the connection being from the 4-ohm tap through a 1 megohm re-

sistor to the first 6N7 cathode. It was found that unless the plate leads to the 6L6's were correct, oscillations would take place. The leads should be transposed if this happens.

With this circuit I can mix phono and mike, using the same tone control for both.

JOSEPH SWARTZ,
Toronto, Canada.

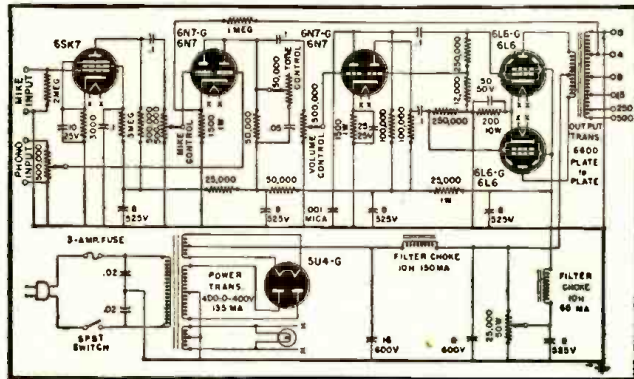

SIMPLE THERMOCOUPLE SUBSTITUTE

When designing a "Q Meter" to test high-frequency coils, trouble started when I looked around for a thermocouple ammeter of suitable range to control the output voltage of the oscillator. I used an old discarded 26 tube (E_f = 1.5 volts, I_f = 1.05 Amps.) and applied the RF voltage to be controlled across the filament of the tube, heating it in this way. Applying sufficient voltage, at least 0.3 volts, the filament starts emitting electrons toward grid and plate (tied together), to which is connected a positive voltage through a protective series resistor. Electron flow is indicated by inserting in the plate circuit a resistor, and measuring the voltage drop across it with a

VTVM, or by using an electron-ray tuning indicator tube (6E5). The set may be adjusted to let the tuning eye shut exactly when the predetermined RF, AF, or DC voltage is applied to the filament of the 26 tube (ranging from 0.3 volts up to 1.5 volts). Using different tubes with other filament voltages, other readings may be obtained, resistors may be applied in series, or in parallel with the filament, I preferred the 26 type tube for its very low resistance; less than 1 ohm when not completely heated. The V-shaped filament offers very low inductance to RF currents, thus contributing to accurate readings.—Haroldo Ellern, Sao Paulo, Brazil.

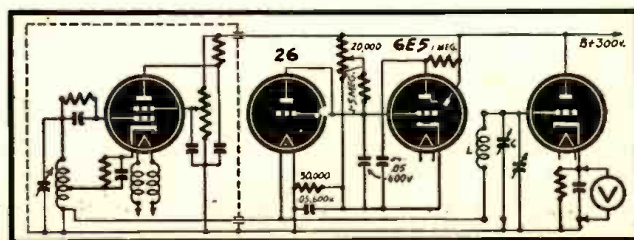

TRANSITRON

The transitron oscillator is very useful as a B.F.O. signal generator, audio or superhet oscillator since it does not require a tapped coil or separate tickler for feedback and has the advantage of being as stable as a crystal without temperature regulation. It is particularly good as a B.F.O. reducing frequency drift and consequent change in note.

To add a B.F.O. to a superhet use one coil and trimmer from an I.F. transformer of the same I.F. frequency as the set and couple thru a small condenser (around 10μF) to the 2nd detector.

The circuit shown will oscillate readily from audio frequencies up to 15 Mc. at any plate voltage from 100 to 250 volts. Voltage regulation will improve stability. Since the transitron depends on the negative resistance developed by a

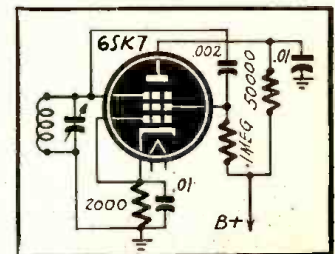

pentode when the plate is operated at a lower potential than the screen (a non-standard characteristic) it may be necessary to try several tubes to find a good oscillator.

JOHN A. DEWAR, RA3,
Dartmouth N. S., Canada.

SELF-SIGNAL TRACER

The signal tracer shown in the diagram is merely part of the set being tested. An outside antenna is attached to the loop of the set. The center connec-

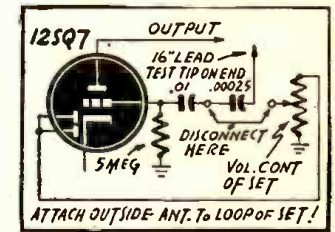

tion on the volume control is disconnected and a .00025 or .0005 condenser is connected to the grid that originally ran to the center position of the volume control. By this means you can use the radio being tested as a signal tracer and it will enable you to check every stage but the one disconnected. The fact that this circuit works as the signal tracer indicates to the serviceman that it also is functioning properly.

RALPH BLOOM,
Brooklyn, N. Y.

World-Wide Station List

Edited by ELMER R. FULLER

WHEN the change was made back to Eastern Standard Time, it sure made a mess of the short wave schedules; and it looks as though it would take some months before all the revisions can be brought up to date. This month, and in the succeeding two months, we will present to you a short wave station log in geographical arrangement. This has been compiled to fulfill the requests of several of our readers. All schedules are given in Eastern Standard Time.

Changes in frequencies and schedules are coming in fast, and it seems next to impossible to keep up with them. Since the last issue, we have had a complete change in the schedules of the U. S. A. stations. Regarding the Japanese stations, there is much confusion as we go to press; therefore, we are leaving the schedules as they have been until we have further information on them. Most of the broadcasts to North America have been stopped and they are being used only for domestic service. The Armed Forces Radio Service have been heard a few times on some of the Japanese stations, but no definite pattern seems to be followed. We hope we will have additional information for you on this matter before next month's column appears.

In the past few weeks several new stations have made their appearance, and many more will appear in the near future. The Belgium Broadcasting Corporation is again broadcasting from their studios in Brussels. Heard occasionally on the east and west coasts is Z O J in Colombo, Ceylon. It uses a frequency of 15.275 megacycles and is heard with the news in English at 10 pm and midnight. They are also on 11.810 megacycles from 5 am to noon, but reports are rather scant on reception of this frequency.

K U 5 Q in Guam has been heard for the past couple of months on 15.920 at 9 pm to 3 am. This is the U. S. Army station, and is heard with very good results on the east coast. Other frequencies are in use, but this is the best received. H V J in Vatican City has been heard several times lately on 9.660 megacycles from noon to 1:30 pm. The Voice of Poland is again being heard from Lublin on 6.115 megacycles from 12:15 to 3:45 pm; and sometimes later in the afternoon than this. Results on the east coast are fair, with no reports from west or middle-west. F Z I in Brazzaville is still one of the best received stations in the eastern part of the country. Several frequencies are used, but the best

one is probably 9.440 from 11 am to 8 pm; and midnight to 2:30 am; and on 11.970 megacycles from 11 am to 6:45 pm; and midnight to 1:30 am.

The British are again broadcasting from Victoria in Hong Kong on 9.465 megacycles from 6 to 8:30 am; and the old pre-war call ZBW is again in use. Wellington, New Zealand, is being heard fairly well on the east coast on 6.715 megacycles around 4:30 am. The call of this latter station is ZLT7.

Reports on reception of the Aussies may be addressed to: The Australian News and Information Bureau, 610 Fifth Avenue, New York City. Reports are most welcome, and verification will be made. Reports of hearing FO8AA from the island of Tahiti have been received. They are on 6.980 megacycles on Fridays and Saturdays at 11 pm to midnight. Let's try for them, and send us reports on their reception.

If you have any ideas for this department, they will be most welcome. All correspondence will be answered, and we are always ready and eager to hear from our readers. Send all mail for this department to the Short Wave Editor, *Radio-Craft*, 25 West Broadway, New York City, 7. Until next month, best of luck and fb dx!

Location	Station	Frequency and Schedule	Location	Station	Frequency and Schedule	Location	Station	Frequency and Schedule
ALASKA	WVFG 12.250	North American beam, heard at 10:30 to 11 pm.	Buenos Aires	LRYI 6.090	mornings starting at 6:45 am			
ALGERIA			Buenos Aires	LRAI 9.683	6 to 8:30 pm			am; Philippine beam, 4 to 5 am; Asiatic beam, 5:15 to 6:45 am; 8 to 9:15 am; Indian beam, 9:35 to 9:45 am.
Algiers	6.040	Relays NBC, off at 4:30 pm.	Buenos Aires	LRR 11.880	heard at 7:30 pm	Shepparton	VLC2 9.680	North Asiatic beam, 2:30 to 3:30 am; British beam, 11:15 to 11:45 am around 12:15 am
Algiers	12.120	Afternoons till 5:30 pm	Buenos Aires	LSN3 12.190	6:15 pm	Sydney	VLN 10.420	North American beam, 10 to 10:45 am; 8:45 to 9:45 pm; Tahiti beam, 1 to 1:40 am; British beam, 1:55 to 2:25 am; North Asiatic beam, 2:30 to 2:55 am
ANGOLA			Buenos Aires	LSL3 15.810	heard mornings	Melbourne	VLG3 11.710	North American beam, 10 to 10:45 am; 8:45 to 9:45 pm; Tahiti beam, 1 to 1:40 am; British beam, 1:55 to 2:25 am; North Asiatic beam, 2:30 to 2:55 am
Benguela	CR6RB 9.165	heard signing off at 3:30 pm.	AUSTRALIA			Melbourne	VLA4 11.710	North American beam, 12:10 to 12:40 am
Louanda	CR6RA 9.470	heard signing off at 3:30 pm.	Melbourne	VLA 7.280	8:30 to 10 am	Shepparton	VLC7 11.840	Tahiti beam, 1 to 1:40 am
ARABIA			Perth	VLW7 9.520	5:30 to 10:30 am	Melbourne	VLG4 11.840	North American beam, 12:10 to 12:40 am; 10 to 10:45 am; New Caledonia beam, 8:10 to 4 am; Southwest Pacific beam, 4:30 to 5:15 am; Asiatic beam, 5:15 to 6:45 am
Aden	ZNR2 6.750	heard at 11:30 am to 12:15 pm.	Melbourne	VLG2 9.540	Asiatic beam, 7 to 9 am	Melbourne	VLA6 15.200	10 pm to midnight; 12:10 to 12:45 am
ARGENTINA			Shepparton	VLC5 9.540	North American beam, 7 to 7:45 am	Melbourne	VLG6 15.230	North Australian beam, 10 to 10:25 pm
Buenos Aires	LRSI 5.985	5 to 10 pm	Melbourne	VLG 9.580	Indian beam, 9:35 to 9:45 am	Shepparton	VLC4 15.315	North American beam, 8:45 to 9:45; 12:10 to 12:45 am; Asiatic beam, 5:30 to 6 pm; Philippine beam, 7 to 7:15 pm; North Australian beam, 10 to 10:25 pm
			Shepparton	VLC6 9.615	North American beam, 10 to 10:45	AUSTRIA		
						Vienna	9.823	evenings till 7:30 pm
						AZORES		
						Ponta del Gada	4.040	3 to 5 pm
						Ponta del Gada	11.090	2 to 8 pm
						BAHAMAS		
						Nassau	ZNS4 6.090	off at 9 pm
						BELGIAN CONGO		
						Leopoldville	OTC 9.385	9:45 pm to 2 am
						Leopoldville	OTC 9.745	relays BBC at 8:30 to 14:45 pm



"There just isn't any more privacy around here since I bought that new television set."

Suggested by: Name omitted, Bronx, N. Y.

(Continued on page 208)



designs of
DISTINCTION

In medieval times discriminating knights journeyed to Toledo, Spain, to obtain hand-wrought blades of steel. Only the famed guildsmen of Toledo could produce the flawless metal from which they fashioned graceful foils and swords of sleek beauty.

For hundreds of years these proud guildsmen stamped their guild marks or signatures on their creations.

A few firms today still preserve that spirit of craftsmanship. You find it in the plants of Detrola Radio. That is why the "guild mark" of Detrola Radio on a radio receiver, record changer or other electronic instrument is a guarantee of production quality. The world's finest merchants, and their customers recognize the value of this mark.

DIVISION OF INTERNATIONAL DETROLA CORPORATION  **DETROIT 9, MICHIGAN**



Out of Two Laboratories

comes a **NEW** railroad communications

Rock
Island

SPERRY

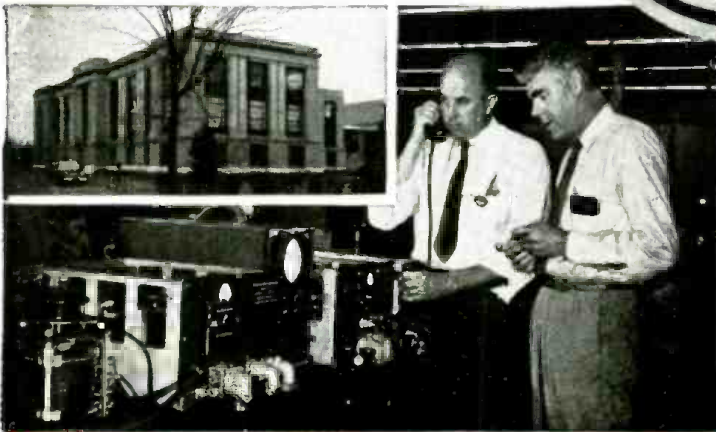

● Sperry's Research Laboratory where Railroad Communications System was designed and developed

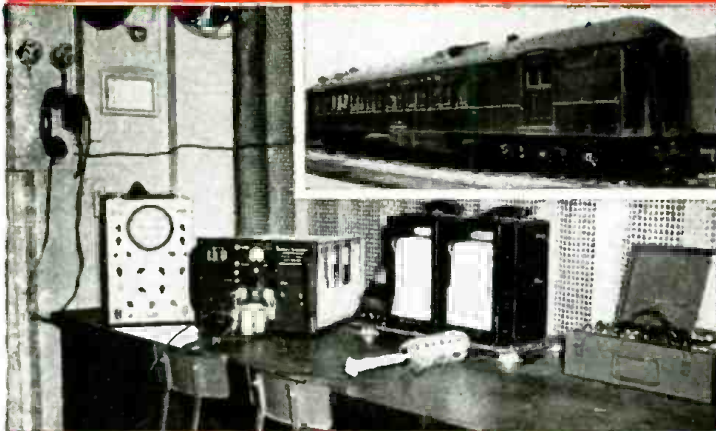

● Rock Island's Mobile Electronic Laboratory where equipment was put to rugged test

THE ENGINEERING STAFF of the Sperry Gyroscope Company, in collaboration with engineers of Rock Island Lines, has perfected a new system of railroad communications.

Designed especially for railroads by Sperry and tested extensively by Rock Island, this system offers to the railroad industry microwave applications, secret until now, which Sperry's vast engineering group developed during the war years in co-operation with the U. S. Navy. With the aid of Rock Island engineers working in their specially equipped Electronic Car, the Sperry system has been completely tested and proved.

Sperry's Railroad Communications System makes possible for the first time clear, audible signals through tunnels, deep gorges, and the usual terrain and atmospheric conditions encountered in railroad service. No man-made

SPERRY GYROSCOPE COMPANY, INC.

Division of the Sperry Corporation

Leaders in the fields of . . . **GYROSCOPICS • ELECTRONICS**

system!

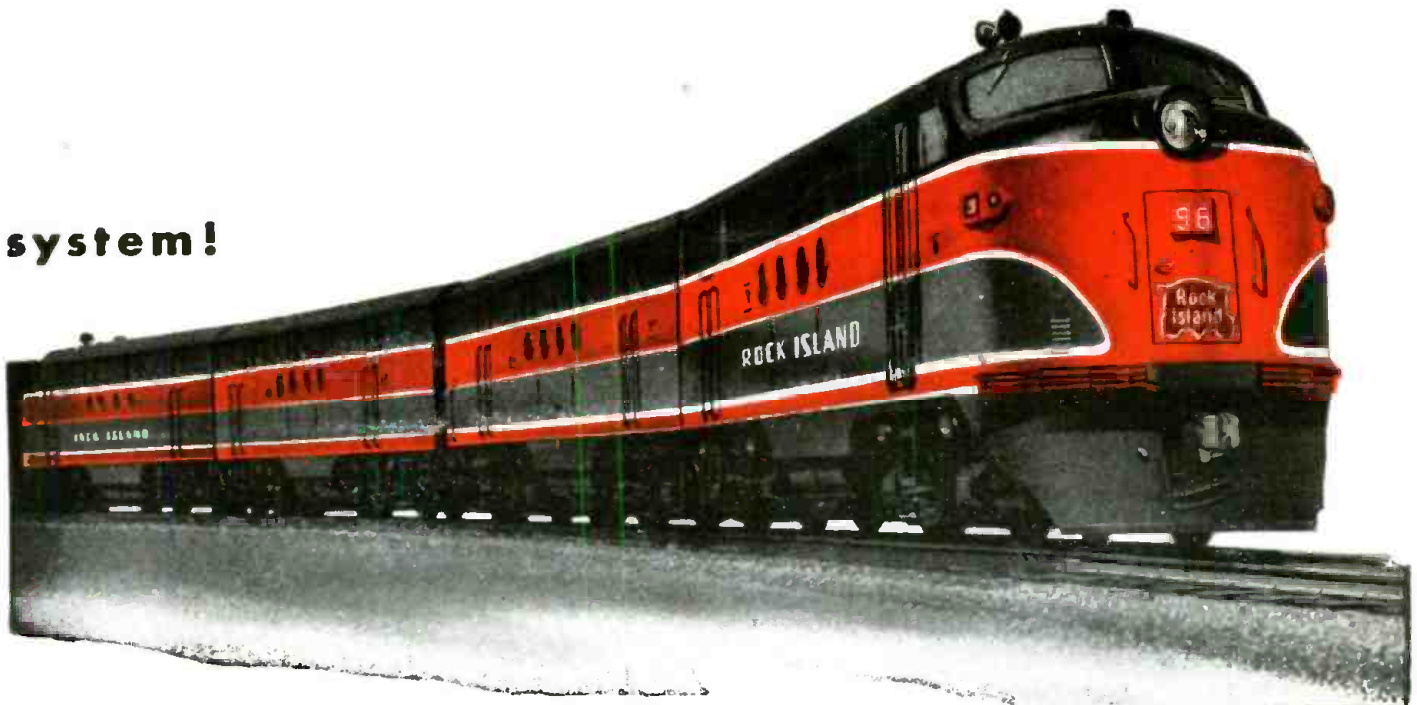

or atmospheric disturbance interferes with vital business!

Automatic relay stations, employing heretofore-restricted radar components that can be substituted for overhead land lines in treacherous storm areas, will link way stations and headquarters, and provide a continuous en route connection between trains and wayside points. A specially designed antenna provides any required degree of directional control.

Rock Island Lines, whose "sole purpose is to provide the finest in transportation," is being equipped with a Sperry Railroad Communications System.

If you would like our help in planning a complete radio communications system to expedite the handling of your freight and passenger traffic, write our Industrial Department for further information.

SPERRY RAILROAD COMMUNICATIONS SYSTEM

- **Microwave applications for the first time**
- **Designed especially for railroads**
- **Greater Range**
- **Increased Signal Strength**
- **FM Signal Audibility through any kind of interference**
- **Any degree of Directional Control**
- **Suitable for indoor and outdoor installations**
- **Available in both VHF and UHF**

GREAT NECK, N. Y. ★ LOS ANGELES • SAN FRANCISCO • SEATTLE • NEW ORLEANS • CLEVELAND • BROOKLYN • HONOLULU ★

RADAR • AUTOMATIC COMPUTATION • SERVO-MECHANISMS

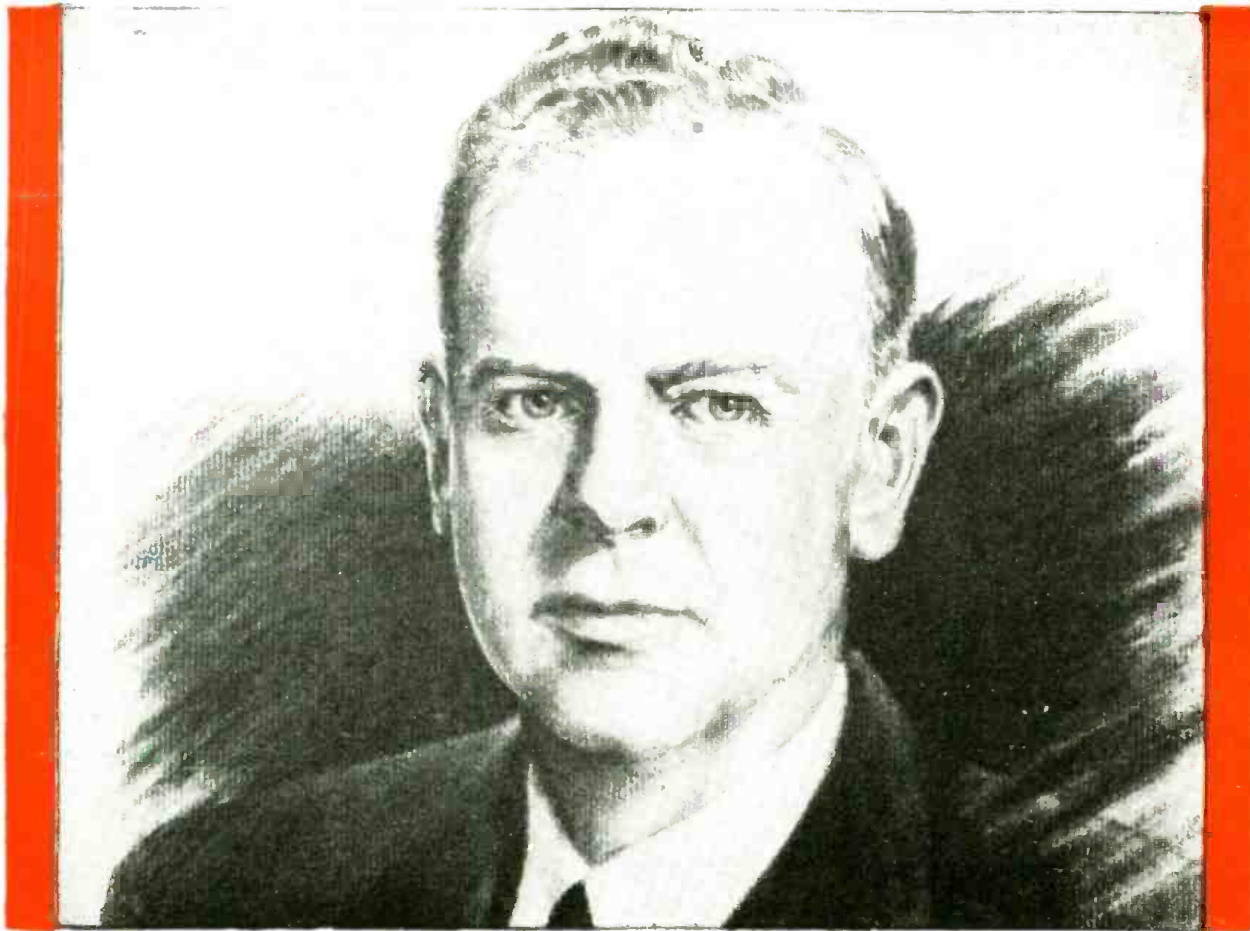

Portrait of Randolph C. Walker by John Carlton

Engineers of Victory

NOW SERVE MEN AT PEACE

The creative engineering which armed our fighting men for Victory has no less a responsibility in the years of peace ahead. Now that the war is won, we have the job of making this a better world.

AIREON produced huge quantities of communications and radar equipment and other machinery for waging war. Its achievements were equal to its heavy responsibilities, and its workers established an outstanding record of performance.

AIREON enters peacetime production with a notable engineering organization, highly skilled personnel and great confidence in the future. We have developed many products which will contribute to better living, for the manufacture of which all 15 AIREON plants will continue in production.

In order to extend our usefulness we recently established an experimental laboratory in Greenwich. AIREON's creative engineering in radio communications, electronics, musonics and hydraulics will team with production proficiency in contributing devices for future service.

In peace, as in war, AIREON will stand for quality and performance.

Randolph C. Walker
PRESIDENT



Cinaudagraph Speakers

A DIVISION OF Aireon

3911 SOUTH MICHIGAN AVENUE, CHICAGO

POSTWAR RECORDERS

(Continued from page 176)

contained, the only external connection being a small microphone which may be held in the hand, worn on a lapel, or clipped to the side of the recorder and carried a la handie-talkie.

TABLE A—SPECIFICATIONS OF MODEL 50

Specifications for Model which was manufactured for the armed services exclusively	
Dimensions	13" wide, 12½" high, 9½" deep
Weight	35 pounds, complete
Wire	11,500 ft. of .004" wire (½ lb.)
Recording time	66 mins. at 2½ ft./sec.—can be adapted for spools containing three times the length
Input A	high. imp. dynamic, ribbon, or crystal microphone
Input B	AM or FM tuner, phono, or 500 ohm, zero level line
Output	10 ohm
Monitor speaker	5" PM, self-contained, automatically cut out on inserting external plug
Tubes	five receiver-type
Background noises	40 DB. below max. signal strength
Frequency response	flat from 200-3000 cycles per second. Can be adapted to respond from 75-10,000 c.p.s. where music is required
Power	40-60 watts

TABLE B—WIRE VS. OTHER RECORDING

ADVANTAGES OF SOUND-ON-WIRE

No needle scratch—low noise level
 No records to turn over
 Not affected by temperature changes
 Unaffected by vibration and shock
 Unlimited re-use of wire
 Instantaneous play-back—no processing
 Unlimited number of play-backs
 Long recording time
 Excellent fidelity
 Light, compact, portable
 Any portion can be erased

The Foundation is planning to introduce a master recorder and a multiple recorder, both now in the development stage. The first will have exceptionally high fidelity for recording professional productions. Duplicates of the master record will be made by the multiple recorder in large numbers faithfully and simultaneously for extensive consumer use and enjoyment. Credits for photos and drawings: Armour Research Foundation, Product Designers, Modern Plastics.



The pocket model's mechanism is very simple.

RADIO PARTS

ELECTRONIC EQUIPMENT

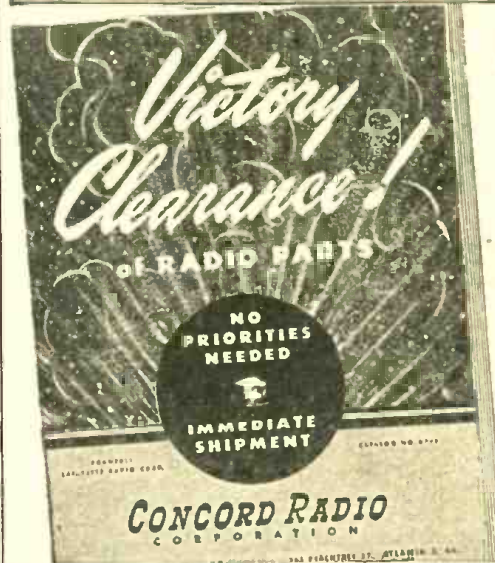

Mail Coupon NOW for CONCORD Victory Clearance Flyer — FREE!

Ready now! 32 Bargain-packed pages listing thousands of standard-make, top-quality radio parts and electronic supplies—now available without priority at low VICTORY CLEARANCE prices. The values listed at the left are typical of the important savings offered in Meters, Condensers, Transformers, Resistors, Controls, Switches, Relays, Test Equipment, Generators, Microphones, Tools, and hundreds of Repair, Replacement, and Accessory Parts. On special requirements, Concord experts are ready to help you in expediting and speeding action on essential needs.

Order Today for Shipment Tomorrow from **CHICAGO OR ATLANTA**

Huge stocks in TWO convenient warehouses—one in CHICAGO and one in ATLANTA—are ready to supply you quickly with needed parts of dependable, nationally-known quality—and at VICTORY CLEARANCE prices that mean real savings. Mail the coupon below NOW for your FREE copy of CONCORD'S VICTORY CLEARANCE Flyer.

Check These Typical CONCORD VALUES



D. C. Milliammeters
 2½" flange atg. type.
 Metal case dull black finish. G. E. 0-200 M. A. C10650.
 Specially Priced \$4.95

Output Transformer

Hermetically sealed.
 Six studs, 1, 2, and 3 are pri. 4, 5, and 6 the sec. Pri. ind. at 5 V., 1000 cy.; .20 H. Ratio sec. to pri. 3.02:1. size: 3¼ x 2 41/64" 5B5045. Your cost \$1.95.



Dry Electrolytic Condenser

Hermetically sealed.
 Size, 1¼" x 3". Can negative. Cap.: 40 mfd. at 475 volts; 15 mfd. at 350 volts; 15 mfd. at 150 volts; 20 mfd. at 25 volts. 5B3161. Each 59c



Plate Power Transformer
 Pri. tapped at 115, 117 and 120 V.A.C. Sec. output 850 V. at 200 ma. c. t. 4¼" L x 3¼" W x 3¾" H. 5B5035. Your cost\$4.29



Mobile High Voltage Power Unit
 Input 12 V. at 10 amps. Output consists of two voltage ranges: (1) 275 at 110 ma. (2) 500 at 50 ma. 5B9518. Your cost\$39.50

CONCORD RADIO CORP.

LAFAYETTE RADIO CORPORATION

CHICAGO 7, ILL.
 901 W. Jackson Blvd.

ATLANTA 3, GA.
 265 Peachtree Street



300 Watt Rheostat
 Wire wound. Vitreous enamel. Cast aluminum base. 6" dia. 2½" deep, 1400 ohms. 5B9517. Your cost\$3.95

CONCORD RADIO CORPORATION
 901 W. Jackson Blvd.
 Dept. RC-125,
 Chicago 7, Ill.



Please RUSH FREE copy of CONCORD'S new 32-page VICTORY CLEARANCE Flyer.

Name
 Address
 City State

New Radio-Electronic Devices

CAPACITORS

Tobe Deutschmann Corp.
Canton, Mass.

A DIVERSIFIED line of oil-impregnated, oil-filled capacitors, embodies the electrical and mechanical design features which have been found best suited to requirements of fluorescent lamp service.

Contained in hermetically

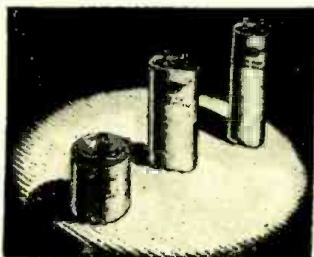

sealed metal cases, these capacitors are impregnated and filled with pure mineral oil, the characteristics of which render the units particularly applicable to use where a wide range of temperatures may be encountered; operating temperatures range from minus 67° to plus 185°F. Oil-tight terminals are insulated with sturdy phenolic bushings and provided with tinned copper soldering lugs. Available sizes include capacitances from 2.0 to 5.25 mfd. and working voltages from 165 A.C. to 440 A.C.

The standard capacitance tolerance of Tobe capacitors for fluorescent lamp service is minus zero plus 20 per cent. Adjustable clamp brackets, separable mounting straps, and permanently attached mounting brackets can be furnished to accommodate installation requirements.

—Radio-Craft

HIGH SPEED RELAY

Stevens-Arnold Co., Inc.
South Boston, Mass.

THE new Stevens-Arnold Millisec Relay is an hermetically sealed sensitive relay capable of speeds up to 1000 operations per second.

The basic design of the moving elements is quite different from conventional relay practice and it is this new design which



makes the ultra high speed possible, at the same time assuring great reliability if operated in the usual speed ranges.

In the illustration a cut through section shows the glass envelope which surrounds all the moving parts and protects them from moisture, dust or corrosive fumes.

With this new type of construction, sensitivities down to ½ milli-watt are possible. Ratings up to 5 amperes can be obtained. Closing time can be less than one milli-second.

The outside dimensions of the 115 volt A.C. 1 ampere rating are three inches high and one and one-half inch base diameter.—Radio-Craft

RADIOACTIVITY METER

Rowe Radio Research
Laboratory
Chicago, Ill.

THE Rowe Radio Type RM82 Radioactivity "R" Meter is an exceptionally sensitive electronic apparatus for measuring, directly, very weak radiations from small quantities of radioactive materials. It will indicate



values from 0.000001 to 20.0 "R" units.

The "R" Meter is calibrated directly in fractions of "R" units on a linear scale of a four inch meter. It has five "R" ranges which are quickly selected by pushbuttons. Full scales on these ranges at maximum voltage are: 0.0001, 0.001, 0.01, 0.1 and 1.0 "R" units. By using minimum voltage the least sensitive range can be extended to 20 "R" units.

The meter proper is an electronic device which measures very small currents as low as 0.001 of a microampere. A high voltage power supply with adjustable output from 100 to 2,000 volts D.C. is part of the apparatus. Safety switches are provided so that there is no possibility of the operator being exposed to the high voltages which are required.

Various types of units are employed for holding the chemicals to be measured. The illustration shows one of several arrangements. In this case the material holder and electrodes are enclosed in a bell jar for evacuation. This is not necessary but often desirable.

The Radioactivity "R" Meter is enclosed in two steel cases, each approximately 11 inches wide, by 8 inches high, by 8 inches deep. The finish is a baked black enamel wrinkle.—Radio-Craft

SHORTWAVE ANTENNA

Andrew Co.
Chicago, Ill.

USED for transmitting and receiving at frequencies from 30 to 40 MC and for powers up to 5,000 watts, this Folded Uni-

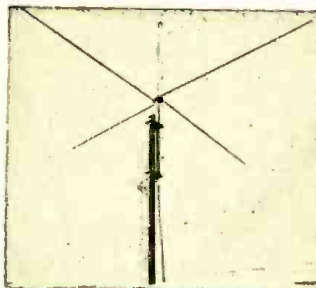

pole Antenna has proved so successful that similar models for higher frequencies are now being designed.

Features light weight—only 15 pounds—which simplifies installation; as well as minimized lightning hazard because of grounded vertical element. "Slide trombone" calibration permits exact adjustment for any frequency between 30 and 40 MC, using only a wrench.

Proper termination of coaxial transmission line, unlike other "70 ohm" antennas, actually provides a non-reactive impedance with a resistive component varying between 62 and 75 ohms. When used with transmitters, there is no standing wave on the line. This means reduced line losses, freedom from reflections, and reduced likelihood of voltage flashover.

Band width is suitable for FM. It is never less than 400 KC wide for a standing wave ratio of 1.2 to 1, and by careful selection of transmission line impedance, may be made as wide as 1 MC.

The antenna may be used with any 70 ohm coaxial cable, solid dielectric or beaded, up to 7/8 inch diameter.—Radio-Craft

INSULATION TESTER

Weston Electrical Instrument
Corp.

Newark, N. J.

THE new Model 799 instrument is an extremely sensitive direct-reading insulation

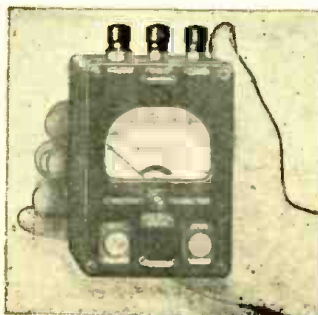

measuring device for applications where high testing potentials are not desired. It provides a single range for readings from 0.1 megohms to 10,000 megohms; with the 10,000 mark at 8 per cent of the scale length, thus providing good readability. The circuit has a test potential of less than 50 volts D.C. An electrical guard circuit is provided for elimination of surface leakages when testing cables.

In electrical testing it replaces expensive or specially built test stands, for checking leakage between windings in transformers, cable resistance, leakage of low-voltage paper and mica condensers without damaging the dielectric, and for other tests.

The size of Model 799 is 5 3/4 x 3 1/4 x 4 7/8 inches. All exposed metal parts are thoroughly insulated for operator's protection. A "press-to-read" switch automatically disconnects battery circuit when not in use. Ferrules in panel permit attachment to lineman's belt or shoulder strap.—Radio-Craft

SMALL INSTRUMENTS

MB Manufacturing Co.
East Haven, Conn.

THOUGH of tiny proportions—only 1-inch in diameter and weighing 1 1/4 ounces—these duplicate the performance of

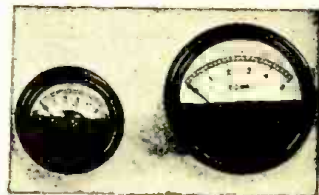

instruments many times their size and weight.

MB meters are designed and built to withstand vibration, shock, temperature extremes and moisture. They conform to the AWS specifications for accuracy and durability. Among their many quality features, they have a precision balanced, lightweight, sensitive moving coil, mounted on standard size jewel bearings and pivots; powerful, Alnico No. 5 permanent magnet with soft iron pole pieces; and a hermetically sealed, anodized aluminum case that mounts with a threaded ring.

They are available in standard D.C. ranges from 100 microamperes through 10 milliamperes, and 0-10 and 0-50 millivolts. Standard multipliers, shunts and rectifiers available to adapt them to all other ranges. The manufacturer also offers a 1 1/2 inch, 1 1/2 ounce model self-contained in all standard D.C. ranges, and rectifier-type A.C. voltmeters and milliammeters.—Radio-Craft

Economical H-V Chokes

IN the design and the construction of cathode ray tube circuits, for transmitting and transmitter design and construction work, and for general electronic and radio experimental design, and construction, a need exists for chokes to filter the hum out of the D.C. power supplied by the rectifier tubes.

Since voltages are high, insulation must be excellent, so these chokes are expensive and not always easily secured. It is to the interest of the constructor and the design engineer to endeavor to use more readily secured materials when it is possible to make a substitution. The method of using filter chokes propounded in this article shows how to use cheaper and more readily available units.

Whether or not a saving is possible in the matter of filter chokes depends on the voltages not at all, but does depend completely on the current.

The method is simply to mount the choke on insulating pillars which are able to withstand the voltage handled. Inasmuch as the function of the choke is to provide an inductance, there is no reason that the choke should be grounded except from the standpoint of safety. We can mount a choke on insulating pillars and the conditions are then such that it is insulated from ground and can be at a high potential.

Let us take a practical example of the saving possible. We require a voltage of 3000 at a current of only 75 milliamperes. We also require 25 henries of inductance. Now if we purchase a choke to these specifications it will be relatively expensive but if we invest a few cents in a couple of insulators we can purchase any choke so long as it will carry the required current and has the needed inductance. If the application is an experimental one requiring 10,000 volts at 50 to 60 milliamperes and we can substitute a low cost and low voltage choke and set it up on four or two stand-off insulators about an inch or an inch-and-a-half tall. There is then a considerable saving.

If the safety factor is of great importance we might mount the choke on the insulators provided and then fashion as simple a case as possible for the purpose of keeping the equipment safe from probing hands. It must be remembered that the case so made must be spaced sufficiently from the choke itself to provide insulation sufficient to withstand the voltage on the choke. The leads to and from the choke can be brought through insulators on the top or on the side of the protecting can. The savings possible increase with the voltage and decrease somewhat with the increase of current flowing through the choke.

This method of mounting the choke on insulators can also be used for conservation of space. By using a protective can or covering and lining the can with many thicknesses of varnished cambric cloth the space factor required for a choke for high voltages and low currents can be considerable.—James E. Dolan.

(The shielding system described by Mr. Dolan should be used in all cases, as otherwise some person might come in contact with the case. Since these are usually grounded, people do not hesitate to place a hand on them, a practice which might be fatal with such chokes. Some amateurs, who do not expect anyone to approach their apparatus, are content to paint the choke red, but shielding is the only safe method.—Editor)

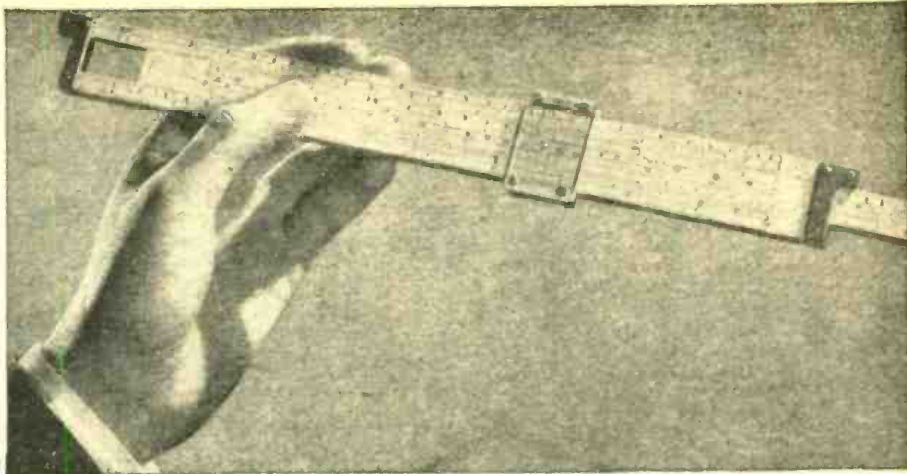

Can You Figure Out Your Own Future?

"Post-War is NOW!" Prepare now with a planned program of CREI technical training ...get the jump on competition—get that better radio job you want—enjoy security!

NOW is the time to take the time to prepare yourself for the important, career jobs in radio-electronics engineering. You will find the knowledge gained from your CREI course useful almost from the beginning. Student C. Whitehead writes: "Your course has been of great value to me in that the knowledge I have gained has enabled me to meet technical situations satisfactorily and has given me the confidence to accept greater responsibility."

In our proved home-study course, you learn not only *how* . . . but *why!* Easy-to-read-and-understand lessons are provided you well in advance, and each student has his personal instructor who corrects, criticizes and offers suggestions on each lesson examination. This is the successful CREI method of training for which more than 10,000 professional radiomen have enrolled since 1927.

Your ability to solve tough problems on paper and then follow up with the necessary mechanical operation, is a true indication that you have the *confidence* born of *knowledge* . . . confidence in your ability to get and *hold* an important job with a secure, promising future. Investigate now the CREI home-study course best suited to your needs, and prepare for security and happiness in the New World of Electronics! Write for all the facts today.



WRITE FOR FREE 36-PAGE BOOKLET

"Your Opportunity in the New World of Electronics"

If you have had professional or amateur radio experience and want to make more money, let us prove to you we have something you need to qualify for a better radio job. To help us intelligently answer your inquiry—PLEASE STATE BRIEFLY YOUR BACKGROUND OF EXPERIENCE, EDUCATION AND PRESENT POSITION.

CAPITOL RADIO ENGINEERING INSTITUTE

HOME STUDY COURSES IN PRACTICAL RADIO-ELECTRONICS
ENGINEERING FOR PROFESSIONAL SELF-IMPROVEMENT

Dept. RC-12, 3224 16th St., N. W., Washington 10, D. C.

Contractors to U. S. Navy—U. S. Coast Guard—Canadian Broadcasting Corp.
Producers of Well-trained Technical Radiomen for Industry.

MEMBER: NATIONAL COUNCIL OF TECHNICAL SCHOOLS

REPAIR ANY KIND OF RADIO EQUIPMENT!

SEE SPECIAL CHRISTMAS OFFER IN COUPON!

THE BOOK THAT HELPS YOU FIX TWO RADIOS IN THE TIME NORMALLY REQUIRED FOR ONE

Whether you repair radios for a living—whether you only tinker with them occasionally—or whether you simply want to fix your own radios and phonographs at home, Ghirardi's famous **RADIO TROUBLESHOOTER'S HANDBOOK** is one big book you can't afford to miss. You don't have to study it. You simply refer to it when you want to learn how to repair a particular receiver model quickly or when you need specific information, substitution data, etc., on tubes and other components and dozens of other vital subjects. It tells exactly **WHAT** to do **AND HOW**. It eliminates the need for using costly test equipment all the time. It helps you repair Radios twice as fast—and repair them right!

This big 744-page manual-size book pays for itself in time saved the first time you use it. Now contains 404 pages of receiver Case Histories, giving common Trouble Symptoms, their causes and how to fix them, for over 4,000 receiver models. It gives specific data on practically every Radio now in common use.

How to "test" A RADIO in 2 Minutes!

Simply look up the Trouble Case History data for the set you want to repair. **NINE** times out of ten, the **HANDBOOK** will tell you just what is wrong, and **EXACTLY** how to fix it in a jiffy! No extensive testing! No guesswork! No lost motion! More sets fixed per day!

A. A. GHIRARDI
Radio's foremost servicing authority and most widely read magazine and book author.



All this, however, is just the beginning of **THE HANDBOOK'S** usefulness. Other features include the most modern, most complete, and genuinely helpful Tube Chart you've ever seen, including complete substitution data. In addition, there are dozens of pages devoted to I-F alignment peaks for over 20,000 subtypes; I-F transformer troubles; and hundreds of tables, graphs, charts, and data compilations of all kinds designed to quickly give you every type of servicing help **WHEN YOU NEED IT**.

This big 744-page book is yours **COMPLETE** for only \$5 (\$5.50 foreign)—and it comes to you on a **5-DAY MONEY-BACK GUARANTEE BASIS**. You can't lose!

Learn to be a PROFESSIONAL Radio-Electronic Service Expert

Don't guess! Don't waste time! Know exactly what you are doing and why you are doing it every step of the way! Ghirardi's **MODERN RADIO SERVICING** is the only inexpensive one-volume guide that gives you a complete course in professional radio servicing and which includes the essential theory and practice for practically every branch of electronic servicing! You'll be amazed to find how Ghirardi makes even the most "complicated" subjects crystal clear and easy to understand—at home without an instructor. Subjects include thorough explanation of all Test Instruments; how and where and why they are used; Scientific Troubleshooting Procedure; Circuit Analyses; Test and Repair of Parts; Installations; Adjustments; How to Start a Successful Service Business—and dozens more! 700 illustrations; 786 different topics; 720 review questions; 1300 pages! Only \$5 (\$5.50 foreign). **5-DAY MONEY BACK GUARANTEE!**



CHRISTMAS GIFT TIP de luxe!

Give Ghirardi's Radio-Electronic books to friends this Christmas—ask friends and relatives to give them to you! Someone is wondering what on earth you'd like for Christmas. Why not suggest using the attached coupon today. They'll appreciate the hint—and you'll appreciate the books every day of your life!

5-DAY MONEY-BACK GUARANTEE

MURRAY-HILL BOOKS, INC., Dept. RC-125
232 Madison Ave., New York 16, N. Y.

Enclosed find \$..... for books checked (send postpaid); or send C.O.D. (in U.S.A. only) for this amount plus postage. If I am not fully satisfied, I may return the books within 5 days and receive my money back.

- MONEY-SAVING COMBINATION CHRISTMAS OFFER**—Both of the above big books for only \$9.50 for the two (\$10.50 foreign).
 Ghirardi's **RADIO TROUBLE SHOOTER'S HANDBOOK**, \$5 (\$5.50 foreign)
 Ghirardi's **MODERN RADIO SERVICING** \$5 (\$5.50 foreign)

Name

Address

City & Dist. No. State

The books that tell you **WHAT** to do **HOW** to do it

RECORDER ON TAPE

(Continued from page 168)

require only the insertion of a plug into one of the jacks to accomplish the necessary switching.

When SW5 is in the "record" or "neutral" position, the circuits are all connected to the amplifier. However, they are disconnected in "playback" position, and the circuit from the playback head is substituted.

The *microphone circuit* is the only input circuit which does not have a jack switch. This circuit operates through the first stage (tube 1V) after passing through a switch in the line-carbon-mike jack. The output of the first stage passes through the switch section of the radio jack before reaching the rest of the amplifier.

The *radio circuit* operates directly into the grid of tube 2V, and does not use the first stage (tube 1V). This circuit is used for direct recording of programs on the air from the output of a radio receiver.

The *line tap circuit* (telephone) operates through the input transformer into the second stage (tube 2V). This circuit must not have any electrical connection to the amplifier chassis, as the recorder puts no drain on telephone circuits. The line tap circuit is so designed that recordings may be obtained either by physical tap or by induction.

The *carbon mike circuit* operates in series with 1.5-volt batteries, which are plugged into the bottom jack (mike battery) on the left-hand side of the panel, and the input transformer T3. The secondary of this transformer is connected back through the carbon-mike jack to the second stage (tube 2V), the output of which goes through the switch of the radio jack to the rest of the amplifier.

Two other circuits, playback and meter, are also provided. The *meter circuit* (which indicates the recording volume level) is connected across the recording head line, and operates only when the amplifier switch is in the "record" position.

Recordings are made as follows: from a microphone through the *mike* input; from a radio receiver output directly through the *radio* input; from a telephone through the line tap input; and from a carbon microphone through the *carbon mike* input.

By using a microphone with the unit turned to neutral position, the recorder may be adapted for use as a public address system.

Film recordings, made by any of the above methods may be monitored through earphones, and played back through a 5-inch PM built-in speaker or fed through an output jack which is provided for external speaker, public address system or to the modulator of a radio transmitter. The unit is so designed that it may be monitored for playback purposes while recording is taking place, without interfering with the recording procedure. This is effective for playing back either the immediate recording taking place, or any previous portion of the recording.

Correcting or erasing any part of a recorded film is a simple process. This is done by running off the original film and re-recording its content on copy, or dub, film. When an undesirable word, sentence or phrase is heard, the dub machine is switched off until the danger spot is passed.

So precise is the process that words—sometimes even infinitives—can be split. In reporting a certain phase of the Normandy

operations during the war, the word "convoy" was censorable. In one of the recordings made at the time, this sentence was heard: "Reinforcement convoys coming." The word "convoy" had to be deleted, leaving: "Reinforcement coming." To correct the grammar, censors turned off the copy machine just long enough to cut out all but the letter "s" in "convoys". The sentence then read, correctly: "Reinforcements coming."

BICYCLE RADIO WITH FOUR TUBES

(Continued from page 172)

kilocycles. The input lead is now connected again to the modulator grid of the 1R5, (pin No. 6) and the variable condenser is turned to the minimum capacity position (rotor plates turned completely out). The trimmer C3 on the oscillator section of a variable condenser is now adjusted so that the maximum output is obtained from the speaker. If two responses are heard, a strong signal with the trimmer tightly closed and another with the trimmer almost open wide, the signal received with the trimmer *open wide* is the correct one.

In the event that more than two signals are heard the output of the generator should be reduced until the signals are barely audible. With low generator input the spurious responses should disappear.

The generator is now set at 1400 kilocycles and entirely disconnected from the set. The output lead of the generator is placed close by the whip antenna. The trimmer on the R.F. section of the variable is opened wide (no adjustments are made with this trimmer). The receiver variable is now rotated so that the 1400 kilocycle signal being radiated by the generator is heard. If the signal from the generator is not heard in the receiver, the output of the generator may be too low and should be increased until the signal is heard. The variable should be rotated to the position giving the maximum signal output at 1400 kilocycles. Now, adjust the antenna trimmer C1 (15-200 mmfd.) for maximum output.

When used aboard the sailboat with the guy wires as the antenna system, a station at approx. 1400 kilocycles is "tuned in" and a small screw driver used to change the antenna trimmer C1 for loudest reception.

This receiver has given the Author many hours of enjoyable reception when used on a bicycle or on board the sailboat.

CODE ON CANADA'S COIN



The latest Canadian nickel, issued just before the end of the war, carries a message in International Morse. Readers of the code will be able to spell: "We Win When We Work Willingly." The new nickel is also original in that it is eight-sided instead of round.

Who said it costs a lot of money to LEARN RADIO-ELECTRONICS?

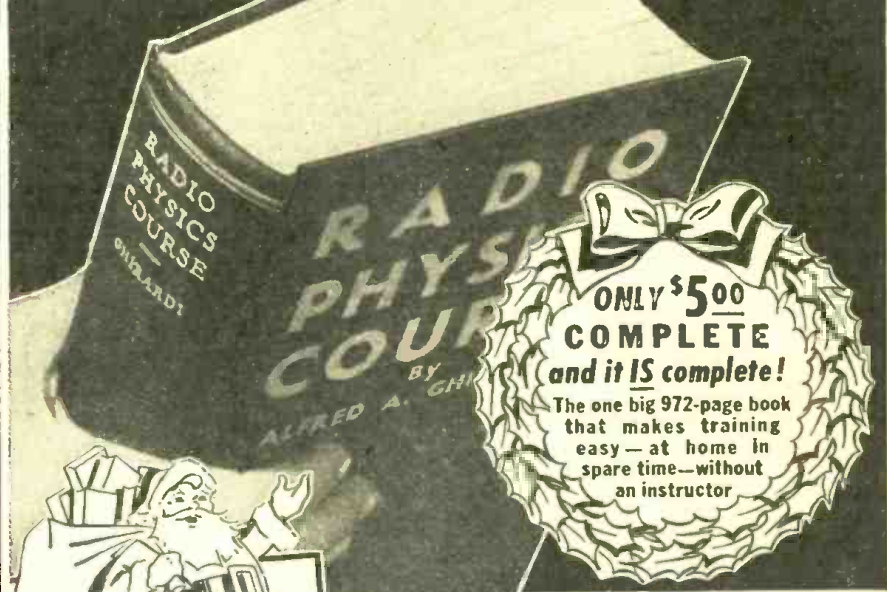

Get it for **CHRISTMAS!**

Give it for **CHRISTMAS!**

What finer Christmas gift could you ever hope to receive—or give to a radio inclined friend—than this 3 1/2-lb. book that can pave the way for big pay or a self-owned business in the most fashionable, fastest-growing industry of all? Friends or relatives are wondering what to give YOU this Christmas. Why not drop a hint that you'd like A. A. Ghirardi's RADIO PHYSICS COURSE and give them the attached coupon to mail?

THE MOST WIDELY USED RADIO-ELECTRONIC TRAINING BOOK IN THE WORLD

No sir! Radio-Electronic Training doesn't have to be expensive. The amazing fact is that A. A. Ghirardi's famous 972-page RADIO PHYSICS COURSE gives you just the training you need—ALL YOU NEED—easier, better, faster—AT A TOTAL COST OF ONLY \$5.00 COMPLETE. Proof? It's a matter of record that RADIO PHYSICS COURSE is more widely used for home study, by more civilian schools and colleges, and more universally employed in Signal Corps and Navy Schools than any other book of its kind. As proved by an actual survey, 9 out of 10 radio men themselves endorse it as the finest, easiest-to-understand Radio-Electronics training course on the market.

MAKE MORE MONEY IN A BETTER POST-WAR JOB

No previous knowledge of Radio-Electronics is necessary when you use Ghirardi's RADIO PHYSICS COURSE, for it carries you rapidly from Basic Electricity (over 200 pages) to the latest, most modern developments. Nothing is omitted. Nothing is condensed. Every step is made crystal clear by simplified, thorough explanations and by more than 500 clear, specially prepared illustrations. Each section is followed by Self-Testing Review questions, so you can check your progress every step of the way! There are no monthly lessons to wait for. You go ahead as fast as you want to. All you need is a little spare reading time plus a desire to get started NOW to make more money in a better, more interesting future in broadcasting, aviation radio, P-M, television, radio servicing, electronic manufacturing—or any other of Radio-Electronics' fast growing branches.

YOUR MONEY BACK!

Send coupon today! Compare Ghirardi's RADIO PHYSICS COURSE with any other Radio book or course AT ANY PRICE. Use it for 5 days. Then, if you are not more than satisfied that it will teach you basic Radio-Electronics EASIER, FASTER, and at LESS COST, return it. We will refund your money WITHOUT QUESTION!

36 COURSES IN ONE!

Actually, RADIO PHYSICS COURSE gives you the scope of 36 complete courses in one big book. If it were broken into sections and sold as a series of lessons, you'd regard it as a bargain at \$50 or more. It's yours, however, in this handy 1-vol. form for only \$5 COMPLETE (\$5.50 foreign)—and you don't even take the slightest chance on that amount.

MAIL THIS COUPON NOW!

MURRAY HILL BOOKS, Inc., Dept. RC-125, 232 Madison Ave., New York 16, N. Y.

Enclosed find \$5 (\$5.50 foreign) for A. A. Ghirardi's 972-page RADIO PHYSICS COURSE book; or send C.O.D. (in U.S.A. only) for this amount plus postage. In either event, it is understood that I may return the book in 5 days for refund if not satisfactory.

Name
Address
City & Dist. No. State

Learn at home — EASIER, BETTER, FASTER

THE QUESTION BOX

AUDIO AMPLIFIER

Q Will you please publish a diagram of an audio amplifier using an 80 or a 5Y3 as a rectifier and a 6V6 or two as amplifiers. I wish to amplify a 60-cycle A.C. hum. If possible we would like to amplify it so as to be able to use a loud-speaker and volume control but no tone control will be needed.—J.M.Z., Bay City, Mich.

A. There is no need of an amplifier to accomplish the result you desire. A 60-cycle frequency hum of any intensity you desire within the power range of a loud-speaker may be obtained by using a circuit as shown in the

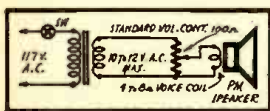
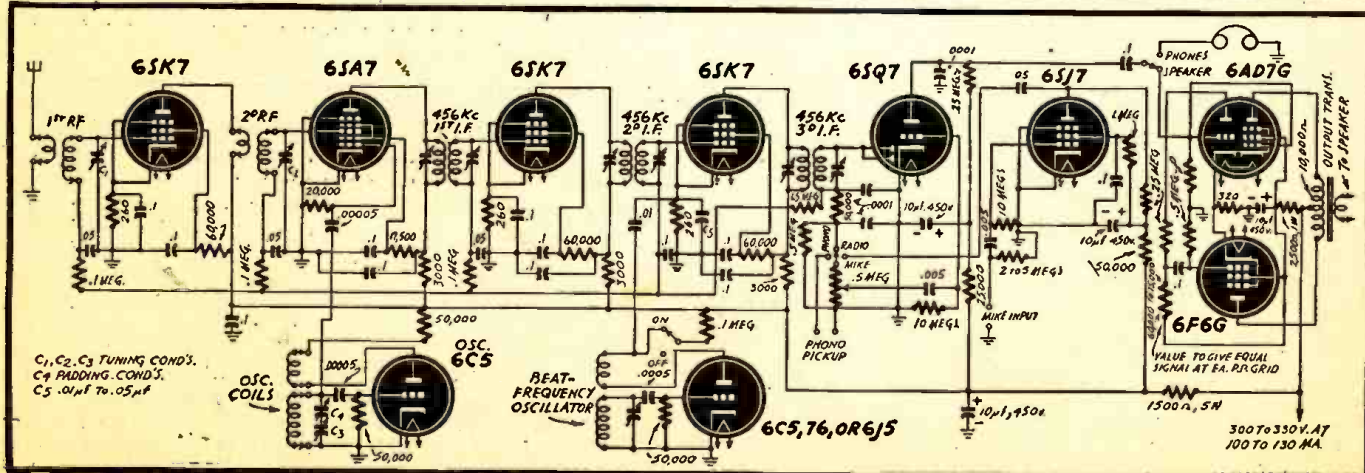

diagram. The voltage may be controlled as shown by using a volume control of a different value on the primary side of the transformer or by using a tap switch on a tapped transformer. The transformer should have a wattage rating higher than that of the speaker. The voltage rating of the secondary will depend on the speaker and the output wattage desired from it but a maximum of 12 volts would be sufficient for most standard types of PM speakers.

RECEIVER FOR AMP

Q I have just constructed a high-fidelity amplifier. The first audio stage is resistance-coupled to the push-pull output stage. The input is fed through a .005-mfd. mica condenser and a 500,000-ohm volume control to the grid of 6SJ7. I would greatly appreciate it if you could print a diagram of a hookup for a short-wave receiver along the lines of a communications receiver that can be used with this amplifier.—J.H.F., Ottawa, Ont.



A. The input to your amplifier will have to be from 100,000 to 500,000 ohms to obtain satisfactory results using a crystal mike and most phono pickups. To accomplish these results, as well as to incorporate a receiver of communications type, the diagram shown at the bottom of page has been prepared. The receiving section gives the essential elements to which you may add refinements. The first R.F. and second I.F. stages may be omitted if you wish to reduce the overall gain. All stages are individually decoupled for stability but care will be needed in shielding.

NAZI SETS

Q I have a Nazi radio, similar to the one described in the October issue of Radio-Craft, that was sent to me by a soldier overseas. I am trying to revise this set but have had considerable difficulty in determining which tubes are what. Perhaps you may be able to help me out. I would like to know the characteristics of the following tubes: DL-11, DF-11, DCH-11, DAF-11, VF-11, VBF-11, VCH-11, VY-11.

—E.A.W., New York City

A. We have been able to obtain information on the following four tubes only. Others than those listed here are not contained in our files and we are unable to supply any characteristics. Perhaps some of our readers can help you out.

The DL-11 is an output pentode. Its heater current is .05 Ma., heater voltage 1.2, plate voltage, 120, plate current 5 Ma., grid bias -6 volts, screen voltage 120, screen current 1 Ma., mu of 10, plate resistance 22,000 ohms, and the output 1 watt.

The DF-11 is a variable-mu pentode, high-frequency and I.F. amplifier. The heater voltage is 1.4, heater current .025 amperes, plate voltage 120, plate current .9 Ma., grid bias 0, screen current .15 amp., and the power output .5 watts.

The DCH-11 is a variable-mu triode hexode. It is used as an oscillator modulator and mixer. The heater voltage is 1.2, heater current is .075 amp., plate voltage 120, plate current .8 Ma., screen voltage 60, the combination triode hexode grid is -5 volts, bias voltage 0 volts, and power output .5 watts.

The DAF-11 is a simple diode-pentode. The heater voltage is 1.2, heater current is .29 amps., plate voltage 120, plate current .29 Ma., screen voltage 20 volts, screen current .05 Ma., is 110, plate resistance 300,000 ohms, bias 0 volts, and maximum power output .6 watts.

The DL-11 corresponds roughly to our 1LA4. The DF-11 corresponds approximately to the 1N5. The DCH-11 is similar in characteristics to the 6K8 except for the filament voltage and current ratings. The DAF-11 has no American counterpart. The diode and pentode sections of the 1G8 could be used to replace it. These are only approximations as it is obvious that the Nazis and our manufacturers haven't been working hand in hand to standardize types, sizes, or features, during the past few years.

TUBE TESTER

Q In your article "Tube Tester" on page 804 of the September issue, what are the values of the "voltage divider" the condenser across the high-voltage line, and the shunt re-

sistor across the meter? At what voltages does the tester operate? Is the push-button in the control-grid circuit normally open or closed?—R. L. O., Tell City, Ind.

A. Plate voltage may be 250 and screen grid 100. Dropping resistors can be used with lower-voltage tubes. Bleeder may be any value between 5,000 and 25,000 ohms. Shunt across meter should vary from zero to about 10 times meter's resistance. Filter condensers — 50% higher than the highest D.C. voltage you intend using. Switch should be a normally-open type. Grid winding may deliver 3 to 5 volts. A 1-meg resistor may be run from grid jack to minus B.

POCKET RECEIVER

Q Can you publish a diagram of a pocket portable receiver using a 1T4, 1S5, and 1S4? I would like to have a loop antenna, and would also like to have the set work on only 10 penlite cells. I want it to work with headphones and to be as compact as possible. — C.B., Atlantic City, N. J.

A. The receiver diagrammed below will fill the bill for you. It is a T.R.F. hookup. For the B-supply you may use penlite cells or a small 45-volt battery. The tuning condensers may be any small type of approximately 350 mmfd., to cover the broadcast band.

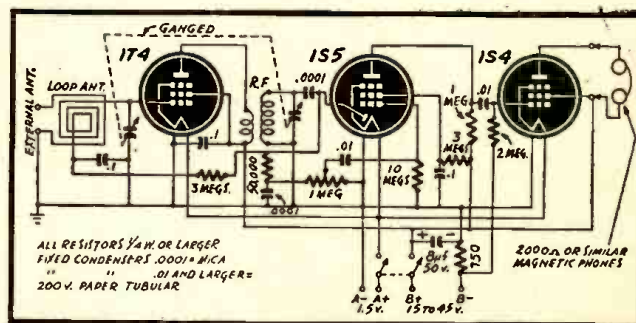



Long Scale, Wide Range Volt-Ohm-Milliammeter

DOUBLE SENSITIVITY D.C. VOLT RANGES
 0-1.25-5-25-125-500-2500 Volts, at 20,000 ohms per volt for greater accuracy on Television and other high resistance D.C. circuits.
 0-2.5-10-50-250-1000-5000 Volts, at 10,000 ohms per volt.

A.C. VOLT RANGES
 0-2.5-10-50-250-1000-5000 Volts, at 10,000 ohms per volt.

OHM-MEGOHMS
 0-400 ohms (60 ohms center scale)
 0-50,000 ohms (300 ohms center scale)
 0-10 megohms (60,000 ohms center scale)

DIRECT READING OUTPUT LEVEL DECIBEL RANGES
 -30 to +3, +15, +29, +43, +55, +69 DB

TEMPERATURE COMPENSATED CIRCUIT FOR ALL CURRENT RANGES
 D.C. MICROAMPERES
 0.50 Microamperes, at 250 M.V.

D.C. MILLIAMPERES
 0-1-10-100-1000 Milliampere, at 250 M.V.

D.C. AMPERES
 0-10 Amperes, at 250 M.V.

OUTPUT READINGS
 Condenser in series with A.C. Volts for output readings.

ATTRACTIVE COMPACT CASE
 Size: 2 1/4" x 5 1/2". A readily portable, completely insulated, black, molded case, with strap handle. A suitable black leather carrying case (No. 629) also available, with strap handle.

LONG 5" SCALE ARC
 For greater reading accuracy on the Triplet RED • DOT Lifetime Guaranteed meter.

SIMPLIFIED SWITCHING CIRCUIT
 Greater ease in changing ranges.



**HERE'S THAT NEW
 TRIPLET
 625-N**

Triplet

ELECTRICAL INSTRUMENT CO. BLUFFTON, OHIO

would be of some value during emergencies when wire facilities are interrupted as a result of hurricane, flood, earthquake, or other disaster, as has been so ably demonstrated by the invaluable work the hams in the amateur service have performed in the past with large numbers of low-power sets.

In view of the controversy over the new allocations and their effect on the present FM set owner, *Radio-Craft* contacted the leading manufacturers and FM broadcasting companies, asking the following questions:

1. What is your opinion as to the effect the new allocations might have on the sales of FM?
2. What will happen to the present FM sets?
3. Do you (in the case of the manufacturers) intend to put out a service bulletin informing the radio serviceman how to proceed in the service of your FM sets?
4. Would you recommend converter units for the present FM sets?
5. Would it be better from your standpoint if the user were to return the set to your factory's repair department rather than have a serviceman repair it in his shop?
6. What effect, in your opinion, will this new set-up have on television?
7. What do you plan in post-war FM?

These questions were asked by telephone and by wire.
 The replies follow:
 Mr. W. J. Halligan, President of The Hallcrafters Company "believes that the new allocations will greatly increase the sales of FM sets. Converters are recommended. The FCC did an excellent job under difficult circumstances."

Mr. E. G. May, Sales Manager of Sentinel Radio Corporation states: "The new

NEW FM BANDS (Continued from page 163)

allocation results in increased cost in receivers and changes in transmitters. . . . combining to result in reduced sales. . . . From a technical standpoint . . . the new wave band will improve service to the actual purchaser and may . . . prove to be a desirable procedure."

Mr. Ray H. Manson, President of Stromberg - Carlson Company is also of the opinion that the change will delay the advent of full commercialized FM on a standard now comparable with AM. In regard to converters, he states: "the only type which will give completely satisfactory service is one which has a complete R.F. system, up to and including the detector, so that this converter may be

This cross-section of earth and sky depicts the various reflecting layers which turn back different radio waves.

plugged into a phonograph jack of the regular receiver and thereby employ only the audio system."

Mr. Isidore Goldberg, president of Pilot Radio, believes that two bands are necessary at present; otherwise sales will be affected. He states: "Sets now out of date (Continued on page 216)

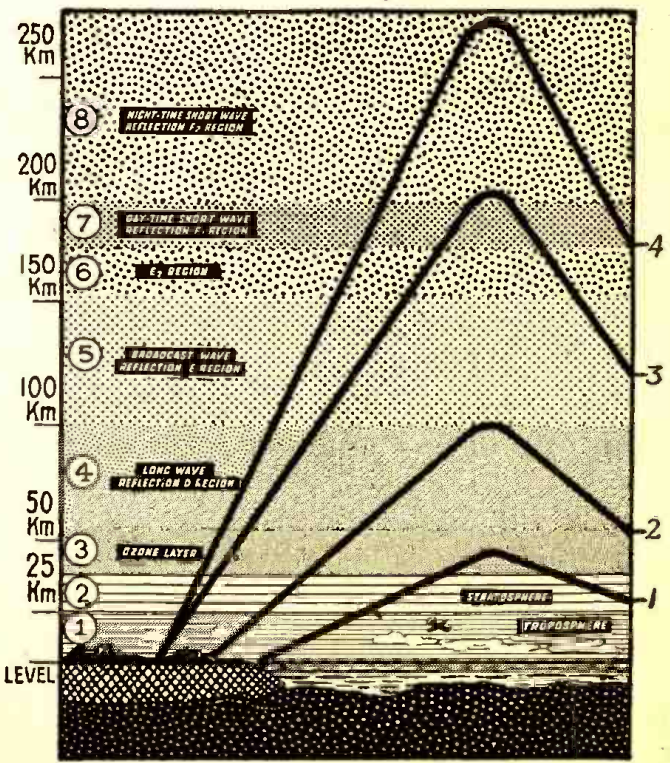

TRY THIS ONE!

SERIES OUTLET

The sketch and photographs show a simple series-parallel attachment outlet which has a multitude of uses around the repair shop.

One of the many uses would

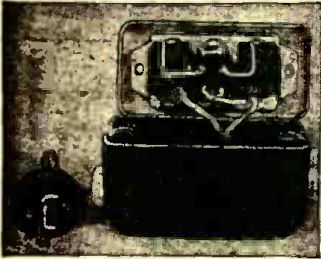

How the outlet box is wired up.

be to connect the soldering iron to one outlet and a 100-watt lamp (or other size depending on the wattage of the iron) to the other. To keep the iron



The box has a neat appearance.

warm but to prevent tip burning, throw switch to series position. For full heat throw to parallel position.

The use of two photoflood lamps of the kind used in photography, connected to these outlets permits, in the series position, plenty of light for focus-

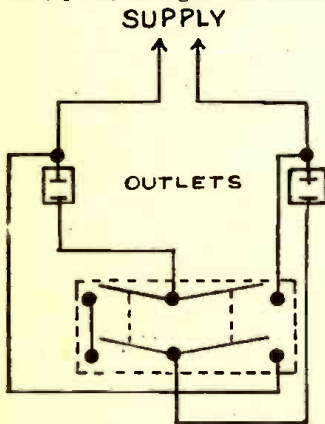

SWITCH

ing and composition together with exceptionally long life, and a pre-conditioning before turning on full brilliancy in the parallel position.

For compactness, the standard interchangeable line of plate and receptacles is used. The radio type, double-pole, double-throw switch is mounted in one of the triple knockouts in the plate and wired as per sketch.

A. B. KLYNE,
Dover, Ohio

Radio-Craft wants original kinks from its readers, and will award a seven-month subscription for each one published. To be accepted, ideas must be new and useful. Send your pet short-cut or new idea in today!

CABLE JACK

I have found a new use for old fluorescent starters. After failing in my attempts to find a cable extension jack, I hit upon the idea of using a standard chassis jack and a defective fluorescent starter for the purpose. The starter is first disassembled. The metal shell is used for the housing. The plastic bottom plate is used as a base for the jack. The starter is disconnected from this plate and the terminals are punched out, leaving two small holes. A hole is drilled in the closed end of the metal shell. Wires are connected to the chassis jack and are pushed through the holes in the plastic base. The nut is screwed on the jack and then the base is fitted to the casing. Insert the paper insulator that originally was in the starter. Bend the metal tabs back into position and the job is done. An ordinary phone plug is used.

JERRE H. PAPIER,
Columbus 5, Ohio

BINDING POSTS

Here is a good idea for amateurs and experimenters when stuck for binding posts or phone terminals. The brass female contacts inside an ironing-cord plug can be used in the following manner. A wood screw is used to hold the contact to a breadboard. The wire from the unit being connected is wound around the head of the screw. The screw is then tightened down securely. Phone tips or test leads can then be plugged in at will. If there is any high voltage present, the contacts can be covered with cellulose tape to prevent shock and minimize the danger of shorting.

V. GZOWSKI,
Halifax, Nova Scotia

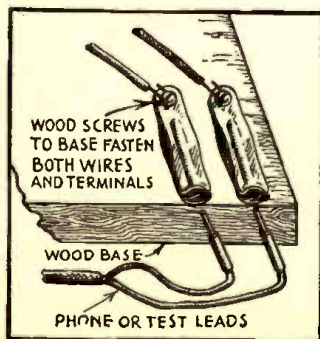

HOME-MADE SHIELDS

If you don't happen to have a shielded lead when you need one, here is a good method of constructing one. Cut a suitable length of insulated wire and wind it closely and evenly with No. 22 (approximately) enamelled or bare copper wire. This not only provides good shielding, but the result is also very flexible. One use for this type of shielding is for grid cap leads.

HAROLD R. NEWELL,
Bradford, N. H.

(Occasionally the inductance or resistance of the insulated wire reduces the shielding effect. In such cases, thin strips of tin-foil wound in the same manner may be found to give better results.—Editor)

FLASHLIGHT CELLS

As flashlight batteries were difficult to obtain, we tried to recharge them on our battery charger. We put four in series to make up the required six volts and charged them at .060 amps for about 24 to 30 hours. They lasted quite well and could be recharged several times before wearing out.

KENNETH C. DIKE,
Seattle, Wash.

SHIELD CANS

If you ever need a shield for a small tube, perhaps this will be the solution. I hit upon the idea of using the zinc can of a dead dry-cell flashlight battery from which I removed the electrolyte and carbon. I found that it fitted snugly over the tube which I was using, and the shielding results were remarkable.

FRED W. SPARKS,
Oak Ridge, Tenn.

GRID CAP REPAIR

When the top grid cap of the tube comes off, it can be repaired in the following manner: Hold the cap in a pair of pliers. Clean the inside out and melt the old solder out of the hole in the top. Wind a piece of wire around the stub of the wire coming from the top of the tube. Push this through the hole left by the melted solder. Place a small lump of plastic wood inside of the cap and press the cap down on the top of the tube. After the plastic wood is

dry, cut the end of the wire off and solder it to the cap. Clean off the excess plastic wood, and the job is finished, putting a useless tube back into action.

DAVID KALLANDER
Framingham, Mass.

(The usual stunt is to use Duco cement instead of plastic wood but this idea might work just as well.—Editor)

VOLTAGE ADJUSTER

To prolong tube life in experimental apparatus where the line voltage ran to about 124 volts, I converted a bell-ringing transformer into an auto-transformer which permits lowering the voltage. Simply connect one terminal of the secondary winding to a terminal of the primary so that they aid each other and connect the two windings in series across the line.

The transformer used in this case had a 16-volt center-tapped secondary. A few sockets, the transformer, a fuse block and a snap switch all mounted on a breadboard, provide a handy power supply outlet for the work-bench. A more elaborate device can be constructed if desired by using a multiple switching arrangement as shown in the figure, from which you can obtain a boosting or bucking auto-transformer or a straight step-down to rated secondary voltages.

HAROLD J. MAHAFFEY,
Skokie, Illinois

(A bell transformer is not too good for this purpose. An ordinary toy transformer would be more efficient (as it is built for continuous load.—Editor)

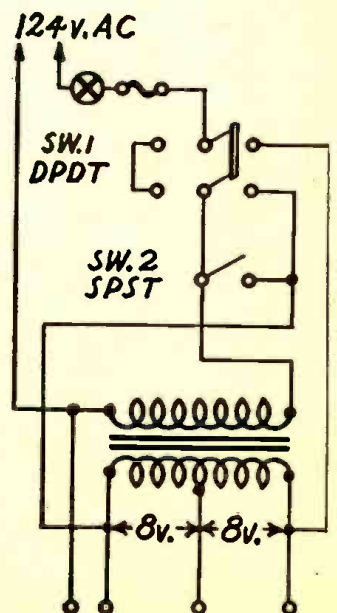

MEASURING U.H.F.

By FRED SIMPSON

THE radio serviceman of tomorrow is likely to find that much of his work will be with high frequency equipment. Many servicing generators do not reach up to the very high frequencies used for television and FM. Since FM and television receivers will require alignment, an ultra-high frequency generator is essential. Undoubtedly special equipment purposely designed for such work will be available, but there may be times when it will be necessary for the serviceman to use what he has, an ordinary generator.

Many servicing generators extend upwards to 20 megacycles. By setting the generator so that an output of 10 megacycles can be obtained, marker points 10 mc apart can be secured. The set-up appears in Fig. 1.

The harmonic series will then run from

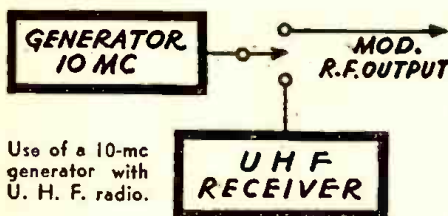

100 to 110-120-130-140 or simple multiples of the fundamental 10 mc signal will be obtained. A chart showing the fundamentals and harmonics for typical cases is also shown. The serviceman can easily work out a chart to meet his own special requirements.

Note that the difference between successive harmonics is equal to the fundamental frequency. This fact aids in identification of the signal, but to facilitate the work it would be desirable to use a calibrated UHF receiver. If the receiver is a TRF type the work will be simplified, since there will be no local receiver oscillator signal to cause spurious responses. As an example, suppose that the local receiver oscillator frequency is 5 mc higher than the I.F. of the set, and is equal to 120 mc. The incoming signal frequency will be, normally, 120-5 or 115 mc. The image is twice the I.F. away from the desired signal or equal 10 mc distant. Since the oscillator of the radio is on the high side of the signal the image will be on the high side or on 125 mc. If the receiver is being aligned and the R.F. circuit is broad, it will not be difficult to mistake the image for the desired signal. Using the calibrated receiver to check the harmonic will make the work easier.

Suppose, for example, that you are able to tune in the signal on the calibrated receiver at 120-132-144-156 mc. The difference value between each frequency mentioned is equal to the fundamental. Then,

$$\begin{aligned} 132 - 120 &= 12 \\ 144 - 132 &= 12 \\ 156 - 144 &= 12 \end{aligned}$$

From the above, it would be seen that the fundamental has a value of 12 mc. Also note that starting at 120 mc. and not counting the first signal of 120 mc., but 132 equals 1, 144 equals 2, 156 mc. equals 3, that we have 3 separate points. The difference is 156-120 or 36 mc. and dividing this difference by the number of points we find the fundamental is 36/3 or 12 megacycles.

Some servicemen have signal tracing equipment equipped with adapters extending the range to the UHF values, which

33 well overlapped ranges . . . plus long-life dependability!



WESTON

(Model 665 Type 1)

VOLT-OHM-MILLIAMETER

Its compactness, versatility and rugged dependability make Model 665 the ideal instrument for use in the field, or in the shop . . . whether servicing communications equipment, testing electrical components in production, or research or maintenance work. Provides 33 AC and DC voltage, DC current, and resistance ranges . . . with simplified switching arrangement for rapid operation. Built to WESTON standards to assure dependable measurement accuracy throughout the years. Full details on request. Weston Electrical Instrument Corporation, 599 Frelinghuysen Avenue, Newark 5, N. J.

WESTON Instruments

Fundamental 10 Mc.	HARMONICS						
	10th Harmonic 100 Mc.	11th	12th	13th	14th	15th	16th
11	110	120	130	140	150	160	
12	110	121	132	143	154	165	176
13	120	132	144	156	168	180	192
14	130	143	156	169	182	195	208
15	140	154	168	182	196	210	224
16	150	165	180	195	210	225	240

may be used in place of the calibrated receiver.

ATOM POWER NOW USABLE

The question, "How many years will it be before atomic energy is tamed to provide a source of power usable in industry?" has already been answered by scientists who played a part in developing the atomic bomb.

Dean Taylor of Princeton's Department of Chemistry, points out: ". . . in the process of production of materials for the bomb, major quantities of power become simultaneously available. We read in Smyth's report (Dr. Harry deW. Smyth, Chairman of the University's Department of Physics, and co-worker on the atomic bomb) that the piles in the Hanford plants in the early summer of this year were all operating at the desired power, producing plutonium, and, so Smyth relates, actually heating the Columbia River. It is not hard to visualize therefore the development of power plants in which nuclear fission will provide the energy. Other applications will surely follow."

Controlled atomic power is here now. The only question to be solved in making atomic power general is an economic one. Atom power will replace other forms if and as soon as it becomes cheaper.

OHMITE RESISTORS

Your Guide to

DEPENDABLE RESISTANCE CONTROL

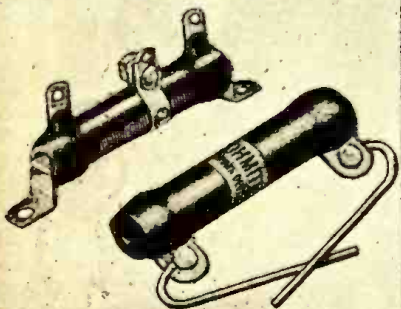

The service record of Ohmite Brown Devil and Dividohm Resistors before and during the war... is your best guide to resistance-control now. Ohmite construction insures long, trouble-free performance... makes these units favorites for the best in resistor replacement.

Write for Stock Unit Catalog No. 18
Authorized Distributors Everywhere



OHM'S LAW CALCULATOR

Figures ohms, watts, volts, amperes... easily. Solves any Ohm's Law problem with one setting of the slide. Send only 10c in coin.

OHMITE MANUFACTURING CO.
4896 FLOURNOY ST. • CHICAGO 44, U. S. A.

Be Right with OHMITE
RHEOSTATS • RESISTORS • TAP SWITCHES

New Radio Patents

Conducted by I. QUEEN

METER TYPE RELAY

Anthony H. Lamb, Hillside, N. J.
Patent No. 2,380,851

THIS patent covers certain improvements in the construction of instrument type relays, resulting in a more satisfactory device.

In order to eliminate need for machining per-

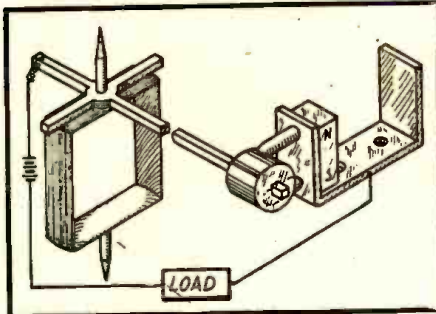

manent magnet material, which is difficult, use is made of a small block of Alnico or similar material, but the actual pole pieces are of soft magnetic material which may be properly machined. As shown a cylindrical rider of soft iron is mounted on a pointer which deflects in response to current through the coil which is mounted on pivots. At a predetermined current, attraction takes place thus closing the external circuit to the load.

INTERFERENCE ELIMINATION

Clarence W. Hansell, Port Jefferson, N. Y.
Patent No. 2,381,496

THE use of R.F. generators for industrial and therapeutic purposes has resulted in serious interference with communication circuits at times. The former are usually unstable in frequency and their radiations may wander in and out of important frequency bands.

To eliminate this type of interference, it is suggested in this patent that the R.F. generator be frequency modulated rapidly through a wide range. Preferably this modulation may take the

form of a triangular wave as shown. This change may be made at the rate of 1,000 megacycles per second for example, in which case any radiated energy will remain in a 10 K.C. band only 10 microseconds! This is found to be equal to an interference reduction of 60 Db.

A general circuit for an R.F. oscillator is shown in the figure. A push-pull stage is frequency modulated by a rotating condenser connected across a portion of the tuning tank. The same motor may be used to operate a blower for cooling the tubes.

FM RESONANCE INDICATOR

Bertram Trevor, Riverhead, N. Y.
Patent No. 2,379,765

IN an FM detector, a frequency swing in one direction results in a positive potential. If the swing is in the other direction (from the carrier) there is a negative potential output. This simple indicator operates on these voltages.

A low voltage A.C. is applied out of phase to the first and third control grids of a 6SA7 or similar type tube. With the switch SW closed,

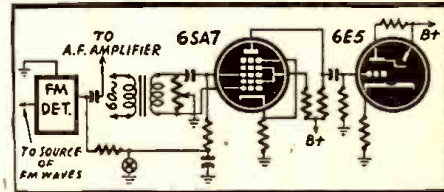

the potentiometer is originally adjusted to balance out the A.C. component in the plate circuit as shown in pattern (a) obtained on the 6E5.

With the switch open, a signal may now be tuned in. If it is properly resonated, pattern (a) will remain because there is still no voltage at point A due to the signal. If the signal is off tune, however, point A will become either positive or negative and therefore unbalance the 6SA7 and an A.C. component will appear in its plate circuit. The electron-ray will then show pattern (b). The light green area is the result of the rapidly fluctuating A.C. at its input circuit. The size of this area indicates the degree of off-tuning.

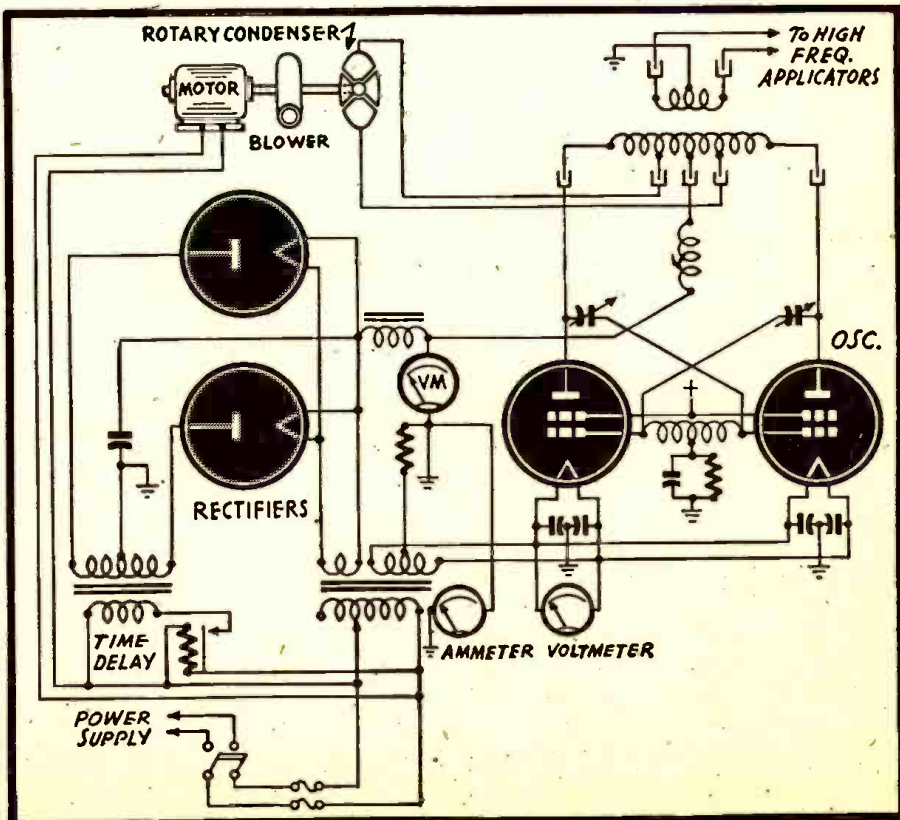

New Superregenerator

A BRITISH patent has been issued to M. K. Taylor and I. N. Vaughan-Jones as a result of a new development in the super-regeneration field, which permits the use of a high quench frequency. This results in less distortion. Heretofore the use of a high frequency did not permit sufficient time to elapse for the amplified signal to drop to its input level before the next "build-up."

According to the description in *Wireless World*, the circuit uses a tank coil L, a positive feedback coil L1 and a negative feedback coil L2. The quench oscillator is connected through C to the suppressor of a pentode, the bias being adjusted by P. The object is to add degeneration at the moment when the gain decreases.

When the amplification drops, the plate begins to take current, thus feeding back an out-of-phase voltage to the grid. When the gain rises, the plate current is cut off, eliminating the degeneration. The second grid acts as the plate of an oscillating triode.

The British patent number is 566209.

(Note—On purely theoretical considerations, it would seem that the circuit might operate if L1 were degenerative and L2 the regenerative coil. Then a negative quench-

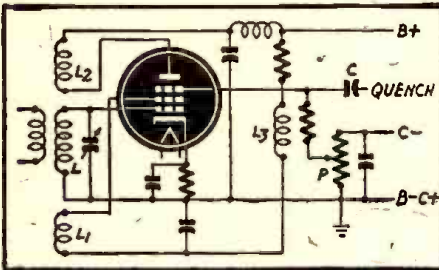

ing voltage would cut off plate current so that only negative feedback would occur, causing rapid attenuation of the signal. On the other hand, a positive quench would permit plate current to overcome the action of L1. Super-regenerative action would then occur.

In either case the circuit looks like a good one to experiment with. We would be glad to hear of the efforts of our readers.—I.Q.)

Tubes Use Tiny Parts



Super-small metal parts, presenting a variety of sizes and shapes, must be used in modern miniature tubes. This photo of Sylvania tube parts shows some of these minute pieces.

Not just another book on the vacuum tube, this typical Rider Book offers a new approach and technique that makes its message easy to understand. Here is a solid, elementary concept of the theory and operation of the basic types of vacuum tubes.

After explaining the electron theory, the text presents a discussion on electrostatic fields. The reader's understanding of the distribution and behavior of the fields within a tube gives him a better picture of why amplification is accomplished within a tube.

Many diagrams and graphs are repeated to minimize the turning of pages in reading text and drawings. Anaglyphs give "three-dimensional" pictures of phenomena heretofore seen only in two dimensions; an aid in rapid understanding of the text.

Although an elementary book on a fundamental subject, therefore a goldmine for the student; developments in radio and the new fields of television and microwaves make it a must for the libraries of servicemen, amateurs and engineers.

Place your order today.

OTHER RIDER BOOKS

RIDER MANUALS (14 VOLUMES)	
Volumes XIV to VII . . .	\$12.50 each volume
Volumes VI to III . . .	9.50 each volume
Abridged Manuals I to V (1 Vol.) . . .	\$15.00
Record Changers and Recorders . . .	7.50
The Cathode Ray Tube at Work . . .	4.00
Frequency Modulation . . .	2.00
Servicing by Signal Tracing . . .	4.00
The Meter at Work . . .	2.00

The Oscillator at Work	\$2.50
Vacuum Tube Voltmeters	2.50
Automatic Frequency Control Systems . . .	1.75
A-C Calculation Charts	7.50
Hour-A-Day-with-Rider, Series—	
On "Alternating Currents in Radio Receivers"	
On "Resonance & Alignment"	
On "Automatic Volume Control"	
On "D-C Voltage Distribution"	1.25 each

JOHN F. RIDER PUBLISHER, INC., 404 Fourth Avenue, New York 16, N. Y.

Export Division: Rocket-International Electric Corp. 13 E. 40th Street, New York City Cable: ARLAB

RIDER MANUALS *are complete* IN 14 VOLUMES

POWERFUL ALL-PURPOSE INDUCTION MOTOR

IDEAL FOR EXPERIMENTERS—101 USES



Sturdily constructed to precision standards, this self-starting shaded pole A.C. induction motor is powerful enough for a number of uses. Some of these are: Automatic Timing Devices, Current Interrupters, Electric Fans, Electric Chimes, Window Displays, Photocell Control Devices, Electric Vibrators, Small Grinders, Buffers and Polishers, Miniature Pumps, Mechanical Models, Sirens, and other applications.

Consumes about 15 watts of power and has a speed of 3,000 r.p.m. When geared down, this sturdy unit will constantly operate an 18-inch turntable loaded with 200 lbs. dead weight—**THAT'S POWER!** Dimensions 3 1/2" high by 2" wide by 1 3/4" deep; has 4 convenient mounting studs; shaft is 3/16" diameter, and runs in self-aligning oil-retaining bearings. Designed for 110-220 volts, 50-60 cycles, A.C. only. Shp. Wt. 2 lbs.

ITEM NO. 147 YOUR PRICE **\$2.95**

HUDSON SPECIALTIES CO.
25 West Broadway, New York 7, N. Y.
(See other advertisement on page 207)

NEW TINY POCKET SIZE RADIO!



Slips in your pocket or purse—Wt. only 3 ozs. Complete. **READY TO PLAY** as shown with self-contained phone for personal use. Smooth, durable black and silver plastic case. Has patented Fixed Crystal—Slide Tuning Dial! NO TUBES, BATTERIES OR ELECTRIC PLUG IN REQUIRED. Little if any upkeep cost—ever. Should last for years. **USUALLY RECEIVES LOCAL BROADCASTS CLEARLY** without outside aerial wire.

GUARANTEED TO WORK

when connected and used according to instructions sent with each radio. Can be used in homes, offices, hotels, cabins, bed, after hours, etc.

SEND ONLY \$1.00 (cash, money order, check) and pay postman \$2.99, plus delivery fees on arrival or send \$3.99 for postpaid delivery. **IDEAL GIFT FOR CHILDREN OR ADULTS. ALIKE!** Newest Practical Novelty. Get your **PA-KETTE RADIO** NOW for real enjoyment. **ORDER TODAY—NOW.** Dealers in most cities.

PA-KETTE RADIO COMPANY
DEPT. RC-12 KEARNEY, NEBRASKA

KEEP UP WITH POSTWAR RADIO! READ RADIO CRAFT!

**YOU NAME IT,
WE'LL SUPPLY IT**



**EVERYTHING IN RADIO
AND ELECTRONICS**

R. W. T., world's oldest and largest Radio Supply House is ready again with tremendous stocks of sets, parts and equipment. You can depend on our quarter-century reputation for quality, sound values and super-speed service. Orders shipped out same day received. All standard lines already here or on the way, including: National, Hammarlund, R. C. A., Hallicrafters, Bud, Cardwell, Bliley and all the others you know so well.

Originators and Marketers of the Famous

Lafayette Radio

Radio Wire

Television Inc.

100 Avenue of the Americas
(Formerly 6th Ave) New York 13
Boston, Mass. • Newark, N. J.

SEND TODAY!

R. W. T. DEPT. JL-5, 100 AVENUE OF THE AMERICAS, NEW YORK 13, N. Y.

I want your big new post-war Catalogue.

NAME _____

ADDRESS _____

NAME? (CALL LETTERS) _____

ENGINEER? SERVICE MAN? STUDENT?

U. S. CARRIER RADAR

(Continued from page 162)

line at the top of the board. When the planes are identified, they are then classified as either "bandit" or "friendly" and the color of pencil is changed accordingly. The course of the flight arc is then charted at one-minute intervals as shown by the same line travelling in an arc. The opposite-arc'd lines indicate "plot points" at one minute intervals. The purple arrow crossing the azimuth lines at the top indicates the present course of the ship. As the course changes, this line is erased and the new course is put in at its proper place. What appears to be a box score at the left of the board is exactly that. Enemy planes shot down are marked in one column with one color of pencil and our own losses are marked in another column with a different color of pencil. Once the correct number of planes is determined that number is also placed on the board and a box is drawn around it. Since the center of the board is the ship itself, distances relative to its position can be plotted accurately.

One operator can be seen behind the board and the hand of another can be no-

target, "ETD" is the Estimated Time of Departure from the ship after they are in satisfactory formation overhead, and "ETA" is the Estimated Time of Arrival back at the carrier. The column marked "Remarks" takes in a lot of territory and is used to cover any variation from the norm or any emergency that might occur. Thus a trained operator can tell the entire situation practically at a glance, where the enemy is, where the carrier's planes are, where the carrier is at the moment, what is happening as far as combat and patrol are concerned and several other factors.

Photo 1 shows a closeup of the antenna array of an Essex-class flat-top such as the U. S. S. *Lake Champlain*. In the foreground are five-inch gun batteries whose fire is directed by fire-control radar.

Photo 2 shows the same type of plotting board laid down to form a table top. Plotting in this case is accomplished entirely from the top, illumination being provided by overhead lighting. The picture was taken during operations in the China Sea in December of 1944. The cold calculation of

Photo 3—The Combat Information Center or control room on a flat-top carrier of the Essex class. A PPI (Plan Position Indicator) in use by a radar operator in this photo is being adjusted for signal pickup. The simple A scope can be seen just above his head to the left. A rack-and-panel set-up is employed in most of these installations.

Official U.S. Navy Photo



ted near the edge. These operators have to take special courses in writing backward quickly, legibly, and accurately. The reason these operators work from the rear of the board is that they do not obscure the fire controlman's view for even a moment. Therefore, these operators are trained to read and write backwards much the same as a printer or linotype reads type upside down and backwards. The operator sitting at the far right is one of the radarmen.

In addition to this board, what is known as a "Strike and Patrol Status Board" is shown set up alongside of this plotting Board. Fig. 1 shows the general layout of this type of board, which is also transparent. When a plane is sent out, its purpose and target is marked up in the space designated "Mission." The particular call letters or call code is put in under the column marked "Call." The operating frequency is placed under "Frequency." The next four designations refer to the four types of planes, i.e.; "VF" for Fighter, "VBF" for Fighter-Bomber, "VT" for torpedo plane, and "VB" for medium (or if possible, Heavy) bomber. "TTO" is the Time of Take Off from the carrier, "ETA" is the Estimated Time of Arrival back at the

the men working with the figures and information provided by the extra-sensory perceptions of radar and the air of tension surrounding them can be felt by the on-looker. This type of board is used on most of the larger ships. Most battleships carry them on their open deck rather than the transparent kind used on the carriers. Fleet displacements are plotted on this flat top board with the aid of different colors and sizes of movable "checkers."

Photo 3 shows the PPI (Plan Position Indicator) of a type used on the Navy's ships. The simple A scope can be seen in the upper center of the photo as part of the radar installation in the Combat Information Center. The Plan Position Indicator is the "scope into which the operator is looking. Such combination installations of two or even more types of radar are common aboard American battleships.

The importance of electronics in modern warfare is impressed upon every visitor who sees this combination of radar and communications apparatus, used not only for search and location, but to lay guns automatically on an enemy target, and even for the comparatively pacific purpose of helping navigate the vessel.

PULSE-TIME MODULATION

(Continued from page 161)

tion in relation to the marker-pulse. Since this variation in timing of the transmitted pulse corresponds to the audio-frequency of the impressed signal, it is only necessary at the receiver to have a device which is sensitive to these variations and which will convert them back to audible sound.

The marker-pulse serves to synchronize the receiver with the transmitter, so that the receiver will examine the input on each of the 24 channels in sequence, at the same rate of speed and repetition as the transmitter. It is apparent that each audio channel is actually "sampled," or interrupted, 8,000 times per second, but these interruptions occur at such high speed that they are not audible to the listener.

Since only the spacing of the pulses is important, requirements for the design of pulse-time modulation relay stations are much less critical than for those used with other methods of modulation. Moreover, since distortion is not cumulative any number may be used. Inasmuch as the pulse shape need not be exactly reproduced most of the noise that is inevitable in any receiver using vacuum tubes can be eliminated merely by clipping the bottoms and peaks of the received pulses, resulting in a much better signal-to-noise ratio than that obtained (for instance) with amplitude modulation. Crosstalk, or interference from adjacent channels, is completely eliminated because of the fact that only one channel is actually on the air at one time. Another advantage of the system is the fact that telephone

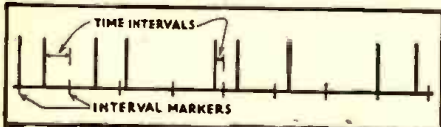

Fig. 3—PTM signals and interval markers.

dialing and bell-ringing operations can be affected simply, since it is entirely feasible to transmit direct-current for these functions without the need for additional equipment.

A number of programs can be sent at the same time by a system of multiplexing. At the transmitter, "fragments" of each program being sent are picked out by a radial beam tube, similar to the simple type shown in Fig. 4 which was described in the *Radio-Craft* August 1944 issue. The tube in use today is vastly more complex, but this type will suffice for an illustration of the principle.

As an announcer in the studio starts to speak, his voice is amplified at audio frequency and fed to one of the plates of the radial beam tube. The electron stream from the cathode is deflected either magnetically or electrostatically into a beam which revolves or rotates or scans at the rate of 24,000 times a second. It picks out a small "fragment" of the audio component (the announcer's voice or music as the case may be), from each plate as it passes around. As the beam continues scanning, it picks out a small sample from the other plates in the tube, which might carry voices of people, music, or conversations. When it comes around again to the first plate, another 1/24,000th of a second has elapsed and the next sample is taken.

If an announcer, for example, were to say the word "at," the beam would take only a small sample of part of the "a—" sound. As the beam comes around again, the next sample taken would still be of the "a—" sound, and so on. Since it might conceivably take two seconds for the an-

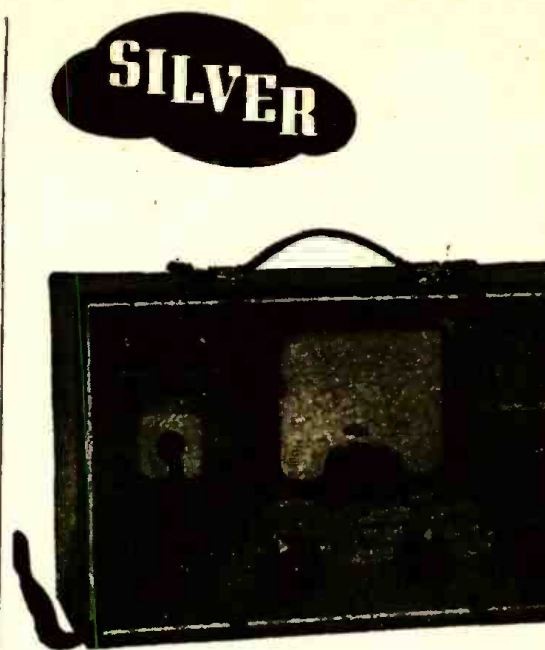

1. Brand new post-war design . . . positively not a "warmed-over" pre-war model.
2. More than an "electronic" voltmeter, **VOMAX is a true vacuum tube voltmeter** in every voltage/resistance/db. function.
3. Complete signal tracing from 20 cycles through over 100 megacycles by withdrawable r.f. diode probe.
4. 3 through 1200 volts d.c. full scale in 6 ranges at 50, and in 6 added ranges to 3000 volts at 125 megohms input resistance.
5. 3 through 1200 volts a.c. full scale in 6 ranges at honest effective circuit loading of 6.6 megohms and 8 mmfd.
6. 0.2 through 2000 megohms in six easily read ranges.
7. -10 through +50 db. (0 db. = 1 mw. in 600 ohms) in 3 ranges.
8. 1.2 ma through 12 amperes full scale in 6 d.c. ranges.
9. **Absolutely stable**—one zero adjustment sets all ranges. No probe shunting to set a meaningless zero which shifts as soon as probes are separated. Grid current errors completely eliminated.
10. Honest, factual accuracy: $\pm 3\%$ on d.c.; $\pm 5\%$ on a.c.; 20 μ through 100 megacycles; $\pm 2\%$ of full scale, $\pm 1\%$ of indicated resistance value.
11. Only five color-differentiated scales on 4 $\frac{1}{2}$ " D'Arsonval meter for 51 ranges (including d.c. volts polarity reversal) eliminate confusion.
12. Meter 100% protected against overload burnout on volts/ohms/db.
13. Substantial leather carrying handle. Size only 12 $\frac{3}{4}$ " x 7 $\frac{3}{4}$ " x 5 $\frac{1}{2}$ ".

SEND FOR FREE CATALOG!

OVER 34 YEARS OF RADIO ENGINEERING ACHIEVEMENT

McMurdo Silver Company
1240 MAIN STREET, HARTFORD 3, CONNECTICUT

nouncer to pronounce the word "at", 48,000 fragments of this one word would be taken! These successive fragments are then transmitted in pulses at a frequency of approximately 1300 MC. Thus while the fragments are taken and fed to the antenna at the rate

Cathode-ray picture of modulation by pulses. All are of equal amplitude. Modulation is effected by their spacing from a regular standard time interval. Total energy from the transmitter is concentrated in the vertical lines, base-line being supplied by the cathode-ray scope.

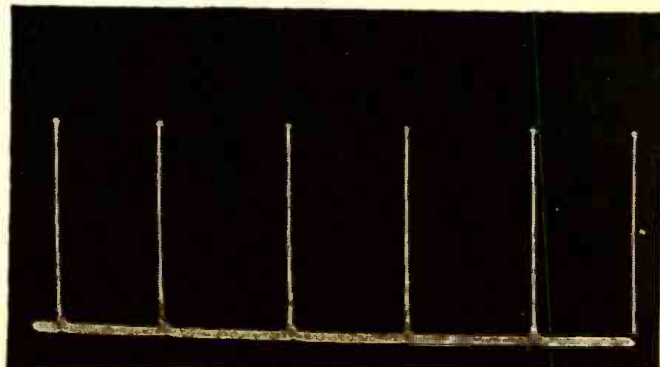

"VOMAX"

Measures EVERY Voltage

The secret of the overwhelming demand for "VOMAX" is just that simple. With it you can measure every voltage in radio receiver design and servicing.

"VOMAX" handles a wide range of d.c. and a.c. voltages of meter resistance so astronomically high that you can measure directly and accurately every such voltage. It goes far beyond conventional volt-ohm-meters. For "VOMAX" will measure every a.f., i.f. and r.f. voltage from 20 cycles right up to beyond 100 megacycles.

This remarkable post-war instrument gives you vitally important visual dynamic signal tracing. Read the briefed specifications at left practically a complete service station by itself . . . see how "VOMAX" makes you the master, no longer the victim, of tough service jobs. Imagine the time you'll save, the increased efficiency, the multiplication of your profits when you put "VOMAX" to work and can at last measure every voltage.

Requiring no priority and despite heavy demand, your favorite jobber can arrange quick delivery . . . if you act fast.

NET PRICE \$59.85
ONLY

AMATEUR PARTS & KITS

Born out of the war are many more money-saving new SILVER developments. As an up-to-the-minute amateur you'll want to know all about the new 904 resistance-capacitance bridge . . . new 1.6 thru 30mcs. "all-band" 5 to 500 watt transmitting inductors . . . u.h.f. tuners "harnessing" 112 thru 470 mcs. . . the new SILVER am/Im receiver/kit covering 1.6 thru 150 mcs. . . new "progressive" 5 to 500 watt xmitter/kit 1.6 thru 500 mcs. absorption frequency meter.

of 24,000 per second, pulses used to carry this and to provide the synchronizing time base are sent out at the rate of 1,000,000,000 a second. This pulsing would correspond to the carrier in an AM or FM system. The
(Continued on following page)

Everything FOR THE SERVICE DEALER

We have, ready for immediate delivery, a complete stock of tools, replacement parts, inter-communication systems, public address systems, test equipment . . . everything in radio equipment for the progressive service dealer. For big profit items . . . for quick delivery . . . place your order now with Leo.

6 TUBE AC-DC KIT

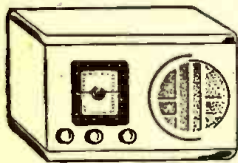

Complete,
ready for
assembly.

\$23.75

Cat. No. 7-691

A two-band, superheterodyne kit with all tubes, speaker, chassis, and all parts for easy assembly. Broadcast band from 540 to 1620 KC. Short wave from 5.7 to 18.3 MC. Cabinet, \$5.25.

WRL MULTITESTER

All purpose tester.
Money back
guarantee.

\$18.75

less leads

Cat. No. 16-439



Handles AC DC Voltmeter, DC Milliammeter, high and low range Ohmmeter. 3" meter with sturdy D'Aronsvaal movement. Size 5 1/2 x 8 x 3 1/4.

Exclusive at WRL!

Our latest flyer . . .

12 page V-J edition of

merchandise and

radio values. FREE.

Handy Tube-Base

Calculator25c

Giant Radio Reference

Map, 3 1/2 x 4 1/2 ft. . .15c

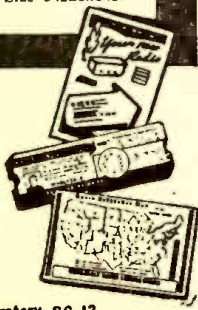

MAIL TODAY

Wholesale Radio Laboratory RC-12

744 West Broadway Council Bluffs, Iowa

Rush WRL Multitesters. Cost, \$

Send 6-tube AC DC Kits and cabinets. Cost, \$

I want a tube-calculator. 25c enclosed.

Ship me your radio map. 15c enclosed.

Send me your new V-J Flyer free.

Enclosed is \$; Balance C.O.D.

Name _____

Address _____

Town _____ State _____

I am an amateur; experimenter;

service man.

We invite industrial inquiries for electronic equipment and devices of all kinds.

QUICK SERVICE FROM LEO
"same day" delivery service from the heart of the nation . . . on anything in radio. Order today.

**Wholesale
RADIO LABORATORIES**

PULSE-TIME MODULATION

(Continued from page 197)

sampling pulses correspond roughly to the modulation characteristic.

The frequency of scanning is so rapid that it is not noticed by the listener. As a matter of fact, a telephone conversation employing pulse-time modulation approaches or surpasses FM in clarity. In this, as in broadcasting, a system of multiplexing using 24 channels is utilized to advantage.

For what is perhaps the first time, "P" can be distinguished from "T" and "F" from "S." No longer will there be any need for "I'm sorry, sir, but I can't understand you. Will you please spell that out." The code complexities of the "Able, Baker, Charlie," days will be gone forever with the advent of PTM on a universal scale.

The transmitting and receiving antennas shown in the photo are mounted at the focal point of the parabolas. The dipole can be seen upon close inspection as two rods inside the plexiglas antenna housing.

The dipole's actual size is about two inches in length by 1/4 of an inch in thickness. This is a quarter-wave antenna at the specified operating frequency.

The parabola is approximately eight feet in diameter and is placed in direct line of sight with another parabola at the receiving station. It will thus be possible to eliminate the "wire" in wire-telephony.

A demonstration recently put on by Federal Telephone and Radio Corporation at the International Telephone Building in New York, beamed 24 separate conversations to a repeater station at Telegraph Hill near Hazlet, New Jersey, then to another repeater station at Nutley, N. J., and from there back to the Telephone Building so that the circuits started and finished there, after travelling 80 miles. Repeater stations are required for approximately every thirty miles of transmission. These repeater stations operate automatically without human attendance. Although this demonstration circuit was only 80 miles long, it could have been 8,000 miles long provided sufficient repeater stations were utilized.

To properly realize what an improvement this is, a group of twelve telephone channels being operated on an amplitude modulation basis may be considered. Properly segregated, on a single sideband, they would occupy a band-width of approximately 50 kilocycles. If we consider the transmission of this group over a pair of wires between 10 and 60 kilocycles the band-width is five times as large as the frequency used.

If the same group is transmitted by radio between 10 megacycles and 10.05 megacycles (single side-band carrier suppressed), the band-width required is only one-half of one percent of the lowest frequency used.

If we now envisage the same transmission at 1000 megacycles (double side-band with carrier), the percentage becomes only one-hundredth of one percent. Thus the number of telephone channels that can be handled on a constant percentage band-width basis is extremely large on the higher frequencies. Several thousand telephone channels can be accommodated if required, in so far

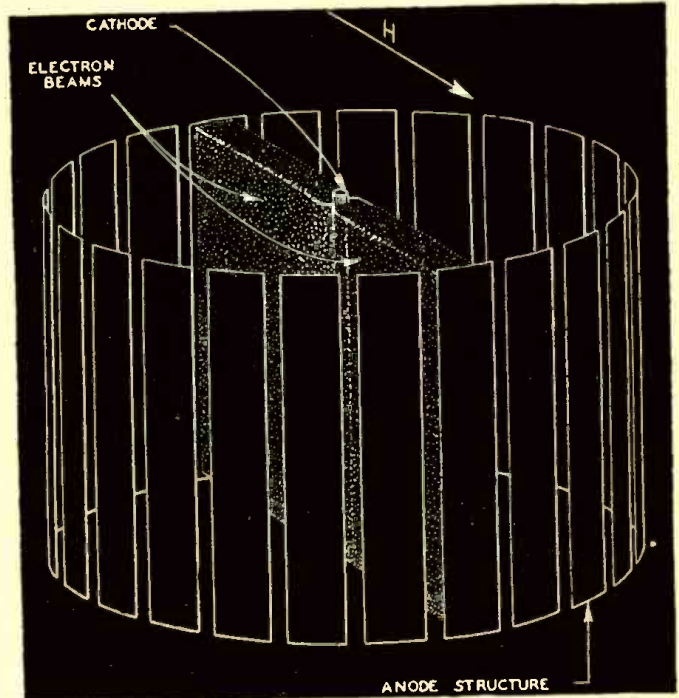
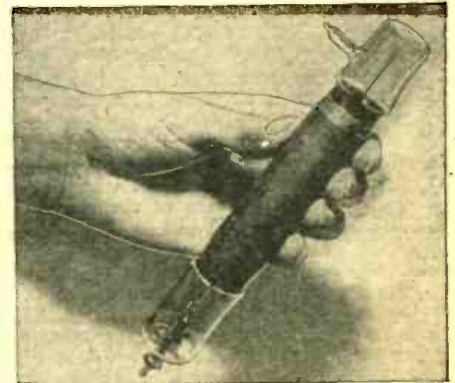

Fig. 4—Simplified presentation of the rotating electron beam tube.

as band-width considerations go.

Thus PTM opens up the most far-reaching possibilities in the field of transmission using very high frequencies, benefiting such branches of electronics as wireless telephony, color television, and improved broadcasting.

ATOM-SPLITTING TOOL



A Geiger-Muller tube manufactured by North American Philips. These tubes are standard detectors of X-radiation or particles from atoms, such as protons or electrons, hence are important in atomic experiments fission. In its simplest form, the Geiger-Muller tube consists of a central wire electrode and a concentric cylindrical metallic electrode separated by some noble gas such as argon.

Book Reviews

ALIGNMENT CHARTS; Construction and Use, by Maurice Kraitchik, Professor of Mathematics, New School for Social Research, New York. Published by D. Van Nostrand Co., Inc. Stiff cloth covers, 6 x 9 1/2 inches, 94 pages. Price \$2.50.

In this volume the basic theory of nomograms is built around determinants. For those not well acquainted with the latter or those who do not remember as much as they should, this subject is reviewed in the early chapters.

One chapter is devoted to scale conversion and actual examples and charts are given. These relate to trigonometric, hyperbolic, logarithmic and exponential functions, among others.

First the simpler forms of nomograms are discussed. These are the straight, parallel line forms. Later, non-parallel constructions are shown and finally special curved nomograms are analyzed. Actual charts are given throughout, to illustrate the theory.

This book will fit the library of the technician who has found nomograms interesting and useful, and who wishes more information than is usually available. A general knowledge of algebraic notation and procedure is desirable—*I. Q.*

APPLIED MATHEMATICS for Radio and Communication Engineers, by Carl E. Smith, Director of Engineering (on leave), United Broadcasting Co., Cleveland. Published by McGraw-Hill Book Company. Stiff cloth covers, 5 1/2 x 8 1/2 inches, 336 pages. Price \$3.50.

A book intermediate in style between the simpler mathematics for radiomen and the engineering math texts, this work approaches the latter far more closely in the ground covered. The simple style is probably due to its having been formerly part of a practical home-study course.

The first chapter, Arithmetic, shows the simple style to advantage in matter often skimmed over as review. Matter is explained so that even the student unacquainted with algebra can start without great difficulty. The relative magnitude of negative numbers, for example, is brought out so that he cannot fall into an error which appears more plausible than the correct conclusion.

Use of the slide-rule is taught in the chapter on logarithms, and operations with vectors are introduced in the chapter on geometry, which would be quite unrecognizable to a high-school geometry student. Trigonometry follows, introducing complex quantities, as the chapter on curves and graphs introduces simultaneous equations.

Determinants are handled in a remarkably clear manner. Hyperbolic functions are the subject of one chapter, and calculus occupies three. Series are dealt with in the last chapter of the book, which also treats wave forms.

There is an exceptionally long appendix (84 pages). This includes a table of Bessel functions and tables of exponential and hyperbolic functions in terms of nepers and decibels.

Electric bulbs are lighted by a match, in demonstrations of electronic apparatus by Dr. Philips Thomas of Westinghouse. The method is, of course, simple to any radioman. The match, when held close to the bulb, is in line with a photoelectric cell, which throws a relay and sends current through the lamp.

MICROPHONES ENGINEERED BY

Electro-Voice

Answers Everyday Sound Problems



Poly-Directional with Adjustable Polar Pattern

The high fidelity Cardak is readily adjustable to reduce any combination of reflected sound. Cuts reverberation or random noise pick-up... minimizes acoustic feedback.



Send for Complete Catalog

Gives valuable data on Electro-Voice Microphones, for communications, public address, broadcasting and recording. Includes helpful Reference Level Conversation Chart.

Authorized Distributors Everywhere

No finer choice than

Electro-Voice

M I C R O P H O N E S

ELECTRO-VOICE, INC., 1239 South Bend Ave., South Bend 24, Indiana
 (Export Division) 13 East 40th St., New York 16, N. Y., U. S. A.—Cables: Ardab



Maximum Intelligibility Under Extreme Noise

Hand-Held, close-talking single button carbon *DIFFERENTIAL microphone for all speech transmission in any noisy, windy, wet or extremely hot or cold location.

* Patent No. 2,359,010



Higher Articulation with Less Fatigue

Moving coil, hand-held Dynamic microphone for high fidelity speech transmission. Uniform response, free from peaks, in the useful frequencies give higher articulation.

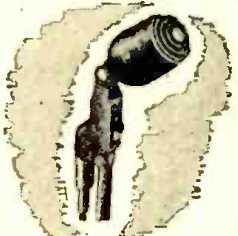

General Purpose Dynamic for Voice and Music

Widely used because of its dependable all-around performance. Excellent frequency response for both indoor and outdoor speech and music pick-up.

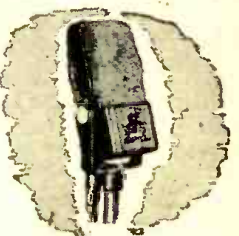

Velocity High Fidelity Bi-Directional Sound Pick-up

Wide, flat frequency response, bi-directional polar pattern, high fidelity characteristics, make it ideal for solo, orchestra, or chorus, for single speaker or groups.

ATTENTION:

RADIO MANUFACTURERS

America's finest moisture-proof tubular condensers are made by Good-All. Meet all Navy and Signal Corps specifications. Used by the millions by the Navy in the secret radar controlled shells. We are proud of our record, you'll be proud of this quality condenser in your radio. Free samples on request.

GOOD-ALL ELECTRIC MFG. CO.

Manufacturers since 1925. Oaflala, Nebraska

The Rock Island Line is installing radar to eliminate possibility of rear-end or head-on-collisions. This is probably the first peacetime use of radar on land analogous to marine use of the electronic navigator.

Make your own Talkies
 WITH PATD. **FILMGRAPH** RECORDER

CIRCULAR

FREE

and Instantaneous Permanent
PLAYBACK UNIT. Lengthy Recordings;
 Clear, Powerful; Eliminates Titles.

MILES REPRODUCER CO., INC. 812 BROADWAY, N.Y.3 RC-12

AVAILABLE AT ONCE
Government Surplus
 RECEIVERS, TRANSMITTERS
 OSCILLOSCOPES, TEST EQUIPMENT

Also our standard lines of Radio Kits \$10.95
 Multi-Testers \$14.95

Send for Details
RADIO KITS COMPANY
 Dept. M 120 Cedar St. New York 6, N. Y.



4 STANDARD TYPES
of Amperite Regulators replace over 400 types of AC-DC Ballast Tubes now in use.
Amperites are real REGULATORS... have patented Automatic Starting Resistor which prevents initial surge and saves pilot light.
... Ask Your Jobber.

AMPERITE

THE *Simplest* WAY TO REPLACE **BALLASTS**

WRITE FOR REPLACEMENT CHART
AMPERITE CO. 561 BROADWAY, NEW YORK, N. Y.

RADOLEK

Radio-Electronic Service Parts



Large stocks assure the finest and most complete selections of all available items at lowest prevailing prices. Thousands of active buyers depend on us for their entire Radio repair and replacement requirements. Because we understand service problems, every order is expedited for delivery in double quick time. Everything we do is planned for convenience and satisfaction to our customers. You will find it profitable to make Radolek your buying headquarters.

FREE BUYING GUIDES

Because of existing conditions we keep our customers right up to the minute on available merchandise by releasing supplements frequently instead of sending our regular Big Profit Guide once a year. Send the coupon now to get these Free Buying Guide Supplements as they are issued.

FREE!

RADOLEK
Buying Guide
RADOLEK COMPANY

FAST SERVICE!

RADOLEK CO., Dept. C-109
601 W. Randolph St., Chicago 6, Ill.

Please send FREE Buying Guide Supplements

NAME _____
ADDRESS _____

ORDER FROM RADOLEK

RADIO FUZE FIRES SHELLS

(Continued from page 160)

similar to a dynamite cap. When the thyatron is triggered by the impulse generated by the approach to the target, enough current flows in its plate circuit and passes through the electrical detonator to cause it to set the explosive charge or booster off. This in turn detonates the explosive filling in the projectile. A cutaway view of the fuze is shown in the photo, and a section drawing at the head of the article.

One of the first tubes—developed by the British with the aid of a Canadian company—was a tetrode of the stacked mica construction. Subsequent tests in the centrifuge and by firing from guns at the Aberdeen Proving Grounds established the fact that this tube was rugged enough to withstand the 20,000g (20,000 times the pull of gravity), which it must endure in its journey from the muzzle of a gun. However, its relatively large size and low amplifying characteristics were not immediately adaptable to use in fuzes for projectiles.

The tubes shown in Fig. 1 appear at first glance to be ordinary special-application types. Casual examination of these will not reveal startling differences from conventional tubes, yet in order to make them sufficiently rigid to prevent undue microphonics during actual use, every element and part had to be carefully designed to stand up under the strain encountered while shooting from a gun. Over 130 million tubes were manufactured during a five-year period, or just about one for every person in the United States. These were manufactured in great secrecy and employees of the companies building them generally believed that these tubes were for radar or hearing-aid use, although they must have sometimes wondered why there were such a tremendous number of deaf officers and enlisted men in the various branches of our armed services.

BATTERIES

The batteries themselves posed another difficult problem. Their shelf life—as little as three to four months under tropical conditions—was the one major disadvantage of the ordinary battery. Therefore, concurrently with research on the dry battery, investigations were carried on to develop a reserve or “wet” type of battery having a very long shelf life, possibly reckoned in terms of years. An innovation in battery design and manufacture was required. Not only was longer shelf life necessary, but the service requirements had broadened to such an extent that it became necessary to produce a smaller battery to permit adaptation of the variable-time fuze to small-caliber guns. All emphasis was placed on a National Carbon design which, in effect, eliminated the dry battery mix and substituted a suitable electrolyte stored in a glass container or ampule. The battery would become active only at the moment of use, when the shock of firing would shatter the ampule and permit the electrolyte to flow between the battery sections, causing current to begin flowing instantly.

One of the first tests on the completed unit was made in 1941. The primary objective of this test was to mount an oscillator circuit in a small shell and subject it to firing tests, noting the results. The oscillator was heard in a ground radio receiver while the shells were in flight, and even after, they were supposed to have landed.

Ten days later, it was discovered that the receiver sensitivity permitted an oscillator to be heard even when it was half-buried in the ground.

With such a sensitive and touchy device there was always the danger of premature explosion or muzzle explosion as the shell leaves the gun. Handling and safety devices had to be provided in addition to those normally included in the conventional time and contact fuzes. Since the detonation is primarily initiated by a miniature type of dynamite cap, one of the basic safety precautions consists of keeping this cap electrically shorted until such time as it is safe to allow it to operate. The cap, commonly called a cannon-primer; has an internal resistance of only 2-7 ohms, and will fire with small currents in the order of 50-100 milliamperes. Therefore the short circuit required to protect it must

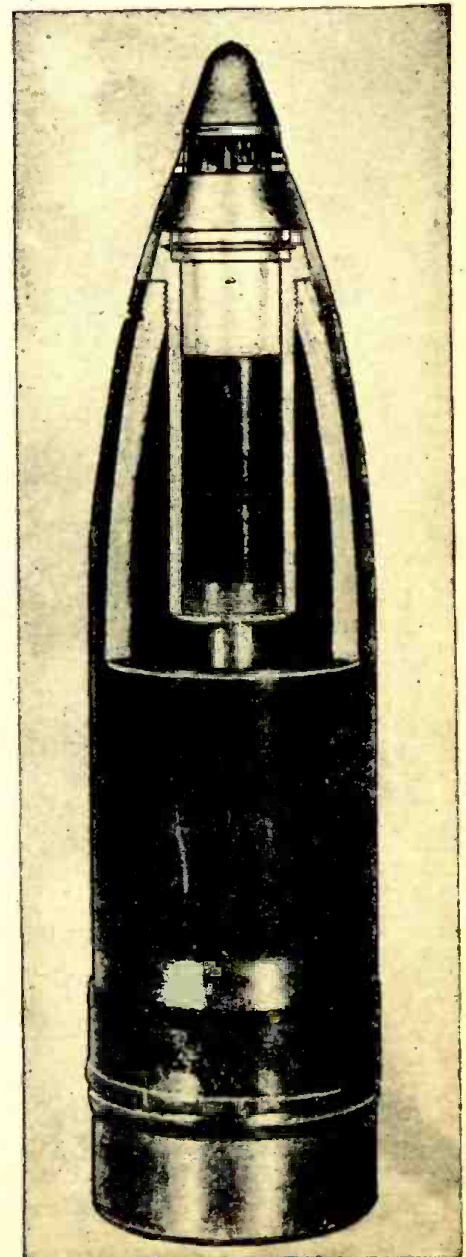

Cutaway view showing fuze inserted (at top).

have an extremely low resistance and must be mechanically secure, capable of withstanding rough handling, and not subject to an increase in resistance as a result of aging. The earliest device was a wire soldered into the circuit so that it effectively short-circuited the primer, and so arranged that the wire was broken after the projectile was fired from the gun. In some of the early designs, the setback force due to the firing of the gun was used to break this shorting wire, while in others, a clockwork mechanism was used to perform this function.

In addition to the safety devices within the fuze itself, there is attached to the base of each fuze an auxiliary detonator in which centrifugal force is used to move the misaligned explosive charges into alignment, thereby permitting the explosion of the cannon-primer to be passed on. Time-delay devices—to prevent muzzle explosions—have been primarily of two types. In one, a clockwork mechanism is used to give a fixed time delay, usually on the order of 5/10th of a second. In the other a mercury switch opens the electrical circuit after a period of time which is dependent on the rate of spin of the projectile. It contains two chambers, an inner or contact chamber in which the mercury maintains an electric short between a central stud and the outside case of the switch, and an outer chamber, or sump, which is empty prior to spin.

The two chambers are separated by a porous diaphragm. The switch is mounted on its side in the rear fitting. The spin of the projectile after it is fired forces the mercury out of the contact chamber through the porous diaphragm into the sump, thereby removing the short between the center contact and the outside shell. The

time of the delay safety period is determined by the porosity of the diaphragm and the spin of the projectile.

A reed spin switch provides a self-destructing feature in cases where the fuze might prove defective. It consists of a flexible metal reed molded at one end in a

**See page 159 for
a modified type of
radio fuse using
a wind generator**

plastic stopper inserted into an insulated metal cylinder. The switch is closed except when being held open by centrifugal force. It is placed in the circuit in such a way as to keep the firing condenser (a condenser which stores up charge and releases it at the instant of thyatron firing to insure sufficient current to detonate the primer) discharged when the projectile is at rest. Upon firing, centrifugal force immediately opens the switch and permits the firing condenser to charge. The fuze is now dependent on the mercury switch to prevent detonation within dangerous proximity to the gun. As the spin of the projectile decreases, the reed slowly returns to its position of contact, by which time the mercury switch has removed the short from the primer. When the reed touches the screw, the firing con-

denser discharges through the primer and detonates it. Nature then takes its course.

An additional self-destructing device is an impact element that assures detonation of the fuze on impact with the ground in case the proximity components fail to function. The prime reason for this safety feature is that fuzes may become functionally inoperative. Acceleration and spin of the projectile combine to produce a pull that would, in effect, cause a miniature tube weighing one ounce, to tip the theoretical scales at one hundred and twenty-five pounds! Breakdowns might well be expected to occur often.

The advent of the fuze in Europe had an interesting psychological effect on our own armies, for, simultaneously with the Ardennes offensive, the *Luftwaffe*, which had been in comparative retirement, suddenly appeared, and with equal suddenness, a large part of it disappeared, thanks to the VT fuze.

In a way, there is really nothing new about the *idea* of a proximity fuze, for the British had been working on one idea that was reported to operate on the Doppler effect and actually designed to be sensitive to varying radiation resistance. In addition, captured Nazi records show that the Germans were trying to develop an electrostatic or capacity-effect type since the early 1930's. There is quite a difference between trying to work out an idea, and actually producing that idea in mass quantities. We did that!

A tribute should be paid to the workers who made a real contribution to the war effort while feeling self-conscious about not being in uniform, and unable to explain satisfactorily to their friends—if not their draft boards—why they weren't in the front lines.

FIX ANY RADIO

Amazing New Invention

**Simplified
Radio
Servicing**

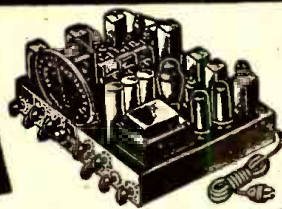

Find radio faults with a new simplified method. Repair all radios in minutes instead of hours. New, revolutionary different *Comparison* method permits you to do expert radio work almost immediately. Most repairs can be made without test equipment. Simple point-to-point, cross-reference, circuit suggestions locate faults quickly and easily. You may try this unique plan without risk or obligation.

Developed by
M. N. Beitman,
radio engineer,
teacher, author,
& serviceman.

NEW EDITION

REPAIR ANY RADIO IN MINUTES

Learn time-saving trouble-shooting short-cuts; find any radio fault with ease. Follow the tests shown on 24 large circuit blueprints. Over 1,000 practical repair hints. Hundreds of simplified tests using a 5c resistor and any filter condenser. Introductory material for beginners and to serve as review for experienced radio men. Several chapters on test equipment. Complete plan in manual form, 64 job-sheets, data on all tubes, large size: 8½x11 inches. Schematics, pictures, charts. Sold on no-risk trial. Use coupon to order—use plan this week. →

This newly developed method tells you how to locate the source of trouble in any radio set without equipment. Make needed tests, measure voltage, trace the signal, by using only a 5 cent resistor, small condenser, and a crystal detector. Inject signals without any signal generator. Test parts by the new *Comparison* method. Test tubes without equipment. Repair any radio expertly following simplified picture plans. Improve your radio servicing ability. Data on all sets, portables, AC-DC, FM, recorders, intercoms, P.A. Examine and apply the plan for 10 days without obligation or risk. Send trial coupon today →

COMPLETE PLAN
\$1.50

NO-RISK TRIAL COUPON

Supreme Publications

PUBLISHERS OF RADIO BOOKS, MANUALS, AND DIAGRAMS

9 S. Kedzie Ave.

Chicago 12, Illinois

Ship postpaid the new complete Simplified Radio Servicing manual for 10 days' examination. I am enclosing \$1.50, full price. I must be entirely satisfied or you will refund my total remittance.

NAME:

ADDRESS:BOD

LEEDS

The Home of RADIO

For more than 25 years, we have been supplying amateurs, servicemen and others, with parts, equipment, sets. Our friends come from practically every part of the globe and now that the war is safely concluded, we are prepared to give full and prompt attention to all orders and inquiries.

OSCILLOSCOPE
6 inch; made by Western Electric for U. S. Army. Complete with 12 tubes and 5 inch cathode ray tube **\$35**
Ship. wt. 175 lbs.

CENTURY CODE PRACTICE SETS
1000 cycle Century buzzer and brass key mounted on mahogany board, with on and off slide switch and connecting block **\$2.50**

QUARTZ CRYSTALS with holder—4 frequency: guaranteed; 3250 MC—4000 MC—4750 MC—3500 MC: each only ... **\$100**

GENERAL ELECTRIC SELSON MOTORS for beam antennas. Extra Special. Pair **\$18**

- | | |
|---|--------|
| GENERAL RADIO 106G—1 MH Standard of Inductance | \$6.00 |
| 9 foot aluminum collapsible antenna | 2.00 |
| Western Electric \$6 No. 1N-26 fixed crystal detector | .35 |
| Weston—0 to 3 amp. RF meters; each | 5.00 |
| General Electric pyranol ½ MFD-5000 v. condenser | 3.00 |
| Westinghouse 1 MFD-5000 v. oil condenser | 7.50 |
| Aerovox 1 MFD 10,000 v. oil condenser | 9.95 |
| Westinghouse 1 MFD 25,000 v. oil condenser | 37.50 |
| Gudeman 4 MFD 1000 v. oil condenser | .85 |
| Gudeman 4 MFD 500 v. oil condenser .. | .50 |
| Gudeman 1 MFD 600 v. oil condenser .. | .25 |
| Gudeman 2 X .5 600 v. oil condenser .. | .25 |
| .00025—7000 v. variable condenser, made by Hammarlund; worth \$30. Special | 5.00 |
| Split stator 15 MMF each section, silver plated condenser; ceramic insulation | .50 |
| Kenyon 2½ v. C.T. 10 amp, 10,000 v. insulation transformer | 3.00 |
| Glazed porcelain strain aerial insulators 7 inch | .10 |
| Ohmite 75 watt, 50 ohm rheostats | 1.00 |

LEEDS RADIO CO.
75 Vesey Street
COrtlandt 7-2612 New York City 7

RADIO Wholesale REPAIR

THIS IS THE ANSWER TO YOUR RADIO REPAIR TROUBLES!

Just SEND us the SET via Railway Express. We REPAIR and RETURN. You ADD MARK-UP AND DELIVER. That's all there is to it.

- Complete Stocks—We can fix 'em all
- 90 day guarantee
- Prompt service
- OUR LOW PRICES mean more Markup for you.

Send that set to
SHEFFIELD RADIO CO.

918 Belmont Ave., Chicago 14, Ill.

ELEMENTS OF RADAR

(Continued from page 170)

designed to operate with a pulse duration of perhaps 30, 40, or 50 microseconds.

As created by the synchronizer, the radar pulse should also have extremely steep sides (Fig. 2). The more abrupt, the more precise will be the final measurement of time by the indicator.

The function of the synchronizer—to generate a recurring pulse form of given duration—is purely electronic. That is, the timing circuits are concerned with the origination and formation of a waveform of low frequency—between 250 and 5000 cycles per second, the established p-r-f of the set.

This important frequency of repetition is usually established in the first stage of the synchronizer.

Then, after a recurrent wave has been generated, the several stages following are used to intentionally distort and reshape the waveform. The duration of the radar pulse is usually established in these later stages of the synchronizer.

TYPES OF SYNCHRONIZERS

Radar synchronizers or timers differ mainly in the methods of originating or establishing the pulse recurrence frequency or p-r-f. A resistance-tuned audio oscillator, multivibrator, or similar low-frequency oscillator performs this important function, usually in the first stage of the synchronizer.

Crystals are not necessary to establish oscillations, because of the low frequency of operation. But oscillations *must* be stable.

Most stable of sine-wave oscillators are those circuits using bridge stabilization. A typical oscillator is shown in Fig. 4, where a buffer amplifier is employed merely as an isolating stage. Oscillations are sustained by plate-grid coupling through a bridge network consisting of high-precision resistance and capacitance. The signal from plate to ground is reduced by this network by an amount equal to the gain of the oscillator tube, thus producing the required phase shift of 180 degrees. Negative feedback voltage is developed across the cathode resistor of the oscillator tube, maintaining a waveform that is essentially sinusoidal.

Fig. 6—Clipping and D. C. restoration circuits used in radar. Both triodes and diodes may be employed in clipping circuits.

Other types of bridge-stabilized master oscillators can be used to produce a sine wave output.

The frequency of the tuned bridge circuit determines the operating frequency of the stage of oscillation, and thus the p-r-f of the radar set. Once created, the sinusoidal voltage is applied to a series of distortion and pulse-shaping stages in the synchronizer to produce a steep-front pulse of the required duration. The large number of such additional stages is one of the primary disadvantages of a sine-wave oscillator.

Since the output of the first stage does not have to be a perfect sine wave but merely recurrent at a fixed frequency, a multivibrator can be used to supply oscillations.

A typical asymmetrical multivibrator (Fig. 5) uses two triodes or, more generally, a double triode of the 6SN7 type. The circuit functions in the conventional manner, but both the positive-going and negative-going waveforms are utilized. Normally, the positive-going wave is passed through appropriate pulse-forming stages to create a pulse of desired duration. The

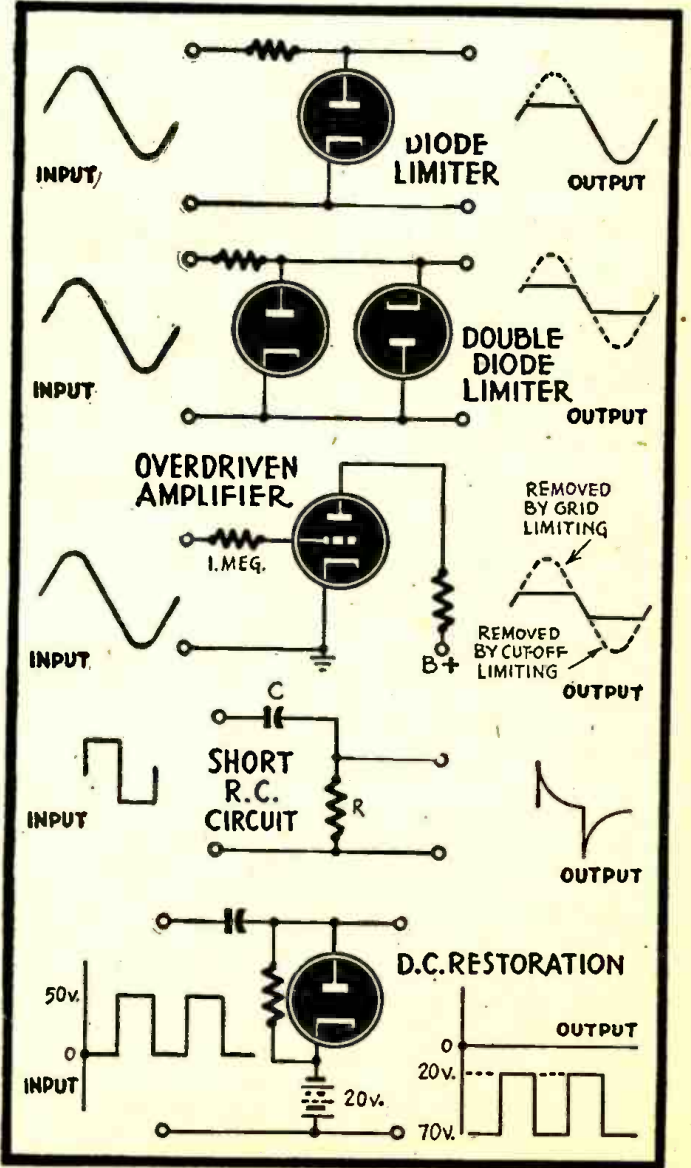

negative-going wave may be used as a "blocking signal" when applied to the cathode of the indicator oscilloscope. After passage through a suitable time-delay stage to synchronize both positive- and negative-going waves, the latter wave is also used to trigger the time base of the oscilloscope and perform a variety of other electronic switching functions in other components of the radar set.

Other types of master oscillators can be used in the first stage of the synchronizer. Modifications of the Hartley, Colpitts, Meissner, or similar circuits are acceptable—providing some degree of stabilization is employed.

Some types of master oscillators are externally synchronized, by introducing a waveform of constant and known frequency to the first stage. This wave may have any recurrent shape, and may be a harmonic or sub-harmonic of the desired pulse recurrence frequency. In some cases which use this means of synchronization, the first stage functions as an amplifier or buffer stage.

The only requirements of the output waveform of the master oscillator or first stage of the synchronizer are that the wave be recurrent and fairly stable in frequency.

SHAPING THE RADAR PULSE

After creation, the recurrent waveform is applied to a series of stages which shape the wave into a voltage pulse of desired duration.

There's no limit to the number or type of these pulse-forming stages in the synchronizer. They include limiter or clipper stages, overdriven or distortion amplifiers, peaking circuits, clamping circuits, cathode followers, and other special electronic circuits.

A *limiter* or clipper is a stage that removes one extremity or the other of an applied wave (Fig. 6). Limiters are used to square off waveforms. One or two diodes are usually used for this purpose, but triode circuits can also be employed. The "shearing off" action of the limiter is applicable to all kinds of wave shapes. With such a stage, rectangular pulses can be shaped from high-amplitude peaked waves.

Another form of limiting is the *over-driver amplifier*, employing a combination of saturation limiting and cut-off limiting (Fig. 6). During positive swings of the input voltage, the high-value grid resistor limits the grid voltage essentially to zero. During the negative input swing, the amplitude of the input voltage is sufficiently high to hold the grid beyond cut-off on the tube's characteristic curve for the greater part of the negative swing.

Distortion circuits are usually simple combinations of resistance and capacitance, the two having a high *time constant* with relation to the applied frequency. Such stages noticeably affect all waveforms other than *pure sine waves*. Thus, when a square wave of voltage is applied to a distortion circuit, the output waveform resembles a peaked or jagged wave—since the RC circuit tends to oppose voltage changes of any considerable frequency. Such a stage is also known as a *differentiating circuit*. (Fig. 6.)

Clamping circuits—sometimes called D.C. restorers—are used to hold either amplitude extreme of a waveform to a given reference level of potential (Fig. 6). The simplest type of clamping circuit utilizes a diode. But a variety of circuit arrangements may be used to hold a signal at any given reference level above or below ground.

(Continued on following page)



A background of Performance—over 50 years—is the inside story of the popularity that has brought leadership to Thordarson transformers.

Consumer acceptance will continue because Thordarson research and design engineers are never satisfied just keeping abreast of the times. These men are continually developing many transformer components which are instrumental in the production of new and better performing devices and equipment for the electronics industry.

Thordarson's well-tested methods of sales promotion and distribution will continue their joint task of making Thordarson Transformers, together with complete information on their applications and use, available to everyone in the field.

500 WEST HURON ST., CHICAGO, ILL.



ORIGINATORS OF TRU-FIDELITY AMPLIFIERS

THORDARSON
ELECTRIC MANUFACTURING DIVISION
MAGUIRE INDUSTRIES, INCORPORATED

THE "Quin-TIP-Lets" MAKE THEIR DEBUT

The electrical industry's newest, trimmest, slimmest soldering tool—the Ungar light-as-a-feather Soldering Pencil—now available in your choice of FIVE INTERCHANGEABLE TIPS—each an entirely different design to solve your particular soldering problems.



Model 776—handle only—80c each



Model 537—soldering tips—80c each



Model 538—soldering tips—80c each



Model 536—soldering tips—68c each



Model 539—soldering tips—80c each

PURCHASED IN QUANTITIES ONE TO TWELVE

Immediate Delivery—Available at All Our Branch Stores

RADIO ELECTRIC SERVICE COMPANY

701 Arch Street, Philadelphia 6, Penna.

3145 N. Broad St., Phila. 32, Pa.
513-515 Cooper St., Camden, N. J.
1042 Hamilton St., Allentown, Pa.

5133 Market St., Phila. 39, Pa.
219 W. 8th St., Wilmington 22, Del.
9 N. 2nd St., Easton, Pa.

SERVICEMEN'S HEADQUARTERS FOR QUICK DELIVERY!

We carry a complete line of Standard

Test Equipment
Amplifiers
Recording Devices
Phono-pickups
Microphones

and the hard-to-get equipment you have waited so long to obtain. Please send us your order or write us what you need. We will show our appreciation by rendering any helpful service to you.



This month's specials are on Weston!

VOLT-OHM-MILLIAMMETER
Model 697
Illustrated

24⁰⁰ NET

Weston Analyzer
Model 772 type 6
\$49.50 net

Weston Tube Checker Model 777

\$49.50 net

Consult us on your many sound problems and requirements. Estimates and help cheerfully given. We have many standard systems now available for immediate delivery. Priced from \$100.00 up, complete with tubes.

JACK GREENE

79 CORTLANDT ST.

NEW YORK, N. Y.

KELNOR

REG. U. S. PAT. OFF.

electric SOLDERING IRONS

AMERICA'S
FINEST LINE
OF LIGHTWEIGHT
IRONS

Designed for
most efficient
soldering in the

**ELECTRONIC,
RADIO AND
INSTRUMENT
manufacturing and
repairing fields**

Easily solders hard-to-reach connections. Cuts down fatigue, increases accuracy. Illustration above about one-third actual size; weighs 9 ounces. Order from your retailer or jobber.

KELNOR MANUFACTURING COMPANY
GENERAL OFFICES: CENTRAL TOWER, SAN FRANCISCO 3, CALIF.

ELEMENTS OF RADAR

(Continued from page 203)

Cathode followers are impedance-matching stages having less than unity voltage gain. They are used primarily as isolating stages, and have no effect on the wave form applied.

The number and arrangement of these pulse-forming stages in a synchronizer are unlimited. A typical arrangement of a complete radar synchronizer is shown in the block diagram of Fig. 7, with appropriate wave shapes indicated.

Important to remember: The output of

the synchronizer will be a series of recurrent, steep-sided pulses of equal duration. The repetition frequency or p-r-f will be the same as the original oscillating frequency of the master oscillator. And the voltage amplitude of the radar pulses will be sufficient to modulate the radar transmitter.

Next month the technical operation of the radar transmitter and antenna system will be considered in Part II of ELEMENTS OF RADAR.

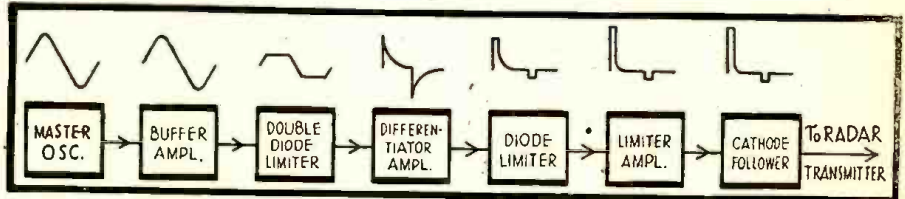

Fig. 7—Typical synchronizer for radar installation, represented in block-diagram style.

A SERVICEMAN'S SIGNAL TRACER

By W. G. ESLICK

THIS "tracer" was designed to fulfill its job simply, easily and be one of the most used instruments in the shop. It uses parts that are very easy to get; probably most servicemen have them lying around.

The "tracer" was designed to trace a signal (from a broadcast station or signal generator) from the antenna post to the speaker of any radio and to locate the faulty stage or part where ordinary instruments can locate the final fault. In this case it was A.C. operated so it could be used on A.C.-D.C. sets easily without any hum. We used what tubes we had, but the builder can use any that fulfills the purpose.

The tracer was designed to have one stage of R.F. amplification feeding into a diode detector which feeds into a common A.F. amplifier. No tube data or layouts are shown as the builder will have his own ideas as to what the finished unit will look like.

To operate this tracer, we'll say we have a radio which oscillates and another which is weak with tone distorted and which is worrying us.

Turn on the switch of the tracer and let it warm up. At the same time turn the radio on. Either have a broadcast station tuned in or signal oscillator hooked to the set. Turn tracer to R.F., fasten one probe to the set and touch the other to the antenna. Vary the gain control of the tracer till a signal is heard. Move probe to grid of first tube—either R.F. or mixer—and if signal is present, move probe to grid of next tube which will be the detector in small TRF sets or mixer or I.F. in superhets. In our test set, we had a signal up to the plate of the mixer—a 12SA7 here—but no signal in the grid of the I.F., a 12SK7. A

faulty transformer was found. So far we used only the R.F. end which uses the tracer as a complete untuned receiver.

On the next set (the one that oscillates) we set the tracer on R.F. and touched the cathodes, screen grids of the R.F.-Det.-I.F.'s and at every point where we could pick up a faint signal, we replaced a by-pass condenser. That cured the oscillation but we still had distorted tone. Now the tracer is switched to A.F. and the second detector cathode, screen grid is touched with the probe to see if the by-passes were doing their duty. They were O.K. For good measure we touched the probe to the AVC line to the controlled tubes to see if any audio frequency is present. If there were, it would mean that an AVC by-pass was open. After checking the second detector plate we find a good clean signal but when we move over to the A.F. (a 42 in this case) we find the signal distorted, so every-point points to the coupling condenser.

Remember we may pick up a signal at the cathode of an audio stage where the by-pass condenser is of very small value. This is O.K. if there isn't any motorboating, but NEVER should we find a signal on the screen grid.

Where hum is bad, turn tracer to A.F. and touch probe to the B plus wires. If loud hum is heard, we usually have a bad filter. (In a few cases it may be a shorted choke or leakage, but the tracer will locate the part at fault.)

Don't expect the tracer to do wonders. It depends on the user and how it is used. It will pin the fault down to a stage or part, where it then may be found by other means if necessary. This locating saves hours of hunting with test meters.

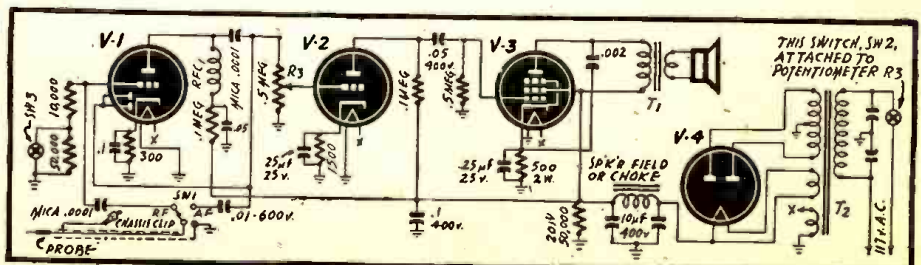

— TECHNOTES —

... PHILCO SETS

A common complaint on certain types of Philco sets with a shield on bottom of the chassis, is fading and/or noise. Take off the shield and replace the tape on the shield to insulate it. Solder all four corners securely. The trimounts do not seem to make good contact in all spots, giving rise to fading and noise intermittently.

BILL BUEHRLE, JR.,
Ferguson 21, Mo.

... CONDENSER BREAKDOWN TESTER

I have had some success with the following procedure in tracking down faulty coupling and by-pass condensers, generally intermittent. I have been using an electrolytic condenser charged across a high-voltage source as my tester. Each suspected condenser is first unsoldered at one end and the charged electrolytic condenser is then placed in parallel with it, observing polarity. The high discharge voltage blows any defective condenser and puts a speedy end to the usual "hunting-around method." This trick can also be used on other components such as coils, resistors, etc.

ELMER WOODS,
Los Angeles, Calif.

(It would not be wise to place a condenser, charged to several hundred volts, across a low-voltage by-pass or electrolytic condenser, as this might lead to a costly job of replacing condensers that formerly were in perfect condition! For the same reason, it would not be advisable to place so high a charge on a fine coil winding, for you might discover that it has suddenly become "open"!—Editor)

... SAFETY KINK

Here is a swell way to prevent accidental shocks and burns from exposed high-voltage jacks on panel fronts. Simply insert about an inch-and-a-half of ¼-inch bakelite rod fastened into a knob with a set screw, into the jack. The knobs can be neatly lettered with the designation of the circuit to which the jack connects. This not only prevents burns and accidental shocks but it also serves as a "delayer"—makes you stop and think twice before inserting a plug into a jack that might prove to be the wrong one.

BILL BUEHRLE, JR.,
Ferguson 21, Mo.

... MAJESTIC MODEL 380

Complaint: Rectifier tube G-84 burnt out. No replacement was available so I adapted an 0Z4 tube. The socket had to be replaced with an octal one. The filament

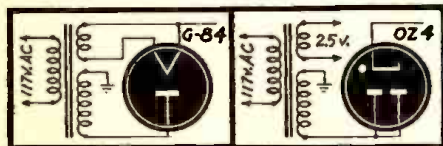

section of the power transformer isn't used. Either or both plates of the rectifier can be connected. The circuit is changed as shown in the diagram.

ALBERT MARTIN,
Pittsfield, Mass.

... EMERSON U-6-F

A common complaint on this set is "intermittent." If changing the audio and volume control—coupling condensers—fails, try changing the two condensers located under the band switch with the common ends connected to the 6A7 cathode.

GORDON V. WEEKS,
Inverness, Fla.



UNIMETER

This unit fulfills an extremely important need for general utility portable service equipment. It has wide range coverage for both a-c and d-c measurements of voltage, current measurements on d-c and the popular ranges on resistance.

The UM-3 is designed to clearly indicate all the functions which aid in the prevention of application of high voltages when preparing for current or resistance measurements.

Other G-E units for better servicing include: Tube Checker TC-3, Unimeter UM-4, and Oscilloscope CRO-3A.

For details write: *Electronics Department, Specialty Division, General Electric, Syracuse, New York.*

Electronic Measuring Instruments



GENERAL ELECTRIC **UM-3**

HALLICRAFTERS ★ HALLICRAFTERS ★



HENRY RADIO

is delivering

HALLICRAFTERS

Henry Radio is delivering:

EC-1A receivers	\$29.50	SX-25	94.50
S20R	60.00	SX-28A	223.00
S22R	74.50	S36A	415.00
S39	110.00	PM-23 speakers	15.00

Mail, wire, or phone your order. No restrictions. No priority required. You can send \$5.00 deposit and pay balance COD. You can trade in your receiver. You can buy on terms. Write for full information. Tell us your wishes. We will help you get the best receiver for your use and will see that you are 100% satisfied. We have a complete stock of all amateur receivers, transmitters, parts, etc. Let's get acquainted. Your inquiries welcomed.

HENRY RADIO SHOPS

211-215 N. Main St.
Butler, Missouri

2331-35 Westwood Blvd.
Los Angeles 25, Calif.

"WORLD'S LARGEST DISTRIBUTOR OF SHORT WAVE RECEIVERS"



CHOKE COIL KITS #236



AN OUTSTANDING VALUE! In this kit of 10 Radio Choke Coils, each choke is wound on a ceramic form. Can be adapted to all types of circuits. Any two chokes are worth the price of the entire kit — yet the cost of 10 assorted coils is only **79¢!** Shpg. wt. 1 lb.

This and many other remarkable values are featured in our newest catalogue of radio parts, tubes, tools and equipment.

DEPT. 12-E **SEND TODAY**
For Your FREE Copy to

RAPIDONE EQUIPMENT CO.
125 W. 42nd St., N.Y.C. 36

Flash! Amazing Opportunities NOW OPEN in These PRACTICAL Money-Making Trades!

watch and clock repairing

Learn At Home • In Your Sparetime Prepare for a happy future of prosperity, security... and get a big-pay job NOW. Fascinating, high-grade occupation. You can EARN WHILE YOU LEARN. An excellent field for part-time work at home.

COMPLETE COURSE IN HOROLOGY
A THOROUGH self-instruction training in American and Swiss watches, clocks. Special sections on alarm clock repairs. A new practical LEARN-BY-DOING instruction method. You Learn QUICKLY, easily. No previous experience necessary. Watchmaking is the basic training for aircraft instrument work and other scientific precision jobs. **Amazing LOW PRICE. Money-Back Guarantee.** Get into this fast-growing field NOW... big opportunities... don't delay. Mail coupon below for free information. No obligation.



locksmithing and key making

Complete UP-TO-DATE COURSE
How to pick locks, do-codes, make master-keys, repair, install service, etc. New, self-instruction lessons for every handy man, home-owner, carpenter, mechanic, service station operator, fix-it shop, hardware dealer, gunsmith.

53 EASY ILLUSTRATED LESSONS
Bargain Price! Satisfaction guaranteed or money back. Write now!

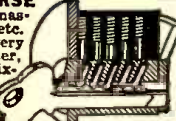

Free Details - Mail Coupon Today!

NELSON CO., Dept. 16M39, 321 S. Wabash, Chicago 4, Ill.

Please send me—FREE and without obligation—illustrated Success Catalog containing information about the course (or courses) I have checked below. No salesman will call.

Watch and Clock Repairing.
 Locksmithing and Key Making.

NAME _____
ADDRESS _____
CITY _____ STATE _____

HALLICRAFTERS

Shipments Being Made
Place Your Order Now
TRENTON RADIO CO.
MORGANTOWN, WEST VIRGINIA

From Pye Radio, Inc., in London, comes news of a new television transmission system, introduced there Oct. 31. The new system utilizes the fraction of a second in which the scanning beam shifts from the end of one line to the beginning of the next to send out pulses which carry the sound.

GERMAN RADAR
(Continued from page 166)

The set consisted of seven separate, demountable components: the transmitter, the antenna array, the electronic timer or modulator, the R.F. portion of the receiver, the quench generator and video amplifier of the receiver, and the indicator unit.

Two triodes were used in the transmitter to give an output power of about 450 watts peak, oscillating at a frequency between 450 and 550 megacycles.

A superregenerative receiver with automatic gain stabilization picked up the returning echoes.

The indicator unit consisted of three cathode ray oscilloscopes. Two tubes with linear time bases determined the azimuth and elevation of Allied aircraft under attack, and the third tube gave an indication of range on a circular time base.

The set was designed to operate at distances up to five miles, but it was only practical in tracking our night bombers within a range of less than two miles.

"SEETAKT" EQUIPMENT

Another use of radar by the Nazis was for locating the positions and movement of surface vessels.

The *Seetakt* (Fig. 8) was one of the first radar sets developed by *Gema*. The coast-watching equipment was in active use early in 1939, months before the war began.

The *Seetakt* was a fixed station, similar in construction to the Limber type *Freya*. And, like the *Freya*, the entire equipment was rotated in azimuth during the search for ship targets.

The *Seetakt* was always installed on high ground overlooked the water area to be scanned. At an elevation of about 500 feet, this set could detect and locate surface vessels up to a distance of about 30 miles.

The transmitter of the *Seetakt* had very poor efficiency, with a peak output power of less than 15 kilowatts. The electronic timer was significant, however, in that it required only two stages to produce the modulator or control pulse. The set operated at a frequency between 350 and 390 megacycles.

A variation of the *Seetakt* was a consid-

erably larger model (Fig. 9), having most of the same technical characteristics but employing a slightly different antenna arrangement.

Other types of radar were also used by the Germans for coast-watching activities. Prior to the Allied invasion of France, it was not uncommon for the Nazis to use any of the various types and classes of radar along the English channel and the North Sea.

WURZBURG EQUIPMENT

The most accurate and efficient radar equipment ever designed by the Germans was the Würzburg—with its many types and variations. Developed principally to direct the fire of anti-aircraft (Flak) guns, the sets were so popular that they were soon used to detect close-range attacking aircraft, to control searchlights and to locate surface vessels. The equipment was often used in conjunction with the *Freya* for aircraft height finding, and as a stand-by for ground control of aircraft interception.

The last model of the Würzburg—shown in Fig. 10—was put into use late in 1942.

A small, rotating dipole was situated at the focal point of a 10-foot parabolic reflector, resulting in an extremely narrow beam of radiation. The power output of the transmitter was about 10 kilowatts peak, and operated on any of several frequencies between 550 and 590 megacycles. In the transmitter-receiver unit 75 tubes were required.

The indicator unit of this set was equipped with three cathode-ray oscilloscopes giving range, elevation, and azimuth data. A fourth cathode ray tube was used for precision range finding.

This mobile set was modified by a larger parabolic reflector, measuring nearly 25 feet in diameter, for fixed installations.

The so-called Giant Würzburg (Fig. 11) had the same technical characteristics as the smaller models, and was used mainly for accurate ground control of aircraft interception. This 13-ton set was also used to detect shipping along certain parts of the English Channel.

Fig. 11—Giant WURZBURG, climax of Nazi development in radar. The big set had a reflector of wire mesh nearly 25 feet in diameter, and was used for detection of both air and surface craft.

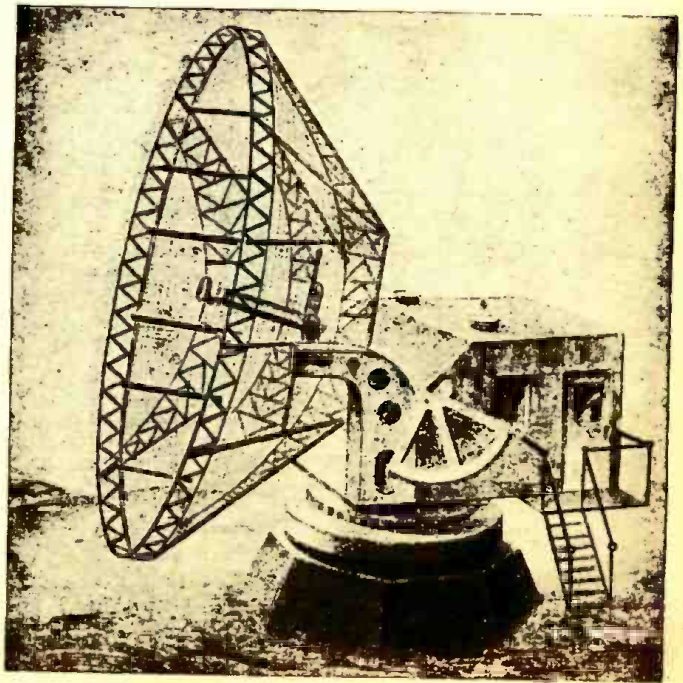

POWER OUTPUT STAGES

(Continued from page 173)

At 4000 ohms:

$$X_L = 6.28 \times 4000 \times .0015 = 37.68 \text{ ohms}$$

Making the assumption that the voice coil inductance is the value indicated at 400 cycles, and that the L value remains constant, it can be seen that the plate load for the tube would become highly inductive were it not for the presence of the shunt condenser across the plate load, which decreases in impedance value as the frequency is raised. Assuming a 20-to-1 turns ratio, at 4000 cycles the reflected inductive reactance in ohms would be 400×37.68 or 15,072 ohms. When X_c equals X_L , resonance is obtained. If X_c equals 15,072 ohms and the value of C is .006 mfd., at what frequency will resonance be obtained?

$$f = \frac{159,184}{15,072 \times .006} = 1760 \text{ approx.}$$

This would result in a resonant boost around 1760 cycles. If the limits of operation of the stage are 80 to 5,000 cycles, the mean frequency would be

$$\frac{5000 - 80}{2} + 80 = 2540 \text{ cycles}$$

By putting the resonant "hump" at 2540 cycles and using enough resistance in the circuit to give a broad resonant peak instead of a sharp resonance, the fidelity can be improved. The plate resistance of the tube is effectively in shunt with the primary of T, since the B supply has low impedance in the operating range. By using a low resistance tube such as a 2A3, the damping will be made even greater. Resonances will then be reduced and the output circuit will be linear to a greater extent.

PUSH-PULL OUTPUT CIRCUITS

Using a pushpull circuit, the voltage excitation on the output tube grids, grid to grid, will be twice the voltage excitation on a single grid, so that additional gain is necessary in the voltage amplifier to drive the output tubes. Lower hum and distortion are obtained with the pushpull arrangement, and there is no need for cathode circuit resistor by-passing. The value of R2 may be 70 ohms instead of 140 ohms. This is shown in Fig. 2.

The plate load for the tubes plate-to-plate, in this case, may be made 3000 ohms, instead of 4000 ohms. Using the 2000-ohm load we find that we can get an output of 2.2 watts with 3.5% second-harmonic distortion (which is important in a single ended stage) and the third harmonic distortion is 8.5% with the 2000-ohm load. We can stand the higher third harmonic in the single ended stage, particularly since the shunt .006 mfd. condenser will get rid of many of the harmonics. The reactance of this condenser at a harmonic frequency will be less than it is at a fundamental frequency. In the pushpull stage, because of the even order harmonic cancellation, we can use a circuit condition that will limit the production of odd harmonics and balance out the even harmonics in the core of the output transformer. With a 1500-ohm load per plate we get 10% second harmonic and 4% third harmonic output. Reduction of third-harmonic output from 8.5% to 4% is well worth while.

Transformer input is shown in Fig. 2, but the driver might be a phase inverter. Triodes will not tolerate as high input impedance as pentodes, so work better with transformer input, while resistance coupling inverters may be used with pentode tubes. Triodes or pentodes operating on higher plate voltages could be used, since the pushpull circuit is basic. When using triodes, however, maximum undistorted power output is obtained for a plate load about twice the tube plate resistance, while for pentode and beam power tubes the plate load is made a fraction of the plate resistance. In the case of the 25L6, having a 10,000-ohm plate resistance and load of 2000 ohms, the fraction is one fifth. Using a 2A3 with a plate resistance of 800 ohms, the recommended plate load is 2500 ohms, or about 3 times R_p , while the 45 using a 4600-ohm load for an R_p of 1700 has a ratio of 4600:1700 or about 2.7.

RADIO-CRAFT for DECEMBER, 1945

HAM HEADQUARTERS FOR

Equipment and Information

15 YEARS of Service

to HAMS throughout the
U.S. and Canada.

Complete Line

of nationally famous
Radio and Electronic
Parts and Equipment.

Thousands of Items

in stock right now . . .
comprising every well
known brand of Compon-
ent Parts and Equipment.



Get Started on Your

"DREAM SET" TODAY!

We have all the component
parts and equipment and our
HAM department, which is
staffed by Engineers, will gladly
help you with your problems.
Write, phone, or visit us today.

FREE

Write today for our current bulletins about extraordinary
values in surplus Radio and Electronic Component Parts and
Equipment.

Radio Product Sales Company

238 WEST 15TH STREET

LOS ANGELES 15, CALIFORNIA

Prospect 7471

Electricity

Models range from 350 to
35,000 watts, A. C. types
from 115 to 660 volts, 50,
60, 180 cycles, single or
three-phase and 400, 500
and 800 cycles, single
phase, D. C. types from 4
to 4000 volts. Also avail-
able in dual voltage and
special frequency types.



FOR RADIO AND
ELECTRONIC APPLICATIONS

ONAN ELECTRIC GENERATING
PLANTS supply reliable, econom-
ical electrical service for electron-
ics and television applications as
well as for scores of general uses.
Driven by Onan-built, 4-cycle gaso-
line engines, these power units are
of single-unit, compact design and
sturdy construction. Suitable for
mobile, stationary or emergency
service.

Model shown is from
W2C series: 2000 to
3500 watts; powered
by Onan-built, two-
cylinder, water-cooled
engine.

D. W. ONAN
AND SONS

2422 Royalston Avenue
Minneapolis 5 Minn.

Write
For Folder
690-A
describing
complete
Onan line.



FREE TO RADIO MEN

COLOR CODE and OHMS LAW CALCULATOR

Burstein-Applebee of Kansas City offers you this great convenience FREE. Easy to work. Solves many problems in a jiffy. FREE to radio men, electronic engineers and others in the business. Attach coupon to your letterhead.

MAIL COUPON NOW

BURSTEIN-APPLEBEE CO.
1012 McGEE, KANSAS CITY 6, MO.

Send me FREE Color Code and Ohms Law Calculator along with latest catalog.

I am _____
STATE CONNECTION IN INDUSTRY

NAME _____

ADDRESS _____

TOWN _____ STATE _____

A Better Selection from LAKE!

RADIO cabinets & parts

Portable Photograph case, of sturdy durable plywood, in handsome brown leatherette finish. Has blank motor board. As illustrated above, specially priced at **\$6.95**

Also blank table cabinets of walnut veneer in the following sizes, with speaker opening on left front side: (Note: 7 1/2" has center speaker grill.)

21" - 8 1/4" L x 5 1/4" H x 4 1/2" D	\$1.95
22" - 8 1/4" L x 5 3/4" H x 5" D	\$2.75
23" - 10 1/4" L x 7 1/4" H x 5 1/2" D	\$3.25
27" - 10 1/4" L x 7 1/4" H x 5 1/2" D	\$2.50
28" - 17" L x 9 1/4" H x 9 1/4" D	\$4.50
29" - 21" L x 9 1/4" H x 10 1/2" D	\$5.50

*Speaker opening in center of front side. Cabinets available in Ivory color and Swedish Modern. Write for prices.

POWER TRANSFORMERS

4, 5, or 6 Tube - 6.3V at 2 amp. **\$2.45**
50 Mill Power Transformer

7, 8, or 9 Tube - 6.3V at 3 amp. **\$2.65**
70 Mill Power Transformer

All types of radio cabinets and parts are available at Lake's lower prices. A large stock is listed in our catalog.

SERVICEMEN-RETAILERS
Join our customer list today.
Write for our NEW, 12 page, illustrated, elaborate catalog! Dept. C

LAKE RADIO SALES CO.
615 W. Randolph Street, Chicago 6, Ill.

Get Started in Radio



10 "HOW-TO-DO-IT" BOOKS

Get a solid foundation in radio by means of these 10c timely text books. Each clearly written, profusely illustrated, contains over 15,000 words. You'll be amazed at the wealth of information packed into these handy books. Excellent for reference-ideal for technical library. Your money back if not satisfied.

5 BOOKS for 50c
10 BOOKS for \$1.00
Sent to You Postpaid

- | | |
|--|-------------------------------------|
| No. 1-How To Make Four Dierle Short Wave Sets | No. 6-How To Have Fun With Radio |
| No. 2-How To Make The Most Popular All-Wave 1 and 2 Tube Receivers | No. 7-How To Read Radio Diagrams |
| No. 3-Alternating Current for Beginners | No. 8-Radio for Beginners |
| No. 4-All About Aerials | No. 9-Simple Electrical Experiments |
| No. 5-Beginners' Radio Dic. | No. 10-Television |
- Remit by check or money order-register letter if you send cash or stamps.
- RADIO PUBLICATIONS, 25D West B'way, New York (7)**

WORLD-WIDE STATION LIST
(Continued from page 180)

Location	Station	Frequency and Schedule	Location	Station	Frequency and Schedule
Leopoldville	OTC	11.720 6 to 7:30 am			
BELGIUM					
Brussels		11.645 evenings about 7:30 pm			
Brussels		11.785 5:30 to 6 pm; 8 to 8:15 pm	Chungking	XGOY 9.646	11:30 am; East Asia and South Seas beam, 11:30 am to 12:45 pm
Brussels		17.845 5:30 to 6:30 am			East Asia and South Seas beam, 6:35 to 8:40 am; North American beam, 8:45 to 10:40 am; European beam, 10:45 to 11:30 am; East Asia and South Seas beam, 11:30 am to 12:45 pm
BOLIVIA			Chungking	XGOA 9.780	11:30 pm to 12:45 am; 4:30 to 7:15 am
La Paz	CP5	6.205 5:15 to 9:45 pm	Chungking	XGOY 11.900	Allied Forces in Far East beam, 7 to 8 pm; Asia-Australia-New Zealand beam, 5 to 5:30 am; East Russian beam, 5:30 to 6 am; Japan beam, 6 to 6:30 am
BORNEO					heard 9:30 to 11:15 pm; also 8 to 8 am
Belikpapan		9.120 5 to 6 pm	Shanghai	XGRS 11.690	10:15 to 11:30 am
BRAZIL			Shanghai	XMHA 11.847	8 to 9 am
Rio de Janeiro	ZYC9	9.610 evenings till midnight	COLOMBIA		
Rio de Janeiro	PRL7	9.720 3 to 9:30 pm	Barranquilla	HJFH 4.880	heard at 9:30 pm
Rio de Janeiro	PSH	10.220 evenings	Bogota	HJAB 4.785	5 to 10:55 pm
Rio de Janeiro	PRL8	11.720 9:30 to 9:55 pm; off Saturdays and Sundays	Bogota	HJCA 4.865	evenings
			Bogota	HJCC 4.965	evenings
Rio de Janeiro	PST	12.080 6 to 7 pm	Bogota	HJCX 6.018	heard at 10:55 pm
BRITISH GUIANA			Bogota	HJCD 6.160	heard at 10:50 pm
Georgetown	ZFY	6.000 2:45 to 7:15 pm	Bogota	HJCT 6.198	evenings till 10:30 pm
BRITISH WEST INDIES			Cartagena	HJAP 4.925	9 am to 1 pm; 7 to 10 pm
Jamaica	ZOI	4.700 4 to 6:30 pm	Cartagena	HJAE 4.965	heard at 7:30 pm
	VRR4	11.595 heard at 10 am	Medellin	HJDE 6.145	4 to 10:30 pm
	VRR6	15.620	COSTA RICA		
BULGARIA			San Jose	TIPG	9.615 8 to 11:30 pm
Sofia		9.350 on at 11 pm	CUBA		
CANADA			Camaguey	COJK	8.665
Edmonton	VE9AI	6.005 11 pm to 1 am	Havana	COCD	6.130 9 am to 10 pm
Edmonton	CJCA	9.540 9:30 am to 11 pm	Havana	COCW	6.330 7 am to 10 pm
Montreal	CFCX	6.005 Sundays, 6:30 am to 11 pm; Monday to Saturday, 5:45 am to 11 pm	Havana	COCL	7.053
			Havana		7.100 heard at 8:30 pm
Montreal	CBFX	9.360 6:30 am to 10:30 pm	Havana	COCG	7.190 heard afternoons
Montreal	CBFX	9.630 Evenings till 11:05 pm	Havana	COCO	8.696 7 am to 11:30 pm
Montreal	CHOL	11.730 European beam, 3:15 to 6 pm	Havana	COCQ	8.830 4:30 am to 12:30 am
Montreal	CBFZ	15.190	Havana	COBZ	9.030 7 am to 11 pm
Montreal	CHTA	15.220 European beam, 6 am to 3 pm	Havana	COCX	9.270 heard at midnight
Toronto	CFRX	6.070	Havana	COBC	9.365 heard at 5:30 pm
			Havana	COBL	9.833 7:15 am to 11 pm
Vancouver	CBRX	6.160	Havana	COX	11.616 11 am to 11 pm
Vercheres	CBFW	6.090	Havana	CMCY	11.680 afternoons and evenings
Vercheres	CBFY	11.705 10 to 11 am	Havana	COCY	11.740 afternoons
Winnipeg	CJRO	6.150 9 to 11 pm	Havana		12.270 evenings
Winnipeg	CKRX	11.720	Santa Clara	CMA5	15.505 6:45 to 7:30 pm
CEYLON			Santiago	COHI	6.455 8 am to 1 am
Colombo	ZOJ	11.810 5 am to noon	San Jose	COKG	9.950 6:30 am to 10 pm
Colombo	ZOJ	15.275 5 am to 10 pm and midnight	CURACAO		
CHILE			Willemstad	PJCI	7.250 3 to 4:30 pm
Santiago	CEI180	12.000 late afternoons	Willemstad	PJY9	9.340
CHINA			CZECHOSLOVAKIA		
Chungking	XGOY	6.140 6:30 to 10:30 am	Prague	OLR2A	6.010 11 pm to 12:45 am
Chungking	XGEA	6.180 fem announcer at 7:30 and 10:30 am	Prague	OLR3A	9.550 2 to 5 pm
			DOMINICAN		
Chungking	XGOY	7.153 East Asia and South Seas beam, 6:35 to 8:40 am; North American beam, 8:45 to 10:40 am; European beam, 10:45 to 11:30 am	REPUBLIC		
			Ciudad Trujillo	HIIN	6.243 evenings
			Ciudad Trujillo	HIIZ	6.315 4 to 9:30 pm
			Santiago	HI2A	7.080 10 am to 1:30 pm; 4:30 to 8:30 pm
			Ciudad Trujillo	HI2G	9.130 heard at 9 pm
			Ciudad Trujillo	HI3X	12.110 11 am to 1:30 pm; 5 to 9:30 pm
			ECUADOR		
			Ciudad Cuenca		
			Quito	HC5EH	3.935 6 to 10:30 pm
			Quito	HCJB	6.240 evenings
			Quito	HCIBF	7.160
			Quito	HCJB	9.965 afternoons and evenings
			Quito	HCJB	12.445 afternoons and evenings
			Quito	HDD	13.000 2:45 to 3:30 am
			Quito	HCJB	15.110 mornings and afternoons
			EGYPT		
			Cairo	JCPA	7.190 10:30 pm to midnight; 2 to 3 am
			EL SALVADOR		
			San Salvador	YSO	7.815
			San Salvador	YPSA	10.400 evenings
			ENGLAND		
			London	GRC	2.880
			London	GRB	6.010
			London	GWS	6.085 European beam, 11 pm to 2:45 am
			London	GSA	6.050
			London	GRR	6.070



"You say you're a radioman? Well, start oscillating!"

Suggested by: Alvin Kolodzeske, Manitowoc, Wis.

HARD-TO-GET PARTS

METERS

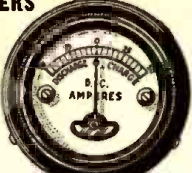
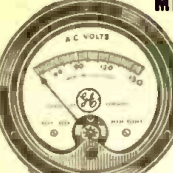

GENERAL ELECTRIC, A.C. Voltmeter, 0 to 150 volts, type AO22, 3 1/4" flush mounting. Shp. weight 2 lbs. ITEM NO. 163 YOUR PRICE \$8.75

GENERAL ELECTRIC, A.C. Ammeter, 0 to 150 Amperes, type AO22, 3 1/4" flush mounting. This is a 5-ampere A.C. meter and may be used as such with no changes. For the 150-ampere range, a current transformer is necessary. Shipping weight 2 lbs. ITEM NO. 164 YOUR PRICE \$7.75

BOYT D.C. Ammeter, 50-25-0-25-50. Type 531. 1 1/2" flush mounting. Shp. weight 1 lb. ITEM NO. 165 YOUR PRICE \$1.75

ULTRA MAGNET

LIFTS MORE THAN 20 TIMES ITS OWN WEIGHT

LITTLE GIANT MAGNET

Lifts 5 lbs. easily. Weighs 4 oz. Made of ALNICO new high-magnetic steel. Complete with keeper. World's most powerful magnet ever made. The experimenter and hobbyist will find hundreds of excellent uses for this high quality permanent magnet. Measures 1 1/4" x 1 1/4" Shp. Wt. 1/2 lb. ITEM NO. 159 YOUR PRICE \$1.50



GENUINE MICROPHONE TRANSMITTERS



Regular telephone transmitters taken from a large telephone supply company's overflow. Work perfectly on 2 dry cells. Can be used on P.A. systems, call systems, intercommunications, etc., short-line telephone circuits, house-to-house or farm-to-farm phone lines, also to talk through your own radio or as concealed dictaphone pick-up. Useful replacements on battery-operated rural telephone lines.

THESE ARE GENUINE TRANSMITTERS, MADE BY KELLLOGG, WESTERN ELECTRIC AND STROMBERG-CARLSON. Excellent in appearance and operation. A remarkable value and one seldom offered in these times. Shp. Wt. 1 lb. ITEM NO. 160 YOUR PRICE \$1.50

AMAZING BLACK LIGHT!

Powerful 250-Watt Ultra-Violet Source

The best and most practical source of ultra-violet light for general experimental and entertainment use. Makes all fluorescent substances brilliantly luminescent. No transformers of any kind needed. Fits any standard lamp socket. Brings out beautiful opalescent hues in various types of materials. Swell for amateur parties, plays, etc. to obtain unique lighting effects. Bulb only. Shp. Wt. 1 lb. ITEM NO. 87 YOUR PRICE \$1.95

WESTERN ELECTRIC BREAST MIKE

This is a fine light-weight aircraft carbon microphone. It weighs only 1 lb.

Mike comes with breastplate mounting and has 2-way swiveling adjustment so that it can be adjusted to any desired position. There are 2 woven straps; one goes around the neck, the other around chest. Straps can be snapped on and off quickly by an ingenious arrangement.

This excellent mike can be adapted for home broadcasting or private communication systems. By dismounting breastplate, it can be used as desk mike.

Comes complete with 6-foot cord and hard rubber plug. Finished in unscratched plate, non-rustable. Shipping weight, 2 lbs.

ITEM NO. 152 YOUR PRICE \$2.55



WATTHOUR METER

Completely overhauled and ready for immediate service.

Designed for regular 110-volt, 60 cycle 2-wire A.C. circuit. Simple to install.

2 wires from the line and 2 wires to the load. Sturdily constructed in heavy metal case, 8 1/2" high, 6 1/2" wide, 5" deep. Westinghouse, G. E. Ft. Wayne, Sanyamo or other available make. Shp. Wt. 1 1/2 lbs.

ITEM NO. 33 YOUR PRICE \$4.95



HUDSON SPECIALTIES CO.

40 West Broadway, Dept. RC-12-45, New York 7, N. Y.

I have circled below the numbers of the items I'm ordering. My full remittance of \$... (NO C.O.D. include shipping charges) (NO C.O.D. ORDERS UNLESS ACCOMPANIED WITH A DEPOSIT.) OR my deposit of \$... is enclosed (20% received, ship order, O.K. balance, NO C.O.D. ORDER FOR LESS THAN \$5.00. (New U. S. stamps, check or money order accepted). Circle Item No. wanted: 163, 164, 165, 159, 160, 87, 152, 33

Name

Address

City

State

Please Print Clearly

Location	Station	Frequency and Schedule
London	GWM	6.090
London	GSL	6.110 North American beam, 9:15 to 11:45 pm
London	GWA	6.125
London	GRW	6.150 Central American beam, 7 to 10:30 pm; South American beam, 7 to 9:15 pm
London	GWK	6.165
London	GRO	6.180 European beam, 12:30 to 2:45 am; 4:30 to 5:30 pm; African beam, 12:30 to 12:45 am; 1:15 am; 1:30 to 1:45 am; 2:30 am; 4:30 to 5:30 pm
London	GRN	6.195
London	GRS	7.065 African beam, 11 pm to 12:30 am; 4 to 5:30 pm; Mediterranean beam, 11 pm to 3:30 to 5 pm; Italian beam, 11 pm to 2 am; 1 to 5:30 pm
London	GRM	7.120 Australian beam, midnight to 10:45 am; New Zealand beam, midnight to 10:45 am
London	GRT	7.150 European beam, 11:30 pm to 2 am; 5 to 7:30 am; 10:15 am to noon; 12:30 to 4 pm
London	GRK	7.185
London	GWL	7.205 African beam, 2 to 3:30 pm; European beam, 5 to 7:45 am; 10:15 am to 4 pm
London	GSW	7.230 Australian beam, 11 pm to 2:45 am
London	GWI	7.250
London	GSU	7.260 North American beam, 4:15 to 11:45 pm
London	GWN	7.280 European beam, midnight to 12:30 am; 1 to 2:15 am; 5 to 7:30 am; 10 to 11 am; noon to 1:40 pm; 2 to 5:30 pm
London	GRJ	7.320 Near East beam, 11 pm to midnight; South American beam, 6 to 10:30 pm; Italian beam, 11 pm to midnight.
London	GRI	9.410 African beam, 12:30 to 2:30 am; 5:30 to 7:45 am; 10:30 am to 1 pm; 2:30 to 5:30 pm; European beam, 12:30 to 2:45 am; 5 to 7:45 am; 10:15 am to 4 pm; 4:30 to 5:30 pm
London	GWF	9.490
London	G5B	9.510 Near East beam, 11 pm to 1:15 am; 12:30 to 4 pm; South American beam, 4 to 9:45 pm; Italian beam, 12:30 to 3 am; 12:30 to 4 pm
London	GWJ	9.525 Near and Middle East beams, 11:45 pm to midnight; 3:30 to 4 pm; African beam, 3:30 to 4 pm; European beam, 11:30 pm to 1:45 am; 5 to 8 am; 10:15 to 11:30 am; noon to 4 pm

CORRECTION

In the diagram of a two-tube phono amplifier on page 788 of the September issue, two dots have run together in printing. This connects the filament of the 45 tube, which is the high-voltage element, to ground. Such a connection would effectively short out the high-voltage supply, and the amplifier would not work if left on too long, the 45 would also be damaged.

Our thanks are due to Mr. E. Delphia of Mt. Vernon, N. Y., who was the first of a number of our readers to call this to our attention.

Radiomen's Headquarters

BUFFALO RADIO SUPPLY

219-221 Genesee St., Dept. C
Buffalo 3, N. Y.

All Kinds of Radio Tubes in Stock at Best Wholesale Prices

Mail in your orders for all types needed, not just the critical numbers, and we'll try to fill them completely !!!

Bargains in Wire: No. 18 POSI, 2 conductor parallel rubber Zipcord, black or brown, 250' spool, \$4.00, No. 18 EF (fixture wire), 1000' or 2000' spools, \$6.95 per M; No. 18 SV, round rubber covered double wire for electric drills, wash machines, etc., 250' for \$5.95; No. 18 single conductor stranded with spun glass 5000V insulation, per foot, \$0.02; No. 18 PO brown rayon covered parallel lampcord, 250' spool, \$4.50. All kinds of hook-up wire in stock.

Replace broken radio plugs with new bakelite plugs or caps, 100 for \$2.00.

27 most popular asst. radio dial bolts in metal cabinet with belt hook, \$3.75.

Universal Microphone Co. high grade Model W sensitive single-button Carbon microphone with diagrams for use included, only \$2.95; 3 Pole double throw slide switches, \$1.15; Highest quality Stromberg Carlson input and output Push-Pulls in single brown crackle case (for 6P6, 6V8, etc.), \$1.20.

SPEAKER SPECIALS—P. Magnet Dynamics—2 1/2" \$1.45; 4" \$1.45; 5" \$1.25; 6" \$1.75; 8" \$3.95; 10" \$3.95; 12" (21 oz. magnet) \$7.95. Electro-dynamics—4", 5", or 6"—\$1.50.

92" highest grade standard type 8 section car aerials, with low-loss lead—\$2.95.

115 V., 60 cycle, Half Shell Power Transformers at prices you can't beat.

4 or 5 Tube Sets, 850V, 40 MA. HT., 5V FIL, and other 6.3 or 2.5 FIL. \$1.40
5 or 6 Tube Sets, 850V, 45 MA. HT., 5V FIL. 1.55
6 or 7 Tube Sets, 675V, 50 MA. HT., 5V FIL. 1.70
and either 6.3 or 2.5 FIL. 1.70
7 or 8 Tube Sets, 700V, 70 MA. HT., 5V FIL. 2.05
and either a 6.3 or two 2.5 FIL. 2.05
9 to 11 Tube Sets, 700V, 100 MA. HT., 5V FIL. 2.75
and either a 6.3 or two 2.5 FIL. 2.75
Filter Chokes, Cadmium Plated Straps, 2" Mounting, 200, 300, 400 or 500 ohms .49

AUDIO TRANSFORMERS: 1 Plate to Single Grid, 3:1, \$6.9; 1 Plate to Push-Pull Grids, 3:1, \$6.9; Universal Output Tapped for Various Impedances, \$7.9; Single or Double Button Mike Transformers, \$6.9.

High Grade Shure Crystal Pickups—\$3.75

Condensers guaranteed 1 year. Prices in Lots of 10, either 1 type or asst. 100 Mfd. 25V—35; 50 Mfd. 150V—45; 20-30 Mfd. 150V—40; 20-20 Mfd. 150V—30; 25 Mfd. 25V—20; 10-10 Mfd. 450V—45; 20 Mfd. 150V—20; 16 Mfd. 450V—40; 12 Mfd. 150V—15; 10 Mfd. 450V—27; 10 Mfd. 50V—15; 8 Mfd. 450V—23; 25 Mfd. 600V—18; 1 Mfd. 600V—10; .05 Mfd. 600V—09; .02 Mfd. 600V—08; .01 Mfd. 600V—08; .008 Mfd. 600V—05; .005 and all smaller capacities in 600V rating—.07 each; 100 asst. now but out-dated condensers, no guarantee, average 3 pounds—\$3.90.

Bullet Crystal Mikes—\$5.45, Bullet Dynamic Mikes—\$7.45. Free Stroboscopes with each order while supply lasts. Send for our test equipment catalog.

LOWEST PRICES • COMPLETE STOCKS
FAST SERVICE
STANDARD MERCHANDISE!

Amazing Electric Switch

ELECTRIC SWITCH OF A THOUSAND USES.
MILLIONS NOW IN USE.

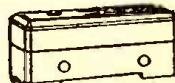

Turn on your porch light when you open the door—sound an alarm when the mail is put in the box—shut off the water when the tank gets full, these and many other services are performed with this amazing switch. Shipped with an instruction sheet showing more than 40 illustrated uses for this device, at the bargain price of \$1.00 postpaid.

ELECTRONIC PRODUCTS CO. St. Charles 11, Illinois

RADIO SERVICEMEN:

RADIO PARTS—TUBES

BARGAIN PRICES—NO PRIORITIES

KING P.M. SPEAKERS, 4 or 8 inch \$1.19
12.5KT, 250V, 2.5G, 50LGT98
FILTER COND., 20-20 Mfd., 150 V98
BY PASS COND., .01, .02, .05, 1-600 V07
VOL. CONT., 5 Meters, W. SW., Tap, 3" shaft98
A.C. CORD and PLUG SET, 8 Ft.39
RESISTOR KIT—50 Ass'd, 1/3 to 1 Watt99

Write Today for Bargain Bulletin
RADIO DISTRIBUTING CO., Pasadena 18, Calif.

150 DIAGRAMS and HOW TO READ THEM
150 DIAGRAM BOOK FREE
 For Examining My
 New 7 Volume Set on
ELECTRICITY

HERE'S a valuable book of 150 Electrical and Radio wiring diagrams with charts and instructions. Practical information you need to win security and promotion. It's yours FREE merely for examining my 7-Volume Set on Applied Practical Electricity on 7-day's free trial. This 7-Volume Set COVERS EVERYTHING ELECTRICAL from HOUSE WIRING to ADVANCED AC-DC MOTORS and EQUIPMENT. Thousands of diagrams and photos... written so both "beginners" and "old-timers" can easily understand.

7-DAY'S FREE TRIAL I want to send you the 7-volume set AT MY RISK, postpaid, for 7-day's FREE examination. I'll also send you the FREE book of 150 Shop Prints which you are to keep as my gift regardless of whether or not you return the 7-book set. (No salesman will call.) Offer Limited—Send Coupon Now!



FREE COUPON NOT AN ORDER—JUST A REQUEST TO SEE BOOKS

H. C. Lewis, Pres., Coyne Electrical School, Dept. 95-T1, 500 S. PAULINA STREET, CHICAGO 12, ILLINOIS
 Send me the new 7-volume set "Practical Electricity." Also send the book of 150 Shop Prints which is a FREE gift to me regardless of whether or not I keep the 7-volume set. I'll either return the 7-book set in 7 days and keep the 150 Shop Prints book as a gift from you and owe you nothing, or pay \$3 within 7 days and \$3 a month until \$21 is paid, or I'll send the cash price of \$19.75. One year FREE Consultation Service and Technical Bulletins included.

NAME _____ Age _____
 ADDRESS _____
 TOWN _____ Zone _____ STATE _____
 Check here if you want to save \$1.25 by paying the postman the cash price of \$19.75 on delivery. Same 7-day's examination and Money-Back Guarantee.

SIGNAL CORPS TELEGRAPH KEY



Genuine U. S. Signal Corps key with switch to close contacts, polished durable enameled metal base mounted on a bakelite base, key lever is nickel-plated brass-silver contacts; packed in new, original boxes. Ship. weight, 1 lb. 10 for \$11.00

Army-Navy Type Headphones

Moisture-proof, sensitive and durable. Extra heavy-duty bakelite cap. Soft rubber cushions included. bi-polar magnet, 8000 ohms. Furnished with cord and plug leather headband. Ship. weight, 2 lbs.



Order from your jobber. Write for our illustrated literature featuring all types of radio parts. Dept. D.

ARROW RADIO CO.

2205 W. Division St. Chicago 22, Illinois

speco
PLASTIC PLIERS

● Weighs 1 1/2 ounces!
 ● Absolutely shock-proof non-magnetic!
 ● 6,000 volt breakdown!
 ● Heat resistance 240 to 300 degrees!
 ● Tensile strength of material, 5000 lbs. per square inch!
 ● Pick up nuts, screws and washers without danger of shorting!
 ● Relocate wiring without disturbing magnetic fields while equipment is operating!

DEPT. C-12
ROBERTS ASSOCIATES, P. O. BOX 622, G. C. ANNEX, N. Y. 17

POSTWAR RADIO SHOP
 (Continued from page 171)

ular patrons will be those whose homes are within strolling distance. You may attract a clientele from all sections of the community if your advertising and your service merit some. But before locating in a factory-worker or foreign-element section of town, be very certain that sufficient service business exists to justify the setting up of a radio shop.

It is of course axiomatic that your service shop be attractive in its appearance. Nor is this as simple as it may seem. Mr. Reynolds has planned a typical radio service emporium which he feels will prove desirable for himself. Because it contains a number of unusual features we are reproducing its salient points below.

"The windows of my postwar service unit will be of the type found frequently on the Main Streets of larger communities. The glass will be so constructed that a passer-by may seemingly be able to reach into the window itself and handle the merchandise displayed therein. Actually however, his fingers touch resistant glass when he attempts to complete this maneuver.

"I plan to maintain a pair of display windows, one of which will house service merchandise such as handie talkies, auto radios, residential burglar alarms, electronic items for the home, etc.

"The second window will house a miniature radio service bench with a group of puppet radio repairmen which can be worked automatically by strings from above so that an action window display is perpetually available if desired. This window will serve as a day-to-day reminder that my business is radio repairing.

"The doors will open automatically when an individual or group steps in front of them. This is not unduly difficult nor expensive and will heighten community interest in my store and its wares.

"The inside of my shop will prove different from many in that the first-floor interior will be devoted to a display of recorders, public address systems, headphones with adapters, noise-reduction antenna kits, etc.; merchandise which I have for sale. The service department will be located on the second floor. I strongly believe that a two-floor establishment is desirable.

"By locating the service units on the second floor away from prying eyes the radiomen do not feel that 'someone is continually watching them.' It matters not how separated radio repairman and customer are. Even if plate glass intervenes, a sensation of 'being continually watched' is present if the serveshop is located within consumer reach. Admittedly console radios may have to be carried upstairs, but this is a minor deficiency and cannot well be avoided. A slightly enlarged dumbwaiter or freight elevator for sets may be installed at an expenditure amply justified.

"An intercommunication system will enable the receptionist below to talk directly with radio repairmen above and ascertain if a particular receiver has or has not as yet been adequately serviced. I believe that this arrangement will work out most satisfactorily to all concerned.

"I intend to air-condition the entire establishment; not only the reception center below but the actual service chambers themselves. It is my belief that service rooms are, in general, either too cold or too hot to complete set repairs with maximum efficiency.

"And I believe that the lighting arrangement requires earnest consideration. For the downstairs or 'patron section' I shall use colored fluorescents for each and every display case with indirect lighting above of the ceiling variety.

"Each service bench in the second floor service section will be equipped not only with a powerful fluorescent above the bench proper, but with a bench spotlight at either side of the bench. This bench light will be equipped with three-way control varying the illumination secured from dim to intense.

"I am particularly interested in adapting several new service techniques in my postwar establishment. I intend to gather around me four associates, each one of whom will prove a specialist in his own right. One will confine his servicing efforts solely to automobile radios, another to portables, a third to FM and television models which come in for service at the present time, and a fourth for all around general utility.

"It is my opinion that in this fashion work can be speeded up considerably. At the same time each and every man on my staff will be able if necessary to handle any type of service requirement which arises in the course of normal servicing routine. Hence in case of sickness or an emergency any service associate of mine will be able to step in and handle the missing partner's bench chores.

"My service lab will consist of four completely equipped service benches. Each bench will be furnished with all service tools, including a tube tester, set analyzer, a complete stock of tubes, and a component bin.

"A special bench placed in the center of the service quarters will house such instruments as a cathode-ray oscillograph, Chanalyst, and other higher-priced units. When anyone of the staff requires an item from this bench he will obtain it and return it to its rightful bench position when the particular task for which it was borrowed has been completed.

"It is my intention to entirely eliminate house calls after the war save for installation and maintenance of the television receivers in the community which will obviously in many instances require home service.

"It is my intention to establish a 'zoned' delivery service whereby set pickups and deliveries will be made daily in various sections of the city. In the morning, for example, the North and East side will be



Suggested by: Anonymous, Canton, N. Y.

covered, while the afternoon will find West and South side inhabitants' wants attended to.

"No charge will be made for delivery and pickup on any transaction which amounts to \$2.00 or more. In instances where the service charges amount to less than the \$2.00 minimum, a small delivery and pickup charge will be made. Through this arrangement I hope to eliminate the need for "padding" a service fee statement merely to justify such set pickup and return costs.

"I intend to utilize discharged war veterans entirely as members of my delivery and pickup staff. They will undoubtedly prefer out-of-doors activity and will especially be interested in driving the service fleet of trucks. With a total of three service trucks and one autoglide with basket for portable pickup and return I believe that both urban and rural community serv-

EDITOR'S COMMENT

After reading the glowing account of this most modern of shops, the poor serviceman glances over his own "sloppy shoppe" and vaguely wonders how much it might cost to refurbish his establishment to suit the munificent picture. Checking carefully into this matter we have arrived at the following figures:

Air Conditioning	\$1400.00
Special Polarized Windows	1300.00
Show Cases	500.00
Test Equipment, Fixtures & Misc.	5000.00
Supplies & Stock	2000.00
Special Installations, (Elevator, etc.)	1000.00
Trucks	5000.00
Labor	300.00

Total\$16,500.00

In addition to all this, the weekly upkeep of such a store and staff would be tremendous in comparison with the weekly income. The following figures are for salaries alone at approximately the prevailing rate of pay:

Four Servicemen	\$200.00
Receptionist	25.00
Salesmen (3)	150.00
Truckmen (3)	120.00
Handlers (3)	90.00
Messengers, Handbill Passers, etc.	60.00
Porter and Scrubwoman	60.00
Bookkeeper	50.00
Owner	100.00

Total\$855.00

This is the weekly layout for salaries alone. Add to this the monthly rent divided by four, the phone bill divided by four, the electric bill divided by a like amount, insurance, advertising expenses, taxes, cash layout for stock rotation, etc.

These are all approximate estimates and are not intended as final figures but merely to demonstrate that the cash layout and operating expenses CAN mount up to quite a sum.

Polarized windows are business-getters, without doubt, but in a moderate-sized city the serviceman may have to be content with a good reputation, which brings the customer back again and again, rather than with spectacular display, more useful in attracting the transient customers of a metropolis.

Prompt pickups and deliveries are another of the things which aid in getting and keeping satisfied customers, but a fleet of four delivery trucks would again seem ambitious. One wonders just where all the business is going to come from—again assuming the set-up is in a moderate-sized city.

With all due respect to the Armed forces and their methods of training, it is our

belief that the training provided in the various branches of the armed services is insufficient alone as a basis for preparing the veteran for a position behind the service bench of his own store. We are acting in the belief that it is better to know the unadorned picture than to fail in attempting to materialize a rosy dream. Quite a bit of other knowledge besides knowing a condenser from a power transformer is required. This includes a fair knowledge of business practices, business acumen, understanding of the principles and value of advertising, judicious use of these principles, jobber contacts, deftness coupled with a knowledge of the various shortcuts, or general "know-how". While stories have been told of successful businesses growing nicely without benefit of business practice knowledge, these cases are in the minority rather than the majority.

"I intend to establish two distinct classes of fee-charging systems. A client may choose to have a radio repaired at a cost of \$2.00 for the first service hour and \$1.50 per service hour thereafter. Or the customer may elect to have the radio repaired on a flat fee basis of \$7.50 or \$10.00, depending upon whether said radio falls into one of two categories. If the set to undergo service is in the 1925-1933 category, the fee will amount to \$10.00 but if in the 1934 through 1941 brackets, the flat fee charged will be \$7.50.

"Summing it up, I believe that by employing sufficient care in choosing my location and in designing my service establishment attractively yet practically, I will be able to serve my chosen community to the satisfaction of all concerned."

It is a fairly good practice to head for the local Chamber of Commerce for inside information, as they are, in most cases honest and impartial. Sometimes, however, in the interest of serving the town, they mislead the unwitting, for their enthusiasm can get the better of them with disastrous results. On the average, it is far better to establish yourself in your own home town or in one with whose conditions and localities you are familiar, rather than start from scratch in a place where you are totally unknown.

Surveys are now available, showing how many radio sets break down yearly. Such estimates, coupled with a fair estimate of the number of radios in the area in which the service shop is to be located, give an idea of the maximum business obtainable. A so-called "specialist" in one type of radio work might tend to become typed, much as an actor is typed after playing a given style of role for several pictures in succession. He would get the reputation and the work of a specialist, while the average run-of-the-mill jobs (better-paying in most cases) would go to the general serviceman.

It appears that Mr. Reynolds has relegated the service shop to a second-floor sideline, with the sales department as his major income-producer. Perhaps this is just as well, for with this type of set-up, and with a flat service fee of \$7.50 being charged, perhaps at least the sales of appliances and sets, will prevent this white elephant from collapsing before it gets started.

It is, of course, pleasant to dream, but businesses were never successfully founded on dreams. Hard-headed, cold, calculating ideas are needed to put a business on a solid rock foundation rather than just on the rocks; only gumption and acumen will keep it there.

Attention Servicemen!

Precision Multimeters

Model 832-A
19.00 Net

Power Transformers

300-0-300 70MA 6.3 C.T. 2.0 amp
5.0 3.0 amp Universal Mount
Net 2.79

Universal Outputs 1.00 net

Tube allotments to dealers
Ken-Rad, Hytron Brands
RME 45 Receivers 166.00 net

Send ten cents for lists

Radio Supply Service

221 NORTH AURORA ST. ITHACA, NEW YORK

EARTHBOUND

IS THERE a strange, ethereal mental cord that binds the consciousness of those departed from this world with those who remain? Is psychic phenomena a farce or fact? Let the Rosicrucians (not a religious organization), reveal the satisfying truths about these mysteries of self to you. Write for free introductory Sealed Book. Address: Scribe O.N.G.

The ROSICRUCIANS
SAN JOSE (AMORC) CALIFORNIA

Do you need

BINDING POSTS?



The XL PUSH POST with its Spring Action assures Constant Contact and quick connection.

Manufactured in All Aluminum Type B at 12c each.

Aluminum Body, Bakelite Top Type B1 at 15c each.

Types CP or NP. ALL BRASS-STAIN-LESS STEEL SPRING & PIN. PROVEN by 240 HR. SALT SPRAY TEST as NON-CORROSIVE at 28c each.

Manufacturers and Dealers Liberal Discounts

X. L. RADIO LABORATORIES

420 West Chicago Ave., Chicago 10, Ill.

RADIO PHONE SET



Dynamic microphone and dynamic receivers of the finest quality. Made to U.S. Army Signal Corps specifications and passed by Signal Corps Inspectors. Waterproof, weather and altitude proof. Precise and delicate in a watch-rugged case. Were used on tank and aircraft intercom systems. Part of B-19 equipment. Can be used for recording telephone sets, for talking through radio, and many other uses. Inside of earphones make fine loud speakers for pocket radios. Complete set consisting of two receivers, microphone and dynamic microphone for less than regular cost of dynamic mic: \$14.95 post paid.

Electronic Products Co., St. Charles 2, Ill.

BUILD YOUR OWN!

*FAST-FREEZER

PLANS \$1.00

Every amateur will be proud to build this household necessity which requires no expert knowledge. Operates on 32 or 110 volts. There's fun in building and profit in using this handy freezer. Saves up to 75%.

PLANS ARE SIMPLE

These 8 to 40 cubic foot sizes can be built of new or used parts. Mail \$1 bill or check for complete plans and catalog. LEJAY MFG., 456 Lejay Bldg., MINNEAPOLIS 6, MINN.

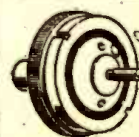

"WONDER" ELECTRIC BUTTON

Most interesting electrical apparatus ever discovered. Make your own Telephone-Amplifier Detectaphone. Transmit your voice or music to distant rooms. Perform hundreds of fascinating experiments. So tiny it can be concealed in dozens of places. Send \$1 now for button and free 5,000 word instruction booklet with 50 illustrated experiments. SPECIAL OFFER: 6 buttons and booklets sent postpaid for \$8. Write now to BUCK MFG. COMPANY North Aurora, Illinois

500 FORMULAS TO SUCCESS

MANY million dollar firms started with a single formula, for which they paid a big price. Here you have 500—no less—tried and tested formulas, recipes and processes for making things... all at the ridiculously low price of 25c. Here is your opportunity to start a business with but a few dollars' capital and with untold profits in prospect. You can also use these formulas in your own home to cut household expenses to the bone. Or you can put them to use in your workshop to cut costs as much as 100%.

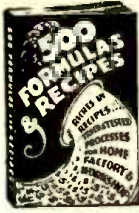

Quit paying out many dollars in profits to manufacturers, wholesalers, and dealers, when you can make the same thing yourself for a few cents. It's so easy when you follow our simple instructions.

66 PAGES, 3200 WORDS IN TEXT. Send for "500 FORMULAS AND RECIPES" today. Enclose 25c, that's all! You won't be asked for another cent now or later. Sold on a money-back guarantee.

NATIONAL PLANS INSTITUTE
P. O. BOX 26 R. STATION N. New York 23, N. Y.

AMAZING MYSTERY

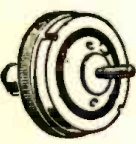

BUTTON

Startles Everybody. With this Electronic Button you can make your own Telephone—Amplifier—Detectophone. Attach this button to pieces of cardboard—transmit conversation to another room. Music also transmitted to distant places. Most interesting electrical apparatus ever discovered. Enables you to perform hundreds of experiments.

So tiny it can be concealed in dozens of places. Free War Product. Electronic Button including 5000 word instruction booklet with 50 illustrated experiments postpaid only \$1.00.

Electronic Products Company, Saint Charles 14, Illinois

MANUFACTURERS?

ARE YOU INTERESTED IN INCREASING YOUR EXPORT SALES?

We are seeking additional lines for export representation either on a commission basis or can purchase for our own account paying you cash in New York funds. We handle all correspondence, paper work, details. Write Box 7

The RADELMA Company
53 Park Place New York City 7

OPPORTUNITY AD-LETS

Advertisements in this section cost 20 cents a word for each insertion. Name, address and initials must be included at the above rate. Cash should accompany all classified advertisements unless placed by an accredited advertising agency. No advertisement for less than ten words accepted. Ten percent discount six issues, twenty percent for twelve issues. Objectionable or misleading advertisements not accepted. Advertisements for January, 1946, issue must reach us not later than November 20, 1945.

Radio-Craft • 25 W. B'way • New York 7, N. Y.

5 X 7 RADIO TELEGRAPH CODE-TIME CHART. TWO 3c stamps postpaid. HALOO, 801 Clintonia Avenue, San Jose 10, Calif.

AMATEUR RADIO LICENSES. COMPLETE CODE and theory preparation for passing amateur radio examinations. Home study and resident courses. American Radio Institute, 101 West 63rd Street, New York City. See our ad page 216.

EMBOSSED AND PLAIN BUSINESS CARDS. SPADA. 10 Lexington, Wethersfield 9, Conn.

UNIVERSAL RADIO TOOLS—DANDY 18 PIECE SET: Midget Pliers, Diagonal Cutters, Four Midget End Wrenches, Needle-nose Pliers, Screw Holder, Six Punches and Chisel, Round File, Midget Crescent Wrench. \$14.85. Remit with order. Immediate Shipment Overnight by Air to Anywhere, U.S.A. Universal Tool Company, 1527 Grand RC, Kansas City, Mo.

MAGAZINES (BACK DATED)—FOREIGN, DOMESTIC, arts, Books, booklets, subscriptions, pin-ups, etc. Catalog 10c (refund). Cleorone's, 863 First Ave., New York 17, N. Y.

MULTITESTER FOR SALE. BRAND NEW \$18.75. Order Today! Omaha Radio Products Co., 300 Brandeis Theatre Bldg., Omaha, Nebr.

CORRESPONDENCE COURSES AND SELF-INSTRUCTION books, slightly used. Sold, Rented, Exchanged. All subjects. Satisfaction guaranteed. Cash paid for used courses. Complete information and 92-page illustrated bargain catalog Free. Write—NELSON COMPANY, Dept. 2-39, Chicago 4.

URGENTLY NEEDED—TUBE TESTER. ANY MODEL. Send full details, also price. Write James Moffitt, Warrensburg, N. Y.

BELIEVE IT OR NOT: AROUND THE WORLD ON loud speaker, without antenna or ground. Marvellously sensitive 5 tube receiver. Complete construction data, 4 blue prints, 4 photographs and coil data \$5, or circuit only \$1. F. C. Morrison, 1230 North Berendo, Los Angeles 27, Calif.

CRYSTAL FREQUENCY CONTROL UNITS. ALL kinds, including 1000 KC calibrating crystals. Also blanks. High quality. Low price. Prompt delivery. Standard Pico Company, Box 164, Carlisle, Pa.

BEGINNERS RADIO REPAIR BOOKLET 25c. REPAIR radio tubes. Instructions 25c. Radio Box 811 RC, Benton Harbor, Michigan.

Communications

WAS THE CORRECTION INCORRECT?

Dear Editor:

Regarding your "Correction" item, October issue, page 47, concerning the U.H.F. circuit in the June issue, page 597, permit me to suggest that it may have been the author's intention to provide a filter capacitor from the "high" side of the screen-grid resistor of the first R.F. tube to its cathode,

instead of arranging the circuit as "corrected." Since this circuit will be utilized only by radiomen familiar with U.H.F. technique, it is probable that the circuit as originally presented would not long have been a problem.

R. D. WASHBURNE,
New York, N. Y.

THIS ZEDDER LIKES U. S. EQUIPMENT

Dear Editor:

I have almost a complete set of *Radio-Craft* since January 1936, and find the back numbers most useful for reference purposes. It is a shame that the servicing data and circuit diagrams of U.S. receivers which used to appear in each month's issue, have not been included for quite a long time. They were most helpful, and we miss them. They gave us over here a "line" on the latest set and amplifier design in the U.S.A., which seems to set a standard for the world. We are particularly interested in Indoor Public Address, and any articles

on this subject are much appreciated.

Thanks to your past articles, we have been able to give a public address service to the U.S. Forces here which they stated was equal to any in the U.S.A., and the orchestra leaders were more than satisfied with the results. Again thanks.

PHIL T. STEBBING,
Avondale, Auckland, N. Z.

(Now that U.S. manufacturers are beginning to set up their civilian production lines once again, diagrams and service data sheets will be printed as soon as they become available.—Editor.)

LEARNED HIS ATOMICS WITH THE AID OF R-C

Dear Editor:

So much heralding these days of this newest of science's miracles, the atomic bomb. I want you to know that I have before me a letter dated November 1, 1935, on *Radio-Craft* stationery which was in answer to one of my many inquiries throughout the years to the Gernsback magazines. This letter advised me that I might find the particular information which

I was seeking, in a book entitled—"Matter And Radiation," by Buckingham. I found this book helped me a lot in an experiment I had tackled at that time. Anyone who might have had the privilege of reading this book would have been provided with a much better conception of the thing called the "atomic bomb."

GEORGE COFFEE,
Providence, R. I.

MORE ON HIGH-FIDELITY AMPLIFIERS

Dear Editor:

I realize the trouble that a technical magazine editor goes through to get out just one issue of his periodical, but your industry as well as mine has its "gremlins." There are a few little misprints in the input circuit of the Hi-Fi amplifier on page 812 of the September issue of *Radio-Craft*. I thought that I had better call your attention to the matter before we both get called on the "carpet."

The errors affect the frequency response very definitely, as the incorrect connection of the volume control would throw the R/C network off. Also it would short out the cathode resistor and condenser when the pad is shut. The suppressor grid should be connected to the cathode and nothing else. The output transformer is a UTC-PA-2L6. The corrected input circuit is shown in Fig. 1.

I am submitting herewith a diagram for a Hi-Z phono mixing circuit that is designed to eliminate the high and low frequency losses. Those who are familiar with broadcast work will recognize the network as a Hi-Z L-pad bridged for high frequency compensation (Fig. 2). Notice that the moving arm of the pad goes to the Hi-Z grid and the other side is grounded. The input impedances are 500,000 ohms. Use a crystal pickup preferably. Grid impedance of the input tube should be 250,000 or 500,000 ohms as the case may be. For mag-

netic or dynamic pickup use 100,000 ohms.

G. BRADFORD TIFFANY,
Chief Engineer, WECB,
Boston 16, Massachusetts.

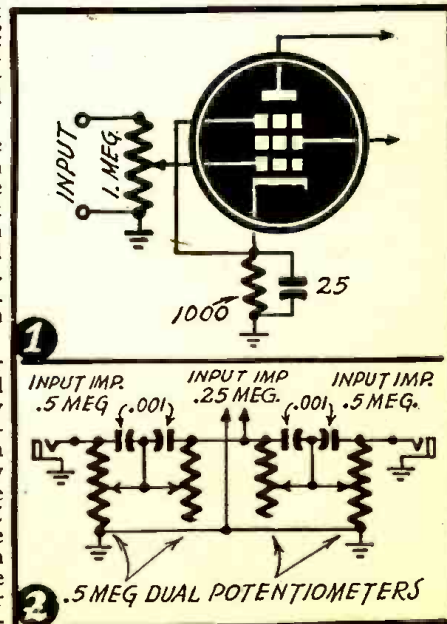

WIRING with PAPER

It has long been known, says *Scientific American* in a recent issue, that various materials could be mixed with printers' ink and then printed on ordinary materials for various effects. Among the common uses are the printing of metallic inks to produce striking effects.

Latest in this field is the printing of metallic inks in diagrams which will act as electrical circuits in low priced portable radios.

Amateurs will remember the India-ink grid-leaks of 1915, made by drawing a heavier or lighter line on a piece of paper clamped down between two terminals a shorter or longer distance apart. Later "grid-leak" paper, impregnated with special ink, was sold, from which resistors as low as a few thousand ohms could be cut. Highly-conductive impregnated paper was unknown in the old days, however.

The base stock upon which the printing is done must be stiff and strong enough so it will not bend or break to rupture the printed lines and thus break the circuit. It also must be non-hygroscopic enough so that it will not absorb enough moisture on humid days to cause short circuits. And it must not expand and contract enough under temperature changes to cause trouble.

All of these properties are to be had in treated cardboards and other base stocks which in peace-time sell for low prices. As a result, the printed metallic electrical circuit is on its way. But, according to *Scientific American*, the developers of it are sitting on the lid; they are keeping its present stage of development secret.

STATEMENT OF THE OWNERSHIP, MANAGEMENT, CIRCULATION, ETC., REQUIRED BY THE ACT OF CONGRESS OF AUGUST 24, 1912, AND MARCH 3, 1933.

Of Radio-Craft and Popular Electronics, published monthly at Springfield, Mass., for October 1, 1945.

County of New York } ss.
State of New York }

Before me, a Notary Public in and for the State and county aforesaid, personally appeared Hugo Gernsback, who, having been duly sworn according to law, deposes and says that he is the editor of Radio-Craft and Popular Electronics, and that the following is, to the best of his knowledge and belief, a true statement of the ownership, management (and if a daily paper, the circulation), etc., of the aforesaid publication for the date shown in the above caption, required by the Act of August 24, 1912, as amended by the Act of March 3, 1933, embodied in section 537, Postal Laws and Regulations, printed on the reverse of this form, to wit:

1. That the names and addresses of the publisher, editor, managing editor, and business managers are: Publisher, Radercraft Publications, Inc., 25 West Broadway, New York 7, N. Y.; Editor, H. Gernsback, 25 West Broadway, New York 7, N. Y.; Managing Editor, none; Business Managers, none.

2. That the owner is: (If owned by a corporation, its name and address must be stated and also immediately thereunder the names and addresses of stockholders owning or holding one per cent or more of total amount of stock. If not owned by a corporation, the names and addresses of the individual owners must be given. If owned by a firm, company, or other unincorporated concern, its name and address, as well as those of each individual member must be given.) Radercraft Publications, Inc., 25 West Broadway, New York 7, N. Y.; H. Gernsback, 25 West Broadway, New York 7, N. Y.

3. That the known bondholders, mortgagees, and other security holders owning or holding 1 per cent or more of total amount of bonds, mortgages, or other securities are: (If there are none, so state.) None.

4. That the two paragraphs next above, giving the names of the owners, stockholders, and security holders, if any, contain not only the list of stockholders and security holders as they appear upon the books of the company but also, in cases where the stockholder or security holder appears upon the books of the company as trustee or in any other fiduciary relation, the name of the person or corporation for whom such trustee is acting, is given; also that the said two paragraphs contain statements embracing affiant's full knowledge and belief as to the circumstances and conditions under which stockholders and security holders who do not appear upon the books of the company as trustees, hold stock and securities in a capacity other than that of a bona fide owner; and this affiant has no reason to believe that any other person, association, or corporation has any interest, direct or indirect, in the said stock, bonds, or other securities than as so stated by him.

5. That the average number of copies of each issue of this publication sold or distributed through the mails or otherwise, to paid subscribers during the twelve months preceding the date shown above is (This information is required from daily publications only.)

(Signature of publisher)

H. GERNSBACK.

Sworn to and subscribed before me this 8th day of October, 1945.

MAURICE COYNE, Notary Public
(Commission expires March 30, 1946)

(Seal)

RADIO-CRAFT for DECEMBER, 1945

SPEED UP REPAIRS WITH THESE G-C AIDS!



FREE
STEEL
CABINET

G-C Dial Belt Kits

Every Serviceman needs a G-C Dial Belt Kit. Save money—be ready for that repair job. Finest woven fabric replacements. Easy to install—no stretch—no adjustments. Supplied in kits of 25, 50, 100, 200 or 300 Belts in sturdy metal box with slide-in drawer. Free Belt Guide and measuring device.



G-C Dial
Drive Cables

G-C has a complete line of Dial Drive replacement cables. Available by the spool for prompt servicing of all sets. Every Serviceman should have a complete assortment. Best quality—extra strength. Preferred by Radio Men everywhere.



G-C Radio
Service
Cement

The best Cement for Speaker and Radio Work. Especially suitable for cementing replacement cones and repairing rattling and torn cones. Also used on glass, to seal adjustments, hold wires in place, etc. Dependable, vibration proof, water-proof and fast drying.

Write for New G-C Catalog No. 146
and G-C Dial Belt and Service Book

Immediate Delivery on all G-C Products

Order From Your Radio Parts Jobber
ALWAYS ASK FOR G-C PRODUCTS



GENERAL CEMENT MFG. CO.
ROCKFORD, ILLINOIS

POST-WAR Special



6 TUBE "SUPER HET" RADIO KIT

Complete, including Attractive Walnut Cabinet.
Diagram Furnished. Uses 6SA7—6SQ7—6SJ7—
6SK7—2516—2526.

ALL PARTS MOUNTED

To assemble, all one needs is a soldering iron
and 30 minutes of your time.

\$16.95 LESS
TUBES

Limited Quantity on Hand

TERMS: 10% DEPOSIT WITH ORDER—BALANCE C. O. D.

LIBERTY SALES CO., INC.

115 WEST BROADWAY · NEW YORK 13, N. Y.

The New York State Police are considering installation of a complete state-wide three-way radio system which will bring the whole facilities of the State police to bear on an emergency in any part of their area. The new system would cost approximately two million dollars.

Roehr Distributing Company

St. Louis' Radio
Mail Order House

has

General Cement Products

Necessities for the
Serviceman

Write for Our General
Cement Catalogue

ST. LOUIS 3, MO.

NOW AVAILABLE

Test Equipment Made By
TRIPLET—RCA—SUPREME
Deposit with order—Prompt delivery—Get
acquainted offer—Special Kit 100 Resistors
½ and 1 W. Aast. \$1.75.

CHIEF ELECTRONICS

Hudson Valley's only Distributor

WRITE US YOUR NEEDS!

224 Main St. • Poughkeepsie, N. Y.

Ted McElroy
 World's Largest Manufacturer of
 Wireless Telegraphic Apparatus
 COMPLETE CENTRAL OFFICE EQUIPMENT
McElroy Manufacturing Corp.
 82 Brookline Avenue • Boston, Massachusetts

TEST EQUIPMENT
 —SHIPPED FROM STOCK!—
 SUPERIOR 400—electronic multimeter.....\$52.50
 SIMPSON 260—volt-ohm-milliammeter..... 33.25
 RADIO CITY 805—tube and set tester..... 89.50
 TRIPLETT 666-H—volt-ohm-milliammeter..... 16.00
 25% deposit with order, balance C.O.D.
 Also many other types available.
SCENIC RADIO & ELECTRONICS CO.
 53 Park Place • New York City 7

MAGIC CUTTER
 Cuts up to 4" hole in
 plastics, wood and
 metal. Wonder tool for
 amateurs and profes-
 sionals developed by
 famous lab for own use.
 Send \$1 to: Dept. C-12
ROBERTS ASSOCIATES
 P.O., Box 822, 6 C, ANNEX, N.Y. 17

In the Rocky Mountain Region
 it's
RADIO & TELEVISION SUPPLY CO.
 806 EUCLID AVE., PUEBLO, COLO.
 "If we don't have it, we'll get it—
 or it can't be had! Phone 572B"

BUILD YOUR OWN RADIO SETS
 All instructions including simple, easy-to-follow
 schematic diagrams. All kits complete with tubes.
 4-tube T.R.F. \$10.75
 5-tube Superhet \$17.95
 Also available in quantities at special discounts.
 Write for our complete catalog of hard-to-get parts.
NATIONAL RADIO DISTRIBUTORS
 Dept. C, 140 West 42nd Street, New York 18, N. Y.

**MINIATURE TUBULAR
 CONDENSERS**
 Specialists in the manufacture of tin7, paper, tubular,
 condensers for hearing aids, portable radios, etc.
 Moistureproof. High I.R., accurate capacity, and very
 small physical dimension. We make them by the
 millions for the armed forces. Tell us your needs.
GOOD-ALL ELECTRIC MFG. CO.
 Manufacturers since 1925. Osallala, Nebraska

CANNON-BALL
 Circular R-12 covers
 complete line of sensi-
 tive, clear-tone, depend-
 able Headsets. Get it.
 Choose the super-qual-
 ity Headset you like
 best. Twenty years
 headset specialization
 insures satisfaction.
 Write
C. F. CANNON COMPANY
 SPRINGWATER, N. Y.
Headset Headquarters

**Adson
 RADIO CO.**
 Dept. C—221 FULTON ST. N. Y. 7, N. Y.
 EVERYTHING FOR AMATEURS AND SERVICEMEN
 COMPLETE LINE OF ELECTRONIC EQUIPMENT

INDEX TO ADVERTISERS

Adson Radio Co.	214
Allied Radio Corporation	156
Amperite Company	200
Arrow Radio Co.	210
Audel & Co., Theo.	220
Buck Manufacturing Co.	211
Buffalo Radio Supply	209
Burstein-Applebee Co.	208
Cannon Co., C. F.	214
Capitol Radio Engin. Institute	187
Centralab	155
Chief Electronics	213
Cinaudagraph	184
Concord Radio Corp.	185
Coyne Electrical School	153, 210
DeForest's Training, Inc.	149
Eastern Amplifier Co.	
..... Inside Back Cover	
Electro-Voice Co.	199
Electronic Products	209, 211, 212
General Cement Mfg. Co.	213
General Electric Co.	205
Good-All Manufacturing Co.	199, 214
Greene, Jack	204
Henry Radio Shops	205
Hudson Specialties Company	195, 209
International Detrola Corp.	181
International Resistance Company	217
Kelnor Mfg. Co.	204
Lake Radio Sales Co.	208
Leeds Radio Co.	202
LeJay Manufacturing Co.	211
Liberty Sales Co.	213
McElroy, T. R.	214
McMurdo Silver Co.	197
Mallory and Co., Inc.	
..... Inside Front Cover	
Miles Reproducer	199
National Plans	212
National Radio Distributors	214
National Radio Institute	145
National Schools	151
National Union Radio Corp.	146
Nelson Company	206
Ohmite Mfg. Co.	194
Onan & Sons, D. W.	207
Opportunity Adlets	212

RADIO SCHOOL DIRECTORY

Page 216

American Radio Institute	
Candler System	
Capitol Radio Engineering Institute	
Commercial Radio Institute	
Lincoln Engineering School	
Melville Radio Institute	
RCA Institutes	
Tri-State College	
Western Radio Institute	
PA-Kette Radio Co.	195
Radelma Co.	212
Radiart Corporation	218
Radio Corporation of America	
..... Back Cover	
Radio Distributing Co.	209
Radio Electric Service	203
Radio Kits	199
Radio Production Sales Co.	207
Radio Publications	208
Radio Supply Service	211
Radio & Television Supply Co.	214
Radio Wire Television	196
Radionic Equipment Co.	206
Radolek Company	200
Raytheon Manufacturing Co.	219
Rider Publisher, John F.	195
Roberts Associates	210, 214
Roehr Distributing Co.	213
Rosicrucians	211
Scenic Radio & Elec. Co.	214
Sheffield Radio	202
Sperry Gyroscope Co.	182, 183
Sprague Products Co.	148, 154
Sprayberry Academy of Radio	147
Superior Instruments Co.	152
Supreme Publications	201
Technical Division, Murray Hill Books	188, 189
Thordarson Electric Mfg. Division	203
Trenton Radio Co.	206
Triplet Electrical Instrument Co.	191
Weston Electrical Instrument Co.	193
Wholesale Radio Laboratories	198
X.L. Radio Laboratories	211

WAR RADIO FOR PEACE

(Continued from page 157)

Godsend. Even airplanes will have such modified radar installations making it possible for them to land in the thickest fog as if the fog did not exist.

For moderate-priced television sets, miniature cathode-ray tubes which give small but clear images will soon be available. A host of brand new radio tubes that were developed during the war, some of which have not even been released as yet, will also make their appearance in the near future.

Many of these new tubes will be ideal for simple and more efficient radio sets and other electronic devices. They are more efficient too, as well as having a number of other technical advantages.

The war experience gained with microwaves and centimeter waves is already making itself felt in many new industrial and other peacetime uses. In this particular domain the surface has not been scratched and some of the greatest wonders of radio are yet to come in this particular field.

With the new atomic energy radio-active elements will be abundant and cheap. Entirely new electronic-radio devices will make their appearance in the near future. When radioactive materials were expensive it was because they were based on radium. Very little research with a practical purpose was made. This has now all been changed.

Radioactivity first means conductivity for electric currents without a hot cathode. Consequently, a cold-radio self-powered tube must be placed in the list of distinct near-future possibilities. Radioactivity also means generation of electric current. This fact alone will open up entirely new vistas in radio and electronics, so far-reaching that it is difficult to even imagine all the new developments of this phase of the new art alone.

Fears that broadcast station licenses might be suspended for insufficient reason were discounted by Paul Porter, Chairman of the Federal Communications Commission, in a broadcast over CBS September 2 "Stations always get a renewal of their franchise unless somebody complains about them with great vigor," he said, "and then they usually get it anyway!"

The statement was made in the course of a talk in which the FCC chairman urged the listening public to make their appreciation (or otherwise) of programs more directly felt by writing direct to their stations, sponsors and networks, thus exercising democratic control over programs received.

?? WHY NOT ??

Have you ever asked yourself, "Why can't I have this or that gadget on a radio? Why aren't programs made to fill such and such a need?" If so, you are a charter member of the Radio-Craft "Why Not" club. Send us your "Why Not's" on all subjects—serious or screwball, practical or idealistic. We will pay \$1.00 for every one we believe will interest the readers of Radio-Craft. You can get the idea from the "Why Not's" printed below. Send in as many as you like. One dollar will be paid for each one printed.

RADIO-CRAFT regrets that it cannot accept the following "Why Not's":

1—Why not compel manufacturers to paste or print a diagram of the circuit on the back or bottom of the set?

2—Why not compel manufacturers to stamp the model number of each set into the chassis metal? (There are many variations on this; some servicemen would be content if the model number were included in any form, others point out that often it is printed on card or paper stapled or glued to cabinet or chassis, from which it disappears shortly.)

3—Why not have the manufacturers stamp the tube numbers on the chassis sockets or alongside the tube positions.

In most cases where two or more *Why Not's* on the same subject are received, Radio-Craft accepts the earliest one. In the case of the above three, two or more of each are received every day. It would appear that everyone who submits two or more *Why Not's* includes one of the above. Therefore we cannot give any particular individual the credit—it seems that these are questions asked by the whole radio fraternity. Radio manufacturers please note!

Why not have the manufacturers place open circuit jacks in the rear of each receiver wired for output volts so that a set can be aligned without tearing it up to get at the plate of an output tube? *R. Voigt, Flint, Michigan.*

Why not sell phonograph records in "halves" so the customer can pick out two favorite tunes and cement them together to form a regular record. So many times a late hit tune is found with an out-of-date tune on the reverse side. —*Put. Robert E. Smith, Las Vegas, Nevada.*

(Nothing prevents you doing this with existing records! "Half" records would cost as much as "double" ones.—*Editor*)

Why not have a push-button receiver that both tunes the receiver and adjusts the volume for each tuned station to a desired or predetermined level?—*J. H. Homric, Oak Park, Ill.*

Why not have a radio receiver arranged so that one push button will give the latest weather reports and time signals.—*J. H. Homric, Oak Park, Illinois.*

Why not have binding posts on the back of receivers with connections to the amplifier section and power supply so that they may be used separately?—*C. W. Clay, Jr., Greenacres, Wash.*

Why not have a radio program to teach beginners the fundamentals of radio? It could be sponsored by some radio parts or set manufacturers.—*Thomas Acord, Grants Pass, Oregon.*



FREE WANT-AD SERVICE

By Former Soldiers, Sailors, Marines

Radio-Craft offers its help-wanted columns free for the use of honorably discharged men in the armed services. State the type of position you seek, preferred locality, your experience, education, and other details. Confine ad to 50 words, or less. Supply name and address. Army veterans send section number or photostat of discharge paper. Navy men send photostat of discharge paper. Address RADIO-CRAFT, Classified Ad. Dept., 25 West Broadway, New York 7, N. Y. Your ad will contain a box number and replies will be forwarded to you.

AVAILABLE

ASST. ELECTRONIC ENGINEER: radio licenses; college (night Poly Tech); excellent army, civilian background. Ray Goldstein, 1605 Lincoln Pl., Brooklyn 33.

RADIO construction, maintenance; installation; radio amateur, Signal Corps radio repair; army exp. coms.; deslin. installation. Inspection. Joseph Schimper, 79 W. 45th Street, Bayoune, N. J. Bay 3-4291.

RADAR, 24; 2 years exp., all conditions; knowledge material; navy type gear; desires career opportunity. W. M. Cook, 87-24 88th St., Woodhaven, L. N. Y.; V1 7-5678.

RADIO LAB. TECHNICIAN—experienced in test engineering and development lab. design, layout and construction. Desires permanent position in radio lab. Box G-1245, % Radio-Craft, 25 West Broadway, New York 7, N. Y.

KNOWLEDGE of Radio Maint.; electrical wiring, adaptable, ambitious; seeks permanent pos. with future. married. Gary M. Gilbert, 1880 Crotona pkwy., Bronx 60.

ELECTRONICS TECH., 25; coll.; pos. lab. asst. or supervisory capacity radio and radar; formerly with nationally known firm. Eugene Doutsch, 320 Beckman Ave., Bronx, N. Y.

RADAR or radio equipment; desires position with good future; exp. in requisitioning, storing, issuing, taking inventory. Young man; married. J. Wody, 588 Pine St., Brooklyn 2.

BROADCAST TECHNICIAN first class phone license. Three years transmitter experience, including AM and FM transmitters. Handicraft master control, studio shows, remotes, recordings, maintenance. Two years of college. Louis Halpern, 1593 Prospect Place, Brooklyn 23, N. Y.

ELECTRONIC LAB ASSISTANT, 22, radar training, experience radio repair, wire communications; skilled with electrical and mechanical equipment; 2 yrs. college business administration; studying E.E.; desires position in radio or television. Martin L. Garry, 2039 So. Blvd., Bx. 60.

RADIO OR TELEVISION—5 yrs. navy exp. radar; radio maintenance and repair. grad. RCA Institute; desires pos. in lab. Morris Buczacz, 1836 Belmont Ave., Bronx 57, N. Y.

RADIO OPERATOR, 29, single; 4½ yrs. exp., desires pos. in radio communication or learn radio repairing. Robert Wasserman, 1050 President St., Brooklyn 25.

RADIO, 26, married; A-1 bench mechanic, 5 yrs. exp.; 3 yrs. schooling radio engineering; laboratory exp. Wright Field, Dayton, O. Herb Schneider, 408 Saratoga Ave., Brooklyn 33; GL 2-4511.

ELECTRONIC TECHNICIAN, 26; B.S. degree; ex-radar officer, inspection and testing. Exp. driver's license; married; lab. or sales work preferred. David Greenberg, 524 Powell St., Brooklyn 12, N. Y.; DI 2-6816.

RADIO TECH., 3½ yrs. exp.; supervised 30 men in radio work; seeking employment in research lab.; will start from bottom. Martin Greenberg, 423 Hinsdale St., Brooklyn 7.

FORMER RADAR MAINTENANCE OFFICER, 28; B.S., M.A., executive ability, 2 yrs. teaching exp.; desires electronics field, will consider others; \$60. Edmond R. Artessohn, 96-11 65th Rd., Forest Hills 610, L. I.; HA 3-3872.

PART-TIME POS. NEEDED; prefer radio; studying at RCA Inst.; anything in lower Manhattan or Brooklyn appreciated. S. Stempler, 1941 65th St., Brooklyn 4; BD 6-5867.

RADIO TECH.; exp. factory tester, trouble shooter; lab. asst.; some exp. radio store; college; desires pos. above capacity. S. Geller, 1879 Prospect Ave., Bronx 57.

TECHNICIAN; sales and service; signal corps telephone-teletype, 10 yrs. previous exp. electro-mechanical devices. J. Ahern, 409 2d St., Brooklyn 15.

WANTED—Ex-Marine Master Technical Sergeant seeking employment in Television or FM industry. Qualifications—Class "A" Amateur License. Radio service experience. Graduate of two marine radar maintenance schools with high marks. Section Chief of long range search radar in Pacific Theater. Will consider all offers. Marlon H. Culver, 322 North 18th St., Unionville, No.

RADIO TECH.; electrical lab.; knowledge circuits, terms, test instruments; attending night electronics school. R.C.A.; desires pos. to gain exp., advancement. Nathan I. Lawres, 552 Sutter Ave., Brooklyn 12.

YOUNG VETERAN wishes job in radio field. Comm. Exp. 4½ yrs. Army radio-operation and maintenance. Driv. lic. Coll. ed. L. Zander, 330 W. 85th, Apt. 3 M, New York, N. Y.

Why not print a yearly index of *Radio-Craft* at the end of the year in the December issue? Then your readers would know just where to find a given article or story without having to waste hours of time hunting through an entire year's copies. It would also be valuable for those who want to locate all available articles on a given subject.—*B. Buehrle, Jr., Ferguson, Mo.*

(Such an index would occupy too many valuable pages. Past experience indicates that not many readers desire it.—*Editor*)

Why not use 110-volt neon pilot lights in our radios as some of the German manufacturers do? This would eliminate the series connections and pilot light tap failures so common in our A.C.-D.C. sets. Also there would be less power consumption, though this would be practically negligible anyway.—*B. Buehrle, Jr., Ferguson, Mo.*

Why not build all post-war radios with removable chassis sections or stages which can be replaced quickly and easily by unlatching or uncoupling? A serviceman could replace the unit by another unit of the same type loaned to the customer while his unit is taken away. In this manner the customer would have continuous service.—*Otto Lenz, Paterson, N. J.*

(The excessive cost of this makes the idea wholly impractical. It would practically double the cost of the set. It can be done—and is done—on certain communications receivers.—*Editor*)

Why not have the manufacturers center-tap all twelve-volt tubes so they could be operated from either six- or twelve-volt sources simply by changing the filament connections?—*Robert Hollister, Aultsville, Ont.*

RADIO SCHOOL DIRECTORY

PREPARE NOW FOR SKILLED JOBS IN RADIO AND ELECTRONICS

MAKE a place for yourself in a new world of radio and electronics—a world in which revolutionary electronic developments will require highly specialized technical knowledge. Take a good course now to fit yourself for a good paying job. The training you need can be supplied by one of the schools advertised in this publication.

RADIO *Engineering*

DEGREE IN 27 MONTHS

Complete Radio Engineering Course in 27 months. Bachelor of Science Degree. Radio (television, talking pictures) and the vast electronic field offers unusual opportunities. Men and women. VETERANS under the G. I. Bill or Public Law 16 can complete work here in shortest possible time. Special Prep. Dept. Also Refresher Courses. Courses also in Civil, Electrical, Mechanical, Chemical, Aeronautical Engineering; Business Administration, Accounting, Secretarial Science. Tuition, living costs low. Enter January, March, June, September, 62nd year. Write for Catalog
24125 College Ave. Angola, Ind.

TRI-STATE COLLEGE

RCA INSTITUTES, Inc.

Offer thorough training courses in all technical phases of **Radio and Television**

DAYS—EVENINGS WEEKLY RATES

VETERANS: RCA Institutes is approved under G. I. Bill of Rights
For Free Catalog Write Dept. RC-45

RCA INSTITUTES, Inc.
A Radio Corporation of America Service
75 VARICK STREET NEW YORK 13, N. Y.

RADIO

RADIO Technician and Radio Communications courses. Register now for new classes starting first MONDAY of each month. Day and Evening Classes.

AMERICAN RADIO INSTITUTE
101 West 63rd St., New York 23, N. Y.
APPROVED UNDER GI BILL OF RIGHTS.

RADIO-TELEVISION

ENGINEERING & SERVICING

Now Training Veterans Under "G.I." Bill Prepare now for profitable career! ENTER AT ANY TIME. Residence school classes in Radio-Electronics Engineering, Broadcast & Television Engineering and Servicing. Write for FREE Booklet

Capitol Radio Engineering Institute
Dept. RC-12, 3224 16th Street, N. W., Washington 10, D. C.

See Big Ad. Page 187

NEW AMATEUR CONTEST

News of a contest assures the amateur that the war is really over, and the world of hamdom coming back to normal.

To enter the contest, the contestant need only furnish a complete description of the transmitter he would like to own; nothing to buy. The best description of the best designed transmitter wins the contest.

The prizes for this contest consist of the winning transmitter itself, complete from microphone to antenna post, built to the contestant's specifications and presented free of all charges by TAYLOR TUBES, Inc., plus \$1125 in Victory Bonds, furnished by the participating manufacturers. Two first prizes will be awarded; one in final power input classification up to 250 watts, and the other in power input classification of from 251 watts to 1,000 watts.

Entrants must fill out an Entry Blank. These may be obtained direct from Taylor Tubes or from this magazine. Address Contest, c/o Radio-Craft, 25 West Broadway, New York 7, N. Y.

RADIO

Train with professionals. Complete, intensified courses; Repair & Maintenance, Communications, High-speed telegraphy, Slip transcription, FCC exams, etc.

High School Students accepted for training as Merchant Marine Radio Officers. Gov't sponsorship available to veterans.

"A Radio School managed by radio men."
45 W. 45th St., Dept. RC, New York 19, N. Y.

MELVILLE RADIO INSTITUTE

Correspondence Courses in **RADIO and ELECTRICAL ENGINEERING**

ELECTRICAL ENGINEERING Get good grasp of wide electrical field. Prepare yourself, at Low Cost, for secure future. Modern, simplified you can understand quickly. **RADIO ENGINEERING** Extra fine course in radio, publication, address, photo-electric work. Trains you to be super-man, real vacuum tube technician. Servicemen needed badly. Diploma on completion. Tuition \$25, either course. Deferred payment plan. Get copies of school catalogs, student magazines, complete details. SEND NOW!

FREE

LINCOLN ENGINEERING SCHOOL Box 931C-82
Lincoln, Nebr.

CODE SENDING SPEED

Be a "key" man. Learn how to send and receive messages in code by telegraph and radio. Commerce needs thousands of men for jobs. Good pay, adventure, interesting work. Learn at home quickly through famous Candler System. Write for FREE BOOK.

CANDLER SYSTEM CO.
Dept. 3-O, Box 928, Denver 1, Colo., U.S.A.

COMMERCIAL RADIO INSTITUTE

A radio training center for twenty-four years.

RESIDENT COURSES ONLY

Broadcast, Service, Aeronautical, Television and Marine telegraphy classes now forming. Literature upon request. Veteran training. Classes now forming for mid-year term February 1st.

Dept. C, 38 West Biddle St., Baltimore 1, Md.

LEARN RADIO QUICKLY

Send for Free Information;
"3 Ways to Learn Radio"

Approved for Training Veterans
WESTERN RADIO INSTITUTE
1457 Glenarm, Denver 2, Colo.

NEW FM BANDS (Continued from page 191)

should be rebuilt rather than have a converter unit installed as part of the set. The frequency shift will have a favorable effect on television."

Mr. Harvey Anhalt, Chief engineer for WGYN—FM station, says that: "The shift in frequencies will have no effect on sales, and is desirable from a television standpoint."

The National Broadcasting System made no comment, referring to the testimony of Niles Trammel at the FCC hearing.

Mr. Robert Howard, Sales Manager of Admiral Radio believes that: "The shift will increase the sales of FM without discouraging buyers." He believes that "sets now in use will be obsolete and that they should be junked."

Mr. Bernard Shapiro, Service Manager of Emerson Radio and Phonograph Co., is of the firm conviction that "the user should definitely return the set to the factory for conversion."

Dr. Harrison Summers, Manager of Public Service of the American Broadcasting Company, believed that "the sales volume should increase as a result of the frequency change. Sets should be converted."

Mr. John V. L. Hogan, president of WQXQ, FM station of WQXR, New York, states: "The new allocations will have no effect on the sale of FM sets after new sets become available, BUT these sets may not become available as rapidly as FM sets would have if there had been no change in frequency. Converters have not been satisfactory. . . . Would prefer one complete set to do the job." He also states that they dislike any delay . . . "which may result from the change in frequency."

Mr. Parker H. Ericksen, Director of sales of the Majestic Radio and Television Corporation says: "There should be no adverse effect on the sales of FM . . . converters will be manufactured and it will be up to the public to decide whether or not to buy, their preference being on cost and convenience differentials between converters and new receivers."

General consensus of opinion was that: the shift will increase sales; market possibilities will in no way be affected; new sets are proposed or are already in production in most plants; and opinion is divided as to what to do with the sets now in use. Since the average set is about 4 years old now, it might be advisable to "turn it in for a later model."

Troublesome "ghosts" are caused by reflections, as shown in the drawing. Most troublesome in big cities, a ghost may be produced in rural areas by reflection from a cliff or steep hill. Since difference of time between arrival of the direct and reflected signal is the cause of ghosts, double reflections are important. One such is shown in this illustration.

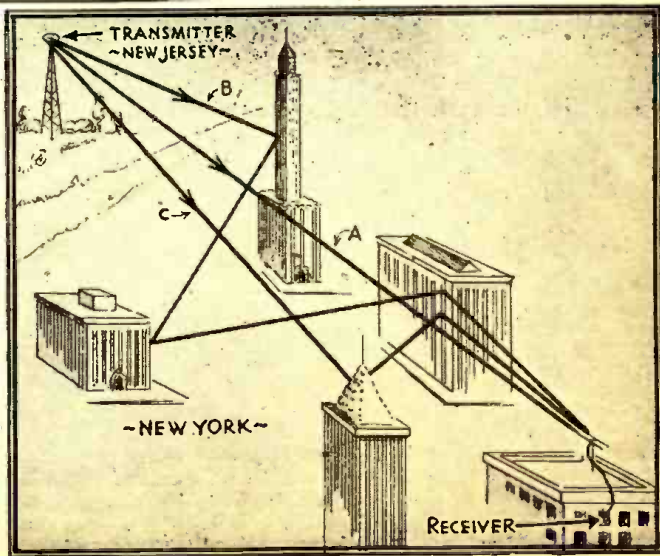

AUDELS REFRIGERATION & AIR CONDITIONING GUIDE \$4

New from Cover to Cover—1280 Pages, Fully Illus. Covering basic principles, operation & repair of household, commercial & industrial refrigeration & air conditioning. A gold mine of essential important facts for engineers, servicemen, shopmen & users.

AUDELS SHEETMETAL PATTERN LAYOUTS \$4

Developed by Experts for Sheet Metal Workers, Layout Men & Mechanics. A Practical Encyclopedia in 10 Sections, size 7 x 10 x 2—1125 Pages—360 Layouts—1500 Illustrations. 1001 Key Facts. Fully indexed for ready reference in answering your layout problems. Covers all phases of sheet metal work including Pattern Cutting, Pattern Development & Shop Procedure.

AUDELS SHEETMETAL WORKERS HANDY BOOK \$1

Practical inside information. Fundamentals of Sheet Metal Work. 388 pages. Fully illustrated. 11 sections. Clearly written. Essential & important facts, figures, pointers in everyday language. Ready Reference Index.

AUDELS WELDERS GUIDE \$1

A concise, practical text on operation and maintenance of all welding machines for all mechanics. Over 400 pages, fully illustrated. Covers all methods of electric and acetylene welding including airplane work.

AUDELS ANSWERS ON BLUE PRINT READING \$2

For Mechanics & Builders. Covers all types of blue print reading including ship & airplane. 376 pages, fully illustrated. New, complete.

AUDELS NEW MACHINIST & TOOLMAKERS HANDY BOOK \$4

Covers modern machine shop practice in all its branches. 5 practical books in 1. New from cover to cover. Tells how to set up & operate lathes, screw and milling machines, shapers, drill presses and all other machine tools. 1600 pages, fully illustrated, 5 x 6 1/2 x 2. Indexed. 5 sections. 1—Modern Machine Shop Practice. 2—Blue Print Reading & How to Draw. 3—Calculations & Mathematics for Machinists. 4—Shop Physics. 5—How to Use the Slide Rule. 60 chapters. Easy to read and understand. A shop companion that answers your questions.

AUDELS MATHEMATICS & CALCULATIONS FOR MECHANICS \$2

Mathematics for home study or reference. 700 pages, 650 illustrations. Practical mathematics from beginning. How to figure correctly. New, easy, correct methods covering a complete review. Illustrated & Indexed.

AUDELS AUTOMOBILE GUIDE \$4

A practical quick ready reference book for auto mechanics, service men, operators & owners. Explains theory, construction and servicing of modern motor cars, trucks, buses & auto type Diesel engines. 1540 pages, fully illustrated. 55 chapters. Indexed. A standard book for mechanics.

AUDELS DIESEL ENGINE MANUAL \$2

A practical, concise treatise with questions and answers on the theory, operation and maintenance of modern diesel engines including General Motors 2 cycle Diesel. 384 pages, fully illustrated, flexible binding, pocket size. All details plainly brought out, this book is of extreme value to engineers, operators & students.

AUDELS SHIPFITTERS HANDY BOOK \$1

288 pages of information, instruction, pictures & reference charts, together with many short cuts & trouble savers for shipfitters in their work.

AUDELS RADIOMANS GUIDE \$4

A key to the practical understanding of radio including Frequency Modulation, Television, etc., Aircraft & Marine Radio. For radio engineers, servicemen, amateurs. 772 pages, 400 illustrations & Diagrams. Photos. Review Questions, Answers, Reference Index. Authentic, clear, concise.

AUDELS MECHANICAL DICTIONARY \$4

950 pages. Over 17,000 new and standard mechanical terms, words, phrases, tables, formulas, helps, hints, short-cuts and practical suggestions. The right word when needed most.

AUDELS HANDY BOOK OF PRACTICAL ELECTRICITY \$4

For maintenance engineers, electricians & all electrical workers. 1440 Pages, 2600 Illustrations. Covers important electrical information in handy form—including Marine Wiring, Radio Principles, Welding. Fully indexed. The key to a practical understanding of electricity.

AUDELS CARPENTERS & BUILDERS GUIDES—4 Vols. \$6

A practical illustrated trade assistant on modern construction for carpenters, joiners, builders, mechanics and all woodworkers. 4 vols., 1600 pages, 3700 illustrations, flexible covers. Each volume pocket size. Sold separately \$1.50 a vol.

AUDELS PLUMBERS & STEAMFITTERS GUIDES—4 Vols. \$6

A Practical Trade Assistant & Ready Reference. Explaining in plain language & by clear illustrations, diagrams, charts, graphs, pictures the principles of modern plumbing practice including Marine Pipe Fitting and Air Conditioning. 4 Vols.—1670 Pages—3642 Diagrams. Each Vol. Pocket Size. Sold Separately \$1.50 a Vol.

AUDELS WIRING DIAGRAMS \$1

210 Pages, Illustrated. Gives practical facts on wiring of electrical apparatus. It explains clearly in simple language how to wire apparatus for practically all fields of electricity. Each diagram is complete & self-explanatory. A Highly Endorsed Pocket Companion.

AUDELS ELECTRIC DICTIONARY \$2

For Every Worker Who Has To Do With Electricity. Enables you to understand and explain electrical problems. Defines more than 9000 words, terms & phrases in plain, unmistakable language, compiled with accuracy & thoroughness. Alphabetically arranged, reference index.

AUDELS MILLWRIGHTS GUIDE \$4

Practical up-to-date information on Plant Installation, Operation and Maintenance. 1200 pages completely illustrated, fully indexed, 1000 facts at your fingertips in 6 convenient sections with ready reference.

GUETHS MECHANICAL DRAWING . . . \$1

A Concise Drawing Course. 150 pages, 50 plates. A complete instructor & reference work. Gives many helpful hints & suggestions on How to Draw.

AUDELS ELECTRONIC DEVICES \$2

Tells What You Want to Know About Electric Eya. Easily Understood. Covering Photo-electric cells & their applications. Amplifiers, illumination, frequencies, voltage, photocell, tubes, Ohm's Law, wiring diagrams, etc.

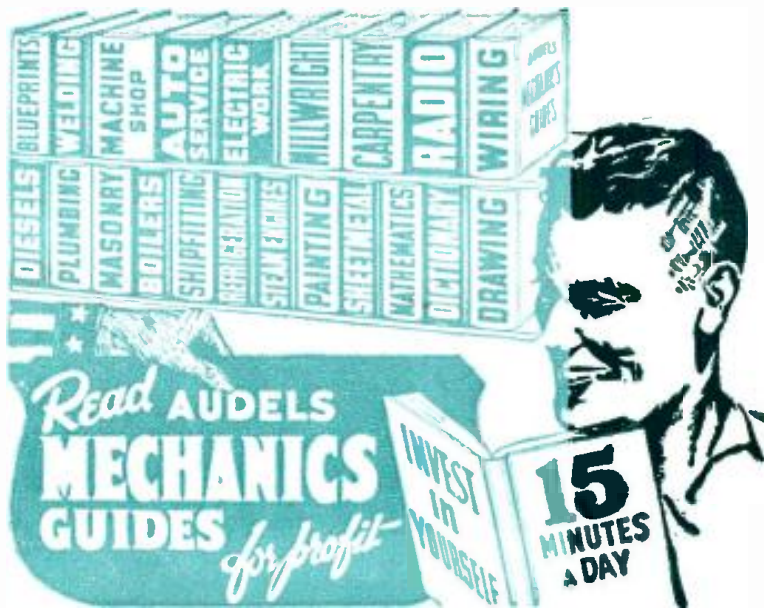

**Information in a Handy Form!
AN AUDEL GUIDE IS A GOOD FRIEND!**

Use the brains and experience of others in these Guides of the Trades. Save time and money with right methods, short cuts, labor-saving ideas—"Learn more to earn more." Use our generous 7-day free examination privilege and our dollar a month payment plan. Become a Master in your Trade, and understand the Trades that tie into yours.

How to obtain these Guides for examination. Mark X on the order blank the Guides desired. Every Audel Guide is complete, up-to-date, easily understood with Questions and Answers, fully illustrated and indexed. They speak for themselves. Send for yours today at our risk and expense. Ask to see them.



Check NOW!

You Can Look Over Any Guide In Your Own Home

Start the Easy Payments If Satisfied

MAIL THIS TODAY

CUT HERE MAIL ORDER
THEO. AUDEL & CO., 49 W. 23 St., New York 10, N.Y.

Please mail me for 7 days' free examination the books marked (X) below. I agree to mail \$1 in 7 days on each book or set ordered, and to further mail \$1 a month on each book or set ordered until I have paid purchase price.

- If I am not satisfied with Guides I will return them.
- Audels REFRIGERATION & Air Conditioning Guide . . . \$4.
- Audels POWER PLANT ENGINEERS GUIDE 4.
- Audels PUMPS, HYDRAULICS & AIR COMPRESSORS 4.
- Audels WELDERS GUIDE 1.
- Audels BLUE PRINT READING 2.
- Audels SHEET METAL WORKERS Handy Book 1.
- Audels SHEET METAL PATTERN LAYOUTS 4.
- Audels AIRCRAFT WORKER 1.
- Audels MATHEMATICS and CALCULATIONS 2.
- Audels MACHINISTS & TOOLMAKERS Handy Book . . . 4.
- Audels MECHANICAL Dictionary 4.
- Audels AUTOMOBILE GUIDE 4.
- Audels DIESEL ENGINE MANUAL 2.
- Audels MARINE ENGINEERS Handy Book 4.
- Audels SHIPFITTERS Handy Book 1.
- Gueths MECHANICAL DRAWING COURSE 1.
- Rogers DRAWING and DESIGN 2.
- Audels MILLWRIGHTS and Mechanics Guide 4.
- Audels CARPENTERS and Builders Guides (4 vols.) . . 6.
- Audels PLUMBERS and Steamfitters Guides (4 vols.) . . 6.
- Audels MASONS and Builders Guides (4 vols.) . . . 6.
- Master PAINTER and DECORATOR 2.
- Audels GARDENERS & GROWERS GUIDES (4 vols.) . . 6.
- Audels ENGINEERS and Mechanics Guides 4.
- Nos. 1, 2, 3, 4, 5, 6, 7 and 8 complete 12.
- Audels Answers on Practical ENGINEERING 1.
- Hawkins Aids to ENGINEERS EXAMINATION 2.
- Audels ELECTRICIANS EXAMINATIONS 2.
- Audels WIRING DIAGRAMS 1.
- Audels Handy Book of PRACTICAL ELECTRICITY . . . 4.
- Audels ELECTRICAL POWER CALCULATIONS 2.
- Hawkins ELECTRICAL Guides at \$1. each 10.
- Audels ELECTRONIC DEVICES 2.
- Audels ELECTRIC Dictionary 4.
- Audels RADIOMANS GUIDE 4.
- Audels NEW ELECTRIC LIBRARY at \$1.50 a Volume . . .
- Vols. I, II, III, IV, V, VI, VII, VIII, IX, X, XI, XII.

Name _____
Address _____
Occupation _____
Employed by _____ RCF

Many headlines like this
have raised the question

**RADIO RACKETEERS
ASSAILED BY COURT**

Declaring that radio repairmen were fleecing customers by charging all the traffic
New State Jan

Should Radio Service Dealers be *Licensed?*

RAYTHEON

HAS THE ANSWER!

and will announce it shortly . . .

Screaming headlines in the New York Times, the World Telegram, the Herald-Tribune, articles in *The Reader's Digest*—you know the unfavorable talk they have helped spread, the hardship they have worked on every *honest* radio service dealer.

DEALER LICENSES DISCUSSED

You are well aware that federal regulation, *dealer-licensing* and even *finger printing*, are being suggested and discussed by a lot of influential people.

What's the answer? *Raytheon will announce it shortly* for Raytheon has been working for years on a new, foolproof way to protect the public—and to help the *ethical radio service man*. A revolutionary new merchandising plan that will raise the public's opinion of the radio servicing profession and protect the reliable service dealer from outside interests.

GREAT COMPETITIVE ADVANTAGE

You can see the tremendous competitive advantage this Raytheon plan will give every dealer who can qualify! Watch for all the facts on the Raytheon program to protect the public — and help the honest service-dealer!

Raytheon Manufacturing Company

RADIO RECEIVING TUBE DIVISION

NEWTON MASSACHUSETTS • LOS ANGELES • NEW YORK
CHICAGO • ATLANTA

COPYRIGHT 1945 RAYTHEON MANUFACTURING COMPANY

DEVOTED TO RESEARCH AND THE MANUFACTURE OF TUBES FOR THE NEW ERA OF ELECTRONICS

RADIO-CRAFT for DECEMBER, 1945

219



RADIART VIBRATOR GUIDE (Most Complete Published)

Makes
Vibrator Servicing
Easy!

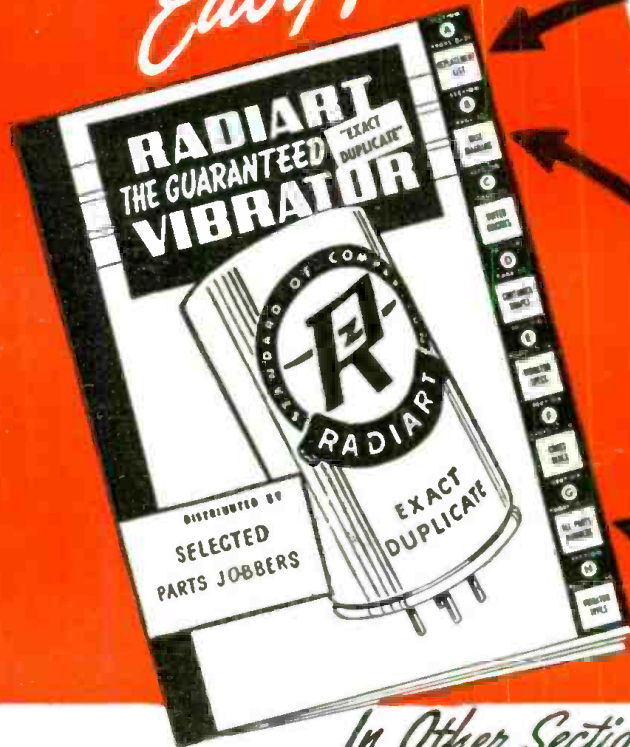

Section A...Vibrator

Name, Model No.	Mfrs. Part Number	Radiart Number	List Price	Base Dia.	Buffer Condenser
CHRYSLER					
C1808 (Elec. P. B.) (Philco—1941)...	83-0027	5326P	3.00	A	.008
25C6 (Wells-Gardner—1938)...	19A32	5437	6.95	AB	.018
600 (Mech. P.B.) (Colonial—1941)...	43697	5301	3.55	A	.004
601 (Colonial—1942)...	911545	5301	3.55	A	.004
800 (Philco—1941)...	83-0027	5326P	3.00	A	.005

Every model listed includes all available data. The correct Radiart Replacement number and other essential information is determined instantly.

SECTION "B"—Cross

Diagram Number	Shape	Voltage	Diam.	Ht.	Freq.	Identifying Characteristics	Max. Load Amperes
B 3417	2	6	1 1/2	4 1/2	105	6
3915	9	6	1 1/2	4 1/2	105 Spec. Cup	6
C 5309	1	6	1 1/2	2 3/8	105	6
5321	1	6	1 1/2	3 1/8	105	6
D 4286	1	6	1 1/2	3 1/8	105	10
4256-12	1	12	1 1/2	3 1/8	105	6

In addition to conventional base diagram drawings this section is unique in that it groups all similar base types together indicating readily the differences between vibrators with the same base wiring. All characteristics are shown, including frequency and maximum load limit of each type.

In Other Sections..

Section "C"—Buffer Condenser Values and Circuits.

Section "D"—Container Shapes permitting an easy method of "visual" identification.

Section "E"—Complete Vibrator Specifications arranged numerically by number. Contains necessary data not published in any other replacement guide.

Section "F"—Long a favorite with users of this guide. The only cross-index of all other manufacturers or merchandisers of vibrators, converting their type numbers to the Correct Radiart Replacement.

Section "H"—Numerical Listing of Radiart Vibrators. Furnishes complete information as to all models serviced by each unit. Also advises year each type was originated.

Auto Radio Service Dealers:

Obtain this Guide free of charge from your Radiart Distributor. Ask him to furnish you with a stock of the popular 12 types of Radiart Vibrators each of which is guaranteed to CORRECTLY service the applications listed for it in this guide. With these 12 types you can satisfy nearly all of the "Demand" types. But — RADIART is a complete line and your Radiart Distributor renders a complete service and can quickly furnish all of the necessary slower moving correct Radiart Replacement Vibrators as well.

Manufactured by the makers of RADIART Rust Proof Aerials.

SECTION "G"—Radiart and Original Equiv.

Original Equipment Part No.	Radiart No.	Original Equipment Part No.	Radiart No.	Original Equipment Part No.
75	3283	1974	5301	8539
80-161	5421	2080	3417	8540
83B	6341M	2110	3417	8541
83-0017	5326P	2259	6413	8542
83-0025	5326P	2404	6340M	8501
83-0026	5326P	2501	5411	8663

Another Radiart Vibrator Guide EXCLUSIVE feature. When called upon to duplicate a vibrator and no information is available except the number on the old one, use this cross-index which shows the original manufacturer's number (as stamped on vibrator) and the CORRECT Radiart Replacement.

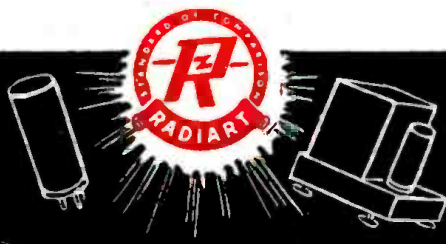

Radiart Corporation

3571 W. 62nd STREET • CLEVELAND 2, OHIO
Export Division • Canadian Office
25 Warren St., New York 7, N.Y. 455 Craig St., W., Montreal, Canada



Your IRC Distributor is now prepared to furnish you with all of the many types of resistance devices you most frequently need in your electronic servicing and installation work.

Months ago IRC made plans and preparations to provide you with ample quantities of quality controls and resistors immediately civilian restrictions were eased or abolished. Today, the results of those plans can pay off in added profits for you.

Every Cataloged Item in Stock

Every item shown and described in IRC's new Service Catalog No. 50 is now either on your Distributors' shelves or can be obtained for you practically over-night. This is possible because of newly created Servicemen's Stock Room recently set up at the IRC plant. That this stock will be kept well supplied is assured by IRC's tremendous production capacities which were stepped up to an all-time high to meet heavy war quotas.

If you do not have your copy of the new IRC Service Catalog No. 50 get one from your Distributor today or write direct to Dept. 25-L.



INTERNATIONAL RESISTANCE CO.

401 NO. BROAD STREET • PHILADELPHIA 8, PA.

IRC makes more types of resistance units, in more shapes, for more applications than any other manufacturer in the world.

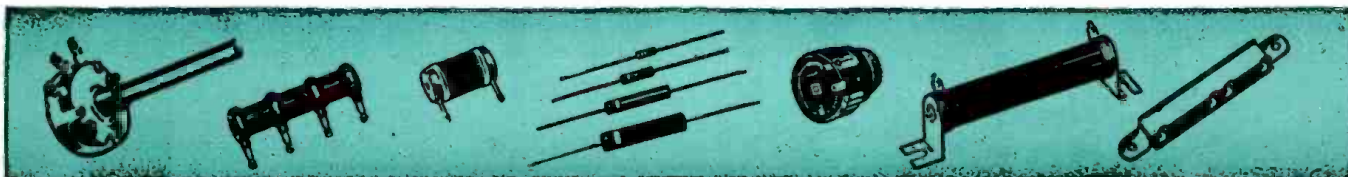

*AMPLITUDE



*ROTO-VUE

Ethical Engineering is the Basis of Eastern's 21 STAR FEATURES

*UNICABLE



Ethical engineering at Eastern is the history of many years in the service of sound amplification. The 21 Star Features are the result of intensive experience dating back to the early days of radio—the pioneer 20s! Today this engineering background accounts for the many innovations we have designed for the new 1946 Eastern Amplifiers—the 21 Star Features that produce Eastern's

famous *Quality Performance*. No other amplifiers, regardless of price, incorporate so many novel and useful features. . . . For complete information and price list—for the first edition of our 1946 Catalog—write today! . . . Eastern Amplifier Corporation, 794 East 140th Street, New York 54, N. Y. Dept. 12L.

RECESSED CONTROLS

*CODED CABLE

EASTERN AMPLIFIERS

*U.S. Reg'n Applied For

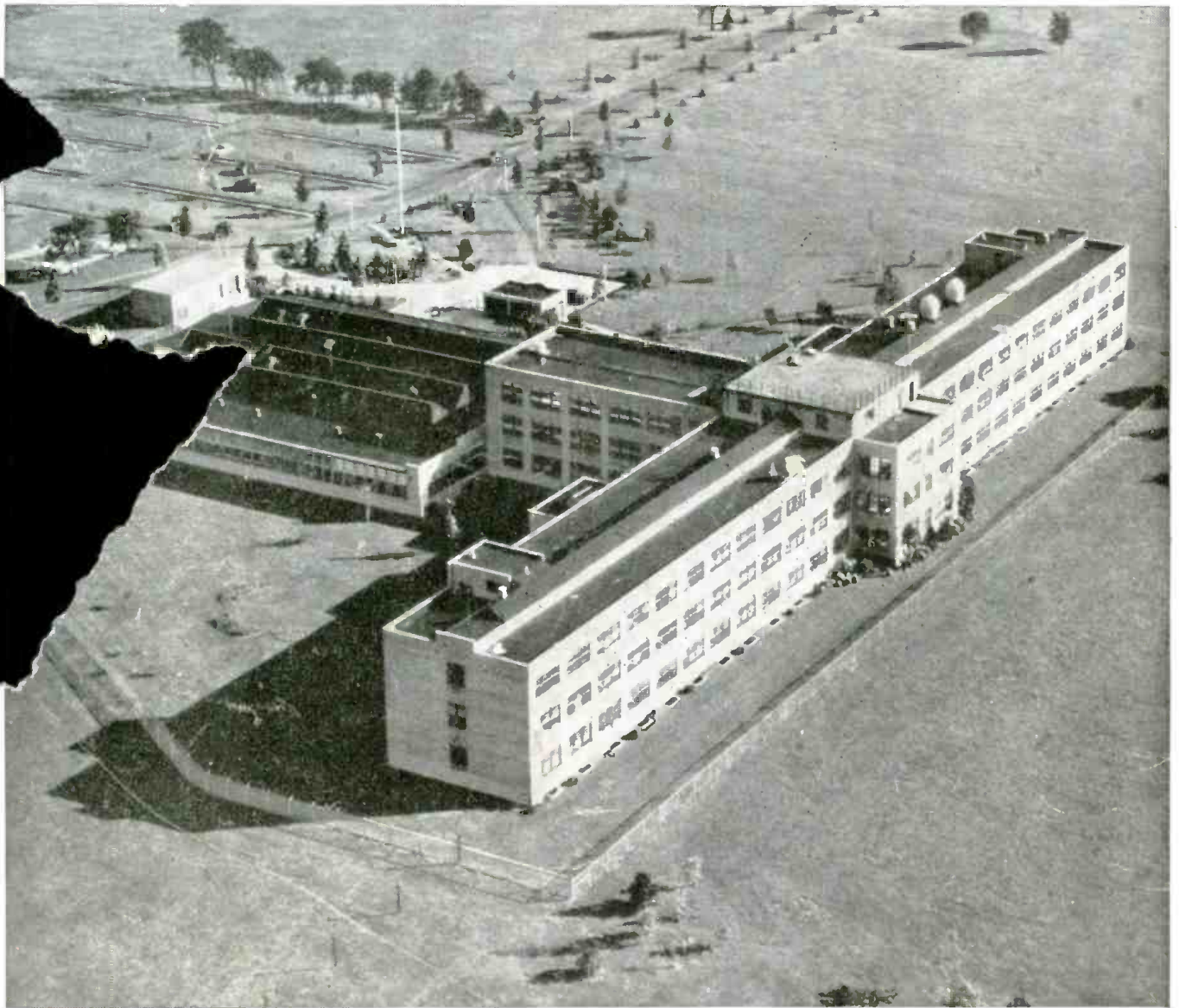

RCA Laboratories—Center of Radio and Electronic Research

RCA Laboratories at Princeton, N. J., are far more than one of the most modern and best-equipped laboratories ever built. It is a community of scientists, research men and technicians—each a top man in his field—each working with the other—contributing wherever and whenever his specialized knowledge will help.

It is a “university of ideas”—where visions are graduated as practical realities . . . where human wants are fulfilled through the creation of new products and processes, new services and markets.

It is a birthplace of scientific, industrial and social progress for the entire nation.

It is the reason why anything bearing the letters “RCA”—from a radio tube to your television receiver of tomorrow—is one of the finest instruments of its kind that science has yet achieved.

For just as the RCA electron tube, television receiver, radio, or the Victrola, is stamped by the RCA trademark, so does the product itself bear a stamp of experience and research that gives RCA pre-eminence in the field of radio and electronics.

Radio Corporation of America, RCA Building, Radio City, New York 20. *Listen to The RCA Show, Sundays, 4:30 P. M., Eastern Time, over the NBC network.*

PIONEERING

Scientists and research men who work in RCA Laboratories made many vital contributions in helping to win the war through application of radio, electronic, radar and television techniques. Their skills now are devoted to peacetime applications of these sciences.

At RCA Laboratories the electron microscope, radar, all-electronic television (featuring the projection system for the home) and many other new instruments of radio, including hundreds of new electron tubes, were developed to improve and to extend the services of radio around the world.



RADIO CORPORATION of AMERICA