

RADIO'S GREATEST MAGAZINE

RADIO-CRAFT

Incorporating

**RADIO &
TELEVISION**

HUGO GERNSBACK, Editor

MANY ARTICLES
FOR THE
**RADIO
BEGINNER.**



SEE PAGE
406

APRIL

25¢

NADA 30¢

1943

OVER 100 ILLUSTRATIONS

HT-4B



HERE is that high-powered rig you have always wanted to own... one that you can depend upon for peak operating efficiency. Hallicrafters have built into the HT-4B the resultant experience from years of engineering research.

Model HT-4B delivers a carrier output of 325 watts on phone and 450 watts on CW. The preamplifier supplied with the transmitter can be mounted conveniently at the operating position, controlling volume, keying and standby... once adjusted to any band the rig may be operated remotely.

When, once again, we are permitted to sell communications equipment for civilian use — your HT-4B will be waiting for you.

hallicrafters

CHICAGO, U. S. A.

World's largest exclusive manufacturer of short wave radio communications equipment.



FREE Lesson in Radio

Here is a Partial List of Subjects This Lesson Teaches

With 31 Photos, Sketches, Radio Drawings

- How superheterodyne receivers work
- How to remove tubes, tube shields
- Three reasons why Radio tubes fail
- Electrodynamic loudspeaker:
 - How it works
 - Replacing damaged cone
 - Recentring voice coil
 - Remedies for open field coil
- Output transformer construction, repair
- Gang tuning condenser:
 - Construction of rotor, stator
 - How capacity varies
 - Restranging dial cord
 - Straightening bent rotor plates
- I.F. transformers—
 - What they do, repair hints
- How to locate defective soldered joints

GETTING ACQUAINTED WITH RECEIVER SERVICING

- Inside story of carbon resistors
- Paper, electrolytic, mica, trimmer condensers
- How condensers become shorted, leaky
- Antenna, oscillator coil facts
- Power transformer: construction, possible troubles
- Installing power cord
- Troubles of combination volume control, on-off switch
- Tone controls
- Dial lamp connections
- Receiver servicing technique:
 - Checking performance
 - Testing tubes
 - Circuit disturbance test
 - Isolating defective stage
 - Locating defective part



See For Yourself How I Train You at Home to BE A RADIO TECHNICIAN

J. E. SMITH, President
NATIONAL RADIO INSTITUTE
Established 28 Years

Mail the Coupon for a FREE lesson from my Radio Course. It shows how N.R.I. trains you for Radio at home in spare time. And with this Sample Lesson I'll send my 64-page illustrated book, WIN RICH REWARDS IN RADIO. It describes many fascinating jobs Radio offers, tells how you can train for them at home in spare time!

More Radio Technicians and Operators Now Make \$50 a Week Than Ever Before

There's a big shortage of capable Radio Technicians and Operators because so many have joined the Army and Navy. Fixing Radios pays better now than for years. With new Radios out of production, fixing old sets, which were formerly traded in, adds greatly to the normal number of servicing jobs.

Broadcasting Stations, Aviation and Police Radio, Ship Radio and other communications branches are scrambling for Operators and Technicians to replace men who are leaving. You may never see a time again when it will be so easy to get started in this fascinating field. The Government now needs hundreds of competent civilian and enlisted Radio men and women. Radio factories, with huge war orders to fill, have been advertising for trained personnel. And think of the NEW jobs Television, Frequency Modulation, Electronics and other

Radio developments will open after the war! This is the sort of opportunity you shouldn't pass up.

Many Beginners Soon Make \$5, \$10 a Week Extra in Spare Time

There's probably an opportunity right in your neighborhood to make money in spare time fixing Radios. I'll give you the training that has started hundreds of N.R.I. students making \$5, \$10 a week extra within a few months after enrolling. The N.R.I. Course isn't something just prepared to take advantage of the present market for technical books and courses. It has been tried, tested, developed, perfected during the 28 years we have been teaching Radio.

Find Out What N.R.I. Can Do For You

MAIL COUPON NOW for FREE Sample Lesson and 64-page illustrated book. You'll see the many fascinating jobs Radio offers and how YOU can train at home. If you want to jump your pay—mail Coupon at once in an envelope or paste on a penny post!—J. E. SMITH, President, Dept. 3DX, National Radio Institute, Washington, D. C.

TRAINING MEN FOR VITAL RADIO JOBS



\$10 a Week in Spare Time

"I repaired some Radio sets when I was on my tenth lesson. I really don't see how you can give so much for such a small amount of money. I made \$600 in a year and a half, and I have made an average of \$10 a week—just spare time." JOHN JERRY, 1337 Kalamath St., Denver, Colorado.

\$200 a Month in Own Business

"For several years I have been in business for myself making around \$200 a month. Business has steadily increased. I have N.R.I. to thank for my start in this field." ARLIE J. FROEHNER, 300 W. Texas Ave., Goose Creek, Texas.



N.R.I. Graduate Now Lieutenant in U. S. Army Signal Corps

"I cannot divulge any information as to my type of work, but I can say that N.R.I. training is certainly coming in mighty handy these days." (Name and address omitted for military reasons.)

Chief Operator Broadcasting Station

"Before I completed your lessons, I obtained my Radio Operator's license and immediately joined Station WMPC where I am now Chief Operator." HOLLIS F. HAYES, 327 Madison St., Lapeer, Michigan.



Service Manager for Four Stores

"I was working in a garage when I enrolled with N.R.I. I am now Radio Service Manager for the M. Furniture Co. for their four stores." JAMES E. RYAN, 119 Pebble Court, Fall River, Mass.

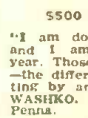

\$500 per Year in Spare Time

"I am doing spare time Radio work, and I am averaging around \$500 a year. Those extra dollars mean so much—the difference between just barely getting by and living comfortably." JOHN WASHKO, 97 New Cranberry, Hazleton, Penna.



Extra Pay in Army, Navy, Too



Men likely to go into military service, soldiers, sailors, marines, should mail the Coupon Now! Learning Radio helps Servicemen get extra rank, extra prestige, more interesting duties, MUCH HIGHER PAY. Also prepares for good Radio jobs after service ends. Over 1,700 Servicemen now enrolled.

GOOD FOR BOTH 64 PAGE BOOK SAMPLE LESSON FREE

MR. J. E. SMITH, President, Dept. 3DX, NATIONAL RADIO INSTITUTE, Washington, D. C. Mail me FREE, without obligation, Sample Lesson and 64-page book. "Win Rich Rewards in Radio." (No Salesman will call. Write plainly.)

Ago

Name

Address

City State 4FR-2



RADIO-CRAFT

Incorporating

RADIO & TELEVISION

HUGO GERNSBACK
Editor-in-Chief

KARL E. SCHUBEL
Associate Editor

FRED SHUNAMAN
Technical Editor

G. ALIQUO
Circulation Manager



Contents APRIL, 1943 Issue

VOLUME XIV -- NUMBER 7

Mailbag	388
Editorial: Radio and Post-War Peace	by Hugo Gernsback 391
O.S.I. Freezes Radio Troubles for Duration	392

ELECTRONICS

Popular Electronics	by Raymond Francis Yates 394
Electronics—Versatile as a Genius	by S. R. Winters 397
Electronics Primer	by Dr. Joseph Slepian 398
Photo Electric Organ	by Leslie Gould 400
The Encephalophone	401
Electronic Heat Solders Crystals	402

SERVICING

Systemized Trouble Shooting	by Eric Leslie 403
RADIO SERVICE DATA SHEET:	
No. 332 General Electric Models LC-759, LC-759B & LC-768	404

TREASURE LOCATORS

Metal Locator—1943 Model (Cover Feature) ...	by G. M. Bettis 406
--	---------------------

CONSTRUCTION

A Compact A.C.-D.C. Portable	by Edward M. Yard 409
Power Supply for Battery Portables	by R. S. Havenhill 410
Handy Tester and Signal Tracer	by E. Pottruff 411
Direct Reading Capacity Bridge	by L. W. Smith 412

EXPERIMENTERS

Elementary Mathematics of Radio Direction Finding	by John R. Kearny 413
Plate and Screen Dissipation Ratings	414
Condensers, Chokes and Lenz' Law	by Fred Shunaman 415

SOUND

Practical Audio Amplifier Theory, Part III	by Ted Powell 416
A Small Interphone	by Arthur Blumenfeld 418

BEGINNERS

Power Supplies for Beginners	K. E. Schubel 423
Code Oscillators for the Beginner	424

DEPARTMENTS

Mailbag	388
RADIO SERVICE DATA SHEET: (See Servicing)	404
Latest Radio Apparatus	420
Question Box	426
Radio Hookups	428
Radio Kinks	430
Books Reviews	447

★

Published by Redcraft Publications, Inc. Publication office: 29 Worthington Street, Springfield, Mass. Editorial and Advertising Offices: 25 West Broadway, New York City. Chicago Advertising Office: RADIO-CRAFT, 520 North Michigan Avenue, Chicago, Ill.

RADIO-CRAFT is published monthly, on the first of the month preceding that of date; subscription price is \$2.50 per year in U. S. (In foreign countries, 75c additional per year to cover postage; Canada, 50c additional.) Entered at the post office at Springfield as second-class matter under the act of March 3, 1879. All communications about subscriptions should be addressed to: Radio-Craft, 25 West Broadway, New York, N. Y.

★

Foreign Agents:

London—Gorrings's American News Agency, 9A Green St., Leicester Square, W. C. 2, England.

Melbourne—McGill's Agency, 179 Elizabeth St., Australia.

Dunedin—James Johnston, Ltd., New Zealand.

★

Text and illustrations of this magazine are copyright and must not be reproduced without permission of the copyright owners.

★

Copyright 1943 Redcraft Publications, Inc.

7 Days FREE TRIAL

Costs You Nothing to Examine This Amazing New Three Volume Set of REFERENCE BOOKS OF PRACTICAL



ELECTRICITY

Each Book 8½ x 11 inches. Handsomely Bound in Harvard Red and Gold Leatherette.

AT LAST! A set of electrical books written in clear, understandable language for the "beginner" or "old timer." Solves your everyday electrical problems easily, quickly and thoroughly.

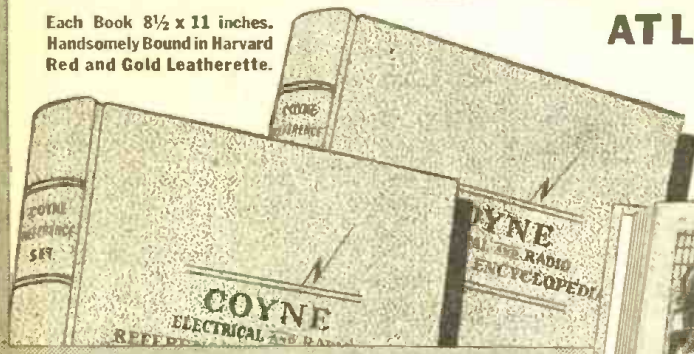

SEND NO MONEY! COUPON BRINGS COMPLETE SET!

Now at last, it's easy, practical to get a knowledge of Electricity at home. Whether you want to learn Electricity or whether you are now doing electrical work, you need these books.

AUTHORITATIVE. PRACTICAL—prepared by experts. Used regularly on the job by hundreds of Electricians, service men, radio men, air cadets, students, maintenance men, etc. **EASY. COMPLETE.** Covers everything Electrical: Armature winding, A.C. and D.C. Motors, generators, electronics, automotive electricity, refrigeration, etc., etc. Answers your electrical questions quickly, clearly, completely. Also includes Radio, Television.

FREE — with Reference Books

Send for these reference books now, and I'll include 1 full year of Technical Service—personal advice by mail on any Electrical or Radio subject.

SEE THEM—RISK FREE!

Don't send a penny. Simply mail coupon below and receive your set. Examine books 7 days, with no obligation. Then, if you decide they are the finest, most practical reference set you ever saw, send \$1.95, and then \$2.00 monthly until total price of \$13.95 is paid. I'll prepay all shipping charges. Offer is limited. Mail coupon NOW.

H. C. LEWIS, Pres., COYNE ELECTRICAL SCHOOL
500 So. Paulina St. Dept. 43-T2 Chicago, Ill.

HUNDREDS OF PICTURES AND DIAGRAMS! HUNDREDS OF ELECTRICAL SUBJECTS AT YOUR FINGER TIPS!

A few of the many branches of Electricity explained and pictured in this amazing set are:

- | | | |
|------------------|-----------------|----------------|
| Air Conditioning | Refrigeration | Power Plants |
| Telephony | House Wiring | Diesel Engines |
| Auto Electricity | Electric Signs | Motors |
| Talking Pictures | Home Appliances | Armatures |
| Generators | Switchboards | A.C. and D.C. |

*Complete Ready Reference Index of over 2000 listings tells you instantly where to look up any electrical fact.

H. C. LEWIS, Pres.
COYNE ELECTRICAL SCHOOL
500 S. Paulina St., Dept. 43-T2
Chicago, Ill.

NO RISK COUPON

Send me the big 3-volume Coyne Electrical and Radio Encyclopedia, postpaid. Within 7 days after receiving the books, I'll either return them or send you \$1.95, and \$2 a month until advertised price of \$13.95 is paid.

NAME

ADDRESS

CITY STATE

OCCUPATION AGE

SAVE 10%. Send cash price, \$12.55, with order if preferred—you save \$1.40. Same 7-day free trial and return privilege.

JUST OUT! NEW ALLIED 1943 BUYING GUIDE FOR EVERYTHING IN RADIO AND ELECTRONICS

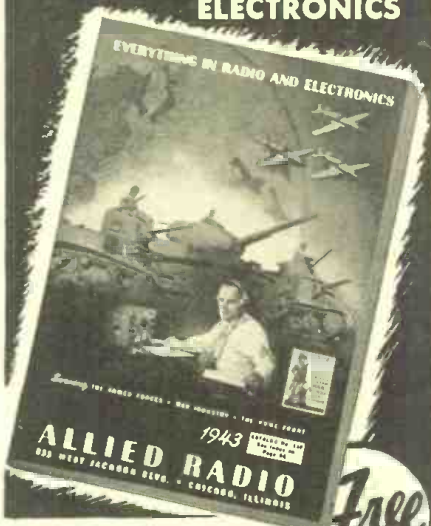

SEND FOR YOURS
...NOW!

Free

The latest streamlined 1943 Catalog of everything in Radio and Electronics. Get all your needs quickly from this ONE dependable central source of supply . . . over 10,000 items for the Armed Forces, for Radio Training, for Research Laboratories, for War Industries and for Service Replacement. Our large complete stocks speed delivery. Our experienced staff is ready to help you. Send for your new Allied Catalog today . . . it's FREE!

SEND FOR THESE VALUABLE NEW BOOKS!

RADIO DATA HANDBOOK
No. 37-754

Formulas, charts and technical data 25c



RADIO CIRCUIT HANDBOOK
No. 37-753

Practical data and schematic diagrams. 10c

DICTIONARY OF RADIO TERMS
No. 37-751

Simple definitions of radio terms . . . 10c



SIMPLIFIED RADIO SERVICING
No. 37-755

Short cuts in trouble-shooting 10c

WRITE FOR QUANTITY QUOTATIONS

ALLIED RADIO CORP., Dept. 2-D-3
833 W. Jackson Blvd., Chicago, Ill.

Please send following books (. . . c enclosed)
 FREE No. 37-754 No. 37-751
1943 Catalog No. 37-753 No. 37-755

Name
Address
City State

★ ALLIED RADIO ★

SUBMARINE DETECTOR

Dear Editor:

I take the liberty of addressing you in regard to a subject that has engaged my attention, and been the source of considerable discussion in the newspapers for some time.

Reading your editorial article in the February issue of *Radio-Craft*, and noting particularly everything you say in regard to the U-boat menace, I have come to the conclusion that no effort in physics will ever be a cure for this problem, especially in a raging sea.

To my mind, the quickest and surest way would be something on a line with the photoelectric cell cameras employed on the race tracks, synchronized with, and sighted on, a rapid-fire gun.

This combination to be placed in the hatchway of all merchantmen and freighters.

This to be a swivel gun with battery attachment and camera as a unit. This Beam-Ray, or scanning eye, when moved around and sighted on a periscope, especially at night, will eventually spell doom for any U-boat.

J. C. DANFORTH,
New York, N. Y.

(This idea might be feasible if the periscope of the submarine were above water, but useless when the submarine is totally submerged, and lies waiting for its prey.—Editor)

ENTHUSIASTIC BEGINNER

Dear Editor:

No doubt you receive letters every day telling you and your staff of what a fine job you are doing for the radio industry. You pick up the beginner, give him a helping hand, and send him off into the radio world. This act alone is deserving of much credit, for in that act you are helping to develop tomorrow's geni of radio.

I had my start in radio six years ago when I joined the Boy Scouts of America. For six tinkering years I have been numbered among the nation's radio beginners. That's a long time to stay in the same class, but radio has been with me only a hobby. However, almost every day, after I return from school, I manage to spend a few moments in my "lab." I go to a prep school, and the headmaster has given me a room in the basement where I keep my "junk." Candidly, I know little of radio, but what I do know, *Radio-Craft* has taught me.

My main interest lies in signaling. In my lab I have rigged up a code practice set from an old electric train transformer, a telegraph key, and an old headset. I have found that a small P.A. speaker can be made to respond also. Volume is controlled by controlling the voltage that enters the phones.

This is undoubtedly nothing new to you, but I haven't seen such a set-up in any of the twenty-eight "*Radio-Craft*" publications I have in my radio library. It is a simple set, and one which can be very easily made.

I close this letter with the hope that *Radio-Craft* will continue its policy of aiding the beginner.

C. THOMAS GRIMM, II,
Claymont, Delaware.

TESLA EULOGY

Dear Editor:

After reading in the February issue your beautiful eulogy and praise of the late Dr. Nikola Tesla, it struck me as a kind thought for you to have had a mask taken of this wonderful scientist. I felt prompted to write you about my sentiments in the matter.

As you say, Dr. Tesla was very reticent, and the writer hopes that Westinghouse

and G.E., who profited so much from his inventions, will at least do as much as you have done to perpetuate his name.

SIDNEY B. MARTIN,
Elizabeth City, N. C.

BRAIN WAVES AND NERVE CURRENTS

Dear Editor:

After having read many inspiring articles in your magazine *Radio-Craft* and also noticing the "unbelievable" things that radio scientists have done, I would like to interest someone in a new field of experiment.

I am badly disabled in that I am completely paralyzed from my hips down. This is due to a fractured spine and the severance of my spinal cord, which carries the various nerves from the brain to all parts of the body.

Now, it seems that these nerves in the spinal cord are the only things that will carry an impulse to or from the brain. In other words this nerve "cable" conducts or transmits messages from the brain to every part of the body. No movement or sense of feel can be accomplished without this.

The point I am leading to is this: It may be possible for these nerve impulses to travel from the brain to the various parts of the body without going through the spinal cord. Probably some sort of electrified circuit with peculiar frequency characteristic would respond to the workings of the brain. Perhaps a high-frequency apparatus could generate impulses that would be common to both the brain and the various members of the body. If I could get a message through the gap in my spinal cord or could by-pass it in some way I could probably get well.

I am well aware of the great achievements of Dr. Lee DeForest. If you would be so kind as to forward me his address I would like to see if this matter would interest him. If you know of anyone whom you think may be interested in this, would you please tell them or give them this letter.

STACEY M. FIELDS,
558 Westwood Avenue,
Mobile, Alabama.

THE BATTLE IS OVER!

Dear Editor:

We first wish to make it known that since we were not privileged to have read Mr. Moody's or Mr. Risk's articles, we are not aware of what has gone on heretofore, and therefore, are only interested in this electron flow vs. current flow discussion.

We do feel, however, that Mr. Petersen has unwarrantedly been over-sarcastic in his references to the other parties involved, which forces us to the conclusion that the manpower shortage must really be acute, in the editor's office, to have allowed Mr. Petersen's letter to have been published without edit, and also in the field of instructors, which, unfortunately, is going to create a war class of radiomen with personal theories not in accord with basic scientific theory.

Really, Mr. Petersen, we feel justified in making this statement, after having read what was really an unwarranted attack upon the sincere beliefs of an individual.

We also serve notice that any further discussion regarding the basic theory which we present, must, of necessity, be taken up with the various professors, whose business it is to teach, and whose proof of ability is attested to by the D.S., E.E., and other college degrees they have earned the right to display. And also the scientists, whose ACTUAL experimentations have laid down the very basic theory, and is then handed to you and me on a silver platter. It merely

remains for us to interpret these theories correctly, which apparently hasn't been done very well or even convincingly by some.

Now Mr. Petersen, and Mr. Shapiro as well as the rest of you who would call CURRENT flow from plus to minus, and ELECTRON flow from minus to plus, and who say that CURRENT is one thing, and ELECTRONS another, prepare yourselves for a rude, if not timely, awakening!!!

ELECTRON FLOW and CURRENT are ONE AND THE SAME THING!

Q.—What constitutes an electric CURRENT?

A.—“The drift of ELECTRONS along a conductor, due to the application of an electro-motive force, constitutes an ELECTRIC CURRENT.” (*Sterling, Terman, Henney, The Radio Handbook.*)

Q.—What constitutes an ampere?

A.—“When 6.28×10^{18} electrons are in motion in a conductor, a CURRENT of one ampere is flowing.” (*The Radio Handbook.*)

CURRENT—“Current strength, that is, the number of electrons moving per second, is measured in amperes.” (*Sterling*)

Need anything be more plainly written to convince even the layman that electron flow and current are one and the same animal?

“Electric CURRENT in a conductor, is a simple passing of electrons through the conductor.” (L. W. Chubb, Director of Research, Westinghouse, in March, 1943, *Electronics.*)

Since we are not so glib as to expect anyone to accept statements made here as being gospel truth simply because we might be able to tack some titles on our signatures, we quote directly from RECOGNIZED authorities, and credit the quotations.

Now as regards the direction of CURRENT or the ELECTRON flow, we quote the 1941 *Radio Handbook*:

“Many textbooks speak of CURRENT flow in the CONVENTIONAL sense, that is, from positive to negative, NEVERTHELESS IT HAS LONG BEEN AN ESTABLISHED FACT THAT THE CURRENT FLOW IN A METALLIC CONDUCTOR IS THE ELECTRONIC FLOW FROM THE NEGATIVE TERMINAL OF THE SOURCE OF VOLTAGE, THROUGH THE CONDUCTOR TO THE POSITIVE TERMINAL. EXCEPT in the case of gaseous and electrolytic conductors, where the flow of POSITIVE IONS toward the cathode, or negative electrode constitutes a positive flow in the opposite direction to the electron flow.

“Before the discovery of the electron, scientists ASSUMED that the flow of current was from the point of positive potential to a point of negative potential. At this date, however, ALL scientists agree that the ELECTRONS in motion ARE the CURRENT, and therefore CURRENT flows from a NEGATIVE to a POSITIVE potential.” (Direct quote from *Sterling*; and found almost word for word in *Terman, Henney, Cooke, Everitt, Ghirardi, and Radio Handbook.*)

Concerning that part referring to the flow of positive ions from plus to minus, in the case of gaseous or electrolytic conductors, it is upon the behavior of the ELECTRON that depends the study of electricity and radio, and the action of the positive ion is of little concern, other than the effects it has upon the electron flow.

For example, in a “gassy” tube, electron flow will increase because of “ionization.” Electrons moving from cathode to plate, through the gas, collide with gas atoms knocking one or more electrons loose. These dislodged electrons then join the flow to the plate, while the atoms struck become positive ions because of their electron loss, and

flow toward the cathode. When they arrive, they acquire the number of electrons they lost and become neutral atoms again.

One can see that this flow of positive ions from plus to minus is in addition to the only flow we are primarily interested in, and represents, in 95% of electrical work, an undesirable condition.

In electrolytic conductors, we have a state of ionization by chemical reaction. Both positive ions and negative ions are present, the former flowing to the negative electrode and the latter to the positive electrode, which is immersed in the solution.

Any “doubting Thomas,” regardless of how many titles he tacks on his name in order to enhance his mutterings, should be able to comprehend such plain English.

Gentlemen, it is really deplorable, when, in view of the fine advancement we have had in the field of electronics, that people of the old school, the “die-hards,” you might call them, consistently refuse to accept proven theories of later date, and thereby sow the seeds of doubt in the mind of the average student who is trying his best to understand what is already, in itself, a complicated subject.

It would seem that so-called “instructors” (and we only refer to those unwilling to teach basic theory, and just teach a brand of their own) should THEMSELVES accomplish an understanding of “electrical nomenclature,” remove their OWN blindfold, and DO the job of teaching that has been placed in their trust, with BOTH hands.

FRANK C. CHAMPLIN, *Sound Engr. Garvey, California*

WORCESTER BOWEN, *Associate, IRE, Temple City, California*

(It is usually the unhappy lot of the Editor of a radio or electrical magazine to have a staid and uninteresting Mailbag, devoid of the lively arguments seen in those journals which deal with “controversial” subjects.

In this case we have to thank our correspondents for as lively a little battle as ever graced the pages of a political, economic or religious periodical. Unfortunately, the viewpoint presented in the above letter is so exhaustive, so forceful, and so CORRECT, that we are forced to admit with regret that the debate has been brought to an end.—*Editor*)

THE NAVY NEEDS ENGINEERS

The rapid extension in Navy surface vessels, submarines and aircraft has created several hundred additional billets for officers trained in electrical engineering who are needed to serve in engineering work in connection with ultra-high frequency electronic apparatus, the Navy announced last month.

The Navy has issued a call for qualified engineers to fill the new vacancies. Technically qualified for this work are men who hold degrees in electrical engineering and have practiced in the field of engineering since their graduation, or men who have majored in physics, mathematics, or other branches of engineering and who have acquired a sound working knowledge of alternating-current circuits and electronics.

Men commissioned for this electronic work are given the Navy's three-months' course in ultra-high frequencies at either Harvard University, or Bowdoin College, followed by an additional three-months' laboratory course at Massachusetts Institute of Technology. Upon graduation, these officers are assigned to responsible engineering positions having to do with research, design, instruction or maintenance of the Navy's ultra-high frequency equipment.

Qualified engineers are urged to apply for a commission at the nearest Office of Naval Officer Procurement. These offices are located in principal cities throughout the United States.

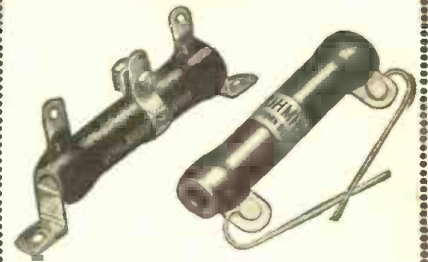

It's the way Ohmite Resistors are designed and built that makes them so reliable for today's critical service on the war front, and the home front. These sturdy, wire-wound units stay accurate, prevent burnouts and failures—insure permanent performance under the toughest operating conditions from the arctic to the tropics. This is your best assurance in maintaining the service of existing equipment or in developing new devices to defeat the enemy and build for tomorrow's peace.

Send for These Handy Aids



Ohm's Law Calculator—Helps you figure ohms, watts, volts, amperes—quickly, easily. Solves any Ohm's Law problem with one setting of the slide. All values are direct reading. Available for only 10c. (Also available in quantities.)

Quick-Reference Catalog 18. Free—Gives helpful information on Ohmite stock resistors, rheostats, chokes and tap switches for all types of applications.



Authorized Distributors Everywhere
Ohmite Mfg. Co., 4894 Flournoy St., Chicago



Audels -MANS RADIO GUIDE

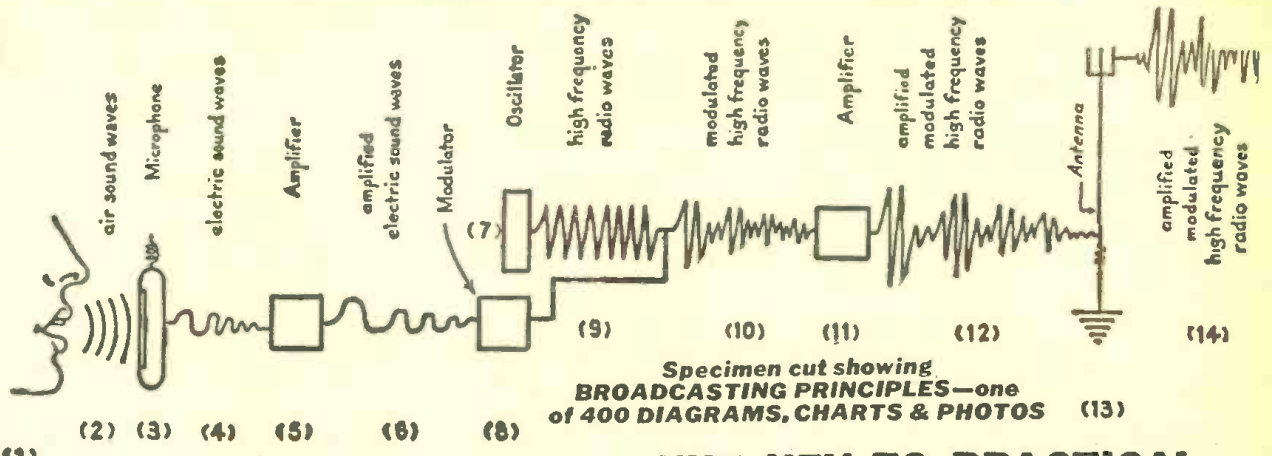

(1)
**QUESTIONS
AND
ANSWERS**

**1001
FACTS**



THE KEY TO PRACTICAL RADIO INFORMATION

Including Frequency Modulation—Television, etc.
Inside Information for Aviation, Marine, Commercial Operators
and Technicians, Servicemen and Students

772 PAGES, 400 DIAGRAMS, CHARTS & PHOTOS

This well organized reading course in Radio is especially suitable for home study and as a ready reference guide to help you learn the inside facts about radio. The amount of mathematics required for a successful study of this book is fully covered as the various chapters include numerous practical radio problems, carefully worked out, step by step, to their final solution. The contents are PROGRESSIVELY ARRANGED AND CAREFULLY INDEXED.

LATE DATA—EASY TO READ AND UNDERSTAND

Gives Authentic Principles and Practices in Construction, Operation, Service & Repairs. Covers clearly and concisely Radio fundamentals—Ohm's Law—Physics of sound as related to radio science—Measuring instruments—Power supply—Resistors—Inductors—Condensers—Transformers and examples—Broadcasting stations—Radio Telephony—Receivers—Diagrams—Construction—Control systems—Loudspeakers—Antennas—Auto Radio—Phonograph pickups—Public Address Systems—Aircraft & Marine Radio—Radio Compass—Beacons—Automatic Radio Alarms—Short Wave—Coil Calculations—Testing—Cathode ray oscillographs—Static Elimination—Trouble Pointers—Underwriter's standards—Units & tables. REVIEW QUESTIONS—Ready Reference Index.

HIGHLY ENDORSED—ASK TO SEE IT ON 7 DAYS' FREE TRIAL

-----MAIL COUPON TODAY-----

THEO. AUDEL & CO., Publishers, 49 West 23rd St., New York
Mail AUDELS NEW RADIOMAN'S GUIDE for free examination. If O.K. I will send you \$1 in 7 days; then remit \$1 monthly until \$4 is paid. Otherwise I will return it.

Name.....

Address.....

Occupation.....

Reference..... RCF

**\$4 COMPLETE
PAY \$1 A
ONLY 1 MO.**

RADIO-CRAFT

Incorporating

RADIO & TELEVISION

“RADIO'S GREATEST MAGAZINE”

RADIO AND POST-WAR PEACE

By the Editor — HUGO GERNSBACK

. . . Radio can be
responsible for post-
war security . . .

STRANGE as it may seem, most peoples of the world still do not realize that we are living in a changed world where man-made or other boundaries no longer mean anything.

The triumphant ascendancy of the airplane has done away not only with political, but with geographical boundaries as well. Airplanes are no respecters of lines drawn on the map; or of rivers, mountain chains or oceans; they simply fly over them—and, if necessary, with potential death and destruction in the hold or in the bomb bays. Most people realize all this but, unfortunately, they are not aware of the tremendous implications, even after the return of peace.

A hundred efficient future bombers secreted on a little-known island or in a subterranean mountainside, will be a constant challenge to world peace; at least until such time when a really effective answer to the airplane menace has been found. Surprise attacks—while nations are at peace with one another—are always bound to be costly and destructive. We were taught an expensive lesson with Pearl Harbor, where a single attack cost us over 3,000 lives and untold damage to war matériel. Far-seeing statesmen are well aware of the airplane menace to the future peace of the world and it is a constant nightmare to them, because no final answer to the problem has been found. You cannot expect the big nations to go back on a peace basis with complete disarmament while the secret airplane menace exists. The Germans have shown how fast a large war air force can be brought into being, starting with transport airplanes, which were supposed to be used for commercial purposes only.

Far-thinking men realize that with the advent of peace, all the nations will have large commercial air fleets again, all of which make a foundation for bombing planes. It was so in pre-war Nazi Germany, and it will be so after peace has come once more. International treaties and international policing will not solve the problem. For this reason, it has been realized by many that the great nations which have most at stake must have, even when peace returns, huge air fleets for war purposes, purely as a defensive measure, if they hope to avoid attack by some future dictator or would-be world conqueror.

Inasmuch as it is the surprise element which gives the enemy air armada a tactical and military advantage, it would seem that only by constantly having an alert air force ready at all frontiers, potential destruction could be avoided.

Every statesman, however, also knows that after peace comes, no country will have much enthusiasm to keep up tremendous air war forces. So unless something is done, we will be slipping back to where we were before Pearl Harbor and invite death and destruction to our great cities and industrial centers. And the fact should not be overlooked that future airplanes will be able to land invasion troops without much trouble. And do not forget

what every military expert can tell you, that a small air-borne invasion army of only 5,000 men could control a large industrial section—or seaboard cities like New York, Philadelphia or Washington—during peace times.

A part answer to the problem is an organized radio defense. This radio defense can be even more impregnable than our war-time radio defense now in vogue. We must not only have radio observation posts all along our frontiers, but these posts must be manned in peace time as in war time. This means complete control of all incoming and outgoing airplanes, in order to plot the exact whereabouts of ALL planes in the air. But this is not enough and it will fall far short of the mark during peace times. It may be necessary to anchor on special floats at a distance of from 300 to 500 miles off shore automatic radio airplane detectors. There would be a station every 50 to 75 miles. Such a chain of radio detecting beacons would give our shore stations sufficient time to get fighting airplanes into the air where they are most needed if an invading air armada should try to break through to our shores. There would be one such chain in the Atlantic, another one in the Pacific, and beyond our insular possessions. Thus, the Hawaiian Islands, for instance, would be surrounded by such a ring of beacons. It would then become very difficult for a surprise attack to be made on the United States in peace time. If an attack were to be made, there would be sufficient warning so that adequate preparations for the defense could be made in the meanwhile.

Moreover, future radio-electronic detection apparatus will be such that the unfortunate Pearl Harbor incident—where a young private soldier actually heard the invading Japanese airplanes and where his superior officer laughed it off—could not happen again. By the time the war is over, electronic devices will make it possible that the human element will not be of so much importance as it is today. The radio-electronic devices will automatically set off not only powerful sirens, which cannot be laughed off, but there will also be visual warnings, on screens, and automatic ink recorders which will show on a moving paper band the direction and distance of any airplane force larger than two. Duplicate recorders will be located in the interior of the United States in Federal observation centers, where all this information is relayed automatically. Thus there will be at all times a large number of observers who will know exactly what is going on thousands of miles away and make the necessary defense arrangements at whatever point it will be needed.

If such a comprehensive radio detecting net was actually in use, any enemy would think twice before he attacked, and that precisely is the value of a first-class protection. If you are known to have a foolproof burglar alarm, no second story man—whether his name be “Catfoot” Harry, or Adolf Hitler, or Hirohito—will make a serious attempt to ransack your house while you are at the movies.

O.S.I. FREEZES RADIO

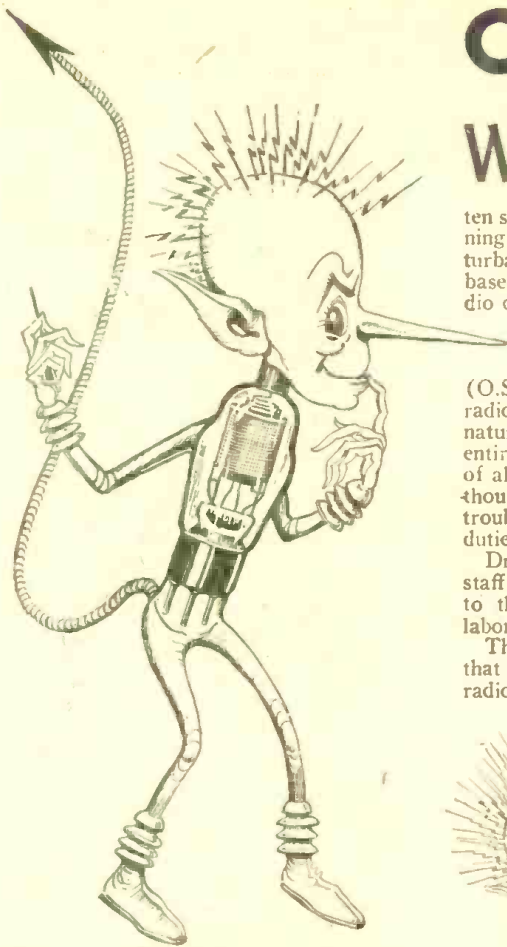

TUBIMP

The RADIMPS, supported by their brethern, the TECNIMPS and the MISCHIMPS, make their official bow to the Radio Fraternity in this issue of RADIO-CRAFT.

If we do not miss our guess, the Radio Industry will welcome these lovable IMPs with open arms.

After all, if aviation can boast of its Gremlins, Radio can answer back with its RADIMPS.

WASHINGTON, March 29. The O.S.I. (Office of Strife Information), through its Director, Dr. Sassafrass Q. Flitternix, announced in a written statement to the Radio Press, that beginning May 25, 1943, all radio troubles, disturbances, quarrels, radio strikes (including baseball strikeouts announced by radio), radio controversies on or off the air, radio set troubles of whatever nature, will be FROZEN for the duration.

The Office of Strife Information (O.S.I.) is prepared to take over every radio trouble, every radio complaint of any nature whatsoever. It will thus relieve the entire radio industry of its responsibility of all these various troubles as well as free thousands of radio workers and radio troubleshooters for the more important war duties.

Dr. Flitternix explained that his lavatory staff had been working for over one year to this end, but only recently had their labors been crowned with success.

The lavatory's research staff discovered that every one of the thousands of different radio troubles originate in reality in a

species of electronic IMP. They are normally invisible to the unclad (naked) eye. However, Dr. Flitternix demonstrated to the amazed members of the Press how these RADIMPS (first syllable pronounced as in *radio*)—as Dr. Flitternix calls them—can now be made visible to everybody.

Pulling aside a dark curtain behind him and flicking a switch, Dr. Flitternix gave an epoch-making demonstration. On a small table was a maze of apparatus, while ten feet away a white screen was hung. The doctor explained that he used a suterhetero-ultra-oscillatory-infra-galvanoplex hook-up, coupled to a series of green dillpickles. The resulting hyper-current-phase—which never phased him, as he explained smilingly—was then fed through an ordinary bromo-oscilloscope. The only difference here is, that instead of the customary screen coating of fluorescent salts, a thin layer of vitrified Limburger Cheese was used. This, Dr. Flit-

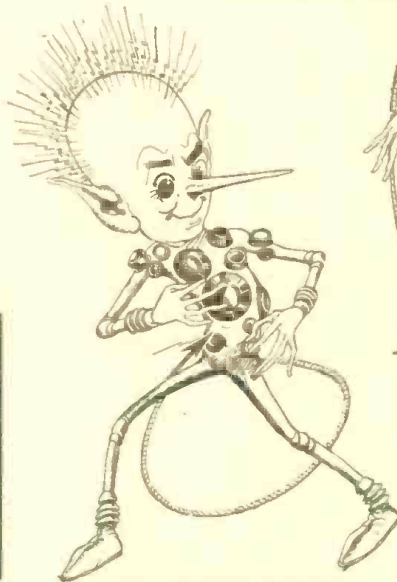

FIDDELIMP

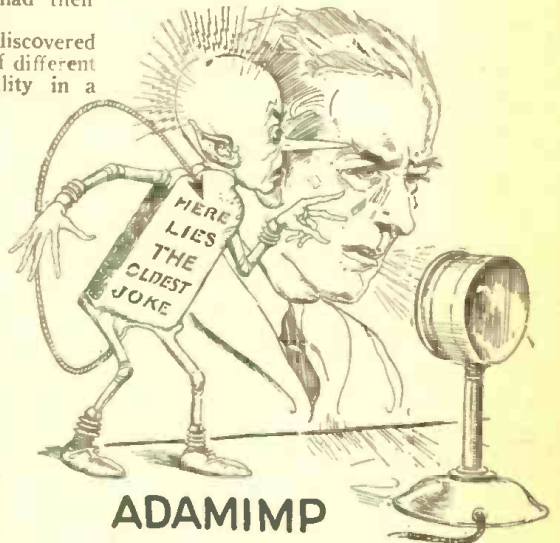

ADAMIMP

ternix explained, attracts the Radimps irresistibly and gives them their powerful trouble-making constitution, due mainly to the high Vitamin content of the cheese.

The Radimps are then thrown on the screen where they appear in their natural technicolors. By twisting a series of dials, the illustrious doctor introduced several dozen of the newly discovered Radimps to the gasping newsmen who could not believe their eyes.

Dr. Flitternix assured his listeners that the Radimps would take over ALL radio troubles beginning May 25. "Hereafter," he continued, "no human being can or will be legally blamed for any kind of radio trouble, no matter what its cause. The new battle slogan will be 'Blame the Radimps.'"

The Press then wanted to ask some questions and Dr. Flitternix graciously consented to answer a number of these.

One of the correspondents wanted to know what would happen if a customer brought in a radio set for repair. He remembered an instance where the owner, due to shortage of radio materials, could get neither tubes nor condensers, so the customer substituted six spark plugs and a carburetor, but the set still didn't perform. He insisted that the serviceman fix it, nevertheless.

"In such a case," replied Dr. Flitternix, "the O.S.I. would order the radio set laid up for the duration, in order to save gasoline and 'tubes.' If the customer still in-

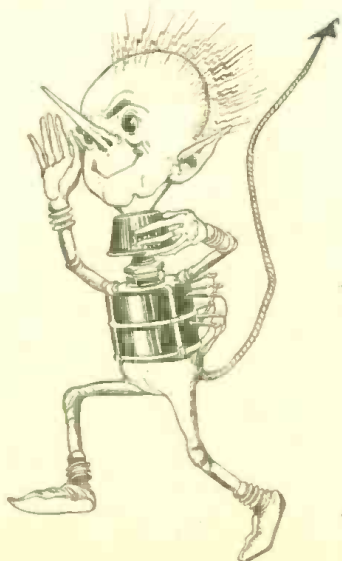

VOLIMP

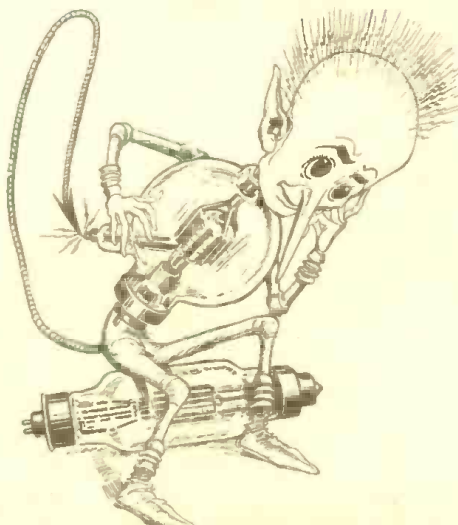

ELECTRONIMP

TROUBLES FOR DURATION

sisted on having the set fixed, he would be deprived of his coffee ration coupon."

Another question was: If one radio comedian finds that a rival has stolen *his* jokes and was using them on the air, what would the O.S.I. do about this? Would one comedian be permitted to sue the other, as heretofore, or not?

Dr. Flitternix answered that in such a case the O.S.I. would call in the two comedians, put BOTH into a padded cell and make them listen to a phonograph recording of this particular joke, for eight hours. If after that the two comedians still felt like fighting—which he doubted—the treatment would be repeated.



METERIMP

Another question: "Why did the O.S.I. decide on the word IMP?" The answer to this was to be found in Webster's dictionary, and the learned doctor read off the following:

"IMP: A young or inferior devil, a little malignant spirit, a puny demon, a contemptible vile worker." Dr. Flitternix felt that for this reason, the word IMP covered every imaginable radio trouble that you could possibly think of. The Press seemed to think likewise.

He also explained that there were really two different types of RADIMPS:

(a) MISCHIMPS. These are the purely personal type of imps, having to do mostly with humans; they are known for their mischief-making, from which they derive their name.

(b) TECNIMPS. These are the technical type of imps; and, as their name implies, they are super-technicians. They are the ones who are found in radio sets and radio appliances of all types and raise their usual rumpus therein.

Dr. Flitternix then passed around a type-written sheet on which were listed the various types of IMPS. The list follows:

TECNIMPS

ABIMPS. Their habitat is the "A" battery which they help to run down when you least expect it, by eating holes into the zinc containers, etc.

ANTIMPS. These are found in antennas and aerials. They help in corroding and otherwise breaking down weak points in their structure.

BLOWIMPS. These are the ones responsible for blowouts, short circuiting innocent looking connections and blowing out a set of tubes, condensers, transformers and the like. They are a particularly nasty type and highly dangerous.



MELANKOLIMP

CONDIMPS. These are found in every sort of condenser and are the main cause for breakdowns, punctures, etc.

ELECTRONIMPS. This type feeds primarily on electrons; they are responsible for creating all sorts of mischief in every type of electronic appliance. Vicious in the extreme, they eat only the nucleus, throwing the rest of the electron away.

FADIMPS. This is the particular sort of Imp who causes radio sets to fade when you least expect it. They get into tubes, wire connections, and particularly into tube sockets. They are one of the worst types of Imp known, because it is often impossible to find out just where their nefarious work is perpetrated.



TRANSIMP

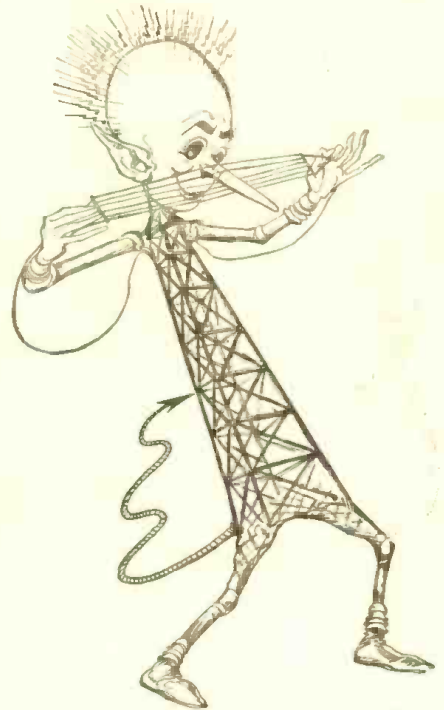

KILOCIMP

GRIMPS. These are the ground Imps and are responsible for all sorts of ground noises, loose connections, ground clamp and ground connections, and the like.

INDIMPS. They live only in inductances which they love to short circuit, particularly adjacent turns.

KILOCIMPS. These are the kilocycle devils who infest radio transmitters. They cause the station to go off their frequency so that thousands of listeners get a loud squeal in their radio set when two stations heterodyne each other.

LOOCONIMPS. This is the most nasty type of Imp because they cause the loose connections in radio sets, particularly in places where you least expect it. It is most difficult to trace them to their lair because they use a terrific amount of cunning to hide their work.

(Continued on page 427)



STINKIMP

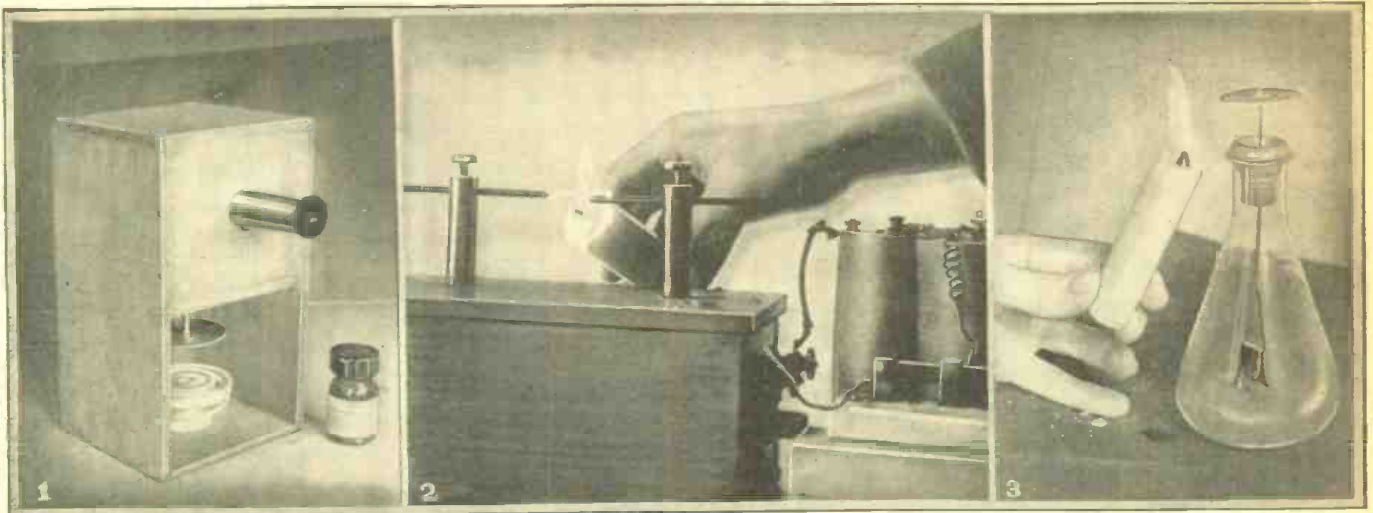

The photos show (1) A special home-made electroscope for observing radioactive phenomena. (2) The spark gap, under the influence of the hot air from the candle, produces a bigger spark. (3) The ordinary electroscope also demonstrates the effect of heated air on electric charges.

POPULAR ELECTRONICS*

By RAYMOND FRANCIS YATES
PART III

IN Part II we learned something about the most important law in the universe. It was found that similar charges of electricity, such as negative + negative or positive + positive charges, repelled each other. Everything in the world is either electrically positive, negative, or neutral, and insofar as the larger conglomerates of matter are concerned, any electrical condition is transitory. Electricity and electrical charges are in a constant state of movement,

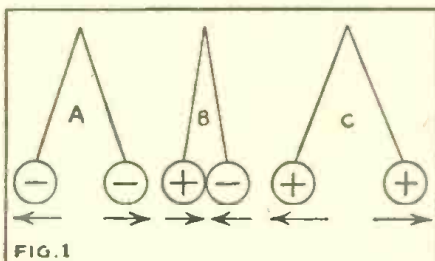

FIG. 1
The common example of the two pith balls to show the interaction of like and unlike charges. Like charges repel; unlike charges attract.

change and flux. If a scientist wishes to keep a certain body charged for a long period of time, rather elaborate isolation is required or else arrangements must be made to replace the charge as rapidly as it leaks away.

No perfect insulator has been discovered and the higher the voltage of any electric charge, the more difficult it becomes to keep it isolated and prevent its quick dissipation and re-distribution. Even comparatively weak charges, although confined with a fair degree of caution, will rapidly escape under favorable conditions. We can prove this nicely with the aid of the simple little electroscopes described previously. After giving it a charge, we bring a lighted candle near it as shown in the photograph. Curiously enough, the leaves quickly collapse and come together. We must decide from this and also keep the fact in mind that,

*Application for Trade Mark Title, pending in U. S. Patent Office.

for some reason or other, hot air is a better conductor of charges than cold air.

ELECTRONS AND MATTER

The phenomenon of electric charges surely does not sound like the most important thing in the universe, but it is. Because if it is not, then the electron theory of matter, which we are about to consider, is a hoax and a delusion. But the experimental evidence to date makes it appear to be anything but an illusion.

This theory tells us that the atoms of matter are organized patterns of electrical charges, nothing more, nothing less. The electron is a negative particle; a negative unit of charge; a basic fundamental thing. The "king and all his horses" cannot destroy it or alter it in any way, and all the electrons are exactly the same in mass, size and degree of charge. Most electrons in the universe are prisoners in the atomic configurations of organized matter. Others, countless quintillions of them, are detached, are free to move in and about matter. When

through metallic conductors, they form electric currents. The rate at which they move from positive to negative is called the voltage, and the number of them that pass a given point in a given period of time is called the current. To put it simply, voltage is electronic *speed*, amperage or "current" is electronic *volume*. A 50-watt electric light requires the passage of three billion billion electrons per second. From this, we assume

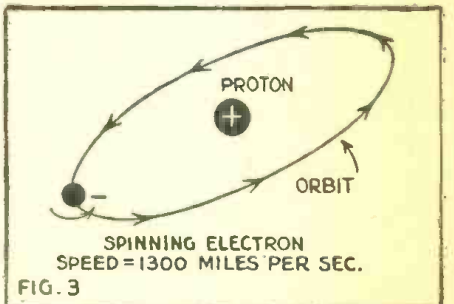

FIG. 3
The universe of the microcosm, showing how a single electron spins about the proton at the center in a definite path or orbit. These universes are different for each atom of the different elements.

that the electron is a very tiny thing. It is. Its mass amounts to only 9×10^{-28} grams. Its electric charge amounts to only 1.6×10^{-19} goulombs. (A goulomb is one ampere flowing for one second.) Now there is a second principal unit of matter, the electrical counterpart of the electron, called the proton. Unlike the electron, it is not a rover. Compared to the electron it leads a fairly sedate and inactive life. While it has a mass substantially greater than the electron (2000 times greater), it nevertheless has an equal but positive charge. Thus if we had the same number of protons and electrons associated in a mixed pack, we would have an electrically neutral sphere.

From these rudiments we may assemble our first atom of matter, the atom of hydrogen—simplest and lightest of all. (See Fig. 3.) The atomic weights, we discover early in our study, depend entirely upon the number of electrons and protons in the atoms. The hydrogen atom has but one

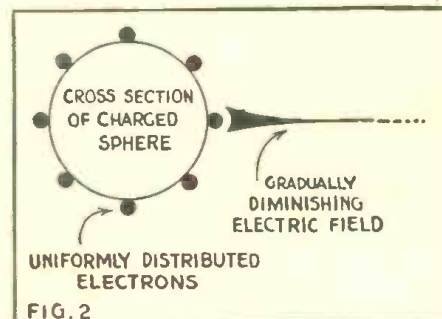
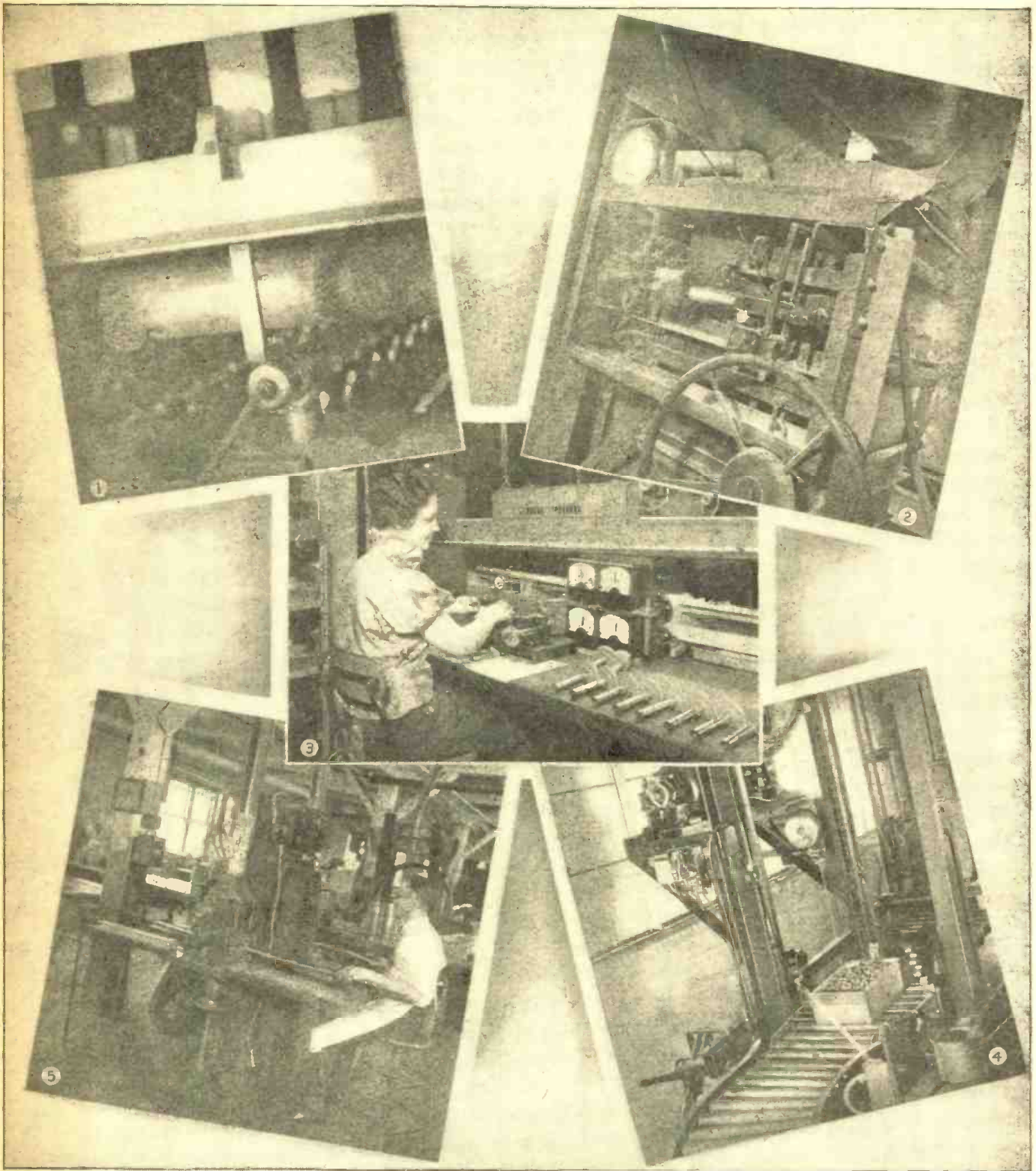

FIG. 2
The fundamental conception of "field." The space about the charged sphere is under the influence of the charges, and is called the field. The field diminishes outwardly from the center of the sphere, according to the famous inverse square law.

they do happen to accumulate on a restricted area, a negative charge is created. When they are absent, or nearly so, a condition of positive charge or electrical neutrality results. When, under certain electrical conditions, they are concentrated and forced



Applications of electronics in industry. The photos show (1) a photo-electric relay controlling the operation of a hot bar shear in a steel mill; (2) photo-electric relay mounted on cement scales to control accurate weighing; (3) Electronic indicator of minute parts of an inch in precision manufacturing to close tolerances; (4) Tote boxes shunted to branch lines by intercepting a light beam. The "flag" on the box determines whether it is to be branched off or not; (5) Photo-electric magnetic counter counts number of mica strips in groups, which are checked for thickness accuracy.

electron and one proton. The proton forms the nucleus or central part not only of the hydrogen but of all atoms. The electron is the dynamic part. It spins around the single proton of the hydrogen atom at a prodigious speed and in a spiral-like or shifting orbit. So far as it is known, it is a perpetual spinning, the radius of the orbit being the same, the speed neither growing faster nor slower.

A MINIATURE UNIVERSE

Curiously enough, the atom of hydrogen,

or any other atom for that matter, is largely space. If the atom of hydrogen could be magnified to the size of the sun, we would probably have to search for a long time before its single electron could be discovered, for it would be no less than 93,000,000,000 miles away from its single proton. We assume from this, and not without perfect justification so far as the electron theory is concerned, *that all matter is mostly space.* Let us not break our hands pounding a brick

wall in desperate repudiation of this fact. Our senses are crude and deceiving.

The list of chemical elements and their weights serve as an excellent guide to the number of electrons and protons in each atom. The greater the weight, the more electrons that are present.

If an atom such as oxygen has eight electrons, then it will also have eight protons in its nucleus. This may amount to over-simplification, however. The truth is

(Continued on following page)

that some nuclei have a larger number of protons than the number of their associated electrons and then there is also the fact that some proton nucleus groups contain electrons; but these things amount to complications that do not need to bother the student of electronics. They are primarily of interest to chemists and atomic physicists only.

As yet we have not accounted for our free and roving electrons; the jitterbugs

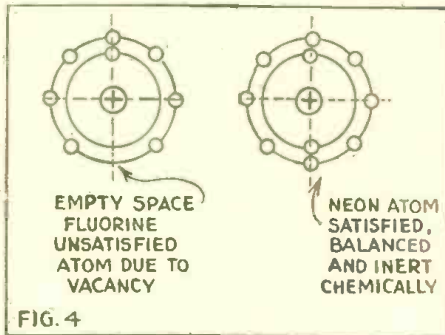

Diagrammatic representation of the two possible conditions of atoms, the unsatisfied, and the satisfied, the basis being a lack or a sufficiency of electrons in the atomic orbit.

of the real workaday world of electricity. Where do they come from?

It so happens that all atomic configurations or atomic patterns are not as stable as the hydrogen atom. Some have one or more electrons to spare, others are constantly in search of an electron or two, to satisfy a set of conditions that may not amount to exact electrical neutrality.

ELECTRONS AND CHEMISTRY

We discover that all chemical activity, as well as electrical activity, is due to the movement of electrons. In the case of chemical activity, which amounts to atoms combining to form the molecules of compounds, an interchange of electrons between atoms is formed. An atom with a deficiency of electrons will combine with an atom that can spare some. (See Fig. 4.) It is a matter of complete and incomplete electron orbits. These electron orbits are not quite as simple as one might expect. When larger groups of electrons are involved, we have one orbit near the nucleus, one outside of that, etc.

The atom of sodium, as a case in point, has three electron orbits and the outside one, or satellite orbit, is incomplete. Thus sodium is instantly ready to combine chemically with any other element offering the slightest inducement. Fluorine has two orbits and is in much the same condition, while neon has a perfect configuration, involving two orbits, and it turns out, like helium, to be chemically inert.

RADIO ACTIVITY

We must understand that as the number of protons and electrons increases, the weight of the atoms increases. Thus the

heavier elements like mercury, gold, lead, etc., have large numbers of electrons and protons, and relatively complicated atomic configurations. At the end of the list of elements, we find the ponderous atoms of the elements radium (226) and uranium (238). Here, it would almost seem, Nature has run out of ideas for atomic architecture, because these atoms are self-destroying. They gradually "explode," throwing off electrons at high velocities and dispersing in waves. Radium, as one example of the so-called radioactive group (radium, uranium, polonium, thorium, etc.) constantly emits three types of radiation, alpha, beta and gamma rays. Curiously enough two of these rays behave rather suspiciously when near powerful magnetic fields. The alpha ray is deflected in one direction and the beta rays in an opposite direction. They also respond to electrostatic fields and hence it was found that they must be particles. The beta rays were really not rays at all but streams of electrons. The alpha rays turned out to be positively charged as might have been expected by their opposite behavior in electromagnetic and electrostatic fields. The alpha "rays" turned out to be atoms of helium. The gamma rays are X-rays.

Much of the electron theory of matter,

the idea back of industrial electronics, was pieced together from a study of radioactivity. Had Edison known something about it, he would have invented the vacuum tube. Fleming, the creator of the diode, knew that electrons were negative, that they were expelled from hot filaments. Also de Forest knew something about the behavior of elec-

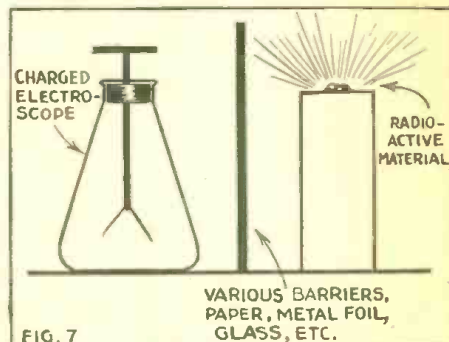

How the ordinary electroscope must be protected by various barriers from the field of radio-active materials, nearby, as wrong indications would be obtained.

trons, as these things were revealed by such great minds as Rutherford, Soddy, Stoney, etc.

EXPERIMENTS TO PERFORM

What with all of the stories about the fabulous cost of radium and the intricate and costly devices employed by researchers in this field, the experimentally inclined student has always felt that these things were hopelessly beyond him. Not so, fortunately, for an insignificant whiff of one of the radioactive materials costs very little, and an ultra-sensitive electroscope can be assembled with inexpensive materials. All of the large chemical supply houses carry radioactive compounds, such as the radioactive ore *carnotite*. A smear of radium salts may also be had from the Hammer Laboratories, Denver, Colo., for a small amount. Uranium and thorium nitrates may be had from chemical supply houses at low cost.

BUILD AN ELECTROSCOPE

To experiment with these substances and at the same time introduce ourselves to the study of the conduction of electricity through gases, we should construct the simple electroscope shown in Figs. 5 and 6

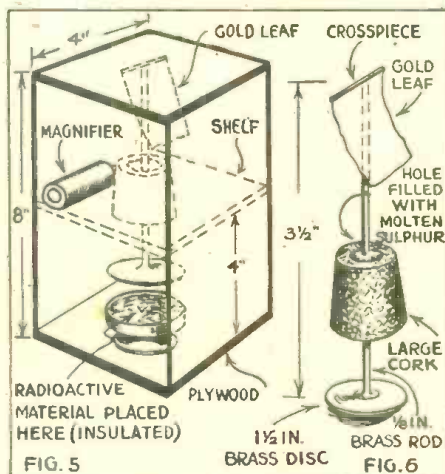

Construction details of the special electroscope to observe radio-active phenomena. It is a little more complicated than the ordinary electroscope, which does not have to be shielded to protect the eyes.

THE ELEMENTS AND THEIR ATOMIC WEIGHTS

1 Hydrogen	1	31 Gallium	70	62 Samarium	150
2 Helium	4	32 Germanium	73	63 Europium	152
3 Lithium	7	33 Arsenic	75	64 Gadolinium	157
4 Beryllium	9	34 Selenium	79	65 Terbium	159
5 Boron	11	35 Bromine	80	66 Dysprosium	162
6 Carbon	12	36 Krypton	83	67 Holmium	163
7 Nitrogen	14	37 Rubidium	85	68 Erbium	165
8 Oxygen	16	38 Strontium	88	69 Thulium	169
9 Fluorine	19	39 Yttrium	89	70 Ytterbium	173
10 Neon	20	40 Zirconium	91	71 Lutecium	175
11 Sodium	23	41 Columbium	93	72 Hafnium	178
12 Magnesium	24	42 Molybdenum	96	73 Tantalum	181
13 Aluminum	27	43 Manganese	—	74 Tungsten	184
14 Silicon	28	44 Ruthenium	102	75 Rhenium	189
15 Phosphorus	31	45 Rhodium	103	76 Osmium	191
16 Sulphur	32	46 Palladium	107	77 Iridium	193
17 Chlorine	35	47 Silver	108	78 Platinum	195
18 Argon	40	48 Cadmium	112	79 Gold	197
19 Potassium	39	49 Indium	115	80 Mercury	200
20 Calcium	40	50 Tin	119	81 Thallium	204
21 Scandium	45	51 Antimony	122	82 Lead	207
22 Titanium	48	52 Tellurium	127	83 Bismuth	209
23 Vanadium	51	53 Iodine	127	84 Polonium	210
24 Chromium	52	54 Xenon	130	85 (Undiscovered)	210
25 Manganese	55	55 Caesium	133	86 Radon	222
26 Iron	56	56 Barium	137	87 (Undiscovered)	—
27 Cobalt	59	57 Lanthanum	138	88 Radium	226
28 Nickel	59	58 Cerium	140	89 Actinium	—
29 Copper	64	59 Praseodymium	141	90 Thorium	232
30 Zinc	65	60 Neodymium	144	91 Protoactinium	—
		61 Illinium	—	92 Uranium	238

and the photograph. This will prove to be an ultra-sensitive device, being equipped as it is with a magnifying lens that can detect the slightest movement of the gold leaf upon the edge of which it is focused. These eye-pieces with a power of 10 or so, may be purchased with engraved scales or cross hairs. If the experimenter cannot afford such luxury, then an ordinary reading glass will help.

After the electroscope has been built, it is charged in the same manner as an ordinary electroscope, like the one built previously, for instance. For comparisons to be (Cont. on pg. 442)

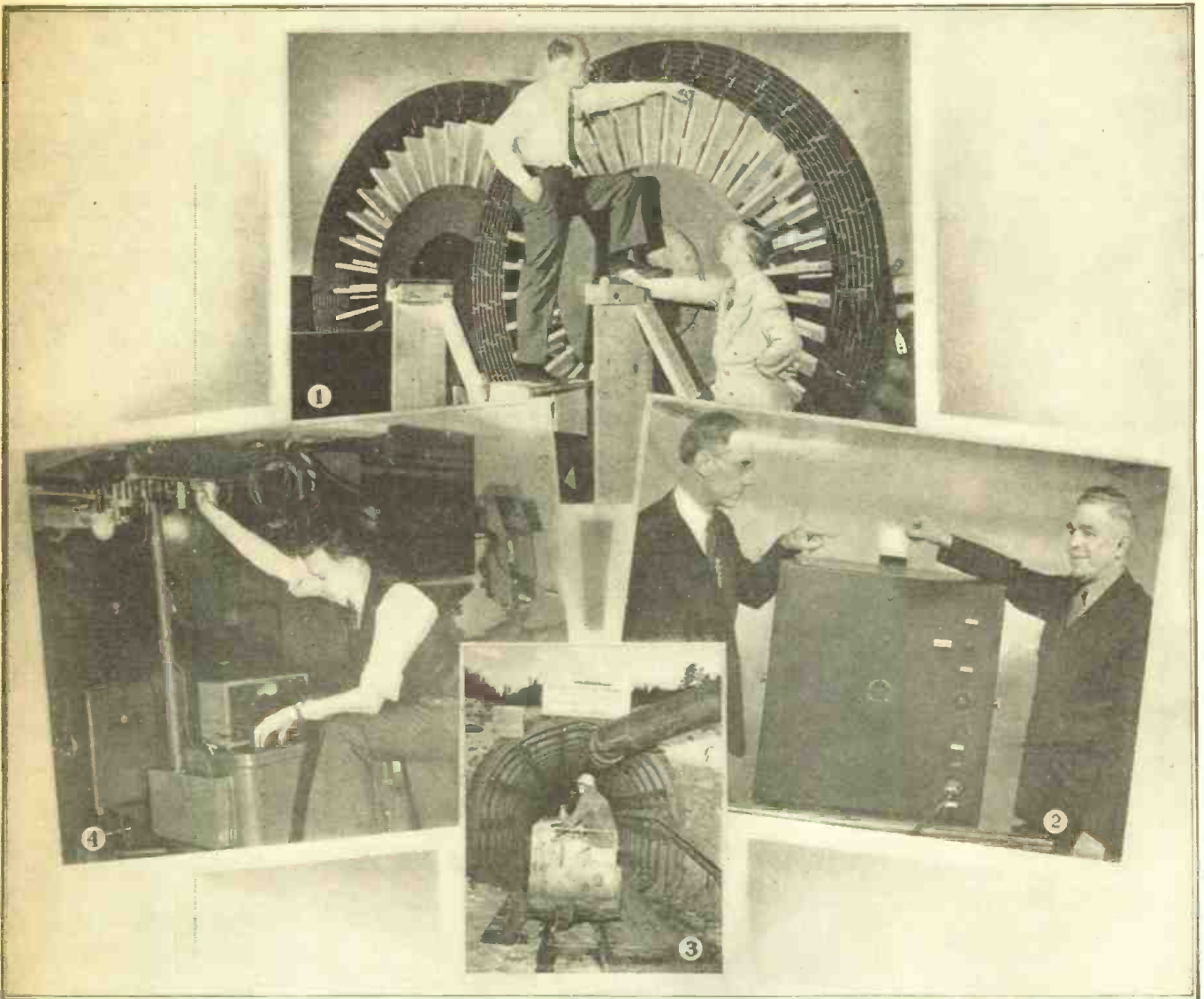

Electronic devices pervade many fields. The photo at the top (1), shows Dr. E. E. Charlton, and W. F. Westendorp, the latter pointing to the large coils to be used in the induction electron accelerator, a device which causes electrons to move at terrific speed, for certain applications. Photo (2), on the right, shows how Harry Steers, veteran bowler, casts his vote in the photo-electrically controlled ballot box, at the A. B. C. recent meeting. Photo (3), bottom, shows a locomotive entering the Continental-Divide tunnel in Colorado. This one-track railway is electronically controlled to assure safety at all times. Photo (4), left, shows a color register control on a multicolor gravure press. Observations and adjustments can be made rapidly, and registration kept constant.—Photos Courtesy of General Electric

ELECTRONICS — VERSATILE AS A GENIUS

By S. R. WINTERS

THE late Thomas A. Edison once defined genius as a composite of 95 per cent perspiration and 5 per cent inspiration. He was thinking in terms of human qualities—little dreaming that his invention of the incandescent lamp, the fluoroscope, and other things electrical were only forerunners of the electron tube—the magic performer of a thousand appointed fasks. As versatile as a genius, it may be described as the robot of the species. Its uses are so many and varied that the mind flounders in search of a simile—the cotton fiber alone claiming such manifold applications.

Electronic devices count votes at the ballot-box (thus insuring an incorruptible franchise) on the one hand, and assume the role of "Seeing-Eye" dog on the other hand.

Electronic tubes automatically write the records of fighter planes doing power dives at 500-mile-per-hour speed, and yet leisurely and patiently these same devices will measure the creep of metals under the stress of heat. Elephantlike, this vacuum or gas-filled tube (first cousin to our familiar radio tubes) can speed the traffic of men and materials in a tunnel 13 miles long or, like the new General Electric Company's "induction electron accelerator," it will step up X-ray machines to 100,000,000 volts, thus penetrating deeply into armor plate. Unlike the motion picture portraying the flying career of the famed Amy Mollison, in which screen version modern blind-flying instruments were absent, electrons are the vehicles upon which "happy landings" may be made in fog.

Both government and commercial concerns have developed blind-landing systems whereby a pilot is guided in making a descent by momentarily watching an illuminated screen—similar to the screen in a television set. Fog as thick as that beclouding London will not necessarily cause airplane collisions in the future, if we are to believe scientific reports, because the pilot can turn on his electronic blind-landing apparatus, lifting the veil of fog, as it were. Signals, through the head-telephones of his radio receiver will inform the pilot where to start his glide for a successful landing—even suggesting the time and point of bringing the plane's wheels down on the runway. Progressively, from second to second, such an electronic blind landing is ac-

(Continued on page 440)

ELECTRONICS PRIMER

By DR. JOSEPH SLEPIAN*

ELECTRONICS, electronic engineering! These are words which fire the popular imagination today. Radio and television, the talking movie, the door opening electric eye, the dentist's X-ray tube, the new fluorescent lamps, all these, evident in our daily lives, are said to be products of the science of electronics. The press, and our electrical manufacturers hint of marvels accomplished in the war, and the revolutionary devices to come after the war, all out of this science of electronics.

What is this science of electronics? Perhaps no very exact answer can be given at this time. In technical or scientific literature a new word is given a sharp, precise meaning by definition by those who first use it, but a popular word may have initially only a vague meaning, which becomes more definite only after considerable usage. Gradually, and partly through discussions such as I am offering in this essay, a meaning emerges upon which most people will agree.

Consider a moderately well-educated young man, say one who has just come out of high school, and let us follow him in his explorations in trying to arrive at a good definition of the "science of electronics," or "electronics engineering." He has already met the electron. He knows that its existence was established by J. J. Thomson in the 1890's. He knows that it carries a negative charge of 4.77×10^{-10} electrostatic units, and has a mass only 1/1830th of the mass of the hydrogen atom. He knows, also, that its dynamics is quite different from that of bodies in everyday life, that it must be regarded as a wave, as well as a particle, and that a newly developed "wave-mechanics" can describe its motions where the older Newtonian mechanics fail.

His first impulse is perhaps to say that the "science of electronics" deals with those phenomena in which the electron enters, and that "electronics engineering" deals with apparatus or machines in which electrons play a necessary part. But he then immediately realizes that such a meaning is too comprehensive. He has learned that the electron is omnipresent, that it is a part of every electrical manifestation of matter, and even of those manifestations which are not ordinarily thought of as electrical. He has come to believe that so commonplace a matter as the conducting of a current by a metal wire, is accomplished by the motion of tremendous numbers of these tiny electrons along the wire. With his first definition he would then be making the "science of electronics" and "electronics engineering" synonymous with the "science of electricity" and "electrical engineering." He would be making an electric motor or an electric toaster, "electronic apparatus."

He then feels the need of a drastic restriction in his definition, and perhaps proceeds next to examine a tube of his radio, which he is very sure is an "electronic apparatus." Such a tube has in it a hot filament from which electrons emerge, a highly

evacuated space, in which these electrons can move about under the influence of electric fields without encountering grosser matter, and various electrodes, grids and plate for creating the electric fields to cause the motion of these free electrons.

He is now ready to consider this definition. An "electronic apparatus" is one which accomplishes the purpose for which it was constructed, through the intermediary of electrons, relatively free from the grosser matter to which they are ordinarily bound. The "science of electronics" then, deals with free electrons, the means for setting them free, their motions when free, and the effects they can produce by being acted upon while free.

This definition seems quite good. For example, the free electrons in the radio tube, through the charges they carry, and the control the grids exert upon them, can change direct current into high frequency alternating and vice versa, so that radio tube is an "electronic apparatus." The free electrons in the X-ray tube are accelerated to high kinetic energy, while free, and strike their target, producing Roentgen rays. The X-ray tube is an "electronic apparatus." Quanta of light arriving at the cathode of the photo-tube set free electrons to carry their charge to the anode. The "electric eye" or photo-tube is an "electronic apparatus." Free electrons in the fluorescent lamp strike mercury atoms so violently that they are excited, and emit ultra-violet light, which in turn excites the material on the glass to fluorescence. The fluorescent lamp is an "electronic apparatus."

But the young man looks again at the metal wire, and pauses. Do not the electrons in the wire move readily when acted upon by an electric field? Are they not, then, free? Again the electric motor and electric toaster intrude. Are they also "electronic apparatuses"? He is back to his original dilemma.

Somchow, the young man feels, the electrons in the "electronic apparatus" are free in a different sense and in a different way than the electrons in the metal wire. And by examining the modern theory of the atom, and the modern theory of the electronic states of a metal, he begins to see how he may distinguish between the two kinds of freedom.

An isolated atom of an element in its normal state, he knows, according to Rutherford, Bohr, and their followers, has a positively charged nucleus surrounded by a swarm of electrons, and these electrons are in a kind of regular motion about the nucleus. Bohr regarded these electrons as moving in special radiationless orbits. But while moving in these orbits, and thus in a sense free, the electrons remain always close to the nucleus. Thus, they still remain bound. Impressed electric and magnetic fields will alter the motion of electrons about the nucleus, as is shown by the Stark and Zeeman effects. But the orbits are only shifted slightly or perturbed by the fields. They continue to surround the nucleus closely. The change in energy of the elec-

trons with the largest attainable impressed fields is only a fraction of a volt, while their normal energies are many volts.

Now let two nuclei with their accompanying swarms of electrons, approach each other. When about 10^{-8} cm apart, the orbits of the outermost electrons begin to overlap. A new set of orbits form, in which the outermost electrons now circulate around the two nuclei. Thus the outermost electrons have become free. Such an outer electron is no longer bound to a single nucleus, but can and does move from the neighborhood of one nucleus to the neighborhood of the other.

Now, by building up a chain of these nuclei, with their overlapping electron swarms, the young man in search of a definition of "electronic apparatus," begins to see what happens in a metal, and why a metal wire may not be an "electronic apparatus." In the metal wire the electrons become free only by being able to follow orbits which go from nucleus to nucleus. They are thus still bound in their freedom. They remain always within about 10^{-8} cm from some nucleus.

The young man now triumphantly proposes his more refined definition of the "science of electronics." The "science of electronics" deals with electrons which are free in the sense of being substantially at much greater distances from the nuclei of atoms than the radii of the outermost stable orbits of the normal atom. That is, free electrons, in the sense developed here, are farther away from nuclei than many times 10^{-8} cm. In the usual radio tube, for example, the electrons in the vacuum space are generally more than 10^{-4} cm away from any atom. They are free. In the metal wire, however, the conduction electrons are never more than a few times 10^{-8} cm away from a nucleus. In spite of their mobility, they are not free in the sense used here.

The "science of electronics" is the science of these now sufficiently well defined free electrons. It deals with the means for setting electrons free; thermionic emission, photoelectric effect, secondary emission, etc. It deals with the properties of free electrons, their motion in electric and magnetic fields, as in the electron microscope, their space charge effects, etc. It deals with effects produced by free electrons acting on other matter, excitation, and ionization of atoms by collision, generation of X-rays, excitation of fluorescence, activation of a photographic film. It deals with the ways free electrons lose their freedom, recombination with positive ions, attachment to neutral molecules to form negative ions, etc. "Electronics engineering" is the applied "science of electronics." It deals with the development, design, and application to useful purpose of electronic apparatus, that is apparatus employing electrons free in the sense which has just been described.

The "free electrons" of an electronic ap-

*Associate Director of Research, "Westinghouse Electric and Manufacturing Company."



Symbols of modern radio and industry! Photo (1) shows four of the big air-cooled 50,000-watt modulating tubes used in a large broadcasting station. Two of these are spares or "standbys." Simply by pushing a button the operator can put them into service without removing defective tubes or interrupting the transmission. The center photo (2) shows the special moisture-defecting tube going into place in an electronic installation for control of moisture in a manufacturing process. The photo at the upper right (3) shows U.H.F. tubes used in inter-continental communications. Photo at the lower right (4) gives some idea of the appearance of a precision electronic timer, which automatically divides the time required for a spot-weld, into fractions of a second. Photo (5) shows the hand of an operator setting the adjustments on an electronic furnace control, which provides high efficiency, not obtainable by other means. —Photos, Courtesy of Westinghouse.

paratus, must of course have space in which to exercise their freedom, so every electronic apparatus has in it a vacuum or gaseous space in which electric current is carried by free electrons. This is clear because in any liquid or solid element of a circuit the atoms or nuclei are so close together electrons cannot be free there in the sense defined above. This suggests a fully equivalent alternative definition of an "electronic apparatus." An "electronic apparatus" is a device in which electric conduction current is carried through a vacuum or gaseous space. This form of definition has the advantage of avoiding theory in its formulation, and referring only to objects which can be directly and immediately observed.

According to the two equivalent definitions, "electronic apparatus" obviously include the various vacuum tube detectors, amplifiers, oscillators of radio, X-ray tubes, photo-tubes, ultra-violet germ-killing lamps, fluorescent lamps, neon signs, thyratrons, and ignitrons. But they also include devices which in the past we have not thought of as electronic devices. Electric switches which use the electric arc for safely interrupting power circuits, spark gaps in lighting arresters and similar devices for protecting electric circuits, spark plugs for igniting in proper sequence the explosive mixtures in internal combustion engines,

electric arc welders, electric arc furnaces, the precipitron for electrically cleaning air of dust, these are all electronic devices according to the definitions developed above. Shall we try to modify the definition so as to exclude these devices? No, that is not possible. Rather we must accept these familiar things as truly electronic apparatus, and even more we must expect confidently that the "science of electronics" now and in the future will make clearer the manner of operation of the devices, and will teach us how to make better these devices. In fact, some of the "next" things in electrical engineering will be great developments and improvements in these devices through "electronic science."

When we examine these electronic devices, we find that they fall into two rather definite classes. All employ free electrons, but some make important use also of positively charged atoms or molecules of the gas through which the electrons pass. These positively charged atoms or molecules are called ions, so perhaps the devices using them might be called ionic devices, or perhaps still better electro-ionic, indicating that they use both free electrons and ions.

The ions in an ionic or electro-ionic device are generally produced by the free electrons themselves. If the circumstances are such that free electrons acquire ten to twenty volts of kinetic energy and then

strike neutral molecules, the neutral molecules are broken up into positively charged ions, and other free electrons. Conversely, as we shall point out presently, the ions may produce free electrons, so that a new possibility arises, namely, the self-maintaining gas discharge, as in the glow in the neon sign, the quick acting spark in the lightning arrester, the energetic arc in the electric circuit breaker, and the silent cleansing discharge in the precipitron.

The ions in an electro-ionic device generally exercise a very useful function in neutralizing the space charge of the free electrons. When large numbers of free electrons are introduced into a space, the electrical effects of their charges are additive, and large electrical fields are produced. These fields react on the motion of the electrons, and the net effect is that large currents can be carried by free electrons above, only by using excessively large impressed voltages. If, however, a corresponding number of positive ions are interspersed among the electrons, the additive effect of the charge on the electrons is neutralized, and large currents may be carried by quite low impressed voltages. For example, in the ignitron tubes supplying the direct current for making aluminum and magnesium, thousands of amperes are carried with a voltage of less than twenty volts. Without

(Continued on page 443)

PHOTO-ELECTRIC ORGAN

By LESLIE GOULD

THIS is a simple two-octave musical instrument that can be built with parts usually found around the experimenter's workshop. The only odd part that has to be made is the disc used for modulating the light beam.

The drawing shows clearly just what is needed, and how it is set up. The disc pattern on the disc is placed there by photography or similar means.

The powerful light beam is projected through the disc and through a slot, onto a horizontal ground-glass screen at the top of the console. The light wavers or flickers about, according to the pattern on the disc, and can be picked up by the two photo-electric pickup heads mounted in handles.

These handles are passed over the ground glass screen in any manner you wish, thus producing the different tones.

The detail drawing shows the construction of the P.E. cell pickup head. It consists of a small metal can (such as a talcum powder can), in which is mounted the gaseous type caesium photo-electric cell.

A piece of lucite or glass rod, about $\frac{3}{8}$ " in diameter, is mounted so that the light will pass through it and strike the cathode of the P.E. cell.

PRODUCTION OF SOUND

The sound created of course might be harsh sometimes, but the idea is to vary the speed of the motor, or vary the manner in which the handles are passed over the

ground-glass screen. No two flickerings of the light will be alike, and the different combinations possible will somewhere yield pleasant-sounding tones. Once the technique is learned the production of musical tones is fairly simple. The whole idea behind this set-up is that it gives plenty of leeway to the experimenter.

AMPLIFIER

A four-stage amplifier is used, to permit building up the weak signals with minimum distortion. With the output of the amplifier fed to a 12-inch PM speaker the quality should be fairly satisfactory.

MOTOR; MIRROR; ETC.

The driving motor used should be of the adjustable speed type, but when operated should be run at some constant speed.

The slot used to confine the light beam is made of a piece of tin about 4 x 8 inches, with an opening about $\frac{1}{2}$ x 6 inches.

Note that a mirror is used, which is set at a 45 degree angle. Also an ordinary magnifying glass.

CONSOLE

All the apparatus may be combined in one console, or the speaker may be isolated in a separate compartment so the output will not be muffled by the operator standing in front of it.

The experimenter with ingenuity will find this organ a source of diversion and will have a lot of fun with it.



How the photo-electric pickups are moved about over the ground glass screen to receive the varying light beams.

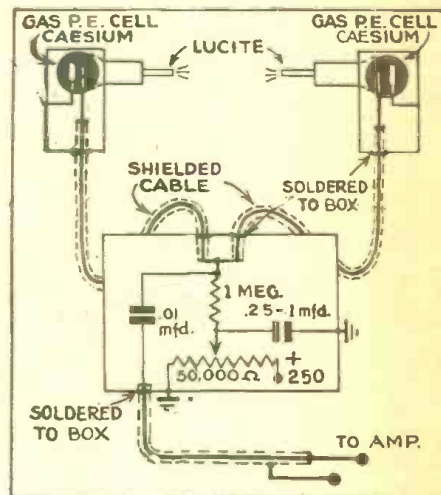

Simple input circuit for the combined P.E. Cell pickups. Shielded cabling is used, with the shields grounded to the metal handles and to the chassis of the input network.

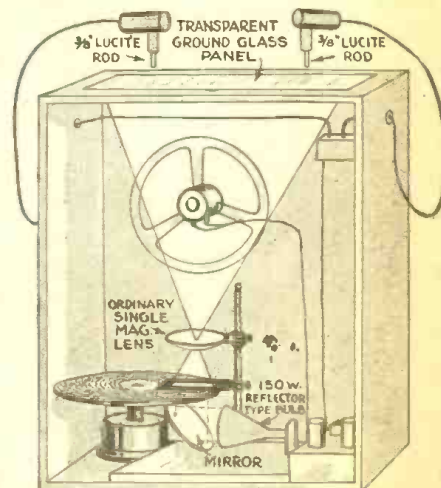

Left, typical pattern which the reader can use as is, or enlarge it by photographing it. A pattern of this sort is used to modulate the beam of light from the 150-watt reflector. Above, rear view of the console, showing the simple and easy arrangements of parts and of the amplifier.

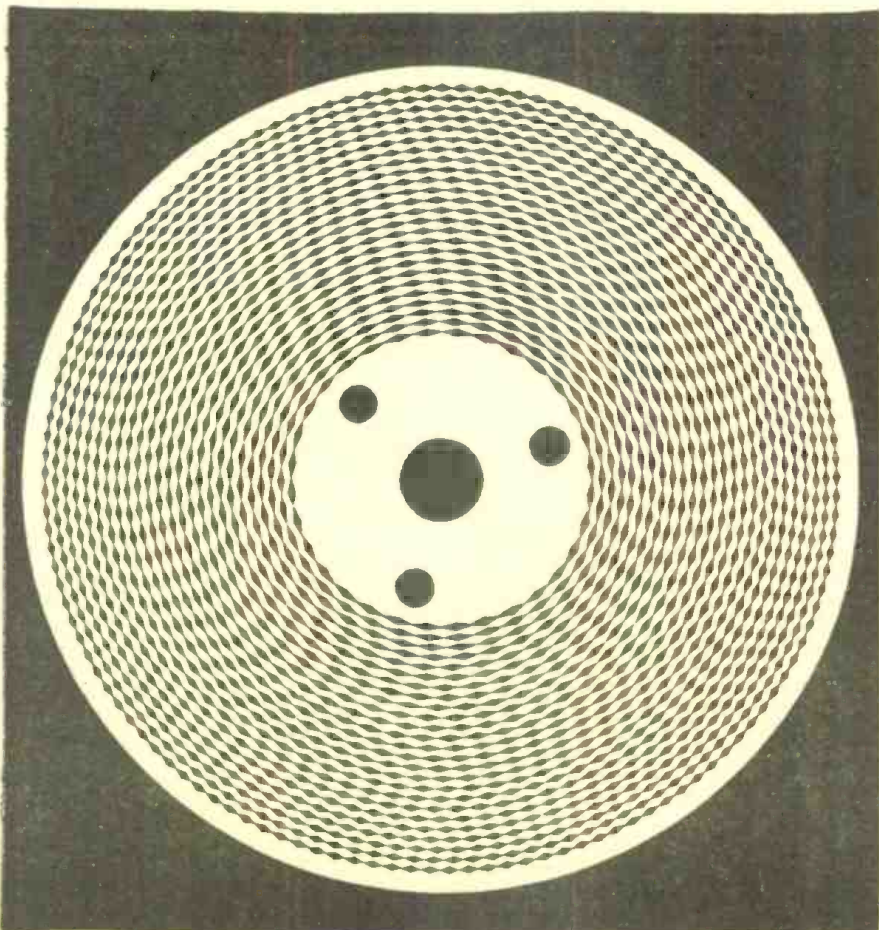

THE ENCEPHALOPHONE

THE electro-encephalograph (recorder of brain-wave oscillations) has become standard equipment in most of the better-equipped psychiatric laboratories. Obscure types of mental irregularities can be discovered with the aid of this instrument under conditions which preclude their discovery by any other method. An example is the detection of the peculiar type of brain-wave in epileptic patients during the intervals between attacks, when the subject is in all other respects perfectly normal.

Two methods are in common use. Both depend on minute variations of electric potential in the scalp of the patient. These are picked up by a pair of electrodes, placed by the skilled technician to include such area of the scalp that the workings of a certain definite portion of the brain will be reflected in their potential differences. Leads from the electrodes are brought to an audio amplifier (preferably one of the direct-coupled type capable of handling frequencies from zero to a few dozen cycles per second.

One method of obtaining encephalographs is to now amplify these minute waves in an extremely high-gain voltage amplifier, and to use the output to operate the deflector plates of a large cathode-ray tube. Photographic records may be made from the screen of the tube. This method is accurate and permits long watches to be made of the brain activity. It is, however, troublesome and slow, requiring a complete laboratory for the special purpose of making these studies.

The second method is more popular for clinical use. The brain-wave potentials, after being amplified, are used to operate a pen writing with ink directly on a paper strip. Not as much gain is required as in the cathode-ray encephalograph, but the amplifier must be of the power amplifier type as opposed to the straight voltage amplifier used in the first method. A certain amount of energy is required to operate the electric pen in the output stage. The great advantage of the method is that it gives immediately a cheap and permanent record of the whole period of observation. The installation, however, comprises a large mass of electrical machinery, and the records (generally on a paper strip 3 inches wide and 1 inch long per second's observation) soon become so bulky as to be hard to manage.

THE ENCEPHALOPHONE

In view of the disadvantages inherent in both these types of instruments, two British investigators, Drs. C. A. Beevers and R. Furth of the Edinburgh Royal Infirmary, have sought to develop a simpler type of instrument, cheaper both in first cost and upkeep and having the great advantage of portability. Such an instrument would be suitable for surveys of large numbers of cases. Such an instrument could be produced by sacrificing the permanent record feature, using an amplifier which would convert the potential changes from the head into sounds.

A special advantage of such apparatus is its suitability for use in studies of unconscious patients. These are usually undergoing treatments which preclude their being taken to a laboratory. Studies of unconscious subjects—whose brain-waves are

free from the stimuli of external sensations—are of special interest and value. A feature of the audio method is that it leaves the operator free to visually observe the patient, noting extraneous potentials arising from friction, body movements or muscular or eyelid activity. In the visual methods of encephalography this is not easy, but in an audio method the observer's visual perceptions are left entirely free to watch the patient.

CIRCUIT OF THE INSTRUMENT

The circuit diagram of the instrument is shown in the figure. It contains two high-frequency Hartley oscillators, each consisting of a triode (V1 and V2), a single-layer coil of ten turns with center-tap (L1 and L2) and a condenser of 100 mmf. (one of which, C1, is variable and the other fixed). R1 and R2 are grid leak resistors of 50,000 ohms each and C4 and C5 are coupling condensers of 100 mmf. capacity. C3 is a 10 mmf. trimmer, used for fine adjustment of the first oscillator's frequency. The frequency of the two oscillators is in the order of 5 mc.

The two high-frequency oscillations are electronically mixed by V3. C6 and C7 are coupling condensers of .05 mfd. each, and the coupling resistors R3 and R4 have a value of 50,000 ohms each. C8 to C11, and R6 to R9, form a decoupling filter to prevent interlocking between the two oscillators.

By slightly varying the frequency of the first oscillator by means of C1 and C3, we get an audible "beat note" due to the heterodyning of the two oscillators in the mixer tube. This note can be set to a convenient frequency in the audible range. The intensity of the note can be controlled by the potentiometer P connected across the output of the phone transformer.

The idea of the new method is to make the head potential variations audible. This cannot be done by simply connecting the electrodes through an amplifier to headphones, as the frequencies involved are at all times far below the range of audibility. But just because of this comparatively slow rate of potential change, a "frequency modulation" method can be used. This consists of producing an electric oscillation in the

audible range which is changed in frequency by the change of brain potential. A steady musical note will be heard in the telephone as long as the potential is constant, and the pitch of the note will go up or down when the potential is increasing or diminishing.

The advantage of this set-up is that a very slight change in the frequency of one of the oscillators will result in a large relative change in the beat note. If for example, one of the oscillators is set at 5 mc. and the other at 5 mc. plus 500 cycles, a beat-note of 500 cycles per second is heard. If now the first oscillation is increased by 50 cycles per second—a change of 0.001 per cent—the beat frequency is decreased from 500 cycles to 450 cycles, a drop of about 10 per cent, and the pitch is lowered by a whole tone.

This also shows that the lower the beat note the higher will be the sensitivity of the instrument. It was not possible to lower the note as much as would have been desired, as the two oscillators interlock if the frequency difference reaches a certain minimum value, in spite of the decoupling precautions. It is hoped that further design will overcome this difficulty.

Frequency modulation is achieved with the help of V4, a variable- μ (super-control) pentode, which is connected effectively in parallel to the second oscillating circuit. A change of the control grid potential of this tube changes its impedance and hence the oscillating frequency of the circuit, in accordance with well known F-M principles. Thus a change of this potential is converted into a change of pitch in the note heard in the telephones.

Since tests showed that a voltage of 0.1 volt between cathode and control grid was necessary to produce an easily-recognized change in the beat-note, whereas an efficient electro-encephalograph should be able to detect potential changes in the order of one micro-volt, the need for an amplifier was clearly indicated.

In the present experimental instrument, a two-stage amplifier is used, giving a voltage amplification of about 500. This is not sufficient for practical work, and in actual

(Continued on page 445)

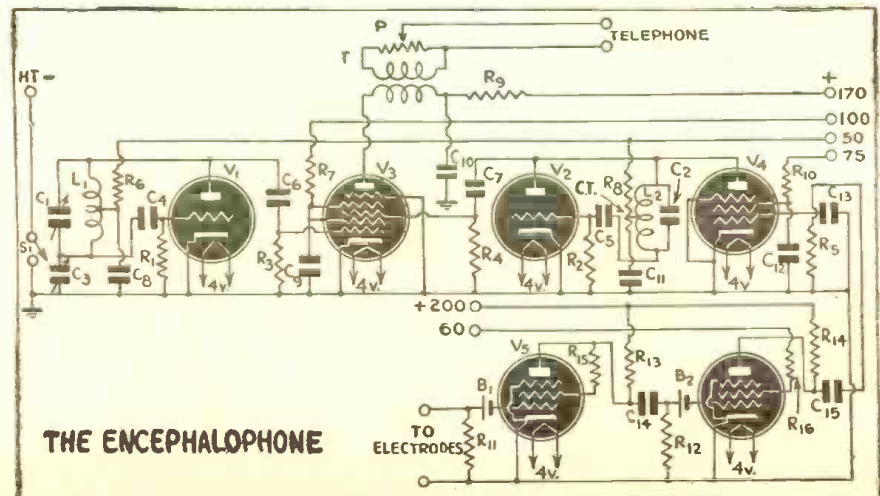

ELECTRONIC HEAT SOLDERS CRYSTALS

ELECTRONIC high-frequency induction-heat has taken the place of gas heat, in the soldering of crystal units which are used to maintain frequencies in war-radio equipment manufactured by the General Electric Company.

The soldering of the shell of the crystal unit to its base proved a critical operation

when performed with gas ring burners. The crystal is mounted on a bracket inside a metal shell. The bracket is mounted on a base or "header," and the shell is assembled over it, and soldered in place. If the leader is overheated, or heated too slowly, the heat is conducted up the bracket to the crystal, sometimes causing internal distortion. There

is also a possibility of producing injurious effects due to the products of high-temperature gas-combustion.

These difficulties were hard to overcome when the operation was performed by gas ring-burners, but with the use of the vacuum tube oscillator, they disappeared.

METHOD

The crystal unit is placed in a fixture which locates it with respect to a two-turn inductor-coil and a perforated airblast ring-nozzle. Heat is induced in the metal of the unit for a few seconds, after which a cooling air-blast is operated for ten seconds. The entire sequence is automatically timed to attain uniform seals. During the heating cycle the operator twists the shell slightly to assure uniform distribution of the solder.

It is pointed out that there are many brazing and soldering operations which could be done faster and better by this electronic induction heat method.

Induction heat can best be explained by likening it to the radiant heat from the sun. The sun's rays pass through space with little loss, yet when they strike a dark body (in space or on the earth) the surface is heated. In like manner, the high-frequency pulsating magnetic waves, radiated from the induction heater coil, pass through all insulating materials with little loss, and create heat when they strike any metallic body.

In practice, the part to be heated is placed in a water-cooled copper tuning-coil, and current is passed through the coil at frequencies of about 500,000 cycles per second. This current generates the pulsating magnetic field which heats the part.

Intervening air, or any parts of the human body which may be in the magnetic field, are not affected.



THE ELECTRONIC INDUSTRY AND ITS FUTURE

By REAR ADMIRAL S. C. HOOPER, U. S. N. (Ret.)

THE electronics industry, contributing as it does to the improvement and production of electronic devices for the Armed Services, is earning the right to great pride in its war record.

When one recalls that the seat of radio development and production was in foreign lands prior to World War I, the old timers in this field should feel pretty proud of the results of their efforts in changing this situation. American ingenuity in new developments, as well as our superior mass production, is already having a telling effect on our enemies. We lead the world

in this branch. Such ingenuity will more and more give us the edge necessary for victory.

The industry must be maintained in prosperous shape. The solid foundations which led to our present efficiency must be preserved, reviewed and improved.

One strong prop is to maintain the sacredness of patents, without which there can be no stability or insurance of incentive to progress. With so many new patents evolving from War developments and so few remaining old unexpired patents, now is the opportunity for the electronics indus-

try itself, as a whole to bring about a patent exchange arrangement under which patents will be owned by and available to all the industry and research workers on a fair and far-sighted basis.

Also, through cooperation with the Government, readiness for war production must be maintained so that the lag in shifting from peace to war status will be eliminated if war comes again. This includes factory facilities, tools, trained personnel, systems for obtaining materials, and many other items.

LEE DE FOREST COMMENTS

Mr. HUGO GERNSBACK, *Editor Radio-Craft*

Dear Mr. Gernsback:

I have just read with intense interest the tributes to Nikola Tesla contained in the February number of *Radio-Craft*.

Particularly interesting is your article in summing up the character of that strange genius. You were characteristically bold in placing Tesla ahead of Edison as the world's greatest inventor. I am not sufficiently fa-

miliar with all of Tesla's inventions and patents to be able to justly compare him and Edison in this respect. But, as you sagely point out, it was Tesla's misfortune to have held himself so completely aloof from the engineering profession which he was so well fitted to lead and dominate. Had he associated more closely with others of the profession, his later years doubtless would have produced many more inventions of genuine practical worth than they did. I feel certain

that in this respect the world was a great loser.

The electrical and radio profession stand deeply indebted to you for having undertaken this tribute to Tesla, which I regret to say will probably stand unique. His passing should have aroused more of tribute than it did from electrical and radio editors.

Very sincerely yours,

LEE DE FOREST
Los Angeles, California

SYSTEMIZED TROUBLE SHOOTING

By ERIC LESLIE

ONE of the greatest advantages of the new channel analyzers has been that they have forced servicemen to inject system into their methods. Hundreds of men who really knew better were forced out of the ancient point-to-point methods of the day when few understood what was really happening in the receiver.

Even today we receive the odd query: "We have low volume on a *Loudio Eight*. All parts check O.K. What is the matter?" Some of the poor fellows look puzzled when you ask, "Where is the volume low?"

This group are hopeless. There are, however, many servicemen who have merely got into a rut and are using ancient methods of circuit analysis through sheer inertia.

THE APPARATUS

You can use "chanalysis" without an expensive multi-channel signal chaser. Dig out an old phonograph motor and turntable and put a *good* crystal pickup on it. Bring the leads from the pickup out to a pair of test prods. Insert a .05 condenser into one of the leads to keep D.C. voltages off the crystal. This, with the shop's Signal Generator, will make up your signal chasing equipment.

System is the secret of this method of servicing. When a set comes into the shop, follow a standard system of steps in finding out what is wrong with it.

The first step is to take a look at the set. If a tube is missing or loose, or if serious damage, such as burning out a power transformer, has occurred, it should be evident. Then plug the set in and turn it on. Note what the trouble seems to be, and guide future steps accordingly. For our purposes we will assume the set is dead. First check the high voltage at the output end of R9, to make sure the rectifier circuit is O.K. Tubes are then checked and found O.K.

The next step is of course to pull the chassis. Once out and turned up, look it over again. Burned-out resistors, wires

shorting to chassis, may be seen immediately. If there is nothing obviously wrong, we are ready to start tracing.

THE METHOD

Step No. 1. Find out whether the trouble is in the audio or radio end. This used to be done in the old days of grid-capped tubes by simply placing the finger on the cap of the 75, 6Q7 or what have you. In the set we are dealing with, the detector is a single-ender. We can find out immediately whether the audio is working by placing the phono prods across the volume control, R4. If music is reproduced perfectly, the trouble is somewhere in the circuit before this point.

If nothing is heard, the prods are moved forward to R5. Signals here indicate that R4 or C15 is open, or that C14 is shorted. Tests on these parts will show up the defective one. If no signal is heard from this point, it will be necessary to try the prods from the 12SQ7 plate to ground. A signal from here may indicate that R6 is burned out, or, if it is O.K., that there is something wrong with the tube which failed to show up in the tester. An open R5 may make trouble here, too.

Assuming that we still get no signal, we try the prods across R7. If music is reproduced from here, it will not be particularly loud. Normal operation from this point indicates R6 or C17 open, or C16 short.

The phonograph will not give us a strong enough signal to work from the plate lead of the 50L6. If the oscillator is capable of putting out a strong signal, placing its prods across the output transformer primary will give us a weak sound from the speaker. This would indicate a shorted C18 (probably) or possible trouble in R8 or R7. No signal from this point shows a burned-out output transformer or an open voice coil.

This is a systematic method of approach. It can be further shortened by considering that breakdowns of circuits carrying high voltage are more common than troubles in

other circuits. Time will be saved, if, after discovering that the audio end is at fault, the voltage at the plates of the 12SQ7 and the 50L6 is checked. Lack of voltage at either of these two points immediately narrows our investigation to two components—a resistor and condenser in one case, and the output transformer and a condenser in the other.

There is another possibility. We are likely to get music, more or less badly distorted, from any of these test prod positions. It is for this reason that we prefer a phonograph for audio testing, instead of using the signal generator throughout. The generator may produce a tone in the output in which no distortion is recognizable, when the phonograph will show distortion up very clearly.

Distortion in these circuits can also be tracked. If it is the 12SQ7 and its associated circuits which is to blame, the music from test prod positions across R7 should be perfect. If distortion persists here, C17 may be leaky, or R7 or R8 bad. Once you have confined the trouble to a single part of the receiver, it is comparatively easy to find the reason for it.

If Step 1 gives us perfect phonograph music, we are safe in assuming the audio end to be in good condition, and we can abandon the phonograph for the test oscillator. The process is much the same as that used in aligning a receiver. First try the signal generator on the grid of the 12SK7 I.F. tube. Listen to the output and judge whether the signal is of normal strength. If it is, the trouble is still further forward in the set.

If no signal appears in the initial test of Step 2, the trouble lies between the I.F. grid and the detector. A voltage check on the plate will show whether the trouble is an open in the I.F. primary or not. Further checks with the generator from the

(Continued on page 431)

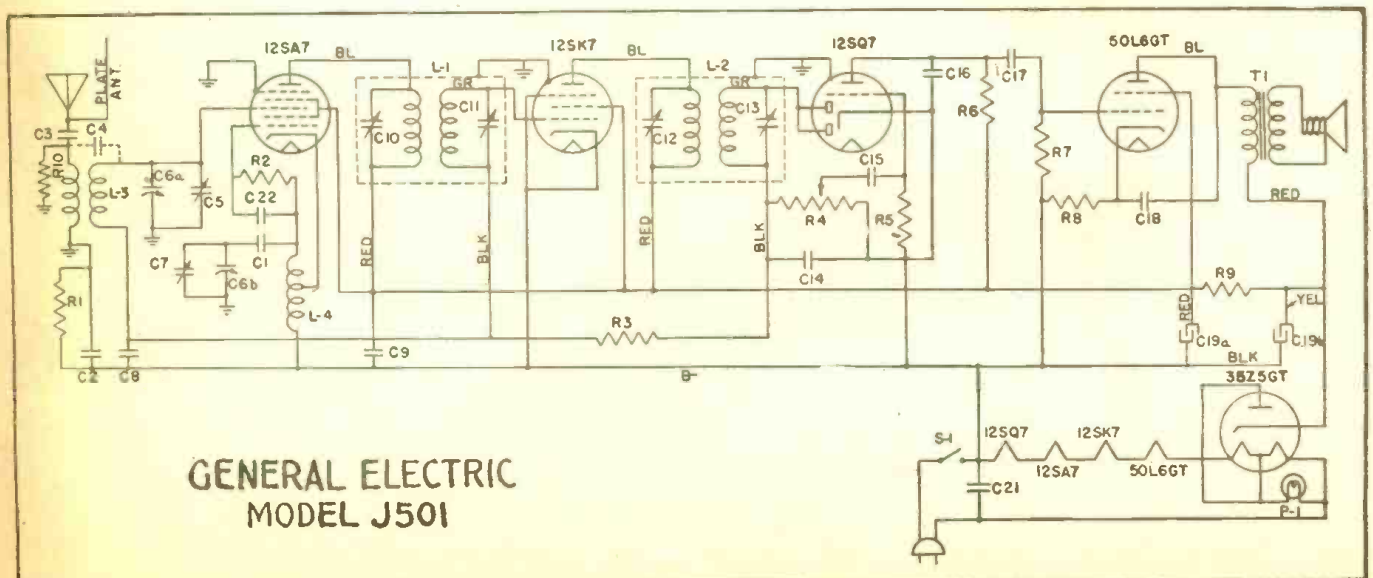

GENERAL ELECTRIC
MODEL J501

GENERAL ELECTRIC RADIO-PHONOGRAPH COMBINATIONS

MODELS LC-759, LC-759-B, & LC-768



General Electric Model LC-768

Electrical Rating
 Rating "A6" 110-125 volts, 60 cycles, 130 watts.
 Rating "A5" 110-125 volts, 50 cycles, 130 watts.
Tuning Frequency Range
 "BC" Band.....550-1720 KC
 "SW1" Band.....1.7-5.2 MC
 "SW2" Band.....5.2-18.1 MC
Intermediate Frequency.....455 KC
Electrical Power Output
 Undistorted.....7.5 watts
 Maximum.....12 watts
Loud-speaker—Electrodynamc
 Outside cone diameter...11½ inches
 Voice coil impedance (400 cycles).....5 ohms
 Field resistance.....400 ohms
Phonograph Mechanism
 Type changer.....Model LRP-170
 Type pick-up.....Crystal
 Turntable speed.....78 RPM
Tubes
 RF Amplifier.....GE-6SG7
 Converter-Oscillator.....GE-6SA7
 IF Amplifier, Demodulator, AVC.....GE-6SF7
 Audio Amplifier, Phase Inverter.....GE-6SC7
 Audio Output.....(2) GE-6V6GT
 Rectifier.....GE-5Y3G
 Dial Lamps.....Mazda No. 44

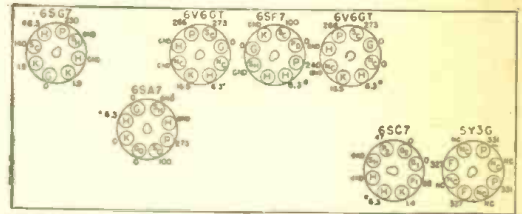

BOTTOM VIEW OF CHASSIS
 VOLTAGES MEASURED BETWEEN TERMINALS AND CHASSIS AT 170C LINE USING VOLTMETER PER VOLT METER. 0 INDICATES VOLTS A.C.

Fig. 3
 Socket Voltages

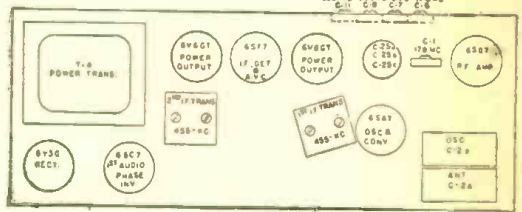

Fig. 4
 Trimmer Location

GENERAL INFORMATION

These models are seven-tube three-band superheterodyne receivers of conventional design using in combination an Automatic Record Changer.

Phonograph Tone Compensation

The schematic diagrams shown on the opposite page, is that of the Model LC-768, with the tone compensation built into the changer. Models LC-759 and LC-759B have no compensation on the changer but it is built into the chassis as indicated in Fig. 2, otherwise the schematic is identical for all three receivers.

ALIGNMENT PROCEDURE

The location of trimmers is shown in Fig. 4. All oscillator and R.F. trimmers are accessible from the rear of the cabinet.

All I.F. adjustments may be made with the chassis removed from the cabinet. However, the R.F. adjustments should be made with the chassis and loop antennas securely fastened in the cabinet, as the relative position of the loop antenna with respect to the chassis materially affects alignment. The R.F. signal should be capacity-coupled to the receiver loop by connecting a two-foot wire for an antenna on the test-oscillator output post (high side). Keeping this antenna two feet or more away from the receiver loop will generally insure freedom from too much coupling.

Metal objects such as meters, tools, etc., should not be placed on top of the receiver cabinet.

DETAILS OF ALIGNMENT PROCEDURE

Step 1.—Set signal generator at 455 Kc., connect to 6SF7 I. F. grid in series with .05 mfd. condenser. Set receiver pointer at 550 Kc., BC band. Adjust trimmers C17 and C16, on second I. F. transformer, for maximum output.

Step 2.—With signal generator still at 455 Kc., connect to 6SA7 Converter grid in series with .05 mfd. condenser. Receiver pointer setting as before. Adjust trimmers C14 and C13, on first IF transformer, for maximum output.

Step 3.—With the R. F. signal capacity coupled to the receiver as previously described, set the signal generator to 580 Kc. Set receiver pointer to 580 Kc., BC band, and adjust C11 for maximum output. Rock gang condenser while making this adjustment. C11 is the right-hand condenser at rear of chassis.

Step 4.—With signal generator capacity coupled as before, set it to 1500 Kc. Adjust receiver pointer also to 1500 Kc., BC band. Adjust C8, (beside C11) for maximum output, again rocking the gang condenser slightly while making adjustment.

Step 5.—Set the signal generator to 580 Kc., capacity coupled to receiver as before. The

receiver pointer is also set to 580 Kc., BC band, and C11 is retrimmed for maximum output, following the exact procedure as in Step 3.

Step 6.—Set the signal generator to 5MC, retaining capacity coupling to receiver. Set the receiver pointer to 5 MC on SW1 band. Adjust C7 (beside C8) for maximum signal, rocking gang very slightly while making adjustment.

Step 7.—Set signal generator to 17.9 MC, capacity coupled. Set receiver pointer to 17.8 MC on SW2 band. Adjust C6. (Left-hand trimmer at rear of chassis, beside C7) to maximum signal. Maximum will occur at two settings of C6. The low-capacity peak is the correct one, the one obtained with more capacity is the "image" peak.

Step 8.—With signal generator as before, (17.8 MC, capacity coupling), adjust C1, (on the chassis, between 6SG7 and filter condenser) for maximum signal, again rocking the gang slightly during alignment.

The set is now correctly aligned and no retrimming of any of the condensers is likely to be necessary or desirable.

SPECIAL SERVICE INFORMATION

The following data is taken with a vacuum-tube voltmeter or similar measuring device.

- (1) Stage Gains
 Antenna post to R. F. Grid 6.5 at 1000 Kc.
 R. F. Grid to Converter Grid 10 at 1000 Kc.
 Converter Grid to I. F. 45 at 1000 Kc.
 Converter Grid to I. F. Grid 60 at 455 Kc.
 I. F. Grid to 6SF7 diode plate 110 at 455 Kc.

- (2) Audio Gains
 .09 volts, 400-cycle signal across volume control with control set to maximum will give approximately ½-watt output to speaker.

- (3) D-C voltage developed across oscillator grid resistor R6 averages 7 volts at 1000 Kc., 9 volts at 4000 Kc., or 6 volts at 10,000 Kc.

Variations of ±20% permissible. All readings taken with minus 1½-volt fixed bias on AVC bus.

MODEL NUMBERS

The three model numbers, LC-759, LC-759B and LC-768, refer to cabinet finishes and slight dimensional changes. LC-759 and LC-759-B have the same dimensions:

- Height36 inches
- Width34¾ "
- Depth16¾ "

Model LC-759 is finished in Mahogany Veneer, while LC-759B has a Blond Mahogany finish.

Model LC-768 differs slightly from the other two models in dimensions as well as in finish. The cabinet of the LC-768 is 38 inches high, 28 inches wide and 14 13/16 inches deep. The finish is Walnut Veneer.

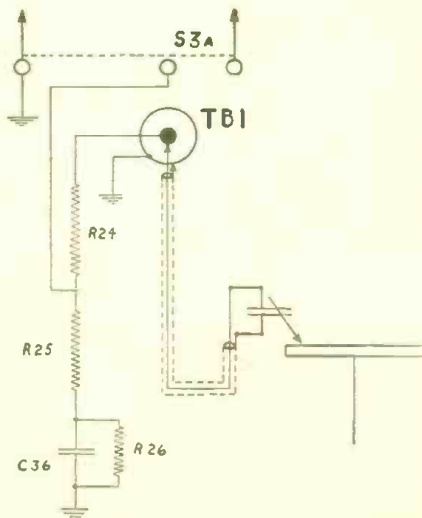

Fig. 1
 Band Switch Wiring

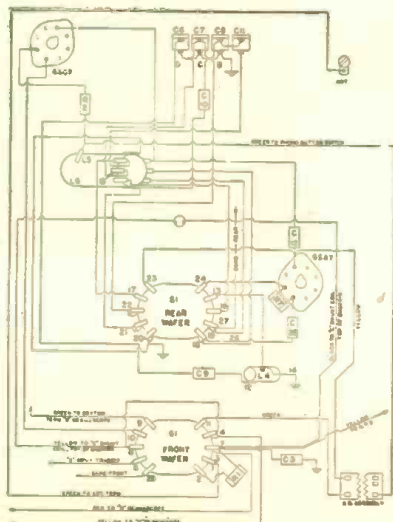
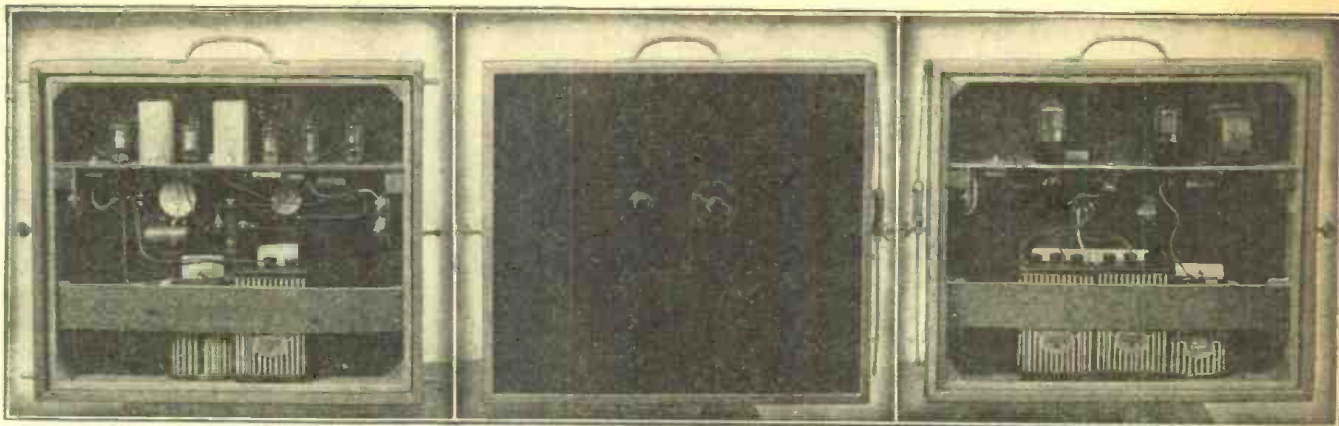

Fig. 2
 Phonograph Tone Compensation (LC-759 and LC-759B)



The photos show (left), the back view of the receiver; (center) front view of transmitter; (right) back view of the transmitter; and (lower left) the front panel of the receiver. Note the neat workmanlike construction and the compact arrangement of batteries and chassis.

METAL LOCATOR —1943 MODEL

By G. M. BETTIS

Here is a metal and ore locator that **REALLY WORKS!** It is easy to construct, is very simple electrically, and has dozens of applications. This is the latest article on the subject, written for RADIO-CRAFT in response to the recent great demand. We know that those who are interested will benefit greatly from Mr. Bettis' instructions.

THE metal locator to be described is not an experimental model but one that has actually done productive work. Tests made with it have been more than satisfactory. A similar model was described in the December, 1940, issue of *Radio-Craft*, but the first locator of this exact type was made in August, 1941, by the writer, for a pipe line engineer. This engineer made several suggestions as to the design, which have been proven in the field, many times under adverse conditions.

PRACTICAL USES

The practical uses of this locator are many. To mention a few: Exact location of buried pipe lines, such as oil, gas, and water pipe lines; checking location of construction projects for any buried metal or lines; checking and searching for metal and ore deposits; tracing pipe lines, or veins of ore, once they are located, etc.

This locator is very easy to operate and use, as simplicity and efficiency were the paramount ideas when it was designed. The most practical way to get acquainted with this locator is to study all the details set forth in this article and then check the lo-

locator on known buried objects and metal lines. Results will be easy to produce if you build it properly and learn how to make it respond to the different situations under various and adverse conditions. In other words get acquainted with the locator as you would your small son's electric train that Santa Claus brought him for Christmas.

Just as an example of what one may be called on to do with his locator—I was asked to locate two sections of a pipe line that had broken out and was lost somewhere down stream in a river bed. The

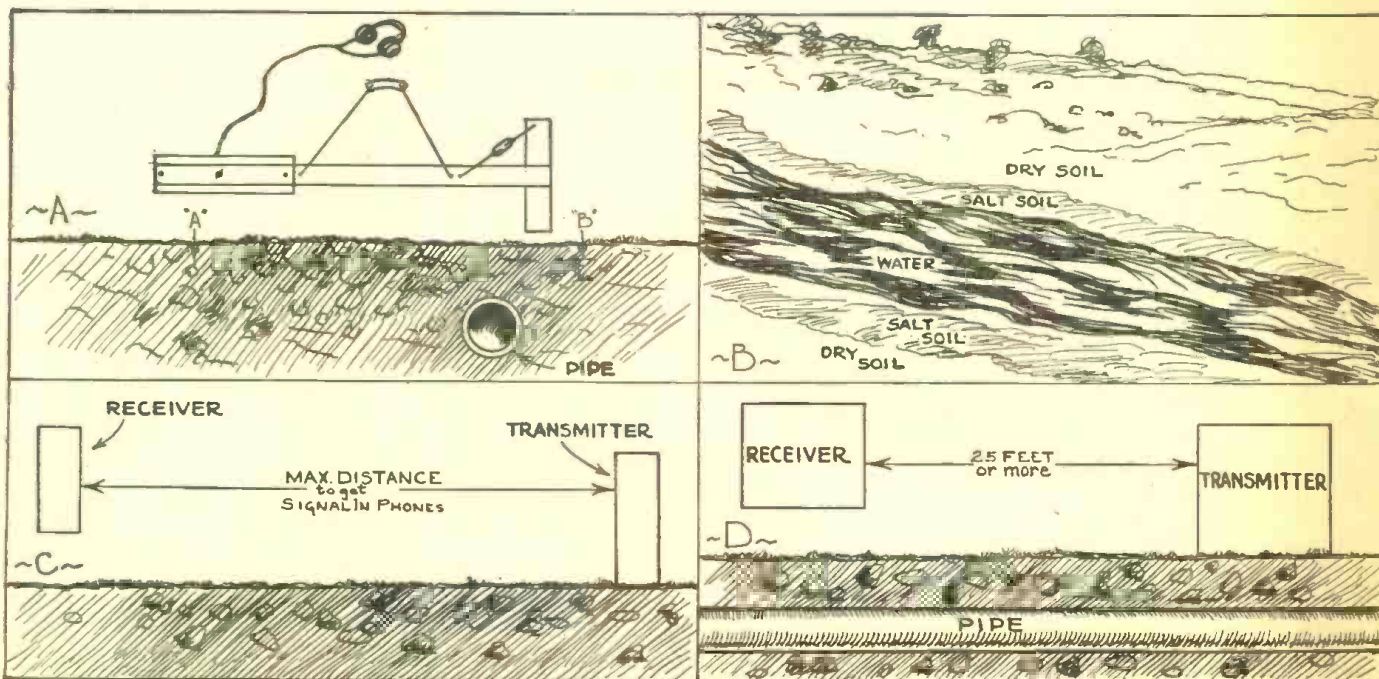

Fig. A shows how the locator is used to determine location of buried metal. Fig. B. Typical river bed. Fig. C One Method of localizing an area. Fig. D Tracing a pipe line.

river, the Prairie Dog Branch of the Red River in North Texas, was 7,000 feet wide and usually could be waded. Floods caused two sections of line about 900 feet long, to be broken out and lost. Dry sand, wet sand, fresh water, salt water, and various combinations of soil were found in this particular location as there was a lot of salt water flowing into the river just a few miles above the pipe line.

Many operators of metal locators will say you can't do any good in a spot of that kind. You can, if you get acquainted with this locator, because we *did* find those lines, and staked them to where a ditching machine went on the job and uncovered them. The ditching machine operator said one of the fifty stakes was about a foot off the center of the line. The lines were 5½ feet deep under sand and mud.

The method used to do this job will be shown under *Operating Instructions*.

FEATURES

Some of the features of this locator are:

1. Highly efficient use of the 1T4, 1S5, and 1S4 type tubes, from 1.5-volt "A" supply, and only 45-volts "B" supply, in three T.R.F. stages, 2 audio stages, and one vacuum-tube-voltmeter stage.
2. Plate Modulation. Uses two 1G6gt twin-triode tubes, one as a Hartley electron-coupled oscillator, the other as an audio oscillator used for modulation. This type modulation increases the output of the transmitter tremendously and sharpens the tuning of the carrier also. Distinct advantages over the self-modulated type transmitters.
3. Not an experiment. Makes use of the proven radio balance principle, resulting in high sensitivity, stability and efficiency, with the advantages of two indications—visual and audible.
4. Light weight. High-grade construction of standard parts. No trick circuits nor special unobtainable parts needed.
5. Alternate tubes may be used. The 1N5GT, 1H5GT, and the 1T5, respectively

can be used in place of the 1T4, 1S5, and the 1S4. The miniature type tubes are recommended because of their high efficiency on low plate voltage.

6. Flexibility of Operation. As a single unit by joining the transmitter and receiver with the two handles in order to exactly spot some desired metal object, and as two separate units in tracing metal or ore after spotting with the single unit, or when at least one point of the desired metal or ore is known.

7. Results, or the type of work this locator will do. This is the most important feature. I know from tests and experience that this locator has easily located the following, which may serve as a guide as to what to expect: ½-inch water line, 2 feet deep, more than half-scale deflection of meter; 4-inch water line, 4½ feet deep, more than half-scale deflection of meter; 6-inch oil line, 11-feet deep, about third-scale deflection of meter. Six- and ten-inch pipe lines that were located in river bed under 5½ feet of sand, salt water, and mud, show from half to almost full scale deflection of meter. I have made many other tests, and know that this locator will work well on aluminum, brass, copper, lead, and silver as well as it does on iron.

8. Detailed diagrams and schematics. Fig. 1 is detail of cabinet corner; Fig. 2 is cabinet from rear; Fig. 3 is battery holding-strip; Fig. 4 is cabinet from front; Fig. 5 is drilling pattern of receiver front-panel; Figs. 6 and 7 show details of loop frame; Fig. 8 is drilling pattern of transmitter front-panel; Fig. 9 is pattern of receiver chassis strip; Fig. 10 is inside of transmitter; Fig. 11 is transmitter chassis strip; Fig. 12 is detail of carrying handle; Receiver schematic and transmitter schematic.

CONSTRUCTION

The diagram Figs. No. 1 through No. 12 show in detail how the cases for transmitter and receiver should be constructed as well as drilled for the parts listed.

The cases shown in the pictures were

made from Philippine mahogany; the panels and chassis strips from tempered Masonite. Due to present conditions this exact material may not be available but any good dry wood, fibre, bakelite, or non-conductive material will be suitable.

The coils are wound with 48 turns of No. 28 enamelled wire, 24 turns each side of center tap, and wound in the same direction. Not critical as to size of wire or covering of wire as long as coils will tune to 175-kc., which is the operating frequency of this locator.

The tube sockets are mounted first in the chassis strips and then all other parts in both chassis strips and front panels.

The chassis is wired with no stiff connections to the miniature tube sockets because of danger of breaking the glass base of these tubes when placing them in sockets. Leads are left so as to reach parts mounted on front panel. The coil and chassis strip are fastened to the case with brass wood screws and the wiring is completed. The wiring of both the receiver and transmitter is conventional.

The meter I like to use in the receiver when available is the Model No. 27 0-100 D.C. Micro-ammeter made by Simpson, but any good 0-1 D.C. milliammeter will do the work.

When all wiring is finished, check and double check, as there is danger of burning out a complete set of tubes by having one wire in the wrong place. Connect the batteries, and measure the voltages at the tube sockets before placing tubes in sockets.

It will be well worthwhile to test the audio oscillator with headphones in order to see that it is producing a good signal of about 400 cycles. It may be necessary to switch the "ground" or "grid" leads of the transformer.

First test the receiver by aligning the I.F. transformers and the trimming condenser "TC," so as to have the greatest signal in the 'phones, and the greatest deflection of

(Continued on following page)

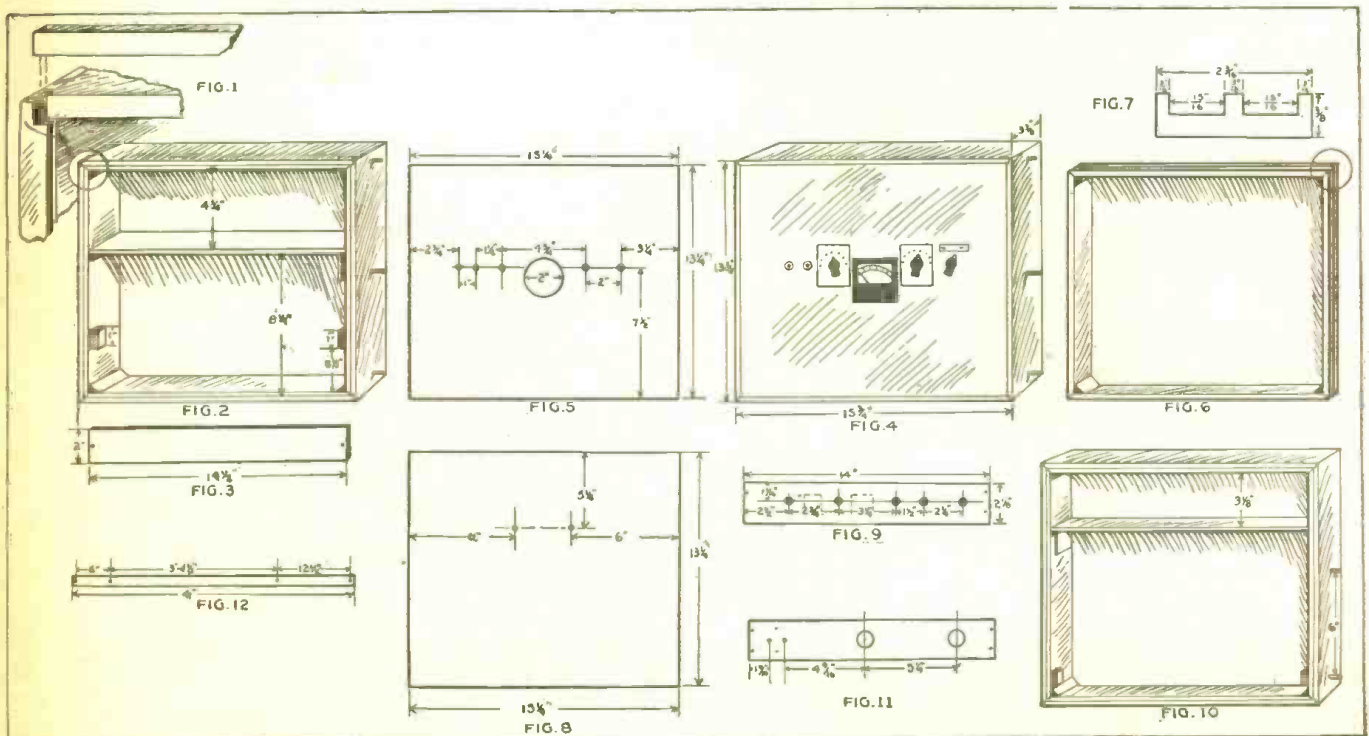

Figs. 1 to 12 show dimensions for constructing the panels and cases of the transmitter and the receiver. The constructor can build these himself or have a cabinet maker build them for him.

TREASURE LOCATORS.

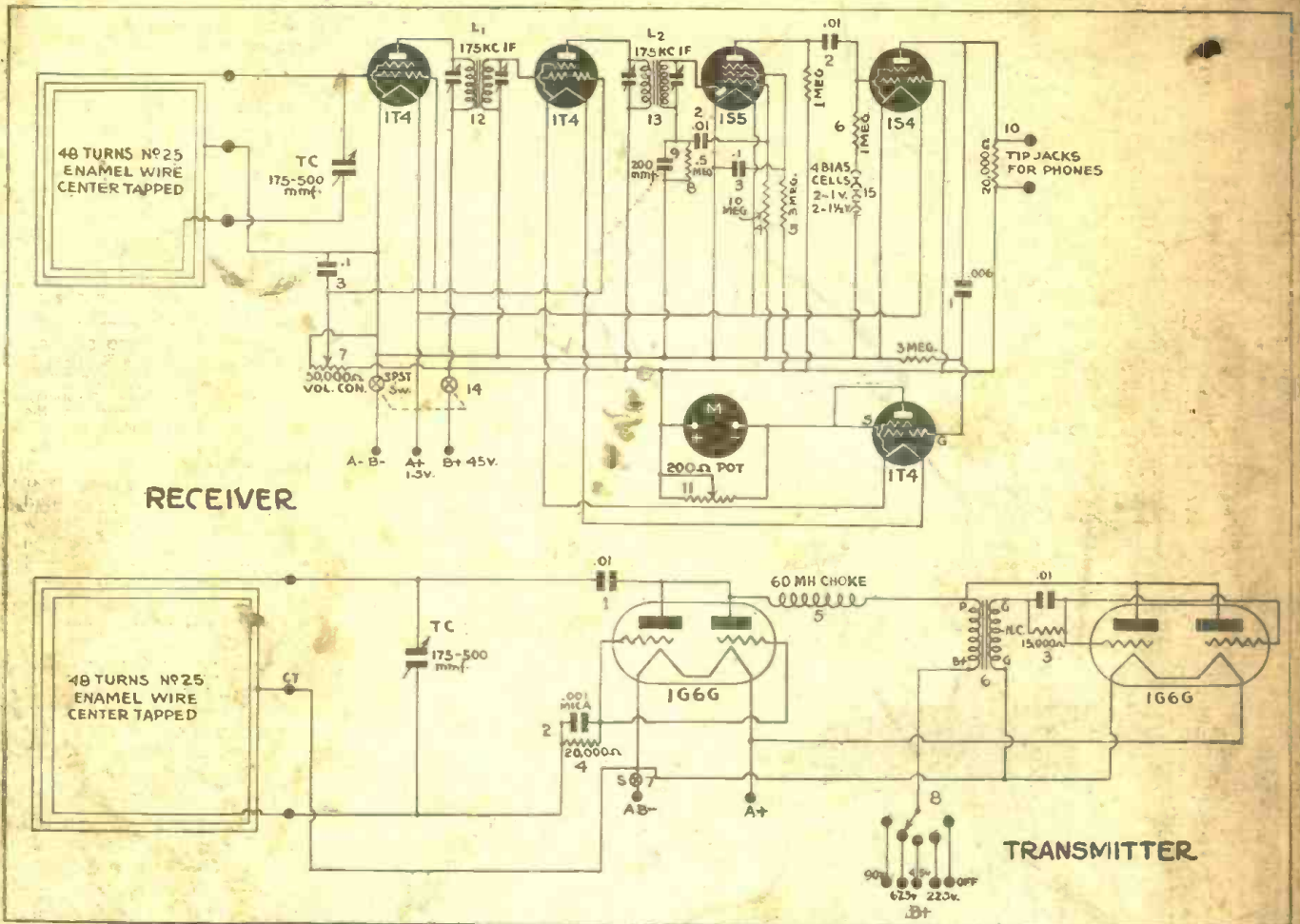

Circuit diagrams of the receiver and of the transmitter of the pipe line and metal locator. The constructor should experience no difficulty in following these or in the actual building of the devices.

(Continued from previous page)

the meter when using a calibrated oscillator set at 175 kc. These adjustments should be made with the volume or gain control advanced just under the regeneration point. A competent radio serviceman can do this, if a calibrated oscillator is not available.

The transmitter is turned on and the trimming condenser "TC" adjusted for greatest signal in receiver. This adjustment should be made with the power switch in "Position 2." Then move the transmitter parallel to, and away from, the receiver so as to hear a faint signal in the 'phones. Then adjust condenser "TC" for maximum signal in the receiver.

OPERATING INSTRUCTIONS

When not in use the controls must be in the "Off" position. The transmitter controls are the switch and the power control with 4 positions. The receiver controls are the switch, meter sensitivity control, and headphone jacks. To test, plug headphones in jacks of receiver, turn receiver switch on, adjust meter indicator to full scale, and then advance the sensitivity control slightly less than the point where a whistle is heard in the headphones. This is the most sensitive spot to operate receiver. Turn the transmitter switch on, then advance the power control to positions 1, 2, 3, and 4. There will be a loud signal in 'phones and the meter pointer will deflect downward toward zero.

Be sure all controls are turned off when not in use.

Assemble the transmitter and receiver as

shown, between wooden handles, attaching wire extension handles and turnbuckle. Turn the receiver on, turn transmitter switch on, and then place the power control on position 2. With the locator in the position in which it is to be used, adjust the turnbuckle until the highest reading of meter in receiver is obtained, then tighten turnbuckle so there is a slight deflection of the meter, and a low signal heard in the phones, then tighten the lock-nut on the turnbuckle. The top of the transmitter case will be slightly forward. This is called "balancing the locator." It must be balanced for each position of power control. Power control in position 2 is usually the best way to use the locator. When crossing buried metal or a pipe line there will be a loud signal in phones and the meter will deflect sharply downward. The metal object will be directly under the transmitter as shown by the lowest meter reading and the loudest signal in phones. Metal objects or pipe lines are located easily when crossed.

This locator does not respond very well to metal objects that are on top of the ground, so please notice this when making tests, as the locator will be a disappointment except on buried objects, and ones that have been buried for sometime.

With the locator set up as described in Fig. A, with a metal object or pipe line to be located somewhere between points "A" and "B" with different types of soil, it is best to determine the exact area of each type of soil with the locator (See Fig. B). This will show by the rise and fall of the meter pointer. Mark these areas. It will be necessary to balance the locator over each type of soil. Then cover each type of soil

with the locator as balanced for that particular type. The locating of a metal object or a pipe line is the same as in Fig. A.

When it is desired to trace a line or a vein that has been located (See Fig. D.) or if there is a known spot, the transmitter should be placed over and parallel to the line. Then with the switch on and the power control on position 2 the receiver should be turned on 25 feet or more away from the transmitter and moved back and forth above and parallel to the apparent course of the line. There will be a peak signal heard, and the loudest spot is directly above the line or vein. When the signal gets too weak as the receiver is moved along the line advance the power control to positions 3 and 4, as far as the line can be followed. Mark the exact spot of the line and bring the transmitter to this position and place over line and proceed as before. In this way two operators can trace and mark a long line very efficiently.

Another method to exactly locate a line is to place the receiver horizontally over the line where the peak signal was heard (See Fig. C), with the top of the receiver toward the transmitter and close to the ground. Move back and forth across line. When you are directly above the line there will be a null, or "no signal" in the headphones.

The locator is tuned and aligned with the power control in position 2. If there is to be quite a bit of use of the locator with other power control positions, place the transmitter on the ground and the receiver slightly above the ground, facing each other,

(Continued on page 448)

A COMPACT A.C.-D.C. PORTABLE

By EDWARD M. YARD

This little receiver uses only two tubes (of the obtainable type by the way), with loudspeaker volume. It should fill the bill for the many who have looked for a line-operated receiver of very small size.

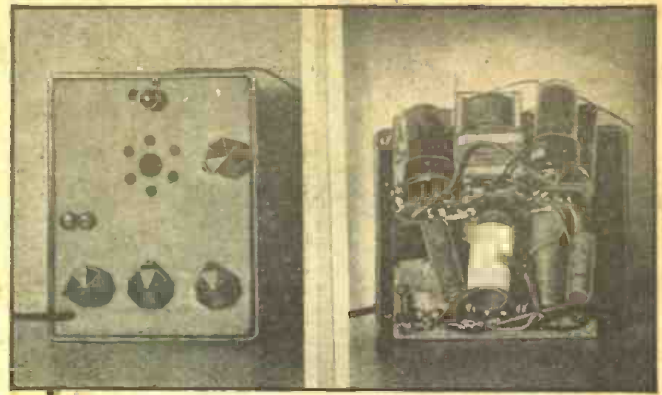

Appearance of the receiver. Its 2½-inch speaker allows more space for parts. On the right is shown the under-chassis view, giving some idea of the arrangement.

THERE seems to be considerable and recurrent interest in compact radios. *Radio-Craft's* Mailbag has contained any number of requests for pocket receivers, and the like. Some readers suggest using a crystal detector, others, one tube. Most of them lack the knowledge to design the set they want, and desire constructional data. They probably are not fully aware of the problems involved, the most difficult of which is the fact that each individual has a different idea of his requirements, while any design of general interest must be a compromise of features. With the present shortages of parts, and the almost complete unavailability of batteries, the problem of designing a small set of general interest is tough.

To discuss all of the possible designs with a view to making clear why one design was finally chosen, would be an endless task. A little careful thought will show why crystal-detectors, earphones, one-tube sets, and similar features are discarded in a set for general interest. The average set using earphones takes up as much room as an entire receiver circuit when you try to pack the equipment into an overnight bag. This is not to say that a truly pocket-type receiver, to operate the hearing-aid type of headphone is not possible. It is possible. And it would be interesting. But the parts and the batteries are too difficult to obtain.

The receiver described here is a compromise. It is small, but it won't fall over when you try to tune it. You might slide it into a large overcoat pocket, but it is not a pocket radio. You will find that it tucks away handily into an overnight bag, or even in your brief case. It is built into a bakelite meter case 6½" long, 5¼" wide, 2½" deep. This is smaller than any other set having real loudspeaker operation which the author has ever seen.

This set includes self-contained loudspeaker operation, 117-volt A.C.-D.C. power supply, and bandspread tuning. The coil is the only homemade part.

Most people desiring such a set do not expect it to compete with the more elaborate and larger sets. They do want adequate reception of local stations, and powerful out-of-town stations over reasonable distances, say fifty to seventy-five miles, without awkward antenna set-ups, ground connections, etc. They expect a set that is small enough to travel with them. This set will do these things.

The circuit is simple. It is not critical. It works. Only two tubes are used. A 12SJ7GT/G is used as the regenerative detector. A 70L7GT/G is used as the audio amplifier output stage, and its rectifier section provides D.C. plate-current. The filaments are operated in series with a voltage-dropping resistor. (A line cord is not used

because of its bulk.) The speaker is a 2½" permanent-magnet unit.

Regeneration provides sensitivity and selectivity. There is provision for adjusting the antenna coupling-condenser, as this also affects the sensitivity. Once set for a given band and antenna, it need not be altered during operation. Screen grid regeneration control is used because of its smoothness, its simplicity, and the absence of detuning effects. Bandspread is included, despite the extra space, to make tuning easy with small knobs.

All parts are mounted on the front panel. This, and the speaker frame, serve as a chassis. The photographs, the diagram, and the description will locate all the parts adequately. While they are compactly placed, no difficulty should be encountered getting them all in, as there is really lots of room. In a general way, the parts may be placed as follows (Looking at the panel from the back.): Upper right hand corner, filament series resistor, filter resistor, 70L7GT/G; upper center, speaker transformer, antenna binding post and coupling condenser; upper left, screen-grid by-pass-condensers, screen-grid regeneration control, 12SJ7GT/G; bottom left, main tuning-condenser, filter-condenser; center bottom, bandspread tuning condenser, RFC; bottom right, volume control, main filter condenser, cathode by-pass-condenser, and line by-pass-filter. Most of the smaller re-

sistors and condensers are located near their respective sockets in the space behind the lower part of the speaker cone. A few pieces of insulating cardboard have been scotch-taped at strategic points, as deemed necessary. No ventilating holes have been provided in the case or in the panel. None were found necessary for intermittent operation.

The panel used was a piece of ¼" plywood. Any insulating material considered as suitable may be used, but do not use metal since one side of the line (117-volts A.C.-D.C.) is connected to the return or "ground" side of the circuit. There is a possibility of its becoming grounded to a metal panel.

All holes should first be drilled in the panel. The output transformer should be soldered to the speaker frame. Mount the antenna binding post in the top center of the panel with the antenna coupling-condenser attached. Make sure that the adjusting screw of this trimmer lines up with the hole in the panel so that it may easily be adjusted from the front. The antenna binding post is simply a No. 6-32 screw with three or four nuts to give clearance behind the panel for the condenser. Now mount the speaker, and bolt the sockets to the frame. Place the two variable resistors. Wire up the speaker to the transformer, and the transformer to the output. Con- (Continued on page 437)

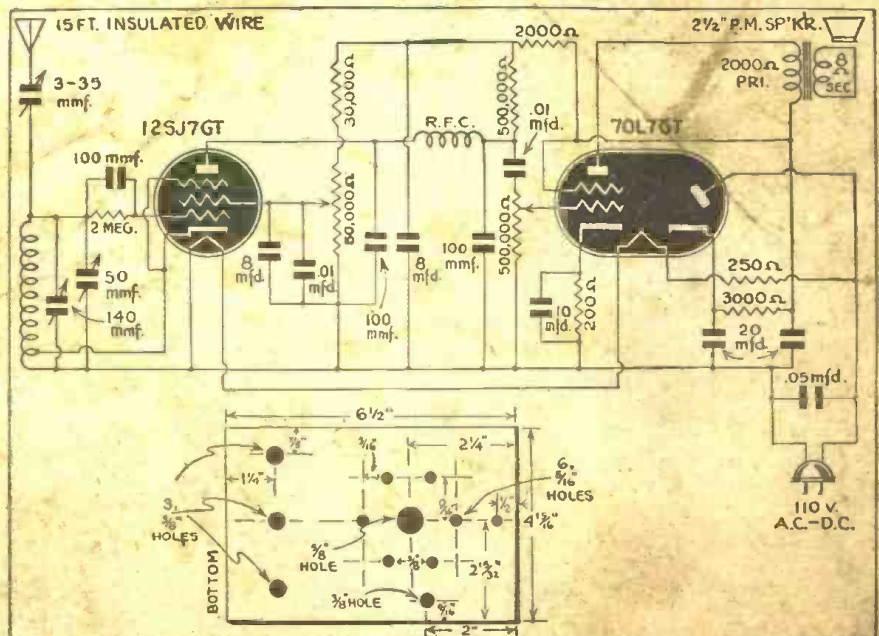

Circuit diagram and chassis layout of the compact A.C.-D.C. portable. The 12SJ7GT and the 70L7GT are on the list of tubes to be manufactured in 1943

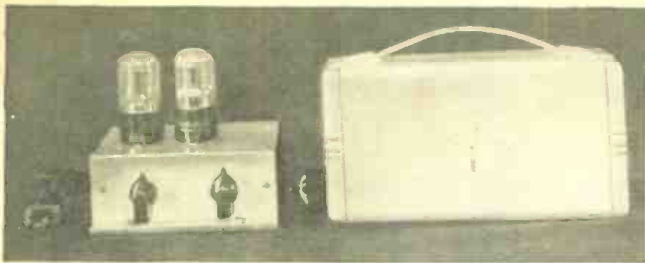

With the scarcity of batteries getting worse daily, the use of a power pack for portables becomes imperative, and the information given herein is welcome. One difference between this power pack and those recently described in Radio-Craft, is that it provides "C" bias voltages as well as the usual "A" and "B" supply. This job is compact, light and flexible, and will provide enough power for sets using up to 250-milliamperes of filament current.

POWER SUPPLY FOR BATTERY PORTABLES

By R. S. HAVENHILL*

DUE to the war, severe restrictions have been placed on the manufacture and sale of all types of portable batteries.

In fact, the small 45 and 67.5 volt "B" batteries for the miniature portable radios cannot be purchased any more and the "A" batteries, which are ordinary flashlight cells, are becoming difficult to obtain. Unless suitable power packs can be obtained, these radios will have to be put on the shelf for the duration. It is the purpose of this article to describe the author's design of a small light-weight 115-volt A.C.-D.C. type portable power pack for these sets.

An excellent article entitled "Portable Receiver Power Packs" by Fred Shunaman appeared in the January issue of *Radio-Craft* which prompted the writer to send in this article.

The power pack herein described was designed to work on 115-volt A.C. 60-cycle power lines and to furnish "A," "B," and "C" power for a Crosley 45-BV commuter personal portable radio. However, the design is also applicable to other miniature

receptions of the filaments would result in a simpler power pack but this is not practical, as the 1S4 draws 100 mils. of filament current while the other tubes draw 50 mils. Series connections would also mean rewiring of the set and the use of complicated switching arrangements to change from batteries to A.C. operation.

Since the tubes are connected in parallel, this means that the current supplied must be the sum of the requirements for each tube, or approximately 250 MA at 1.4 volts. The easiest way to obtain this would be to use a transformer and a dry disc-rectifier. However, these parts are difficult to obtain, are bulky and heavy, unless specially designed to do the job. It was decided to use a tube rectifier and a voltage divider to obtain the necessary voltages.

The "B" supply requirements for these sets are approximately 67.5 volts at 10 mls. This is easily obtained.

A "C" supply of approximately 5 volts will suffice, as these sets are not noted for high fidelity reception.

DESCRIPTION OF PRESENT CIRCUIT

Refer to the picture of the power supply plugged in to the radio. One of the knobs shown in the photo is the "B" supply adjustment, while the other is the "on-off" power switch.

Since a small light-weight power pack was desired, two 50Y6GT bantam type tubes were chosen for the rectifiers. The filaments are connected in series with a 100-ohm dropping resistor, across the 115-volt line. Two 117Z6GT tubes with parallel filament operation might be used, but the current output rating on these is insufficient according to the manufacturer's rating in the tube manual.

"A" BATTERY SUPPLY

To supply the heavy "A" current both of the cathodes of one tube and one cathode from the other tube were connected together. A 500-ohm voltage divider was used with taps for "A" and "C" power as shown. Since this is a half-wave rectifier, and it was desired to have no heavy chokes for filtering, rather large values of filter capacity were necessary.

The 20-mfd. condenser was connected at 238 ohms from the B+ side of the voltage divider as hum tests with an oscilloscope showed this to be the point for maximum reduction in hum. In fact, practically no hum is observed with the cathode-ray oscilloscope in either the "A," "B," or "C" circuits.

The remaining cathode of the rectifier tube was used for the "B" supply and is connected in a conventional half-wave circuit using a 5000-ohm resistor in place of the usual choke, and a 16-8 mfd. dual filter condenser. A 5000-ohm variable resistor is included for adjusting the "B" output.

The location of the A+ and A- taps or sliders on the voltage divider will be approximately as shown in the schematic. Their location can be determined before connecting to the receiver by placing a load resistor equal to the filament load of the receiver $1.4/250=5.6$ -ohms, across (A+, A-) on the voltage divider, and an 800-ohm resistor across A- and B- for a C bias resistor, and adjusting to 1.4 and 4.9 volts respectively. Final adjustments can be made if desired after the power supply has been plugged into the set.

The 500-ohm voltage-divider and rectifier tubes should be located outside the small chassis for proper ventilation. The voltage-divider is on the back of the chassis and does not show in the photograph.

(Continued on page 412)

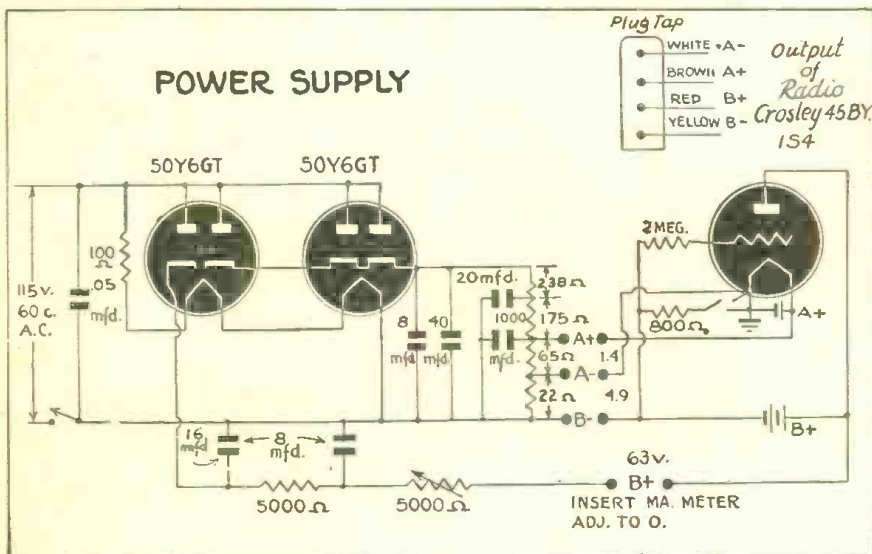

Schematic of the "Miniature Power Pack." Simplicity and good engineering mark its design.

portables. Refer to the July, 1941, issue of *Radio-Craft* for schematic of the Crosley model 45-BV, and also the Zenith *Pocket-radio*.

DESIGN CONSIDERATION

In most of these sets the tube complement consists of a 1R5 converter; 1T4 I.F.; 1S5 Det.; and a 1S4 power tube. Series con-

*Research Laboratories, St. Joseph Lead Company, Johnstown, Pa.

Since the "A" and "B" return leads of a tube type power supply must necessarily be common, and the C bias in these receivers is obtained by a 700 or 800 ohm resistor in the B- lead, the A- and B- returns of the power supply cannot be connected together.

The method used by the writer to obtain C bias was to take the "A" and "C" voltages from a voltage-divider as shown in the circuit diagram.

HANDY TESTER AND SIGNAL TRACER

By E. POTTRUFF

HERE is a combination signal tracer and test unit which I built and found to be very useful. It is inexpensive to build and simple to operate. There are no dials to set nor any complicated circuits to adjust, yet the rig will pick up and convert the signal anywhere from the aerial

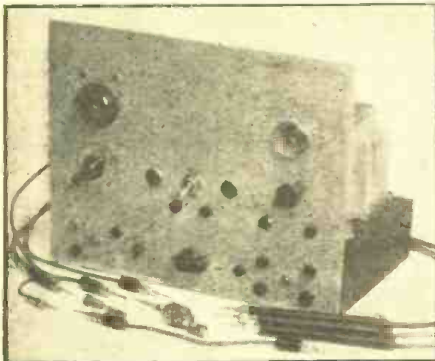

Neat attractive appearance of the tester and signal tracer.

coil, or input to the first R.F. stage, or first detector, right through to the loudspeaker from point to point, and at the same time furnish an estimate of gain per stage. If a signal generator and output meter are used with this instrument fairly accurate gain per stage measurements may be made.

I wanted a test instrument of this kind for some time and saw two articles in *Radio-Craft*, July and August 1940 issues, which gave me the idea. One used batteries

and provided no R.F. gain, and an experimental set-up of the other did not provide enough R.F. gain. I experimented further and worked out circuits with tubes I favored and obtained a very satisfactory unit. I wish to express my thanks to the authors of the articles concerned.

All circuits are made quickly available through the use of insulated phone tip jacks. The power pack is also brought out to these terminals so that voltages are readily available for substitution or experimental purposes.

USES 6E5

A 6E5 tuning indicator tube is provided for handy connection to the receiver under test for alignment purposes and measurement of A.V.C. voltages. This is a very simple arrangement of a 1-megohm variable resistor between target and plate with a calibrated scale. When the shadow angle is adjusted to zero by moving the resistor control, the A.V.C. voltage is indicated on the scale by the pointer on the resistor. The 6E5 gives a range of 0 to -8 volts. If the builder desires a greater range than this, a tube with a somewhat more extended cut-off may be used, such as the 6U5/6G5, which will give a reading up to -22 volts. To calibrate, a separate voltage source must be used so that the negative terminal may be connected to the grid. Use a 2000-ohm wire-wound potentiometer with a sensitive voltmeter, and mark off the voltages on the scale when the shadow angle has been adjusted to zero.



Chassis layout and parts arrangement present a professional-looking job.

NEON TESTER

The neon tube is useful for rough voltage and polarity indication and will save wear and tear on your voltmeter. As D.C. and A.C. voltages are readily available at tip jack terminals the neon tube may be used for continuity tests and checking condenser leakage. A.C. voltage for continuity tests is taken from the 117-volt line through two 0.1 mfd. condensers as shown which eliminates the danger of accidental shorts, yet allows more than ample current to excite the ¼-watt 117-volt neon bulb. The 0.5 meg variable control in series with the neon lamp will furnish full protection for the neon lamp for voltages up to 300-volts. at about half scale. This resistor may easily be provided with a calibrated scale and found useful for rough voltage indication. Sufficient resistance should always be included when determining unknown voltages. The lamp will glow on approximately 65 volts. For 117-volt operation, all of the resistance should be cut out.

R.F. SECTION

There is nothing very difficult or complicated about the R.F. section of the tracer unit itself. Ordinary receiving circuit practice is all that is required in construction. If the builder follows the layout shown, crowding may be avoided, and at the same time a small chassis used. The chassis measures 6 x 10 x 2 inches, and the panel 8 x 10 inches. There is room on the panel for the addition of a small loudspeaker if the builder so desires, or other units which he may wish. There is also room on the chassis for other additions. Two handy ground connections are made by means of two tip jacks, one in the center of the R.F.-A.F. group on the left hand side of the panel, and the other in the center of the voltage terminal group on the right hand side. The holes for these jacks should be drilled first, and be a good snug fit so as to hold the panel firmly to the chassis.

PILOT LAMPS

Two pilot lamps are provided, one red which shows when the power pack is "on",

(Continued on page 436)

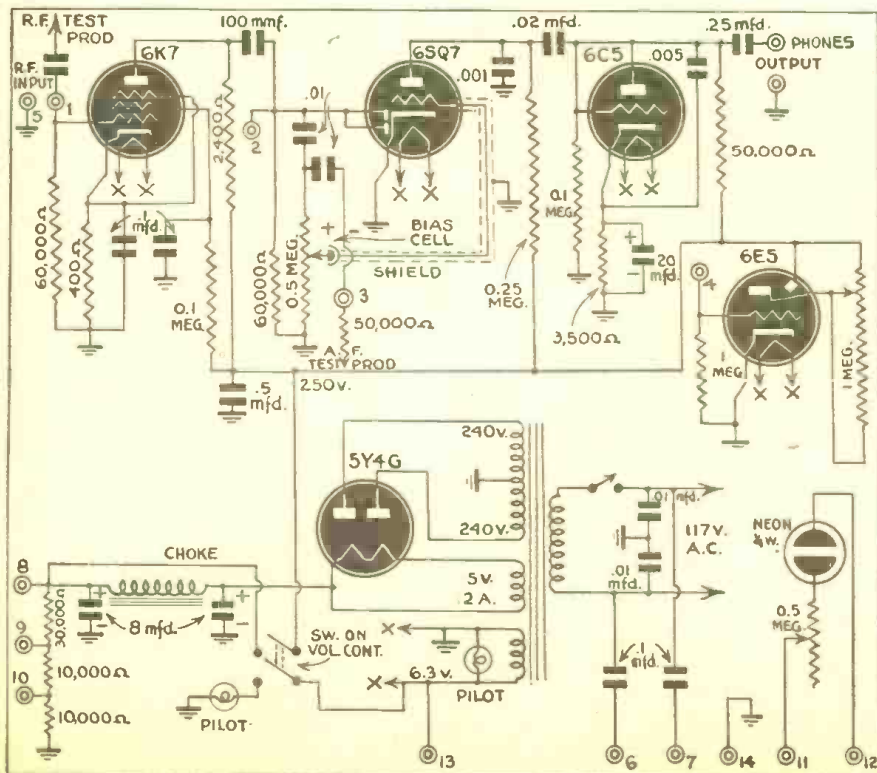

DIRECT-READING CAPACITY BRIDGE

By L. W. SMITH

FIG. 1 illustrates a simple direct reading capacity bridge, which is capable of measuring capacities from 50 mmfd. to 16 mfd. in three ranges.

The potentiometer P_1 forms the ratio arms of the bridge circuit, and it is on this

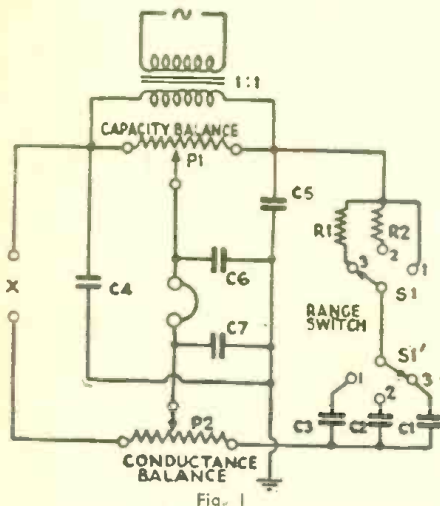

Fig. 1

Circuit diagram of the direct-reading capacity bridge. Note the 1:1 ratio power supply transformer used, to isolate the 60-cycle current from the lines.

potentiometer that the capacity is measured. P_2 serves to balance out the conductance of the condenser under test, thus giving a quieter minimum. In most cases, where the conductance is a reasonable figure, a silent point is obtainable.

The addition of condensers C_4 and C_7 gives the circuit a "balanced-to-ground" condition, and serves to swamp out the ca-

capacity unbalances introduced by the input transformer and phones, thereby insuring accuracy on low readings.

Condensers C_1 and C_3 are the offsetting condensers, arranged so that with no capacity in the "x" arm of the bridge, the potentiometer P_1 is set at one end of its travel for balance—this point being marked as zero for the three scales. These condensers are switched in, one for each range, in conjunction with R_1 and R_2 , which are introduced to ensure that the zero balance falls on the same point on the dial for each range.

The values given for these components are those found by experiment by the writer, but it should be borne in mind that the values of the condensers are interdependent, and will vary with different condensers, even if they have the same nominal capacity. The resistance values are best found by trial and error, until the values required to bring the potentiometer back to the zero position are obtained.

In the case of the writer's bridge, the 0.5-mfd. condenser was found to unbalance the potentiometer very nearly to its mechanical zero. So to save time this position was marked as zero, and R_1 and R_2 were adjusted accordingly.

COMPONENTS AND CALIBRATION

It is necessary to use good condensers, preferably mica, and C_4 and C_7 should be chosen to be as nearly the same value as possible. The resistances may be of the carbon variety. S_1 and S_2 are the two leaves of a three-position two-gang switch. The potentiometers P_1 and P_2 should be of the wire-wound type, smooth in action.

Wire-wound potentiometers are usually of the "linear" type, without taper, but make sure of this point before purchasing them.

The bridge is calibrated by connecting

condensers of known value across the "x" terminals, and marking the point of balance on the appropriate scale of P_1 (Fig. 2). The accuracy of the bridge is of course dependent on the accuracy to which the values of the test condensers are known, and the care with which the balance points are marked.

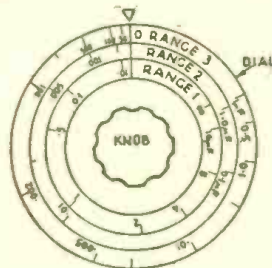

Fig. 2

Dial markings of the potentiometer dial. It has three scales, 0.01 to 16-mfd.; 0.001 to 1.0-mfd.; and 0.001 to 0.5-mfd. The three ranges should be clearly marked to avoid confusion.

OPERATION

Having connected a signal-generator or high frequency buzzer to the appropriate terminals, the condenser to be measured is placed across the "x" terminals and the bridge balanced. The value is then read straight off the appropriate scale of the potentiometer. It will be found necessary to rotate P_1 and P_2 alternately, in order to obtain the exact balance point.

This bridge has been found very useful in the writer's station, and the fact that it is of the direct reading type obviates the necessity for calculation, thereby making the measurement of condensers of unknown value, a very simple process.—RSGB Bulletin, London

POWER SUPPLY FOR BATTERY PORTABLES

(Continued from page 410)

Connections of this power supply to the set are simple and require no switching arrangements whatever. The small 4-contact hearing-aid plug is wired to the power supply through the 4-wire cable. There is just enough room in the end of the radio receiver to cut and fit in the 4-contact hearing aid socket. Connections to this socket are as shown in the schematic drawing Fig. 1. Only the plate, grid, and filament of the 1S4 output tube are shown in the schematic drawing, as connections are made to only these elements.

OPERATION

To operate the receiver on A.C. the four-contact plug is plugged into the receiver, and the A.C. plug is connected to the 115-volt A.C. 60-cycle supply, and the set will operate when the cover is opened (It contains the "on-off" switch.) provided, of course, the power switch on power supply is turned on. During the short time interval during which the rectifier tubes are heating up, the set will be operating on batteries with some distortion as the 800-ohm bias resistor in the receiver is in parallel with the 65-ohm section of the voltage divider in the power supply. However, as

soon as the power supply takes over, the volume and quality of reception will be considerably better than when set is operated on batteries.

A 5000-ohm variable resistor is shown in the B+ circuit of the power supply. This is to adjust the plate voltage so that it will be exactly equal to the "B" battery voltage, in order that no current will be drawn from the "B" battery.

To adjust this resistor, remove the B+ lead on the "B" battery and connect a 0 to 15 MA meter in circuit, then adjust the variable resistor until meter reads 0; now remove meter, reconnect B+ lead to "B" battery, and adjustment is finished.

When this condition obtains, no current is being drawn from the "B" battery and the power pack is supplying the set.

Under these conditions the batteries "float" across the power lines and act merely as filters.

When it is desired to use the radio as a battery-operated portable, the 4-contact plug is pulled out of the set and the receiver is ready to play anywhere on batteries.

The writer has used this outfit for over a year as a portable during the day and as an A.C. outfit in the evenings while at home.

The reception is very good. The use of this power pack prolongs the life of the existing batteries and since it will work when the "A" and "B" batteries are completely removed from the set, it provides a means of enjoying radio reception with the miniature portable when the batteries are exhausted and no replacements are forthcoming.

Parts List

- 2—Octal sockets Ampherol MIP-8
- 1—4 wire cable—10 inches long
- 1—Cornell-Dubilier "Beaver" dual dry electrolytic condenser 40MFD-20 MFD—150 volt D.C. DRL—4215
- 1—8 MFD 500 volt D. C. Beaver dry electrolytic BR-850
- 1—Dual 16-8 MFD—250 volts BRL-8125
- 1—1000 MFD—6 volt BRH-610
- 1—.05 MFD 400 volt D. C. tubular D.T. 4S5
- 1—100 ohm 10 watt resistor IRC type AB
- 1—5000 ohm 10 watt resistor IRC type AB
- 1—5000 ohm variable 4 watt resistor Yaxley M5MP
- 2—bar knobs ICA type 1274 for variable resistor and power switch.
- 1—500 ohm 50 watt voltage divider IRC type EPA with 3 sliders
- 1—ON-OFF switch SPST
- 2—R.C.A. or equivalent 50Y6GT Bantam tubes
- 1—chassis 3 1/2 x 5 x 1 3/4
- 1—hearing aid socket 4-contact Ampherol 77-26
- 1—hearing aid 4 prong plug Ampherol 70-26

ELEMENTARY MATHEMATICS OF RADIO DIRECTION FINDING

By JOHN R. KEARNY

Owing to the requirements of the services, that a radio man have a broad view of the application of radio equipment, this simplified treatise of the mathematics of radio direction finding is presented. Many readers no doubt will find this an easy approach to the subject, from which point they may proceed to the more difficult phases.

THE usefulness of the radio compass, or direction finder as it is often called, is readily apparent, and it is considered a valuable aid to the navigator who cannot always depend with certainty on "dead reckoning." As in other branches of applied science, mathematics plays an important role and we are interested here in dealing with some of the rudimentary principles involved.

First of all, we want to have a knowledge of the fundamental dimensions of the earth, since in any problem involving navigation such knowledge is helpful as background and as a key to the solution of problems. For practical purposes we can take the circumference of the earth as 25,000 miles, either on the meridian or on the equator, although actually there is some difference between the two values. The equatorial circumference is 24,902 miles and the meridional is 24,860 miles. The diameter of the earth at the equator is 7,926.677 miles and through the poles it is 7,899.988 miles. The difference between these two diameters is 26.689 miles and the ratio for the earth's flattening at the poles is 1 part in 297. The

Now, since h is very small compared to r , it can be neglected in calculating the distance d . Hence, since h is small,

$$BP = \sqrt{2rh}$$

The earth's diameter is, of course, twice

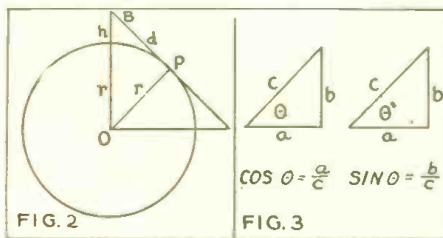

Fig. 2—Simple triangulation for determining heights and ranges.

Fig. 3—Explanation of sine and cosine which fundamentally are ratios.

radius. It amounts to $8,000 \times 5,280$ or about 42.5 million feet. The square root is nearly 6500 feet, so distance $d = 6500 \sqrt{h}$ where h is the elevation in feet. If h is in feet, and d in miles, the coefficient is $6500/5,280$ or 1.25. If h is 400 feet, the square root of 400 is 20, and multiplying by 1.25 we have 25 miles as the distance to the horizon. Using a direction-finder on frequencies of the order of 60 megacycles would mean taking into account the line-of-sight distance. Zero pickup is obtained for zero angle as shown, the signal induced varying as the cosine of the angle. That is, the induced voltage is a certain percentage of the maximum voltage obtained when the plane of the loop is in line with the signal route and the loop is pointing towards the station.

The cosine function is illustrated in Fig. 3. It is equal to the ratio (a/c) of two sides of the angle.

Another important relationship is the sine function. The sine is equal to the ratio of the sides b and c . Referring to Fig. 4, we make use of the sine law which is:

$$\frac{\sin A}{a} = \frac{\sin B}{b} = \frac{\sin C}{c}$$

We also recall that the sum of the angles in any triangle, whether oblique or not, equals 180° . Now, suppose that we are in an aircraft and that we get a bearing of "B" angle on the radio compass. The ship then flies a straight course and we take a second bearing at point C on the transmitter which is at point T. Having a knowledge of the speed of the ship in miles per hour, we find the distance traveled on course from the relation,

$$d = t \frac{s}{60}$$

where t = time in minutes
 d = distance in miles
 s = speed of the plane in miles per hour

We can then find the distance "b" by this formula:

$$b = \frac{\sin B a}{\sin A}$$

But suppose that we want to know our distance from the transmitter, a certain time after the second bearing is made, that we want to predict our position at that time. We assume a certain distance "d," and find the time required, from the relation

$$t = \frac{d}{s}$$

We assume an arbitrary angle E and again work out the problem.

Thus, we merely swing the direction-

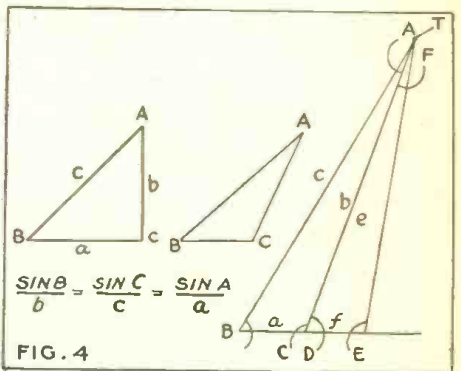

Proportionality of sides to corresponding angles, used in solving triangles.

finder to give us a bearing angle of the desired magnitude. We fly "on course" until again the minimum is heard.

On short wave the errors are sometimes too great, due to out-of-phase signals causing misleading readings for this type of service.

On standard commercial instruments designed for direction-finding, operation is on about 800 meters and skip distance, reflection and out-of-phase signals are not as serious a problem.

Distance range is limited, however, to about 150 miles, but may be greater at times.

Only a few fundamentals are given here and the reader should invest in good books on the subject for a complete understanding.

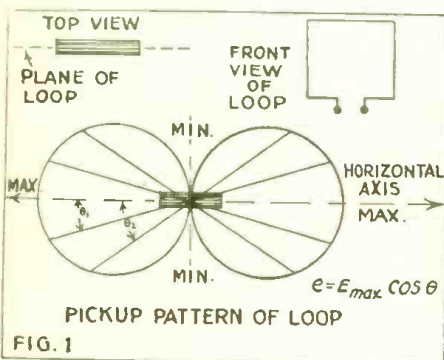

Symbol for the loop, as used in diagrams, and the common response pattern of pick-up by the loop.

length of one degree of longitude along the equator is 69.2 miles and each degree of longitude represents four minutes of time. A degree of latitude measures 68.7 miles at the equator and increases to 69.4 at the poles.

As we have seen that the earth's diameter is about 8,000 miles, let's put this fact to work for us. Referring to Fig. 2, we observe that a line drawn from a point at a certain distance above the earth's surface, such as on a high hill or elevation, will cut the horizon at point P. The distance from center O to point P is the same as from O to point B. The center O is the center of the earth core. Consequently we have what amounts to a right-angle triangle, and the values are related according to the well known formula, $OB^2 = r^2 + 2rh + h^2$

PLATE AND SCREEN DISSIPATION RATINGS

VACUUM tube ratings provide an accurate guide to assist the engineer or serviceman in securing efficient tube performance. The use of this information, coupled with careful attention to circuit considerations and proper installations will generally pay dividends in satisfactory operating efficiency. Among the important factors are the ratings of maximum plate and maximum screen dissipations.

The interpretation of tube ratings published in the *Sylvania Technical Manual* is in accordance with RMA standards, and the conditions outlined in the introductory section of the Manual, for the plate and screen are:

A.C. or D.C. Power Line: The maximum ratings of plate and screen voltages and dissipations given on the tube type data sheets are Design Maximums. For equipment designed for use in the United States on nominal power-line services of 105- to 125-volts, satisfactory performance and serviceability may be anticipated, provided the equipment is designed so as not to exceed these Design Maximums at a line voltage of 117-volts.

Storage Batteries: Automobile battery operated equipment should be designed so that when the battery voltage is 6.6-volts, the plate voltage, the plate dissipation, the screen voltage, the screen dissipation, and the rectifier load current will not exceed 90% of the respective recommended Design Maximum values given in the data for each tube type.

"B" Batteries: Equipment operated from "B" batteries should be designed so that under no condition of battery voltage will the plate voltage, the plate dissipation, the screen voltage, and the screen dissipation ever exceed the recommended respective maximum values shown in the data for each type by more than 10%.

In general, electrode dissipation is the power dissipated in the form of heat by an electrode as a result of electron and ion

bombardment, or both. Each tube type must have maximum ratings assigned, these being dependent upon the tube design, its component parts and the kind of service it is to perform. Experience has shown that when maximum ratings are exceeded, particularly for an appreciable time, the performance capabilities may be impaired and the tube life shortened.

POWER LOSSES

The total power dissipated by the tube consists of plate and grid losses plus the power used in heating the cathode. All of this heat must be carried away from the tube, principally through the envelope of the tube. A major proportion of the energy which is dissipated in tubes having glass bulbs is produced at the plate of the tube. Consequently, the plate has to be capable of radiating all the heat generated at its surface, and also the heat radiated to the plate by the cathode and other elements, without damage or adverse results. Any excessive heat, above that stipulated by the maximum dissipation ratings, can produce very detrimental effects. These will be covered in detail.

CLASS "A" TRIODES

As a first example, consider a triode power amplifier such as the 6A3, operated resistance-coupled, under the rated Class "A" conditions. The plate characteristic indicates that with 250-volts applied to the plate, -45-volts grid bias, and the recommended load of 2500-ohms, the rated plate-current is 60-ma. This requires a plate-supply voltage of 400-volts, for with 60 ma. flowing through the load-resistor of 2500-ohms there will be a voltage-drop across R_L of 0.06 ma. x 2500 ohms or 150-volts.

The D.C. power dissipated in the load resistor will be $I^2 R_L$ or $(E_b - E_p) (I)$ watts. Using the latter expression this gives 150 volts x 0.06 ampere or 9 watts. This power is represented on the diagram by

the rectangle at the right. The plate dissipation of the tube will be $E_p I$ or 250 volts x 0.06 ampere which equals 15 watts. This is represented by the rectangle at the left. These values apply only when no input signal is applied to the grid.

When an alternating voltage is impressed on the grid, the voltage at the plate of the tube will also fluctuate since it will differ from the supply voltage by the drop in the load-impedance. With the signal on the positive half-cycle, the plate-current will increase, causing a larger drop in R_L so that the plate potential will be less than its value at the operating point.

On the negative half-cycle the instantaneous grid voltage will be more negative than -45 volts, the instantaneous plate-current will be less than the average value, and the drop in R_L will be reduced. Consequently the instantaneous plate-voltage is higher during the negative half-cycle.

With an impressed input signal whose peak voltage equals the bias voltage, the A.C. power developed in the load is rated at 3.2 watts. This A.C. power is dissipated in R_L in addition to the D.C. power dissipation of 9 watts mentioned above.

The plate dissipation is therefore reduced by the amount of the power output. This decrease in plate dissipation under dynamic (operating) conditions is a characteristic of all Class "A" amplifiers. Hence, Class "A" power amplifiers should be so designed that the dissipation under static conditions will not be exceeded.

The RMA ratings for the 6A3 specify a maximum plate-voltage of 325-volts and a maximum plate-dissipation of 15 watts. Since a plate-current of 60-ma. is obtained when 250-volts are applied to the plate with a grid bias of -45-volts, it is apparent that if a higher plate voltage is employed, the maximum plate-dissipation will be exceeded unless more bias is provided to reduce the plate-current to a safe value. In general, the allowable plate-dissipation will determine the maximum operating plate-current for a given plate-voltage. For some types of tubes the allowable dissipation may be high enough so that the operating point and load resistance may be based upon considerations of distortion, flow of grid-current, and desired power output.

PENTODES AND BEAM TUBES

With pentodes and beam tubes additional factors must be taken into consideration. The total B-supply input power will be the power in the plate-circuit plus the power dissipated in the screen-circuit. With an input-signal whose peak voltage equals the bias, the power delivered to the plate-circuit is the product of the maximum-signal-plate-current and the corresponding plate-voltage. The heat dissipated by the plate will be the power supplied to the plate circuit, less the power delivered to the load.

Screen dissipation increases quite rapidly with applied signal-voltage and may be several times greater at the maximum signal condition than it is when the signal is zero. The increase in D.C. screen-current, with

(Continued on page 438)

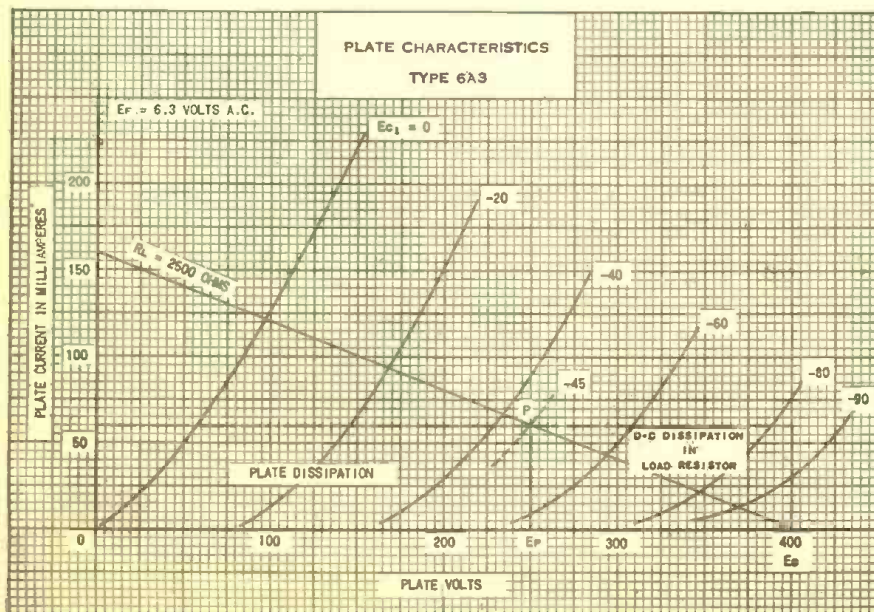

CONDENSERS, CHOKES AND LENZ' LAW

By FRED SHUNAMAN

This is the second of Mr. Shunaman's series of Radio Physics articles for the practical Serviceman. The first was "Lenz' Law in Modern Speech," in the February issue. Next month the mysterious subject of phase will be investigated.

FIND a good big coil. The power transformer from an old broadcast set will do if it's big enough. We can use the secondary and ignore the other windings. Hook it up as shown in Fig. 1. Now close the switch, and note that the voltmeter swings up to full reading immediately. Not so the milliammeter. It takes its time, and swings slowly up to its steady value. If the

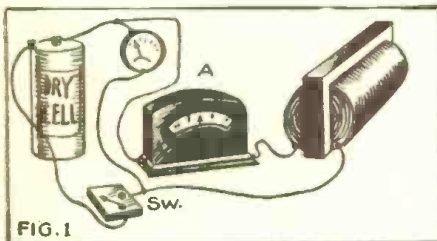

FIG. 1 Set-up of dry cell, ammeter, large choke, voltmeter, and switch, to demonstrate behavior of current flow through an inductance. The ammeter should be shunted properly in order to give its maximum reading without needle moving off the scale.

inductance is big enough this may take one or more seconds. Every serviceman has noticed this when checking large coils with an ohmmeter, which is fundamentally a milliammeter in series with a small battery and the coil under test.

The current is simply remembering its Lenz. As soon as it starts to flow into the coil, it builds up a magnetic field. This field tries to set up a current of its own, which of course wants to flow in the opposite direction to the one from the battery. It is the argument between these two currents or forces—the one from the battery and the one set up by the rising field around the coil—that prevents the current from rising immediately. In time the magnetic field is built up to full strength, and can no longer exert a back pressure on the battery. There is no further opposition to current flow through the coil as long as the supplied current remains steady.

Now let's see what happens to the current in the coil when the battery voltage is cut off suddenly. We can't break the circuit, because then there could be no current flow, so we'll have to resort to the device of circuit of Fig. 2. A switch is placed across the coil so that ammeter "A" is in the circuit composed of coil and switch. The resistor R is put in so that we won't wreck the battery when the switch is thrown to short coil L. (You have no doubt already noticed that all well-behaved coils are named L.)

Now throw Sw2. The voltmeter immediately drops to zero. But ammeter A jumps up to a slightly higher point than before, before it drops slowly back to zero. We might have expected the opposite thing—that the current which ran into the coil would run back out, but we would have been doing our expecting without reference to Lenz. Whenever there is a change in the current flowing through a coil, the resultant change in the magnetic field will always set up a bucking force.

In this case the change is a drop of cur-

rent from maximum to zero. This pulls the protons out from under the magnetic field. It disappears, breaks down, collapses. In so doing it sends a current through the coil in the same direction as the original battery current. It opposes the dropping current by supplying a current of its own. The force which opposed a build-up of current through the coil now opposes a break-down with equal force.

What would have happened if we had broken the circuit would have been altogether different. The collapsing field in trying to drive a current across the gap would build up a voltage vastly greater than that of the battery, and we would have had a nice spark at the break.

An example of this is a toy electric shocking machine, which was constructed by Mr. H. Gernsback for his children, and described in his magazine, *Everyday Science and Mechanics*, in 1936. You can build the machine easily from the drawings given here; a description of each part is given in the drawing.

This high-frequency buzzer produced vol-

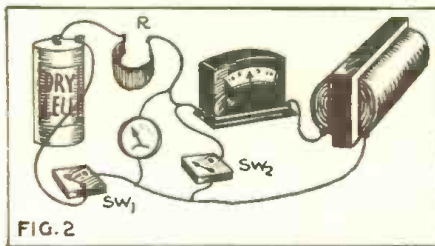
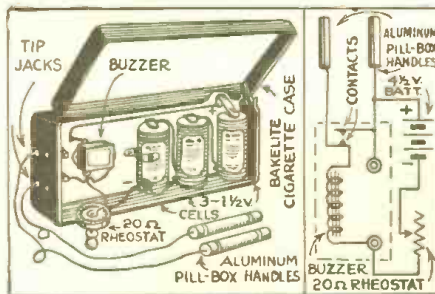

FIG. 2 Same set-up as in Fig. 1 except that resistor R and switch Sw2 have been added, to show effect of resistance on current flow.

tages of nearly 400 from the 3 flashlight cells, totalling 4½ volts. All this because of the speed with which the magnetic fields around the buzzer coils broke down with each break of the high-speed contacts. A low-frequency buzzer will not give such good results, although even an ordinary buzzer will give powerful shocks.

Where does the field get this energy? The



A high-frequency buzzer shocking machine. The battery voltage may be stepped up 100 times by the action of the small buzzer coil.

answer is—out of the battery. As soon as we connected it up, it started putting power into the coil. That power was used in building up the magnetic field. Now the breaking down of the field returns that power to the

circuit in the form of electricity. It takes the current the same amount of time to drop back to zero that it took to build up to maximum in the first place. Fig. 3 shows how the two are alike.

This habit of inductance is put to very good use in the filter of a power supply unit. As rectified A.C. from the 80 or other tube

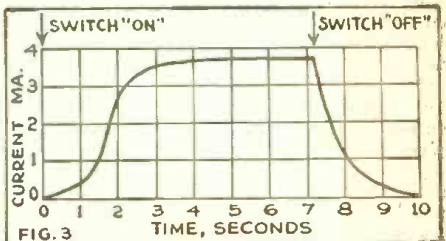

FIG. 3 Current flow charted against time as switch goes off and on.

meets the choke, every increase in current causes the field around it to become stronger. This rising field bucks back some of the current trying to get through the coil. Every decrease in current weakens the magnetic field around the coil, and every such weakening of the field actually supplies some current to the circuit. Thus the current leaving the coil is not as strong at its strongest—or as weak at its weakest—as the current entering. A couple of such coils will make practically pure D.C. out of the strongly pulsating stuff that comes out of the rectifier. The help of a couple of condensers is required to do this effectively.

CONDENSERS

The condenser is the electrical opposite to the coil. At first it doesn't seem natural that it should work to produce the same effect. We are forgetting another law of nature, almost as important as that of conservation of energy. It takes two opposites to make a whole. The very universe is built up on the oppositeness of the proton and electron.

A condenser is often thought of as a sort of storage tank for electricity, and this description is good enough for anything we are now proposing to do with one. Try hooking a good big condenser up as in Fig. 4. The set-up is the same as we had in Fig. 2, with the condenser in place of the inductor. Now what do we see when Sw1 is thrown? The ammeter jumps ahead immediately and the voltmeter follows it up. It is easy to see why this should be. Plate + and - of our condenser were at exactly the same potential when the switch was thrown. The battery was practically shorted. As electricity rushes into the condenser, the voltage rises rapidly, until, as the current ceases to flow—the voltage across the plus and minus terminals of the battery.

Usually this takes so little time it is hard to note the lag of the voltmeter pointer, but by making R and C both large, it may be made to swing up rather slowly. This surge of current as the condenser charges in fact

(Continued on page 438)

PRACTICAL AUDIO AMPLIFIER THEORY

By TED POWELL
PART III

It is rather difficult to describe the inter-related effects of grid and plate loading-resistors upon an amplifier circuit's response by means of a simplified word picture. The various factors involved present a rather complex set-up representing the compromises to be made to achieve optimum results. The exact analysis of amplifier tube loading calls for considerable mathematics. However, some non-technical remarks can be made with which to describe the effects of the major circuiting constants upon amplifier response.

PLATE LOAD RESISTORS

If the plate load-resistor is increased in value, the lower frequency response improves, for the simple reason that the load-resistor is actually a high impedance "short" across the tube's output and is a series impedance in the signal's return path to the cathode. The higher the frequency the more effectively it is "choked" by the load resistance. The lower the frequency the more readily it works through the load-resistor to the cathode or "ground." However, as the value of the load-resistor is increased, the high frequencies begin to suffer because the amplification of the middle frequencies is increased appreciably. Since the higher frequencies are not amplified, (because of stray circuit and tube capacitances which cut them off) we get an exaggerated "bend," or "knee," in the tube's characteristic at the frequency range where these stray capacitances take control. This exaggerated bend, in the response curve, naturally results in an increase in distortion.

Conversely, if the plate loading-resistor is decreased in value, the higher frequencies will improve, because, as the lower frequencies are cut off, the middle frequencies will be amplified somewhat less, and stray shunt capacitances will take control more gradually. Also the bend in the tube response curve tapers off, and distortion effects at the high frequencies is decreased.

Another point involved is the fact that as size of the load-resistor is increased, the tube plate-current drops off, and the tube's "effective" plate resistance increases. Good low-frequency loading then begins to decrease instead of increase, and both the low and the high frequencies suffer.

Thus it can be seen that a compromise value must be arrived at. It must be determined by individual tube characteristics, general amplifier system characteristics and by the frequency range to be handled.

GRID RESISTORS

Similar effects take place in the case of grid loading-resistors. There is an additional effect to consider in the case of grid loading. It lies in the fact that even in Class "A" circuits, some grid current flows, (a few microamps) due to leakage, tube gas-ionization, or thermionic grid-emission. As a result, appreciable variable grid circuit "IR" drops become evident, if the grid load-resistor is made too high in value. This type of non-linearity is symmetrical but contains odd-order harmonics. This is

partially supported by the fact that the smaller size tubes can take higher values of grid resistance without showing any ill effects in the response.

There is an over-all effect which takes in with these various factors, called the

In Part III the author takes up the design and performance details of the individual parts of the amplifier, showing the advantages and disadvantages of components most commonly used. The relationship of these to ultimate acceptable sound reproduction is explained.

"Miller Effect." Its value, when measured, approximates the tube input admittance, and it is the constant most generally used in amplifier circuit calculations.

At any rate, as in the case of the plate load resistor, compromise values must be determined for optimum results.

It must also be remembered that the grid and the load resistors have an indirect effect upon each other, in that they affect the tube's response. The plate circuit of one tube affects the input circuit of the following tube (reflected impedance). Generally speaking, where ordinary amplifier tubes are concerned, standard tube constants and circuiting conditions are such that the plate-resistor value is about one-half that of the following grid-resistor. When electrode voltages are pushed up, all resistor values must be raised proportionately. However, since the gain is also pushed up, fidelity suffers.

CHOICE OF RESISTORS

The matter of resistor types and sizes might be considered here. While the size, wattage rating and type of resistor used might seem rather immaterial as far as circuit performance is concerned, these factors do have some minor effects upon amplifier circuits which merit some discussion.

Cheap carbon resistors are to be avoided wherever better-than-average performance is desired. Since these units are a powdered carbon conductor dispersed in a clay-like mass, they may tend to cause a sort of "shot effect." Furthermore, they will not as a rule hold their initial resistance values to the same extent as the better types do. In fact, cheap units sometimes become "intermittents" or actually "open" in time, when operated at full-rating conditions. They have a temperature-vs.-resistance characteristic more exaggerated than that of other types. They might even possibly have a slight temperature-vs.-frequency characteristic at low frequencies.

The so-called "metallized" type of resistor is perhaps the best all-round resistor to use. The ceramic-encased types have

lower dielectric losses and leakage, but their heavy lead-alloy ends present some stray capacity problems in U.H.F. and hi-gain amplifier work. The phenolic-encased units, while capable of developing some dielectric losses, especially at high frequencies, are perhaps more suitable for audio amplifier work because of their low stray capacity effects, their greater compactness and their more complete insulation. It seems rather strange that no manufacturer has yet come out with a metallized resistor encased in polystyrene. It would combine the advantages of both, without the disadvantages of either.

Non-inductively-wound resistors are the finest made, but the most expensive. They are the quietest, and hold their values most closely. They are available in 1% and 1/10 of 1% accuracy ratings. They are of great value in phase-inverter and push-pull circuits. They are particularly valuable as shunts and multipliers in test equipment. (However, they present some capacitance, inductance and dielectric loss problems in high frequency work.)

6L6 INPUT CONSIDERATION

In the amplifier discussed in the preceding issue, the impedance-coupled network used between the driver and the beam-power stages is more or less in reverse. However, since the 6L6's are run in a strictly Class "A" circuit, no grid current (theoretically) flows under normal conditions, and grid resistances are permissible. (Grid chokes here would be futile in fact, should be avoided, because of hum pick-up, cross-talk, effects, etc.) Of course, where Class "B" circuits are involved, grid chokes or transformers are necessary because of the appreciable grid currents flowing.

If grid resistors are used, poor grid circuit "regulation" and third harmonic distortion will occur, because of the variable grid-circuit IR drops.

INSTABILITY CONSIDERATIONS

In spite of these objections, chokes have been used to load up the driver plates. This was done mostly to attain low-frequency stability and good response. Although instability is seldom a problem in the case of low-gain amplifiers, it sometimes crops up.

Thus, while direct and resistance coupling methods may produce superior frequency response, instability must be contended with.

Since the frequency range to be handled in phono work is definitely limited, the superiority of resistance coupling over impedance coupling in a driver stage is open to some discussion.

In the case of the resistance-coupling, instability shows up as a form of square-wave (or multivibrator) oscillation, especially when circuit constants are set up so as to get extended low-frequency response. In the case of high-gain circuits, it may occur at fairly high frequencies as a chattering squeal.

In the case of direct coupling, plate and grid unbalance effects take place which cre-

ate instability (distortion, oscillation and grid blocking).

In the case of transformer or impedance coupling, the instability is usually of the sine-wave type, and may either be regeneration or degeneration, depending on the circuit constants. (That is, if the feedback has not reached the grid-blocking point.) This type of instability is evident as howls or whistles.

It is usually a waste of time to attempt to eliminate such instability by simply increasing the amount of filtering and bypassing, since that will result only in a change of the oscillation frequency.

Rearranging circuit components, lowering the values of coupling condensers and loading resistors, generous use of shielding, lowering circuit gain in one way or another, and the use of various reverse feedback and bridge-type balancing-out networks, will tend to eliminate instability. Thus in the case of direct-coupling, many trick self-balancing and self-stabilizing circuits have been developed, even when Loftin-White evolved their first amplifier.

In the case of resistance coupling, the instability problem can usually be met by simply lowering the values of the coupling condenser and of the loading resistors, and by improving the shielding.

In the case of transformer or impedance coupled amplifiers, changing over the first one or two stages to resistance-coupling may have to be resorted to.

At any rate, by impedance-coupling the driver stage, we have resistance, impedance and transformer coupling in the three stages, and the phase relationships in the common plate supply are altered sufficiently to minimize the major source of feedback. Thus circuiting constants can be set up so as to obtain low-frequency response with stability.

While square-wave motorboating will normally be absent with this impedance coupled stage in the amplifier, there may still be some sine-wave instability in the form of a slight "folding-up" effect. This trouble can be cleared up by lowering the values of the coupling condensers slightly till the trouble clears up.

A problem often encountered in phono

work is "turntable rumble." This can sometimes develop into an over-all acoustic feedback similar to mike feedback. Its correction calls for a renewal, or an overhaul, of the turntable assembly, and possibly some circuit correction.

HOW THE TRIODE HELPS

As stated previously one point in favor of the low-mu triode is the fact that the lower the mu (and therefore the lower the plate resistance of the amplifier tube), the greater the superiority of resistance coupling over impedance coupling. This is true for the following simple reason. Since the plate resistance of the 6AE5-GT is only 3,500 ohms, the plate-choke need have a theoretical impedance of about 10,000 ohms at 15 cycles and 7 ma. to produce a frequency response flat to within 1/2 DB down, at 15 cycles. According to the simple $2\pi fL$ formula, this calls for a choke of about 100 henries at 7 ma. In practice, values somewhat higher than the theoretical are required because of circuit-losses.

Such a small choke will have relatively small high-frequency shunt-effects, especially if it is a small alloy core unit. At any rate, the shunt effects will not be noticeable at the frequency ranges handled in phono work. Invariably there is some sort of tone-corrector circuit cutting off the higher frequencies in this section of the amplifier system anyway.

The shunt cut-off effects are especially mild where a push-pull driver is concerned and a small single C.T. choke is used. Such a unit will be even smaller than two separate units and will have relatively less shunt capacity effects upon the high frequencies, since the two plate currents of the push-pull drivers neutralize each other's core-saturation effects and a very small magnetic core can be used with the same A.C. impedance rating, and produce the same low frequency response.

Therefore, in practice as well as in theory, it will be found that there is but little difference in the frequency response obtainable from resistance or impedance loading of low-mu drivers, where a limited frequency range is to be passed. In fact, superior low-frequency response can be obtained because of the heavier driver plate

currents. However, it will be admitted that direct or resistance coupling will produce slightly superior high-frequency response, which might be detected by some critical ears.

OUTPUT TUBE CONSIDERATIONS

The choice of output tube hinges about the superiority of the power triode vs. the beam-power tetrode. Perhaps the easiest way to answer the question would be to simply state that the superiority of one over the other depends upon the particular use and conditions under which the equipment must operate. (The war has repeatedly demonstrated this simple fact in the case of planes, guns and tanks.)

Generally speaking, the power triode has superior frequency characteristics over the beam-power tetrode. The power triode has a flatter plate-current vs. grid-bias characteristic, and therefore generates less harmonics. The triode also has a much lower mu, lower gain and lower plate resistance. As a result it has a damped plate-circuit characteristic and exhibits little peak and transient effects across the load, and therefore generates less distortion.

Triodes in a carefully balanced Class "A" push-pull circuit generate practically zero harmonics, whereas beam-power tubes put out a minimum of 2%. This means that under certain signal conditions the total harmonic and intermodulation distortion may total as high as 8%.

A power triode's plate current varies less with signal voltage than does that of a beam-power tube, and therefore its plate circuit has better regulation and causes less voltage disturbance of the power supply. This means better power supply regulation, a lowering of amplifier non-linearity and less harmonic distortion. A triode output stage needs no tone-control or reverse-feedback circuit such as the beam-power tetrode needs, in order to minimize harmonic and transient distortion effects.

To sum up briefly, the power triode output is largely "current" power since the gain is low (about 4), while the beam-power tetrode output is appreciably "voltage" power, since its power sensitivity is fairly high. This simple fact explains the triode's

(Continued on page 432)

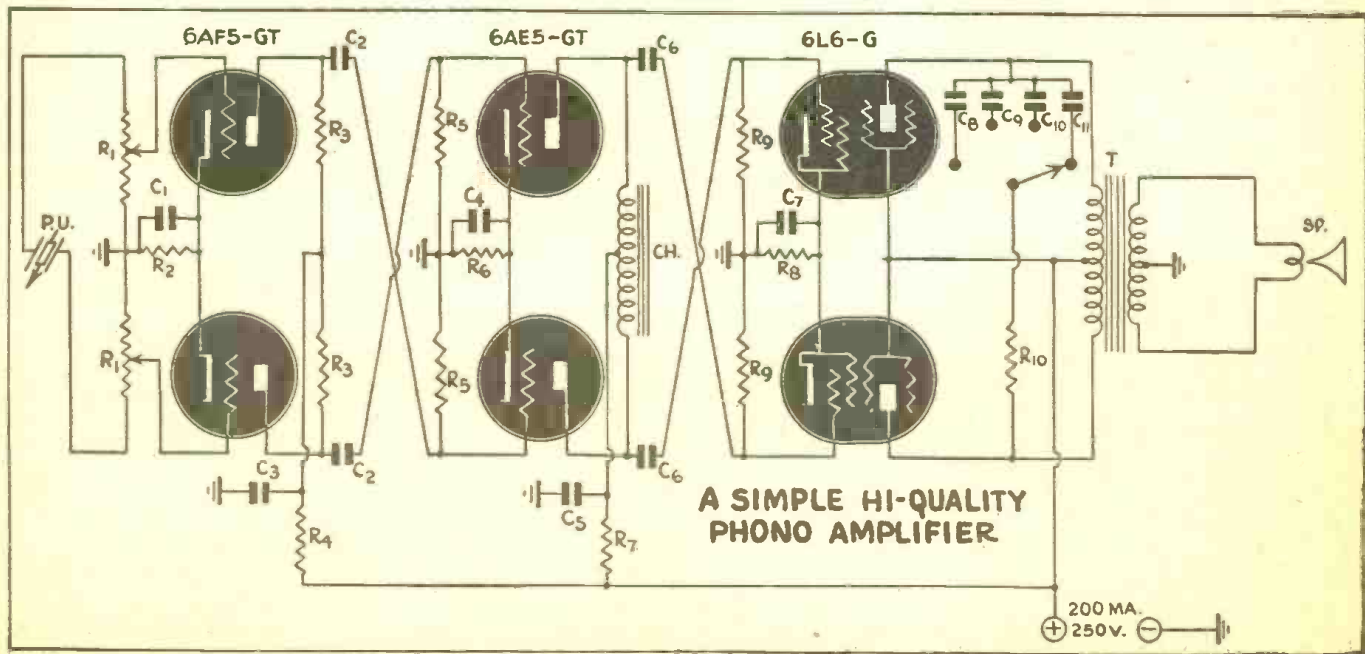

Circuit diagram of the high-quality amplifier, reproduced again to assist comparison with the text, where additional design features are discussed.

A SMALL INTERPHONE

By ARTHUR BLUMENFELD

THE carrier-type interphone has many advantages over its wire-bound twin. While wired interphones are simpler, more dependable, and usually less trouble to maintain, the carrier-current job is wonderfully adapted to temporary installations or places where installation of wire may be undesirable. It is far more flexible in operation, and can be put into action at a moment's notice, without waiting for the necessary wiring.

The experimenter or radio enthusiast will find a number of personal uses for this type of communicator. It can be employed to link rooms in different parts of the house, as a "radio nurse," etc., and for experiments in "wired wireless."

The chief factor holding many back from constructing such a device is the fear of not being able to make the apparatus work without going to much trouble, either in the construction or the maintenance. Interphones in the past have been notably temperamental, and building and maintaining them has not always been pleasant work.

The 2-tube A.C.-D.C. unit here described is an attempt to overcome these objections. It is as nearly fool-proof as possible. There are no possibilities of undesired circuit oscillation, hum or what-have-you, as is so often the case in the multi-tube units when they are not perfectly constructed. Possibility of breakdown has been reduced to a minimum by the elimination of all parts not vitally necessary to the operation of the set, and cost has been reduced to a minimum.

The system shown here is of the single-channel type—that is, for use between two points. Let us look into the "why's" and "wherefore's" of the design.

DESIGN CHARACTERISTICS

A carrier-communication unit is composed of the following essential units:

- (1) Radio-frequency oscillator tube—this may be used as the detector when receiving.
- (2) Power modulator tube—for modulating the R.F. (3) Voltage amplifier tube—to step up the signal from the microphone (in this case the permanent-magnet dynamic speaker). When receiving, this is used as an audio amplifier.
- (4) Rectifier tube—to deliver the required operating current.
- (5) Switching system—to put all the components in their proper relationship when sending or receiving.

These components are shown in the block

diagram of Fig. 2, which shows graphically how the change-over system works. Our problem is to combine all these functions in two tubes.

The combination of oscillator and voltage amplifier is made easy by the use of the 6C8G twin-triode. An important—for our purpose—design feature of this tube, is that it has separate cathodes. This enables us to completely isolate the oscillator-detector section (as we will use the tube) from the amplifier section of the tube. The grid (cap) section is used for the voltage amplifier, and the lower section for the oscillator-detector.

To combine the remaining functions—power tube and rectifier—a 12A7 is used. A 25A7 may be used if the proper changes are made in the filament resistor.

CIRCUIT ANALYSIS

This brief explanation will make it easier to understand the circuit diagram (Fig. 1). First examine the switching arrangement. Sw.2 is a 4-pole double-throw switch, and is used to change over from the "Talk" to the "Listen" position. The 4 sections of the switch are lettered A, B, C, D. The B and C section changes the triode portion of the 6C8G from an oscillator in the "Talk" position, to a diode type of detector in the "Listen" position. The A section of the switch is used to swing the input grid (cap) of the other triode portion of the 6C8G tube to a diode detector in the "Listen" position, or to the P.M. speaker (used as a microphone) in the "Talk" position.

The "D" section of the switch is used to change over the P.M. speaker from the T2 input transformer in the "Talk" position, to the T1 output transformer in the "Listen" position.

Note that in the diagram of Fig. 1 the switch is in the "Talk" position. The front view of the switch is shown in the diagram.

THE TALK POSITION

Now let us trace the path of the signal when the unit is in the "Talk" position. The microphone, (Spkr) picks up the sound, and the output voltage is brought to the gridcap triode of the 6C8G by the step-up transformer, T2. The amplified signal is sent to the pentode section of the 12A7. This signal, which is now about 50-volts peak, is used to modulate the oscillations of the second R.F. signal is passed to the low-impedance primary of the R.F. transformer,

L, and then on to the line by means of the condenser C1.

THE LISTEN POSITION

The other unit which is in the "Receive" position, picks up the signal from the line. Then it is sent through the R.F. transform-

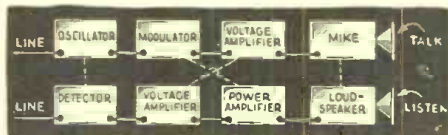

Fig. 2 Block diagram showing the dual functions of parts.

er, L, to the grid of the second section of the 6C8G. This tube is now being used as a diode, the real plate of the tube being grounded by the "C" section of Sw.2.

The detected signal then passes through a low-pass filter—R4, C8—which permits only the A.F. component of the signal to pass. After passing the volume control, R, the signal goes through section A of Sw.2, to the grid cap of the 6C8G.

The signal is then amplified by the pentode section of the 12A7 and after passing T1 and section D of Sw.2, is finally reproduced by the loudspeaker, (Spkr).

CONSTRUCTION DETAILS

The details of the construction of the oscillator coil L are shown in Fig. 3. Coil L1

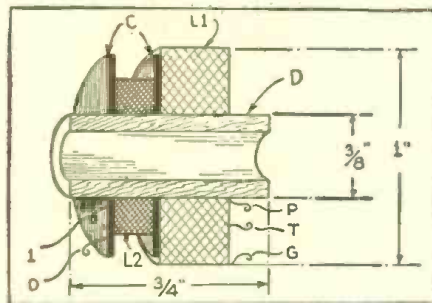

Fig. 3 Coils L1 and L2 are wound on the same coil form. Winding L1 is a honeycomb or "universal" winding with a tap as shown. Coil L2 is layer-wound between the washers, C, placed next to coil L1. The core may be either wood or impregnated paper. (This combination constitutes unit L in the schematic circuit, Fig. 1)

includes 300 turns of No. 30 D.S.C. copper wire-wound, honeycomb fashion, on a dowel 3/8-in. in dia. and 3/4-in. long. When complete, the winding should be approximately 1 in. in dia. and 3/16-in. wide. A tap-off, T, is taken at 150 turns. Coil L2 is composed of 50 turns of No. 26 D.C.C. copper wire wound, straight layer fashion, between 2 cardboard washers (as shown). The outer end, O, of L2 goes to ground and the inner end, 1, goes to condenser C1. The outer end, G, of L1 goes to the grid and the inner end, P, goes to the switch, Sw.2.

Tuning of the coil is effected by means of condenser C6 and trimmer C5. This trimmer may be omitted if desired, as the tuning is quite broad. The frequency of the carrier is approximately 130 kc.

TONE QUALITY

The frequency response characteristic of the 2 communicators in cascade is flat plus or minus 2 db. from about 350 to 5,000 cycles.

(Continued on page 432)

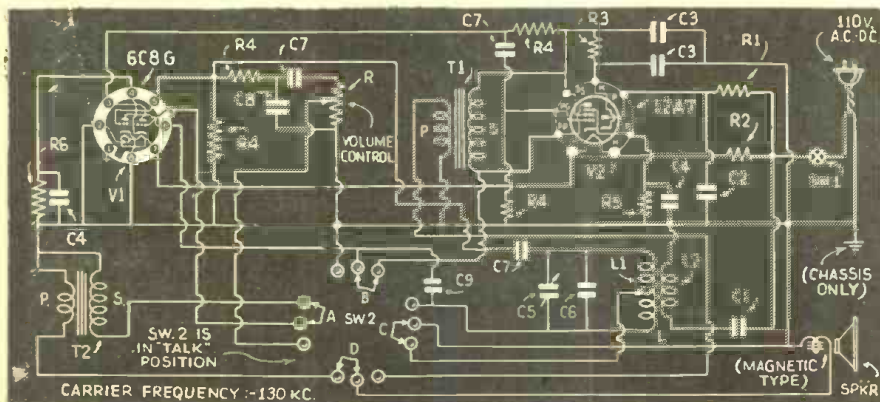
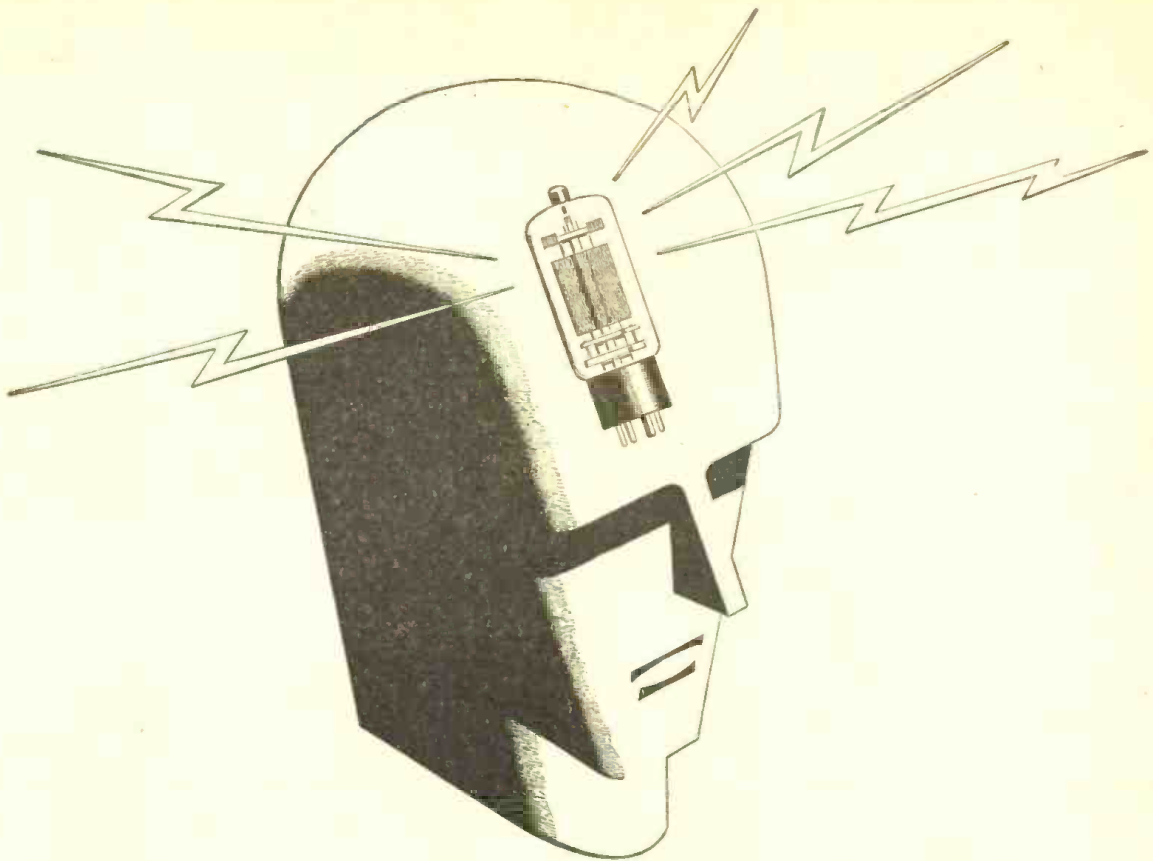

Fig. 1 Schematic circuit of the unit with Sw. 2 in the "talk" position. See list of parts for values.



RADIO... NERVE-CENTER OF VICTORY!

This is a war of science. Radio tubes add speed, precision and safety to hundreds of industrial operations, as well as to the performance of planes, ships and tanks. *Radio science is in the fight on every battlefield.*

This is a war of mobility and speed. Mobility on land, sea and in the air is made possible by speed of communication. *Radio carries voice, code and pictures at the speed of light.*

This is a war of morale. Soldiers, sailors and home folks must be informed and entertained. Understanding must be maintained with allied peoples. Courage and hope must be brought to those awaiting liberation. *Radio broadcasting builds morale.*

For more than two decades, the Radio Corporation of America has pioneered in the progressive development of radio, electronics and television. In the present crisis, those developments — in communications, broadcasting, research, engineering and manufacturing — are performing services of vital importance to the United Nations. Out of RCA's war experience will come new and finer products and services for industry, the home, and the nation — to help make life more than ever worth living.



RADIO CORPORATION OF AMERICA

RCA LEADS THE WAY IN RADIO, ELECTRONICS, TELEVISION

The Services of RCA: RCA Victor Division • R.C.A. Communications, Inc.
Radiomarine Corporation of America • RCA Laboratories • National Broadcasting Co., Inc.
Blue Network Co., Inc. • RCA Institutes, Inc.

For outstanding achievement in the production of vital radio equipment, these awards have been given to RCA plants:



Army-Navy "E" to an RCA Instrument plant



Army-Navy "E" to an RCA Tube plant



Army-Navy "E" to the RCA Radiomarine Service

BUY WAR BONDS EVERY PAYDAY

• LATEST RADIO APPARATUS •

CONVERS-O-CALL

Fred E. Garner Co.
Chicago, Ill.

THE new President's Model provides a combination all-master system that greatly facilitates factory and office inter-communication. It is easy to operate, and an entire factory can be paged or a private conversation carried on with one or more departments instantly. The load on the telephone switchboard is thereby lightened.



No switches need be pushed while talking. Calls go through even if the power of the station called is not turned on. An increase in tube life is claimed, up to 300% of usual life. Installation can be made by plant electrician or radio man.—Radio-Craft

PLASTIC ELECTRIC DRILL

Independent Pneumatic Tool Co.
Chicago, Illinois



RADICALLY new in 1/4-inch portable electric drills, the grip handle, field case, and gear case, are made of Thorite, the new plastic specially developed for the purpose.

Tests have proven this drill to have more power per pound, greater strength, greater protection from shock. Its compactness and light weight permit faster working. Coolness in operation is also a feature, in hot weather or in close quarters.—Radio-Craft

MICROPHONE CORD ASSEMBLY

Universal Microphone Co.
Inglewood, Calif.

THE new CD-318 and CD-508 microphone cord assemblies comprising switch, plug and jack, are announced. The SW-141



Left—SW-141 switch
Right—SW-141 switch and CD-318 cord assembly

switch, uses the high-impact phenolic case.

Though primarily used in aircraft and parachute operations, these assemblies can be adapted to tank work and other mobile field units. Under field conditions the double-circuit microphone switch has withstood the extremes of heat and bitter cold. Although it operates as a press-to-talk switch, it has a locking button for continuous operation.

The cordage is rubber-covered and no extra molded rubber parts are required.

The switch dimensions are 4 15/32 long x 1 3/4 long wide x 3/4 inches thick.—Radio-Craft

MULTIFORM INSULATORS

Corning Glass Works
Corning, N. Y.

THESE insulators constitute an entirely new line of electrical insulation, embracing radio coil forms, bushings, tube socket bases, bar insulators, antenna insulators, filament guides, rectifier rings, co-axial line



spacers, and various beads and wafer forms.

Advantages claimed for the product include minimum frequency drift, negligible water absorption, and low loss factor. Such stability oftentimes will obviate the use of crystals or other compensating devices.

The high degree of accuracy in the tolerances now enables these parts to replace valuable metal and expensive porcelain or quartz materials used heretofore. Also problems in glass, involving grooves, holes and threads, have been met by the new system of manufacture.

Although the mechanical and dielectric strengths are slightly lower than those of glasses made by conventional methods, these have proved adequate for a broad group of purposes.—Radio-Craft

LEVER SWITCHES

Donald P. Mossman, Inc.
Chicago, Illinois

THIS No. 0-42 lever switch is primarily designed for radio, communication, annunciator, alarm, industrial and aircraft applications. It is available in an almost unlimited series of combinations of contact assemblies. Contacts, pile-ups, and lever action can be modified to meet specific requirements.

The design and the construction combine to make it a rugged positive-action switch, yet light in weight and attractive in appearance. It can be made locking, non-locking (spring-return to neutral position) and with no-throw stops.

The large properly designed handle permits a firm grip by a gloved hand.

Maximum rating recommended, 5 am-

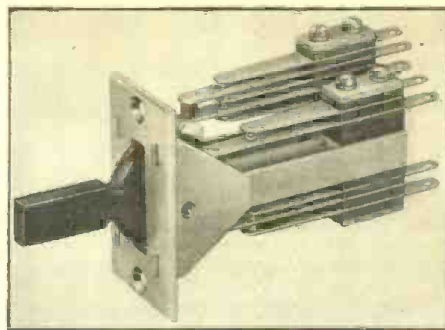

peres, 117-volts, A.C. (non-inductive).
—Radio-Craft

THROAT MICROPHONE

Miles Reproducer Co., Inc.
New York, N. Y.

THIS improved throat microphone is primarily intended for use in aircraft, submarines, and tanks, or in other applications where the noise level is high.

The microphone is placed around the neck, over the larynx. Words spoken by the wearer, without shouting, are picked up and amplified, and in the case of industrial plants, may be transmitted over the P.A. system.

The amplifier needed may be any type that is designed to operate from a crystal or other high impedance microphone.

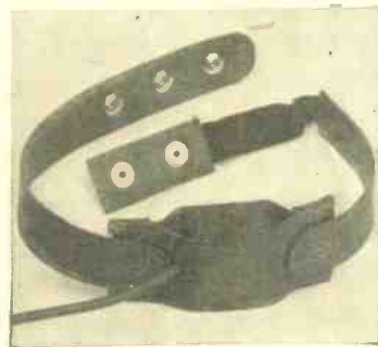

The construction of the microphone is based on the inductor-dynamic principle, with unusual clarity and brilliance, is rugged and compact, and weighs only 2 ounces.

A code system may be devised whereby tapping with the fingers may be used instead of the voice.—Radio-Craft

PLATE TRANSFORMER

Acme Electric & Mfg. Co.
Cuba, N. Y.

THIS transformer was developed to overcome the effects of aging due to continuous operation under high-voltage conditions.

Rated 3300-volts, 1.8-amperes secondary, it is intended for transmitter service.

Of sturdy construction and with special emphasis on the insulation, it is especially suitable for continuous duty.—Radio-Craft



SHUTTER TYPE PILOT LIGHT

Gothard Manufacturing Co.
Springfield, Illinois

THIS company announces a new shutter type pilot light, which is particularly suited to signal, marine, and aircraft applications, where various intensities of light are desired under constantly changing conditions.

These lights permit a gradation of light from bright, through the intermediate glows, to total dark, with 90 degree rotation of the shutters.

These lights are available with red, green, amber, blue or opal lenses, and also with polarized lens.—Radio-Craft.

ULTRA SENSITIVE MULTI-TESTER

Radio City Products Co., Inc.
New York, N. Y.

THE Model 461 has a sensitivity of 20,000 ohms per volt, on all D.C. scales, resulting in negligible loading on delicate circuits. The sensitivity on the A.C. scales is 1,000 ohms per volt.



The long scale on the 4½-inch meter permits very easy reading. Measurements as low as 1-micro-ampere are possible on the 100-micro-ampere scale. Shunts are accurate to within 1%. A suppressor-type copper-oxide rectifier is employed.

Ranges of the tester embrace 0 to 5000 volts, D.C., A.C., and as an output voltmeter; 0 to 100 micro-amperes D.C.; 0 to 500 milliamperes D.C.; 0 to 10 megohms; and from -10 to 50 Db.

Dimensions are 7 x 5½ x 3 inches. Battery supply accompanies the instrument.—Radio-Craft

TELEGRAPH KEY

American Radio Hardware Co.
New York, N. Y.

THE new J-38 sending key is intended for school and front line use, and embraces the features regarded by amateur and professional alike as being desirable in an instrument of this kind, namely, facility of



wrist action, and touch control. The frame is a solid casting, with all bearing parts of finely machined brass, mounted on ¼" high-grade bakelite base. An eyelet in the base prevents phone cords from pulling loose, and a special shorting lever for receiving is provided.

The contact points are of pure coin silver, insuring positive contact.

A special feature of this key is the use of laminated electric-grade bakelite in place of the usual hard rubber washers on contacts and binding posts.—Radio-Craft

THE CONSUMER RADIO SITUATION

TRANSFORMERS for audio and power supply are getting to be a difficult problem because of their use of copper. The few available are left-overs of poor quality. The better ones of course go to those with priorities for use in war equipment, etc.

This does not affect the midget A.C.—D.C. sets at all, but does affect the old-line A.C. receivers ten years or more old. But these can be repaired by using parts removed from similar models.

As regards the 10,000,000 automobile radios, it looks as though little can be done for them. They must take second place to the "one receiver kept in operation in each home."

Then there are a few radios still left in the stores. These will all be gone by the end of May. We hear that in some localities even some of the older models are being touched up and refurbished to sell for rebuilt new.

It is suggested to avoid buying the A.C.—D.C. type of receiver, new or old, as the tubes burn out frequently. These tubes are often special, and impossible to obtain now. Even if standard, they are hard to get. It is better to recondition an old A.C. set that had plenty of pep in its time, because it is much easier to get the 2.5-volt tubes. They last longer; are more rugged; and will stand more overloading.

One satisfaction will be that most of the special tubes will be eliminated from dealers' shelves and after the war we can return to a sane basis of having only a 100 or so of standardized tubes, instead of the line of 800 it was approaching in 1942.

Owners of farm type radios (using air-cells and B-batteries) will not have cause to worry, they have been assured by government utterances, as it is planned to allocate some of the battery production to them.

In addition to the lack of parts and tubes, the difficulty of finding competent servicemen to service home receivers is increasing daily. Men ordinarily engaged in this work are either in defense industries or are in the armed forces. Youngsters who might be trained are not yet available, and the men of 38 or over cannot be trained in a week, and may prefer to stick to their old line of work anyway. Even the government itself is hiring servicemen skilled in maintenance, which reduces the available personnel still more.

All in all, it looks as though the set owner had better treat his radio very gently, and pray that it lasts till the war is over, for he must take a back seat when it comes to getting service on his receiver.—Abstracted from Consumer's Research-Bulletin.

SEND Your ORDER
For these high quality replacement parts while these low prices prevail . . .



Magnetic Recording Cutting Head

6-8 ohm impedance to match speaker voice coils. Direct replacement for all low impedance cutting heads. Complete with needle screw and 4" flexible leads. 1¼" x 2¾" x ¾". Shipping weight 1 lb.

Only \$4.95



Recording Discs—Paper Base

6½" size. 8 in each package. Slow-burning; nationally known brand. All fresh stock. Shipping weight 1 lb.

Only \$.69

7" 6 Volt Auto Speaker

6-8 ohm voice coil; 4 ohm field. Extra heavy construction. Less transformer. 3¼" deep. Shipping weight 2 lbs.

Only \$.95



6½" x 9" Oval Auto Speaker

6-8 ohm voice coil—6 volt 4 ohm field. Complete with 12" shielded cable and 4 prong plug. 3¾" deep. Shipping weight 2 lbs.

Only \$1.19



3½" P.M. Speaker

6-8 ohm voice coil. Fully shielded construction makes it an ideal microphone unit or replacement speaker in midget sets. Less transformer. 1½" deep. Shipping weight 1 lb.

Only \$.95

Above prices do not include postage. Send cash with order or 20% deposit on C.O.D.'s. Satisfaction guaranteed or your money will be refunded.



"Quick Delivery on Radio, Sound and Electronic Parts"



GRAB YOURSELF A COPY OF THIS BRAND NEW MANUAL BOYS! ITS JAM PACKED WITH DATA, CIRCUITS AND ALL THE SET INFO YOU NEED UP TO DATE OF GOVERNMENT SHUT DOWN APRIL '42.

Read These Facts!

LOOK AT A COPY NOW

See for yourself — COMPARE!

MORE LISTINGS: This 1942 Radio Circuit Manual has nearly 400 more listings than the last edition of a similar manual. Covers receivers manufactured up to time of Government shut down order in April 1942. The set you're looking for here when you need it!

MORE POPULAR SETS: Listings of many popular set models are far more complete than in other manual recent edition. Check for yourself on such makes as Lafayette, Emerson, Pilot, Philco, RCA, Stewart Warner. This completeness will save you many times the cost of the book by saving your time enabling you to handle work more promptly.

PERFECT DIAGRAMS: There's nothing more annoying or costly than finding an incomplete circuit drawing. An artist carefully checked and retouched every diagram in the Radio Circuit Manual to make sure of PERFECT diagrams. The printing is clear, distinct, complete! You'll enjoy using this manual.

MORE ON PAGE: Ever had to fumble around turning pages because complete information didn't appear on one page? The Radio Circuit manual has big roomy pages which permit more complete data on a single page than any other manual. Another time-saver for you.

HANDY SIZE: The Radio Circuit Manual is thin, not fat, dumpy and bulky. This thin size and large page size makes it much easier to handle, easier to store

in a minimum of shelf space. The book lies open too, without pages flopping over so you have to hunt for your place again.

QUICK REFERENCE INDEX: The index in this manual is complete for both 41 and 42 editions. A big feature is the fact it tells you at a glance if a model is the same as another model number. No hunting back and forth, it's right there. Big readable page numbers and model numbers make for quick finding of what you want.

SPECIAL REFERENCE CHARTS: Special late edition charts on tube and battery interchangeability, pilot lights, ohms law, color codes. The information you often search for is here. Also a special article by F. L. Sprayberry to make your wartime service job easier.

COMPLETE DATA: The big pages feature not only Schematics, but quick reference IF spot, Parts Lists, Dial Stringing diagrams, tuning range and data, tube locations, voltage charts, trimmer locations, push button set-ups, alignment notes and procedures, record changer details.

Published By
RADCRAFT PUBLICATIONS, INC.
25 WEST BROADWAY.
NEW YORK, N. Y.

RADCRAFT PUBLICATIONS, INC., 25 WEST BROADWAY, NEW YORK, N. Y. DEPT. RC 4.43
 Gentlemen: Enclosed find my remittance of \$10.00 for which send me, POSTPAID, my copy of the RADIO CIRCUIT MANUAL—1942
 Name Address City State
 (Send remittance in form of check or money order; register your letter if you send cash)

POWER SUPPLIES FOR BEGINNERS

By K. E. SCHUBEL

For those beginners who have reached the point where they are building power supplies, or re-wiring some old receivers, the information given herewith should be of help. Not all the details are given; but the highlights are touched upon and the important facts stressed.

A POWER supply, generally speaking, may consist of dry cells, storage batteries, motor-generator sets, electrolytic devices, or transformer-rectifier devices. However, as it is generally understood among radiomen today, it means either a transformer-rectifier unit, or an A.C.-D.C. rectifier of the 25Z5 type.

When the first radios came out to operate off A.C. lines, the power supply was called a B-battery eliminator (if it had a separate battery supply for the filaments or heaters) and the apparatus was heavy but well-designed, and operated well without heating up excessively.

Radios designed exclusively to operate off the D.C. lines in the larger cities, were obsolete some 8 years ago, and are practically zero today. They have been replaced by the A.C.-D.C. type receiver.

In this discussion we want to confine the attention to the type of power supply that operates exclusively off the 117-volt A.C. lines, using a power transformer and an 80, or a 5Z3 type, rectifier.

TRANSFORMERS

Those who have followed the articles by F. Shunaman and others in *Radio-Craft*, are familiar with the basis on which the power supply transformer operates, namely that 117-volts A.C. flows in the primary winding, and various voltages (according to the number of turns of wire in the different secondary windings) both high and low, are obtained in the secondary windings. In other words, the 117-volts of the primary is stepped-up for plate-voltage supply, and stepped-down for the heater or filament supply.

PRACTICAL CONSIDERATIONS

We do not wish to go any further, at this time, into the theoretical ideas of transformers and chokes, but we would like to go into what might be called "practical notes," that is, to give some idea of what ratings mean, and data as given in catalogs, and how these are checked against the needs of the job you are trying to do at the time.

For example, you spot a circuit you think you would like to try. It calls for a power supply and you get hold of a power transformer. If the job calls for relatively low plate-current drain, almost any transformer, no matter what size, will do.

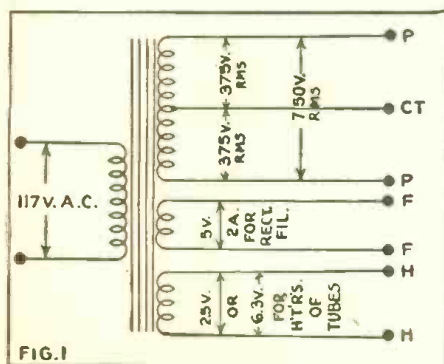

Diagram of a simple transformer of the cheaper type. The high-voltage winding is sometimes cataloged as "350-volts C.T." or "700-volts plate-to-plate." The usual rectifier used is the 80 type.

The average cheap power transformer (See Fig. 1) has three secondary windings (7 leads). One winding is 5 volts for the 80 rectifier; another is about 375-volts RMS (you have probably learned what RMS means; if not, it simply means A.C. voltage as read on an A.C. voltmeter); then there

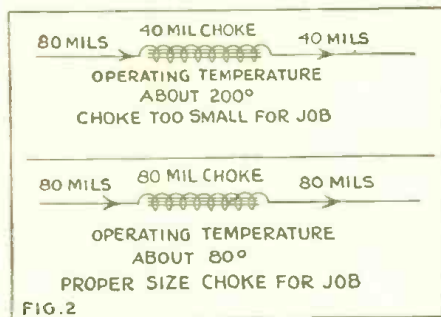

FIG. 2

Chokes compared. The first one is too small for the job. It gets hot and robs the set of the current it needs. The current that disappears (40 mils), is lost in heat. The second one, a choke of the proper size passes all the current needed, and runs cool.

is a 2.5-volt or a 6.3-volt winding for supplying filament or heater current to the tubes. The 375-volt winding has a center tap for the "B-" connection, and is usually rated 40 mils; or 70 mils; or in some cases 85 mils. Mils. is the abbreviation for milliamperes. Ma. is still another.

Now suppose you got the notion you want to build a set using several tubes. The

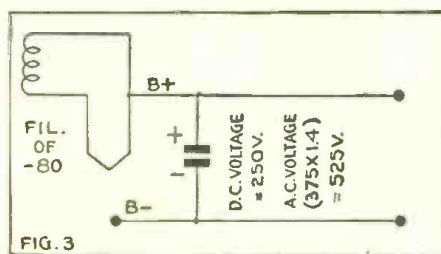

FIG. 3

Working voltage of a filter condenser. The condenser at this point is subjected to two strains, the D.C. output voltage, and the peak A.C. ripple. As shown, the latter is the higher of the two, and the working voltage should be based on that.

procedure to follow is this. Look up in the tube manual the plate and screen current for each tube, and add them all up. This gives the total mil. load. Then add 10 mils. to cover current through "the bleeder" (we'll explain "bleeder" later) which fluctuates as strong and weak signals pass through the radio.

Now suppose you have several pentodes in the R.F., a diode-triode detector and a 6F6 or a 2A5 power output tube. The total plate and screen current would be about 70 mils. Adding 10 mils. for the bleeder, gives about 80 mils.

When you check your transformer see to it that the high-voltage winding is rated at 85 mils. at least. If it is good for 90, or even 120 mils., that is still better.

Now check the filament windings. Are they 2.5-volt or 6.3-volt? If it has a 2.5-volt winding you must use tubes with 2.5-volt

filament or heater rating. If 6.3-volt, you can get the equivalents or counterparts of the 2.5-volt types in the 6.3-volt rating.

In this manner you will have selected a power transformer that will operate the tubes at the proper potentials, and will not overheat on load. *Transformers too small for the job overheat, burn-out, and cause all kinds of trouble. Stay away from them.*

CHOKE COILS

Choke coils as used in the filter system (See Fig. 2) must be checked as to mil. rating just as transformers are. If you put 80 mils. through a 40-mil. choke you will rob the set of current it needs, heat up the choke and one day burn it out. If the set draws 70 mils. and 10 mils. is needed for the bleeder, the choke must have a rating of at least 80 mils. A rating of 90 or 120 mils. is even better. In this way it will always run cool.

FIELD COILS AS CHOKES

Sometimes the field of an electro-dynamic speaker is used as one of the filter chokes and you must make sure it will carry all the current. (In this case it must carry 80 mils.) Since field coil windings are given in ohms, (900-ohms, 2500-ohms, etc.) it is necessary to select the proper size. Suppose for instance, you selected one rated 2500-ohms. Resistance times current gives voltage-drop, or $2500 \times 80/1000$ gives 200. In other words the voltage would drop 200-volts across this field! Since you have only about 300-volts to start with, at the output of the rectifier, you can see you will have only 100-volts to supply to the set. Obviously you can't use the 2500-ohm field. (The chances are it would soon be burned out, too, because it wasn't designed to carry 80 mils.)

In general we would not advise using field coils as chokes, unless you want to figure that the drop across one of them should not exceed 50 volts and then by Ohm's law find the necessary ohms rating. For example, if you want to pass 80 mils. through it, with a 50-volt drop, you have, by Ohm's law, 50 divided by $80/1000$, or 625-ohms. This is an unusual size. You may find one in an old receiver, but to buy

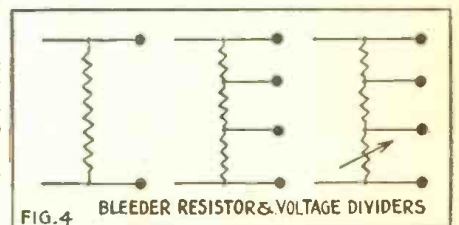

FIG. 4

Different types of bleeders and voltage dividers. If a straight resistance is used, it is called a bleeder. If it has taps, it is called a voltage divider. A bleeder is used to stabilize output voltage. A voltage-divider is used not only to stabilize but to supply different voltages and currents to the different parts of the set.

one may be difficult. Thus it can be seen why the idea is discouraged.

FILTER CONDENSERS

As you probably know, a filter condenser (Continued on page 439)

CODE OSCILLATORS FOR THE BEGINNER

MANY beginners are now learning the International Code, as preparation for service with the armed forces, for WERS work, or in preparation for an amateur career in the future.

Code practice calls for a good code oscillator. A number of such have appeared in *Radio-Craft* recently, some of them however being of an advanced type using combination tubes and a loudspeaker. The beginner can start with a much simpler type of oscillator, adapted for headphones, and amplify it for a speaker with a simple audio amplifier.

NEON OR RELAXATION OSCILLATOR

The simplest of all code oscillators is the neon type. An ordinary half-watt or larger neon lamp is used as the oscillator. The hookup is shown in Fig. 1. The only apparatus needed is a resistor, a small fixed condenser, a pair of headphones, a telegraph key and a source of direct current, 90 to 120 volts.

Make sure when buying your neon bulb that it will light on 90 volts. Many of these lamps will not light unless the voltage is well over 100. The type with no resistor in the base will always work. The 90 volts may be obtained from a B battery, or—if you live in parts of Manhattan or in small towns supplied with direct-current for lighting—from the electric light line. *This hook-up will not work on the ordinary electric light line, which is A.C.* It requires D.C. for its operation.

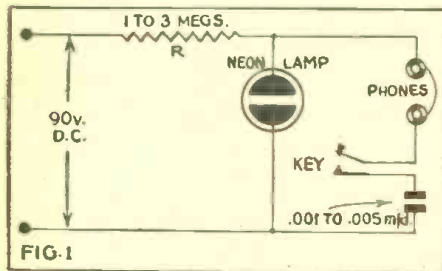

The method of operation is simple and interesting. When the key is depressed, current starts to flow through the circuit composed of the resistor R, the headphones and the condenser C. It takes a certain amount of time to charge condenser C, depending on the capacity of the condenser and the size of resistor R. When enough electricity has flowed into condenser C to raise it above the voltage required to light the neon lamp, it lights. This short-circuits condenser C, and current from it flows through the lamp,

till the voltage drops to a point much below that required to light it in the first place. Then the light goes out, and the voltage begins to build up to the point required to light it again.

If we select condenser C and resistor R to have such values that the neon-lamp lights and goes out, say one thousand times

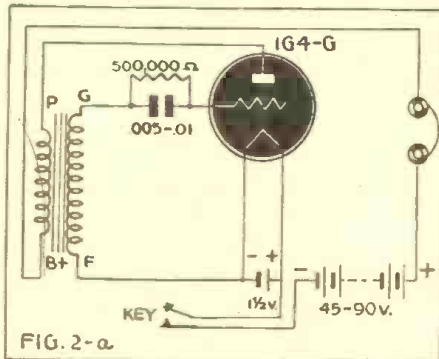

a second, we will hear a thousand-cycle note in the headphones. There are a thousand pulses per second as the current from the condenser rushes through the phones when shorted by the lamp.

REGENERATIVE OSCILLATOR

The next simplest code oscillator is the standard regenerative audio amplifier. It is shown in Figs. 2a and 2b. This set-up is the same as the regenerative receivers you have been building, with a tickler coil to feed back some of the output to produce regeneration. The unit oscillates at a frequency which depends on the size of the coils and the size of the grid-leak and condenser. The easiest

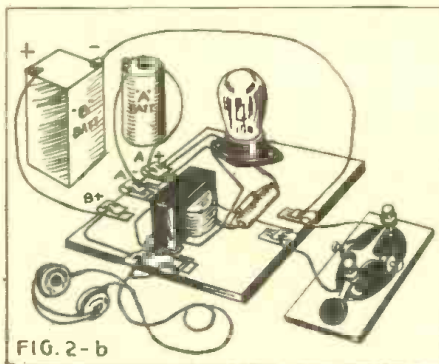

way to change the note—if the one you get is not pleasing—is to change the size of the grid condenser. Changing the plate or filament voltage—particularly the latter—will also change the note.

All that is needed to make this oscillator is an audio-frequency transformer, a triode or 1G4 or other convenient dry-battery triode, a grid-leak and condenser, and the usual phones and key. The hook-up is simple and can readily be grasped from the diagram.

You may find that when all hooked up, the oscillator refuses to work. This is usually due to the tickler being wound in the wrong direction. Reverse the leads of either the grid or the tickler winding, and the oscillator will usually start right out.

A very interesting oscillator of this type was shown in the February issue. Instead of using the separate grid and tickler coils, the secondary of a push-pull transformer was used, hooked-up in what is called a Hartley oscillator circuit. This is an extremely reliable circuit and there is no danger of getting the leads reversed. If you happen to have on hand an old push-pull transformer (one with the primary burned out will do) this circuit will be well worth trying. The primary of a push-pull output transformer may also be used.

If you want to use a loudspeaker, or if it is easy to get loudspeakers but hard to get a set of headphones, you can add an

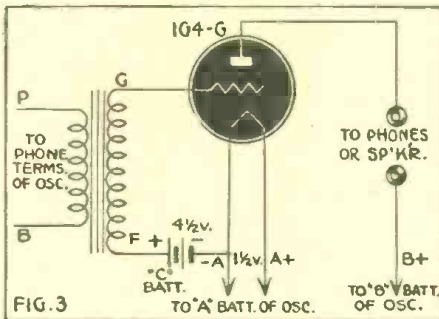

audio amplifier to either one of these oscillators. Fig. 3 shows a simple audio amplifier which will bring in the signals up to the volume level where several persons can copy them.

SQUEGGER OSCILLATOR

There is still another type of oscillator which is sometimes used, but it is not highly recommended. This is the "squegger" or *(Continued on page 437)*

NEON CONDENSER TESTER

I have seen many diagrams of various condenser testers and have built a number of them and used costly meters, but I was never able to get one to check anything from an electrolytic down to a mica.

I began a little experimenting with an old power transformer and a neon light and the results are amazing.

By shading the neon bulb from outside light, you can test a mica condenser or any other kind used in radio work. The shading is necessary.

Condensers C1, C2, and C3 are 8 mfd., and have a working voltage of 475 volts.

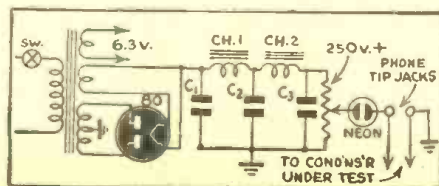

The resistance across the power supply output should be about 10,000 ohms, 100 watt or (at least 50 watt), with taps or a slider. The neon bulb must be of the resistorless type.

I have used this tester for several years and it has been of great value to me in my work. I have built several for my friends and I believe there will be many more who would want to build this tester.

J. A. SEAY,
Spartanburg, W. Va.

"IT'S A SWELL PLACE FOR MY
ECHOPHONE EC-1 AND BESIDES,
SHE LIKES TO GET POLICE CALLS"



Echophone Model EC-1 6 tubes, 3 bands. Tunes from 550 kc. to 30 mc. Beat frequency oscillator. Bandspread logging scale. Self-contained speaker. Electrical bandspread on all bands. AC/DC. 115-125 volts. ECHOPHONE RADIO CO., 201 EAST 26TH ST., CHICAGO, ILLINOIS

QUESTION BOX

By FRED SHUNAMAN, Technical Editor

QUERIES

All queries should be accompanied by a fee of 25c to cover research involved. If a schematic or diagram is wanted please send 50c. To cover circuits up to 5 tubes; for 5 to 8 tube circuits, 75c; over 8 tubes, \$1.00.

No picture diagrams can be supplied.

Back issues 1942, 25c each; 1941, 30c each; 1940, 35c each.

Any issue, prior to 1940, if in stock, 50c per copy.

USING OLD TYPE TUBES

? Will you please give me a circuit for a superheterodyne using old-type tubes? I have an old set using several 24's and 35's, a couple of 56's and push-pull 45's. I wish to use this with a 280-volt power pack, as I do not want to use the pack on the set.—G. F., Hamilton, Ont.

A. A circuit using 2 24's, 2 56's, a 35 and

2 45's is shown. L1 and L2 are a pair of standard broadcast antenna and oscillator coils.

Even though you use your 280-volt power pack to supply "B" voltages, you will be well advised to use your old transformer to supply filament voltages, as the drain of these tubes is very heavy, and no doubt the transformer was built for it.

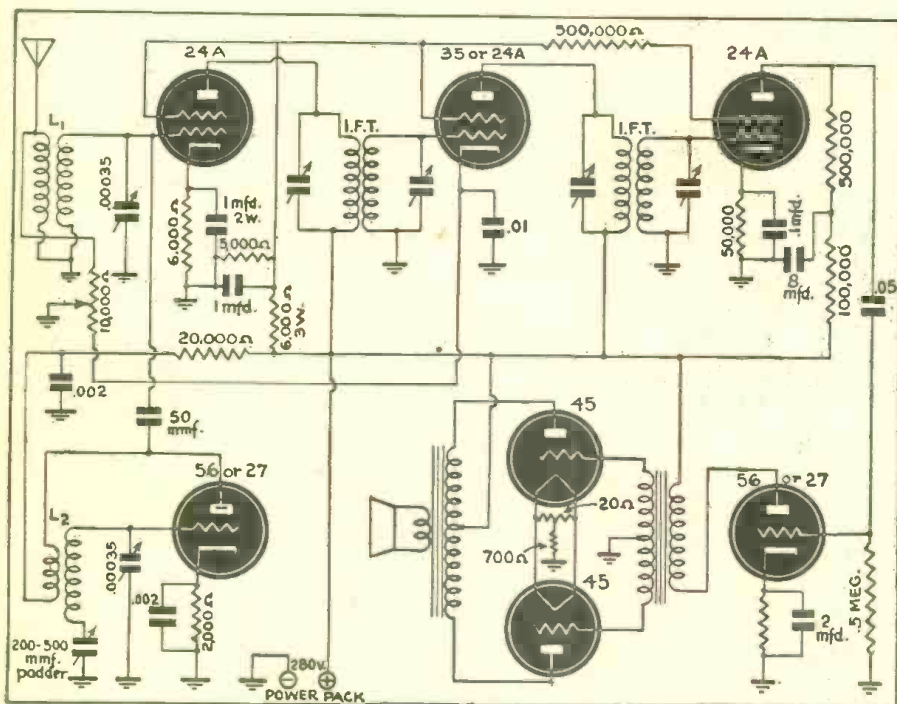

A SIMPLE AMPLIFIER

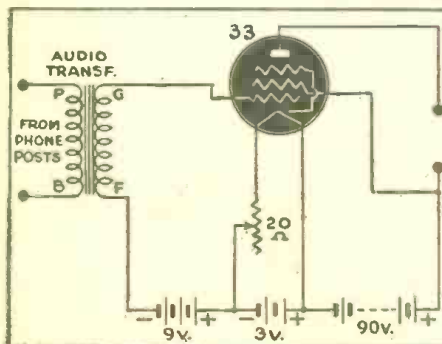

? Please draw me a simple amplifier for a dry-cell tube, using transformer coupling.—J. N., Sask., and A. H., North Dakota.

A. Herewith the circuit, drawn for a 33, as requested by one of the readers. Other types of 2-volt and 1.4-volt tubes may be used by changing the "C" voltage. Correct values for 90 volts "B" are: 1A5, 4.5 volts; 1C5, 7.5 volts; 1F5, 3 volts; 1G5, 6 volts; 1Q5, 4.5 volts, and 1T5, 6 volts. The 1S4 is not recommended for more than 67½ volts, for which the grid voltage should be -7.

CONSTRUCTING A SOUND HEAD

? I would appreciate it if you would send me any article you may have on construction of a sound head.—Philip Paladino, no address.

A. While no article on the construction of a sound head has been published, the

December, 1935 issue of *Radio-Craft* carried a very informative article on sound heads, with a schematic and a couple of photos, from which a skilled constructor could no doubt build a head. This was the first of a short series of articles on "Servicing Theatre Sound Systems."

AN ELIMINATOR

? I have an old short-wave battery radio set. Now that it is impossible to get batteries I would like you to publish a simple eliminator with taps for 6 and 9 volts.—E. T., Lynbrook, N. Y.

A. Designing an eliminator for a battery set is not as simple as that. If this is to be an "A" as well as a "B" battery eliminator, it will be necessary to know the type and number of tubes. If the set uses tubes with indirect-heated cathodes like the 36, 6D6, etc., alternating current can be used on the filaments. If the tubes are 201A's, this will not work, and direct current will have to be provided.

If your tubes are of the dry-cell type the portable power packs shown in the January issue will be suitable.

If it is simply a "B" eliminator, any one of the power packs shown recently in the *Question Box* and in the *Experimenters' Section*, can be used by simply putting a bleeder resistor, with two adjustable taps, across the output, and setting the taps to 6 and 9 volts.

CHECKER & ANALYZER

? Will you kindly print a diagram of a condenser analyzer and leakage checker?—J. W., Red Oak, Iowa.

A. The two drawings show an analyzer (capacity and power factor measurer) and a leakage checker. The 12,000-ohm resistor gives the capacity, the 20,000 the power factor. The null indicator may be a vacuum-tube voltmeter or an electron-ray (6E5) tube. Calibrate with condensers of known capacity.

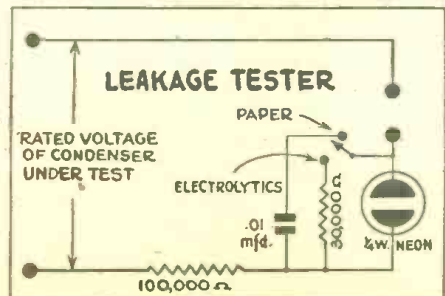
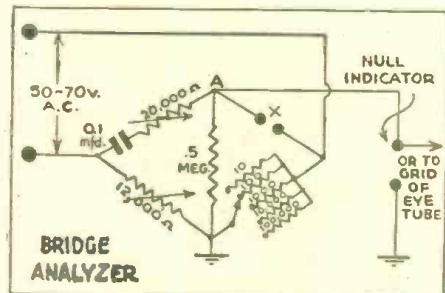



KLEPTOMIMP

LOOPIMPS. These are a little-known type, which hide in the stationary loops of receivers, where they create disturbances and radio noises of many varieties.

LOUSIMPS. Under this descriptive name we find those Imps who infest loud speakers. Here they cause distortion, loose and rattling cones and other speaker troubles—too many to speak about. You know most of them anyway.

METERIMPS. This particular breed of Imp resides in all types of meters with which they play havoc. They make the hands stick, interfere with the delicate mechanism, and otherwise make the meter say what it shouldn't.

MICRIMPS. Their habitat is in micro-phones; if a mike gives poor quality, it is usually the MICRIMP that does it.

POPIMPS. These live in power packs and are not only dangerous but expensive, because their only mission is to ruin a high-priced power pack by blowing valuable transformers, condensers, or both.

PUBADIMPS. Under this musical name we classify the public address Imps. Their job is to create distortion, feed-backs, etc.,

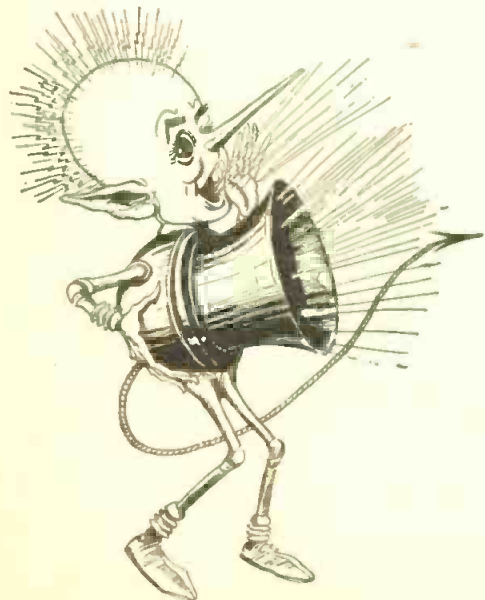

LOUSIMP

O.S.I. FREEZES RADIO TROUBLES FOR DURATION

(Continued from page 393)

and make the man at the mike sound as if he were his own grandmother.

RESISTIMPS. Known to every radio repairman, these mean Imps can't resist the temptation to put every type of resistor out of order, whether variable or fixed. Their one delight is to short the resistor and overheat it, as they thrive best in hot temperatures.

SHORTIMPS. These work hand in hand with the BLOWIMPS, and we understand that they recently formed a union. They create all kinds of short-circuits where none are supposed to ever take place. They love to bring in small metal particles from the devil knows where and manage to get them into variable condensers, adjoining wires, etc., and causing short circuits.

SKWHEELIMPS. This is the well-known variety responsible for making a radio set squeal when it is not supposed to oscillate at all. They help to give off those unearthly squeals which certain receivers emit when



MICRIMP

you least expect it. Try and find the cause, if you can!

STATIMPS. This is the type of Imp who is responsible for all types of static, both natural and man-made. Frequently it is also *Statimp-made*. In other words, the Imps create static right in the set itself and defy you to find out just how they do it.

SWIMPS. This particular type of Imp resides only in switches. Watch out for them; they love to jam radio switches and are the cause of loose switches, loose knobs, open connections, and other disturbances.

TRANSIMPS. These Imps live only in transformers where they cause the usual burnouts and blowouts.

TUBIMPS. These are Imps which cause the hundreds of tube noises. There are really very many in this class, as different tubes make for different Imps. They abhor the vacuum in the tube and do their best to spring a leak in it. They also play hide and seek with electrons, causing inferior electronic emission.

VOLIMPS. These are the Imps who reside in volume controls. They are never



RESISTIMP

happy unless a volume control creates harsh noises in the radio set.

MISCHIMPS

ADAMIMP. This is the type of mischievous Imp who inspires the comedian or jokester to excavate a joke that was ancient when Adam first roamed the earth. We understand that there is an epidemic of these Imps in radio studios right now.

BLASTIMP. These mischievous type of Imps reside in broadcasting microphones only. They have magnetic powers in making Amazon sopranos "hug" the mike and "blast" it. This causes heart failure in the control room and radio listeners to fall flat on their backs—or turn off their receiver.

CACOFONIMP. This type of Imp is attracted only to radio singers. They have a long invisible feather with which they tickle the throats of crooners and sopranos, (Continued on page 446)

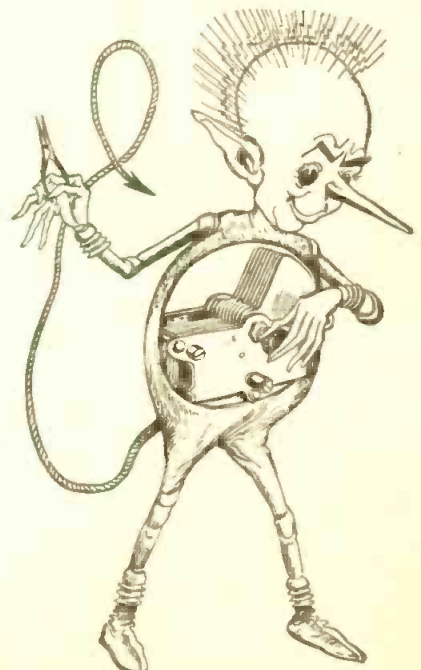

CONDIMP

Diagrams for

THE RADIO EXPERIMENTER

If you have a new Hook-Up, send it along; a pencil diagram will do. Be sure to include a brief description.

All diagrams and descriptions accepted and published will be awarded a year's subscription. Diagrams may be for receivers, adapters, amplifiers, etc. Send them to Hook-Up Editor, RADIO-CRAFT, 25 W. Broadway, New York City.

THREE-TUBE T.R.F. RECEIVER

I designed and built this three-tube T.R.F. two years ago and it has proven to be very efficient and economical.

The R.F. coils used in this set are of the powered-iron core type. I used a Meissner No. 14-1496 antenna coil, and an Aladdin

No. 1007, and Meissner No. 14-1997 in the interstage and detector stages respectively.

The main tuning condenser, .000365 mfd., is of the T.R.F. type of course, ganged, with trimmers.

The current drain is fairly low, being only .20 amp. in the "A", and 8 to 11 mils. in the "B".

The selectivity and sensitivity is as good as any small medium priced superhet., while the tone quality is even better. The A.V.C. system functions remarkably well.

Using this circuit with good parts one can build a fool-proof, trouble-free set, which will give more pleasure and satisfaction per dollar of expense.

No electrolytic condensers are used in this set to cause future trouble. A 1-mfd. paper type was found to be sufficient in the B-supply circuit.

The R.F. tubes had to be shielded to prevent oscillation on some stations.

CURTIS SHAMP
Brewster, Minn.

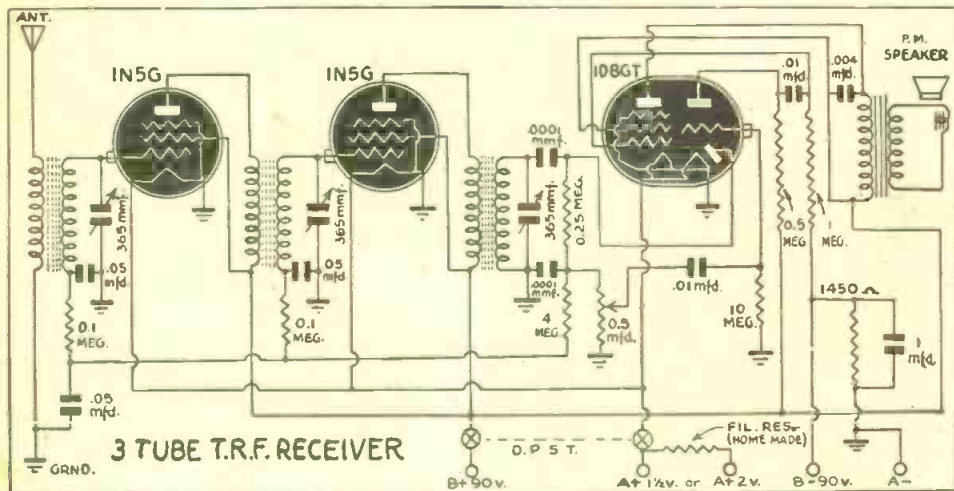

GROUP OSCILLATOR

Following is a schematic diagram of my audio oscillator code practice unit that I built to teach code to a group of girls.

I have been using this oscillator for about two years and believe it is a novel circuit.

I have found this oscillator to be more powerful than the commercial two-tube oscillators brought in by my students. It has enough volume to fill a large school room by using magnetic speakers and enough power to operate twenty pairs of earphones.

Because of the volume of output from

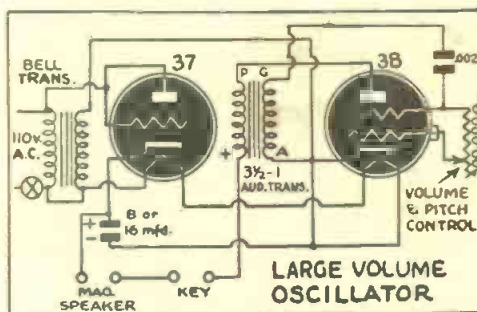

this unit, I have not attempted to change the circuit to use double-purpose tubes, line cord resistance, etc. A dynamic speaker is not necessary for power.

Parts List

- 1—Bell transformer
- 1—Audio transformer
- 2—Tubes, sockets, 5 prongs
- 1—8 mfd. electrolytic condenser
- 1—.002 fixed condenser
- 1—1/2 megohm pitch control
- Key, speaker, binding posts, "on-off" switch.

EDNA F. DOTEN
West Lynn, Mass.

A.C. - D.C. TUBE TESTER

The diagram shows a fairly simple tube tester. The operation proceeds in the following manner: Close switch S2 and place tube under test into the correct socket. If Pilot P1 glows continuously, the filament of the tube is OK. If pilot P1 winks or does not glow at all, the tube has a defective filament.

This test holds true for all tubes except the 35Z5 and 50Z7G.

For these tubes S2 is closed as before but this time both pilots should glow continuously. Switch S2 is then opened and pilot P2 should go out and P1 should continue to burn steadily.

If pilots do not perform as mentioned above the filament of the tube is open or shorted to cathode, and is defective.

Parts List

- P1, P2—47 pilot lights
- S1, S2—S.P.S.T. toggle switch
- R1—1,500 ohm, 20-watt resistor
- R2—50 ohm, 1-watt resistor

PAUL SCHAFFER
Middletown, Ohio

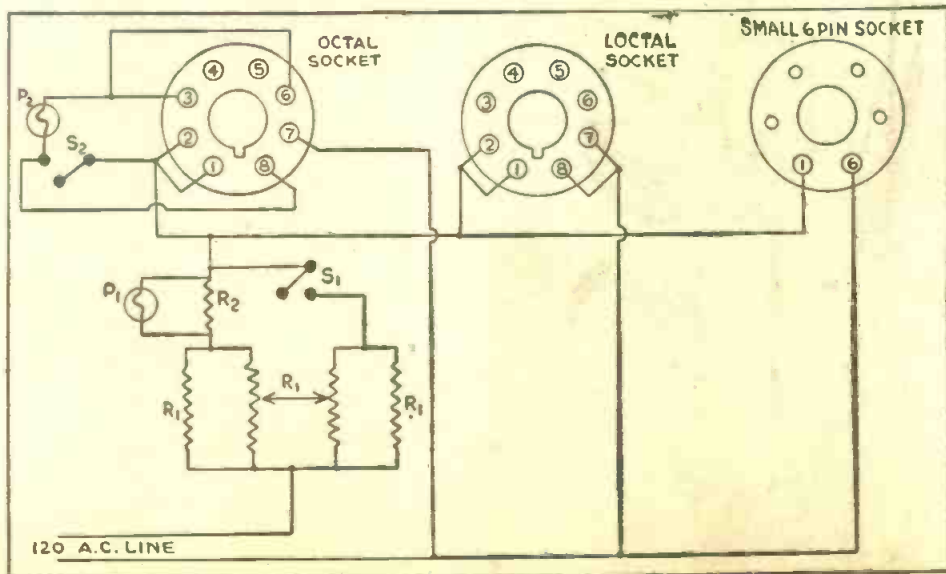

TEN-WATT, CLASS B AMPLIFIER FOR PORTABLE USE

This is a very handy P. A. system to have around in these times of war when we can't be sure of having power from the AC line at all times.

Very easily obtainable parts make up this high quality amplifier. When this is used with a double-button

carbon mike there is more than enough gain. Power can be easily supplied from most car radio power supplies.

Even the beginner will find the circuit easy to follow.

JAMES R. LIMBECK,
Glendale, Calif.

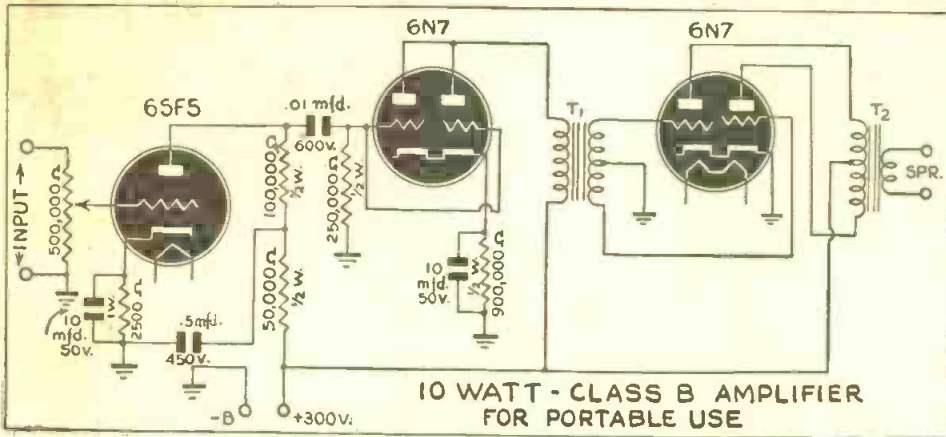

ELECTRONIC RELAY

This circuit is designed to positively

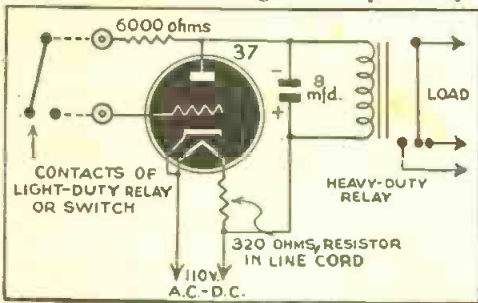

actuate a heavy-duty relay from the light contacts of a small switch or relay. No strain is put upon these contacts, as there is no induction and very little current.

The tube can be practically any triode, and different values should be tried for the plate resistor.

This arrangement is of value in body-capacity and photo-cell hook-ups, as it does away with relay batteries and burnt contacts.

HENRY CLINTON,
East Haven, Conn.

AUDIO FREQUENCY SIGNAL GENERATOR

The instrument is useful for supplying a signal to the input of an amplifier, for testing purposes; or for use as a code practice

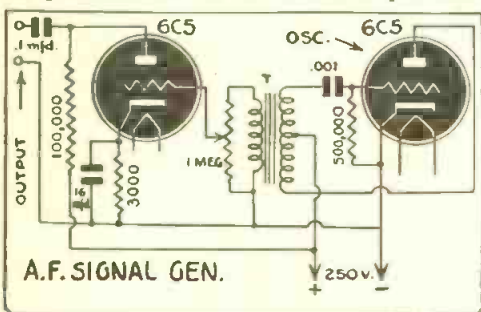

oscillator, when hooked to a speaker, and a key inserted in the plate circuit.

Also, if the output signal is applied to a speaker, and the terminals of a condenser bridge across the output, a means is readily available of determining whether a particular condenser is open or shorted.

If a vacuum-tube-voltmeter is used in place of the speaker, the drop in voltage across the output terminals is proportional to the capacity of the bridging condenser, and the voltmeter may be calibrated in terms of the effective impedance of the condensers used as calibrators, or in mfd. units.

JOHN KEARNEY,
Washington, D. C.

FIVE-WATT PHONO AMPLIFIER

This circuit is unusual and interesting inasmuch as I believe it contains the smallest number of parts possible in consideration of the output and tonal quality.

The economy in parts is made possible by the 6B5 tube, which contains 2 stages of dynamic-coupled amplification in "Class B" output. Notice that although the 6B5 is really one tube, the associated parts needed are those for two.

This unit will supply more than sufficient volume for a very large room, and will easily drive any speaker.

NORMAN HAMEL,
Williamstown, Mass.

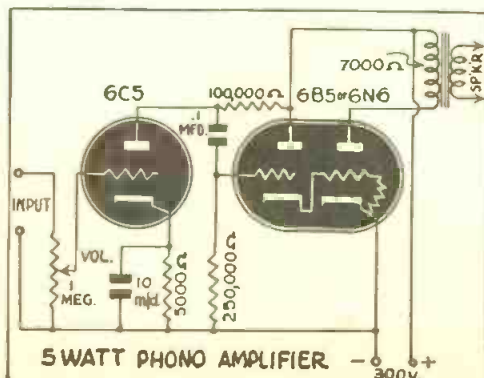

Exactly the Training the Armed Forces want!

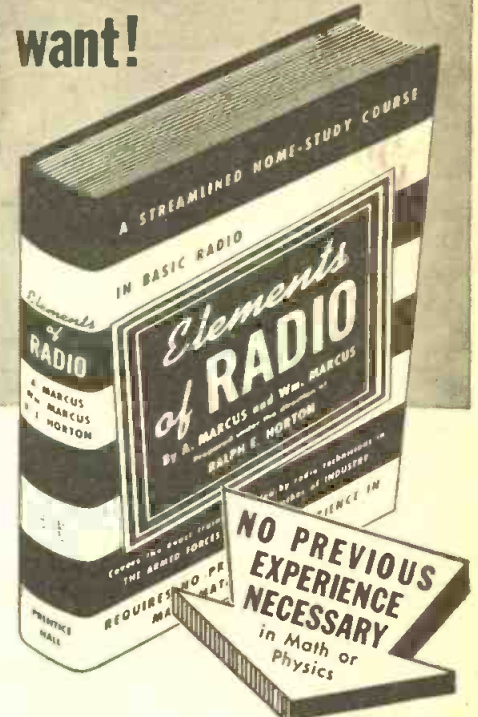

"Start from scratch" qualify quickly in Basic Radio
Written to the exact prescription of the U. S. War Department, you can master this whole fascinating A-to-Z of basic radio communications in a few short weeks, without any previous instruction, without any previous training in math or physics, without wasting time on non-essentials, without outside help.

ELEMENTS OF RADIO

by Marcus and Horton is a home study course that gives you exactly the training the armed forces want. It helps you qualify for the higher position, pay and privileges open to radio technicians. It is the perfect brush-up course for those who already have some radio background.

LEARN AT HOME—SCORE HIGH ON TESTS

If time is short and you want rapid training in the essentials you must master to score high-ratings on qualifying tests, ELEMENTS OF RADIO is the shortcut you need. Features include:

- 535 working diagrams and illustrations
- Step-by-step directions for actually building experimental radio sets
- Brush-up and review questions at the end of each section
- Non-technical explanations throughout
- Book contains nearly 700 pages and is bound in flexible handbook style for ready use

A Complete Home-Study Course For Only \$4

Pre-inductee courses in Basic Radio cost from \$100.00 to \$500.00. Yet ELEMENTS OF RADIO, at a cost of only \$4, gives you exactly the training wanted by the armed forces, broadcasting stations and industry—for convenient, rapid self-instruction at home. Right now, and at our risk, send for a copy of ELEMENTS OF RADIO. Look it over. Read it. Study it for 7 days without obligation. Return for refund of the full purchase price if, for any reason, you decide not to keep it!

ON APPROVAL COUPON

PRENTICE-HALL, Inc.
Dept. ER-1, 70 Fifth Avenue, New York, N. Y.

Please RUSH a copy of ELEMENTS OF RADIO to me. If after seven days I decide not to keep it, I will return the book and you will refund the purchase price promptly.

I enclose \$4.00.
 Send C.O.D.. In which case, I will pay the few cents extra charges.

NAME.....
ADDRESS.....
CITY & STATE.....

RADIO KINKS

OSCILLATONE

Due to present wartime conditions I have been unable to purchase a commercial oscillatone without a priority. Therefore I devised this gadget which works very well.

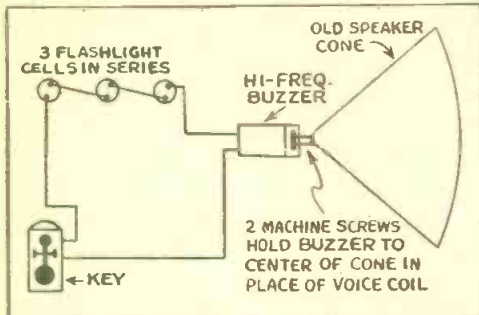

By using an ordinary high-frequency buzzer with a plastic body and an old magnetic speaker with magnets and coils removed and hooking it up as shown in the diagram, a pure crystal D.C. note, readable at 30 to 40 feet is produced.

PHIL WEINGARTEN
New York, N. Y.

DIFFERENT VOLTAGES

Often one desires to alter the line voltage, higher or lower, for the apparatus being used. To do so all one needs is a good power transformer from the "junk" box and a little ingenuity as shown in the accompanying diagram.

When the filament taps are connected as shown in the diagram, they will either add or subtract, depending on connections. The connections desired must be determined by trial.

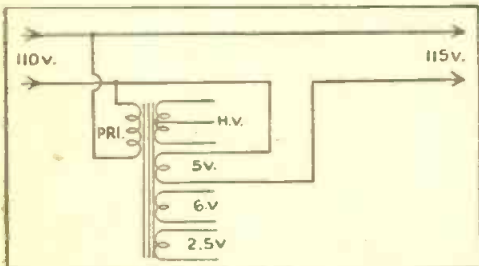

Filament voltages can be connected to each other to form different correcting voltages. Example: 5, 6, and 2.5 V. in series give 13.5V which can be added or subtracted from 110 V.

The number of combinations possible is up to the experimenter's genius.

Check all results with a voltmeter. Do not use over 200 watts on this transformer arrangement.

H. W. VAN NESS,
Wollaston, Mass.

PHONO MOTOR SPEEDS

While looking over some of the late issues of *Radio-Craft* I noticed the readers who contribute to the *Mailbag* section like to see new kinks and circuits. Here is a kink for phonographs that I have worked out for changing a 78 r.p.m. phonograph to the 33-1/3 r.p.m. speed.

The phono I happened to use is a Wells-Gardner portable recorder and playback.

Do you have any interesting and novel kinks which you would like to bring to the attention of RADIO-CRAFT readers? If so, send them in addressed to the Kink Editor. A seven-month subscription to RADIO-CRAFT will be awarded for each kink published.

With the 78 r.p.m. phono, remove the gear or friction drive so that the turntable revolves freely.

On another motor, remove the turntable and replace with a pulley of a smaller size. The formula for finding the size of the small pulley may be stated:

$$\frac{\text{diameter of small pulley}}{\text{diameter of turntable}} = \frac{33-1/3}{78}$$

$$\frac{\text{diameter of turntable}}{78} = \frac{33-1/3}{\text{diameter of small pulley}}$$

The motor may then be mounted to the same height as the turntable and connected with a flat belt.

It will require a fairly heavy motor for recording, if such is desired.

I find this set-up very satisfactory for recording and playback.

ROBERT ROGERS,
Buckner, Missouri.

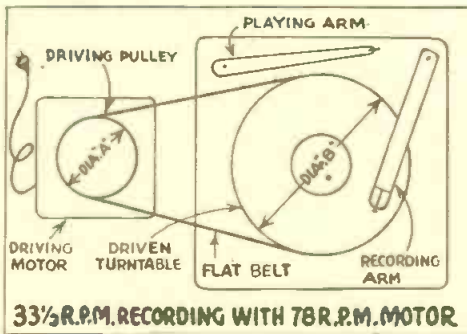

USE OLD TUBES AS RESISTORS

Here is a use for gassy tubes, or tubes that have good filaments or heaters but whose elements have shorted. They can be used as ballast resistors.

The high-voltage types are the kind to use. Just clip off all the prongs except No. 2 and No. 7 on the octal base tubes, No. 1 and No. 7 on the seven-prong tubes, and Nos. 1 and 6 on the six-prong tubes.

Since some tubes have filament connections different from those mentioned, it will be necessary to refer to a tube manual before cutting off any prongs.

The unused connections on the tube socket may be used as soldering terminals. Ohms' law must be used to find the resistance of a tube.

A tube should not be used as a ballast in a circuit that carries more current than that for which it is rated. For example, a

MARK RESISTANCE
ON TUBE

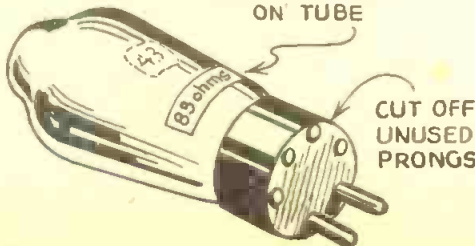

50L6 rated at 0.150 amperes should not be used in a circuit in which the current is 0.3 amperes.

This kink will help the radio man conserve money and materials, both of which are vital to the war effort.

BILL KOTHEIMER,
Louisville, Ky.

SMALL WIRE SOLDERING

The job of soldering small-wire connections is simplified at General Electric by making the iron stationary and dipping the connections into a small hole filled with solder near the tip of the iron.

As shown by the drawing, the soldering iron can be fixed for use in this man-

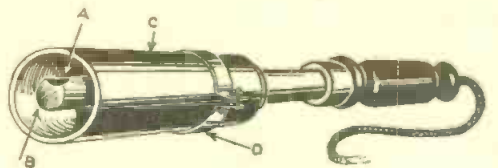

ner by drilling a hole (A) into the tip (B). A nickel-steel tip will last much longer than other types.

The drip and splash guard (C) catches surplus or drips of solder coming off the iron. It is made of 1/32-inch steel and is fastened to the iron with a hose clamp (D).

HOME MADE WAFER SWITCH

Oftimes we need a switch of the wafer type, but do not have one on hand or cannot get one at the usual sources of supply.

On such an occasion I took an eight-prong octal type tube base and reamed the lock pin hole to a larger size to accommodate an old volume control bushing.

The top of the insulating fibre material must first be removed so the socket connections are bare at the top.

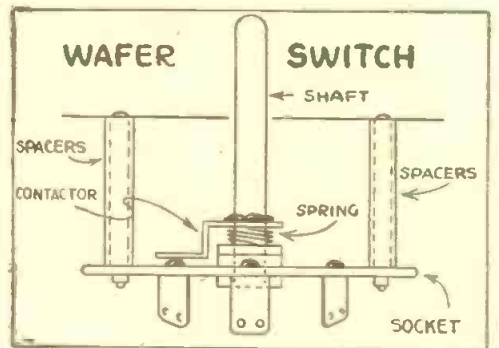

Machine screws or round-head rivets are inserted into the prong holes to act as contact points. These contacts are then held down tightly by an insulating washer and a hex nut.

The 1/4-inch diameter shaft is then placed into the slot and a small spring and bent brass contactor is soldered toward the end of the shaft.

The socket is then mounted by the usual tube socket holes and bushed up to the desired length.

One or more of these switches can be hooked up as ganged switches.

HOMER L. DAVIDSON,
Steward, Nebraska.

SYSTEMIZED TROUBLE SHOOTING

(Continued from page 403)

12SK7 plate and the diode terminals of the 12SQ7 socket will localize the fault.

Should everything be O.K. from the 12SK7 grid, attach the generator to the grid of the 12SA7 in the manner approved for set alignment. Trouble can be traced as above described. Perfect signals from this point narrow the trouble down to two places: the oscillator and R.F. circuit.

The oscillator may in many cases be checked by tuning the set to the strongest local station, attaching the signal generator to the oscillator grid or oscillator anode, and tuning it to the correct oscillator frequency (signal plus I.F.). On some sets this will bring the signal in as well as with the local oscillator—in others the injected signal is so thoroughly shorted out by the set's circuit arrangement that no signal is heard. In the latter case, a high-resistance voltmeter across R2 will show the presence of oscillation. A slight deflection indicates oscillation, as the No. 1 grid is somewhat negative during oscillation.

Should the set be oscillating properly, a detuning of the oscillator with the R.F. may be causing the trouble. Line up the oscillator, supplying a signal across L-3, then hook the generator to the antenna-ground terminals and make a final check. A burned-out antenna coil, open C3, or trouble in the secondary will show up here.

It will be seen from the foregoing that we have no quarrel either with channel analysis or the old point-to-point system. What we are trying to drive home is that the intelligent serviceman may reap some of the benefits of signal tracing methods with apparatus already in the shop. The channel analyzer will of course do anything that this apparatus will, and do it quicker and better.

Neither is point-to-pointing entirely to be abandoned. A check of plate voltages has been pointed out as the quickest method of procedure in many cases. What we are against is the blind use of the method—the checking of every circuit in a set instead of first localizing the trouble and then checking the two or three circuits or parts in which the defect *must* be found. Once the trouble is located, checking parts is the logical method of procedure.

We have entirely neglected the question of power supply. If, when the high voltage is taken, it is found low or absent, the method of procedure is so obvious as to require no comment.

RECTIFIER TUBE REPLACEMENTS

THE present shortage of radio tubes is causing the servicemen no end of trouble in devising ways and means of using types which are available as substitutes for types which can not be procured. There is perhaps more danger in substituting rectifiers without carefully considering the problems, than is the case in substituting most other types of tubes.

The best rule to follow, wherever possible, is to replace the cathode type tube with a cathode type tube, and a filament type tube with a filament type tube. Then make certain that the voltage-drop in the tube being substituted is approximately the same as in the tube that was replaced. Otherwise the voltage supplied to the filter condensers may be so high as to exceed their rating.

The substitution of a cathode type rectifier tube for a filament type rectifier tube invariably results in an additional voltage

Learn Right
FROM THESE 8 STANDARD TEXTS



Rider Radio Books are used as texts in teaching radio to members of all our armed forces.

In addition to their use in all our armed forces, Rider Radio Books are used in such famous technical schools as MIT, University of Pennsylvania, Georgia Tech., Virginia Polytech, Harvard and Syracuse. The standard among professional Radio Technicians for years, YOU can learn easier and better from them. Order today.

FREQUENCY MODULATION
Gives principles underlying this new type radio transmission. Goes into adjustment and repair of FM receivers. Selling 1,000 copies a month. 136 pp.—\$1.50.

OSCILLATOR AT WORK
Shows how to get maximum utility, test and repair all kinds of oscillators—one of most important pieces of radio servicing equipment. 243 pp.—\$2.00.

SERVICING BY SIGNAL TRACING
Explains this fundamental system of radio servicing, which has been embraced by thousands of professional repairmen. U.S. Coast Guard is one of the many Government institutions to adopt it. 9th printing 360 pp.—\$3.00.

AN-HOUR-A-DAY-WITH-RIDER SERIES
Fundamental books every radio beginner should read to provide solid foundation for advanced study. on Resonance and Alignment on Automatic Volume Control on D-C Voltage Distribution on Alternating Currents in Radio Receivers
Hard covers—90c each.

AUTOMATIC FREQUENCY CONTROL SYSTEMS
On new push-button radios. Explains simple and complicated a-f-c and automatic tuning systems. 143 pp.—\$1.25.

METER AT WORK
Elementary, Theoretical and practical. Covers all kinds of electric meters. 5,000 copies sold past 3 months. 152 pp.—\$1.50.

VACUUM-TUBE VOLT-METERS
Favorite tools of radio engineers and servicemen. v-t volt-meters are explained theoretically and practically in this newly published book. Advance orders required second printing. 179 pp.—\$2.00.

CATHODE RAY TUBE
This book is the accepted authority on the cathode-ray tube—how it is employed in the oscillograph—and its application to radio servicing. Now in 12th printing. 338pp.—\$3.00.



Send for New Catalog

JOHN F. RIDER PUBLISHER, Inc.
402 FOURTH AVENUE, NEW YORK CITY
Export Division: Rocke-International Elec. Corp., 100 Varick St., N. Y. C. • Cable: ARLAB

of 30 to 50 volts being available across the filter, and means that the filter condensers will have to take this extra voltage. If they are already operating close to their maximum rating, this will probably result in premature filter condenser failure.

The substitution of a filament type tube for a cathode type tube will usually result in less voltage finally being applied across the filter condenser.

However another situation that may arise in connection with this type of substitution may be very serious. This comes about because the filament type tube heats up within two seconds, whereas the cathode type rectifier tube requires about nine seconds before the operating temperature reaches a value sufficient to permit normal operation of the tube.

Most present day receivers employ cath-

ode type output tubes which also require about nine seconds before they are ready to operate satisfactorily. When a combination of cathode type output tubes and cathode type rectifier tubes are employed, voltage is available across the filter when the output tube is ready to draw current so that the voltage across the filter condenser rises slowly. If, however, a fast heating filament type tube is substituted in place of the cathode type rectifier, the rectifier tube will supply voltage to the filter after two seconds but the drain on the receiver will be practically nothing until nine seconds has elapsed. This means, therefore, that the voltage available across the filter system will be very high due to the fact that low current is being drawn.

This voltage in extreme cases may be (Continued on page 448)

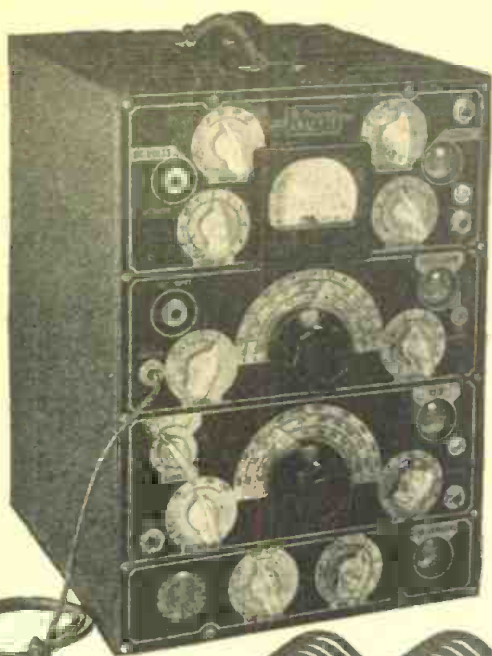

- Locates Faults by "Signal Tracing"
- Every Channel on a Separate Panel
- All Controls Fully Calibrated
- Shielded Test Cables and Prods
- All Terminals on Front Panel
- New 4-Range Electronic Voltmeter
- Wide-range Audio Test Channel
- Oscillator Trouble-Shooter Channel
- 95-1700 kc RF-IF Channel
- Line Current Indicator Channel
- Measures Gain, Stage by Stage
- Locates Intermittent Faults Faster
- Checks Alignment of Receivers
- Pays for Itself in Faster Service
- Voltmeter Input is 10,000,000 ohms
- All Channels May be Used at Once
- Uses Four Electron-Ray Indicators
- Operates on 110-volts, 60-cycles
- Faster—More Profitable Servicing
- Portable—Convenient to Use

LOCATE TROUBLE QUICKLY!

The MEISSNER Analyst

with 4 Range Electronic V. M. Undoubtedly the most modern complete servicing instrument on the present day market . . . the Meissner Analyst has the ability to locate obscure faults . . . in any make of receiver. Entirely fundamental in its testing procedure, the Analyst will not become obsolete. Faults are located by the signal tracing method—proven to be the fastest and most reliable method known at the present time. The Analyst is not however just another signal tracer. It has been thoroughly engineered to do this work with peak efficiency.

Five separate and distinct channels provide as many different functions, each is separated in its own panel division and all controls are accurately calibrated with functions clearly indicated.

The Meissner Analyst is completely wired, aligned and laboratory tested. Shipped complete with 12 tubes—ready to operate. Net price \$96.50.

See your Meissner distributor, or write for complete catalog



Meissner

MT. CARMEL, ILLINOIS

"PRECISION-BUILT PRODUCTS"

PRACTICAL AUDIO AMPLIFIER THEORY

(Continued from page 417)

superior "quality," its lack of a peaked response curve and transient distortion effects across inductive loads, and its lower harmonic output. Its low mu, low gain and low plate resistance, its "heavy" tone quality and its good "bass" are obtained without the need for phony tone controls. How any radio man can question the power triode's fidelity superiority, taking tube against tube, is rather difficult to understand.

However, there are conditions under which this superiority will not stand up, and for many commercial purposes the beam power tube has so many all-round advantages that the power triode is not even

given a minute's consideration in the design rooms of most plants. It is not as a tube in itself that the triode loses its advantages but as a unit in an audio circuit as a whole.

It must be remembered that the power sensitivity of the beam-power tube is much greater than that of the triode. Its grid bias is only one third that of the triode's, (under similar operating conditions) and therefore it requires only about one-third the driving signal.

It is for this reason that the writer used the 6L6's in the amplifier discussed. Listening tests bore out the above line of reasoning, and the use of the beam-power

tubes resulted in superior all-round results because the low-gain triodes were used.

Where factors, other than fidelity, are under consideration the beam-power tube has so much superiority it is given first choice. In commercial work, where large power output, high power sensitivity, reasonable distortion, and high efficiency, all at low cost, are concerned, the beam-power tube stands supreme. A pair of 6L6's can put out from 18 to 55 watts of audio power (depending on whether Class "A" or "AB2" circuiting is used) with the use of ordinary power supplies and surprisingly nominal amounts of plate current.

To minimize distortion in the Class "AB2" circuits, inverse feedback may be used, with good results.

BIAS CONSIDERATIONS

The cathode resistor and by-pass condenser are standard and not much need be said about them. The electrolytic by-pass condenser used has a heavy capacitance rating to allow for the drying effect of age. A heavy wattage resistor was used in order to keep down temperature and consequent changes in resistance and to reduce chances of failure. The use of an extra-heavy by-pass condenser insures a long time constant and helps prevent degeneration low frequencies.

BALANCED OUTPUT

The power output tubes were matched tubes and their plate currents were the same, in order to set up a balanced output stage, and to eliminate the need for separate biasing of the two tubes.

All power tube leads should be kept as short and direct as possible, criss-crossed over each other and not too close to each other, for under certain conditions power tubes may oscillate at one or more high frequencies and generate distortion.

The voice-coil and the frame of the speaker should be carefully grounded as well as the output transformer case.

A Class "A" circuit was chosen because it was desired to obtain the utmost in fidelity. It should be noted that while a Class "AB1" circuit puts out much more power, with the same distortion, than a Class "A" circuit, so far as comparative tube ratings is concerned, this does not always hold good in actual practice.

It should be noted that the change in total cathode current, with signal swing, is smaller for a Class "A."

It should be noted that the change, in cathode current, with signal swing, is much smaller with Class "A" operation than it is with similar circuits based on Class "AB1" or "AB2" operation. This means greater power-supply stability, and therefore less distortion.

A SMALL INTERPHONE

(Continued from page 418)

This range is sufficient for good, clear (understandable) tone quality. The cut-off at 350 cycles is accomplished deliberately by means of the 0.001-mf. condensers, C7. This is necessary, due to the fact that most loudspeakers have a decided peak in the region of 150 cycles. The combination of 2 such peaks in combination with the cavity resonance of the cabinets results in muffled and "boomy" tone unless the low frequencies are attenuated. In case a tone control is desired, the inter-tube coupling condensers, C7, should be of the variable type,

NOW WESTON MODEL 785 INDUSTRIAL CIRCUIT TESTER!



Tests Insulation and Cable Covering Resistance Values as Well!

With this new, compact unit which fits into the spare compartment and connects into the ohmmeter circuit with a pair of leads, Model 785 now provides for resistance measurements up to a value of 900 megohms. Thus the broad range coverage of this versatile maintenance tool now is as follows:

DC VOLTAGE . . . 0-1/10/50/200/500/1000 volts — 20,000 ohms per volt. (*5000 volt range with external multiplier.)

AC VOLTAGE . . . 0-5/15/30/150/300/750 volts — 1000 ohms per volt.

DC CURRENT . . . 0-50 microamperes, 1/10/100 milliamperes, 1 ampere and

10 amperes (*ranges above 10 amperes with external shunts).

AC CURRENT . . . self-contained ranges 0-.5/1/5/10 amperes (*higher ranges with an external current transformer).

RESISTANCE . . . 0-3000, 0-30,000, 0-300,000 ohms, 0-3 megohms, 0 to 30 megohms (self-contained batteries). 0-900 megohms (*with compact Model 792 Resistance Tester shown in illustration).

*Extra equipment on special order.

For complete facts on Model 785 write Weston Electrical Instrument Corp., 599 Frelinghuysen Ave., Newark, N. J.

WESTON Instruments

HARRISON HAS IT!

Echophone

COMMUNICATIONS RECEIVERS



MODEL EC-2

- Model EC-2 \$42.50
- Model EC-3 59.50
- Model EC-1 24.50

HALLICRAFTERS

- Sky Buddy S-19R \$32.50
- Sky Champion S-20R 54.50

Orders for these receivers should carry a priority rating of AA-4, or better. Not available for individual civilian use. Apply at your local War Production Board.

CODE PRACTICE SET

Buzzer and key, heavily nickel plated, of single unit construction, mounted on wood base. Adjustable high frequency pitch. Complete with silk covered cord, in attractive box with code chart on cover. Works on one or two flashlight or dry cells.

Postpaid—\$2.45

6L6G TUBES

First grade, meter tested, fully guaranteed.

Postpaid—\$1.37 each

(Three for \$3.75—postpaid)

P. M. DYNAMIC SPEAKERS

5 inch, with output transformer to match single plate of 8000 ohms \$1.95

Magnavox, 10 inch. 16 ounce magnet! 6 ohm voice coil \$5.25 (Not postpaid)

Immediate delivery of the above items, without priority, while quantities last. SEND REMITTANCE WITH ORDER. TODAY! (Money back if not satisfied.)

HARRISON

RADIO CORPORATION

11 WEST BROADWAY

NEW YORK CITY

NAZIS 10 SECONDS LATE!

WONDER if any of you fifth columnists who habitually listen to the transmissions of the Axis stations have observed the curious background of noise which accompanies all programmes. When I first noticed it I suspected my set, and promptly disembowled it. I do not, of course, mean the normal slight background noise which is inevitable when receiving any station other than a purely local one, but a curious "breathing" noise which radio men of an older generation will always associate with the magnetic detector.

It was this very resemblance to the magnetic detector background which gave me the clue to the puzzle as there flashed into my mind that there is another and more modern radio-associated instrument which also makes use of a moving-iron band, namely, the steel-tape recorder, or Blattnerphone, as some people invariably call it. If you listen to the B.B.C. programmes when they are being re-transmitted by one of these moving-wire recorders you will instantly recognize the noise to which I refer. But whereas this faint but distinctive background noise is only heard from B.B.C. stations when recorded programmes are being given, it is an inevitable accompaniment to all Axis transmissions.

For a long time I was puzzled as to why the Axis stations, and the German ones in particular, were apparently making use solely of recorded programmes, but what really aroused my interest was the discovery that, judging by the fact that the same background noise was present, the German time signals were recorded, too. The absurdity of such a procedure nearly led me to abandon my theory until I made the still more remarkable discovery that the time signals were invariably ten seconds late. Having studied Conan Doyle's "Science of Deduction" in my youth, it did not take me long to fathom the mystery, the accuracy of my solution being subsequently confirmed by interrogation of a certain highly placed prisoner of war who fell into our hands some time ago.

The programmes including the time signals are all coming from a recording, but they have been recorded only ten seconds previously. The signals from the microphone, instead of being passed to the transmitter in the usual manner, are fed to the recording coil of steel-tape instrument. A short distance along the taps is a pick-up coil which passes the signals to the transmitter, the distance between the two coils being such that it takes ten seconds for any given point on the tape to traverse it. Therefore broadcast items are all subject to ten seconds' delay.

Half-way between the two coils is a wipe-out coil connected to a switch on which rests the heavy hand of a Gestapo agent wearing headphones connected to the microphone output. Thus the Nazi broadcasting system is protected from any subversive remark suddenly shouted out by a broadcaster. Musical programmes are similarly treated because of the revelations I recently made about Morse signals being interwoven into musical items by our friends in Europe.—Wireless World, London.

BUY WAR BONDS
AND HELP WIPE
OUT THE AXIS

NEW RADIO-CRAFT LIBRARY BOOKS

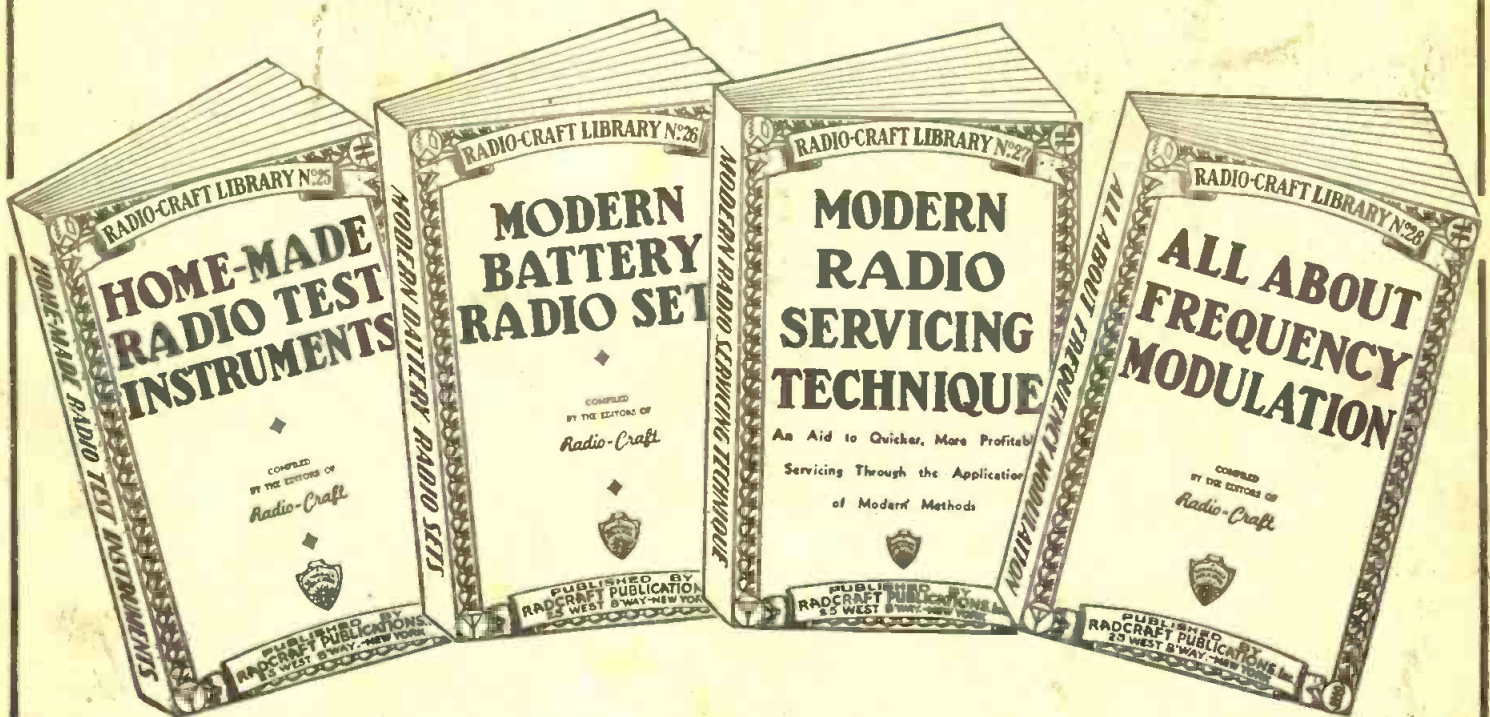

THE four latest books of our well-known RADIO-CRAFT Red Books—Nos. 25, 26, 27 and 28—recently published.

These four books are all on timely subjects and we recommend every one of them to you strongly.

Now, more than ever, radio education has become a burning question. If you are to be in the National Service; in the Army, Navy or Air Force—practical radio knowledge is of paramount importance. **YOU CAN GET BETTER RATINGS AND ADVANCE QUICKER IF YOU HAVE A GOOD RADIO BACKGROUND.**

Conversely, if you are not with the armed forces, there is a whole of a job to be done at home. With more and more men going into the service, the demand for practical servicemen becomes greater each day. Therefore we say: **PROFIT BY THESE UNIQUE BOOKS, WHICH ARE PRICED SO LOW THAT THEY ARE WITHIN THE REACH OF EVERYONE'S PURSE.**

No. 25—HOME-MADE RADIO TEST INSTRUMENTS

This book includes articles covering a wide range of test apparatus of live interest to every radio man. Servicemen will find many circuits in this book to make their work more profitable. New ideas in test equipment make it possible to service radio receivers more quickly.

Laboratory workers and experimenters will find many articles which describe in detail construction and use of all essential radio test units—multi-meters, oscillators, stage-analysis testers, oscilloscope equipment, V.-T. voltmeters, etc. Even advanced technicians will be interested in the circuit arrangements showing the new and improved variations of well-known, basic test equipment. A MUST for every serviceman. This book contains 86 illustrations.

Outline of Contents: A Low-Cost Signal Chaser—Signal Tracer Test Unit—Simplified Practical Signal Tracer—A Home-Made Infinite-Resistance Tube Checker—Build This Direct-Reading V.-T. Voltmeter—How to Make a Modern V.-T. Voltmeter—Measuring High Values of A.C. Voltage and Current With a Low-Range Meter—How to Make a Meter-Range Extender—How to Build a Practical Tube Tester and Set Analyzer Adapter—The Beginner's Simple Volt-Milliammeter—Build This Simplified Neon-Type Test Unit—Midget Oscilloscope—How to Make and Use a Frequency Wobbler—Double Tracing Your Oscilloscope—Home-Made Frequency Modulator.

No. 26—MODERN BATTERY RADIO SETS

Whether you are a radio man or a beginner, the articles in this book give you basic circuit arrangements or elementary radio receivers which serve the dual role of teaching the elements of radio reception, as well as making perfectly operating 1- and 2-tube radio receivers. Picture diagrams and bread-board layouts galore.

Advanced radio set builders are offered more complicated arrangements. Laboratory workers and engineers will find in many of the articles circuit and constructional features which have become commercial practice. Many entirely new ideas are given in this book. One of the most important volumes we recently issued. This book contains 76 illustrations.

Outline of Contents: Beginner's 1-Tube High-Gain All-Wave Receiver—Beginners-Build This 1-Tube Loop Receiver—A "3-in-1" Battery Portable—An Easily-Built "Flewelling Superregenerative" 2-In-1 "Card File" Battery Set—A 2-Tube Superhet. With Pentagrid Regenerative 2nd-Detector—The 4-Tube Superhet. Vacation Portable—The "Lunchbox 5" Battery Portable—"The Seafarer" Loop-Type Boat Radio Set—4-Tube Permeability Portable—An All-Purpose Portable—A Typical Commercial 3-Way Portable (Pilot Models X-1452 and X-1453)—Switch for Varying "C" Bias on Battery Radio Sets—Making a Simple Portable Aerial—Making a Pilot-Light Fuse—Old Auto Sets for New Cars—Using a Loop Portable in Cars—Quasi-Electric Soldering Iron—Lamp Bulbs as Resistors.

No. 27—MODERN RADIO SERVICING TECHNIQUE

Here is a book of great importance to every radio man, every radio engineer, and particularly all radio servicemen. A list of the contents which follows shows the importance of this book. Literally jam-packed to overflowing with radio-meat. Whether you are a servicing beginner or whether you are an experienced serviceman—you will find many important helps in this volume.

Book is eminently practical and will solve many problems for you. More important: It will show you many short-cuts, all calculated to save your time and patience. Practical everyday data on standard receivers appears throughout the book. A whole of a book compressed into a minimum of space. Contains 96 important illustrations.

Outline of Contents: Elementary Servicing Technique—Correct Procedure for the Servicing Beginner—Elementary Procedure for Servicing Radio Sets—A.F.C. Alignment Made Easy—Dynamic Servicing—Dynamic Testing Simplified Servicing—Modern Receiver Test Requirements—Servicing Universal A.C.-D.C. Receivers—Servicing "Orphans" and Private-Brand Sets—Emergency Servicing Without Test Meters—Servicing Coils—Servicing R.F. Coils—Servicing Oscillator Coils—General Information—RMA Transformer Color Code—What Causes Echo, Fading?—Radio Service Puzzlers.

No. 28—ALL ABOUT FREQUENCY MODULATION

Here is a complete compilation of pertinent data on the entire subject of the new coming art of Frequency Modulation.

There is no question but that Frequency Modulation is already revolutionizing radio broadcasting in this country. Were it not for the war, there would now be a tremendous boom in this new art—yet, even with war restrictions imposed upon it, Frequency Modulation is still jumping ahead by leaps and bounds.

With Frequency Modulation no longer a theory—with hundreds of stations already dotting the land and with countless hundreds of others to come when peace is achieved once more—every radio man should read up and know all there is to know on this most important subject.

This particular handbook is chuck-full with a tremendous amount of information which you probably will not find in any similar book in print.

Outline of Contents: The ABC of F.M.—Frequency vs. Amplitude Modulation—Basic Facts About F.M. Broadcasting—Construction—Build This Practical F.M. Adapter—Audio Amplification—F.M. Audio Amplifier, Part 1—F.M. Audio Amplifier, Part 2—F.M. Audio Amplifier, Part 3—F.M. Service—Part 1, Antenna Installation and Service—Part 2, Receiver Alignment and Diagnosis—Part 3, Test Equipment for F.M. Servicing, Engineering—Part 1, The How and Why of F.M.—Part 2, The How and Why of F.M.—Theory and Design Considerations of R.F. and I.F. Coils in F.M. Receivers.

SPECIAL SEND-NO-MONEY OFFER

It is not necessary that you send money with order. If you wish to take advantage of our C.O.D. plan, simply cut out the coupon, paste it on a post card and send it to us. Books will be sent to you immediately.

All four books are listed uniformly at 50c each. No discount on less than three books.

If you wish to take advantage of our special offer, ordering three books or more, we make an unusual low price to you as follows:

3 books—\$1.25
4 books—\$1.50

Do not fail to send coupon today!

RAD-CRAFT PUBLICATIONS, INC.
25 West Broadway, New York, N. Y.

RAD-CRAFT PUBLICATIONS, INC. 443
 25 West Broadway, New York, N. Y.
 Gentlemen:
 Rush to me by return mail, as per your special offer, the following books: (Check books selected.)
 No. 25—HOME-MADE RADIO TEST INSTRUMENTS.
 No. 26—MODERN BATTERY RADIO SETS.
 No. 27—MODERN RADIO SERVICING TECHNIQUE.
 No. 28—ALL ABOUT FREQUENCY MODULATION.
 I will pay postman \$1.00 (if two books are ordered) plus a few cents postage and charges; \$1.25 for three books, plus a few cents postage and charges; \$1.50 for four books, plus a few cents postage and charges. WE CANNOT SEND A SINGLE 50c BOOK C.O.D.
 NAME PLEASE PRINT CLEARLY
 ADDRESS
 CITY STATE
 Save shipping and C.O.D. charges! Check here if you send cash with order. (Cash, U.S. new postage stamps, money order, check.) Foreign countries no C.O.D. Add 20% to all prices quoted.

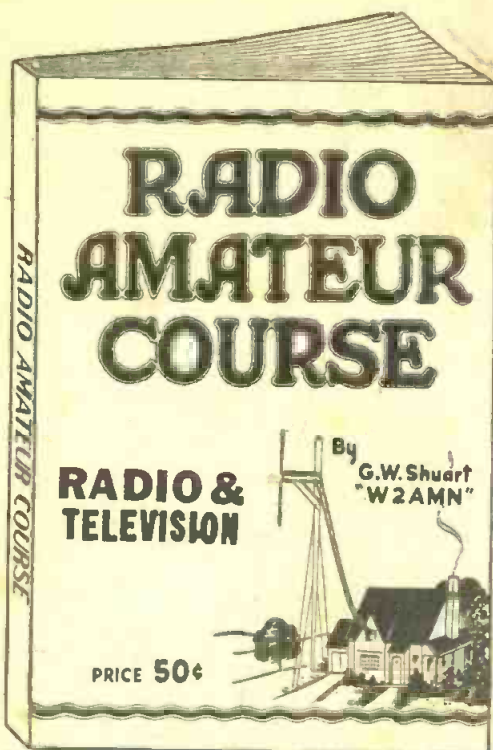

RADIO AMATEUR COURSE

RADIO & TELEVISION



PRICE 50¢

148 PAGES

6 x 9 INCHES

OVER 150 RADIO DIAGRAMS and TECHNICAL PHOTOGRAPHS

RADIO AND TELEVISION

25 West Broadway New York, N. Y.

Your Money Back—

If the **RADIO AMATEUR COURSE** does not represent the greatest book value ever offered to the radio "fans" for **50c**

To convince you that there isn't a better book buy today, the publishers of the **RADIO AMATEUR COURSE** make the sensational offer of a money-back guarantee on such a low-priced book. Stop in at any of the many dealers handling this book and examine it. See for yourself if the **RADIO AMATEUR COURSE** isn't just the book you've always wanted.

Printed on the finest coated paper—well illustrated attractive 4-color cover—complete with radio information you must have. It contains a step-by-step program for obtaining a short-wave radio education.

Written by **George W. Stuart, W2AMN**
foremost short-wave authority

RADIO AND TELEVISION
25 West Broadway, New York, N. Y.

Gentlemen: I enclose herewith my remittance of Fifty Cents (50¢) for which please send me POST-PAID, my copy of the **RADIO AMATEUR COURSE**. (Remit by check or money order; register letter if you send cash or unused U. S. Postage stamps.)
PLEASE PRINT CLEARLY

Name

Address

City State RC-4-43

lead is grasped, and not the wire itself, the circuits under test will not be thrown out of tune sufficiently to be noticeable. A very small condenser, however, must be used on the end of the test prod itself. An old neutralizing condenser such as was used in old style Fada T.R.F. sets lends itself admirably to this purpose.

USING THE TRACER

Turn up the gain control of the signal tracer to about half-way, and hold the test prod to the input grid of the receiver under test. Tune-in a local station, or signal generator, on the set under test. When the signal is tuned-in it should be quite audible in the headphones. Proceed from grid to plate on through, noting gain if any, until the I.F. stage is reached. At this point it may be necessary to slightly retune the set under test, as the R.F. stages are very sensitive to even very minute changes in capacity. Once the I.F. circuits have been reached however, no such disturbance will be manifest. Proceed right on to the second detector with the R.F. prod. The signal will quit coming through when the dead spot is reached. When making an R.F. search, always be sure to use the small condenser on the end of the test lead and not a resistor, because if the latter is used, very feeble audio currents if they exist anywhere in the chassis will feed through and be amplified and confuse the search.

If it is desired to check the second detector without any R.F. amplification obtained from the signal tracer, connect the test prod to tip jack terminal No. 2.

HUM TRACING

For audio frequency and hum search, connect the test prod to terminal No. 3, and use a 50,000-ohm resistor on the end of the test prod. As very high voltage-amplification is secured, a piece of shielded crystal microphone cable with the shield grounded to the chassis of the signal tracer should be used. This cuts out hum and other strays so well that it is well worth the trouble of making up this kind of a lead. In making this test it will be found very easy to trace down sources of hum. With the gain control turned well up, hum will be indicated without actually making contact to the source of trouble, by just bringing the test prod near it.

OPPORTUNITY AD-LETS

Advertisements to this section cost 15 cents a word for each insertion. Name, address and initials must be included at the above rate. Cash should accompany all classified advertisements unless placed by an accredited advertising agency. No advertisement for less than ten words accepted. Ten percent discount six issues, twenty percent for twelve issues. Objectionable or misleading advertisements not accepted. Advertisements for May, 1943, issue must reach us not later than April 10, 1943.

Radio-Craft • 25 W. B'way • New York, N. Y.

HANDY TESTER AND SIGNAL TRACER

(Continued from page 411)

when it is desired to use the power supply for other purposes without the load of the rest of the rig, and a green pilot light across the filament winding. The filament and the "B" voltages of the tracer are switched by means of a D.P.S.T. switch on the 500,000-ohm volume control.

CIRCUIT DETAILS

In order to secure maximum R.F. gain the plate resistor of the 6K7 should be 2400-ohms, and the screen resistor 0.1 meg-ohms. The plate coupling condenser should not be over 100 mfd. Use a bias cell or small flashlight battery in the grid lead of the 6SQ7 at the volume control end. Don't forget to include the .001-mfd. condenser from 6SQ7 plate to ground, or the .005-mfd. condenser from plate to cathode of the 6C5, or serious feedback trouble will be encountered. The grid lead of the 6SQ7 should be shielded with "snakeskin", as this is a high-gain tube.

LINING UP THE TRACER

The signal tracer may be tested when complete by connecting a tuning condenser with coil and aerial and ground to the 6K7 input. Local stations should come in very loud and clear. When used to check a receiver, the chassis of the signal tracer should be grounded and connected to the receiver under test. It is not necessary or advisable to use co-axial cable for the R.F. test lead. Use an ordinary test lead, but not longer than two feet. The shorter the better. As long as the bakelite handle of the test

ALIGNMENT, CONTINUITY AND LEAKAGE TESTS

Connecting terminal No. 4 to the A.V.C. circuits will provide the use of the 6E5 for alignment purposes and to check voltages, etc.

A.C. continuity checks may be made with test leads at terminals Nos. 6 and 12, with a jumper between 7 and 11. Remove the ground connection between the signal tracer and the chassis under test.

Condenser leakage tests may be made with prods at 8 and 12, with jumper between 14 and 11 for 250-300 volts D.C.; or test prods at 9 and 12 for 110-volts D.C. Be sure to include sufficient resistance in series with the neon lamp before testing with voltages over 115 volts.

If an audio-frequency signal is desired to test out an amplifier, this may be generated with the signal tracer by connecting the jumper between the headphones output terminal and terminal No. 2. Adjust the gain control until the desired tone is secured. The output may be had by connecting to terminal No. 3. This will give the audio-frequency voltage through a 0.01 mfd. condenser.

WANTED: CHANNEL ANALYZER. CONDENSER Tester. Oscillator. Signal Generator. Cabon, 629 Ardmore, Ferndale, Mich.

SONG POEMS WANTED TO BE SET TO MUSIC. Send poem for immediate consideration Five Star Music Masters, 415 Beacon Bldg., Boston, Mass.

WANTED: OSCILLOSCOPES, VOLT-OHM-MILLIAMMETERS, Vacuum-tube Voltmeters—RCA, Hickok, Supreme, Precision, or equivalent makes. Hallierafters, SX28, SX25 Receivers, Super Pro's and HRO's. Also 0-1 milliammeters and 0-5, 0-10, 0-25 AC or DC ammeters, 3-inch size. Idle test units and meters are needed for the war effort. Help train thousands of radio personnel by selling your equipment now. Send equipment for liberal appraisals to Allied Radio Corporation, Dept. 2X-D-3, 833 West Jackson Boulevard, Chicago.

TRUETONE CODE PRACTICE SET. PROFESSIONAL Type Key and De Luxe Buzzer. Complete Only \$2.35. Rathert Electric Company, Cresco, Iowa.

EVERY RADIO STORE

AND RADIO SERVICE MAN

will want to Display the one and only one of its kind—**HAWKINS RADIO SERVICING CARD**. It Builds GOOD-WILL, by telling the customer how many reasons there can be for each kind of trouble. Details Free. **HAWKINS SPECIALTIES**, 537 S. Dearborn St., Chicago.

USED Correspondence Courses

Illustrated bargain catalog FREE. Write today! **NELSON COMPANY**, 500 Sherman, Dept. D-210, Chicago

COMPLETE HOME-STUDY COURSES and self-instruction books, slightly used. Ad. rented, exchanged. All subjects. Satisfaction guaranteed. Cash paid for used courses. Full details and 84-page

A COMPACT A.C.-D.C. PORTABLE

(Continued from page 409)

tinue with the power supply, filaments, output stage, screen-grid circuit of the detector, and the tuning circuit. No particular scheme of assembly and wiring is necessary, but the above proved convenient. Since the wiring is open on so many sides, there should be no trouble getting the soldering iron to the various points. A little common sense and some forethought should simplify matters.

COIL

The coil should be wound on a form, 1-inch in diameter, and about 1 3/4" long. Any fibre or bakelite coil-form of this size salvaged from an old radio will serve very well. However a coil form can be made of almost any insulating material that can be had in these dimensions. A piece of dowel pin thoroughly soaked in paraffin wax will do.

The coil should be wound with No. 36 enameled copper wire, 130 turns, grid to tap, and 2 3/4 turns tap to ground, close wound in a single layer. For a hand-wound coil this will turn out about 1" long. This coil with the condensers shown will give good coverage of the broadcast band, if located as in the author's set.

Most experienced constructors will recognize the possibilities of using plug-in coils to cover other bands. The set in the photographs has a plug-in coil, but it is not expected that this feature may be used much. Those desiring it can easily work out suitable socket and coil forms from materials on hand. There do not seem to be any regularly available suitable plug-in coils for this type of set. The author salvaged a "B" battery terminal socket, a battery plug, and a Philco coil-form, to make up the coil shown in the photographs. Tube bases, wafer sockets, etc. are excellent materials for such use.

TESTING

Check over the circuit carefully before trying it out. When sure there are no mistakes, plug in the tubes, and connect the set to the line. There is no switch, so plugging it in turns it on. Allow a minute for the set to warm up. Advance the volume control, and tune like any regenerative detector.

Turn up the regeneration control until a rushing sound, or a whistle, or a squeal, is heard from the speaker; now, back off the regeneration control until this just stops. Then rotate the main tuning condenser until a signal or a squeal is heard. Then tune it in exactly, by using the bandspread condenser. When a squeal indicates a station, the station is right at the center of the two squeals which are heard on each side of the true position. If there is any whistle or mushiness with the signal, back off the regeneration until it just disappears. Maximum volume is to be had just before oscillation starts. Practice will make the whole thing an automatic procedure.

ANTENNA TRIMMING

The antenna trimmer-condenser should be set for maximum volume with the antenna you intend to use, by means of an insulated screw driver through the hole in the

front of the panel. Once set this may be left alone as long as the same antenna is used for that band. You should also try reversing the plug in the line socket to get better results. Maximum volume will be obtained when the grounded side of the 117-volt line is connected to the ground or return side of the set circuit.

When used in a fixed location this set can be connected to a good outside antenna, and its performance correspondingly increased. However, it is intended to work from a short portable antenna, and may be expected to do so whenever there are stations within a reasonable radius.

Parts List

CONDENSERS

- 1-140 mmfd. variable, Hammarlund Star Midget
- 1-50 mmfd. variable, Hammarlund Star Midget
- 1-3-35 mmfd. midget mica compression trimmer
- 3-100 mmfd. midget mica
- 1-.05 mfd. 400 volt paper
- 2-.01 mfd. 400 volt paper
- 2-8 mfd. 150 volt dry electrolytic
- 1-20-20 mfd. 150 volt dry electrolytic
- 1-10 mfd. 25 volt dry electrolytic

RESISTORS

- 1-2-Megohm 1 watt
- 1-30,000 ohm 1 watt
- 1-500,000 ohm 1/2 watt
- 1-2,000 ohm 1 watt
- 1-200 ohm 1/2 watt
- 1-50,000 ohm Centralab N115, variable
- 1-500,000 Centralab N103, variable
- 1-3,000 ohm 10 watt, wirewound
- 1-250 ohm 20 watt, wirewound

MISCELLANEOUS

- Midget output transformer, 2,000-ohm primary, 8-ohm secondary
- 2 1/2" Permanent magnet Cinaudagraph speaker
- 70L7GT/G tube
- 12SJ7GT/G tube
- 2 Amphenoctal sockets
- 1 piece plywood, 6 1/2" x 4 15/16" x 1/4" thick
- Midget rubber plug
- 6 feet rubber-covered parallel lamp-cord
- Coil form, salvaged or otherwise, 1" diam. x 1 1/4" long
- 15 feet insulated No. 20 flexible wire, for antenna
- Hardware, wire, solder, etc.

CABINET

- 6 1/2" x 5 1/4" x 2 1/2" bakelite meter box, Lafayette K10531

CODE OSCILLATORS FOR THE BEGINNER

(Continued from page 424)

interruption oscillator. Any regenerative receiver can be made into a squegger type oscillator, if the tickler is made large enough, and if the regeneration control is turned up far enough.

You have no doubt noted that when the tickler or feedback condenser is turned beyond a certain point, the signal breaks into a loud howl. A key can be inserted in the B-battery circuit, and the receiver used as an audio oscillator. To make a detector oscillate well in this fashion, the tickler winding should be larger than it is when used as a detector, and the grid-leak should

be higher, about 10 megohms or more.

The reason this oscillator is not recommended is that it oscillates at radio frequencies as well as at audio frequencies, and may cause severe interference.

If it is convenient to use your receiver as an oscillator of this type, observe the following precautions:

Keep it well away from the aerial. Simply disconnecting it is not enough. Move the aerial lead one or several feet away. Have it tuned to a point in the broadcast band where there is no station. With these two

(Continued on page 439)

GUARDING COMMUNICATIONS WHERE THE GOING IS TOUGH!

SUPREME

TESTING INSTRUMENTS

The famous 504-A and other SUPREME Testing Instruments are on active duty in all parts of the world. Now more ruggedly built, more accurate and dependable than ever, SUPREME Instruments will be your logical choice when victory is won.



GREENWOOD, MISSISSIPPI

LEARN CODE the way you'll be using it by **SOUND**



The best way to learn to read code is by listening to code. The best way to learn to send code is by hearing your own sending repeated back to you. With the new All-Electric Master Teletype Code Teaching Machine, you learn code the natural, easy, fascinating way. Only instrument ever produced which records your sending in visible dots and dashes—then SENDS BACK your own key work at any speed you desire. There are NO PERFORATIONS—NO INK. Far superior to anything ever developed—a marvel of simplicity. That's why practically every school teaching code uses TELEPLEX. We furnish complete course, including the All-Electric Master Teletype, give you personal instruction with a MONEY BACK GUARANTEE—all at a surprisingly low cost. Write today for FREE catalog S4. No obligation.

TELEPLEX CO., 107 HUDSON ST., JERSEY CITY, N. J.

Headset Headquarters



Scientifically Built Heavy bar magnets greatly increase their efficiency.

Our Headphones are used, by the United States Canadian, New Zealand and South African Governments as well as other Governments not directly in the war. Folder C-4 illustrates rugged, unusually sensitive, dependable Cannon-Ball Headsets.

C. F. CANNON COMPANY SPRINGWATER, N. Y.



LOOK AHEAD YOUNG AMERICA

A new thrill for air-minded readers... up-to-the-minute: real news; fine articles. The perfect 3-point landing... flying, model building, air news. Get all 3 in every issue of

AIR-AGE

Large size 8 1/2 x 11 1/4 inches. Cramped full of actual photographs—scenes that will excite you. Leading authorities on aviation tell you just what you want to know.

On Sale Now...
All Newsstands
Special subscription offer.
10 issues for \$1.00 a copy

Clip a dollar to coupon and send now.

SILCO PUBLISHING CORP., Dept. R
160 West Broadway
New York, N. Y.

Send me the next 10 issues of AIR-AGE. My dollar enclosed (cash or money order.)

NAME.....
ADDRESS.....

**GEOPHYSICAL
PROSPECTING PRINTS
TREASURE FINDERS**



50c
EACH

BLUEPRINTS and INSTRUCTIONS

For Building the Following Treasure Finders and Prospecting Outfits

Folder No. 1. The "Radioflector Pilot"—consists of a 2-tube transmitter and 3-tube receiver. Principle: radiated Wave from transmitter loop is reflected back to receiver loop. Emits visual and aural signals.

Folder No. 2. The "Harmonic Frequency Locator"—Transmitter radiates low frequency wave to receiver, tuned to one of Harmonics of transmitter. Using regenerative circuit. Emits aural signals.

Folder No. 3. The "Beat-Note Indicator"—Two oscillators so adjusted as to produce beat-note. Emits visual and aural signals.

Folder No. 4. The "Radio-Balance Surveyor"—a modulated transmitter and very sensitive loop receiver. Principle: Balanced loop. Emits visual and aural signals. By triangulation depth of objects in ground can be established.

Folder No. 5. The "Variable Inductance Monitor"—a single tube oscillator generating fixed modulated signals and receiver employing two stages R.F. amplification. Works on the inductance principle. Emits aural signals.

Folder No. 6. The "Hughes Inductance-Balance Explorer"—a single tube Hartley oscillator transmitter and sensitive 3-tube receiver. Principle: Wheatstone bridge. Emits aural signals.

Folder No. 7. The "Radiodyne Prospector"—a completely shielded instrument. Principle: Balanced loop. Transmitter, receiver and batteries enclosed in steel box. Very large field of radiation and depth of penetration. Emits aural signals.

With any one of the modern geophysical methods described in the Blue-Print patterns, radio outfits and instruments can be constructed to locate metal and ore deposits (prospecting); finding lost or buried treasures; metal war relics; sea and land mines and "duds"; mineral deposits; subterranean water veins; oil deposits (under certain circumstances); buried gas and water pipes; tools or other metallic objects sunken in water, etc., etc.

Each set of blueprints and instructions enclosed in heavy envelope (9 1/2" x 12 1/2"). Blueprints 22" x 34"; eight-page illustrated 8 1/2" x 11" folder of Instructions and construction data. **50c**

The complete set of seven folders **\$3.00**
Shipping weight 2 lbs. (add 25c for shipping anywhere in U.S.A.)

TECHNIFAX

RC-443

1917 S. STATE ST. CHICAGO, ILL.

TECHNIFAX 1917 So. State, Chicago, Ill.

Enclosed herewith \$..... for which mail to address below:

Treasure Finder No. 1, 2, 3, 4, 5, 6, 7.

Complete set of seven folders.

NAME

ADDRESS

CITY STATE

RC-443

CONDENSERS, CHOKES, AND LENZ' LAW

(Continued from page 415)

miliar to every serviceman, and it is a shameful fact that many have no other way to check the condition of a condenser.

Now let's throw Sw2. Condenser C discharges, kicking the ammeter needle backwards with the same force it was kicked forward when voltage was applied originally. This looks reasonable, and is. The electricity that was put in is now coming out—the two plates are returning to a condition of equal voltage.

We see that a coil causes current flow to delay when voltage is applied to it—causes the current to lag behind the voltage. A condenser causes current to rush ahead of the voltage when it is hooked up in a circuit. After the initial period (called the "transient state") current passes through just as if no coil were there. In the condenser, no current flows at all after the first surge (if it's a good condenser). Coil and condenser are running true to form as opposites.

FILTERS

Fig. 5 shows us an ordinary power pack. We all know that the tube supplies current to the filter circuit—here made up of the coil CHOKE and the two condensers, C1 and C2—in a form called pulsating D.C. Sometimes it isn't even dignified by the title of D.C., but is referred to as rectified A.C. It is D.C., nevertheless, but a D.C. that comes in 120 packages per second. During each of these short periods, the current rises from absolutely nothing to a value far higher than we expect to get in our D.C. output circuit, and falls back to zero again. The voltage rises and falls with the current, as we

Meanwhile the voltage has fallen below the terminal voltage of C1, which was charged up to the peak voltage of the pulse. C1 starts to discharge—through the choke,

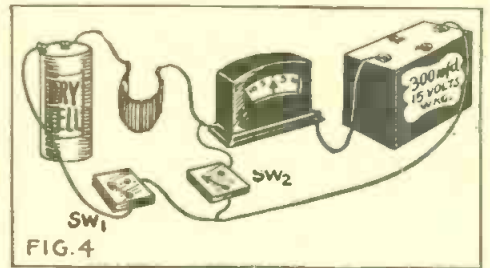
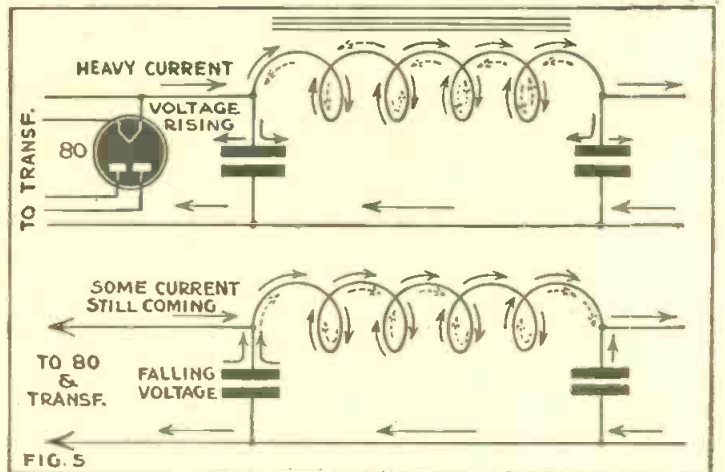

FIG. 4
Using a condenser instead of a resistance, the effect on current flow may be noted.

as it cannot send any current back through the rectifier. This adds still more current. As the amount of current received from the rectifier sinks to zero, C1 and CHOKE are furnishing all the current in the output. Before C1 has discharged very far, and before the field around CHOKE has entirely collapsed, another pulse has arrived and the function of C1 and CHOKE reverses. The condenser now begins to take electricity from the rectifier and the coil absorbs part of the rising current in its magnetic field.

Every serviceman knows that two condensers and a choke are sufficient to smooth out rectified alternating current to D.C., smooth enough for the finest receivers, if the condensers and choke are big enough.

So far we haven't mentioned C2. It also



Picture of current flow in the filter choke of a power pack. When the voltage is rising, the induced, or back E.M.F., is in the opposition direction. When the voltage is falling, the back E.M.F. persists in the direction of the original rising voltage.

well know in calculating "peak voltages" for filter condensers.

If we watch one of these pulses trying to get through the filter, we can understand how inductance and capacity work together to the same end. As the voltage and current rise, C1 begins to receive a charge and a magnetic field is set up around CHOKE. This field tends to slow down the flow of current, which the rising voltage drives into C1. As the voltage reaches its peak and starts to drop, the collapsing magnetic field around CHOKE supplies actual current to the circuit, trying more or less successfully to keep it from decreasing.

helps to smooth out slight variations in the output of CHOKE. More important to the receiver, it supplies extra current when sudden demands are made. When a bass note hits the Class-B and heavy current is drawn, it is C2 that supplies the additional juice and prevents receiver voltages from dropping.

We know now what inductors and capacitors will do to D.C. and R.A.C. (yes, that's rectified alternating current), but we are still in the dark as to what happens in A.C. circuits, where these parts are mostly used. Neither do we know what all this has to do with that mysterious quantity, PHASE.

PLATE AND SCREEN DISSIPATION RATINGS

(Continued from page 414)

signal, occurs because of the effect of plate-potential on screen-current, and is particularly noticeable when a high value of load-resistance is employed. This condition should be avoided, not only to maintain the screen dissipation within limits, but also

to keep the distortion at an acceptable value.

TYPICAL EXAMPLE

As a second illustration of zero-output and rated-output screen and plate condi-

tions we will survey the ratings for the 7C5, or the octal-based equivalent 6V6GT/G, when employed as a single-ended Class "A" amplifier. Maximum ratings are:

Plate Voltage.....	315 Volts
Screen Voltage.....	250 Volts
Plate Dissipation.....	12 Watts
Screen Dissipation.....	2 Watts

Recommended operating conditions are:

Heater Voltage.....	6.3	6.3	Volts
Plate Voltage.....	250	315	Volts
Screen Voltage.....	250	225	Volts
Grid Voltage.....	-12.5	-13	Volts
Peak Input Signal.....	12.5	13	Volts
Plate Current (Zero Signal).....	45	34	Ma.
Plate Current (Max. Signal).....	47	35	Ma.
Screen Current (Zero Signal).....	4.5	2.2	Ma.
Screen Current (Max. Signal).....	7.0	6.0	Ma.
Load Resistance.....	5000	8000	Ohms
Power Output.....	4.5	5.5	Watts
Total Distortion.....	8	12	Per Cent

For the 250 volt condition the dissipation values computed from the above figures show:

Zero output plate dissipation is $250 \times 0.045 = 11.25$ Watts
 Zero output screen dissipation is $250 \times 0.0045 = 1.125$ Watts
 Full output plate dissipation is $(250 \times 0.047) = 4.5 = 7.25$ Watts
 Full output screen dissipation is $250 \times 0.007 = 1.75$ Watts
 —Sylvania News

CODE OSCILLATORS FOR THE BEGINNER

(Continued from page 437)

precautions, the "squegger" can safely be used.

If a wire is attached between the antenna post of a "squegger" oscillator and the antenna post of your broadcast receiver, and the two tuned to some vacant spot on the broadcast band, you can use your receiver as an amplifier for your code practice signals. Be sure to take the outside aerial off the receiver first!

POWER SUPPLIES FOR BEGINNERS

(Continued from page 423)

is placed from B+ to B- (See Fig. 3), right after the rectifier, and before the choke. (This is called "condenser-input" filtering. Its opposite, "choke-input," will be discussed later.)

The most important thing about the filter condenser is its *working voltage*. The working voltage is the maximum D.C. that is placed across it by the rectifier. In the case under discussion, the D.C. output is about 300-volts. Hence the *working voltage* is 300-volts—at first glance. However, there is still some high-voltage A.C. running back and forth across this condenser, which is 1.4 times greater than the rated RMS voltage of 375, or about 525-volts! Hence, to prevent breakdown in service, or complete burn-out, it is advisable to use a condenser with a working voltage of 550-, 575-, or even 600-volts. The capacity does not have to be great. It may be 8-mfd. or less. It is the second or the third condenser in the filter that may be 16-mfd. or even 32-mfd., with the larger one across the output.

BLEEDER OR VOLTAGE DIVIDER

In many radios, both manufactured and home-made, the bleeder or voltage-divider is not even used. The set seems to work well without it. But if you are following a diagram which calls for its use, you want to know why it is used, and how its size should be calculated.

It is nothing more than a resistance across the output. It may be all one piece, or it may be tapped, or it may be a group of resistors, all hooked in series. No mat-

(Continued on page 446)

10 BEST RADIO BOOKS 10¢ ea.

RADIO FANS EVERYWHERE—these fine ten cent text books give you an excellent foundation for the study of RADIO. They are clearly written, profusely illustrated and contain over 15,000 words in each book. You'll be

amazed at the wealth of information contained in these handy books. Excellent for reference—ideal for every technical library. YOUR MONEY BACK if you are not satisfied. PROMPT SHIPMENTS

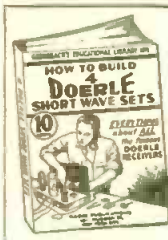

No. 1 HOW TO BUILD FOUR DOERLE SHORT WAVE SETS

Thousands of radio fans have built the famous DOERLE Short Wave Radio Receivers. So insistent has been the demand for these receivers, as well as construction details, that this book has been specially published.

Contains EVERYTHING that has ever been printed on these famous receivers.

No. 2 HOW TO MAKE THE MOST POPULAR ALL-WAVE 1- and 2-TUBE RECEIVERS

This book contains a number of excellent sets, some of which have appeared in past issues of RADIO-CRAFT. These sets have been carefully engineered. They are not experiments. Not only are these sets described in this book, but it contains all of the illustrations, lookups, etc.

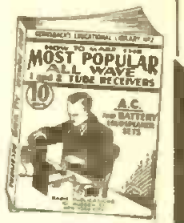

No. 3 ALTERNATING CURRENT FOR BEGINNERS

This book gives the beginner a foothold in electricity and radio. Electric circuits are explained. Ohm's Law, one of the fundamental laws of radio, is explained, the generation of alternating current; sine waves; the units—volts, amperes, and watts are explained. Condensers, transformers, A.C. instruments, motors and generators.

No. 4 ALL ABOUT AERIALS

This book explains the theory underlying the various types of aerials; the inverted "T", the Doublet, the Double Doublet, etc. It explains noise-free reception, how low-impedance transmission lines work; why transposed lead-ins are used. It gives in detail the construction of aerials suitable for long-wave broadcast receivers, for short-wave receivers and for all-wave receivers.

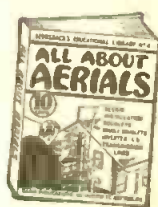

No. 5 BEGINNERS' RADIO DICTIONARY

Are you puzzled by radio language? Can you define Frequency? Kilocycle? Tetrad? Screen Grid? Beam Anode? Triode? Pole? Ionization? Joule's Law? Harmonic? Gravity Cell? If you cannot define these very common radio terms and dozens of other, more technical terms used in all radio magazines and instruction books, you need this book in your library.

No. 6 HOW TO HAVE FUN WITH RADIO

Stunts for Parties, practical jokes, scientific experiments and other amusements which can be done with your radio set are explained in this fascinating volume. It tells how to make a newspaper table-top radio, how to make visible music—how to make a "silent radio" unit usable by the deafened—how to make toys which dance to radio music, etc. etc.

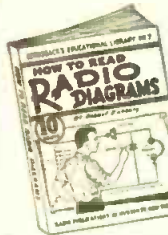

No. 7 HOW TO READ RADIO DIAGRAMS

All of the symbols commonly used in radio diagrams are presented in this book, together with pictures of the apparatus they represent and explanations giving an easy method to memorize them. This book by Robert Eichberg, the well-known radio writer and member of the editorial staff of RADIO-CRAFT Magazine, also contains two dozen picture-wiring diagrams of simple radio sets that you can build.

No. 8 RADIO FOR BEGINNERS

Hugo Gernsback, the internationally famous radio pioneer, author and editor, whose famous magazines, RADIO AND TELEVISION and RADIO-CRAFT are read by millions, scores another triumph with this new book. Any beginner who reads it will get a thorough ground work in radio theory, clearly explained in simple language, and through the use of many illustrations. Analogies are used to make the mysteries of radio clear.



No. 9 SIMPLE ELECTRICAL EXPERIMENTS

Over 100 interesting and practical electrical experiments are described in this book, covering every branch of electricity—from simple experiments with magnets to high frequency "stunts." All of the experiments described can be carried out with simple apparatus, most of which can be found about the home.

No. 10 TELEVISION

Every one is asking the question: How does television work? This book explains all of the different systems of television from the simplest to the most complex. It describes in A-B-C style just how the image is scanned, how the scene is picked up by the television camera and broadcast to your home, etc. Various types of television systems are described.



BOOKS ARE ALL UNIFORM

Every book in the GERNSBACK EDUCATIONAL LIBRARY has 32 pages—with illustrations varying from 30 to 66 in number. Each title volume contains over 15,000 words. Positively radio's greatest book buy! If you do not think these books worth the price asked, return them in 24 hours and your money will be instantly refunded.

Win \$10

by suggesting a title for a new Gernsback book! Each of the above books gives full details.

PRIZE WINNERS

ALFRED CETTIE, Seattle, Wash. Title: ALL ABOUT AERIALS. Book 4
 RUDY RUZICKA, St. Louis, Mo. Title: BEGINNER'S RADIO DICTIONARY. Book 5
 KENNETH WARNER, Burbank, Ohio. Title: HOW TO READ RADIO DIAGRAMS. Book 7
 CLYDE SORRELL, Rockyford, Colo. Title: RADIO FOR BEGINNERS. Book 8.

RADIO PUBLICATIONS • 25 WEST BROADWAY • NEW YORK, N. Y.

RADIO PUBLICATIONS, Dept. RC-4-43
 25 WEST BROADWAY, NEW YORK, N. Y.

Gentlemen: Please send immediately, POSTPAID, the book numbers circled below. I am enclosing.....cents —each book being 10c. No C. O. D. orders accepted.

1 2 3 4 5 6 7 8 9 10
 Send FREE listing of 48 new 10c publications.

Name Address

City State

Remit by check or money order—register letter if you send cash or unused U. S. postage stamps.

MAIL COUPON TODAY!

craft zooms at a speed of 500 miles per hour or more. These recording instruments, including electronic tubes, write "autographs" of the terrific strain imposed upon bombers and test flights as they dive, twist, and do other maneuvers at speeds that by comparison, would figuratively reduce those of fast railway trains to the fabled gait of the hare and tortoise. Electronic strain gages are mounted at strategic points on the aircraft to detect stresses in the structure—a stress detective, as it were. Stresses are translated into electrical impulses, which, when amplified by electron tubes, actuate sensitive oscillograph galvanometers. In turn, these electrical indicating devices deflect light beams of an optical system, the galvanometers then recording the strain-gage impulses on a photographic film. This apparatus is calibrated before the plane is subjected to flight tests and, therefore, the photographic film can be converted to either pounds per square inch of load on the aircraft structure, or by thousands of an inch deflection.

Measuring the creep of metals may sound like a fantastic attempt at determining the number of threads of a so-called measuring worm, but an electronic robot can reveal the rate at which metals flow when subjected to heat. No longer does a human observer eye the metal sample through a microscope; the electronic tube is more sensitive than a person, it works non-union hours, and without fatigue, although watching the creep or flow of materials may seem like the difficult undertaking of excavating a man from a well when he climbs up one foot and drops down two feet. Formerly, months were required in making such measurements with a bar of the sample metal, heated in a special furnace to the temperature range of 800 to 1,400 degrees Fahrenheit.

The new electronic method uses a thin wire of the metal under study—say, the makings of a steam turbine—passing electric current through the sample of wire until it heats to 2,000 degrees Fahrenheit. The wire is encased in a glass cylinder protecting it from air currents. A weight is attached to the wire. Here is how the novel creep-test operates: A light shines through a glass grid, ruled with horizontal black lines, each 1/250th of an inch wide and an equal distance apart. Affixed to the bottom of the test wire is another grid, almost in contact with the first grid. A lens forms an enlarged image of these grids on the surface of the photoelectric cell, which converts the light into electricity. An extremely sensitive meter—employing electron tubes—makes, in ink on a moving strip of paper, an "autograph" of the changes in current from the "electric eye"—therefore, in the changes in brightness or the movement of the second grid. Thus, it is possible to determine any extension of the wire to the infinitesimal fraction of 1/10,000th of an inch. Developing alloys that will hold their shape under great stress and high temperatures means more efficient steam turbines or other metallic equipment—hence the significance of measuring the creep or flow of metals.

PHOTO CELLS CONTROL CARS IN TUNNEL

When the 13-mile-long Continental Divide Tunnel, located between Grand Lake and Estes Park, Colorado, was constructed, an electronic device expedited the movement of men and materials flowing in both directions. The tunnel trains were operated on a 24-inch-gage single track, with shifting tracks at suitable intervals. This photoelectric block signal system indicated to the train crews the presence of a train in an-

other section of the tunnel. Manifestly, this warning prevented accidents, and also curtailed the time element at passing tracks during hauling operations. Oddly enough, this "electric eye" signal system was designed without mechanical or electrical switches connected to the rails—this arrangement prevented premature ignition of the blasting charge.

The track was divided into 6,000-foot blocks, each block ending wherever a turnout occurred for passing. At the beginning and end of each block two photoelectric relays were placed about 30 feet apart. These units controlled the alternating operation of red and green signals in any specific block. Each relay was provided with two sources of light across the track, and spaced 15 feet apart, so that only one locomotive or train could actuate the signal lights. All green lights were on when the track in a particular block was clear. If a train or locomotive entered the block and intercepted the beams of light focussed on the first relay, there was no reaction, as this particular relay controlled the already-illuminated green lights. However, when the beams of light directed on the second relay were interrupted, the green lights were extinguished and the red lights illuminated. The reverse action took place when the train emerged from the other end of the block.

ELECTRON ACCELERATOR

When Roentgen discovered the X-ray, he perhaps never contemplated that it would "see" through metals, as well as human bodies. Now, however, an X-ray machine, developed by the General Electric Company, will penetrate through more than eight inches of steel, giving a "picture" of the insides of large castings, as it were. Heretofore, a million-volt industrial X-ray machine was the ultimate in power—this unit "seeing" through only eight inches of steel—but recently there was introduced a 100,000,000-volt X-ray apparatus which is said to give electronic energy exceeding that of any similar equipment ever devised by man.

Its Goliath electromagnet weighs 125 tons; it is not solid but was pieced together with more than 100,000 bits of silicon steel, each 0.014 of an inch thick. These 100,000 pieces are fastened together with a special cement. The heart of this magnet contains a 6-foot hollow glass "doughnut"—a veritable merry-go-round for electrons. "Shot" from an electron gun, the electrons will be whirled in a dizzy fashion at the speed of a quarter of a million times in 1/240th of a second, on each journey receiving a 400-volt shove. These electrons will travel a total distance of 800 miles, which implies that the electronic path must be one of unflinching accuracy. Dr. Ernest E. Charlton, head of the X-ray section of the General Electric Laboratory, describes this electronic bombardment "like shooting on a curve for a distance as great as that from Schenectady to Chicago and hitting a three-inch target."

PHOTOTUBES IN INDUSTRY

If anyone should still doubt the versatility of the phototube, he should just ponder its uses in traffic control, door-opening, packaging, and weighing. The steel industry and the machine tool industry have thousands of different applications for control, measuring, and instrumentation. Foundries and heat-treating factories control chemical content and physical characteristics of metals and alloys with it. The printing business, with complex presses, and color work, cannot do without the phototube.

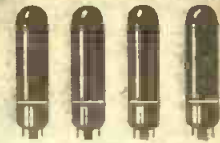

4 STANDARD TYPES

of Amperite Regulators replace over 400 types of AC-DC Ballast Tubes now in use. Amperites are real REGULATORS... have patented Automatic Starting Resistor which prevents initial surge and saves pilot lights... Ask Your Jobber.

AMPERITE

THE *Simplest* WAY TO REPLACE

BALLASTS

WRITE FOR REPLACEMENT CHART

AMPERITE Co. 561 BROADWAY, NEW YORK, N. Y.

TRIPLETT

Combat Line

INSTRUMENTS

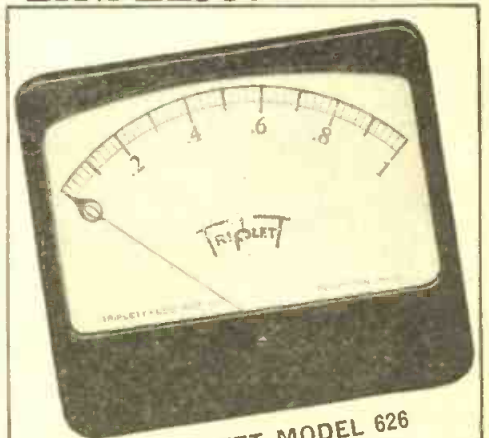

TRIPLETT MODEL 626 with 100g 5.60" scale

This illustration is 1/3 actual size. Note broad scale and minimum panel space required.



A WORD ABOUT DELIVERIES

Naturally deliveries are subject to necessary priority regulations. We urge prompt filing of orders for delivery as expeditiously as may be consistent with America's War effort. TRIPLETT ELECTRICAL INSTRUMENT CO., BLUFFTON, O.

WHILE THEY LAST

All of the attractive items listed here are brand new. ALL are in PERFECT WORKING ORDER. In many cases, the parts alone total more than the price we are asking. 100% satisfaction guaranteed or your money refunded. ORDER FROM THIS PAGE. Use the convenient coupon below. Include sufficient extra remittance for parcel post charges, also order shipped express, collect. Any excess will be refunded. C.O.D. shipments require 20% deposit. If full remittance accompanies order, deduct 2% discount. Send money order, certified check, new U. S. stamps. No C.O.D. to foreign countries.

ORDER TODAY LIMITED QUANTITIES PROMPT SHIPMENTS ASSURED

THE SODERWAND SUPER SOLDERING IRON

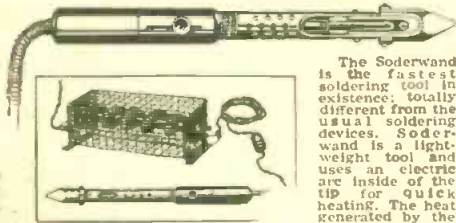

The Soderwand is the fastest soldering tool in existence, totally different from the usual soldering devices. Soderwand is a light-weight tool and uses an electric arc inside of the tip for quick heating. The heat generated by the arc is so intense the copper is hot enough to flow solder. There is a constant surplus of heat which makes quick soldering jobs seem easy. Current consumption is small, as only intermittent current is necessary to keep iron hot. Convenient thumb control cuts current on or off. Simple in design. Burn-out impossible as there is no heating element to burn out.

The Soderwand is an all-purpose tool that takes care of the heaviest or most delicate job with equal ease. IMPORTANT. This is a brand new item and comes in its original packing. We acquired the manufacturer's entire stock, which is the reason why we can sell the tool for so little money. THE ORIGINAL PRICE WAS \$5.00.

Supplied with regular No. 5 pyramidal tips, 14 feet of cord, attachments, pliers, resistance unit, and two extra sets of carbons. Made for 110 volts A.C. 60 cycles, or D.C. Size: 13" long. Tool weighs 10 oz. Ship. wt. of outfit 4 lbs. ITEM NO. 154 YOUR PRICE \$3.00

WATCH-CASE MICROPHONE

This mike contains a unit like the famous Skinderviken Button, mounted in a cast-aluminum case resembling a large headphone unit. 2-inch diaphragm. A push-to-talk switch is mounted in the case. 200-ohm impedance. Works into any transformer designed for single-button microphones. Operates on one dry cell. Just the thing for home telephone sets, "home broadcasting," use with phonograph amplifiers, etc. Case finished in black enamel. Slightly used. Size 2 3/4" by 1 1/2". Shipped postpaid. ITEM NO. 156 YOUR PRICE \$1.00



SENSITIVE RELAY

This relay has back and front contacts, breaking one contact and making another when actuated. 3-ohm coils, sterling silver contacts, 5 binding posts. Relay can be adjusted to trip at 30 milliamperes. Invaluable to experimenters. Can be used for remote control of apparatus, as circuit-breaker, etc. Will operate as electronic relay in plate circuit of average power tubes, as in air-raid "alert" units and other automatic devices. Adjustable hair-spring lens. Heavy slate-and-iron base 2 3/4" by 5 1/4". All metal parts (except base) in heavy brass. Slightly used, but a first-class relay in all respects. Ship. Wt. 3 lbs. ITEM NO. 155 YOUR PRICE \$1.85

POWERFUL ALL-PURPOSE INDUCTION MOTOR IDEAL FOR EXPERIMENTERS—101 USES

Sturdily constructed to precision standards, this self-starting shaded pole A.C. induction motor is powerful enough for a large variety of uses. Some of these are: Automatic Timing Devices, Current Interrupters, Electric Fans, Electric Chimes, Window Displays, Photo-cell Control Devices, Electric Vibrators, Small Grinders, Buffers and Polishers, Miniature Pumps, Mechanical Models, Sirens, and other applications.

Consumes about 15 watts of power and has a speed of 3,000 r.p.m. When geared down, this sturdy unit will constantly operate an 18-inch turntable loaded with 200 lbs. dead weight—THAT'S POWER! Dimensions, 3" high by 2" wide by 1 1/2" deep; has 4 convenient mounting studs; shaft 1 3/8" long by 3/16" diameter, and runs in self-aligning oil-retaining bearings. Designed for 110-20 volts, 50-60 cycles, A.C. only. ITEM NO. 147 YOUR PRICE \$1.45

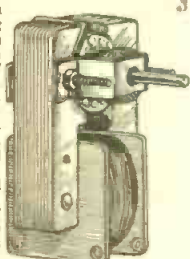

WESTERN ELECTRIC BREAST MIKE

This is a fine light-weight aircraft carbon microphone. It weighs only 1 lb.

Mike comes with breast-plate mounting and has 2-way swiveling adjustment so that it can be adjusted to any desired position. There are 2 woven straps; one Koss around neck, the other around chest. Straps can be snapped on and off quickly by an ingenious arrangement.

This excellent mike can be adapted for home broadcasting or private communication systems. By dismounting breastplate, it can be used as desk mike. Comes complete with 6-foot cord and hard rubber plate. Finished in shoradized plate, non-rustable.

THIS IS A BRAND NEW MIKE. IT HAS NEVER BEEN SOLD AT SUCH A LOW PRICE BEFORE. ORIGINAL LIST PRICE \$15.00. Shipping weight, 2 lbs.

ITEM NO. 152 YOUR PRICE \$2.55



VARIABLE SPEED UNIVERSAL MOTOR

For 110 Volts, A.C. or D.C. All Nickel Plate



Edison Dictaphone motor 1/50 H. P. Used but in excellent condition. For buffing, polishing, drilling, sawing; runs phonographs, fans, models, blowers, lathes, etc. Special control permits variable speeds up to 1500 r.p.m. 5/16" shaft extends from both sides of motor. Cast iron base has 3 screw mounting holes.

Height 4 1/2"; length 7 1/2"; width 5 1/2" long on one side. Ship. Wt. 8 lbs. ITEM NO. 157 YOUR PRICE \$2.95

POWER ADJUSTABLE RHEOSTAT

Here is an excellent rheostat used especially to regulate speeds of small motors, such as our Handy Workshop Outfit. This rheostat can be used in connection with motors up to 1/20 h.p.



This fine rheostat is wire-wound on porcelain insulation. The black enamel steel casing is perforated for ventilation. Adjustable handle regulates speed of motor easily and smoothly. Size 2 1/2" x 2 3/4" overall. Ship. Wt. 2 lbs. ITEM NO. 153 YOUR PRICE \$1.45

AMAZING BLACK LIGHT!!

Powerful 250-Watt Ultra-Violet Source



The best and most practical source of ultra-violet light for general experimental and entertainment use. Makes all fluorescent substances brilliantly luminous. No transformers of any kind needed. Fits any standard lamp socket. Made with special filter glass permitting only ultra-violet rays to come through. Brings out beautiful opalescent hues in various types of materials. Swell for amateur parties, plays, etc., to obtain unique lighting effects. Bulb only. Ship. Wt. 1 lb. ITEM NO. 87 YOUR PRICE \$2.00

WATT-HOUR METER

Completely overhauled and ready for immediate service. Designed for regular 110-volt, 60 cycle 2-wire A.C. circuit. Servicemen use it in their shops to check current consumption of sets, soldering irons, etc. Keeps costs down. If dismantled, the parts alone would bring the price. The elaborate gear train could be used as a counter on machines of various kinds. Simple to install; 2 wires from the line and 2 wires to the load. Sturdily constructed in heavy metal case, 8 1/2" high, 6 1/4" wide, 5" deep. Westinghouse, G. E. or Ft. Wayne makes. Ship. Wt. 14 lbs. ITEM NO. 33 YOUR PRICE \$4.95



POPULAR ELECTRONICS

(Continued from page 396)

made later, however, it will be necessary to determine the actual time required for this new electroscopie to discharge. To do this, we charge the instrument, note the position of the leaf and time the discharge. A well-made dry instrument should hold its charge for a considerable length of time. Now, if we place a radioactive material on the insulated table underneath the brass disk and find, for instance, that the rate of discharge is tripled or quadrupled, we shall have a direct index of the strength of the radioactive compound employed. The stronger it is, the faster the electroscopie loses its charge. A large amount of radium bromide would cause it to lose its charge instantly. Small amounts of low powered radioactive materials will, however, greatly accelerate the loss of charge.

The loss of charge is due to a phenomenon called ionization; the gas (air) surrounding the electroscopie is rendered conductive and the charge borne by the electroscopie is permitted to leak away. Much of this so-called ionization is caused by alpha particles or the helium atoms we discussed previously. Thus if we place our electroscopie in the position shown (Fig. 7) and charge it, we find that the rate of discharge is considerably lowered if not actually stopped by placing a few sheets of thin paper between the radioactive material and the electroscopie. Cardboard or aluminum foil will screen off the beta particles (electrons), but the gamma rays, which are really X-rays, will penetrate sensible thicknesses of lead sheet. Many experiments will suggest themselves to the imaginative worker using this simple equipment.

ULTRA-VIOLET LIGHT

Several agencies aside from beta and alpha particles and the gamma rays from radium compounds are able to ionize gases. We take, for example, invisible or ultra-violet light. Here again the anxious and

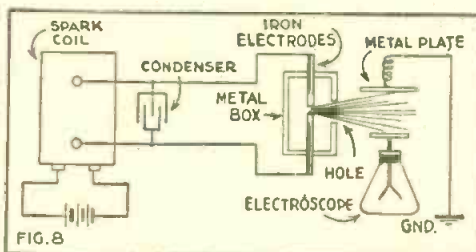

FIG. 8 Set-up of apparatus for experimenting with ultra-violet light. Effects on the electroscopie can be noted.

ambitious experimenter may feel that generators of such light are costly and beyond his means. Not so. A good and fairly rich source of such light, in amounts sufficient to conduct a number of interesting experiments, may be had from an ordinary Ford spark coil, relics of the Model T days, still found in the auto junk yards for 25 cents each. These are provided with a small glass plate condenser made by coating 8 or 10 plates (7 x 5) with tin or aluminum foil. The connections are illustrated in Fig. 8.

In Fig. 8 we also see the details of an absorbing experiment with ultra-violet light. After the electroscopie is fully charged, the source of UV light is brought near so that the weak UV light coming from the opening in the box will pass between the brass or metal plates. This quickly discharges the electroscopie.

A piece of glass placed over the hole in the box will completely screen off the UV light. Other materials will affect the light more or less, depending on nature, thickness, etc.

HUDSON SPECIALTIES CO., 40 West Broadway, N. Y. C.

IT'S EASY TO ORDER—CLIP COUPON—MAIL NOW ORDER FROM THIS PAGE.

HUDSON SPECIALTIES CO., 40 West Broadway, Dept. RC-4-43, New York, N. Y.

I have circled below the numbers of the items I'm ordering. My full remittance of \$..... (include shipping charges) is enclosed. NO C.O.D. ORDERS UNLESS ACCOMPANIED WITH A DEPOSIT.

OR my deposit of \$..... is enclosed (20% required), ship order C.O.D. for balance. No C.O.D. order for less than \$2.00. (New U. S. stamps, check or money order accepted.)

Circle Item No. wanted: 33 87 147 152 153 154 155 156 157

Name Address

City State

Send remittance by check, stamps or money order; register letter if you send cash or stamps.

ELECTRONICS PRIMER

(Continued from page 399)

the space charge neutralizing effect of the positive ions, the use of free electrons for rectifying large alternating currents would be practically impossible.

Another useful function of ions in electro-ionic devices, is their action in setting free electrons at the cathode, so that a hot filament is not a necessary element in an electro-ionic tube. The cathode ray tubes which J. J. Thomson used in discovering the electron, and the tube which blackened Roetgen's photographic plate, had in them no thermionic filament. But ions in the gas striking the cathode set free the electrons which started the electronic age.

When the current density at the cathode is sufficiently large, a new phenomenon appears, the so-called cathode spot, which sets free enormous numbers of electrons from the otherwise unheated cathode. Thousands of amperes of free electrons per square inch emerge from the cathode spot with a voltage drop of less than twenty volts. The detailed mechanism of the cathode spot is still not known, but there is little doubt that the positive ions are an absolutely necessary part of this mechanism.

It is extremely easy to produce such a cathode spot. Davy in 1808 separated a pair of carbons in a circuit carrying a few amperes, and produced the dazzling electric arc, with its free electrons, ions, and cathode spot. Thus an electro-ionic device appeared for scientific experiment nearly a century before the discovery of the electron. Also, antedating the electron discovery, the electrical industry started street lighting with electric arcs, and before the knowledge of the free electron was wide spread, was using mercury arcs in glass tubes for supplying the direct current for the series arc street-lighting systems. Thus the electrical engineers of that time were practicing "electronic engineering" without knowing it, like the famous gentleman who was surprised to find that he had been speaking prose all his life without knowing it.

But while these electro-ionic devices are very simple in their physical structure, enough has been said to indicate that their theory is complex, and that they present problems upon which "electronic science" has shed light, but still has not solved. We may confidently expect, however, that these problems will be more and more resolved by the electronic scientists and engineers of the future. And with the resolution of these problems, far-reaching improvements of the older electro-ionic devices will result, as well as the invention and development of entirely new devices.

To consider a few specific instances, let us regard first the homely electric switch. In the mid 1920's the expansion of the electrical power systems was threatened with an impasse because the limit in interrupting capacities of the circuit breakers then available had been reached. The arcs formed between the separating contacts in switches in these large current high voltage systems could not be extinguished by the available means. Then in 1928 one of the first of a series of revolutionary developments was announced by an electrical equipment manufacturer under the name De-ion, thus bringing out into the open that the switch was now an electro-ionic device, and that its future progress depended on the contributions which would be made to it by electronic science. The conductivity of the electric arc was recognized as due to presence in the gas space of free electrons and ions,

(Continued on following page)

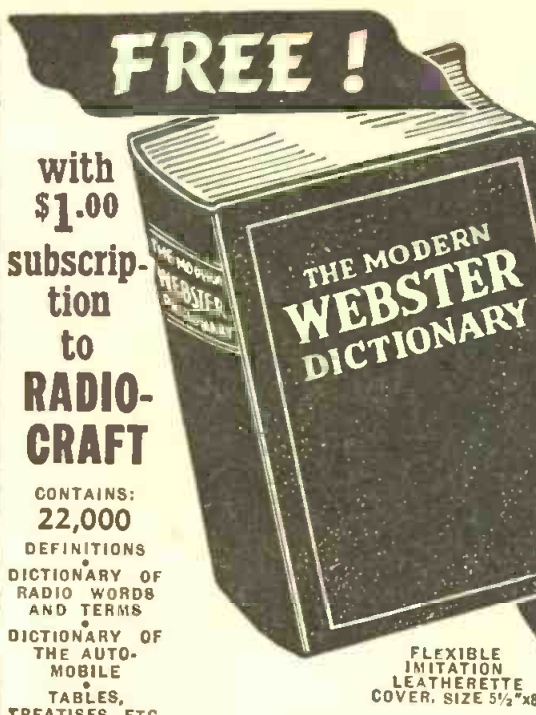

with \$1.00 subscription to RADIO-CRAFT

CONTAINS: 22,000 DEFINITIONS
 DICTIONARY OF RADIO WORDS AND TERMS
 DICTIONARY OF THE AUTOMOBILE TABLES, TREATISES, ETC.

FLEXIBLE IMITATION LEATHERETTE COVER. SIZE 5 1/2"x8"

SPECIAL NOTICE TO OUR READERS

Due to wartime curtailment of paper, we are unable to meet the increasing news-stand demand for RADIO-CRAFT. We are therefore making this special introductory offer to our readers. Assure yourself of getting a copy of RADIO-CRAFT monthly by subscribing now and at the same time co-operate in making this wartime measure effective. Don't delay—Send in your order today. If you wish to take advantage of our special long-term offer and protect yourself against any possible increase in price, send \$1.50 for 12 issues.

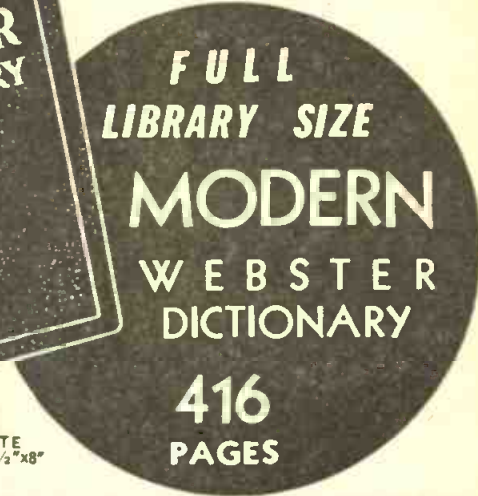

FILL OUT—MAIL THIS COUPON TODAY!

 RADIO-CRAFT, 25 West Broadway, New York, N. Y.
 This is a New Order Extend my present subscription
 Gentlemen: Enclosed you will find One Dollar for which enter my subscription to RADIO-CRAFT Magazine for Seven Months. Send me ABSOLUTELY FREE and POST PAID, my copy of the MODERN WEBSTER DICTIONARY.
 Name Please print clearly
 Address
 City State
 RC 4-43
 (Remit by check or money order; register letter if you send cash or unused U.S. Postage Stamps)

If you will take advantage NOW of our special subscription offer of seven months for \$1.00, we will send you ABSOLUTELY FREE and POST-PAID this 416 page full library size MODERN WEBSTER DICTIONARY—useful and instructive to everyone. This self-pronouncing authoritative dictionary—a new work throughout—contains the most up-to-date words now in common use, 22,000 definitions in all. It also features a Glossary of Radio Words and Terms, Dictionary of the Automobile, Treatises on Practical Syntax, Etymology, Punctuation and Standard English by well known authorities, Metric Tables, Time, State Flowers, National Parks of the U. S., etc.

This is a time limited offer, so don't delay in returning the Coupon.

RADIO-CRAFT
 25 WEST BROADWAY NEW YORK CITY

HAY WIRE RADIO SAVES COMMANDOS

IN the thin air of a Timor mountain hideout, four haggard, bearded Australian soldiers worked over a crazy radio transmitter by the light of a pig-fat flare.

"Three of them watched anxiously as the fourth pounded a key. Weak batteries sent the dots and dashes dimly across the Arafura Sea and to Northern Australia. The tension became almost physical as the operator strained his ears for a reply, but no reply came."

They did not know that their message had been picked up on the Australian mainland and passed on to Darwin, that all transmitting stations had been warned off the air and instructed to listen for Timor the next night.

Thus was radio the means of rescuing a group of Australian commandos stranded for four months on Portuguese Timor. Unheard from for 59 days after the Japanese took possession, they had already been written off as missing or dead.

The only radio apparatus available was an old American broadcast receiver—brought in by a Dutch sergeant who collapsed after reaching camp—and a transceiver designed to work over distances of a mile or two. Available tools consisted of a hatchet, a pair of large pliers and a screw-driver.

With this equipment, Signaller Joe Loveless and three other members of the Signal Corps constructed the crazy transmitter, Named "Winnie the War Winner." Calibra-

tion means had to be devised, a receiver thrown together, and raids made on the Japanese lines for auxiliary apparatus, before success crowned their efforts.

The first transmissions were without result. The signalmen blamed lack of calibration, due to the crude coils, which were wound on lengths of bamboo. The set was redesigned, but by this time the batteries were dead and there was no means of recharging them. Fourteen of the commandos volunteered to go through the Japanese lines to recover a battery charger abandoned in the former headquarters.

Within 100 yards of enemy sentries, and protected by the dark, the Aussies dug up the charger they had buried when the headquarters were evacuated. A later raid was made to replenish the supply of motor fuel.

A new attempt was made with the fresh batteries. Unknown to the little group, the rebuilt transmitter got through to the mainland. The next night—with all channels cleared—two-way communication with Darwin was established. Rescue was then only a matter of detail.

Safe in Australia, the commanding officer gave full credit to Signaller Loveless and his assistants, Sergeant, Donovan, Parker, and the unnamed Dutch sergeant who had carried the raw materials for "Winnie" through 40 miles of "the roughest country in the world."

"I don't like to think of what would have happened if we hadn't got through," he said.—Daily Mirror, Sydney, Australia.



“Der
Cherry
Sisters”

More blue notes than harmony from the Axis just now.

Let's keep them howling . . . War Bonds will help. They're the best possible investment for every cent of your surplus income. Are you buying all that you can?

Erwood Sound Equipment Co.

223 WEST ERIE STREET

CHICAGO, ILL.



FREE

SEND TODAY FOR THIS
BIG RADIO BARGAIN
BOOK.



Buy Your
ECHOPHONE
NOW from LEO

● Get needed equipment now while still available. We have the best stock on hand, low prices to save you money. Easy terms, quick delivery. Send today for our new catalog of radio bargains. Write to LEO, W9GFQ.

**WHOLESALE
Radio Laboratories**

744 WEST BROADWAY
COUNCIL BLUFFS, IOWA

ELECTRONICS PRIMER

(Continued from previous page)

and the problem of the proper extinction of the arc at the proper moment, was the problem of de-ionizing, or making disappear at the proper moment, and sufficiently rapidly the free electrons and ions which the arc itself engendered. The development of de-ionizing means, while guided by electronic theory, is still largely empirical. In the future much of this empiricism may be removed by electronic science, and new electro-ionic switches of extraordinary capacity may be expected.

The igniton is another example of how modern electronic science revolutionized an older electro-ionic device. The mercury arc rectifier was invented by Peter Cooper-Hewitt in 1903, shortly after the discovery of the electron. Cooper-Hewitt did not talk of free electrons, and their emission from the cathode, but spoke of a vague "cathode reluctance" to explain the rectifying effect he had found. This was his way for describing the fact that emission of free electrons from the cathode is a necessary part of conducting current through mercury vapor, and that by providing one electrode from which electrons are freely emitted, and another from which such emission is lacking, a rectifier of alternating current is obtained. A cathode-spot, initiated by breaking contact between the mercury pool cathode and an auxiliary electrode, was Cooper-Hewitt's method of producing electron emission from the cathode.

Under the guidance of electronic science, the mercury arc rectifier in the 1920's was developed up to large sizes, and particularly in Europe displaced dynamo-electric converters for railway electrification and in the electro-chemical industry.

About 1930, the use of stainless steel and light metals was rapidly expanding, particularly in transportation equipment, and methods for rapid electrical welding were devised. For welding of such metals it is necessary to use a rapid sequence of accurately measured pulses of electric current, accurately timed. Mechanical switches, because of their inertia, were not practical for controlling these current pulses. It was very natural by this time to turn to electronic science for the answer, and because of the large currents involved, an electro-ionic type of tube was indicated and particularly the mercury arc tube, with its indestructible mercury pool cathode made electron emissive by means of a cathode spot.

However, the only reliable means for starting a cathode spot known at that time was that of mechanically breaking a circuit comprising the mercury pool and an auxiliary electrode, and again mechanical inertia introduced insuperable difficulties. What was wanted was a purely static means for initiating the cathode spot at great frequency and under perfect control.

Electronic science gave a beautiful solution to this problem. A rod of high resistance material was stuck down into the mercury, and current passed down through the rod into the mercury. Analysis of electrical conditions at the junction of the rod with the mercury indicated that there would be there a large concentration of current, and an intense field, just the conditions for starting a cathode spot. Experiment bore out this expectation. Sure enough, when a few amperes passed down the resistance rod, a cathode spot appeared on the adjacent mercury. This could be done as quickly and repeatedly as desired. The small current for thus initiating the cathode spot could be

TECHNICAL BULLETINS

Technical bulletins give reliable information in easy-to-follow form, and save valuable time otherwise spent in laborious reading of numerous books. Every subject is treated briefly and concisely, yet completely. No complicated mathematics, chemistry, electricity, or theory. Each bulletin is written in simple language.

PRICE \$1.00 EACH POSTPAID
ORDER BY NUMBER

ELECTRICAL DESIGN & CONSTRUCTION

D-111—DESIGNING AND BUILDING TRANSFORMERS.—Simple, non-mathematical methods for designing transformers of all kinds. Also special transformers such as are used for ultra-violet lamps, Neon tubes, etc. No complicated formulas.

D-112—DESIGNING ELECTRO-MAGNETS.—The subject of electro-magnet design is so clearly explained that anyone can design and build magnets for practically every purpose. Complete, practical data covering both A.C. and D.C. magnets.

D-113—HOW TO DESIGN SOLENOIDS AND PLUNGER MAGNETS.—Anyone who is interested in solenoids or plunger magnets cannot afford to be without this non-mathematical, simple and practical information.

D-101—USING NICHROME RESISTANCE WIRE.—Explains how to repair electric flat irons, toasters, rheostats, resistors and other electric heating devices. Simplified methods of figuring lengths and sizes of wire for any job.

D-106—REWINDING ELECTRIC MOTORS.—Complete information, diagrams, sketches, tables, etc., to enable any shop man, mechanic, electrician, experimenter, etc., to rewind A.C. and D.C. motors and generators of all types. For the man who wants to know "how" rather than "why."

D-144—A. C. CURRENT CONTROLLED WITH EASILY MADE CHOKO COILS.—How to design and construct choke coils. How to determine size and amount of wire required, how to find the core size. Full details on assembly and coil winding.

D-148—DESIGNING AND USING ELECTRIC RELAYS.—Simple practical instructions for designing, building, and using A.C. and D.C. relays; also thermo-electric relays. Includes practical relay control systems for motors and machinery.

D-127—SMALL ELECTRIC LIGHT PLANTS, DESIGN AND CONSTRUCTION.—Tells how to design and build small electric light plants for cottages, camps or country homes at small cost. Covers construction of a 110-volt system to light six 30-watt lamps, how to build a 6-volt system using an auto-generator, with or without a battery, and how to convert a Ford model "T" generator to a 110-volt, A.C. generator.

D-134—ELECTRICAL EXPERIMENTS WITH SIMPLE MATERIALS.—How anyone without previous knowledge of electricity can perform harmless, interesting, and educational experiments with simple, inexpensive materials.

D-131—MODEL MAKERS & INVENTORS GUIDE TO REMOTE-CONTROL SWITCHING.—Controlling electrical devices, train models, equipment of all types at a distance by means of a telephone dial.

D-137—ELECTRICAL METERS EASILY BUILT.—Information that will enable students to build experimental electrical meters to measure alternating or direct currents, including ammeters, voltmeters and wattmeters sufficiently accurate for experimental purposes.

D-136—SMALL A.C. ARC WELDER CONSTRUCTION AND USE.—Tells how to build arc welders capable of fusing iron and steel sheet up to 3/16 inch in thickness and rods as large as 1/4 inch in diameter for use on 110-volt, 60-cycle A.C., 110-volt 25-cycle A.C., or on 220-volt 60 cycle A.C.

Each Bulletin consists of a set of large sheets, assembled in one packet, size 9 x 14 1/2"; weight 1/4 lb. Numerous illustrations, diagrams, charts to supplement text.

TECHNIFAX

1917 S. STATE ST. RC443 CHICAGO, ILL.

443
TECHNIFAX 1917 So. State, Chicago, Ill.
Enclosed find \$..... for which please send me postpaid the following Technical Bulletins:
Nos.
Name
Street and Number
City and State

readily handled by a more usual thermionic, grid-controlled, electro-ionic tube. After the cathode spot was formed, thousands of amperes needed by the weld would pass through the mercury arc tube. Thus the ignitron was born. It immediately found wide application in thus electronically controlling the welding of these new materials.

It was then found that the use of this gift of electronic science, the mercury-arc ignitor permitted a radically new design of the high-power mercury-arc rectifier with a better efficiency and greater reliability than had been attained before. Hence we find that in the great expansion of production of aluminum and magnesium occasioned by the war, the tremendous direct currents needed for electrolysis are being supplied by the new ignitron mercury arc rectifiers.

These examples are only a few of the instances where electronic science is modifying and improving the apparatus of the electric-power industry. We may be quite sure that the next steps in electrical engineering will include further improvements in electro-ionic apparatus, and wider applications.

THE ENCEPHALOPHONE

(Continued from page 401)

operation the instrument had to be used in conjunction with the first two stages of the amplifier unit from a commercial encephalograph. There is of course no doubt that an instrument with all the necessary stages of amplification can be built in one single compact unit.

The amplifier must be specially designed for the amplification of very low frequencies. In abnormal cases, oscillations of 3 cycles per second, and even lower frequencies, occur. The response of the amplifier should also be fairly uniform over a wide range.

Because of the high value of the time constant of the amplifier it takes a considerable time (in the order of one minute) before normal conditions are established after the instrument had been switched on, or the electrodes handled. During this time the pitch of the note in the headphones changes and finally becomes steady. Only then does the sensitivity of the instrument reach its normal value.

With the two-stage amplifier alone the waving of a charged insulator (fountain pen) at a distance of 10 cm. from the "live" electrode transforms the steady tone into a trill, and with the pre-amplifier in operation the same effect is obtained at a distance of about 60 cm.

Local electrical disturbances are heard as a roughness in the telephone tone, and make the observation of small changes difficult. Complete and thorough shielding of leads carrying A.C. as well as those from the scalp electrodes, is necessary, and the apparatus should be operated at a distance from A.C. lines.

The experimental model of the encephalophone described above has been tried out at the Edinburgh Royal Infirmary for a period of several months. It gives readily readable and often very striking indications of the brain potentials.

In its present form the audio method does not permit a very accurate measurement to be made of the size of the activity observed. This can be improved in further develop-

(Continued on following page)

SPRAYBERRY RADIO TRAINING FULL EQUIPMENT

Experience Easily Acquired at Home



You Do Practice - Giving Experiments. Many Special Features... ALL Designed to Help You Make Fast Progress

SPRAYBERRY

Training starts right at the beginning of Radio... unfolds each subject in a simplified, logical, understandable style. You easily learn Television, Frequency Modulation, Signal Tracing, Mobile Radio (Auto-Tank), Aviation Radio, Electronics, Facsimile Radio, Radio Set Repair and Installation Work.



Training Prepares You for a Business of Your Own... or Good Radio Jobs—Civilian or Military. The important and fascinating field of Radio offers many opportunities to the man who wants to get ahead. My Training will help you win quick promotion in the Army or Navy... will fit you for a bright Civilian career. SPRAYBERRY Methods are thorough and practical. Your Training will not interfere with your present duties. No previous experience is needed.

You Get a Dual-Purpose Radio Set I supply you with Radio Parts which you use to gain pre-experience in Repair work. These same Parts are used as a Modern Signal Generator and for Signal Tracing, etc. You'll find my Course and Equipment fully described in the catalog offered below.

Earn While You Learn My BUSINESS BUILDERS show you how to put your equipment to actual use in handling money-making Radio Service Jobs shortly after you begin Training. THE SPRAYBERRY COURSE IS SOLD UNDER MONEY BACK AGREEMENT



RUSH COUPON for BIG FREE BOOK

SPRAYBERRY ACADEMY OF RADIO
F. L. Sprayberry, President
620-D University Place, N. W.
Washington, D. C.
Please rush me FREE copy of "HOW TO MAKE MONEY IN RADIO."
Name Age
Address
City State
(Mail in envelope or paste on penny postcard)

HELP US FIGHT CANCER

160,000 Americans die of cancer annually. Authorities say many of these deaths could be avoided.

Help us spread the knowledge that cancer can, in many cases, be cured. Enlist today in your local unit of the Women's Field Army!

In the Metropolitan Area, address the New York City Cancer Committee, 130 East 66th Street

AMERICAN SOCIETY FOR THE CONTROL OF CANCER
350 Madison Avenue, New York, N. Y.

NOW—A REALLY HIGH-POWERED—
Radio Engineering Library

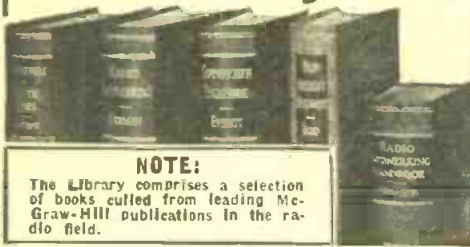

NOTE:

The Library comprises a selection of books culled from leading McGraw-Hill publications in the radio field.

- especially selected by radio specialists of McGraw-Hill publications
- to give most complete, dependable coverage of facts needed by all whose fields are grounded on radio fundamentals
- available at a special price and terms

THESE books cover circuit phenomena, tube theory, networks, measurements, and other subjects—give specialized treatments of all fields of practical design and application. They are books of recognized position in the literature—books you will refer to and be referred to often. If you are a practical designer, researcher or engineer in any field based on radio, you want these books for the help they give in hundreds of problems throughout the whole field of radio engineering.

6 VOLUMES, 3319 PAGES, 2289 ILLUSTRATIONS

1. Eastman's FUNDAMENTALS OF VACUUM TUBES
2. Terman's RADIO ENGINEERING
3. Everett's COMMUNICATION ENGINEERING
4. Hund's HIGH FREQUENCY MEASUREMENTS
5. Henney's RADIO ENGINEERING HANDBOOK

10 days' examination. Easy terms. Special price under this offer less than books bought separately. Add these standard works to your library now: pay small monthly installments, while you use the books.

10 DAYS' FREE EXAMINATION—SEND COUPON

McGraw-Hill Book Co., 330 W. 42nd Street, N. Y. C.

Send me Radio Engineering Library, 5 vols., for 10 days' examination on approval. In 10 days I will send \$3.00 plus few cents postage, and \$3.00 monthly till \$24.00 is paid, or return books postpaid. (We pay postage on orders accompanied by remittance of first installment.)

Name

Address

City and State

Position

Company RC 4-43

LAWRENCE SLIDE RULES

With A, B, C, D, C1 and K Scales

FEATURES: Nickel Silver Framed Indicator with integral friction springs. Scales calibrated directly on well seasoned wood. Will retain accuracy regardless of temperature or humidity changes.

Instructions and illustrations of primary operations clearly printed on back of rule for ready reference or teaching. Each rule in a durable pocket carrying case for convenience and protection.

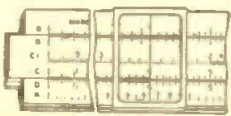

The extremely low price of these slide rules and their absolute accuracy makes them ideal for the student as well as the working man who has always wanted to learn to use a slide rule.

- LAWRENCE 10 inch white-enameled slide rule with flat magnifier, in black case. Price, including 28-page instruction book No. 457.. 60c
- Secret Code Slide Rule, with 20-page book No. 458.. 30c (2 for 50c)
- 28-page illustrated book of instructions, postpaid No. 459.. 15c

GOLD SHIELD PRODUCTS

350 Greenwich St. (Dept. RC4) New York City



HIGH EFFICIENCY results in Sound National Defense this is why NATIONAL DEFENSE SOUND SYSTEMS are equipped with University Reflex HIGH POWER LOUSPEAKERS UNIVERSITY LABS. 195 CHRYSTIE ST. N. Y. C.

O.S.I. FREEZES RADIO TROUBLES FOR DURATION

(Continued from page 427)

causing the singers to give off weird notes, particularly in the high register.

FIDDELIMP. This is a pernicious type of Imp who causes radio listeners to fiddle their dials when they should be listening to their favorite station. This nasty Imp gets into your fingers and hair, as well as ears, and before you know it, you fiddle with your radio set dial trying to get another program—which you should know is worse than the one you had before.

KLEPTOMIMP. This is a really bad devil who hears a joke over the radio (he is built and wired for radio himself), then immediately inspires this self-same joke to be uttered by the hapless comedian on whose shoulder he hops,—and who gets the blame for stealing the other fellow's jokes—which are worse than his own perpetrations.

MALODORIMP. This is the type of Imp who prods the radio performer who must reel off *double entendres*—questionable jokes of questionable taste and questionable manners. As the name of this Imp implies, he has a bad odor and should be fumigated from radio studios, wherever possible.

MELANKOLIMP. This particular type of Imp attacks comedians and causes their jokes to fall flat. They infect the comedian with melancholia, making him talk in a sad voice when he should be laughing an infectious belly-laugh, intended to roll his public in the aisle. Usually the comedian blames his failure on the joke, when as a matter of fact it is the MELANKOLIMP's fault.

NOSTRADAMIMP. This particular type of mischievous Imp helps radio commentators and others to make wrong prophesies so often that the unlucky commentator has to eat his own words later on.

SKREECHIMP. This particular Imp attacks only sopranos and makes them screech by plucking the soprano's vocal cords, which they play as you would play a harp. The effect is colossawful.

STINKIMP. This is the type of Imp responsible for those gosh darn awful jokes over the radio, which we all know.

STINKERIMP. Same as the one above, except that this also includes not only mirthless jokes but an entire program.

STUCKONIMP. All of us know this particular type of Imp who loves masters of ceremonies and other radio "artists," so stuck on themselves that they can see only their own virtues. The Imp helps them in this to the nth degree, making them out worse to the radio audience than they really are—if that were possible!

PRIZES FOR CONTESTANTS

"**RADIO-CRAFT**" will be happy to give a year's subscription to contributors who discover new types of imps, whether RADIMPS, TECHNIMPS or MISCHIMPS. If you think you know of a bad and nasty imp not described in this article, you are invited to send your contribution to **RADIO-CRAFT** magazine. Prizes will be given in the order in which letters are received. In case of a duplication, both contestants will get the same prize. Each entry should be accompanied by a few words describing the particular imp, and a rough sketch if possible. This is a monthly contest, till further notice. Each contest closes on the 2nd of each month.

NOTE—RADIO MANUFACTURERS AND ADVERTISING AGENCIES

If you are interested in any one of the particular imps shown in this article for advertising purposes, **RADIO-CRAFT** will be very happy to cooperate with you or your advertising department, or your advertising agency. The Gremlin type of imp is now very popular and in many cases enhances the value of a product, as well as the advertising.

RADIO-CRAFT has gone to a great deal of expense in order to originate these technical imps; 14 different artists were consulted before the present type of Imp was evolved.

Please communicate with **RADIO-CRAFT** if you wish us to create a particular type of Imp for your product, or advertising.

COPYRIGHT 1943, BY HUGO GERNSBACK

THE ENCEPHALOPHONE

(Continued from previous page)

ment of the instrument by fitting it with an artificial source of very small potential changes, which can be made to produce the same changes in pitch as the brain activity does. These potentials can be measured, either directly or with an amplifying vacuum-tube voltmeter.

It is sometimes important to observe encephalograph potentials between more than one pair of electrodes simultaneously. In the standard method this is done by using a number of "channels" (usually three). In the audio method the observa-

tion could be carried out by using two independent channels and leading the outputs of these to the two ears of the observer. In normal subjects the two hemispheres of the brain are always very similar, showing waves of the same frequency, size, waveform and phase. A departure from identity in any of these features provides evidence of abnormal functioning. If the two channels were used symmetrically on both hemispheres an experienced observer would readily detect any asymmetry of electrical activity.—*Electronic Engineering, London*

POWER SUPPLIES FOR BEGINNERS

(Continued from page 439)

ter which way it is, the most important thing about it is its *wattage*. For the job in hand it must carry 10 mils., with 250-volts across it. Since wattage equals current times voltage, we have 10/1000 x 250, or about 3 watts. This might be all right if the tubes were always lighted, but suppose the power supply was turned on when the tubes in the set were not connected? Then the full output of the B- supply would be across this resistor. The chances are it would burn out right away. To prevent such

an occurrence, it is advisable to make this resistor of such size as to absorb the full output of the power supply. In such case, the resistance is 250 ÷ 80/1000, or about 3100 ohms. Since 5000-ohms is commercially available, it would be better to use that. Please understand that the preceding is only an example. It may not be practicable in every instance, as circuit constants vary, and what size the resistance should be depends on what currents and voltages are desired.

BOOK REVIEWS

TESTING RADIO SETS, by J. H. Reyner. Published by Sherwood Press. Stiff cloth covers, size 6 x 9 inches, 239 pages. Price \$4.50.

This is a highly practical work written by a man who obviously knows what he is talking about, one who is obviously an engineer as well as a serviceman. Due to the differences between British and American receivers his instructions in detail are in many cases not applicable; but his fundamental methods could be imitated with profit by many servicemen who ask: "What is the trouble? All the parts test O.K."

One thing unusual is that relatively crude apparatus is considered good, a 500-ohm per volt meter for instance! And it is hoped that the repairmen have signal generators to aid them in their work.

A simple form of "dynamic testing" with the apparatus at hand, is the method advocated. This includes moving the aerial up to the detector stage—a trick well known in the days when signal generators were rare.

An important part of the book is the section dealing with laboratory tests of receivers. Here the equipment described is by no means crude, and the intelligent serviceman should get several hints from the manufacturers' methods of checking sets for performance. Much of the apparatus described can be built by the amateur engineer.

This is a worthwhile text for those familiar with British practice.

RADIO-1, by R. E. Williams and Charles A. Scarlott. Published by American Book Company. Stiff cloth covers, 6 1/4 x 9 1/4 inches. 132 pages. Price \$1.04.

This text complies with the requirements of the Army for pre-induction radio instruction for those having no previous acquaintance with the subject, but possessing a working knowledge of elementary algebra.

It has a very interesting introduction to the subject in the first chapter, called "About Radio In General." With a few basic notions of radio operation and history, it explains the language of radio—symbols and schematics, for in the field a man must know every element in the circuit, how it connects, and why.

Electrical theory, constituting the basis of radio, is reviewed in very understandable language, with the electron theory, magnetism and magnetic fields acting as keys to the subject.

Alternating currents are explained in terms of revolving vectors. One diagram in particular, which shows the growth and decay of a magnetic field about a wire carrying an alternating current, appealed to us. Very fundamental, but a concept too often lost sight of in the cramming of innumerable facts which is oftentimes necessary.

Inductance and capacitance are thoroughly discussed, followed by resonance, with diagrams which illustrate the factors involved in vector addition.

The fundamentals of vacuum tubes are touched upon, with electron flow, emission and diode rectification as the bases.

This text is excellent for those having laboratory facilities, and an instructor.

PRE-SERVICE COURSE IN ELECTRICITY, by William C. Shea. Published by

RADIO-CRAFT for APRIL, 1943

John Wiley & Sons, Inc. Stiff cloth covers, 5 3/4 x 8 3/4 inches. 276 pages. Price \$2.00.

This book lives up to its title very well. Scheduled for high-school students and others who intend following radio or electrical work in the armed forces, it covers the fundamentals of the subject in an excellent manner.

The type is easy to read, well-spaced for eye comfort, and is copiously illustrated. Rather than depending on long mathematical discussions to prove facts, the illustrations, drawings and diagrams convey the information in clear forceful style.

Embracing modern theory, it stresses certain data in terse form, which is usually more easily remembered. For example, in connection with power generation the statement is made "that the revolving coil does not generate a current. It generates, or induces, a voltage, which in turn forces a current to flow, if the coil is connected to a closed circuit." Thus the importance of the idea of potential difference is brought to the fore, in connection with power generation.

The chapters progress smoothly from one to the other, each one a foundation for the next. The subjects covered are Magnetism; Electrostatics; Primary Cells; E, I, and R; Electromagnetism; Meters; Heating Effects of Current; Work, Energy and Power; Induce E.M.F.; Motors; Mutual and Self Induction; Rectification of Current.

This book is well fitted for its task.

A COURSE IN RADIO FUNDAMENTALS, by George Grammer. Published by The American Radio Relay League. Paper covers, size 6 1/2 x 9 1/2 inches, 104 pages. Price 50 cents.

The contents of this unique work originally appeared as a series of articles in *QST*, and so great was the enthusiasm with which they were received, it was deemed advisable to put them all under one cover.

This is not a book that you can pick up and learn radio from just by reading. You've got to perform the experiments indicated, study the A.R.R.L. Handbook for theory, and answer the examination questions listed. In this manner any person having the time and the equipment can obtain the full benefit of this compact course in radio.

Its chief benefit lies in its two-way adaptation for home study or classroom work. For the home student it gives explicit directions and explanations. For the instructor it provides a course outline in the absence of a planned course or where time does not permit an individual synthesis.

The apparatus required for the experiments is simple and can be constructed from junk box or replacement parts.

ELECTRONICS ENGINEERING MANUAL, VOL. III, published by McGraw-Hill Co. Stiff cloth covers, 6 x 9 inches, 256 pages. Price \$1.00.

In this new book, electronic articles written in popular language have been selected, with the result that the non-professional radioman and experimenter will find the volume as understandable and interesting as will the engineer.

The book is divided into four sections: Industrial Applications, Sound Reproduction & Communication Applications, Broad-

cast & Television, and Design & Research.

The radio-minded reader will find Section II solidly interesting. Articles on Loudspeaker Dividing Networks, Preselectors for B-C Receivers, Cardiod Microphones, Automatic Record Changers, Powdered Iron R.F. Cores, and Simple Carrier-Current Communicators, give an idea of the type of matter carried.

More than half the articles in the other sections have a direct application to the needs of the radio man. Section I, on industrial applications, reveals how slight is the barrier between radio and non-radio applications of electronics. Section III, Broadcast & Television, is a radio section dealt with from the viewpoint of the broadcaster.

The last section, Design & Research, carries articles on L-type Impedance Transforming Circuits, V-T Voltmeters, D.C. Amplifiers with A.C. Operation, Voltage Multipliers, Cathode-Ray Circuits, etc., making it of practical value to the radio reader.

COYNE REFERENCE SET. Published by Coyne Electrical School, Inc. In three volumes, 8 1/2 x 11 inches, 1212 pages. Stiff covers, imitation red morocco. Price \$12.00 for the set.

Called by its authors a "reference set," this work combines the features of a complete electrical course with those of an encyclopedia. This is achieved by the arrangement of the subjects, in conjunction with a very complete topical index.

Each volume is divided into a number of sections, arranged in the same order in which the subjects are taught in the Coyne School. The sections—each of which covers a separate field of electrical knowledge—are further divided into sub-sections for easier reference.

The book starts out with the simplest type of D.C. theory, then takes up practical work of an elementary nature—door bells, call systems and related subjects in the second section. The following section covers electrical construction and light and power wiring.

Two sections, comprising 140 pages, are devoted to D.C. machines, apparatus and testing. The next 209 pages cover alternating current theory, alternating current machines, and their care and repair. Power generation, transmission and distribution is dealt with in the next section.

Electric Storage Batteries, Automotive Electricity, and Electric Refrigeration and Air Conditioning receive one section each, the coverage of refrigeration and air conditioning being exceptionally complete for an electrical work. There is a short section (70 pages) on Diesel engines, which are so commonly used in generating electric power.

The last section (163 pages), deals with Radio and Television. The radio subjects are handled from the viewpoint of the student already somewhat familiar with electrical principles and apparatus. While no attempt is made to turn the student into a finished radioman, he is left in a position to approach each problem with confidence, and to make all the simpler type of repairs on most types of radio apparatus.

The extreme simplicity of the explanations and the clarity of the language used is possibly the most impressive thing about the work. An unusually large number of

If you were only a crystal gazer and NOW was 1945....

What a wonderful world 'twill be. We will then be offering electronic devices with applications for the sound industry that were undreamed of two years ago.

The design and research work done by our engineers for the war effort to date has created a feeling of exuberant enthusiasm and pride in our own contributions to Victory.

We've solved some really tough problems which we can't talk about yet, but if you need some help in your war work, be sure to write us.

Electronic Division

Amplifier Company of America

17 West 20th Street New York, N. Y.

ELECTRONICS

Engineers
Laboratory Assistants
Production Men

Well Paying War Job Plus Peace Time Career!

Ideal working conditions with expanding manufacturers now at war work and planning peace time developments. Unlimited opportunity for an important place in a New World of Radio.

Men employed at full skill in war industry should not apply!

All others write Today!

PANORAMIC RADIO CORP.
242 West 55th Street

New York New York

Complete Plans

For Building Useful and Practical Things at Home. Each issue of Popular Homecraft is crammed with plans for making such beautiful and useful things as: Furniture, Bird Houses, Lamps, Outdoor Garden Furniture, Candle Equipment, etc. Covers lathe work, tools, wood-working, leathersmith, copper. You'll find "how" to make almost everything from the pages of Popular Homecraft. Scores of drawings and photographs make every step simple as A B C. A real "How-To-Do-It" magazine.



Six Months' Trial \$1.00

Send \$1.00 today for trial six months' subscription. Money Back If Not Delighted.

POPULAR HOMECRAFT

937 Palmolive Building Chicago, Ill.

Trial 6 Months \$1.00

Inventions Wanted Patented or Unpatented

We have been successfully selling inventions, patented and unpatented, since 1924. Write us if you have a practical, useful idea for sale.

CHARTERED INSTITUTE of AMERICAN INVENTORS

Dept. 109 Barrister Building, Washington, D.C.

PATENTS—TRADE MARKS

Booklet concerning Inventions & Patents Form "Evidence of Conception" with instructions for use and "Schedule of Government and Attorneys Fees"—Free
LANCASTER, ALLWINE & ROMMEL
Registered Patent Attorneys

436 Bowen Bldg. Washington, D. C.

excellent illustrations is a further aid to the student in understanding all points covered. Large type on very good paper, and the convenient division into three volumes of approximately 400 pages, make each an easy book to read or consult.

RECTIFIER TUBE REPLACEMENTS

(Continued from page 431)

come so high that every by-pass and coupling condenser in the receiver may be blown. This has been taken care of in many receiver designs by supplying a self-regulating wet electrolytic condenser at the input to the filter. This type of condenser has the property of having extremely high leakage when the voltage exceeds its rating and the leakage returns to a normal value when this voltage returns to its rated value.

This is a good place to point out also that when the first section of a filter system is replaced, the condenser should be replaced with one of the same type since otherwise the leakage characteristics may result in unexpected surges which may cause permanent damage to condensers in other parts of the circuit.

It is hoped that the points brought out in this article will serve to save the embarrassing situations which might otherwise arise in connection with less careful methods of substitution of rectifier tubes in existing equipment.—*Sylvania News*

METAL LOCATOR—1943 MODEL

(Continued from page 408)

as shown, and as far apart as possible to still hear a weak signal in the phones. Then adjust the trimming condenser TC of the transmitter so as to get the maximum signal in the phones and the greatest deflection of the meter with the power control on the position on which it is desired to operate.

Parts List For the Transmitter

CONDENSERS

- 1—Trimmer 175-500 mmfd.
- 2—0.01 mfd.
- 1—Mica 0.001 mfd.

RESISTORS

- 1—15,000 ohms
- 1—20,000 ohms

MISCELLANEOUS

- 1—R.F.C., 60 mhy. iron core
- 1—Class B input transformer, A-4721, Stancor
- 1—Midget S.P.S.T. switch
- 1—No. 474 dial plate, Mallory
- 1—Switch, 3215J, Mallory
- 2—Burgess Z30NX 45-volt B-batteries
- 1—Burgess 2FBP, 1.5-volt A-battery

For the Receiver

CONDENSERS

- 1—Trimmer 175-500 mmfd.
- 1—0.006 mfd.
- 2—0.01 mfd.
- 2—0.1 mfd.
- 1—200 mmfd.

RESISTORS

- 1—10 megohms
- 2—3 megohms
- 2—1 megohm
- 1—50,000-ohm control
- 1—0.5 megohm
- 1—20,000 ohms
- 1—200-ohm potentiometer

MISCELLANEOUS

- 1—175 Kc. I.F.T., Meissner No. 16-6649
- 1—175 Kc. I.F.T., Meissner No. 16-6651
- 1—0-100 micro-ammeter
- 5—Octal sockets
- 2—Phono jacks, Bud PJ-837
- 1—Pair headphones, 2000 ohms
- 1—Switch, Mallory No. 3222J
- 1—Dial plate, Bud N-1169
- 2—Dial plates, Bud DP-982
- 3—Knobs
- 1—GB-14 bias cell holder
- 2—Bias cells, 1-volt
- 2—Bias cells, 1¼-volt
- 5—Tubes (3 1T4; 1 1S4; 1 1S6)

Index to advertisers

Allied Radio Corp.	388
American Society for the Control of Cancer	445
American Radio Hardware	440
Amperite Co.	441
Amplifier Co. of America	448
Audel & Co., Theo.	390
Cannon Co., C.F.	437
Chartered Institute of America	448
Coyne Electrical School	387
Echophone	425
Erwood Sound Equipment Co.	444
Gold Shield Products	446
Hallcrafters, Inc. Inside Front Cover	
Harrison Radio	434
Hawkins Specialties	436
Hudson Specialties Company	442
Lafayette Radio	421
Lancaster, Allwine & Rommel	448
McGraw-Hill Book Co.	446
Meissner Manufacturing Co.	432
National Radio Institute	385
National Schools	433
National Union Corp.	440
Nelson Company	436
Ohmite Manufacturing Co.	389
Opportunity Adlets	436
Panoramic Radio Corp.	448
Popular Homecraft	448
Prentice-Hall, Inc.	429

Acme Trade Schools, Inc.	
American Radio Institute	
Candler System Co.	
Capitol Radio Engineering Institute	
Commercial Radio Institute	
Lincoln Engineering School	
Mass. Radio School	
Metropolitan Technical School	
N.Y. Y.M.C.A. Schools	
RCA Institute	
Radio-Television Institute	
Tri-State College	

Radcraft Publications, Inc.	422, 435, 443
Radio Corporation of America	419
Radio Publications	439
Radio & Television	436
Rider, Publisher, John F.	431
Silco Publishing Co.	437
Sprayberry Academy of Radio	445
Supreme Instruments Corp.	437
Supreme Publications	Back Cover
Technifax	438, 445
Telex Company	437
Triplett Electrical Instrument Co.	441
University Laboratories	446
Weston Electrical Instruments	434
Wholesale Radio Laboratories	444

(While every precaution is taken to insure accuracy, we cannot guarantee against the possibility of an occasional change or omission in the preparation of this index.)

Radio School Directory

TO OUR READERS

NOW, more than ever before America needs trained radio men. The Army, the Navy and the Air Force are continuously on the lookout for men who have had training in radio. Scores of war industries require radio men in various capacities throughout the country. There now is and there

will be a great shortage of radio men for years to come. **NOW IS THE TIME TO TAKE UP RADIO.**

The leading radio schools listed in these pages are training thousands of men in all branches of radio. We suggest that you read their advertisements carefully.

... Here's How You Can Qualify for a BETTER RADIO JOB!

• • • CREI technical training is preparing others for good-paying radio jobs—WHY NOT YOU?

Are you finding yourself in a routine job—a job that any other man can handle just as well as you? Today, radio JOBS are many—but radio CAREERS are few! Now is the opportune time for you to equip yourself with the necessary technical training to qualify for an important engineering position with a sound future.

NOW when industry needs men, is the time for you to investigate radio career training. Your radio experience backed by modern CREI technical training will equip you to share in the good-paying jobs that await trained men—and to make good in the important positions that lead to security and happiness!

WRITE TODAY! If you are a professional or amateur radio-man and want to make more money—let us prove to you we have something you need to qualify for the better job opportunities that can be yours. To help us intelligently answer your inquiry—please state briefly your education, radio experience and present position.



CAPITOL RADIO ENGINEERING INSTITUTE

Dept. RC-4, 3224 16th St., N. W., Wash., D. C.

LEARN RADIO TELEVISION

600 LICENSED graduates placed in past 7 years in shipping, broadcasting, aviation, police, etc.; we also teach radio servicing and repairing; new beginners' class now forming; 60-page catalog free; oldest, largest and best equipped.

MASS. RADIO SCHOOL

18 BOYLSTON ST., BOSTON, MASS., Est. 1899

COMMERCIAL RADIO INSTITUTE

A radio training center for over twenty years. Well equipped. Excellent faculty. Practical resident courses in Defense, Radio Telegraphy, Broadcast, Servicing, Industrial, Television, Aeronautical, Drafting, Mathematics and Studio Technique. Placement bureau. Classes now forming. Catalog upon request.

Dept. D, 38 West Biddle Street, Baltimore, Md.

LEs Correspondence Courses in RADIO and ELECTRICAL ENGINEERING

ELECTRICAL ENGINEERING Get good grasp of wide electrical field. Prepare yourself, at Low Cost, for secure future. Modern, simplified, you can understand quickly.
RADIO ENGINEERING Extra fine course in radio, public address, photo-electric work. Trains you to be super-service man, real vacuum tube technician. Servicemen needed badly. Diploma on completion. Tuition \$25, either course. Deferred payment plan. Get copies of school catalogs, student magazines, complete details. **SEND NOW!**
FREE Lincoln Engineering School P.O. 971-248 LINCOLN, NEBR.



Send for the FREE 52-page Book. It shows that "crack" operators rely on something besides practice to develop their high speeds and proficiency; it explains the "knack" of sound-sense and sound-consciousness—the secret of speedy sending and receiving. Once you acquire these mental processes, reading code becomes almost second nature to you; just as the swing rhythm of a dance band becomes automatic to musician and dancer.

Champions endorse the Candler System. Used in training commercial operators, Amateurs and Radiotelegraph Specialists in Signal Corps, Navy, Marine Corps, Coast Guard, Naval Reserve, Airlines. Wherever the fastest and most efficient operators are found, there you will find Candler trained men.

If you want speed, if you have any difficulties in operating technique, if 40 50 and more w.p.m. seem fantastic speeds to you—send for this revealing book now. It's yours without cost or obligation. Simply send your name and address.

CANDLER SYSTEM CO.

P. O. Box 928, Dept. 3-D,
Denver, Colorado, U. S. A.

Craven House, 121, Kingsway, London, W. C. 2

RADIO ENGINEERING!

RADIO today offers GREAT FUTURE for WOMEN as well as men. Demand for graduates exceeds supply. Courses also in Civil, Electrical, Mechanical, Chemical, Aeronautical Engineering; Business Administration, Accounting, Secretarial Science. Tuition, living costs low. Cosmopolitan student body. Enter June, September, January, March. Catalog.

TRI-STATE COLLEGE 2443 COLLEGE AVE
ANGOLA INDIANA

RADIO COMMUNICATION COURSES

STUDY RADIO BEFORE BEING CALLED TO ACTIVE SERVICE
Our graduates are now actively engaged as radio operators or instructors in
U.S. SIGNAL CORPS • U.S. AIR FORCES
U.S. NAVY • U.S. COAST GUARDS
Instruction by Federally licensed instructors
AMERICAN RADIO INSTITUTE
44 EAST 23rd ST. NEW YORK CITY

RADIO TECHNOLOGY

RCA Institute offers an intensive two-year course of high standard embracing all phases of Radio and Television. Practical training with modern equipment. Also shorter specialized courses in Commercial Radio Operating, Radio and Television Servicing, and Aviation Communications. For Free Catalog write Dept. RC-43.
RCA INSTITUTES, Inc.
A Radio Corporation of America Service
75 VARICK STREET NEW YORK

WELDERS IN GREAT NEED BY WAR INDUSTRIES



Your time if invested now (at small expense) in a Welding career will qualify you for immediate earnings as there is a definite shortage of Welders in our war effort.
In the new world of tomorrow Welders will be in great demand as important factors in the rebuilding of essential ships, planes, etc.
You learn welding by actually "Doing Welding" under the guidance of experts.

Join our Spring Classes now being formed—Have a trade that pays earnings in the higher income brackets. Write or call us today.

ACME TRADE SCHOOLS, Inc.

236 West 54th St., New York, N. Y.

RADIO - TELEVISION VITAL to War Effort

Enroll now with new groups. Opportunity under war conditions and real future in peacetime.

Radio-Television Institute

Dept. R. C.
480 Lexington Ave., New York, N. Y.

PRE-INDUCTION RADIO COURSES

FOR CIVILIANS AND THOSE ENTERING MILITARY SERVICE
NEW CLASSES NOW STARTING
• RADIO OPERATING • CODE
• RADIO SERVICING
New York Y.M.C.A. Schools
4 W. 64th Street New York City

RADIO COURSES for Men and Women PRE-INDUCTION AND CIVILIAN TRAINING

Write, Phone or Call 9 a.m. to 9:30 p.m.
METROPOLITAN TECHNICAL SCHOOLS
Licensed by State of New York
RADIO DIVISION Dept. R
7 CENTRAL PARK WEST, N. Y. Circle 7-2515

FIX ANY RADIO

Amazing New Invention



Learn radio by a simplified method. Repair radios in minutes instead of hours. Revolutionary, different Comparison technique permits you to do expert work almost immediately. Most repairs can be made without test equipment. Simple point-to-point, cross-reference, circuit suggestions locate faults quickly and easily.

COMPLETE
\$1.50
ONLY
SPECIAL OFFER
READ THE DETAILS

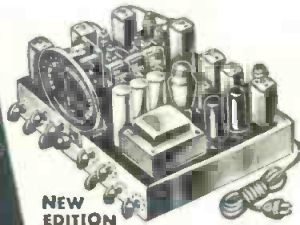

REPAIR ANY RADIO IN MINUTES

Learn how to localize the trouble without any equipment. Make tests, measure voltage, trace the signal with a resistor, small condenser, and a crystal detector. Inject signals without any signal generator. Test parts by the new Comparison method. Test tubes without equipment. Repair any radio expertly following illustrated, simplified plans. Improve your radio servicing ability. Examine the plan without obligations—without risk. Send coupon.

FOR BEGINNERS OR EXPERTS

Understand radio principles; find any radio fault with ease. Follow the comparison tests given on 16 large trouble-shooting blueprints. Over 1,000 practical repair hints. Hundreds of simplified tests using a 5¢ resistor and a filter condenser. Covers every radio set—new and old. Introductory material for beginners and to serve as a review for experienced radio men. Also several chapters on test equipment. Presented in manual form, 112 fact pages 8½ x 11 inches. Entire plan is stark new and will help you get ahead in radio quickly.



Developed by M. N. Beitman, radio engineer, teacher, author, & serviceman.



PRACTICAL USEFUL FACTS AND HINTS

Hundreds of service hints, trouble-shooting ideas, simplified tests, repair suggestions, and alignment methods are included. Benefit by the experience of others. Use the most practical method for finding the fault and making the repair. Save time on every job.

Other Practical Radio Manuals

How to MODERNIZE RADIOS for Profit



Cash in by improving audio circuits, modernizing cabinets, adding features usually found on late model sets. Practical job-sheets with schematics and photographs make the work easy. You are told how to obtain modernization work, what to charge, and how to complete the job quickly and efficiently. Large size, 8½x11 in. manual is priced at only **\$1.00**

MOST-OFTEN-NEEDED RADIO DIAGRAMS



The most popular radio diagrams available in low priced manuals. Large size: 8½ x 11 inches.
1942 Manual, Volume 5, 204 pages....
1941 Manual, Volume 4, 192 pages.... **\$2.00**
1940 Manual, Volume 3, 208 pages....
1939 Manual, Volume 2, 192 pages....
1926-38 Manual, Volume 1, 244 pages, alignment, hints, parts lists..... **\$2.50**

PRACTICAL RADIO MATHEMATICS



Introduces and explains the use of arithmetic and elementary algebra in connection with units, color code, meter scales, Ohm's Law, alternating currents, ohmmeter testing, wattage rating, series and parallel connections, capacity, inductance, mixed circuits, vacuum tubes, curves, the decibel, etc., etc., and has numerous examples. Net..... **25c**

SEE YOUR RADIO JOBBER OR SEND COUPON

FIX MOST SETS WITHOUT TESTERS

Follow the COMPARISON technique and repair 4 out of 5 sets without equipment. Speed up your work; locate faults quickly; make repairs efficiently. Be fair with yourself and try this new plan without obligation. Take advantage of our "no-risk" trial. Send coupon today. Use this time-saving, money-making radio servicing training for 10 days without any obligations. See how quickly you will learn helpful methods. Save time every day on every radio job. Learn new short-cuts in radio servicing. Get ahead in Radio. Repair sets for fun and profit. Prepare for higher rank and better pay in the Army. Act today.



MONEY-BACK GUARANTEE

You must be entirely satisfied or your money will be refunded without a question. The training will more than pay for itself on the first radio job or with higher rank in the Army. Examine and use this unique plan for 10 days at our risk. Send coupon right now—use the plan this week.

"NO RISK" TRIAL ORDER COUPON

SUPREME PUBLICATIONS, 328 S. Jefferson St., Chicago, Ill.

Ship my copy of the complete Simplified Radio Servicing by COMPARISON Method manual. I must be entirely satisfied or you will refund my total remittance.

- I am enclosing \$1.50, full price. Send postpaid.
- Send C. O. D. I will pay the mailman \$1.50 and a few cents postage.
- Also send other Supreme Publications books as listed in letter.

NAME

ADDRESS

(Use Coupon or Send Order in a Letter)

Supreme Publications

PUBLISHERS OF RADIO BOOKS, MANUALS, AND DIAGRAMS

328 South Jefferson Street

Chicago, Illinois