

RADIO'S GREATEST MAGAZINE

47

K

# RADIO-CRAFT

Incorporating

## RADIO & TELEVISION

HUGO GERNSBACK, Editor

NEW FM ANTENNA  
See Page 398

SPECIAL  
FREQUENCY  
MODULATION  
**-FM-**  
NUMBER



MARCH

25¢

CANADA 30¢

1942

OVER 125 ILLUSTRATIONS

# At your service . . .

## PRICES?

No matter what happens to prices—here at Harrison our large scale purchasing and our tremendous stock enable us to continue to give you the lowest possible prices at all times.

*It pays to buy from Harrison!*

## DELIVERY?

With production facilities already greatly overtaxed, deliveries are falling behind more every day. But, we anticipated this "Back-order Era" and placed protective orders many months ahead.

Right now we have more receivers, parts, tubes, etc., *on hand* than at any time in our busy sixteen year history!

*You get faster delivery from Harrison!*

## TRIAL?

When you buy anything from Harrison it has to be entirely satisfactory or you don't keep it. Try out your next receiver for ten days without charge or obligation by ordering it from us.

*You get 100% cooperation from Harrison!*

## TRADE-IN?

By fair dealing we have built up the largest Reconditioned Receiver business in the world! We have a ready market for your old set, and that means we can give you the very best trade-in allowance. (We also buy receivers, transmitters, etc., for cash.)

*You get the best deal at Harrison!*

## TERMS?

Certainly! Charge Account or Easy Payment Plan. Buy your Receiver, transmitter, parts, etc., on our easier terms at lowest cost.

*Your credit is good at Harrison!*

## GUARANTEE?

Everything is "guaranteed," but your best guarantee is the integrity of the person with whom you deal. Here at Harrison we go far beyond the standard warranty in order to please you!

*You get a square deal from Harrison!*

I'll be looking for your order!

73,  
BILL HARRISON, W2AVA

*(Send for my latest list of New and Reconditioned Receivers)*



**hallicrafters Super Skyrider**

Model SX-28. "Tops" in performance. 15 tubes, 2 r.f. stages, calibrated bandspread, etc. Covers .55 to 42 mc.



**hallicrafters Sky Buddy**

Model S-19-R. A six tuber that offers good results for a moderate price. .545 to 44 mc with continuous electrical bandspread.



**hallicrafters Sky Champion**

Model S-20-R. Excellent value. Nine tubes, noise limiter, preselector stage. .545 to 44 mc. bandspread, etc. Socket for battery or vibro-pack operation.



**hallicrafters Super Defiant**

Model SX-25. Has all the features of sets selling for nearly twice as much!



**hallicrafters Sky Traveler**

Model S-29. You can take it with you! Works on self contained batteries or any AC or DC line. Built-in telescoping antenna. 9 tubes. .542 to 30.5 mc. bandspread. internal speaker, battery recharger.

*It's* **HARRISON** *for*  
**hallicrafters and SERVICE!**

**HARRISON RADIO COMPANY**

11 West Broadway, New York City  
Worth 2-6276

# Get Into RADIO Quick!

## RADIO TECHNICIANS in Demand More Needed Now Than Ever Before



RADIO TECHNICIANS, OPERATORS hold good jobs in the 882 Broadcasting Stations in the U. S. with average pay among the country's best paid industries. Aviation, Police, Commercial, Marine, Government Radio, forging ahead even during the War, employ Radio Technicians and Operators. Soldiers, Sailors, Marines with Radio training win extra rank, pay, are ready for good jobs after their military service is over. I train you to be ready when Television opens jobs in the future. Mail Coupon for complete details.

REPAIRING, SERVICING, home and auto Radio sets (there are now 50,197,000 in use) gives good jobs to thousands, offers more opportunities now than ever. Loudspeaker Systems are another source of profit for Radio Technicians. Many Radio Technicians operate their own spare time or full time Radio business, servicing, repairing, selling Radio sets. Get the facts. Mail the Coupon.



### These Men and Hundreds More Got Their Start This Way



#### \$200 a Month in Own Business

For several years I have been in business for myself making around \$200 a month. Business has steadily increased. I have N.R.I. to thank for my start in this field.—**ARLIE J. FROEHNER, 300 W. Texas Ave., Goose Creek, Texas.**

#### \$5 to \$10 Extra a Week in Spare Time

I am engaged in spare time Radio work. I average from \$5 to \$10 a week. I often wished that I had enrolled sooner because all this extra money sure does come in handy.—**THEODORE K. DUBREE, Horsham, Penna.**



#### Operating Naval Radio Station

I am now operating the Radio Range Station, one of the new simultaneous types, here at the Naval Air Station. Glad to give N.R.I. its share of credit in the success I have had thus far.—**GRIFFITH SECHLER, Radioman First Class, U. S. Navy** (Address omitted for military reasons.)



## Learn At Home To Make \$30 \$40 \$50 a Week

MAIL THE COUPON! Find out about the many opportunities Radio offers you to make more money quickly and to prepare yourself for a good-pay job after the War. Whether you're eligible for military service or exempt, you should get my 64-page Book, "Rich Rewards in Radio." It's FREE. It tells about Radio's present and future opportunities and how I train beginners at home in spare time to be Radio Technicians and Operators; how I teach operating principles of Army, Navy, Civilian Defense Radio equipment.

### 5 Reasons Why You Should Learn Radio Now

- (1) The Radio Repair Business Is Booming. Because of the shortage of new sets, and increased interest in Radio programs, fixing Radios offers many extra new opportunities for Radio Technicians.
- (2) U. S. Government is calling for thousands of CIVILIAN Radio Technicians, Operators and is paying well for their services.
- (3) Government Orders for Radio Equipment, amounting to millions of dollars are creating opportunities for men with Radio training to earn good pay, overtime.
- (4) Radio Is Ready to Expand After the War. Television, Frequency Modulation, Electronic Instruments and Controls will offer new opportunities in the future.
- (5) Extra Pay in Army, Navy, Too! Radio Training offers men likely to enter military service, soldiers, sailors, marines, many opportunities to win extra rank, extra prestige, more interesting duty and earn up to 6 times a private's base pay.



### Why Many Radio Technicians Make \$30, \$40, \$50 a Week

Radio is one of the country's fastest-growing peace-time industries. It is a vital industry during wartime, too. That's why N.R.I. trained Radio Technicians and Operators earn good pay in practically every branch of Radio today: in Broadcasting, Aviation, Commercial, Police, Marine, Government Radio Stations; in Radio Factories; fixing Radio sets in spare time or full time; in Radio businesses of their own. Many fields of Radio are expanding fast during the war. Many more new branches of Radio (Television, Frequency Modulation, etc.) held back, will create new peace-time opportunities after the war. N.R.I. gives you the required knowledge of Radio to take advantage of these present and future opportunities.

### Beginners Soon Learn to Make \$5, \$10 a Week Extra in Spare Time

Part time Radio Technicians have more opportunities now than ever before. In fact, many men I train prefer to hold their regular jobs, and make extra money fixing Radios sets in their spare time. I give you special training and show you how to start fixing Radios early. As you progress with my Course, I show you how to do more and more money-making Radio jobs. Many men I train pay for their Courses, and have extra money to spend besides, by doing Radio repair work while learning.

### How I Give You Practical Experience While Learning

Very soon after you enroll I start sending you my 6 Big Kits of Radio Parts. As my student you spend about half your time building Radio Testing Equipment, Radio Circuits, Complete Radio Sets, small Radio Transmitters, Frequency Modulated Circuits. You conduct more than 100 Radio Experiments, make more than 600 Radio measurements which give you broad practical experience. My fifty-fifty method of training—half working with real Radio parts, half studying my lesson texts—holds your interest—makes learning Radio at home fascinating, practical.

### Find Out How I Train You for Good Pay in Radio

MAIL THE COUPON BELOW! I'll send my big 64-page book FREE. It tells about my Course; the types of jobs in the different branches of Radio today; Radio's opportunities for the future; shows letters from more than 100 men I trained so you can see what civilian and service men are doing, earning. You owe it to yourself to get these facts NOW. MAIL THE COUPON in an envelope or pasted on a penny postcard.

**J. E. SMITH, President**  
Dept. 2CX, National Radio Institute  
Washington, D. C.

### MAIL NOW for Quick Action

J. E. SMITH, President, Dept. 2CX  
National Radio Institute, Washington, D. C.

Mail me FREE, without obligation, your 64-page book "Rich Rewards in Radio" which tells about Radio's opportunities now and for the future. (No salesman will call. Write plainly.)

Name ..... Age .....

Address .....

City ..... State .....



# RADIO-CRAFT

Incorporating

**RADIO & TELEVISION**

**HUGO GERNSBACK**  
Editor-in-Chief

**H. W. SECOR**  
Managing Editor

**CARLOS FROWEIN**  
Art Director



## Contents MARCH, 1942 Issue

VOLUME XIII -- NUMBER 7

|                                   |                    |
|-----------------------------------|--------------------|
| Mailbag .....                     | 388                |
| Editorial: Radio War Guards ..... | Hugo Gernsback 391 |

### F. M.

|  |                   |
|--|-------------------|
| What Radio Leaders Think About "FM" .....                                  | 392               |
| Frequency Modulation and Its Future Uses<br>Major Edwin H. Armstrong ..... | 394               |
| W2XQR Broadcasts Concert Music on FM. Russell D. Valentine .....           | 397               |
| W45D—Detroit Gives F.M. Antenna Facts .....                                | 398               |
| WOR's New FM Station .....   | 400               |
| FM in 1942—As I See It .....   | J. R. Poppele 401 |
| NBC's FM Station to go to 10,000 Watts. O. B. Hanson .....                 | 402               |
| One of New York's FM Broadcasters—CBS Station W67NY .....                  | 404               |
| FM Future at a Glance .....  | 406               |
| "FM" Map Grows Rapidly .....   | 407               |
| Chicago Turns to FM .....  | Cyril Wagner 408  |
| Mount Washington Highest FM Station .....                                  | A. F. Sise 410    |
| How FM Cuts Out Static .....   | 413               |
| FM Sets for All .....  | 414               |
| FM Station List .....  | 416               |
| K45LA—Only "Commercial" on West Coast. Frank Kennedy .....                 | 418               |
| W55M Milwaukee Calling!—The FM Voice of the Milwaukee Journal .....        | 420               |

### RADIO DEFENSE

|   |     |
|---|-----|
| Ears For The Fleet—Radio, The Naval Reserve—and YOU ..... | 421 |
|---|-----|

### SERVICING

|   |               |
|---|---------------|
| Grid-Bias Resistor Values. Alfred A. Ghirardi, B.S., E.E. ....              | 423           |
| Trouble for you in '42. Harold Davis .....                                  | 424           |
| RADIO SERVICE DATA SHEET:<br>No. 320: Hallicrafter S27 FM/AM Receiver ..... | 426           |
| FM and the Serviceman .....   | Bob Stang 428 |

### SOUND

|  |     |
|--|-----|
| A "Tobacco Tin" Hearing Aid. Samuel B. Simer ..... | 432 |
| The Penetron .....                                 | 436 |

### DEPARTMENTS, ETC.

|   |     |
|---|-----|
| Mailbag .....                                   | 388 |
| Operating Notes .....                           | 430 |
| RADIO SERVICE DATA SHEETS (See Servicing) ..... | 426 |
| Latest Radio Apparatus .....                    | 438 |
| Book Review .....                               | 431 |

### RADIO & TELEVISION

|   |     |
|---|-----|
| In This Receiver 2 Tubes Equal 4. Joseph P. Hiatt .....                       | 440 |
| Foot Pedal Break-In. Rod Newkirk, W9BRD .....                                 | 442 |
| Calibrated Oscillator for the Ultra-High Frequencies<br>A. Binneweg, Jr. .... | 444 |
| Question Box .....  | 446 |
| Radio Kinks .....   | 447 |



Published by Radcraft Publications, Inc. Publication office: 29 Worthington Street, Springfield, Mass. Editorial and Advertising Offices: 25 West Broadway, New York City, Chicago Advertising Office: RADIO-CRAFT, 520 North Michigan Avenue, Chicago, Ill.

RADIO-CRAFT is published monthly, on the first of the month preceding that of date; subscription price is \$2.50 per year in U. S. (In foreign countries, 75c additional per year to cover postage; Canada, 50c additional.) Entered at the post office at Springfield as second-class matter under the act of March 3, 1879. All communications about subscriptions should be addressed to: 29 Worthington Street, Springfield, Mass., or Director of Circulation, 25 West Broadway, New York, N. Y.



#### Foreign Agents:

London—Gorrings's American News Agency, 9A Green St., Leicester Square, W. C. 2, England.

Paris—Messageries Dawson, 4 Rue Faubourg, Poissonniere, France.

Melbourne—McGill's Agency, 179 Elizabeth St., Australia.

Dunedin—James Johnston, Ltd., New Zealand.



Text and illustrations of this magazine are copyright and must not be reproduced without permission of the copyright owners.



Copyright 1942 Radcraft Publications, Inc.



## Another Instance of How IRC Helps Servicemen Build Business

**THIS** little tag, factory-packed with all IRC Volume Controls sold through the jobbing trade, is designed to be hung on the control knob whenever you use an IRC Control for replacement. Read it carefully. You'll quickly see that there is no better way of building public confidence. No customer will fail to see it. None will fail to be impressed with the fact that you have used a replacement of highest quality.

The reverse side of the tag has space for your name, address and 'phone number. This not

only serves as a reminder to call you when future service is required—but it is also suggested on the tag that customers recommend your services to their friends. This means that the tag actually does double duty in working for you.

Use IRC Controls to insure utmost quiet and long, dependable performance on every job. Use the IRC Volume Control Tag to build confidence, insure future business and to build new business from people who may never have heard of you before!

### Save Time...Money...Work...on Control Replacements

By actual count, 10,859 of the radio models listed in the IRC Control Replacement Manual call for one or more replacements that can be supplied from the 18 Type D Controls and accessories included in the IRC Master Volume Control Cabinet. The Cabinet equips you for prompt service on the big majority of jobs. It saves you money, because Type D Controls with Tap-in Shafts can often be used in place of costly "specials." It saves time because Tap-in Shafts are easier and quicker to install. Ask your IRC jobber for details—today!



# RESISTORS and CONTROLS

INTERNATIONAL RESISTANCE COMPANY, 401 North Broad Street, Philadelphia, Pa.

•MAILBAG•

**SPRAYBERRY  
RADIO TRAINING**  
*includes*  
**FULL EQUIPMENT**



Experience Easily Acquired  
at Home

You Do Practice-Giving  
Experiments. Many Special  
Features . . . ALL Designed  
to Help You Make Fast Progress

SPRAYBERRY Training starts  
right at the beginning of Ra-  
dio . . . unfolds each subject  
in a simplified, logical, understandable style.  
You easily learn Television, Frequency Modu-  
lation, Signal Tracing, Mobile Radio (Auto-  
Tank), Aviation Radio, Electronics, Facsimile  
Radio, Radio Set Repair and Installation  
work.

Training Prepares You for a Business of  
Your Own . . . Or Good Radio Jobs  
at Excellent Pay

The Great fascinating and progressive  
field of Radio offers many opportunities  
to the man who wants to get ahead.  
My Training is designed to give you  
quick access to these opportunities.  
SPRAYBERRY Methods are thorough  
and practical. Your Training will not  
interfere with your present work. No  
previous experience is needed.

You Get Professional Test Equipment  
Plus Complete Radio Set

with the Radio Parts Given (everything  
needed to build a Complete Receiver)  
. . . you conduct interesting informa-  
tive experiments with your own hands.  
Also you are supplied a modern  
TESTER-ANALYZER.

Earn While You Learn  
My BUSINESS BUILDERS show you  
how to put your equipment to actual use  
in handling money-making Radio Ser-  
vice Jobs shortly after You  
begin Training.

THE SPRAYBERRY  
COURSE IS SOLD UNDER  
MONEY-BACK AGREEMENT

**RUSH COUPON for BIG FREE BOOK**

SPRAYBERRY ACADEMY OF RADIO  
F. L. Sprayberry, President  
520-C University Place, N. W.  
Washington, D. C.

Please rush my FREE copy of "HOW TO MAKE  
MONEY IN RADIO."

Name . . . . .  
Address . . . . .  
City . . . . . State . . . . .

(Mail in envelope or paste on penny postcard)

**PREPARE YOURSELF**

for a commercial radio position through a  
home study course written for the man who  
has forgotten higher mathematics and who  
has had a non-technical education.

This course qualifies you to pass the Federal  
Radio Telegraph and Telephone examina-  
tions.

An easily read, and easily understood course.  
Moderate tuition fee. Write for particulars.

**AMERICAN RADIO INSTITUTE**

1123 Broadway New York City

**LEARN RADIO**

**TELEVISION**

600 LICENSED graduates placed in  
past 7 years in shipping, broadcasting,  
aviation, police, etc.; we also teach radio  
servicing and repairing; new beginners'  
class forming Sept. 8th; 60-page catalog  
free; oldest, largest and best equipped.

**MASS. RADIO SCHOOL**

18 BOYLSTON ST., BOSTON, MASS., Est. 1899

**PATENTS—TRADE MARKS**

Booklet concerning Inventions & Patents  
Form "Evidence of Conception" with  
instructions for use and "Schedule of  
Government and Attorneys Fees"—Free

LANCASTER, ALLWINE & ROMMEL  
Registered Patent Attorneys  
436 Bowen Bldg. Washington, D. C.

**RADIO COURSES**

- RADIO OPERATING—BROADCASTING
- RADIO SERVICING—a practical course
- RADIO AMATEUR CODE ● TELEVISION
- SPECIAL RADIO TECHNICIAN COURSE
- ELECTRONICS—1 yr. day course 2 yrs. eve.  
Day and Evening Classes. Booklet Upon Request.

New York Y.M.C.A. Schools  
4 W. 84th Street New York City

**PRACTICAL INFORMATION  
NEEDED**

Editor:

Away back in the early "twenties," when  
I first became enthused with the idea of  
learning what there was to be known at  
that time about Radio, and "what makes  
it tick," there were no schools available  
near by from which I, and many others  
like me, could get thorough instruction in  
Radio.

The only source of information on cir-  
cuits, and how to connect apparatus so that  
we could listen to the programs available  
at that time were periodicals such as  
RADIO-CRAFT.

So, it happens that what success I have  
enjoyed for the last fifteen years, as a  
service engineer and instructor in Radio  
Communications, U.S. Vocational School,  
located in this city, is, almost entirely, cre-  
ditable to the knowledge gained by "hooking  
up" receivers from diagrams and instruc-  
tions found in such periodicals as RADIO-  
CRAFT.

I have found by my experiences, both in  
learning Radio, and teaching it, that the  
requirements of the greater percentage of  
students is more along practical lines than  
technical. So, my classes are conducted  
along these lines. That is—my students are  
taught to learn by doing, with just enough  
technical material or radio physics, to let  
them understand why the radio parts func-  
tion, as well as how they function.

This system of instruction enables me to  
prepare the student for an amateur license  
in about six months, with six hours' instruc-  
tion per week. Or prepare him to become  
quite efficient as a serviceman within twelve  
months.

I notice that, within the last few years,  
RADIO-CRAFT and other radio periodicals  
have forgotten the beginner in radio, except  
for the occasional insertion of a diagram  
of a one- or two-tube "bloop" set that  
more often will not work. Instead you have  
perfected a wonderful magazine for ad-  
vanced servicemen, who seldom have time  
to read it.

Also I would suggest that a Question and  
Answer department be carried for the ben-  
efit of beginners.

B. F. MILLS,  
Great Falls, Mont.

**"MUD SLINGING"**

Editor:

I have not the "honor and glory forever"  
of being a Serviceman, or a "Ham," or  
even an (un)Sound man, but I do opine  
that space in Radio-Craft is too valuable  
to be used by a few of these gentlemen in  
the childish sport of throwing mud.

If anyone contributes something that is  
new, or helpful, or constructive—or even  
educational, I am sure your readers will  
show the same approval regardless of  
whether the author is a well known college  
professor—or some humble modest genius  
"In a Little Spanish Town" like Lost Angels  
(Lows Angle-ease) if you please. After  
all—Bright Jewels do not originate "On  
the Sidewalks of New York"—too many  
Gold Bricks there.

This is by no means a criticism of Mr.  
Moody et al., who are like England—capable  
and willing to help the little fellows, but  
instead have to FIGHT them, because they  
are too jealous to be appreciative and co-  
operative. That is why all of the "little  
fellows" in Europe fell before a Plague of  
Germs, and their plight should be a precept  
for us and U.S.—co-operate and pull to-  
gether—find time to help—but be too darn  
busy to throw mud!

ACIDOLFUS GERM HITMUSS  
Sum ware in Cognito.



**QUICK, EASY WAY  
TO TRAIN FOR  
RADIO  
in 8 WEEKS**

H. C. Lewis

**I'LL FINANCE YOUR TRAINING**  
Mail the Coupon TODAY and I'll  
not only tell you about my quick,  
easy way to train for a good pay  
job in Radio, Television and Sound,  
BUT, I'll also tell you how you can  
get it and pay for it, in easy  
monthly payments starting 60  
days after 8 weeks' training period.

**LEARN BY DOING**  
On Real Equipment in Coyne Shops  
Simple, easy method of Practical  
Training. You don't need previ-  
ous experience or a lot of book  
learning. You work on real equip-  
ment in the Coyne Shops at  
Chicago. This 8 weeks training pre-  
pares you for a job in service and  
repair work—we also offer radio  
operating training. Full details of  
this training will also be sent you  
when you send coupon.

**EARN WHILE LEARNING,  
Job Help After Graduation**

We help you get part time work to help with living expen-  
ses and then give you employment service after graduation.

H. C. LEWIS, President,  
Radio Division, Coyne Electrical School,  
500 S. Paulina St., Dept. 32-8H, Chicago, Ill.

Dear Mr. Lewis:  
Please send me your Big FREE Book, and details of  
your PAY-AFTER-GRADUATION-PLAN.

NAME . . . . .  
ADDRESS . . . . .  
CITY . . . . . STATE . . . . .



**SEND  
COUPON  
TODAY**

**DATAPRINTS**

**TESLA-LOUDIN COILS**



- 20c Ea. in order for 10  
(Data and Drawings only.)
- 36" Sp'k Tesla-Oudin Coil 40c
- (1 K.W. Exc. Trf. Data incl.)
- 8" Sp'k Tesla-Oudin Coil 40c
- (1/2 K.W. Exc. Trf. Data incl.)
- 3" Sp'k Oudin; 110 Vt.
- "Kick Coil" type . . . . . 40c
- 3" Tesla Works on Ford  
Coil . . . . . 40c
- 1" Sp'k Vibrator Hi-Freq. Coil 40c

NEW! 5 ft. Sp'k. Oudin Coil & Exciter  
Data . . . . . 75c

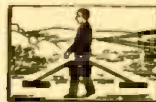

**Induction PIPE &  
ORE LOCATOR**

Induction Type, Data . . . . . 40c  
Radio Type . . . . . 40c

**More DATAPRINTS 40c each!**

- 5 Meter Superhet.
- 1/2 Meter Tr. & Rec.
- 20 A.C. Probs. & Ans.
- 20 Telephone Hook-ups
- 100 Mech. Movements
- 20 Motor Hook-ups
- Television Hook-up
- 20 Elec. Party Tricks
- Solenoids and Magnets  
—get list.
- Fry Eggs on Ice!
- Experimental Photo-  
phone
- Radio Control for  
Models
- Diathermy Apparatus
- Inductor Organ
- Electric Refrigerator
- Wheatstone Bridge
- Weld. Transf. 2 K.W.
- Rewinding Armatures
- String Galvanometer
- 20 Simple Bell Circuits
- Steel Wire Recorder!
- Water Wheels
- Water Turbines
- Photo Cell and Relay
- Ring 4 bells: 2 Wires
- 20 Tesla Tricks
- Polarized Relay
- Induction Balance
- Electric Pipe Thawer

Special Prices: 4 prints \$1.00; 10 for \$2.00;  
Single, 40c each. Get New Catalog 100 A.

**The DATAPRINT Co.**

Lock Box 322D, Ramsey, N. J.

**Inventions Wanted  
Patented or Unpatented**

We have been successfully selling inventions,  
patented and unpatented, since 1924. Write us,  
if you have a practical, useful idea for sale.

**CHARTERED INSTITUTE  
OF AMERICAN INVENTORS**

Dept. 109 Barrister Building, Washington, D.C.

# DETROLA

## AUTOMATIC RECORD CHANGER

### RADIO-PHONOGRAPHS



Designed by DETROLA  
Engineered by DETROLA  
Produced by DETROLA

THE WORLD'S Easiest-to-Operate AUTOMATIC RECORD CHANGER

They're simple, trouble-free . . . A child can operate them. You will marvel at this wondrous performance!

Every Model Has All Five EXCLUSIVE DETROLA FEATURES

1. The only Automatic Changer that plays home recordings
2. Gearless, noiseless operation.
3. Manual or automatic record selector.
4. New type center-post with amazing features for convenience in adding or removing records.
5. Free-floating tone-arm prevents record harm.

And That's Not All . . .

Each plays ten 12" or twelve 10" records—has feather-weight tone-arm, everlasting needle. Radio or phonograph. YOU GET PERFECT TONE!

Also Complete Line of DETROLA 3-way Personals And Portables TABLE MODEL RADIOS FARM SETS AND RECORDIOLAS

See Your Detrola Dealer

# DETROLA

DETROLA BLDG. DETROIT, MICH.

### LIKED MR. GERNSBACK'S ARTICLE

Editor:

Three cheers for Mr. Gernsback's article in the September issue on "Radio Servicemen Are Gyps." Let us hope that all servicemen throughout the country will read this article. I do not agree with Mr. Samuel Steur that all radio repairmen should be licensed by the Government, because that would mean taking an examination, in which many servicemen who are excellent mechanics but poor theorists might fail. If a man can convert a radio so that it will give satisfactory performance, he is a good serviceman.

Yours very truly,

FELIX ASTRUCK,  
New York, N. Y.

### WHAT TO DO WITH "QUACKS"

Editor:

I am a subscriber to your "R-C." magazine and also a part-time radio technician. I say technician because I do not "fiddle" around in servicing receivers. I tell my customers that sometimes it takes longer to fix some sets than it does others.

I am a licensed Radio Serviceman and by that I mean I belong to the Radio Servicemen of America (RSMA).

I do not intend to be offensive, by saying I am not a Serviceman but a Technician, but there are some who are "quacks" and want to ruin our profession just as a "quack" doctor tries to ruin the professional physician.

I am a high school graduate and have studied theory and fundamentals of radio and am taking a "shop course" in servicing and operating; I will soon take a course in radio shop operating and a communications course; this will be an advanced course.

I hope then not only to be able to do expert radio technician service work, but also to hold down a good operating job. A man can never learn too much in this modern progressive world as it is today.

I won't have to worry about the "bread-line" like some people who have no trade whatsoever.

I like all of your publications of "R-C." but like best the September, 1941, issue and the two articles: "Isolating the Defective Stage," by Wm. Franklin Cook, and "64% of the Radio Servicemen Are Gyps," by Hugo Gernsback, Editor.

Yes sir! I approve very much of licensing the qualified radio Servicemen under Federal supervision, so that all "quack-servicemen" will be eliminated and that such statements as "64% of the Radio Servicemen Are Gyps" will never need to be made again.

I vote that we get together, we Servicemen, and write a so-called "group" letter from all of us and send it to Washington, (to the F.C.C.) who would probably have jurisdiction over it, and ask them to legislate a move to take up the matter and bring it to a solution, so that anyone servicing would have to pass an examination to get his license to service, just like the radio operator. Even then there will be "bootleggers," but if then the public would demand proper "credentials" of the Serviceman, when he arrives to service a set, the "quack" would slip into oblivion.

These are merely suggestions, perhaps someone else knows a better one. I am merely stating my opinion on the matter, but I do urge that we "spur" the matter about the license business.

NORMAN A. ZUEHL,  
San Antonio, Texas.

## TODAY is the time to turn your RADIO JOB into a SECURE POSITION!

Do You Want a BETTER JOB? — A Secure Future? NOW is the time to prepare Yourself for a Lasting, Profitable Career in Radio Engineering

Don't fool yourself! The good jobs—the permanent positions in radio don't come easy. The sure way to success is to build your future on a sound foundation of knowledge and ability . . . and the ability that you develop now is your assurance of a steady, sure income that will outlast temporary emergencies such as the present. Dividends for increased ability have never before been so certain. CREI technical training is designed to do just one thing—to increase your ability, enabling you to hold the more responsible positions which lead to higher salaries. Hundreds of CREI students have accomplished this through the help of CREI training—just as many more hundreds will do in the future!

WRITE FOR FACTS TODAY!

Our free booklet and personal recommendations may hold the answer to your success. In your inquiry, please state briefly your background, education, present position—and whether interested in home study or residence training.



**CAPITOL RADIO**  
Engineering Institute

Dept. RC-3, 3224 16th Street, N. W., Washington, D.C.

## COMMERCIAL RADIO INSTITUTE

A radio training center for over twenty years. Well equipped. Excellent faculty. Practical resident courses in Radio, Telegraphy, Broadcast, Servicing, Industrial, Television, Aeronautical, Drafting, Mathematics and Studio Technique. Placement bureau. Classes now forming. Catalog upon request.

Dept. D, 38 West Biddle Street, Baltimore, Md.

## RADIO-TELEVISION

Oldest, largest Radio-Television school in West trains you for good pay job. Complete instruction including Radio future. Modern, simplified, you can understand. Quickly. Construction and Service, Broadcast Operating, Sound, Talking Pictures, Television, Public Address, etc. Flexible plan to meet specific needs of those with or without jobs. Transportation allowed to L.A. Barn room and board while learning. Request Free Catalog.

Dept. RC-3 Los Angeles

## NATIONAL SCHOOLS

Correspondence Courses in RADIO and ELECTRICAL ENGINEERING

**ELECTRICAL ENGINEERING** Get good grasp of wide electrical field. Prepare yourself, at Low Cost, for secure future. Modern, simplified, you can understand. Quickly. **RADIO ENGINEERING** Extra fine course in radio, public address, photo-electric work. **Train you to be super-service man!** Vacuum tube technician. Exper. kits furnished. Diploma on completion. Tuition, \$25. either course. Deferred payment plan. **FREE** Get copies of school catalogs, student magazines, complete details. **SEND NOW!**

LINCOLN ENGINEERING SCHOOL Box 631-632, LINCOLN, NEBR.

## RADIO ENGINEERING

broadcasting, aviation and police radio, servicing, marine radio telegraphy and telephony, Morse telegraphy and railway accounting taught thoroughly. 48 weeks' Engineering course equivalent to 3 years of college radio work. All expenses low. Catalog free. School established 1874. The Dodge Institute, Turner St., Valparaiso, Ind.

## RADIO TECHNOLOGY

RCA Institutes offer an intensive course of high standard embracing all phases of Radio and Television. Practical training with modern equipment at New York and Chicago schools. Also specialized courses in Aviation Communications, Radio Servicing and Commercial Operating. For Free Catalog write Dept. RC-42.

**RCA INSTITUTES, Inc.**  
A Radio Corporation of America Service  
75 Varick St., New York, 1154 Merchandise Mart, Chicago

**USED Correspondence Courses**  
COMPLETE HOME-STUDY COURSES and educational books, slightly used. Sold, rented, exchanged. All subjects. Money-back guarantee. Cash paid for used courses. Full details and illustrated 72-page catalog FREE. Write today!  
NELSON COMPANY, 500 Sherman, Dept. C-210, Chicago



# A WAR MESSAGE to ALL EMPLOYERS

★ From the United States Treasury Department ★

WINNING THIS WAR is going to take the mightiest effort America has ever made—in men, in materials, and in money! Every dollar, every dime that is not urgently needed for the civilian necessities of food, clothing, and shelter, must, if we are to secure final Victory, be put into the war effort.

An important part of the billions required to produce the planes, tanks, ships, and guns our Army and Navy need must come from the sale of Defense Bonds. Only by regular, week by week, pay-day by pay-day investment of the American people can this be done.

This is the American way to win. This is the way to preserve our democratic way of life.

Facing these facts, your Government needs, urgently, your cooperation with your employees in *immediately* enrolling them in a

## PAY-ROLL SAVINGS PLAN

The Pay-Roll Savings Plan is simple and efficient. It provides, simply, for regular purchases by your employees of United States Defense Bonds through systematic—yet voluntary—pay-roll allotments. All you do is hold the total funds collected from these pay-roll allotments in a separate account and deliver a Defense Bond to the employee each time his allotments accumulate to an amount sufficient to purchase a Bond.

The Pay-Roll Savings Plan has the approval of the American Federation of Labor, the Congress for Industrial Organization, and the Railroad Brotherhoods. It is now in effect in several thousand companies varying in number of employees from 3 to over 10,000.

In sending the coupon below, you are under no obligation, other than your own interest in the future of your country, to install the Plan after you have given it your

consideration. You will receive—1, a booklet describing how the Plan works; 2, samples of free literature furnished to companies installing the Plan; 3, a sample employee Pay-Roll Savings authorization card; and 4, the name of your State Defense Bond administrator who can supply experienced aid in setting up the Plan.

To get full facts, send the coupon below—today! Or write, Treasury Department, Section B, 709 Twelfth St., NW., Washington, D. C.

## HOW THE PAY-ROLL SAVINGS PLAN HELPS YOUR COUNTRY

- 1 It provides immediate cash now to produce the finest, deadliest fighting equipment an Army and Navy ever needed to win.
- 2 It gives every American wage earner the opportunity for financial participation in National Defense.
- 3 By storing up wages, it will reduce the current demand for consumer goods while they are scarce, thus retarding inflation.
- 4 It reduces the percentage of Defense financing that must be placed with banks, thus putting our emergency financing on a sounder basis.
- 5 It builds a reserve buying power for the post-war purchase of civilian goods to keep our factories running after the war.
- 6 It helps your employees provide for their future.

**MAIL THIS COUPON NOW**

Treasury Department, Section B  
709-12th St., NW.  
Washington, D. C.

We want to do our part. Please  
rush full information regarding  
the Pay-Roll Savings Plan.

NAME.....  
POSITION.....  
COMPANY NAME.....  
ADDRESS.....  
NUMBER OF EMPLOYEES.....



**MAKE EVERY PAY-DAY... BOND DAY!**  
**U. S. Defense BONDS ★ STAMPS**

This space is a contribution to NATIONAL DEFENSE by Radio-Craft.

GPO 16-25943-1 Form No. DSS-BP-2

RADIO-CRAFT for MARCH, 1942



---

---

# RADIO-CRAFT

Incorporating

RADIO & TELEVISION

---

---

"RADIO'S GREATEST MAGAZINE"

... Radio **MUST** be used  
to greater advantage in  
our war effort ...

## RADIO WAR GUARDS

By the Editor — HUGO GERNSBACK

**T**HE lamentable burning of the *Normandie* in New York Harbor at its pier, early in February, teaches us a great lesson—how radio is NOT being used for most obvious purposes, during this war.

Whether the *Normandie* fire was of incendiary or natural origin need not concern us at the moment; but a preliminary investigation brought out the fact that most valuable time was lost before an alarm was turned in to the local Fire Department. It seems to be well established at this writing that it took approximately eleven minutes before such an alarm was turned in—a sufficiently long time for the flames to make such headway that the disaster followed as a necessary consequence.

Here is an instance where radio could have been used to great advantage and certainly should be so used in the future, particularly while we are at war. The burning and damaging of the *Normandie* will not be the last ship that will go up in flames and we may be certain that the enemy is trying to do all he can to prevent troop and war cargo ships from sailing. Sabotage is nothing new in America. Those who are old enough will remember what happened in the first World War, but unfortunately we still do not seem to have learned the lesson.

Even with the strictest of supervision—which certainly was lacking in the *Normandie* case—it will still be possible for saboteurs to fire ships during this war, and even the strictest vigilance will probably not prevent the enemy from accomplishing his nefarious work.

Ships are common not only in New York but also in San Francisco, Boston, Galveston and elsewhere, and that *instant communication* which should be maintained by them with the land, is not always made use of.

While it is true that some ships have telephone cables going right aboard, most of the larger freighters and even many of the sizable passenger ships are not equipped so that (wire) telephone calls can be made directly from ship to shore. Also of importance is the fact that to make such calls, telephone cables are required to temporarily connect the ship's switchboard with the dock. These cables are vulnerable and can be cut and sabotaged just when they are needed most. Of course all ships do have radio stations on board, but these stations are usually not tuned for instant transmission of police calls, nor is the average ship operator conversant with putting through calls of this type to either the Police or Fire Departments. Nor has the steamer's radio cabin instantaneous means of communication with all parts of the ship.

In most of our larger cities, particularly those along our seaboards, the police are radio-equipped now. Some of our cities now also have Fire Department radio-communication of some sort.

The idea I propose seems absurdly simple, but when it comes to protecting ships during war time—when seconds count—there must be instantaneous means of getting in touch with either the Police or the Fire Department. Waiting for someone to run across a deck and onto the dock means loss of valuable seconds. How much simpler then is the idea of equipping guards with

portable transceivers, many models of which are now available. Some of these models, which do not weigh more than five pounds, can contact Police Headquarters or the Fire Department *instantly*, while the guard walks about the ship. Consider a valuable ship such as the *Normandie*. It does not seem unreasonable that a dozen such Radio Guards could have been stationed at strategic points throughout the ship. This would mean two things—one, that the guards could communicate with each other; two, that the one stationed on the top deck could have radioed the alarm instantly to the Police or Fire Department. Such Radio Guards should be stationed on all ships during war time.

As an additional protection there should be one or two land guards, radio-equipped, watching the ship from shore and several more on the dock or pier, because pier and dock fires have been all too numerous and frequently disastrous. Only a month before the burning of the *Normandie* there was a disastrous pier fire, only a few blocks away from where the *Normandie* now lies. Quick radio action could conceivably have saved the pier.

It should be always remembered that it is most difficult for the Police to patrol the long pier lines efficiently in most of our maritime cities. During war time, therefore, additional precautions must be taken and for the little expense that is involved in posting these Radio Guards, there will be truly enormous savings in ships NOT destroyed.

And what holds true of ships also holds true of buildings, and particularly those buildings which are used for war effort purposes. Every plant, no matter what its description, if successfully fired or bombed by saboteurs can prove an important "bottle-neck" and tie up many other plants. For this reason Radio Guards stationed on roofs and the surrounding property can be in instantaneous touch with Police Headquarters and Fire Departments, preventing the burning or damaging of the plant.

There are several other reasons why ammunition and other war effort plants should be protected, even those without direct fire threats.

As has become all too apparent lately, important war plants draw loiterers and prowlers who are always there for a purpose. They do not happen to be there just by chance. *They are put there by the enemy.* Normally, in the very nature of things there are never sufficient armed guards, but if we substitute Radio Guards for the present-day guards and the Radio Guard sees a prowler and puts in a call with Police Headquarters, the suspects can be apprehended even before they know they have been observed. Radio works instantaneously and an alert Police Force can pick up prowlers and loiterers in a matter of seconds, as has been demonstrated often in the past.

It is to be hoped that more use will be made of Radio Guards during this war. It will save thousands of lives and untold millions of dollars in property, and more important, *it will help to bring the war to a speedier close.*

A disaster such as the *Normandie* sets back the country's effort for months at a time. *It should not happen again!*

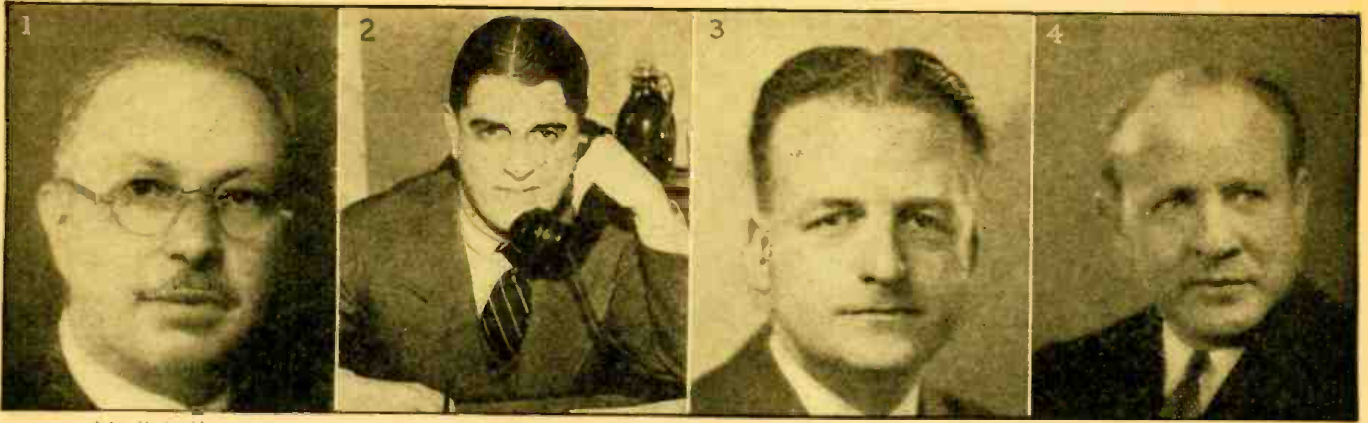

John V. L. Hogan

Fred Weber

J. R. Poppele

Lewis Allen Weiss

# WHAT RADIO LEADERS

## NOTES ON FM JOHN V. L. HOGAN

Consulting Engineer and Inventor, Licensee of W2XQR and President of WQXR

FROM the FM facts developed by the best engineering analysis that I can contribute, I have concluded that wide-band FM gives us (as broadcasters or as listeners) the most effective way that has yet been suggested for the practical use of what are still called Ultra High Frequency waves (in spite of the fact that they certainly are no longer *Ultra* h.f.). The 40-60 megacycle band is about 1000 times more free of natural statics or true "atmospherics" than is the standard broadcast band of 550-1600 kilocycles. But the high frequency band is more subject to interference from man-made "static," such as the electrical noises produced by diathermy, automobile ignition, oil burners and what have you. Along with Major Armstrong, I believe that the use of wide-band FM on these high frequencies gives us not only the inherent benefit of the high frequencies themselves in overcoming atmospheric, but also the ability of wide-band FM (with a suitable limiter in the receiver) of overcoming man-made electrical noise. Of course, I may be wrong, but I think not.

In any event, W2XQR may be taken as an evidence of my faith in wide-band FM, both as to the present and the future. W2XQR was, I believe, the first FM broadcast station to go on the air in New York. Of course Major Armstrong's W2XMN at Alpine was the pioneer experimental station, and C. R. Runyon's Yonkers station W2AG, collaborating with the Major on about 102 megacycles, was far ahead of us in point of time, but, as far as I can find, W2XQR beat out all the rest in trying to bring you a regular, scheduled, daily broadcast FM service. Soon, we hope, W2XQR will become W59NY and cover the 8500 square miles designated as the New York City service area. Why don't you take an observation on W2XQR (45.9 mc.) as it now is, and send me a note, giving your opinion as to our progress?

## MBC ENTHUSIASTIC ON FM FRED WEBER

General Manager, Mutual Broadcasting System

THE Mutual Network was founded on a basis of additional service to the radio audience. It is natural therefore that any advance in radio which tends to this ideal should be of keen interest to Mutual, its member and affiliated stations.

It is gratifying to us as we watch the rapid progress being made by this new branch of broadcasting to reflect on the part played by Mutual stations in its development. Out of 24 commercial FM stations now operating, 6 are operated by Mutual affiliates or stockholders. These are W71NY, New York City (WOR), W59C, Chicago (WGN), K45LA (Don Lee Network), W43B Boston-W39B Mt. Washington, New Hampshire (Yankee Network) and W45V, Evansville, Indiana (WGBF). Five Mutual stations have commercial FM stations under construction and four others have applications pending before the FCC.

As an aid in programming, Mutual has made its service available to the six FM stations operated by its affiliates and also to one independent FM broadcaster—W47A, Schenectady. These seven stations have been listed on Mutual program sheets since the summer of 1941 as an indication of the networks interest in their growth and potential development into an active sales medium. One FM station, W71NY, is originating a series of programs to the full network.

Conscious of its public responsibility to be alert for and receptive to new methods that indicate progress, Mutual is watching the developments of relay transmission without the use of wire lines between FM stations. W71NY, New York City, has already been active in this field and it is anticipated that a permanent exchange may soon be arranged between New York and W49PH, the FM station of Mutual's Philadelphia outlet, WIP.

In accord with the views expressed by F.C.C. Chairman Fly, I do not believe that frequency modulation will ever totally supplant our present form of broadcasting. Rather, the two methods complement each other and the opportunity for new frequencies and unmonopolized channels for the dissemination of information, education and entertainment are of great interest to us.

Mr. Telford Taylor, general counsel of the F.C.C., in an address last July emphasized the great opportunity open to FM stations to serve as outlets for program material that might not otherwise be available. Mutual stations have been quick to realize the importance of this service.

## FM TODAY AND TOMORROW

J. R. POPPELE

Chief Engineer WOR, New York

RADIO has gone to war. And since this is a war of machines—a war powered and armed by science—radio is in the front

lines. As one of the latest achievements of modern broadcasting science, Frequency Modulation is one of war's most important recruits from the ranks of radio. FM is proving itself on many battlefronts.

On the home front, FM is continuing its progress, making particularly great strides during the past year. At this time, I do not want to play prophet and predict the course of FM's development in civilian life while the nation is at war. However, I am optimistic for FM's future. There are already enough receivers in the hands of listeners and enough FM stations on the air to guarantee a healthy status quo for FM during the war and to insure continued development of FM programming and engineering.

Certainly there will be no let-up in WOR's extensive activities in Frequency Modulation through its FM outlet, W71NY. W71NY's new 10,000 watt transmitter is already serving a sizable audience—50,000 receivers have already been sold in New York. To the owners of these 50,000 sets W71NY has proved that FM is definitely a superior system of broadcast transmission. In war or peace, we intend to continue our pioneering in Frequency Modulation, to improve our programming service to our FM listeners, to maintain our research and experimentation in all aspects of FM. For FM is here to stay!

## DON LEE NETWORK FAVORS FM LEWIS ALLEN WEISS

Vice-Pres. and Gen. Manager, Mutual-Don Lee Network

IT appears that Frequency Modulation will see no serious setback in the coming year, despite wartime exigencies. War is making its demands on metals and parts. However, manufacturers will probably use their limited quotas of materials for manufacturing quality FM-AM combination receivers.

Those who are acquainted with the qualities of FM have wholeheartedly accepted the new static-free broadcast system. A consistent growth of FM listeners has been noted for Southern California since Don Lee's commercial station K45LA was inaugurated August 11, 1941. All the promotion in the world will not put a project over like mouth-to-mouth advertising. Written testimonials of satisfied listeners show that the broadcast neophyte steadily is winning its place in the public favor.

In a few short months sales in this area have boomed to 15,000 units, a 400% increase over the original number already in use at the August opening of K45LA. This



John Shepard, 3rd.

Dr. Ray H. Manson

E. F. McDonald, Jr.

G. V. Rockey

# THINK ABOUT "FM"

is evidence of the fast stepping-ahead of FM for the immediate future.

While material parts may be restricted, manufacturers as well as broadcast stations are nevertheless doing their share of educating the public to the wonders of the new broadcasting art. Special broadcasts devoted to FM, and showing of explanatory film in school meetings, club gatherings and civic groups are introducing the newest phase of broadcasting to the general public. Complete effect of this "get-acquainted-effort" will probably not be known until after the war has ended and volume production of receivers is reinstated. But meanwhile the job of educating the public goes on. Don Lee station K45LA continues daily broadcasts and when the restricting fetters are broken the populace will not only "know" but undoubtedly will ask for "FM."

## FM AND THE YANKEE NETWORK

JOHN SHEPARD 3RD

President, the Yankee Network

**A** GLANCE at the record for 1941 is one which will amaze many people.

It has been estimated that only about 15,000 FM receivers were in the hands of the public on January 1, 1941; by December 31, the estimate is that there were in the neighborhood of 250,000 sets in the hands of the public. The great majority of these sets were sold during the last three or four months of the year, and the rate of distribution has continued up to the present time.

Unless it becomes essential that all receiver production be limited to military needs, there will no doubt be an ever-increasing proportion of FM receivers to AM receivers being sold.

New FM transmitters are continually being added to the list of those that have been operating for some time, and the FM listener is receiving better and better programs all the time.

Under such conditions, one can hardly have anything but an optimistic outlook for the future of Frequency Modulation.

## FREQUENCY MODULATION

DR. RAY H. MANSON

Vice-Pres. and Gen. Manager, Stromberg-Carlson Telephone Mfg. Co.

**M**Y personal opinion of FM, based on over three years of first-hand experience, including the installation and opera-

tion of an FM broadcasting station and the design and production of three complete lines of FM-AM receivers, is that Major Armstrong gave the radio industry successful answers to most of the technical ills of broadcasting. His system gives workable answers to the majority of the operating difficulties which have beset the broadcasting industry from the beginning. Furthermore, if FM is given a chance to make progress during the war period, it is destined to be the leading factor in radio expansion during the reconstruction period and, in the meantime, it may become an important war aid.

Nearly everyone acquainted with radio recognizes the main advantages of FM, such as its astounding reduction of static and station interference and its ability, when using a fully adequate FM receiver, to give a reproduction which is *breath-taking* in naturalness and clarity. However, one of the most important advantages of FM, from the standpoint of channel allocations, is the assigning of sufficient power and height of antenna to give reliable reception to an assigned "service area," which may be a local community or a whole rural area surrounding the transmitter antenna. This guarantees exclusive use of the area for the particular FM channel, without station interference from other transmitters assigned to the same channel, which may be located at a sufficient geographical distance to serve other areas of the country.

Here, for the first time in radio, is a system which gives each broadcaster a definite field of operation (audience), and this operation is not dependent on time of day or night, season of the year or condition of the weather. Thus, in any given locality served by a number of FM stations, the audience appeal will be based solely on the quality of the program material furnished, rather than on any advantages of channel assignment as in AM. This is a vital FM advantage as it takes the guess out of the potential audience which can be served by a broadcast transmitter.

The logical ultimate development of FM broadcasting will be to replace all local AM shared channel stations with the interference-free FM stations, leaving the high power cleared channel stations to cover large areas and thereby serve sparsely settled as well as rural communities.

The radio receiver of the future must thus provide for three kinds of service, if the owner is to get full coverage with his instrument:

1. There will be an FM band for the high quality and completely reliable local service and this band may be designated "Local."
2. There will be an AM (standard broadcast) band for the high power AM stations required for covering fairly large areas and this can be labeled "National."
3. There will be the customary short-wave band for handling programs coming from great distances and, in particular, from other countries. This band can be designated as "International."

Summing up, FM gives to radio broadcasters a new lease on life, which provides a new and efficient tool for maintaining and advancing its leadership as the most important means for instant distribution of news, educational programs and mass entertainment features.

## FM AS ZENITH SEES IT

E. F. MC DONALD, JR.

President Zenith Radio Corporation

**T**HE tremendous swing to FM during 1941 has been highly gratifying to all connected with the growth of this newest phase of radio art. At the turn of the year, approximately 23 commercial and 14 experimental FM broadcasting stations were on the air. The sale of Frequency Modulation sets built under genuine Armstrong FM patent has been strong the country over, even by points not yet served by a FM station. The public has been quick to grasp the added enjoyment FM has to offer through *noise-free reception* and true *high-fidelity tonal range*.

Apart from the purely entertainment angle FM is proving its mettle in a number of functional applications. Police departments are rapidly resorting to FM for inter-communications between patrol cars and headquarters. Just the other day I read of a most dramatic way in which FM is helping speed defense.

Transformed over night from a peaceful prairie farmland into a mighty unit in America's first line of defense production, a large munitions plant, whose location I shall not mention is a scene of incessant activity by day and night. Sprawled over 15,000 acres and housing hundreds of small buildings, two essentials of uninterrupted production are transportation and communication—and sometimes a combination of the two. To provide continuous and instantaneous communication between central control room and the nine Diesel locomotives hauling explosives within the plant, a

(Continued on page 412)



© by Bachrach

Major Edwin H. Armstrong

# FREQUENCY MODULATION AND ITS FUTURE USES

MAJOR EDWIN H. ARMSTRONG

*Prof. of Electrical Engineering, Columbia University*

## SOLVES MANY PROBLEMS

The new method solves not only the noise problem but many others which are inherent in the existing system. Due to a number of reasons, present-day broadcasting can transmit and reproduce only a part of the

musical range; that is, instead of transmitting the range of 30 to 15,000 cycles which is required for natural reproduction, the range of 30 to 5,000 cycles is about the limit in present practice. In addition, this restricted part of the range which is actually utilized is reproduced none too faithfully by the existing system, on account of various distortions which occur in different parts of the transmitting and receiving equipment. Because of these limitations a radio "sounds like a radio." The new method is capable of transmitting the full frequency range (30 to 15,000 cycles), with a minimum of distortion and with practically the full dynamic range (i.e., maintenance of the proper relative amplitudes of the loudest and softest notes) that is required, so that it is possible to obtain a naturalness of reproduction never before achieved; in short, a reproduction which does not sound "like a radio."

The solution of these problems alone would warrant the application of the new technical methods, even though nothing more was accomplished than the paralleling of the existing service by the new system and the gradual transfer of the listening audiences per se from the old to the new type of broadcasting. But there is another contribution which this system can make that has very great social and political significance.

For years there has been a shortage of "wave lengths" or channel space, and the attempt to allocate equitably the inadequate facilities available has been the bane of the existence of those charged with this duty. With present methods, no permanent solution is possible; in fact, the interference situation has become worse in recent years due to increases in the number of stations operating in the United States and to the construction and operation at high power of numerous stations located beyond our southern borders.

The new system offers a solution not only to the national and international interference problem, but to the problem of giving every community one or more channels on the air so that stations particularly adapted to local needs can be set up and operated without interference. This result has come about because the system operates most

effectively on wave lengths hitherto not put to use and because it has a curious immunity to interference from other frequency modulation stations, even though they may be on the same wave length channel. It becomes possible, therefore, to place stations much closer together geographically, and consequently to permit the use over and over again of the same channel within the confines of the United States. So effectively can this be done that the number of available channels may easily exceed the demand, with the factor which determines whether or not a community may have a local service resting solely upon the community's ability to support it. This alone would insure the adoption of the new system.

## TRANSMITTING THE SPOKEN WORD

It is beyond the scope of this article to describe the technical processes by which these results are accomplished. They were originally described in a paper presented before the Institute of Radio Engineers in November of 1935, and to date no question has arisen as to the technical accuracy of this description or our understanding of what the new method can accomplish. But without entering into a detailed explanation of the phenomena involved, it would probably be helpful to explain some of the terms which the lay reader encounters in press and magazine articles concerning frequency modulation and to venture a sort of "curbstone" explanation of how the reduction in noise is achieved.

Radio transmission is accomplished by connecting an electrical pump (the transmitter) to a conductor known as an antenna, usually elevated above the earth, which pumps electricity into the conductor and sucks it out again hundreds of thousands or millions of times a second. Because of certain laws of nature, with which we need not concern ourselves for an understanding of the subject of this article, this process causes an exactly similar flow of electricity in conductors known as receiving antennas suitably placed within the range of the transmission, and this electric current flows up and down the receiving antenna the same number of times per second that the transmitting current flows in its antenna. The received current is weaker, of course, than the current in the transmitting antenna, being in fact a most minute replica of the current produced at the transmitting point. This weak current, however, is applied to a receiver, which amplifies it up to a strength where it may be detected and ob-

ONCE in a while an invention is made that overcomes so many of the problems with which an industry has been contending that its methods are quickly recognized as the right ones to follow by those who understand its technical phases. Sometimes the new invention fits nicely into the established financial structure of an industry; sometimes it does not. In the one case, the inventor is met with open arms; in the other, he probably is assured that he really has a very fine invention and that if the art were starting out afresh no doubt it would be adopted, but to replace the existing plant—even though obviously it is now obsolete—would be too staggering a thing to be considered.

History teaches that the best method inevitably forces its way into use and ultimately becomes standard. Sixty years ago the electric light and power industry started off on the wrong road in its method of distribution. It undertook to distribute electric power, using the best; in fact, it used the only practical method at the time, namely, the low-voltage direct current system. Some years later the soundness of this procedure was challenged by the high-voltage alternating current system which, surmounting all obstacles placed in its path, went forward against powerful opposition and eventually superseded the direct current system in over 90 per cent of its applications. Looking back, one can see the absolute inevitableness of this result, yet the literature during the time of transition reflects a period of most violent controversy.

A large part of the radio industry, particularly the broadcasting division, is now facing a similar transition period, for a new principle has been discovered which furnishes a solution to the problem of "static." This term includes all those disturbances which have their origin in natural causes, such as lightning storms, and all those man-made noises which have their origin in the various kinds of electrical machinery found in towns and cities, such as electric razors, refrigerators, oil-furnace motors, elevators, etc. This new principle makes use of a process known as "frequency modulation," although much more than a method of modulation is involved.

Modulator for Transmitter at Major Armstrong's famous "FM" station at Alpine, N. J. The Major personally supervised the erection of the antenna and climbed up into the lofty mast himself to check the details.

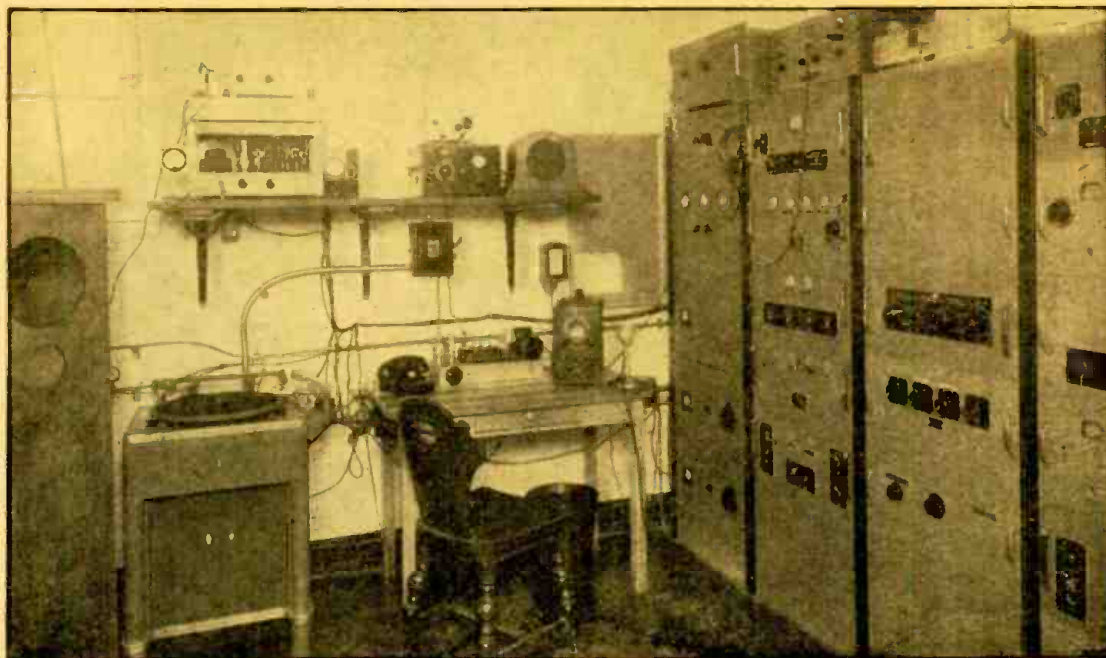

served. This constitutes radio transmission, but not communication of intelligence.

In order to transmit intelligence it is necessary to perform some operation upon the transmitted wave so that this operation may be observed at the receiver. In the case of transmission of the spoken word, the process of impressing the voice, or molding it upon the transmitted wave, is called modulation. It has been standard practice to accomplish this by *varying the strength of the current in the transmitting antenna in accordance with the fluctuations of the voice*. This may be called strength, or, technically, "amplitude" modulation. The function of the receiving equipment is to translate these modulations into voice currents so that they may be heard in a telephone receiver or loudspeaker. In this type of signaling the speed of the pump at the transmitter is not changed during modulation; the electric current flows up and down the antenna the same number of times per second, regardless of the changes in the strength of the current.

There is another form which is almost as old as *amplitude* modulation. In this form of modulation the strength of the antenna current is not varied in any way; it remains constant. But the number of times that the electric current is pumped up and down in the antenna by the transmitter is varied (speeded up and slowed down) in accordance with the fluctuations of the voice. This type of modulation is known as "*frequency modulation*." At the receiving system, where similar changes in the number of times the current flows up and down the antenna occur in consonance with those which occur at the transmitter, a somewhat different form of receiving system from the amplitude modulation system converts these changes in frequency into the voice currents that may be heard in the loudspeaker. For twenty-five years this method of modulation was considered to hold no promise of development, and it appeared to have no practical use whatsoever.

#### THE PROBLEM OF STATIC

Ever since its earliest days, but particularly after the invention of sensitive amplifying receivers around 1912, radio has suffered from disturbances produced by lightning storms and commonly referred to as "static." More recently, with the advent of radio broadcasting where receivers are located in metropolitan areas in the vicinity of all sorts of electrical machinery, it has also suffered from so-called man-made static. For a good many years it was believed that some form of circuit could be devised which would separate the signaling current from the currents created by these disturbances, but eventually it came to be understood that both the signaling currents and the disturbing currents were essentially the same in their nature and that very little

could be done to reduce their effect except to raise the power of the transmitting station; or, in the case of man-made disturbances, to place the receiving antenna as far away as possible from the source of the noise. Subsequently it was proposed to use frequency modulation, on the theory that these disturbances were essentially amplitude modulation and hence would be rejected by a frequency modulation system; but it was found that the disturbances contained frequency changes as well as amplitude, and very little improvement resulted. However, it was observed by the writer during the course of a series of experiments that these frequency changes appeared to be limited in extent to about the same changes in frequency as were being used in the frequency modulation system. The idea presented itself, therefore, that if the frequency changes in the signaling wave could be artificially increased in extent beyond those changes which existed in the disturbing currents, and a receiving system created which was immune to the amplitude modulated part of the static—feebly responsive to its small frequency changes but fully responsive only to the wide changes in frequency of the specially modulated wave—a means could be found for differentiating between the signaling currents and the disturbances. This proposal turned out to be a sound one and improvements of one thousand to one in noise reduction can now be readily produced in practice. Not only could this advantage be obtained, but, because the system operated most effectively in the ultrahigh frequency band, a further advantage over standard broadcast methods was secured as much less static was present in the ultrahigh frequency range.<sup>1</sup>

#### OPPOSITION TO THE SYSTEM

After many years of laboratory work to put it in practical form, the system was brought to the attention of the Radio Corporation of America and was demonstrated to its executives and its engineering staff. These demonstrations began at the end of 1933 and continued for almost two years, at the end of which time the Radio Corporation declined to undertake the task of putting the system into public use. Various reasons were advanced to prove the impracticability of the system, such as its

<sup>1</sup>The ultrahigh frequency range may be considered as below 10 meters (30,000 kilocycles).

alleged inability to work beyond the horizon, the necessity of constructing new transmitting stations, and the high cost of new receivers. The proposition was also advanced that if amplitude modulation was used in the ultrahigh frequency range, substantially the same freedom from noise could be secured, as well as the same quality of reproduction. Subsequently, when the better quality of frequency modulation was demonstrated, the proposition was advanced that the public would not appreciate it and did not want it.

Still later, when a phenomenon was encountered in television transmission in large cities, which resulted in multiple images (ghosts), it was stated that frequency modulation transmission could not avoid a similar type of distortion.

The proposition was also advanced that the system was wasteful of channel space in the radio spectrum and that if ultrahigh frequencies were ever used in broadcasting the amplitude method of modulation would be more economical thereof.

The writer, disagreeing with all these conclusions, undertook the burden of introducing the invention to the public and started the construction of a high-powered station whose success or failure would take the matter out of the realm of academic discussion. As it was essential that the performance be so outstanding that any "talk down" campaign would be silenced, the station was designed to have a power ten times greater than ever before produced at ultrahigh frequency. A site was selected at Alpine, New Jersey, some seventeen miles north of New York City, and construction was started. Meanwhile an amateur station, W2AG, located in Yonkers, New York, owned and operated by C. R. Runyon, was equipped with the frequency modulation system. The performance of this station disposed of many of the bugaboos so cheerfully predicted for frequency modulation. After witnessing the demonstrations, the Yankee Network management, operators of a chain of stations throughout New England, and the owners of Station WDRC in Hartford, Connecticut, became interested and started the erection of stations in Paxton, Massachusetts, and Meriden, Connecticut. This entry into the field by two successful broadcasting interests, and the demonstrations which were carried out by the Yonkers station, stimulated a dozen or more

enterprising broadcasters to secure construction permits and to start the erection of transmitters. The importance of the part played in this development by Mr. Runyon's station can hardly be overestimated. During the three-year period prior to the Alpine station's completion, scores of demonstrations were made to representatives from all branches of the radio industry, who were given every opportunity to examine the system's performance. No one was refused the opportunity to observe the operation under all conceivable conditions.

It was possible with very little vision to extrapolate this comparison between a 500-watt frequency modulation station and the 50,000-watt standard amplitude modulation broadcasting station, and to forecast what the service of the Alpine station would be like. There were a few enthusiastic disciples as a result of some hundreds of demonstrations.

The performance of the Alpine, Paxton, and Meriden transmitters convinced the broadcasting industry that a change was inevitable, and approximately 150 applications were filed with the Federal Communications Commission. Since the frequency allocation assignment made no adequate provision for this number of stations, in the fall of 1939 the Commission suspended the granting of experimental licenses in order to review the situation and to consider the point which had been raised by the Radio Corporation of America that the standards which were being used were not the best. After a hearing held in March of 1940 the Commission approved the standards which were then in use, removed the experimental limitation, arranged to issue commercial licenses as of January 1941, and reallocated a part of the frequency spectrum to increase several-fold the channel assignments for frequency modulation. The lower frequency part of the assignment to television, which had not fulfilled the early predictions of its readiness to furnish a public service, was rearranged. Nineteen channels had been assigned to television. Each television channel was sufficiently wide to accommodate 30 frequency modulation stations. The lower or Number 1 television channel was assigned to frequency modulation and the two lower television channels moved progressively upward, the new Number 1 occupying the old Number 2 position and the old Number 2 moving up into a space previously allocated to government use. This action by the Commission was taken in May 1940, and the art prepared to move forward.

The enthusiasm over the quietness of the reception was as expected, but the most gratifying result has been the response to the improved quality of transmission. The point had been made, and in some quarters was strongly urged, that the public would not appreciate so-called "high fidelity" reception; in fact, that it did not want it. This contention was supported by reference to the public reaction which attended the introduction of standard broadcast system receivers which had a wider range than the usual 5,000 cycles. One or two attempts had been made to create a market for receivers whose frequency range extended up to 7,000 or 8,000 cycles. It was found that these receivers did not sell well, and when they were sold the listener made rather drastic use of the tone control, which prevented the higher frequencies from being reproduced. Hence it was concluded that the public, from some impairment of its sense of aural perception, did not want the higher frequency range. Quite the reverse, however, was the case. What the average listener objected to was not the increased range of the frequencies reproduced, but the pres-

ence of certain harmonic distortions which are particularly offensive in the upper frequency ranges. These tones, together with the increased noise which always attends the extending of the frequency range, were the things which were really being rejected. When the harmonic distortions and the noise were removed from the signal by means of the frequency modulation system, the full frequency range was instantly appreciated. The reproduction then became natural. It is difficult now for one to credit that the contention was actually made that an unnatural type of reproduction was to be preferred to a natural one.

#### WIRE-LINE FACILITIES

At the present time only one obstacle stands in the way of a full realization of the advantages of frequency modulation throughout the country, and that is the limitation upon network operation imposed by the deficiencies of wire-line connections. These connections as at present set up are limited to the transmission of a frequency range up to 5,000 or 6,000 cycles, with a residual noise level considerably greater than that required for the full dynamic range of studio orchestral productions. This

*Edwin H. Armstrong is professor of electrical engineering, Columbia University, New York City. He was associated with Professor Michael I. Pupin in research at the Marcellus Hartley Research Laboratory of Columbia University, 1914-1935; served as Captain and Major in the Signal Corps of the United States Army, 1917-1919; and is the inventor of the regenerative circuit, the superheterodyne, the superregenerative circuit, and a method of eliminating static in radio by means of frequency modulation.*

limitation does not, of course, affect the static-eliminating qualities of the system, but would reduce the quality of the transmission to that imposed by the characteristics of the wire lines. Some improvement may be expected in these characteristics, but they will probably not be set up to carry the full frequency range for a long time to come. There is, however, a relatively simple solution which is now in use in New England. By means of *radio relays*, Boston, Paxton, and Mount Washington have been successfully linked together, and within the coming year it should be possible to extend this circuit to include New York,\*\* so that no wire-line facilities whatever will be required. No major technical difficulties are likely to be encountered.

While it may be possible ultimately to obtain the same technical performance by the use of the coaxial-cable method of transmission, there will be large sections of the country where it is not economically fea-

\*\*This Plan for the FM Relay Network, which includes New York City was carried out successfully during the past year. The advantages of frequency modulation transmission for relaying purposes was manifested when the programs were received without any noise or distortion, after having been relayed several times. Such noise-free, distortion-less transmission of voice and music cannot be duplicated by existing wire telephone lines.

ible to use this, and where it cannot compete with the radio relay. This is particularly true in the mountainous sections of the country. The establishment of regional networks entirely radio connected, extending throughout large sections of country of this type, is entirely practicable, and several such projects are now under way. Very rapid development in the radio relaying field may be expected.

Looking at it from the standpoint of the broadcaster, it is easy to see that the lower cost of the transmitting equipment, its economies of operation, and the possibility of the reduction of wire-line costs by the use of radio relays, are all in his favor. For the manufacturer of transmitters, and more particularly for the manufacturer of receivers, there lies a vast new market in an industry which has unquestionably reached a saturation point. Superficially, one might be led to believe that the industry would welcome a development such as this, but the fact remains that, with a few exceptions, it has not been welcomed by the large units of the industry. The burden of the development has been carried almost entirely by the smaller units. The reasons for this opposition are quite obscure, but nonetheless they are very real ones. It is important in the interest of the future progress of the radio art that at some time they should be brought out into the light of day.

#### PRACTICAL APPLICATIONS

In this article, the application of the frequency modulation system to the broadcast service has been treated. This is, of course, its major application. There are, however, applications to numerous other services, and the field is widening almost daily. At the moment, the greatest activity is in its application to the emergency services, particularly to the police service.

The largest project at the present time is that undertaken by the Connecticut State Police, who have in operation nine fixed stations and approximately two hundred mobile stations equipped for two-way operation with the fixed stations and with each other. The installation has been completely successful and the State is effectively covered.

The next largest project is in the City of Chicago, where some two hundred mobile units are in process of installation. Numerous other projects for police service and for emergency use by the power companies are being put forth, and it is doubtful whether many new installations employing amplitude modulation will be made in the future. It is, of course, needless to say that there are many important military uses; and its application in the field of aircraft appears to be a promising one.

The one important field in which progress has been inexplicably slow has been television, where its advantages, particularly on the sound channel, could be effectively utilized at once. A limited use has been made of frequency modulation for the relaying of the television sight channel.

In recent years it is only in the broadcast service where interstation interference has caused serious difficulty, and now this situation is likewise about to be cleared up. If in the future the demand for broadcast channels exceeds the facilities of the channel space now practically available, the engineering world is prepared to open up new bands in that space technically known as the ultrahigh and micro-wave region where the ratio of the unused channel space compares to that now in use as the unsettled to the settled parts of the earth. The trend of radio inevitably will be upward into the higher frequencies.—Reprinted by permission from *The Annals of The American Academy of Political & Social Science*.

# W2XQR

## Broadcasts Concert Music on FM

RUSSELL D. VALENTINE  
Specially Written for *Radio-Craft*

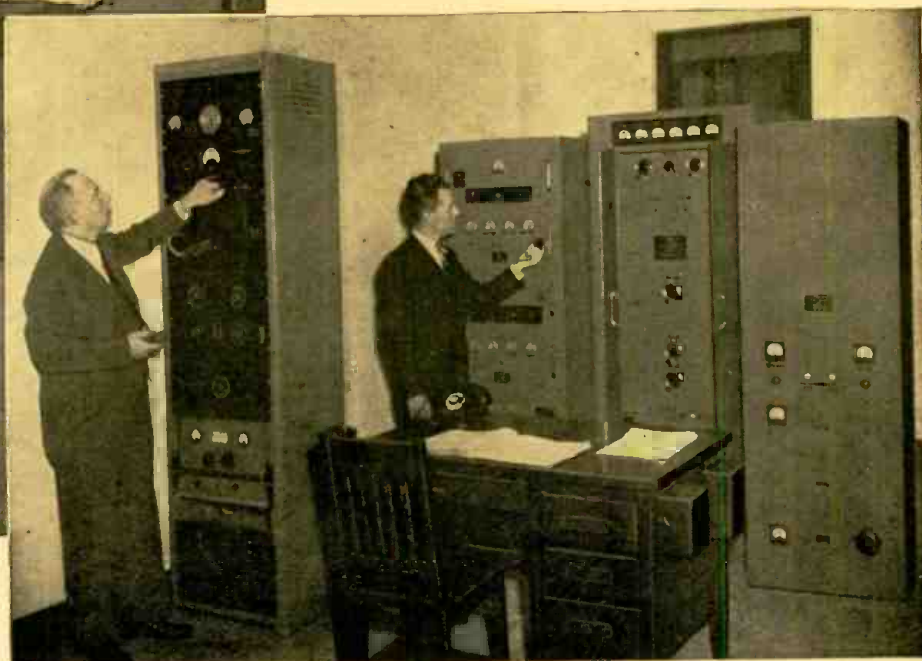
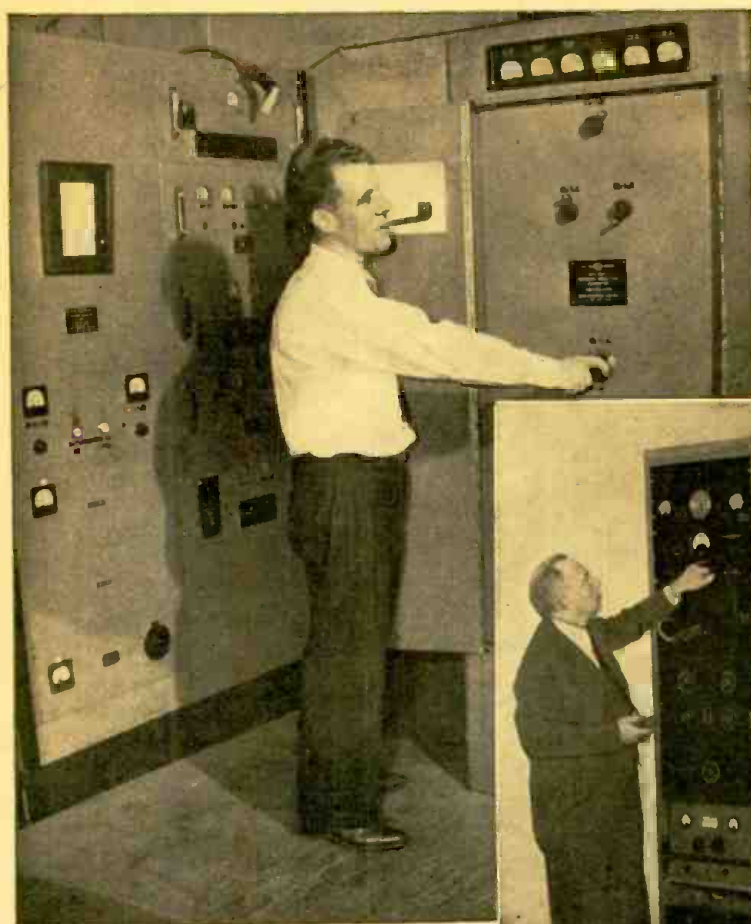

Above—Russell D. Valentine, chief engineer for WQXR, New York, and its FM affiliate, W2XQR, keeps an eye on FM operations. Right—John V. L. Hogan (left) and Russell D. Valentine, the engineers responsible for W2XQR, line up the FM transmitter atop New York's Chanin Building.

**A**LTHOUGH it has been operating for less than three months from its new home, about seven hundred feet above sea level from atop New York's Chanin Building, W2XQR, New York, has already shown results which justify the belief of its founder, Radio Engineer John V. L. Hogan, that a major FM station, specializing in *concert music*, would find rapid acceptance among New York listeners.

W2XQR was the first FM station directly affiliated with a standard broadcaster in the New York area, and its parent station, WQXR, was the first in this area actively associated with the new FM technique.

But, because it was located rather unfavorably in Long Island City, where it had been established for purely experimental purposes, it was not until December 15, 1941, that W2XQR really began functioning in a way which services its community adequately. On that date, it began broadcasting from the 54th floor of the Chanin Building at Lexington Avenue and 42nd Street.

The new location gives W2XQR a radiation increased about *sixteen* times over that of its former site, despite the fact that the station still operates at 1,000 watts. Shortly, we hope, we shall increase W2XQR's power to 10,000 watts and begin use of our permanent call letters, W59NY, with full commercial operation.

WQXR and W2XQR have made FM history in several ways. WQXR "fed" its programs of good music to the first FM station, Major Armstrong's W2XMN in Alpine, N. J., and thus became the first station to have its programs and artists heard on the new band.

In the meantime, Mr. Hogan, president of

the Interstate Broadcasting Company and an internationally famous radio engineer and inventor, applied for an experimental FM license of his own. On October 3, 1939, the construction permit for that station was granted by the FCC. A transmitter was installed at once at Mr. Hogan's laboratory in Long Island City. Broadcasting from W2XQR began on December 11, 1939, making W2XQR the first local FM station to begin regular programming on the new band.

Because fine music, played through transcriptions and by artists in person, had proven such successful program material for WQXR, the plans for the operation of W2XQR, from the beginning, were drawn around the idea of providing, through this improved transmission technique, more and more programs of fine symphonic music.

FM, making noiseless and faithful reproduction of tones and overtones possible over larger areas for a given amount of power, is most ideally suited, we find, as a medium for the transmission of good music, because in good music *exceptional fidelity* is required.

From these early days of experimental FM operation, W2XQR attracted an increasingly large audience to its broadcasts of WQXR's musical programs each evening, although the need for increasing its coverage began to make itself felt.

At the same time, WQXR "crusaded" for public recognition of frequency modulation. Back in September of 1939, at the time when no one but radio engineers realized the possibilities of the new invention, WQXR was broadcasting the "Treasury of Music" programs, sponsored by Stromberg-

Carlson, and on that series, was presenting the first messages to the public about FM. These were, incidentally, the first advertising messages on FM used anywhere.

Later, Stromberg-Carlson and WQXR cooperated to broadcast the first commercial program over a group of FM stations. This was organized on November 28th of last year, and has been operating several nights a week ever since when the "Treasury of Music" program is on the air, from 7:30 to 8 p.m. WQXR originates the program and feeds it to W2XQR and W2XMN. W2XMN in turn *beams* the program to W65H (FM station) in Hartford, Conn.

W2XQR, now, as it awaits its commercial license and increase in power, continues to broadcast WQXR's programs over 45.9 megacycles from 5 to 10 p.m. daily. Most of these programs are musical or news commentary. W2XQR was probably the first FM station to broadcast a full symphonic program when it, along with WQXR, on November 27, 1939, transmitted the NBC Symphony Orchestra playing from the stage of Madison Square Garden.

The rapid public acceptance of frequency modulation, and the increasing interest being shown through sale of receivers, mail received at W2XQR and through other sources, makes W2XQR's future a bright one. Mr. Hogan, one of the earliest entrants into the FM field, has said on many occasions that "FM has demonstrated its ability to render an excellent broadcast service. Its future now depends almost entirely upon its acceptance by the listening public."

There is no longer any doubt about that acceptance, even though FM is still supplementary to regular broadcasting service.

# W45D — DETROIT

Front Cover Feature

## Gives F. M. Antenna Facts

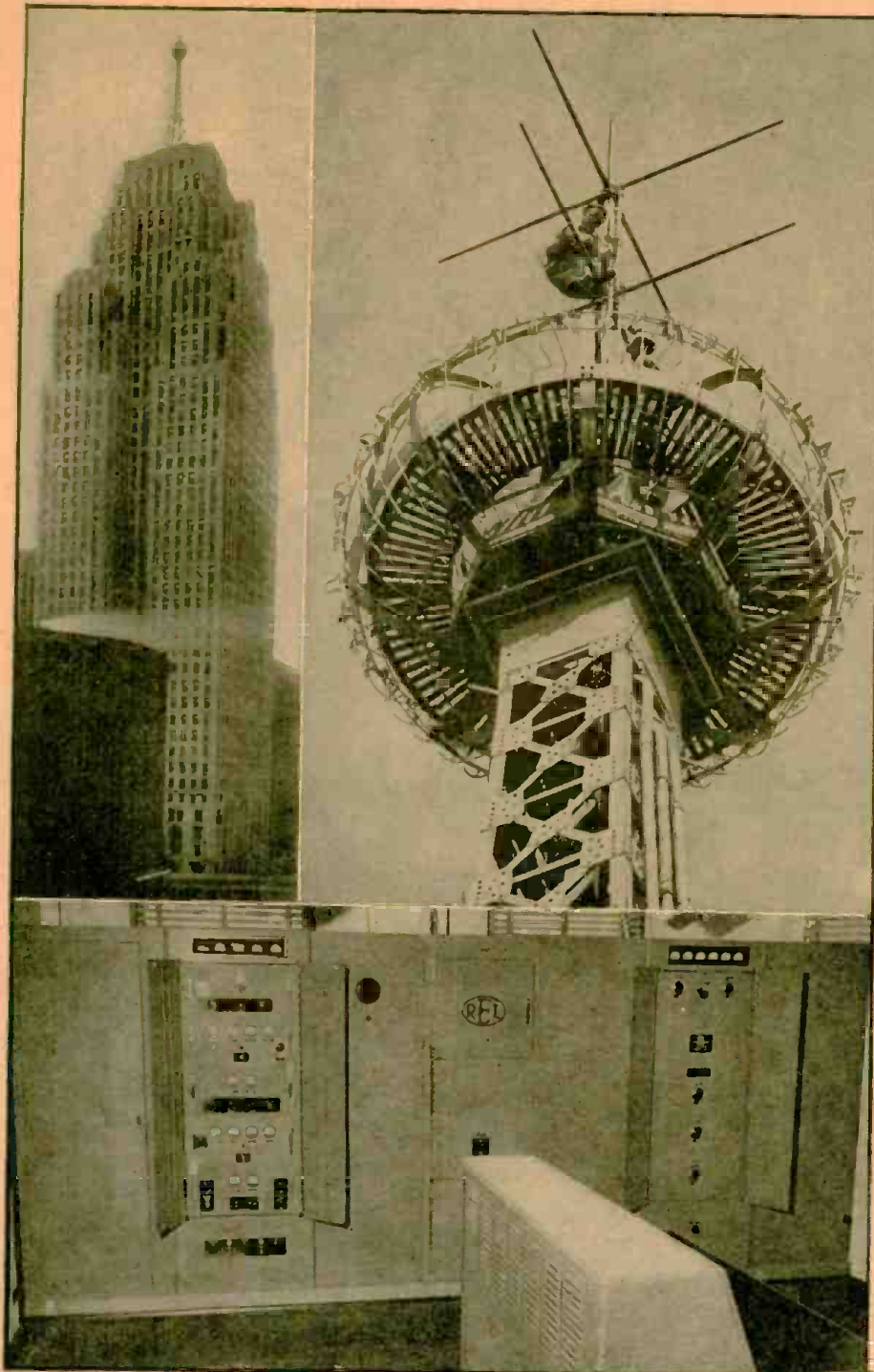

Photo—The Detroit News  
 Top left—Station W45D occupies the entire 45th floor of the Penobscot building in downtown Detroit. Top right—2-Bay turnstile antenna atop neon ball and tower. Bottom—R.E.L. 3 KW. driver for 50 KW. amplifier.

radio scheduled to play a vital part in disseminating news and maintaining public morale, there will probably be no great slackening in FM's constantly growing popularity.

Not only does FM supply the listener with virtually static-less reception, but it provides him with a new source of programs including, especially, fine music that has been all too frequently crowded off the air by "soap operas" and comedians.

Surveys have shown that the W45D audience particularly favors concert and classical music by the better-type orchestras—even though they may be transcribed—and the music of the Novachord and organ. In its 18 hours of programs a day, W45D includes a generous portion of classical music shows. Audience response to those has been gratifying.

FM is now reaching into thousands of homes giving *static-less* radio reception to all who have changed over to radios designed to receive the *wide-range* Frequency-Modulated signal. Set owners are generally encouraged to install outside antennas of a prescribed type, since the proper antenna greatly improves reception.

In order to understand the importance of a good receiving antenna, it must be realized that the noise elimination or noise reduction on FM is due more to the presence of an FM signal in the receiver, than to the FM receiver circuit itself. The stronger the FM signal that is being fed into the receiver, the more noises of various sorts will be reduced, and finally suppressed entirely when the signal input reaches the value necessary for that particular receiver to give *complete noise suppression*. The receiving antenna is the *signal "collector"* and its efficiency determines how much signal is fed into the receiver. In other words: it is possible for noise to be heard on an FM receiver, if the signal received from an FM broadcast station is *TOO WEAK* to suppress all noise, or if the *receiving antenna used is NOT suited for FM reception*.

Fortunately it is rather simple to construct and install a receiving antenna that is much more effective for FM, than even the best low frequency antenna used by most listeners for AM. An antenna's effectiveness depends, among other things (according to Carl Wesser, chief engineer of station W45D), upon its *length* in relation to the *operating frequency*. The *higher* the frequency, the *shorter* the wavelength and the more nearly we approach a *half-wave* in length of the receiving antenna, the more effective it will be.

### SIMPLE "FM" RECEIVING AERIAL

A simple way to construct an FM antenna is by cutting a piece of antenna wire to the approximate half-wave length of the middle of the FM broadcast band. This wire would be about 10'-6"-0" long. In order to make this antenna as effective as possible, we should plan on hanging it well in the clear of surrounding objects, or at least by 15 feet, and as high above ground and buildings as we can. This would remove the antenna well from the receiver, which necessitates a "link" or transmission line between the antenna and the set. This transmission line can be a piece of twisted lampcord, such as is sold in most 5 and 10 cent stores. To connect this transmission line to the antenna, it becomes necessary to cut the 11-foot length of wire in the middle,

**F**M may be a youngster, yes—but a mighty healthy one that is growing up fast.

FM offers two qualities far superior to Amplitude Modulated Broadcasting: (1) It permits the transmission of a sound range *identical* with that of the *human ear*. (2) It is *static-less!* These two remarkable advances, developed by Major Edwin H. Armstrong (inventor of the super-heterodyne circuit) have made it possible for anyone in his home to hear sounds exactly as they are created in the studio, with all

their subtle inflections, overtones, and harmonics. FM's first-time listener finds reception as much improved over ordinary AM broadcasting as AM broadcasting is over the sound he gets from his shrill, raspy telephone.

No wonder Mr. Listener has responded with contagious enthusiasm!

The number of FM receivers in Detroit alone increased from 1,500 in May, 1941 (when W45D began broadcasting) to 12,000 by January, 1942—and the ratio of increase is by no means diminishing. With



and insert a small glass antenna insulator at this point. The same type of insulator should be used at each of the "free" ends of the antenna. To the inner ends of the two halves of the antenna we now connect the two wires of the twisted transmission line, while the opposite ends of this line should connect to the two antenna posts of the set. To hang the antenna, rope should be used from the free-end insulators to whatever it is to be tied, since wire of any kind at these points will affect the operation of the antenna noticeably.

The antenna, or di-pole, as just described, should be stretched in a horizontal position. This is necessary because it should be in the same position as the transmitting antenna, and by now most FM broadcast stations are using horizontal "polarization." In hanging a di-pole it should be remembered that this type of antenna is directional and will pick up no signals from the directions of the free ends, and will have maximum pick-up on signals that arrive from a broad-side direction. Be sure that your antenna is oriented *broadside* to the general directions from which FM stations are to be received.

If your location is such that desired FM stations are located in various directions around you, it may become desirable to construct a rotatable di-pole. This can be done by substituting two pieces of metal fish pole, or buggy whip car antenna, cut to the required length and mounted on two pairs of small stand-off insulators on a piece of 1" x 2" wood, about three feet long, with a pivot in its center, and ropes or some other simple means for rotating the di-pole into the position that gives the best signal on the desired station. This arrangement can often be used to eliminate signals from stations other than the desired one, but operating on the same frequency. All FM broadcast stations serving the same area operate on different frequencies.

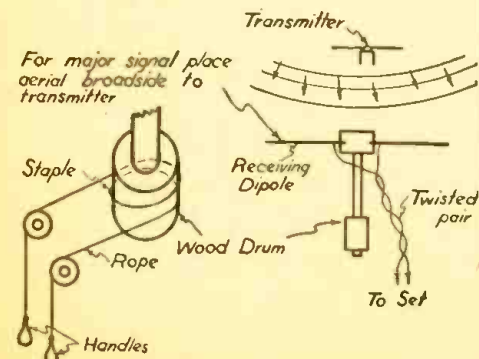
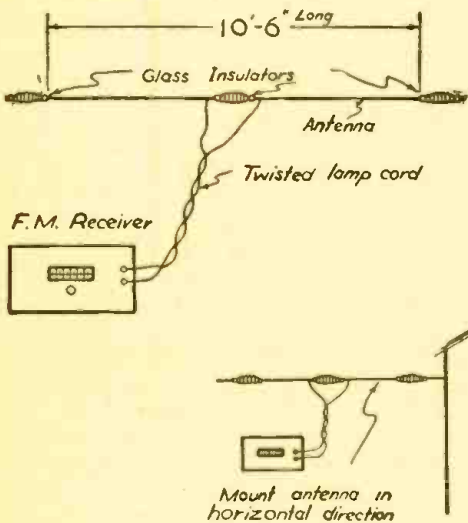

# High Fidelity P-A Tuner

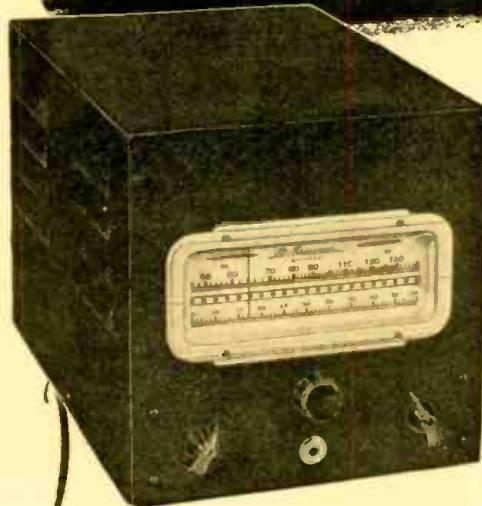

Engineered  
for  
Highest  
Quality  
Reception

Meissner engineered and specially designed for highest quality reception from local or semi-distant powerful broadcast stations . . . provides the solution to many of the problems encountered by the modern Sound Engineer where quality radio reproduction is required. Unusually noise-free T.R.F. circuit with band-pass transformers provide true high fidelity reproduction. Tunes from 535 to 1600 kc. to cover the regular broadcast band. Self-powered, operates on 110 volts, 50-60 cycles. Output connections provide impedances of 2,500 and 10,000 ohms; easily adapted for coupling into a 200 or 500 ohm line.

Model No. 10-1152 High Fidelity P-A Tuner Kit containing all necessary parts for construction (less tubes) including detailed instructions and pictorial diagrams—\$48.00 List. Meissner Kits are easy to build.

Write for New 1942 Catalog - Dept. RN

**Meissner**

MT. CARMEL, ILLINOIS

"PRECISION-BUILT PRODUCTS"

## Music Lovers Opportunity 100,000 Phono-Records

are going to be sold by us at the biggest money-saving opportunity ever offered on records.

We ship anywhere in the world where mail and freight are still rendering us service.

**HERE'S A FEW OF THE BARGAINS!**

Set of 25 Popular Dance Records such as Glenn Miller, B. Goodman, T. Dorsey, J. Dorsey, etc. Special . . . . . \$4.00

Set of 25 Hillbilly, Cowboy, or Blues Special . . . . . \$4.00

Set of 20 assorted Red Seal 12 each Classical double faced records. Special . . . . . \$7.00

(We pay shipping charges on above, east of the Rockies) Terms: Send 20% with order. Bal. C.O.D.

Music Lovers and dealers can now obtain outstanding values from one of the few outlets dealing exclusively in Phono-Records. We can supply all your record needs. Write us for Special Bargain Kits of Records consisting of classical or popular, etc.

## IF YOU HAVE ANY OLD PHONOGRAPH RECORDS WE BUY THEM

Dig them up and ship to us. Classical or popular. Victor records. Liberal purchase payment sent the day records are received.

**GENEROUS TRADE-IN ALLOWANCE!**

We will also add an extra 10% appraisal allowance on records sent us against any purchase made by you. We have unusual records in stock but need more and more for our customers. Don't hesitate in becoming a member of the preferred Coyne record family—it pays and SAVES!

MAIL and PHONE ORDERS Promptly Filled.

**COYNE MUSIC SHOP**  
(nothing but records)

58 Cortlandt St., New York City

# WOR's New FM Station

Power 10KW      Freq. 47.1 MC      Call W7INY



Left: The vertical coaxial antenna, used by W7INY, Frequency Modulation station owned and operated by WOR, New York, is the only one of its kind in existence. It was designed by WOR engineers and is used for FM broadcasting with favorable results.

Below: The 10,000-watt transmitter of W7INY, Frequency Modulation station of WOR, New York. The transmitting plant is located at 444 Madison Avenue, New York City.

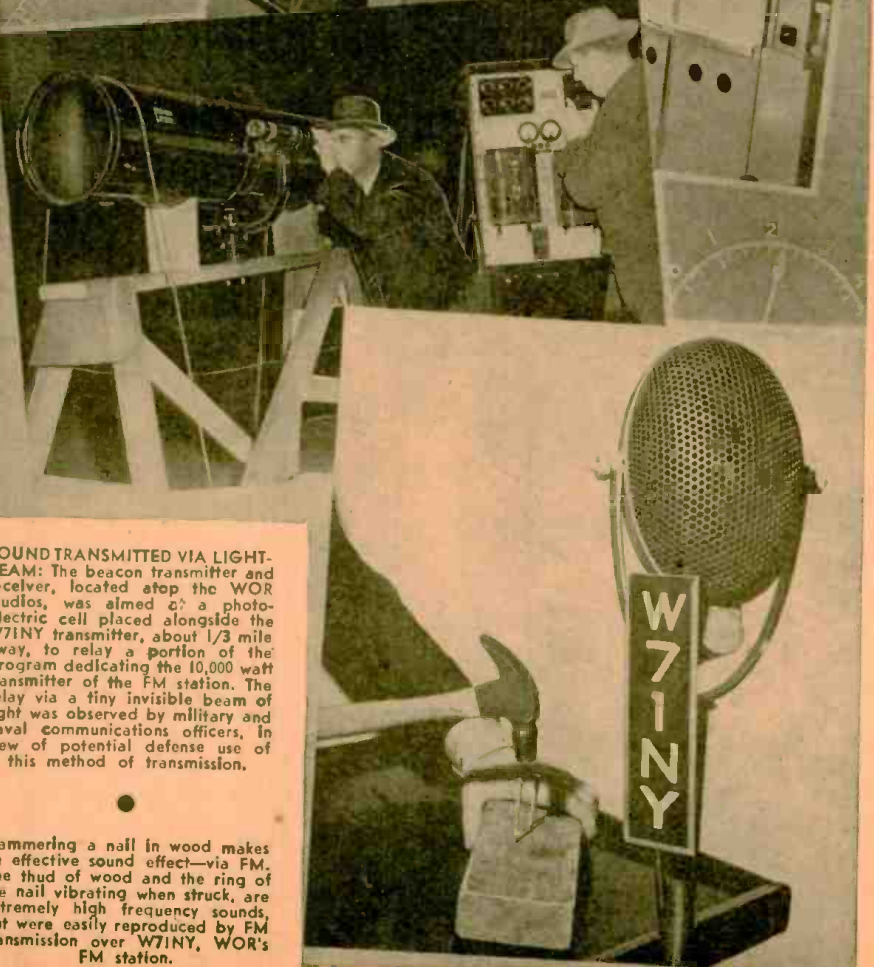

**SOUND TRANSMITTED VIA LIGHT-BEAM:** The beacon transmitter and receiver, located atop the WOR studios, was aimed at a photoelectric cell placed alongside the W7INY transmitter, about 1/3 mile away, to relay a portion of the program dedicating the 10,000 watt transmitter of the FM station. The relay via a tiny invisible beam of light was observed by military and naval communications officers, in view of potential defense use of this method of transmission.

Hammering a nail in wood makes an effective sound effect—via FM. The thud of wood and the ring of the nail vibrating when struck, are extremely high frequency sounds, but were easily reproduced by FM transmission over W7INY, WOR's FM station.

**G**REATEST strides in frequency-modulation broadcasting development to date are incorporated in the trim, compact, 10,000-watt transmitter of W7INY—the FM affiliate of WOR—which went on the air the night of November 30 with a formal dedication program.

Known as Model 506 A-1, the new transmitter was designed and built by Bell Telephone Laboratories and Western Electric Company technicians and represents sensational gains over earlier FM broadcasting units; its advantages over the very efficient 1,000-watt unit previously utilized by W7INY are manifold.

The transmitter unit as well as the entire technical layout of W7INY located on the forty-second floor of 444 Madison Avenue, New York, is accorded the description of "model facilities", by prominent engineers who have inspected it. It is the first 10-kilowatt transmitter of its kind, but, despite its pioneering nature, is a laboratory-perfected job that takes to the air as the result of costly research and collaboration by a group of the nation's leading engineers. It serves a radius of approximately 52 miles, on 47.1 mc. (megacycles).

A radical new type of amplifier circuit gives the transmitter the distinction of being the first of its kind to use a single tube in the last amplifier. This simplification was made possible by grounding the plate in the final phase. No tuning condensers are incorporated, all tuning control being done by changes in inductance, effected by motor-driven controls.

The single tube used in the final amplifier is the brand new type known as 389 AA; it weighs 55 pounds and is one of the heaviest valves developed for FM work.

The quality of transmission is so high that provisions have been incorporated by W7INY engineers to have certain possible extreme "highs" compressed; actually the quality of the set's frequency range can be better than the human ear can hear it; however, this exceptional range taking to the air on FM could ordinarily raise havoc with neighboring FM channels. This protective development is a W7INY contribution to the art of FM and its engineers have the hope that future commercial FM stations will adopt similar methods so that W7INY, in turn, will be safe from external frequency infringement.

Distortion at the transmitter is less than one per cent—and this is regarded as a definite technical achievement. There is no trace of noise at carrier; the high-fidelity performance is further enhanced by the fact that audio characteristics are flat  $\pm 1$  db., 30 to 15,000 cycles.

The original 1,000-watt Western Electric transmitter continues in use as an auxiliary standby. Its filaments remain lit at all operating hours so that it can substitute for the 10-kw. unit in any emergency without the loss of a minute's air time. Both transmitters are controlled from a duplicate speech input and monitoring board.

Two Special high-fidelity telephone lines link the speech-input board with the WOR studios where the bulk of W7INY's independent schedule originates. These wires cover frequencies between 20 to 20,000 cycles and are ideal for FM. In the event

that both feed-lines fail at the same time (a very remote possibility) W71NY will still function without an air break; this is assured by having a supersensitive receiver on the control panel constantly tuned in to WOR. In the event of a landline break, the mere throw of a switch assures a continuous program feed to the W71NY speech input.

While programs do not originate at the transmitter location, mikes and turntables, in addition to special acoustical wall construction, make possible the use of the transmitter hall itself as a studio. Technically and practically, the apparatus room can accommodate any "live" program from a single speaker to a symphony concert.

The new 10-kw. transmitter is equipped with a brand new 25-foot vertical coaxial antenna. It was designed by the WOR Laboratories Facilities Division and is the first and only one of its kind in the world. Two vertical 20-foot aeriels are also located on the roof, one to serve the auxiliary 1-kw. transmitter, the second to accommodate a

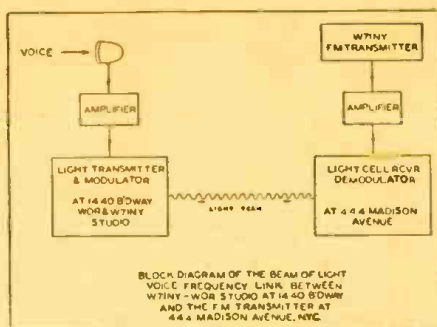

Diagram of Light-Beam Transmission

100-watt unit normally used for short-wave contacting of WOR mobile broadcasting units; this transmitter, however, is also at hand for facsimile broadcasting purposes.

Laboratory and workshop equipment is incorporated in the transmitter floor layout. Costly measuring equipment—a considerable amount of it designed and built by pioneer-

ing W71NY FM engineers because of its market unavailability—is located here. This apparatus includes built-in measuring devices as well as costly-intricate portable equipment for measuring signal strength in the field.

Representatives of both the Army and Navy attended the dedication of W71NY's new 10,000-watt transmitter. Special interest was expressed on the part of military and naval observers in W71NY's experiment in transmitting sound over a beam of light from the WOR studios at 1440 Broadway to W71NY's transmitter at 444 Madison Avenue where the dedication was held.

The use of light beams to transmit sound was developed in the laboratories of Western Union. Previously tested in the laboratory, W71NY's experiment demonstrated for the first time out of the laboratory the latest equipment developed by Western Union. Military and naval authorities will study its possible uses in connection with practical warfare.

## FM in 1942 — As I See It

J. R. POPPELE

Chief Engineer, Stations WOR and W71NY

It would take a prophet of the ancient world to tell what the status of frequency modulation broadcasting will be twelve months from now. But for those who may have grave doubts, occasioned by the possible limitations of set output due to war efforts, let's see what we have to date.

First, there are 50,000 sets on which to receive FM programs in Greater New York, with the National total reaching a quarter of a million. Secondly, as of January 15, 1942 there were 24 commercial FM stations on the air with 39 more in the process of being built. There are 53 applications for commercial licenses pending in Washington and 12 experimental stations offering program service, in most cases prior to commercial transmission.

From the above it would seem that FM, which started out as a radio step-baby, is no longer an immature child. FM is here to stay and is growing daily. If the manufacture of sets should be seriously curtailed during the months to come, there are already in existence enough sets and enough stations broadcasting programs to guarantee a healthy status quo pending resumption of set manufacture.

If I take W71NY, WOR's station, as a typical example, it is with the pardonable pride of one of its "fathers". Ever since April 1, 1941, the station has been New York's first full-time commercial FM outlet. On November 30, 1941, W71NY's new 10,000 watt transmitter was dedicated on top of 444 Madison Avenue in New York City. During both 1940 and 1941 W71NY broadcast a daily schedule from 8 a.m. to 11:30 p.m. composed of a small percentage of WOR programs, some Mutual network programs not otherwise heard in our territory, but primarily programs of W71NY's own origination.

This complete program schedule plus the original investment of capital, reaffirmed by the purchase of the 10,000 watt transmitter is an indication of WOR's faith in FM as a broadcasting medium. Granted that the 10,000 watt installation was planned before the United States entry into the war, with all of its subsequent potentialities of limitation of non-essential pro-

duction, the fact remains that we are continuing to operate normally.

Our present plan is to continue to operate for the same number of hours for the first half of the year to come. At that time we will undoubtedly reevaluate our operation in terms of set sales, audience, and commercial possibilities. Unless world events and our production set-up take an acute turn for the worse, the chances are we will continue our activities for the second six months on about the same basis. We feel that FM has been developed too far to be sidetracked, and we regard an audience of 50,000 sets with their multiple listeners for each, an audience worth cultivating.

I've been writing about the future. Let's consider one or two of the highlights of the past year. One of the most notable of these was the linking together of six stations for point-to-point broadcasting. This special one-time network, which carried commercials, was assembled as part of a salute program for W71NY's new transmitter. The technical results were amazingly successful. The stations involved—W2XMN, Alpine, N. J.; W65H, Hartford, Conn.; W43B, Boston; W53PH, Philadelphia; W39B, Mt. Washington, N. H., and W47A, Schenectady, N. Y., "blanketed" New England. Although the test was made under clear winter conditions, it is easy to realize how such a test under summer conditions with attendant static, would have been even more dramatic, especially to listeners in the more remote receiving locations such as the mountainous regions of New England.

Not much publicity has been given to FM as a communication medium for Army and Navy use. The reasons for this reticence are obvious, but it is easy to conceive and foresee the potentialities of such use. Unpublicized as military use of FM is, radio broadcasters are mindful of their contribution to this phase of our national military efforts, by continuing the fostering of frequency modulation transmissions with its attendant experimentation.

Up until now the advertisers have been extremely helpful in furthering the sales of FM sets. How much longer their cooperation can be expected if production is

curtailed is, of course, problematical. But, I do not believe that any of us, today engaged in this form of broadcasting expect prompt financial returns on our efforts. We are prepared to carry on for a number of years before receiving any substantial return on our investments.

The above does not mean to say that there will be no returns. An audience of some 150,000 listeners in our area is not an audience to be disregarded. Once we know more about this audience we will be able to cater more directly to its preferences and we will have a story to tell our advertisers. Research will do much to foster the commercial advancement of FM and research is included in our plans.

It wasn't so very long ago that the average man on the street was completely ignorant of the meaning of the letters "FM". It is gratifying to find out that this is no longer the case. Here again, the set manufacturers and dealers were wise enough to promote FM generally in their advertising along with the merits of their individual sets. They realized that a job had to be done and they went out whole-heartedly to do it. The FM broadcasters are doing the same thing.

One indication of the effectiveness of this general education process and the growing interest in the subject, is the fact that two large New York morning newspapers—the *Herald-Tribune* and the *New York Times* both now list W71NY's program schedule daily in its entirety. Furthermore, at the time of the W71NY dedication in November, 1941, the *Herald-Tribune* published a 16 page special FM section, devoted to this form of broadcasting as a whole, and tracing the rapid advances that have been made. The interest in newspapers, which in turn are guided by their reader interest, is a healthy sign of the shape of things to come. There have been other effective special newspaper sections in various areas of the country during the past year as well.

One point that must not be neglected during the coming year is *program service*. It is not enough to point to the technical virtues of *frequency modulation*. People must have something to which they can listen with enjoyment and interest.

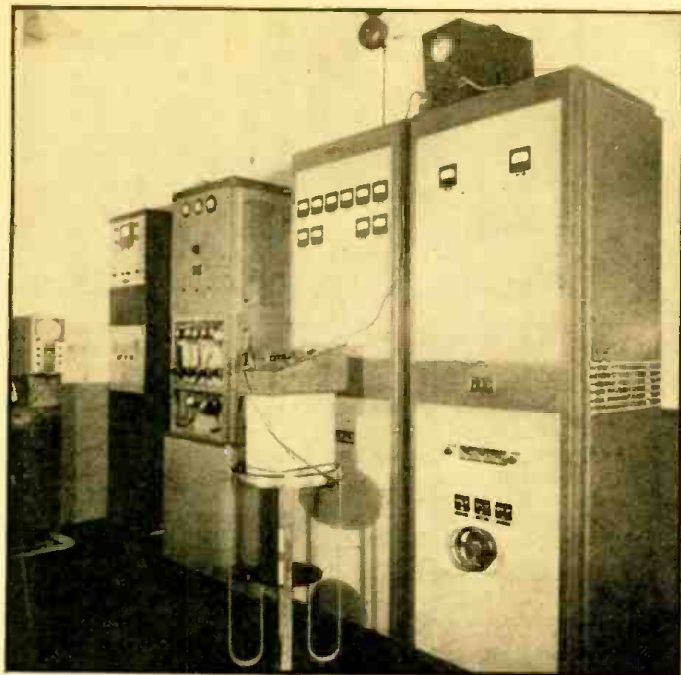

Here is the snappy 1 KW transmitter for NBC's FM station W2XWG. The antenna is atop the 1,250-foot Empire State Building, which gives it superior coverage.

NBC New York

FM Station

to go to

10,000 Watts

O. B. HANSON

Vice-President and Chief Engineer,  
National Broadcasting Company.

**T**HOSE of us who have made radio broadcasting our life's work may be pardoned, I am sure, for nursing a specialized grudge against those who so brutally shattered the peace of the world. For, first the threat of war, and then its full impact, have imposed severe limitations on the growth of radio's promising children.

One of these is *frequency modulation*, or FM broadcasting. The system is complete, its product of a quality beyond question. It should have its fair chance for a place in radio's expanding ranges of services to the American public. The national effort, however, demands intense concentration by the radio industry on every activity that will carry forward the battle for American freedom. Like other new radio developments, FM will undoubtedly fit usefully into that effort. Meantime we must divert energy and materials which might otherwise have gone into expanding FM's role in the field of broadcasting.

All the more laudable, therefore, that some broadcasters and some manufacturers have carried the cause of FM to the American listener as successfully as they have these last two years.

A tabulation before me as I write, lists more than twenty commercial FM stations already on the air, with nearly forty in process of completion. Another fifty applications await action by the Federal Communications Commission. Figures released by FM Broadcasters, Inc., indicate that about 240,000 receivers capable of receiving FM programs have been bought by the public.

Such figures are impressive in themselves, but even more so as an indication of the future of FM in radio broadcasting.

**Advantages of FM.** We have evidence, therefore, that FM has appeal for radio listeners. It has almost complete freedom from static. To critical ears it offers *higher fidelity*. Technically stated, the advantages of FM over AM transmissions (the latter in the standard broadcast band) may be stated as follows: (1) reduction of noise in reception, permitting a greater signal-to-noise ratio, (2) higher fidelity trans-

mission, i.e., a wider range of audio frequencies than is practicable on present channels in the standard broadcast band, (3) greater dynamic range in the program material being transmitted, and (4) less potential interference between stations having the same, or adjacent, carrier frequencies.

The last-named quality may be traced to the *limiter action* in the receiver, and the fact that in all UHF reception a directive antenna, of small physical dimensions, may be used to give one signal a distinct advantage over another, at locations where

The National Broadcasting Company conducted some of the earliest experiments in FM transmission. They were also one of the first in the industry to establish regular FM program service; W2XWG went on the air in April 1939 for the purpose of making extensive field tests. Regular FM programs have been broadcast since January 1940. NBC will erect an FM transmitter in Chicago.

stations on the same frequency would otherwise be received with approximately equal signal strength.

**FM Channels Give 15,000 Cycle Fidelity.** The higher fidelity characteristics of FM are attributable in part to the wider audio range which can be transmitted in the wider channels allocated for FM by the F.C.C. Forty channels have been set aside in the band extending from 42.1 megacycles to 49.9 megacycles. Each is 200 kilocycles wide. The channel in the standard broadcast band is but 10 kilocycles wide, ordinarily limiting the audio frequency range to 5,000 cycles. In the FM channels we find it possible to transmit a range of audio frequencies up to 15,000 cycles. This range permits the inclusion of all of the higher audible harmonics, or overtones, of music, which contribute to realism in the reproduced program.

These commendable characteristics of FM have sent many broadcasters searching for high buildings on which to perch their

UHF antenna arrays. Antenna height becomes an important factor in UHF transmission, since ground attenuation of the signal enters as a factor only when the optical horizon, as measured from the transmitting antenna, is reached. Beyond that horizon the UHF waves are governed by formulas for wave propagation on the surface of the ground. Here the UHF signal attenuates far more rapidly than it does within horizon limits. It is desirable, therefore, to push the horizons as far distant as possible. Hence the search for the highest possible antenna locations.

So much for the advantages of FM in ultra-high frequency broadcasting. Where does the broadcaster stand? The answer will be found in the list of actual and prospective commercial FM broadcasters.

Anticipating the future of UHF in radio broadcasting, the National Broadcasting Company selected the highest building in New York City for the installation of experimental transmitters with which to conduct propagation studies and developments in this field. Some of the first experiments in FM transmission were carried on at our station in the Empire State Building.

The National Broadcasting Company also was one of the first in the industry to establish an FM station. Its Station W2XWG went on the air in April, 1939, for the purpose of conducting extensive field tests of the comparative qualities of AM and FM. These findings have been the basis for numerous technical papers and talks.

A regular program service five days a week, eight hours or more a day, has been offered over the NBC station since January, 1940. Since it has been on the air, NBC has received numerous complimentary messages from discriminating listeners, who comment on the exceptionally high quality of the station's performance. Special programs and carefully selected material from NBC's daily schedules are heard over the station. In selecting program material from the network schedules, we have favored programs originating in the Radio City studios, since these afford us the opportunity of transmitting the wide range of audio frequencies that makes FM attractive to our listening audience.

# THE STRANGE CASE OF SERVICEMAN WALDO MUDD

Our present transmitter, of RCA design, was installed under the direct supervision of NBC's radio facilities engineer, Raymond C. Guy. Operating on a frequency of 45.1 megacycles, it has an output of 1,000 watts. The principal innovation in its design is an FM modulator of the type developed by Murray G. Crosby, of the Radio Corporation of America. This modulator consists of several tubes, including an oscillator, a reactance tube, a crystal beating oscillator, a discriminator and a filter.

**Power of FM Station to Be Increased.** NBC holds a commercial construction permit under which the power of the FM station is shortly to be raised to the limits permitted by the F.C.C. in covering a service area of 8500 square miles with a minimum signal strength of 50 microvolts. The feat will not be difficult, inasmuch as the antenna location is the top of the Empire State Building tower, the highest and most advantageous site in the city (1250 ft.). The antenna array used, incidentally, is the video (picture) component of the familiar NBC television antenna, the transmission characteristics of which are substantially flat over 30 megacycles.

Transmitter equipment with a rating of 10,000 watts was ordered more than a year ago. The manufacturers have found themselves so deeply engaged in defense production, however, that delivery has been necessarily delayed. We hope to be on the air with increased power very shortly. NBC also holds a construction permit for a station at Chicago where an FM transmitter will be completed as soon as possible.

**Future of FM Broadcasting.** The fate of FM broadcasting will not rest with the broadcaster. The ultimate arbiter will be the American listener. For it is he who will judge for himself whether its superior service offsets the cost of a new FM receiver. The better his service from powerful AM stations in the standard broadcast band, the less likely he is to be impelled to rush to his nearest radio dealer to buy an FM set. Those who do not get comparatively noise-free reception from AM stations are likely soon to become FM enthusiasts.

Frequency modulation receivers designed to realize the full value of FM's high fidelity potentialities command a higher price than the best AM sets. If the listener is to enjoy the full benefits of FM transmissions in his home he must have a receiver incorporating a high-fidelity audio amplifier and loudspeaker system. Such a receiver cannot be manufactured to sell at a price comparable to those prevailing for the most popular AM models. There are, however, FM adapters on the market. These may be used in conjunction with the listener's AM receiver to yield the full value of FM's noise-free reception. Fidelity, however, is here limited to the characteristics of the AM receiver's audio amplifier and loudspeaker. It is worthy of note that many of this year's more expensive console models include an FM band. This will add to the new service's expanding audience.

A conservative estimate of FM's future would be that it will progress, not sensationally, but steadily. It also seems quite probable that when armies have ceased to march, when the dive-bomber's scream has been stilled, that FM will march briskly into an expanding future alongside that other infant prodigy of radio—television!

## New I.R.E. President

Arthur F. Van Dyck, Manager of the Industry Service Section of the RCA Laboratories, has been elected President of the Institute of Radio Engineers it was announced today by that technical organization. The

*Dear Miss Barefacts*

I know that your column is entitled "Advice to the Loveless" and I am not loveless. As a matter of fact, I have more love than I know what to do with. That's why I am writing to you.

You see, Miss Barefacts, I am a radio service man. I make good money and I'm very happy. I mean I was happy until I met Arabella Blotts. She is one of my customers. In fact, she is my very best customer. That's the trouble.

Arabella has a very nice apartment with about eight radios in it. The first time she called me, I went over and fixed two of the radios in about half an hour. Then Arabella asked me to sit down and have a drink with her.

The correspondence course I took in radio servicing didn't say anything about what to do in a case like this. Besides, I don't drink anything but ginger ale. However, Arabella insisted, so I asked for ginger ale. It was very funny tasting ginger ale and I even felt funny after I drank it.

Then Arabella sat down beside me. She is a very big girl. Also, she is very determined. Every time I moved away from her, she shoved over closer to me. Finally, I was at the end of the davenport and couldn't move any farther. Also, I was at the end of my wits.

When I got back to my shop, I remembered she hadn't paid me for fixing the radio. Also, I was dizzy and didn't feel like working any more that day.

The next day, Arabella called and said both of the radios I had fixed were broken again and would I please come right over. Well, there wasn't anything to do but go over and fix them. So I did.



Then the same thing happened again, the very next day.

However, Miss Barefacts, I will not bore you by telling you any more of this sort of thing. Suffice to say, it was six months ago that Arabella first called me. Since then, she has called me almost every day. I have fixed all of her radios at least a half dozen times each and she still hasn't paid me for a single job. What's more, I am afraid to send her a bill. Arabella is funny that way. She might get mad and not call me any more. After all, she

is the best customer I have.

What shall I do?

*Very truly yours,*

**WALDO MUDD,**  
Radio Service Man.

★ ★ ★

*Dear Mr. Mudd*

Don't worry. Your problem should be an easy one to solve. My first suggestion is that you marry Arabella Blotts. Evidently that would please her. Then you can repair her radios in your spare time and spend the rest of your time at work for which you will be paid. My second suggestion is that, in the future, you use Sprague Condensers and Koolohm Resistors for every replacement. Once you install them you can forget them—and so can your customer. Then, the next time you meet a girl like Arabella, she will have to be more original in finding an excuse to invite you back again.

*Sincerely yours,*

**GERTRUDE BAREFACTS,**  
Editor, "Advice to the Loveless Column."

• ATOMS are made in five different types, thus making them practically universal for any replacement job whether it calls for a single-section or multi-capacity unit, lug mounting, or a condenser with separate positive and negative leads.

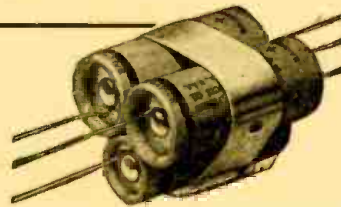

Make up hard-to-get replacements by strapping individual Atoms together with ST Mounting Straps—supplied free! You'll find the combined Atoms actually smaller, often cheaper, and fully as reliable. You save time—money—space.

# SPRAGUE PRODUCTS CO.

North Adams, Mass.

GOOD CONDENSERS—EXPERTLY ENGINEERED—COMPETENTLY PRODUCED

Institute is the most important technical radio society in the world with 7000 members in 74 countries.

Van Dyck has been a well-known personality in radio from its earliest days. He has made many technical contributions to the art, the most recent being the RCA Alert Receiver, a device by which civilian defense workers are notified in times of emergency and called to a special radio to receive instructions for action. This development led to his appointment as Member of the Communications Liaison Committee of the Office of Civilian Defense. His interest in radio dates from his school days. He has some thirty patents to his credit, and a variety of interests that are as broad as an industry which comprises many diverse branches.

Arthur Van Dyck began his career in radio as a radio amateur. Later, he served as a ship operator for the United Wireless

Telegraph Company during college vacation periods. After receiving his Ph.B. at Yale, he joined the laboratory of Professor Reginald Fessenden, at Brant Rock, Mass., where he participated in many of the experiments of that pioneer which have since become technical classics. Afterwards he went to the Westinghouse Company at Pittsburgh, to serve as laboratorian, and later was instructor in Electrical Engineering in the Carnegie Institute of Technology.

During World War I Van Dyck was Expert Radio Aide in the U. S. Navy, which experience led to his appointment as Chief Factory Engineer of the Marconi Wireless Telegraph Company of America when peace-time radio was resumed. There followed a period of service with the General Electric Company, when he was in charge of development and design of radio receivers.

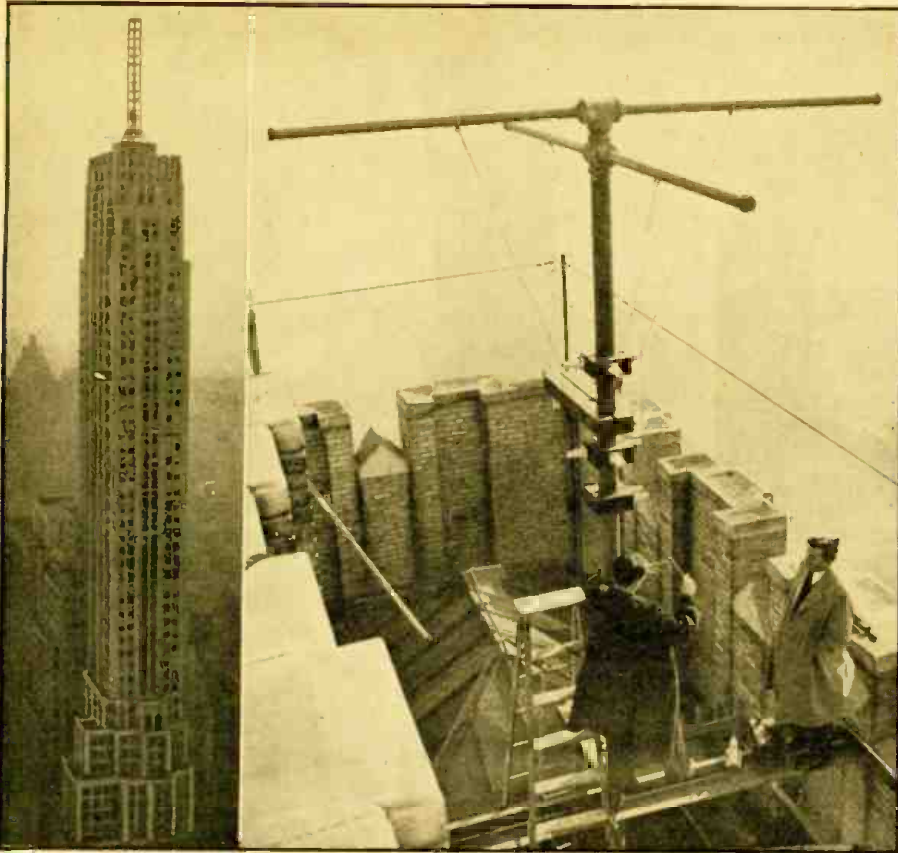

Right: CBS radio engineers complete tuning the temporary FM antenna atop the Salmon Tower (left) at 500 Fifth Avenue, New York City, preliminary to inauguration by the Columbia Broadcasting System of a schedule of FM news and music programs. The programs serve the New York area, which includes about 8500 square miles.

One of  
New York's  
**FM**  
Broadcasters  
**CBS**  
Station  
**W67NY**

**W**67NY, New York City FM station of the Columbia Broadcasting System, has been broadcasting news and music programs six hours daily, Mondays through Fridays, since Monday, December 1, at 3:00 P.M., EST. Broadcasts are scheduled from 3:00 to 6:00 P.M. and from 7:00 to 10:00 P.M. The programs are carried by high fidelity wires from a studio in the CBS Building at 485 Madison Avenue to the new temporary FM transmitter atop the Salmon Tower at 500 Fifth Avenue (New York).

A new antenna-supporting pole has been built atop the same structure at 500 Fifth Avenue for a permanent antenna that may be installed in a couple of months. The pole has a 65 foot mast supported on a 25 foot steel base, projecting a total of 90 feet above the tank house steel atop the building. The pole consists of 24,000 pounds of steel structure, and its top is 782 feet above the ground.

Installation of the permanent FM antenna is to be delayed due to national defense demands on necessary materials. Powered with a 3-kilowatt transmitter, the permanent installation will operate under the call letters W67NY, and will serve the standard New York area of 8500 square miles with a population of 12,000,000. The temporary antenna now in operation covers the same area. It is a single-bay turnstile antenna that first went on the air November 17th. Operating at a reduced power of 250 watts on that day, the temporary antenna broadcast an unmodulated carrier signal.

The roof of the Salmon Tower is peculiarly well-adapted for an antenna construction because it has a workable surface area with no spires or decorative ornaments. CBS engineers examined fifteen of New York's tallest buildings before they decided upon the Salmon Tower.

The antenna-supporting pole is con-

structed atop the water tank on the roof of the building. A special bracing has been added to the water tank to support the pole. The pole is comprised of twelve units and weighs 12 tons. Special fixtures were made by machine tools to accommodate the swedged fittings of the twelve units.

The pole was designed to meet the radio specifications of the CBS radio engineering department, and to meet the physical specifications of their construction department. The construction job was supervised by Columbia's C. R. Jacobs and Kingdon S. Tyler. Radio engineering was supervised by Clyde Houldson who had been detached from other CBS engineering duties to be the engineer on the premises.

All materials which went into the construction was brought into the building via its 30 West 42nd Street service entrance. They were then carted through the basement and placed on the elevator where they were hoisted to the 58th floor. From there they went through hatchings to the elevator machine room on the 60th floor. Then they were raised to the roof through skylights. Light-weight wood poles, the same size and shape of the steel sections, were first carried through to check this route to the roof.

The permanent antenna installation will have 4 stacks of "loop" antennas at sixteen foot intervals starting five feet from the

top of the tower. The "loop" is an improved antenna design developed by Andrew Alford, an engineer of the Federal Telegraph Company. One "loop" gives twice as much power as the earlier "turnstile" antennas. As the number of loops is increased, power is concentrated on the horizon with greater efficiency.

The signal radiated by a four-stack loop antenna in all directions is equal to that of a standard antenna in its best direction using four times as much power. The rules governing FM broadcasting preclude competitive advantages of one station over another. A specific area has to be covered in each instance; this is effected by making the most desirable compromise between height of antenna, power of transmitter, and antenna gain.

A series of matching elements is mounted on the antenna-supporting pole. With four loop antennas there are naturally four signals. With the matching elements, however, a single signal arrives in step at the receiver.

Each loop consists of a maze of two and a half inch copper-plated steel pipes folded to form a six-foot square. There are two gaps in opposite corners of the square. These are metal plates thirteen inches in diameter, and are condensers used to increase the radiation efficiency of the antenna.

Inside the pipes are electrical heating elements which are used as a protection against sleet. They prevent ice from forming on the antenna.

A pair of two and five-eighth inch tubular transmission lines connect the transmitter in the control room on the 60th floor to the antenna. The sound, as in AM radio, comes from the broadcasting studio over a special high quality line.

The structure is designed to withstand simultaneously a 125 mile an hour gale and a two and one-half inch ice load, over its entire 90 foot length.

•  
**FM Listeners!**

Write to the program director of your local FM Station: Tell him how the station comes in at your location, how and what type of programs you enjoy, etc.—Editor

•

# For Better Servicing - For Bigger Profits -

## FOR A WIDER KNOWLEDGE OF TECHNICAL SUBJECTS, READ THE BOOKS IN THE RADIO-CRAFT LIBRARY SERIES

GET into the swing of reading instructive, authoritative books on technical subjects—Radio, Air Conditioning and Refrigeration. The RADIO-CRAFT LIBRARY SERIES is the most complete set of volumes individually treating all important divisions in these fields. Each book has been written for the purpose of giving you the opportunity to specialize in one or more of the popular branches of the various subjects and we know of no easier, quicker or less expensive way to improve your knowledge. The material in each book is very helpful—you'll find them valuable in your work. The authors are all well known and are authorities on the subjects on which they have written. This is the first time that you are enabled to build a library of technical books by such popular writers.

### ALL BOOKS ARE UNIFORM

The books in the RADIO-CRAFT LIBRARY SERIES are all uniform. The size is 6 x 9 inches. Each volume contains 64 pages and an average of 50 to 150 photographic illustrations and diagrams. The books are printed on an excellent grade of book paper and have stiff flexible covers. PRICE 50c PER BOOK. All books are sent postpaid.

|  |  |  |  |
|--|--|--|--|
|  <p><b>Book No. 13</b><br/><b>ABC OF AIR CONDITIONING</b><br/>An accurate simplified technical review of the fundamentals of this latest branch of engineering, including servicing data on present-day units. By Paul D. Harrigan.<br/>50c</p> |  <p><b>Book No. 17</b><br/><b>SERVICING WITH SET ANALYZERS</b><br/>A Study of the Theory and Proper Application of Modern Set Analyzers and Associated Apparatus. By H. G. McEntee.<br/>50c</p>   |  <p><b>Book No. 18</b><br/><b>POINT-TO-POINT RESISTANCE ANALYSIS</b><br/>For Service Men Theory and Application of this Modern Test Procedure to Everyday Radio Service Problems. By Bertram M. Freed.<br/>50c</p>                           |  <p><b>Book No. 21</b><br/><b>BREAKING INTO RADIO SERVICING</b><br/>Simple Instructions and Procedure for Starting a Profitable Radio Servicing Business of Your Own. By Robert Eishberg.<br/>50c</p>                 |
|  <p><b>Book No. 14</b><br/><b>POCKET RADIO GUIDE</b><br/>Edited by N. H. Lestrom. Handy Reference Book for Radio Men—Set Construction Articles—Audio Amplifier Circuits—Useful Radio Formulas and Data—Handy Short-Cuts.<br/>50c</p>            |  <p><b>Book No. 15</b><br/><b>ABC OF REFRIGERATION</b><br/>A carefully written volume, starting with the basic principles of refrigeration, by mechanical means, and leading up to a complete analysis of the servicing of commercially available units. By Traflet Mason.<br/>50c</p> |  <p><b>Book No. 19</b><br/><b>PRACTICAL RADIO KINKS AND SHORT CUTS</b><br/>The contents of this book have been planned with the view to help Radio Dealers, Servicemen, Experimenters and Set Builders.<br/>By B. Baker Bryant.<br/>50c</p> |  <p><b>Book No. 22</b><br/><b>NEW RADIO QUESTIONS AND ANSWERS</b><br/>Answers to Questions Most Frequently Asked by Both Novices and Experts. By Robert Eishberg.<br/>50c</p>                                       |
|  <p><b>Book No. 16</b><br/><b>PRACTICAL RADIO CIRCUITS</b><br/>A Comprehensive Guide to All Types of Radio Circuits for the Service Man, Constructor and Experimenter. By David Bellars.<br/>50c</p>  |  <p><b>Book No. 20</b><br/><b>THE CATHODE-RAY OSCILLOSCOPE</b><br/>Theory and Function, Power Supplies and Associated Circuits, Sweep Circuits, Operation of Typical Unit, Methods of Measurement, Practical Applications of C-R Oscilloscope. By Charles Sciaranza.<br/>50c</p>      |  <p><b>Book No. 23</b><br/><b>PRACTICAL PUBLIC ADDRESS</b><br/>Modern Methods of Servicing and Installing Public Address Equipment. By B. Baker Bryant.<br/>50c</p>  |  <p><b>Book No. 24</b><br/><b>AUTOMOBILE RADIO PRINCIPLES AND PRACTICE</b><br/>A Complete Treatise on the Subject Covering All Phases from Installing to Servicing and Maintenance. By B. Baker Bryant.<br/>50c</p> |

New titles are constantly being added to the RADIO-CRAFT LIBRARY SERIES. But, on the other hand, stocks of certain titles are running low, and they may not be reprinted for some time. We would therefore suggest that at this time you order as many different titles as you are interested in. Remember, that if you delay, some of the books may later be out of print.

**USE THIS HANDY COUPON WHEN ORDERING**

**RADCRAFT PUBLICATIONS, Inc.**  
25 WEST BROADWAY NEW YORK, N. Y.

RADCRAFT PUBLICATIONS, Inc., 25 West Broadway, NEW YORK, N. Y.  
Gentlemen: Enclosed find my remittance of \$..... for which send me, POSTPAID, the Books indicated below.

RADIO-CRAFT LIBRARY SERIES @ 50c EACH  
Circle book numbers wanted: 13 14 15 16 17 18 19 20 21 22 23 24

Name ..... Address .....

City ..... State .....

(Send remittance in form of check or money order; register your letter if you send cash or unused U. S. Postage Stamps.) RC-342

# FM FUTURE at a Glance

75% of nation is now FM conscious . . . Estimated 2,000,000 FM sets will be sold in 1942-43 . . . 40,000,000 people now in FM service areas.

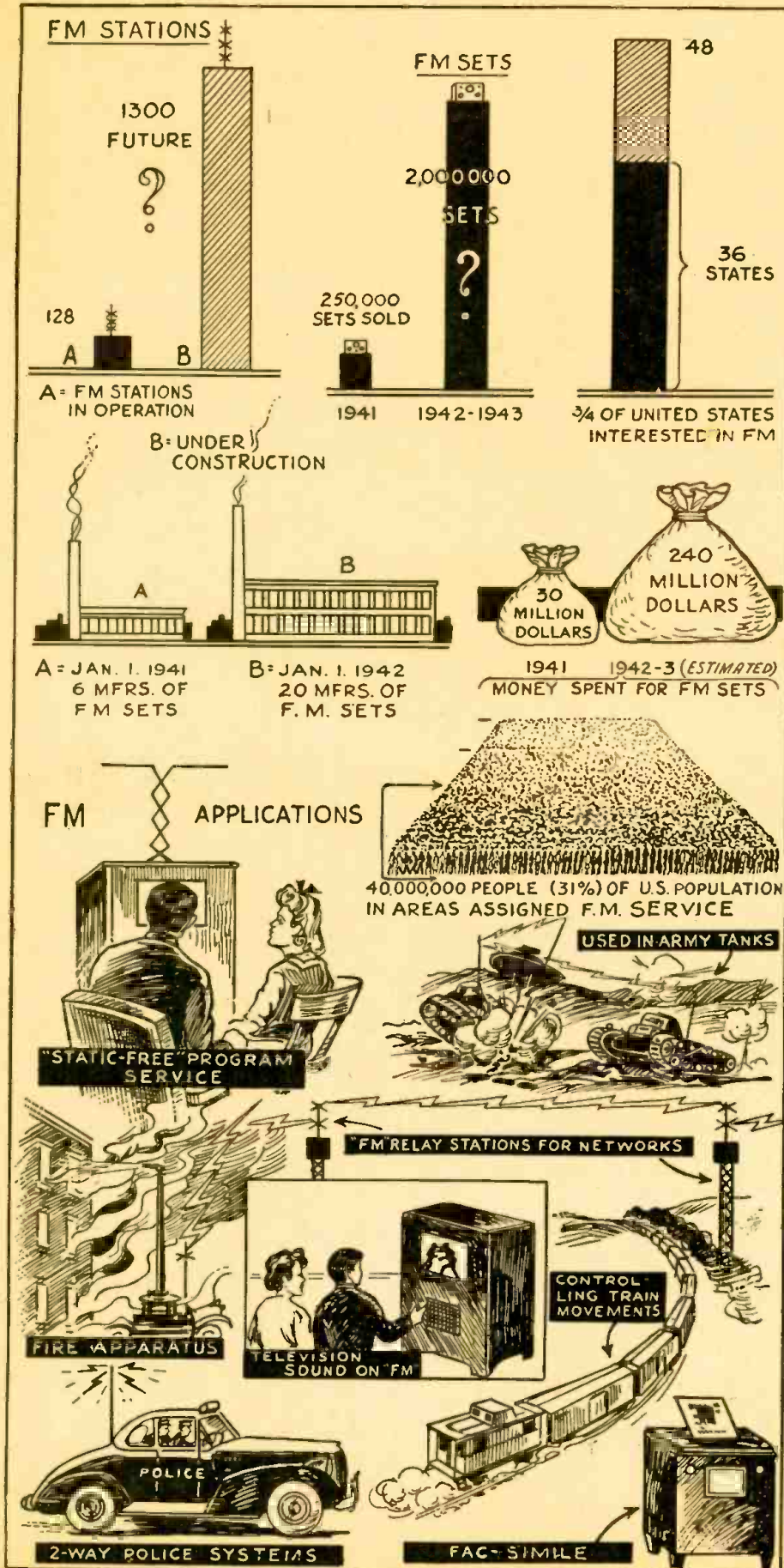

**E**VEN with the war conditions and great curtailment of sets produced for public use, it has been estimated that 2,000,000 FM receivers will be built and sold in 1942-43 compared to 250,000 FM sets in use January 1st, 1942. Now a total of 128 FM stations are on the official record; 24 FM stations spread across the country are now in daily operation with commercial programs. Thirty-nine FM stations are under construction and many of them will go into operation shortly.

There are 53 FM station applications pending with the F.C.C. in Washington. There are also 12 experimental FM stations still offering program schedules preparatory, in most cases, to instituting service with commercial transmitters now being installed. Seventy-five percent, or 36 out of 48 states in the Union, are now interested in FM, through stations now in operation or soon to be active in these states. In many cities FM transmitters are in use by the police. Other commercial applications of FM are its use in despatching trains, communication between fire apparatus and headquarters, transmission and reception of facsimile pictures, FM transmission of voice and music for television, and a number of military uses, including FM sets in army tanks.

**50,000 FM Receivers in New York.** Latest figures on sales of FM receivers, indicate that there were approximately 50,000 sets equipped for frequency modulation reception in the vicinity of New York City alone on January 1. The national total is close to the quarter million mark.

The New England states may now claim between 22,000 and 24,000 sets, while Chicago has reached 25,000—most of which were sold in the past three months. Other large cities include Philadelphia with 12,000; Los Angeles, 15,000; Milwaukee, 6,500; Detroit, 12,000; Pittsburgh, 8,000.

Figuring on the conservative basis of three persons to each receiver, statistics thus indicate that New York's 50,000 receivers serve an audience of about 150,000 listeners. Six different FM stations already serve this growing New York audience which, recently, has expanded by 15,000 to 20,000 persons each month. Four additional stations are being built.

In Chicago four FM stations now operate. The Los Angeles total of 15,000 sets, representing a minimum of 45,000 listeners, has been achieved almost entirely since last August.

**More Manufacturers Facing FM Production.** The recently issued trade directory of the Radio Manufacturers Association lists several concerns, hitherto not closely associated with FM, as now producing or planning to produce FM broadcast receivers for the home.

**Newest FM Station Approved Will Be Sixth in Philadelphia.** Philadelphia's sixth FM station received a go-ahead from the Federal Communications Commission.

Already operating in Philadelphia are WFIL's W53PH, and W69PH of WCAU. Under construction are W49PH (WIP), W57PH (KYW) and W81PH (WIBG). The newest FM license, first to be granted by Washington in 1942, brings the total of high frequency broadcast stations in the nation so far authorized to 63. Of these, 24 are now on regular operating schedules.

Recently it was estimated that 93% of the population in the six New England states lives within range of W43B and W39B. Only 87% are within the normal range of all 52 AM stations. The AM stations would keep an FM receiver constantly tuned to the nearest FM transmitter. Because no vulnerable wire lines are involved in this method of co-ordination, only an explosion or direct hit on the FM transmitter could prevent messages from getting through infallibly to all parts of New England.



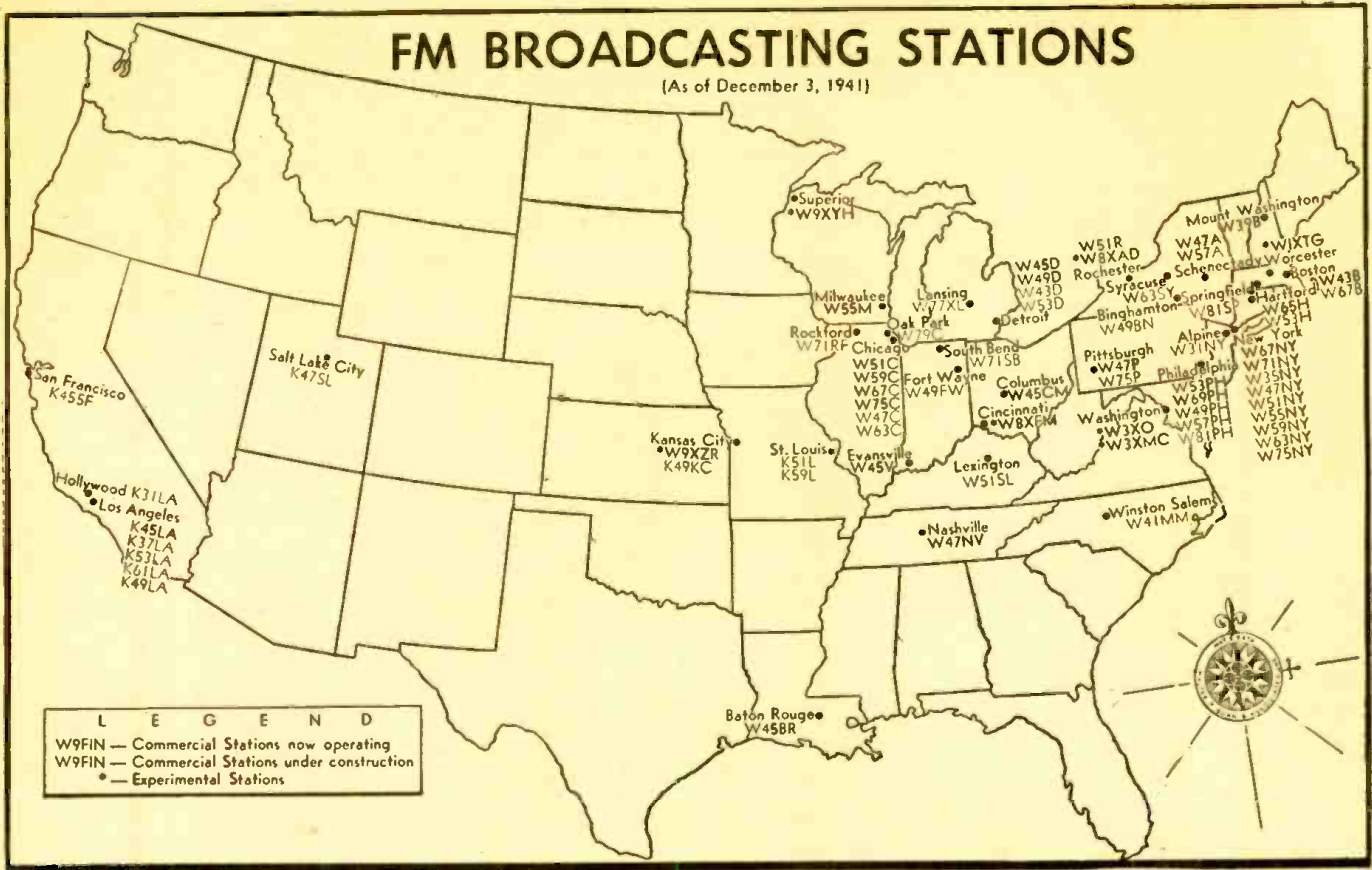

—Reproduced by courtesy of TIDE Magazine.

This map shows the amazing spread of "FM" broadcasting across the nation.

# "FM" MAP Grows Rapidly

**A** YEAR AGO most of the stations were strung along the East or West Coasts. Today they dot the whole eastern half of the country (see map); within a few months as many cities will have commercial FM stations as now have standard stations on the basic coast-to-coast networks.

The section most lacking in FM service is the whole Midwest from the Mississippi west to the Rockies. But in such vast rural areas, AM is expected to be the dominant system for some years to come. Even so, no less than 40,000,000 people are estimated to live within earshot of an FM transmitter.

The roster of FM operators now includes many names aside from Major Edwin H. Armstrong and his clique of enthusiasts, including some with such huge investments in AM that they did not exactly welcome FM's advent. Among those with commercial FM stations on the air are Columbia Broadcasting (Manhattan and Chicago), Don Lee Network (Los Angeles), WGN (Chicago). The list with stations building is even more inclusive: Metro-Goldwyn-Mayer (Los Angeles), Hughes Tool Co. (Los Angeles and San Francisco), NBC (Manhattan and Chicago), Westinghouse (Boston, Springfield, Fort Wayne, Philadelphia and Pittsburgh).

In view of the small audiences available, some of the stations have made substantial progress in selling time. The time costs are still nothing but token rates: W71NY, for example, charges \$100 an evening hour, compared to \$1,100 for its parent, WOR.

But there appears to be a growing number of sponsors sure enough of FM's future to want to experiment before the rates increase.

New York, one of the first centers to get service, has been one of the most backward to promote it. But at the moment, WOR and CBS both have salesmen peddling their FM time and within a few weeks WQXR, Muzak and WHN will open commercial outlets with coverage as broad as the existing stations. (Muzak eventually will have another, non-commercial outlet.)

Similarly, Chicago and Philadelphia have two or more competing stations. Both W59C and W67C, owned by WGN and CBS, respectively, have sold time and both will continue to solicit sponsors. The same is true in Philadelphia, where WFIL and WCAU have commenced operating W53PH and W69PH respectively. Most other big cities are due to have competing commercial stations soon, which should result in a still bigger drive to get sponsors.

The war will crimp the broadcasters' style, of course, but perhaps not as much as

might be expected, for many stations already have their equipment.

There also may be a pinch at the receiver manufacturing end. As of Dec. 1, the statistical firm of Ernst & Ernst reported, the public had bought 180,000 sets, with the rate increasing regularly month by month. Total for October: 36,000. Though the industry's output is currently running at 1,500 a day, FM Broadcasters, Inc., estimates that the demand in areas with service is 20% to 50% above the supply.

On the other hand, the 20 manufacturers now making FM sets are, like the rest of the industry, using their precious materials on their higher-priced models and most of these tend to be AM-FM combinations. So as long as they continue to make any sets, they presumably will be making ones that can receive both systems. All the companies use Major Armstrong's patents except Philco and Crosley.

Estimates for 1942 production range hopefully upward from 1,000,000.

The FM network carrying the recent program was formed for that particular purpose and will not function again as a group except perhaps to broadcast some special event later. Columbia and its affiliates, however, already have the skeleton of a huge chain which may emerge at some distant date as a going concern. The new, cooperative American Network is stymied at the moment for want of a Manhattan outlet capable of relaying programs to its nearest station to the North, in Hartford.—*Courtesy "Tide" Magazine.*

## FM Is Here To Stay!

The Editors will include many more FM articles in future issues of this magazine. Articles on new FM Stations, FM activities, FM Set-Servicing, construction of FM Sets, etc.

# Chicago Turns to FM

CYRIL WAGNER

FM Station W59C (FM Outlet of Famous WGN in Chicago)



Left—Art Avery, WGN and W59C engineer makes a final inspection of the air filter in the new FM transmitter. Above—FM Station W59C helped to introduce FM by means of a popular demonstration before a group of local radio dealers. Right—Carl J. Meyers, Chief Engineer of WGN and W59C (left) and his Assistant, Clyde White, during installation of FM transmitter.

**F**REQUENCY modulation offers listeners a better system of broadcasting." That, in the words of Carl J. Meyers, chief engineer of WGN and its FM outlet, W59C, sums up the reasons for the growing popularity of frequency modulation broadcasting and at the same time gives an implied prediction of its future.

Meyers gave specific reasons for his praise of FM. He pointed out, as an important point in his case, that FM offers reception without interference, without static and without noise—reception unmarred by crashing roars when lightning streaks the sky or when a neighboring electrical appliance is switched on.

But more than all that, Meyers points out, FM offers reception with a naturalness and realism in the reproduction of music, speech and sounds beyond the capabilities of AM (amplitude modulation) broadcasting. This because FM is capable of reproducing the full range of sound, from 20 to 15,000 sound cycles per second.

All these FM advantages in the field of wide range tonal reproductions are accomplished by the employment of a different principle in transmission. In standard radio employing amplitude modulation the power at the transmitting antenna is varied in accordance with the sound in the stu-

dio, the frequency (number of sound cycles transmitted per second) remaining the same. The reverse is true for FM, and that is where the big difference comes in. In FM the power remains constant, whereas the frequency is varied over a wide range, in accordance with the sound from the studio. All this leads us to the question: How can these transmission benefits be applied to programming for the good of the listener? Estelle Barnes, program director of W59C, realizing that music will benefit most under these conditions, has scheduled a predominantly musical fare for Chicago and listeners in the 10,800 square miles serviced by WGN's FM station. A special FM orchestra has been formed for exclusive use on W59C. Stars of opera, radio and the concert stage have special "live" programs, and a library of high fidelity, vertical cut transcriptions has been collected for the W59C audience.

Taking cognizance of all these facts, Henry Weber, musical director of W59C and WGN, has predicted that music will always find a welcome among FM listeners.

"For the first time," said Mr. Weber, "we can reproduce the complete dynamic range of orchestral and vocal sound. And that means a great deal. For now that listeners can at last hear good music in all its naturalness, they will want more of the same."

The very high quality of FM transmission and programming has found a reflection in the sponsors airing programs on W59C. William A. McGuineas, sales manager of W59C and WGN, has pointed out that distributors of high class commodities and services have found a very responsive market among FM listeners. To illustrate his point he called attention to such W59C sponsors as the Marshall Field and company department store, the Ernest Ricketts and Hardings restaurants and the Monarch Finer Foods company, all quality merchandisers. This tendency, McGuineas predicted, would continue in the future.

FM, it is true, has advantages. This we can see from the above facts. But every listener must remember a few points if he is to reap the rewards of FM transmission. Meyers points out that although an antenna on the FM receiver is not absolutely essential, listeners living near the extreme range of seventy miles from any FM transmitter may improve their reception by putting up an antenna on their house top. A very short wire will do the trick, Meyers explained, with the length of approximately twelve feet offering the best results.

If these suggestions are followed, listeners will be hearing FM at its best. And that is radio at its best.

## EDUCATIONAL BROADCASTS ON FM

**A**pplications by the Board of Education of the city of Chicago, the San Diego (Calif.) Unified School District and the University of Illinois to engage in non-commercial educational broadcast service is indicative of the value of FM in developing the five high frequency channels reserved by the Federal Communications Commission for non-profit educational use.

An average school station can now be installed at the price of one classroom.

This rearrangement of the high frequencies to make commercial FM broad-

cast service possible has a distinct advantage in that the close proximity of the non-commercial educational bands and the new FM commercial bands makes it possible to adapt standard FM receivers to receive both types of broadcast. In other words, the FM receivers now being marketed are capable of receiving non-profit educational as well as the regularly sponsored programs.

However, the University of Kentucky had received a construction permit for a system to bring educational program service to some 50 mountain schools, available to

adults as well as students.

Subsequently, the Board of Education of the San Francisco Unified School District was authorized to use radio for instructional, administrative, supervisory and other functions through the medium of 13 studios in schools in that area, all connected with the central broadcast station KALW by leased wires.

More recently the Cleveland Board of Education, which serves more than 150 receivers in its municipal school system, received permission to change to FM.

# More Than Ever— YOU NEED THIS 1942 ALLIED RADIO CATALOG!

Everything in Radio at Lowest Prices



SPRING  
AND  
SUMMER  
1942

## FOR SERVICEMEN • DEALERS • SOUND MEN • AMATEURS • BUILDERS

Today, more than ever, **ALLIED** is the one name that means Everything in Radio. Today, more than ever, you can always depend on **ALLIED** for vast, complete stocks of the leading makes of diversified equipment in every field of radio and electronics. You can always depend on **ALLIED** for quality merchandise that's "tops," for rush-service direct to you on all orders, for those extra values you'll not find equalled anywhere in radio today. There's never been so value-packed a catalog as the new 1942 **ALLIED** book—the **FREE** Spring and Summer Catalog you'll need to keep up with radio. Servicemen, Dealers, Amateurs, Sound Men, Experimenters—send for your copy of Radio's newest Catalog with the lowest prices in the entire field.

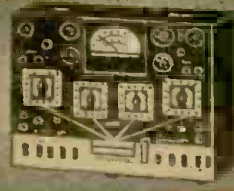

### 40 NEW SET MODELS

You'll want to see the 1942 **KNIGHT** "Radio Hit" models—more than 40 of them—featuring the newest styling, latest developments, low prices that can't be challenged. There's a radio for every room—New **FM-AM** models; luxurious **Phono-Radio** Period Models; **Table Models**; portables, recorder-radios; farm sets; auto radios—radios for every purse and purpose!

### KNIGHT SETS PA PACE

See the very latest in powerful 1942 Sound Systems—ranging from 7 to 60 watts; new biased-power amplifiers; new-type "Bantam" Portable Systems. Everything in microphone, speaker and phono accessories. The most complete quality line in the PA field. Get the facts of our 15 Day Trial Offer, and buy with absolute confidence. Write for **FREE** advice regarding PA problems.

### BIG SERVICE SECTION

Now, more than ever, Radio Service plays a vital role in the maintenance of American radios. See the very latest quality Test Equipment—all the leading makes—all the newest gadgets, tools, books, to make service work easier, faster, and far more profitable. Over 15,000 quality replacement parts for repairing any make and model radio. It's the Serviceman's Buying Guide!

### SPECIALIZED EQUIPM'NT

See all the new communications receivers, special radio and electronic parts, accessories, and equipment for industrial applications, for defense instruction, for research labs, etc. Serve your local industries and governmental agencies with quality radio equipment. Today, when speed and service and complete stocks count most, it will pay you to keep your **ALLIED** Radio Catalog handy!

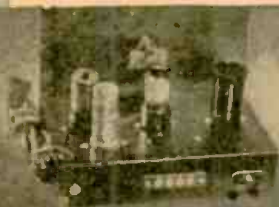

### BUILDERS' GUIDE

Nothing like it for the Builder and Experimenter has been published before. Pages of new build-your-own kits; the popular "DX-ers" in new versions; new **FM** kits; "Popular Mechanics" Kits; dozens of new diagrams, circuits; everything for the Radio Builder and Experimenter! We'll supply **FREE** parts lists for any circuit described in magazine construction articles. You'll want this great 1942 Catalog—send for it now!

### MORE THAN 15,000 PARTS

Today, more than ever, you can count on **ALLIED'S** vast stocks for everything you need in radio. Our experienced staff of merchandise specialists have spent months in combing the market to maintain and build up the most complete stock in radio's history. All the famous makes are offered; complete listings in every field are available—and all at lowest prices. And don't miss the big special Bargain Section that shows exceptional values!



### FLUORESCENT LIGHTING

For those extra profits, and extra savings, see our completely new Fluorescent Lighting section. Here's a wide variety of low priced easy-to-install new fixtures and accessories for commercial, industrial and home lighting applications—at new low prices that will amaze you. It will pay you large dividends to investigate this profitable new field! Clip the coupon below for the most reliable guide to profitable Fluorescent selling.



Free  
SEND  
COUPON

### ALLIED RADIO CORP.

833 W. Jackson Blvd., Dept. 2-C-2  
CHICAGO, ILL.

Rush me a copy of your **FREE** Spring and Summer Complete Radio Catalog, No. 109, for 1942.

Name .....

Address .....

City ..... State .....

# ALLIED RADIO

833 W. JACKSON BLVD. • CHICAGO

## Mount Washington Highest FM Station

*With tremendous winds sweeping its 100-foot tower and buildings Station W39B, located on the 6,288-foot mountain has a radius of 100 miles and reaches a potential "FM" audience of 2,000,000 people.*

**A. F. SISE**

*Member, Engineering Staff, Yankee Network*

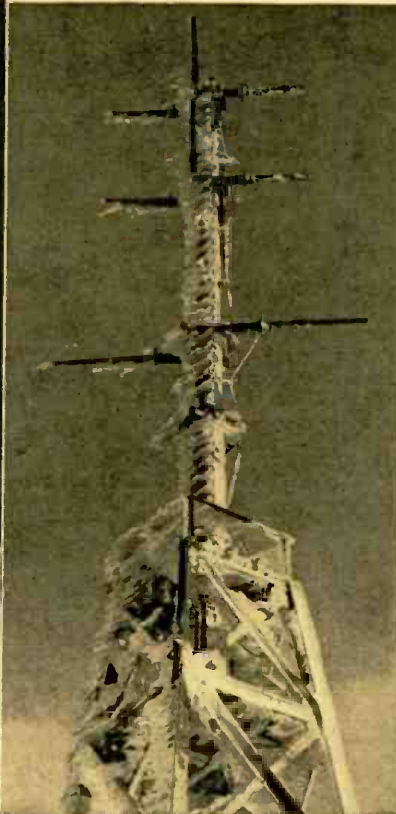

Left: Ice-covered mast of the Yankee Network's FM Station W39B, Mt. Washington. Tons of these ice feathers are continually forming on all exposed surfaces. Right: Another view of the antenna of W39B, Mt. Washington, showing peculiar auto-spring construction of antenna arms. They are constructed to stand the weights of tons of ice.

**B**ACK in the fall of 1932, a little group of people gathered together around the old wood stove in the AMC Hut nestled in Pinkham Notch at the base of Mt. Washington, most lofty peak in New Hampshire's White Mountains. I was one of these five men, who were sitting in this isolated log cabin, listening to Joseph B. Dodge, Chief Hut-Master of the AMC (sometimes called The Old Man of the Mountains) tell of his idea of organizing a weather observatory to record the extremes of weather on the highest point of land in the Northeastern United States. We were all familiar enough with Mt. Washington to realize that even on a relatively good day in the valley below, the fiercest of storms might rage on the Mountain Slopes.

Accordingly, in October 1932, the Mt. Washington Observatory was born, under the leadership of Joe Dodge and with the active cooperation of Dr. C. F. Brooks of Harvard's Blue Hill Observatory, Mr. Henry Shaw of Exeter, Dr. G. W. Pickard of Seabrook Beach, and the N. H. Academy of Science. The old stage office building belonging to the Mt. Washington Summit Road Company was made over into suitable quarters for the Observatory. This building was anchored to the ground by means of chains to hold it against the tremendous

winds encountered. We all remember our first real storm of super-hurricane proportions and how the building swayed and tugged at the chains that held it captive.

After two months on Mt. Washington, I left this environment to go to Harvard's Blue Hill Observatory under Dr. C. F. Brooks, head of the Meteorological Department at Harvard and Dr. Pickard, to attempt to communicate with the Mt. Washington Observatory using the hitherto unexplored *ultra high frequencies* or very short radio wave-lengths. These waves were not supposed to travel beyond the horizon and one certainly cannot see Mt. Washington from the Summit of Blue Hill in Milton, Massachusetts. Imagine our surprise, when with a very rudimentary radio transmitter we were able to successfully communicate with Mt. Washington. Immediately improvements were made in the equipment used, and a permanent radio transmitter utilizing these very short waves was set up at Blue Hill. A third station was built in Dr. Pickard's residence at Seabrook Beach, N. H., another at the residence of Mr. Henry Shaw at Exeter, N. H. Immediately followed a series of experiments by this group of men, mostly in their spare time, as a hobby that was destined to play its own small part in introducing a fundamental change in the whole industry

of broadcasting. Everyone was surprised at the good reception obtained and the ease of communication. Signals from these transmitters did not fade out at the optical horizon, as was expected, but went much farther beyond.

Encouraged by this fact and foreseeing the great possibilities that lay ahead, Dr. Pickard suggested putting a small radio transmitter, utilizing these very short waves, in an automobile. This was done and many months were spent driving this car about Southern New Hampshire, Maine and Northern Massachusetts, talking most of the time that it was in motion, with Dr. Pickard, Mr. Shaw, The Mt. Washington Observatory and others. During this period Dr. Pickard displayed the most remarkable enthusiasm, which was quite contagious. His was the most inspiring sort of leadership. Night after night he would work with us until nearly sunrise, his enthusiasm, determination, always driving us on. His droll wit relieved the most trying moments. Many a night was spent on hill tops, talking with stations in the valley below.

It was during one of these trips that Mr. Paul de Mars, then Technical Director of the Yankee Network, spent a considerable period of time talking with the mobile car. Mr. de Mars was troubled with the problem of providing a better broadcasting service to the people of New England. Coupling a keen imagination with a gift for being able to foresee developments in the broadcasting industry long before many of its leaders, Mr. de Mars saw in these simple experiments the possibility of an answer to his problem. Accordingly, this work was carried on for some time by the Yankee Network under the direction of Mr. de Mars and Dr. Pickard.

A small radio transmitter using these very short waves was placed in a boat. This boat communicated with Dr. Pickard at his home, down by the waters' edge at Seabrook Beach, N. H. It then put out to sea sending out a radio signal that was recorded by Dr. Pickard. Over sea water it was easy to tell when the optical horizon was reached. There was no sudden change in the signal received after this point had been passed. In fact, the boat went many miles beyond this optical horizon and still maintained excellent communication with the shore station.

Encouraged by this experiment and foreseeing the great possibilities that might lie ahead, the Yankee Network installed a broadcasting transmitter utilizing these very short waves. This transmitter was located in the same building with WNAC and WAAB, Yankee owned stations at Squantum, Massachusetts. The transmitter was in operation for a period of years. During this time Yankee Engineers listened to these programs on receivers installed in their homes and in especially made sets installed in their cars. They finally came to the conclusion that utilization of these very short waves could never in itself solve the problems troubling the broadcasters. They solved some of these problems, did some wonderful things that they weren't sup-

posed to do, but nevertheless, the utilization of these waves under the existing method of broadcasting could never provide a better type of radio service to the public.

**FM ATTRACTS OUR ATTENTION**

Then, along came "Major", as he is endearingly called by his friends. Just at the time when it seemed as though these years of experimenting might be of no avail, or at least no use to us, Major Edwin H. Armstrong of Columbia University began to demonstrate to the radio art his new invention called "Frequency Modulation", or FM.

In 1935, Major Armstrong first presented a paper before the Institute of Radio Engineers describing his new miracle. The results he claimed from this new and fundamentally different type of radio transmission and reception seemed utterly impossible, fantastic. Imagine listening to a radio station seventy miles away, during a thunderstorm and enjoying crystal clear reception of the program. And doing all this on these very short waves where there was plenty of room for an almost unlimited number of stations. Well, it just seemed too good to be true.

Early in 1936 a group of three Yankee Engineers, Mr. de Mars, Mr. Irving Robinson, Chief Engineer, and myself, took a trip to New York City in order to see and hear for ourselves this remarkable new invention. This was indeed a dramatic occasion. Armstrong was the genius who had first invented the regenerative circuit during the early days of radio. With these thoughts in mind it was a most exciting and dramatic occasion when we were ushered by the Major into a small room with a perfectly normal, although large looking radio receiver in front of us. After a few words of explanation the receiver was turned on. Lo and behold utter silence! A most impressive absence of any sound. One could hear a pin drop. We thought the set had broken down, were about to say something, when startled by a strange voice in the room with us. It took some seconds to realize that this was FM in operation. The voice was not in the room with us, but was one of the Major's associates, Mr. C. R. Runyon, up in Yonkers, saying hello to us over the air. A few musical selections followed which were of truly unbelievable clarity, but they were unimportant. We were still recovering from our surprise at that initial silence and that first hello from the little man who wasn't there.

It did not take Mr. de Mars long to sell John Shepard 3rd, President of the Yankee Network, the idea that here was the answer to many of radio's most baffling problems. Here was the only manner by which a real improved radio service could be provided for the public. Therefore, in the spring of 1937, the Yankee Network embarked upon a program designed to provide this new FM Service to practically all of the rural sections of New England, as well as the more thickly populated urban centers. Our modest experiments of 1932-1933 suddenly took on a big league aspect.

This brings us right back to where we started, Mt. Washington. With height being a dominant factor in this new system of broadcasting, it was only natural that we should consider Mt. Washington.

It was estimated at the outset that some 2,000,000 people could be provided with a truly perfect interference-free radio service from this location. Most of these people could never have been provided with a really satisfactory radio service in any other manner as this is mostly a rural population spread over a large area. Certainly one of the most difficult problems we had to over-

*New* SELF-BALANCING  
DRIFT-CORRECTING

## DIRECT-COUPLED AMPLIFIERS

FOR DISCRIMINATING MUSIC LOVERS

Designed by A. C. Shoney

These new amplifiers bridge the gap between the laboratory and the home, and make available for the first time, extraordinary equipment at less than ordinary prices. Built in a new way, without interstage coupling condensers or transformers. Although specifically designed to meet the strictest requirements of professional sound engineers, these direct-coupled amplifiers embody all desirable features sought by the most discriminating music lovers. Send for Literature.

**AMPLIFIER CO. of AMERICA**

17 W. 20TH STREET, NEW YORK, N. Y.

come in order to build a station on this exposed peak, 6,288 ft. above sea level, was the weather. Mt. Washington has the most severe climatic conditions of any mountain, regardless of altitude, that has been visited by humans often enough to provide any sort of weather records. Mt. Washington has more severe weather than mountains in Arctic, Spitzbergen, other higher mountains in the Alps, or even Admiral Byrd's Little America in the Antarctic. The world's maximum wind velocity was recorded on Mt. Washington during April 1934, officially clocked by the Observatory at 231 miles per hour. We have seen ice and rime formations build out from exposed objects to a length of eight feet or more, giving all structures on the summit a most weird appearance.

It was at this bleak and inhospitable Arctic outpost that the Yankee Network dared to spend \$35,000 in 1937, in the belief that FM held the key to the future of radio broadcasting. An FM station was not built immediately, but during the summer and fall of 1937 the experimental broadcasting station at Squantum, which operated on the same short waves that FM would use, was moved to the summit of Mt. Washington. Space was rented in the Mt. Washington Observatory's brand new building in order to house this transmitter and its operators. Land was leased from the Mt. Washington Railway Company who own the summit of the Mountain, and the erection of an antenna tower was commenced. This tower was to be 100 ft. high and had to be especially designed and braced to withstand the super-tornado winds.

And so, radio Station W1XER went on the air during the fall of 1937, with 500 watts power and a temporary antenna. This station was used during the winter of 1937-'38, and the early part of 1939, to transmit weather reports from the Summit of Mt. Washington to the Yankee Network Studios in Boston, Massachusetts. It also

**SERVICE MEN HAVE BOUGHT OVER 100,000 SUPREME TESTERS**

Be sure you see the complete SUPREME line before you purchase new test equipment. See your Jobber or write for new catalog.

WRITE FOR  
NEW CATALOG  
AND PRICES

# SUPREME

TESTING INSTRUMENTS

GREENWOOD,  
MISSISSIPPI  
U. S. A.

**NEW CATALOG**

**OF SOUND AMPLIFYING SYSTEMS**

AUDIOGRAPH Sound Systems represent the latest in Public Address equipment—a complete line plus pre-tested accessories.

**NEW LOWER PRICES**

Outstanding quality and performance at prices that help you meet any competition.

WRITE FOR YOUR FREE COPY

## AUDIOGRAPH

THE FIRST NAME IN SOUND

John Beck Industries—1215 W. Randolph Street, Chicago, U. S. A.

**GOLDENTONE .50% OFF**

DEAL DIRECT  
FACTORY PRICES.

Over 75 models to choose from—4 to 12 tubes. Portables \$8.98 up. Farm sets \$8.98 up. Car sets \$8.98 up. Foreign band sets \$8.98 up. Sample 50% off. Quantity discounts. Free 1942 Bargain catalog. Give details of 10-day FREE trial, agent's proposition and discounts. No obligation.

Mail postcard to:  
GOLDENTONE RADIO CO., DEPT. RC, DEARBORN, MICH.

Free  
Catalog  
RCA  
RECORDS

HIGH EFFICIENCY results in **Sound National Defense** that is why **NATIONAL DEFENSE SOUND SYSTEMS** are equipped with **University Reflex HIGH POWER LOUSPEAKERS** UNIVERSITY LABS. 195 CHRYSLER ST. N. Y. C.

provided the long sought opportunity to observe how an FM Station using the same wave-lengths might be expected to perform from the same location. In addition, it provided an opportunity to experiment with different forms of antennas under unusually severe conditions. No one had ever con-

structed a radio station in such a severe climate before, and no one knew just what kind of a transmitting antenna system to build.

During the summer of 1938, the remainder of the weird antenna tower on Mt. Washington took form. Instead of wires for an aerial, the heaviest-duty truck springs were used. Eight of these springs weighing 360 pounds apiece were mounted on the gigantic steel pole which rises 50 ft. above the fabricated four leg steel tower. These springs were chosen as the best available mechanical contrivance that would have the necessary electrical properties of a transmitting aerial and at the same time would have a chance of surviving Mt. Washington's climate.

During 1938-1939 and 1940 the development of FM was rapid. However in 1940 the plan evolved by Yankee in 1937, for eventually providing all New England with an interference-free radio service by means of FM, entered its second phase, the construction of an FM Broadcasting Station on Mt. Washington.

In spite of all the obstacles Yankee's FM Station W39B went on the air from the top of storm swept Mt. Washington on December 18, 1940, with a regular broadcast program. This completed the first step of the second phase of Yankee's FM program in New England.

At the time of this writing the new transmitter building is all closed in against the weather. It contains four double bedrooms, office, bath, flush toilets and two lavatories on the second floor, livingroom, dining room, and modern kitchen on the first floor. In addition to this, in another wing on the

first floor there is a public lobby and observation corridor, where one may view the transmitter in operation.

W39B is now operating from its temporary home in the Observatory Building, using a temporary power of one thousand watts. The broadcasting day begins at 6:00 AM and continues until 12:00 midnight on week days. Sundays it goes on the air two hours later. The program is picked up from W43B at Boston, by means of FM and is rebroadcast over W39B Mt. Washington, for use in Northern New England. By mid-winter W39B should be operating from its new home with a substantial increase in power.

The first year of operation of W39B has been very gratifying. Continuous rebroadcasting of programs originating in Boston, with such clarity that they are impossible to tell from the original broadcast, has become an accomplished fact. Enthusiastic letters have been received from listeners throughout New England, some from surprisingly distant points. These letters show an appreciation of the better type of radio service available through FM. Yankee Engineers have listened in at most of the cities and towns within the estimated service area. Reception has been as good as, or better than expected even, in many unfavorably located areas. With the new higher power transmitter installed this winter, everyone living within an air line distance of 100 miles from Mt. Washington—and many people at much greater distances, should be able to enjoy that clear, interference-free reception, that only FM can give.

Did YOU Buy  
that  
**DEFENSE BOND**  
Yet?

See page 390



Michigan's pioneer F.M. station is now on the air. Independent programming 18 hours daily. Owned and operated by The Detroit News, associate station WWJ.

Rate Card on Request

# W 4 5 D

4500 Penobscot Bldg.  
DETROIT, MICHIGAN

## PRACTICAL RADIO INFORMATION

Including Frequency Modulation—Television, etc.

Inside Radio Information for all Servicemen—Aircraft Pilots; Students. AUDELS RADIO-MAN'S GUIDE contains 772 Pages, 400 Diagrams & Photos is complete—gives Authentic Principles & Practices in Construction, Operation, Service & Repairs. Covers clearly and concisely Radio fundamentals—Ohm's Law—Physics of sound as related to radio science—Measuring Instruments—Power supply—Resistors—Inductors—Condensers—Transformers and examples—Broadcasting stations—Radio Telephony—Receivers—Diagrams—Construction—Control systems—Loud speakers—Antenna systems—Auto Radio—Phonograph pickups—Public Address Systems—Aircraft & Marine Radio—Radio Compass—Beacons—Automatic Radio Alarms—Short Wave—Coil Calculations—Testing—Cathode ray oscillographs—Static Elimination—Trouble Pointers—Underwriter's standards—Units and tables—Frequency Modulation—REVIEW QUESTIONS & ANSWERS, Ready Reference Index.

**\$4 COMPLETE • PAY ONLY \$1 A MO.**  
Get this practical information in handy form for yourself—Fill in and—  
—MAIL COUPON TODAY—

AUDEL Publishers, 49 W. 23rd St., N.Y.  
Mail AUDELS NEW RADIO-MAN'S GUIDE for free examination. If O. K., I will send you \$1 in 7 days; then remit \$1. monthly until \$4 is paid. Otherwise I will return it.

Name \_\_\_\_\_  
Address \_\_\_\_\_  
Occupation \_\_\_\_\_  
Reference \_\_\_\_\_ RCF

## What Radio Leaders Think About "FM"

(Continued from page 393)

two-way radio system was required. But ordinary radio communication could not pierce the shield of static set up by the roaring Diesel powered generators in the locomotives. A few years ago the problem would not have been possible of solution, but today FM came to the rescue.

No static—whether caused by violent electrical storms, high tension power lines or electrical machinery can affect the reception of an FM broadcast. And, so, over the roar of the exhaust of the powerful Diesel engines, unaffected by the whirling generator located only a few feet from the receiving set, the messages from the control room reach the engineers in their cabs—simplifying and speeding this vital segment of national defense production.

Our own FM station, W51C, here in Chicago, will round out two years of continuous broadcasting early in February. Recently we increased our power to a full 50,000 watts and now serve the entire greater Chicago area.

### FM IS A "SURE-THING" BET

... SAYS G. V. ROCKEY,

Vice Pres. Meissner Mfg. Co.

IF 1941 can be employed as a yardstick with which to measure the future popularity of FM, a prediction would fall in the same category as "betting on a sure thing"! The spectators, who witnessed '41 activity from a ring-side vantage point, require no additional proof that FM is standing on its own two feet and winning universal acceptance.

Sales statistics for 1941 might be introduced at this point as positive evidence that FM has been accepted with open arms by a "completely sold" radio public. It would be simple to observe the past sales record and to indicate how many hundred percent FM sales PROGRESSIVELY INCREASED from month to month during the past year. Although the sales record of the industry offers proof in abundance that FM is established on a foundation of complete solidity, with its future status definitely assured, I can vision the reaction of a statistically burdened public to "another flock of figures"! Without apology, our sales record will not be introduced in this report.

The future status of FM, from the standpoint of civilian use, will necessarily be affected by our war program. For the duration, little time can be spent in engineering, manufacturing and marketing radio receivers for civilian use. It is only logical and reasonable for the entire radio manufacturing industry to accept with pride, a well-deserved commission in the war program; a service commission to build the specialized equipment required by the Army, Navy, Marine and Air Corps. This is not a part time job! It must necessarily be an "all out" duty that will last for the duration.

Happily this war, like all wars, must end. Victory in war will introduce a future wherein civilian radio production can and will be resumed with a BANG! FM will not be compelled to search for friends and acceptance at that time. The countless thousands who daily enjoy FM, ("Radio Reception at its Best"), will maintain public interest at its present high level throughout the war period. Yes, we at Meissner believe in the future of FM.

# HOW FM CUTS OUT STATIC

And also provides startling fidelity in reproduction of music and voice.

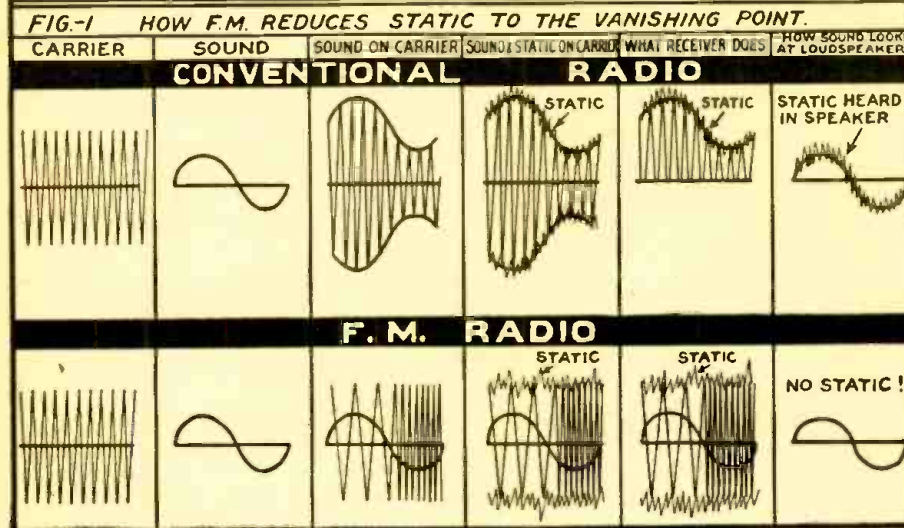
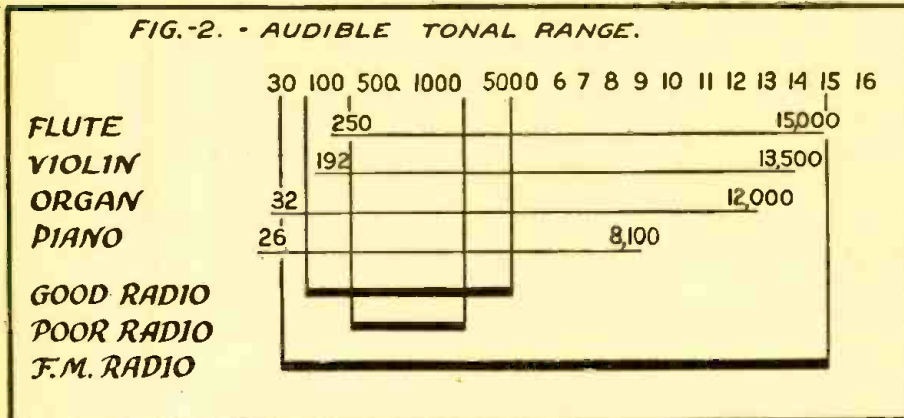

Diagrams reproduced by courtesy of General Electric Co.

The top diagram shows why FM radio is so necessary for high-quality sound reproduction. The lower diagram shows how FM eliminates static.

## WHY "FM" IS GROWING RAPIDLY

If we were to ask you what improvements in radio reception you would like, you would undoubtedly mention:

1. Eliminate static—man-made, such as electric razors, vacuum cleaners, other noise sources caused by an electric arc, as well as nature-static such as lightning.
2. Eliminate interference from stations on the same or adjacent channels which causes that chattering cross talk, distortion and whistles which are so annoying when one is trying to listen to a favorite program.
3. Eliminate "fading," that is the condition where the station you are tuned to comes in loud one moment, then disappears the next, causing distorted reproduction.
4. Make possible the life-like reproduction of radio programs with crystal clearness, in other words, genuine high fidelity.

## HOW FM REDUCES STATIC TO THE VANISHING POINT

To explain, let's see how FM reduces static to the vanishing point. Note how the appearance of the carrier (Fig. 1) is changed when the electrical sound wave is placed on it.

The carrier wave on the conventional system increases or decreases in height in accordance with the sound in the studio—the distance between each wave remaining constant. All changes in the conventional system occur in an up and down direction. On the FM system the carrier wave does not change in height but the distance between the individual waves increases or decreases with the sound in the studio. All changes in the FM system occur in a right or left sideways direction.

Now, the program has left the broadcast station and is travelling through space to your radio set. We introduce the "bugaboo" of radio reception—"Old Man Static."

(a) Here's what happens to the wave when static (see diagram) hits it. You will note that the static, which is really a miniature broadcasting station, fastens itself on both the conventional and FM waves producing a saw-tooth pattern.

(b) Now in the conventional system it is necessary to use the entire upper half of the wave so the receiver picks up the static along with the sound. In the FM system the upper and lower portions of the wave, which are affected by static, are cut off, allowing the sound wave to come out of the loudspeaker without interference.

(c) So in the conventional system you hear the presence of the static as shown mixed with the sound, whereas in the FM

system the static has been reduced to the vanishing point. Thus, the sound originating in the distant FM studio has travelled through static, and when it comes out of your FM receiver loudspeaker it looks like the sound that began at the studio.

You will recall that the second improvement we would make in radio reception would be the elimination of interference between two stations located at the same or adjacent points on our dial. The reason why an FM receiver picks up only one of two stations located at the same point on the dial, is because it has the ability to select the stronger of two FM stations.

## AUDIBLE TONAL RANGE

The fourth point was the enjoyment of genuine high fidelity. To explain, let's understand what is meant by high fidelity. If the numbers across the top (Fig. 2) represent the range of frequency that can be heard by the human ear, let's see what the range of various musical instruments is. A flute has a range of from 250 to 15,000 cycles. A violin from 192 to 13,500 cycles. An organ from 32 to 12,000 cycles and a piano from 26 to 8,100 cycles.

Now in order to get high fidelity reproduction of a radio program, the station and the receiver must be able to carry the entire sound frequency range from 30 to 16,000 cycles. Otherwise some of the overtones or high notes from a given instrument will be lost and hence a true life-like reproduction will not be possible.

A good conventional radio receiver has a sound frequency range of 5,000 cycles because that's all the conventional broadcast stations are generally allowed to transmit. Hence all the higher frequencies are lost.

Then if we cut down the size of the loudspeaker and the quality of the sound system in the receiver, which is generally true in table models, the sound frequency range is even more limited and all the real low and a larger portion of the higher frequencies are completely lost.

With FM, however, it is possible to transmit the sound frequency range between 30 and 16,000 cycles and all of the high frequencies are present, so genuine high fidelity is possible.

Conventional stations are limited to 5,000 cycles of audible sound because each station has been assigned a channel which is only 10,000 cycles wide in which to operate. Since its operation requires the carrier frequency to be centered in each band, the sound frequency range is limited to 5,000 cycles. The FM broadcasting station is not hampered in this respect because each station has a channel width of 200,000 cycles. As in the conventional system the FM carrier frequency is centered in each band so that the sound frequency range is not 5,000 but 100,000 cycles either side of the carrier. This band width is ample to take care of the full sound frequency range from 16 to 16,000 cycles as well as wide volume changes from a soft to a very loud note.

This article has been prepared from data supplied by courtesy of Radio and Television Dept., General Electric Co.

If you like this FM number—tell the Editor. Do you want more articles on FM? What kind?

# FM SETS

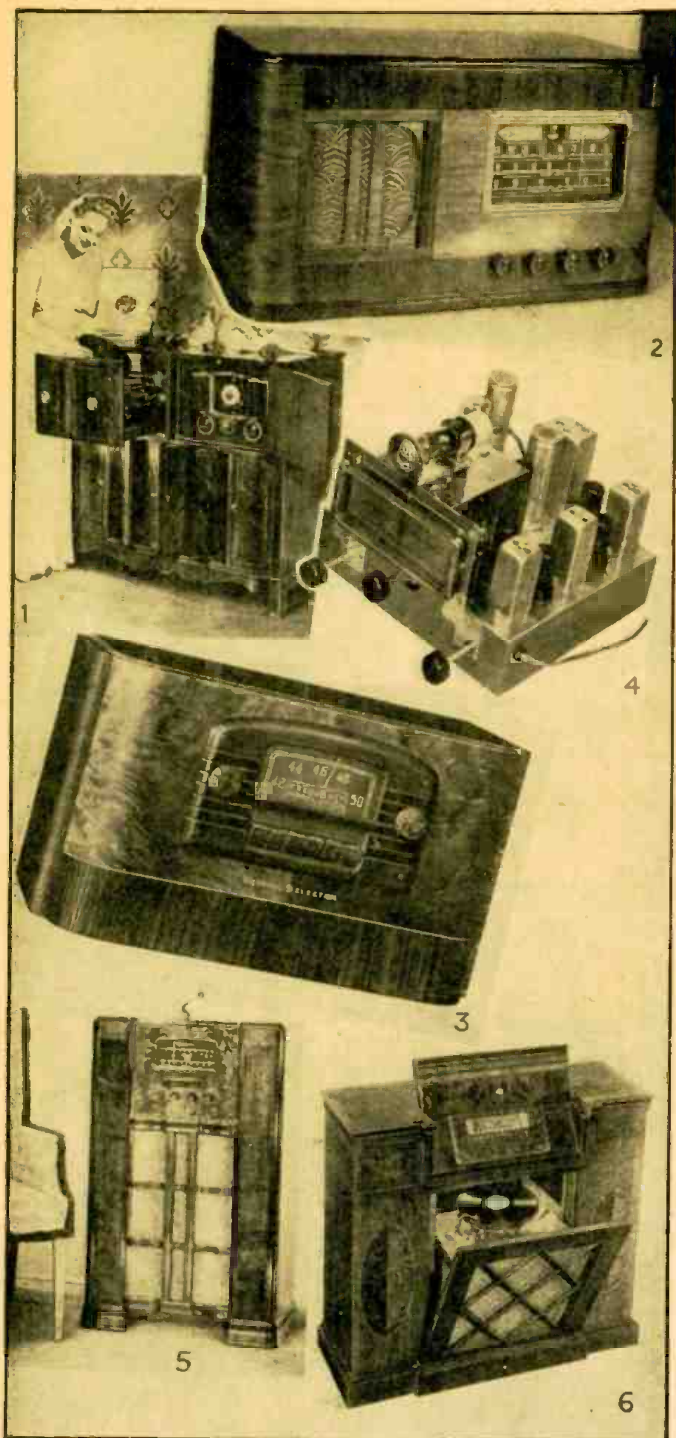

## ZENITH FAVORS FM

FIG. 1 illustrates a large Zenith model of combination FM and AM receiver containing 22 tubes, the Zenith Concord in a Hepplewhite cabinet. This complete musical instrument plays and automatically changes as many as 16 records at one loading. It also receives the new Frequency Modulation broadcasts, plus the usual standard, short-wave and amateur programs. Three matched speakers and the Radiorgan—tone color blender—are employed to insure maximum listening pleasure.—Zenith Radio Corp.

## MEISSNER FM-AM TABLE MODEL

A COMPLETE "Dual System" receiver providing Frequency Modulation reception along with the standard Broadcast and Short-Wave bands is shown at Fig. 2. The cabinet measures 12 $\frac{1}{4}$ " high by 22 $\frac{3}{4}$ " wide and 11" deep. The glass-scale dial, edge-lighted, is fully calibrated to indicate frequencies on all bands. Tuning indicator is incorporated in dial scale.

A high-fidelity PM dynamic speaker is built in. Wide-band I.F. transformers in the AM channel insure full response on all

frequencies. Audio response is essentially flat from 30 to 6,500 cycles on the AM bands and from 30 to 15,000 cycles on the FM band.

A power output of 6 $\frac{1}{2}$  watts, undistorted, is provided by the push-pull audio output system: full automatic volume control is incorporated.

Seventeen Tubes—Three Bands: The AM bands cover the Broadcast range, from 540 to 1,660 kc. and the most popular Short-Wave range, from 5.9 to 18.8 mc. The FM band provides full coverage—from 42 to 50 mc. Sensitivity on the AM bands to 5 mv. and on the FM band 10 mv.

A 6AC7 is used as an RF amplifier on the FM band with a 6SA7 mixer-oscillator and three 6SK7's as I.F. amplifiers. The limiter is a 6SAC7 and discriminator a 6H6. The RF amplifier on the AM bands is a 6SK7 with a 6K8 as mixer-oscillator, 6SK7 I.F. amplifier and 6H6 second detector. Common to both systems are the 6SQ7 first audio, 6AD7G output and phase inverter, and 6F6G output audio amplifier tubes. A 6AC7 provides interstation silencing on the FM band while a 6E5 is used as a tuning indicator. The rectifier is a 5U5G. This receiver operates on 117 volts A.C., 50-60 cycles.—Meissner Manufacturing Co.

## FM ADAPTER

THE G. E. Translator or FM Adapter is shown in Fig. 3. It represents a well-designed FM tuner which can be connected with any good quality radio receiver of the usual AM or broadcast type. Only one simple connection between the FM translator and the AM receiving set is necessary. The translator has push-button tuning keys for 6 FM stations, an easily read illuminated dial, and 9 tubes including rectifier. The FM adapter is mounted in a handsome cabinet and it may be placed on a small table alongside the broadcast receiver, or else mounted on top of the present set.

The translator cabinet measures 9 in. high, 15 $\frac{1}{2}$  in. wide and 7 $\frac{3}{4}$  in. deep. The adapter is operated from a 110-volt A.C. circuit and is known as Model JFM-90.—General Electric Company.

## BROWNING FM TRANSCRYPTOR

THE Browning Transcryptor or FM Adapter chassis is shown in Fig. 4. This FM Adapter is available in any cabinet and can be connected to any high-quality broadcast receiver of the AM type and thus permit reception of FM programs. Another larger model of this chassis is available as a complete FM receiver. The unit is self-powered and is easily connected to an AM broadcast receiver of the usual type, by merely plugging the output of the transcryptor into the phonograph jack. The adapter may also be used with any good audio amplifier system.—Browning Laboratories, Inc.

## PHILCO FM/AM MODELS

PHILCO'S FM/AM receiver illustrated in Fig. 5 is unique in that FM programs, standard broadcasts and short-wave programs are all tuned in with a single dial and a single set of controls. Due to a new circuit development every tube in the FM/AM receiver set operates on both FM and AM. The receiver here shown, Model 1013, is a radio-phonograph combination utilizing a 10-tube superheterodyne with electric push-button tuning. Standard short-wave and frequency modulation tuning bands are made available and there is also an automatic phonograph record changer. A built-in aerial system is provided and an FM di-pole aerial for reception of FM stations.

This receiver is also designed to pick up the sound channel of a television program. The audio output is 8 watts, the power supply 115 Volts 60 Cycles A.C., and the power consumption 125 watts. The turn-table is provided with a dual speed motor that can be adjusted to play records at 78 r.p.m. and also slow speed records at 33 1/3 to 39 r.p.m. The record changer is also fitted for attaching a home recording unit.—Philco Radio & Television Corp.

## STROMBERG-CARLSON FM/AM SETS

STROMBERG-CARLSON'S Model 515-M receiver is illustrated in Fig. 6; it reproduces both FM and AM programs. The outstanding features of this receiver are that it has three tuning ranges—short wave, standard and FM; it has 8 push-buttons—six for favorite stations, one for phonograph or television connection, one for standard or FM radio; and it has tuning, automatic drift compensator and three-gang capacitor for high selectivity. Other important features contained in this receiver are that it has a tone-true acoustical labyrinth, a 10 $\frac{1}{4}$  inch leather speaker, high fidelity on the FM band, tone and



# FOR ALL

automatic volume control, separate bass and treble controls, and a phonograph and television connection with built-in-jack controlled from a push-button. Other models of FM receivers are available.—*Stromberg-Carlson.*

## CROSLY FM CONSOLE

IN Fig. 7 the Crosley FM Console Model 22CA as illustrated. This receiver for both FM and AM reception employs a 12-tube A.C. superheterodyne circuit. A 15-watt push-pull power output stage is provided. An extra large tuning dial is used on this receiver. This is a great help in tuning in the short-wave stations. The four complete bands covered by this console set are: Frequency Modulation Band 42-50 mc., Standard American Broadcast 550-1600 kc., Police, Airplane, Ship and Amateur 1.6-5 mc., and International Short-wave and Foreign 5-18 mc. The Service Switch provides at the twist of the wrist AM, FM Sharp, FM Broad, or Phonograph. A built-in loop antenna is included and a Master Tone Control with 6 buttons provides more than 60 actual tonal variations. The concert loudspeaker is 14 inches in diameter.—*The Crosley Corporation.*

## ANSLEY FM/AM RECEIVER

THE Ansley FM/AM receiver illustrated in Fig. 8 has a 14-tube chassis which covers broadcast as well as short-wave reception. It is adapted for the reception of FM by the addition of a 7-tube unit, providing a total of 21 tubes. This chassis is provided in a variety of cabinet styles. A dual coaxial speaker system is incorporated, with a "tweeter." The power output is 15 watts. The audio frequency range is 30 to 12,000 cycles. A built-in loop aerial with an additional antenna coil for use with an outside aerial where a greater output is desired is also included. Individual bass and treble tone controls are provided. The usual broadcast band is covered and the short-wave band covers 6 to 18 megacycles. An automatic record-changer and phono pickup is also included.—*Ansley Radio Corp.*

## PILOT FM/AM RADIO

FIG. 9 shows a handsome table model FM/AM receiver designed by the Pilot Radio Corp. engineers. This FM and AM combination is also supplied in console models. The table model here illustrated employs 8 tubes and is furnished with a 6-inch loudspeaker. The tuning range for AM or standard broadcast band is 535-1620 kc.; the FM band covers 41.4 to 50.4 mc. A large slide-rule type illuminated dial is furnished. The set is designed for 110-125 volt A.C. or D.C. supply. The set uses the Armstrong FM superheterodyne circuit. The tone control is continuously variable with a sharp cutback at higher audio frequencies. It operates in an inverse feedback circuit.—*Pilot Radio Corp.*

## HOWARD FM RECEIVER

HOWARD'S Victory Model FM and AM receiver is shown at Fig. 10. This is a 14-tube, 4-band combination set. Other cabinet styles are available in the FM/AM models. The Victory Model shown (718X-FM-C) has four bands—the Frequency Modulation (41-50 mc.), the standard AM broadcast band (540-1720 kc.) and two short-wave bands (1.7-5.6 mc. and 5.6-18 mc.). The audio output stage delivers 10 watts from a push-pull circuit. A tuned RF stage operates on all bands. Other features are electric push-button tuning, 12-inch Jensen FM speaker, bass and treble tone controls, built-in antenna, automatic record-changer and a special compartment for albums. The cabinet dimensions are 37½ in. high, 35 in. wide and 18¼ in. deep.—*Howard Radio Company.*

## FARNSWORTH FM SET AND RECORD-CHANGER

THE house of Farnsworth has introduced among other models the one illustrated at Fig. 11 in a Chippendale cabinet. The superheterodyne receiver covers three wave bands—the Frequency Modulation band, broadcast band and foreign band. The set is equipped with an automatic record-changer playing fourteen 10-inch records or ten 12-inch records. Other features are the Built-in-tenna with a convenient Rotor directional control at the side of the cabinet, special tone control, high spot dial for full view of all wave bands and a special filter circuit for improved short-wave reception and the elimination of long wave interference. The cabinet of this particular model measures 42 in. high by 29 in. wide and 13 in. deep.—*Farnsworth Television & Radio Corp.*

## ESPEY FM/AM MODEL

ILLUSTRATED at Fig. 12 is the Espey FM/AM chassis which provides three tuning bands—standard broadcast, European short-wave and FM. Fourteen tubes are used with push-pull

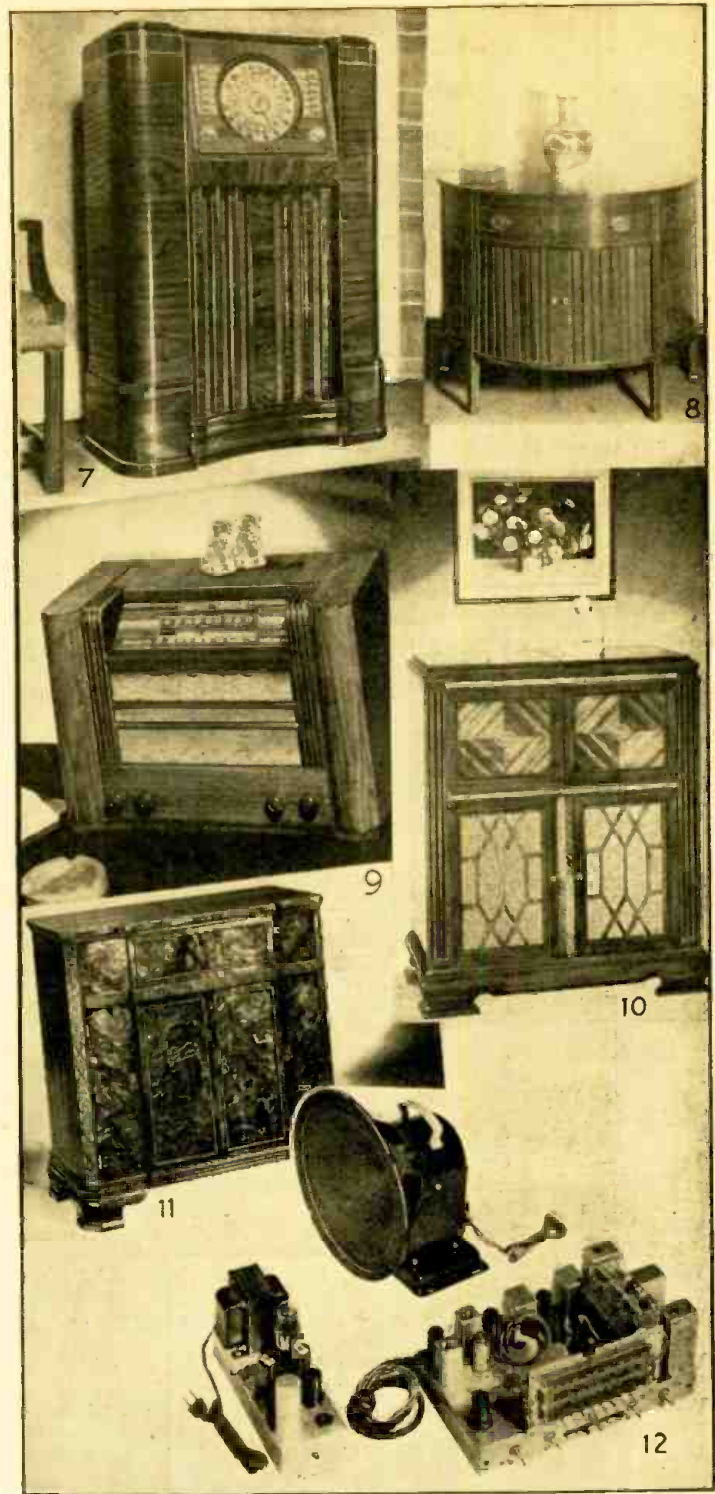

output of 12 watts. A separate bass and treble control is provided. A 12-inch loudspeaker provides high fidelity reproduction. Special broad-band frequency coverage is provided for, including a separate amplifier and a separate tuning unit. Push-button tuning for six broadcast stations is provided and an illuminated dial governs all change-over switches.—*Espey Manufacturing Company, Inc.*

## FM CONVERTER

A NEW Frequency Modulation converter for use with a standard broadcast receiver has been added to the well-known Motorola line. This converter is most convenient and practical, the cabinet being only 13 inches long, 7¼ inches high and 6½ inches deep. When the converter is connected to a standard broadcast set, it will provide FM reception that is limited only by the quality of the audio amplifier of the radio set itself. It connects to phonograph, television or FM terminals of any radio receiver or phonograph combination so equipped. The dial is calibrated in FM channels for easy tuning. (Not illustrated.)—*Galvin Mfg. Corp.*

# FM STATION LIST

THE month of December saw 24 commercial FM stations operating on regular daily schedules. A total of 38 other FM transmitters, approved by the Federal Communications Commission, are in the process of construction and expected on the air shortly.

In addition, 54 applications for commercial FM licenses are still pending at Washington. There are also 14 experimental FM stations still offering program schedules preparatory, in most cases, to instituting service with commercial transmitters now being installed.

Data in the lists that follow comprises, in order given, the megacycle channel which has been assigned (or requested), and size of service area to be covered.

## FM

### COMMERCIAL STATIONS NOW OPERATING:

#### CALIFORNIA

K45LA—Don Lee Broadcasting System, Los Angeles; 44.5 mc.; 6,944 sq. mi.

#### CONNECTICUT

W65H—WDRG, Inc., Hartford; 46.5 mc.; 6,100 sq. mi.

W53H—Traveler's Broadcasting Service, Hartford; 45.3 mc.; 6,100 sq. mi.

#### ILLINOIS

W51C—Zenith Radio Corp., Chicago; 45.1 mc.; 10,800 sq. mi.

W59C—WGN, Inc., Chicago; 45.9 mc.; 10,800 sq. mi.

W67C—Columbia Broadcasting System, Chicago; 46.7 mc.; 10,800 sq. mi.

W75C—Moody Bible Institute, Chicago; 47.5 mc.; 10,950 sq. mi.

#### INDIANA

W45V—Evansville on the Air, Evansville; 44.5 mc.; 8,397 sq. mi.

#### LOUISIANA

W45BR—Baton Rouge Broadcasting Co., Baton Rouge; 44.5 mc.; 8,100 sq. mi.

#### MASSACHUSETTS

W43B—The Yankee Network, Boston; 44.3 mc.; 18,647 sq. mi.

#### MICHIGAN

W45D—The Evening News, Detroit; 44.5 mc.; 6,820 sq. mi.

W49D—John Lord Booth, Detroit; 44.9 mc.; 6,800 sq. mi.

#### NEW HAMPSHIRE

W39B—The Yankee Network, Mount Washington; 43.9 mc.; 31,000 sq. mi.

#### NEW YORK

W47NY—Muzak Corporation, N. Y. C.; 44.7 mc.; 8,500 sq. mi.

W67NY—Columbia Broadcasting System, N. Y. C.; 46.7 mc.; 8,500 sq. mi.

W71NY—Bamberger Broadcasting Service, N. Y. C.; 47.1 mc.; 8,500 sq. mi.

W47A—Capitol Broadcasting Co., Inc., Schenectady; 44.7 mc.; 6,589 sq. mi.

W51R—Stromberg-Carlson Co., Rochester; 45.1 mc.; 3,200 sq. mi.

#### OHIO

W45CM—WBNS, Inc., Columbus; 44.5 mc.; 12,400 sq. mi.

#### PENNSYLVANIA

W47P—Walker-Downing Radio Corp., Pittsburgh; 44.7 mc.; 8,400 sq. mi.

W53PH—WFIL Broadcasting Corp., Philadelphia; 45.3 mc.; 9,300 sq. mi.

W69PH—WCAU Broadcasting Co., Philadelphia; 46.9 mc.; 9,300 sq. mi.

#### TENNESSEE

W47NV—National Life & Accident, Nashville; 44.7 mc.; 16,000 sq. mi.

#### WISCONSIN

W55M—The Journal Co., Milwaukee; 45.5 mc.; 8,540 sq. mi.

## FM

### COMMERCIAL STATIONS UNDER CONSTRUCTION:

#### CALIFORNIA

K31LA—Columbia Broadcasting System, Hollywood; 43.1 mc.; 28,000 sq. mi.

K37LA—Earle C. Anthony, Inc., Los Angeles; 43.7 mc.; 28,000 sq. mi.

K49LA—Hughes Tool Co., Los Angeles; 44.9 mc.; 7,315 sq. mi.

K53LA—Standard Broadcasting Co., Los Angeles; 45.3 mc.; 7,000 sq. mi.

K61LA—Metro-Goldwyn-Mayer, Los Angeles; 46.1 mc.; 7,000 sq. mi.

K45SF—Hughes Tool Co., San Francisco; 44.5 mc.; 10,800 sq. mi.

#### ILLINOIS

W47C—WJJD, Inc., Chicago; 44.7 mc.; 10,800 sq. mi.

W63C—National Broadcasting Co., Chicago; 46.3 mc.; 10,800 sq. mi.

W79C—Oak Park Realty & Amusement Co., Chicago; 47.9 mc.; 10,800 sq. mi.

W71RF—Rockford Broadcasters, Inc., Rockford; 47.1 mc.; 3,900 sq. mi.

#### INDIANA

W71SB—South Bend Tribune, South Bend; 47.1 mc.; 4,300 sq. mi.

W49FW—Westinghouse Radio Stations, Inc., Fort Wayne; 44.9 mc.; 6,400 sq. mi.

#### KENTUCKY

W51SL—American Broadcasting Corp. of Kentucky, Lexington; 45.1 mc.; 6,298 sq. mi.

#### MARYLAND

W59??—Baltimore Radio Show, Inc., Baltimore; 45.9 mc.; 4,980 sq. mi.

#### MASSACHUSETTS

W67B—Westinghouse Radio Stations, Inc., Boston; 46.7 mc.; 6,700 sq. mi.

W81SP—Westinghouse Radio Stations, Inc., Springfield; 48.1 mc.; 2,500 sq. mi.

#### MICHIGAN

W77XL—WJ1M, Inc., Lansing; 47.7 mc.; 3,000 sq. mi.

W53D—WJR, The Goodwill Station, Detroit; 45.3 mc.; 6,800 sq. mi.

W73D—King-Trendle Broadcasting Co., Detroit; 47.3 mc.; 6,800 sq. mi.

#### MISSOURI

K51L—St. Louis University, St. Louis; 45.1 mc.; 13,000 sq. mi.

K59I—Columbia Broadcasting System, St. Louis; 45.9 mc.; 13,000 sq. mi.

K49KC—Commercial Radio Equipment Co., Kansas City; 44.9 mc.; 4,400 sq. mi.

#### NEW YORK

W31NY—Edwin H. Armstrong, Alpine, N. J.; 43.1 mc.; 15,610 sq. mi.

W35NY—Municipal Broadcasting System, N. Y. C.; 43.5 mc.; 3,900 sq. mi.

W51NY—National Broadcasting Co., N. Y. C.; 45.1 mc.; 8,500 sq. mi.

W55NY—William G. H. Finch, N. Y. C.; 45.5 mc.; 8,500 sq. mi.

W59NY—Interstate Broadcasting Co., N. Y. C.; 45.9 mc.; 8,500 sq. mi.

W63NY—Marcus Loew Booking Agency, N. Y. C.; 46.3 mc.; 8,500 sq. mi.

W75NY—Metropolitan Television, Inc., N. Y. C.; 47.5 mc.; 8,500 sq. mi.

W57A—General Electric Co., Schenectady; 45.7 mc.; 6,600 sq. mi.

W49BN—Wylie B. Jones Adv. Agency, Binghamton; 44.9 mc.; 6,500 sq. mi.

W63SY—Central N. Y. Broadcasting, Syracuse; 46.3 mc.; 6,800 sq. mi.

#### NORTH CAROLINA

W41MM—Gordon Gray, Clingman's Peak; 44.1 mc.; 69,400 sq. mi.

#### PENNSYLVANIA

W49PH—Pennsylvania Broadcasting Co., Philadelphia; 44.9 mc.; 9,300 sq. mi.

W57PH—Westinghouse Radio Stations, Inc., Philadelphia; 45.7 mc.; 9,300 sq. mi.

W81PH—Seaboard Radio Broadcasting Corp., Philadelphia; 48.1 mc.; 9,300 sq. mi.

W75P—Westinghouse Radio Stations, Inc., Pittsburgh; 47.5 mc.; 8,400 sq. mi.

#### UTAH

K47SL—Radio Service Corp. of Utah, Salt Lake City; 44.7 mc.; 623 sq. mi.

## FM

### APPLICATIONS PENDING ON DECEMBER 15, 1941:

#### CALIFORNIA

Don Lee Broadcasting System, San Francisco; 43.5 mc.; 18,050 sq. mi.

Trihune Building Co., Oakland; 46.5 mc.; 1,216 sq. mi.

Sun Company of San Bernardino, San Bernardino; 44.1 mc.; 17,101 sq. mi.

#### COLORADO

Eugene P. O'Fallon, Inc., Denver; 46.5 mc.; 1,403 sq. mi.

#### DISTRICT OF COLUMBIA

M. A. Leese Radio Corp., Washington; 47.1 mc.; 5,600 sq. mi.

#### ILLINOIS

WHFC, Inc., Cicero; 48.3 mc.; 10,800 sq. mi.

Chicago Federation of Labor, Chicago; 47.9 mc.; 10,800 sq. mi.

# FM STATION LIST

**INDIANA**  
 Associated Broadcasters, Inc., Indianapolis; 47.3 mc.; 6,665 sq. mi.  
 Indianapolis Broadcasting Co., Inc., Indianapolis; 45.3 mc.; 13,640 sq. mi.

**IOWA**  
 The Gazette Co., Cedar Rapids; 44.7 mc.; 7,400 sq. mi.

**KENTUCKY**  
 Ashland Broadcasting Co., Ashland; 46.1 mc.; 4,160 sq. mi.  
 Courier-Journal & Louisville Times, Louisville; 45.7 mc.; 13,200 sq. mi.

**LOUISIANA**  
 Alexandria Broadcasting Co., Inc., Alexandria; 44.7 mc.; 3,025 sq. mi.

**MAINE**  
 Portland Broadcasting System, Falmouth; 47.1 mc.; 3,980 sq. mi.

**MARYLAND**  
 The A. S. Abell Co., Baltimore; 46.3 mc.; 6,040 sq. mi.

**MASSACHUSETTS**  
 E. Anthony & Sons, Inc., New Bedford; 45.7 mc.; 1,787 sq. mi.  
 Worcester Telegram Pub. Co., Worcester; 46.1 mc.; 10,000 sq. mi.  
 Columbia Broadcasting System, Boston; 43.5 mc.; 16,230 sq. mi.  
 Boston Edison Company, Boston; 44.7 mc.; 6,930 sq. mi.

**MICHIGAN**  
 James F. Hopkins, Inc., Detroit; 46.5 mc.; 3,050 sq. mi.  
 Federated Publications, Inc., Grand Rapids; 46.1 mc.; 5,300 sq. mi.  
 Federated Publications, Inc., Lansing; 47.1 mc.; 3,820 sq. mi.  
 Federated Publications, Inc., Battle Creek; 48.1 mc.; 4,100 sq. mi.  
 King-Trendle Broadcasting Corp., Grand Rapids; 45.5 mc.; 4,340 sq. mi.

**MISSOURI**  
 Globe-Democrat Publishing Co., St. Louis; 44.7 mc.; 13,083 sq. mi.  
 Pulitzer Publishing Co., St. Louis; 45.5 mc.; 11,301 sq. mi.  
 Star-Times Publishing Co., St. Louis; 44.7 mc.; 12,480 sq. mi.

**NEW HAMPSHIRE**  
 Radio Voice of New Hampshire, Manchester; 43.5 mc.; 20,290 sq. mi.

**NEW JERSEY**  
 Mercer Broadcasting Co., Ewing Township; 44.7 mc.; 3,700 sq. mi.

New Jersey Broadcasting Corp., Newark; 49.1 mc.; 5,580 sq. mi.  
 Bremer Broadcasting Corp., Jersey City; 49.5 mc.; 6,135 sq. mi.

**NEW YORK**  
 Greater New York Broadcasting Corp., N. Y. C.; 48.7 mc.; 8,500 sq. mi.  
 Frequency Broadcasting Corp., N. Y. C.; 45.9 mc.; 8,500 sq. mi.  
 Wodaam Corp., N. Y. C.; 46.7 mc.; 8,500 sq. mi.  
 WBNX Broadcasting Co., N. Y. C.; 48.3 mc.; 8,730 sq. mi.  
 FM Radio Broadcasting Co., Inc., N. Y. C.; 48.3 mc.; 8,600 sq. mi.  
 Knickerbocker Broadcasting Co., N. Y. C.; 48.3 mc.; 8,550 sq. mi.  
 News Syndicate Co., Inc., N. Y. C.; 47.9 mc.; 8,500 sq. mi.  
 The Debs Memorial Radio Fund, Inc., N. Y. C.; 48.7 mc.; 8,600 sq. mi.  
 WOKO, Inc., Albany; 45.1 mc.; 7,164 sq. mi.  
 WHEC, Inc., Rochester; 44.7 mc.; 3,200 sq. mi.  
 The American Network, Inc., N. Y. C.; 47.9 mc.; 8,840 sq. mi.

**NORTH CAROLINA**  
 Piedmont Publishing Co., Winston-Salem; 46.7 mc.; 4,600 sq. mi.

**OHIO**  
 United Broadcasting Co., Cleveland; 48.5 mc.; 8,420 sq. mi.  
 William F. Maag, Jr., Youngstown; 43.5 mc.; 12,304 sq. mi.

**PENNSYLVANIA**  
 Pittsburgh Radio Supply House, Pittsburgh; 46.5 mc.; 8,400 sq. mi.  
 Gibraltar Service Corp., Philadelphia; 46.1 mc.; 9,318 sq. mi.  
 William Penn Broadcasting Co., Philadelphia; 47.3 mc.; 9,352 sq. mi.  
 Hawley Broadcasting Co., Reading; 46.5 mc.; 4,275 sq. mi.

**RHODE ISLAND**  
 The Outlet Co., Providence; 48.5 mc.; 4,840 sq. mi.  
 Cherry & Webb Broadcasting Co., Providence; 47.5 mc.; 6,207 sq. mi.

**TEXAS**  
 Amarillo Broadcasting Corp., Amarillo; 45.1 mc.; 5,629 sq. mi.

**WISCONSIN**  
 Head of the Lakes Broadcasting Co., Superior; 44.5 mc.; 2,754 sq. mi.  
 La Crosse Tribune Co., La Crosse; 46.5 mc.; 7,040 sq. mi.

## OPPORTUNITY AD-LETS

Advertisements in this section cost 15 cents a word for each insertion. Name, address, and initials must be included at the above rate. Cash should accompany all classified advertisements unless placed by an accredited advertising agency. No advertisement for less than ten words accepted. Ten Percent discount six issues, twenty percent for twelve issues. Objectionable or misleading advertisements not accepted. Advertisements for April, 1942 issue, must reach us not later than February 20th, 1942.

Radio-Craft • 25 W. B'way • New York, N. Y.

### EDUCATIONAL COURSES

**CORRESPONDENCE COURSES AND EDUCATIONAL** books, slightly used. Sold, Rented, Exchanged. All subjects. Satisfaction guaranteed. Cash paid for used courses. Complete details and bargain catalog FREE. Write NELSON COMPANY, 500 Sherman, Dept. C-242, Chicago.

### FLUORESCENT LIGHTING

**24" FLUORESCENT BENCH LIGHT \$1.49. LESS TUBE.** Harold Davis, Jackson, Mississippi.

### RECEIVERS

**REVISED PLANS 18 CRYSTAL SETS (SW RECORD 4800 miles)** with "Radiobuilder"—year 25c. Laboratories, 1406-A 77th Ave., Oakland, Calif.

### FOR SALE

**FOR SALE: 22 CAL. "POWDER-LESS" RIFLE** (Crosley) \$5.00. Old "Indian Wars" Book (1830) \$8.00. Fleming's (1908) Principles of Electric Wave Telegraphy \$4.00. Harry Secor, c/o RADIO-CRAFT, 25 W. Broadway, New York City.

### TECHNICAL CONSULTANT

**TECHNICAL CONSULTANT, MEMBER OF A.A.A.S.,** associate member of I.R.E.-A.I.E.E. Receiver and transmitter engineering, trade information, technical literary research. Willard Moody, 1923-16th St., N.W., Washington, D. C.

**REMEMBER PEARL HARBOR!**  
**Keep 'Em Flying!**  
**BUY DEFENSE BONDS**

RADIO-CRAFT for MARCH, 1942

**FREE!**

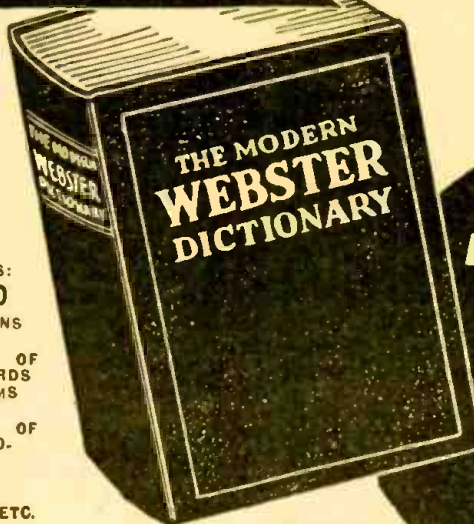

CONTAINS:  
**22,000**  
 DEFINITIONS  
 •  
 DICTIONARY OF  
 RADIO WORDS  
 AND TERMS  
 •  
 DICTIONARY OF  
 THE AUTO-  
 MOBILE  
 •  
 TABLES,  
 TREATISES, ETC.

FLEXIBLE  
 IMITATION  
 LEATHERETTE  
 COVER, SIZE 5 1/2"x8"

with \$1.00 subscription  
 to

**RADIO-CRAFT**

**FULL  
 LIBRARY SIZE  
 MODERN  
 WEBSTER  
 DICTIONARY  
 416  
 PAGES**

### FILL OUT—MAIL THIS COUPON TODAY!

-----  
 RADIO-CRAFT, 25 West Broadway, New York, N. Y.  
 This is a New Order     Extend my present subscription  
 Gentlemen: Enclosed you will find One Dollar for which enter my subscription to RADIO & TELEVISION Magazine for Eight Months. Send me ABSOLUTELY FREE and POST-PAID, my copy of the MODERN WEBSTER DICTIONARY.  
 Name .....  
 Address .....  
 City ..... State .....  
 RC 3-42  
 (Remit by check or money order; register letter if you send cash or unused U.S. Postage Stamps)

If you will take advantage NOW of our special subscription offer of eight months for \$1.00, we will send you ABSOLUTELY FREE and POST-PAID this 416 page full library size MODERN WEBSTER DICTIONARY—useful and instructive to everyone. This self-pronouncing authoritative dictionary—a new work throughout—contains the most up-to-date words now in common use, 22,000 definitions in all. It also features a Glossary of Radio Words and Terms, Dictionary of the Automobile, Treatises on Practical Syntax, Etymology, Punctuation and Standard English by well known authorities, Metric Tables, Time, State Flowers, National Parks of the U. S., etc.

This is a time limited offer, so don't delay in returning the Coupon.

**RADIO-CRAFT**

25 WEST BROADWAY NEW YORK CITY

# K45LA—ONLY "COMMERCIAL" ON WEST COAST

**FRANK KENNEDY**

*Chief Engineer, Don Lee FM System.*

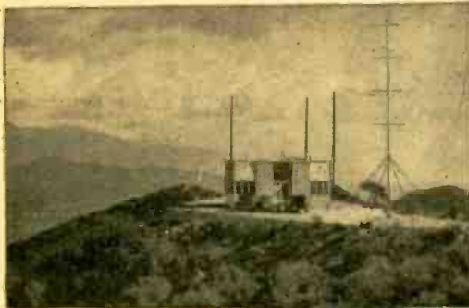

Above—View of FM station K45LA, erected atop Mt. Lee in Hollywood. Right—Virginia Sfmms takes a peep at the internal structure of the W. E. Frequency Modulation Transmitter operated by the Don Lee Broadcasting System in Hollywood.

Below—A "bug's-eye" view of the 4-bay turnstile antenna of FM station K45LA.

Lower right photo shows the W.E. 1000 watt FM transmitter; note the "blackout" curtains.

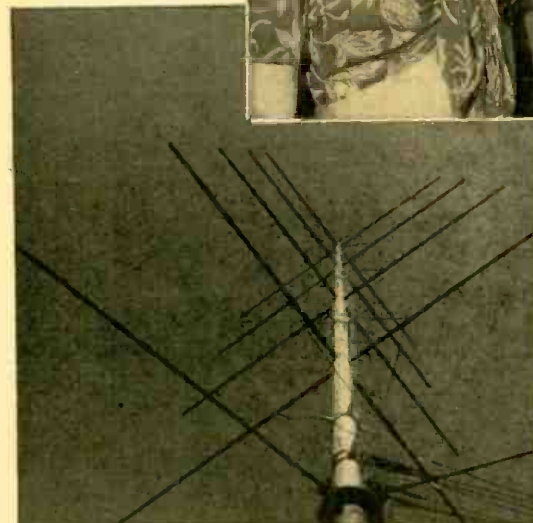
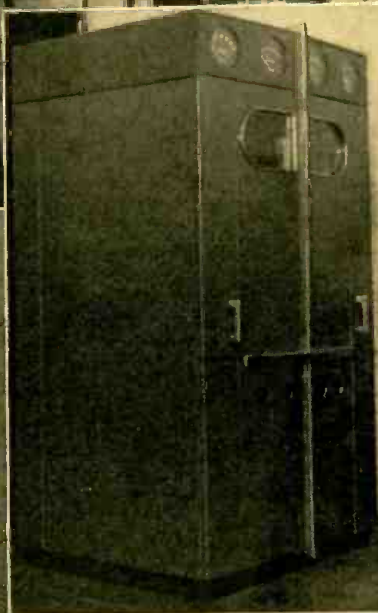
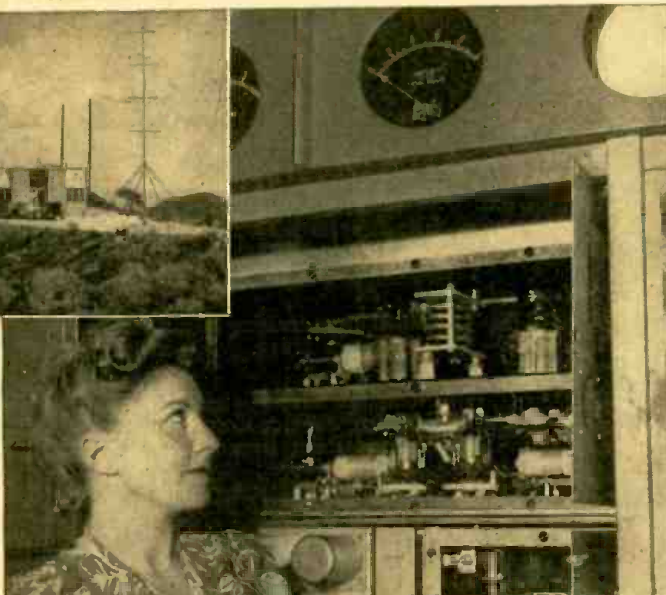

diated was two kilowatts output for one kilowatt input. This is believed to be the first check, by free-space measurement on an FM antenna in the United States.

The first commercial FM station on the Pacific Coast, K45LA made its official bow at an auspicious ceremony arranged by Lewis Allen Weiss, Vice President and General Manager of the Mutual Don Lee network, owners and operators of the FM station, on the evening of August 11, 1941.

Using a large volume of its own origina-tions, the World Recording library and occasional programs off the Mutual and Don Lee lines, K45LA maintains its indi-vidual program structure, although the brilliant musical programs such as the Coca Cola "Spotlight Bands" program, the Standard Symphony hour, and the Betty Rhodes show, "Adventures in Melody," with Dave Rose, are duplicated from the Mutual Don Lee network.

It has been found desirable to use a non-directional antenna at the receiver which will receive all stations. A simple type is shown in the illustration which incorporates two horizontal dipole or rod antennas arranged at right-angles. They are vertically spaced about one-fourth wavelength apart or approximately  $5\frac{1}{4}$  feet. The center of each rod antenna can be supported on a pole. A twisted-pair feeder is connected, one wire to each half of the top section. The connection is made about 12 inches from each side of the center. Another twisted pair is connected to the bottom section in the same manner. Then the two twisted pairs are connected together a little lower down, and continue as one twisted pair to the receiver. This provides an antenna somewhat similar to the "turnstile" antenna used by FM broadcast stations.

## NO SERIOUS SETBACK TO FM GROWTH

Mutual Don Lee Vice President and General Manager Lewis Allen Weiss recently surveyed radio's position in the present emergency, to foresee an even closer gearing of broadcast operations with the national "all-out" effort to win this war.

Said the Pacific Coast executive who manages the 32-station Don Lee chain from Canada to Mexico, "Twenty-four hour broadcast schedules are a first step in radio's service to listeners, in a total program of strengthening morale and keeping the public informed within bounds of national safety, while making broadcast facilities immediately available to governmental uses whenever the need may require."

Despite wartime demands on metals and parts, Weiss sees no serious setback in 1942 for Frequency Modulation, radio's newest contribution to an improved, high-fidelity system of broadcasting. He believes that manufacturers will probably use their limited quotas of materials for manufacture of quality FM-AM combination sets, to make up for volume production of cheap AM midget receivers stopped by material shortages. Don Lee introduced Frequency Modulation to the Pacific Coast with inauguration of its commercial FM station K45LA on August 11, 1941, and has been on a daily broadcast schedule since that

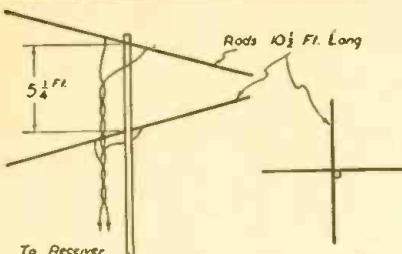

Simple FM Receiving Aerial

**T**HE Don Lee setup is one of the most interesting in the United States because the Western Electric transmitter, Model No. 503 A-1 is located in a special building atop 1,700-foot Mt. Lee, overlooking Hollywood.

The station operates on 44.5 megacycles and there is no trace of noise at the carrier. Audio characteristics are flat, plus or minus one decibel, 30 to 15,000 cycles. Frequency stability is better than 1,000 cycles at carrier. The linear modulator has a 75-kilo-

cycle swing. Distortion is less than 1%.

The station operates on 1,000 watt power and Western Electric cardioid microphones are used in the studios.

Programs originate at the Don Lee studios at 5515 Melrose Avenue in Hollywood, where all studios, announcer booths and associated circuits were designed and built for FM quality. A 15,000-cycle line leads directly over a four-mile path from the Don Lee studios in Hollywood to the transmitter atop Mt. Lee. In addition, half a dozen remote spots have been equipped with special high-fidelity telephone lines leading to Hollywood Don Lee studios.

Listener-response has been tremendous and auditors from San Diego to Ventura indicate that some of them live more than 100 miles from the transmitter atop Mt. Lee.

A new achievement in free-space measurement was made by the author recently when he circled the site in the Goodyear Blimp, "Resolute." Proof was obtained that the calculated effective useful power ra-

# New Direct-Coupled FM - AM AMPLIFIER MANUAL

By **A. C. SHANEY**

Chief Engineer, Amplifier Co. of America



**For the Layman, Serviceman  
Recordist and Engineer**

Regardless of whether you are interested in the finest type of phonograph reproduction, high fidelity recording, sound-on-film applications, FM or AM programs, you will find invaluable information in this practical handbook. Written by the leading exponent of direct-coupled amplifiers who has spent more than 10 years improving and perfecting the famous Loftin-White circuit.

**Explains the theory and practical application of:**

- Variable Speed Non-Overloading Push-Pull Expansion
- Non-Frequency Discriminating Scratch Suppression
- Push-Pull Balanced Direct-Coupled Amplification
- Push-Pull High-Frequency Equalization
- Push-Pull Low-Frequency Equalization
- Push-Pull Volume Compression
- Automatic Volume Limitation
- Automatic Volume Control
- Calibrated V.U. Indicator
- Audio Spectrum Control
- Remote Control

If you are interested in the latest audio developments, you can't afford to be without this complete compilation of authentic articles on Direct-Coupled Amplifiers. 32 pages 8 1/2" x 11". Over 100 diagrams and illustrations.

Priced to Cover Cost of  
Printing and Mailing **20c**  
Send Stamps or Coin

**AMPLIFIER CO. of AMERICA**  
17 WEST 20TH STREET, NEW YORK, N. Y.

## YOU ARE NEEDED! ★

Our Army, Navy and civilian industry need expert Radio Operators NOW!

Your opportunity to learn code easily or become a highly proficient operator is with the Candler System, right in your own home, with interest and surprising progress. Thousands of successful operators have been trained by the Candler System. Courses for beginners and advanced operators.

**Get All the Facts!**

Write today for the New Candler Book of Facts. It's FREE! It tells you the whole interesting story of how you can build a career. Send for it today. A postal obligation.

**CANDLER SYSTEM CO.**

Dept. S-2  
Box 928, DENVER, COLORADO

### Many FM Questions

Are answered in articles on the subject, which have appeared in back numbers of this magazine. Send for list of these "FM" and "Television" Articles and the Reference Numbers.

time, with a consistent growth noted in number of listeners for the area.

"Radio will continue to entertain and to educate," concludes Don Lee's managerial head, "but with one main objective in view . . . a calm, unhysterical welding together of America's mind, heart and muscle in a whole effort to defeat the enemy and effect an early, sure peace."

Los Angeles is one of the best cities in the nation for FM. Since Station K45LA went on the air on August 11 an additional 15,000 sets were put into use, bringing the total number of sets in operation on the Pacific Coast up to 20,000. At the present time there are 2,000 sets being sold per month. Dealers, jobbers, and retailers are well stocked and sales are "going to town" with the whistle cord tied down, according to reports from the Los Angeles sector.

## FM Grows Amazingly

**FM in Philadelphia:**—Definite plans for inauguration of service on W53PH, WFIL's new FM station, were recently announced. W53PH, Philadelphia's first FM transmitter, went on the air Monday, November 10, and operates daily from 2 to 8 p.m. The antenna is located on top of the Widener Building in the very heart of Philadelphia.

Program plans call for no duplication of AM service, with the exception of a few outstanding shows and some special events. The schedule will have "news" for five minutes before each hour and the rest of the schedule will be classical and semi-classical music. The station will also include special events features planned for FM only, and will release some of the network shows which WFIL is unable to carry locally.

**Audience Over Quarter Million:**—Continued gains in sales of FM receivers have boosted the available listening audience for the country's FM stations far beyond the most optimistic expectations.

On the basis of reports from manufacturers, now turning out about 1,500 receivers a day, FM's national trade association, FM Broadcasters, Inc., has compiled figures showing that over 240,000 frequency modulation sets are today in American homes.

The largest single group is found within the New York City service area where approximately 50,000 have been sold. Chicago's total is well over 25,000. New England has more than 22,000 sets. Other areas where FM listener growth has been correspondingly swift include Detroit, 12,000; Los Angeles, 15,000; Milwaukee, 6,500; Pittsburgh, 8,000.

Several cities where FM stations are still under construction already claim sizable quotas of sets. An outstanding example has been Philadelphia which, until recently, enjoyed no local FM service and yet had approximately 5,000 receivers available in homes.

Production schedules, together with current sales trends, indicate further heavy increases in the FM listening audience through this spring's receiver buying. At the start of 1941 there were approximately 15,000 FM sets in the entire country.

Construction permits authorized for additional FM transmitters will further extend frequency modulation service in the cities of Chicago and Detroit. The Federal Communications Commission also approved an educational FM station for Memphis, Tennessee.

This brings the total of commercial FM broadcast installations thus far sanctioned by the FCC to 63.



MR. GEO. BRUZEE  
Geneva, New York

National Union Products have been one of the bases on which I have built the most successful service business in this trading area. I have sold National Union with full confidence for more than ten years and the results have fully justified my faith in the merchandise and the company. Naturally I have taken every advantage of National Union deals, but of equal importance to my mind is the fact that N. U. has kept the market clean and enabled me to make a sales profit.

WHERE YOU FIND  
**NATIONAL UNION**  
YOU FIND BETTER  
**RADIO SERVICE**

**PREMIUM**  
*Quality*  
**TUBES**

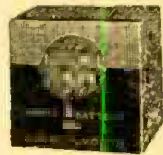

**BATTERIES**  
**CONDENSERS**

also Transmitting tubes, panel lamps, cathode ray tubes, exciter lamps, sound equipment, photo electric cells, sound accessories, dry batteries, flash light bulbs.

NATIONAL UNION invites . . .

All radio service dealers to enjoy the benefits of the N. U. Shop Equipment Plan. The latest in tube testers and test equipment are available to you . . . prompt delivery. More than 60,000 completed deals prove the success of this plan. Investigate now.

Ask Your N. U.  
Distributor or Write



**NATIONAL UNION**  
**RADIO Corp.**  
57 STATE ST., NEWARK, N. J.

# W55M, MILWAUKEE, CALLING

*The FM Voice of The Milwaukee Journal*

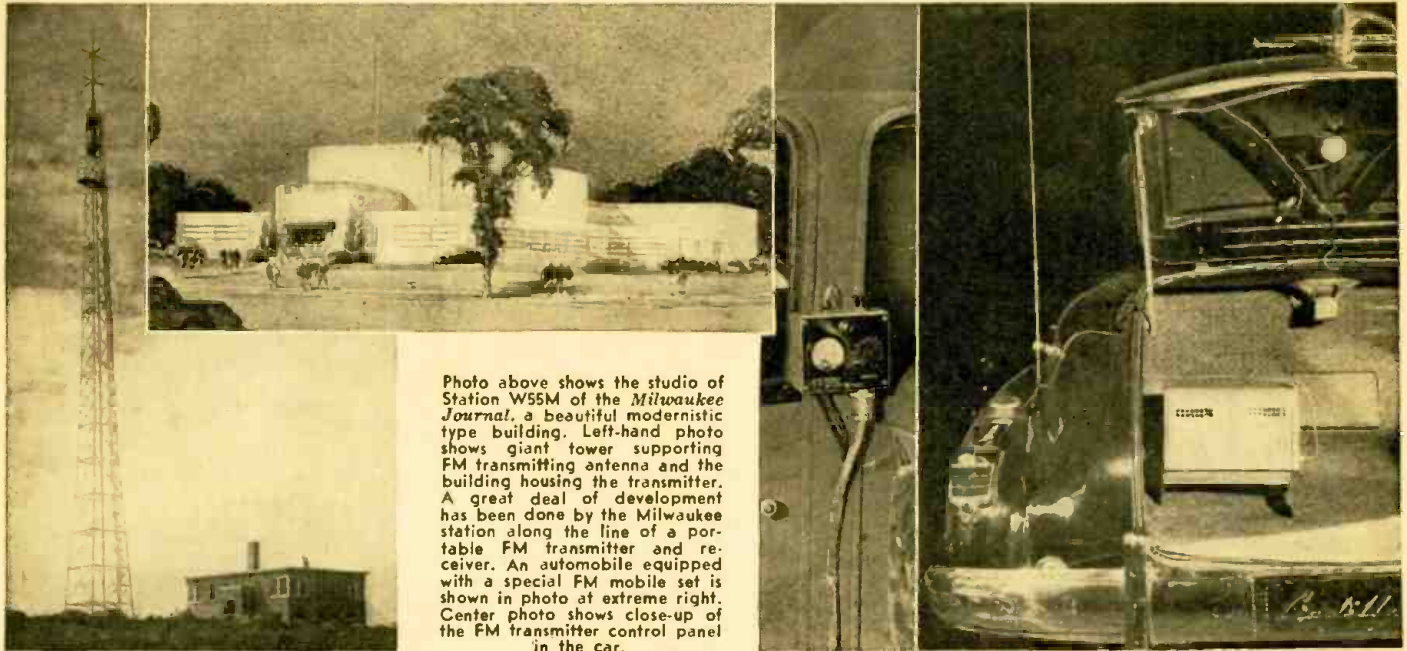

Photo above shows the studio of Station W55M of the *Milwaukee Journal*, a beautiful modernistic type building. Left-hand photo shows giant tower supporting FM transmitting antenna and the building housing the transmitter. A great deal of development has been done by the Milwaukee station along the line of a portable FM transmitter and receiver. An automobile equipped with a special FM mobile set is shown in photo at extreme right. Center photo shows close-up of the FM transmitter control panel in the car.

## W55M's Technical Equipment

D. W. GELLERUP

Chief Engineer WTMJ, W55M, WMJT

THE W55M Transmitter is a 50 kilowatt model built by Radio Engineering Laboratories of Long Island City, New York. It employs the new type phase modulator giving the transmitter a modulation characteristic of a frequency response that is flat from 30 to 15,000 cycles with a variation of plus or minus of 1/2 db. Distortion is in the neighborhood of 1% over the entire frequency range.

Frequency stability of the transmitter, due to a rather unique Frequency Controlled Circuit, is well within the limits required by the Federal Communications Commission (approximately 200 cycles). Output of the transmitter is fed to the base of the tower in two three-inch concentric lines. In a coupling house at the base of the tower is phasing equipment. From this equipment eight 1 1/8 inch concentric lines run 220 feet up the tower to a two-bay turnstile, this being an antenna gain of one.

In order to cover what is described as the Milwaukee trading area, it will be necessary to radiate approximately forty kilowatts from the antenna. This means an input of between forty-five and fifty kilowatts to the transmission line. The antenna is so arranged as to allow for the increase of the number of bays at a later date thus allowing an increase of antenna efficiency if this is found desirable.

The location of the transmitter is on a hill 1260 feet above sea level. The major portion of the city of Milwaukee is between 600 and 650 feet above sea-level so that the antenna proper is approximately 600 feet above the average level of the city. We plan to feed this transmitter from studios using either a 15,000 cycle telephone loop or a studio-to-transmitter radio link. These two circuits will be interchangeable at a moment's notice.

The amplifying equipment at the transmitter is capable of handling frequencies from 30 to 17,000 cycles with practically no distortion. Studio equipment has been re-

vamped to give us a 15,000 cycle characteristic with noise level of better than minus 60 db. With completion of the studios at Radio City next summer, and with the addition of better acoustic characteristics and closer noise tolerances, the overall characteristic from studio out through the transmitter should be improved appreciably.

What is believed to be the first thoroughly practical pleasure car FM receiver has been installed in the car of Walter J. Damm, General Manager of Radio for the *Milwaukee Journal*, operating W55M and WTMJ.

The outfit consists of the receiver proper, speaker, antenna, and control unit. The antenna is a vertical full quarter wave of the telescopic type fed to the set proper by a co-axial cable. The receiver is fixed to the W55M frequency by crystal control. The control unit contains a signal strength indicator calibrated in micro-volts per meter and a sensitivity control. The main unit of the receiver is installed in the luggage compartment of the car with the speaker behind the rear seat. The control unit is within easy reach of the driver.

## FM Programs Important

WALTER J. DAMM

General Manager of Radio

THE MILWAUKEE JOURNAL

ALTHOUGH The Journal Company has been operating a standard broadcasting station in Milwaukee since 1925, we look upon FM as a new entity which will eventually dominate the radio scene.

Our convictions with regard to programming are, briefly, as follows:

A. If the public is going to buy FM sets, it needs an incentive—therefore, FM programs must be distinctly worth-while and fill a genuine need.

B. It follows that FM program schedules must be entirely independent from AM schedules. FM's advantages of high fidelity reproduction and freedom from static are, alone, not enough in most cases to make people switch from AM to FM.

C. FM should be programmed to meet

the radio desires of the discriminating listener who enjoys good music, and both sustaining and commercial programs should utilize the high fidelity reproductive advantage of FM to the utmost. In this respect, we believe that there is a place for electrical transcriptions, as well as live talent, on FM programs. Experience has shown that the new high-fidelity electrical transcriptions now available to the broadcasting industry are remarkably well adapted to FM. They will provide the means of presenting famous artists and musical groups which could not otherwise be heard over an individual FM station until the American Network begins operation.

D. While music should be the basis of FM schedules, we recognize that drama, news special events and children's programs have their place. However, every effort will be made to place such programs where they best fit into the daily life of the listener.

E. We believe that daily luncheon and dinner concerts of uninterrupted music should be scheduled, as these two periods will make it possible for the listener to enjoy the benefits of FM to the utmost. The dinner concert, particularly, should fill the wishes of many set owners who have hungered for a program of music and not one made up of 15-minute units, ranging from children's programs to dramatics, sports and news.

F. We believe that by concentrating on music during the afternoon, FM will attract set owners who do not care for the continuous procession of dramatic shows now on the air. Herein lies an opportunity for the FM broadcaster to awaken interest in daytime radio on the part of those set owners who are now a dead loss so far as AM broadcasting is concerned.

G. Lastly, we believe that the FM broadcaster should always model his programs according to the listening public's demands and should not permit himself to be swayed from his set course by the idiosyncrasies of the advertiser and the advertising agency. Steadfast adherence to a policy based on genuine public service can open up a listening field of unbelievable proportions.

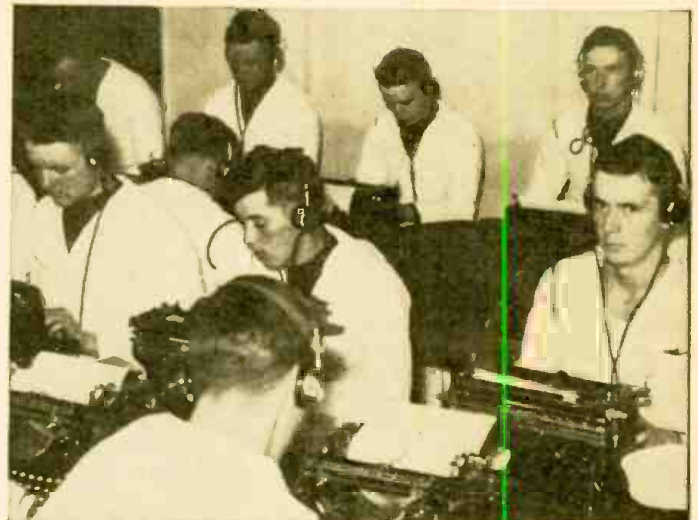

Top left:— Class in Radio Materiel— U. S. Navy Radio School. Top right:— Naval radio operator's class. Lower left:— Naval class in radio materiel theory. Lower right:— Class in radio code reception.—U. S. Navy Photos.

# EARS FOR THE FLEET

## RADIO, THE NAVAL RESERVE — and YOU\*

**D**URING recent weeks, with a total war effort the fundamental concern of this nation, there has come a sudden and nationwide recognition of the vital importance of radio, in air-raid and submarine defense. The deadly accuracy of initial Axis underwater and bombing attacks has quickened public interest in *radio locators*, chief weapon for effective defense against repetitions of these enemy successes. To operate these mechanisms our Navy needs qualified radiomen, and needs them urgently.

Recently, the Navy announced virtually unlimited opportunities for amateur radio operators and radio servicemen in this branch of the service. For men eager to contribute to America's defense, and, at the same time,

*Radiomen - Servicemen, experimenters and amateurs— are urgently needed by the Navy. Attractive pay and rating are offered, as explained in this specially written article.*

to build careers for themselves in one of radio's newest fields, the subsequent paragraphs have a message and an important one.

### GROUND FLOOR OF A NEW FIELD

The Navy's new and secret equipment for locating distant planes and other craft is the most important radio development of recent years. It's going to be boomed in peace time, also. So men being trained in its operation

today are getting in on the ground floor of a new field. This training will mean good paying positions for many after the war is over.

But the Navy offers plenty of advantages right away to men who qualify for this training. Accepted applicants become petty officers in the Naval Reserve immediately. They are paid \$72. a month base pay, and are given, in addition, their food and quarters, medical and dental care, initial uniforms worth \$118. and, for married men, an allowance for their dependents of \$1.15 a day. These advantages come right away upon enlistment.

### TRAINING AT TREASURE ISLAND

Radiomen who qualify for this special course of training will be sent to the new Radio Materiel School on Treasure Island in San Francisco, or possibly to the Radio Materiel School at Bellevue, D. C. An eight

\*An article prepared especially for *Radio-Craft* by the U. S. Navy Recruiting Bureau. Further information regarding enlistment in the Naval Reserve's radio class may be obtained by writing to that Bureau, N. Y.

# SUPER SPECIALS

All of the attractive items listed here are brand new. ALL are in PERFECT WORKING ORDER. In many cases, the parts alone total more than the price we are asking. 100% satisfaction guaranteed or your money refunded.

ORDER FROM THIS PAGE. Use the convenient coupon below. Include sufficient extra remittance for parcel post charges, else order shipped express collect. Any excess will be refunded. C.O.D. shipments require 20% deposit. If full remittance accompanies order, deduct 2% discount. Send money order, certified check, new U. S. stamps. No C.O.D. to foreign countries.

ORDER TODAY LIMITED QUANTITIES PROMPT SHIPMENTS ASSURED

## HANDY WORKSHOP OUTFIT

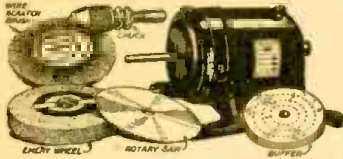

Here is a marvelous article that to the best of our knowledge has never sold at such a low price. This outfit must be seen to be appreciated. It delivers the goods! It comprises a variable speed universal motor for 110 volts A.C. or D.C. Made originally for dictaphone machines by American Gramophone Co. Motor is reconditioned and in excellent condition; all other parts are brand new. Special lever control permits various speeds up to 3000 r.p.m. Measures 7 1/2" x 3 1/4" diam. overall.

Included in the outfit are the following items, as illustrated: 1 excellent chuck which takes drills and other tools—chuck is easily secured to motor shaft; standard emery wheel, 4" diameter; fine steel rotary saw, 4" diameter; wire scratch brush, 4" diameter; standard cloth buffer, 3" diameter. Total Wt. 9 lbs.

ITEM NO. 149 Complete outfit, including motor. **\$4.95**  
Your Price .....

## WESTON MODEL 562 A.C.-D.C. AMMETER

Designed by Weston for the Eastman Kodak Co. It is a precision-built magnetic-vane type ammeter which, with suitable shunts, can be used as a milliammeter too. It is 2" in diameter and designed for panel mounting. Bakelite base and black-enamel cover. Snp. Wt. 2 lbs.



ITEM NO. 35 **\$1.25**  
Your Price .....

## POWERFUL ALL-PURPOSE INDUCTION MOTOR IDEAL FOR EXPERIMENTERS—101 USES

Sturdily constructed to precision standards, this self-starting shaded pole A.C. induction motor is powerful enough for a large variety of uses. Some of these are: Automatic Timing Devices, Current Interrupters, Electric Fans, Electric Chimes, Window Displays, Photoelectric Control Devices, Electric Vibrators, Small Grinders, Buffers, and Polishers, Miniature Pumps, Mechanical Models, Sewing Machines, Phonograph Motors, Coffee Grinders, Motion Picture Projectors, Motorized Valves, Sirens, and other applications.

Consumes about 15 watts of power and has a speed of 3,000 r.p.m. When geared down, this sturdy unit will constantly operate an 18-inch turntable loaded with 200 lbs. dead weight—THAT'S POWER!

The motor is of midsize dimensions, 3 inches high by 2 inches wide by 1 1/2 inches deep; has 4 convenient mounting studs; shaft is 7/8" long by 3/16" diameter, and runs in self-aligning, oil-retaining bearings; the best materials. Perfect precision assembly and rigid inspection certify to its high quality, and assure long life. Designed for 110-20 volts, 50-60 cycles. A.C. only.

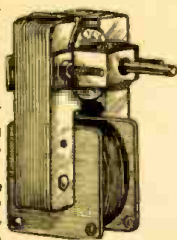

ITEM NO. 177 **\$1.29**  
YOUR PRICE .....

## 100 POWER TELESCOPE LENS KIT

Make your own high powered 6 ft. telescope! Now you can thrill to a close-up view of the worlds out in space. See the rings around Saturn, the mountains of the moon! Kit contains 3" diam., 75" focal length, ground and polished objective lens and 2 astronomical eye-pieces, magnification 50x and 100x. Complete kit with full instructions.

ITEM NO. 123 **\$1.95**  
YOUR PRICE .....

NEW—EXTRA LARGE LENS KIT—contains completely finished 4" diameter 100" focal length ground and polished objective lens, three 1 1/4" diameter eye-pieces giving 66x, 133x, and 200x, an aluminumized diagonal for overhead viewings, and a color filter for insertion in any eyepiece.

ITEM NO. 123L **\$3.95**  
YOUR PRICE .....

## WELDING! BRAZING! SOLDERING! 3-IN-1 PORTABLE ELECTRIC TORCH

WORKS FROM 110 VOLTS A.C. OR D.C. LINE

This electric torch is not a gadget or a toy but a sturdily built outfit using the finest materials. With it you are able to do professional type of welding, brazing and soldering work, regardless of whether or not you've had previous experience. It will do a thousand and one jobs: fender welding, auto body repairs, bumpers, cylinders, tanks and industrial repairs—ideal for a tool fitters, plumbers, sheet metal jobs, engineers, maintenance men, radio and bicycle repair men, etc. Works on aluminum, brass, copper, iron, steel and other metals!

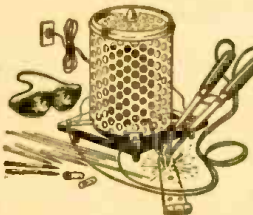

The 3-in-1 electric torch is so simply constructed that even a boy can operate it after reading the simple and concise instructions furnished with the unit. Not necessary to know how to strike an arc! All you do is plug the torch into the light socket, adjust the carbons per instructions, and presto—you have an intense, blazing flame, ready for work. The outfit complete with power unit, electric cord, electrode holder, carbons, welding rods, blazing rods, solder flux, goggles, and instructions.

Save money! Do your own repairing. Earn money by doing repairing for others. Simple, practical, durable and safe to handle—that's why the price is amazingly low. Don't delay—order one today. Snp. Wt. 8 lbs.

ITEM NO. 50 **\$6.95**  
Your Price .....

## VARIABLE SPEED UNIVERSAL MOTOR FOR 110 VOLTS, A.C. OR D.C.

Made for Dictaphone machines by American Gramophone Co. Used, but in excellent condition. Special lever control permits variable speeds up to 3000 r.p.m. 1/2" shaft extends from both sides of motor. Measures 7 1/2" x 3 1/4" diam. overall. Snp. Wt. 6 3/4 lbs.

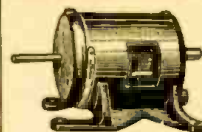

ITEM NO. 11 **\$1.55**  
Your Price .....

## AMAZING BLACK LIGHT!! Powerful 250-Watt Ultra-Violet Bulb



The best and most practical source of ultra-violet light for general experimental and entertainment use. Makes all fluorescent substances brilliantly luminous. No transformers of any kind needed. Fits any standard lamp socket. Made with special filter glass permitting only ultra-violet rays to come through. Brings out beautiful opalescent hues in various types of materials. Swell for amateur parties, plays, etc., to obtain unique lighting effects. Bulb only. Size of bulb.

Snp. Wt. 1 lb. **\$2.00**  
ITEM NO. 87  
YOUR PRICE .....

## WESTINGHOUSE WATTHOUR METER

Completely overhauled and ready for immediate service. Designed for regular 110-volt, 60 cycle 2-wire A.C. circuit. Servicemen use it in their shops to check current consumption of sets, soldering irons, etc. Keeps costs down. If dismantled, the parts alone would bring the price. The elaborate gear train could be used as a counter on machines of various kinds. Simple to install: 2 wires from the line and 2 wires to the load. Sturdily constructed in heavy metal case. Size: 8 1/2" high, 8 1/2" wide, 3" deep. overall. Snp. Wt. 14 lbs.

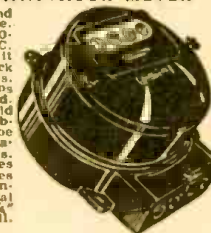

ITEM NO. 33 **\$4.50**  
Your Price .....

months' course of training follows—in mathematics, radio theory, and the maintenance of radio locators. The course is intensive; it has to be. Training, because of the war, has been accelerated. But it hasn't been shortened, or simplified.

## MUST BE HIGH SCHOOL GRADUATES

Work in this new Navy field of radio detection is of the most confidential and secret nature. Special duties will be assigned to applicants who complete their training successfully. Consequently, the Navy has to be sure of its men before it accepts them for training. The following requirements for this class of the Naval Reserve have been set up. An applicant must:

1. Be a male citizen between 17 and 50 years of age.
2. Be of good character.
3. Be a high school graduate.
4. Hold or have held an Amateur Class A or B license. Applicants, however, who fail to meet this last requirement, are not necessarily disqualified. If they are actively engaged in radio repair or service work, or have had experience in connection with high frequency design, transmission, or reception, they may still qualify, although they are not actually licensed. In this connection, experience with superheterodyne receivers, u.h.f. equipment, or cathode ray tubes, is particularly valuable.

## STILL OPENINGS FOR RADIO OPERATORS

Graduates of the course at Treasure Island will be assigned to radio locator technical and maintenance work, not to radio operating. They will be rated as petty officers as high as Chief Radioman. If qualified for this rating, they will be paid \$99 a month, plus the allowances specified above.

Although the majority of the graduates will be assigned to this special work, openings still exist for those who wish to become operators. But the Navy's particular need today is for radio locator experts. To obtain and train these men is the purpose of this new course.

To reduce the possibility of damaging enemy successes at distant naval bases, the Navy needs radio men—and it needs them now!

## RADIO OPERATORS WANTED!

WAR Department, Federal Communications Commission, Civil Aeronautics Administration, Coast and Geodetic Survey, and other Government agencies are needing radio operators. Persons are needed to stand regular watch for the transmission and reception of radio messages and other communications. In some cases operators will be responsible for the maintenance and operation of a radio station and its equipment. In others they may have to transmit messages by teletype as well as in code.

To fill the jobs, which pay \$1,620 to \$1,800 a year, an examination was recently announced by the Civil Service Commission. Because of the large number of vacancies which exist applications will be accepted at the Commission's Washington office until further notice.

While no paid experience is required, applicants for these positions must show that they are able to transmit and receive messages by radiotelegraph at a rate of 20 words a minute, transmitting either by hand or bug. For some positions persons are needed who can operate a regular typewriter at 40 words per minute, or a teletypewriter at 35 words per minute. The age limits are 18 to 55. Persons are to be rated on their experience or training and fitness to perform the work.

Operators who are interested in this work and who would be available for Government employment are urged to secure the proper application forms from the Commission's representative at first- or second-class post offices, or direct from the Commission in Washington.

## HUDSON SPECIALTIES CO., 40 West Broadway, N. Y. C.

IT'S EASY TO ORDER—CLIP COUPON—MAIL NOW ORDER FROM THIS PAGE.

HUDSON SPECIALTIES CO., 40 West Broadway, Dept. RC-3/42, New York, N. Y.

I have circled below the numbers of the items I'm ordering. My full remittance of \$..... (include shipping charges) is enclosed.

OR my deposit of \$..... is enclosed (20% required), ship order C.O.D. for balance. No C.O.D. order for less than \$2.00. (New U. S. stamps, check or money order accepted.)

Circle Item No. wanted: 11, 33, 35, 50, 87, 123, 123L, 147, 149

Name ..... Address .....

City ..... State .....

Bond remittance by check, stamps or money order; register letter if you send cash or stamps.



# GRID-BIAS Resistor Values

ALFRED A. GHIRARDI, B.S., E.E.

**T**HERE are many instances when the serviceman has no ready means of identifying the value of a faulty bias resistor—as in the case of "Orphan," "Special Brand," or other receivers employing a special and unfamiliar resistor color code (or none at all), and for which no schematic circuit diagram with resistor values is readily available.

## NET "PLATE VOLTS" AND "SCREEN VOLTS"

It must be remembered that the net "plate voltage" (voltage actually existing between plate and cathode) is equal to:

*Net plate voltage = Total B-Supply voltage — (voltage drop in plate-load resistance + grid bias voltage)*

Similarly:

*Net screen voltage = Total B-Supply voltage — (voltage drop in screen resistor + grid bias voltage)*

It is the net voltages (which are, therefore, always less than the B-supply voltage) that alone determine the correct value of grid bias to apply to the tube. The reasons, therefore, for compiling this grid-bias resistor chart\* on the basis of net "plate volts" and "screen volts" are:

- (1) that it is easier for the serviceman to refer to standard tube data when the net "plate volts" and "screen volts" are specified
- (2) that since it is the actual net "plate volts" and "screen volts" applied to the tube that determine the correct grid bias to apply to it, if one is to determine the correct grid bias and grid-bias resistor to use, he should know the net "plate volts" and "screen volts" actually being applied to the tube

In some circuit arrangements, particularly in resistance-coupled amplifier circuits employing high resistances in the plate circuits, the voltage-drop in the plate load may be appreciable, and the actual net "plate volts" may be considerably less than the "B-supply volts."

## DETERMINING CORRECT BIAS WHEN NET PLATE OR SCREEN VOLTAGES DIFFER FROM THOSE SPECIFIED

It is well, also, to remember two useful mathematical relations for determining the correct grid bias voltage to apply to a tube when the net plate or screen voltages being applied to it are known. These are:

### (1) For Triodes:

First, look up (in a *Grid Bias Resistor Chart*)\* the bias volts specified for a net plate voltage nearest to that actually being applied to the tube. Then,

Desired Bias =  $\frac{\text{Specified bias}}{\text{actual net plate voltage being applied}}$

or, Desired Bias =  $\frac{\text{Specified bias} \times \text{actual net plate voltage being applied}}{\text{nearest specified net plate voltage}}$

### (2) For Screen-Grid Tubes:

First, look up the bias volts specified for a net screen voltage nearest to that actually being applied to the tube. Then,

Desired bias =  $\frac{\text{Specified bias} \times \text{actual net screen voltage being applied}}{\text{nearest specified net screen voltage}}$

## BIAS-RESISTOR VALUE FOR TUBES IN PUSH-PULL

When two tubes are operated in push-pull and a single common bias resistor is used

\*See page 547—Ghirardi's "Radio Troubleshooter's Handbook"—2nd revised edition.

Reprinted from new 2nd revised edition of the *RADIO Trouble Shooters Handbook*. Copyright, 1941, Radio & Technical Publishing Co. Copyright in Canada and Great Britain, and all countries subscribing to the Berne Convention, by Radio & Technical Publishing Co. All rights reserved.

for both of them, the resistance value of the bias resistor to be employed is usually half of that specified in the chart for a single tube of the same type and operating at the same plate and bias voltages. This is true unless stated otherwise in the table. The wattage rating of the bias resistor employed for the push-pull arrangement should be the nearest commercial size that is approximately double that of the bias resistor specified for a single tube.

## HOW TO "CALCULATE" BIAS-RESISTOR VALUES

Although the correct self-bias resistor values for all present tubes are tabulated in the chart mentioned, it is well for the serviceman to know exactly how to calculate the resistance and wattage ratings of the self-bias resistor required, for any tube or tubes under any specified operating conditions, so that he will understand how to calculate bias resistor values for all new tubes which are brought out in the future. The grid-bias resistor value for self-bias is given by the following formula:

$$R = \frac{E_s \times 1,000}{(I_b + I_c) n}$$

where  $R$  = the grid-bias resistor value in ohms

$E_s$  = the grid-bias required in volts (at the plate and screen voltages at which the tube is operating)

$I_b$  = the plate current of the single tube, in milliamperes

$I_c$  = the total screen current of the single tube, in milliamperes

$n$  = the number of such tubes passing their cathode currents through the grid-bias resistor

For triodes, the screen current term,  $I_c$ , disappears, and no screen voltage need be considered.

For tetrodes, the "screen current" is that of the single screen grid.

For pentodes, the "screen current" is the sum of the screen-grid and suppressor grid currents.

For pentagrid converters the plate, total screen, and oscillator plate currents must be

When making all such calculations be sure to determine first:

- (1) the net plate voltage at which the tubes are working
- (2) the net screen voltage (if a tetrode or pentode)
- (3) the correct value of grid bias voltage required at these plate and screen voltages
- (4) the plate and screen currents for one tube at the given net plate and screen voltage
- (5) the number of such tubes passing their cathode currents through the bias resistor.

Remember that the net plate voltage alone (not the total B-supply voltage) determines the correct value of grid bias which must be applied to the tube by the grid-bias resistor.

## HOW TO CALCULATE BIAS-RESISTOR "WATTAGE" SIZE

After the necessary "resistance" value of the grid-bias resistor has been calculated, attention must be directed to see that the actual resistor selected is of sufficient size and heat dissipating ability (wattage rating) to carry the current without excessive temperature rise. The actual wattage dissipated in a resistor can easily be calculated from the following formula (which is deduced indirectly from Ohm's law):

$$\text{Watts} = \frac{E^2}{R}$$

where  $E$  = the voltage drop across the resistor (volts)

$R$  = the resistance in ohms

When selecting the actual resistor for a given use, the wattage value given by the foregoing formula should be multiplied by from 2 to 10, depending upon such factors as the amount of air circulation, mounting position and proximity of other heat-producing parts, which will exist when the resistor is mounted in the place provided for it. For a given wattage dissipation, the larger the resistor, the lower will be its operating temperature per unit of surface area.

## CUT-OFF BIAS VOLTAGE

Since servicemen must often replace volume controls which vary the grid bias on one or more tubes in the receiver, they should be familiar with the matter of "cut-off" bias and the formula for calculating it. The "cut-off" is the point where plate current ceases to flow as the grid voltage is made increasingly negative. In grid-bias type volume control circuits, the volume control resistor value should be such that the control range is never extended into the "cut-off" region, otherwise serious distortion will result. For triode tubes, the formula for the "cut-off" voltage is:

$$\text{"Cut-off" voltage} = \frac{\text{Plate voltage}}{\text{Mu}}$$

It must be remembered that this simple formula applies to triode tubes only. It cannot be used for calculating the "cut-off" bias voltage for tetrodes, pentodes and variable-mu tubes. The *Tube Characteristic Chart* and the *Grid-Bias Resistor Chart* previously referred to give the "cut-off" voltage values for these more complicated types of tubes.

# TROUBLE FOR YOU IN '42

HAROLD DAVIS\*

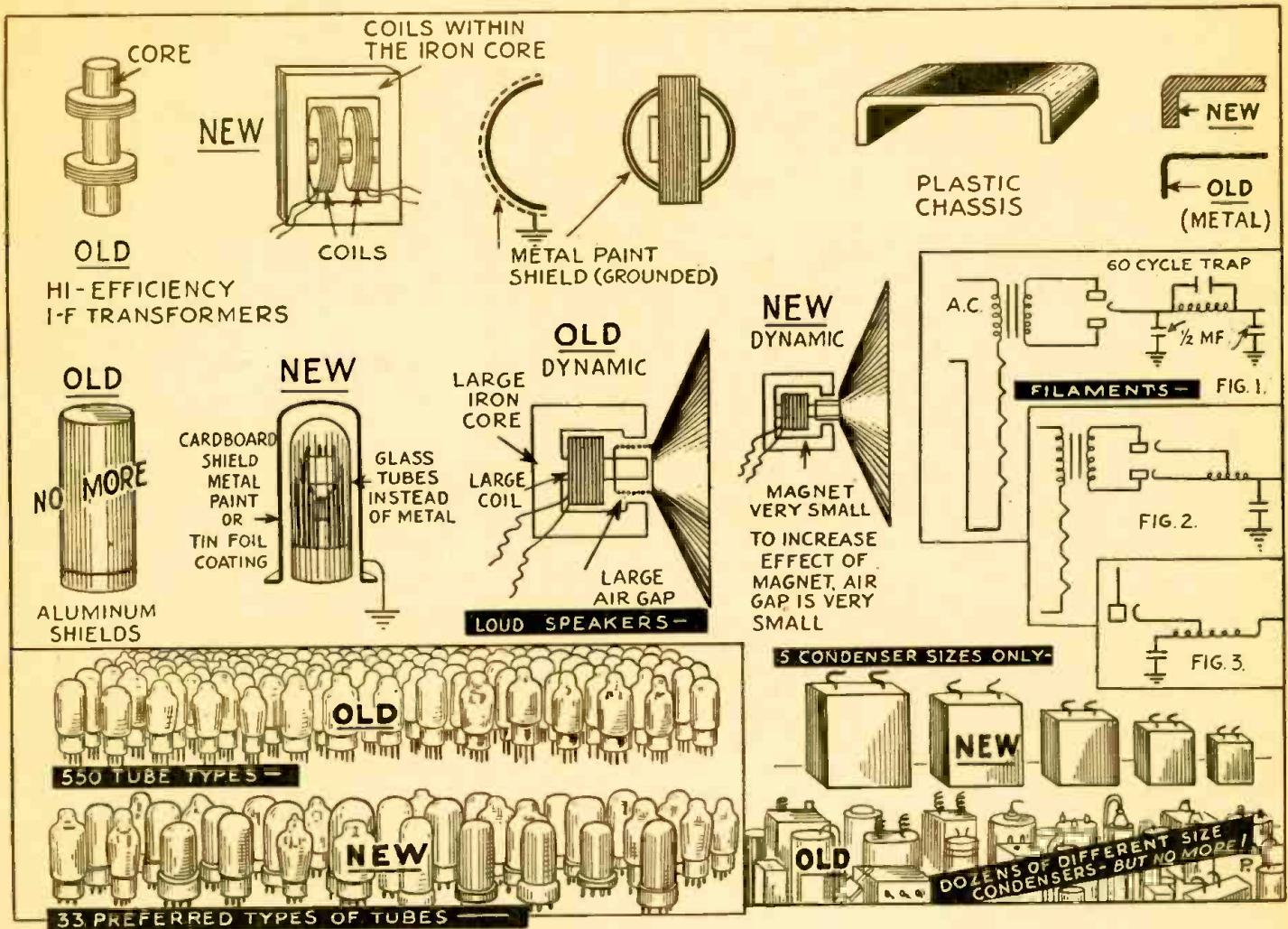

Among the problems which will confront the Serviceman in the "war months" ahead, he will find only a few sizes of condensers instead of several hundred for his servicing requirements. Again, tube types will be cut down to a minimum, and parts requiring aluminum and copper will be reduced almost to the vanishing point.

If necessity is the mother of invention, the old girl is certainly being kept busy these days. What! With the OPM snatching away materials as fast as ingenious scientists can develop them, and the whole nation hitting a new high in sales and business upturn. And the changes being made to cope with this situation by radio parts and set manufacturers will leave their signs on the radio serviceman.

For years now, the serviceman has been taught not to fool with patch-work—to localize the defect and then throw in all new parts in that particular circuit, if the case showed the slightest tendency of becoming stubborn.

Good servicemen have been those, who, when a defective section of a condenser bank was found bad, threw in a complete new bank of the exact duplicate variety, did the job up so that it rivaled the original factory installation and prided himself on not having wasted much time. Well, in a few months we are going to look back and say, "Those were the good old days". Yes, it appears that in a few more months, time is going to be the thing of which we have the mostest! And this, in spite of the fact that the telephone will be ringing off the wall, and customers will be down on their knees begging for attention.

\*Radio engineer, Designer and Writer

The "nigger in the woodpile" of course will be replacement parts. In case you haven't heard, they're gettin' sca'se. Not only getting scarce, but the ones they plan on giving us are about on a par with those we tumble around in our "junk box" every day.

Typical of what may be expected in the future is the electrolytic condenser. When the RMA committee appointed to see what they could do about this business, started checking the thousands of types and varieties being manufactured, they were amazed. No wonder there was an aluminum shortage! Hundreds upon hundreds of condensers, each different from the other only in the length of the leads or the shape and color.

### 5 CONDENSERS—TAKE 'EM OR LEAVE 'EM!

Needless to say a stop has been put to this. A strong standardizing program has gone into effect and the replacement trade—which means you, as a serviceman—have been promised five puny condensers with which to take the hum from the nation's radios. These five consist of 20 mf. 150 v., 20 mf. 450 v., 25 mf. 25v. (for cathodes), 8 mf. 350 v. and 8 mf. 450 v. Moreover, they will be in a cardboard container with lugs, wire being an item which is almost im-

possible to obtain. In fact, plain tin wire is now being used, with spaghetti slipped over for insulation.

These five types will have to suffice, and to answer in advance the questions of those who want to know how they are going to put them into the "peace-disturbing" midgets, in the words of a well-known radio engineer, "build an annex!" And he didn't smile when he said it!

This and many another "How" is going to have to be answered by the serviceman himself. When the manufacturer was courting your business, he tried to give you the things you wanted. If you wanted a condenser with a red band around it, he made it. Today the manufacturer believes you are old enough, so that your wants will not hurt you. They are certainly not going to hurt him. The OPM has already done that!

### I-F TRANSFORMERS

But the electrolytic condenser isn't the only thing we're not going to get. We are not going to get some I-F transformers, too. And, the ones they are going to give us are so camouflaged that even their own designer wouldn't recognize them.

It all started when some guy discovered that it took 9 pounds of copper to manufacture 1000 I-F coils. So what? So they

cause of improper functioning is alignment trouble. Due to the limited transmitting scope of FM, a number of stations located some distance apart may be on the same or adjacent frequencies. Usually this will not cause trouble because, unlike AM, if two signals are received at the same point on an FM dial, the signal two times or more stronger than the other will be heard to the exclusion of the other signal. Sometimes the receiving location may be midway between two transmitters so that both signals are received with equal strength. In this case antenna rotation will usually cut down the strength of one to its exclusion. The better sets use R.F. stages but there are no special precautions as regards aligning these stages. Their purpose, as in AM sets, is image elimination, to prevent signals at I.F. frequency from causing interference, and for whatever gain can be obtained. To further prevent I.F. interference, wave traps are used in the I.F. circuits. Where they are not used, and I.F. interference is had, it may be necessary to insert such traps in the circuit. Frequently re-alignment of the I.F.s will eliminate such interference. A glance at some standard I.F. circuits will show that common practice is to load the I.F. transformers with resistors so as to broaden their response in order that they will pass the wide band of frequencies required. This method, of course, results in low gain, but should one of these resistors open or change its value sufficiently, the high mu tubes used in the circuit would cause a considerable change in the I.F. response curve. If no oscillation is caused this will not be too serious, as the limiter will usually flatten the curve if it is not too extreme. For a common cause of I.F. oscillation, look at the loading resistors.

One of the principal advantages of FM reception is the relative absence of noise. Almost all noise caused by natural or man-made static is eliminated or cut down to a point where it is not heard through a carrier. Noise caused by defective components and tubes is not eliminated, however, and is a frequent cause of complaint. The signal tracer is the best means for discovering sources of such noise. Because of the high frequencies used, the field strength around wires is considerable and for this reason signal tracing probes must be shielded right down to their ends. Placement of parts is also very critical and when making replacements the serviceman must be very careful to locate the new part exactly where the old one was or oscillation will frequently result. Moving a by-pass lead from a grounded point on the chassis by as little as one-half inch will frequently cause trouble.

In aligning the limiter stage a departure from AM alignment procedure is necessary. In AM work, a weak signal below the AVC threshold is desirable. In FM work a signal strong enough to cause the limiter grid to draw current is used. This will cause loading of the I.F.s and a change in resonant peak and for this reason the limiter transformer is aligned first, feeding the signal into a previous I.F. stage. The output indicator is placed across the limiter grid resistor which is the AVC source.

After the limiter stage is aligned we align the other I.F. stages, leaving the output meter in the same circuit and adjusting for maximum deflection. After the I.F.s are aligned, we turn to the discriminator stage. This portion of the circuit is equivalent to the 2nd detector of our AM set but functions in a different manner. In operation it is similar to an AFC discriminator stage. Its purpose is to convert variations in frequency to variations in amplitude at audio frequencies. The discriminator transformer's primary is quite

broad in tuning but its secondary is quite sharply tuned. For best possible alignment here it is advisable to use a sweep-modulated signal generator used in conjunction with an oscilloscope. The signal generator should be tuned to the middle of the I.F. band and the secondary aligned at the peak frequency of the I.F.s. With the method described, proper discriminator alignment is indicated by a crossover pattern on the 'Scope. A properly proportioned pattern with lines of equal length represents an equal voltage output from both diodes. The 'Scope is connected so that its vertical deflection plates are connected across the output resistor network of the discriminator, and the signal generator is fed into the grid of one of the preceding I.F. tubes. Synch pulses from the sweep circuit are fed into the 'Scope to keep the pattern stationary. Proper alignment procedure is to adjust the discriminator transformer primary for maximum amplitude of the entire crossover pattern, and the secondary for proper positioning of the crossover point, midway between peaks.

Alignment can be done with an AM signal generator in the following manner. Connect a VTVM across one diode load resistor as an output meter and feed the unmodulated signal at I.F. frequency into one of the preceding I.F. stages. Adjust the discriminator transformer primary for maximum deflection. Then connect the VTVM across the entire resistor network of the both discriminator diodes and adjust the secondary for the equivalent of the crossover pattern, which in this case will be the point at which zero deflection of the VTVM will occur. This is because at the proper alignment point the voltage output of both diodes is equal but opposite in polarity. The VTVM connected across the entire network reads the resultant voltage which at this point would be zero.

The alignment procedures discussed are the critical ones. As concerns the oscillator, R.F. and Mixer stages, these are aligned exactly as are the equivalent stages of an AM receiver.

**WGEO and WGEA Beam News to Europe:**—Co-operating in one of the greatest short-wave radio projects ever undertaken in this country, WGEO and WGEA, powerful international stations of the G. E. Co., in Schenectady, N. Y., have revised their schedules to send a continuous stream of news to Europe, from 10:00 a.m. to 6:00 p.m. six days a week (approximately 3:00 p.m. to 11:00 p.m. in Western Europe and 5:00 p.m. to 1:00 a.m. in Eastern Europe).

The new schedule includes broadcasts by WGEA in seven languages—Swedish, Finnish, Italian, German, French, Portuguese, and Spanish, and by WGEO in Spanish, French, and English. It is now in effect. In addition, WGEO will continue its 15 minutes of news sent out six evenings a week in Czech and its Sunday afternoon broadcasts of news in Greek.

WGEA, which will be beamed to Europe on 15,330 kilocycles (19.56 meters), operates at 50 kilowatts. WGEO, which will broadcast on 9530 kilocycles (31.48 meters), with its license for 100 kilowatts is the most powerful short-wave station in the western hemisphere.

*New Handy* **UNIVERSAL REPLACEMENT Capacitors**

Write for Catalog

**SOLAR MFG. CORP., Bayonne, N. J.**

# BIG BOY

MODEL 860

**Performance . . . Eye Appeal . . . Value . . . Sensationally Priced at \$19.65, Dealer Net Price**

**Readrite RANGER**

Here is an AC-DC Volt-Ohm-Milliammeter with all the ranges you want . . . easily readable on the large 7" instrument with extra-long 6" scale. In a new up-to-the-minute three-tone case. DC Volts 0-10-50-250-500-1000 at 5000 Ohms per volt DC; 1000 ohms per volt AC; AC Volts 0-10-50-250-1000 at 400 ohms per volt; DC Ma. 0-1-10-100; Resistance ranges: 0-1500 Low Ohms; 0-150,000 Ohms and 0-7.5 and 0-15 Megohms. Maroon case with red and silver panel, attached handle.

Dealer Net Price, \$19.65

For Catalog Write—Section 316 College Drive

**READRITE METER WORKS, Bluffton, Ohio**

## GETS DOWN TO BUSINESS

### RCP Test Equipment

*..priced down, too!*

You are just as determined as the next American to put an end to non-essentials for the duration of the emergency. Are you still paying, then, for "non-essentials" in the test equipment you buy . . . paying more for test instruments than you need? Not if you are one of the thousands changing over in these critical times to RCP Test Equipment.

In designing this low-cost line, RCP engineers got right down to business, saving materials for defense . . . saving important money for you. Every essential is in every model in the complete RCP line, engineered ahead to increase your efficiency, enable you to handle more jobs in less time. Only the "frills" have been eliminated! That's why today, more than ever, it pays to specify RCP test equipment—and get what you pay for.

Ask for CATALOG NO. 125 Just Off Press

**RADIO CITY** *RCP dependable TEST instruments*

PRODUCTS COMPANY, INC.

88 PARK PLACE • NEW YORK, N. Y.

### OUR SUPER SPECIAL

**RCP 411**

**Supertester**

Complete \$19.07 only

Here's a tester designed for top efficiency. Equivalent of 33 individual instruments.

\*5 range AC-DC voltmeter scale from 0 to 5,000 volts. \*AC-DC amps from 0 to 25 amps. \*DC milliamps 0 to 100. \*DC microamps 0-200. \*AC milliamps 0-500. \*db meter from -10 to +69 in 5 stages. We carry a complete stock of Radio City Products Test Instruments. Order today for prompt delivery and protection against rising prices. Let us quote you on your radio needs! Ask for free catalog.

**ADSON RADIO CO.**

221 Fulton St., New York, N. Y.

Save money at  
**PUBLIC ADDRESS  
HEADQUARTERS**



**RADOLEK  
Sound Systems  
for Every  
Requirement**

Come to Radolek — Public Address Headquarters — where you get more for your money in Performance, Styling, Dependability and Reserve Power. Radolek Deluxe PA Sound Systems, in 15, 30, 50 and 100 watt sizes, incorporate every desirable feature — multiple input channels, built-in input and mixer controls, AVC, "feedback" tone control circuit, output impedance selection, electronic mixing system — all engineered for plus performance. Models for permanent, portable or mobile use. Wide choice of microphones, speakers and related apparatus.

**Get the Best at Lowest Cost**

Radolek's modern direct policy and volume sales on every amplifier design make it possible for you to get the finest, most modern equipment at rock bottom prices. Thousands of successful Radolek PA installations are proof of quality, dependability and top performance. Send the coupon today for complete information!

**EVERYTHING NEW IN RADIO**

Radolek stocks every replacement part to repair any radio — every type of tube — everything for auto radio installations, transfer and repair.



**FREE!**

**RADOLEK'S  
RADIO SERVICE GUIDE**

Contains hundreds of up-to-the-minute service items, test equipment, sound apparatus, etc. at lowest prices. Indispensable to every serviceman, dealer and sound engineer. Radolek gives you what you want when you need it. Send for your copy of this great new Radolek catalog today!



**Large Stocks - Fast Service**

**SEND TODAY!** PASTE ON A POST CARD

**RADOLEK CO., Dept. C-64  
601 W. Randolph St., Chicago, Ill.**

Please send information on Radolek Public Address Equipment — also the Big Radio Service Guide.

Name \_\_\_\_\_  
Address \_\_\_\_\_

Dealer  Serviceman  Sound Eng.

**Operating Notes**

... ZENITH 6D410  
Complaint: Dead. Trouble sometimes can be traced to a shorted 0.03 mf. by-pass condenser connected from the primary of output transformer to cathode of 35L6G type tube. Replace to make set operative again.

... CROSLLEY 855  
Complaint: Tunable hum. A loud hum when a station is tuned in and which can be eliminated when you slightly off-tune can be traced to a defective 8 mf. electrolytic condenser. This condenser is one of a group of 3 condensers in the same can and is located under the chassis. Replace the whole can of condensers to avoid future trouble and the set will play OK.

... CROSLLEY 635  
Complaint: Whistles. Check the 0.02 mf. condenser located between the screen grid and cathode of the 6A7 tube; replace to stop whistle.

... RCA RC-457  
Complaint: Distortion. Check the 0.01 mf. coupling condenser between plate of 2nd detector and grid of output tube, replace condenser and check output tube, so as to be sure to clear up trouble.

JOHN STEPHENS,  
York, Penna.

... SENTINEL 240-W FARM RADIO SET  
Inoperative. Oscillator dead. One of screws, which mounts tuning condenser to chassis, touching plates of oscillator section. It may be a good idea on sets of this model still to be sold or that come in for other service to note the position of this screw and to replace with shorter screw or use a washer if it is close to touching condenser plates and this is usually the case.

SYLVAN SIGMUND,  
Sigmund Television Service,  
Peruque, Mo.

... PHILCO 1940-41  
Complaint of pushbutton drift off stations on a Philco 1940-41 with permeability tuned oscillator on pushbutton tuning can be corrected by replacing dual 370 mmf. fixed condenser that is placed across the oscillator circuit, with a new Philco part or two silver mica condensers of approximate value.

MARSHALL J. WAGNER,  
Baltimore, Md.

... RCA  
Defective crystals on record-players are usually easily detected by pressing on the side of the tone-arm while playing a record. Press toward, then away from the center of record, noting change in volume. Be sure that the needle is a good steel one when making the above test, as some special needles give a misleading effect.

MARSHALL J. WAGNER,  
Baltimore, Md.

... EMERSON AC-DC 1941  
In cases where a sharp sixty-cycle hum that sounds like an outside interference is heard, the trouble usually disappears when a strong signal is tuned in. Replace 20-20 mf. filter condenser.

MARSHALL J. WAGNER,  
Baltimore, Md.

... GENERAL ELECTRIC HB-403  
Complaint: the set would distort; the resistance of the diode load, the volume control, measured ten megohms. It should have been 1 meg. Replacement was made, and trouble cured.

WILLARD MOODY,  
New York, N. Y.

**DISPOSAL SALE**

**AMPLIFIERS & PARTS**

THIS sale comprises parts used in the construction of Juke-Boxes; made by well known amplifier manufacturers such as: Rauland and Operadio. All equipment is reconditioned and in perfect mechanical and electrical condition.

Photo shows  
30 watt ampl.

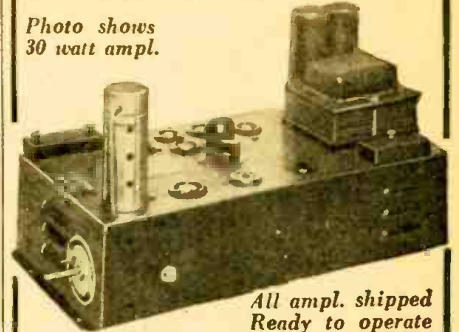

All ampl. shipped  
Ready to operate

**12 WATT PUSH-PULL 2A3 AMPLIFIER**  
Tube complement 2-2A3, 1-56, 1-67 and 1-5Z3. To be used with one or two 2500 ohm dynamic speakers 16 ohm voice coil. May be changed over to use P.M. speakers. Input for magnetic pickup. Variable tone control. Schematic furnished to change unit over to use crystal pickup, crystal microphone and P.M. speakers.  
Shipping Weight 25 lbs. **\$8.75**

**15 WATT PUSH-PULL 6B5 AMPLIFIER**  
Tube complement 2-6B5, 1-6AB, 1-76 and 1-5Z3. To be used with one or two 2500 ohm dynamic speakers 16 ohm voice coil. May be changed over to use P.M. speakers. Input for magnetic pickup. Variable tone control. Schematic furnished to change unit over to use crystal pickup, crystal microphone and P.M. speakers.  
Shipping Weight 22 lbs. **\$9.85**

**30 WATT PUSH-PULL 6L6 AMPLIFIER**  
Tube complement 2-6L6, 1-6AB, 1-6C6, 1-5Z3. amplifier as is, has input for magnetic pickup, volume control, variable tone control. Supplies field current to one or two 2500 ohm dynamic speakers, output impedance 2.6, 3.2, 4, 5.3, 8, and 16 ohms. Full 30 watts output. Schematic furnished to change unit over to use crystal pickup and crystal, dynamic or velocity microphone and change over to use P.M. speakers.  
Shipping Weight 25 lbs. **\$12.05**

All Amplifiers Less Tubes & Speakers.



**JENSEN 10 INCH  
ELECTRO-DYNAMIC  
SPEAKER**  
2500 OHM  
FIELD  
16 OHM  
VOICE-COIL  
EACH **\$2.95**  
Shipping Weight 7 lbs.

**R.C.A. MAGNETIC  
PICK-UP HEAD**  
IMPEDANCE 3000 OHMS  
Ship. weight 1 lb. EACH **\$1.89**



**NATIONALLY ADVERTISED TUBES  
(in sleeves)**

|          |          |          |
|----------|----------|----------|
| 6L6      | 6N7      | 56       |
| 6B5      | 53       | 57       |
| 2A3      | 6A6      | 6C6      |
|          |          | 76       |
|          |          | 5Z3      |
| Each .49 | Each .30 | Each .25 |

Ship. weight ca. 8 oz. Additional tubes 4 oz. ea.

**ORDERS SHIPPED SAME DAY AS RECEIVED.** All goods are sent Express collect if no money for Parcel Post is included in remittance. Customers in Foreign countries are requested to remit in U. S. currency or International Money Orders and include enough money to ship goods prepaid. Order from this ad.

**25% deposit required on all C.O.D. orders.**  
**PEERLESS RADIO  
AND SOUND CORP.**

25 S. JEFFERSON ST., Dept. 342 CHICAGO, ILL.

BOOK REVIEW

**RADIO SERVICING COURSE BOOK**, 5th Edition. (Reprinted in 1941.) Published by Supreme Publications, Chicago, Ill. Size 8 1/4 x 9 3/4 ins., stiff paper covers, illustrated. Price \$2.50.

This book was prepared by the staff of consulting engineers and instructors of the Radio Technical Institute. The subject material has been selected from the latest sources and is up-to-date.

This book is especially adaptable for "home study" use. The material is presented in twenty-two lessons. At the end of each lesson a series of questions are given, in order to enable the reader to test himself on the knowledge he has acquired in the lesson.

Some of the lesson titles are: Elementary Electricity; Radio Batteries; Radio Frequency Inductances; Radio Tubes; Meters—Testing Methods; Elements of Radio Transmission; Photoelectric Cells.

Throughout the book very helpful charts and diagrams are given. The Radio Tubes Characteristics charts and the Reactance and Resistance in Parallel line graphs are especially interesting. Also the "service hints" given on various sets, including Belmont, Crosley, General Electric, Majestic, RCA and many other sets are very helpful to the Serviceman in general.

**MOST-OFTEN-NEEDED SERVICE NOTES ON RECORD PLAYERS, AUTOMATIC CHANGERS, WIRELESS UNITS AND HOME RECORDERS**, compiled by M. N. Beltman (1941). Published by Supreme Publications, Chicago, Ill. Size 8 1/2 x 10 1/2 ins., stiff paper covers, 128 pages.

The first eight pages in this book present general information and apply to all makes. Throughout the book many different units are described, especially automatic record changers and recorders. While these units are listed under one specific manufacturer, they are actually used in combinations of other makes. This is true, since many different manufacturers have used the identical record-changers and recorders.

By becoming familiar with all the data included in this manual, the reader will be able to find the material needed more quickly and will also learn all the important facts dealing with automatic record changers, home-recorders, phono players, and wireless oscillators, so that he will be able to repair the units of similar types not listed in this book.

Some of the companies represented: Wilcox-Gay Corp., Belmont Radio Corp., Detrola Corp., RCA Manufacturing Co., Inc., and many others.

The fact that the book is profusely illustrated makes it easy to follow the instructions given.

**PRACTICAL RADIO MATHEMATICS—A Booklet for Home Study**, by M. N. Beltman. Published by Supreme Publications, Chicago, Ill. Stiff paper covers, size 5 1/2 x 8 3/4 ins., 32 pages.

This book is intended for the general student, Serviceman and others interested in elementary radio mathematics. A table of radio symbols is included and the opening chapters deal with numbers, fractions, decimals, and simple radio formulas.

The Standard Resistor Color chart is given; also examples of how to apply Ohm's Law, how to read graphs, etc. Later chapters deal with series—parallel circuit calculations, inductance of coils, reactance and impedance—and their calculations, amplifiers and calculation of the amplification factors, etc. The closing section deals with service hints, point-to-point testing, the decibel (with a table giving the values of different gains in DB and the power ratio values).

**VOCATIONAL AND PROFESSIONAL MONOGRAPHS—The "Program Side of Radio"**, by George Jennings. Published by Bellman Publishing Company, Inc., Boston, Mass. Paper Covers, size 6 x 9 ins. Soft paper covers, 15 pages. Price 50c.

This interesting monograph was prepared by the Program Director of the Radio Council, Chicago Public Schools, Chicago, Ill. It has been carefully prepared to supply the following authoritative information: Personal qualifications required for engaging in the work; scholastic training needed; complete analysis of employment opportunities; remunerations received; chances for advancement; frank statement of advantages and disadvantages; possibilities for both men and women in the vocation or profession.

**ELECTRONICS**, by Jacob Millman, Ph.D., and Samuel Seely, Ph.D. Cloth covers, size 6 1/2 x 9 1/2 inches, 722 pages. Illustrated. Published by McGraw-Hill Book Co., New York, N. Y.

This volume is intended for the serious student of electronics and assumes that he has a good grounding in mathematics. The general student can learn much from this ambitious work also, as the diagrams and text presented very clearly the action taking place in electronic devices. The first chapter deals with electronic principles.

sources of electrons, diodes, diode rectifiers, photo tubes, triodes, gas diodes, thyratrons and ignitrons.

The motion of charged particles in electric and magnetic fields is discussed and the practical application of this phenomena to such devices as cathode ray tubes, the cyclotron and the magnetron.

Other topics which the engineering student must understand today are the kinetic theory of gases, electrical discharges in gases, how rectifiers work, photo-electricity, triode characteristics, the action occurring in multi-electrode tubes, voltage amplifiers and various types of audio frequency power amplifiers.

This 722 page book is a *must* for the radio student who wishes to know exactly what is going on inside a vacuum tube. The subject matter is the result of class-room experience in teaching radio engineering to students at the College of the City of New York.

**PERPETUAL TROUBLE SHOOTER'S MANUAL**, Vol. XII, by John F. Rider (1941). Published by John F. Rider Publisher, Inc. Hard covers of looseleaf binder 9 x 11 1/2 ins.; pages measure 8 1/4 x 11 ins.; volume is 4 ins. thick, has 1,648 pgs. Price \$10.

The new Vol. XII, "Rider Manual," in addition to being a compilation of servicing data, introduces something new in manual make-up: "Clarified Schematics."

In this new section, involved circuit arrangements in more than 200 receiver schematics are dissected and individually diagrammed for convenient reference. This eliminates the necessity of "buzzing out" a circuit during servicing, to determine the continuity of a circuit not readily visualized in the complete receiver diagram. Time is also saved because individual circuits are available for study, for possible sources of trouble, even though the master diagram shows only one of the possible circuit arrangements (as for example where the master diagram shows switches in position for Band 1 reception, but Clarified Schematics show additional positions of the switches [Band 2, Phono, etc.] )

The master diagrams include not only circuit arrangements but also essential servicing data such as intermediate frequencies, operating voltages, alignment frequencies, coil resistances, ratings of components, dial cable adjustments, etc. The cross-index of Vol. XII, a separate 44-pg. booklet, also covers Vol. XI; the many hundreds of radio receiver models shown by complete schematics in Vol. XII cover sets made since May, 1940, and embrace some export models, communications receivers, electronic music instruments and wireless record players. The intricacies of automatic record changers are illustrated and described in detail.

It is noteworthy that a set of "double-spread" pages, showing large diagrams in double-width, are included. The houseorgan *Successful Servicing* is sent each month to purchasers of Rider Manuals.

**RADIOTELEPHONE PROCEDURE—U. S. AIR CORPS**. This booklet can be obtained for 10 cents (cash, no stamps) from the Superintendent of Documents, Washington, D. C.

Radio students will find this book very interesting as it contains descriptions and diagrams covering such important subjects as weather reports, radio call signs, radio range stations, procedure for communicating with Civil Aeronautic Administration range stations, etc. Some of the valuable data included in the appendix are—symbols of the weather report, chart of wind directions, sample teletype weather reports, standard control tower light signals, phonetic alphabet. The chapter on Range Stations is very interesting and contains special drawings showing the field strength pattern of the two pairs of towers used in radiating the "A" and "N" signals.

**1941 RADIO DIAGRAMS ON SERVICING INFORMATION**. Compiled by M. N. Beltman.

This book, measuring 8 3/4 x 10 3/4 inches, contains 192 diagrams most often needed by the radio service man. The general radio student will find this book valuable for reference and study, as it contains diagrams of the standard popular receivers, all the way from a pocket size set to a large console multi-tube job. A few of the manufacturer's sets covered will give some idea of the wide scope of the volume. We find such names as Admiral, Air King, Allied Radio, Belmont Radio, Crosley, Detrola, Emerson, Zenith, General Electric, Philco, RCA, Sears Roebuck, Westinghouse, Noblitt-Sparks, Packard-Bell, Montgomery Ward, Midwest, Majestic, Hallicrafters, Howard Radio and Lafayette.

GET READY  
FOR A REAL  
RADIO CAREER!

Make 1942 Your Year!

I. C. S. Radio Courses, Studied at Home, Prepare You for Part-time or Full-time Radio Jobs!

During 1942, many thousands of men will achieve success and prosperity in the growing field of radio. *Will you be among them?* You may be—if you get the *sound, practical training* that is essential to success in radio work.

A few hours of your leisure time each day—in the comfort of your own home—may qualify you for big earnings in this rapidly expanding field. And studying an I. C. S. Radio Course is a thrilling adventure in practical science.

Every one of the five I. C. S. Radio Courses includes Frequency Modulation and Television—and is designed to enable you to capitalize on the profit-opportunities which these new developments are opening to *trained men*.

Your Choice of 5 Courses

For those who wish to secure broad, comprehensive training, I. C. S. offers a *General Radio Course* and a *Radio Operating Course*. The *I. C. S. Practical Radio Servicing Course* enables you to begin practice soon after you start studying—many students pay for the course out of *earnings* before it is completed! (Note to Selectees: Radio training is a big advantage in the Army.)

The *Sound Technician's Course* is an advanced course for the service technician. The *Sound-Picture Projectionist's Course* deals with operation, maintenance and repair of sound equipment, such as is used in talking-picture installations.

One of these I. C. S. Radio Courses, or a combination, may fit you for bigger earnings than you ever dreamed possible—and at a cost of only a few dollars monthly! Mail this coupon immediately for full details.

All I. C. S. Courses include FM and TELEVISION



INTERNATIONAL CORRESPONDENCE SCHOOLS

Box 2878-G, Scranton, Penna.

Explain fully about your course in the subject marked X:

- GENERAL RADIO
- RADIO OPERATING
- PRACTICAL RADIO SERVICING
- SOUND TECHNICIAN
- SOUND-PICTURE PROJECTIONIST

Name \_\_\_\_\_ Age \_\_\_\_\_

Address \_\_\_\_\_

City \_\_\_\_\_ State \_\_\_\_\_

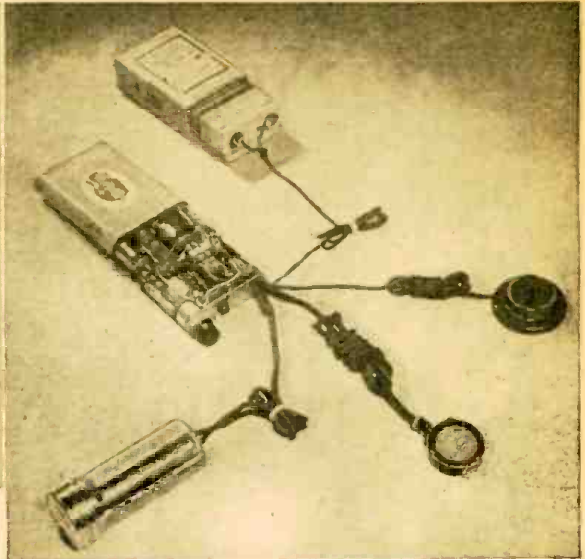
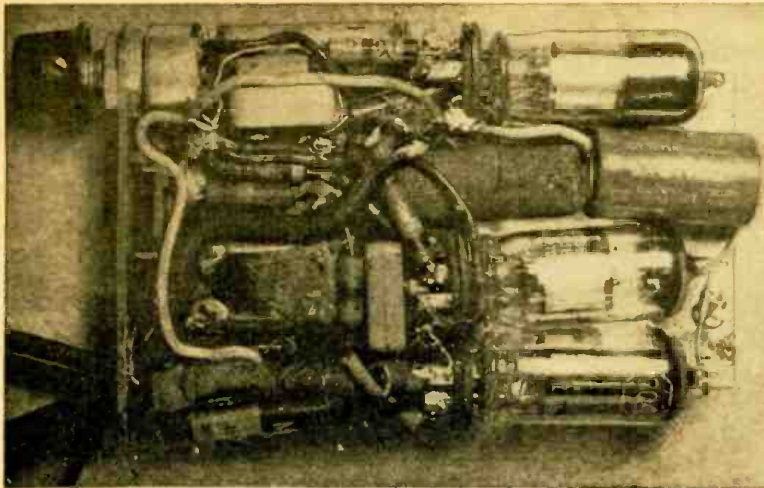

Two photos above show chassis and also exploded view with mike, batteries, etc.

It is difficult to understand why servicemen generally permit such a lucrative field as the hearing-aid business to be monopolized by a few large concerns, unless they are perhaps dazzled by the high-pressure (pseudo?) medical advertising in which some of these concerns excel.

Servicemen's standards of tone quality are generally rather high, and they have difficulty adjusting themselves to the limitations of response set by the size and power of hearing-aids; particularly those to be worn on the person. However, hearing-aids are a necessity, and a lucrative business. Therefore, the serviceman should inform himself of the essential facts of the business, and take his rightful place in this field. These facts are as follows:

(1) An instrument will not restore the easy and quick perception associated with normal hearing and an active mind, so don't be discouraged if a customer doesn't understand everything said to him immediately.

(2) The instruments overload easily, so don't try to demonstrate full power in a noisy place or with radios on loud.

(3) The receivers must be of the best quality, sensitive, and fit the ear absolutely close. Leakage of sound in the phone's rear chambers, such as through the cord entrance, must be sealed with wax to prevent feedback, and loss of quality. If miniature phones are used, an individually molded ear-piece is essential; it must fit the ear and the receiver perfectly—allowing no leakage of sound. Otherwise, all quality is lost, and the high-grade microphone and vacuum tube amplifier are of no great benefit.

Most any dentist can and will insert a greased cotton plug a quarter inch into the ear canal and make a plaster cast of the ear, which can then be sent to S. S. White & Company for a molded earpiece.

(4) A standard circuit, using standard parts—with the usual crystal receiver—will give satisfactory results in practically all cases. A few people, perhaps, have peculiar hearing losses of a short frequency range, rather than the usual extensive loss of either, the high, the low, or perhaps the middle range. These people are likely to be dissatisfied with any hearing aid, whether it is fitted from an audiometer hearing test or not. The usual customer can be satisfied easily by selection of microphone, receiver, and circuit tone adjustment.

(5) In a "pocket type" hearing aid, one thing is of the utmost importance! That is intelligibility. A hearing aid with indistinct and ragged response is a sure business loser and must be avoided. Poor results are almost always due to undesired circuit

feedback, or, to a poor quality or poorly fitting receiver. Intelligibility is not achieved by cutting the lows, but by careful workmanship and perfect tube and circuit performance.

The pocket type hearing-aid, described here, is recommended to the serviceman as being particularly suited to his requirements for easily available, standard parts and tubes; and, has power and quality equal to any such device sold.

#### AMPLIFIER FITS IN TOBACCO TIN

The container is a common, smoking tobacco tin (or its equivalent), which is given a coat of crystallizing lacquer, or flock, when completed. It measures  $\frac{3}{4}$ " thick x 3" wide x  $4\frac{1}{4}$ " long, approximately; a convenient size for personal wear.

The bottom is fastened in by a fold of the metal over the end. This is filed through and the bottom (Fig. 1) is pushed out and is hereafter called the top. The hinged top of the tin is to be the bottom of the hearing aid, and is convenient for inspecting and replacing the tubes without the necessity of opening the entire instrument.

The top will be replaced in the tin—upside down—to make a smoothly rounded top of the instrument (Fig. 2). Inside the top, solder two  $\frac{7}{16}$ " standard machine washers, as shown in Fig. 3, and punch and file the holes. The hole for the switch is  $\frac{1}{4}$ " x  $\frac{1}{2}$ ". At one end the volume control is placed. The cords for the microphone, batteries, and receiver are threaded through the other end hole, and the D. P. S. T. slide switch is soldered in place in the central hole. This switch is too large, and must be trimmed down, as shown, in order to fit into the space allowed. (Fig. 4.)

Cut a piece of thin sheet metal  $2\frac{3}{8}$ " x  $4\frac{3}{8}$ " and solder on the top along the side for a base for the parts and sockets. (Fig. 5.)

Take the wafer sockets and remove the excess material as shown in Fig. 6.

The sockets are mounted by soldering their filament minus prong tab directly to the chassis. Two and one half inches from top of tin to bottom of glass base of tube.

Mount the insulated binding strip one inch from the side as shown in Fig. 7.

The exact position of each item may be determined from Fig. 7. Keep grid and plate leads separated as far as possible—particularly, those belonging to separate tubes. Use spaghetti tubing and thin fibre insulation in tight spots.

The output transformer or choke should be mounted with the iron core parallel to the base plate. The transformer shown, is one I bought to match a miniature receiver, taken from an old carbon hearing-aid. The receivers on these old instruments are fairly good, even when the rest of the old instrument is plain junk. Ten ohms output winding on the transformer will match practically any of them; with the exception of one make, which requires a higher impedance of 200 ohms.

For all crystal phones, including the miniature, the output chokes listed should be used.

If desired, one can make room for a tone control in this hearing-aid by using a "Half and Half" telescoping tobacco tin, and expanding the two halves enough to make room for the other control. In this case, the cords are brought in through small holes drilled in the top wherever possible. This control would be  $\frac{1}{2}$  megohm, wired in series with the crystal receiver.

Considerable variation of tone may be had by selecting the proper choke, and by the usual tone control methods of series resistor and shunting condensers.

If the user does not require the maximum volume of the instrument, the inverse feedback arrangement is very satisfactory.

Figure 8 shows how to adapt a cheap two-cell flashlight case to use one cell from a Burgess 4 FH 1.5 volt battery. These cells, of which there are four in each battery, make an inexpensive and durable "A" supply.

The writer has had the personal experience of being utterly unable to reconcile his hearing needs with any audiometer chart. My hearing test chart shows extensive loss of high frequencies; yet, any attempt to emphasize the highs, and thus

(Continued on page 434)

## A "TOBACCO TIN" HEARING AID

S. B. SIMER

# A New Type of Service Manual!

## RADIO CIRCUIT MANUAL — 1941

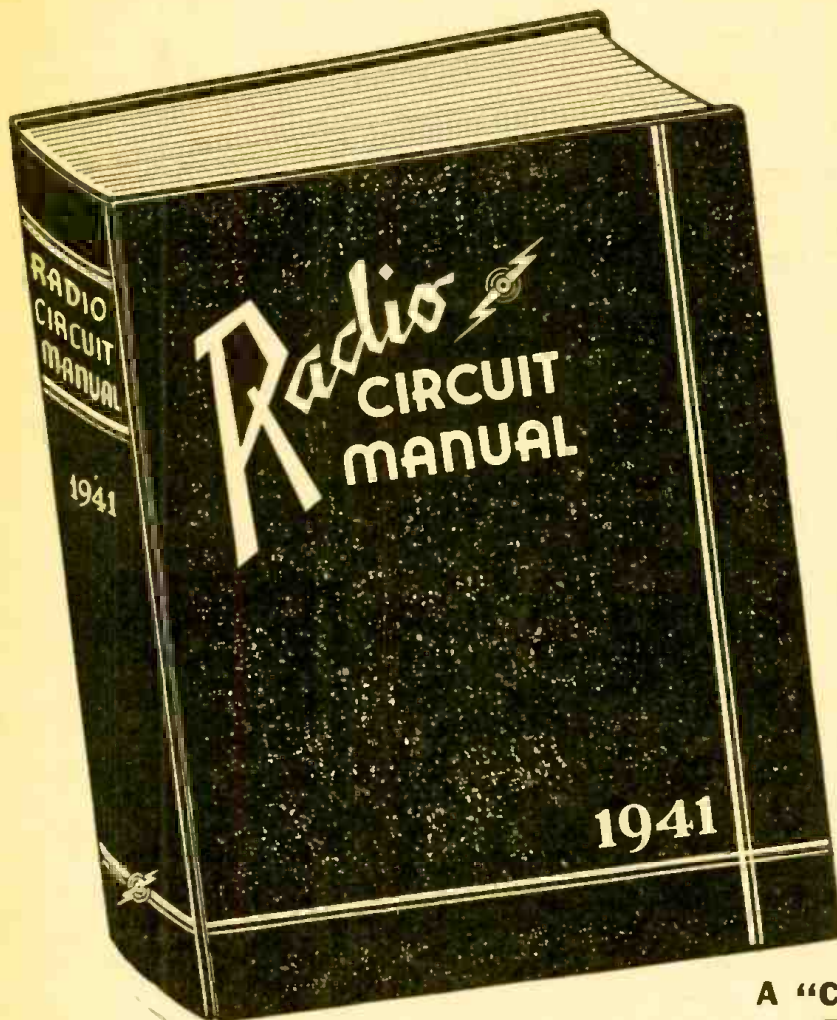

**The Only EDITED Manual  
Ever Published!**

**DIRECTORY OF RECEIVERS MANUFACTURED IN 1940 AND UP TO JUNE, 1941**

### MORE INFORMATION IN HALF THE NUMBER OF PAGES

The value of a service manual is measured not by the number of pages but by the amount of useful information. Thus, in only 736 pages this Radio Circuit Manual covers over 200 receiver models MORE than does any other competitive manual in twice the number of pages.

HOW DID WE DO IT? . . .

. . . By increasing the size of our page; by discarding non-essential data and editing the balance; by listing only those receivers which the Service Engineer will definitely have to repair (no communications or export receivers, no shortwave sets or amplifiers, no electronic devices, etc.); by many months of hard work based on a definite plan of procedure and a clear understanding of the actual requirements of the Service Engineer. There is no "dead weight" information to add bulk to this Manual. Every word counts. Every minute of reading time is well spent.

### OUTSTANDING FEATURES

- Contains data on more than 1800 receiver models!—more than any other radio service manual.
- Only 736 pages!—less than half the bulk of any other manual and more than 1/3 lighter.
- All information is EDITED!—all non-essential data deleted and the balance checked and correlated with the schematics and sketches.
- 40% larger page permits listing of all information on one page. (A few unavoidable cases excepted.)
- I.F. peaks for all superhet circuits are boldly displayed in black boxes;—none missing, all accurate.
- No space wasted on communications and export receivers, amplifiers, electronic musical instruments, etc.—a 100% Service Engineer's Manual.

### A "CUSTOM-TAILORED" MANUAL FOR SERVICE ENGINEERS

Here, at last, is a Service Manual deliberately PLANNED for the Service Engineer. Instead of a mere hodge-podge collection of service data, as manuals have been in the past, this RADIO CIRCUIT MANUAL is an orderly compilation of essential radio diagrams and service information, carefully edited and uniformly presented for the maximum convenience of the busy Service Engineer. All time-consuming, non-essential data have been weeded out, and the remaining information, vitally important to the rapid and efficient servicing of modern radio receivers, has been laid out in a logical, easy-reading style which cuts time from the day's work. Because of this and other features which are self-evident upon first observation, it has been possible to list all information pertaining to a given model on a single page.

In 736 pages this Manual presents essential service data on over 1800 receiver models;—more than any other existing service manual on the market!

### ONLY ONE MANUAL PER YEAR!

The new technique used in compiling this RADIO CIRCUIT MANUAL—1941 makes it possible to include in a single book all the new receiver models which the radio industry can produce in a single year. This factor alone represents an important saving to all Service Engineers.

### A PERMANENT INSTITUTION

This Radio Circuit Manual—1941 is NOT a one-time proposition. Next year there will be a Radio Circuit Manual—1942, the following year, 1943 and so on indefinitely—each Manual better than the other as new methods are worked out for expediting and simplifying the work of the practicing Service Engineer.

← THE OLD TYPE MANUALS—Bulky, heavy, hard to handle, space consuming, less USEFUL data despite greater number of pages.



OUR NEW MANUAL—Lighter, compact, easy to handle, takes half as much room on the shelf, more USEFUL information despite fewer number of pages. →

### MANUALS NOW READY!

RADCRAFT PUBLICATIONS, INC.,  
25 West Broadway, New York, N. Y.

Gentlemen: Enclosed find my remittance of \$10.00, for which send me, POSTPAID, my copy of the RADIO CIRCUIT MANUAL—1941.

Name .....

Address .....

City .....

State .....

RC-3-42

(Send remittance in form of check or money order; register your letter if you send cash.)

### ORDER YOUR MANUAL IMMEDIATELY — NOW!

Get your copy directly from us by filling out and mailing the convenient coupon shown at left, or get it directly from your favorite distributor.

736 pages; size 13 3/4 x 10 1/4 x 2 in. thick; loose leaf, leatheroid-covered stiff binder; net weight 6 1/2 lbs.

ONLY  
**1000**

**RADCRAFT PUBLICATIONS, INC.**  
**25 WEST BROADWAY NEW YORK, N. Y.**

RADIO-CRAFT for MARCH, 1942

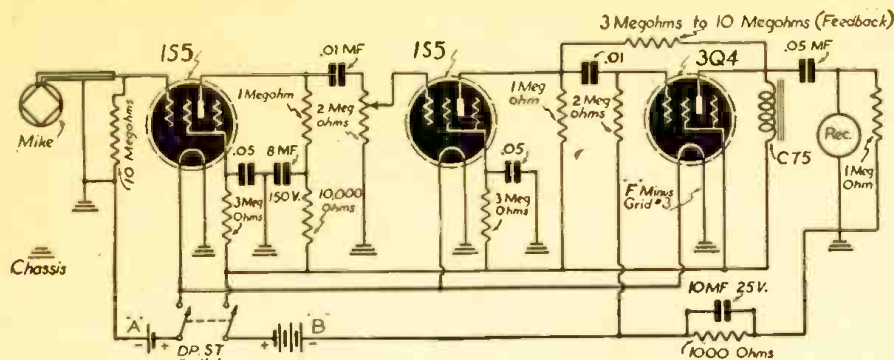

Bottom end of tin  
File thru  
Drill for V.C. - Sw.  
and cords. See Fig 3

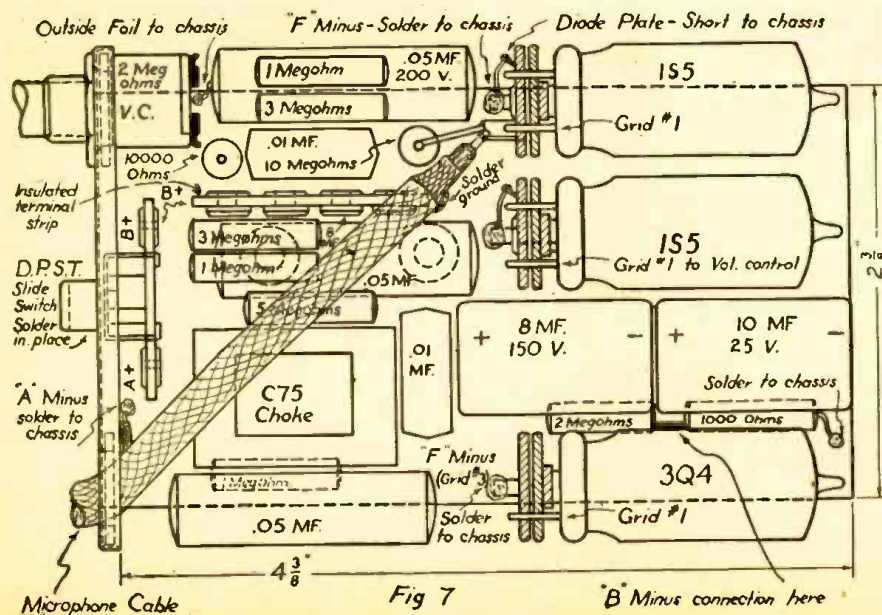
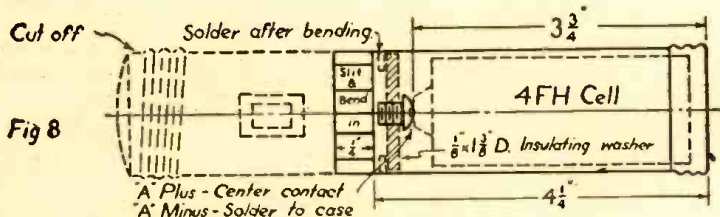
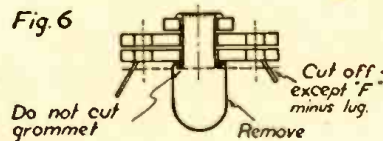
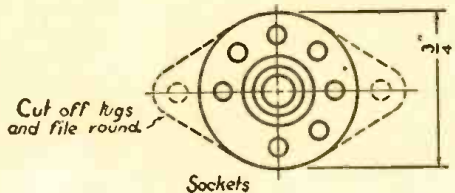
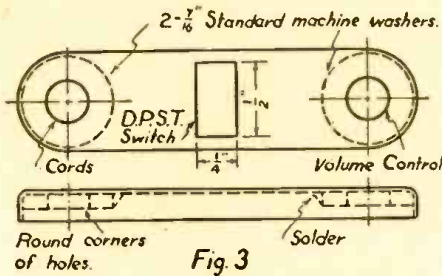
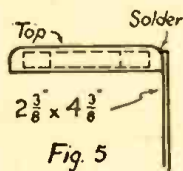
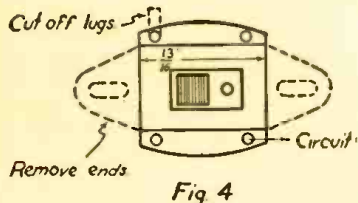
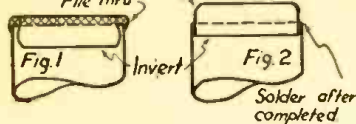

Diagram of the amplifier together with microphone, and details of construction are shown.

(according to audiometer theory for fitting hearing-aids) replacing the loss, invariably caused me dissatisfaction and no noticeable increase in intelligibility. The high pitched sounds, even though made very loud, do not seem clear, and cause me annoyance by interfering with the lows, which I do understand. Therefore, in my opinion, if a serviceman adjusts the tone of an instrument to make it agreeable and comfortable for the user, he is doing all any one can do for the user.

**HOW TO FIND CUSTOMERS' NEEDS**

The best way to learn the requirements of a prospective customer is to have a couple of sets made up, with tone control, to be used by the customer for a day or two. If the customer wants a set with tone control—very well—it adds a profit for you, but it won't be used much after the first month.

The writer has noted with great interest the recent growing propaganda for licensing of hearing-aid dealers; the argument being that special knowledge and skill is required to fit a user with a proper hearing-aid.

This argument is not convincing to anyone who takes the trouble to ascertain the facts. First, the tone deficiency, if any, is corrected by the tone control and circuit. Second, the air conduction versus bone conduction argument may be settled by supplying both types of receivers, and permitting the return of the one not desired. Third, it is not the province of either the licensed hearing-aid dealer, or the radio serviceman, to pretend that he is able to decide if a particular person should or should not use a hearing-aid, and particularly one incorporating the miniature type air conduction receiver, with the accompanying earpiece. In short—find out if the doctor says the ear canal may safely be plugged by the earpiece.

No large line-operated hearing-aid should be supplied with more power output than two type 6C5 tubes in push-pull, unless an automatic volume control is used.

Briefly, hearing-aids represent a nice business, and price competition is not desired by anyone but the hearing-aid user; licensing would be a neat way to shut out the radio serviceman.

The Astatic Model 218 is a good choice when the customer is extremely hard of hearing, or for bone-conduction sets.

**Parts List**

**RESISTORS**

- One—I.R.C., 1/2-W., 10 megs.
- One—I.R.C., 1/2-W., 5 megs. (for feedback, if desired)
- Two—I.R.C., 1/2-W., 3 megs.
- One—I.R.C., 1/2-W., 2 megs.
- Three—I.R.C., 1/2-W., 1 meg.
- One I.R.C., 1/2-W., 10,000 ohm.
- One I.R.C., 1/2-W., 1,000 ohm.

**CONDENSERS**

- Three Cornell-Dubilier, .05 mf., 200 V., paper;
- Two Aerovox, .01 mf., 200 V. "Postage Stamp" size mica condenser.

**MISCELLANEOUS**

- One—"Pipe Tobacco" tin.
- One—Astatic Microphone Co., Model L-1 (Crystal) Microphone. (with three-foot cord) or Model 218 for bone conduction instruments.
- Optional—Shure Bros. No. 76-B Lapel Mike.
- One—Brush Development Co., A or B Crystal Headphone.
- One—Stancor Hearing-Aid Chokes (Five Part Numbers available for Various Tubes and Tone Response, Nos. C65, C66, C67, C75).
- One—Central Lab. Vol. Control, "Eli," 2 megs.
- One—Insuline Corp. of America, D.P.S.T. Slide Switch.
- One—2-Cell Flashlight Case.
- One—4 FH 1.5 Volt Dry Battery (contains four cells)
- One—Eveready Hearing-Aid Battery No. 455 and connectors, 45 Volt.
- One—Cornish Wire Co., 20 ft. Replacement Antenna Lead Wire (for A & B battery leads).
- Two—RCA Radiotrons, 155.
- One—RCA Radiotron, 3Q4.
- One—Cornell-Dubilier "Beaver" Dry Electrolytic, Capacity 8 mf., 150 Volts.
- One—Cornell-Dubilier "Beaver" 10 mf., 25 Volts.



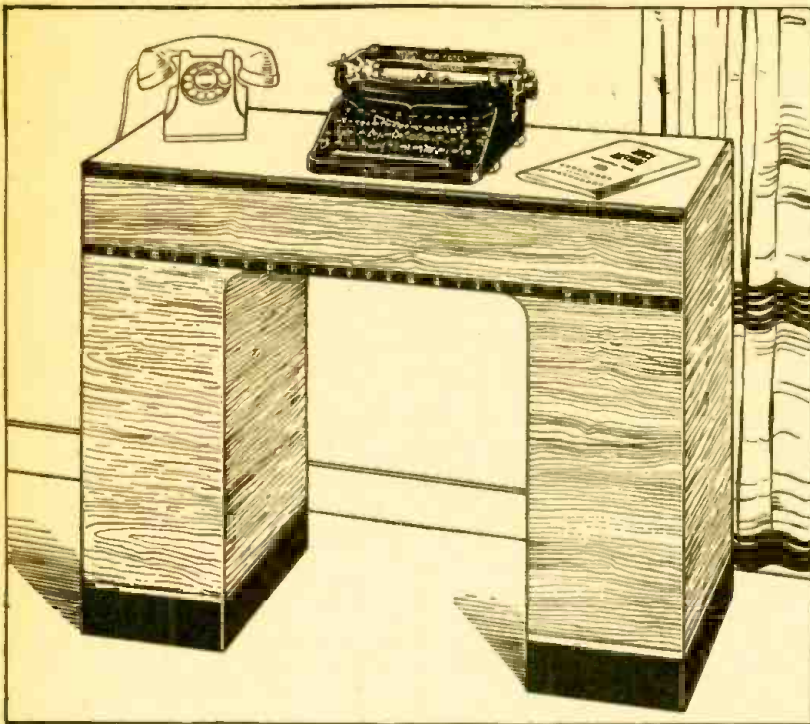

**THIS  
BEAUTIFUL DESK**  
for only \$1.00 EXTRA

WITH ANY  
**REMINGTON**  
PORTABLE TYPEWRITER

A beautiful desk of handsome Walnut grain, finished with rich Burgundy top which will fit into the decorations of any home, and made of sturdy fiber board, is now available for only one dollar (\$1.00) extra to purchasers of a Remington Portable Typewriter. The desk is so light a child can move it, so strong it will hold six hundred (600) pounds! What a combination this desk and a Remington Portable Typewriter make—a miniature office in your home! Learn complete details of this offer. Mail the coupon today!

## Remington's Amazing Combination Offer

How easy it is to get this combination of a desk and Remington Deluxe Noiseless Portable Typewriter. Just imagine, a small deposit and the balance on Remington's easy 10 pay plan. This will actually make you immediately the possessor of this amazing office-at-home combination. You assume no obligations by sending the coupon.

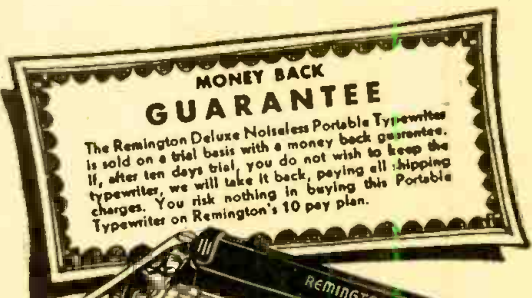

### THESE TWO EXTRAS FOR YOU

#### LEARN TYPING FREE

To help you even further, you get free with this special offer a 44-page booklet, prepared by experts, to teach you quickly how to typewrite by the touch method. When you buy a Noiseless you get this free Remington Rand gift that increases the pleasure of using your Remington Deluxe Noiseless Portable. Remember, the touch typing book is sent free while this offer holds.

#### SPECIAL CARRYING CASE

The Remington Deluxe Noiseless Portable is light in weight, easily carried about. With this offer Remington supplies a sturdy, beautiful carrying case which rivals in beauty and utility the most attractive luggage you can buy.



### SPECIFICATIONS

ALL ESSENTIAL FEATURES of large standard office machines appear in the Noiseless Portable—standard 4-row keyboard; back spacer; margin stops and margin release; double shift key and shift lock; two color ribbon and automatic ribbon reverse; tabulator; variable line spacer; paper fingers; makes as many as seven carbons; takes paper 9.5" wide; writes lines 8.2" wide. There are also extra features like the card writing attachment, black key cards and white letters, touch regulator, rubber cushioned feet. These make typing on a Remington Deluxe Noiseless Portable a distinct pleasure. Thousands of families now using the Remington Deluxe Noiseless Portable know from experience how wonderful it is!

**MAIL  
COUPON  
NOW!**

Remington Rand Inc., Dept. 189-1  
Buffalo, N. Y.

Tell me, without obligation, how to get a free Trial of a new Remington Deluxe Noiseless Portable, including Carrying Case and Free 44-page Touch Method Instruction Book. Also about your 10 pay plan. Send Catalog.

Name.....  
Address.....  
City..... State.....

# The PENETRON

*Windows that whisper, walls that talk, floors that carry music, tables in night clubs that greet distinguished guests, pianos reproducing radio programs and regular disc records, automobiles that talk—are but some of the practical applications of this new sound instrument.*

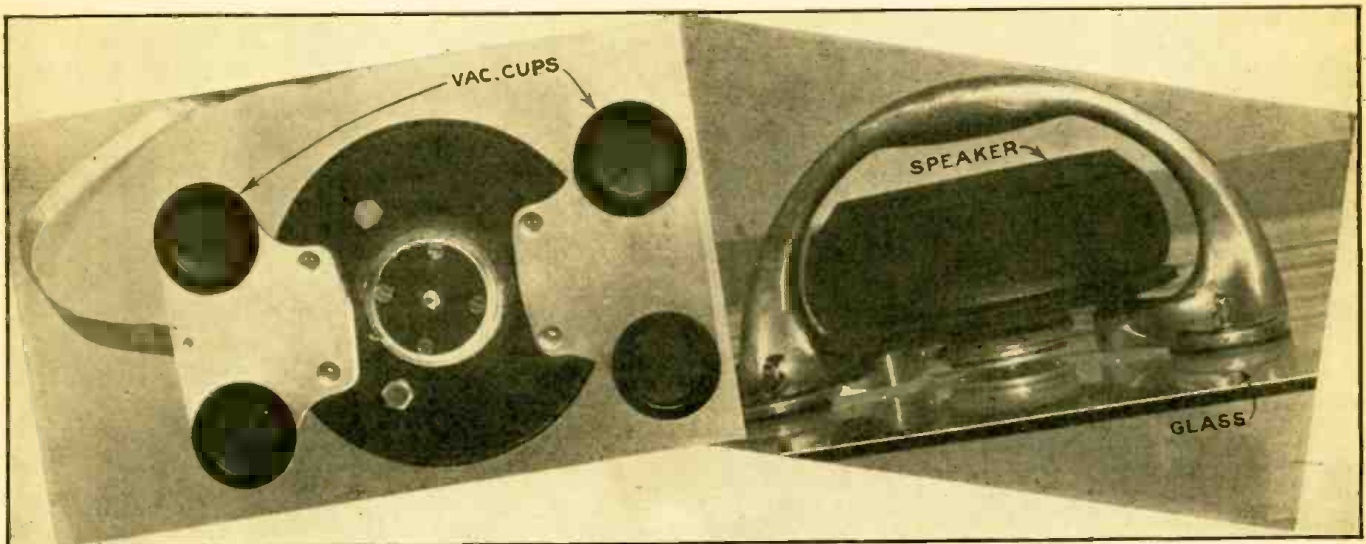

Photos above show front and side views of the Penetron sound reproducing instrument; it is held to the glass of a store window by vacuum cups as indicated. Photo below—How easy it is to place the Penetron into a new Location—the rubber vacuum cups lock it in position.

**A** NEW and revolutionary sound reproduction instrument has recently been invented by Glen Holland, an industrial designer of Bronxville, New York.

Mr. Holland has named it the *Penetron*. It is made in two styles, dynamic and PM. It embodies all of the conventional features of either kind of loudspeaker except that it incorporates a patented *voice-coil and stylus assembly*. When this stylus is pressed against any hard surface such as glass, wood, steel, concrete, etc., it transmits to such surface all of the vibrations emanating from the voice-coil. The latter is actuated from any of the conventional sources—radio, amplifier, electric record-player, etc. The Penetrons range in size from the largest, which is used in window displays and measures about 12 inches by 7 inches by 5 inches high, to the one used on your piano at home, which measures about 5 inches in diameter and 3 inches high.

**Window Displays:** The most spectacular installation of the Penetron to date in window display, was made in Franklin Simon's on Fifth Avenue in New York. The display consisted of pastel-dyed baby chicks and a microphone was placed in the brooder to pick up the chirping of the chicks. The Penetron was held against the inside of the display window by means of small rubber vacuum cups and carried the sound to the crowd outside. The special feature of this is that the sound may be kept at a very low level, so that it is heard only three or four feet away from the window, but along the entire length of the window. When a sign is placed over the Penetron on the outside of the window, there is no apparent source of sound emanation. It was not necessary to secure a license to use sound since



it did not disturb the neighbors across the street or next door. The same store expects to use it again in connection with a holiday display and this time sound will consist of a woman's voice in a whisper, reminding the passers-by of the event.

The Penetron in this application lends itself to many uses not possible heretofore with the regular public address systems. For instance, in a display of beach clothes there could be the sound effects of waves breaking on the beach and the water receding; a dude ranch display with the sound of horses neighing and whinnying; a camping scene with the sound of bird calls, crickets, frogs, etc. It gives show window displays a new dimension of sound atmosphere. The nuisance element of the regular public address system in such applications is eliminated; also the cost of

installation and the inconvenience. No special tools or ability is necessary to install it. Simply press it against the window, run the ribbon (concealing the wires) back to the display or background (and thence to the amplifier), adjust the volume and collect your check. It's as simple as that.

Mr. Holland has found that the best, and in the end, the least expensive source of sound for this application of the Penetron, is a sound track on regular 16 mm. safety film. He also has a machine which is rented either with or without the Penetron, which will pick up the sound to film; it is entirely automatic. The film used in the machine is spliced together at the ends, making it endless and it can be made to operate any kind of animated display, flash lights, operate continuously, intermittently or at predetermined intervals.

**Home Use:** This developed from Mr. Holland's meeting Rubinfoff, the popular violinist, on Broadway recently. Rubinfoff was listening to the playback of some recordings he had made of piano accompaniment for his violin. Mr. Holland volunteered to let him hear how they would sound on an actual piano. By simply placing the Penetron (small size) on the sounding board of a piano and playing the recordings (disc) through the regular record player and amplifier, it reproduced them almost as if Rubinfoff himself were playing them.

For music from popular or classical records it is unequalled. Technically it will entail cutting out the speaker of the existing radio or record player through an adequate amplifier and providing a lead to the Penetron in the piano, but this is a comparatively inexpensive job—but nonetheless a job for radio dealers and repairmen.

**Tables in Night Clubs:** Although no ac-

tual installations of this have as yet been made by Mr. Holland, a few demonstrations have been made and a contract with one night club seems a certainty. The Penetron in this application may be either the dynamic or PM type, the latter is preferable, and the instrument is attached to the underside of the table. It is not necessary that every table in the restaurant or night club have a speaker attached, since the sound emanating from one will be sufficient to carry to those immediately surrounding. But, used in place of the conventional public address system, it is most effective. All the speaker units are connected through the amplifier to the microphone on the stage or band-stand. The master of ceremonies and the orchestra, soloists or other performers use it. Certain of the tables are reserved for special guests, and as they come in and are seated, the M. C. greets them through their own table. You can imagine the rush on the part of John Q. Public to get one of the chosen tables! The real advantage, aside from the showmanship described, is that the fidelity of sound is noticeably better and is obtained through most of the P.A. systems in night clubs; the level of sound can be much lower, which makes it much more comfortable and less annoying to the guests.

**Talking Automobiles:** Mr. Holland is negotiating at present with one of the large distributors of gasoline for use of the Penetron in filling stations. In this application it would carry a sales message on film and the speaker would be placed on the roof of the car as it comes to a stop before the gas pump. As the tank is being filled the customer in the car would hear the story about the new oil, or tires, etc. The entire inside of the car would carry the message, but it would be barely audible outside. As the car drove away the speaker unit would

slip off the roof and is ready for the next customer.

Naturally it follows that the Penetron in this application is a natural for use in "drive-in" movies. Heretofore one had to try to catch the sound accompanying the picture from a loudspeaker placed somewhere in the lot. On a cool evening it became quite uncomfortable before the program finished because it was necessary to leave the windows down in order to hear the sound. With this device you simply drive in, pay your admission, the attendant places a speaker unit on the roof of your car (rumble seat, if it is an open car) and you enjoy the picture with the windows open or shut!

**Other Applications:** Tests have proven the following applications of the Penetron, but Mr. Holland believes further experimentation is desirable before they are included in the repertoire of remarkable effects that may be achieved. On numerous occasions during a demonstration of the Penetron, the inventor has whispered into a microphone and the device has carried it with high fidelity through four and six inch hollow tile walls, and, amazing as it might seem, through eight inches of reinforced concrete. The applications indicated from this would be for its use in churches, theatres, auditoriums, etc., where present sound facilities are not giving the best results.

In auditoriums with poor acoustic qualities a number of Penetrans, Mr. Holland believes, installed in the floor and walls would carry the sound to every point with equal clarity, volume and fidelity and without echoes. This also indicates the use of the new system for annunciator systems in large industrial plants and factories, where they now use a bell or other calling system, which operates only when the person paged happens to hear his number or name called.

Pictures below show the limited range of the average loudspeaker used for show window attraction purposes, and by comparison, how all of the people standing in front of a store window hear the voice or music as reproduced through the vibration of the glass.

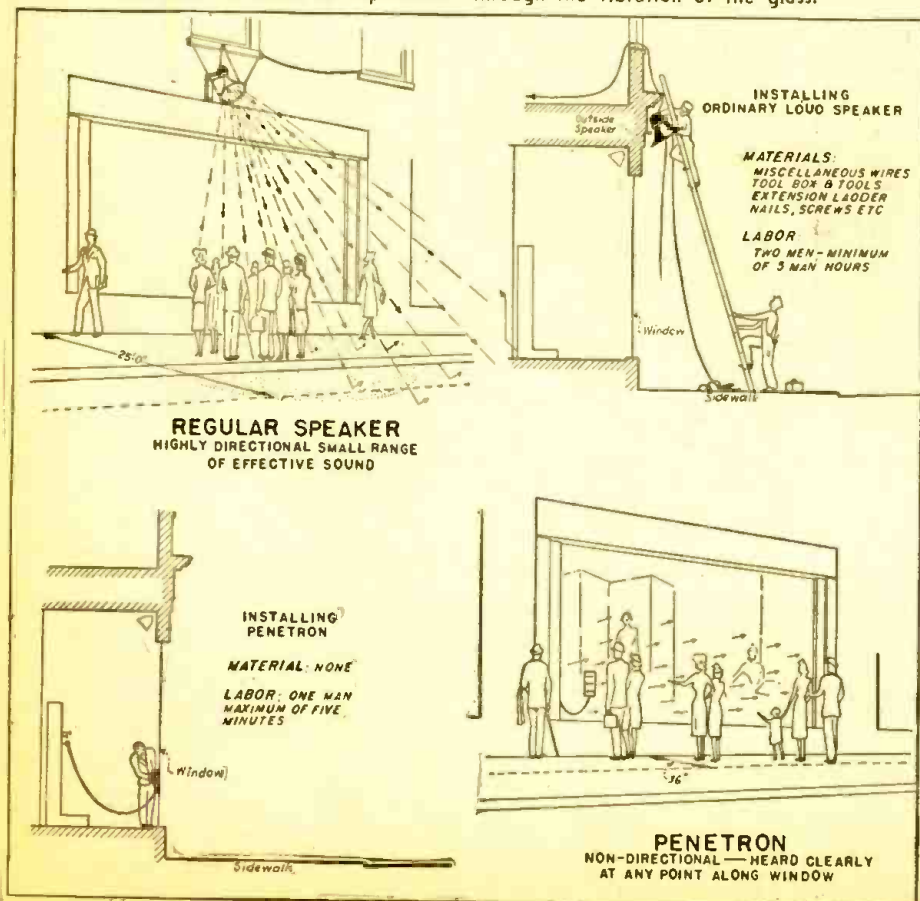

# INTRODUCING SYLVANIA SERVICEMAN SERVICE

by  
**FRANK FAX**



**Y**OU probably wonder who I am, writing you under that handle above. Well, I'm a Sylvania engineer assigned to the one task of helping you all I can with your problems and your selling.

I've quite a staff to help me, too — backed by the Sylvania engineering and promotion departments in full force.

Our purpose is to give you a SERVICE-MAN SERVICE, the like of which the radio business has never seen.

Yes, a personal service for you individual radio experts — all set to answer any technical questions you send me, and to supply whatever promotion helps your own business needs.

What's it to us? Just this: the more we can help you do a better job, the more business you'll get and the more Sylvania tubes you'll need.

So come on with those questions that have been puzzling you. Send 'em to me today, and see how this new SYLVANIA SERVICEMAN SERVICE can help you in a big way. Address your queries to me personally: Frank Fax, Hygrade Sylvania Corporation, Emporium, Pa.

Our advice, of course, is absolutely FREE. So are some of the sales helps we can supply you — with all others available at substantial savings to you. Just take a look at the typical "helps" listed below:

1. Window displays, dummy tube cartons, timely window streamers, etc.
2. Counter displays
3. Electric clock signs
4. Electric window signs
5. Outdoor metal signs
6. Window cards
7. Personalized postal cards
8. Imprinted match books
9. Imprinted tube stickers
10. Business cards
11. Doorknob hangers
12. Newspaper mats
13. Store stationery
14. Billheads
15. Service hints booklets
16. Technical manual
17. Tube base charts
18. Price cards
19. Sylvania News
20. Characteristics sheets
21. Interchangeable tube charts
22. Tube complement books
23. Floor model cabinet
24. Large and small service carrying kits
25. Customer card index files
26. Service garments
27. 3-in-1 business forms
28. Job record cards (with customer receipt)

# SYLVANIA

# • LATEST RADIO APPARATUS •

## TRANSCASTER

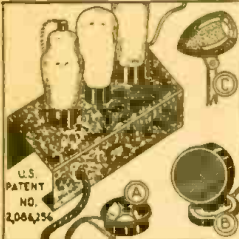

**WIRELESS!** Hundreds of practical applications. Will broadcast voice or music from any room or floor in home, office or store in a building **WITHOUT CONNECTING WIRES!** Operate from any lighting socket. Transmit your favorite recordings thru any radio without connections between radio and phonograph. Your radio becomes a public address or inter-communication system with a Transcaster.

Home broadcasting without wires. Great fun for parties, auditions. Use as a detective device to listen to secret conversations. A few other uses include wireless nursemaid, pipe line tracer, mind reader, trick ventriloquist, bingo announcer, talking dog, etc. Impossible to enumerate many other uses in this limited space. Transcasters are completely wired, laboratory tested and ready to use. All fully guaranteed as to materials and workmanship and also against damage in transit.

### DE LUXE MODEL TRANSCASTER-TRANSMITTER

Powerful, high-gain device engineered so that it will transmit high-fidelity music without connection wires to remote radio set. No sacrifice of quality or power. Operates from 110 v. a.c. or d.c. Frequency range 1500 to 1750 kc. Price (less tubes and mike) **\$4.95**

Set of 3 Matched Tubes for Deluxe Model **\$1.95**

**SPECIAL 5-TUBE TRANSCASTER** This ultra-compact device has been engineered especially for advanced experimental and professional uses. Employs two extremely high-gain pre-amplifier stages ahead of the audio modulated oscillator. When used with crystal microphone it will pick up and transmit a whisper with mike concealed anywhere in room. Suitable for special police work, for use with recorders, etc. Price, complete with 5 tubes, ready to plug into any a.c. or d.c. outlet (less mike) **\$15.00**

**TRANSCASTER ACCESSORIES** Dynamic Microphone (Fig. B) \$2.95, \$25 List Wide Range Response Crystal Mike (Fig. C) \$5.95 High Impedance Crystal Pickup \$4.45; Earphone Mike (Fig. A) \$1.25.

### TELEJECTOR

#### RADIO'S MOST AMAZING ACCESSORY

Picks up telephone conversations without tapping wires. Merely place device near telephone instrument or wire to listen to both sides of any telephone conversation through the loud speaker of your radio. Works from any a.c. or d.c. outlet. Complete with tubes, ready to use **\$7.90**

**H. G. CISIN, Chief Engineer**  
**ALLIED ENGINEERING INSTITUTE**  
91 Warren St., Dept. 81, New York, N. Y.

## NEW "SELF-SOLDERING" UNITS

Jigger, Inc.

215 West Illinois St., Chicago, Ill.



• A NEW product, Jiggers, should have great appeal to all electricians, electrical service and maintenance men, contractors and manufacturers of electrical products. Each jigger is a small, self-contained soldering unit that contains just the correct amount of 50-50 solder and flux hermetically sealed within a waterproof heat-generating outer shell. To obtain a strong, perfectly soldered electrical connection, it is only necessary to push the wire splice into the unit and touch a lighted match to it. The shell ignites and produces the proper temperature to flow the solder into the splice. The burnt shell is then dropped off and a smooth, perfectly soldered splice is revealed.—Radio-Craft

## QUICK FUSE-CHANGER

Littlefuse, Inc.

4797 Ravenswood Ave., Chicago, Ill.

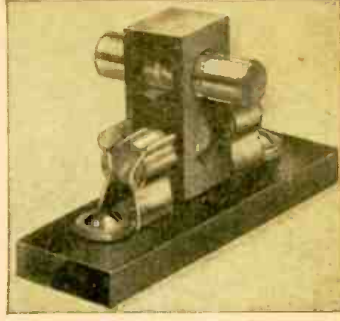

• AN entirely new convenience for changing fuses in close quarters—replacing a blown fuse in a twinkling—and giving notice on inspection that another spare is required, are features compactly embodied in a Spare Fuse Holder and Puller combined, just announced by Littlefuse, Incorporated.

The fuse in circuit goes through one end of the soft rubber rectangular Littlefuse Holder, between the clips. Above, and at right-angle, is an opening in the holder for the spare fuse. When inserted, the caps of the spare fuse project beyond the holder, affording an easy grip for two fingers.

When the fuse in circuit blows, all the operator has to do is to pull and reverse the holder.

One end of the holder and puller is painted red. Until a fuse change is necessary, the red end is underneath, out of sight. When a reverse is made, putting the spare fuse in circuit, the red end is brought into full view on top. To an inspector or service man this red signal instantly indicates that a fuse has blown and that another spare is required. If the end is black and both the fuse in circuit and the spare are still serviceable. Fuses are easily removed and replaced.

"Windows" in the spare fuse holder and puller keep the elements of both fuses in view at all times.—Radio-Craft

## HAMMER FINISH KIT

General Cement Mfg. Co.

919 Taylor Ave., Rockford, Ill.



• THE ACCOMPANYING illustration shows an interesting new Hammer Finish Kit which includes a can of cement and a bottle of hammer finish spray, with a special nozzle for spraying the liquid onto the treated surface. This finish is desired by many radio set-builders and experimenters in general, and no doubt they will be greatly pleased to learn that such a kit is available on the market.—Radio-Craft

## OIL-FILLED PLUG-IN CAPACITORS

Aerovox Corporation  
New Bedford, Mass.

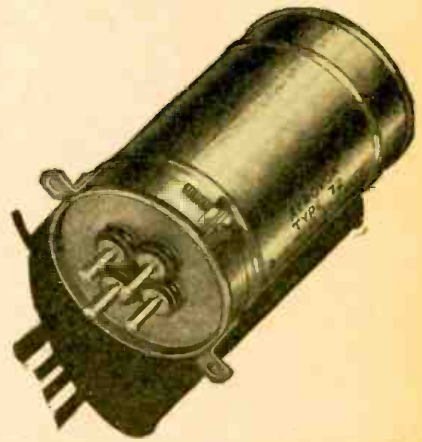

• IN STEP with the growing popularity of the plug-in capacitor technique, already widely used in the electrolytic and wax-filled paper types, the Aerovox Corporation of New Bedford, Mass., announces a new Series -72 oil-impregnated oil-filled capacitor with four-pin base that fits into a standard UX socket, as distinguished from the octal base of other plug-ins.

The aluminum-sprayed tin-plate round can comes in 2, 2½ and 3 inch diameter sizes, and from 2½ to 4¼ inch high. It is provided with a mounting ring with lugs, so as to be held securely in place and in accordance with Underwriters requirements. These oil-filled plug-ins are available in single-section units up to 16 mfd., and up to 4-4-4 mfd. in multiple-section units, in both the 400 and 600 v. D.C.W. ratings.—Radio-Craft

## 30-WATT "JIFFY" SYSTEM

Allied Radio Corporation

833 West Jackson Blvd., Chicago, Ill.



• HERE'S the answer to those rush PA jobs—to those difficult speaker installations. The KNIGHT 30-watt "Jiffy" can be set up in no time. Sturdily constructed speaker cases easily mount on the two ingenious fold-down speaker tripod stands, which may be placed wherever you desire. The stands can be extended from 46 to 78 inches and are provided with adjustable swivels.

The complete system includes: 1 30-watt Amplifier with Phono Top and Tubes; two 12-inch Dynamic Speakers; 1—"Unplex" low-feedback mike; 1—taken-down stand; compact portable case (22½" x 19½" x 15" closed); and 2—tripod speaker stands. All necessary cables and instructions for maximum results are included. For 110 volts, 60 cycles A.C.—Radio-Craft

**The Book that takes Drudgery out of Mathematics**

Only **50¢** postpaid

**SOLVES EVERYDAY PROBLEMS—HELPS YOU GET AHEAD IN LIFE**

How many times have you lost money because of a mistake in figuring? Do you know how to figure quickly and correctly? Can you figure discounts, interest rates, taxes and all the other calculations you meet up with in your daily life?

Are you having trouble qualifying for Army or Navy promotion because you're not up on mathematics?

Here is the book that gives you a good background in mathematics; that takes all the irritation and drudgery out of it. You don't need to be scared of mathematics, because here's the subject explained without frills, without useless computations.

Here's the book for men in the armed forces; for business men; technicians and craftsmen, explaining and answering everyday mathematical problems in easy-to-understand words and illustrations.

Yes, it's the key to a simple understanding of mathematics. It's a real home-study course in mathematics for the man who's alert to the importance of mathematics in the world today.

## ELEMENTARY MATHEMATICS

• EASY—SIMPLIFIED—PRACTICAL •

**CONTENTS OF BOOK—**

- CHAPTER I. Arithmetic—Addition—Subtraction—Multiplication—Division
- CHAPTER II. Factoring and Cancellation—Fractions—Decimals—Percentage—Ratio—and Proportion.
- CHAPTER III. The Metric System.
- CHAPTER IV. How to Measure Surfaces and Capacity (Geometry).
- CHAPTER V. Powers and Involution—Roots and Evolution.
- CHAPTER VI. Mathematics for the Manual and Technical Craftsman—Thermometer conversions—Graphs or Curve Plotting—Logarithms—Use of the Slide Rule.
- CHAPTER VII. Special Mathematics for the Radio Technician.
- CHAPTER VIII. Commercial Calculations—Interest—Discounts—Short Cut Arithmetic.
- CHAPTER IX. Weights and Measures—Useful Tables.

Send Stamps, Cash or Money Order.

Send today for your copy of this indispensable book. It can be carried readily in your pocket. (Size 6 1/2 x 9 in.)

**ONLY 50¢ POSTPAID**

**TECHNIFAX**  
1917 S. State St., RC-342, Chicago, Ill.

**NEW VACUUM-TUBE VOLTMETER**

Hewlett Packard Company  
481 Page Mill Rd., Palo Alto, Calif.



• HERE is a new vacuum-tube voltmeter which should be of particular interest. With the Model 400A Vacuum Tube Voltmeter measurements up to 1 megacycle are now as simple as measurements with the usual multi-range meter at d-c. This new meter may ordinarily be used with no precautions whatsoever; there are no adjustments to make or check before taking a reading; the high input impedance will not affect the circuit being measured; a large overload will not damage the instrument; and the accuracy is excellent because waveform errors and turnover effect are minimized. The meter has a frequency range from 10 cps to 1 megacycle. Nine voltage ranges are provided with full scale sensitivities from .03 to 300 volts. The voltage scale is linear and a decibel scale based on 600 ohms and 1 milliwatt is provided. The reading of the meter is independent of line voltage and tube characteristics. This instrument is excellent for all types of audio frequency work. It is particularly valuable at the present time for carrier current, supersonic measurements, television, and measurements throughout the broadcast field.—Radio-Craft

**J.-T. HIGH-GAIN ANTENNA**

Jefferson-Travis Radio Mfg. Corp.  
380 Second Ave., New York, N. Y.

• JEFFERSON-TRAVIS RADIO MFG. CORP. OF NEW YORK has augmented its extensive line of aircraft, marine, and mobile radio communication equipment by the addition of a new type of antenna, known as the J-T High-Gain Antenna. The basic element of the High-Gain Antenna is its tuning coil assembly, which consists of a weatherproof high Q coil, enclosed in a metal shield. This is surmounted by a short whip. Extreme flexibility of mounting is provided for by a base stud, by means of which the tuning coil assembly can be supported on a tubing or pipe of appropriate length. The High-Gain Antenna is of advantage in that (1) it permits a shorter or lower antenna to be used without loss of operating efficiency and (2) it makes for greater efficiency when it is the same height or length as would be a conventional type antenna. The tuning coil assembly provides an accurate means of matching the transmitter to the antenna at the operating frequency. Standard models of the High-Gain Antenna for marine and vehicular use are described in a comprehensive data sheet published by the manufacturer.—Radio-Craft

**NEW SUPER-CARDIOID MIKE**

Shure Bros.  
225 W. Huron St., Chicago, Ill.

• A NEW "Super-Cardioid" Broadcast Dynamic Microphone has been announced by Shure Brothers of Chicago. This new Series "556" introduces a "Super Cardioid" polar pattern that is twice as unidirectional as the Cardioid, from the standpoint of receiving front sounds and rejecting rear sounds, yet has wide-angle front pick-up. Decreases pick-up of reverberation

energy and random noise 73%. The axial polar pattern is symmetrical at all frequencies. Improved "Ultra" wide-range frequency response from 40 to 10,000 cycles assures full reproduction of music, crisp reproduction of speech. The new moving-coil unit is highly immune to mechanical vibration and wind noises. This new performance is made possible through the "Uniphase" single-unit construction, which eliminates the necessity of using two dissimilar microphone elements in one microphone for obtaining true unidirectional operation. The new microphone is functional in design and modern in appearance. Compact, sturdy construction makes it easy to handle in the studio or to take along on "remotes." The Super-Cardioid is available for immediate delivery in three models: Model 556A for 35-50 ohm circuits, Model 556B for 200-250 ohm circuits, Model 556C, high impedance.—Radio-Craft

**RADIAL CONE SPEAKER PROJECTORS**

University Laboratories  
195 Chrystie St., New York, N. Y.



• A COMPLETELY new line of Radial Cone Speaker Projectors designed for uniform sound projection in all directions has been announced by University Laboratories. The model RBP radial projectors, not only have the pleasing appearance and compact construction of the flat ceiling type speakers, but, in addition, have the high tone quality of a large, well designed wall speaker enclosure the manufacturers claim. It is the "infinite baffle" sealed acoustic chamber in the Model RBP which is responsible for the added bass response. The flat-top design is suitable for ceiling or single suspension mounting. Waterproof for outdoor use. All steel construction with "Floating Rubber" speaker mounting and "Non Resonant" rubber rims; especially useful for music reproduction in defense factories. Available for 12 inch and 8 inch cone speakers.—Radio-Craft

**CROLITE COIL FORMS**

Henry L. Crowley & Co., Inc.  
1 Central Ave., West Orange, N. J.



• THE production of precise coil forms in Crolite, combining mechanical and electrical characteristics meeting the most rigid specifications, is one of the many National Defense activities in the recently enlarged plant of Henry L. Crowley & Co., Inc., in West Orange, N. J. These coil forms range from a fraction of an inch to several inches in diameter, are helically grooved to take different sized wires and winding pitches, and have a plurality of different holes accurately positioned for winding taps as well as threaded holes for mounting screws. Various Crolite "bodies" or formulae are utilized in meeting the radio characteristics required at different operating frequencies, particularly in the ultra-high-frequency spectrum. These precision coil forms start from solid extruded rods or tubing, of Crolite, which are subsequently turned and bored to correct outside and inside diameters, followed by grooving and drilling and tapping. The pieces are then fired at critical temperatures in kilns, assuming the final rock-hard characteristic of Crolite.—Radio-Craft

**MICAS**  
for meter shunting

TYPICAL of the extent of the Aerovox line of mica capacitors are the units with meter-mounting brackets. Two types of mounting brackets are available and adjustable to connect directly to meter terminals for r.f. bypassing of meter windings. A choice of mountings, terminals, sizes, ceramic standoff insulators and other features complete this outstanding molded-in-bakelite mica capacitor line. Ask local Aerovox jobber about Aerovox micas. Ask for catalog—or write us direct.

**AEROVOX CORPORATION**  
NEW BEDFORD, MASS., U. S. A.  
In Canada: AEROVOX CANADA LTD., Hamilton, Ont.  
EXPORT: 100 Varick St., N. Y. Cable 'ARLAB'

**SAVE UP TO 50% FACTORY-TO-YOU**

**9 BANDS (ON 6 DIAL SCALES)**  
20 TIMES EASIER FOREIGN TUNING with SUPER BAND SPREAD RADIO!  
with SPEAKER, TUBES, PUSH-BUTTON TUNING, MAGNA TENNA LOOP AERIAL... READY TO PLAY  
**\$19.75 COMPLETE**  
UP TO \$50.00 TRADE-IN

THINK of it . . . 20 times easier to tune . . . 10 times more sensitive than ordinary radios! Crystal-Clear High Fidelity Tone. Famous 30-day trial plan fully protects you and enables you to prove Midwest's amazing new 1942 Super Spread Band performance in your own home, without obligation. Write today. Your name on a 1¢ postal card will do. Send for big FREE 1942 Catalog, showing Radios, Radio-Phonos, Home Recorders — from \$12.95 to \$212.50.  
UP TO 16 TUBES  
9 BAND CONSOLE \$43.95 COMPLETE  
30 DAYS TRIAL  
E-Z TERMS  
USER AGENTS WANTED

**MIDWEST RADIO CORPORATION**  
DEPT. 12-G CINCINNATI, OHIO

**MAKE OLD RADIOS NEW**  
You can learn quickly to modernize all sets. Lack of new sets will make a tremendous market for this service in 1942. Cash-in by improving audio circuits, modernizing cabinets, adding features usually found on late model sets. Practical job-sheets with schematics and photographs make the work easy. You are told how to obtain modernization work, what to charge, and how to complete the job quickly and efficiently. Complete, 8 1/2 x 11 inches, manual only \$1.50, post-paid. Money back guaranteed.  
**SUPREME PUBLICATIONS**  
328 S. Jefferson St. Chicago, Ill.

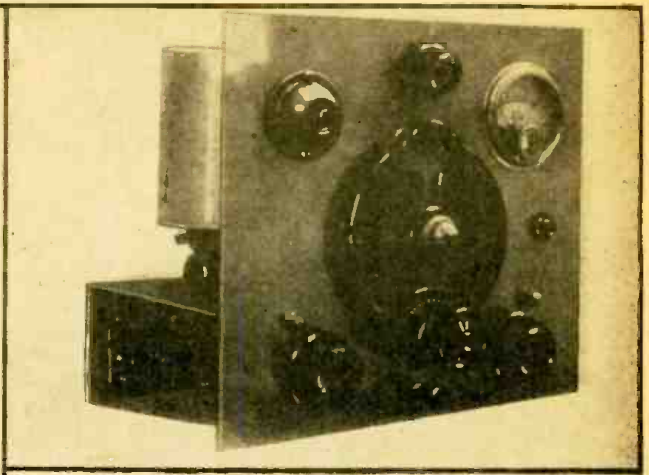
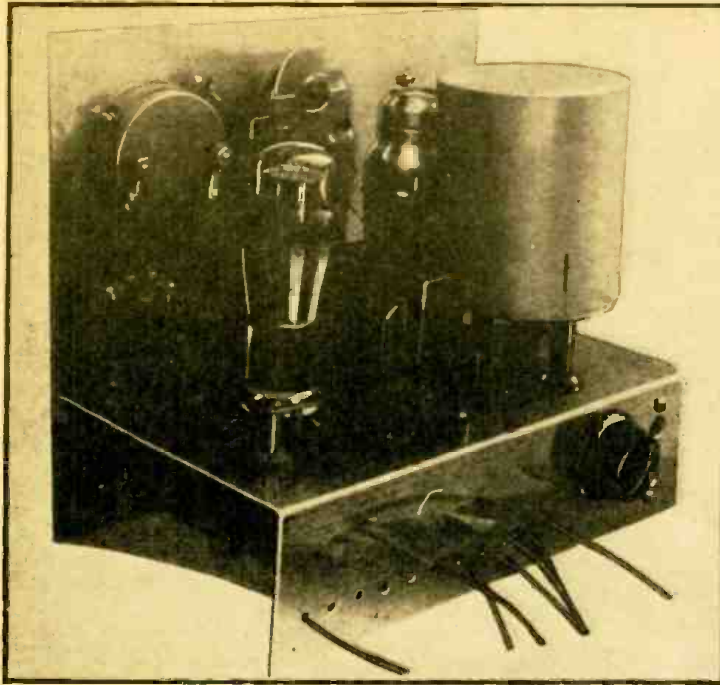

The unusual receiver here described by Mr. Hiatt is shown in the photos above and at the left. The meter shown on the front panel is used for the purpose of indicating the voltage applied to the filaments of the tubes. The large shield can covers the tuning coil. The set operates on batteries and will make a very fine portable.

*In This Receiver*

# 2 TUBES EQUAL 4

JOSEPH P. HIATT

● ECONOMY of space is the watchword today. We give thanks to the tube designers, who have crowded two tubes into a space where only one was previously found, and this without loss of efficiency. The twin

triode 1J6G is the tube here under consideration; it is a two-volt tube and very economical in "A" battery consumption.

In this set the first section of V1 is operated as an aperiodic (untuned) radio

frequency amplifier, which keeps all disturbances caused by the second section—which operates as a grid bias detector—away from the aerial, or interference with other sets in the immediate neighborhood,

The diagram for building two-tube receiver here described is simple and easily followed.

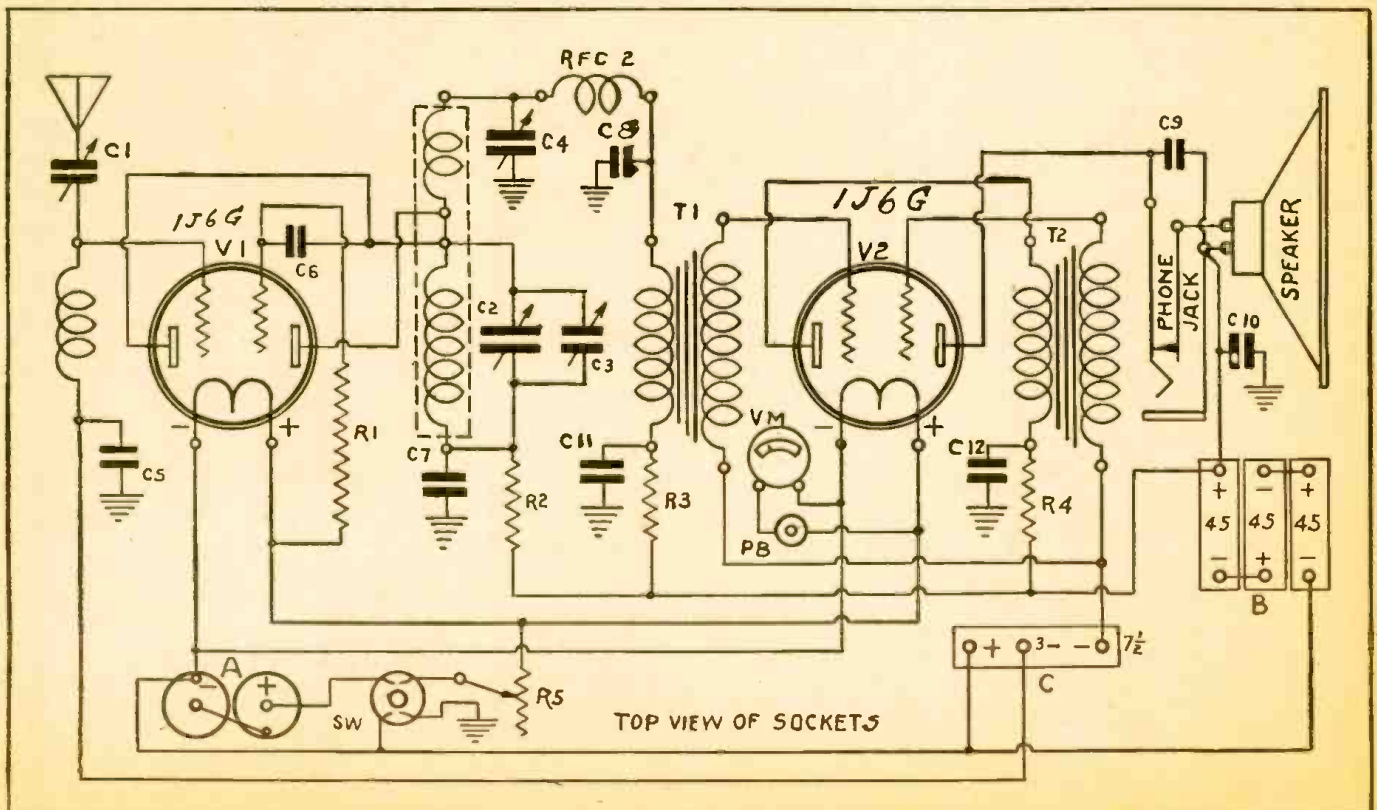

| Meters wave length | Grid coil turns | Tickler turns | Coil space  | Between coils |
|--------------------|-----------------|---------------|-------------|---------------|
| 10-20              | 5 No. 24 DSC    | 5 No. 26 DSC  | 1"          | 3/8"          |
| 18-38              | 9 No. 24 DSC    | 7 No. 26 DSC  | 1 1/2"      | 3/8"          |
| 35-75              | 16 No. 24 DSC   | 11 No. 26 DSC | 1 1/2"      | 3/8"          |
| 70-145             | 30 No. 24 DSC   | 15 No. 26 DSC | Close wound | 3/8"          |

in the nature of howls or whistles. The first section of V2 serves as an audio transformer-coupled amplifier, the second section, also transformer-coupled, acts as an output tube, thus producing *four tube results* in very little space.

This circuit is of the "variable-condenser" controlled regeneration type and has been thoroughly tested in experimental practice and found to be unusual in efficiency, as well as sufficiently powerful to operate a permanent magnet dynamic speaker with volume to spare.

Care should be taken to use insulating shoulder washers in mounting all variable condensers, verniers and phone or speaker jacks from the base or panel, except the regeneration control condenser, which need not be so protected.

To the beginner who wants the greatest returns for his time and money expenditure (and we all do), this is a mighty good bet, as there is nothing ticklish or critical throughout the whole process of construction or operation, but a diligent watch must be exercised all the while, so that nothing goes astray.

These tubes are eight-prong tubes but only six prongs are used, and the prongs are not far between which makes it advisable to figure about the approximate length of wire each connection will require, and solder them to the socket terminals *before* final mounting of the socket on the base. By this method number 24 bare copper wire can be employed for all the connections, except the battery leads, which must pass through the metal panel and require insulation protection.

The radio frequency-detector tube as well as the regenerative tuning coil must be shielded, and the shielding well connected to ground to make it most effective.

The regeneration control is of the variable condenser type, as it is the most simple to install and easiest to operate.

The panel and base is a standard stock sheet of aluminum 8" x 18" cut in the center, making two sheets 8" x 9", and while one of these pieces is used as a front panel, the other is so bent that it forms a base and support when bolted to the front panel. The base is 2 1/2" above the bottom of the panel, while the base dimensions are 5 1/4" x 9", thus leaving space to spare.

In the photograph showing the front panel, the push-button for the voltmeter is located above and to the left of the tuning dial. The knob directly above the tuning dial is the vernier tuning condenser, which is connected in parallel with the main tuning condenser. The voltmeter is located above and to the right of the main tuning dial. The phone or speaker jack is located to the right and on a center line with the tuning dial. The knob below and to the right is the regeneration condenser control; the one immediately under the main tuning dial is the push-button double-pole single-throw switch, which opens A, B and C battery circuits—all at the same time. The knob below and to the left of the dial is the 10 ohm rheostat; the two acorn nuts are 6-32 and clamp the base onto the panel.

Bear in mind that a good long aerial will do wonders when opportunity to erect one is possible, and a good ground connection works still greater wonders.

This set, though not designed for a *portable*, can easily be adapted to that purpose, so the constructor may be able to develop something very interesting along that line. I would suggest omitting the speaker and connect about three good headsets in series and use only 90 volts on the plates, which would surely produce results that would be highly satisfactory in every respect.

List of Parts

HAMMARLUND

- C1—50 mmf. star type MC variable midget condenser
- C2—140 mmf. star type MC variable midget condenser
- C3—20 mmf. star type MC variable midget condenser
- C4—260 mmf. star type MC variable midget condenser

SPRAGUE

- C5, C7, C11 and C12—.01 mf. bypass fixed condensers
- C6—.0001 mf. bypass fixed condenser
- C8—.0005 mf. bypass fixed condenser
- C9—.004 mf. bypass fixed condenser
- C10—.1 mf. bypass fixed condenser

I.R.C.

- R1—3 megohm 1 watt resistor
- R2—5000 ohm 1 watt resistor
- R3—10,000 ohm 1 watt resistor
- R4—15,000 ohm 1 watt resistor

Miscellaneous

- 1—CS-3 shield can for coil
- 1—Form fitting tube shield for 1J6G
- 1—4" NATIONAL vernier dial
- 1—4 prong EBY socket
- 4—HAMMARLUND SWF coil forms
- 1—Midget short phone jack
- 1—Twin jack for antenna and ground
- 2—IMP cord tips
- 1—Phone plug
- 1—25 feet roll of hookup wire
- 1—1/4 pound spool DSC No. 26 magnet wire
- 1—1/4 pound spool DSC No. 24 magnet wire
- 1—Piece 3/8" outside diameter bakelite tubing, 6" long
- 12—1/2" soft rubber plumbers' washers
- 12—Insulating 1/2" shoulder washers
- 1—FROST DX special headfones
- 1—6" KNIGHT P.M. dynamic speaker
- 4—1 1/2" bakelite pointer knobs
- 2—1" bakelite pointer knobs
- 2—1 1/2 volt EVEREADY ignition cells
- 3—45 volt EVEREADY B battery cells
- 1—7 1/2 volt EVEREADY C battery cell
- 1—0.3 READRITE voltmeter
- 1—Aerial kit
- 1—Spool rosin core solder
- 1—Soldering iron
- 1—Water pipe ground clamp
- R5—10 ohm MALLORY-YAXLEY rheostat
- V1 and V2 1J6G RCA tubes
- T1 and T2 type T47A25 THORDARSON audio transformers
- SW—YAXLEY double-pole single-throw switch
- 1—Aluminum panel, 8" x 18" x 1/16" thick. (See text.)

(CAUTION)—Be sure to use soft rubber plumbers' washers between panel and sockets.

"Hams"—Please tell the Editors what type of articles you would like to see in the Amateur Section of this magazine, now that War has been declared and a general ban placed on Amateur Station operation. Let us hear from you, Pronto!—Editors



**4 STANDARD TYPES**  
of Amperite Regulators replace over 400 types of AC-DC Ballast Tubes now in use.

Amperites are real REGULATORS... have patented Automatic Starting Resistor which prevents initial surge and saves pilot lights... Ask Your Jobber.

**AMPERITE**  
THE *Simplest* WAY TO REPLACE **BALLASTS**

WRITE FOR REPLACEMENT CHART  
AMPERITE CO. 561 BROADWAY, NEW YORK, N. Y.

**HOW TO Learn CODE**

Whether you wish to enter radio as a career or merely add another valuable and fascinating accomplishment to your achievements, the All Electric Master Telex Code Teaching Machine will show you how. Telex records your sending in visible dots and dashes on a specially prepared waxed paper tape and then sends back to you at any speed you desire. It does not merely show you code. It is code. No experience needed. There are NO PERFORATIONS—NO INK. Far superior to anything ever developed... a marvel of simplicity. While not designated as standard equipment, Telex is used at many U.S. Army Posts, Naval Training Stations as well as by the American Tel. & Tel. Co. Also by practically every private school in the U.S. teaching code; and many foreign governments. We furnish you complete course, including practice messages, the All Electric Master Telex, plus a personal service on a MONEY BACK GUARANTEE. Low cost. Easy terms. Without obligation write for booklet "S3".

**TELEPLEX CO.**  
107 HUDSON ST. JERSEY CITY, N. J.

**Whatever YOU WANT In A HEADSET**



You'll find in a Cannon-Ball Guaranteed Headset: Sensitivity. Clarity of tone. Dependable performance. Quality at fair price. Folder C-3 illustrates complete line. Write Headset Headquarters.

**C. F. CANNON COMPANY**  
SPRINGWATER, N. Y.

# Foot-Pedal Break-In

The foot-operated switch described herewith enables the operator to switch from the transmitter to the receiving position and vice versa instantly and with a minimum of effort. As many circuits as desired may be opened or closed by this simple foot-operated switch.

ROD NEWKIRK, W9BRD

● THE most up-to-date c.w. amateur stations are equipped to work 'break-in.' This is operation wherein both the station transmitter and receiver are used simultaneously. The advantages of such a setup are immediately obvious when compared with the usual "take turns" operating technique. Wasted power, time and patience are avoided, for when interference or fading sets in while you are transmitting, the station with whom you are in contact merely presses his key to stop your sending.

This is really the most intelligent way to operate since it comes closest to simulating actual conversation. One doesn't shut one's ears when speaking in person with a friend, or over the telephone.

The reason that so comparatively few amateurs use this system is that of the constructional disadvantages encountered.

The transmitter must be keyed in the oscillator stage so that there will be no signal from the station rig heard in the receiver to interfere while listening. This usually requires that the transmitting stages following the oscillator be externally biased to prevent damage to tubes and components due to rising current without excitation. (The power supply is kept running during communication.)

Furthermore, it is usually more difficult to secure a T9X note from the transmitter when the oscillator is keyed. This is especially true of an electron-coupled or self-excited oscillator. Considerable experimenting with supply voltages, voltage regulation, etc., may be required before a satisfactory note is obtained.

Then, too, the station receiver must be sufficiently shielded from the transmitter field to prevent blocking when the transmitter is keyed. Break-in is no pleasure if there is a great racket in the receiver while keying. Care must be taken to see that the receiver is not damaged by its antenna picking up r.f. energy from the transmitting antenna; this means that a short, non-resonant antenna should be used, preferably run at right angles to the regular transmitting antenna.

Thus it is evident that a sturdy, high-grade receiver is needed for efficient break-in work, especially with weak and DX signals. A circuit, used in conjunction with the transmitter keying, can be used to provide bias for the receiving tube grids to kill the receiver when the key is pressed.

One thing about break-in which appeals to most anyone is the fact that no send-receive and stand-by switching is necessary; when one wants to receive he simply listens and when one wants to transmit he just begins keying. This elimination of all switching probably has caused the most converts to break-in, as there is otherwise little use to go to all of the trouble usually encountered in getting a break-in system func-

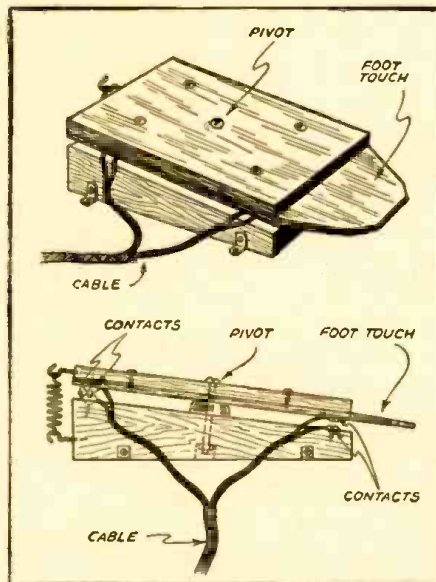

By simply rocking the switch back and forth with the foot, the transmitting and receiving circuits are opened and closed.

tioning properly when so few other stations use it (except the traffic handlers).

Hence we have a vicious circle which tends to discourage widespread use of break-in.

Obviously, the next best thing to actual break-in is to be able to switch from the send to the receive position and vice versa instantly and with a minimum of effort. Using a handswitch or switches for this purpose is a handicap to speedy operation besides being an inconvenience. Some form of a foot-operated switch is in order. In the accompanying drawing is what was evolved here at W9BRD.

It is a glorified teeterboard with receiver circuit contacts on one side and transmitter circuit contacts on the other. The foot rests on the part designated as A and a mike spring or two keeps the pedal in the receive position on the side away from the foot. Slight pressure by the foot automatically opens the receiving contacts, killing the receiver and then closing the transmitting circuits for the send position.

This idea is probably being used by many amateur stations and yet is not wide-spread practice. There is practically no limit to the number of circuits which may be switched with the gadget nor the combina-

tions which can be obtained. And use of the switch will become something of a sixth sense after a period of use.

As compared with break-in, there is the disadvantage that the receiver is dead during the 'send' periods and the frequency of the station in contact cannot be continuously monitored. This makes such a foot-switch affair undesirable for traffic and network use.

But against this are the following advantages: No circuit changes are necessary in the station for installation, such as keying, bias supply, etc.—just put the foot-pedal in parallel with the present switches you have to throw by hand for send-receive. The transmitting antenna can be used for reception, resulting in improved receiver performance. Power is conserved in that power supplies may be switched on and off. One power supply can be used for two purposes. (Here at W9BRD a 200 volt supply is switched from the e.c.o. to the receiver preselector and back.) No doubt many amateurs will put the pedals to many other uses and arrangements.

The foot-pedal switch shown in the drawing can doubtless be improved upon and is given merely to illustrate general construction. The contacts themselves may be of ordinary roundhead bolts; they must be carefully filed and adjusted so that all circuits close simultaneously and with a minimum of arcing. If there is too much sparking and arcing of the contacts of high voltage circuits, relays should be used. Leads to the unit should be neatly cabled and well-insulated; those carrying quite high current or voltage should be suitably insulated and of heavy cable. Contacts should be in no way exposed.

No dimensions are given as that is up to the individual. A pedal for switching three circuits naturally will not have to be as wide as one for switching six. Overall length should be kept not much longer than twelve inches for installation convenience and the protruding part on which the foot rests should be close to the floor for maximum comfort.

While in communication, switching can be accomplished so swiftly that it conveys the impression you are using actual break-in. It is handier for use in 'phone stations than 'push-to-talk,' both hands being free. Another thing, should you ever be suddenly called from the operating table you will never accidentally leave the high voltage on.

Knife switches in parallel and in series with the foot-pedal leads will enable you to operate the transmitter independent of the pedal for antenna adjustments, etc., and to open all circuits to the transmitter whether or not the pedal is accidentally closed by someone else while you work on the transmitter, changing coils, etc.

## Other Uses!

The Radio and Electrical experimenter will find many other applications for this foot-operated switch, such as switching from phones to loud-speaker; switching from one set to another. etc.





I can Give You  
**IMMEDIATE  
DELIVERY**  
on  
Hallicrafters  
Receivers!

*If you want a better receiver—  
here is your opportunity.*

*I sell more amateur receivers than anyone else, because I really make it to your advantage to buy from me. I have the biggest stock and can give you the best trade-in on your present receiver. I can do this because I finance all terms myself and give you the best of the breaks. You can also have a ten day free trial, I want you to always be satisfied and know exactly what you are buying. Why not trade-in your out-of-date receiver now, it may be worth a liberal trade-in allowance from me.*

*You know there must be a very good reason why we, located way down here in Butler, Missouri, have grown to be the **WORLD'S LARGEST DISTRIBUTOR OF AMATEUR RECEIVERS**. The best reason for our success is my personal service on every order received.*

*Drop me a line today, tell me what you want, it will pay you to get acquainted . . . remember you don't have to wait, I can make immediate shipment!*

For the Western States we also have a big complete store at:

2335 Westwood Blvd.  
West Los Angeles, Calif.



**“WORLD'S LARGEST DISTRIBUTORS OF SHORT WAVE RADIOS”**

# CALIBRATED OSCILLATOR

## for the Ultra-High Frequencies

A. BINNEWEG, Jr.

The short-wave experimenter will find this Oscillator very useful—it enables one to ascertain the wavelength by measuring the current in the Oscillating circuit.

circuit wires AB and CD (Fig. 1), your oscillator will operate close to the frequency of the oscillator I have constructed and calibrated. The lengths of wires AB and CD maintaining each at the same length, were varied and for each length of oscillating circuit the frequency of operation was measured. The results, given later, will enable you to tell quite closely where your oscillator will operate! (C is plate terminal.)

### Checking the Results

Say you built the oscillator and measured the wires as will be clear later, so that your oscillator was operating on say 5 meters exactly. We don't care whether it is 5.05 or 4.95 meters for the time being, because we can check it up and find out more exactly later on. We thus can come fairly near a correct value and not be far off.

Using a simple regenerative receiving set (one tube), near the oscillator, tune in a short-wave station around 30 meters the wavelength of which you know or can easily find. Say, it was a 30-meter station, and the wavelength was exactly 30 meters. Tune in this station exactly. Now listen in the headphones of the oscillator of Fig. 1. It should be near the sixth harmonic of the regenerative receiver, but it would be only luck if you heard it in the phones without any adjustments at all. If you don't hear the sixth harmonic, move the regenerative receiver dial, keeping the tube oscillating, until you do hear it in the headphones. Be sure the coupling between the oscillating circuit and the regenerative receiver is very close. For example run the parallel wires of the oscillator near the top of the coil in the receiving set. You could adjust the lengths of the wires AB and CD in Fig. 1 until you do hear the sixth harmonic of the 30-meter frequency, but this would not be very easy. It is better to tune the receiver around until you can pick up the harmonic on the short-wave oscillator headphones. Then you can gradually adjust the oscillating circuit wires until you hear the sixth harmonic of the 30-meter wave. You could first calibrate the receiver dial from known stations and then it would not be necessary to adjust the lengths of the oscillating circuit wires.

It will be seen at once that you can cali-

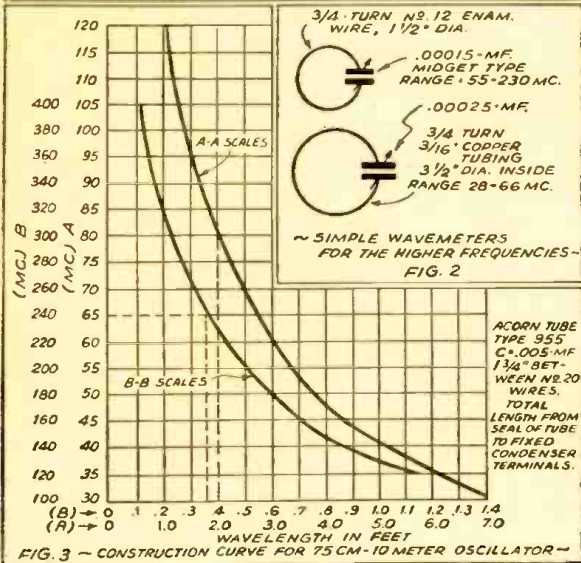
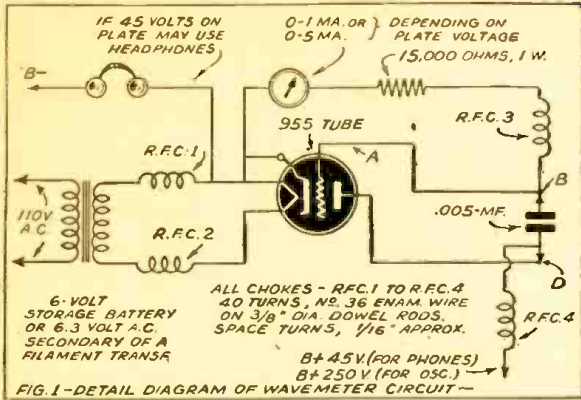

● THE most important point to know when operating at ultra-high frequencies is the wavelength at which the oscillator is operating. Many experimenters wish to know the wavelength of operation and they have no calibrated wavemeter. A calibrated receiver is also often useless because it will not pick up unmodulated waves such as those produced by simple oscillators. In fact, there are very few people indeed that have any kind of receiver, let alone a calibrated one, that will pick up oscillations at a wavelength of 10 meters and lower.

I have perfected a new type of wavemeter that generates an ultra-short-wave and does not have to be calibrated but the wavelengths can be found by simply measuring the lengths of the leads in the oscillating circuit. This is a new idea; it is known that coil specifications can be given, but it is also true that it is very easy to slip up in these specifications and so change the frequency materially. The present wavemeter is perhaps the most perfect in this respect of any, because its oscillating circuit consists only of two straight wires, the lengths of which can be very exactly determined. It is possible (if a 955 tube is used) to build an oscillator to specifications that will oscillate very near any desired frequency. To find the frequency of operation, simply measure the wires and take the wavelength of operation from a prepared graph which is shown later on in this article.

A common method for measuring frequencies is the use of two parallel wires and a shorting bridge, but these wires have to be made rather long and they have to be

strung tightly which requires troublesome and perhaps undesirable fixed supports of some kind. The 955 tube makes it possible to construct an oscillator and measure the length of the oscillating circuit to find the frequency of operation.

In Fig. 1, a complete diagram of connections for the wavemeter is shown. A 955 tube has its cathode supplied from a filament transformer. Two chokes are used in the filament transformer leads. If headphones are to be used to listen for beat-notes with other oscillators or regenerative receiver, connect as shown. If headphones are not needed, omit the phones and close the lead. If you use a gridmeter as shown, and it is 0/1 milliamperes D.C. 1 maximum scale, shunt it with a resistor so it reads 1/5 milliamperes when 1 milliamperes is passing through it; then its maximum range will be 5 milliamperes which is the required maximum scale-reading when 250 volts is used on the plate of the 955 tube.

The chokes are all made as described in Fig. 1. Drill the dowel rods at the ends and tie a heavier wire around the rod, soldering the choke wire lead to the heavier wires which are used as leads. Boil the rods in hot paraffin before you wind the wire on.

A 15,000-ohm 1-watt grid resistor is the correct value to use.

### Use of Wavemeter

The oscillating circuit of the oscillator consists of a pair of parallel wires and the correct lengths to use will not vary very much with different 955 tubes. Hence, if I tell you how long to make the oscillating

brate your oscillator for different lengths of wires by first calibrating the dial of your regenerative receiver. This receiver need have only one tube. A simple '30 tube regenerative detector can be used if desired.

If you do not wish to calibrate your oscillator (as in Fig. 1), transfer the wavelength measurements from its tuned circuit to a wavemeter circuit having a good dial upon which you can mark the wavelength values. You could also plot a calibration curve (wavelength or frequency values vertically and dial-setting values horizontally, for example).

In Fig. 2, you will find the complete dimensions for the high frequency wavemeters. Build up some simple tuned circuits having shield front case and large plain 4-inch dial and the back open so you can couple small coil to oscillating circuit.

**Tuning In**

For precise adjustments, tune in a harmonic by adjusting the regenerative receiver to zero beat with the oscillator. The accuracy will be more than sufficient for ordinary work, and with the measurements of the oscillating circuit known (as will appear later), you can't be very far off. In fact, some may accept the measurements as they are and feel content, since they will not re-

quire a great degree of accuracy and do not care to operate their oscillators as transmitters. The only danger for error there ever was, was the possibility of turning in the wrong harmonic (5th instead of 6th, etc.), but this danger has been eliminated by furnishing you with calibration data for the oscillator.

Fig. 3 shows the calibration curves. I took a lot of readings using one of these oscillators having parallel wires and plotted values all the way from 75 centimeters to 10 meters which took quite a little time. The results are shown in Fig. 3.

As an example of how to use the graphs of Fig. 3, the lines show that 80 mc. is found when a wire length of 2 ft. is used in each wire of the two parallel wires of the oscillating circuit. The wires in the oscillating circuit were always each of the same length, which is the basis for the curves of Fig. 3. If you don't like "feet," change it to inches by dividing a foot length line into twelfths. Remember that 3.28 ft. is one meter. As another example of the use of the curves, in this case the other curve which uses the other two scales, the lines show 240 mc. at .35 ft. length for each oscillating circuit wire from right at the tube seal to the condenser terminals themselves.

# TECHNICAL BULLETINS

Technical bulletins give reliable information in easy-to-follow form, and save valuable time otherwise spent in laborious reading of numerous books. Every subject is treated briefly and concisely, yet completely. No complicated mathematics, chemistry, electricity, or theory. Each bulletin is written in simple language.

**PRICE \$1.00 EACH POSTPAID  
ORDER BY NUMBER**

**D-103—AUTOMOBILE SPECIALTY CHEMICAL PRODUCTS.**—Formulas for products used by automobile owners: Penetrating Oil, Chromium and Nickel Polish, Radiator and Cooling-System Cleaner, Anti-Dimming Paste for Windshields, Protective Battery-Terminal Coating, Auto-Finish Cleaner, High Gloss Rubbing Wax Polish, Road-Tar Solvent, Polishing Cloth.

**D-111—BUILDING TRANSFORMERS.**—Simple, non-mathematical methods for designing transformers. Also special transformers for ultra-violet lamps, Neon tubes, etc.

**D-124—SOLDERING.**—How to produce perfectly soldered joints. Solders and soldering fluxes and how to make them. How to make electric soldering irons for light and heavy work, how to construct an alcohol blow-pipe.

**D-136—SMALL A.C. ARC WELDER CONSTRUCTION.** How to build arc welders for fusing iron and steel sheet up to 3/16 inch in thickness and rods as large as 1/2 inch in diameter for use on 110-volt, 60-cycle and 25 cycles, A.C. or on 220-volt 60 cycles A.C.

**D-142—ELECTRIC MUFFLE FURNACES.** How to design efficient electric muffle furnaces for heat-treating metals, case-hardening, enamel-baking, firing porcelain, melting metals, etc. Temperature up to 1650 degrees Fahr. and up to 2000 degrees Fahr.

**D-107—ELECTROPLATING WITH COPPER, NICKEL AND CHROMIUM.**—Latest methods, formulas, and trade secrets that will enable anyone to do professional work. Includes formulas for cleaning, directions for polishing, and buffing, etc.

**D-112—ELECTRO-MAGNETS.**—Electro-magnet design so clearly explained that anyone can build magnets for practically every purpose. Complete data covering both A.C. and D.C. magnets.

**D-123—MIRROR SILVERING.**—Simplified directions for resilvering old mirrors and making new ones. Contains all details required to become an expert. Colored mirrors, front-surface mirrors, transparent mirrors, and photo mirrors.

**D-137—ELECTRICAL METERS.**—Information to build experimental electrical meters to measure alternating or direct currents. Including ammeters, voltmeters and wattmeters.

**D-145—HEAT TREATMENT OF IRON AND STEEL.**—Complete and specific directions for modifying the characteristics of iron and steel by heat treatment. How to identify the various kinds of steel and iron; how to anneal, harden, and to temper.

**D-131—REMOTE-CONTROL SWITCHING.**—Controlling electrical devices at a distance by means of a telephone dial.

**D-138—GOLD-LEAFING METHODS.**—All details about handling gold-leaf for gilding. Reliable, practical methods so that anyone can do the work in an expert manner.

## SPECIAL

The books listed below have never been sold by us before. The value of each book is 50c. They are exactly the same as RADIO & TELEVISION'S 50c blue books which have been on the market for years. For a short time only we are selling these at a special reduced price of only 75c for the 3 books. All of the books contain numerous photographic illustrations and diagrams and have stiff flexible cover.

**ABC OF TELEVISION**

Contains latest material on television developments. It covers theory of scanning, simple television receiver, how the eye sees, the photo-electric cell, neon lamps; need for broad channel width in transmission signals; cathode ray tube and television receivers; Farnsworth system of television transmission, and other important features.

**SHORT WAVE GUIDE**

Covers hundreds of short-wave questions and answers; illustrates popular short-wave hanks; gives explicit instructions for building simple short-wave receivers; instruction on the best type of antenna installation; diagram and construction details for building transmitters.

**S. W. RADIO QUIZ BOOK**

This book covers questions and answers on transmitters, short-wave receivers, ultra short-wave receivers; practical hanks, wrinkles and technical data; novel coil windings for experimenters; hook-ups for experimenters; how to "hook-up" converters, noise silencers, beat supplies, modulators, pre-oscillators, antennas, preselectors, 5-meter receivers.

Popular Book Corp.,  
25 W. Broadway,  
New York, N. Y.

Gentlemen:  
Enclosed you will find remittance for 75c (cash, new U. S. stamps or money order accepted) for which please send me at once your 3 books  
**ABC OF TELEVISION SHORT WAVE GUIDE  
SHORT WAVE RADIO QUIZ BOOK**

Name .....

Address .....

City ..... State..... RC-3-42

## 10 BEST RADIO BOOKS 10 CENTS EACH

- RADIO FANS EVERYWHERE**—these fine ten cent text books give you an excellent foundation for the study of RADIO. They are clearly written, profusely illustrated and contain over 15,000 words in each book. You'll be
- No. 1—HOW TO BUILD FOUR DOERLE SHORT WAVE SETS
  - No. 2—HOW TO MAKE THE MOST POPULAR ALL-WAVE 1- AND 2-TUBE RECEIVERS
  - No. 3—ALTERNATING CURRENT FOR BEGINNERS
  - No. 4—ALL ABOUT AERIALS

- amazed at the wealth of information contained in these handy books. Excellent for reference—ideal for every technical library. **YOUR MONEY BACK** if you are not satisfied.
- PROMPT SHIPMENTS**
- No. 5—BEGINNERS' RADIO DICTIONARY
  - No. 6—HOW TO HAVE FUN WITH RADIO
  - No. 7—HOW TO READ RADIO DIAGRAMS
  - No. 8—RADIO FOR BEGINNERS
  - No. 9—SIMPLE ELECTRICAL EXPERIMENTS
  - No. 10—TELEVISION

**BOOKS ARE ALL UNIFORM**

Every book in the GERNSBACK EDUCATIONAL LIBRARY has 32 pages—with illustrations varying from 30 to 66 in number. Each title volume contains over 15,000 words. Positively radio's greatest book buy! If you do not think these books worth the price asked, return them in 24 hours and your money will be instantly refunded.

### RADIO PUBLICATIONS • 25 WEST BROADWAY • NEW YORK, N. Y.

RADIO PUBLICATIONS, Dept. RC-3-42  
25 WEST BROADWAY, NEW YORK, N. Y.

Gentlemen: Please send immediately, **POSTPAID**, the book numbers circled below. I am enclosing ..... cents —each book being 10c.

1 2 3 4 5 6 7 8 9 10  
NEW NEW

Send FREE listing of 48 new 10c publications.

Name .....

Address .....

City ..... State.....

Remit by check or money order—register letter if you send cash or unused U. S. postage stamps.

**MAIL COUPON TODAY!**

## TECHNIFAX

1917 S. STATE ST. (DEPT. 342) CHICAGO, ILL.

DEPT. 342

**TECHNIFAX** 1917 So. State, Chicago, Ill.

Enclosed find \$..... for which please send me postpaid the following Technical Bulletins:

Nos. ....

Name .....

Street and Number .....

City and State .....

Edited by HERMAN YELLIN, W2AJL

**Loud-Speaker on Crystal Set**

**?** Can a loud-speaker be used with a crystal set?—R. J. Kolb, St. Louis, Mo.

**A.** Any speaker, even the smallest, requires a very much larger amount of power to operate than an earphone. The power output available from a crystal receiver is that obtained by rectifying the R.F. voltage intercepted by the antenna, and this is very small indeed, so that unless the receiver is located under the very shadow of a powerful broadcasting station, there would be an insufficient amount of power to actuate the speaker.

gain. This tickler can be wound over the end of the dowel holding the regular I.F. coils, using about 15 to 20 turns of No. 30 wire. Try reversing the tickler connections to get proper regeneration.

**Reducing Amplifier Hum**

**?** I have an amplifier using a 6J7, 6SJ7, 6C5 and push-pull 2A3 tubes. The 6J7 is used for the microphone while the phonograph is connected to the 6SJ7. Can you tell me how to reduce the hum which results when the mike gain-control is turned up?—John Quoddy, Long Beach, Calif.

**3-TUBE RECEIVER HOOK-UP**

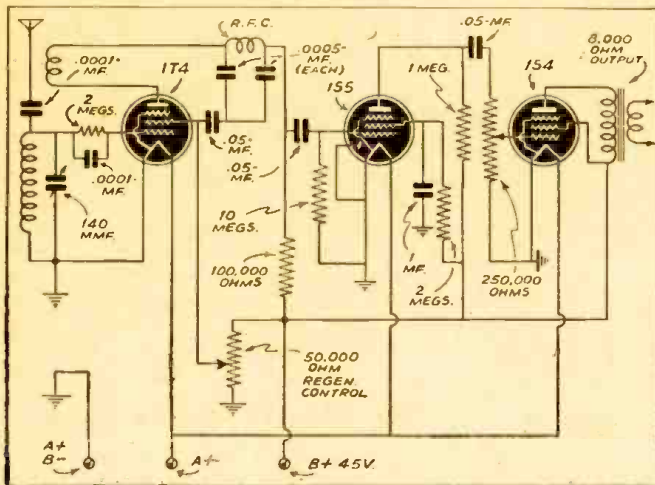

A 3-tube receiver diagram of interest to the radio experimenter. A regenerative hook-up which can be used with plug-in coils to cover all short wave bands. It is shown with low voltage battery tubes, but any other tubes can be used with a suitable current supply. This set will work a loud-speaker and is suited to battery operation.

**Wave Trap**

**?** Can you give me some information on constructing a wave-trap for use with my all-wave receiver?—R. Bengak, N.Y.C.

**A.** The wave-trap shown in the diagram can be connected in series with the antenna lead to the receiver and tuned to the frequency of the interfering station, which will result in eliminating that and any other station on that frequency, from the receiver input. In order to handle a wide frequency range, several coils will be needed. They can be either of the plug-in type or built onto a switch. In either case, the coil and condenser should preferably be shielded.

| Frequency range  | Turns | Wire size |                         |
|------------------|-------|-----------|-------------------------|
| 1,500-3,500 kc.  | 60    | #24       | wound on 1 1/4" diam.   |
| 3,500-8,000 kc.  | 35    | #18       | 1 1/4" diam., 1" long   |
| 7,000-15,000 kc. | 20    | #18       | 1 1/4" diam., 3/4" long |

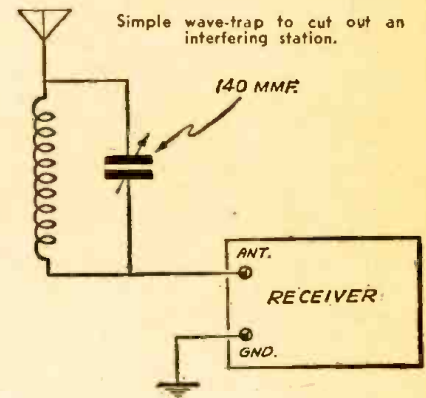

**Garage Door Opener**

**?** Recently I attached a motor to the garage doors so they will open and close by turning a switch. Is there any way I can operate the motor by remote control from the automobile?—E. M. Price, Confluence, Pa.

**A.** On page 298 of the September 1940 issue of this magazine there appeared a constructional article on a sensitive receiver-operated relay, which could be actuated by the noise emanating from the auto's ignition system. The relay can be connected across the switch controlling the door motor.

**Compact Portable Query**

**?** What kind of coils are used in the Argentine's Compact A.C. Portable shown on page 10 of the May 1941 issue?—L. Myers, New York City.

**A.** The R.F. coil contains two primary windings, one for standard long antennas and the other for doublets; however, any standard single primary R.F. coil can be used. The oscillator is also a standard two-winding coil. The single I.F. transformer is however a special coil, providing a tickler for regeneration, to increase the

**A.** First make sure you are using shielded cable from the microphone to the amplifier input. Second, your grid leads to the first two tubes should be as short as possible, and if longer than one inch, should be shielded. Your diagram is technically correct, so these two items should correct your difficulty. Frequently, however, a new 6J7 tube will also eliminate the hum as many 6J7 tubes, although perfectly satisfactory for other purposes, will prove to have too much hum when used in a high-gain amplifier. A little experimenting will soon disclose what the cause of the hum is.

**BATTERY RECEIVER WITH PUSH-PULL OUTPUT STAGE**

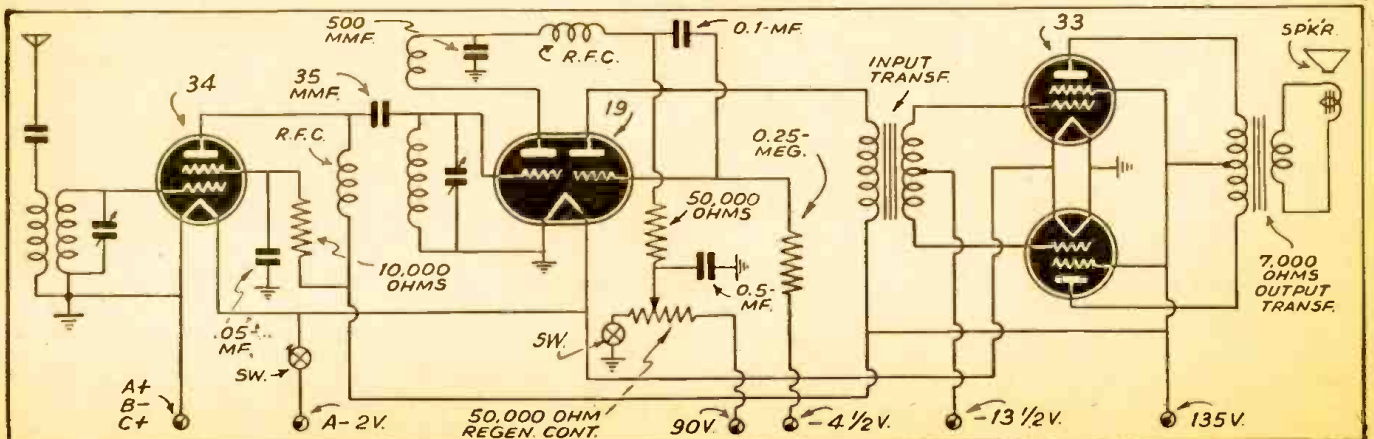

Here's a more ambitious hookup for a battery receiver. It can be built for short-wave reception with plug-in coils, or just for "broadcast" reception if desired. The push-pull output stage gives excellent reproduction. The set may be operated from a power-pack.

**First Prize  
FLUORESCENT LAMPS**

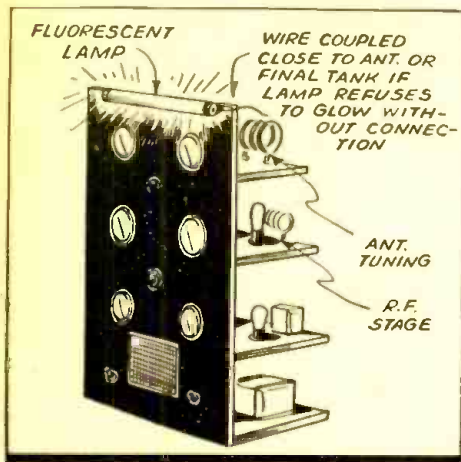

Burnt out fluorescent lamps may be used to advantage by Radio Amateurs. They may be used as resonance or output indicators on the transmitter. They may be mounted on the panel of the R. F. stage of the transmitter, or coupled closely to the antenna feeders. If the R. F. output is not great enough to light the lamp, a wire connected to it should be placed close to the tank coil or the antenna post. Not only does it serve this purpose but it also beautifies the transmitter with its glow. It may be used as a modulation indicator on phone transmitters, since it will glow brighter when the audio voltage is impressed on the carrier.—*Alexander Riccio, W2NBJ.*

**SCREWDRIVERS FROM OLD  
SAWBLADES**

Old sawblades of hacksaws are made of an excellent steel and are too good to throw away. Cut them in half lengths, grind the teeth away and grind the end without the spanning hole just to the shape you need. Without any cost you are able to make yourself a set of screwdrivers from the width of  $\frac{3}{8}$ " to about  $\frac{1}{16}$ " for very small screws, sunken and concealed screws. The figure below may give some ideas. If you keep the hole of the sawblade, which usually fits into the mounting of the saw, on the opposite end of the shaping, you are able to keep your screwdriver set nicely together with a safety pin as often used for curtains, which permits you to take the screwdriver out easily.—*R. Glass.*

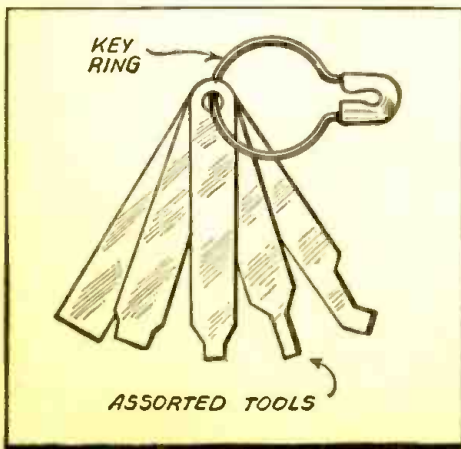

**HOME-MADE DRILL**

I recently ran out of small drills and then came upon this idea for drilling coil forms. File off the head of a small brad, sharpening the point if necessary and use it as a regular bit. Mine actually cut through the bakelite form quicker and more easily than the standard bit. If you file the point, be sure that the pyramid effect remains, as shown in the accompanying diagram, since this is the cutting surface. The only difficulty that may be encountered is that after two or three holes have been drilled the bit is apt to bend, but they are cheap enough to replace.—*Richard Jeffrey.*

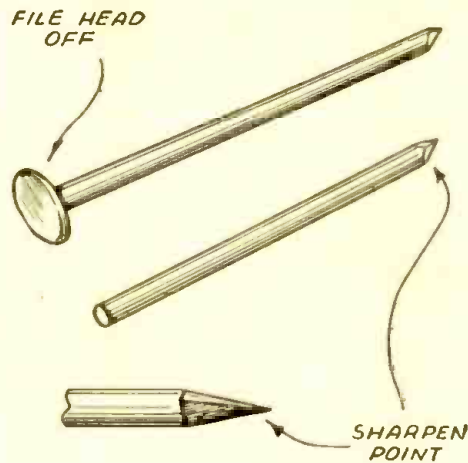

**INTERFERENCE ELIMINATOR**

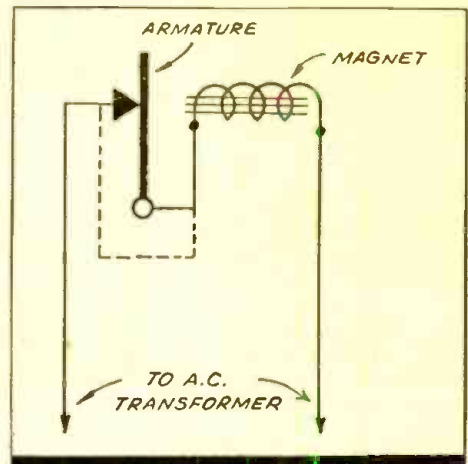

Interference in radio receivers caused by doorbells can be eliminated in two ways: (1) By connecting a condenser across the contacts of the bell, or (2) by making the bell an alternating current type. Since most bells now work on a transformer, this can be easily done. The wire leading to the armature contact of the bell is removed and connected to the coil, as shown in the diagram. The bell will vibrate as well with this connection on A.C. as it did previous to the change. The armature may have to be stiffened slightly to permit vibration.—*V. Petrucelly, Jr.*

**TO RESTORE LETTERING**

To reprint numbers I purchased in a 5-10 cent store for a dime a dater (see sketch) which stamps the month, day, and year. I used the numbers of the days to reprint the numbers on the selector switch. Aluminum paint works better than ink or enamels to print with. For numbers such as 300, 140, etc., where three digits are needed, the final zero was made by changing the dater around to utilize the "O" of "Oct." MA., D.C., A.C. and other signs can also be printed with a little ingenuity by the user. If larger words or numbers are wanted (get a small set of rubber type, with holder).—*Robert Lindberg.*

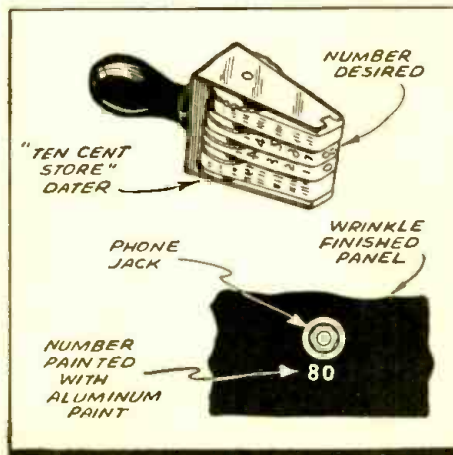

**"B" POWER SUPPLY PACK**

In many cases a small power supply may be found useful on the service bench to test small receivers or adjust a speaker. The writer built a unit as shown in the diagram herewith and found it especially useful for this purpose.

This pack can also be employed to energize a 2500 ohm dynamic speaker by omitting the choke and second capacitor. The output of the supply is about 100 volts with a current of between 12 to 30 mils.

"T" represents a  $2\frac{1}{2}$  v. transformer; "V" a '27 type tube, "C1" and "C2" 4 mfd. capacitors, "CH" 30 henry choke.—*I. W. Stubblebine in "C-D Capacitor."*

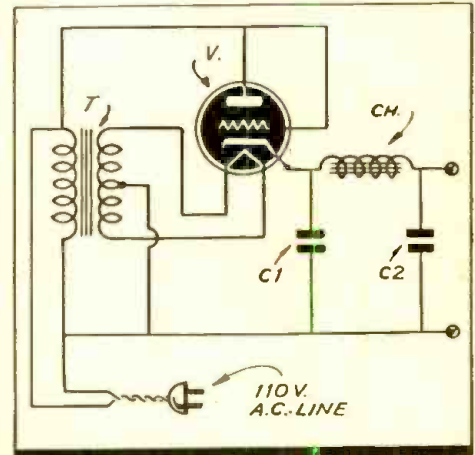

**RADIO KINKS**

published on these pages will win their senders 8 months' subscription to RADIO & TELEVISION. The best kink published each month will win a 2 years' subscription. Read these kinks; they will be of real use to you, besides indicating what is wanted. Send a typewritten or ink description with sketch of favorite to the Kink Editor

**NOW—A REALLY HIGH-POWERED—  
Radio Engineering  
Library**

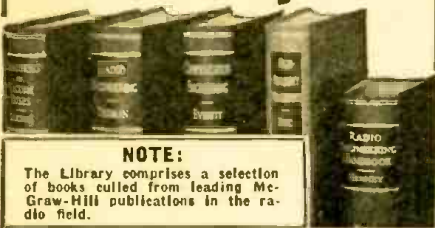

**NOTE:**

The Library comprises a selection of books culled from leading McGraw-Hill publications in the radio field.

- especially selected by radio specialists of McGraw-Hill publications
- to give most complete, dependable coverage of facts needed by all whose fields are grounded on radio fundamentals
- available at a special price and terms

THESE books cover circuit phenomena, tube theory, networks, measurements, and other subjects—give specialized treatments of all fields of practical design and application. They are books of recognized position in the literature—books you will refer to and be referred to often. If you are a practical designer, researcher or engineer in any field based on radio, you want these books for the help they give in hundreds of problems throughout the whole field of radio engineering.

**5 VOLUMES, 3319 PAGES, 2289 ILLUSTRATIONS**

1. Eastman's FUNDAMENTALS OF VACUUM TUBES
2. Terman's RADIO ENGINEERING
3. Everitt's COMMUNICATION ENGINEERING
4. Hund's HIGH FREQUENCY MEASUREMENTS
5. Henney's RADIO ENGINEERING HANDBOOK

10 days' examination. Easy terms. Special price under this offer less than books bought separately. Add these standard works to your library now; pay small monthly installments, while you use the books.

**10 DAYS' FREE EXAMINATION—SEND COUPON**

McGraw-Hill Book Co., 330 W. 42nd Street, N. Y. C.

Send me Radio Engineering Library, 5 vols., for 10 days' examination on approval. In 10 days I will send \$3.00 plus few cents postage, and \$3.00 monthly till \$24.00 is paid, or return books postpaid. (We pay postage on orders accompanied by remittance of first installment.)

Name .....

Address .....

City and State .....

Position .....

Company ..... RC-3.42

**Do you need  
BINDING POSTS?**



The XL PUSH POST with its Spring Action assures Constant Contact and quick connection.

Manufactured in All Aluminum Type M at 12c each.

Aluminum Body. Bakelite Top Type B1 at 15c each.

Types EP or NP. ALL BRASS—STAINLESS STEEL SPRING & PIN. PROVEN BY 240 GR. SALT SPRAY TEST as NON-CORROSIVE at 28c each.

Manufacturers and Dealers Liberal Discounts

**X. L. RADIO LABORATORIES**  
420 West Chicago Ave., Chicago, Ill.

**TIME-SAVING OPERATOR LIC. COURSE**

This New Course will get you a License to Operate Television, Facsimile, Radiotelephone and Broadcasting Stations. Latest, Inexpensive, Short-Cut Course by A. Binneveg, Jr., B. Sc. Includes 150-Page Book for self-study, showing diagrams necessary. Answers over 700 Necessary Questions. We answer any other Questions by Mail. NO CODE NECESSARY. Send \$1.00 now for Self-Study Book. Pay another \$2.00 when book is received, and \$1.00 later when you complete the Course.

**RADIO-TELIO INSTITUTE**  
524 Fairbanks Ave., Oakland, California

**Amazing New "WALSCO"  
STAPLE DRIVER**



for radio men, electricians, or anyone doing stapling. Makes wire and cable installations twice as easy—much neater—saves half the time. Wires can be stapled in corners, behind pipes, into moldings—places never accessible with a hammer and ordinary staples. Drives staples even into walls, brick, mortar, etc. Magazine works automatically and holds strips of staples which come in several colors. Ask your jobber for demonstration and catalogue 41.C of all WALSCO PRODUCTS

or write **WALTER L. SCHOTT CO.**  
5264 W. Pico Boulevard, Los Angeles, California

**EARPHONE CUSHION**

This earphone cushion can be made from a rubber sponge obtainable from any five and ten cent store.—*Max Goodstein.*

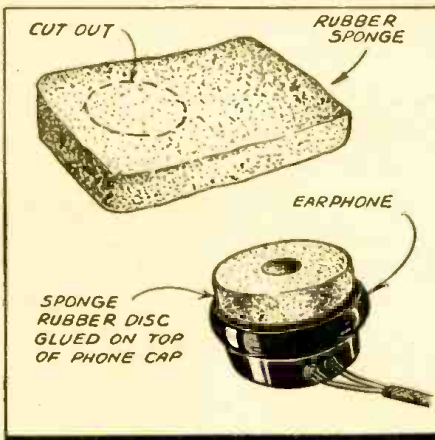

**ALIGNING TOOL**

The tool may be made from an old pipe stem, or piece of round hard-rubber. Drill a hole in the material, then clamp a screw-head of the proper size firmly in a vise and heat very hot with the soldering iron. While keeping the head hot, gently but firmly force the tool with the hole in it over the head and keep it there until cool.—*Tony Fratia, W9NKK.*

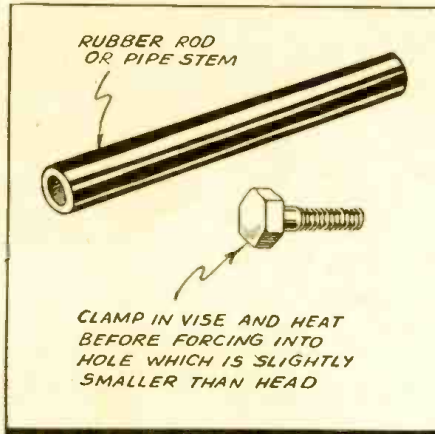

**MATCHING TRICK**

When using a tube with a high plate resistance, it is not satisfactory to use an audio transformer and a resistance coupling

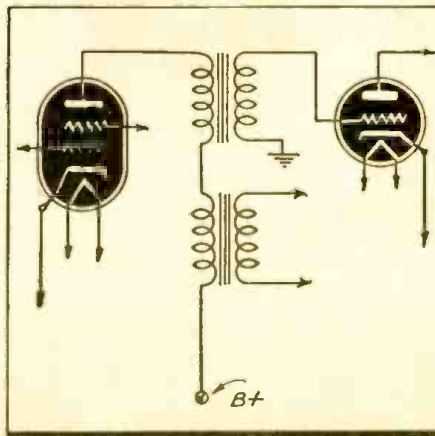

means higher voltages. I used the primary of one audio transformer and the secondary of another in series.—*W. D. Lyons.*

**BIG FREE CATALOG**



**EVERYTHING IN RADIO**

Sets, parts, supplies, public address systems, amateur equipment, testers, kits and fluorescent lighting at lowest prices. Huge stocks, bought months ago... ready for shipment the same day your order is received. The Defense Program is making big demands on our industry but because of our advance buying we are able to fill your orders promptly and efficiently.

**BURSTEIN-APPLEBEE COMPANY**  
1012-14 Mc GEE, KANSAS CITY, MO.



**"Lum and Abner"**

**BIG PRIZE CONTEST**  
54 wonderful prizes—\$100 U.S. Defense Bond, 7-Tube All-Wave Radio, Set of Aviation Books, Woodworking Lathe, Model Gas Engine, Power Scroll Saw, Daisy Air Rifle, and many other prizes valued at \$400.00 given away FREE.

**CONTEST OPEN TO ALL**  
Costs nothing to enter. Win a valuable prize. Get Science and Mechanics at your newsdealer today for full details. Or send 15c direct to Science and Mechanics, Dept. A-5, 800 North Clark St., Chicago, for a copy.

**SCIENCE AND MECHANICS**  
On Sale at All Newsdealers

**Index to advertisers**

|  |                    |
|--|--------------------|
| Adson Radio.....                               | 429                |
| Aerovox Corporation.....                       | 439                |
| Allied Engineering Institute.....              | 438                |
| Allied Radio Corporation.....                  | 409                |
| American Radio Institute.....                  | 388                |
| Amperite Corporation.....                      | 441                |
| Amplifier Co. of America.....                  | 411, 419           |
| Audel & Co., Theo.....                         | 412                |
| Burstein-Appleby Co.....                       | 448                |
| Candler System Co.....                         | 419                |
| Cannon Co., C. F.....                          | 441                |
| Capitol Radio Engineering Institute.....       | 389                |
| Classified Ads.....                            | 417                |
| Chartered Institute of American Inventors..... | 388                |
| Commercial Radio Institute.....                | 389                |
| Coyne Electrical School.....                   | 388                |
| Coyne Music Shop.....                          | 399                |
| Data Print Co.....                             | 388                |
| Detroit Corp.....                              | 389                |
| Dodge's Institute.....                         | 389                |
| Don Lee Network.....                           | 412                |
| Goldentone Radio Co.....                       | 411                |
| Harrison Radio Co.....                         | Inside Front Cover |
| Henry Radio Shop.....                          | 443                |
| Hudson Specialties Co.....                     | 422                |
| Hygrade Sylvania.....                          | 437                |
| International Correspondence Schools.....      | 431                |
| International Resistance Co.....               | 387                |
| Lancaster, Allwine & Rommel.....               | 388                |
| Lincoln Engineering School.....                | 389                |
| Mass. Radio School.....                        | 388                |
| McGraw-Hill Book Co., Inc.....                 | 448                |
| Meck Industries, John.....                     | 411                |
| Meissner Mfg. Co.....                          | 399                |
| Midwest Radio Corp.....                        | 439                |
| National Radio Institute.....                  | 385                |
| National Schools.....                          | 389                |
| National Union Radio Corp.....                 | 419                |
| Nelson Co.....                                 | 389                |
| New York YMCA Schools.....                     | 388                |
| Peerless Sound & Radio Corp.....               | 430                |
| Radio City Products Company.....               | 429                |
| Radio-Telio Institute.....                     | 448                |
| Radolek Company.....                           | 430                |
| RCA Institutes.....                            | 389                |
| RCA Manufacturing Co.....                      | Back Cover         |
| Redrite Meter Works.....                       | 429                |
| Remington Rand, Inc.....                       | 435                |
| Solar Mfg. Corp.....                           | 429                |
| Schott Co., Walter L.....                      | 448                |
| Science & Mechanics.....                       | 448                |
| Sprague Products Co.....                       | 403                |
| Spragberry Academy of Radio.....               | 388                |
| Supreme Instruments Corp.....                  | 411                |
| Supreme Publications.....                      | 439                |
| Technifax.....                                 | 438, 445           |
| Telex Co.....                                  | 441                |
| Treasury Department.....                       | 390                |
| Triplet Elec. Instrument Co.....               | 425                |
| University Laboratories.....                   | 411                |
| W45D.....                                      | 412                |
| Weston Elec. Instrument Corp.....              | Inside Back Cover  |
| X.L. Radio Laboratories.....                   | 448                |

(While every precaution is taken to insure accuracy, we cannot guarantee against the possibility of an occasional change or omission in the preparation of this index.)

# INSTRUMENTS *for the Long Pull!*



*Weston Model 774  
Checkmaster*



*Weston Model  
669 Vacuum  
Tube Voltmeter*



*Weston Model  
772 Super-Sensi-  
tive Analyzer*



*Weston Pocket-Size  
Test Instruments*

To the serviceman who owns WESTON test equipment, *that name on each instrument panel has real meaning* these days. Normally, it means long, uninterrupted service and substantial savings in instrument replacement costs. It means *all this and more* today. It means that he has tools that will give him dependable service . . . *work and earn for him without interruption . . . all during the uncertain period ahead.* Weston Electrical Instrument Corporation, 599 Frelinghuysen Ave., Newark, New Jersey.

Laboratory Standards . . . Precision DC and AC Portables . . . Instrument Transformers . . . Sensitive Relays . . . DC, AC, and Thermo Switchboard and Panel Instruments.

# WESTON

Specialized Test Equipment . . . Light Measurement and Control Devices . . . Exposure Meters . . . Aircraft Instruments . . . Electric Tachometers . . . Dial Thermometers.

**FOR OVER 53 YEARS LEADERS IN ELECTRICAL MEASURING INSTRUMENTS**

From the Earth to the Moon—that's the distance that the 80,000,000 metal tubes manufactured since 1935 would reach, placed fifteen feet apart!



Proved by ACCEPTANCE... Proved by PERFORMANCE!  
**"METAL" means MODERN!**

ACCEPTANCE! In a little over six years, more than 80,000,000—yes, 80 million—RCA Metal Receiving Tubes have been used by the Industry in over 300 electronic applications. And today, RCA is turning out *more metal tubes than ever before*—for 1941 production outstripped all previous records!

ACCEPTANCE! Of the six largest-selling receiving tube types throughout the entire Industry... four are metal types—

two-thirds of the total!

PERFORMANCE—and performance alone—is the cause of such leadership. Metal tubes permit the designer to turn out better equipment... more efficient, more dependable! For six years, the majority of important receiving-tube improvements has appeared *first* in metal types—and many advantages still appear *only* in metal types!



**"DESIGNED FOR METAL TUBES"**  
**Means Better Equipment!**

Look for metal-envelope tubes in the equipment you buy and sell. Remember that metal tubes give the highest efficiency... the highest performance standards... the highest reliability. And that means—lasting customer-satisfaction... extra good-will for you!



**METAL TUBES**

RCA Manufacturing Company, Inc., Camden, New Jersey

A Service of the Radio Corporation of America • In Canada: RCA Victor Company, Ltd., Montreal