

RADIO-CRAFT

HUGO GERNSBACK, Editor

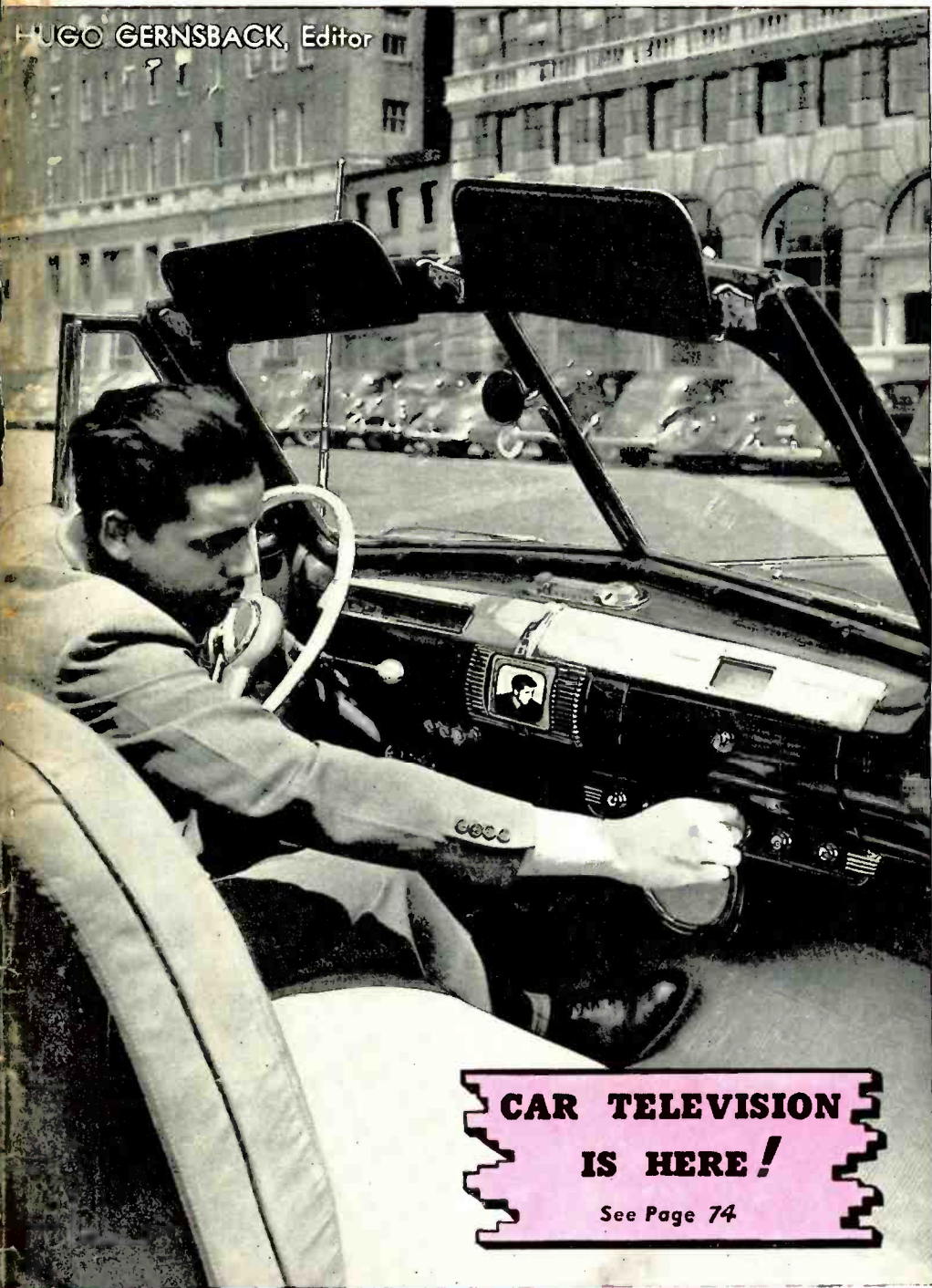

**CAR TELEVISION
IS HERE!**
See Page 74



TRAFFIC P.A.

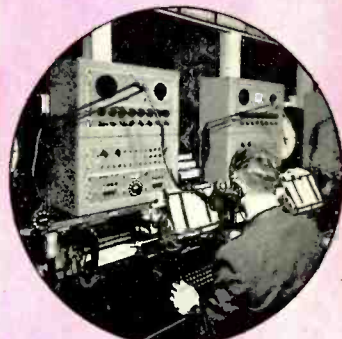

AIR RADIO-CENTER



MIKE WIND-TUNNEL



THEATRE TELEVISION

AUG. 25c
CANADA 30c
1941

RADIO'S GREATEST MAGAZINE

F.M. PHONO PICKUP • THEATRE SOUND-CONTROL • "WIRELESS" OSCILLATORS

VACUUM-TUBE VOLTMETER • METAL-TREASURE LOCATOR CONSTRUCTION HINTS

THERE'S MORE DRAMA and excitement packed into amateur reception when your communications receiver is a Hallicrafters. Back of Hallicrafters precision engineering is long experience, and it is this that accounts for the finer, broader, more accurate and dependable reception amateur owners enjoy. Lafayette Radio offers a complete line of latest Hallicrafters models. Time payments make owning one easy. Send for **FREE** catalog today, or visit branch nearest you.

Hallicrafters



MODEL S-19R

Efficient superheterodyne circuit employs 6 tubes, of which two are double-purpose types, providing 8 tube performance. Complete tuning range of the receiver from 545 kc. to 44 mc. in 4 tuning bands. Electrical band spread on each band. Broadcast band coverage, beat frequency oscillator, automatic volume control switch, built-in speaker and a separate band spread dial. Designed for operation from any 110-120 volt 50-60 cycles a.c. line. Antenna connections provided for both doublet and Marconi type antennas. Cabinet beautifully finished - 17 1/2" x 8" x 8 1/2".

\$29⁵⁰



MODEL S-20R

New improved 9 tube model. Covers the complete range from 545 kc. to 44 mc. in four bands. Employs a stage of pre-selection on each band for added sensitivity and selectivity. Controls: r.f. gain, audio gain, tone control, a.v.c. switch, B.F.O. switch, band switch, main tuning control, separate band spread control, and "stand-by" switch. Built-in speaker. Circuit features electrical band spread, automatic noise limiter, r.f. amplifier. Designed for 110 volts 50/60 cycles a.c. operation, (plug and jock provided for batteries or vibrapack operation). Steel cabinet measures 18 1/4" x 9 3/8" x 8 1/2".

\$49⁵⁰



MODEL S-29

Precision-built communications receiver in portable form. Operates on either 110 volts AC or DC or from self-contained batteries. Self-contained telescopic antenna. Receiver covers four complete bands: 11.26 mc. to 1490 kc. Employs an r.f. stage on all bands, incorporates an automatic noise limiter; electrical band spread. Built-in speaker. Controls include: main tuning—band spread—r.f. gain—A.f. gain—band switch—power switch—a.v.c. "off-on" switch—BFO "off-on" switch—ANL "off-on" switch—send-receive—standby switch. Dimensions: 7" high, 8 1/2" wide, 13 1/4" deep.

\$59⁵⁰

Lafayette

100 SIXTH AVE., NEW YORK

901 W. JACKSON BLVD., CHICAGO

265 PEACHTREE ST., ATLANTA

boston • newark, n.j. • bronx, n.y. • jamaica, l.i.

THE WORLD'S LARGEST RADIO SUPPLY HOUSE

MAILING THIS COUPON
has started hundreds
on the way to
BETTER PAY
IN RADIO

You Can Train at Home for Radio and Television

Clip the coupon and mail it. I want you to see how I train ambitious men at home in spare time to be Radio Technicians. I will send you a sample lesson free. Examine it, read it, see how clear and easy it is to understand. See how my Course is planned to help you get a good job in Radio, a young, growing field with a future. You needn't give up your present job, or spend a lot of money to become a Radio Technician. I train you at home in your spare time.

Why Many Radio Technicians Make \$30, \$40, \$50 a Week

Radio broadcasting stations employ many operators, technicians and pay well for trained men. Radio manufacturers employ testers, inspectors, servicemen in good-pay jobs with opportunities for advancement. Radio jobbers and dealers employ installation and servicemen. Many Radio Technicians open their own Radio sales and repair businesses and make \$30, \$40, \$50 a week. Others hold their regular jobs and make \$5 to \$10 a week fixing Radios in spare time. Automobile, police, aviation, commercial Radio; loudspeaker systems, electronic devices, are newer fields offering good opportunities to qualified men. And my Course includes Television, which promises to open many good jobs soon.

Many Make \$5 to \$10 a Week Extra In Spare Time While Learning

The day you enroll, in addition to my regular Course, I start sending you Extra Money Job Sheets—start showing you how to do actual Radio repair jobs. Throughout your Course I send plans and directions which have helped many make \$5 to \$10 a week in spare time while

learning. I send special Radio equipment; show you how to conduct experiments, build circuits. This 50-50 training method makes learning at home interesting, fascinating, practical. I devote more than 10 Lesson Texts exclusively to Television methods and applications, and cover Television fundamentals thoroughly in my Course.

You Get This Professional Servicing Instrument



This instrument makes practically any test you will be called upon to make in Radio service work on both spare time and full time jobs. It can be used on the test bench, or carried along when out on calls. It measures A.C. and D.C. voltages and currents; tests resistances; has a multi-band oscillator for aligning any set, old or new. You get this instrument to keep as part of your N.R.I. Course.

Get Sample Lesson and 64-page Book Free

Act today. Mail coupon now for Sample Lesson and 64-page book. They're FREE. They point out Radio's spare time and full time opportunities and those coming in Television; tell about my Course in Radio and Television, show more than 100 letters from men I trained, telling what they are doing and earning. Read my money back agreement. Find out what Radio offers you. Mail Coupon in envelope or paste on penny postcard—NOW!

J. E. SMITH, President, National Radio Institute
Dept. 1HX, Washington, D.C.

MR. J. E. SMITH, President
National Radio Institute, Dept. 1HX
Washington, D. C.

Dear Mr. Smith: Mail me FREE, without obligation, your Sample Lesson and 64-page book, "Rich Rewards in Radio," which tells about Radio's spare time and full time opportunities and explains your 50-50 method of training men at home to be Radio Technicians. (No salesman will call. Write Plainly.)

Age.....

Name

Address

City State

14X1

**I Trained
These Men**



**Truck
Driver
Now Owns
Business**

Before taking the N.R.I. Course I was a truck driver making \$25 a week. Now I have my own Radio service shop. My business has grown every month. I owe my success to N.R.I. training. J. Alan Mohr, 2047 Fillmore St., San Francisco, Calif.



**Makes \$500
A Year
In Spare
Time**

I started to earn money about 3 months after enrolling with N.R.I. and made about \$600 before graduating. In a year I earned \$500 in spare time. S. G. Pier-son, Box 71, Dry Creek, W. Va.



**Operates
Public
Address
System**

I have a position with the Los Angeles Civil Service operating the Public Address System in the City Hall Council. My salary is \$170 a month. R. H. Reed, R. 136, City Hall, Los Angeles, Calif.



**Had Own
Business
6 Months
After
Enrolling**

I went into business for myself 6 months after enrolling. In my Radio repair shop I do about \$300.00 worth of business a month. I can't tell you how valuable your Course has been to me. A. J. Baten, Box 1168, Gladewater, Texas.



**Chief
Operator
Broad-
casting
Station**

Before I completed your lessons, I obtained my Radio Broadcast Operator's license and immediately joined Station WMPG where I am now Chief Operator. Hollis F. Hayes, 327 Madison St., Lapeer, Michigan.



**Has Good
Job in
Aviation
Radio**

I owe the beginning of my interest in my career to the time I clipped the coupon and enrolled for your Course. I am now in charge of the Radio Department for the American Airlines at Cleveland. Walter B. Murray, American Airlines, Municipal Airport, Cleveland, Ohio.

Sample Lesson FREE

My sample lesson text, "Radio Receiver Troubles—Their Cause and Remedy," covers a long list of Radio receiver troubles in auto, D.C., battery, universal, T.R.F., superheterodyne, all-wave and other types of sets. And a cross reference system gives you the probable cause and a quick way to locate and remedy these set troubles. A special section is devoted to receiver check-up, alignment, balancing, neutralizing, testing. You can get this lesson free by mailing the coupon.

RADIO-CRAFT

HUGO GERNSBACK, *Editor-in-Chief*

N. H. LESSEM
Associate Editor

THOS. D. PENTZ
Art Director

R. D. WASHBURNE, *Managing Editor*

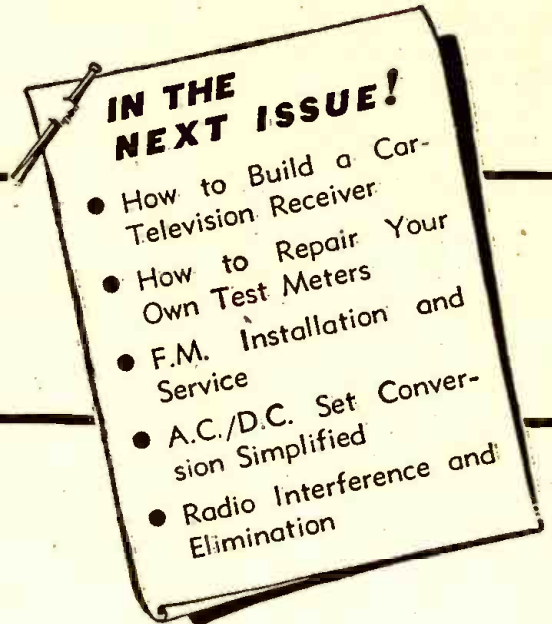

Contents AUGUST, 1941 Issue

VOLUME XIII -- NUMBER 2

Mailbag	67
Editorial: Radio Aircraft Detector	Hugo Gernsback 73
The Radio Month in Review	74

SERVICING

New Circuits in Modern Radio Receivers—No. 47	F. L. Sprayberry 76
Making Money by Building Wireless Phono-Oscillators	L. M. Dezettel 77
Operating Notes	79, 85, 109
Newest Technique in Servicing Car-Radio Sets	80

RADIO SERVICE DATA SHEETS:

No. 312—Lafayette Chassis Model B-100 (Table Model B-103; Console Models B-101, B-102)	86
No. 313—Ditto	87

F. M.

An Engineer Analyzes the How and Why of Frequency Modulation—Part II	Raymond F. Guy 88
New!—F.M. Phono Pickup	N. H. Lessem 90

SOUND

Sound Engineering—No. 20.....Conducted by A. C. Shaney	92
How to Build a Modern 30/15 Watt P.A. -Radio-Recording Console—Part III	R. J. Bergemann, Jr. 94
An A.F. Amplifier and a Power Supply Featuring Voltage Multiplication	Steve Kusen 99

TEST INSTRUMENTS

Build This Practical and Inexpensive Vacuum-Tube Voltmeter	A. K. McLaren 102
--	-------------------

ELECTRONICS

Type 931 Electron-Multiplier Phototube	106
--	-----

EXPERIMENTERS

Construction Hints and Experiments with Metal-Treasure Locators	G. M. Bettis 108
---	------------------

RADIO DEVELOPMENTS

Unique Theatre Sound-Control—Using Subsonics, Reverberation and the "Vocoder"	Harold Burris-Meyer 110
---	-------------------------

RADIO DEFENSE

In Reply to—"Our Ailing Radio Defense Program"	112
--	-----

DEPARTMENTS, ETC.

Mailbag	67
The Radio Month in Review	74
New Circuits in Modern Radio Receivers—No. 47	F. L. Sprayberry 76
Operating Notes	79, 85, 109
RADIO SERVICE DATA SHEETS (See Servicing)	86, 87
Sound Engineering—No. 20.....Conducted by A. C. Shaney	92
Latest Radio Apparatus	115
Classified Radio Directory—Section V (Revised)	120
Shop Notes—Kinks—Circuits	127
Book Reviews	128



Published by Radcraft Publications, Inc. Publication office: 29 Worthington Street, Springfield, Mass. Editorial and Advertising Offices: 20 Vesey Street, New York City. Chicago Advertising Office: RADIO-CRAFT, 520 North Michigan Avenue, Chicago, Ill.

RADIO-CRAFT is published monthly, on the first of the month preceding that of date; subscription price is \$2.50 per year in U. S. (In foreign countries, 75c additional per year to cover postage; Canada, 50c additional.) Entered at the post office at Springfield as second-class matter under the act of March 3, 1879. All communications about subscriptions should be addressed to: Director of Circulation, 20 Vesey Street, New York, N. Y.



Foreign Agents:

London—Gorrings American News Agency, 9A Green St., Leicester Square, W. C. 2, England.

Paris—Messageries Dawson, 4 Rue Faubourg, Poissonniere, France.

Melbourne—McGill's Agency, 179 Elizabeth St., Australia.

Dunedin—James Johnston, Ltd., New Zealand.



Text and illustrations of this magazine are copyright and must not be reproduced without permission of the copyright owners.



Copyright 1941 Radcraft Publications, Inc.

A PLAN TO SAVE VITAL ALUMINUM

Dear Editor:

Enclosed herewith (printed below—Ed.) is a letter sent to the principal manufacturers of aluminum-can capacitors.

Their answers will determine whether the plan outlined is practical and feasible.

If the recovery of such defective units could be made without the necessity of re-fabrication of the aluminum containers much effort could be released for Defense work and the scarcity of aluminum be somewhat offset.

Your position in the radio industry can be of utmost importance in making such a campaign successful.

As time is an essential essence in this endeavor, I am writing to ask that you immediately give serious consideration to this project.

The campaign proposed could be coordinated under the direction of some national body such as the Radio Manufacturers Association (R.M.A.).

HENRY B. DUNCAN,
Duncan Radio Laboratory,
Wilmington, Delaware.

Aerovox Corporation,
New Bedford, Massachusetts,
Gentlemen:

The scarcity of aluminum will soon cause a serious shortage of aluminum-can capacitors.

Could you, as a manufacturer re-use the can containers of defective capacitors if radio servicemen saved them from their replacement jobs?

If so, the writer believes a national campaign could be instituted urging every radio serviceman to save aluminum capacitors from all repair jobs.

The local radio supply jobbers would be the logical receiving depots, as they would be best able to separate the containers as to their make and return the same to the manufacturer in bulk shipments. The manufacturer would only be obligated to pay transportation charges.

If this plan is feasible, it could be extended to include all aluminum radio parts, such as shield cans, etc.

I have no doubt that radio servicemen's associations, jobbers, radio periodicals, and even the broadcasters would cooperate in this effort.

HENRY B. DUNCAN

BOMBAY SPEAKS

Dear Editor:

Let me take this opportunity of thanking you for publishing Classified Radio Directory.

I am regularly subscribing (locally) to your *Radio-Craft* for the past 4 years. Speaking about this publication, I can boldly say that it is the only magazine which fulfills the demands of Servicemen and Trade.

Editor, you are lucky to get the cooperation of Messrs. Shaney, Sprayberry, etc. I would appreciate very much if Mr. Shaney would publish formulas required in designing amplifiers. This will enable any P.A. man to have his own amplifier.

Lastly I want you to help our firm in trade. Will you please contact us with Canadian and American Manufacturers desiring their lines to be represented in India?

For ourselves, you may refer to the National City Bank of New York, Bombay 1.

Thanking you in advance; wishing *Radio-Craft* long life.

J. RAY D. BAKSHI,
Manager, Radio Dept.,
J. V. Mehta & Co.,
Opera House Tram Terminus,
Bombay, India

"WALKED 10 MILES TO GET RADIO-CRAFT"!

Dear Editor:

This writer is another purveyor in the same boat with our esteemed writer *Mr. Emil (Earl?—Ed.) Russell. May I express my thanks to you Mr. Editor, who by the way has given us *The Radio Voice* (via "R.-C.").

I am an old pioneer in the game, over 30 years. Many's the happy hour that I used to spend with Dr. Lee de Forest on the old Youngs Pier, Atlantic City, N. J. Consequently, I get a great kick out of "The Wireless Dept." of this TOPS magazine. Chiefly the previous article of Mr. Willard Moody, published in "R.-C." of Feb., '41.

While I am an old New Yorker of many years' residence, it's impossible for me to sit idle and permit such nonsense to be given valuable space in your magazine of which I have been a reader and also a newsstand customer for many years. When I hear the Burro's yelp (or bray)—they are called "onion donkeys" out here—I can't help but think of Mr. Moody. *Your concern deserves much credit for giving "him" space.* With all of his apparent ego (yes I must use that term) I am surprised that he cares to contribute the results of his learning (???) to your valuable publication.

Pardon, just a few words more. 'Tis said that if one opens his mouth wide and loud enough, he (or she) advertises his (or her) want of brains. Permit me to subscribe to the article of Mr. Henry Louis Trudeau (as of May, 1941, "R.-C.", pg. 647). Furthermore, permit me, Mr. Editor-in-Chief, to state: "No one who receives his living from the radio-minded public can afford to be without your publication." If he does try to do it, it's solely due to thoughtlessness on his part. There is another old saying: "Walk a mile for a camel." Well, I used to walk 10 miles to purchase my *Radio-Craft*—and missed many meals in so doing. Keep up your good work and don't change anything. This is from a radio man who made his pile prior to the depression and lost it (but I am not alone).

H. C. HARRIS,
Delta, Colorado
c/o Bx 166, R.2

*See "Mr. Russell Retorts," May, 1941. "Mailbag."

SHANEY AMPLIFIERS IN HOLLYWOOD

Dear Editor:

I rise up to holler. In the May, 1941, issue of your book one Ellsworth Dodrill rakes you over the coals for the lack of detailed information as to the construction of Doc Shaney's brain children ("A. C. Shaney's Sound Articles," pg. 643, "Mailbag".—Editor). Although I am not a Serviceman I cannot see for the life of me, what more could possibly be put into the article criticized. To my mind anything added would be something to wade through to get at the meat of the thing.

I have built 2 of the original 10-watt P.-P. amplifiers, one of the 30-watt, and have just now finished a copy of the recording-playback unit as of the April, 1940, issue of "R.-C." This is being installed in the Mrs.'s voice coaching studio for regular use.

I hesitate to quarrel with a stranger but would like to call the attention of Mr. Dodrill to some of the conditions preceding his era.

Can you, dear Editor, remember back when OHX used to push his key and have every op within 40 miles tear his phones off and cuss the Herald's bright boy for blistering their cars? And old DF could be heard all over the North Atlantic? When the snazziest thing in ham xmtr junk was

SPRAYBERRY TRAINS YOU for GOOD PAY! STEADY WORK! ADVANCEMENT! in RADIO and TELEVISION



DON'T WAIT! START NOW!

You Can Make Money Almost At Once
You'll be quickly shown how to get and do neighborhood Radio Service jobs... for practice and profit. You easily learn Television, Frequency Modulation, Signal Tracing, Mobile Radio (Auto-Tank), Aviation Radio, Electronics, Facsimile Radio, Radio Set Repair and Installation Work. I'll Prepare You Quickly in Spare Time

At Home Or At Camp
SPRAYBERRY Training does not interfere with your present work. You will receive personal coaching service all the way. You'll be fitted to hold down a good paying job in Radio or to have a Radio business of your own.

You Get Professional Test Equipment
Plus Experimental Outfits
Includes 148 RADIO PARTS (to build complete Radio Receiver), RADIO TOOLS and a TESTER-ANALYZER. MY EXPERIMENTAL OUTFITS enable you to conduct actual experiments with your own hands.

NO EXPERIENCE NEEDED
It makes no difference what your education has been, I can fit you to become a real RADIO TECHNICIAN. Your success is my full responsibility.

THE SPRAYBERRY COURSE IS SOLD UNDER MONEY-BACK AGREEMENT

RUSH COUPON for BIG FREE BOOK

SPRAYBERRY ACADEMY OF RADIO
E. L. Sprayberry, President
120-H University Place, N. W.
Washington, D. C.
Please rush me FREE copy of "HOW TO MAKE MONEY IN RADIO."

Name Age.....
Address
City State.....
(Mail in envelope or paste coupon on penny postcard)

RADIO TRAINING

Founded in 1909

PORT ARTHUR COLLEGE, a non-profit making educational institution, offers a practical radio operator's course at the lowest tuition price in its history. Each radio graduate receives two months' actual operating experience at the college's commercial broadcasting station KPAC. This station is equipped with the latest type 1000 watt high fidelity RCA transmitter—1250 kc.—directional antenna system. KPAC operates in new modern studios located on the campus. The college has never advertised jobs or positions in lieu of education. Today it is well known there is a shortage of radio operators in every branch of radio; therefore, we believe it is good common sense to mention that Port Arthur College is the sole radio school in America which owns a commercial broadcasting station with commercial advertising representatives in New York, Chicago, San Francisco, and many of America's leading cities, with active membership in the National Association of Broadcasters, and Broadcast Music Incorporated. Through these contacts the college receives from the broadcast industry alone a great many more calls for student radio operators than it is possible to supply. Authorized to teach RCA texts.

If interested, write for Bulletin R-41
PORT ARTHUR COLLEGE
PORT ARTHUR (World-Known Port)
TEXAS

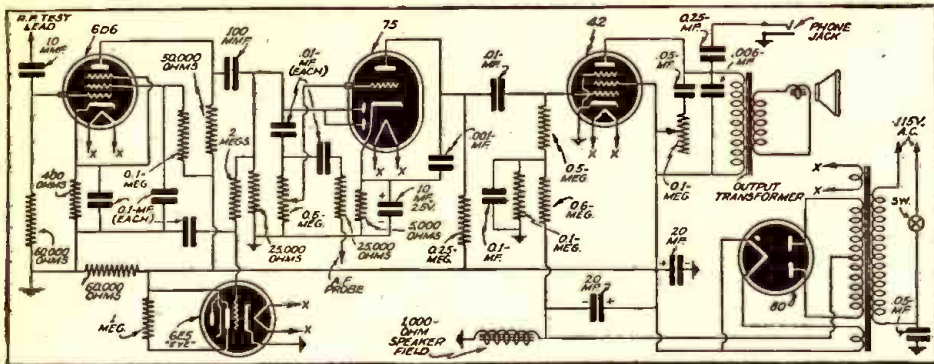

Complete corrected diagram of Olson's Signal Tracer which appeared in July, 1941, *Radio-Craft*. (See Mr. K. R. Tanner's "Mailbag" letter.)

Hugo's ELECTROLYTIC INTERRUPTER in the E. I. Co.'s window? And you paid \$12 for an Audion BULB and carried it home on the subway wrapped in cotton in a cigar box, so the filament wouldn't break before you got there? Those were the days when information as to the insides of radio gadgets was definitely lacking! How many superhets. have you helped try to set up, practically out of thin air?

I wonder what Mr. Dodrill would have done if he had been put aboard the *E1 Cid* 20 minutes before sailing time to make the old single- and double-slide tuning coils work on the new loop aerial then in favor? (And if the slide condenser didn't enable you to high enough, you slapped a piece of paper on either side of each movable plate and gave 'er a good dose of shellac?—Ed.) When the only service data available was an article entitled "My Trip to the Ice Fields" by D. Sarnoff? (In *Marconigraph* magazine, wasn't it?—Ed.) And what would have to be done when the spark from the 10-inch Rumkorff coil started to slither along the top of the rubber case instead of acting in a seagoing manner?

True, that the equipment of today has been elaborated and complicated greatly, but after reading a few issues of "R.-C." I think the tools of the Serviceman and builder have gone even further.

I remember taking out a set on the Great Lakes in the spring of '17 (one of those vest-pocket rotary sync jobs) and after calling everything in the book, Cleveland told me I was on about 980 meters instead of 600. We tuned the set by ear by air and went merrily on our way.

I must be getting old, but thanks for the space anyway. I haven't had a pair of cans on my head since 1923 commercially but I still get a kick out of your mag. Give 'em hell and we subscribers can fight it out on the sidelines in a friendly manner.

Keep up the good work and when you go plumb crazy put it out weekly and I'll still be here waiting for the postman.

Yours in a cloud of dust,

PAUL H. MANNING,
Hollywood, Calif.

OLSON'S SIGNAL TRACER

Dear Editor:

I have been considerably interested in the Signal Tracer test unit described on page 22 of your July, 1941, issue of *Radio-Craft*, and plan to construct one like it. The July issue mentioned a Signal Tracer to be described in the August issue, and I thought it might be a continuation of the one shown and described in the July issue, so waited in anxiety to read it. However, I was disappointed, because the August Tracer was altogether different.

I would like to see the complete wiring diagram, including the tuning eye and the 5th tube shown on the picture at the lower-left corner of page 22—in the text only the 6D6, 75 and rectifier tubes are indicated.

I request you contact the author R. B. Olson, and obtain the complete diagram if possible and practicable, which I should appreciate no end.

I thank you in advance for anything you may find it possible to do for me about this and assure you that I find *Radio-Craft* more enjoyable and useful to me as the days go by.

K. R. TANNER, Radioman 1st Class,
Aircraft Squadron, VJ-2,
Naval Air Station,
San Diego, Calif.

This letter was brought to the attention of author Olson, whose reply appears here.

Dear Mr. Tanner:

Granting your request, forwarded to me by *Radio-Craft*, I enclose the complete diagram of this instrument (Diagram reproduced above.—Editor). You will find the diagram I have enclosed slightly different in respect to the value of the 6D6 tubes' cathode resistor and the resistor located in the A.F. probe. These values were typographical errors in the magazine.

When using this instrument for testing R.F. or I.F. stages the radio must be retuned after the probe has been attached due to the detuning effect of the tester.

If you have any further difficulties do not hesitate to write to me.

R. B. OLSON,

MOODY: "I ASKED FOR IT!"

Dear Editor:

Well, I asked for it! Mr. Charles Pilgrim has told me to be quiet in a polite way.

He's right, I'm young, 24 years, but I've repaired thousands of sets in 5 years of busy servicing. Before that, I was an amateur for 5 years. So it isn't a case of having just gotten a diploma. And he, himself, does not appear to be a "dopey Serviceman," although he puts himself in that classification by saying, "Us dopey Servicemen are

the ones who keep you eating regular, etc." The fact is that a dopey Serviceman doesn't keep anyone eating regular because he doesn't make any money. He makes enough to pay his bills and is always one jump ahead of the creditors. Further, there have been some young men who were sure of themselves and proved their worth. There is no need for a pseudo-philosophical attitude which says, "The kid means well." Mental maturity comes early to some, never arrives for others.

WILLARD MOODY,
New York, N. Y.

RE: "AN ORIGINAL PHASE INVERTER"

Dear Editor:

I enclose an old reprint (*) covering the type of cathode phase inverter (See circuit, reproduced here.—Editor) described in your June "letters to the editor" (The letter, "An Original Phase Inverter," of Mr. Waldemar de Oliveira," Sao Paulo, Brazil, pg. 707 of "Mailbag."—Editor). By application of Negative bias to the cathode resistor re-

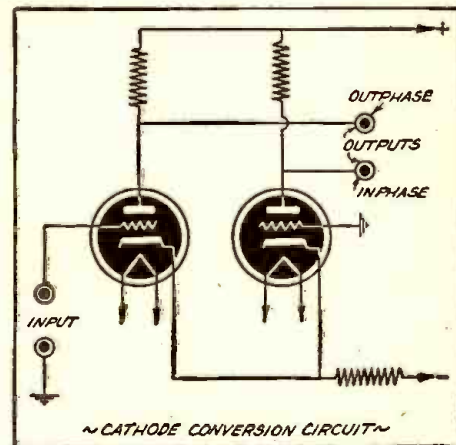

turn as described in this paper the objection to the use of triodes can be met without sacrificing the desirable D.C. amplification characteristic inherent in the cathode phase inversion method.

This type of circuit has been in use for several years for amplification of nerve potentials where extreme frequency fidelity (0-50,000 cycles/sec.) and high amplification (up to 40,000,000 voltage amplification) are required and has proved highly successful.

I might point out other highly desirable features of the amplifier:

(1) Signal may be applied to either control-grid and thus the inverter serves admirably as a mixer and/or fader.

*The enclosure was a reprint, "Cathode Phase Inversion," from the March, 1938, issue, *Jour., St. Insts.*

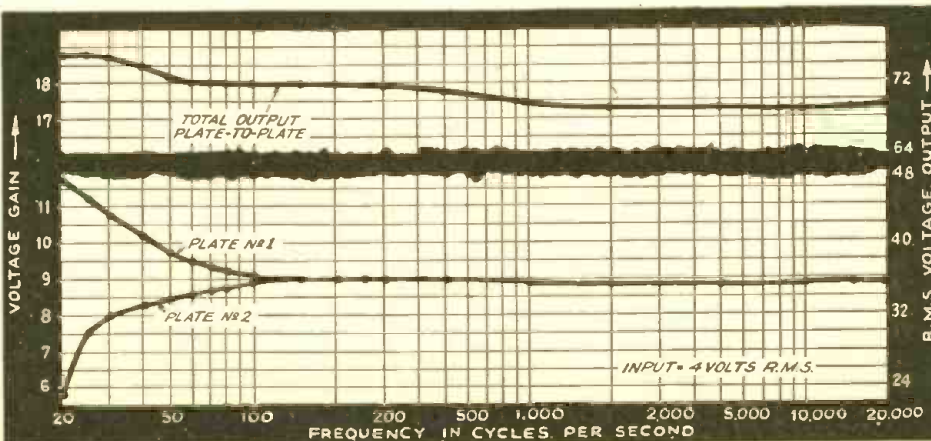

Curves submitted by Otto H. Schmitt in his "Mailbag" letter titled "Re: 'An Original Phase Inverter.'"

(2) Two or more stages of the phase inverter may be used successively, each reducing the residual imbalance from the last.

(3) Used as a cathode-ray amplifier, the desirable state of balanced operation may be obtained while retaining D.C. amplification and permitting adjustment of zero position of the beam by a bias applied to that control-grid to which signal is not applied.

(4) Because of the essential symmetry of the circuit, hum cancels out and relatively poorly filtered plate power can be used. Also because of the constant total plate current, motorboating is made less likely.

In an article on this type of amplifier-inverter now in preparation for publication (probably in *Review of Scientific Instruments*) a method of introducing adjustable attenuation into this circuit through variable cathode degeneration is being described.

As was mentioned in the published article, an alternative method for obtaining satisfactory inversion without introducing excessive bias consists in including a small choke in the common cathode circuit. The enclosed curve (See page 68.—*Editor*) illustrates the way in which amplification splits between the 2 plate circuits at various frequencies and how the total amplification (Plate 1 + Plate 2) covers the audio range. The circuit uses a 6F8G as the inverter with a Thordarson 72C30 as the choke.

OTTO H. SCHMITT,
University of Minnesota, Minn.

ANENT BUCK'S "ALIGNING SUPERHETS."

Dear Editor:

Since two of your correspondents in the April, 1941, issue (*) are arguing about my old radio set at Windsor, Ontario, some information about it may be in order.

It is a "Goldentone D7" of 1936, made (or assembled) at Dearborn, Michigan. It was a very popular type about like diagram No. 4, pg. 180, RCA Tube Manual of 1937, with added electron-ray indicator, short-wave band, etc. It has 2 standard 456 kc. double-tuned I.F. transformers of unknown make.

It was a good radio for the money (\$16 mail-order); everything was in good adjustment and reception was good all around the dial except for a few images and harmonics, the worst being from the strong stations at 750 and 2,414 kc., on the weak station at 1,500 kc.

The 1,500-kc. station came in at estimated dial readings of from 1,490 in cold weather to 1,508 in hot weather. The image of the 2,414 kc. Detroit police from 1,489 in cold, to 1,512 in hot weather.

I'll let them do the figuring and arguing, but these readings give me 457½ to 455 I.F.; or 1/3% off, instead of Mr. Buck's 3% to 20%, or Mr. Moody's 0.0001%. We seem to be talking about 3 different things.

GILBERT S. WALKER,
Pittsburgh, Pa.

Surprised to meet your customer, the "fellow by the name of Walker," via the "Mailbag" column of *Radio-Craft*, Mr. Buck? "R-C." gets around doesn't it? Hi!—*Editor*

BUCK GETS A VOTE!

Dear Editor:

In regard to Homer C. Buck's recent article on **aligning superheterodynes, the

**Anent Homer Buck's 'Aligning Superhets.' signed Willard Moody; and "Tuning I.F.s by Ear." signed H. C. Buck.

RADIO-CRAFT for AUGUST, 1941

method is possible, and perfectly logical (contrary to what some of your readers—whose letters appeared in subsequent issues of "Mailbag"—seem to think) although it is somewhat slow and cumbersome.

This method assumes that the set has an accurately-calibrated dial which is in perfect mechanical alignment. In this method we use 2 knowns: (f1) the station frequency (preferably some local station); and, (f2) the intermediate frequency which is half the difference between the image and fundamental as read on the dial.

To take a practical case let us align a superhet. whose I.F. should be on 456 kc. but is actually on 440 kc. and whose oscillator is also off. The first step is to tune-in some known station, say 1,500 kc. (assigned frequency) and adjust the oscillator trimmer so that this station comes in at 1,500 on the dial. Next tune-in the image which is 1,500-f2 (440) or 620 kc. on the dial. This determines the I.F. It is now necessary to retune the I.F. trimmers. These should be retuned, a step at a time so as not to overshoot the mark, in the following manner:

The image on the dial should be at 1,500-f2 (456) or 588 kc. but the I.F. trimmers should be only opened enough to bring the image to about 610 kc., or less than half the difference between 620 kc. and 588 kc. The station will now be found to come in at some point above 1,500 kc. and it is necessary to open the oscillator trimmer until the station again comes in at 1,500 kc.

Next the image is checked and it should now come in very near 588 kc. which is the correct frequency. Let us say it comes in at 600 kc. on the dial. Let out the trimmers of the I.F. amplifier so that the image comes in at 595 kc. and open out the oscillator trimmers until the station again comes in at 1,500 kc. on the dial, and readjust the I.F. trimmers for proper image.

If this procedure is repeated enough times a very accurate alignment job will result but it is obvious that a *strong local station must be used and it should be on the upper portion of the dial.*

When several R.F. stages are used it may be necessary to reconnect the antenna to the input of the 1st-detector through a suitable impedance-matching device in order to receive an image at all. I hope this may be of help to any reader who doesn't understand this method of alignment or checking alignment on superhets.

JOHN R. SIMPSON,
Gainesville, Fla.

***Aligning Superhet. Receivers." Jan., 1941, pg 401.

2- OR 3-COLOR TELEVISION?

Dear Editor:

I read with interest the television items starting on page 586 of your April, 1941, *Radio-Craft*. A point made in a sentence on that page should, I believe, be amplified to keep the record straight. The sentence: "The 2-color system exhibits less flicker than does the 3-color system."

All other things being equal, flicker is a function of single color repetition rate. If a 2-color disc is added to a television system with present standards for black-and-white, the repetition rate for each color is 30 per second. With the same level of picture brightness, the C.B.S. 3-color system on the other hand has a single color repetition rate of 40 per second, and therefore less, not more, flicker.

The flicker problem is most serious when the color of a televised object matches one of the color filters. Since there are thousands of colors, such a match is rare—irrespective of the color system in use.

New Direct-Coupled FM - AM AMPLIFIER MANUAL

By A. C. SHANEY

Chief Engineer, Amplifier Co. of America



For the Layman, Serviceman
Recordist and Engineer

Regardless of whether you are interested in the finest type of phonograph reproduction, high fidelity recording, sound-on-film applications, FM or AM programs, you will find invaluable information in this practical handbook. Written by the leading exponent of direct-coupled amplifiers who has spent more than 10 years improving and perfecting the famous Loftin-White circuit.

Explains the theory and practical application of:

- Variable Speed Non-Overloading Push-Pull Expansion
- Non-Frequency Discriminating Scratch Suppression
- Push-Pull Balanced Direct-Coupled Amplification
- Push-Pull High-Frequency Equalization
- Push-Pull Low-Frequency Equalization
- Push-Pull Volume Compression
- Automatic Volume Limitation
- Automatic Volume Control
- Calibrated V. U. Indicator
- Audio Spectrum Control
- Remote Control

If you are interested in the latest audio developments, you can't afford to be without this complete compilation of authentic articles on Direct-Coupled Amplifiers. 32 pages 8½" x 11". Over 100 diagrams and illustrations.

Priced to Cover Cost of 20c
Printing and Mailing

Send Stamps or Coin

AMPLIFIER CO. of AMERICA
17 WEST 20TH STREET. NEW YORK, N. Y.



LEARN RADIO

SERVICING COURSE - 8 WEEKS
OPERATING COURSE - 5 MONTHS

H. C. Lewis

I'LL FINANCE YOUR TRAINING

Mail coupon today for free book showing how you can learn Radio Operating, Servicing, Sound and Television in a few short weeks in Coyne Shops and also how you can pay tuition in easy monthly payments after graduation.

LEARN BY DOING

On real Radio receiving and transmitting equipment at Coyne. Simple, easy method of practical shop training. You don't need previous experience. Prepare for Radio Operators' Government license Exam. and for good jobs in Broadcast, Police Radio, Aircraft Radio, Ships, Commercial Radio stations, or in service shops and radio factories. "Learn by doing", the quick, modern way, at Coyne Shops in Chicago.

EARN WHILE LEARNING

We assist you in getting part-time work to help pay living expenses and give you real employment service after you graduate. Mail coupon now for all details of my plans to help you.

H. C. LEWIS, Pres., COYNE ELECTRICAL SCHOOL (Radio Div.)
500 So. Paulina St., Dept. C1-8M, Chicago, Ill.
Please send me your free book and details of easy Pay-After-Graduation Plan.

NAME _____
ADDRESS _____
CITY _____ STATE _____



SEND
COUPON
TODAY

FIRST AGAIN!

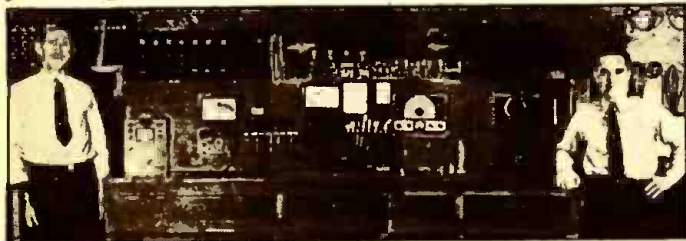

Owatonna's Latest and Most Up-to-the-Minute Radio Mechanical Equipment

I have added to my staff a Radio Engineer and Technician of outstanding ability and training and have provided him with the latest and most scientific radio repair equipment on the market today. The addition of this man guarantees prompt, thorough service with two experienced men always ready to answer your radio problems!

Authorized Philco, Motorola, General Motors Car Radio Service Station

AL'S RADIO SERVICE

Dial 2105

ALFRED J. BEAUCHAMP

Owatonna

MYRON C. JONES

128 W. Pearl

We repair ALL makes of radios, but sell none—HOWEVER, we are the only radio shop in this territory completely equipped to satisfy your sound equipment needs and office call system's requirements. We SELL or RENT public address systems. Inquire today about DORA-FONE office call systems. We carry a complete line of inter-office communication systems.

Aggressive Mr. Beauchamp is on his toes not only with his "up-to-the-minute Radio Mechanical Equipment" but with his ability to capitalize on it through the medium of intelligent advertising. Read his "Mailbag" letter in the first column, this page.

An additional point is that in a 3-color system, every picture element is reproduced in the 3 colors of the filter disc—the same 3 colors necessary to faithful representation. In a 2-color system, half of the picture elements are reproduced by only one of the colors, while the other half are reproduced by the other color. In other words, all the picture elements are never reproduced by both. This means that when the color of a televised object approximates one of the colors in the 2-color disc, there is a severe loss of vertical definition.

WIL MARCUS,
New York, N. Y.

Editor's Note:—We asked General Electric's Dr. Alexanderson to comment on this letter. His interesting remarks follow:

Dear Editor:

The tests in Schenectady were made to show that the present-day standard television receivers can be used to reproduce color. Only in this connection is it true that 2 colors cause less flicker than 3 colors. When special receivers are used, such as Dr. Goldmark's, the 3-color system is in every way superior.

E. S. W. ALEXANDERSON

GAUNTLET OF A MINNESOTAN

Dear Editor:

I have been a regular reader of *Radio-Craft* for the past 8 years. I have watched the page on which you have been putting different "Service Shops" from all over the country. But I have never seen one of them yet that has been as modern, up-to-date and complete as my shop is. Therefore I am sending you a picture of my last advertisement, showing my shop, which I would like to see come out in your magazine. It's a good one for your Servicemen readers to shoot at. I'm sending you this as a challenge to other Servicemen.

ALFRED J. BEAUCHAMP,
Al's Radio Service,
Owatonna, Minn.

THE "HOME RECORDING" ARTICLE

Dear Editor:

In your March, 1941, edition you have published an article by I. Queen, entitled "Home Recording".* There are a number of statements in this article that I would question rather seriously:

(A) Mr. Queen states that professional recordings are made on wax blanks. As a matter of fact most professional recordings today use *plasticized cellulose nitrate*. There are very few organizations left in this country using wax. For example Columbia Recording Corporation and National Broadcasting Company both use enormous quantities of our Master blanks for processing work. This has been their common practice for a considerable period of time, and there is no doubt that the use of wax is definitely old fashioned.

(B) Mr. Queen implies that a nitrate disc is "highly inflammable". This is not the case. As a matter of fact, a plasticized nitrate-coated aluminum disc is non-inflammable. The nitrate thread is somewhat inflammable, but by no means as inflammable as propagandists have pictured it. For example a handful of thread may take 10 seconds to burn or even longer. Considering the large area exposed, this is indeed slow burning. Slow burning is achieved in any good formula by the addition of various non-inflammable plasticizing agents which make the material in only small part cellulose nitrate.

I know of no professional acetate-coated discs. I know of no successful acetate-coated home recording discs. A number of home recording discs have been made using cellulose derivatives other than the acetyl or nitro compounds.

Any home recording discs that have ever been coated with a material other than plasticized cellulose nitrate have been conspicuous for their high surface noise and difficulty of cutting.

(C) Your statement that a *sapphire* needle is brittle is correct. However, the *stellite* needle which you refer to as an alloy needle is also brittle under the treatment which under-

*"Home Recording—Theory and Practice of Sound-on-Disc."

skilled users give it. The big advantage of a stellite needle is that the resharpening costs are less, and therefore a dropped and chipped needle can be repaired easier. We handle all 3 kinds of needles and I think, therefore, that this comment cannot be ascribed to favoritism of any sort.

In the interests of the rapidly-growing Home-Recording Industry, I hope that you will accept this comment in the spirit with which it is offered and will endeavor to incorporate proper corrections in subsequent articles.

C. J. LE BEL, Vice-President,
Audio Devices, Inc.

These highly informative remarks were called to the attention of the author of the article in question. Mr. Queen's interesting comments follow.

Dear Editor:

In reply to the letter of Mr. Le Bel, the following are my reactions:

(A) Regarding blanks used for recording by professional companies, I mentioned wax blanks because this type of blank has been in use for a number of years and is, in fact, still being used. It is true, however, that this material is giving way to the more solid cellulose-nitrate discs.

The discourse on professional recording was not written to fully cover this field but rather to give an inkling to the home-recorder of how it was done. The emphasis was therefore placed upon the various processes which the discs underwent. It would have been better for me to have mentioned that before long, professional recording would probably be mostly done on the latter. The article, of course, does not intimate that ALL professional recording is being done on wax.

(B) Your reader's note intimates that cellulose-nitrate as coated on recording discs is not inflammable. Cellulose-nitrate is in fact a basic explosive and is the material used on moving-picture film which makes the latter so highly dangerous. Naturally, the amounts of this material used on recording discs are small, but this should in no way detract from the necessity of taking extra care.

It is easy to conceive of a home-recorder cutting several large discs at once and placing the shavings in a corner near a hot radiator or perhaps holding a lighted cigarette near them, unconscious of the potential danger. My article states that "the latter may be either nitrate or acetate," the latter meaning, of course, the last item referred to—the celluloid coating and not the metal discs. Naturally, aluminum is non-inflammable. Your writer then goes on to say that special formulas are being used so that the material is only in small part cellulose nitrate. Since it is only the latter which my article calls inflammable, the disc is no longer a cellulose-nitrate one and probably is non-inflammable.

The criterion for inflammability is not the length of time the shavings burn but the ease with which they may catch fire from either an open flame or radiated heat and then in turn pass a flame to nearby curtains, papers or other combustible material. I would say that the home-recorder would do well to purchase discs which are known to be non-inflammable such as the acetate or any of the newer formulas which your reader (as representing a manufacturer of such material) maintains is also non-inflammable. As he states, however, the cellulose-nitrate shavings are inflammable, and therefore under suitable conditions and with lack of care may prove to be as much a danger as

unapproved wiring or the storage of small amounts of benzine, etc. I would rather over-emphasize the potential danger rather than try to minimize it.

My article mentions that "the latter is widely used" referring to the acetate-coated discs. You will note that I am referring to home-recording and not professional cuttings, at this point. Your reader states that acetate coatings cannot be successful and cannot be used. I have heard excellent cuttings made of this material which have combined excellent fidelity and low noise level. He apparently objects to my statement that the acetates are widely used. As a matter of fact practically all blanks for the home recordist are of this material and I am sure that perusal of the catalogs of manufacturers and mail-order houses will speedily convince him of this fact.

It must be kept in mind that newer materials are being constantly developed and no doubt in the very near future more improvements will be made. This whole question seems very far-away to say the least, since, first of all, it is a matter of opinion, and secondly, the article which I wrote concerns home-recording practice and there probably aren't quite half-a-dozen *Radio-Craft* readers who care whether their blanks are made of this, that, or the other material, so long as they get good results. The fact that acetate-coated discs are widely used holds, however. Again I point to the fact that I refer to home recording and *not* to professional (which of course uses the nitrates for the cuttings).

(C) Your reader states that sapphire needles are brittle as I mentioned in my article and objects because I didn't mention the alloys as being brittle.

The sapphire is, of course, an exceptionally brittle material. This disadvantage stands out especially because of the high first cost and the high cost of reconditioning should damage take place. I wrote of alloys in general, stellite being one in particular. Alloys in general are not as brittle as sapphires should damage take place due to mishandling, they can be resharpened easier. As a matter of fact, I might mention that the steel cutting stylus is also susceptible to damage due to improper handling, as indeed is any piece of apparatus, but it is wise to point out that a very expensive piece of equipment which can be easily ruined should receive even more care than one which is a little easier to replace or repair.

This is the only meaning I intended to convey. In other words, each stylus had listed one advantage and one disadvantage. If it were not for lack of space, I might have listed 8 or 10 advantages and 12 or 15 disadvantages, etc.

In summarizing, I would state that the letter received by you from your reader sounds to me like quibbling. The sound-on-disc article was written for home recordists, both beginners and semi-professionals, who don't give an extra thought to the exact composition of discs and who only want to know when they are playing with inflammable materials so that they can be on the look-out. Whether a given volume of shavings burns 10 seconds or 11 will probably never concern many. If they get good results using acetate discs they will be more than happy, and I am sure they would like to know that a sapphire being so expensive should also be handled with especial care, even though they probably won't go around dropping the stellites and steel ones, because they are not so brittle.

On practically every point of issue, we are apparently only differing in the way the article should have been worded and not on

any fundamental fact in the story.

I trust the above clears up the matter.

I. QUEEN

AGREES WITH OUR BOSS

Dear Editor:

I am glad that Mr. Gernsback, in his editorial for October, in which he called attention to the inability of the vast majority of Hams to service receivers and even transmitters. I hope that if ever any government official raises the point, that Mr. G. again reiterates his statement, and qualify it further by stating that a license (3rd, 2nd, or 1st) is no guarantee of the servicing proficiency of the holder of said slip of paper. It matters not that the government requires it; it was made in ignorance of the real facts in the matter. This confounded license business is always hitting me in the eye and I'm sore. Logically I should go after a license, but I don't care a tin dime about getting on the (h)air and yodelling SEE-CUE, etc., etc., ad infinitum. To maintain that same license you must make contacts throughout the year, over the air, and that means a transmitter, and I don't want one of them either.

I wish Mr. Gernsback would also let those same government officials know that servicing and Ham-ing are separate fields in the art of Radio and that if Uncle Sam is going to sit back of that clause about a license first, or no work, then again we are due to suffer, all of us, for lack of the really skilled and qualified men. Never let it be said that there is any lack of what it takes, here in America; we have it if we are given the opportunity to produce, but not measured as we are now by the wrong type of yardstick. Because a guy can lie like all Hell, spread a smooth line on an exam paper, pass all the theoretical junk which is wafted his way, that proves he's better than Gunga Din, eh? Lord, yes, we need experienced men, but we can't get 'em. To be sure you can't if you deliberately choose the guy who looks swell on paper and pass the real guy who has been producing right along.

Are you still with me after all that?

And one final shot—the age bogey. We'll be licked before we start if we don't forget this awful caterwauling about "how old is he?" "he's too old, he's an old fogey" and the like. The trouble today is everybody wants someone with 20 years' experience but still not more than 30 years of age! I'm 32 and I still think I'm dumb on a good many things, but I know that when I look back 10 or 12 years to what I was then, I marvel that anything so dumb could get by! We let street car motormen operate one or more cars (3 sometimes here in Boston) carrying hundreds of passengers until they (the motormen) are "most 70 years of age, yet every once in a while, one of them drops dead at the controls, and only by the grace of God, is the car stopped safely. Here is a logical place for the imposition of the age limitation.

Let's make our motto "What can I do to help prepare?"

EDWIN A. WOLF,
West Roxbury, Mass.

THE "MAILBAG'S" GETTING HOTTER

The timely discussions taking place in this department each month are conclusive proof that RADIO-CRAFT is a LIVING magazine—YOUR magazine. Keep up the good work fellers! Help us give you an always-better magazine.

—The Editors

Get the Job You Want!

CREI Technical Training Enables You To Go After -- and Get the Jobs That Mean Something in Radio!

Jobs that provide security . . . Jobs that will mean something long after "tomorrow" has come and gone . . . must be won and held on ability! Now is the time for you to plan your career for the future and not just relax in your job today. You have a "jump" on the other fellow, because your present experience is a valuable asset. If supplemented by CREI modern technical training. It's worth taking time right now to find out how CREI offers you a planned program for advancing yourself in radio.

THINK THIS OVER: Actual Records Show—
● CREI graduates, as a group, are among the highest paid in radio! ● CREI men are in more than 350 broadcasting stations! ● More than 5,000 radiomen have taken this course of training! ● Employers are increasingly calling upon CREI for personnel replacements and additions.

WRITE TODAY! If you are a professional radioman and want to make more money, send for free booklet and factual information. To help us intelligently answer your inquiry—please state briefly your education, radio experience and present position.



CAPITOL RADIO ENGINEERING INSTITUTE

Dept. RC-8 3224 16th St., N. W. Wash., D. C.

RADIO TECHNOLOGY

RCA Institutes offer an intensive course of high standard embracing all phases of Radio and Television. Practical training with modern equipment at New York and Chicago schools. Also specialized courses in Aviation Communications, Radio Servicing and Commercial Operating. For Free Catalog Write Dept. RC-41.

RCA INSTITUTES, Inc.
A Radio Corporation of America Service
75 Varick St., New York. 1154 Merchandise Mart, Chicago

RADIO-TELEVISION

Oldest, largest Radio-Television school in West trains you for good pay job. Complete instruction including Radio Construction and Service, Broadcast Operating, Sound, Talking Pictures, Television, Public Address, etc. Flexible plan to meet specific needs of those with or without jobs. Transportation allowed to L.A. Earn room and board while learning. Request Free Catalog.

NATIONAL SCHOOLS, Dept. 8-RC
Los Angeles

RADIO COURSES
Start September
RADIO OPERATING—BROADCASTING
● RADIO SERVICING—a practical course
● RADIO AMATEUR CODE ● TELEVISION
● ELECTRONICS—1 yr. day course 2 yrs. eve.
Day and Evening Classes. Booklet Upon Request.
New York Y.M.C.A. Schools
4 W. 64th Street New York City

Correspondence Courses in
RADIO and ELECTRICAL ENGINEERING
ELECTRICAL ENGINEERING Get good grasp of wide electrical field. Prepare yourself, at Low Cost, for secure future. Modern, simplified, you can understand quickly.
RADIO ENGINEERING Extra fine course in radio, public address, photo-electric work. Trains you to be super-service man, real vacuum tube technician. Exper. kits furnished. Diploma on completion. Tuition, \$25, either course. Deferred payment plan.
FREE Get copies of school catalogs, student magazines, complete details. SEND NOW!
LINCOLN ENGINEERING SCHOOL, Box 931-932, LINCOLN, NEBR.

COMMERCIAL RADIO INSTITUTE

A radio training center for over twenty years. Well equipped. Excellent faculty. Practical resident courses in Radio Telegraphy, Broadcast Servicing, Industrial, Television, Aeronautical, Drafting, Mathematics and Studio Technique. Positions guaranteed. Fall term Oct. 6. Catalog upon request.
Dept. D, 38 West Biddle Street, Baltimore, Md.

Order your copy NOW—the only

P. A. HANDBOOK

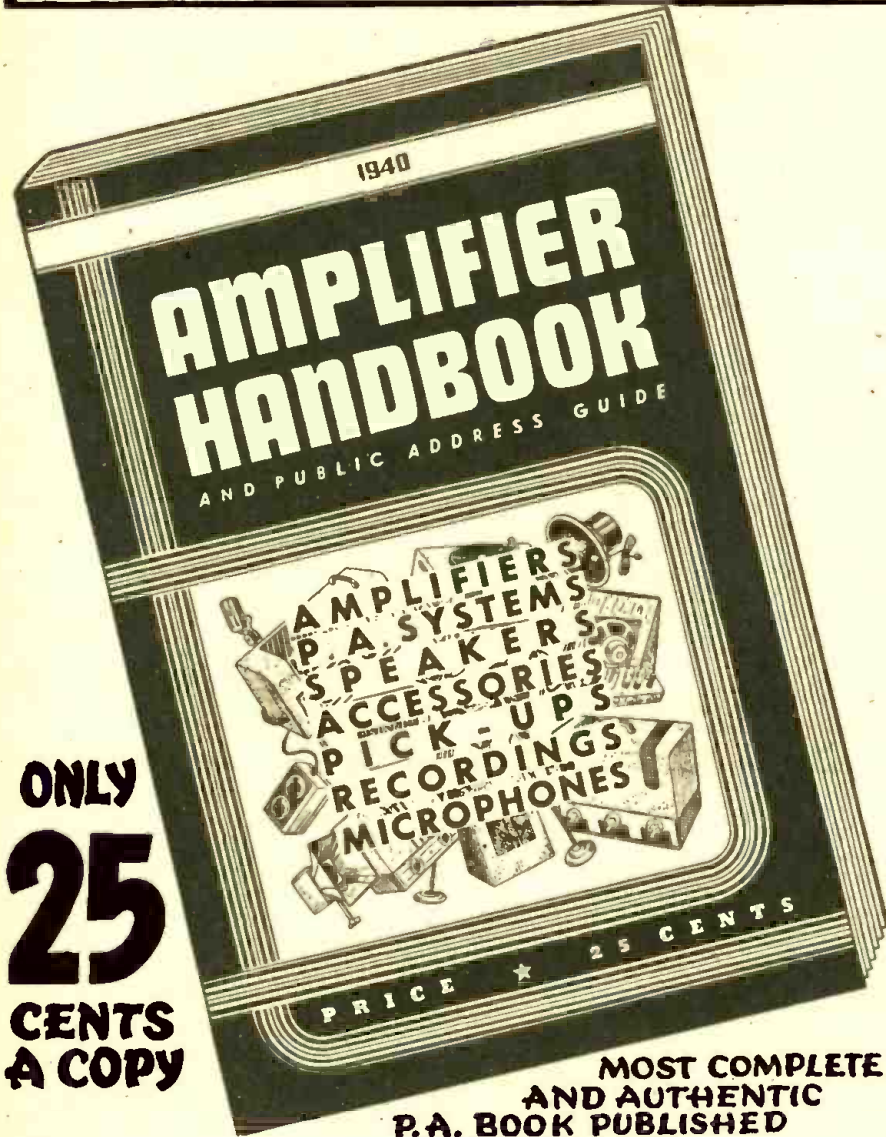

**ONLY
25
CENTS
A COPY**

THAT no book has yet been published which covers amplifiers and sound systems (also kindred systems) in one complete, authentic volume is almost unbelievable. Yet, it is a fact, there is no book in print which covers Public Address from A to Z. To bridge this wide-spread gap, RADIO-CRAFT will publish a complete, magnificent volume on Public Address of such magnitude—so complete and authoritative—that every man engaged in radio can have both a theoretical and practical knowledge of the function and operation of sound systems. The editorial pages are so filled with instruction and recipes with illustrations that the volume fully justifies its title of 1940 AMPLIFIER HANDBOOK AND PUBLIC ADDRESS GUIDE. This great HANDBOOK on Public Address should be read and studied by those who consistently build, service and sell sound equipment.

A MATCHLESS VOLUME
As complete as you would expect to find any engineering handbook—this is how the radio or P. A. man finds the AMPLIFIER HANDBOOK AND PUBLIC ADDRESS GUIDE. With essential technical data compiled from an exceptionally large number of sources, the volume covers nearly a hundred different subjects coordinating every conceivable branch or sub-division of Public Address.

THE CONTENTS
To actually show the scope and magnitude of the AMPLIFIER HANDBOOK AND PUBLIC ADDRESS GUIDE, an analysis of the contents is found at the right, showing the breakdown of the material featured within each particular section. A thorough reading of the contents shows the completeness of this book.

RADCRAFT PUBLICATIONS ■ 20 VESEY STREET ■ NEW YORK, N. Y.

RADCRAFT PUBLICATIONS, INC. ★ 20 VESEY STREET ★ NEW YORK, N. Y. RC-841
Gentlemen: Enclosed find my remittance of 25c for which send me POSTPAID, one copy of your NEW—1940 AMPLIFIER HANDBOOK AND PUBLIC ADDRESS GUIDE.

Send me others, for friends, also POSTPAID @ 25c each.

Name Address

City State

Remit by check or money order; register letter if you send cash or unused U.S. Postage Stamps.

A Resume of the Contents of the AMPLIFIER HANDBOOK AND PUBLIC ADDRESS GUIDE

FOREWORD

INTRODUCTION

Definitions—decibels, frequency, input, output, impedance, etc.

SECTION I—SOURCE

Carbon microphones (single-button and double-button)
Condenser microphones
Velocity (ribbon) microphones
Dynamic microphones
Crystal microphones (sound-cell types, crystal diaphragm types)
Cardioid microphones
Contact microphones
Phonograph pickups (magnetic types, crystal types)

SECTION II—AMPLIFIERS

Voltage Amplification

Design of resistance-coupled voltage amplifiers
Commercial voltage amplifier

The Power Stage

Class A amplifiers
Class AB amplifiers
Class AB₁ amplifiers
Class AB₂ amplifiers
Class B amplifiers
When to apply class A, AB, and B amplification

Power Supplies

Half-wave rectification
Full-wave rectification
Voltage doublers

Filter Circuits

Power supply regulation, etc.

Practical Hints on Amplifier Construction

Microphonism
Placement of components
Tone compensation
Inverse feedback
Remote control methods

SECTION III—DISTRIBUTION

The Loudspeaker

Dynamic speakers
Speaker performance (frequency response, efficiency)
High-fidelity speakers
Speaker Baffles and Housings
Outdoor speaker installations
Power cone speakers
Radial (360° distribution) speaker baffles

SECTION IV—COORDINATION

Input impedance matching
Matching speakers to P.A. installations

Phasing speakers

Effect of mismatching speakers to amplifier output

A typical P.A. installation (in a skating rink)

SECTION V—USEFUL PUBLIC ADDRESS DATA AND INFORMATION

Speaker matching technique
The ABC of Db., VU, Mu, Gm and Sm

Charts and formulas useful to the practical P.A. sound man
Handy index to important articles on public address and sound

Order Your Copy NOW—

*Clip Coupon and
Mail Today!*

RADIO-CRAFT

"RADIO'S GREATEST MAGAZINE"

. . . *Radio is the answer
to the bombing plane* . . .

RADIO AIRCRAFT DETECTOR

By the Editor — HUGO GERNSBACK

IN the first part of last June the public all over the world was thrilled by the British announcement regarding their new Radio Plane Detector which had been perfected by English radio engineers.

The point that created additional interest to us was that England called on America to supply thousands of radiomen to man these new machines which are being installed all over the English island fortress.

While at present the final details of the new Detector are not available for publication, there is nothing very new about it, indeed it has been in the experimental stage by probably all major nations of the world for many years.

As far back as 1935, I stated editorially in *SHORT WAVE CRAFT Magazine* (November 1935 issue) in an article entitled "Short Waves and War" as follows: "A city, during the next war, will easily be protected against unheralded enemy aircraft by having a barrage of microwaves surrounding the entire city, the action being automatic in such a manner that automatic recording instruments will immediately sound the alarm when an airplane appears overhead within the confines of the city. It will be impossible, in the future, for an enemy airplane to get through such a short-wave barrage."

Not only is it possible to use the new Detector on the ground but it has become known that the British have installed similar means in their airplane fighters as well as bombers, which puts them into the strategic position to locate enemy airplanes not only at a distance and in fogs, but during total darkness as well. The latter is most important because heretofore it was almost impossible for one airplane to see another one during the night except for very short distances. Inasmuch as the noise of the propeller interferes with hearing, it is therefore impossible for one airplane to hear another plane. Thus the Micro-Wave Detector becomes an immensely valuable means to locate other planes even at distances as far as 100 miles away. That means that once the enemy craft has been detected, it will become difficult to lose track of it—it will become next to impossible to escape unless it has superior speed.

Of course the question will immediately be asked—

Suppose the enemy does the same thing, what then? The answer to that is that in all military actions in the past as well as at the present *the better the two opponents are prepared and the more equal their strength, the less likelihood there will be of war.* If the Allies had not been asleep, if the French and the English had had the same weight in tanks and airplanes as the Germans, the latter probably would not have started the war at all.

So with the Radio Airplane Detector. If both sides use the same new weapon, in due time it will be used less and less because the strategic advantages tend to nullify each other. If the two sides know that on account of radio detecting mechanism they can no longer fly safely over enemy territory, naturally the value of military aircraft will become less as time goes on except for special purposes where loss of aviators and loss of planes counts for little when greater odds are at stake.

It has also become known recently that in addition to the new Radio Plane Detector, the English as well as the Americans and probably the Germans also are now using a *radio-controlled anti-aircraft gun.*

Heretofore it was necessary to use listening instruments or otherwise the plane had to be sighted; then a calculating machine attached to the guns would automatically get the enemy plane's range, then fire upon the hostile craft.

Here too radio has supplanted older, more cumbersome and slower methods.

By using ultra-shortwave apparatus it is now possible for guns to be trained automatically on a warplane *which may be out of sight or behind clouds, or even in total darkness.* Not only does the shortwave instrumentality locate the plane quickly, but the anti-aircraft guns are kept on the unseen plane for as long as it is within the range of the A.A. guns. It thus becomes possible for the anti-aircraft batteries to fire at the enemy plane with much greater accuracy than has been the case heretofore.

From all this it will be seen why the Germans lately have become more careful in their raids over England. As time goes on it will become more and more difficult and unprofitable for ruthless bombing to go on on a large scale as was the case last Fall.

•THE RADIO MONTH IN REVIEW•

The "radio news" paper for busy radio men. An illustrated digest of the important happenings of the month in every branch of the radio field.



CAR TELEVISION IS HERE!
(Cover Feature)

We all knew that automotive television—the viewing in an auto of events while they are occurring—was a "coming thing." Radio-Craft therefore is glad to present here a composite illustration of an experimental car-television receiver, devised by a New York radio man. Screen, center; controls, right. An early issue of Radio-Craft will tell how to make it.



RADIO-CONTROLLED TARGET-TANK

The latest in mechanized warfare is the radio-controlled target-tank (right), used in place of the usual target (left), as shown last month in a "News of the Day" sound newsreel.

DEFENSE

FREE, twice-weekly classes in radio telegraphic code are being established by KDKA as an added contribution to National Defense by teaching code to women and those men who are not likely to be drafted. Passing proficiency is reached in about 6 months. Classes are held in KDKA's Pittsburgh studios (to which applications may be addressed).

With the aid of a specially-equipped airplane coordinated with mobile radio units operating on the ground, the F.C.C. last month uncovered the illegal operation of a transmitter by a person who signed himself "Fritz," and who defied the Government to apprehend him. It was the first time in the annals of the Commission that aircraft had been employed "in the continual vigil for unlicensed transmission," now acute by reason of National Defense requirements.

Purporting to be transmitting from a ship off Boston, the unlicensed operator, Stanley W. Magdalensky, aged 35, was traced to a dwelling in Haydenville, Mass., where the equipment was seized. "Fritz" Magdalensky hasn't yet succeeded in digging up \$5,000 bail.

How can radio manufacturers aid the Defense program? Philips D. Reed, chairman of the board of the General Electric Company, at the 25th annual meeting of the National Industrial Conference Board, last month answered this question thusly: "Manufacturers now engaged in making civilian products will do well in their own interests to convert part or all of their operations to Defense manufacture." Continuing, he answered the question of how manufacturers, with the interests of America at heart, could take practical measures in this direction: "32 field offices of the O.P.M. are prepared to help in the selection of Defense products suitable for manufacture in various kinds of plants."

SHORTWAVES

CHALK-UP another mark for the always-reliable ham-radio operators—they're as dependable as the United States Army! Right now, it's this same Army they are serving in a new capacity. Of the roughly 90,000 licensed radio amateurs, whose avocation is the exchange of radiophone and code-radio conversations with kindred "hams" within the long-arm reach of Radio, about 1,500 are licensed to operate on the frequency of 3,497.5 kc. (about 116 meters), for contact with the U. S. Army. Friends and relatives are welcome to use this service, gratis, to contact the "men-folk" now in the Service, anywhere.

The F.C.C. is continuing its inquiry into the problem of muzzling the interference characteristics of radio diathermy equipment. Progress has necessarily been slow. For example, some years ago the Council of Physical Therapy of the American Medical Association expressed to the F.C.C. the desirability of producing a diathermy machine designed to hold the output frequency to its position in the spectrum within 0.03% through the use of crystal control. To date, no such instrument has been brought forward, it is claimed. Machines submitted to the U. S. Bureau of Standards have operated on the following settings: 13.665 mc., 27.33 mc., and 40.995 mc. Manufacturers have expressed the wish that wavelength tolerances be held to 0.5%±. Agreement on wavelength assignments for diathermy operation is without doubt an effective temporary solution of the diathermy-machine interference problem, pending the unlocking of the secrets of shielding—a subject which has been under intensive study for a number of years by Interference Specialist J. G. Goldner, and a number of other individuals and groups.

INDUSTRY

FIGURES on the Broadcast Industry were not included in those the U. S. Labor Dept. released last month, but N.A.B. has worked up figures, based on F.C.C. reports, as follows, for average weekly wages in

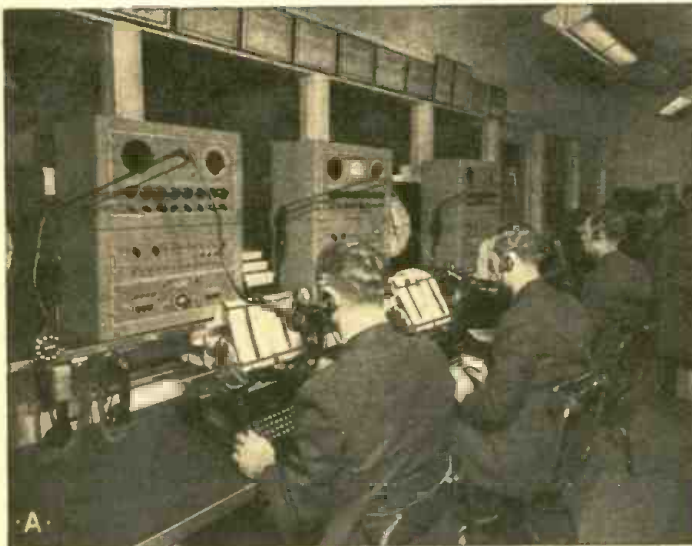

AIR RADIO-CENTER

Last month United Air Lines announced completion of 3 far-reaching projects said to achieve an unprecedented improvement in 2-way radiophone reliability between planes and ground stations. (1) New 5,000-watt radio transmitters—the most powerful aeronautical ground station transmitters in the world 'tis said—are being installed at key points along the system; (2) a new, light combination receiver-transmitter for planes, affords automatic selection by the pilot of any one of 10 frequencies; (3) a gigantic antenna for ground reception—it's 1,200 ft. long, 500 ft. wide and 100 ft. high—is said to almost entirely eliminate static, etc. (It's being placed at major terminals.) (A) shows newly-completed Communications Center of United Air Lines at Chicago.

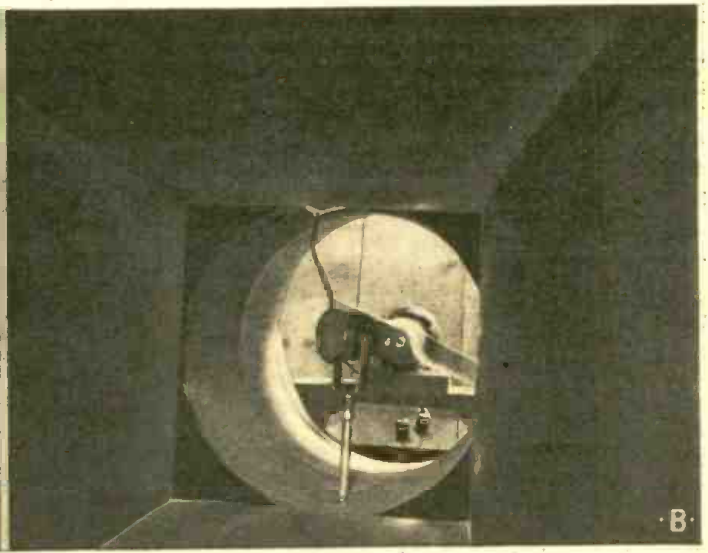

MIKE WIND-TUNNEL

Wind has an effect on microphones when they are used out-of-doors. Studies in the Acoustics Section of RCA Laboratories, made possible by the use of the wind-tunnel shown in the picture (B), have substantially reduced the amount of unwanted noise in outside sound pick-ups. A microphone, mounted on a stand a short distance inside the throat of the wind-tunnel, is subjected to the controlled draft developed by the propeller at the mouth. Simulated conditions of the effect of direct wind upon the microphone under test, ranging from a zephyr to a junior or even a senior gale, may be observed. One result of such tests has been the development of microphones having minimum susceptibility to the breath from speakers talking directly into the microphone.

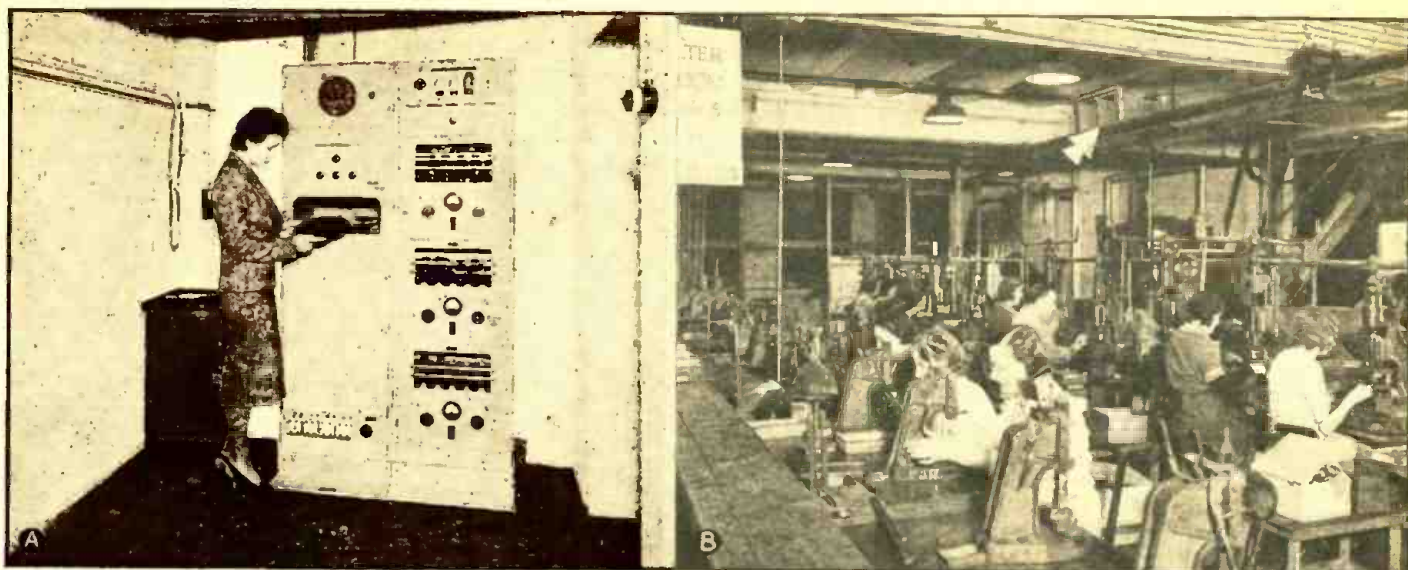

FACTORY SOUND SYSTEM AIDS BRITISH DEFENSE

The American Defense Program can take a leaf from Great Britain's Book of Knowledge of activities now aiding in the defense of the "tight little isle." One such activity is here illustrated. At A is shown the control panel of the broadcast system installed in the General Electric Company's factory near London. At B (arrow), one of 220 loudspeakers throughout the building is shown delivering sound to a comparatively noisy drilling room. Both radio

and phonograph music is supplied to the sound system; a microphone in the control room allows the broadcasting of A.R.P. air-raid alarms and other announcements. The British government has officially advocated, and the Medical Research Council has recommended, "factory sound"; and, the B.B.C. has instituted the special mid-morning and mid-afternoon 1/2-hr. program, "Music while you work."

the U. S.: Machine Tool Workers, \$41.78; Radio Broadcasting, \$41.08; Automobile Manufacturing, \$40.50; Printing, Newspaper and Periodical, \$38.42; Insurance, \$37.76; Telephone and Telegraph, \$31.30.

Last month, one-time Republican presidential candidate Thomas E. Dewey, announced the formation of the United Service Organizations for National Defense, Inc. This non-partisan group will combine the efforts of the Y.M.C.A., National Catholic Community Service, Salvation Army, Y.W.C.A., Jewish Welfare Board and Travelers Aid Assoc. Neville Miller, President of the National Assoc. of Broadcasters, heads the active radio committee comprising 17 leaders in the Radio Industry.

SOUND

THE servicing of Mills Panoramic Soundies and other coin machines of this type will be handled by "RCA National Service," a new RCA organization.

Want to be a transcription recordist? The phrase, "the following program is transcribed" means the following to WHK-WCLE's Warren Miller who during his 19 months as transcription chief of the stations has garnered the following statistics:

Most of the big 16-inch jobs are 15-minute programs. They total over 5,000 records weighing about 2 1/2 tons; piled-up they would stack 23 1/2 feet high. Working about 8 hours a day, he has spent approx. 1,250 hours cutting transcriptions. The length of the groove on each record is slightly over 1,288 feet or a grand total of 1/2-million feet.

New twist to sound recording: WOR's new air program starring Frazier "Spike" Hunt, international reporter, will be electrically transcribed. So what? So a unique feature of his programs will be the inclusion of important news flashes by a local announcer in the last few minutes of the program. The cut-in will be made separately by each station airing Hunt's broadcasts.



TRAFFIC P.A.

This Public Address system has reduced accidents and speeded up traffic. Hytron Corp. conceived and installed it in Salem, Mass., as a civic project. System uses a 12-W. amplifier, University non-directional loudspeaker (atop booth), and Turner mike.

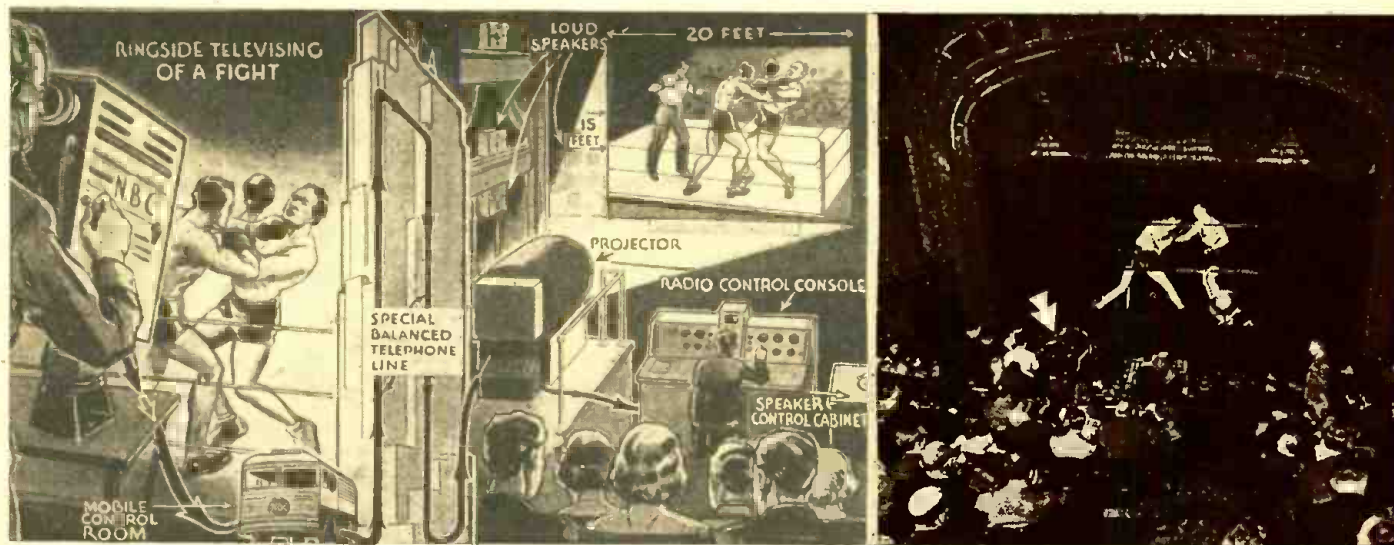

THEATRE TELEVISION

The artist's drawing at left shows how the Soose-Overlin middleweight championship fight was televised on a 15 x 20 foot movie screen, in a World's Preview of large-screen theatre television staged last month by RCA Manufacturing Co. at the "New Yorker Theatre," for an invitation audience of 1,200 film, sports, radio and newspaper executives. The fight at Madison Square Garden, televised, was transmitted to Radio City over a special telephone wire. From there, it

was relayed over a special balanced telephone line to the theatre, where a steel-barreled projector, pointed over the edge of the balcony, cast the image on the screen, 60 feet away. The sound console controlled the sound-system of 16 loudspeakers set up throughout the house. The dubbed-in photo, in the view at right, gives an excellent idea of the placement of the television camera (arrow), the comparative size of the screen, etc.

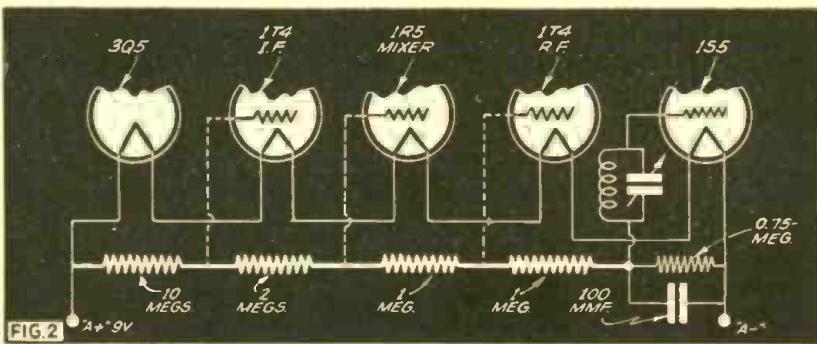
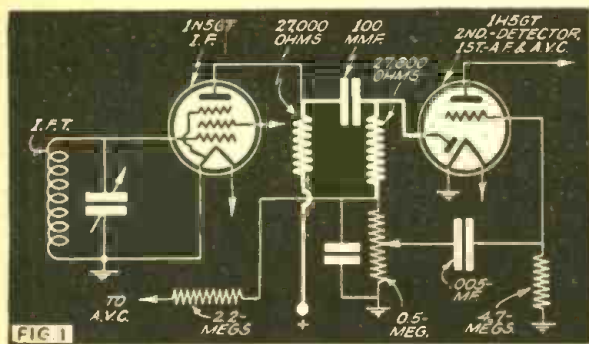

NEW CIRCUITS IN MODERN RADIO RECEIVERS

In this series, a well-known technician analyzes each new improvement in radio receiver circuits. A veritable compendium of modern radio engineering developments.

F. L. SPRAYBERRY

No. 47



(FIG. 1.) RESISTANCE-LOADED DETECTOR DIODE

GENERAL ELECTRIC MODEL LB-530.—Capacity coupling between the 2nd I.F. tube and diode detector with resistance I.F. plate loading and resistance diode plate loading contributes to the high gain and good fidelity of this circuit.

In Fig. 1, the advantages of the full gain of 2 I.F. stages is gained in this circuit while using only 2 tuned I.F. transformers. An additional tuned transformer with critical or lower coupling providing a single peak response would sharpen the tuning beyond the limits of good fidelity while a capacity-resistance coupled I.F. stage would limit the desired gain of the I.F. amplifier. This arrangement, therefore, achieves both these advantages with no more apparatus than is required in earlier designs.

(FIG. 2.) A.V.C. SHUNT DIVIDER SUPPLIES CORRECT BIAS AND A.V.C. VOLTAGES IN SERIES FILAMENT WIRING

AUTOMATIC RADIO MFG. CO. MODEL P-65.—A high-resistance shunt divider from the diode load (volume control) connects to the positive end of the series filament group. With no signal it provides the correct bias for each tube.

Application of a signal to the circuit as in Fig. 2, will produce A.V.C. voltages on the R.F., mixer and I.F. grids of almost equal value. The circuit permits all tubes capable

of this type of control to be controlled in a series filament circuit without disturbing the minimum bias requirements. The circuit is simpler and more effective than an individual bias system would be without the use of A.V.C.

(FIG. 3.) OUTPUT TRANSFORMER USED AS FILTER SEGMENT

"SILVERTONE" (SEARS, ROEBUCK & Co.) MODELS 3611, 3711, 3811.—A very effective filter for half-wave rectification is formed by autotransformer action, thus supplementing the regular "brute force" filter of the power supply.

As indicated in Fig. 3, the output transformer primary is tapped near the "B+" end, where all other high-voltage connections are made except that to the I.F. plate. In this way a neutralizing voltage is produced at the power amplifier plate through autotransformer action, which compensates any ripple voltage entering this tube at its grid. It is similar to a former circuit described using this tap as the "B+" input from the rectifier with a somewhat different plate supply arrangement.

(FIG. 4.) A.V.C. FILTER USED AS GRID LOAD

"KNIGHT" (ALLIED RADIO Co.) MODEL B-17110.—The grid circuit of the 6SA7-GT mixer tube having the I.F. wavetrap in it and being fed from a low-resistance R.F. plate load would obtain no real advantage with a high-resistance load.

Figure 4 shows that the A.V.C. filter is divided into 2 sections of 0.1-meg. each, the junction of which is connected to the grid. The grid is loaded by about 50,000 ohms in this way except at the I.F. value when it is essentially shorted by the series I.F. wavetrap. The I.F. wavetrap forms a more effective filter to I.F. components fed back to the mixer from the 2nd-detector than an ordinary bypass condenser because the impedance to ground consists only of the apparent I.F. resistance of the coil.

(FIG. 5.) NEON-TUBE RECORDING INDICATOR

ALLIED RADIO Co. MODEL B-17136.—The electrical level of the signal operating the record cutter is indicated at critically high values in the absence of sound, by means of a neon tube.

Connected to the output plate and some lower D.C. voltage determined by a voltage divider as in Fig. 5, the neon tube, N, flashes when the sum of the peak signal voltage at the output plate and its predetermined applied D.C. voltage reaches its ionization potential. The circuit constants are chosen so that this will be just below the maximum undistorted output at which the cutter can effectively operate. By keeping the volume adjustment for recording at a point where the neon tube will only occasionally flash or will not light at all, we will know by this fact that the recorder is not overloaded.

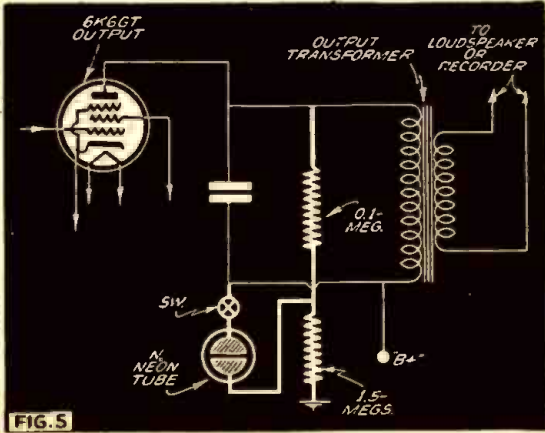
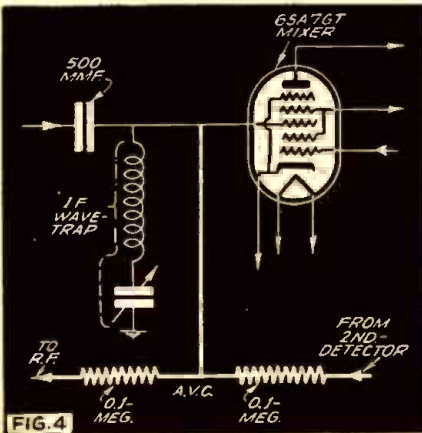
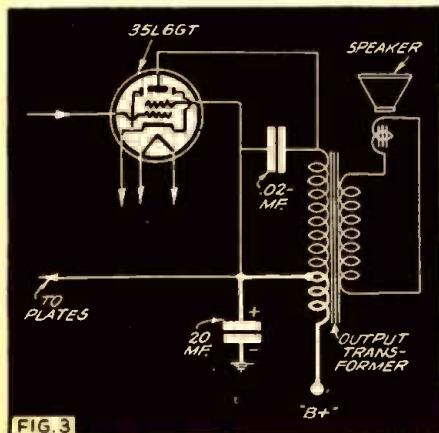

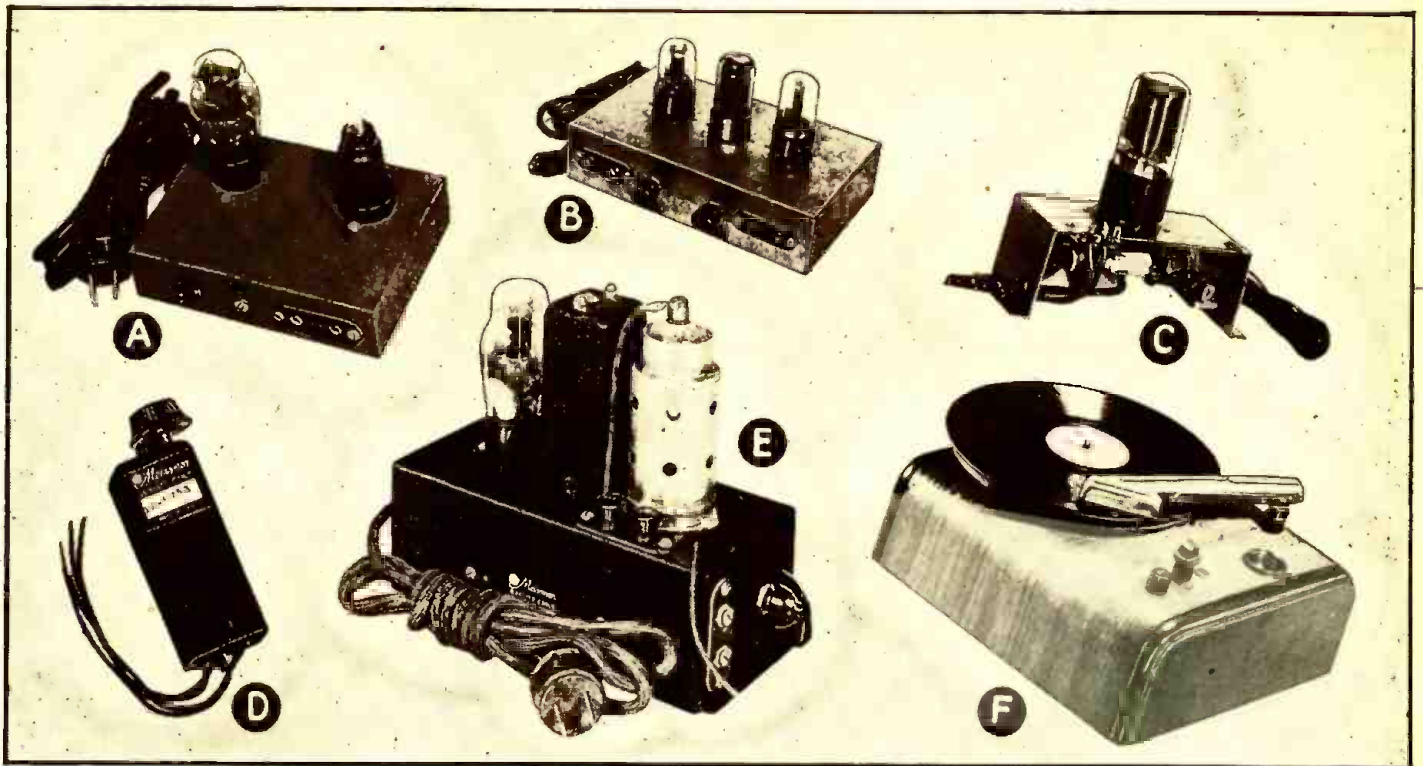

Illustrations of the component units and the completed "Wireless" Phono-Oscillators described and identified in the text.

Making Money by Building

WIRELESS PHONO-OSCILLATORS

The following article on "Wireless" Phono-Oscillators is presented in answer to the insistent demand of Radio-Craft readers for an authoritative article describing the latest development in this type of equipment. Servicemen will find this article exceptionally useful in view of the popularity of these "wireless" phono players which enable any record player to be operated in connection with any radio set.

L. M. DEZETTEL

PEOPLE say that the musical trend today is "back to the phonograph records." The word "back" is a misnomer. Actually, improved methods of recording and lower prices on records have appealed to the public, making them desirous

of forming a permanent library of some of the best musical works as well as popular pieces.

This trend towards phonograph music has brought about the use of phonograph reproducing units in combination with home

"radios." In most cases, especially in the case of modern-type superheterodynes, terminal strips are provided on the back of the radio set to which a phonograph pickup can be connected. In the majority of cases the terminals connect to the 2nd-detector.

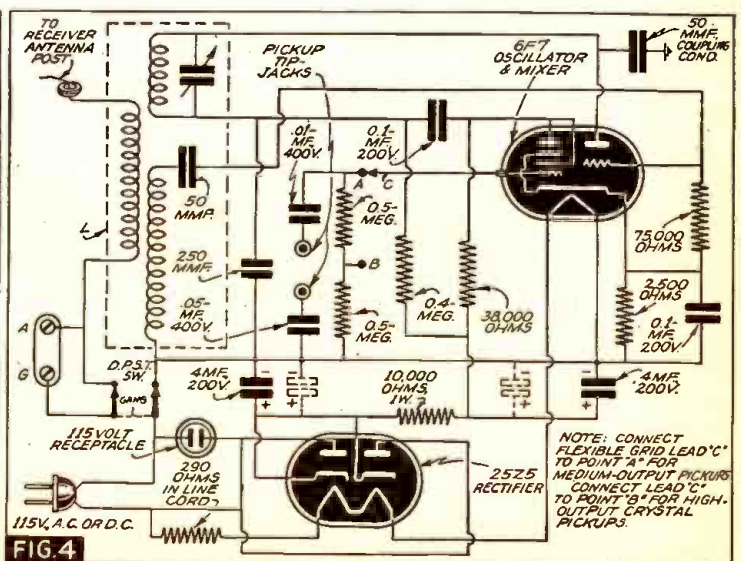
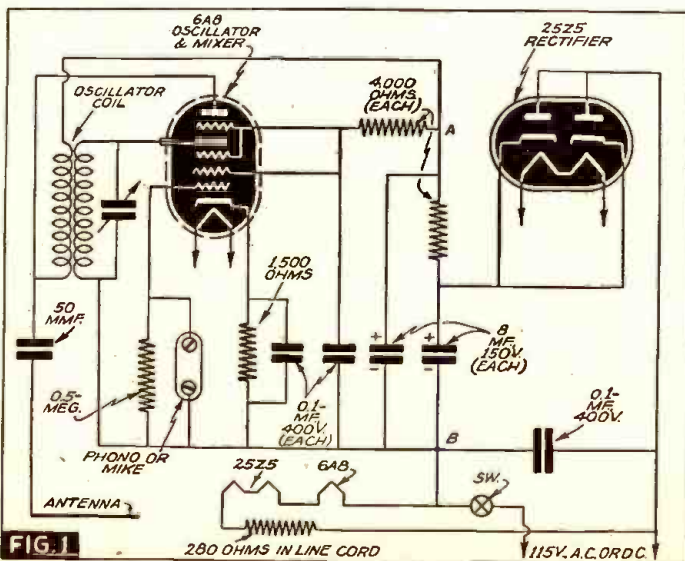

Schematic circuits of 2 of the Phono-Oscillators described in the accompanying article, and illustrated at top of page pictorially.

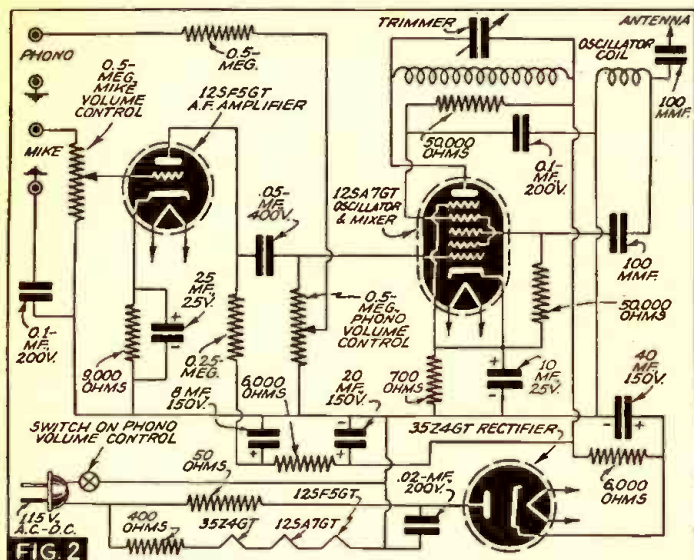

← Schematic circuit of the 3-tube high-gain Phono-Oscillator.

→ A 1-tube Phono-Oscillator designed for A.C.-D.C. operation. The 70L7GT incorporates in one envelope the functions of oscillator, mixer, and rectifier.

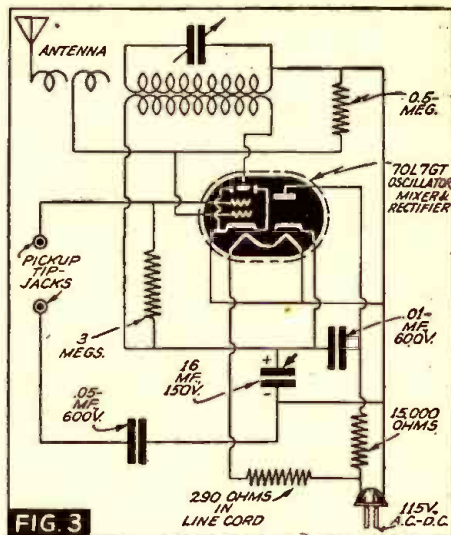

RECORD-PLAYING THROUGH ANY RADIO SET

But there are, still, millions of radio sets that do not have the connection strip on the back. Here, then, is a potential market for additional sales which the radio dealer and Serviceman should take advantage of.

Most Servicemen know how to connect a phono pickup to the average radio receiver. But "radios" that are not of superhet. type do not lend themselves well to phono-pickup connection. The midget T.R.F.s, for example, which are so numerous on the market today are among those to which connections cannot easily be made. In many cases too, the radio dealer or Serviceman prefers not to tamper with the customer's radio receiver, but would rather sell their customer a unit which can be used to play phonograph records through their radio set but without direct connection to it. Here is where the "wireless phono-oscillator" plays its part.

The wireless phono-oscillator is exactly what the name implies. In simple words, it is a broadcast station, which when modulated by the voltage generated by a phonograph pickup transmits a signal to the radio receiver. The oscillator usually consists of a simple receiving-type tube in an oscillator circuit. A multi-element tube is used—in which at least one extra grid is available for modulation purposes.

For the Serviceman with some spare time and some spare parts, here are a few phono oscillator circuits that can be built at very low cost. We suggest that one or two of the various models be built up and kept on hand for immediate sale. While basically the circuits are similar, each of them differs slightly and have their particular application. Let us review these circuits and explain their function.

2-TUBE "6A8" PHONO-OSCILLATOR

Figure 1 represents one of the simplest circuits for a wireless phono-oscillator. In this circuit, as in all of the other circuits, the unit is self-powered in the usual A.C./D.C. fashion. Since not much current is used by the oscillator tube, resistance-capacity filtering is employed. This type of filtering is economical and entirely adequate.

The grids in a 6A8 tube which are normally used for input and output are in this case used as an oscillator. The grids normally used as H.F. oscillator in a superhet. receiver become the modulation circuit. Modulation voltage is impressed upon grid No. 1, which modulates the electron stream flowing from the cathode. This may be considered "electron-modulation," the modulation volt-

age having very little effect upon the stability of the oscillator.

A simple oscillator is used and plate feedback is employed. The variable condenser is a compression-type mica trimmer of sufficient capacity to tune the coil into the broadcast band. The adjustment is generally made so that oscillations occur at a quiet spot in the broadcast band. Radiation takes place from a short length of indoor-type antenna which is coupled to the "hot" side of the oscillator coil through a 50-mmf. condenser.

The completed unit is shown in photo A.

DE LUXE "12SA7GT" PHONO-OSCILLATOR

Figure 2 represents a de luxe type of phono-oscillator, in which an additional tube is used to provide sufficient gain for microphone input. The oscillator tube used here is of a newer type and has a bit more stability than the one used in Fig. 1.

There is an additional innovation used in this circuit, in which the plate winding of the oscillator coil is the one that is tuned. Electrically this produces better frequency stability in the oscillator circuit.

Independent inputs are used for phono and mike, the volume of each control being independently adjusted. The additional amplification of the 12SF5GT tube adds sufficient gain to the circuit so that crystal mikes or the popular priced P.M.-type microphones may be used on the input.

The finished article of Fig. 2 appears in photo B. A simple chassis, just large enough to accommodate the parts, was used; obviously, any arrangement more suitable to individual needs may be substituted. In any of these circuits the actual, physical layout of parts is not very important.

1-TUBE UNIT

Figure 3 is a circuit of a 1-tube phono-oscillator using a 70L7GT tube. As you know, this tube actually is 2 tubes in 1. The diode section is used for power and the pentode section is used as oscillator.

Notice that 2 loops of wire are coupled to the "hot" end of the grid coil and take the place of separate condensers. The grid coupling condenser and the antenna coupling condenser are thereby eliminated. In this circuit the screen-grid is modulated. A 3-megohm dropping resistor applies a small potential to the screen-grid. In addition, the screen-grid is not bypassed as would be the case in usual oscillator circuits using this tube. In other respects, the oscillator circuit is conventional.

A 0.05-mf., 600-volt condenser, used in one of the pickup connection leads, prevents D.C. from being applied to the crystal pickup.

The unit is pictured in photo C. A small U-shaped chassis is used, making the entire unit small enough to fit within any type of record player.

2-TUBE "6F7" PHONO-OSCILLATOR

A slightly different arrangement is used in Fig. 4. Here we find a somewhat different setup in the use of the 6F7 tube. This tube has a pentode and a triode in one envelope. The triode section of the 6F7 comprises the oscillator, in which we find plate tuning used again. The pentode section of the 6F7 amplifies the signals of the phono pickup and plate modulates the oscillator section.

This circuit is based on the use of a Meissner type 17-9373 coil, L, pictured in photo D. This circuit when wired and assembled will look something like photo E.

The circuits shown here are representa-

FIG. 5

Pictorial diagram of the Phono-Oscillator shown schematically in Fig. 1.

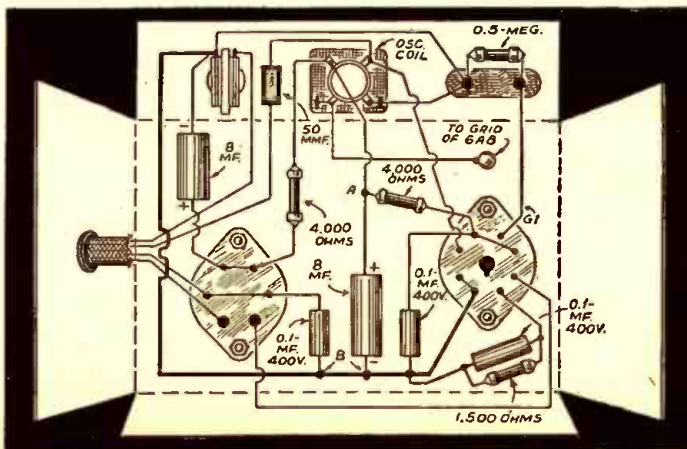

tive of nearly all Wireless Phono-Oscillator circuits. In general, we want a simple oscillator circuit which will radiate a weak signal in the broadcast band. While frequency instability is not a serious factor in the average phono-oscillator, we should not overlook this point altogether. Any simple method of increasing the stability of the frequency, that is, preventing the oscillator from drifting in frequency, or preventing the frequency from shifting under modulation, will improve results. The simple means of tuning the plate winding of the coil instead of the grid winding is usually sufficient.

One precaution that must be observed when using any phono-oscillator with a crystal pickup is that of guarding against over-modulation. Unfortunately phono-oscillators are not capable of 100% modulation such as actual transmitters. If distortion occurs turn down the record player volume control until the quality clears up. If increased volume is required, the volume

control of the radio set should be turned up. If this precaution is observed good-quality reproduction can be expected from any one of these units.

For those of you who would like to build the simplest one of these circuits, we include Fig. 5 which is a pictorial diagram of Fig. 1, photo A. The diagram shows the end view of the coil, the side view of which looks just like an I.F. transformer without the shield can.

All of these phono-oscillators are available in kit form and with complete instructions for home assembly. A complete parts list for the unit shown in Fig. 5 is given below. All of these phono-oscillators may be fitted into individual phonograph record-players. The completed assembly may then present the exterior appearance of the unit shown in photo F.

LIST OF PARTS

RESISTORS
Two, 4,000 ohms, 1/2-watt;

One, 50,000 ohms, 1/4-watt;
One, 1,500 ohms, 1/4-watt;
One, 280-ohm line cord with built-in antenna.

CONDENSERS

Two, 8 mf., 150-volt tubular electrolytic;
Three, 1 mf., 400-volt paper tubular;
One, 50 mmf., mica.

MISCELLANEOUS

One, 6-prong wafer socket;
One, octal wafer socket;
One, Knight No. N2925 drilled chassis;
One, Knight No. 2279 oscillator coil with trimmer;
One, Knight No. N2924 package hardware;
One, 6A8 tube;
One, 25Z5 tube;
One metal tube grid cap;
One, S.P.S.T. toggle switch;
One, input jack strip marked Phono.

This article has been prepared from data supplied by courtesy of Allied Radio Corp.

OPERATING NOTES

Trouble in . . .

... MOTOROLA 50-XCI, '2 '3, '4
Hum and distortion in this model receiver may be caused by insufficient clearance between pole-piece and voice coil. This pole-piece is held in place by a screw in back of the speaker and after a few weeks of service works loose, causing the voice coil to rub. Also some of these pole-pieces are coming through from the manufacturer in a fairly rough condition and require removing and polishing.

... BELMONT 519
This set uses a P.M. speaker and the voice coil is grounded to one side of the chassis. I have found that any corrosion between the speaker frame and chassis on sets of this type will set up a high resistance between the voice coil and chassis, causing the set to play intermittently. Cleaning thoroughly with carbon tetrachloride between speaker frame and chassis will clear up this type of trouble completely. The above holds good if a P.M. speaker is installed in this manner on quite a few of the small A.C.-D.C. "radios."

J. S. O'DAY,
Swanson Radio Service,
Seattle, Wash.

... PHILCO, 610, 620, 625, 630
Noisy volume control action can usually be traced to leakage in the A.V.C. condenser, Part No. 8035 DG. This is a double 110-mm. unit.

... PHILCO 623
Intermittent reception is usually caused by leakage in bypass condenser, Part No. 3903 SU (This is a 0.01-mf. bakelite unit.); or, weak contacts in the battery on-off switch.

... RCA-VICTOR 86K
In cases where RCA-Victor 86K skips frequency, and the dial doesn't calibrate, the trouble will usually be found in the oscillator condensers (C12, a mica 600 mmf. unit and C14, a 0.005 mf. paper condenser). They develop leakage or opens. This causes intermittent reception; or, stations of 700 kc. coming in 200 to 300 kc. off the regular dial calibration.

... PHILCO 931-32
Lack of reception in Philco Auto-Radio model 931-32 has been caused by an open

SERVICEMEN—

What faults have you encountered in late-model radio sets? Note that *Radio-Craft* will consider your Operating Notes (they need not be illustrated) provided they relate to **CHARACTERISTIC (repeatedly encountered) faults** of a given set model. Payment is made after publication of the Operating Notes.

voice coil. If you find that the tone in these models is badly distorted, it is well to check the 7C6 tube, which may have leakage between the elements.

... RECENT STEWART-WARNER MODELS
Several late-model Stewart-Warner "radios" coming in with complaints of distorted tone, or no reception, have been found to have leaky or shorted audio coupling condensers. We replace these with standard, 600-working-voltage condensers and to date have not had a similar complaint on these models.

CLARENCE J. TABER,
Bluefield, Va.

... PHILCO 96
Lack of reception in Model 96 Philcos, in several cases, was found to be caused by an open resistor (No. 36) in the divider circuit.

... SILVER-MARSHALL (57AUS; ALSO MODEL 30)
No reception in Silver-Marshall 57AUS is usually found to be caused by an open primary in the 1st I.F. coil.

Low volume in model 30 Silver-Marshall has in several instances been traced to a change in value of the detector plate resistor (R10, 300,000 ohms, 2 watts).

... GENERAL MOTORS S3A
Weak reception in the General Motors S3A is usually found to be caused by an open voltage divider resistor (R1, 150 ohms, 1/2-watt).

Weak or no reception in Majestic 20, has been found to be caused by a shorted primary and secondary coil in the 1st I.F. transformer.

... BRUNSWICK 16
Complaint of no reception in the Brunswick 16 usually can be traced to an open audio plate-load choke coil.

... ATWATER KENT 75 P
Weak reception in Atwater Kent 75P, is usually caused by a change in value of the plate bleeder resistor in the 1st audio stage.
CLARENCE J. TABER,
Taber Radio Service,
Bluefield, Va.

... SILVERTONE 6436
A Silvertone 6436 played, when turned on, until the cabinet was jarred or until the set had been turned on for awhile. All voltages and current readings checked perfectly. The set would sometimes snap on while under test; at other times it would be completely silent, or play intermittently.

The trouble was found due to an intermittently-open voice coil connection. This series of sets has a complex dial cable system for pushbutton operation, and the dial cord tends to break, thus causing tedious and oft-recurring repair jobs. When replacing the cord use the strongest available. Do not make the cord too taut since this will make for many breakdowns, in addition to being very "hard" on pushbutton operation.

... GENERAL ELECTRIC HB-412
A G.E. of this model played awhile, then broke into oscillation and buzzing. The trouble was traced to the 0.01-mf. condenser at the control-grid of the 1T5 tube.
SALVATORE OCCHIPINTI,
New York, N. Y.

... STROMBERG-CARLSON 145, 150, 160 & 180
Complaint: strong hiss either on or off station regardless of antenna or signal strength. These sets have a 6J7 oscillator and 6A8 mixer, and 26K7 I.F. amplifiers. The hiss originates in the triode section of the 6A8. The company originally recommended changing anode No. 1 from cathode to screen-grid of the 6A8 but this reduced the hiss level only slightly. The only permanent cure is to replace the 6A8 with a 6J7, and realign the circuits. The suppressor-grid of the 6J7 falls on exactly the same terminal as the control-grid of the 6A8. Therefore, no changes in wiring are needed. After trying almost every different type tube, the 6S7 was found to give best results.
MORRIS MANDEL,
New York, N. Y.

(See pages 85 and 109 for other Operating Notes.)

Newest Technique in

SERVICING CAR-RADIO SETS

Modern radio sets incorporate new developments in circuits and components which outmode a certain amount of the car-radio servicing procedure of preceding years. For this reason, Radio-Craft is especially indebted to Cadillac Motor Corporation for permission to reprint the following up-to-date article.

THE following article concerns only actual servicing procedure as distinguished from installation procedure, the general technique of which is familiar to all car-radio Servicemen; individual installation procedures vary slightly with the various makes, and the Serviceman quickly acquires a knowledge of these variations. For this reason this article presupposes a knowledge of such installation data as the installation of ignition suppressors, static collectors, etc., in addition to the usual problems of antenna and set installation. The problems of fault finding however require more specialized knowledge and it is this information which is presented in detail here.

Note that while this article is primarily a discussion of car-radio receiver faults, much of the information on fault finding is also applicable to home radio sets of all types.

SEMI-TECHNICAL

That phase of trouble shooting that can be performed with the radio receiver in the car by the average Serviceman without the use of special radio test equipment other than a tube tester, is here classed as "Semi-Technical."

Practically all radio complaints registered by owners will come under one or more of the following classes:

- (1) Dead
- (2) Inoperative
- (3) Intermittent
- (4) Weak
- (5) Noisy

In the following pages, a section will be devoted to each type of complaint, the proper procedure for diagnosis and the proper correction.

(1) DEAD

A "dead" set is one where the dial or indicator lights do not light, the tubes are not heating and the vibrator does not function or hum. This failure is always due to a break in the "A" or power supply line from the ammeter to the set, or to an open "A" circuit within the set. Proceed as follows:

- A. 1. Check fuse.
If blown, replace vibrator with known good vibrator and replace fuse. If set operates normally and fuse does not blow again, failure was due to sticking vibrator points. If fuse blows again, failure is undoubtedly due to a short in "A" circuit, either in switch or leads and set must be removed for bench repair. Replace original vibrator in set.
2. If fuse is not blown, the failure is due either to an inoperative On-Off switch or an open circuit in the "A" leads. Check pushbutton operation of On-Off switch to make sure no interference at that point is preventing switch from turning on. If OK, then it will be necessary to remove set for bench repair.

COMMON CAR-RADIO COMPLAINTS

The proper procedures for diagnosis and proper correction for one or more of the following classes of complaints registered by practically all owners of car-radio receivers are described in the accompanying article:

- (1) Dead
- (2) Inoperative
- (3) Intermittent
- (4) Weak
- (5) Noisy

There is a right way and usually several wrong ways of tackling a faulty car-radio receiver. It is the purpose of the accompanying article to show the procedure recommended by the radio service engineers of Cadillac Motor Car Division of General Motors.

(2) INOPERATIVE

An inoperative set is one where the dial lights light, the tubes heat, the vibrator may or may not hum, but no signal is reproduced. This failure will be due to a shorted or open antenna connection to the set, defective vibrator or tubes, or an open or shorted connection within set. Proceed as follows:

- A. If vibrator is not functioning (humming) replace vibrator. If known good vibrator does not function, replace original vibrator and remove set for bench repair.
- B. Check to make sure signals are getting to receiver by inserting a wire, long enough to reach outside of the car (equipped with a Delco male connector), into the antenna socket of the set. If signals are received, look for:
 - (1) Damaged insulator bushings in antenna socket or lead.
 - (2) Shorted or broken lead-in wire, due to kinking or a sharp bend in the lead.
 - (3) Loose or broken connection at lead to antenna.
 - (4) Check for water in the Vacuum Aerial cylinder by pulling up the antenna rod rapidly by hand. Presence of water will be indicated by small drops forming on the rod just above the insulator. This will cause fading and weak reception.
- C. Check tubes to see if they are lighted or warm. Check rectifying tube OZ4 first; if cold, replace. If all tubes are warm, remove tubes and replace with a set of known good ones or test in a tube tester, replacing those that are defective.

If trouble is not located, the receiver must be removed from the car for bench repairs.

(3) INTERMITTENT

Intermittent operation is the most difficult trouble to locate unless the car is brought in when the set is not functioning. In cases of intermittent complaint, the owner should be contacted and as accurate a history of the failure as possible be obtained to guide in diagnosis. Intermittent operation is caused by:

- A. Intermittent short or open connection in antenna lead-in or lead-in connectors.
- B. Intermittent tube failure.
- C. Intermittent vibrator failure or
- D. Intermittent open or short in wiring or component part within the radio set.

The first step is to analyze and check to try to duplicate the intermittent operation of the set while still on the car. Proceed as follows:

- A. Check antenna lead-in for possible open or short circuit of lead to ground by twisting or moving the lead about in the car with the set operating.
- B. Check antenna for intermittent contact by tuning to a weak station and raising and lowering the antenna by vacuum. If the station cuts out intermittently either in the process of raising or lowering, in the fully extended position or fully collapsed position, it is evidence of dirty contact springs or water or both in the aerial tube. Check further by fully extending the aerial, both manual and vacuum, and oscillate the aerial rod by flipping. If the set is scratchy or cuts out as the antenna comes to rest, the contact springs are weak and/or dirty. Disassemble the antenna, clean out the water, clean off contacts and bend slightly to increase contact pressure (replace if necessary).

When reassembling the antenna, care should be exercised when inserting the antenna rod and piston so that the leather piston washer is not damaged by the threads on the cylinder.

- C. Check vibrator for intermittent failure by turning set on and off 15 or 20 times about 5 seconds apart. If vibrator fails to function at any time, replace.
- D. Check tubes for intermittent failure by tapping with the butt end of an insulated screwdriver while set is operating. If under tapping any tube shows up as noisy, scratchy, or cuts out, replace.

If these tests fail to reveal any intermittent operation of the set, remove the set from the car for further diagnosis.

(4) WEAK

A weak radio receiver is where the set operates normally in all respects except its volume is below standard. This type of failure is due to incorrect adjustment of antenna trimmer, an open connection in the antenna lead-in, defective vibrator, defec-

**BUY HALLICRAFTERS
ON BOB HENRY'S (W9ARA)**

Easy Terms!



You always get satisfaction in a purchase from me . . . I personally guarantee you can't buy for less or on better terms elsewhere. You can't beat my friendly credit plan. Write and tell me what you want—I sell all makes and models of receivers and amateurs parts—remember we can always arrange the terms. **BOB HENRY (W9ARA)**



The Sky Traveler (Model S-29) A universal receiver, you can take it with you anywhere. Operates on 110 volt AC-DC or from self-contained batteries. 9 tubes. Covers from 542 kc. to 30.5 mc. (553 to 9.85 meters) on 4 bands. Self-contained extension type antenna. Wt. including batteries 18 lbs. **\$5950**



Model SX-25 Incorporates every worthwhile advancement that has been made in the communications field. 12 tubes, covers from 540 kc. to 42 mc. in 4 bands. Separate calibrated bandspread dial for the 10/20/40/80 meter amateur bands. 10" heavy duty PM dynamic speaker in matching metal cabinet. Complete with speaker, crystal and tubes **\$9950**



The Sky Buddy (Model S-19R) designed to produce superior performance at a moderate price. 6 tubes; 4 bands; continuous coverage 44 mc. to 545 kc.; Electrical bandspread; built-in line filter **\$2950**



Model SX-24. A great communications receiver value. 9 tubes; 4 bands; frequency range of from 540 kc. to 43.5 mc.; one stage of preselection; Single-signal crystal filter standard equipment; DC operation socket-battery or vibra-
pack **\$6950**



The 1941 Sky Champion (Model S-20R) Represents the best value in the communications field. 9 tubes; 4 bands; covers 545 kc. to 44 mc.; separate electrical bandspread; Inertia bandspread tuning; battery-vibrapack DC operation socket **\$4950**



New 1941 Super Skyrider Model SX-28. Sets a new high in quality performance. 15 tubes; Two stages preselection; 80/40/20/10 meter amateur bands calibrated; 6 step wide range variable selectivity; Calibrated bandspread inertia controlled; Frequency coverage 550 kc. to 42 mc. With Crystal and Tubes **\$15950**

HENRY RADIO SHOP
BUTLER, MISSOURI

SERVICING

tive tubes, misalignment, or a failure within the set proper. Check as follows:

- A. Check antenna trimmer adjustment and make sure it is properly set, referring to instructions for the particular model radio set.
- B. Check antenna lead-in and antenna proper for open connection, as described under "Intermittent," paragraphs A and B above.
- C. Check vibrator by replacing with known good one.
- D. Check tubes by tapping with butt end of insulated screwdriver. If a tube shows up as noisy, or if while tapping the volume increases to normal, replace that tube. If this test fails to reveal bad tube, replace all tubes with known good set or test in the tube tester.

If set is still weak, remove for further diagnosis and repair.

(5) NOISY

Noisy radio receivers are caused by many things. Most complaints of noise are caused by *ignition radiation* due to faulty installation. The first step is to determine the kind of noise and to trace the source. This can be discovered by making a road test. Try the radio set tuned on and off station, with the engine of the car running and off, and with the car in motion and standing still.

- A. If the noise is constant with the engine running, standing still or in motion, but absent with the engine off, whether standing still or in motion, it is **IGNITION** or **HIGH-TENSION RADIATION**.
- B. If the noise is present when the car is in motion, engine off or on, but absent when the car is standing still, whether the engine is off or on, it is **WHEEL** or **TIRE STATIC**.
- C. If the noise is present with the engine off or on and the car in motion or standing still, it is **ELECTRICAL**, or within the radio receiver or its connection.

After the kind of noise is determined, the next step is to correct—using the following procedures as a guide. For simplicity this section on noise has been divided into 3 parts:

- A. Ignition Radiation
- B. Wheel or Tire Static
- C. Electrical Noise

A. Ignition Radiation

Ignition radiation is electrical interference generated by the ignition system of the automobile engine and can get into the radio in 2 ways:

1. Through the battery circuit via the power connection or "A" lead to the receiver, known as *Primary or Backway Radiation*, or
2. Through the antenna system, known as *Secondary Radiation*.

To determine presence of "Backway" interference remove the antenna plug, insert a *shielded dummy antenna* of proper capacity (see Service Bulletin on model radio set involved) into the antenna socket and check for noise with volume control fully on, Local-Long Distance switch (if so equipped) on Distance side, tone control at maximum Treble position, and with the engine running.

Secondary Radiation into the antenna system is a broad problem and is the common cause of ignition noise complaints for all series. Proceed as follows to correct:

1. Make certain ignition suppression has been installed as directed in the manual and instruction sheet for the model involved.
2. Inspect the engine ground straps to see that they are bolted tightly in place

and contact surfaces are free from paint and dirt.

3. Check antenna lead-in shield and make sure the clip is making good contact to ground. (Make sure hood is closed when making antenna tests to prevent radiation from ignition system.)
4. Check the points at which the radio receiver is attached to the dash and instrument panel to make sure good ground contacts are obtained at each point.

CAR-RADIO TROUBLE QUIZ

If you encountered the following complaints, and made the indicated preliminary checks, what service procedure would you follow to finally cure the particular trouble?:

- (1) Set reported "dead":
 - A1. Fuse blown; A2, set fuse not blown.
- (2) Set inoperative:
 - A. Vibrator not functioning (humming).
 - B. Signals getting to receiver.
 - C1. Tubes warm; C2, tubes cold.
- (3) Intermittent operation due to:
 - A1. Antenna; or, A2, lead-in fault.
 - B. Tube failure.
 - C. Vibrator failure.
 - D. Faulty wiring.
- (4) Reception weak due to:
 - A. Trimmer adjustment.
 - B. Antenna and lead not open.
 - C. Vibrator possibly at fault.
 - D. Defective tubes.
- (5) Noisy operation caused by:
 - A. Ignition or high-tension radiation.
 - B. Wheel or tire static.
 - C. Electrical (within the receiver or its connection), and exhibited as:
 1. Intermittent frying or crackling.
 2. Constant frying or crackling.
 3. Constant hum or buzz.
 4. Intermittent squeals or hisses.
 5. Rattling or buzzing on sounds of certain pitch.

The answers to these and many other questions are given in the accompanying article.

It is unnecessary to scrape paint from metal if shakeproof washers are next to metal surface, as their sharp edges will cut through paint and establish a good bond contact.

5. Inspect radio rotor bar and peen slightly if clearance is too great. (This "radio rotor bar" is the special distributor rotor recommended to be installed in the ignition distributor in place of the standard rotor.)
6. On some cars the hood, side-panels, and fenders may not be grounded sufficiently to shield the ignition system from the vacuum antenna. This is due to variations of paint thickness between points of metal-to-metal contact in the hood, side-panel and fender assembly. This permits the hood and side-panels to become a radiator instead of a shield. This may be determined by inserting a shielded dummy antenna of 35 mmf. capacity in the radio set. If the noise has disappeared, the interference is undoubtedly radiated into the antenna. To correct, remove the various parts to which the side-panel and hood are attached, scrape away the paint from the points at which they contact the body or install an external lock washer between these points. This will result in a uniform ground potential throughout the hood and side-panels,

thereby acting as a shield. The most important points of good ground contact are—hood-to-body through hinges, sidepanel-to-body through rear mounting bracket and sidepanel-to-radiator shell through front mounting bracket.

7. If noise is still present, bond both motor blocks to the dash or fire wall and the transmission housing to the floor pan. Make the bond leads as short as possible, using heavy ground straps and attach to sheet metal by using self-tapping screws and flat washers. Make sure the paint and dirt is removed from points of contact.

In case some ignition radiation is still present, go over the procedures taken so far, to check and make sure no error has been made.

B. Wheel or Tire Static

Wheel or tire static is reproduced in the radio speaker as an almost continuous roaring sound, resembling somewhat heavy atmospheric static.

The intensity of the static does not vary appreciably with car speed, and increasing the car speed has but slight effect on the loudness of the interference. Generally, the noise is greater on a dry, sunshiny day and is often times hardly noticeable on a humid or rainy day. The noise varies considerably according to the construction of the road. It is usually greatest on an asphalt highway, less on a concrete surface and practically unnoticeable on either gravel or dirt roads. This noise will also vary as the wheels of the car pass from dry spots to damp or wet spots, such as found after showers on the streets.

Wheel static is due to an electrostatic charge being built up in the wheels of the car and accumulated until the leakage to the car body or to the ground from the tires is sufficiently high to be radiated into the car antenna where it is audible above the level of the signal being reproduced. It is caused by the flexing of the tires in contact with the road and also by the air friction of the wheels, tires and body.

Another form of wheel static is caused by irregular wearing of the brake lining. This form of wheel static, however, is different in sound as it "clicks" or "pops" whenever the high spot of the brake lining contacts the drum.

Occasionally brake static is confused with a popping sound noticeable in some cars when the brake pedal is depressed. This is invariably due to the electrical contact of the stop-light when the brakes are applied. This should not be objectionable, but if the owner complains, it can be corrected by putting a condenser across the stop-light terminal.

If wheel static, either tire or brake or both types, is present first check the *static eliminators* in both front and rear wheels. (These "static collectors" are provided in the radio kit for installation in the front wheels of Cadillac cars. Rear-wheel static collectors are standard equipment on all late-model cars.) Cars which do not have these "static collectors" should be provided with them.

Make sure the static collectors are properly installed, making good contact, and free from grease. (Refer to Installation Instructions under "Suppression," in most car-radio manuals.) If the noise is due to brake static only, the correction is proper adjustment of the brakes. If static collectors are all functioning correctly and wheel static (not brake static) noise is still present, it may be one of the rare cases where the tires are extremely susceptible to the formation and accumulation of static.

First, try cross-interchanging the tires.

Move the left-front to the right-rear, and the right-front to the left-rear, etc.

If still unsatisfactory, dismount all tires and tubes, clean inside of tires and tire sidewalls with naphtha or high-test gasoline, and paint tire sidewalls and beads with a conducting paint mixed from 1 pt. naphtha, 8 ozs. powdered graphite and 1½ ozs. patching cement. Do not permit paint to get on tubes or inside of casings.

Also, clean inside of rim flanges and rim ledges, removing all paint, dirt and rust with a wire brush and gasoline, and apply the conducting paint. Do not remount the tires until the paint is dry.

C. Electrical Noise

Some owners may object to the *electrical noise* caused by the contacts in the turn indicator while it is in operation. This can be eliminated by installing a 0.1-mf. condenser across the contacts at the indicator control relay.

Electrical noise in radio receivers can usually be classified as one of the following types:

1. Intermittent frying or crackling
2. Constant frying or crackling
3. Constant hum or buzz
4. Intermittent squeals or howls
5. Rattling or buzzing on sounds of certain pitch.

For simplicity in diagnosing point of failure, each type of noise is covered separately.

1. *Intermittent frying or crackling* is caused by a loose connection in the antenna circuit, loose elements in tubes, or a loose connection in the radio receiver.

- a. Check antenna lead-in by moving the lead-in while the set is tuned to a station.
- b. Check tubes by tapping with the butt end of a screwdriver. If noise is intensified or stopped, replace the tube.
- c. If noise is still present, remove radio set and take it to the shop for correction.

2. *Constant frying or crackling* is caused by bad vibrator, tube or open or shorted condensers.

- a. Replace vibrator.
- b. Check tubes by tapping with butt end of screwdriver. If tapping reveals no failure, replace complete set of tubes.
- c. If noise is still present, remove radio receiver and take it to the shop for correction.

3. *Constant hum or buzz* is usually caused by a noisy vibrator, but oftentimes by tubes or open or shorted condensers.

- a. Replace vibrator.
- b. Check tubes by tapping with butt end of screwdriver. If tapping reveals no failure, replace complete set of tubes.

c. If noise is still present, remove radio set and make further tests and corrections in the shop.

4. *Intermittent squeals or howls* are sometimes caused by tubes, but are usually open or short circuits within the receiver. Check tubes by tapping; if no failure revealed, remove receiver and turn over to the shop Serviceman for correction.

5. *Rattling or buzzing on sounds of certain pitch* is caused by a loose part either on the instrument panel or in the radio case vibrating with the frequency of the note.

- a. Check instrument panel for loose parts.
- b. Check case cover to make sure it is tight.
- c. Remove case cover and make sure

In the Test Equipment Field, Too.



OLD FRIENDS ARE BEST!

—because they are time-tried—
PROVED.

So is the current line of SUPREME testing instruments. Each and every one has been proved SUPREME in service.

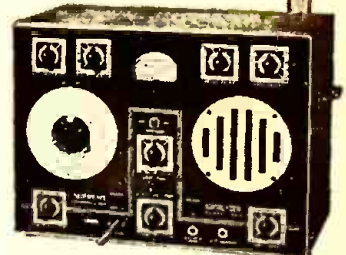

SUPREME MODEL 562

That's why SUPREME announced no new models at the show.

If and until advance in radio develops a need for new testing equipment, SUPREME will NOT merely rearrange a panel just to be able to announce a new instrument. SUPREME will stick staunchly to its policy of continuous improvement of its current models.

Look them over at your Jobber's. Feature for feature, you will find they represent the "tops" in instrument value.

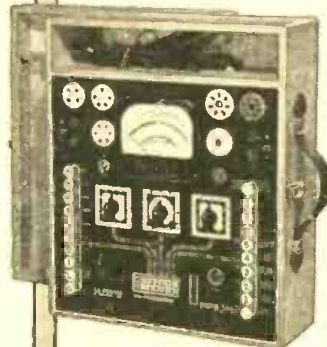

SUPREME MODEL 504-A

Model 562 Audolyzer above, and Model 504 Tube and Set Tester at left, just made their third Parts Show. They were good the first time, and due to our policy of continuous improvement, they are better NOW.

SUPREME

SUPREME INSTRUMENTS CORP.
GREENWOOD, MISSISSIPPI, U. S. A.

MAIL COUPON TODAY!

SUPREME INSTRUMENTS CORP., Dept. RC-4
Greenwood, Miss.
Please send me illustrated literature on the complete line of PROVED SUPREME Instruments.

NAME _____
ADDRESS _____
CITY _____ STATE _____

tubes and vibrator are tight in sockets.

- d. If noise is still present, drop radio set and inspect loudspeaker screen. If screen is pushed in or too close to speaker, pull away carefully with a hooked piece of wire.
- e. If these steps do not correct rattle, continue the analysis and correction in the shop.

TECHNICAL

The following information offers the basic procedure to guide and direct the Serviceman in diagnosing and correcting troubles that occur within the radio chassis proper. These procedures deal with bench testing and repair of the radio receiver off the car. The same 5 classifications of failure are followed as in the Semi-Technical section, namely:

- (1) Dead
- (2) Inoperative
- (3) Intermittent
- (4) Weak
- (5) Noisy

(1) DEAD

- A. Check "A" line lead from connector to On-Off switch in radio set.
- B. Check switch.
- C. Check connection from switch to vibrator transformer.

(2) INOPERATIVE

- A. Check tubes.
- B. Check audio system with speaker connected by introducing a low-frequency signal into the 1st grid of the audio stage. This may be done by touching the control-grid of the tube with a test prod or metal screwdriver, or if an

SERVICING

audio-frequency oscillator is available, introduce a signal from the A.F. oscillator.

- C. Check the I.F. system by applying a signal of the proper frequency to the control-grid of the 1st detector. Refer to Service Bulletin on the specific model on which the failure occurred.
- D. Check the R.F. system by applying a signal of broadcast frequency to the grid of the R.F. tube and then to the antenna terminal.

By this method the point of failure may be located and with reference to the Service Bulletin on the particular model receiver, the trouble can easily be corrected.

(3) INTERMITTENT

Intermittent operation is caused by intermittent tube failure, intermittently open or shorted connection, intermittently open condenser or resistor, or sticking vibrator. When checking for intermittent operation it is desirable to use an 8-volt storage battery, as the condition will show up more quickly. Use a heavy lead from set to battery so that the voltage drop will be negligible.

- A. Check tubes.
 - B. Check all wiring connections carefully, using procedure detailed under "Inoperative" in preceding paragraph.
- ## (4) WEAK
- A. Check tubes.
 - B. Check vibrator.
 - C. Check I.F. and R.F. alignment, referring to alignment procedure in Service Bulletin for specific model radio set being tested.

(5) NOISY

Noisy operation due to defects within the

radio receiver chassis will fall within one of the following classifications:

- A. Vibrator hash
- B. Vibrator hum—electrical
- C. Vibrator hum—mechanical
- D. Oscillation (squeals, howls, motorboating)
- E. Distortion (tone distortion, scratchiness, etc.)
- F. Case and speaker rattles.

The following procedures should be followed to determine point of failure and correction.

A. Vibrator hash—

- (1) Check vibrator.
- (2) Check tubes for heater to cathode short.
- (3) Check primary filter circuit condensers for open or loose grounds.
- (4) Check ground connection for loose or open connections.
- (5) Check buffer condenser.
- (6) Check rectifier tube.

B. Vibrator hum—electrical—

- (1) Check tubes for shorted elements.
- (2) Check electrolytic filter condensers for open or intermittent circuit.
- (3) Check buffer condenser for intermittent open-circuit.

C. Vibrator hum—mechanical—

This trouble is due to excessive mechanical vibration of the vibrator unit proper which resonates at case frequencies, or loose vibrator mounting, causing parts to vibrate excessively. Correct by replacing vibrator or tightening vibrator mounting if loose.

D. Oscillation

High-frequency oscillations are high-pitched whistles and are usually heard when tuning across signal; they vary

in pitch as the station is tuned to resonance. Cause: oscillation of the R.F. tube circuits.

- (1) Check tubes.
- (2) Check for open or shorted condensers in the R.F. circuit.
- (3) Check for loose connections (causing intermittent oscillation).

Low-frequency oscillations are medium- and low-pitched howls constantly heard, not affected by tuning through a signal and not greatly affected by volume control. This is caused by an open condenser, usually electrolytic, in the cathode circuit of the 1st audio stage.

- (1) Check audio driver and output tubes.
- (2) Check electrolytic condenser across cathode circuit of 1st audio stage.
- (3) Check resistor or condenser in screen-grid circuit of 1st audio stage if equipped with pentode tube.

NOTE: Even though replacement of tube eliminates howl, always check electrolytic condensers for possible open-circuit, as new tube may draw more current, thereby causing higher voltage across electrolytic condenser TEMPORARILY correcting open-circuit in condenser.

Very-low-frequency oscillations, or motorboating, are constant and are almost always caused by an open grid-return circuit. Trace complete grid-return circuit until open is found; referring to schematic wiring diagram of the particular radio set model.

E. Distortion—

Tone distortion includes scratchiness as well as definite tone distortion. Scratchiness is usually caused by a defective tube, loose connection, dirt in tuning condenser, or loose parts. If set is scratchy momentarily when jarred:

- (1) Check tubes for loose elements.
 - (2) Check for loose connection of component parts by jarring individually with set operating.
- If tone is definitely distorted:
- (1) Check for defective tube.
 - (2) Check for loose voice coil in loudspeaker.
 - (3) Check for voice coil leads rattling against cone.
 - (4) Check for voice coil rubbing pole pieces.
 - (5) Check for short or open condenser or resistor.

TECHNICAL REVIEW OF CATALOGS, ETC.

UTC Quality Transformers for Broadcast and Commercial Subjects (Bulletin No. BC-1).—Contains not only diagrams on complete amplifiers, but also extensive engineering information on sound equipment design and construction, including amplifiers, transmitters, equalizers and filters. (United Transformer Corp., New York, N. Y.)

Radio Transmitter Capacitors—Cornell-Dubilier Catalogue No. 160-T 1939-40.—Includes "Guide to Selection and Use of Dykanol Capacitors," with capacity and frequency charts; also, curves and useful data concerning condenser ratings, as for example "Test Volts Effective Rating." (Cornell-Dubilier Electric Corp., So. Plainfield, N. J.)

Turner Vibrator Manual for Radio Service Engineers.—Technical information concerning Turner vibrators; and vibrator replacement list covering 2- to 32-volt vibrators in practically all radio sets utilizing vibrator-type power supplies. Also has "Buffer condenser replacement chart for radio sets" having vibrator-type power supplies. (The Turner Co., Cedar Rapids, Iowa.)

FREE!

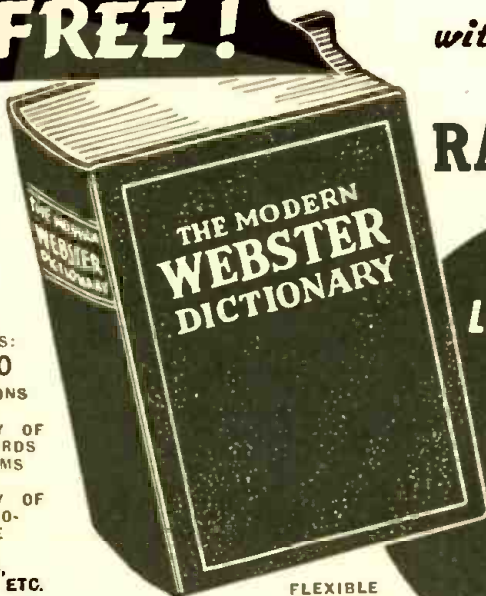

CONTAINS:
22,000
DEFINITIONS
•
DICTIONARY OF
RADIO WORDS
AND TERMS
•
DICTIONARY OF
THE AUTO-
MOBILE
•
TABLES,
TREATISES, ETC.

FLEXIBLE
IMITATION
LEATHERETTE
COVER, SIZE 5½" x 8"

with \$1.00 subscription

to
RADIO-CRAFT

FULL
LIBRARY SIZE

**MODERN
WEBSTER
DICTIONARY**

**416
PAGES**

FILL OUT—MAIL THIS COUPON TODAY!

RADIO-CRAFT, 20 Vesey Street, New York, N. Y.

Gentlemen: Enclosed you will find One Dollar for which enter my subscription to RADIO-CRAFT Magazine for EIGHT Months. Send me ABSOLUTELY FREE and POSTPAID, my copy of the MODERN WEBSTER DICTIONARY.

This is a New Order Extend my present subscription

Name

Address

City State

RC-841

(Remit by check or money order; register letter if you send cash or unused U.S. Postage Stamp)

If you will take advantage NOW of our special subscription offer of eight months for \$1.00, we will send you ABSOLUTELY FREE and POSTPAID this 416 page full library size MODERN WEBSTER DICTIONARY—useful and instructive to everyone. This self-pronouncing authoritative dictionary—a new work throughout—contains the most up-to-date words now in common use, 22,000 definitions in all. It also features a Glossary of Radio Words and Terms, Dictionary of the Automobile, Treatises on Practical Syntax, Etymology, Punctuation and Standard English by well known authorities, Metric Tables, Time, State Flowers, National Parks of the U. S., etc.

This is a time limited offer.
so don't delay in returning the Coupon.

RADIO-CRAFT

20 VESSEY STREET

NEW YORK CITY

RADIO-CRAFT for AUGUST, 1941

OPERATING NOTES

(See pages 79 and 109 for other Operating Notes.)

Trouble in

... CHEVROLET 985255

Complaint: intermittent reception. The set will stop playing, but when you try to test it, it starts again. The trouble is usually one of the 3 cathode bypass condensers located in a small can near the tuning condenser. The condenser develops an intermittent partial-short.

... TRUETONE D-719

Complaint: noisy, with excessive hum. This condition is usually intermittent. This is a 6-volt set, and the battery cable contains rubber-covered wires under a tight-fitting shielding. The rubber melts in hot weather and causes a partial short inside the shielding. This is easily overlooked when testing.

... PHILCO 623

Reception only on the low-frequency end of dial sometimes can be cured by changing the oscillator tube from a 1C6 to a 1A6. The permanent cure however is to replace the oscillator coil.

... PHILCO 38-34

Very weak, or "dead," symptoms may indicate that the pilot bulb is burned-out. This set must have a pilot bulb, since it is wired in the filament circuit in such a way that some of the tubes do not receive proper voltage without it.

... PHILCO 37-33

Characteristic fault: insufficient volume, though properly sensitive and selective. These sets are not very loud at their best. Rewire the audio system of this set, using a small push-pull input transformer instead of the phase-inversion system employed. This will boost the volume plenty, and the tone will be good.

... FORD FT-6

If regeneration and oscillation are experienced on the low-frequency end of dial, be sure the tuning condenser is grounded well. If it is, replace the oscillator coil. Nine times out of 10 this is the trouble. The 10th time you will find an open bypass or grid resistor in the mixer circuit.

... PHILCO 700

Complaint: distortion when volume is turned down—good tone at high volume. The speaker is defective—and there is no way of adjusting it. Replace it with a 6- or 8-inch P.M.

... TRUETONE Z-5

Observed effect: noisy reception, resembling effects of a defective volume control. Look inside the 1st I.F. transformer can and resolder all connections. I have encountered this trouble on 5 of these sets in the past 3 years.

... RCA

Excessive hum at times is usually caused by a defective 0.05-mf. condenser connected from the volume control to the control-grid of the 6B7, and used as a coupling condenser.

NORRIS CHAMBERS,
Cross Cut, Texas.

... PACKARD-BELL 5

Quite often, when the complaint is that the set is "dead," you will find the oscil-

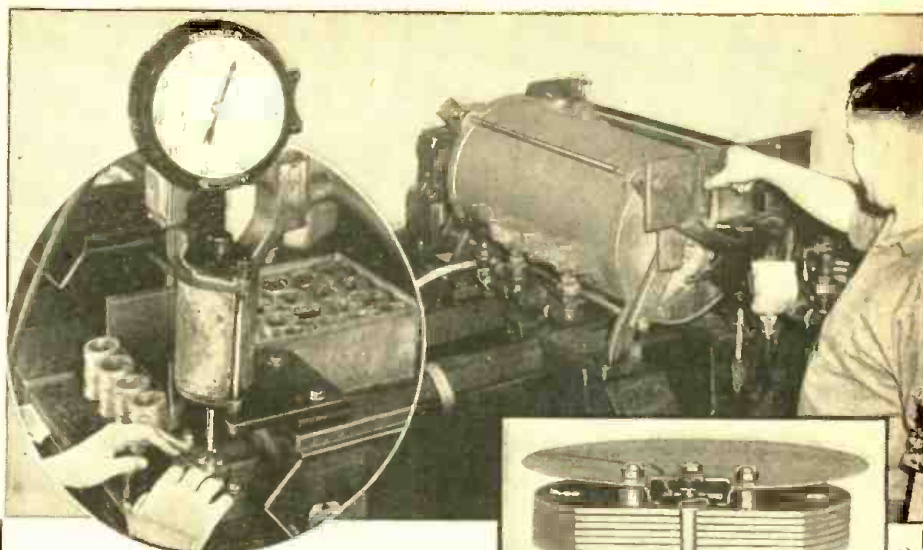

It's got to be right

TO BE **TRIPLET**

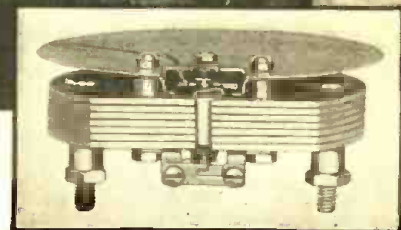

Interior View of D.C. Movement . . . Double truss bridge protects against any vibration—insures permanent perfect alignment of bearing supports, and provides correct scale readings.

In every phase of manufacture, Triplett exercises rigid control over the quality of every part. In instrument manufacture, for example, heat-treating magnets the Triplett way, plus careful ageing, insures permanency. Following heat-treating, processing by special electric hammers insures initial uniformity and freedom against change. Triplett instruments have perfect alignment magnetically and mechanically, with the result that scale readings are linear and free from "curve error." That is why Triplett instruments have been recognized internationally for their precision, long life, and reasonable prices. That is why more and more people are standardizing on Triplett instruments, because they know—"It's got to be RIGHT to be Triplett."

Write for Catalog—Section 168 Harmon Avenue

THE TRIPLETT ELECTRICAL INSTRUMENT COMPANY
Bluffton, Ohio

lator does not function. This is often due to moisture in the oscillator coil. Replace the coil, or dry by inserting a soldering-iron tip inside the coil form, being careful not to touch the form itself.

LEO G. SANDS,
San Francisco, Calif.

... PILOT F.M.12

All complaints.—Replace following resistors: screen-grid of 6SJ7, 40,000 and 15,000 ohms, replace with 1 W. carbon resistors; screen-grid of 6AC7 2nd I.F. amplifier, replace 40,000 ohm resistor with 1 W. carbon. Do not use insulated-type resistors. Plate circuit of 6SJ7, replace 75,000 ohm unit with 2 W. insulated resistor. Replace the 75,000 ohm resistor, in the voltage divider circuit of the noise suppression circuit, with 2 W. insulated type; 60,000 screen-grid of 6AC7 1st R.F. stage, replace with 2 W. insulated type; two 25,000 ohm resistors in voltage supply of oscillator circuit of 6K8—replace with 2 W. insulated type from "B+" to center and 1 W. insulated type from center to grid. The 5 mmf. temperature-compensated condenser in this circuit must be taped securely to both resistors and be put back in exactly the same place or else the low-frequency end of the F.M. band will shift either up or down dial scale. The 0.1-meg. resistor from "B+" to center, in the plate of the "eye" circuit, should be changed to 50,000 ohm, 1 W. carbon resistor. This completes all the changes necessary to bring the Pilot F.M.12 up-to-date.

PILOT RADIO CORP.

HOW TO MODERNIZE A.C./D.C. RECEIVERS!

See the article on simplified conversion in the September, 1941, issue of *Radio-Craft*.

LEOTONE

The House of a Million Parts and a million bargains.
A FEW OUTSTANDING BUYS

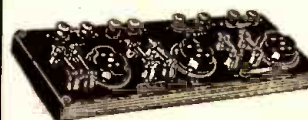

DeJure Molded Bakelite Bases: 8 3/4" x 3 1/2" including 6 resistors, 3 4-prong sockets, 8 binding posts; wired for resistance-coupled amplifiers; can be used for 3-tube shortwave sets or amplifiers. . . . 35c ea.
Gen-Win .00035 Binoc. R.F.'s: matched set of 3 . . . 29c ea.
Audio Transformers: 3 to 1 ratio . . . 19c ea.
AC Relays: 2" sq.; S.P.D.T.; 5 Amp. contact points; mounted on sturdy diecast base: 1M ohm 98c ea.; 5M ohm . . . \$1.29 ea.
H. Bernard Walnut Meter Boxes: 3" x 5 1/2" x 2 1/4" High; engr. aluminum panel; for 2" motor 49c ea.
12" Phono Felts: Green or Brown . . . 15c ea.
.00035 3-Circuit Tuners: 2 1/2" x 3" . . . 75c ea.
Micromold Fixed Conds.; most caps. in stock 35c doz.
Minimum order \$1.00, 20% deposit required

LEOTONE RADIO CO.

63 Dey St., Dept. RC-3, New York, N. Y.
Leading for 20 years as mfrs. of cones and field coils.

Sensational New!

"WALSCO UNIBELT"
ADJUSTABLE DIAL BELT
THE GREATEST TIME SAVER FOR RADIO MEN IN YEARS!
Belts are adjustable and come apart. They can be installed without taking the dial mechanism apart. Patented zipper-like fastener gives instant connection. The WALSCO UNIBELT comes with a stretch and one can do a replacement job in two minutes that before took an hour or more.
Ask your lobster for FREE WALSCO CATALOG No. 42A Or write to WALTER J. SCHOTT CO. 5246 Pico Blvd., Los Angeles, Calif.

Be a RADIO SERVICE EXPERT—LEARN AT HOME IN SPARE TIME

The demand for radio experts grows every day. Learn this paying profession under personal guidance of qualified engineer and educator. Clear, fascinating instruction and experimental kits make learning easy. Leaders in the radio industry endorse R.T.A. methods. Spare time profits soon pay for training.
FREE book telling what R.T.A. training can do for you.
RADIO TRAINING ASS'N. OF AMERICA
1559 Devon Ave. Dept. RC-81 Chicago, Ill.

LAFAYETTE CHASSIS MODEL B-100 (TABLE MODEL B-103; CONSOLE MODELS B-101, B-102)

A 9-Tube, 5-Band A.C. Superhet., with Tuned R.F. Stage on All Bands; A.V.C.; Automatic Bass Compensation; High-Q Loop Antenna; Self-contained Counterpoise Antenna; Provision for Outdoor Antenna; Mechanical 6-Pushbutton Tuning; Edge-lighted Sliderule Dial; Tuning "Eye"; Provision for Phonograph or Automatic Phonograph and Recording Microphone (and therefore Television and F.M. Adapters), and for an External Loudspeaker. Consoles use up to 14-in. Speaker; Table model, 8-in. Power Consumption, 75 Watts (117 V., 60 cycles); Power Output, 9.5 W. undistorted, 11 W. max.

(See Data Sheet 312 for schematic diagram.)

The Model B-100 Chassis is used in a series including phonograph combinations equipped with an automatic record changer. Models not equipped with record player are provided with facilities for the playing of records through the radio set (see illustration, showing parts placement atop chassis and at rear). Volume and tone control are used in the same manner for phonograph reproduction as for radio reception. Selectivity at 1,000 times signal strength, 30 kc. broad. The Tone Control affords radio reception when turned to far right until a click is heard, and then backed-up for tone control; phonograph operation is obtained when this knob is turned to the far left until the click is heard, and then turned forward for tone control.

Setting Buttons.—When setting-up the manual pushbutton tuning buttons, it is preferable to follow in a kilocycle sequence, starting with the lowest kc. setting at left. To set a button, unlock the pushbutton mechanism from the back of the radio receiver. On the drive pulley shaft and at the left side (from the back of the radio set) of the pushbutton tuning assembly is a locking screw (see Fig. 1). Turn the manual tuning knob until the locking screw is available and loosen it with a small-handled screwdriver. To set stations accurately do not jar the radio set or the buttons while the mechanism is unlocked. Having tuned-in a station to accurate resonance, by means of the tuning eye, hold the manual tuning knob with one hand and with the other push one of the station buttons all the way in. Double-check the resonance, meanwhile holding the button all the way in, then slowly release the button. Do not touch this button again while the mechanism is unlocked. Now tune-in the second station following the same procedure; and so-on for the remaining buttons. After all the stations are set, the mechanism is locked by turning the manual tuning knob until the locking screw can be easily reached; with a small-handled screwdriver, the locking screw is then tightened.

Antenna and Ground.—Two built-in aerials are incorporated in the cabinet. One is a loop type for broadcast reception and the other is a counterpoise foil aerial used for reception on shortwave bands. For reception of nearby stations, an outside antenna and ground are usually not required, however if local noise is excessive it may be desirable to use an outside antenna, in which case it should be about 50 to 60 feet long including lead-in. In the console models, when operating the radio set on broadcast band with the built-in loop antenna, directional effects are obtained; in the loudspeaker compartment is a rotatable loop antenna. In the table model receivers the loop is fixed.

For best shortwave reception an outside antenna and ground are recommended.

A wire with an antenna marker will be found coming out of the chassis. If the loop and counterpoise foil aerials are used do not connect this wire to anything. If an outside antenna is used, connect this wire to the lead from the outside antenna. The wire which is connected to the counterpoise foil aerial should never be disconnected.

On the back of the chassis is the socket for record-player connections. The cable connector

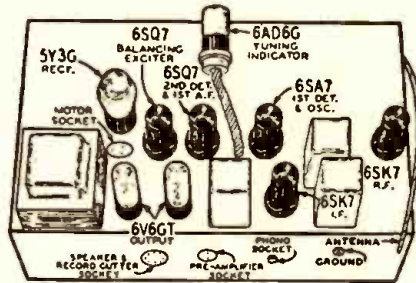

This illustration shows the parts placement atop chassis and at rear.



Lafayette-Table model B-100. Certain of the knobs are multi-function (see text).

must be a single shielded pin. Part No. 6A224. On the top of the chassis is an A.C. phono motor socket. On the back of the chassis is a socket to which a microphone preamplifier

may be connected. The speaker socket provides connections for the record cutter and power for the preamplifier. Dial lamps are bulb No. 51, bayonet pin type.

TUNING RANGES & SENSITIVITY CHARACTERISTICS

Band	Frequency Range	*Sensitivity
B Range	528 to 1,730 kc.	1.5 Microvolts (Average)
13-16 Meters	17.5 to 21.8 mc.	1 Microvolt (Average)
19 Meters	12.4 to 15.45 mc.	1 Microvolt (Average)
25-31 Meters	8.7 to 12.3 mc.	1 Microvolt (Average)
41-60 Meters	2.3 to 7.4 mc.	2 Microvolts (Average)

*External antenna; for 0.5-W. output.

ALIGNMENT PROCEDURE

Volume Control—maximum, all adjustments.
Connect radio chassis to ground post of signal generator with a short, heavy lead.
Allow chassis and signal generator to "heat up" for several minutes.

The following equipment is required for aligning:
An all-wave signal generator which will provide an accurately calibrated signal at the test frequencies as listed.
Output indicating meter; Non-metallic screwdriver.
Dummy antennas: .01 mf.; 100 mmf.; and 400 ohms.

Signal Generator Range Frequency Setting (I.F.)	Connection at Radio Set	Dummy Antenna	Band-Switch Setting	Condenser Setting (Rotor Position)	Adjust Trimmers to Maximum
Remove chassis from cabinet—Reconnect loop antenna plugs.					
456 kc.	Grid of 1st Det.	0.1 mf.	B Range	Full Open	1st I.F. (C31) & (C32) 2nd I.F. (C35) & (C36)
B 1,730 kc.	Antenna Lead	100. mmf.	B Range	Full Open	Oscillator Range B (C16)
1,500 kc.	Antenna Lead	100. mmf.	B Range	Max. Output Set Indicator to 1,500 kc. (See Note A)	Ant. Range B (C6) Int. Range B (C11)
600 kc.	Antenna Lead	100. mmf.	B Range	Max. Output	600 kc. (C17) Rock Rotor (See Note B)
C 7,490 kc.	Antenna Lead	400 ohms	C Range	Full Open	Oscillator Range C (C15)
7,900 kc.	Antenna Lead	400 ohms	C Range	Max. Output	Ant. Range C (C5) Int. Range C (C10) Rock Rotor (See Note B)
D ₁ 12,300 kc.	Antenna Lead	400 ohms	D ₁ Range	Full Open	Oscillator Range D ₁ (C14)
11,900 kc.	Antenna Lead	400 ohms	D ₁ Range	Max. Output	Ant. Range D ₁ (C4) Int. Range D ₁ (C8) Rock Rotor (See Note B)
D ₂ 15,460 kc.	Antenna Lead	400 ohms	D ₂ Range	Full Open	Oscillator Range D ₂ (C13)
15,250 kc.	Antenna Lead	400 ohms	D ₂ Range	Max. Output	Ant. Range D ₂ (C3) Int. Range D ₂ (C8) Rock Rotor (See Note B)
D ₃ 21,800 kc.	Antenna Lead	400 ohms	D ₃ Range	Full Open	Oscillator Range D ₃ (C12)
21,500 kc.	Antenna Lead	400 ohms	D ₃ Range	Max. Output	Ant. Range D ₃ (C2) Int. Range D ₃ (C7) Rock Rotor (See Note B)
LOOP R 1,500 kc.	Antenna Lead (See Note C)	100 mmf.	B Range	Max. Output	Ant. Range B (C6)

Attenuate the signal from the signal generator to prevent the levelling-off action of the A.V.C.

After each range is completed, repeat the procedure as a final check.

NOTE A—If the pointer is not at 1,500 kc. on the dial, remove pointer from drive cord. Set pointer at the 1,500 kc. mark on the dial scale. Attach pointer to drive cord.

NOTE B—Turn the rotor back and forth and adjust

the trimmer until the peak of greatest intensity is obtained.

NOTE C—Re-assemble chassis in cabinet.

CAUTION—When aligning the shortwave bands, be sure NOT to adjust at the image frequency. This can be checked as follows: Let us say the signal generator is set for 15,000 kc. The signal will then be heard at 15,000 on the dial of the radio set. The image signal, which is much weaker, will be heard at 15,000 less 912 kc., or 14,088 kc. on the dial. It may be necessary to increase the input signal to hear the image.

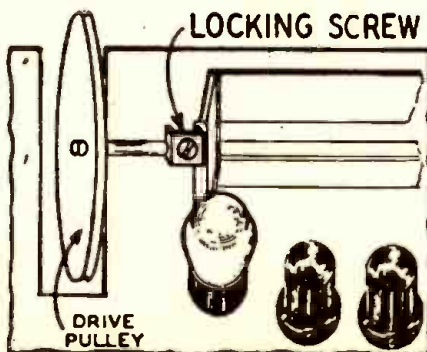

Fig. 1. View from back of cabinet.

An Engineer Analyzes the

HOW and WHY of FREQUENCY MODULATION

By special permission of the Association of Technicians, Radio-Craft here presents an article on F.M., from the A.T.E. Journal, which covers the engineering aspects of Frequency Modulation more completely than any previously published in Radio-Craft, and does it in a thoroughly understandable manner. Part I, last month, generalized on the topic and discussed the results of measurements made on the transmissions of N.B.C. Station W2XWG; Part II (conclusion), presented here, describes transmitter pre-emphasis and receiver de-emphasis, noise threshold phenomena, and simultaneous same-channel operation.

PART II

RAYMOND F. GUY

Radio Facilities Engineer, N.B.C.

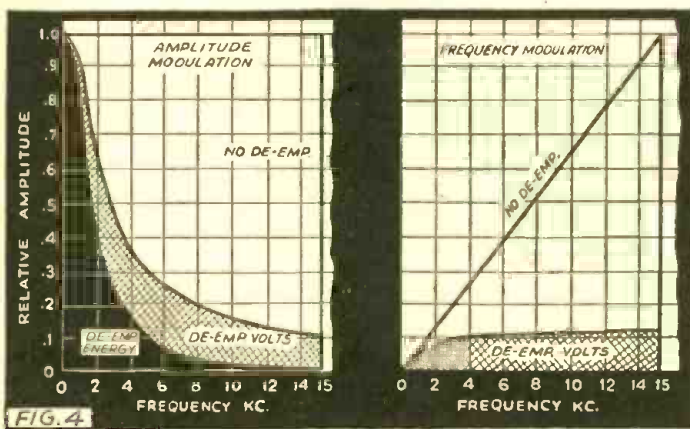

Fig. 4. High-frequency pre-emphasis is used in the transmitter and de-emphasis is used in the receiver to improve the signal/noise ratio. The importance of this characteristic in ultra-H.F. broadcasting and its greater effectiveness in F.M. are illustrated at left. Comparison is on the same scale of relative amplitude.

microsecond filter is a combination of resistance and capacity which will charge to 63% of maximum, or discharge to 37% of maximum in 100 microseconds.

It was shown that in F.M., the noise amplitude decreases as its frequency decreases whereas in A.M. it doesn't. Therefore, de-emphasis is more effective in F.M.

Consider Fig. 4. The full rectangle at the left is the A.M. noise spectrum. The full triangle at the right is the F.M. spectrum. The application of de-emphasis reduces these areas to those combining the hatched and black sections. Squaring those ordinates gives the black areas, corresponding to power, or energy. Extracting the square root of the ratios of these black areas gives the r.m.s. voltage advantage of F.M. over A.M. It is 4, corresponding to 12 db. Bear in mind that this 12 db. includes the gains contributed by both the triangular noise spectrum and de-emphasis. The spectrum advantage was 4.75 db. Hence the de-emphasis advantage is 12 db. minus 4.75 db. or 7.25 db.

All commercial F.M. receivers include de-emphasis and all F.M. transmitters include pre-emphasis. It's an F.C.C. requirement. (Italics ours.—Editor)

Now let's sum up. We saw (Part I) that the F.M. noise spectrum advantage was 4.75 db., the de-emphasis advantage was 7.25 db. and the deviation ratio of "F.M. 75" was 14 db. Combining these gives us 26 db.

Let's now see what advantage we actually measured as part of the field test project. Your attention is directed to Fig. 5 which has on it a great deal of information.

It actually condenses to one illustration much of the data we sought and obtained. Many pages could be devoted to it. The curves may be extended to the upper-left in parallel lines as far as desired. The actual field intensity of the noise can be determined from the A.M. curve. For instance, for 10 microvolts at the receiver terminals the A.M. signal-to-noise ratio is about 25 db. or 18 to 1. Hence the noise is 1/18 of 10 microvolts, or 0.6-microvolt r.m.s.

The ordinates are identified in receiver input microvolts, microvolts-per-meter and miles distance. Use the one you are most interested in. If you want condensed distance tables refer to the bar chart, Fig. 6.

Compare the measured gains with the calculations we went through. They look to be the same. They are. That means we found that the theoretical gain of F.M. can be and was obtained in practice.

Note the dotted sections of the F.M. curves. They are dotted to indicate that operation is not only below the "noise threshold" but is far enough below it that a noticeable increase of noise results as soon as modulation occurs. The dotted sections

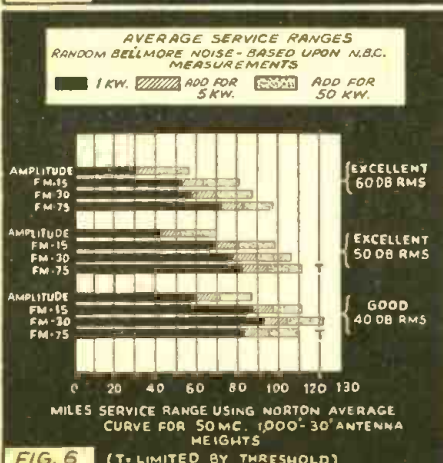
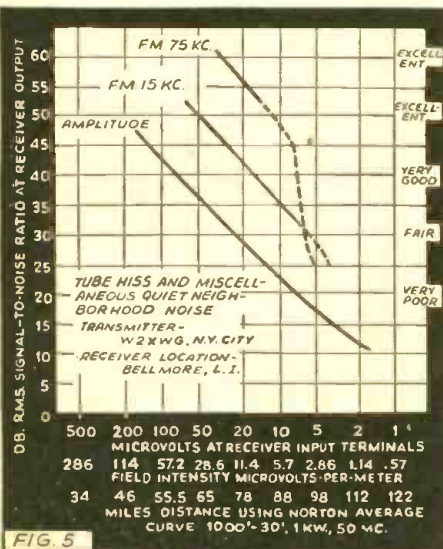

TRANSMISSION and reception on ultrashort wavelengths is not a new idea—not even sound programs utilizing the technique of Frequency Modulation.

The truth of this statement was discussed in Part I of this article (Radio-Craft, last month) in which it was shown that the basic method of F.M. for voice transmission and reception was the subject of patents issued in 1905. From this general introduction, the writer proceeded to discuss subsequent technical developments culminating in the wide-band system of F.M. espoused by Major Armstrong. The pros and cons of such characteristics as fidelity, noise threshold, triangular noise spectrum, deviation ratio, field intensity, etc., upon which tests were made at a cost of \$30,000 by N.B.C., were described.

We now continue with the further details of these tests, including discussion of pre-emphasis, de-emphasis, F.M. noise threshold (the effects of ignition interference, etc.), and the simultaneous operation of 2 F.M. stations on the same channel.

DE-EMPHASIS

When the high frequencies are attenuated in a receiver, the high-frequency noise is, of course, attenuated by the same amount. This may make a noisy signal more pleasant to the ear, but it degrades the fidelity. However, if the high frequencies are increased in amplitude in the transmitter, the overall fidelity will be restored. Nevertheless the noise which comes in at the receiver remains attenuated and therefore a reduction of noise results from this practice.

The use of a 100-microsecond filter to accomplish this purpose has been adopted as standard practice in Television and ultra-H.F. sound broadcasting by the Radio Manufacturers Association and recently by the F.C.C. It has actually been in use for several years. (Italics ours.—Editor) A 100-

represent noise in the unmodulated condition. During modulation they break even sharper than indicated. Since there is no such thing as a noise threshold in A.M. there is no such break. Wherever usable A.M. entertainment service is provided "F.M. 15" is 12 db. quieter and "F.M. 75" is 26 db. quieter.

F.M. NOISE THRESHOLD

An interesting series of events takes place in a Frequency-Modulated system when the noise peaks equal or exceed the peaks of the carrier. The result is a rapid increase of the noise level or decrease of the signal-to-noise ratio with modulation.

In Frequency Modulation wherein the maximum swing is 150 kc. the point where this begins to occur is reached when the unmodulated signal/noise ratio is about 60 db. When the unmodulated signal/noise ratio is less than about 60 db., or 1,000 to 1, the noise level rises with modulation, and as the noise peaks exceed the carrier peaks by a considerable amount, this noise level may go up 20 db., or 10 times. When operating above the threshold limit the noise changes very little as the station is modulated. Below the threshold limit the effect is not unlike harmonic distortion in an overloaded amplitude transmitter.

In Frequency Modulation of a lesser swing, such as 30 kc., a similar effect occurs. In this case, however, the threshold limit occurs at about 35 db. signal/noise ratio. Figure 7 shows the results of some of the measurements we made. In order that the noise would not be confused with the small amount of inherent distortion in a practical F.M. system, the measurements were made in such a manner that the effects of distortion were eliminated. This was done by modulating the transmitter with a 17,000-cycle tone and eliminating at the output of the receiver with a 14,000-cycle low-pass filter, not only the fundamental modulating tone but all distortion products, leaving only the noise.

This effect has no doubt been observed by many without being understood. It is inherent in a frequency modulation system.

The noise threshold in the case of an "F.M. 40" system having a total band width of 100 kc. occurs at about 43 db. Since this provides a very good signal/noise ratio and the required band width is only 100 kc., F.M. 40 is believed by many to have more overall merit than F.M. 75 when the comparative gains and limited space in the allocation spectrum are considered.

So far as is known, the data on the F.M. threshold effect presented here, and data published by Murray Crosby of R.C.A.C. constitute the only measured data ever published.

Figure 8 shows ignition noise measurements with peak noise input microvolts plotted against peak signal to noise ratio, based upon the signal resulting from maximum 400-cycle modulation. The "F.M. 15" threshold is shown. The F.M. 75 threshold is not shown because at the time the measurements were made A.C. hum within the system made the accuracy of S./N. measurements in the 60-db. region uncertain.

It should not be assumed that peak S./N. ratios of 20 or 30 db. are unusable when the noise arises from ignition systems because it isn't true. The relative infrequency of ignition peaks produces an audible result which is very deceiving. Ratios as low as 10 db., while distracting, do not entirely ruin service as is the case with fluctuation noise.

It will be noted that the curves of ignition noise threshold flatten off at the bottom. This is to be expected from the char-

acter of ignition noise. The impulses are very short in duration, very high in amplitude and (relatively) widely separated. They literally blank-out only small portions of the signal waves, without impairing the remainder. The short, blanked-out intervals of the signal change little over a wide range in noise peak amplitude. Once an ignition peak has risen to the value required to control the receiver and blank-out the signal a further rise in the noise level will not occur until the peak increases in breadth, or duration, or until there is a sufficient rise in certain low-amplitude components of ignition noise having fluctuation noise characteristics.

The peculiar shapes of such curves below the threshold values are due to the wave shapes and crest factors of ignition noise, but they are also influenced by the method of measurements.

OPERATION OF 2 F.M. STATIONS ON THE SAME CHANNEL

By referring to the section covering noise interference it can be seen that the worst condition of shared-channel operation occurs when both stations are unmodulated and a fixed beat-note, therefore, results. It will also be seen that the higher this beat note the greater will be its amplitude. Figure 9 was made on the basis of the worst conditions, which occur when the difference in carrier frequency reaches approximately 5,000 cycles. Were it not for the effect of de-emphasis in the receiver the beat-note amplitude would rise with frequency. However, de-emphasis of the high frequencies prevents that from happening and the effect may be further understood by referring to the section on pre-emphasis and de-emphasis. It will be noted that the noise on the desired station caused by the undesired station varies inversely with the deviation ratio; F.M. 75 has a deviation ratio of 5 compared with 1 for F.M. 15.

When either of the stations producing the beat-note becomes modulated, the beat-note disappears because one carrier sweeps across the other one. When the desired station is approximately 20 db. stronger than the undesired station, interference and cross-talk effects become unnoticeable. At 12 db. difference they are noticeable but it is the opinion of some engineers that the 12-db. ratio would be tolerable. Frequency Modulation offers a great advantage over Amplitude Modulation in the allocation of stations on the same frequency. In A.M. the carrier amplitude of the desired station must be 100 times, or 40 db. greater than the undesired carrier amplitude for a 40-db. signal to beat-note ratio. For F.M. 75 it need be only 10 db., or 3 times greater. For F.M. 30 it need be only 17.5 db., or 8 times greater. For F.M. 15, it need be only 24 db., or 10.5 times greater.

The result is that F.M. stations can be located much closer geographically, and therefore many more station assignments can be made per channel. All interference due to sky-wave transmission from distant stations is automatically rejected in F.M. because the interfering signals never reach the high amplitude required. This is not so in A.M. transmission.

Figure 10 shows the results of adjacent-channel measurements using one of the RCA Field Test receivers and 2 commercial models of other manufacture. It should be noted that the undesired station was modulated with fixed tone of uniformly high modulating level. As a result the interference was probably somewhat more severe than would be the case for program transmission in which the average modulating level is rather low.

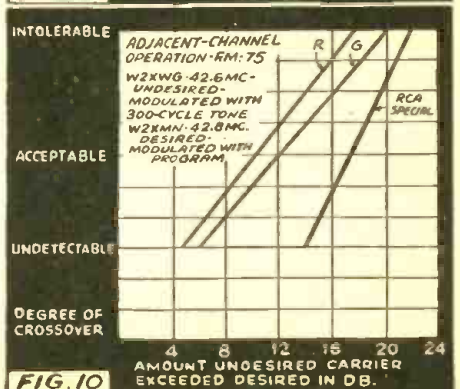
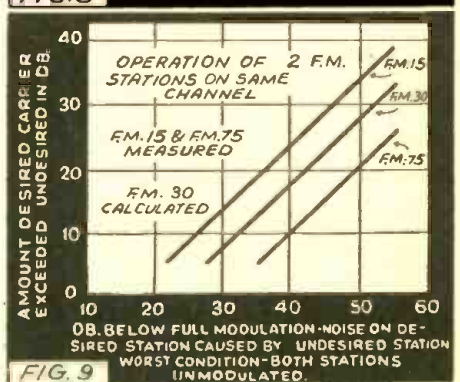
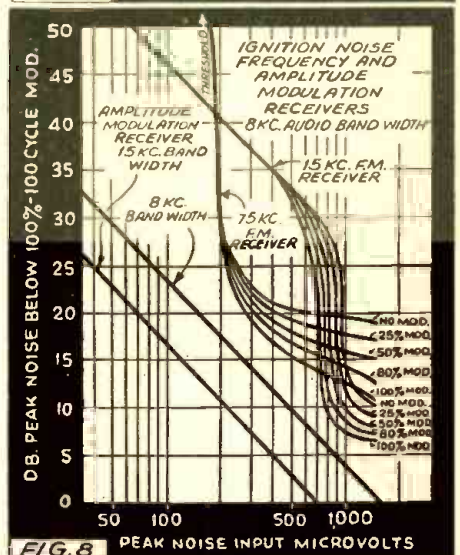
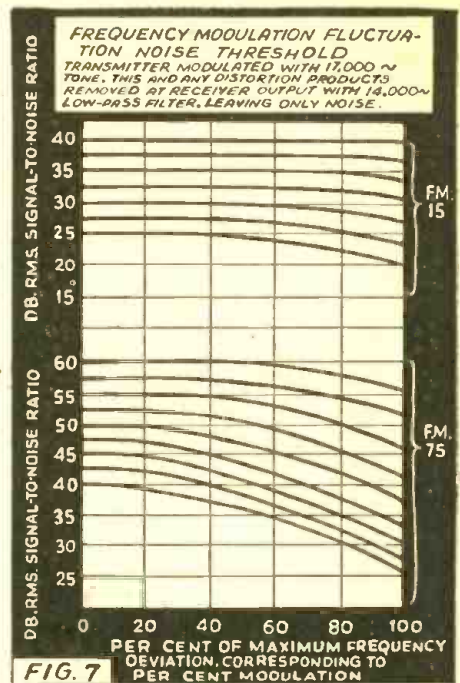



Pictorial illustration of the new F.M. Phono Pickup shown in more detail in Fig. 1.

NEW!— F.M. PHONO PICKUP

In this article, exclusive to Radio-Craft, is presented a description of a "wireless" Frequency Modulation Phono Pickup system which in addition to its feature of simple, inexpensive construction, takes full advantage of the high-fidelity reproduction possibilities in wide-band F.M. receivers.

N. H. LESSEM



HARD on the heels of Frequency Modulation broadcasting comes this ingenious development of a Bridgeport, Conn., radio man. Here for the first time in any radio magazine are the complete details for the home construction of this "wireless" F.M. Phono Pickup, a unit which bids fair to replace, in time, all other types of pickups. Patent applications have been made by its inventor.

FIDELITY

The most amazing thing about this Frequency Modulation Pickup, developed by Leslie A. Gould, is its extreme simplicity. If this were its only achievement the new instrument would be outstanding; but it goes much further! Its fidelity range—the band of audio frequencies which it is able to transmit—is said to go considerably beyond that of the ordinary crystal and magnetic types. Being a Frequency-Modulated device, its inherent range of frequencies is

limited primarily by the mechanical serrations in the record groove.

What is the frequency range? It must be remembered that this is an experimental pickup. More highly engineered commercial models would undoubtedly exhibit better performance. Therefore it is especially interesting to note that as nearly as the inventor can judge the frequency response of the model here illustrated is approximately 16 to 8,000 cycles. It is expected that with an improved stylus holder it should be quite possible to reproduce up to 15,000 cycles. The latter frequency "top" of course presupposes that the recording extends out to this high frequency.

However the bottle-neck in present-day phono record reproduction is not in the recording but in playback. How does the output voltage compare with crystal and magnetic units? With present models, approximately the same. Whereas formerly, the various types of pickups were used as a means for modulating a carrier frequency generated by any other instrument such as an oscillating tube this unit performs the functions of both. The R.F.-carrier frequency generated by a built-in vacuum tube

is shifted back and forth in frequency, a process which in itself is a form of modulation.

CIRCUIT

A much better picture of the extreme simplicity of this device may be had by referring to the circuit shown in Fig. 3. Here a type 6C5 is used as an oscillator tube in the simplest type of oscillatory circuit imaginable. To get down to the Frequency Modulation band an oscillator coil consisting of 9 turns of No. 20 enameled wire wound on a 1/2-in. lucite form is used. This coil is mounted at the forward end of the pickup.

Like any other oscillatory circuit, any metal placed in the vicinity of this oscillating coil will change the frequency of the circuit. Capitalizing on this phenomenon, Mr. Gould mounts a small metal ring adjacent to this oscillating coil, and since the ring is mechanically fixed to the needle-holding stylus or armature, the vibration of the needle is translated into the mechanical motion of the metal ring which in turn shifts the frequency of the circuit back and forth over the definite range determined by the recording.

That is the entire unit. Few resonance

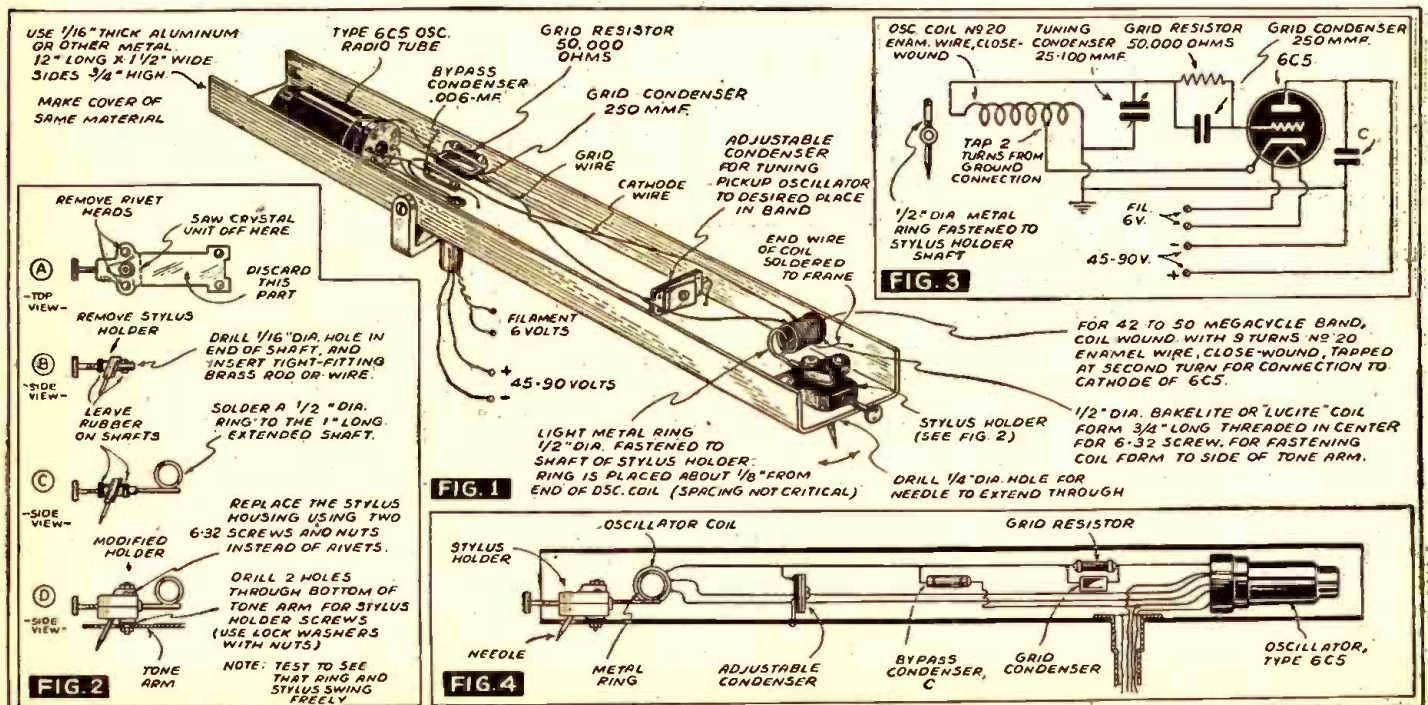

Construction details of the new Frequency Modulation Phono Pickup system. The circuit of the accompanying F.M. oscillator is given in Fig. 3.

points, no expensive parts, no complicated electromechanical systems requiring delicate armatures, and crystals or permanent-magnets.

CONSTRUCTION

Details for the construction of this pickup may be obtained from the various illustrations which accompany this article. These are explanatory and complete in themselves.

The body of the pickup was made from an old, cast-off crystal pickup. The oscillator tube for shortest possible leads is mounted directly on the pickup arm. The reader may wish to improve upon the method of mounting the stylus and can usually do so. The method shown in the drawings is simple and very effective. However, there is no question but what better methods can be found and employed. It is merely necessary to say that the minimum amount of friction or damping should be used in the mechanical attachment of this stylus to the arm, since the frequency range of the unit is limited mainly by its mechanical system.

The 1/2-in. ring used in this pickup can be an ordinary brass curtain ring found in most 5c-and-10c stores. These rings, being hollow, and very light and stiff, are ideal for the purpose. When soldering the ring to the stylus shaft use as little solder as possible thereby keeping the stylus as light in weight as possible which will give the best results on the high-frequency portion of audio reproduction.

"WIRELESS" PHONO-OSCILLATOR

No antenna is necessary. The pickup transmits a Frequency-Modulated wave direct to your F.M. radio receiver up to 50 ft., or above, under usual conditions. If an antenna is desired, a short piece of insulated wire about 6 ins. long can be connected to the cathode terminal of the radio tube socket and allowed to extend through the rear end of the tone arm.

The F.M. signal from this pickup can also be received on a superregenerative type of receiver. It may be necessary in some locations that are noisy to disconnect the regular antenna of your F.M. Receiver and connect in its place a short, 1-wire antenna about 3 to 6 ft. long when tuning-in on this pickup.

NEWS ITEMS

History Speaks! The impact of the *talking history*, of World War II and the events which lead up to it, now preserved intact at station WOR has not as yet made itself felt. In later years however this most complete set of sound recordings in the United States will thrill the post-war generation as they listen to the shrill, nervous exclamations of Hitler after his portentous entrances into the Sudetenland, Czechoslovakia, and Munich; the somber tones of Chamberlain announcing peace "in our time"; the terse dictates of Daladier, the farewell of Benes; the almost tearful pleas of Paul Reynaud; and the voice of Churchill, pledging "blood and sweat and tears." They are all preserved for history, these incontrovertible proofs of the history-making statements, etc., of 1, 2, and 3 years ago. Historians, sociologists, and student of propaganda will find these 2,000 slides, now filed in chronological order, a Sound Library of momentous importance. They provide *living documents*, the like of which never before existed.

"Bulldog Drummond," the WCLE-Mutual mystery series, has introduced a technique new to radio but borrowed from the theatre.

**Stands Out
BECAUSE IT
STANDS UP!**

Here's the instrument that has been leading the field for five years . . . and still is "tops" for radio servicing. That's because it measures in fundamental quantities . . . *no trick circuits or gadgets to cause early obsolescence* . . . and because it is designed and built to high WESTON standards. It is an instrument that, with usual instrument care, will remain serviceable indefinitely. Be sure to get full information on this complete, inexpensive test instrument. Write for bulletin describing Model 772 and other WESTON instruments for radio and television servicing. Weston Electrical Instrument Corp., 599 Frelinghuysen Avenue, Newark, N. J.

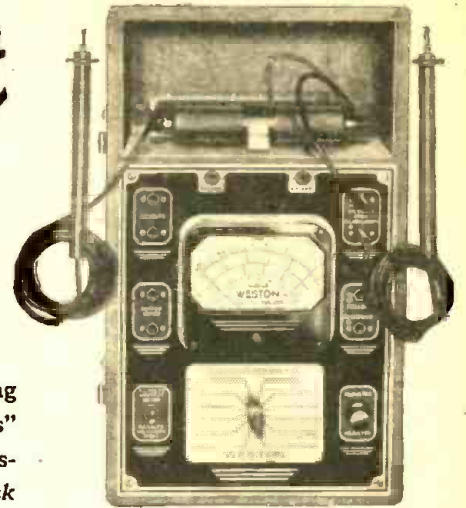

**WESTON Model 772
Super-Sensitive Analyzer**

RANGES

- Volts... DC—2.5/10/50/250/1000... sensitivity 20,000 ohms per volt
- AC—2.5/10/250/1000... sensitivity 1000 ohms per volt.
- Current... DC—.1/1/10/50/250 milliamperes 1/10 amperes
- Ohms... 0-3000; 0-30,000 ohms . . .
- 0-3 megohms; 0-30 megohms
- Decibels... -14 +2/-2 +14/+12 +28/+26 +42/+38 +54

WESTON Radio Instruments

Here's how it works. Players on the stage of the Mutual Network's Radio Playhouse are thrown in sharp relief by a spot-light, but the program's production men and sound effects crew remain unseen in the wings. The psychological effect is particularly eerie for persons attending the theatre show. (Here's where some of Professor Burriss-Meyer's theatre sound-control devices would form an admirable acoustic complement to the visual effects.)

The Research Council of the Academy of Motion Picture Arts and Sciences ("AMPAS") plans to make available from time to time new test reels and new tools, as part of the theatre sound standardization program, to assist theatres in maintaining the best possible sound quality. Last month the council announced the availability of a "replacement excerpt" consisting of new dialogue recording to be included in the Research Council Theatre Sound Test Reel (ASTR-2).

"EBCC"—Do you know what it means? Under this title a recent edition of the magazine *Egyptian Radio* carried an article describing the chief purpose of the "Empire Broadcasting Co-ordinating Committee," which is to insure that on-the-spot reports of the troops in the Middle East reach every corner of the Empire as soon as possible after they are sent down from the front. An excerpt from the article follows:

"The procedure is simple, if there are no breakdowns. The commentator records on a disc at the front his story of an action or some important development in the Empire offensive. This disc is brought by courier and aeroplane to Cairo. It is censored, and

if necessary amended by the somewhat complicated technical process known as "dubbing." Then it is played from the studios of E.S.B. direct to London by a beam circuit which is available at five o'clock every afternoon.

"The commentator's voice which reaches London is re-recorded on another disc, and within a few hours—sometimes within a few minutes this second disc is played direct to Australia, New Zealand, Canada, India, or any other part of the Empire where a broadcasting service is waiting to record it a third time before broadcasting it to its own listeners.

"The Cairo Committee also exists for another purpose. It is the liaison between the army authorities and the broadcasting services of the Empire."

America's Radio Defense interests, please note.

15 MANUFACTURERS NOW LICENSED TO MAKE F.M. SETS

A recent survey shows that some 15 manufacturers are actively licensed under the Armstrong frequency modulation patents to produce F.M. receivers. At least half of these are currently merchandizing a number of different models, with more than 20,000 sets estimated to be in use throughout the country at this time.

The majority have been sold in the East, with some 8,000 or 9,000 operating in the New York area. These figures are based upon actual compilations of manufacturers' sales figures, and do not include sets out "on approval," nor units built by experimenters.

SOUND ENGINEERING

Free Design and Advisory Service
For Radio-Craft Subscribers

Conducted by A. C. SHANEY

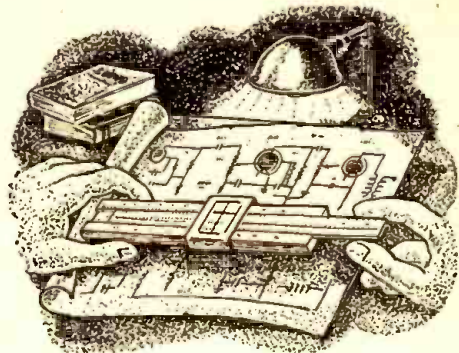

This department is being conducted for the benefit of RADIO-CRAFT subscribers. All design, engineering, or theoretical questions relative to P.A. installations, sound equipment, audio amplifier design, etc., will be answered in this section. (Note: when questions refer to circuit diagrams published in past issues of technical literature, the original, or a copy of the circuit should be supplied in order to facilitate reply.)

NO. 20

IMPROVEMENT OF AN AMPLIFIER HAVING EXPANSION - COMPRESSION

The Question . . .

Recently I built a phonograph amplifier according to the accompanying diagram, Fig. 1 (except for the high-gain 6J7 stage, which has not been wired as yet). The amplifier performs only moderately well, and I would appreciate greatly your suggestions and advice concerning it.

But first, a few remarks about the design of the amplifier are in order. The circuit is compounded from parts of perhaps a half-dozen commercial or standard circuits to give the desired features.

Both low- and high-impedance, high-gain input connections are (to be) available, with 2 additional low-gain, high-impedance inputs. Then there is a more or less conventional 6C5, 6H6, and 6L7 compression - expansion stage. This is followed by a dual equalization control in the cathode circuit of the 2nd 6C5. Then follows a 6N7 phase-inverter stage driving a pair of 6L6s in class A1 push-pull.

The output transformer is supposed to maintain a response of $\pm 1/2$ db. from 30 to 15,000 c.p.s., with a maximum operating level of +35 db. The power supply is operated well under capacity and is designed for long life and dependable service (incidentally, it takes up more than half of the 10 x 17 in. chassis). The low capacities in filter and cathode circuits are explained by

the fact that all condensers (with one exception) are 4-mf. paper.

Perhaps it may be worth while to mention the auxiliary equipment: an Astatic FP-38 High-Fidelity (to 10,000 c.p.s.) low-needle-pressure pickup, with a Jensen PM12-CT high-fidelity reproducer. Hence, it will be seen that my problem boils down to this: that the amplifier be the strongest (that is, highest fidelity) rather than the weakest link in the chain.

The principal source of trouble at present is (I believe) harmonic distortion, developing in the phase-inverter and output stages. I have tried a 0.02-mf. condenser in series with 6,500 ohms from plate-to-plate of the 6L6s in lieu of inverse feedback but this cuts the high-frequency response altogether too much, while not seeming to stop the distortion at all.

I would like to have you design a substitute or revised driver and output combination giving about 10 to 15 watts (preferably as high as possible), with 2% or less distortion (total), if possible. Preferably no more than the present number of tubes should be used, and no driver transformer, both because of space limitations on and in the chassis. You may use either the 6L6s with inverse feedback (from the primary of the output transformer), or else discard the 6L6s entirely and use 6A3s, 6A5Gs or similar tubes. Maximum fidelity is the one most important feature desired. Incidentally, fixed-bias may be obtained, possibly, from part of the voltage across the 1,000-

ohm voltage-dropping resistor in the power supply.

Further trouble is given by the compression - expansion circuit. There seems to be a certain rather low level of distortion (or garble) noticeable when the compression or expansion circuit is used, but this disappears when the circuit is disconnected (by disconnecting the control-grid of the first 6C5); this sounds as though it might possibly be rectified audio from the 6H6, but I have been unable to isolate it. Further, the circuit overloads when the compression - expansion control is turned up, say, over halfway (on either compression or expansion) and produces a great deal of distortion. Also, it seems to be impossible to adjust the -13 volt bias on the compression - expansion voltage divider to have both the expansion and compression work at all properly concurrently (either one or the other can be made to work fairly well, but not both).

HOWARD E. BRITTON,
Ndrwood, Mass.

The Answer . . .

There are many ways of materially improving the performance of your amplifier which suggest themselves by casually studying the circuit you enclosed. We are offering, therefore, the following corrections, which we are sure will improve the overall performance:

(1) The use of a 1,000-ohm resistor in series with the 15-henry filter choke greatly impairs the regulation of the power supply. I believe you inserted this resistor in order to reduce the voltage output. You will find it far more desirable, however, to replace the power transformer with the one having the correct high-voltage windings so that it will not be necessary to use any series resistor between the power supply output and

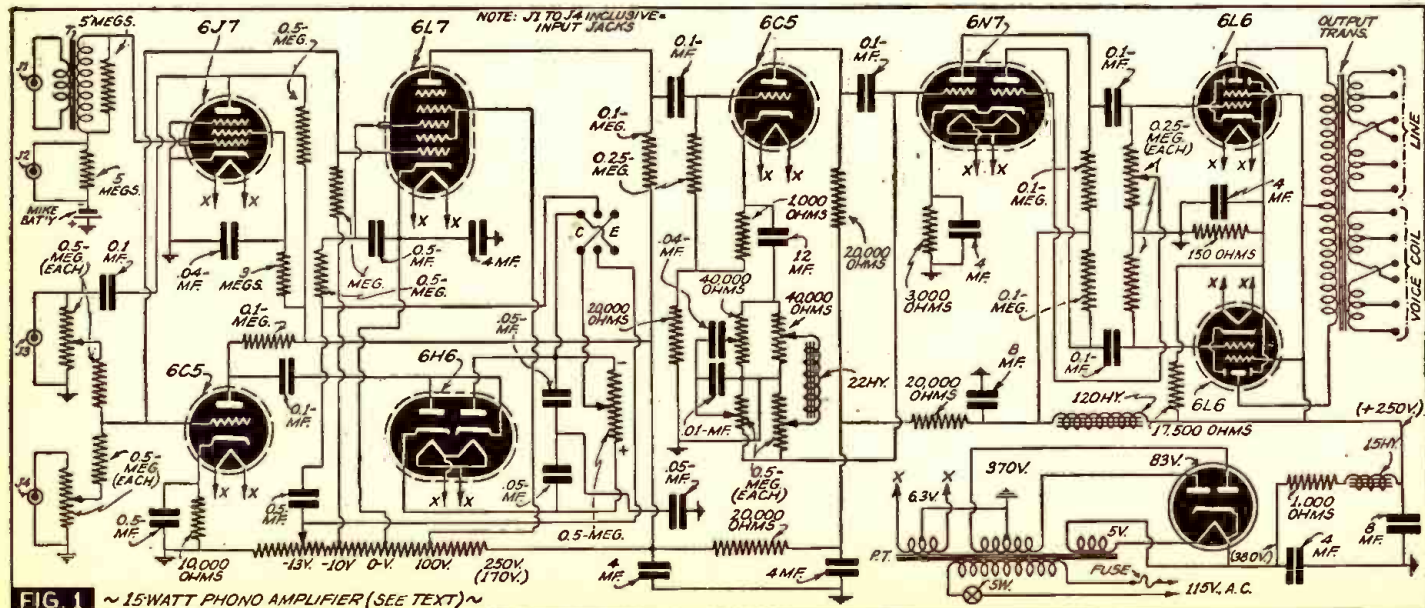

FIG. 1 ~ 15-WATT PHONO AMPLIFIER (SEE TEXT) ~

the center-tap of the output transformer.

(2) The 4-mf. bypass condenser across the 6L6 cathode resistor should be increased to 20 mf.

(3) Your 6N7 inverter circuit should operate to entire satisfaction. It is of course important that you carefully adjust the ¼-meg. potentiometer so as to obtain the identical voltages from each 6N7 plate. If this is done, no excessive distortion should be introduced by this portion of the circuit.

(4) The use of a 6L6 as a combined expander and scratch-suppressor is not desirable. In fact, laboratory experience has shown that this type of circuit is notorious for producing distortion, particularly if it is not carefully employed.

One of the unusual circuit conditions which surround the use of a 6L7 is that its signal acceptance ability changes with various degrees of expansion or compression. In other words, when the circuit is initially adjusted to provide for a high degree of expansion, a comparatively low input signal will cause distortion. This type of circuit (particularly in its single-ended version) is therefore not recommended.

Circuits for push-pull expanders have appeared in past issues of *Radio-Craft* (see page 268, November, 1939, issue).

(5) The audio hash that you complain of is undoubtedly carried over from the output of the rectifier through the ½-meg. series resistor which connects into the control-grid (element No. 3) of the 6L7. If this is the case, it can be eliminated by incorporating a 2-section resistor - condenser network by adding an additional ½-meg. resistor and 0.05-mf. condenser. It might also be necessary to increase the 4-mf. cathode bypass condenser to 20 mf. You might also find it desirable to add a bypass condenser from screen-grid to ground.

(6) The reason you are unable to obtain satisfactory compression and expansion, is that you are evidently expecting too great a range from each circuit setting. You should be able to obtain a total range of 15 db. If this amount is divided so that you have 7½ db. expansion and 7½ db. compression, you should encounter no difficulty. An adjustment can easily be made by first determining the maximum degree of compression or expansion that you can obtain. Then adjust the bias voltage so that ½ of this amount is utilized.

(7) The low-impedance input circuit you have connected in series with the high-impedance input circuit, will materially affect

the response of the high-impedance circuit because the distributed capacity from the secondary of the transformer to shell and ground, will shunt the high-impedance input and undoubtedly cause a considerable loss of high frequencies. A separate tube should be used for each input, so as to avoid this condition.

LOW-POWERED 25-CYCLE F.M. AMPLIFIER

The Question . . .

I have been extremely interested in the F.M. Amplifier described in recent numbers of *Radio-Craft*, and contemplate doing some experimenting with a modified form of it.

In order to secure less volume for living room use, I intend using 6Y6G output tubes instead of 6L6s. The lowered voltage requirements would permit single-stage voltage supply furnished by a 5U4G followed by a 10-henry, 84-ohm input choke and a 30-henry, 152-ohm smoothing choke.

There are several points about which I am in doubt, and if you consider them of sufficiently general interest, would be pleased to have any information you would be good enough to supply on the following points: What filter condenser would be required for 25-cycle, A.C. operation? What departures from the method of calculating resistors as suggested in your July and October, 1939, and January, 1940, issues, would be necessary?

H. R. ERB,
Toronto, Ont., Canada

The Answer . . .

You can interpolate the required capacities for any filtered network when operated at a given frequency, by changing the capacities of the condensers, by a factor equal to the frequency for which the equipment was designed, divided by the new frequency. In your particular case, the fraction is

$$\frac{60}{25} = 2.4.$$

In other words, it will be necessary to multiply the capacity of the 60-cycle filter condenser by 2.4 in order to obtain the correct condensers for 25-cycle operation.

The method of calculating the resistors, as suggested in the July and October, 1939, issues, will hold for any direct-coupled amplifier, regardless of the type of output or driver tubes employed.

HELPFUL SHOP HINTS

Here are a few hints which I found very useful:

To insure against damage to all equipment connected on the electrical service line in the shop, the thing to do is to install a master switch which will disconnect all instruments, soldering iron, lights, etc., when going home for the night, or when leaving the shop for any length of time. A simple flip of the switch and you are sure everything is off, or when starting to do any work on the bench simply throw on the switch and everything is all set. This one master safety switch will supplant a half-dozen or more switches that many Servicemen use.

The best way of testing the portable and also other types of batteries, "A", "B", "C", is to test them with an ordinary voltmeter with the radio receiver connected to the batteries and the radio set turned ON. When the set is turned on and connected to the batteries it of course constitutes a load on the batteries and then a true check of them will result. Many times with the receiver

turned off, the batteries will check good, but as soon as the set is turned on and current is drawn, the batteries may show very poor, or dead. This really works.

Oscillation in all of the RCA receivers which use iron-core I.F.s (All RCA from 1937, up) will almost always result when a new I.F. tube is installed. This is especially true of the newer receivers using the new single-ended tubes. It may even cause motor-boating. The cure for this is a complete I.F. alignment. Can be detuned but a loss of sensitivity occurs. The only way to align a job like this is to start with the last stage and work towards the first. The important thing to remember is not to touch the tuning of any of the stages once they have been tuned. Do not for instance tune the 3rd I.F., go to the 2nd, and then go to the 3rd again. This procedure is critical and important. Also by using a metal tube, it will aid desired oscillation.

MILTON V. RATYNSKI,
Richmond, Va.

Learn RADIO SERVICE WORK with these 2 BIG Ghirardi BOOKS

MODERN Radio SERVICING
Learn How with this!
Here's the world's most highly praised course in practical radio service work—all for you in this one handsome 1300-page home-study book. First, a big 420-page section explains all types of servicing test instruments—how they work, how to use them—also, how to build your own. Then, 900 more pages give you a thorough, step-by-step procedure course in trouble-shooting, testing, aligning and repairing all makes of radio sets and other electronic devices by latest scientific "factory methods." Learn radio servicing this quick, easy, economical way. Learn WHAT to do and HOW to do it. Send for your copy today. Use the coupon below!
1300 pp., 708 illus., 720 review quest. **\$4**

RADIO Trouble-Shooter's HANDBOOK
Save Time with this!
Here's real help for servicemen—518 big manual-size pages of valuable, time-saving, factory-checked servicing data right at your finger tips to help you do every servicing job quickly and accurately. Its 52 BIG SECTIONS contain 275 large pages of time-saving Case Histories on over 3,300 receivers. Alignment data for over 15,000 superhets. . . Servicing and installation data for all Auto Radios. . . Trouble-Shooting Charts. . . Tube, Resistor and Condenser Charts. . . EVERYTHING! Speed up your servicing work with this vital servicing data NOW! **\$3**
518 pp., 134 illus., 8 1/2 x 11 size.

CLIP-OUT! MAIL NOW

Radio & Tech. Publ. Co., Dept. RC-81
 45 Astor Pl., New York
Enclosed find payment for:
 MODERN RADIO SERVICE BOOK
 RADIO TROUBLE SHOOTER'S HANDBOOK
 Check here for FREE circulars.
 BOTH books at \$6.50 Money-Saving Combination Price

NAME _____
ADDRESS _____
CITY _____ STATE _____

MONEY-BACK IF NOT SATISFIED!

Make more money faster, with RCP DEPENDABLE TEST EQUIPMENT

Leading Service Engineers, Training Schools, and Government Departments, specify RCP Test Instruments when they want extra dependability and accuracy. Yet, RCP Test Equipment actually costs less! Before you buy any test equipment, investigate RCP. See how much more profit-building equipment your money will buy at RCP. The complete RCP line of Test Instruments, that will help you do any job faster and better, is described in FREE Catalog #125.

RCP dependable TEST instruments

RADIO CITY PRODUCTS COMPANY, INC.
88 PARK PLACE • NEW YORK, N. Y.

PATENTS — TRADE MARKS
Booklet concerning Inventions & Patents Form "Evidence of Conception" with instructions for use and "Schedule of Government and Attorneys Fees"—Free

LANCASTER, ALLWINE & ROMMEL
Registered Patent Attorneys
436 Bowen Bldg. Washington, D. C.

HIGH EFFICIENCY!
University Reflex Speakers will project sound clearly for two miles with less than 25 watts input. Write for catalogue.

UNIVERSITY LABORATORIES
193 Chrystie St. New York City



The theoretical description of the 30/15-watt Sound Console built by Mr. Bergemann, Jr., appeared in Part I (May Radio-Craft); construction details appeared in Part II (July issue); the concluding Part, presented here, mainly discusses the operation of the recorder.

◀ During the course of making a recording, as shown at left, cutter shavings ordinarily become a problem. The use of a shavings remover however will reduce this problem to a minimum. If you look closely you will see how the shavings collect around the pin of the turntable when a shavings remover is used. By keeping the cuttings from again getting in front of the cutter more satisfactory recordings will be made.

How to Build a Modern 30/15-Watt

P.A. - RADIO - RECORDING CONSOLE

R. J. BERGEMANN, JR.

PART III

THIS final installment on the Sound Console is devoted mainly to the discussion of the operation of the recording mechanism. After listening to many recordings, we can set down approximately what constitutes a good recording. Electrical and mechanical qualifications will be considered before the subject of the recording.

RECORDING CONSIDERATIONS

(1) *The recording must be quiet.*—Background hiss, usually severe in commercial pressings, can be eliminated almost entirely in acetate recordings. The cause is usually a dull cutting needle, incorrect cutting angle, or poor recording discs. Discs that are quiet may become extremely noisy after repeated playings unless light pickups with correctly-shaped needles are used.

In practice, the writer found, the discs mentioned in the List of Parts were found to give 200 playings with the 1-ounce crystal pickup, at an increase of only 4 decibels in the noise level. This was still barely audible at normal playback level.

The correct cutting angle for the discs specified is obtained when the stylus is perpendicular to the record as in Fig. 10B. The angle adjustment is reached by lifting the recording arm. Turning the screw clockwise makes the needle slant back as in Fig. 10C. Turning the screw counterclockwise makes the stylus slant forward as in Fig. 10A. Once set, the adjustment need not be changed throughout the life of the cutting stylus.

If the recordings are to be played-back with heavy pickups, bent-shank needles should be used. These needles transfer some of the downward force on the groove, to a forward force, thus lengthening disc life and lowering noise level. Some liquid acetate "record hardeners" are available, and if the recording is to get severe use, it should be coated with this preparation.

Motor rumble often becomes annoying on high-fidelity playback equipment. This low-frequency "growl" can be eliminated somewhat by loosening the mounting of the recording motor and floating it on rubber if

this has not already been done. The recorder used in this unit is floated, and has a rubber idler wheel to insure minimum "growl."

(2) *A good recording must be free from "wows."*—"Wows" are caused by slight changes in speed of the turntable during recording. The motor chosen for the recorder must have sufficient torque and speed regulation to maintain a constant speed under the drag of the cutting stylus.

The idler wheel on the mechanism used in the article provides more coupling from the drive shaft to the turntable rim when the turntable is retarded, so that wows are markedly decreased with the use of this type of drive mechanism. Simply tightening the spring on the idler wheel, thus increasing drive force and decreasing slippage, will eliminate any wows present. Do not make the spring too tight, or the motor growl will increase because the compressed rubber wheel on the idler will transmit mechanical vibrations from the motor to the turntable.

(3) *A good recording must have wide and uniform frequency response.*—Since acetate discs can be practically noiseless, it is possible to extend the high-frequency response far beyond that of the commercial pressings. A good commercial pressing is practically uniform from 60 to 800 cycles/second (c.p.s.), and above that point, the higher frequencies are attenuated. This is called *constant-velocity* recording. If played-back with a good, lightly-damped magnetic pickup, the result will be practically equivalent to keeping a uniform response to 5,000 c.p.s.

At present, there is a great deal of agitation for *constant-amplitude* recording. For this, a constant voltage is applied to a good cutter, and the playback is accomplished with a crystal unit. Since the displacement of the crystal is dependent on voltage, and not frequency, the result will be a uniform response over the spectrum accomplished with the "highs" on normal instead of attenuated as in commercial pressings.

This Sound Console makes use of constant

amplitude recording. The useful response is from 50 to 7,000 c.p.s., as shown by the frequency response diagram, Fig. 12. This response is much better than that obtained with a magnetic cutting head costing several times as much.

(4) *A good recording must be free from non-linear and harmonic distortion.*—Non-linear or amplitude distortion is usually caused by overloading a microphone by speaking too close, or overloading the cutter. A dull cutting stylus will also cause distortion in the higher frequencies, since the recording lacquer will be chewed-out instead of being cleanly cut. In most cutters, overload distortion will not occur before the stylus cuts over to the next groove, so that if distortion occurs at ordinary volume, suspect a poor stylus. An increase in background noise will clinch the case against the stylus. Harmonic distortion is not noticeable in crystal cutters.

(5) *The recording level should be uniform throughout the recording.*—If the level is too high, the pickup may skip grooves in playback. In some cases of excess level, an echo or "ghost" will be heard. This is caused by excessive level pushing some of the recording lacquer into an adjacent groove causing a similar modulation twice. The result will be slight echo following, or more usually leading, the modulation by one revolution of the turntable.

When the above electrical and mechanical specifications are complied with, it is time to worry about the detail of setting up the mike and composing the record.

MICROPHONES

To get the maximum results under adverse conditions, use a microphone with a *variable pickup pattern*. The mike chosen for this job (see List of Parts) has 4 defined pickup patterns, as shown in Fig. 11, as well as intermediate patterns. The pickup is selected by screwdriver adjustment of a potentiometer in the back of the case.

Position No. 1: *Semi-directional pressure*

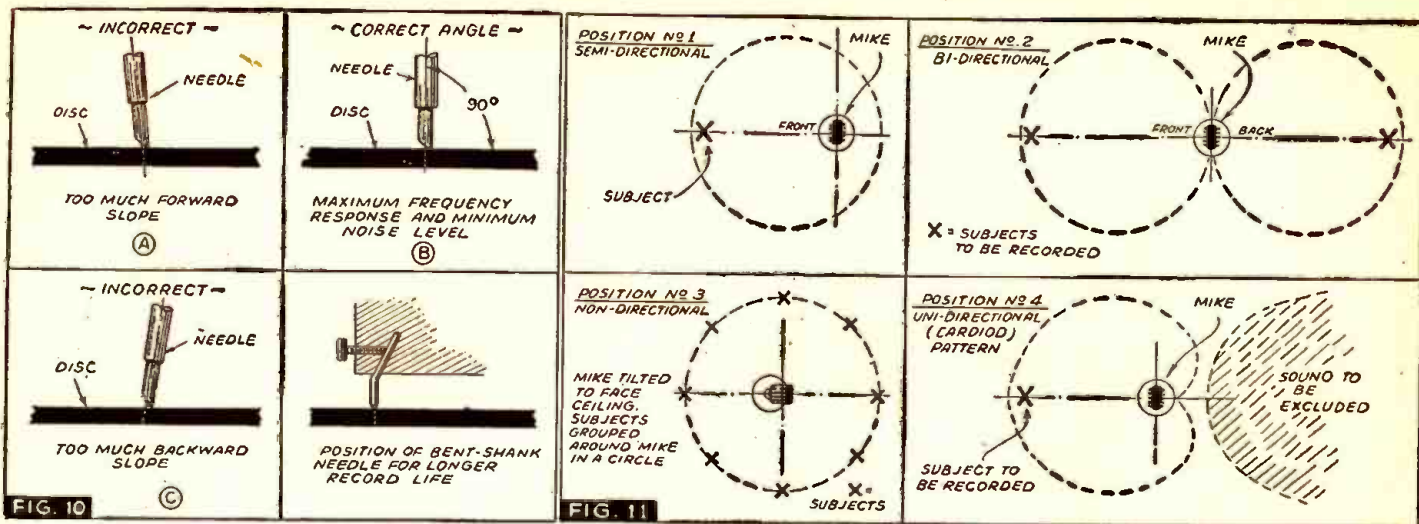

Correct and incorrect needle angles, and proper use of the microphone selected for use in the Sound Console, are illustrated above.

Mike characteristic.—Use this pattern for general work where it is not necessary to exclude any noise from the back or sides.

Position No. 2: Bi-directional pattern.—Characteristic of velocity mike's pattern. This is useful for recording a vocalist and a band, or any similar combination. With this pattern, the vocalist may watch the accompanists on the other side of the mike.

Position No. 3: Non-directional.—The mike is set to the semi-directional position and tilted back so that the front faces the ceiling. In this position, there will be no discrimination in the horizontal plane, so that performers may be grouped around the mike in a circle for equal pick-up. This position is used most frequently for dramatic work.

Position No. 4: Uni-directional.—This position should be used when it is necessary to make a recording when a high noise level is present. The performer can speak close to the front, and as the rear sensitivity of the mike in this uni-directional position is very low, background noise will not be so noticeable. This position is also useful in picking-up solo instruments in a band.

FIDELITY CONTROL

Just because the equipment has high fidelity throughout does not mean one can make a record of a band sound natural. It is usually necessary to use the electronic tone controls to compensate for the characteristics of the hall, or to correct for grouping in front of the mike. For example, it is usually necessary to decrease the bass to attenuate the bass drum slightly. Also, when the brass or woodwinds solo, the highs should be boosted somewhat if a separate mike is not available for them. Moving the bass fiddle and guitar closer to the mike seems to give the recording of an orchestra a professional touch, and together with the absence of scratch in playback, the recording very closely simulates the actual band.

When speech is to be recorded, the bass should be attenuated slightly, since speech which is recorded with natural bass sounds slightly boomy due to the room's high-frequency absorption being greater than the low-frequency absorption.

In duplicating records or dubbing, always use the 1-oz. crystal pickup, because it will make the most faithful reproduction, absolutely free of peaks, and at the same time not wear the record, thanks to its light weight, and correctly-shaped point.

It is always helpful to monitor recordings

with phones or speaker together with the meter. This insures that the sound level the meter indicates is the sound desired to be recorded. For instance, if a vocalist is being recorded with a band, the voice should be pushing the meter needle, not the band, or the singer will be drowned out. Sound effects in dramas should be picked up with a separate mike so that they can be properly blended.

RECORDING SPEED, FEED AND CUT

For ordinary recordings not over 5 minutes, a turntable speed of 78 r.p.m. can be used, since this recording may be played-back on all machines. For drama, or longer selections, use the slow (33 1/3 r.p.m.) speed as a master, and copy duplicates to the high speed for the performer's individual copy.

For your own work, and for testing, it is much more economical to use the slow speed, but at the slow speed, the high frequencies fall off excessively at the inside of the disc. It is therefore advisable to boost the highs with the electronic tone control as the cutter approaches the center. Increase the highs gradually, not all at once; and never cut nearer than 2 ins. from the center if you want good highs.

The feed on the mechanism used in this article has an enclosed drive at approximately 120 lines-per-inch. This is finer than usually used, but the volume obtained before overcut is entirely ample, and the finer feed makes for increased record time. A 1/2-in. disc lasts 3 1/2 minutes at 78 r.p.m. and 7 minutes at 33 1/3 r.p.m. One can readily appreciate the economy on discs at the slow speed and fine feed.

Between 0.002- and 0.003-in. seems to be the best depth of cut. If the cut is too deep, not only is there danger of dulling the needle by hitting the base of the disc, but the needle will not be able to cut out the additional material as fast as before, so that the high notes will "mush." Terrific distortion and noise will result. Since the shortage of aluminum, the steel and glass base discs are replacing those now on the

market, hence hitting the base on one of these discs will mean good-bye needle.

NOTES

Cutting stylus.—Sapphire is the best in the long run, but extreme care must be taken with it. Stellite is cheaper initially, and gives very good high-frequency response also. Both of these types of stylus can be resharpened many times.

Chip disposal.—The little rubber finger mounted on the cutting stylus is the best chip remover (except a vacuum pump) I have ever used. The strip of rubber serves to entangle the thread so that it winds around the spindle instead of being whirled off the turntable to be entangled in the drive mechanism. (See photo on first page.)

Care of the crystal devices.—The crystal cutter and crystal playback should receive more than ordinary care if they are to have a long life. If they are subject to temperatures above 120 deg., they will be permanently damaged. Extremely cold weather will cause the bass response to become exaggerated, and the highs will be missing. The best results will be obtained therefore at ordinary room temperature. If you have any recording jobs to do at the North Pole, or the Equator, you had better use magnetic devices instead of crystals.

Moisture should be kept away from crystals as much as possible. If the location is extremely damp, cover the crystals with *pliofilm*, the waterproof covering that is used when storing tennis and badminton rackets.

A great deal of enjoyment can be had with the recorder at parties, and when friends drop in. As soon as the neighborhood learns you have a recorder, you will have little trouble building up a small business. (*) Be on the lookout for small, semi-professional bands. Many of them want recordings made to help them get engagements. In short, there is a great deal of fun and money in store for you with your new versatile recorder!

* See "Profits in Recording," Radio-Craft, May (Part I) and June (Part II), 1939.

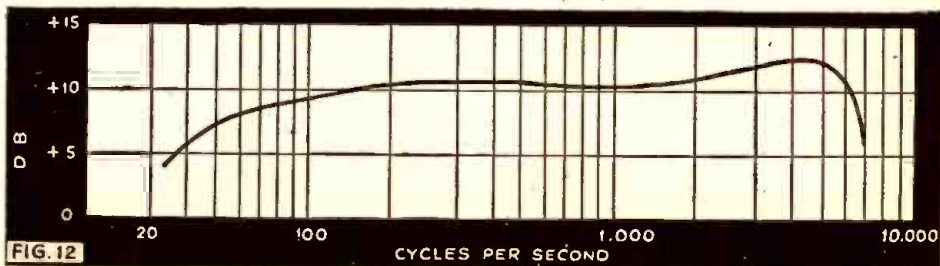

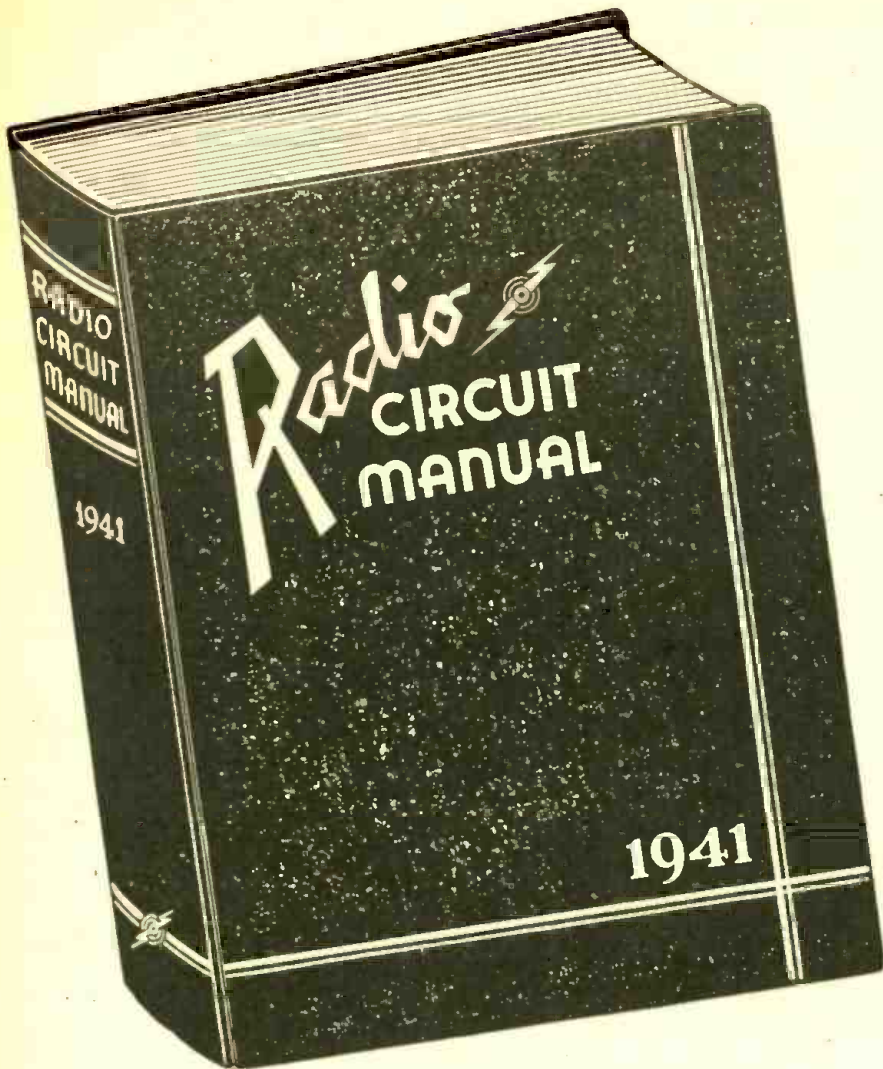

A New RADIO

**The Only EDITED Manual
Ever Published!**

**DIRECTORY OF RECEIVERS
MANUFACTURED IN 1940
AND UP TO JUNE, 1941**

OUTSTANDING FEATURES

- Contains data on more than 1800 receiver models!—more than any other radio service manual.
- Only 736 pages!—less than half the bulk of any other manual and more than 1/3 lighter.
- All information is EDITED!—all non-essential data deleted and the balance checked and correlated with the schematics and sketches.
- 40% larger page of all information (A few unavoidable exceptions.)
- I.F. peaks for all circuits are boldly black boxes;—no inaccuracies.
- No space wasted on unnecessary details and export instructions, etc.—the Service Engineer's Manual.

A "CUSTOM-TAILORED" MANUAL FOR SERVICE ENGINEERS

Here, at last, is a Service Manual deliberately PLANNED for the Service Engineer. Instead of a mere hodge-podge collection of service data, as manuals have been, this RADIO CIRCUIT MANUAL is an orderly compilation of essential and service information, carefully edited and uniformly presented for the convenience of the busy Service Engineer. All time-consuming, non-essential data weeded out, and the remaining information, vitally important to the rapid servicing of modern radio receivers, has been laid out in a logical, easy-to-use format which cuts time from the day's work. Because of this and other features evident upon first observation, it has been possible to list all information for each given model on a single page.

In 736 pages this Manual presents essential service data on over 1800 receiver models more than any other existing service manual on the market!

ONLY ONE MANUAL PER YEAR

The new technique used in compiling this RADIO CIRCUIT MANUAL—made it possible to include in a single book all the new receiver models which the manufacturer can produce in a single year. This factor alone represents an important advantage for Service Engineers.



← THE OLD TYPE MANUALS—Bulky, heavy, hard to handle, space consuming, less USEFUL data despite greater number of pages.



→ OUR NEW MANUAL—Lighter, compact, easy to handle, takes half as much room on the shelf, more USEFUL information despite fewer number of pages.

MANUALS NOW READY!

RADCRAFT PUBLICATIONS, INC., 20 Vesey St., New York, N. Y.

Gentlemen: Enclosed find my remittance of \$10.00, for which send me, POSTPAID, my copy of the RADIO CIRCUIT MANUAL—1941.

Name

Address

City State

RC-841

(Send remittance in form of check or money order; register your letter if you send cash.)

ORDER YOUR MANUAL IMMEDIATELY—NOW!

Get your copy directly from us by filling out and mailing the convenient coupon shown at left, or get it directly from your favorite distributor.

736 pages; size 13 3/4 x 10 3/4 x 2 in. thick; loose leaf, leatheroid-covered stiff binder; net weight 6 1/2 lbs.

ONLY
10⁰⁰

This Radio Circuit Manual and so on in the other as expediting and Service

RADCRAFT PUBLICATIONS

20 VESEY ST.

NEW

RADIO-CRAFT for AUGUST, 1941

Type of Service Manual!

CIRCUIT MANUAL—1941

MORE INFORMATION IN HALF THE NUMBER OF PAGES

The value of a service manual is measured not by the number of pages but by the amount of useful information. Thus, in only 736 pages this Radio Circuit Manual covers over 200 receiver models MORE than does any other competitive manual in twice the number of pages.

HOW DID WE DO IT?
 By increasing the size of our page; by discarding non-essential data and editing the balance; by listing only those

receivers which the Service Engineer will definitely have to repair (no communications or export receivers, no shortwave sets or amplifiers, no electronic devices, etc.); by many months of hard work based on a definite plan of procedure and a clear understanding of the actual requirements of the Service Engineer. There is no "dead weight" information to add bulk to this Manual. Every word counts. Every minute of reading time is well spent.

nits listing
 one page.
 cases ex-

erhet cir-
 played in
 issing, all

mmunica-
 ivers, am-
 usical in-
 0% Serv-

L

ineer. In-
 the past,
 diagrams
 num con-
 have been
 d efficient
 ding style
 are self-
 ining to a

models;—

makes it
 industry
 ing to all

PERMANENT
 ITUTION

Manual—1941 is NOT a one-
 ct year there will be a Radio
 2, the following year, 1943
 ly—each Manual better than
 methods are worked out for
 ifying the work of the prac-
 eer.

INC.
 RK, N. Y.

RADIO CIRCUIT MANUAL — 1941

RADIO CIRCUIT MANUAL — 1941

RADIO CIRCUIT MANUAL — 1941

**SENTINEL RADIO CORPORATION
 MODEL 210B**

VOLTAGE TABLE

ALIGNMENT PROCEDURE

PARTS LIST

TEST OSCILLATOR		RECEIVER	
For receiver dial 15	Adjust test oscillator frequency to	Receiver blue antenna lead	Receiver blue antenna lead
Any point where no interfering signal is received	455 K. C.	Receiver blue antenna lead	Receiver blue antenna lead
	.02 MFD. condenser	Receiver blue antenna lead	Receiver blue antenna lead
	High side to grid terminal of 1A7G tube DO NOT REMOVE CAP.	Receiver blue antenna lead	Receiver blue antenna lead
	Adjust each of the second I. F. transformers for maximum output—then adjust each of the first I. F. transformers for maximum output.	Receiver blue antenna lead	Receiver blue antenna lead
	Adjust 1720 K. C. oscillator for maximum output.	Receiver blue antenna lead	Receiver blue antenna lead
	While rocking gang condenser adjust 1400 K. C. antenna trimmer for maximum output.	Receiver blue antenna lead	Receiver blue antenna lead
	While rocking gang condenser adjust 600 K. C. condenser to maximum output.	Receiver blue antenna lead	Receiver blue antenna lead

SPECIMEN PAGE
 (greatly reduced)

THE ACTUAL PAGE SIZE IS
 10 By 12 3/4 Inches

SUPER SPECIALS

All of the attractive items listed here are brand new. ALL are in PERFECT WORKING ORDER. In many cases, the parts alone total more than the price we are asking. 100% satisfaction guaranteed or your money refunded. ORDER FROM THIS PAGE. Use the convenient coupon below. Include sufficient extra remittance for parcel post charges, else order shipped express. collect. Any excess will be refunded. C.O.D. shipments require 20% deposit. If full remittance accompanies order, deduct 2% discount. Send money order, certified check, new U. S. stamps. No C.O.D. to foreign countries.

ORDER TODAY LIMITED QUANTITIES PROMPT SHIPMENTS ASSURED

VARIABLE SPEED UNIVERSAL MOTOR

FOR 110 VOLTS. A.C. OR D.C.

Made for Dictaphone machines by American Gramophone Co. Used but in excellent condition. Special lever control permits variable speeds up to 3000 r.p.m., 1/4" shaft extends from both sides of motor. Measures 7 1/2" x 3 1/2" diam. overall. Shp. Wt. 6 1/2 lbs.

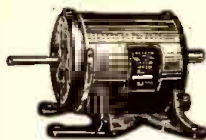

ITEM NO. 11
Your Price \$1.55

POWERFUL ALL-PURPOSE INDUCTION MOTOR

IDEAL FOR EXPERIMENTERS—101 USES

Sturdily constructed to precision standards, this self-starting shaded pole A.C. induction motor is powerful enough for a large variety of uses. Some of these are: Automatic Timing Devices, Current Interrupters, Electric Fans, Electric Chimes, Window Displays, Photocell Control Devices, Electric Vibrators, Small Grinders, Buffers and Polishers, Miniature Pumps, Mechanical Models, Sewing Machines, Phonograph Motors, Coffee Grinders, Motion Picture Projectors, Motorized Valves, Sirens, and other applications. Consumes about 15 watts of power and has a speed of 3,000 r.p.m. When geared down, this sturdy unit will constantly operate an 18-inch turntable loaded with 200 lbs. dead weight—THAT'S POWER! The motor is of midsize dimensions, 3 inches high by 2 inches wide by 1 1/2 inches deep; has a convenient mounting studs; shaft is 7/8" long by 3/16" diameter, and runs in self-aligning, oil-retaining bearings; the best materials, perfect precision assembly and rigid inspection certify to its high quality, and assure long life. Designed for 110-20 volts, 50-60 cycles, A.C. only.

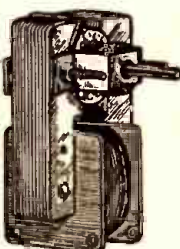

ITEM NO. 147
YOUR PRICE \$1.29

WESTINGHOUSE WATTHOUR METER

Completely overhauled and ready for immediate service. Designed for regular 110-volt, 60 cycle 2-wire A.C. circuit. Servicemen use it in their shops to check current consumption of sets, soldering irons, etc. Keeps costs down. If dismantled, the parts alone would be the price. The elaborate gear train could be used as a counter on machines of various kinds. Simple to install; 2 wires from the line and 2 wires to the load. Sturdily constructed in heavy metal case. Size: 8 1/4" high, 6 1/4" wide, 5" deep, overall. Shp. wt. 14 lbs.



ITEM NO. 33
Your Price \$4.50

100 POWER TELESCOPE LENS KIT

Make your own high powered 8 ft. telescope! Now you can thrill to a closeup view of the worlds out in space. See the rings around Saturn, the mountains of the moon! Kit contains 3" diam., 75" focal length, ground and polished objective lens and 2 astronomical eye-pieces, magnification 50x and 100x. Complete kit with full instructions.

ITEM NO. 123
YOUR PRICE \$1.95

NEW—EXTRA LARGE LENS KIT—contains completely finished 4" diameter 100" focal length ground and polished objective lens, three 1 1/4" diameter eye-pieces giving 66x, 133x, and 200x, an aluminum diagonal for overhead viewing, and a color filter for insertion in any eyepiece.

ITEM NO. 123L
YOUR PRICE \$3.95

HUDSON SPECIALTIES CO., 40 West Broadway, N. Y. C.

IT'S EASY TO ORDER—CLIP COUPON—MAIL NOW ORDER FROM THIS PAGE.

HUDSON SPECIALTIES CO., 40 West Broadway, Dept. RC-841, New York, N. Y.

I have circled below the numbers of the items I'm ordering. My full remittance of \$..... (include shipping charges) is enclosed.

OR my deposit of \$..... is enclosed (20% required), ship order C.O.D. for balance. No C.O.D. order for less than \$2.00. (New U. S. stamps, check or money order accepted.)

Circle Item No. wanted: 11, 33, 58, 87, 123, 123L, 125, 147

Name Address

City State

Send remittance by check, stamps or money order; register letter if you send cash or stamps.

AMAZING BLACK LIGHT!

Powerful 250-Watt Ultra-Violet Bulb



The best and most practical source of ultra-violet light for general experimental and entertainment use. Makes all fluorescent substances brilliantly luminescent. No transformers of any kind needed. Fits any standard lamp socket. Made with special filter glass permitting only ultra-violet rays to come through. Brings out beautiful opalescent hues in various types of materials. Swell for amateur parties, plays, etc., to obtain unique lighting effects. Bulb only. Size of bulb. Rhp. Wt. 1 lb.

ITEM NO. 87
YOUR PRICE \$2.00

WELDING! BRAZING! SOLDERING!

3-IN-1 PORTABLE ELECTRIC TORCH

WORKS FROM 110 VOLTS A.C. OR D.C. LINE

This electric torch is not a gadget or a toy, but a sturdily built outfit using the finest materials. With it you are able to do professional type of welding, brazing and soldering work, regardless of whether or not you've had previous experience. It will do a thousand and one jobs: fender welding, auto body repairs, bumpers, cylinders, tanks and industrial repairs—ideal for auto fitters, plumbers, sheet metal jobs, engineers, maintenance men, radio and bicycle repair men, etc. Works on aluminum, brass, copper, iron, steel and other metals!

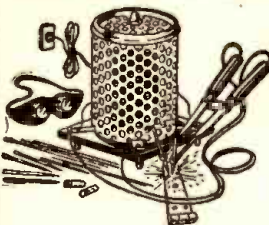

The 3-in-1 electric torch is so simply constructed that even a boy can operate it after reading the simple and concise instructions furnished with the unit. Not necessary to know how to strike an arc! All you do is plug the torch into the light socket, adjust the knobs per instructions, and presto!—you have an intense, blazing flame, ready for work. The outfit comes complete with power unit, electric cord, electrode holder, carbons, welding rods, blazing rods, solder flux, goggles, and instructions.

Save money! Do your own repairing. Earn money by doing repairing for others. Simple, practical, durable and safe to handle—that's why the price is amazingly low. Don't delay—order one today. Shp. Wt., 8 lbs.

ITEM NO. 50
Your Price \$6.95

ELECTRIC HUMIDIFIER FOUNTAIN

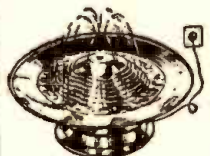

Adds healthful moisture to the air in winter. Evaporates as much as a pint of water in 24 hours. Fountain is 14" in diam. Sprays 8 streams of water 5" above fountain head. Made of spun aluminum. Comes in five colors: Bronze, chrome, copper, red, green. No water connections required. Just plug into 110 volt, 60 cycle A.C. outlet. Current consumption few cents a month. Complete with base switch and 8 ft. power cord. Shipping wt. 9 lbs. List price \$14.95. Only a limited supply on hand.

ITEM NO. 125
YOUR PRICE \$4.95

1941 Catalog

A POSTAL CARD BRINGS IT TO YOU

SEND FOR IT TODAY

SOUND NEWS

The first use in radio, of authentic sound effects of the war over Britain made by a London firm since retired from business, will be in WMCA's new series, "True Stories From Britain," which provides interviews with well-known people returned from Europe who have witnessed combat procedures. These sound effects were obtained during air raids and contain sounds of falling incendiary and high-explosive bombs; the work of the fire fighters; anti-aircraft activity; the work of the ambulance corps; civilization mobilization in air-raid shelters, etc.

A 1/4-million phonograph records went up in smoke when the RCA Mfg. Co. warehouse in Los Angeles burned to the ground last month.

The Code Committee of the American Federation of Radio Artists, according to an issue of *Broadcast—Broadcast Advertisers* one day last month, has devised a Code described as classifying transcriptions into 2 groups. Class A includes (a) custom-built discs, to be used by one sponsor once only in each locality for any of the sponsor's products; and, (b) open-end transcriptions, which may be used on any number of stations of any power for one or more sponsors. Class B discs are open-end recordings restricted for use on stations of 1,000 watts power or less. Rates are higher than at present although less than the AFRA minimums for live broadcasts. Code will expire on Nov. 1, 1943, together with the Codes for commercial and sustaining network programs.

Business tip for getting more record-blank biz: Presto Recording Corporation announced the availability of *disc order cards* which illustrate the prices of various types of home recording discs and needles, and require no postage for mailing. They're furnished free of charge to Servicemen in quantities up to 100. Imprinted with the name, address, and telephone number of the service organization, they can be left with the home owner at the time a radio set is adjusted.

CORRECTION

In the May, 1941, issue we printed an Operating Note submitted by M. F. Crowell, but failed to include the accompanying diagram. We reprint this Note below together with the required diagram.

ZENITH RECEIVERS

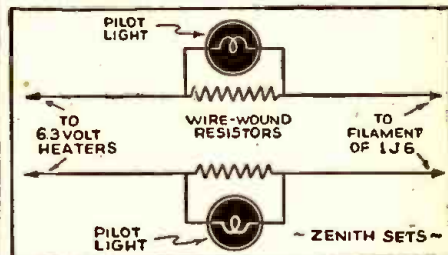

Some models in the Zenith line operate either on 110 V. A.C. or 6 V. D.C. by the flip of a switch. The last A.F. stage is a 2-V. tube (a 1J6), all other tubes being 6.3 V. types. This 2-V. tube receives the correct 2 V. as per diagram. As can readily be seen, the burning-out of either of the 2 pilot lights causes the filament voltage on the 1J6 tube to drop to about 1 V., causing distortion.

M. F. CROWELL, JR.,
Crowell, Texas.



← High-gain, high-power A.F. amplifier, complete with voltage multiplier type of power supply designed to deliver high voltage without requiring the use of a step-up transformer.

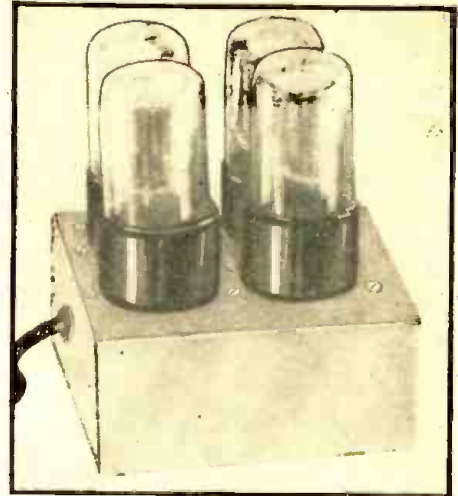

→ An easily-built, experimental high-voltage power supply which by voltage multiplication will deliver up to about 1,000 volts without requiring a transformer.

AN A.F. AMPLIFIER AND A POWER SUPPLY FEATURING VOLTAGE MULTIPLICATION

Although transformerless power supplies have been described in a previous article, you will find the circuits described here radically different and superior. This article also describes how these circuits can be put to practical use in conjunction with a high-gain, high-power amplifier.

STEVE KUSEN

In a preceding article ("Voltage Multipliers and How they Work," Jan., 1941) the writer described various types of power circuits which were developed in our laboratory. In the following article, are described improved circuits of this sort and how these circuits can be put to practical use, by utilizing them in conjunction with a high-gain high-power amplifier. The voltage multiplier power supply is an invention of the writer and as stated in the preceding article *extreme caution must be exercised when trying out these circuits.*

With proper tubes and constants the circuit described here can be made to give any amount of current at any desired voltage. Looking at Figs. 1 to 4, incl., we see that the current drain of the circuits can easily be increased by adding more tubes in parallel and using higher-capacity condensers. We can just as easily increase the voltage of the output by adding more half-wave rectifiers and condensers in a cascade arrangement (see Figs. 3 and 4). The voltage received at the output is pure D.C. This is due to the quadruple full-wave rectification employed in these circuits. For the benefit of the reader we repeat a description of the voltage doubler circuit and bridge rectifier circuit. This is done, so that the reader may make a comparison analysis of the circuits and thus be able to understand them more easily.

TRANSFORMERLESS CIRCUIT

In Fig. 1 we see a simple transformerless full-wave rectifier. As shown here, we can by making use of well known properties of the half-wave rectifier, cause an alternating current to automatically switch itself at just the exact time so as to cause all positive cycles to separate from the negative cycles and to continue so along separate wires, the ends of which when impressed across a suitable load will cause a continuous flow of direct current.

The reason that the flow of current does

change is because the polarity of the voltage across the load always remains the same, and as we know, an electric current will always flow from negative to positive only (theory).

FULL-WAVE VOLTAGE TRIPLERS AND POLARITY REVERSERS

In Fig. 2 we see that by connecting 2 condensers in series across the output of the transformerless full-wave rectifier, and connecting their midpoint to any side of the line, we thus will be able to obtain at the output a direct current voltage 3 times the value of the peak voltage impressed at the input.

This circuit works upon the same principles of the common type of voltage doubler (see Fig. 5A), whereby on one part of the cycle condenser No. 1 is charged, while condenser No. 2 is discharging in series with the voltage which is charging condenser No. 1. On the next part of the cycle the reverse occurs, thereby giving us across the load at the output a direct current voltage twice the value of the input voltage.

There is a bit of difference in the circuit described in Fig. 2 because unlike the ordinary voltage doubler, we are able to obtain at the output a direct current voltage 3 times the value of the input voltage. And on D.C. we obtain at the output a fixed-polarity voltage equal to the input voltage regardless of the polarity of the input voltage.

This circuit can also supply more current than the ordinary type of voltage doubler due to the fact that each half-wave rectifier conducts on one part of the cycle only. Looking back at Figs. 1, 2 and 3, we stop to wonder how it is possible for this circuit to permit a higher drain of current (twice as high) than the circuit illustrated in Fig. 5A. If we trace the circuits in Figs. 1, 2 and 3, we can easily see that there are 2 rectifiers in series with the load during one period of the cycle and that there are 2 others

in series with the load during other periods of the cycle. Since the permissible current drain of any one rectifier is 75 milliamperes, we thus reason that we are able to draw 75 ma. during each half of 60 cycles. Since an electric current is the flow of electricity per second (*coulombs*), we thus come to the conclusion that we are able to draw twice as much electricity per second (150 ma.), in Figs. 1, 2 and 3, as compared to Fig. 5A. All tests were made on 60 cycles/second A.C.

VOLTAGE MULTIPLIER POWER SUPPLIES

In Figs. 3 and 4, we see that by adding 2 more tubes we can obtain at the output a D.C. voltage 6 times the value of the voltage impressed at the input, at twice the current capacity of the ordinary voltage doubler. We see here that during various periods of the A.C. cycles, an alternating voltage is impressed in series with the condensers on the positive side of the line which at that moment are discharging. This combined voltage is rectified by a half-wave rectifier and impressed upon a succeeding condenser on the positive side of the line.

On other periods of the A.C. cycle, the condensers at the negative side of the line undergo the same phases as their partner condensers, therefore when the condensers at the negative side of the line, at the output, discharges it does so with a series voltage (3 times the value of the input voltage) which at the moment is charging the condenser at the positive side of the line, thus we obtain across the load at the output a voltage equal to 6 times the peak value input voltage. Unusual, isn't it?

At Fig. 4 we see a circuit which uses the same amount of tubes as the preceding circuit but gives us a D.C. voltage at the output of 900 volts (9 times as much as the input voltage). The maximum current drain of the circuit however is 75 ma. as compared to the preceding circuit which is 150 ma. This is obtained by figuring the maximum steady current of any single rectifier.

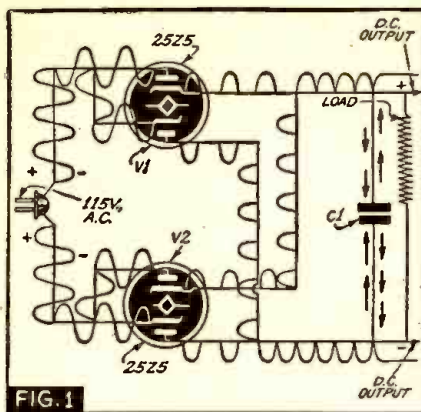

FIG. 1

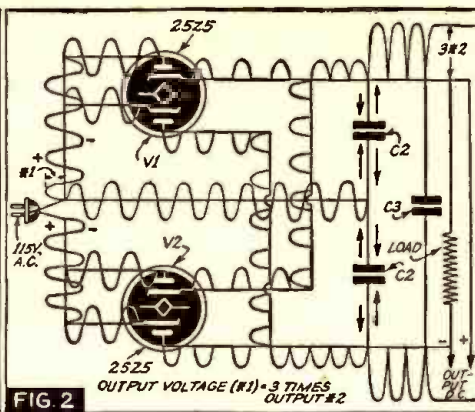

FIG. 2

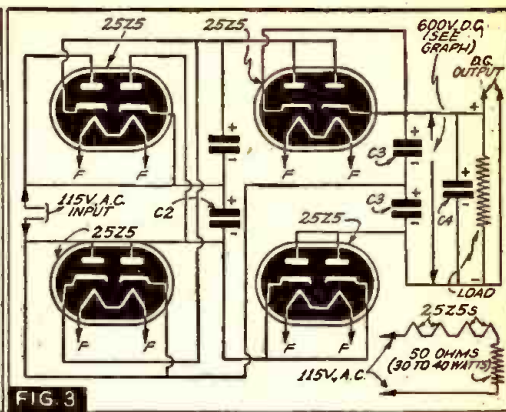

FIG. 3

Compare these power supplies with the ordinary transformer and choke power supply which can supply an equal amount of current at equal amount of voltage—compare the versatility, etc. These types of power supplies draw less current from the line than do the ordinary type of power supply. This is due to the efficiency of the circuits.

VOLTAGES OBTAINABLE

Besides having the advantages described in the preceding notes these circuits have many other possibilities. Now by closely analyzing the circuit described in Fig. 4 we can see that by tapping-in at various points of the circuit we can obtain various voltages which are independent from each other. For example, if we connect a load across the output terminals of the circuit shown in Fig. 4 we should get 900 volts. If we also connect a load across the output of the preceding rectifier we could get 600 volts; and, we can also connect a load across the rectifier preceding the 2nd rectifier and be able to get across that load 300 volts.

These voltages are independent of each other although the current drain of any one of the loads will diminish the voltage of each circuit. This diminishing of the voltages is only noticeable when the current drain is very high and the condensers used throughout are of low capacities.

After reading about this circuit the reader will wonder if rectifiers of other than the tube type can be employed. Well, the fact is any type of rectifier can be used whether it be the copper-oxide type (this type is widely used in foreign countries), electrolytic type, etc., provided that the inverse voltage (resistance to reverse currents) and current-handling properties of these rectifiers be known. The writer has recently heard a report which said that in England radio manufacturers are resorting to use of the half-wave universal type of power

supply. This is due to the shortage of iron, hence the high price of transformers. Well if some wide-awake manufacturer takes notice he will find the circuits described here will prove a perfect substitute.

HIGH-GAIN TRANSFORMERS AMPLIFIER

In Fig. 5B is shown the diagram of a high-gain, high-power amplifier using a transformerless type of power supply. This amplifier does not use any of the power supplies described here but instead uses a series cascade type of voltage multiplier circuit.* This type of circuit was also invented by the writer.

Although this type of circuit is not as efficient as the one described here, it still does produce excellent results. The only transformer used in this circuit is the one on the speaker. Since the voltage across the output is more than is needed, we therefore utilize the speaker field as a choke, connecting it in series with the output circuit. As no power transformer is used, therefore, we have to resort to connecting the heaters of the tubes in series, through a suitable resistor across the supply voltage. Note that when connecting tubes of a high-gain amplifier in this manner the first 2 stages should always be connected near the negative side of the output voltage (electrically). When compared to an amplifier of equal ability, the amplifier described here takes up less space, is lighter, cheaper to construct, is easily serviced and can easily be rebuilt for more power.

The power supply of this amplifier employs two 25Z5 tubes and 5 condensers, and can supply a filtered direct current of 75 ma. at 390 volts. Note that the watts power

*Various types of circuits of this sort and their technical descriptions were described by the writer in the January, 1941, issue of Radio-Craft. When one desires an efficient and low-price circuit which can be easily serviced, lighter in weight, requires less parts, takes less space, and can be changed to give a higher voltage or supply more current at almost a moment's notice, then I advise the use of these circuits.

consumed by the series dropping resistor is 25 watts. When tested the amplifier gave humless reproduction with unusual quality. The gain of this amplifier is sufficient to operate directly from a crystal mike.

This amplifier when plugged into a D.C. power line, will not blow a fuse or cause injury to any parts employed in it. In fact, it will operate on D.C. at very low volume. If permanent-magnet type speakers are employed and the speaker field connections on the amplifier shorted, the amplifier will operate at higher volume on both currents.

LIST OF PARTS FOR AMPLIFIERS

CONDENSERS

- One Cornell-Dubilier, miniature electrolytic, type BRH 251, 200 mf., 25 V., C7;
- Two Cornell-Dubilier, electrolytic, type BR 1650, 16 mf., 500 V., C4, C5;
- One Cornell-Dubilier, electrolytic, type BR 4015, 40 mf., 150 V., C1;
- One Cornell-Dubilier, electrolytic, type BR 1625, 16 mf., 250 V., C2;
- One Cornell-Dubilier, electrolytic, type BR 1645, 16 mf., 450 V., C3;
- One Cornell-Dubilier, electrolytic, type BR 845, 8 mf., 450 V., C6;
- Three Cornell-Dubilier, paper tubulars, type MD 8S4, 0.03-mf., 800 V., C8, C9, C10.

RESISTORS

- One I.R.C., metallized volume control with switch, type 18-133-C, 0.5-meg., R₁
- One I.R.C., 25 ohms, 2 w., R1;
- One I.R.C., 50 ohms, 25 w., R2;
- One I.R.C., 175 ohms, 25 w., R3;
- **One I.R.C., 400 ohms, 3 w., R4;
- **One I.R.C., 600 ohms, ¼-w., R5;
- **One I.R.C., 1,000 ohms, 3 w., R6;
- **One I.R.C., 1,200 ohms, ¼-w., R7;
- **One I.R.C., 20,000 ohms, ¼-w., R8;
- **Two I.R.C., 0.1-meg., ¼-w., R10, R9;
- Four I.R.C., insulated metallized, 0.25-meg., ¼-w., R11, R12, R13, R14;

**Insulated, metallized units.

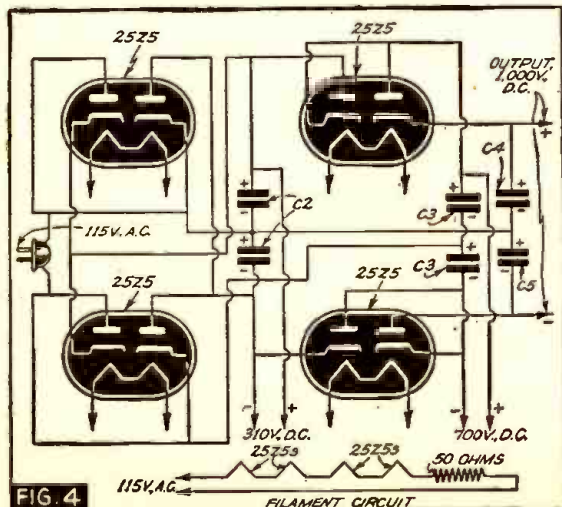

FIG. 4

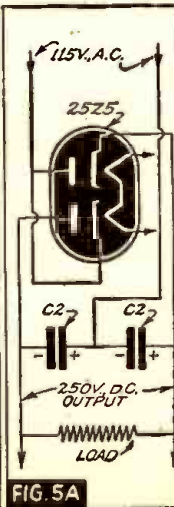

FIG. 5A

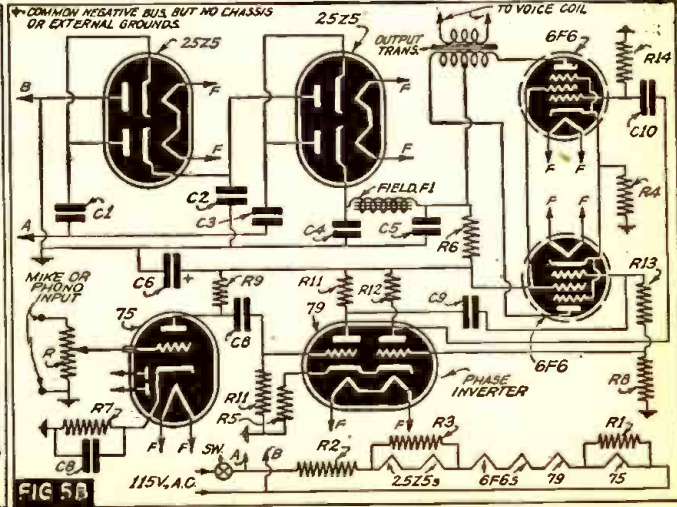

FIG. 5B

TUBES

- One Triad, glass, type 75;
- One Triad, glass, type 79;
- Two Triad, metal, type 6F6;
- Two RCA glass, type 25Z5.

MISCELLANEOUS

- One Cinaudagraph loudspeaker, with 1,000-ohm field, 8 in. dia., 15 W. to match two 6F6s in push-pull f1, S1;
- Four 6-prong sockets;
- Two octal sockets;
- One 6-hole chassis;
- One twin jacks;
- One knob;
- Twenty-five feet of hookup wire;
- Two dozen 6/32 screws and nuts;
- Three 6/32 winged nuts (for speaker connections);
- One Goat shield for 79 tube;
- One Goat shield for 75 tube;
- Two grid caps;
- One Astatic pickup, crystal mike and shielded cable.

National Defense RADIO NEWS

"Wheels for Democracy," new ½-hour air program of WMCA, is a series scheduled to extend into next Winter and designed to demonstrate the work of cities along the Eastern seaboard in industrial and civil Defense.

Radio company aids Defense program: Reporting on its progress in the production of materiel for the National Defense program, Stewart-Warner Corp. last month disclosed that as prime or subcontractor, it is now producing for the armed services of the United States and Canada: fuses, heaters for bomber motors and cockpits, practice bombs, parts for airplane motors, tank ammunition racks, stirrup pumps for fighting incendiary bomb fires, parts for field ranges, filters for troop drinking water, radio equipment, and numerous forms of instrument panels, gauges, military transportation equipment and maintenance items.

In connection with its "National Defense Through Fire Defense" campaign, the National Board of Fire Underwriters last month announced that awards of gold medals would be made to the newspaper and radio station which, in the opinion of the committee of fire prevention experts and men of recognized standing in the fields of press and radio, performed the most meritorious service within its field during the coming year in the cause of fire prevention and fire protection.

Reading the daily reports from overseas, little imagination is required to visualize the priceless value of a "fire-proofed America." Hence, any contributions in this direction will pay big dividends in times of peace as well as war.

T. R. Kennedy, Jr., writing in the *New York Times* one day last month, in a column entitled "Call for Operators," pointed out that a signal personnel of 50,000, a majority of whom must be expert in radio, is required to maintain the radio apparatus of an army of 1,000,000 during military maneuvers.

Effective immediately, General Electric has frozen commercial radio receiver designs for 1941-'42, in order to release development and research personnel and

New SELF-BALANCING
DRIFT-CORRECTING

DIRECT-COUPLED AMPLIFIERS

FOR DISCRIMINATING MUSIC LOVERS

Designed by A. C. Shaney

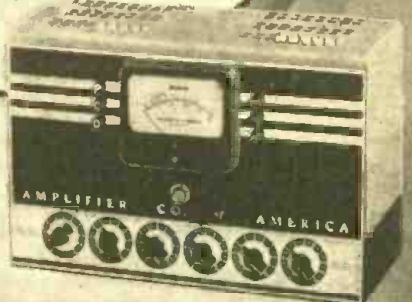

These new amplifiers bridge the gap between the laboratory and the home, and make available for the first time, extraordinary equipment at less than ordinary prices. Built in a new way, without interstage coupling condensers or transformers. Although specifically designed to meet the strictest requirements of professional sound engineers, these direct-coupled amplifiers embody all desirable features sought by the most discriminating music lovers. Send for Literature.

AMPLIFIER CO. of AMERICA

17 W. 20TH STREET, NEW YORK, N. Y.

facilities for work on new radio and electronic apparatus urgently needed by all branches of the armed services to meet Defense demands.

How will the present priorities regulations affect the radio business? In what direction may equipment makers find profitable business during the coming year? Hints to the answers may lie in the following comments from Philco, which points out that the company plans to use plastics and glass in its products to an ever-increasing extent; that the biggest unsaturated market for radio is on wheels (remarking that its car-radio sales during the first 9 weeks of 1941 were double the same period in 1940); and, that "the tide which swept compact radios into popularity a couple of years ago is now surging up on portables," so that today the portable business has doubled since the company first introduced its line.

New War Dept. Training Sound-Film, made under the direction of the Research Council of the AMPAS: "The Light Machine Gun Platoon, Horse Cavalry Rifle Troop."

Broadcast Music, Inc., last month announced that its music would be made available, gratis, for use by public or private authorities sponsoring National Defense programs over the air. This includes all departments of the Government, States, and Municipalities, and sponsors who are contributing commercial time on the air to National Defense programs. Take a bow, B.M.I.!

The present unavailability of aluminum for civilian use has created a demand that the plastics interests plan to fill, insofar as possible, according to the current issue of *Radio Jobber News*. The claim is that the higher cost of plastics is offset by the lower cost of finished dye-castings.

The smallest current which the average man can detect when the current flows through his two hands is about 1 milliampere (0.001-ampere). Currents above 15 milliamperes produce such muscular contraction that the victim cannot release his grip on the electrode. Current intensity and not the voltage determines the shock intensity, it is reported. (THE OHMITE NEWS)



FREE!

HAMMARLUND
NEW "41"
RADIO CATALOG

The latest Hammarlund catalog with complete data, illustrations, drawings and curves on the entire Hammarlund line. Address Department RC-8-1 for your free copy.

HAMMARLUND MFG. CO., INC.
424-438 West 33rd Street, New York City

EVERYTHING
IN RADIO





HAS
TRA

This big book serves your entire needs. It includes sets, parts and supplies, public address, amateur equipment, testers, kits, fluorescent lighting. Nationally known favorites at lowest possible prices. Write today for your copy of this

BIG FREE CATALOG

BURSTEIN-APPLEBEE COMPANY

1012-14 McGEE STREET, KANSAS CITY, MISSOURI

NEW AUDIOGRAPH
Sound Catalog

AUDIOGRAPH Sound Systems represent the latest in Sound Engineering and Design—a complete line plus pre-tested accessories.

NEW LOWER PRICES

Outstanding quality and performance at prices that help you meet any competition.

WRITE FOR FREE COPY

JOHN MECK INDUSTRIES
1313 W. Randolph St., Chicago, ILL

The Only Book of Its Kind!
AMPLIFIER HANDBOOK & PUBLIC
ADDRESS GUIDE
See Page 72.

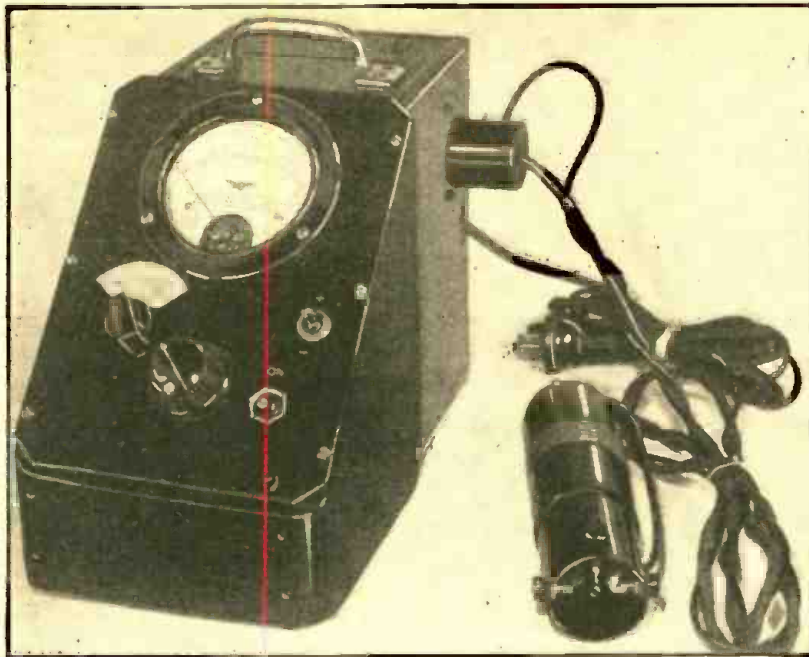

The author of this article describes the construction of a vacuum-tube voltmeter designed to afford accurate ranges on D.C. and "fairly accurate" A.C. and R.F. voltage ranges, in an economical compromise between range, accuracy, and the various other factors that enter into the design and construction. The cost of construction would be under \$10, states Mr. McLaren.

◀ View of completed V.-T. Voltmeter. The positive range switch is shown at left; zero-adjust, center knob; 110 V. power switch, lower-right, and negative to positive switch, upper-right. The prod tube shown at right connects by cable to the instrument through a plug-and-jack at the side of the case.

Build This Practical and Inexpensive

VACUUM-TUBE VOLTMETER

A. K. McLAREN

A Vacuum-Tube Voltmeter is a useful instrument for the amateur or Serviceman and is a necessity for measuring voltages in high-impedance circuits and for A.C. and R.F. circuits.

Vacuum-tube voltmeters may be purchased that may or may not be accurate at all frequencies and which may or may not load the circuits under test. Most of them are a compromise between cost, range, accuracy and a host of other things that enter into the design and manufacture of the instruments.

Here are design specifications and information for building a vacuum-tube voltmeter that may be made absolutely accurate on D.C. voltages and fairly accurate on A.C. and R.F. voltages, subject to the compromises before mentioned. Thus there may be some loss of accuracy below 60 cycles and on low-power R.F. tuned circuits. However it is accurate enough for most purposes and considering the cost is well worth the effort of building.

The cost will be less than \$10, depending on the type of meter used and the cabinet or box used. A zero-to-1 milliamperemeter is used with multivoltmeter scale, such as 0 to 6 volts, 0 to 12, 1 to 120, and 0 to 300 volts, as used in the one described; other values may be used but will require changes in the values of resistors employed; this will be explained later.

POWER SUPPLY

The power supply is a standard brute force type of filter; and the transformer may be of the midget type which in this case supplies 350 volts D.C. under operating conditions. Line voltage changes have little effect on the accuracy as the meter may be set to zero for any line voltage changes, and due to the design of the circuit this compensates for any voltage change. Dropping the line voltage to 75 volts results in a 0.2-V. difference in accuracy on the 6-volt range.

The first thing to do is build the power supply complete with bleeders and mount in

the enclosure so that the probe tube cable can be plugged in. The probe tube should be mounted in bakelite tubing just sufficiently large to accommodate the tube and should be long enough to contain the two 100 mmf. condensers and the 0.01-mf. condenser. These should be small mica condensers. If bakelite tubing can be secured in 2 sizes which telescope together it will be easier to make connections.

Insulated tip-jacks may be used for the probe contacts, and in making adjustments the test cords should be removed from the jacks while resetting the meter to zero. It is not necessary nor desirable to short the contacts in calibrating to zero. Also the negative of the power supply should be grounded to a good ground. An actual ground is best as water-pipes may pick up A.C. and effect the zero reset.

Care must be used if the meter is operated with a ground and the switch is set on the low-voltage scale. Touching the hand to the probe causes the meter to fly off scale due to the body acting as a condenser to ground and the other parts of the meter picking up 110 volts A.C. due to the capacity between windings of the power transformer, which makes the meter act the same as if 110 volts A.C. were applied to the test terminals.

Without test cords connected to the jacks there will be no effect on zero reset and the meter may be used with the same accuracy if these precautions are observed.

A terminal board of good insulating material with plenty of lugs for connecting resistors, condensers and switches should be secured.

RANGES

Any meter range may be used for preliminary testing for linearity, the instrument being adjusted so as to correspond to the linear scale of the 10 to 1 ma. meter.

It is best to bring out leads from the terminal board so that connections can be made to the resistors as the different ranges

are adjusted. All condensers should be connected before any adjustments are made. The meter, together with the 0.4-meg. resistor and the 3,500-ohm resistor which furnishes the bucking voltage, the 2,000- and 4,000-ohm resistors and the 0.1-meg. variable control (Centralab recommended) should also be connected.

Of course the other resistors for the range being adjusted should also be connected.

The power should then be turned on and if you are using the 12-volt scale you should be able to adjust the meter to approximately center scale and also be able to reduce it to below zero. In any case with no test cords connected set the meter to zero. Connect test leads and apply 3 or 4 volts positive to the grid of the tube. Then apply voltage to bring meter near full-scale. If meter reads high, according to the voltage scale, the cathode resistance must be increased.

If the meter reads about right at the low end of the scale, and runs high at the high end, resistor R12 in series with the meter must be increased.

The meter used in the instrument described was a 49-ohm movement. The resistance of the 1-ma. meter determines the value necessary at R12 to make the voltmeter linear over the whole range. The ordinary 1-ma. meter has a resistance of about 50 ohms and if your meter is not of this value R12 will have to be adjusted until the meter reads linear over the whole range. One meter we tried required 5,000 ohms at R12. However once the value of this resistor is found, it will not have to be changed for the other ranges.

CALIBRATION

This is the most important part of the calibration. You will notice that the 12-volt range uses a bleeder in series with the cathode resistor. In making adjustments you will find that decreasing the value of the bleeder will make the meter read high-

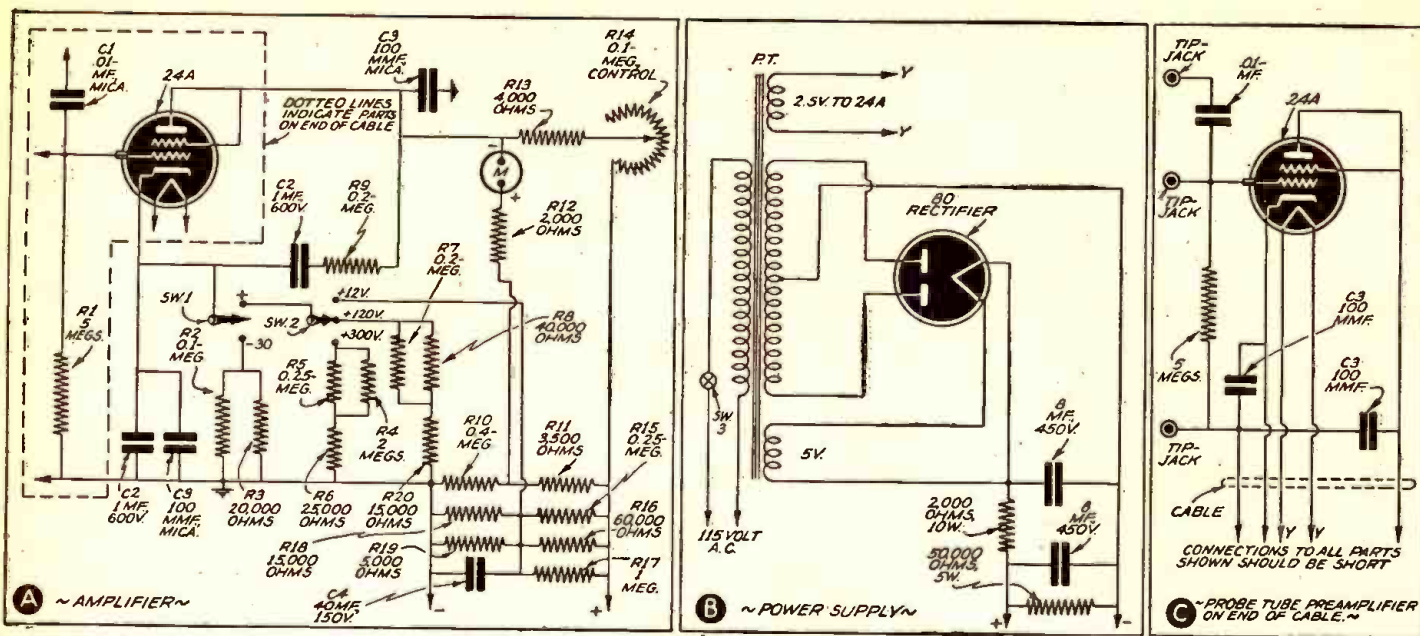

er, and vice versa; also, decreasing the cathode resistance will lower the range of the meter, that is, the voltage required to swing the meter to full-scale.

Different values of resistors should be tried in these positions until you get somewhere near the correct values. You will find that these values are very critical but by paralleling or placing resistors in series the correct values can be obtained. The values shown were arrived at by this means and different resistors may require other values of parallel resistors to obtain the same result. In the case of the 12-volt ranges shown, the 60,000-ohm resistor is the main resistor and should be a 5- or 10-watt wire-wound unit. The other resistors used are all 1-watt and in this case were Erie resistors. These resistors are very little affected by temperature changes and this factor should be taken into account in purchasing resistors.

Most good resistors manufactured nowadays are good in this respect and as they are not expensive it is well to have a couple of each value, as slight differences may give you just the value you need.

Any multiscale meter may be used by figuring out different values for resistors from the values given for this meter, up to 300 volts. Scales above this value should not be used because with a power supply of 350 volts, values higher than 300 volts applied to the grid of the tube will run into the upper bend of the tube's characteristic curve and the response will not be linear.

It may be better to make first adjustments on the medium range as this range does not use a bleeder and the only adjustments will be on the cathode resistor and the meter series resistor R12. A power-supply furnishing this voltage with a potentiometer for adjustments will be necessary. Batteries are best for this if available.

An accurate A.C.-D.C. voltmeter should be used for calibrating and should be left connected while readings are taken with the vacuum-tube voltmeter as the meter will load the circuit and cause the voltage to rise if disconnected. The A.C. voltage scale is different from the D.C. scale and a separate scale may be drawn up to correspond to the D.C. divisions of the meter, scale or may be put directly on the upper side of the D.C. scale. A 60-cycle A.C. supply is used for calibrating and this calibration is used for A.F. and R.F. voltage testing.

A 24A-type tube is used with the screen-grid and plate tied together. Use of this tube results in some frequency discrimination at the high frequencies and a different

tube may be used but then the values of the components may be quite a bit different from the ones given. Also a tube must be used that will stand 2.5 or 3 ma. of plate current which is required with a meter of this sensitivity.

SAFETY

The purpose of C2 and R9 is to prevent the meter from slamming when the prods are removed from the circuit when measuring high voltages. When the prod is removed from a high voltage, condenser C2 connected from cathode to ground discharges through the cathode resistor and holds the tube at cut-off, causing the bucking voltage to slam the meter back past zero: C2 and R9 counteract this. When turning the power on it is best to set the range switch in the high-voltage position.

The switch Sw.1 is used for switching from positive to negative. The meter is read from full-scale down, for negative voltages, and is calibrated the same as the one for positive voltages.

This is a single-pole double-throw switch and is connected so as to shift the cathode to the common terminal of Sw.2 which is a single-pole 3-position switch. A reversing switch might be used for reversing the meter to make it read up, on negative voltages, but is not necessary. The negative range is 30 volts and of course all ranges may be doubled by using a 5-meg. resistor in series with the input to the prod tube. Input for A.C. voltages is to condenser C1.

An insulated panel for mounting the meter and switches should be used and it will be better if all parts are insulated from the case.

In the photo the positive range switch is to the left. The center knob is for zero-adjust, the lower toggle switch is the 110-volt power switch and the one at upper-right is for switching from negative to positive. To the right is the prod tube, in its bakelite tubing, on the end of cable which is plugged into the side of the case. The metal box is 7 1/2 inches high and the panel is 7 7/8 inches x 5 inches. The front part of the case is made of 1/2-inch wood.

LIST OF PARTS

***RESISTORS**

- One Erie, 5 megs., R1, 1 watt;
- One Erie, 1 meg., 1 watt;

*Precision type not required as any resistors used may require some shifting around to get the various ranges lined up.

- One Erie, 0.1-meg., 1 watt, R2;
- One Erie, 20,000 ohms, 1 watt, R3;
- One Erie, 2 megs., 1 watt, R4;
- Two Erie, 0.25-megohms, 1 watt, R5 and R15;
- Two Erie, 15,000 ohms, 1 watt, R18 and R20;
- One Erie, 25,000 ohms, 1 watt, R6;
- Two Erie, 0.2-meg., 1 watt, R7 and R9;
- One Erie, 40,000 ohms, 1 watt, R8;
- One Erie, 5,000 ohms, 1 watt, R19;
- One Erie, 60,000 ohms, 10 watt, R16;
- One Erie, 2,000 ohms, 5 watt, R21;
- One Erie, 50,000 ohms, 10 watt, R22;
- One Erie, 2,000 ohms, 1 watt, R12;
- One Erie, 4,000 ohms, 1 watt, R13;
- One Erie, 0.4-meg., 1 watt, R10;
- One Erie, 3,500 ohms, 1 watt, R11.

CONDENSERS

- One Aerovox type 1450, 0.01-mf., mica, C1;
- Two National Union type U61, paper, 1 mf., 600 V., C2;
- Two National Union type AT-8450, dry electrolytic, 8 mf., 475 V., C5;
- One National Union type AT-4015, dry electrolytic, 40 mf., 150 V., C4;
- Two Aerovox type 1460, 100 mf., mica, 900 V., C3.

(Additional List of Parts on following page)

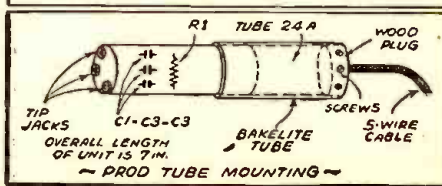
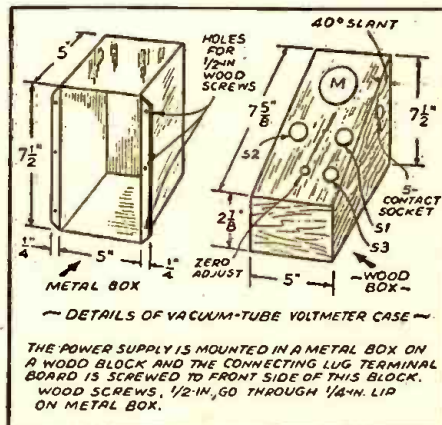

Construction details.

• TEST INSTRUMENTS •

BIG BOY

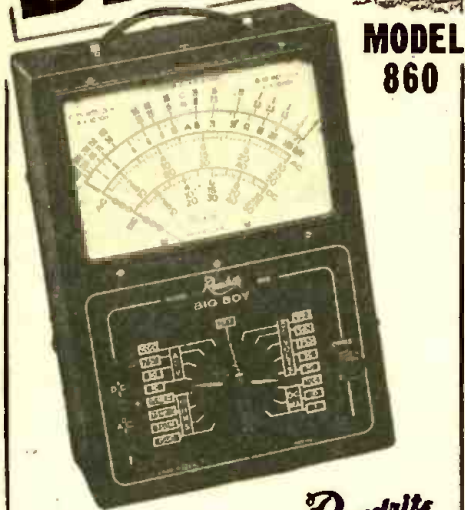

Performance . . . Eye Appeal . . . Value . . . Sationally Priced at \$19.65, Dealer Net Price.

Here is an AC-DC Volt-Ohm-Milliammeter with all the ranges you want . . . easily readable on the large 7" instrument with extra-long 6" scale, in a new up-to-the-minute three-tone case. DC Volts 0-10-50-250-500-1000 at 5000 Ohms per volt; AC Volts 0-10-50-250-1000 at 400 ohms per volt; DC Ma. 0-1-10-100; Resistance ranges: 0-1500 Low Ohms; 0-150,000 Ohms and 0-7.5 and 0-15 Megohms. Maroon case with red and silver panel, attached handle. Dealer Net Price, \$19.65

For Catalog Write—Section 816, College Drive

READRITE METER WORKS, Bluffton, Ohio



ELEMENTARY MATHEMATICS

EASY — SIMPLIFIED — PRACTICAL

HERE is a book for the business man, the technician and craftsman explaining and answering every operation and meaning with interpreting illustrations and examples. It is the key to a simple understanding of many perplexing problems in daily life. In clear, positive and definite language, the author popularizes and clarifies every subject and helps the reader to overcome any apparent difficulty in the study of mathematics. A real home study-course in mathematics for the student or the man who wants to achieve proficiency or desire to brush-up on his knowledge.

Entire Chapter on Special Mathematics for the Radio Technician

CONTENTS OF BOOK

- CHAPTER I. Arithmetic—Addition—Subtraction—Multiplication—Division.
 - CHAPTER II. Factoring and Cancellation—Fractions—Decimals—Percentage—Ratio—and Proportion.
 - CHAPTER III. The Metric System.
 - CHAPTER IV. How to Measure Surfaces and Capacity (Geometry).
 - CHAPTER V. Powers and Involutions—Roots and Evolution.
 - CHAPTER VI. Mathematics for the Manual and Technical Craftsman—Thermometer conversions—Graphs or Curve Plotting—Logarithms—Use of the Slide Rule.
 - CHAPTER VII. Special Mathematics for the Radio Technician.
 - CHAPTER VIII. Commercial Calculations—Interests—Discounts—Short Cut Arithmetic.
 - CHAPTER IX. Weights and Measures—Useful Tables.
- "Elementary Mathematics" can be carried readily in your pocket. Send Stamps, Cash or Money Order.

ONLY 50c POSTPAID

TECHNIFAX

1917 S. State St. RC-841 Chicago, Ill.



FREE! RAOLEK'S 1941 RADIO PROFIT GUIDE

Everything New in Radio at Bargain Prices! Radio parts—Sets—Accessories—Ham gear—Electric appliances and supplies—Public Address Systems. Don't Wait—Send for the Big FREE Radolek Profit Guide Now! Save Money at Radolek.

RAIOLEK CO., Dept. C-57 601 W. Randolph St., Chicago, Ill.

TUBES
One RCA 24A;
One RCA 80 Rectifier.

MISCELLANEOUS
Seven in. bakelite tubing, 1 1/2 ins. O.D.;
Five ins. of bakelite tubing, 1 1/2 ins. O.D.;
Two 5-prong sockets, wafer type;
One 4-prong socket, base mounting;
Three tip-jacks, 2 red, 1 black;
Five ft. Belden 5-wire cable;
One 5-contact cable connector plug or tube base;
One Yaxley single-pole triple-throw switch with bar knob 2315-J;
One H. & H. single-pole double-throw toggle switch;

One H. & H. standard on-off toggle switch;
One ICA round knob, 3/8-in.;
One Stancor type 300 P1 power transformer, 40 ma. at 650 V., C.-T.; 4 1/2 A. at 250 V.; and, 2 A. at 5 V.;
One Centralab control, type 72-1041, 0.1-meg., R14;
One 0 to 1 ma. milliammeter. (Jewel pattern) 444, or any 0 to 1 ma. with multivolt scale), M;
One 7 1/2 x 5 in. metal box with 1/4-in. lip on long sides (some plus 1/2-in. wood pieces);
One bakelite panel, 7 1/2 x 5 ins., for meter panel;
One bakelite panel, 4 1/2 in. square, for connecting lugs;
Hardware—screws, etc.

BRIGHTER OUTPUT INDICATION

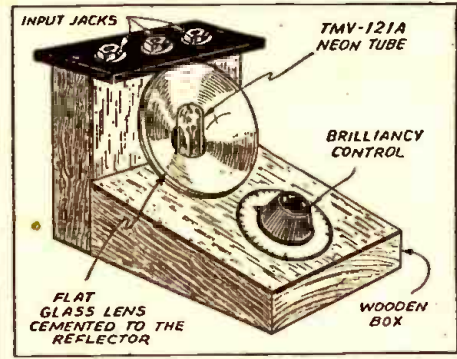

OWNERS of the RCA type TMV-121A neon output indicator will be interested in the writer's device for obtaining greater brilliancy from the neon tube used for indication in this unit.

Finding that low input levels did not produce enough illumination for quick servicing of some receivers, the writer hit upon the idea illustrated here, of arranging the reflector from a flashlight with a neon bulb brought close to the focal point, as shown. It works OK.

JOSEPH SERRET, New York City

NOVELTY CAPACITY METER

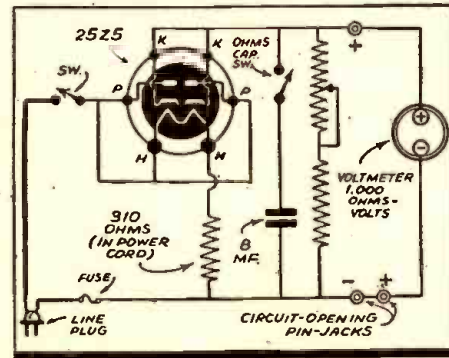

IT IS well known that the rectified voltage output with condenser input is much greater than with choke input. This fact is the basis of the following Capacity Meter which measures the capacity of filter and bypass condensers larger than 0.5-mf., by shunting it across the output of the rectifier.

As an examination of the curves for the 2525 will show, the change in voltage per mf. increases with the load. On the other hand, the heat dissipation of the load also increases. A fair compromise is to operate the tube at half rated load, 50 ma., at which current 100 volts is obtained with an 8 mf.

condenser. The load resistor is a 1,500-ohm, 10-watt unit in series with a 500-ohm, 4-watt rheostat. With no capacity, the output voltage is about 50 volts. The voltmeter is calibrated using known capacities. With this set-up, a low-voltage filter condenser can be measured under operating conditions.

The same device, with an 8 mf. condenser across the load, supplies 100 volts for a Megohmmeter—which is simply the 100-volt range of a 100 ohms/voltmeter. The voltage variation is negligible; the calibration

is, therefore: $X = .1 \frac{I}{1-I}$ megohms (I in milliamperes). The range is from 200 ohms to 5 megs. This is a valuable supplement to the Ohmmeter, which generally goes up to 0.1-100-V meg only, or $X = .1 \frac{V}{V}$ (V in Volts).

Instructions—To measure capacity: throw switch to Cap., connect to voltmeter and insert test leads in + and -. Touch prods to condenser, being careful to observe polarity with electrolytics. Take voltage reading with condenser out and adjust to standard zero point. Read meter with condenser in, and refer to chart.

To measure resistance: throw switch to res., connect to 100-volt range, and adjust to 100 volts. Pull prod from single plus and insert in double plus, which automatically opens the circuit.

SAMUEL EIDENSOHN, Bronx, N. Y.

OPERATING NOTES

ATWATER KENT 555
If the complaint is: "audio frequency distortion," replace the 4 mf. plate filter condenser in the A.F. circuit.

FERRODYNE R-137 and 138
Oscillation or lack of sensitivity on the low-frequency band, and failure to align properly at the low-frequency end of the band (600 kc.), frequently is caused by a defective mica bakelite condenser connected across the oscillator padding trimmer. Its capacity value is 11 mf.

GEORGE F. BAPTISTE, Howard, R. I.

HOWARD 400X and 425
Noisy pushbuttons are a common complaint on these models. Opening the push-button box and cleaning the contacts with an ordinary pencil eraser will do the trick.

On the model 400X, another common trouble is distortion and low output caused by one side of the push-pull output transformer opening. Replace with a new transformer.

LEO G. SANDS, San Francisco, Calif.

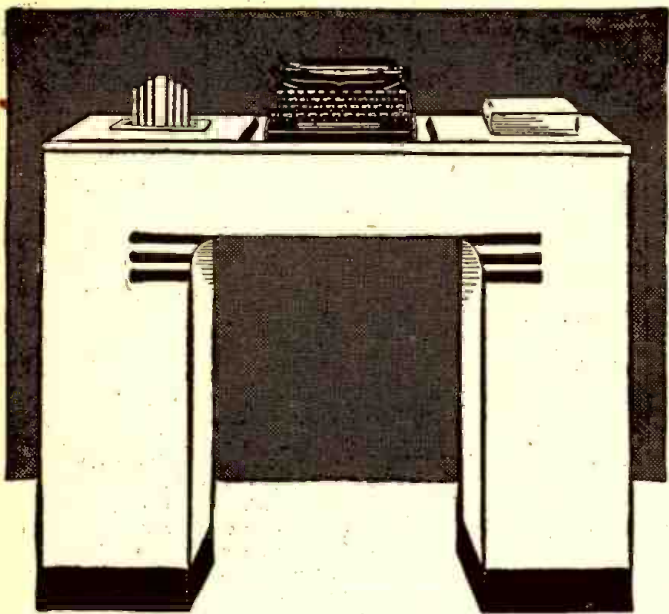

**THIS
BEAUTIFUL DESK
for only \$1.00 EXTRA**

**WITH ANY
REMINGTON
PORTABLE TYPEWRITER**

The
COMBINATION
FOR AS LITTLE AS
10¢ A DAY

How easy it is to pay for this combination of desk and Remington Deluxe Noiseless Portable Typewriter! Just imagine, a small good will deposit with terms as low as 10c a day to get this combination at once! You will never miss 10c a day. Yet this small sum can actually make you immediately the possessor of this amazing office at home combination. You assume no obligations by sending the coupon.

A beautiful desk in a neutral blue-green which will fit into the decorations of any home—trimmed in black and silver—and made of sturdy fibre board—is now available for only one dollar (\$1.00 extra) to purchasers of a Remington Noiseless Portable Typewriter. The desk is so light that it can be moved anywhere without trouble—it is so strong that it will hold six hundred (600) pounds. With this combination of desk and Noiseless Deluxe Portable Typewriter, you will have a miniature office at home. Learn the complete details of this offer. Mail the coupon today.

THESE TWO EXTRA FOR YOU

LEARN TYPING FREE

To help you even further, you get free with this special offer a 32-page booklet, prepared by experts, to teach you quickly how to typewrite by the touch method. When you buy a Noiseless you get this free Remington Rand gift that increases the pleasure of using your Remington Noiseless Deluxe Portable. Remember, the touch typing book is sent free while this offer holds.



SPECIAL CARRYING CASE

The Remington Deluxe Noiseless Portable is light in weight, easily carried about. With this offer Remington supplies a sturdy, beautiful carrying case which rivals in beauty and utility the most attractive luggage you can buy.



SPECIFICATIONS

ALL ESSENTIAL FEATURES of large standard office machines appear in the Noiseless Portable—standard 4-row keyboard; back spacer; margin stops and margin release; double shift key and shift lock; two color ribbon and automatic ribbon reverse; variable line spacer; paper fingers; makes as many as seven carbons; takes paper 9.5" wide; writes lines 8.2" wide. There are also extra features like the card writing attachment, black key cards and white letters, touch regulator, rubber cushioned feet. These make typing on a Remington Deluxe Noiseless Portable a distinct pleasure. Thousands of families now using the Remington Deluxe Noiseless Portable know from experience how wonderful it is!

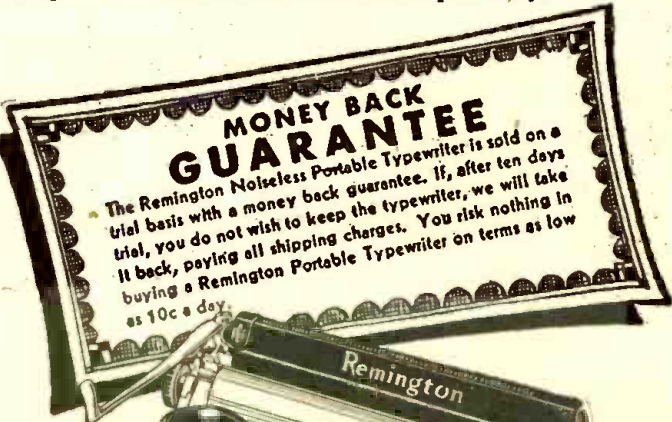

**MAIL
COUPON
NOW!**

Remington Rand Inc., Dept. 189-B
465 Washington St., Buffalo, N. Y.

Tell me, without obligation, how to get a Free Trial of a new Remington Deluxe Noiseless Portable, including Carrying Case and Free 32-page Typing Instruction Booklet on terms as low as 10c a day. Send Catalogue.

Name.....

Address.....

City..... State.....

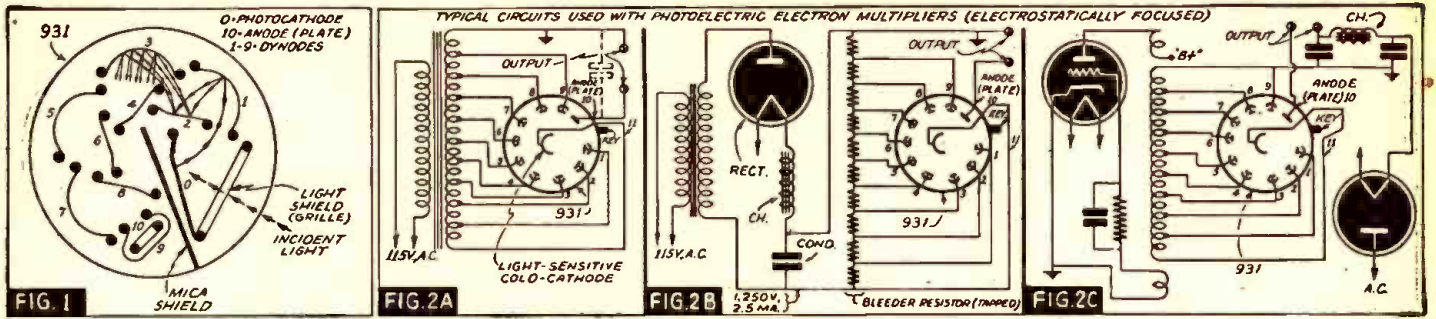

Fig. 1, Sectional view (schematic arrangement), from top, of the 931 electron-multiplier phototube; Fig. 2, typical circuits used with electron multipliers of the electrostatically-focused type.

TYPE 931 ELECTRON-MULTIPLIER PHOTOTUBE

This article describes in more detail the new type of phototube first shown, in RADIO-CRAFT, on page 586 of the April 1941 issue. The photocurrent produced at the light-sensitive cathode is multiplied as much as 1/4-million times (nearly) by secondary emission occurring between the 9 successive electrodes or "dynodes" within the tube. The applications of this type 931 tube, based on its higher sensitivity to blue-rich than to blue-deficient light, are described.

FOR those who have often wished for a photo-sensitive tube which would be sensitive to extremely small amounts of light, give sufficient current output to operate a relatively inexpensive meter or a relay directly, and supply sufficient voltage swing to operate an output power tube for a loudspeaker, a powerful electromagnet or a recording mechanism, the new electrostatically-focused Electron-Multiplier Phototube (see photo) manufactured by RCA Manufacturing Co., Inc., in Harrison, N. J., will be of great interest.

931

This RCA type 931 Multiplier utilizes the new photosensitive cathode now familiar because of its use in the 929 phototube to a large number of experimenters and industrial engineers. This cathode has high sensitivity to tungsten light of normal temperatures and provides extreme sensitivity to actinic radiation.

The principle of electron multiplication employed in this tube makes it practical to

amplify the feeble currents produced by small amounts of light as much as 230,000 times! The final amplified current can be as much as 2.5 milliamperes and provide over 50 volts of undistorted signal in the output circuit.

By no means a minor feature of the tube is its ability to amplify modulated currents of frequencies well into the ultra-shortwave spectrum with the same ease as it handles unvarying currents. Furthermore, these benefits are obtained with a good signal-to-noise ratio; the tube actually makes possible measurements of lower light levels than can be attained with the conventional phototube circuits.

9 STAGES

One would imagine such a tube must be a complicated and tremendous device. However, this is far from the truth; this powerful new electronic tool is contained in a small tube only about 3 1/2 inches high by slightly over 1 1/4 inches in diameter. All leads are brought out through an 11-pin

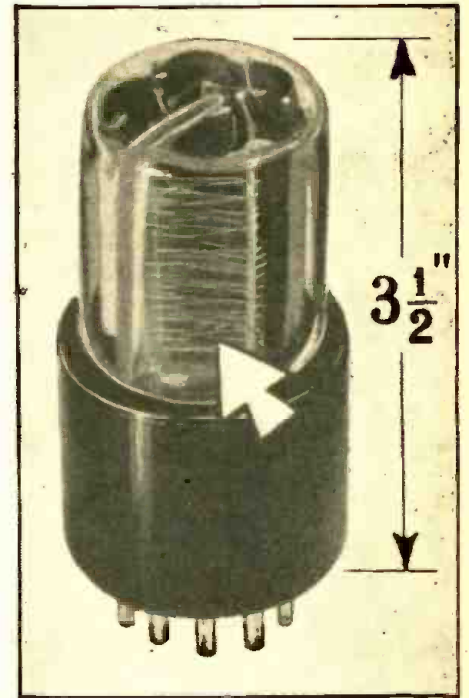

The 931 tube incorporates 9 stages of voltage amplification in an envelope only 3 1/2 inches high! The arrow is pointing to the light-sensitive cathode, or terminal 0 (the photo-cathode) shown in Fig. 1.

base. These provide for connections to the photo-cathode, the 9 stages of amplification, and the anode, or collector.

The internal structure is illustrated by the sketch of Fig. 1 which shows a view of the tube from the top. When light strikes the photo-cathode 0, electrons are emitted and are directed along curved paths by the fixed electrostatic fields to the first sec-

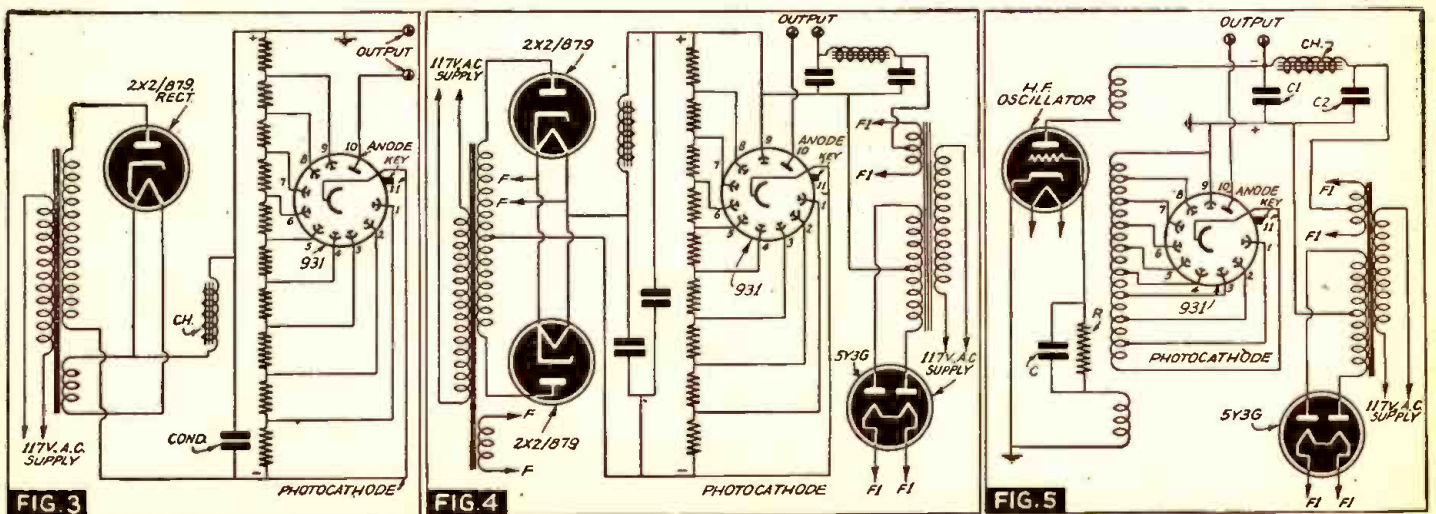
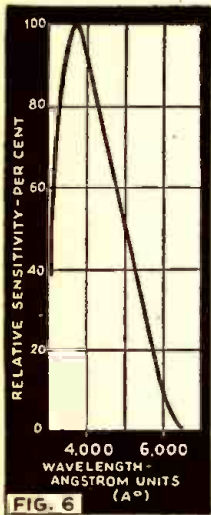

Fig. 3, simple half-wave rectifier power supply, with bleeder, delivering D.C. to the 931; Fig. 4, full-wave circuit delivering D.C. to dynodes 1 and 9 and separate D.C. for the anode stage; Fig. 5, this circuit shows the use of H.F. oscillators for feeding A.C. to dynodes 1 and 9, and separate D.C. for the anode stage.



Spectral sensitivity characteristic of the 931 phototube utilizing a type S4 photo surface in a lime-glass bulb. The sensitivity is given in $\mu\text{A.}/\mu\text{W.}$ radiant flux at $3,750 \text{ A}^\circ$ at 100 V. per stage. The 931 employs the S4 photosurface which, it is seen, has higher sensitivity to blue-rich light than to blue-deficient light.

useful. The circuit in Fig. 3 utilizes a half-wave rectifier to provide the D.C. voltages for the 931. A choke-input filter is employed to improve regulation. In applications where excellent regulation particularly for wide variation in output current of the 931 is required and where minimum hum modulation is essential, the circuit in Fig. 4 may be used. In this circuit, the D.C. power supply is arranged so that the dynode voltages are furnished by the 2X2/879 rectifiers while the anode-stage voltage is supplied by the 5Y3G rectifier.

In certain audio-frequency applications, such as sound-track reproduction, the circuit in Fig. 5 is of special interest. In this circuit, the dynodes are supplied with A.C. voltage from an oscillator at a frequency considerably higher than the uppermost signal frequency. The anode voltage is most economically obtained from a separate low-voltage, D.C. source. Under these conditions, the output of the 931 consists of a series of rectified pulses occurring during the positive halves of the cycles. Each voltage pulse produces tremendous gain as its instantaneous values near its peak value. Because of this tremendous increase in gain, the A.C. sensitivity is nearly equal to the D.C. sensitivity for the same r.m.s. values.

As previously stated, the multiplier gain rises rapidly with increase in electrode voltage. It follows that the multiplier gain will vary considerably with voltage fluctuations, an effect which can be minimized, however, by a judicious method of feedback.

SUMMARY

The 931 phototube which RCA has developed may be briefly described as being a new type of phototube in which the photocurrent produced at a light-sensitive cathode is multiplied many times by secondary emission occurring between 9 successive dynodes (or specially-shaped electrodes, coated to provide secondary emission to a succeeding electrode) within the tube. It is capable of multiplying feeble currents produced by weak illumination as much as 1/4-million times! Focusing of the electron stream is accomplished electrostatically within the tube.

Because of its small size, rugged construction, enormous sensitivity, low noise level, low dark current, freedom from distortion, and relatively low cost, the 931 has practical application in light-operated relays, in sound reproduction from films, in facsimile transmission, and in other operations involving high-quality optical signals.

This form of photoelectric electron multiplier promises to find many important and wide-spread applications wherever a compact, extremely sensitive photo-amplifier of simple construction is needed.

Tentative Data
 Direct interelectrode capacities (approx.):
 Anode to dynode No. 9 3.5 mmf.
 Anode to all other electrodes 6.5 mmf.
 Max. dia., 1 5/16 ins.; bulb, T9; base, small-shell submagnal 11-pin; mounting position, any.
 Cathode photosurface, S4; cathode window area, 0.25-sq. in.

Maximum Ratings and Characteristics
 Anode-supply voltage (D.C. or peak A.C.) 1,250 max. volts
 Voltage between dynode No. 9 and anode 400 max. volts
 Anode current 2.5 max. ma.
 Anode dissipation 0.5-max. watt
 Ambient temperature 50 max. °C
 Typical operation:
 Voltage per stage 100 125 volts
 Sensitivity \square° 0.6 2.3 amp./lumen
 Amplification \diamond° 60,000 230,000

*Referred to cathode.
 \square° For conditions where a Mazda projection lamp operated at a filament color temperature of 2,870°K is used as a light source. The method employed for determining sensitivity made capacity effects negligible. A light flux of 0.002-lumen and a 0.01-megohm load were used.
 \diamond° On basis of lighted cathode area of approximately 7 sq. mm. (3 mm. in diameter).
 \diamond Ratio of anode sensitivity to cathode sensitivity.

ondary emitter (called a "dynode") where each electron which strikes this electrode will knock off many other electrons, the number depending on the speed of the electron as it strikes the dynode electrode. This multiplying process is repeated as each new electron reaches the next successive dynode, until a greatly amplified number of electrons are emitted by dynode 9 and collected by the final anode, 10.

This process of making one electron start a chain of events which will finally give a great multitude of electrons can be visualized by remembering how a tiny pebble can cause an avalanche when given the correct conditions on a steep slope covered with loose earth, pebbles or snow. In this multiplier, however, control of the electron "avalanche" is maintained at all times.

ELECTRONIC MAGNIFICATION

The voltage for each stage of the multiplier tube is made equal, but as in all directly-coupled D.C. amplifiers, the anode voltage of each succeeding stage must be higher than that of the previous stage. The gain of the multiplier increases rapidly as the voltage is increased, a fact which makes possible large amplification with only 9 stages and a reasonable voltage supply. The peculiar shape of dynode 9 prevents electrons from straying out of its range with change in collector potential. The collector is actually a grid which allows electrons to pass through it to dynode 9. Since the voltage between dynode 9 and the collector is non-critical, the use of a high load impedance becomes possible. The mica partition shown in Fig. 1 prevents ion and electron feedback.

The diagram of Fig. 2 shows how simply the connections to this new tube can be made. Figure 2 illustrates the connections to a uniformly-tapped transformer. The sensitivities of the multiplier tube for A.C. and D.C. voltages having the same r.m.s. values are approximately equal, a feature which makes this circuit of benefit in relay work. However, since the signal-to-noise ratio is definitely better for D.C. operation than for A.C., the circuit of 2B is preferable for sensitive measurements. A circuit such as Fig. 2 which utilizes a high-frequency oscillator as a source of voltage is found useful for sound movie work. It is usually found most economical in high-frequency voltage operation to use a separate source of low-voltage D.C. to supply the collector (plate), as illustrated in Fig. 2, and this artifice may sometimes be found advantageous for D.C. operation as well.

CIRCUITS

For sensitive measurements and in applications where a low signal-to-noise ratio is important, the circuits in Figs. 3 and 4 are

to obtain
Superior Performance

WITHOUT ADDITIONAL COST

ALWAYS USE

Meissner

PRECISION - BUILT PRODUCTS

Progressively Engineered

for the

Servicemen

Radio Amateur

Sound Engineer

and Experimenter

Write for Free 48-page Catalog

DEPT. C-8



YOUR CHOICE



of these two popular writing instruments for only \$1.50, postpaid by insured \$1.50 mail to any U.S. (or Canadian) address, delivery guaranteed.

Illustration at left (2-3 size) shows our high grade safety self-filling Fountain Pen fitted with guaranteed solid 14 kt. gold iridium tipped pen.

Illustration at right (2-3 size) shows our solid 14 kt. hardened gold point safety self-filling Ink Writing Pencil. Ideal for carbon copying and all writing purposes.

Both items in an attractive satin lined gift box to one address for only \$2.50.

Encourage the boys in training camps to write home by remembering them with this splendid writing set. Delivery guaranteed.

Guaranteed against imperfections in materials or workmanship, either item will make an Ideal Gift for school opening, Christmas, birthday, or any occasion. Remit by check, P. O. or Express money order.

Laughlin Mfg. Company,
 954 Majestic Bldg.,
 Detroit, Michigan

Agents Wanted

272 PAGES, ONLY BOOK OF ITS KIND! The 1941 edition of the Sylvania Tube Complement Book is now ready. Indispensable to the serviceman. Contains tube replacement information for 100,380 tubes or sockets, THE FIRST AND ONLY COMPILATION OF PANEL LAMP NUMBERS EVER ATTEMPTED, and wealth of other material. Patented Wire-O binding allows you to open book without cracking or tearing. Send 35c to Hygrade-Sylvania Corp., Dept. RC80, Emporium, Pa.

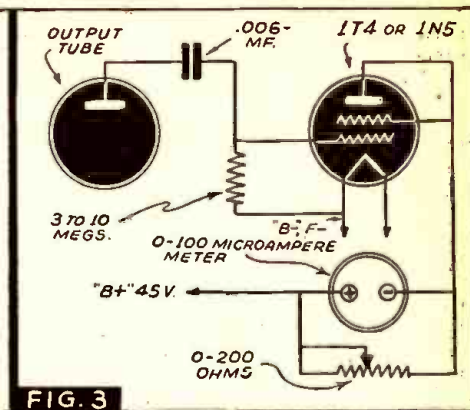
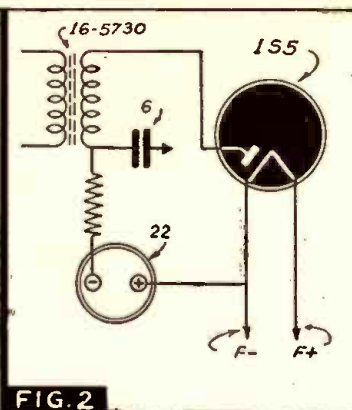
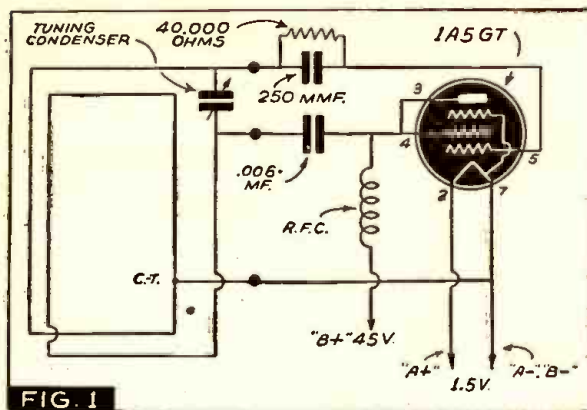

Construction Hints and Experiences with METAL-TREASURE LOCATORS

A Metal ("Treasure") Locator specialist, tells RADIO-CRAFT readers the cures for many of those tantalizing problems which frequently beset the builders of these instruments, including types described in past issues.

G. M. BETTIS

IN building a Locator from construction articles that have been published in radio magazines (including past issues of *Radio-Craft*) there are many questions that seem to trouble quite a few constructors. I will try to cover some of these points as I have found them. Some of the remarks I will make concern the general characteristics of Metal-Treasure Locators as they appear to me.

FREQUENCY

First I will cover the frequency of operation. My experiments are with frequencies later referred to as *low* of 175 kilocycles (kc.) and as *high* of 3,000 kc. The band of from 550 to 2,050 kc. is usually skipped when building these low-power portable transmitters and receivers used in Locators because of possible interference from strong commercial and amateur stations.

The lower frequencies are better for larger objects that are deep in the ground and the lower frequencies are also more stable to operate.

The higher frequencies are better for Locators when they are designed to locate small objects at shallow depths but they are harder to operate properly because of the capacity effect which makes them very hard to stabilize.

Therefore the lower-frequency locators are more practical for most jobs this type instrument is called upon to do. They are very sensitive and quite selective as to the exact location of buried metal objects. Their use in determining the exact location of buried pipe-lines makes these Locators valuable and useful to a wide field of concerns.

In reference to the "radio balance" type of Locator: when the Transmitter and Receiver units are placed closer to each other, greater sensitivity to small objects of shallow depth is obtained; increasing the distance of Transmitter and Receiver from each other will increase the depth range, but to much larger objects.

This will therefore necessitate a compromise for most practical uses. The transmitter power will have to be small for close spacing as there will be difficulty in tuning to a balance, or near-zero signal, with too much power being generated by the transmitter.

COIL CONSTRUCTION

The coils of the transmitter and receiver seem to be quite a problem to some who wish to construct Locators.

A coil to tune to 175 kc., and measuring $12\frac{1}{2} \times 14\frac{1}{2}$ as used in the "Metal-Treasure Locator" described in the December, 1940, *Radio-Craft*, had 44 turns of No. 21 enameled wire and was center-tapped; tuning was accomplished with a (dual) 300 mmf. and a 100 mmf. variable condenser. The wire size is not critical but it is best to use as large wire as practical because of resistance to these low-powered jobs. The total length of wire in one coil is 198 ft. The total capacity used is 700 mmf.

To make a coil of different size to tune to the same frequency I use the same tuning capacity and number of feet of wire which will work when there is not an unreasonable variation in the size of the coil. A fixed, mica-dielectric condenser of 500 mmf., and a 200-mmf. trimmer condenser, will usually tune to resonance if care is used in making the coils.

To figure a coil for a higher frequency I use the old ratio-and-proportion method which is reasonably accurate. This is done by converting kilocycles to meters (by dividing 300,000 by the kilocycle figure.—Ed.)

The coils I build are tested by connecting them to a Hartley oscillator as shown in Fig. 1, and checking on a broadcast receiver. A 175-kc. coil will generate harmonics that can be heard on 700, 875, and 1,050 kilocycles on the regular broadcast radio receiver. It is important to know that the coils to be used will tune to resonance at the desired frequency.

The tuned-radio-frequency or T.R.F. coils used are usually I.F. transformers, and usually have to be properly aligned to give maximum results. This can be done by ear but I will suggest that the receiver section be aligned by a radio Serviceman who has the proper equipment and is familiar with this job.

There should not be too much shielding in the receiver and none in the transmitter. If too much shielding is used in the receiver—especially close to the loop or around the loop—there will be no, or only slight, pickup of the transmitter signal when the ap-

paratus is finally assembled for operation.

Just a word here to say that I have found it is well worth while to use standard, high-grade parts. The same value of different brands will work but the use of one defective part or one faulty connection may spoil what was otherwise a good construction job. Good parts are cheaper, when all is said and done; and the results are better, when a little care is taken during the process of construction.

The diode detector and audio circuits need no special discussion as they are well known.

NOTES

There was an error in the article—in the December, 1940, *Radio-Craft*—on the "Metal-Treasure Locator," in Fig. 15, which gives information on alignment with a 100-microampere meter in the diode circuit of the receiver unit. It should have appeared as shown in Fig. 2.

The meter circuit I find simple and very easy to use with the least amount of trouble, yet which is very sensitive, is the one shown in Fig. 3.

The Miniature-type 1S4, 1S5, and 1T4 tubes used in the Dec. '40 Locator are quite efficient when using only 45 volts on the plates. Care should be taken to prevent any sort of strain on the prongs of these tubes.

The 1.5-volt tubes, types 1G6GT, 1A5GT, 1N5GT, etc., also the Lock-in tubes especially designed for portable equipment—the types 1LN5, 1LA4, 1LD5, 1LC5, etc., are very desirable as they require only a 1.5-volt "A" cell and operate on 45 to 90 volts "B" battery. Of course there were quite a few Locators built using the type 30 and 31 tubes but they are practically obsolete now.

The self-modulated oscillators of the earlier-type Radio Balance Locators, and all that I have noticed published in *Radio-Craft* other than the one in the Dec. '40 issue, do not have the efficiency of high-level, plate-modulated oscillators, which require a source of audio signal; I chose a practice oscillator similar to that used to learn code.

I will now comment on some of the Metal ("Treasure") and Ore Locator construction articles that have appeared in *Radio-Craft*,

during the past few years, that I have had some experience with.

"An Improved Treasure Locator," in the Aug. '34 *Radio-Craft*, was a pretty good model in its day, but the one thing that was the "headache" or "bug" to most constructors was the proper positions of the R.F. chokes in the plate circuits of the first 2 tubes of the receiver to control the regeneration. This was the success or failure with many. A fair job in its day.

"The Newest in Treasure Locators," in Oct. '35 *Radio-Craft*, would work to a certain extent to shallow depths but it was almost impossible to keep tuned and was not very practical for many to use.

"The Newest in Treasure Locators," Dec. '36 *Radio-Craft*, was an improved Balance-Type Locator, and in its day would do good work. The R.F. chokes used were still unexplained for the average constructor as to importance of their proper adjustment of positions for regeneration. Also there were no instructions on the use of a turnbuckle on the transmitter, to tune and anchor firmly, so the instrument would stay tuned. The most sensitive spot was to tune slightly off zero signal with the top of the transmitter slightly forward which would produce a weak signal in phones and a slight deflection on meter. This is true of all *balance-type* Locators.

"How to Make a Modern Radio Treasure Locator," in Sept. '39 *Radio-Craft*, failed to produce results for me consistently. The boxes were bulky, the mechanical arrangement could have been greatly improved upon.

All of the Radio Balance type of Locators will operate much better when extension handles are used to carry the Locator within one foot of the ground or less.

In conclusion may I stress the importance of using good parts, and the necessity of careful construction by a technician who knows how to build radio apparatus. By this I mean that one who has never had any experience constructing radio apparatus of any kind can hardly expect to get the parts and throw them together, and any more than just hope that they will work; instead, there is definite need for the knowledge of at least the general principles of good radio construction. Most of the complaints and questions come from those who want a Locator to use but who know very little about what they are trying to construct. One solution is to call in a good radio technician for the construction.

I hope the above remarks, based on my experience with Metal-Treasure Locators, will be of practical help to others interested in building such instruments.

OPERATING NOTES

(See Pages 79 and 85 for other Notes)

Trouble in . . .

. . . . ZENITH 5810, 5811, and 5719 Chassis
Set was very weak with voltages far below normal. This condition is very often due to decrease in capacity of electrolytic condenser C19 which is a 30-mf. 250-volt unit. Hum level is still very low even if the capacity of this condenser is low, but as this set uses a voltage doubler circuit and the current handling ability of this circuit is limited by this condenser, use only a 30-mf. 250-V. unit for replacement.

. . . . GENERAL ELECTRIC HJ618 A.C.
I have had 3 of these sets that came in with the complaint of being weak, and off-calibration. Set would not align properly and on checking-over the chassis with the service sheets I found a 0.004-mf. mica condenser connected from junction of C3 (a padder condenser) and C16 (a 47-mmf. condenser) to ground. This condenser is not shown on the G.E. service sheets and when it was removed the set aligned perfectly and the owners remarked that these sets "played better than when they bought them."

. . . . GRUNOW 12B Chassis
Set dead with smoke coming from chassis due to a shorted 0.1-mf. 400-V. condenser (Part No. 28726) which is located under the shield covering the tuning coils. This shorted condenser causes the 500-ohm 3-watt carbon resistor located near the rear of the chassis to burn up. Replace this condenser with a 0.1-mf. 600-V. unit, and replace the resistor with a 500-ohm 10-watt unit. Intermittent reception may be due to a defective cathode condenser on the 6K7 R.F. tube. This is a 0.01-mf., 400 V. unit, part No. 29135.

. . . . RCA MODEL 9K3
This set came in with the complaint of intermittent and choked reception. This would happen sometimes 2 or 3 times in an hour and then again not for days. Trouble was traced to the compensator pack which is located on the right front edge

of the chassis. This pack consists of condenser C38, C39 and C40, and resistors R12 and R14. As I could not purchase a replacement part I made one up using two 0.01-mf. and one 0.05-mf. 600-V. condensers and a 25,000- and 40,000-ohm resistor.

HARRY HUDSON,
Detroit, Mich.

. . . . GRUNOW 12B and 12W
In 13 cases of this model coming into the shop for fading, 12 times the trouble has been traced to the 0.05-mf. bypass condenser, bypassing the grid-return of the 1st I.F. transformer (factory part No. 30143 later changed to No. 34436).

The cause is the condenser installed between 2 lugs, the pigtail wires of which drawn taut, thus pull loose from the foil. Remedy: Install a new condenser, loosely. A complete cure has been reported on all 12 sets so repaired.

SCOTT MAYTAG CO.,
H. D. Coffman, Service Manager,
Phillippi, W. Va.

. . . . G. E. M42 (Same as RCA 103)
Sets of this model sometimes motorboat on the last-quarter position of volume control, and reception then stops. I have had several of these and nothing is wrong except alignment. Align carefully, and set is as good as new.

. . . . PHILCO 45
"Intermittent, when first turned on, and every hour or so cuts out," was the complaint. This set was in 4 other service shops, one of them a Service Engineer for the Distributor of a nationally-known set, who said the only cure was to replace ALL of the condensers, as they all tested OK with his instrument.

However I found the trouble by substitution. Replace the bakelite block, Philco Part No. 4989Z containing two 0.09-mf. condensers, with two 0.1-mf. 600-V. paper tubulars; then align the set, and the trouble is gone.

R. J. SCHOONMAKER,
Port Jervis, N. Y.

FREE
180 PAGE
CATALOG
SEND
FOR IT
NOW!

**EVERYTHING
IN RADIO**
At Lowest Prices!

**EVERYONE IN RADIO
NEEDS THIS BOOK!**

Service man, Dealer, P.A. Man, Amateur or Builder, get your ALLIED Catalog now! It's the most complete Radio Catalog out today—your Guide to real savings on everything in Radio!

50 NEW SETS. Real Radio hits—3-Way Personal Portables, phonographs, home recorders, auto radios, amateur sets, etc.

NEW P.A. Great new sound Systems—7 to 75 watts—for Churches, Orchestras, Schools, Churches, etc. New ideas—new amplifiers—new low prices—Time Payments—15-Day Trial, etc.

SERVICEMEN. New Test Equipment—tools and gadgets—more than 15,000 quality replacement parts. Big Special Bargain Section, too! Feature values.

BUILDERS. Count on ALLIED for all the new kits and builders' supplies. You can depend on ALLIED as your Radio Supply Headquarters because ALLIED is the 100% Radio House that's always at your service.



ALLIED RADIO CORP.

833 W. Jackson Blvd., Dept. 2-H-1
Chicago, Illinois
Send me your FREE 1941 Radio Supply Catalog.

Name

Address

City State

★ ★ **SOLAR** ★ ★

SERVES THE SERVICES

Solar is proud of . . . and is zealously guarding . . . the reliability which its Capacitors add to radio and electrical control equipment for the Armed Service Branches of our Government. Solar reliability is built into all types of electrical condensers for industrial, radio and service applications.

SOLAR Mfg. Corp. Bayonne, N. J.

20 TIMES EASIER FOREIGN TUNING!
with **SUPER BAND SPREAD CHASSIS**

9-BANDS {DIAL SCALES} ON 6

REPLACE YOUR OLD CHASSIS WITH THIS NEW 1942 MIDWEST

30 DAYS TRIAL

FACTORY TO YOU SAVES YOU UP TO 50%

UP TO \$50.00 TRADE-IN

WRITE for his FREE catalog. New 1942 models include Radios, Radio-Phones, Home Recorders. Sensationally low factory-to-you prices: \$9.95 to \$199.50 . . . up to 16 tubes. (User Agents Wanted).

COMPLETE \$19.75 WITH SPEAKER, TUBES, PUSH-BUTTON TUNING, MAGNA Tenna LOOP Aerial. READY TO PLAY

MIDWEST RADIO CORPORATION
DEPT. 12-B CINCINNATI, OHIO

A New Subscription Offer!
Full Library Size Webster Dictionary FREE!
See Page 84.

UNIQUE THEATRE SOUND-CONTROL

Using Subsonics, Reverberation and the "Vocoder"

The results of the Second Sound Show, presented in the Theatre of Stevens Institute of Technology, Hoboken, N. J., last month, are described in this article. This Show, which demonstrated the latest developments in the use of Sound in the theatre, included tests of phenomena not previously employed on the legitimate stage or for opera, namely the uses of (1) subsonics, (2) reverberation control, and (3) the re-made human voice.

HAROLD BURRIS-MEYER

THE theatrical uses of (1) subsonics, (2) reverberation control, and (3) the re-made voice, were tested for the first time in legitimate production at a recent experiment—the Second Sound Show (the First Sound Show was presented in 1934)—conducted in the Theatre at Stevens Institute of Technology.

SUBSONICS

Subsonics were achieved by producing a signal with the thunder screen, filtering out all frequencies above 16 cycles per second, and reproducing the signal through loud-speakers fastened to the underside of the theatre floor.

The signal thus reproduced was employed to establish the rhythm of the drumbeat in Eugene O'Neill's THE EMPEROR JONES before the drum became audible, and to give it throughout the episode a nondirectional, all-pervasive quality. Subsonic drum was found to be extremely critical in that the threshold of sensation was only 3 db. below the threshold of audibility.

REVERBERATION

Reverberation control was achieved by picking up music from orchestra, organ, singers and chorus, in the church scene in Gounod's FAUST, recording the music on steel-tape and reproducing it from a number of pickups so spaced and attenuated as to simulate reverberation. The spatial quality achieved by predetermined reverberation gave the scene a validity which it is impossible to secure by conventional means.

A similar technique was employed to add reverberation to the organ performance of Widor's TOCCATA in F.

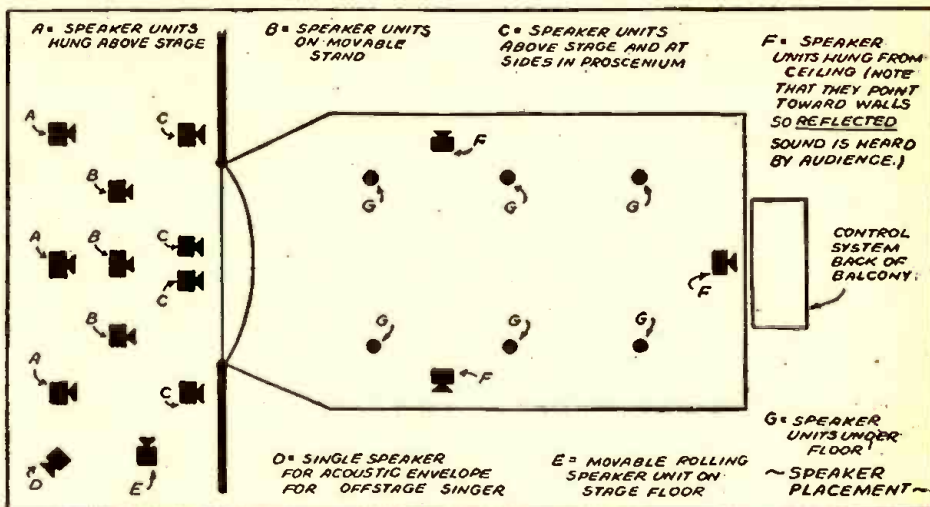

Rough sketch of the speaker placement in the Theatre of Stevens Institute of Technology.

The steel-tape reverberation device has the advantage of a considerable degree of flexibility. The heads may be so spaced and attenuated as not to re-enforce the normal reverberation of the theatre and to produce any decay characteristic which may be artistically desirable, whether or not that be an exact imitation of nature.

For example by wide spacing of the pickup heads, it is possible to achieve an echo repeated as many times as may be necessary. The echo was first tried out in the Metropolitan Opera House last October, and employed in the Stevens production for comic effect when applied to a speech by the master of ceremonies.

RE-MADE VOICES

The re-made voice differs from the filter microphone technique which was also pioneered at Stevens, and which is now used in many radio programs, in that the voice is used to modulate another sound which can be produced from any standard source, or generated by a number of oscillators of various kinds, on an instrument called the "Vocoder" (The progenitor of the *Voder.—Ed.), a development of the Bell Telephone Laboratories.

The Vocoder was used to synthesize the frequency spectrum of an ass's voice. The

*See "Manufactured Speech," Radio-Craft, April 1939.

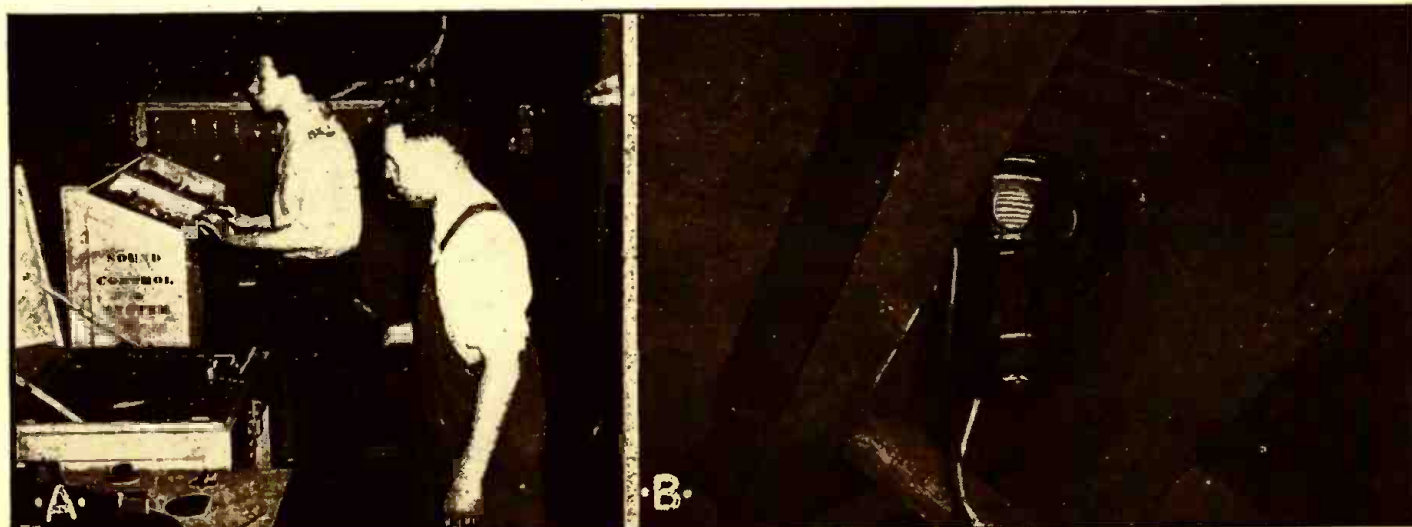

In A, we see Geo. Euler, '41, and Otto Niederer, '42, 2 of the men in the Sound Department, at the controls. At B is shown one of the under-floor loud-speakers used in producing the subsonic vibrations in the rendition of THE

EMPEROR JONES, Scenes 1 and 2, in which this Subsonic Drum is used to establish cadence before the Audible Drum is heard. It is one of the 6 loud-speakers, for this theatrical illusion, shown in the sketch above.

sound thus produced was modulated by the speech of an actor to speak the lines of Bottom in A MIDSUMMER NIGHT'S DREAM when Bottom wears an ass's head. The actor playing Bottom spoke in his own voice except during the episode in which he is transformed. During that episode, the ass's voice was dubbed onto him from speakers placed upstage.

The Vocoder was also used to synthesize arbitrary voices for the Witches in the Witch Scenes in MACBETH, to allow Ariel to speak with the voice of thunder in THE TEMPEST and to give a musical quality to the laughter of Lazarus, in Eugene O'Neill's LAZARUS LAUGHED. A chord played on the organ was modulated with laughter and also mixed with the original laughter. Relative intensities of original laughter, re-made laughter and original music provided the necessary variation for the episode.

The voices produced with the Vocoder were dubbed to actors moving about the stage through individual control of a number of outputs and were moved about the house where Ariel flies in the air, and rose up out of the orchestra pit in LAZARUS LAUGHED.

CONTROL SYSTEM

The Stevens Sound Control System employed in the experiments has 8 outputs of 50 watts each. More than 60 loudspeakers were used in various locations onstage and in the theatre. Control was located at the back of the balcony where the operators could both see and hear the show.

Frequency range of the system is flat from 30 to 16,000 cycles and a frequency discrimination network provides sharp attenuation for octaves through the audible range. Of the phenomena tested in the experi-

mental production, only 2 seem to have immediate application to radio. The re-made voice increases the scope within which speech may be used to convey intelligence and, at the same time, establish atmosphere, mood and contribute to the progress of the play. It seems to be most effective when the sound modulated by the human voice is of such a nature as to re-enforce or supplement the intelligence as conveyed by the lines.

Reverberation control as conventionally employed in radio does not permit much variation from the standard sound decay curve found in reverberant rooms. By employing the steel-tape recording and reproducing device, the reverberant sound may bear any dynamic relation to the original that is artistically appropriate, and the echo becomes not only possible but susceptible of infinite variation.

Subsonics have no radio use at the moment because of the limitations of the broadcast band and the loudspeaker in the receiving set. (Maybe this is where Frequency Modulation comes in.—Editor)

All the techniques employed have been assumed by people of the theatre to offer an opportunity for more effective production of the plays involved than is possible by conventional means. Their usefulness can be determined only by the extent to which audiences accept the Show as a show. If the audience's attention is monopolized by acoustical tricks, the experiment will be to a large extent a failure. The intention has been to control the sound only to the extent which most clearly seems to carry out the intention of the playwright. In the case of THE TEMPEST and LAZARUS LAUGHED, there are specific demands in the script for the techniques employed though they did not exist at the time the plays were written.

Features in August RADIO & TELEVISION

- A Beat Oscillator for the Ham Beginner—L. M. Dezettel, W9SFV
- "End-Fed" Zepp for Receiving—R. H. Newkirk, W9BRD
- AM Audio System and Modulator for "Pull-Swing" FM Transmitter—Ricardo Muniz, E.E., Donald Oestreicher, Warren Oestreicher
- 600-Watt Deluxe Transmitter—Larry LeKashman, W2IOP
- How to Practice the Code—L. B. Robbins
- Your "First" Short Wave Set—Wm. J. Vette
- "CQ"—News of the Hams—Larry LeKashman, W2IOP
- Question Box
- Short Wave "DX" Tips—Joe Miller
- "March of Radio"—Robert Eichberg
- A Dual-Purpose Public-Address System—Andrew Tait
- Battery-Operated Short Wave Receiver—Joseph Hiatt
- Radio Kinks
- Radio Patents of the Month
- Drafting the Amateur Station for National Defense—W2IOP
- A Telesvisor YOU Can Build—Ricardo Muniz and S. Morton Decker
- Recording with a High-Fidelity Amplifier—Herman Yellin, W2AJL
- Building a Practical E.C.O. (Electron Coupled Oscillator)—John T. Wilcox, W2CLS
- International Radio Review
- "Television News"
- Ultra High-Frequency "Pocket" Receiver—George F. Baptiste

NEWS ITEM

The American Radio Relay League last month earmarked \$10,000 as a special "Defense fund." It was appropriated for use in carrying out a program concerning the A.R.R.L.'s activities in close cooperation with the U. S. Government on work of urgent and emergency nature, including the Defense Program. At the same meeting a formal request to the F.C.C., to let down the bars to amateur radio experimentation with Frequency Modulation on 29.25 to 30 mc., was drawn up.

Mr. Serviceman!

Get your RSA Membership



FREE!

Now without one cent of cost to you, you can have a membership in the RSA, the only national organization that has the sponsorship of the RMA, the NAB, the Sales Managers' Clubs and the Trade Journals.

This includes the RSA Membership Certificate, the RSA Pocket Membership Card, the House Organ, access to the RSA Technical Helps Bureau, and participation in all the functions and benefits RSA offers!

Act Now! Take Advantage of this Special Offer!

RADIO SERVICEMEN OF AMERICA, INC.

"Reliable Service Assured"

304 S. DEARBORN ST., CHICAGO, ILLINOIS

It's simple! . . . easy! All you have to do is send in 5 memberships of your fellow Servicemen with a \$5.00 bill (that's \$1.00 for each) for 1941 National RSA Dues, and you get your membership Free of charge. Applicants in present chapter areas will be referred to the local chapter.

RADIO SERVICEMEN OF AMERICA, INC.
304 S. Dearborn Street, Chicago, Illinois

- \$5.00 enclosed for 1941 National Dues for 5 memberships in RSA. Names and addresses attached herewith.
- \$1.00 enclosed for 1941 National RSA Dues for single membership.

Name

Address

City State

Radio-Craft—Aug. '41

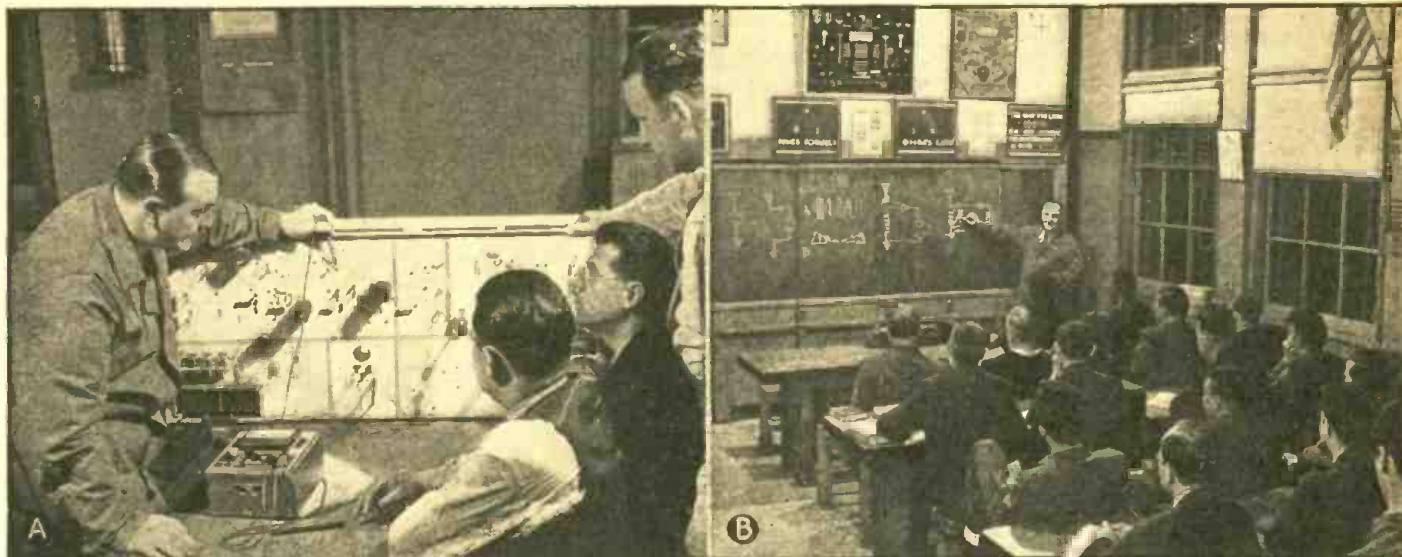

Pictured here are a few students in the Defense Program radio shop class of a metropolitan New York school. They are receiving instruction on the "dynamic demonstrator" built by one of the students. The "board" is an actual working receiver on which troubles may be set up and located.

Shown above is a portion of the Defense Program radio theory class of a Metropolitan New York school. This particular shop and theory class totaled 23 students, all taking the "refreshener" course; of this group, 20 were classed as WPA, 2 employed and 1 unemployed.

In Reply to—

"OUR AILING RADIO DEFENSE PROGRAM"

Last month Radio-Craft presented the article, "Our Ailing Radio Defense Program" in which the author, Leo Fenway, analyzed the present status of enrollees in the radio trainer and "refreshener" courses being given throughout the country as part of the National Defense Program. The question was raised as to whether the present teaching program meets the existing requirements, and to what extent modification of this program may be desirable. Presented here are comments on this article by branches of the government, and New York City, mentioned by Fenway.

FOLLOWING are the comments of those organizations and groups mentioned by Mr. Leo Fenway in his article in *Radio-Craft*, last month, entitled, "Our Ailing Radio Defense Program," dealing with the instruction and "refreshener" courses now being conducted throughout the nation. Of interest are the widely differing viewpoints of the various commentators; and, the references to published literature supplied by the various interested correspondents.

Federal Communications Commission, Washington, D.C.—Comment by a representative of the Commission on the story by Mr. Fenway follows:

"Though passing reference is made to the Federal Communications Commission, the article seems to cover the field of private employment primarily.

"Speaking frankly as a former newspaperman and magazine writer, I feel that the article is somewhat unfair in not taking cognizance of the Government's enrollment of radiomen for military and other services under the present emergency.

"As far as the Federal Communications Commission itself is concerned, our augmented national defense activities have brought about the employment of some 850 additional technicians and other experts. About 500 of this number are being enrolled to supplement domestic monitoring and field staffs, while the other 350 represent a force necessary to operate the new listening posts being established throughout this country and its possessions in cooperation with the Defense Communications Board to record, digest and study foreign shortwave broadcasts.

"You may be interested in the fact that, under date of July 15 last, we invited radio operators generally to apply for temporary positions with the Commission in connection with this emergency program. The response was below expectations, and barely helped fill Commission needs.

"I am reliably informed that even today the Government as a whole is having difficulty in finding radio specialists for the various branches of service.

"For your possible interest, I am inclosing some selected information (*) with particular reference to the respective roles of the Federal Communications Commission and the Defense Communications Board in the present situation."

Defense Communications Board, Washington, D.C.—Noting that *Radio-Craft* had also addressed a letter of inquiry to the Federal Communications Commission, the Defense Communications Board advised that there was nothing further that could be added on behalf of the Board to the reply (reproduced above) *Radio-Craft* received from the F.C.C.

Executive Office of the President, Office for Emergency Management, Washington, D.C.—The reply from this office to the inquiry of *Radio-Craft* was identical to that

(*) The selected information referred to by the Commission included the following: "Announcement Regarding Temporary Positions for Radio Operators in the Federal Communications Commission," "Defense Communications Board," Revision No. 5, February 12, 1941 (a complete description of the Board and its purposes), "6th Annual Report, Federal Communications Commission," Fiscal Year ended June 30, 1940 (With Notation of Subsequent Important Developments), "An ABC of the FCC," "Radio—A Public Primer."

of the Defense Communications Board, and referred to the foregoing reply from the F.C.C.

Board of Education of the City of New York.—Authorities in charge of the Defense Training Program reported on the article by Mr. Fenway as follows:

"The radio courses in the Defense Program have been organized to give intensive training to increase the skills of employable workers for Communications Code and Servicing.

"We have received a commendation for the radio course we are conducting for the Artillery and Cavalry units of the Government forces.

"The paragraph in your proof entitled 'A Course without Fundamentals' is not true with respect to our courses because our courses do contain the fundamentals and we teach the very things that the author says are not taught."**

United States Civil Service Commission, Washington, D.C.—The following is an informal comment on the reply in July *Radio-Craft* received from the C.S.C.—not as comments of the Commission but as those of two individuals.

Comment No. 1: "This article, 'Our Ailing Radio Defense Program,' appears to be setting forth two main complaints. The first

**The following teaching syllabus was enclosed in the letter from the Board of Education: "Emergency Training Program for National Defense—Radio Communications." (Instructions to Teachers of the Radio Classes, including Suggestions for a Series of Approved Jobs for Communications and Code Unit of the Radio Course. The teaching syllabus on Servicing has not as yet been brought to the attention of *Radio-Craft*.)

is that radio mechanics, including persons who have taken Defense courses, are not being absorbed in Defense activities in large numbers. Assuming that this is a true condition, though the author does not present any facts to support the contention, a very reasonable explanation might be that such type of personnel is not needed in excessive quantities. It is difficult to see why industry would not hire to the extent of its needs if persons, properly prepared, are available in large numbers.

"In the matter of whether or not there are great needs in industry for radio mechanics, I am not prepared to express an opinion. No very great demands have appeared in the government set-up, except perhaps for radio inspectors. We have had greater demands than we could fill for radio engineers and, at one time for radio operators as well. Radio monitoring officers, also, were at one time in great demand but the acute situation with respect to these monitoring officers is now corrected and it appears that all needs may be easily met.

"The second great complaint of the author is that the Defense courses are not adequate. In this connection it appears that the author is not too particular in distinguishing between the various types and grades of radio personnel, that is, mechanics, Servicemen, operators, engineers, etc. A course designed for one type should not be expected to qualify all men for any type of position. It is fairly obvious for example that no Defense course of 400 hours can make a radio engineer out of a radio service mechanic; and the same goes, more or less, for other classifications as well.

"Perhaps the author is expecting too much from an abbreviated course such as the Defense courses naturally are. Such courses should be looked upon more as a supplement to in-service training, or as a completion of training previously acquired, or possibly as a "refreshener" for training or experience which has become stale. They are not intended to take recruits without any previous training, like at least two of the men in the author's story, and make finished mechanics, operators, engineers, or monitoring officers out of them.

"Defense courses are intended primarily for industry rather than for government, although the government may well use some of the product. The first reaction of prospective students and school officers too, seems to be to find out for what government jobs the graduates of any course may be accepted. Actually any particular course may not be designed for government jobs at all.

"For these reasons the Commission itself has not been called upon to develop these courses, nor has it participated largely in the formulation of objectives and methods. It is not our place then to pass on the adequacy, validity or necessity of the courses as applied to industry. It would seem that, if any defense of the courses is necessary, it should come from the Office of Education (See A.A.S.A. reply on this page.—Editor) under whom the courses were promulgated.

"As to the facts in the article, there are probably no great misstatements. There are actually very few facts presented. It is in the inferences that may be drawn that the errors, if any, lie."

Comment No. 2: "The article entitled 'Our Ailing Radio Defense Program' appears to me to have been written on the basis of false premise. So far as I know, it is not expected that the vocational Defense training program will turn out many, if any, fully-qualified mechanics in any field. It could only do so in case partially trained persons were already available who in a very short time could perfect the skills necessary in an all-around trained mechanic.

"The general purpose of these courses, as

I understand it, is to give some preliminary training and background to those who then can be further trained on the job. In other trades it is mostly mechanics' helpers or operators of single machines that are being turned out.

"The course for enlisted radio operator-mechanics in the Air Corps as conducted at Scott Field involves full time in a very concentrated program for a period of 22 weeks. The men turned out are not skilled radio mechanics in the sense that they can manufacture or perform major repair work on radio sets. It could hardly be expected, therefore, that in a 400-hour course for people who had not had considerable previous experience finished radio mechanics could be trained.

"On the other hand, preliminary training in any mechanical field, if properly integrated with in-service training programs in any industry or governmental establishment, can do much to help the situation by preparing people to be useful in some capacity from the very outset of their employment. It must be understood, however, that this training usually has to be supplemented by in-service training or supplementary training while a person is being employed, unless he is to remain indefinitely in the helper status.

"I have not had a chance to go thoroughly into the question of the present supply of trained radio mechanics with reference to the need. Much of the article is based upon a presumption that a vast number of new mechanics need to be trained. *I am not sure how true this assumption is.*" (Italics ours.—Ed.)

The American Association of School Administrators (a department of the National Education Association), Washington, D. C.

—In response to inquiries made by Radio-Craft concerning Mr. Fenway's article, this association in reply sent a copy of the official report of its Atlantic City Convention and called attention to the Convention address of Philip Murray (President, C.I.O., and Member of the Board of Education, Pittsburgh, Pa.). The report is too lengthy to permit publication in its entirety in Radio-Craft. However, Mr. Murray's address apparently was called to the attention of Radio-Craft in answer to the portions of Mr. Fenway's article which dealt with the possibilities for employment of radio technicians now taking the courses offered in the Defense Training Program, and therefore only abstracts of Mr. Murray's address seemingly pertinent to this topic follow:

"... Two or 3 months ago this organization (the C.I.O.—Editor), in an effort to render an effective assistance to our country, went to the White House, through the medium of its representatives, and talked to the President about some things of a constructive nature that could and should be done by our government to help our nation in this period of national emergency. We felt then, as we feel now, that lags and bottlenecks in production are almost wholly attributable to discriminatory and disproportionate allocations of the nation's business to a few of the large corporations producing military essentials. We said so 6 months ago. We stated that the army, navy, and National Defense Advisory Council were exercising the rankest kind of discrimination in the allocation of government's business to a few large industrial enterprises.

"... Two months ago I was told by a government official in Washington that there were 12,000 separate individual plants in the United States capable of producing goods essential to the promotion of national defense, military goods, and out of those 12,000 plants, 2 months ago, some 30% were

LATEST DATA



It's now FREE!

Yes, you too can now get the AEROVOX Research Worker month after month, absolutely free, if you qualify as a practical radio worker.

This well-known engineering bulletin, just chockful of latest radio and electronic data fresh from the AEROVOX Engineering Department, is simply indispensable in your work. Contains applicable data, charts, formulae, diagrams, suggestions—data of permanent reference value.

Ask for it . . .

See the local AEROVOX jobber about a free subscription. Or write us for sample copy and subscription blank. Also ask for latest AEROVOX Catalog.



DATAPRINTS

TESLA-LOUDIN COILS



- 20c Ea. in order for 10 (Data and Drawings only.)
- 36" Sp'k Tesla-Oudin Coil 40c (1 K.W. Exc. Trf. Data incl.)
- 8" Sp'k Tesla-Oudin Coil 40c (1/4 K.W. Exc. Trf. Data incl.)
- 8" Sp'k Oudin: 110 Vt. "Kick Coil" type40c
- 3" Tesla Works on Ford Coil40c
- 1" Sp'k Vibrator Hi-Freq. Coil 40c

NEW! 5 ft. Sp'k. Oudin Coil & Exciter Data75c



Induction PIPE & ORE LOCATOR

- Induction Type. Data40c
- Radio Type40c

More DATAPRINTS 40c each!

- 5 Meter Superhet. Electric Refrigerator
- 1/4 Meter Tr. & Rec. Wheatstone Bridge
- 20 A.C. Probs. & Ans. Weld. Transf. 2 K.W.
- 20 Telephone Hook-ups Rewinding Armatures
- 100 Mech. Movements String Galvanometer
- 20 Motor Hook-ups 20 Simple Bell Circuits
- Television Hook-up Steel Wire Recorder I
- 20 Elec. Party Tricks Water Wheels
- Solenoids and Magnets —get list. Water Turbines
- Fry Eggs on Ice! Photo Cell and Relay
- Experimental Telephone Ring 4 bells: 2 Wires
- Radio Control for Models Polarized Relay
- Diathermy Apparatus Induction Balance
- Inductor Organ Electric Pipe Thawer

Special Prices: 4 prints \$1.00; 10 for \$2.00; Single, 40c each. Get New Catalog 100 A.

The DATAPRINT Co.

Lock Box 322D, Ramsey, N. J.

• RADIO DEFENSE •

Social Security Name Plate
Only **35¢**

Bronze Plate with your Name & Number on it and This **GENUINE LEATHER BILLFOLD** without Extra Charge.

For the nominal amount of 35c we will send you the following values:

1. One duo-tone imperishably etched Bronze Name Plate, size 3x1 1/2 inches with your Social Security number and name permanently stamped upon it.
2. One Genuine Leather Billfold, size 8 1/2 x 3 inches in natural brown color, with four compartments, as per illustration above.

This Pocketbook is our free present to you. Absolutely no strings of any kind. We make you this gift because we expect you to do us a favor by showing your name plate to your friends, to interest them in ordering one for themselves. That's all. Help us and you will profit yourself.

ACT NOW! Mail the coupon below and enclose 35c in coins. The bronze name plate and the Leather Billfold will be forwarded to you at once.

PREMIUM DISTRIBUTING SERVICE
Wrigley Bldg., Chicago, Dept. RC-841

Enclosed find 35c for which mail to the address below, my Social Security Name Plate and the Genuine Leather Billfold without extra cost, as per your offer.

My Social Security Number is

NAME

ADDRESS

CITY STATE

BRAND NEW! INVALUABLE!
ONLY **25¢** copy

1000 FORMULAS & RECIPES
RICHES IN RECIPES TRIED & TESTED PROCESSES PRACTICAL SIMPLIFIED FORMULARY FOR HOME, FACTORY & WORKSHOP

The greatest, most compact formula book in print. Contains actually 1000 trade secrets, recipes and processes for home, factory and work shop.

Check full of money-making ideas. Has newest tried and tested formulas for making Glues, Cements and Adhesives; Cleaning Compounds; Paint and Pigments; Wood Stains; Varnishes; Disinfectants and Deodorants; Fire Proofing and Extinction; Gases; Work Ink; Inks; Insecticides; Laundry Processes; Metal Work; Etching Fluids; Solders; Preserving Solutions; Plastics; Plating Solutions; Fireworks; Soaps; Creams; Dyes; Toilet Preparations; Dentifrices and Cosmetics; Hair Preparations; Manicure Preparations; Sun Burn Creams and Lotions; Waterproofing; Waxes and countless others.

A Wonder Book of Useful Knowledge! Worth its weight in gold.

Book is up-to-date. Newest methods—latest discoveries. Remember—1000 clearly described SIMPLIFIED formulas, processes and recipes—MANY NEVER BEFORE DISCLOSED.

68 pages. Printed on good paper.

Send for your copy TODAY. Remember, great fortunes are made from formulas.

25c a copy, sent postpaid anywhere

Send money order, check, unused U.S. stamps or coin.

NATIONAL PLANS INSTITUTE
246-R Fifth Avenue New York, N. Y.

enjoying the benefit of government contracts; 70% were without any government business, indicating a complete lack of understanding of production problems, particularly as those problems relate themselves to questions of national defense.

"It was in an effort to solve that problem that the C.I.O. suggested to the National Defense Advisory Council, to the President, and to the leaders of our federal Congress the creation of industrial councils. These councils would be composed of representatives of labor, industry and government, whose functions it would be to coordinate the work of each industry, securing thereby the ultimate in production; to discontinue the practice of disproportionate allocations; to put the brakes on discriminatory practices of the federal government with respect to letting of contracts; and to enable each advisory council, through regulations prescribed by the President, to get the ultimate out of each industry through

the promotion of accelerated production. . . ."

An outline ("Radio Course Outline—Communications and Code") of a teachers' syllabus of one of the courses (Communications and Code) included in the Emergency Training Program for National Defense was made available to *Radio-Craft* by the Board of Education of the City of New York subsequent to preparation of the article by Mr. Fenway. Note that up to this time an equivalent outline for a Radio Service course had not yet been formulated (Section II, Item D). Note also that this radio course outline lists Communications and Code as a "proposed" course of study; its topics were taken from the questions listed in the "Study Guide" by the Federal Communications Commission. Considerable progress has been made, according to reports reaching *Radio-Craft*, in the application and expansion of the teaching course indicated in the outline and reproduced elsewhere in this article.

*RADIO COURSE OUTLINE—COMMUNICATIONS AND CODE

I. Major Objective of the Defense Training Course.

- A. The major objective is to give intensive training to increase the skills of employable radio workers to fit them for national defense industries or Army and Navy service.
- B. Specific objective of the Radio Communications Course. The specific objective of the course is to provide theoretical and practical instruction in the operation of communication equipment.

II. Functional Aspects of the Communications Course.

- A. The units in this proposed course of study should be supplemented with necessary shop work.
- B. Trainees in this course should be prepared to operate standard communications equipment and to qualify for the theoretical part of the government examination for 2nd Class radio operators.
- C. The course, while intensive in nature, is to be inclusive enough to provide instruction in basic radio theory with foundation units in electricity and magnetism, sending and receiving code, and practical experience in the operation of radio receivers, transmitters, and other equipment.
- D. This course is not intended for use in radio service. Such a course is now being prepared.

III. General Instructions to Teachers.

- A. Complete mastery of each topic listed in the Index (Because

of lack of space this Index is not included here.—*Editor*) is not an objective of this course. The approximate number of hours to be allotted to each topic is indicated (in other pages of the syllabus—*Editor*). Variations may be made to fit in with available equipment, supplies, and trainee ability.

- B. For the purposes of this course, special emphasis should be given to topics 1, 2, 3, 4, 7, 16, 17, 18, 20, 21, 22, 23, 24, and 26. Consult with your trade and subject supervisors about these special topics.
- C. Prepare jobs and lesson sheets for the topics used in your classes. Jobs should be selected on the basis of industrial needs and individual ability levels.
- D. Give instructions concerning safety regulations and insist that trainees comply with these regulations.
- E. Make every effort to place trainees as workers in industry.
- F. Since learning is an individual achievement teachers should be alert to see that the learner understands the importance of individual responsibility for habit formation and learning.
- G. Teachers should supplement prepared lessons on these topics with unit tests, additional sets of test questions, and practical tests to discover the effectiveness of the teaching and the learning ability of the learner.

*From the teachers' syllabus of the Board of Education of the City of New York, Emergency Training Program for National Defense.

A NEW TYPE OF RADIO SERVICE MANUAL!

JUST OFF THE PRESS is a new type of radio service manual known as "Radio Circuit Manual—1941." It is a complete directory of radio receivers manufactured in 1940 and up to June 1941. The outstanding achievement of this manual is that all the service data and diagrams covering this period—some 1,800 receiver models—have been condensed into a book of only 736 pages! This was accomplished by the simple expediency of editing all material. (To our knowledge this is the very first edited radio service manual ever to be published.) All non-essential data have been deleted as have been data and diagrams on communications and export receivers, amplifiers, and other such allied apparatus which the Serviceman seldom, if ever, is called upon to repair. Other features include a larger page permitting (with some exceptions) all data on a given receiver to be listed on a single page; all I.F.'s boldly displayed in black squares; all pages laid out uniformly, and with a definite text sequence. The manual measures 13 1/2" x 10 1/4", only 6 1/2 pounds and is only 2" thick. (See pages 96 and 97 for further details.)

• LATEST RADIO APPARATUS •

6-TUBE A.C.-D.C. SUPERHET.

Allied Radio Corp.
833 W. Jackson Blvd., Chicago, Ill.



MODEL B17100 is a 6-tube, 2-band superhet. The broadcast band covers the range of 535 to 1,650 kc.; the shortwave band, 5.7 to 18.3 mc. Its outstanding features include high-gain "Magna-Beam" loop antenna; sliderule-type dial; 5-in. dynamic speaker; A.V.C.; and, beam power output.

Cabinet measures 13 x 6½ x 7½ ins. Operates on 110-120 V., A.C. or D.C.—*Radio-Craft*

SIGNAL GENERATOR

Triumph Mfg. Co.
4017 West Lake St., Chicago, Ill.

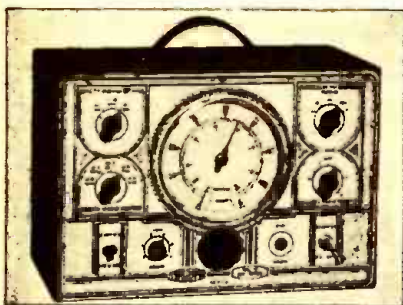

MODEL 131 Signal Generator has a large dual-scale dial, calibrated ½ of 1% from 100 kc. to 96 mc. Multiplier-attenuator allows sensitivity, selectivity, A.F.C., A.V.C., and overload tests of receivers. Variable percentage modulation at 400 cycles or any other frequency 0 to 2½ V. of 400 cycle at output cable. Ivory, green, and black panel on brown wrinkle case. Size 13 x 9 x 7 ins.—*Radio-Craft*

R.F. STAGE, 3-WAY PORTABLE

Emerson Radio & Phonograph Corp.
111 8th Avenue, New York, N. Y.

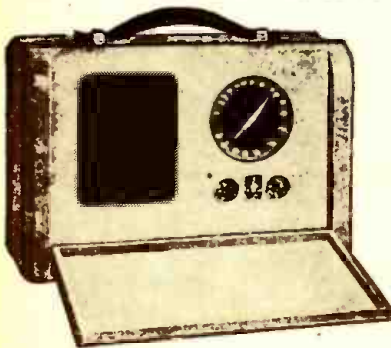

MODEL 428 illustrated above is one of a series of 3 new portables which in addition to 3-way operation, features an R.F. stage. This extra stage of R.F. results in increased sensitivity, greater DX abilities, and greater power output. Other features include automatic volume control, radium-treated pointer which glows in the dark, beam power output, automatic shift from batteries to power line and vice versa, and low-battery drain. It has a built-in loop

antenna and covers both broadcast and police bands in its range of 540 to 1,630 kc.—*Radio-Craft*

MEDIUM-POWER HORN UNIT

University Laboratories
195 Chrystie St., New York, N. Y.

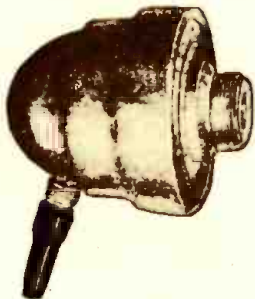

THIS model MD8 is an extremely compact speaker unit designed to be used with reflex horns. In spite of its small size, it has very high efficiency, and a uniform response at all frequencies in the range of 90 to 5,000 cycles. It is rated at 12 watts (continuous). A spun-aluminum can hermetically seals the unit, making it absolutely waterproof without any additional protection. Connections to the unit are made by means of a standard chassis-type screw connector wired into the cover of the unit. Its impedance is 8 ohms. Size 3½ x 3½ ins.—*Radio-Craft*

RADIO-PHONO COMBINATION

Fada Radio & Electric Co., Inc.
30-20 Thomson Ave., Long Island City, N. Y.



A NEW table model of radio-phonograph combination which is available for A.C. (model PT208) or A.C.-D.C. (model PTU208) operation. Its features include 5-tube superhet. circuit, wide tuning range (535 to 1,720 kc.), automatic volume control, continuously-variable tone-control, low-distortion diode detector, beam power output, built-in "Fa-Da-Scope" loop antenna, 5½-in. dynamic speaker, and illuminated "golden glo" dial. The phonograph is equipped with a self-starting, 60-cycle A.C. motor and can play either 10- or 12-inch records. Cabinet measures 14¾ x 9¾ x 13 ins.—*Radio-Craft*

2½-METER TRANSMITTER RECEIVER

Radio Transceiver Laboratories
Richmond Hill, New York, N. Y.

THIS instrument may be used either at fixed points or in mobile units. When used between 2 fixed stations with average antenna at either end, reliable communication up to 30 miles or more may be had; in mobile units, 10 miles.

Known as model TR112, this instrument incorporates a stable medium-power transmitter and a sensitive full audio level receiver in a compact cabinet. Its frequency range is 112 mc. to 116 mc., continuous coverage in both transmitter and receiver,

with provision for 224 mc. changeover. The entire unit measures 15 x 7 x 6 ins., and weighs 14 lbs.—*Radio-Craft*

TUNING-FORK TIME STANDARD

American Instrument Co.
8010 Georgia Ave., Silver Spring, Md.

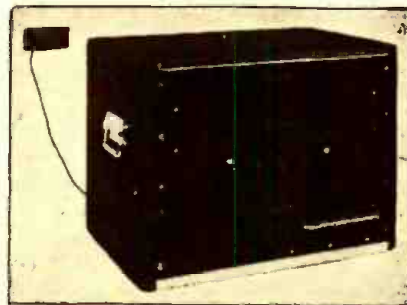

A SHIELDED, self-starting, electrically-driven tuning-fork is the heart of this model 5-3500 Time Standard instrument. The standard model uses a tuning-fork with a frequency of 500 cycles, ±0.1-cycle at 25° C. and a temperature coefficient of -0.06-cycle/deg. C. Draws 200 W.

Besides tuning-fork, the instrument comprises electrically-isolated pickup and power amplifier. The output is an undistorted sine-wave, steplessly controlled from 0 to 2.5 watts by a front-panel knob. Maximum undistorted voltage, at 500 ohms, 25 V. Output impedances of 4, 8, 15 and 500 ohms are available.—*Radio-Craft*

BATTERY-OPERATED AIRPLANE RECEIVER

Setchell Carlson, Inc.
2233 University Avenue, St. Paul, Minn.

THIS instrument designed especially for private airplane use has a tuning range of 195 kc. to 605 kc., plus a pushbutton selector for traffic control (278 kc.). Complete with all batteries, it weighs only 6½ lbs. Its compact size is only 4 x 6 x 8 ins.

Among its features are a 3-gang condenser, superhet. circuit, R.F. stage for added sensitivity, selectivity and image rejection, high sensitivity (2 microvolts for 20 milliwatts output), complete shielding for noise-free reception, plug-in shielded antenna lead.—*Radio-Craft*

A.C. ARC WELDER

Ideal Commutator Dresser Co.
Sycamore, Illinois



THE design of this A.C. electric arc welder includes a reactance winding on a separate core in addition to the transformer. This acts as a stabilizer, making it easy to strike and hold the arc. Four different welding heats between 20 and 175 amperes are available, giving the

operator accurate heat and penetration control for individual jobs. These heats are at 2 voltages, 45 and 70 V. Penetration may be up to ¼-in. or more if desired. The welder is rated at 9 KVA and is designed to operate on the 230 V., 60 cycle A.C. line.—*Radio-Craft*

• LATEST RADIO APPARATUS •

MOBILE P. A. SYSTEM

Allied Radio Corp.
833 W. Jackson Blvd., Chicago, Ill.



A COMPLETE 30-Watt Deluxe Mobile Sound System which operates on either 6-V. battery supply or 110 V. A.C. power line. Housed in 2 compact, portable cases which include a 30-watt amplifier with phono top, 2 Knight 12-in. dynamic speakers, an Electro-Voice type 631 dynamic microphone, a take-down floor stand and all tubes. Output impedance, switch selected: 2, 4, 6, 8, 250, and 500 ohms. Two phono channels, controlled by a single fader, are incorporated. Frequency response is 40 to 10,000 c.p.s.—*Radio-Craft*

NEW TUBE SHIELD

Goat Metal Stampings, Inc.
314 Dean St., Brooklyn, N. Y.

THESE tube shields known as "1330 series" are designed for GT/G, GT, and Loktal tubes. Made of one piece, the new Formfit Tube Shield is solid-drawn with attractive ribbon design. They are quickly and easily attached and are automatically grounded to the base of the tubes. Four different types are available.—*Radio-Craft*

CHROMIUM NEEDLE

Duotone Co., Inc.
799 Broadway, New York, N. Y.

THIS new Chromium Needle is claimed to be good for at least 50 playings. It is highly polished for smooth, even tone and minimum record wear. Each needle is individually shadowgraphed for detecting flaws. Ideal for record changers.—*Radio-Craft*

RADIAL BOOSTER SPEAKER

University Laboratories
195 Chrystie St., New York, N. Y.



MODEL IBR is a Radial Booster Speaker designed for intercommunication. High efficiency is claimed for this unit so that it may be placed in the center of a manufacturing plant to give clear voice intelligibility on a low-power paging or intercommunication system. Its high efficiency is obtained by means of a reflex exponential driver unit system. Bell diameter, 8 ins.; overall, 8 ins.; voice coil impedance, 8 ohms; power capacity, 10 watts. The unit is completely

weatherproofed for permanent outdoor installations.—*Radio-Craft*

BROADCAST RECEIVER KIT

Allied Radio Corp.
833 W. Jackson Blvd., Chicago, Ill.

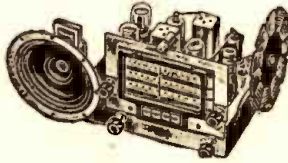

THIS 6-tube, 2-band A.C./D.C. Broadcast Receiver Kit has been especially designed for radio students, experimenters and builders. It is easily assembled and requires merely a screwdriver, pliers and soldering iron. The chassis comes drilled and punched, and all components down to the slightest detail are included; an especially-prepared set of instructions couched in non-technical terms is furnished with each kit. The superhet. receiver features built-in loop antenna, pushbutton tuning, automatic volume control, phono input and affords 2 tuning ranges: 535 to 1,720 kc., and 5.65 to 18.3 mc.—*Radio-Craft*

NEW 6-V. "PORTA-POWER," "A" AND "B" SUPPLY FOR 1.4 V. SETS

General Transformer Corp.
1250 W. Van Buren St., Chicago, Ill.

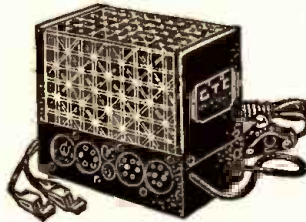

THIS new model C "Porta-Power" supplies 1½ V. "A" and 90 V. "B" to battery receivers when connected to a 6 V. D.C. source. It is especially designed to permit the mechanical operation of 1.4 V. battery receivers in locations where electricity is not available.—*Radio-Craft*

LINE-VOLTAGE REGULATOR

Clarostat Mfg. Co., Inc.
285 North 6th St., Brooklyn, N. Y.

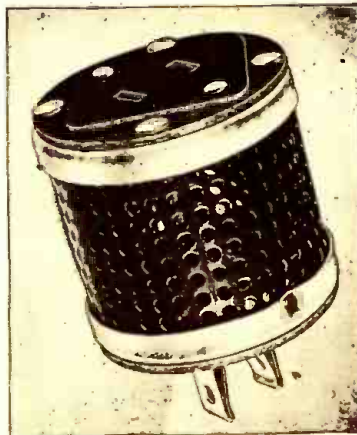

AUTOMATIC Line Voltage Regulators of the type illustrated here have been known in many instances to safeguard receivers from the heavy powerline fluctuations due to lightning. In such instances the heavy current induced in the power lines burns out the line voltage regulator and thus damage to the receiver itself is prevented. The Line Voltage Regulator there-

fore performs a secondary function—that of "lightning fuse" for the receiver. This unit, of course, doesn't provide any protection to receivers whose antennas are struck by lightning.—*Radio-Craft*

MICROPHONE CONTROL

RCA Manufacturing Co., Inc.
Camden, N. J.

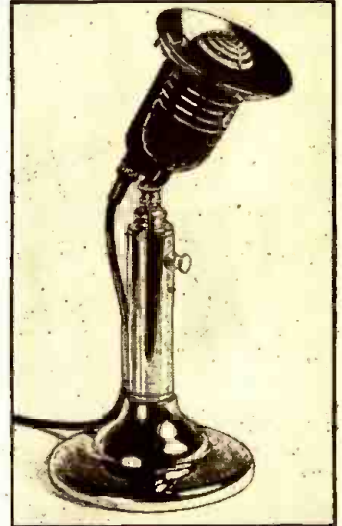

THIS new "pushmike" adapter and stand is ideal for mobile or portable operation of public address systems. The switch adaptor is fitted with a double-pole double-throw, low-capacity leaf switch with a "push-to-talk" button that can be locked in the "talk" position with ease. The switch adaptor may be fitted to any stand with ¼"-27 thread. Available with or without base. Without base it may be used as a hand grip or in conjunction with a floor stand.—*Radio-Craft*

AIRPLANE INTERCOMMUNICATOR

Mellaphone Corp.
Rochester, N. Y.



DESIGNED expressly for intercommunication between the student pilot and instructor, the unit consists of an amplifier, microphone, and earphones, and does away with the former cumbersome rubber-hose speaking tube system. The amplifier complete with batteries and tubes is small enough to fit into a jacket pocket. Two mike jacks and 2 headphone jacks permit 2-way communication when needed. The small low-drain tubes are used.—*Radio-Craft*

•LATEST RADIO APPARATUS•

"TRIGGER ACTION" MICROPHONE STAND

Atlas Sound Corp.
1443 39 St., Brooklyn, N. Y.



THE special height adjustment mechanism of this new microphone stand requires only a "touch-of-the-finger" to release the locking mechanism and permit vertical adjustment. The "trigger" device permits 1-hand control of the microphone height, and eliminates fussing and loss of composure on the part of the speakers and entertainers, who very often have to struggle with the customary twist-lock arrangements used on most microphone stands.—*Radio-Craft*

F.M.-A.M. CONSOLE

Allied Radio Corp.
833 W. Jackson Blvd., Chicago, Illinois



THE Knight 14-tube F.M./A.M. Phono-Radio Console is a 3-way combination for reception of Frequency and Amplitude Modulation programs; included is an automatic record changer. The receiver has a 14-tube high-fidelity chassis with a tuning range of 540-1,650 kc. for A.M. reception and 40-51 mc. for the F.M. reception. Other features include R.F. stage, automatic volume control, 3-gang condenser, high-fidelity audio channel with frequency response of 50-10,000 cycles, 20 watts output, inverse feedback, 12-inch P.M. dynamic speaker. Console measures 36 x 36 1/4 inches wide x 18 1/2 inches deep; designed for operation on 110-120 V., 60 cycles A.C.—*Radio-Craft*

A.M./F.M. PHONO - RADIO COMBINATION

Howard Radio Company
1735 Belmont Ave., Chicago, Ill.

A NEW 14-tube, 4-band phono-radio combination housed in a modern version of a period Chippendale cabinet. The receiver tunes in 3 A.M. bands from 540 kc. to 22 mc. (555 to 13 meters) and the F.M. band from 41 to 50 mc. The automatic record changer plays twelve 10-in. and 12-in. records, intermixed. A 12-in. Jensen dy-

amic speaker handles the high fidelity of F.M. very well. All bands utilize dual tone control for boosting bass or accentuating treble.—*Radio-Craft*

AUTOMATIC MICROPHONE

The Turner Co.
Cedar Rapids, Iowa



THIS new Dynamic Microphone is of the saltshaker type, utilizing a new-type magnetic structure and acoustic network. Its frequency range is 30-10,000 cycles. A unique diaphragm structure results in extremely low harmonic and phase distortion without sacrificing high output level. The mike has a tilting head balanced line output and 25 feet of cable. The 500-ohm model has an output of 2.5 millivolts for 10-bar signal, while the 200-ohm model has an output of 1.6 millivolts for 10-bar signal. Another model, 30-50 ohm, has an output of 0.25-millivolt for 10-bar signal.—*Radio-Craft*

POWER RESISTOR DECADE BOX

Clarostat Mfg. Co., Inc.
285-7 North Sixth Street
Brooklyn, N. Y.



THIS Decade Box used in laboratories, engineering offices, plants, etc., cuts time in solving practical resistance problems under actual working conditions. Instead of affording a mere measurement of resistance values this Decade Box actually provides precise power resistors of anywhere from 1 ohm to 999,000 ohms for actual use in a given circuit. Six rotary switches provide the various range of values desired.—*Radio-Craft*

NEW CONVERTER

Eicor
1060 W. Adams St., Chicago, Ill.

THIS unit is more compact, more modern and more convenient for permanent or portable use. It converts D.C. to A.C. for use with amplifiers, projectors, phonographs, radio receivers, transmitters, medical equipment, etc. All are ball-bearing units with or without radio filters. Available for 5, 12, 32, 115, and 230 V. D.C. inputs.—*Radio-Craft*



A new HOTEL
AWAITS YOU
in New York

This world famous establishment, formerly the American Woman's Club, is now one of New York's newest and finest hotels. Its unique facilities include six lounges, five sun-decks, music studios, library, art gallery and three popular priced restaurants. Many floors are reserved exclusively for women.

*
1200 Rooms with Bath
DAILY—Single, from \$2.50;
Double, from \$3.50
WEEKLY—Single, from \$12;
Double, from \$16
Special Floors and Rates for Students

John Paul Stack
General Manager

Henry Hudson
HOTEL

353 WEST 57th STREET * NEW YORK

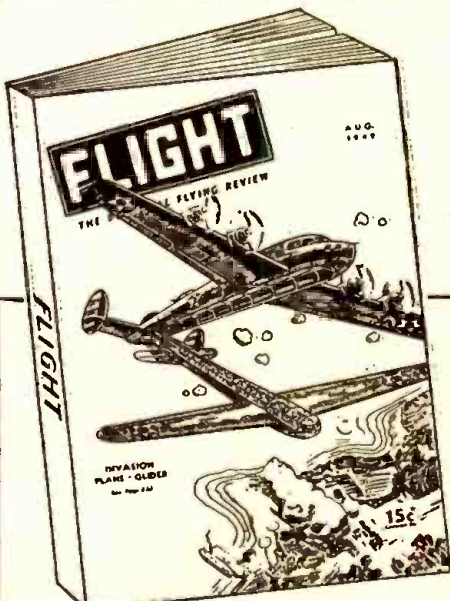

FLIGHT THE PICTORIAL FLYING REVIEW

Brings you all the phases of world aviation and aeronautics in a non-technical yet educational manner—exciting articles which catch your breath, yet give you the fundamentals of flying and ALL related subjects.

FLIGHT keeps you abreast of all the major developments as fast as they appear anywhere. Now, when planes and flying are of vital importance to all, you just can't do without this highly absorbing yet instructive publication. This must be "in the know."

Partial Contents of the August issue:
Invasion Plane—Gliders—Hugo Gernsback.
The Curtiss P-40
Invasion by Chute Troops
Italian "Freight" Plane
Stuka Dive-Bomber Tactics
Acrobatics Are Easy!
Versatile R.A.F. Lysander
How Supercharger Works
Sectional View "Wittie V-12"
Sikorsky Flying Boat
Question Box

Attractive three-color cover, numerous illustrations.
15¢ a copy
Send 10c for a Sample Copy.

Subscription price \$1.50 a year, Canada and foreign \$2.00.

FLIGHT MAGAZINE, 20-R Vesey St., New York, N. Y.

• LATEST RADIO APPARATUS •

OPPORTUNITY AD-LETS

Advertisements in this section cost 15 cents a word for each insertion. Name, address and initials must be included at the above rate. Cash should accompany all classified advertisements unless placed by an accredited advertising agency. No advertisement for less than ten words accepted. Ten percent discount six issues, twenty percent for twelve issues. Objectionable or misleading advertisements not accepted. Advertisements for September 1941 issue must reach us not later than July 7th.

Radio-Craft • 20 Vesey St. • New York, N. Y.

BOOKS AND MAGAZINES

ASSURE YOURSELF OF GREATER PROFITS BY doing radio service jobs more quickly. Authentic service guides show you the way to locate and correct troubles in any radio receiver. Gernsback Official Radio Service Manuals show you how to complete more repair jobs in less time—how to earn more money by faster servicing. Radcraft Publications, 20 Vesey St., New York City.

WE HAVE A FEW HUNDRED RADIO ENCYCLOPEDIAS, by S. Gernsback, second edition, originally sold at \$3.98. Book has 352 pages, weight 3 lbs., size 9 x 12 inches. Red morocco—keratol flexible binding. Send \$2.49 in stamps, cash or money order and book will be forwarded express collect. Technifax, 1915 So. State Street, Chicago, Illinois.

WHAT DO YOU KNOW ABOUT AMPLIFIERS AND Sound Systems? The Amplifier Handbook and Public Address Guide covers P.A. from A to Z. Most complete and authentic book published on the subject. Contains 80 pages of vital information on Amplifiers, P.A. Systems, Speakers, Accessories, Pickups, Microphones, etc. Printed on fine coated stock, with numerous photographic illustrations and explanatory diagrams, and only 25c. See page 72.

EDUCATIONAL COURSES

CORRESPONDENCE COURSES AND EDUCATIONAL books, slightly used. Sold, Rented, Exchanged. All subjects. Satisfaction guaranteed. Cash paid for used courses. Complete details and bargain catalog FREE. Write Nelson Company, 500 Sherman, Dept. H-242, Chicago.

FLUORESCENT LIGHTING

24" FLUORESCENT BENCH LIGHT \$1.49. LESS TUBE. Harold Davis, Jackson, Mississippi.

PHOTOGRAPHY

1/100,000 OF A SECOND SPEED FLASH UNIT FOR Stereoscopic Photography, \$200.00. Apt. 63, 782 West End Ave., New York City.

RADIO

All-Wave Receiver, complete with 12-inch electrodynamic speaker and separate power pack. Cost originally \$145. Will sacrifice for \$25.00. Set is 1935 model, rarely used and in good working condition. Excellent sensitivity and selectivity. A resonance tuning meter, wave-band switch, photograph input terminals, an ideal set for the DX fan. Excellent tonal fidelity. All components mounted on a beautiful chromium-finished chassis. Rush! First come, first served! D. Kreisman, 1430 Ocean Ave., Brooklyn, N. Y.

WANTED—ELECTROLYTIC DETECTOR; ADAMS- Morgan wooden-case, variable condenser. Have radio sets, meters, etc.—or what do you want? R. Bernard, 40 Manning Ave., No. Plainfield, N. J.

TECHNICAL ART SERVICE

DRAFTING AND ART SERVICE—A COMPLETE Service for the Industrial and Commercial Marketers. If your business or plant can't afford a designing or drafting staff, don't let this stop you from going ahead with that new product you intend marketing, or that catalog of mechanical or electrical items which needs fine detailed drawings and highly retouched photographs. Any mechanical, electrical or radio problem can be solved for you by our associated staff of designers, draftsmen and artists, and technical copywriters. Write for any additional information as to methods and price for this service. Tee-Art Drafting Service, 228 Charlotte Terrace, Roselle Park, N. J.

WANTED—TO BUY

WANTED: HI-FI AM-FM EQUIPMENT. PRIVATE. Cash. Box 81, Radio-Craft.



PAPER-BASE RECORDING DISC

RCA Manufacturing Co., Inc.
Camden, N. J.

MANY tons of aluminum have been freed for use in the National Defense program by the successful development of a new 16-in. fire-resistant paper-core recording blank for use in radio studios, airline terminals, and other locations where sound is recorded for "reference" purposes. Suitable for transcriptions. The blanks are being sold at ½ the price of the old aluminum-base discs.—Radio-Craft

"DEFENSE"-SIZE METAL-CAN ELECTROLYTIC

Sprague Products Co.
North Adams, Mass.



THE Government's request to reduce all non-defense uses of aluminum as much as possible has spurred this company to smaller sizes in metal-can electrolytics. The 8-mf. condenser previously housed in an aluminum can 1 ½ ins. in diameter have been reduced to 1 in.—an aluminum saving of better than

35%. This reduction in size is being made right down the entire line of metal-case condensers.—Radio-Craft

MARINE RADIO TELEPHONE

Western Electric Co., Inc.
195 Broadway, New York, N. Y.

KKNOWN as Model 226D this radio telephone instrument features instantaneous selection of any one of 10 pre-tuned frequencies, quartz crystal control of transmission and reception, extreme signal clarity, low noise, and semi-automatic operation. Installation is extremely simple, involving connection only to antenna, ground, and power supply. Only 3 front panel controls are necessary for operation. The instrument operates on a 110 V., 60 cycles A.C., but may be used on other power sources through the medium of a rotary converter.—Radio-Craft

POCKET TESTER

Triumph Mfg. Co.
4017-19 West Lake St., Chicago, Ill.

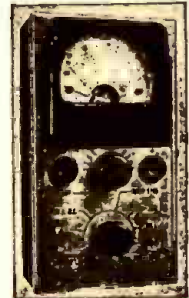

MODEL 323 Test Set is a pocket-size, general-purpose, high-sensitivity, instrument for A.C. or D.C. use. Its A.C. ranges are 15 and 150 V.; D.C. ranges, 30, 300, and 1,500 V. Other ranges are 150 ma., D.C. 3,000 ohms and 300,000 ohms. Size 2 ½ x 5 ¼ x 1 ½ inches.—Radio-Craft

IMPROVING DEALERS' RECEPTION WITH BUILT-IN ANTENNAS

BOTH loop and line antennas will usually provide excellent reception under average conditions in the home. Unfortunately, conditions in a distributor's or dealer's demonstration room are far from average, and usually are such as to provide very poor reception. Thus, receivers with built-in antennas show up to decided disadvantage. To provide better set demonstrations in such locations, we suggest the following remedies.

On a dealer's floor or in a home where line antenna operation is poor, we suggest that the dealer connect an outside antenna to the live side of the power line through a 0.01-mf., 600-volt condenser. With an arrangement of this kind, the aerial picks up the radio signal and feeds it into the power line, where it is available for the line antenna set. This idea also works out very nicely in the home where a small line antenna set may be moved from room to room.

There is one other thing that will seriously reduce signal pick-up with a line antenna set. Practically all A.C.-D.C. sets on the market (and all loop operated Stewart-Warner sets), use a buffer bypass condenser across the power line. This condenser will also bypass any radio signal in the line, so that the line antenna of any set that may be plugged into the same line will get no radio signal to speak of. In demonstrating line antenna sets, it is therefore advisable to disconnect all other non-line antenna sets from the same power line.

If it is essential to demonstrate line an-

tenna operation when other sets may be connected to the same power line, one of our Part Number 117643 Line Antenna Attachment Units may be used as a line filter for the other sets. The filter built into this unit prevents the set from short-circuiting the radio signal in the power line. Since the line antenna unit is used as a line filter in this case, no connections need be made to its 4 terminals. It is simply plugged into the electric outlet and the radio set, in turn, plugged into the unit.

If necessary, more than one set may be connected to the same Line Antenna Attachment Unit provided that their total power consumption is not over 300 watts.

Loop antenna sets operate under severe handicaps in buildings of steel construction since the steel framework acts as a shield and permits very little radio signal to pass through. To demonstrate loop antenna sets under such conditions, an outside aerial may be connected to any large metallic object in the demonstration room near the loop sets. If a more finished installation is desired, the outside aerial may be connected to a large plate of metal or a copper screen fastened underneath the table on which the loop sets rest. The outside aerial serves to bring the radio signal into the building so that the loop antenna can pick it up.

M. J. SCHINKE,
Service Department, Stewart-Warner.
(There's another side to this story.
See next page.)

OUTDOOR ANTENNA STILL PROVIDES BEST RECEPTION

"THERE'S no substitute for a good outdoor antenna." So states Ernest V. Amy, of the radio engineering firm of Amy, Aceves & King, Inc., long identified with antenna developments. Despite the recent revival of the old loop idea in some present-day radio sets, this authority insists that best reception can still be had more satisfactorily with a good noise-reducing antenna system. And he can prove it!

"The elimination of the outdoor antenna is a definite step backwards," states Mr. Amy. "Economically, the use of a loop or a few feet of wire stretched out as an indoor or abbreviated antenna, may be justifiable with midget receivers selling under \$10. Obviously, a good outdoor noise-reducing antenna costs out of all proportion to those cheap sets, particularly if the Serviceman makes the installation. But . . .

"With better grade sets the outdoor antenna is *economically*, as well as *practically*, a necessity. The use of a good outdoor antenna means a gain in signal strength corresponding to at least 1 stage of amplification. That's an important factor. Also, there's a very marked reduction in background disturbances. And that's a mighty important factor, especially as set-owners become more tone minded after hearing the quality of static-free frequency modulation reception.

"Speaking of background noises or 'man-made static', the loop does not eliminate such interferences in most instances, contrary to beliefs or claims. In most localities inductive interference is fairly widespread and comes from all directions. Therefore, while the loop may be turned, it is true, to minimize interference from any given direction, particularly if that loop is shielded on its sides for a truly electromagnetic directional pick-up, other interference sources may still break through to mar reception. Where inductive interference is general, loop reception is of little aid to noise suppression since it simply swaps one noise for another in swinging about the compass. Also, a loop has but a fraction of the signal pick-up of a good outdoor antenna, which lowers the desired ratio between signal and background levels.

"So we turn again to the outdoor antenna. When confronted by surrounding inductive interference and weak signals, there is something constructive we can do about it. By elevating the aerial portion of the antenna system high above the inductive interference zone, and then neutralizing the long downlead to the set against surrounding inductive effects, we build up intercepted signal strength on one hand and minimize background noise on the other. In other words, we are using the principle of the genuine *noise-reducing antenna system*.

"Few set-owners have as yet come to enjoy the idea of combination of a quality radio set operating on a genuine noise-reducing antenna system. Indeed, during the past half-dozen years the market has been flooded with poorly-designed antenna kits masquerading as 'noiseless antenna systems'. It is a safe guess that more than 75% of such kits did not reduce noise in direct comparison with an ordinary antenna, and, by fooling their buyers, gave the antenna-kit business a real black eye.

"However, there are on the market well-engineered *noise-reducing antenna systems*, as well as *master antenna systems* for apartment houses and other multi-set buildings. It will avail the set-owner little if he buy a quality set only to sacrifice potential tone quality and program choice by using a loop or an indoor antenna."

RADIO-CRAFT for AUGUST, 1941

● IT IS always the well-trained man who wins out over the horde of thousands of superficially trained and incompetent men. You are reading this magazine because you are interested in radio. Sooner or later, the time will come when you will wish to cash in on your knowledge. You also realize that, at the present time, there are many branches of the radio art which you do not know as thoroughly as you should. Knowledge, these days, can be gotten cheaper than

AMERICA'S BEST RADIO BOOKS

ever before. It isn't necessary for you to go to college to become proficient in radio. Start today, to build a REAL radio library and become acquainted with all branches of this great and growing art. In this page are listed the world's best radio books. We have combed the market for the really important books in radio, so that, no matter what branch you are interested in, you can pick out the best books that are now printed.

We present the most complete collection of recent important radio books. We have, after an exhaustive study, selected these volumes because they represent the foremost radio books of their kind in print today. There is such a great variety that we are sure it will satisfy any taste as well as any requirement that the student of radio might have. We publish no catalog and ask you to be kind enough to order direct from this page. Prompt shipments will be made to you direct from the publishers. We merely act as a clearing house for a number of radio publishers and OUR PRICES ARE AS LOW OR LOWER THAN WILL BE FOUND ANYWHERE. Remit by money order or check. Register all cash.

HOW TO BUILD RADIO RECEIVERS. Paper covers, 8x11", profusely illustrated, 168 pgs. Price Prepaid **60c**

Grade A construction articles on many devices including a "wireless" phono oscillator, signal tracer, hi-fi P.A. tuner, etc.

MARCONI—THE MAN AND HIS WIRELESS. by Orrin E. Dunlap. Cloth covers, 6x8 1/2", illustrated, 360 pgs. Price Prepaid **\$3.50**

This is the life-story of Marconi. It is divided into 5 parts dating from 1874 to 1937. A story every radio man should know.

CATHODE MODULATION. by Frances C. Jones. Stiff paper covers, 8 1/2 x 11", well illustrated, 96 pgs. Price Prepaid **\$1.00**

The description of an economical system of radio transmitter modulation, by its inventor, of especial interest to ham-radio operators.

POLICE COMMUNICATION SYSTEMS. by V. A. Leonard. Cloth covers, 5 1/2 x 8 1/2", illustrated, 590 pgs. (with a chapter on radio legislation) and a Bibliography. Price Prepaid **\$5.00**

The present head of the Police Communication system at Ft. Worth, Tex., comprehensively describes every phase of modern police-radio.

THE LIE DETECTOR TEST. by Wm. Moulton Marston. Cloth covers, 8x8", 8 illus., 182 pgs. Price Prepaid **\$2.00**

What is a Lie Detector? How does it work? These and many other questions are answered in detail by a capable author.

HOW TO MAKE GOOD RECORDINGS. Hard covers, 5 1/2 x 8", well illustrated, 128 pgs. Price Prepaid **\$1.25**

No owner of disc sound recording equipment should be without this book, which tells how to make records at home, add sound to silent home-movies, etc.

THE RADIO AMATEUR'S HANDBOOK. 8th Edition, by A. Frederick Collins. Cloth covers, 5 1/2 x 8", well illustrated, 342 pgs. Price Prepaid **\$2.00**

A practical and easily-understandable guide to radio construction and repair, complete with schematic and picture diagrams.

RADIO OPERATING QUESTIONS AND ANSWERS. 7th Edition, by Arthur H. Nilson and J. L. Hornung. Cloth covers, 5x8", well illustrated, 416 pgs. Price Prepaid **\$2.50**

This entire book is in the form of questions and answers on obtaining Government radio licenses. Covers radio theory and practice.

PRINCIPLES OF TELEVISION ENGINEERING. by Donald G. Fink. Cloth covers, 6x9", 313 illus., 541 pgs. Price Prepaid **\$5.00**

American practice in the design, construction and use of television transmitters and receivers, presented in text-book style.

DEMONSTRATION EXPERIMENTS IN PHYSICS. edited by Richard Manly Sutton. Cloth covers, 6x9", 408 illus., 545 pgs. Price Prepaid **\$4.50**

A compilation of 1,200 Experiments, especially suitable for high schools and colleges, designed to demonstrate the principles of (radio) physics.

ELECTRON OPTICS IN TELEVISION. by I. G. Maloff and D. W. Epstein. Cloth covers, 6 1/2 x 9 1/4", profusely illustrated, 299 pgs. Price Prepaid **\$3.50**

This book develops the theory of optics and its most useful application—the television cathode-ray tube.

RADIO FREQUENCY ELECTRICAL MEASUREMENTS. 2nd Edition, by Hugh A. Brown. Cloth covers, 6x9", profusely illustrated, 384 pgs. Price Prepaid **\$4.00**

A useful manual on test procedure for the practicing engineer, as well as for the technically-minded radio amateur and experimenter.

RADIO ENGINEERING. 2nd Edition, by Frederick Emmons Terman. Cloth covers, 6 1/2 x 9 1/4", well illus., 814 pgs. Price Prepaid **\$5.50**

A University Professor Presents a comprehensive engineering treatment of the more important radio vacuum-tube phenomena. A "must".

THEORY OF VACUUM TUBE CIRCUITS. by Leo James Peters. Cloth covers, 6x9", 110 illus., 256 pgs. Price Prepaid **\$3.00**

A standard school textbook on the fundamentals of triode vacuum-tube circuits. To know radio circuits, read Peters.

RADIO PHYSICS COURSE. 2nd Enlarged Edition, by Alfred A. Ghirardi. Cloth covers, 7 1/4 x 9 1/4", 510 illus., and numerous tables, 510 pgs. Price Prepaid **\$4.00**

Most recommended general reference book on radio. Embryo as well as advanced radio men are urged to put it in their library.

RADIO & ELECTRONIC DICTIONARY. compiled by Howard P. Manly. Cloth covers, 6x9", 550 illus., 280 pgs. Price Prepaid **\$2.50**

Defines 3,800 words and terms used in Radio (including sound movies, television, public address and electronics).

PRINCIPLES OF RADIO COMMUNICATION. by J. H. Morecroft. Cloth covers, 6x9 1/2", profusely illus., 988 pgs. Price Prepaid **\$7.50**

This radio classic presents in exceptionally lucid style the elements of the entire radio art. Second to no book in its class.

TELEVISION. by V. K. Zworykin and G. A. Morton. Cloth covers, 6x9", profusely illustrated, 846 pgs. Price Prepaid **\$6.00**

All the most intimate details of electronic television transmission and reception, as practiced today, are bared for technicians.

ORDER DIRECT FROM THIS PAGE

PRINCIPLES OF RADIO. 3rd Edition, by Keith Henney. Cloth covers, 5 1/2 x 8", 311 illus., 456 pgs. Price Prepaid **\$3.50**

This book starts with Ohm's Law and winds up discussing television. On the way it presents detailed information on Radio's Principles and Instrumentalities.

SHORT WAVE DIATHERMY. by Tylor de Choinky. Cloth covers, 6 1/2 x 8 1/2", well illustrated, 310 pgs. Price Prepaid **\$4.00**

The principles and practice of Radio Diathermy are gone into in great detail. The design of equipment and its use are discussed.

RADIO OPERATORS' LICENSE GUIDE. 2nd Edition, by Wayne Miller. Paper covers, 6x9", illustrated, 158 pgs. Price Prepaid **\$3.00**

Over 1,250 acceptable answers to questions based on the F.C.C.'s new "6-element" quiz for amateur or commercial licenses.

WE PRESENT TELEVISION. edited by John Forterfield and Kay Reynolds. Cloth covers, 6x9", 43 illus., 288 pgs. Price Prepaid **\$3.00**

The comprehensive and easily-readable writings of a group of television technicians, each expert in a particular subject.

FOREIGN POSTAGE

For foreign countries, please remit in addition to the above prices the following amounts for postage:—
Up to \$1.00—10c
Up to \$2.00—15c
Up to \$3.00—25c
Up to \$6.00—35c

HOW TO ORDER
We cannot ship C. O. D. Our prices are net, as shown. Books sent prepaid in U.S. only.

THEORY AND APPLICATIONS OF ELECTRON TUBES. by Herbert J. Reich. Cloth covers, 6 1/2 x 9 1/4", completely illustrated, 870 pgs. Price Prepaid **\$5.00**

Students are given a thorough grounding in electron tube principles, associated circuits and equipment. A "final authority".

TELEVISION BROADCASTING. by Lenox R. Lohr. Cloth covers, 6 1/4 x 9 1/4", 88 illus., 274 pgs. Price Prepaid **\$3.00**

The status of radio, remote, and film television, is described. Recommended to everyone in television.

LOOK AND LISTEN. by Milton B. Slicer. Durable spiral flexible binding, 6x9 1/2", over 100 illus., 96 pgs. Price Prepaid **\$1.00**

Cloth binding **\$1.50**
A handbook on television as of April, 1939 (when 411-line scheduled telecasting started).

TELEVISION AND SHORT-WAVE HANDBOOK. by F. M. Camm. Cloth covers, 5 1/2 x 8", 130 illus., 272 pgs. Price Prepaid **\$2.50**

Principles and practices of the foremost television systems, presented in simplified descriptions, circuits and picture diagram.

RADIO PUBLICATIONS 20-R Vesey St., New York, N. Y.

Where to Buy It! —

SECTION V (REVISED)

CLASSIFIED RADIO DIRECTORY

Handy Buying Guide, by Products and Companies' Names and Addresses, for the entire Radio Industry

There is no charge for regular light-face listings in the Classified Radio Directory. However, if dominant bold-face listings are desired, we make a charge of \$2 for concern names and \$1 for trade names for each bold-face listing. Please write to the Advertising Dept., Radio-Craft, 20 Vesey St., New York, N. Y., for details.

This DIRECTORY is published in sections—1 section per month. This method of publication permits the DIRECTORY to be constantly up-to-date since necessary revisions and corrections can be made monthly. All names preceded by an asterisk (*) indicate that they are trade names.

If you cannot find any item or manufacturer in this section or in previously-published sections, just drop us a line for the information. Canadian radio manufacturers are unable to purchase any merchandise from the States, Radio-Craft is advised. Our readers, however, may wish to make Canadian purchases, and hence, current listings are being continued.

Presented here is Section V of the completely revised Second Edition of the CLASSIFIED RADIO DIRECTORY.

While every precaution is taken to insure accuracy, Radio-Craft cannot guarantee against the possibility of occasional errors and omissions in the preparation of this Classified Directory. Manufacturers and readers are urged to report all errors and omissions at the earliest moment to insure corrections in the very next issue.

SCHOOLS



Correspondence	C
Residence	R
SUBJECTS TAUGHT:	
Amateur radio (and/or code)	AR
Broadcasting	B
B.Sc. in Radio Engineering	BS
Communications (Land & Marine)	C
Electronics	E
Facsimile	F
Frequency Modulation	FM
Military radio	MR
Radio Engineering	RE
Radiotelegraphy	RT
Servicing	S
Sound (and/or Public Address)	SO
Sound motion pictures	SP
Television	T
Other radio courses	OC

AMERICAN RADIO INSTITUTE, 1123 Broadway, New York, N. Y.—C, R: AR, RT
 THE AMERICAN SCHOOL, 850 E. 58th St., Chicago, Ill.—C: RE, S, T
 BECK SCHOOL FOR RADIO, Keith Bldg., 1722 Hennepin Ave., Minneapolis, Minn.—R: B, OC
 BLISS ELECTRICAL SCHOOL, Takoma Park, Washington, D. C.—R: OC
 CANDLER SYSTEM CO., Box 331, Asheville, N. C.—C: AR, RT, OC
 CASE SCHOOL OF APPLIED SCIENCE, Cleveland, Ohio—R: E, RE, OC
 CHICAGO TECHNICAL COLLEGE, 118 E. 26th St., Chicago, Ill.—R: RE, S
 COYNE ELECTRICAL SCHOOL, 500 S. Paulina St., Chicago, Ill.—R: AR, B, C, RT, S, SO, T
 DeFOREST TRAINING, INC., 2533 N. Ashland Ave., Chicago, Ill.—C, R: AR, B, C, E, RE, S, SP, T
 DODGE'S TELEGRAPH & RADIO INSTITUTE, Valparaiso, Ind.—R: AR, B, C, E, RE, S
 LINCOLN ENGINEERING SCHOOL, 859 S. 37th St., Lincoln, Nebr.—C: RE, OC
ELECTRIC RADIO-TELEVISION INSTITUTE, Redick Tower, Omaha, Nebr.—C, R: AR, B, C, E, F, RE, S, SP, T
 GULF RADIO SCHOOL, 1007 Carondelet St., New Orleans, La.—R: AR, B, C, E, S, T
 MASSACHUSETTS TELEVISION INSTITUTE, INC., 56B Commonwealth Ave., Boston, Mass.—C, R: B, E, RE, S, T, OC
 MIDLAND RADIO & TELEVISION SCHOOLS, INC., Power & Light Bldg., Kansas City, Mo.—C, R: AR, B, C, E, RE, E, T
 NATIONAL RADIO INSTITUTE, Washington, D. C.—C, AR, B, C, E, RE, S, SO, T, OC
 NEW YORK Y.M.C.A. SCHOOLS, 5 W. 63rd St., New York, N. Y.—R: B, E, S, T, OC
 NILSON RADIO SCHOOL, 51 E. 42nd St., New York, N. Y.—C: AR, B, C
 NORTHERN INSTITUTE OF TECHNOLOGY, LTD., (or, RADIO COLLEGE OF CANADA), 54 Bloor St., W., Toronto, Ont., Can.—C, R: AR, B, C, E, MR, RE, S, T

PACIFIC RADIO SCHOOL, 735 Larkin St., San Francisco, Calif.—C, R: AR, B, C, S, T
 PORT ARTHUR COLLEGE, Port Arthur, Tex.—R: AR, B, C, E, RE, T, OC
 RADIO COLLEGE OF CANADA, 54 Bloor St., W., Toronto, Ont., Can.—See NORTHERN INSTITUTE OF TECHNOLOGY, LTD.
 RADIO INSTITUTE OF CALIFORNIA, College of Engineering, Pacific States University, 1117 Venice Blvd., Los Angeles, Calif.—R: AR, B, BS, C, E, RE, S, SO, T
 RADIO-TELEVISION INSTITUTE, INC., 480 Lexington Ave., New York, N. Y.—R: B, E, S, T
 RADIO TRAINING ASSOC. OF AMERICA, 1559-61 Devon Ave., Chicago, Ill.—C: AR, C, E, RE, S, T
 RCA INSTITUTES, INC., 75 Varick St., New York, N. Y.—R: AR, B, C, RE, RT, S, T
 SPRAYBERRY ACADEMY OF RADIO, 2548 University Pl., N.W., Washington, D. C.—C: A, B, C, E, S, T
 UNIVERSAL RADIO-TELEVISION INSTITUTE, 2549 Farnam St., Omaha, Nebr.—C, R: AR, B, C, E, RE, S, T
 UNIVERSAL TELEVISION SYSTEM, 2107 Grand Ave., Kansas City, Mo.—C, R: AR, B, C, S, FM, RE, S, T

DOW RADIO SUPPLY CO., 1759 E. Colorado St., Pasadena, Calif.—BE, EL, SM, TU
 FEDERATED PURCHASER, INC., 80 Park Pl., New York, N. Y.—AD, BE, EL, F, FR, IN, R, SM, SO, T, TU
 FINCH TELECOMMUNICATIONS, INC., 1819 Broadway, New York, N. Y.—F
 FISCHER DISTRIB. CORP., 222 Fulton St., New York, N. Y.—AD, EL, FR, IN, SM, SO, T, TU
 GENERAL ELECTRIC CO., Schenectady, N. Y., & Bridgeport, Conn.—SM
 HARRISON RADIO CO., 12 W. Broadway, New York, N. Y.—AD, BE, FR, IN, R
 HYGRADE SYLVANIA CORP., 500 5th Ave., New York, N. Y.—TU
 E. F. JOHNSON CO., Waseca, Minn.—AD, BE
 *KNIGHT—Allied Radio Corp.
 LAFAYETTE RADIO CORP., 100 6th Ave., New York, N. Y.—AD, BE, EL, F, FR, IN, SM, SO, T, TU
 P. R. MALLORY & CO., INC., 3029 E. Washington St., Indianapolis, Ind.—SM
 MEISSNER MANUFACTURING CO., Mt. Carmel, Ill.—BE, FR, SM
 MONTGOMERY WARD & CO., INC., 619 W. Chicago Ave., Chicago, Ill., **Airline—AD, BE, EL, R, SM, SO, TU
 OFFENBACH ELECTRIC CO., 1452 Market St., San Francisco, Calif.—AD, BE, EL, F, FR, IN, SM, SO, T, TU
 PHILCO RADIO & TELEVISION CORP., Troga & "C" Sts., Phila., Pa.—SM
 RADIO ELECTRIC SERVICE CO., INC., N. W. Cor. 7th & Arch Sts., Phila., Pa.—AD, BE, EL, F, FR, IN, SM, SO, T, TU
 RADIO COLLEGE OF CANADA, 54 Bloor St., W., Toronto, Ont., Can.—SM
 RADIO EQUIPMENT CORP., 326 Elm St., Buffalo, N. Y.—BE, EL, FR, SM, SO, TU
RADIO & TECHNICAL PUBLISHING CO., 45 Astor Pl., New York, N. Y.—AD, BE, IN, R, SM, S, SO, T, TU
 RADOLEK COMPANY, 601 W. Randolph St., Chicago, Ill.—AD, BE, EL, F, FR, IN, R, SM, SO, T, TU
 RCA MANUFACTURING CO., INC., Camden, N. J.—AD, BE, EL, F, FR, SM, SO, T, TU
 JOHN F. RIDER PUBLISHER, INC., 404 4th Ave., New York, N. Y.—AD, BE, EL, FR, SM, T, TU
 ROGERS-MAJESTIC CORP., LTD., 622 Fleet St., Toronto, Can.—SM
 WALTER L. SCHOTT CO., 5266-70 W. Pico Blvd., Los Angeles, Calif., **Walsco—W
 MAURICE SCHWARTZ & SON, 710-712 Broadway, Schenectady, N. Y.—AD, BE, EL, F, FR, IN, SM, SO, T, TU
 SEATTLE RADIO SUPPLY CO., INC., 2117 2nd Ave., Seattle, Wash.—AD, BE, EL, FR, IN, R, SM, SO, T, TU
 SHELLEY RADIO CO., 1841 S. Flower St., Los Angeles, Calif.—AD, BE, EL, F, FR, IN, SM, SO, T, TU
 S.O.S. CINEMA SUPPLY CORP., 636 11th Ave., New York, N. Y.—EL, SO, T, TU
 SPRAGUE PRODUCTS CO., N. Adams, Mass.—IN
 STROMBERG CARLSON TELEPHONE MFG. CO., 100 Carlson Rd., Rochester, N. Y.—FR, SM
 SUN RADIO CO., 212 Fulton St., New York, N. Y.—AD, BE, EL, FR, IN, SM, SO, T, TU
 SUPREME PUBLICATIONS, 3727 W. 13th St., Chicago, Ill.—AD, BE, R, SM, SO, T
 THORDARSON ELECTRIC MFG. CO., 500 W. Huron St., Chicago, Ill.—BE, SM, SO
 TRY-MO RADIO CO., INC., 85 Cortlandt St., New York, N. Y.—AD, BE, EL, F, FR, IN, R, SM, SO, T, TU
 VICTOR ANIMATOGRAPH CORP., Davenport, Iowa—SO
 *WALSCO—Walter L. Schott Co.

SERVICE MANUALS & BOOKS



Acoustics (see Sound, below)	
Advanced theory	AD
Beginners' theory	BE
Electronics	EL
Engineering	EN
Facsimile	F
Frequency Modulation	FR
Interference elimination	IN
Physics	PH
Radio	R
Service manuals	SM
Servicing	S
Sound	SO
Television	T
Tubes	TU
Woodworking & finishing	W

AEROVOX CORPORATION, New Bedford, Mass.—IN
 *AIRLINE—Montgomery Ward & Co., Inc.
 ALLIED RADIO CORP., 833 W. Jackson Blvd., Chicago, Ill., **Knight—AD, BE, EL, F, FR, IN, R, SM, SO, T, TU
 AMPLIFIER CO. OF AMERICA, 17 W. 20th St., New York, N. Y.—SO
 AUDIO DEVICES, INC., 1600 Broadway, New York, N. Y.—SO
 AUDIOGRAPH SOUND SYSTEMS, 1313 W. Randolph St., Chicago, Ill.—SO
 THE BLAKISTON COMPANY, 1012 Walnut St., Phila., Pa.—EN, PH, SO
 CAMERON PUBLISHING CO., Coral Gables, Fla.—S, SO, T
 CORNELL DUBILIER ELECTRIC CORP., S. Plainfield, N. J.—SM
 CRUMPACKER DISTRIB. CORP., 1801 Fannin St., Houston, Tex.—IN, SM
 HAROLD DAVIS, INC., 428 W. Capitol St., Jackson, Miss.—FR, SM, SO, T, TU

Please say you saw it in the Radio-Craft "Classified Radio Directory"

• CLASSIFIED RADIO DIRECTORY •

SOUND MOTION PICTURE MACHINES (& EQUIPMENT)



- 8 mm. A
- 16 mm. B
- 35 mm. C
- Record players R
- Test films T
- Voltage regulators V

AMPRO CORPORATION, 2839 Northwestern Ave., Chicago, Ill.—A, B
 BELL & HOWELL CO., 1801 Larchmont Ave., Chicago, Ill.—A, B, C, R
 DEVRY CORPORATION, 1111 Armitage Ave., Chicago, Ill.—B, C
 MELLOPHONE CORPORATION, 65 Atlantic Ave., Rochester, N. Y.—C
 S.O.S. CINEMA SUPPLY CORP., 636 11th Ave., New York, N. Y.—B, C, T, V
 VICTOR ANIMATOGRAPH CORP., Davenport, Iowa—B, R
 WEBER MACHINE CORP., 59 Rutter St., Rochester, N. Y.—C

SOUND STILL PICTURE MACHINES (& EQUIPMENT)

Machines & equipment M

TALKING SALES PICTURES, INC., 317 E. Ontario St., Chicago, Ill.—M

SOUND SYSTEMS (& ACCESSORIES)



- Acoustic materials A
- Attenuators AT
- Baffles (see Loudspeakers & Parts)
- Carrying cases CC
- Intercommunicators (see Intercommunicating Systems)
- Loudspeaker mountings (vacuum type, for car tops, etc.) L
- Marine sound systems MS
- Marine talk-back P.A. systems MT
- Microphones (sound-measurement) M
- Remote controllers R
- School sound systems S
- Sound systems (centralized) SS
- Sound systems (complete) SC
- Stethophone, electronic ST
- Test films, frequency TF
- Tuners T

ACOUSTIC EQUIPMENT CO., 323 Walton Bldg., Atlanta, Ga.—SC (sell and rent)
 *AIRLINE—Montgomery Ward & Co., Inc.
 ALLIED RADIO CORP., 833 W. Jackson Blvd., Chicago, Ill., *"Knight"—A, CC, SC
 ALLISON BAFFLE CO., 207 S. 86th St., Birmingham, Ala.—CC
 AMERICAN COMMUNICATIONS CORP., 123 Liberty St., New York, N. Y.—A, SC
 AMERICAN TELEVISION CORP., 130 W. 56th St., New York, N. Y.—SC
 AMPLIFIER CO. OF AMERICA, 17 W. 20th St., New York, N. Y.—R, SC, ST
 ATLAS SOUND CORP., 1451 39th St., Brooklyn, N. Y.—A, CC, SC
 AUDIO DEVELOPMENT CO., 123 Bryant Ave. N., Minneapolis, Minn.—S, SC
 AUDIOGRAPH SOUND SYSTEMS, 1313 W. Randolph St., Chicago, Ill.—CC, SC
 BANK'S MANUFACTURING CO., 5019 N. Winthrop Ave., Chicago, Ill.—SC
 BARKER & WILLIAMSON, Ardmore, Pa.—SC
 BELL SOUND SYSTEMS, INC., 1183 Essex Ave., Columbus, Ohio—CC, S, SC
 DAVID BOGEN CO., 663 Broadway, New York, N. Y.—CC, SS, SC, T
 *BROWN DEVILS—Ohmite Manufacturing Co.
 BUD RADIO, INC., 5205 Cedar Ave., Cleveland, Ohio—CC
 THE CELOTEX CORPORATION, 919 N. Michigan Ave., Chicago, Ill.—A

CHICAGO SOUND SYSTEMS CO., 315 E. Grand Ave., Chicago, Ill.—A, SC
 CINEMA ENGINEERING CO., 1508 S. Verdugo Ave., Burbank, Calif.—SC
 *CLARION—Transformer Corp. of America
 CRACRAFT, INC., 28 Grove St., New York, N. Y.—SC
 CRUMPACKER DISTRIB. CORP., 1801 Fannin St., Houston, Tex.—SC
 HAROLD DAVIS, INC., 428 W. Capitol St., Jackson, Miss.—CC, SC
 *DETERMOMH—Ohmite Manufacturing Co.
 DEVRY CORPORATION, 1111 Armitage Ave., Chicago, Ill.—A, CC, SC
 *DICTAFILM—Miles Reproducer Co., Inc.
 DOW RADIO SUPPLY CO., 1759 E. Colorado St., Pasadena, Calif.—CC, SC
 E. A. ECKSTEIN COMPANY, LeRoy, Minn.—SC
 ELECTRONIC SOUND & MUSIC CO., 10 Stuyvesant St., New York, N. Y.—CC, SC
 ELECTRO PRODUCTS LABS., 549 W. Randolph St., Chicago, Ill.—AT
 ERIE RESISTOR CORP., 644 W. 12th St., Erie, Pa.—A
 ERWOOD SOUND EQUIPMENT CO., 224 W. Huron St., Chicago, Ill.—CC, SC
 FEDERATED PURCHASER, INC., 80 Park Pl., New York, N. Y.—A, CC, SC
 *FILMGRAPH—Miles Reproducer Co., Inc.
 FISCHER DISTRIB. CORP., 222 Fulton St., New York, N. Y.—A, CC, SC
 *FLEXIFONE—Ohmite Mfg. Co.
 GENERAL CEMENT MFG. CO., 919 Taylor Ave., Rockford, Ill.—A
 GENERAL COMMUNICATION PRODUCTS CO., 6245 Lexington Ave., Hollywood, Calif.—SC
 GLOBE PHONE MFG. CORP., Reading, Mass.—SC
 GUIDED RADIO CORP., 118 E. 25th St., New York, N. Y.—MS, MT, SC
 HAMMOND MANUFACTURING CO., Guelph, Ont., Can.—CC
 HARTONE MANUFACTURING CORP., 123 S. 15th St., Newark, N. J.—CC
 HARRISON RADIO CO., 12 W. Broadway, New York, N. Y.—SC
 HETRO ELECTRICAL INDUSTRIES, INC., 5819 N. Drake Ave., Chicago, Ill., *"Hetro"—SC
 HETRO—Hetro Electrical Industries, Inc.
 HERBERT H. HORN, 1201 S. Olive St., Los Angeles, Calif.—A, SC
 INSULINE CORP. OF AMERICA, 30-30 Northern Blvd., L. I. City, N. Y.—CC
 *CHARLES JACK MFG. CORP., 27 E. Philadelphia St., York, Pa.—SC
 *KNIGHT—Allied Radio Corp.
 LAFAYETTE RADIO CORP., 100 6th Ave., New York, N. Y.—A, CC, SC
 LAUREHK RADIO MFG. CO., 3918 Monroe Ave., Wayne, Mich.—CC
 LEOTONE RADIO CO., 63 Dey St., New York, N. Y.—SC
 THE LINCROPHONE CO., INC., 1661 Howard Ave., Utica, N. Y.—CC, SC
 M & H SPORTING GOODS CO., 512 Market St., Phila., Pa.—CC, SC
 MARINE RADIO CORP., 117-19 168 St., Jamaica, N. Y.—SC
 JOHN MECK INDUSTRIES, 1313 Randolph St., Chicago, Ill.—CC, SC
 MILES REPRODUCER CO., INC., 812 Broadway, New York, N. Y., *"Filmgraph," "Dictafilm"—SC
 MILLION RADIO AND TELEVISION, 1617 N. Damen Ave., Chicago, Ill.—CC, SC
 MONTGOMERY WARD & CO., INC., 619 W. Chicago Ave., Chicago, Ill., *"Airline"—CC, SC
 *MULTIVOLTS—Ohmite Manufacturing Co.
 MUSIC MASTER MFG. CO., 508 S. Dearborn St., Chicago, Ill.—SC
 NATIONAL DOBRO CORP., 400 S. Peoria St., Chicago, Ill.—SC
 NATIONAL UNION RADIO CORP., 57 State St., Newark, N. J.—CC, SC
 NORTHERN ELECTRIC CO., LTD., 1261 Shearer St., Montreal, Que., Can.—A, CC, SC
 OFFENBACH ELECTRIC CO., 1452 Market St., San Francisco, Calif.—A, CC, SC
 OHMITE MANUFACTURING CO., 4835 W. Fournoy St., Chicago, Ill., *"Flexifone," "Ohmite," "Brown Devils," "Multivolts," "Determohm," "Riteohm"—AT
 *OHMITE—Ohmite Manufacturing Co.
 OPERADIO MFG. CO., St. Charles, Ill.—SC
 PACENT ENGINEERING CORP., 79 Madison Ave., New York, N. Y.—SC
 PHILCO RADIO & TELEVISION CORP., Tioga & "C" Sts., Phila., Pa.—SC
 PHONOTONE LABORATORIES, INC., S.E. 15th St., Washington, Ind.—SC
 RACON ELECTRIC CO., INC., 52 E. 19th St., New York, N. Y.—A
 RADIO ELECTRIC SERVICE CO., INC., N. W. Cor. 7th & Arch Sts., Phila., Pa.—A, CC, SC
 RADIO EQUIPMENT CORP., 326 Elm St., Buffalo, N. Y.—A, CC, SC
 RADIOTONE, INC., 7356 Melrose Ave., Hollywood, Calif.—SC
 RADOLEK COMPANY, 601 W. Randolph St., Chicago, Ill.—A, CC, SC
 THE RAYLAND CORPORATION, 3333 Belmont Ave., Chicago, Ill.—SC

RAY-LAB COMPANY, Grand Central & 11th St., Elmira Heights, N. Y.—CC, SC
 RCA MFG. CO., INC., Camden, N. J.—SC
 REGAL AMPLIFIER MFG. CORP., 14 W. 17th St., New York, N. Y.—CC, SC
 *RITEOHM—Ohmite Manufacturing Co.
 *ROCKET—Shure Brothers
 ROTOPHONE CORPORATION, 26 Journal Sq., Jersey City, N. J.—A (for hard-of-hearing)
 ROWE INDUSTRIES, INC., 3120 Monroe St., Toledo, Ohio—SC
 MAURICE SCHWARTZ & SON, 710-712 Broadway, Schenectady, N. Y.—A, CC, SC
 SEATTLE RADIO SUPPLY CO., INC., 2117 2nd Ave., Seattle, Wash.—A, CC, SC
 SETCHELL CARLSON, INC., 2233 University Ave., St. Paul, Minn.—SC
 SHELLEY RADIO CO., 1841 S. Flower St., Los Angeles, Calif.—SC
 SHURE BROTHERS, 225 W. Huron St., Chicago, Ill., *"Shure," "Unidyne," "Uniplex," "Rocket," "Stratoliner," "Super-Level," "Ultrawide-Range," "Zephyr"—M, ST
 *SHURE—Shure Brothers
 MAR SIMPSON DISTRIB. CO., INC., 16 Hudson St., New York, N. Y.—CC, SC
 S.O.S. CINEMA SUPPLY CORP., 636 11th Ave., New York, N. Y.—A, CC, SC, TF
 SOUND APPARATUS CO., 150 W. 46th St., New York, N. Y.—CC, SC
 SPEAK-O-PHONE RECORDING & EQUIPMENT CO., 23 W. 60th St., New York, N. Y.—CC, SC
 *STRATOLINER—Shure Brothers
 SUNDT ENGINEERING CO., 4757 Ravenswood Ave., Chicago, Ill.—SC (high power)
 SUN RADIO CO., 212 Fulton St., New York, N. Y.—A, CC, SC
 *SUPER-LEVEL—Shure Brothers
 TECHNICAL PRODUCTS INTERNATIONAL, 135 Liberty St., New York, N. Y.—SC
 THORDARSON ELECTRIC MFG. CO., 500 W. Huron St., Chicago, Ill.—CC
 TRANSFORMER CORP. OF AMERICA, 69 Wooster St., New York, N. Y., *"Clarion"—SC
 TRY-MO RADIO CO., INC., 85 Cortlandt St., New York, N. Y.—A, CC, SC
 *ULTRAWIDE-RANGE—Shure Brothers
 *UNIDYNE—Shure Brothers
 *UNIPLEX—Shure Brothers
 VAC-O-GRIP COMPANY, 2023 Detroit Ave., Toledo, Ohio—L
 THE VEGA COMPANY, 155 Columbus Ave., Boston, Mass., *"Vega," "Vitar"—CC
 *VEGA—The Vega Company
 VICTOR ANIMATOGRAPH CORP., Davenport, Iowa—SC
 *VITAR—The Vega Company
 THE VOLU-TONE COMPANY, 252 S. Broadway, Los Angeles, Calif.—CC, SC
 WEBSTER-CHICAGO CORPORATION, 5622 W. Bloomingdale Ave., Chicago, Ill.—SC
 WEBSTER ELECTRIC CO., Clark & DeKanen Ave., Racine, Wis.—SC
 WESTERN ELECTRIC CO., INC., 300 Central Ave., Kearny, N. J.—SC
 WESTERN SOUND & ELEC. LABS., INC., 311 W. Kilbourn Ave., Milwaukee, Wis.—SC
 *ZEPHYR—Shure Brothers

SPECIAL SERVICES



- Electronic display novelties (design & construction) E
- Engraving on bakelite panels EB
- Engraving on insulation (except bakelite) EI
- Engraving on metal EM
- Frequency measuring FM
- Hearing-aid & sound services for churches, factories, etc. HS
- Mechanical & electrical assemblies & supply assemblies, to order M
- Mixers (design & construction) MX
- Moldings, cellulose acetate MC
- Moldings, synthetic plastics (except cellulose acetate) MS
- Power Supply Engineering P
- Sound record pressings S
- Stampings, metal SM
- Transcriptions S

ACOUSTIC EQUIPMENT CO., 323 Walton Bldg., Atlanta, Ga.—S, T
 AMPLIFIER CO. OF AMERICA, 17 W. 20th St., New York, N. Y.—M, P
 BOONTON MOLDING CO., 326 Myrtle Ave., Boonton, N. J.—MS
 FLOCK PROCESS CORP., 17 W. 31st St., New York, N. Y.—MC
 FULLER SPECIALTY CO., 1406 Avery St., Parkersburg, W. Va.—HS, MX

Please say you saw it in the Radio-Craft "Classified Radio Directory"

THE FINEST RADIO BOOK FREE WE EVER OFFERED :- the 1940-41 Radio-Television Reference Annual With \$1.00 subscription to RADIO - CRAFT

WITH our compliments, we want to send a copy of the 1940 RADIO-TELEVISION REFERENCE ANNUAL to you FREE. If you will simply take advantage of RADIO-CRAFT magazine's special subscription offer NOW. This offer is being made for a limited time only.

The 1940 RADIO-TELEVISION REFERENCE ANNUAL has 68 pages, large size 8 1/2 x 11 1/2, with over 170 illustrations. The contents of this book has never appeared before in handy book form. Its pages cover practically every branch of radio sound, public address, servicing, television, construction articles for advanced radio men and technicians, time and money-saving kinks, wrinkles, useful circuit information, "ham" transmitters and receivers, and a host of other data.

The Annuals have always been regarded as a standard reference work for every practical branch of radio operation and service. This 1940 edition ably sustains this reputation. Every radio man wants a copy of this valuable book. Just as this book will be of unquestionable value to you, so, too, will every monthly issue of RADIO-CRAFT. This magazine brings you big value every month. It keeps you intelligently informed about new developments in radio and television. You want the news, want it fully but concisely, want it first—that is why you should read RADIO-CRAFT regularly.

This very special offer is made for just one purpose—we want you as a regular subscriber. The Annual, whose contents appears at the right, is not sold, but a copy is FREE to you if you subscribe now.

**SAME SIZE AS
RADIO-CRAFT**



THIS COUPON BRINGS YOU THE ANNUAL

RADIO-CRAFT • 20 VESEY STREET • NEW YORK, N. Y.

Gentlemen: Enclosed you will find One Dollar for which enter my subscription to RADIO-CRAFT Magazine for Eight Months. Send me ABSOLUTELY FREE and POSTPAID, my copy of 1940 RADIO-TELEVISION REFERENCE ANNUAL.

This is a new order Extend My Present Subscription

NAME ADDRESS

CITY STATE

DON'T DELAY — MAIL TODAY! RC-841

**Read the summary of contents
in this FREE BOOK!**

THE 1940 RADIO-TELEVISION REFERENCE ANNUAL contains a collection of the best and most important articles. Covering as they do nearly every branch of radio, they form a handy reference works. In addition, many time and labor-saving kinks, circuits and wrinkles, tried and tested by practicing Servicemen, experimenters and radio fans have been included. This book cannot be bought anywhere at any price. Yet it is yours by merely subscribing. Use the convenient coupon below.

BEGINNER'S SIMPLE INEXPENSIVE CONSTRUCTION ARTICLES

Beginner's Breadboard Special - a 1-Tube High-Gain All-Wave Receiver—Wiring Pointers for Radio Beginners—A Watch Charm Size 1-Tube Set—Beginner's Simple Volt-Milliammeter—Making a 1-Tube Broadcast Loop Receiver—A.C.-D.C. Power Supply for Battery Portables—A 1-Tube Short-Waver with Band Coil Switching.

MORE ADVANCED SET CONSTRUCTION

The "High-Seas 4" Broadcast Lamp Radio—How to Build a 6-Tube 1.4-Volt Short-Wave Superhet for the "Ham" or Short-Wave Fan—Build the "Lunch Box 5" Super Set - a Broadcast Battery Portable—How to Build a Plug-Together 8 Tube Broadcast Set—The "5-In-4" All-Wave Radio for A.C. Operation—An Easily-Built 3-Tube Midget Broadcast Superheterodyne Receiver.

THE SERVICEMEN'S SECTION

Base Tone Control—Simplified Variable Selectivity—Practical Servicing Pointers—Servicing Universal A.C.-D.C. Receivers—Killing the "Intermittent" Bug—A Service Shop A.C. to D.C. Power Supply—Sideline Money for Servicemen—Adding A.V.C. to any Screen-Grid T.R.F. Receiver—Iron Particles in Speaker Air Gap.

TEST INSTRUMENTS

A Useful Neon Lamp Tester—An Inexpensive Output Meter—Making Milliammeter Multipliers—Home-Made Frequency Modulator—The Busy Servicemen's V.T. Volt-Meter.

PUBLIC ADDRESS AND AMPLIFIERS

Build this Combination A.C.-D.C. Radio and Inter-Communicator—Speaker Placement in P.A. Work—The Design and Construction of an Inexpensive All-Push-Pull 10-Watt Amplifier—Obscure Sources of Hum in High-Gain Amplifiers—How to Build a High-Fidelity 5-Watt Versatile Amplifier.

"HAM" SECTION

Ultra-High Frequency Antennas—The Beginner's Low-Cost Xmitter—Modulator Meter—Phone Monitor—The Beginner's "Ham" Receiver—2 1/2 Meter Acorn Transceiver.

TELEVISION

How to Build a 441 Line T.R.F. Television Receiver—Useful Notes on Television Antennae.

MISCELLANEOUS

Simple Photo-Coil Relay Set Up—Making a Burglar Alarm—How to Build A.C.-D.C. Capacity Relay—How to Make a Modern Radio Treasure Locator.

USEFUL KINKS, CIRCUITS AND WRINKLES

Making a Flexible Coupler—Two-Timing Chime—A Simple Portable Aerial—An Improvised Non-Slip Screw-Driver. NOTE: The book contains numerous other useful Kinks, Circuits and Wrinkles, not listed here.

(approximately)

45 ARTICLES

(approximately)

170 ILLUSTRATIONS

68 BIG PAGES

**RADIO-CRAFT
20 VESEY STREET
NEW YORK, N. Y.**

CLASSIFIED RADIO DIRECTORY

HUNTER PRESSED STEEL CO., 8th St. & Maple Ave., Lansdale, Pa.—M
 KURZ-KASCH, INC., 1421 S. Broadway, Dayton, Ohio—MC, MS
 PRECISION CRYSTAL LABS., Springfield Airport, Springfield, Mass.—FM
 SCIENTIFIC RADIO SERVICE, 124 Jackson Ave., University Park, Hyattsville, Md.—FM
 TALKING DEVICES CO., 4447 W. Irving Park Rd., Chicago, Ill.—E
 UNITED RADIO MFG. CO., 191 Greenwich St., New York, N. Y.—EB, EI, EM
 ZIERICK MANUFACTURING CORP., 385 Gerard Ave., Bronx, N. Y.—SM

SWITCHES & RELAYS



Acoustic	A
Anti-capacity	AC
Automatic code machines	AM
Circuit breakers	C
Inertia	I
Mercury	ME
Mercury relays	MR
Power	PO
Power (tap)	PT
Protective	PR
Relays	RE
Reverse-current cutouts	RC
Test equipment	TE
Time	TI
Time-delay relays	TD
Timers (electronic)	TM
Vacuum	VA
Wavechange (receiver)	WR
Wavechange (transmitter)	WT

ADVANCE ELECTRIC CO., 1260 W. 2nd St., Los Angeles, Calif.—C, PR, RE, TI
 *AIRLINE—Montgomery Ward & Co., Inc.
 ALLEN-BRADLEY COMPANY, 1326 S. 2nd St., Milwaukee, Wis.—PO, RE
 ALLIED CONTROL CO., INC., 227 Fulton St., New York, N. Y.—PO
 ALLIED RADIO CORP., 833 W. Jackson Blvd., Chicago, Ill., *Knight"—PO, PR, RE, TE, TI
 AMERICAN COMMUNICATIONS CORP., 123 Liberty St., New York, N. Y.—AM
 AMERICAN GAS ACCUMULATOR CO., 1029 Newark Ave., Elizabeth, N. J.—TI
 AMERICAN RADIO HARDWARE CO., INC., 476 Broadway, New York, N. Y.—TE
 VICTOR J. ANDREW CO., 6429 S. Lavergne Ave., Chicago, Ill.—RE, WT
 ARROW HART & HEGEMAN ELEC. CO., 103 Hawthorn St., Hartford, Conn.—C, ME, PO, RE
 BANK'S MANUFACTURING CO., 5019 N. Winthrop Ave., Chicago, Ill.—RE
 BARKER & WILLIAMSON, Ardmore, Pa.—RE, VA, WT
 *BIRNBACH—Birnbach Radio Co., Inc.
 BIRNBACH RADIO CO., INC., 145 Hudson St., New York, N. Y., *Birnbach"—PO
 BOND PRODUCTS CO., 13139 Hamilton Ave., Detroit, Mich.—C, PO, TE
 *BROWN DEVILS—Ohmite Manufacturing Co.
 J. H. BUNNELL & CO., 215 Fulton St., New York, N. Y.—C, PR, RE
 CANADIAN MARCONI CO., 211 St. Sacramento St., Montreal, Can.—C, ME, PO, PR, RE, WR, WT
 CENTRALAB, DIV. OF GLOBE-UNION, INC., 900 E. Keefe Ave., Milwaukee, Wis.—TE, WR, WT
 CINEMA ENGINEERING CO., 1508 W. Verdugo Ave., Burbank, Calif.—RE, TE
 CIRCLE MANUFACTURING CO., 720 Monmouth St., Trenton, N. J.—PO
 HAROLD DAVIS, INC., 428 W. Capitol St., Jackson, Miss.—RE
 *DETERMOMH—Ohmite Manufacturing Co.
 DOW RADIO SUPPLY CO., 1759 E. Colorado St., Pasadena, Calif.—AM, RE, TE
 DURAKOOL, INC., 1010 N. Main St., Elkhart, Ind.—ME, MR
 ELECTRONIC CONTROL CORP., 2667 E. Grand Blvd., Detroit, Mich.—PR
 FEDERAL A-C SWITCH CORP., 1200 Niagara St., Buffalo, N. Y.—AC
 FEDERATED PURCHASER, INC., 80 Park Pl., New York, N. Y.—AM, PO, TE
 FISCHER DISTRIB. CORP., 222 Fulton St., New York, N. Y.—RE
 FONDA CORPORATION, 29 W. 57th St., New York, N. Y.—RE
 GENERAL CEMENT MFG. CO., 919 Taylor Ave., Rockford, Ill.—PO, PR, TE
 GENERAL ELECTRIC CO., Schenectady, N. Y., & Bridgeport, Conn.—C, ME, P, PR, RE, TE, TI, VA

GORDON SPECIALTIES CO., 1104 S. Wabash Ave., Chicago, Ill.—PO
 GUARDIAN ELECTRIC MFG. CO., 1621 W. Walnut St., Chicago, Ill.—C, MR, PR, RE, TI
 GUIDED RADIO CORP., 118 E. 25th St., New York, N. Y.—RE
 HARRISON RADIO CO., 12 W. Broadway, New York, N. Y.—AM, C, ME, PO, PR, RE, TE, TI, WR, WT
 HARTMAN ELECTRICAL MFG. CO., 31 E. 5th St., Mansfield, Ohio—C, PR, RE, RC, TI
 H-B INSTRUMENT CO., INC., 2518 N. Broad St., Phila., Pa.—ME, RE
 HEINEMANN CIRCUIT BREAKER CO., 95 Plum St., Trenton, N. J.—C
 INDUSTRIAL TIMER CORP., 101 Edison Pl., Newark, N. J., *Time Delay Relay"—TI
 INERTIA DEVICES, INC., Room 608, 90 State St., Albany, N. Y.—I
 KELLOGG SWITCHBOARD & SUPPLY CO., 6650 S. Cicero Ave., Chicago, Ill.—C, RE, TE
 *KNIGHT—Allied Radio Corp.
 LAFAYETTE RADIO CORP., 100 6th Ave., New York, N. Y.—AM, C, PO, PR, RE, T, WR, WT
 *LAKE—Lake Manufacturing Co., Inc.
 LAKE MANUFACTURING CO., INC., 2323 Chestnut St., Oakland, Calif., *Voycall", "Lake"—RE
 LEACH RELAY CO., 5915 Avalon Blvd., Los Angeles, Calif.—C, PO, PR, RE, TD
 LITTELFUSE, INC., 4787 Ravenswood Ave., Chicago, Ill.—ME
 LUMENITE ELECTRIC CO., 407 S. Dearborn St., Chicago, Ill.—C, RE
 T. R. McELROY, 100 Brookline Ave., Boston, Mass.—AM, RE
 M & H SPORTING GOODS CO., 512 Market St., Phila., Pa.—PR, RE, TE, TI, VA, WR
 P. R. MALLORY & CO., INC., 3029 E. Washington St., Indianapolis, Ind.—TE, WR, WT
 *MARK-TIME—M. H. Rhodes, Inc.
 MEISSNER MANUFACTURING CO., Mt. Carmel, Ill.—PO, RE, WR, WT
 JAMES MILLEN MFG. CO., INC., 150 Exchange St., Malden, Mass.—RE, TI, VA
 MONTGOMERY WARD & CO., INC., 619 W. Chicago Ave., Chicago, Ill., *Airline"—RE
 *MULTIVOLTS—Ohmite Manufacturing Co.
 MUSIC MASTER MFG. CO., 508 S. Dearborn St., Chicago, Ill.—RE, WR, WT
 NORTHERN ELECTRIC CO., LTD., 1261 Shearer St., Montreal, Que., Can.—PO, RE, TI, WT
 OAK MANUFACTURING CO., 1260 Clybourn Ave., Chicago, Ill.—TE, WR, WT
 OFFENBACH ELECTRIC CO., 1452 Market St., San Francisco, Calif.—AM, ME, RE, TE
 OHMITE MANUFACTURING CO., 4835 W. Flournoy St., Chicago, Ill., *Ohmite", "Brown Devils", "Multivolts", "Determohm", "Riteohm"—PT, TE, WT
 *OHMITE—Ohmite Manufacturing Co.
 PHILMORE MANUFACTURING CO., INC., 113 University Pl., New York, N. Y.—C
 RADIO ELECTRIC SERVICE CO., INC., N.W. Cor. 7th & Arch Sts., Phila., Pa.—RE, TE
 RADIO EQUIPMENT CORP., 326 Elm St., Buffalo, N. Y.—AM, RE, TE
 RADIO RECEPTOR CO., INC., 251 W. 19th St., New York, N. Y.—TI
 RADOLEK COMPANY, 601 W. Randolph St., Chicago, Ill.—A, C, ME, PO, PR, RE, TE
 R-B-M MANUFACTURING CO., Div. Essex Wire Corp., Hanna & Chestnut St., Logansport, Ind.—C, PO, PR, RE
 RCA MANUFACTURING CO., INC., Camden, N. J.—TE
 REMIND-O-CLOCK CORP., 1241 High St., Oakland, Calif.—TI
 M. H. RHODES, INC., 30 Bartholomew Ave., Hartford, Conn., *Mark-Time"—TI
 *RITEOHM—Ohmite Manufacturing Co.
 ROWE RADIO RESEARCH LAB. CO., 4201 Irving Park Blvd., Chicago, Ill.—TE, TI
 MAURICE SCHWARTZ & SON, 710-712 Broadway, Schenectady, N. Y.—AM, C, ME, PO, PR, RE, TE, TI, VA, WR, WT
 SEATTLE RADIO SUPPLY CO., INC., 2117 2nd Ave., Seattle, Wash.—AM, PO, PR, RE, TE, TI, VA, WR, WT
 SHALLCROSS MANUFACTURING CO., 10 Jackson Ave., Collingdale, Pa.—WR, WT
 SHELLEY RADIO CO., 1841 S. Flower St., Los Angeles, Calif.—TE
 SIGMA INSTRUMENTS, INC., 76-78 Freeport St., Boston, Mass.—A, RE
 STACKPOLE CARBON CO., Tannery St., St. Marys, Pa.—WR
 STANDARD ELECTRICAL PRODUCTS CO., 417 1st Ave. N., Minneapolis, Minn.—RE
 STROMBERG-CARLSON TELEPHONE MFG. CO., 100 Carlsgen Rd., Rochester, N. Y.—RE
 STRUTHERS DUNN, INC., 1315 Cherry St., Phila., Pa.—RE
 SUN RADIO CO., 212 Fulton St., New York, N. Y.—AM, C, ME, PO, PR, RE, TE, TI, VA, WR, WT
 *TIME DELAY RELAY—Industrial Timer Corp.
 TORK CLOCK CO., INC., 1 Grove St., Mt. Vernon, N. Y.—TI
 TRIPLETT ELECTRICAL INSTRUMENT CO., Bluffton, Ohio, *Triplett"—RE, TE
 *TRIPLETT—Triplett Electrical Instrument Co.

TRY-MO RADIO CO., INC., 85 Cortlandt St., New York, N. Y.—A, C, ME, PO, PR, RE, TE, TI, VA, WR, WT
 UNITED CINEPHONE CORP., Torrington, Conn.—TM
 UTAH RADIO PRODUCTS CO., 812 Orleans St., Chicago, Ill.—C, RE
 *VOYCALL—Lake Manufacturing Co., Inc.
 WARD LEONARD ELECTRIC CO., 31 South St., Mt. Vernon, N. Y.—PO, PR, RE, TI
 EARL WEBBER CO., 4348 W. Roosevelt Rd., Chicago, Ill.—TE
 WESTERN SOUND & ELECTRIC LABS., INC., 311 W. Kilbourn Ave., Milwaukee, Wis.—RE
 WESTINGHOUSE ELEC. & MFG. CO., E. Pittsburgh, Pa.—C, ME, PO, PR, RE, TI
 WESTON ELECTRICAL INSTRUMENT CORP., 614 Frelinghuysen Ave., Newark, N. J., *Weston"—RE
 *WESTON—Weston Electrical Instrument Corp.
 WHEELCO INSTRUMENTS CO., 1933 S. Halsted St., Chicago, Ill.—C, PO, PR, RE, TE
 WIRT COMPANY, 5221 Greene St., Phila., Pa.—PO, WR
 WORNER PRODUCTS CORP., 1019 W. Lake St., Chicago, Ill.—RE

TELEGRAPH KEYS, CODE MACHINES & CODE RECORDS



Automatic keys	A
Code-lesson records	CL
Code recorders	CR
Code transmitters	CT
Electronic keys	E
Manual keys	M
Semi-automatic keys	S

*AIRLINE—Montgomery Ward & Co., Inc.
 ALLIED RADIO CORP., 833 W. Jackson Blvd., Chicago, Ill., *Knight"—A, CL, CR, CT, E, M, S
 AMERICAN COMMUNICATIONS CORP., 123 Liberty St., New York, N. Y.—A, E, M, S
 *ANTENNEX—M. M. Fleron & Son, Inc.
 J. H. BUNNELL & CO., 215 Fulton St., New York, N. Y.—A, M, S
 CANADIAN MARCONI CO., 211 St. Sacramento St., Montreal, Can.—M
 HAROLD DAVIS, INC., 428 W. Capitol St., Jackson, Miss.—E
 DOW RADIO SUPPLY CO., 1759 E. Colorado St., Pasadena, Calif.—A, E, M, S
 FEDERATED PURCHASER, INC., 80 Park Pl., New York, N. Y.—A, E, M, S
 FISCHER DISTRIB. CORP., 222 Fulton St., New York, N. Y.—A, E, M, S
 *FLERON—M. M. Fleron & Son, Inc.
 M. M. FLERON & SON, INC., 113 N. Broad St., Trenton, N. J., *Antennex", "Fleron", "Safest", "Signaler"—M
 HARRISON RADIO CO., 12 W. Broadway, New York, N. Y.—A, E, M, S
 KELLOGG SWITCHBOARD & SUPPLY CO., 6650 S. Cicero Ave., Chicago, Ill.—M
 *KNIGHT—Allied Radio Corp.
 LAFAYETTE RADIO CORP., 100 6th Ave., New York, N. Y.—A, CL, CR, CT, E, M, S
 T. R. McELROY, 100 Brookline Ave., Boston, Mass.—A, CR, E, M, S, CT
 M & H SPORTING GOODS CO., 512 Market St., Phila., Pa.—A, CL, CR, CT, M, S
 MONTGOMERY WARD & CO., INC., 619 W. Chicago Ave., Chicago, Ill., *Airline"—A, CL, CR, CT, M, S
 NORTHERN ELECTRIC CO., LTD., 1261 Shearer St., Montreal, Que., Can.—M
 OFFENBACH ELECTRIC CO., 1452 Market St., San Francisco, Calif.—A, CL, CR, CT, E, M, S
 PHILMORE MANUFACTURING CO., INC., 113 University Pl., New York, N. Y.—M
 RADIO ELECTRIC SERVICE CO., INC., N.W. Cor. 7th & Arch Sts., Phila., Pa.—M
 RADIO EQUIPMENT CORP., 326 Elm St., Buffalo, N. Y.—M
 RADOLEK COMPANY, 601 W. Randolph St., Chicago, Ill.—A, CL, CR, CT, E, M, S
 *SAFEST—M. M. Fleron & Son, Inc.
 MAURICE SCHWARTZ & SON, 710-712 Broadway, Schenectady, N. Y.—A, CL, CR, CT, E, M, S
 SEATTLE RADIO SUPPLY CO., INC., 2117 2nd Ave., Seattle, Wash.—A, E, M, S
 *SIGNALER—M. M. Fleron & Son, Inc.
 SUN RADIO CO., 212 Fulton St., New York, N. Y.—A, E, M, S
 TRY-MO RADIO CO., INC., 85 Cortlandt St., New York, N. Y.—A, E, M, S
 ULTIMATE TRANSMITTER CO., 4163 Budlong Ave., Los Angeles, Calif.—A, M, S
 THE VIBROPLEX CO., INC., 832 Broadway, New York, N. Y.—A, M, S

Please say you saw it in the Radio-Craft "Classified Radio Directory"

CLASSIFIED RADIO DIRECTORY

TELEVISION



Antennas	A
Cabinets for television	C
Cathode-ray tubes	CH
Coaxial cables	CL
Coils	CS
C.-R. tube sockets	CT
Kits	K
Optical units	OP
Other television tubes	OT
Sets	S
Sight adapters	SA
Sound adapters	SO
Sound converters	ST
Television service oscillators	TS
Television test meters	TT
Transformers, chokes &/or yokes	TR
Transmitters	TS

ALDEN PRODUCTS CO., 715 Center St., Brockton, Mass.—CT
 ALLIED RADIO CORP., 833 W. Jackson Blvd., Chicago, Ill.—*Knight"—A, CH, CL, CT, OT, TS
 ALPHA WIRE CORP., 50 Howard St., New York, N. Y.—A, CL
 AMERICAN COMMUNICATIONS CORP., 123 Liberty St., New York, N. Y.—A
 AMERICAN PHENOLIC CORP., 1250 W. Van Buren St., Chicago, Ill.—CL, CT
 AMERICAN TELEVISION CORP., 130 W. 56th St., New York, N. Y.—CH, S, TR, TS
 AMPLIFIER CO. OF AMERICA, 17 W. 20th St., New York, N. Y.—TR
 VICTOR J. ANDREW CO., 6429 S. Laverne Ave., Chicago, Ill.—A, CL
 ARCO TUBE CO., 227 Central Ave., Newark, N. J.—CH, OT
 BARBER & HOWARD, INC., East Ave., Westerly, R. I.—CS
 BARKER & WILLIAMSON, Ardmore, Pa.—TS
BELDEN MANUFACTURING CO., 4647 W. Van Buren St., Chicago, Ill.—A, CL
 *BIRNBACH—Birnback Radio Co., Inc.
 BIRNBACH RADIO CO., INC., 145 Hudson St., New York, N. Y.—*Birnback"—A
 L. S. BRACH MFG. CORP., 55 Dickerson St., Newark, N. J.—A
 CANADIAN MARCONI CO., 211 St. Sacrament St., Montreal, Can.—A, CL
 CASTLEWOOD MANUFACTURING CO., 12th & Burnett Sts., Louisville, Ky.—C
 THE CLOUGH-BRENGLE CO., 5501 Broadway, Chicago, Ill.—TT
 CONSOLIDATED WIRE & ASSOCIATED CORPS., 512 S. Peoria St., Chicago, Ill.—A, CS
 CORNISH WIRE CO., INC., 15 Park Row, New York, N. Y.—A
 DELTA RADIO CORP., 115 Worth St., New York, N. Y.—CS
 DOOLITTLE RADIO, INC., 7421 Loomis Blvd., Chicago, Ill.—CL
 ALLEN B. DUMONT LABS., INC., Passaic, N. J.—CH, S, TS
 HUGH H. EBY, INC., 4700 Stenton Ave., Phila., Pa.—CT
 FARNSWORTH TELEVISION RADIO CORP., 3700 E. Pontiac St., Ft. Wayne, Ind.—A, CH, OT, S, SA, SO, ST, TS
 ESPEY MANUFACTURING CO., INC., 305 E. 63rd St., New York, N. Y.—S
 FISCHER DISTRIB. CORP., 222 Fulton St., New York, N. Y.—A, CL, K, TS, TT
 FONDA CORPORATION, 29 W. 57th St., New York, N. Y.—CH, OT, TR
 GARDNER ELECTRIC MFG. CO., SPECIALTY DIV., 4227 Hollis St., Oakland, Calif.—TR
 GENERAL ELECTRIC CO., Schenectady, N. Y. & Bridgeport, Conn.—A, CH, CL, OT, S, SA, TS
 EDWIN I. GUTHMAN & CO., INC., 400 S. Peoria St., Chicago, Ill.—CS, TR
 THE HALLDORSON COMPANY, 4500 Ravenswood Ave., Chicago, Ill.—TR
 HAMMOND MANUFACTURING CO., 40 Wellington St. W., Guelph, Ont., Can.—TR
 HARRISON RADIO CO., 12 W. Broadway, New York, N. Y.—A, CH, CL, CS, CT, OT, S, TS, TR
 HYGRADE SYLVANIA CORP., 500 5th Ave., New York, N. Y.—CH, OT
 INSULINE CORP. OF AMERICA, 30-30 Northern Blvd., Long Island City, N. Y.—A, CL
 INTERNATIONAL TRANSFORMER CO., 17 W. 20th St., New York, N. Y.—TR
 JEFFERSON ELECTRIC CO., Bellwood, Ill.—TR
 J. F. D. MANUFACTURING CO., 4111 Ft. Hamilton Pkwy., Brooklyn, N. Y.—A
 KENYON TRANSFORMER CO., INC., 840 Barry St., Bronx, N. Y.—CS, TR

*KNIGHT—Allied Radio Corp.
 LAFAYETTE RADIO CORP., 100 6th Ave., New-York, N. Y.—A, CH, CL, CT, K, OT, TS, TT
 JOHN E. LINGO & SON, INC., 28th St. & Buren Ave., Camden, N. J.—A
 M & H SPORTING GOODS CO., 512 Market St., Phila., Pa.—CH, CL, CS, TS, TR
 MAC-ADAMS EQUIPMENT CO., INC., 507 W. 56th St., New York, N. Y.—A, S, SA
 MAGNETIC WINDINGS CO., 16th & Butler Sts., Easton, Pa.—CS, TR
 MAJESTIC RADIO & TELEVISION CORP., 2600 W. 50th St., Chicago, Ill.—CS, TR
 MEISSNER MANUFACTURING CO., Mt. Carmel, Ill.—CS, K, S
 J. W. MILLER COMPANY, 5917 S. Main St., Los Angeles, Calif.—*Miller Quality Products," "Miller"—CS
 *MILLER—J. W. Miller Company
 *MILLER QUALITY PRODUCTS—J. W. Miller Company
 MISSION BELL RADIO MFG. CO., INC., 831 Venice Blvd., Los Angeles, Calif.—S
 NATIONAL COMPANY, INC., 61 Sherman St., Malden, Mass.—*National," "AC"—CT
 *NATIONAL—National Company, Inc.
 NATIONAL UNION RADIO CORP., 57 State St., Newark, N. J.—CH, OT
 OFFENBACH ELECTRIC CO., 1452 Market St., San Francisco, Calif.—A, CH, CL, OT, TS, TT
 PACENT ENGINEERING CORP., 79 Madison Ave., New York, N. Y.—S
 PHILCO RADIO & TELEVISION CORP., Tioga & "C" Sts., Phila., Pa.—A, CL, TS, TT
RADIO ELECTRIC SERVICE CO., INC., N.W. Cor. 7th & Arch Sts., Phila., Pa.—A, CL, CT
 RADIO RECEPTOR CO., INC., 251 W. 19th St., New York, N. Y.—A, CL, TS
 RCA MANUFACTURING CO., INC., Camden, N. J.—A, CH, OT, K, S, TS, TT
 MAURICE SCHWARTZ & SON, 710-712 Broadway, Schenectady, N. Y.—A, CH, CL, CS, CT, K, OT, S, SA, ST, TS, TR, TS
 SEATTLE RADIO SUPPLY CO., INC., 2117 2nd Ave., Seattle, Wash.—CH, CL
 SHELLEY RADIO CO., 1841 S. Flower St., Los Angeles, Calif.—K, S
 SIMPSON ELECTRIC CO., 5216 W. Kinzie St., Chicago, Ill.—TT
 STEWART-WARNER CORPORATION, 1826-1852 Diversey Pkwy., Chicago, Ill.—S
 STROMBERG-CARLSON TELEPHONE MFG. CO., 100 Carlston Rd., Rochester, N. Y.—S
 SUN RADIO CO., 212 Fulton St., New York, N. Y.—A, CH, CL, CS, CT, K, OT, S, SA, ST, TS, TT, TR
SUPREME INSTRUMENT CORP., 414 Howard St., Greenwood, Miss.—TS, TT
 TECHNICAL APPLIANCE CORP., 17 E. 16th St., New York, N. Y.—A
 TELERADIO ENGINEERING CORP., 484 Broome St., New York, N. Y.—CS, TR
 TELEVISIO PRODUCTS, INC., 1135 N. Cicero Ave., Chicago, Ill.—TS
 THORDARSON ELECTRIC MFG. CO., 500 W. Huron St., Chicago, Ill.—TR
 TRANSMARINE RADIO, INC., 1184 Broadway, Hewlett, L. I., N. Y.—TS
 TROY RADIO & TELEVISION CO., 1144 S. Olive St., Los Angeles, Calif.—S
 UNITED STATES TELEVISION MFG. CORP., 220 E. 51st St., New York, N. Y.—CS, S
 THE VALPEY CRYSTALS, Box 321, Holliston, Mass.—OP
 VERTI-FLEX ILLINOIS SEATING CO., 2138 N. Racine Ave., Chicago, Ill.—A
 VERTROD MANUFACTURING CO., 132 Nassau St., New York, N. Y.—A
 WARD PRODUCTS CORP., 1523 E. 45th St., Cleveland, Ohio—A
 WESTON ELECTRICAL INSTRUMENT CORP., 614 Frelinghuysen Ave., Newark, N. J.—*Weston"—TT
 *WESTON—Weston Electrical Instrument Corp.

TEST EQUIPMENT — LABORATORY, PRODUCTION & FIELD



Amplifiers (see Amplifiers)	
Artificial crystal ear	A
Audiometers	AU
Battery testers	B
Beat-frequency generators	BG
Bridges	BR
Cabinets for test equipment	CT
Capacity-Inductance checkers	CC
Condenser testers	C
Distortion meters & analyzers	D
Dummy antennas	DA
Electronic switches	E
Electronic test equipment (see Electronic Equipment)	

Field-strength meters	F
Field-strength recorders	FR
F.M. signal generators	FG
Frequency filters	FF
Frequency meters	FM
Inductance (coils) testers	I
Insulation testers	IT
Interference locators	IL
Meters (laboratory type)	M
Microphones—laboratory type (for sound measurement)	ML
Microvoltmeters	MM
Motor-starting condenser (capacitor) selectors	MS
Neon indicators	N
Oscillograph cameras	OC
Oscillographs	OG
Oscilloscopes	OS
Output recorders	OR
Power supplies (see Power Supplies —A.C. and/or D.C.)	
Resistor testers	R
Scientific equipment	S
Sound-level meters	SM
Square-wave generators	SQ
Standard cells	SC
Standard-signal A.F. gen.	SA
Standard-signal R.F. gen.	SR
Stroboscopes	ST
Surge generators	SU
Sweep oscillators	SW
Television test equipment	T
Test panels	TP
Timers	TM
Tube testers	TT
Vacuum-tube voltmeters	V
Wave analyzers	W

ACME ELECTRIC & MFG. CO., 14 Water St., Cuba, N. Y.—IT
 *AC—National Company, Inc.
 AEROVOX CORPORATION, New Bedford, Mass.—BR, CC, IL, MS
 *AIRLINE—Montgomery Ward & Co., Inc.
 ALLEN ELECTRIC & EQUIPMENT CO., 2101 N. Pitcher St., Kalamazoo, Mich.—B
 ALLIED RADIO CORP., 833 W. Jackson Blvd., Chicago, Ill.—*Knight"—B, BR, DA, F, FM, IL, M, MM, OG, OS, S, SM, V
 AMERICAN COMMUNICATIONS CORP., 123 Liberty St., New York, N. Y.—IT
 AMERICAN RADIO HARDWARE CO., INC., 476 Broadway, New York, N. Y.—IT
 AMPLIFIER CO. OF AMERICA, 17 W. 20th St., New York, N. Y.—FF, I, IT, S, SM, SA, V
 ASSOCIATED RESEARCH, INC., 431 S. Dearborn St., Chicago, Ill.—B, BR, IT, M
 BARKER & WILLIAMSON, Ardmore, Pa.—C, E, F, FM, I
 BENDIX RADIO CORP., 920 E. Fort Ave., Baltimore, Md.—FM, SA, SR
 BOONTON RADIO CORP., P.O. Box 390, Boonton, N. J.—BG, FG
 *BROWN DEVILS—Ohmite Manufacturing Co.
 BROWNING LABORATORIES, INC., 750 Main St., Winchester, Mass.—FM, SA, SR
 BRUSH DEVELOPMENT CO., 3311-3405 Perkins Ave., Cleveland, Ohio—A, M, OG
 WILLIAM W. L. BURNETT RADIO LAB., 4814 Idaho St., San Diego, Calif.—FM, S
 BURTON-ROGERS CO., Sales Div. for Hoyt Elec. Inst. Works, 857 Boylston St., Boston, Mass.—B
 CAMBRIDGE INSTRUMENT CO., INC., 3732 Grand Central Terminal, New York, N. Y.—BR, F, FM, M, OG, OS
 CANADIAN MARCONI CO., 211 St. Sacrament St., Montreal, Can.—A, BR, C, D, DA, E, F, FM, I, IT, IL, M, MM, OG, OS, R, S, SM, SA, SR, V, W
 CANADIAN RADIO CORP., LTD., 622 Fleet St. W., Toronto, Ont., Can.—SA, SR
 CARRON MANUFACTURING CO., 415 S. Aberdeen St., Chicago, Ill.—SA, SR
 CASTLEWOOD MANUFACTURING CO., 12th & Burnett Sts., Louisville, Ky.—CT
 CINEMA ENGINEERING CO., 1508 W. Verdugo Ave., Burbank, Calif.—BR, D, R, SM
 THE CLOUGH-BRENGLE COMPANY, 5501 Broadway, Chicago, Ill.—B, BR, FM, MM, OG, OS, SA, SR
 CRUMPACKER DISTRIB. CORP., 1801 Fannin St., Houston, Tex.—B, OG, OS, SA, SR, V
 THE DAVEN COMPANY, 158 Summit St., Newark, N. J.—BR, M, R, SM
 HAROLD DAVIS, INC., 428 W. Capitol St., Jackson, Miss.—OG, OS, SA, SR, V
 DAYCO RADIO CORP., 915 Valley St., Dayton, Ohio—OG, OS
 *DETERMOMH—Ohmite Manufacturing Co.
 TOBE DEUTSCHMANN CORP., Canton, Mass.—BR, C, IL

Please say you saw it in the Radio-Craft "Classified Radio Directory"

**Preceding Listings in RADIO-CRAFT'S
CLASSIFIED RADIO DIRECTORY**

Sec. I (Revised), April '41:

Amplifiers
Antennas & Accessories
Automatic Tuners & Parts
Auto-Radio Controls
Aircraft Radio (see Receiving Sets—including Adapters and Converters)
Battery Chargers (& Parts)
Batteries (& Cells) Dry & Wet (Storage)
Books (see Service Manuals, Books & Magazines)
Cabinets, Cases, Parts & Services
Chemicals for Radio
Coils & Transformers (R.F. & I.F.) & Accessories
Coin Controls (see Records & Record-Playing Equipment; also, Receiving Sets)
Condensers, Fixed
Condensers, Variable
Crystals (Quartz)

Sec. II (Revised), May '41:

Crystals (for detection—receiving) & Detectors
Dials & Parts
Electric Fence Controllers
Electronic Equipment
Electronic Musical Instruments & Parts
Facsimile
Fluorescent & Neon Lamps (& Equipment)
Frequency Modulation Equipment
Hardware—Connectors & Misc. Parts & Supplies
Headphones
Hearing-Aids
Hearing-Aid Parts

Sec. III (Revised), June '41:

Insulation
Intercommunicating Systems
Kits
Knobs (see Dials & Parts)
Line Filters (Also see Noise Elimination Equipment)
Loudspeakers (& Parts)
Machinery (Production)
Magnets & Solenoids
Metal for Radio
Metal, Ore, Oil & Leak Locators
Microphones and Accessories
Noise-Elimination Equipment
Paint, Cement & Wax Products
Plastics
Plastic Molders

Sec. IV (Revised), July '41:

Power Supplies (A.C. and/or D.C.) (Also see Batteries [& Cells] Dry & Wet [Storage])
Public Address (See Amplifiers; Loudspeakers [& parts]; Microphones [& accessories]; Sound Systems [& accessories])
Radio Logs, Maps & Globes
Receiving Sets (including Adapters & Converters)
Recording Equipment
Records & Record-Playing Equipment
Rectifiers
Relays (See Switches & Relays)
Resistors—Fixed, Adjustable & Variable (Attenuators & Networks)

Sec. IV, Jan. '41 (in part):

Schools
Service Manuals, Books & Magazines
Servicing Equipment
Sound Systems, Amplifiers & Accessories

Sec. V, Feb. '41:

Speakers (& Parts)
Switches & Relays
Television
Test Equipment—Laboratory & Production
Tools
Transformers & Chokes
Transmitters (& Equipment)

Sec. VI, March '41:

Tubes (& Parts)
Vibrators
Wire
Literature

The above back-issues of *Radio-Craft* are available at the regular price of 25c per copy.

Next month: Section IV of the Classified Radio Directory, revised, with new classifications, and new names and addresses added; and with obsolete listings removed. Reserve your copy, today, from your regular newsdealer.

DOOLITTLE RADIO, INC., 7421 Loomis Blvd., Chicago, Ill.—FM
DOW RADIO SUPPLY CO., 1759 E. Colorado St., Pasadena, Calif.—B, F, FM, M, OG, OS, V, W
ALLEN B. DUMONT LABS., INC., Passaic, N. J.—E, OG, OS, T
ELECTRONIC CONTROL CORP., 2667 E. Grand Blvd., Detroit, Mich.—E, IL, OC, SM
THE EPPLEY LABORATORY, INC., 12 Sheffield Ave., Newport, R. I.—BR, SC
THE ESTERLINE-ANGUS CO., INC., Box 596, Indianapolis, Ind.—FR, M, OR, SA
FADE-OMETER COMPANY, 1027 S. W. Broadway, Portland, Ore., *FAde-Ometer"—C, V
*FADE-OMETER—Fade-Ometer Company
FEDERATED PURCHASER, INC., 80 Park Pl., New York, N. Y.—OG, OS, SA, SR, V, W
FERRIS INSTRUMENT CORP., Boonton, N. J.—F, FM, IL, MM, SA, SF, V
FISCHER DISTRIB. CORP., 222 Fulton St., New York, N. Y.—B, BR, F, FM, IL, M, MM, OG, OS, SM, SQ, SR, V, W
FISHER RESEARCH LAB., 1961 University Ave., Palo Alto, Calif.—F, IL, S
GARDNER ELECTRIC MFG. CO., 4227 Hollis St., Oakland, Calif.—E, TP
GENERAL CEMENT MFG. CO., 919 Taylor Ave., Rockford, Ill.—R
GENERAL ELECTRIC CO., Schenectady, N. Y. & Bridgeport, Conn.—B, BR, EM, MM, OS, S, SM, SQ
GENERAL RADIO CO., 30 State St., Cambridge, Mass.—BR, C, D, FM, I, IT, M, MM, OG, OS, R, S, SM, SA, SR, V, W
GUIDED RADIO CORP., 118 E. 25th St., New York, N. Y.—SM
HARRISON RADIO CO., 12 W. Broadway, New York, N. Y.—B, DA, E, F, FM, IL, MM, OG, OS, WM, V
HEWLETT-PACKARD COMPANY, 481 Page Mill Rd., Palo Alto, Calif.—D, SQ, SA, W
HICKOK ELECTRICAL INSTRUMENT CO., 10514 Dupont Ave., Cleveland, Ohio—BR, FM, M, MM, OG, OS, SA, SR, V
HERBERT H. HORN, 1201 S. Olive St., Los Angeles, Calif.—BR, OG, OS, SA, SR
HOWARD RADIO CO., 1731 W. Belmont Ave., Chicago, Ill.—SR
INDUSTRIAL INSTRUMENTS, INC., 156 Culver Ave., Jersey City, N. J.—IT
INTERNATIONAL RESISTANCE CO., 401 N. Broad St., Phila., Pa.—R
JACKSON ELECTRICAL INSTRUMENT CO., 129 Wayne Ave., Dayton, Ohio—BR, OG, OS, SA, V
KELLOGG SWITCHBOARD & SUPPLY CO., 6650 S. Cicero Ave., Chicago, Ill.—FM
*KNIGHT—Allied Radio Corp.
LAFAYETTE RADIO CORP., 100 6th Ave., New York, N. Y.—B, BR, F, FM, IL, M, MM, OG, OS, SM, SA, SR, V, W
LAMPKIN LABORATORIES, Bradenton, Fla.—FM
LAUREHK RADIO MFG. CO., 3918 Monroe Ave., Wayne, Mich.—AU, SA
LEEDS & NORTHRUP CO., 4970 Stenton Ave., Phila., Pa.—BR, M
LITTELFUSE, INC., 4787 Ravenswood Ave., Chicago, Ill.—N
M & H SPORTING GOODS CO., 512 Market St., Phila., Pa.—B, OG, OS, SA, SR, V
MARINE RADIO CORP., 117-19 168th St., Jamaica, N. Y.—OG, OS
MEASUREMENTS CORPORATION, 212 Harrison St., Boonton, N. J.—F, FM, MM, SA, SR, V, W
JAMES MILLEN MFG. CO., INC., 150 Exchange St., Malden, Mass.—FM
MILLION RADIO & TELEVISION, 1617 N. Damen Ave., Chicago, Ill.—SA, SR, V
MONARCH MANUFACTURING CO., 3341 Belmont Ave., Chicago, Ill.—BR, MM, SR
MONTGOMERY WARD & CO., INC., 619 W. Chicago Ave., Chicago, Ill., *Airline"—B, BR, DA, FM, IL, M, MM, OG, OS, SA, SR, V
*MULTIVOLTS—Ohmite Manufacturing Co.
MUSIC MASTER MFG. CO., 508 S. Dearborn St., Chicago, Ill.—BR, D, FM, SM
THE MUTER COMPANY, 1255 S. Michigan Ave., Chicago, Ill.—BR
NATIONAL COMPANY, INC., 61 Sherman St., Malden, Mass., *National, *AC"—OS
*NATIONAL—National Company, Inc.
NORTHERN ELECTRIC CO., LTD., 1261 Shearer St., Montreal, Que., Can.—M
OFFENBACH ELECTRIC CO., 1452 Market St., San Francisco, Calif.—B, BR, F, FM, M, MM, OG, OS, SM, SA, SR, V, W
OHMITE MANUFACTURING CO., 4835 W. Flournoy St., Chicago, Ill., *Ohmite, *Brown Devils, *Multivolts, *Determohm, *Riteohm"—DA, R
*OHMITE—Ohmite Manufacturing Co.
PHILCO RADIO & TELEVISION CORP., Tioga & "C" Sts., Phila., Pa.—B, OG, OS, V
PIERSON-DeLANE, INC., 2345 W. Washington Blvd., Los Angeles, Calif.—FM
PRECISION APPARATUS CO., 647 Kent Ave., Brooklyn, N. Y.—B, SA, V
RADEX CORPORATION, 1733 Milwaukee Ave., Chicago, Ill.—BR, I
RADIO CITY PRODUCTS CO., INC., 88 Park Pl., New York, N. Y.—B, BR, V
RADIO ELECTRIC SERVICE CO., INC., N.W. Cor. 7th & Arch Sts., Phila., Pa.—B, BR, FM, IL, M, MM, OG, OS, SM, SA, SR, V

RADIO EQUIPMENT CORP., 326 Elm St., Buffalo, N. Y.—B, BR, FM, MM, OG, OS, SM, SA, SR, V
THE RADIOTECHNIC LABORATORY, 1328 Sherman Ave., Evanston, Ill.—SA, SR, TT, V
RADLEK COMPANY, 601 W. Randolph St., Chicago, Ill.—B, BR, C, FM, IT, M, MM, OG, OS, R, SA, SR, V, W
RAWSON ELECTRICAL INSTRUMENT CO., 110 Potter St., Cambridge, Mass.—IT, M, MM, S
RAYTHEON PRODUCTION CORP., 55 Chapel St., Newton, Mass.—S
RCA MANUFACTURING CO., INC., Camden, N. J.—F, FM, IL, M, MM, OG, OS, SM, SA, SR, V, W
READRITE METER WORKS, 135 E. College Ave., Bluffton, Ohio—B
*RITEOHM—Ohmite Manufacturing Co.
ROGERS-MAJESTIC CORP., LTD., 622 Fleet St., Toronto, Can.—V
ROWE RADIO RESEARCH LAB. CO., 4201 Irving Pk. Blvd., Chicago, Ill.—BR, F, OG, OS, SW, TM, V
MAURICE SCHWARTZ & SON, 710-712 Broadway, Schenectady, N. Y.—B, BR, F, FM, IL, M, MM, OG, OS, SM, SA, SR, V, W
SEATTLE RADIO SUPPLY CO., INC., 2117 2nd Ave., Seattle, Wash.—B, BR, C, DA, E, F, FM, IL, M, MM, OG, OS, R, SM, SA, SR, V
SHELLEY RADIO CO., 1841 S. Flower St., Los Angeles, Calif.—B, BR, IL, M, MM, OG, OS, SA, SR, V
SHURE BROTHERS, 225 W. Huron St., Chicago, Ill., *Shure, *Unidyne, *Uniplex, *Stratoliner, *Super-Level, *Ultra-Wide-Range, *Zephyr"—ML
*SHURE—Shure Brothers
SIMPSON ELECTRIC CO., 5216 W. Kinzie St., Chicago, Ill.—B, SR
SOLAR MANUFACTURING CORP., 25th St. & Ave. "A", Bayonne, N. J.—BR, C
S.O.S. CINEMA SUPPLY CORP., 636 11th Ave., New York, N. Y.—SM
SOUND APPARATUS CO., 150 W. 46th St., New York, N. Y.—SM
STARK ELECTRICAL INSTRUMENT CO., 161A King St. W., Toronto, Ont., Can.—B, BR, C, MM, R, S, V
THE STATES COMPANY, 19 New Park Ave., Hartford, Conn.—DA
STERLING MANUFACTURING CO., 9205 Detroit Ave., Cleveland, Ohio—B
SUN RADIO CO., 212 Fulton St., New York, N. Y.—B, BR, F, FM, IL, M, MM, OG, OS, SM, SA, SR, V, W
SUPERIOR INSTRUMENTS CO., 136 Liberty St., New York, N. Y.—FM
*SUPER-LEVEL—Shure Brothers
*STRATOLINER—Shure Brothers
SUPREME INSTRUMENTS CORP., Greenwood Miss.—B, BG, CT, C, FG, MM, OG, OS, R, SQ, SA, SR, T, TP, TT, V
TAY BERN EQUIPMENT CO., INC., 135 Liberty St., New York, N. Y.—AU
TELEVISIO PRODUCTS, INC., 1135 N. Cicero Ave., Chicago, Ill.—MM, SA, SR, V, W
THE WM. A. THOMAS COMPANY, 321 Caroline St., Neenah, Wis.—BR
THORDARSON ELECTRIC MFG. CO., 500 W. Huron St., Chicago, Ill.—OG, OS
TRIPLETT ELECTRICAL INSTRUMENT CO., Bluffton, Ohio, *Triplet"—B, M, SM, SA, SR, V
*TRIPLETT—Triplet Electrical Instrument Co.
TRY-MO RADIO CO., INC., 85 Cortlandt St., New York, N. Y.—A, BR, C, E, M, MM, OG, OS, R, S, SM, SU, W
*ULTRA-WIDE RANGE—Shure Brothers
*UNIDYNE—Shure Brothers
*UNIPLEX—Shure Brothers
EARL WEBBER CO., 4350 W. Roosevelt Rd., Chicago, Ill.—OG
JOS. WEIDENHOFF, INC., 4344 W. Roosevelt Rd., Chicago, Ill.—B, C, D, DA, FM, IT, OS, SM, SA, SR
WESTINGHOUSE ELECT. & MFG. CO., E. Pittsburgh, Pa.—E, M, MM, SM
WESTON ELECTRICAL INSTRUMENT CORP., 614 Frelinghuysen Ave., Newark, N. J., *Weston"—FM, M, SM, SCM, V
*WESTON—Weston Electrical Instrument Corp.
WHEELCO INSTRUMENTS CO., 1933 S. Halsted St., Chicago, Ill.—BR, E, M, R, S
*ZEPHYR—Shure Brothers

TEST EQUIPMENT—SERVICING



Accessories	AC
Adapters	AP
Audio oscillators	AU
Capacity - Inductance testers	CI
Cathode-ray oscilloscopes	CA
Condenser testers	CO
Crystal calibrators	CY
Decade boxes (resistance)	D

Please say you saw it in the Radio-Craft "Classified Radio Directory"

CLASSIFIED RADIO DIRECTORY

Fluorescent lighting test units	FL
Frequency analyzers	F
Frequency meters	FR
Gain & transmission measuring sets	G
Ground testers	GT
Impedance bridges	I
Instrument fuses (and/or mountings)	IF
Meters	M
Multi-meters	MU
Neon indicators	NE
Ohmmeters	O
Osc. frequency modulators	OF
Output indicators	OI
Radio chemical kits	RK
Resistance bridges	RE
Set analyzers	S
Signal analyzers	SA
Signal generators	SG
Signal tracers	SR
Speaker testers	SP
Stage analyzers	ST
Tube testers	TB
Tuning wands	TU
Vacuum-tube voltmeters	V

*AC—National Company, Inc.
AEROVOX CORPORATION, New Bedford, Mass.—CI, CO, RE, S, V (bridge)
 *AIRLINE—Montgomery Ward & Co., Inc.
ALDEN PRODUCTS CO., 715 Center St., Brockton, Mass.—AP
ALLIED RADIO CORP., 833 W. Jackson Blvd., Chicago, Ill., *"Knight"—AP, AU, CA, CO, D, F, FR, I, IF, M, MU, NE, O, OI, RE, S, SA, SG, SO, TB, V
AMERICAN PHENOLIC CORP., 1250 W. Van Buren St., Chicago, Ill.—AP
AMPLIFIER CO. OF AMERICA, 17 W. 20th St., New York, N. Y.—AU, D, FR, I, OI, V
 *ANTENNEX—M. M. Fleron & Son, Inc.
APPROVED TECHNICAL APPARATUS CO., 123 Liberty St., New York, N. Y.—CO, M, MU, O, OI, S, SA, SR, SG, SP, TB
ASSOCIATED RESEARCH, INC., 431 S. Dearborn St., Chicago, Ill.—D, GT, M, O, RE
 *ATOMS—Sprague Products Co.
 *BROWN DEVILS—Ohmite Manufacturing Co.
BROWNING LABORATORIES, INC., 750 Main St., Winchester, Mass.—FR, SG
BRUSH DEVELOPMENT CO., 3311-3405 Perkins Ave., Cleveland, Ohio—M
BUD RADIO, INC., 5205 Cedar Ave., Cleveland, Ohio—AP
BURTON-ROGERS CO., Sales Div. for Hoyt Elec. Inst. Works, 857 Boylston St., Boston, Mass.—M, MU
CANADIAN MARCONI CO., 211 St. Sacramento St., Montreal, Can.—AP, AU, CA, CO, D, F, FR, I, IF, M, MU, NE, O, OF, OI, RE, S, SA, SG, SP, ST, TB, TU, V
CANADIAN RADIO CORP. LTD., 622 Fleet St. W., Toronto, Ont., Can.—AU, CO, O, OI, SG, TB, TU
CARRON MANUFACTURING CO., 415 S. Aberdeen St., Chicago, Ill.—AU, SA, SG, TU
CINEMA ENGINEERING CO., 1508 W. Verdugo Ave., Burbank, Calif.—D, G, M, RE
THE CLOUGH-BREngle CO., 5501 Broadway, Chicago, Ill.—AU, CA, CO, D, I, M, MU, O, OF, OI, RE, S, SG, SP, TB
CORNELL-DUBILIER ELECTRIC CORP., S. Plainfield, N. J.—CO, D (capacitance)
CRUMPACKER DISTRIB. CORP., 1801 Fannin St., Houston, Tex.—AP, AU, CA, CO, M, MU, NE, O, OI, S, SA, SG, SR, SP, TB, V
THE DAVEN COMPANY, 158 Summit St., Newark, N. J.—D, G, I, OI, RE
HAROLD DAVIS, INC., 428 W. Capital St., Jackson, Miss.—AP, AU, CA, CO, CY, MU, O, OF, OI, RE, S, SA, SG, SR, SP, TB, TU, V
DAYCO RADIO CORP., 915 Valley St., Dayton, Ohio—CA, MU, O, S, TB
DAYTON ACME CO., 2339 Gilbert Ave., Cincinnati, Ohio—AU, CA, FL, F, OF, S, SA, SG, SR, TB, V
 *DETERMOM—Ohmite Manufacturing Co.
TOBE DEUTSCHMANN CORP., Canton, Mass.—CO
DIRECT TEST INSTRUMENT CO., 17 W. 60th St., New York, N. Y.—CO, M, MU, O, OI, S, SA, SG, SR, TB, V
DOOLITTLE RADIO, INC., 7421 Loomis Blvd., Chicago, Ill.—FR
DOW RADIO SUPPLY CO., 1759 E. Colorado St., Pasadena, Calif.—CA, CO, CY, F, FR, M, O, OF, OI, S, SG, SP, TB
FADE-OMETER COMPANY, 1027 S. W. Broadway, Portland, Ore., *"Fade-Ometer"—CO, OI, V
 *FADE-OMETER—Fade-Ometer Company
FEDERATED PURCHASER, INC., 80 Park Pl., New York, N. Y.—AP, AU, CA, CO, D, M, MU, NE, O, OI, S, SA, SG, SP, ST, TB, TU, V
FISCHER DISTRIB. CORP., 222 Fulton St., New York, N. Y.—AP, AU, CA, CO, CY, D, F, FR, I, IF, M, MU, NE, O, OF, OI, RE, S, SA, SG, SR, SP, TB, TU, V
M. M. FLERON & SON, INC., 113 N. Broad St., Trenton, N. J., *"Antennex," "Fleron," "Safest," "Signaler"—NE

*FLERON—M. M. Fleron & Son, Inc.
GENERAL CEMENT MFG. CO., 919 Taylor Ave., Rockford, Ill.—AC, NE, RK
GENERAL ELECTRIC CO., Schenectady, N. Y. & Bridgeport, Conn.—M, MU, OF, RE, SG, TB
GENERAL RADIO CO., 30 State St., Cambridge, Mass.—AU, CA, CO, D, F, FR, I, M, O, OI, RE, SG, V
HARRISON RADIO CO., 12 W. Broadway, New York, N. Y.—AP, AU, CA, CO, D, F, FR, I, IF, M, MU, NE, O, OF, OI, RE, S, SA, SG, SP, ST, TB, TU, V
HEWLETT-PACKARD COMPANY, 481 Page Mill Rd., Palo Alto, Calif.—AU
HICKOK ELECTRICAL INSTRUMENT CO., 10514 Dupont Ave., Cleveland, Ohio—AU, CA, CO, FR, I, M, MU, O, OF, OI, RE, S, SG, SP, ST, TB, V
HOWARD RADIO CO., 1731 W. Belmont Ave., Chicago, Ill.—FR
INDUSTRIAL INSTRUMENTS, INC., 156 Culver Ave., Jersey City, N. J.—RE
JACKSON ELECTRICAL INSTRUMENT CO., 129 Wayne Ave., Dayton, Ohio—AU, CA, CO, MU, O, OF, SA, SG, TB, V
 *KNIGHT—Allied Radio Corp.
 *KOOLOHMS—Sprague Products Co.
LAFAYETTE RADIO CORP., 100 6th Ave., New York, N. Y.—AP, AU, CA, CO, CY, D, F, FR, I, IF, M, MU, NE, O, OF, OI, RE, S, SA, SG, SR, SP, TB, TU, V
LAMPKIN LABORATORIES, Bradenton, Fla.—FR
LAUREHK RADIO MFG. CO., 3918 Monroe Ave., Wayne, Mich.—AU
LEOTONE RADIO CO., 63 Dey St., New York, N. Y.—SP
LITTELFUSE, INC., 4757 Ravenswood Ave., Chicago, Ill.—IF, NE
MARINE RADIO CORP., 117-19 168th St., Jamaica, N. Y.—CA
T. R. McELROY, 100 Brookline Ave., Boston, Mass.—AU
MEISSNER MANUFACTURING CO., Mt. Carmel, Ill.—SA
MILLION RADIO & TELEVISION, 1617 N. Damen Ave., Chicago, Ill.—AU, MU, O, OI, SG, TB, V

IMPORTANT

DO YOU
 find the Classified Radio Directory useful in your work?
 Please let us have your vote on whether you wish this department to be continued. Or, if you would prefer to see other material in the same space, kindly let us have your recommendations.
 If your answer is "yes!" be sure to let us know at once; otherwise, the readers who prefer other use of these pages may outnumber you.

MONARCH MANUFACTURING CO., 3341 Belmont Ave., Chicago, Ill.—SG
MONTGOMERY WARD & CO., INC., 619 W. Chicago Ave., Chicago, Ill., *"Airline"—AP, AU, CA, CO, D, F, FR, I, IF, M, MU, NE, O, OF, RE, S, SA, SG, TB, V
J. L. D. MORRISON CO., 1816 Wisconsin Ave., Washington, D. C.—SA, SR
 *MULTIVOLTS—Ohmite Manufacturing Co.
MUSIC MASTER MFG. CO., 508 S. Dearborn St., Chicago, Ill.—AU, OI
THE MUTER COMPANY, 1255 S. Michigan Ave., Chicago, Ill.—RE
NATIONAL COMPANY, INC., 61 Sherman St., Malden, Mass., *"National," "AC"—AU, CA
 *NATIONAL—National Company, Inc.
OFFENBACH ELECTRIC CO., 1452 Market St., San Francisco, Calif.—AP, AU, CA, CO, CY, D, F, FR, I, IF, M, MU, NE, O, OF, OI, RE, S, SA, SG, SR, SP, TB, TU, V
OHMITE MANUFACTURING CO., 4835 W. Flournoy St., Chicago, Ill., *"Ohmite," "Brown Devils," "Multivolts," "Determinohm," "Riteohm"—D
 *OHMITE—Ohmite Manufacturing Co.
PHILCO RADIO & TELEVISION CORP., Tioga & "C" Sts., Phila., Pa.—AP, AU, CA, CO, O, S, SG, TB, V
PIERSON-DeLANE, INC., 2345 W. Washington Blvd., Los Angeles, Calif.—FR
PRECISION APPARATUS CO., 647 Kent Ave., Brooklyn, N. Y.—AU, CA, MU, O, OI, SG, TB, V
RADEX CORPORATION, 1733 Milwaukee Ave., Chicago, Ill.—SA, SG, TU
RADIO CITY PRODUCTS CO., INC., 88 Park Pl., New York, N. Y.—AP, I, MU, S, SG, TB, V
RADIO DESIGN CO., 1353 Sterling Pl., Brooklyn, N. Y.—MU, O, OI, S, TB
RADIO ELECTRIC SERVICE CO., INC., N.W. Cor. 7th & Arch Sts., Phila., Pa.—AP, AU, CA, CO, CY, D, F, FR, I, IF, M, MU, NE, O, OF, OI, RE, S, SA, SG, SR, SP, TB, TU, V
RADIO EQUIPMENT CORP., 326 Elm St., Buffalo, N. Y.—AU, CA, CO, CY, D, F, FR, I, IF, M, MU, NE, O, OF, OI, RE, S, SA, SG, SR, SP, TB, TU, V
THE RADIOTECHNICAL LABORATORY, 1328 Sherman Ave., Evanston, Ill.—O, TB, V
RADOLEK COMPANY, 601 W. Randolph St., Chicago, Ill.—AP, AU, CA, CO, D, F, FR, I, IF, M, MU, NE, O, OF, OI, RE, S, SA, SG, SP, ST, TB, TU, V
RAWSON ELECTRICAL INSTRUMENT CO., 110 Potter St., Cambridge, Mass.—M, MU

RCA MANUFACTURING CO., INC., Camden, N. J.—AP, AU, CA, CO, CY, F, FR, I, O, OF, OI, S, SA, SG, SR, SP, TB, TU, V
READRITE METER WORKS, 135 E. College Ave., Bluffton, Ohio—AP, M, MU, O, S, SG, TB
 *RITEOHM—Ohmite Manufacturing Co.
 *SAFEST—M. M. Fleron & Son, Inc.
MAURICE SCHWARTZ & SON, 710-712 Broadway, Schenectady, N. Y.—AP, AU, CA, CO, CY, D, F, FR, I, M, MU, NE, O, OF, OI, RE, S, SA, SG, SR, SP, TB, TU, V
SEATTLE RADIO SUPPLY CO., INC., 2117 2nd Ave., Seattle, Wash.—AP, AU, CA, CO, FR, IF, M, MU, NE, O, OF, OI, RE, S, SA, SG, SP, TB, TU, V
SHALLCROSS MANUFACTURING CO., 10 Jackson Ave., Collingdale, Pa.—D, RE
SHELLEY RADIO CO., 1841 S. Flower St., Los Angeles, Calif.—AU, CO, F, FR, NE, O, RE, S, SA, SG, SR, SP, TB, V
 *SIGNALER—M. M. Fleron & Son, Inc.
SIMPSON ELECTRIC CO., 5216 W. Kinzie St., Chicago, Ill.—M, MU, O, S, SG, TB
 *600 LINE—Sprague Products Co.
SOLAR MANUFACTURING CORP., 25th St. & Ave. "A," Bayonne, N. J.—CO
SPRAGUE PRODUCTS CO., N. Adams, Mass., *"Sprague," "600 Line," "Atoms," "Koolohms," "Telohmike"—CO
 *SPRAGUE—Sprague Products Co.
STARK ELECTRICAL INSTRUMENT CO., 161A King St. W., Toronto, Ont., Can.—CO, MY, NE, O, OI, S, TB, V
THE STERLING MFG. CO., 9205 Detroit Ave., Cleveland, Ohio—M
SUN RADIO CO., 212 Fulton St., New York, N. Y.—AP, AU, CA, CO, D, F, FR, I, IF, M, MU, NE, O, OF, OI, RE, S, SA, SG, SR, SP, TB, TU, V
SUPERIOR INSTRUMENT CO., 136 Liberty St., New York, N. Y.—MU, O, OI, S, SA, SG, TB, V
SUPREME INSTRUMENTS CORP., Greenwood, Miss.—AC, AP, AU, CI, CA, CO, FR, M, MU, O, OF, OI, S, SA, SG, SR, ST, TB, V
TECHNICAL PRODUCTS INTERNATIONAL, 135 Liberty St., New York, N. Y.—M
TELEVISIO PRODUCTS, INC., 1135 N. Cicero Ave., Chicago, Ill.—AU, CY, FR, SG, V
 *TELOHMIKE—Sprague Products Co.
THE WM. A. THOMAS CO., 321 Caroline St., Neenah, Wis.—RE
THORDARSON ELECTRIC MFG. CO., 500 W. Huron St., Chicago, Ill.—CA
TRIPLETT ELECTRICAL INSTRUMENT CO., Bluffton, Ohio, *"Triplett"—M, MU, O, OI, RE, S, SA, SG, TB, V
 *TRIPLETT—Triplett Electrical Instrument Co.
VACO PRODUCTS CO., 1603 S. Michigan Ave., Chicago, Ill.—NE
EARL WEBBER CO., 4350 W. Roosevelt Rd., Chicago, Ill.—CA, MU, O, OI, S, SA, SG, TB, V
JOS. WEIDENHOFF, INC., 4344 W. Roosevelt Rd., Chicago, Ill.—CA, CO, F, MU, O, S, SA, SG, SP, ST, TB, V
WESTINGHOUSE ELEC. & MFG. CO., E. Pittsburgh, Pa.—FR, M, O, OI
WESTON ELECTRICAL INSTRUMENT CORP., 614 Frelinghuysen Ave., Newark, N. J., *"Weston"—FR, M, MU, O, OI, S, SG, ST, TB, V
 *WESTON—Weston Electrical Instrument Corp.
WHEELCO INSTRUMENTS CO., 1933 S. Halsted St., Chicago, Ill.—M, RE
J. R. WILLIAMS & SONS, 1313 W. Randolph St., Chicago, Ill.—TB

TECHNICAL REVIEW OF CATALOGS, ETC.

Stancor Fluorescent Ballasts—"High and Low Power Factor Compensators"; "Ballast Facts," with an accompanying "Interchangeability Chart"; and "Wiring Diagrams," are 3 useful references in this new folder. (Standard Transformer Corp., Chicago, Ill.)
The New Meissner "How to Build" Instruction Manual, 1941 Edition.—Price 60c. Contains complete constructional data for set builders on 22 kits, including F.M. receivers, phono recorder, servicing and amateur equipment. Includes a complete outline of Frequency Modulation theory. (Meissner Mfg. Co., Mt. Carmel, Ill.)
Burgess Replacement Guide—Portable Radio Batteries. Revised Edition issued June 1941.—This guide, like the preceding one, lists the Burgess Battery complements of practically every portable radio receiver on the market as of issue date. (Burgess Battery Co., Freeport, Ill.)
Utah 1941 Replacement Vibrator Manual—An extensive listing of the vibrator and transformer replacement requirements for practically every radio receiver on the market incorporating a vibrator-type power supply. — (Utah Radio Products Co., Chicago, Ill.)
Phototubes—RCA—This booklet supplies circuits and applicational data for "electric eye" equipment including equipment used for light-operated relays, light measurement, and sound reproduction.—(RCA Mfg. Co., Inc., Radiotron Division, Harrison, N. J.)

IGNITION NOISE LOCATOR

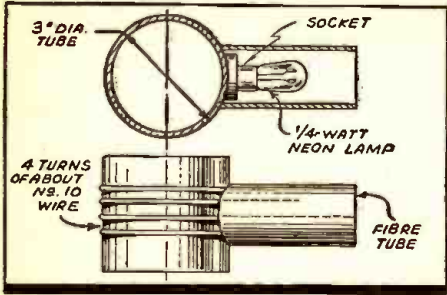

● I HAVE recently used a home-made gadget for locating car-radio noise due to the ignition wiring of automobiles. By using this coil, I have found many leaky wires which I could not have found otherwise.

It consists of 4 turns of about No. 10 wire on a 3-in. form which I cut to the size of the wire and covered with cotton tape (to keep the turns from coming off). I then tied a small porcelain socket to this coil, connecting both ends of the coil to the socket, and using a 1/4-watt neon light, which I protected with a piece of tubing about the size (in diameter) of the base of the socket. I held this in place with sealing wax. This protects the neon lamp and also acts as a cover to keep out side light so as to see the bulb light more easily.

To use this unit, move the coil slowly along the ignition wire to be tested, holding the coil by the tubing.

W. J. ROBINSON,
Belleville, N. J.

CHEAP RESISTANCE STANDARDS

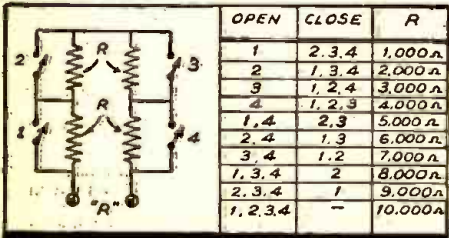

● PRECISION resistors cost money, switches are cheap. By switching, as shown, a considerable amount may be saved in constructing decade resistance boxes. Where, for a series of tens, hundreds, thousands, ten-thousands, there would be required under ordinary circumstances a total of 40 resistors, by this method of switching only a total of only 16 resistors would be needed.

WILLARD MOODY,
New York City.

PRE-SETTING THE VOLUME CONTROL

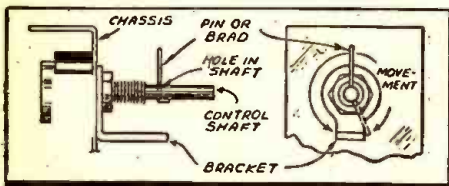

● A CUSTOMER confronted me with the problem of altering the volume control on his radio set so that it could not be turned above a certain level.

I solved the problem by inserting a metal angle-piece, with a suitable hole in it, over the control shaft in place of the washer. Then I drilled a hole through the control

shaft and inserted a wire brad in the hole so that it would come in contact with the angle at the setting of the control that produced the maximum amount of volume wanted: A drop of solder held the brad in position.

ELMER KALER, JR.,
St. Louis, Mo.

WAVETRAPS

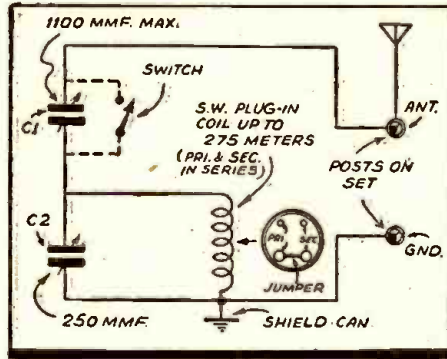

● HERE is a diagram of a wavetraps that I am using on a Philco 90. The set is in good condition, with new tubes, but the wavetraps shown here enables me to get many stations I could not otherwise tune in.

This wavetraps was made up and mounted inside a half-pound tobacco tin in order to afford sufficient shielding from local stations. When condenser C1 is shorted by means of the switch, condenser C2 should then be nearly unmeshed, to tune from 550 kc. to about 1,000 kc. Note that both the primary and secondary windings are used (see sketch showing base of plug-in coil); a jumper connects the coils in series.

THOMAS C. JENSEN,
Togus, Me.

TONE CONTROL FOR CRYSTAL PICKUP

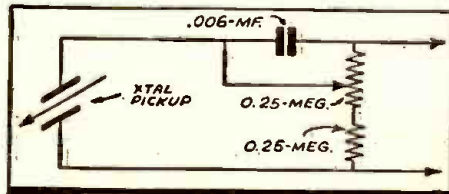

● ABOVE is shown a simple circuit I have found very effective for varying the bass response of a crystal pickup with very little loss of output.

H. ORLO HOADLEY,
Rochester, N. Y.

REMOVING LOOSE RIVETS

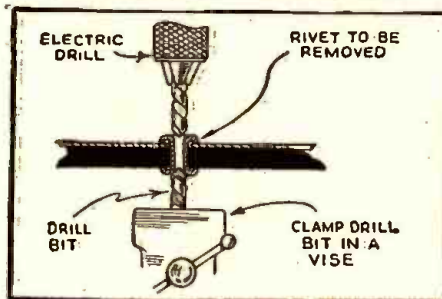

● HAVE you ever tried to drill-out a rivet and found that the drill would spin the rivet in its hole instead of cutting? Such a loose rivet can be very exasperating, especially if it is located where it cannot be reached with a file. But the following simple trick will solve the difficulty:

Clamp a drill bit point-upwards in a vise.

GEOPHYSICAL PROSPECTING PRINTS

50¢ EACH
7 FOR \$3.—



With any one of the modern geophysical methods described, instruments can be constructed to locate metal and ore veins, subterranean water and oil deposits, buried pipes, tools, or other metallic objects sunken in water, etc. Folder contains blueprints and detailed data covering each instrument.

- Folder No. 1. Radio Reflector Pilot. Construction and use of 2 tube transmitter and 3 tube receiver. Reflected wave principle. Visual and aural signals.
- Folder No. 2. Harmonic Frequency Locator. Radiates low frequency wave to receiver. Aural signals.
- Folder No. 3. Beat Note Indicator. 2 oscillators. Visual and aural signals.
- Folder No. 4. Radio Balance Surveyor. Balanced loop principle. Modulated transmitter. Visual and aural signals.
- Folder No. 5. Variable Inductance Monitor. Inductance principle. Aural signals.
- Folder No. 6. Hughes Inductance Balance Explorer. Bridge principle. Aural signals.
- Folder No. 7. Radiodome Prospector. Balanced loop principle. Very large field of penetration. Aural signals.

Each set of blueprints and instructions enclosed in heavy envelope (9 1/2" x 12 1/2"). Blueprints 22" x 34"; eight-page illustrated 8 1/2" x 11" folder of instructions and construction data. Add 5c for postage.

The complete set of seven folders. Shipping weight 2 lbs. (add 25c for shipping anywhere in U.S.A.) \$3.00

TECHNIFAX

1917 S. STATE ST. CHICAGO, ILL.

Set the bottom of the rivet on the point of this bit, and apply an electric drill to the top of the rivet. Then, regardless of whether the rivet turns or not, one of the two drill bits will cut into it, and it can be quickly drilled out.

This method works most easily for tubular rivets, but can be applied to other types by first center-punching the rivet to provide a start for the drills.

B. WINTERS,
Columbia, Mo.

TRANSFORMERLESS FILAMENT VOLTAGE ADAPTER FOR TUBE TESTER

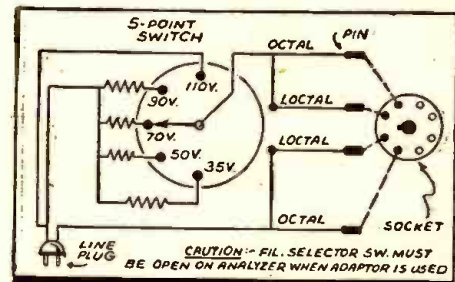

● THE article by Mr. D. J. Foard, E.E., in the April, 1941, *Radio-Craft*, page 600, was quite interesting; it induced me to submit my idea which I use on a 385 automatic Supreme tester. It is simple to construct and the cost is slight. It is necessary however that the technician be careful that the filament voltages do not exceed the tube rating in any section. A sketch of the adapter is shown. I made this unit by using an Ohiomh "Universal Cordohm."

W. F. ONDER,
Kimmswick, Mo.

Index to advertisers

PUBLISHERS

Amplifier Co. of America.....	69
Data Print Co.....	113
National Plans Inst.....	114
Radcraft Publications, Inc.....	72, 96, 97
Radio & Technical-Pub. Co.....	93
Radio Publications.....	119
Technifax.....	104, 127

RADIO PARTS

Aerovox Corporation.....	113
Hammartund Mfg. Co.....	101
National Union Radio Corp.	Inside Back Cover
Solar Mfg. Corp.....	109

RADIO SETS

Meissner Mfg. Company.....	107
Midwest Radio Corp.....	109

RADIO SUPPLY HOUSES

Allied Radio Corp.....	109
Buratein-Applebee Co.....	101
Henry Radio Shop.....	81
Hudson Specialties Co.....	98
Leotone Radio Co.....	85
Lafayette Radio Corp.....	Inside Front Cover
Radolek Co.....	104

SCHOOLS

American Television Laboratories..	Back Cover
Capitol Radio Eng. Inst.....	71
Commercial Radio Institute.....	71
Coyne Radio School.....	69
Lincoln Engineering School.....	71
National Radio Institute.....	65
National Schools.....	71
New York Y.M.C.A. Schools.....	71
Port Arthur College.....	67
Radio Training Assoc.....	85
RCA Institutes.....	71
Sprayberry Academy of Radio.....	67

SOUND & RECORDING EQUIPMENT

Amplifier Co. of America.....	101
John Meck Industries.....	101
University Laboratories.....	98

TEST EQUIPMENT

Radio City Products Co.....	93
Readrite Meter Works.....	104
Walter L. Schott Co.....	85
Supreme Instruments Corp.....	83
Triplett Electrical Instruments Co.....	85
Weston Elec. Instrument Corp.....	91

TUBES

Hygrade Sylvania Corp.....	107
----------------------------	-----

MISCELLANEOUS

Classified Section.....	118
Flight Magazine.....	117
Henry Hudson Hotel.....	117
Lancaster, Allwine & Rommel.....	93
Laughlin Mfg. Co.....	107
Premium Distributing Service.....	114
Radio Servicemen of America, Inc.....	111
Remington Rand, Inc.....	105
Woodstock Typewriter Co.....	118

(While every precaution is taken to insure accuracy, we cannot guarantee against the possibility of an occasional change or omission in the preparation of this index.)

BOOK REVIEWS

FLUORESCENT LIGHT—AND ITS APPLICATION (1941), by H. C. Dake and Jack De Ment. Published by Chemical Publishing Co., Inc., Brooklyn, N. Y. Size 6 x 9 1/4 ins., 256 pages. Price \$3.00.

A fitting introduction and treatise to the broad subject of fluorescent light and its application, so ably analyzed from the standpoint of the radio Serviceman in the various articles on this subject in recent issues of *Radio-Craft*, is "Fluorescent Light and Its Application."

It is a book with interest not only for the technical man but also for the non-technical reader of *Radio-Craft*; and as the listing of chapters (below) indicates, covers every phase of this new art.

The Fluorescent Art is destined to grow to very large proportions and the ambitious technician will do well to study the basis of this new technique in cold-light, inasmuch as it utilizes the instrumentalities with which he is already familiar, in such useful applications as: theatrical lighting, prospecting, chemical analyses, identification of gems, examination of antiques for authenticity, etc. Class Fluorescent I lighting with the other fields in which many radio Servicemen and Servicemen-dealers now have contact, viz., Refrigeration, and Air Conditioning.

Chapter headings: I, Historical Aspects of Luminescence; II, Radiation—Color—Perception, The Eye; III, Types of Luminescence; IV, Theory of Luminescence; V, Methods of Examination and Technic; VI, Sources of Ultra-Violet Radiations; VII, The Fluorescent Minerals.

MOST-OFTEN-NEEDED 1939 RADIO DIAGRAMS—AND SERVICING INFORMATION; compiled by M. N. Beltman. Published by Supreme Publications, Chicago. Soft paper cover, size 8 1/2 x 11 inches, 192 pages. Price \$1.50.

The diagrams in this manual are said to represent the sets which have been sold in large quantities during the 1939 radio season and hence represent the "most often needed" diagrams.

Like the volume on 1940 radio diagrams previously reviewed in *Radio-Craft* (Dec., 1940, issue), this manual includes the essential servicing information the average Serviceman may require in quickly locating and repairing the general run of faults he may encounter, including such routine operations as alignment, installation and operation; hence this volume includes diagrams, alignment data, hints for servicing, and parts lists.

MATHEMATICS FOR RADIO AND COMMUNICATION, by George F. Maedel, A.B., E.E. Published by Maedel Publishing House, Brooklyn, N. Y. Cloth covers, size 9 1/4 x 6 ins. Two volumes: Book I, 314 pages; Book II, 329 pages. Book I price \$3.75; Book II price \$4.00.

Radio has waited a long time for a book which would answer the innumerable questions which arise in the mind of every radio technician who reaches the point in his education where a knowledge of Ohm's Law becomes essential. Author Maedel has met this unquestioned need with a set of 2 books: Book I, Algebra, Geometry, and Arithmetic; Book II, Advanced Algebra, Trigonometry, Complex Numbers. (A few chapters from each conclude this review.)

They have been written especially for students in school and at home to prepare them to read technical books and magazine articles on radio. Chief instructor of RCA Institutes, Maedel's books are official texts on mathematics in that school.

We cannot stress too strongly the fact that these books are of practical value to the radio man inasmuch as they use everyday problems in illustration of the subject matter. Every serious radio technician will find that these books are a worth-while investment even though he may have no immediate need for them; merely to have them on hand for instant reference on some important occasion may repay their cost.

Chapter titles selected from the total of 314 pages in Book No. I: Addition, Subtraction, Multiplication and Division in Arithmetic; Definition and Symbols; Factoring; Decimals and Powers of Ten; The Metric System; Engineering Problems and the Slide Rule; Solid Geometry. From a total of 329 pages in Book No. II: Algebraic Formulas, Logarithms and Decibels, Trigonometric Functions, The Binomial Theorem; etc.

HOW TO MAKE GOOD RECORDINGS (Revised Edition). Published by Audio Devices, Inc. Size 8 x 5 1/4 ins., hard paper cover, profusely illustrated, 127 pages. Price \$1.25.

A new Revised Edition of "How to Make Good Recordings" (the first edition of which was reviewed in the April, 1941, issue of *Radio-Craft*) contains corrections and additions which although not very extensive, nevertheless are important to the sound recordist to whom every bit of information on this topic contributes to the making of better sound recordings on discs.

MEN AND VOLTS, by John Winthrop Hammond. Published by J. B. Lippincott Company. Cloth covers, size 9 1/4 x 6 ins., 436 pages, well illustrated. Price \$2.50.

"Men and Volts" is the story of Electricity from the major achievements of Brush (1876) to the present decade; this easily readable history is woven around the achievements and developments of the General Electric Company and constitutes one of the most authoritative and entertaining word-picturizations of the Electric Age so far published.

Although this book carries the byline of John Winthrop Hammond, it is actually the literary work of Arthur Pound, who has whipped into an absorbing book the historical material collected over a period of 3 years by John W. Hammond. He left a 800,000-word manuscript, when he died in 1934, delineating the paving blocks as they were laid down by such American inventive immortals as Thomas A. Edison, Chas. F. Brush, Elihu Thomson, Chas. Proteus Steinmetz, and many others.

Such epic battles of the times as that of A.C. versus D.C., the Electric Lamp versus the Electric Arc, and others are again brought to life in the pages of this fascinating book.

Since the Hammond manuscript closed with the year 1922, an epilogue has been added highlighting major succeeding achievements. "Men and Volts" should be in every school library if only for its inspirational value. The fact that it is technically accurate merely adds lustre.

Following are the titles of the 8 parts into which this book is divided:

Part I, The Creative Period of the Arc Light and the Incandescent Light; Part II, The Period of Commercial Introduction of Electric Lighting; Part III, Electric Transportation, Motors, the Transmission of Power; Part IV, The Period of Expansion and Consolidation; Part V, The Formation of the General Electric Company; Part VI, The Development of Big Generating Units, Beginning of Hydroelectric Projects, Expansion of Systems through Transmission; Part VII, The Development of Steam Turbines, Start of Industrial Research and of Commercial and Financial Expansion; Part VIII, Spectacular Applications and Discoveries, Continued Expansion, Birth of Radio, Major Achievements—Marking the End of the Pioneer Period.

RUNNING AN ENGINE LATHE, by Fred H. Colvin (1941). Published by McGraw-Hill Book Co., New York. Cloth covers, size 4 1/4 x 7 1/2 ins., 114 pages, 106 illustrations. Price \$1.25.

In this day of awakening interest in the possibilities of small-shop production of essential Defense products, attention has been centered upon the fortunate owners of home machine shops. The radio man who has found that a lathe is a shop asset that facilitates his work, will be interested to know that "Running An Engine Lathe" is also the subject of a book which offers to young assistants or machine apprentices, practical suggestions concerning the foundation of engine lathe work.

In view of the fact that the average lathe owner is inclined to limit the use of his lathe to certain types of work with which he is most familiar, this book is also valuable as a refresher on the many possibilities of this power tool, as the following contents indicate.

Chapter I—The Engine Lathe; Chapter II—Centering Lathe Work; Chapter III—Driving the Work; Chapter IV—Tools and Turning; Chapter V—Steady and Follower Rests; Chapter VI—Faceplate Work; Chapter VII—Chucks and Chucking; Chapter VIII—Boring Tools; Chapter IX—Taper Turning; Chapter X—Cutting Screw Threads; Chapter XI—Test Indicators and Their Use; Chapter XII—Three Types of Centering Mandrels; Chapter XIII—Care of the Lathe.

FREE TRAINING COURSE

IN AIRLINE RADIO ★ COMMUNICATIONS ★ TELEVISION

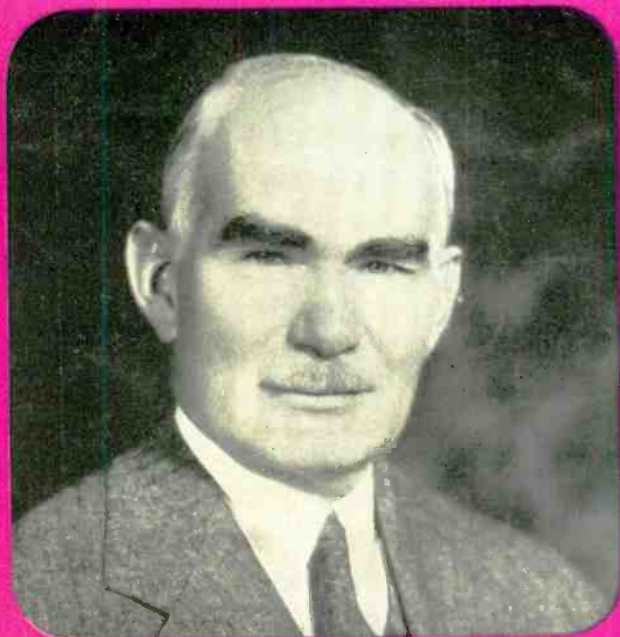

Dr. LEE deFOREST
"FATHER OF RADIO"



U. A. SANABRIA
TELEVISION PIONEER

START NOW... TRAIN WITHOUT COST UNDER THESE WORLD FAMOUS AUTHORITIES

A GIANT NEW INDUSTRY is now ready to go full speed ahead! For, the United States Government has approved commercial TELEVISION. Properly trained men are needed NOW. And as this fascinating industry rapidly expands, the demand for trained television engineers should be far greater than the supply, for years to come. YOUR GREATEST OPPORTUNITY COMES NOW!

Dr. Lee deForest and U. A. Sanabria, heads of the American Television Laboratories, have assured the government and the industry that they would make available large numbers of well trained men for key positions in television, airline radio, and communications. To make good on

this promise, they will accept suitable young men NOW for their valuable **FREE TRAINING COURSE**... 99 lessons with over a million words of text... a really amazing offer to progressive, serious-minded men with enough foresight to prepare for a substantial future. *It's an offer you simply can't afford to miss!*

Television with the aid of these famous engineers, has been developed to a high degree of perfection. Everyone, with reasonable qualifications can take advantage of this **FREE TRAINING**. Your future in this wonderful new industry is **SQUARELY UP TO YOU!** Remember, there are no "strings" attached to this offer. This technical training costs you nothing!

Don't wait. Be first. Mail the coupon to us NOW!

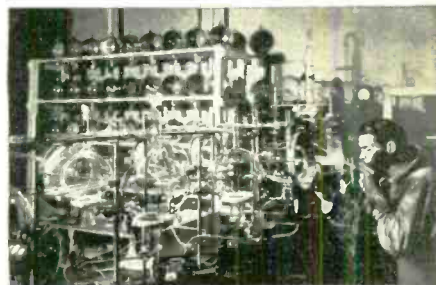

View of the Electronic's Laboratory in the training division of the American Television Laboratories in Chicago. These facilities are used exclusively for providing students with practical instruction necessary for a successful future in television.

AMERICAN TELEVISION LABORATORIES
DEPT. 5T, 433 EAST ERIE ST., CHICAGO, ILL.

Gentlemen: I am interested in your **FREE Training Course** in Television Radio Electronics. Without obligation send me all facts at once.

Name _____ Age _____

Street _____

City _____ State _____

**U. S. GOVERNMENT APPROVED
COMMERCIAL TELEVISION
TRAINED MEN ARE NEEDED!**

BE FIRST... ACT NOW... MAIL COUPON FOR APPLICATION AND ALL THE FACTS

Where you find
NATIONAL UNION



You find
BETTER

RADIO SERVICE

The buying public learns faster than most dealers think. That is why National Union Dealers prosper. With better equipped shops they can give better service.

Why not get wise and equip your shop with the latest tube testers and test equipment the *EASY N. U. WAY* . . . then you too will be on the road to . . . **BETTER**

BUSINESS.



Mr. Ben Myers and his attractive radio shop Marshfield, Oregon . . . N. U. Dealer for many years.

N. U. BETTER RADIO SERVICE IS BACKED BY QUALITY PRODUCTS THAT GIVE LASTING SATISFACTION



Radio Tubes

. . . More Radio Service Dealers use National Union than any other make . . . there must be a good reason why.



Batteries

. . . The only line of Dry Batteries sold exclusively to the Radio Trade . . . You can make more money.



Condensers

. . . Same Super Quality as found in N. U. Tubes. Just try them.



Sound Extra Tubes

. . . a line of heavy duty radio tubes for sound work . . . an exclusive N. U. development.



Radio Sets

. . . Performance that satisfies the critical demand of the Radio Service Dealer. Try them yourself.

Ask Your N.U. Distributor or Write

NATIONAL UNION RADIO

Corp.

57 STATE STREET
NEWARK, N. J.