

RADIO-CRAFT

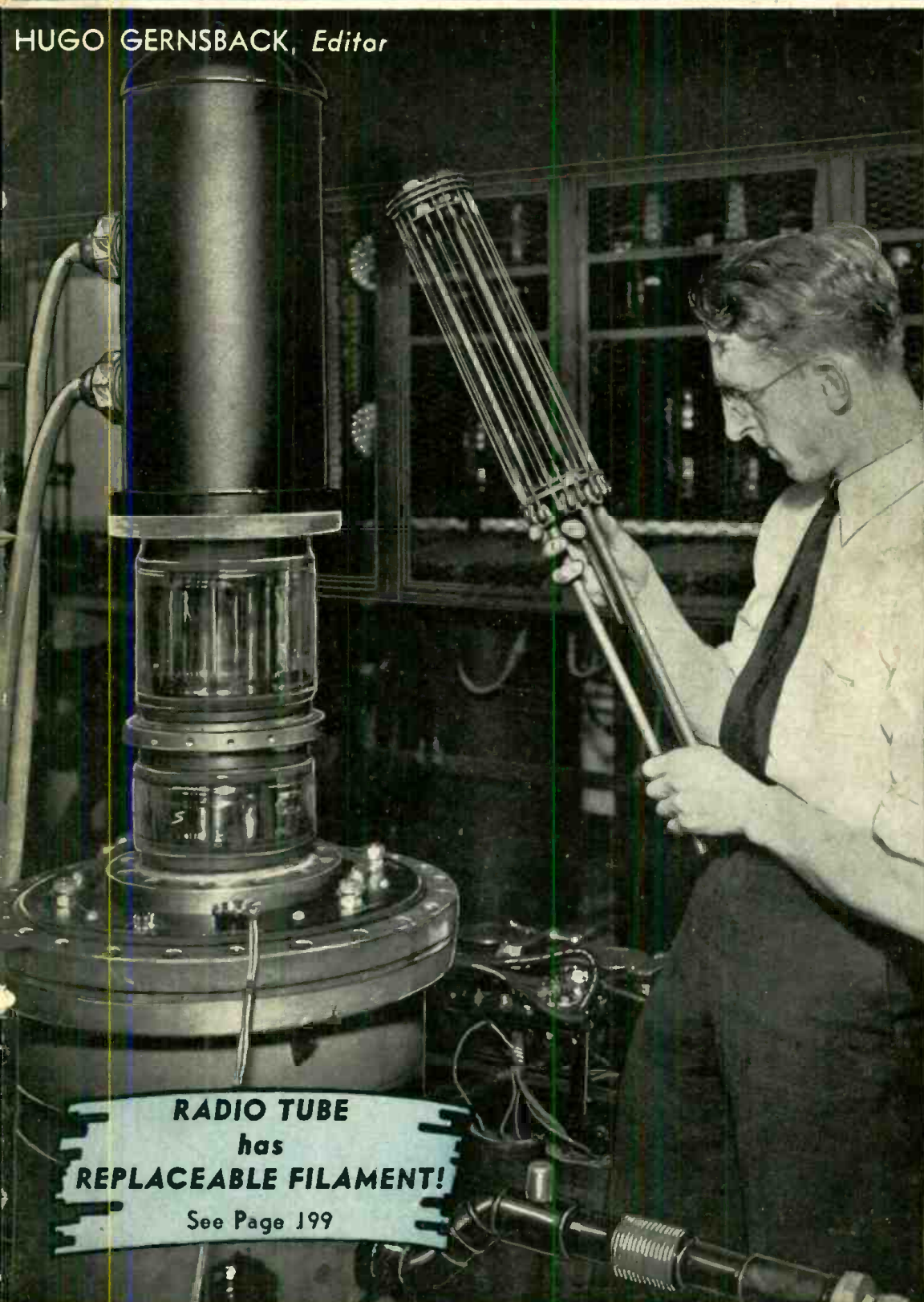

HUGO GERNSBACK, *Editor*

RADIO TUBE
has
REPLACEABLE FILAMENT!
See Page 199



DeFOREST CURES HORSE

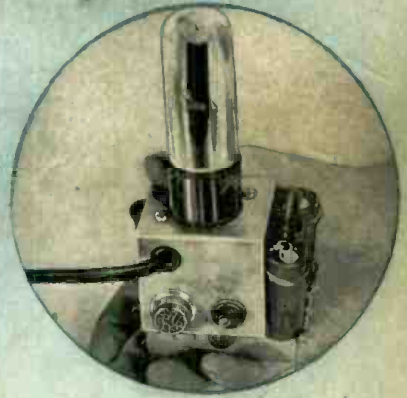

ELECTRIFIES PORTABLES!



2-WAY WIRE-TELLY

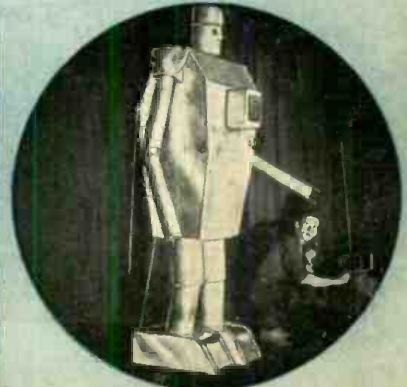

CLARENCE-RADIO ROBOT

3 OCT.
25c
U. S. AND
CANADA

RADIO'S GREATEST MAGAZINE
A FLEXIBLE 30-W. DIRECT-COUPLED AMPLIFIER • 8 NEW TUBES
HOME-MADE FREQUENCY WOBBLER • Contest Awards—2nd Group
www.americanradiohistory.com

Now...

5

VITAL FEATURES COMBINED AND UNIFIED IN THE AMPERITE VELOCITY WITH ACOUSTIC COMPENSATOR

UNI-DIRECTIONAL
PICK-UP FIELD
COMPENSATOR UP

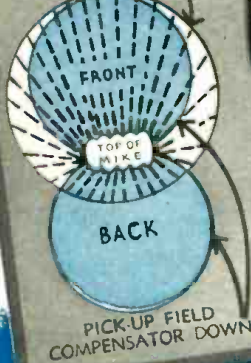

PICK-UP FIELD
COMPENSATOR DOWN



PUSH UP TO
INCREASE
HIGHS
PUSH DOWN
TO INCREASE
LOWS.

it's a VELOCITY
it's a DYNAMIC
it's UNI-DIRECTIONAL
it's NON-DIRECTIONAL
gives HIGH OR LOW PITCH

By moving up the Acoustic Compensator, you change the Amperite Velocity Microphone to dynamic operation—without peaks. At the same time you reduce the back pickup, making the microphone practically uni-directional. With the Acoustic Compensator down, the microphone is bi-directional... 120 degrees front and back without frequency discrimination. Rotating the microphone until it parallels the ceiling makes the microphone non-directional. THE ACOUSTIC COMPENSATOR is a regular feature of these models: RBHk (hi-imp); RBMk (200 ohms) LIST \$42.00. RSHk (hi-imp); RBSk (200 ohms), \$32.00 LIST



FOR TOP-NOTCH QUALITY,
AND AMAZING RUGGEDNESS,
AT LOW COST

specify Model RAH (or RAL).

Here's why this popular Amperite Velocity Microphone leads the low-price field: (1) It is excellent for both speech and music; (2) has flat response without undesirable peaks; (3) reduces feedback; (4) stands up under rain, wind, heat, and rough handling. Frequency range 60 to 7500 CPS. Output—68 db. MODEL RAH (hi-imp), with 12' of cable; MODEL RAL (200 ohms), with 8' of cable. . . \$22.00 LIST.

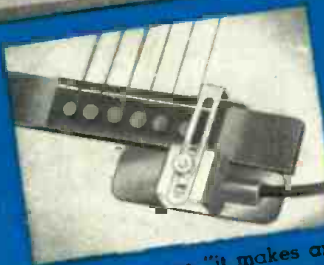
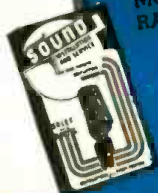

SELL "CONTACT MIKES"
to Professional and
Amateur Musicians.
New high output model can
be used in the home.

Professional musicians are buying Amperite "Contact Mikes" because "it makes an ordinary violin sound like a Strad." Now amateurs, too, can benefit by the "Contact Mike." The new HIGH OUTPUT MODEL SKH can be used in the home. It operates on most radio sets made since 1935. It is connected to the phono-input, or to grid ground of detector tube, or across the volume control. Note new clamp, making the mike easy to attach to guitars, ukes, etc. MODEL SKH (hi-imp), SKL (200 ohms) \$12.00 LIST. Any number up to 5 SKH's can be put in parallel and fed into one input. NEW FOOT PEDAL \$12.00 LIST. CLAMP for Contact Mikes \$1.00 LIST.

Sales Aids for the P. A. Man

(1) FREE Window Decal advertising your Sound Service. Size 5 1/4 x 9 1/4, finished in 4 colors. (2) FREE Window Display, 8 1/2 x 17. (3) Special Sound Equipment Letterheads, Samples and prices on request. (4) FREE use quantities for printing business cards, etc.

AMPERITE CO. 561 BROADWAY, N. Y. U.S.A. CABLE ADDRESS ALKEM, NEW YORK

"Better Systems
Specify Amperite"



VELOCITY

AMPERITE

MICROPHONES



I WILL TRAIN YOU TO START A SPARE TIME OR FULL TIME RADIO SERVICE BUSINESS WITHOUT CAPITAL

J. E. SMITH, President
National Radio Institute

Read what My Training
did for These Men



"For the past 2 years I have been in business for myself making between \$200 and \$300 a month. Business has steadily increased. I have N.R.I. to thank for my start in this field."
ARLIE J. FROEHNER,
300 W. Texas Ave.,
Goose Creek, Texas

"I am now making from \$10 to \$25 a week in spare time while still holding my regular job as a machinist. I owe my success to N.R.I."



WM. F. RUPP,
611 Green Street,
Bridgeport, Pa.



"When I completed 20 lessons, I obtained my Radio Broadcast Operator's license and immediately joined Station WMPC, where I am now Chief Operator."

HOLLIS F. HAYES,
327 Madison St.,
Lapeer, Michigan

"Before completing half the N.R.I. Course I was servicing sets, and I made \$1,000 to \$1,200 before graduating. I am doing Radio service work for myself now."



ASHLEY G. ALDRIDGE,
1228 Shepherd St.,
Petersburg, Va.

Sample Lesson Free

I want to prove my Training gives practical, money-making information, that it is easy to understand—what you need to master Radio. My sample lesson text, "Radio Receiver Troubles—Their Cause and Remedy," covers a long list of Radio receiver troubles in A.C., D.C., battery, universal, auto, T.R.F., superheterodyne, all-wave, and other types of sets. And a cross reference system gives you the probable cause and a quick way to locate and remedy these set troubles. A special section is devoted to receiver check-up, alignment, balancing, neutralizing, testing. You can get this lesson Free by mailing the coupon.



A Tested Way
to BETTER PAY

The world-wide use of Radio has made many opportunities for you to have a spare time or full time Radio service business of your own. Four out of every five homes in the United States have Radio sets which regularly need repairs, new tubes, etc. Servicemen can earn good commissions too, selling new sets to owners of old models. Even if you have no knowledge of Radio or electricity, I will train you at home in your spare time to sell, install, fix, all types of Radio sets; to start your own Radio business and build it up on money you make in your spare time while learning. You don't need to give up your present job or spend a lot of money going away to school to become a Radio Technician. Mail coupon for my 64-page book. It's Free—it shows what I have done for others—what I am ready to do for you.

MANY MAKE \$5 TO \$10 A WEEK EXTRA IN SPARE TIME WHILE LEARNING

The day you enroll I start sending Extra Money Job Sheets which start showing you how to do Radio repair jobs. Throughout your training I send plans and directions that made good spare time money—\$200 to \$500—for hundreds, while learning. I send you special Radio equipment to conduct experiments and build circuits. This 50-60 method of training—with printed texts and conducting experiments—makes learning at home interesting, fascinating, practical.

WHY MANY RADIO TECHNICIANS MAKE \$30, \$40, \$50 A WEEK

Radio is already one of the country's large industries even though it is still young and growing. The arrival of Television, the use of Radio principles in industry, are but a few of many recent Radio developments. More than 28,000,000 homes have one or more Radios. There are more Radios than telephones. Every year millions of Radios get out of date and are replaced. Millions more need new tubes, repairs, etc. Over 5,000,000 auto Radios are in use and thousands more are being sold every day. In every branch, Radio is offering opportunities—opportunities for which I give you the required knowledge of Radio at home in your spare time. Yes, the few hundred \$30, \$40, \$50 a week jobs of 20 years ago have grown to thousands.

JOBS LIKE THESE GO TO MEN WHO KNOW RADIO

Radio broadcasting stations employ engineers, operators, station managers, Radio Technicians and pay well. Radio manufacturers employ testers, inspectors, foremen, service-

men in good-pay jobs with opportunities for advancement. Radio jobbers and dealers employ installation and servicemen. Many Radio Technicians open their own Radio sales and repair businesses and make \$30, \$40, \$50 a week. Others hold their regular jobs and make \$5 to \$10 a week fixing Radios in spare time. Automobile, police, aviation, commercial Radio; loudspeaker systems, electronic devices, are newer fields offering good opportunities to qualified men. Television promises to open many good jobs soon.

I ALSO GIVE YOU THIS PROFESSIONAL SET SERVICING INSTRUMENT

Here is the type of instrument Radio Technicians use—an All-Wave Set Servicing Instrument. It contains everything necessary to measure A.C. and D.C. voltages and current; to check resistances; adjust and align any set, old or new. It satisfies your needs for professional servicing after you graduate—can help you make extra money fixing sets while training.

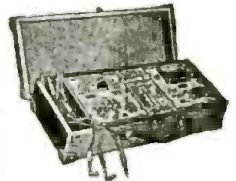

YOU ARE TRAINED FOR TELEVISION

With N.R.I. you take up Television principles right along with Radio principles—the correct method—since Television receivers combine both sight and sound. You also get more than ten text books devoted entirely to Television.

FIND OUT WHAT RADIO OFFERS YOU

Act Today. Mail the coupon now for Sample Lesson and 64-page book. They're free. They point out Radio's spare time and full time opportunities and those coming in Television; tell about my course in Radio and Television; show you letters from men I trained, telling what they are doing and earning. Read my Money Back Agreement. Find out what Radio offers YOU! MAIL COUPON in an envelope, or paste on a postcard—NOW!

J. E. SMITH, President
National Radio Institute
Dept. 9KX
Washington, D. C.

THIS
FREE BOOK
HAS HELPED
HUNDREDS OF
MEN MAKE
MORE
MONEY



Good for Both 64 PAGE BOOK SAMPLE LESSON Free

J. E. SMITH, President, National Radio Institute
Dept. 9KX, Washington, D. C.

Without obligating me, send your Sample Lesson and 64-page Book FREE. I am particularly interested in the branch of Radio checked below.

- Radio Service Business of My Own
- Spare Time Radio Repair Work
- Service Technician for Retail Stores
- Broadcasting Station Operator
- Aviation Radio Technician
- Loud Speaker Systems, Installations and Service
- Auto Radio Installation and Service
- Television Station Operator
- Commercial Radio Station Operator
- All-around Servicing Technician

(If you have not decided which branch you prefer—mail coupon now, for information to help you decide.)

Name ARO

Address 14X1

Please Say That You Saw It in RADIO-CRAFT

RADIO-CRAFT

HUGO GERNSBACK, *Editor-in-Chief*

N. H. LESSEM
Associate Editor

THOS. D. PENTZ
Art Director

ROBERT EICHBERG
Trade Digest Editor

R. D. WASHBURNE, *Managing Editor*

Contents OCTOBER, 1939 Issue

VOLUME XI -- NUMBER 4

Editorial: Radio at the World's Fair— <u>Where?</u>Hugo Gernsback	197
The Radio Month in Review.....	198
Clarence—Radio Robot.....Austin Huhn	200
Radio—In Our National Parks.....W. C. Hilgedick	201
How to Design a Flexible All-Push-Pull Direct-Coupled 30-Watt Amplifier	202
Awards—\$4,000 Public Address Contest (Part II).....	204
Sound System Guides Brewery Tours.....	205
New Circuits in Modern Radio Receivers—No. 25.....F. L. Sprayberry	206
Service Data on Pilot Lights.....	207
Video Amplifier Design.....C. L. Ragsdale	208
A Real Portable Receiver.....	209
Behind the Scenes of a Trans-Atlantic Hookup.....Eugene Goddess	210
A.C.-D.C. Power Supply for Battery Portables.....N. H. Lessem	212
8 New Tubes.....R. D. Washburne	213
"Iron-Core 6" Broadcast Set.....Michael G. Relsum	215
Servicing Television Receiver Faults—Part V (Conclusion).....S. West	216
Home-Made Frequency Modulator.....George F. Baptiste	219
Emergency Servicing Without Test Meters—Part II....Charles R. Leutz	220
The Latest Radio Equipment.....	222
Servicing "Coin-Operated" Phonographs—No. 5.....Sanford Miller	223
RADIO SERVICE DATA SHEETS:	
No. 262—Pilot B.C.—S.W. Model T-1452 Battery—A.C.-D.C. "Twin-Set" Portable	224
No. 263—Philco Models 40-195 and 40-200 11-Tube Superheterodyne	225
Test Your Radio Knowledge—With Questions and Answers from Radio Schools	226
Radio Trade Digest.....	227
Book Reviews.....	251

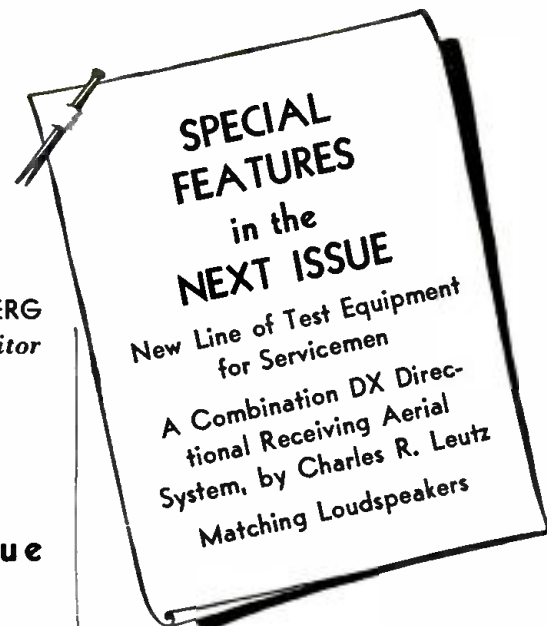

★

Thousands and thousands of portable radio receivers are being sold throughout the entire country—a potential source of income for the Serviceman because sooner or later the owners of many of these sets are eventually going to have them electrified in order to eliminate the expense of replacing batteries.

How to electrify them, inexpensively? The answer is on pg. 212 of this issue—and it's so simple as to be amazing!

★

Published by Radcraft Publications, Inc. Publication office: 29 Worthington Street, Springfield, Mass. Editorial and Advertising Offices: 99 Hudson Street, New York City. Chicago Advertising Office: RADIO-CRAFT, 520 North Michigan Avenue, Chicago, Ill.

RADIO-CRAFT is published monthly, on the first of the month preceding that of date; subscription price is \$2.50 per year in U. S. and Canada. (In foreign countries, \$3.00 a year to cover additional postage.) Entered at the post office at Springfield as second-class matter under the act of March 3, 1879.

Foreign Agents:

London—Gorrings's American News Agency, 9A Green St., Leicester Square, W. C. 2, England.
Paris—Messageries Dawson, 4 Rue Faubourg Poissonniere, France.
Melbourne—McGill's Agency, 179 Elizabeth St., Australia.
Dunedin—James Johnston, Ltd., New Zealand.

★

Text and illustrations of this magazine are copyright and must not be reproduced without permission of the copyright owners.

★

Copyright 1939 Radcraft Publications, Inc.



WE HAVE GROSSED THE THRESHOLD OF TOMORROW

For twenty years we here at Wholesale Radio Service Company have blazed new trails in Public Service. Scarcely a phase of the communications field has been left untouched during the years of our growth. Today thousands of discriminating buyers in every land are listed among our satisfied customers. For into every shipment we have always put more than just top-flight merchandise.

It has been this spirit of extra service that has enabled us to grow from a modest shop into a world-wide organization. We operate seven retail branches

today, with three giant central distributing points from which flow thousands of shipments daily.

As we have grown however, so too have grown the demands of the people we serve. Industry, for new and better materials; individuals, for finer instruments and forms of reception. We have lived to see many new developments replace the old, many of our former services, once essential, no longer required.

In fact, our very name for so many years perfectly adapted to our business now belongs to yesterday. It does not fit with our plans for tomorrow.

Naturally, we were attached to our old name, but sentiment has no place in progress. And so from now on we shall be known as

Radio Wire Television Inc.

A name selected because it accurately pictures the very business we are engaged in.

What do we mean? Let's look at that name more closely.

RADIO: Up through the years we have grown and expanded with Radio—very backbone of our business. Yet even in the face of today's magic, life-like reception, much remains to be done. So naturally Radio Broadcasting will continue to engage our interest.

WIRE: A new service gaining momentum with each day is WIRE BROADCASTING. Already many of today's entertainment forms are available by means of wire with great fidelity, reliability, and economy. We believe that soon the art of broadcasting by wire will encompass the transmission of both sight and sound. Every current technological development points to this end.

TELEVISION: Third and newest term in our name. Breath-taking is television's power to reproduce for man's entertainment and knowledge, the life and happenings of storied lands afar, the news events that will make tomorrow's headlines. With television a vast new field of human relationship is magically thrown open. Whichever way you choose to receive your television programs, by wire or radio, we will offer the finest services available anywhere.

The new name, thus embodies all of those features which from now on are to comprise the principal part of our business. Radio Wire Television Inc., proposes to extend its activities into every phase of the electronic art. Several associate enterprises which control important patents relating to the entire communications field have already been merged with our com-

pany. With these patents, we hope to throw open a vast number of new services to the general public. Of special interest are plans to expand the number of retail outlets for Radio Wire Television Inc. in order that local branches may be placed at the disposal of all who are interested in finer entertainment services, better products and lower costs.

Radio Wire Television Inc., is licensed by arrangement with Electrical Research Products Inc. under patents of Western Electric Company, Bell Telephone Laboratories, Inc., and American Telephone & Telegraph Company.

Radio Wire Television Inc.

formerly **WHOLESALE RADIO SERVICE CO., Inc.**

NEW YORK • CHICAGO • ATLANTA • BOSTON • NEWARK • BRONX, N. Y. • JAMAICA, L. I.

Please Say That You Saw It in RADIO-CRAFT

For Better Servicing - - For Bigger Profits - - Use Gernsback Manuals and Books!



SINCE 1931 Servicemen have been buying more GERNSBACK OFFICIAL RADIO SERVICE MANUALS year after year. The authentic material, easily accessible diagrams and complete service data make them invaluable to dealers and radio Servicemen. Without a Gernsback Service Manual at the repair job, there's time and profit lost. Your service kit or laboratory is incomplete without all the GERNSBACK OFFICIAL RADIO SERVICE MANUALS. There are GERNSBACK MANUALS for servicing auto-radios, also refrigeration and air conditioning equipment.

- VOLUME 7 OFFICIAL RADIO SERVICE MANUAL**
Over 1,800 Pages • Over 3,000 Illustrations • Stiff, Leatherette, Looseleaf Covers • Size 9 x 12 Inches • Net Weight 10½ lbs. **\$10.00**
- 1936 OFFICIAL RADIO SERVICE MANUAL**
Over 1,200 Pages • Over 2,500 Illustrations • Stiff, Leatherette, Looseleaf Covers • Size 9 x 12 Inches • Net Weight 8 lbs. **\$7.00**
- 1935 OFFICIAL RADIO SERVICE MANUAL**
Over 1,000 Pages • Over 3,000 Illustrations • Flexible, Leatherette, Looseleaf Covers • Size 9 x 12 Inches • Net Weight 3¾ lbs. **\$7.00**
- 1935 OFFICIAL AUTO-RADIO SERVICE MANUAL**
Over 240 Pages • Over 500 Illustrations • Flexible, Leatherette, Looseleaf Covers • Size 9 x 12 Inches • Net Weight 1¾ lbs. **\$2.50**
- 1934 OFFICIAL RADIO SERVICE MANUAL**
Over 400 Pages • Over 2,000 Illustrations • Flexible, Leatherette, Looseleaf Covers • Size 9 x 12 Inches • Net Weight 2¾ lbs. **\$3.50**
- 1932 OFFICIAL RADIO SERVICE MANUAL**
Over 1,000 Pages • Over 2,000 Illustrations • Flexible, Leatherette, Looseleaf Covers, Size 9 x 12 Inches • Net Weight 4½ lbs. **\$5.00**
- OFFICIAL REFRIGERATION SERVICE MANUAL (Volume 1)**
Over 352 Pages • Over 300 Illustrations • Flexible, Leatherette, Looseleaf Covers, Size 9 x 12 Inches • Net Weight 1½ lbs. **\$5.00**
- OFFICIAL AIR CONDITIONING SERVICE MANUAL**
Over 352 Pages • Over 600 Illustrations • Flexible, Leatherette, Looseleaf Covers, Size 9 x 12 Inches • Net Weight 2¼ lbs. **\$5.00**

To order these famous Manuals, see or write to your jobber or favorite mail order house. If more convenient, mail coupon directly to publishers.

RADCRAFT PUBLICATIONS, Inc.
99 HUDSON STREET NEW YORK, N. Y.

Many New Books Have Been Added to RADIO-CRAFT LIBRARY SERIES

Get into the swing of reading instructive, authoritative books on technical subjects—radio, air conditioning and refrigeration. It's the easiest, quickest and most inexpensive way to improve your knowledge on these topics. In this series, popularly known as the RADIO-CRAFT LIBRARY SERIES, are all the titles necessary to your personal advancement. Only by careful study of these enlightening books, can you gain adequate experience in fields of radio, air conditioning and refrigeration. Each book is uniform. The volumes measure 6 x 9 inches—contain 64 pages, and have stiff, flexible covers. PRICE 50c PER BOOK. All books are sent to you postpaid.

Here Are The Titles:

- | | |
|---|---|
| Book No. 2
MODERN VACUUM TUBES | Book No. 18
POINT-TO-POINT RESISTANCE ANALYSIS |
| Book No. 6
BRINGING ELECTRIC SETS UP-TO-DATE | Book No. 19
PRACTICAL RADIO KINKS AND SHORT CUTS |
| Book No. 13
ABC OF AIR CONDITIONING | Book No. 20
THE CATHODE-RAY OSCILLOSCOPE |
| Book No. 14
POCKET RADIO GUIDE | Book No. 21
BREAKING INTO RADIO SERVICING |
| Book No. 15
ABC OF REFRIGERATION | Book No. 22
NEW RADIO QUESTIONS AND ANSWERS |
| Book No. 16
PRACTICAL RADIO CIRCUITS | Book No. 23
PRACTICAL PUBLIC ADDRESS |
| Book No. 17
SERVICING WITH SET ANALYZERS | |

EACH BOOK IN THIS SERIES—50c

RADCRAFT PUBLICATIONS, Inc., 99 HUDSON ST., NEW YORK, N. Y.
Gentlemen: Enclosed find my remittance of \$..... for which send me, POSTPAID, the Manuals or Books indicated below by a cross (x) in the Panel.

() Volume 7 @ \$10.00 () 1936 Manual @ \$7.00 () 1935 Manual @ \$7.00
 () 1935 Auto-Manual @ \$2.50 () 1934 Manual @ \$3.50 () 1932 Manual @ \$5.00
 () Refrigeration Manual (Vol. 2) @ \$5.00 () Air Conditioning Manual @ \$5.00

RADIO-CRAFT LIBRARY SERIES @ 50c EACH
 Circle book numbers wanted: 2 6 13 14 15 16 17 18 19 20 21 22 23

Name Address

City State

(Send remittance in form of check or money order; register your letter if you send cash or unused U. S. Postage Stamps.) RC-1039

Please Say That You Saw It in RADIO-CRAFT

RADIO-CRAFT

“RADIO'S GREATEST MAGAZINE”

RADIO AT THE FAIR—WHERE?

By the Editor — HUGO GERNSBACK

If a hundred years from now an enterprising historian should come across the voluminous record of the New York World's Fair of 1939, he probably would be quite bewildered. *Radio as a unit was not represented at the World's Fair.*

He would be amazed to find that radio, as one of the world's wonders of the 20th Century, was not represented at the Fair, in a large individual exhibit, as far as Radio itself is concerned.

He probably could not understand why Radio was treated so shabbily in this manner and, indeed, we of the 20th Century are equally amazed at the stepchild-treatment of Radio at the New York World's Fair.

The same remarks can be made as far as the 1939 San Francisco Exposition is concerned because, so far as is known, there is no general exhibit devoted to radio as a whole.

To be sure, if you look patiently enough, you will find stowed away somewhere at both Fairs a few radio sets, chiefly among the big industrial exhibits of Radio Corporation of America, General Electric, Westinghouse, Crosley, etc. But, as for a big building devoted entirely to radio in its vast and multifarious branches, *it just does not exist.*

The few concerns just mentioned (with the exception of Crosley), it is true, have fairly large exhibits featuring *television*, where people are televised and where the images are projected on television receivers. Yet, for radio itself, even these big exhibitors have found very little room for radio as a whole.

Radio is such a vast industry, and such a tremendous art, that it seems a great pity that no concerted effort has been made by the entire radio industry to present radio to the public as it should be shown.

Now take, for instance, the petroleum industry. They put up a very large and glamorous building of extraordinary shape and commanding appearance. Then, in order to sell oil to the public, they showed inside the vast hall just what oil is all about, in easy-to-understand charts, movable exhibits and moving models which cost a young fortune. Then to cap the climax, they obtained considerable extra space alongside the main exhibit, and here you will see in actual operation just how oil is drilled—not by means of a small model—but by actual drilling machinery erected at great cost. Here we have a tower (derrick) 200 ft. high with all its machinery as used in actual drilling for oil wells. Huge steel shafts, 120 ft. in length are joined together until they reach the amazing total of about 440 ft. which actually descend into the earth's bowels, just as is done in drilling actual oil wells. And, a little further on, we have a huge pump, again not a model but actual full size machinery, showing the on-looker how oil is pumped from a great depth. Gigantic cross-sections of the earth's crust are also shown; and other details too numerous to mention.

And, most amazing of all, is the fact that the oil industry has nothing to sell to you except *the industry itself*. No names are mentioned, and you will look in vain for the name of any of our big oil interests.

Here then we have a concerted effort of an intelligent, well-managed industry which is selling the public the idea of Oil in its various ramifications.

Can you imagine that the radio industry would have ever—even if they had thought about it—erected such an exhibit to sell the idea of radio to the public? What would have happened, most likely, is that the various members of the radio industry would have fought among themselves to have their names and products plastered all over the place, all calculated to befuddle the public.

Radio is in the doldrums today, simply because there has never been a concerted effort of the industry to sell itself to the public. If you doubt this, witness the present sad spec-

tacle where the industry is continually at loggerheads with itself; where one class of manufacturers denounces in vitriolic terms when the other pioneering part of the industry tries to build up a new branch of radio—namely, Television.

It is easy to envisage a large building—“*Radio World of Tomorrow*”—given over entirely to the hundreds of wonders of radio, present and future. The public still knows altogether too little about radio broadcasting. There are few people at large who have any idea whatsoever how it is accomplished. Here, then, was a tremendous opportunity to sell some 100,000,000 people, who come to see and gape and wonder, what radio broadcasting is all about.

Witness the tremendous crowds at the American Telephone and Telegraph Company building, where thousands of people stand in line daily waiting for a chance to participate in a coast-to-coast telephone conversation. Paralleling this, how simple it would have been for our broadcasting nets to have the public itself broadcast a few words now and then; particularly in the morning and afternoon, when radio programs are not crowded with commercial contracts.

Here, too, there would have been a marvelous chance to show the public why advertising over the air is an absolute necessity. Today, all radio advertising is a terrific irritant to most people. This irritation, by good showmanship, could have been turned into actual life-long good-will.

The radio set industry could have done itself proud by actually showing how radio sets are assembled. If automobile tires, cigarettes, and frankfurters can be shown at the Fair in the making, why not radio sets?

In the great Radio Exhibition (which never was built) we could have had a fine exhibit by the radio amateurs, showing how radio traffic is actually handled by them.

An heroic model of a radio set 40 feet tall could have been constructed and with it shown how radio waves are received till the sound is produced (Westinghouse Exhibit makes a weak attempt in this direction, but it is so technical that only a technician who can read a radio diagram can follow it). There was also an excellent opportunity, in our imaginary “House of Radio” to show what Public-Address is all about and how it works.

The radio service industry, too, could have been represented in force, and tremendous good-will could have been created, by the radio industry, for radio Servicemen (a condition which does not exist today, simply because the radio industry and Servicemen never, or seldom, meet and never are made to look eye to eye).

And how about the young and rising radio generation? I can picture a whole floor given over to juvenile Marconis who would have been allowed to come to the exhibit at any time in order to build a radio set or radio instrument of their own invention, to their hearts' content.

Every radio manufacturer of any size has tons of radio material for which he no longer has any use, and usually sacrifices as scrap. What a chance to send material to the Fair where the boys could have used it to build radio sets and other radio doodads! The radio industry could have offered cash prizes for the best receiving set or new radio idea. If this had been done, the manufacturers would certainly have received sufficient new ideas to pay for the radio “scrap” which they had furnished.

But why go on describing the great “Radio House of Tomorrow” that was never built and, probably, never will be built?

But perhaps somewhere, somehow, some one will think well of the idea. Indeed it is not too late for, despite the “official” closing date of Oct. 31, betting is 9 to 1 that the New York World's Fair will still be going at full blast in 1940; and, perhaps, the “Radio House of Tomorrow” may still be built at the Fair—although I have my doubts.

THE RADIO MONTH



"DE FOREST DAY"

The Veteran Wireless Operators Association last month announced its participation in "De Forest Day" at the New York World's Fair 1939, on September 22. The inscription on the photo reads: "To V.W.O.A. One & All, with sincerest best wishes and 73, Lee de Forest, Jan. 1939."



2-WAY TELEVISION!

Successful 441-line 2-way television was demonstrated last month by RCA between 2 floors in the Ambassador Hotel, Atlantic City (N.J.).



NEWEST TELLY SET

Philco model 10TK teleceiver uses a 10-in. "flat" C.-R. tube (September *Radio-Craft*, pg. 141.).

TELEVISION

ZENITH RADIO CORP. last month received an OK from the F.C.C. to operate a 50-watt portable telly transmitter on 45.25 megacycles, for one month, to survey the site of a new location for experimental television station W9XZV.

The United States Television Mfg. Corp. has been chartered to "manufacture and deal in radios and television sets." Capital stock is \$150,000, \$1.00 par value. Directors are: J. B. and P. H. Milliken and L. P. Jubien, New York City.

A \$17,500 land-yacht made its initial appearance in Radio City last month and demonstrated to N.B.C. officials the television equipment in this privately-owned trailer. Designed and built by Myron C. Zobel, wealthy sportsman and advertising executive, this Graduate Group Continental Clipper, as it is named, has been touring the country for the past 4 months. It includes amateur radio station W1SLV, a 1,000-watter. The trailer also carries a motor scooter, for getting supplies, etc., from nearby towns, which is equipped with a 2-way transmitter-receiver!

For several months this department has been telling you about the Gaumont-British and Scophony large-screen theatre-size television. Last month the E.M.I.-Marconi group demonstrated to Londoners their new cathode-ray system for images 12x15 ft. using either front- or rear-of-screen projection, reported *Variety*. Plan is to install set No. 1 in Metro's big Empire theatre in Leicester Square, London. (E.M.I., incidentally, stands for Electrical and Musical Industries—"Biggest Radio and Recording Trust" in England.)

Reports are that RCA is working on television equipment employing 16-millimeter films in place of the present 35-mm. size. It is said that a West Coast group is making a survey with a view to making films exclusively for television. To quote an issue of *Radio Daily* last month:

With 16 mm., it is pointed out, economies could be achieved, fire hazards lessened, and mechanical design simplified.

Further, that with new and improved 16 mm. cameras, films could be made essentially for television, whereas the larger 35 mm. cameras are not as well adapted.

Use of 16 mm. from the television industry's inception will not only tend to bring about a standard which is not likely to be outmoded, as appears to be the destiny of 35 mm., according to 16 mm. advocates, but will also enable the telly field to make use of large reservoirs of narrow-gauge footage. This, in turn, would reduce the "famine" facing television as a result of the refusal on part of entertainment-film producers and distributors to release films for telecasts.

Television, radio and related activities of the General Electric Company were centered as one new department at Bridgeport, (Conn.), last month.

SOUND

CONEY ISLAND, Brighton Beach and Manhattan Beach bathers last month were bathed in the audio output of the Trump Show Boat, a 65-ft. yacht equipped with a P.A. system capable of sending sound programs for nearly a mile. Purpose of the sound broadcasts was to help Mr. Trump sell the idea of becoming a Brooklyn, N.Y., home purchaser under F.H.A. financing. Backing up his sound program—an idea which sound men everywhere can apply with profit—was the releasing of 5,000 balloons in one week which entitled capturers to a credit of 25 to 250 dollars (figures stamped on balloons) toward payment on one of the homes.

Church carillons using "electronic bells" had a new application in Chorley Wood Parish Church in England, last month. Prior to the bell-peal a short speech is now made over the 10-W. sound system urging communicants to attend Sunday services.

A good sales argument put forth by Marconiphone (England) for church electronic bells is that they may be used in belfries so old as to be unsafe with the ordinary heavy bells.

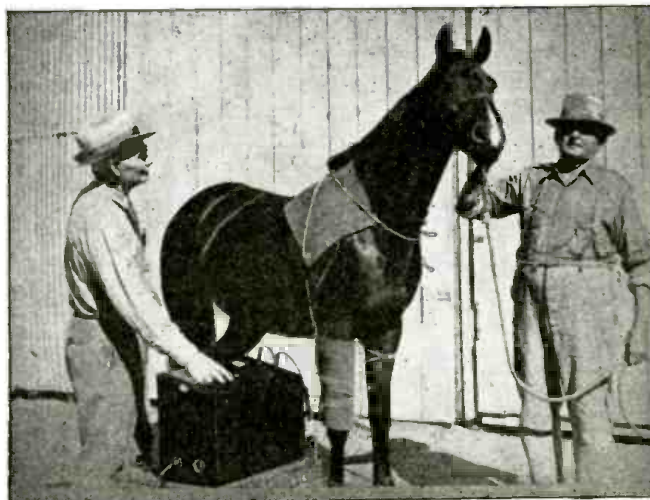

NEW USE FOR RADIO DIATHERMY

Dr. Lee de Forest, famous inventor, is shown at left demonstrating the use of an 18-meter diathermy apparatus for the treatment of a sprained tendon in a show-horse. Veterinarians now have a new curative agent.

IN REVIEW

BROADCASTING

SITTING in N.B.C.'s studio 8-H, last month, the U.S. Army's General Staff described maneuvers in the Army's far-flung outposts during a remarkable 2-way broadcast which employed 73 microphone points on a 100,000-mile radio circuit. The program revealed graphically how defense plans of every Army unit could be coordinated and expedited in case of war, through the facilities of the radio broadcasting networks. Included in the demonstration were pick-ups from airplanes and armored cars.

Another radio war broke out in Europe last month. Germany is said to have started the hostilities by setting-up a broadcast station near Bogunin a railroad station on the Polish-German frontier, and opening-up a barrage of propaganda. Poland promptly built a station of equal power just across the line, the *Evening Star* (Washington, D.C.) reported last month.

Radio-Craft was in receipt of information last month from G. R. Waldron, chief technician of the DeBouchelle Archeological Expedition, that this expedition plans to broadcast from the interior of the Bolivian jungle. The Expedition is scheduled to leave in October. Added interest of the broadcasts will be the releases from the \$80,000 special type airplane which will be used by the Expedition. It is contemplated making broadcasts from the plane during the flights over the Bolivian jungles and the high peaks of the Cordillera Range.

SHORT WAVES

JOHAN L. REINARTZ, long a consultant to RCA on amateur-radio tube applications, last month became liaison officer for the Naval Communications Reserve, Washington, D.C.

Chas. Milliken, graduate electrical engineer at Calif. Inst. of Tech., pops corn in a cellophane bag by placing the transparent container in the field of a strong shortwave transmitter, it was reported last month. (June *Radio-Craft* told how Westinghouse is doing the same thing at the N.Y. World's Fair.)



STATION WOEG—ON WHEELS!
General Electric built for Union Pacific's exhibition train (top photo), which last month completed a Kansas City-Boston hop, portable shortwave station WOEG. The studio controls are shown (bottom photo) being operated by Robert Lingle, G.E. radio engineer from Schenectady, N.Y.

A "talking ghost" that alarmed Miss Eleanor Wagner, a church organist at Fitchburg, Mass., last month was found to be the electric organ's amplifying system which had detected and amplified short-wave radio programs.

"Book" makers took a licking last month, according to *U.P.*, when a radio-equipped feminine better on the galloping nags, placed bets that always won. It seems that just before the handbook shop received word by telephone, that the horses were off, the lady with a radio set in her hat, received the information by radio from friends, near the track, in a radio-transmitter-equipped automobile.

(Continued on page 232)



MAIN COVER FEATURE
The new G.E. 100-kw. plotron is shown here with its exhausting apparatus, and replaceable filament.

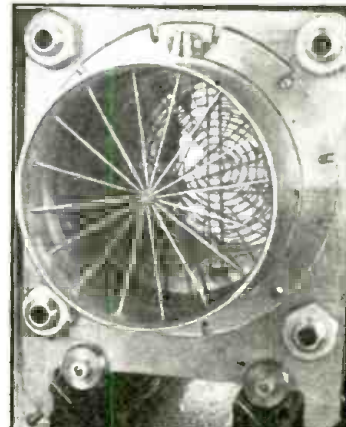
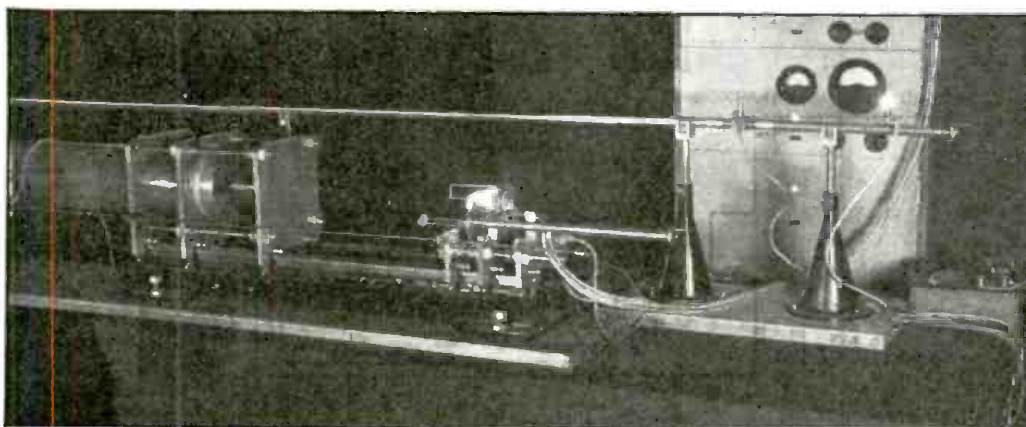

I.T.T.'S NEW MICROWAVE GENERATOR **TRANSFORMER**
In middle of photo above: 8-centimeter generator and its wavemeter; at left, coupling apparatus to a 12-cm. (dia.) dielectric guide; at right, receiving apparatus of a 16-mm. (inside dia.) dielectric guide. Extreme right: microwave transformer to convert E_o wave into H_o wave; and an E_o wave filter.

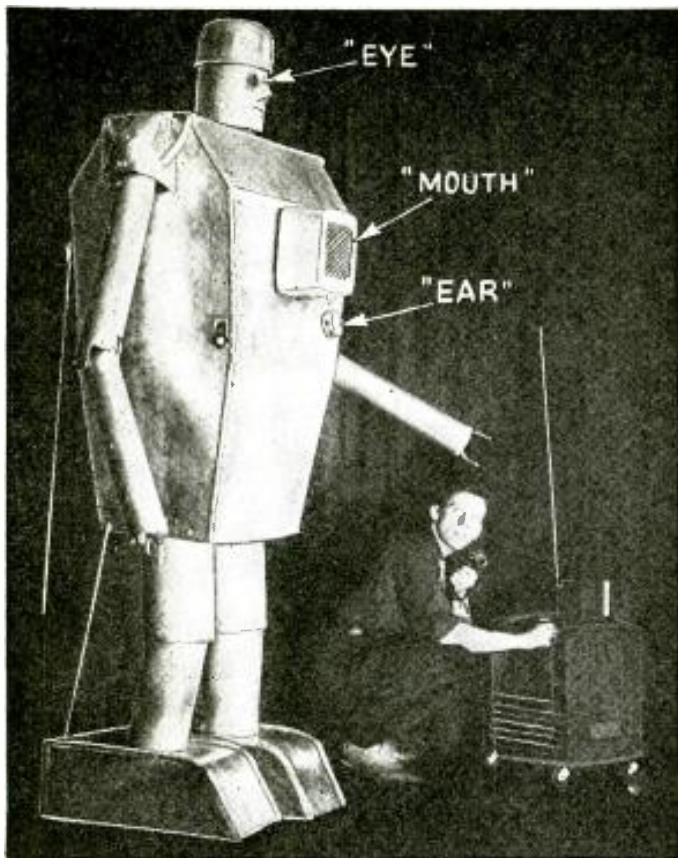

"Little" Clarence gets his instructions via radio from his creator, Austin Huhn, shown at the radio controls.

Clarence

RADIO ROBOT

Something new! A completely self-contained robot which operates within 150 ft. of a remote control unit. Oscillators—very similar to the currently popular "wireless" phono oscillator—supply control signals.

AUSTIN HUHN

quite a bouncing hulk for a baby. He's 300 pounds in weight, stands 8 feet tall and is gentle as a kitten. Radio controlled, he operates, "by permission of the Federal Communications Commission," up to distances of 150 ft. from the Remote Control unit (at right in photo).

Clarence is the first mechanical man in the world who can wander around without trailing wires behind him. Furthermore, he uses no records or transcriptions but says anything which happens to come into his mind. The only flaw thus far found seems to be that Clarence is pretty poor at broadjumping, pole vaults and swimming.

HOW "HE" OPERATES

Clarence's walking and his arm movements are controlled by a photoelectric cell and by a radio beam. Both these methods were combined to insure dependable operation.

There are 2 separate receiving circuits in Clarence, and 1 oscillator with its corresponding preamplifier and microphone. In the Remote (concealed) Control unit there is 1 receiver, to hear via Clarence's ear, and 2 oscillators (see block diagram). The oscillators are similar in principle to the "wireless" phono oscillators recently described in *Radio-Craft*, and like them, operate at one end of the broadcast band.

When Clarence "hears" a question being asked by an interlocutor or bystander Microphone No. 1 picks up the voice, passes it through a preamplifier to modulate Oscillator No. 3 over the "hearing" antenna on Clarence. This modulated signal is picked up by Receiver No. 1 on the Remote Control, is amplified and is heard through the speaker on the Control.

When Clarence "speaks," Microphone No. 2 on the Control is used. This signal is radiated from the antenna on the Control marked "mouth." It is received over the corresponding antenna on Clarence marked "mouth" by Receiver No. 2, is amplified and is heard through the speaker on Clarence's

(Continued on page 245)

"CLARENCE," the "Man of Tomorrow," last month visited the New York World's Fair, and in many respects put to shame Westinghouse's \$10,000 "Electro" and Bell Telephone's "Pedro the *Voder" (Both robots were described in August *Radio-Craft*.) because those mechanistic boys are pretty limited in ability. Pedro can't move anywhere, talks only when an operator permits him to with a regular lingual keyboard. Electro wanders only as far as the wires attached to him allow. He speaks predetermined platitudes.

But Clarence—ah, there's a mechanical man for you. He goes *anywhere* and says *anything*. There are no wires attached.

How does he work? Clarence himself told guests with Dave Driscoll and Jerry Danzig during WOR-Mutual's "Welcome Neighbor" program at the World's Fair, and answered a lot of very personal questions.

Clarence's papa, the writer, has devoted his spare time these 2 years past to perfecting the mechanical man and he is

*Now known as the *Vocoder*.

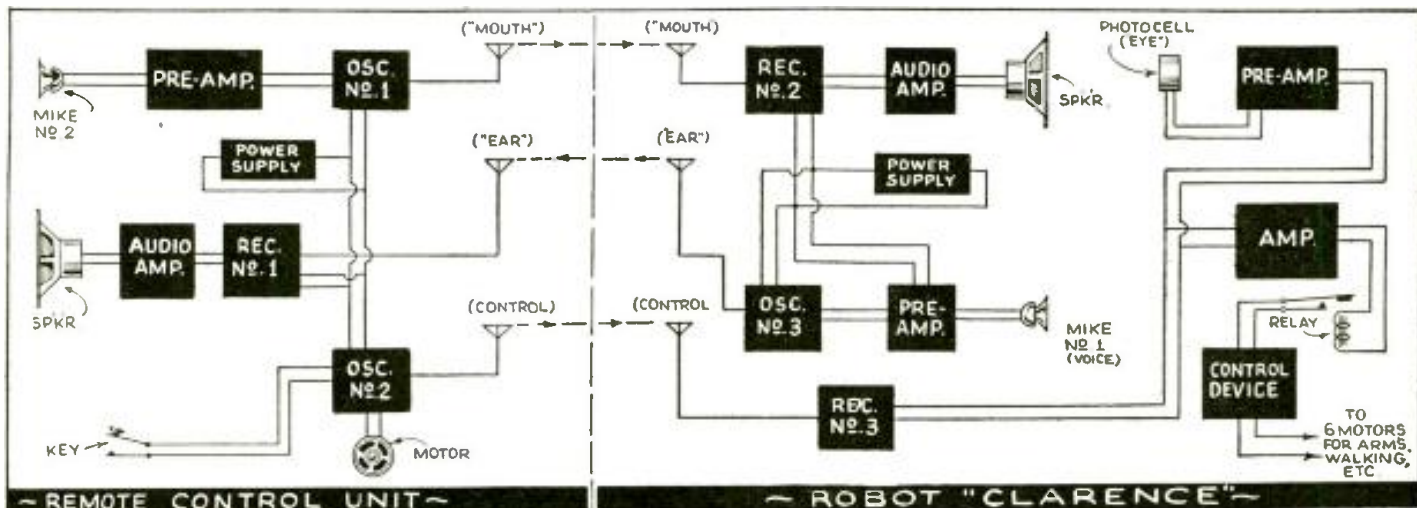

Block diagrams of the complete apparatus in (left) the innards of Clarence and (right) the innards of the radio remote control unit.

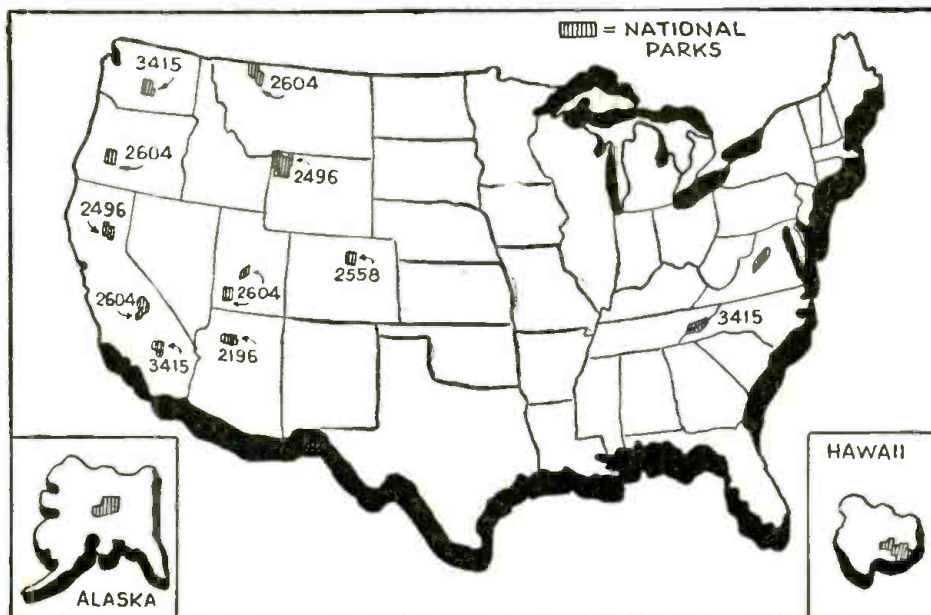

The National Park Service areas, except Carlsbad Caverns, Mammoth Cave and Wind Cave, are radio-equipped.



District Ranger Station, Waterton Lake, Glacier Nat'l Pk., Mont. Note windcharger on extension at left.

RADIO — in Our National Parks

Use of 2-way radio sending and receiving sets has been developed in the National Park Service so that there are now about 30 radio-equipped areas in the U.S. and Alaska!

THE National Park Service areas, with the exception of a few parks such as Carlsbad Caverns, Mammoth Cave and Wind Cave, are equipped with individual 2-way radiotelephone communication systems operating on frequencies of 2,496 to 3,415 kc. and in the 40- and 75-megacycle bands.

TYPES OF SERVICES AND SETS

These systems are used 1st, to extend the facilities of the park telephone lines to isolated ranger stations and temporary camps; and 2nd, to furnish quick communication to any point in the park for forest fire or searching party work.

The usual park radio system includes

W. C. HILGEDICK
Radio Engineer

3 types of sets. The Control Station located at the Park Headquarters is a 50-watt station. The District Ranger Stations throughout the park have 15-watt sets. The 3rd type is the small portable, self-contained dry-battery-powered Field Set of 3 watts power output that is used on the forest fires, in lookout towers, and other remote places where a separate source of power is not available.

HEADQUARTERS SETS

A typical headquarters station is located at Gatlinburg, Tennessee, headquarters of the Great Smoky Mountains National Park. The 50-watt transmitter is one of our older types. All of the

controls, consisting of the necessary switches, microphone, receiver and telephone, are located on the desk for the use of the Fire Dispatcher. A park map on the wall shows directional lines or azimuths inked-in at each fire lookout tower. This allows the Dispatcher to locate the fire within a few seconds by triangulating the azimuth readings sent in by radio or telephone from the other lookout tower.

The latest type of Park Service headquarters set is shown below, at left. This set also has 50 watts power or unmodulated carrier output and is much more compact, due to radio engineering developments since the time the older sets were designed. It is designed as a complete station for placing on a ranger's desk as can be seen from the photo. Incidentally, this picture was
(Continued on page 255)



Great Smoky Mountains National Park Headquarters radio station at Gatlinburg, Tenn., may soon have the above-type 50-W. Fire Dispatcher's radiophone.



Field Headquarters, with ranger receiving messages from stations out on the line of action. Note field telephone which provides another outlet for messages.



Fig. A. View of the 30-W. direct-coupled amplifier with variable expander feature included.

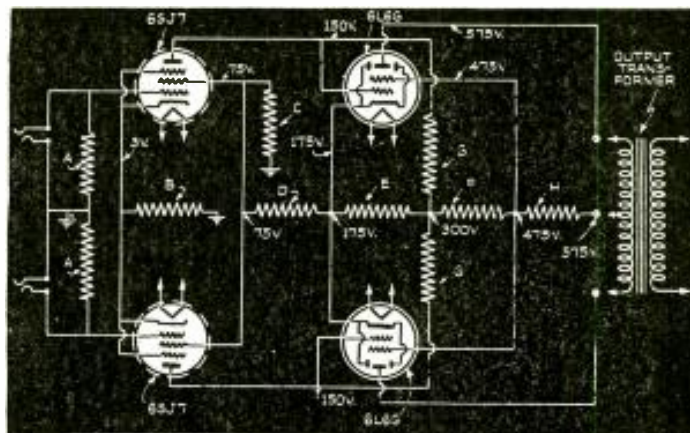

Fig. I. Schematic diagram of the fundamental circuit of the direct-coupled 30-W. amplifier.

How to Design ALL-PUSH-PULL DIRECT-COUPLED

Here's basic design data on a versatile power amplifier which delivers Features may be added to suit individual preferences. A new scratch

A. C.

THE enthusiasm which greeted the writer's all-push-pull and all-direct-coupled 10-watt amplifier (completely described in the July 1939 issue of *Radio-Craft*) proves beyond any question of doubt that a truly flat amplifier has a universal appeal.

The opinion expressed by many readers definitely pointed towards the desirability of developing an amplifier with a number of additional features including:

- (1) High power output.
- (2) Built-in push-pull expander.
- (3) Bass-accentuating attenuation control.
- (4) High-frequency accentuating and attenuation control.
- (5) High overall gain (approx. 130 db.).
- (6) Automatic volume control.
- (7) First-stage inverter for accommodating single-ended signals.
- (8) A non-frequency-discriminating scratch suppressor.
- (9) Remote volume control.

THE IDEAL AMPLIFIER (TO END ALL AMPLIFIERS)

A careful analysis of the design principles involved in constructing a direct-coupled amplifier will readily indicate the inadvisability of attempting to make one amplifier having all features! Furthermore, no one individual (of all those who wrote for special amplifiers) requested all features.

The plausible solution to this problem was quite evident. It merely revolves about the design of a basic high-

Flexibility PLUS . . .

You can make more than 100 different kinds of amplifiers by combining any one or more of the various features which may be incorporated into this 30-watt direct-coupled amplifier.

Without any basic design changes, you can add any one or all of the following features:

- Variable speed expander.
- Individual low-frequency boost or cut.
- Individual high-frequency boost or cut.
- High-, medium- or low-gain preamplification.
- Automatic peak limiter.
- Automatic volume compressor.
- Automatic volume control.
- Degenerative low-gain inverter.
- Degenerative high-gain inverter.
- Non-frequency-discriminating scratch-suppressor.
- Remote control.
- One or more high- or low-impedance microphone inputs.
- One or more high- or low-impedance phono or line inputs.

power (30-watt), direct-coupled amplifier which could have any one or more features added to it, in order to fill special requirements.

The prime purpose of the following description is to place before the average constructor or dealer sufficient information to build or buy a versatile amplifier which retains all of the valuable features of a direct-coupled ampli-

fier in addition to any special features that he may require.

The overall function and performance of the amplifier will of course depend upon the number of special circuits incorporated. The essential difference between this unit and commercial amplifiers is that it offers the possibility of combining a number of features, not available at any price!

ADVANTAGES OF SPECIAL FEATURES

High Power Output. It is obvious that a high power output will not only enable its use in a wide variety of applications, but will also provide for the production of lower levels with correspondingly reduced distortion. In addition, the high available output will prevent overload when either the expander or any of the frequency-accentuating circuits are employed.

Built-In Push-Pull Expander. Although much has been written about expanders, few have covered the advantages of a *Push-Pull Expander*.

Many fine receivers and high-priced amplifiers have offered a conventional expander utilizing a single pentode or pentagrid mixer. But while many buyers of the finest equipment are aware of the fact that 2nd-harmonics cancel in a push-pull stage, few consider the 2nd-harmonics generated in a single-ended stage. And that these spurious frequencies, of course, carry on through any subsequent push-pull stage. This condition can be eliminated by the use of a push-pull expander.

There are a number of other features

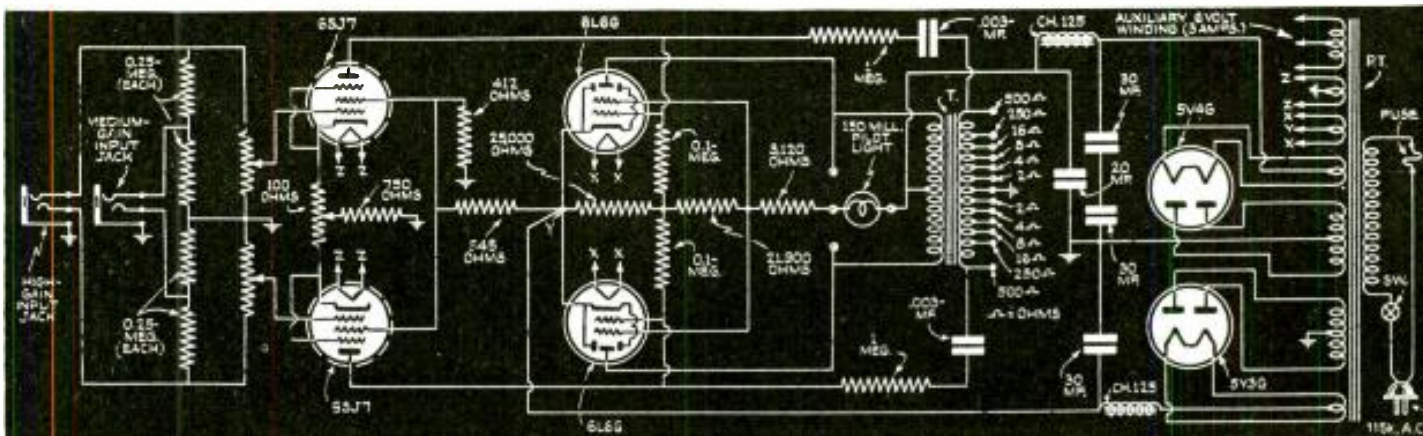

Fig. 2. Complete schematic diagram of the 30-W. all-push-pull direct-coupled amplifier.

a Flexible 30-WATT AMPLIFIER

30 watts at about 3 per cent distortion, from 2—6L6's in class AB1. filter without frequency discrimination is described by its originator.

SHANEY

of this expander which are highly desirable such as a *Variable Time Delay Control* so as to enable the proper playback of both slow and fast music.

The additional metal tubes shown in Fig. A (2—6SQ7's and 2—6SJ7's) comprise the expander circuit, and the additional 5Y3G rectifier supplies plate voltage to this portion of the circuit. The controls on the front skirt of this amplifier are as follows: Jacks: upper-left, Radio Input; lower-left, Phono Input. Knobs, left to right: Radio Volume, Phono Volume, L.F. Control, H.F. Control, Expander Degree Control, Expander Speed Control. Upper-right corner: On-Off Pilot Light; lower-right, On-Off Switch.

Bass-Accentuating Attenuation Control. The Bass Accentuating Control is desirable in compensating for many known existing deficiencies in either the speaker, microphone, radio, phono pickup, etc. The type of bass boosting employed is not only effective, simple and economical, but also insures against a rising hum level with increasing bass accentuation.

High-Frequency Control. This circuit provides for the simple accentuating or attenuation of all frequencies above 1,000 cycles. Maximum effect takes place at 20,000 cycles.

High Overall Gain. The value of increased gain is self-evident since it not only enables the attainment of full power output from low-level input devices, but also provides for maintaining peak power operating level under any degree of high- or low-frequency atten-

uation. Total gain is about 130 db.

Automatic Volume Control. The use of *Automatic Volume Control* has gained considerable popularity during the past few years. A fine distinction exists between many of the control circuits employed; some of them are of the compressing type, others of the peak-limiting type. Few are true automatic volume controlling circuits since they do not tend to raise the power output when the input signal level drops; and inversely, few tend toward maintaining a constant power output when the input signal level rises.

The effectiveness of any of these circuits is a function of its controlling range and harmonic production. The type of push-pull circuit to be described has an exceedingly wide operating range and, because of its push-pull action, introduces a negligible amount of distortion.

Inverter Input Circuit. Although it is desirable to maintain push-pull operation throughout the entire amplifier, there are a number of input devices which do not lend themselves to an input push-pull circuit without the use of a conventional transformer. Because of this condition, a degenerative type of inverter is made available so as to accommodate any type of single-ended input signal.

Non-Frequency-Discriminating Scratch Suppressor. This appears to be an impossibility. The usual method of suppressing scratch was based upon the fallacy that scratch frequencies lie between 1,000 and 3,000 cycles. This band

was therefore suppressed. Of course, this type of treatment not only greatly alters the character of the reproduced music, but it also fails to completely eliminate scratch, because of the fact that scratch frequencies lie over a much wider band. They may be found below 300 cycles and well above 3,000 cycles. In order to effectively suppress scratch without altering frequency response, it becomes necessary to differentiate between scratch, and music or voice. A scientific approach to this troublesome problem reveals the following interesting situation:

In normal signal-to-scratch ratio records, scratch is not objectionable at high-level outputs. It gradually becomes more and more objectionable as the signal level decreases, simply because the signal-to-scratch-ratio has increased. It is therefore evident that an *effective method of decreasing objectionable scratch is to automatically lower the overall gain of the amplifier at low-level outputs.* This furnishes us with a form of "inverted expansion," a condition which maintains an average volume level at high output levels, but effectively decreases objectionable scratch at low levels.

An interesting test which demonstrates the effectiveness of this type of scratch suppressor circuit may easily be made by listening to the scratch at the end of a record under the "normal" and "expander" conditions. When the circuit is changed from *normal* to *expansion* the scratch level *actually drops 10 db.*

(Continued on page 234)

2nd GROUP of PRIZE WINNERS

Radio-Craft's P.A. Contest

Servicemen, radio dealers and sound specialists are here given the article which won the 2nd Prize in the Second Section of RADIO-CRAFT'S \$4,000 P.A. Contest. The winner's contribution shows how "mike oscillators" solved problems at a monster (20,000-person) bingo game.

1ST PRIZE—"Filmgraph" Complete Sound - on - Film Recorder, \$225.00.

Offered by Miles Reproducer Company.

Won by S. J. White, White Sound Service, 151 West 63rd St., New York, N. Y.

2ND PRIZE—Complete Mobile P.A. System, 28 W., type 32MP28SD, \$178.00.

Offered by Vocagraph Sound Systems.

Won by Robert H. Lehfeldt, Flagler Radio Co., Inc., 1068 W. Flagler St., Miami, Fla.

3RD PRIZE—50-60 W. Beam Power Amplifier, with tubes, ready to operate, \$136.50.

Offered by Radolek Company.

Won by Albert W. Dugan, Radio Service Co., P.O. Box 109, Fayetteville, N. C.

4TH PRIZE—25-W. Deluxe Amplifier, \$90.00.

Offered by Montgomery Ward and Co.

Won by Ray W. Winter, 418 West Erna St., La Habra, Calif.

5TH PRIZE—25-W. Deluxe Amplifier, type AM-25, \$71.

Offered by Amplitone Products Co.

Won by Max Martin, 92 Third Ave., Ottawa, Ont., Canada.

6TH PRIZE—15-18 W. Amplifier, with tubes and cover, ready to operate, \$44.00.

Offered by Lafayette Radio Corp.

Won by Norman L. Chalfin, 545 West 162nd St., New York, N. Y.

7TH PRIZE—Velocity Microphone, type RBHK, \$42.00.

Offered by Amperite Company.

Won by L. Waterman, Box 75, Arroyo Grande, Calif.

8TH PRIZE—8-W. Micro-Beam Amplifier, type ACA-8C, \$40.00.

Offered by Amperite Company of America.

Won by John H. Malloy, Malloy's Radio Service, 121A New Britain Ave., Hartford, Conn.

9TH PRIZE—Velocity Microphone, type 90, \$30.00.

Offered by The Lifetime Corp.

Won by Jose R. Garcia, 63 Ponce de Leon Ave., Puerto de Tierra, San Juan, P.R.

First

10TH PRIZE—P.M. Dynamic Driver Unit, for air-column trumpets, \$30.00.

Offered by University Laboratories.

Won by M. C. Turner, Precision Radio Service, Langdon, N. Dak.

Second

10TH PRIZE—Assortment of Condensers, \$25.00.

Offered by Sprague Products Company.

Won by Al. C. Meusch, c/o Winkelmeyer Furniture Co., Marshall, Mo.

11TH PRIZE—Auto-Top Carrier for Mobile Sound Installations, platform size, 30 x 54 ins., type PA26, \$22.50.

Offered by Vac-O-Grip Company.

Won by Lawrence A. Wolcott, Box 104, Hanover, Ill.

THIS IS THE FIRST-PRIZE MANUSCRIPT

ONE of the most unusual temporary sound installations made by this company was for a monster bingo game on Staten Island (N. Y.) recently. The game was held during the evening on an athletic

field one-third of a mile in length, and was attended by about 20,000 persons.

The job called for 8 microphones distributed out on the field among the players and one on the main grandstand. Each

microphone on the field was to be set up as a "call-back station" so that winners could readily report "bingo" back to the main platform from which the numbers were called.

However, the unusual aspects of this installation consisted in the fact that the producers of the game required that the sound company post a \$500 bond to insure against failure or breakdown of the equipment. Apparently they had suffered much grief in the past, and had practically come to the conclusion that all sound systems were "a pain in the neck." The nature of this particular game was such that 30 individual games had to be concluded before Midnight at which time the Police Department permit required that the games terminate. The games, therefore, had to be run off snappily, without delays or interruptions. Each individual bingo game averaged 7 minutes including "call-back" or verifica-

(Continued on page 236)



Fig. A



Fig. B

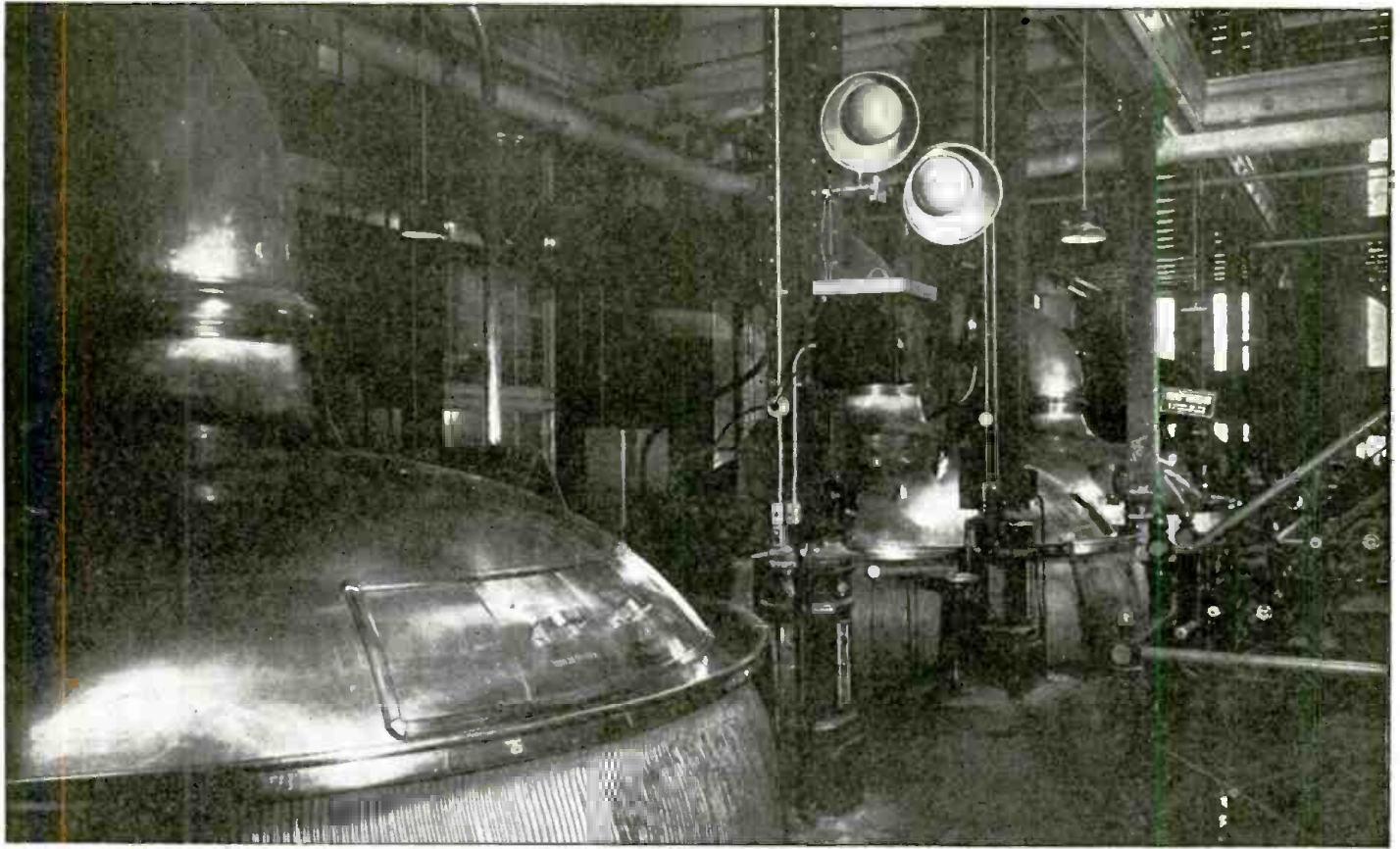

Visitors to the Schlitz Brewery Company in Milwaukee, Wis., hear from loudspeakers near the ceiling a description of brewing processes.

SOUND SYSTEM GUIDES BREWERY TOURS

THE Schlitz Brewing Company, Milwaukee, had a problem on its hands when it found that 5,000 people came every week to visit their plant and inspect the brewing operations. The guides had a difficult time trying to

override the noise of machinery, and the solution was the installation of a record playing and amplifying system using Atlas Sound "Marine Horns."

The record transcriptions were made by Bob Heiss, announcer for WTMJ,

Milwaukee. Installation was completed by the Continental Engineering Corporation of Milwaukee.

The speakers, installed in the brew house, racking house, engine room, in the Brown Bottle guest hall, and the bottling house, now come forth in fine stentorian tones and offer an excellent description of the Schlitz brewing operations.

The guide, assigned to a group of visitors, has only to press a button as
(Continued on page 245)

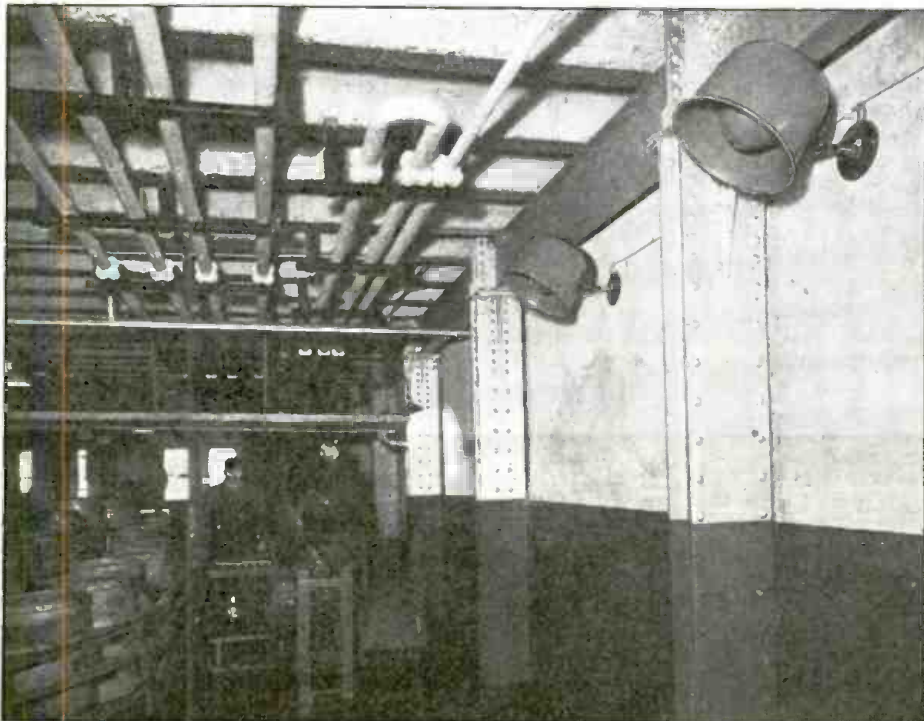

At this Milwaukee brewery visitors hear a serialized talk from the 2 loudspeakers at upper-right.

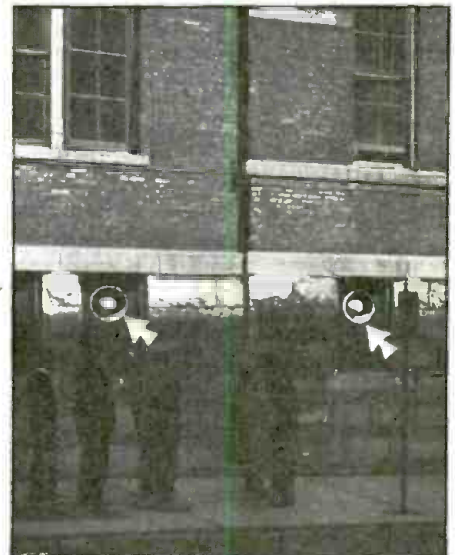

Sidewalk loudspeakers describe buildings to visitors.

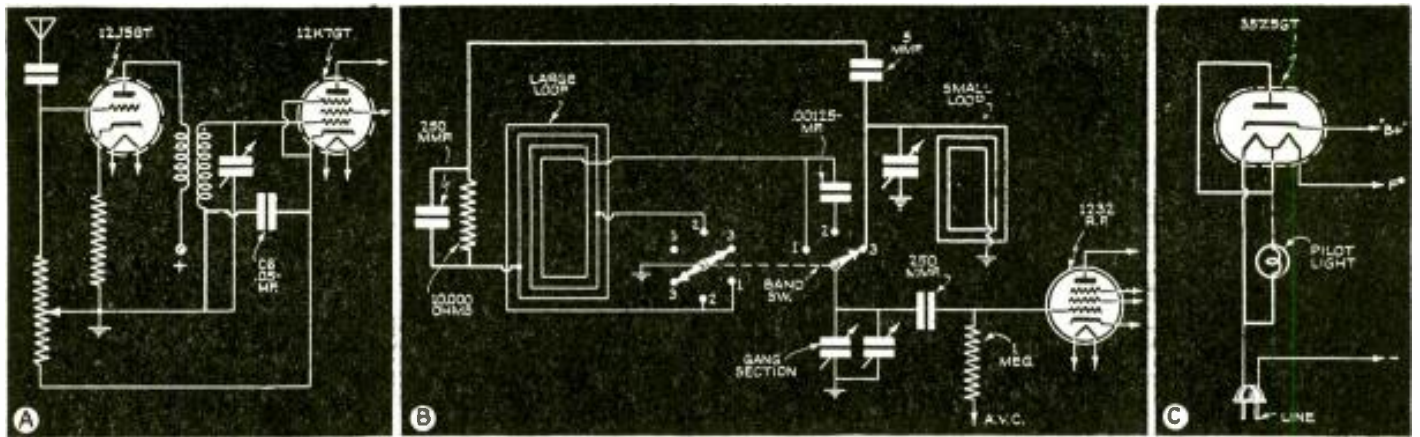

Fig. 1. New circuit features of (A) Emerson Model CU-265; (B) Philco Models 40-180, 40-185, 40-190; (C) General Electric Model H-400.

NEW CIRCUITS IN MODERN RADIO RECEIVERS



The details of the modern radio receiver circuits that make them "different" from previous designs are illustrated and described each month by a well-known technician.

F. L. SPRAYBERRY NUMBER 25

(1) CONTROLLED REGENERATION USED

Emerson Model CU-265. *Regeneration which at no time can produce oscillation but will vary from maximum at minimum volume to minimum at maximum volume is used in this T.R.F. set to greatly improve its selectivity and sensitivity.*

Compensation for only 2 tuned circuits in this receiver is greatly affected through the use of controlled regeneration. A loop is wired in series with the first grid-tuned circuit (see Fig. 1A), and the R.F. voltage drop across it due to signal current flow at resonance is coupled to the cathode of the 12K7GT through C6. This differs from the cathode-tap method of feedback only in being a *shunt-coupled* instead of a *series* circuit. The additional advantage of shunt coupling is provided by permitting the antenna-bias method of volume control in this same tube.

Little or no regeneration for selective purposes is needed for distant stations of weak signal strength and the maxi-

imum sensitivity of the set is adequate. However, for strong stations regeneration is valuable for greatly improved selectivity and so as the volume is reduced to minimum for powerful signals, regeneration is increased by reason of the high resistance from cathode to ground.

(2) USES SEPARATE LOOP ANTENNA FOR HIGH FREQUENCIES

Philco Models 40-180, 40-185 and 40-190. *To avoid the large losses, in tuning a very small section of the large loop for high frequencies, a separate small loop is used.*

Connections and means of switching the small loop are illustrated in Fig. 1B. The large loop is switched entirely out except for coupling connections between the loops to add to the signal pick up of the small loop. The loops are individually tuned by the R.F. gang condenser section, the small one having a separate compensator. The main gang compensator, of course, serves for the large loop.

(3) TUBE APPLICATION MAKES FOR HIGH-EFFICIENCY CIRCUIT

General Electric Model H-400. *Taking advantage of the heat wasted by a filament series resistor, the 35Z5GT tube is provided with a filament tap for a pilot light connection. In its most widely accepted application for small sets as in the G.E. model H-400 its wiring is shown in Fig. 1C.*

The drop across the pilot section of the filament while connected as shown, is 5 volts. The rectifier plate is connected at the junction of the 2 filament sections, permitting more definitely a longer life for the tube under normal operating conditions. The tube may be used without the pilot connection indicated. With the proper associated tubes and circuit there need be no series filament resistor as the sum of the filament voltages will equal the line voltage. A circuit of this kind represents a material gain in efficiency over the types using series filament resistors.

While the rectified D.C. output of the
(Continued on page 243)

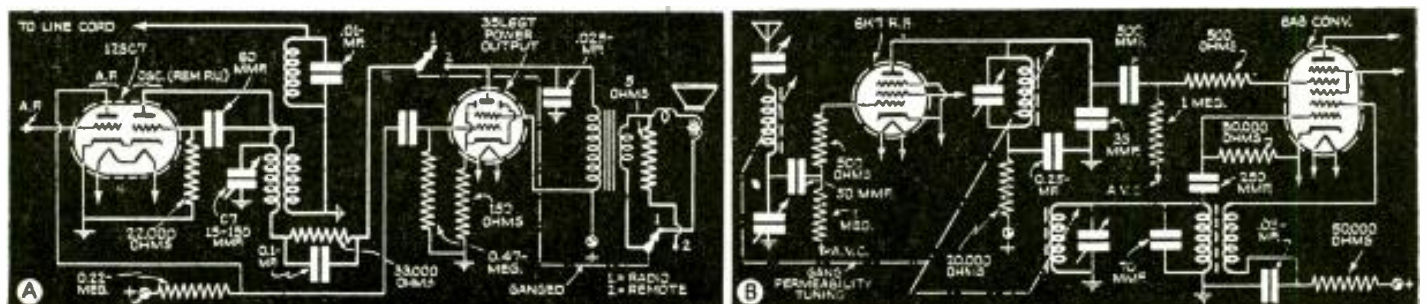
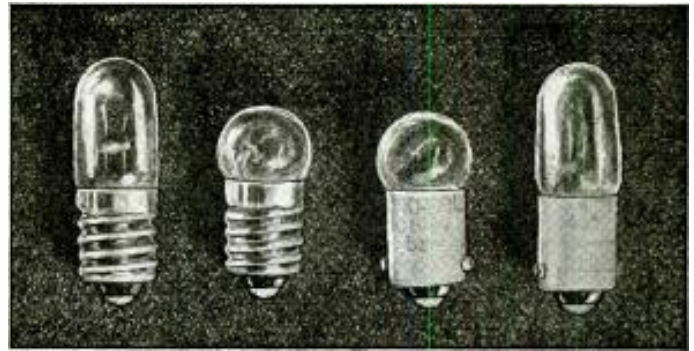

Fig. 2. New circuit features of (A) RCA Model 5X5; (B) Belmont Model 677.

Service Data ON PILOT LIGHTS

Here is useful information for Servicemen and others who may have occasion to install new or replacement pilot lights.



Illustrating the various types of pilot lamps available to the Serviceman.

PILOT Lamps are used in radio receivers as power "on-off" indicators and miniature floodlight for dials. Current for lighting the lamps may be obtained in either of two ways. In the first, the lamps are connected across a secondary winding on the power transformer and in the second, the lamps are connected in series with the tube heaters and other necessary elements, across the power line. It is the purpose of this paper to discuss only the second class, its problems, and their solution. Receivers using the second method are generally referred to as A.C.-D.C. receivers and will be so called in this discussion.

Table I contains a table of lamps generally used and considered to give sufficient life and illumination in A.C.-D.C. receivers. The color of the bead inside the bulb is the most convenient form of identification. Satisfactory operation of pilot lamps in A.C.-D.C. receivers must take into account the following 3 problems which are highly interdependent.

- (1) Lamp operating voltage to give satisfactory life and illumination on either A.C.-D.C.
- (2) Lamp surge voltages reduced sufficiently to prevent lamp burnouts and lengthen lamp life.
- (3) Satisfactory receiver operation with burned-out pilot lamp.

Heaters of vacuum tubes have a much higher resistance when hot than when cold. When an A.C.-D.C. receiver is turned on with the tubes cold, the initial current which flows in the heater circuit is therefore very high. This initial high current is commonly called the *surge current* and as the tubes heat up this heater current decreases to its normal operating value. Pilot lamps also have a much higher resistance when hot than when cold. However, the lamp filament is much smaller than the heaters of vacuum tubes and requires a much shorter time to come up to operating temperature. The pilot lamp (see Fig. 1) is effectively in series with the tube heaters. It comes up to temperature much faster than the tube heaters, while the surge current is still flowing and thus is subjected to a resultant high voltage drop (or surge voltage) and flashes brightly as the power switch is turned on. The life of a lamp decreases at an extremely great rate, with applied voltage. For satisfactory lamp life, circuits which apply a high surge voltage to the lamp must operate the lamp at a low voltage, while those circuits which

apply low surge voltage to the lamp may operate the lamp at a higher voltage.

Figure 1 shows what has become current design practice for the heater circuits of A.C.-D.C. receiver using 0.3-ampere heaters (a series resistor, the tube heaters, and pilot lamp with its shunt, all in series across the line). This is the circuit of a receiver using a resistor or ballast tube. The higher the shunt resistor the more the current through the lamp and the higher its operating voltage and illumination. But, a higher shunt resistor also gives a higher surge voltage and both effects shorten the lamp life. The value of the series resistor is determined by the number of tubes in the receiver and is such as to make the normal operating heater current 0.3-ampere.

As the number of tubes in the receiver increases, the (fixed) series resistor decreases, this causing the cold series resistance of the heater circuit to decrease. This then results in a higher surge current and higher lamp surge voltage with a receiver using more tubes. For example, in a 4-tube receiver using a brown-bead No. 47 lamp, the surge voltage is 10.6 volts, whereas in a 7-tube receiver the surge voltage increases to 14.3 volts. In both receivers, the operating lamp voltage is the same. For still larger receivers, the surge voltage becomes excessively high causing premature lamp failure. For still larger receivers, the same type of circuit is used (Fig. 1) but a ballast tube, designated by the letter B before the type number is used, instead of a resistor tube. In a ballast tube is a pilot-lamp shunt resistor whose resistance is low when cold and high when hot, like vacuum tube heaters. This permits the surge current to be bypassed and gives a low surge voltage while operating the lamp at a higher voltage.

The problems in receivers using 0.15-ampere series-operated heaters are more difficult of solution. In these receivers the sum of the heater voltage approaches or equals the line voltage. Since the heater current is equal to, or less than, the rated pilot lamp currents, the shunt resistor must be very large to get satisfactory illumination. Both conditions contribute to a high surge voltage. Moreover, with pilot lamp failure, the voltage drop, due to the total heater current passing through the shunt resistor becomes excessive. The problem cannot be solved by a ballast tube since

very little current is available for heating the shunt element, so as to cause its resistance to change.

By designing the circuit so that the rectifier current is also passed through the pilot lamp and its shunt, additional current for lighting the lamp is made available (see Fig. 2). With this arrangement a lower resistance lamp shunt may be used because of the additional current available. The rectifier current does not flow until the tubes have heated up and the surge current fallen to a low value. The lamp then comes up to full brilliancy, giving the effect of a partial ballast action. The use of a lower shunt resistor also gives a lower surge voltage. A suitable value of shunt resistor to use with the brown-bead lamp No. 40 or 47 is 40 ohms. The series resistor should be adjusted to give rated current in the heater circuit. With a shunt resistor of 40 ohms, the series resistor should not be less than 80 ohms.

A much more satisfactory means of pilot lamp operation in 0.15-ampere

(Continued on page 252)

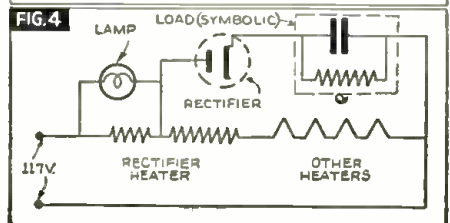
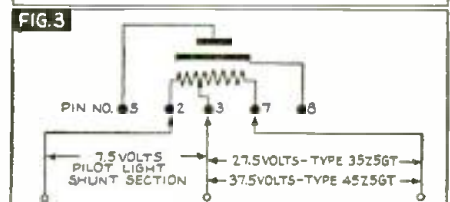
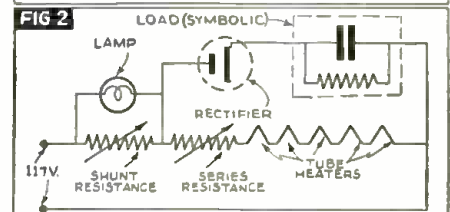
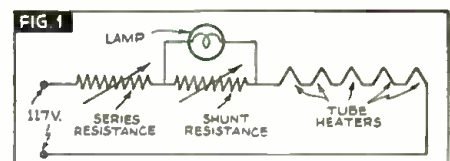

VIDEO AMPLIFIER DESIGN

An old-timer in television discusses for experimenters the basic principles and problems involved in video or sight-frequency amplifiers for television reception.

C. L. RAGSDALE

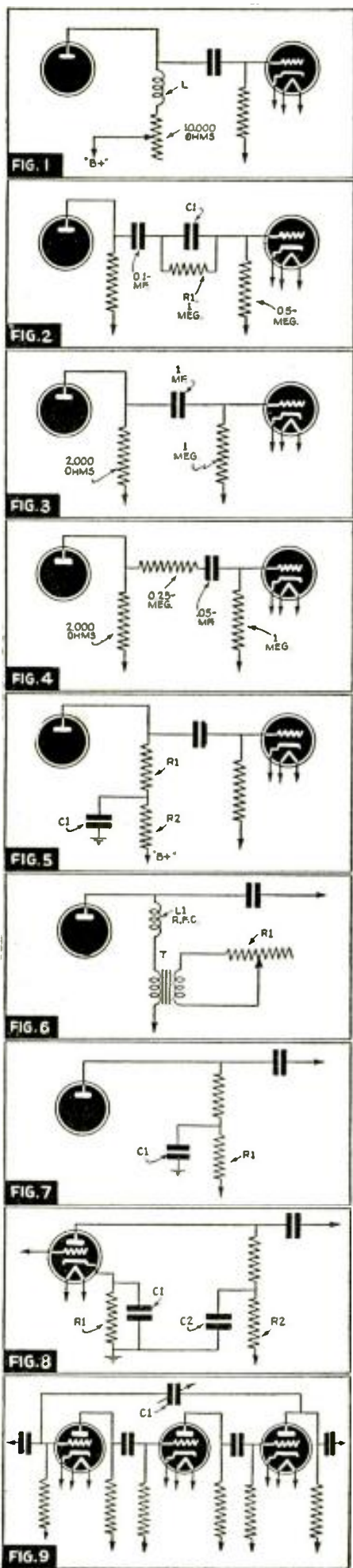

BACK in 1928 or '29, when some experimenters were using 24-hole scanning discs, designing a television amplifier was not much of a problem. Audio transformer coupling was even used, because the highest frequencies necessary to be passed were only about 4,000 cycles.

To find the highest frequency which a video amplifier must pass, it is necessary to multiply the number of image elements in one line by the number of lines. Then multiply by the frame frequency, which is the number of complete images transmitted per second. The result is then divided by 2, giving the highest frequency in cycles-per-second. The reason for dividing by 2 is that 2 image elements are required to make 1 cycle, as when light falling on the photoelectric cell in the camera changes from very bright to black. As an example: $24 \times 24 \times 15 \div 2 = 4,320$.

It becomes evident that when the number of lines is doubled, the frequency becomes 4 times as high. However, the number of elements (image detail) is also 4 times as high. Other difficulties of doubling the number of lines are—the problems and expense of building wide-band R.F., I.F., and video amplifiers, as well as detectors, which results in a lower signal-to-noise ratio of the receiver; and with double-sideband transmission, the transmitter requires a band 8 times as wide, and with single-sideband—4 times as wide.

INCREASED BAND-PASS

With the advance to 60 lines, the frequency went up to 42,000 cycles. Audio transformers of course would not pass this wide band, so resistance coupling was tried. This was an improvement but the highest frequencies were still missing. The reason being that the plate-to-cathode and grid-to-cathode capacities of the tubes shorted out the highest frequencies.

Then came the *compensated* resistance-capacity coupled amplifier as shown in Fig. 1. This might be called "a half A.F. and half R.F. amplifier." In this circuit the interelectrode capacities of the tubes are used to tune the coil L to a frequency just above the highest video frequency. For video frequencies up to 42,000 cycles the plate inductance may be an R.F. choke of about 200 millihenries. This is the *inductive plate load* method of compensation, which is in common use in 441-line amplifiers.

Figure 2 is another method of *low-frequency compensation* (to bring up the high frequencies). In this, part of both the lows and highs are held back

by R1. But the highs are bypassed around R1 by the Condenser C1, which is too small to pass the lows. Unit C1 may have a capacity of about 500 mmf., or less. A non-inductive resistor such as R1 reduces the highs and lows an equal amount. In this circuit some of the highs are lost because of tube capacities, but lows are lost to the same degree in resistor R1.

Tubes for the voltage amplifier stages should have a high amplification factor and low interelectrode capacities. Not only low plate-to-grid capacity, but low overall capacity. Comparison of various tubes reveals that a triode such as a 75 has as low overall capacity as many of the favored pentodes. While the pentode has less plate-to-grid capacity, some of the triodes have less plate-to-cathode capacity.

FREQUENCY COMPENSATION

As far as a flat response is concerned, it does not matter whether the highs are amplified more, or the lows reduced.

Some very pleasing results have been obtained with the circuit in Fig. 6, when it was necessary to reduce the lows. The audio transformer T and resistor R1 form an absorption circuit at the low frequencies, while the highs are held up by L1.

Returning to Fig. 1, when the plate resistor is reduced to a value of about 1,000 ohms or less, there is a sudden dropping off of the lows, and only the highs come through. This is a positive method of low-frequency compensation.

Figure 3 shows a method of compensation, where R1 has much less resistance than ordinarily. The usual plate resistor of a 75 is 250,000 ohms. Reducing it to about 2,000 ohms cancels the effect of tube capacity, but results in less gain per stage. Tube capacities are too small to have any effect at low frequencies.

It is the sudden changes of light intensity from one element to the next that causes the highest frequencies. Slow changes from bright to dark or vice versa, covering several elements, create the medium frequencies.

A little-known method of compensation is shown in Fig. 8. The time constant of C1-R1 is the same as C2-R2.

Controlled feedback through the small condenser C1, in Fig. 9, will build up the highs.

With such circuits as these in the last stages, the highs or lows can be built up, even if they are partly lost in the first stages or the PE. cell; though it is considered good practice for all of the
(Continued on page 246)

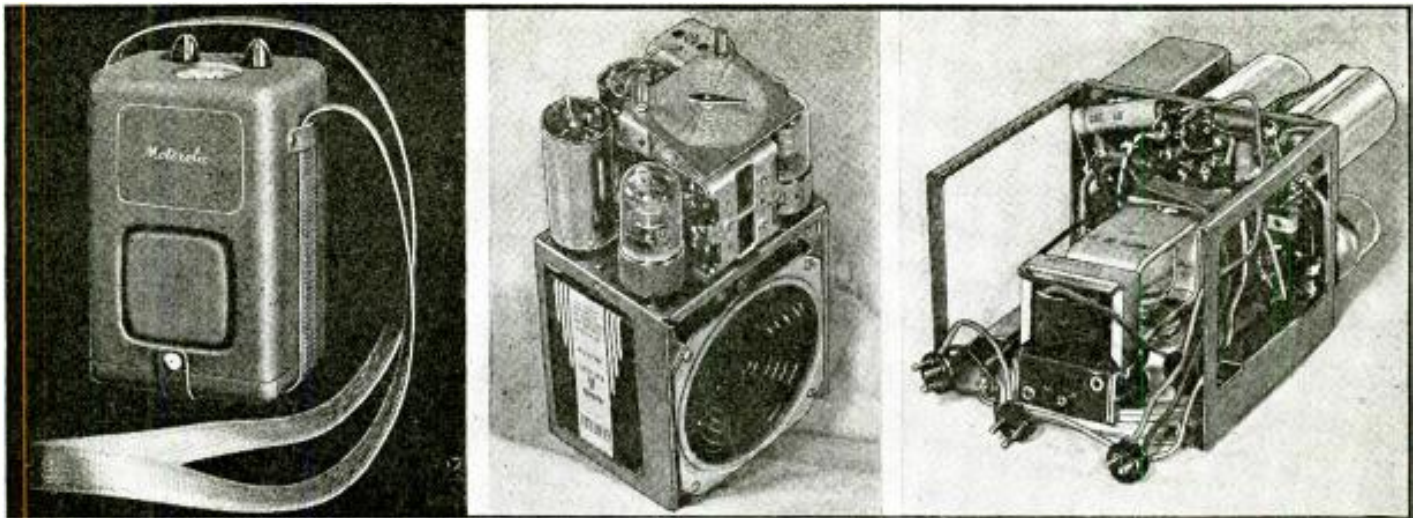

A—Close-up of the Motorola "Sporter." B—Front and top view of the Sporter chassis. C—Rear and lower view. The batteries slide into place. Note terminal plate for the plug-in loop.

A Real PORTABLE RECEIVER

Weighs only 6¼ lbs.! . . . Yet it's a complete, practical, portable radio set. Editor Hugo Gernsback recently stated, ". . . when we go down to about 5 or 6 lbs.—a not impossible figure—we will have a receiver of much greater popularity . . ."—and here it is!

APPARENTLY at least one manufacturer has taken seriously the comments by Mr. Gernsback, in his editorial "Radiobservations", in the May 1939 issue of *Radio-Craft*, that the so-called portable sets up to that time hardly took advantage of the possibilities of modern radio equipment for small-space construction, and that, in the sense of being conveniently portable, the so-called small-space loudspeaker radio sets with self-contained power supply left much to be desired.

One of the latest portable receivers to make its appearance on the market is the Motorola type 41-S "Sporter" model. Tested last month by *Radio-Craft*, it brought in a good 2-dozen stations, and at satisfactory loudspeaker volume. By utilizing all the advances that have been made in vacuum tube and other components, and in applying them in a super-heterodyne circuit, it has been possible to produce, in the 41-S, a portable that weighs, complete with batteries and permanent-magnet dynamic loudspeaker, only 6¼ lbs., in a case which measures only 4 x 5½ x 9 ins. high.

SHOULDER-STRAP LOOP ANTENNA

The requisite loop antenna has been utilized as the shoulder strap! It may be interesting to note that this new type

of loop, (patent pending) is provided with 2 prongs which are sufficiently long to extend through the bottom of the casing and into the receiver chassis. The leather strap which serves as the hinge for the underneath cover is provided with snap fasteners which also serve to hold this loop in place. A unique fact is that the shoulder-strap antenna, which is ordinarily worn diagonally as illustrated, exhibits but slight directional effect.



CIRCUIT

As is shown by the schematic circuit of this 4-tube portable the actual circuit is quite standard. The secret of how this radio set performs so well is found in the use of high (Continued on page 239)

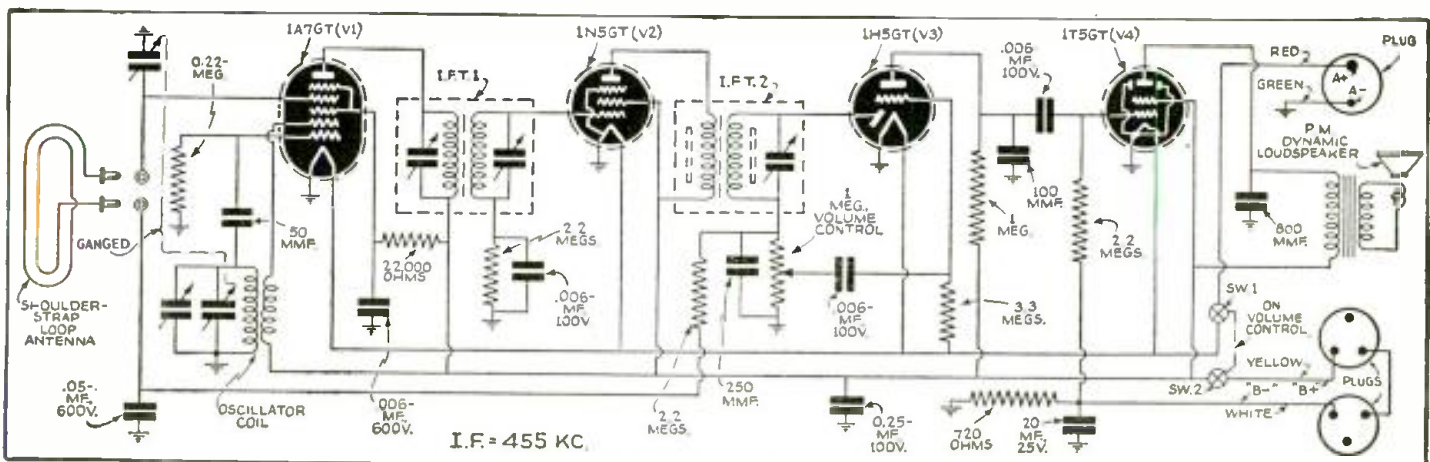

Diagram of the Motorola type 41-S model "Sporter" personal radio set. The chassis may be put into operation for servicing the loop back into place. Frequency range is 540 to 1,560 kc. Uses General batteries Nos. 2F1 ("A"), 20AAA9, and 34AAA9 (latter 2 for "B").

BEHIND THE SCENES OF A

Radio men and those who plan to make radio their business will be interested involved in transoceanic and particularly trans-Atlantic broadcast programs.

EUGENE



The Board at R.C.A.C., 66 Broad St., N. Y. C., through which all international programs are cleared to the networks.

P OINT-TO-POINT communication was given one of its severest tests during the Czechoslovakian crisis. In 3 weeks, N.B.C. delivered 110 international broadcasts, C.B.S. made 98 foreign pick-ups, while M.B.S., which made its coverage by play-backs of recorded foreign news broadcasts, contributed 5 European broadcasts—altogether a total of 213 completed and broadcast foreign programs. National differences were forgotten, that the public might be served.

Ignoring the problem of radiophoto work, because it has a few individual problems of its own,¹ one wonders that so

many broadcasts could be completed without a serious operating "hitch."

Considering some of the differences we find that a point-to-point radio program service must be more dependable than a point-to-point radio telephonic service. Once a program is sent, it is gone, and there is no re-sending it.

Another difference is that radio programs must be supplied with the high fidelity and quality to which the public is accustomed at the time.

A third difference is the necessity for *cue signals* and *time checks* so that the transition period between programs is passed smoothly, thereby eliminating time waste and poor broadcast technique. A detailed examination would reveal more points of contrast.

RCA COMMUNICATIONS, INC.

Engaged in trans-Atlantic voice communications, R.C.A.C. supplies a point-to-point radio program service which has the characteristic of message privacy given to radiotelegraphic messages. Available only for programs to be used for direct broadcast, the point-to-point transmissions are made in either one or both directions as the client desires; and as such a service the transmissions are made on point-to-point frequencies. All transmissions in this type of service must be directed to a particular point and to a particular party. It must be pointed out that communications are made in both directions only when necessary from the entertainment point of view.

Most of the trans-Atlantic transmissions are sent on short-waves between 4 and 22 mc., and are received on the latest-type diversity receivers.² To supply infallible service, all programs received for rebroadcasting are transmitted on TWO frequencies. Both frequencies are connected to a mixer, so if trouble should develop the troublesome frequency can be faded-out and the remaining or "safety factor"-frequency

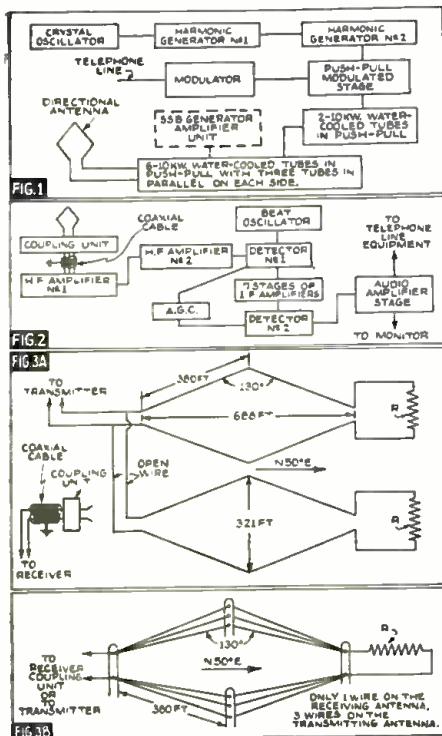

← Fig. 1. Transmitter, alternative SSB (single-side-band) unit in dotted lines.

← Fig. 2. Block diagram of DSB (double-side-band) receiver.

← Fig. 3A. Transmitting and receiving antenna details. Resistance R for transmitting, 600-ohm transmission line; R for receiving, 800-ohm carbon resistor.

← Fig. 3B. Antenna setup. See Fig. 3A for value of R.

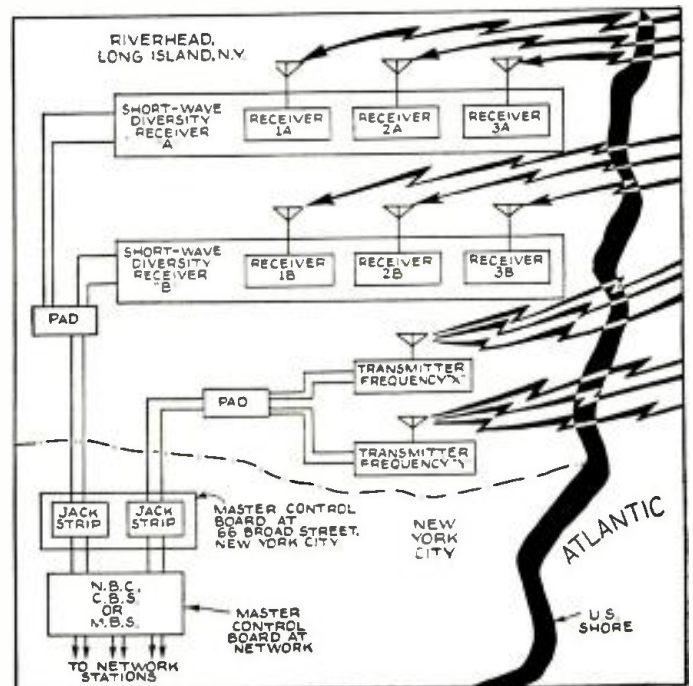

From Riverhead, L. I., International radio programs jump the big pond . . .

TRANS-ATLANTIC HOOKUP

*in this absorbing story of how technicians now meet the innumerable problems
Important factors are wavelengths, hours and power, and particularly, antennas.*

GODDESS

faded in, and the program continued. Since each program is received on 2 frequencies, and each frequency is received by a diversity receiving system composed of 3 receivers, a single reception of program quality will utilize 6 receivers!

Most of the European transmitting equipment is pretty much the same as the American. It seems, however, that European companies are beginning to realize that American receivers are superior to theirs, and as a result they are purchasing or making American-designed diversity units.

Depending on the time of the day and the frequency used, the power necessary to cross the Atlantic varies between 5 and 50 kilowatts. By working a 5-10 kw. transmitter into an antenna with a power gain of from 10 to 20, R.C.A.C. can attain an equivalent power of 50 kw. in the direction of maximum signal.

At the Rocky Point, L. I., station, "tea-cart" modulators (so called because they are mounted on wheels and can be rolled about like a tea cart) are available to voice-modulate any one of the available radio telegraph transmitters. The station houses more than 20 transmitters.

A European program sent westward goes by land line to the nearest transmitting point. Usually the traffic is confined to a few points, since this practice automatically improves operating technique and decreases time waste. Sometimes, due to changing political conditions, a program may be routed in 3 different ways in as many months.

EXAMPLE

Suppose an American network advises R.C.A.C. that a program is desired from Geneva, Switzerland, at 3:15 P.M. Eastern Standard Time. The responsibility for establishing communications lies with R.C.A.C., which immediately advises Geneva in a service message that on a certain date communications will be established on 2 frequencies at 19:45 G.M.T. to begin tests for a program which will start

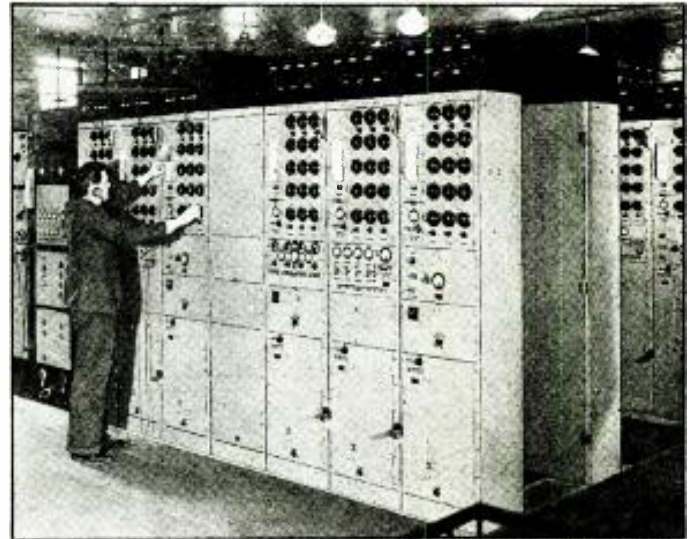

The diversity shortwave radio receiver at RCA International receiving station at Riverhead, L. I.

at 20:15 G.M.T. When the day rolls around, Geneva is called at the time designated over the prearranged frequencies. The receiving station selects one frequency for immediate service, while the other is used as a "safety factor"-frequency being hooked into the fader as previously described.

Both frequencies are checked for stability and modulation. A time check is made by the transmitting studio, the Geneva transmitter, the American receiving station, and the American receiving network, to insure that all 4 points are using the exact same time.

Levels are checked at all the important points on the complete circuit. Cues are repeated, the time rechecked, and the testing period is almost up. The stations stand by their respective equipment until the cue is passed, at which time the program starts. The testing period varies in length depending on the program and the circuit conditions. These testing periods are so accurately computed by the experienced transmission engineers, that the standby time between the

(Continued on page 238)

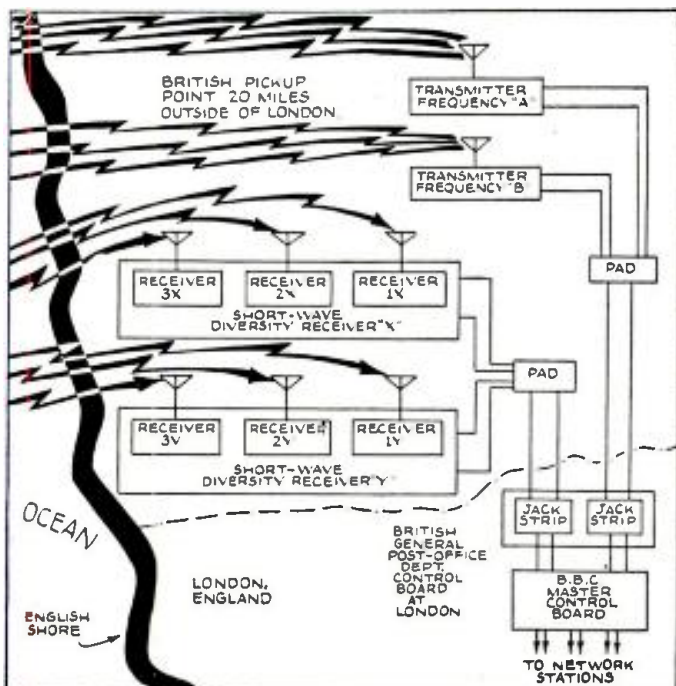

... to a pick-up point 20 miles outside of London, and thence to Europe.

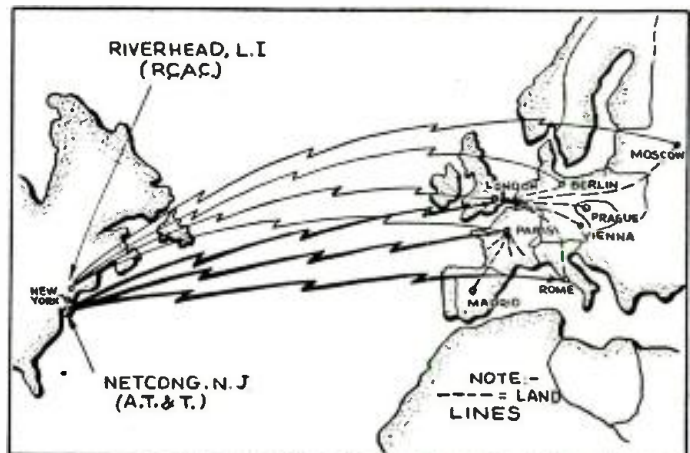

Radio circuits are shown solid; land lines are dotted. The A.T.&T. station at Netcong, N. J., has radio circuits to London and Paris only. The remainder of Europe is contacted by land lines. The R.C.A.C. station in Riverhead, L. I., has radio circuits to all the capitals of Europe.

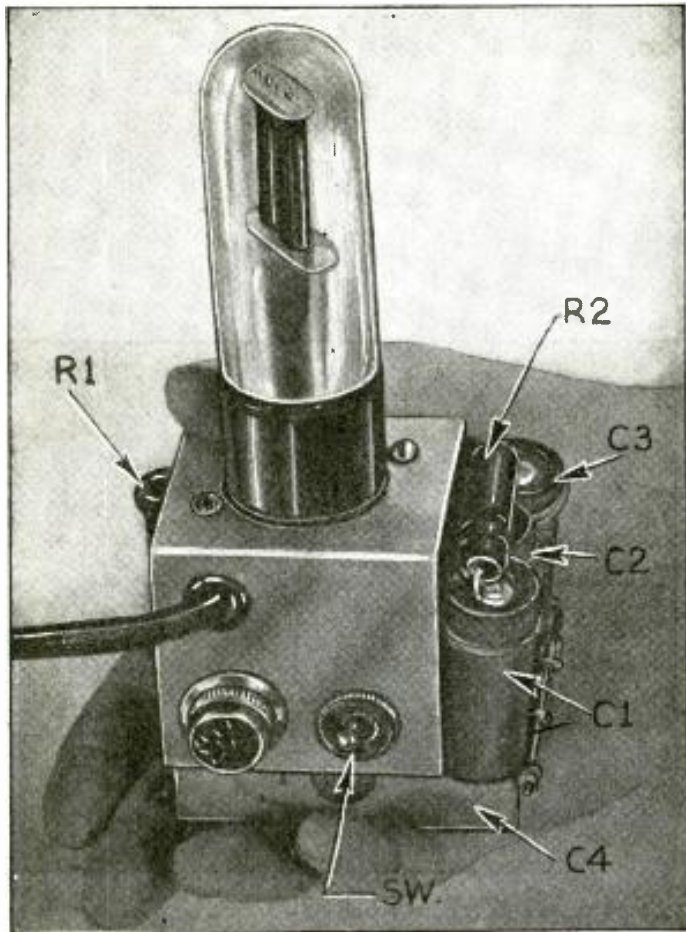

Front view of Power Supply. Tiny, isn't it?

LAST month in describing the "Permeability Portable" mention was made of the fact that subsequently a power supply would be described which would permit the operation of this portable from the 115-V. light lines, either A.C. or D.C., when not being used out-of-doors. The unit described here is that power supply. The only requirements for using it with a battery receiver are (1) that it have 4 tubes of the 1.4-V. variety and, (2) that these tube filaments be wired in series, to provide a voltage drop of 6 volts.

With this in mind, the tubes used in the "Permeability Portable" had their filaments wired in series. The Power Supply is so elementary in principle and in construction that the simple schematic diagram shown on this page,

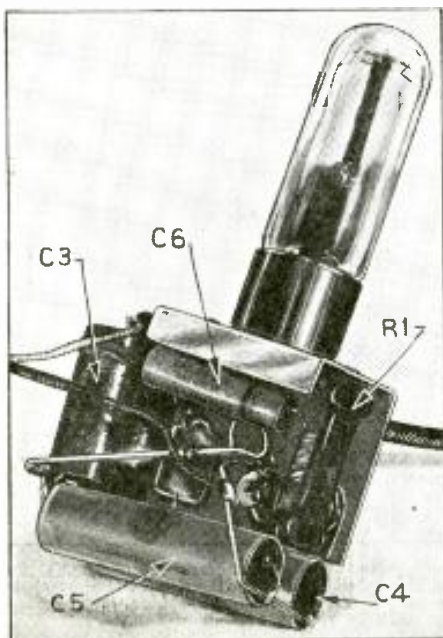

Rear view of Power Supply. The parts go together in no time at all.

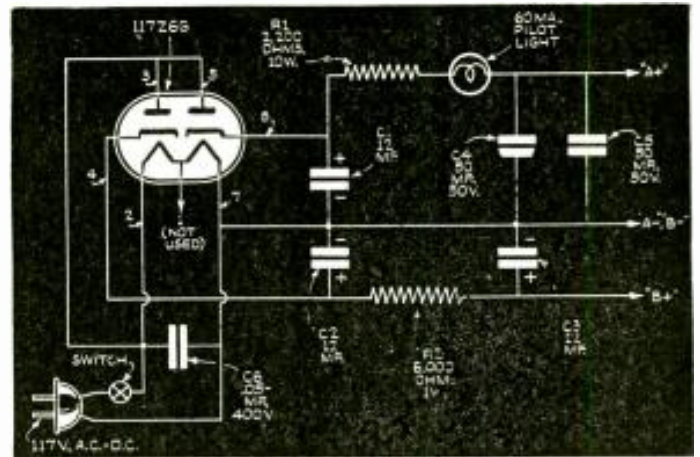

Diagram of Power Supply for operating battery-portables on A.C.-D.C. light lines.

A.C.—D.C. POWER SUPPLY For BATTERY PORTABLES

A few simple parts, a new tube that eliminates the "resistor line-cord" or ballast tubes, and presto!, we have a "battery economizer."

N. H. LESSEM

could in itself be the "article". However a few simple pointers and admonitions concerning the unit would not be amiss.

The Power Supply consists of 2 resistors, several condensers, an on-off switch, pilot light and a tube—and, oh yes, an "ordinary" line cord.

117-V. RECTIFIER

The tube itself is very interesting. It is a new high-vacuum full-wave rectifier which is designed to operate with the filament connected directly across the 115-V. electric power line. *No resistor line-cord or ballast tube is required at all!*

Each of the 2 plates has its own cathode and filament as usual, and each section is capable of delivering 60 milliamperes—a total of 120 ma., whereas the permeability portable (which is typical of the large majority of commercial portables on the market) consumes a total of only 65 milliamperes (50 ma. for the filament circuit and approximately 15 for the plate circuit). Two 12-mf. electrolytic condensers and a 6,000-ohm 1-W. resistor, supply all the necessary filtering action for the "B" section of the Power Supply, and a total of 112 mf. and one 2,200-ohm 10-W. resistor supply the filtering for the "A" section. Practically no hum is noticeable when the set operates from the electric lines.

POINTERS

If the power supply is to be used to permanently replace batteries then it is suggested that the on-off switch in the set be shorted in order to make it ineffectual and that the power switch on the unit itself be used.

If the Power Supply is to be used as auxiliary to the batteries, then it is necessary that the "A+" lead of the Power Unit be connected to the "A+" terminal of the batteries, the "B+" to "B+" of the batteries, and the "A-B-" connections to the respective terminals of the batteries. Under these conditions the batteries constantly "float" across the output of the rectifier.

When plugged into the electric light lines, the set will immediately start playing since it will operate from its
(Continued on page 252)

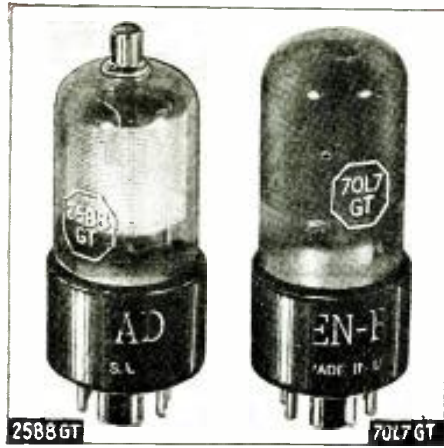
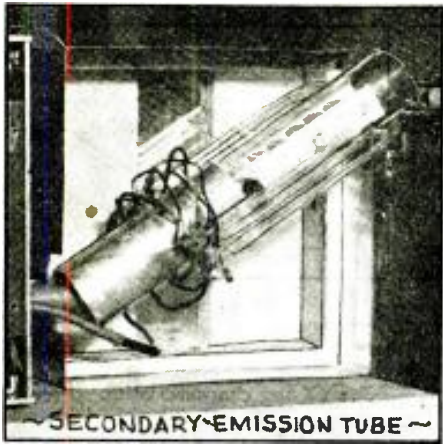

8 New Tubes

Included in the following group of diversified types of tubes are not only tubes of importance to Servicemen but also several new designs of special interest to experimenters.

R. D. WASHBURNE

THE gamut of new tubes described this month includes not only the 3-in-1 dry-cell tube which heads our story but also several special types which point the way to new services and increased efficiency in existing services. Symbols for the various tubes here described are illustrated at the end of the article. See manufacturers' data sheets for curves and further data.

1D8GT—3-in-1 Tube: Pentode-Triode-Diode

Last month the writer described a progenitor of the new 1D8GT, the 25D8GT or 25-V. filament pentode-triode-diode; this month, however, we call special attention to the new RCA 3-in-1 tube which makes available in a single type T-9 bulb a combined diode, triode and power amplifier pentode which requires only a single drycell for filament voltage.

This type 1D8GT tube incorporates a diode for use as detector and A.V.C. rectifier, a triode for use as the 1st audio amplifier, and a pentode for use as the power output amplifier. As a result this tube facilitates the design of battery-operated receivers featuring compactness and reduced filament drain. Come on fellows, let's see what you can do with this tube!

See Table I for characteristics.

Du Mont 2-Way Television Image Tube

An improved system of 2-way television communication in which a single cathode-ray tube at each station serves both as pick-up device to develop image signals for transmission and as a receiver or viewing device to reproduce images transmitted from the remote station, is disclosed in U.S. Patent No. 2,157,749 just issued to Allen B. Du Mont, assignor to Allen B. Du Mont Labs., Inc.

This system greatly simplifies and reduces the cost of the apparatus over that of prior systems in which separate pick-up and viewing tubes must be used at each station. Another advantage is that of simultaneous 2-way communication (as for instance in an office "inter-viewer-phone"), instead of having to go from one tube to another for the respective transmitting and receiving functions.

The du Mont 2-way television communication system is based on the use of a dual-function cathode-ray tube (see Fig. 1) which includes both photo-sensitive screen (pick-up) and fluorescent screen (viewing) side by side or in an otherwise convenient arrangement, but served by a single or common cathode-ray beam. Thus when the tube is transmitting an image, the cathode-ray beam swings over to the photo-sensitive screen or photoelectric mosaic, which it scans in the conventional manner, while at the other end the cathode-ray beam swings over to the fluorescent screen which it scans in order to reconstruct the images being transmitted from the remote station. This switching of cathode-ray beams may be accomplished manually or automatically, the invention covering various means of switching, climaxed by a revolving switching means which alternates the beams from transmitting to receiving positions, for simultaneous 2-way television commu-

New 3-in-1 tube, combining pentode, triode and diode in one envelope, operates from a single drycell!



tion. (The tube is not yet on the market. —Author)

Allen Electron-Multiplier Tube

A secondary-emission or electron-multiplier tube, only 2 ins. in diameter, has been developed at the Department of Physics, University of Minnesota, Minneapolis, which makes it possible to obtain extremely high amplification from extremely low inputs. In fact this new tube, which is shown at upper-left, with 330 V. per stage will multiply the primary current by a factor of 10^6 or 100,000 times. This makes it possible to successfully count single positive ions, electrons and photons, and thus is particularly useful when used in connection with a mass spectrograph with the electron multiplier-connected to the grid of the first

(Continued on following page)

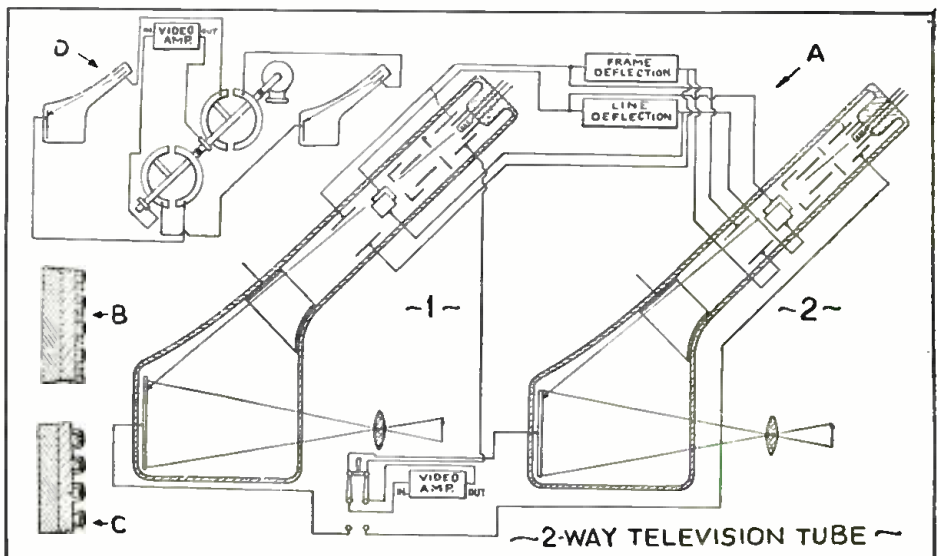
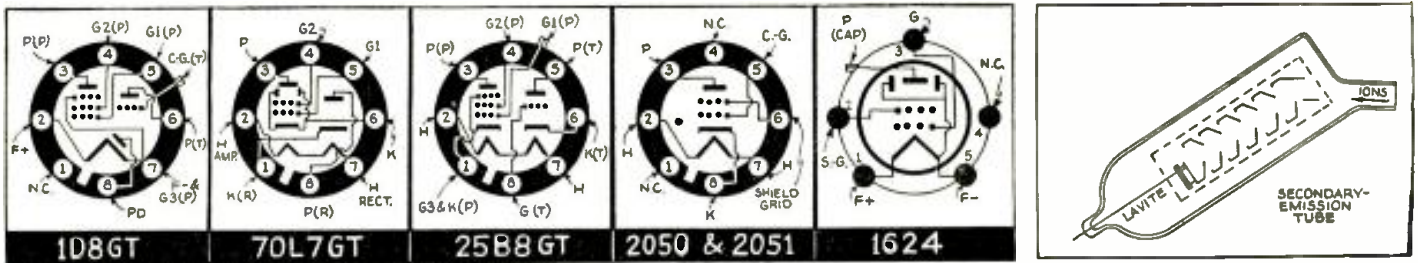

Fig. 1. A—At 1, the 2-way C.-R. tube for pick-up; at 2, the 2-way tube used for reception. B, C—Alternative composite mosaics. D—Switching system for reversing use (as for instance in an "inter-viewer").



(Continued from preceding page)

tube in a high-gain audio amplifier. (This first tube is housed in a steel cylinder inside a metal box.) It then is capable of measuring even "the minute amount of electricity carried by a single electron passing down a wire every 5 minutes," to quote *Science Digest*.

According to a description by James S. Allen, originator of this new design, in an article in *Physical Review*, this tube has 12 electrodes covered with a thin layer of beryllium. The use of guard ring insulation and electrostatic shielding for the final cooling electrode has reduced the background current to an extremely low value.

70L7GT—Duplex Beam Power Amplifier and Half-Wave Rectifier

The Ken-Rad 70L7GT is a cathode-type duplex tube consisting of a beam power amplifier and a half-wave rectifier in a single envelope. It is especially designed for use in small A.C.-D.C. receivers where space and heat dissipation are prime considerations. The 70L7GT is a glass tube equipped with an octal base. It is recommended that the end of heater used for the power amplifier section be connected so that a minimum voltage results between this point and ground.

Transformer or impedance-coupled input systems are recommended. If resistance coupling is used the D.C. resistance in the grid-return must be limited to 0.5-megohm for self-biased conditions and 0.1-megohm for fixed-bias conditions. See Table II for characteristics.

25B8GT—Duplex Pentode Triode

The Ken-Rad 25B8GT is a cathode-type duplex tube consisting of a pentode unit and a triode unit within a single envelope. The 25B8GT is a glass tube equipped with an octal base. See Table III for characteristics.

2050—Hot-Cathode Gas Tetrode

The RCA 2050 is a sensitive gas-filled tetrode of the indirectly-heated hot-cathode type, designed for grid-controlled rectifier service.

This tube has a steep control characteristic (high control ratio) which is independent of ambient temperature over a wide range. Because of the special electrode structure employed, the pre-conduction or gas-leakage currents to the anode are extremely small right up to the beginning of the conduction cycle. In addition, the grid current is very low (less than 0.1-microampere), so that a high resistance may be used in the grid circuit. This characteristic provides the tubes with a high sensitivity and permits its operation directly from a vacuum-type phototube. The 2050 has a very low grid-anode capacity and consequently is not appreciably affected by line-voltage surges.

It is preferable to apply the heater voltage at least 10 seconds before the plate voltage is drawn to prevent shortening the useful life of the tube.

*Vol. 55, "The Detection of Single Positive Ions, Electrons and Photons by a Secondary Electron Multiplier."

The cathode preferably should be connected to the midpoint or to one side of the heater circuit. Although the cathode may be made positive with respect to the heater, the potential difference between them should be held as low as possible. It is recommended that the cathode never be made negative with respect to the heater.

The shield grid (grid No. 2) is normally connected to the cathode. It may, however, be used as a control electrode, because the control characteristic of grid No. 1 can be shifted by varying the potential of grid No. 2. As the shield grid is made negative, the control-grid characteristic is shifted positive. With -4 V. on the shield grid, the control-grid characteristic lies completely in the positive region.

The 2050 operates by virtue of the fact that for any specific shield-grid potential and positive anode potential, there is a critical value of control-grid voltage. If the control-grid is kept more negative than this critical value and the tube is not conducting, the anode current will remain zero. If the control grid is made less negative, the tube becomes conducting and the anode current assumes a value determined by the applied anode potential and the impedance in the anode circuit. In the conducting condition, the tube voltage drop is quite low and is substantially independent of the value of both anode current and control-grid bias. To extinguish the discharge and to allow grid No. 1 again to assume control, the anode potential should be reduced to zero or made negative.

The 2050 is designed primarily for grid-controlled rectifier service where the operating frequency is relatively low. In relay applications, the anode voltage may be supplied from either a D.C. or an A.C. source. When a D.C. supply is used, the circuit possesses a "lock-in" feature because the anode potential must be removed momentarily in order to restore the tube to a non-conducting condition. When an A.C. supply is used, the circuit has no "lock-in" feature, but the average anode current may be controlled by the relative phase of the control-grid, shield-grid and anode potentials. A typical light-operated circuit is shown in Fig. 2.

See Table IV for characteristics.

2051—Hot-Cathode Gas Tetrode

Like the type 2050 tube described above, the RCA type 2051 tube is a sensitive, gas-filled tetrode of the indirectly-heated hot-cathode type designed for grid-control rectifier service, but at lower anode voltages. The

description given above for the 2050 applies also to the 2051; this includes reference to Fig. 2.

See Table IV for characteristics.

1624—Transmitting Beam Power Amplifier

The RCA type 1624 tube is a beam power transmitting tube with a typical power output of 35 W. for class C telegraph service. It is designed with a fast-heating, coated filament. The high power sensitivity and the quick-heating feature of this tube make it especially suited for use as an A.F. or R.F. amplifier, modulator frequency multiplier, or oscillator in equipment where quick off-on operation is essential.

The 1624 can be operated at maximum ratings in all classes of service at frequencies as high as 60 mc. Neutralization of the tube is generally unnecessary in adequately shielded circuits. In push-pull class AB² audio service, 2 tubes will deliver an output of approximately 72 W. Maximum plate dissipation is 25 W.

The base of the 1624 fits the standard 5-contact socket which should be installed to hold the tube in a vertical position with the base either up or down.

The beam-forming plates of the 1624 are connected to one side of the filament (pin No. 5) within the tube. When a D.C. filament supply is used, pin No. 5 should be connected to the negative side of the supply voltage.

See Table V for characteristics.

1D8GT—TABLE I

Tentative Data		
Filament voltage (D.C.)	1.4	volts
Filament current	0.1	ampere
Maximum overall length	3-5/16"	
Maximum diameter	1-5/16"	
Bulb	T-9	

(See Table IA, pg. 251, for additional data.)

70L7GT—TABLE II

Rating and Characteristics		
Heater:		
Voltage	70	volts A.C. or D.C.
Current	.150	ampere A.C. or D.C.
Operating Conditions		
Beam Power Amplifier Section		
Plate voltage	110	volts max.
Screen-grid voltage	110	volts max.
Control-grid voltage	-7.5	volts min.
Plate current (zero signal)	40	milliamperes
Plate current (max. signal)	43	milliamperes
Screen-grid current (zero signal)	3.0	milliamperes
Screen-grid current (max. signal)	6.0	milliamperes
Peak signal	7.5	volts
Mutual conductance	7,500	micromhos
Plate resistance	15,000	ohms
Load resistance	2,000	ohms
Total harmonic distortion	9.5	per cent
2nd harmonic distortion	5.5	per cent
3rd harmonic distortion	7.0	per cent
Power output	1.8	watts
Rectifier Section		
A.C. plate voltage (r.m.s.)	125	volts max.
D.C. load current	70	milliamperes max.
Peak plate current	350	milliamperes max.
Average tube voltage drop	20	volts at 140 ma.

(Continued on page 250)

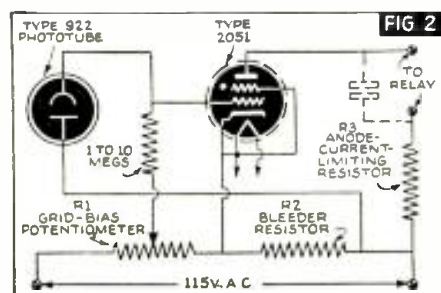

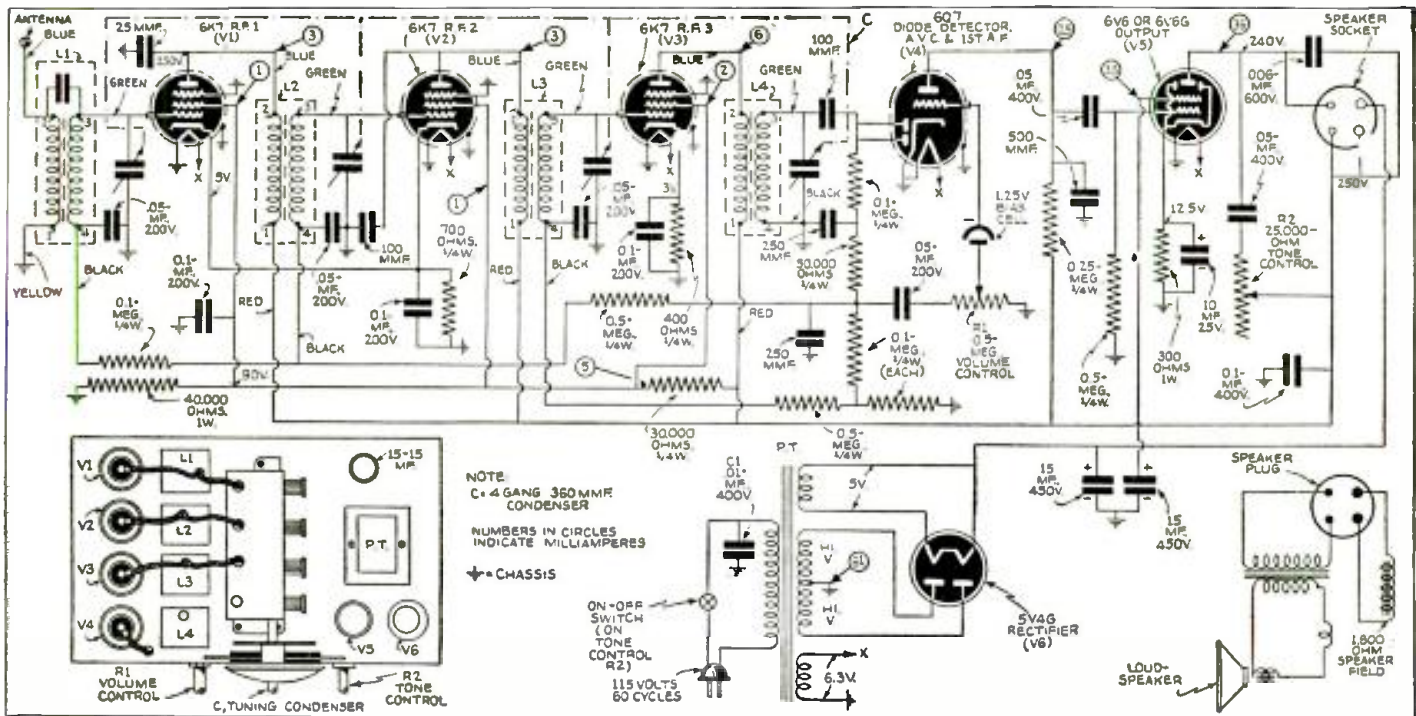

Complete schematic diagram of the 6-tube T.R.F. broadcast set. The use of iron-core R.F. and I.F. coils throughout affords high sensitivity and selectivity.

"IRON-CORE 6" BROADCAST SET

A good T.R.F. receiver can compare favorably in all respects with a superhet.—and the author proves it with this excellent 6-tube job. It makes an excellent replacement receiver for large, expensive cabinets.

MICHAEL G. RELSUM

NO tricks are incorporated in this receiver—it's just a straightforward *tuned-radio-frequency* job having tone quality that worked rings around more complicated sets with which it was compared. Although primarily intended as a good local-station receiver, it has ample sensitivity and selectivity for all ordinary needs, by reason of its 4 tuned circuits, iron-core coils, and 3 stages of high-gain amplification. Modern metal tubes permit its efficient circuit arrangements to be employed.

CIRCUIT

This receiver has been designed for the high-fidelity-seeking experimenter and Serviceman, willing to forego short-wave features, consigned to the super-

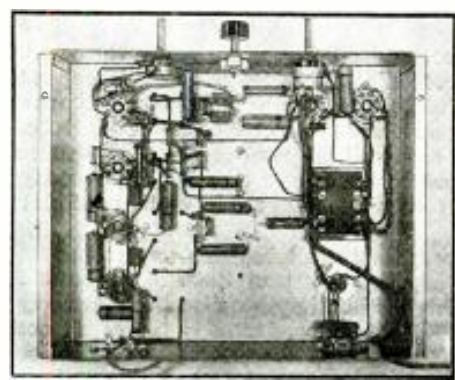

To obtain good results, even with the best of parts, it is necessary for the wiring to be neat and carefully done; and for the parts to be arranged in a neat and sensible order such as shown above.

The complete radio set, with its large, matched speaker, presents a handsome appearance. Owners of expensive radio cabinets would appreciate a replacement receiver such as this — Servicemen, please note. A T.R.F. circuit and high-quality components result in tone quality which leaves little to be desired.

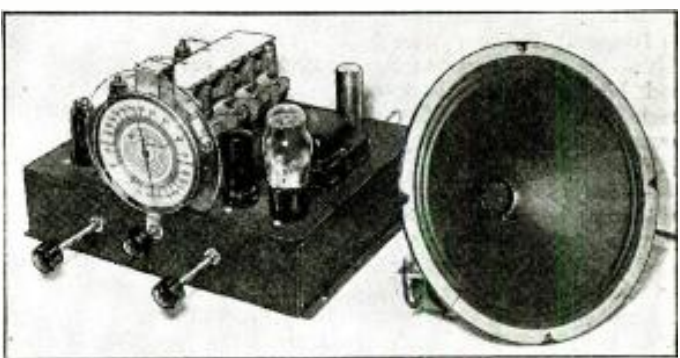

heterodyne circuit. Four tuned circuits utilizing Ferrocart (iron-core) coils, provide the maximum sensitivity and selectivity per stage.

Three metal 6K7 screen-grid tubes are used as R.F. amplifiers with A.V.C. voltage supplied by the diode detector section of the 6Q7. The triode section of the 6Q7 is resistance-capacity coupled to the 6V6 metal beam output tube, delivering more than 3 watts. The 5Y4G is a "glass octal" rectifier tube.

There are 3 controls, viz., tuning, volume and tone. The airplane-type illuminated dial is calibrated in kilocycles making it easy to tune-in the stations. Using the volume control in the 1st audio stage instead of any of the R.F. stages, permits the proper R.F. loading of the diode detector circuit, resulting in better tone quality. Although the author prefers to omit tone compensation or control, some experimenters desire this feature which en-

ables them to adjust the attenuation of the "highs" to suit their individual requirements. It should be noted that the on-off switch is an integral part of the tone control. This permits a relatively permanent setting of the volume control which is not disturbed by the turning on or off of the receiver.

Simplicity of filament wiring is facilitated by the grounding of one filament terminal on each of the 6.3-volt tubes and the grounding of one side of the 6.3-volt winding on the transformer.

The receiver chassis is relatively small (10 x 12 x 3 ins. high) enabling it to be mounted into a small or large console. To secure the full frequency response made possible by the dynamic speaker, the experimenter should provide proper speaker baffling. Should the cabinet reverberate at certain frequencies, the use of celotex slabs on the inside of the cabinet will absorb or break

(Continued on page 255)



Fig. 2. This curious effect results from the combination of incorrectly-tuned oscillator, and inadequate frequency response in the I.F. circuits.



Fig. 3. This photograph depicts effects similar to those shown in Fig. 2, these are, incorrect tuning of the oscillator, and low I.F.-circuit frequency response.

SERVICING TELEVISION

Unlike previously published articles of a theoretical nature on the servicing of television and Short-Wave World (London, England), is a practical analysis illus-

S. WEST

LAST month the vision-frequency output amplifying stage was treated from the point of view of its *low-frequency* response requirements. It is necessary now to consider the question of the *high-frequency* response, from which is assumed the response to frequencies from some 10,000 cycles to 2 or 2.5 mc. Although there are various circuits for achieving this end, by far the simplest way to ensure linear gain at such high frequencies is to include a correcting inductance in series with the plate coupling resistance of the V.F. tube.

Actually linear response can be secured with a drastic reduction in value of the load resistance, indeed, with certain types of resistance, e.g., wire-wound types having some inherent inductance, with a sufficiently low value of load resistance the response can well be linear to 5 mc. The gain secured from the stage, however, is very low as is apparent from the fact that the gain from such a stage, wherein a pentode tube is employed, is given accurately by the relation: Gain = mutual conductance (ma. per volt) × coupling resistance (ohms).

The usual procedure is to employ an inductance having such a value that in conjunction with the associated tube and circuit capacities a resonant circuit

is secured, the frequency of resonance being somewhat higher than the highest frequency the stage is to handle.

H.F.-RESPONSE PITFALLS

It is not proposed to deal with the question of phase shift for it is considered that no difficulties will be encountered in this respect as, in general, if the response is linear up to the highest frequency desired then the phase shift will be of such degree that it can be ignored. There are, however, two pitfalls likely to be encountered while striving for this stringent frequency response requirement. First, the ratio of inductance to resistance must be low, for the circuit damping is critical if transient distortion is to be avoided. If the resistance is too high in value the abrupt transitions are lost due to the roundings of the corners of the transient wave; if too low there is a possibility of "ringing" occurring in the circuit; this will distort the wave shape giving rise to effects similar to those depicted in the photograph Fig. 1.

It is seen in this photograph that the transition from the black edge of the lettering to the uniform background is not correctly rendered, the effect being as though a white border follows the lettering. With a white letter the reverse effect would, of course, be obtained. This effect is due to the fact that the wave shape rises abruptly from the black edge of the letter then oscillates momentarily; it is a damped oscillation, before assuming the correct illumination level.

Secondly, the question of determining what value the stray capacity has is not without difficulties. So much will depend upon the form of sync. filter employed and also, largely, upon the length of the modulating lead to the grid of the C.-R. tube. Also, if the C.-R. tube's high-voltage source has its positive terminal grounded the capacity to ground of the grid blocking condenser (which will necessarily be a large, high-voltage affair) will be appreciable.

There is a method for accurately assessing this total capacity, including that due to the input capacity of the C.-R. tube and the remaining tubes, but this method implies a certain accuracy in calibration of the apparatus employed and is therefore not easily applicable.

It is probably reasonably safe to assume that this output capacity, including that due to the tube, is in the region of 35-40 mmf., with an indirect tube connection, and approximately 25-30 mmf. when a direct connection is employed.

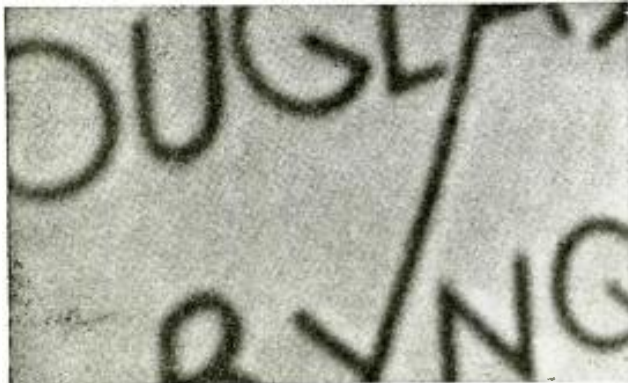

Fig. 1. The effect of incorrect damping in the video frequency stage is clearly revealed in the above photograph.



Fig. 4. Still another photograph showing the effects of oscillator detuning, and inadequate frequency response in the I.F. circuits.



Fig. 6. The uneven background illumination in this photograph is due to the loss of, or inadequate restoration of, the D.C. component.

RECEIVER FAULTS

vision receivers this series of articles, which we reprint by special permission of treated with photographs of images which depict the actual faults being discussed.

PART V (Conclusion)

Suitable values for both the inductance and the resistance to ensure a correct L/R ratio and to permit the response to be maintained to over 2 mc. can then be obtained by reference to curves. Alternatively, it will be found that a load resistance of 3,500 ohms and an inductance consisting of 89 turns of 38 D.S.C. instrument wire close-wound on a $\frac{5}{8}$ -in. diameter coil form will satisfy most requirements.

Some slight experimental adjustment of the turns number may be required, but it will be preferable to endeavor to reduce the capacity due to the C.-R. tube feed arrangements before resorting to this measure. If it proves necessary to remove a substantial number of turns then the load resistance should also be reduced in value. It is a simple matter to check that the gain is substantially maintained to the upper high-frequency limits by applying the output of a signal generator to the grid of the V.F. tube.

CHECKING GAIN

The procedure is as follows: With the generator connected as above, it is set to produce a signal at about 1.5 mc. (200 meters) the output being adjusted so that the C.-R. tube screen is reasonably illuminated. With careful adjustment of the sync. controls this frequency will produce a large number of vertical white lines.

The frequency is then slowly increased to a little over 2 mc., the individual lines, now increased in number, should still be plainly rendered at an approximately equal illumination level, although even if there is an appreciable change in the illumination level it can be disregarded; it is the ability of the system to render this large number of lines plainly that is the real test. Close examination of the screen will be required for there will be approximately 200 lines, though it is not suggested this figure be checked. If this large number of lines is secured with good definition it can be safely assumed that the high-frequency response of the V.F. stage and associated circuits is excellent.

TRANSIENT DISTORTION

It is not such a simple matter to determine the amount of transient distortion present unless a square-wave generator is employed. This entails construction of such an instrument however, as it is an item not usually available. It is simpler to determine the performance by examining closely suitable scenes.

Now it is an unfortunate fact that similar transient distortions can occur in the intermediate frequency stages of a super-

heterodyne vision receiver and, moreover, if both effects are present at the same time or if an attempt to make good a response deficiency, due to the I.F. amplifier, by overcorrecting the V.F. stage is made, very unpleasant image distortions will result. (See Fig. 2.) This photograph gives some idea of what to expect, but actually the effect is manifest by a large variety of such distortions. In general, it can be assumed that where it is possible to eradicate this fault by tuning the oscillator for maximum sensitivity, then it is likely, though not necessarily so, that the I.F. pass band is inadequate or non-linear.

Figures 3 and 4 depict similar effects. In each case where images such as these are secured, either the I.F.'s pass band characteristic, or the setting of the oscillator tuning, should be suspect. Figure 3 actually is taken from a receiver whose I.F. amplifier had a very marked tendency to "ring." Such a condition is mainly engendered by a non-linear response within the I.F.'s pass band and suitable re-adjustment or an increase in the circuit damping will invariably effect a cure.

GHOST IMAGES

Two somewhat similar effects, not illustrated here, (Continued on page 218)



Fig. 5. As is apparent from this photo considerable loss of definition results from poor over-all frequency response of the receiver.

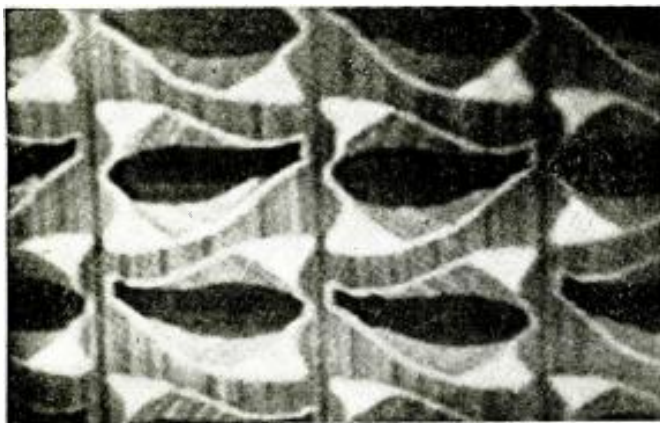

Fig. 7. The above photograph shows the good definition and uniform illumination rendered by a correctly-adjusted receiver.

(Continued from preceding page)

are worthy of mention. The first is an image in which the subject matter appears as though in relief; such a fault is invariably due to incorrect oscillator tuning and is caused by an over accentuation of the higher modulation frequencies in relation to the low. It is conceivable that such an effect could occur due to a coupling condenser in the V.F. stage becoming open-circuited and it is perhaps as well to check such components.

The second effect is very similar to that depicted in Fig. 3, but, in this case, the subject matter is broken up into a number of such ghost images as are shown in this photograph. Generally speaking, this trouble is more usually experienced in single-sideband amplifiers where the requirements in regard to phase shift and linearity are very much more stringent than are those for a double-sideband amplifier.

While referring to Fig. 3 it can be added that a precisely similar effect as is depicted obtains when the aerial termination is not correctly matched either at the receiver or to the aerial. The severity of this effect is largely determined by the length of the aerial feeder, for the fault is due to reflections occurring in this; that is to say, due to the mismatch, reflections occur in the feeder and thereby give rise to secondary images delayed according to the distance they have traveled, this will result in the production on the screen of ghost images rendered later than the true image.

INADEQUATE FREQUENCY RESPONSE

To give an idea of the effect in the received image due to an inadequate overall frequency response characteristic, the photograph Fig. 5 is reproduced, though it is hardly necessary to show what constitutes a poor image. However, the lack of definition can be noted, due in large measure to the fact that unless the high-frequency response is adequate, sudden transitions cannot be truly rendered and rapidly repetitive transients not at all.

The photograph Fig. 6 shows the big improvement in definition resulting when the response at high frequencies is reasonably good although this photograph is mainly included as it depicts a fault which is quite common. Examination will reveal that the background illumination is very uneven, the white lettering being followed by dark areas. This effect is common in receivers where the D.C. component is lost as far as the tube modulation is concerned, but it can occur, though not so readily, in receivers employing a direct tube connection.

Upon a cursory examination of a circuit wherein the tube is connected directly to the V.F. tube's plate, which is in turn D.C.-coupled to the demodulating diode, one is tempted to think that the D.C. component is accurately preserved, but it is necessary

to take into account the time constant as a whole or in part of the high-voltage supply circuit which can influence the D.C. level. The effect of these circuits can be largely removed, but there exist a number of reasons why a direct tube connection, to a V.F. stage, should not be employed, and in the writer's view it is preferable and simpler to employ some form of D.C. restorer, especially as such a device is invariably necessary for most types of sync. pulse separators.

Even where a D.C. restorer is employed, however, care in the choice of the circuit constants is necessary for, unless the time constant of the restorer is high, it will be unable to maintain the D.C. level throughout the changes in a line's modulation; particularly is this the case when the load resistance of the D.C. restorer has its effective value reduced during white modulation. This can happen, for example, due to the lowered input resistance of a sync. separator tube during modulation, or for other reasons.

The point is that a high time constant is required for the D.C. restorer throughout the image modulation cycle, and if this is not ensured the effect in the image will be, for example, an apparent black band backing up a row of white letters, and similar effects, some of which are revealed by Fig. 6. A time constant equal to approximately half the image area's scanning time appears to be satisfactory, but considerable latitude is permissible providing it is no less than a few lines.

INTERLACING

The question of ensuring good interlacing of the lines is a somewhat difficult one. It is necessary fully to understand what is de-

manded of the system to ensure that correct interlacing is possible and perhaps the most important point to realize is that the framing pulses for odd and even frames are identical and occur at a regular rate. That is to say the interlace is not effected by having the pulses for odd and even frames occurring in some irregular manner, as is often thought; it is essential that these occur with extreme regularity, the interlace being due to the fractional relationship between the line and frame frequency.

To make this perfectly plain, consider an image of 5 lines. If the frame frequency is 25 per second then the line frequency is $5 \times 25 = 125$ per sec., and the system is a straightforward sequential scanning one, i.e., it is not interlaced. Supposing that the frame frequency is now doubled retaining the original line frequency of 125 per sec., then it is obvious that only $2\frac{1}{2}$ lines occur during each frame, the system being an interlaced one, for alternate sets of lines are spaced by a half-line and must therefore be interpolated one set with the other. But the frame frequency is entirely regular. In short, any system in which the number of lines is an odd number so that a fractional relationship exists between the frame and the line frequency is necessarily an interlaced one.

From the foregoing it is apparent that the principal requirement for ensuring interlacing is extremely regular operation of the frame time base and everything possible should be done to render the frame time base stable in operation. Secondly, the sync. filter section and the pulse application network should be capable of providing pulses accurately corresponding in time with the transmitted pulses.

CONSTANT AMPLITUDE

Also it is extremely important to ensure that the amplitude of the pulses is constant irrespective of the modulation depth. If this is not ensured, interlace will not result, even though the timing be perfect, for the change in amplitude of the pulse will move the odd lines in relation to the even lines, or vice-versa and will result, in mild cases, in pairing of the lines or more severely, in a complete lack of interlace. Also in the case of an integrator network the timing will naturally be affected, for the change in amplitude will result in the necessary voltage being reached at varying times.

In addition to these precautions adequate high-voltage filtering is necessary and care taken to avoid induced powerline hum to

(Continued on page 237)

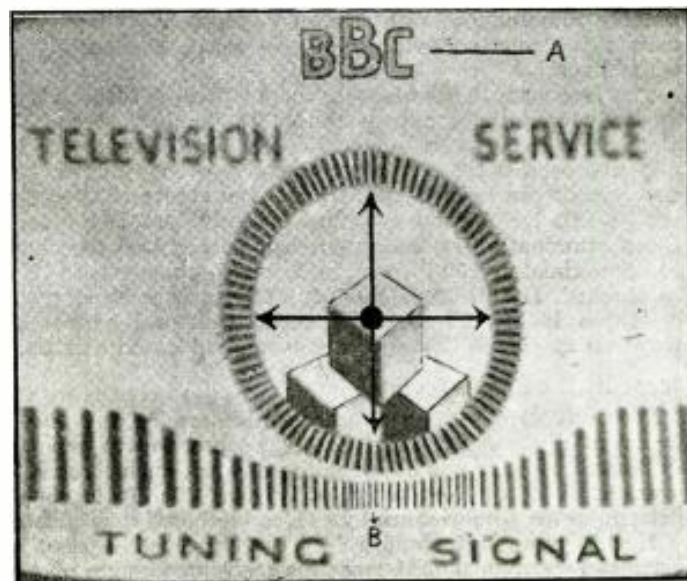

Fig. 8. This test pattern furnishes an excellent indication of the correct image proportions and frequency response to aim at. The small serrations at A should be plainly visible and the center pattern should be a true circle.

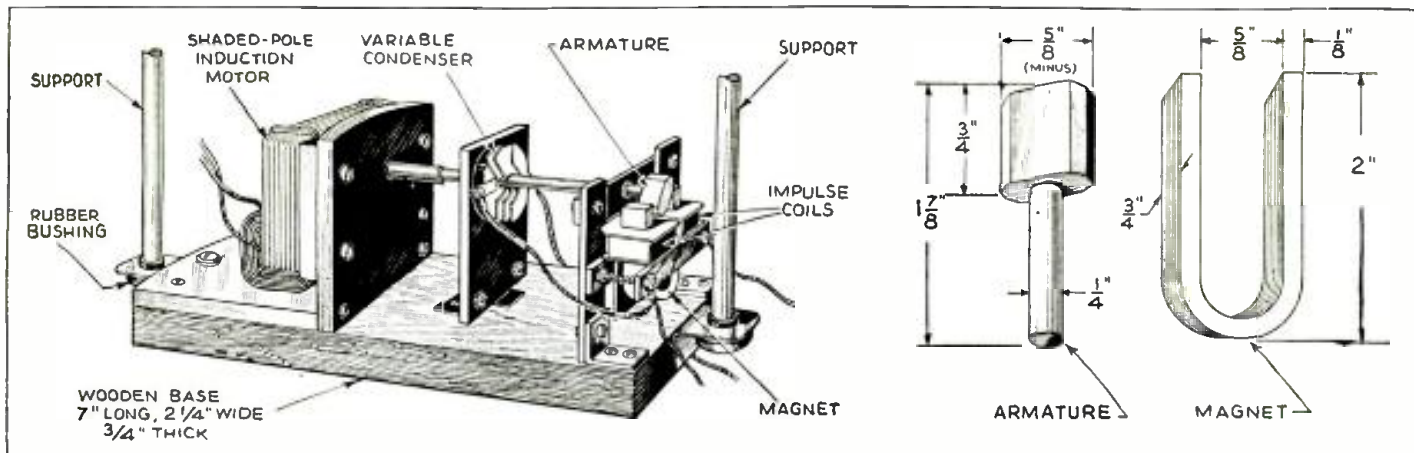
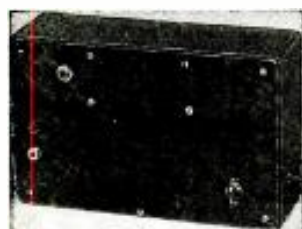

Fig. 1. Complete constructional drawing for building the frequency modulator (wobbler) and impulse generator.

Home-Made Frequency Modulator

Here's a "wobbler" (frequency modulator), complete with sweep- and pulse-frequency generators, for use with any service oscilloscope and signal generator, which the author figures the average Serviceman can build for under \$2.

GEORGE F. BAPTISTE



The completed frequency modulator.

HOW many Servicemen are without a Frequency Modulator? Well there is no longer any need to be without one for here is one that can be built for \$1 or \$2 at the most. The only part necessary to buy is the motor, which should be a shaded-pole induction-type of fractional-horsepower, 1,500 to 3,000 r.p.m.

Speed can be controlled by means of a rheostat in the primary. All the other parts can be found in the junk-box. This device can be built by any Serviceman in his spare (?) time and when completed will give him something to be proud of.

The reason this was built was due to the fact that I had so much trouble getting a replacement condenser for a well-known frequency modulator, and did not wish to buy a new one. The resulting "wobbler" worked just as well as the factory-made job and has more than paid for itself already; in fact, it was cheaper than the replacement condenser I bought for the factory-made job.

The degree of "wobble" is determined by the value of C1.

PARTS REQUIRED

Figure A shows the parts assembled and ready to use. The variable condenser can be any size depending upon the sweep frequency desired. The one used here has a capacity of 8 to 40 mmf. Figure 2A shows the circuit; M is the motor, C—coupling shaft, C1—variable condenser, J—jack, A—armature rotor, Ma—horseshoe magnet, L1-L2—impulse coils; the sweep jack connects across the signal generator condenser, and the high or low output from the impulse coils goes to the pulse on the oscilloscope.

Figure 1 is a mechanical drawing of the entire assembly. The mounting is made on a board $\frac{3}{8}$ -in. thick and the length necessary for your own assembly. This illustration gives an idea as to how the board is mounted on rubber washers, and bolted to the cabinet to prevent vibration when running.

MOUNTING ARMATURE

The method of mounting the armature rotor is very important, the spacing between armature and magnet being kept at a minimum. Note the shape of the impulse armature rotor, which is the unit hardest to make; its size will depend upon the horseshoe magnet used. Since the horseshoe magnet used here measured 2 in. long x $\frac{3}{8}$ -in. (outside x $\frac{5}{8}$ -in. deep, (Continued on page 241)

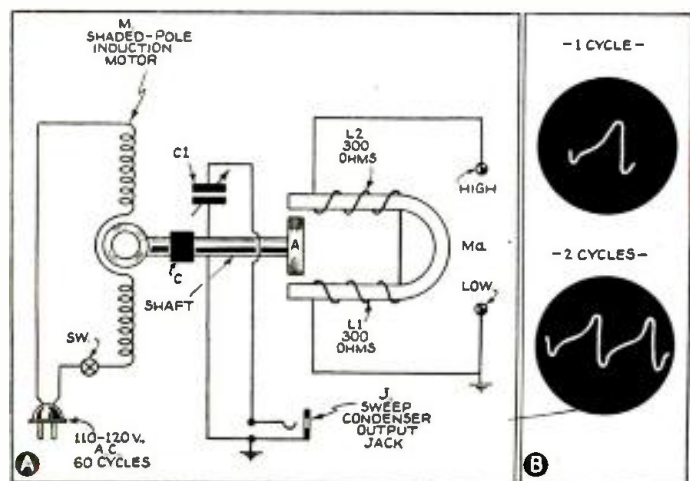

Fig. 2. (A) Schematic diagram of the frequency modulator and impulse generator, and (B) the waveform of 1 and 2 cycles of the impulse generated.

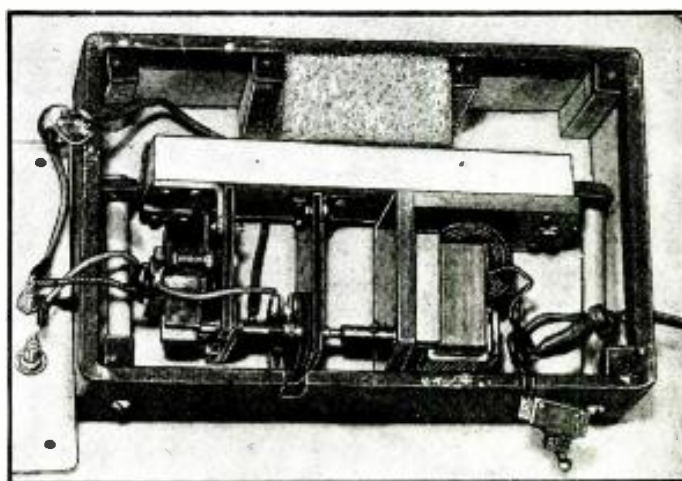
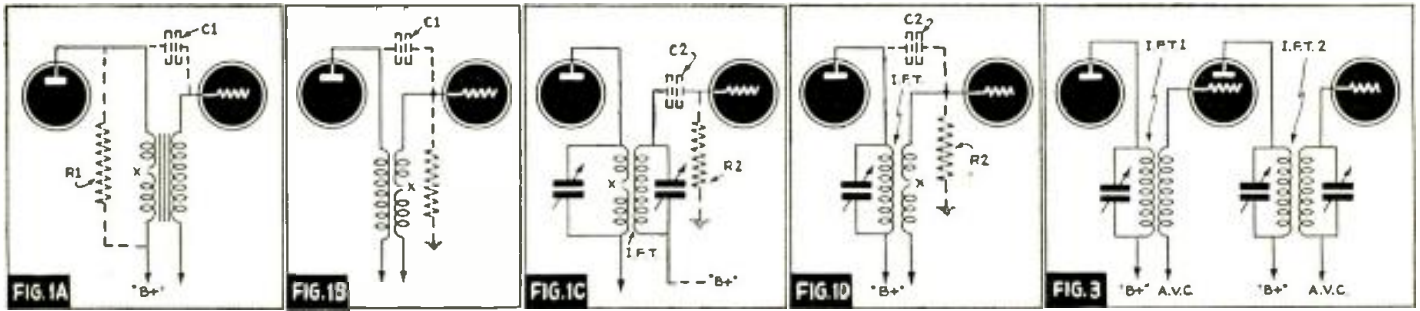

Fig. A. Inside view of the instrument showing method of suspension inside case.



EMERGENCY SERVICING

Any radio man knowing the fundamentals and provided with a little used in servicing, need not fear to tackle a fractious radio set, says Mr.

CHARLES R. LEUTZ



In the preceding (August *Radio-Craft*) article most attention was given to various service difficulties caused principally by the failure of circuit parts

It should be mentioned that audio frequency (A.F.) or intermediate frequency (I.F.) transformers found to have either an open primary or secondary, can be arranged to continue in service by making alterations as shown in Fig. 1.

Figure 1A shows an audio frequency stage with the primary of the transformer open. The resistor R1, of about 50,000 ohms, is connected as a plate load, together with the coupling capacitor C1 having a capacity of about 0.05-mf. On the other hand, if the secondary winding is open, the proper connections are given in Fig. 1B. In the latter case the resistor R1 can have a higher value with some tubes, allowing increased amplification if required. Defective intermediate frequency transformers can be treated in a similar manner, for example in Fig. 1C the primary is open; accordingly the secondary circuit alone is used as a single-circuit plate coupling load. Condenser C2 should have a capacity of about 100 mmf. and the grid leak can have a value of from ¼-megohm to 1 megohm. With an open secondary, the primary is then used as the load as shown in Fig. 1D.

Incidentally it is often desirable to remove certain component parts with the connecting leads intact. If the leads have been threaded through a closed eye lug, removal is simplified by cutting an opening in the lug (see Fig. 2) with a pair of sharp side-cutting pliers.

The alignment of radio receivers without using a signal oscillator and output meter is not difficult, especially if the receiver is in such condition that at least some signals come through.

R.F. ALIGNMENT

Using a signal oscillator, T.R.F. receivers are usually aligned at 1,400 kc., but when using a received signal a more accurate alignment is obtained at about 1,500 kc., especially if the minimum tuning range extends to 1,550 kc., or more. Assuming a signal can be brought through at about 1,500 kc. the first attempt for readjustments should be made at that point.

Often true alignment cannot be obtained with the set of trimmers alone, due to one or more of the R.F. transformer secondaries being too large. In that case it is better to remove one or more turns from the large inductances and then completely align the tuner properly, even if the dial settings fall offscale a higher percentage than standard.

Lacking an output meter and provided the receiver has automatic volume control, a "tuning eye" tube can be connected in circuit temporarily as an indicator of maximum response, while making alignment adjustments. With an accurate alignment at 1500 kc. and provided the multiple tuning condenser has not been damaged, the receiver can be expected to perform satisfactorily over the entire scale.

I.F. ALIGNMENT

Intermediate frequency amplifiers are somewhat more difficult to align especially if the trimmers have been thrown all out of adjustment for one reason or another; however a satisfactory readjustment can be made without a signal oscillator. Assuming the superheterodyne does operate, even though unsatisfactorily, first attention should be directed to the I.F. amplifier. The tuning controls should be adjusted to bring in a broadcast signal around 1,500 kc., or if it is a multiple-band receiver, it can be adjusted to bring in an interrupted continuous wave (I.C.W.) signal at the high-frequency end of one of the short-wave bands. The I.C.W. signal provides

a source of oscillation of uniform amplitude.

Before making any trimmer adjustments, make a sketch of the I.F. transformer trimmer adjusting screws and position of the slots. All changes of trimmer adjustments should be recorded on this sketch, so many turns clockwise or counterclockwise as the case may be during the operation. Following this procedure the settings can be returned to the starting point if necessary.

If a factory-adjusted 465 kc. I.F. transformer is available, or can be borrowed from a good set, it can be substituted for one stage (Fig. 3) of the receiver under test. It is then known that stage is adjusted to 465 kc. and it can be used as a standard to readjust the other, preceding stages. Then the standard is removed again, the original transformer replaced and is adjusted to resonance with the balance of the entire amplifier, this is shown schematically in Fig. 3.

Another method of alignment can be used if the receiver was properly aligned and calibrated originally. This method consists of tuning-in a radio signal at about 1,500 kc. and running a jumper from the mixer plate to the plate terminal of the detector input transformer, A to A', removing tube 3, as per Fig. 4. If the received signal is 1,500 kc. and the dial indicator at 1,500 kc., maximum response will be obtained with transformer I.F.T.3 adjusted to 465 kc.; accordingly the trimmers on I.F.T.3 can be adjusted simultaneously until that condition is fulfilled. Thereafter, I.F.T.1 and I.F.T.2 can be brought into alignment (after removing the jumper) and finally a close overall adjustment made to all 3 transformers. A tuning eye tube, if available, can be connected into the circuit temporarily for an indicating device during these operations, the adjustments being made for minimum-shadow angle, see Fig. 4.

After the I.F. amplifier has been adjusted satisfactorily, attention can be

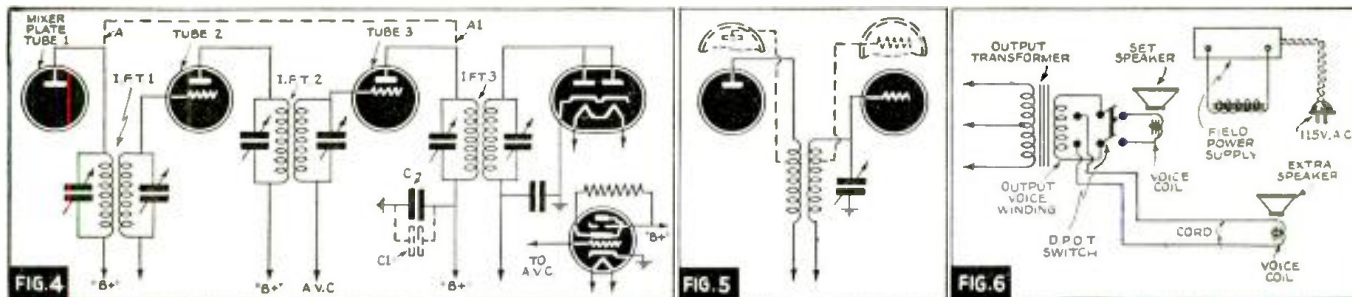

WITHOUT TEST METERS

common sense, though unaided by most of the meters, etc., ordinarily Leutz, co-originator of the famous old "Golden-Leutz Superhet."

PART II

directed to the radio-frequency amplifier, mixer and oscillator circuits. On all bands, trimmers are adjusted with the gang condenser set toward the high-frequency end of the scales and the padding adjustments (if provided) made at the low-frequency end of the scales.

OSCILLATOR ALIGNMENT

In checking the broadcast band, a received signal of 1,500 kc. is ideal. Even if the signal is of irregular amplitude, by making the trimmer adjustments very slowly, definite maximum response is readily discernible. With the dial set at 1,500 kc. and a 1,500 kc. signal coming through (even though not in exact resonance), the oscillator trimmer can then be adjusted for maximum response. After obtaining a satisfactory oscillator adjustment, the R.F. and antenna trimmers can be brought into alignment. The main tuning control is then changed to a lower frequency toward the opposite end of the dial and the padding condenser adjusted. In case signals are not available at lower frequencies, the padder can be adjusted for maximum "hiss" if the receiver has sufficient sensitivity. In making this padding adjustment, the gang condenser should be "rocked" (turned back and forth) to keep the circuits tuned. Finally, the dial setting should be returned to 1,500 kc. and the trimmer settings rechecked.

The other bands can be aligned in the same manner, trimmer adjustments being made at the high-frequency end of the dials and padding condensers, if included, adjusted at the low-frequency end of the dials on each band.

The received signals used for alignment should be kept at low levels; instead of connecting the antenna directly to the receiver, the antenna lead-in can be loosely coupled to a short wire connected to the receiver antenna post.

When the antenna is indirectly coupled to the receiver, a "dummy an-

tenna" must be connected to the antenna and ground posts; for the broadcast band a condenser of 200 mmf. and for the shortwave bands a resistor of about 350 to 450 ohms will serve as a "dummy antenna."

OSCILLATION

Oscillation in an I.F. amplifier is a common difficulty; the entire amplifier may be in an oscillating condition or the oscillations may be confined to one stage. In looking for the cause of oscillations, attention should be directed to parts which may change with service or age, viz., carbon resistors, electrolytic condensers, variable condenser bearings and joints, and even paper condensers. Worn variable condenser bearings or moving contacts often fill up with oily grit and develop high resistance, causing overall oscillation in the circuit. The remedy is to dismantle the condenser, thoroughly clean the bearings or joints, and preferably install new pig-tail connectors from each baffle plate to the shaft at each rotor.

The most common cause of overall oscillation is due to electrolytic condensers deteriorating with age and developing high resistance, especially in bypass circuits. The performance of questionable electrolytic bypass condensers can be instantly checked by shunting a good paper condenser in parallel with the condenser under test, while the receiver is in an oscillating condition. The new paper condenser will stop the oscillations if the electrolytic condenser is at fault; this is shown schematically in Fig. 4, C being the imperfect condenser, and C1 being the supplementary paper condenser.

Oscillations confined to one stage may be due to a number of different conditions. A change of tubes may cure the fault if the original tube has a high interelectrode capacity for some reason. Severe cases of single-stage oscillation can be corrected in tuned-radio-frequency circuits by either reducing the

number of plate turns in the R.F. transformer or tapping the grid connection to a lower point on the secondary; also by inserting a series resistor of about 400 to 1,000 ohms in series with the grid, these alterations being shown in Fig. 5. The above changes should not be made until a fair effort has been made to correct the difficulty with rearrangement of grid and plate leads, better bypass condensers or reasonable readjustment of bias voltage.

A.F. DISTORTION

Often an audio-frequency amplifier which gives good reproduction with a phonograph pickup input, appears to distort radio reception when adjusted to high levels. This distortion obviously is not in the audio circuit, but due to the last I.F. tube being unable to supply sufficient power to the diode detector for complete excitation. An immediate check can be made by temporarily disconnecting the A.V.C. from the last I.F. tube and providing same with a normal fixed bias. If the distortion is eliminated under the above situation, it is well to leave the last I.F. with a fixed bias independent of the A.V.C. circuit.

DX fans experimenting with long-range shortwave reception are often discouraged by audio feedback "howls" when the receiver is adjusted to approach maximum sensitivity for weak signals. Endless time can be spent on experiments to correct this condition, without much success. Some tubes are less microphonic than others and accordingly a change of detector or audio tubes may reduce the disturbance. Suspending both the receiver chassis and the speaker on soft sponge-rubber will reduce the effect, but the best solution consists of using a second loudspeaker removed from the set cabinet. With that arrangement, preliminary tuning is accomplished using headphones and then switching to the external speaker after the desired signal is properly tuned-in; see Fig. 6.

THE LATEST RADIO EQUIPMENT

These new radio products are so laid out that they may be conveniently referred-to when writing to manufacturers for additional information.

100-W. TRANSMITTER WITH EXCITER UNIT

Hammarlund Mfg. Co., Inc.
424 West 33 St., New York, N. Y.

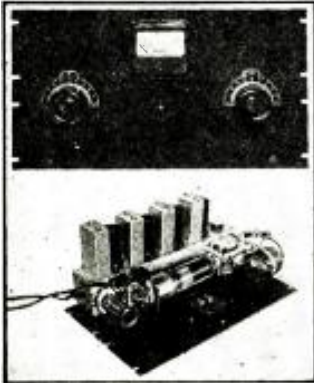

THIS 100-W. transmitter operates on all bands from 80 to 10 meters and includes a 4-stage band switching exciter unit. The entire transmitter, including everything but the power supplies, measures 17 x 9¼ x 8 ins. deep and requires a 19 x 10½ in. panel for rack or cabinet mounting. When completed, the transmitter has but 2 tuning controls. All other adjustments are made when the transmitter is first put into operation, requiring no further attention thereafter.

October 1939 *Radio-Craft*

POWER SUPPLY FOR BATTERY PORTABLES

General Transformer Corp.
1250 West Van Buren St., Chicago, Ill.



October 1939 *Radio-Craft*

KKNOWN as the "Porta-Power", this unit supplies hum-free "A" and "B" voltages to portable radio sets having from 4 to 6 tubes. The "A" supply is obtained from a full-wave copper sulfide rectifier with an output voltage of 1.5 under a load of 200 ma. This drops to 1.1 V. with a 300 ma. load. The "B" supply employs a type 76 tube as half-wave rectifier. This outputs 90 V. at a load of 13 ma. and increases to 102 V. with a load of 8.5 ma. Operates from 110-120 V., 60-cycle line, A.C. only.

CINEMA-MODEL MIKE

Universal Microphone Co.
Inglewood, Calif.

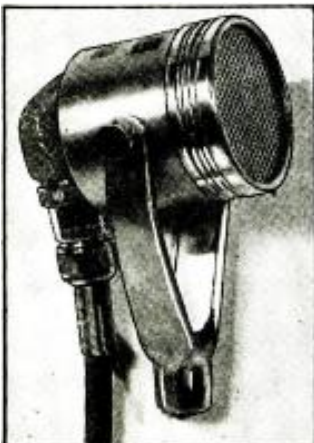

ALTHOUGH designed primarily as a cinema model in swivel yoke for movie use, this new precision instrument, finished in a new type of golden gun-metal, makes an attractive microphone for stage or orchestral use. The mike is said by its manufacturers to be outstanding because of its wide-range pick-up, freedom from background noises and its ability to withstand climatic changes of all kinds. No polarizing voltage is required to energize it. The mike is made in crystal and dynamic types, and in several impedances.

October 1939 *Radio-Craft*

VERTICAL U.-H.F. ANTENNA

RCA Manufacturing Co., Inc.
Camden, N. J.

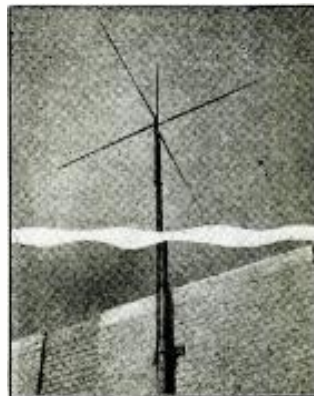

October 1939 *Radio-Craft*

THIS new antenna can be used for both transmitting and receiving on the same or nearby frequency. The antenna as a receiver picks up signals equally well from all directions. As a transmitting antenna the system radiates vertically polarized waves. Conversely the antenna receives only vertically polarized waves. The unit consists of 4 horizontal rods at right-angles to each other and a vertical rod above them, all of the same length. The latter is the antenna while the others are "ground" rods. Each rod is ¼-wavelength long.

"VISOGRAPH" TUBE CHECKER

Triumph Mfg. Co., 4017 W. Lake St., Chicago, Ill.



October 1939 *Radio-Craft*

DESIGNED for counter installations in retail stores merchandising radio tubes, this new radio and television tube tester is available in several colors to match surrounding fixtures. Illuminated, colored tube facsimiles indicate the condition of the tube under test. The tube data is selected on a large roller-type chart and most of the controls are of the pushbutton type. The instrument checks loctals, bantam juniors, gas rectifiers, ballast tubes, tuning eyes, special tube used in remote radio tuning controls, and tubes having 35-, 50-, 75-, 85- and 117-V. filaments.

RECORD PLAYER

Allied Radio Corp.,
833 W. Jackson Blvd., Chicago, Ill.



October 1939 *Radio-Craft*

AN unusual feature of this record player is its remote control unit in the form of a compact hand-size case which can be operated as far as 50 ft. from the instrument. This control can stop and start the turntable and adjust the volume. Has a 16-in. cast-aluminum turntable which will accommodate records up to 17½ ins. Other features include built-in high-fidelity amplifier, with 4 W. output; Jensen 10-in. P.M. dynamic speaker; Astatic 12-in. transcription-type pickup; heavy-duty induction-type dual-speed (78 and 33 1/3 r.p.m.) motor for 110 V. A.C.-D.C., 25-60 cycles.

(See page 240 for other new equipment)

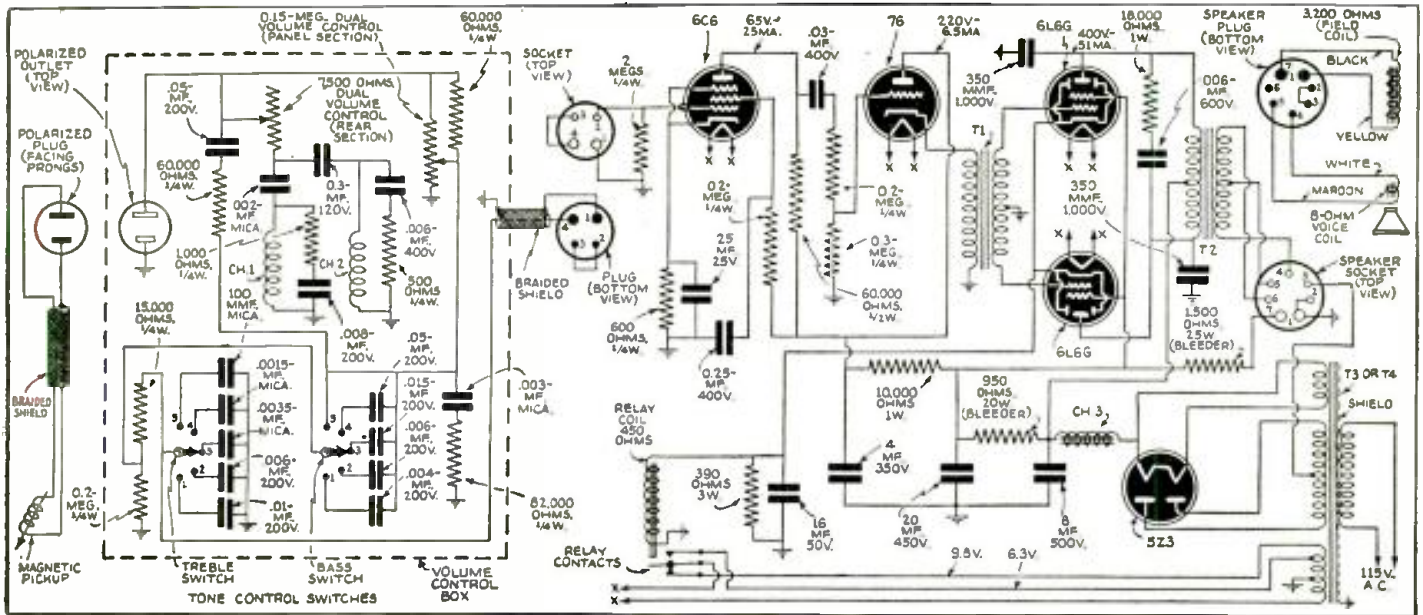

Coin phonograph Servicemen will find this diagram of the Wurlitzer models 500 and 500A quite useful since these are popular machines. The amplifier itself is known as No. 854.

SERVICING "Coin-Operated" PHONOGRAPHS

Servicemen will find that, on 9 out of 10 calls, it's the sound system and not the mechanical system of coin-operated electric phonographs which requires servicing. There's business here for you.

SANFORD MILLER

No. 5

A REMOTE COIN-BOX is a great convenience in many coin-operated phonograph locations that use an extension speaker. However, the average operator shies away from the subject on account of installation difficulties. These devices are comparatively simple to install and the Serviceman able to handle remote coin-box installations will find them remunerative.

Essentially, a remote coin-box consists of a gravity-operated butterfly switch which closes momentarily each time a coin is inserted. The actual hook-up varies with different models but the same remote box can be used on all phonographs. Selections, of course, can not be made on these remotes.

Most Wurlitzer models use a mechanical play-registering system where the coin-slide is used to move the coin ratchet wheel to which the operating switch is attached. In addition several models also have a magazine switch assembly which is used for remote operation.

The Wurlitzer Model 616 has both a magazine switch and a coin-box transformer, which makes the installation of a remote box a matter of simply terminating the 2 wires from the remote unit to a male plug which is inserted into the receptacle on the transformer box marked "Remote." See Fig. 1.

The 412 Wurlitzer has no transformer box but the coin magnet can be energized by a 150-watt lamp inserted into the receptacle provided near the maga-

zine switch. The coin-box plug is then inserted into one of the duplex receptacles. The other receptacle is used for the magazine switch plug.

In the Wurlitzer Model 616A, 24A, 500A and 600A a magnetic coin mechanism is used. The remote box wires are terminated in a male plug. A cube tap is inserted in the transformer box receptacle marked "Butterfly Switch," and the 2 male plugs are inserted into the cube tap. See Fig. 2.

The model 24, 500 and 600 Wurlitzer models have no coin magnets and in installing a remote box to these models it will be necessary to procure from the Wurlitzer distributor a transformer box, solenoid assembly, and receptacles, and follow the directions enclosed.

To hook remote boxes to all Seeburg Models simply connect the remote wires in parallel with the coin trigger switches as shown in Fig. 3. Care must be exercised in determining that the service light switch is turned off when completing any work on these models as the 60-watt bulb is used to energize the coin magnet and if this light is left on the machine will not operate.

The procedure for installing remote boxes on Rock-Ola models is to hook the remote wires in parallel with the trigger switches on the coin chute.

It is extremely important that all remote wiring be of the armored type to prevent tampering. Obviously sticking a pin or nail through unarmored cable will result in the phonograph playing free.

OPERATING NOTES

Wurlitzer 616. A loud hum was encountered on a Wurlitzer 616 and paralleling additional condensers across the filter system showed no improvement. The hum was caused by an open dual 8-mf., 200-V. bias filter condenser. Replacing this unit (C, in Fig. 4) cured the trouble.

Wurlitzer 500 and 600. Considerable difficulty has been experienced on the 1939 Wurlitzer 500 and 600 models in (Continued on page 243)

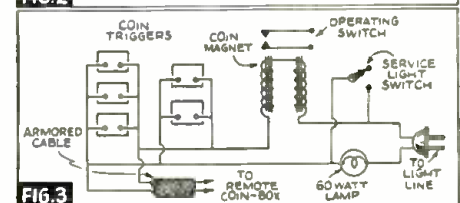
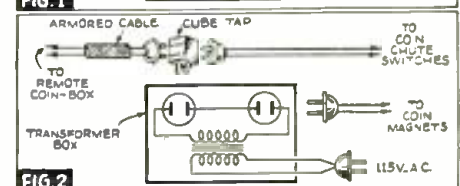
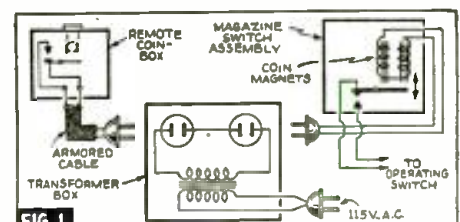

PILOT B.C.—S.W. MODEL T-1452 BATTERY—A.C.-D.C. "TWIN-SET" PORTABLE

Battery Portable and 110-V. A.C.-D.C. Operation; Superhet. Circuit; 4 Tubes Used as Battery Set, 5 Tubes Used as A.C.-D.C. Set; Automatic Changeover; A.V.C.; Broadcast and Shortwave Bands—563 to 187 Meters (532 to 1,600 kc.) and 5.55 to 15.7 Megacycles (54 to 19.1 Meters); Built-In Loop Antenna.

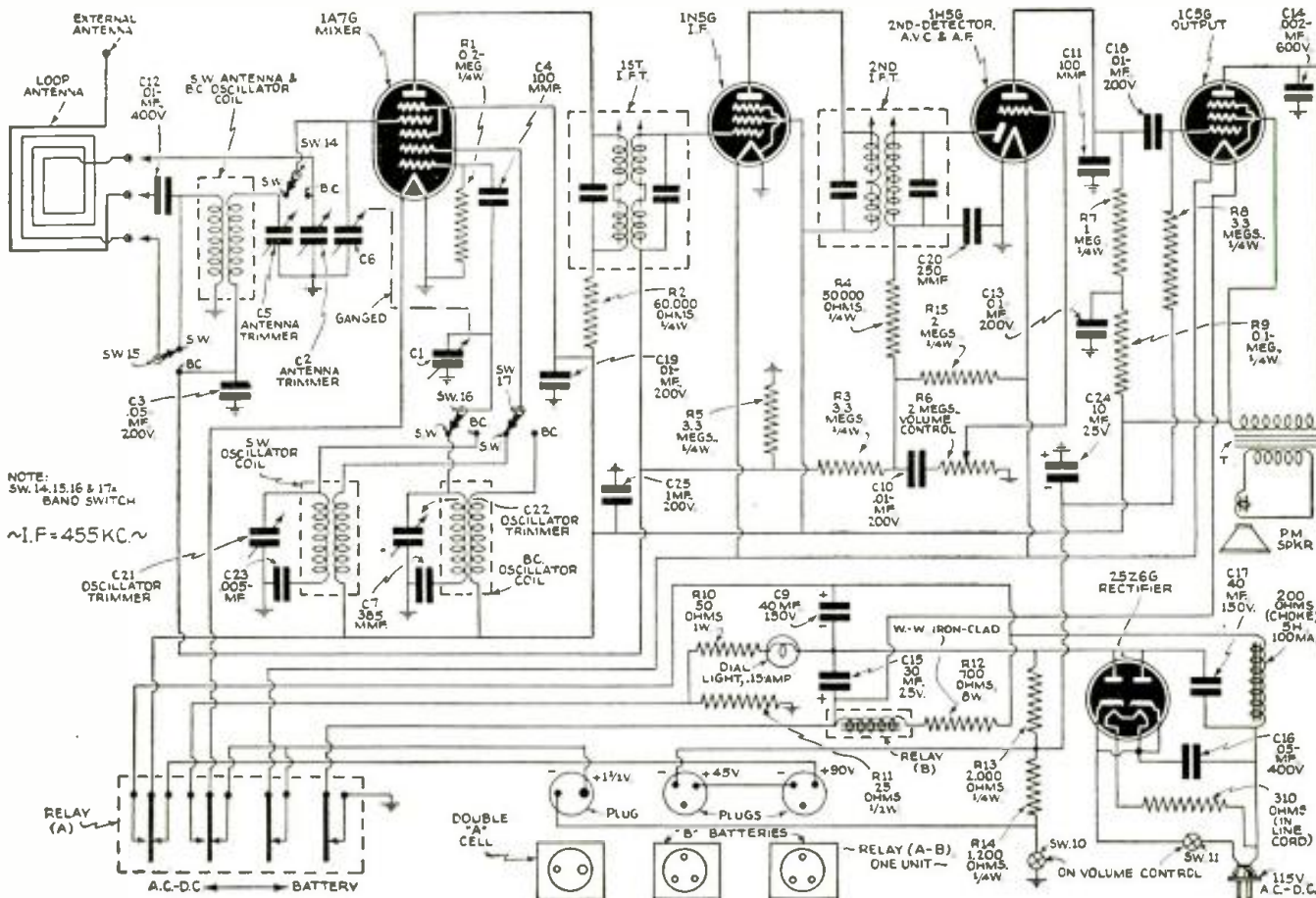

Pilot model T-1452 battery and A.C.-D.C. portable.

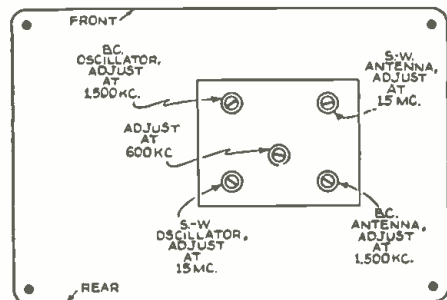

Fig. 1. Bottom view of the cabinet.

OPERATING HINTS

When operating on house current the receiver "plays" instantly without waiting for tubes to warm up. This is due to the fact that the batteries operate the tubes until the rectifier warms up, when an automatic relay cuts out the battery supply and substitutes the power line supply. When this happens an audible click is heard and the dial lights up. When operating on D.C., if the click is not heard and the dial does not light in about 1 minute, simply reverse the plug in the light socket. On alternating current if hum is considerable try reversing plug in light socket.

If reception happens to be weak rotate the entire receiver slowly until signal strengthens. This is due to the directivity of the built-in loop antenna. If the set is located a considerable distance from broadcast stations it may be necessary to use an external antenna. The rear of the cabinet in the center of the back has a screw connector at the left-hand side of the line cord pocket. This is the external antenna binding post.

Be absolutely certain not to use a ground connection when the receiver is operated on house current.

ALIGNING INFORMATION

Intermediate frequency is 455 kc. The aligning frequencies are 1,500 to 600 kc. for the broadcast band and 15 megacycles for the shortwave band. The locations of the screws for adjusting the R.F. and

I.F. circuits are shown in Figs. 1 and 2. The I.F. amplifier may be aligned with the chassis out of the cabinet but with the loop antenna plugged in. When aligning the R.F. amplifier the "B" batteries must be in place, the receiver and loop antenna correctly mounted in the cabinet and the "A" battery outside of the cabinet but connected to the set.

If the receiver is aligned using one power source it will be in alignment with the other.

Align the I.F. transformers first by feeding a 455-kc. signal from a service oscillator to the grid of the 1A7G tube through a 200-mmf. dummy antenna. Align for maximum response. Then align the oscillator circuit to track with the dial calibration on both broadcast and shortwave bands, according to the frequencies given above.

CIRCUIT CHANGE

All receivers leaving the factory after June 2, 1939, will have the following alterations in their circuits: Condenser C8, 0.06 mf., 400 V., will be missing, and condensers C24 and C25 will be added.

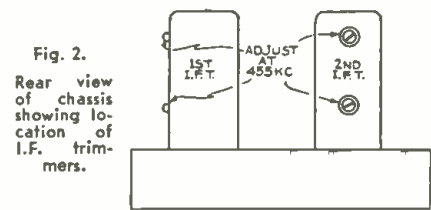

Fig. 2. Rear view of chassis showing location of I.F. trimmers.

TEST YOUR RADIO KNOWLEDGE

—With Questions and Answers from Radio Schools

When you ask for a radio job, you've got to answer questions; when the customer consults you about doing some work, you have more questions fired at you; and when you really get down to doing the work, still more questions arise—to which you must know the answers or else step back and let the next fellow, who does know, step in and take your place. So, RADIO-CRAFT urges you to use the following questions and answers, selected at random from a number supplied with the kind cooperation of foremost radio schools, as a check-up on your knowledge of radio. DO IT TODAY—IT WILL PAY.

Questions . . .

(The following questions were submitted by New York Y.M.C.A. Trade and Technical Schools.)

- Q.1. What is the most important cause for reflections or "standing waves" in a radio transmission line?
 Q.2. How may the plate load impedance of a parallel resonant circuit be determined?
 Q.3. What is the relation of the power output to the grid excitation voltage in a class B amplifier?
 Q.4. Give one cause for the production of frequency distortion in an amplifier and tell how it may be eliminated.
 Q.5. How is frequency modulation made audible at a receiving station?
 Q.6. To what class of amplifier may the vacuum-tube oscillator be compared?

(The following questions were submitted by Radio Training Association, Chicago, Ill.)

- Q.7. What determines the net gain in a degenerative audio amplifier?
 Q.8. Why does a set that is aligned perfectly in the shop often tune broad and sound distorted when returned to the customer's home?
 Q.9. What frequently causes an output pentode to overheat?
 Q.10. How does the 6SA7 differ from other pentagrid converters?
 Q.11. What is the operating principle of the "trimmer substitution" systems of automatic tuning?
 Q.12. When aligning adjustments are being made in a receiver equipped with automatic tuning, how should the tuning mechanism always be set?
 Q.13. What is meant by permeability tuning?
 Q.14. Why are tone compensating circuits often added to manual volume control systems?

(The following questions were submitted by Sprayberry Academy of Radio, Washington, D. C.)

- Q.15. A receiver power transformer operating on a 115 volt A.C. line at 80% power factor is drawing a current of 1 ampere and on removing the rectifier tube from the receiver the primary current drops to 0.65-amp. What is the new power factor, primary phase angle and power, neglecting losses and reactive loads?
 Q.16. The series elements of a T pad are measured and found to be 50 ohms each, while the shunt element has 400 ohms. What line impedance is it intended to match and what is its voltage loss in db?
 Q.17. In a pushbutton tuner the oscillator frequency drift is -7 kc. at 1,000 kc., due to temperature effects other than capac-

ity changes. Full compensation is achieved by replacing the 90 mmf. total capacity of the trimmer for this pushbutton with a 90 mmf. unit of the temperature compensating type. If the temperature rise is 15° C. what is the temperature coefficient of the new condenser?

Q.18. For the greatest possible vertical sensitivity in using a type 913 cathode-ray tube which 2 of the following 4 things would you use:

(1) outer deflector plates? (2) inner deflector plates? (3) 2nd anode + 500 volts? (4) 2nd anode + 250 volts?

Q.19. In visual alignment of a tuned filter using the oscilloscope, if the resonance curve is not symmetrical about the vertical axis, is this remedied by a coupling or a tuning adjustment?

Q.20. A 6J5G tube is used as a split-load phase inverter, that is, with 45,000 ohms in its plate and the same in its cathode circuit. It is fed from an audio amplifier. Characteristics of the 6J5G in part are: R_p 7,700 ohms; E_p 250 volts; G_m , 2,600 micromhos; E_c , -8 volts. What gain does this phase inverter contribute to the amplifier?

Answers . . .

A.1. This effect is generally due to an improper impedance termination or unbalanced line.

A.2. At the resonant frequency,

$$Z = \frac{2\pi FL}{R} \text{ ohms.}$$

A.3. The power output in a class B amplifier is proportional to the square of the grid excitation voltage.

A.4. Regeneration is one of the most common causes of frequency distortion in an amplifier. It may be reduced to a negligible value by the introduction of a negative feedback system.

A.5. Frequency modulation is made audible at the receiving end by a system which will convert it to amplitude modulation.

A.6. The vacuum-tube oscillator is generally operated in equivalent terms to the class B or class C amplifier.

A.7. The net gain in a degenerative audio amplifier depends primarily on the magnitude of the feedback factor, and is practically independent of the amplification occurring in the amplifier itself.

A.8. When a set is aligned in the shop it is usually done just below the level at which the A.V.C. cuts in. When the set is installed in the home, it operates at a higher input signal level and an A.V.C. bias is impressed on the I.F. amplifier tube. This changes the input capacity of the tube which is in parallel with the secondary trimmer condenser,

and hence the secondary or grid circuit is badly detuned.

A.9. An output pentode sometimes overheats because the screen-grid operates at a higher potential than the plate due to the drop across the primary of the output transformer. This causes the screen-grid to attract more electrons, which means an increase in screen-grid current and hence overheating of the screen-grid.

A.10. The 6SA7 differs from other pentagrid converters in that it has no anode grid but does have a suppressor-grid which is internally connected to the metal shell. The effect is a higher conversion gain.

A.11. In the "trimmer substitution" automatic tuning systems a series of pre-set trimmer condensers are shunted across the tuned coils in place of the regular tuning condenser.

A.12. For alignment adjustments in receivers equipped with automatic tuning, the tuning mechanism should always be set for manual tuning.

A.13. Permeability tuning is the method of tuning a circuit by varying the inductance of the coil with an iron core that is movable within the coil and that changes the magnetic permeability and also the inductance.

A.14. Tone compensating circuits are added to manual volume control systems to compensate for the decreased sensitivity of the human ear over the low and high frequencies at reduced volume.

A.15. Let subscripts (0) and (1) represent original and new conditions respectively. Then for primary impedance and current ratios for the two conditions we have:

$$(1) Z_0 = \frac{E}{I_0} \text{ and } Z_1 = \frac{E}{I_1}$$

$$(2) \frac{Z_1}{Z_0} = \frac{E/I_1}{E/I_0} = \frac{I_0}{I_1} = \frac{1}{.65} = 1.54$$

The impedance Z_0 of the primary with coupled-in shunt resistance R_0 would be:

$$(3) Z_0 = \frac{R_0 X_L}{\sqrt{R_0^2 + X_L^2}}$$

In which we know that R_0 and X_L are disposed at right-angles and R_0 of which represents the opposite leg of the triangle with respect to the phase angle being sought. This allows us to write immediately that:

$$(4) \sin \theta_0 = \frac{R_0}{\sqrt{R_0^2 + X_L^2}}$$

Conditions being similar in the new case we may also write:

(Continued on page 244)

All the worthwhile
Radio Trade News
of the past Month—
Digested for busy
radio men.

RADIO Trade Digest

A PLEDGE: — To
print the important
news of the radio
industry; to review
major news events;
to help point a path
to radio profits.

IMPORTANT HAPPENINGS OF THE MONTH IN THE RADIO INDUSTRY

No. 14

OCTOBER, 1939

No. 14

NEW RSA OFFICERS FOR 1939-'40 TERMS

G. F. Duvall, President, with
K. A. Vaughan as V-P—
Big Drive Goes On.

Elected to the highest office of RSA, National President George F. Duvall, 8005 Third Ave., Brooklyn, N.Y., in his inaugural address to the members of RSA, said:

"Our organization is the result of cooperation; cooperation between Servicemen, cooperation with the Sales Managers Clubs, the RMA, the Trade Journals, and other branches of the radio industry, and now cooperative action in the RMA-NAB campaign for the betterment of radio. Cooperation is the foundation of RSA."

Elected vice-president for 1939-'40 was Kenneth A. Vaughan, 312 Market St., Johnstown, Pa. Donald H. Stover, 9 South Galena Ave., Freeport, Ill., and Lee Taylor, 1352 Catalpa Ave., Chicago, Ill., were re-elected Secretary and Treasurer respectively for the fiscal year 1939-'40.

(Continued on page 248)

RMA Reorganizes Parts Div.

As directed at the annual meeting of the Parts & Accessories Div. of RMA, H. E. Osmun, Milwaukee, new chairman, has commenced reorganization. Director Octave Blake, Plainfield, N. J., has been appointed chairman of the Eastern Div.; Director J. J. Kahn, Chicago, Ill., chairman of the Western Div. Principal groups of mfrs. will be organized separately to develop requisite RMA services.

RADIO INDUSTRY MOURNS U. J. "SPORT" HERRMANN



In the passing of Commander U. J. "Sport" Herrmann, the radio industry has lost one of its most philanthropic and colorful characters, while Zenith Radio Corporation suffers the loss of one of its oldest and best liked directors. Mr. Herrmann had been a director from the company's incorporation in 1923 to the time of his death at Sturgeon Bay, Wisconsin, resulting from a taxi accident near that town.

For years "Sport", whose nickname was given him as the result of his intense and sincere interest in sports of every kind, conducted the radio industry's shows both in New York and Chicago. During his operation of the radio shows, he paid many thousands of dollars in profits to the Radio Manufacturers Association. In fact, during the Association's days of early struggle, he was one of its main supporters.

It was Brownie the dog (above, with Sport) who helped to save Walter C. Wagner, Chief Engineer of the Chicago Public Library, who was with Mr. Herrmann at the time of the taxi accident that resulted in his death. Sport never drove a car, and had hired the taxi and driver to connect him with his boat at Sturgeon Bay. Wagner who was sitting in the rear seat with Brownie fell on the dog during the crash. The 4 people in the two cars were knocked unconscious by the force of the impact.

(Continued on page 248)

NEW RADIO RULES TO REGULATE BIZ

Federal Trade Commission Has
Announced Regulations
For the Trade

Over-enthusiastic manufacturers, jobbers and dealers will do well to cast an eye on the new rules for the radio industry, recently published by the Federal Trade Commission.

Among the practices which earn a frown from the FTC is advertising that world-wide reception is possible with sets that are not actually capable of such performance. Other too-optimistic advertising is also forbidden. Additional rules regarding deceptive selling practices and other unfair business methods are also under the FTC ban.

According to a special story in the New York Evening Sun, about 7,150,000 complete sets were sold in '38, with a total value of approximately \$225,000,000 at retail. These sales were computed to have brought the total number of sets in use today to some 41,000,000. Incidentally, other recent figures gave the broadcasting industry (as distinct from the radio mfg. biz) an inventory of nearly \$1,000,000,000!

5% Radio Tax to Continue

Congress has voted to extend the 5% Federal tax on radios & phonos until June 31, 1941. Despite this, the RMA, undaunted, will continue its fight to get the tax repealed or, at least, reduced. There is some hope for action when the next Congress convenes this autumn. The RMA Legislative Committee will submit data toward that end, for the industry's benefit.

FIRST DISTRIBUTOR SOUND SHOW



Otto K. Olsen Co., of Hollywood, RCA commercial sound distributors, drew an audience of 8,000 to the 1st distrib-sponsored public showing of commercial sound equip. Invites went to schools, police, aircraftsmen, movie men, etc.

WINDOW STARS SINGLE SET



One lone Westinghouse portable was dramatically highlighted by being the only set in the Haynes-Griffin window display in New York's Hotel Roosevelt. Cleverly chosen accessories gave outdoor touch & (them hats!) sex appeal.

Changes & New Addresses
Where to Reach Old and New Companies

HARRY B. SEGAR, Ellicot Sq. Bldg., Buffalo, N. Y., has been appointed Thordarson rep for Upper N.Y. & Erie, Pa. (See pic, Pg. 230.)
ANCHOR DISTRIBUTING CORP., 955-957 Liberty Av., Pittsburgh, Pa., is the former Anchor Lite Appliance Co. They're Crosley distributors—& have a Wheeling, W. Va. office, too.
TELEVISION TRAINING SCHOOL, Grand Central Palace, N.Y.C., has added 1,200 sq. ft. of space for labs.
(Continued on page 249)

DU MONT'S "PEEK-A-BOOTH"



Forming a huge shadow box, the Du Mont "Peek-A-Booth", designed by that co.'s sales mgr., L. F. Cramer, permits telly sets to be demonstrated in brightly lighted stores. Offered at cost to dealers handling the line, it is big enough to hold a console.

MAKE A DATE WITH \$\$\$



National Union dealers can get calendars like this (or in 3 other designs) at \$4.50 per 100, including imprint, to keep firm name before prospects. Distributors now have samples on hand, so dealers & Servicemen can get a look at the full-color reproductions of oil paintings.

Personal

These men are worth knowing; meet them here.

SAMUEL E. MILBOURNE, Service Engineer of Supreme Instruments Corp., Greenwood, Miss., made a recent trip to N. Y. There were unverified rumors that the stay might be unexpectedly lengthy.

JOHN ALTMAYER, for more than 2 yrs. Adv. Mgr. of Brush Development Co., Cleveland, O., has left to become acct. exec. & tech. consultant of Gregory & Bolton, Inc., adv. agy. of Cleveland & Youngstown, who handle Brush advtg. A "ham," Altmayer's call is W8DAR.

HOWARD J. FAIRBANKS, Pittsburgh div. mgr. of Hygrade Sylvania Corp., now has the
(Continued on page 250)

Sales Helps and Deals

New Paths to More Business

Stewart-Warner's 25 models of 1940 sets are presented to potential customers in a new 2-color manual now being furnished to dealers.

Du Mont's shadow box "Peek-A-Booth" helps dealers demonstrate telly sets in brightly lighted stores. (See pic; this pg.)

Arcturus Radio Tube Co. has 4 colorful window or counter cards to plug their mdse.—& more coming. Free to dealers
(Continued on page 249)

THORDARSON SALES FORCE MEETS



The annual get-together of the entire Thordarson sales group at the Steven's Hotel was presided over by W. S. Hartford, new sales chief. Sales engineers pointed out the salient features of the recently announced line of broadcast components & additions to the regular transformer line. Sales representatives from all sections of the country were reported as especially enthusiastic concerning the new amplifiers.

TOGETHER WITH FOREIGN DISTRIBUTORS

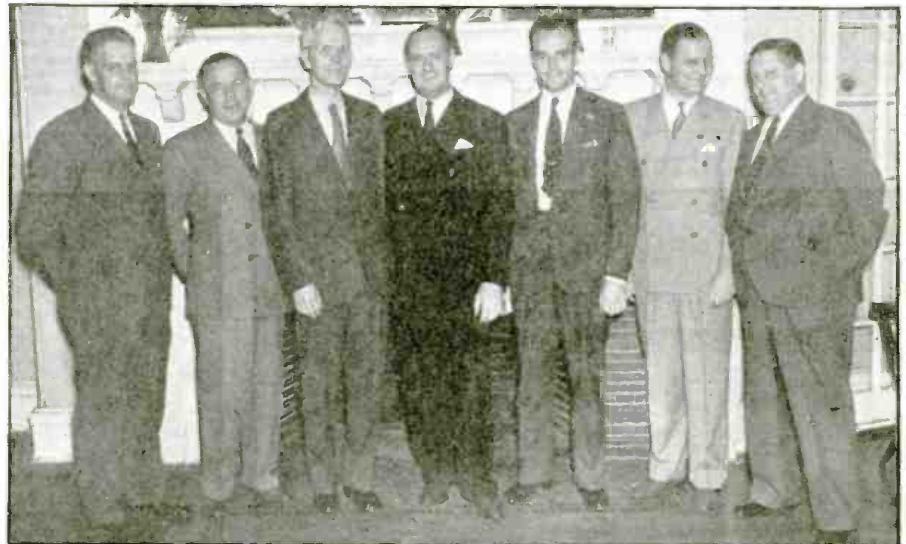

Foreign distributors from remote corners of the earth, including South Africa, India, South America, Cuba, Greece, Turkey, convened in New York to view the 1940 line of Philco export radio models. L. to R. are: C. E. Carpenter, mgr. of tube, battery and auto-radio sales division; John S. Haber, vice-pres., Export Division; W. S. Crammer, export mgr.; David Earnshaw, export engineer; E. J. Krause, mgr. of radio-phonograph sales div., and Maurice O'Grady, treasurer, export div.

AN EDITORIAL

By Artie Dee

Did you ever hear the story about the fellow who was walking home along a dark street late at night? This chap saw a tough-looking citizen leaning up against a doorway, and broke into a cold sweat. When he had gotten a little way past the plug-ugly, he mopped his brow in relief and continued on his way. A little further along, he looked over his shoulder and saw the tough egg running after him. Terrified, the timid lad broke into a gallop, and tore through the darkness with the thuggish gent a couple of lengths behind. When he could run no more, he stopped, to let his fate (in the person of his pursuer) catch up with him. "Take my wallet," he gasped, "but spare my life."

"Your wallet?" panted the plug-ugly. "You dropped it; I been chasing you to give it back."

"Why didn't you yell at me?" asked the timid soul.

"Say," said the gentle hard guy, "I needed all my breath for myself."

The above is not merely an anecdote—it's a parable. You, Mr. Dealer, are the timid citizen; Television is the fearsome stranger, really a friend.

Remember that television does not mean fewer radio sales; it means *bigger* sales. Minimum sale of a radio set is about \$6; minimum sale of a television set is about \$200. Figure out how many radio sets you'd have to sell in order to make as much net profit as one television sale would bring you.

If you are located within a radius of, say, 30 miles of any city with a population of 100,000 or more, you ought to be out right now, fighting to get a television station erected.

Television will mean money in your pocket. Don't run away from it.

\$'s & No.'s Dept.

\$7 MILLION NET from a \$68 million gross biz in '38 was the enviable record rolled up by the 3 major nets, plus 23 "managed & operated" stations.

G-E BIZ UP, as orders received during 1st 6 mos. of '39 topped \$169 million, beating same period of '38 by 32%.

EXPORTS ZOOMED in May—some \$67,000 above same mo. of '38—to \$1,728,843. The breakdown:

Sets (#)*	41,605
Sets (\$)*	\$760,955
Tubes (#)*	608,491
Tubes (\$)*	\$243,465
Parts (\$)	\$421,894
Speakers (#)*	45,483
Speakers (\$)*	\$65,301
Xmtg equip't (\$)*	\$243,228

(*Indicates divisions ahead of preceding year; only parts & accessories dropped.)

OFF THE PRESS

Latest Publications to Keep You Informed

BULLETINS. Crowe Name Plate & Mfg. Co., Chicago, Ill. #230 shows complete line of remote controls & panel kits for auto radios. #225 shows components for radio, telly, sound & experimental work.

(Continued on page 249)

DE LUXE TELLY ANTENNA

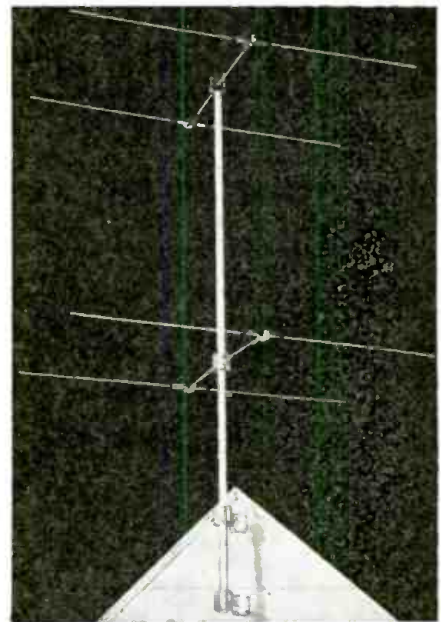

When telly sets are installed where sigs are weak, something like the G-E double dipole with reflectors, shown above, is just what the M.D. ordered. Line includes other models &, of course, a wide range of teleceivers.

QUINTS IN COLOR

The appeal of the Five Little Girls is used to boost the sales of midget sets to the juvenile market & to oldsters who think youngsters "cute". Emily, Yvonne, Marie, et al., appear in full-color photographic reproductions atop this new Stewart-Warner set. (By the way, what ever happened to other makers' M. Mouse & C. McCarthy models?)

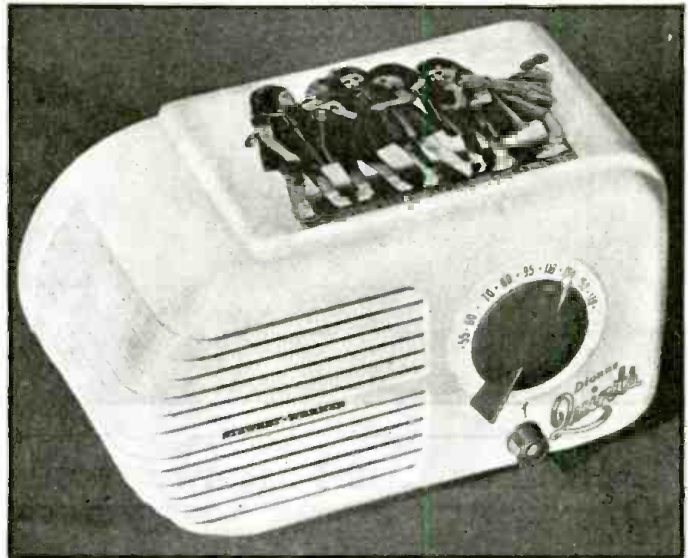

LAFAYETTE SOUND SYSTEM PROMOTES ROAD COURTESY FOR SHELL OIL



Rear view of the Crusader, showing apparatus, including "gas" driven motor-generator power supply, mounted in ventilated luggage compartment accessible from inside or outside of car.

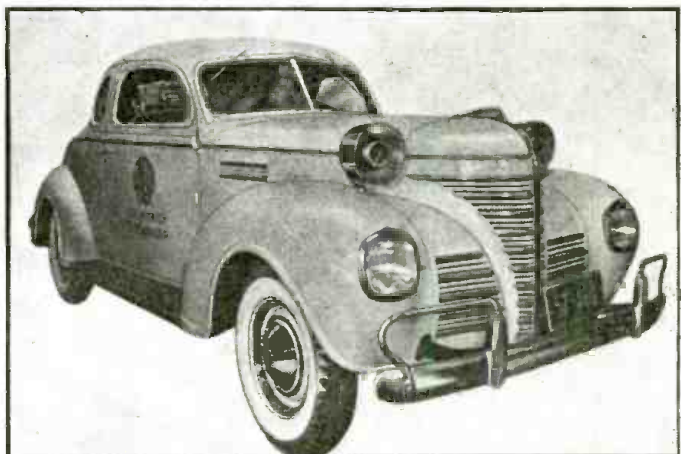

Twin chromium loudspeakers mounted on the fenders of the Shell Oil "Courtesy Crusader" are fed by a 30-watt Lafayette model 271 standard amplifier. Operator in car handles controls & breast mike.



Parts used in telly deflecting circuits have now been made available to experimenters by RCA—with diagrams! . . . Vic Mucher of *Clarostat* sees the south as a lively market, with negro share-croppers pinching pennies to buy sets . . . Did we tell you *IRC* type CS metallized controls have the new plug-in shafts? If not, scuse, plizz . . . Ad man Myron C. Zobel has equipped his \$17,500 trailer with telly; it has a 1 kw. xmtr (W1LSV), too.

Telly won't supplant radio, but will supplement it, says Dr. W. R. G. Baker of G-E, confirming everybody else's opinion . . . 15 of the 25 models in Stewart-Warner's '40 line are new, including the telly set . . . The co. gave each distrib a sales manual, with a silver \$ in the cover . . . Anchor Light
(Continued on page 249)

TELEVISION TRENDS

BROKER IS OFFICER

American Television Corp., N.Y.C., has strengthened its board of directors with the appointment of A. W. Tahaney, Holland, Mich., Raymond Starr, former Att'y-Gen. of Mich., & Maxwell Landsman, ex-theatrical producer. Dewey Bullock, pres. of Roger Verseput & Co., in-

(Continued on page 249)

RCA SERVICE MANAGER



W. L. Jones, who joined RCA by way of the old American Marconi Company, in 1919, was a marine radio operator until '28, when he became a motion picture field engineer with Photophone in N.Y. In '31 he became N.Y. District Service Mgr., and in '37 headed all Photophone service activities. Now he's Natl. Service Mgr.!

HE'S A LONG, LONG WAY FROM HOME!



Biz in S. Africa has been slowing up, due to the international situation, though there are still some sales, according to E. G. Long-Innes, secy. of H. Pollack & Co., Johannesburg, S.A., Crosley distrib. L. to R.: Lewis M. Crosley, exec. v-p; Mr. E. G. L-I; & O. Bermudez, Crosley export mgr.

NEW ASST. DIV. MGR.



Fred W. Wentker, new asst. Photophone div. mgr., became associated with RCA in '28 as a Photophone service engineer in the New York area. In '34 he moved to Pittsburgh as Dist. Service Mgr., and 3 yrs. later was named Assistant Service Mgr. at Camden headquarters.

STROMBERG-CARLSON BOOTH AT BOSTON TRADE SHOW



Gross Sales, Inc., S-C distrib, had mobs listening to the Louis (they spell it "Lewis")-Galento scrap at Boston Trade Show. Set used was Model 480-M, which will also catch frequency-modulation bcsts.

THORDARSON REP



Harry B. Segar, in the radio parts biz since '22, now represents Thordarson in upper N.Y. State & Erie, Pa. Mr. Segar has been a factory rep for the past 5 yrs.

DEALERS! SERVICE MEN! AMATEURS! P.A. SPECIALISTS! BUILDERS!





Get Radio's Biggest Catalog!



204 PAGES!
FREE

ALLIED'S *New* 1940 CATALOG BRINGS YOU EVERYTHING IN RADIO AT LOWEST PRICES

Never before a book like ALLIED's 1940 catalog! 204 pages, exclusively radio—5 big complete sections, for Dealers, Servicemen, Amateurs, Sound Specialists and Builders. Whatever your interest in radio, here's everything in radio at your fingertips, for instant reference, at lowest prices! Packed with the latest equipment from cover to cover—more than 15,000 items—newest Sets, Kits, P.A., Recording Equipment, Ham Gear, Test Equipment, parts, books, tools, etc., all organized for quick and easy reference. This new 1940 catalog from ALLIED's "Radio Headquarters" saves you time and saves you money, and assures you of the highest quality merchandise at amazingly low prices. Send coupon today for ALLIED's 1940 catalog—it's Free.

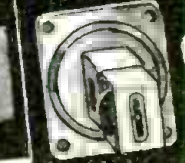
<p>60 NEW SETS</p>  <p>Greatest set values in ALLIED's history! 60 new Knight models, 4 to 12 tubes, featuring built-in Air-Magnet Aerials and new Push-Button Tuning. New lower-priced portables—1½-volt models, AC-Battery, strap-type, etc.—new plastic cabinets, etc.—sets for every purpose—and phonographs (1-tube electric, etc.)—phono-radios (5, 7, 11 tube)—new recorder-phono-radio combination cabinets, complete phono accessories—they're all in ALLIED's new catalog at lowest prices. Send coupon today.</p>	<p>P. A. 3 NEW LINES</p>  <p>Now, "Economy," "Standard," and "De Luxe" lines—14 new systems, portable, mobile, permanent, 6-65 watts. New beauty utility. New system for 110 volts AC-DC, battery, 32 volts, etc.—20-watt with built-in phono, new Power Stages, etc. Also new Knight "mikes," complete recording equipment and P.A. accessories, new low-priced discs, etc.—Hearing Aid, and other specialties.</p> <p>New Time Payment Plan Lowest carrying-charge, easiest terms. See ALLIED's 1940 Catalog.</p>	<p>HAM GEAR! ALL LEADING LINES</p>  <p>The largest Ham Section ever published!—every receiver, transmitter, transceiver from every leading line, spread before your eyes at lowest prices! All newest receivers, Sky-riders, "Defiant," Television equipment, Rotary Beam equipment, etc. 20,000 Amateurs buy from ALLIED, because ALLIED knows Ham problems, needs, desires. Get this big new Catalog today!</p> <p>New Time Payment Plan Lowest carrying-charge, easiest terms. See ALLIED's 1940 Catalog.</p>	<p>TESTERS! ALL NEWEST ITEMS</p>  <p>ALLIED's biggest Service Section, with everything in Test Equipment from every leading manufacturer. New television equipment, latest Analyzers, Oscilloscopes, Set-Testers, Meters, etc. 110-volt tube testers, Rider Volt-Ohmyst, etc. And all the parts you need under one roof, for instant shipping. Thousands of service men know it pays to order from ALLIED—saves time, money, saves satisfaction always. Write for Catalog today. Time Payment Plan.</p>	<p>ALL THE NEWEST KITS</p>  <p>In ALLIED'S 1940 Catalog, dozens of new kits. Beginners 1, 2, and 3-tubes to the most advanced—New Television Kit, Wireless Phono and diagrams and projects for building 100 different circuits, ALLIED is Builders' Headquarters, answers hundreds of letters daily on building orders from builders all over the world. See what's new in ALLIED'S 1940 Catalog.</p> <p>FREE PARTS LISTS We supply matched kits for any circuit described in any magazine.</p>	<p>PARTS! BIG NEW SECTION</p>  <p>See latest new type tubes—110, 117-volt, etc.—thousands of exact duplicate and exact duplicate parts for every need—new tool replacement, complete list, everything new in accessories—television attachment, new Book Section—"Everything in Radio" in one book, at lowest prices! Send for a Free Catalog today—make ALLIED your headquarters for radio supplies, as thousands do, and save time and trouble on every order.</p>
--	--	---	---	---	--

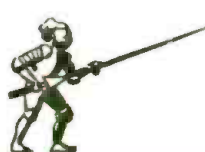

And a Big New Bargain Section Where Prices meet their Waterloo!

Specials, every one!—the country's biggest radio bargains, in the special "color" section. Don't miss these values!

ALLIED RADIO CORPORATION

FREE SEND COUPON

ALLIED Radio Corporation
833 W. Jackson Blvd.,
Chicago, Ill. Dept. 2-K-O

Send your Free 204-page Radio Catalog.

Name

Address

City State

Please Say That You Saw It in RADIO-CRAFT

THE RADIO MONTH IN REVIEW

(Continued from page 199)



**RADIO—
MANY OPPORTUNITIES
STILL AHEAD**

• The radio industry has hit its full stride! The future, with Television, presents great opportunities—for the trained man! The I. C. S. Radio Course, prepared by experts in practice as well as theory, is constantly revised to meet new developments. This Course can make you a trained man — prepare you for promotion and a trained man's salary! Send for free booklet.

INTERNATIONAL CORRESPONDENCE SCHOOLS

Box 6679-E, Scranton, Penna.

Send me—free—information on subject checked

- Radio
- Radio Operator
- Radio Service Man
- Electrical Engineer

Name.....

Address.....



FAMOUS MEMBERS OF A FAMOUS FAMILY

Preserved for posterity on the pedestals of popularity are these four genial kents who represent the millions of Quality Parts in use throughout the world.

As a foursome . . . or individually . . . they stand for sterling honesty in performance . . . integrity in service . . . and all the other glowing virtues that a radio-part should possess.

So, if you are a ham . . . a serviceman . . . an experimenter . . . fall not . . . on sundry and all occasions . . . to SPECIFY CENTRALAB.

- RADIOHM
- FIXED RESISTOR
- CERAMIC CAPACITOR
- WAVE BAND SWITCHES



DIV. OF GLOBE-UNION INC.
900 E. Keefe Ave., Milwaukee, Wis.

MISCELLANEOUS

CONFIRMING *Radio-Craft's* report in the September issue that Sept. 22 would be "De Forest Day" at the New York World's Fair 1939, the Veteran Wireless Operators Assoc., via pres. McGonigle, last month telegraphed *Radio-Craft* that all scientific societies would participate "in deserved tribute to prolific inventor in many humanitarian fields. De Forest Day activities at World's Fair to culminate in Jubilee Dinner. . . ." (Photo, pg. 198.)

The "Century of Progress" exhibition train of Union Pacific (photo, pg. 199) housed portable broadcast station WOEG (150 meters, 50 watts; range, which is sufficient for rebroadcasting, 15 to 20 miles using a 200-ft. antenna stretched on top of 3 cars) in a specially-constructed, sound-proofed room in a standard baggage car, which followed the 2-unit, 5,000-h.p. steam-electric locomotive. G.E.'s v.-p. Andrews, who "fathered" this locomotive, last month swapped interest in engines for a new love, appliances, upon becoming director of the company's appliance activities.

When calves began to die like flies, when pneumonia developed during shipments; and when a year later cattle on the same ranch developed diphtheria, a ranch owner's technically-inclined son found that short-wave radio diathermy was a curative. The efficacy of radio as an aid to the veterinarian is attested to by the findings, last month, of the Los Angeles County Live Stock Association in checking up on the work of Mr. Richard Hathaway, at his father's ranch at Santa Fe Springs, Calif. A wavelength of approximately 18 meters, generated by a De Forest Dynatherm, was found to be efficacious. Pet Hospitals also report extensive use of shortwave treatments for small animals, especially in Hollywood and Beverly Hills. Cats, dogs and other animals respond to treatment for everything from sore throat to actual bone injuries.

A new type 100-kilowatt radio tube in which the filament can be replaced, the first of its kind in this country, has been developed by engineers of the General Electric Company, the company announced last month.

They are the largest tubes of their kind yet to be built in this country and when used with the new Alexanderson panel antenna, are expected to produce an effective directional power output from international shortwave broadcast station W2XAF of more than 600,000 watts.

(This tube, shown on the cover of this issue of *Radio-Craft* and on page 199, is known as the G.E. developmental demountable pliotron, 100 kw., type FZ-1-C1. In the latter photo the demountable filament assembly is shown being held in a man's hand, at right. This view also shows the entire tube, and its exhausting apparatus.)

The new tube makes possible greater power output with a simpler set-up at the transmitter, thus providing greater efficiency in transmission. Whereas 6 tubes are now used to obtain a power output of 40 kilowatts, 2 tubes of the new type will have a power output of 100 kilowatts. (The need for increased power became known when it was found that foreign listeners often experienced side-band interference.)

The filaments of the new tubes can readily be replaced. Instead of the tubes being sealed off when built, an electrically driven pump is attached to them which runs continuously, thereby maintaining the vacuum at all times.

A new-type filament of activated tungsten was used in the tubes which allows greater current at lower voltages. Whereas the 50-kilowatt stations have been using upwards of 15,000 volts to operate the tubes, the new units will operate on from 5,000 to 8,000 volts.

Cooling of the tubes is accomplished by a circulating water system.

Laboratories in Europe of International Standard Electric Corporation, which manages the greater part of the manufacturing and sales properties of I.T.&T. throughout the world, have conducted extensive research in the field of extremely high frequencies in connection with their general development work on wire, cable and radio telephone and telegraph transmission and on television. I.T.&T. engineers abroad were the first to employ successfully micro-waves, with tiny wavelengths of 17 centimeters; and they have made outstanding advancements in multi-channel ultra-shortwave telephone operation.

Whereas frequencies of about 10 megacycles per second employed in multi-channel telephony or in television are propagated by means of coaxial conductors, wave of a few centimeters (10,000 million cycles per second; for instance) can be transmitted successfully over simple, pipe-like tubes without any central lead, and these are known as dielectric guides.

The propagation of these waves in guides of practical dimensions involves, of course, the use of oscillations of extremely high frequencies. For instance, within the past 6 months, the I.T.&T. engineers have demonstrated in Paris the operation of two oscillators the first derived directly from their ultra-shortwave radiotelephone experience, able to produce waves of 50 centimeters in length; and the second, an oscillator of the magnetron type which is capable of producing oscillations of 20,000 million cycles per second, a wavelength of approximately 1.5 centimeters.

Such oscillations are transmitted in a peculiar manner by the dielectric guides and although it is possible, from the Maxwell Equations, to foresee the essential properties, it is not an easy matter to show the different types of waves and the distribution of electric and magnetic fields which characterize them. Several interesting instruments developed recently by the I.T.&T. engineers include trial equipment for demonstrating in dielectric guides of 12 and 16 millimeters diameter, the propagation of 3 main types of waves, and an apparatus which makes it possible to transform one type of wave into another; unlike other transformers, wound with coils of wire around an iron core and transforming voltage; this transformer with a squirrel cage appearance, transforms an Eo type wave into an Ho.

Referring to the photos of these new devices, shown on page 199 and released last month, in the middle is an 8 cm. wavelength generator together with its wavemeter. On the left, the coupling apparatus to a dielectric guide 12 cm. in diameter. On the right-hand side, the receiving apparatus of a dielectric guide 16 mm., inside diameter.

The photo at extreme right shows the apparatus used to transform one type of wave into another (here Eo wave into Ho wave); and the associated filter to eliminate the unwanted remaining portion of the original wave (Eo). Transmission takes place back to front in the apparatus as shown.

Please Say That You Saw It in RADIO-CRAFT

THE NEW MODEL 1250 MULTITESTER



Sloping panel for precise rapid servicing.

Specially designed electronic rectifier enables linear A.C. scale, high stability and little or no temperature drift.

Here is an opportunity to acquire a Multi-Service, Precision Engineered Instrument, for less than you would have to pay for an ordinary Volt-Ohm Milliammeter. Besides making the usual volt, resistance and current measurements (both A.C. and D.C.) this unit accurately measures the CAPACITIES of mica, paper and electrolytic condensers, INDUCTANCE of coils, chokes, and transformers, DECIBEL gain or loss, of power amplifiers and public address systems, WATT'S output of amplifiers, receivers, etc.

SPECIFICATIONS

- Complete A.C. and D.C. Voltage and Current Ranges.
- D.C. Voltage: 0-15, 0-150, 0-750 Volts.
- A.C. Voltage: 0-15, 0-150, 0-750 Volts.
- D.C. Current: 0-1, 0-15, 0-150, 0-750 ma.
- A.C. Current: 0-15, 0-150, 0-750 ma.
- 2 Resistance Ranges: 0-500 ohms, 500-5 megohms.
- High and Low Capacity Scales: .0005 to 1 mfd. and .05 to 50 mfd.
- 3 Decibel Ranges.
- 10 to +19, -10 to +38, -10 to +53.
- Inductance: 1 to 700 Henries.
- Watts: Based on 6 M.W. at 0 D.B. in 500 ohms .006000 to 600 watts.

Model 1250 works on 90 to 120 Volts 60 cycles A.C. Complete with test leads, tabular charts and instructions. Shipping weight 9 pounds. Size 9 1/2" x 11" x 6 1/2". Our Net Price **\$11⁸⁵**
Portable Cover \$1.00 Additional

THE NEW MODEL 1240 TUBE TESTER



Instantaneous snap switches reduce actual testing time to absolute minimum.

Tests all tubes 1.4 to 117 volts.

Sockets for all tubes — no adapters.

Superior is proud to offer the newest and most practical tube tester ever designed. Unbelievably low in price—unbelievably high in performance.

- ★ Tests all tubes, 1.4 to 117 volts, including 4, 5, 6, 7, 7L, octals, loctals, Bantam Jr., Peanut, single ended, floating filament, Mercury Vapor Rectifiers, the new 8 series. In fact every tube designed to date.
- ★ Spare socket included on front panel for any future tubes.
- ★ Tests by the well-established emission method for tube quality, directly read on the GOOD ? BAD scale of the meter.
- ★ Jewel protected neon.
- ★ Tests shorts and leakages up to 2 megohms in all tubes.
- ★ Tests leakages and shorts in all elements AGAINST all elements in all tubes.
- ★ Tests BOTH plates in rectifiers.
- ★ Tests individual sections such as diodes, triodes, pentodes, etc., in multi-purpose tubes.
- ★ Latest type voltage regulator.
- ★ Features an attractive etched aluminum panel.
- ★ Works on 90 to 125 volts 60 cycles A.C.

INSTANTANEOUS SNAP SWITCHES REDUCE ACTUAL TESTING TIME TO ABSOLUTE MINIMUM.

Model 1240 comes complete with instructions and tabular data for every known type of receiving tube. Shipping weight 12 pounds. Size 6" x 7 1/2" x 10 3/4". Our Net Price **\$11⁸⁵**
Portable Cover \$1.00 Additional

THE X-RAYOMETER FEATURES A NEW

GIANT 9 INCH METER—AND A BUILT-IN POWER SUPPLY ENABLES RESISTANCE MEASUREMENTS UP TO 30 MEGOHMS

SPECIFICATIONS

- RESISTANCE MEASUREMENTS IN 3 RANGES: 0-1000 Ohms, 0-100,000 Ohms, 0-30 Megohms.
- D.C. VOLTAGE MEASUREMENTS IN 5 RANGES: 0-50, 0-250, 0-500, 0-1000, 0-2500 Volts. Television and other high voltage power supply circuits easily measured.
- A.C. VOLTAGE MEASUREMENTS IN 4 RANGES: 0-50, 0-250, 0-500, 0-1000 Volts.
- D.C. CURRENT MEASUREMENTS IN 6 RANGES: 0-1 Ma., 0-50 Ma., 0-250 Ma., 0-1 Ampere, 0-10 Amperes, 0-25 Amperes. High current ranges suitable for automotive and industrial work.
- CAPACITY DIRECTLY READ ON METER SCALE IN 2 RANGES: .005-1 Mfd. 2 Mfd.-50 Mfd.
- PERCENTAGE OF LEAKAGE of electrolytics read DIRECTLY on meter scale. Actual condition of condenser quickly determined.
- INSULATION, INTER-ELEMENT and A.V.C. LEAKAGES directly read on meter scale up to 30 Megohms.
- OUTPUT MEASUREMENTS IN 4 RANGES: 0-50, 0-250, 0-500, 0-1000 Volts. Built-in blocking condensers enable rapid alignment of radio equipment.
- INDUCTANCE MEASUREMENTS IN 2 RANGES: 0-7 Henries, 7-703 Henries.
- DECIBEL MEASUREMENTS IN 3 RANGES: D.B. based on 6 M.W. at 500 Ohms. -10 to +29, -10 to +43, -10 to +49. Audio frequency measurements in both radio and P.A. amplifiers.

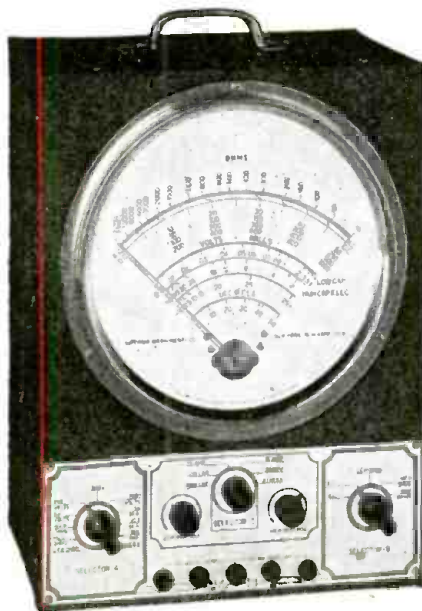

X-RAYOMETER comes housed in a new army gray crystalline, heavy gauge cabinet. Complete with test leads, instructions and tabular data. Shipping weight 20 pounds. **\$17⁹⁵**
ONLY

THE NEW MODEL 1130-S SIGNAL GENERATOR WITH AUDIO FREQUENCIES

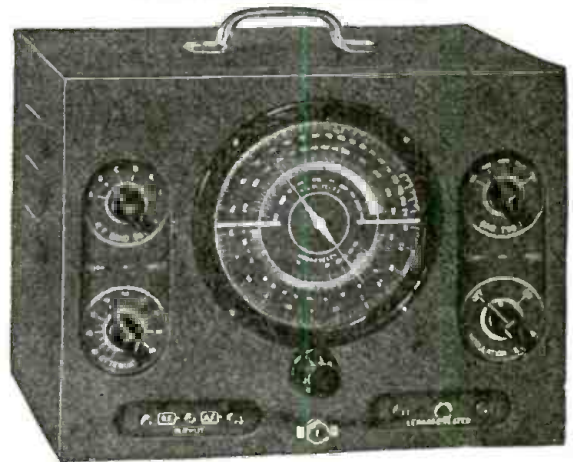

1. Combination R.F. and Audio Signal Generator. R.F. 100 kc. to 100 megacycles A.F.—100-7500 cycles. All direct readings, all by front panel switching.
2. R.F. and A.F. output independently obtainable alone or with A.F. (any frequency) Modulating R.F.
3. Accuracy is within 1% on I.F. and Broadcast bands; 2% on higher frequencies.
4. Audio frequencies in 5 bands: 100, 400, 1000, 5000, and 7500 cycles.
5. Giant airplano full vision, direct-reading dial.
6. Condenser and other leakages tested to 100 megohms.
7. All services on 90-130 volts A.C. or D.C. (any frequency).

Model 1130-S comes complete with tubes, test leads, carrying handle and instructions. Shipping weight 16 lbs. **\$11⁸⁵**
Our net price

**SUPERIOR INSTRUMENTS CO. 136 LIBERTY STREET, RC-10
NEW YORK, N. Y.**

Please Say That You Saw It in RADIO-CRAFT

QUICKER, EASIER WAY TO TRAIN FOR **ELECTRICITY** 12 Weeks Practical WORK IN MY CHICAGO SHOPS



WANT TO EARN MORE MONEY?

Of course you'd like a good-pay job. But wishing won't get it for you. Dreaming won't do it. Doing can! And I'm ready to help you on your way to a start.

I'm ready to make it easy for you to get 12 weeks of real shop training in **ELECTRICITY**—training that can help you toward a better job.

This is no correspondence course I'm talking about. You do actual work right in my Chicago shops—real work on real generators, motors and dynamos. You do house wiring and wind armatures. You work in many other branches of electricity. And right now I'm including valuable instruction in Diesel, Electric Refrigeration and Air Conditioning.



HOUSE WIRING
only one of the many branches you "Learn By Doing"



Coyne has first class instructors to teach you the simplest things to start with and they have the equipment to show you these things as you advance.
Ben Rickman, S. Car



Everything was just as stated in literature. And by Coyne methods plenty of instructors to take care of everything, easy to learn. I really was satisfied with Coyne Training.
J. Hatyk, Canada



I'LL FINANCE YOUR TRAINING

If you are short of money you can get this training first—then pay for most of it later in 12 easy monthly payments, starting 60 days after your 12 weeks training period is over.

If you need part-time work to help out with expenses while training in my shops, my employment department will assist you. And after graduation, you'll get lifetime employment service. Mail the coupon today and I'll send you my big free book filled with interesting facts and pictures of students at work—doing the same things you will do. I'll also tell you about my "Pay After Graduation" Plan and how many of my students earn while learning. Fill in, clip, and mail the coupon today. H. C. Lewis, President.

COYNE
ELECTRICAL SCHOOL
500 S. Paulina St. Dept. 79-78, Chicago



MAIL THIS COUPON NOW

H. C. Lewis, President
COYNE ELECTRICAL SCHOOL
500 S. Paulina St., Dept. 79-78, Chicago, Ill.
Please send me free your big catalog and full particulars of your "Pay After Graduation Plan"—also other facts.

NAME.....
ADDRESS.....
CITY.....STATE.....

ALL-PUSH-PULL DIRECT-COUPLED 30-WATT AMPLIFIER

(Continued from page 203)

When the same change is made during normal signal levels, no change in volume takes place. The overall result is both an apparent and actual reduction of scratch to less than 1/16th its original value! Worn records with excessive scratch become tolerable. New records with normal surface noise become scratchless.

By choosing the proper circuit constants for the inverse expanding circuit so that a flat response is maintained between 20 and 20,000 cycles, the scratch-suppressing circuit becomes non-frequency discriminating.

If we bear in mind that the operating principle of this scratch suppressor is based on an important differentiating characteristic between objectionable and tolerable scratch (signal-to-scratch ratio), we can mentally appreciate its effectiveness. Nevertheless, like many other aural phenomena, it must be heard to really be appreciated. (Insofar as the author is aware this new principle in scratch filters has never before been described in print.—*Editor*)

Remote Control. Like all of the other features mentioned, *Remote Control* may under certain conditions become a prime requisite in an amplifier installation. Many types of remote control circuits have been developed—some good, others bad; but few indeed have been incorporated into push-pull circuits. The control of gain by applying a variable bias (via the cathode circuit) to a variable- μ tube has met with wide approval. Its distortion characteristics, at various attenuation levels, are usually overlooked because subsequent distortion introduced in the following stages usually masks that of the input stages.

The remote control circuit employed with this amplifier introduces no 2nd- and a negligible amount of odd-harmonics. Its smooth attenuating range, freedom from microphonics, minimum distortion, ability to use

ordinary tubes, and extreme simplicity mark it as a distinctive contribution to remote control circuits.

Flexibility of Input Circuits. The wide variations of applications to which a general amplifier may be subjected makes it imperative to design a flexible input circuit whereby any number of high- or low-impedance inputs may be made available to accommodate any combination, or type of input signal devices. Such a flexible input system is described, for use in conjunction with the basic 30-watt direct-coupled amplifier.

Flexibility of Gain. By making available a choice of a high-, medium- and low- μ input stage (or any combination) it becomes possible to provide a wide choice of overall gain which may be judiciously selected in accordance with the type of input device employed. To augment the input stage a high- or low-gain inverter is offered, for special applications to further increase the gain range.

TAILORING THE AMPLIFIER TO FIT REQUIREMENTS

Packaged Engineering. The great variety of variables that can be introduced, added or selected for use with this basic amplifier places into the hands of the layman the ability to construct or select any specific type of amplifier regardless of the complexity of its overall circuit. Furthermore, it is no longer necessary to purchase or build a complex amplifier, having a number of unnecessary features in its initial design just because one or two of its many features are really necessary.

The simple expedient of providing an isolated, well-regulated additional rectifier enables the addition of as many as 10 extra low-level input tubes without upsetting the voltage distribution balance within the amplifier. An extra heater winding which may

CALCULATION OF RESISTOR VALUES

$$\text{Resistor H} = \frac{100}{2(I_{c_2}^* + 4(I_b + I_{c_2}))} = \frac{100}{2(.012) + 4(.0015 + .0005)} = 3.125 \text{ ohms.}$$

$$\text{Resistor F} = \frac{175}{4(I_b + I_{c_2})} = \frac{175}{4(.0015 + .0005)} = 21,900 \text{ ohms}$$

$$\text{Resistor G} = \frac{150}{I_b} = \frac{150}{.0015} = 100,000 \text{ ohms}$$

$$\text{Resistor E} = \frac{125}{2(I_b) + 4(I_{c_2})} = \frac{125}{2(.0015) + 4(.0005)} = 25,000 \text{ ohms}$$

$$\text{Resistor D} = \frac{100}{2(I_{c_2}^* + I_{c_2}^*) + 2(I_b) + 4(I_{c_2})} = \frac{100}{2(.077 + .012) + 2(.0015) + 4(.0005)} = 546 \text{ ohms}$$

$$\text{Resistor C} = \frac{75}{2(I_{c_2}^* + I_{c_2}^*) + 2(I_b + I_{c_2})} = \frac{75}{2(.077 + .012) + 2(.0015 + .0005)} = 412 \text{ ohms}$$

$$\text{Resistor B} = \frac{3}{2(I_b + I_{c_2})} = \frac{3}{2(.0015 + .0005)} = 750 \text{ ohms}$$

Resistor A = 0.5-meg.

*Indicate currents for output (6L6G) tube.

Please Say That You Saw It in RADIO-CRAFT

or may not be used provides optional heater current for ten 0.3-amp. tubes.

The Design of the Fundamental Amplifier. The design considerations involved in this amplifier follow closely the principles laid down for the 10-watt model previously described. The essential difference being however that the output tubes are operated with a plate voltage of 400 and screen-grid voltage of 300. As the circuit is of the class AB1 type, no grid current is drawn during any part of the input cycle.

If we list the tubes and their corresponding applied potentials, we have the essence of our new 30-W. Direct-Coupled Amplifier.

Operating Conditions

ELECTRODE	6SJ7	6L6G
Plate volts (Ep)	150	400
Control-grid (Ec1)	3	25
Screen-grid (Ec2)	75	300
Suppressor-grid (Ec3)	0	...
Plate current, av. (Ib)	1.5	77 ma.
Screen-grid current, av. (Ic2)	0.5	12 ma.

Although the voltages and current indicated above are for a single-ended amplifier, the push-pull model utilizes the same voltages and twice the screen-grid and plate currents of 1 tube.

Figure 1 shows the basic circuit diagram of the amplifier. It will be noted, by comparison with the basic 10-Watt Direct-Coupled Amplifier (see page 17, July 1939 issue *Radio-Craft*) that only 1 additional resistor is required. Resistor H, which is used to drop the 400 volt plate voltage to 300 for the screen-grids of the 6L6G tubes.

Calculation of Resistor Values. The design procedure necessary to calculate the values of the 7 important resistors (B, C, D, E, F, G, H) simply involves the application of Ohm's Law. If we remember that the voltage drop in resistors G should be made equal to the voltage applied to the plate of the input tubes, it is evident that the voltage at the junction of the resistors E-F should be 300 volts (off ground). In order to apply an effective screen-grid voltage of 300 volts to the screen-grids of the output tube, 475 volts as measured (from ground) should appear at the junction of resistors F-H.

Knowing the voltage drop desired in each resistor, and as well as the current flowing through it, its value is calculated as shown on the opposite page.

The power supply utilizes 2 separate sets of rectifier circuits to avoid the use of high voltages. One rectifier delivers 400 volts for the output plate voltage while the other furnishes the 175 volts required for the 1st stage and any auxiliary circuit which may be added. Excellent regulation is maintained in this latter circuit by maintaining a comparatively large "bleeder" current across its output. This so-called "bleeder" current (of approximately 168 ma.) is actually the plate and screen-grid current of both output tubes after they have done their useful work in the power output stage.

The completed circuit diagram is shown in Fig. 2. It will be noted that a number of refinements have been added. The "tube balancer" placed in the cathode circuit of the input stage enables the matching of what would ordinarily be considered "mismatched" tubes. It also provides for a single hum-balancing adjustment.

A 150 ma. pilot light is placed in series with the plate supply of the power output stage to avoid damage to the output tubes, should the bias rectifier be accidentally removed. Complete circuit details and design factors for all of the available auxiliary circuit features for this 30-Watt Direct-Coupled Amplifier will be described in the following issue of *Radio-Craft*.

This article has been prepared from data supplied by courtesy of the Amplifier Co. of America.



LIKE THE WORLD OF TOMORROW . . .

This new **FREE** Lafayette catalog for 1940 is different from anything you have ever seen before. The size is bigger, the selection is bigger, the savings are bigger! Send for a copy at once.

EVERY MAN INTERESTED . . .

In radio and sound—the ham, serviceman, experimenter and dealer will want this great new book for what it can do for him. Has everything in radio—receivers, parts, tubes, equipment, new Build-It-Yourself Kits—all arranged for split-second reference. Makes ordering by mail easy, quick, sure. Here's a book that saves you time!

PRICES ROCK-BOTTOM . . .

On all latest type nationally advertised merchandise. Literally thousands of items listed, and every one a smashing value. Here's a book that saves you money on everything you buy! Make it your easy-chair shopper.

SEND AT ONCE . . .

For big **FREE** copy. Know what it is to have a book like this at your elbow—complete, up-to-the-minute, money-saving! Tear out this coupon and mail.

LOOK WHAT IT COVERS!

- 1940 RADIOS • PARTS • TUBES
- PUBLIC ADDRESS EQUIPMENT
- ELECTRICAL APPLIANCES
- HAM APPARATUS

Radio Wire Television Inc. formerly WHOLESALE RADIO SERVICE CO., INC.

LAFAYETTE RADIO

NEW YORK • CHICAGO • ATLANTA
100 SIXTH AVE. • 301 W. JACKSON BLVD. • 755 PEACHTREE ST
BOSTON • JAMAICA • BRONX • NEWARK

TEAR OUT AND MAIL COUPON Today!

Radio Wire Television Inc.
Dept. 3K9—100 Sixth Ave., New York, N. Y.
Rush **FREE** 1940 Radio Catalog No. 78

Name.....
Address.....
State.....
City.....

Please Say That You Saw It in RADIO-CRAFT

Money-Makers for SERVICE MEN

MODERN Radio SERVICING

LEARN HOW with This!

Here is the famous Ghirardi training course in practical radio service work complete in this 1 big 1300-page book—explains everything essential for a thorough grounding in the basic fundamentals of modern service work. Ghirardi teaches you HOW to do it and makes it all wonderfully clear and easy to understand. Here's what it covers:

- Test Equipment—Theory, Descriptions, Diagrams of all Commercial Instruments, How They Work, Construction Data, etc.
- Trouble-Shooting—Newest short-cut methods for troubleshooting even the most complicated receivers.
- Repairing—Advanced "Factory Methods" for Repairing all Parts, explained fully.
- Special Problems—Servicing All-Wave and High Fidelity Sets, "Intermittent" Sets, etc.



1300 PAGES \$4
706 ILLUS.

RADIO Trouble-Shooter's HANDBOOK

WORK with This!

Here's a new kind of servicing reference manual, a time-saver for service men—different from anything you've ever seen before. It's check-full of factory-checked "bench-data" that will speed up every service job you do! It's the greatest mass of practical working data ever assembled in one book! It's a Profit-Maker!

- 3,313 Case Histories—Trouble Symptoms and Remedies for 3,313 different receiver models compiled from actual Service Records.
- I-F Peaks—Data for 1-4 alignment of over 15,000 Superhets.
- Other Data—Auto-Radio Data for Installation, Interference Elimination, etc.
- Trouble-Shooting Charts; Servicing Intercommunications; Trade Directories; Tube Data; and dozens of Charts and Tables.



510 PAGES, 13 ILLUS., Standard Manual Size (8 1/2 x 11), Paperback-bound \$3

USE THEM 5 DAYS—our risk

Return them if not satisfied

MAIL NOW!

Radio & Tech. Publ. Co.
48 Astor Pl., New York, Dept. RC-109

Enclosed find payment for:

MODERN RADIO TROUBLE-SHOOTER'S HANDBOOK BOTH books at \$6.50 Special Combination Price

NAME _____

ADDRESS _____

CITY _____ STATE _____

MIDWEST FACTORY-TO-YOU 20th ANNIVERSARY SPECIAL!



WITH TELEVISION ADAPTATION

Here's today's biggest radio value—the 1940 TELEVISION-ADAPTED Midwest at sensationally low factory-to-you price. Now enjoy exciting foreign reception. Absolute satisfaction guaranteed on money-back basis. Send 1c postcard for FREE 1940 Catalog. (User-agents make easy extra money!)

See Midwest's Answer to TRADE-INS!

14 TUBE CONSOLE \$29.95 COMPLETE

PUT THIS 1940 14 TUBE CHASSIS IN YOUR PRESENT CABINET \$19.95

COMPLETE CHASSIS WITH TUBES AND SPEAKER

SAVE UP TO 50% 30 DAYS TRIAL EASY PAY PLAN

MIDWEST RADIO CORPORATION DEPT. 12-B CINCINNATI, OHIO

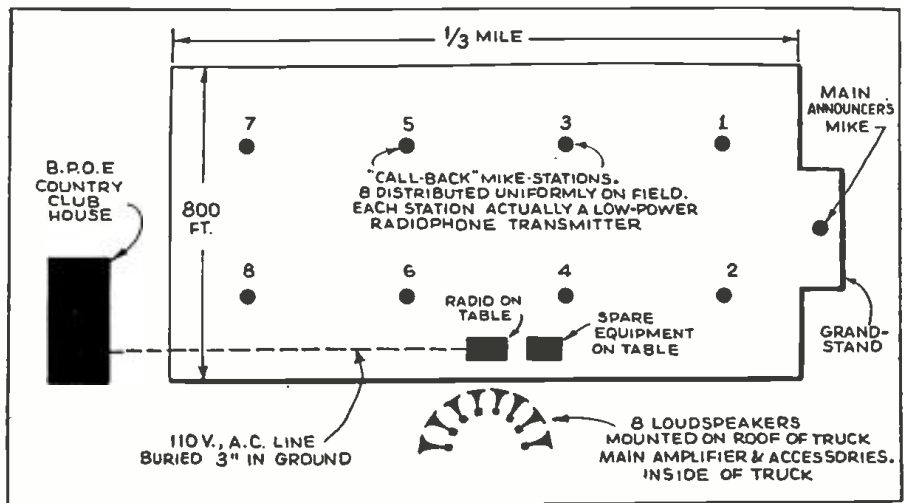

PRIZE MANUSCRIPT

(Continued from page 204)

of the numbers on the winning card. As each 7-minute game represented to the producers a revenue of about \$2,000, it becomes apparent why a bond was demanded. Our contract exacted a penalty from us of \$20 per minute for each minute of interruption due to failure of the sound system. The contract was awarded to us after the producers had visited our shop, inspected our equipment, and checked on the quality and reliability of our services during other large outdoor events.

The installation was planned with an unusually high degree of safety. We realized at once that the greatest possibility of failure in this case would lie with the microphone lines. Something like 3,500 feet of mike line would have to be run across the grounds as there were no poles or other means of keeping the lines well overhead. An additional hazard lay in the fact that the field would be covered with 20,000 folding chairs which would never stay where placed. Our first thought was to dig small trenches about 3 inches deep and bury the mike lines in these, but the extent of the terrible back-breaking work involved was not justified by the price of the job, although we adopted this stunt for the 110 V. A.C. power line.

Our final plan consisted in equipping each microphone with a small battery-operated transmitter, similar in principle to the so-called "wireless" record layers," except that they were designed to operate from low-level ribbon microphones. These phone transmitters were compact and clamped directly on the mike stand (see Fig. A) leaving absolutely no trailing wires. They were all adjusted uniformly to transmit on 885 kc., for minimum local-station interference.

This was simplicity itself. The units were assembled in our shop and all that was necessary on the job was to stand them in their proper position on the field. The mike stands were tied to a leg of a table to keep them from over-balancing or being knocked over accidentally. The mike stands were of course at ground potential. The aerial (see photo) is a 1/4-inch aluminum rod, 4 feet high. However, on 3 mikes located farthest from the receiving set, it was necessary to increase the radiated energy by using about 25 feet of heavy rubber-covered wire tied across several chairs as an aerial. Each mike station has its own ON-OFF switch.

Speech transmitted from these miniature broadcasting stations was picked up by a Hallicrafters Super Sky rider. The excellent A.V.C. action of this receiver kept all microphones at uniform output level which auto-

matically solved the mixing problem. As these low-powered transmitters have an exceedingly low R.F. output their field strength diminishes very rapidly, a difference of only 100 feet making a marked difference in received energy, therefore the problem would have been serious without good A.V.C. action in the receiver. The nearest microphone was 200 feet from the receiving set, and the one on the main platform from which the numbers were called was 900 feet from the set.

The output of the radio set was fed to a 100-watt amplifier and connected to 8 high-efficiency driver units fitted with trumpets of the projector type. These speakers were arranged (on top of the sound car, see Fig. B) to project over an arc of 180 degrees. With the main announcer's mike 900 feet away, the full output of the amplifier could be supplied to the speakers without feedback. Under this condition the "sock" could be heard almost a mile away. 110 volts A.C. was taken from the clubhouse 1,100 feet away. This line was buried 3 inches in the ground for safety's sake, this job alone requiring 15 hours of labor. In addition a gasoline-driven generator mounted in the sound truck was held in readiness in case of accidental failure of the commercial power.

A couple of spare microphone and transmitter units were held in readiness in case of failure of any one of the 9 set-ups. All that would have been necessary had a mike failed would have been to dash out to the station with the spare. Spare amplifiers and units of all sorts were wired in place ready to be switched into service in case of trouble.

Fortunately, the entire system functioned perfectly, and none of the spare equipment was called into service. The atmospheric conditions were also favorable as only a negligible amount of static was encountered. Background noises of the receiver when the greatest R.F. gain was in action could not be heard more than 100 feet from the loudspeakers.

In conclusion, each of our 9 miniature broadcasting stations probably exceeded the F.C.C. formula for this type of remote control system. However, as the installation was made out in the "sticks" where there were very few nearby homes and in addition a frequency was selected on an unoccupied portion of the broadcast band, we feel that no inconvenience was caused to any B.C.L. Nevertheless, this method is not to be widely and indiscriminately recommended without special permission of the F.C.C.

S. J. WHITE,

White Sound Service, New York City.

Please Say That You Saw It in RADIO-CRAFT

SERVICING TELEVISION RECEIVER FAULTS

(Continued from page 218)

the grids of the sync. separator and the blocking oscillator. Adequate precautions must also be taken to remove all trace of the line sync. pulses. Two simple methods for ascertaining whether or no correct interlacing exists are applicable. The best of these is to open up the scan in the vertical direction to permit readily an examination of the line formation. The other plan is to allow the eyes to travel from bottom to top of the screen when, if interlacing is being effected, the picture will temporarily appear coarse, the lines being plainly visible.

In concluding this series it is probably just as essential to show what constitutes good image reproduction, as to show faults that have already appeared.

GOOD IMAGES

The writer's receiving station is located 100 miles from the transmitter thus rendering it a somewhat difficult task to secure an image such as is possible with carefully-designed apparatus in regions of high field strength. Actually, it is surprising what extraordinary definition can be secured when full use of the frequencies transmitted by Alexandra Palace is made. This was very apparent while testing some apparatus, in which every effort had been made to secure adequate frequency response, within 12 miles of the transmitter. Any effort expended in ensuring maximum use of the frequency spectrum transmitted is amply repaid because of this enormous improvement in definition.

It seems desirable in locations where an adequate signal exists to aim at a level response extending considerably in excess of the conventional 2 mc. and a continual improvement appears to be secured up to 3 mc.

Despite this difficulty of securing photographs that will accurately show what can be achieved the 2 photographs Figs. 7 and 8 were shown last month. Figure 7 is the type of picture which reveals the even illumination resulting from an accurate D.C. control and also is of value for checking the presence of phase and frequency distortion. Figure 8 is the familiar caption that generally precedes normal program transmissions. This picture is of particular value for a great deal of information is provided by examining the appearance of this upon the screen. Adverting to Fig. 8 the following points should be examined.

For the B.B.C. indicated with the letter A, the black outline of these letters should be clearly and definitely rendered, both the leading and following edges of the outline being sharply and cleanly defined. The pattern at the center, indicated with arrows, should be a perfect circle; when this is so the image proportions are correct. The serrated strip pattern along the base of the caption provides a reliable indication of the response to the very high (vision) frequencies. The very narrow serrations in this strip, indicated with the letter B should be accurately and plainly rendered.

It is perhaps needless to add that the overall screen illumination should be quite even, with an absence of shadows or highlights. If all these points enumerated above are satisfied one can be reasonably well content with the performance of the equipment as a whole.

CONVERTING A 5-INCH TELEVISION KIT TO USE A 9-INCH TUBE!

Read Part I of this interesting article in next month's issue of RADIO-CRAFT. Here's a new money-saving idea which Servicemen will find profitable.

Here's YOUR Practical TRAINING for RADIO All in ONE Handy Volume!

Every phase of Radio, Electricity, Television, Sound and Cathode-Ray Tubes made crystal-clear by A. A. Ghirardi in his fascinating, readable style. Never before has profitable radio study been such a delightful pastime.

COMPLETE Radio Training Course in 1 Big Book

YOU need no longer be held back from a radio career because you could not spend the time or money to take a course in radio and electricity. You need not stay back in a hum-drum boring job because you lack the background for the good position just ahead! Here, in a single volume, is all you missed—and more! Here are the essentials demanded of every radio technician by modern broadcast stations, radio service organizations, manufacturers, sound film studios, etc. Never before has profitable radio study been such a delightful pastime!

The Opportunity of a Lifetime

Ghirardi's Radio Physics Course is an easy to read as your daily newspaper. A few minutes' day spent with this amazing volume will quickly transform you into a well-trained radio man. Prepare yourself for advancement, more money, a congenial occupation, a satisfying profession and the respect of your friends by this simple means which is sheer pleasure, more fun than ball games or movies.

SHORT-CUT COURSES OF SELF-INSTRUCTION Prepared by That World-Famous Authority, ALFRED A. GHIRARDI

Radio Physics Course is a miracle of condensation. Thirty-six volumes packed into 972 pages, complete with review questions for self-study. 508 helpful illustrations, with schematic diagrams, charts, photos, etc. Never before have the basic facts about Sound, Speech and Music been so clearly and usefully presented. Never before have the fundamental principles of Electricity been so easy to master and so practical to use. No knowledge of mathematics is required, nor does it matter whether or not you have had any previous electrical training. This great book was written especially to teach you radio in your own home.

36 Volumes in 1

RADIO, ELECTRICITY and SOUND Complete Plus Many Other Valuable Special Features are covered in these 36 big Chapter-Sections, 508 Schematic Diagrams, Charts and Photos, 856 Review Questions.

- | | |
|--|---|
| 1. Radio Broadcasting System. | 19. Construction Features of Vacuum Tubes. |
| 2. Sound, Speech and Music as Related to Broadcasting. | 20. Vacuum Tube Detector and Amplifier Action. |
| 3. Electron Theory, Electric Current. | 21. Radio Frequency Amplification. |
| 4. Electrical Units, Ohm's Law, Resistance. | 22. Superheterodyne Receivers. |
| 5. Electrical Circuits, Batteries. | 23. Design of R.F. Amplifiers and Tuning Coils. |
| 6. Magnetism. | 24. Audio Amplification. |
| 7. Electromagnetism. | 25. Loud Speakers. |
| 8. Electromagnetic Induction. | 26. The Battery Operated Receiver. |
| 9. Inductance and Inductors. | 27. The Power Supply Unit. |
| 10. Capacitance and Condensers. | 28. Electric Receivers. |
| 11. Alternating Current Circuits. | 29. Automobile and Aircraft Receivers. |
| 12. Electrical Filters. | 30. Phonograph Pickups and Sound Amplifier Systems. |
| 13. Electrical Measuring Instruments. | 31. Short Wave Reception. |
| 14. Electromagnetic Radiations. | 32. Vacuum Tube Applications and Photoelectric Cells. |
| 15. Radio Transmission, the Broadcasting System. | 33. Television. |
| 16. The Receiving Station, Detection with Crystals. | 34. The Antenna and Ground. |
| 17. Elementary Study of the Vacuum Tube. | 35. Testing and Servicing. |
| 18. Vacuum Tube Characteristics. | 36. Sound Motion Pictures. |

972 Pages

Get Started - RUSH COUPON NOW!

WE BUY FOR CASH

In any quantity
USED CLASSICAL PHONOGRAPH RECORDS
— REGARDLESS HOW OLD —
MAIL US LIST OF ARTISTS & SELECTIONS
HIGHEST PRICES PAID
MODELL'S — DEPT. R-10
58 CORTLANDT ST., New York, N. Y.

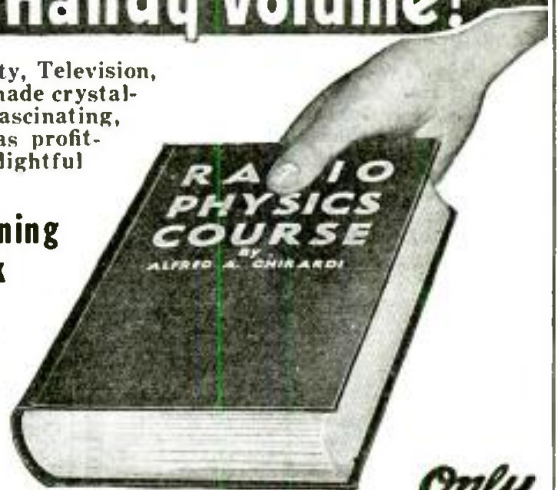

So Easy It's Amazing!

Only \$4.00 No Further Payments

The whole science of Radio unfolds before you, from elementary theory right up through the latest developments and applications, in word pictures and graphic diagrams so vivid you cannot ever forget them. The intricacies of Cathode-Ray Tubes and Photoelectric Cells are explained away so simply you will wonder how they could ever puzzle you. The facts about Public Address Systems, Sound Motion Pictures, Phonograph Pickups become tools in your hands, tools with which to work in building your future in the coming specialized profession of Sound Engineering.

Learn Television, Too!

The story of Television becomes a living drama, with its technical problems so clearly set forth you will understand them better than do many of the "old-timers". Testing and Servicing: Automobile, Aircraft and Marine Radio; Short-Wave Reception; and invaluable Appendices complete this huge, comprehensive Radio Course, making it the greatest bargain in radio education of all time! That's why it's used and praised by more radio schools and students than any other radio book in the world. It's complete! It's concise! It's easy! It's authoritative!

USE IT 5 DAYS—OUR RISK!

We want you to see this book. We want you to judge for yourself, in your own home and at your leisure. Just how much it can mean to you. Fill out the coupon below and mail it at once. Ghirardi's Radio Physics Course will be sent you by return mail. Examine the fine binding, the large, clear type; take your first Radio lessons and check yourself on the knowledge you gain. Keep and read the book five days—then decide if you wish to own it at the amazing price of only \$4, postage prepaid.

Money-Back Guarantee — ACT NOW!

If after reading and examining Radio Physics Course, you are not thoroughly satisfied in every way return the book in good condition within the five-day trial period, and every penny of your money will be immediately refunded. You see you cannot lose! So send the coupon without delay. This is the greatest opportunity ever offered you for a complete radio education at this astounding price. You couldn't do better anywhere. Don't pass up your one big chance to get inside "the profession with a future." It all depends on what you do about that little coupon below. FILL IT OUT! MAIL IT, AT ONCE!

MAIL COUPON TODAY!

RADIO & TECHNICAL PUBL. CO., Books
45 Astor Place, New York. Shipped Post-
Dept. RC-109. paid Anywhere!

Enclosed find \$4 for my copy of Ghirardi's "RADIO PHYSICS COURSE," with your 5-day money back guarantee.

NAME

ADDRESS

CITY STATE

Please send me free descriptive literature about "RADIO PHYSICS COURSE."



UNIVERSAL 5MM.

All purpose microphone including amateurs, P.A., schools, stage, etc. Beautiful in appearance. Small in size. Superlative in performance. High fidelity reproduction voice and music, incl. locking plug and 25 ft. cable. Direct to grid or any desired impedance. In De Luxe package at your jobbers now.

UNIVERSAL MICROPHONE CO. LTD.
424 Warren Lane, Inglewood, Calif., U.S.A.

Please Say That You Saw It in RADIO-CRAFT

MEMO TO ALERT SERVICEMEN
Lafayette's the P.A. Bet!

HERE'S CUSTOMER APPEAL — For 1940, Lafayette engineers again offer three complete lines—a DeLuxe, Standard and an Economy. All 3 bear the stamp of Lafayette advanced engineering. All are star performers — streamlined for buy appeal.

BIG SURPRISE of the new triple line is Lafayette's consistently lower prices. You make more on every system you sell. And you sell more because Lafayette P.A. can't be matched—at any price! In profit, as in performance, Lafayette's the best bet!

SEND TODAY for new FREE 1940 catalog. See the "triple threat" line. You, too, can earn big money selling Lafayette P.A.

Radio Wire Television Inc.

formerly
WHOLESALE RADIO SERVICE CO., Inc.



NEW YORK, N. Y.
100 SIXTH AVENUE
CHICAGO, ILL.
901 W. JACKSON BLVD.
ATLANTA, GA.
265 PEACHTREE STREET
BOSTON, MASS. • BROWN, N. Y.
NEWARK, N. J. • JAMAICA, L. I.

LAFAYETTE PUBLIC ADDRESS EQUIPMENT

Radio Wire Television Inc.
Dept. 3KP9—100 Sixth Ave., New York.

MAIL THE COUPON FOR THE FULL PROFIT STORY

Name.....
Address.....
City..... State.....

PASTE COUPON ON PENNY POSTCARD

RADIO plus TELEVISION mastered by pre-tested Training

No matter where you are or what you do, National has a complete training plan for you—to fit your circumstances. National's plan is for those seeking immediate shop-training as well as for those who cannot give up present employment and income. Mail coupon.

NATIONAL SCHOOLS

NATIONAL SCHOOLS, Dept. 10-RC
4600 So. Figueroa St., Los Angeles, Calif

Please send free literature and full details

NAME..... AGE.....
ADDRESS.....
CITY..... STATE.....

SOLAR
quality above all

ALL TYPES OF FIXED CAPACITORS FOR RADIO AND TELEVISION . . .

Catalog on Request

SOLAR MFG. CORP. Bayonne, N. J.

FREE NEW CATALOG 1939 AMPLIFIERS

Featuring amazingly low prices; Free Trial Offer; 5-Year Guarantee. Write for Catalog No. 3911.

AMPLIFIER CO. of AMERICA
17 WEST 20th STREET NEW YORK, N. Y.

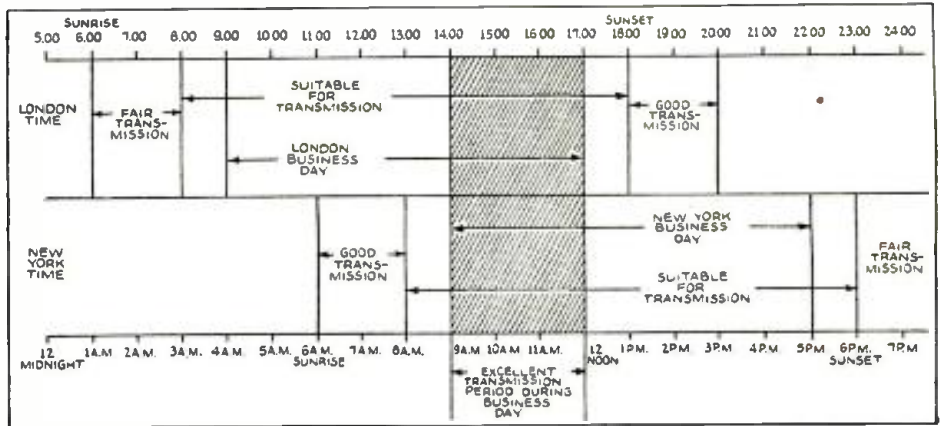

Fig. 4. The best operating frequencies for various hours of the day, for West to East, and East to West transmissions, are shown here.

BEHIND THE SCENES OF A TRANS-ATLANTIC HOOKUP

(Continued from page 211)

end of the testing period and the start of the program is about 1 minute.

Should something go wrong and the Geneva station fail to hear the prearranged cue signal, the Geneva speaker will commence his talk a few seconds after the agreed-upon time. While Switzerland may have trouble in hearing America, the speaker knows he is speaking to America over 2 frequencies and more than likely he is being heard.

The greater part of the communication between the stations is done in voice and in the English language; the remainder is done in code.

THE AMERICAN TELEPHONE AND TELEGRAPH COMPANY

Trans-Atlantic radiotelephone circuits of the A.T.&T. terminate in London and Paris. Paris serves as the land terminal for France and its colonies, while the remainder of Europe trafficks its messages through London. All operating is done in English.

With shortwave transmitters located in Lawrenceville, N. J., and longwave transmitters at Rocky Point, L. I., the A.T.&T. continues a service inaugurated in 1927.^{3, 4} Two of the available transmitters at Lawrenceville are of the SSB (Single-Side-Band) type, in which the high-frequency components such as pretuned circuits and crystals are selected by means of switches in the low-powered stages.

The DSB (Double-Side-Band) transmitters shown in Fig. 1 are composed of the following 6 stages: (1) The Crystal Stage; (2) The 1st Harmonic Stage; (3) The 2nd Harmonic Stage; (4) A Push-Pull Amplifier Stage; (5) Two 10 kw. Water-Cooled Tubes in Push-Pull; and (6) Six 10 kw. Water-Cooled Tubes in Push-Pull Operated with 3 Tubes in Parallel on a Side. Using low-level modulation the transmitters deliver 60 kw. at modulation peaks when 100% modulated; the unmodulated power output from the last stage is 15 kw.

In the newer type SSB transmitters, the first 4 stages are replaced by an SSB generator amplifier unit which is connected to the 5th stage as is shown in Fig. 1, the SSB being shown in dotted lines. The peak envelope power output of the SSB unit is 2 kw. The use of SSB transmission increases the effective power transmission by 10 times.

The receiving station at Netcong, N. J., has 3 SSB-type receivers, and 7 DSB-type receivers. The DSB receivers have an R.F. gain of over 120 db. Besides the beat oscillator containing 1 tube, the DSB receivers use 13 tubes in the following 12 stages (see Fig. 2): (1) H.F. Amplifier using 1 Tube;

(2) H.F. Amplifier using 1 Tube; (3) 1st Detector using 1 Tube; (4 to 10, incl.) Intermediate Frequency Amplifier Stages using 7 Tubes in all; (11) 2nd-Detector Stage using 1 Tube; (12) An Audio Stage using 1 Tube. Mounted in three 19-inch racks, the receiver is 5 feet wide, 6 feet high, and about 1 foot deep.

Since the receiver noise of both the SSB and the DSB is very low the factor limiting reception is usually atmospheric noise.

For transmitting, Twin Rhombic Antennas having their long axis pointed toward London (N 50 E) are joined in parallel. To prevent the antenna from radiating along both directions of the long axis, a 600-ohm resistance in the form of a stainless-steel transmission line is connected at the forwardmost end of each antenna. The antennas, made entirely of open wire, are composed of 3-wire radiators which make common connections at the extremities of the long axis.

Similar to the transmitting antennas in configuration (see Figs. 3a and 3b), the receiving antennas differ in that they consist of a single wire, and the 600-ohm dissipation line is replaced by an 800-ohm carbon resistor, which has the effect of suppressing reception from the unwanted or westernly direction. The antenna is coupled to the receiver by means of a coupling unit and coaxial cable.

THE TRANSMISSION MEDIUM

In general, there are 5 different types of radio transmission path troubles: (1) Magnetic Storms; (2) Fading; (3) Appearance or Disappearance of Signals, due to a shifting of the critical reflected frequency for a given ionospheric layer; (4) Abrupt level change due to change of transmission from one ionospheric layer to another; and (5) Fadeouts.

Magnetic storms can be overcome by the use of longwave circuits,⁵ low-latitude circuits, since the disturbance decreases with latitude, or—if the storm is not too severe—by the use of wide-pattern antennas. From the studies made, the years 1940 and 1941 will give plenty of trouble as far as magnetic storms are concerned.

Another very serious disturbance is the Dellinger Effect, in which the incoming signal is suddenly cut off—as though a switch were opened.^{6, 7, 8, 9} The answer to this sort of trouble is to use shortwaves of frequencies higher than those affected. The longwave frequencies are unaffected and may even be improved by the Dellinger Effect.

The quality of the transmission is gen-

Please Say That You Saw It in RADIO-CRAFT

erally affected by the frequency on which it is made, the higher frequencies being less disturbed by static and noise. The optimum (best) frequency for a transmission at a given time depends on the time of the day, the time of the year, the status of the solar cycle, and a knowledge of the earth's magnetic currents. In Winter it is better to work the lower frequencies, while in Summer the higher frequencies are more amenable. The Spring and Fall Equinoxes supply the most troublesome periods. At any given instant, it is equally difficult to transmit in either direction.¹⁰

As far as the time of the day goes, a consideration of Fig. 4 reveals that from 8 A.M. to 1 P.M., E.S.T. are the hours of excellent conditions. Night hour conditions have been found to be more disturbed than those of the daytime. Solar phenomena have been shown to affect radio circuit disturbance on the earth.¹¹

Should a solar explosion occur the condition of the ionosphere would be disturbed, and the earth's magnetic condition would be disturbed, these troublesome conditions being reflected by a radio transmission circuit disturbance.

Thus the SUN is a source of trouble in trans-Atlantic communications, where the trend is toward overcoming that obstacle—a trend that has become a parade of communication science.

NOTES

1. IRE Proc., Vol. 23, No. 12, December 1935, Callahan, Shore, Whitaker.
2. RCA Review, Vol. 2, No. 1, July 1937, Moore.
3. AIEE Jour., April 1928, Waterson.
4. AIEE Jour., May 1928, Blackwell.
5. AIEE Trans., Vol. 49, p. 621, April 1930.
6. Electronics, Vol. 19, p. 25 (1936) Dellinger.
7. Phys. Rev., Vol. 48, p. 703 (1935).
8. Phys. Rev., Vol. 50, pp. 1,189 (1936).
9. Jour. of Appl. Phys., Vol. 8, No. 11, p. 732, Nov. 1937.
10. Terman, "Radio Engineering," p. 644, sec. 128, McGraw-Hill (1937).
11. Same as Note No. 9.

A REAL PORTABLE RECEIVER

(Continued from page 209)

efficiency iron-core I.F. transformers, the loop antenna of comparatively large dimensions, precise values of resistors and condensers, and the use of high-gain tubes. By thus giving special attention to every factor in the design of this portable, it has been possible to obtain an extremely sensitive and selective chassis with good audio output with a plate voltage of only 82 V. The "C" bias for the beam power tube is obtained as the drop across a 720-ohm resistor in the "B-" lead. This circuit arrangement necessitates a ganged switch with one section in the "A+" lead and the other in the "B+" lead. This 2-gang switch is mounted on the volume control.

The diode section of V3 also delivers A.V.C. voltage to the first 2 tubes. The triode section of V3 operates as a first A.F. or driver of V4.

One important factor in making possible the small-space feature of this receiver is the series of Bantam-type tubes. Four of these new small tubes are used.

Special batteries had to be designed, to fit the limited available space, in order to secure 82 V. of "B" voltage. This voltage is derived as the total of the "A" supply of 1.5 V., and the "B" battery of 80.5 V. (A 45-V. and a 35.5-V. "B" battery, in series.)

A set of batteries should provide 50 to 75 hours of life, depending upon the type of service in which it is used; that is, whether the portable is used for long periods of time, or whether it is used for really short periods with plenty of time in between for the batteries to recuperate.

Radio-Craft predicts that, now that radio sets are within sight of being really PORTABLE—so that milady can carry them a block without gasping for breath—the battery-portable is destined to "go places" not only in design, but also commercially!

6 REASONS

... why more servicemen are buying the SUPREME 504 than any other kind

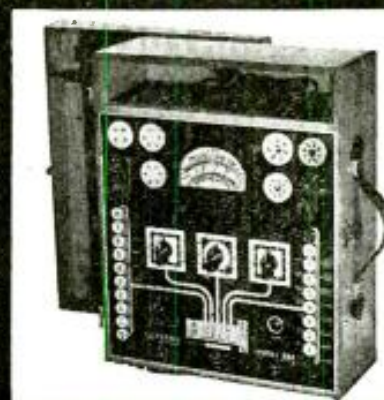

1. SERVICEMEN DEMAND OVER-ALL ACCURACY. The 504 has an over-all guaranteed accuracy of 2% on all D.C. and 3% on all A.C. functions. Contrast this with instruments in which ONLY THE METER is guaranteed 2%, or ONLY THE RESISTORS to some percentage. SUPREME guarantees the accuracy of the ENTIRE INSTRUMENT—not just one component part.

2. SERVICEMEN DEMAND BETTER RECTIFIER PERFORMANCE. The copper-oxide rectifier in the 504 is unconditionally guaranteed for 90 days—exactly the same as every other part.

3. SERVICEMEN DEMAND ACCURACY REGARDLESS OF TEMPERATURE. The 504 incorporates an entirely new "Perma-Grad" TEMPERATURE compensated circuit. Each rectifier is individually matched with a specially wound spool of HYTEMCO wire which nullifies the result of temperature change on the rectifier by reacting in the opposite direction. Thus accuracy is not guaranteed at only one temperature but is guaranteed to be within 3% over a wide range of 40 degrees to 95 degrees. THIS IS AN EXCLUSIVE FEATURE. Summer or winter your 504 is always accurate.

4. SERVICEMEN DEMAND A COMPLETE CONDENSER ANALYZER. The 504 is also a COMPLETE condenser analyzer and will check leakage of all electrolytics, regardless of the CAPACITY or the WORKING VOLTAGE. There are seven D.C. test voltages from 25 to 450 volts with complete

listings on the roll chart. Tests are made on an English reading scale and discard limits were set with the co-operation of three of the leading condenser manufacturers.

5. SERVICEMEN DEMAND PROTECTION AGAINST OBSOLESCENCE. There are two ways in which a tube tester can become obsolete: (1) a change in tube base arrangements and (2) a change in filament voltage.

The 504 has a "PATENTED DOUBLE FLOATING FILAMENT RETURN SELECTOR" which AUTOMATICALLY re-connects every tube socket to the proper arrangement while the instrument is being set-up according to the tube chart. This is done REGARDLESS OF PRESENT OR FUTURE TUBE BASE CONNECTIONS. There are now about 120 different bases—the Model 504 does not care if there are 1000 or more.

The 504 has also licked obsolescence due to high filament voltages by using the SUPREME VARI-VOLT FILAMENT SELECTOR CIRCUIT which makes possible any filament voltage from 1.5 to the full line voltage. Arrow-way test system, set controls from left to right—just follow the arrows.

6. SERVICEMEN DEMAND QUALITY AT A PRICE THEY CAN AFFORD TO PAY. If you can afford a telephone or if you can buy your cigarettes you can afford the Model 504. This big Model 504 laboratory, combining a 7-way tube tester, a 31 range set tester, and a complete condenser analyzer, costs you no more than 18c a day on the world's easiest installment terms.

NO WONDER SUCCESSFUL SERVICEMEN EVERYWHERE ARE CHOOSING THE MODEL 504. BIG NEW CATALOG OF 1940 MODELS JUST OFF THE PRESS. WRITE FOR YOUR COPY TODAY.



MAIL COUPON TODAY!
 SUPREME INSTRUMENTS CORP. Dept. C-9
 Greenwood, Miss.
 Please RUSH me your newest information on SUPREME 504 and many other completely new SUPREME 1939 Models.
 Name _____
 Address _____
 City _____ State _____

Be a RADIO EXPERT - Learn AT HOME

RADIO SPECIALISTS NEEDED

Modern receivers with their complicated circuit systems have knocked out the old time cut-and-try radio fixer. Trained men with up-to-the-minute knowledge are needed to service these new sets.

HERE IS YOUR OPPORTUNITY

Your possibilities of making money and getting ahead are limited only by your ability and skill—but you must know more than the other fellow. You must be a radio service specialist, as R.T.A. can train you.



FREE
 OF EXTRA COST

To start you making money without delay we equip you with this Circuit Analyzer and Point to Point Resistance Tester.

PRACTICAL TRAINING AT HOME

Our home study course is practical "shop and bench" training combined with a thorough set of practical lessons prepared by an experienced Radio service engineer. Four working outfits are also furnished.

MAKE SPARE TIME MONEY

Our training is complete and practical. We show you how to make money almost from the start. The course can easily be made to pay its own way. Investigate now, write for free book of details.

WHAT R.T.A. STUDENTS SAY

Norwood, Ohio
 I have connected with a large firm as Radio Service Manager and wish to extend my thanks for your help.
 Joseph Rapien, Jr.

Yorkville, Ohio
 From Aug. 1 to Dec. 7, 1936, I repaired 163 radios and put up 43 serials which is very good for part time work while studying your course.
 Chas. Koerber.

RADIO TRAINING ASS'N OF AMERICA
 Dept RC-109, 4525 RAVENSWOOD AVE., CHICAGO

Please Say That You Saw It in RADIO-CRAFT

THE LATEST RADIO EQUIPMENT

(Continued from page 222)

YOU CAN BECOME A MONEY-MAKING RADIO EXPERT
 WITH THE **New SPRAYBERRY**
Personalized
HOME TRAINING in RADIO and TELEVISION

You Learn Easily In Your Spare Hours
By Doing Many Experiments with Up-To-Date Equipment

Here's a really fine, up-to-the minute Radio and Television Training that's specially designed to give you quick results. **TRAINING PREPARES YOU FOR GOOD RADIO JOBS . . . AT EXCELLENT PAY.** My training starts right at the beginning of Radio . . . unfolds each subject in a simplified, logical, understandable style. You easily learn Television, Electronics, Facsimile Radio, Radio Set Repair and Installation Work, etc.

NO PREVIOUS EXPERIENCE NEEDED
 It makes no difference what your education has been. I can fit you for a good-paying Radio job. Your success is my full responsibility.

YOU GET PROFESSIONAL TEST EQUIPMENT PLUS EXPERIMENTAL OUTFITS
 . . . Includes 146 Radio Parts (to build complete Receiver), Tools, All-Wave, All-Purpose Analyzer, and Experimental Outfits for conducting actual experiments with your own hands.

I Supply

- 146 RADIO PARTS
- RADIO TOOLS
- ALL PURPOSE ANALYZER

EARN WHILE YOU LEARN
 My **BUSINESS BUILDERS** show you how to put your equipment to practical use in handling actual money-making Radio Service Jobs shortly, after you begin training.

SERVICEMEN
 I offer Advanced Training for those already in Radio. Get complete details in my **FREE 52-page Book**. The *Sprayberry Course* is Sold Under a Money-back Agreement.

RUSH COUPON for BIG FREE BOOK

SPRAYBERRY ACADEMY OF RADIO
 F. L. Sprayberry, Pres.
 220-K University Place, N.W.
 Washington, D. C.

Please send me **FREE** copy of "HOW TO MAKE MONEY IN RADIO."
 Name AZO
 Address
 City State
 Tear off this coupon, mail in envelope or paste on penny postcard. Servicemen—Check here

JUST OUT!
A PRACTICAL DISCUSSION OF THE CATHODE RAY OSCILLOSCOPE and FREQUENCY MODULATED SIGNAL GENERATOR
 with applications in modern radio service work. A new book needed by every service man who wants to be up-to-date and know about modern instruments and how to use them in the analysis and alignment of present day receivers. Presented in clear, understandable language, by a man who is a practicing service man and who knows and understands everyday service problems.

ONLY \$1.00 Postpaid
 Limited Edition. Send order promptly. Don't be disappointed. Send \$1.00 with stamps to Arthur G. Mohaupt, 4523 Ravenswood Ave., Chicago, Ill.

REMOTE CONTROL FOR A. C. RADIOS

A wireless remote control that tunes ANY electric set. Without wires to your radio! From distances up to 20 ft. you can tune your 5 favorite stations by just touching a button! Change the volume, too. Just plug the Remote Control in any electric outlet. Handsome cabinet. Size: 4 1/2 x 14 x 9 1/2 inches. Complete with 3 tubes and instructions for setting up. For 110-120-volt, 50-60 or 25-cycle A.C. or D.C. Shuk, wt., 6 lbs.

List Price \$20—Your Price **\$4.88**

ARROW SALES CORP., 619 W. Randolph, Chicago, Ill.
 Send for 24 PAGE catalog.

LET'S Correspondence Courses in **RADIO and ELECTRICAL ENGINEERING**

ELECTRICAL ENGINEERING Get good grasp of wide electrical field. Prepare yourself, at Low Cost, for secure future. Modern, simplified, you can understand quickly.

RADIO ENGINEERING Extra fine course in radio, published by address, photo-electric work. Trains you to be super-service man, real vacuum tube technician. Exper. kits furnished. Diploma on completion.

Tuition, \$25, either course. Deferred payment plan. **FREE** Get copies of school catalog, student magazines, complete details. **SEND NOW!**

LINCOLN ENGINEERING SCHOOL, Box 931-C10, LINCOLN, NEBR.

FREE AMPLITONE
New 1939 Sound Catalog

Special consultant service free on any Electioneering, Sound System or P.A. problem.
 Get your **FREE** catalog today!
AMPLITONE PRODUCTS CO.
 135 Liberty St. New York City, N. Y.

"FILATROL" FOR LOCTAL TUBES

Weston Electrical Instrument Corp., Newark, N. J.

RADIO SERVICEMEN can bring their old tube checkers up to date with this "Filatrol" unit equipped with 2 leads—1 which plugs into any 110-V. A.C. outlet, the other into the 4-prong socket of the tube checker. A switch on top of the "Filatrol" unit can then be turned to the proper position to provide the proper voltage for the tube being tested. Switch settings from 35 to 100 V. Provisions are made for testing higher filament voltages when they are introduced.



October 1939 Radio-Craft

TELLY ANTENNA

American Communications Corp.
 123 Liberty St., New York, N. Y.

THIS new telly antenna, the manufacturer claims, is inherently free from distortion because all metal supports within its field are eliminated, producing an image in the receiver entirely free from the reflection disturbances and of considerable brilliance. By means of various elements this antenna may be so adjusted and "beamed" in the position of maximum signal strength as to realize "metropolitan area" reception in outlying and rural districts. It may also be adjusted to eliminate unwanted disturbance and interference emanating from man-made sources such as power houses, transformer stations, X-ray and diathermy equipment, etc.

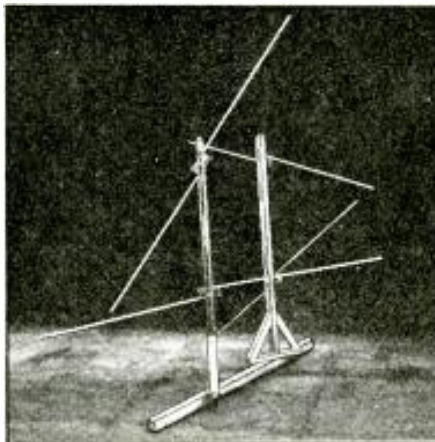

October 1939 Radio-Craft

NEW "VEDOLYZER" TESTER

Supreme Instruments Corp.,
 Greenwood, Miss.

ANOW you can see the signal when you service broadcast and television receivers and you can also see where distortion occurs. The Vedolyzer, as the manufacturer claims, traces the radio signal through every stage so that you can actually see the signal and its distortion on the screen of the C-R. tube in the instrument. You see where the signal begins to distort and how much. You can also test actual operating voltages, A.V.C., A.F.C., R.F. signal grid and D.C. grid voltages under actual operating conditions. Further you can check for amount and frequency of hum and intermittent reception in any part of set. The Vedolyzer contains a frequency-compensated, wide-range amplifier from 20 to 4.5 megacycles, and R.F. oscilloscope, a balanced bridge type V-T. voltmeter with 7 D.C. ranges up to 6,000 V., 6 A.C. ranges to 900 V., 4 R.F. voltage ranges to 30 V., 7 resistance ranges up to 1,000 megohms; a wave analyzer and frequency meter; and many other useful circuits. The instrument is almost a complete portable laboratory in itself. Is known as the model 560.

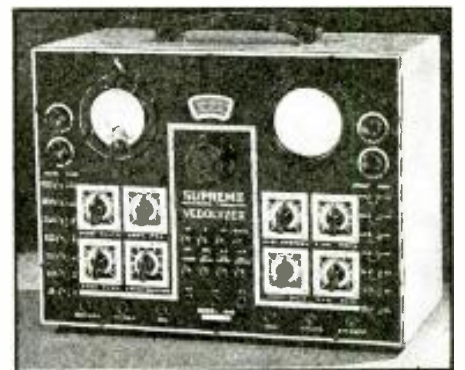

October 1939 Radio-Craft

"WIRELESS" MICROPHONE

Mystic Mike Co., 362 Wooster Ave., Akron, Ohio

KKNOWN as the "Mystic Mike," this unit permits voice or music to be heard over any radio in the home without the use of inter-connecting wires. Essentially the device is a modulated oscillator which radiates a radio signal within the tuning range of all types of broadcast receivers. It is merely necessary therefore for the receiver to tune to the frequency of this oscillator in order to hear the speech or music picked up by the microphone. The device is designed to operate from the A.C. or D.C. light-line and is quite simple to operate.

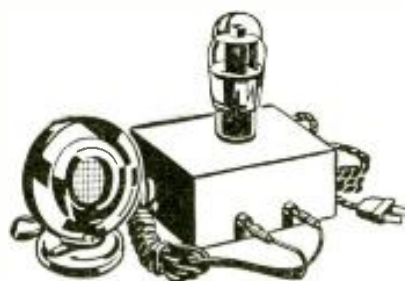

October 1939 Radio-Craft

(See page 212 for other news items.)

Please Say That You Saw It in RADIO-CRAFT

HOME-MADE FREQUENCY MODULATOR

(Continued from page 219)

the required armature size was 3/8-in. long by the inside dia. of the magnet. This left enough space for clearance when turning; as explained, this space must be kept at a minimum. The armature is tapped, and screwed onto the condenser shaft, as shown. The correct position for this mounting in regard to the variable condenser is obtained when the rotor plates are either meshed with the stator plates, or at minimum capacity (unmeshed), and the armature is set horizontal with the air-gap between the magnet poles at minimum.

The impulse coils are bobbins from an early-type loudspeaker and are slipped over the magnet poles. These coils are rewound to have a resistance of anywhere between 250 and 300 ohms, per bobbin; these bobbins can be hand-made very easily by winding No. 40 fibre-board forms with No. 40 plain enamel-covered wire. The correct polarity of these coils is very important; the 2 inside wires of the bobbins connect together, while one outside wire (see Fig. 2A) connects to the High, and the other to the Low terminal on the pin-jacks. This is the pulse input to the oscilloscope. To test the polarity of same, when finished, connect a 500-micro-ampere, D.C. meter to the High and Low terminals, and turn the rotor assembly by hand. This should produce a deflection of the meter; if turned in the wrong direction the meter will not indicate.

If upon using this wobblor with your oscilloscope jagged edges are seen, on the impulse wave, it will be necessary to use a grounding brush on the shaft to ground (same was found unnecessary so far). This can be a piece of strip brass, about 1/4-in. wide, wiping the side of the shaft and connecting to ground.

The waveform produced by the completed Frequency Modulator was excellent. Figure 2B shows 1 cycle of the wave; and also, 2 cycles. The method of connecting up the wobblor when aligning a receiver can be found in *Radio-Craft.

One thing that must be remembered is that when connecting up the impulse generator use shielded leads and ground same; otherwise considerable "hash" will be observed on the screen of the cathode-ray tube as explained.

LIST OF PARTS

(for those who do not have a junk-box)

One Hammarlund variable condenser, straight-line-capacity type SM50, 50 mmf., or Bud with extended shaft (or, as described in text, a unit from any old radio set); one single-circuit jack; two combination jacks for phone tips or banana plug; one metal cabinet, 12x7 1/4 x 6 1/2 ins., or size to suit own requirements; one fractional-horsepower A.C. motor 1/100-h.p., or 1/200-h.p. (can be obtained at most any wholesale radio supply house); six rubber insulating washers; two bolts, 5/32 x 4-ins. long (and lock washers for same); one 1/4-in. shaft coupling; bobbins and magnet (obtained from an old-type magnetic loudspeaker, or from most any radio dealer); one 1/4-lb. spool No. 40 plain enam. wire; rotor armature (made from a small piece of soft steel, to suit own requirements); (extra connecting shaft is obtained from an old variable condenser, etc.), and five strips of bakelite 1/2-in. x 3 ins. long (for mounting magnet); brass bolts for holding above strips together, washer, etc.

**How to Make and Use a Frequency Wobblor," July 1939.
 "Frequency 'Wobblers' for Service Oscillators," Nov. 1937.
 "Complete Step-by-Step Dynamic Servicing," Parts I to V, incl., Jan. to May 1939, incl.

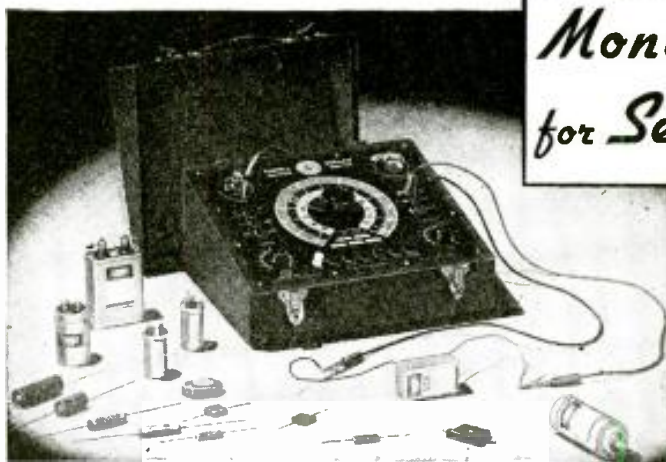

Money-maker for Servicemen!

CORNELL-DUBILIER'S New CAPACITOR Analyzer

MEASURES CAPACITY. Measures capacity of paper, mica, air, electrolytic and motor starting capacitors from .00001 to 240 mfd.
MEASURES POWER FACTOR. Measures power factor from 0 to 50% on all types of electrolytics including motor starting types.
INDICATES INSULATION RESISTANCE. Measures insulation resistance of paper and mica capacitors.
INDICATES LEAKAGE. Measures leakage of electrolytics by means of built-in D.C. power supply.
VISUAL EYE LEAKAGE INDICATOR. Provides leakage tests on all types of capacitors.
HIGH SENSITIVITY. Amplifier for capacity, power factor and leakage tests provides sharp and accurate readings. AMPLIFIER BUILT IN ANALYZER.
DIRECT READING LINEAR SCALE CALIBRATIONS. All scales uniformly spaced.
PUSH BUTTON SWITCHING. All test changes made by push button switches.
SIX COLOR CODED SCALES. Uniformly spaced over total spacing of 60 inches. No "blind spots".
SELF CONTAINED... PORTABLE. Complete in itself, requiring no external equipment. A portable unit for 110 V. 50-60 cycle operation, in walnut cabinet with removable cover and carrying handle.

Check this new CAPACITOR ANALYZER, feature for feature with your idea of the perfect capacitor test instrument. See if you don't agree when we say, "No up-to-date service shop ought to be without it".

For here's the Analyzer that has everything. It's fast and convenient. It reduces time in servicing. Servicemen who have used the C-D Analyzer say they wouldn't sell it for twice its value. You'll say it's the finest instrument you've ever used. Check up. Mail the coupon today for Catalog No. 167-A and the complete C-D Analyzer story. Model BF-50 Capacitor Analyzer, Dealer Net \$24.90 Price .. (less tubes)

PRODUCT OF THE WORLD'S LARGEST MANUFACTURER OF CAPACITORS

TEAR OFF AND MAIL COUPON

CORNELL-DUBILIER ELECTRIC CORPORATION. RC1039 SOUTH PLAINFIELD, NEW JERSEY

Please rush to me the following catalog material.

Catalog No. 167A on Capacitor Instruments.
 Catalog No. 165A on complete line of C-D capacitors.
 Catalog No. 166A on Quietone Interference Filters.
 Place me on your mailing list for Free C.D. House Organ.

Name.....
 Address.....
 City..... State.....

CORNELL-DUBILIER ELECTRIC CORPORATION
 1014 Hamilton Boulevard, South Plainfield, New Jersey
 Cable Address: CDREJ

FREE!

HAMMARLUND NEW '39' RADIO CATALOG

The latest Hammarlund catalog with complete data, illustrations, drawings and curves on the entire Hammarlund line. Address Department RC-10-39 for your free copy.

HAMMARLUND MFG. CO., INC.
 424-438 West 33rd Street, New York City

EXTRA! BARGAIN BULLETIN

BIG MONEY SAVING CATALOG
Just off the press

Hundreds of items at New Low Prices. Radios, Sporting Goods, Jewelry, Electrical Appliances, Furniture, Luggage, Typewriters, Binoculars, Silverware, Gifts, Novelties, etc.

MAIL THIS COUPON FOR FREE CATALOG

RADIO CIRCULAR CO.
 915 Broadway, New York, N. Y.
 Rush Free Copy of BARGAIN BULLETIN. No obligation.

Name.....
 Address.....
 City..... State.....

WHAT STRANGE POWERS
Did The Ancients Possess?

WHERE was the source of knowledge that made it possible for the ancients to perform miracles? These wise men of the past knew the mysteries of life and personal power. This wisdom is not lost—it is withheld from the masses. It is offered freely TO YOU, if you have an open mind. Write for free sealed book. Address: Scribe XZM

The ROSICRUCIANS
 San Jose (AMORC) California

THE COIL YOU WANT!

whether it's an Iron Core High Gain IF, Regenerative Iron Core IF or any other coil used in communications or broadcast receivers or in UHF transmitters. —you will find it in the latest catalog of DX precision made coils. DX Coils are used by well known receiver manufacturers, engineers, service men, set builders, etc. Teachers of radio and students praise DX color coded circuits as easy to understand. Leading radio jobbers have DX Coils or can get them for you at attractive prices. Send 15c today with your jobber's name and receive DX Deluxe catalog illustrating DX coils in full size photos.

DX COILS
"The Best It's Good Inside"

DX RADIO PRODUCTS CO.,
 1575-B Milwaukee Ave., Chicago, Ill.
 Also manufacturers spiderweb loop antennas used on latest model receivers.

Please Say That You Saw It in RADIO-CRAFT

A NEW Pocket Size

Reedite
RANGER



MODEL 739

NET PRICE \$9.90

A.C.-D.C. VOLT-OHM-MILLIAMMETER

• Selector Switch • Molded Case • Precision 3-Inch Triplet Meter Has 2 Genuine Sapphire Jewel Bearings (RED-DOT Lifetime Guarantee)
 Ranges: A.C.-D.C. Volts 0-15-150-750-1500 (D.C. 1000 ohms per volt); D.C. Milliamperes 0-1 1/2-15-150; 0-500 low ohms; 0-500,000 ohms.
 Complete with accessories **\$9.90**
 Net Price

WRITE FOR CATALOG

SECTION 1016 COLLEGE DRIVE

READRITE METER WORKS, Bluffton, Ohio

Our Great, New 68-Page Book

"CASH IN"

SHOWS 300 WAYS TO MAKE MONEY IN SPARE TIME!

Costs only 10c per copy

Book has 40,000 words in text SOLD ON A MONEY-BACK GUARANTEE! In "CASH IN" you get ALL the real money-makers—dozens of profitable tested mail-order plans, confidential business secrets, many practical tested formulas, successful tested schemes, tested money-makers, actual experiences of men who have started on a shoestring— with less than \$10 capital.

CASH FOR YOUR SPARE TIME!

BUYERS OF THIS BOOK TELL US

"Biggest value I've yet to see. Book is worth at least a dollar."

S. BUDA, Brooklyn, N. Y.
 "Your book is at good, if not better, than others selling at \$1.00"

GEORGE BRUNET, Montreal, Can.
 "CASH IN is the best value I have yet to see in the mail order field"

LAWRENCE FOX, Brooklyn, N. Y.
 "CASH IN" contains only tested ideas covering every type of full- or spare-time enterprise — IT'S A MASTER-GUIDE FOR SMALL BUSINESS VENTURES.

10c per copy. Sent POSTPAID any- where upon receipt of 10 cents in U.S. stamps or cash.

NATIONAL PLANS INSTITUTE
 246-R FIFTH AVENUE, NEW YORK, N. Y.

A Tested Plan for a Future in Practical RADIO and TELEVISION

• Write for FREE New Illustrated Booklet

48 interesting pages about our training—what it has done for others—what it can do for you. Send for your copy. No obligation.



CAPITOL RADIO ENGINEERING INSTITUTE

Dept. RC-10, 3224-16th St., N. W. WASH., D.C.

THE LATEST RADIO EQUIPMENT

(Continued from page 240)

ANTENNA BOOSTER COILS

Consolidated Wire & Associated Corporations,
 524 So. Peoria St., Chicago, Ill.

RECENTLY announced is the introduction of auto radio aerial "booster coils" which will fit into present aerial installations without change of fittings to give highly increased efficiency and reduced noise in reception. A specially-designed coil, contained in a tube from which it is shielded, fits between the lead-in and the receiver. A spring within the unit assures positive contact at both end connections. Because of their ease of installation, these units offer an easy, inexpensive way to increase materially the efficiency of auto radio aeri- als.

The coils are shown here mounted on a card as they are displayed by recognized parts jobbers.



"BABY-BULL" HORN

Western Electric Co., Inc., 195 Broadway, New York, N. Y.

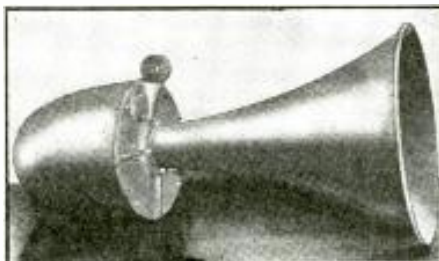

length and 25 ins. wide at the bell. It is known as the 6030B horn.

THE "baby-bull" speaker consists of a single metallic expansion horn driven by 2 permanent-magnet dynamic speaker units enclosed within a moisture-proof aluminum housing. This type of loudspeaker has directional characteristics which permit faithful reproduction through an angle of 30 degrees. This helps solve the public-address engineer's problem of distributing the sound to desired areas without creating a disturbance in adjacent locations. The unit weighs 65 lbs. complete, measures 50 ins. overall in

October 1939 Radio-Craft

DUAL METAL-CAN ELECTROLYTICS

Aerovox Corp., New Bedford, Mass.

THIS manufacturer announced the addition of several dual-section sizes to its "Dandee" line of popular midget metal-can electrolytics. These are the 8-8 and 8-16 mf. at 450 V.; 8-8, 8-16 and 16-16 mf. at 200 V.; and the 20-20 mf., 150 V.; and 10-10 mf., 25 V. The 10-10 mf., 50 V. unit, previously included in the line, rounds out the line of dual-section midget metal can electrolytics. These midget jobs should not be confused with the larger-can electrolytics which are still recommended for heavy-duty service over a term of years. The company points out that these midget units are not a 100% replacement for the standard-size units.

October 1939 Radio-Craft



NEW V.-T. VOLTMETER

The Hickok Electrical Instrument Co.,
 Cleveland, Ohio

THIS new V.-T. voltmeter, known as model T120, incorporates such useful features as the ability to measure high-frequency A.C. and high voltage D.C.; which extends its usefulness to all types of radio and television servicing. The high-frequency input is through a low-capacity type 955 tube at the end of a 4-ft. connecting cable. This section has 4 ranges from 1 1/2 V. full-scale to 150 V. full-scale; and negligible frequency error to over 100 megacycles. The input is strictly capacitive and no return D.C. path is necessary. The D.C. input has 8 ranges from 5 to 7,500 V. with input resistance of 25 megohms to 250 V. and 700 megohms up to 7,500 V. Calibration of all A.C. and D.C. ranges is entirely independent of line voltage fluctuations from 100 to 130 V. Accidental overload can in no way damage the meter or equipment.



October 1939 Radio-Craft

Please Say That You Saw It in RADIO-CRAFT



6 AND 115 V. PORTABLE P.A. SYSTEM

Lafayette Radio Corp.
100 Sixth Ave., New York, N. Y.

THE 30-W. output amplifier, phono turntable and pickup, and 6-V. motor-generator are all built into a metal carrying case with removable cover. The entire apparatus is extremely compact and operates with equal effectiveness from either the 115-V. line or a 6-V. car battery. Some of the features are: 10-tube amplifier with push-pull parallel 6Y7G's in class B final stage; 3 input channels for mixing 2 microphones and phono; response 50 to 10,000 c.p.s.; gain 130 db. for low-level inputs and 9 db. for phono input; standby switch for battery economy, quick changeover from 6 V. to 115 V. operation.

October 1939 Radio-Craft



BRINGING A CARGO OF EXTRA PROFITS from the ARCTURUS EQUIPMENT DEAL!

Signing up for an Arcturus Equipment Deal means Full Speed Ahead to better tube business! Arcturus Tube quality, the completeness of the Arcturus line and the sales-pulling Arcturus Dealer Helps will help you increase your regular business—bring new customers into your store—pave the way to a more profitable tube and service business.

Then too, by taking advantage of the Arcturus Equipment Deal, you can equip your shop with the newest, most modern store and testing equipment—at almost no cost to you! No other Equipment Deal on the market today gives you such liberal, easy terms—Lower Down Payments, Standard Tube Prices, Low Tube Requirements, the Latest Models of high-quality equipment, a wide selection of valuable, useful items that you need every day.

NEW EQUIPMENT NOW AVAILABLE!

The recently announced models of famous makes of store and shop equipment are now included in the Arcturus Deal! Take time NOW to mail the coupon below for complete details about the liberal Arcturus Plan. Get started now to get your share of the EXTRA PROFITS Arcturus dealers enjoy.



ARCTURUS

ARCTURUS RADIO TUBE CO., Newark, N. J. C-22
Without cost or obligation, send my copy of the ARCTURUS DEALER HELPS Folder and details of the ARCTURUS EQUIPMENT DEAL.

Name.....
Street.....
City.....State.....
 I am a dealer I am a serviceman. My jobber is.....

For your convenience this coupon can be pasted on a penny postcard

NEW CIRCUITS IN MODERN RADIO RECEIVERS

(Continued from page 206)

tube is limited somewhat by this connection, it is adequate for ordinary uses and for the set design which has taken this into account.

(4) FULL REMOTE CONTROL EQUIPMENT INCLUDED IN SMALL TABLE-MODEL RECEIVER

RCA Model 5X5. Acting as a completely self-contained table-model receiver, it includes a modulated oscillator which produces a new carrier frequency for any signal which it will pick up.

The circuit as in Fig. 2A uses 1 triode section of the double-triode 12SC7 tube as an oscillator which is switched so as to be plate-modulated by a conventional constant-current high-percentage system. By means of the oscillator plate tuning condenser C7 (adjustable), the oscillator is tuned to preferably around 540 kc. A tuned circuit couples the oscillator carrier to one lead of the power cord.

The Radio-remote switch for remote operation connects the power amplifier (35L6GT) plate through a 33,000-ohm resistor to the oscillator plate supply, disconnects the speaker voice coil and shunts the output transformer with a 5-ohm resistance.

This output loading fixes the transformer's primary impedance so that it will be suitable as a modulation reactor without operating the speaker in the 5X5 receiver.

When the receiver to be controlled is tuned to 540 kc. or to the frequency of the 5X5 oscillator, any broadcast stations may be tuned-in on the 5X5 and a phonograph connection permits remote record playing.

(5) GANGED PERMEABILITY TUNING

Belmont Model 677. Having no gang condenser, this receiver is completely tuned by means of iron-core units in the antenna, R.F. and oscillator circuits.

The antenna section is a series unit while the R.F. and oscillator sections are shunt units. Trimming adjustments are accomplished by regular adjustable condensers as usual. The variable tuned circuits are shown in Fig. 2B. Note that the R.F. plate circuit rather than the detector grid circuit is tuned and that tracking is acquired by an oscillator transformer in shunt with the oscillator tuning unit. The combination of the two inductances produces a higher frequency by the amount of the I.F. which is 465 kc. for this receiver.

SERVICING "COIN-OPERATED" PHONOGRAPHS

(Continued from page 223)

the 350 mmf. (.00035-mf.), 1,000-volt 6L6 plate bypass condensers blowing. These condensers are difficult to obtain and removing them altogether is not always satisfactory as some models develop a slight, low-pitched growl with the condensers out of the circuit. This problem can be overcome by plac-

ing these condensers from 6L6 plate to screen-grid instead of to ground. Thus adequate bypass is assured without subjecting the condensers to the high voltage surges that cause them to blow. It is suggested that this change be made whenever working on 24-record Wurlitzers. See Fig. 5.

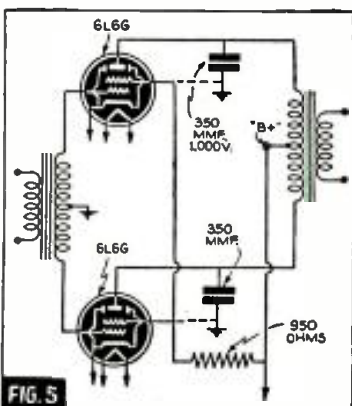
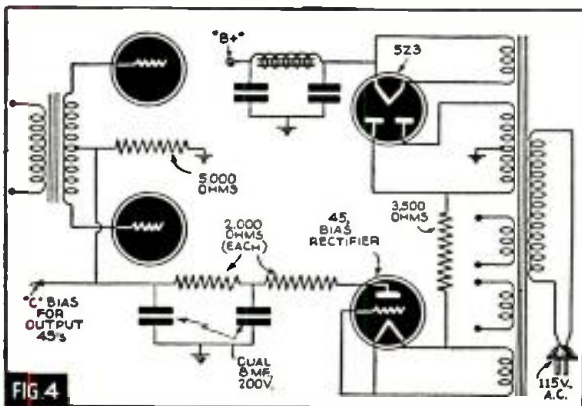

Please Say That You Saw It in RADIO-CRAFT

Mr. Serviceman: YOU'RE IN GOOD COMPANY WHEN YOU'RE IN THE RSA!

RSA is the only organization of Servicemen that has the sponsorship of the Radio Manufacturers' Association and the Sales Managers' Clubs, as well as the endorsement of the entire industry.

RSA is proud to announce that final details of plans for complete cooperation with the NAB, through local broadcasting stations, are rapidly being completed.

RSA chapters will receive, entirely free of charge, complete Television Course for instruction in television servicing and installation in the very near future.

RSA has helped thousands of its members solve their technical problems during the past year.

Membership quotas in some sections of the country have practically been completed.

We urge all interested servicemen to contact the RSA immediately for details of membership.

Let's Grow Together in 1939!



RADIO SERVICEMEN OF AMERICA, Inc.

Joe Marty, Jr., Executive Secretary
304 S. Dearborn Street, Chicago, U.S.A.

MAIL THIS COUPON NOW!

RADIO SERVICEMEN OF AMERICA, INC.
304 S. Dearborn St., Chicago, Ill.

Name
Address
City State

I am interested in RSA Membership. Tell me about it.
I am enclosing \$4.00 for National dues and initiation.
(Does not include Local Chapter dues where Local Chapters are organized.) RC-1039

TEST YOUR RADIO KNOWLEDGE

(Continued from page 226)

Answers . . .

$$(5) \sin \theta_1 = \frac{R_1}{\sqrt{R_1^2 + X_L^2}}$$

Combining equations (3) with (4) and then (5) we have:

$$(6) Z_o = X_L \sin \theta_o$$

$$(7) Z_1 = X_L \sin \theta_1$$

From whence with equation (2) we have:

$$(8) \frac{Z_1}{Z_o} = \frac{X_L \sin \theta_1}{X_L \sin \theta_o} = \frac{\sin \theta_1}{\sin \theta_o} = 1.54$$

Solving for $\sin \theta_1$ we have;

$$(9) \sin \theta_1 = 1.54 \sin \theta_o$$

And having been given a power factor of 80% which is .8 to start with we find that since:

$$\cos \theta_o = .8$$

$$\theta_o = 36^\circ 20' \quad (\text{original phase angle of primary})$$

Also:

$$\sin \theta_1 = 1.54 \sin 36^\circ 20'$$

$$= 1.54 \times .5995$$

$$= .923$$

$$\theta_1 = 67^\circ 30' \quad (\text{new primary phase angle})$$

$$\cos \theta_1 = .3827 \text{ and new power factor} = 38\% \text{ approximately}$$

And further as power = EI Cos θ we have for:

$$\text{Original case } 115 \times .65 \times \cos 67^\circ 30' = 92 \text{ watts}$$

$$\text{New case } 115 \times 1 \times \cos 36^\circ 20' = 28.8 \text{ watts}$$

A.16. The line impedance for which this pad is intended must have a value equal to the square root of the product of the open and shorted values of the pad. Its open

value is simply the sum of R_1 and R_2 , while its shorted value is

$$R_1 + \frac{R_1 R_2}{R_1 + R_2}$$

According to the problem these values will be:

$$(1) R_1 + R_2 = 450 \text{ ohms}$$

$$(2) R_1 + \frac{R_1 R_2}{R_1 + R_2} = 94.4 \text{ ohms}$$

Their product will be 42,500 and the square root of this is approximately 206 ohms. This is the line impedance, which we will call Z_o . The total voltage lost by the pad will be the product of the ratios of the voltage across R_2 to the input voltage and that across Z_o to that across R_2 . The former ratio expressed in terms of resistance and impedance is:

$$(3) \frac{Z_o - R_1}{R_1 + (Z_o - R_1)}$$

While the latter is:

$$(4) \frac{Z_o + R_1}{Z_o}$$

The product of these (3 and 4) is:

$$E_o = \frac{Z_o - R_1}{Z_o} \times \frac{Z_o + R_1}{Z_o}$$

$$E_i = \frac{Z_o - R_1}{R_1 + (Z_o - R_1)} \times \frac{Z_o + R_1}{Z_o} \times E_o$$

$E_o = \text{Input voltage}$
 $E_i = \text{Output voltage}$

$$\frac{Z_o - R_1}{Z_o} \times \frac{Z_o + R_1}{Z_o}$$

$$(5) \frac{E_o}{E_i} = \frac{Z_o - R_1}{Z_o + R_1}$$

Substituting values as above:

$$\frac{206 - 50}{206 + 50} = \frac{156}{256} = .609$$

$$\text{However } \frac{E_i}{E_o} = \frac{1}{.609} \text{ or } 1.641$$

$$\text{db. loss} = 20 \log 1.641 = 20 \times .215 = 4.3 \text{ db. loss}$$

A.17. Correct frequency = 1,000 kc. (f_o)
Frequency drifts to 1,000 - 7 or 993 kc. (f_1)

Capacity decrease to fully compensate for this from the relation:

$$\frac{C_1}{C_o} = \left(\frac{f_o}{f_1} \right)^2 \text{ is } C_1 = C_o \left(\frac{f_o}{f_1} \right)^2$$

$$C_1 = 90 \left(\frac{1000}{993} \right)^2 = 90 \times (1.00704)^2 = 90 \times 1.01413 = 91.2717 \text{ mmf.}$$

Temperature coefficient per degree dC

$$C. = \frac{dT \times C}{dC} = \frac{-1.2717 + 90}{90} = -1.2717 \text{ mmf.}$$

$dT = 15 \text{ degrees}$
 $C = 90 \text{ mmf.}$

Substituting:

$$\frac{-1.2717}{15 \times 90} = -.000942 \text{ per degree C.}$$

A.18. Use the inner deflector plates because their deflection sensitivity averages about 35% better than the outer ones and use + 250 volts on the 2nd anode as the

Please Say That You Saw It in RADIO-CRAFT

deflection sensitivity is nearly inversely proportional to the anode voltages within practical operating limits.

A.19. It is remedied by a tuning adjustment as this principally controls the symmetry of the resonance curve while the coupling controls its width principally.

A.20. It actually contributes a slight loss to the amplifier because the grid-return must be connected to the cathode load. As the signal voltage at the latter point approaches that of the grid the effective signal input approaches zero. Thus, since neither the cathode nor the plate can vary as much as the grid there will be some loss in the phase inverter. Of course, it serves its purpose as a phase inverter, but actually causes a small loss in the signal.

(This concludes the Second Test in a Series.)

SOUND SYSTEM GUIDES BREWERY TOURS

(Continued from page 205)

he reaches one point after another on a prescribed tour of the brewing company's property. This sets the record transcription equipment in momentary operation to play only a particular portion of the large transcription record. To again start the sound record in order to play the next portion of the transcription, it is necessary to go to the next point of interest on the tour and press the button at that point; and so-on until the tour and playbacks of all the recordings on the disc, are completed.

The important point about this installation of interest to sound men is that it offers an entirely new approach to the sale of sound equipment to large industrial organizations. Instead of suggesting that the sound installation be made merely to serve as a call system—an approach which may have little appeal in view of the adequacy of a possible existing call system, such as the use of bells—the sound man may suggest that the call system is a supplementary service always available in addition to operation as a P.A. unit used to create goodwill among visitors. Note that in order to obtain maximum appeal, the radio announcer of a broadcast station was drafted to make the original transcription, in the case of the brewery installation just described.

CLARENCE—RADIO ROBOT

(Continued from page 200)

chest (below which is mounted the mike).

Oscillator No. 2 in the Control radiates a controlled carrier signal radiating from the antenna marked "control." This carrier signal is picked up by the antenna marked "control" on Clarence through Receiver No. 3, to trip a relay which actuates a controlling device. This controlling device turns on and off the 6 motors which govern Clarence's walking, arm motions, etc.

A photocell in Clarence's eye is directly connected to a preamplifier located in Clarence's head. An additional amplifier in Clarence's body also feeds into the controlling relay circuit. Thus when a light is placed on Clarence's eye the controlling relay may be closed to control Clarence's motions.

The electric motors which drive Clarence's gears, cams and shafts, are of special design, built to operate on the power supply available. Special automatic selective gearing helps give Clarence a variety of motions with fewer motors. Two different-type storage batteries, plugs, and 3 types of drycells, form the basis for Clarence's source of power.

RCP TEST INSTRUMENTS check on all 3!

✓HIGH QUALITY ✓WANTED FEATURES ✓LOW PRICE

If you've never used RCP test equipment, if you don't know the time-saving value of every instrument in this complete line, if you're not aware that RCP can make servicing easier and a great deal more profitable, go see your jobber today. Find out about RCP high quality, RCP's parade of features and RCP low prices combining to make these instruments far and away your best test equipment buy!

Here's a lot of value for a little money

Model 308 Dynoptimum Tube Checker

Tests (under R.M.A. specified plate voltages and loads) up to 117 volt tubes all metal, M.G., glass, 024, cold cathode rectifiers, octal, loctal and single end tubes. Tests all ballast tubes (separate chart included). Hot interelement short and leakage test between all individual elements. Noise test. Spare socket.



Model 308C. Counter type net \$16.95
Model 308P. Combination portable, counter type \$18.95



This Year An Even Better Buy!

Model 445 AC-DC Multi-tester

D'Arsonval meter accurate within 2%. Five range D.C. voltmeter 0/5/50/250/500/2500 at sensitivity of 1000 ohms per volt. Four range A.C. voltmeter 0/5/50/500/1000 volts. Three range ohmmeter 0/500/100,000/500,000. Four decibel ranges—12 to -8/28/28-48/34-54 db. Four output ranges. Five current ranges 0/1/10/100 milliamperes, 0/1/10 amperes. This year's Multi-tester buy at \$9.95 net.

Here's How Your Money Buys More Service

Model 801 Combination Tube and Set Tester

Nowhere could you buy these two essential instruments individually at this low price. Tests all new and old tubes; hot interelement short and leakage tests on each individual element. As multi-tester Model 801 provides four ohmmeter ranges 0/500/10,000/1 meg./10 meg., four range D.C. and A.C. voltmeter 0/10/50/500/1000. Four range D.C. milliammeter 0/1/10/100/1000. D.C. Ammeter 0/10. New Alnico Magnet—fused D'Arsonval meter. Compact, light, complete with tube, battery and test leads. net \$27.95



See your jobber today, or write direct for detailed information on the complete RCP line.

RADIO CITY Products Co.
88 PARK PLACE NEW YORK CITY

COMPLETE RADIO COURSE \$1.95

Regular RADIO TECHNICAL INSTITUTE Training



A SPECIAL OFFER

A limited quantity of R.T.I. \$39.00 radio courses have been reprinted and are offered to you at only \$1.95. These are the latest courses, complete in every detail, and exactly the same as the originals.

Radio is the present-day opportunity field. Hundreds of men with no special talents have studied Radio Servicing for a short time and are now making twice and three times as much money. R.T.I. unique radio training brings rich rewards; you can get ready quickly, inexpensively, easily, and in your spare time for a good job in radio.

ACCEPTED BY INDUSTRY

Forty large radio manufacturers have helped to prepare the R.T.I. course. Just think what this backing by the radio industry means to you. R.T.I. practical training will give you facts and real data you will need on the job. Hundreds of diagrams and illustrations will help you. You will pass quickly from lesson to lesson and in a surprisingly short time will be ready to do real radio servicing.

COMPLETE IN ALL DETAILS

No special previous education or experience is needed. R.T.I. course will give you all the training you need. The lessons are clear, interesting, easy to master and use. Fellows who knew nothing about radio before taking a radio course are now the leading servicemen in their communities. This is your chance to obtain R.T.I. excellent course for only \$1.95.

From the very start you are introduced to practical servicing equipment and practices. You are told how to open your own shop or radio store. Lesson 15, "The Radio Servicing Business," will give you many practical ideas and hints. The course is so planned that you will be able to earn spare-time money before you have reached your tenth lesson. The special \$1.95 price of the complete course can be earned in a single hour's work of radio servicing.

YOUR GUARANTEE

You are completely protected. We guarantee these courses to be exactly as the original \$39.00 Radio Technical Institute courses. Money back guarantee. References: Liberty National Bank, Chicago, Dun & Bradstreet, or any magazine publisher.

3 COURSES IN 1

R.T.I. course is really three complete essential courses combined. You get training in (1) Practical and Applied Radio; (2) Fundamentals of Radio Principles; and (3) Advanced Specialized Training. This is the training that will place you above the average radio servicemen—and you get this training for only \$1.95.

There are over 37,000,000 radio sets in use. The R.T.I. easy practical course will pave the way to your success in Radio work.

TELLS HOW TO USE INSTRUMENTS

The training is complete. Everything from simple facts to complex alignment problems. Many servicemen have found that R.T.I. training is excellent for brush up and study of modern servicing methods. This is the best buy in a radio education. Take advantage of the bargain price today.



LATEST DATA

Yes, in the R.T.I. course you will find a complete explanation of A.V.C., how to use an oscilloscope, sound feed-back, resonance phenomenon, every possible fact you must know to be the best serviceman. You get a real radio training. One of the BEST radio courses is yours for only \$1.95.

LIMITED QUANTITY

Hurry your order to us today. There is but a small quantity of the courses left at the special price. You are completely protected with our guarantee. Postal money orders, checks, currency, unused stamps accepted. Answer today.

SUPREME PUBLICATIONS,
3727 W. 13th St., Room 105,
Chicago, Illinois

Please send the complete R.T.I. radio course at the special \$1.95 price. I am to be protected with your money back guarantee.

I am enclosing \$1.95, send prepaid.
 Send C.O.D. I will pay mailman \$1.95. Plus a few cents postage.

NAME
ADDRESS

Please Say That You Saw It in RADIO-CRAFT

QUALITY at LOW PRICE



CONSOLIDATED Volume and Tone Controls

Ask your jobber today about these quality controls at exceptionally low prices. He will be glad to show you how a small stock of Consolidated Volume and Tone Controls will cover 90% of your replacement calls. Five types of controls are available with resistances ranging from 1,000 to 2,000,000 ohms.

See Them at Your Jobbers Today!

CONSOLIDATED
WIRE AND
ASSOCIATED
CORPORATIONS
524 S. Peoria St. Chicago, Ill.

PATENTS—TRADE MARKS

Booklet concerning Inventions & Patents Form "Evidence of Conception" with instructions for use and "Schedule of Government and Attorneys Fees"—Free

LANCASTER, ALLWINE & ROMMEL
Registered Patent Attorneys
436 Bowen Bldg. Washington, D. C.

EVERYTHING IN RADIO!
A COMPLETE SOURCE FOR YOUR RADIO NEEDS
Our immense stock of radio sets, parts and supplies enables you to purchase your entire needs on one order. You will find all your Nationally Known Favorites in this big book which is FREE for the asking. Practically every order is shipped the same day it is received.
WRITE FOR BIG NEW CATALOG
BURSTEIN-APPLEBEE CO.
1012-14 McGee St. • Kansas City, Mo.

RADIO ENGINEERING

RCA Institutes offer an intensive course of high standard embracing all phases of Radio and Television. Practical training with modern equipment at New York and Chicago schools. Also specialized courses and Home Study Courses under "No obligation" plan. Catalog Dept. RC-39.

RCA INSTITUTES, Inc.

A Radio Corporation of America Service
75 Varick St., New York 1154 Merchandise Mart, Chicago

JOIN OUR RECORD CLUB
Send for your copy of this big 500 page Record Catalog & Encyclopaedia. Contains lists of thousands of famous records and musical data on pronunciations and dates of composers 25¢ plus 10¢ for mailing. (stamps or coin) It also enrolls you in our Record Club. We carry a large selection of records from 10¢ up. Write today.
MODELL'S
58 Cortlandt St. 301 New York City

DESIGNED BY A. C. SHANNON
DIRECT COUPLED AMPLIFIERS
FROM 9.88
Sensational value in this new line.
10, 20, 30 Watt Models. ALL-PUSH-PULL THROUGHOUT. Ideal for all high-fidelity amplification.
10 WATT BASIC KIT \$9.88; 20 WATT BASIC KIT \$14.52.
Top-notch performance guaranteed.
WRITE FOR NEW BULLETIN
AMPLIFIER CO. OF AMERICA
17 WEST 20th STREET NEW YORK, N. Y.

VIDEO AMPLIFIER DESIGN

(Continued from page 208)

stages to be compensated.

It is just as important to amplify the lows in the proper amount as the highs—and sometimes as difficult.

AMPLIFYING THE LOWS

The perfect video amplifier should have a flat response from 0 cycles (D.C.) to the highest frequency. To do this, the *time constant* of the coupling circuit must be the same for all frequencies. Returning to Fig. 3, when the plate resistor is reduced to a small value, the coupling condenser must be much larger in order to pass the extreme lows. If too small it would charge and discharge too fast to pass the lows. In some instances it would be too large to be practical; then a resistor may be used in series with the coupling condenser, as in Fig. 4, which permits a smaller condenser to be used.

If the lows of 60 cycles and less are to be properly amplified the power supply must be unusually well filtered to prevent hum, especially when more than 3 stages are used.

One of the most efficient methods of amplifying the extreme lows is shown in Fig. 5. The plate resistor is divided into 2 parts, R1 and R2. Unit R1 is the effective plate resistor for both the highs and lows. Condenser C1 bypasses the highs but not the lows, around R2. Thus in effect there is more resistance in the plate circuit at low frequencies than at high, which gives more amplification of the extreme lows.

The cathode bias resistor and bypass condenser must have a very long time constant to avoid L.F. *degeneration*, and L.F. *phase shift*. Small values of bias resistors require such large bypass condensers that it is often more convenient and less expensive to use grid bias cells, especially with such tubes as the 75 which needs only 1.5 V. grid bias.

Instability such as motorboating and oscillation can be remedied by the decoupling resistor R1 and condenser C1, in Fig. 7. The time constant of this must be very long to prevent unwanted over-amplification of the lows, and hum. Too large a coupling condenser may cause slow motorboating of about 1 or 2 cycles. A separate power supply is generally used with 2 or 3 stages. A resistor in series with the coupling condenser will also promote stability.

PHASE SHIFT

The plate coupling impedance of a tube causes a 180-degree *linear phase shift* of all frequencies, in each stage. But the inter-electrode capacity of the tube causes *non-linear phase shift* of the highs, which does not affect the lows because the capacity is too small. An inductive plate load, or the resistor R1 and condenser C1 in Fig. 2, causes a phase shift in the opposite direction, so are valuable circuits for phase-shift correction at high frequencies, and for frequency correction as well.

Circuits for phase-shift correction cannot be considered for that purpose alone. Both frequency correction and phase shift correction are considered at the same time in video amplifier design. In fact, a well-designed amplifier with frequency compensation is usually not bothered with phase shift.

Non-linear phase shift at the low frequencies is equally as important to consider, especially in an amplifier having poor low-frequency response. Cathode bypass condensers, and coupling condensers which are too small can cause L.F. phase shift. An I.F. phase-shift correction circuit is shown in Fig. 5, which is also used for H.F. correction.

Please Say That You Saw It in RADIO-CRAFT

FREE- REAL ELECTROPLATING OUTFIT



Now— You Can ELECTROPLATE EASILY WITH A BRUSH

SOMETHING new for radio men—something which gives you the opportunity to make additional profits—or to improve your type of service. Here's an ELECTROPLATING KIT amazingly simple to operate—you just Electroplate with a Brush!

NOT A TOY!

Electroplate for profit, hundreds of things in the household—ashtrays, fixtures, water faucets, worn brackets, door knobs, musical instruments, jewelry and silverware and other articles. It's an indispensable piece of equipment—plate articles in hotels, apartments, office buildings, medical and dental offices, factories, schools, laboratories, etc. Exactly the same outfit (but larger) is used professionally by electricians, radio service men, automobile repair shops, etc. Requires one single dry cell 1 1/2 volt battery to operate.

You can electroplate tarnished receiver parts, escutcheons, contacts, worn radio parts and accessories, and display chassis. Put this REAL ELECTROPLATING KIT to use immediately—make it the most useful article in your shop or laboratory. And you can get it absolutely FREE (except for slight mailing cost).

Subscribe today to RADIO-CRAFT for One Year (12 issues) and receive absolutely FREE this ELECTROPLATING KIT. New subscribers are accepted or extend your present subscription twelve months. Mail remittance of \$2.00 (plus 10¢ for shipping charge on kit) to the publishers. (Canada and foreign \$2.85). You will receive your FREE, REAL ELECTROPLATING OUTFIT by return mail. Use coupon below to enter subscription.

RADIO-CRAFT

99 Hudson Street New York, N. Y.

RADIO-CRAFT RC1039
99 Hudson Street, New York, N. Y.

Gentlemen: Enclosed find my remittance of \$2.00 for which enter my subscription to RADIO-CRAFT for One Year (12 issues). Send me FREE, ELECTROPLATING OUTFIT (Canada and foreign \$2.85). In U. S. add only 10¢ additional to cover shipping charges on kit.

New Subscriber Extend Present Subscription

Name

Address

City State

(Send remittance by check, money order or unused U. S. postage stamps. Register letter if you send cash or stamps.)

D.C. AMPLIFICATION

Last but not least to consider is the D.C. component (brightness level) of the signal. A good video amplifier must amplify D.C. as well as A.C. Without it, the image would be less natural, and it would be hard to synchronize.

The D.C. component controls the illumination of the scene as a whole, or the amount of background light. For instance, if a scene is taken in bright sunlight, the background of the image at the receiver would be bright; and if suddenly switched to a studio scene with a dull interior, the effect would appear at the receiver.

All of the video frequencies and the D.C. component are present in the output of the diode detector of a teleceiver. However, as soon as they reach the first video coupling condenser, the D.C. is lost because of the condenser. D.C. amplifiers have been built using direct coupling without a condenser, but they are very difficult to design when more than 2 stages are used.

Some of the lower-priced sets and kits now on the market ignore the D.C. and use coupling condensers with fair to good results. The better television sets also use coupling condensers, but have provision in the circuit to restore the D.C. at the grid of the C-R. tube. Two methods of doing this are in use.

The first uses a diode tube shunted across the grid circuit of the C-R. tube, with the cathode of the diode connected to the grid of the C-R. tube. The plate of the diode is connected to a resistor network so that the diode bias (if any) may be at the correct value.

The other method makes use of a power tube in the final stage of the video amplifier. This tube is operated at zero grid bias, without bias resistor or bias cell. Both the cathode and grid-return are grounded. The plate is connected directly to the C-R. grid, with the cathode of the C-R. tube being connected to a positive point of the amplifier circuit. The D.C. is restored through the rectifying action of the output tube grid, operating at zero bias.

It was found that the lowest frequencies are also restored along with the D.C., in these D.C. restorer circuits. Due to this, the amplifiers do not need to pass the very lowest frequencies, and thus extra filtering is not needed in the power supply.

IMAGE EFFECTS

Lack of low, medium, or high frequencies can be recognized merely by observing the image. In extreme cases of a deficiency of lows, all of the vertical lines in the image will be followed by an unwanted bright vertical line, giving the peculiar effect of a 3-dimensional image. All of the dark horizontal lines of the "picture" are missing. When looking at a closeup view of a person's face, part of the features will be missing. For instance, the left half of the lips may be black but the right half may fade into the light background of the image.

When only the medium frequencies are coming through, all of the fine details will be missing, and large, black areas will be merely gray, instead of black.

A lack of highs causes a loss of all fine details. When both the medium and high frequencies are insufficient, all that can be seen is a group of large, black shadows.

To experimenters who construct very many experimental chassis, here is a time-saving suggestion: Use light-weight galvanized iron. It is easy to bend, and holes can be punched with an ice-pick much faster than they can be drilled. A brace and bit can be used to drill neat socket holes in metal, if you do not have a circle cutter or punch.

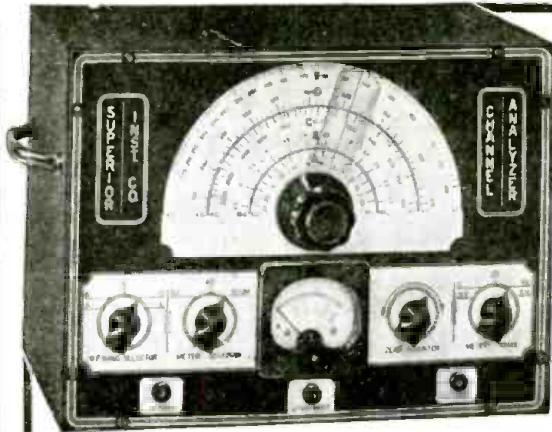

THE NEW
Channel Analyzer

Follows Signal from Antenna to Speaker of any set.

Fundamentally, what the Superior Channel Analyzer does is to permit the serviceman to follow the SIGNAL from antenna to speaker through each and every stage of any set ever made, and inferentially, of any set that ever will be made, using the SIGNAL as the basis of measurements. Thus if there is trouble in one particular channel or stage of a receiver, the serviceman can isolate the faulty stage and then proceed to ascertain the very part or component that causes the trouble. Many of the troubles in modern receivers are due to the Automatic-Volume-Control and Automatic-Frequency-Control circuits and ordinary instruments do not permit measurements directly upon these circuits, so the Superior Channel Analyzer includes a direct-current Vacuum-Tube Voltmeter that DOES make these measurements directly and with a negligible loading of the measured circuits. Other problems cease to be problems too, when the quick-solution method of the Channel Analyzer is applied. For instance, suppose a local oscillator in a superheterodyne drifts. The Channel Analyzer has a switch operated, tuned input circuit with amplifier, whereby not only the presence of drift may be discovered, but also the amount and direction of drift. Distortion is another difficulty that often nettles a serviceman. The Channel Analyzer has a jack for the insertion of earphones so that you can listen to the signal directly from any stage and, therefore, discover the stage in which the

distortion takes place. Next, the VTVM is used to discover the very component in that circuit that is causing the trouble. How often have you cherished the hope that some day you would own an instrument that enables you to measure the actual signal voltage across the load of any stage in the set, and thus by comparison determine the gain per stage. The Channel Analyzer enables those dynamic voltage measurements and does a whole assortment of other work besides, yet at a price much less than that usually asked for a dynamic voltmeter alone. D.C. Voltages have important bearings on receiver performance. All these voltages can be measured on the Channel Analyzer with the receiver in reproducing operation. In fact, that one important consideration, MEASUREMENTS WITHOUT MOLESTATION OF THE RECEIVER, gets rid of the drawback of most conventional equipment which greatly reduces the very voltage it attempts to measure, or kills the signal completely. Tubes that are used in the receiver under test are also given a thorough check by the Channel Analyzer and as such a specialized tube tester, this new and remarkable instrument is proof against any possibility of obsolescence.

The Superior Channel Analyzer comes housed in shielded cabinet and features an attractive etched aluminum panel. Supplied complete with tubes, three specially engineered shielded input cables, each identified as to its purpose. Also full operating instructions. Size 13"x10"x6". Shipping weight 19 pounds. Only

\$1975

SUPERIOR INSTRUMENTS COMPANY
136 LIBERTY ST., DEPT. RC-10 NEW YORK, N. Y.

At Last! **a NEW and DIFFERENT Sound Catalog**
An Encyclopedia on SOUND!

SHOWS YOU How to Choose the Right Sound System for ANY location! Just measure the auditorium and look in the book. It tells you what amplifier you need—and how many speakers of what kind and where to place them!!

DO YOU KNOW you should not use a Velocity Mike in the Wind? Or a Crystal Mike in the Sun? Speakers must be "Focused" like spotlights?

JUST A FEW of the facts this fascinating book contains!

MOST COMPLETE LINE of Sound Equipment ever assembled in one catalog!

TIME PAYMENTS! 15 DAY TRIAL!

MONEY BACK GUARANTEE!

FULLY LICENSED!

LOWEST PRICES!

NO SOLDERING!
(Everything plugs together)

MORE THAN 20 YEARS EXPERIENCE
in Sound and Radio!

MONTGOMERY WARD 580 RETAIL STORES
10 GREAT MAIL ORDER HOUSES

FREE! MAIL THIS COUPON NOW!

Montgomery Ward & Co.
Dept. RZ-31, Chicago, Ill.
Please RUSH me your New FREE Sound Equipment Catalog.

Name _____
Address _____
City _____ State _____

Please Say That You Saw It in RADIO-CRAFT

Radio Men Find This Book Handy

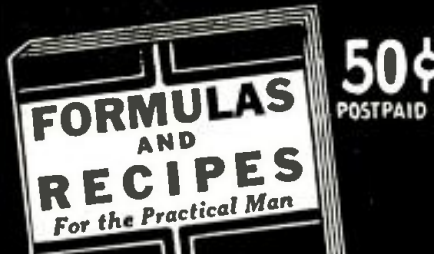

50¢ POSTPAID

FORMULAS AND RECIPES
For the Practical Man

Here is the Contents of the Book

1. Adhesives: Glues, Cements, Gums, Mucilages, Lubricants
2. Cleansing: Stain Removers, Paint Removers, Bleaches, Cleaning Fluids
3. Metal Craft: Coloring, Oxidizing, Plating, Repairing, Welding, Polishes, Alloys, Solders, Amalgams
4. Paints: Colors, Stains, Varnishes, Enamels, Luminous Paint, Washable Paint, Paint-Remover, Waterproofing, Fireproofing
5. Glass-Working: Cutting, Drilling, Boring, Bending, Blowing, Etching, Engraving, Frosting, Silvering, etc.
6. Wood-craft: Fillers, Fireproofing, Acid-proofing, Waterproofing, Furniture Polishes, Finishes, etc.
7. Ink Recipes, Eradicators, Ink Stain Removers, Special Inks, Colored, Insoluble, Sympathetic, Invisible, Hectograph
8. Photography: Developers, Emulsions, Fixers, Sensitizing, Toning, Printing, Photographic Paper, Blueprint Paper
9. Antidotes for Poisons, Remedies for Burns and Scalds, Disinfectants, First-Aid in Accidents, Emergency Remedies, Home Remedies
10. Preparation, Manipulation, Handling, Mixing, Measuring, Weighing, Filtering, Straining Solutions; List of Technical Substances; Emulsifying; Use of Hydrometer, Use of Thermometer; Tables of Weights and Measures, Decimal Systems, Useful Tables

TECHNIFAX, Division RC-1039
1915 So. State Street, Chicago, Illinois

TECHNIFAX, Division RC-1039
1915 So. State Street, Chicago, Illinois

Gentlemen: Enclosed please find 50c (check, money order, coin or unused U.S. stamps accepted) for which send me POSTAGE PREPAID, One Copy of FORMULAS AND RECIPES For the Practical Man.

Name

Address

City

State

DATAPRINTS

TESLA-LOUDIN HI-FREQ. COILS

20c Ea. in order for 10 (Data and Drawings only.)

36" Sp'k Tesla-Oudin Coil 40c (1 K.W. Exc. Trf. Data, included FREE!)

8" Sp'k Tesla-Oudin Coil 40c (1/4 K.W. Exc. Trf. Data, included FREE!)

3" Sp'k Oudin; 110 Vt. "Kick Coil" type 40c

3" Sp'k Tesla Works on Ford Sp'k Coil 40c

1" Sp'k Violetta Hi-Freq. Coil 40c

FREE with order \$1.00 or more—20 Tricks with Hi-Freq. Coils (40c separate)

Induction PIPE & ORE LOCATOR

Construction Data 40c

YOU need these DATAPRINTS!

5 Meter Superhet.	Resistance Measuring
1/2 Meter Tr. & Rec.	Bridge
20 A.C. Probs. & Ans.	Weld. Transf. 2 K.W.
20 Telephone Hook-ups	Rewinding Armatures
20 Mech. Movements	String Galvanometer
20 Motor Hook-ups	20 Simple Bell Circuits

Special Prices: 4 prints \$1.00; 10 for \$2.00; Single, 40c each. Get New Catalog 100 A.

The DATAPRINT Co.
Lock Box 322C, Ramsey, N. J.

RADIOS SAVE UP TO 50%



DEAL DIRECT-FACTORY PRICES! Many models to choose from at wholesale prices. AC-DC midsets \$4.98. Portable and battery sets \$8.98 up. Car sets \$11.75 up. Also consoles, all-wave etc. Samples at 50% off. Send for FREE 1940 bargain catalog giving details of 10 day FREE trial and agent's proposition and discounts. No obligation, write today.

Free Catalog

R.C.A. 495

GOLDENTONE RADIO CO., DEPT. RC, DEARBORN, MICH.

RADIO TRADE DIGEST

NEW RSA OFFICERS FOR 1939-'40 TERMS
(Continued from page 227)

New RSA Directors are: Frank L. Clark, 311 Marshall Ave., Nashville, Tenn.; Winston B. Jones, 912 Eye St., S.E., Washington, D. C.; Fred Olson, 1521 E. Walnut St., Green Bay, Wis.; Ingvar Paulsen, 211 Roxbury St., Roxbury, Mass.; Norman W. Smith, Box 273, Jamestown, N. Y.; Carl Williams, 377 S. Main St., Phillipsburg, N. J.; and George D. Wooley, 318 15th St., Rock Island, Ill.

Re-elected Directors and holdover Directors are: Joseph A. Cole, 13605 Camden Ave., Detroit, Mich.; L. G. Deering, 420 N. Hudson, Oklahoma City, Okla.; George F. Duvall, 8005 Third Ave., Brooklyn, N. Y.; Henry M. Lutters, 758 E. 230th St., Bronx, N. Y.; Carl A. Rauber, 46 South St., Somerville, N. J.; T. P. Robinson, 2712 N. Henderson Ave., Dallas, Tex.; Donald H. Stover, 9 S. Galena Ave., Freeport, Ill.; Lee Taylor, 1352 Catalpa Ave., Chicago, Ill.; Albert J. Theriault, 2715 W. 25th St., Cleveland, Ohio, and Kenneth A. Vaughan, 312 Market St., Johnstown, Pa.

OTHER RSA NEWS

CHICAGO CHAPTER: Found that Brandex directory of service info on private brand & off-brand sets, sold like hot cakes during the convention. Only RSA men can get it, since it is a project of RSA Chicago Chapter. RSA members can get copies from Chapter Treasurer.

DANVILLE, ILL., CHAPTER: Now has a weekly radio program over station WDAN, entitled "Behind the Mike with RSA." This is a program to bring to the public the men and women putting on their programs and describes their duties and interesting facts in their lives. Chapter plans to get representatives from every branch of the radio industry since this program is donated for an indefinite period.

LANSING, MICH., CHAPTER: Discussion of group advertising resulted in the decision to enter a 13-week contract for space in local daily, with costs to be shared by the group.

It was decided after discussion, to provide copies of Schedule of Service Charges to non-member Servicemen of Lansing who are worthy and will cooperate.

SPRINGFIELD, ILL., CHAPTER: Met to consider the proposed changes in National Bylaws, as outlined by Director Stover. Mr. Crabtree gave a very interesting talk on servicing costs, using data and articles published by National RSA for comparison.

The stag party held at the Leland Hotel, was a howling success. Glen Sillman says poker pays about the same as radio service! When it came to the door prizes, the secretary held the box of names, and the president, Doc Spindel, drew them. *The first name out was that of the Secretary, and the second was that of the president!* So-o-o they started over!

RADIO INDUSTRY MOURNS U. J. "SPORT" HERRMANN

(Continued from page 227)

Both cars involved in the crash began to burn. Brownie tugged at Wagner until he revived, and despite a broken ankle, Wagner was able to drag the other occupants of the burning automobiles to safety, among them Sport Herrmann himself, whose injuries were at first not thought serious.

Mr. Herrmann was 67 years old when he died. He was a retired Commander in the United States Naval Reserve, a Past Potentate of the Medinah Shrine, a director of Zenith Radio Corporation and other organizations. He was unmarried at the time of his death. Most of his estate will go to old friends and employees, to a surviving brother and niece, to a fund for crippled children, and to various charities and hospitals in which during his life he took a daily interest.

Please Say That You Saw It in RADIO-CRAFT

NEW!



A NEW GERNSBACK PUBLICATION

The Constructive Photo Magazine

ON ALL NEWSSTANDS

FOR serious-minded amateur photographers, here's a photo magazine, FOTO-CRAFT, vastly different from any you've read. It tells you how and why to do things—it's a constructive publication which shows what can be done with the equipment you have, and how to make handy, photographic accessories. FOTO-CRAFT, with its broad editorial features, covers such important branches of photography as—New Scientific Researches; Developing; Printing; Enlarging; Dodging; Cropping; Photomicrography; Color Photography; Amateur Movies; How to Make It Items.

A Few of the Articles in the Current Issue

What Makes a Good Photograph—Making Photos Without a Camera—A One-Eye Stereoscope—A Coin Tripod—Scorer—Pistol or Gun Grip for Your Camera—Edge and Border Designs—Making a Scene Selector—Permanent Retouching Desk—Building a Focus Magnifier—Motor Driven Film Tank—Stamp Photos—Color in Photography—Film and Print Drier—Ventilated, Dustless Garage Dark-room—Making a Dial-Type Film-Tank Thermometer—Combination Spot and Floodlight—Home-Made Fan and Tripod Head—Home-Made Emergency Changing Bag—Creator of Illusions—Photo Quiz—Use Your Enlarger for Copying—Most Bizarre Photo Contest—Hints and Kinks—Questions and Answers—What's New.

Fotocraft—Two magazines in one—Now Combined with Photo Review.

And another Free Gift—Tonechrome Viewing Filter.

BIG OPPORTUNITY!! Get a FOTO-CRAFT Press Card today—With it you can get permission to take photos which might be difficult to obtain. PRESS CARDS are sent FREE to subscribers of FOTO-CRAFT. Enter your subscription for Seven Months for \$1.00—and get your PRESS CARD immediately.

FOTO-CRAFT
89-R HUDSON STREET NEW YORK, N. Y.

FREE TRIAL OFFER

NEW REMINGTON NOISELESS PORTABLE!
AS LITTLE AS



10¢ A DAY

Famous Remington Noiseless Portable that speaks in a whisper. Pay as little as 10c a day. Guaranteed by the factory. Standard keyboard. Automatic ribbon reverse. Variable line spacer and all the conveniences of the finest portable ever built. PLUS the NOISELESS feature. Act now. Send coupon TODAY for details.

You don't RISK a Penny

We send you Remington Noiseless Portable for 10 days' free trial. If not satisfied, send it back. We pay all shipping charges.

Typing Course and Carrying Case

You will receive FREE a complete simplified home course in Touch Typing, a handsome sturdy carrying case is included. No obligation. Mail coupon for full details—NOW.

Remington Rand, Inc., Dept. 189-10,
465 Washington St., Buffalo, N. Y.

Tell me, without obligation, how to get a Free Trial of a new Remington Noiseless Portable, including Carrying Case and Free Typing Course for as little as 10c a day. Send Catalogus.

Name

Address

City

State

RADIO TRADE DIGEST

SALES HELPS & DEALS (Continued from page 228)

handling the line.

National Union Radio Corp. is ready with 4 types of handsome calendars for dealers to give customers. (See pic; pg. 228)

Philco has several ideas to help its dealers sell. (1) Attachable monograms to "personalize" sets. (2) New display packages for needles, interference eliminators, etc. (3) Counter-window display on auto aerials.

SNOOPS & SCOOPS

(Continued from page 230)

Appliance Co., Pittsburgh & Wheeling, has switched its moniker to Anehor Distrib. Co.; Crosley equip't is handled.

Fada Radio & Elec Co., N. Y., plans an ad campaign on billboards, radios, mags & papers; **Sternfield-Godley** will handle it . . . **Crosley** reports 10,000 people came to see its new midget car on first day in single store; does not say how many bought, how many laughed . . . **Kuthrauff & Ryan, Inc.**, ad agy., has landed the **Majestic Television & Radio** account.

Watters Products Co., N.Y.C., is selling its **Capps styli** to the public for the 1st time through distributors & drs . . . **RCA's** policy on their new test equip't line will "minimize obsolescence," they do say . . . **Iud Radio, Cleveland, O.** has a new line of 6" diam. "Giant" condensers for transmitting; also new series of osc. & buffer coils to fit 5-prong socket, & new metal xmtr & rcvr cabinets.

CONGRATS to the **Crosley Corp.** which has just been notified that it was awarded a gold medal by the Paris International Exhibition of 1937—and we always heard the French were fast! . . . A new line of lightweight generating plants by **D. W. Onan & Sons**, of Minneapolis, includes models for airplane use.

TELEVISION TRENDS

(Continued from page 230)

vestment brokers, Grand Rapids, Mich., has been elected v-p.

SERVICEMEN'S COURSE

Andrea Radio & Television Corp., Woodside, L.I., signed more than 100 Servicemen for its course in telly servicing during the first week it was offered.

BUYS DEMONSTRATOR

KSTP, St. Paul, Minn., bestg station, is installing an **RCA** telly demonstration system (like those in use at the 2 World's Fairs) as fast as possible. Watch for a boom in that area!

2 NEW STATIONS

WOR and a dept. store combine have each applied for a new telly channel in N.Y.C.

OFF THE PRESS

(Continued from page 229)

MASTER CATALOG—1940. Radio Wire Television, Inc., N.Y.C. 188 pp. Carries 40 pp. of home, portable & auto radios, & accessories; 35 pp. of P.A. equip't.; 50 pp. of equip't. parts & tools for Servicemen; 30-odd pp. for Hams & telly experimenters, as some of its major sections.

DX COILS. DX Radio Products Co., Chicago, Ill. 24 pp. Full data on coils, chokes, inductances, transformers & trimmer condensers, with 27 valuable diagrams, giving all values.

STANCOR CATALOG. Standard Transformer Corp., Chicago, Ill. 32 pp. Pix, specs & descriptions of wide assortment of transformers, plus 11 power packs.

AMPHENOL RADIO PARTS. American Phenolic Corp., Chicago, Ill. 32 pp. Pix, specs & descriptions of adapters, plugs, sockets, coaxial, insulators, sheet stock & tubing.

SPEAKER ENCYCLOPEDIA. Oxford-Tartak Radio Corp., Chicago, Ill. 8 pp. pix, specs & descriptions of speaker line.

STEWART-WARNER RADIO. 36 pp. (See under Sales Helps)

NEW RADIO TEST EQUIPMENT. Triplett Electrical Instrument Co., Bluffton, O. 12 pp. Complete illustrated data on service instruments. (Also new are mfr's. instrument price sheet & circular on wattmeters & portable appliance tester.)

JEFFERSON RADIO TRANSFORMERS & CHOKES. Jefferson Electric Co., Bellwood, Ill. 16 pp. Pix, specs & descriptions.

DATABOOK SUPPLEMENT. Raytheon Production Corp., Newton, Mass. 52 pp. Now bound in complete 25c Databook, brings it up-to-date with 73 newer tubes.

SHEET. Arco Tube Co., Newark, N. J. Specifications of Cath-Ray electrostatic & electro-magnetic television c-r tubes.

CAPACITORS CATALOG 10. Solar Mfg. Corp., Bayonne, N. J. 32 pp. Illustrates & describes complete line, with special section on mfr's test instruments.

HOT SHOT NO. 3 (Supplement to Catalog 55). Burstein-Applebee Co., Kansas City, Mo. 96 pp. Sets, parts, phonos, fence electrifiers, fans, etc., many at bargain prices.

CATALOG. Radolek, Chicago, Ill. 24 pp. Sets, parts, etc., many at bargain prices.

BATTERY REPLACEMENT GUIDE FOR TEST INSTRUMENTS. Burgess Battery Co., Freeport, Ill. 4 pp. Tells what batteries to use in many makes of instruments.

RCA SOUND EQUIPMENT. RCA Mfg. Co., Camden, N. J. 56 pp. Complete listing of sound systems for educational, industrial & entertainment fields; "buyer's guide"; chime systems; recorders & playbacks; mikes; directory of co.'s Commercial Sound distributors & district offices.

SHEET. Lectrohm, Inc., Cicero, Ill. Pix, specs & descriptions of fixed & adjustable w-w resistors. Co. also has flyer on new "Quick Heat Solder Pot".

CAPACITOR ANALYZER (Cat. #167A). Cornell-Dubilier Electric Corp., S. Plainfield, N. J. 8 pp. Pix, specs & descriptions of Analyzer, Bridge, & Decades for capacitor work.

RADIO NOISE FILTERS (Cat. #166A). Pub. by same. 8 pp. Pix, specs & descriptions of complete line of interference filters.

RADIO TRANSMITTER CAPACITORS (Cat. #160T) Pub. by same. 32 pp. Pix, specs & descriptions of line.

CHANGES & NEW ADDRESSES

(Continued from page 228)

ELLIOT-LEWIS CO., 2518 N. Broad St., Phila, Pa., will handle the **Stromberg-Carlson** line in Phila., N. J., Del. & Md.

HENRY O. BERMAN, 25 W. Baltimore St., Baltimore, Md., will distribute the same line in Baltimore.

JOSEPH HORNBERGER CO., Reading, Pa., & **J.R.S. DISTRIBUTORS**, York, Pa., will distribute same line locally.

More new **Stromberg-Carlson** distributors: **BYRUM MUSIC CO.**, 25 S. Main St., Greenville, S.C. (10 counties in n-w S.C.); **WIMBERLY & THOMAS HARDWARE CO., INC.**, 201 1st Av., N. Birmingham, Ala. (throughout Ala.); **RAYBRO ELECTRIC SUPPLIES, INC.**, 812-814 Slight St., Tampa, Fla. (all Fla. & part of S-E. Ga.); **TRACY & CO., INC.**, Providence, R. I. (R.I. area, plus New London & Windham counties, Conn.; Bristol, Barnstable & S. Plymouth county, Mass.)

ROBERT MILSK, 2964 Gladstone Av., Detroit, Mich., will represent **Setchell Carlson, Inc.**, in Mich. & Ind.

SENTINEL RADIO CORP., is in its new 4-story plant at 2020 Ridge Blvd., Evanston, Ill., which is 14 mi. from downtown Chi.

C. L. HOFFMAN CORP., Pittsburgh, Pa., has appointed the following mfr's. reps, who will handle pocket (Duratron) hearing aid through radio parts distributors:

James J. Backer, 109 Bell St., Seattle, Wash.
H. S. Baumgarten, 405 Penn Ave., Pittsburgh, Pa.
Fred G. Groves, 2317 Third Ave., Richmond, Va.
J. B. Higgins, 429 Fayne St., Detroit, Mich.
Jack L. Hursch, 436 Continental Oil Bldg., Denver, Colo.
Lewis & Sachs Co., 220 Fifth Ave., New York, N. Y.
Joe Muniot, 1005 Carondelet St., New Orleans, La.
Norman B. Neely, 5334 Hollywood Blvd., Hollywood, Calif.
Clem Robinson, 2711 N. 76th St., Milwaukee, Wisc.
Maitland K. Smith.

(Continued on following page)



Model 1232-A \$29.84 Dealer Net Price

- ★ **Triple Shielding**—and completely NEW design. Top panel is insulated from R.F. Main wiring is beneath double shielded panel. Coils and the band switch are individually shielded.
- ★ **Improved Attenuation**—Zero for all practical purposes.
- ★ **Large Dial Opening**—180°—Improves readability. Scale is 345°. Dial is direct geared, permitting quick and accurate settings.
- ★ **Six Bands**—cover frequencies from 115 Kc. to 30.5 Mc. Total scale length over 50 inches. Direct reading.

LINE Filter—Filters RF between Oscillator and the line.

Six Trimmer Calibrated Coils—For accuracy well within servicing requirements on all bands.

400 Cycle Audio Note obtained from panel jacks.

This new model is made with full vision dial having six scales with total length of over 50 inches. Improved accuracy, shielding and attenuation equal to oscillators for which you would pay much more.

Model 1232-A, complete with accessories.

Dealer Net Price **\$29.84**

THIS NEW MODEL NOW READY FOR DELIVERY

WRITE FOR CATALOG

THE TRIPLETT ELECTRICAL INSTRUMENT CO.

Section 1610, Harmon Ave.
BLUFFTON, OHIO



Please Say That You Saw It in RADIO-CRAFT

QUALITY—VALUE—GUARANTEE!

WESTINGHOUSE POWER GENERATOR

Manufactured for U. S. Signal Corps

A. C. ELECTRICAL POWER
 from a Windmill, from available Waterpower, from your Automobile, from your Motorcycle, from your Bicycle, Footpedals or Handcrank (for transportable Radio Transmitters, Strong Floodlights, Advertising Signs); operate two generators in series to get 200 V. AC; obtain two phase and three phase AC, etc., etc.

There Are Over 25 Applications
 Some of which are:

A.C. Dynamo lighting from eight to ten 20 Watt 110 Volt lamps. Short Wave Transmitter supplying 110 Volts AC for operating "Ham" transmitter. Motor Generator, Public Address Systems. Electric Sirens on motor boats, yachts, etc. Camp Lighting. Short Wave artificial "fever" apparatus. Television. Pelton Water-wheel for lighting or other purposes. Airplane: for lighting strong search lights or electric signs. Laboratory work, etc., etc. 1/4 to 1/2 H.P. needed to run generator.

Generator, as described, including BLUE-PRINT 22 x 28 in. and our Page 8 1/2 x 12 in. INSTRUCTION SHEETS \$7.90
 Send \$2.00 deposit balance C.O.D. Shipping weight 18 lbs.

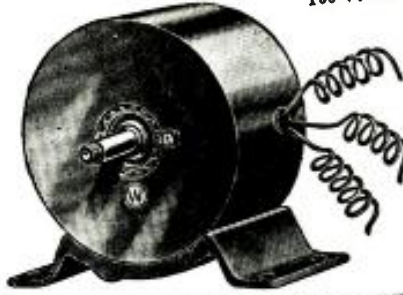

200Watt.
100 V. AC

PYRO PANTAGRAPH

Size of box: 12 1/2" x 8 1/2"



\$2.75
 VOGUE

This electrical outfit is especially designed for burning designs permanently on leather, wood, cork, boards, Bakelite, etc. Simply plug the DC outlet and it is ready to use. Plus in any 110-volt AC or cord furnished as part of equipment. The use of a special Pantagraph included in the outfit, any design may be reproduced in the original, reduced or enlarged form. Outfit consists of three hardwood plaques, one bottle of Varnish, one tracing tip and four-page instruction sheet.

\$2.75

G. E. PHONOGRAPH MOTOR

Formerly Sold for \$15.00



\$ ONLY 4.95

Variable speed induction type self-starting. 110 volt. 25 to 60 cycle. A.C. with speed control, plug and cord. Speed range from 5 to 200 R.P.M. Can be installed in place of old fashioned, hand-winding speed motor. Also ideal for display turn table, and a hundred other uses. These General Electric Motors have never been used and come four packed in original carton. G. E. Electric Phonograph motor as described (with out turntable) \$4.95

Shipping Weight—12 lbs.

ALL OUR MERCHANDISE IS UNUSED AND SOLD ON A MONEY-BACK GUARANTEE

MICROPHONE AND RECEIVER

This Microphone and telephone headset outfit was built especially for the U. S. Navy Aviation Corps. The outfit to Government specifications. The outfit consists of a low-impedance carbon metal breastplate, securely fastened to a impedance earphones. A specially constructed switch on the back of the breast-plate controls the microphone circuit. The earphones are U.S.N. 20-ohm type, attached to adjustable headband of not more than 10 volts should be used. A storage battery is the most satisfactory current supply.

U. S. Navy Airplane-type Microphone and Receiver as described \$4.96
 Shipping Weight—8 lbs.

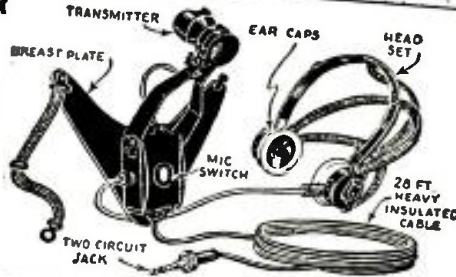

WELLWORTH TRADING CO.

Dept. HC-1039

1915 SOUTH STATE ST., CHICAGO, ILLINOIS

★ ORDER DIRECTLY FROM THIS ADVERTISEMENT ★
 WE SHIP 24 HOURS AFTER RECEIPT OF YOUR ORDER, BY EXPRESS COLLECT OR PARCEL POST IF YOU INCLUDE SUFFICIENT POSTAGE.

RADIO TRADE DIGEST

645 N. Highland Ave., Atlanta, Ga. G. G. Willison. West Building. Houston, Texas. W. S. Trinkle, 2324 Riley St., Philadelphia, Pa. Nicholas I. Allen, 234 Boylston St., Boston, Mass. J. M. Cartwright, 1288 Vinton Ave., Memphis, Tenn. C. G. Curry, 815 N. Riley, Indianapolis, Ind. R. R. McDermott, 441 Oakdale St., Chicago, Ill.

PERSONAL

(Continued from page 228)

Baltimore territory, too—and has moved to the latter city. (HOWARD's brother, DAN, by the way, is gen. sales mgr. of *International Resistor Co.*)

PHILIP M. PRITCHARD, formerly in charge of SYLVANIA'S renewal tube sales in Baltimore, has been made assistant to L. A. WHEELOCK, Western div. equip't sales mgr. at the co.'s Chi. office.

SYLVESTER T. THOMPSON, who did such a great job for the export biz of *Zenith Radio Corp.*, Chicago, has been elected a v-p of that co. DR. RALPH L. POWER, adv. mgr. of *Universal Microphone Co., Ltd.*, Inglewood, Cal., has sailed on a 4-mos. biz trip through Australia & N.Z.

ROBERT PRELL, just out of college, has joined the research staff of the same co.

AL CADWALLADER, in charge of special mfrs' acc'ts for CLAROSTAT MFG. CO., INC., N. Y., has gotten a pilot's license, so he can fly to serve customers faster.

VIC MUCHER, sales mgr. of same co., back from 4-state swing through Dixie, reports biz as "lively & growing."

RADIO WIRE TELEVISION, INC., nee WHOLESALE RADIO SERVICE CO., PLANS NEW SERVICES AND PRODUCTS

BELIEVING after 20 years in the radio industry that television "is destined to even reach greater heights than modern radio," according to Pres. A. W. Pletman, Wholesale Radio Service Co., Inc., last month evidenced its faith in this belief by a change of name and policies.

Radio Wire Television, Inc., is the new name; co. is a subsidiary of Radio Wire Television Corp. of Amer. (John E. Otterson, former pres. of Winchester Repeating Arms Co., ERPI and Paramount Pix, pres.). A. W. Pletman is also v-p of the major co. as is J. R. West, ex of ERPI. "RWT, Inc." plans to expand its activities into every phase of the electronic art—a step which new patent agreements make possible. However the co. will continue its present activities, too.

The co. believes that present technical advances point to "the ultimate distribution of entertainment by wire".

DO YOU SERVICE COIN-PHONOGRAPHS?

Let us know how our department on this topic (see px. 223) can be improved to meet your needs.

8 NEW TUBES

(Continued from page 214)

Note: Ratings maximum and minimum are design centers for a line voltage of 117 V.

25B8GT—TABLE III Rating and Characteristics

Heater: Voltage 25 volts A.C. or D.C.
 Current .150 ampere A.C. or D.C.
 Note: Voltage between heater and cathode should be kept at a minimum if direct connection is not possible.

Operating Conditions (Pentode Section)

Plate voltage 100 volts
 Screen-grid voltage 100 volts
 Control-grid voltage -3 volts
 Plate current 7.6 milliamperes
 Screen-grid current 2.0 milliamperes
 Mutual conductance 2,000 micromhos
 Amplification factor 370
 Plate resistance .185 megohm

(Triode Section)

Plate voltage 100 volts
 Control-grid voltage -1 volt
 Plate current .60 milliamperes
 Mutual conductance 1,500 micromhos
 Plate resistance .075 megohm
 Amplification factor 112.5
 Approx. grid voltage for plate current cut-off -2.5 volts
 Direct interelectrode capacities:
 Pentode input 5.5 mmf.
 Pentode output 10.0 mmf.
 Triode grid to cathode 5.0 mmf.
 Pentode plate to triode grid 0.75 mmf.
 Pentode G₁ to triode plate .009 mmf.

2050 & 2051—TABLE IV

Tentative Characteristics and Ratings

Heater voltage (A.C./D.C.) 6.3 volts
 Heater current 0.6 ampere
 Heating time* 10 min. seconds
 Grid-anode capacity 0.2 mmf.

Grid-Controlled Rectifier Service

	Type 2050	Type 2051
Peak forward anode volt.	650 max.	350 max. volts
Peak inverse anode volt.	1300 max.	700 max. volts
Shield grid (grid No. 2)	0	0 volts
Peak anode current	500 max.	375 max. milliamperes
Aver. anode current†	100 max.	75 max. milliamperes
Tube voltage drop	8	14 volts
Grid resistor‡	0.01 min.	0.01 min. megohm
" "	10 max.	10 max. megohms

*The heater voltage preferably should be applied at least 10 seconds before anode current is drawn.
 †Averaged over a period of not more than 30 seconds.
 ‡When the tube is operated with an A.C. anode voltage and a high value of grid resistance, the grid-anode capacity should be made as small as possible by placing the grid resistor directly at the socket terminal, by connecting pins No. 4 and No. 8 together at socket, and by using a close-fitting shield connected to cathode terminal.

Please Say That You Saw It in RADIO-CRAFT

1D8GT—TABLE IA

Pentode Unit—Class A₁ Amplifier

Operating conditions and characteristics:

Plate voltage	45	62.5	67.5	90	max. volts
Screen-grid voltage	45	62.5	67.5	90	max. volts
Control-grid voltage	-4.5	-5	-6	-9	volts
Plate resistance	0.3	0.2	0.2	0.2	megohm
Transconductance	650	875	875	925	micromhos
Plate current	0.3	3.8	3.8	5.0	milliamperes
Screen-grid current	1.6	0.8	0.8	1.0	milliamperes
Load resistance	20000	16000	16000	12000	ohms
Total distortion	10	10	10	10	per cent
Power output	35	90	100	200	milliwatts

Triode Unit—Class A₁ Amplifier

Operating conditions and characteristics:

Plate voltage	45	67.5	90	max. volts
Grid voltage	0	0	0	volts
Amplification factor	25	25	25	
Plate resistance	77000	55500	43500	ohms
Transconductance	325	450	575	micromhos
Plate current	0.3	0.6	1.1	milliamperes

Diode Unit

The diode is located at the negative end of the filament, and is independent of the triode unit and pentode unit except for the common filament.

1624—TABLE V

Tentative Characteristics and Ratings

Filament voltage (A.C. or D.C.)	2.5	volts
Filament current	2	amperes
Transconductance, for plate cur. of 50 ma.	4000	approx. micromhos
Direct interelectrode capacities:		
Grid-plate (with external shielding)	0.25	max. mmf.
Input	11	max. mmf.
Output	7.5	max. mmf.

Maximum Ratings and Typical Operating Conditions
As Push-Pull Class AB₂ Audio-Frequency Amplifier (partial listing)

D.C. plate voltage	600	max. volts
D.C. screen voltage (grid No. 2)	300	max. volts
Max.-signal D.C. plate current*	90	max. milliamperes
Typical operation with fixed bias: (Unless otherwise specified, values are for 2 tubes)		
D.C. grid voltage (grid No. 1)†	25	volts
Load resistance (per tube)	1870	ohms
Peak grid input power***	1.2	watts
Max.-signal power output (approx.)	72	watts

†The total effective grid-circuit resistance should not exceed 25,000 ohms.

**At crest of audio-frequency cycle with modulation factor of 1.0.

‡Subscript (2) indicates that grid current flows during a part of input cycle.

*Averaged over any audio-frequency cycle of sine-wave form.

†Grid voltages are given with respect to the mid-point of the filament operated on A.C. If D.C. is used, each stated value of grid voltage should be decreased by 1.75 volts and the circuit returns made to the negative end of the filament.

(Additional data on the above type of operation, and complete data on the use of the 1624 as a grid-modulated R.F. power amplifier in class C telephony, in telegraphy, etc., are given in a technical data sheet available from RCA Radiotron.)

BOOK REVIEW

PRACTICAL OPERATING MANUAL ON THE OSCILLOSCOPE, by Arthur G. Mohaupt (1939). Published by Arthur G. Mohaupt. Size 8½ x 11 in., paper cover, 48 pgs., 27 diagrams and circuit details. Price, \$1.00.

With a view to making available to the practical radio Serviceman newest advances in the technique of using a service oscilloscope in dynamic testing, author Mohaupt has prepared a fine Operating Manual, which includes the following chapters: Dynamic Testing; Why the Cathode-Ray Oscilloscope (The Cathode-Ray Tube and its Connections and Controls); The Sawtooth Sweep Frequency Oscillator (and its Voltage, Controls and Waveform); The Synchronizing Control (and its Purpose and Use); Operating an Oscilloscope; Circuits of Commercial Oscilloscopes (Supreme model 546, Triumph model 830, Triplett model 1691 De Luxe); Visual Alignment and Frequency Modulation; Supreme model 529 Frequency Modulator; Alignment Procedure with a Frequency Modulator (I.F. Response, Double Images); Alignment Preliminaries (Preparing

Set, Connecting Oscilloscope); Visual Alignment Procedure (Part I, I.F.; Part II, R.F., 1st-det., and Osc.); Misc.: Optimum Alignment, Wave-traps, A.V.C., Distortion, A.F.C., Hum Analysis; Dynamic Analysis.

Features in October Radio & Television

- 2-Inch Tube, Low-Cost Television Receiver.
- The Navy Amateur Net—John L. Reinartz.
- Conversion Chart for ALL Frequencies.
- International Radio Review.
- Switch-type, All-band, Ham Transmitter.
- QSL Card Contest.
- 2-Tube Portable Receiver; 110 V. A.C.-D.C.
- Facsimile Recorder Assembled in 4 Hours.
- Accurate S.-W. Station List.

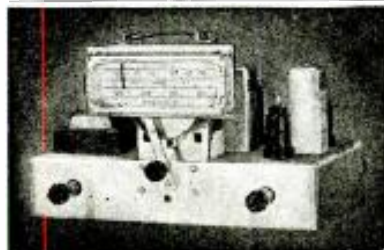

Licensed under one or more of the following Johnson Laboratories, Inc. patents: 1,940,228 1,978,600 1,982,689 1,982,690 2,018,626 2,051,012 2,113,603 2,122,874. Other patents pending.

ALADDIN RADIO INDUSTRIES, INC., Dept. C8, 466 W. Superior St., Chicago, Ill.

Please Say That You Saw It in RADIO-CRAFT

RIMCO DYNALYZER

THE FIRST COMPLETE DYNAMIC TESTER

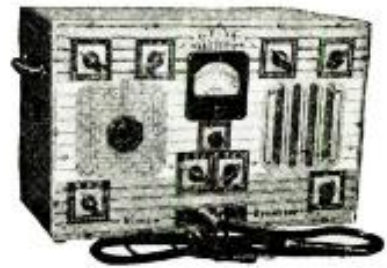

IT'S NEW! Built-in DYNAMIC speaker for audible tests in R-F and I-F, as well as A-F stages • Illuminated electronic meter for gain comparisons and voltage measurements, including A.V.C. and A.F.C. • Resistance measurements from 1 ohm to 10 megohms.

Accurately checks frequencies from 95 Kc to 15Mc • SIMPLE . . . FAST . . . USEFUL • The tester others will imitate • Write TODAY for literature.

Floyd Fausett, President,
Radio Instruments Mfg. Company,
627 W. Monument Street,
Jackson, Mississippi, U. S. A.

Please send me complete information on the new RIMCO DYNALYZER, Model 701.

Name

Address

City State

Please Print

Coming Soon... RIMCO'S NEW MODEL 89 TUBE TESTER

RADIO COURSES

New Fall Classes Now Starting
RADIO OPERATING—BROADCASTING

- RADIO SERVICING — a practical course
- RADIO AMATEUR CODE • TELEVISION
- ELECTRONICS—1 yr. day course 2 yrs. eve.

Day and Evening Classes. Booklet Upon Request.
New York Y.M.C.A. Schools
6 W. 64th Street New York City

BUILD YOUR OWN RADIO

by means of an

OUTSTANDING ENGINEERING DEVELOPMENT

YOU—whether an inexperienced beginner or an advanced experimenter—can build this set in a short time from simple diagrams, photographs and complete, detailed instructions. YOU will obtain practically uniform gain and selectivity covering the entire broadcast band and police calls without the use of gang tuning condensers.



When building the new ALADDIN PERMEABILITY TUNER Receiver you familiarize yourself with electrical circuit symbols, gain a background of radio fundamentals, and you have the pleasure of listening to a high quality receiver made by YOURSELF.

WRITE NOW WHILE FREE INSTRUCTION BOOKLETS ARE AVAILABLE.

STOP—LOOK and BUY

Rockbottom Prices on All Our Merchandise

When prices are low we buy! They're low now—LOWER THAN THEY EVER WILL BE—hence this sale. 100% satisfaction on each transaction or your money refunded. ORDER FROM THIS PAGE. Use the convenient coupon below. Be sure to include sufficient extra remittance for parcel post charges, else the order will be shipped express, charges collect. Any excess will be refunded. C.O.D. shipments require a 20% deposit. If full remittance accompanies order deduct 2% discount. Send money order—certified check—new U. S. stamps. No C.O.D. to foreign countries.

ORDER TODAY QUANTITIES LIMITED QUICK SHIPMENTS ASSURED

VARIABLE SPEED UNIVERSAL MOTOR

FOR 110 VOLTS, A.C. OR D.C.

Made for Dictaphone machines by American Gramophone Co. Used, but in excellent condition. Special lever control permits variable speeds up to 3000 r.p.m. 1/2" shaft extends from both sides of motor. Measures 7 1/2" x 3 1/4" diam. overall. Shp. Wt. 6 1/2 lbs.



ITEM NO. 11
Your Price **\$2.55**



NEW FUEL PUMPS

Brown & Sharpe pumps. Brand new—never used. Can be used for gasoline, oil, kerosene, and other fuels. Not good for water. Takes standard thread 1/4" input and output pipes. Has 1/4" drive shaft. Measures 4 x 3 3/4 x 3 1/4" diam.

overall. Shp. Wt. 8 1/2 lbs.
ITEM NO. 24 Your Price **\$4.45**

WELDING! BRAZING! SOLDERING!

3-IN-1 PORTABLE ELECTRIC TORCH

WORKS FROM 110 VOLTS A.C. OR D.C. LINE

This electric torch is not a gadget or a toy but a sturdily built outfit using the finest materials. With it you are able to do professional type of welding, brazing and soldering work—regardless of whether or not you've had previous experience. It will do a thousand and one jobs: fender welding, auto body repairs, bumpers, cylinders, tanks and industrial repairs—ideal for steel fitters, plumbers, sheet metal jobs, engineers, maintenance men, radio and bicycle repair men, etc. Works on aluminum, brass, copper, iron, steel and other metals.

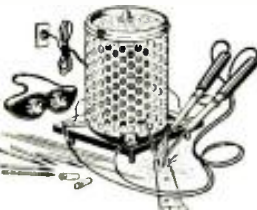

The 3-in-1 electric torch is so simply constructed that even a boy can operate it after reading the simple and concise instructions furnished with the unit. Not necessary to know how to strike an arc! All you do is plug the torch into the light socket, adjust the carbons per instructions, and presto—you have an intense, blazing flame ready for work. The outfit comes complete with power unit, electric cord, electrode holder, carbons, welding rods, blazing rods, solder flux, goggles, and instructions.

Save money! Do your own repairing. Earn money by doing repairing for others. Simple, practical, durable and safe to handle—this is why the price is amazingly low. Don't delay—order one today. Shp. Wt. 8 lbs.

ITEM NO. 50
Your Price **\$6.95**

POWER JIG SAW

A trouble-proof powerful tool with self-contained power unit. Cuts 7200 strokes per minute, leaving smooth edges. An ideal machine for wood-crafters, model makers, handy-men, etc. Has 10" square table and gray iron frame mounted on rubber to absorb vibration. Arm blade depth 13 1/2". Designed for 110-120 V. AC use. Measures 9 1/4" x 19 1/2". Adjustable guide and stroke. Sold complete with 8 ft. approved cord and plug, ready to use. Shp. Wt. 12 lbs.



ITEM NO. 45
Your Price **\$9.96**

COMPLETE ELECTRIC SPRAYER OUTFIT

Consists of a sturdy compressor 110 V. 1/4 HP, 1750 RPM motor, 10 ft. hose, efficient spraying gun and all necessary mounting accessories. Costs only 2 cents per hour to operate. Delivers considerable air pressure. Positively will not dump oil. Few working parts to wear. Sprays practically anything. Shp. Wt. 40 lbs.

ITEM NO. 46
Kit less motor, but with gun
Your Price **\$6.36**

ITEM NO. 47
The complete kit including 1/4 HP motor
Your Price **\$14.53**

SPERRY GYROSCOPE LIQUID COMPASS

Made for U.S. Signal Corps; sensitive and accurate. Quick readings easily made from top; accurate readings of graduations through focusing magnifying lens on side of instrument. Complete with level sights and russet leather carrying case. Excellent for boats, boy scouts, campers, hikers, etc. A few turns of wire around this case makes it usable as a galvanometer. Shp. Wt. 3 lbs.



ITEM NO. 12
Your Price **\$1.85**

1/75 HP AC MOTOR

Develops 1/75 HP at 2000 RPM. The entire motor is only 3 3/4 inches in diameter. 7/32" shaft. Inductor type motor with shaded pole for self starting. Speed can be varied with suitable rheostat. Complete with cord, plug and base, but less pulley. For use on 110 V. 60 cycles AC line. Shp. Wt. 3 lbs.

ITEM NO. 44
Your Price **\$1.75**

20,000 RPM HAND GRINDER

Save 50% on a tough little hand grinder that is extremely useful to radio servicemen, experimenters, jewelers, dental mechanics, etc. Develops 20,000 RPM. Fits solidly in the palm of the hand. Operates on 110 V. AC or DC, 25 or 60 cycles. Its features are: high torque, oilless bearings, sturdy thrust, cool running, handy switch, collet chuck for 1/8" and 3/32" wheels, finger support for precision work. Shp. Wt. 6 lbs.



ITEM NO. 48
Your Price **\$7.62**

VENTILATION FAN

Handy for eliminating kitchen odors. Installs on either window or flue on chimney. Can also be used as radiator fan for room circulation. Induction motor. Operates on 110 volts, 60 cycles A.C. only.

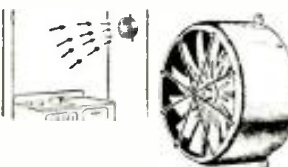

ITEM NO. 49
Your Price **\$4.50**

A.C.-D.C. POWER SUPPLY FOR BATTERY PORTABLES

(Continued from page 212)

batteries. However just as soon as the rectifier warms up and begins to supply current it "takes over", the batteries automatically ceasing to supply energy. If the line cord is then pulled out of the socket, the set will continue playing, having automatically reverted to battery power.

It is important when operating from the line to turn the set on first and then the rectifier, since if the rectifier is permitted to heat up first and then the filaments of the set are switched on, the low resistance of the cold filaments will cause a surge current to blow out the tubes.

As a safety factor then it might be wise to replace the switch on the set with one that will turn both the rectifier circuit and the set on at the same time. The completed unit as shown in the illustrations is quite small and will fit into the available space of most any portable. It measures but 2 1/2 x 2 1/2 x 6 1/2 ins. high overall.

The chassis was made from a strip of 1/16-in. aluminum 2 x 4 1/2 ins. On the front panel are the on-off switch and the pilot light which goes on only when the rectifier is sufficiently heated and begins to supply current.

NOTE—If this Power Supply is fitted into a battery portable it is essential, for full battery life, to locate the rectifier tube where it will not raise the temperature of the batteries.

Incidentally, use of the 117Z6G in this Power Supply, as a means of eliminating need for either a power cord or a ballast resistor tube, was suggested to the writer by R. D. Washburne. Other useful applications of this tube will be described in forthcoming issues of *Radio-Craft*.

It is suggested that the List of Parts be followed as closely as possible if the results obtained are to be as good as those obtained with the original model—and they were good!

LIST OF PARTS

- Two Cornell-Dubilier condensers type EDJ-3500, 50 mf., 50 V., C4, C5;
- Three Cornell-Dubilier condensers, type BR1215, 12 mf., 150 V., C1, C2, C3;
- One Cornell-Dubilier condenser, type DT-4S5, 0.05-mf., 400 V., C6;
- One I.R.C. resistor, type AB, 2,200 ohms, 10 W., R1;
- One I.R.C. resistor, type BT1, 6,000 ohms, 1 W.;
- One Sylvania type 117Z6G tube;
- One Amphenol type MIP8 octal socket;
- One Mallory-Yaxley type B-310 pilot light housing;
- One Tung-Sol 60-ma., 2-V. (pink bead) pilot light with bayonet base;
- Hardware, sheet aluminum, etc.

SERVICE DATA ON PILOT LIGHTS

(Continued from page 207)

series heaters is obtained by the use of rectifiers with tapped heaters. The 35Z5GT and 45Z5GT are half-wave rectifiers designed to be used in 0.15-ampere A.C.-D.C. receivers as combined power rectifiers and ballast shunt resistors. Figure 3 shows the internal wiring of these types and the location of the tap; and Fig. 4 shows its circuit application. The tap is brought out for the pilot lamp at a point which is 7.5 volts from one end of the heater when rated heater voltage is applied and only heater current flows. Since the pilot lamp shunt is part of

WE HAVE NO CATALOG. ORDER DIRECT FROM THIS PAGE.

HUDSON SPECIALTIES - 40-R West B'way - N.Y.C.

IT'S EASY TO ORDER—CLIP COUPON—MAIL NOW

HUDSON SPECIALTIES CO., 40-R West Broadway, New York, N. Y. RC-1039

I have circled below the numbers of the items I'm ordering. My full remittance of \$..... (include shipping charges) is enclosed.

OR my deposit of \$..... is enclosed (20% required), ship order C.O.D. for balance. (New U.S. stamps, check or money order accepted.)

Circle Item No. wanted: 11 12 24 43 45 46 47 48 49 50

Name Address

City State

Send remittance by check, stamps or money order; register letter if you send cash or stamps.

Please Say That You Saw It in RADIO-CRAFT

OPPORTUNITY AD-LETS

Advertisements in this section cost five cents a word for each insertion. Name, address and initials must be included at the above rate. Cash should accompany all classified advertisements unless placed by an accredited advertising agency. No advertisement for less than ten words accepted. Ten percent discount for six issues, twenty percent for twelve issues. Objectable or misleading advertisements not accepted. Advertisements for November, 1939, issue must reach us not later than September 7th.

Radio-Craft • 99 Hudson St. • New York, N. Y.

AGENTS WANTED

300% PROFIT SELLING GOLD LEAF LETTERS FOR store windows; Free samples. Metallic Company, 451 North Clark, Chicago.

BOOKS AND MAGAZINES

WE HAVE A FEW HUNDRED RADIO ENCYCLOPEDIAS, by S. Gernsback, second edition, originally sold at \$3.98. Book has 352 pages, weight 3 lbs., size 9 x 12 inches. Red morocco-keratin flexible binding. Send \$2.49 in stamps, cash or money order and book will be forwarded express collect. Technifax, 1915 So. State Street, Chicago, Illinois.

CAMERAS & SUPPLIES

BULK FILM: 100 FT. 8MM. \$.90; DOUBLE, \$1.60; 16 mm., \$1.20. Titles of pictures. Chemicals, outfits. Big catalogue for stamp. Hollywood Studios, South Gate, Calif.

ROLLS DEVELOPED 25c COIN. TWO 5x7 DOUBLE weight Professional enlargements. 8 gloss prints. Club Photo Service, LaCrosse, Wis.

GENERA FILM IN BULK FOR ALL MOTION PICTURE cameras. 100 feet for Univex, \$1.00; 100 feet double 8mm. \$1.75; 16mm. \$1.35; 400 feet 16mm. \$4.25, postpaid. Sample for stamp. Process with our prepared powders and simplified outfits: 8mm. \$3.75, 16mm. \$4.95. Promaders, Des Moines, Iowa.

EDUCATIONAL COURSES

USED CORRESPONDENCE COURSES AND TECHNICAL Books Bought, Sold, Rented, Exchanged. Catalog Free. Vernon Educational Exchange, Henshaw, Ala.

CORRESPONDENCE COURSES AND EDUCATIONAL BOOKS, slightly used. Sold, Rented, Exchanged. All subjects. Satisfaction guaranteed. Cash paid for used courses. Complete details and bargain catalog FREE. Send name. Nelson Company, K-242 Manhattan Building, Chicago.

FOR INVENTORS

CASH FOR UNPATENTED IDEAS. STAMP Appreciated. Mr. Ball, 9441-J Pleasant, Chicago.

FORMULAS

FORMULAS FOR MAKING INSECTIDES, ANTISEPTICS, Bleaching Solutions, Cements for all Purposes, Stain Removing Preparations, Cosmetics, Depilatories, Dyes, Fertilizers, Fire Extinguishing Preparations, Inks, Lacquers, Paints, Plating Solutions, Soaps, Varnishes, Wines and Liquors, and Many Everyday Preparations. Send 10c for each formula. Complete satisfaction or money immediately refunded. L. Feldman, 640 Ramapo Rd., Teaneck, N. J.

MISCELLANEOUS

MEXICAN DIVORCES; NO PUBLICITY. AMERICAN attorney. Box 1736, El Paso, Texas.

OFFICE SUPPLIES

SEND COPY AND \$1.00 FOR 125 8 1/2 x 11 BOND Letterheads and 125 envelopes, both beautifully printed. Benneville, 907 West Roosevelt, Philadelphia.

RADIO

WE BUY AND SELL USED RADIO TESTING EQUIPMENT. Time payments if desired. Harold Davis, Inc., Jackson, Miss.

8-TUBE CAR-RADIO. WILL SWAP ARVIN CAR SET in good working condition. Has 12-in. speaker (fine tone). Offer candid camera or what have you? Doane Bernard, 40 Manning Ave., No. Plainfield, N. J.

BRAND NEW, GUARANTEED, RADIO TUBES 25c each. Box 37, Station P, Brooklyn, N. Y.

PLANS 18 DISTANCE CRYSTAL SETS—SW RECORD 4250 miles, with "Radio-builder" year. 25c. Laboratories, 7700-B East 14th, Oakland, California.

USED RADIO EQUIPMENT FOR SALE: AMATEUR, servicing, and public address. Write for list. Virgie Craik, Norcatur, Kansas.

ANY RADIO DIAGRAM. 25c. SPECIFY MANUFACTURER, model. Radio magazine free. "Television Encyclopedia" 25c. Supreme Publications, 3727 West 13th, Chicago.

WANTED: USED RIDER MANUALS. REFRIGERATION manuals and test equipment. Jacobs Electric Co., Carrollton, Ga.

STAMPS

TWELVE SCARCE OLD STAMPS—1853 to 1899. ALSO 25 Czechoslovakia, 25 Denmark—10c. Gerhardt, Rt. San Saba, Texas.

JUBILEES, CORONATIONS, SHIPS, WAR, AIRMAILS. Commemorative. Farleys, Packet 10c. Box 211, Malden, Massachusetts.

TREASURE LOCATORS

TREASURE FINDER (METAL LOCATOR) CUSTOM built by engineer. Great penetrating power. No fancy gadgets. Uses latest radio developments. Simple, inexpensive to operate. Delivery ten days. Write for details and low price. A. Stuart, 1015 Wilson Avenue, Teaneck, N. J.

the heater, it has all the requirements for proper ballast action (low resistance, cold and high resistance when hot) and so protects the pilot lamp. The rectifier current passes through the lamp and shunt combination and further ballast action is obtained.

With the same D.C. rectifier current more illumination is obtained from the pilot lamp on A.C. operation than on D.C. In A.C. operation each time the line voltage goes positive with respect to the D.C. output voltage of the rectifier, the line supplies current to the load circuit. This current is of a very high peaked form since it has to charge the input filter condenser. Currents of this form, flowing through the lamp and shunt, give high illumination from the lamp. For the same reason, higher values of condenser also give more light from the pilot lamp. The input filter condenser should be limited to 40 mf. Higher values cause early lamp failure when the set is turned off and on again while the tubes are still hot.

TABLE I

Lamp No.	Bead Color	Volts	Amperes	Bulb	Base Miniature	Approx. Candle Power
40	Brown	6.3	0.15	T-3 1/4	Screw	0.5
44	Blue	6.3	0.25	T-3 1/4	Bayonet	0.8
46	Blue	6.3	0.25	T-3 1/4	Screw	0.8
47	Brown	6.3	0.15	T-3 1/4	Bayonet	0.5
50	White	7.5	0.2	G-3 1/2	Screw	1.0
51	White	7.5	0.2	G-3 1/2	Bayonet	1.0

Typical pilot lamp operation in 150-ma. receivers is shown in Table II as obtained in a 5-tube superheterodyne receiver.

TABLE II

TYPICAL PILOT LAMP OPERATION IN 150-MA. RECEIVERS SUPPLY V. = 117 VOLTS

WITH A.C. SUPPLY VOLTAGE

	Rectifier Pilot Lamp D.C. R.M.S. in Volt- age	Pilot Lamp Rectifier Cathode	"B" Volt- age after 400- Ohm Speaker Field
35Z4GT ^B			
No pilot lamp receiver	54	—	132 108
35Z4GT ^A			
Brown-bead lamp	48	4.3	124 105
White-bead lamp	49	3.9	125 105
Blue-bead lamp	50	2.9	126 106
Pilot lamp burned out	45	—	117 99
35Z5GT ^{BC}			
Brown-bead lamp	50	5.0	124 104
White-bead lamp	50	4.3	125 105
Blue-bead lamp	51	3.3	126 106
Pilot lamp burned out	47	—	118 99

WITH D.C. SUPPLY VOLTAGE

35Z4GT ^B			
No pilot lamp receiver	42	—	111 94
35Z4GT ^A			
Brown-bead lamp	40	3.2	108 92
White-bead lamp	40	2.9	108 92
Blue-bead lamp	41	2.1	109 93
Pilot lamp burned out	38	—	104 89
35Z5GT ^{BC}			
Brown-bead lamp	43	3.6	109 92
White-bead lamp	43	3.2	109 92
Blue-bead lamp	43	2.3	110 93
Pilot lamp burned out	40	—	105 89

^A Shunt res. = 40 ohms. Series res. = 80 ohms. Output tube is the 35L6GT, cathode res. = 100 ohms.

^B Output tube is the 50L6GT, cathode res. = 140 ohms.

^C For the 45Z5GT the output tube is the 35L6GT, cathode res. = 100 ohms.

This article has been prepared from data supplied by courtesy of Tung-Sol Lamp Works, Inc.

Have You Seen...

The NEW Meissner 1939-40 Catalog—just off the press that describes in its 48 pages over 800 new, different and improved Radio and Television items including:

- TELEVISION KIT for \$139.50—pages 4 and 5
- 9-TUBE "TRAFFIC" SCOUT—page 8
- PRESELECTION and 5 and 10 METER CONVERTER—page 9
- PORTABLE BATTERY OPERATED KIT—page 19
- SIGNAL CALIBRATOR AND AUTOMATIC ANTENNA SELECTOR—page 22
- DELUXE SIGNAL SHIFTER—page 23
- ADAPTER KITS AND 6 PUSH BUTTON TUNER—pages 24-26
- POWER RELAY AND ANTENNA CHANGE-OVER RELAY—page 29
- IMPROVED PLASTIC I. F. TRANSFORMER for \$1—page 33

and hundreds of other up-to-the-minute developments in radio and television.

FREE!!! To all service men, amateurs, hams, experimenters. Mail coupon below today for your copy.

SEND 50 CENTS for Meissner's "NEW GUIDE TO RADIO AND TELEVISION," a complete, scientific instruction book and Trouble-Shooter's Manual for Kit Builders and Operators. Fully illustrated. 168 Pages.



Meissner Mfg. Co., Mt. Carmel, Ill.—Dept. RC-10

- Mail me Meissner's New 1939-40 Catalog.
- Enclosed find 50 cents for Instruction Book.

Name

Street

City State

You Need Our NEW Speaker Catalog

Unique Different More Complete

Must be seen to be appreciated

FREE write for your copy today

★ **WRIGHT-DECOSTER, Inc.**

2251 UNIVERSITY AVE., ST. PAUL, MINN.
Export Dept.: M. Simons & Son Co., New York
Cable Address: "Simontrice"

Canadian Representatives:
Wm. F. Kelly Co., 1207 Bay St., Toronto, Ontario
Taylor & Pearson, Ltd., Edmonton, Alberta

Please Say That You Saw It in RADIO-CRAFT

It's NEW—and it's the one and only

P. A. HANDBOOK



THAT no book has yet been published which covers amplifiers and sound systems (also kindred systems), in one complete, authentic volume is almost unbelievable. Yet, it is a fact, there is no book in print which covers Public Address from A to Z. To bridge this wide-spread gap, RADIO-CRAFT will publish, on September 15th, a volume on Public Address of such magnitude—so complete and authoritative—that every man engaged in radio can have both a theoretical and practical knowledge of the function and operation of sound systems. The editorial pages are so filled with instruction and replete with illustrations that the volume fully justifies its title—1939-40 AMPLIFIER HANDBOOK AND PUBLIC ADDRESS GUIDE. This great HANDBOOK on Public Address should be read and studied by those who consistently build, service and sell sound equipment.

A MATCHLESS VOLUME
As complete as you would expect to find any engineering handbook—this is how the radio or P. A. man finds the **AMPLIFIER HANDBOOK AND PUBLIC ADDRESS GUIDE**, an analysis of the contents is found at the right, showing the breakdown of the material featured within each particular section. A thorough reading of the contents shows the completeness of this book.

THE CONTENTS
To actually show the scope and magnitude of the **AMPLIFIER HANDBOOK AND PUBLIC ADDRESS GUIDE**, an analysis of the contents is found at the right, showing the breakdown of the material featured within each particular section. A thorough reading of the contents shows the completeness of this book.

RADCRAFT PUBLICATIONS ■ 99 HUDSON STREET ■ NEW YORK, N. Y.

RADCRAFT PUBLICATIONS, INC. * 99 HUDSON STREET * NEW YORK, N. Y. RC-1039
Gentlemen: Enclosed find my remittance of 25c for which send me POSTPAID, one copy of your NEW—1939-1940 AMPLIFIER HANDBOOK AND PUBLIC ADDRESS GUIDE.

Send me others, for friends, also POSTPAID @ 25c each.

Name Address

City State

Remit by check or money order; register letter if you send cash or unregistered U.S. Postage Stamp.

A Resume of the Contents of the AMPLIFIER HANDBOOK AND PUBLIC ADDRESS GUIDE

PREFACE

INTRODUCTION

CHAPTER I—FUNDAMENTALS
Vacuum Tube as Amplifier—Ratings—Bels and Decibels—Harmonics—Distortion—Attenuation—Gain—Ohm's Law—Bridge Circuits—Rectification—Microphones—Condensers—Resistors—Impedance—Phase—Resonance—Inductance—Frequency—Magnetism—Shielding.

CHAPTER II—VACUUM TUBES
Voltage Amplifiers—Power Amplifiers—Control and Indicator Tubes—Rectifiers—Ballast and Regulator.

CHAPTER III—CIRCUIT ANALYSIS
Inputs—Coupling—Degeneration (Inverse Feedback)—Frequency Compensation—Outputs—Push-Pull—Phase Inversion—Class A, A-B, B, A', etc.—Hum-Bucking—Automatic Gain Control—Spectrum Control—Time-Delay—Tone Compensation—Voltage Dividers—Swinging Chokes—Beam Power—Push-Push.

CHAPTER IV—MICROPHONES
Carbon—Condenser—Electrodynamic—Ribbon (Velocity)—Crystal—Lapel—Uni-directional (cardioid)—Electromagnetic—Transducers.

CHAPTER V—AMPLIFIERS AND PREAMPLIFIERS
A.C.—D.C.—A.C.—D.C. (120 V.)—A.C.—D.C. (6 V D.C.—120 V. A.C.)—Mobile—Portable—Multi-Channel—Biphonic—Preamplifiers—Monitors.

CHAPTER VI—LOUDSPEAKERS
Magnetic—Dynamo—P.M. Dynamo—Crystal—Horn Units.

CHAPTER VII—HORNS AND BAFFLES
Flat—Infinite—Octave Resonance—Exponential—Flares—Labyrinths—Peridynamic—Biphonic.

CHAPTER VIII—AMPLIFIER COMPONENTS
Resistors—Condensers—Transformers—Chokes—Fuses—Sockets—Chassis and Housings—Meters—Name Plates and Bezels—Terminals—Jacks and Plugs—Switches—Frequency Filters—Bias Cells—Tone and Volume (Attenuator) Controls—Pads—L, T, H, etc.

CHAPTER IX—POWER SUPPLIES
Power Lines—Batteries—Converters and Generators—Rectifier Tubes—Dry Rectifiers—Vibrators and Inverters—Bias Supplies—Field Exciters—Ballasts and Regulators.

CHAPTER X—ACCESSORIES
Coin Phonographs—E.A. Tuners.

CHAPTER XI—RECORDING AND PLAYBACK
Pickups—33-1/3 and 78 r.p.m. Turntables—Film, Disc and Wire Recorders—Lateral and Vertical (hill-and-dale) Recording—High Fidelity Recording and Playback—Accessories.

CHAPTER XII—MATCHING AND MIXING
Input to Amplifier—Amplifier to Line—Line to Speakers—Pads—Attenuators—Matching Amplifiers—Booster Amplifiers.

CHAPTER XIII—ACOUSTICS
Absorption—Reverberation and Echo—Low-Level Distribution—High-Level Distribution.

CHAPTER XIV—SELLING SOUND
Ethics—Who are the prospects?—What are reasonable charges?—Sidelines—Accounting—Advertising and Publicity.

CHAPTER XV—SCHOOL SOUND SYSTEMS

CHAPTER XVI—CALL SYSTEMS
Railroads—Hotels—Restaurants.

CHAPTER XVII—INTERCOMMUNICATORS
Wire Type—Wired-Radio Type—Switchless—Multiple-Station.

CHAPTER XVIII—TALKIES
Soundheads—Amplifiers—Loudspeakers—Sound-on-Film—Sound on Disc—Home-Talkies—Commercial-Talkies.

CHAPTER XIX—HEARING AIDS
Tubeless—Tube Type.

CHAPTER XX—MISCELLANEOUS APPLICATIONS

CHAPTER XXI—FORMULAS AND TABLES

CHAPTER XXII—TEST EQUIPMENT
Milli-Meters—C.R. Oscilloscope—A.F. Oscillator (Output Level) Indicators—V.T. Voltmeters.

CHAPTER XXIII—INSTALLATION PROCEDURE
Placement of Equipment (Microphones, Amplifiers, Loudspeakers)—Use of Woofers and Tweeters—Wiring—Indoors and Outdoors—Portable and Mobile Set-Ups—Permanent Installations.

CHAPTER XXIV—SERVICING

Order Your Copy NOW—
Clip Coupon and Mail Today!

Please Say That You Saw It in RADIO-CRAFT

RADIO—IN OUR NATIONAL PARKS

(Continued from page 201)

taken of an emergency set-up in the San Francisco laboratory of the manufacturer for use until telephone communication was restored with Yosemite National Park which had become isolated due to floods. Two of these sets were subsequently installed in Mount McKinley National Park, Alaska.

FIELD SETS

The portable-type field set, shown in use on pg. 201, is entirely self-contained. The antenna reel is mounted on the cover, and only the necessary controls are brought out to the frontpanel. The microphone and receiver in the handset fit into the space made available by recessing the control panel. The batteries are carried in a tray that clamps on the bottom of the case containing the set. An auxiliary loudspeaker may be plugged-in if desired, such as in a fire camp where several men may be interested in hearing the incoming reports.

This portable type field set may be clamped onto one of two different size battery trays, or it may be used with a heavy-duty separate wooden battery box. All 3 sizes of battery supplies have the same voltage but a different milliampere-hour capacity, or in other words can be operated longer with the larger batteries. The largest size will run the set under intermittent operation, several times each day, for 6 to 8 months, and the smallest size will run the set for 2 to 3 weeks.

The weight of the set is 16 lbs. Equipped with the small tray the weight is 21 lbs., and with the large tray 36 lbs. The separate heavy duty battery box weighs 80 lbs. The set and small tray fit neatly on a hiker's back-pack cradle, such as a "Nelson trapper," allowing both arms free. In this manner the set can easily be carried for miles.

The source of power for our station sets varies from commercial power usually available at the Park Headquarters to small gasoline-engine-driven generators and wind generators used to keep a bank of storage batteries charged, in outlying areas. The photo taken at Waterton Lake shows a wind generator mounted on the side of a fire lookout tower. Such types of generators are entirely satisfactory if care is taken to select locations where reliable winds are available. The cost of upkeep is low.

"CONTACT" FOR 60 DAYS

Some of the most outstanding results from a radio viewpoint were obtained about a year ago by a party that went by boat through Grand Canyon National Park using one of our portable field sets. From the Colorado River with cliffs rising abruptly for as much as 3,000 feet from the water's edge, communication was maintained for 60 days with the South Rim Headquarters.

Different setups were made each night from points down in the Canyon and satisfactory communication was had for as great a distance as 110 miles airline. No radio technician was in the party—which gives an indication of the simplicity of operation of the set. Twice the set fell in the river and in spite of this and the many knocks and humps it was sure to get, it functioned whenever called upon.

Many other interesting and exciting stories are told by park rangers who have used radio sets on forest fires, rescue parties, winter patrols, and expeditions into the back country where in spite of precautions taken occasions will arise that require immediate contact with headquarters or a distant ranger station.

(Radio-Craft takes this opportunity to thank Mr. Oliver G. Taylor, Chief of Engineering, U.S. Dept. of the Interior, Washington, D.C., and Hugh R. Awtrey, Assoc. Recreational Planner, U.S. Dept. of the Interior, National Park Service, Region No. 1, Richmond, Va., for their cooperation.)

Locations, call letters and operating frequencies of National Park Service stations, corrected to May 20, 1939, follow:

Call	Location	Frequency (kc.)
WSEF	Great Smoky Mts. N.P., Tenn. and N.Car.	3,415
WSEG	Ft. Jefferson N.M., Florida	2,994
WSEH	Isle Royale N.P., Houghton, Mich.	3,235
WSEI	Isle Royale N.P., Mott Island, Mich.	3,235
WSEJ	Transient Camps, N.Car.	2,558
WSEK	Shenandoah N.P., Virginia	5,287.5
KNJA	Lassen Volcanic N.P., Calif.	2,496
KNJB	Yellowstone N.P., Wyo.	2,496
KNJC	Grand Canyon N.P., Arizona	and 34,780
KNJD	Crater Lake N.P., Oregon	2,604
KNJE	Oregon Caves N.M., Oregon	2,604
KNJF	Lava Beds N.M., Calif.	2,604
KNJG	Glacier N.P., Montana	2,604 and 61,020
KNJH	Yosemite National Park, Calif.	2,604
KNJI	Zion National Park, Utah	2,604
KNJJ	Bryce Canyon N.P., Utah	2,604
KNJK	Lehman Caves Nat. Monument, Nevada	2,604
KNJL	Cedar Break Nat. Monument, Utah	2,604
KNJM	Mesa Verde N.P., Colo.	3,235
KNJN	Mt. McKinley N.P., Alaska	3,235
KNJO	General Grant N.P., Calif.	3,415
KNJP	Grand Teton N.P., Wyo.	3,415
KNJQ	Sequoia N.P., Calif.	3,415
KNJR	Death Valley N.M., Calif.	3,415
KNJS	Mt. Rainier N.P., Wash.	3,415
KNJT	Rocky Mountain N.P., Colo.	2,558
KNJU	Olympic N.P., Wash.	3,415
KNJV	Black Canyon of the Gunnison N.M., Colo.	34,820

"IRON CORE 6" BROADCAST SET

(Continued from page 215)

up those sympathetic frequencies and eliminate the difficulty.

The color coding of the mica condensers used is as follows: red-green-black, 25 mmf.; brown-black-brown, 100 mmf.; red-green-brown, 250 mmf.; green-black-brown, 500 mmf. See diagram for tube voltages.

TESTING AND ALIGNING

Alignment of the receiver may be made with a signal generator if available. However, a broadcast signal of about 1,400 kc. will suffice. If a broadcast signal is to be used for alignment purposes, an antenna of about 6 feet should be used in conjunction with a good ground.

Check the dial setting to be sure that the pointer is horizontal when the gang condenser is closed. With the receiver tuned to 1,400 kc., turn the volume control to a point where the signal is just audible. Adjust the trimmers located on top of the gang condenser, commencing with the trimmer toward the rear of the set and working grad-

(Continued on following page)

Please Say That You Saw It in RADIO-CRAFT

Save Money!

With the

RADOLEK RADIO PROFIT GUIDE!



EVERYTHING IN RADIO AT LOWEST PRICES

164 PAGES

Radolek offers you the MOST for your money! Lowest Prices! Best Quality! Biggest Values! Most Complete Stock! Fastest Service! Send for your FREE copy NOW!

OVER 15,000 REPAIR PARTS

The world's most complete stock of radio repair parts and exact duplicate replacements. All leading brands. All guaranteed. Lowest Prices!

COMPLETE TUBE SELECTION

All types. RCA, Sylvania, Raytheon, Philco, etc. Includes Kellogg, special Majestic types and transmitting tubes. Complete selection.

NEWEST TEST INSTRUMENTS

The most complete line ever displayed in any catalog. All leading makes. Latest improved models at lowest prices.

GREATEST RADIO VALUES

A huge selection of super values as low as \$5.20. New Phono Radio combinations. Automatic tuning sets. Beautiful cabinets. New "Ham" receivers and equipment.

EVERYTHING FOR AUTO RADIO

Complete auto radio section. Includes vibrator replacement guide, new auto serials, custom panel control plates for all autos, newest Auto Sets.

COMPLETE P. A. SELECTION

New 1940 public address amplifiers from 10 to 100 watts. Complete P. A. Systems for permanent, mobile and portable installations. Best values!

NEW ELECTRICAL APPLIANCES

Extra profits for you! Standard Brand Electric Irons, Stoves, Heaters, Percolators, Waffle Irons, Vacuum Cleaners, Toasters, Mixers, etc., at lowest prices!

FREE!

Mail Coupon Catalog!

The **RADOLEK Co.**
601 W. Randolph, Chicago,
Dept. C-34
Send the 1940 Radolek Radio Profit Guide FREE.

Name

Address

Service man? Dealer? Experimenter?

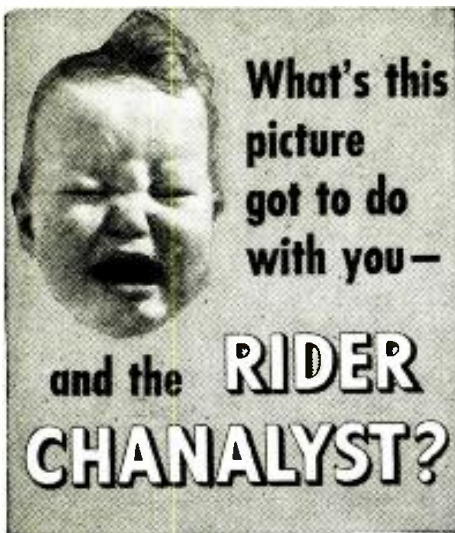

Plenty! ... When babies start crying it's oftentimes pretty hard to locate the source of their distress. And in a radio receiver the story is pretty much the same... Unless you own a Rider Chanalyst.

You know from experience that locating the defect in a radio receiver is the major problem—a time consuming and costly operation. And the more complicated the receiver, the greater the time spent—time that means money to you and for which you can't collect.

The Rider Chanalyst solves this problem. With this modern service instrument you can work rapidly—accurately—profitably—on any one of the 40 million radio receivers now in use. Founded upon the most basic element in communication—the signal itself—the simplest and most complicated receivers are serviced with equal ease—quickly!

You can trace the signal—hear the signal—and, if you connect your Oscillograph to the Rider Chanalyst, you can see the signal, any place in the receiver. The Rider Chanalyst is a proved service instrument. Ask the man who has used one.

Listen to the Magic Key, every Monday 8:30 to 9:30 P.M., E.D.S.T., on NBC Blue Network

Over 335 million RCA Radio Tubes have been purchased by radio users... in tubes, as in parts and test equipment, it pays to go RCA All the Way.

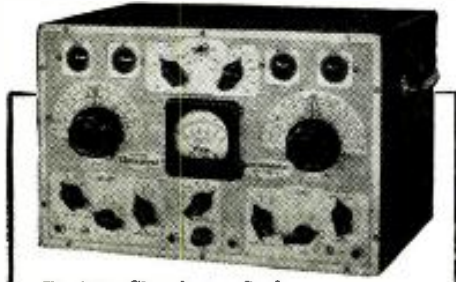

The Rider Chanalyst... Stock No. 162, \$107.50 net—It will pay for itself by saving your time—upping your profits!



(Continued from preceding page)

ually toward the front. It is suggested that, after adjusting each trimmer for maximum signal strength, the volume be reduced to the original level. After all 4 trimmers have been adjusted, it will be wise to go over them once again in the order named. It is important to remember to align at low signal levels, to reduce A.V.C. effect.

WHY A KIT?

Although a complete list of parts is shown this receiver may be secured in kit form, from chassis, formed and punched, to the last bit of hardware and wire. When purchasing the kit, the experimenter has what we might term a "week-end" set. Purchasing the kit and additional items such as tubes and speaker at the start of a week-end, the experimenter or Serviceman should find the receiver so easy to build, that at the close of the week-end he should be enjoying the fruits of his labors.

The author being an old hand at designing and building receiver kits, remembers the many difficulties experimenters and set builders had when they commenced building a receiver published in a magazine. Oftentimes, days and sometimes weeks elapsed, waiting for specified parts; endless trips to the parts supplier; drilling, cutting and mauling the chassis; then considerable lapse of time and headaches clearing the "bugs" were encountered, before the receiver was actually completed and operating up to one's expectations—hence this receiver from a complete kit.

Simplifying the construction in this manner, the builder needs only a screwdriver, pliers and a soldering iron to produce this receiver. The punched chassis in addition to saving time and labor in preparation, assures proper placement of parts, which plays a very important factor in securing peak performance. (A picture wiring diagram [accompanying the kit] further simplifies the job, especially for beginners.)

PARTIAL LIST OF PARTS (Remaining data on diagram.)

- One Meissner calibrated airplane dial and escutcheon, part No. 23-8203;
- Three sets No. 2 mounting screws, nuts and lockwashers;
- Two 6.3-V. dial lights, bayonet base;
- One 4-gang tuning condenser, 365 mmf.;
- One condenser shield assembly;
- One Meissner ferrocarr antenna coil, No. 14-1496;
- Three Meissner ferrocarr R.F. coils, No. 14-7860;

Misc.

- One Mallory bias cell and holder;
- One length shielded wire;
- Five lengths No. 20 hookup wire, one each of black, red, blue, orange, green;
- One Meissner punched steel chassis, No. 11-8211, 10 x 12 x 3 ins.;
- Screws, shakeproof lugs, resin-core solder, braided sleeving, wood panel and dial spacers, nuts and lockwashers, rubber grommets (2 ¼-in. and 1 ⅜-in.), knobs, Ant.-Gnd. terminal strip, and 6 insulated-terminal tie-lugs: 2 single, 3 double, and 1 triple.

(All parts listed above, plus the parts shown in the diagram, may be secured complete in Meissner kit No. 10-1102.)

Additional Parts

- Three RCA type 6K7 metal tubes;
- One RCA type 6Q7 metal tube;
- One RCA type 6V6 metal tube;
- One RCA type 5Y4G rectifier tube;
- One Jensen 10-in. dynamic speaker type C-10-RS, with output transformer for 6V6 tube, and with an 1,800-ohm field.

This article has been prepared from data supplied by courtesy of Meissner Mfg. Co.

Index to advertisers

A	
Aladdin Radio Industries.....	251
Allied Radio Corporation.....	231
Amperite Corporation.....	Inside Front Cover
Amplifier Co. of America.....	238, 246
Amplitone Products Company.....	240
Arcturus Radio Tube Company.....	243
Arrow Sales Company.....	240
B	
Burstein-Applebee Company.....	246
C	
Capitol Radio Engineering Inst.....	242
Central Radio Laboratories.....	232
Classified Section.....	253
Consolidated Wire & Assoc. Corps.....	246
Cornell-Dubilier Elec. Corp.....	241
Coyne Electrical School.....	234
D	
The Data Print Company.....	248
DX Radio Products Company.....	241
F	
Foto-Craft Magazine.....	248
G	
Goldentone Radio Company.....	248
H	
Hammarlund Mfg. Company.....	241
Hudson Specialties Company.....	252
Hygrade Sylvania Corporation.....	Back Cover
I	
International Correspondence Schools.....	232
L	
Lancaster, Allwine & Rommel.....	246
Lincoln Engineering School.....	240
M	
Meissner Mfg. Company.....	253
Midwest Radio Corporation.....	236
Modell's.....	246
Modell's.....	237
Arthur G. Mohaupt.....	240
N	
National Plans Institute.....	242
National Radio Institute.....	193
National Schools.....	238
New York Y.M.C.A. Schools.....	251
R	
Radio & Tech. Publishing Co.....	236, 237
Radio Circular Company.....	241
Radio City Products Company.....	245
Radio Instruments Mfg. Co.....	251
Radio Servicemen of America.....	241
Radio Training Association.....	239
Radio Wire Television, Inc.....	195, 235, 238
Radolek Company.....	255
RCA Institutes, Inc.....	246
RCA Manufacturing Co., Inc.....	256
Readrite Meter Works.....	242
Remington Rand, Inc.....	248
The Rosicrucian Order.....	241
S	
Solar Mfg. Company.....	238
Sprague Products Company Inside Back Cover	
Sprayberry Academy of Radio.....	240
Superior Instruments Company.....	233, 247
Supreme Instruments Corporation.....	239
Supreme Publications.....	245
T	
Technifax.....	248
Triplett Elec. Instrument Co.....	249
U	
Universal Microphone Co., Ltd.....	237
W	
Montgomery Ward & Company.....	247
Wellworth Trading Company.....	250
Wright-DeCoster, Inc.....	253

(While every precaution is taken to insure accuracy, we cannot guarantee against the possibility of an occasional change or omission in the preparation of this index.)

Here's New!

HOW TO ELIMINATE RADIO NOISES at the Source!



A new Master Interference Analyzer—new Interference Locator—new TWT's and chokes—these are but a part of the good news just issued from the big Sprague factories. To top things off, we've just printed a big 24-page Interference Elimination Manual that is by far the most complete, most practical ever issued in this fast-growing phase of radio servicing.

TUNE IN ON THIS PROFITABLE NEW BUSINESS

This Sprague Manual tells how to eliminate all types of man-made interference at the source—quickly, efficiently and profitably. It is easy to understand, and it covers the subject from A to Z. Now available for only 25c net of all Sprague jobbers, or you can order direct from us.

FREE!... Just Out!

The big new Sprague Catalogs just off the press, is yours for the asking. Get one today—let it pave the way to countless condenser savings and efficiencies in your work. Get next to the many new condenser types, etc. listed here for the first time! No serviceman, experimenter or amateur should fail to have a copy for quick, easy condenser reference.



Don't Miss This!

It's Free!

See your Sprague jobber or write to us for a copy of the new Sprague Condenser News & full-sized bulletin, plenty of helpful news, diagrams, radio tips, short cuts, etc. for everyone interested in radio. They're free as long as the supply lasts.

SPRAGUE PRODUCTS CO.
NORTH ADAMS, MASS.

4 SPRAGUE CONDENSER LEADERS

SWING 'EM—BEND 'EM— OR ADJUST 'EM

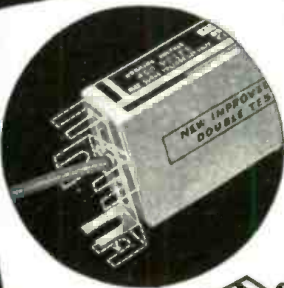

Your job made easier! Always a leader in quality, Sprague Type PTM 450 V. small cardboard drys are now equipped with a Universal Mounting Tab which makes them doubly useful, doubly easy to install. Mount 'em in any position. Put 'em any old place or in any old chassis holes. And don't forget! PTM's are conservatively rated at 525 volts but will stand surges as high as 560 to 580 volts—and come back for more. They're tops for any radio need!

**"The Quality Condensers
for Those 'Careful' Jobs"**

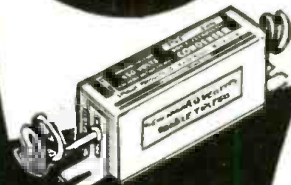

MONEY-SAVERS FOR UNIVERSAL REPLACEMENT USE

Sprague ATOMS (midget drys) are the fastest selling condensers on the market today—and for one reason only! The more you test 'em, the more you use them, the better you like them, and dual combinations in all voltages for every replacement need. They're made in both single and dual combinations in all voltages for every lower leakage. They've got lower power factor, against "blow-ups." They're first choice of smart buyers for old replacement jobs where the call is for big league condenser performance at a rock-bottom price.

Typical Atom Values

TA-10, 10 mfd.,
25 volts
1 1/8" x 1 1/8"
Net 24c

UT-8, 8 mfd.,
450 volts
1 3/16" x 1 1/8"
Net 36c

UT-88, 8-8 mfd.,
450 volts
1" x 2 3/8"
Net 60c



Other values and sizes
in proportion

NEW HIGH CAPACITY—HIGH VOLTAGE CONDENSERS

CAN—CARDBOARD—RECTANGULAR

Now you can get high-grade, fully reliable condensers, especially designed for use with all P.A. and theatre applications where the working voltage is high and where surges run well over 600 volts. A new line of Sprague dry electrolytics gives all needed types and capacities with working voltages up to 800 volts. Write for new catalog, or ask your jobber to show you this important Sprague development.

HERE'S REAL BY-PASS RELIABILITY



Servicemen who started using Sprague TC Tubulars more than ten years ago still insist on them today. There is no better evidence of the dependability that has made TC's the most widely used condensers ever produced! Test voltage 1,200 volts; working voltage 600 volts.

**"Not a
Failure
in a
Million"**

Made in all ranges from .001 mfd. to 1.0 mfd. Sold singly or in handy kits that save you time and money.

SPRAGUE

THE NAME THAT HAS STOOD FOR BETTER
CONDENSERS SINCE THE BEGINNING OF RADIO

APPROVED
by the World



SYLVANIA

In six short years Sylvania popularity has spread from 20 to 124 countries. And during the same period...Sylvania sales in the markets of the world have enjoyed an average yearly increase of over 80%! Only the fine quality of the product itself could achieve such amazing records of growth. Truly...Sylvania has been "approved by the world."

SYLVANIA

SET-TESTED RADIO TUBES



HYGRADE SYLVANIA CORPORATION • EMPORIUM, PA. • CABLE HYSYLVANIA, N. Y.