

RADIO-CRAFT

HUGO GERNSBACH, Editor

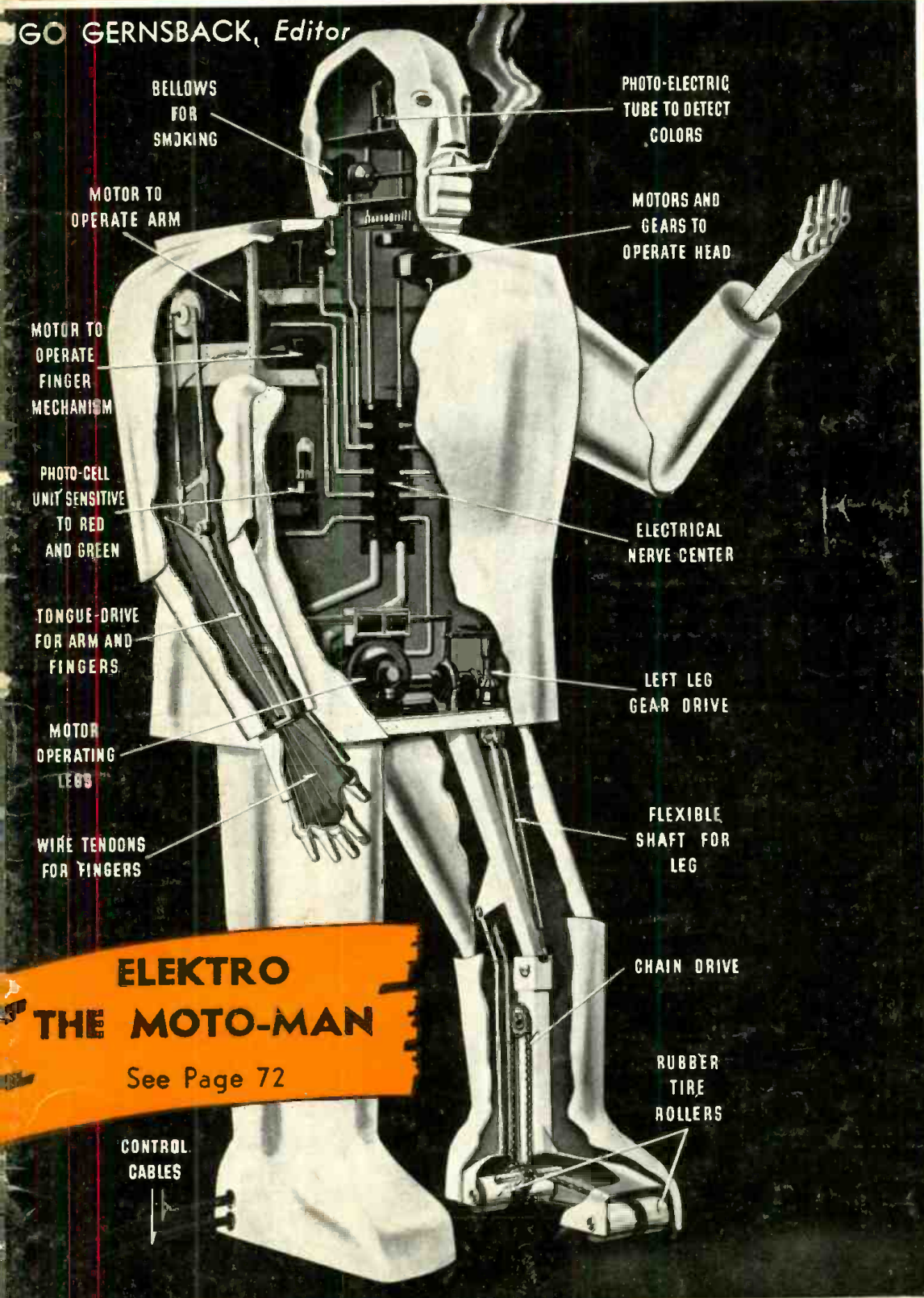

ELEKTRO
THE MOTO-MAN
 See Page 72

★
Last Call!
\$4,000⁰⁰
PUBLIC ADDRESS CONTEST
 ★

See Page 80

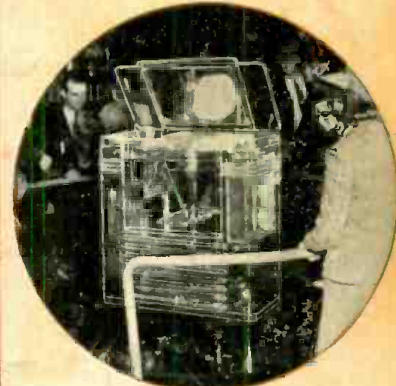

PHANTOM TELECEIVER

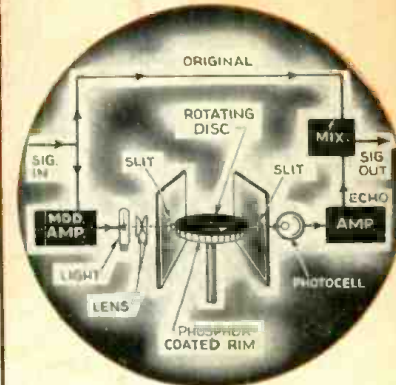

ECHO MAKER



MECHANICAL RADIO WAVE

3 NEW MEISSNER P. A. TUNERS IN KIT FORM



NEW "HIGH FIDELITY" TUNER

\$28.95 net



NEW "DUAL BAND" TUNER

\$25.65 net

A P-A Tuner Kit for every purpose! New High-Fidelity model designed for local—or high-level—station reception only; Utility model for general purpose use, portable or stationary, for local and distant reception; Dual Band model for use where Short Wave reception is desired, or where extreme selectivity is required because of near-by powerful stations. All P-A Tuner Kits are designed for use with a good external audio amplifier; low-gain coupling stage is incorporated in each unit. See your parts jobber for Time Payment Plan.

NEW "HIGH FIDELITY" TUNER

Figure A. Designed entirely for reception from local, or near-by powerful broadcast stations. Has wide-band selectivity to permit true high-fidelity reproduction; audio response is essentially flat from 40 to 10,000 cycles. Circuit is band-pass T. R. F. type, using a 4-gang, 365-mmf tuning condenser. Covers broadcast band only, from 535 to 1600 kc. Careful design of filter circuits assures an exceptionally low hum-level.

Kit includes all coils, variable condenser, dial and escutcheon, chassis, panel and cabinet, transformers, resistors, condensers, sockets, knobs, hardware, wire, solder, etc. Clearly written instructions, with pictorial and schematic diagrams, are supplied. Kit does not include tubes.

Complete Kit, with Panel and Cabinet
No. 10-1172. List \$48.25. Net \$28.95
Complete Kit, less Panel and Cabinet.
No. 10-1152. List \$43.25. Net \$25.95

NEW "DUAL BAND" P-A TUNER

Figure B. A public address tuner kit for use where reception from distant stations is a necessity, or where short-wave programs are desired. Covers 540 to 1600 kc, and 5.9 to 18.8mc. Has good selectivity to reduce interference to a minimum. Makes use of a super-het circuit with a stage of R. F. on each band. Includes a Tuning Eye; diode A. V. C. is built in.

Kit contains all parts necessary for construction, including coils, condensers, chassis, panel and cabinet, dial and escutcheon, knobs, resistors, hardware, wire, solder, etc. Supplied with complete instructions, pictorial and schematic diagrams that are easy to follow. Kit does not include tubes.

Complete Kit, with Panel and Cabinet.
No. 10-1171. List \$42.75. Net \$25.65
Complete Kit, less Panel and Cabinet.
No. 10-1151. List \$37.50. Net \$22.50

"UTILITY" TUNER

Figure A. A general purpose Tuner kit, small enough to be used with portable P-A systems, as well as in built-in institutional systems. Uses T. R. F. circuit (4 tuned circuits) for excellent sensitivity and fair selectivity—may be used for local or distant station reception. Covers Broadcast band from 530 to 1600 kc.

Kit includes all parts, such as coils, condensers, dial, chassis, panel and cabinet, transformers, resistors, controls, knobs, screws, wire and solder, necessary for construction. Clearly written detailed instructions and diagrams for assembling, wiring and operating are also supplied. (Tubes are not included in Kit.)

Complete Kit, with Panel and Cabinet.
No. 10-1178. List \$45.75. Net \$27.45
Complete Kit, less Panel and Cabinet.
No. 10-1119. List \$40.75. Net \$24.45

Mail coupon below for Meissner's new 1939-40 Catalog featuring 28 Radio Kits (1 to 14 tubes) and over 800 Meissner Products for Set Builders, Amateurs and Experimenters. Also Meissner's new GUIDE TO RADIO and TELEVISION, a complete scientific Instruction Book telling how to build 28 different Kits, including TELEVISION. 168 pages. ONLY 50c.

MAIL IN ENVELOPE OR PASTE ON PENNY POSTCARD

MEISSNER MANUFACTURING COMPANY
Mt. Carmel, Illinois, Dept. RC-8

Send me Meissner's FREE 1939-40 CATALOG.

Enclosed find 50c for the Radio and Television Instruction Book.

Name

Address

City State



RADIO-CRAFT

Be a Radio Expert

Many make **\$30 \$50 \$75** a week



J. E. SMITH, President, National Radio Institute
Established 25 years
He has directed the training of more men for the Radio Industry than anyone else.

I will train you at home for many Good Spare Time and Full Time Radio Jobs

Radio offers you many opportunities for well-paying spare-time and full time jobs. And you don't have to give up your job, leave home or spend a lot of money to train to get those jobs—to become a Radio Expert.

equipment to conduct experiments and build circuits. This 50-50 method of training makes learning at home interesting, fascinating, practical.

I Also Give You This Professional Servicing Instrument



Here is the instrument every Radio expert needs and wants—an All-Wave, All-Purpose Set-Servicing Instrument. It contains everything necessary to measure A.C. and D.C. voltages and current; to test tubes, resistance; adjust and align any set, old or new. It satisfies your needs for professional servicing after you graduate—can help you make extra money fixing sets while training.

You Are Trained for Television Also

With N. R. I. you take up Television principles right along with Radio principles—the correct method—since Television receivers combine both sight and sound. You also get more than ten text books devoted entirely to Television.

Find Out What Radio Offers You

Act Today. Mail the coupon now for "Rich Rewards in Radio." It's free to any fellow over 16 years old. It points out Radio's spare time and full time opportunities and those coming in Television; tells about my training in Radio and Television; shows you letters from men I trained, telling what they are doing and earning; tells how my Money Back Agreement protects you. Find out what Radio offers YOU! MAIL COUPON in an envelope, or paste on a postcard—NOW!

J. E. SMITH, Pres., National Radio Institute
Dept. 9HX
Washington, D. C.

THIS FREE BOOK HAS HELPED HUNDREDS OF MEN MAKE MORE MONEY



Set Servicing
Fixing Radio sets in spare time pays many \$5, \$10, \$15 a week extra while learning. Full time repair pays as much as \$30, \$50, \$75 a week.

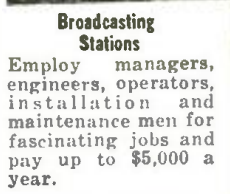

Broadcasting Stations
Employ managers, engineers, operators, installation and maintenance men for fascinating jobs and pay up to \$5,000 a year.



Loud Speaker Systems
Building, installing, servicing, operating public address systems is another growing field for men well trained in Radio.

Get Ready Now for Jobs Like These

Radio broadcasting stations employ engineers, operators, station managers and pay well for trained men. Fixing Radio sets in spare time pays many \$200 to \$500 a year—full time jobs with Radio jobbers, manufacturers and dealers, as much as \$30, \$50, \$75 a week. Many Radio Experts open full or part time radio sales and repair businesses. Radio manufacturers and jobbers employ testers, inspectors, foremen, engineers, servicemen, in good-pay jobs with opportunities for advancement. Automobile, police, aviation, commercial Radio and loud speaker systems are newer fields offering good opportunities now and for the future. Television promises to open many good jobs soon. Men I trained have good jobs in these branches of Radio. Read how they got their jobs. Mail coupon.

Why Many Radio Experts Make \$30, \$50, \$75 a Week

Radio is young—yet it's one of our large industries. More than 28,000,000 homes have one or more Radios. There are more Radios than telephones. Every year millions of Radios get out of date and are replaced. Millions more need new tubes, repairs. Over \$50,000,000 are spent every year for Radio repairs alone. Over 5,000,000 auto Radios are in use; more are being sold every day, offering more profit-making opportunities for Radio experts. And RADIO IS STILL YOUNG, GROWING, expanding into new fields. The few hundred \$30, \$50, \$75 a week jobs of 20 years ago have grown to thousands. Yes, Radio offers opportunities—now and for the future!

Many Make \$5, \$10, \$15 a Week Extra in Spare Time While Learning

The day you enroll I start sending Extra Money Job Sheets; show you how to do Radio repair jobs. Throughout your training I send plans and directions that made good spare time money—\$200 to \$500—for hundreds, while learning. I send you special Radio

HERE'S PROOF THAT MY TRAINING PAYS



\$50 Monthly in Spare Time
"I work on Radio part time, still holding my regular job. Since enrolling seven years ago, I have averaged around \$50 every month."
JOHN B. MORISSETTE, 809 Valley St., Manchester, N. H.

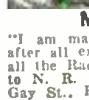

Makes \$50 to \$60 a Week
"I am making between \$50 and \$60 a week after all expenses are paid, and I am getting all the Radio work I can take care of, thanks to N. R. I." H. W. SPANGLER, 126 1/2 S. Gay St., Knoxville, Tenn.



Operates Public Address System
"I have a position with the Los Angeles Civil Service, operating the Public Address System in the City Hall Council. My salary is \$170 a month." R. H. HOOD, Rt. 136, City Hall, Los Angeles, Calif.

LESSON ON RADIO SERVICING TIPS—FREE

I want to prove that my training gives practical, money-making information, is easy to understand—is what you need to master Radio. My sample lesson text, "Radio Receiver Troubles—Their Cause and Remedy" covers a long list of Radio receiver troubles in A.C., D.C., battery, universal, auto, T. R. E., superhet, electrodyne, all-wave, and other types of sets. And a cross reference system gives you the probable cause and a quick way to locate and remedy these set troubles. A special section is devoted to receiver checkup, alignment, balancing, neutralizing and testing. Get this lesson FREE. No obligation. Just mail coupon.



This Coupon is Good for One FREE Copy of My Book

J. E. SMITH, President, Dept. 9HX
National Radio Institute, Washington, D. C.

Dear Mr. Smith: Without obligation, send me free the Sample Lesson and your 64-page Book, "Rich Rewards in Radio," telling about spare time and full time Radio opportunities, and how I can train for them at home in spare time. (Please write plainly.)

NAME AGE

ADDRESS

CITY STATE 14-X1

Please Say That You Saw It in RADIO-CRAFT

RADIO-CRAFT

HUGO GERNSBACK, *Editor-in-Chief*

N. H. LESSEM
Associate Editor

THOS. D. PENTZ
Art Director

ROBERT EICHBERG
Trade Digest Editor

R. D. WASHBURNE, *Managing Editor*

Contents AUGUST, 1939 Issue

VOLUME XI -- NUMBER 2

Editorial: Whither Radio?.....	Hugo Gernsback	69
The Radio Month in Review.....		70
Elektro—The Moto-Man		72
The "VOSYN"—Newest Sound Robot.....		72
High-Fidelity Broadcasting.....	James D. Parker	73
1939 Commercial Teleceiver—Part II (Conclusion).....		74
How to Make a "B"-Batteryless Receiver.....	R. D. Washburne	76
Obscure Sources of Hum in High-Gain Amplifiers.....	A. C. Shaney	78
\$4,000 Public Address Contest [4th Month].....		80
Latest Circuit Features in Modern Public-Address Amplifiers—Part II	L. M. Feiler and M. N. Beitman	81
Telly Piped Over Phone Wires!—And With 441-Line Definition.....		82
Modern Receiver Test Requirements.....		83
Emergency Servicing Without Test Meters.....	Charles R. Leutz	84
Servicing Television Receiver Faults—Part III.....	S. West	86
New Circuits in Modern Radio Receivers—No. 23....	F. L. Sprayberry	88
Modernize Old Phonographs!.....	Harry Paro	89
12 New Tubes.....	N. H. Lessem	90
Tuning Dial Scales.....	Esten Moen	91
Operating Notes		91
Servicing Questions & Answers.....		91
Useful Kinks and Circuits.....		92
Test Your Radio Knowledge—With Questions and Answers from Radio Schools		93
Servicing "Coin-Operated" Phonographs—No. 3.....	Sanford Miller	94
Mailbag		95
RADIO SERVICE DATA SHEETS:		
No. 258—Admiral (Knight) "Aeroscope" Models 161-5L, 162-5L, 163-5L Midget Sets.....		96
No. 259—RCA Victor Model M-70 Auto-Radio.....		97
The Latest Radio Equipment.....		98
Radio Trade Digest.....		99
Book Reviews		67

In the August 1938 issue of *Radio-Craft* Mr. Ricardo Muniz was to make a Pulse Separator to make a Pulse Separator regular television programs be received on a Servicen. standard oscilloscope and ordin. broadcast receiver! When N.B.C. declared its moratorium on telly transmissions these experiments were temporarily shelved.

But when N.B.C. went on the air recently, work on the project was resumed. Result? *Radio-Craft* last month watched the Baer-Nova fight as seen on a standard service oscilloscope!!!

Read all about how to do it in the concluding article on "TELEVISION EXPERIMENTS WITH A SERVICING 'SCOPE'".

★

A number of articles, scheduled to appear in the August issue of *Radio-Craft*, due to last-minute changes could not be included in this issue. Instead these articles have been rescheduled for the September issue. We are sorry for any disappointment this may have caused readers who were especially interested in certain of the articles.

★

Published by Radcraft Publications, Inc. Publication office: 29 Worthington Street, Springfield, Mass. Editorial and Advertising Offices: 99 Hudson Street, New York City. Chicago Advertising Office: RADIO-CRAFT, 520 North Michigan Avenue, Chicago, Ill.

RADIO-CRAFT is published monthly, on the first of the month preceding that of date; subscription price is \$2.50 per year in U. S. and Canada. (In foreign countries, \$3.00 a year to cover additional postage.) Entered at the post office at Springfield as second-class matter under the act of March 3, 1879.

Foreign Agents:

London—Gorrings' American News Agency, 9A Green St., Leicester Square, W. C. 2, England.

Paris—Messageries Dawson, 4 Rue Faubourg, Poissonniere, France.

Melbourne—McGill's Agency, 179 Elizabeth St., Australia.

Dunedin—James Johnston, Ltd., New Zealand.

★

Text and illustrations of this magazine are copyright and must not be reproduced without permission of the copyright owners.

★

Copyright 1939 Radcraft Publications, Inc.

BOOK REVIEWS

REMINISCENCES OF MENLO PARK. Vol. II (1939), by Francis Jehl. Published by The Edison Institute. Size, 4½ x 7 ins., 450 pgs., 300 illustrations. Price, paper cover, 50c; cloth cover, \$1.00.

In our review of "Reminiscences of Menlo Park," Vol. I, in the February, 1939, issue of *Radio-Craft*, we expressed "pleasurable anticipation of doing a review on Vol. II." In this second volume, just received, we find that Mr. Jehl has now completed the intimate story of the wizard of Menlo Park; with the restoration of Thomas A. Edison's original Menlo Park laboratory in Greenfield Village, Dearborn, Mich., memories of those Menlo Park days have been recalled and placed on record in these "Reminiscences" (an undertaking which was made possible by Henry Ford, whose interest in preserving Americana for posterity is too well known for comment). Even at this early date Vol. I of this series has gone through 3 printings, and it is this reviewer's hope that Vol. II (which incidentally contains corrections to the preceding volume) receives equally favorable acceptance. A third book dealing with the introduction of the Edison system in Europe and America is in preparation.

Volume II, discussing the work of Edison from 1879 to 1880, covers an important period in the development of electric lighting, as witness the following chapter headings, selected at random:

Part III, Early Developments of Electric Lighting, Chapter LIV—The World in 1880 (opening chapter of Vol. II); LVI, The Swan Case; LVII, The First Central Station; LIX-LX, Life at Menlo Park, Parts I and II; LXIV-LXVI, The Electric Railway, Parts I to III, incl.; LXVII-LXIX, Bamboo Filament, Parts I and II; LXX-LXXI, Edison's Electric Light Meter, Parts I and II; LXXXVII-XC, The Jumbo Dynamo, Parts I to III, incl.

THE AMPLIFICATION AND DISTRIBUTION OF SOUND, by A. E. Greenlees (1938). Published by Chapman and Hall, Ltd., London, England. Size 6 x 8¼ ins., cloth cover, 254 pgs., 82 illustrations. Price 10s. 6d. (approx. \$2.75).

This English publication presents a general survey of the principles of sound amplification and distribution, showing the practical considerations involved, together with sufficient technical detail to enable the reader to appreciate the fundamental principles.

This book is intended to be of interest to those connected with the various applications of sound amplification for public-address, entertainment or similar purposes; as well as to the more general reader. The chapter on fundamentals has been included for the sake of completeness and convenience. Technical details of transformer design have been included to aid in the solution of the various impedance matching problems which the sound man will encounter. Briefly, the chapters discuss fundamentals, chokes and transformers, amplifiers, P.A. tuners, auxiliary equipment (microphones, loudspeakers, etc.), and installation planning, procedure and maintenance. An appendix defines technical terms.

RADIO ANNUAL 1939, compiled by the staff of *Radio Daily*. Size 6½ x 9½ ins., cloth cover, 960 pgs. A "Radio Daily" subscription premium.

The newest edition of a valuable reference for professional radio men exceeds all preceding issues in scope and detail. An extensive index is included; this 8-pg. index details the following items: Advertising, F.C.C., Broadcast Networks, Personnel of Radio Programs, Program Production, Television.

Although this book supplies mostly detailed information on broadcast stations, it also is an invaluable reference to most of the elements that are included in the business of radio. Of special interest to *Radio-Craft* readers is the chapter entitled, "The Technical Side."

ELECTRON OPTICS IN TELEVISION, by I. G. Maloff and D. W. Epstein (1938). Published by McGraw-Hill Book Company, Inc. Size 6½ x 9¼ ins., cloth cover. 299 pgs., profusely illustrated. Price \$3.50.

Develops the theory of electron optics and its most useful application—the television cathode-ray tube, emphasizing those phases of the sub-

Hot off the Press....

THIS 56-PAGE CATALOG OF THE HOTTEST SOUND LINE IN HISTORY!



Here are the contents of this catalog

ACCESSORIES • AMPLIFIERS: Amplifier Units, Amplifier Cabinets (Metal), Cables for Amplifier Remote Controls, Input Transformer, Mixer and Mixer Pads, Panels for Amplifier Cabinet, Remote Control Devices, Signal Mixer Units • ANTENAPLEX (Multi-Wave) • ANTENAPLEX (Standard) • Baffles (see Loudspeakers) • COMPLETE SOUND SYSTEMS • CHIMES (Electric) • CONTROL CABINETS • HEARING AIDS • INTER-OFFICE COMMUNICATING SYSTEMS (Victor-Phones) • LOUDSPEAKERS: Baffles, Control Devices, Electro-Dynamic Speakers, Field Supply Units, Housings and Boxes, Matching Transformers, Permanent Field Speakers • MASTER CONTROL SYSTEMS (De Luxe) • MASTER CONTROL SYSTEMS (Junior), Typical Master Control Installations • MICROPHONES AND ACCESSORIES • MOBILE PUBLIC ADDRESS SYSTEM • PORTABLE PUBLIC ADDRESS SYSTEMS • PUBLIC ADDRESS SYSTEMS: Series Systems • RECORDING EQUIPMENT: Accessories, Recording Blanks • SOUND POWER TELEPHONES • TURNTABLES: Accessories and Records • VICTOR-PHONES • VOLUME CONTROLS • WIRE AND CABLE.

SEND FOR YOUR FREE COPY TODAY!



Get your free copy today from your RCA distributor, or mail this coupon.

Plan now to cash in on a huge market with

COMMERCIAL SOUND

RCA Mfg. Co., Inc., Camden, N. J.
A Service of Radio Corp. of America

Commercial Sound Section, Dept. CM-8
RCA Manufacturing Co., Inc.,
Camden, N. J.

Please send me my copy of the new
RCA Sound Equipment Catalog.

Name _____

Address _____

City _____

State _____

Any sound system sounds better equipped with RCA Radio Tubes

ject with which the authors have had first-hand experience at the Research Laboratories of the RCA Manufacturing Co., Inc., Camden, N. J.

Following a brief description of a complete cathode-ray television system for the purpose of clarifying concepts and terms, the book covers in Part I the theory of electron emission and electron optics, and in Part II the problems encountered in designing tubes that are practical and economical to construct and capable of producing satisfactory television images when used with suitable associated apparatus.

Chapter headings: Electronic Optics—Fundamental Concepts, Electron Emission, Analogy Between Electron Optics and Light, Motion of Electrons in Axially Symmetric Electrostatic Fields, Electrostatic Electron Lenses, Electrostatic Lenses of Television Cathode-Ray Tubes, Defects of Electron-Focusing System of TCR Tubes, Magnetostatic Focusing; Television Cathode-Ray Tube—The Electron Gun, Deflection of Electron Beams, Luminescent Screens for TCR Tubes, Classifications, Rating and Characteristics of TCR Tubes, Accessories, Vacuum Practice.

THE LIE DETECTOR TEST, by William Moulton Marston. Published by Richard R. Smith. Size 6 x 9 ins., cloth cover, 182 pages, 8 illustrations. Price, \$2.

What is the Lie Detector? How does it work? Who "invented" it? Where and how is it used? What standing has the Lie Detector Test in court? How many banks, police departments, prosecutors, department stores use the Lie Detector? These, and many other questions, are answered by a psychologist, lawyer and originator of the "Lie Detector Test."

The nature of its contents is evident from the following chapter headings: The High Cost of Lying; The 6000-year Search for a Truth Test; Discovery: The Blood Pressure Test; Science Tests the Lie Detector; The Lie Detector Goes to Court; Legal Obstacles—The Hauptmann Case; Prosecutors and Police Adopt the Lie Detector; The Lie Detector Enters Business and the Banks; Love and the Lie Detector; A New Field for the Lie Detector; Tomorrow and the Day After; Practical Suggestions on Technique.

Please Say That You Saw It in RADIO-CRAFT

For Better Servicing - - For Bigger Profits - - Use Gernsback Manuals and Books!



SINCE 1931 Servicemen have been buying more GERNSBACK OFFICIAL RADIO SERVICE MANUALS year after year. The authentic material, easily accessible diagrams and complete service data make them invaluable to dealers and radio Servicemen. *Without a Gernsback Service Manual at the repair job, there's time and profit lost.* Your service kit or laboratory is incomplete without all the GERNSBACK OFFICIAL RADIO SERVICE MANUALS. There are GERNSBACK MANUALS for servicing auto-radios, also refrigeration and air conditioning equipment.

VOLUME 7 OFFICIAL RADIO SERVICE MANUAL
Over 1,800 Pages • Over 3,000 Illustrations • Stiff, Leatherette, Looseleaf Covers • Size 9 x 12 Inches • Net Weight 10½ lbs. **\$10.00**

1936 OFFICIAL RADIO SERVICE MANUAL
Over 1,200 Pages • Over 2,500 Illustrations • Stiff, Leatherette, Looseleaf Covers • Size 9 x 12 Inches • Net Weight 8 lbs. **\$7.00**

1935 OFFICIAL RADIO SERVICE MANUAL
Over 1,000 Pages • Over 3,000 Illustrations • Flexible, Leatherette, Looseleaf Covers • Size 9 x 12 Inches • Net Weight 3¾ lbs. **\$7.00**

1935 OFFICIAL AUTO-RADIO SERVICE MANUAL
Over 240 Pages • Over 500 Illustrations • Flexible, Leatherette, Looseleaf Covers • Size 9 x 12 Inches • Net Weight 1¾ lbs. **\$2.50**

1934 OFFICIAL RADIO SERVICE MANUAL
Over 400 Pages • Over 2,000 Illustrations • Flexible, Leatherette, Looseleaf Covers • Size 9 x 12 Inches • Net Weight 2¼ lbs. **\$3.50**

1932 OFFICIAL RADIO SERVICE MANUAL
Over 1,000 Pages • Over 2,000 Illustrations • Flexible, Leatherette, Looseleaf Covers • Size 9 x 12 Inches • Net Weight 4½ lbs. **\$5.00**

OFFICIAL REFRIGERATION SERVICE MANUAL (Volume I)
Over 450 Pages • Over 1,200 Illustrations • Flexible, Leatherette, Looseleaf Covers • Size 9 x 12 Inches • Net Weight 2½ lbs. **\$5.00**

OFFICIAL REFRIGERATION SERVICE MANUAL (Volume II)
Over 352 Pages • Over 300 Illustrations • Flexible, Leatherette, Looseleaf Covers • Size 9 x 12 Inches • Net Weight 1½ lbs. **\$5.00**

OFFICIAL AIR CONDITIONING SERVICE MANUAL
Over 352 Pages • Over 600 Illustrations • Flexible, Leatherette, Looseleaf Covers • Size 9 x 12 Inches • Net Weight 2¼ lbs. **\$5.00**

To order these famous Manuals, see or write to your jobber or favorite mail order house. If more convenient, mail coupon directly to publishers.

RADCRAFT PUBLICATIONS, Inc.
99 HUDSON STREET NEW YORK, N. Y.

Get into the swing of reading instructive, authoritative books on technical subjects—radio, air conditioning and refrigeration. It's the easiest, quickest and most inexpensive way to improve your knowledge on these topics. In this series, popularly known as the RADIO-CRAFT LIBRARY SERIES, are all the titles necessary to your personal advancement. Only by careful study of these enlightening books, can you gain adequate experience in fields of radio, air conditioning and refrigeration. Each book is uniform. The volumes measure 6 x 9 inches—contain 64 pages, and have stiff, flexible covers. PRICE 50c PER BOOK. All books are sent to you postpaid.

Here Are The Titles:

- | | |
|---|---|
| Book No. 2
MODERN VACUUM TUBES | Book No. 16
PRACTICAL RADIO CIRCUITS |
| Book No. 3
THE SUPERHETERODYNE BOOK | Book No. 17
SERVICING WITH SET ANALYZERS |
| Book No. 6
BRINGING ELECTRIC SETS UP-TO-DATE | Book No. 18
POINT-TO-POINT RESISTANCE ANALYSIS |
| Book No. 9
AUTOMOBILE RADIO AND SERVICING | Book No. 19
PRACTICAL RADIO KINKS AND SHORT CUTS |
| Book No. 10
HOME RECORDING AND ALL ABOUT IT | Book No. 20
THE CATHODE-RAY OSCILLOSCOPE |
| Book No. 13
ABC OF AIR CONDITIONING | Book No. 21
BREAKING INTO RADIO SERVICING |
| Book No. 14
POCKET RADIO GUIDE | Book No. 22
NEW RADIO QUESTIONS AND ANSWERS |
| Book No. 15
ABC OF REFRIGERATION | Book No. 23
PRACTICAL PUBLIC ADDRESS |

EACH BOOK IN THIS SERIES—50c

RADCRAFT PUBLICATIONS, Inc., 99 HUDSON ST., NEW YORK, N. Y.
Gentlemen: Enclosed find my remittance of \$..... for which send me, POSTPAID, the Manuals or Books indicated below by a cross (x) in the panel.

- () Volume 7 @ \$10.00 () 1936 Manual @ \$7.00 () 1935 Manual @ \$7.00
 () 1935 Auto-Manual @ \$2.50 () 1934 Manual @ \$3.50 () 1932 Manual @ \$5.00
 () Refrigeration Manual (Vol. 1) @ \$5.00 () Refrigeration Manual (Vol. 2) @ \$5.00
 () Air Conditioning Manual @ \$5.00

RADIO-CRAFT LIBRARY SERIES @ 50c EACH

Circle book numbers wanted: 2 3 6 9 10 12 13 14 15 16 17 18 19 20 21 22

Name Address

City State

(Send remittance in form of check or money order; register your letter if you send cash or unused U. S. Postage Stamps.)

RC-839

Please Say That You Saw It in RADIO-CRAFT

RADIO-CRAFT

“RADIO'S GREATEST MAGAZINE”

WHITHER RADIO?

By the Editor — HUGO GERNSBACK

SOMETIMES it is difficult to know in advance into what road Radio is turning, all predictions notwithstanding.

Very often radio experts in the trade have certain ideas as to what radio will do next, only to find out that predictions leave much to be desired.

For instance, one of the last things that any radio man would think would come into huge vogue is the old loop antenna which we used away back in the '20's. This was discarded for over a decade, only to be resurrected now to march to new glory in our present-day portable as well as stationary sets.

The answer here is, of course, that our radio tubes are much more efficient than they used to be, making it possible to use a ridiculously small loop aerial; considerably smaller in fact than we used to use many years ago.

So far, there has been one great trouble with these loop aerials and that is, they are extremely directional and therefore a radio set, particularly if it is not portable, will work much better in one location of the room than in another. As a matter of fact, some of these sets will not bring in certain stations at all in a certain position, but if you move the set one or two feet, the station will come in loudly. This is a difficulty in our present loop antennas which probably will be done away with by better engineering in the near future.

From loop aerials and short antennas such as we use in our automobiles, the next stop probably will be *no aerial at all*. This, of course, is nothing new, either. Most non-mobile sets which we use in our homes can be worked readily with very little aerial pick-up, using only the connecting cord in lieu of the aerial proper. The trouble here is too much pick-up of extraneous noises, static, and the like. It is conceivable that this trouble will be overcome in the future because as our radio tubes advance in sensitivity no aerial at all will be required. The chassis or a small metallic plate as a counterpoise will probably be used in the future.

Again, this is nothing new because it, too, has been done before. The reason that it has not been continued is found in the fact that with our former tubes there was too much noise, too much man-made and other static which discouraged radio designers from going on with the no-aerial set at that time.

This, brings us to the static bug-a-boo which now seems to have been solved by Major Armstrong's Frequency Modulation System. Anyone who has heard one

of the new radio sets (operating in either the 40-megacycle or 3-megacycle regions) and receiving signals from a Frequency Modulated station is mystified at the tremendous improvement in reception. It is uncanny to listen to one of these sets and it is difficult to believe that the radio set is actually turned on because there are no background noises—indeed, no noises whatsoever. Listening to one of these new sets is a revelation by itself and one which has dumbfounded even radio experts.

Of course, at the present time due to the extremely high frequencies (short wavelengths) that this system makes use of, there does not seem to be an immediate stampede to frequency modulation as far as we can discern at this time. Adopting the system would mean that 30-odd million sets in this country would all become obsolete over night—a thing quite inconceivable.

It is in the realm of possibility, however, that there will be a gradual turnover to frequency modulation by way of our shortwave stations. Many of our broadcast stations at the present time broadcast simultaneously on long and short waves. It is conceivable that some time in the future most broadcast stations will have companion stations with frequency modulation. Then, as the public becomes sold on the idea of frequency modulation, there can be a gradual changeover. This, of course, will take many years to accomplish as you cannot sell 30-odd million new radio sets of the frequency-modulated type in a short time.

Long before this, it is also quite conceivable, and in fact to be expected, that television will have come along; indeed, inasmuch as television must be on a low wavelength, frequency modulation (which itself must be on low wavelengths) will then work hand-in-hand with television, much more so than is the case today. At the present time our television sets actually require 3 wavelengths in order to be commercially feasible; for example, television requires one wavelength (around 6 meters, roughly) for sight, and a second, on a channel in the same wavelength region, for the accompanying sound portion of the program, while in order to listen to regular programs we require a third waveband in the region of 550 to (about) 200 meters.

All this tends to make our present-day television sets not only cumbersome, but expensive as well, for the simple reason that there must be a duplication of radio circuits, extra tubes and extra parts. Most of this will be avoided (by multiplexing on one "F.M." carrier) once every transmitter operates on frequency modulation.

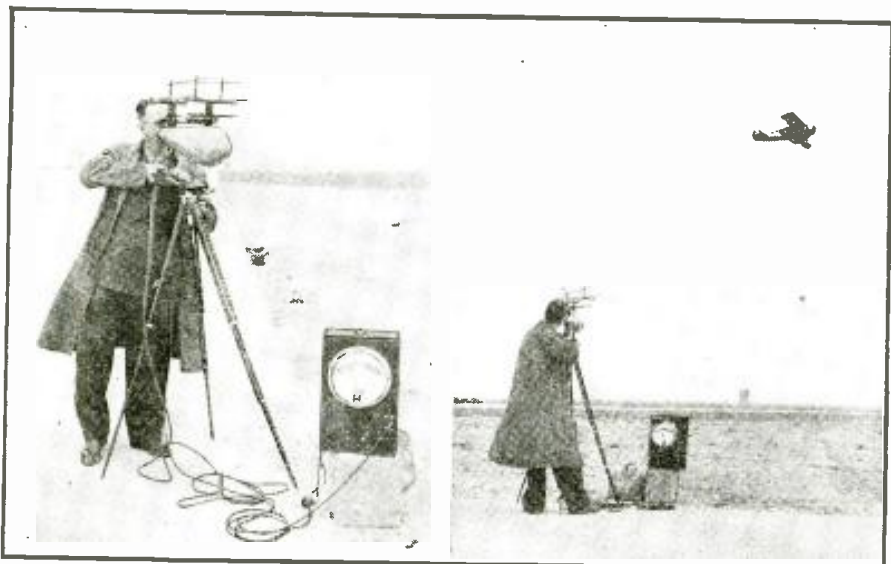

(Rudy Arnold Photos)

Above, left, inventor Harry Dickens with his "sensytrol"-power beam apparatus which was granted a U.S. patent for power projection based upon radically new concepts in the field of electricity by utilization of microwaves. This "object-detector" requires no receiving apparatus at all for picking up the reflected wave. Above, right, Mr. Dickens as he demonstrated his "sensytrol" beam last month—over a distance of 14 miles!—at Floyd Bennett Airport, Brooklyn, New York City. The huge meter shown indicates hits. Some of its many uses: locating of aircraft above overcast clouds, spotting of icebergs or boats in a fog, detection of mountain ranges and other obstacles from airplanes, etc.

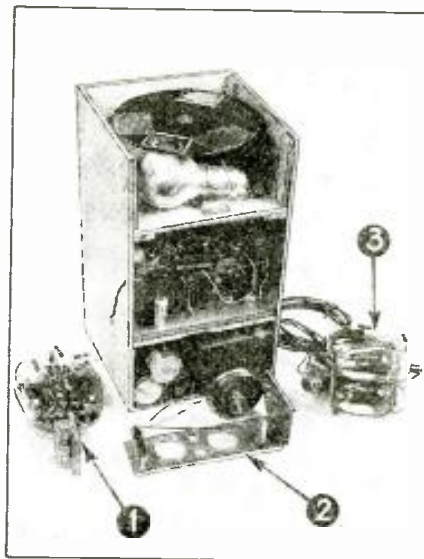

Ultraviolet solar intensity meter type of "radiosonde" (photo released last month by Bureau of Standards). At the side and front of the device are (1) the balanced amplifier, (2) barometric pressure switching device, and (3) the radio transmitter. Transmits measurements of ultraviolet intensities from unmanned balloons to a ground station. Operates on about 50 megacycles; range, up to 100 miles.



Dr. Goldmark (right), chief television engineer of C.B.S., discusses his synthetic reverberation machine with engineer Paul Hendricks. (Diagram below.)

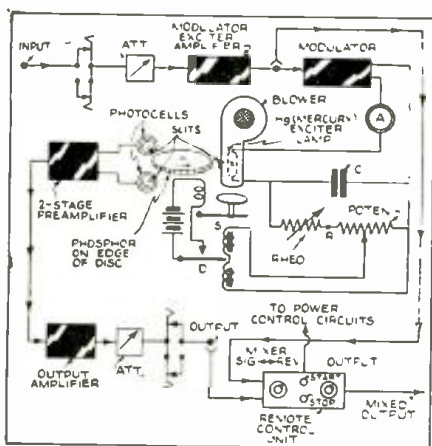

Sound to which reverberation is to be added is made to modulate a mercury-vapor quartz lamp and lens system, the light from which is projected on the phosphorescent edge of the revolving disc. The varying intensity of the bars of light produced as a result, is synchronized with the intensity of the light signal fed into the device. This light image of the sound, temporarily "engraved" on the disc's phosphorescent material is then picked off by photoelectric cells placed around the disc's circumference. The process is complete when the secondary sound image is picked up and superimposed on the original sound. The blower cools the mercury vapor light source. See basic diagram on the front cover.

THE RADIO MONTH

BROADCASTING

BULLETINS flashed over broadcast stations, to officers and men of the U.S.S. cruiser *Brooklyn*, last month, calling them to immediate duty, aided in rescuing sailors imprisoned in the sunken U.S. submarine, *Squalus*, 240 ft. deep, 10 miles off-shore at Portsmouth, N. H.

Glenville High School of Ohio last month won a Public Address system as its First Prize award in the National A.A.A.U. Radio Script contest.

Believe It or Not Ripley last month, in broadcasting from Carlsbad Caverns, New Mexico, had only 1 line available from his position 800 ft. underground as he broadcast a "blow by blow" description of a new cavern being blasted open. Since no cue wires were available, timing was had by split-second synchronizing of watches—believe it or not!

An interconnected RCA police radio system was used last month by 2 Illinois towns—Normal and nearby Bloomington—to catch 2 heavily-armed desperados who had been hunted across country for 14 months. Utilizing the 2 radio systems, after a tip-off, authorities directed an encircling movement of a posse that took its quarry without a shot.

Dr. (C.B.S.) Goldmark last month disclosed his electro-optical reverberation device for broadcast studios. "Heart" of the machine is a phosphor-edged disc, 20 ins. in diameter, which rotates at 400 r.p.m.

The *Cracraft All-Electronic Orchestra* made its air debut over WJZ last month; by which time it had grown, from the 10-piece ensemble described exclusively in July *Radio-Craft*, pg. 14. As M. B. F. Miessner, guest speaker, pointed out, this dance band produces its tones entirely by means of electronic amplification. André Monici directed the orchestra in novelty arrangements written especially for the broadcast by Lewis Raymond. Many musical instruments were simulated; and listeners heard new tones incapable of being produced by any previously-existing musical instrument! A master control panel afforded complete control of individual instrument volume as well as overall volume control!

It is interesting to note that this broadcast came close on the heels of a prophecy, last month, by N.B.C.'s Mr. Roy Shield that "an all-electronic orchestra is just around the corner"!

ABOVE 1,500 KC.

OWEN J. DOWD, 21-year operator of amateur radio station W2JHB, Brooklyn, N.Y., won the coveted Hiram Percy Maxim Award for 1938, last month, beating out a field of 51,000 other "hams." Last year he handled 5,000 free messages to all parts of the world.

Wilson E. Burgess, a 29-year amateur radio operator of Westerly, Rhode Island, last month received the William S. Paley Amateur Radio Award for 1938, for heroic performance, during the New England hurricane, last year,

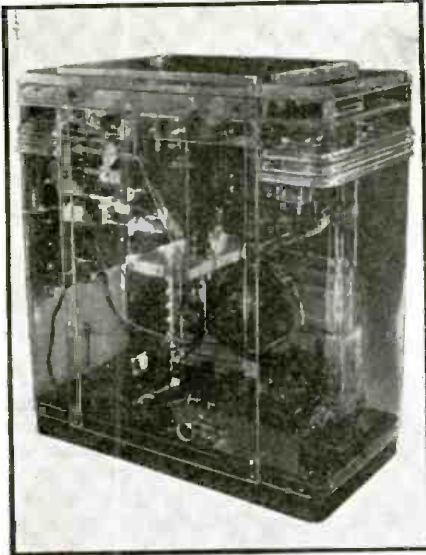

This phantom 37-tube teleceiver incorporates a working chassis and kinescope built into a cabinet made of Plexiglas, a transparent plastic material. The instrument is on display at the RCA exhibit at the New York World's Fair 1939. Another view of the receiver may be seen on the front cover of this issue. The funnel-shaped tube in the center is the kinescope on which the image appears.



Above, left, a complete radio station is located on Pan American Airways' Boeing Yankee Clipper, which last month made its maiden voyage to Europe and return. It is equipped with 3 radio transmitters and 3 receivers, 2 for long-range telegraph and 1 for short-range voice. The radio officer sends out regular half-hourly weather reports as well as those relative to aircraft speed position altitude, and other such necessary information. Upper-right, the radio officer at the controls of Pan American Airways' patented long-range 1,000 mile direction finder. Other direction finders at various Ground bases can spot the Clipper at 2,000 miles. Inset—photo of this huge 42-ton, 74-passenger flying boat.

IN REVIEW

in sticking to his emergency radio setup for 46 hours.

Sheriff Ted Schaffer of Fort Collins, Colorado, last month came out of a prize-fight ring with the winner's purse of \$1,300, which the Sheriff put in the kitty toward a shortwave radio setup for his office. Hats off to Sheriff Schaffer!

An azimuthal map, with New York as center, appeared as a 2-pg. spread in the May 15 issue of *Life* magazine, in the article, "Shortwave Radio Uses a New Kind of Geography." Other maps related to radio are shown.

SOUND

WHEN New York's City Council stenographer fainted, last month, station WNYC made transcriptions of the broadcast and thus legalized the proceedings. At that, the stock of blanks ran short and a dozen more were rushed by police car from WOR (which seems to be making a name for itself as a "good neighbor").

Thespians occasionally find it difficult to get back into character if left too long out of radio script. Jeanne Juvelier eliminated this problem, on N.B.C.'s "Guiding Light" show, by recording all her character roles and playing them back when necessary.

A new "Spoken Letter" service is now

available in 2 German Post Offices and 2 German department stores. If a person doesn't want to "take his pen in hand," he may buy an unbreakable record-blank and record his message of 130 words on 1 side of the disc for a small sum; for twice the fee both sides may be recorded upon. Leaving the booth (which contains a condenser mike and, alongside, an operator in a second booth), the "Spoken Letter", with an accompanying needle, is dropped into an envelope and posted.

On his 11th Alaskan Expedition Father Bernard R. Hubbard will record on an RCA Victor recording setup the vanishing native music and chants of the primitive Eskimo race. This sound will later be dubbed onto motion picture film,

(Continued on page 119)

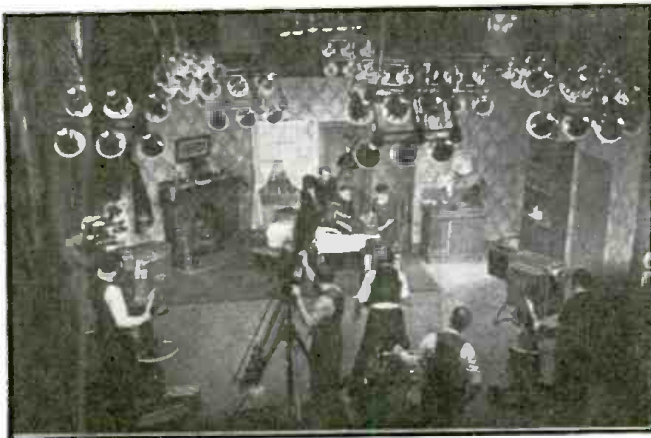

A new system of television studio lights has been installed at N.B.C. studios. It does away with the necessity of using the heavy heat-giving, movie-type "suns", "spots" and "broads". A complete pre-setting of lighting units that formerly required the services of 3 men for several hours, is now accomplished by one man in less than 10 minutes. The system consists of many remotely-controlled lighting units suspended from the ceiling of the studio. Unit mounts a bank of 6 lamps and may be raised, lowered or tilted at will from the lighting engineer's control desk. William C. Eddy, N.B.C. telly engineer, is the inventor.

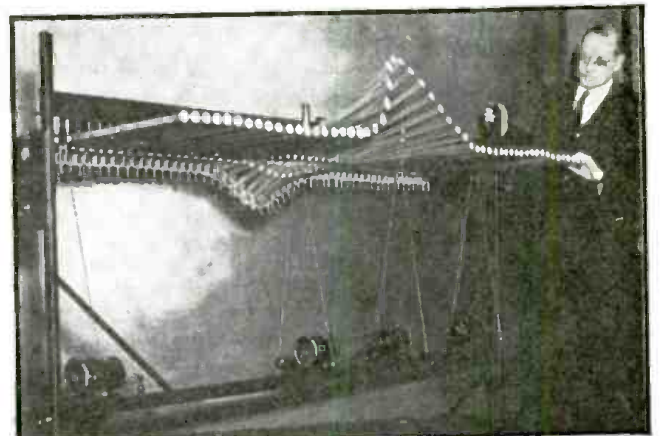

Resembling a streamlined xylophone, this apparatus devised by C. F. Wagoner of Westinghouse Electric & Mfg. Co., is able to illustrate in slow motion the number of electrical waves. By substituting metal arms, springs and damping or resistance elements for their electrical counterparts, Mr. Wagoner has produced a model of a transmission line on which he can dramatize a surge of current and prolong its life from 1-10/1000 of a second to as much as 5 or even 10 seconds—long enough to permit engineers to visually study these electrical waves. (Also see photo on cover of this issue.)

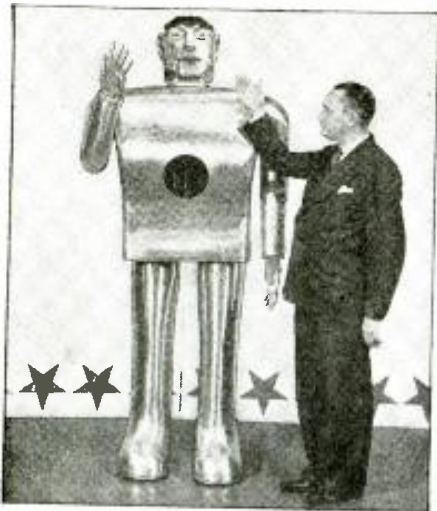

ELEKTRO—The Moto-Man

This 260-lb. mechanical man at the New York World's Fair 1939 walks, talks, smokes, and selects colors! His anatomy includes an "electric eye," 48 relays, 11 motors, a microphone, grid-glow tube, and amplifiers.

THIS mighty automaton is never brain-weary because his brain lobes are 48 electrical relays. These devices do all the thinking for him; he

← "Hi, pal!" says Mr. Elektro to J. M. Barnett, his creator. Three years were spent perfecting the mechanism which performs 36 tricks for visitors at the New York World's Fair 1939.

merely obeys their promptings which are delivered through his nervous system of motors, levers, gears and chains. His spinal column is made of wire, and there's enough of it wound around his coils to encircle the world at the equator. His name?—

● "Oil on the knee" is Mr. Elektro's affliction, but it is also an aid to his locomotion. Elektro's walking mechanism is given the once-over.

← "Elektro." He's "A Latin from . . ." —Pittsburgh!

"INSIDE" STORY

He stands 7 ft. high in his aluminum feet and has an 82-inch chest expansion. His chest, however, is always expanded because, like the rest of his body, it is made of aluminum over a steel frame. His feet are 18 inches long and

half as broad. His food he takes from the nearest light socket, for Elektro is an electrical robot. He's the Westinghouse "Moto-Man."

All told, Elektro has a bag of 26 tricks. He not only walks forward, but he can back up just as readily. He bows his head as prettily as a débutante or turns it 45 degrees in either direction to gape like a rowdy. If in the mood, he will bring either hand up to his face in a patriotic salute, and if properly coached he will raise his hands and count on his fingers, bending them one at a time in approved finger-counting style.

Elektro's favorite colors are red and green. As a matter of fact, they are the only colors he sees, and when they are flashed with a light before his eyes he speaks out "red" or "green" as the case may be.

However, Elektro is at his prodigious best when it comes to smoking. He not only puffs and inhales, but he blows the smoke in billows from both nostrils.

But frankly Elektro is a dullard by comparison with any man, and he can

(Continued on page 117)

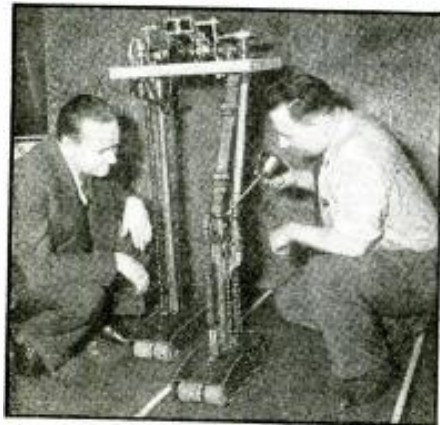

THE "VOSYN" —Newest Sound Robot

A new instrument, incorporating the *Voder's principles, was demonstrated by Bell Telephone Laboratories last month. In an interesting and dramatic program it was shown how a man's voice can be transformed into that of an aged person, a soprano or a giant; demonstrator sang a duet with himself and then sang in the actual tones of a musical instrument!

A NOVEL instrument for the investigation of speech was introduced to members of the Acoustical Society of America at their convention in New York last month. By means of an electric circuit, developed by Homer Dudley and his associates in Bell Telephone Laboratories, a speaker's voice could be raised or lowered in pitch; be given a falling inflection for a rising one; or be made to carry on a dialogue with it. The circuit, called the Vosyn, is like the "Voder" (now on demonstration at the World's Fair), but in the Vosyn control is by a speaker's voice instead of by keys.

Usefulness of the instrument in speech studies lies in its ability to vary,

*See "Manufactured Speech!" Radio-Craft; April, 1939.

singly or together, each of the elements of speech. The raw material of speech is 2 streams of sound. The proper variations of these 2 streams give us intelligible speech.

The 1st sound stream is characterized by 3 properties: (1) it has a *pitch* (determined by the fundamental frequency of vibration); (2) it has an *intensity* (determined by the total sound power issuing from the mouth of the speaker); and, (3) it has a *quality* (determined by the relative amounts of sound power carried in fixed frequency bands). All 3 of these properties of the stream vary as the stream proceeds. The 2nd sound stream is characterized by having no pitch; it is a noise and has an intensity

(Continued on page 117)

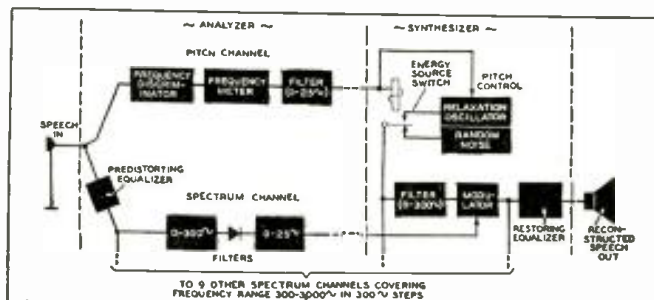

Block diagram of the circuit by which a voice could be raised or lowered in pitch, give a falling inflection or a rising one, or made to carry on a dialogue with itself.

H. W. Dudley (right) controls inflection of C. W. Voder's voice. Arrow points to Vosyn's loudspeaker.

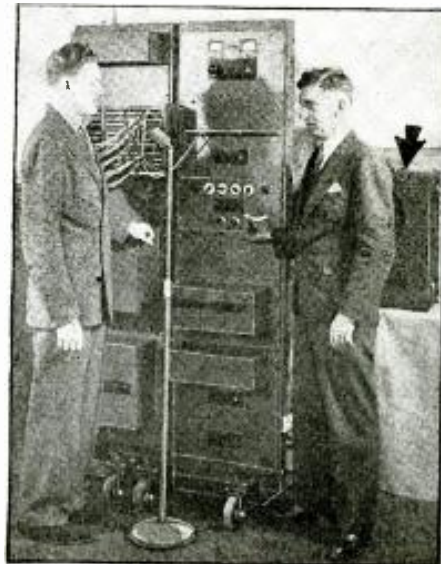

High-Fidelity Broadcasting

RADIO-CRAFT welcomes this opportunity to present what is believed to be the first published explanation in simple terms of: (1) why high-fidelity programs are transmitted today over a channel width of 20 kc. in apparent contradiction of the fact that Federal Communications Commission regulations seemingly prohibit a broadcast-channel width exceeding 10 kc.; (2) why it is necessary to transmit up to 10,000 cycles (or 10 kc., which results in a channel width of 20 kc.); and, (3) how the improved transmissions have been effected.

JAMES D. PARKER
Assistant Engineer, C.B.S.

WITH the announcement of several commercially-available high-fidelity receivers for home use (*See *Radio-Craft*.), an increasing interest is being expressed by radio retailers and consumers concerning the physiological as well as the technical aspects of *high-fidelity* transmission and reception.

It is pertinent, at this time, therefore, to review briefly the significance of "High Fidelity" as it concerns the audio response versus frequency characteristics, assuming that the amplitude distortion characteristics and signal-to-noise ratio are satisfactory.

REVIEWING 1st PRINCIPLES

It is generally accepted that the normal ear can recognize sound vibrations of any frequency from about 20 to 16,000 cycles per second. All ordinary sounds contain one or more *fundamental* frequencies and many *harmonic* frequencies of the fundamentals. The higher-order harmonic frequencies are of decreasing intensity and may even be inaudible, but the lower-order harmonics constitute a distinct portion of the sound—in some instances the major portion—and are termed "useful" harmonics.

In order to assist in "visualizing" the frequency ranges encountered in ordinary sounds, several of the most common musical instruments have been illustrated (Fig. 1) along with their corresponding range of fundamental and of useful harmonic frequencies. It should be noted that the fundamental frequencies in all cases are included below 5,000 cycles per second; whereas in

most instances the "useful" harmonic frequencies extend up to and even beyond 10,000 cycles per second. (**Major Edwin H. Armstrong has said that even frequencies as high as 18,000 cycles may be useful in obtaining natural rendition of music.—*Editor*)

It is the presence of the useful harmonic frequencies that enables sounds of different musical instruments which have the same fundamental frequency, or *pitch*, to be distinguished from one another. This is also true of the human voice except that, in this case, the useful harmonic range is not so extensive.

It is obvious, therefore, that it is the harmonic frequencies which constitute the quality, or *timbre*, of sounds, and it is the reproduction of these harmonic frequencies which distinguishes high-fidelity reproduction from ordinary reproduction.

The average radio receiver now found in the home, even when operated with the tone control in the "Fidelity" position, considering the overall response from receiver input to loudspeaker output, reproduces frequencies only up to

approx. 4,000 cycles per second. Figure 1 also illustrates which of the common musical instruments lack true tonal quality because of the inability of the receiver to reproduce the higher harmonic frequencies. The darker pictures indicate that only a small portion of the frequency range is lost while the lighter or "ghost" instruments lose considerable or all of their characteristic harmonics.

HI-FI BROADCASTING

In anticipation of the present trend towards true high-fidelity reception, the Columbia Broadcasting System for several years has been installing equipment, built to more rigid specifications, or modifying existing equipment so that the equipment facilities are capable of transmitting all frequencies in the range of at least from 40 to 10,000 cycles per second.

At the C.B.S. studios the equipment

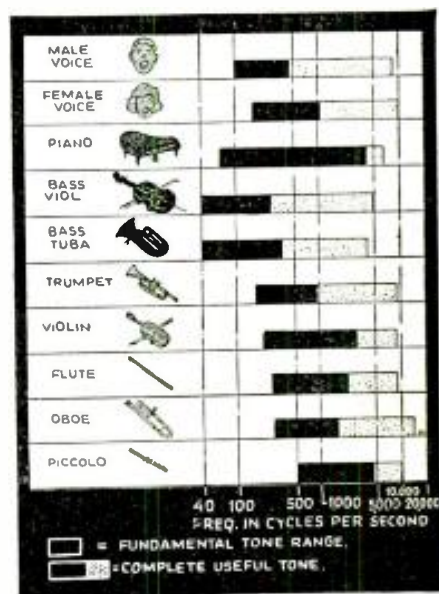

Fig. 1. Visualizing not only voice and music fundamental but also harmonic frequency ranges.

in use has, for several years, been capable of handling the above range of frequencies from the input of the microphone to the output of the studio channel at Master Control.

At the WABC transmitter, from the audio-equipment input to the antenna output, the response-frequency characteristic is substantially flat over the above range of frequencies. Specially-engineered lines having similar response-frequency characteristics connect the studios to the transmitter, which results in a flat overall response-frequency characteristic from microphone input at the studios to the antenna output over the range from 40 to 10,000 cycles per second, guaranteeing high-fidelity transmission for those listeners residing in the New York or *primary service* area.

This excellent overall response-frequency characteristic has been brought about by careful engineering, the utilization of high-fidelity equipment all along the line, and operation in accordance with the best modern engineering practices. The microphone and amplifiers must meet rigid specifications with regard to low distortion, high signal-to-noise ratio, and extremely flat response-frequency characteristics. All lines of appreciable length are compensated for

(Continued on page 107)

* "Remote-Controlled High-Fidelity Receiver" (Patent set), p. 735, June 1939.
** Stewart-Warner High-Fidelity Sets (Chassis Models 81-82, 98-82, 910-82), pp. 549, 552, March 1939.
"RCA Victor High-Fidelity Models HF-2, HF-4, V-130," pp. 484, 485, 487, Feb. 1939.
"High-Fidelity Goes to Town!" (RCA HF-1 hi-fi set), p. 154, Sept. 1938.
"RCA Victor Model HF-1 (Symphony) High-Fidelity 8-Tube Superhet," pp. 159A, 159B, Sept. 1938.
"McMurdo Silver Remote-Controlled High-Fidelity Receiver," p. 96, Aug. 1938.

** June 1939 *Radio-Craft*, p. 711.

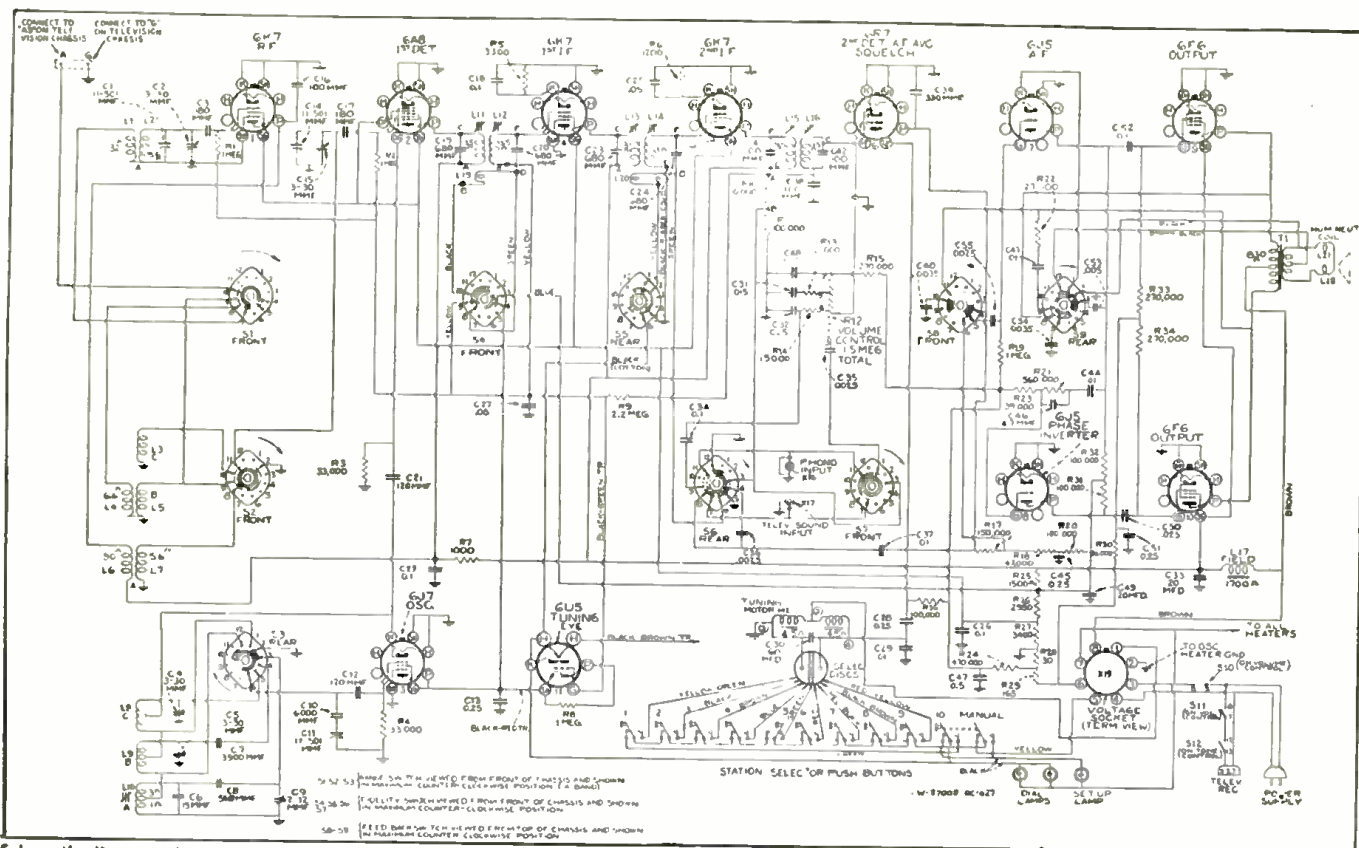

Schematic diagram of the telly-sound channel following the 2nd-detector, and the radio receiver chassis, for RCA Victor television receiver models TRK-9 and TRK-12.

1939 COMMERCIAL TELECEIVER

Here is an added schematic circuit and additional information on the RCA Victor models TRK-9 (9-in.) and TRK-12 (12-in.) teleceivers shown and described in part last month. In conclusion, the remaining sections which complete this modern teleceiver are described.

PART II (Conclusion)

THE preceding article illustrated and described the complete television-sight portion, together with the portion of the television-sound up to the output of the 2nd-detector, of the RCA Victor Models TRK-9 and TRK-12 telly-radio sets. We now go on from there, completing the telly set-up and describing the regular radio unit.

TELEVISION CONTROLS

There are 3 dual control knobs for Television to the right of the screen, and 4 single control knobs in the Radio section to the left. Two of these single control knobs are all-purpose controls and are used on Television, Radio and Phonograph reproductions. See Fig. 1.

Power-Volume Control—The knob

nearest the front of the cabinet on the left-hand side turns on the power to the receiver when rotated clockwise from its extreme "Off" position. Rotating it further increases sound volume for Television, Radio or Phonograph (when an attachment is used).

Fidelity-Selector—The second knob from the front in the Radio section selects the type of entertainment you wish, i. e., "Victrola," "Radio" or "Television."

Turned to the position marked "Victrola" it provides for operation of a Victrola Attachment. There are 3 variations of tone possible.

(1) Fully counter-clockwise modifies tone, reducing surface noise on old recordings and emphasizing low tones.

(2) The middle Victrola point minimizes bass response, thus emphasizing higher tones.

(3) The next point in a clockwise direction sets the instrument for full-tone phonograph reproduction.

The position marked "Radio," sets the instrument for Radio reception and provides 4 variations of radio tone control. Turning clockwise these are:

(1) Reduction of static and circuit hiss, and emphasis on low tones.

(Continued on page 110)

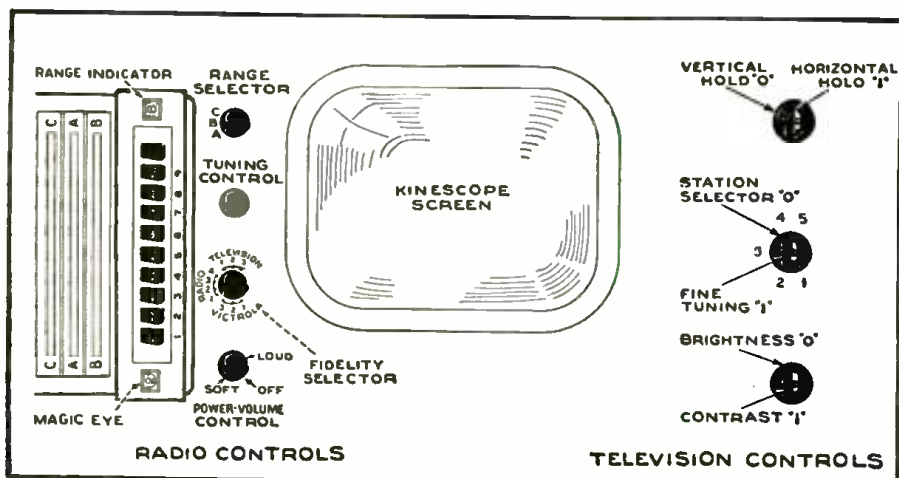

Fig. 1. These front-panel controls are for owner use. The Television Serviceman makes screwdriver adjustments on the rear of the chassis.

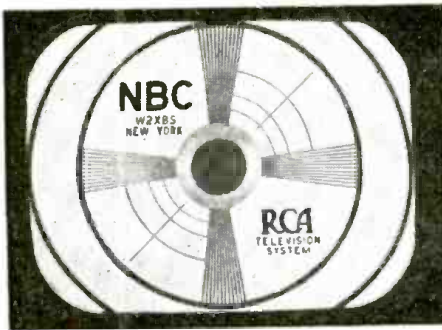

Fig. 2—CORRECT IMAGE



Fig. 3—INCORRECT FOCUS
To correct—Adjust focusing control for sharpest image.

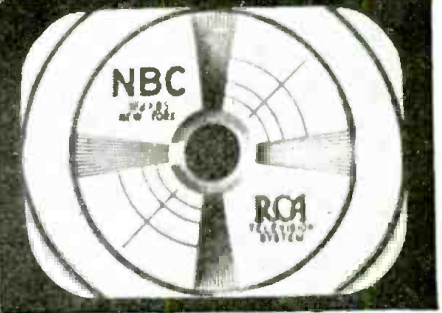

Fig. 4—TOO MUCH CONTRAST
To correct—Turn contrast control counter-clockwise and brightness control clockwise.

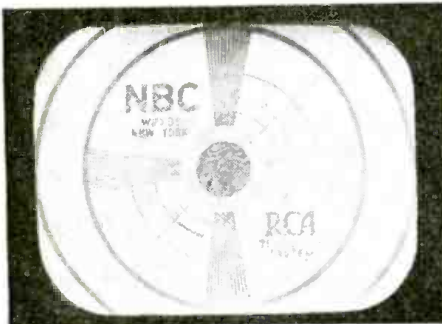

Fig. 5—TOO LITTLE CONTRAST
To correct—Turn contrast control clockwise and brightness control counter-clockwise.

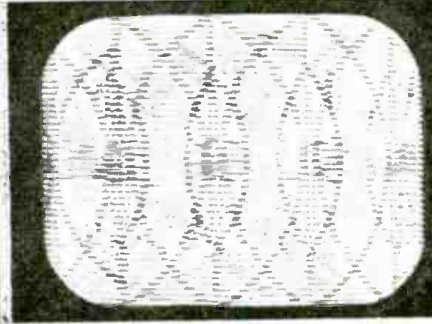

Fig. 6—INCORRECT HORIZONTAL HOLD
To correct—Adjust horizontal hold control until image "locks in."

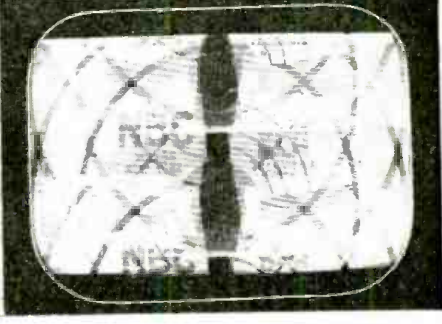

Fig. 7—INCORRECT VERTICAL HOLD
To correct—Adjust vertical hold control until image "locks in."

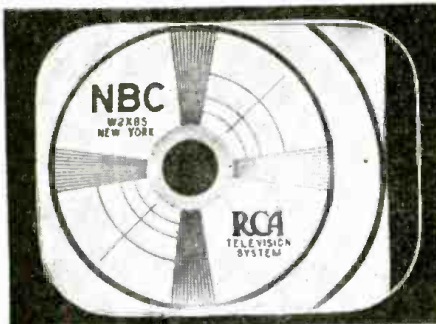

Fig. 8—INCORRECT HORIZONTAL CENTERING
To correct—Adjust horizontal centering control (screwdriver adjustment) to center image horizontally.

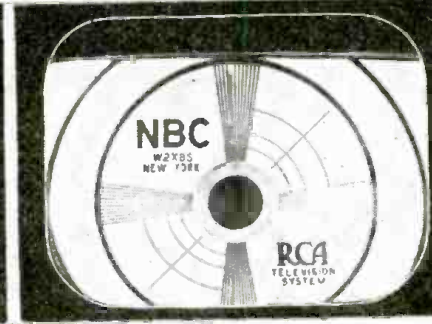

Fig. 9—INCORRECT VERTICAL CENTERING
To correct—Adjust vertical centering control (screwdriver adjustment) to center image vertically.

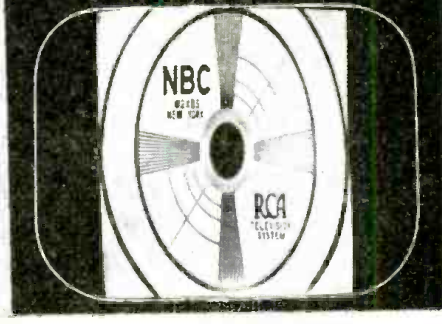

Fig. 10—INCORRECT WIDTH
To correct—Adjust width control (screwdriver adjustment) for correct width of image.

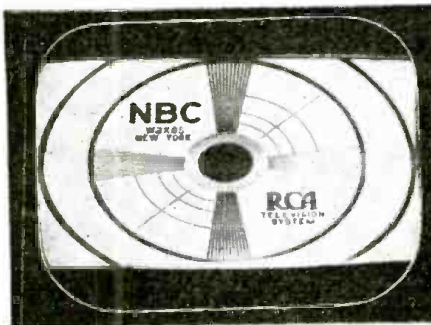

Fig. 11—INCORRECT HEIGHT
To correct—Adjust height control (screwdriver adjustment) for correct height of image.

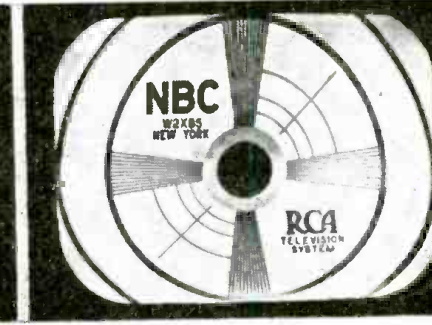

Fig. 12—INCORRECT VERTICAL LINEARITY—RAISE
To correct—Turn vertical linearity control counter-clockwise and height control clockwise (screwdriver adjustments).

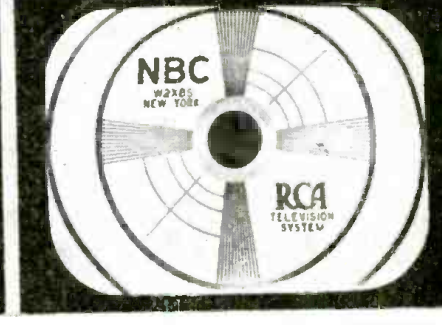

Fig. 13—INCORRECT VERTICAL LINEARITY—LOWER
To correct—Turn vertical linearity control clockwise and height control counter-clockwise (screwdriver adjustments).

⊙ SOME of the incorrect television images pictured above, Figs. 3 to 13 incl., may be corrected by means of certain of the top-of-panel adjustments available to the set owner. See illustration at lower-left, pg. 74. Others of these corrective measures should be made only by the Serviceman; these respective screwdriver adjustments to be made at the rear of the television receiver are indicated in the captions. See

illustration of these "fixed" or semi-fixed controls at the top of pg. 61 in the preceding issue. Many other and more complex images which may be encountered from time to time while servicing televisions are pictured in the multi-part article, "Servicing Television Receiver Faults," which started in the June, 1939 issue of *Radio-Craft*. Certain of these video controls are akin to Tone and Volume audio controls.

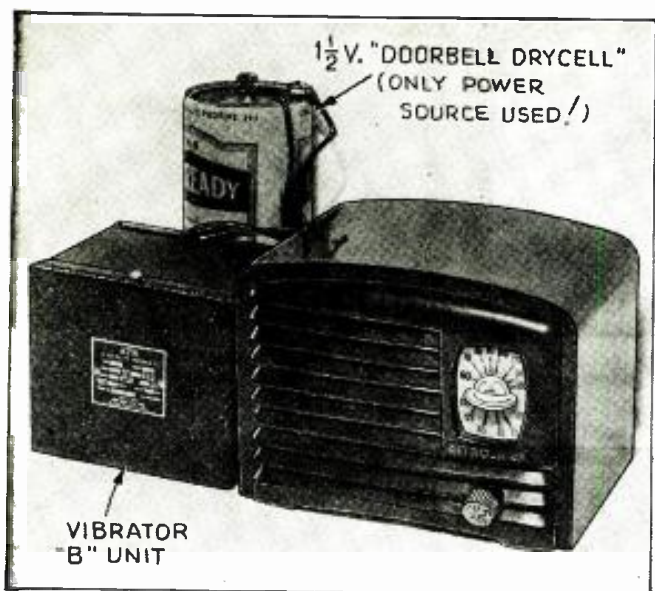

Fig. A. The completed Uni-Power Set, half the size of most portables!

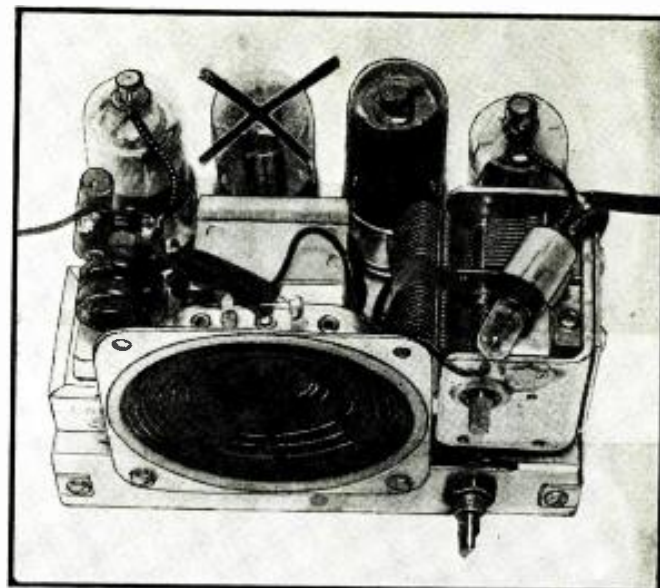

Fig. B. The Electric Set before removing rectifier-tube "X".

How to Make a "B"-BATTERYLESS RECEIVER

The author asks: "Is it not logical to derive all the operating voltages for a "battery" radio set from the single 1.5-V. drycell source just as all the operating voltages of an electric set are obtained from only the 115-V. electric light lines?" New "battery bantams" are used in this simple 3-tube set.

R. D. WASHBURNE

HAVE you a discarded or inoperative A.C.-D.C. midget in your home or shop? Convert it into a so-called "battery-portable" for pleasure or added profit. This idea will save building up an entire chassis!

Those battery portables being offered today are quite the rage and very practical for picnic, boat, or country home.

The completed Uni-Power Set is shown in Fig. A, with each part separate for use at home. For portable use, all the units may be mounted in a portable case, after removing the basic chassis from its cabinet; result—a set about half the size and weight of present portables!

ORIGINAL SET

The particular receiver converted for this story is a very small job (overall, 6 1/4 x 4 3/4 x 4 ins. deep) utilizing 1 stage of T.R.F., detector, output and rectifier when in its original form. The Detrola model 280-U Pee-Wee, Jr., was selected

as being one of the most efficient T.R.F. midgets on the market. Converted, we have 1 stage of T.R.F. (A.V.C. supplied by the diode), detector, and 2 stages of audio, counting the triode section of the 1H5GT and the output (1Q5GT) stage. It is obvious that there will remain 1 unused socket, that of the rectifier which is not required. Although a T.R.F. job was used for conversion, it is fairly simple to convert sets of the superheterodyne class. It is your author's opinion that there is a marked comparison between the original A.C.-D.C. set-up and the converted job, though the output of the 1Q5GT is rated at only 300 milliwatts.

Let us assume that you have a small A.C.-D.C. job on hand, the circuit of which approximates the circuit illustrated in Fig. 1. Check the values of the resistors and condensers of the receiver on hand with the values of the parts shown in the diagram of Fig. 2. Secure the parts required that are not available in the receiver on hand. If your

receiver uses other than octal sockets, it will be necessary to replace with octals.

CONVERTING

To simplify matters, it is suggested that all fixed condensers, resistors, volume control and speaker be carefully removed and the octal sockets cleansed of excess solder. After this clean-up work has been done, commence re-assembling and wiring the specified parts carefully. Take particular note of the antenna coil of the receiver being converted. If the grid-return is grounded, it will be necessary to un-ground the coil lead so that A.V.C. may be employed. If the ground end of the antenna winding is terminated as common to the grid-return, run the antenna coil ground lead to chassis, thereby utilizing the lug as a terminus for the grid-return lead and the A.V.C. network, as this point must be above ground.

Note that a 4-wire cable is used. One lead is for "B+", 2 for the "A" supply, and the 4th for the positive "A" lead of the vibrator-type "B" eliminator operating from the single No. 6 drycell. Negative "A" should be common for the receiver and vibrator-"B" supply. If regular "B" batteries are used, disregard the 4th lead.

Practically all A.C.-D.C. midgets are equipped with field coil dynamic speakers. Due to drycell use, it will be necessary to substitute a permanent-magnet dynamic speaker, having an output transformer to match a 7,000-ohm load.

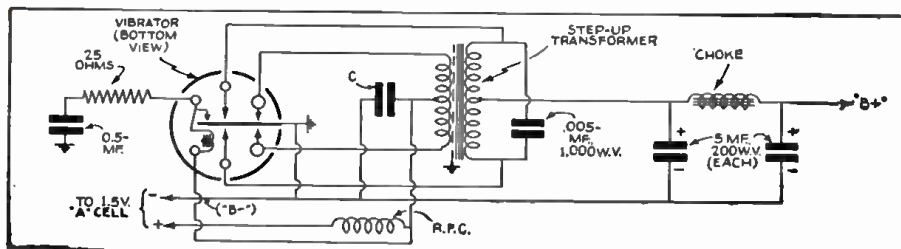

Fig. 2. Schematic circuit of the vibrator-"B" unit. Condenser C is 0.5-mf., 200 W. V.

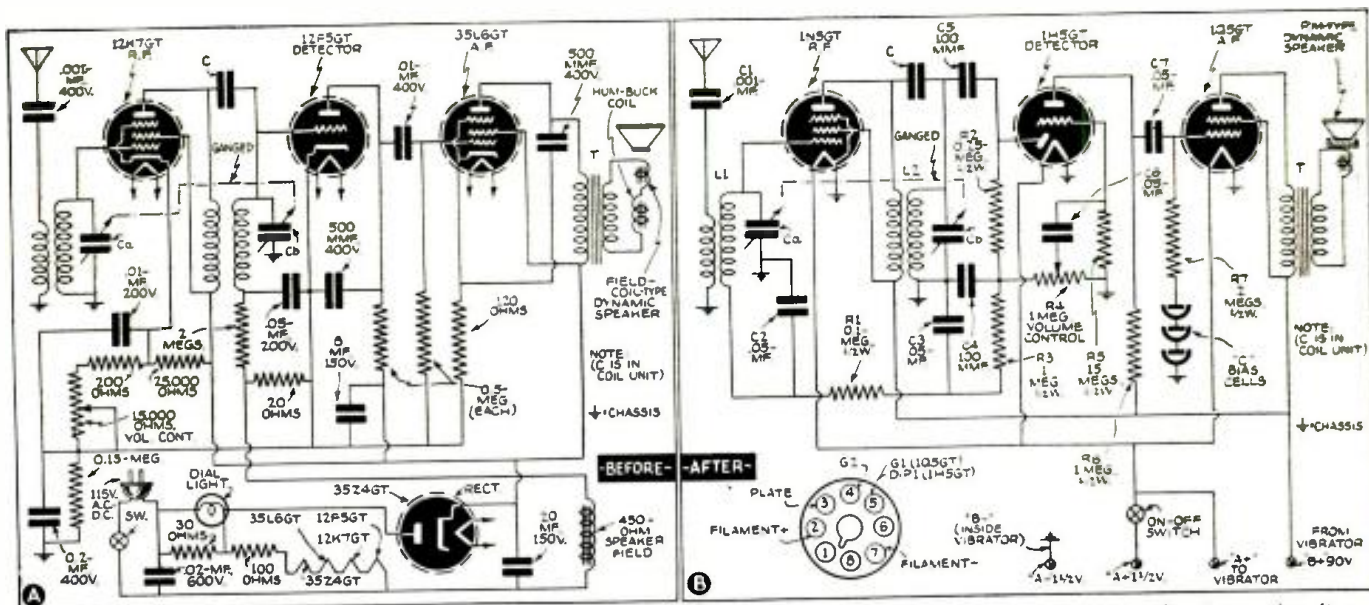

Fig. 1. A—The original A.C.-D.C. circuit of this midget set which included a type 35Z4GT rectifier. B—The circuit changed over for drycell operation. It was necessary to alter the coupling of L1.

A small volume control with switch must be used. Make sure of the space available for this unit before purchasing.

BANTAM TUBES

The original tubes used in the A.C.-D.C. version were the bantam types. The regular battery equivalents, though, are 11/16-in. longer than the electric bantams. One manufacturer made "battery bantams" available. The full-sized battery tubes are numbered 1H5G, 1N5G, etc., but the same tubes in the bantam size are numbered 1H5GT, 1N5GT, etc. In the particular receiver converted, the use of the newer bantam types (see pg. 90) permitted the receiver to be re-installed in its original tiny cabinet.

After the wiring has been completed and a visual check-up has indicated that all the wiring has been done correctly, connect the "A" supply and the "B" eliminator; and readjust the trimmer condensers when tuned to a station at about 1,400 kc. It may be advantageous to readjust the coupling of the antenna coil primary to secondary. This may be done by carefully heating the wax with your soldering iron and while the wax is warm, slightly rotate the primary coil back and forth so that it may be moved once the wax has cooled. Select a weak station at about the frequency mentioned and slide the primary coil closer to or further from the grid coil. When the loudest response is obtained, carefully re-heat the wax and let it cool as this will cement the coil to its permanent position.

One of the reasons the 280-U receiver was selected was that it employed all the newest developments for obtaining high gain and good selectivity in a tuned-radio-frequency circuit. This T.R.F. circuit was selected in preference to the more common superheterodyne hook-up

in view of the much greater simplicity of the T.R.F. set-up. This is an important point when it is remembered that interelectrode capacities in an indirect-heater converter tube designed for use in an electric set may have quite different values from those of a direct-heater converter tube intended for battery operation. In such a case, capacitative variations throw off not only the R.F. tuning but also the I.F. tuning, at one point or another in the tuning range, with such annoying results as weak reception, crosstalk, or both.

With just the short "hank" of antenna wire supplied with the original electric set, excellent results were secured with the job rewired for drycell power.

VIBRATOR "B"

In order to make this set independent of any 2nd or 3rd set of batteries, as would be the case if "B" and "C" batteries were em-

ployed, it was decided to derive all the set's power from only the "A" supply. Eliminating the "C" battery was simple—merely a matter of using "C"-bias cells, as shown in the schematic circuit. Note that under NO circumstances must any current whatsoever be drawn from these odd, self-generating devices; they become absolutely worthless if accidentally shorted, so wire these units in last, taking care to see that they are poled with positive terminal to chassis.

Eliminating the 90-volt "B" battery was somewhat of a problem until a solution was found which it is believed is described here for the first time in any radio magazine—a vibrator "B" unit of the general type used in 6-V. car-radio sets was completely redesigned to work from a 1.5-V. power supply, i.e., a standard No. 6 or "doorbell"-size drycell.

Before the advent of the low-drain, 1.4-V. drycell tubes, such an arrangement would not have been economical; but now, the idea is practicable.

Vibrators approach an efficiency of 60%, whereas, motor-generators, and other arrangements which were analyzed in the search for a device which would deliver a "B" voltage from the "A" supply, were discarded, in 1937, as having too low efficiency (*about 6%, overall). Note however that a vibrator's efficiency is less at sub-normal "A"-cell voltage.

A study of vibrators was started last year, and in January, 1939, Pauley-James Corp. undertook to build for the writer a 1.5-V. full-wave, self-rectifying vibrator—"B" unit; it was completed in March, and the outside dimensions of its copper shield case were 4½ x 6¾ x 3 ins. deep, with a weight of 4 lbs. 10 ozs. (Model 2PJ-1).

Subsequently, American Television & Radio Co. built a unit, a little lighter, which measured only 4 x 3½ x 3 ins. deep. This unit is shown in Fig. A.

Both synchronous units were complete with all filter components and a step-up transformer, and were quite free of both mechanical and electrical hum.

Several of the biggest radio set makers are now understood to be working on this "B"-batteryless idea. One manufacturer points out that the large No. 6 drycell is well able to stand considerable current drain, and is less expensive in the long run than "B" supplies which employ batteries built-up of a large number of small and (comparatively) inefficient cells.

Another important reason for using only a single drycell to power the set is that it is instantly replaceable—no fuss, no bother; and in an emergency, the chances of locating a drycell are far greater than of finding 45-volt "B"-blocks. It's also easier to get a fresh drycell—every hardware store carries 'em—than it is to get fresh "B" batteries; and the drycell has a longer shelf-life. Also, you have only 2 leads to connect, which reduces if not eliminates the possibility of reversing leads.

*Figure from Putman Electrical Development Co.

(Continued on page 113)

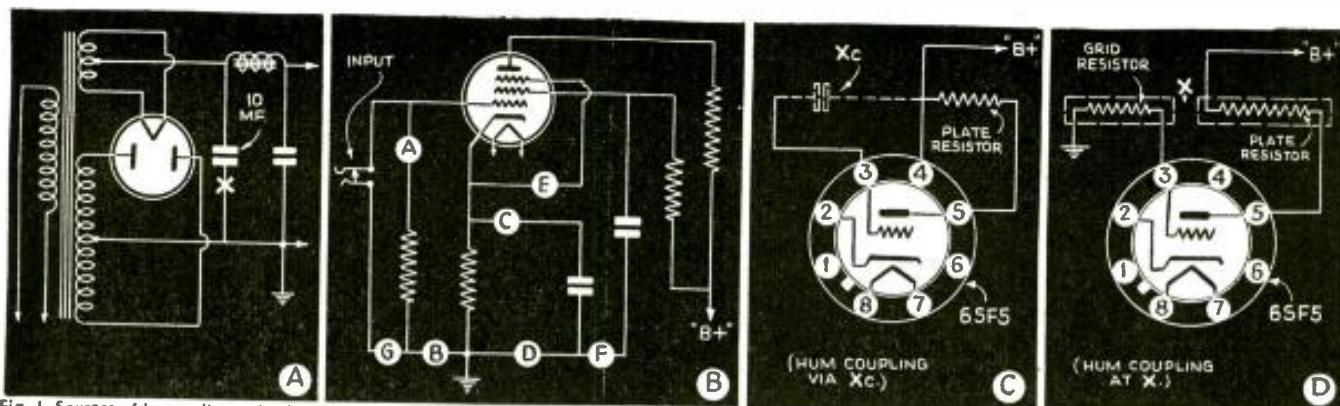

Fig. 1. Sources of hum voltage. A—Across a low-resistance lead; B—In a pentode circuit, at lettered points; C—Prong inter-capacity; D—Inter-capacity of components.

OBSCURE SOURCES OF HUM

This authoritative discussion brings to the foreground, in an easy-to-understand manner, a amplifiers. This story makes shooting hum a quicker and easier job for the Serviceman.

In order to permit a concise discussion of only the subject of *obscure* sources of hum in high-gain amplifiers, it is necessary to arbitrarily classify hum sources under (a) generally known and (b) obscure categories. Inasmuch as one source may not cause hum in one particular amplifier, while it may in another, makes it necessary to also classify amplifiers as (a) average and (b) high-gain. While it is true that no sharp line of demarcation occurs between generally known and obscure sources of hum, nor between average and high-gain amplifiers, we shall consider "obscure sources" as those which are often encountered, but not readily recognized; while "high-gain" will be applied to amplifiers which develop a gain of 100 db. or more.

A. C. SHANEY

amplifier should be established in terms of surrounding noise level and distance from loudspeaker to nearest listener.

In the absence of any such standards, and solely for the purpose of discriminating between objectionable and non-objectionable hum levels in P.A. amplifiers, we will arbitrarily select a hum rating of -20 db. (0.00006-watt or 60 milliwatts) as a maximum of passable hum level. This arbitrary standard, however, is not to be construed as an acceptable value for all applications. It is merely being used to expedite our discussion. In fact, a hum rating of -20 db. can easily be heard in an average home at a distance of 10 feet from the loudspeaker.

HUM RATINGS

Although no definite standards have ever been set for desirable hum levels, it has been common practice of designers to set a "hum level of 60 db. below maximum power output," as satisfactory. This rating, by no means, establishes any consensus of opinion, as many commercial amplifiers are sold with hum levels ranging from 30 to 70 db. below maximum power output. It is important, however, to establish some maximum hum level so as to further classify disturbing sources of hum, because a contributing source may be considered objectionable for one hum standard, and non-objectionable for another.

It is the writer's opinion that the classification of hum level below peak power output, while it has many advantages in its favor, is unsatisfactory from a practical viewpoint, because the amount of residual permissible hum in an amplifier, is dependent upon a number of external factors, aside from either the "peak" or "rated" power outputs.

For example, the permissible residual hum of an amplifier used in an outdoor racetrack may be much higher than the hum level of a smaller amplifier used in the home. There are two important points to consider when minimum hum levels are being determined. One is (a) the distance from the loudspeaker to the nearest listener, and the other is (b) the surrounding noise level.

The fallacy of rating an amplifier in a given number of db. below its rated power output will be readily noted, when it is realized that objectionable hum is most readily heard *when no signal is being amplified*. While it is true that the sensitivity of the ear diminishes as the signal intensity increases the fact remains, however, that when no signal is present the sensitivity of the ear rapidly increases, and readily discerns hum levels which would easily be masked were a normal signal present.

It therefore follows, that *permissible hum level of an*

INTRODUCTION TO OBSCURE SOURCES OF HUM

Before we delve into this interesting amplifier problem, let us readjust ourselves in the same manner that an astronomer would, who deals in distances in terms of *light years* (the distance traveled by light or radio waves, traveling at a speed of 186,000 miles per second, in one year), when he looks into a microscope and measures distances in terms of *microns* (a micro-millimeter or one one-millionth of a millimeter). From our arbitrary permissible hum level of 0.00006-watt, we can readily calculate that a voltage of 0.0173-V. must be present in a 500-ohm line to produce this sound level. An amplifier that has a gain of 100 db. (which corresponds to a voltage amplification of 10 billion times) will amplify a disturbing hum-producing voltage of 0.00000000000173-volt or 1.73 micro-microvolts.

This voltage brings us into a realm rarely measured by average laboratory instruments, and opens a new field of investigation in the production of objectionable causes of hum. It is to be borne in mind, that this latter voltage represents the upper limit in our arbitrary standard of an input hum voltage to produce an acceptable hum level in an amplifier having a gain of 100 db. It should also be remembered, that for a high-gain amplifier of 130 db., this permissible input hum voltage must further be divided by 1,000!

ANALYSIS OF OBSCURE SOURCES OF HUM VOLTAGES

If the output D.C. voltage of a standard rectifier circuit, as shown in Fig. 1A, has a component ripple voltage of approximately 10 volts, a 10 mf. condenser shunting this output will have an A.C. flowing through it of approximately 60 milliamperes. If the negative lead of the filter condenser is connected with a No. 12 buss-bar to the ground-return of the center-tap, of the high-voltage secondary, a voltage drop will take place across this lead, which may, under certain conditions, be applied to the input circuit of an amplifier and subsequently be amplified to appear in the output voltage.

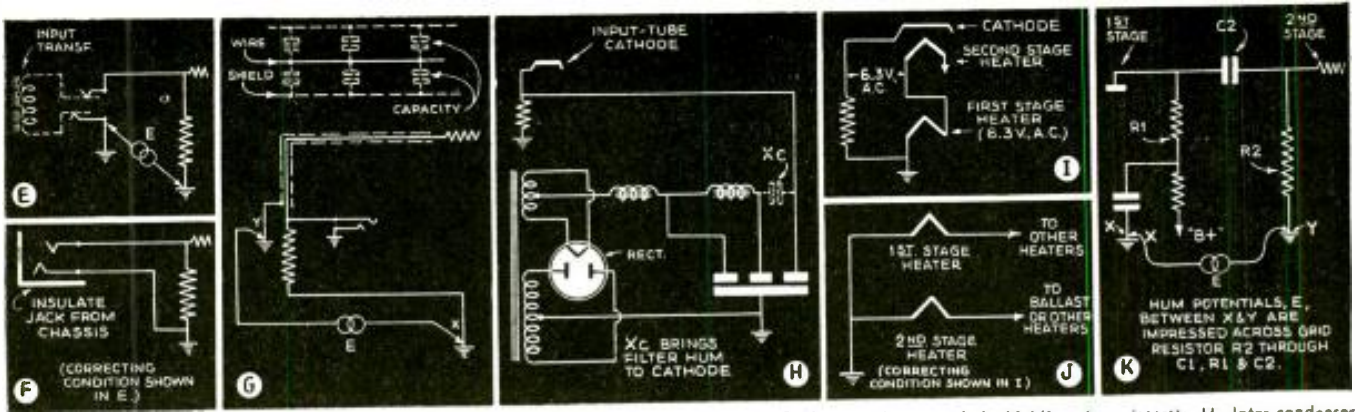

Fig. 2. More sources of hum. E—Poor placement of input jacks; F—Correcting condition E; G—Incorrectly grounded shielding (see insert); H—Inter-condenser coupling; I—Filaments in series; J—Correcting condition I; K—Hum potentials between X-Y follow circuit C1 (condenser at X)-R1-C2, to R2.

IN HIGH-GAIN AMPLIFIERS

number of the less obvious factors which account for the excessive production of hum in many There are literally hundreds of causes that contribute to the development of hum in amplifiers.

Although No. 12 wire is rarely used for this purpose, it has been selected to illustrate how even such a heavy wire will sometimes cause a detrimental hum voltage. Standard wire tables indicate that No. 12 wire has a resistance of 0.0016-ohm per foot. An inch will have a resistance of 0.000133-ohm. An A.C. of 60 milliamperes flowing through 1 inch of No. 12 wire will produce a voltage drop of 0.0000798-volt (7.98 microvolts), which is approximately 4 million times as great as the maximum hum voltage which can be permitted to enter an input circuit of a high-gain amplifier.

Assuming that the power transformer in a high-gain amplifier employs 3 turns per volt, 1 turn will develop an induced voltage of 0.33-volt. Although this transformer may be shielded, a single turn of wire near the transformer will develop an appreciable voltage (0.3-volt or less) dependent upon the leakage flux existent in the vicinity of the transformer. One one-thousandth of a turn, which may conceivably become a part of the circuit wiring, will develop 0.003-volt. It can therefore be readily seen that input circuit wiring may be looked upon (insofar as electromagnetic hum pick-up is concerned) as small fractions of a turn of the power transformer.

It is also well known among "hum probers" that when the leakage flux of the transformer cuts the chassis proper, it likewise induces a voltage therein, dependent upon the configuration (shape) of the chassis at the point of its interception of the flux lines. It can therefore be readily seen that hum voltages of the order of 3 microvolts, may easily be distributed within the chassis proper. Furthermore, the conductivity of the metal usually employed for chassis construction, is far less than that of copper, and these comparatively low potentials (but highly detrimental) tend to flow within amplifier wire circuits instead of remaining within the chassis proper.

It can also readily be shown by a simple mathematical analysis, that the potential distribution within a chassis may easily be capacitatively coupled to high-impedance circuits connected with unshielded wires. While these pick-up voltages are normally ignored, they are, nevertheless, large enough to produce considerable hum in the output of high-gain amplifiers.

HOW HUM VOLTAGES ARE INTRODUCED INTO AMPLIFIER CIRCUITS

Figure 1B shows a conventional pentode input circuit, and indicates, by letters, 7 different points at which hum voltage of the magnitude previously discussed, may be induced to produce objectionable hum in the output (other well-known sources of hum, such as filter ripple, induced hum, tubes, etc., are being omitted for the sake of brevity).

Many technicians who have designed high-gain amplifiers, are undoubtedly aware of some or all of these points. Many laymen incorrectly believe that the disturbing hum voltages are usually introduced at the input terminals of the amplifier. It can, however, easily be shown from a casual observation of Fig. 1B, that equivalent hum disturbances may be produced by introducing identical voltage at points G, A and B. A cursory analysis of this circuit will show how the voltages introduced at these points produce the same grid voltage swing as when the voltage is connected to the input circuit.

If the grid-return resistor of the input circuit is not directly connected to the ground side of the cathode resistor, a hum voltage may be introduced at the point B, particularly when the ground side of the grid resistor is connected to a chassis which contains leakage flux voltages. Likewise, when long leads or portions of the chassis are introduced at points C and D, hum voltages are also introduced into the grid circuit by producing slight variations within the cathode circuit proper. If under some wiring conditions the suppressor-grid lead is looped near the transformer before being returned to the cathode, a disturbing hum voltage may easily also be introduced at point E. Hum potentials at the screen-grid will also affect the output hum level. Aside from voltage ripple hum, disturbing potentials may be introduced at point F.

Naturally, the limiting value of the disturbing voltage will vary, and be dependent upon the point of the circuit at which it is introduced. The higher the gain after the point at which the voltage is introduced, the lower will be the tolerable level of the disturbing voltage. If these basic fundamentals are understood, it becomes relatively simple to recognize obscure hum sources and effect suitable remedies.

ADDITIONAL SOURCES OF HUM

(1) *Indiscriminate Use of Spare Prongs on Sockets* may induce, under certain unfavorable conditions; as illustrated in Fig. 1C, sufficient capacitive coupling between normally isolated circuits, to pick up detrimental hum potentials. Hum voltage is here shown capacitatively coupled to the grid of the amplifier by the effective capacity Xc.

(2) *Careless Arrangement of Resistors* may likewise produce unanticipated inter-coupling and hum pick-up. See Fig. 1D.

(3) *Carelessly Grounded Input Jacks* pick up chassis hum voltages, and introduces them into input grid circuits. This can be remedied by isolating the jack from the chassis. Hum voltage between grounds, as shown, is connected to grid when input circuit is completed. See Figs. 2E and 2F.

(Continued on page 104)

AMPLIFIER CO.
OF AMERICA

MONTGOMERY
WARD & CO.

\$4,000 P.A. CONTEST

→ [FOURTH and FINAL MONTH] ←

\$4,000 Worth of Prizes

(Approximately \$1,000 in prizes per month for 4 consecutive months)

will be given to

**SERVICEMEN, RADIO DEALERS AND
SOUND SPECIALISTS**

for **BEST** letters describing

ACTUAL PUBLIC ADDRESS SYSTEMS INSTALLED

During the Past 8 Months and up to the End of This Contest

OBJECT OF THE CONTEST

PUBLIC ADDRESS is now on the upswing and all indications point to a bigger sound business this coming season. In order to stimulate interest at this time in public address (Continued on page 106)

CINAUDAGRAPH
CORP.

RADOLEK
CO.

FOX SOUND
EQUIPT. CORP.

FILMGRAPH
MILES REPRODUCER
CORP.

ALLIED-BURNS
CO.

AMPLITONE PRODUCTS CO.

AMPERITE
CO.

LAFAYETTE
RADIO CORP.

EASTERN
MIKE-STAND
CO.

ATLAS SOUND
CORP.

GERNSBACK'S
MANUAL

VOCAGRAPH
SOUND
SYSTEMS

VAC-O-GRIP
CO.

LIST OF PRIZES

FIRST PRIZE—30-40 W. Complete P.A. System, \$150.00
Offered by Wholesale Radio Service Company

SECOND PRIZE—"Filmgraph" Model A, \$149.50
Offered by Miles Reproducer Co., Inc.

THIRD PRIZE—Airline Marine-Type Speaker, \$62.00
Offered by Montgomery Ward & Company

FOURTH PRIZE—Set of Low-Pass, Band-Pass and High-Pass Amplifier Filters, \$61.00
Offered by Amplifier Co. of America

FIFTH PRIZE—15-W. Deluxe Amplifier, type AM-15, \$57.00
Offered by Amplitone Products Company

SIXTH PRIZE—5-W. Complete P.A. System, type 32-06PX, \$55.80
Offered by Vocograph Sound Systems

SEVENTH PRIZE—Permanent Magnet Speaker Unit, No. 7, \$52.50
Offered by Fox Sound Equipment Corp.

EIGHTH PRIZE—Velocity Microphone, type RBHK, \$42.00
Offered by Amperite Company

NINTH PRIZE—Velocity Microphone, model 50, \$40
Offered by Allied-Burns Company

TENTH PRIZE—Transducer Microphone, \$27.50
Offered by Radolek Company

(Continued on page 106)

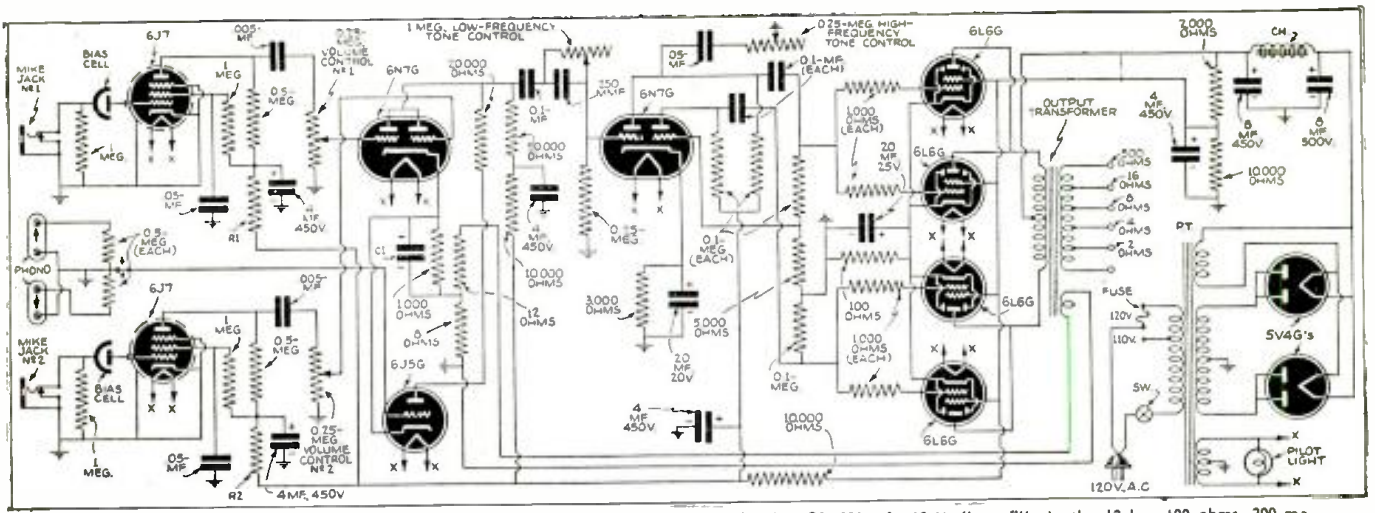

Fig. 4. Diagram of a modern 65 W. P.A. amplifier. Units R1 and R2, 20,000 ohms (each); C2, 200 mf., 12 V. (hum filter); ch., 12 hy., 100 ohms, 200 ma.

LATEST CIRCUIT FEATURES

In Modern Public-Address Amplifiers

What makes this year's amplifiers different from those of last year? What are the advantages of these innovations and changes? In this article two writers collaborate to present to RADIO-CRAFT readers many informative answers to these pertinent questions insofar as they relate to new models in one well-known make of amplifiers.

L. M. FEILER and M. N. BEITMAN

THE circuit features in new 1939 power amplifiers, rated at 8, 12 and 18 watts, discussed last month in Part I included versatile inputs, a medium-level mixer, a high-level mixer, an inexpensive negative-feedback circuit, dual phono inputs, bass boosting, circuit-grounding jacks, a simple method of eliminating cathode-to-filament leakage, a low-cost filter, and a flexible negative-feedback circuit. Now let us analyze some of the unusual circuit elements in a new 65-watt amplifier.

Feedback Voltage-Divider. In the 65-watt amplifier illustrated in Fig. 4, the feedback voltage is obtained from a separate single-turn, placed on the output transformer. Although a single turn of wire is used for this purpose, even this develops an excessive voltage—and a voltage divider circuit is employed to reduce the value also.

Dual Tone Control. The dual tone control incorporated in this unit will be of special interest to you. Notice that in connection with the low-frequency control a very large series blocking condenser is used. This condenser keeps the D.C. plate voltage away from the grid of the 6N7G inverter but offers little opposition to the low-frequency audio signal. While the 1-megohm resistor is wide open, the current finds an easy path through the smaller 250 mmf. mica condenser, and since the reactance of a condenser is inversely proportional to the frequency, the "lows" will be reduced. When the potentiometer is reset so that its resistance is considerably lower than the reactance of the condenser, very little discrimination for the lower frequencies is present.

The other tone control attenuates the high frequencies when the resistance of the 0.25-meg. potentiometer is reduced. But even with this control's total resistance in the circuit, a desirable but limited attenuation of the "highs" is accomplished with the second 0.002-mf. condenser.

The use of 2 tone controls enables the fine adjustment of the response to suit individual requirements. Also these controls are very useful in eliminating feedback in places having poor acoustics.

110 V. A.C.-6 V. D.C. In the 18-watt mobile universal type amplifier, Fig. 6, by incorporating 2 primary windings on

PART II

the power transformer, the changing from 110 volts A.C. to 6 volts D.C. is accomplished by simply replacing the connecting cable and plug. The power supply section of this amplifier is perhaps more interesting and more ingeniously designed than any other part of this modern unit.

When the D.C. source of power is employed, a special heavy-duty vibrator is used to interrupt the current and enable the transformer to step this voltage up to the required value. The full-wave non-synchronous vibrator and center-tapped primary are connected in the familiar circuit, and at first examination it may seem that about 6 volts is impressed on each side of the primary during the corresponding alternations. However, in terms of the effective A.C. voltage, only about 3.2 volts appear. There is a definite voltage drop in the connecting cable and also the transformer winding.

(Continued on page 112)

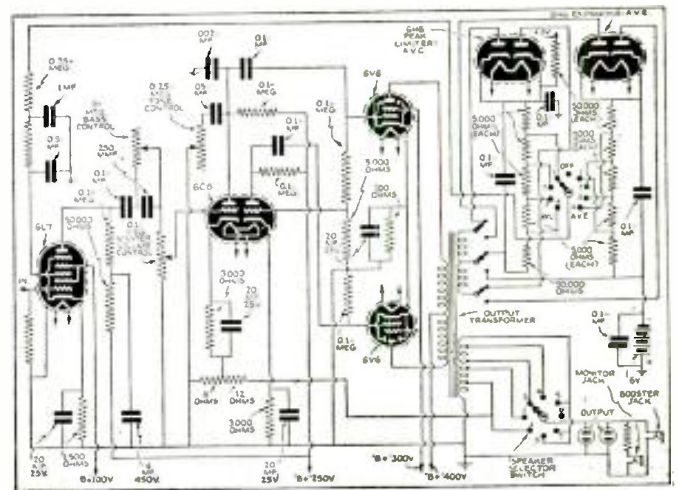
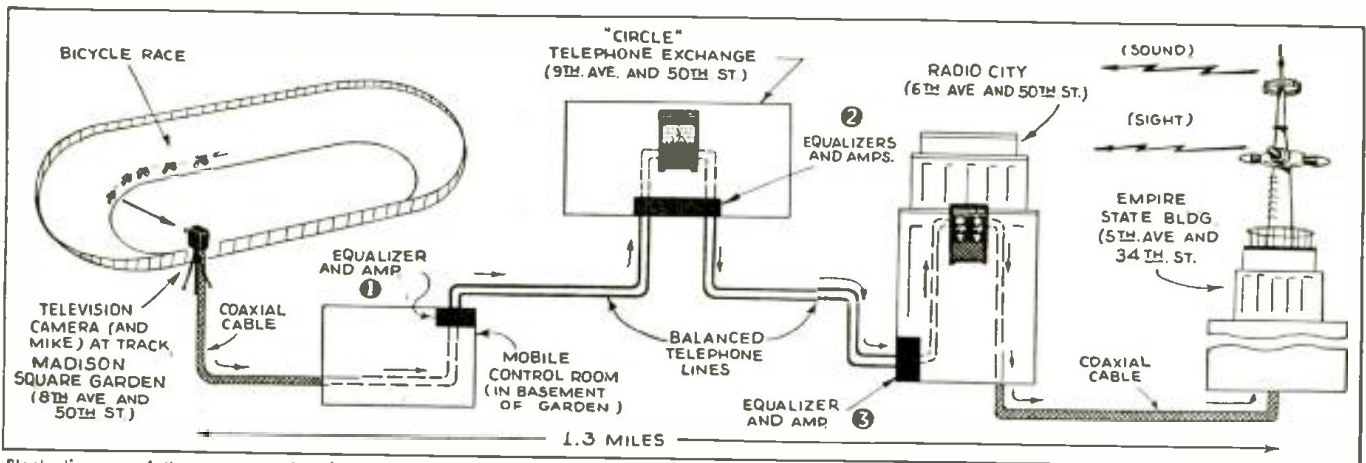

Fig. 5. An 18-W. amplifier with novel A.V.C. and A.V.E. Circuits.



Block diagram of the set-up employed in televising the 6-day bicycle races in Madison Square Garden (New York), last month, using ordinary telephone lines for transmission to transmitter.

TELLY PIPED OVER PHONE WIRES!

—and with 441-Line Definition

"It's impossible," was the stock answer to the question of whether high-fidelity (441-line definition) television could be sent over ordinary telephone lines. Last month, however, engineers of the National Broadcasting Co. and Bell Labs. demonstrated this "impossible" feat. The success of this tremendously significant experiment may foreshadow nation-wide television networks.

An ordinary telephone line, one of the thousands used every day by New York's millions, has finally transmitted a high-definition television image. The feat, long considered impossible, was accomplished in a National Broadcasting Company telecast of the 6-day bicycle race at Madison Square Garden, over Station W2XBS, last month.

As seen in New Jersey, Connecticut

and New York, the television images clearly presented the riders as they whirled over the boards or sat in a tent inside the track being interviewed by Gene Hamilton, N.B.C. announcer.

In the Madison Square Garden experiment, the scene was picked up by a television camera near the edge of the indoor track. (See photo.) The lighting employed was the regular Garden system of arc lights located high in the

building. These "spotted" the group of internationally-famous riders as they raced about the oval track. The image was monitored in the control room of the N.B.C. mobile television station in the basement of the Garden.

The public has understood that it was "impossible" to use ordinary telephone wires for transmitting the highly complex television signal. The coaxial cable, an experimental link of which was installed several years ago between New York and Philadelphia at a cost of about \$5,000 a mile, was considered one answer to the problem of finding a satisfactory means of relaying the television signal. N.B.C. at present uses one of these cables in connecting its studios at Radio City to its main transmitter in the Empire State tower.

Engineers, however, have been aware for some time that theoretically at least, the feat was possible. The N.B.C. telecast from Madison Square Garden proved their point and forecast the widening of television's theatre of operations in the near future without the delay and terrific expense of establishing a local coaxial cable network.

The telephone hook-up consisted of an ordinary "pair", or twin-conductor length of wire in the cables of the New York Telephone Company. For the purposes of television, however, a considerable amount of modification was necessary. The ordinary telephone circuit is brought out at intervals to a terminal box to facilitate connections for telephone installations. These are called "bridge taps."

Engineers of the Bell Telephone Laboratories, who modified the circuit for the N.B.C. relay, had to disconnect all these taps to smooth the circuit and

(Continued on page 118)

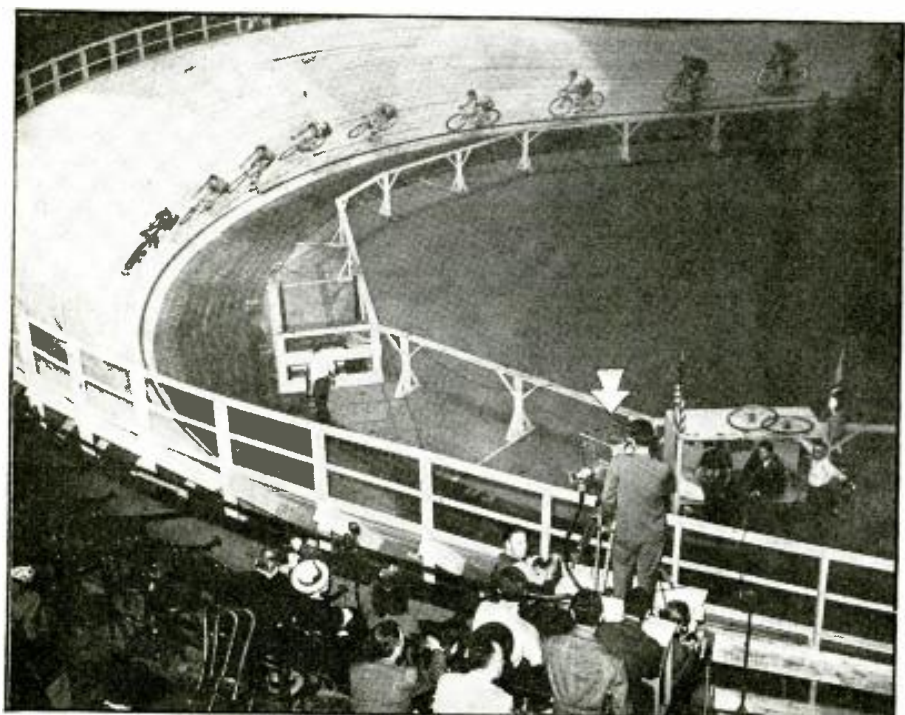

At the pick-up end, the Iconoscope camera in its position shown above (arrow), was able to command quite a wide view of the racing arena. Many viewers claim they saw all the riders from one end of the track to the other.

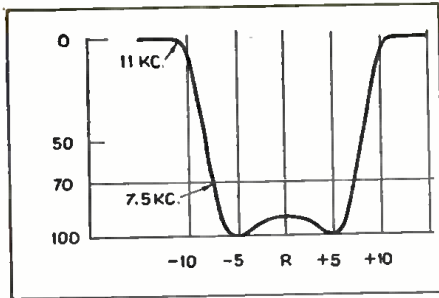

Fig. 1. Typical selectivity curve for a high-fidelity receiver.

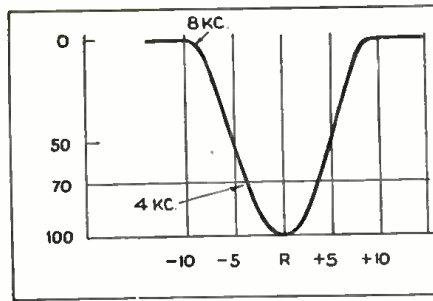

Fig. 2. Typical selectivity curve for an ordinary receiver.

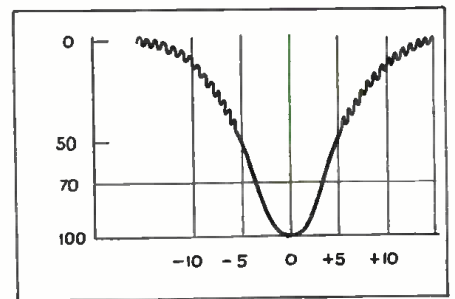

Fig. 3. Selectivity curve showing signal-to-noise ratio "ripple".

MODERN RECEIVER TEST REQUIREMENTS

Here's a fast-moving story which tells how the major elements of modern radio receivers may be quickly and simply analyzed by means of Oscilloscope, V.-T. Voltmeter, and Signal Generator.

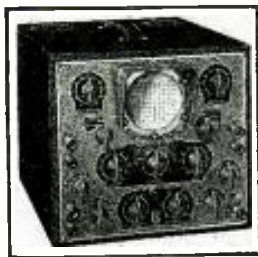

Fig. A. Oscilloscope.

ity, to meet the following specifications:

- (1) High sensitivity;
- (2) Sharp selectivity;
- (3) High selectivity;
- (4) A low noise-to-signal ratio.

Investigating these attributes separately, it is found that a receiver must have *high sensitivity* to bring in distant stations at a satisfactory volume level, especially the low-power stations.

The receiver must have *sharp selectivity* to discriminate distinctly between stations on adjacent channels and to prevent interference of one station with the other. This interference appears as cross talk, or hearing both stations at the same time.

The better-grade receivers are expected to give *high-fidelity* reproduction. This means that the R.F. sections of the receiver must pass, without appreciable attenuations, audio sidebands with a width of 5 to 7 thousand cycles per second, also that the audio amplifier in the receiver must be capable of amplifying, with equal response, frequencies between approximately 50 and 7,000 cycles per second. (And even higher—see "High-Fidelity Broadcasting," in this issue, pg. 73.—*Editor*)

To produce a satisfactory volume level with freedom from extraneous noise—i.e., to have *low noise signal ratio*—is probably one of the most vital points to the receiver owner.

CURRENT RECEIVER DESIGN

To manufacture receivers of this quality and meet the specifications pointed out, the design engineer has developed iron-core I.F. coils, over-coupled I.F. coils, automatic volume control, automatic frequency control, rejection

filters, high-fidelity audio channels, and other complicated circuits.

Eventually there comes a day when the modern receiver will not operate correctly. The owner goes to a radio service laboratory to have the receiver restored to its original condition. This means that the Serviceman must be conversant with current receiver design, and possess the proper equipment to service the instrument. In order to assure himself ample profit from the work, the technician must be able not only to complete the work rapidly, but know that every circuit in the receiver is functioning properly when he is finished, so as to forestall subsequent failure and customer dissatisfaction.

ANALYSIS



Fig. B. V.-T. Voltmeter.

depicted on the cathode-ray oscilloscope. The mechanical method of obtaining this response curve is to adjust the receiver to resonance with a signal generator. An output meter is connected to the receiver output stage. By moving the signal generator off-resonance approximately 2 kc. at a time, and observing the output reading, it is possible to plot the output voltage against frequency off-resonance and obtain a selectivity or response curve.

Typical curve for a high-fidelity receiver is shown in Fig. 1, while the typical curve for the ordinary receiver is shown in Fig. 2.

Sensitivity is represented by the height of the selectivity curve, while selectivity is determined by the width of the curve at the zero voltage line. Fidelity of the receiver is judged from the width of the curve at approximately 70% of maximum voltage. If the signal generator is operated at low output

voltage, the noise-to-signal ratio can be judged very closely. Experience with previous receivers will allow the technician accurately to determine this value. A high noise-to-signal ratio will appear usually along the base of the curve, as shown in Fig. 3.

After the curve for ordinary receivers illustrated in Fig. 2 is adjusted for maximum height and symmetry, it may then be analyzed for selectivity. The point at which the curve reaches zero voltage is 8 kc. off-resonance. In this instance, there would be no cross-talk from the station operating in the adjacent channel, which is 10 kc. off-resonance. Checking at 70% of maximum voltage, the curve intersection appears at 4 kc. This means that the R.F. section of the receiver will pass only 4,000 cycles of audio frequency as a maximum. If the audio section of the receiver is flat to 4,000 cycles or more, audio frequency which can appear at normal volume in the speaker will be 4,000 cycles per second. The base of the curve is relatively smooth, and it can be assumed that the noise-to-signal ratio is sufficiently low.

If a similar analysis is made of the high-fidelity response curve shown in Fig. 1, it will be found that the curve comes to the base line at 11 kc. The amount of cross-modulation from the station in the adjacent channel would undoubtedly be negligible in this instance. The 70% line intersects the curve at 7,500 cycles, which can be considered very good fidelity.

WHISTLES

Many superheterodyne receivers employ an I.F. rejection filter, which must be accurately adjusted with a signal generator and a suitable indicating instrument to prevent extraneous whistles over a certain portion of the dial.



Fig. C. Signal Generator.

(Continued on page 104)

EMERGENCY SERVICING

Any radio man knowing the fundamentals and provided with a little common sense in servicing, need not fear to tackle a fractious radio set, says Mr. Leutz,

CHARLES R.

THERE are occasions—sometimes emergencies—when the radio technician is called upon to make repairs and for one reason or another, wiring diagrams, service instruments and spare parts are not available. Under these unusual circumstances, the real ability of the radio Serviceman is instantly demonstrated.

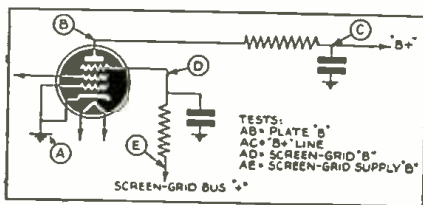

Fig. 1. Voltage tests.

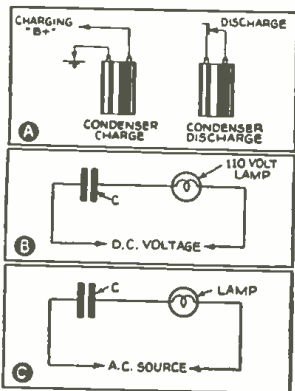

Fig. 2.

A—Testing condensers; and testing voltages at low current.

B—Lamp-test of D.C. voltage.

C—Lamp-test of A.C. supplies.

hookups. It is well to try a 110-volt, 60-watt lamp sometime when applied to voltages of 50 and 25 volts and make a mental note of the relative brilliancy, for some future occasion.

When limited current is involved the electric lamp-test is impractical. By using a paper condenser, for example one of about 1 mf. capacity and rated at 600 volts, this can be charged and discharged from voltages of 25, 50, 100, 250, 450 and 600 volts. Naturally the condenser will absorb the largest charge when charged by the highest voltage. Accordingly the highest charge, when discharged (condenser terminals shorted), will create the greatest spark. A mental note is made of the corresponding discharge intensities for the different voltages tried; and experience will dictate the allowance to be made for leakage (particularly if an electrolytic condenser is being used). Using a condenser of 4 or 8 mf. capacity, the difference in discharges for the different voltages is very marked.

Using a condenser in this manner one can readily test for plate, screen-grid or cathode voltages for most receivers. The same test can be applied to amplifier or the smaller transmitting tubes. Likewise voltages being delivered by power packs, across bias resistors or to speaker fields may be estimated.

Indications that resistors associated with the plate and screen-grid tube terminals are in working order, is automatically determined in these tests, see Fig. 1.

"WIND YOUR OWN" CONDENSERS

In case an extra paper condenser is not available, often one can be removed temporarily from the piece of apparatus being tested, without impairing the circuit's operation. Or, one can be obtained from an old telephone box or automobile ignition suppressor circuit. A good substitute or emergency receiving condenser can be quickly made by winding 2 pieces of enameled wire on a spool. The wires are wound parallel to each other.

The starting ends are separated and insulated from each other. At the finish the two ends become the condenser terminals. Using a small-gauge wire, any reasonable capacity can be obtained, increased capacity being obtained through the use of longer pieces of wire. A fair-sized condenser can be made in a relatively small space as the condenser dielectric (the enamel film) is very thin.

A paper or mica condenser can be readily tested for capacity, an open, or a short by trying to charge and discharge across a direct-current source, as shown in Fig. 2A. However if the condenser is of a type which will not hold a charge, it can be tested by connecting in series with a lamp of low watts rating and across a direct-current source. In this case a perfect condenser will pass no current to the lamp. See Fig. 2B.

Another indication of a condenser's capacity can be obtained by connecting same across an alternating-current source, with a small lamp in series, as per Fig. 2C. The larger the capacity of the condenser, the greater the brilliancy the lamp will show. For relatively small condensers, the lamp should preferably be a 110-volt neon test type or a small flashlight bulb.

CONTINUITY TESTS

Continuity of coils or resistors can be readily tested by discharging a charged condenser across the coil or resistor terminals. The resulting discharge spark will be less than a direct short and this also gives some indication of the resistance involved.

Even before removing a chassis from a cabinet, the source of trouble can sometimes be instantly located by cautiously feeling the tubes after the apparatus has been turned on for a short period. A cold tube indicates that the tube or parts associated with it are inoperative. A tube which experience indicates is abnormally warm may indicate a short-circuit (of the tube elements or, possibly, the filter circuit).

Under such conditions the qualified expert not only locates the difficulty but also proves resourceful enough to make the necessary substitute parts out of any limited material that may be available.

The little fundamentals pointed out in this article are of course instantly obvious when called to one's attention. Whether or not the average Serviceman would think of these ideas while working under stress, and without meters, is another question.

LAMP-BULB "VOLTMETER"

A means to measure voltage without a voltmeter is frequently useful. Of course if the line being measured can supply ample current, electric light bulbs in series can be used and will give an accurate indication. Thus with 2, 3, 4 or more 110-volt bulbs in series, we can measure 220, 330, 440 or more volts, depending upon the number of bulbs in series; a couple desk lamps or floor lamps may conveniently supply the required sockets, wiring, etc., for series

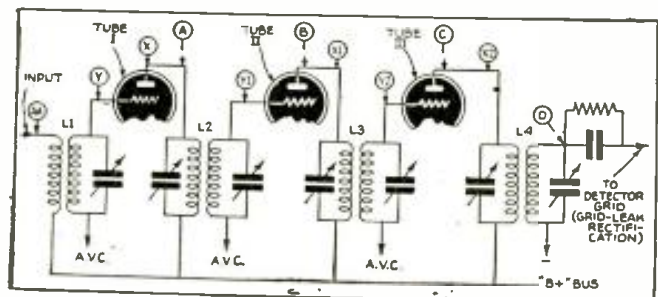

Fig. 3. Checking the R.F. and detector circuits.

WITHOUT TEST METERS

mon sense, though unaided by most of the meters, etc., ordinarily co-originator of the famous old "Golden-Leutz Superhet."

LEUTZ

In a cascade amplifier, whether a direct tuned radio frequency, an intermediate radio frequency or audio frequency, a defective stage can invariably be located by "jumping-out" one stage of the amplifier at a time. This procedure is very useful as the difficulty may be a defective tube and no spare available.

For example in Fig. 3, suppose tube II is "dead"; by connecting a jumper from X to X1, the set becomes operative. However, under this same condition the trouble might be in the R.F. transformer connected to the plate circuit of tube I. But by exchanging tubes I and II it is determined that tube II will not work in place of tube I.

EXAMPLE: "NO SOUND"

Suppose we start with a receiver or audio amplifier connected to an electrodynamic speaker, wherein all the tubes light or heat, but no sound of any kind is audible from the speaker. See Fig. 4.

To determine if the speaker is receiving field current, it is simply necessary to cautiously approach the speaker pole piece with a screwdriver, or other piece of iron, to test for magnetism. Lack of vigorous magnetism indicates the field coil is open, shorted or not receiving any voltage.

Let us say the field voltage is tested and found OK, it is also found that "B" voltage is going to the plates of the push-pull output tubes, IV and V. Now if the tubes IV and V are working, if either one or the other is moved out and in the tube socket quickly, a decided click should be heard in the speaker, due to the plate current being broken. Otherwise the trouble is in the voice coil circuit and may be an open or shorted voice coil or secondary of the output transformer.

Suppose an imperfect connection to the voice coil and repair same, then at least some hum is heard at the speaker, which is correct. Now upon removing and inserting either of the power output tubes we get a healthy click in the speak-

er, indicating that the output circuit, from the plates on, anyway, is in order.

Knowing that the output stage and the speaker are in order, it is simple to locate any difficulty in the balance of the audio circuit back to the detector plate.

First by tapping tube I by hand, if the audio circuit is working, a microphonic rattle is heard in the speaker. Or the same effect can be obtained by removing and reinserting tube I, to temporarily break the plate current. Assume there is no click, we then apply the same test to tube II and also receive no click. However upon making this test on tube III, there is a strong click in the speaker. Now we know the trouble is somewhere between tubes I and II.

By connecting a jumper between point X and X1, we have eliminated the 1st audio stage and now find upon tapping tube I the microphonic rattle sounds in the speaker. The trouble may be in the 1st A.F. transformer, T1, or it may be tube II. With connections left just as they are, tube II is substituted for tube III and the circuit is again dead. We then know tube II is dead and the seat of the trouble.

This procedure of jumping-out part of a circuit is extremely useful in many ways. Suppose the secondary of transformer T2 was open. A jumper connected from Y to Y1 makes the circuit operative, with one less stage.

In a push-pull audio output stage, often 1 tube or half the circuit is inoperative and not noticed. One tube, say IV, should be removed. Then try the apparatus using tube V alone, and then move tube V to the socket formerly used for tube IV. If tube V is good and both sides of the circuit are in order, the apparatus will work under both of the above conditions. Then tube IV can be tested in the same manner.

EXPLORING UNITS

An audio "feeler" or exploring coil can be made by connecting an iron core choke or primary of a transformer to a

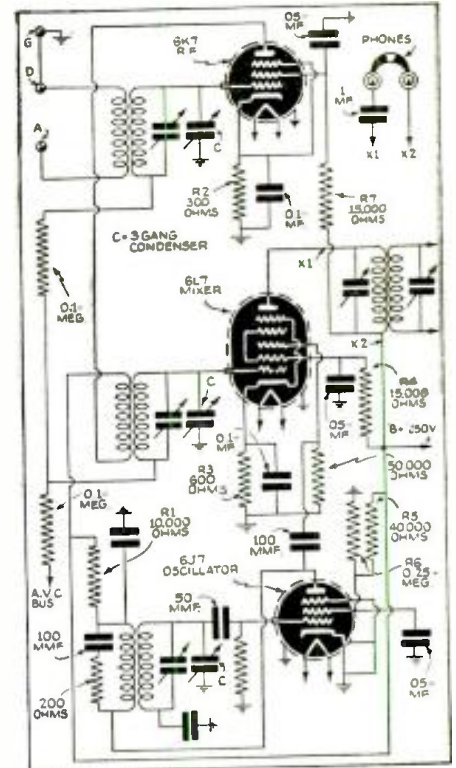

Fig. 5. Checking superhet-circuit elements; and testing components.

pair of head telephones, as shown in Fig. 4B. This "feeler" can be inductively coupled to audio transformers or chokes while they are in operation to instantly locate any units which are not excited or in order.

Or, the head telephones can be connected (through a condenser) to the primaries or secondaries of the various audio transformers, as shown in Fig. 4C. Extreme care should be taken in making this test at the primary of the output push-pull circuit if high voltages are involved. This is also a good test across audio plate coupling inductances or resistors as the blocking condenser prevents the phones from temporarily substituting a workable plate coupling unit.

FAULTY R.F. SECTION

Referring again to Fig. 3, assume it represents a straight tuned-radio-frequency receiver, working satisfactorily from the detector on, as previously covered; I, II and III being identical R.F. amplifier tubes.

By connecting the antenna directly to point D, and turning the tuning condenser to its lowest-capacity position, some signal should be heard; especially, if the receiver is within 20 miles of a broadcast transmitter. The receiver will not tune properly as the antenna capacity is directly in parallel with the detector grid circuit.

By connecting the antenna to point C the antenna is inductively coupled to the

(Continued on page 116)

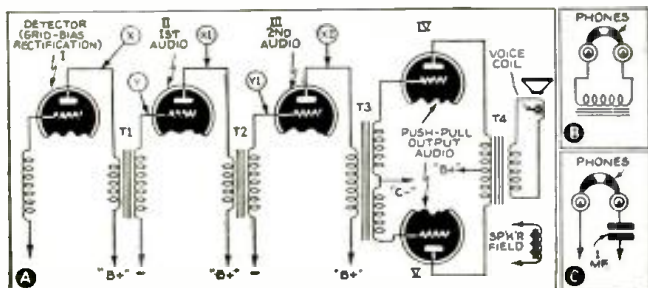
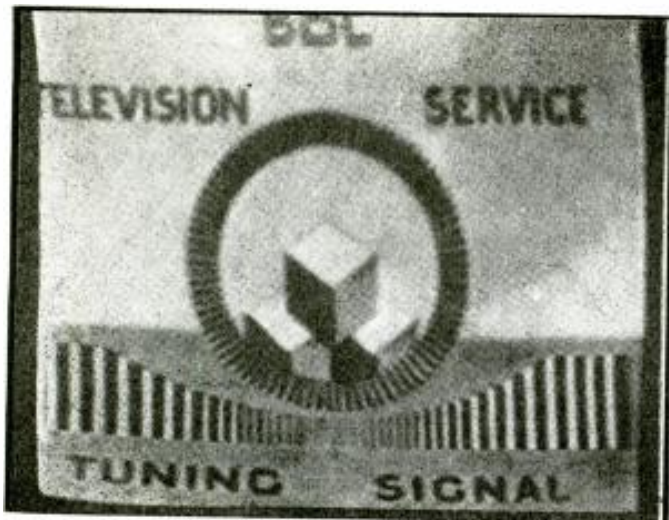

Fig. 4. Checking the detector and A.F. circuits.



Figs. 1 and 2. Two photographs showing effect of slow line flyback.

SERVICING TELEVISION

Unlike previously published articles of a theoretical nature on the servicing of television and Short-Wave World (London, England), is a practical analysis illus-

S. WEST

UP to the present, in this series, we have been mainly concerned with the various faults likely to occur in the *time base*. It was intended in this article, to describe the defects likely to be encountered due to incorrect sync. pulse conditions in the vision unit, but actually no such nice distinction for a certain class of fault can be made.

Also a very prevalent fault, even in quite carefully constructed apparatus, attributable to slow "flyback" in the horizontal scan circuit, has not yet been dealt with. As a consequence, we have perforce to continue with time bases for the time being.

SLOW LINE FLYBACK

Dealing first with the effect of slow line flyback. The result of this in the received image is depicted in Figs. 1 and 2. The latter photograph being a somewhat severe case. Figure 1 is the more usual form in which this trouble manifests itself. It is not unusual for the fault, in mild forms, to be tolerated, for unless interesting subject matter extends completely to the left edge of the image, the defect passes unnoticed.

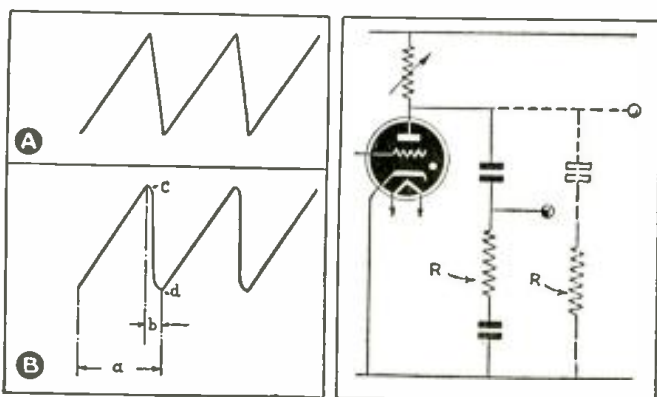
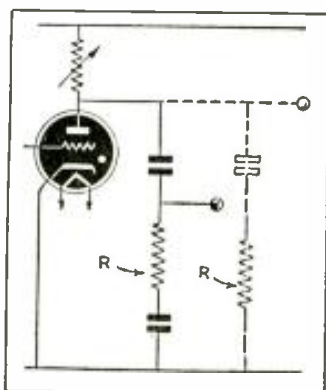

Fig. 3. In A above is shown the required wave shape. In B the flyback tends to slow down when nearing completion, but providing (b) is equal to or less than 10 per cent of (a) no harmful result obtains.

Fig. 4. Inclusion of a resistor R increases the flyback speed. An alternative arrangement is shown by the dotted connections.



A brief explanation for the cause of this fault follows, the remedy being afterwards outlined.

The image is scanned from left to right in 405 lines every 1/25th of a second. Upon completion of a single line, the light spot flies back to the left ready to commence the next line of its frame. For the complete, correctly-interlaced image, this actually is the next alternate line, but this point does not concern us for the present.

Each line including the return of the light spot, is completed in approximately 100 microseconds, 15.5 per cent of this time being assigned for the retrace, i.e., 15½ microseconds. This involves quite high frequencies, and it is failure on the part of the system to accommodate these frequencies, that causes the fault.

To clarify our conception of what takes place to cause this apparent loss of some part of the image, let us consider what happens when the line re-trace occupies too long an interval.

A line commences reproducing a section of the image in sympathy with the transmitted intelligence. Upon completion of the line the sync. pulse arrives and the light spot, now blanked by this negative sync. pulse, commences its return. Before it is enabled to reach the left image edge the intelligence for the next line commences, thus, a part of the retrace is modulated and results in a brightening and often, depending on the shape of the retrace curve, a confusion of the left-hand image edge. It is obvious also that this part of the modulation is lost as far as the left edge is concerned, hence the effect depicted in Figs. 1 and 2.

A little consideration shows that no deleterious effect results from a too rapid flyback.

It should be appreciated fully from the foregoing that it is the left-hand image edge that is affected and is revealed, with modulation, as a loss of or confusion of the image detail of this edge; or in the plain "raster" as a bright vertical band at the extreme left edge.

SOURCES OF TROUBLE

The writer has encountered this fault upon innumerable occasions invariably finding it to result from a too conscientious adherence to orderliness in the finished outfit.

Laced leads to the horizontal deflecting plates must be immediately suspected. These leads should be well spaced from grounded objects and preferably kept short. The main

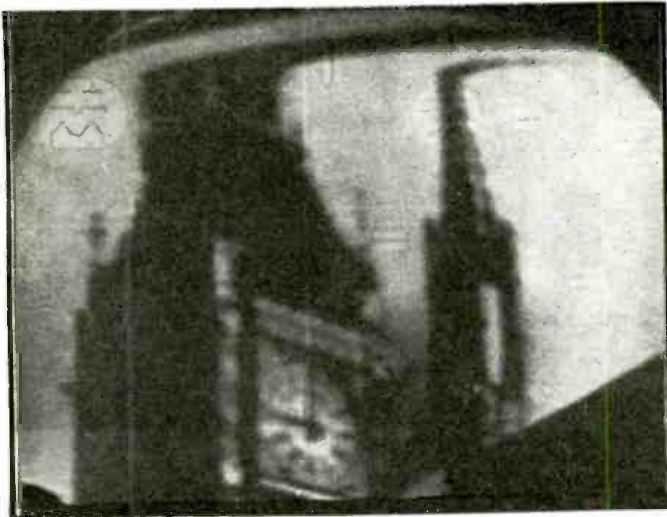

Fig. 5. The type of image produced by poor line synchronism.

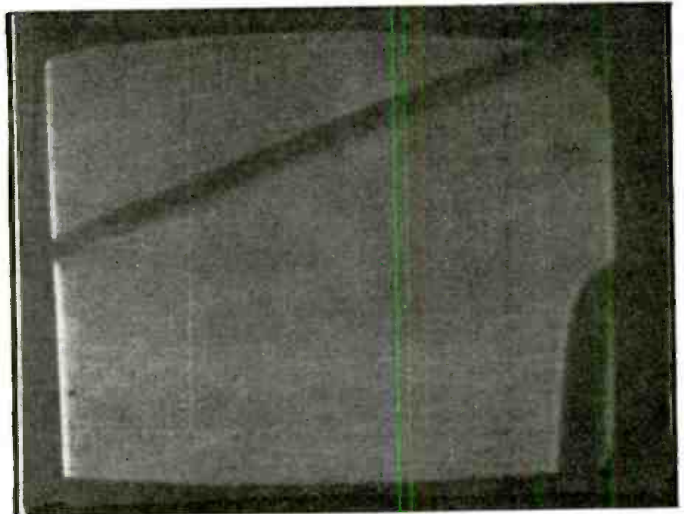

Fig. 6. Effect of bad line synchronism on plain format.

RECEIVER FAULTS

*vision receivers this series of articles, which we reprint by special permission of
trated with photographs of images which depict the actual faults being discussed.*

PART III

thing is to avoid any unnecessary capacity to ground between the deflecting plates, their connecting leads and the plate circuits of the associated amplifying tubes. It is bad practice to have the output from the horizontal amplifiers connected to a plug-and-socket arrangement having appreciable capacity to chassis and it is inviting trouble to lace tightly the various C.-R. tube leads together. Excessive capacity in the grid circuit of the second amplifying tube also must be avoided.

In isolated cases, a very similar effect may result from a poor wave shape output from the blocking oscillator (gas relay, etc.). If all efforts to cure the fault fail with attention to the points enumerated above, this section must be suspected.

An oscilloscope is very desirable in order thoroughly to investigate the waveform of this oscillation. The resourceful technician will have no difficulty in providing this with the frame time base and remaining equipment. The waveform should be substantially as shown by Fig. 3A. No particular concern need be felt if that shown in B results provided the slope *c-d* is steep, i.e., occupies 10 per cent or less of the period of the cycle. This is simply ascertained by actual measurement. Bear in mind it is 10 per cent (1/10) of the complete cycle.

To improve matters, should this waveform be poor, re-arrangement of the layout will help. If a resistance, *R* in Fig. 4, which can have a value of about 1,000-4,000 ohms, 2,000 ohms being an average value, is not now installed, its inclusion will greatly improve matters. Some experiment to ascertain the optimum value will be required in obstinate cases.

It can be added in terminating this description of faults due to slow flyback that troubles of this nature do not occur in the vertical scanning circuits. The available time for the frame flyback being relatively lengthy.

SYNCHRONIZING FAULTS

As earlier remarked, it is difficult in certain cases of unstable synchronism, to state exactly to what cause the fault can be attributed. Similar effects result from poor sync. pulse filtering, where such arrangements are employed, and incorrect sync. pulse application networks. It is intended, therefore, in the following, where the above applies, to deal with the fault shown for each section of the receiver

that may be responsible. The reader must then determine which is applicable to his own case.

Figure 5 depicts the effect of poor line synchronism. This fault is similar in appearance to one later to be described, and is not to be confused with this. In this case, it is seen that the top of the image is falling to the right. This is not a stable condition, a few seconds later the image usually will slip across the screen. This fault is due to insufficient amplitude of sync. pulse. The hold is not sufficiently positive. In general where the circuit arrangements permit variation in amplitude of these pulses, re-adjustment of the controls will effect a cure. Where fixed networks are included, some change of the constants may prove desirable or, readjustments of the sync. pulse filter may be required. The main point is to increase, in the most convenient way, the amplitude of the sync. pulses applied to trip the blocking oscillator.

Figure 6 gives the same fault in a slightly more advanced state. In this case for the plain image format. A few seconds later the raster will dissolve into unintelligibility. In passing, it is interesting to note in this photograph, the diagonal
(Continued on page 112)

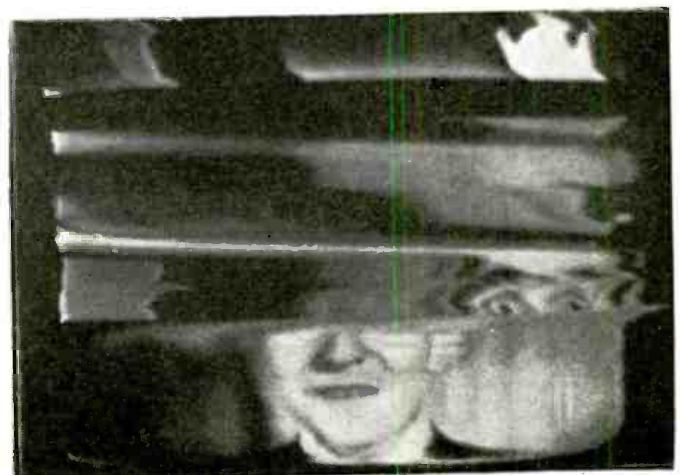

Fig. 7. Picture of image due to operation of receiver with pronounced unstable line synchronism.

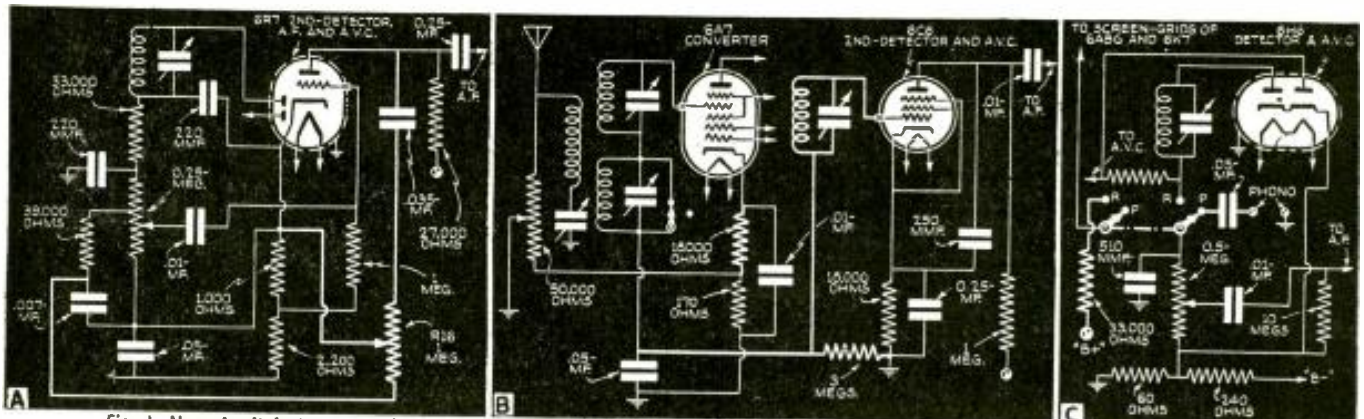

Fig. 1. New circuit features of (A) RCA model M-70; (B) Majestic model 55; (C) Stewart-Warner models 01-61, 010-61, 01-61S, 010-61S.

NEW CIRCUITS IN MODERN RADIO RECEIVERS



The details of the modern radio receiver circuits that make them "different" from previous designs are illustrated and described each month by a well-known technician.

F. L. SPRAYBERRY NUMBER 23

(1) COMBINATION OF TONE CONTROL WITH BASS COMPENSATION CIRCUIT

RCA Model M-70. The low-signal end of the tone control potentiometer is connected between the resistance and condenser of the bass-compensating shunt on the volume control so that when full high-frequency response is desired the condenser section of the bass compensator is shorted out but when the high frequencies are increasingly modified, the effectiveness of the bass compensation becomes greater.

Ordinarily a bass-compensation system as in Fig. 1A without the tone control connection will act as a "progressive audio divider," that is, it will divide the portion of A.F. drop across each section of the volume control in accordance with its frequency. For example, for equal voltage at all frequencies supplied to the control there may be 4 times as much voltage at 125 cycles as there is at 500 cycles, because of the frequency-reactance characteristics of the bass compensating condenser C21.

If a resistor is placed across C21, not only will the total impedance across it be reduced, but will be more constant

with frequency. As this resistance is lowered sufficiently the frequency reactance characteristics of the compensation circuit become negligible and there is no bass compensation. This is what happens and what is desired when the full high-frequency range is made available by placing the slider at the bottom end of R16. Condenser C21 is thus shorted and there is no bass compensation. As the high-frequency response is modified by raising the R16 slider toward the 0.035-mf. condenser, the resistance across C21 becomes greater and the normal bass compensation action progressively increases.

(2) CONTROL-GRID USED AS POWER DETECTOR GRID AND A.V.C. DIODE

Majestic Model 55. A 6C6 tube, 2nd-detector with a fairly high self-bias receives the signal in its control-grid, rectifying the positive half-cycles for A.V.C., and maintaining an average A.F. plate current component.

Note in Fig. 1B that by reason of self-bias the 6A7 converter is already reasonably biased. The 6C6 grid acting as a diode provides rectified I.F. in por-

tion to that fed to it. But for the 0.05-mf. bypass condenser at the 6A7 grid-return this would be largely A.F. superimposed on D.C. The rectified I.F. plate current is filtered in the 6C6 plate circuit, while the D.C. produced is used to automatically control the 6A7 bias just as for A.V.C.

The manual volume control is of the antenna-bias type and is independent of the A.V.C. action.

(3) RADIO-PHONOGRAPH SWITCH CUTS OFF SCREEN-GRID VOLTAGE

Stewart-Warner Models 01-61, 010-61, 01-61S and 010-61S. So that there will be no radio signal, even by stray capacitive coupling with the R.F. and I.F. sections of the set, the latter sections are made inoperative by opening their screen-grid circuits during phonograph operation.

A double-pole, double-throw switch is used for this purpose as illustrated in Fig. 1C. One section of the switch throws the "maximum signal" end of the volume control from the diode-return to the phonograph jack, while
(Continued on page 105)

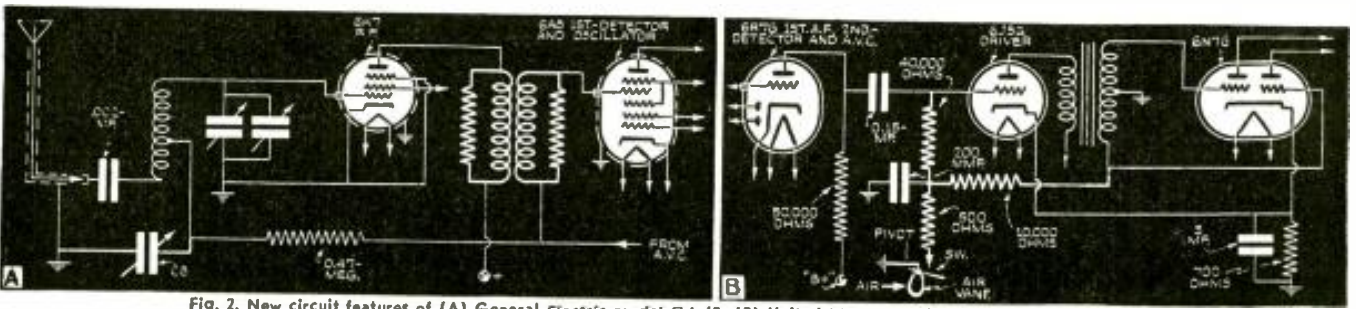

Fig. 2. New circuit features of (A) General Electric model GA-62; (B) United Motors Service model 983568 (Pontiac).

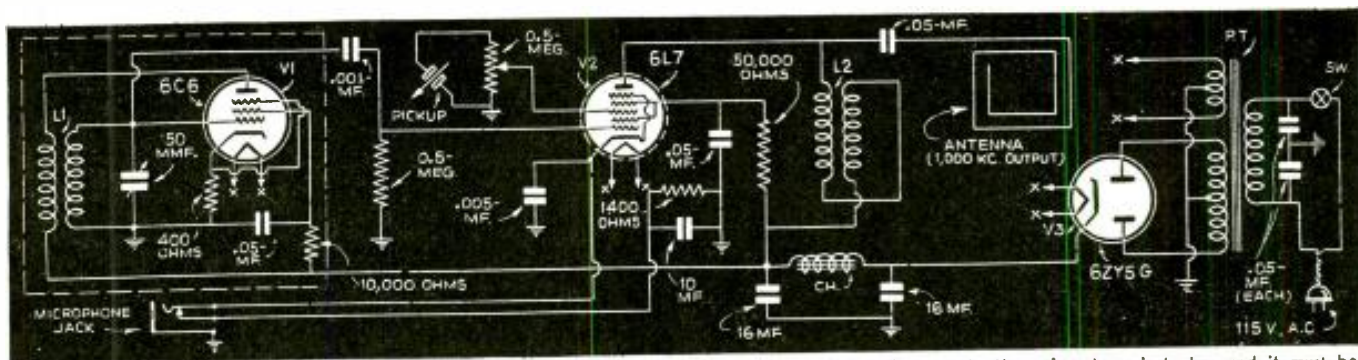

Fig. 1. Schematic diagram of the "flea-power" transmitter used to provide "wireless" operation of the phonograph. If a microphone is to be used it must be of the single-button carbon type only.

Modernize Old Phonographs!

The Serviceman if he looks around among his clients will undoubtedly find many who have old phonograph equipment on hand which is definitely outmoded, if not actually inoperative. Because such equipment represents a double investment on the part of the owner—in the equipment itself and in the accumulation of records—he is a likely prospect for a modernization job and this is right down the Serviceman's alley.

HARRY PARO

WITH the many portable record players now on the market it might seem scarcely worthwhile, from the standpoint of the owner, to attempt to modernize his older equipment. The fact remains, however, that to discard such equipment and purchase entirely new, would among other items involve replacement of a turntable motor, which may be just as good today as the day it left the factory. Moreover, his old phonograph may be in a cabinet by itself which he does not care to discard, because it provides for record storage and perhaps likewise serves as a useful or decorative piece of furniture.

A SAMPLE JOB

The extent of the modernization job will vary with circumstances. In some cases it may consist only of the installation of a new pickup; in others, provision for coupling and matching the new pickup into the receiver, a new volume control to match the new pickup, etc.

It will be the purpose of this article to describe a recent job which suggests a standardized method of treatment for practically all installations where the phonograph and radio are separate units. This particular revamping operation has provided the utmost satisfaction to the owner, combining high-quality reproduction of music with maximum operating convenience. From the standpoint of the Serviceman who did it, it was a speedy, clean job requiring no alterations whatsoever in the receiver.

The situation encountered was one involving an old end-table phonograph which in its prime was a combination record player and recorder, the old magnetic pickup pinch-hitting as a recording head. Its panel (shown in one of the accompanying photos), in addition

to the turntable and pickup, also included a number of switches and other gadgets necessary to this dual operation. The magnetic pickup had deteriorated with age with the result that for some 2 years the phonograph had not been used.

The radio set was a good quality all-wave console. This was located in the living room while the phonograph unit had been relegated to use as a table in the foyer.

The turntable, motor, speed control, on-off switch and needle cups were salvaged and mounted on a new plywood panel finished to match the cabinet. On this was also mounted a new volume control and a modern crystal pickup.

With these changes modernization was attained so far as the phonograph itself was concerned, but there was still left the problem of feeding the output to the receiver. To accomplish this in the usual manner would have involved some work on the receiver chassis and the installation of a 25-foot connecting cable.

M.O.P.A. "WIRELESS" PHONO

A simpler solution was found in the installation of a "wireless" phonograph oscillator in the phonograph unit. This simple expedient eliminated interconnecting wires entirely and, moreover, did away with the necessity for alterations in the receiver.

These "wireless" units are not a new thing by any means. They are simply miniature broadcast transmitters utilizing an oscillator to provide the "carrier" and the output of the phonograph pickup to modulate this carrier. With the oscillator tuned to some frequency in the broadcast band it is only necessary to tune the receiver to this same frequency in order to pick this signal out of the air just like that from any other

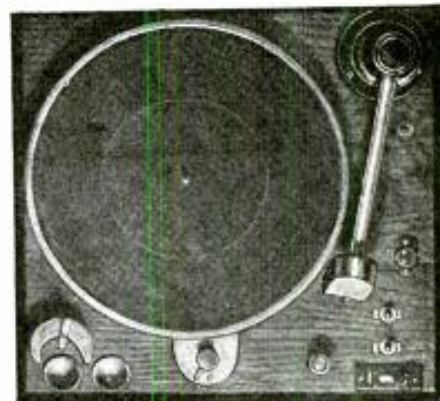

This is the panel of the phonograph end-table before the remodeling operation was started. In a case like this, where the original panel contains numerous unnecessary gadgets, the easiest plan is to employ a new plywood panel.

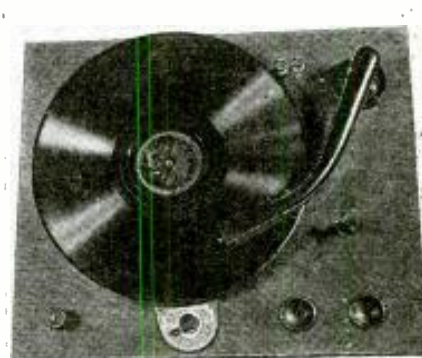

The new panel, to which all salvagable parts of the original unit were transferred, and the new pickup, and volume control; also the miniature transmitter which "broadcasts" the phonograph output to the radio set in the next room without aid of wires.

broadcast station.

Basically, this scheme is entirely sound but it is a recognized fact that when an oscillator is modulated directly
(Continued on page 108)

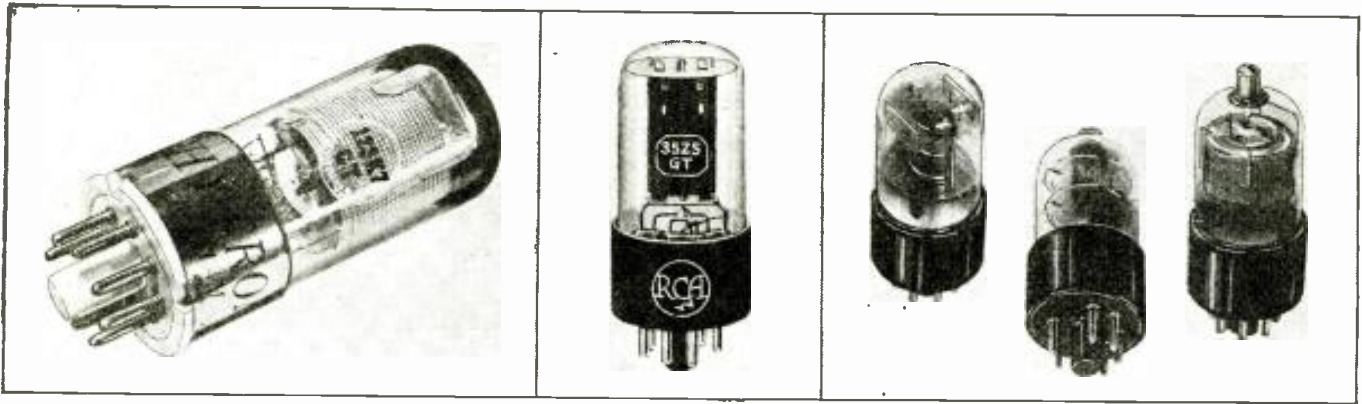

12 New Tubes

Portable radio sets have been sold in huge quantities during the last year or so—but only because of the availability of the new series of 1.4-volt, low-drain tubes; this month, another advance has been made—the tubes are coming through with a “bantam” or small-space envelope which makes possible smaller portables. Other new tubes are also described in the following article.

N. H. LESSEM

IMPROVEMENTS in tubes are not always apparent, but the developments this month are readily recognized. For instance, the new tubes with low-loss base afford much better results in shortwave apparatus; the new tapped-filament tube prevents pilot light burn-outs (Servicemen shouldn't find it difficult selling this point to customers); and, the new series of small-space battery tubes makes possible battery chassis having the same tiny sizes as the metal and bantam-glass tubes have afforded for some time in electric sets.

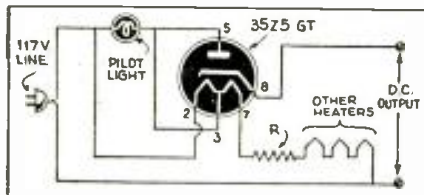

Fig. 1. Application of the 35Z5GT. The drop across R and all heaters (with pilot lamp) should equal 117 V. at 0.15-ampere.

Types 6A8GTX, 6J5GTX, 6J7GTX, 6K7GTX, 6X8GTX—Low-Loss-Base Tubes

Hytronic Laboratories are now supplying a line of “Bantam” receiving tubes equipped with a low-loss ceramic base. (Note suffix “X”). They are 6A8GTX, 6J5GTX, 6J7GTX, 6K7GTX, 6K8GTX.

The tubes are designed for use in short-wave receivers where maximum signal gain and circuit stability are needed.

Interchangeable with the corresponding metal and “G”-type tubes, these “Bantams” may be used as replacements for the high-frequency, radio-frequency stages, converter stage and oscillator section of all-wave receivers.

In order to make these tubes directly interchangeable with metal types, the tube types requiring shielding are furnished complete with a shield which is automatically grounded to the metal shell at the base of the tube.

This series of “Bantam” tubes is being limited to the octal type of base and when it is desired to use a ceramic-based tube in a receiver using the older-style tubes, it will be necessary to change the sockets to accommodate the octal-type base.

35Z5GT—High-Vacuum, Half-Wave Rectifier with Heater Tap for Pilot Lamp

The 35Z5GT is a close-spaced, cathode type of half-wave rectifier intended primarily for service in A.C.-D.C. receivers. The heater has a tapped section which can be shunted by a 0.15-ampere pilot lamp as shown in Fig. 1. With the pilot lamp so connected, the pilot-lamp voltage does not substantially exceed its operating value when the receiver is turned on and off. It will be noted that the plate of the 35Z5GT is connected to the tap on the heater as well as to one side of the line through the pilot lamp. This arrangement permits the plate current of the 35Z5GT to pass through the pilot lamp and the pilot-lamp section of the heater. As a result, a higher level of illu-

mination is obtained when the receiver is in operation. This tube is made by RCA Mfg. Co., RCA Radiotron Division. Tentative characteristics—Table I.

National Union has brought out a complete line of new low-filament-drain 1.4 volt battery tubes. Arcturus Radio Tube Co. also has announced this type. They are as follows:

1A5GT—Filament-Type Power Amplifier Pentode

This tube is designed for service in the output stage of receivers operating from a low-voltage battery filament supply. The power output is relatively large—about 100 milliwatts—for the low filament and plate inputs available in such receivers.

1C5GT—Filament-Type Power Amplifier Pentode

This tube is designed for service in the output stage of receivers operating from a low-voltage battery filament supply. The power output is relatively large—about 200 milliwatts—for the low filament and plate inputs available in such receivers.

1A7GT—Filament-Type Heptode Pentagrid Converter

The type 1A7GT tube is designed for service as a combined oscillator and mixer tube in superheterodyne circuits operating from a low-voltage battery filament supply.

(Continued on page 126)

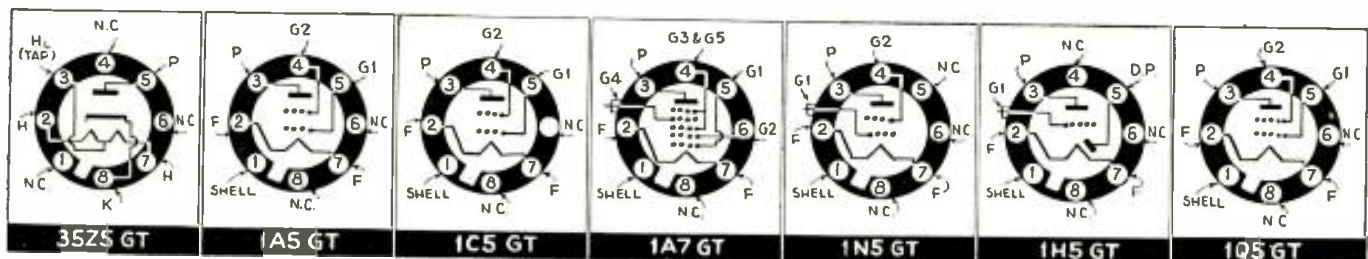

Tuning-Dial Scales

Made at Home

By SERVICEMAN
ESTEN MOEN

AHOY, ahoy, brother radio Servicemen—when ya need a new scale for some dial—some dirty, torn or awful thing that has to be replaced—and ya can't find a "Duplicate" in any doggone catalogue then whatayado? You get out the drawing board, tha drawing paper and tha instruments and tha "India ink". Yeah, but suppose it has to be white or color against black??? Sure just suppose . . . but I'll tell ya about it.

Did you know that the "regular" white drawing inks ain't fit for shining shoes let alone come on some artist's drawin' board? No, Sir!, but I discovered that just this cheap "dime store enamel" (it is paint,—oil-paint with dryer) makes a darn good ink. It has a high viscosity and it is oily and slippery (treacherous in that it may drop off the ruling pen without warning) but when you get the hang of an hour's practice, boy, does she do high handsome beautiful?

SELECTION FOR CONTRASTS. On white paper it is best to use "dark" colors like red, blue green and violet—but against black paper you can use white, yellow orange and a light "emerald green" (lots of yellow in it).

PREPARING BLACK PAPER. With brush, apply 1 coat of black India ink, smoothly, and speed the drying by holding paper over hot stove. (In all this work keep a hot stove handy beside the drawing table—you'll see.)

DRAWING ON BLACK. Just to tell you what it's like—and it's fun when you get going—well, this enamel flows some 10 times slower than ink, but time smoothens everything anyway and ya gotta kill time now and then, so take it easy.

Now after the line is drawn, 10 minutes will allow the enamel to soak into the paper so you can proceed without smudging the curve and the celluloid triangle—the hot stove will cut the time down to half-a-minute, "in between shots". You see, when one white line is dry it sort of fades and ya gotta intensify it with a second coat, in fact it pays to go over everything twice or more so the white or colors will really "stand out on the black".

I forgot to say, use a thin wood splint to stir and drop the enamel and use an old rayon undershirt on which to wipe clean the stirring splint and instruments. It MAY help to use a few drops of turpentine to thin the enamel, but **WAIT FIRST**; try the paint raw-strength and maybe you won't need to cut it—it flows faster after being cut but then it has lost the dye-strength.

GLOSS FINISH. One coat of white shellac makes the dull black into a lustrous sheen, mirror- and ebony-like—and you have something sun-proof (no fading), waterproof and foolproof. Use shellac also for a glue to attach the scale to its base; a first coat on both surfaces is allowed to set half-an-hour; a second coat is allowed to dry 15 minutes until tacky. Now squeeze the drawing down and leave to set under live pressure (books, etc.) of 20 to 50 lbs. for 10 hours.

For making special slide-rule dials of your own, or the round "wheel dials", or for making your own "blue prints, diagrams and schematics"—the above method is suitable and for many others that you can think of.

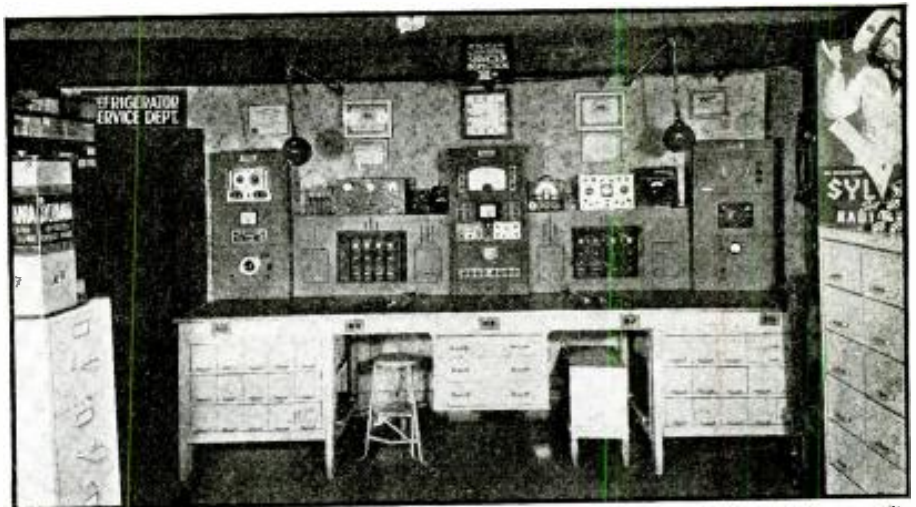

DEAR EDITOR: Herewith is a photo of our radio and sound service department. Undoubtedly you will recognize all of the equipment which includes a chanalyst, an oscilloscope, audio beat generator, A.C. and D.C. voltage regulators, universal speaker, etc. With the exception of the middle rack, which is Jackson, the equipment was built into the Jackson racks, the gray wrinkle finish on the panels being baked-on in our sound department. As you will notice we have all of Rider's "Manuals" and quite a few of his other books. In the drawers of the bench is a portion of the stock of parts we carry. We usually give 1-day service on any radio set as our parts stock is adequate to handle almost any repair without ordering. We service for several stores and garages, and have a service clientele built up over a radius of 25 miles. Our service also includes warranty service on Philco, RCA, Motorola and Zenith custom-built car radios. FORAST FOX, Fox Radio Service, Richmond, Indiana. (Just peeping into photo, at top, is a flashlight cell Fox is using a chain-pull—Editor)

OPERATING NOTES

Trouble with . . .

. . . GENERAL MOTORS 640 AND 641

A rather unusual trouble found occasionally on General Motors models 640 and 641.

The set will pick up local stations fairly well, but having a high noise level. The trouble may be an open secondary in the 1st I.F. transformer, the trimmer will sometimes show some tuning effect even though the transformer is open.

A temporary repair may be made, if a replacement is not available, by coupling the intact primary to the grid of the 6D6 with a 100 mmf. condenser and a 0.25-meg. resistor.

GEORGE DUFF,
Wynyard, Sask.

. . . CHAMPION 4-T

This set like other midget sets of many different makes would oscillate all over the

dial. I have found that if a 0.01- to 0.5-mf. paper condenser is shunted across the electrolytic condenser that 9 times out of 10 it will cure this condition.

. . . MONARCH (No number)

This was another 4-tube T.R.F. set with a very bad A.C. hum. The 0.1-mf. filter condenser was leaky. I replaced this condenser with a 0.25-mf. tubular condenser instead of using a condenser of the same value as the original one. This effectively cured the trouble.

I hope these few notes will prove of value to some other serviceman.

RICHARD DECKER,
Brooklyn, New York.

. . . STUDEBAKER PHILCO F-1626

Vibrator hash found in Studebaker-Philco model F-1626 was traced to the volume con-
(Continued on page 120)

SERVICING Questions & Answers

AUDIO HOWL

(133) M. C. Cobanks, Franklin, Virginia

(Q.) I have in my shop an Atwater Kent radio model 325. When brought in this set had the power transformer burned-out. I replaced the power transformer and the filter condensers, one of which was shorted and caused the power transformer to burn out.

Now the trouble with this set is that it has an audio howl. The set picks up stations O.K. when the volume control is not turned up quite half-way; if I turn the volume control any further the set starts to howl and will howl till volume control is wide open then the howl stops.

Also it will not howl if the tone control is on Bass, but when the tone control is turned to Treble it starts to howl and squeal; with volume $\frac{3}{4}$ -way open it will howl and squeal on the high notes, in other words it is not a steady squeal.

The tubes are O.K. (2 are new).

I have checked this set good and cannot seem to find the trouble. Please help me.

(A.) The condition described has been traced to various causes in the Atwater Kent model 325 receiver. Check the 2-megohm grid resistor in the 2A6 grid circuit, and the 2A5 grid resistor of 1 megohm, for an increase in resistance. An open-circuited 2A6 plate filter condenser, a 0.2-mf. section of a triple-section bypass block located near the I.F. 58 tube socket, will cause the howl mentioned. Check the 2A5 cathode bypass condenser and the 2A6 plate bypass, a 250 mmf. section of a dual condenser.

LOW VOLUME—INTERMITTENT

(134) Walter E. Grim, Red Lion, Pa.

(Q.) I was called to service a Sparton radio-phono combination receiver. The owner informed me that it had been out of Service for a few years. The power supply was disconnected from the other units. I checked the power supply and found all
(Continued on page 125)

Useful Kinks and Circuits

Contributions to this new department are paid-for at space rates; what previously-unpublished ideas to help fellow Servicemen, experimenters, etc., do YOU want to submit? A short description and pencil sketch will do.

ADAPTING LOCTALS TO PRESENT TUBE CHECKERS

● I AM a Serviceman, been in the game since it started and I am a steady reader of *Radio-Craft* magazine. I read in your April edition where you were going to give more information on those loctal tubes so I thought if you don't beat me to the punch I am going to send you a diagram on 2 adapters that will test every single one of those loctal tubes and also a diagram with a few switches added on to it. You can install a loctal socket in your tester and bring it up to date without adapters. Either way will both work the same.

I have a friend that works in a tube factory and he got me all those tubes so I could make an adapter for all of them. I found that in order to test them all I had to make 2 adapters (see diagrams) or if you installed a loctal socket in your tester by using the switches I rolled the 2 adapters into one. I have been using them since they started to market the loctal tubes.

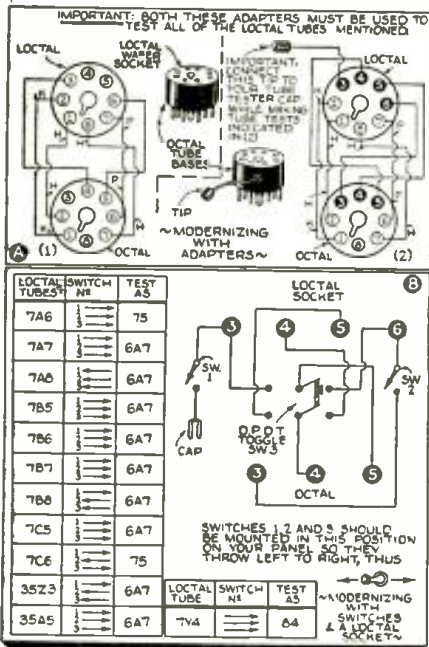

In Fig. A, adapter No. 1 tests: 7B5, 7B6, 7C6, 7A7, 7C5, 7B7 and 35A5; No. 2: 7A6, 7A8, 35Z3, 7B7.

Set filament switch in your tube tester to 7.5V. for all tubes except 35Z3 and 35A5 which have 35V. filaments. In latter case, set your filament switch at highest setting which is 30V. Then all tubes will read the same as a 6A7 tube. Simple, isn't it?

ALFRED MARTELL,
Watertown, Mass.

USE FOR OLD "V.D." TUBES

● THE following arrangement provides a handy use for old voltage-doubler ("V.D.") tubes of the 25Z5 type which have one section dead. By using two tubes in a series connection, we may still use them as a voltage doubler—besides giving us an additional voltage drop for series filament operation. Most of the rectifier tubes of this type which we have had to replace in A.C.-D.C. sets usually have only one section dead. This however, renders them unfit for further use in the set as a voltage doubler. But they can be used in experimental hook-ups, or as a source of D.C. power for shop instruments, where high D.C. voltage is required. The hookup is illustrated below.

CLARENCE J. TABER,
Taber Radio Service,
Bluefield, Va.

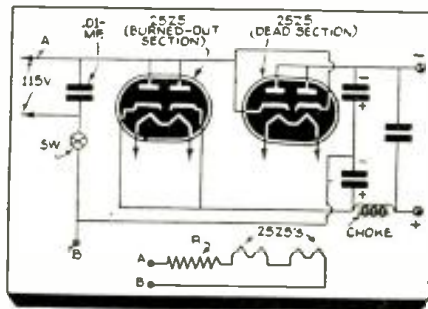

TESTS NOISY TUBES

● HEATER-TYPE tubes which are noisy, usually have cracked insulators which allow escape of electrons to the cathode.

This type of short does not show on the average short checker but will be detected by the checker I am describing.

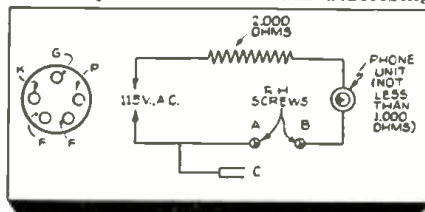

Preheat tubes in set, then quickly touch tube prongs to points A & B in the following order—F,K—K,G—G,P—P,F. Screen grid tubes from cap "C" to K,G,P,F, etc. If a short is present an A.C. hum will be heard in phone.

F. F. FEINER,
St. Louis, Mo.

IRON PARTICLES IN SPEAKER AIR GAP

● I FELT quite flattered in finding my operating notes in the May and June issues of your fine magazine and so en-

couraged, I thought you might be able to use a service 'kink' or so of mine.

A large percentage of my servicing in this area is on battery operated radios and of course they are mostly equipped with permanent magnet dynamic speakers, that are continually causing trouble by getting iron filings in the voice coil field and since the magnetism is permanent, it makes it difficult to remove these offenders.

I have found three methods of quickly removing these small iron particles.

The first method is commonly known, viz., the use of a small strip of adhesive tape on a very small thin prod which is worked through the small space between poles of the magnet. Most of the filings will adhere to the tape and be drawn out. Two objections to this method are; (1) many poles are too close together for a clumsy contraption like this; (2) oftentimes one replaces the cone to find that there are still some filings not removed.

The second method I use sometimes, is to fuse them out with a tiny contraption I make out of two narrow and thin pieces of mica with openings carved out lengthwise through the centers, and between which is sealed a thin piece of metal foil. This foil is connected to one side of a battery, or small transformer and the other side is attached to the metal frame of the speaker. The construction of this gadget should be so planned that when it is worked through the opening of the magnetic field, the metal conductor, between the insulating mica strips will not contact the poles of the magnet but will contact any small protruding metal filings, which will instantly be fused to nothingness.

This is how I make it:

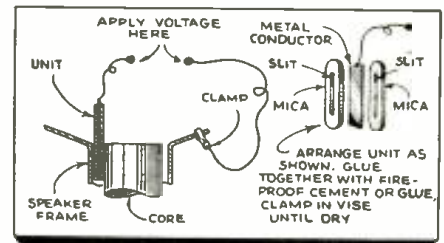

This method is very good but care must be taken not to use too much voltage or it may melt your metal fuser plate between the mica insulators. This fuser is also fine for removing metal filings from rotor and stator condensers.

The third method I use more than any other. It is the simplest and most effective of all. Melt paraffin between the poles of the magnet, making sure that it melts and flows deep into the aperture and then, after it cools, claw it out with a small metal probe having square edges. This method removes the filings with the paraffin and any filings left deep between the magnetic poles are prevented from causing any trouble, because they are sealed in paraffin.

One must bear in mind, when poring wax in *electro dynamics*, that the field coils often heat considerably. Therefore don't leave too much residue wax in this type speaker.

C. D. O'NEAL,
West Union, W. Va.

(Continued on page 114)

TEST YOUR RADIO KNOWLEDGE

—With Questions and Answers from Radio Schools

When you ask for a radio job, you've got to answer questions; when the customer consults you about doing some work, you have more questions fired at you; and when you actually get down to doing the work, still more questions arise—to which you must know the answers or else step back and let the next fellow, who does know, step in and take your place. So, RADIO-CRAFT urges you to use the following questions and answers, selected at random from a number supplied with the kind cooperation of foremost radio schools, as a check-up on your knowledge of radio. DO IT TODAY—IT WILL PAY.

Questions . . .

(The following questions were submitted by Coyne Electrical School, Chicago, Ill.)

- Q.1. Give one advantage of using a full-wave instead of a half-wave rectifier.
 Q.2. Give the rule for finding the value of the grid-bias resistor.
 Q.3. What current value is used to determine the bias voltage in a push-pull circuit using a bias resistor connected between the cathodes and "B" negative?
 Q.4. What percentage of safety factor should be considered in figuring the watts rating of a resistor?
 Q.5. What is the most common size of R.F. filter condenser used in the power detector tube plate circuit?
 Q.6. What condenser should be aligned first in a superheterodyne receiver?
 Q.7. Give 4 reasons for aligning a superheterodyne.
 Q.8. If the plates of a rectifier tube get red hot, what would the trouble be?
 Q.9. Name 3 troubles that would not be shown on a set analyzer.
 Q.10. What is the "grid test"? What is it used for?
 Q.11. What frequencies are required for the vertical and also the horizontal deflecting coils of a television cathode-ray image receiving tube?
 Q.12. What factors limit the dependable range of a television transmitter operating on ultra-shortwaves?
 Q.13. Why will adding or subtracting 1 stage in the video amplifier of a television set-up reverse the image from positive to negative, or vice versa?
 Q.14. Why is sound placed 20 frames ahead of the picture on a sound film?

(The following questions were submitted by Lincoln Engineering School, Lincoln, Nebr.)

- Q.15. Explain how "reverberation" and "echo" tend to distort sound.
 Q.16. Define the term "optimum period of reverberation".
 Q.17. Define the term "period of reverberation".
 Q.18. How can a high period of reverberation in an auditorium be corrected?
 Q.19. What are the essential units of any public address installation?
 Q.20. Which has the greater output, the condenser-type or the carbon-button-type microphone?
 Q.21. In general, which type of microphone is the more faithful from a frequency response standpoint, the carbon or the condenser?
 Q.22. Compute the amplification factor of a tube in which a change in grid voltage of 10 volts produces a change in plate current of 20 milliamperes, whereas it takes 30

volts change in plate voltage to produce the same plate current change.

- Q.23. If a change in plate voltage of 20 volts produces a change in plate current of 2 milliamperes, what is the plate impedance of the tube?
 Q.24. Compute the mutual conductance of a tube whose plate current changes 10 milliamperes when the grid voltage is changed 2 volts.
 Q.25. State 3 principal characteristics of mercury-vapor tubes.
 Q.26. What is the principal difference between the action of the Tungar type of

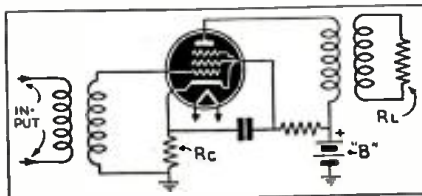

Q.30. A pentode amplifier.

rectifier tube and the mercury-vapor type (such as the 82, 866, etc.)?
 Q.27. Why do gas-filled tubes have low voltage drops compared to the high-vacuum type?

(The following questions were submitted by Tri-State College, Angola, Ind.)

- Q.28. A 2-wire transmission line is to be used to couple a 15 kw. transmitter to an antenna which is 1,000 ft. from the transmitter. The line is to have a surge Z of 600 ohms and is to be of No. 6 copper wire. The actual power transferred over the line is to be 16 kw. Determine the spacing between wires of the line, the D.C. resistance of the line and the power loss. (Assume R.F. resistance to be 10 times the D.C. resistance.)
 Q.29. Find the power expended in an A.C. circuit having a voltage of 1,000 volts, 90 cycles frequency, 0.5-hy. inductance, 100 ohms resistance, and a 100 mf. capacity. The L, R, and C are in series.
 Q.30. A pentode tube is to be used in the given circuit with the characteristics and values as follows:
 Eg -20 volts
 Load resistance (RL), 8,400 ohms.
 Power output for 6% distortion, 5 watts
 Cathode current (plate + screen) 50 ma.
 Determine the value of Rc, r.m.s. component of plate current at signal frequency, A.C. voltage across Rc, and voltage needed to drive grid normally. If Rc is omitted so as to get degeneration what will be the required voltage to drive the grid and what effect will it have on amplification, and what would the resulting power output be?

Answers . . .

- A.1. It is more economical and easier to filter.
 A.2. Required resistance = $\frac{\text{Required grid volts per tube}}{\text{Total direct current flow in amperes through the biasing resistance}}$
 A.3. The plate current of both tubes in the case of a triode-tube hook-up; and if the tube has a screen-grid, both the screen-grid and plate current must be considered.
 A.4. At least a 50% safety factor.
 A.5. .00025-mf. (250 mmf.)
 A.6. The I.F. compensating condensers.
 A.7. (1) Poor sensitivity. (2) Poor selectivity. (3) Oscillation. (4) Dead spots on the dial.
 A.8. It would most likely be a shorted filter condenser.
 A.9. (1) Open primary in antenna coil. (2) The rotors of the main tuning condenser shorted to the stator plates. (3) Shorted voice coil in the speaker.
 A.10. The grid test is a means of changing the negative grid bias of a tube to determine the amplifying merits of the tube.
 A.11. The frequency supplied to the vertical deflecting coils must be equal to the field frequency of the transmitter. The frequency supplied to the horizontal deflecting coils must be equal to the number of scanning lines per second produced by the transmitter.
 A.12. (1) Short waves travel in straight lines. (2) The ground-wave is quickly absorbed. (3) The sky-wave reflected from the ionosphere shifts from point to point, making this signal unreliable for regular reception. These conditions limit the dependable range to the straight line of vision distance.
 A.13. As a signal passes through a resistance-capacity coupled stage, the polarity of the signal is reversed 180 electrical degrees.
 A.14. When the film passes through the sound projector, it enters the projection gate first and then passes on down several inches before it enters the sound gate. When a certain frame is over the projection gate, the sound belonging to it must be over the sound gate.
 A.15. Distortion from reverberation and echo is due to the reflected sound waves arriving at the listener's ear out-of-phase with the sound waves which travel to the listener direct from the sound source.
 A.16. The term "optimum period of reverberation" refers to the desired period of reverberation for rooms of various sizes. For example, a room whose volume is 20,000 cubic feet would have an optimum period of 1.1 seconds. The smaller a room the smaller should be the optimum period.

(Continued on page 121)

SERVICING "Coin-Operated" PHONOGRAPHS

Service men will find that, on 9 out of 10 calls, it's the sound system and not the mechanical system of coin-operated electric phonographs which requires servicing. There's business here for you.

SANFORD MILLER

No. 3

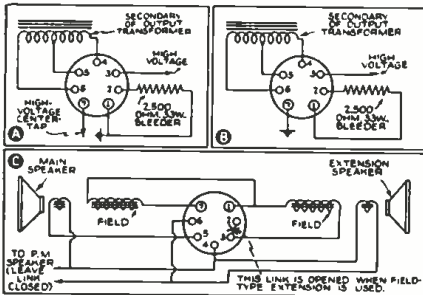

Fig. 1. In A, existing speaker plug connections for manufacturer's extension speaker; in B, wiring changes in plug for attaching your own speaker.

A LARGE percentage of coin-operated phonographs are located in taverns and cabarets, and the machine is usually placed near the bar where it may be used to furnish music and entertainment to daytime patrons.

Evenings, music is often required in the cabaret proper for dancing and entertainment and this has necessitated the use of *extension speakers and microphones* in conjunction with the phonograph. It is the purpose of this article to discuss the different extension speaker and microphone installations.

WURLITZER EXTENSION SPEAKERS

Many of the older Wurlitzer machines—such as the 412 and 616, use the field supply furnished by the amplifier to energize the extension speaker.

The original extension speakers furnished for the 412 and 616 models used a set of plugs and sockets (see Fig. 1A) and when plugged into the amplifier the extension was ready for operation without any wiring changes or soldering.

By examining Fig. 1B it can be readily seen that any 2500 Ω dynamic can be used as an extension speaker on these two models by making a few simple connections to the speaker plug and opening the link between the No. 2 and No. 3 prongs of the speaker socket. Thus the enterprising radio Serviceman can furnish and install extension speakers and spare the operators the additional expense for the more complicated plugs, sockets, etc.

Furthermore, although most phono. manufacturers sell extension speakers to operators, the radio Serviceman has a distinct advantage in that he can furnish a wide selection of appropriate speaker housings to harmonize with the interiors of various locations, whereas, the operators previously had no choice.

A large outdoor summer garden, for instance, would require a directional, weatherproof speaker enclosure properly placed and installed and the Serviceman is in a better position to furnish and install speakers than for an operator to depend on one standard unit to fill all his extension speaker requirements.

Your writer was called upon to furnish 3 extension speakers on one location and it was comparatively simple to hook up 3 P.M. speakers to the instrument, whereas the manufacturer had no speakers of this type available that could be plugged into the amplifier. The prohibitive cost of extra field exciters and 4-wire speaker cable prevented the use of the customary field type.

Since the speaker plug wiring is the same on all Wurlitzer models made so

far, when using P.M. speakers the voice coil is hooked to the No. 4 and No. 6 prongs. If the speaker line is to run more than 100 ft. it is a good idea to use a 500-ohm line as shown in Fig. 2.

The amplifier used in the model 24 Wurlitzer has no provision for external field supply. However a dynamic with a 500-ohm to 1000-ohm field can be used for extension if hooked-up as follows: Break link between the No. 2 and No. 3 prongs on speaker plug and connect field wires from extension speaker to these 2 prongs. Connect voice coil leads to the No. 4 and No. 6 prongs. This places the field between the center-tap of the high-voltage secondary and ground.

MIXING METHOD

In Fig. 3 is shown a useful mixing method that can be used with any extension speaker. This mixer enables an extension speaker to operate at a high volume level while the main speaker is running at a whisper or turned completely off. Both voice coils are wired in series.

Figure 4 shows the hookup for all Seeburg models. No field supply is available and only P.M.'s can be used.

There are 2 methods of wiring extension speakers to all Mills Novelty Co. machines. The 2 taped leads coming out of the amplifier on all models are taps on the output transformer primary for connection to a 4,000-ohm primary matching transformer for an extension speaker; or the voice coil of the extra speaker may be wired in parallel with that of the main speaker. P.M. speakers only can be used.

For installing an extension speaker on Rock-Ola phonographs, the voice coil leads are simply connected to the 2 screws marked "Ext. Spkr." on the amplifier terminal strip.

MICROPHONE INSTALLATIONS

The installation of microphones on coin-operated phonographs is another source of income to the radio Serviceman. Here again manufacturers offer no selection of mikes to the operators and the hookups are not flexible enough to satisfy the critical location owner. The Serviceman, on the other hand, can install the mike to fit the requirements of the various locations, and can also offer a wide variety of types and stress the fact that each installation can be "tailor-made" to requirements.

The average location, unless a very high volume level is essential, can have a mike operate through the phonograph without a preamplifier if a high-level mike (approx. -45 db.) is used such as

(Continued on page 121)

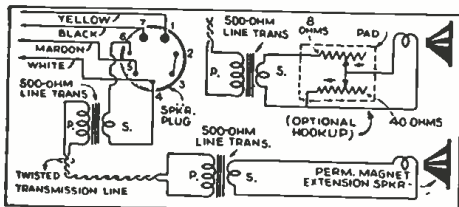

Fig. 2. Use a 500-ohm transmission line for long runs on P.M. dynamic speaker extensions

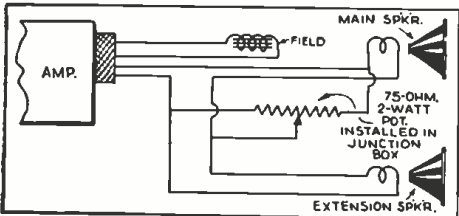

Fig. 3. A simple "mixer" for extension speakers.

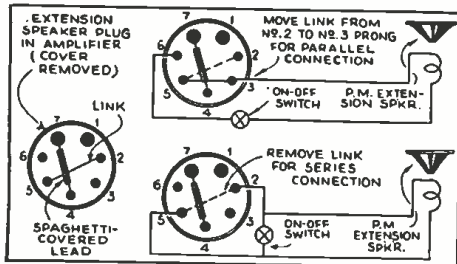

Fig. 4. Extension speaker hookup for Seeburg jobs.

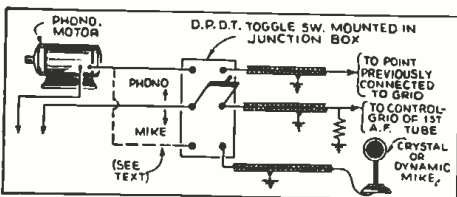

Fig. 5. Installing a high-level microphone.

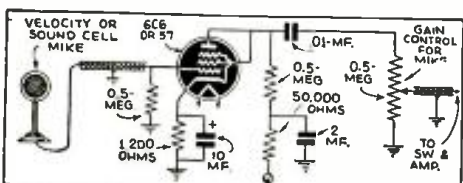

Fig. 6. Preamplifier for use with low-level mikes.

CANADIAN RADIO BIZ STALEMATED

Dear Editor:

The Canadian radio license fee is \$2.50, since April Fool's Day 1938 (hi, hi).

In other words we have to pay \$2.50 per each radio to hear U.S. programs. If we have 2 house radios and 1 auto radio, cost is \$7.50. Some fun, eh?

I am enclosing a sticker (shown below) placed in every Canadian made-in-Canada radio. Please reprint for your American friends.

The law says that we Servicemen cannot service a radio unless the radio license accompanies the set; if the owner has no radio license, we can be fined \$50.00 for repairing the set.

Perhaps a few words here as to how this mess started will help.

Since the day radio broadcasting started in Canada, privately-owned stations were operated. For the last 6 or 8 years we have been bombarded with advertising, until the dear public would stand for it no longer. Also the coverage of these stations was small. So, as the good (?) old government said, we will build some high-power stations, which they did, and cut out the advertising and commercials, which they did not, so now the government said to the public, you will have to pay for these stations, etc., and there you have the short story.

Radio sales in Canada have not moved ahead for 3 years; auto-radio sales are flat.

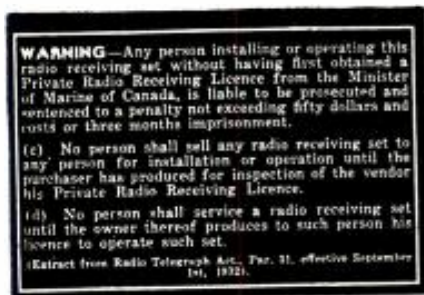

Why?; would you pay \$2.50 per radio? Number 1A propaganda was that story on Canada interference.

ROBERT ROGERS,
Lachute, Quebec, Canada

AMPLIFIER DISTORTION TESTS

Dear Editor:

May I congratulate you on the May *Radio-Craft* article "Intermodulation" by A. C. Shaney. (Thank you!—Editor)

I have been keenly aware of this type of distortion for many years. I have called it "cross-modulation" and have long used a technique for measuring it.

This technique consists, in our electronic piano tests, of striking 2 notes at a time in the upper registers and listening for the lower beat frequency. For example, if we strike together the second C above middle C and the E above it, having frequencies of 1,046.50 and 1,318.51 cycles respectively, the "difference" or beat tone resulting from the cross-modulation of their fundamental components is 272.01 cycles, which is between middle C and middle C sharp, 2 octaves lower. This frequency is easily heard in the presence of the other two.

There is, of course, also a "summation" frequency present which is equal to the sum of the 2 fundamentals or 2,365.01 cycles, but this is much less audible because it falls between the second partial of the C and the second partial of the E which are 2,093.00 and 2,637.02 cycles respectively and is easily masked by them. Since the fundamentals

Mailbag



are not pure tones but on the contrary complex, many other summation and difference combination tones may appear but these too are usually so weak as not to be easily heard.

This test is naturally only qualitative but since it uses the ultimate criteria of distortion, the ear, as a detector it is simple and very effective. In making this test the amplifier gain is reduced to a point where the beat tone is not heard while the 2 individual tones are still strongly audible. If the electrical output of the amplifier be then measured we have the operating power at which cross-modulation is unnoticed.

My quantitative method utilizes 2 simultaneous sine wave signals as input to the amplifier. A harmonic analyzer (such as General Radio, which I use) measures the output voltages of the 2 input signals and that of their resultant beat frequency. These 2 frequencies may be of whatever values are convenient and whose difference will fall well within the operative frequency range of the amplifier, say 1,000 and 1,200, which yield a difference frequency beat of 200 cycles. If the 2 sine wave signals are adjusted to give an output voltage of 100 units each, then the output voltage of the beat frequency can be expressed directly as a percentage representing cross-modulation distortion, and the amplifier can be rated with this distortion percentage for various outputs. Probably 1 per cent is a safe allowable maximum.

Many high-grade amplifiers which we have so tested could not be given a power rating of more than 20 per cent of their ratings based on total harmonic content with single frequency distortion measurement methods. (Italics ours.—Editor)

Our methods are the only ones which yield any really reliable distortion indicators and we have found them indispensable in our tests. Certainly all high-grade amplifiers used especially with electronic musical instruments should be tested and given a rating for this form of distortion.

BENJAMIN F. MIESSNER,
Miessner Inventions, Inc.,
Millburn, N. J.

MR. SHANEY REPLIES

Dear Mr. Miessner:

Your recent letter has been brought to my attention by *Radio-Craft*.

The technique you use in determining the distortion on your electronic piano is very interesting, but I believe, not ideal.

As you undoubtedly know, products of intermodulation may be formed in any non-linear generator or conductor, and there therefore is a strong possibility that intermodulation is produced in the strings and

pickup device, and its associated mechanical structure.

You really cannot use the ear as the ultimate criteria of distortion, because it is subject to conditioning. Fletcher, Olson and Massa have proven that the ear will detect varying percentages of distortion, depending upon what it has heard previously. While this method may be arbitrarily used, I believe it is much more advisable to use laboratory equipment to measure the actual total harmonics present.

With your method, you may adjust the amplifier so that cross-modulation is unnoticed when 2 notes are struck. However, these modulatory products may be greatly increased when 3 or more notes are struck, which I believe is what actually takes place during the average piano rendition.

In making your laboratory analysis with 2 signal generators, it is of utmost importance that these original signals be entirely free of harmonics. Band-pass filters should be used for each of these frequencies so as to insure an ideal laboratory measuring set-up.

Your power rating data, as based on total harmonic content, with 2 signals, as compared with a single signal frequency, closely approximates measurements made in our laboratories on commercial amplifiers. Unfortunately, competitive ratings make it unsatisfactory to rate amplifiers to include intermodulation, because many ultimate consumers are unaware of the differences in ratings, which would result by following this plan. As you can readily see, the manufacturer who rates his amplifier based on a dual test frequency, appears in a poorer light.

A. C. SHANEY,
Amplifier Co. of America,
New York, N. Y.

NOTE RE. "BOAT-RADIOPHONE MARKET"

Due to unforeseen circumstances the above titled article, scheduled to appear in this issue, has been re-scheduled for the following issue of *Radio-Craft*.

FREE SPEECH—AND HOW!

Dear Editor:

In regard to the "Servicing Questions & Answers" feature of your magazine, the kind of problems printed are not the kind men in this city are likely to encounter.
(Continued on page 125)

ADMIRAL "AEROSCOPE" MODELS 161-5L, 162-5L AND 163-5L MIDGET SETS

5-Tube (and Ballast) Superhet.; 110 V. A.C.-D.C.; "Aeroscope" (Built-In Loop) Antenna; Beam Power Output; Range: 535 to 1,730 kc.; Automatic Volume Control.

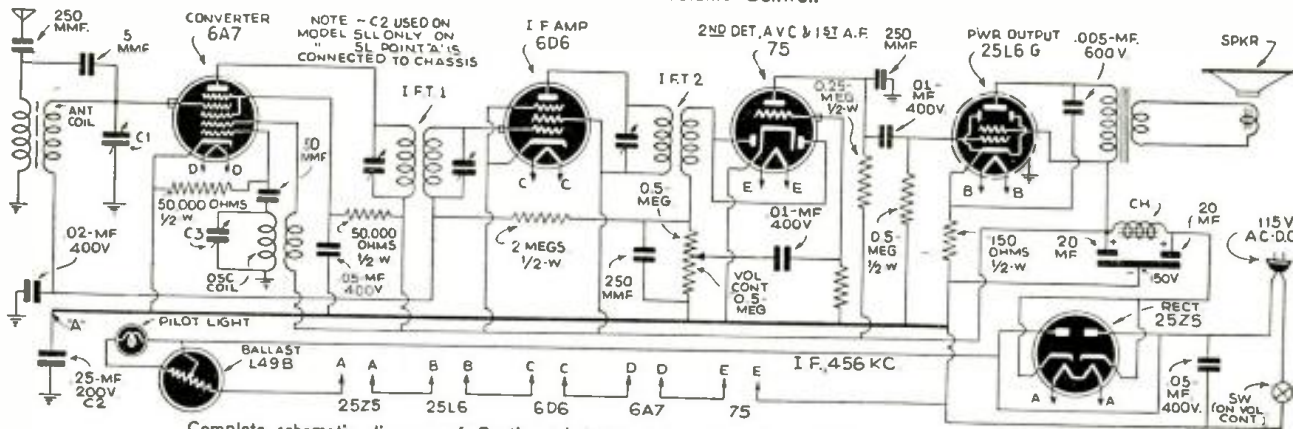

Complete schematic diagram of Continental Radio & Television Corp. 161-5L, 162-5L and 163-5L receivers.

I.F. ALIGNMENT

Adjust the test oscillator to 456 kc. and connect the output to the grid of the 1st detector tube (6A7) through a 0.05- or 0.1-mf. condenser. Connect ground or test oscillator to chassis ground through a 0.1 mf. condenser. Align all 3 I.F. trimmers to peak or maximum reading on the output meter.

BROADCAST-BAND ALIGNMENT

Adjust the oscillator to 1,730 kc. and connect the output to the antenna lead, through a 200 mmf. mica condenser. Set the gang condenser trimmer (oscillator) to receive this signal. After this has been carefully done, the next step is to set the generator to 1,400 kc. and after tuning in the signal adjust the antenna trimmer to peak. This is all that is necessary for the alignment unless the plates of the gang condenser have been bent out of shape. In case of bent plates, set the test oscillator and the receiver to 600 kc. and bend the plates into the position for maximum output.

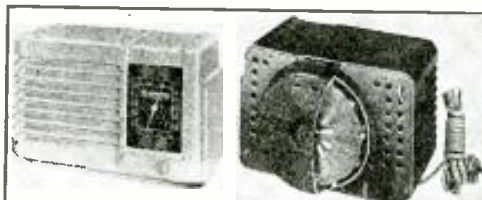

Front and rear views of the model 162-5L. Note built-in spider-web "Aeroscope" loop antenna.

The loop antenna, although comparatively small, is quite efficient due to the use of "spiderweb" construction. That is, the wire weaves in and out of a number of radial (wooden) dowels.

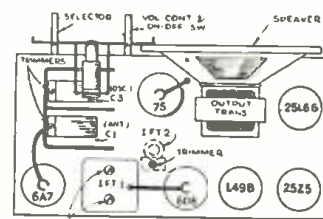

Location of tubes and trimmers.

KNIGHT (ALLIED RADIO CORP.) MODEL E10716 BATTERY PORTABLE

4-Tube Superhet.; Low-Drain 1 1/2-V. Tubes; Self-Contained Battery Pack; "A" Drain, 0.25-A.; "B" Drain, 10 ma.; 5-in. P.M. Dynamic Speaker; Vertical "Slide Rule" Dial; Automatic Volume Control; Extended Range: 535 to 1,720 kc.

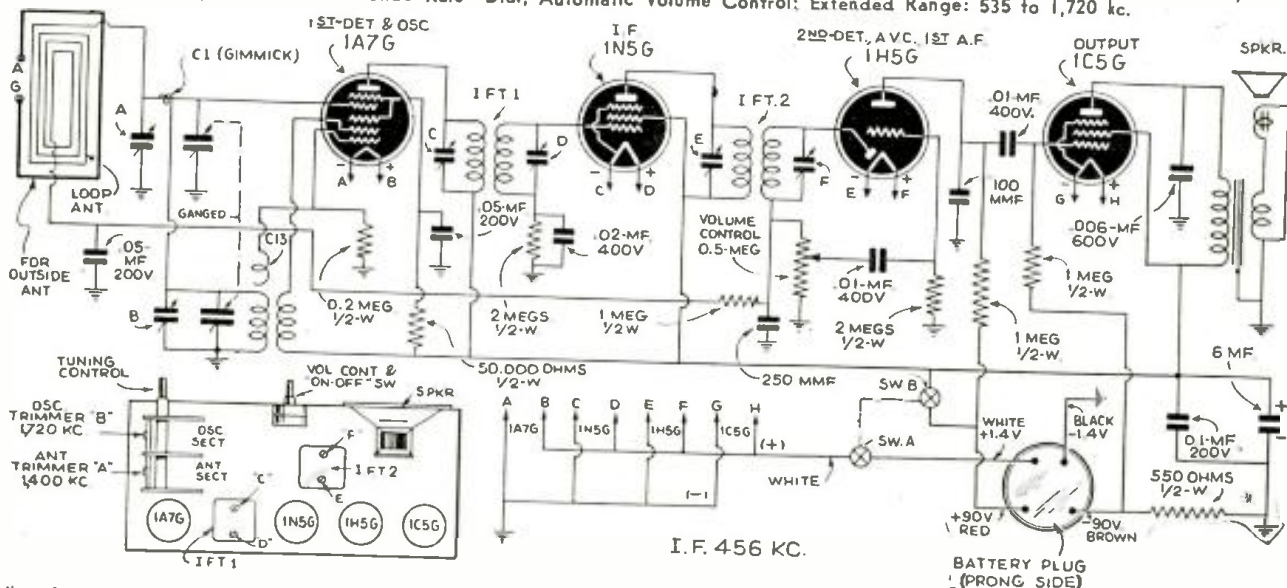

ALIGNMENT PROCEDURE

The alignment of this receiver—for max. gain and correct dial calibration—requires the use of an accurately-calibrated test oscillator that will cover the frequencies of 456, 600, 1,400 and 1,720 kc., and an output meter to be connected across the primary or secondary of the output transformer. Align with volume control on max. and test-oscillator output reduced to prevent the A.V.C. from operating and giving false readings. After the I.F. transformers have been properly adjusted and peaked, the broadcast band should be adjusted. With the gang condenser set at minimum, adjust the test oscillator to 456 kc. and connect the output to the grid of the 1A7G 1st-detector tube through a 0.05- or 0.1-mf. condenser. The ground on the test oscillator should be connected to the chassis ground. Align all 4 I.F. trimmers to peak or maximum reading on the output meter. Connect the antenna terminal to the generator through a 200 mmf. dummy and the ground terminal to the generator ground. Set the dial and generator at 1,720 kc. (gang at minimum capacity). Align the B.C. oscillator trimmer for maximum output. Set the test oscillator at 1,400 kc. and tune in the signal with the dial and adjust the antenna trimmer for maximum output. Check the sensitivity at 600 kc.

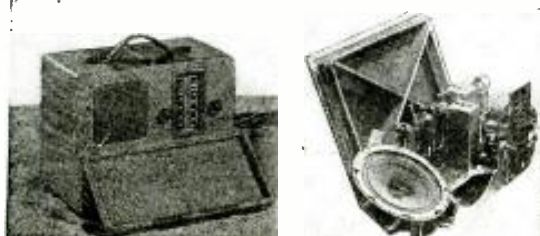

RCA VICTOR MODEL M-70 2-UNIT AUTO-RADIO (Chassis No. RC-394)

7-Tube Superhet.; Pushbutton Tuning; Power Supply and 8-watt Output Stage in Speaker Housing; Delayed A.V.C.; Low- and High-Frequency Tone Control; Push-pull Beam Power Output.

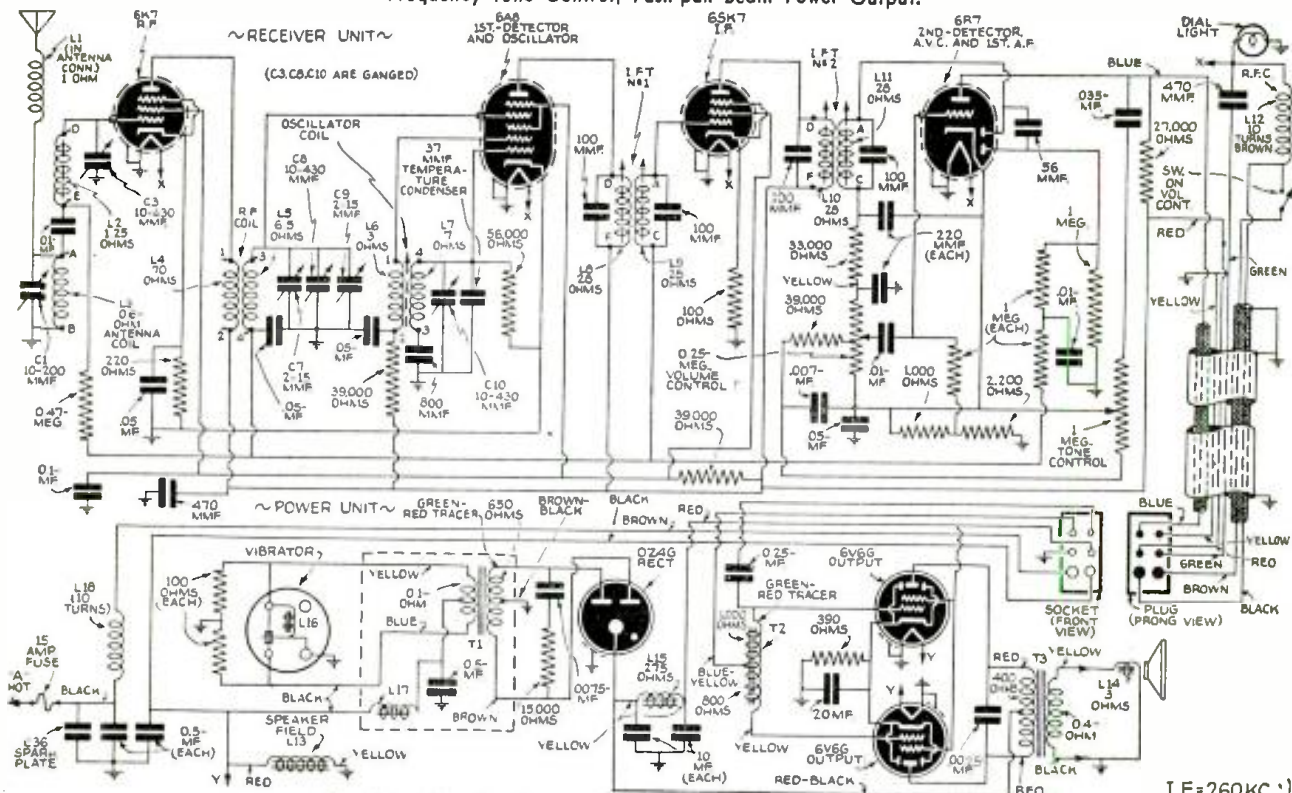

Complete schematic diagram of the RCA Victor model M-70 auto-radio.

I.F.=260KC.)

MR. SERVICEMAN:

This is No. 259 in a series of Radio Service Data Sheets which Radio-Craft instituted with the October, 1929 issue. During this time the manner of presenting these Data Sheets has undergone considerable modification in accordance with comments by readers. Can you suggest any changes which will make these Data Sheets of greater value to the majority of the Servicemen who read Radio-Craft?

Alignment Procedure

- **Test Oscillator.**—For all alignment operations, connect the low side of the test oscillator to the receiver chassis, and keep the output signal as low as possible to avoid A.V.C. action.
- **Cathode-Ray Alignment** is the preferable method. Connections for the oscilloscope are as follows: Vertical "H1" to terminal "C" on 2nd I-F transformer;

vertical "0" to chassis.

Output Meter.—Connect the output meter across the speaker voice-coil and turn the receiver volume control to maximum (fully clockwise) and the tone control to middle of range.

Dial Calibration.—Rotate the gang condenser to its full-mesh (maximum-capacity) position and then adjust dial scale so that the pointer is aligned to the last calibration mark at the low-frequency end of the scale.

Steps	Connect the high side of test-osc. to—	Tune test-osc. to—	Turn radio dial to—	Adjust the following for max. Peak output
1	6SK7 I.F. grid (No. 4 pin) in series with 0.01-mf.	260 kc.	No Signal	L10 and L11 (2nd I.F. Trans.)
2	6A8 Det. grid cap in series with 0.01-mf.	260 kc.	550-750 kc.	L8 and L9 (1st I.F. Trans.)
3†	*Ant. connector in series with 60 mmf.	600 kc.	600 kc.	L7 (osc.)
4†	*Ant. connector in series with 60 mmf.	1,400 kc.	1,400 kc. signal	C7 (det.)
5†	*Ant. connector in series with 60 mmf.	600 kc.	600 kc. (rock)	L7 (osc.)
6†	*Ant. connector in series with 60 mmf.	1,400 kc.	1,400 kc. signal	C7 (det.)

*Note 1.—This 60 mmf. condenser must be inserted at the antenna connector of the receiver. The lead from the test oscillator to the 60 mmf. condenser may be shielded if desired, but no shielding should be used between condenser and antenna connector.

†Note 2.—These adjustments should be made with unit enclosed in its shielded case, through holes provided for adjustment purposes.

**Note 3.—Final adjustment of C1 must be made after the receiver has been installed and the antenna connected. See "Antenna (Result)."

Antenna Circuit

It is very important that these instructions be followed when installing the M-70 receiver.

The antenna circuit is designed to work with an antenna having a total capacity including the shielded lead-in not to exceed 150 mmf. If an antenna having a larger capacity is to be used, it will be necessary to add a condenser in series with the lead from the antenna filter L1 to the antenna coil terminal ("A"). Where a "Doublet Under the Running Board" type of antenna is to be used having a capacity of approximately 200 mmf., the condenser added should be approximately 500 mmf. The insulated running board type having an approx. capacity of 550 mmf. will require a condenser of approximately 150 mmf. Cars using an insulated steel top of approximately 3,500 mmf. will require a series condenser of 150 mmf.

After installation and with antenna connected, tune in a weak station near 1,400 kc. and adjust capacitor trimmer C1 for maximum signal output. This trimmer is accessible by removing plug button near antenna jack on top of receiver. If a maximum (peak) signal output cannot be obtained in the range of the antenna trimmer, the effective capacity should be checked and compensated for by varying series capacity as described above.

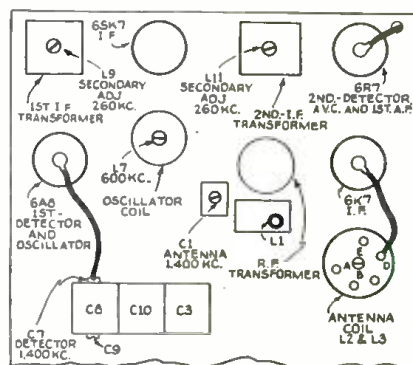

Locations of tubes and alignment trimmers.

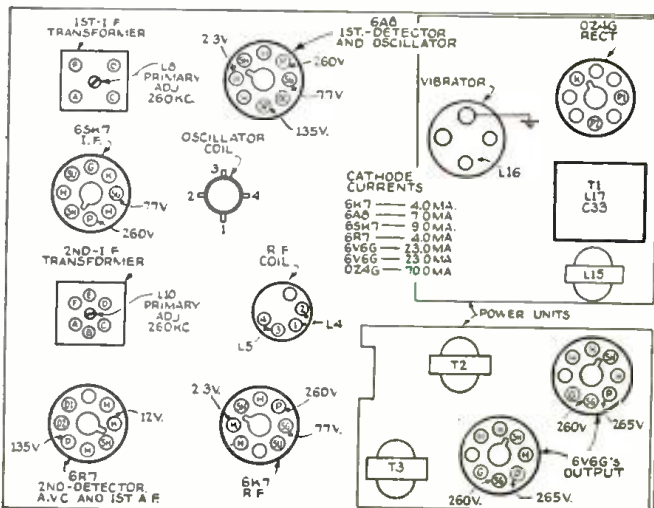

Under-chassis views of receiver and power unit giving socket voltages.

THE LATEST RADIO EQUIPMENT

The address of any mentioned manufacturer will be sent on receipt of a self-addressed, stamped envelope. Mention of item number hastens reply.

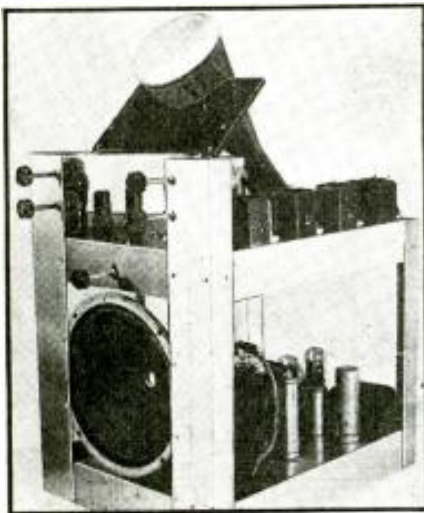

Latest telly kit. (1765)

LATEST TELEVISION KIT (1765) (Fulton Radio Corp.)

THIS high-definition television kit markets for a little under \$90 to which add about \$60 for a set of tubes, including a 7-in. C.-R. tube—with a 5-in. C.-R. tube probably a few dollars less. The image appears on either a 5- or 7-in. black and white C.-R. tube. These are not directly interchangeable without any circuit changes. Eighteen other tubes are used in the "Observox". An interesting claim of the manufacturer is a provision for positive control over the synchronizing impulse separator thereby insuring steadiness of image no matter how feeble the signal may be. Three video I.F. stages, each with only one adjustment are incorporated. The kit is easy to assemble since there is plenty of room on the chassis, and since the instructions are concise, and include pictorial and schematic diagrams.

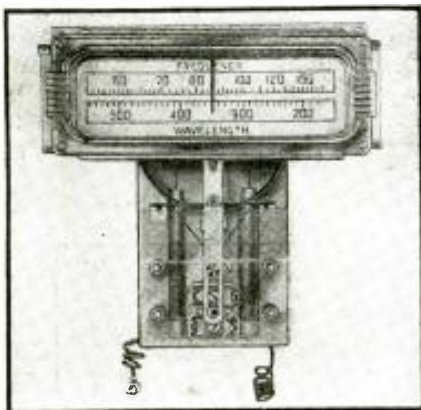

Permeability tuner. (1766)

PERMEABILITY TUNER (1766) (Aladdin Radio Industries, Inc.)

ALTHOUGH the principle of this tuner is about as old as radio itself it now, for the first time, becomes both practical and convenient to use. Tuning is accomplished by varying inductance instead of capacity in tuned circuits by the insertion of "polyiron" cores within the respective fields of the coils. A novel and ingenious mechanical movement enables one to tune the receiver in the conventional manner by the rotation of a knob. Uniform gain and selectivity across the entire broadcast band may be obtained with this unit. The manufacturer is marketing a foundation kit, including the permeability tuner, matched I.F. transformers and all essential condensers required for the R.F. tuned circuits. Complete and detailed instructions accompany the kit.

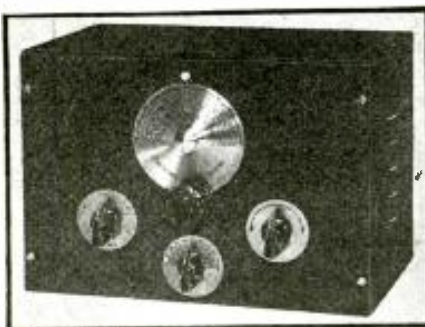

Hi-gain preselector. (1767)

HIGH GAIN PRESELECTOR (1767) (Browning Laboratories, Inc.)

THIS new general-coverage preselector tunes over a frequency band of from 5 to 185 meters (64 to 1.6 megacycles). Unit has 5 bands, and is claimed

to be extremely "hot" on all bands. A type 1852 tube is used as regenerative I.F. amplifier. Image rejection ratios are obtainable, while a marked gain in signal-to-noise ratio results from the use of a very-high-Q tuned antenna system. It is claimed that the R.F. gain may be as high as 800 or more times (even on the 5- and 10-meter bands), according to the amount of regeneration used.

SCHOOL RADIO AND TALK-BACK SYSTEM (1768) (Bell Sound Systems, Inc.)

THIS new apparatus provides for radio, phonograph or voice amplification as well as intercommunication, with as many as 40 outlying stations. The instrument embodies an 8-in. audible monitor, 25-W. amplifier, ratio tuner and phono turntable. All 40 outlets are controllable by individual key type switches—as well as a master switch for emergency use. Bass and treble compensation are employed.

ZERO-CURRENT VOLTMETER (1769) (Hickok Electrical Instrument Corp.)

THIS new bench tester in a streamlined case features a 9¼-in. rectangular meter, having a scale length of 8¾ in. Electrical characteristics include a zero-current voltmeter circuit which gives infinite ohms-per-volt to 250 V. D.C.

New ranges added for television servicing include 1,000 and 10,000 V. at 880 ohms-per-volt. Over 880 megohms resistance at 10,000 V.

Another fine feature is the metered power outlet in the panel by which power consumption of unit under test may be checked at any time or watched for intermittent troubles. Other than these the instrument covers the usual ranges of A.C. and D.C. faults, at 1,000 ohms

(Continued on page 127)



School sound system. (1768)



Above, new meter. (1769)
Right, new regulator. (1770)



All the worthwhile
Radio Trade News
of the past Month—
Digested for busy
radio men.

RADIO Trade Digest

A PLEDGE: — To
print the important
news of the radio
industry; to review
major news events;
to help point a path
to radio profits.

IMPORTANT HAPPENINGS OF THE MONTH IN THE RADIO INDUSTRY

No. 12

AUGUST, 1939

No. 12

RSA CHAPTERS NOW PLUG NEW BIZ DRIVE

Profit Angle Getting More
Thought; Moves Made to
Combat Price Cuts

DANVILLE, ILL., CHAPTER: "Showmanship" was the subject of instruction, and Owen McArdle, George R. McKinney, Ben Williamson, and George Daniels all contributed their talents to make this a very beneficial program in a series on business. Dramatization of the right and wrong way to make a service call; a talk on showmanship in business, stressing the value of impressions on the customers; and specific cases where showmanship would have changed an average call into a profitable experience, made up the program.

A 15-minute program on WDAN sold its purposes as an organization to the public. A display in a prominent downtown window in observance of National Radio Week also helped.

DETROIT CHAPTER: A new feature, Business Case Histories, was added to the program of the Detroit meetings. This should develop into a very valuable period, since most members are very much interested in the business side of
(Continued on page 122)

WILL PHONE LINES STOP WORRIES ABOUT NATIONAL TELEVISION NET?

Industry Wonders if Broadcast Carried on Standard
Wires 1 1/3 Miles from Bike Race to Xmtr
Marks New Era. Phone Co. Says Not

When the announcer at the 6-Day Bicycle Race in Madison Square Garden casually mentioned that both sound and images of the race were being sent to the NBC transmitter, W2XBS, in the Empire State Bldg. not by short wave link or coaxial cable, but over phone lines, engineers at their home receivers pricked up their hairy ears and wondered if the millennium had arrived. Had some new principle, they asked themselves and each other, been discovered, to make possible transcontinental telly networks over leased lines no more expensive than those used by standard sound broadcasting stations? They hoped so; some even thought so.

When morning came, the switchboards at Bell Labs. and the A.T.&T. were swamped with calls—among them one
(Continued on page 122)

CAN'T IT HAPPEN HERE?

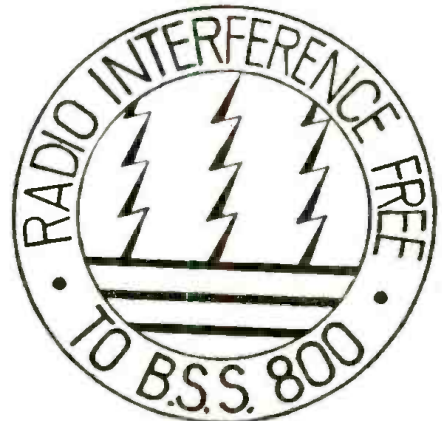

The British Standards Institution awards this seal to mfrs. of household & other elec. appliances which have been tested & found not to cause interference.

RECORD CROWD AT "RSA-WESTON" TELEVISION DEMONSTRATION



More than 1,200 Servicemen in the Metropolitan N.Y. area attended a meeting to see demonstrations & hear discussions on television installation & servicing equip't. Speakers included Norman Hall, Television service mgr. of Du Mont Labs.; J. K. Whittaker, Chief Instructor of RCA Institutes, O. J. Morelock, Television engineer, & V. E. Jenkins, mgr. of Radio Sales, Weston Electrical Instrument Corp.

VISITS NEW SOUND SALES & ENGINEERING HOME



When Art Beyer, T. O. Sullivan & L. E. Harris opened their new Sound Sales & Engineering Co. headquarters in Houston, Tex., one of their first visitors was Walt Marsh, sales mgr. of Meissner Mfg. Co. The men mentioned above appear in the picture in the order their names appear—left to right.

Personal

These men are worth knowing; meet them here.

B. E. PALMGREN, formerly in the appliance biz on the west coast, replaces **DEAN LEWIS**, resigned, as northwest-central district sales mgr. of the Stewart-Warner radio div.

DR. W. R. G. BAKER, until now chairman of General Electric's radio management committee, is now mgr. of the co.'s Radio & Television Dept. (See pic. below.)

JAMES MILLEN, long a leading spirit of the National Co., Inc., has left to establish his own company. (See New Addresses column.)

KEN R. DYKE, ex-NBC eastern div. sales mgr., is now the co.'s Director of Nat'l Sales Promotion. His former asst., **I. E. SHOWERMAN**, succeeds to his old position.

A. H. MORTON, now vice-president in charge of television for NBC, formerly headed the department covering managed & operated stations.

WILLIAM S. HEDGES, former v-p in charge of NBC station relations, now heads the newly-created Stations Dept., which includes ever so many things.

CLAYLAND ("CLAY") T. MORGAN ex-head of the NBC Publicity Dept., is special press & promotion asst. to Pres. **L. R. LOHR**.

FRANK E. MASON also a v-p & asst. to the Pres. there, is in charge of the new Dept. of Info., and not only that, but of the Short-Wave Div., too.

(Continued on page 123)

Versatile Midget Receiving Sets Add Remote Control to Functions

New RCA midget set not only is complete radio, but will act as remote control tuner for a full-size console. And that's not all; when a phono pickup and turntable are added, it will reproduce recorded music through its own speaker or that of the console. More, too, it can be used as the sound end of the small RCA television sight receiver. Models are A.C.-D.C.; cost \$14.95 & \$16.95.

Television Report By FCC Committee

That the television standards proposed by RMA to the Federal Communications Commission be neither approved nor disapproved was recommended in the first report of the FCC Television Committee.

In addition to standards, the FCC Committee's report discusses such television problems as stages of development, present status of technical development, television as a future industry, limited number of channels, future progress, financing, and action necessary.



Pictured at left is Perry F. Hadlock, recently appointed manager of G-E's Radio Sales Division. He has been with the co. for 11 years; has been in radio since 1921.

At the right is Dr. W. R. G. Baker, who will manage the co.'s consolidated radio, television & associated activities. Dr. Baker has been with G-E's research labs. since 1917.

Below, left to right, are 5 new appointees. They are: H. A. Crossland, mgr. of television sales; Arthur A. Brandt, mgr. of merchandising services; Charles R. Barhydt, commercial engineer; Philip R. Butler, mgr. of technical sales & service; Fred A. Ray, mgr. of Radio Sales.



MANY RECEIVE ADVANCEMENT AT GENERAL ELECTRIC COMPANY



AN EDITORIAL

By Artie Dee

A Pacific Coast radio distributor recently ran a blast against television in his monthly house organ. He says, among other things, "... the man who has paid a couple of hundred bucks for a television receiver ... is shortly going to demand *real entertainment* from his costly investment."

Programs Needed While Artie Dee does not agree with most of the rest of the article, he can find no quarrel with that statement. In fact, he has never heard a criticism of the technical excellence of television; but he has heard several persons complain about programs.

There have been some fine broadcasts. Lowell Thomas, Helen Morgan, Mitzi Green, and others have been before the pick-up. But while the owner of a television receiver enjoys the performances of these stars, they are not sufficiently attractive as entertainment to make the non-owner go out and buy a set.

Broadcasting stations cannot be expected to spend large sums on programs, for under present FCC rulings, the stations have no opportunity to get such monies back. If manufacturers, jobbers & dealers want to sell telly they will probably have to arrange for the financing of some programs with real appeal. That will be the first step to putting television over in a BIG way.

Scared Press The second step will be to educate the newspapers. At present, the press is timorous of television, seeing in it a threat to advertising revenue. If papers will forget their fears and plug telly as hard as they now plug broadcasting, ads of the telly mfrs., retailers & Servicemen will repay them many fold.

It's time for everybody to start work now, to bring television to its coming boom as quickly as possible.

Let's all make some money!

BRITISH TELEVISION DIRECTOR ARRIVES IN U.S.A.



Arthur A. Lee (left) went down to the boat & met Mr. & Mrs. Ian C. Javal when they arrived in U.S.A. from England. Mr. Lee is v-p. of Gaumont-British Pictures Corp. of Amer.; Mr. Javal is Commercial Director of Baird Television, Ltd. He brought demonstration equip't with him.



Crosley's new kerosene-operated refrigerator costs only 3c-7c a day to run—a swell selling point. . . . A Kleenex tissues best contest will use 1,000 G-E battery portables as prizes; 100,000 window displays plug the contest. . . . Vance Babb, who managed NBC's Press Div., and left to direct publicity for the United Brewers Industrial Foundation, will not be replaced.

Amtorg Trading Corp. has bought complete electrolytic condenser mfg. equip't from Solar Mfg. Corp., for the gov't of the U.S.S.R. (That's Russia, &

not a New Deal agency.) . . . Lewis Crosley, grandson of Powel, Jr., busted a bottle of gasoline over the Corp.'s new car's radiator to Xsn it. . . . E. F. Johnson Co., of Waseca, Minn., wants the world to know it has bought the complete equip't, inventory, goodwill & patent rights of the Centralab socket contacts.

Universal Microphone Co.'s "Unicorn", small, low-cost 1-unit complete recorder, made its debut at the Chi. Parts Show. . . . And the same co. announces

(Continued on page 123)

SAW STROMBERG RADIO & TELEVISION RECEIVERS; THEN ATE



Stromberg-Carlson officials & distributors from eastern U.S. met in Rochester, N. Y., to see & hear the co.'s television & "staticless radio" receivers. New sales aids for merchandising the line, & sales plans for 1940 were presented.

SUMMER SELLER SET-UP



This portable phonograph with 3-band radio ought to sell well to suburbanites this summer, although it requires A.C. supply. Also in the new RCA line are a de-luxe 3-band table model, a hand-wind phono, a table model phono, and a big console with automatic record player (no amplifier or speaker) & space for albums. One nice thing about selling phonos is that customers give repeat biz on records.

\$'s & No.'s Dept.

NET GAIN of more than \$250,000 for 1st ¼ of '39 was enviable record of Belmont Radio Corp., Chicago. Net profit for 1938 was \$298,212—or nearly \$1 per share on the common stock.

CBS GAINED 17.7% over April of last yr., with gross of \$2,854,026. This was largest of all network sales for the mo.

NBC GAINED 7.7% over 1st 1/3 of '38, with a total biz of \$15,514,431 for both nets. Apr. billings were up 7.6%.

MAJESTIC'S NEW PRES.



Ross A. Lasley, President of R. A. Lasley, Inc. management consultants, has been elected pres. & director, Majestic Radio & Television Corp. The co., already licensed by RCA & Hazeltine, recently took out a Du Mont television license. Re-financed, it will announce a new line soon.

PORTABLE OSCILLATOR CHECKS HI-FREQ SIGNALS



Capable of generating sigs ranging from 22 to 150 mc., Weston's new portable oscillator can be used just as readily for television & aviation radio as for checking the receivers in police cars. It can be used for zero-beat freq. check on transmitters; it has a phone jack.

Sales Helps and Deals

New Paths to More Business

BULLETIN BOARD—FOLDER RACK

The combo bulletin board & folder rack that Clarostat Mfg. Co. of Brooklyn, N. Y., is distributing to jobbers can be hung on the wall or stood on a counter. It takes 8½ x 11 in. news bulletin sheets, which announce timely items to resistance users, & when a rack is slipped over the news bulletin part, the display features Clarostat products, calls attention to the new service manual, & offers a colorful folder. The board is attractively printed in green & yellow.

MUELLER CLIP CONTEST

"Tricks With Mueller Clips" is the theme of a contest being run by Mueller Electric Co. of Cleveland, O. Fifteen prizes up to \$25 are offered for the best "trick" uses for the clips, whether electrical or non-electrical. Rules are that unusualness, novelty & usefulness will determine the winners. & the clip itself must be the major part of the gadget. Example:—Using the clip as a hat hanger, by screwing it to the wall.

6 NEW STUFFERS

Six envelope-stuffer-size folders covering line-voltage ballasts and regulators, plug-in resistors, composition and wire-wound controls, sound system controls and attenuators, and power resistors, are now being distributed. Printed in vivid red, green and black, these colorful folders are handy for persons interested in some specific type of resistor or resistance device. Individual folders or the entire set may be had from the local jobber or direct from Clarostat.

Changes & New Addresses

Where to Reach Old and New Companies

OCHLTREE ELECTRIC CO., long G-E distributors, have moved to new ¼s at 101 Penn Ave., Pittsburgh, Pa., where they'll occupy 38,000 sq. ft. of floor space.

JAMES MILLEN MFG. CO., INC., is at 6 Pleasant St., Malden, Mass. The co. will design & mfg. radio communication products, including components, receivers & transmitters.

H. L. HILDENBRAND, 36-43 212th St., Bay-side, L. I., N. Y., is representing Esterline-Angus products in the N. Y. metropolitan area.

PRECISION APPARATUS CORP., expanding for the 2nd time in a yr., has executive offices & factory both now at 647 Kent Ave., Brooklyn, New York.

W. B. PRAY SALES, 84 State St., Boston, Mass., now represents Ward-Leonard Electric Co. radio products in the New England States.

WHOLESALE RADIO SERVICE CO. has moved its Newark branch to larger quarters at 24 Central Ave., Newark, N. J.

OFF THE PRESS

Latest Publications to Keep You Informed

500-D BROADCAST UNITS. Thordarson Electric Mfr. Co., 16 pp. Transformers for broadcast purposes, including the new automatic voltage regulators.

CHARACTERISTIC CHART—7th Ed. Tung-Sol Lamp Works, Inc. 30 pp. Besides full data on tubes, it gives standard RMA codes on resistors, transformers, etc.

ENVELOPE STUFFERS. Clarostat Mfg. Co. 6 folders printed in vivid colors to describe resistors.

BULLETIN T-1. Solar Mfg. Corp. Diagrams & specifications on condensers for television.

CORNELL-DUBILIER CORRECTION. Catalog 162A describes electrolytic motor-starting capacitors (condensers); 162B describes those of the Dykanol type.

THE DYNAPHONE. Ansley Radio Corp. 24 pp. Handsome catalog of receivers selling from \$34.50 to \$500.

UTAH. Utah Radio Products Co. 32 pp. Data on speakers, vibrators, transformers, resistors, jacks, etc.

(Continued on page 122)

TWO FIFTY MODELS



These Stromberg-Carlson telly sets have 32 tubes, and produce 8- x 10-inch image; others in line range down to 5-inch tube. Dealers witnessing first demonstration were reported pleased.

BUY DIRECT FROM THE MANUFACTURER AND SAVE. From the very beginning we have always practiced a direct to consumer sales policy. This is NOT a makeshift sales plan to increase sales, but the ONE and ONLY way SUPERIOR has ever done business. Buying and

selling for cash, high quality parts, careful workmanship, rigid inspection, careful shipping, prompt attention to all orders, PLUS the elimination of distributors' and dealers' profits makes it possible for us to offer high quality instruments at unbelievably low prices.

Superior Instruments Are Guaranteed for One Year

THE NEW X-RAYOMETER

Features:

★ GIANT 9" D'ARSONVAL TYPE METER

★ Built-in power supply enables resistance measurements up to

30 MEGOHMS

(Without external batteries or power supply)

★ 1/2 Ohm easily read on low ohm scale

★ D.C. volts up to 2500 volts

★ A.C. volts up to 1000 volts

★ D.C. currents up to 25 amperes

★ 2 Capacity Ranges. Micaf, papers, electrolytics read up to 50 Mfd. 2% ACCURACY.

★ PERCENTAGE OF LEAKAGE of electrolytics read DIRECTLY on scale.

★ Insulation, inter-elements and all other leakages directly read up to 30 megohms.

★ 4 Output Ranges up to 1000 volts.

★ 2 Inductance Ranges up to 703 Henries.

★ 3 Decibel Ranges

★ Cathode Ray high voltage power supplies easily measured.

SPECIFICATIONS:

Resistance measurements in three ranges: 0—1000 ohms, 0—100,000 ohms, 0—30 megohms. Less than 1 ohm easily read on meter scale.

D.C. Voltage measurements in five ranges: 0-50/0-250/0-500/0-1000/0-2500 Volts. Television and other high voltage power supply circuits easily measured.

A.C. Voltage measurements in four ranges: 0-50/0-250/0-500/0-1000 Volts. D.C. current measurements in five ranges: 0-50/0-250/1 Amp /10 Amps/25 Amps. High Current ranges suitable for automotive and industrial work. Capacity directly read on meter scale in two ranges: .005—1 Mfd./2 Mfd.—50 Mfd. Percentage leakage of electrolytic condensers directly read on meter scale. Actual condition of condenser quickly determined. Insulation, inter-element and A.V.C. leakages directly read on meter scale up to 30 megohms. Output measurements in four ranges: 0-50/0-250/0-500/0-1000 Volts. Built-in blocking condensers enable rapid alignment of radio equipment. Inductance measurements in two ranges: 1—7 Henries/7—703 Henries. Decibel measurements in three ranges: —10 — +29/—10 — +43/—10 — +49. Audio frequency measurements in three ranges: —10 — +29/—10 — +43/—10 — +49. Audio frequency measurements in three ranges: —10 — +29/—10 — +43/—10 — +49.

X-Rayometer utilizes an etched aluminum panel in both radio and P. A. amplifiers.

Model 1180-S complete with test leads, tabular charts, instructions, and many transmitting tubes. Shipping weight 18 pounds. Our net price.....

Our net price

Our net price

Our net price

Our net price

Our net price

Our net price

Our net price

Our net price

Our net price

Our net price

Our net price

Our net price

Our net price

Our net price

Our net price

Our net price

Our net price

Our net price

Our net price

Our net price

Our net price

Our net price

Our net price

Our net price

Our net price

Our net price

Our net price

Our net price

Our net price

Our net price

Our net price

Our net price

Our net price

Our net price

Our net price

Our net price

Our net price

Our net price

Our net price

Our net price

Our net price

Our net price

Our net price

Our net price

Our net price

Our net price

Our net price

Our net price

Our net price

Our net price

Our net price

Our net price

Our net price

Our net price

Our net price

Our net price

Our net price

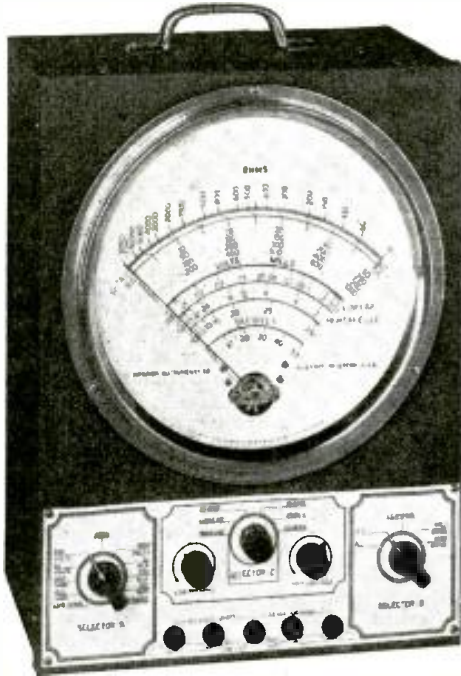

\$17⁹⁵

THE NEW MODEL 1130-S SIGNAL GENERATOR WITH AUDIO FREQUENCIES

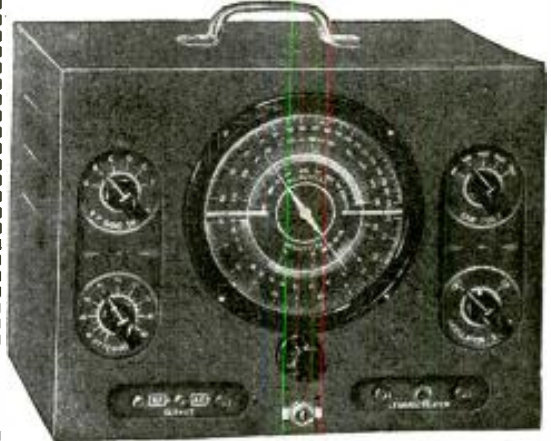

SPECIFICATIONS

1. Combination R.F. and Audio Signal Generator. R.F. 100 kc. to 100 megacycles A.F.—100-7500 cycles. All direct readings, all by front panel switching.
2. R.F. and A.F. output independently obtainable alone or with A.F. (any frequency) Modulating R.F.
3. Accuracy is within 1% on I.F. and Broadcast bands; 2% on higher frequencies.
4. Audio frequencies in 5 bands: 100, 400, 1000, 5000, and 7500 cycles.
5. Giant airplane full vision, direct-reading dial.
6. Condenser and other leakages tested to 100 megohms.
7. All services on 90-130 volts A.C. or D.C. (any frequency).

Model 1130-S comes complete with tubes, test leads, carrying handle and instructions. Shipping weight 16 lbs. Our net price..... **\$11⁸⁵**

THE NEW MODEL 1180-S LABORATORY METER

A Complete Testing Laboratory All in One Unit!!

Tests all tubes, reads A.C. Volts, D.C. Volts, A.C. Current, D.C. Current, High Resistance, Low Resistance, High Capacity, Low Capacity, Decibels, Inductance, and Watts. Comes housed in sturdy black case with sloping panel, for rapid and precise measurements.

SPECIFICATIONS

Works on 90-120 volts 60 cycles A.C.
 Tests all 4, 5, 6, 7, 7L, octal and loctal base tubes, including diodes.
 Tests by the well established emission method for tube quality, directly read on the Good-Bad scale of the meter.
 Affords separate neon test for leakage and short between elements.
 Complete A.C. and D.C. Voltage and Current Ranges.
 D.C. Voltage:—0-15, 0-150, 0-750 volts.
 A.C. Voltage:—0-15, 0-150, 0-750 volts.
 D.C. Current—0-1, 0-15, 0-150, 0-750 ma.
 A.C. Current:—0-15, 0-150, 0-750 ma.
 2 Resistance Ranges. 0-500 ohms, 500-5 megohms.
 High and Low Capacity Scales. .005 to 1 mfd. and .05 to 200 mfd.
 3 Decibel Ranges, —10 to +19, —10 to +38, —10 to +53.
 Inductance: 1 to 700 Henries.
 Watts: Based on 6mw. at 0 D.B. in 500 ohms, .006 to 600 Watts.
 Model 1180-S complete with test leads, tabular charts, instructions, and many transmitting tubes. Shipping weight 18 pounds. Our net price..... **\$17⁹⁵**
 Portable cover 95c extra



SUPERIOR INSTRUMENTS CO.

136 Liberty St., RC-8
 NEW YORK, N. Y.

Please Say That You Saw It in RADIO-CRAFT

www.americanradiohistory.com

Money-Makers for SERVICE MEN

MODERN Radio SERVICING

LEARN How with This!

Here is your practical training for radio service work complete in this 1 big 1300-page book—explains everything essential for thorough grounding in the basic fundamentals of modern service work. Knirard makes it all wonderfully clear and easy to understand. It's the last word in radio servicing course! Here's what it covers:

- Test Equipment—Theory, Descriptions, Diagrams of all Commercial Instruments, How They Work, Construction Data, etc.
- Trouble-Shooting—Newest short-cut methods for trouble-shooting even the most complicated receivers.
- Repairing advanced "Factory-Methods" for Repairing all Parts, explained fully.
- Special Problems—Servicing All-Wave and I-F Sets, "Intermittent" Sets, Auto-Radio Sets, etc.



1300 PAGES \$4
706 ILLUS.

RADIO Trouble Shooter's HANDBOOK

WORK with This!

Here's a new kind of time-saver for service men—different from anything you've ever seen before. It's a check-full of factory-checked "bench-data" that will speed up every service job you do! It's the greatest mass of practical working data ever assembled in one book! It's a "Prof's-Water!"

- 3,313 Case Histories—Trouble Symptoms and Remedies compiled from actual Service Records.
- I-F Peaks—Over 15,000 Listings for Alignment of all Superhets.
- Other Data—Auto-Radio Data for Installation, Interference Elimination, etc.
- Trouble-Shooting Charts; Servicing Intercommunicators; Trade Directories; Tube Data; and dozens of Charts and Tables.

518 PAGES, 134 ILLUS., Standard Manual Size. (8 1/2 x 11) Fabricated-board.



\$3

USE THEM 5 DAYS—our risk

Return them if not satisfied

Radio & Tech. Publ. Co.
45 Astor Pl., New York,
Dept. RC-89

Enclosed find payment for:

MODERN RADIO SERVICING

RADIO TROUBLE SHOOTERS' HANDBOOK

BOTH books at \$8.50 Special Combination Price

NAME _____

ADDRESS _____

CITY _____ STATE _____

MAIL NOW!

Check here for FREE Circuits

BRUSH

BJ HEADPHONES

Communications type—lightweight, durable aluminum case—phones encased in molded rubber jackets—good earseal.



Write for your Brush catalog today

THE BRUSH DEVELOPMENT CO.

3311 Perkins Ave. Cleveland, Ohio

Insure Your Future—Train Now for TELEVISION

There're always good jobs for good men. CREI offers you either home-study or residence training in Practical Radio and Television Engineering. CREI men now in over 285 radio stations. Write for details and FREE BOOK.

Capital Radio Engineering Institute
Dept. RC-8
3224-16th St., N.W., Wash., D. C.

OBSCURE SOURCES OF HUM IN HIGH-GAIN AMPLIFIERS

(Continued from page 79)

(4) *Ineffective Shielding of Grid Leads* prevents complete isolation of grid leads from chassis voltages. It is therefore necessary to use shields which are 100% effective. A loosely-braided shield may cause trouble. For very-high-gain amplifiers and high chassis voltages, it may be necessary to use lead-covered grid leads.

(5) *Careless Grounding of Grid Lead Shields* may produce a capacitive coupling between two separated chassis points and thereby introduce a hum potential in critical input grid circuits. In Fig. 2G hum voltage is developed between chassis points X-Y.

(6) *Improper Placement of Input Tubes* may bring the grid within the magnetic field of a power transformer and thereby induce within this element a disturbing hum potential. Complete magnetic shielding of the tube, or its removal from the vicinity of the transformer, will be necessary to eliminate this disturbance.

(7) *Choke Coils* (filter reactors), particularly those used in choke-input filter circuits, are capable of producing as much disturbance as some power transformers. While this unit is rarely suspected, it should be isolated from low-level transformers, tubes, and circuits.

(8) *Inter-Condenser Coupling* may bring hum voltages from filter circuits into cathodes of critical circuits, thereby directly introducing disturbing hum potentials. Figure 2H shows how phantom capacity Xc brings filter hum to the cathode.

(9) *Unshielded Coupling Condensers* in high-gain circuits, particularly when placed close to disturbing components, will pick up considerable hum potential.

(10) *Series Filament Arrangement* in high-gain A.C./D.C. circuits will invariably show excessive hum being introduced into the second stage, because 6.3 volts A.C. is introduced between one side of heater and cathode. Figure 2I illustrates this condition. To remedy it, one side of the heater of the first 2 stages should be grounded as indicated in Fig. 2J.

(11) *Chassis Grounds* are of vital importance in high-gain input circuits; for ideal results, the amplifier common should touch the chassis at but one point.

(12) *Incorrect Grounding of Decoupling Filter Condensers* will induce hum potentials into the grid circuit of the succeeding stages, as illustrated in Fig. 2K. It is therefore essential to insulate the case of the condenser from chassis, and connect the case directly to the common ground terminals.

(13) *Unshielded Volume Controls* will pick up hum potentials from chassis by capacitive coupling. It is therefore important that high-gain circuits employ shielded volume controls.

(14) *Chassis Vibration* of a very minute nature (caused by transformer or choke vibration) may cause tube elements to vibrate and affect the electronic stream, thereby producing a microphonic hum disturbance, which can be cured by floating the tube involved, or removing the disturbing source of vibration.

(15) *Inadequate Shielding* is one of the most common causes of hum in high-gain amplifiers. A careful distinction must be made between electrostatic and electromagnetic shielding and their application to the circuits involved. When disturbing hum potentials are being picked up from capacitive coupling, "electrostatic" shielding is required. If, on the other hand, the circuit involved is picking up hum by induction, then an "electromagnetic" shield is necessary.

(16) *Tubes* are a contributing source of hum in many high-gain circuits, particularly

when the proper selection of circuit values is not made. It is beyond the scope of this discussion to describe the hum-producing factors within tubes and their effect upon high-gain amplifiers. This phase however may be covered in a future article if sufficient interest among *Radio-Craft* readers exists.

CONCLUSION

Much has been written on the isolation and recognition of various types of hum. Needless to say, before any such work can be attempted, it is imperative that the technician determine how many different hum potentials are present in the output. Otherwise, corrective methods can not be properly applied, for, what may prove to be beneficial to the overall hum voltage, may in itself, be introducing another hum voltage which will not subsequently be suspected.

The technique of introducing hum-bucking voltages has always received considerable attention from designers and experimenters. But this method of eliminating residual hum is not recommended unless only one specific type of hum exists. The theory behind this remedy lies in the selection of a voltage equal in potential and frequency, but opposite in phase to the disturbing hum, and introducing it in a suitable portion of the circuit, so that the original disturbing source is cancelled. It naturally follows, that this method cannot be applied when a number of complex hum voltages are present in the output of the amplifier. Furthermore, it is often very difficult to generate or pick up a hum voltage exactly 180 degrees out-of-phase with the disturbing source. When two or more out-of-phase hum voltages are present, the difficulty of complete cancellation of both these voltages is quite obvious. It is far better to eliminate disturbing hum voltages at their sources than to attempt to correct them by excessive bypassing, shielding, isolation, or hum-bucking.

The author will be glad to answer any questions relative to hum—its cause, detection and cure, if inquiries are addressed c/o *Radio-Craft*, and are accompanied with a self-addressed stamped envelope.

MODERN RECEIVER TEST REQUIREMENTS

(Continued from page 83)

These heterodyne whistles are produced by commercial signals, outside of the broadcast band, feeding directly through the I.F. channel.

In many of the better-grade receivers, a 10,000-cycle cut-off filter will be found. This filter must be adjusted with a variable audio oscillator, and is for the purpose of removing heterodyne whistles which frequently occur when 2 relatively equal powered stations are operating on adjacent channels.

The cathode-ray oscilloscope (see Fig. A), or a vacuum-tube voltmeter (see Fig. B), should be used properly to adjust automatic frequency control receivers, as this adjustment is very critical, and only the most sensitive instruments may be used. Receivers having normal I.F. amplifiers may be aligned with an oscillator, as shown in Fig. C, and an output meter. High-fidelity receivers having over-coupled I.F. amplifiers must be adjusted on the cathode-ray oscilloscope if their fidelity is to be maintained.

This article has been prepared from data supplied by courtesy of The Clough-Brengle Co.

Please Say That You Saw It in RADIO-CRAFT

NEW CIRCUITS IN MODERN RADIO RECEIVERS

(Continued from page 88)

the other section opens the 6A8G and 6K7 screen-grids at the load end of their common series supply resistor (33,000 ohms).

In this way the Radio signal circuit is completely cut off, and there is no possibility of induced signals through stray capacities.

(4) R.F. PADDING CONDENSER SERVES FOR SET AND ANTENNA ALIGNMENT

General Electric Model GA-62. An adjustable-type padder condenser is placed in series with the input R.F. tuned circuit, in such a way that it may be used to align the R.F. and oscillator circuits at low frequencies and may at the same time, adjust the antenna circuit to favor the antenna characteristics.

The circuit, Fig. 2A, shows that this condenser, C8, occupies the same position in the circuit that an A.V.C. filter condenser would ordinarily have. It is adjustable and is adjusted exactly like an oscillator padder at the low-frequency end of the band. For matching of the antenna C8 is re-set and the adjustment is not likely to be far off its proper padding setting. For the higher frequencies in the band, the importance of the padder is negligible while the antenna matching is important. Although a single setting of C8 does not provide optimum adjustments for both the padding and matching facilities, the sacrifice of the padding adjustment in favor of the antenna matching adjustment is very much worth while.

As a justification for the use of this circuit, the R.F. 1st-detector coupling circuits are untuned so that no padding is required for another tuning condenser and so the circuit may be broad enough in tuning to compensate for the possibility of the padding adjustment being far removed in favor of the antenna adjustment.

(5) AIR SWITCH ON AUTO-RADIO ADJUSTS VOLUME TO SPEED

United Motors Service Model 983568 Pontiac. By making use of the fact that, upon switching off degeneration the output volume increases, a switch is operated by air pressure so that degeneration is automatically cut out at a predetermined car speed.

The unusual degenerative circuit is shown in Fig. 2B. Transformer coupling supplies the output push-pull grids from the single driver; and to one of the push-pull grids, having approximate phase opposition to the driver 6R7G grid, is attached a 10,000-ohm resistor in series with the grid-return of the 6J5G. By this means a good portion of the output grid voltage is fed back into the 6J5G, thus obtaining degeneration. At the junction of the 10,000-ohm degenerative series resistor and the 40,000-ohm grid resistor for the 6R7G is placed a small bypass condenser of 200 mmf. and a 500-ohm resistor at the end of which is the air switch.

The air switch is mounted directly back of the radiator cooling fan in the car, so that at a pre-determined speed the air pressure is sufficient to close the switch and thereby ground the other end of the 500-ohm resistor. This almost completely stops degeneration and greatly increases volume. The air and engine noise at high speed make this desirable, and although fidelity is not as good without degeneration, lack of it cannot easily be detected through the usual acoustic noise level.

VEDOLYZER

**SUPREME'S CONCEPTION
OF A NEW, AMAZINGLY
FAST AND COMPLETE
METHOD OF RADIO SERVICE**



Can you . . . check R. F. filtering in detector and A. V. C. circuits visually . . . see and locate the noise created by faulty parts . . . attach test oscillator to dead receiver and go from stage to stage and locate dead portion without turning any knobs or tuning any circuits . . . check receiver oscillator performance without tuning any test instrument circuits . . . measure FREQUENCY AND AMPLITUDE of the signals in all stages of a receiver . . . measure 6,000 D. C. VOLTS with a 150 MEGOHM INPUT . . . measure from ONE BILLION OHMS down to ONE HALF OHM . . . make NO-CURRENT VOLTAGE measurements without disturbing receiver's operation . . . SEE the actual Broadcast. I. F. and A. F. SIGNAL any place and every place in any receiver . . . measure radio signal throughout set in MICROVOLTS and VOLTS . . . SEE where DISTORTION occurs . . . SEE THE SIGNAL during broadcast and television receiver servicing?

Every up-to-date serviceman, radio and television engineer should have the complete story on the VEDOLYZER.

Don't buy any instrument until you have the complete and interesting story on this new SUPREME equipment. Write today for literature, soon available, and nearest place and date of demonstration in your locality.

The Supreme 561 Combination Signal Generator includes (1) a sinusoidal A. F. wave output from 15 to 15,000 cycles.

(2) an unmodulated R. F. wave output from 65 K. C. to 20.5 M. C. on fundamentals and above 60 M. C. on harmonics. (3) a variable audio modulated R. F. signal using the internal 15-15,000 cycle audio oscillator. (4) a metered variable percentage of modulation control on this R. F. signal from 0 to 75%. (5) a frequency modulated oscillator having a 30 K. C. wide band pass which may be used. (6) to frequency modulate the internal R. F. oscillator for visual alignment and also for A. F. C. adjustments. (7) availability of externally modulating the R. F. signal with suitable equipment.

A. F. oscillator has power output of 150 milliwatts and open circuit voltage of 35 volts. Continuously variable on 6" illuminated dial; 4 output impedances (center tapped) for correct matching.

R. F. oscillator uses iron core coils and air dielectric trimmer condensers. 1/2 of 1% accuracy assured. Ladder type attenuator. 2 speed tuning control. Shadow type, razor edge, tuning indicator and illuminated dial. Frequency modulator uses famous SUPREME LOCK-CENTER-SYNCHRONIZE circuit which completely eliminates image wandering.



SUPREME

SUPREME INSTRUMENTS CORP.
GREENWOOD, MISSISSIPPI, U. S. A.

EXPORT DEPT., Associated Exporters Co., 145 W. 45th Street, New York
Cable Address: LOPREH, N. Y.

GET A BEAUTIFUL DESK LAMP ABSOLUTELY FREE!

Complete details as to how it is possible to get a Beautiful Desk Lamp FREE, appears on page 124 of this issue

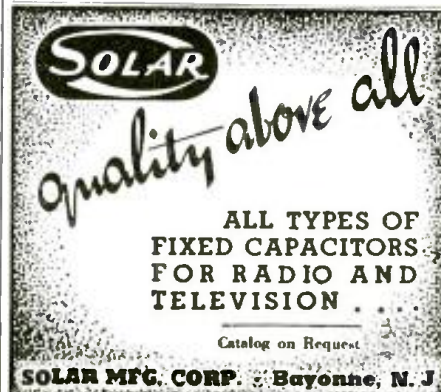

SOLAR

Quality above all

**ALL TYPES OF
FIXED CAPACITORS
FOR RADIO AND
TELEVISION**

Catalog on Request

SOLAR MFG. CORP., Bayonne, N. J.

RADIO plus TELEVISION

-mastered by
pre-tested Training

No matter where you are or what you do, National has a complete training plan for you—to fit your circumstances. National's plan is for those seeking immediate shop-training as well as for those who cannot give up present employment and income. Mail coupon.

NATIONAL SCHOOLS

NATIONAL SCHOOLS, Dept. B-RC
4000 So. Figueroa St., Los Angeles, Calif.
Please send free Radio and Television Booklet.

NAME _____ AGE _____

ADDRESS _____

CITY _____ STATE _____

Please Say That You Saw It in RADIO-CRAFT

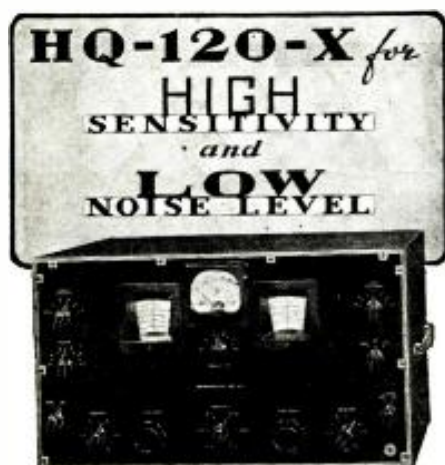

HIGH SENSITIVITY and low noise level have made the "HQ-120-X" radio's outstanding low priced receiver. The variable selectivity feature permits the operator to tune out strong stations and pull in the weak distant stations that would normally be buried in QRM. Remember, the weak stations are there, but it requires a sensitive and selective receiver to get them. If you want the best in high frequency performance, use an "HQ-120-X." Send for booklet!

HAMMARLUND MFG. CO., INC.
424-438 W. 33 St., N. Y. City RC-9

Please send 16-page booklet.

Name

Address

City State



HAMMARLUND

Canadian Office: 41 West Ave. No., Hamilton, Ontario

AN ULTRA COMPACT CAPACITOR BRIDGE For Servicemen and Technicians

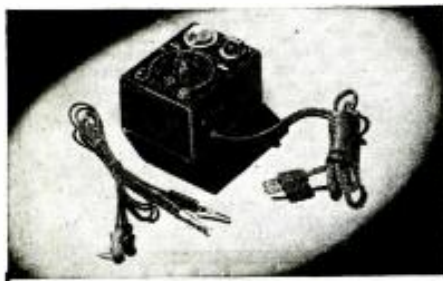

Built in an attractive walnut Bakelite case this Capacitor Bridge is the most compact useful instrument of its type ever offered to the service field. No serviceman can afford to be without one of these useful, economical instruments. Check these outstanding features found only in the C-D Capacitor Bridge.

Measures Capacity . . . of all type capacitors between limits of .00001 mfd. to 50 mfd.

Detects Defective Capacitors . . . will check for opens, shorts, high and low capacity, and high power-factor.

Checks Circuit Continuity . . . may be used as continuity meter.

Employs Wien Bridge . . . accuracy independent of line voltage variations.

Visual Eye Bridge Balance . . . dual type visual bridge balance for accurate measurements facilitates quick tests on service jobs.

Direct Reading Scale . . . direct reading ranges with all scale markings directly in microfarads.

Economical . . . List price, less tubes, \$16.50. Dealer's Net \$9.90.

Other features of this outstanding C-D Capacitor Bridge described in Catalog No. 167-A free on request.



**CORNELL-DUBILIER
ELECTRIC CORPORATION**

1014 Hamilton Blvd., So. Plainfield, N. J.
Cable Address: "CORDU"

\$4,000 P.A. CONTEST

(Continued from page 80)

installation and to emphasize the fact that ANY radio man can engage in this profitable activity, *Radio-Craft* has instituted this contest.

There are no strings attached—anyone with the ability to make a public-address installation is eligible. The contest rules are explained below.

Radio-Craft feels that many individuals and organizations have made public-address installations introducing equipment or setup innovations, or employing P.A. apparatus, which meet entirely new and novel conditions; or other worthwhile P.A. installations. Therefore, in order to give our

readers first-hand information we plan to run a series of articles based on the winning entries of this contest.

In order that these may be the cream of public-address installation articles, valuable awards are being given each month, for four (4) consecutive months. These awards will be made available through the co-operation of well-known manufacturers of public address and sound equipment.

For this reason, every Serviceman, dealer, public-address specialist or group of specialists capable of making what may be considered a worthwhile public-address installation will find it profitable to enter this contest. This is the last call!

CONTEST RULES

Section No. 4 (August)

- (1) Write a letter of not more than five hundred (500) words, exclusive of list of components, describing in detail a practical public-address installation, whether it be rental, permanent, or portable. Give the *date* when the order was received.
- (2) Outline in the letter the business angle of the deal:
 - (A) How and where you got the lead, how you followed it up, and how you clinched the sale. *Clients' names need not be mentioned.*
 - (B) Cost of apparatus, sale price, profit involved. In fact, give all the details which will guide other men in the radio field in undertaking similar work.
- (3) Outline the technical angle of the deal:
 - (A) Purpose of installation.
 - (B) Technical problems involved.
 - (C) Choice of equipment and reasons for use of same.
 - (D) How installation problems were solved.
- (4) Letters will be judged strictly on the merits of the installation jobs, i.e.: the choice of properly-rated equipment for the particular service to be rendered, ingenuity in solving installation problems, also initiative and business ability displayed in consummating the deal. Literary style or manner of presentation will not be considered.
- (5) Photographs and diagrams, although not requisite to this contest, are desirable and shall be considered as a permissible influence upon the judges.
- (6) All letters, photographs or diagrams submitted become the property of *Radio-Craft*. None can be returned.
- (7) This contest is not open to the officials or employees of *Radio-Craft Magazine* nor to any officials or employees of the companies submitting prizes for this contest.
- (8) The *final* closing date of this contest has been advanced from midnight August 10th, 1939, to midnight September 10, 1939. All letters entered in this contest must be addressed to the PUBLIC ADDRESS CONTEST EDITOR, RADIO-CRAFT Magazine, 99 Hudson Street, New York, N. Y., and must bear the postal cancellation stamp not later than midnight, September 10th, 1939.
- (9) Section No. 4 (final section) opens July 11th and closes September 10th (runs for two months); postmarked dates will be considered conclusive.
- (10) A board of judges will decide the winners and their decisions are final.
- (11) THE JUDGES FOR THIS MONTH'S CONTEST
Herman T. Tauber, Wholesale Radio Service Co., Inc.
R. D. Washburne, Managing Editor, *Radio-Craft*.
N. H. Lessem, Associate Editor *Radio-Craft*.
- (12) A complete list of winners of Section No. 1 (May-issue contestants) will appear in the September, 1939 issue. Winners of Section No. 2 (June-issue contestants) will appear in the October, 1939 issue. Winners of Section No. 3 (July-issue contestants) will appear in the November, 1939 issue. Winners of Section No. 4 (August-issue contestants) will appear in the December, 1939 issue.

List of Prizes

(Continued from page 80)

- 2 ELEVENTH PRIZES—Velocity Microphone, model 30, \$22.50
Offered by Allied-Burns Company
Auto-Top Carrier for Mobile Sound Installations, platform size 30 x 54 ins., type PA26, \$22.50
Offered by Vac-O-Grip Company
- 3 TWELFTH PRIZES—Auto-Top Carrier for Mobile Sound Installations, platform size 30 x 36 ins., type PA22, \$16.00
Offered by Vac-O-Grip Company
12-in. P.M. Speaker, type FB12-M, \$15.50
Offered by Cinaudagraph Corp.
12-in. P.M. Speaker, type FB12-M, \$15.50
Offered by Cinaudagraph Corp.
- 4 THIRTEENTH PRIZES—Floor-Type Chrome Microphone Stand, model EF-17, \$12.50
Offered by Eastern Mike-Stand Company
Floor-Type Chrome Microphone Stand, model EF-17, \$12.50
Offered by Eastern Mike-Stand Company
Floor-Type Chrome Microphone Stand, model EF-17, \$12.50
Offered by Eastern Mike-Stand Company
"Marine Midget" Speaker Horn and Unit, type WZ5SP, \$12.50
Offered by Atlas Sound Corp.
- 16 FOURTEENTH PRIZES—VOLUME 7 OFFICIAL RADIO SERVICE MANUAL, \$10.00 each
Offered by Radcraft Publications, Inc.
- 2 FIFTEENTH PRIZES—Desk-Type Microphone Stand, type ED-127, \$3.75
Offered by Eastern Mike-Stand Company
Desk-Type Microphone Stand, type ED-127, \$3.75
Offered by Eastern Mike-Stand Company

Please Say That You Saw It in RADIO-CRAFT

HIGH-FIDELITY BROADCASTING

(Continued from page 73)

any loss in the response-frequency characteristic by using extended-range equalizers. The installation of feedback in the WABC transmitter played a major role in improving the response-frequency characteristic of the station.

WHAT ABOUT "ADJACENT-CHANNEL INTERFERENCE"?

The transmission of frequencies up to 10,000 cycles per second naturally signifies wider side-band transmission, or, in other words, the transmitter carrier frequency is modulated plus or minus 10 kc. either side of the carrier frequency.

This would seem to imply that, since the station channel assignments (in this country) are separated by only 10 kc., there must result some form of heterodyne interference between 2 stations on adjacent channels. A consideration of the present allocation of stations, as well as of the per cent of energy actually contained in the frequencies above 5,000 cycles per second, soon makes it apparent that when receiving a station while in its primary service area, there will result no adjacent-channel interference.

As is well known, (1) the high-power stations on any one frequency either have exclusive use of the channel or, if more than one operates on one channel, employ directional antennas, mutually protecting each other's service areas; or, (2) in the case of lower-power stations, they are so geographically located or employ directional antennas, if necessary, so that certain well-defined interference limitations are not exceeded.

Although not so well known, it also is true that definite interference limitations are set up and maintained with regard to stations on adjacent channels, and even, for that matter, with regard to stations separated by 20, 30, or even 40 kc. In other words, the stations in the United States are so situated, geographically, that the signals on adjacent channels of a particular station, are of negligible intensity within the primary service area of the desired station.

Consequently, when located within the primary service area of a station—in any case where the desired signal is much stronger than the signals of adjacent channels—a listener employing a high-fidelity receiver can be assured that the intensity of the signal is sufficiently greater than that of the stations on adjacent channels, so that side-band interference is not present.

When endeavoring to select a weaker signal adjacent to a strong signal, however, the lower frequencies of the strong signal will interfere and be received as high-frequency sounds ("hash," cross-talk, etc.—*Editor*). In a typical transmission, the energy contained in the frequencies above 5,000 cycles per second is less than—roughly—10 per cent of the total energy and, therefore, the high frequencies of the strong adjacent-channel station would not interfere with the low frequencies of the desired station.

When listening to distant stations during the evening or to particularly weak signals, high-fidelity reception is not feasible, and it becomes necessary to cut off the response of the receiver at, say, 5,000 cycles per second. Under this condition, as mentioned above, since the energy content above 5,000 cycles per second is small, adjacent-channel interference on weak signals is not present

(Continued on page 109)

Make Your Service Calls Pay Double with an RCA Victor RECORDER



Sell customers Records of themselves —earn extra profits!



Now when you call to "service" a set, take along this new lightweight RCA Victor Recorder. Make recording arrangements while you're on the phone answering the "service call." You'll find it's easy to sell —because everyone likes to hear himself on a record.

This remarkable, compact instrument makes records of amazing high quality. With very little effort or investment on your part, you can build a recording service that will be a real money maker. Get details from your RCA Victor distributor or fill out and mail the coupon below.

*Price f.o.b. Camden, N. J., subject to change without notice. For finer radio performance—RCA Victor Radio Tubes

Portable RCA Victor Recorder MI-12701 comes in attractive gray carrying case with handle. Turntable speed 78 r.p.m. Will handle discs up to 12". All necessary elements for recording and reproducing, including RCA Aerodynamic Microphone. Employs outside-in recording method. \$179.00*

AMATEURS!

This new RCA Victor Portable Recorder will double your DX enjoyment. With it you can put the important and interesting things you broadcast or receive on records.

PUT IT ON A RECORD

RCA Victor RECORDERS

Commercial Sound Section • RCA Mfg. Co., Inc. Camden, N. J. • A Service of Radio Corp. of America

Commercial Sound Section, Dept. RC8
RCA Mfg. Co., Inc. Camden, N. J.

Gentlemen: Please send me without obligation full details on RCA Victor Recorders

Name _____

Street _____

City _____ State _____

YOUR LAST OPPORTUNITY TO GET THIS FREE BOOK!

Only a few copies of the RADIO REFERENCE ANNUAL are still available! It's the BIG, FREE BOOK of 64-pages you receive when you subscribe to RADIO-CRAFT. The ANNUAL covers set building, servicing, public address, test equipment, plus a number of other interesting topics. Send your remittance of One Dollar to RADIO-CRAFT, 99-R HUDSON STREET, New York, N. Y., and you will receive a subscription to RADIO-CRAFT for Seven Months, and your copy of the RADIO REFERENCE ANNUAL will be mailed postpaid immediately.

SAVE MONEY

ON RADIO SETS AND PARTS

SEND FOR OUR FREE GIANT NEW CATALOG ILLUSTRATING AND DESCRIBING OVER 1,000 MONEY SAVING ITEMS.

UNITED RADIO COMPANY

BOX 1000 NW-NEWARK, N. J.

FREE AMPLITONE

New 1939 Sound Catalog

Illustrating our complete line of modern sound equipment.

Write for your FREE copy NOW!

AMPLITONE PRODUCTS CO.

135 Liberty St. New York City, N. Y.

Please Say That You Saw It in RADIO-CRAFT

MODERNIZE OLD PHONOGRAPHS!

(Continued from page 89)

Radio's Biggest P.A. VALUES!



18 WATT AMPLIFIER
\$19.95

GET ALLIED'S SUMMER CATALOG!

Amazing values now in ALLIED'S Free 161 page Summer catalog! New Sound Systems for every purpose, 8-85 watts. Over 14,000 parts; radio's biggest line of Record Players, Phonographs, Recorders; latest Test Equipment; new Amateur Gear; dozens of Kits; books, tools, etc.—and 62 new "KNIGHT" Sets, as low as \$5.95—all types, new 3-in-1 Portables, etc. Everything in radio at lowest prices. In ALLIED'S catalog. FREE—send coupon!

7 NEW PORTABLES

ALLIED BOOKS 10c

RADIO BUILDERS! P.A. MEN!

"Radio Builder's Handbook"—For beginners, tells how to select circuits, read diagrams, make chassis, etc.—only 10c!
"Essentials of Recording"—Complete facts, tips on making records, re-producing, etc.—only 10c. send coupon

FREE CATALOG

ALLIED Radio Corp., Dept. 2-H9, 833 Jackson Blvd., Chicago

- Send your Free Radio Catalog.
- 1c Enclosed—Send Builder's Handbook.
- 10c Enclosed—Send book on Recording.

Name

Address

SPRAGUE ATOMS
"Mightiest Midgets of All"

JUST A FEW ATOMS EQUIP YOU FOR HUNDREDS OF CONDENSER REPLACEMENTS

Tune in on real efficiency! Buy Sprague ATOMS (midget dry electrolytics) in handy kits. A few kits equip you for quick, money-saving replacements on almost any job. ATOMS are smaller than any other midgets. Made in more voltages and capacities including duals with common negative leads. Don't be afraid to use 'em—and use 'em plenty. They've got real "guts". They're unconditionally guaranteed against blow-ups.

An 8 mfd. 450 Volt ATOM lists at only 60c—a dual 8-8 at \$1.00. Think of the saving! Write for complete Sprague Condenser Catalog—just out.



Sold singly or in handy kits of five quantities needed capacities.



SPRAGUE 450 VOLTS

SPRAGUE PRODUCTS CO.
North Adams, Mass.

its frequency stability is unfavorably affected, with resulting distortion of the loud passages in a recording. This can be largely overcome by cutting down the output of the pickup to a point where even the loudest passages will provide only a relatively low modulation percentage. But where this is done, so great is the dynamic range of modern records, the modulation will drop so low on soft passages as to make them substantially inaudible.

In this phono oscillator, which incidentally is commercially available (a fact you might find useful if it's inconvenient to make your own), a principle new in this field but universally used in transmitting stations is utilized. This involves use of a separate oscillator tube the output of which is fed into another tube which serves as amplifier and mixer. The modulation is then applied to this second tube in such a way that it cannot react on the oscillator. This will be recognized as the standard "M.O.P.A."—master-oscillator power-amplifier—arrangement employed in all modern transmitter circuits.

CIRCUIT

The circuit diagram of this tiny transmitter is shown in Fig. 1. The 6C6 oscillator is capacity-coupled to the R.F. input grid of the 6L7 mixer tube; and the audio output of the pickup is fed into the thoroughly insulated injector-grid of this same tube. The output of this tube, in the form of a modulated carrier, is fed into the transmitter "antenna" which actually consists of about 6 ft. of wire tacked on the underside of the phonograph panel. Included in the unit is a self-contained A.C. power supply.

The tuning of the oscillator is accomplished by means of the 150 mmf. trimmer condenser in the grid circuit. This tunes over a small range in the vicinity of 1,000 kc. to permit selection of a channel on which there is no broadcast station operating to cause interference. The output of the 6L7 tube is untuned, or perhaps it might be more accurate to say very "broadly fixed-tuned" by means of the inductance in its plate circuit.

For readers who may be interested in experimenting with such a circuit as this coil L1 may be a standard broadcast oscillator coil shunted by a variable capacity of approximately 400 mmf. Or, if a standard broadcast antenna coil is at hand it will serve the purpose, in which case a tuning capacity of 150 mmf. (as shown in the diagram) will be suitable. The untuned output coil may require a little experimenting. One simple arrangement is to use a pi-wound R.F. choke of the 2.5 millihenry type. For this purpose taps should be made between the pi's so that different values of inductance can be tried to find the value which gives the greatest output.

Another workable stunt is to use a standard broadcast R.F. coil of the pi-wound type with its primary and secondary connected as shown in Fig. 1. A little experimenting with connections will be necessary here to obtain the best combination. The values of all other parts are indicated in the circuit.

F.C.C. RULING

For readers who may attempt to construct a "transmitter" such as shown in Fig. 1 (or any other "wireless" unit for that matter) a word of warning is in order. This is a radio transmitter in every sense of the word, but through a special ruling of the Federal Communications Commission is not officially recognized as such and therefore does not require a government license provided its

radiation is of such a low order that its carrier cannot be picked up at a distance of 150 feet by a highly-sensitive receiver. If capable of being picked up at this distance, it automatically falls into the transmitter classification and its operation without both transmitter and operator's licenses is illegal.

There is one necessary precaution, and that is the thorough shielding of the entire oscillator circuit including the tube. This is important because the only signal reaching the receiver should be the modulated carrier output of the unit. If additional unmodulated energy at the carrier frequency is radiated directly by the oscillator the effect on the receiver due to the A.V.C. action, will be much like that of a very strong carrier with very little modulation.

So important is this that in this (Lafayette) unit not only is the 6C6 tube completely inclosed within a shield, but its socket and wiring beneath the chassis are isolated by means of a partition which extends across the chassis.

ADDING "PRIVATE ADDRESS"

An interesting feature shown in the circuit diagram is the provision for plugging-in a carbon microphone to permit a speaker's voice to be reproduced through the radio. No external batteries are required for this microphone, as the same purpose is served by the cathode current of the 6L7 which flows through it. The microphone, which must be of the single-button carbon type, functions by varying the cathode voltage and therefore the affective grid bias, these bias variations resulting in reproduction of the original speech.

In the remodeling job under discussion, the transmitter unit was mounted on the underside of the turntable panel as shown in one of the photographs. Not being accessible, its own on-off switch is not used but instead a toggle switch was mounted on the panel beside the turntable switch to control this unit. Its line cord was connected directly into the line cord of the phonograph motor so that the latter cord supplies both. (A single switch used to control both would have the drawback that when the turntable is started after being stopped to change records, the tubes in the transmitter would require a few seconds to heat.)

In order to avoid the pick-up of hum, the leads from the phono pickup to the volume control and from here to the transmitter unit's input are inclosed in shield braid, the braid itself serving as the grounded lead between the pickup and the volume control.

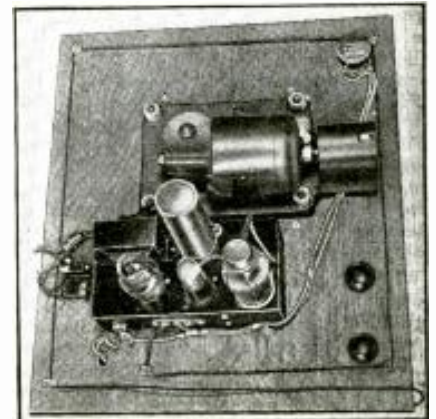

The underside of the new panel shows the 3-tube "flea-power" transmitter mounted in clear space beside the motor. Note the transmitter's antenna tacked on the panel in the form of an open loop.

Please Say That You Saw It in RADIO-CRAFT

After the wiring was completed but before actually mounting the unit on the panel, tests were made with it in operation to select a frequency clear of local broadcast stations. Once tuned to such a frequency (by means of the screwdriver adjustment of the oscillator trimmer condenser) it was permanently mounted. It happens that it was necessary to do this before mounting the unit as the phono motor blocks access to this adjustment screw in this particular installation.

The use of a microphone was not contemplated in this job. If it had been, the microphone jack could have been removed from the transmitter chassis and mounted on the panel instead.

I PHONO FOR 3 SETS!

In the apartment where this job was done there are radio sets in 2 of the bedrooms, in addition to the main one in the living room. These are within 30 feet or so of the phonograph and its output is readily picked up on all of them—an interesting advantage offered by the "wireless" system as against wire connections between the phono and radio. One of these bedroom sets provides pushbutton tuning and by pre-setting one of the pushbutton circuits to the frequency of the phonograph oscillator its output is made quickly available at any time that the phonograph is in operation.

In addition to remodeling jobs, there are others where the phonograph equipment is up-to-date but a wireless unit would provide advantages not now enjoyed. It's a thought which Servicemen can logically promote. The "wireless" unit can simply be placed on the turntable panel, or can be mounted inside.

Even in cases where modern record players are in use the addition of a "wireless" unit offers advantages and this is another "angle" which the Serviceman (or dealer) can profitably promote.

This article has been prepared from data supplied by courtesy of Wholesale Radio Service Co.

HIGH-FIDELITY BROADCASTING

Continued from page 107)

even though the stations are transmitting up to 10,000 cycles per second.

CARRIER HETERODYNE

There is, however, one further technical consideration. As the stations are separated by 10 kc., there is always present an inherent 10,000-cycle carrier beat note (or "heterodyne"). If the high-fidelity receivers can reproduce frequencies including 10,000 cycles per second, then this heterodyne beat note can be heard. To counteract this, the receivers must cut off just below 10,000 cycles per second.

The broadcasters have been, and are continually, exerting every effort toward effecting high-fidelity transmission and the programs are produced with this consideration in mind. The listener who avails himself of high-fidelity reception not only obtains the most nearly perfect reproduction, but enables himself to receive the program with the maximum amount of enjoyment and ease.

P.A. AIDS STEEPLEJACKS

When a foreman on the ground recently went hoarse yelling instructions to painters atop WOR's mast the station's engineers set up a P.A. system to project orders nearly 400 ft. upward!



Model 432-A
\$17.85

TODAY'S TESTER—TESTS TOMORROW'S TUBES... MODEL 432-A

• Today's outstanding tube tester value—a guaranteed quality tester at a price you can afford to pay. The needs of tomorrow have been anticipated by the advanced design of Model 432-A, along with complete provision for today's testing.

Greater filament switching ranges . . . 20 steps from 1 to 110 volts . . . Anticipates future filament voltages. Broader Testing Facilities . . . Checks Loctals, Single Ends, Bantam Jr., Gaseous Rectifier, Ballast, the New High Voltage Series and all other present types. Direct-Reading GOOD-BAD scale . . . 3" Triplet precision indicating instrument (Grade "A" only). Approved RMA circuit. Neon shorts test—Separate plate tests on diodes and rectifiers.

Professional appearing black leatherette case has handle and removable cover. Modernistic etched panel—black and polished nickel . . . as good as it looks.

Model 432-A . . . U.S.A.

Dealer Price **\$17.85**

Model 432-A—742 is a combination Tube Tester and Volt-Ohm-Milliammeter in a similar case, but slightly larger. Volt-Ohm-Milliammeter panel is a separate section. Ranges: AC-DC Volts 0-10-50-250-500-2500 (DC at 1000 ohms per volt); DC Milliampers 0-1-10-100; Resistance .5 to 500 with 25 ohms center scale; 0-100,000 and 1½ Megohms. Model 432-A—742 U.S.A.

Dealer Price **\$26.85**

YOUR PROFITS ASSURED with these NEW Readrite RANGER TESTERS

When you buy Readrite testers you get the best at a price you can afford to pay. Your profit is assured with Readrite quality and low cost investment. Readrite has made tube testers since radio tubes first were used for broadcasting and receiving. Buy a lasting product from a reputable manufacturer and you buy right. Honest repair service is a Readrite feature that goes with every tester—our lasting reputation has stood the test of this service we feel we owe to every user. Made by a tester manufacturer with a modern plant, modern equipment and manned by thoroughly trained workmen. **BUY READRITE AND YOU BUY RIGHT!**

MODEL 738

D.C. Pocket Volt-Ohm-Milliammeter with precision Triplet instrument having two genuine sapphire jewel bearings. Has selector switch, molded case. Ranges: D.C. Volts 0-15-150-750-1500 at 1000 ohms per volt; D.C. Milliampers 0-1½-15-150; 0-500 low ohms, backup circuit; 0-500,000 ohms. Complete with accessories. U.S.A. Dealer Price \$7.50



MODEL 739

AC-DC Pocket Volt-Ohm-Milliammeter with precision Triplet instrument having two genuine sapphire jewel bearings. Has selector switch, molded case. Ranges: AC-DC Volts 0-15-150-750-1500 (DC 1000 ohms per volt); D.C. Milliampers 0-1½-15-150; 0-500 low ohms; 0-500,000 ohms. Complete with accessories. U.S.A. Dealer Price \$9.90



READRITE METER WORKS
816 College Dr., Bluffton, Ohio

Please send me more information on

- Model 432-A; 432-A—742;
- Model 738; Model 739.

Name

Address

City

State

CLOSING DATE OF \$4,000 PUBLIC-ADDRESS CONTEST EXTENDED

Complying with many requests from our readers that we extend our Contest over a longer period of time in order to permit them to take advantage of P.A. installations made during the summer months, we have extended the closing date of the Contest from midnight, August 10, 1939, to midnight, September 10, 1939. Unlike other branches of the radio industry, the sound business is at its peak during the summer months.

If you have already made a P.A. installation or if you contemplate making one shortly, take advantage of this extension and shoot-in your description of the job—rental or otherwise—according to the rules of the Contest. See pgs. 80 and 106 for complete details.

PATENTS—TRADE MARKS

Booklet concerning Inventions & Patents

Form "Evidence of Conception" with instructions for use and "Schedule of Government and Attorneys Fees"—Free

LANCASTER, ALLWINE & ROMMEL

Registered Patent Attorneys

436 Bowen Bldg. Washington, D. C.

Correspondence Courses in RADIO and ELECTRICAL ENGINEERING

ELECTRICAL ENGINEERING Get good strap (wide electrical field. Prepare yourself, at Low Cost, for secure future. Modern, simplified, you can understand quickly.

RADIO ENGINEERING Extra fine course in radio, publication. Lic. address, photo-electric work, technician. Exper. kits furnished. Diploma on completion.

FREE Get course. Deferred payment plan. Get copies of school catalogs, student magazines, complete details. **SEND NOW!**

LINCOLN ENGINEERING SCHOOL, Box 851-C6, LINCOLN, NEBR.

Please Say That You Saw It in RADIO-CRAFT

NOISE REDUCING AUTO RADIO AERIALS

**INCREASED
EFFICIENCY**
with this
**NEW TYPE
BOOSTER COIL
ANTENNA**



Here is the aerial every serviceman has been wanting. It combines increased efficiency and noise-reduction with the best in design. These tri-bar aeriels fold down to very short lengths (as shown in the illustration) or open out to reach well above the car to pick up broadcast signals. An ingenious slide arrangement allows these aeriels to be used at any length between the two extremes to give a variable capacity effect. They are furnished for either cowl mounting or hinge mounting. A trial will convince you of their performance.

GUARANTEED RATTLE FREE.
See Them at Your Jobber's Today!

CONSOLIDATED
WIRE AND
ASSOCIATED
CORPORATIONS
524 S. Peoria St. Chicago, Ill.

GET A REAL ELECTROPLATING KIT ABSOLUTELY FREE!

Complete details as to how it is possible to get a Real Electroplating Kit FREE, appear on Page 122 of this issue. TURN TO IT NOW!

JOIN OUR RECORD CLUB
Send for your copy of this big 500 page Record Catalog & Encyclopedia. Contains lists of thousands of famous records and musical data on pronunciations and dates of composers; 25¢ plus 10¢ for mailing. (stamps or coin) It also enrolls you in our Record Club. We carry a large selection of records from 10¢ up. Write today.
MODELL'S 58 Cortlandt St. 301 New York City

RADIO COURSES
New Fall Classes Start in September
RADIO OPERATING—BROADCASTING
● RADIO SERVICING — a practical course
● RADIO AMATEUR CODE ● TELEVISION
● ELECTRONICS—1 yr. day course 2 yrs. eve. day and evening classes. Booklet Upon Request.
New York Y. M. C. A. Schools
6 W. 64th Street New York City

FILMGRAPH
Newly patented "FILMGRAPH"—instantaneous SOUND-ON-FILM RECORDER and REPRODUCER. No dark room or processing is required. Special models to make "TALKIES" in conjunction with camera or silent (as well as sound) projectors. Also models for use with or without pictures. 84 minutes of recording (without pictures) may be had on a 100 feet of 16 mm. film costing only 95 cents. Permanent PLAYBACK. Moderate initial cost of FILMGRAPH—only expense for putting SOUND-ON-FILM. MILES REPRODUCER CO., INC., 812-RC BROADWAY, NEW YORK.

Schematic diagram of the RCA Victor type RS-83E power supply unit. This separate plug-in unit is used to supply heater and plate voltages to the Radio chassis.

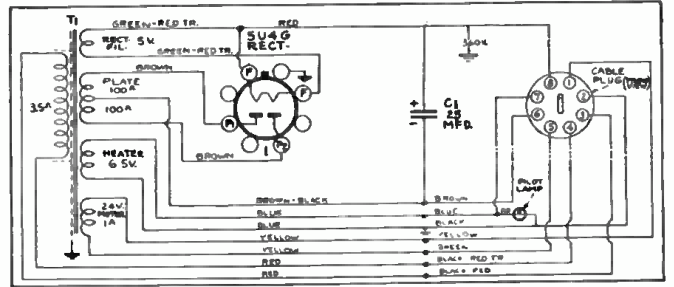

1939 COMMERCIAL TELECEIVER

(Continued from page 74)

- (2) Speech position with a modification of low tones.
- (3) Full tone reception for normal reproductions.
- (4) High-fidelity reception for special musical programs giving all the tone values possible.

The position marked "Television" sets the instrument for Television sound reception. The 1st and 2nd points give modified tones as for the "Victrola" position, points (1) and (2); and the third point (3) gives full tone reception.

Horizontal and Vertical Hold Controls—The dual knob at the back of the panel on the right controls the image stability. The inner section designated by "I" is the Horizontal Hold Control and when being set should be turned slowly to the point at which the image "locks in" horizontally. Fig. 6 shows the effect of incorrect setting of the control.

The outer ring "O" is the Vertical Hold Control and when being set should be turned to the point where the image "locks in" vertically. See Fig. 7.

These 2 controls on this dual knob should not ordinarily require readjustment after good image reception has once been obtained. An occasional resetting will be necessary due to changing to a different station, and to the gradual aging of the tubes.

Station Selector and Fine Tuning—The outer ring "O" section of the central dual control knob on the right-hand side of the panel selects the station from which it is desired to receive television transmission. The range covers 5 television channels:

- (1) 84 to 90 mc.
- (2) 78 to 84 mc.
- (3) 66 to 72 mc.
- (4) 50 to 56 mc.
- (5) 44 to 50 mc.

Set the selector to the number corresponding to the station from which it is desired to receive Television Broadcasts.

The inner "I" section of this knob is used to obtain best image reception by elimination of distortion resulting from interfering radio signals. These interfering signals show as a moving ripple in the image. Adjustment of this knob will often eliminate the interference. A slight downward pressure must be exerted on the knob while turning.

Contrast and Brightness Controls—The inner "I" Contrast section regulates the sensitivity of the receiver, varying the black and white tones of the image being received. Too much contrast gives blurred details and a lack of half-tones, while too little contrast makes it all half-tones or grays. Turning clockwise increases contrast from grays, to black and white. See Figs. 2, 4 and 5.

The outer ring "O" is the Brightness Control and affects the average illumination of the image. Turning clockwise increases the brightness. See Figs. 2, 4 and 5.

Focusing Control—This is a knob located on the back of the cabinet near the bottom

and is used for adjustment of the image focus. This adjustment affects the sharpness (detail observable) of the image and must be carefully made when the receiver is first placed in operation. It may be checked occasionally to insure continuous best focusing. See Fig. 3.

Pilot Light—A little jewel pilot light at the bottom of the front of the cabinet indicates when current to the Television Receiver is on.

Other Controls—There are 5 other controls on the television chassis. All of these are to be adjusted by the television technician at the time the set is installed, but may require occasional resetting. This is a job for the dealer's Serviceman. These controls are accessible from the back of the cabinet. (See illustration on Page 61, Part I, last month.) They are adjustable by means of a screwdriver through a vertical row of holes in the right side of the cabinet. They should be adjusted only by a trained television technician.

RECEIVING THE IMAGE

To obtain image reception:

- (1) Turn the Fidelity-Selector Control on the radio panel to "Television," fully clockwise.
- (2) Turn Power-Volume Control on radio panel clockwise and advance about half-way.
- (3) Set the Station Selector on the Television panel to the desired station (1-2-3-4 or 5).
- (4) Turn the Contrast Control fully counterclockwise and then turn Brightness Control slowly until illumination of the screen almost disappears. Advance the Contrast Control until the image appears at its best as viewed in the mirror on the lid. The Contrast Control turned too far clockwise causes blurring. Make final adjustment for best image by adjusting both the Contrast and Brightness Controls. The illustrations shown in Figs. 2, 4 and 5 give an idea of the effect of the Brightness and Contrast Controls. Incorrect setting has effects somewhat similar to under- and overexposure on photographic prints.
- (5) If the image is not steady, the "Hold" controls will require slight readjustment. If the image is moving sideways the Horizontal Hold (inner "I" section of the knob) requires readjustment. If the image is moving up or down or is off position, then the outer ring "O" of the knob, Vertical Hold Control, requires readjustment. See Figs. 6 and 7.
- (6) Adjust the Volume Control and the Tone Control (Fidelity-Selector knob) for best sound reception.
- (7) If an interfering ripple is observed in the image, adjustment of the Fine Tuning knob may reduce or eliminate the distortion. If it does not, the dealer's technician should make a check-up.
- (8) If the image appears out of focus, carefully turning the Focusing Control on

Please Say That You Saw It in RADIO-CRAFT

the back of the cabinet should remedy the condition. Otherwise, only the dealer's technician should check-up.

As long as the Television Receiver is not moved in any way, only an occasional setting of the other controls will be required.

A spot in the center and also a slight discoloration of the television screen may gradually appear as the Kinescope ages. This is normal and in no way affects good image reproduction. (It is due to the fact that, in "magnetic" deflection, only the electrons are deflected; the ions continue forward, from the cathode, undeflected. In "electrostatic" deflection, electrons and ions, both are deflected.—Editor)

RADIO CONTROLS

There are 4 control knobs at the right of the row of pushbuttons. These are shown in Fig. 1.

(1) *The Power-Volume Control.*—See "Television Controls."

(2) *The Fidelity-Selector Control.*—See "Television Controls."

Position No. 4 ("High Fidelity," see Fig. 1) provides High-Fidelity reception. All available sound waves that the receiver can reproduce, including low and high notes that are usually lost, are brought through in this position. However, there are limitations to the use of high-fidelity reception of which the owner should be aware in order to make the best use of the TRK-12. On weak stations, and at times on strong stations, atmospheric and other conditions may be such as to cause interfering sound waves from external sources, including adjacent channel stations, to mar your enjoyment of the program with the control on "High Fidelity." At such times, turning the knob back (counterclockwise) will lessen the interference by offering 3 successive positions for varying control of tone and selectivity. Adjustment of this knob permits obtaining clear and uninterrupted, pleasing reception under almost any circumstances.

(3) *The Tuning Control.*—The 3rd knob from the left operates the sliding pointer on the dial scales and brings in your station on manual dial tuning when the "Dial Tuning" pushbutton is pressed down.

(4) *The Range Selector.*—The knob at the back selects the major frequency band for dial tuning and operates the range indicator at the back of the pushbuttons, thus indicating on which major frequency band your receiver is set for tuning—"A" broadcast, "B" medium, or "C" shortwave.

INSTALLATION AND SERVICE

Tubes age so gradually that unless the instrument is checked over at least once a year the owner may not obtain the best performance, without knowing exactly why. The dealer's Serviceman should give this instrument a "check-up" at least once every year. In the event that the image tube should fail to give satisfactory service in this receiver, the dealer from whom the tube or the receiver was purchased should be immediately notified.

The Kinescope is packed in a separate carton and all labels on the carton should be read and observed. It is a high-vacuum device and is hazardous for handling by anyone not familiar with such apparatus.

A location should be carefully planned for the receiver where it can be installed by the technician in a level position, convenient to an electrical outlet, and where no light will shine on the screen in daytime or night time, and the illumination can always be conveniently dimmed for image reception.

Provision should also be made for locating the antenna at a good height above the roof

with as direct a path as possible for the transmission line and easy access to the receiver. A good ground connection to a cold water pipe or the equivalent is indispensable.

The correct installation of both receiver and antenna is most important for the reception of satisfactory images, and requires a trained television technician. High-frequency electric discharges reaching the antenna or receiver will spoil the image. Such discharges are caused by ignition systems on gasoline and oil engines, and by high-frequency electrical apparatus such as X-ray generators and similar devices used for medical and other purposes. The effect of aircraft passing overhead is to slightly reduce the brightness according to their proximity. Automobiles near at hand may produce slashes of light and in certain cases destroy synchronization in the image. Medical electrical equipment is apt to cause speckled and herringbone bands across the image.

"The necessity of the best possible installation with good permanent ground connection of both receiver and antenna, with full consideration of all local conditions, thus becomes apparent and we therefore emphasize the advisability of having a trained television technician make the installation."

There are 4 chassis in the back of the receiver. Looking in the back, the Television Receiver chassis is at the top-left in a vertical position, with fixed controls and antenna terminal board visible, and the Radio chassis is at the top-right with the Electric Tuning device facing downwards. Two power chassis are on the bottom shelf. The Focusing Control is on the Television Power Chassis. Two interlock safety switches, on the side panels, make contact when the back is correctly secured in place.

ANTENNA

Three types of television antennas are available:

- (1) The Double "V";
- (2) The Double Dipole;
- (3) The Double Dipole, with Reflector.

Under favorable conditions, good images may be obtained with the Double "V" Wire Type. In areas of weak signals or where interference or double images mar the images a Double Dipole or Double Dipole and Reflector become necessary.

The circuit is designed so that the television antenna may also be used for Standard Broadcast and Short-Wave Radio reception.

"Good television and radio reception depend upon a correctly designed antenna, properly installed. Your television technician should make the installation."

HEAT-OPERATED RELAY

THE "Curie point" in magnetized iron is now the basis of heat-controlled relays. The Battelle Memorial Institute has announced that magnetized iron can be made to lose its magnetism at any desired temperature between 150 degrees below zero to 1100 degrees above; thus, room temperature can be controlled, fans turned on or off, fire sprinklers or fire alarms operated, and refrigeration and air-conditioning equipment controlled with relays operating on this principle.

The development is a practical application of the effect, discovered in 1600, with which every student in radio and electricity is familiar. The classical schoolroom demonstration employs a candle flame to heat the magnetized bar which then releases its keeper—and attracts it again when the magnet is cooled. New magnetic alloys make the relay possible.

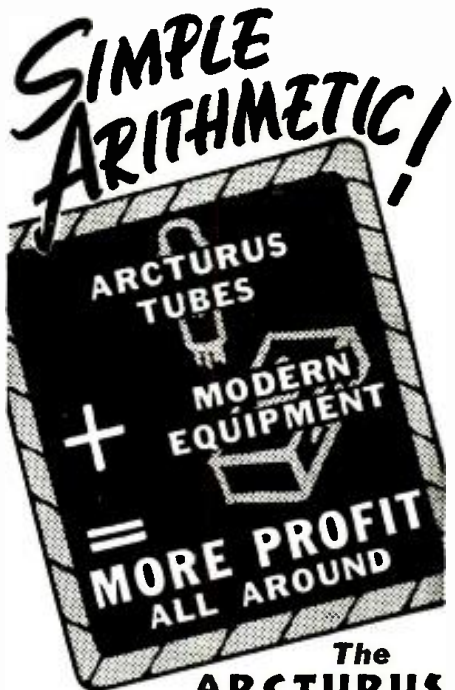

The ARCTURUS EQUIPMENT DEAL*
 Gives You the New Equipment You Need . . . Practically FREE!

No doubt about it! With all the new tubes recently introduced, you need modern store and shop equipment to keep up with the demands of present day Radio. You must be geared up to render fast, efficient and accurate service on all types. You've got to have equipment that proves to your customers that you are wide awake—prepared to give them excellent service at a reasonable price.

That's why Arcturus offers you an Equipment Deal.* That's why we've made it the most liberal Deal ever devised. We know you'll sell more tubes, take care of more service work, attract new customers if you are properly equipped. That means we both make more money—and you make a worthwhile EXTRA PROFIT in the form of the equipment you need!



**GET STARTED!
 You Can't Lose!**

Arcturus Equipment Deal DOWN PAYMENTS are much lower than any other! . . . TUBE REQUIREMENTS are kept at a minimum! . . . you get IMMEDIATE DELIVERY of the units you select! . . . and you still pay only STANDARD PRICES for tubes! Get all the facts—get started today!

(*Offer good in U.S.A. only)

ARCTURUS

ARCTURUS RADIO TUBE CO., Newark N. J. C-21
 Without cost or obligation, send my copy of the ARCTURUS DEALER HELPS Folder and details of the ARCTURUS EQUIPMENT DEAL.

Name.....
 Street.....
 City.....State.....
 I am a dealer I am a serviceman, My jobber is.....

For your convenience this coupon can be pasted on a penny postcard

Please Say That You Saw It in RADIO-CRAFT

Radio Men find This Book Handy

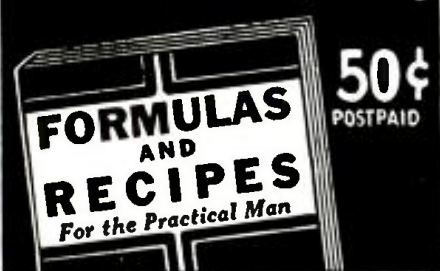

Here is the Contents of the Book

1 Adhesives: Glues, Cements, Gums, Mucilages, Lubricants. 2 Cleansing: Stain Removers, Paint Removers, Bleaches, Cleaning Fluids. 3 Metal Craft: Coloring, Oxidizing, Plating, Repairing, Welding, Polishes, Alloys, Solders, Amalgams. 4 Paints: Colors, Stains, Varnishes, Enamels, Luminous Paint, Washable Paint; Paint Removing, Waterproofing, Fireproofing. 5 Glass Working: Cutting, Drilling, Boring, Bending, Etching, Engraving, Frosting, Silvering, etc. 6 Wood-craft: Fillers, Fireproofing, Acid-proofing, Waterproofing, Furniture Polishes, Finishes, etc. 7 Ink Recipes, Eradicators, Ink Stain Removers, Special Inks, Colored, Insoluble, Sympathetic, Invisible, Hectograph. 8 Photography: Developers, Emulsions, Fixers, Sensitizing, Toning, Printing, Photographic Paper, Blueprint Paper. 9 Antidotes for Poisons, Remedies for Burns and Scalds, Disinfectants, First-Aid in Accidents, Emergency Remedies, Home Remedies. 10 Preparation, Manipulation, Handling, Mixing, Measuring, Weighing, Filtering, Straining Solutions; List of Technical Substances; Emulsifying; Use of Hydrometer, Use of Thermometer; Tables of Weights and Measures, Decimal Systems. Useful Tables.

TECHNIFAX, Division RC-839
1915 So. State Street, Chicago, Illinois

TECHNIFAX, Division RC-839
1915 So. State Street, Chicago, Illinois

Gentlemen: Enclosed please find 50¢ (check, money order, coin or unused U.S. stamps accepted) for which the POSTAGE PREPAID, One Copy of FORMULAS AND RECIPES For the Practical Man.

Name

Address

City State

Short-Wave fans need this

WORLD-TIME CLOCK

The Only Clock for Universal Use Throughout the Entire World!

- A REGULAR CLOCK with A.M. and P.M. divided dial
- A WORLD-TIME CLOCK Instantly indicating time in all 24 zones
- INTERNATIONAL CLOCK with A.M. and P.M. 24 hour dial



Here is really the first new clock advancement in 200 years—three clocks in one, a world-time clock. It is revolutionary! It is years ahead! The Sky Dial WORLD-TIME CLOCK is the only clock designed for use anywhere in the world. For short-wave fans this clock offers great convenience—it is educational and at the same time indicates world time differences. In a few seconds you can determine the correct time in London, Moscow, Hawaii, Tokyo, Buenos Aires, Halifax—anywhere, American made—it is exceptionally easy to operate. It carries a guarantee of ninety days against defects in material or workmanship. In modernistic design, it is made of brushed brass—measures 5 1/4" high by 4 3/4" wide—and has convex crystal.

Spring driven model \$4.95
Electric driven (for A. C. 110-120 volts, 60 cycles) \$5.95

Remit by check or money order; register letter if you send cash or unused U.S. postage stamps. Add 25¢ to cover postage and insurance in U.S.A. Canadian and foreign add 35¢.

RADIO AND TELEVISION Magazine
99-R HUDSON STREET NEW YORK, N. Y.

LATEST CIRCUIT FEATURES IN MODERN P.A. AMPLIFIERS

(Continued from page 81)

Also the waveform is far from the ideal sine curve, and the effective r.m.s. voltage is reduced considerably. This reduction incidentally works out very well, as we will see shortly.

The remaining winding is used for the 110-volt primary when the A.C. plug is inserted, and this plug also serves as an automatic switch.

When the 6-volt D.C. power supply, however, is employed, this winding produces 110-volt, 60-cycle A.C. and is used to operate a regular 78 r.p.m. synchronous motor turntable. The tubes with this mode of operation are connected directly to the 6-volt D.C. power supply.

When the A.C. plug is inserted, the amplifier is ready for 110-volt operation. The phono motor runs directly from the power supply; and since the turns ratio of the high-voltage to the 110-volt winding remains the same, the correct voltage results for the plate supply.

The one-half "vibrator" primary has been designed with a turns-ratio of 3.2 to 110, as far as the A.C. primary is considered. The heaters are now connected to this total winding, and the proper 6.4 volts supply is impressed on the tubes.

This power supply has the advantage of universal operation, simplicity of change-over and conservative rating. The plug-in

vibrator simplifies replacement when it may be needed.

Simplified A.V.C.-A.V.E. Circuit. We now refer to Fig. 5, where a part of the schematic covering the 18-watt de luxe amplifier is illustrated. A special and somewhat different A.V.C.-A.V.E. circuit is employed.

Individual 6H6 tubes are used for each one of these functions and are switched over from one to the other. A tap switch with jumping resistors is used to control the action of each one.

The input voltage to the A.V.C.-A.V.E. circuit is obtained from a low-impedance source and has been so designed to give fast-starting control operation while the "let-go" action is somewhat delayed for best results.

The actual time delay and additional filter action is accomplished with a resistor-condenser network incorporated in the return circuit. Of course, the regular 6L7 tube is used as the automatic control tube.

There are a great many other recent developments that have been incorporated in these amplifiers as will be noted by you. However, the ones explained are of greatest interest and have but recently been adapted to commercial equipment.

This article has been prepared from data supplied by courtesy of Allied Radio Corp.

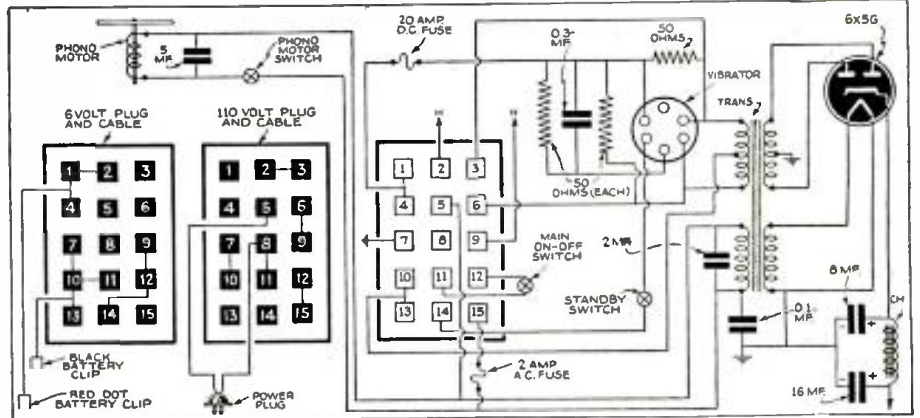

Fig. 6. The provisions for changing from electric to battery operation in an 18-W. mobile amplifier.

SERVICING TELEVISION RECEIVER FAULTS

(Continued from page 87)

white streaks superimposed on the vertical flybacks. These are due to the change in shape of the sync. pulses during the framing period. They actually are caused by the half-line pulses, maintained during the vertical pulses, to ensure the lines are kept in step during these intervals. We shall have occasion to refer to these later.

LOW-PULSE

The fault of Figs. 5 and 6 is due then to insufficient amplitude of pulse. Now it is not unusual for a receiver to be operated in this condition, unstable synchronism being tolerated, for the simple reason that if more positive control is attempted, the instability becomes worse. The appearance of the image is, then, that of Fig. 7. It is seen that the effect is as though one side of the image is pulled sideways. This is caused by the presence of image modulation in the sync. circuits. This modulation being positive, causes the time bases to fire irregularly. Naturally, as the modulation changes, e.g., scene changes or subject movement take place, this tearing of the image will vary.

It should be added that the above applies only to conventional sync. pulse filtering arrangements of the amplitude separator or

unilateral type. More recent methods for securing synchronism do not suffer from this defect, though they, nevertheless, have their own failings.

To ensure that no image modulation is applied to the blocking oscillators, care in adjusting the operating conditions of the filter circuit is required. Again, an oscilloscope is an invaluable ally and the frame time base and equipment can be pressed into service. It is a simple matter then, to adjust the filter conditions until all image modulation is removed.

This condition is readily apparent for, with correct adjustment, the base line of the pattern is perfectly level. At the same time a check on the regularity of amplitude for the pulses can be made; that is to say, the tops of the pulses should be substantially of equal height. It is necessary to retain the D.C. component to secure these results. A direct connection to the deflecting plates will ensure this.

With a little practice it is possible to adjust sync. filters with the aid of headphones only. Adjustment in this method is continued until no audible change in pulse-pitch occurs during image modulation.

(To be continued)

HOW TO MAKE A "B"-BATTERYLESS RECEIVER

(Continued from page 77)

or of accidentally connecting a "B" battery to the "A" leads and burning-out all the tubes (such things do happen!). And finally, the necessity for special-size, and -type (poled, for instance), "B"-blocks is eliminated.

The vibrator-"B" unit shown here delivers about 9 ma. at 90 V., which is ample for this radio set. A sponge-rubber "coat" around the vibrator absorbs all mechanical vibration; it's impossible to hear it vibrating in a quiet room. *This vibrator-"B" unit may be used to replace "B"-batteries in any equivalent battery-portable.*

UNI-POWER

This is not the ultimate "B"-batteryless radio set, but it does represent a definite effort to create a new concept in small-space drycell radio set design.

The whole idea of having a separate source of battery power supply for the "B" voltage in the opinion of the writer is fundamentally wrong. (We long ago eliminated the need for "C" batteries, to deliver a currentless control-grid tube bias voltage, by using *oxide bias cells*.)

Is it not logical to derive all the operating voltages for a "battery" radio set from the single 1.5-V. drycell source just as all the operating voltages of an electric set are obtained from only the 115-V. electric light lines?

In the first place it is fundamentally impossible to so design a radio set that the rates of "A" and "B" drain will be completely uniform (changing tube characteristics for example illustrates this point); and, it is quite improbable that different manufacturers will ever agree to follow only a given radio set pattern merely so that battery drains will be uniform.

Hence it is seldom that the "A" and "B" supply can be changed at the same time to best advantage; and even then it becomes either an extravagance to discard the partially-used unit or an inconvenience to wait until a later date to replace it (especially if the "B" unit is at all special—as for instance with poled terminals).

Furthermore everyone operates a radio set differently. Some people "play" their set frequently while others operate the set at different volumes (people who are accustomed to playing their battery set outdoors or whose hearing is impaired tend to turn the volume control higher); this results in increasing the "B" drain, due to increased plate current drain of the tubes, over operating the set infrequently (or at low volume). Since the life of a drycell or battery, apart from its shelf life, is a function of its rate and frequency of discharge, it is evident therefore that the above-described diversified ways of operating a radio set place a disproportionate drain on the "A" and "B" supplies.

A study of the comments just made also reveals why it is uneconomical to combine the "A" and "B" supplies in one "battery pack".

The use of a vibrator-"B" unit designed especially for operation from the "A" supply perfectly solves all these problems; and, as such "drycell vibrator-"B" units" are further engineered for this particular class of service, their comparative economy will become increasingly evident.

The purchase price of the vibrator-"B" unit of course is greater than that of an individual 90-V. "B" battery. However, since it seldom requires replacement and its upkeep is practically nil, its "cost" is relative.

At a current drain of about 500 ma., cut-off of 1.1 V., and operating 4 hours per day, engineers of National Carbon Co. have estimated for the writer that certain of the Eveready 1.5-V. drycells and "batteries", and 2-V. Air Cell, will give services as follows:

Lbs. Wgt. of "A" Unit	Power Supply No.	Est. Service Hours	Cost Per 100 Hours
6%	*740	300	\$.60
2%	741	76	1.25
2-1/16	743	32	2.34
2%	No. 6 Ignitor	40	1.00
8 1/4	*A-1300 Air Cell	600	.41

(* Recommended for permanent installations—boats, etc.—rather than in portable services.)

CREDITS

The writer takes this opportunity to extend credit and thanks to Mr. Maurice Musler who converted from electric to dry-cell operation the midget set here illustrated; and to the manufacturer who made this highly-efficient broadcast receiver available (in its A.C.-D.C. form).

The writer does not claim any originality in the idea of developing high or so-called "B" voltage from an "A" supply—not even where this "A" supply is a drycell. This was an accomplished fact years ago in, for instance, early types of *radiosondes* where a buzzer, which might be broadly termed a "doorbell" buzzer, stepped up the voltage from a drycell to a value sufficient to supply the plate of a tube which was utilized in a balloon transmitter to send signals which revealed meteorological conditions in the stratosphere. The plate voltage developed in this way was used "raw," that is unrectified and unfiltered, the rectifying action of the tube being sufficient for the intended use.

However the idea of using a highly perfected and "A"-driven "B" supply unit—such as the synchronous vibrator in a noise-proofed housing and delivering a completely filtered noise- (and hum-) free power output sufficient for several tubes, and yet operating from only a single drycell source of power supply, to deliver a completely uniform current output at a specified terminal voltage—is believed to be an original, widely-applicable development.

LIST OF PARTS

- One Detrola model 280-U Pee-Wee, Jr., (basic A.C.-D.C., midget T.R.F. set);
- Four Cornell-Dubilier 0.05-mf., 200-volt condensers;
- Two Cornell-Dubilier 100 mmf. mica condensers;
- One I.R.C. resistor, 0.1-megohm, 1/2-watt;
- One I.R.C. resistor, 0.25-megohm, 1/2-watt;
- Two I.R.C. resistors, 1 megohm, 1/2-watt;
- One I.R.C. resistor, 2 megohms, 1/2-watt;
- One I.R.C. resistor, 15 megohms, 1/2-watt;
- One Clarostat volume control, 1 megohm, type U, with switch;
- One 4-wire battery cable;
- One Oxford-Tartak 3-in. Permago dynamic speaker with matching transformer (7,000 ohms);
- Three P. R. Mallory & Co. bias cells, with mountings;
- One American Television & Radio Co. 1 1/2-volt-operated vibrator-"B" unit;
- One National Union type 1N5GT bantam tube;
- One National Union type 1H5GT bantam tube;
- One National Union type 1Q5GT bantam tube;
- One National Carbon Co. No. 6 Ignitor 1.5 V. drycell.

New RCA TUBE TESTER



— even better than its predecessor — and yours at the same LOW PRICE **\$37.95*** NET

Man—here's the buy of a lifetime! This brand-new RCA Tube Tester offers all these

NEW FEATURES

- 1—Tests Loktal and Miniature Base Tubes
- 2—Tests Flashlight and Christmas Tree Bulbs
- 3—Has Two Spare Sockets
- 4—Has provision for test of tubes of virtually any filament voltage
- 5—Has On-Off Pilot Light
- 6—Has revised up-to-date Roller Chart—9 ft. long with space for insertion of new types.

—plus all the features that made its predecessor an outstanding value! These include one-finger operation . . . indication of line voltage up to instant of actual test without necessity of setting line voltage prior to insertion of tube in socket . . . and the ability to test all standard types of receiving tubes including ballast tubes, new battery tubes, Magic Eye Tubes, and many others. Makes all tests according to R.M.A. standards.

*This new RCA Tube Tester is available in two types—for counter use, Stock No. 156C, \$37.95 . . . for portable use, Stock No. 156B, \$39.95. Get yours today from your RCA Test Equipment Distributor.

Over 335 million RCA radio tubes have been purchased by radio users . . . in Tubes, as in Parts and Test Equipment, it pays to go RCA All the Way.



Please Say That You Saw It in RADIO-CRAFT

PRICED FOR CLEARANCE!

Rockbottom Prices on Overstocked New and Rebuilt Merchandise

When prices are low we buy! They're low now—**LOWER THAN THEY EVER WILL BE**—hence this sale. Most of the merchandise is new—never used; some of it reconditioned. 100% satisfaction on each transaction or your money refunded. **ORDER FROM THIS PAGE.** Use the convenient coupon below. Be sure to include sufficient extra remittance for parcel post charges, else the order will be shipped express, charges collect. Any excess will be refunded. C.O.D. shipments require a 20% deposit. If full remittance accompanies order deduct 2% discount. Send money order—certified check—new U. S. stamps. No C.O.D. to foreign countries.

ORDER TODAY QUANTITIES LIMITED QUICK SHIPMENTS ASSURED

WESTINGHOUSE WATTHOUR METER

Completely overhauled and ready for immediate service. Designed for regular 110-volt, 60 cycle 2-wire A.C. circuit. Servicemen use it in their shops to check current consumption of sets, soldering irons, etc. Keeps costs down. If dismantled, the parts alone would bring the price. The elaborate gear train could be used as a counter on machines of various kinds. Simple to install: 2 wires from the line and 2 wires to the load. Sturdily constructed in heavy metal case. Size: 8 1/2" high, 6 1/4" wide, 5" deep, overall. Shp. Wt. 14 lbs.



\$4.50

PORTABLE TELEGRAPH AND BUZZER FIELD SETS



Made for military use by Western Electric. A wonderful buy if only for the parts it contains. Never been used. Good for code practicing, signaling, communications, etc. Contains 2-tone, high-frequency buzzer with platinum contacts, telegraph key, telephone switches, earphone, condensers, transformers, chokes, etc. A \$50 value easily. Complete in wooden case with diagrams and instructions. Shp. Wt. 12 lbs.

ITEM NO. 10 Your Price \$5.45

SERVICEMEN!—EARN MORE MONEY

Electrifying Domestic Sewing Machines



While you're repairing that radio suggest electrification of the old sewing machine. The cost is amazingly low. Every "foot-treadle" housewife is a likely prospect. Only one hole drilled to mount the entire assembly. Labor cost low, profit high.

COMPLETE EQUIPMENT SUPPLIED

Nothing else to buy. Kit includes motor, bracket to fit any machine (mention name) cord, pulley and rheostat for knee or foot control. Motor is 1/20 HP 110 volts AC or DC. 25 or 60 cycles. 5,000 RPM variable. double 1/2" shafts for either rotation. flat-sided case to permit use on drop-head machines. Size 5" x 3" x 2 1/4". Shp. Wt. 16 lbs.

ITEM NO. 37 Your Price \$8.65

WESTON MODEL 562 A.C.—D.C. AMMETER

Designed by Weston for the Eastman Kodak Co. Range, 0 to 6 Amperes. It is a precision-built magnetic-rod type ammeter which, with suitable shunts, can be made to measure heavier currents too. It is 2" in diameter and designed for panel mounting. Bakelite base and black-enamelled cover. Shp. Wt. 2 lbs.



ITEM NO. 35 Your Price \$1.25

1/20 HP 2-SPEED AC-DC MOTOR

Double-Shaft. 5000 and 230 RPM

Brand new back-gear motors. Never been used. Steel worm and fibre driven gears. The 230 RPM shaft is at right angles to main shaft and delivers power up, down, right or left by moving gear train. A suitable-sized rheostat may be used for controlling the speed. Shaft is 3/16". For 110-volt A.C. or D.C. 25 or 60 cycles. Servicemen and others will find the double speeds useful for grinding, buffing, winding coils. Shp. wt. 12 lbs.

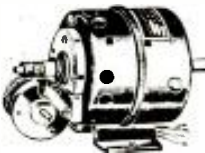

ITEM NO. 40 Your Price \$5.25

1/100 HP AC MOTOR

Excellent for experimenting, mechanical toys, dynamic window displays, etc. Develops 1750 RPM. Has 2-sided shaft with fan blade on one end for cooling the motor. Housed in sturdy case with attached mounting bracket. Shp. Wt. 5 lbs.



ITEM NO. 41 Your Price \$1.49

MOTOR-SPEED REDUCER

Reduces the speed of electric motors 12 1/2 times. The gears are totally enclosed in a steel case. Shaft, 1/2" sleeve bearings 2 3/4", shaft extension 3 3/4" base to shaft centers 7". High speed shaft on top. Mounting bolts 3 11/16" x 2 5/8". Shp. Wt. 8 lbs.



ITEM NO. 42 Your Price \$4.72

WELDING! BRAZING! SOLDERING!

3-IN-1 PORTABLE ELECTRIC TORCH

WORKS FROM 110 VOLTS A.C. OR D.C. LINE

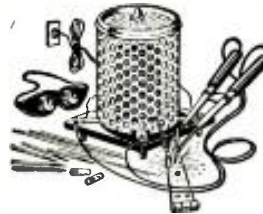

This electric torch is not a gadget or a toy but a sturdily built outfit using the finest materials. With it you are able to do professional type of welding, brazing and soldering work, regardless of whether or not you've had previous experience. It will do a thousand and one jobs; fender welding, auto body repairs, bumpers, cylinders, tanks and industrial repairs—ideal for steel, filters, plumbers, sheet metal jobs, engineers, maintenance men, railro and bicycle repair men, etc. Works on aluminum, brass, copper, iron, steel and other metals.

The 3-in-1 electric torch is so simply constructed that even a boy can operate it after reading the simple and concise instructions furnished with the unit. Not necessary to know how to strike an arc! All you do is plug the torch into the light socket, adjust the carbons per instructions, and presto!—you have an intense, blazing flame, ready for work. The outfit comes complete with power unit, electric cord, electrode holder, carbons, welding rods, brazing rods, solder flux, goggles, and instructions.

Save money! Do your own repairing. Earn money by doing repairing for others. Simple, practical, durable and safe to handle—that's why the price is amazingly low. Don't delay—order one today. Shp. Wt., 8 lbs.

ITEM NO. 50 Your Price \$6.95

USEFUL KINKS AND CIRCUITS

(Continued from page 92)

A "JUNKBOX" "B" POWER UNIT

● I AM entering a description of a "B" power supply, in your Short-Cuts section, which operates from the car battery. I have built this device exactly as shown and it works fine. It is filtered well enough so that the vibrator noise is almost inaudible.

This "junkbox" power supply is built to furnish "B" power to small portable receivers from the car battery while the car is not running.

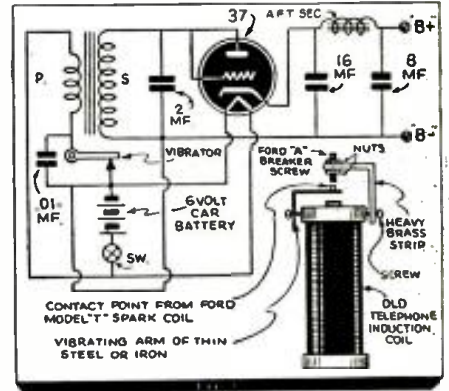

The power transformer is an old telephone induction coil with a home-made vibrator attached to one end as shown. Adjust the vibrator screws for best results. The current consumption is very small.

LAWRENCE LONG,
Seattle, Wash.

A 110 VOLT D.C. AMPLIFIER

● THE amplifier, herein described, has given satisfaction in every way and it may be of interest to Servicemen in D.C. districts. The cost is moderate, the performance excellent.

The output stage consists of four type 48 tubes in class A parallel push-pull, preceded by two stages: a 6F5 resistance-coupled to a 6C5, which in turn is transformer-coupled to the final stage. This gives a voltage gain of about 90 db., sufficient to use with a carbon or crystal mike or pickup.

The circuit is quite conventional and there are only a few points to observe. The filter choke must have a very low D.C. resistance; the maximum drop should not be greater than 5 volts. The original was 1000 turns of number 26 plain-enamel magnet wire, wound on a suitable core.

The output transformer carries about 120 ma. in each half and requires to be large enough to carry the current; one suitable for push-pull 2A3's is used.

The tone control provides for attenuation of lows or highs to suit different conditions.

The 48's are biased with a 22 1/2 V. "C" battery to allow the use of the full line voltage on the plates. Where the line voltage is under 110 volts the 400 ohm screen dropping resistor may be omitted. Some concern was felt regarding the connecting of the four 48 tubes in series across the line, it subjects two of them to high cathode-to-heater voltage; however, in six months' operation there has been no evidence of leakage.

A 3-ampere auto-type fuse protects the machine in case of shorts or reversed line connections.

Altogether the machine has been fully up to expectations and has ample power for

WE HAVE NO CATALOG. ORDER FROM THIS PAGE.

HUDSON SPECIALTIES CO. - 40-RC West Broadway - N. Y. C.

IT'S EASY TO ORDER - CLIP COUPON - MAIL NOW

HUDSON SPECIALTIES CO., 40-RC West Broadway, New York, N. Y. RC-839
I have circled below the numbers of the items I'm ordering. My full remittance of \$..... (include shipping charges) is enclosed.

OR my deposit of \$..... is enclosed (20% required), ship order C.O.D. for balance. (New U.S. stamps, check or money order accepted.)

(Circle Item No. wanted: 16 33 35 37 40 41 42 50

Name Address
City State

Send remittance by check, stamps or money order; register letter if you send cash or stamps.

Please Say That You Saw It in RADIO-CRAFT

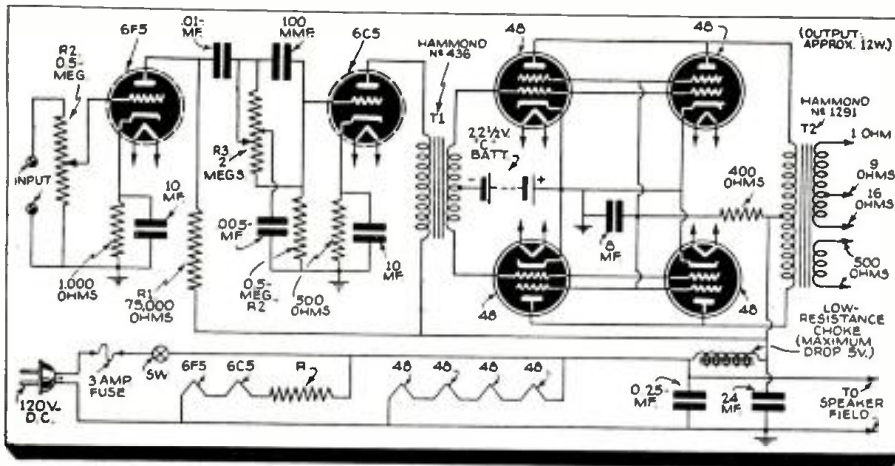

Circuit Diagram of 110-Volt D.C. Amplifier.

small skating rinks, sports days in small centres, and other similar applications.

LIST OF PARTS USED IN THE ORIGINAL

- 1 Hammond No. 1450 chassis.
 - T1 Hammond No. 436 input transformer.
 - T2 Hammond No. 1691 output transformer.
 - 4 RS6 Amphenol sockets.
 - 2 RS8 Amphenol sockets.
 - Speaker plug and socket.
 - 1 72-106 Centralab volume control.
 - 1 72-142 Centralab tone control.
 - R1 500 ohm adjustable.
- The other parts are all marked in the diagram.

THE 6C5 DETECTOR-OSCILLATOR CIRCUIT

● THE circuit shown in the above diagram has been used in regenerative and super-het receivers.

- The features of the circuit are:
- 1—Controlled feedback.
- 2—Tremendous feedback and sensitivity.

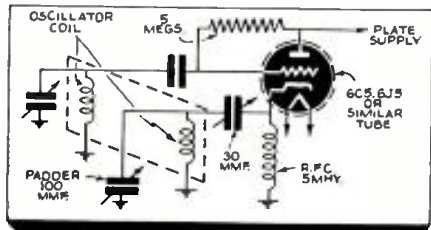

The oscillator is excellent for high frequency work. The diagram shows a separate triode, but the circuit may be incorporated with a 6A8 or similar tube, in which the anode grid of the oscillator section is connected where the plate of the triode is shown.

F.C.C. Classification of Radio Transmissions

The Federal Communications Commission classifies radio transmissions, or "emissions," according to the purpose for which they are used; assuming their modulation or their possible keying to be only in amplitude, as follows:

Continuous Waves:

Type A0. Waves the successive oscillations of which are identical under fixed conditions. (These waves shall be used only in special cases, such as standard frequency emissions.) Continuous waves, no signaling.

Type A1. Telegraphy on pure continuous waves. A continuous wave which is keyed according to a telegraph code; Morse code, Baudot code, Stop-start printer, or Scanning-type printer.

Type A2. Modulated telegraphy. A carrier wave modulated at one or more audible frequencies; the audible frequency or frequencies or their combination with the carrier wave being keyed according to a telegraph code. Telegraphy modulated to musical frequency.

Selectivity is gained through the use of a 100 mmf. condenser across the tickler coil. The 5 meg. grid leak supplies negative bias to osc. grid, making it sensitive and increasing amplification. The 5 MH RFC supplies sufficient impedance to the cathode to make it regenerate.

ALBERT E. MOULIN, JR.,
PAUL ORCHARD, II,
New Orleans, Louisiana

CODE-PRACTICE OSCILLATOR

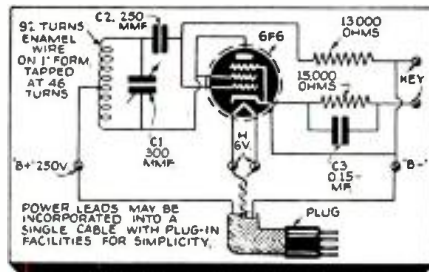

● HERE is a diagram of a self modulated Oscillator suitable for code practice.

The main idea of this circuit is the fact that it enables the operator to receive his signals on his own radio with much the same note as a high powered commercial station.

The circuit is self explanatory with the exception of C-3 which may be of a value between .01 mfd. and .25 mfd. The variation of this condenser changes the note of the modulated signal.

I sincerely hope that you can use this in your "Useful Circuit Ideas," or some other department.

ARTHUR L. TURNER,
Red Bluff, Calif.

QUICKER, EASIER WAY TO TRAIN FOR ELECTRICITY
12 Weeks Practical WORK IN MY CHICAGO SHOPS



WANT TO EARN MORE MONEY?

Of course you'd like a good-pay job. But wishing won't get it for you. Dreaming won't do it. Doing can! And I'm ready to help you on your way to a start.

I'm ready to make it easy for you to get 12 weeks of real shop training in ELECTRICITY — training that can help you toward a better job.

This is no correspondence course I'm talking about. You do actual work right in my Chicago shops—real work on real generators, motors and dynamos. You do house wiring and wind armatures. You work in many other branches of electricity. And right now I'm including valuable instruction in Diesel, Electric Refrigeration and Air Conditioning. Also, I'm including an extra 4 weeks course in Radio at no extra tuition cost.



HOUSE WIRING
only one of the many branches you "Learn By Doing"



AN EXTRA 4 WEEKS COURSE IN RADIO INCLUDED



I'LL FINANCE YOUR TRAINING

You can get this training first—then pay for most of it later in 12 easy monthly payments, starting 60 days after your 12 weeks training period is over.

If you need part-time work to help out with expenses while training in my shops, my employment department will assist you. And after graduation, you'll get lifetime employment service. Mail the coupon today and I'll send you my big free book filled with interesting facts and pictures of students at work—doing the same things you will do. I'll also tell you about my "Pay After Graduation" Plan and how many of my students earn while learning. Fill in, clip, and mail the coupon today.

H. C. LEWIS, President

COYNE ELECTRICAL SCHOOL
500 S. Paulina St. Dept. C9-78, Chicago

MAIL THIS COUPON NOW

H. C. Lewis, President
COYNE ELECTRICAL SCHOOL
500 S. Paulina St., Dept. C9-78, Chicago, Ill.
Please send me free your big catalog and full particulars of your "Pay After Graduation Plan"—also other facts, including offer of extra 4 weeks Radio Course at no extra tuition cost.

NAME.....

ADDRESS.....

CITY.....STATE.....

Please Say That You Saw It in RADIO-CRAFT

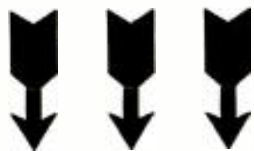

The RSA Works for YOU, Mr. Serviceman!

MAIL THIS COUPON!

RADIO SERVICEMEN OF AMERICA, INC.
304 S. Dearborn St., Chicago, Ill.

Gentlemen:

I hereby make application for membership in the Radio Servicemen of America.

Name

Address

City State

I am enclosing \$4.00 for Dues and Initiation.
(Does not include Local Chapter Dues where Local Chapters are organized.)

RC-839

★ Yes . . . the RSA is Yours! It's run by and for its members—uncontrolled by any outside interests. You elect your representatives (all responsible officers are bonded)—and they work for your benefit.

Here is what RSA gives you: ★ Advanced Circuit Notes for Members each month. ★ Technical Help on Service Problems. ★ Access to its National Speakers' Bureau. ★ Advanced Service Course to Members at slight cost. ★ A Monthly RSA Publication. ★ Annual Convention. ★ And many other benefits now being planned.

Take advantage of RSA activities. Send the Coupon Today—and be "in" with your fellow servicemen.

National Yearly Dues . . . \$3.00
Initiation Fee \$1.00

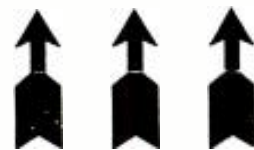

Let's Grow Together in 1939!

RADIO SERVICEMEN OF AMERICA, INC.

Joe Marty, Jr., Executive Secretary ★ 304 S. Dearborn Street, Chicago

EMERGENCY SERVICING WITHOUT TEST METERS

(Continued from page 85)

detector input transformer and the receiver tuning condenser will tune more normally. Strong local broadcast signals can be heard fairly well under these conditions. In a similar manner the antenna lead-in can be transferred to point B and then to point A. In each case an increased signal response should be obtained, if the amplifier circuits are working.

However suppose upon moving the antenna from point B to A that the signal stops instead of being amplified. A jumper is connected from X to X1, with the antenna at A, and the signal is again heard. Tube II is now out of the circuit. Tube II is tried in place of III and works perfectly. The trouble is therefore not with the tube but some other part of the circuit associated with tube II. The primary of R.F. transformer L2 is easily checked for continuity by the voltage test at the plate of tube I. The secondary of R.F. transformer L2 is suspected and examination shows it is shorted or open. Or in a similar manner a jumper can be connected from Y to Y1, or Y1 to Y2 to check secondaries of the R.F. transformers.

SUPERHET. CIRCUITS

Where intermediate-frequency or I.F. transformers are involved, the same procedure can be followed. The signals picked up will not be from broadcast stations but from commercial radio telegraph transmitters working on frequencies close to the intermediate frequency of the amplifier. The signals may be I.C.W. or C.W. To receive

the latter the amplifier can be arranged to oscillate (autodyne) during tests by connecting a small midget condenser from X back to Y.

Turning to the antenna end of a receiver, Fig. 5 illustrates a typical multi-band superheterodyne circuit consisting of 1 direct radio-frequency stage, a mixer, and an oscillator. For sake of simplicity band switches are omitted and only 1 band shown.

Assume the balance of the receiver is in working order as determined by the tests previously described. The first step is to make sure the R.F., mixer and oscillator tubes are receiving plate and screen-grid voltages by the "charged condenser" test.

A 1-TUBE SET!

Now by connecting the antenna leading to point X, removing the oscillator tube and connecting a pair of head telephones to points X1 and X2, we have a 1-tube receiver. The receiver simply consists of the mixer tube, acting as a non-regenerative detector.

On the broadcast band, it is now possible to tune and receive local broadcast stations faintly. Then by inserting the oscillator tube, the received signal will now be garbled, indicating that the oscillator tube is working; otherwise the oscillator tube is dead or some part associated with it defective.

By moving the antenna from X to the receiver antenna post A, the signals previously received should be amplified by the R.F. tube and accordingly come in stronger.

Otherwise the R.F. tube is dead or some part associated with it defective.

In checking the oscillator tube, it may be necessary to temporarily readjust the oscillator condenser trimmer to get "beats" or to garble the signals for tests.

CHECKING COMPONENTS

The matter of checking principal circuit resistors is very simple. For example suppose we know the 250-volt supply is coming into this section of the receiver, as determined with a charged condenser. If resistor R5 (Fig. 5) is open the oscillator tube will not receive any screen-grid voltage. If R6 is open, the oscillator screen-grid voltage will be too high. Unit R4 open prevents the mixer from receiving screen-grid voltage. Likewise with R7 open, the R.F. tube has no screen-grid voltage.

Unit R1 open prevents the oscillator from receiving plate voltage. In the above mentioned cases, the lack of voltage might also be due to a shorted bypass condenser; however that is usually followed by the associated resistor discoloring from excessive heat or burning out.

Temporary substitute resistors can be made from "lead"-pencil graphite, using one long piece or several short pieces in parallel depending upon the resistance required.

Upon removing a chassis for repairs, before any tests are made it is well to make a careful visual examination. Parts which are burned-out usually show discoloration; give off a peculiar "burnt" odor; or may have dripped molten wax. Such an examination often enables locating the trouble immediately and same can quickly be verified by tests.

Please Say That You Saw It in RADIO-CRAFT

ELEKTRO—THE MOTO-MAN

(Continued from page 72)

never hope to compete with human intelligence and muscular control. There are 292 different muscles in the human body, capable in combination of producing unestimated thousands of different movements beyond the 500 most elementary motions. On the basis of Elektro's 260-pound weight and 26 tricks, he requires about 10 pounds for every motion. Theoretically he would have to weigh about 5,000 pounds in order to accomplish the most rudimentary human movements.

Elektro's "brain" weighs approximately 60 pounds and occupies more than 4 cubic feet of space outside the robot's body. The "brain" or control unit includes an "electric eye," 48 electric relays and signal lights. He is "bossed" by human commands spoken softly into a microphone, jumps to obey, although there is no visible connection between the microphone and the robot.

VOICE CONTROL

Spoken words set up vibrations which are converted into electrical waves by a grid-glow tube. The electric impulse then lifts a shutter in front of an electric lamp and sends a flash of light across the room to a photoelectric tube or "electric eye" in the control unit (not shown) which serves as Elektro's brain.

The "electric eye" acts as a sensory nerve. It receives the light command, translates it into a feeble electric current which is amplified and sent on to the bank of relays. The relays, which operate on the same magnetic principle that makes the front door bell ring, close and open electric circuits to start Elektro's motors turning.

Talking to Elektro is like dialing an automatic telephone, using light impulses instead of numbers to cause the relays to act. It makes no difference what words are used to give the command so long as the proper number of light impulses are produced.

One word or impulse places a series of relays in position to act. Two words close the electrical circuit and release current to the motors employed in any particular movement of the robot. Three words activate relays to stop Elektro, and 4 words bring all of the relays back to their normal position of rest.

Signal lights on the control panel inform the operator which movement of the robot is next in sequence. By speaking single words or a series of words properly spaced, the operator can cause the relays to skip over any number of these "points of motion." When the light flashes over the desired "point of motion" on the control panel, a 2-word command will start the proper relay.

Just as the "electric eye" converts light waves into electric currents to put life into the robot, two other "electric eyes" enable it to discern colors. These photoelectric cells are placed directly back of Elektro's glass eyes. A filter in front of one tube lets only the relatively hot rays from red light through to the cell. A filter in front of the other tube permits only the relatively cool heat waves of green light to reach the tube. When the proper lights are flashed in Elektro's eyes, one or the other of these "electric eyes" energizes a relay to start a record revolving on a turntable to produce the word "red" or "green."

WALKING AND TALKING

Elektro's walking is accomplished by means of 4 rubber rollers under each foot which are driven by chains and shafts connected to a motor in the middle of the

automaton. Nine motors are required to operate the fingers, arms, head and turntables for talking. Another small motor works the bellows for Elektro's smoking.

Like some radio programs, Elektro does his talking by means of transcriptions. His speech usually lasts about 1 minute and uses only 75 words. He has 8 turntables, each of which could be used to give 10-minute talks. Actually, except for an opening talk of about a minute, his other speeches will be only a few seconds long. A solenoid (a tubular coil) activated by electrical impulses in proportion to the harshness or softness of spoken words makes Elektro's aluminum lips move in rhythm to his speech-making.

Automatons have indeed come a long way since Aristotle speculated upon the possibility of making mechanical men. Elektro's direct forebear is Willie Vocalite, a robot developed a few years ago in the Westinghouse research laboratories. Willie is voice-operated and can stand up and sit down, but he can't walk. Their common ancestor was named Televox, but he responded only to sounds transmitted by telephone wires and went through life without an "electric eye."

These are actors on the stage of electrical living. The scientific principles which they dramatize are already quietly at work in industry. The Televox has now supplemented supervisory control in power transmission systems, enabling the system dispatcher to reroute the supply of electricity when a power line has been damaged. The "electric eye" and relays are employed in countless tasks of sorting, counting, and regulating, freeing human hands from monotonous and dangerous tasks. The sole reason for making Elektro was to dramatize the action of these sensitive electrical devices.

THE "VOSYN"—A ROBOT

(Continued from page 72)

and quality which vary as the stream proceeds. During most of the speech only one of these 2 streams is active at one time.

THE BUZZ-AND-HISS SOUND STREAMS

Mr. Dudley proceeded to demonstrate the first-mentioned sound stream which he designated as "the buzz." It was a rich full note, something like a muted automobile horn. From this note, electrical filters picked out 10 different ranges of overtones covering the gamut of the human voice. The same filters then broke down the second stream—a hissing sound—into 10 ranges. These different sounds in their proper proportion form all the sounds of speech.

The Voder, astonishing telephone robot at the two World's Fairs, mixes sounds by finger controls. What Mr. Dudley was demonstrating was a circuit which analyzes a voice into 20 parts and then uses the results to control the proper amount of each of the sounds before they reach the loudspeaker. A shift in relative amounts was shown to change one vowel into another.

After letting his audience hear a test sentence before and after it had been broken down and put together, Mr. Dudley showed how it would sound when the buzzer alone was used and its pitch was held constant: a flat monotone like a chant. By releasing the pitch, so it could follow the speaker's voice, more naturalness was secured. Normal speech was converted into a whisper when the hiss was substituted for the buzz. While the hiss is relatively faint, it is essential in discriminating between "church" and "shirts", as was then demonstrated.

(Continued on page 119)

AUDEL'S NEW RADIO MANS GUIDE THE KEY

FOR HOME STUDY

TO WHAT EVERY RADIOMAN SHOULD KNOW

JUST PUBLISHED—1939

—All the latest information on the new developments in Radio & Television. Explains Repairs, Servicing & Building of Sets for pleasure or profit —Easy to read & understand. Gives all the important phases of Modern Radio, Electricity & Sound. Ready reference guide. A real Helpful, Easy Way to secure authentic data on Radio Troubles—Static Elimination—Broadcasting—Antennas—Electronic Television—Repairs—Service—Short Wave—Auto Radio—Including Questions and Answers—34 chapters—772 Pages. Over 400 Diagrams & Illustrations. Handy Size, Sturdy Flexible Binding. A Good Investment for Servicemen—Experimenters—Electronic Television Students—Aviation & Marine Radio Operators and all others. Get this practical information in handy form for yourself! Fill in and mail coupon today.

COMPLETE • PAY ONLY \$1 A MO.

THEO. AUDEL & CO., 49 West 23rd Street, New York

Mail AUDEL'S NEW RADIOMANS GUIDE for free examination. If O. K., I will send you \$1 in 7 days; then remit \$1 monthly until price of \$4 is paid. Otherwise, I will return it.

Name.....

Address.....

Occupation.....

Reference..... R.C.F.

Have it your own way but have it the long way

Old Man Centralab is willing to be neutral as to your choice of Volume Control as long as you select one of his famous products . . . with the wall type resistor strip that hugs the inner circumference of the bakelite housing. Choose one of the Centralab family—STANDARD . . . MIDGET . . . or ADASHAFT . . .

STANDARD RADIOHM

The old reliable "Standard" that is 1 1/2" in diameter . . . used wherever sufficient space for this control is available.

ADASHAFT KIT

Housed in metal box, hinged, contains ten Midget Radiohms, five types of attachable shafts, etc. . . . for more than 400 makes of receivers.

Centralab

Div. of Globe Union Inc., Milwaukee, Wis.

Please Say That You Saw It in RADIO-CRAFT

DATAPRINTS



TESLA-LOUDIN HI-FREQ. COILS

- 20c Ea. in order for 10 (Data and Drawings only.)
 - 36" Sp'k Tesla-Oudin Coil 40c (1 K.W. Exc. Trf. Data, included FREE!)
 - 8" Sp'k Tesla-Oudin Coil 40c (1/4 K.W. Exc. Trf. Data, included FREE!)
 - 3" Sp'k Oudin; 110 Vt. "Kick Coil" type.....40c
 - 3" Sp'k Tesla Works on Ford Sp'k Coil.....40c
 - 1" Sp'k Violetta Hi-Freq. Coil.....40c
- FREE with order \$1.00 or more—20 Tricks with Hi-Freq. Coils (40c separate)

20 ELECTRIC PARTY AND LODGETRICKS! How to Shock 'em! Loads of Fun!.....40c

Television Hook-Up—Sight & Sound.....40c —Get Our List of SOLENOID & MAGNET DATA PRINTS



RADIO CONTROL FOR MODEL BOATS, PLANES, ETC.

Circuit data40c Get our List of Model Ship prints

S-W DIATHERMY (Artificial Fever)

Dataprint giving Constructional data for Small, Medium and Large size APP. (All 3)...40c



YOU need these DATAPRINTS!

- 5 Meter Superhet. Resistance Measuring
- 1/2 Meter Tr. & Rec. Bridge
- 20 A.C. Probs. & Ans. Weld. Transf. 2 K.W.
- 20 Telephone Hook-ups Rewinding Armatures
- 100 Mech. Movements String Galvanometer
- 20 Motor Hook-ups 20 Simple Bell Circuits

Special Prices: 4 prints \$1.00; 10 for \$2.00; 40c each, single orders.

The DATAPRINT Co. Lock Box 322C, Ramsey, N. J.

TELLY PIPED OVER PHONE WIRES!—AND WITH 441-LINE DEFINITION

(Continued from page 82)

prevent the picking up of extraneous "noise". They then made a "run" (or test) with an oscillator to measure the characteristic of the circuit and determine the transmission losses at the various frequencies. The higher frequencies are attenuated much more than the lower ones. A special equalizer was built by the Bell Laboratories to bring the components of the television signal to their proper phase relationships at the terminal. To bring up the signal level to its proper volume special amplifiers were also built and installed at the Circle Exchange of the New York Telephone Company. The circuit, about 1.3 miles in length, ran from the basement of Madison Square Garden, through the Circle Exchange, to Radio City. From this point it was transmitted through coaxial cable to the Empire State tower transmitter.

This experiment confirms the opinions in a paper by Bell Labs.' Mr. A. B. Clark before the A.I.E.E. in January, 1935!

Telephone lines used for ordinary conversation are corrected to operate over a frequency range 4 times wider to accommodate high-fidelity broadcasts; but television requires a frequency correction 10 times greater than sound broadcasting's needs.

Bell Labs. engineers point out that "the energy loss of television currents . . . in passage over a mile of ordinary telephone cable is about 1,000,000 times greater than over a mile of coaxial cable." Also, high-frequency impulses travel faster along a telephone wire than do the lower ones. It is for this reason that phase-correcting equipment is required at frequent intervals to

bring the phase relationships of the various frequencies back to normal. Amplifiers, too, are required to compensate volume losses. A qualitative examination of this experimental television transmission as represented by the block diagram on pg. 82 may be made by reference to the set of graphs, A-F, which follow.

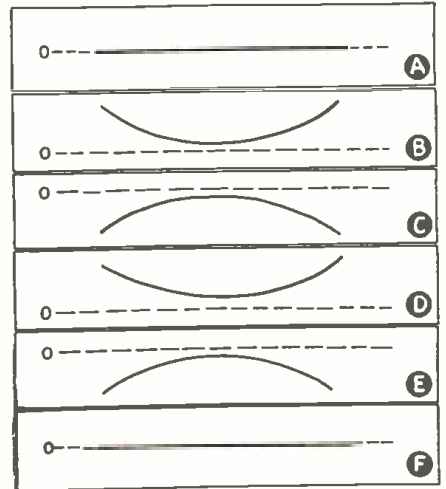

Line A represents the television signal, level in intensity across the entire television-frequency range, as it was fed at the Garden into equalizer and amplifier No. 1; the output of this unit looked something like B, which shows that a portion of the frequencies to be sent out over the balanced telephone line connecting with the "Circle" telephone exchange have been disproportionately intensified above the normal or reference level (0) so that after being attenuated in transmission they will still establish at the "Circle" exchange a passable signal/noise ratio as indicated at C. Starting out again from the "Circle" exchange, the television signal looks something like D, and after arrival at Radio City, like E. Note in E that the input signal is not only very low in intensity at certain frequencies, a condition which equalizer No. 3 corrects, but also below the "normal" or zero-reference line (0) at all frequencies, a deficiency which is compensated by amplifier No. 3, which feeds a "normal" signal, F, to the coaxial cable that regularly joins the television equipment at Radio City with the apparatus at the Empire State Building.

This method of affecting television transmission via telephone lines is, by comparison, much more expensive than by using the now orthodox coaxial cable. It gives promise, however, of making possible the pick-up of programs originating from congested areas (N.Y.C., for example) where the more desirable coaxial cable facilities are not available. Further, experimentation in this direction may demonstrate the feasibility of employing at some future date high-quality balanced telephone lines, such as those now used for high-fidelity sound broadcast programs, in long-distance wire-line television networks—at least until rights-of-way can be obtained, installation made, etc., for permanent lines of the more suitable coaxial cable.

Just how successful was this 1/2-hour wire-and-radio telly transmission? According to the June, 1939, issue of *Bell Labs. Record*, "The adjustment of the overall circuit was such that the signal was delivered at Radio City without noticeable impairment." (Italics ours.—Editor)

RADIO MEN . . . HERE IS THE BEST REFRIGERATION SERVICE MANUAL EVER PUBLISHED - -

The OFFICIAL REFRIGERATION SERVICE MANUAL has been prepared so that it gives comprehensive technical information on servicing in this growing refrigeration industry. It contains detailed material on servicing; outlines of theory and methods of operation; instructions for the handling of refrigerants; charging systems; diagnosing troubles; trouble charts; electrical hookups; charges of oil and refrigerant in different models; advice on the selection of oils; placement and temperature required by foods; valve settings; compressor construction, faults, overhauling; estimating coil and machine loads; are encompassed in this volume on refrigeration servicing.

Here is the contents of the Official Refrigeration Service Manual

- History
- Food Preservation
- Theory and Fundamental Laws
- Methods of Refrigeration
- Refrigerants, Lubricants and Brines
- Handling, Testing and Storage of Refrigerants
- Compression System of Refrigeration
- Liquid Throttle Devices and Valves
- Refrigeration Systems
- Electric Control Devices
- Compressors, Types, Seals, Valves, Capacities, Service
- Evaporators and Cooling Units
- Service Tools, Equipment and Tool Manipulation
- Commercial Unit Specifications and Service
- Household Unit Specifications and Service
- Service Refrigeration Apparatus:
- Low Side Float Valve Systems;
- High Side Float Valve Systems;
- Expansion Valve Systems; Thermodynamic Valve Systems; Restrictor and Capillary Tube Systems
- Charging Systems with Refrigerant
- Electrical Service; Motors, Fuses, Hookups
- Estimating Refrigeration Loads, Coil and Machine Sizes

OVER 352 PAGES
OVER 300 DIAGRAMS
Flexible, Looseleaf Binder
Complete Service Data

RADCRAFT PUBLICATIONS, INC.
99 Hudson Street,
New York, N. Y.

RADCRAFT PUBLICATIONS, Inc. RC-839
99 Hudson St., New York, N. Y.
Gentlemen:—Enclosed you will find my remittance of \$5.00, for which send me one copy of the OFFICIAL REFRIGERATION SERVICE MANUAL (Vol. II). I understand that this book is to be shipped to me POSTAGE PREPAID.

Name

Address

City State

(Remit by check or money order; register letter if you send cash or unused U. S. postage stamps.)

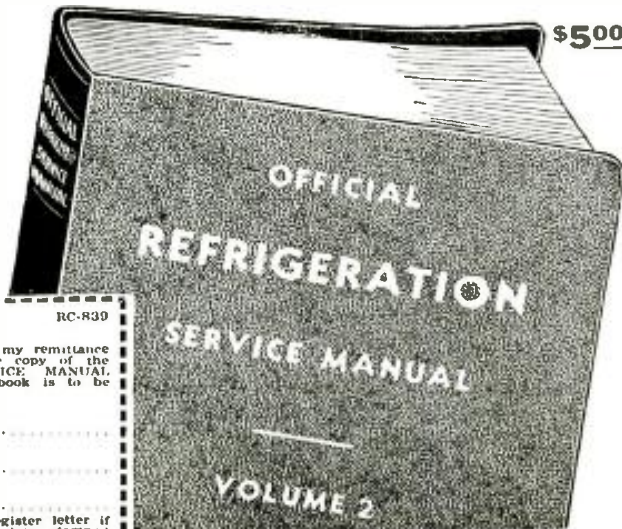

Please Say That You Saw It in RADIO-CRAFT

THE RADIO MONTH IN REVIEW

(Continued from page 71)

showing accompanying views for use on a lecture tour.

TELEVISION

BIGGEST attraction at the New York World's Fair 1939 was said to be the television exhibits. Visitors in hundreds of thousands have witnessed this newest wonder, to date, at the following exhibits: RCA, Ford, Westinghouse, Crosley, General Electric.

Crosley-made television sets were exhibited last month when Cincinnati was given its first taste of television. The press and dealer demonstrations of 441-line programs, via "wire," took place on the top floor of the Carew Tower, tallest structure in the city, which stands 574 ft. high. As soon as the F.C.C. says "OK", the 1 kw. transmitter will go on the air over the 50-56 megacycle band. Close to press date Crosley Corp. informed *Radio-Craft* that the F.C.C. had neither assigned call letters nor granted a license.

The entire 14th floor of a storage building at Santa Monica Blvd. and Highland Ave., in Hollywood, Calif., has been leased by the Earle C. Anthony radio interests for an experimental television studio, transmitter, etc. The F.C.C. has KFI-KECA's application for space in the 42-56 mc. band, with 1 kw.

A telly permit, for the 44-50 mc. band and 1 kw., was granted last month by the F.C.C. to National Battery Broadcasting Co., St. Paul, Mich. Construction is under way.

A coaxial cable 195 miles long, between Stevens Point, Wis., and Minneapolis, Minn., is due to be constructed by the American Tel. & Tel. Co. at a total cost estimated at about \$2,000,000. Its immediate use will be to provide 480 telephone circuits via wired-radio; later, television may enter the picture.

The Don Lee television station is replacing its 300-line cathode-ray television equipment with 441-line apparatus. This station has given West Coast viewers continuous telly service for 7 years, over station W6XAO! Director of television is Harry R. Ludeke.

N.B.C. telly broadcasts last month suffered for want of cameras. The telecasting of the baseball game between Princeton and Columbia was an outstanding example of this lack of facilities; the 6-day bicycle race at Madison Square Garden, turned out much better; and the fistic encounter between Max Baer and Lou Nova was still better—and yet, it too suffered, when the view of flying fists was obstructed (as when one of the fighters had his back to the camera). More cameras are on the way, everyone will be glad to hear.

The big handicap of N.B.C./RCA's television transmissions, the dearth of cameras, mentioned above, is a lack which was particularly evident at the first baseball game televised over W2XBS last month. The mobile television station was used at this game between Columbia and Princeton U.'s at Baker Field, New York City. Reports are

that 2 additional cameras soon will be made available. If one of these is a good telephoto job it will immeasurably increase interest in the long-shots at large outdoor affairs.

This department saw Baer-Nova on a standard Du Mont cathode-ray oscilloscope as used in radio service work! We expect to have the story in shape for RADIO-CRAFT readers in time for the next issue so that every owner of a service oscilloscope can try his hand at using it as the basis for an experimental television receiver! For the first steps in this direction, see the article, "Television Experiments With a Servicing 'Scope," by Ricardo Muniz, in the August 1938 issue of RADIO-CRAFT; work on this setup was suspended during the time N.B.C. was off the air. The job, now completed, worked excellently, in the RADIO-CRAFT offices; thus proving that "it can be done"!

According to "Hoyle," telly sigs are limited pretty much to the line-of-sight distance; in the instance of transmissions from the Empire State Bldg., in New York City, this would mean an airline distance of about 50 to 60 miles. But last month General Electric Co. engineers received a 2-hour program from this world's tallest building over a distance of 130 miles (over a mountain to a receiver located 12 miles from Schenectady, N.Y.), or 8,000 ft. below the line of sight. The receiver was a standard console mounted in a truck and gasoline-engine powered.

"Look and listen" for Columbia Broadcasting System's new telly station, W2XAX. Sight is on 51.25 mc.; sound, 55.75 mc.

(Continued on page 124)

THE "VOSYN"—A ROBOT

(Continued from page 117)

Speech can also be created out of a complex sound; such as the music of a pipe organ; the organ selection was "The Bells of St. Mary's". Modulated by the spoken words of the lyric, the organ then seemed itself to sing.

SUPER-"TONE CONTROL"

Expression, said Mr. Dudley, is due to the constant swinging up and down of pitch as one speaks; when the swings are cut in half, the voice seems flat and dragging; when the swings are twice normal, the voice seems more brilliant; when 4 times normal it sounds febrile, unnatural. The controls can be reversed so that high becomes low: tune of a song is unrecognizable, and speech has the odd lilting character of the Scandinavian tongues. By certain electrical changes, a man's vigorous tones were changed into the quavering voice of a grandfather, and then into the tearful pleadings of a lovelorn girl. The basic pitch of the circuit was set a third higher than that of the singer, who then raised his voice so the audience could hear a duet between man and machine.

NEW AMPLIFIER

In September *Radio-Craft*, read Mr. A. C. Shaney's article on the "Universal" 32-Watt Amplifier with Neutralized Feedback." An exclusive story.

Please Say That You Saw It in RADIO-CRAFT

YOU CAN BECOME A MONEY-MAKING RADIO EXPERT WITH THE **NEW SPRAYBERRY** Personalized HOME TRAINING in



You Learn Easily in Your Spare Hours ... By Doing Many Experiments with Up-To-Date Equipment

Here's a really fine, up-to-the-minute Radio and Television Training that's specially designed to give you quick results. **TRAINING PREPARES YOU FOR GOOD RADIO JOBS ... AT EXCELLENT PAY.** My training starts right at the beginning of Radio ... unfolds each subject in a simplified, logical, understandable style. You easily learn Television, Electronics, Facsimile Radio, Radio Set Repair and Installation Work, etc. **NO PREVIOUS EXPERIENCE NEEDED** It makes no difference what your education has been, I can fit you for a good-paying Radio job. Your success is my full responsibility.

YOU GET PROFESSIONAL TEST EQUIPMENT PLUS EXPERIMENTAL OUTFITS

Includes 136 Radio Parts (to build complete Receiver), Tools, All Wave, All-Purpose Analyzer, and Experimental Outfits for conducting actual experiments with your own hands.

I Supply



EARN WHILE YOU LEARN My **BUSINESS BUILDERS** show you how to put your Equipment to practical use in handling actual money-making Radio Service Jobs shortly after you begin training.

SERVICEMEN

I offer Advanced Training for those already in Radio. Get complete details in my FREE 52-page Book, *The Sprayberry Course is Sold Under a Money-back Agreement*

RUSH COUPON FOR BIG FREE BOOK

SPRAYBERRY ACADEMY OF RADIO 526 University Place, N.W., Washington, D. C.

Please send the FREE copy of "HOW TO MAKE MONEY IN RADIO."

Name Age

Address

City State

Tear off this coupon, mail in envelope or paste on penny postcard.

Servicemen—Check here

FREE TRIAL OFFER

NEW REMINGTON NOISELESS PORTABLE!

AS LITTLE AS

10¢ A DAY



Famous Remington Noiseless Portable that speaks in a whisper. Pay as little as 10¢ a day. Guaranteed by the factory. Standard keyboard. Automatic ribbon reverse. Variable line spacer and all the conveniences of the finest portable ever built. PLUS the NOISELESS feature. Act now. Send coupon TODAY for details.

You don't RISK a Penny

We send you Remington Noiseless Portable for 10 days' free trial. If not satisfied, send it back. We pay all shipping charges.

Typing Course and Carrying Case

You will receive FREE a complete simplified home course in Touch Typing, a handsome sturdy carrying case is included. No obligation. Mail coupon for full details—NOW.

Remington Rand, Inc., Dept. 189-8, 465 Washington St., Buffalo, N. Y.

Tell me, without obligation, how to get a Free Trial of a new Remington Noiseless Portable, including Carrying Case and Free Typing Course for as little as 10¢ a day. Send Catalogue.

Name

Address

City State



UNIVERSAL 5MM.

All purpose microphone including amateurs, P.A., schools, stage, etc. Beautiful in appearance. Small in size. Superlative in performance. High fidelity reproduction voice and music. Incl. locking plug and 25 ft. cable. Direct to grid or any desired impedance. In De Luxe package at your jobbers now.

UNIVERSAL MICROPHONE CO. Ltd. 424 Warren Lane, Inglewood, Cal., U.S.A.

QUALITY—VALUE—GUARANTEE!

WESTINGHOUSE POWER GENERATOR

Manufactured for U. S. Signal Corps

A. C. ELECTRICAL POWER
from a Windmill, from available Waterpower, from your Automobile, from your Motorcycle, from your Bicycle, Footpedals or Handcrank (for transportable Radio Transmitters, Strong Floodlights, Advertising Signals, operate lights or electric signs, Laboratory work, etc., etc.)

There Are Over 25 Applications
Some of which are:
A.C. Dynamo Lighting from eight to ten 20 Watt 110 Volt lamps. Short Wave Transmitter supplying 110 Volts AC for operating "Hunt" transmitter. Motor Generator, Public Address Systems. Electric Sirens on motor boats, yachts, etc. Camp Lighting, Short Wave artificial "fever" apparatus. Television. Pelton Waterwheel for lighting or other purposes. Airplane: for lighting; strong search lights or electric signs. Laboratory work, etc., etc.
1/4 to 1/2 H.P. needed to run generator.

Generator, as described, including BLUE. PRINT 22 x 28 in. and Four-Page 8 1/2 x 12 in. INSTRUCTION SHEETS **\$7.90**
Send \$2.00 deposit balance C.O.D. Shipping weight 14 lbs.

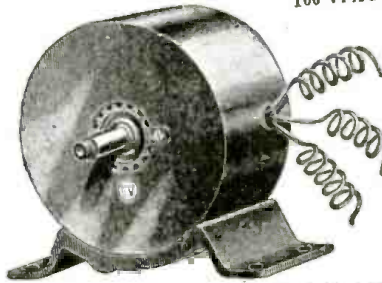

200 Watt.
100 V. AC

PYRO PANTAGRAPH

Size of box: 12 1/2" x 8 1/2"



\$2.75

This electrical outfit is especially designed for burning designs permanently on Leather, Wood, Cork, Gourds, Baskets, etc. Simply plug the Pyro-electric pencil in any 110-volt AC outlet and it is ready to be used. Plus DC outlet and is ready to be used. DC outlet and cord furnished as part of equipment. By the use of a special Pantagraph included in the outfit, any design may be reproduced either in original, reduced or enlarged form. Outfit consists of: one Pyro-electric pencil; one Pantagraph; three hardwood plaques; one bottle of Varnish; one Brush; one tracing tip and four-page instruction sheet. **\$2.75**

G. E. PHONOGRAPH MOTOR

Formerly Sold for \$15.00

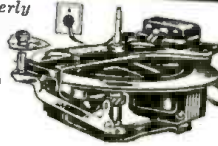

\$4.95

Variable speed induction type self-starting. 110 volt. 25 to 60 cycle. A.C. with speed control, plug and cord. Speed range from 5 to 200 R.P.M. Can be installed in place of old-fashioned, hand-winding speed motor. Also ideal for display turn table, and a hundred other uses. These General Electric Motors have never been used and come four packed in original carton. G. E. Electric Phonograph motor as described (with-out turntable) **\$4.95**

Shipping Weight—12 lbs.

ALL OUR MERCHANDISE IS UNUSED AND SOLD ON A MONEY-BACK GUARANTEE

MICROPHONE AND RECEIVER

This Microphone and telephone headset outfit was built especially for the U. S. Navy Aviation Corps. The Holzer-Cabel Electric Company constructed the outfit to Government specifications.

The outfit consists of a low-impedance carbon microphone (transmitter), securely fastened to a metal breastplate, and a set of heavy-duty, low-impedance earphones. A specially constructed switch on the back of the breastplate controls the microphone circuit. The earphones are U.S.N. Utah type, attached to adjustable headband. Twenty-eight feet of very heavy weather and waterproof conductor cable is furnished. Carrol of not more than 10 volts should be used. A storage battery is the most satisfactory current supply.

U. S. Navy Airplane-type Microphone and Receiver as described **\$4.96**

Shipping Weight—9 lbs.

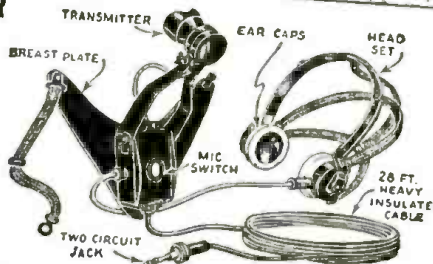

WELLWORTH TRADING CO.

Dept. RC-839

1915 SOUTH STATE ST., CHICAGO, ILLINOIS

★ ORDER DIRECTLY FROM THIS ADVERTISEMENT ★

WE SHIP 24 HOURS AFTER RECEIPT OF YOUR ORDER. BY EXPRESS COLLECT OR PARCEL POST IF YOU INCLUDE SUFFICIENT POSTAGE.

300 WAYS TO MAKE MONEY

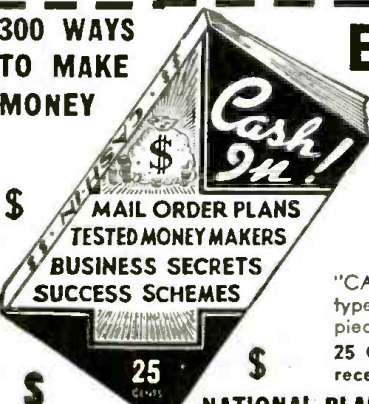

EXTRA Money For You

A Marvel Book 40,000 Words in Text!

In "CASH IN" you get ALL the real money-makers—dozens of profitable tested mail order plans, confidential business secrets, dozens of practical tested formulas, successful tested schemes—actual experiences of men who have started on a shoestring—with less than \$10 capital. Money-Back Guarantee.

"CASH IN" contains only tested ideas covering every type of full—or spare-time enterprise—it's a "masterpiece" in business ventures.

25 CENTS per copy. Sent POSTPAID anywhere upon receipt of 25 cents U. S. stamps or coin.

NATIONAL PLANS INSTITUTE, 246-R Fifth Ave., New York, N. Y.

OPERATING NOTES

(Continued from page 91)

trol circuit. This can be entirely corrected by disconnecting the volume control leads and passing them along the side of the chassis opposite the power supply. These wires are connected to a socket in the end of the set where the volume control and pilot light plug in. The same trouble may be found in Ford-Philco sets using push-button tuning.

HERMAN F. IRELAN,
Okmulgee, Oklahoma.

1939 STEWART-WARNER SETS
RE-CENTERING SPEAKER VOICE COILS. This Note applies only to the speakers with the following part numbers which are used in the chassis models indicated:

Speaker No.	Chassis Model	Speaker No.	Chassis Model
U-115008	91-51, 98-51,	910-51	
U-115021	910-63	U-115044	01-631
U-115028	3147	U-115046	321
U-115031	3167	U-110547	01-54
U-115043	01-53, 01-61	U-110548	91-648

In these speakers, the spider is cemented to the speaker frame. Even though this type of speaker does not seem to be adjustable, it is frequently possible to re-center the voice coil since the voice coil, spider and cone are fastened together by means of thermo-plastic cement which melts when heated, and hardens as soon as it cools.

The first operation in re-centering the voice coil is to insert at least 3 shims in the air gap to hold the voice coil in the proper position. NOTE: Do not use celluloid shims but use metal or paper ones.

In place of 3 shims, it is often desirable to use a piece of stiff paper as wide as the circumference of the pole piece so that it goes all around the pole piece. The shims will pull the voice coil to the proper place even though both the cone and spider are glued down. Then hold the speaker with the cone facing downward, and hold the tip of a hot soldering iron against the end of the pole piece. The purpose of this is to soften the thermo-plastic cement which holds the voice coil to the spider. The soldering iron should not actually touch any parts of the speaker except the pole piece. Keep the soldering iron in the position indicated until the thermo-plastic cement is thoroughly soft. This will take a minute or two. Remove the iron, and let the speaker cool. When the shims are pulled out, the voice coil should be perfectly centered.

The above method will require a little practice before you can melt the cement just enough to permit the voice coil and spider to move slightly with respect to each other, but it is very effective where the difficulty is due only to an off-center voice coil.

REMOVING PARTICLES FROM AIR GAP. Where there are particles in the air gap, it is frequently possible to blow them out by means of compressed air. In using compressed air, care must be taken that the blast of air does not injure the cone. In other cases, small particles which are in the inner air gap can be removed with a thin speaker shim.

In the event you are unable to repair the speakers as suggested above, it will be necessary for you to replace the entire cone and voice coil assembly. (Full instructions for doing this are included with each service cone.)

J. N. GOLTEN,
Service Department,
Stewart-Warner Corporation.

TEST YOUR RADIO KNOWLEDGE

(Continued from page 93)

A.17. The length of time a sound persists after the source is quiet is known as the "period of reverberation".

A.18. By treating the room with some good acoustic material such as acoustical celotex.

A.19. The microphone or phonograph pickup, fader panel, amplifiers, power level indicator, loudspeakers.

A.20. The carbon-button type microphone has much higher output than the condenser type, generally taken as 50 decibels higher.

A.21. The condenser-type microphone is assumed to have the best response if properly designed.

A.22.

$$\text{Amp. Factor} = \frac{dE_p}{dE_g} \left(\text{same change in plate current} \right) = \frac{30}{10} = 3$$

A.23. Plate Impedance

$$R_p = \frac{dE_p}{dI_p} = \frac{20}{.002} = 10,000 \text{ ohms.}$$

A.24. Mutual Conductance

$$G_m = \frac{dI_p}{dE_g} = \frac{.01}{2} = 0.005\text{-mho.}$$

A.25. (a) Mercury-vapor tubes have a much lower voltage drop than the high-vacuum type. The drop is approximately 15 volts in most types of mercury-vapor tubes. (b) The peak current may be 4 times the load current with condenser input to a filter system connected to a mercury-vapor tube; hence, choke input to the filter is recommended in most cases. (c) Mercury-vapor tubes have a tendency to set up radio frequency interference, this can be remedied by enclosing the tube in a metallic shield and placing an R.F. choke coil in series with each lead to the plate.

A.26. The mercury-vapor type tube such as the 866 contains gas under a much lower pressure than the Tungar type of tube; hence, these tubes are capable of handling higher voltages. Tungar tubes are most useful in connection with battery charging and other high-current low-voltage applications.

A.27. This is due to the positive ions, which are created by collision of the electrons and gas molecules, drifting back to the filament or cathode and neutralizing the negative space charge which is the principal factor that governs the internal resistance of any tube.

A.28. By wire tables No. 6 copper wire

has a resistance of 0.402-ohm per 1,000 ft. and a diameter of 162 mils or 0.162-in. diameter.

Since $D = 75d$

$$D = 75 \times 0.162 \text{ or } 12.15 \text{ ins. spacing between wires.}$$

where D is the spacing between wires and d is diameter of wire.

$$I = \sqrt{P/R} = \sqrt{\frac{16,000}{600}} = 5.16 \text{ amps. line cur.}$$

Since this is a 600-ohm line it requires a 600-ohm coupling to prevent radiation. E of line = $I Z = 5.16 \times 600 = 3,096$ volts. No. 6 wire (by tables) has a resistance of 0.402-ohm per 1,000 ft. Entire line length = 2,000 ft., so total resistance (D.C.) = $2 \times .402 = 0.804$ -ohm.

R.F. resistance = $10 \times .804 = 8.04$ ohms. Power loss = $I^2 R = (5.16)^2 \times 8.04 = 214.07$ watts.

A.29. $X_L = 2\pi FL = 6.28 \times 90 \times .5 = 281.25$ ohms.

$X_C = \frac{1}{2\pi FC} = \frac{1}{6.28 \times 90 \times 100 \times 10^{-6}} = 17.69$ ohms.

$Z = \sqrt{R^2 + X^2} = \sqrt{R^2 + (X_L - X_C)^2}$
 $Z = \sqrt{100^2 + (281.25 - 17.69)^2} = 281.9$ ohms.

$\tan \phi = X/R = \frac{281.9}{100} = 2.819$

$\tan \phi = 2.819; \phi = 70:48^\circ$

$\cos \phi = .3341$

$I = E/Z = \frac{1,000}{281.9} = 3.548$ amps.

$P = E I \cos \phi = 1000 \times 3.548 \times .3341$
 $P = 1,185$ watts expended in circuit.

A.30. $R_c = \frac{20}{.05} = 400$ ohms

Load R now actually should be $8,400 - 400 = 8,000$ — ohms due to R_c being effective in plate circuit

$I = \sqrt{P/R} = \sqrt{5/8,400} = 0.0225$ -amp. r.m.s.
 E across $R_c = .0225 \times 400 = 9$ volts. r.m.s.
 Voltage needed to drive grid = $E_c/\sqrt{2} = .707 \times 20 = 14.14$ r.m.s.

If C_c is omitted, necessary voltage to drive tube will be $E_g = 14.14 + 9 = 23.14$ volts r.m.s.

Thus using degeneration the amplification has been reduced by $14.14/23.14 = .611$.

SERVICING "COIN-OPERATED" PHONOGRAPHS

(Continued from page 94)

Astatic D-104, Shure 70H or the Transducer TR-5.

Figure 5 shows one method of installing a mike. With this hookup it will be necessary to throw the D.P.D.T. switch to the mike position and insert a coin into the machine to place the microphone into operation. When through using the mike, the switch is thrown to the phono. position and a record will play through. The instrument will automatically shut off as soon as the record is finished.

By adding the jumper on the switch indicated by the dotted lines the mike can be used for approximately 3 minutes for each coin inserted. With this hookup the motor is on, and the record being played will not be heard. The mike will remain in operation until the record is finished—about 3 min-

utes—when the record will trip the cancelling mechanism and shut the instrument off unless another 5c coin is inserted.

For larger locations, or where all the available output power is required or where low-level mikes (velocity, sound cell, etc.) are to be used, it will be necessary to add a preamplifier as shown in Fig. 6. All Seeburg machines have a 4-prong socket on the amplifier marked "mike." This socket is used to plug the Seeburg preamplifier into, and furnishes the necessary filament and plate voltages. This socket can be drilled out when installing a mike and a 6-prong socket bolted into its place for the preamplifier tube. On all other machines that require a preamplifier it will be necessary to make a shielded unit and bolt it in place near the amplifier.

Please Say That You Saw It in RADIO-CRAFT

FREE!

and it saves you
**TIME,
TROUBLE,
MONEY**



This FREE catalog is your dish. Has everything in Radio — thousands of parts, tubes, Test Instruments, Sound Systems, Receivers, build-it-yourself kits, etc. Every item nationally advertised, arranged for quick, easy reference. Order at home. Save time and trouble. And take advantage of real money saving prices. Not just on some items. There's value after value right through this book's 188 pages. You save on everything you buy! Send at once for your copy. Remember, it's FREE! Just tear out and mail the coupon NOW.

LAFAYETTE RADIO CORPORATION

WHOLESALE RADIO SERVICE CO., INC.

Rush New FREE Catalog No. 76

SALES OFFICES IN
 NEW YORK 100 Sixth Avenue
 CHICAGO 381 W. Jackson Blvd.
 ATLANTA 182 Peachtree Street
 Boston, Mass. Bronx, N. Y.
 Newark, N. J. Jamaica, L. I.

NAME _____ PLEASE PRINT
 ADDRESS _____
 CITY _____ STATE _____

LAFAYETTE RADIO CORPORATION
 Dept. 3H9 — 100 Sixth Ave., New York, N. Y.

RADIO ENGINEERING

RCA Institutes offer an intensive course of high standard embracing all phases of Radio and Television. Practical training with modern equipment at New York and Chicago schools. Also specialized courses and Home Study Courses under "No obligation" plan. Catalog Dept. RC-39.

RCA INSTITUTES, Inc.
 A Radio Corporation of America Service
 75 Varlek St., New York 154 Merchandise Mart, Chicago

ELECTRICITY

FROM YOUR OWN ELECTRIC PLANT WHEN POWER LINES FAIL

OHAN A.C. ELECTRIC PLANTS supply current for Radio, Transmitters and Receivers, P. A. Systems, Movie Projectors, Sound Truck Apparatus, Tools, Lamps, All Appliances, Used as Standby Equipment in Schools, Hospitals, Theatres and Public Buildings in case of Power Line Failure due to Storms, Floods, etc. Available in 110 or 220 Volt A.C.—12, 22 and 110 Volt D.C.—Also Dual Voltage A.C.-D.C. Types Manual, Full-Automatic & Self-Starting. \$19 and up. Shipped, Ready to Run.

D. W. OHAN & SONS
 686 Regulator Avenue Minneapolis, Minn.

"R. M. S. SUPER" COMPACTS

Exclusive Radios for the Serviceman
 Low list prices—Big Discounts
 Also PHILCO PARTS and TUBES
 Send 10c in stamps for "R.M.S. SUPER" broadside, PHILCO Parts Catalogue and Wholesale Prices.

WILLIAMS PHILCO CO.
 802 S. Adams St. Peoria, Ill.

THOUGHTS HAVE WINGS

YOU CAN influence others with your thinking! Learn to impress others favorably—get across your ideas. Let the Rosicrucians show you how to use the power of mind. For free book write Scribe E. M. D.

The ROSICRUCIANS (AMORC)
 San Jose, California

COMPLETE with a 1938-39 Supplement bound in its center. Sylvania's new Tube Complement Book contains the tube complements and i-f peaks of even the new, recently-announced sets—221 pages for only 25c! Or if you already own a Sylvania Complement Book, bring it up-to-date by getting the Supplement—at 10c. Send to Dept. C, Hygrade Sylvania Corp., Emporium, Pa.

FREE- REAL ELECTROPLATING OUTFIT



Now
You Can **ELECTROPLATE**
Easily with a **BRUSH**

SOMETHING new for radio men—something which gives you the opportunity to make additional profits—or to improve your type of service. Here's an **ELECTROPLATING KIT** amazingly simple to operate—you just Electroplate with a Brush!

NOT A TOY!

You can electroplate for profit, hundreds of things in the household—ashtrays, fixtures, water faucets, worn brackets, door knobs, musical instruments, jewelry and silverware and other articles. It's an indispensable piece of equipment to you for plating articles in hotels, apartments, office buildings, medical and dental offices, factories, schools, laboratories, etc. Exactly the same outfit (but larger) is used professionally by electricians, radio service men, automobile repair shops, etc. Requires one single dry cell 1½-volt battery to operate.

And for radio work, you can electroplate tarnished receiver parts, escutcheons, contacts, worn radio parts and accessories, and display chassis. Put this **REAL ELECTROPLATING KIT** to use immediately—make it the most useful article in your shop or laboratory. And, you can get it absolutely **FREE** (except for slight mailing cost).

Send your subscription today to **RADIO-CRAFT** for One Year (12 issues) and receive absolutely **FREE** this **REAL ELECTROPLATING KIT**. New subscribers are accepted or you may extend your present subscription another twelve months under this offer. Mail your remittance of \$2.50 (plus 10c for shipping charge on kit) to the publishers of **RADIO-CRAFT** (Canada and foreign \$2.85). You will promptly receive your **FREE REAL ELECTROPLATING OUTFIT** by return mail. Use the coupon below to order your subscription.

RADIO-CRAFT

99 Hudson Street New York, N. Y.

RADIO-CRAFT RC839

99 Hudson Street, New York, N. Y.

Gentlemen: Enclosed you will find my remittance of \$2.50 for which enter my subscription to **RADIO-CRAFT** for One Year (12 issues). Send me promptly my **FREE REAL ELECTROPLATING OUTFIT** (Canada and foreign \$2.85). In U. S. add only 10c additional to cover shipping charges on kit.

New Subscriber Extend Present Subscription

Name

Address

City State

(Send remittance by check, money order or unused U. S. postage stamps. Register letter if you send cash or stamps.)

RADIO TRADE DIGEST

RSA CHAPTERS PLUG BIZ DRIVE

(Continued from page 99)

radio servicing. In line with this, Blakely Brothers, a firm of printers and advertisers, furnished an excellent speaker and offered to work with a committee on a plan for publicizing RSA, as well as advertising methods for Servicemen in their own businesses.

A committee was also appointed and is working on a minimum service charge plan. They will soon present a definite program, representative of the ideas of a majority of the RSA qualified members in the Detroit Chapter. The interest shown so far is an indication that the time is now here for definite action on the price situation and the establishment of a better understanding between Servicemen and the public on this very vital part of the servicing industry.

LANSING, MICH., CHAPTER: A schedule of suggested minimum service charges for use of members was drafted and discussed.

Ralph Keyes was the winner of the Rider Manual prize in the renewal dues contest.

LEHIGH VALLEY, PA., CHAPTER: "The Use of an Impact Excitation Generator in Servicing Intermittent Receivers" was the subject discussed by R. G. Herzog, Editor of *Service*.

At a business meeting a week later, J. F. Hess of the local newspaper presented several plans of advertising to get the RSA emblem known to the public. The tube situation was discussed but nothing definite was decided.

LONG ISLAND, N. Y., CHAPTER: "Making the Public RSA Conscious" was the subject of a Round Table Discussion. Chapter decided to have cards printed to be attached to a knob of radios repaired or sold, this card to tell the aims and public need for RSA, and to list on the back the names and 'phones of members of the Chapter. The card will have a small discount value at any member's shop. This is an inducement to keep the card. All members in their future advertising, and on their stationery will include the phrase, "Member RSA".

SPRINGFIELD, ILL., CHAPTER: After quite a discussion on price cutting and free service calls, Charles Beatty, G. L. Spilley, and Robert Jones were appointed to check the newspaper ads, and to contact offenders. Kenneth Beatty gave an illustrated talk on the right and wrong way of making a service call, and the probable results of each.

Suggested minimum prices for work on auto-radios was adopted. Charles Beatty was elected librarian to take charge of books and pamphlets which are loaned to members for 2-week periods.

FLINT, MICHIGAN, CHAPTER: "Automatic Tuning in Motorola Auto Receivers" was discussed by Charlie Wykoff of the Ingram-Ferguson Company, Detroit. The talk was accompanied by an actual demonstration of methods of setting up the automatic model.

Chapter is trying to eliminate the use of the word "free" from all radio service advertising. This has been accomplished in the telephone book ads, and progress is being made along other lines as well.

NEXT MONTH—

The September issue of *Radio-Craft* will tell you how to make a Battery-Portable using the new permeability tuner. Build this "condenser-less" set.

STUEBENVILLE, OHIO, CHAPTER: Bob Levinson reported on his talks with the owners of several cut-price tube outlets. Bob described the different grades of tubes, and explained what standards they must pass to be classed as 1st Grade.

The noise situation was again discussed, and it was decided to have the Secretary contact the station engineers of several local broadcasters to see if their aid can be had in tracing down the noise, as it is detrimental to the stations as well as the Serviceman.

WILL PHONE LINES STOP WORRIES?

(Continued from page 99)

from RTD. Informants there said that while standard lines were usable over short distances, the loss in such transmission was so great that their use was impractical for inter-city linkage. Repeaters, equalizers & stuff have to be used at least once per mile.

OTHER TELLY TOPICS

Stewart-Warner's 26-tube telly set "will be marketed as the market & consumer demand develop."

On May 5, it was announced that Gaumont-British was planning to equip 2 or 3 Broadway movie houses with Baird giant-screen telly receivers by May 15. At going-to-press time, no Broadway theaters had been thus equipped.

If Solomon Sagall has not arrived in U.S.A. by the time this reaches the stands, don't expect him until early Autumn. He is busy putting Scophony giant-screen equip't in London cinema palaces.

NBC press release that its engineers have devised a revolutionary system of studio lighting is borne out by results. Images improved vastly in first 4 wks. of transmissions.

Du Mont has appointed 6 factory reps to cover the Metropolitan N.Y. district, & plans are afoot to increase factory space. A service manager has also been appointed; he is N. C. Hall.

Four unions are battling to determine which shall have jurisdiction over telly performers.

The construction permit which *Radio Weekly* reports having been granted to Kolorama Labs., Irvington, N.J., will be for low-definition images, according to this dept.'s scouts.

Belmont Radio Corp., of Chi., has developed a telly set, which will be marketed "just as soon as conditions warrant", according to co.'s pres., P. S. Billings.

OFF THE PRESS

(Continued from page 102)

TECHNICAL BULLETINS. Atlas Sound Corp. No. PM-25 describes permanent-magnet, aluminum-diaphragm trumpet units; SP-101 describes marine type horns & units.

TRANSFORMER COMPONENTS (PS-403). United Transformer Corp. 16 pp. Describes wide variety of units.

ENGINEERING DATA. Centralab. 8 pp. Characteristics of fixed resistors. Also a new sheet on low-capacity, lever-action switches.

Please Say That You Saw It in **RADIO-CRAFT**

RADIO TRADE DIGEST

CINAUDAGRAPH SPEAKERS. (Cat. 1238) Cinaudagraph Corp. Description of several models.

SERVICE MANUAL. Clarostat Mfg. Co. Volume control replacement data for all standard sets.

CAMERA CATALOG. Lafayette Camera Corp. 40 pp.

MILLER QUALITY PRODUCTS. J. W. Miller Co. 32 pp. Descriptions & prices of the mfr.'s line, with numerous circuit diagrams. (Price 25c from mfr.)

BENDIX BATTERY ANALYZER. Bendix Radio Corp. Data on new auto-battery checker.

overtime & produces the following: (1) "Little Pal", 9 lb., is smallest portable; (2) New auto-radio parts kit is ready; (3) Bracket for new "underhood side cowl auto antenna" is easy to install; (4) New sales helps push air conditioners; (5) Type 933 auto-radio is easy to install; (6) There are 3 new farm radios; (7) Dealers like new electric refrigerators; (8) New accessory kit simplifies air conditioner installation. *Boy, was that press agent busy!*

LATE FLASH: Bert Nussbaum & Johnnie Lamson, representing Radio-Craft at the Chicago Radio Parts Show, brought back nothing but pleasant news . . . manufacturers expanding plants & rushing to fill orders, jobbers reporting great dealer enthusiasm, jobbers and dealers placing orders right & left . . . **EXTRA!** John Rider sold his test instrument line to RCA, lock, stock & barrel.

PERSONAL

(Continued from page 100)

SIDNEY STROTZ heads the net's Central Div.; his HQ are in Chi.

JOHN AALBERG, sound director of RKO Radio, will represent the AMPAS Research Council.

FRANK E. MULLEN, mgr. of RCA's Dept. of Info., is now v-p in charge of Adv. & Publicity. **HORTON HEATH** succeeds to his old title.

JAMES R. FOUCH, pres. & gen. mgr. of Universal Microphone Co., is making an extended biz trip. And **MARJORIE McDEVITT**, office secy. of the same co., married **ROGER OHMS**, Chief Electrical Engineer, U.S.N., in May.

J. W. SAVAGE, long with G-E, has been made asst. to that co.'s exec. v-p., **C. E. WILSON**. His HQ will be in N.Y.C.



(Continued from page 101)

new press-to-talk hand sets . . . Who said "side-lines"?—One apt. house in St. Paul, Minn., just bought 6 carloads of 530 Stewart-Warner kitchen ranges & electric refrigerators . . . **Mark-Time** has announced a new medium-cost switch to turn radios on & off.

W. H. Ochiltree, G-E distrib. in Pittsburgh, has special depts. for radio tests & service, & for sales helps. . . **Internat'l Kadette** is the latest to go in for making cameras; unconfirmed rumor says this may dominate if not supplant their radio biz. But we wonder. . . Who said "LITTLE Nipper"? Famed RCA trademark pouch is 6' high at N.Y. World's Fair exhibit—& talks!

Publicity pic from Pilot shows workman building Fair exhibit, "Little Miracle Town", taking time out to tune no-battery portable. . . **Philco's** press dept. works

New Lines Just Announced



← **Stromberg-Carlson's** new bid for biz includes this Frequency Modulation receiver. Others in the group: 7 Labyrinth models; 7 table models, including a portable; 7 radio-phonos, several specialties, and telly jobs (see pix, pg. 102).

Jensen's new line of 18-→ inch Auditorium Speakers with Permanent Magnet are offered in 4 types. Model BR-18 Peri-dynamic enclosure is provided for all models. Complete descriptive literature available on request to the Jensen Radio Mfg. Co.

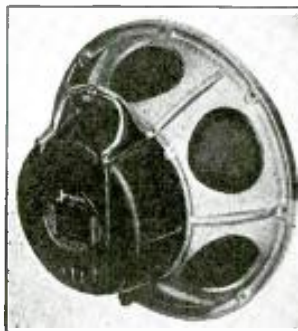

↑ Described as to its functions on Page 100, this new RCA midget has the following additional features:—streamlined, modern style cabinets; powerful heterodyne circuits; new edge-lighted, full-vision dial; standard broadcast and police reception; A.C.-D.C. operation; Underwriters approval; low-drain tubes, including 3 double-purpose tubes.

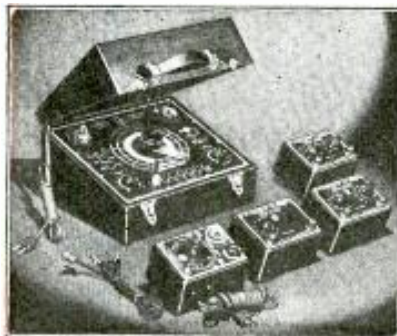

↑ First instruments to be built by C-D will be the the Capacitor Analyzer, Capacitor Bridge and complete line of Capacitor Decade Boxes. Model BF 50 Capacitor Analyzer measures all important characteristics of paper, mica, oil, wet and dry electrolytic and motor starting condensers. Midget Capacitor Bridge measures all types of capacitors between 10 mmf. and 50 mf. All are described and detailed in Catalog No. 167A. Copies free on request at any authorized C-D distributor.

A GREAT RCP INSTRUMENT
now improved for you



MODEL 660 ELECTRONIC

MULTITESTER

Here's RCP's new vacuum-tube Volt-Ohmmeter for the serviceman who realizes the importance of being properly equipped. Lowest voltage reading 0.1 V. (full division), highest voltage reading 6,000 V. Lowest ohmmeter reading 0.1 ohm, highest 1,000,000,000 ohms. Maximum voltage used in ohmmeter 7½ V. No exposure to high voltages when making high resistance measurements. Supplied complete in hand-rubbed sloping walnut case. Net **\$18.85**

Other features of the Model 660, as well as the complete RCP quality line of Test Equipment, described in Catalog, free on request. Send for your copy NOW!

RADIO CITY PRODUCTS CO. INC.
88 PARK PLACE, N. Y. C.

BE A RADIO SERVICE EXPERT



Modern receivers require men with modern training for service work
LEARN AT HOME
Our home instruction method and service equipment offer starts you earning money almost at once. Up to \$3 an hour easy in a short time. Write for free book.
Radio Training Ass'n of America
Dept. RC-89
4525 Ravenswood Ave., Chicago



EVERYTHING IN RADIO!
A COMPLETE SOURCE FOR YOUR RADIO NEEDS
Our immense stock of radio sets, parts and supplies enables you to purchase your entire needs on one order. You will find all your Nationality Known Favorites in this big book which is FREE for the asking. Practically every order is shipped the same day it is received.
WRITE FOR BIG NEW CATALOG
BURSTEIN-APPLEBEE CO.
1012-N. McGee St., Kansas City, Mo.

CONDENSERS

Dry Electrolytic and Paper Complete Line—Time tested Quality
Reasonably Priced

Dealers, Distributors, Jobbers, Service Men, write for Information and Price sheets.
ILLINOIS CONDENSER CO.
1160 N. Howe St. Chicago, Ill.

WE BUY FOR CASH

In any quantity
USED CLASSICAL PHONOGRAPH RECORDS
— REGARDLESS HOW OLD —
MAIL US LIST OF ARTISTS & SELECTIONS
HIGHEST PRICES PAID
MODELL'S — DEPT. R-8
58 CORTLANDT ST., New York, N. Y.

FREE **NEW CATALOG 1939 AMPLIFIERS**
Featuring amazingly low prices; Free Trial Offer, 5-Year Guarantee. Write for Catalog No. 3911.
AMPLIFIER CO. of AMERICA
17 WEST 20th STREET NEW YORK, N. Y.

Please Say That You Saw It in RADIO-CRAFT

THE RADIO MONTH IN REVIEW

(Continued from page 119)

Attractive
MODERN DESK LAMP
 Absolutely **FREE**
 READ THE DETAILS



↑
**THIS
 SHADE
 TILTS
 UP AND
 DOWN**

JUST THINK OF IT—you can get absolutely FREE, the beautiful desk lamp which is shown above. This attractive desk lamp is suitable for home, desk, den, office, laboratory, studio or workshop. It is sent to you by the publishers with their compliments for a one-year subscription to RADIO-CRAFT. Look at the many fine features which this handsome desk lamp has. Read the list below.

HERE ARE THE LAMP FEATURES!

- ⊙ Constructed of metal with attractive bronze finish.
- ⊙ Scientifically constructed to give glareless, diffused light.
- ⊙ Helmet-type shade can be tilted to any convenient angle.
- ⊙ Stands 13" high and has 10" metal shade.
- ⊙ 5-foot rubber insulated cord and plug.
- ⊙ Constructed to last for many years.

Clip Coupon Today—and Mail!

Send your subscription today to RADIO-CRAFT for One Year (12 issues) and receive absolutely FREE one of these truly remarkable desk lamps. New subscribers are accepted or you may extend your present subscription another twelve months under this offer. Mail your remittance of \$2.50 (Plus 25c for shipping charges on lamp) to the publishers of RADIO-CRAFT. (Canada and foreign \$3.25.) In U. S. add 25c additional to cover shipping charges on lamp.

RADIO-CRAFT

99 Hudson Street NEW YORK, N. Y.

RADIO-CRAFT
 99 HUDSON STREET, NEW YORK, N. Y.

Gentlemen: Enclosed you will find my remittance of \$2.50 for which enter my subscription to RADIO-CRAFT for One Year (12 issues). Send me promptly my FREE DESK LAMP. (Canada and foreign \$3.25.) In U. S. add 25c additional to cover shipping charges on lamp.

() NEW SUBSCRIBER
 () EXTEND PRESENT SUBSCRIPTION

Name

Address

City State

(Send remittance by check, money order or unused U. S. Postage stamps. Register letter if you send cash or stamps.)

RC-839

BREVITEMS

THE Federal Communications Commission last month asked the Census Bureau to take a count of radio receiving sets in homes, when the regular census is taken next year, to determine the potential emergency status for broadcasts during a national crisis.

Army maneuvers in upper New York State on August 16 to 24, inclusive, will be covered in a comprehensive series of broadcasts.

The sham battle, the largest in the history of the United States Army, will employ 50,000 men divided into opposing forces. The Blues, operating from headquarters at Saranac, N. Y., will attempt to defend their territory from the opposing Black forces.

National Broadcasting Company announcers and field engineers, equipped with mobile units, shortwave transmitters, pack sets and other essential paraphernalia, will report the progress of the mock fight from all angles. Descriptions will be relayed throughout the United States over the combined N.B.C. Red and Blue Networks, and in addition will be shortwaved around the world for the benefit of service men in far-flung outposts.

Arch Oboler's play, starring Boris Karloff as "The Ugliest Man in the World," in the air drama of that title, was sold by Oboler to N.B.C. in a novel way. He placed a phonograph on the desk of Lewis H. Titterton, N.B.C. script division manager, and turned the machine on; a disc recording of the radio drama sold the production!

The F.C.C. last month released the pamphlet, "Chapter VI—Rules Governing Fixed Public Radio Services." Definitions of radio terms employed by the F.C.C. are given.

A coffin, in a church in Athens, Greece, seemingly containing the body of the wife of a Greek-Italian architect last month was found to contain a high-powered radio sending set. Greek police nabbed Vincenzo Caivalo, a Greek-Italian, as a spy.

John L. Baird, television pioneer and president of Baird Television, Ltd., England, is said to have perfected a device which will enable airplanes to see electrically as far as the eye can see optically on a clear day; the apparatus is also said to penetrate fog to considerable distances. Because of its value in wartime the apparatus is being closely guarded. The apparatus is described as picking up views of the terrain and reflecting it on an adjustable ground glass plate set in the dashboard of the plane.

It would seem from this description that Baird is using almost a standard television camera and direct-connected viewing tube, the former sensitive in the infra-red region.

The huge 85-ton and tremendously expensive *cyclotron* at the University of California someday may be found to have paid back its cost many times over in having made possible, last month, the discovery of "Element 43" which the device manufactured by disintegrating molybdenum atoms.

Not enough of this element yet exists to be seen by the naked eye, but tests prove its existence.

This element was first reported to have been detected in a natural state, in manganese (radioactive) ore, by a German physicist 12 years ago; and tests of the ra-

dio-activity of the recent samples in the Radiation Laboratory apparently thereby prove that the cyclotron has alchemistically created this radioactive element.

A broadcast sketch titled "Back of the Dials" last month demonstrated the improvements which have taken place in radio transmission and reception. The story, written by Thomas Langan of the N.B.C. script division, was presented as part of the company's celebration of radio's "Open House Week."

The scene was set in the back room of a radio dealer who had kept a sort of museum of receiving sets from the early days. The dealer is a lover of orchestral music and the plot revolves around his efforts to arouse the enthusiasm of prospective customers by tuning-in on fine musical programs with the various sets so that they may judge for themselves the vast improvements that have taken place in recent years.

The life of most radio transmitter tubes is taken as about 1,000 operating hours. Last month, WOR retired one of its 50 kw. tubes after 17,000 hours' use!

A machine designed to accurately record the mechanism of speech has been invented by Dr. Herbert Koepp-Baker, head of Pennsy State College's speech clinic. It's called an "electrical phonokinesigraph," or sound-movement writer.

MORE TELLY

An outstanding feature of the Philco service meetings scheduled last month to be held at the National Convention of Philco at French Lick Springs, Ind., will be the staging of a television school at which television problems and technique will be elaborated and explained for the benefit of service managers. The purpose of the school is to provide instruction on the fundamentals of television and its service problems.

General Electric planned last month to double its telly set-up to 16 receivers at the New York World's Fair 1939, to meet the demand of lookers-in.

N.B.C. is said to be about to lease the tiny Belmont Theatre in New York City and convert it into the world's first telly theatre, with invited audiences at all regular broadcasts, to quote a newspaper item.

An improved projection television tube last month permitted increased definition on a 20 x 15 ft. screen in London theatres equipped by Baird Television apparatus. In 12 theatres so equipped a total audience of 25,000 paid \$2.50 per head to see the running of the Derby at Epsom Downs.

The U.S. Department of Commerce reports that Italy plans to install 50 television transmitters, during the coming year, with transmitting equipment to be manufactured in Italy and receivers to be imported (from the U. S. A.?).

Frequent trans-Atlantic reception, at Riverhead, L.I., of London television signals was the topic of a talk by D. R. Goddard, of RCA Communications, Inc., at a joint meeting of the International Scientific Radio Union (American Section) and I.R.E., held at Washington, D.C., last month.

Please Say That You Saw It in RADIO-CRAFT

MAILBAG

(Continued from page 95)

They don't, I believe, help New York's radio Servicemen. They are instructive, in an abstract fashion. Evidently, you have a national circulation. The fellows in Podunk may be benefited, but not the metropolitans. Besides, I wonder what kind of a Serviceman writes to a magazine for information on how to do his job. If he hasn't had sufficient technical training and is not equipped in every way to properly service his particular trade, then the courses open to him are to either study and get equipment or go back to digging ditches. Writing to a magazine is ridiculous, when it means asking a lot of fool questions. Maybe I'm wrong, but you asked for an expression of opinion, and you have had mine.

The kind of stuff that Servicemen like is the work of a man like Sprayberry. His descriptions of new circuits are always interesting and timely. Howard G. McEntee does pretty well, too. I liked the article by him on the vacuum-tube voltmeter, Oct. '38 *Radio-Craft*. In the same issue, Sicuranza has a monstrosity to offer that is unsurpassed for sloppiness. The diagram that goes with it isn't legible on its gray background. Phooey! A cheer for the *Radio Trade Digest* feature. "The Latest Radio Equipment" feature is superfluous, and we can get the same stuff in catalogs or just read the advertising pages.

WILLARD MOODY,
New York City.

wide circulation here and abroad, and therefore, its editorial content must necessarily be aimed to interest many different classes of readers in widely separated localities.

As regards the Latest in Radio department, we've had comments pro and con on this, too. Most readers, however, confirm our belief that this department is invaluable in acquainting technicians with the new developments in radio. Not every radio man has the time, inclination or facilities for keeping tabs on the many new items marketed each month; and of course it is frequently many months before an item released to the magazine readers makes its appearance in a catalog, if, indeed, it ever appears in a catalog (and remember, no radio man sees all the catalogs and circulars put out by all the companies).

THANK YOU!

Dear Editor:

Regarding your inquiry on page 150, *Radio-Craft*, September '38, as to the Serviceman's acceptance, and the practicability to him of "Servicing Questions & Answers:"

Permit me to say that I have filed alphabetically, every service note, answers to questions, and in short, every article that has appeared in your esteemed publication, *Radio-Craft* from the initial number to date. Needless to state this data has proved invaluable.

I suspect that you as publishers, as well as we Servicemen, experience the fact that as long as no brickbats are hurled, we may judge our service to the public as satisfactory, hence this letter.

E. H. MOSS,
Moss Radio Service,
Waco, N. C.

SERVICING QUESTIONS & ANSWERS

(Continued from page 91)

parts O K, except 2 "dead" type 50 amplifier tubes. I replaced these and connected the power unit to the receiver, and thought it worked fairly well.

Now the owner's complaint is that the volume is low on phono, and the radio signals come through, unless the dial is turned to the low-frequency end.

I can find no model number on this job, the power pack checks to the model 109, the voltage also checks close to this model, only this model uses one 226 ahead of the type 50 power tubes.

When the receiver switch is turned to Radio there is no filament and bias voltage on the 226, but there is voltage on these elements when the switch is on Phono, and the phono switch is closed. Are these operating conditions correct or may I have misplaced wires in my connections?

(A.1) Regarding the Sparton receiver: In this model, which we believe is the 99 ensemble, the type 26 tube is used only in Phono position. The action of the phono-radio switch is such that in Phono position, the heater circuit to the type 484 tubes is opened, and the primary circuit of the filament transformer supplying the type 26 tube is closed. In the Radio position of the transfer switch, the reverse action takes place.

The fact that radio reception is heard in the Phono position of the transfer switch

points to a faulty switch since the R.F. tube heater circuit should be open.

This model did not possess great volume for record reproduction, as compared with present-day standards, but a general overhauling of the magnetic pickup should accomplish a good deal. Re-magnetize the permanent magnet and re-center the armature.

(Q.2) I have a Silvertone, model 1650. Complaint is intermittent noise. All tubes and condensers check O K. When this receiver is first turned on the plate voltage rises to 300 volts and as the set warms up it gradually drops down to 200 volts; the plate current on the 47's rises to 20 milliamperes and drops to 8. This condition looks to me like a high resistance leak yet I cannot find it, none of the parts seem to be overheated. I have tried a new power transformer filter condenser, the output transformer checks O K.

Can you help me out on this?

(A.2) Regarding the Silvertone receiver: Normal plate current for type 47 tubes with 200-250 volts on plate and grid bias of approximately 15 V. is approximately 30 milliamperes. Check the 400-ohm resistor in the speaker field-return to chassis, and the 10,000- and 8,000-ohm plate and screen resistors, for resistance change. Replace with wire-wound units.

(Continued on page 128)

METALEX HORNS

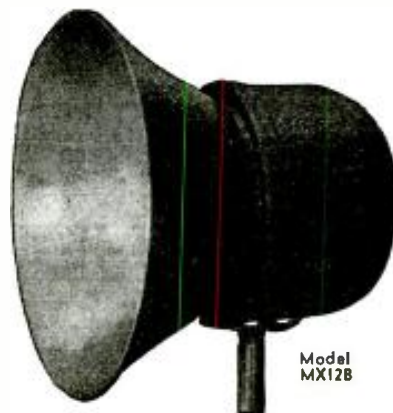

Model MX12B

- Steel for Wear
- "Ex" for objectionable resonances
- Truly Exponential

Size: bell opening 20"—length overall 15"

Rightly

The most popular public address horn.

Write for latest introductory offer giving a speaker FREE with the Model MX12B Horn.

- Are you on our mailing list?

Those Who KNOW Demand Wright-DeCoster WRIGHT-DECOSTER, Inc.

2251 University Ave., St. Paul, Minn.
Export Dept.: M. Simons & Son Co., New York
Cable Address: "Simontrice"

Canadian Representatives:
Wm. F. Kelly Co., 1207 Bay St., Toronto, Ontario
Taylor & Pearson, Ltd., Edmonton, Alberta

RADIO Simplified!
with Ghirardi's Home-Training Course COMPLETE IN 7 BIG BOOKS

Every phase of Radio, Electricity, Television, Sound and Cathode-Ray Tubes is made crystal-clear by A. A. Ghirardi in this fascinating self-instruction course. Here at last is your practical training for Radio all in 1 big, handy, inexpensive book—compact and complete. That's why it's the most popular radio text in the world!

QUICK and EASY
Let Ghirardi prove to you how simple it is to master the fundamentals of radio quickly. So easy to understand it reads like "A.B.C."

36 Volumes in 1—972 pp.—508 illus.

1. Radio Broadcasting System
2. Sound, Speech, Music
3. Electron Theory: Elec. Current
4. Elec. Units: Ohm's Law; Resistance
5. Elec. Circuit: Batteries
6. Magnetism
7. Electromagnetism
8. Electromagnetic Induction
9. Inductance
10. Capacitance
11. A. C. Circuits
12. Filters
13. Measuring Instruments
14. Radio Waves
15. Broadcasting
16. Receiving
17. Vacuum Tube Principles
18. Vacuum Tube Characteristics
19. Vacuum Tube Construction
20. Vacuum Tube Detector and Amplifier Action
21. Radio Frequency Amplification
22. "Superhets"
23. R.F. Amplifiers: Tuning Collis
24. Audio Amplifiers
25. Speakers
26. Battery-Operated Receivers
27. Power-Supply Units
28. DC Receivers
29. Automobile and Aircraft Radio
30. Phono Pickups: sound Systems
31. Short-Wave
32. Photoelectric Cells: Cathode-Ray Tubes
33. Television
34. Antennas and Grounds
35. Testing Servicing
36. Sound Pictures. . . . 856 Self-Review Questions!

USE IT 5 DAYS—OUR RISK!
Our money-back guarantee protects you 100%. So there's no need to postpone your radio training another day! Clip and mail the coupon—right now!

MAIL COUPON TODAY!
RADIO & TECHNICAL PUBLISHING CO.,
45 Astor Place, New York, Dept. RC-89

Here is my \$4. Please send RADIO PHYSICS COURSE postpaid, with money-back guarantee.

NAME

ADDRESS

CITY State

Send free descriptive literature.

OPPORTUNITY AD-LETS

Advertisements in this section cost five cents a word for each insertion. Name, address and initials must be included at the above rate. Cash should accompany all classified advertisements unless placed by an accredited advertising agency. No advertisement for less than ten words accepted. Ten percent discount for six issues, twenty percent for twelve issues. Objectionable or misleading advertisements not accepted. Advertisements for September, 1939, issue must reach us not later than July 7th.

Radio-Craft • 99 Hudson St. • New York, N. Y.

AGENTS WANTED

300% PROFIT SELLING GOLD LEAF LETTERS FOR store windows: Free samples. Metallite Company, 451 North Clark, Chicago.

BOOKS AND MAGAZINES

WE HAVE A FEW HUNDRED RADIO ENCYCLOPEDIA, by S. Cernyback, second edition, originally sold at \$3.98. Book has 352 pages, weight 3 lbs., size 9 x 13 inches. Red morocco—keratol flexible binding. Send \$2.49 in stamps, cash or money order and book will be forwarded express collect. Technifax, 1915 No. State Street, Chicago, Illinois.

CAMERAS & SUPPLIES

AMBERTINT 16MM. CAMERA FILM, \$1.85 FOR 100 feet, including machine processing. Daylight loading Weston Eight, Nonmagitation. Two rolls \$3.50. Order now. Hollywood Studios, Southgate, Calif.

GENERA FILM—ALL MOVIE CAMERAS, 100 FEET 8 mm., \$1.00; double, \$1.75; 16mm., \$1.35. Sample for stamp. Processing Powders, Outfits, Fromaders. Davenport, Iowa.

BULK FILM: 100 FT. 8MM. \$90; DOUBLE, \$1.60; 16 mm., \$1.20. Titles of pictures. Chemicals, outfits. Buy catalogue for stamp. Hollywoodland Studios, South Gate, Calif.

COINS AND STAMPS

53 U.S.A. FARLEY'S, TIPEX, COMMEMORATIVES, rev. postage, coronations, jubilees, air mails and lists 25c. Box 211, Malden, Mass.

FOR INVENTORS

CASH FOR UNPATENTED IDEAS, STAMP APPRECIATED. Mr. Ball, 9441-J Pleasant, Chicago.

FORMULAS

FORMULAS FOR MAKING INSECTIDES, ANTISEPTICS, Bleaching Solutions, Cements for all Purposes, Stain Removing Preparations, Cosmetics, Depilatories, Dyes, Quers, Pains, Plating Solutions, Soaps, Varnishes, Wines and Liquors, and Many Everyday Preparations. Send 10c for each formula. Complete satisfaction or money immediately refunded. L. Feldman, 640 Ramapo Rd., Teaneck, N. J.

HOMES WIRED FOR RADIO

ARCHITECTS, BUILDERS, HOME-OWNERS!—PLAN for concealed, built-in radio in every room. Put radio in attic, cellar or closet, tune it remotely from any room. Up to 4 different stations heard independently in each room. We supply complete plans and specifications for your individual requirements. We also sell all necessary equipment and actual installations. Write for prices and complete details. A. Stuart, 1015 Wilson Ave., Teaneck, N. J.

MISCELLANEOUS

MEXICAN DIVORCES: NO PUBLICITY. AMERICAN attorney, box 1736, El Paso, Texas.

BOYS, GIRLS, AGENTS: MEXICAN JUMPING BEANS, 5 for 10c, 15-25c. J. J. Frank, 525-L Palm, Rockford, Ill.

MONUMENTS & TOMBSTONES

GENUINE MARBLE, GRANITE, FREIGHT PAID. Catalog free. \$11 up. United States Marble & Granite Co. A-27, Oneco, Fla.

OFFICE SUPPLIES

SEND COPY AND \$1.00 FOR 125 8 1/2 x 11 BOND LETTERHEADS and 125 envelopes, both beautifully printed. Benneville, 907 West Roosevelt, Philadelphia.

2,000 BUSINESS CARDS, \$1.50. RECEIPTS, STATEMENTS, envelopes, noteholders, \$1.75-1.000, 25 printed salesbooks, \$1.50. Bargain Printers, Box 823, Huntington, West Virginia.

2,000 BUSINESS CARDS \$1.50—15c POSTAGE. Vincent Sallee, 150-28 14th Avenue, Whitestone, N. Y.

RADIO

WE BUY AND SELL USED RADIO TESTING EQUIPMENT. Time payments if desired. Harold Davis, Inc., Jackson, Miss.

SERVICEMEN: RADIO CARTOONS ENLIVEN ADVERTISING, boost business. Cut catalogue 10c. Harloloahs, Winnipeg, Canada.

ALGEBRA PROBLEMS SIMPLIFIED \$1.30; LOW Voltage Transformer Construction \$0.60; Data on 500 to 20,000 Volt Step-up Transformer Construction \$1.35. H. Ackerson, Box 322-R, Ramez, N. J.

BRAND NEW, GUARANTEED, RADIO TUBES 25c each. Box 37, Station P, Brooklyn, N. Y.

WANTED—QUALIFIED RADIO TUBE DISTRIBUTOR in U.S. by French radio tube manufacturer making tubes with American characteristics at prices which will interest American trade. Write, Radio Ets Morbel, 12 Rue de L'Isly, Paris 8, France.

SONG POEM WRITERS

SONGWRITERS! MELODY FOR WORDS \$1.00. Little, 215 Mason Theatre, Los Angeles, California.

TREASURE LOCATORS

TREASURE FINDER (METAL LOCATOR) CUSTOM built by engineer. Great penetrating power. No fancy gadgets. Uses latest radio developments. Simple, inexpensive to operate. Delivery ten days. Write for details and low price. A. Stuart, 1015 Wilson Avenue, Teaneck, N. J.

12 NEW TUBES

(Continued from page 90)

1N5GT—Filament-Type Pentode Amplifier

Here is a tube designed for service as a high-frequency amplifier in receivers operating from a low-voltage battery filament supply.

It may also be employed as a bias detector or audio-frequency voltage amplifier and in such use is capable of comparatively high gain.

1H5GT—Filament-Type Single Diode-Triode

This dual-purpose detector and audio amplifier tube consists of a high- μ triode and a shielded diode in a single envelope. The combined functions of detection, automatic volume control, and audio amplification can be performed by this tube in receivers operating from a low-voltage battery filament supply.

1Q5GT—Filament-Type Beam Power Amplifier Output Tube

The type 1Q5GT is designed for applications requiring high efficiency and low distortion in receivers operating from a low-voltage battery filament supply.

TENTATIVE CHARACTERISTICS

35Z5GT—TABLE I

Heater voltage (A.C. or D.C.):	
Entire heater (Pins No. 2 & 7)	35 volts
Pilot-lamp section of heater (Pins No. 2 & 3)	7.5 volts
Heater Current (entire heater)	0.150 ampere
Max. overall length	3-5/16"
Max. diameter	1-5/16"
Bulb	T-9

Maximum Ratings and Typical Operation

A.C. plate voltage (r.m.s.)	125 max. volts
D.C. output current:	
With type 40 pilot-lamp* and plate-to-heater tap connection (Fig. 1)	50 max. ma.
Without pilot lamp and no plate-to-heater tap connection	100 max. ma.
Typical operation with type 40 pilot lamp* (See Fig. 1):	
Voltage across pilot-lamp section of heater with rectified current of 50 ma. plus heater current flowing in parallel path between Pins No. 2 & 3	5 approx. volts
Voltage across entire heater with rectified current of 50 ma. plus heater current flowing in parallel path between Pins No. 2 & 3, and heater current only between Pins No. 3 & 7	31 approx. volts
*6.3 volt, 0.150-ampere.	

1A5GT—TABLE II

Rating	
Filament voltage	1.4 D.C. volts
Filament current	0.05 ampere
Max. plate voltage	90 volts
Max. screen-grid voltage	90 volts
Amplifier—Class A	
Plate voltage	85 volts
Screen-grid voltage	85 volts
Control-grid bias	-4.5 volts
Transconductance	800 mmhos
Plate current	3.5 ma.
Screen-grid current	0.7 ma.
Load resistance	25,000 ohms
Total harmonic distortion	10 per cent
Power output	100 milliwatts

1C5GT—TABLE III

Rating	
Filament voltage	1.4 D.C. volts
Filament current	0.1 ampere
Max. plate voltage	90 volts
Max. screen-grid voltage	90 volts

Amplifier—Class A	
Plate voltage	83 90 volts
Screen-grid voltage	83 90 volts
Control-grid bias	-7 -9 volts
Amplification factor	165 180
Plate resistance	0.110 0.115 megohm
Transconductance	1,500 1,500 mmhos
Plate current	7 6 ma.
Screen-grid current	1.6 1.4 ma.
Load resistance	9,000 8,000 ohms
Total harmonic distortion	10 10 per cent
Power output	200 210 milliwatts

1A7GT—TABLE IV

Rating	
Filament voltage	1.4 D.C. volts
Filament current	0.05 ampere
Max. plate voltage	90 volts
Max. screen-grid voltage	45 volts
Max. anode grid (No. 2) voltage	90 volts
Direct Interelectrode Capacities	
G ₁ to P (control-grid to plate)	0.40 mmf.
G ₁ to G ₂ (control-grid to osc. anode grid)	0.25 mmf.
G ₁ to G ₃ (control-grid to osc. grid)	0.12 mmf.
G ₁ to G ₂ (osc. grid to plate)	1.5 mmf.
G ₁ to all other electrodes (R.F. input electrode)	7.5 mmf.
G ₂ to all other electrodes except F ₁ (osc. output electrode)	4.0 mmf.
G ₃ to all other electrodes except G ₂ (osc. input electrode)	3.2 mmf.
Plate to all other electrodes (mixer output electrode)	10.0 mmf.
Frequency Converter	
Plate voltage	90 volts
Screen-grid (No. 3 and No. 5) voltage	45 volts
Anode grid (No. 2) voltage	90 volts
Control-grid (No. 4) bias	0 volts

NEW!

A NEW GERNSBACK PUBLICATION
The Constructive Photo Magazine



ON ALL NEWSSTANDS

FOR serious-minded amateur photographers, here's a photo magazine, FOTO-CRAFT, vastly different from any you've read. It tells you how and why to do things—it's a constructive publication which shows what can be done with the equipment you have, and how to make handy, photographic accessories. FOTO-CRAFT, with its broad editorial features, covers such important branches of photography as—New Scientific Research; Developing; Printing; Enlarging; Dodging; Cropping; Photomicrography; Color Photography; Amateur Movies; How to Make It Items.

A Few of the Articles in the Current Issue
By such authorities as Herbert C. McKay; Malcol and Mario Scacchi; Dr. E. Badler; Leonard Hyman; Carl Ditt, etc., the titles include: Plenty to Photograph Right Under Your Nose—Soup Is Soup—It's All Greek; Alpha, Beta, Gamma, Delta—Photographic Designs Without a Camera—Noodle Titles—The Simplest Synchronizer Tester—Stereoscopic Table Top—Home-made Synchronizing Flashgun—Super Cabinet for Enlarging—Tomorrow's Photography—International Photo Digest—Table Top Photo Contest—Watch the Birds; Modern Style—Electric Photographs—Bus Reliefs Made by Treating Photographs—Movie Trick and Action Titles—Paper Negative Technique—Print It Yourself—Photo Hints and Tricks—What's New—Questions and Answers—Photo Quiz, etc.

BIG OPPORTUNITY!! Get a FOTO-CRAFT Press Card today—with it you can get permission to take photos which might be difficult to obtain. PRESS CARDS are sent FREE to subscribers of FOTO-CRAFT. Enter your subscription for Seven Months for \$1.00—and get your PRESS CARD immediately.

FOTO-CRAFT

99-R HUDSON STREET NEW YORK, N. Y.

Oscillator grid (No. 1) resistor	200,000	ohms
Plate resistance	0.6	megohm
Conversion transconductance	250	mmhos
Plate current	0.55	ma.
Screen-grid current	0.60	ma.
Anode-grid current	1.2	ma.
Oscillator grid current	35	ua.
Total cathode current	2.4	ma.
Conversion transconductance (approx.) (at control-grid bias -2.0 volts)	50	mmhos
Conversion transconductance (approx.) (at control-grid bias -3.0 volts)	5	mmhos

1N5GT—TABLE V

Rating		
Filament voltage	1.4	D.C. volts
Filament current	0.05	ampere
Max. plate voltage	90	volts
Max. screen-grid voltage	90	volts
Direct Interelectrode Capacities		
G ₁ to P (control-grid to plate)	0.007	max. mmf.
G ₁ to F, G ₂ and G ₃ (input electrode)	2.2	mmf.
P to F, G ₂ and G ₃ (output electrode)	9.0	mmf.
Amplifier—Class A		
Plate voltage	90	volts
Screen-grid voltage	90	volts
Control-grid grid bias	0	volts
Plate resistance	1.5	megohms
Transconductance	750	mmhos
Plate current	1.2	ma.
Screen-grid current	0.3	ma.
Transconductance (approx.) (at control-grid bias -3.2 volts)	50	mmhos

Transconductance (approx.) (at control-grid bias -4.0 volts) 5 mmhos

1H5GT—TABLE VI

Rating		
Filament voltage	1.4	D.C. volts
Filament current	0.05	ampere
Max. plate voltage	90	volts
Direct Interelectrode Capacities—Triode Section		
G to P (grid to plate)	1.1	mmf.
G to F (input electrode)	0.35	mmf.
P to F (output electrode)	*4.0	mmf.
Amplifier Class A Triode Section		
Plate voltage	90	volts
Grid bias	**0	volts
Plate resistance	0.24	megohm
Transconductance	275	mmhos
Plate current	0.15	ma.

*Diode plate current to pin No. 7.
**Return to Neg. Fil. pin No. 7.

1Q5GT—TABLE VII

Rating		
Filament Current	1.4	D.C. volts
Amplifier Operation—Class A		
Plate voltage	90	volts
Screen-grid voltage	90	volts
Control-grid voltage	-4.5	volts
Plate current	9.5	milliamperes
Screen-grid current	1.6	milliamperes
Mutual conductance	2100	mmhos
Load resistance	8000	ohms
Power output	.27	*watt
Total harmonic distortion	7.5	per cent

*E signal—3.2 volts r.m.s.

THE LATEST RADIO EQUIPMENT

(Continued from page 98)

volt to 2,500 V.; D.C. milliamperes; resistance to 50 megohms; capacity to 200 microfarads; and decibel ranges.

UNIVERSAL LINE VOLTAGE REGULATOR (1770)

(Lafayette Radio Corp.—Wholesale Radio Service Co.)

THIS compact line voltage regulator permits maintaining the A.C. voltage supply constant within + or - 2 per cent of the normal required voltage even though the line voltage may drop to 95 or rise as high as 135 V. It may further be used to boost or reduce normal line voltages in 5-V. steps. The unit is rated to handle loads up to 240 W. It includes a direct-reading 0 to 150 V. A.C. voltmeter. The "jogger" is available in kit form.

MIDGET CONTROLS WITH UNIVERSAL SHAFT (1771)

(International Resistance Co.)

KNOWN as type D midgets, these controls have a case diameter of only 1-9/64-in.; depth 33/64-in. without switch or 23/32-in. with switch. They are made in 17 popular ranges and tap-type units from 5,000 ohms to 2 megohms. They are also designed to accommodate 2 types of plug-in shafts. Viz.,

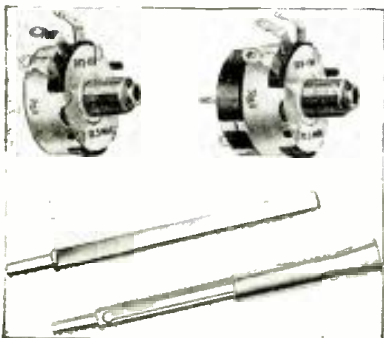

New Midget Controls. (1771)

one designed for use where definite flat location is necessary and the other for use where either a slotted or tongued shaft is required. These plug-in shafts eliminate any necessity for removing other radio components in order to get space to work, as sometimes happens in midget sets.

"DRIFTLESS" COMMUNICATIONS RECEIVER (1772)

(The Hallicrafters)

IN GENERAL this receiver is an 11-tube instrument providing continuous tuning coverage from 540 kc. to 34 megacycles. It includes such features as a crystal filter, stabilized tuning with drift compensation, automatic noise limiter, amplified A.V.C., wide bandspread, "S" meter, variable selectivity, etc. Freedom from drift is obtained by utilizing material in coils and condensers with temperature coefficients such that frequency changes, due to overheating, compensate each other.



PERIODICALS RECEIVED

RADIOGRAM. Scott Wholesale Radio Co. June issue has blast on television.

PHILCO SERVICEMAN. Philco Radio & Tel. Co.

SERVICE NEWS. Spokane Radio Co., Inc.

OHMITE NEWS. Ohmite Mfg. Co.

PRISMA NEWS. Phila. Radio Service Men's Assn.

Please Say That You Saw It in RADIO-CRAFT

Save Money!

With the

RADOLEK RADIO PROFIT GUIDE!

164 PAGES

EVERYTHING IN RADIO AT LOWEST PRICES!

Radolek offers you the MOST for your money! Lowest Prices! Best Quality! Biggest Values! Most Complete Stock! Fastest Service! Send for your FREE copy NOW!

OVER 15,000 REPAIR PARTS

The world's most complete stock of radio repair parts and exact duplicate replacements. All leading brands. All guaranteed. Lowest Prices!

COMPLETE TUBE SELECTION

All types, RCA, Sylvania, Raytheon, Philco, etc. Includes Kellogg, special Majestic types and transmitting tubes. Complete selection.

NEWEST TEST INSTRUMENTS

The most complete line ever displayed in any catalog. All leading makes. Latest improved models at lowest prices.

GREATEST RADIO VALUES

A huge selection of super values as low as \$3.20. New Phono-Radio combinations. Automatic tuning sets. Beautiful cabinets. New "Ham" receivers and equipment.

EVERYTHING FOR AUTO RADIO

Complete auto radio section. Includes vibrator replacement guide, new auto aerials, custom panel control plates for all autos, newest Auto Sets.

COMPLETE P. A. SELECTION

New 1939 public address amplifiers from 10 to 100 watts. Complete P. A. Systems for permanent, mobile and portable installations. Best values!

NEW ELECTRICAL APPLIANCES

Extra profits for you! Standard Brand Electric Irons, Stoves, Heaters, Percolators, Waffle Irons, Vacuum Cleaners, Trains, Clocks, Mixers, etc., at lowest prices!

FREE!

Mail Coupon Catalog!

The **RADOLEK Co.**
601 W. Randolph, Chicago,
Dept. C-32

Send the 1939 Radolek Radio Profit Guide FREE.

Name

Address

Serviceman? Dealer? Experimenter?

Now..

5 VITAL FEATURES COMBINED IN AMPERITE VELOCITY WITH ACOUSTIC COMPENSATOR

By moving up the Acoustic Compensator, you change the Amperite Velocity Microphone to dynamic operation — without peaks. At the same time you reduce the back pickup, making the microphone practically **UNI-DIRECTIONAL**.

With the Acoustic Compensator down, the microphone is **NON-DIRECTIONAL**... 120 degrees front and back without frequency discrimination. Rotating the microphone until it parallels the ceiling makes the microphone **NON-DIRECTIONAL**.

THE ACOUSTIC COMPENSATOR is a regular feature of these models: RBHk (hi-imp); RBMk (200 ohms) LIST \$42.00. RSHk (hi-imp); RBSk (200 ohms) LIST \$32.00

Write for Complete Illustrated Bulletins and Valuable Sales Helps

AMPERITE 561 BROADWAY, N. Y. C. Cable Address: Alkem, New York

AMPERITE Velocity MICROPHONES

NATIONAL UNION Radio Tubes



BEST PROPOSITION for the SERVICE PROFESSION!

WRITE FOR DETAILS

NATIONAL UNION RADIO CORP.

NEWARK, NEW JERSEY

SERVICING QUESTIONS & ANSWERS

(Continued from page 125)

DISTORTION

(135) M. J. Sokolowski, Central Falls, R. I.

(Q.) General Electric Popular Console K62, with antenna connected to set, distorts on 3 local (6 miles distant) stations. Outside stations are OK. Also, although there is volume control action, local stations are heard quite well with volume turned way down. There appears to be A.V.C. action.

Can you tell me what the trouble is?

Voltage on all plates 200 V. except osc. 60 V.; screens, approx. 90 V. Tubes and parts appear to be OK. Tubes were substituted for A.V.C. tube and osc.

(A.) Distortion such as you describe with a General Electric K62 receiver is usually due to insufficient A.V.C. voltage. This condition is the result of leaky bypass condensers in the A.V.C. circuit. In most cases, a perfect repair is effected by replacing 5 condensers, all of which are part of a large bypass block. However, each may be tested individually by substitution and only the defective unit replaced.

Check both bypass units in the A.V.C. tube grid-return circuit, the A.V.C. tube cathode bypass, the A.V.C. tube plate load bypass, and the R.F. secondary-return grid filter condenser. One or more of these condensers is the trouble.

"VOLTAIC CELL 2,000 YEARS OLD?"—CORRECTION

The vase of the strange, 2 V. voltaic cell recently discovered at Khujut Rabu'a, to the south-east of Bagdad, is made of clay and not, as

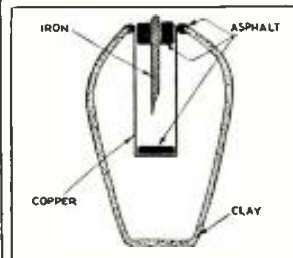

described in *Radio-Craft*, last month on pg. 43, of silver; corrections in the text should be made accordingly. This device, which is apparently a grand-daddy of the voltaic cell, is believed to date back to the dynasty of Sasanides—between 224 to

651 A.D. Others of these strange devices have been discovered near Tel-Ourar and at Ctesiphon near Bagdad.

Features in the August Issue of RADIO & TELEVISION

- 2-Band "Portable"—Broadcast and S-W Receiver, W. C. Palmer, E. E.
- 1-Tube Television "Sound Converter."
- LT-6 Loktal Superhet-Receiver for HAM or Fan, Harry D. Hooton, W8KPX.
- Television Antennas and Their Installation, W. Hollander Bohlke, RCA engineer.
- A Ham Frequency Meter, Herman Yellin, W2AJL.
- 2½ Meter ACORN Transceiver—A de luxe "Build It Yourself" feature, Howard G. McEntee, W2FHP.
- Ham Beginner's Transmitter-Receiver, D. L. Warner.
- Accurate List of World SHORT WAVE Stations.

Index to advertisers

A

Allied Radio Corporation.....108
 Amperite Corporation.....128
 Amplifier Co. of America.....123
 Amplitone Products Company.....107
 Arcturus Radio Tube Company.....111
 Theo. Audel & Company.....117

B

Brush Development Company.....104
 Burstein-Applebee Company.....123

C

Capitol Radio Engineering Inst.....104
 Central Radio Laboratories.....117
 Classified Section.....126
 Consolidated Wire & Assoc. Corps.....110
 Cornell-Dubilier Elec. Corp.....106
 Coyne Electrical School.....115

D

The Data Print Company.....118

F

Foto-Craft Magazine.....126

H

Hammarlund Mfg. Company.....106
 Hudson Specialties Company.....114
 Hygrade Sylvania Corporation.....121

I

Illinois Condenser Company.....123

L

Lancaster, Allwine & Rommel.....109
 Lincoln Engineering School.....109

M

Meissner Manufacturing Co. Inside Front Cover
 Miles Reproducer Company.....110
 Modell's.....123

N

National Plans Institute.....120
 National Radio Institute.....65
 National Schools.....105
 National Union Radio Corp.....128
 New York Y.M.C.A. Schools.....110

O

D. W. Onan & Sons.....121

R

Radio & Technical Publ. Company...104, 125
 Radio & Television Magazine.....112
 Radio City Products Company.....123
 Radio Servicemen of America.....116
 Radio Training Association.....123
 Radolek Company.....127
 RCA Institutes, Inc.....121
 RCA Manufacturing Co., Inc.....118, 107, 67
 Readrite Meter Works.....108
 Remington Rand, Inc.....119
 The Rosicrucian Order.....121

S

Solar Manufacturing Company.....105
 Sprague Products Company.....108
 Sprayberry Academy of Radio.....119
 Superior Instruments Company.....103
 Supreme Instruments Corporation.....105

T

Technifax.....112
 Triplett Elect. Instrument Co....Back Cover

U

United Radio Company.....107
 Universal Microphone Co., Ltd.....119

W

Wellworth Trading Company.....120
 Weston Elect. Instrument Co. Inside Back Cover
 Wholesale Radio Service Co., Inc.....121
 Williams Philco, Inc.....121
 Wright-DeCoster, Inc.....125

(While every precaution is taken to insure accuracy, we cannot guarantee against the possibility of an occasional change or omission in the preparation of this index.)

NEW LOW PRICES

EFFECTIVE JUNE 7th!



NOW ONLY \$49⁵⁰
(Lead phones not included)

Model 669
Vacuum Tube Voltmeter
and Signal Detector



NOW ONLY \$24⁰⁰

Model 697
Pocket Volt-Ohmmeter



NOW ONLY \$45⁰⁰

Model 773
Portable Tube Checker



NOW ONLY \$93⁰⁰

Model 775
Combination Super-Sensitive
Analyzer and Tube Checker



NOW ONLY \$49⁵⁰
Prices net to servicemen in U.S.A.

Model 772
Super-Sensitive Analyzer

WESTON *Fundamental* RADIO-TELEVISION TEST EQUIPMENT

Here's a *two-fold* opportunity for you . . . an opportunity to *save* on the initial cost of these *proved* radio-television test units—and an opportunity to *save substantially* through owning fundamental WESTON instruments. For WESTON instruments will serve you dependably for many years; eliminate rebuilding and replacement costs due to early instrument obsolescence. Remember, too, that these instruments are *not* discontinued models; nor has there been any change in quality. The *only* change has been in price! Return coupon for complete information.

While at the RADIO PARTS SHOW . . . be sure to visit the WESTON Booth Nos. 419-421 Marconi Boulevard, and see TELEVISION equipment demonstrated . . . see how to install and service television with WESTON instruments.

NOW!
it costs no more
to own
WESTON'S
*Return
Coupon*

Weston Electrical Instrument Corporation
599 Frelinghuysen Ave., Newark, N. J.
Send complete information on WESTON radio and tele-
vision test equipment.

Name _____
Address _____ State _____
City _____

THE SET TESTER WITH EVERYTHING

TRIPLETT

Model 1604

WITH **RED • DOT**
LIFETIME
GUARANTEED METER



A NEW Sensational Set Tester—Triplet quality-made, with the features that give the serviceman everything he will want. Twelve A.C. and D.C. Voltage ranges, D.C. at 25,000 ohms per volt; Nine Direct Current ranges; Low and High Ohms ranges; Complete Free Point Tester; Condenser Tester, and provisions for Decibel readings make the Model 1604 the outstanding Multi-Purpose Set Tester of them all.

D.C. VOLTS—0-10-50-250-500-1000-2500 at 25,000 ohms per volt.

A.C. VOLTS—0-10-50-250-500-1000-2500 at 1000 ohms per volt.

DIRECT CURRENT—0-50 Microamperes; 0-1-10-50-250-500 Milliampers; 0-1-2-20 Amperes.

RESISTANCE—0-500 Low Ohms, shunt type circuit; 0-20,000 and 0-200,000 Ohms, 2 and 20 Megohms, series type circuit.

CONDENSER TESTER—Ranges for capacity checking, .001 to 30 mfd. Electrolytic leakage test.

FREE POINT TESTER—Makes all series and parallel meter connections through seven sockets, including Loctal and Bantam Jr. types. Standard RMA markings.

DECIBEL METER—Special chart provides Decibel readings against volts from minus 20 to plus 55.

LARGE MODERNISTIC INDICATING INSTRUMENT with Red • Dot Lifetime Guarantee against defects in materials and workmanship. Tester also has separate line voltage meter for line control.

RESISTANCE MEASUREMENTS BY EXCLUSIVE CIRCUIT (Patented). The ohmmeter zero adjustment is unique in this tester. There is but one adjustment for all resistance ranges. It is more accurate and does not require re-setting of zero when reading different ohmmeter scales. The only tester which can employ this remarkable proven circuit.

PLUG-IN RECTIFIER—Simplifies replacement in case of accidental damage. Rectifier is pre-calibrated for the tester.

NEW ATTRACTIVE QUALITY CASE—heavy steel with black suede baked enamel finish. Size 14½" x 7⅝" x 4½". Leather strap handle. Black, silver and red etched panel. A new feature is the snap-on metal cover. Elastic band inside cover convenient for accessories and instructions. Rubber feet on two sides of case for convenience in using.

Model 1604... Complete with all accessories. Shipping weight 26 pounds. U.S.A. Dealer Net Price... \$49.84.

\$49⁸⁴

DEALER NET

TRIPLE SHIELDED SIGNAL GENERATOR

This new model is now made with full vision dial having six scales with total length of over 50 inches. Improved accuracy, shielding and attenuation equal to oscillators for which you would pay much more. Six bands 115 Kc. to 30.5 Mc.—A.C. operated. Write for full details of this oscillator and other Triplet test instruments you'll be proud to own.



NET PRICE **\$29⁸⁴**

Model 1232-A

THE TRIPLETT ELECTRICAL INSTRUMENT CO.
168 Harmon Ave., Bluffton, Ohio

Please send me more information on Model 1604; Model 1232-A; I am also interested in

Name

Address

City State