

RADIO'S LIVEST MAGAZINE

OVER 175 ILLUSTRATIONS

Radio-Craft

★

HUGO GERNSBACK EDITOR

Special
PRIVATE
ADDRESS
Number

June

25 Cents

in The Best Season
and Climate



**TRAILER-TO-CAR
INTER-COMMUNICATOR
SYSTEM**

See Page 716

**A Simplified Carrier Communicator—A Service Man's Audio Oscillator
Portable 6-Tube Battery Superhet.—A Home-Made All-Wave Car-Radio Set**

OVER 50,000 RADIO MEN READ RADIO-CRAFT MONTHLY

AGAIN SUPREME SCOOPS THE FIELD!

WITH A

2"
INCH



CATHODE RAY TUBE!

ONLY \$29.95
\$4.14 FOR 7 MONTHS

THE GREATEST OSCILLOSCOPE VALUES EVER OFFERED!

Imagine! An oscilloscope with a brand new Cathode Ray Tube which has a large 2" screen—but costs you no more than any ordinary oscilloscope containing a Cathode Ray Tube having only a 1" screen. It's the most amazing oscilloscope value in the radio testing industry! **A Scoop In Engineering!** And what a scoop! Supreme engineers, to prove the merit of the 1" Cathode Ray Tube before incorporating

it in an instrument bearing the Supreme name—discovered that the 1" oscilloscope was too small for efficient operation!

The result was Supreme's 2" oscilloscopes—with a screen area 4 times as large as the 1" size! Plus extra, exclusive practical features that only Supreme can offer—at no extra cost to you! Write for details today.

Model 535—2" Oscilloscope

10 EXCLUSIVE features found in no other instrument of similar price!

1. The only 2" Oscilloscope at this price!
2. Exclusive RETURN SWEEP ELIMINATOR for completely removing high frequency linear sweep return!
3. Exclusive SELECTIVE RETURN SWEEP ELIMINATOR for inclusion or rejection of power supply frequency return sweep!
4. Exclusive SNAP-LOCK SYNCHRONIZER for positive interlock between linear time base and incoming signal—Range 15 cycles to over 500 k.c.!
5. Exclusive UNI-CONTROL allows separate control of two potentiometers from one shaft protrusion—Grouping of controls eliminates groping for controls!
6. Exclusive ANTIQUE BRONZE PANEL!
7. Exclusive SMALL SIZE AND LIGHT WEIGHT!
8. Exclusive MINIMUM number of PANEL KNOBS control MAXIMUM number of INSTRUMENT FUNCTIONS!
9. Exclusive "POWER ON" INDICATOR lamp!
10. Exclusive FLEXIBILITY OF CONTROL FUNCTIONS!

Model 530—2" Oscilloscope

8 EXCLUSIVE features found in no other instrument of similar price!

1. The only 2" Oscilloscope at this price!
2. Exclusive SELECTIVE RETURN SWEEP ELIMINATOR for inclusion or rejection of power supply frequency return sweep!
3. Exclusive UNI-CONTROL allows separate control of two potentiometers from one shaft protrusion on the panel!
4. Exclusive ANTIQUE BRONZE PANEL!
5. Exclusive LIGHT WEIGHT and SMALL SIZE!
6. Exclusive "POWER ON" indicator lamp!
7. Exclusive MAXIMUM FUNCTIONS with MINIMUM number of PANEL KNOBS!
8. Exclusive FLEXIBILITY OF CONTROL FUNCTIONS!

SPECIAL INSTALLMENT TERMS ON SIGNAL GENERATOR-OSCILLOSCOPE COMBINATION
Write for Descriptive Folder



ONLY \$49.95
\$5.50 Down
\$4.95 for 10 Months

SOLD BY YOUR PARTS JOBBER ON SUPREME S. I. C. EASY TERMS

SUPREME INSTRUMENTS CORPORATION
GREENWOOD, MISSISSIPPI

COYNE TRAINING PAYS

"I have never spent an equal amount of time, energy or money which paid me such great and ever increasing returns as that which I spent at Coyne."
—Norman B. Neely, California



GOT A JOB and A RAISE

"It didn't take me long to get a job after finishing your course. Also the training I received there has helped me to a raise already."
—Kenneth F. Larson, Alabama



CREDIT TO COYNE

"I would like to report that I have been working with an electrical contractor as a repair man of all electrical devices . . . I want to give all the credit to Coyne Training that I have been able to hold a job of this kind."
—Donald Shears, Pa.



THOUSANDS are MAKING
\$30-\$40-\$50 a WEEK
in **ELECTRICITY**
LEARN BY DOING —
12 WEEKS TRAINING IN BIG COYNE SHOPS
GIVES YOU YOUR START IN THIS GIGANTIC FIELD



It's Easy to Train at Coyne for your start in Electricity. Break out of the Low-pay, untrained class. If you are interested in bettering your position in life, send in the coupon for information on COYNE Practical Training in Electricity.

Thousands of Trained Electrical Men are making good money in the many branches of Electricity. Industry everywhere is being modernized with new electrical equipment . . . will use more electricity. Many Power Plant Operators now make up to \$50 per week. Electrical Maintenance Men are paid \$150 a month and up. Refrigeration and Air Conditioning Service Men earn \$30-\$40-\$50 a week. Armature Winders make \$40 a week and more. Aviation and Auto Ignition Men also make good money at steady jobs. Many others operate their own business. These are only a few of the opportunities in Electricity.

Train on FULL SIZE Equipment—NOT by Correspondence—NOT by Text Books

COYNE Shop Training is NOT by correspondence or Home Study. You come right to the big COYNE Shops in Chicago to get this practical Training. You work on real equipment—such as generators, real dynamos, you wind armatures, work on diesel engines, airplane motors, and do many other practical Electrical jobs. Here is one of the greatest working outlays of its kind in America. No embarrassing reciting. No dry text books. You don't need high school education or previous experience. It is this real job Training that enables COYNE to train you for a better pay job.

AIR CONDITIONING, DIESEL and ELECTRIC REFRIGERATION included

Spreading over the nation is a vast network, these fast developing branches of ELECTRICITY are employing more men and paying more in salaries every year. Homes, offices, factories, trains, autos, airplanes are being air-conditioned. Autos may soon be diesel-powered. This valuable instruction included without extra cost. Clip and send Coupon—NOW!



YOU TRAIN HERE
Many thousands of dollars worth of real practical equipment and machinery is installed in our fireproof modern school.

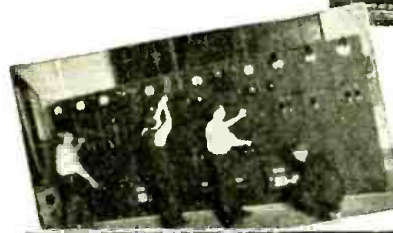

Many shop views like this shown in my catalog



Send for EASY PAYMENT PLAN —New Low Cost Board and Room Plan

My friend, don't waste the golden years of your life saying, "I can't afford Specialized Training!" Of course you can! Get my catalog—see for yourself how we help graduates year after year. I have a special new low cost Board and Room Plan whereby students take care of their living expenses while at COYNE. Don't let lack of money hold you back. Be sure to send the Coupon for information on how to get training first, then pay tuition in 18 easy Monthly Payments, starting 5 months after you begin school.

PART TIME EMPLOYMENT

If you need part time work to help pay living expenses while here, we'll help you. We help hundreds of students through this special department and may be able to help you.

JOB AFTER GRADUATION SERVICE

We keep in touch with many large firms in many branches of ELECTRICITY, ready at all times to supply their needs for trained men. After you graduate you get Lifetime job assistance through our Free Employment Department. As a COYNE graduate you get free business service and technical consultation to help you as you advance in your job; also, the privilege of review at any time without additional tuition charge.

Employers PRAISE These COYNE Graduates

"Mr. Lingerfelt's services very satisfactory. His practical shop training at COYNE has certainly helped increase his efficiency."

"John Lindquist was given an increase in salary due to the high quality of his work."

(Names of companies on request). We have scores of such letters. Get complete story. You owe it to yourself. Clip and send Coupon—NOW!

GET FULL FACTS

You'll see everything in the Big FREE COYNE Book . . . facts, . . . opportunities . . . jobs . . . salaries . . . actual photos of hundreds of ambitious fellows preparing for better jobs. You'll see proof that COYNE training pays. This big Book is yours without obligation. So act at once. Just mail Coupon.



MAIL THIS NOW for MONEY MAKING DETAILS

H. C. LEWIS, President,
COYNE ELECTRICAL SCHOOL,
500 S. Paulina St., Dept. A7-78, Chicago, Ill.
Without obligating me, send full details and your Big FREE Illustrated Catalog.

Name.....Age.....

Street.....

Town.....State.....

Mail in Envelope or paste on Postcard

COYNE ELECTRICAL SCHOOL
H. C. LEWIS, President
500 S. Paulina Street Dept. A7-78 Chicago, Illinois

Please Say That You Saw It in RADIO-CRAFT



HUGO GERNSBACK, Editor-in-Chief
 C. W. PALMER Technical Editor
 R. D. WASHBURNE, Managing Editor
 C. P. MASON Associate Editor

CONTENTS - JUNE, 1937, ISSUE

Volume VIII Number 12

Editorial: Modern Communication....Hugo Gernsback 709
 The Radio Month in Review..... 710
 Making the RADIO-CRAFT Simplified Carrier Interphone—Part I 712
 Radio Pictorial 714
 A Portable Radio Research Lab.Dr. Harry Rowe Mimno 714
 How a Radio Truck Aids News "Scoops" Stoddard White 715
 The Private-Address Field.....R. D. Washburne 716
 Trailer Radio.....C. W. Palmer 716
 Newest Car-Radio Ideas..... 717
 The New Interphones..... 718
 Car-Radio Sets for 1937..... 720
 Introducing—A Cathode-Drive High-Fidelity 32-W. Beam Amplifier—Part II.....A. C. Shaney 722
 A Kit-Type Carrier Interphone.....N. Adelman 723
 An Electromechanical Oscilloscope....Louis J. Fohr, Jr. 723
 Condensers in Auto-Radio Noise EliminationLeon L. Adelman 724
 Acoustics for the Practical P.A. Man.....E. L. Richards 724
 A Stabilized Feedback 6-W. 25L6 A.C.-D.C. Amplifier—Part II.....Ralph Kenyon 725
 Operating Notes 726
 A Service Man's Audio Oscillator....Charles Sicuranza 728
 International Radio Review..... 729
 Build the RADIO-CRAFT 1937 Car-Radio Set—Part I 730

Make the High-Power "Portable 6".....Gustav Klein 732
 World's Smallest 45 V. "B" Battery!.....L. S. Fox 733
 Selective and Non-Selective Private-Address SystemsH. W. Paro 733
 A Simple T.R.F. Receiver with A.V.C.Clifford E. Denton 734
 How to Use V.-T. Voltmeters in Radio and P. A. Servicing—Part III.....Kendall Clough 734
 How to Make the RADIO-CRAFT DeLuxe Carrier Interphone—Part II 735
 The Latest Radio Equipment..... 736
 This Room-to-Room Phone Plugs-in Like a LampH. G. McEntee 737

RADIO SERVICE DATA SHEETS:

No. 200—Silvertone Models 4488 and 4588 (Chassis No. 101412) and 4488A and 4588A (Chassis No. 101412A) 738
 No. 201—(Continuation of Data Sheet No. 200)..... 739
 ORSMA Members' Forum..... 740
 "White" is a Rainbow of Colors!—Part IIW. E. Reynolds and A. R. Hext 740
 Technicians' Data Service..... 742

JULY RADIO-CRAFT ANNUAL SERVICE ISSUE

The forthcoming July issue is one issue particularly prepared for SERVICE MEN! Each year, one issue is devoted to this important part of the radio industry. In spite of the fact that every issue of RADIO-CRAFT contains many pages of particular value to the servicing profession, this one issue features many phases of the subject which are not covered in the other 11 issues because of space limitations. Don't miss it!

For example the Annual SERVICE NUMBER will contain an article of a Universal Test Speaker; one describing An Interference Analyzer; another on Recent Findings in Interference Elimination; one on An Easily Built Volume Expander; a description of the Automatic Distress Alarm; and many others.

Published by Radcraft Publications, Inc. Publication office: 29 Worthington Street, Springfield, Mass. Editorial and Advertising Offices: 99 Hudson Street, New York City. Chicago Advertising Office: L. F. McClure, 919 North Michigan Avenue, Chicago, Ill. Western Advertising Office: Loyd B. Chappell, 530 West Sixth St., Los Angeles, Calif.

Foreign Agents:
 London—Gorrings American News Agency, 9A Green St., Leicester Square, W. C. 2, England.
 Paris—Messageries Dawson, 4 Rue Faubourg, Poissonniere, France.
 Melbourne—McGill's Agency, 179 Elizabeth St., Australia.
 Dunedin—James Johnston, Ltd., New Zealand.

RADIO-CRAFT is published monthly, on the first of the month preceding that of date; subscription price is \$2.50 per year in U. S. and Canada. (In foreign countries, \$3.00 a year to cover additional postage.) Entered at the post office at Springfield as second-class matter under the act of March 3, 1879.

Text and illustrations of this magazine are copyright and must not be reproduced without permission of the copyright owners.

Copyright 1937. Radcraft Publications, Inc.



J. E. SMITH
President
National Radio
Institute
The man who has
directed the home-
study training of
more men for the
Radio Industry
than any other
man in America.

I WILL TRAIN YOU

to start a spare time or full time

RADIO SERVICE BUSINESS

WITHOUT CAPITAL

and for TELEVISION'S coming OPPORTUNITIES

**HERE ARE A FEW EXAMPLES
OF THE KIND OF MONEY
I TRAIN MY MEN TO MAKE**



**EARNED \$50 FIRST MONTH
IN SPARE TIME**
"I knew nothing about Radio. After four lessons I began servicing Radios, earning \$50 the first month. Last winter I made as high as \$100 a month in spare time."—**G. F. WALTON**, 808 West Olney Road, Norfolk, Va.

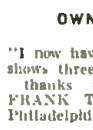

**OWN BUSINESS PAYS \$300
A MONTH**
"I now have my own Radio business which shows three hundred dollars a month profit, thanks again to National Radio."—**FRANK T. REESE**, 39 N. Felton St., Philadelphia, Penna.



**CHIEF OPERATOR IN BROADCASTING
STATION WMPG**
"When I completed 20 lessons, I obtained my Radio Broadcast Operator's license and immediately joined Station WMPG, where I am now Chief Operator."—**HOLLIS F. HAYES**, 85 Madison St., Lapeer, Mich.

Get My LESSON on Radio Servicing Tips FREE

I'll prove that my Training gives practical, money-making information, that it is easy to understand—that it is just what you need to master Radio. My sample lesson text, "Radio Receiver Troubles—Their Cause and Remedy," covers a long list of Radio receiver troubles in A.C., D.C., battery, universal, auto, T. R. F., super-heterodyne, all-wave, and other types of sets. And a cross reference system gives you the probable cause and a quick way to locate and remedy these set troubles. A special section is devoted to receiver check-up, alignment, balancing, neutralizing and testing. Get this lesson Free. No obligation.



**MAIL
COUPON
NOW**

**The Tested WAY
to BETTER PAY**

Do you want to make more money? The worldwide use of Radio has made many opportunities for you to have a spare time or full time Radio service business of your own. Television is developing fast and it will add many more opportunities to these in the future. Today, three out of four homes in the United States have Radio sets which regularly require repairs, servicing, new tubes, etc. Many sets are old and are being replaced by new models. I will train you at home in your spare time to sell, install, service, all types of Radio sets—to start your own Radio business and build it up on money you make in your spare time while learning. I will give you the training you need to cash in on the profitable opportunities coming with Television. Mail coupon for my 64-page book. It's Free—it shows what I have done for others.

**Many Radio Experts Make
\$30, \$50, \$75 a Week**

Radio already gives good jobs to more than 300,000 people. In 1936, Radio enjoyed one of its most prosperous years. More than \$500,000,000 worth of sets, tubes and parts were sold—an increase of more than 60% over 1935. Over a million Auto Radios were sold, a big increase over 1935. 24,000,000 homes now have one or more Radio sets and more than 4,000,000 autos are Radio equipped. Every year millions of these sets go out of date and are replaced with newer models. More millions need servicing, repairs, new tubes, etc. A few hundred \$30, \$50, \$75 a week jobs have grown to thousands in 20 years. And Radio is still a new industry—growing fast.

**Many Make \$5, \$10, \$15 a Week Extra
in Spare Time While Learning**

Almost every neighborhood needs a good spare time serviceman. The day you enroll I start sending you Extra Money Job Sheets. They show you how to do Radio repair jobs that you can cash in on quickly. Throughout your training I send you plans and ideas that have made good spare time money—from \$200 to \$500 a year—for hundreds of fellows. I also send you Special Radio Equipment which gives you practical Radio experience. I show you how to conduct experiments and build circuits with this equipment illustrating important sound and Television Radio principles of transmitters and receivers.

**Get Ready Now for Your Own Radio Business
and for Jobs Like These**

Radio broadcasting stations employ engineers, operators, station managers and pay up to \$5,000 a year. Spare time Radio set servicing pays as much as \$200 to \$500 a year—full time servicing jobs pay as much as \$30, \$50, \$75 a week. Many Radio Experts own and operate their own full time or part time Radio sales and

service businesses. Radio manufacturers and jobbers employ testers, inspectors, foremen, engineers, servicemen, paying up to \$6,000 a year. Radio operators on ships get good pay and see the world besides. Automobile, police, aviation, commercial Radio, and Loud Speaker Systems are newer fields offering good opportunities now and for the future. Men I have trained are holding good jobs in these branches of Radio.

**Television Will Offer Many Good Jobs
to Well Trained Men**

In the past fifteen years, Radio has grown from an experimenter's plaything to one of the country's great industries. And Television today is as advanced as Radio was about 15 years ago. Already millions of dollars have been spent developing Television equipment. Television receivers have been built which produce images equal to home moving pictures. About twenty experimental Television stations have already been licensed. N.R.I. not only gives you the training you need to make good money in Radio now, but in addition, gives you Television training which will help you cash in on the profitable opportunities coming with Television.

**Money Back Agreement Protects You
Save Money—Learn at Home**

I am so sure that I can train you at home successfully that I agree in writing to refund every penny you pay me if you are not satisfied with my Lessons and Instruction Service when you finish my Course. I'll send you a copy of this agreement with my Book.

**Find Out What Radio and Television Offer
Get 64-Page Book Free Now**

Act Today. Mail the coupon now for my Free Lesson and my book, "Rich Rewards in Radio." Both are free to anyone over 16 years old. My book describes Radio's spare time and full time opportunities and those coming in Television; tells about my Training in Radio and Television; shows you actual letters from men I have trained, telling what they are doing and earning. Find out what Radio and Television offer YOU! MAIL the COUPON in an envelope, or paste it on a penny post card—NOW!

**J. E. SMITH, President
National Radio Institute
Dept. 7FX
Washington, D.C.**



**GOOD FOR BOTH 64 PAGE BOOK FREE
SAMPLE LESSON FREE**

**J. E. Smith, President, Dept. 7FX
National Radio Institute, Washington, D. C.**

Dear Mr. Smith: Without obligating me, send your sample lesson and the book which tells about spare time and full time Radio opportunities and those coming in Television, and how I can train for them at home in spare time.
(Please write plainly.)

Name Age
Address
City State 14x1

Please Say That You Saw It in RADIO-CRAFT

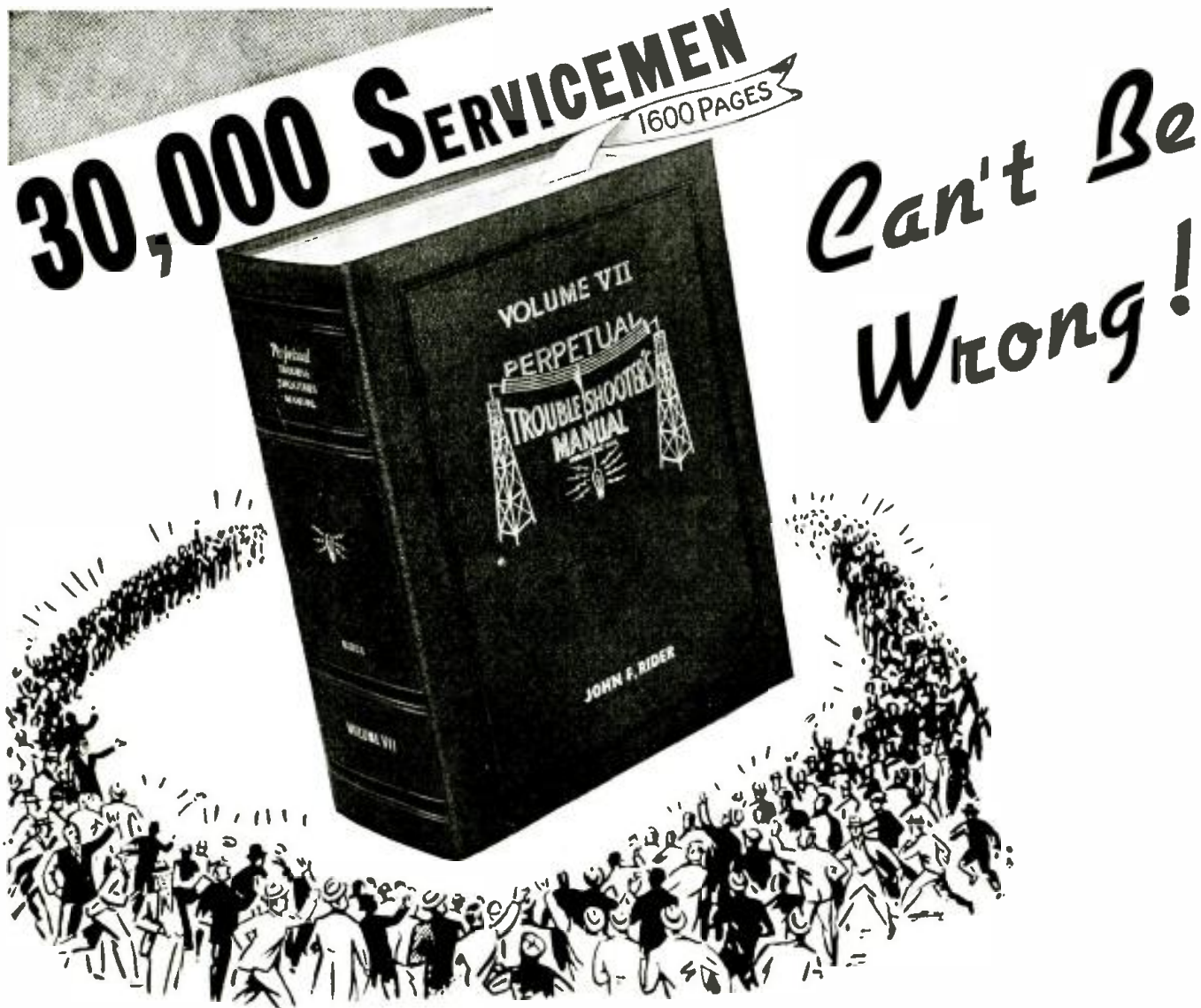

By all odds, the greatest endorsement ever accorded any Manual is that given to Rider by the 31,000 servicemen who have, year after year, bought the latest volume from their jobbers.

These men are more than technicians—they are business men-technicians.

To suggest that servicing data comparable to that contained in Rider Manuals could be obtained at a lower price and in a smaller book is to question the wisdom of 31,000 servicemen who have invested their hard-earned money in Rider Manuals.

But rather than your depending upon the findings of others, we suggest you yourself Compare Rider Manuals with any other similar service now available. Compare them for *Completeness* in number of set manufacturers, number of models of each manufacturer, alignment instructions, I. F. peaks, replacement parts lists. Compare them for *Convenience* of use from the standpoint of clearly printed diagrams of sufficient size to be easily followed, ease in obtaining pertinent data on *any* set alphabetically indexed and with all the facts on that set together in one place—in *one book*. Compare the number of pages, compare the type of binding, compare anything and everything upon which their usefulness to you will depend.

That's all . . .

- Vol. VII—1600 PAGES—\$10.00—Covering 1936-37
- Vol. VI—\$7.50—1935-36
- Vol. V—7.50—1934-35
- Vol. IV—7.50—1933-34
- Vol. III—\$7.50—1932-33
- Vol. II—6.50—1931-32
- Vol. I—7.50—1930-31

JOHN F. RIDER • Publisher • 1440 Broadway • New York City



EVERY SERVICEMAN SHOULD HAVE THESE RIDER BOOKS . . .

The Cathode-Ray Tube of Work
 With introduction of new, cheaper Cathode-Ray Tubes, this book is even more indispensable for its complete practical information on Oscillographs, etc. 336 pp. \$250 450 ill. Price

Aligning Philco Receivers
 This new book presents authentic and complete instructions for fast and accurate alignment operation on ANY Philco receiver. Every trimmer is located for you. 176 pp. Hord cover. Only \$100

Servicing Receivers By Means of Resistance Measurement
 Tells how to take guess-work out of servicing by using an ohmmeter. This method is in line with continuity data being furnished by set manufacturers. 203 pp. 93 ill. \$100 Price

Servicing Superheterodynes
 Changes, changes, changes! That has been the history of the superheterodyne circuit. Make repairs quickly by analyzing the different parts of the circuit quickly. Rider shows you how. 288 pp. profusely ill. Price \$100

" HOUR A DAY WITH RIDER" BOOKS

ON RESONANCE AND ALIGNMENT
 A clear, easily understood explanation of what happens when a circuit is tuned to resonance. You need this! 96 pp. 48 explanatory figures . . . 60c

ON AUTOMATIC VOLUME CONTROL
 In Rider's personalized style. Chock-full of information to make your AVC work easier—more profitable. 96 pp. 65 ill. Hord covers 60c

ON D-C VOLTAGE DISTRIBUTION IN RADIO RECEIVERS
 Theory and practice of d-c voltages—how they are led through various types of networks to the tube elements—calculation of resistances, etc., etc. 96 pp. 69 ill. Hord covers 60c

ON ALTERNATING CURRENTS IN RADIO RECEIVERS
 Explanation of behavior of radio frequency and other currents in receivers. Out in March . . . 60c

Please Say That You Saw It in RADIO-CRAFT



"Takes the Resistance out of Radio"

Editorial Offices: 99 Hudson St., New York, N. Y.

HUGO GERNSBACK, Editor

Vol. VIII, No. 12, June 1937

MODERN COMMUNICATION

An Editorial by HUGO GERNSBACK

BEFORE broadcasting was invented, and before we had radio-telephonic communication, I published, in 1911, a book called *The Wireless Telephone*. This was the first book on the subject to be printed anywhere, and in it I made the following observation:

"The author realizes that the future use of the wireless telephone will be confined to the low-power or battery system; as the present instruments, necessitating 220 and 550 volts for their successful operation, are not desirable nor practical enough for everyday use.

"The wireless telephone of the future must be as flexible as the wire telephone of to-day.

"Every farmer will be able to operate his wireless telephone, when the sending and receiving instruments will be housed in a box a foot square, without depending upon the lighting current for its operation."

It is a curious thing that we have world-wide radio communication today, but the very thing I predicted in 1911 has, as yet, not been accomplished. We still cannot talk to our neighbors by radio at will, and every farmer still cannot talk to his farmer neighbors via radio.

No doubt, in the not too distant future, this important problem will be solved too; because mobile radio has become more versatile, and inter-communication sets have become smaller and lighter. As a matter of fact, the prediction made by me in 1911 has long been solved, theoretically as well as practically; and it would be indeed an easy matter for anyone to communicate with his neighbor today, if it were not for the radio law which forbids doing just this thing.

Technically, there is no obstacle; it is just a matter, first, of not having a sufficient number of channels (wavelengths) and, secondly, our government insists that, in order to operate a private radio telephone, even of the simplest design, you must take out a license—to obtain which you must know the telegraphic code.

The government quite wisely insists upon this because even the simplest transceiver (a combination radio-telephone transmitter and receiver) can get out of order easily, and the wavelength may shift. If that happens, there will be chaos in the radio spectrum—a thing that the Federal Communications Commission is most anxious to avoid. Perhaps at a later date, some means will be found to circumvent these difficulties; but today "personal" radio communication between your friends still lies in the future.

In the meanwhile, other forms of communication are forging ahead rapidly, as indicated in my last month's editorial entitled, "Private-Address Boom." An entirely new industry has already sprung up in these new office, factory, and home inter-communications systems. A great deal of the present issue of *Radio-Craft* is given over to this interesting form of person-to-person communication, which uses radio instrumentalities, over existing electric wire systems.

This again brings us to the old radio-broadcast problem of communication, namely, *wired radio*.

Wired radio has been exploited by a number of large firms in several cities of the United States, wherein entertainment programs are sent over existent lighting wires

by means of radio-frequency currents. Instead of using a regulation radio set and an aerial, you merely plug into the nearest electric lighting outlet and, by means of a special receiving set, a few programs are thus received. The sponsors rent the sets to you at certain stipulated fees but, unlike a modern radio set, they give you little choice of programs. At the most, three or four can be chosen; whereas, with your regulation radio set, you can listen to hundreds of stations, if the selectivity of your set is fair. This is one of the reasons why wired radio has never made much headway in this country.

Using wires for radio or rather "wireless" communication is not a new idea. Indeed, long before the advent of radio, when the telephone had just been born, in the early '80s, it was found that, if you stretched a wire for over a mile or more, you could stretch another wire running parallel to it, almost a mile distant from it, and still hear the conversations going on over each wire circuit. This was a purely inductive effect and had nothing whatsoever to do with radio. It is chiefly interesting because, in recent years, railroads have made use of telegraph or telephone wires running parallel to the train tracks to communicate with the trains *en route*. This was an old dream when Edison still was young, and he already had invented a system whereby, using such instrumentalities, constant communication could be maintained with moving trains.

It is quite possible that such a system may be used before long by automobiles on the road. Practically every road of importance has a telephone or telegraph wire line paralleling it. It should be a simple matter to organize a service, whereby a *special* set installed in the car can be used for a two-way communication system without making use of actual radio waves. The means here would simply be by utilizing a capacity, or inductance effect (or a combination of both), the amplification to be effected by the usual vacuum tubes. With such a system, without disturbing the present wire lines, cars *en route* can be notified by a simple signalling system.

In this manner, just for example, physicians can be notified on the road. Trucking concerns can be in constant communication with their drivers and, in case of trouble—tire trouble, collisions, etc.—the truck can instantly get in touch with the nearest garage or the home office. Such a communication system would not be expensive, and it could be installed in every car for between \$30 and \$40, or perhaps less. It would not take the place of the regular car-radio installation; it would be simply an auxiliary and much needed help for drivers of cars.

Very frequently, for instance, at the time of a collision, it is difficult to get help or ambulance service, and passing automobiles must be relied upon to pass on information of the accident to the nearest police station or the nearest garage or service station. This may take anywhere from half an hour to two hours or more; and often, when minutes are valuable and when life is ebbing away, instant communication is needed, and needed badly. Anyone can realize this when he consults the mortality tables of automobile accidents in the United States, today.

THE RADIO MONTH



The 20 ft. loop to aid plane dispatching.

GIANT LOOP AIDS PLANE RADIO

THE American Airlines, last month, completed the installation of a huge 20 ft. loop aerial at Glendale, Calif., near the spot where one of the recent tragic plane crashes occurred.

This loop, which is used with an 800 W. transmitter is capable of sending code messages across the country, without relay stations and to send voice (modulated) messages over 500 miles. The transmitter is equipped with a dial-phone system for rapidly changing from day to night frequencies.

The increased speed of sending messages by the use of this "beam" transmitter is expected to increase the safety of plane dispatch—a much needed factor, in view of the many air crack-ups.

Machine keying is used to further increase transmission speed—a *fore-runner of facsimile for planes (coming next winter!)*.

RADIO AIDS EXPLOSION VICTIMS

WHENEVER tragedy raises its ugly head, radio plays an important part in the rescue and reconstruction work which follows. The case of the gas explosion in the New London (Texas) school, last month, was no exception. The small radio transmitter which had been put in operation in a Henderson hotel (near New London) only 24 hours before the disaster proved to be an invaluable aid in obtaining food supplies, antitoxin, medicine and men to help in the rescue work. Families in the district listened to the bulletins to hear about their loved ones.



A tug telephone (insert), and the land central.

SHIP-TO-SHORE RADIOPHONE

SINCE the sea-going tugs of the Atlantic Communications Corp. were equipped with the "harbor radio telephone service" of the W. E. Co. last month, several "life and death" calls have been made.

The motorship Point Breeze sent a radiogram that one of the ship's engineers was desperately ill. A radiophone message to the tug Atlantic off Paulsboro, N. J., resulted in the man being picked up and transferred to an ambulance within 3 hours.

Even quicker action was recorded in response to an emergency phone call from the tug Atlantic itself. One of the firemen was suffering from intense pain in the abdomen. Within an hour he was in St. Agnes Hospital, Philadelphia.

Another man was taken off the tanker Karabagh by the tug Van Dyke.

The use of the ship to shore radiophone thus is proving to be a dependable life saver!

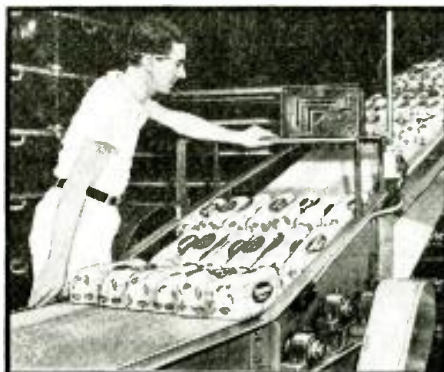

The production department receives a call for so many loaves of bread

BROADCASTING AND TELEVISION

AS usual, in the fast moving fields of radio broadcasting and television, there were numerous happenings of interest to radio men, last month.

Chairman William P. Connery of the House Labor Committee told the Rules Committee that a radio monopoly exists. Mr. Connery named the NBC, CBS and MBC as "controlling all the best radio time and 96 per cent of all time."

Senator King of Utah accused the Administration of using the large networks to aid the President's court reorganization plan. Senator King said "In my opinion they are discriminating against the opposition." Senators King and Wheeler plan an investigation of the F.C.C. and the large networks. NBC and CBS both denied the accusations.

The Don Lee Broadcasting System broadcast what was called the first film premier via their television station W6XAO in Los Angeles. The picture was "Empire of the West."

A commercial television station was started at the base of the Eiffel Tower, to replace the present experimental transmitter. The new transmitter having 30,000 W. power is said to be the largest to be made, to date.

PRIVATE ADDRESS IN BREAD FACTORY

ONE of the innumerable uses for Private-Address Systems was brought to light last month—in a large baking plant in Brooklyn, N. Y.

The noise of machinery made it quite a problem to communicate from one department to another—an important item in maintaining smooth running of the plant. The P.A. system permitted workers to give and receive orders without leaving their posts.

Many other useful applications for these units are mentioned in this issue.



And the shipping department is assured that they will be received on schedule.

IN REVIEW

Radio is now such a vast and diversified art it becomes necessary to make a general survey of important monthly developments. RADIO-CRAFT analyzes these developments and presents a review of those items which interest all.

DOC BRINKLEY AGAIN

SOME time ago, we reported the activities of one Dr. Brinkley, who "got in dutch" with the F.C.C. and the Interstate Commerce Commission about his advertisements of patent medicines and sex life over his Kansas station.

Subsequently, Dr. "Goatglands" Brinkley hopped across the Mexican border and erected a 350,000 watt station—as near the border as he dared.

For a time the Federal authorities were powerless to do anything about this situation—however, last month, charges were brought up by several persons before the F.C.C. charging that section 225-B of the Communications Act has been violated. (Section 225-B provides that any person, persons, or such, who send a record, a transcription or other material to a foreign country for rebroadcast into the U.S. must have a license from the Commission.)

It seems that Doc Brinkley is back in hot water again!

MOSCOW TO USE "SYNCHRO-OPERA"

A NEW method of combining recorded music and singing with living actors, singers and musicians which has been developed by the American conductor, Vladimir Shavitch, to permit grand opera to be presented to the masses without great expense, has been adopted by the Soviet Fine Arts Commissariat, during the past month.

The Synchro-Opera, as Mr. Shavitch calls his new system, consists of a sound-film recording of orchestra and chorus of operas—with a small group of actual singers and a small supplementary orchestra. In the demonstration given before the Commissariat, only 34 persons were used, of whom 18 were non-singers, yet the effect was that of an orchestra of 100 and a chorus of 50.

NEW ELECTRON TUBE USES

EVEN with the myriad of applications to which electron tubes have been put, in the past, every day brings new and interesting applications of these "wonder bottles."

Last month, *Industrial Britain*, an English industrial magazine described how an electron tube which measures the conductivity of materials is being used to separate coal into its many sizes. Thus electron tubes replace the picking belt with a resulting increase in sizing speed.

And in last month's Coyne Graduate News, another interesting use of photocells in turning on and off a sprinkler to wet down coal before it is dumped from railroad cars, was described. Previously, a man stationed at the switches controlled the sprinkler, but now, as the front end of the car passes before the electric eye, the sprinkler automatically goes on until the car passes.

OSCILLOGRAPHS IN INDUSTRY

SEVERAL new commercial applications for cathode-ray tubes were brought to light, last month by *Radio-Craft*.

The first is in the Columbia Playhouse of the CBS in New York, where two 9-in. cathode-ray tubes are used to show the audience in the studio just what the voices and sounds look like.

Oscillographs are also being used in conjunction with contact microphones to indicate the noise level of automobile transmissions. A demonstration set-up showing the comparison of old and new transmissions was displayed last month.

Another use in the automotive industry is to test the sound-proofing of automobile doors and walls. By this means, the minimum amount of insulating material consistent with good sound-proofing is determined.



Photo G. E. Co.
The latest picture of Prof. Elihu Thomson.

DEATH OF ELIHU THOMSON

PROFESSOR ELIHU THOMSON, 83, dean of American scientists, died in his home in Swampscott, Mass., last month. He had been ill since January. Professor Thomson together with Thomas A. Edison, James J. Wood, and Charles F. Brush were the great quartet which created the electrical industry.

Some of Professor Thomson's many inventions were types of arc lights, the resistance method of arc welding, the repulsion-type induction motor, the magnetic blow-out type of lightning arrester, the oil-cooled type of transformer, the constant-current transformer and the modern method of treating fused quartz. He held upward of 700 patents in the U.S. alone.

There was hardly any aspect of electrical science which Thomson was not associated with at one time or another. More than 10 years before Hertz discovered electromagnetic waves, Thomson was demonstrating the transmission of signals without wires. He originated the 3-phase electric dynamo; developed the first practical wattmeter and literally thousands of other useful devices.

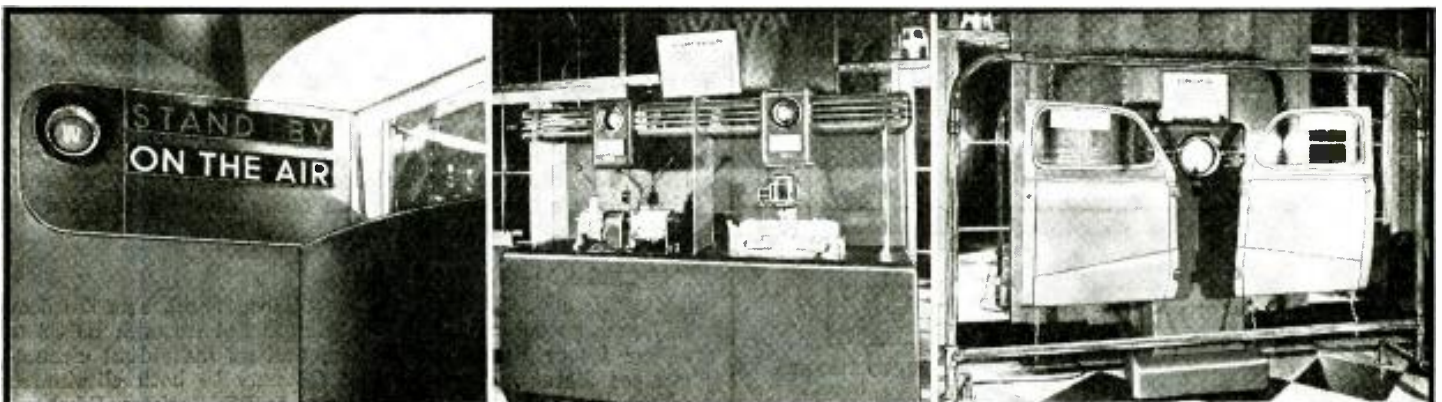

Three useful applications of the cathode-ray oscilloscope—in broadcast studios; to check the noise of gas motors and in sound-proofing.

MAKING RADIO-CRAFT CARRIER

This is the "baby brother" of the deluxe interphone which was described in the May issue.

PART I



Fig. A. Morning orders from the boss—the phone affords secrecy.

THE INTER-OFFICE communicating system is more and less than a luxury in these days of new prosperity and business speed-up. It is, to put it bluntly, an indispensable convenience, without which no organization may function in a really efficient manner and especially where contact between officials is a customary, frequent, and very necessary action during the business day.

To be practical on the one hand and available to individuals and concerns of limited means on the other, any such system must be simple in design, reliable in adjustment and performance, and, last but not least, inexpensive. It should use the A.C. line for hookup of individual units and be preferably of the carrier-signal design now so popular. Units themselves must be physically small and portable and must have a minimum of controls.

THE RADIO-CRAFT COMMUNICATOR

The *Radio-Craft* communicator unit has been designed to meet these requirements exactly. A 5-tube circuit (4, where the builder substitutes a single 25A7 rectifier-power tube for the 25A6 and 25Z6 used in the laboratory model), one tube of which is a rectifier and one a filament dropping voltage ballast, is used and is engineered to permit transmission or reception at will "a la transceiver." The unit is thoroughly self-contained (1) with power supply and reversible speaker or "transducer"; (2) uses the A.C. line for connection to other stations; (3) is portable and ready for service whenever and wherever an outlet is available for plug-in; (4) has a jack to permit a sometimes very desirable headphone reception; and (5) is provided with pilot lights indicating "send" and "receive", a gain control, and a send-receive switch. The cabinet is extremely small (6 x 9 x less than 5 ins. deep) and is of metal to prevent R.F. radiation. The whole construction is extremely com-

mercial and attractive in appearance and may be duplicated almost over-night by any radioman.

Tubes in the lab. model are run at slightly less than rated filament voltage to preserve their length of life, as the job will be used in service without turn-off 10 hours or so each day.

THE CIRCUIT—GENERAL

The detector-oscillator is a 25A6 triode-connected (screen-grid and plate tied together) and wired in an ultraudion and very simple and effective circuit. Transformer I.F.T.1, by the way, may be anything—an I.F. transformer "as is", one with turns removed to permit tuning up to any desired frequency, a broadcast R.F. transformer tunable to a point below or above the regular broadcast channels, or simply a home-made single-winding coil tuned by a trimmer condenser to any desired operating frequency. (The R.F. chokes must, of course, be effective at the desired wavelength.) In the lab. model a 456 kc. I.F. transformer is employed, a 16 millihenry choke serving to keep the R.F. out of the A.F. portion of the circuit.

The transformer output winding need not be used. Sometimes, however, where C7 is tied directly to the oscillating circuit at point Y and wired to the A.C. line, the load may prevent circuit oscillation, and looser coupling through the second winding may be found advisable. For that reason such connection is shown in the circuit diagram.

Units R1 and C1 are the gridleak and condenser, whose values are such as to permit super-regeneration when we are receiving. Tube V2 is the 25A6 modulator-power amplifier and V3 is the 6F5 voltage amplifier for the speaker used as microphone. A 4-pole double-throw switch permits speedy changeover from receive operation to send. Coil T1 is simply a universal output transformer with voice-coil winding unused. The speaker is a 5-in. permanent-magnet job provided with a high impedance (10,000 ohm) transformer. It works exceptionally well as either reproducer or microphone. The power supply is quite conventional and uses the familiar 25Z6, a 300-ohm A.C.-D.C. choke, and two 8-mf. electrolytics.

The voltage output from the rectifier is approximately 110, with the measured D.C. and filtered output something like 100 V. on "listen." On "talk" some trouble may be experienced in getting a decent "B" voltage, as the triode connected 25A6 oscillator draws a rather high current. It might be said here and now that some builders may not be able to use such a tube as oscillator because of its high drain and that a 6C5 or 6J7 pentode will perhaps have to be substituted. Power output (carrier) will in such cases be much lower than that afforded by the 25A6 but should be quite sufficient for ordinary communicating purposes. Full plate modulation with the audio set-up recommended will be of course facilitated.

THE CIRCUIT—FOR RECEIVING

On "listen", R2 is not connected to ground. The 25A6 or 6J7 acts as detector, and the A.F. is fed through RFC2 to either R9 or R5, as we prefer, and as individual circumstances dictate. Parts R9 and C8 may be both eliminated where the feed connection is made to R5. Resistor R5, however, must be a high resistance (0.25-meg.), and the "B"

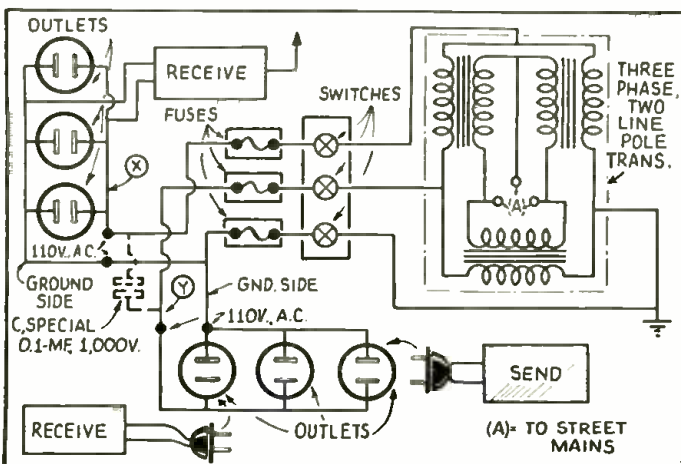

Fig. 2. Difficulties in split phase lines are avoided in this way.

THE SIMPLIFIED INTERPHONE

Designed under the direction of Raymond Adams, this device represents the simplest type of carrier-current Private Address system which can be used dependably. The cost has been reduced to the lowest value consistent with really good results.

voltage from this resistor to and through RFC2 may be too low to permit detector circuit super-regeneration.

Super-regeneration, as we have suggested, may or may not be desired for the detector. It will, of course, permit the development of an exceptionally strong signal. (The R1-C1 combination oscillates at a high audio frequency and prevents the circuit from actually oscillating at R.F.) If we do want it, we must feed the audio output from RFC2 to R9, which should have a low enough resistance to afford a detector plate voltage high enough to develop if not actually cause (because of the super-regenerative action) circuit oscillation at radio frequency. Then again R9 resistance must prevent any such thing as a "B" voltage at the detector which is so great that circuit oscillation will result in spite of the action of R1 and C1. A value of 50,000 ohms should be satisfactory, but that is said with the warning that the values of both this resistor and the fixed condenser C2 are quite critical and may be individual for the individual construction.

On "listen" the 6F5 is or is not used as audio first amplifier, as the case may be. The second 25A6, however, is employed and feeds its output to the speaker through the condenser C13. For headphone service, the jack opens the speaker circuit and connects the plugged-in phone from C13 to "B minus."

The chassis is connected to "B minus" only through C16. Returns for both electrolytic filter condensers and all bypass condensers go to "B minus." The "B plus" is bypassed to chassis with one small condenser, C17.

THE CIRCUIT—FOR TRANSMISSION

On "talk", R2 (10,000 ohms) is connected to ground to cause strong 25A6 or 6J7 oscillation and to stabilize the circuit. The circuit is now, of course, developing a healthy R.F. signal at the desired frequency as determined by I.F.T.1.

The speaker connection is shifted from T3 to R3 and the

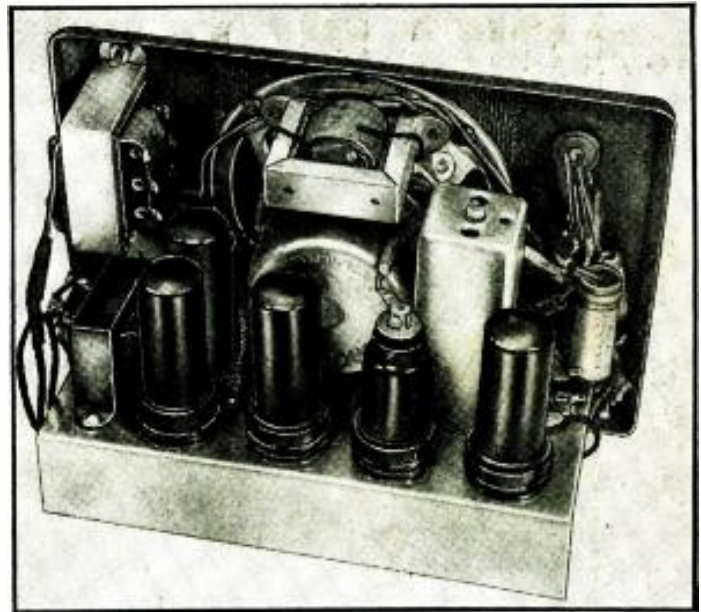

Fig. B. The compact construction and layout of parts are evident.

input to the 6F5 voltage amplifier, which builds up the voice frequency A.F. and feeds it to the second A.F. stage, V2. Tube V2 is now operating to modulate V1, whose plate voltage is supplied from the center-tap of T1.

As we have stated earlier, there may be difficulty in making a 25A6 oscillate in the V1 position because of high drain, large drop across ch., and low available plate voltage. In such a case the 6J7 stands recommended as signal generator. Here, as the A.F. developed by the audio system may be more than enough to fully modulate the signal, we may substitute a 25A7 in the output stage, using its amplifier section as modulator and its diode section as "B" voltage rectifier. Its use will, of course, require employment of a ballast of different rating than the one specified. The total voltage drop across the series filaments will be reduced to 37.6 (with a 6J7 in V1 position), and the ballast must drop the line voltage to this new figure from 117.5 V. RMA line standard.

OPERATION

Most "convertible" mikes (speakers used as mikes) have pronounced and not at all desirable low-frequency response causing "boomy" transmission and sometimes unintelligible speech. It may be necessary to reduce the size of C8 (if it is used) in order to prevent bypassing of higher frequencies and further emphasis of "lows." Using the constants given in the circuit diagram, satisfactory operation will be had—

(Continued on page 744)

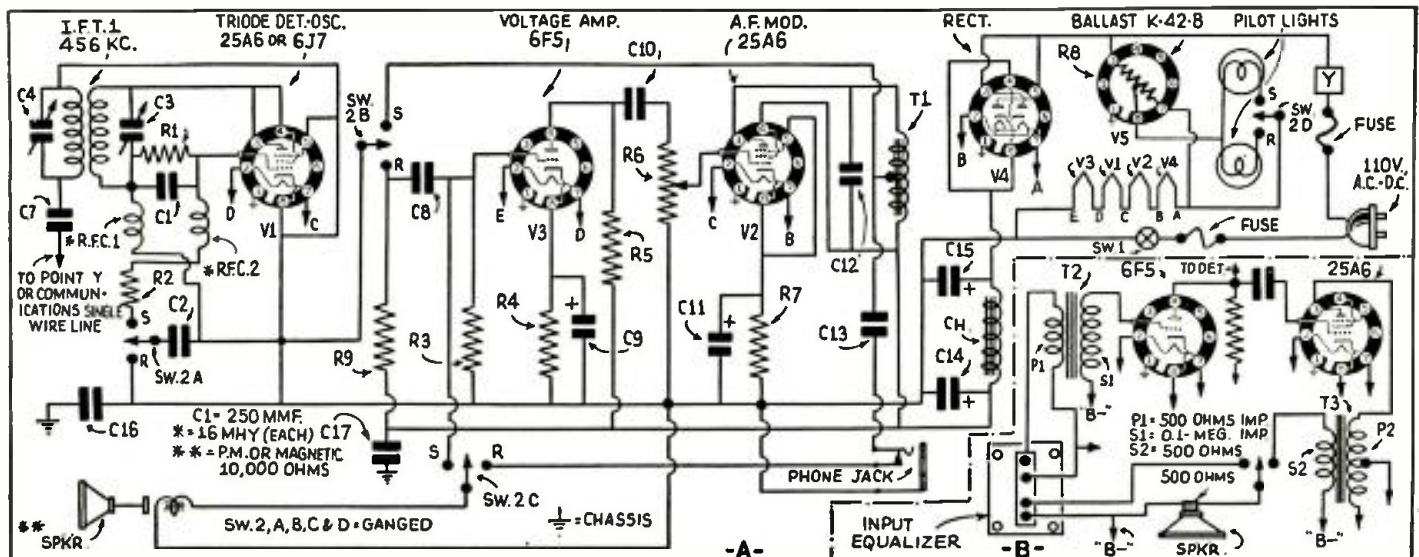
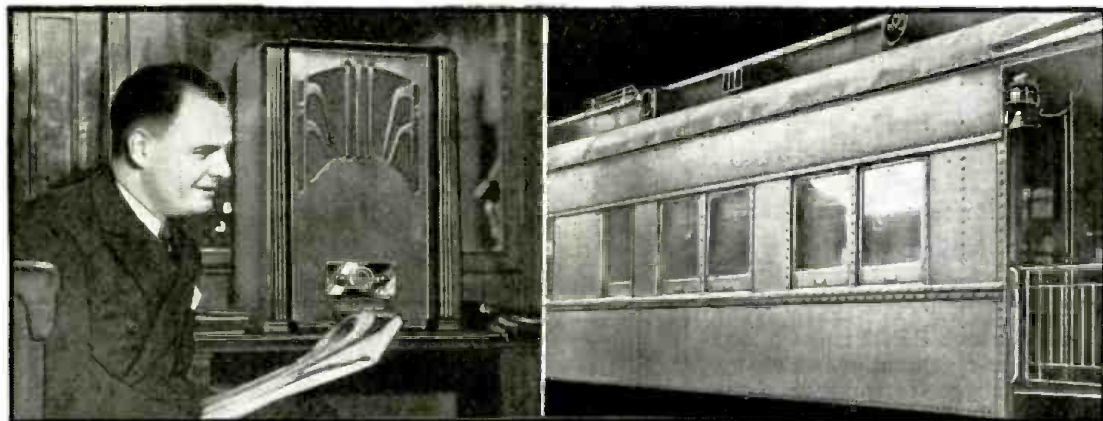

Fig. 1. The schematic circuit at A; the List of Parts gives the values of the components. The detail at B shows how an equalizer is connected if needed.

RADIO PICTORIAL



Photo—National Carbon Co.

The B. & O. R. Diplomat Limited is now equipped with 7-tube radio receivers. The aerials are under-car auto aerials about 3½ ft. long, but mounted a few ins. above the car roof. No other equipment is needed for interference elimination.



Photos—Crosley Radio Corp.

An Evanston, Ill., police ambulance is now equipped with a 2-way radio system to permit instant communication with the hospital via the police department. Such calls as instructions to prepare the operating room, etc., are made.



Photos—General Electric Co.

Meteorograph radio balloon returns by parachute after the balloon has exploded. (See page 733)

A PORTABLE RADIO RESEARCH LAB.

Harvard Research Lab. is equipped with a mobile radio lab. for scientific work.

DR. HARRY ROWE MIMNO

THE CRUFT LABORATORY of Harvard University has recently constructed an experimental car to be used in a variety of new radio investigations. Experimental trucks have often been used and other agencies interested in some special type of engineering application. Ordinarily these

trucks have been employed in making surveys of field strength produced by a definite transmitting station, or in relaying special broadcasts to a control station.

The new portable laboratory differs from these previous experimental trucks in purpose and in construction. It is

designed to carry on in the field a wide variety of scientific measurements which have hitherto required the facilities of fixed stations, and to undertake new types of experiments which could not be performed in ordinary laboratory buildings. For this reason the new car carries equipment which is novel in design and extremely flexible in operation.

The new developments are based on experience previously obtained by the Cruft Laboratory staff in less-extensive field measurements, involving the use of two automobile trailers. More than a year ago echoes of radio signals were recorded automatically on photographic paper at points many miles distant from Harvard University and were compared with echoes received in Cambridge, close to the transmitting station. In this way it was possible to obtain an indication of the movement of individual clouds of electrons, drifting over the earth at a height of approximately 100 kilometers (62 miles). The echoes appeared and disappeared several minutes earlier
(Continued on page 744)

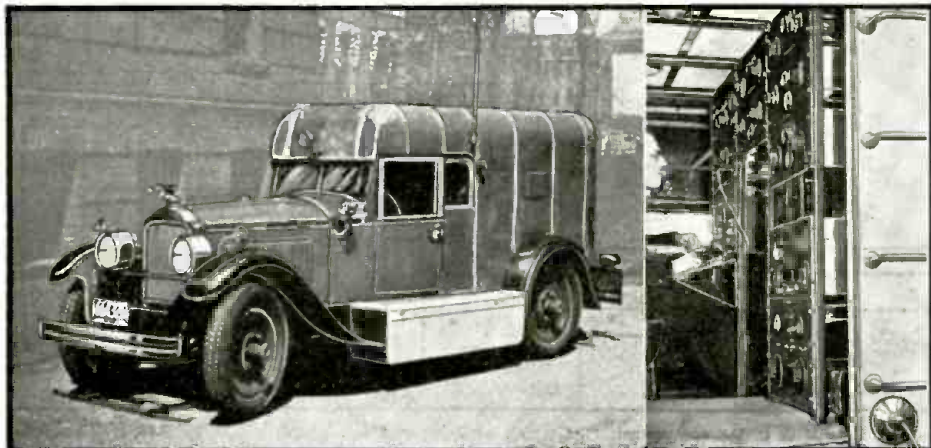

HOW A RADIO TRUCK AIDS NEWS "SCOOPS"

Radio transmitter, pack transmitters and a photo-transmission machine permit spot news items to be rushed to editor, post haste!
STODDARD WHITE

THE LATEST development in the newspaper and radio worlds, a unique journalistic achievement, is the brilliant red radio and photographic field car of The Detroit News.

The mobile unit, seen as a pioneer in a new field of news-gathering, was specially designed by automotive engineers in co-operation with the paper's radio and photographic experts.

Wherever an important news story "breaks," the mobile unit is designed to speed to the scene, carrying a crew of reporters, photographers and radio announcers and technicians. Despite its total weight of 8,800 pounds, plus the weight of the crew, the mobile unit will have a top speed of 65 miles an hour. In addition to the news-gathering crew, the unit carries a technically trained crew, including a master mechanic to handle motors, generators and maintenance; a radio engineer, a photographic technician, and a general helper. Pack transmitters, of which the first two of several contemplated already are installed, enable announcers of WWJ, and W8XWJ, the paper's ultra-high frequency station, to describe any sort of important news event to the radio audiences.

(Continued on page 745)



The external appearance of the news truck ready for calls.

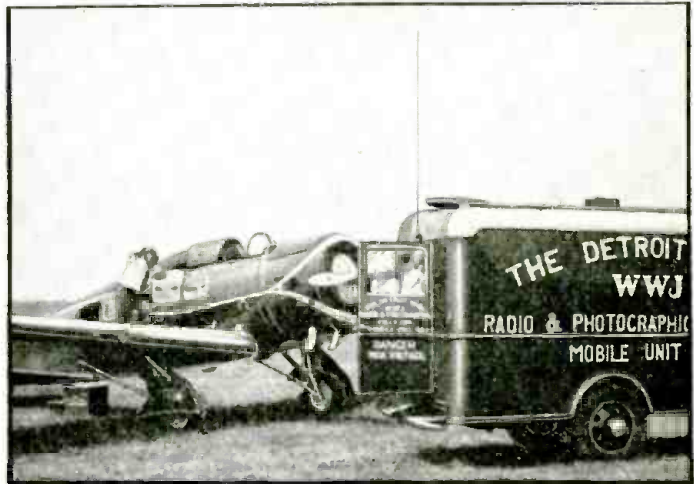

The Detroit News car and plane shown here work together. Note the rod aerial on the back of the truck.

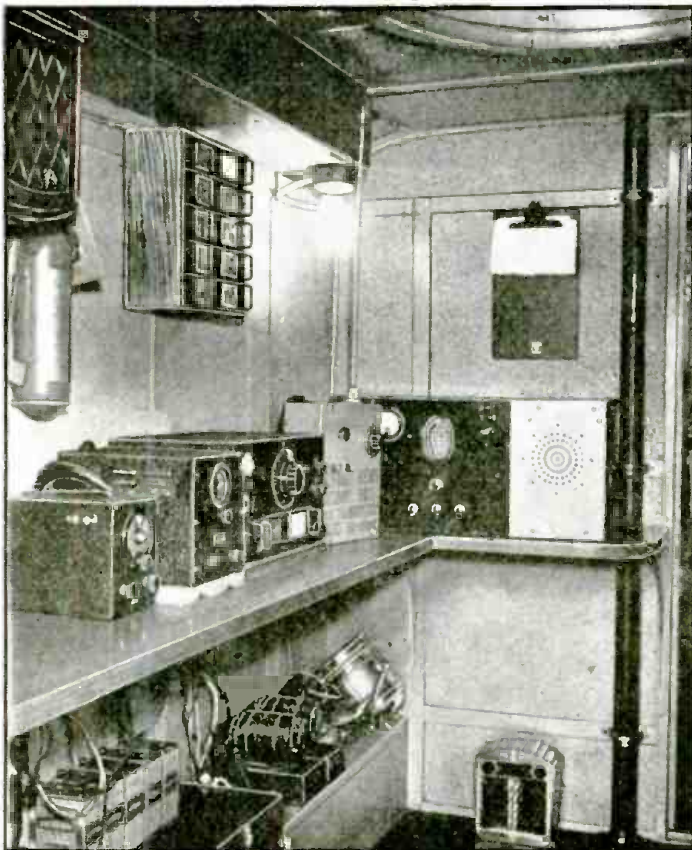

Radio equipment in the rear compartment of the truck.

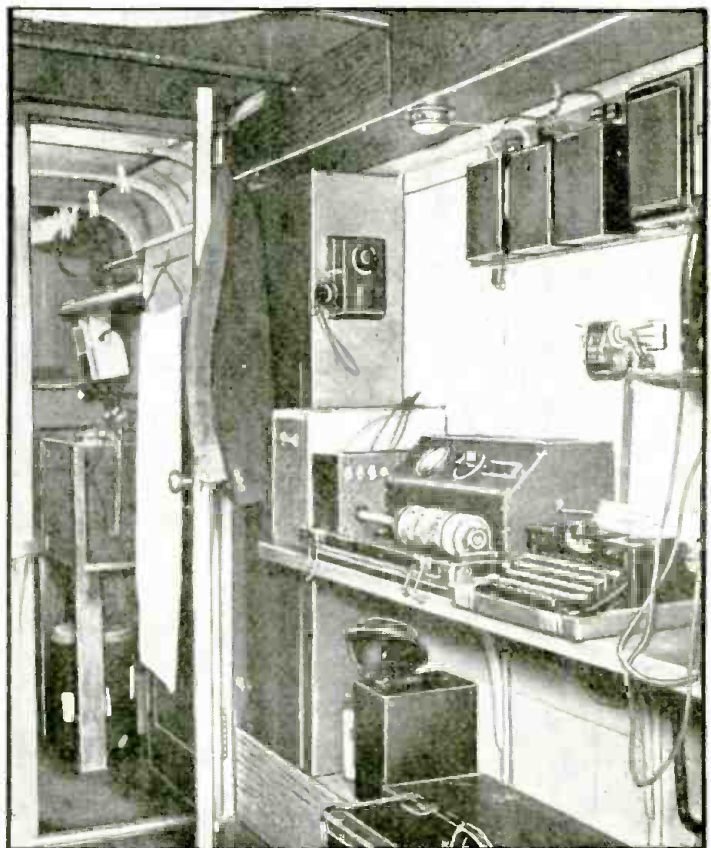

The photo-transmission equipment in the rear compartment.



Fig. A. An interphone ties the trailer to the car.

"MR. JONES" . . . a clear, distinct voice on your desk calls. "Yes" you reply, without moving from your work.

"Mr. Smith to see you."
"Ask him to come in."

This is a typical conversation on a modern private-address system. Not one moment wasted—no irritating bells or buzzers—no necessity to stop what you are doing or to turn to listen to your secretary. The voice at normal voice level is heard from a small, attractive box on your desk—the private-address unit.

And with this same unit, you can speak to the reception clerk—the stock

THE PRIVATE-ADDRESS FIELD

A short resume of the possibilities of private address as a source of income to radio men is presented.

R. D. WASHBURNE

department—your secretary—your business associates in adjacent offices or in fact any part of your business establishment which is provided with one of these indispensable units.

This is the explanation for the Private Address Boom!

People everywhere have been intrigued by the possibilities of these simple little units which only have to be plugged into the nearest outlet to permit direct conversation to any point on a local power line circuit. The possible uses are almost unlimited.

Even to mention a few of the appli-

cations of the private-address system would fill more space than this entire article. They can be used in dozens of different ways in homes, offices, hospitals, restaurants, hotels, warehouses,

(Continued on page 759)

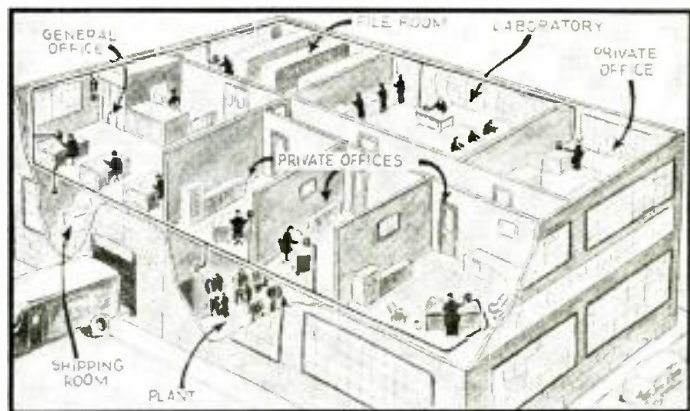

Fig. B. A cross-section of a typical private-address installation.

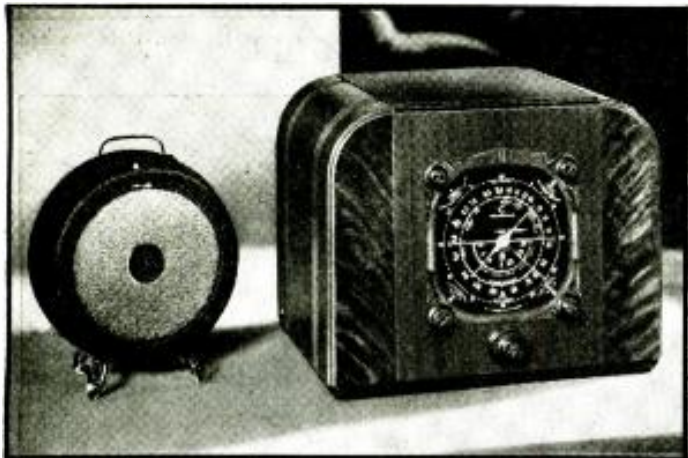

Fig. A. A type of radio set, especially made for trailer use.

SURPRISING as it may seem to the casual observer, there are over 250,000 auto trailers in use now in the United States. These modern "covered wagons" will be found in every nook and cranny of the country—and they are becoming such an important part of American life that towns are setting aside trailer camps, parks and "auto courts."

And these "rolling homes" are not the crude boxes on wheels that our ancestors used in their trek across the country. The demand of the American people for "all the comforts of home," wherever they go, has been adequately answered. Such conveniences as refrigeration, heating, running water, electric light and even—radio—are regular

TRAILER RADIO

The fact that there are over 250,000 trailers in the U.S. waiting for radio sets should be "a word to the wise" to Service Men.

C. W. PALMER

features of the modern trailer.

In the last two items, alone, lies a lucrative field for the up 'n' comin' Service Man. These trailers must be serviced; their electric power plants require attention; the lights burn out; the batteries run down; the radio sets need service, etc.

Then too, there is the possibility of

selling "new gadgets" to add to the comfort of the trailer dwellers. For example, a radio set of special design to withstand the rigors of outdoor life and much bouncing and vibration (such as the one shown in the photo and the schematic diagram) yet attractive enough in appearance to be used in the deluxe type of trailer, can be sold to passing trailer owners. Or, as shown in the cover illustration of this issue, a "Private-Address" system can be in-

(Continued on page 760)

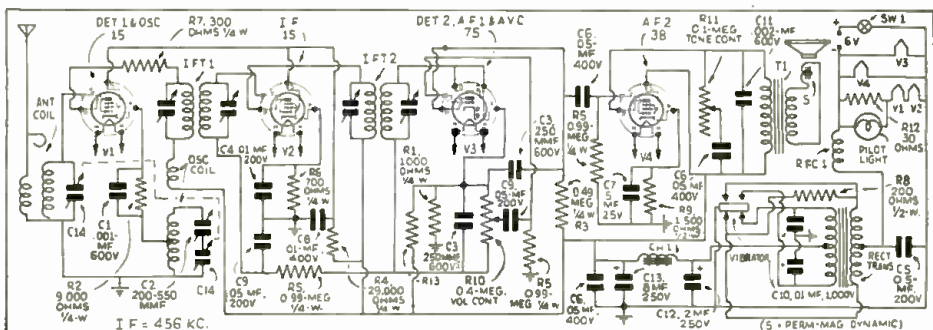

Fig. 1. Circuit of the trailer radio set—use it home, after a trailer "season"—shown in Fig. A, above.

NEWEST CAR-RADIO IDEAS

Recent innovations in car-radio equipment have greatly improved both the appearance and efficiency of the sets.

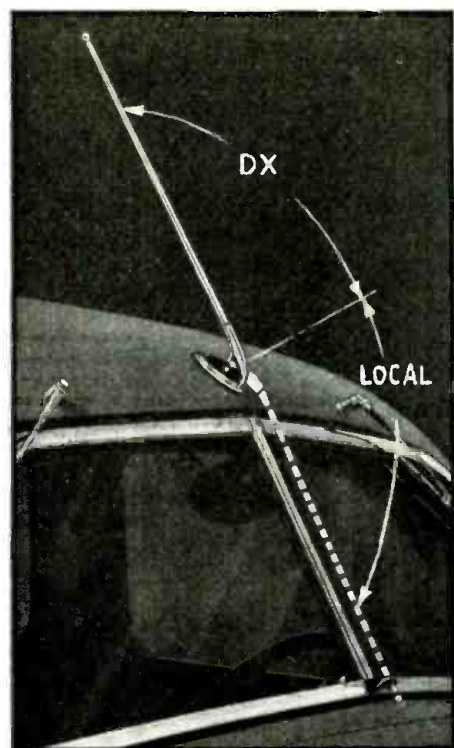

Fig. A. The new type of "fishing-rod" aerial. A knob on the header bar controls either the raised (DX) or lowered (local) position. An extension telescopes into the rod shown, making the extended length 30 ins.

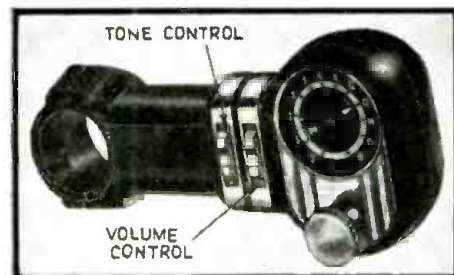

Fig. B. The stream-line steering column remote control of the Zenith line. Note the tone and volume controls. A driving-safety feature is that only the scale and pointer are illuminated.

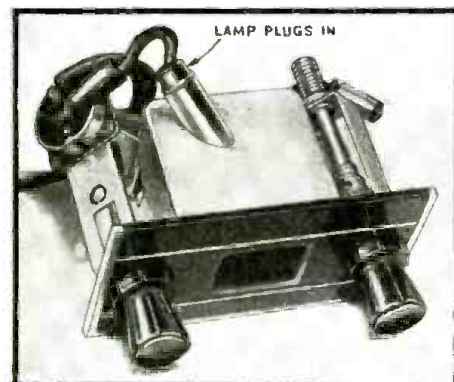

Fig. C. The universal remote control unit.

IN A RAPIDLY-expanding business such as the auto-radio industry, it is only natural that, in a year's time, many novel and interesting changes will be made in the appearance and operation of the products.

This year, however, auto radio has outdone itself. The innovations which have been incorporated in the new sets are far beyond the expectations of even Ol' Timers who have seen radio grow, from a few crude experiments, into a vast industry, in a matter of 2 decades.

Local-Distance Antenna. An idea of some of the outstanding innovations in the new car sets can be obtained from the photos on this page. Take for example, Fig. A. This is the latest type of "fishing pole" aerial, made by Ford-Philco, which is now mounted on the top of the car instead of the bumpers and is arranged to swivel by turning a knob on the header-bar of the car. By rotating the aerial to either the up or down position, the sensitivity and pick-up can be adjusted to suit conditions, without leaving the driving seat. *Within the aerial is a 12-in. rod for reserve use which may be extended when it is desired to increase the intensity of broadcast signals. The aerial and extension have a total length of 30 ins.!*

Streamlined Remote Control. The remote control tuning head shown in Fig. B, made by Zenith, is called a streamlined type and is certainly neat in appearance. The sensitivity and tone controls are edgewise-mounted thumb discs instead of the usual knobs.

Improved Dash Control.* The dash control shown in Fig. C, of the back-illuminated type, is designed to fit a large number of cars, by means of plates which match the dash fittings. A carefully-machined gear train carries the knob motion to the dial drum. Large, easily-grasped knobs make tuning and volume adjustments possible with-

(Continued on page 746)

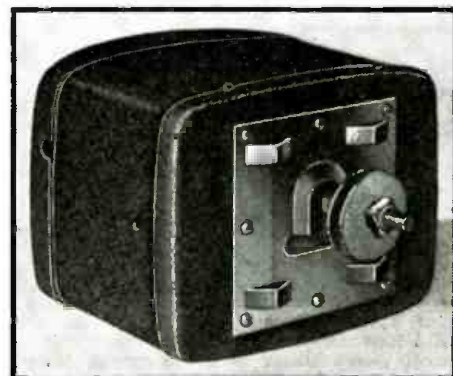

Fig. D. Spring mounting of Zenith sets.



Fig. E. The new Philco car-top aerial which is bolted or cemented to the car.



Fig. F. The combined sensitivity and tone control used in Motorola sets.

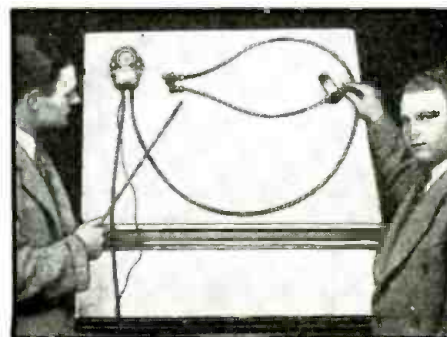

Fig. G. This unit permits tuning from the back seat of the car as well as at the dash.



Fig. H. Stations are tuned-in by just pushing the 5 buttons on this steering-column unit.

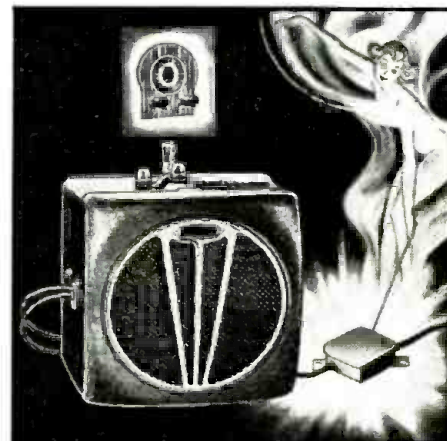
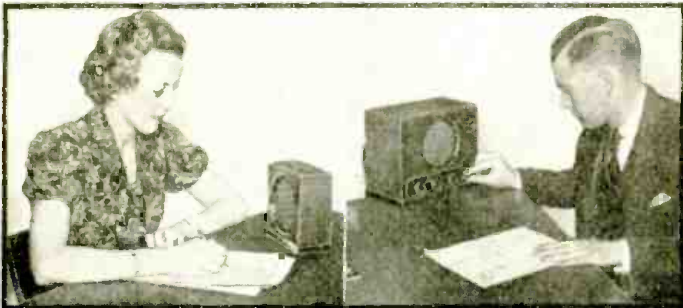

Fig. I. The Arvin antenna filter provides high gain.

THE NEW INTERPHONES

A resume of some of the many commercially available private-address systems of both the R.F. and the A.F. types. Inter-station and master controlled systems are shown.



Philco Phone. A master control unit (shown above—right) with volume control, selector switch and "talk"-knob used with 1 to 4 remote units comprises this A.F.-type system. A 4-tube A.C.-D.C. amplifier in the master unit provides the necessary gain for normal voice sound level.

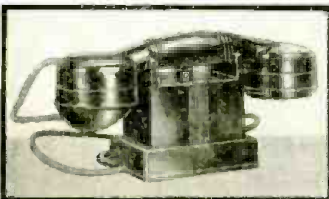

Universal Microphone Co., Ltd. A French-phone comprising transmitter and receiver is the distinctive feature of this common-battery system which permits any number of stations to be used—and selectively called. An amplifier is not needed.

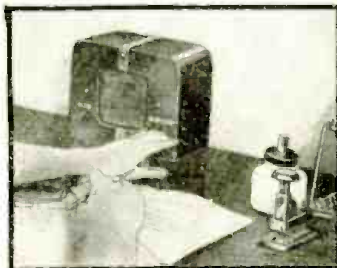

Operadio Mfg. Company. This audio-type interphone is available in 3 types for communicating between any 2 persons; a return speech system with a master station and 1 to 10 remote stations; and the intercommunicating system comprising 3 to 11 master stations with selective switching.



Transducer Corp. Three different methods are provided by this system which employs the distinctive "bullet-phone." The first system uses one amplifier with a master station and 1 to 4 remote stations. The second system employs only 2 stations which may call each other at will. The third system uses all master units and is the most flexible of the three.

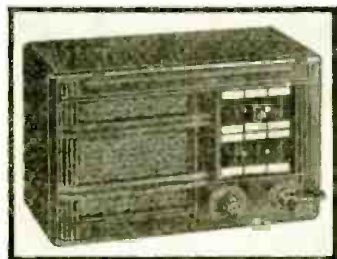

Remier. With this interphone system a normal voice can be picked up from 25 to 75 ft. distant depending upon the noise level. A single wire connects the stations. Three systems are available:—between 2 stations; between 1 to 13 master stations; and between a master station and 1 to 12 outlying stations.

The units are of the A.F. type operating from either A.C. or D.C. lines. A key switch controls "talk"- "listen" circuit.

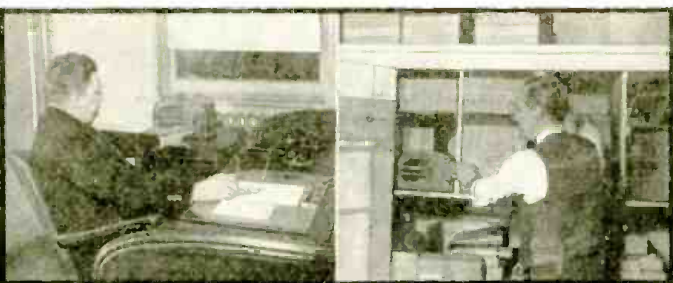

Transfone. This carrier-type inter-office communicator operates from either the D.C. or A.C. 110-V. line and does not require interconnecting wires. Any number of stations may be used, each having its own oscillator and amplifier. Condenser jumpers are needed on 3-wire lighting systems.

Name and address of any manufacturer will be sent on receipt of self-addressed, stamped envelope. Kindly give (number) in above description of device.



Webster Teletalk. Both the selective and non-selective communicating systems of the A.F.-type are available from this manufacturer. The units may be operated from either A.C. or D.C. and at 2,000 ft. distance no reduction in volume level is noticeable. The master selective unit is shown above. Outlying stations contain only a speaker.

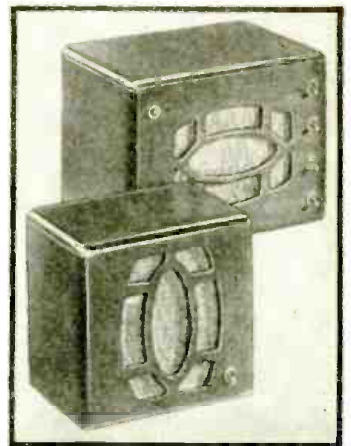

Allied Radio Corp. Four systems are available in this A.F.-type intercommunicator:— 1st, a complete 2-way system; 2nd, a master station system accommodating 4 outlying units; 3rd, a master station system which accommodates 6 outlying stations provided with 50-ft. cables and plugs; and, 4th, a "private" system between 2 stations.

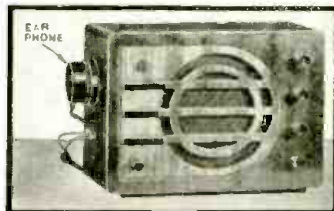

The P.D.Q. System. An automatic central is used in this audio system which accommodates up to 9 stations. Three set-ups may be had: (1) the group-call system, (2) selective speech system with one master control, and (3) super-selective system with individual master controls.



Communo-Phone. This carrier-type communicator permits communication between 2 stations without connecting wires or even without the use of condenser jumpers in split-phase systems, even though one of the two stations may be on a different A.C. line from the second or one station is plugged into a D.C. outlet and the other into A.C. Five tubes are used in the amplifier in a specially-designed R.F. circuit which provides sufficient R.F. output to feed signals over long power lines and across phase windings of power generators. Has combined switch and volume control, and 6-circuit double-throw "talk-listen" switch.

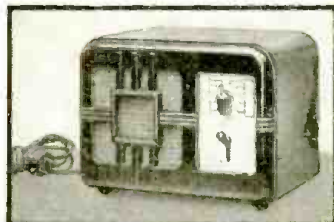

Webster Amplicall. Four circuit arrangements are provided by this company. First, a call system which provides only 1-way conversation; 2nd, master station unit in multiples of 2 to 10 stations; 3rd, 2-station system each having its own amplifier; and, 4th, selective system using 1 to 10 amplifiers at separated points. Uses interconnecting wires.



The Radolek Co. A selective A.F. system using a master unit and 1 to 5 outlying stations is the essential part of this interphone. The amplifier in the master unit contains 3 tubes—a 6C6, a 43 and 25Z5 for A.C.-D.C. power supply. Interconnecting cables are used between the master and outlying stations.

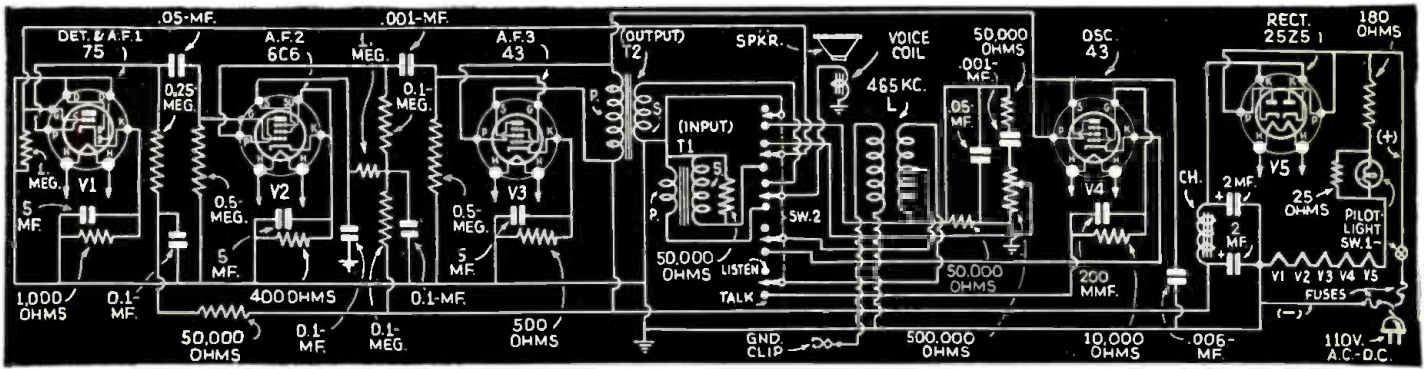

Communo-Phone. This R.F.-type interphone develops a sufficiently strong carrier to pass from one A.C. line to another without connecting wires or condenser jumpers. It will work over long power lines and across phase windings of power-line generators. The type 43 tube (A.F.3) in the diagram above is the speech modulator in the "talk" position.

Remler. An A.F. circuit system is used, with a single conductor and shield-return between stations. Three systems are available—(1) multi-station with master station and secondary units; (2) 2-station system, shown in the circuit at right; and (3) all-station selective system with all master units in which any one of 12 stations may call any of the others.

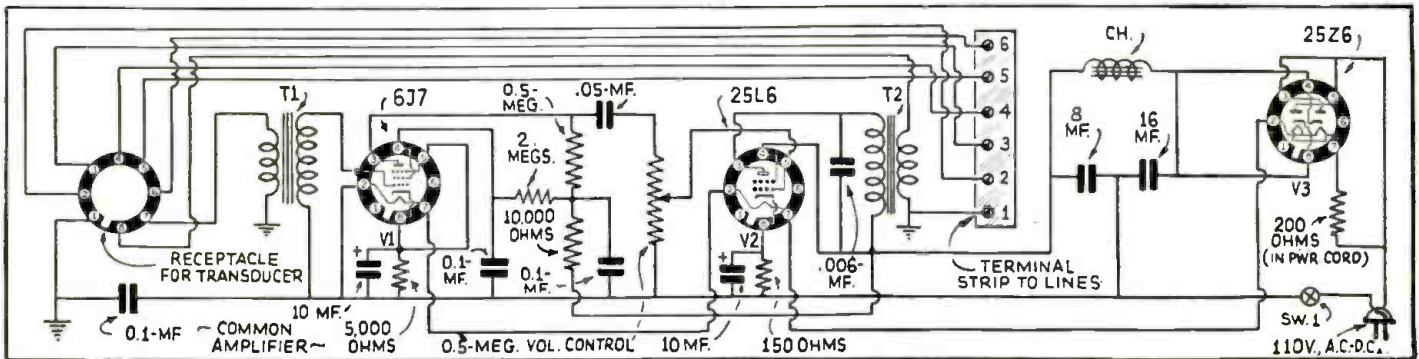
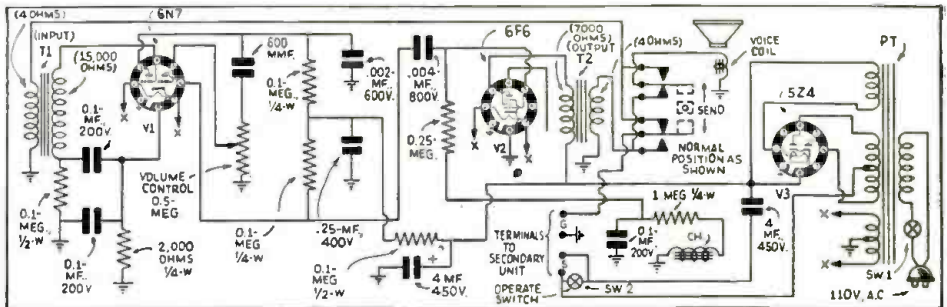

Transducer Corp. The interphone shown above is an A.C.-D.C. type unit using the A.F. principle in which a single amplifier is used with the "bullet-phone" units in either 2-way or master selective systems. A third system permits calling from any station (3 or 4 stations) and uses individual amplifiers.

Philco Phone. This communication system calls for a master control unit which permits the use of 1 to 4 remote units. The circuit of the master control (an A.F. type) is shown at the left. Only one amplifier is required.

Wright-DeCoster, Inc. This well-known manufacturer has designed a system, shown by diagram below, of the A.F. type (A) which features a busy indicator (B) and input equalizer (B) for attenuating the low-frequency output, to reduce hum response, of Nokoil ("P.M.") speakers used as mikes.

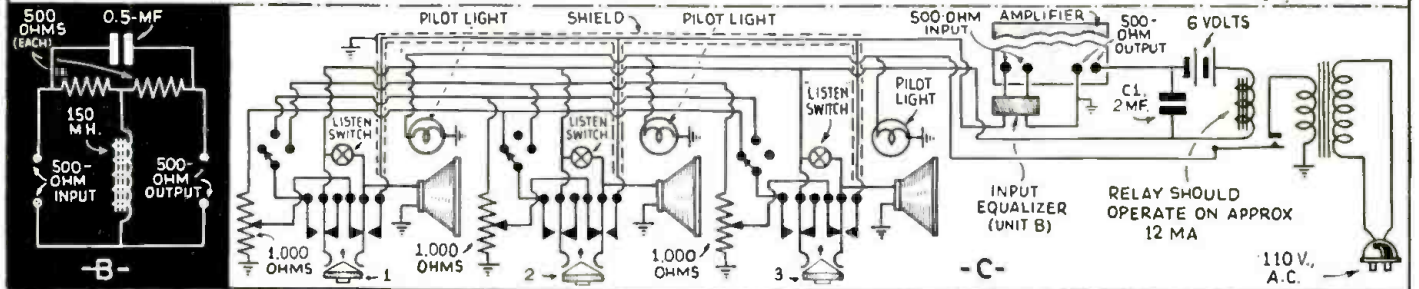
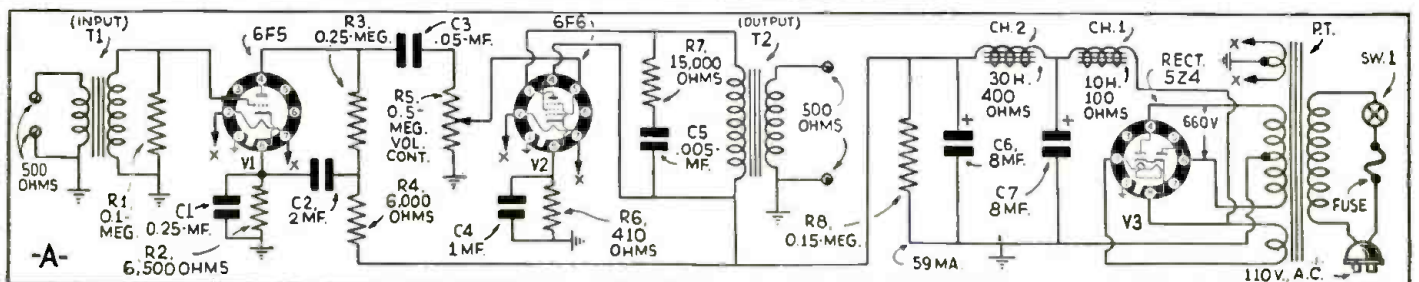
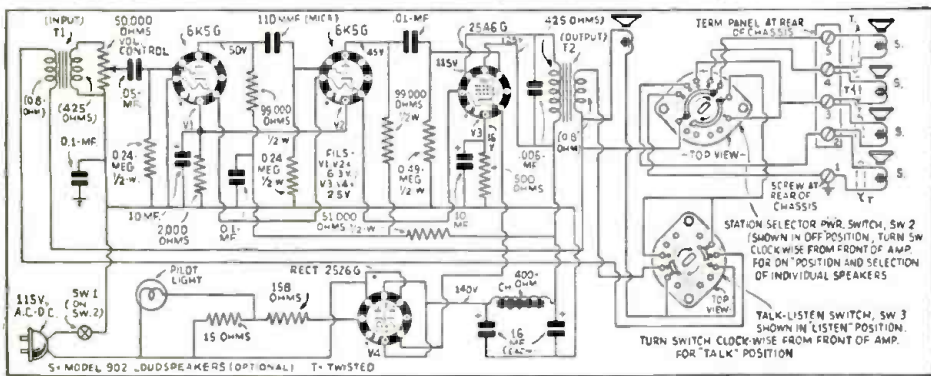

CAR-RADIO RECEIVERS FOR 1937

Car-radio improvements this year, over last, are many. Note the availability of automatic frequency control.

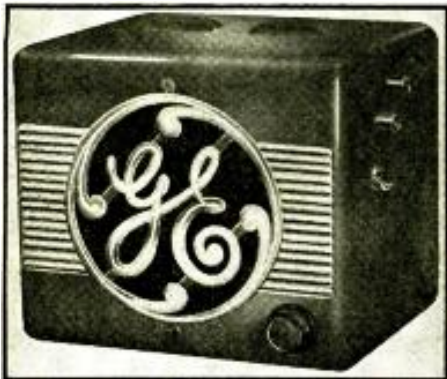

General Electric Co. Car-radio set with automatic frequency control.

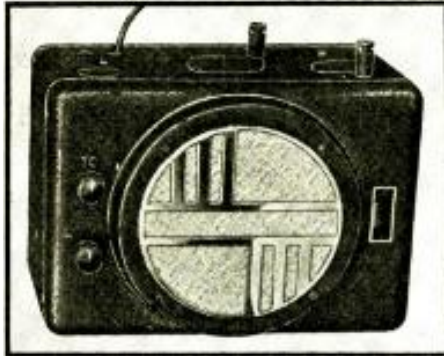

Wells-Gardner. Has automatic bass compensation at low volume.

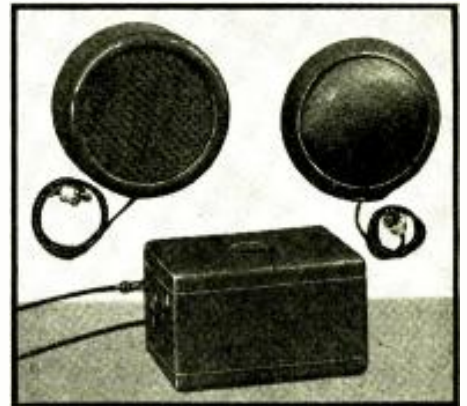

Sparton. A recessed wing-nut is a servicing convenience.

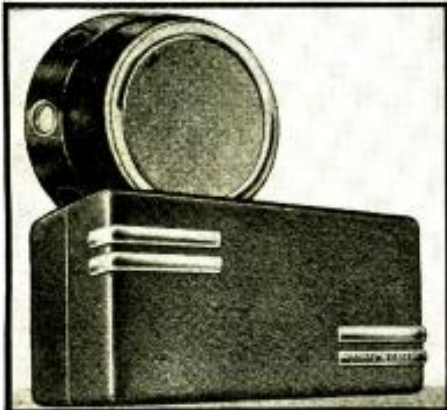

Galvin Motorola. Has "acoustinator" tone and sensitivity control.

General Electric Co. Here is a modern, 8-tube car-radio receiver, the FA-80, built around the characteristics of the new line of G.E. metal tubes. Its outstanding feature is the use of AUTOMATIC FREQUENCY CONTROL (which automatically corrects slightly off-tune adjustments), for added driving safety. Range, 540 to 1,600 kc.; output, 4 W.; has A.V.C. and antenna-matching facilities. See circuit page (facing).

Galvin Motorola. Features of this 1937 deluxe, "Golden Voice" car-radio set: Reversible-phase "magic eliminode," 8-in. P.M.-type reproducer with adjustable tone chamber for compensating car acoustics, "acoustinator" tone and sensitivity control, A.V.C., push-pull output at 13 W., inter-carrier noise suppression knocks down off-signal noise in 10-to-1 ratio, "A" drain is 7 A., antenna-matching control. See circuit.

Zenith. Here is an 8-tube, high-quality automotive-radio receiver, type 8-M-195, with a maximum sensitivity (at 1 W. output) of 0.9-microvolt; maximum available output is 9W. Operates on car antenna or any of following types: undercar, over-the-top (sedan), over-the-top (coupe), "fleet wing," and bumper pole, all of which are available from the same manufacturer. Equipped with both built-in noise filter and provision for plugging-in either or both of 2 loudspeaker types (dash and header).

Chrysler. One of several features in this model C-1450, 6-tube Chrysler-Philco radio receiver in the availability of an additional, rear-seat loudspeaker called the "comfortone courtesy speaker." The manner in which the dual-unit set conveniently mounts under the instrument panel is illustrated. Designed for use with either a "roadway dual" or a "skyway" antenna.

Wells-Gardner. This latest 6-tube, Series 6J car set is of single-unit type, with remote control. Has an output of 6 W. from a 6A6, and has a sensitivity of 1 microvolt (absolute). Tone control is continuously variable. One-hole mounting. The "A" drain is 8 A. Circuit develops AUTOMATIC BASS COMPENSATION at low-volume levels. Frequency range: 535 to 1,575 kc.

Crosley Roamio. In addition to having a continuously-variable tone control this Roamio model A-177, 2-unit set includes a music-speech switch; this 7-tube receiver is also provided with under-dash and regular (or special General Motors) header loudspeakers. Sensitivity is 1 microvolt; output, 9 W. A new-type A.V.C. is used. See circuit page (facing).

Sparton. The easily-serviced, 6-tube, dual-speaker car set illustrated incorporates adjustment, available at side of case, for matching into various types of antenna inputs. Includes both drum and header loudspeakers. Recessed wing-nut affords rapid accessibility for tube removal, etc.

DeWald Motortone. Upon mounting this radio set on the firewall of the car the reproduction is projected, from the sloping speaker, at angle and, states the manufacturer, "without repercussion." The chassis utilizes 5 tubes, and iron-core antenna coil. Note the following service features: may be mounted without removing any obstructions from the dashboard; individual construction permits removal of chassis from case without unsoldering wires; tubes and vibrator may be replaced without removing chassis from container.



Zenith. Sensitivity, 0.9-microvolt; output, 9 W.



Chrysler. Includes "comfortone courtesy speaker" (not shown), under the robe-rail in front of the rear seat.

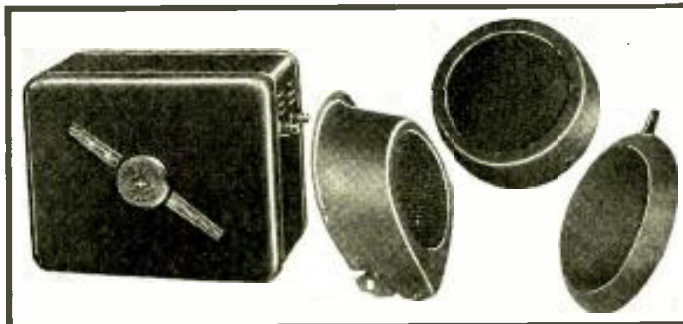

Crosley Roamio. In addition to a continuously-variable tone control this 7-tube set includes a music-speech switch for more convenient tone adjustment. Two loudspeakers (1—under-dash, and 1—header) are included; a G.M. header unit also is shown. A "tear drop" type of steering column control is used; also available is the airplane-type remote control. This set, states the manufacturer, requires no sparkplug suppressors; and, has "automatic dial logging." Home-set fidelity is due, in part, to the use of an 8-in. speaker with back-pressure release.



DeWald Motortone. Service Men will find this set easy to service.

Name and address of any manufacturer will be sent on receipt of a self-addressed, stamped envelope.

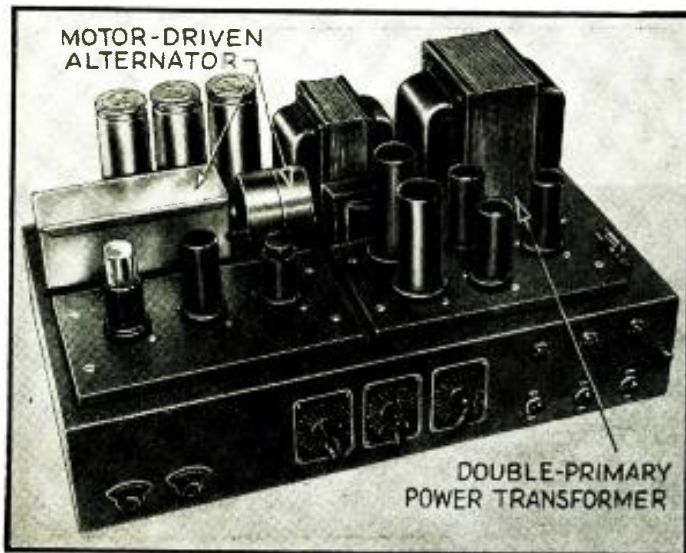

Fig. B. The appearance of the amplifier, ready for service.

INTRODUCING— A CATHODE-DRIVE HIGH-FIDELITY 32-W. BEAM AMPLIFIER

Conclusion of this article, which discloses a new idea in amplifier design, is given.

A. C. SHANEY

PART II

THE FIRST PART of this article briefly described the *motor-driven alternator* as well as the circuit of this advanced-design, high-fidelity amplifier.

Among the unusual features included in the design of this novel amplifier besides the motor-driven alternator system of providing equivalent and highly efficient operation from both 110 V. A.C. and from a 6-V. storage battery, is the new 2-phase fixed-voltage rectifier and low-distortion cathode-type driver.

ALTERNATOR DESIGN FEATURES

The "heart" of this unit (illustrated in the May 1937 issue, page 665), consists of the 4 synchronized make-and-break contacts which are constructed of special tungsten-silver alloy, noted for its wear resisting and unusually low contact resistance. Of paramount importance in the design of this unit are the individual contact adjusters which enable large amounts of current to flow in the primary winding with minimum loss of power across the contacts themselves. The coupling spring is driven by an eccentric cam on the motor rotor. This drive provides for positive contact pressure—an important advantage over usual magnetic-drive vibrators.

Another design feature of unusual interest is the fact that it can never "stick" or "burn" because the "Stand-by" and "On-Off" switch circuit is so arranged that voltage cannot be applied to the contacts while in a motionless state.

As will be noted from the schematic diagram, Fig. 1 (see May 1937 issue, page 665) the standby switch is wired in series with the positive side of the motor and the center-tap of the 6.3-V. winding so that voltage is applied only after the motor is in operation.

The contacts themselves are welded to special springs characterized by high electrical conductivity, high resistance to heat, and unusual strength. Each one of the springs is "backed up" by a husky brass conducting strip so as to further reduce the internal resistance of the alternator circuit. This feature is of

paramount importance particularly in view of the fact that approximately 15 A. pass through this circuit. If it had a contact resistance of 0.1-ohm, it would develop a voltage drop of 1.5 V. and dissipate 22.5 W. needlessly.

2-PHASE BRIDGE RECTIFIER

The operation of this rectifier system can be best understood by reviewing the analysis of the rectifier system utilized in the "Direct-Coupled 30-W. Beam Tube Amplifier" described in the March and April 1937 issues of *Radio-Craft* (pages 534 and 601 respectively).

The unconventional design employed in the rectifier circuit of this highly efficient amplifier is hinged around the "grounding" of all plates of the 6X5 tubes used as half-wave rectifiers. This brings the center-tap of the high-voltage secondary approximately 330 V. off ground (at a positive potential). An additional hundred volts is added on to this by utilizing a series-aiding conven-

tional full-wave rectifier. (A 6N7 is used for simplicity of design, though any other full-wave arrangement may be used provided sufficient current is rectified.) Naturally the cathode of this rectifier is approximately 100 V. more positive than the center-tap of the high-voltage secondary and is, therefore, 430 V. above ground.

At first glance it might appear that this extra voltage comes from nowhere, but it actually is provided by rectifying one phase of the alternating high voltage which is ordinarily disregarded. This system may be likened to an off-set voltage-doubling arrangement which provides fixed voltages for the plate (400 V.) and screen-grid (300 V.) of the 6L6 power tubes as well as for the plates of the driver, voltage amplifier and preamplifier tubes. The advantages of this type of power supply system were completely covered in the February 1937 issue of *Radio-Craft*, page 476.

LOW-DISTORTION CATHODE-DRIVER SYSTEM

This degenerative system is highly recommended whenever it is necessary to obtain maximum efficiency from the power output tubes. Naturally if grid current is drawn during any part of the input cycle ordinary methods of inverse feedback cannot be utilized as considerable grid circuit distortion will predominate. Aside from this fact, assuming that the output tubes do not draw grid current and are in themselves of high-fidelity design, the driver itself may be characterized by inherent distortion. The output would therefore contain this distortion in an exaggerated degree.

The degenerative driver shown in the schematic diagram utilizes a special input transformer connected in the cathode circuit of the driver without the usual plate load. An additional cathode resistor is connected in series to provide a suitable bias. This resistor network is bypassed to avoid unnecessary degeneration.

Because this driver is of a degenerative nature, a high input signal is re-

PAGING THE SERVICE MAN

Show this issue of RADIO-CRAFT to the Service Men whom you know; they probably will be pleased to note the servicing material which this June issue of RADIO-CRAFT contains—including the various schematic circuits of broadcast receivers, communicators, trailer and car-radio sets, etc.

You may want to suggest to these Service Men that they ask their local magazine dealer to put in his order today for the forthcoming July special Service Number which will contain even more information of time- and money-saving value to the Service Man.

A few of the items planned, in addition to the usual range of articles, for July RADIO-CRAFT: modernizing old radio sets, adding volume expansion, new cathode-ray testing units, eliminating interference, 4 radio servicing Data Sheets, 2 pages of Operating Notes, a test loudspeaker, coil and condenser testing, an infinite-ohms/volt meter, etc., etc.

A KIT-TYPE CARRIER INTERPHONE

Because this unit has been made available as a kit, it is simple to make and low in cost.

N. ADELMAN

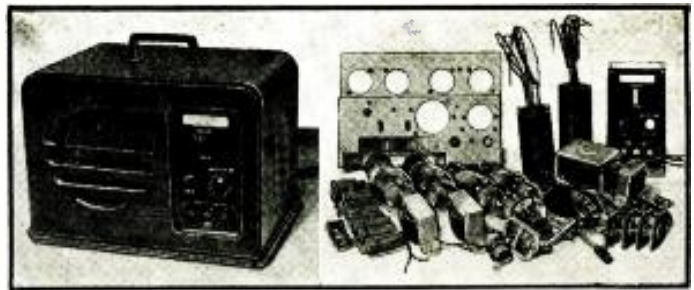

TO SAY THAT the field for carrier-type interphones is unlimited is to make a statement that is almost without exaggeration. It would indeed be hard to name a type of business wherein the system would not be of decided advantage. Even in the home, innumerable uses can be found that would save the housewife time and energy.

The carrier-communicator is almost as simple to construct as it is to install.

WIRING IS SIMPLE

With the aid of a soldering iron, a pair of pliers and a screwdriver, the experimenter, by using the parts specified and following the diagram in Fig. 1, can build a complete unit in little more than an hour.

Few precautions other than the usual neatness and thoroughness need be taken. The wiring, in general, should

be flat on the chassis rather than across in space. When small parts, such as resistors and condensers, have one end connected to a grid or a plate, that lead should be as short as possible and at the expense of the lead at the other end of the part.

Tubular bypass condensers have one connection marked outside foil. This lead, where possible, should be grounded.

(Continued on page 746)

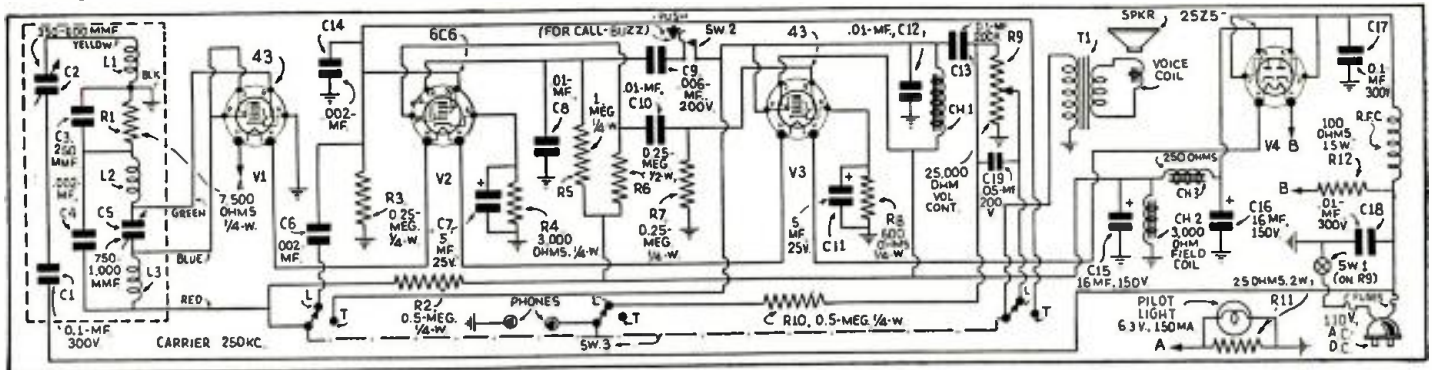

Fig. 1. The circuit of the carrier-type interphone using the parts shown in the photo at the head of this article.

AN ELECTROMECHANICAL OSCILLOSCOPE

Mirror oscilloscopes were used long before cathode-ray tubes were invented—this unit uses the mirror principle.

LOUIS J. FOHR

CONSIDERABLE interest has been given to gaseous-tube oscilloscopes in the last year and while the basic principles are not new, some of the recent developments are. The essential part of one of these oscilloscopes is the tube itself and an understanding of the principles of gaseous discharge tubes is necessary.

FUNDAMENTALS

Gaseous discharge tubes are roughly

divided into two classes—(1) direct discharge tubes and (2) glow tubes. In the direct discharge type the conduction of current is directly between electrodes and through the ionized rarefied gas; a neon sign is an example. In the glow type the direct discharge is usually limited by design as much as possible and the discharge is confined to a glow on the electrodes only. The familiar glow lamp is an example. The gaseous

(Continued on page 760)



Fig. A. The neon-and-mirror oscilloscope appearance.

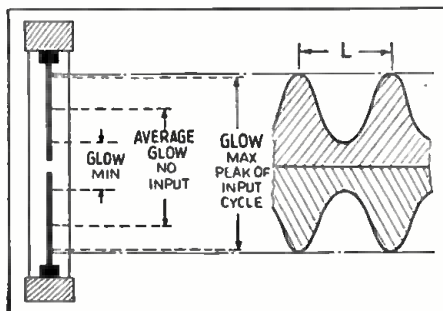

Fig. 1. The tube and image appearance.

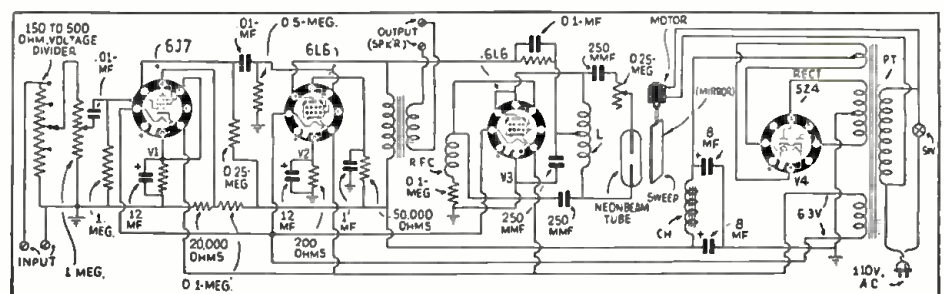
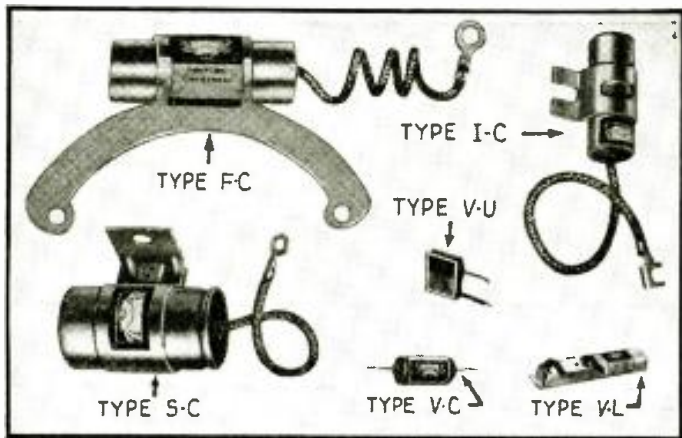

Fig. 2. Circuit of the unit—amplifier, oscillator and neon tube.



CONDENSERS IN AUTO-RADIO NOISE ELIMINATION

Reduction of ignition noise in car radio installations is dependent entirely on these units.

LEON L. ADELMAN

THE IRRESISTIBLE appeal of "music-on-wheels" has created a ready and eager demand for auto-radio sets resulting, during the past year alone, in sales of one and one-half million such receivers. This tremendous increase in sales has been made possible largely through measures which have been taken to overcome the difficulties formerly encountered in making satisfactory, noise-free installations. In modern cars, the mechanical and electrical problems have been so simplified that the average complete installation may be made in less than 1 hour. Undeniably, tough cases are still occasionally found though and, to be able to handle them efficiently, a knowledge of the fundamental causes of such disturbances is of value.

Noise in auto-radio receivers is produced in three ways; by radiation or conduction of the higher harmonics of the motor ignition system; by friction, causing static charges to accumulate on brake linings, hub caps and body contacts which are spring-suspended; and by chemical action, due to corrosion which creates poor electrical contacts.

The measures to be taken to overcome these conditions are all designed to limit or confine

the source of noise to as small an area as possible. The ignition system is usually the greatest offender. Differences of radio-frequency potential along circuits must be kept at a low value. This is accomplished by proper shielding, bypassing, and using low-impedance ground connections. It has been found, for instance, that at 1,500 kc. the voltage drop of a 10 ma. current will be 9,000 microvolts along a pair of No. 20 wires only 1 ft. long. Under the same conditions, but with copper braid over a single wire, the drop will be only 230 microvolts. Therefore, thick copper braid must be employed for all bonding together of metal parts if best results are to be secured.

Bypass condenser leads must be as short as possible or the condenser will not be wholly effective. Radiation from such leads will be of the same order as that indicated in the preceding paragraph and modern auto-radio sets are able to pick up not only weak signals but also low extraneous potential variations. Only metal-cased condensers should be employed. In the engine compartment, it is obvious that the heat radiated would soon melt the compound in an ordinary tubular type, but installers occasionally

use cardboard types for bypassing around the meter panel. Heat conducted along the car frame soon melts these also, creating a mess within the car and often leads to short-circuiting of the inferior condenser.

The type FC condenser shown represents a modern, high-grade bypass condenser designed especially for the Ford V-8. Note the curved bracket which enables a perfect-fitting, workmanlike job which will stay put. It may be installed very quickly and there is no time wasted in fitting, filing or other make-shift operations.

Other types of cars use a wide variety of generators. The type SC condenser, for instance, has a reversible mounting arrangement which enables installation in cramped quarters and keeps the lead short. It may be installed permanently and rapidly by means of its single-hole mounting.

The car battery and leads form not only a common source for radio and ignition power, but also a common medium for the coupling of generated noise. This should be bypassed within the car at a point near the ammeter. The type IC condenser shown is a familiar model which
(Continued on page 753)



Photo, courtesy The Turner Co.
A portable sound reinforcing unit used by George Gervenko's band.

A COMPLETE P.A. system is a combination of several essential parts. To determine the number and size of these parts, it is convenient to start with the speakers and determine how many are needed, and the power required to produce proper volume and distribution of sound. Installations outdoors require about twice as much power for a given-size audience as required indoors. The outdoor audience is usually spread over a larger area and very little reflected sound is depended upon to reinforce the amplified sound in outdoor installations.

Where there is a large amount of extraneous noise and excessive absorption, greater power output must be used. The amplifier installed should have sufficient power to serve for unfavorable conditions, but must have suitable gain controls and indicating devices so that the operator can keep the volume just great enough for good audibility as the acoustical conditions change. A certain hall which may be used for a dance

To use volumes in excess of actual requirements for good audibility is a bad practice. High-level operation not only causes the amplified sound to be unnatural, but it also tends to increase the acoustical feedback from the speaker to the microphone. The microphone will pick up this return sound and feed it back through the amplifier again. Thus we have a condition of regeneration which causes howling.

REPRODUCER INSTALLATION

The number of loudspeakers used and their locations will depend upon the nature of the entertainment and the size of the area to be served; or, in some cases, the number of rooms to be served. When the listener can see the entertainers, it is always good policy to hide the reproducers from view and locate them sufficiently close to the entertainers so that the entire amplified sound appears to come directly from the stage.

ACOUSTICS FOR THE PRACTICAL P.A. MAN

The highly complex subject of acoustics has been simplified for the practical P.A. worker.

E. L. RICHARDS

one night and public speaking another night would require an amplifier of greater power than if the hall was used for public speaking only. (Keep this point in mind when you go into your sales patter.)

Care should be taken to mount the speakers in front of the microphone so that the latter will not receive direct sound from the loudspeakers, otherwise howling will be encountered. When considerable extraneous noise is present, such as at dances and at card parties, and when the loudspeakers are close to the microphone, as the volume is increased to exceed this noise we may encounter "feedback" before sufficient audible volume for the whole area is produced. In such cases it is better to locate several speakers at suitable positions throughout the room and direct the sound so that each speaker will cover only its own particular area. By this method, proper distribution can be obtained without the necessity of increasing the volume to the point of the acoustical feedback. In installations where the speakers are located in separate rooms away from the microphone, acoustical feedback is never troublesome.

ROOM ACOUSTICS

The acoustical properties of a room, if poor, must be corrected before a satisfactory installation can be made. In some cases this is very easily done by hanging drapes over hard reflecting surfaces in the back of the room, while in other cases the ceiling and walls must be lined with special sound absorbent wallboard, involving greater expense. Hard reflecting surfaces
(Continued on page 753)

A STABILIZED FEEDBACK 6-W. 25L6 A.C.-D.C. AMPLIFIER

A further discussion and details of a new type of inverse-feedback power amplifier.

RALPH KENYON PART II

SINCE the principles of feedback were enumerated in the previous issue of this magazine, no further discussion of the theoretical aspects of this amplifier are deemed necessary, except for a few notes which will be mentioned in this article.

The main amplifier employs 25L6s in the output, and will deliver a peak output of 8 W., audio. These tubes have not been previously used in this connection, and so their operation characteristics are given in Table I.

As would be expected, distortion due to plate and screen-grid voltage regulation is serious, unless feedback is used to aid in correcting this. The main amplifier uses a push-pull arrangement throughout, since push-pull 6C5s are required to drive the 25L6s, and using two input tubes simplifies the circuit. With full feedback the gain of the main amplifier is 58 db., which provides a total gain of 110 db. when used with the preamplifier discussed in last month's article. The feedback arrangement is more complicated than that used in the preamplifier.

Three separate feedbacks are used.

The 1st, from plate to input of the 6J7s is used to provide a means of response control, while it also may be used, if desired, to reduce hum, since if the feedback ratio is the reciprocal of the gain of the stage (that is,

$$\frac{\text{Feedback voltage}}{\text{Output voltage}} = \frac{1}{\text{Gain}}$$

hum, distortion and noise introduced by the stage will be cancelled out. This is due to inherent electrical characteristics of the stage. Furthermore, 2 feedback controls, R1 and R2 are incorporated, since the hum, noise, and other characteristics of the two input stages may not be the same. This is because their filaments are not at the same potential with respect to ground.

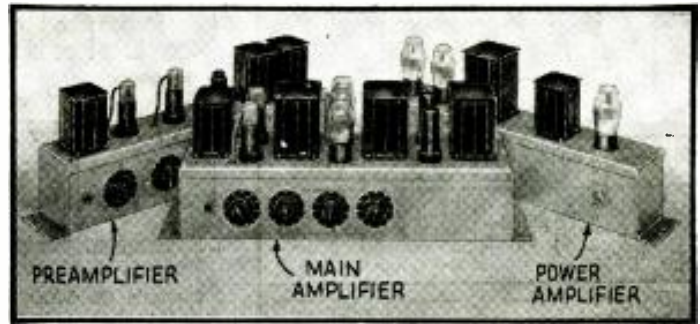

Fig. 8. The appearance of the complete amplifier.

The 2nd feedback, from grids of the 25L6s to cathodes of the 6C5s is used to correct distortion in the 6C5s and in the driver transformer T2, since this driver transformer was chosen with the effects of feedback on the driver stage in mind.

The 3rd feedback is from plates to grids of the 25L6s, to compensate for supply voltage regulation and to aid in correcting the 3rd-harmonic distortion of the 25L6s. Two outputs are provided, to either a 500- or 200-ohm line, or to several voice-coil impedances.

In construction of both the main and preamplifier units, note that shielding is imperative if hum is to be kept at a minimum. The preamplifier should have completely shielded wiring and the main amplifier should at least be shielded in the 6J7 stages and also in the grid circuit of the 6C5s.

The unit incorporates 2 separate power supplies for the 2 audio amplifiers, to keep hum and line noise at a minimum. Further filtering to the low-level stage is used, with a pi-section choke and condenser filter. The side of the input marked Lo should be connected to the grounded side of the A.C. or D.C. line, and for the sake of quiet operation it is well to positively ground this side in some manner, either at the amplifier, or at the socket, the latter probably being the safest. Two switches are provided in the power supply so that the main amplifier may be used alone if a high-level source is available.

This is accomplished by cutting the filaments on the preamplifier. The main amplifier incorporates a low-frequency booster in the feedback circuit, and optional circuits are shown for incorporating a high-frequency booster (Fig. 3) and a low-frequency cut-off filter (Fig. 2) for applications where hum level pick-up is too serious to permit the use of a flat response. This has the disadvantageous effect of reducing the gain. It does, however, eliminate low-frequency response and thus the hum.

The responses of the amplifier are shown clearly by the curves in Fig. 4. Curve A illustrates the response of the main amplifier when feedback is adjusted so that the hum and noise level is at a minimum; that is, when the input

(Continued on page 748)

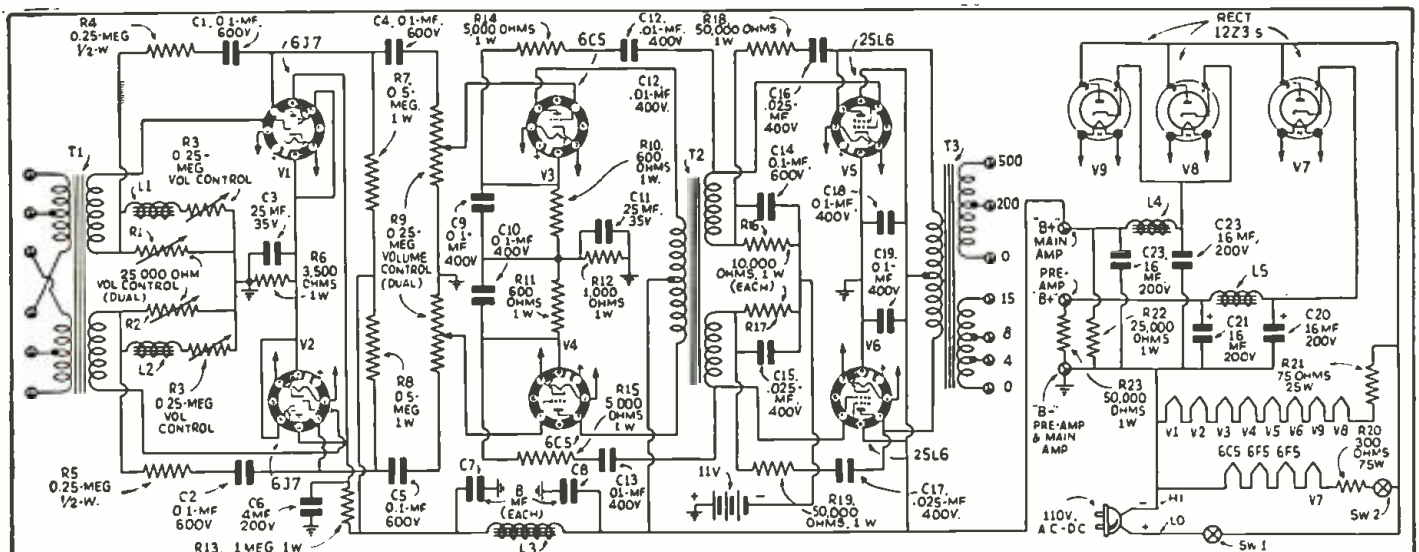

Fig. 3. The schematic circuit of the amplifier described, including the preamplifier and main amplifier—controlled by inverse feedback.

OPERATING NOTES

ANALYSES of RADIO RECEIVER SYMPTOMS

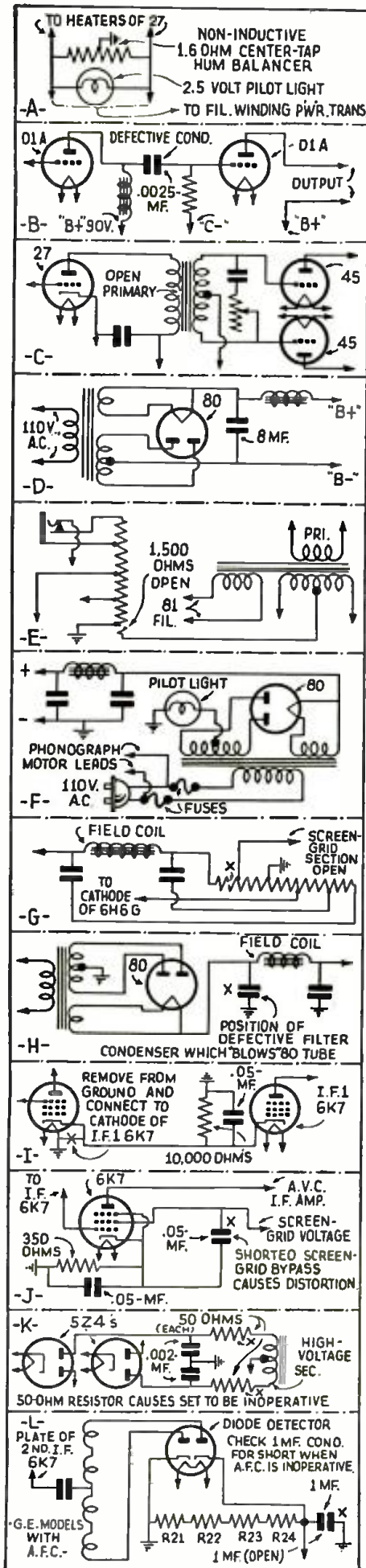

Fig. 1. Illustrations of the defects described.

Majestic 90. When a Majestic model 90 set was turned on, a loud hum and weak, distorted reception was experienced. After the set was on for 10 or 15 minutes, it would play for a short time and then hum and distort again.

Inspection of the chassis disclosed that the 1.6-ohm balancer (Fig. 1A) had become hot, burned the insulation off and shorted to the chassis. There was also a cathode-to-heater short in the type 27 1st R.F. tube. Replacing the 27 tube and the hum balancer restored normal reception.

Pfansteihl 20. Weak and distorted reception in a 6-tube Pfansteihl battery model 20 set was traced to the 1st A.F. stage by connecting a pair of headphones in the output of the 2nd A.F. stage. At this point reception was OK but when the phones were connected in the last A.F. stage, distortion was present. The trouble was found to be a defective blocking condenser feeding the grid of the last A.F. tube. See Fig. 1B.

Burley 31. No reception in a Burley Model 31 receiver was caused by an open primary winding in the push-pull input transformer. See Fig. 1C.

Gloritone 26P Midget. A loud hum and weak reception in a Gloritone model 26P midget was caused by a defective 8 mf. electrolytic filter condenser. Bridging this condenser with a new one quickly isolated the cause of hum. See Fig. 1D.

Spencer K Midget. No reception, smoke and plenty of odor in a Spencer model K midget set was caused by a shorted power transformer.

Polydyne 7 tube. An open section of the resistance bank in this set caused distortion and weak reception. See Fig. 1E.

MYRON BARKHURST

Transformer replacements. A Philco series 71 and 2 Fada 75s installed aboard a ship whose power supply is furnished by a 120 V. D.C. to 110 V A.C. converter, which in turn operates from the ship's supply, recently had their power packs ruined from high voltage surges. The voltage surges were due to the ship's generator output variations, which caused the converter's A.C. output to vary an excessive amount.

Upon servicing the sets, the primary and high-voltage secondaries of the power transformers were found to be short-circuited beyond repair, and also the first filter condenser of the high-voltage filter was open.

Shopping around for protective devices revealed no low-price article suitable both as to price and as to having sufficient control over such a wide variation of voltage. But, after due consideration, the following plan for protecting the power packs was adopted:—a small flashlight bulb (3.8 V.) was inserted in series with the high-voltage negative return to ground from the center-tap of the rectifier tube's transformer winding (Fig. 1F). The current from the rectifier will pass through the bulb and if it is excessive due to a short or partial short the flashlight bulb will burn out, thus protecting the rectifier tube and associated parts. During normal operation of the set the flashlight bulb will either glow dimly or not at all, depending on the amount of current drawn from the power supply.

Such a fusing scheme is easily installed and is adaptable to any receiver or power supply unit and is well worth the initial cost and installation. To illustrate this fact, during an 80 rectifier replacement a few days after installing the flashlight fuse, the type 80 tube was accidentally inserted incorrectly in the tube socket (due to worn pin holes in the socket plus poor light) thus causing the high-voltage to be momentarily shorted to the filament of the rectifier tube. Serious damage would have resulted (at least a ruined tube) but beyond replacing the flashlight bulb which of course burned

out with a bright flash, no harm occurred and the 80 tube is still functioning.

As an additional safety factor, the primary of each transformer was fused with a pair of 1 A. fuses thus protecting the power transformer, as the only circuits left unfused are the filaments which will burn out the tubes themselves before giving any transformer trouble.

For calculating power transformer fuses for primaries, if watts rating of the set is known, the following approximate formula will equal the proper size fuse to use:

$$\text{Size fuse (amperes)} = \frac{\text{Watts rating of set}}{\text{Line supply volts}}$$

When the rating of the set is such that the size of the fuse is less than 1 A. a 1 A. fuse will be sufficient protection.

For sets that have phono motors, omit fusing the motor circuit by tapping-off the motor supply ahead of the fused primary. This does not protect the motor but separate fuse blocks for the motor may be installed if necessary. (Phono motor burnouts from excessive voltage surges are rare and it is not necessary to fuse them.)

A. H. ERICKSON,
US CGC Chelan.

All Grunow 1937 Models. A common trouble on all Grunow models which makes the set inoperative on the broadcast band can be traced to an open oscillator broadcast coil or a defective 6K7 R.F. tube.

Zenith Model 6S152. When volume cannot be lowered at the minimum setting of the volume control, it is usually attributed to a defective 2-meg. volume control. When the receiver is insensitive and no short-wave stations can be tuned in, but only powerful local stations can be received—this is usually due to an open screen-grid section of the voltage divider (Fig. 1G). This section has a resistance of 1,100 ohms.

Zenith Model 6S52. If the tuning dial slips, due to a worn drive belt, in order to replace the worn dial band the entire dial assembly must be taken off, making sure to remove the back washer on the shaft, enabling you to put on a new band.

Emerson Models 101 and 102E. You find the set is dead and the 80 tube blown. This is generally due to a shorted filter condenser (Fig. 1H). It is best practice to replace the entire condenser block. In these models one of the most common complaints is hum, and is due again to the filter condenser capacity being below normal. On the Emerson model 102 A.C.-D.C. receivers, where the set is inoperative, and sometimes smoke emanates from the chassis, the trouble can usually be traced to a defective 25A6 power amplifier tube.

Emerson Model B131. A resonance hum is usually present when a poor ground is used. If possible connect the ground wire to a water pipe connection.

On the Emerson model L113, I have frequently found the set to have intermittent short-wave reception and have traced it to improper soldered connections on the short-wave coils. Resoldering all the connections on these coils will remedy this condition.

All Sparton Models. Where the stations do not correspond to the correct dial settings, remove the chassis from the cabinet and set the dial pointer to the correct setting. You will note that this pointer is merely pressed on to the shaft and invariably will work loose due to vibrations.

Fada A.C.-D.C. Models. These receivers usually hum and distort when the filter condensers are below the normal capacity. In replacing the condenser be sure that the polarity is correct.

Fada A.C.-D.C. Models. You find the set is inoperative. Check carefully for a defective ballast or a 196-ohm filament resistor tapped at two 38-ohm sections for pilot bulbs. Sometimes a defective tube will also be at fault since all heaters are connected in series.

G.E. Model 75. Fading is usually attributed to a defective volume control.

G.E. Model E86. When set is inoperative it can usually be traced to an open screen-grid section of the voltage divider. On this same model when there is a terrific amount of noise between stations, by making this change it will minimize background noise between stations. You will note that on the 6K7 I.F. socket there is a 2,200-ohm bias resistor. Remove this resistor and in its place install a 10,000-ohm resistor. See Fig. 11. At the same time remove the cathode-lead from ground connection on the 6K7 R.F. tube socket and connect it to the 10,000-ohm resistor. By doing this it will delay the A.V.C. action to a higher bias on both the R.F. and I.F. tubes. I have frequently run up against a noise condition prevalent in this model only. A ticking noise would become audible only after the set is on a half hour. This ticking noise sounds like a commutator ripple. By changing the 6L6 power output tube, the trouble disappeared. Yet when that same defective 6L6 tube was tested, nothing could be discovered wrong with it.

G.E. A125. Broadcast reception was terribly distorted while all the short-wave bands were clear. This was found to be caused by a shorted .05 mf. bypass condenser located in the screen-grid circuit of the A.V.C. 6K7 I.F. amplifier tube. See Fig. 1J.

G.E. Model E105. Reception is very weak and the green focus lights are constantly on, and do not change when set is tuned. This is usually caused by a defective 5Z4 rectifier tube.

G.E. Model E155. If fuses blow, it is usually due to a defective 5Z4 rectifier tube. On this same model I found this set inoperative due to an open 50-ohm resistor on one of the two 5Z4 plate connections. You will find these resistors connected from the secondary high-voltage windings to one of the plates of each 5Z4 rectifier tube, as shown in Fig. 1K. Make sure when you replace these resistors to use 25 W. units, otherwise they will burn out again if the 5Z4 becomes shorted. On all the G.E. models with colorama tuning, where you find that the green focusing lights are not operating, check carefully for a defective one of the 3 bulbs, for they are wired in series.

All G.E. Models. On all G.E. models using A.F.C. where you find the set motorboats, look for an open 1 mf. bypass condenser which is located on the 6H6 diode socket, as seen in Fig. 1L. When the A.F.C. is inoperative look for the following: the plate lead of the 6J7 control tube, shorting to the shield, and it will be found to be caused by the vibration, causing the wire to cut through the insulation. This trouble is usually found on the 12 or 15 tube sets. Another common trouble which causes the set to be inoperative is due to a shorted 1 mf. cathode condenser on the 6H6 diode detector socket.

All RCA Models. On all RCA sets using the 6E5 magic eye tube, and you find the eye very dull, if the eye cannot be brightened by replacing the 5Z4 rectifier tube, then it is necessary to substitute a new 6E5 tube. Also on this same model, when you encounter noisy volume controls, it is not necessary to replace it, but by dismantling the control and adding a metal washer on the inside to tighten the tension of the arm, this trouble will be corrected.

Philco Model 37-9X. Distortion on powerful local signals will usually be found to be caused by the discriminator I.F. transformer being out of alignment. This set is equipped with A.F.C. and unless the discriminator transformer is properly aligned, this condition will be present. When changing from magnetic tuning to standard tuning, receiver should operate at its maximum efficiency; that is, there should be no noted change when the magnetic tuning is put in the circuit or taken out of the circuit. If distortion or de-tuning of the receiver is noticed, then it is necessary to refer to the Philco notes to properly align the discriminator transformer.

(See Philco notes for alignment procedure.) I have found a very common complaint on the Philco model 37-9X receiver, which is the old story of resonating vibrations on high frequencies. This can be corrected and is usually traced to loose voice-coil windings on the cone. To clear up this condition disassemble the speaker and apply some voice coil dope on the loose windings.

General Notes on All 1937 Philco Models. It seems that the 1937 run of receivers came through with a great many antenna and R.F. coils opening up. This is due to the leads from these coils being made as short as possible and being pulled too tight. Vibrations usually cause these leads to snap. On the Philco 1937 models when you encounter noisy volume controls, it is due to the lack of tension on the rotating arm of the control. This condition can be remedied by inserting a thin metal wire between the brass bushing and metal ring on the outside of the shaft. This will tighten the tension of the arm and eliminate the noisy control. It is not always necessary to replace this control. Philco model 116X with slipping dial. Disassemble the entire mechanism, clean thoroughly, then saturate the internal sleeve with kantrust. This will avoid slipping dials in the future. Philco A.C.-D.C. models with shadowgraph tuning. If you find the pilot and shadowgraph bulbs are out, notice that these sockets are wired in series and therefore if there is one defective bulb between the two, the other will not light.

D. BELLARE

Crosley 40S. Twenty-five V. on plate of one 45 tube, the one next to the 80 tube. The output transformer was tested and found OK. All bypass condensers, and filter condensers tested OK. The trouble was found at the prong of the socket for the 45 tube. Where the wire goes onto the plate, it had pulled the tab over against the jack of the field coil, shorting out 175 V. Pressing the tab back, putting on a longer wire protected with tape, brought back the plate voltage to 200 and the set ran OK.

The symptoms of the trouble were that it played when first turned on for about 10 min., then noise, and entirely fading out appeared. I spent 3 hours finding this trouble.

F. H. MYERS

Radiola 44. The chassis frame of the R.F. tuning unit of this model is made of cast aluminum and warps badly. The ends of the frame contain the bearings of the 3-gang tuning condenser and therefore the entire rotor assembly is thrown out of line by the warping of the end frames. The writer recently encountered one instance where the warping had forced the bearings far enough apart to allow the rotor shaft to drop out of the bearing at the end opposite the dial. This called for a new bearing to be added.

It is rather puzzling to attempt a re-aligning job after such distortions, as the stator plates cannot be moved sideways enough to center in the rotors, and the solution as to the moving of the rotor plates is not obvious, judging from the attempts of Service Men to solve the problem by slotting the holes of the bakelite supports of the stator plates.

The collar to which the dial is attached seems to be sweated to the shaft, with an inside frame collar pinned to the shaft. This, however, is a wrong conclusion, as the dial collar offsets at the bearing and passes through it, and it is over this collar that the inner one is pinned, the pin passing entirely through the shaft. If the pin is driven out the shaft can be moved to a position which will center the rotor plates once more. The inner collar is then turned to a new position on the large collar and a new hole drilled for the pin, keeping sufficient tension on the brush washer.

In extreme cases the warping of the dial end of the condenser case will force the dial drum to rub against the bearing support of the volume control shaft. The remedy is to file the side of the support.

E. L. DEETER

Universal Model 5010. A.C.-D.C. super with octal base glass tubes. This set had a low A.C. hum all the time and a very bad tuneable A.C. hum. A careful check showed that a .1-mf. condenser from the high of the 400-ohm choke to the output of the 25A6 rectifier cured all hum (Continued on page 747)

SERVICING QUESTIONS & ANSWERS

Service Men may write, requesting answers to specific service questions. Address inquiries to Service Editor. For questions answered by mail, a service fee of 25c per question is made. Only questions of wide interest can be published.

OSCILLATOR DRIFT

(1) William Radder, N. Y. City.

(Q.) I have had numerous headaches with oscillator drifting on the Philco model 19 receivers. Please advise me what causes this condition.

(A.) In reference to your inquiry relative to oscillator drift. A few of the most important reasons will be given:—

(a) The most common cause for drifting is traced to the oscillator padding condenser, and is due to the heat of the chassis warping the plates on the condenser.

(b) On quite a few of these sets drifting results when the mounting screws which support the stator plates of the oscillator-tuning condenser work loose due to the vibration of the set.

HARD TO FIT CHASSIS

(2) Stanley Rider, Buffalo, N. Y.

(Q.) Please advise an easy way of fitting the 1937 model Philco receivers back into their cabinet. Most of these sets have protruding pins on the front of the chassis.

(A.) In reference to your inquiry relative to finding any easy method of installing these chassis back into the cabinet, it has been found that by greasing these protruding pins the difficulty was overcome.

STATION HISS

(3) Bert Williams, Rich. Va.

(Q.) What causes station hiss on the Emerson model 102 receiver?

(A.) Usually, on this model, station hiss is attributed to one of two reasons. The set may be either out of alignment, or you will find the preselector coil open.

FADING AND OSCILLATION

(4) Herbert Paley, Pitt., Pa.

(Q.) What are the causes of fading, and circuit oscillation when tuning the Stromberg-Carlson model 642 receiver?

(A.) Fading of this receiver is usually caused when any of the bypass condensers in the R.F. return circuits open up. (See Fig. Q4.) You will notice upon examination of the set that these bypass condensers are housed in 3 cans below the copper plate. Another reason for fading is due to a defective antenna volume control. Circuit oscillation while tuning is caused when the tuning condenser wipers are corroded or very dirty. It is advisable to replace them with pigtails.

TUNING METER BURNED OUT

(5) Sam Wilnow, Flushing, L. I.

(Q.) I have a Stromberg-Carlson Model 482 (Continued on page 742)

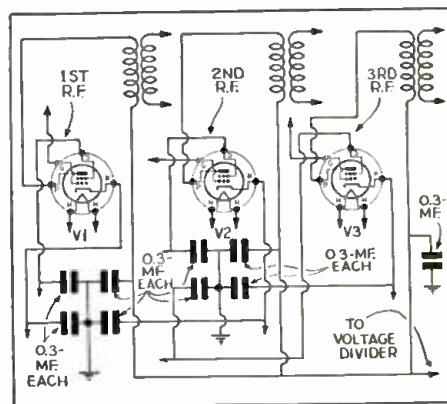

Fig. Q4. Condenser trouble in Stromberg 642.

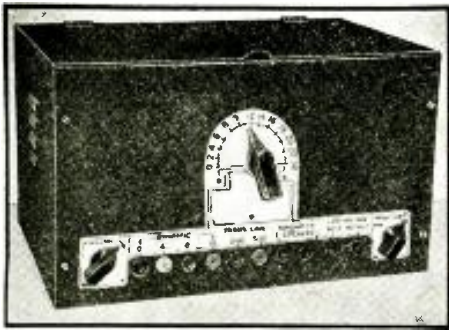

Fig. A. Front panel and cabinet of the oscillator.

A SERVICE MAN'S AUDIO OSCILLATOR

Service Men and P.A. workers will find this beat-frequency oscillator invaluable in work on A.F. amplifiers.

CHARLES SICURANZA

AUDIO-FREQUENCY oscillators have been used for years in laboratories. Many Service Men have felt the need of such an instrument, but because of the usually high cost of commercial models, could not afford to own one. In addition, most commercial models do not fit the average Service Man's picture as regards all-round utility and ruggedness.

As is the case with almost every radio instrument, audio-frequency oscillators come in various types and sizes. Some are small 1-tube affairs with "1-fly power," while others may have 15 tubes and 60 W. output. Some may use a simple feedback circuit, while an elaborate one might contain a temperature-controlled crystal in the circuit. Stability of operation, frequency

range, power output and ease of handling are only a few of the factors involved in the design of such an instrument.

For over a year, the author experimented with different circuits and tubes, bearing in mind certain desired features and working with only one end in view, to make a really useful instrument for the progressive Service Man's laboratory. The circuit chosen for this instrument comprises two electron-coupled oscillators, a diode-detector and audio stage working into a pentode power amplifier. It utilizes a highly-filtered power supply fed from the 115 V. A.C. line. Metal tubes were used throughout because they offer superior performance in this application.

The entire unit is housed in a metal

cabinet of unique construction, which comes knocked down and requires only a few self-tapping screws to assemble. In this connection, the author wishes to point out that most Service Men balk at the idea of making a metal box or cabinet. Judging by letters received from home constructors, this has been the usual stumbling block to the completion of other instruments. For this reason, the initial design of our instrument included a ready-made commercially available cabinet.

OBTAINING "ZERO-BEAT"

Two R.F. oscillators are utilized in this instrument, neither of which is modulated and each producing a continuous wave of R.F. current. When
(Continued on page 749)

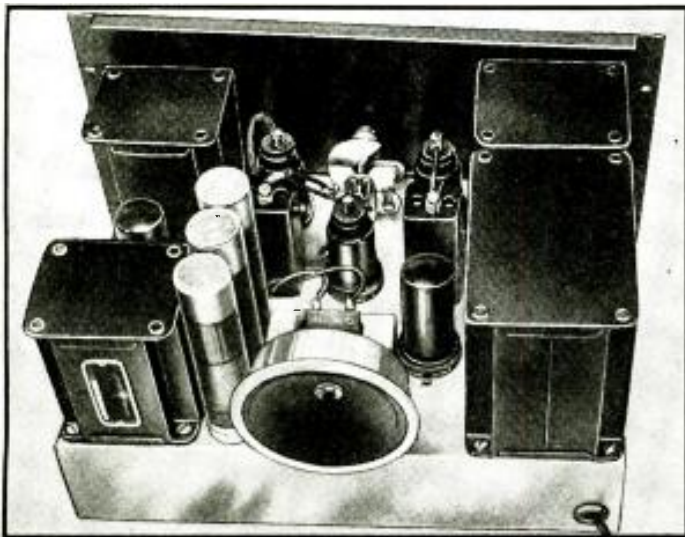

Fig. B. The positions of parts can be seen in this view.

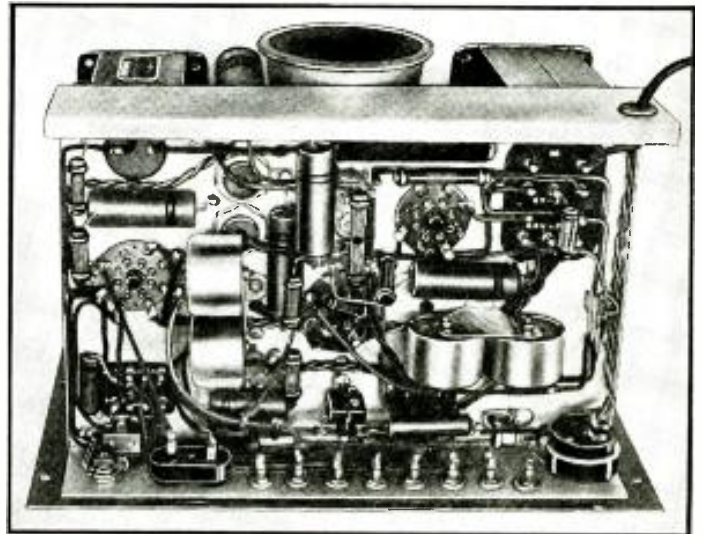

Fig. C. The under-chassis parts are placed in this manner.

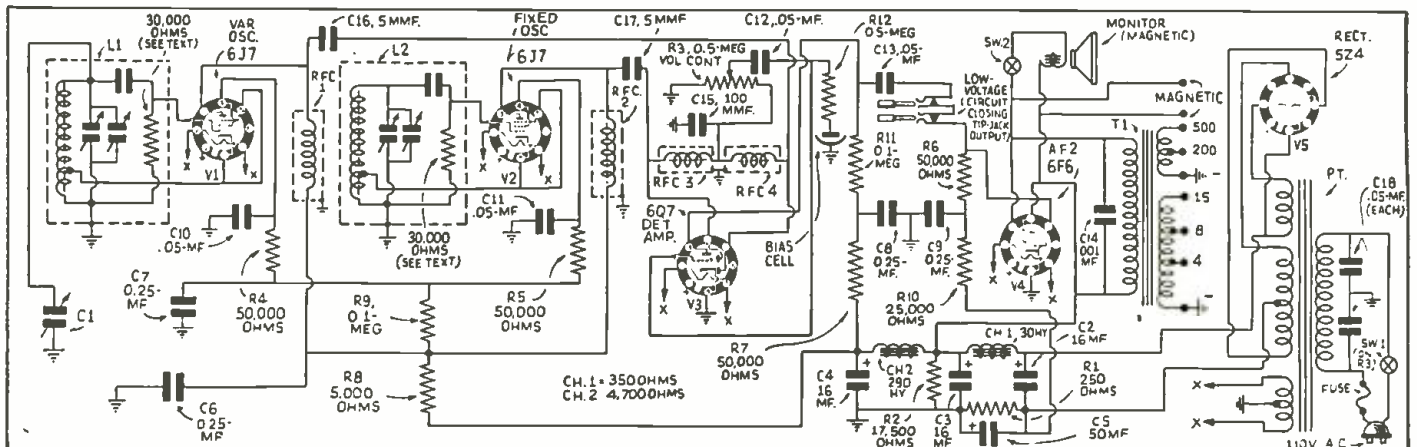

Fig. 1. The circuit of the 2 oscillators, the mixer amplifier and power supply, which make up the complete instrument.

INTERNATIONAL RADIO REVIEW

RADIO-CRAFT receives hundreds of magazines from all parts of the world. Since the cost of subscribing to each of these would be prohibitive for most radio men, we have arranged with technical translators to prepare reviews for our readers.

A RESISTANCE—CAPACITY BRIDGE

AN interesting type of bridge for the measurement of resistances and capacities was described in a recent issue of *Conseil-Radio* (Brussels). It consists of 2 units, the bridge unit, which has 2 toggle switches, one for changing from low-value resistors or condensers to larger-value units and the other for changing the circuit from a capacity bridge to one for measuring resistance.

A 20,000-ohm potentiometer which is calibrated by the builder, against known values of resistance and capacity on a paper scale mounted on the case of the instrument, serves as the adjustable unit for balancing out the "tone" of the applied A.C. source.

The second unit of the measuring set is an A.F. oscillator which supplies the required alternating current for the bridge.

The circuit of the bridge is shown in Fig. 1, and that for the oscillator in Fig. 2. The values on both units are indicated on the circuits.

A FRENCH CAPACITY METER

THE indication of capacity by the usual neon-type capacity meter is inadequate for measuring small capacities, such as trimmers and small fixed paper and mica units.

In the latest issue of *L'Accessoire et la Pièce Détachée* (Paris), a new bridge-type capacity meter of novel design was illustrated—see Fig. A. It is built in a neat metal case having a sloping panel with a large dial and pointer covering three scales and a meter mounted in a swivel support. The meter is used for indicating a balanced condition of the bridge which is operated from the A.C. supply lines. The instrument covers 3 ranges of 0-150 mmf.; 0-500 mmf.; and 0-20 mf.

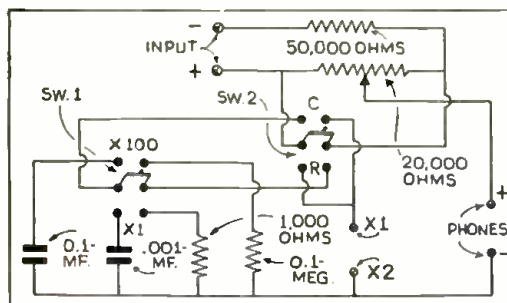

Fig. 1. The circuit of the capacity bridge.

A DOUBLE-PURPOSE TABLE SET

A RECENT issue of *Radio Trade-Builder* (Toronto) contained a short description and photo of a new table-model set which is sold in Canada. The set, shown in Fig. B, is enclosed in a modernistic cabinet having the speaker grille at one end and the dial and control knobs at the other. A movable end, with a slide which fits in a slot in the base of the cabinet permits the set to be used also as an attractive book end—thus making it a doubly useful home furnishing item.

The set is a 5-tube model covering 2 tuning bands—the standard broadcast band and the foreign short-wave band of 5.9 to 17.5 mcs.



Fig. A. A new French bridge capacity meter.



Fig. B. A combined table set and book-end.

THE CLOCK DIAL

TUNING dials, in European sets, have taken many forms, from "thermometers" to "maps"—but one of the most popular types is, without doubt, the "clock" type.

This type of dial consists of the usual dial face with an "hour" hand and a "minute" hand. The ratio of the 2 hands is usually 12 to 1 so that stations can be "logged" according to the "time" at which they are received, instead of in the usual way according to frequency or an arbitrary scale.

A popular example of this "clock" type of dial is shown in Fig. C, as reprinted from a recent issue of *Practical and Amateur Wireless* (London).

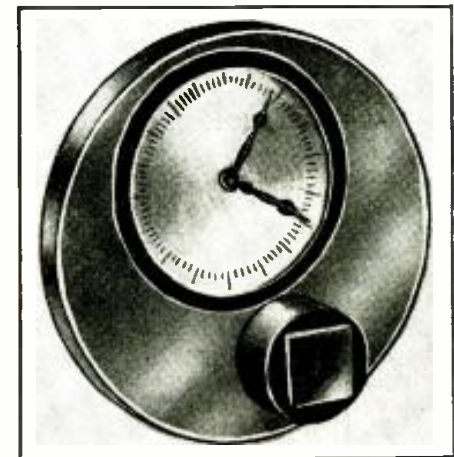

Fig. C. A clock dial radio tuning dial.

A SOUTH AMERICAN LABYRINTH

AN interesting and easily-made form of "acoustical labyrinth" was described in one of the recent issues of *Radio Technica* (Buenos Aires). In common with other forms of "infinite" (Continued on page 753)

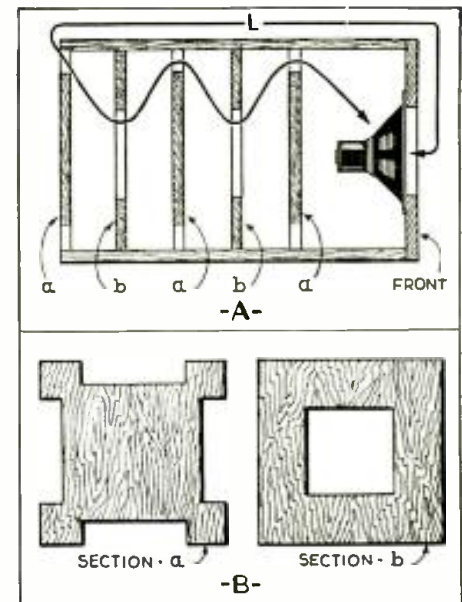

Fig. 3. A novel type of "infinite baffle."

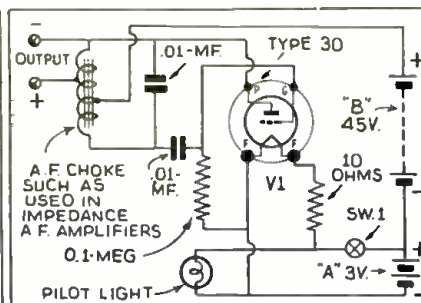

Fig. 2. The A.F. driving oscillator circuit.

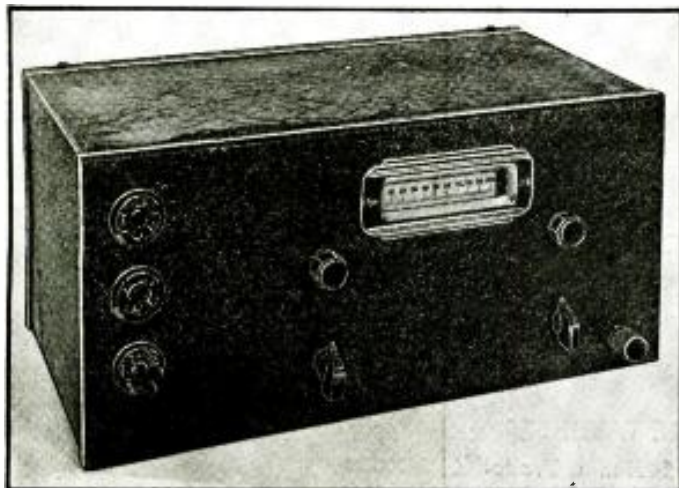

Fig. A. The set in its crackle-finished case—note the dial.

BUILD THE RADIO-CRAFT 1937 CAR-RADIO RECEIVER

This ne-plus-ultra set (Built under direction of Raymond P. Adams) includes A.F.C., B.F.O., class B and ALL-WAVE RECEPTION.

PART I

“HERE’S exactly what I want,” explains a critical customer in an expansive and enthusiastic moment:—“An auto radio which is entirely out of the ordinary—something which isn’t competitive with the fanciest factory job on the market and which will leave nothing to be desired in either appearance or performance. I want an all-wave car set of unusual sensitivity, tone quality, and short-wave efficiency, and I’d like it to be adaptable to all kinds of mobile and portable service. Can you build it for me?”

That said in introduction, let’s get right down to the business of describing the 1937 *Radio-Craft* job—designed to precisely meet such requirements and presented as perhaps the most advanced and notable car-radio set we have yet offered to our custom-building readers as a practical model for exact reproduction.

GENERAL DESCRIPTION

The *Radio-Craft* 1937 Car-Radio Set is not an ordinary set, as we’ve taken some pains to hint at once. It is beyond any question of a doubt in a class by itself. It is, first of all, thoroughly all-wave—with a tuning range down to 7 meters. Six G.E. metal tubes are employed in a carefully engineered circuit (7 if a beat-frequency oscillator is used and 8 if automatic frequency control action is desired), the basic arrangement covering an R.F. stage on all bands except the ultra-high, mixer and oscillator stages employing a single 6A8, a high-gain ferrocarr transformer-coupled I.F. stage, a combination diode detector—A.V.C. rectifier—1st A.F. stage, a driver A.F. stage, and a class B power output stage feeding a high-quality P.M. speaker and permitting use of additional speakers with voice coils in series or parallel to match various output transformer impedance connections. To the basic circuit the individual builder may add A.F.C. if he so wishes, 2 additional tubes being required—1 for separate I.F. signal rectification and balance, and one for oscillator control. A B.F.O. stage may be added by the amateur builder interested in code reception.

Physically, the receiver may seem somewhat larger than the ordinary set at first glance. But the cabinet is quite thin, though long, and lends itself to easy installation in the average car, between the steering post and the bulkhead if the receiver is to be remote controlled, or behind the dash and slightly forward if it is to be directly controlled. It is really in no way bulky or of impractical dimensions.

It is thoroughly self-contained and the cabinet has ample space inside for installation of either the generator “B” supply or a substituted vibrator power supply. A notable refinement is the illuminated dial installed directly on the set, controlled by a separate knob, and geared to match the 6-1 ratio of the remote control gear-reduction unit on the condenser shaft. This permits either type of control and the use of the set without remote tuning when it has been pulled from the car for service in the home, summer camp, or private yacht. All knobs (or shafts for remote control connection) and plugs for speaker, “A” supply, and optional exterior power supply are on the front panel.

The set is ideal for the auto, for watercraft, for the summer camp, for the trailer-home, for the commercial bus—for all types and kinds of mobile and portable service. It is in every way “universal,” and, what is more, it will provide the sort of reception we expect of a good all-wave receiver designed for home use—especially when an efficient antenna is used for signal pick-up. Highest quality of reproduction is assured not only by the speaker previously mentioned but by the use of the very best of available transformer components.

THE R.F. CIRCUITS

The R.F. stage, using a 6K7 A.V.C. controller, is built up around a set of ultra-efficient and exceptionally small inductances to be made available, with coils for the detector and oscillator stages, in a complete kit form by their manufacturer. It is tuned by one section of a 3-gang variable condenser of exceptionally low minimum capacity and wide air spacing between sections and provides an unusual degree

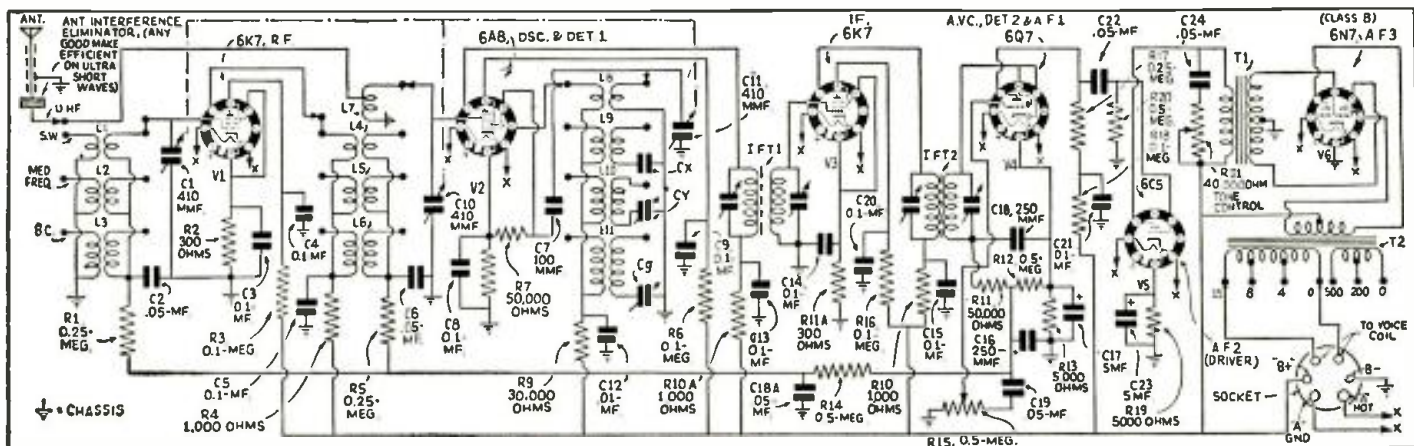

Fig. 1. Here is the diagram of the set, minus the A.F.C. tubes and controls and the B.F. oscillator. These will appear in Part II.

of signal and image preselection as well as R.F. gain.

The detector and oscillator circuits are quite conventional, employing a 6A8 as mixer, and using small size coils matched to those in the input circuit.

All coils in all 3 circuits (except the ultra-high frequency inductances) are align-aire capacity trimmed (trimmers permit 3,600 degrees of micrometer tuning, afford permanence of adjustment in spite of severe changes in humidity and the vibration encountered in mobile service, and assure peak adjustment), and are mounted directly on the 3-section isolantite insulated selector switch. Shield pieces installed between the switch sections effectively isolate the 3 circuits from each other, and a side piece makes the coil-and-switch assembly a complete unit which may be built-up and wired before any other constructional work is done.

As we have noted before, no ultra-high frequency R.F. stage is employed, the wiring being so arranged that when we are switched to this band the antenna is connected directly to a tap on the detector coil. No padders are used in the U.H.F. oscillator circuit.

Padders for the police or middle-frequency band and the broadcast band are variable, with the one for the short-wave band fixed.

Tuning ranges: B.C.—167 to 555 meters; middle frequency—48.5 to 177 meters; short wave—16.4 to 51 meters; ultra high—7.5 to 20 meters. The U.H.F. band has reduced sensitivity and is not A.V.C. controlled in the R.F. and mixer stages.

Both screen-grids are fed from "B plus" through voltage-dropping resistors and are adequately bypassed to ground. Both cathodes have their individual bias resistors and are similarly bypassed. No variable control of bias voltage for either tube is afforded as such a refinement would call for another knob on the cabinet. Tubes are simply biased for maximum conductance at low signal, A.V.C. action and the manual A.F. control being used to afford a desired attenuation of strong signals.

THE I.F. STAGE

A single intermediate stage is employed, tuned to exactly 456 kc. It is quite conventional except that it is not A.V.C. controlled. The use of A.V.C. on this stage, of course, would afford perhaps a more effective signal levelling action and suggest itself as proper if we were confined in frequency coverage to simply the broadcast band. However, on the short waves, we want to keep the I.F. not only working at full gain but full effective selectivity. Selectivity is a function of gain in a way—and naturally a reduction of the latter affects the ability of the circuit to discriminate properly between signals. Then, too, A.V.C. tends to make peak alignment uncertain—a condition we can ill afford in such a receiver and particularly if no 2nd I.F. stage is employed itself feeding a balanced rectifier for A.F.C. control. Be that as it may, A.V.C. may be added to the I.F. if it is desired and if A.F.C. is not used.

Both input and output transformers are of the high-gain, ferrocarr iron-core type, peaked to exact frequency by means of align-aire trimmers similar to those employed in trimming R.F., detector, and oscillator coils. The tube screen-grid is individually fed through a dropping resistor from "B plus," the cathode has its own limiting resistor to ground, and the plate circuit is decoupled to assure stability. Plenty of bypassing is employed for obvious reasons.

2nd-DETECTOR—A.V.C.—1st-AUDIO

The 4th tube in the line-up—a 6Q7—acts as detector, A.V.C. rectifier, and 1st A.F. amplifier. Diode plates are connected together and connect to one side of the I.F. output transformer secondary. The return for the transformer winding is made through 50,000 ohms to a .5-meg. resistor to cathode; both the A.V.C. voltage for the R.F. stages and the A.F. voltage for the triode section of the tube being taken from the point of juncture between the two resistors. The cathode is biased to ground and bypassed with a 5 mf. electrolytic condenser.

DRIVER AND OUTPUT STAGES

Some early experiment in feeding the output of the 6Q7 triode section directly into the 6N7 power amplifier was

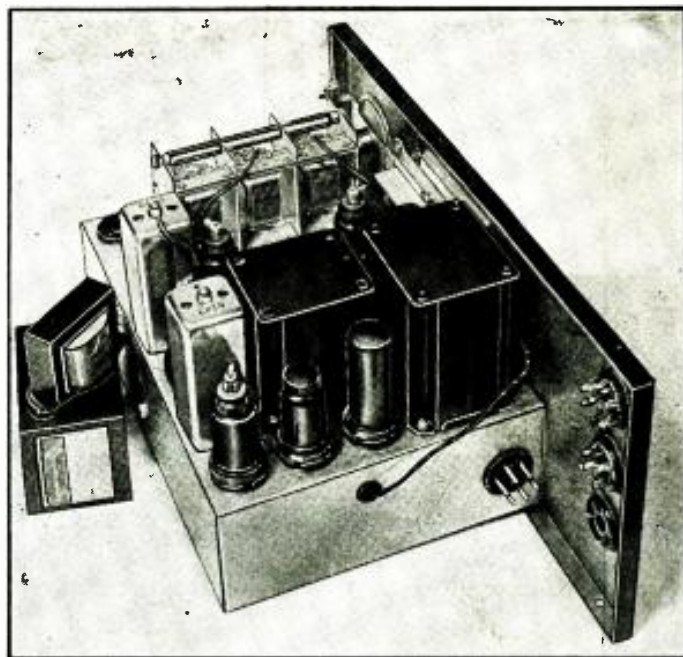

Fig. 8. Chassis appearance. Space at right is for power supply.

more or less unsuccessful and showed us that the conventional driver stage was quite necessary to effective class B output action. A 6C5 is, therefore, employed as a driver and affords sufficient output—even when biased rather highly to swing the 6N7 over the usable limits as dictated by matters of available powering current.

The 6N7 works beautifully when the receiver is supplied with about 250 V. at 100 ma. At low signal levels it draws no more current than a class A pentode, and the power supply is called upon to give maximum current only on strong signals and to give a 30 per cent permissible overload (so far as the generator supply specified is concerned) only on peaks. Of course neither genemotor or vibrator supply output regulation can be considered good and at first thought it may seem poor engineering to use class B at all. But, as a matter of fact, a typical supply designed to give about 300 V. at 75 ma. at no signal (our receiver draws just about this much current at low signal levels) will drop-voltage output to no less than 250 when the signal level rises and the 6N7 plate current increases to cause a total drain of 100 ma. The receiver being adjusted for maximum R.F. efficiency at low signal levels, any increase in level up to a practical limit simply drops the "B" voltage to 250, the audio output increasing and the R.F. efficiency slightly decreasing. Thus we have a sort of secondary A.V.C. action on strong signals tending to prevent too much peaking and a rise in 6N7 current beyond a certain value. This all may seem like rather unorthodox figuring—but its practicality is well born out by the performance of the receiver. The scheme works, affords a much higher output than any conventional pentode will deliver, and does afford economical operation at low signal levels. At moderate signal levels, the whole set draws no more than the average job with an average pentode output stage, and at all signal levels quality of reproduction doesn't seem to suffer in the slightest. (Of course, the driver stage must be adjusted so that it will not deliver high level signals strong enough to swing the class B 6N7 grids too

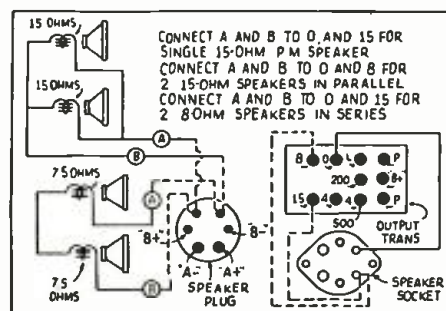

Fig. 2. The three methods of connecting speakers to the output transformer of the set are indicated. A single speaker is connected to the 15 ohm tap; two 15 ohm voice coils are paralleled and connected to the 8 ohm tap; and two 7.5 ohm voice coils are used in series on the 15 ohm tap.

(Continued on page 765)

WORLD'S SMALLEST 45 V. "B" BATTERY!

These batteries, designed particularly for meteorological work, are the smallest commercially available in the world.

L. S. FOX

HOPES of meteorologists that a new era in weather prediction is at hand, in which accurate forecasts may be made as much as 2 weeks in advance instead of the present 24 to 48 hours, center around the development of the world's smallest "B" battery, which is actually smaller than a flashlight battery!

The radio-meteorograph is a combination of weather instruments—barometer, thermometer and hygrometer—with a short-wave radio trans-

mitter, and a recording receiver on the ground prints the signals on a tape, from which they may be interpreted in terms of air pressure, temperature and humidity.

For the radio-meteorograph to attain maximum altitude every unnecessary ounce of weight must be eliminated. As "B" batteries were one of the major items of weight the "Eveready" Research Laboratories developed this new 45 V. battery, No. X-180, weighing only 1.9 ozs. and measuring only 2 ins. high and 1½ ins. in dia. A "layerbuilt" type of battery is used for only with the layerbuilt construction is it possible to build so tiny a 45-V. battery. The 30 flat disc-shaped cells, each but little larger than a quarter, are bound together under pressure and equipped with 2 flexible-wire leads.

The layerbuilt construction, similar in appearance to the "voltaic pile" with which the electrical student is



Fig. A. The appearance of the complete layerbuilt battery. The comparative size can be seen against the hand.

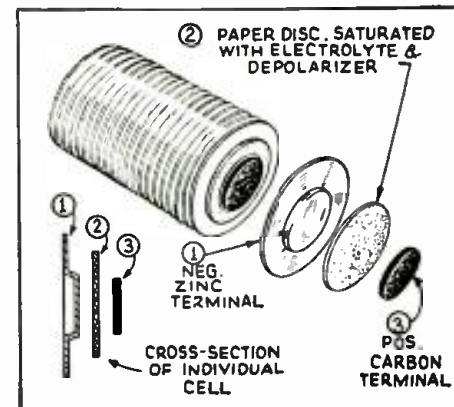

Fig. 1. The assembly of the discs into a battery is shown above. The blotting paper holds the electrolyte and depolarizer.

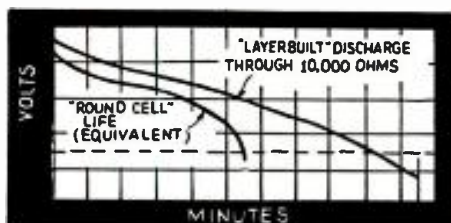
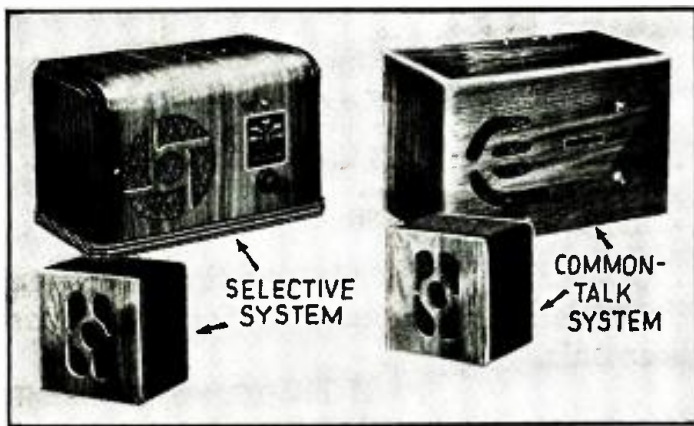

Fig. 2. The linear discharge of the tiny "B" battery compared to an ordinary battery of equivalent size is evident.

(Continued on page 753)



SELECTIVE AND NON-SELECTIVE PRIVATE-ADDRESS SYSTEMS

Private-address systems may be either selective between two individuals, or non-selective between groups. Both types are described.

H. W. PARO

THE MOST recent developments in loudspeaker communicating systems open to every radio man a market that is almost literally endless. Potential users exist wherever two or more persons are separated by short distances and wish to communicate. The latest ingenious design has brought prices down to a point where no one with any reasonable use for such equipment will hesitate at its cost.

A PROFITABLE FIELD FOR WIDE-AWAKE SERVICE MEN

Stores, offices, factories, warehouses, schools, restaurants and cafeterias represent, but do not nearly exhaust, the categories of possible purchasers of these systems. They are quicker and easier to use than the telephone, and do not tie up the switchboard or inter-

fere with incoming or outgoing calls. While in some cases it is necessary to manipulate a "push-to-talk" switch, in others busy people can hold 2-way conversation without using their hands in any way and at several feet distance from the instrument. The older, tele-

phone type of intercommunicating system is far clumsier as well as incomparably more expensive.

Stores, except of the smallest one-man type, use them for quick communication between counters and stockroom,

(Continued on page 750)

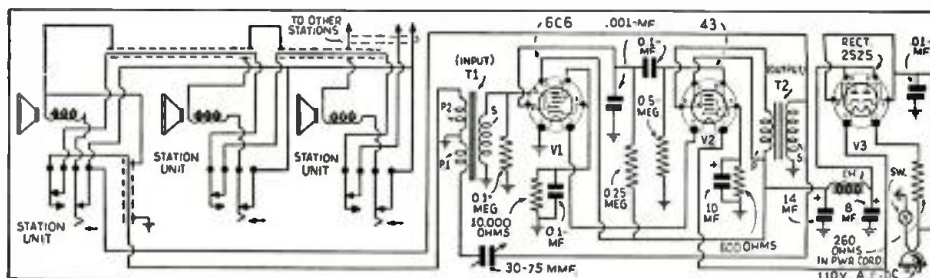

Fig. 1. The circuit of the selective-type private-address unit described.

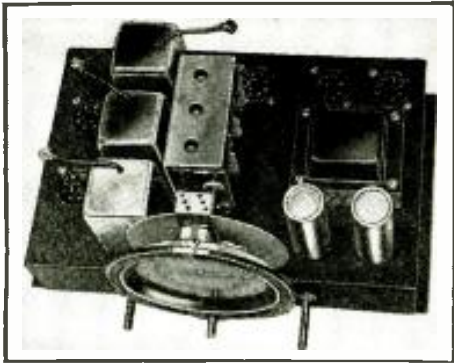

Fig. A. The chassis of the completed receiver.

A SIMPLE T.R.F. RECEIVER WITH A.V.C.

High-gain coils and tubes makes this T.R.F. set a rival for superhets. of equivalent size.

CLIFFORD E. DENTON.....

enhanced the popularity of the Super. Today, high gain can be obtained with the new iron-core transformers and A.V.C. action is easily incorporated as a study of the circuit diagram of the

receiver being described discloses. Thus, if you are interested in a simple receiver for broadcast reception only, read on and get a new picture of the
(Continued on page 752)

SO MUCH attention has been given to Superhet. circuits for the last few years that the T.R.F. receiver seems to be a lost factor in modern design. Many readers will remember the fine results obtained with T.R.F. jobs. In fact many a word battle took place when a "super fan" tangled with a "T.R.F. bug." In the early days, the T.R.F. receivers were in the majority but the Super faction slowly grew until those famous initials were only to be found in a text book. Of course the Super advocates had to add T.R.F. in front of their Supers to obtain the present type of set that is accepted as worthwhile.

Without going into the "pros" and "cons" to any extent it is apparent that the greater gain and the simplicity of obtaining A.V.C. action were two of the major contributing factors which

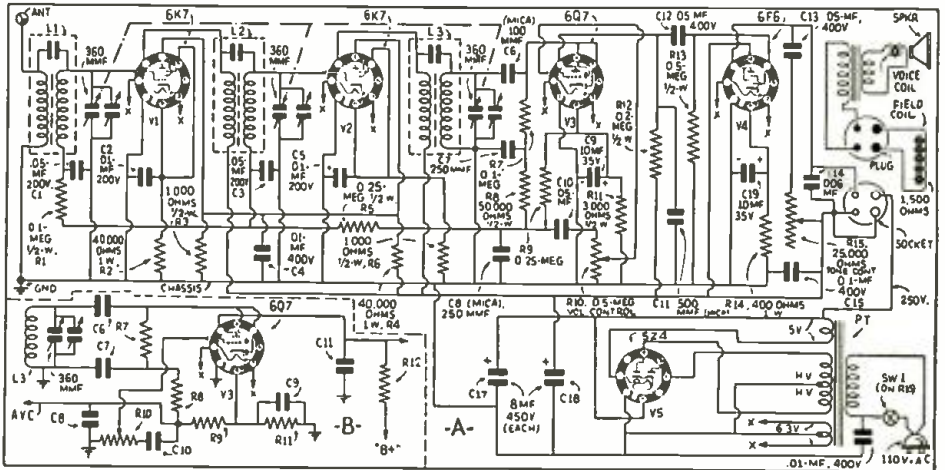

Fig. I. Schematic circuit of the receiver and a detail drawing of the A.V.C. scheme.

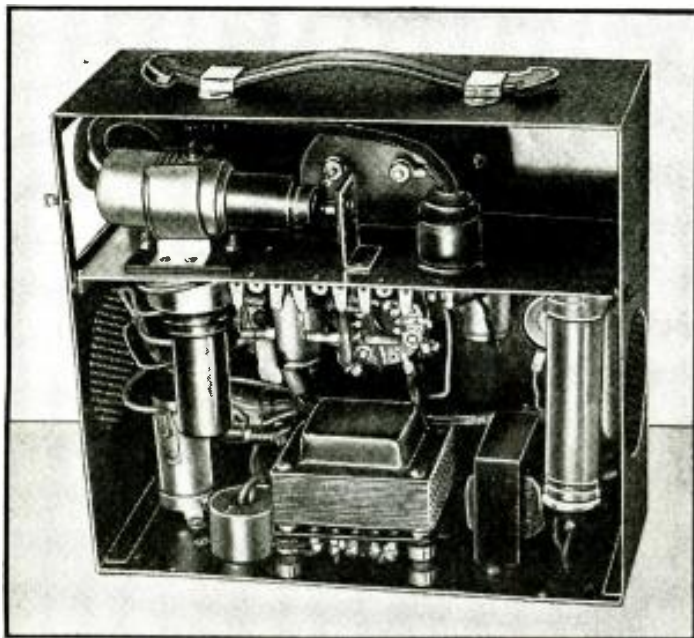

Fig. B. The interior of the V.-T. voltmeter cabinet.

HOW TO USE V.-T. VOLTMETERS IN RADIO AND P.A. SERVICING

The "peak" V.-T. meter of the instrument described can also be used for D.C. measurements.

PART III—D.C. MEASUREMENTS

KENDALL CLOUGH.....

plete solution of the problem. There are many circuits that cannot be shunted with even this high value of resistance without affecting their total resistance, and the voltages existing therein.

The modern combination vacuum-tube voltmeter and peak voltmeter with an input resistance of over 5 megohms offers incomparably greater freedom from this difficulty and allows accurate voltage measurement in even the highest resistance circuits. Likewise, it has many other applications to radio receiver servicing, such as in the adjustment of automatic-frequency-control circuits.

CHECKING A.V.C. VOLTAGES

The peak voltage scales of the instrument should be used for this measurement. In using the combination peak voltmeter to measure D.C. voltages, it must be remembered that the peak and R.M.S. values of a D.C. voltage are the same and the values indicated on this instrument are identical to those secured by the use of a d'Arsonval meter, providing
(Continued on page 755)

THE VACUUM-TUBE peak voltmeter may be used to measure direct current as well, without introducing additional current drain to the circuit and thus distorting circuit conditions.

Recent receiver developments have brought to the front the need for a measuring device in receiver servicing, having a higher input impedance. To attain this, new d'Arsonval meter movements of greater resistance, some as high as 20,000 ohms-per-volt on their base scale have been developed and employed in analyzers. These instruments are without doubt a noteworthy advance, but are not the com-

HOW TO MAKE THE RADIO-CRAFT DELUXE CARRIER INTERPHONE

Details of construction and operation of this unusually complete "private-address" and radio system designed by Messrs. Washburne and Adams are given in this Part.

PART II

HAVING completed the design of the Deluxe Carrier Interphone, we can now proceed to assemble the desired number of units for the projected installation. Compactness is desirable in a device which is to be kept on an office desk, and a rather small chassis is more or less required. The particular size used in the lab. model shown in the photos (in Part I) lends itself to the design rather well—but calls for some rather careful work if all the necessary parts are to be installed above and beneath the chassis. As a matter of fact, one of the bypass electrolytics had to be mounted on the side wall, and the builder might just as well figure on the same procedure unless the round, physically-small electrolytics for both 25A6 and 6C5 A.F. cathode bypass are used. Space for these might be found somewhere.

The variable condenser, a small 3-gang type, is mounted to the right and positioned to permit speaker-dial control. The speaker itself is mounted on right angle brackets extending well out beyond the chassis front drop and is then bent back on its supports until it hits the I.F. transformer, located immediately behind the reproducer. It, therefore, faces not only forward but slightly upward—and at an angle permitting the operator to talk down and into it when transmitting.

The regular speaker output transformer is mounted to the left of the dynamic and the filter choke behind the I.F. coil shield can. Tube placement is readily understood by referring to both the chassis layout diagram and the chassis photographs in Part I.

The audio volume control in the 25A6 control-grid circuit is not mounted on the chassis but is left free for placement directly on a cabinet and in line with the knob controlling the tuning of the radio. It is equipped with switch for A.C., line on-off, and all lead wires are brought to it through grommets from under-chassis components.

The front drop supports the two 3-way switches—one for radio—listen—talk, the other for operating frequency selection. No phone jack is provided, it being thought that the individual builder will prefer to mount such an item directly on the cabinet.

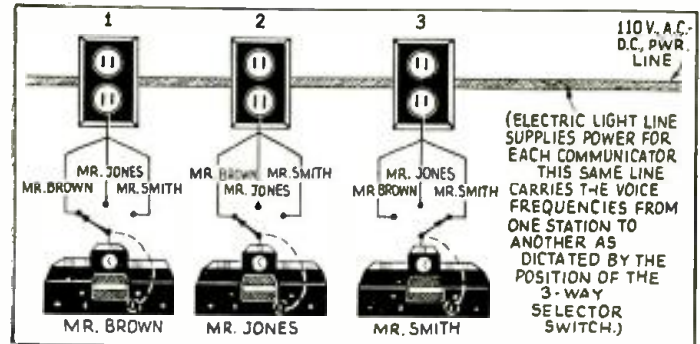

Fig. 3. Block hookup of four of the deluxe interphone units.

Very little need be said about the wiring. Keep leads as short as possible, wire in bypass and other components right where they belong—and remember that the rather compact construction calls for every care in isolating circuits. Keep the capacity between coupling condensers and filter electrolytics low by separating these components as much as is physically possible.

Inside the chassis, on the front wall, is mounted the universal output transformer used here as an input affair for matching the speaker into the audio amplifier for voice transmission. Connect its center-tap lead to the switch for detector tube feed on "listen," its brown lead to "B plus," its green lead through a coupling condenser to the control-grid circuit of the 1st A.F. amplifier.

The antenna coil (for radio input) is mounted above-chassis behind the tuning condenser and is positioned to permit short leads to both condenser stator and R.F. tube. Radio frequency and oscillator coils are placed below chassis, with that for the R.F. supported on the right-hand wall, and that for the oscillator circuit on the rear drop and near the padding or low-frequency limit alignment trimmer.

The "B minus" lead is not connected directly to the chassis but the variable condenser stator is so connected through its frame. To complete the L/C circuits in the radio tuner,

(Continued on page 763)

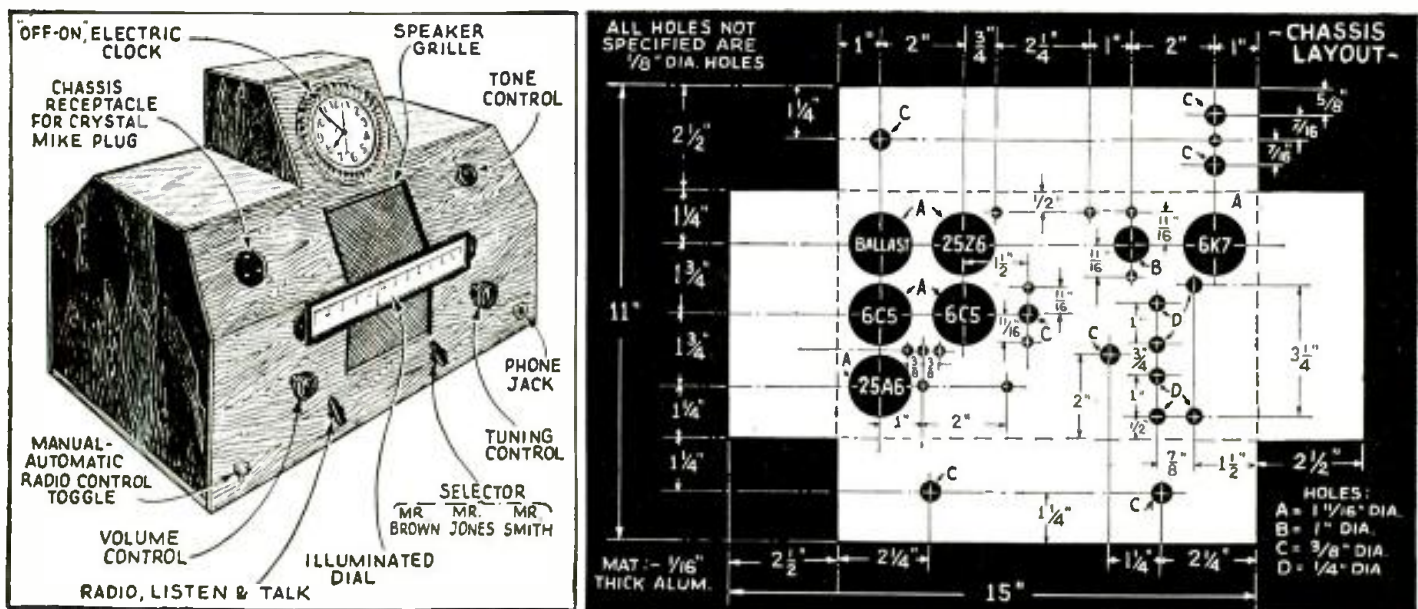

Fig. 2. The appearance of the complete unit with its control clock. The chassis details are given at the right.

THE LATEST RADIO EQUIPMENT

This department brings to you each month the newest developments in electronic, radio and public-address equipment. Aggressive technicians use this department to keep posted on the newer and better ways of doing things.



School portable recorder. (1351)

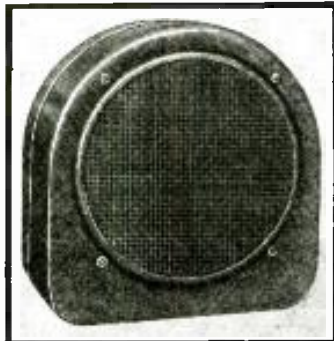

Novel-grille P.M. unit. (1356)



Emission-type tube test. (1357)

sound output may be secured. Either stud or base mounted. Universal output transformer.

NEW TUBE TESTER (1357) (The Readrite Meter Works)

AN EMISSION-TYPE circuit for quick and accurate testing is utilized. Instrument checks any type radio tube for value, shorts and inter-element leakages, under load conditions, in 4 operations. Size, 5 7/8 x 7 7/8 x 4 1/4 ins. deep. Panel finish, modernistic silver and black.

FACTORY CALL-SYSTEM (1358)

HERE is a factory call-system adaptable to any size factory from the smallest to the largest. It may be wired into circuit in place of existing lights or buzzers. One end of the system in use is illustrated (note reproducer recessed into wall); together with a close-up of one of the permanent-magnet dynamic reproducers in an optional desk box.

2-WAY AIRPLANE STATION (1359)

DESIGNED to operate from the 12-V. airplane storage battery this new instrument incorporates the newest ideas in aircraft radio equipment. Output, 30 to 40 W.—either phone or C.W. Affords inter-phone operation for communication between pilot and co-pilot, etc. Crystal-controlled output on 45 to 110 meters. Uses metal-beam power tubes (see illustration). Transmitter weighs about 18 lbs. An ideal instrument for the private flier.

(Continued on page 757)



Handy kit of vibrators. (1360)

SCHOOL-TYPE PORTABLE RECORDER (1351) (Universal Microphone Co.)

A SOUND recorder especially designed to meet the needs of schools and colleges and said to be the smallest in size and weight of any recording machine yet devised, is illustrated. The black leatherette case measures 16 x 22 x 9 ins. deep; weight, about 50 lbs. Includes velocity microphone, folding mike stand, and complete recorder and playback equipment for instantaneous work. The high-gain amplifier incorporates a low- and high-pass filter. Neon volume indicator. Designed to enable the novice to make good recordings.

values to 1 meg. and switch capacity of 15 A. at 10 V. Note their comparative size with match book.

IMPROVED VOLUME AND TONE CONTROL (1354) (International Resistance Co.)

THE MANUFACTURER of this new unit outlines its improvements as follows:

Metallized-type resistance element is permanently bonded to a moisture-proof bakelite base. Terminals deeply fitted in molded bakelite casing will not break off or loosen. Smooth motion is obtained by using 5 contactors. Contacts are corrosion-proof. Case is bakelite. Outside diameter, 1 1/4 ins.

MOBILE P.A. SYSTEM (1355)

A JUMPER plug in this twin (permanent-magnet) speaker sound system permits optional 110 V. A.C. or 6 V. D.C. operation. Input provides for crystal microphone, crystal pickup, and radio tuner. Utilizes 7 tubes with two 6B5s in the output. Note that the 2-speed turntable mounting board may be tilted to maintain a level position. Weight 56 lbs.

CAR-RADIO P.M. SPEAKER (1356) (Wright-DeCoster, Inc.)

AN IMPROVED permanent-magnet (Nokoil) reproducer is available for use in auto-radio installations. The screen covering the grille opening is dusted with a fibre which gives a rich, velvet-finish appearance. Yet, there is no grille cloth of any kind and thus the full

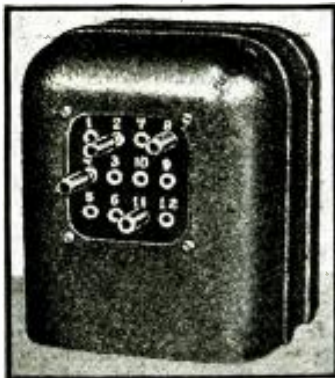

A "multi-match" transformer. (1352)

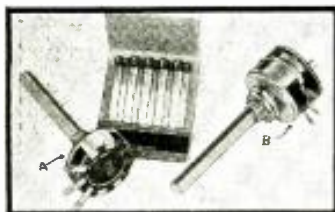

Auto-radio midget resistor. (1353)

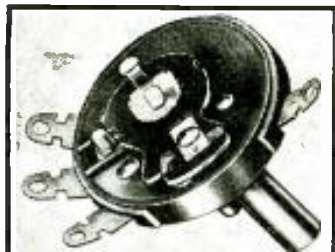

Improved control resistor. (1354)

VARIABLE MATCHING TRANSFORMER (1352) (Thordarson Electric Mfg. Co.)

TERMED as a "multi-match modulation transformer" this unit provides quick matching of any tube to any load. Plug connection is made to jacks on a terminal board, for input and output. Case design is modernistic. The unit is weather-proofed. Available in 4 watts ratings from 50 W. to 500 W.

MIDGET POTENTIOMETER (1353) (Centralab)

AUTO-RADIO technicians will be interested in the newest small-space variable resistor. Case diameter is 1 3/64 ins.; depth of plain controls (A) is 25/64 ins.; and of switch type (B) is 23/32-in. The long aluminum shafts may be cut to length. Available with requisite replacement characteristic. Resistance

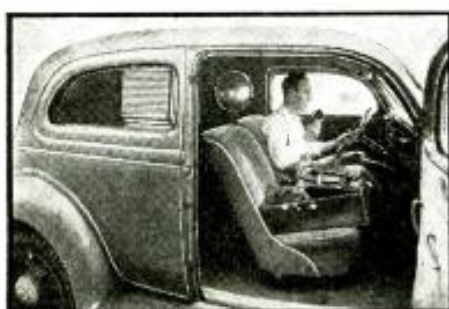

Automobile P.A. system. (1355)



A factory call-system. Note wall reproducer. (1358)

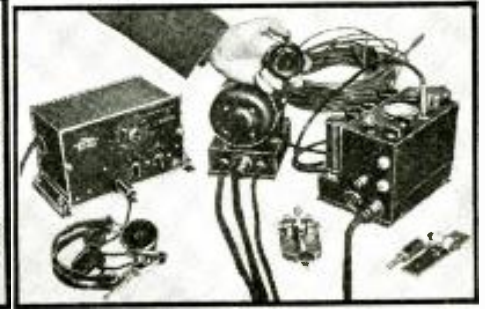
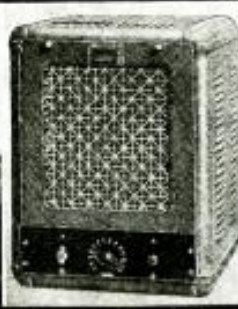

A tri-service 'plane transmitter-receiver. (1359)

Name and address of any manufacturer will be sent on receipt of self-addressed, stamped envelope. Kindly give (number) in above description of device.

SILVERTONE MODELS 4488 AND 4588 (CHASSIS No.101412) AND 4488A AND 4588A (CHASSIS No. 101412A)

(For Complete Diagram see Data Sheet No. 291, on opposite page.)

13-Tube Superheterodyne, 4-band (540-1,500 kc., 1.5-4.5 mc., 6-11 mc., 10-18 mc.) A.F.C., "Flash-Tuning" to pre-selected stations, A.V.C., 12.8-W. Undistorted Output.

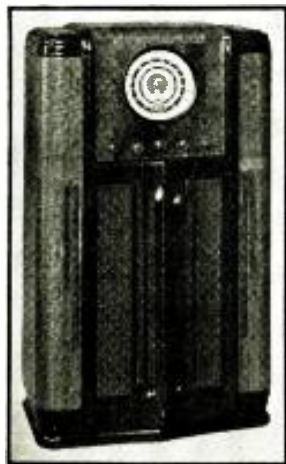

Fig. A. Silver-tone 4588; controls (L to R): "On-Off-Vol."; Waveband; Selector Tone Cont.; Flash-Tuning-Select.

This receiver is manufactured for Sears, Roebuck & Co. by Colonial Radio Corp., Buffalo, N. Y., from whom replacement parts should be ordered.

Intermediate frequency is 465 kc. To reduce code or other interference, a wavetrapped may be obtained, and inserted as in Figs. 2H and 2I, below. Its leads should be as short as mechanically possible, and excess lengths cut off. If

necessary, tune wavetrapped off the I.F. to that of the interference. It should be noted that this trap reduces sensitivity on the long-wave end of the broadcast band by 50 per cent.

If a whistle is heard on a 930 kc. station, this is due to a beat with 2nd harmonic of the I.F. If there is such a station, often listened to, the I.F. is altered by turning I.F.T. trimmers, with a signal generator, until it is, say, 457.5 kc. (Determine at what point on the tuning range the whistle would cause least interference—between stations, presumably—and divide this by 2. Half of 915 kc., for instance, is 457.5 kc., as above.)

Oscillator tube V4 is a 6C5G type. There are 2 models of this tube: one contains a perforated mesh screen, close to the inside of the bulb. This is not suitable for use on the short-wave ("Foreign") bands, and should not be used; obtain the "unshielded" 6C5G, which has no mesh screen and in which the plate of the tube (about 3/4-in. dia.) can be seen.

The voltage drop across the 1/2-meg. resistor, R, is used to obtain automatic volume control, as well as frequency control; while the .004-mf. condenser, C37, feeds the audio

signal to V8.

Audio howl may be due to failure to remove wooden strips under the chassis as shipped, or pieces of tape at the rear holding dial housing to cabinet. Remove these and let chassis rest on rubber cushions.

The center dial light is removed by pulling the small handle projecting from rear-center of housing. Be careful not to push lamp holder too far, after replacing. (Fig. 2G.)

The Flash-Tuning lamp is removed through a small snap cover on the top of the dial housing (see Fig. 2G). Dial pointer should be straight up, and arm that carries lamp exactly in line with it. If light is only slightly out of line, adjust lamp shade.

Band-indicator light is protected against excessive voltage by special resistor; but, if replacement is necessary, chassis must be taken out and dial removed. This is done by taking off knobs, 4 screws under shelf and 1 in speaker plug, which pull out. Then turn middle (selector) shaft full to right—note position of pointer on dial—remove pointer and bend up tabs that hold dial in housing, just enough to remove it. This shows Band Ind. light and shield. Replace shield to give even illumination; note that dial pointer is at proper setting.

Variable selectivity in this receiver is obtained through Sw.2, which changes number of turns in circuit coupling Pri. and Sec. of A.F.T.1. It also turns in the "Flash-Tuning circuit" at which setting tuning is broad and high-frequency audio response increased.

To adjust the A.F.C. circuit, set for "Broad" tuning, Vol. and Tone controls full right. Apply signal at 1,050 kc., 5,000 microvolts output, to antenna through 200 mmf. condenser. Tune receiver to max. signal; switch off modulation of signal; short the movable arm to toothed disc (see Fig. 2C) and light should flash. Apply signal (from second generator) at 465 kc., 10,000 microvolts, through 15 mmf. condenser to control-grid of V2. Tune to zero beat.

Now turn to "Flash-Tuning" position, and adjust trimmer of I.F.T.3 (discriminator unit) for zero beat, about the middle of setting. This is very sharp. Turn back to "Sharp" and then "Broad" tuning; if this affects zero-beat setting, carefully repeat operation just previously described. If the A.F.C. is operating properly, the 1,050 kc. signal can be detuned to 15 or 20 kc. off,

before output meter reading is reduced two-thirds.

The Flash-Tuning system is set up, with pre-selected stations, by removing glass in front panel, held by ring. (See Fig. 2D.) Select list of desired stations (locals or other strong daylight signals, broadcast range, only). Turn switch to "Sharp" tuning, and tune in first station. Then, from rear of set, mark tooth (front or rear on disc—Fig. 2C) nearest rounded projection of spring arm. Turn off radio, tune with selector knob until marked tooth is clear of selector arm, and bend tooth straight up. (The illustration shows a tooth specially designed for this purpose.) Be sure the whole tooth is bent up. This tooth will touch the projection on the spring arm, and light the Flash-Tuning lamp, when the disc is rotated with "F" setting of selectivity knob. Continue until desired stations have been located and marked. Test with the "F" setting; slip a celluloid tab over call letters, and insert under holder (Fig. 2B). Replace glass (Fig. 2A). If 2 powerful stations are so close together that they interfere, the tuning may be obtained with 2 teeth slightly further apart than those originally selected.

If the Flash mechanism does not work satisfactorily, check the movable arm for contact, and set the adjusting screw to touch only bent-up teeth. Check the relay, and keep contacts free from dust. It should close with 60 ma. current; check with 6-V. battery, 100-ohm rheostat and milliammeter.

The relay model has been changed; replacements will be made with new relay—colored leads. Fig. 2E shows connections of old relay; Fig. 2F of new.

Voltage readings are as follows, with 325 V. on rectifier (those omitted are very low):

Terminals	3	4	5	8
V1, V2	255	110	7	7
V3	255	110	4 1/2	4 1/2
V4	90
V5	190	90	...	4 1/4
V8	110
V9	155	12
V10	165	12
V11, V12	280	290

Power transformer code: 110 V., black, green; V13 fl., red; H.-V. center-tap, slate; plates, red and blue; dial lights, black.

Speaker plug: field coil leads, black and yellow; T1 primary brown, green; center-tap, red.

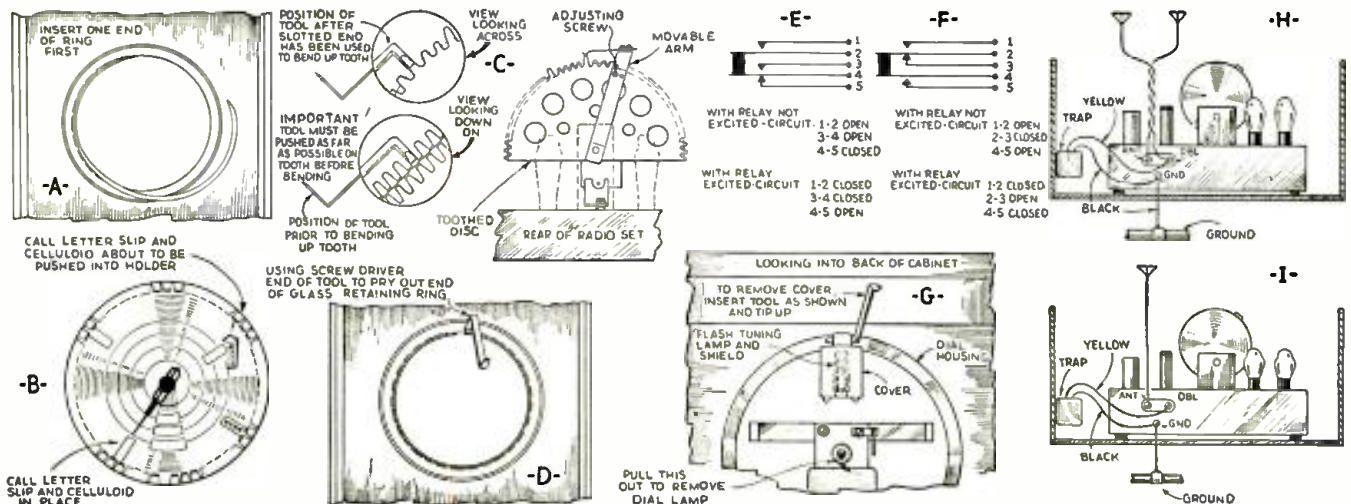

Fig. 2. Left. Inserting station call tabs for Flash-Tuning system, and turning up contact teeth on disc to engage movable arm of flash-tuner; E, old-type relay; F, present-type relay; G, how to replace lamps; H, I, use of wavetrapped with doublet and ordinary antenna.

SILVERTONE MODELS 4488 AND 4588 (CHASSIS No. 101412) AND 4488A AND 4588A (CHASSIS No. 101412A)

(Continued from Data Sheet No. 200.)

Alignment of I.F.T. is made with dial at 550 kc. signal at 465 kc. through 0.1-mf. condenser to control-grid of V2. Trim first I.F.T., then I.F.T.2. (See Fig. 2N.)
 R.F. alignments are as follows (capacities in the given order) for 4 bands "Am.," "Pol.," "For." 1 (outer) and "For." 2 (inner). Dial pointer has been set to fall on "10 mc." when condenser plates are fully meshed. (A 200 mmf. dummy antenna on "Am." 400-ohm on shorter waves.)
 Baml Signal Trimmers
 "Am." 1,400 kc. C28, C2, C10
 "Am." *600 kc. C27
 "Pol." 4 mc. C29, C3, C11
 "Pol." *1,650 kc. C33
 "For." 1 10 mc. C30†
 "For." 1 *6 mc. C34
 "For." 1 10 mc. C4, C12
 "For." 1 6,300 kc. C1†, C9†
 "For." 2 17 mc. C31†
 "For." 2 17 mc. C5, C13
 "For." 2 *11 mc. C83
 †Generator frequency. Rock condenser back and forth to adjust to peak of greater capacity (trimmer screwed in).
 ‡Use bakelite screwdriver.
 Do not again touch adjustment.

Fig. 3. At J, connections, at rear of chassis, for phonograph jack, K, for ear phone (omit connections furthest from jack frame, if desired to operate speaker at same time). Phonograph must not be operated with "Flash-tuning" turned in. Right, physical layouts of chassis, showing trimmers. Relay contacts close "Flash-tuning" circuit to momentarily light up call letters.

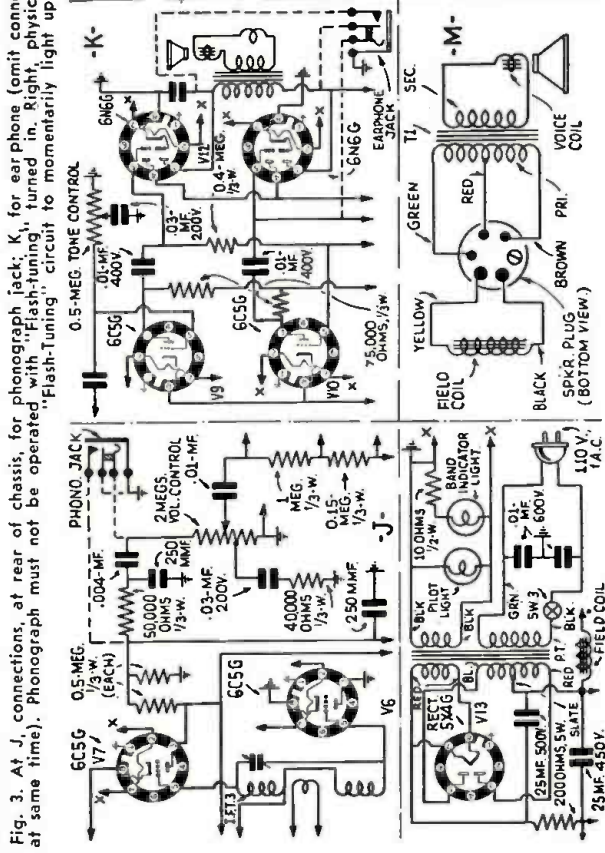
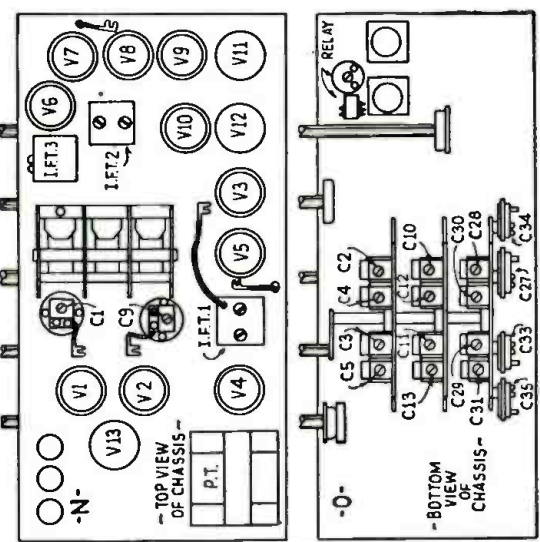
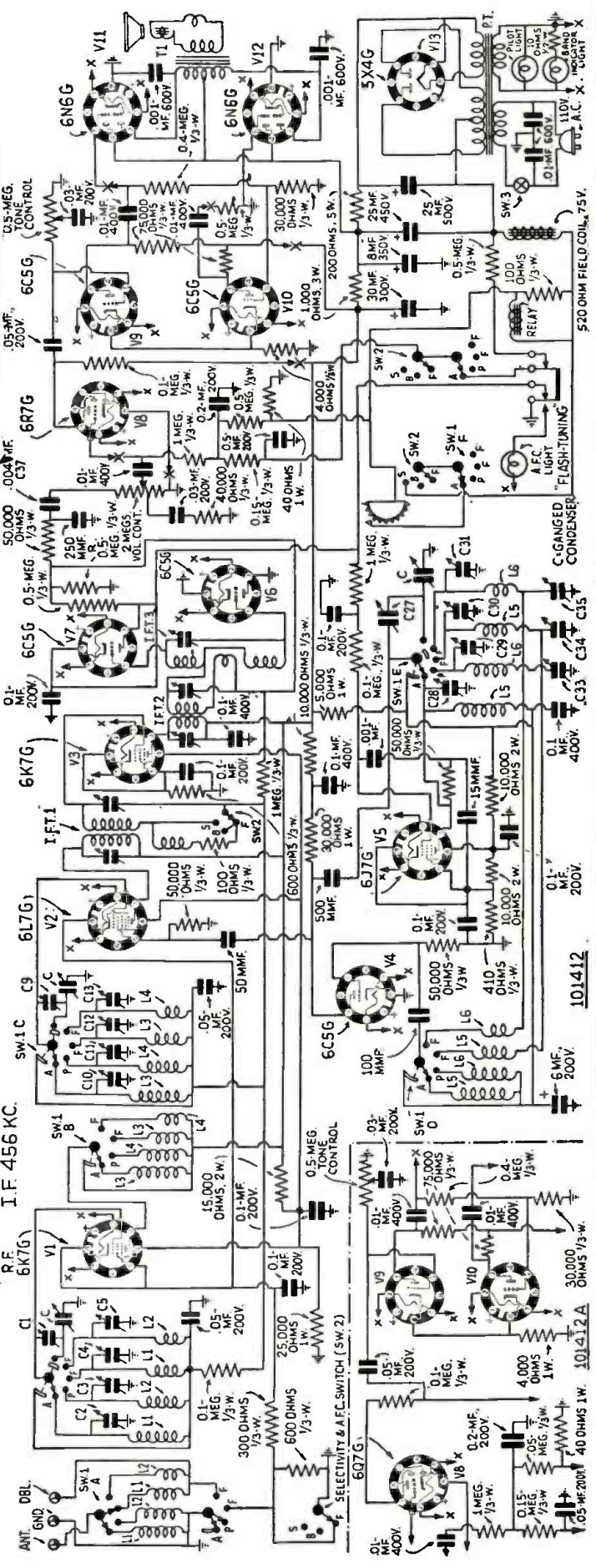

Fig. 4. The 412 and 412A chassis differ in type and connections of V8; latter are shown for 412A at lower-left. Tubes are classed as V1, R.F.; V2, translator; V3, I.F.; V4, Oscillator; V5, A.F.C. control; V6, discriminator; V7, discriminator; V8, 1st A.F.; V9, 2nd A.F.; V10, phase changer; V11, V12, output; V13, rectifier.



SAY, JIM, I'M 'PHONING YOU BIG NEWS!
SUPERIOR HAS A 100 KC TO 100 MC
SIGNAL GENERATOR with
CALIBRATED AUDIO
FREQUENCIES
AT ONLY \$14.40

GREAT!
THAT'S
JUST WHAT
I NEED! I'LL
GET ONE
RIGHT
AWAY!



GENEMETER

HERE'S a signal generator for your life—our Genemeter—extra large, for greatest accuracy, the highest type laboratory equipment. Ranking near the very top, it is priced near the very bottom!

The dial scale is full-size 15-inch diameter protraction. The hairline indicator permits reading to one part in 1,000.

Variable audio frequencies, 24 to 10,000 cycles, are included so all audio systems and components may be separately tested, using three bandspreads, 25-400, 400-5,000 and 5,000-10,000 cycles.

There is a built-in output meter, so that receiver output can be measured with r.f. modulated or by using audio input above.

Not only frequencies are tested, but capacities and all other factors whose leakage enters, by a separate leakage tester.

This is our finest signal generator the Genemeter, with negligible r-f leakage. Model GNT, in a shielded cabinet. fan type dial with separate shield, and expensive planetary drive and 4-1 vernier ratio. Order GNT (shipping weight 10 lbs.)

\$14.40

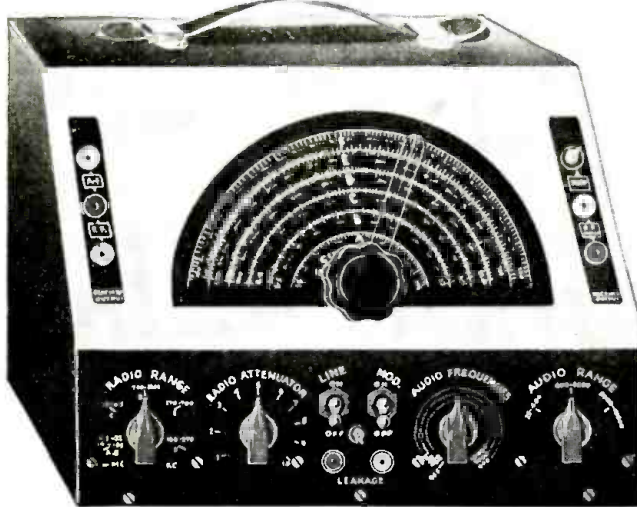

The handsome genemeter appesses the eye as well as the sense of accuracy and the pocketbook.

10 FEATURES

1. Radio frequencies covered on fundamentals. all direct-reading. 100 kc.—22 mc.. In five bands, by switch control. Frequencies to 105 mc. read directly, without confusion.
2. Audio frequencies from 25 to 10,000 cycles, in three steps, switch-controlled. Each band direct-reading in frequencies.
3. Modulation at 25 to 10,000 cycles, the full audio range, on or off by switching.
4. Output meter is built in, for connection across a high impedance, as output transformer primary, or prior grid or plate circuit.
5. Smooth r-f attenuation.
6. Separate posts for r-f and a-f output.
7. All leakages tested, including condensers, tubes, insulation; also shorts.
8. Stabilized r-f oscillator, with grid circuit unloaded.
9. Accuracy on i-f and broadcast frequencies 1/2 of 1 per cent, and for short waves 2 per cent.
10. Operation on a.c. or d.c., 90-130 volts, with high insulation from the line.

NEW 10-40 SERIES OF SUPERIOR TEST EQUIPMENT

Tube Tester

WE absolutely believe this instrument to be the best buy for either novice or expert technician. It is not only as thorough and accurate, but actually a faster tube tester than similar more elaborate and expensive instruments. Tests tubes on the emission principle and permits testing for shorts and leakage between elements so that positive accuracy in checking is obtained. Tests all types of tubes, whether UX or octal base, and allows for separate checking of diode, triode or pentode sections of composite tubes. Real rugged construction, and priced so low that no serviceman or constructor can afford to be without it. The following salient features are incorporated in this instrument:

- Tests all 4, 5, 6, 7S-7L and octal base tubes.
- Tests all diode, triode, pentode and tetrode receiving tubes, as well as many transmitting types.
- English reading meter, with "Bad-7-Good" scale.
- Incorporates Neon Test for determining leakage or shorts between elements.
- Attractively designed front panel, Metal Case. Dimensions: 10 x 6 1/2 x 5 3/4 inches.
- Compact and lightweight.

Ideal for Service Laboratory, or field servicing.
 Model V-45 with complete instructions **\$10.40**

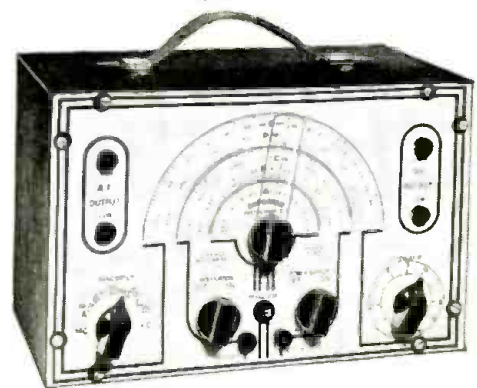

Oscimeter

BESIDES our large Genemeter we manufacture the lowest-priced all-wave signal generator on the market that works on a.c. or d.c. This instrument, the Oscimeter, is direct-reading in frequencies, is switch-operated, and has 1 per cent accuracy i-f and broadcast bands, and 2 per cent accuracy for short waves. Range in five steps is 100 kc. to 22 mc., all fundamentals. The dial scale is protracted on 6" diameter, the largest scale on a low-priced signal generator, and the indexing is by hair-line for extreme accuracy of reading. The bands are marked A, B, C, D and E on coil switch and scale dial scale, also in frequencies on both. The Oscimeter is equipped with attenuator, also with separate 1,000-cycle modulator tube and modulation on-off switch. It enables tests of leakage of condensers, tubes, etc., and affords independent audio output, for testing P.A. and other audio systems, including microphones, speakers, etc. R-f output may be at high or low impedance, by separate posts. Housed in black, wrinkle finish shield cabinet, the Oscimeter weighs 5 lbs. unpacked, and has handle for easy portability. Order Oscimeter Model T-40 (shipping weight 6 lbs.) @ **\$10.40**

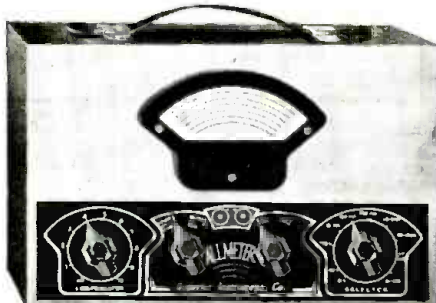

Allmeter

HERE'S a great innovation—a tester that besides making the usual d-c and resistance measurements, also measures resistances to 1 ohm and to 5 meg., likewise capacities from .0001 mfd. likewise capacities from .0001 mfd. to 12 mfd., and both a-c voltages and a-c currents. Yet the price is less than that of an ordinary d-c volt-ohm-ammeter. Imagine paying less for getting 2 1/2 times the amount of service—eight instruments in one, instead of only three!

This innovation, the ALLMETER, works on 90-130 volts d.c. or a.c. (any commercial frequency). For capacity measurements a.c. must be used.

Here are the eight services—the first five the extra ones at less cost, the last three the more usual ones for which you pay more than for the eight:

1. A-C Currents, 15-150-750 ma.
2. A-C Volts, 15-150-750. Serves as output meter, too.
3. High capacity, 1-12 mfd., including electrolytics.
4. Low capacity, .0001-1 mfd. for mica and small paper condensers.
5. Low ohms, .1-100 ohms.
6. High ohms, to 5 meg. (Also for all direct meter readings of all leakages)
7. D-C Volts 15-150-750.
8. D-C Currents, 15-150-750 ma.

\$10.40

Order Model AMR, complete (shipping weight 6 lbs.)



Remit stated prices and products will be shipped express collect. Or send 20 per cent, balance C.O.D. Send for our free Circular on our \$24.60 oscilloscope. Order Direct From

SUPERIOR INSTRUMENTS CO. 136 LIBERTY STREET NEW YORK, N. Y. Dept. RC-6

Please Say That You Saw It in RADIO-CRAFT

TECHNICIANS' DATA SERVICE

JOSEPH CALCATERRA

DIRECTOR



A NEW
BEGINNER'S RIG
USING
STANCOR TRANSFORMERS

● A 40 watt transmitter for c.w. operation that can be built for less than \$40.00 including tubes, crystal and meter. Crystal control . . . capacitive coupled . . . only 2 tuned circuits using the new 6L6G and the new Taylor T20. . . It's one of the simplest and most dependable beginner's rigs ever designed.

FREE
Schematic Drawings on Request

STANDARD TRANSFORMER CORPORATION

850 Blackhawk Street Chicago

AMPLITONE'S — NEWEST!!

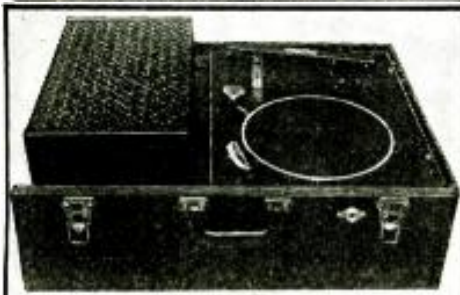

OUR 6 volt DC-110 volt AC universal amplifier, now offered in a complete portable system. May be used indoors or outdoors, for sound car. System consists of 26 watt universal amplifier mounted in carrying case with special motor and turntable and Crystal pickup. Amperite velocity microphone, heavy duty black and chrome floor stand, 25 feet microphone cable and plug, two Jensen 12 inch PM dynamic speakers mounted in "split" carrying case, 50 feet speaker cable and plugs, set of MATCHED RCA tubes. Entire system may be set up in 5 minutes. Two position mixer, allows for using microphone and phonograph together or independently. Voltage changeover easily made by simple toggle switch.

SPECIAL NET PRICE **\$105⁰⁰**

Write for FREE Catalog!

AMPLITONE PRODUCTS CO.
135 Liberty Street, New York, N. Y.

RADIO ENGINEERING



RCA Institutes offer an intensive course of high standard embracing all phases of radio. Practical training with modern equipment at New York and Chicago schools. Also specialized courses and Home Study Courses under "No obligation" plan. Catalog Dept. RT-37.

RCA INSTITUTES, Inc.

75 Varick St., New York 1154 Merchandise Mart, Chicago
Recognized Standard in Radio Instruction Since 1909.

A special arrangement between RADIO-CRAFT magazine and the publishers of this literature, which permits bulk mailings to interested RADIO-CRAFT readers, eliminates the trouble and expense of writing to each individual organization represented in this department.

2. HAMMARLUND CATALOG. Contains complete specifications, illustrations and prices on the Hammarlund line of variable and adjustable condensers; intermediate frequency transformers, coils and coil forms; sockets; shields; chokes and miscellaneous parts for broadcast, short wave and ultra-short wave reception and transmission. Also contains description and prices of the Hammarlund line of "Comet Pro" and "Super Pro" receivers.

5. ELECTRAD 1936 VOLUME CONTROL AND RESISTOR CATALOG. Contains 12 pages of data on Electrad standard and replacement volume controls. Truvolt adjustable resistors, vitreous wire-wound fixed and adjustable resistors and voltage dividers, precision wire-wound non-inductive resistors, center-tapped filament resistors, high-quality attenuators, power (50- and 150-watt) rheostats and other Electrad resistor specialties.

29. THE KEY TO SUCCESSFUL SERVICING. Four different types of combinations of courses on Radio Servicing, Public Address Work, and Television, developed by the Radio Service Institute, are described in this 24-page booklet. Complete information, including outlines of the courses and costs, is given. Two of the courses are designed for the more advanced and more ambitious Service Men who are anxious to get to the top of their profession. The other two courses are for less-experienced Service Men who want to advance more rapidly in the Radio Servicing Field. Please do not ask for this booklet unless you are interested in taking a course in these subjects.

53. POLYIRON COIL DATA SHEET 536. This folder contains complete catalog descriptions, specifications, prices, performance curves and circuits showing applications of the complete line of Polyiron radio components made by the Aladdin Radio Industries, Inc.

57. RIBBON MICROPHONES AND HOW TO USE THEM. Describes the principles and operating characteristics of the Amperite velocity microphones. Also gives a diagram of an excellent humless A.C. and battery-operated preamplifier.

65. THE 1937 LINE OF SUPREME TESTING INSTRUMENTS. This 24-page catalog gives complete information on the entire Supreme line of testing instruments, including the Model 585 Diagonometer; the Model 540 and 550 Radio Testers; the Model 500 Automatic; the Model 505 Tube Tester; the Model 555 Diagonoscope and other Supreme oscilloscopes, tube testers, signal generators and multimeters. Complete details of the Supreme Easy Payment Plan for purchasing testing equipment on the installment plan are also given.

66. SUPREME DESIGN MANUAL "A" OF TUBE AND RADIO TESTING CIRCUITS. This interesting and useful 60-page handbook covers the fundamental principles of meters, measuring instruments and test circuits and illustrates, with detailed explanations, the basic circuits used in Supreme Testing Instruments. Every Service Man who is interested in the "why" of testing circuits should have a copy of this handbook in his kit.

73. HOW TO ELIMINATE RADIO INTERFERENCE. A handy folder which gives very complete information on how to determine and locate the sources of radio noise by means of the Sprague Interference Analyzer. A description of the

Radio-Craft Technicians' Data Service
99 Hudson Street,
New York City, N. Y. RC-637

Please send to me, without charge or obligation, the catalog, booklets, etc. the numbers of which I have circled below.

2	5	29	53	57	65	73
74	75	76				

My radio connection is checked below:

- Service Man operating own business.
- Service Man for manufacturer.
- Service Man for jobber.
- Service Man for dealer.
- Service Man for servicing company.
- Dealer.
- Jobber.
- Experimenter.
- Professional Set Builder.
- Amateur Set Builder.
- Short Wave Work.
- Licensed Amateur.
- Station Operator.
- Radio Engineer.
- Laboratory Technician.
- Public Address Worker.
- Manufacturer's Executive.
- Student.
-

I am a:

Subscriber Newsstand reader
I buy approximately \$..... of radio material a month. (Please answer without exaggeration or not at all.)

Name

Address

City State
(Please print name and address)

Avoid delay. The catalogs and booklets listed are now in stock and will be sent promptly as long as the supply lasts. Please use this coupon in ordering. The use of a letter causes delay.

analyzer and method of using it is included, together with data on how to eliminate interference of various kinds once the source is located.

74. SPRAGUE 1936 ELECTROLYTIC AND PAPER CONDENSER CATALOG. Gives specifications, with list and net prices on a complete line of wet and dry electrolytic, and paper condensers made by the Sprague Products Co. for radio Service Men, set builders, experimenters and engineers. Information on the Sprague Capacity Indicator, for making capacity tests on condensers and in servicing receivers, is included.

75. SPRAGUE TEL-U-HOW CONDENSER GUIDE. A valuable chart, compiled by the Sprague Products Co. which tells the proper types, capacity values and voltages of condensers required in the various circuits of radio receivers and amplifiers, and how to locate radio troubles due to defective condensers. Includes data on condenser calculations.

76. FACTS YOU SHOULD KNOW ABOUT CONDENSERS. A folder, prepared by the Sprague Products Co., which explains the importance of various characteristics of condensers, such as power-factor, leakage, capacity and voltage in determining the efficiency or suitability of a given condenser to provide maximum filtering and safety in operation.

SERVICING QUESTIONS & ANSWERS

(Continued from page 727)

OSCILLATION

receiver, and find the tuning-meter burnt out. Please explain why this occurred.

(A.) We have received quite a few inquiries on this model with burned-out tuning indicators, and this is usually due to a shorted bypass condenser located in a metal housing together with the screen-grid bypass units. Quite a few inquiries regarding fading on this receiver are attributed to faulty bypass condensers which have been found to become leaky. To facilitate further repeat calls on this receiver it is advisable to replace the entire bypass block.

(6) Walter Brown, Austin, Texas.
(Q.) On the Stromberg-Carlson Model 48 I find that an uncontrollable oscillation takes place upon removing first I.F. tube shield. Kindly explain the reason for this.

(A.) With the development of modern tubes a great amplification is possible simply by correct methods of shielding the various tubes as well as all associate components. Therefore it is absolutely essential for the tube shield to be on.

Please Say That You Saw It in RADIO-CRAFT

**RCA ALL
THE WAY**

RCA Radio News

RCA Manufacturing Company, Inc. • Camden, New Jersey
A Service of the Radio Corporation of America

**EVERYTHING IN
RADIO-MICROPHONE
TO LOUDSPEAKER**

To the consumer, RCA means high quality performance at low cost... To the radio man, RCA means easier selling, higher profits

GET NEW CATALOG FREE!

*It's a 32-page Illustrated Booklet on
RCA Test Equipment, Accessories, Parts*



Here it is—hot off the press! A valuable, 32-page illustrated catalog telling about RCA's complete line of test equipment, accessories and parts. Will prove extremely useful to you in service work. Ask your RCA parts distributor how you can get

yours absolutely free—but ask him *today*, before the rush for this fine booklet exhausts his supply!

You Can Make Extra Profits With This New RCA Extension Speaker

There are lots of people who would like to have an extra loudspeaker for use in their playroom, den, porch or garden. And this new RCA extension speaker is ideal!



STOCK NO. 9696

Not only is it light and portable—but it provides excellent tone. In a beautifully carved cabinet it will enhance the appearance of any room. And it costs only \$9.50 list.

Take it with you on service calls. Demonstrate its great usefulness to your customers. It will prove a fine aid to extra profits. Comes complete with 6-inch P.M. speaker, universal matching transformer and switch.

New Radio Program Provides Free Radio Instruction...Free Prizes

RCA, in cooperation with your local RCA tube or parts distributor, is sponsoring a new, weekly radio broadcast on 50 stations from coast to coast, solely for the benefit of radio service men. This fine new program

teaches radio technicalities. Keeps you up-to-the-minute on latest radio developments. Shows the way to more service jobs. Tells how to make sales.

Not only does this program teach—but it offers a chance to win valuable prizes as well. Your local RCA parts distributor will give you full details on request. Ask him today. Tune in for the next broadcast.

The RCA Radiotron Spring "Check-Up" Plan Gives Old Radios New Life... And Means More Service Jobs!

The RCA Radiotron Spring "Check-Up" Plan consisting of a 10-point radio check-up service costing \$1.50 exclusive of parts, is of interest to 73% of the homes in your community, for that many have a radio.

Check-ups are part of American life. People are used to automobile and dental check-ups. Hence they can see the wisdom of a radio check-up. And the RCA Check-Up means giving weak, worn-out radios new life and vigor—restoring to them "new set" tone and performance!

Service men will find, as others have, that the check-up promotes sales of service and parts, new sets and other appliances that they stock. Moreover, they visit sick radios on the basis of "service"—not "sales". And that's a valuable point in their favor. In addition, they get paid for the service they render and, at the same time, are afforded an opportunity to help their customers select other merchandise they may need.

Service Men Get Selling Help from RCA

In order to help you sell this service RCA Radiotron is running full column advertisements in The Saturday Evening Post and Collier's every other week... newspaper ads in over 100 cities... and features the check-up with commercials on a full hour radio program every Sunday. And in all cases YOU are mentioned as the man for the consumer to call in! Besides this, Radiotron also offers you several mailing pieces for your own use—mailing pieces that will produce results. Get some. Use them. Back up this Plan. It will pay you well! Also ask your jobber for details of the new auto radio check-up.

Facts Prove RCA All The Way Means Better Radio

Radio holds many thrills in store for listeners every day. But there's no radio thrill that compares with the thrill of owning a set that gives you the benefits of RCA All The Way reception. And only with an RCA Victor radio can you get this reception!

Here are five facts offering strong proof that RCA All The Way means better radio. Read them. Then have your nearest RCA Victor dealer give you an actual demonstration of radio that's RCA All The Way—from the microphone in the studio to the receiving set in your home.

1 Through the National Broadcasting Company, one of the RCA family, RCA creates and broadcasts the majority of network programs.

2 The actual broadcasting of many programs is done with RCA equipment. More than half the broadcast power on the air is RCA installed.

3 From practical experience in radio communication with 47 foreign countries and ships on all seas, RCA knows how to build superb short wave broadcasting and receiving equipment.

4 RCA is the only company that does everything in radio—from original research to broadcasting.

5 RCA is the only company that makes everything in radio—from microphone to receiving sets.

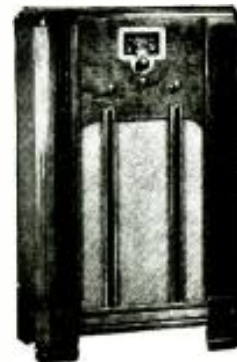

RCA Victor 1937 radios (Model 6K-1 shown here, \$52.95) range in price from \$20.00 up. Including such outstanding RCA Victor features as Magic Brain, Magic Eye, MagicVoice, Metal Tubes and many others, they are today, more than ever, radio's greatest values!

New Tube Manual!

The RC-13 Manual on RCA Radio Tubes gives service men complete information on all receiving tube types including Metal and G-Series tubes. Get your copy from your RCA tube distributor.

Please Say That You Saw It in RADIO-CRAFT

EVERY SERVICE MAN SHOULD OWN THIS COMBINATION VOLT-OHM-MILLIAMMETER AND FREE POINT TESTER



MODEL 640-740

Precision Built DEALER PRICE **\$27.00**

DESIGNED TO WITHSTAND ROUGH FIELD SERVICING NO EXTRA CASES TO BUY

Just what you need for field use. Every service shop should own duplicate servicing instruments as protection against rush work, instruments damaged in service, and for taking care of other emergencies.

The Ranger-Examiner Model 640 Free Point Tester has eight automatic switch type and ten single action jacks. Five sockets for any type radio tube.

Model 740 Volt-Ohm-Milliammeter has 3" Square Trip, et Precision Instrument. Scale readings: 10-50-250-500-1000 A.C. and D.C. Volts at 1000 Ohms per Volt (D.C. Accuracy 2%; A.C. 5%); 1-10-50-250 D.C. M.A.; 0-300 low Ohms; High Ohms to 250,000 at 1.5 Volts. (Rheostat adjustment for 13½ volts for Ohm readings to 2.5 Megohms.) Batteries may be added permitting such readings in 250,000 ohms steps. Low Ohms to ½ ohm with 25 ohms in center of scale. Backup circuit used. Current draw is only 1 M.A.

Dealer Net

Model 640-740 Portable Free Point Tester and Volt-Ohm-Milliammeter\$27.00

Model 640—Free Point Tester only, in Portable Case 9.90

Model 740—Volt-Ohm-Milliammeter only, in Portable Case 18.60

FREE

Booklet, Lists 101 most frequent Radio Troubles, How to Detect and How to Cure. Nothing like it before. Greatly simplifies every-day servicing. Send coupon now.



Readrite Meter Works
616 College Dr., Bluffton, Ohio

□ Please send me more information on Model 640-740; □ Model 640; □ Model 740; □ Free Booklet, "101 Radio Troubles and Their Cures."

Name

Address

City State

MAKING THE RADIO-CRAFT SIMPLIFIED CARRIER INTERPHONE

(Continued from page 713)

but where highest quality pick-up is essential, some sort of equalizing input filter (high pass) so engineered as to attenuate the low-frequency response of the speaker to proper microphone working level is essential. In Fig. 1B are circuit data covering the wiring in of typical standard equalizers designed for use with 500 ohm nokoil speakers.

There should be no trouble with hum if C14 and C15 are of high enough value. Increase their value beyond specified figures if necessary. Check back on filament wiring, remembering that tubes such as the detector and first A.F. amplifier should be filament-connected as electrically close in the series line-up to "B minus" as possible (because of cathode to filament leakage). Use selected tubes, chosen to give humless operation. If a 25A7 has been substituted for the 25A6 modulator and 25Z6 rectifier, be particularly careful in such selection.

Most buildings are wired "three-phase." That is, the pole transformer feeding an individual building has 3 secondary windings, 2 of which are the voltage supply sources for particular groups of A.C. outlets. Such wiring presents certain obstacles to communication between units when such units are not on one single phase line.

Consider a single unit working as transmitter. It feeds into the line, Fig. 2, and will get as far as the pole transformer. If another unit is A.C. connected to this same line at any proper outlet, it receives the signal. If it is connected in the other phase line it will not receive the signal, as there will be no return for the complete circuit. It will be necessary here to provide a return through some auxiliary conductor (connecting C7 in the individual unit to that conductor, which may be ungrounded buzzer wiring or structural steel, etc., or simply a separate lead) or connect a high voltage .1-mf. capacity across the two "hot" phase line leads at points X and Y—such points being located on the outlet wiring side of the fuses. The .1-mf. capacity should certainly do the trick, but it must be properly placed.

LIST OF PARTS

- One Aerovox mica condenser, type 1468, 250 mmf., C1;
- Two Aerovox condensers, type 284, 0.006-mf., C2, C12;
- One Aerovox condenser, type 684, 0.1-mf. (C3 is trimmer in coil can, C4 also), C7;
- Two Aerovox condensers, type 284, 0.05-mf. (C8 value may be smaller to attenuate speaker low-frequency response on "speak"), C8, C10;
- Two Aerovox electrolytic condensers, type PR25, 5 mf., C9, C11;
- One Aerovox condenser, type 284, 0.25-mf., C13;
- Two Aerovox electrolytic condensers, type PR2, 8 mf., C14, C15;

- Two Aerovox condensers, type 284, 0.1-mf., C16, C17;
 - One Continental Carbon insulated resistor, type M5, 1 meg., R1;
 - One Continental Carbon resistor, type M5, 10,000 ohms, R2;
 - One Continental Carbon resistor, type M5, 0.1-meg., R3;
 - One Continental Carbon resistor, type M5, 5,000 ohms, R4;
 - One Continental Carbon resistor, type M5, 0.25-meg., R5;
 - One Electrad potentiometer, 0.5-meg., R6;
 - One Continental Carbon resistor, type M5, 1,000 ohms, R7;
 - One Meissner I.F. transformer, type 5702, 175 kc., or one I.F. transformer, type 5714, 456 kc., or one B.C. R.F. coil, type 2437, I.F.T.1;
 - *One universal output transformer (500 or V.C. secondary optional), T1;
 - One Wright-DeCoster Nokoil reproducer, type 482, with transformer wound for 10,000 ohms impedance, or one similar Nokoil reproducer with transformer wound for 500 ohms impedance and one Wright-DeCoster Nokoil equalizer, type 674, (500-ohm transformer and equalizer optional);
 - One ballast for Fig. 1 line-up, type K-42-B, or substitute value for proper operation, V5-R8;
 - One set of General Electric or National Union tubes: 1-25A6, 1-25Z6, 1-6F5, or 1-25A6; 1-6F5, 1-25Z6, 1-6J7, or 1-6J7, 1-6F5, 1-25A7;
 - *Five moulded octal sockets, with retainer rings, type S8;
 - One piece of sheet aluminum or steel, 6½ x 8 ins., or one chassis, 8 x 3½ x 1½ ins. high, having open ends;
 - *One black crackle-finished cabinet;
 - Two 5- and 10-in. right angle brackets, 2-in. legs;
 - One 5- and 10-in. draw pull for handle;
 - *One escutcheon, type 11229;
 - *One send-receive nameplate dial, type 562;
 - *One volume control dial plate, type 25;
 - *Two knobs, type 588;
 - *One A.C. toggle switch, Sw.1;
 - *One 2-pole, 4-point selector switch, type 2742-2;
 - *One pilot light assembly, type 310-R;
 - *One pilot light assembly, type 310-G;
 - *Two pilot lights, 6.3 V., 150 ma.;
 - One ¼-in. insulating rubber grommet for mounting jack (phone) on panel free from cabinet connection;
 - *One 2-circuit phone jack, type 2A or 702A;
 - Two Meissner R.F. chokes, type 1995, for 456-kc. operation, R.F.C.1, R.F.C.2;
 - One Brush headset (optional), type A.
- *Names of manufacturers will be supplied upon receipt of a stamped and self-addressed envelope.

A PORTABLE RADIO RESEARCH LAB.

(Continued from page 714)

at one station than at the other. The new portable laboratory carries transmitting sets as well as sensitive receiving equipment, and it is now possible to extend the scope and the accuracy of the simultaneous experiments.

"CORKSCREW" WAVE

The transmitting set is a special type that sends a circularly-polarized or "corkscrew" wave, which can be made to spin in a clockwise or counterclockwise direction as it moves through space. The set can also transmit the ordinary type of radio wave. Voice and code modulation are provided for communication with the home laboratory and with other cooperating stations. Two battery-operated high-voltage generators and an alternating-current generator provide full power for all apparatus even when the mobile laboratory is completely isolated, though outside power sources may be substituted when available. A wide choice of wavelengths is provided.

In certain types of long-distance simultaneous echo experiments a trailer is also used. In this case elaborate crystal-controlled vacuum-tube circuits permit extremely accurate synchronization of the receiving apparatus with the transmitter at the home laboratory. This synchronization is

accurate to 0.001-per cent per hour and is independent of the radio wave and the characteristics of the power line.

In addition to the apparatus designed for echo measurements the laboratory carries an ultra-high-frequency transmitter, and three associated receivers operating on 5 meters, 2.5 meters, 1.25 meters, and on special experimental assignments. These are used in studying the effect of geographical and meteorological conditions on this type of transmission.

SPECIAL CAR BODY

With the exception of a standard-signal generator and one receiving set, all of the apparatus has been constructed in the laboratory instrument shops. A special body for the Packard chassis was also built at the laboratory and it contains a number of interesting features, including noise-absorbing walls, electrical shielding, and thermal insulation designed to keep the car warm in winter and cool in summer.

At present the field measurements are being conducted by Mr. H. Selvidge, Mr. Paul King, and Mr. John Alvin Pierce, under the supervision of the writer.

Please Say That You Saw It in RADIO-CRAFT

HOW A RADIO TRUCK AIDS NEWS "SCOOPS"

(Continued from page 715)

Photographers traveling with the unit develop their plates in the truck's insulated and ventilated dark room and dispatch them directly to the editorial office in Detroit by means of a photo-transmission machine, saving precious hours and minutes lost in even fastest transmission by airplane.

Pictures are flashed to Detroit from a Wide World photo-transmitter, operating in the truck and utilizing ordinary telephone lines. The set can be "hooked in" at any telephone, and pictures are received directly to the photographic department of the newspaper. Only a few minutes are required for transmission.

The brilliant red Lockheed Orion monoplane, Early Bird, also will be able to broadcast to the mobile unit, if a description of any event from the air is desired, and thence to the radio audiences by standard and short-wave radio. The news-gathering plane is completely equipped for broadcasting in addition to its regular complement of aviation radio apparatus.

The body of the truck unit is insulated throughout and special refrigeration and heating units keep the photographic dark room at the proper temperature for developing pictures, summer and winter.

A cat-walk on the roof enables photographers to "shoot" their pictures from a point nearly 12 ft. above the ground. At the front of the cat-walk is mounted a 140,000-candlepower flood light for illuminating the scene at night. Radio equipment, all located in the rear half of the 14-foot body, includes an ultra-high frequency receiver and transmitter with a range of from 7 to 10 meters; two pack sets operating on the 7 to 10 meter band and the 1 to 3 meter band, respectively; medium high-frequency transmitters, and all-wave receivers. Other pack transmitters and additional equipment are contemplated for future installation. Latest photographic equipment, including an enlarging camera and a contact printing machine, have been installed in this mobile newspaper office.

The unit carries complete first-aid equipment approved by the American Red Cross, which will be available to Red Cross or other workers at the scene of a disaster or which can be used by trained members of the unit's crew in an emergency. On the door panels of the unit are painted sets of call letters of the six radio licenses now held by The Detroit News. They are: WWJ, America's pioneer broadcasting station; W8XWJ, the ultra-high frequency station located atop the 47-story Penobscot Building; W8XHV, the stationary ultra-high frequency set in the truck; W8XIG, the pack transmitter; WKFB, the standard-band broadcasting station in the airplane, Early Bird; and KHPMN, the short-wave broadcasting set in the plane.

Carl Wesser, WWJ engineer in charge of ultra-high frequency development work, supervised radio-equipping the truck, and Paul B. Olsen, of The News staff, supervised photographic installations.

Power for lights, radio receivers and transmitters and photographic machinery can be obtained from two sources. When feasible, the unit is located near a power line, and current is carried into the truck through built-in conduits in the exterior of the body. When the unit is operated at some distance from a power line, either or both of a pair of gasoline-driven generators under the body operates generators for current.

An intercommunicating telephone connects the dark room and the radio room with the driver's cab, so the staff members working in the rear compartments while the truck is in motion can talk to the driver and other occupants of the cab.

The truck is equipped with lights and traffic insignia to satisfy the legal requirements of nearly every state in the Union.

The mobile unit received its "baptism of fire" early in October 1936 when photographers and announcers covered the explosion of a huge gasoline station and warehouse in Flint, Mich., more than 60 miles from Detroit, in which two persons were killed and 12 others seriously injured. An announcer of WWJ stood among the ruins of the building, 90 minutes after the explosion, and gave the radio audience a word-picture of the scene, while photographers took pictures and sent them back to the Detroit office by photo-transmitter.

IT SOUNDS CRAZY ... but any National Union Service Specialist will tell you IT'S TRUE!

"You guys must be crazy . . . you advertise everything but radio tubes!" We've heard that often . . . And it's true . . . we do tell you about other things. Important things! Seven years ago we knew that Radio Service was going to be an industry. We knew you fellows would need the best doggoned tubes you could get. We made 'em. Then we knew you'd need testers, analyzers, etc., etc. We decided to give 'em to you. We've given 90,648 pieces of equipment to Service Specialists who buy National Union tubes as this issue of *Radio-Craft* goes to press. Right now, today, we're giving instruments made by all leading manufacturers. 'Course we don't talk about tubes in our ads! We tell you what you can get to

build your service business. That's what has always counted most with National Union. We know if your business grows you just can't help but sell more tubes . . . and if we've helped to make it grow, you're going to sell National Union tubes. You fellows who've been growing with us all these years know there's none better anyway. "NUTS"? No, National Union hasn't got a screw loose. *We're selling ideas for better service business and more of it.* Your growth comes first. We're making that growth possible. Are you one of the smart lads who's cashing in on the National Union service specialist plan? You'd better find out why National Union means so much more than radio tubes to top notchers in the chassis chasing game everywhere.

WE'LL BE AT BOOTHS 104-105 NATIONAL TRADE SHOW CHICAGO, JUNE 10-11-12-13

FIND OUT! SEND COUPON!

NATIONAL UNION RADIO CORP.
570 Lexington Ave., New York, N. Y.

RC-637

Who is the nearest N.U. Distributor? I want to hear all about what N.U. is doing for Radio Service Specialists.

Name

Address

City State



Be a RADIO EXPERT - Learn AT HOME

RADIO SPECIALISTS NEEDED

Modern receivers with their complicated circuit systems have knocked out the old time cut-and-try radio fixer. Trained men with up-to-the-minute knowledge are needed to service these new sets.

HERE IS YOUR OPPORTUNITY

Your possibilities of making money and getting ahead are limited only by your ability and skill—but you must know more than the other fellow. You must be a radio service specialist, as R.T.A. can train you.



To start you making money without delay we equip you with this Circuit Analyzer and Point to Point Resistance Tester.

PRACTICAL TRAINING AT HOME

Our home study course is practical "shop and bench" training combined with a thorough set of practical lessons prepared by an experienced Radio service engineer. Four working outfits are also furnished.

MAKE SPARE TIME MONEY

Our training is complete and practical. We show you how to make money almost from the start. The course can easily be made to pay its own way. Investigate now, write for free book of details.

WHAT R.T.A. STUDENTS SAY

Norwood, Ohio
I have connected with a large firm as Radio Service Manager and wish to extend my thanks for your help.

Joseph Radien, Jr.

Yorkville, Ohio
From Aug. 1 to Dec. 7, 1936, I repaired 163 radios and put up 43 aeriads which is very good for part time work while studying your course.

Chas. Koerber.

**RADIO TRAINING ASS'N OF AMERICA
Dept RC-76, 4525 RAVENSWOOD AVE., CHICAGO**

Please Say That You Saw It in RADIO-CRAFT

Well train **YOU QUICKLY**
for Good **FULL-TIME**
and **SPARE-TIME** Jobs in
ELECTRICITY



Train for a Better Job and a Future
Train in your Spare Time,
by PRACTICAL Shop Methods

WITHOUT LEAVING HOME
Now, Electric Institute brings—TO YOUR VERY DOOR—practical training necessary for the rich rewards in Electricity. Keep your present job—no need to leave home—now you learn **ELECTRICITY** easily, practically—**RIGHT AT HOME**—in your spare time.

PREPARE TODAY FOR OPPORTUNITIES AHEAD

Get into a real money making field where there are many opportunities in Electricity. There is no better way to succeed than to TRAIN for work in an industry that is expanding. New Electrical projects constantly mean more jobs for men with practical training. Almost every industry uses TRAINED ELECTRICAL MEN. Or you can own and operate an electrical business of your own.

Opportunities to Earn Up to \$5, \$10 a Week or More While Training

With this amazingly easy, fascinating method of HOME SHOP TRAINING it is possible to start EARNING MONEY almost at once. Do not confuse E. I. Training with dry, theoretical text book courses. Electric Institute tells you exactly WHAT to do—THEN YOU DO the ACTUAL JOBS with ELECTRICAL EQUIPMENT and APPARATUS which comes with your training at no extra cost.

Become a TRAINED man without leaving home or your present job—then be ready to step into a REAL ELECTRICAL JOB.

Money Back If Not Satisfied

You must be satisfied. We give you an agreement to return every cent you pay on tuition if, after completing our training, you are not satisfied in every way with our instruction, equipment or other services given you.

With our training, our graduates receive life time consultation service, employment service and many other features to help them succeed in Electricity.

Electric Institute is ready to show you the way in the great, growing field of **ELECTRICITY**—where trained men are ALWAYS NEEDED. Mail coupon TODAY—for big, free book of facts about this revolutionary Practical Home Shop Training and the tremendous opportunities in **ELECTRICITY**.

DIESEL ELECTRIC POWER, RADIO and REFRIGERATION



Take advantage of the opportunities awaiting trained men in these and many other branches of Electricity, with **ELECTRIC INSTITUTE** practical training. Mail coupon for complete facts about **ELECTRIC INSTITUTE**—it may be the turning point in your life.

RUSH THE COUPON—TODAY—BIG BOOK FREE

H. W. Petersen, President
Electric Institute, Inc.,
Dept. 157G, Hinsdale, Illinois
Send Free Book with all facts about E. I. Home Shop Training.

Name.....Age.....
Address.....
City.....State.....

A KIT-TYPE CARRIER INTERPHONE

(Continued from page 723)

This procedure allows the outside foil to act as a shield for the inner foil. Greater stability will result thereby.

The wires to the "listen-talk" switch, Sw.3, should be shielded and the shield grounded. Any other long grid or plate leads should also be shielded.

Four glass-type tubes make up the circuit. A type 6C6, V2, is used as a voltage amplifier stage. This is resistance-capacity coupled to a type 43 power stage, V3. Another type 43, V1 is used as a local oscillator in the talk position and as a tuned detector in the listen position. A type 25Z5 tube, V4, with a suitable filter network is used to supply the plate, screen-grid and bias currents necessary for the operation of the circuits, as well as for the speaker field.

A 3-deck rotary switch, Sw.3, is used to switch the speaker from the plate circuit of the output tube to the grid of the 6C6 amplifier and also to change the 43 detector to the carrier-frequency oscillator.

Separate phone jacks are provided to enable the user to obtain privacy in conversation where this is desired.

Correction Notice. Referring to the schematic circuit, Fig. 1 on page 723, it will be noticed that the control-grid of the 6C6, V2, is unconnected. The correction is to remove the lead that now connects to the suppressor-grid and connect this lead to the control-grid. Then, connect the suppressor-grid to the cathode. (Incidentally, the carrier frequency has been reduced slightly to 232 kc. instead of 250 kc.)

LIST OF PARTS

- One Arrow transfer unit, L1-L2-L3;
- One Arrow line-filter R.F. choke, L-4;
- One plate modulation choke, ch.1;

- One speaker field, 3,000 ohms, ch.2;
- One filter choke, 250 ohms, ch.3;
- One resistor, 7,500 ohms, 1/4-W., R1;
- Two resistors, 1/2-meg., 1/4-W., R2, R10;
- One resistor, 3,000 ohms, 1/4-W., R4;
- One resistor, 1 meg., 1/4-W., R5;
- Three resistors, 0.25-meg., 1/4-W., R3, R6, R7;
- One resistor, 600 ohms, 1/4-W., R8;
- One control, 25,000 ohms, R9;
- One resistor, 25 ohms, 2 W., R11;
- One resistor, 100 ohms, 15 W., R12;
- One line switch, Sw.1;
- One push-button switch, Sw.2;
- One 3-gang, 2-position rotary switch, Sw.3;
- One speaker transformer, T1;
- One pilot light, 6.3 V., 150 ma., P.L.;
- Two type 43 tubes, V1, V3;
- One type 6C6 tube, V2;
- One type 25Z5 tube, V4;
- Two condenser, 0.1-mf., 300 V., C1, C17;
- One trimmer condenser, 350-600 mmf., C2;
- One mica condenser, 250 mmf., C3;
- Three mica condensers, 0.002-mf., C4, C6, C14;
- One trimmer condenser, 750-1,000 mmf., C5;
- *Two condensers, 5 mf., 25 V., C7, C11;
- Three condensers, 0.01-mf., 200 V., C8, C10, C12;
- One condenser, 0.006-mf., 200 V., C9;
- One condenser, 0.1-mf., 200 V., C13;
- *Two electrolytic cond., 16 mf., 150 V., C15, C16;
- One condenser, 0.01-mf., 300 V., C18;
- One condenser, .05-mf., 200 V., C19;
- One drilled chassis;
- One cabinet;
- Four tube sockets;
- One phone jack;
- Hardware, wire, solder, etc.
- *May be in one can.

This article has been prepared from data supplied by courtesy of Arrow Radio Company.

NEWEST CAR-RADIO IDEAS

(Continued from page 717)

out the necessity of taking your eyes off the road.

Quick-Service Set Design. Spring mounting combined with 1-hole mounting of the latest Zenith sets makes installation as easy as possible. The set is easily removed for service by loosening the bolt and slipping the set up off the bolt, as shown in Fig. D. The U-shaped slot in the spring mounting plate permits this easy removal.

Antenna for Turret-Top Cars. A car-top aerial made of stainless steel, 80 ins. long, is the latest in the Philco line. Streamline mounting insulators made the aerial an attractive addition to the car instead of an eyesore. It is interesting to note that this type of aerial, shown in Fig. E, is free from the ills of under-car aerials, such as being damaged during driving over unpaved roads or by flying stones kicked up during driving, the formation of ice between aerial and car body, the pick-up of wheel static, or the collection of semi-conducting films of oil and dirt; ignition static also is greatly reduced.

Modernistic Sensitivity and Tone Control. The unit shown in Fig. F, is a new type of sensitivity and tone control, called an "acoustinator," which is attached to the new Galvin-Motorola sets. The attractive case has 2 windows—one of which reads City, Country, and Street-Car, and the other, Voice, Music and Bass—to indicate the particular setting being employed to suit varying reception conditions and types of programs.

Set-Controls for the "Back-Seat Driver." The need for controlling the tuning and volume from the back of the car as well as from the driver's seat is answered by the unit shown in Fig. G, which has two control heads with the necessary flexible drive cables. The dash control head is connected to the set in the usual way, and the auxiliary control head, which may be mounted on the back of the front seat, on the arm rest or the side of the car in the back, is connected to the first control head. (This idea was first proposed by Radio-Craft, page 717, June 1935.)

Button Tuning Increases Driving Safety. Another novel attachment which may be added to existing car sets as well as being supplied with one new make of set is the button tuning unit shown in Fig. H. This consists of a small bakelite case having 6 buttons on its face, with spaces for 5 local stations and an off position. By simply touching one of the buttons, any one of 5 local stations is automatically tuned in.

Thus the driver's attention is not distracted during the tuning-in operation.

Signal/Noise Ratio Booster. The unit, called a "phantom antenna," shown in Fig. I in series with antenna lead of the new Arvin set is a combined (a) antenna coupler, (b) transmission line and (c) tuned resonant circuit which affords unusually high gain in the aerial circuit. By means of this unit, which incorporates the desirable features of the Hazeltine series-feed antenna system, permits an over-all gain in the aerial stage of 14 to 24; as well as reducing background noise, cross-talk and ignition pick-up. The antenna coupler is designed to resonate at 500 kc. with an antenna capacity of 75 mmf.; higher capacities reduce the resonant frequency.

Its schematic circuit is shown in Fig. 1. The antenna signal is fed into a low-impedance secondary connected to a matched line which is loaded at the input end with a capacity of 0.001-mf. At the output end the line is coupled in series with the antenna coil winding, the capacity of the line, and the 0.05-mf. loading condenser, all of which combine to form the A.V.C. capacity.

It is interesting to note in closing that one manufacturer of sparkplugs who previously featured a type incorporating ignition suppressors has discontinued this type of plug because of the dropping off in the demand for such ignition suppressors in the recent-model auto-radio sets. This is an important fact since it shows to what extent the suppressor-less design has been carried. (Radio-Craft readers will recall the extremely efficient suppressor-less car-radio receiver construction article that appeared on page 744 of the June 1935 issue.—Editor)

*Names of manufacturers will be supplied upon receipt of a stamped and self-addressed envelope.

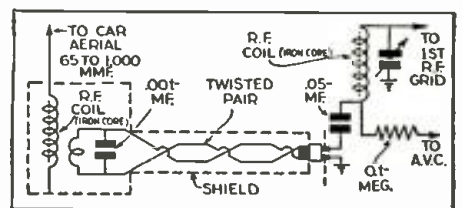

Fig. 1. The "phantom antenna" contains an impedance matching transformer, transmission line and high-gain tuned circuit.

Please Say That You Saw It in RADIO-CRAFT

INTRODUCING—A CATHODE-DRIVE HIGH-FIDELITY 32-W. BEAM AMPLIFIER

(Continued from page 722)

quired to maintain an equivalent power output. This extra voltage is easily developed by employing a high-gain preamplifier and an electronic "mixer" voltage amplifier.

The driver circuit features low inherent distortion because of the low input impedance reflected into the grids of the 6L6s.

The convenient and fool-proof plug and socket change-over system utilized in the "Universal Amplifier" described in the September 1936 issue of *Radio-Craft*, page 141, is carried over in the design of this modernized version. This arrangement avoids any possibility of damage caused by interconnecting errors as it is impossible to connect both the 110 V. A.C. and 6 V. D.C. to the transformer at the same time, unless the amplifier circuit is deliberately tampered with.

The author will be pleased to answer all questions relative to this new type amplifier. Address all requests to *Radio-Craft*, and enclose a stamped and return-addressed envelope.

OPERATING NOTES

(Continued from page 727)

and the set operated perfectly. It seems that this condenser was never put in as it is shown on the diagram.

Admiral Auto Radio. This set had a complaint of a bad cluck-clack that seemed to change frequency with the speed of the car. No mechanical defects of the car, a model A Ford, could be found but a small vulcanized spot on a rear tire casing proved to be the offender giving off a static discharge at every turn of the wheel. The complaint was present only on paved highway. J. O. ROBERTS

Noisy or Fading Philcos. On all Philco models reported noisy or fading, first examine the A.C. plug for loose screws. Many of these screws can be turned by the fingernail. This is not tight enough to pass from 50 to 150 W. without causing fading or noise in the receiver.

Philco Model 84. A Philco model 84 was reported having low volume. Upon arriving at the owner's home, the Service Man asked the usual questions which every good Service Man should ask, that is, whether the radio ceased playing suddenly, if they smelled anything burning, etc., etc.

In this case the radio had played fine until a burnt out pilot light had been replaced by the owner. Ever since, the radio had played very faintly and when a slight odor was noticed at the rear of the cabinet, the set was shut off and the Service Man called.

Naturally, the new pilot bulb was examined first for an internal short, but was found OK. Leaving the bulb out, it was noticed that all filament and plate voltages were low. It seemed strange that simply changing the pilot would cause the set to act this way. During the checking of voltages it was noticed the power transformer was getting abnormally hot. So a short circuit was looked for. It was finally found inside the pilot socket. The new bulb had been screwed in so tight that the small copper contact inside the socket was pushed aside, so that it touched the shell, shorting the 6.3 V. winding of the power transformer. When the socket was disconnected, the set played normally. Of course the pilot socket was replaced.

Keep Radio Sets Away from Open Windows. Service Men should advise radio owners to keep radio sets away from open windows, especially during the summer season. Dirt will collect in the chassis more readily and if the window should accidentally be left open during a rain-storm moisture will collect between the prongs of the tubes.

The writer has replaced many burned out power transformers due to water collecting between the prongs of the 80 rectifier socket. The tube base and socket generally burn first, becoming carbonized, which creates a dead short across the high-voltage winding.

Dampness also causes the set to lose its selectivity, pep and quality temporarily until it dries out. HARRY W. MONEY

ONE OF MANY RADIO JOBS

FOR AN *Atlas* LATHE

This set-up for winding a transformer primary is one of many recently developed for radio men by Atlas Engineers. Their research has demonstrated that an Atlas Lathe is the ideal all-purpose machine for today's radio shop, handling all types of standard and special jobs with speed and accuracy. Radio men tell us "Atlas pays for itself many times over."

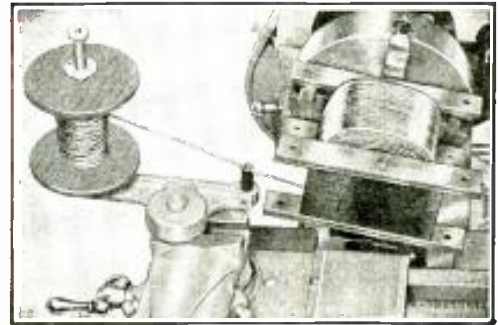

EXTRA VALUES!—SEND FOR CATALOG

Winding R.F. coils, choke coils, short wave coils, and transformers; turning dial shafts and drums, knobs, special screws and studs; making service tools, microphones, special dies and molds—these are just a few of the many radio jobs

you can handle in your own shop when you own an Atlas Lathe! The model shown is the 36" back-gear lathe at \$97.50 less motor—a sturdy, powerful, precision machine with many extra features included at no extra cost. Send for FREE Atlas catalog for full details.

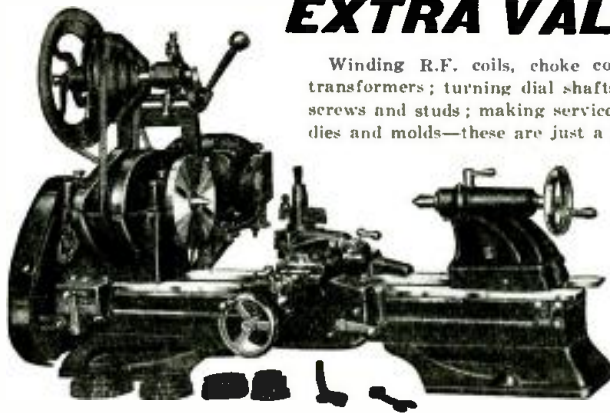

BE SURE THESE TWO BOOKS ARE IN YOUR SHOP



LATHE INFORMATION FOR RADIO MEN

New up-to-date "Manual of Lathe Operation" includes easy-to-understand technical data on coil winding, wire wrapping and spring making. In addition to modern lathe fundamentals and latest directions for machining new metal alloys, plastics, etc. 272 pages, metal binding—opens easily, lies flat. Sold on money-back guarantee—\$1.00 postpaid—mail coupon today.

FREE CATALOG

52 pages showing the latest in shop equipment—metal and wood lathes, drill presses, arbor presses, grinders, motors, vices, tools, and attachments. Send coupon.

ATLAS PRESS CO.

683 N. Pitcher St., Kalamazoo, Mich.

DISPLAYS AT

35 E. Wacker Drive
Chicago

130 W. 42nd St.
New York City

113 N. Third St.
Philadelphia

ATLAS PRESS CO.
683 N. Pitcher St., Kalamazoo, Mich.

- Send your 1937 catalog FREE!
- Enclosed find \$1.00 for new book "Manual of Lathe Operation" to be sent to me postpaid.



Name

Address

City State

FACTORY-TO-YOU SAVES 50%

New
14-TUBE
5-BAND
WORLD-WIDE RADIO

\$39.95

14 TUBES FOR THE PRICE OF 8

MIDWEST RADIO CORPORATION
DEPT. P-12 CINCINNATI, OHIO

EASY PAY PLAN
Write today for the new FREE 40-page catalog describing this bigger, better, more powerful radio. Over 40 advanced features. Glorious tone realism. Easy terms—10¢ a day. Money-back guarantee.

30 DAYS FREE TRIAL

SPECIAL OFFER APPLIES ONLY TO MAIL ORDERS

CRYSTAL HEAD PHONES

SOUND CELL MICROPHONES

Information on request

THE BRUSH DEVELOPMENT CO.
3312 PERKINS AVE. CLEVELAND, OHIO

Please Say That You Saw It in RADIO-CRAFT

A STABILIZED FEEDBACK 6-W. 25L6 A.C.-D.C. AMPLIFIER

(Continued from page 725)

Why
DO INCREASING THOUSANDS OF DEALERS
Pay Cash
FOR RAYTHEON TUBES?



Because thousands of dealers know that (1) RAYTHEON is the tube with great consumer acceptance and fair list prices that insure faster turnover . . . (2) RAYTHEON is the tube that is not sold at cut prices, insuring full profit . . . (3) RAYTHEON is the tube that needs no apologies or explanation, due to its long established quality.

These facts are the reasons why increasing thousands are finding RAYTHEON the safest and most profitable cash tube investment.

ASK YOUR JOBBER



RAYTHEON PRODUCTION CORPORATION
 420 Lexington Ave. 55 Chapel Street
 New York, N. Y. Newton, Mass.
 445 Lake Shore Drive 555 Howard Street
 Chicago, Illinois San Francisco, Cal.
 415 Peachtree St., N. E.
 Atlanta, Ga.

RAYTHEON IS THE MOST COMPLETE LINE—ALL TYPES OF GLASS, OCTAL BASE, METAL, RESISTANCE AND AMATEUR TRANSMITTER TUBES.

feedback is adjusted to the reciprocal ratio. Curve B shows the effect of the low-frequency booster, that is, with R3 at minimum resistance. The low-frequency response may be adjusted to any value between curves A and B. Curve C shows the response with the low-frequency cut-off filter in place.

Several constructional notes are worthy of mention. First, in using dual controls for volume and feedback control, the tapers on the 2 halves of the control must be the same, and should be very close as to resistance. This means good quality controls. Second, resistors used in push-pull feedback circuits should be checked on an ohmmeter. They should be equal within a few per cent for best results.

If this main amplifier is used with the pre-amplifier discussed in Part I, the low-frequency compensation network composed of L1, L2, and R3 may be omitted, as well as the optional high-frequency booster composed of C25, C26, and R24. The low-frequency cut-off filter may find application where hum pick-up is serious, particularly in input lines. The control of response is then accomplished by the controls on the preamplifier as discussed in Part I.

MECHANICAL LAYOUT

The layout of the preamplifier is shown partially by the photographs, but requires some consideration. The circuit designations are those of the previous article. On top of the chassis the layout from left to right facing the panel is as follows:— (1) input transformer, T1. (2) 6F5 tube V1, (3) 6F5 tube V2, (4) 6C5 tube V3, (5) output transformer T2, (6) choke L1. Choke L2 is mounted beneath the chassis.

On the panel of the chassis from left to right the controls are as follows: (1) input jack, (2) response control R15, (3) response control R16, (4) volume control R14, (5) feedback control R5, and (6) the output jack.

The main amplifier is laid out as follows, viewing again from left to right facing the panel. On the top of the chassis, (1) input transformer T1, (2) the low-level 6J7 tubes V1 and V2, (3) choke L3, (4) 6C5 driver tubes V3 and V4, (5) driver transformer T5, (6) 25L6 output tubes V5 and V6, (7) output transformer T3. Chokes L1 and L2 are mounted below chassis.

On the front of the panel the controls are these:— (1) input jack, (2) feedback controls R1 and R2, (3) booster control R3, (4) volume control R9. Connections for power and output terminals are on the back of the chassis. The power supply layout follows. On the top of the chassis from left to right:— (1) main amplifier 12Z3 rectifier tubes V8 and V9, (2) choke L4, (3) choke L5, (4) 12Z3 preamplifier rectifier tube V7. On the front of the chassis are the two switches S1 and S2.

TABLE I
 Values for 2 tubes

Plate and screen-grid voltage	110 V.
Zero signal plate current	65 ma.
Max. signal plate current	90 ma.
Zero signal screen-grid current	6 ma.
Max. signal screen-grid current	17 ma.
Peak A.F. grid volts	28 V.
Power output	8 W.
Bias voltage	-12 V.

LIST OF PARTS

- Two Electrad vol. controls, 25,000 ohms, R1, R2;
- Three Electrad dual volume controls, 0.25-meg., R3, R9, R24;
- Two I.R.C. resistors, 0.25-meg., 1/2-W., R4, R5;
- One I.R.C. resistor, 3,500 ohms, 1 W., R6;
- Two I.R.C. resistors, 0.5-meg., 1 W., R7, R8;
- Two I.R.C. resistors, 600 ohms, 1 W., R10, R11;
- One I.R.C. resistor, 1,000 ohms, 1 W., R12;
- One I.R.C. resistor, 1 meg., 1 W., R13;
- Two I.R.C. resistors, 5,000 ohms, 1 W., R14, R15;
- Two I.R.C. res., 10,000 ohms, 1 W., R16, R17;
- Three I.R.C. resistors, 50,000 ohms, 1 W., R18, R19, R23;
- One Electrad resistor, 300 ohms, 75 W., R20;
- One Electrad resistor, 75 ohms, 25 W., R21;
- One I.R.C. resistor, 25,000 ohms, 2 W., R22;
- Four Cornell-Dubilier paper capacitors, 0.1-mf., 600 V., C1, C2, C1, C5;
- Two Cornell-Dubilier electrolytic capacitors, 25 mf., 35 V., C3, C11;
- One Cornell-Dubilier electrolytic capacitor, 4 mf., 200 V., C6;
- Two Cornell-Dubilier electrolytic capacitors, 8-8 mf., 200 V., C7, C8;
- Four Cornell-Dubilier paper capacitors, 0.1-mf., 400 V., C9, C10, C18, C19;
- Two C.-D. paper capacitors, 0.01-mf., C12, C13;
- Four Cornell-Dubilier paper capacitors, 0.023-mf., 400 V., C14, C15, C16, C17;
- Four Cornell-Dubilier electrolytic capacitors, 16 mf., 200 V., C20, C21, C22, C23;
- One C.-D. paper capacitor, 0.2-mf., C24;
- One C.-D. paper capacitor, 0.05-mf., C25, C26;
- One Kenyon transformer, type T-3, T1;
- One Kenyon transformer, type T-256, T2;
- One Kenyon transformer, type T-306, T3;
- One Kenyon choke, type KC-300, L1;
- One Kenyon choke, type KC-300, L2;
- One Kenyon choke, type T-155, L3;
- One Kenyon choke, type T-152, L4;
- One Kenyon choke, type T-156, L5;
- One Kenyon choke, type KC-300, L6;
- Two type 6J7 tubes, V1, V2;
- Two type 6C5 tubes, V3, V4;
- Two type 25L6 tubes, V5, V6;
- Three type 12Z3, V7, V8, V9;
- Three S.P.S.T. toggle switches, S1, S2, S3.

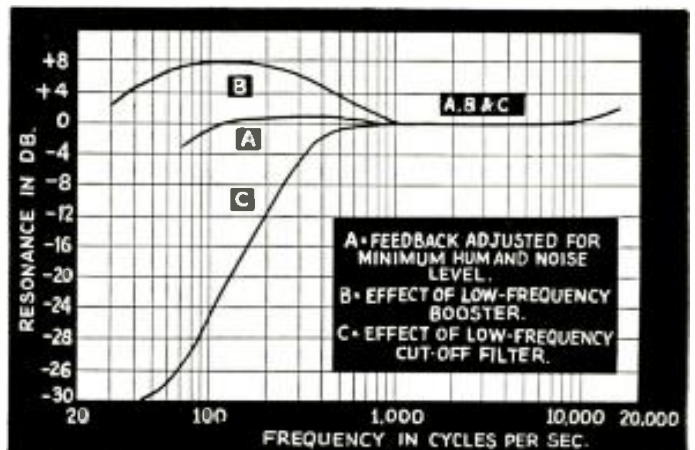

Fig. 4. The effect of the feedback can be readily seen.

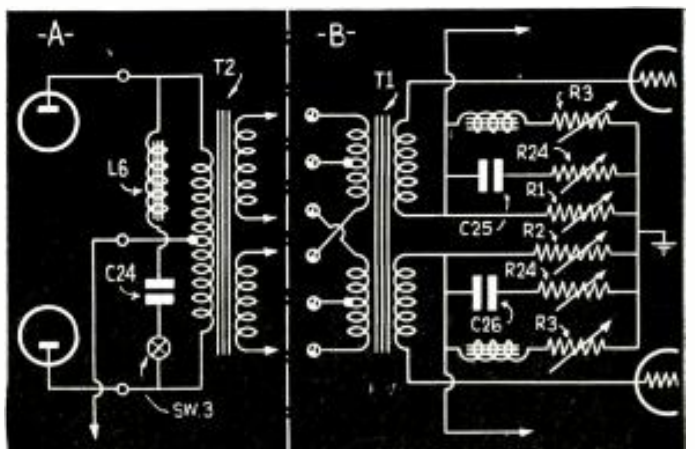

Fig. 5. A—low-frequency response eliminator and B—high-frequency response booster.

Please Say That You Saw It in RADIO-CRAFT

A SERVICE MAN'S AUDIO OSCILLATOR

(Continued from page 728)

both waves are of exactly the same frequency they cancel, and this point is known as the zero-beat.

At every other point, where the variable oscillator differs in frequency from the fixed oscillator, the phenomenon of beat frequencies appears. Thus, if we mix two waves, one of 465 kc. and the other, 460 kc., we will obtain the sum and difference beat frequencies; that is, 465 minus 460 equals 5 kc. and 564 plus 460 equals 925 kc. We are not interested in the frequency of 925 kc. because it is inaudible when both waves are rectified by the 6Q7.

The difference frequency of 5 kc. (5,000 cycles) is the one we want. The essential part of the 2 rectified waves produces a 5 kc. beat which is audible and in our case, is applied to the control-grid of the triode portion of the 6Q7 where it is amplified and applied to the control-grid of the pentode amplifier.

The actual useful range of frequencies generated in this manner extends from below 50 cycles to above 20,000 cycles. The lowest frequency attainable is zero cycles, which is of no use because there is no audio component wave at this point. It is well known that 2 oscillators operating at slightly different frequencies have a tendency to fall in step, or interlock.

It can readily be seen that it takes extremely good design, shielding and other factors to maintain a difference of only 20 cycles or less between oscillators and still prevent interlocking to zero-beat. For this reason most commercial units are rated from 50 cycles, up. Under test our unit has "gone down" to 5 cycles per second and maintained it for several seconds before blooming out. The upper limit is determined by the maximum capacity of the vernier condenser with the plates fully in which in our unit is enough to reach up to about 30,000 cycles. The power output available is close to 5 W. with a total of 7 per cent distortion. Ordinarily this amount of power is used only to determine at what frequencies a dynamic speaker cone will start to rattle or distort.

THE SERVICES OF THE COMPONENTS

A brief discussion of the manner in which the various tubes are used, may be of interest. Referring to Fig. 1, we see a 6J7 electron-coupled oscillator operating at 465 kc. feeding into one of the diodes of the 6Q7. The other 6J7 oscillator also operates at 465 kc. but the vernier condenser, when fully meshed, serves to lower the frequency to about 435 kc. The output of this variable oscillator feeds into the remaining diode plate of the 6Q7. Both the fixed and variable oscillator currents are mixed together at the cathode of the 6Q7.

Colored tip-jacks on the front panel are provided for the purpose of feeding A.F. directly into the voice coil of a speaker to be tested. The secondary winding of the output transformer contained in the instrument has taps of 4, 8 and 15 ohms to accommodate different types of voice coils. An additional winding tapped

at 200 and 500 ohms serves to couple the output into 200- or 500-ohm transmission lines. The 200-ohm tap is useful for testing over-all range of microphone amplifiers; that is, disconnecting the mike and feeding A.F. out of the 200-ohm tap directly into the mike transformer primary.

Transmission lines of 500 ohms may be tested for gain or loss, frequency discrimination and distortion. The entire output of 5 W. can be used to drive the input stage of high-power amplifiers, bearing in mind, of course, that distortion in the A.F. oscillator will appear in the output of the high-power amplifier.

An additional pair of tip-jacks (both colored brown) is provided for testing magnetic speakers and headphones. These tip-jacks are connected directly across the primary of the output transformer. Reduced power must be applied to magnetic speakers to avoid breaking the armature pin. The closed circuit twin jack is provided for the purpose of feeding a low A.F. voltage (at very low distortion level) into high-gain input circuits.

A small magnetic loudspeaker is included within the instrument as a monitor. We believe that this feature is not only novel but useful. As can be seen from Fig. 1, the monitor is connected across the output primary and the front panel switch is used to cut it in or out of circuit. It is of great help in several ways: (1) It indicates whether the amplifier under test is operative, or not. (2) It's helpful in maintaining calibration of dial readings, by checking against tuning fork or piano keyboard. (3) It serves as a protective load across output primary, at moderate volume level. And, (4) it serves as a check of the range of hearing of different people.

A word of caution:—the monitor should always be switched off, when the full power output of the oscillator is to be used. And a further word of caution is to never operate the A.F. oscillator into an open circuit with the volume control fully on. Breakdown of the output transformer may occur under these conditions.

The attenuator, or volume control is a high-resistance potentiometer in the grid circuit of the 6Q7. It affords smooth control from zero to full output at any frequency setting. The 6Q7 grid resistor is connected to the 1-V. special grid-bias cell. This handy little cell is used in

(Continued on page 764)

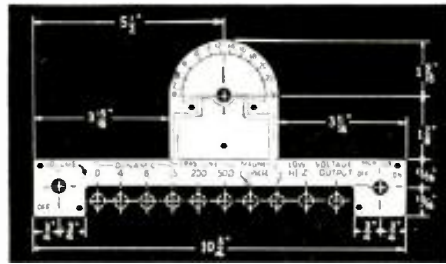

Fig. 2. The figures on the scale are in thousand cycles.

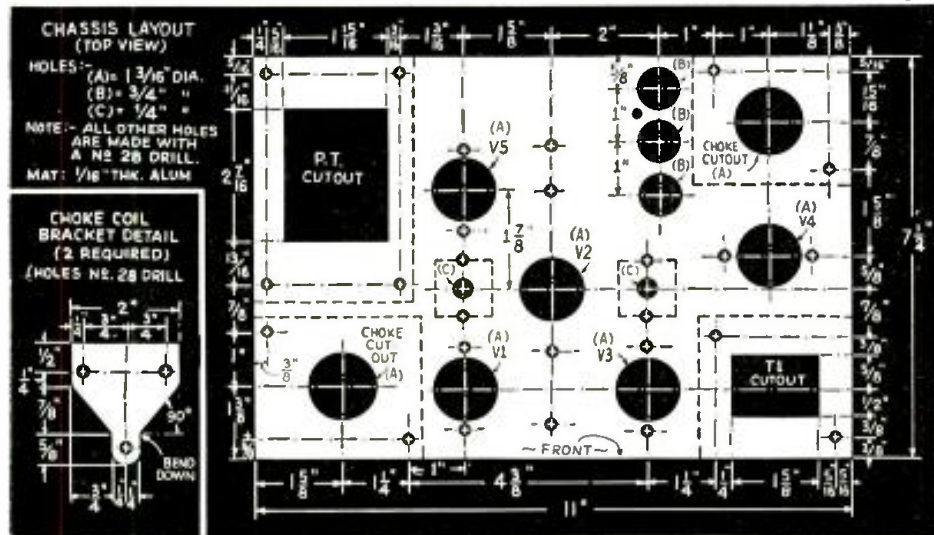

Fig. 3. Details of the chassis and choke coil mounting brackets.

DON'T MISS THIS OPPORTUNITY TO

Equip

WESTON

at today's low prices



(Above)

Model 669 Vacuum Tube Voltmeter, essential to complete your test equipment. Used with or without test oscillator . . . measures gain per stage, r.f. amplitude in oscillator circuit of superhets, makes all tests on AVC circuits, P.A. systems, and all measurements where high frequency is a factor. Direct reading . . . measures without guesswork or confusing adjustments. Price, \$15.00 net in U.S.A. (Carrying case extra.)

Model 692 . . . a real laboratory oscillator, at a serviceman's price. All wave, triple shielded, built to do a precision aligning job on any and all receivers. Price today, \$45.00 net in U.S.A. (Carrying case extra.)

Far-sighted servicemen recognize the economy . . . the added profits . . . which good instruments bring home. For when you buy good instruments, you don't buy instruments so often . . . you're rarely stuck with an obsolete, last-year's model. That's why more and more servicemen are standardizing on WESTONS. They want the same dependability, the same flexibility and the same long years of service which manufacturers and scientists insist upon, and get, from WESTON Instruments. The opportunity is available for you to get WESTON test instruments . . . thoroughly equip with these precision test tools . . . at today's low prices. See your jobber today, or return coupon for complete literature.



Model 772 Analyzer. Sensitivity 20,000 ohms per volt . . . resistance ranges readable up to 30 megohms . . . current indications as low as 1/2 microampere. Price, \$46.50 net in U.S.A.



Model 771 Checkmaster . . . tube checker plus continuity tester. Has 3 voltage and 3 current ranges, and resistance ranges for point-to-point and continuity testing. Price, \$15.00 net in U.S.A.

Weston Electrical Instrument Corporation,
599 Frelinghuysen Avenue, Newark, N. J.

Rush me complete data on WESTON Radio Instruments.

Name _____
Address _____
City _____ State _____

Please Say That You Saw It in RADIO-CRAFT

system control is exercised by the person operating the central or master unit. All stations can hear what is said by the "master" operator, but none can hear the reply, and none can interfere. However, if the rotary station-selector switch is set at "C" or common, any station can call the master only, provided the master key is "listening."

The number of intercommunication stations operating in a single system can be increased, in the case of Fig. 1, up to the limit of the ability of the amplifier to drive the speakers. Since all speakers operate in parallel—except the one serving momentarily as a microphone—increasing the number of stations decreases the volume of each. In general, 4 stations represent about the limit, although when small rooms are to be served it will be practicable to add more, while large rooms will make a further reduction in number necessary.

The system of Fig. 2 is designed to use 5 stations and no more, although the number can be reduced if 5 are too many.

(A larger number of stations at the same power output or at higher power outputs, if required, are available in special systems made to order. Such systems can also be obtained in Lafayette and Auburn high-fidelity models which incorporate means for disseminating entertainment as well as provisions for communication, and are used in the larger schools, in hotels, summer camps, club houses and numerous other applications.)

The master unit and one station unit of the selective system, Fig. 2, are illustrated at the left of Fig. A. The master and one station of the common system, Fig. 1, are shown at the right of the same photograph.

INSTALLATION

Considering Fig. 1, it will be noted that the speaker-microphone incorporated in the master unit is connected in exactly the same way as any of the outlying speakers. All of them, and all the push-to-talk switches, are in parallel. The microphone line is a shielded cable, the grounded shield serving as one side. The speaker line is a separate wire outside the shield, which serves as one side of the speaker circuit also.

If the connecting lines are at all long, totaling 100 ft. or more, open wiring is used, the speaker line being separated from the mike cable by a distance of several inches. The variable condenser shown in Fig. 1 is adjusted for a maximum gain consistent with freedom from feedback. As with all A.C.-D.C. circuits, care is taken to avoid grounding to earth.

The master unit of Fig. 2 is equipped with 5 output jacks, from which 5 cables radiate to as many outlying stations. However, in this system the central "talk-listen" switch must always be in either one position or the other, and feedback and shielding do not present troublesome problems. The cable used is twisted pair, No. 22, in shielding, the shield constituting one of the 3 lines.

In the operation of Fig. 1, the person calling pushes the switch at the top of unit, holding it down while he speaks, and releasing it to listen. Any other station may interrupt and, just as in any conversation, all parties must be willing to listen as well as talk. Everything said at any station is heard at all the others.

Figure 2 has two methods of operation, (1) common and (2) individual. With the selector set at "C" every station hears the master station, and any station can call the master as long as the talk-listen key is set at "listen." No station can hear any other, or talk with any other. All must hold their buttons down to listen as well as to talk.

With the selector set to a specific location no other station can be heard at all. The selected station can reply when the talk-listen key permits. All, however, hear the master, an arrangement that serves as a "busy" signal and can be prevented, when desired, by open-circuiting the top blade of the talk-listen key.

When the selector switch is set to a specific station, that station has no need for its push-to-talk button, and can control nothing with it. Under those circumstances the person at the distant station carries on the talk without having to touch or manipulate anything, and can continue to use his hands in other work with which he may be occupied.

This article has been prepared from data supplied by courtesy of Wholesale Radio Service Co., Inc.

3
IMPORTANT REASONS WHY SERVICE MEN PREFER "PRECISION"

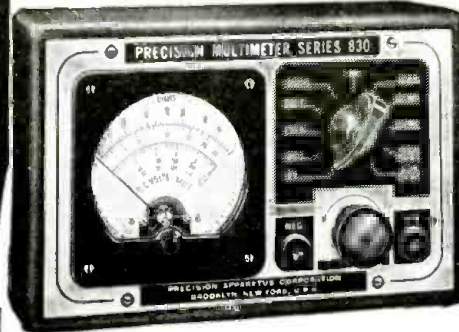

NEW "PRECISION" MULTIMETER NO. 830

This 11 range service instrument contains a large 3 inch D'Arsonval type meter of 2% accuracy, housed in a bakelite case. 5 D.C. voltage ranges: 0-10; 0-100; 0-250; 0-500; 0-1000 at 1,000 ohms per volt. 4 D.C. current ranges: 0-1 ma; 0-10 ma; 0-100 ma; 0-250 ma. 2 resistance ranges: Low ohms shunt method, 0-500 ohms. As low as 1/2 ohm. High ohms reading, 0-300,000 ohms. Selector controlled through-out. Only 2 polarized pin jacks on the panel. 1 1/2 x 7 x 2 1/2. Leather finish.

\$10.95

THE POPULAR "PRECISION" ELECTRONOMETER NO. 600

A combination testing instrument of COMPACT SIZE (12 3/4 x 11 1/2 x 6) for complete modern tube analyzing and point to point set analyzing... housed in an attractive hardwood case... built to withstand "rough" usage... approximate carrying weight is only 15 pounds.

\$45.75

PRECISION Instruments are now available on time payments. Write for details on the P. A. C. easy payment plan.



PRECISION Apparatus Corporation
821 EAST NEW YORK AV., BROOKLYN, N. Y.

The 100% COMPLETE Line of INTERCOMMUNICATING SYSTEMS... MAIL COUPON FOR FACTS



Model 135 Intercommunicating System in both Wood and Steel Cabinet. List Price \$57.50 per pair.

Model 145-10 Intercommunicating System in both Wood and Steel Cabinet. List Price from \$38 to \$56.25 per station.

● Operadio is the ONE Intercommunicating System that outmodes all others... the one COMPLETE line that gives you more plus features than anything on the market today. The line is flexible... both steel and wood models... offers you more stations, more sales outlets.

Priced right... allowing you a liberal discount and a fine profit, the Operadio Intercommunicating Line is the 1937 PROFIT LINE. Buy no others until you see it. Mail coupon for the complete story.

TYPE A—Complete two-way system. Speech may originate at either position, one independent of the others. High quality reproduction.
TYPE B—Return Speech System. Number of Outlying Stations unlimited. Standard models up to ten stations. Outlying Stations can talk back to Master Station but can not call Master Station or talk to another Outlying Station.
TYPE C—Number of Master Stations unlimited. Three to eleven Master Stations standard—in constant communication with each other. Any Station can talk to any other Station simultaneously.

OPERADIO MANUFACTURING COMPANY
Dept. R6C, St. Charles, Illinois.
Please send me literature on your COMPLETE line of Intercommunicating Systems.

Name.....
Firm.....
Kind of business.....
Address.....
My Jobber is.....
Address of Jobber.....

OPERADIO
MANUFACTURING COMPANY
St. Charles, Illinois

Please Say That You Saw It in RADIO-CRAFT

A SIMPLE T.R.F. RECEIVER WITH A.V.C.

(Continued from page 734)

possibilities of T.R.F. reception.

It must be remembered that this is a compact receiver using the minimum number of tubes for adequate performance. Of course, a larger set could be constructed utilizing the fundamental design. A push-pull output stage could be used or an additional R.F. stage offers possibilities. The present compact design finds ready application in cases where it is desired to build-in a simple receiver in one of the popular artificial fireplaces or secretaries. P.A. men also, will find in it the answer to the radio tuner problem. The quality of the output, ease of connection to high-power amplifiers, low cost and the A.V.C. action will be readily appreciated.

When looking at the diode load circuit with R.F. flowing we find that the major portion of the energy will appear across R7 as R9 is bypassed by C8. When the rectified output is checked it will be found that the greatest voltage will appear across the resistor R9, which is as desired, thus making the greatest voltage possible available for A.V.C. and audio signal to the triode grid.

This circuit offers the most surefire method of obtaining A.V.C. action and avoids the necessity of having the rotor plates of the 3-gang tuning condenser insulated from each other and the ground.

ASSEMBLY

The first step in the construction of this receiver is the preparation of the chassis and the mounting of the various parts in their proper location. If the chassis is to be home-made then the drawing of Fig. 2 gives full details. However, the chassis can be obtained ready punched, folded and painted. This will eliminate all of the hard work as most radio labs. are not so well equipped for metal working.

All of the parts should be mounted on the chassis. The photograph and the special mounting instructions furnished with the kit make this a simple matter. Locate the parts very carefully and follow the instructions to the letter. This will save time and trouble later on when the set is placed in operation.

The condenser shield should be mounted on the back of the tuning condenser by means of three 1/4-in. 8-32 machine screws so that the top portion of the shield projects over the top of the tuning condenser. Three leads should be soldered to the bottom stator terminals of the tuning condenser before mounting to the chassis.

WIRING

All wires and connections should be kept as short as possible. Grid and plate connections should be kept close to the chassis and well separated from each other. Resistors and condensers are held in place by their own leads which should be pulled up and cut short before soldering.

Grid wires must be soldered to the grid terminal of the antenna and R.F. coils and brought out through a hole in the top of the shield as near as possible to the grid of the tube to whose cap the lead is to be connected.

The bypass condensers on the R.F. cathodes should be .01-mf., as specified. This will prevent oscillation of the receiver at the low-frequency

THE CIRCUIT

The outstanding features of the circuit include the use of the new high-gain iron-core R.F. transformers with metal tube pentodes and the A.V.C. circuit of the 6Q7 diode-detector voltage-amplifier tube. This combination of high-gain tube and high-Q coil results in a stage gain that will compare favorably with many of the supers on the market today. The precision of coil and condenser manufacture assures satisfactory tracking over the broadcast band providing the receiver has been constructed in accordance with the instructions furnished with the coil kit.

The circuit is conventional except for the diode section of the 6Q7 and for this reason the action of this portion of the receiver will be covered in more detail. The diagram of Fig. 1B simplifies the description.

The signal voltage developed across the secondary of transformer L3 appears across R7. This resistor R7 is part of the diode load which includes resistors R8 and R9. The voltage developed across R9 is available for A.V.C. and audio signal. The volume control R10 is in the audio portion of the receiver as is customary in superhet. design. Resistor R8 and condenser C7 serve as an R.F. filter preventing the R.F. energy from getting into the audio frequency portion of the 6Q7. However, some of the R.F. leaks through, and for that reason, condenser C11 is necessary. Resistor R11 places the proper bias on the grid of the triode section of the 6Q7 and the condenser C9 prevents degenerative action in the cathode circuit. Condenser C6 is the means of coupling between L3 and R7. C8 lowers the R.F. impedance of the effective diode load R9. Resistor R12 is the plate loading resistance of the triode portion of the 6Q7.

WHY PAY MORE?

THE FINEST MULTITESTER YOU CAN BUY AT ANY PRICE



Costs only \$31.50

Complete ready to operate

DEPENDABLE

MODEL 410 MASTER MULTITESTER

● Better performance (by actual test and consensus of users' opinion), higher quality workmanship and appearance than testers sell for considerably more. ● 11 measuring instruments, include 5" D'Arsonval fan type meter, 0-500 microamps, 2% accuracy. ● D.C. voltages—2000 ohms per volt. A.C.—1800 ohms per volt. ● Eliminates troublesome and inaccurate copper oxide rectifier in A.C. measurements (exclusive feature). Rugged rectifier withstands heavy overload. Is easy and inexpensive to replace, has no frequency, temperature or wave form error. Linear A.C. scales—same as D.C. ● The only instrument in its field measuring current in A.C.—microamps, milliamps and amps. ● Accurate capacity tester for paper, mica and electrolytic condensers, 5 condensers. Line voltage fluctuations automatically compensated. ● 6 current ranges in D.C. include microamps, milliamps and amps, 6 individual ohmmeter ranges, measuring less than 24 ohm to 40 megohms. ● Inductance 25 millihenries to 10,000 henries. ● Power level—20 D.B. to +40 D.B. ● Voltages: 0-5-25-100-250-1000. A.C. and D.C. Current: 0-500 microamps; 0-5-25-100-250 milliamps; 0-2.5 amps. Capacity: 0-.03-3-30-300 microfarads. Resistance: 0-100-10,000-100,000 ohms. 0-1-10-40 megohms. Inductance: 25-1000 millihenries, 25-100-1000-10,000 henries. Decibels: -15, +9, +21, +35, +40.

SEE YOUR JOBBER

WRITE TO DEPT. C6 FOR CATALOG

RADIO CITY PRODUCTS CO.
88 PARK PLACE NEW YORK CITY "DEPEND ON DEPENDABLE"



Doing a world-wide job....

little giant



COMPACT Dry Electrolytic CAPACITORS

So small efficient... completely equalling standard sizes in dependability! All usual capacities, two ratings, 450 v.w. and 200 v.w. You won't believe your eyes!

SOLAR MFG. CORP.
599-601 Broadway, New York, N.Y.

Descriptive literature upon request

ARROW'S

8 WATT BEAM POWER HIGH GAIN AMPLIFIER

TO BE USED WITH THE NEW "BULLET" OR CRYSTAL MICROPHONE
Complete Kit of Parts \$10.95 with 8" Speaker

WRITE FOR NEW SPRING FLYER
ARROW SALES COMPANY
631 Washington Blvd., Chicago, Illinois

Learn SOUND RECORDING TALKING PICTURE PROJECTION TELEVISION-RADIO

Master training courses qualify you for good jobs. Practical, easy to learn. Newest equipment. 30,000 graduates. Earn room and board while learning. Coach R. R. fare allowed to L. A. Write for FREE BOOK. Address Dept. 6-RC, 4000 S. Figueroa St.

NATIONAL SCHOOLS - Los Angeles

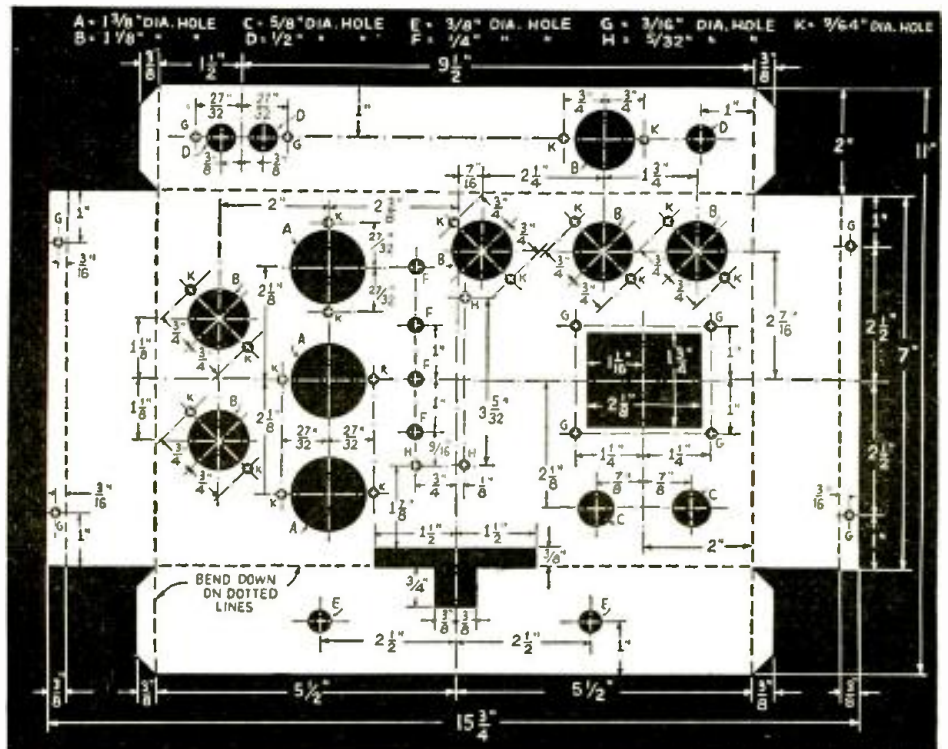

Fig. 2. Chassis drilling details for the T.R.F. receiver.

Please Say That You Saw It in RADIO-CRAFT

end of the tuning range. Larger values at this point will cause oscillation.

ALIGNMENT AND OPERATION

After making all connections and carefully checking to make certain that everything is correct insert the tubes in the proper sockets. Metal tube shields should be placed over the 6K7s and the 6Q7. A very short piece of rubber tubing slipped over the grid lead before soldering the clip to the lead will prevent shortening between the clip and the shield.

In connecting the speaker wires to the 4-prong plug, use the large prongs of the plug for the field leads of the speaker. These leads are generally coded black and yellow. The small prongs on the plug should be connected to the output transformer which is mounted on the speaker.

The speaker should be plugged into its socket before the set is turned ON.

A high resistance voltmeter should be used to check voltages from the chassis to the plates and screen-grids of the tubes. These readings should compare with the values indicated in the circuit drawing.

To align the R.F. and antenna coils, adjust the trimmers located on top of the 3-gang tuning condenser. If everything is working normally and the volume control well on, a station should be tuned in near the high-frequency end of the dial. With such a station tuned in, adjust the trimmers with an insulated screwdriver for maximum volume. If a signal generator is on hand, set to 1,400 kc. and adjust for maximum response using the lowest possible signal level from the signal generator.

The receiver should track perfectly and be free from interaction over the entire tuning range. However, due to the use of ferrocarr iron-core R.F. transformers the gain of the receiver is very great and will compare with a superhet. for gain and sensitivity. If any difficulty is experienced check over all grid and plate leads and note if the layout instructions have been followed exactly.

These precautions cannot be over-emphasized as proper shielding and minimum coupling between high-frequency leads will make all the difference between a sensitive receiver and a collection of parts with no particular merit.

If the circuit oscillation is still troublesome due to variation of Gm in different types of tubes after all checks have been made as to the placement of parts, increase the value of resistors R3 or R6 to 1,500 ohms. This will eliminate any remaining oscillation caused by the high gain derived from the R.F. trans-

formers when used with tubes with abnormal mutual conductance.

LIST OF PARTS

- One Meissner coil and tuning kit, No. 7531, containing: one Ferrocarr antenna coil, No. 1496; one Ferrocarr first R.F. coil, No. 7860; one Ferrocarr second R.F. coil, No. 1497; one 3-gang variable condenser, 360 mmf., No. 15115; one condenser shield, No. 7831; one 4-in. airplane dial, No. 18247;
- Five octal tube sockets;
- Two type 6K7 tubes;
- One type 6Q7 tube;
- One type 6F6 tube;
- One type 5Z4 tube;
- One resistor, 400 ohms, 1 W., R14;
- One resistor, 3,000 ohms, 1/2-W., R11;
- Two resistors, 1,000 ohms, 1/2-W., R3, R6;
- Two resistors, 40,000 ohms, 1W., R2, R4;
- One resistor, 50,000 ohms, 1/2-W., R8;
- Two resistors, 0.1-meg., 1/2-W., R1, R7;
- One resistor, 0.2-meg., 1/2-W., R12;
- One volume control, 0.5-meg., R10;
- One tone control and power switch, 25,000 ohms, R15;
- Two resistors, 0.25-meg., 1/2-W., R5, R9;
- One resistor, 0.5-meg., 1/2-W., R13;
- Three paper condensers, 0.05-mf., 200 V., C1, C3, C10;
- Two paper condensers, 0.01-mf., 200 V., C2, C5;
- One paper condenser, 0.01-mf., 400 V., C18;
- Two paper condensers, 0.05-mf., 400 V., C12, C13;
- Two paper condensers, 0.1-mf., 400 V., C4, C15;
- One paper condenser, 0.006-mf., 600 V., C14;
- Two electrolytic condensers, 10 mf., 35 V., C9, C19;
- One mica condenser, 100 mmf., C6;
- Two mica condensers, 250 mmf., C7, C8;
- One mica condenser, 500 mmf., C11;
- Two electrolytic condensers, 8 mf., 450 V., C17, C18;
- One Meissner chassis kit, 7 x 11 x 2 ins., No. 18216;
- One power transformer: primary 110 V., 650 V. secondary C.T., 50 ma., 6.3 V. secondary at 2 A., 5 V. secondary at 2 A., PT;
- One dynamic speaker with output transformer for 6F6 tube, 1,500-ohm field;
- One 4-prong speaker socket;
- One 4-prong speaker plug;
- One A.C. line cord and plug;
- One antenna-ground terminal strip;
- Three metal tube grid clips and tube shields;
- Two 6.3-V. pilot lights;
- Three 3-terminal tie lugs;
- Two 2-terminal tie lugs;
- Machine screws, wire, soldering lugs, etc.



FREE! THREE MONTHS' SUBSCRIPTION TO SYLVANIA NEWS!

Thousands of service men, from coast to coast, have been using Sylvania News* daily . . . not merely to find out what's going on in radio-service, but to earn extra money, through knowing their job better! That's why we're making this special FREE offer — for a limited time only. We want you to start using Sylvania NEWS as a real business-getter—a genuine profit-maker — just as soon as possible!

You'll get many a technical tip from every issue. You'll find yourself remembering some little hint on your very next job. And the sooner you start receiving Sylvania NEWS, the sooner you'll start using it on many of the calls you make!

QUICK! MAIL FREE-OFFER COUPON

It costs you nothing but a three-cent stamp to take advantage of this offer. Tear out the coupon below. Fill in (print plainly, please) and mail it to us. You'll start receiving Sylvania News and the "Technical Section" insert with the very next issue!

*Sylvania News is the official "house magazine" of Hygrade Sylvania Corporation, Emporium, Pa.

SYLVANIA
The Set-Tested Radio Tube

HYGRADE SYLVANIA CDRP. Emporium, Pa. RC-67

Please send without obligation a FREE 3-months subscription to "Sylvania News." I am (check below) Experimentor Amateur Call Serviceman Employed by dealer Independent

Member Service Organization

Name

Address

City State

Name of Jobber

Address

CONDENSERS IN AUTO-RADIO NOISE ELIMINATION

(Continued from page 724)

is quickly and simply installed by slipping the slotted bracket under a loosened nut.

These necessary adjuncts to efficient auto-radio installation work have received a warm welcome because of their ease of installation, dependability, and very low cost.

This article has been prepared from data supplied by courtesy of Cornell-Dubilier Corporation.

INTERNATIONAL RADIO REVIEW

(Continued from page 729)

baffles" this unit depends on lengthening the path of the back wave sufficiently to prevent cancellation of the low notes.

The inside of a box-type baffle as shown in Fig. 3, is equipped with a number of wooden partitions having two shapes, the two types being alternated. The first type of partition has openings on the 4 sides, while the second type has a square hole in the center. This causes the sounds to be first spread through the 4 openings at the sides of the baffle and then compressed into a comparatively small, square opening, etc. As shown in the sketch, this increases the over-all length of the baffle to a size corresponding to one of very large size (of the usual box or flat type). In addition, the alternate spreading and compressing of the waves causes a cancellation of the back waves, right inside the baffle. The latter action can be accentuated by covering the partitions with rock wool or other sound-absorbing material.

WORLD'S SMALLEST 45V. "B" BATTERY!

(Continued from page 733)

familiar, as compared to the usual round cell, has uniform output as Fig. 2 shows. (The sudden drop in output of the round cell starts when the zinc case begins to be eaten through.)

As would be expected, the service capacity of the battery is small. The current required by the midjet radio transmitter is but a few milliamperes; and that only for the intermittent fractions of a second when the signal is sent out. That the capacity is sufficient for the purpose is shown by the fact that signals have been received for periods of over 2 hours and from altitudes up to 15 miles. Tests show that when discharged through a resistance of 10,000 ohms continuously, the battery will give 80 minutes service down to 34 V., and 225 minutes service down to 24 V.

This article has been prepared from data supplied by courtesy of National Carbon Co. Inc.

ORSMA MEMBERS' FORUM

(Continued from page 740)

for a "few cheap radio firms." None of the large manufacturers will use them. The trouble is when one makes an analyzer for modern Australian conditions it has to have 8 sockets: one, each, 4-pin, 5-pin, 6-pin, 7-pin large, 7-pin small, octal 8-pin, P side contact, V side contact. The P has 8 contacts and the V, 5. One also gets similarly mixed up in attempting to use the adapters, too.

C. S. SIMMONS,
53 Harold St.,
Matraville, Sydney,
Australia

Please Say That You Saw It in RADIO-CRAFT

They give you the 411 THINGS YOU NEED TO KNOW ABOUT

MODERN RADIO Service Work
1736 Pages 813 Illus.

These two Glirard books will give you the whole story on radio servicing—everything there is to know! SUPPLEMENTS supplied for the Data Book several times a year keep it up to the minute. **Get these great books Now!**

- **TEST INSTRUMENTS**—Complete explanations and descriptions of the latest commercial models of test instruments (with circuit diagrams), construction data, etc.
- **SERVICING METHODS**—Every latest test and repair method clearly explained. Receiver analysis. Repairing individual components. Aligning sets (including latest C-R Oscilloscope methods), AVC and QAVC circuits, etc.
- **SPECIAL SERVICING PROBLEMS**—In Auto Radio, All-Wave, High-Fidelity sets, etc., all explained.
- **FIELD DATA**—"Case Histories" of over 1,500 receivers, with trouble symptoms and remedies for each. I.F.'s for 5,421 smerlets. Over 25 other charts and tables.

\$6 With Money-Back Guarantee

RADIO & TECHNICAL PUBL. CO.
45 Astor Place, New York, Dept. RC-67

Encl. and \$6 for both servicing books, including Jan. and June '37 Supplements to Data Book, postpaid. (Foreign \$6.50)

Please send free Circular "CO".

Name

Address

Fill Out - Tear Off - and Mail!

For Sound Trucks
The U.S.E. Type

20-E Amplifier



Operates on car battery or 110 volts a.c.

20 Watts output. Dual mike input. Electric-eye Monitor.

U.S.E.'s new 16-page catalog lists complete Sound Truck Systems using the 20-E Amplifier.

Write for Catalog No. 107 and proposition.



United Sound Engineering Co.
Manufacturers of Electronic Equipment

2239 University Ave.
St. Paul, Minnesota

Licensed by arrangement with E.R.P.I. under patents owned and controlled by A. T. & T. and Western Elec. Co., Inc.

THIS ROOM-TO-ROOM PHONE PLUGS-IN LIKE A LAMP!

(Continued from page 737)

the A.C.-D.C. type, and may be used on 110 V., or, with the proper adapter, on 220 V. systems. The power supply consists of a 25Z5 half-wave rectifier, V4, and the usual single choke and dual-section condenser. A ballast resistor, V5, serves as the heater-circuit dropping resistor. Tube V1 acts as an A.F. amplifier at all times, while V2 is the power amplifier for reception and the modulator for transmission. Tube V3 acts as an oscillator for transmission, and as the detector for reception.

The shift from "talk" to "listen" is accomplished easily and rapidly by manipulation of the changeover switch. Pressing a button on the control panel, with the changeover switch in the "talk" position, sends an audio tone for signalling when the "callee" is beyond voice range. The volume control limits only the strength of the conversation at the receiving end or when the changeover switch is in the "listen" position.

SERVICING DATA

A simple test to determine if the instruments are in proper condition is the following one: plug both units into the same line outlet and set them on a table facing each other; with both warmed up and in the "listen" position, operate each key switch to the "talk" position in turn. A loud audio howl should be heard due to the proximity. (On D.C. circuits, try reversing the line-plug in its socket.)

A line-matching adjustment is provided and is reached through the bottom of the case. Remove the natural-color cork plug and insert a screwdriver. Adjust this screw of each instrument when it is in the "receive" position and a signal is coming from the remote station or normal background noise is heard. This adjustment should not be made unless reception is poor.

In certain types of wiring installations, such

as the 3-wire 110-220 V. lines, the 2 instruments may be plugged in on different sides of the wiring system. The usual indication of this condition is lack of volume. Trouble of a similar nature may be experienced on 4-wire 3-phase systems. Fused condensers to connect across the various "hot" sides of the wiring system, that fit into the raceway of the outlet box, are available for completing the R.F. path so that proper operation may be had no matter which particular circuit is used. (See detail illustrations A and B.)

In some cases, the use of an electrical appliance in the same socket as that used for communication may result in poor or noisy reception. For such cases, an appliance plug (known as the type LP impedance appliance plug) is available, which is inserted between the appliance and the socket. Another type of filter (known as the type SB signal and noise line blocker) is also available for use when the line noise comes from some source remote from the location of the communication system. This unit is cut into the line in the fuse box, and grounds the interference. (See details C, D and E.)

A 3-tip-jack strip is found on the rear of the case, one side marked "IN" and one "OUT." A pair of headphones equipped with individual volume-control potentiometer may be plugged into the "OUT" side for private reception or where the listener-in is hard-of-hearing; or, an amplifier may be used to raise the output so that it may be heard a considerable distance from the unit or above local noise. The "IN" tip-jacks are for the use of a magnetic-type phono pickup or a radio receiver, the output of which may then be sent to the other remote points over the carrier system.

If the system is set-up between adjacent rooms a communicating door being left open may result in audio feedback and consequent howling.

Reducing the setting of the volume control may reduce this effect sufficiently to eliminate the need of closing the door.

Used on a D.C. circuit in the same room while a D.C. radio receiver is in use may result in poor operation. The remedy is to turn off the radio set or else install a previously-mentioned type LP impedance appliance plug.

As a final note be sure that all sockets, fuses, etc., in the circuit are in good condition, so that no noise will come from these sources.

Our Information Bureau will gladly supply manufacturers' names and addresses of any items mentioned in RADIO-CRAFT. Please enclose a stamped and self-addressed envelope.

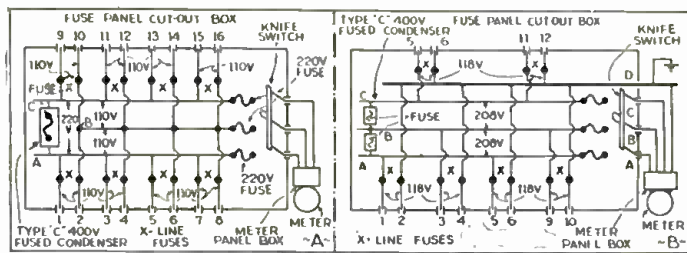

Condenser connections for condenser feed in 3-wire and 4-wire systems.

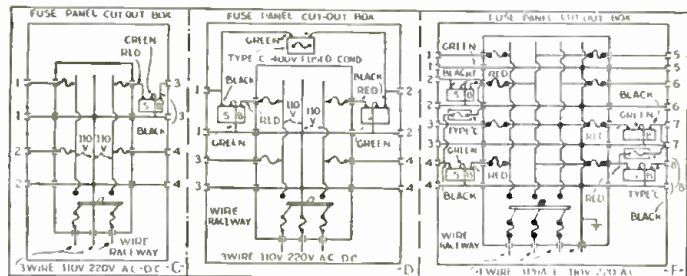

Connections of an "impedance appliance plug" in 3- and 4-wire systems.

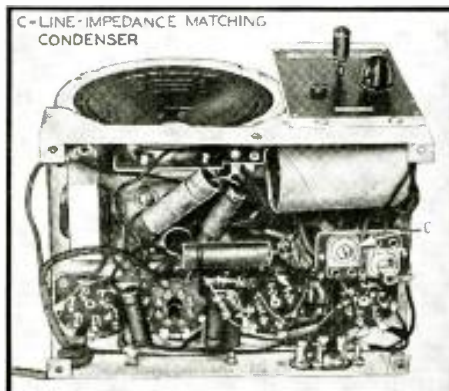

The under-chassis view of the device. The front panel shows the "talk-listen" switch and volume control.



The rear-chassis view. Note the "talk-listen" switch.

Please Say That You Saw It in RADIO-CRAFT

HOW TO USE V.-T. VOLT-METERS IN RADIO AND P.A. SERVICING

(Continued from page 734)

there were none of the causes of erroneous readings described above.

To secure the value of this potential, the volt-meter tube grid should be connected to the cathode of the tube and the other free terminal at the end of the test probe unit housing the vacuum-tube voltmeter, connected to the point where the grid makes its return to the A.V.C. circuit.

As the attenuation of the R.F. signal-generator output is changed, there should be a corresponding change in the voltage indicated on the vacuum-tube voltmeter. Greater input signal to the receiver will cause a corresponding increase in A.V.C. voltage developed if the circuit is functioning properly. The increase in voltage means a higher bias, thus having a tendency to hold the voltage input to the detector grid uniform over considerable range of R.F. signal input voltages.

Thus if the A.V.C. voltage does not vary with a change in the input signal, over usual limits, all components of the circuit should be scrutinized, particularly resistors and bypass condensers.

CONDENSER LEAKAGE RESISTANCE

With the ordinary voltmeter or milliammeter, it is very difficult to obtain an accurate determination of the insulation resistance of paper condensers, due to the high value of resistance which appears between the terminals of a unit in good condition. The fundamental circuit for this test is shown in Fig. 4 and it will be noted that the resistance R1 is the leakage resistance between the terminals of the condenser.

If a fixed resistor, R2 of 1 megohm resistance is used and a potential E of 350 V. is applied to the circuit, the condenser will be charged to its full capacity within a few seconds after application of the voltage. When the condenser has become completely charged, a small current will continue to flow through the circuit due to the insulation resistance R1 thus causing a voltage drop across the resistance R2.

If we measure this voltage drop with the vacuum-tube voltmeter and find it to be 1 V. for example, then it is apparent that the other 349 V. drop must be across the insulation resistance of the condenser R1. Knowing that the resistor R2 is 1 meg., we may then readily determine that the insulation resistance of the condenser denoted by R1, is 349 megs. We may then

$$(E-e) R2$$

formulate the equation $R1 = \frac{e}{(E-e) R2}$.

The insulation resistance of mica and paper condenser should be inversely proportional to the capacity. Thus a 1 mf. condenser will have ten times the insulation resistance a 10 mf. condenser will have of the same type. Therefore, in order to intelligently compare results of this type of measurement, we must express our answer in terms of megohm-mfs. This quantity will then be the same for condensers of different sizes. A good condenser of mica or paper insulation would have an insulation resistance in the neighborhood of 450 meg. mfs., meaning that for a capacity of 1 mf. a condenser should have 450 megs. of leakage resistance between the terminals. Likewise, a condenser of .1 mf. should have 4,500 megs. leakage resistance.

Care should be taken to determine if the condenser is leaky or shorted before making this test for if the condenser was shorted then the total voltage of 350 V. would appear across the resistor R1, thus causing damage to the vacuum-tube voltmeter. The usual continuity test will determine this fact.

This article has been prepared from data supplied by courtesy of Clough-Brengrle Co.

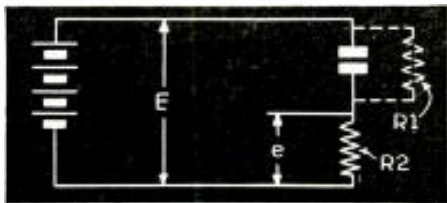

Fig. 4. Fundamental circuit of condenser leakage test.

CORNELL-DUBILIER
 WORLD'S LARGEST EXCLUSIVE MANUFACTURERS
 OF CONDENSERS FOR MORE THAN 27 YEARS
 MICA • DYKANOL • PAPER • WET & DRY ELECTROLYTIC
CORNELL-DUBILIER CORPORATION
 50. PLAINFIELD • NEW JERSEY

CONDENSERS FOR EVERY AMATEUR AND BROADCASTING STATION REQUIREMENT

TWO-WAY instant COMMUNICATION WIRELESS-PHONE NOW in Kit Form!



Build the WIRELESS-PHONE! Fool-proof design—complete instructions—holes drilled in chassis and cabinet. You can't go wrong! Build it in a few hours!

Kit of parts, per unit chassis WP-11	\$8.95
Kit of Sylvania tubes, (1-6C6, 2-43's, 1-25Z5) WP-12	2.82
Cabinet WP-14	2.18
Total	\$13.95
Complete Wireless-phone kit (two units)—nothing	
Else to buy WP-10	\$27.90
Wires and tested—extra—per unit	4.00

'ARROW RADIO, INC.
 82 Cortlandt Street, New York, N. Y.

Simply plug into electric outlet—it's WIRELESS! Voice is reproduced with radio-like quality—volume is more than ample—musical note replaces buzzer call! For the most simple, efficient and economical two-way communication system, Wireless-phone is the logical answer!

ARROW RADIO, INC.,
 82 Cortlandt St., New York, N. Y.

Enclosed please find money order check for \$3.00. (Balance—C.O.D.). Rush Wireless-phone Kit No. at once.

Name

Address

City

SPECIAL CONDENSER OFFER TO RADIO MEN!

We want every radio man to prove conclusively to himself the many advantages to be found in ILLINOIS DRY ELECTROLYTIC & PAPER CONDENSERS. Skilled engineering and the finest of materials have been combined to produce a quality line of condensers at lower cost. ALL ILLINOIS CONDENSERS are designed to withstand temperature extremes, humidity and eliminate costly re-servicing. Every ILLINOIS CONDENSER is unconditionally guaranteed for a period of one year! In order to prove their worth, we will for a limited time only, send post-paid our standard small size 8 MFD., 600 peak voltage condenser, upon receipt of your jobber's name and address, and 15¢ in stamps or coin to cover cost of handling, etc. Send for your trial condenser today and receive illustrated catalog sheet and price list. Trial offer ends June 10th.

ILLINOIS CONDENSER COMPANY
 3252 WEST NORTH AVENUE CHICAGO, ILLINOIS

Please Say That You Saw It in RADIO-CRAFT

FREE!
HAMMARLUND
 25th YEAR
 RADIO CATALOG

The most complete catalog ever published with special illustrations, drawings, curves and a complete description of the famous 16 tube "Super-Pro." Write Dept. RC-6-37.

HAMMARLUND MFG. CO., INC.
 424-438 West 33rd Street, New York

The First Two Installments

OF VOLUME 7 OF THE OFFICIAL RADIO SERVICE MANUAL

ARE NOW READY!

PLANS for publishing Volume 7 of the OFFICIAL RADIO SERVICE MANUAL are vastly different from methods of preceding years. So many new ideas and radical changes are being incorporated that this project opens a "new era" in procedure of radio book publishing.

Practically every one of the fifteen outstanding features in our new plan will interest you and make you enthusiastic about the new Gernsback MANUAL. No other radio publisher has ever dared to make such innovations as we plan for Volume 7—nor has any one attempted to bring to radio men such complete, authentic service data so quickly.

Our new payment plan, outlined in the coupon below, makes it convenient for every radio man in the country to own Volume 7 of the OFFICIAL RADIO SERVICE MANUAL.

Now published in monthly installments!

**HERE ARE THE FEATURES OF THE GERNSBACK
OFFICIAL RADIO SERVICE MANUAL (Volume 7)**

Over 1,800 Pages



PUBLISHED SIMILARLY TO A MAGAZINE

The OFFICIAL RADIO SERVICE MANUAL (Volume 7) will be published in twelve installments—one installment will be mailed every month to subscribers.

DEFERRED PAYMENT PLAN

This new Manual will be sold on the deferred payment plan. Complete details of this "pay-as-you-compile-your-manual" plan appears in coupon below.

150 PAGES OF SERVICE DATA

is sent to you every month. Each installment will never be less than 150 throughout the year.

IN A YEAR YOU HAVE AN OFFICIAL RADIO SERVICE MANUAL OF OVER 1,800 PAGES—

The total amount of service data which you have received during the year exceeds any other service guide published.

CUMULATIVE INDEX EACH MONTH

The index accompanying the first installment lists all sets which appear in that section; the index mailed with the second installment lists sets appearing in both the first and second installments, and so on. You discard the previous index and use the new one furnished with each installment. With the final, twelfth installment, the Master Index which you receive will cover, not only the set data you received during the entire year's monthly service (which constitutes Volume 7), but, in addition, the sets listed in every GERNSBACK OFFICIAL RADIO SERVICE MANUAL since 1931.

OVER 3,000 ILLUSTRATIONS

The largest compilation of complete wiring diagrams, schematics and charts ever included in a single volume of any radio service Manual.

OVER 1,200 MANUFACTURED RECEIVERS

More wiring and schematic and other servicing diagrams will be included in Volume 7 than in any other Manual. At least 1,200 manufactured sets will be covered.

ALL FRESH MATERIALS—NO REHASH

And, most important, there will be no duplication of any material. In Volume 7 you will find material which has never appeared previously in the first six volumes.

RADCRAFT PUBLICATIONS, INC., 99 Hudson St., New York, N. Y.

MANY 1938 MODELS TO BE INCLUDED

At the end of a year's service (12 months), subscribers receive service data and diagrams on many advance 1938 models. This material would ordinarily appear in the 1939 Edition of the MANUAL.

YOU RECEIVE NEW, TIMELY SERVICE DATA EACH MONTH

This new plan permits you to have in your possession service data just released. Previously, the material was a year old or more when it reached you. Service data on older receivers never before published in any other of the Gernsback Manuals, will be included in Volume 7.

COMPLETE SERVICE DATA

This data includes valuable information as I. F. peaks, operating voltages, alignment procedure, chassis and tube socket layouts, values of components, lists of parts, and other vitally important service hints.

SERVICE DATA AND DIAGRAMS NOT LISTED ELSEWHERE

A considerably large portion of the data appearing in the monthly installments will not be found in any other radio service Manual . . . at least not for some time to come. This is an outstanding advantage of this new plan.

SIMPLE TO INSERT EACH INSTALLMENT

You literally "slap" them in . . . one installment on top of the other . . . without any fuss of arranging the pages numerically, alphabetically or otherwise. You merely open the binder and, with one single motion, slip the entire group of pages over the steel binding posts. You don't remove the pages thereafter, they stay in the binder for good. We've done all the filing work for you. . . . That's all there is to it! The specially compiled cumulative index (which you receive with each installment) does the rest. This index shows at a glance where any required information can be found.

EQUIVALENT TO TWO REGULAR SERVICE MANUALS

since the sets covered are those manufactured during the latter part of 1936, all in 1937 and many in early 1938. The second year (starting April, 1938) of this monthly service will begin with sets manufactured during 1938.

RADCRAFT PUBLICATIONS, INC., 99 Hudson Street, New York, N. Y.

RC-637

Please enroll me as a subscriber to Volume 7 of the OFFICIAL RADIO SERVICE MANUAL. I have marked below the plan which I prefer.

PLAN NO. 1

I enclose \$10.00 herewith, for which send me immediately, FREE OF CHARGE, a heavy, stiff binder, and send me thereafter for twelve consecutive months commencing March 15, 1937, regularly once a month, an average of 150 pages of Volume 7 of the OFFICIAL RADIO SERVICE MANUAL. These pages can be immediately filed into the binder. Both the binder and the monthly pages are mailed to me POSTAGE PREPAID. Total cost: \$10.00. THIS PLAN SAVES ME \$2.00.

PLAN NO. 2

I enclose \$3.50 herewith, for which send me immediately, FREE OF CHARGE, a heavy, stiff binder, and send me thereafter commencing March 15, 1937, regularly once a month for twelve consecutive months, an average of 150 pages of Volume 7 of the OFFICIAL RADIO SERVICE MANUAL. At the end of each three-month period bill me for \$2.50 making the total cost for the year's service \$11.00. THIS PLAN SAVES ME \$1.00.

PLAN NO. 3

I pay nothing in advance. Each month an average of 150 pages of Volume 7 of the OFFICIAL RADIO SERVICE MANUAL will be delivered to me. I pay postman \$1.20 plus a few cents for C.O.D. charges each month for ten months. The eleventh and twelfth installments will be delivered to me FREE OF CHARGE. You prepay shipping charges on all installments mailed to me. With the tenth installment send me FREE OF CHARGE a heavy, stiff binder.

I want the binder sent with the first installment, and will pay postman a total of \$2.40 plus a few cents for C.O.D. charges and \$1.20 per month for eight consecutive months thereafter. Under this plan, the tenth, eleventh and twelfth installments are delivered to me FREE OF CHARGE. TOTAL COST UNDER THIS PLAN \$12.00.

NAME ADDRESS CITY STATE

Send remittance by check or money order. Register your letter if you send cash or unused U.S. Postage Stamps.

Please Say That You Saw It in RADIO-CRAFT

A MODERN LATHE IN THE RADIO SHOP

RADIO men everywhere recognize the importance of the lathe as an all-purpose machine. A few of the many jobs its handles: Winding coils and transformers; turning small parts, such as, knobs, shafts, and special screws; making service tools, microphones, and dies for special stampings. The television enthusiast finds the lathe especially useful in laying out mounting discs and making the various mechanical parts. Equipped with several carefully chosen attachments, a back-geared, screw-cutting lathe is almost a complete shop in itself.

Continual improvements in late design and construction have resulted in increased accuracy and convenience for the radio man. The winding of coils and transformers is one example. Notice in this illustration that a simple guide has been mounted in place of the tool post on the compound rest. The set-up, announced recently by the Atlas Press Company, has made coil winding a simple job and is being accepted enthusiastically by all branches of the electrical field.

The latest lathe book, "Manual of Lathe Operation," released in March by the Atlas Engineering Department, should find a place in every radio shop. One series of tables in this manual shows in detail the proper gear set-ups for winding with magnet wire in Brown & Sharpe gauges between 12 and 40, using bare wire or any of the following insulations: single cotton, double cotton, single silk, double silk, enamel, silk enamel, and cotton enamel. Other tables include gear data to obtain proper carriage feeds for spring making, wire wrapping, and coil winding with steel and iron wire in the following gauges: American Steel and Iron Company, music wire, American or B. & S., and Washburn and Moen.

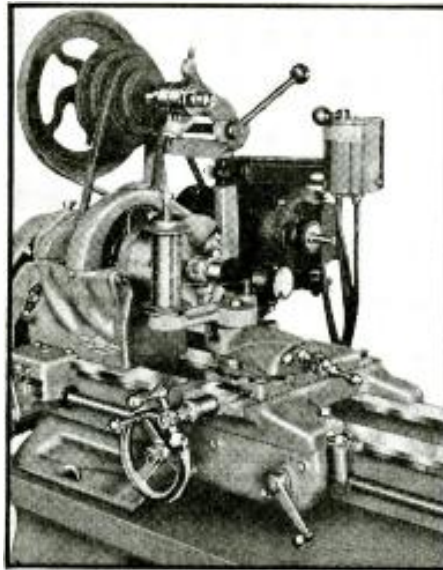

The 1937 Atlas Catalog gives complete details on the new Atlas metal working lathes and attachments for performing the extremely delicate and intricate machining required in the radio shop of today. This catalog will be sent free on request to *Radio-Craft*. Ask for No. 1366A.

THE LATEST RADIO EQUIPMENT

(Continued from page 736)

REPLACEMENT-VIBRATOR KIT (1360)

A COMPACT kit containing one, each, of the 3 types of vibrators used in Philco sets and a Philco replacement for Majestic models 66 and 116 car-radio sets. States the manufacturer: "With nearly 3,000,000 Philco auto-radio sets in use, the company sees a potential vibrator replacement business of about \$10,000,000 a year, plus a substantial replacement of vibrators of other makes. Vibrators, it was found, have an average life of one year. Vibrator replacement is a 'clean' business, free of all labor costs, since replacement is accomplished almost instantly. This business is expanding at the rate of 1,000,000 sets a year, a fact which not only assures a continuance of the market but also a constantly increasing one."

ADJUSTABLE FLOOR STAND (1361)

(Atlas Sound Corporation)

A LIGHT-WEIGHT portable baffle stand which can be raised to a height of 8 ft. and weighs only 11 lbs. is offered for 8 and 12 in. speakers. The stand is finished in bright silver and black lacquer and is fitted with rubber feet.

VOLT-OHMMETER (1362)

(Elgin Precise Instrument Co.)

THIS small multimeter having ranges of 0-5, 50, 500 and 1,000 volts; 0-1 milliampere; 15-500 ohms, and 200 ohms—0.5-meg., has a sensitivity of 1,000 ohms per volt. It contains the ohmmeter batteries and is ruggedly constructed.

LIGHT-SENSITIVE CELL (1363)

(General Electric Co.)

A NEW photo-sensitive cell consisting of a layer of selenium deposited on a small steel plate and having a negligible time lag with an unusually wide frequency characteristic has been introduced. Since the cell is of the self generating type it is particularly applicable to light measurement and similar uses.

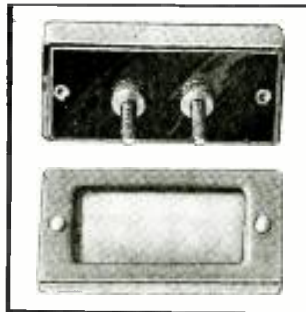
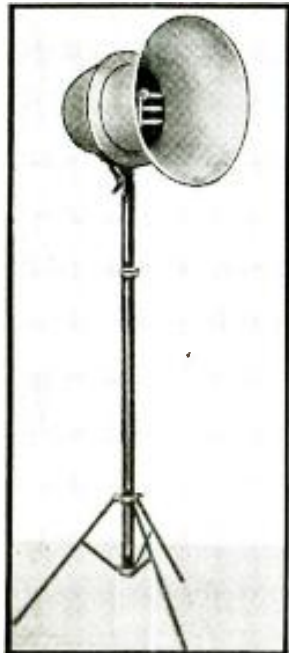

Left. A portable baffle stand which is rugged and attractive (1361). Center. A portable volt-ohmmeter for the practical man (1362). Above. The new selenium photo-cell.



MODEL 1200-A
DEALER PRICE \$21.67

TODAY'S MOST POPULAR VOLT-OHM-MILLIAMMETER

- Separate A.C. and D.C. Instrument Movements.
- Tilting Feature for More Accurate Reading.
- 2% Accuracy both A.C. and D.C.
- Ohm Scales Separately Adjusted to Zero.
- Low Loss Switch (Contact Error on Milliampere Less than 1/2%) (No Contact Error on Voltage Measurements)
- Metal Case with Black Wrinkle Finish.

Model 1200-A scales read as follows: D.C. 10-50-250-500-1000 volts at 2,000 ohms per volt; 1-10-50-250 M.A.; Low ohms backup circuit .5 to 500; 1500 ohms, 1.5 and 3 Meg-ohms. A.C. 10-50-250-500-1000 volts. Contains 22 1/2 and 1 1/2 volt batteries.

Net Price to Dealers \$21.67

A TRIPLET MASTER UNIT

One of a series of co-related single unit testers; made in standard sizes; the most economical method yet devised for completely equipping the all-around radio service shop with high quality instruments.



The Triplet Electrical Instrument Co.
166 Harmon Ave., Bluffton, Ohio

Without obligation please send me more information on Model 1200-A, I am also interested in

Name

Address

City State

Please Say That You Saw It in RADIO-CRAFT

SUCCESSFUL in
PERFORMANCE.. DESIGN..
CONSTRUCTION.. SALES..
say leading P.A. men

AMPERITE VELOCITY
ACHIEVES
UNIQUE RECORD
IN ACTUAL USE

Featuring..

1. Output increased 6 DB.
2. Triple shielded—against all RF or magnetic fields, entirely eliminating hum pickup.
3. Eliminates feedback troubles.
4. Excellent for close talking and distant pickup.
5. Acoustically designed to eliminate any possibility of cavity resonance.
6. Fitted with switch and cable clamp.

NEW! MODELS RBHn (High Impedance): RBMn (200 ohms), with Cable Connector and Switch **\$42.00 LIST**
 NEW! MODELS RBSn, RSHn, streamline; slightly lower output and frequency range than above, with switch only **\$32.00 LIST**
 Models RAL (200 ohms); RAH (2000 ohms). Built to Amperite standards: No peaks. Flat response. Triple shielded. Shock absorber. Swivel bracket **\$22.00 LIST**

Finishes: All microphones have the new standard Gunmetal Finish. Available in Chrome, extra. \$1.00 List.
FREE: WINDOW DECAL advertising your SOUND SERVICE. Four-color design. 5 1/4 x 9 1/4. Write for it now.

AMPERITE Co. Cable Address: Alton New York
 561 BROADWAY NEW YORK

AMPERITE Velocity MICROPHONE

NEOBEAM OSCILLOSCOPE

Makes **HIGH FIDELITY** easy—
 helps modernize old equipment.



Self-contained power supply, sweep system, high gain amplifier and calibrated input.

By attaching just one prod., as illustrated above, you are ready to check every part of your audio system. Before your eyes—as plain as daylight—is an image of sound—a true story of the fidelity of your amplifier, so simple even the less technical layman understands. Now it is easy to adjust the plate and grid loads of the amplifier until each stage can portray a clear **HIGH FIDELITY** tone on the full 4" calibrated screen of the NEOBEAM. The image has contrast—orange and black—you see every detail of hum and distortion. The NEOBEAM OSCILLOSCOPE comes complete with tubes and ready to operate. Full satisfaction guaranteed or money back. \$40.00 net.

SUNDT ENGINEERING COMPANY
 (Affiliate of Littelfuse Laboratories)
 4276 LINCOLN AVE. CHICAGO, ILL.

SUCCESSFUL SERVICING

For Professional Servicemen

RSI advanced home-study training in Radio Service and Public Address work is the "Key" to Successful Servicing. It gives you the latest instruction on what goes into modern receivers, and basic knowledge of how complex circuits work. It familiarizes you with various types of vacuum tubes. It gives you the ability to progress from the "mechanic" stage to that of an expert specialist. Get all details in Free Book!

RADIO SERVICE INSTITUTE (Dept. RC-6)
 3308-14th St., N. W. WASH., D. C.

WRITE TODAY FOR FREE BOOK

ACOUSTICS FOR THE PRACTICAL P.A. MAN

(Continued from page 724)

tend to reflect a greater portion of the sound that strikes them. In some cases this reflected sound will get back into the microphone and "howling" may again be produced. The reflected sound waves will also reach the ears of the audience. If the total distance the reflected sound waves travel before reaching the ear is 60 ft. greater than the distance of the direct sound, an echo will be heard!

When the sound vibrations reflect back and forth between various hard surfaces, there is a mingling of the reflected sound with the original sound. This causes sounds of certain frequencies to continue to be heard (to reverberate) for a certain length of time after the original sound source has ceased to produce them. This condition (reverberation) if it exists to too great an extent, makes the original sound unintelligible. The time required for sound to die out after the source of sound ceases is called "time of reverberation." We should have as much of this reverberation as possible without interfering with articulate sound (intelligibility). The permissible time of reverberation for various size rooms is given in the following Table I, compiled by Prof. F. R. Watson.

TABLE I
OPTIMUM PERIODS OF REVERBERATION

Cubic Feet	Seconds
Below 7,000	1.0
7,000 to 20,000	1.1
20,000 to 45,000	1.2
45,000 to 85,000	1.3
85,000 to 145,000	1.4
145,000 to 225,000	1.5
225,000 to 330,000	1.6
330,000 to 465,000	1.7
465,000 to 630,000	1.8
630,000 to 835,000	1.9
835,000 to 1,100,000	2.0

The various factors involved and their bearing upon "time of reverberation" is expressed in 05V1

Sabine's formula: T equals $\frac{A}{0.16V}$ (Where

T equals time of reverberation in seconds, V equals volume of room in cubic feet, and A equals total number of absorption units in room); A is obtained by totaling the absorption units of all materials in the room, and then measuring the square footage of all the materials employed in the surface construction of the room and multiplying the resulting figures by their respective coefficients of absorption.

These coefficients of sound absorption have been determined for practically all materials, and each square foot is rated by comparison with one square foot of open window space, which is accepted as 100 per cent absorptive, and therefore, has a coefficient of unity or 1.00. Thus if a square foot of curtain material absorbs 3/4 as much sound as 1 square ft. of open window, the coefficient of absorption of the curtain is said to be 0.75. Table II gives the coefficient of absorption units of different materials and individual objects at a standard pitch of 512 vibrations per second.

This table is compiled from information contained in the published works of Professor Wallace C. Sabine, Professor F. R. Watson, and the Bureau of Standards. (This table is more up-to-date than those previously published in *Radio-Craft*.—Editor) It is customary to subtract the absorption factor of the chair from that of a person to obtain the net absorption units brought in by each person. This is because the person covers the chair when seated. It is also assumed that the chair covers three-fourths of the floor space it occupies. It is evident that the size of an audience will affect the time of reverberation; therefore, T should be calculated for conditions such as (1) empty, (2) 1/2-full, and (3) full.

Then by transposing Sabine's formula and solving for A, we find the total number of absorption units required. Subtracting the actual number of absorption units from the required number, we obtain the number that must be added for ideal conditions.

The installation man must keep in mind that the essential parts of a P.A. system must be properly matched with each other. When the loudspeakers are close to the amplifier, low-impedance output windings should connect to voice coils of equal impedances. If two or more speakers are fed by one output winding their

combined impedance should equal the impedance of the winding.

When reproducers are located more than 50 ft. from the amplifier: (1) they should be fed with a transmission line of about 500 ohms impedance; (2) the line should be fed with an impedance of 500 ohms; and, (3) the speakers should contain impedance-matching transformers with primary impedance of such value that their combined impedance will offer a 500-ohm load to the transmission line.

An efficient P.A. system should have some form of volume indicator, the best type being a V.-T. voltmeter calibrated in decibels and connected into the circuit immediately following the mixer panel. This is very essential if the reproducers are not within hearing range of the operator. A monitor panel should be used to give the operator an indication of the quality of the amplified sound at all times.

The field of P.A. work, involving the (a) reproduction, (b) amplification, (c) direction, and (d) control of sound, provides one of the most profitable branches of work for men who possess a thorough knowledge of acoustics and sound equipment.

The subjects described in this article cover but a few of the many interesting phases of P.A. systems which are proven and tested by students in their daily work in the Chicago shop of a well-known electrical and radio school.

TABLE II
SOUND ABSORBING COEFFICIENTS FOR PITCH OF 512 V.P.S.*

Material	Coeff. per Sq. Ft.
Open Window	1.00
Acoustex, 1 in. thick	0.37
Balsam Wool—bare, 1 in. thick, 26-lbs. per sq. ft.	0.44
Brick Wall—plain, set in plaster	0.082
—painted	0.017
—plain, set in cement	0.025
—unlined	0.15 to 0.20
Carpets	—lined with thin padding 0.20 to 0.30
—lined 1/2-in. ozite felt	0.25
Celotex—unperforated 3/4-in. thick	0.20
Acousti-Celotex—type BB, painted or unpainted, 1 1/4 ins. thick	0.70
Cork Tile	0.06
Flaxlinum Acoustic Tile—1/2-in. thick, with metal screen	0.42
Cement—top dressing on concrete	0.025
Concrete	0.015
Cocoa Matting—lined	0.17
Curtains—cretonne	0.15
—chenille	0.23
—velour, heavy folds	0.75
—hung straight, against wall	0.40
—cotton fabric, 10 ozs. per sq. yd.	0.11
Draperies—velour, hung same way, 18 ozs. per sq. yard	0.35
Felt—all hair, 1 in. thick, 75 lbs. per sq. ft.	0.58
Glass—single thickness	0.027
Linoleum	0.03
Marble	0.01
Oil Painting—per sq. foot	0.28
Plaster—on wood lath	0.031
—on metal lath	0.033
—on tile	0.025
—Sabinite acoustical	0.21
Stage Opening—depending on furnishings	0.25 to 0.40
Ventilators	0.50 to 0.75
Wood—plain	0.06
—varnished	0.03
Individual Objects	
Adult Person	4.7
Church Pews—per seat	0.2
Seat Cushions	1.00 to 2.00
Chairs—padded seat and back covered with imitation leather	1.6
—various padding, covered with velour or mohair	2.3 to 3.5
—opera plywood seat and back, plain	0.24
Piano	0.6
Table	0.2

*Vibrations (cycles) per second.

This article has been prepared from data supplied by courtesy of Coyne Electrical and Radio School.

Please Say That You Saw It in RADIO-CRAFT

BARGAIN BULLETIN
SAVE MONEY ON EVERYTHING YOU BUY!

SPORTING GOODS
WATCHES-CLOCKS
TYPEWRITERS
OPTICAL GOODS
CAMERAS-NOVELTIES

RADIO SETS AND REPLACEMENT PARTS

SEND AT ONCE FOR OUR FREE CATALOG!

Buy efficiently, economically, safely! Hundreds of high quality items—leading lines and standard brands—at prices amazingly low! Real bargains! Square dealing! Write today for your big, free copy of this new catalog hot off the press.

RADIO CIRCULAR CO., INC.

915 BROADWAY Dept. RC NEW YORK, N. Y.

DEVELOP & PRINT YOUR OWN SNAPSHOTS

Save One Half!

Save money and have fun developing, printing your own pictures—for fun or profit! No experience needed. Everything included in Central's Professional Dark Room Outfit.

Send us only \$1.95 money order for this professional outfit including electric ruby lamp, developing and fixing trays, chemicals, photograph paper, complete directions—everything needed. Or sent C. O. D. \$1.95 plus postage. Unless perfectly satisfied, return outfit within 10 days and your money will be refunded! Order today—start printing your pictures, right away! Write for Free Bargain Book of Cameras and Supplies. **CENTRAL Camera Co. (Est. 1899) 230 S. Wabash, Dept. A-582, Chicago.**

COMPLETE OUTFIT \$1.95



RADIO MEN! GRAFOLINE

Insures correct permanent repairs for all air exposed contacts and wherever dust and dirt affect moving parts. Ideal for all wavy switches, wire wound volume controls, etc. Easy to apply, insures longer wear for parts. Lubricates electric motors, vacuum cleaners, etc. Full sized bottle 35c from your Radio Parts Jobber. If he cannot supply—WRITE for free circular—complete line. **GENERAL CEMENT MFG. CO., Rockford, Illinois.**



RADIOS 1/2 OFF!



Buy direct. New line of ZEPHYR WORLD-WIDE all-electric, battery and auto radios, 5 to 15 tubes. All latest features. Buy at WHOLESALE PRICES. MONEY-BACK GUARANTEE. Earn extra money with our Agent-User Plan. Write for FREE CATALOGUE.

ZEPHYR RADIO COMPANY
 30 DAYS TRIAL 13141 Hamilton Ave. Detroit, Michigan

BE OUR AGENT!

BIG PROFITS FOR RADIO MEN

Sell our complete line of 16 MM and 35 MM motion picture equipment for theatres, institutions, clubs and home use. We have everything. Tremendous field; liberal profits. Write TODAY. **S. O. S. CORP.** 636-RA Eleventh Ave., N. Y. C. CABLE—SOSOUND, N. Y.

Genuine Majestic

Majestic & Grig-by-Grumow, original and genuine factory radio and refrigerator service. We have purchased all of the assets formerly belonging to Grigby-Grumow. All parts, service replacement units will carry regular factory guarantee. Buy only through our authorized distributors, dealers or ourselves. **GENUINE MAJESTIC PARTS & TUBES** Write for prices. **G & G GENUINE MAJESTIC REFRIGERATOR & RADIO PARTS SERVICE**, 5801 Dickens Avenue, Chicago, Illinois.

THE PRIVATE-ADDRESS FIELD

(Continued from page 716)

ticket offices, theatres, schools, stores, garages, factories, steamship piers, radio stations, police headquarters, courts, farms, bus terminals, armories, air ports, barbecue stands, beaches, gymnasiums, playgrounds, prisons, ships, stockyards, parking lots, yachts, and in fact anywhere that people come in contact with one another and wish to speak.

They can even be used to converse between trailers and their tow cars; this suggestion by Radio-Craft to the sound field has been selected as the feature illustration on the cover of this issue of Radio-Craft.

The important fact about these many possible installations to the radio man is the opportunity they offer to build up a profitable business installing, expanding and maintaining the systems in their localities. The real money-making possibilities, of course, are not in simple 2- and 3-station systems in homes and small business establishments but rather in large multi-unit installations.

Take for example, the cross-section shown in Fig. B. Here we have a medium-size manufacturing plant with a general office, private office, laboratory, factory, and shipping room. Each of these portions of the plant is tied together by means of the Private-Address units, thus—saving steps; saving time; saving mistakes; and saving money for the plant—and what is more important, providing a profitable job for the radio man who installed and has charge of the maintenance of the system.

The private-address systems commercially available may be divided into several types, each suitable for certain classes of work.

(1) First, there is the .F. type which operates at audio frequency and requires connecting wires to tie to the various individual units. The simplest form of this unit consists of individual units, each containing its A.F. amplifier with a speaker which acts as both microphone and speaker depending on whether the selector switch is in the "talk" or in the "listen" position.

A somewhat more complete system of the same general type has a "master" unit and a number of outlying units. In this type of set-up the master unit is equipped with keys which tie up the individual outlying stations as desired by the operator of the master unit. This type of set-up is suitable for installations where it is necessary for one person to be in communication with a number of others at all times. The outlying stations are able to talk back to the master station but cannot call the master station independently, nor talk to another outlying station.

The most flexible type of audio private-address system is one in which each station (usually from 3 to 11 stations) is equipped with keys so that any station may call and converse with any other.

(2) The R.F. systems utilize small oscillators which are modulated by the voice, and require no inter-connecting wires for stations on the same local power supply (the same supply meter). These systems use the well known principles of the "wired wireless" developed by Major General Squires of the U.S. Signal Corps. The carrier signal from the R.F. transmitter is coupled to the electric light wires and follows this wiring system as far as it provides a low-impedance path. At the meter or the "pole transformer" (depending on the particular type of line) the signals encounter a path of high impedance and since only a very small oscillator is used, the signals do not pass beyond this point.

The R.F. types are available for point-to-point conversations between two or more stations on the same line. By a system of signals, using the "audio tone" call provided, one station can speak to any other.

The radio Service Man, in estimating on the cost of installing a system to fill the needs of a certain concern, home or other customer, should keep in mind the fact that it should be flexible enough so that additions and changes can be made without discarding the equipment used in the original installation.

As for getting jobs, there are innumerable prospects in every town and city in the country. People are easily convinced of the usefulness of the private-address system, if the uses in their particular business are pointed out to them, with a practical demonstration right on the spot. You can make money from private address if you have the "go getter" spirit!

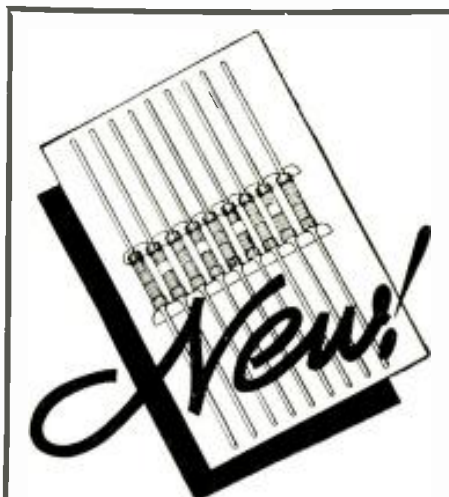

A small end-lead Resistor

in a new and convenient package

Like all Centralab Resistors they are thoroly insulated from all adjacent parts. Its smaller mass results in reduced capacity coupling to adjacent parts. Its effective resistor length is actual length of resistor . . . and its r.f. resistance is practically the DC resistance.

Size 1/2" x 11/16"—rated at 1/2 watt.

Specify Centralab at your jobber.

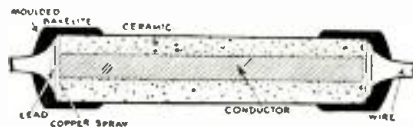

Centralab

MILWAUKEE WISCONSIN

BRITISH CENTRALAB, LTD.
 Canterbury Rd., Kilbourn
 London N.W. 6, England

CENTRALAB
 118 Avenue Ledru-Rollin
 Paris XI, France



REX 6L6 AMPLIFIER OUTPUT 20 WATTS \$22.75

Provides Mike-Phono Mixing • Operates ANY type Mike • Field Supply: 110-140 Volts, 145 mls (22 watts) • Harmonic Content: 2% • Compact: 14 x 10 1/2 x 7 in. tall, ideal for portable use! • Ruby Pilot Light • Plugs—Sockets for input—output connections • Universal Output Impedances • Hum-Free! • Fully Guaranteed

REX Manufactures Amplifier Systems to suit any requirement. For LESS MONEY! Over 90 Models Now Available!

REX "LOUD PHONE"

Inter - Office Amplifier Systems permit dual conversations simultaneously! No "press-to-talk switches"!

WRITE FOR FREE CATALOG REX AMPLIFIER SYSTEMS CO.

148 West 23rd St., New York, N. Y.



"HAM" SPECIAL Standard Teleplex

A highly efficient code teacher using heavy specially prepared waxed paper tape, having two rows of perforations. Write for Free folder A6. We are the originators of this type instrument

Instrument with tapes prepared by expert and complete course, all for \$21.95. Without Oscillator. 72-76 Cortlandt St., N. Y. C.

Please Say That You Saw It in RADIO-CRAFT

BEHIND POWER AMPLIFIERS

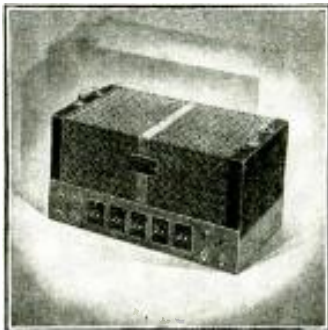

Distinctively Modern. The keynote of all ACA amplifier designs! Models available for every purpose—Industrial, Recreational, Theatrical, Electronic, Educational, etc. A varied line ranging from 10 to 300 watts designed to meet all requirements. Available in portable, semi-portable, mobile and permanent systems. Special universal amplifiers available for operation from 6 volts D.C. or 110 volts A.C. Backed by a 5 year guarantee.

Write for FREE Latest Catalog No. 3709

Mr. A. C. Shancy will gladly help you plan any type of P.A. installation. Send complete details for free expert advice.

AMPLIFIER CO. of AMERICA

AMPLIFIED SOUND SYSTEMS

37 WEST 20TH STREET NEW YORK CITY

TRAILER RADIO

(Continued from page 716)

stalled between the trailer and the gas buggy "up ahead." Such an inter-communicating system, operating from the car and trailer batteries or from the "wind-power installation," if one is used, will be a real convenience to the trailer owners.

Table model sets of sturdy construction—both all-wave and broadcast types—can be changed to operate from the trailer power supply, thus providing much better radio facilities than the ordinary auto-radio set can give. The sets can be converted so that they will operate from either the trailer power or the 110 V. lines, thus allowing the set to be used in the permanent home or in the trailer.

And it is not necessary to have a radio set in the car, if a Private-Address unit is installed as mentioned above, since the amplifier and speaker of the P.A. unit in the car can be used to supply entertainment in the car itself. This has certain advantages from an installation standpoint, as the trailer is so far from the ignition system of the car that no difficulty will be encountered from ignition interference. The aerial, too, can be much more efficient, as the trailer is larger, thus permitting a better and higher aerial than is possible in a car.

These are just a few ideas of how the Service Man can cash-in on the new trailer boom which is sweeping the country to the tune of a quarter-of-a-million trailers today and more being made.

The far-sighted Service Man will, no doubt, visualize a trailer service station in the form of an attractive park where trailers may be parked in their "stop overs"; a store, stocked with all the needs of "trailer travelers" such as food, clothing, fuel, etc., etc.; a recreation hall fitted with a P.A. system, radio, dance floor, soda fountain, etc.; a service shop equipped to furnish electric light, running water, and gas directly to the trailers as well as an attractive display of "gadgets" (radio sets, et al.) to sell to visitors; and a comfort station fully equipped with showers, baths, etc. In other words, a trailer tourists' paradise—and a fine year-round money maker for the owner of the service station.

New "Delta" Tools

More complete than ever before, the Delta line for 1937 includes a full line of wood working and light metal working tools and all necessary accessories and incorporates many new features and improvements and new units. This year the Delta line includes:

A remarkable NEW Belt Sander; Revolutionary NEW 17" Drill Presses; a NEW Precision 4" Jointer; a NEW Precision 11" Drill Press; Improved 14" Drill Presses; Improved Combination Units; NEW Tapping Attachments; NEW Shaper Cutter-head; NEW Tenoning Collars; NEW Belt-Drive Buffer; NEW Belt Guards and Improved Safety Features.

Write for Catalog

Send TODAY for 1937 Delta Catalog containing photographs, prices, and full details on the complete line of Delta motor-driven tools.

DELTA MFG. COMPANY

Dept. 3475, 690-634 E. Vienna Ave. MILWAUKEE, WIS.



Combination Ten-Inch Circular Saw Six-Inch Jointer

Extremely popular combination unit comprising two splendid Delta tools mounted on steel stand. Numerous special features on both tools. No interference. An ideal unit for home workshops and light factory work.

LES Correspondence Courses in **RADIO and ELECTRICAL ENGINEERING**

ELECTRICAL ENGINEERING Get good grasp of wide electrical field. Prepare yourself, at Low Cost, for secure future. Modern, simplified, you can understand quickly.

RADIO ENGINEERING Extra fine course in radio, public address, photo-electric work, trains you to be super-service man, real vacuum tube technician. Experience furnished. Diploma on completion. Tuition, \$25, either course. Deferred payment plan.

FREE Get copies of school catalogs, student magazines, complete details. **SEND NOW!**

LINCOLN ENGINEERING SCHOOL, Box 931-27, LINCOLN, NEBR.

AN ELECTROMECHANICAL OSCILLOSCOPE

(Continued from page 723)

oscilloscope tube belongs to the glow type.

Going back to 1861 we find Feddersen discovered the area of glow covering the electrode of a gaseous discharge tube was directly proportional to current passing through the tube. It had been discovered earlier than this that only the negative electrode glows. In 1904 Gehrke and Disselhorst combined these two principles to produce an oscilloscope by using a tube with elongated electrodes and a rotating mirror to scan the electrodes across them. The construction of the tube is shown in Fig. 1. Since only the negative electrode glows, on alternating current the glow shifts from one electrode to the other at a rate equal to the impressed frequency. (The same set-up has been used recently to check modulation in amateur transmitters.)

The early-type gaseous-tube oscilloscope has several inherent disadvantages. In the first place, the easily ionized rare gases were practically unknown and nitrogen was usually used as a medium. The high ionizing potential of nitrogen limited the use of the instrument to the observa-

tion of relatively high potentials such as condenser discharges.

In the new oscilloscope described this difficulty has been overcome in a unique manner. Instead of making the electrodes glow directly from the input voltage a 6L6 beam-power R.F. oscillator is provided to keep both the electrodes glowing all the time. This changes the entire picture—the disadvantage of high striking voltage is eliminated but more than that—an amplifier and modulator may then be used to modulate the oscillator which in turn causes the glow on the electrodes to rise and fall in direct proportion to the input to the amplifier.

Viewed in a scanning mirror an image is shown like Fig. 1. The tube is essentially the same design as formerly used and is comparatively small, 6 ins. long by 9/16-in. dia. The elongated electrodes measure 2 ins. each, thus permitting a 4-in. image. Distortion in the input is portrayed by changes in the wave outline. Thus instead of 200 V. and 10 ma. minimum to operate the tube we use inputs of as low as 1 microvolt across an input potentiometer of 1 meg. and obtain 100 per cent modulation. By means of a switch the range is extended to 200 V.

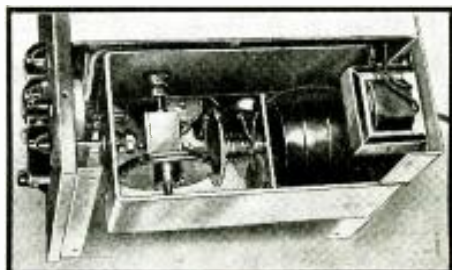
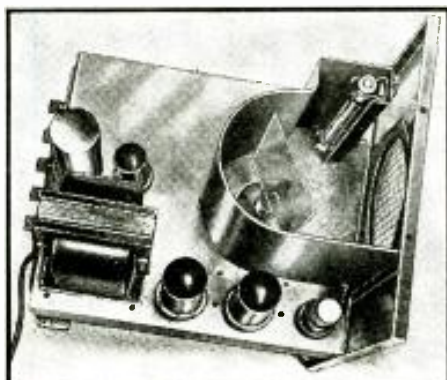

Fig. B, left. The top view of the chassis. Fig. C, above. The motor, variable speed friction drive and speed governor.

HAVE YOU SOME SPARE ROOM

a basement or garage where you can do light work? We can offer you a profitable proposition casting 5 and 10c Novelties, A-lights, Toy Automobiles, etc. as Manufacturer for firm of many years standing. No experience necessary as we furnish full instructions with moulds. If interested in devoting your spare or full time to profitable work and you mean strictly business write AT ONCE for full details as we are now closing 1937 arrangements for supply of our goods.

METAL CAST PRODUCTS CO.
Dept. 26, 1696 Boston Road, New York, N. Y.

On broadcast as well as shortwave frequencies, in any location, you can eliminate "man-made" static with

CORNWICK

NOISE-MASTER

ALL-WAVE ANTENNA

Send for complete literature

CORNWICK WIRE CO., 30 CHURCH STREET, NEW YORK CITY

BUY at FACTORY PRICES as low as **6.95**

ONE YEAR GUARANTEE

FREE HOME TRIAL Money-Back Guarantee

20 beautiful models for farms and homes. 4 to 11 tubes. **SAVE 30%**

Europe Guaranteed Electric-Eye Radio 17.25 Agents: Send 10c for plan- give away radios FREE— make \$100 a week

NEW 1937 CATALOG FREE

WORLD-WIDE RADIO CO., 2868 Elston, Dept 47, CHICAGO

Please Say That You Saw It in RADIO-CRAFT

JUST OUT!

The New SPRAGUE CONDENSER Catalog



FREE!

THE handiest, most helpful Condenser Catalog yet produced! Includes a complete listing of famous Sprague Condensers for every radio service and amateur need. Hundreds of exact duplicate replacements—new small size dry electrolytics—new Trimmers, Mica Condensers, Rectangular Transmitting Units, etc., etc. Don't miss it!

SPRAGUE

The Standard of Condenser Quality

SPRAGUE PRODUCTS CO.
North Adams, Mass.

ELGIN PRECISION INSTRUMENTS

Model 801—Pocket Volt-Ohmmeter

A sensitive, compact and accurate volt-ohmmeter that will be the busiest instrument in your "lab." or out on jobs.

DC voltage readings -0.5-50-500 and 1000. Resistance readings from 1/2 to 500 and 200 to 500,000 ohms. Will read from 0 to 1 Ma. Low resistance range direct reading.



Meter has 1000 ohm per volt sensitivity. Battery is self contained. Panel is clearly lettered. Compensator provided for zero adjustment.

Measures only 5"x3 1/4"x2 1/4"
Your price complete with battery

\$5.75

Send for complete literature on a variety of test instruments and P. A. Equipment

Special—Elgin 800 Tube Tester. Tests all tubes contained in portable leatherette case, easy to operate. Send for further information. **\$11.50** Only

TRY-MO RADIO CO., Inc.
NATIONAL DISTRIBUTORS
85-R Cortlandt Street New York City



MODEL W SINGLE CARBON BUTTON

Only 1 1/2" diameter by 1/4" in thick. Quality high sensitivity. For inter-phones, amateur transmitters, call system, detective work, experiment etc., etc. Thousands of **\$1.80**

Special prices in quantities. Write for complete catalog.

UNIVERSAL MICROPHONE CO., Ltd.
424 Warren Lane, Inglewood, Calif. U. S. A.

Get into **RADIO**
REAL JOBS
REAL PAY

Earn While Learning at Home!

Television, Photo Electric Cells, Public Address

Many R-T-I Trained Men make up to \$75 a week and more in full-time radio jobs—\$5-\$15 in spare time alone. More trained men needed. Learn at home by quick easy

PHILCO CROSLEY ZENITH GRUNDOW and 46 other mfgs. endorse R-T-I.

R-T-I WAY. Endorsed by 60 big concerns. Write for big Opportunity Book FREE. **RADIO and TELEVISION INSTITUTE, Inc.**, 2130 Lawrence Ave., Dept. 22-A, Chicago, Ill.

Since the upper limit of frequency response of a gaseous oscilloscope tube is about 10,000 cycles the operation of this unit is in the range below these frequencies. The scanning mirror is driven by a constant-speed induction motor with an adjustable friction disc clutch, shown in Fig. C. The speed of scanning is calibrated directly in r.p.m. an especially useful feature in making quick frequency determinations. Frequency is determined by the simple formula $f = \frac{L \cdot \text{r.p.m.}}{L}$

where f = frequency, r.p.m. = sweep and L = distance between cycle peaks in ins. See Fig. 1.

In demonstrating waveform it is often desirable to hear as well as see the input signal. For this purpose a speaker connection is provided. See Fig. B. With the speaker connected, the instrument becomes in effect a small P.A. system capable of direct input from a crystal microphone on the input and a 5 W. speaker on the output. While this feature has its uses in making demonstrations in a large class room, its greatest usefulness lies in the fact that distortion can be shown visually that would be impossible to detect audibly.

The circuit diagram of this electro-mechanical oscilloscope is shown in Fig. 2. The input signal is fed into a resistance shunt and potentiometer arrangement to permit inputs from 1/1,000,000th V. to 200 V. (Resistor R12 is 5,000 ohms and condenser C6 has been changed to 1 mf.—Ed.)

The pattern shown by the unit is the modulated wave type—that is, each half-cycle is shown double symmetrically about the zero axis. Thus a sine wave is shown as in Fig. 1.

USES

The uses of this type of oscilloscope are far too many and varied to cover in this article. While it does not have the high frequency response of the cathode-ray oscilloscope its great simplicity and good response to audio frequencies opens fields for its use by non-technical laymen who could not operate the more complex forms of oscilloscopes. Thus it is ideally suited to music teaching work particularly in voice culture.

In radio broadcasting it is used for checking modulation, excitation, line levels, amplifier gain, feedback and for tuning. In radio servicing work it is used for balancing receivers, hum tracing, checking distortion, and fidelity and for making sales demonstrations.

In the laboratory it serves the purpose of a microvoltmeter, a super sensitive A.C. galvanometer, a 125 db. gain radio amplifier capable of direct input from a crystal microphone and a 5 W. speaker output in the secondary.

With reasonable care, an image may be photographed—the combination so formed thus constituting an oscillograph. Wratten hyper-sensitive panchromatic film and about an f4.5 lens are required for best results.

When using this oscilloscope in the field of servicing, a few simple connections are required.

For analyzing a radio receiver or amplifier, merely attach a shielded grounded lead to the terminal marked "input" and ground the other to the chassis under test. As the unit has a coupling condenser already built in, there is no necessity for any impedance match whatsoever. The input is direct through a high-impedance split-up network into the grid of the 6J7 pre-amplifier.

The amplifying system is essentially a flat response amplifier over the constant A.F. range and may be regarded as an absolute check on the audible quality of the impressed e.m.f. It is necessary to provide a constant load on the amplifier to preserve its inherent characteristics at the low frequencies; therefore a 5-ohm shunt resistor is furnished for this purpose when a speaker is not in use. The speaker voice coil should be 8 ohms.

This article has been prepared from data supplied by courtesy of Sundt Engineering Company.

LICENSE NOTICE

The United Sound Engineering Company announces that its complete sound systems and inter-office communication systems are now fully licensed by arrangement with Electrical Research Products, Inc., under patents owned and controlled by A. T. and T. Co. and W. E. Co. Inc. This concern was one of the earliest manufacturers to recognize the necessity of developing a packaged line of P. A. equipment for successful jobber-dealer distribution. U.S.E.'s new 16-page booklet on sound systems is now available. Write to Radio-Craft for booklet No. 1367A.

Please Say That You Saw It in RADIO-CRAFT

GET YOUR COPY TODAY!

Check-Full of Helpful Information



LEARN the truth about so-called "bargain" condensers—get the facts about power factor, leakage, etc. This new 1937 Catalog also includes the famous Sprague Tel-U-How Condenser Guide; complete data on Radio Interference Elimination, duplicate replacements, etc., etc. Get your copy today!

CONDENSERS

USE SPRAGUES... and Note the Difference

SPRAGUE PRODUCTS CO.
North Adams, Mass.

WILL YOUR PRESENT AUDIO AND POWER UNITS Be Obsolete Ten Years from Today?



1937

1947

The new Kenyon line of audio and power components includes a number of Universal Transformers which entirely eliminate obsolescence.

- KEN-O-TAP**
IS THE PRACTICAL SOLUTION TO THE MODULATION PROBLEM
- KEN-O-DRIVE**
IS THE MODERN ANSWER TO CRITICAL DRIVER OPERATION
- KEN-O-DYNE**
IS THE MODERN METHOD OF MATCHING OUTPUT TUBES TO SPEAKERS
- KEN-O-LINE**
IS THE EFFICIENT COUPLING DEVICE FROM UNIVERSAL LINE

KENYON

TRANSFORMER CO., Inc.
840 Barry St., New York, N. Y.

Export Dept. 25 Warren St., New York, N. Y.
Cable Address SIMONTRICE-NEW YORK



"SERVICE MEN KNOW HOW VALUABLE GERNSBACK RADIO MANUALS ARE"

Over 90,000 Gernsback Official Radio Service Manuals and Handbooks are in Use Today—They Must Be Good!

Since 1931 radio men have bought Gernsback OFFICIAL RADIO SERVICE MANUALS—and today they are being purchased by more and more men for service work. The authentic material, easily accessible diagrams and complete service data make them invaluable to active and alert radio Service Men. *Without a Gernsback Manual with you on a service job, there's time and profit lost.* Your service kit or laboratory is incomplete without all the Gernsback OFFICIAL RADIO SERVICE MANUALS.



1936 OFFICIAL RADIO SERVICE MANUAL

Just packed with service data of sets manufactured during 1935, and 1936. There are SCHEMATIC DIAGRAMS of over 1,500 manufactured receivers showing speaker connections, power-transformer connections, R.F. and I.F. coil connections, phonograph connections, and other information. On all set diagrams, with few exceptions, the I.F. peaks are indicated, also socket connections. Notes on alignment procedure are printed with the diagrams, also for over 80% of the sets you will find OPERATING VOLTAGES. Assembly diagrams show the relationship of separate units to each other. A complete index of TRADE NAMES and their respective manufacturers is to be found in the 1936 Manual. A COMPLETE TUBE CHART includes information on hundreds of tubes. A LARGE CUMULATIVE INDEX contains all sets printed in the 1931, 1932, 1933, 1934, 1935, and 1936 Manuals.

1,200 PAGES * OVER 2,500 ILLUSTRATIONS
Looseleaf Binder—Stiff, Hard Covers
Size 9 x 12 Inches * Price \$7.00

1935 OFFICIAL RADIO SERVICE MANUAL

This edition is well noted for containing schematic diagrams and service notes for many older receivers. The volume is printed on a special "Bible Stock" and contains over a thousand pages, still it is only 1 1/4 inches thick. Conveniently rolls to fit into your pocket. Contains a vast amount of information on all-wave receivers, P. A. equipment, midjet sets, auto-radio receivers, and test equipment.

OVER 1,000 PAGES * OVER 3,000 ILLUSTRATIONS
Looseleaf Binder—Flexible, Leatherette Covers
Size 9 x 12 Inches * Price \$7.00

1934 OFFICIAL RADIO SERVICE MANUAL

This manual contains values of I.F. transformers on superheterodyne receivers, valuable tube data, complete list of American Broadcast stations, free question and answer service, service material and schematic diagrams.

OVER 400 PAGES * OVER 2,000 ILLUSTRATIONS
Looseleaf Binder—Flexible, Leatherette Covers
Size 9 x 12 Inches * Price \$3.50

1933 OFFICIAL RADIO SERVICE MANUAL

The 1933 Manual features pictorial views of hundreds of commercial receivers with additional schematic diagrams, location of parts on chassis, values of intermediate frequencies, values of resistors and condensers and other valuable information for Service Men.

OVER 700 PAGES * OVER 2,000 ILLUSTRATIONS
Looseleaf Binder—Flexible, Leatherette Covers
Size 9 x 12 Inches * Price \$5.00

OFFICIAL RADIO SERVICE HANDBOOK

Here's the sensational new book on servicing. It is edited by J. T. Bernsley, well-known radio service authority. It covers over 500 radio topics and gives a complete description of the "Magic Eye." Contains a special section of 250 pages of Operating Notes. The book covers: Circuit Theory and Analysis; Modern Servicing and Test Equipment; Practical Short-cuts in Trouble Shooting and Repairs; Specialized Receiver and Installation Data; Modernization and Conversion Data; Social and Economic Problems of Service Men; and Operating Notes and Practical Data Listings.

OVER 1,000 PAGES * OVER 1,000 ILLUSTRATIONS
Beautiful Linen, Gold-Stamped Cover
Size 6 x 9 Inches * Price \$4.00

1932 OFFICIAL RADIO SERVICE MANUAL

Here is the volume which shows a step-by-step analysis of how to service any receiver. It is one of the early editions and covers many old sets.

OVER 1,000 PAGES * OVER 2,000 ILLUSTRATIONS
Looseleaf Binder, Flexible Covers
Size 9 x 12 Inches * Price \$5.00

1931 OFFICIAL RADIO SERVICE MANUAL

This is the first complete radio Manual published. It contains a comprehensive course for servicing radio sets. This course is invaluable not only to Service Men, but everyone interested in radio.

OVER 650 PAGES (Including Supplements)
OVER 1,500 ILLUSTRATIONS
Looseleaf Binder—Flexible, Leatherette Covers
Size 9 x 12 Inches * Price \$4.50

1935 OFFICIAL AUTO-RADIO SERVICE MANUAL

OVER 240 PAGES * OVER 500 ILLUSTRATIONS
Looseleaf Binder—Flexible, Leatherette Covers
Size 9 x 12 Inches * Price \$2.50

1933 OFFICIAL AUTO-RADIO SERVICE MANUAL

OVER 250 PAGES * OVER 500 ILLUSTRATIONS
Looseleaf Binder—Flexible Leatherette Covers
Size 9 x 12 Inches * Price \$2.50

YOUR RADIO JOBBER OR FAVORITE MAIL ORDER HOUSE SELLS GERNSBACK SERVICE MANUALS AND HANDBOOKS

Clip Coupon and Mail to RADCRAFT PUBLICATIONS, INC., 99 HUDSON ST., NEW YORK, N. Y.

RADCRAFT PUBLICATIONS, INC., 99 Hudson Street, New York, N. Y.		RC-637
Gentlemen: Enclosed you will find my remittance of \$..... for which you are to send me, POSTPAID, the Book or Manual which I have indicated at the right by a cross (x) in the panel.		
Name	<input type="checkbox"/> 1936 Official Radio Service Manual @ \$7.00	<input type="checkbox"/> 1935 Official Radio Service Manual @ \$7.00
Address	<input type="checkbox"/> 1934 Official Radio Service Manual @ \$3.50	<input type="checkbox"/> 1933 Official Radio Service Manual @ \$5.00
City	<input type="checkbox"/> 1932 Official Radio Service Manual @ \$5.00	<input type="checkbox"/> 1931 Official Radio Service Manual @ \$4.50
State	<input type="checkbox"/> (Including Supplements)	<input type="checkbox"/> 1935 Official Auto-Radio Service Manual @ \$2.50
(Send remittance in form of check or money order; register your letter if you send cash or unused U. S. Postage Stamps).		<input type="checkbox"/> 1933 Official Auto-Radio Service Manual @ \$2.50
		<input type="checkbox"/> Official Radio Service Handbook @ \$4.00

Please Say That You Saw It in RADIO-CRAFT

HOW TO MAKE THE RADIO-CRAFT DELUXE CARRIER INTERPHONE

(Continued from page 735)

therefore, it will be imperative to wire-in coupling condensers between the chassis and the return terminals for all 3 coil grid-circuit windings.

Number 1 terminals of all sockets (for grounding tube shells) may be wired directly to chassis. *But make no other chassis contacts except through bypass condensers, as suggested.* "B minus" is entirely isolated from this chassis.

An indication of radio-listen-talk switch position and instrument operation is requisite. It was our first thought here to simply employ the usual 3 bull's eyes—1 amber, 1 red, 1 green, their individual pilots being connected in across the pilot section of the ballast as the switch is moved. As a translucent radio dial was finally decided upon for the final construction and as this naturally lent itself to pilot lighting, our next and more practical idea was to simply use the dial lighting to indicate "radio-on," have it go off and a green bull's eye come on for "listen," and then have both off and a red bull's eye on for "talk." Then we asked ourselves—but why bull's eyes at all, when there's plenty of translucent scale space for 3 pilots? And so we finally mounted all three behind the scale, one clear colored, one painted green, one red.

And here's a warning in connection with proper pilot operation. *Don't try to get away with the usual pilot resistor in series in a filament voltage dropping line.* When we're switching from one pilot to another we want to be definitely sure that we won't run into burnout and other troubles. *Use a ballast—and the particular value of ballast specified—and no such difficulties will be encountered.*

AUTOMATIC OPERATION

By using some sort of a mechanism designed to turn the power on or off at designated times—preferably an electric clock—we lift the burden of remembering just when he's supposed to listen (for head-office announcements) from Mr. C's busy mind. He's sitting there in the earlier hours of his business day and exactly at 9:30 his unit comes on and Mr. A's gruff voice comes bellowing through. At 9:45 off goes the instrument, to come on again at other desired times for communication or general call.

In the laboratory model which we are describing, all this is very nicely effected through the use of a selected clock movement which permits automatic turn on at any hour during the day, or at any quarter hour. It permits turn-off automatically after 15-minute minimums of operation, may be adjusted for any "on" extension required, and features a convenient automatic-to-manual toggle switch for non-automatic service where such is desired.

When the instrument is completed and following a careful point-to-point check with an ohmmeter for shorts, opens and proper continuity, the builder should switch to "radio" operation, turn on the A.C., and check the various voltages. "B plus" will read about 100 V. at the R.F. tube and 25A6 plates and screen-grounds. The pilot will light up rather brilliantly at first but will settle down to proper glow after a few moments of operation.

Now adjust the I.F. transformer, with the frequency-selector switch at the left, for the highest of the desired operating frequencies—preferably something well beyond 456—the frequency to which most I.F. units are tuned. Say this is made 460 or 470 kc. With the unit tuned "on the nose" at 470, then, line up the R.F. stages and tune in broadcast signals. If reception is OK, switch to "listen."

With the switch at No. 2 position for "listen" the main pilot will go out and one of the additional two lamps will come on. Paint this lamp green (using a paint which will permit the light to get through). It should not be possible to receive a broadcast station with the switch in this position.

Shift the switch to "talk." The 2nd-detector should now be oscillating and some sort of receiver tunable to the I.F. must be set up to check on the carrier and the modulation. If the thing is working properly at normal I.F. (in our case a desired 470 kc.), move the frequency-selector switch knob to No. 2 connection and adjust the associated trimmer for a second desired frequency higher or lower than 456 and 465 kc. (to prevent any possibility of pickup by radio receivers operating at these conventional I.F. frequencies). Make similar adjustments for a No. 3 frequency.

A lot remains to be said about proper installation, but we've gone about the limit on word length for a magazine article. So we'll simply close by giving a piece of very good advice.

Check on the position or placement of the A.C. line pole transformer and the leads from this transformer to your office building. Sometimes A.C. outlets for a group of rooms are not all connected in parallel. Some may be isolated from others through separate feed lines from the transformer.

LIST OF PARTS FOR THE "2-IN-1" EMERGENCY RADIO SET IN APRIL, 1937, ISSUE OF RADIO-CRAFT

- One Meissner No. 1496 Ferrocart (iron-core) coil, L1A, L1B;
- One 35 mmf. (maximum) antenna trimming condenser, C2;
- One 350 mmf. tuning condenser, C1;
- One 250 mmf. fixed mica condenser, C3;
- One 500 mmf. fixed condenser, C4;
- One 600 mmf. fixed condenser, C5;
- One Hammarlund 85 millihenry R.F. choke, R.F.C.;
- One Kenyon 5 to 1 or 4 to 1 ratio audio transformer;
- One 50,000 ohm wire-wound volume control, with attached on-off switch;
- One 10 ohm rheostat with screwdriver control shaft, R2;
- One variable gridleak 1/4- to 10 meg, R3 (or, if this is not easily obtainable, a 3 meg. fixed resistor will do);
- Two (optional) 0.5-mf. fixed bypass condensers to prevent circuit oscillation when the batteries "run down", C6, C7;
- One set of sensitive, standard headphones;
- One Type 1E7G tube;
- One octal socket;
- Miscellaneous hardware, carrying case, etc.

SERVICE ORGANIZATION

Recently, the Midwest Radio Corp., announced that they were building a radio Service Men's organization to serve their customers all over the country.

Competent Service Men will be welcomed who can not only make installations of Midwest sets on a fee basis, which the company will pay, but to whom customers can be referred for service at all times. Service Men, write to the Midwest Radio Corp., Cincinnati, Ohio, for complete details.

EVOLUTION!

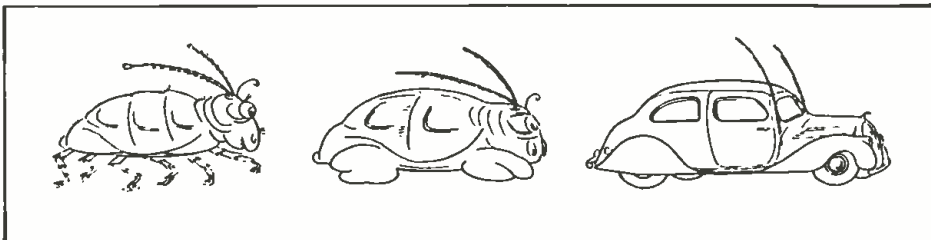

Please Say That You Saw It in RADIO-CRAFT

Here's RADIO'S MONTHS-AHEAD CATALOG!

ALLIED'S 156-PAGE SPRING CATALOG SCOOPS RADIO FIELD!

Here's a new book—a complete book—a book that makes all other catalogs obsolete! Packed with Everything in Radio that's months-ahead, it includes more than 10,000 exact duplicate and replacement parts; latest test instruments—tube checkers, analyzers, oscillographs, meters, set-testers, etc.; 53 new Super-Value Knight Radios; Amateur Gear; new Sound Systems; dozens of Set-Builders' kits; books, tools, etc. See what's new—see what's important in Radio!—Send coupon for this great book today!



FASTER SERVICE—LOWEST PRICES!

You save more—get more—profit more—when you order from ALLIED! Our complete stocks, central location, efficient buying and selling methods, and speedy shipping department mean faster service, lower prices and greater values for you. Make ALLIED—Radio's Leading Supply House—your single dependable source for high-grade radio supplies!

FREE Catalog



ALLIED RADIO Corp.

833 WEST JACKSON BLVD., Dept. 2-F
CHICAGO, ILLINOIS.

Send me your new Spring 1937 Radio Catalog.

Name

Address

City

FITS LOOKS Right! WORKS



- ★ Make no mistake about it: There's nothing to equal an AEROVOX Exact-Duplicate Replacement condenser!
- ★ Restores any set to original NEW status. And that's what fussy trade expects.
- ★ You save time, bother and even money when you use AEROVOX exact duplicates.

Free DATA: Latest AEROVOX catalog contains several pages of exact duplicate condensers. Copy sent on request.





DEMAND THIS NEW Lafayette 30 WATT AMPLIFIER —
FEATURING

- ★ Illuminated "Neo-Dial"
- ★ Reverse Feedback
- ★ Beam Power Tubes
- ★ Automatic Equalizer
- ★ Tone Control
- ★ Shielded Input Plugs
- ★ Photo-cell Connections
- ★ Electronic Mixer
- ★ Fader Controls
- ★ Speaker Field Supply
- ★ Variable Impedances
- ★ Velophone Mike Supply
- ★ Metal or Glass Tubes
- ★ Four Stages

IF YOU WANT THE BEST

Never before have so many features been built into a P.A. system in this price range. Here's a rugged outfit that will not only build your reputation as a Sound Engineer . . . but will turn in a handsome profit on rentals as well. Remember—three nights rental will get back your investment! Get into the P.A. business for REAL profits. Here's your start . . . the 264A with **\$44.73** tubes . . . Your Cost . . .

Dozens of other types of amplifiers in our NEW Catalog. Use the coupon.

FREE 116 PAGE CATALOG!
 It's NEW . . . and it's jammed full of the greatest "buys" in radio that you have ever seen . . . no matter what you need in radio—it's described in the new SPRING catalog. Keep this aid at your elbow for more economical buying . . . COMPARE and SAVE with WHOLESALERS. Send the coupon in RIGHT NOW before you forget.

WHOLESALE RADIO SERVICE CO.
 NEW YORK, N. Y. CHICAGO, ILL. ATLANTA, GA.
 100 B'WAY AVENUE 701 W. JACKSON BLVD. 430 W. PEARSON ST. N. W.
 BRONX, N. Y. NEWARK, N. J. JAMAICA, N. Y.
 343 E. FORDHAM RD. 318 CENTRAL AVE. 1104 1/2 STREET
 WILMINGTON, DEL.

WHOLESALE RADIO SERVICE CO., Inc.
 100 Sixth Avenue, New York, N. Y. **MAIL COUPON NOW**

Rush FREE catalog No. 68-3F7

Name.....
 Address.....
 City..... State.....

A SERVICE MAN'S AUDIO OSCILLATOR

(Continued from page 749)

a special holder. It not only provides fixed bias for the 6Q7, but does away with a bias resistor and condenser, thus avoiding degenerative effects.

CALIBRATION

In the initial calibration it is necessary to obtain zero-beat as close as possible to the extreme left-hand point on the "tuning" scale with the vernier fully unmeshed. If this cannot be done, the next step will be to readjust the beat-frequency oscillator trimmers. Each oscillator coil has a pair of trimmers located at the top of the can. Adjusting any one of these 4 trimmers will affect the zero-beat position.

However, this does not mean you should adjust all 4. The BFO coils are accurately adjusted to 465 kc. at the factory. Inasmuch as we are placing a vernier condenser across one of these coils then that coil will be detuned from 465 kc. even though the vernier is fully out. Therefore, it is only necessary to unscrew (left or right) a very slight amount one or both of the trimmers on this coil only until zero-beat is obtained.

The rest of the dial may be calibrated against a standard piano keyboard, by striking the notes which are closest in frequency to the dial markings and listening to both the monitor note and piano tone until they match exactly. This operation should be carried out for about 10 different settings. The highest frequency which the instrument can produce, is entirely inaudible, but can be observed and studied on the oscilloscope screen.

Before assembling the BFO coils on the chassis, open both, and replace each 0.1-mex. resistor with 30,000-ohm, 1/3-W. resistors. On the BFO which is to be used as the variable oscillator, it is necessary to solder a 4-in. piece of solid hookup wire to the control-grid side of the 2 small trimmers which are wired in parallel. Bring both leads out through the small hole at the top of the can. Enlarge this hole if necessary. The original control-grid lead goes to the top cap of the 6J7 and the new lead goes to vernier stator.

Unstable operation at very low frequencies may be due to unshielded wiring or stray coupling. Both oscillator plate leads should be shielded and grounded. The control-grid leads at the top of the cans should also be shielded.

The chassis layout is given in Fig. 3 as will be seen, the parts are grouped together so as to occupy a minimum of space. We recommend that this layout be followed exactly, and also that no substitution of parts be made, because of the critical nature of some of the circuits involved.

LIST OF PARTS

- One Kenyon power transformer, type T205, PT;
- One Kenyon filter choke, type T153, Ch.1;
- One Kenyon filter choke, type T155, Ch.2;
- One Kenyon output transformer, type T104, T1;
- *One metal cabinet, No. 3828, 12x8x7 ins.;
- *One chassis, No. 1531, 11x7 1/2x2 ins.;
- *One magnet speaker, 3 1/2 ins. dia.;
- *Two beat-frequency oscillators, type C350, L1, L2;
- Four Meissner shielded chokes, No. 5592, R.F.C.1, R.F.C.2, R.F.C.3, R.F.C.4;
- One Hammarlund midget condenser, type MC20S, C1;
- Two General Electric type 6J7 tubes, V1, V2;
- One General Electric type 6Q7 tube, V3;
- One General Electric type 5Z4 tube, V4;
- One General Electric type 6F6 tube, V5;
- Three Aerovox electrolytic condensers, type GLS5, 16 mf., 450 V., C2, C3, C4;
- One Aerovox electrolytic condenser, type PR50, 50 mf., 50 V., C5;
- Four Aerovox bypass condensers, type 484, 0.25-mf., 400 V., C6, C7, C8, C9;
- Four Aerovox bypass condensers, type 484, 0.05-mf., 400 V., C10, C11, C12, C13;
- One Aerovox bypass condenser, type 484, 0.001-mf., 400 V., C14;
- One Aerovox mica condenser, type 1467, 100 mmf., 400 V., C14;
- One Aerovox mica condenser, type 1467, 100 mmf., C15;
- Two Aerovox mica condensers, type 1467, 5 mmf., C16, C17;
- One Aerovox dual condenser, type 484, 0.05-0.05-mf., 400 V., C18;

FACTORY TO YOU

NEW REMINGTON NOISELESS PORTABLE



Famous Remington Noiseless Portable that speaks in a whisper, only 10c a day, direct from factory. Standard keyboard. Automatic ribbon reverse. Variable line spacer and all the conveniences of the finest portable ever built. PLUS the NOISELESS feature. Act now. Send coupon TODAY for details.

You don't RISK a Penny

We send you Remington Noiseless Portable for 10 days' free trial. If not satisfied, send it back. We pay all shipping charges.

FREE Typing Course and Carrying Case

You will receive FREE a complete simplified home course in Touch Typing. Also FREE, a handsome, sturdy carrying case. No obligation. Mail coupon for full details—NOW

Remington Rand Inc., Dept. 189-6
 315 Fourth Ave., New York, N. Y.

Tell me, without obligation, how to get a new Remington Noiseless Portable, plus Free Typing Course and Carrying Case, for 10c a day. Send Catalogue.

Name.....
 Address.....
 City..... State.....

TREASURE LOCATORS

BLUE PRINTS and INSTRUCTIONS

For Building the Following Treasure Finders and Prospecting Outfits

- Folder No. 1. Hughes Induction Balance Circuit
- Folder No. 2. Sensitive Hughes Induction Balance Circuit
- Folder No. 3. Single Super-Sensitive Hughes Induction Balance Circuit
- Folder No. 4. Radio Frequency Oscillator Circuit
- Folder No. 5. Audio Frequency Oscillator Circuit
- Folder No. 6. Combination Radio Transmitter and Receiver Circuit

With any one of these systems you can construct instruments to locate buried treasures, metal war relics, mineral deposits, subterranean water veins, buried gas and water pipes, lost objects, tools and treasures sunken in water, etc.

For each set of blueprints and instructions **\$1.00**
 The complete set of six folders **\$5.00**
 (Sent postpaid)

TECHNIFAX

Division 67C

558 W. WASHINGTON BLVD. CHICAGO, ILL.

ON THE BOARDWALK ATLANTIC CITY

HOTEL KNICKERBOCKER

IN THE HEART OF ALL RESORT ACTIVITY

FIREPROOF CONSTRUCTION AMERICAN & EUROPEAN PLAN SALT WATER BATHS

ROOM AND BATH FROM \$3.50 AMERICAN PLAN FROM \$6.00

C. HENRY LANDOW, Manager

RADIOS..SAVE UP TO 50%

DEAL DIRECT...FACTORY PRICES! Many models to select from! AG-DC All-Waves! Farm sets that operate like city radios! Your name and address on postcard brings you NEW Bargain Catalog in colors FREE. Get details of 30-DAY TRIAL plan and agent-tour proposition! GOLDENTONE RADIO CO. Dept. 88, DEARBORN, MICHIGAN

30 DAY TRIAL \$6.98 UP

Free Catalog

Please Say That You Saw It in RADIO-CRAFT

TECHNICAL BOOKS OF INTEREST TO RADIO MEN

HENLEY'S 20th CENTURY BOOK OF FORMULAS, PROCESSES AND TRADE SECRETS by Prof. T. O'Connor Sloane, Over 880 Pages. PRICE\$4.00

THE FORD V8 CARS AND TRUCKS (Construction, Operation and Repair) by Victor W. Page, Over 725 Pages, PRICE\$2.50

ELEMENTS OF DIESEL ENGINEERING (with Questions and Answers) by Orville Adams, 478 Pages, PRICE\$4.00

HOUSE WIRING by Thos. W. Poppe, 256 Pages, PRICE\$1.00

AVIATION

A B C OF AVIATION (Elementary Edition) by Major Victor W. Page, Over 160 Pages, PRICE\$1.00

HENLEY'S A B C OF GLIDING AND SAIL-FLYING by Major Victor W. Page, Over 290 Pages, PRICE\$1.50

AERIAL NAVIGATION AND METEOROLOGY by Capt. Lewis A. Yancey, 350 Pages, PRICE\$4.00

AVIATION ENGINE EXAMINER by Major Victor W. Page, 440 Pages, PRICE\$3.00

ELECTRICITY

ELECTRICITY FOR BEGINNERS by Edward H. Thomas, 172 Pages, PRICE\$1.50

ARITHMETIC OF ELECTRICITY by Prof. T. O'Connor Sloane, 230 Pages, PRICE\$1.50

STANDARD ELECTRICAL DICTIONARY by Prof. T. O'Connor Sloane, 790 Pages, PRICE \$4.00

HIGH FREQUENCY APPARATUS (Its Construction and Practical Application) by Thomas Stanley Curtis, 269 Pages, PRICE\$3.00

AUTOMOTIVE

AUTOMOBILE WELDING WITH THE OXY-ACETYLENE FLAME by M. Keith Dunham, 167 Pages, PRICE\$1.50

THE MODERN GASOLINE AUTOMOBILE by Major Victor W. Page, 1146 Pages, PRICE \$5.00

ELECTROPLATING

ELECTRO-DEPOSITION OF METALS by Dr. George Langbein and William T. Brannt, 863 Pages, PRICE\$7.50

THE MODERN ELECTROPLATER by Kenneth M. Coggeshall, 276 Pages, PRICE\$3.00

SHOP PRACTICE

SHOP PRACTICE FOR HOME MECHANICS by Raymond Francis Yates, 320 Pages, PRICE\$3.00

MACHINE SHOP KINKS by Robert Grimshaw, 417 Pages, PRICE\$3.00

MISCELLANEOUS

A B C OF TELEVISION by Raymond Francis Yates, 210 Pages, PRICE\$3.00

PROSPECTOR'S FIELD-BOOK AND GUIDE by H. S. Osborn and M. W. von Bernewitz, 364 Pages, PRICE\$3.00

SOLDERING AND BRAZING by Raymond Francis Yates, 90 Pages, PRICE\$.75

CLOCK REPAIRING AND MAKING by F. J. Garrard, 168 Pages, PRICE\$3.00

WATCHMAKER'S HANDBOOK, by Claudius Saunier, Over 500 Pages, 14 Folding Plates, PRICE\$5.00

THE CIVIL SERVICE HANDBOOK, PRICE \$1.00

A B C SHORTHAND, PRICE \$1.00

BREAKING INTO ADVERTISING, PRICE \$1.75

HOW TO MAKE MONEY AT HOME, PRICE \$1.00

SCIENTIFIC WONDERS OF THE WORLD, PRICE \$1.95

HOW TO ORDER

Simply mention title of book and send remittance to us in form of check or money order (cash or stamps only if you register your letter). Add ten cents to cost of each book to cover postage.

GRENPARK COMPANY
99-R Hudson Street New York, N. Y.

- One Aerovox resistor, type 930, 250 ohms, 5 W., R1;
 - One Aerovox resistor, type 931, 17,500 ohms, 10 W., R2;
 - One Centralab volume control and switch, No. 72-105, 0.5-meg., R3;
 - Four Centralab resistors, 50,000 ohms, 1/2-W., R4, R5, R6, R7;
 - One Centralab resistor, 5,000 ohms, 2 W., R8;
 - One Centralab resistor, 0.1-meg., 1 W., R9;
 - One Centralab resistor, 25,000 ohms, 1/2-W., R10;
 - One Centralab resistor, 0.1-meg., 1/2-W., R11;
 - One Centralab resistor, 0.5-meg., 1/3-W., R12;
 - *Five octal wafer sockets;
 - *Two brown tip-jacks, No. 524;
 - *One black tip-jack, No. 521;
 - *One green tip-jack, No. 522;
 - *One light blue tip jack, No. 525;
 - *One orange tip-jack, No. 526;
 - *One yellow tip-jack, No. 527;
 - *One dark blue tip-jack, No. 529;
 - *One black twin jack, No. 432;
 - *Two black bar knobs, No. 366, 1 1/4 in.;
 - *One black bar knob, No. 365, 2 3/4 ins.;
 - *Four terminal connectors, type A016;
 - *One grid-bias cell;
 - *One cell holder, type GB1A;
 - *One S.P.S.T. jack switch, No. 10, Sw.2.
- *Names of manufacturers will be supplied upon receipt of a stamped and self-addressed envelope.

BUILD THE RADIO-CRAFT 1937 CAR-RADIO RECEIVER

(Continued from page 731)

greatly positive and to cause too great a plate current. The 100 ma. maximum for the receiver must never be exceeded).

CONNECTING SPEAKERS

One, two, or more speakers may be used, and Fig. 2 shows how the connections should be made.

The laboratory model uses a genemotor-type power supply delivering 300 V. at 75 ma. or 250 V. at 100 ma. Output is thoroughly filtered internally and externally. The unit is extremely efficient and is exactly what we need in powering the 6-tube class B auto receiver described.

Be that as it may, some builders will prefer the use of a vibrator type unit—and the set has therefore been designed so that either kind may be used. The cabinet contains ample room for the small compact genemotor and more than enough room for the other type of supply.

LIST OF PARTS

- One cabinet 15x8x7 ins. high with removable front panel, 15x7 ins., wrinkle finished steel;
- One chassis, 11x7 3/4 x 3 ins. high;
- *Two steatite 8-prong sockets, type RSS8;
- *Four moulded sockets (6 if A.F.C. is used), type S8;
- *One moulded socket for "A" panel receptacle, type S4;
- *One moulded socket for panel speaker receptacle, type S6;
- *One male chassis receptacle for external powering, type CP6;
- *One nameplate speaker-type dial, 6-1 ratio;
- *Two nameplate bar knobs, type 588;
- *Two nameplate knobs, type 284;
- *One 4-point band-switch selector plate (optional);
- *One volume control nameplate (optional), type 25;
- *One tone-control nameplate (optional), type 26;
- One Meissner set of special car-radio all-wave coils, for 4 bands, det., R.F., osc. with padders, L1, L2, L3;
- One Meissner input I.F. transformer, type 5740, 456 kc., I.F.T.1;
- One Meissner output I.F. transformer, type 5742, I.F.T.2;
- One Kenyon transformer, type T251, T1;
- One Kenyon transformer, type T302, T2;
- One Kenyon type KC200 (optional filter choke for vibrator "B" supply or extra genemotor filtering);
- One Electrad potentiometer with switch, type 203 R15;
- One Electrad potentiometer, type 240, R21;

(Continued on page 768)

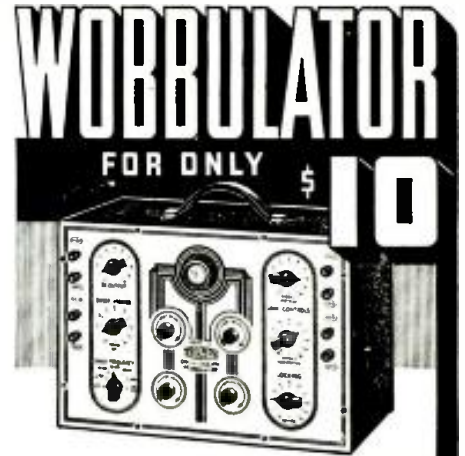

TRIUMPH Model 77 is a WOBBULATOR and OSCILLOGRAPH for only \$49.95!

An Electronic Wobulator combined with the \$39.95 Triumph Model 820 1" Oscillograph circuit, all in one unit, costs only \$49.95! You can't analyse a radio without a Wobulator. You save half the price of any two similar units when you buy the Triumph Model 77 Oscillograph-Wobulator. Ask your jobber.

TRIUMPH MFG. CO.

4021 W. Lake St., Chicago, Ill.
Send FREE Operating Data for Model 77.
Name Address.....
City Jobber.....

OFFICIAL TRIUMPH Headquarters

for Central States

Immediate Deliveries
Wobulators, Oscillographs

RADOLEK

601 W. Randolph St. Dept. T, Chicago

Just off the Press - New Spring and Summer Radolek Profit Guide - FREE



presents

(Exclusively)

NON-GLARE MICROPHONE STANDS

with special cable hangers to prevent tangling and broken cables.

Complete line available on: AMPLIFIERS, PORTABLE SYSTEMS, STANDS AND FITTINGS, HORNS AND TRUMPETS, HORN STANDS AND BRACKETS, MICROPHONES AND SPEAKERS.

Leaders and manufacturers of P.A. Equipment and Inter-Communication Systems since 1928.

FREE CATALOG No. 62 mailed on request to dealers and servicemen only. Consult "RAL" on your P.A. problems.

RADIO AMPLIFIER LABORATORIES
59 WALKER ST. NEW YORK, N. Y.

Please Say That You Saw It in RADIO-CRAFT



NEW 10 CENT PUBLICATIONS for Experimenters

WE list below a large number of radio, short-wave, and mechanical "how-to-make-it" designs. Each is a special publication originated by masters in their respective fields. For the first time, at the low price of TEN CENTS, you are now enabled to buy a complete design with photographic reproductions, complete mechanical layout, and full description to make it possible for anyone to build the project in question.

The name of "Radio Publications" has become a household word because this company has for many years specialized in radio and other literature of special interest to the experimenter.

PLEASE ORDER EACH PROJECT BY ITS PUBLICATION NUMBER, and use the special coupon below.

We accept money-orders, cash, checks or new U. S. stamps. (No foreign stamps or currency can be accepted.) If you send cash or stamps, register your letter to safeguard against loss. Money refunded if you are not satisfied.

ANY TWELVE PUBLICATIONS FOR ONE DOLLAR

Partial List of New 10 Cent Publications

SHORT-WAVE RECEIVER PUBLICATIONS

HOW TO MAKE THE 2 TO 5 METER TWO-TUBE LOUD-SPEAKER SET. This receiver may be used with batteries or with an A.C. power pack. Packs a big wallop... No. 107

HOW TO BUILD THE CIGAR-BOX 1-TUBE "CATCH ALL" RECEIVER. An effective short-wave battery set which fits into a small cigar-box, insuring high portability yet great efficiency... No. 111

HOW TO BUILD THE PORTABLE MINIDYNE SHORT-WAVE BATTERY SET. Uses no aerial, no ground. The total weight is 3 3/4 lbs. and measures 3x3x6 inches. Self-contained batteries, tube, condensers, and loop. Highly sensitive circuit... No. 114

HOW TO BUILD THE HAN-BAND "PEE-WEE" 2-TUBE. A dandy receiver with high efficiency and bandspread tuning. Works a loudspeaker, yet the entire receiver is no larger than your hand. Works with either batteries or an A.C. power pack... No. 115

HOW TO BUILD THE DUO-AMPLIDYNE. The ideal 1-tube set for the beginner. One of the finest 1-tube sets; it really gives 2-tube performance. Made for battery operation. With only ten-foot antenna brings in the good European stations... No. 116

RADIO BROADCAST RECEIVER AND SPECIAL RADIO PUBLICATIONS

HOW TO BUILD A SUPER-SENSITIVE ALL-WAVE CRYSTAL SET. Just the thing for beginners who wish to have an easy-to-operate crystal set on all-waves and which will separate all the stations. Can be made for less than \$2.00. Uses no tubes or batteries... No. 121

HOW TO BUILD THE 2-TUBE "PENTODE PORTABLE" BROADCAST SET. The lightest, smallest set giving loud-speaker volume on batteries. Weighs less than 12 pounds. Built in a small, portable case... No. 122

HOW TO BUILD THE RADIO "TREASURE" FINDER. This is a really sensitive and practical "Treasure" finder. Simple to build and guaranteed to work. Uses 4 tubes. Can be built for less than \$15.00... No. 123

HOW TO BUILD THE GERNSBACK ONE-TUBE PENTODE LOUDSPEAKER SET. This is the best one-tube loud-speaker set ever constructed. It works on batteries, and is for broadcast receiving... No. 124

HOW TO BUILD THE WORLD'S SMALLEST ONE TUBE BATTERY RADIO. So small that it is actually built in a cigarette case. The wonder set of the last New York radio show... No. 125

HOW TO BUILD A 6-TUBE BATTERY ALL-WAVE "FARM PORTABLE" SET. ranging from 12 to 2,100 meters. A real portable that pulls in the stations... No. 126

HOW TO MAKE AN A.C.-D.C. ONE-TUBE "DEAF AID." An excellent aid for the hard-of-hearing and deaf, for theatres, churches, and the home. A Godsend for all afflicted persons. Can be built for a few dollars... No. 127

HOW TO BUILD A PIANOTRON. For less than two dollars, plus a few junk parts which you have, you can now make a beautiful musical instrument. Operated by three radio tubes, it has an actual keyboard, and you can play records. Works on "A" and "B" batteries. A great novelty due to the unusual music which issues from the loud-speaker... No. 128

HOW TO BUILD THE ONE-DOLLAR RADIO. Impossible though it sounds, for one dollar you can build a radio set which includes a radio tube and a pair of headphones and batteries. You make everything yourself, outside of the three last mentioned items, from wood and spare metal parts... No. 129

MECHANICAL PROJECTS PUBLICATIONS

HOW TO BUILD A PEE-WEE AUTOMOBILE. An ultra-small automobile that can be built for less than 10 dollars. Will carry two 17-year-old boys, runs 35 miles per hour and 10 to 125 miles on one gallon of gas... No. 132

HOW TO MAKE A BAND SAW FROM OLD AUTO PARTS. Made from old Ford and Chevrolet parts. Capable of performing delicate and satisfactory work. Uses 25-gauge 10 and 12-inch band saws. Assembly is easy for each part fills its allotted place perfectly... No. 135

HOW TO BUILD A REAL LATHE FOR \$5.00. Requires a few hand tools, about \$5.00 worth of raw material and patience in build. The lathe is capable of drilling, milling, trimming, boring and thread cutting... No. 136

HOW TO BUILD A SIMPLE PORTABLE REFRIGERATOR. A real refrigerator that does not use ice. The cooling unit operates on an alcohol flame, oil burner or open fire. Easy and inexpensive to build. Excellent for boats, camps, picnics, etc... No. 138

HOW TO BUILD LARGE TESLA AND ODIN COILS GIVING 18-INCH SPARKS. Interesting, high-frequency apparatus with which many high-frequency and x-ray experiments can be performed. Capable of producing 15,000 volts... No. 141

HOW TO MAKE AN ARC WELDER. A real arc welder capable of doing commercial jobs satisfactorily. Uses a heavy duty transformer which operates from the 110-volt A.C. main. The output of the machine ranges from 15 to 100 amperes... No. 142

HOW TO USE AN A.C. ARC WELDER. Companion publication to the one listed directly before. Very informative; especially to the garage man or mechanic who has had little or no experience with an arc welder. Contains many important diagrams and photographs of actual work done with an arc welder... No. 143

HOW TO MAKE YOUR OWN MICROSCOPE. A microscope which the home mechanic can easily build in his shop. The lenses are obtained from the flinders of a camera. Although simple and easy to build, it is a thoroughly practical and efficient instrument... No. 144

HOW TO MAKE A WIMSHURST ELECTROSTATIC MACHINE. An easily constructed generator of static electricity capable of discharging a fat three-inch spark. Used in schools where electricity is taught. Can be built for less than \$2.00... No. 145

HOW TO MAKE A POWER DRILL PRESS FROM SCRAP PARTS. An excellent practical drill press that will make work easier for the mechanic. About \$2.00 worth of raw material and scrap iron are the only requirements... No. 146

HOW TO MAKE AND EXPERIMENT WITH AN ELECTROPHORUS. With this device numerous interesting experiments with static electricity can be performed. Many of these experiments are thoroughly explained and illustrated... No. 148

RADIO PUBLICATIONS 99A HUDSON STREET NEW YORK, N. Y.

RADIO PUBLICATIONS, 99A Hudson Street, New York, N. Y. RC-637

I enclose \$_____ for the publications listed by number at right, at 10c PER DOLLAR FOR ANY TWELVE PUBLICATIONS. These publications are to be sent to me postpaid. I have placed a circle around each number which I want. Send me also your list of 27 other 10c publications.

Name	Address	City	State
------------	---------------	------------	-------------

107	111	114	115	116
121	122	123	124	125
126	127	128	129	132
135	136	138	141	142
143	144	145	146	148

BUILD IT YOURSELF

You can build this Trailer with ordinary tools easily from our step-by-step constructional sheets and large sized blueprints. Finest designed Trailer in existence, sleeps 4. Toilet, Shower, Electric Light, etc. Save 75% of the cost by building it yourself. Send 25c for plans sheet, illustrations and details.

THE PLAN SHOP, 910 Palmolive Bldg. Chicago, Ill.

PATENTS and TRADE MARKS

Protect your most valuable assets. Expert service. Prompt attention. Write

LESTER L. SARGENT
Registered Patent Attorney

1115 K St., N. W., Washington, D. C.

PATENTS—TRADE MARKS

All cases submitted given personal attention by members of the firm.

Form "Evidence of Conception" and Instructions
"How to Establish Your Rights"—Free

LANCASTER, ALLWINE & ROMMEL
PATENT LAW OFFICES

436 Bowen Bldg. Washington, D. C.

CLASSIFIED ADVERTISEMENTS

Advertisements in this section are inserted at the cost of twelve cents per word for each insertion—name, initials and address each count as one word. Cash should accompany all classified advertisements unless placed by a recognized advertising agency. No less than ten words are accepted. Advertising for the July, 1937, issue should be received not later than Friday, May 7, 1937.

DOGS

TERRIERS: ALSO BULL PUPS. SHIP ANYWHERE.
Bob Tom, Dallas, Texas.

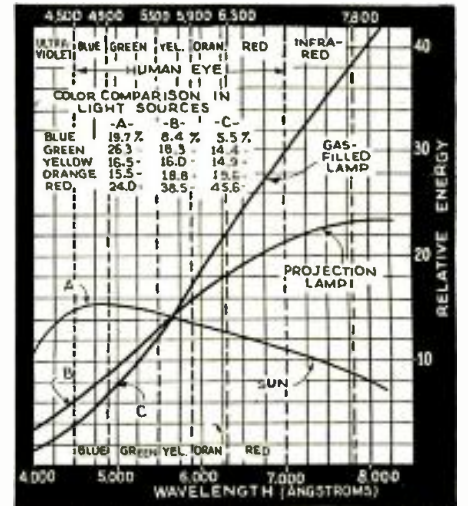

Fig. 3. Duplicating the light content of sun light.

"WHITE" IS A RAINBOW OF COLORS!

(Continued from page 740)

same color (or "total density") and (Table II) the source of the mismatch (or primary color values).

Table I
Matching Shades of Green (without filters)

Reading of Sample No. 1	Reading of Sample No. 2	Points Difference
3-675	3-700	+25

Table II
Analyzing Shades of Green (with filters)

Reading of Sample No. 1	Percent Content	Reading of Sample No. 1	Percent Content	Points Difference
Red 115	30.7	125	32.9	+10
Green 150	40.0	165	43.4	+15
Blue 110	29.3	90	23.7	-20
375	100.0	380	100.0	

SOURCE OF COLOR

A piece of red cloth appears to be red because it reflects only those lightwaves that produce in the mind's eye the sensation of red light and it absorbs those which do not. Hence, visible color is the result of selective absorption. There is absence of color, or black, when a surface absorbs all rays; does not send back or reflect any light that the eye can see and thus resolve into any color. On the other hand when no color is absorbed, and all the light rays that strike an object are reflected into the eyes of the observer, white is the result; its purity then will depend upon the perfection or "power" of the reflector.

The well-trained eye is said to be able to recognize approximately 100,000 different hues and colors. Trained experts are known to detect as many as 200 shades of white and nearly as many shades of black.

However, color engineers have found that shades appearing identical under electric light may vary greatly when examined in daylight. Nor are color lamps dependable in all cases; the slightest variation in line voltage changes the color value of this light source—which to begin with is only a partial substitute for daylight.

APPLICATIONS

Many uses for the reflection-type color meter have become evident but a far greater number of uses have yet to be found. Many of the more interesting applications of this type instrument are given below as showing the capabilities of equipment of this type.

Yarns may be tested by close-winding the yarn

Vest Pocket Adding Machine

Sturdy Steel Construction, Lifetime Pocket Companion. Adds, Subtracts, Multiplies, Divides. Capacity, 999.999.99. A real machine—guaranteed 5 years. Send name and address. We ship immediately. On delivery, pay postman \$2.50 (plus few cents postage). (Foreign countries send cash.) Your money back after 10 days trial if not satisfied. Thousands of satisfied customers. Send for Special Offer to agents.

Free Trial \$2.50
Send no money Total Cost

TAVELLA SALES CO., 21 West Broadway, New York, N. Y.

Please Say That You Saw It in RADIO-CRAFT

G.E. PHONOGRAPH MOTOR

Formerly Sold for \$15.00



Only \$4.95

VARIABLE speed induction type self-starting, 110 volt, 25 to 60 cycle, AC, with speed control. Plug and cord. Speed range from 5 to 200 RPM. Can be installed in place of old-fashioned, hand-winding steel motor. Also ideal for display turn table, and a hundred other uses. These General Electric Motors are brand new, in original factory cartons. **\$4.95**

G.E. Electric Phonograph motor as described

Shipping Weight—12 lbs.

WESTINGHOUSE UNIVERSAL MOTOR

\$2.95 110 Volts AC and DC

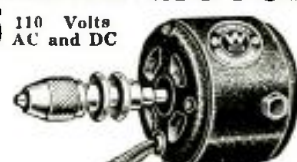

Shipping Weight 9 lbs.

THESE Motors are manufactured by the Westinghouse Electric Co. They are absolutely new. Specifications: 1/30 H.P. operates on either A.C. or D.C., 110 volts, 5000 R.P.M. Rheostat can be used to vary speed. Height 3 3/4", Length 3 3/4", Width 1 1/4", Shaft 1/2" one inch long. Can be used to drive Sewing Machines, Models, Buffing Lathes, Polishing Head, Drills, Grindstones, etc., etc.

MOTOR only **\$2.95**

MOTOR with Arbor and 1/4" Chuck **\$3.95**

Add 25c for special packing and mailing anywhere in U. S. A.

MICROPHONE and RECEIVER



Labels: TRANSMITTER, EAR CAPS, HEAD SET, BREAST PLATE, MIC SWITCH, TWO CIRCUIT JACK, 20 FT. HEAVY INSULATED CABLE.

THIS Microphone and telephone head-set outfit was built especially for the U. S. Navy Aviation Corps. The Holzer-Cad Electric Company constructed the outfit to Government specification. The outfit consists of a low-impedance carbon microphone (transmitter), securely fastened to a metal breast-plate, and a set of heavy-duty, low-impedance earphones. A specially constructed switch on the back of the breast-plate controls the microphone circuit. The earphones are U. S. N. Vah type, attached to adjustable headband. Twenty-eight feet of very heavy weather and water-proof conductor cable is furnished. Current of not more than 10 volts should be used. A storage battery is the most satisfactory current supply.

U. S. Navy Airplane-type Microphone and Receiver as described **\$4.95**

The shipping weight is 9 lbs.

WESTINGHOUSE POWER GENERATOR

Manufactured for U. S. Signal Corps

A.C. Electrical 200 Watt. 110V. AC Power



from a Windmill, from available Waterpower, from your Automobile, from your Motorcycle, from your Bicycle. Foot-pedals or Handcrank (for trans-portable) II: also Transmitters, S.T.R.O.N.G. Floodlights, Advertising Signs; do you want to operate AC Radio sets from 32 V. DC firm light systems; operate two generators in series to get 200 V. AC; obtain two phase and three phase AC, etc., etc. 1/4 to 1/2 H.P. needed to run generator.

There Are Over 25 Applications, such as: A.C. Dynamo light from eight to ten 200 Watt 110 volt lamps, Short Wave Transmitter supplying 110 Volts A.C. for operating "Ham" transmitter. Operating 110 V. AC 60 Cycle Radio Receiver in DC distr. etc. Motor Generator, Public Address Systems, Electric Circuits on motor boats, yachts, etc. Camp Lighting, etc., etc.

Blue-Print 22 x 28 in. and Four-Page Instruction sheet. **\$7.90**

8 1/2 x 12 in. Instruction sheet, Generator and replacement carbon brushes **\$7.90**

Shipping weight 18 lbs.

All merchandise in original packages—never used. Money-back guarantee.

We will forward Shipments by Express Collect if sufficient postage is not included.

WELLWORTH TRADING CO.
560 W. Washington Blvd., Dept. RC-637, Chicago, Ill.

around a flat glass plate about 2 ins. sq. If 2 yarns of slightly different twist are measured the readings, which will be dependent upon the total amount of light reflected, will differ; but if color filters are inserted and readings taken for each color filtration the proportion of each color will be seen to have remained unchanged. In other words, the make-up of the color is determined regardless of its total light reflecting value or the density of the sample. For this reason it is convenient to determine color differences between cloths of different weaves, only the color and not the weave being the factor on which a reading is obtained.

Liquids are tested by placing an amount in a petri dish sufficient to nearly fill it. Then the petri dish is placed upon a white background so that the light rays are reflected back through the liquid to the photoelectric cell. This method benefits by the double travel of light through the liquid and doubles the percentage of error, revealing the most minute variance in 2 liquids. In fact, it becomes possible to discriminate between distilled and double-distilled water. Blood may be tested, by color analysis, for its hemoglobin content.

Oils, kerosene, gasoline, etc., may be checked to determine uniformity or to duplicate repeat orders and blending. Oils ordinarily put out under the same number when given a color-meter test will often show from 200 to 400 points difference.

Steel can be color-meter tested for color differences.

Powders are checked by filling a petri dish and smoothing off the surface with a stick to get a uniform reflecting surface. Carbons and bone blacks when analyzed, by means of the filters, generally show the same green or blue content but immediately reveal a varying red.

Paints, lacquers, or any finishing materials which are to be matched may be tested with the colorimeter. The discrepancy is shown in the total reflected light value. If not a match the discrepancy is shown in plus or minus in each of the primary colors; the percentages of primary colors in the sample and the correction needed to bring the sample to match are indicated. The fading of finishes can be determined upon this percentage basis and will show the component color that has faded out the percentage of fade as compared with the original sample.

Printing inks, analyzed by the same method, may be tested for coverage and fading. Paper may be tested for tints and opacity.

Glass (eyeglass, telescope and camera lenses, for instance) and other transparent materials may be tested for light transmission and color content. Photographic plates and films may be thus tested.

Ceramic materials, depending upon whether they are glossy or dull, may be tested with either the single-lamp or double-lamp units.

Flour samples that appear to the naked eye to be identical when color-meter tested are found to differ considerably in their color composition. An excellent example of this is seen in Fig. 5, which shows that the soft-patent sample selected had considerably less red in its particular shade of white than did the hard-patent sample.

Yea, verily, the reflection-type color meter is an instrument that wide-awake technicians will find easy to merchandise.

Our Information Bureau will gladly supply manufacturers' names and addresses of any items mentioned in RADIO-CRAFT. Please enclose a stamped and self-addressed envelope.

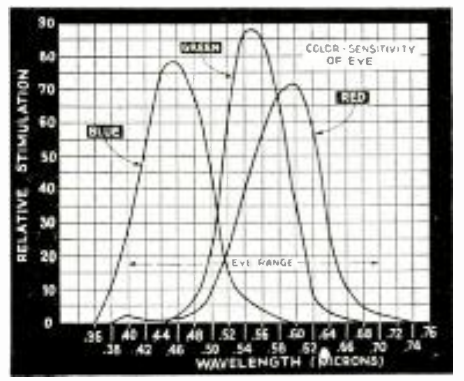

Fig. 5. Primary color content of a sample, in wavelengths.

NOKOIL SPEAKERS

Make The Perfect TALK-BAK* Systems



5" SPECIAL TALK-BAK* SPEAKER

Model 482 T.B. Only \$4.82 List

The 5" model shown above is the most popular, but these speakers which are designed especially for Talk-Bak* Systems can be had in other sizes.

Write for general catalog, special information and drawings on Talk-Bak* Systems

Ask for the name of our nearest distributor. Wright-DeCoster distributors are always anxious to co-operate.

WRIGHT-DECOSTER, Inc.
2251 University Ave., St. Paul, Minnesota
Export Dept.—M. Simons & Son Co., New York.
Cable Address: "Simonrite."
Canadian Office: Associated Sales Co., Guelph, Ont.
*Copyrighted

Send for your free copy

New Revised RADOLEK Profit Guide 1000 New Radio Items



The Spring and Summer edition of the 1937 Radolek Profit Guide is just off the press. The most up-to-date and complete Radio Supply Book. 1000 NEW ITEMS—many presented exclusively—an Oscilloscope using a new 2" Cathode Ray Tube, automatic tuning auto radios, etc. 164 pages of valuable, detailed radio buying information... contains the most complete replacement parts listings of volume controls, condensers, transformers, and vibrators. Over 12,000 Repair Parts—the right replacement items for every radio that you will be called upon to service. A complete new selection of Radios and P. A. Sound Amplifiers. Every page of this catalog will bring extra profits to you. Radolek Quality is guaranteed—Radolek Prices are right—Radolek Service is fastest and most reliable. This is your Profit Guide—it's FREE. Send for your copy NOW!

RADOLEK
601 W. Randolph, Chicago, Dept. C-6

Send me the Radolek Radio Profit Guide free.

Name

Address

Service man? Dealer? Experimenter?

Please Say That You Saw It in RADIO-CRAFT

FINEST FOR Every RADIO NEED



Because...

- Famous Metallized Type Resistance Element,**
- Fully insulated—no shorting.**
- Sealed throughout—impervious to atmospheric effects.**
- Enclosed positive contact—will not break or become "open".**
- Small, sturdy, light in weight.**
- Both RMA color coded and imprinted with resistance value and wattage rating.**



1/2 WATT, List 17c. NET 10c
1 WATT, List 20c. NET 12c
2 WATTS, List 30c. NET 18c
INTERNATIONAL RESISTANCE CO.
401 N. Broad St., Phila., Pa.

INSULATED Metallized RESISTORS

.00001 Ohm to 11 Megohms SHALLCROSS Hi-Lo Resistance Bridge

A direct reading instrument for the measurement of low resistances encountered in relay contacts, coil and armature windings, as well as other resistance of any character within the range of the bridge.



Combines in one instrument a standard Kelvin Bridge and a standard Wheatstone Bridge for measuring resistances from .00001 ohm to 11 megohms.
Send for Bulletin 637-PC

SHALLCROSS MFG. COMPANY
Electrical Measuring Instruments and Accurate Resistors
700 MAC DADD BOULEVARD
COLLINGDALE, PA.

BUILD THE RADIO-CRAFT 1937 CAR-RADIO RECEIVER

(Continued from page 765)

- One Meissner 3-gang variable condenser, type 15130, 410 mmf., C1, C10, C11;
- Three Continental Carbon insulated resistors, type M5, 0.25-meg., R1, R5, R17;
- Three Continental Carbon resistors, type M5, 0.5-meg., R20, R14, R12;
- Four Continental Carbon resistors, type M5, 0.1-meg., R3, R6, R16, R18;
- Two Continental Carbon resistors, type M5, 50,000 ohms, R7, R11;
- Two Continental Carbon resistors, type M5, 5,000 ohms, R19, R13;
- Three Continental Carbon resistors, type M5, 1,000 ohms, R4, R10, R10A;
- Two Continental Carbon resistors, type M5, 300 ohms, R2, R11A;
- One Continental Carbon resistor, type M5, 30,000 ohms, R9;
- One Continental Carbon resistor, type M5, 600 ohms, R8;
- Four Aerovox condensers, type 284, 0.05-mf., C19, C2, C6, C18A;
- Seven Aerovox condensers, type 484, 0.1-mf., C3, C4, C8, C9, C14, C20, C21;
- Three Aerovox condensers, type 484, 0.1-mf., C5, C13, C15;
- Two Aerovox condensers, type 484, 0.05-mf., C22, C24;
- One Aerovox condenser, type 484, 0.01-mf., C12;
- One Aerovox condenser, type 1468, 100 mmf., C7;
- Two Aerovox condensers, type 1468, 250 mmf., C16, C18;
- Two Aerovox condensers, type PR25, 5 mf., C17, C23;
- Nine Meissner align-aire trimmers, type 15230 (not necessary if coils provided with such units);
- *One generator power pack, type 2775 or 3010, with filter or (if desired) one vibrator "B" supply kit (with type 249 or other vibrator). P.4221 or higher power transformer, accessory items, chassis, etc.;
- *One remote-control assembly, type 706-T1-V7; 3—4524 couplings; 1—104 reduction unit for 3/8-in. hub; 3—3119 brackets; 1—mounting kit to individual requirements; 1—8818 tone control; 3—24 in. cables with fittings;
- Continental Carbon ignition suppressors, wheel-static suppressors, "A" filter chokes;
- Aerovox hi-and-low tension filter capacities;
- One set General Electric tubes, 1—6A8, 2—6K7, 1—6N7, 1—6C5, 1—6Q7, 1—6H6 (optional for A.F.C. balanced rectifier), 1—6J7 (optional for A.F.C. oscillator control tube);
- One General Electric type 6F6 tube (in substitution for above-mentioned 6N7 and 6C5 tubes, if desired);
- *One binding post (for antenna), No. 46;
- *One Wright-DeCoster 15-ohm impedance permanent-magnet speaker;
- Two shielded pieces, 8x2 3/4 ins.;
- One shield piece, 10x2 3/4 ins.;
- One Centralab 3-gang, 6-pole, 4-way selector switch, 1 1/2 ins. between sections, type 2-3274; (Note: dial may not be required and may be omitted; 3 knobs also if receiver is built for exclusively remote control; 1 pointer knob in any event required for band switching.)
- *Names of manufacturers will be supplied upon receipt of a stamped and self-addressed envelope. (This interesting auto set was designed by Mr. Raymond P. Adams—Ed.).

A CORRECTION

For those who are interested in the "Precision Aligning Unit" described in the June 1936 issue of Radio-Craft, the correction shown below is given. The wire marked X was omitted in the original diagram.

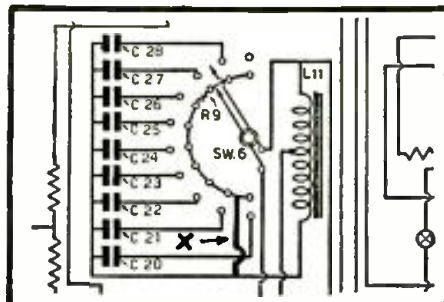

Please Say That You Saw It in RADIO-CRAFT

ADVERTISERS' INDEX

A	Aerovox Corporation.....	763
	Allied Radio Corporation.....	763
	Amberlite Corporation.....	754
	Amplifier Co. of America.....	740
	Amblitone Products Company.....	742
	Arrow Radio, Inc.....	755
	Arrow Sales Company.....	752
	Atlas Press Company.....	747
B	The Brush Development Co.....	747
C	Central Camera Company.....	759
	Central Radio Laboratories.....	759
	Chas-Hill Section.....	746
	Cornell-Dubilier Corp.....	755
	Cornish Wire Company.....	760
	Coyne Electrical School.....	765
D	Delta Manufacturing Co.....	760
E	Electrad, Inc.....	750
	Electric Institute.....	746
G	G & G Genuine Majestic Refrigerator and Radio Parts Service.....	759
	General Cement Mfg. Company.....	739
	General Electric Company.....	Back Cover
	Goldstone Radio Company.....	761
	Greenpark Company.....	765
H	Hammarlund Mfg. Company.....	755
	Hygrade Sylvania Corporation.....	753
I	Illinois Condenser Company.....	755
	International Resistance Co.....	768
K	Kenyon Transformer Co., Inc.....	761
	Hotel Knickerbocker.....	761
L	Lancaster, Alwine & Rohmel.....	766
	Lincoln Engineering School.....	760
M	McGraw-Hill Book Company.....	750
	Metal Cast Products Company.....	760
	Midwest Radio Corporation.....	767
	Million Radio & Television Labs.....	750
N	National Radio Institute.....	707
	National Schools.....	752
	National Union Radio Corporation.....	743
O	Oneradio Mfg. Company.....	751
P	The Plan Shop.....	766
	Precision Apparatus Corp.....	751
R	RCA Institutes, Inc.....	742
	RCA Mfg. Company, Inc.....	741
	Radio & Technical Publ. Co.....	761
	Radio & Television Institute.....	751
	Radio Amplifier Laboratories.....	765
	Radio Circular Company.....	759
	Radio City Products Co.....	752
	Radio Publications.....	766
	Radio Service Institute.....	758
	Radio Training Assoc. of America Inc.....	747
	Raditek Company.....	765
	Raytheon Production Corp.....	743
	Readrite Meter Works.....	741
	Remington Rand, Inc.....	761
	Rex Amplifier Systems Co.....	759
	John F. Rider.....	708
S	S. O. S. Corporation.....	759
	Lester L. Sargent.....	766
	Shallcross Mfg. Company.....	768
	Solar Mfg. Company.....	759
	Syracuse Products Company.....	761
	Sprayberry Academy of Radio.....	Inside Back Cover
	Standard Transformer Corp.....	742
	Sundt Engineering Co.....	758
	Superior Instrument Co.....	741
	Supreme Instruments Corp.....	Inside Front Cover
T	Tacella Sales Company.....	766
	Technifair.....	764
	Telex Company.....	759
	Triplot Elect. Instrument Co.....	757
	Triumph Mfg. Company.....	765
	Try-Mo Radio Co., Inc.....	761
U	United Sound Engineering Co.....	754
	Universal Microphone Co., Ltd.....	761
W	Wellworth Trading Company.....	767
	Weston Elect. Instrument Corp.....	749
	Wholesale Radio Service Company.....	761
	World-Wide Radio Company.....	760
	Wright-DeCoster, Inc.....	767
Z	Zephyr Radio Company.....	750

(While every precaution is taken to insure accuracy, we cannot guarantee against the possibility of an occasional change or omission in the preparation of this index.)

NOW IS THE TIME TO CASH IN ON THE MOST SENSATIONAL HOME TRAINING PLAN IN THE HISTORY OF RADIO



Make Me Prove That Less Than
17c a Day The Mere Cost of a
Pack of Cigarettes

ACTUALLY SETS YOU UP FOR BUSINESS

RIGHT NOW!.... Is the Time to Get Started in an Industry That is Making Fortunes for Live, Wide Awake Men.

THIS new and different kind of Training does more than teach you about all branches of Radio. It teaches you Radio business methods—it sets you up ready for an actual start in business—and it backs up every step of your training with **REAL PROFESSIONAL RADIO EQUIPMENT!**

No matter what kind of Radio Training you take, it is absolutely necessary that you have equipment of this kind BEFORE you are ready to start making real money.

Sprayberry Training brings it to you almost at the start—teaches you just how to use it under actual working conditions. Upon completion you have **COMPLETE** business and technical training **PLUS** the needed equipment to enter business at once for full or part time profits—or to start off on a career in any one of Radio's specialized fields such as Public Address, Auto Radio, Commercial Radio, Broadcasting, etc.

ACT TODAY

Get Into Radio — An Industry That Shows a Profit NOW!

Radio is going ahead by leaps and bounds. And now **TELEVISION** is on its way!

Today is the time to get started—and Sprayberry Training will start you right. Investigate at once! I will show you how an investment of only 17c a day—just about the cost of a pack of cigarettes—can mean a real future for you in one of the fastest-growing professions in the world.

EARN UP TO \$25 A WEEK WHILE LEARNING—READ WHAT THESE MEN SAY



A. H. LANDIE, Northbridge, Mass., writes: "Since enrolling I have cleared a net profit of more than \$150 in spare time alone . . . and I am not half through the course yet. Honestly, I cannot understand how you can give so much 'dope' for so little money."

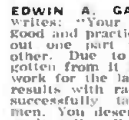

EDWIN A. GAMMON, Auburn, Maine, writes: "Your course is so thoroughly good and practical that it is hard to pick out one part that is better than any other. Due to the knowledge I have gotten from it I have been deluged with work for the last month, achieving good results with radios which had been unsuccessfully tackled by other service men. You deserve all the credit, and I can't tell you how much I appreciate your course."



WALTER DAVIS, Baltimore, Md., writes: "Thanks to the Sprayberry Practical Course (for which I would not take anything of any price) I am now making on an average of from \$10 to \$25 per week in spare time work, and if this keeps up I may go in for full time radio servicing and sales. Thank you again."

I can teach you **QUICKLY**
No previous experience required

No matter where you are or what you have been doing before, I can train you for Radio because my course is **DIFFERENT** and **THOROUGH**. I teach you the principles and practice of Radio in lessons which men say are marvels of simplicity. I train you on **REAL PROFESSIONAL EQUIPMENT**—the stuff real Radio men use. And I teach you tested **BUSINESS METHODS**—I show you the system, the actual tricks of the trade that successful service men use. I tell you all about it in my **NEW Free Book, "MORE MONEY IN RADIO"**. Send for this book **TODAY**.

F. L. Sprayberry
President

YOU GET THIS BIG PROFESSIONAL OUTFIT

This set is the real thing: New "Electric Eye", Set of famous Rider Manuals, Experimental Kit, Tool Kit with Replacement Parts, etc., and big **USEFUL** Triplett Tester—the kind of equipment real service men use to do real jobs.

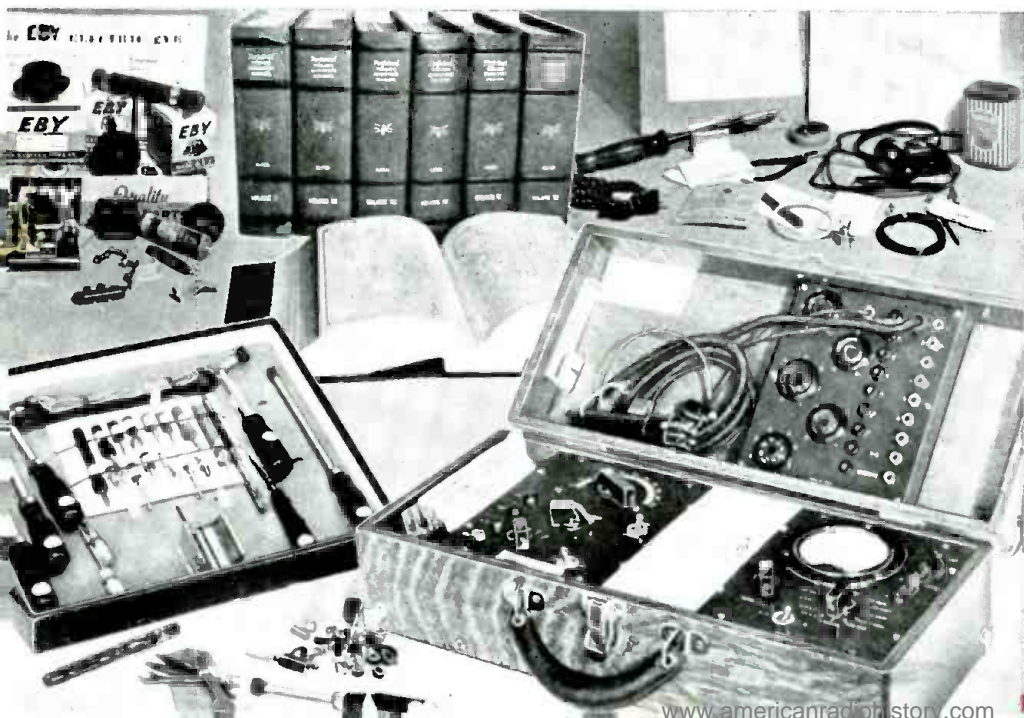

NOW SEND FOR FREE BOOK!

My free book has started hundreds of men on the road to success in Radio and happiness in life. It's crammed with facts you can't afford to miss—filled with **TRUE STORIES** of men that I put into Radio. Get this book and read it. If others can succeed in Radio, so can you—it's all in getting started right. So get the right start **TODAY**—mail this coupon for **YOUR** copy of this great **FREE BOOK!**

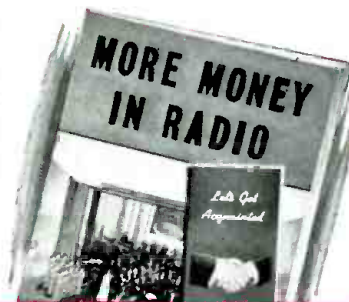

MAIL COUPON TO WASHINGTON TODAY!

SPRAYBERRY ACADEMY OF RADIO,
F. L. Sprayberry, President,
Office No. 20-G, University Place, N. W.,
Washington, D.C.

Please send me, without obligation, "More Money in Radio" and complete facts about your new type of training.

NAME

ADDRESS

CITY STATE

Paste this coupon on a penny postcard and mail **TODAY**.

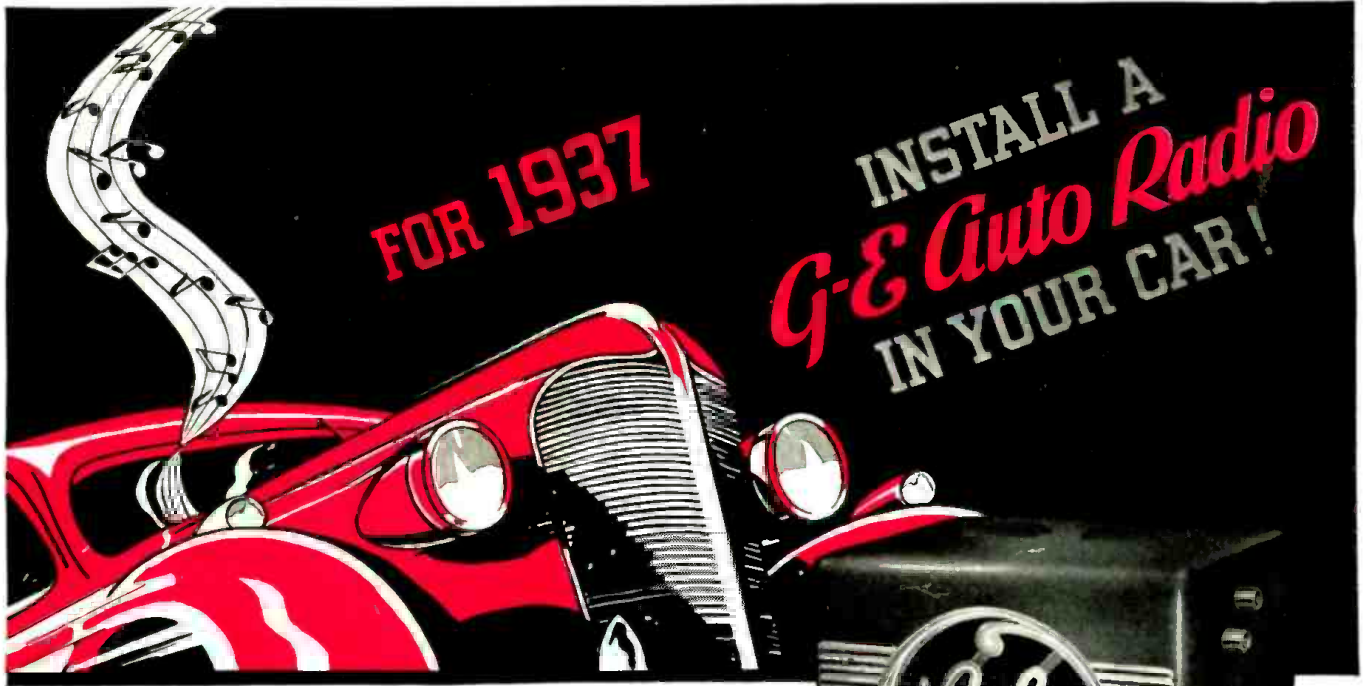

ENJOY RADIO PROGRAMS WHEREVER YOU GO

WITH
Safety Tuning



MODEL FA-80
(8 G-E Metal Tubes)

**Stations Hair-lined Tuned . . . At a Flick of the Dial!
Eyes Concentrated on the Road While Driving and Tuning!**

"FLICK . . . There's Your Station." The driver merely turns the dial to approximately the station's dial position . . . and PRESTO! . . . the program comes in instantly. In a "split second," Automatic Frequency Control shifts the station

into its correctly tuned position. Enjoy reception equal in performance to that obtained on finest home-type sets. Arrange, through your nearest G-E Auto Radio Dealer, for a demonstration of this sensational GENERAL ELECTRIC AUTO RADIO.

TWO Additional POPULAR MODELS



MODEL FA-61



MODEL FA-60

There are also two 6-tube G-E Auto Radio models to choose from.

"CUSTOM-BUILT" INSTRUMENT PANEL CONTROLS FOR ALL MAKES OF CARS



They harmonize correctly with interior decorations.

G-E AUTO ANTENNAS FOR HOME-LIKE RECEPTION



Four new Auto Antennas specially designed for car operation. Easy to install on all cars. Ask for a demonstration.

GENERAL ELECTRIC
Auto Radio

APPLIANCE AND MERCHANDISE DEPARTMENT, GENERAL ELECTRIC COMPANY, BRIDGEPORT, CONNECTICUT