



RADIO'S LIVEST MAGAZINE

Special  
**PUBLIC  
ADDRESS**  
Number

# Radio-Craft

HUGO GERNSBACK Editor

May 36

25 Cents  
in United States  
and Canada

See Page 648



Beginner's 2-Tube All-Wave Set — How Do We Hear? — Making Class B Units  
Announcing New "Wired Audio" Entertainment — Home-Made Microphones

# Flashes from RCA



## 1 RCA Check-Up Plan

At the head of the great profit parade stands the sensational RCA Radio Tube Check-Up Program. Advertisements in *The Saturday Evening Post*, *Collier's*, and 124 newspapers features the necessity of having sets checked up at least once a year if the wonderful radio programs are to be received clearly, enjoyably. This advertising, plus spot announcements over 30 radio stations, brings customers to your shop. Besides the profits from each set check-up, it gives you leads to the sale of tubes, new sets, refrigerators, washers, everything your shop handles. Ask your RCA Tube Distributor how you can participate.

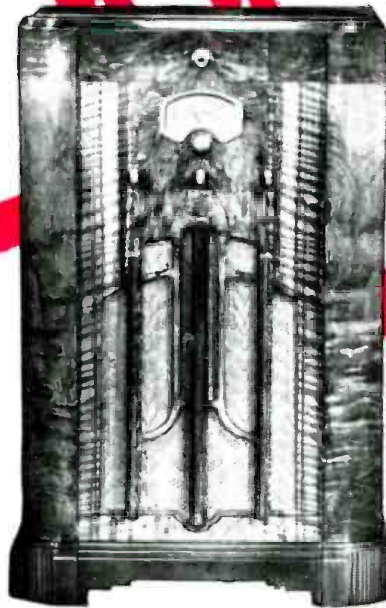

5

## Stupendous Value! \$89.95\*

Here is a great RCA Victor leader for 1936, offering ALL THREE—"Magic Brain," the "Magic Eye," and RCA Metal Tubes, all in a beautiful console at an amazing low price. Has 8 tubes. Tunes 540 to 18,000 kilocycles, covering standard broadcasting and all the short wave services to 15 meters, including police, amateurs, aviation, international broadcasting. Features include adapted Colorband Dial, 3-point tone control, wave trap, 2-speed tuning, 12-inch dynamic speaker. Truly an astounding value. Write for information about this and other RCA Victor home receivers.

\*f.o.b. Camden, subject to change without notice. Other sets from \$19.95.



## 2 RCA Oscillograph

This is a scientific instrument that you can use with the greatest ease, swiftness, accuracy, not only in peaking I. F. transformers, checking distortion, etc., but to help you sell sets. People prefer to deal where skilled service is available. The Oscillograph (\$84.50 net, complete) with the RCA Test Oscillator and RCA Frequency Modulator, enables you to duplicate factory practice. Brings you more service jobs, enables you to do the work with new perfection. Ask your RCA Parts Distributor about this and other RCA service specialties and parts.

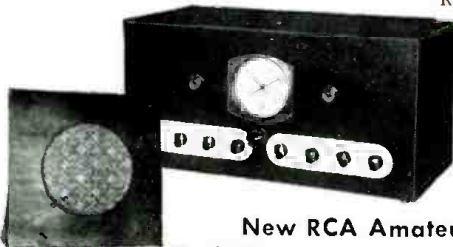

4

## New RCA Amateur Receiver

Here's the newest, most remarkable amateur receiver from the RCA laboratories. Designed by amateurs for amateurs. Has 32 amazing features. Tunes 5 to 600 meters continuous. Ultra-selective crystal filter. "Magic Eye" tuning and signal strength indicator. 11 tubes. Iron-core I. F. trans. for high gain, permanent alignment. RCA Metal Tubes. Astoundingly quiet, due to improved signal-to-noise ratio. Wave-change by switch. Separate dynamic speaker. Many other features. Ideal for short-wave listeners as well as amateurs. A real triumph at \$119.50, amateur's net price f.o.b. Camden, N. J.



3

## Money in RCA P. A. System

New RCA Public Address System offers you two chances to make money—by renting it for special occasions, and by selling it outright to those who have frequent need for it. Model PG-62-D is RCA's latest. Features the famous Velocity Microphone used throughout NBC studios, sensitive, high fidelity, permitting speaker to move freely. Two dynamic loudspeakers. Five-stage amplifier with output of 20 watts undistorted. System easily handles auditoriums of 2500 capacity. Completely portable in two units, or may be installed permanently. At \$395 offers a profit-making opportunity.

RCA MFG. CO., Camden, N. J.  
Gentlemen: I am interested in the subjects checked below.  
Please send me complete information, without obligation.

1  I am interested in the subjects checked below.  
2  Dealer Service Man  
3  S-W Listener  
4  Amateur  
5

Name \_\_\_\_\_ State \_\_\_\_\_  
Street \_\_\_\_\_  
City \_\_\_\_\_

I am (check which)  
Dealer  Service Man   
S-W Listener  Amateur



**RCA Manufacturing Co., Inc.**  
CAMDEN, NEW JERSEY

A Service of the Radio Corporation of America

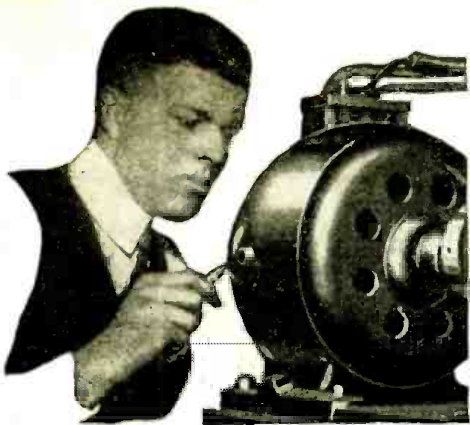

# AMAZING EASY WAY TO LIFE-SUCCESS *in* ELECTRICITY

## LEARN THE GREATEST INDUSTRY OF THE AGE—TRAIN NOW FOR A BIG-PAY JOB I'll Finance Your Training!

Are you dissatisfied with your job? Are you out of a job because you lack **Specialized Training** for a **LIVE** industry? Is your future uncertain? Then let me show you an amazing, easy way to get into **Electricity**, where **TRAINED MEN** are needed . . . Where hundreds of **Coyne Graduates** are drawing **Good Pay** every week. Coyne has been training ambitious fellows for the **Electrical Industry** since 1899 . . . at **Coyne** you do not need **previous experience** or a lot of book learning. It makes no difference if you are 16 or 40 years old, **Electricity thru Coyne training** offers you a big future . . . and you can start any time.

### Many make \$30, \$40, \$50 and up, every week

Here is **YOUR** life opportunity. Every day brings news of new developments in this fascinating, big-pay field, with more jobs and a greater future for the trained man than ever before. If you are ambitious to get ahead, I want to help you. **MAIL THE COUPON BELOW** and I'll tell you about my **finance plan**, which has enabled thousands to get **Coyne Training** with very little money. Get training first, than take 18 months to complete small monthly tuition payments starting **FIVE MONTHS** after you begin your training, or 2 months after your required training period is over. This is **NOT** a correspondence course.



## Learn By Doing In 90 Days

The great Coyne Shops are famous the world over for their unusual **Learn-by-Doing** method of practical, individual instruction. There is no book study, no reciting—you learn quickly and thoroughly by doing actual jobs under the personal guidance of trained instructors, on a great outlay of machinery and equipment assembled strictly for training purposes. That is why, in 12 short weeks, we are able to take fellows **without previous experience** or a lot of book learning, and train them for jobs leading to good pay.

### Many Earn While Learning

If you need part-time work to help pay living expenses while at school, tell us your problems and we may be able to help you as we have hundreds of other students. Then, after you graduate, our **FREE EMPLOYMENT DEPARTMENT** will give you **LIFE-TIME** Employment Service. Every Coyne Graduate also receives a **Life Scholarship**, with free technical and business service and privilege of review at any time without additional tuition charge.

### HOME OF COYNE SHOPS

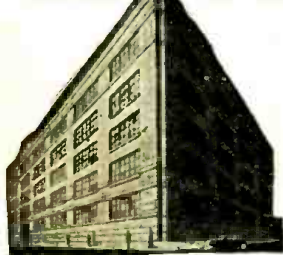

THIS IS our fire-proof modern home wherein is installed thousands of dollars worth of **ELECTRICAL EQUIPMENT**. Every comfort and convenience has been arranged to make you happy and contented during your training.

### PREPARE For JOBS Like These

- DIESEL OPERATOR
- ARMATURE EXPERT
- SUBSTATION OPERATOR
- AUTO ELECTRICIAN
- INVENTOR
- MAINTENANCE ENGINEER
- SERVICE STATION OWNER

and many other money-making opportunities in the Electrical field. Learn by actual work on real dynamos, engines, power plants, autos, switchboards—everything from door bells to full-sized power and lighting plants, in full operation every day.

### DIESEL ENGINES REFRIGERATION AIR CONDITIONING

Trained men are needed in these rapidly expanding fields—the fastest growing industries in America today. **RIGHT NOW** I am including instruction in **DIESEL ENGINES**, Electric Refrigeration and Air Conditioning **AT NO EXTRA COST**.

### PROOF that Coyne Training Gets QUICK Results

"I owe my electrical success to your 12-week shop course," says R. B. Umbarger of Tennessee. "Two weeks after leaving school I took a wiring job," reports E. O. Berndt of Illinois, "and the profits from this one job alone more than paid for the entire course." A. C. Hoehnle of Ohio says, "Received several raises in pay, due to the training I received at Coyne." And I could quote from hundreds of similar letters from successful Coyne-trained men. **WHAT THEY HAVE DONE, YOU SHOULD BE ABLE TO DO!**

### GET THE FACTS . . . NOW

Coyne is your one great chance to get into this big-pay field. This school is 37 years old . . . Coyne training is tested . . . endorsed by large concerns. And **IT COSTS YOU NOTHING** to find out about this amazingly easy, practical way to life success. Simply mail the coupon below and I'll send you the big, free Coyne book, with photographs, facts, jobs, salaries, opportunities. **THERE'S NO OBLIGATION. SO ACT AT ONCE.**



### Send Today for this FREE Book!

H. C. LEWIS, President  
Coyne Electrical School,  
500 S. Paulina St., Dept. 56-78, Chicago, Ill.

Without obligating me, send full details of your **"PAY-TUITION-AFTER-GRADUATION"** Plan and Big Free Illustrated Catalog.

NAME-----

ADDRESS-----

CITY-----STATE-----

Mail in envelope or paste on postcard.

**COYNE** H. C. LEWIS, President Founded 1899  
**ELECTRICAL SCHOOL**  
500 South Paulina Street Dept. 56-78 Chicago, Illinois

Please Say That You Saw It in RADIO-CRAFT



# CONTENTS - MAY 1936, ISSUE

Volume VII

Number 11

Editorial: Public Address Improvements	
.....Hugo Gernsback	645
The Radio Month in Review.....	646
The Trend of Public Address.....R. D. Washburne	648
How Do We Hear?.....N. H. Lessem	649
International Radio Review.....	650
Making a Beginner's 2-Tube Midget All-Wave Set	
.....H. G. Cisin	651
How to Merchandise P.A. Equipment.....R. M. Gray	651
When and How to Use the Volume Expander	
.....C. E. DeRondeau	652
How "Controlled Sound" Aids a Student	
.....Andrew Halbran	653
A.C.-D.C. Sound-Recording Amplifier Design	
.....E. A. Dennis	653
A Modern Sound Truck...J. E. Seidel and C. D. Kiebach	654
Decibel Level vs. Decibel Gain.....S. L. Canterbury	654
Introducing—"Wired Audio" Entertainment	
.....C. W. Palmer	655
Radio Pictorial .....	656
How to Make Your Own Transformers and Chokes	
Part III .....	658
New—Hum-Free Transformers and Chokes!	
.....Leon J. Littmann	659
New Tube Developments.....	659
Home-Made Microphones—Velocity Type	
.....G. E. Faulkner	660
.....—Condenser Type	
.....M. L. Powers	660
ORSMA Members' Forum.....	661

HUGO GERNSBACK, Editor-in-Chief  
 C. W. PALMER Associate Editor  
 H. G. McENTEE Associate Editor  
 R. D. WASHBURNE, Technical Editor

The Design of Modern Test Equipment—Part II	
.....Samuel C. Milbourne	662
Centralized P.A. for Hospitals.....W. S. Parsons	662
Operating Notes .....	663
Crystal-"Mike" Amplifier Considerations	
.....H. W. Johnson	664
Checking Public Address Fidelity.....Paul H. Thomsen	664
Electronic Music Fundamentals—Part II	
.....Edward Kassel	665
RADIO-CRAFT'S Information Bureau.....	666
Metal Tubes in a Modern Preamplifier...I. A. Mitchell	667
Installing Indoor and Outdoor P.A. Systems	
.....E. L. Richards and J. P. Hanan	667
How to Make a Preamplifier.....H. G. McEntee	668
Useful Radio Circuits.....	669

## RADIO-SERVICE DATA SHEETS:

No. 163—Hetro Air-Ace Series M, 9-Tube 4-Band Superhet.; Crosley Model 1155, 11-Tube 4-Band Superhet .....	670
No. 164—Canadian Westinghouse Model 175, 7-Tube Dual-Range Superhet.; Arvin Model 35, 8-Tube Car Radio Receiver.....	671
No. 165—Philco Models 39 and 39A, 6-Tube Dual-Range Battery Superhet.; Philco Packard DeLuxe 7-Tube Superhet. Car Radio.....	673
Important Facts about School Sound Systems	
.....R. H. von Liedtke	672
Servicing 1/4-Million 16 mm. Talkies Units	
.....J. J. Bressler	672
The Latest Radio Equipment.....	674
Readers' Department .....	676
Technicians' Data Service.....	678

## (ANNUAL) AUTO-RADIO NUMBER

At this time of the year, auto-radio installation and repair comes into its own. For this reason, the June issue of RADIO-CRAFT will be just crammed full of articles for the Service Man who specializes in auto-radio work!

The circuits of the new auto sets with detail instructions

for doctoring their ailments, aligning them and getting the best results, will be included.

In addition to these interesting articles on auto radio there will be other articles of interest to those who "like to make their own"—sets, electronic devices, P.A. equipment, etc.

Reserve your copy of the special Auto-Radio Issue of RADIO-CRAFT, on the newsstands May 1, now.

HUGO GERNSBACK, President I. S. MANHEIMER, Secretary  
 Published by Continental Publications, Inc. Publication office: 29 Worthington Street, Springfield, Mass. Editorial and Advertising Office: 99 Hudson Street, New York City. Chicago Advertising Office: L. F. McClure, 919 North Michigan Avenue, Chicago, Ill. Western Advertising Office: Loyd B. Chappell, 511 So. Alexandria St., Los Angeles, Calif.

### European Agents:

London—Gorrings American News Agency, 9A Green St., Leicester Square, London, W. C. 2.

Paris—Messageries Dawson, 4 Rue Faubourg, Poissonniere, Paris, France.

Australian Agent: McGill's Agency, 179 Elizabeth St., Melbourne. RADIO-CRAFT is published monthly, on the first of the month preceding that of date; its subscription price is \$2.50 per year. (In Canada and foreign countries, \$3.00 a year to cover additional postage.) Application for entry as second-class matter at the post office at Springfield, Mass., pending.

Text and illustrations of this magazine are copyright and must not be reproduced without permission of the copyright owners. We are also agents for EVERYDAY SCIENCE AND MECHANICS. Subscription to this magazine may be taken in combination with RADIO-CRAFT at reduced Club rates. Write for information.

Copyright 1936. Continental Publications, Inc.

# I will send you a Lesson Free



J. E. SMITH, President, National Radio Institute, Washington, D. C.—the man who has directed the training of more men for the Radio industry than any other man in America.

## to show how easy it is to learn at home in spare time to fill a

# Good Radio Job

Clip and mail the coupon. I'll send you a FREE lesson. I'll show you that Radio is fascinating; that I give you practical money-making information, easy to learn, easy to put into use. See for yourself why many men with less than a grammar school education and no Radio experience are now making good money as Radio Experts. Get the facts about Radio's spare time and full time job opportunities. Mail the coupon now.

### Many Radio Experts make \$30, \$50, \$75 a week. Get Ready Now for Jobs like these

Broadcasting stations employ engineers, operators, managers, and men for other jobs that pay up to \$5,000 a year. Radio factories employ testers, inspectors, foremen, engineers, servicemen, salesmen, buyers, and pay up to \$6,000 a year. Radio dealers and jobbers employ servicemen, salesmen, buyers, managers, and pay up to \$75 a week. There are many opportunities to have a spare time or full time Radio service business of your own. Radio is picking up. It's a big business—big enough to absorb many more well trained men—and it's growing bigger all the time. Get ready for Radio. Be a Radio Expert. I'll train you at home in spare time.



#### SET SERVICING

Spare time set servicing pays many N.R.I. men \$5, \$10, \$15 a week extra. Full time men make as much as \$30, \$50, \$75 a week. Almost every community offers trained men opportunities to enter this profitable field.

### Many make \$5, \$10, \$15 a week Extra in Spare Time almost at once

Nearly every neighborhood needs a good spare time serviceman. Find out how I help you cash in—how I start sending you Extra Money Job Sheets the day you enroll, for doing Radio repair jobs common in most every neighborhood. How, when you get underway, I send you much more information for servicing sets and for doing other spare time jobs for extra money. My Training is famous as "The Course That Pays for Itself." Many make \$200 to \$1,000 while learning.

### Short Wave, Loud Speaker Systems, Television, Auto Radio, etc., included

New Radio developments are continually making new opportunities. Loud speaker systems, police, auto and aviation Radio, are recent new uses that have been found for it. Television promises many good jobs soon. Television is leaving the laboratory in an impressive way. One million dollars is being spent on two stations. Television receiving sets are being designed and built. New opportunities—many of them—are right ahead. Get full information about how I train you at home in spare time to be a Radio Expert. My 50-50 method of training—half with printed and well illustrated lessons, half with Radio equipment I furnish as part of my training—gives you broad practical experience—makes learning at home interesting, fascinating, practical.

### You Must Be Satisfied

I make an agreement with you in writing—if you are not entirely satisfied when you finish my Course, with the Lesson and Instruction Service I have given you, every penny you have paid me for tuition will be refunded.

### Get a Sample Lesson and my book on Radio's Opportunities

Mail coupon now. I'll send my book "Rich Rewards in Radio" and a FREE lesson at once. Find out about Radio's spare time and full time opportunities; read what others who have taken my Course are doing and making. Read the sample lesson, decide for yourself whether my training is clear, interesting, practical. This offer is open to any ambitious fellow over 15 years old. There is no obligation. Act at once. Mail coupon in an envelope or paste on a 1c postcard.

**J. E. SMITH, President  
National Radio Institute, Dept. 6EX  
Washington, D. C.**



#### BROADCASTING STATIONS

employ managers, engineers, operators, installation and maintenance men for jobs paying up to \$5,000 a year. The larger stations employ as many as 20 to 60 men. Over 600 Broadcasting Stations now in operation.



#### LOUD SPEAKER APPARATUS

Installing, servicing Loud Speaker Systems in auditoriums, for sporting events, political rallies, in schools, factories, etc., is another growing money-making field for which N.R.I. will train you.



I have helped hundreds of men make more money

**MAIL THIS TODAY**

**Good for FREE SAMPLE LESSON and BOOK on RADIO'S OPPORTUNITIES**

J. E. SMITH, President  
National Radio Institute, Dept. 6EX  
Washington, D. C.

Dear Mr. Smith: Without obligation send me the Sample Lesson and your free book about spare time and full time Radio opportunities, and how I can train for them at home in spare time.

(Please write plainly)

NAME ..... AGE.....  
ADDRESS .....  
CITY ..... STATE..... 14X1

**The Tested Way to BETTER PAY**

Please Say That You Saw It in RADIO-CRAFT

# Announcing a New Book for Radio Men!

## Official Radio Service Handibook by J. T. Bernsley

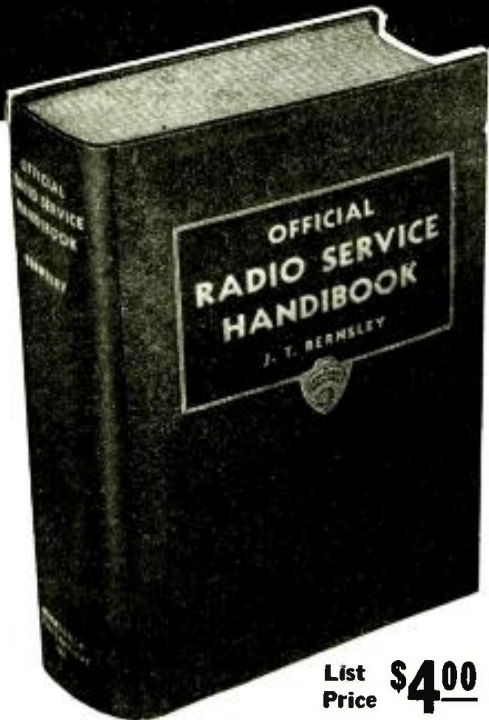

List Price **\$4.00**

**OVER  
1,000  
PAGES**

**Over 750 Illustrations**

**6 x 9 inches**

**Beautiful Leatheroid Cover**

**OVER 250 PAGES  
OF OPERATING NOTES**

Whether it is a fading job, lack of sensitivity, noise within the receiver, aligning a chassis, poor A.V.C. action or any other trouble that is usually the "bugaboo" of most Service Men, you will find the symptoms and remedy clearly described in **OFFICIAL RADIO SERVICE HANDBOOK**. The exact procedure for repairing, as well as the characteristic trouble in almost all models of manufactured sets, will be found in the section on **OPERATING NOTES**—over 250 pages of this data—the most important information to any radio man in the servicing field. The material in this section has been arranged, as well as classified, so there is no difficulty in immediately locating the necessary information.

**H**ERE'S the sensational new book on radio servicing that contains *everything* Service Men must know. The book, **OFFICIAL RADIO SERVICE HANDBOOK**, is edited by J. T. Bernsley, foremost radio service authority. This 1936 service guide is the *only book of its kind*—its editorial material is so well prepared that the technical information can be understood by even beginners in radio servicing. Every page contains new material, new illustrations—no reprinted literature or re-hashed articles.

Over a thousand actively engaged Service Men have helped prepare the service data found in the **OFFICIAL RADIO SERVICE HANDBOOK**. Their contributions, in the form of service notes, short cuts, and trade secrets make this book the outstanding volume on radio servicing ever to be published.

The **OFFICIAL RADIO SERVICE HANDBOOK** covers thoroughly over 500 radio topics. It tells you how to analyze the latest commercial receiver circuits; how to really make money servicing midget sets; and, how aligning supers can be made easy. It stresses the many uses of different types of test equipment; it gives you short cuts in trouble-shooting and repairing; and, contains over 250 pages of operating notes on 1,000 manufactured receivers. So up-to-date is the **OFFICIAL RADIO SERVICE HANDBOOK** that it explains thoroughly what to do when a receiver with the "Magic Eye" goes "cockeyed."

Service Men, previously advised about this great book on servicing, have already ordered their copy. Order your copy **NOW** if you have not already done so.

### SENSATIONAL PRIZE CONTEST!

**\$1,800 Worth of Prizes to Be Awarded to Service Men**

You should be interested in entering one of the greatest radio contests of all times. There are 147 prizes in valuable servicing equipment and radio accessories, totaling over \$1,800, to be distributed. All the details about entering this contest, including a complete list of the 147 prizes, will be sent upon request—simply mail the coupon below.

### Partial Contents of this Great Book

**PART 1—CIRCUIT THEORY AND ANALYSIS**

R.F. Fundamentals; Superheterodyne Receiver Theory; A.V.C. and Tuning Indicator Circuits; A.F. Fundamentals; Power Supply Theory and Circuits; Speakers, Reproducers and Pick-Ups; Commercial Receiver Circuits of All Types, How to Analyze.

**PART 2—MODERN SERVICING AND TEST EQUIPMENT**

Fundamentals of Metering and Test Equipment; Standard Servicing Instruments; The Cathode Ray Oscillograph and Associate Instruments; How to Build Essential Servicing Test Instruments.

**PART 3—PRACTICAL SHORT-CUTS IN TROUBLE SHOOTING AND REPAIRING**

Localizing Trouble by Inspection Methods; Short-Cuts with Test Instruments; How to Quickly and Properly Perform All Types of Repairs; Unusual Servicing Experiences; Tube Troubles and Characteristics.

**PART 4—SPECIALIZED RECEIVER AND INSTALLATION DATA**

All-Wave and High Fidelity Receiver Servicing and Installation Data; Auto Radio Receiver and Installation; Specialized Servicing and Installation (Remote Tuning Controls, Home Recording, Automatic Record Changers, Apartment House Antennas, etc., etc.); Eliminating Noise Interference.

**PART 5—MODERNIZATION AND CONVERSION DATA**

Modernizing and Improving Methods for All Types of Receivers; Converting A.C. Receivers for D.C. Operation and Vice Versa.

**PART 6—SOCIAL AND ECONOMIC PROBLEMS OF THE SERVICE MAN**

Improving Knowledge and Technique; Social Problems—How to Organize, Listing of Servicemen's Organizations; The Future of the Servicing Profession.

**PART 7—OPERATING NOTES AND PRACTICAL DATA LISTINGS**

Operating Notes on Over 1,000 Receivers; I.F. Peaks of Approximately 3,000 Receivers; Voltage Dividers for 300 Receivers, Speaker Field Listing; Radio Mathematics and Measurements.

**CLIP  
COUPON  
MAIL  
TODAY!**

GERNSBACK PUBLICATIONS, Inc. RC-536  
99 Hudson St., New York, N. Y.

Gentlemen: Enclosed you will find my remittance of \$4.00 for one copy of the **OFFICIAL RADIO SERVICE HANDBOOK**. YOU ARE TO SEND THIS BOOK TO ME POSTAGE PREPAID.

SEND ME IMMEDIATELY THE CONTEST BLANK FOR ENTRY IN THE \$1,800 PRIZE CONTEST.

Name .....

Address .....

City ..... State .....

(We accept cash, stamps, money orders or U.S. checks in connection with this offer. If you send cash, be sure to register your letter.)

**GERNSBACK PUBLICATIONS, INC.**

**99 Hudson Street**

**New York, N. Y.**

Please Say That You Saw It in **RADIO-CRAFT**



"Takes the Resistance out of Radio"

## PUBLIC ADDRESS IMPROVEMENTS

An Editorial by HUGO GERNSBACK

**E**VERY year new uses for "P.A." (public address) systems are found, and after they have been adopted we always wonder why no one thought of them before.

While the most obvious P.A. uses have been standardized, such as in theatres and other public rooms, there are many ideas in P.A. that have not been used.

This month's cover suggestion illustrates one of them, whereby are shown lifeguards making use of amplification in overcoming the handicap of their natural voices in the face of thunderous ocean breakers. There are other, equally obvious uses to which sound equipment have not as yet been put—such as P.A. on harbor craft, tugs and ferry boats; at the present time most captains and pilots still use megaphones when, instead, a good P.A. system would be infinitely more effective, supplanting even signaling whistles.

The same is the case with police cars. They should all be equipped with efficient and powerful P.A. systems. Nothing is more effective to clear crowds than the stentorian voice of the police. As tests have proven, traffic can be directed and lax drivers reprimanded much more effectively by means of P.A. than by archaic, present-day methods.

There are also other improvements in P.A. which have not as yet been utilized. For instance, on baseball and athletic fields, and other open areas, where thousands of people are gathered, it has been the custom of American P.A. designers to use the usual horns pointed in various directions—ordinarily, horizontal.

The writer was very much impressed last fall when he visited the Brussels (Belgium) World Exposition, where a very fine P.A. system was installed in a rather unusual manner. There were no visible horns, instead the entire fair grounds was dotted with pillars about 30 feet high which served mainly for night illumination. The horn part was invisible for the simple reason that it pointed straight upwards into the sky, yet withal, the effect was one of excellent quality; diffusion of the sound was such that it was never directional. This system is not used much in this country, but I believe it deserves investigation by P.A. engineers.

There are also other points in P.A. that cry out loudly for improvements. At one time in our motion picture theatres as well as on the legitimate stage, the actors used microphones which were moved in place either by hand or, as on a number of New York stages, the microphones arose from beneath the stage into position when they were required by the performers; and they sank out of sight when no longer needed.

This paved the way to a better system, particularly in the larger amusement houses, where microphones are no longer seen at all. Instead, we now have concealed, highly-sensitive microphones installed at the footlights and facing the performers.

In other cases this system cannot always be used successfully. A recent performance of *Jumbo* in the huge New York Hippodrome affords an excellent example of how *not* to use public address! The microphone, at best, is never an esthetic instrument, as it always insists on getting in the performer's way, or blotting out part of his face. It, therefore, detracts from the performance, particularly if the performer is a woman, because no matter how well a microphone is designed, it is never a thing of beauty when it hides the face.

In the Hippodrome we have the ludicrous situation where the performers in the circus ring have no microphones at

all until they are needed—then, someone having pulled a string or wire, the microphone bobs down from a great height! If, as it often happens, the descending microphone is not exactly timed, the performer nevertheless must speak his lines—which of course are hardly audible; then, when the microphone finally does arrive, the lines are heard to blare out fantastically! It's all so distracting!

In night clubs and other establishments the same system is utilized, because, it is not always possible to place microphones in the footlights (in many of these establishments there are none).

A much better way would be to do away with all visible microphones. In fact, I have originated the following suggestion, which is thoroughly practical because I once tried it myself and know it works. The performer is made to wear a lapel microphone which can be disguised so that it does not show. In the instance of a female performer, it can be hidden underneath the dress. Invisible wires run down the legs in such a manner that one wire goes to each shoe and terminates in a metallic plate under the heel or sole.

Connections then are established through metal strips installed on the stage at desirable locations. All the performer has to do is to step on two metal strips and his weight is sufficient to insure an excellent contact. Thus we are not bothered either with visible microphones or with their trailing wires, and therefore the general effect on the audience is much better.

There is still one more important point in connection with P.A. installations—particularly, those in smaller theatres, halls, etc.—and that is the incorrect placement of the loudspeakers. Very often such units are set up hurriedly without consideration for echoes or other acoustic phenomena. Small wonder then that the resulting reproduction of voice and music is marred by the ensuing echoes and other tricks of sound waves.

It is not possible to use but one type of loudspeaker for all requirements of placement. On the contrary, finding the right "combination" (of speaker and its placement) requires a good deal of "cut and try" experimentation, and no reproducer should ever be permanently installed until it has first been tried out at various points about the room.

Then, there is another consideration, which the inexperienced installation man probably overlooks, and that is the effect of a dense crowd. Take, for instance, the average night club or restaurant where there is entertainment. If, as is likely, the loudspeakers are installed when the premises are denuded of people, an entirely new factor comes about when the room is packed to capacity. An empty or partly-empty room will have certain acoustic effects, whereas the crowded one will entirely change the reproduction. In this instance temporary installation of the reproducers would permit the optimum placement to be quickly determined.

Lastly, P.A. engineers still have much to learn when it comes to the *intensity* of sound. In some cases the intensity is insufficient; in yet others it may be much too loud for comfort! For example, New York dramatic experts were unanimous in their condemnation of the blasting loudspeakers which marred the entire performance—and still do—at the Winter Garden where the current production of the *Ziegfeld Follies* is now running. Enjoyment of innumerable other good shows (and movies) is similarly ruined by such misuse of a sound installation!

# THE RADIO MONTH

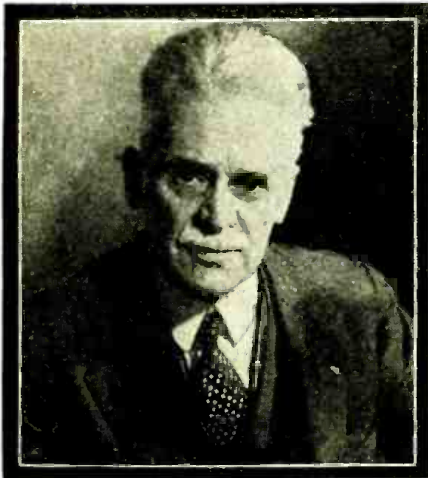

Hiram Percy Maxim—the friend of radio amateurs who died last month.

## HIRAM P. MAXIM DIES

**L**AST month, one of the best known and respected radio men passed away; Hiram Percy Maxim, 67-year-old president of the American Radio Relay League and the International Amateur Radio Union, succumbed to a throat infection, on a trip to the West Coast.

Mr. Maxim besides being a strong supporter of amateurs was also known for his inventions, especially the silencers used on fire arms, motors, etc.

One of his guiding beliefs was that the scientific progress of the world depends on its amateurs—those who experiment “for the fun of it” and whom he (rightly) credited with many basic developments.

Mr. Maxim will long be missed by the American radio amateurs who looked to him for support in maintaining their rights.

## F.C.C. RULINGS ON BROADCASTING

**D**URING the past month, the Federal Communications Commission made two important rulings regarding broadcasting. The first of these concerned that important subject—transcription programs. The new ruling states that it is only necessary to announce the program as a recording at the beginning and end of each 15-minute program. This will, no doubt, increase the use of such programs.

The second ruling concerned duplication of programs and instigated an investigation into the possibilities of reallocation of stations to prevent such program duplications in rural sections where there are only two or three “local” stations.

## ULTRA-SHORT-WAVE BROADCASTING

**T**HE transmission of programs on ultra-short waves, notably 41 and 31.6 megacycles, which was started some time ago, to advance transmission of high-fidelity programs made a notable advance, last month.

Station W8XWJ, the companion station to WWJ, operated by the *Detroit News* started regularly scheduled programs on the 31.6 megacycle band—the first station to transmit *regular* service on these frequencies.

According to the F.C.C., progress on these frequencies is slow, due to the lack of receivers to pick up the programs, but the new “crop” of all-wave sets which will soon appear covers frequencies higher than 56 megacycles and this encouragement will no doubt spur on the efforts of the half-dozen owners of these high-fidelity stations.

## VIOLET RAY SOUND RECORDING

**A** NEW process for photographically recording sound on motion-picture films which is expected to “open a new era of realism” in the reproduction of music and speaking voices was demonstrated last month at a meeting of the Soc. of Motion Picture Engineers.

The present method uses an ordinary incandescent lamp as a light source in recording—but “white” light has some components which are almost impossible to focus sharply in order to get a distinct reproduction of sounds:—this results in distortion.

In the new method, a light filter is inserted in the light path so that only the ultra-violet rays reach the sound track of the film. This filtered light “paints the sound image on the film” more distinctly than the older method.

Below, a comparison of the sound tracks for ordinary light and ultra-violet light. Right, views of the new pocket radio transmitter (above) and receiver (below).

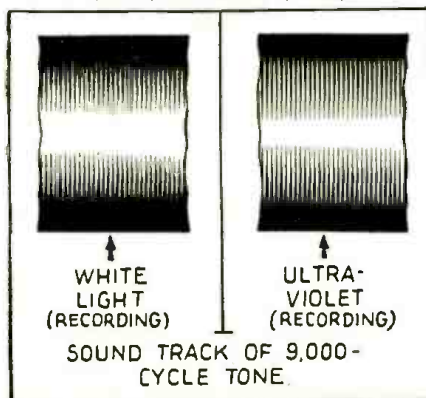

## MINIATURE “SPOT” BROADCAST STATION

**A** TINY transmitter that fits in the palm of the hand and operates on a wavelength of 1 meter was announced last month by the NBC for use in spot broadcasts at remote points.

The transmitter has a range of about 4 miles and because of the extremely high frequency, its penetrating power through steel buildings, etc., is remarkable. This new device will enable announcers to move about at will without being burdened with cumbersome equipment since it weighs less than 4 lbs. with batteries, measures only 3 ins. square. The power output is about 0.2-watt; it uses a tiny “acorn” tube.

As an accompanying unit, a 1-meter receiver has also been developed, using a special super-regenerative circuit, to pick up the signals from the pocket transmitter and feed them into a telephone line so that they can be transferred to the network outlet (station).

The development of these ultra-high-frequency units will greatly facilitate the transmission of sporting events, etc.





# IN REVIEW

Radio is now such a vast and diversified art it becomes necessary to make a general survey of important monthly developments. RADIO-CRAFT analyzes these developments and presents a review of those items which interest all.

## NETWORKS SUED IN MUSIC FIGHT

SINCE our first announcement in March, 1936, *Radio-Craft*, of the fight between ASCAP (or, rather, Warner Brothers Pictures, Inc.) and the national broadcast networks, over the price to be paid for music transmitted, several developments have taken place.

First, both NBC and CBS have been guilty of using music which was banned by Warner Brothers (as might be expected because of the large amount of music controlled by the latter), and both networks were haled into court, last month!

Second, the quarrel is no nearer to an amicable settlement than it was two months ago—which is surprising, considering the large sums involved!

## NEW USE FOR P.A. IN MINES

A NEW and novel use for P.A. equipment came to light, last month, when news was received that a complete P.A. system had just been installed in a colliery at Ogmere Vale, Wales. The P.A. system is used to send safety-first rules, from phono. records, it is also used as a call system to all parts of the mine.

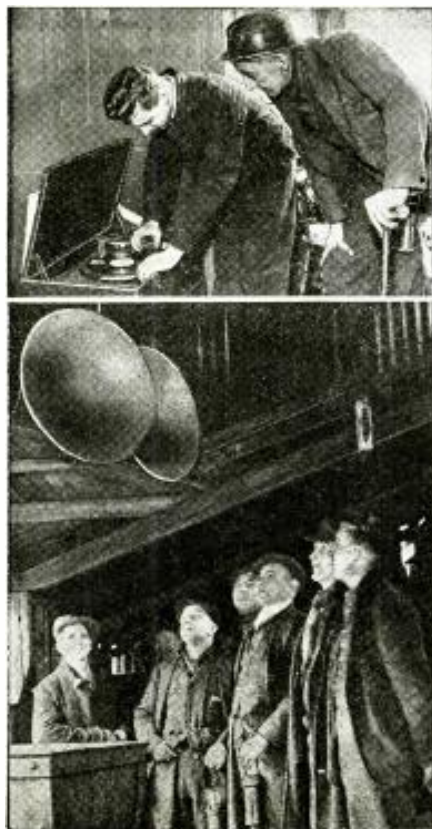

## 1936 OUTLOOK IS ENCOURAGING

ACCORDING to a report from the Radio Manufacturers Association, last month, the radio industry is looking forward to another excellent year. According to the RMA report, "Some industry leaders even feel that the record-breaking sales of 1935 will be exceeded in 1936."

The Presidential election campaign in which radio (and P.A.) will play an important part as well as the soldiers' bonus distribution which will take place, probably in June and July, all point to increased business for "radio" manufacturers.

Broadcast station advertising in 1935 also hit a new high. The total sale of time on the air by the nation's networks and independent stations amounted to \$87,523,848 in 1935 which represents a gain of 20 per cent over sales in 1934.

In the annual report of the Radio Corp. of America for 1935, the net profit was \$5,126,873 which compares with \$4,249,264 for 1934—each quarter of 1935 showed a gain over the corresponding quarter for 1934!

## COSMIC-RAYS ON SHIPBOARD

THE first time that a cosmic-ray recording device has been installed on a ship travelling through northern and southern hemispheres for the purpose of checking the variations of cosmic-ray activity at different parts of the globe was announced, last month, by Dr. Arthur Holly Compton, of the University of Chicago.

Dr. Compton, who received the Nobel prize in 1927, installed a unit consisting of a shield of lead through which cosmic rays but not radio-active rays may pass, and an electronic indicating device (similar to a Geiger counter) attached to a film recorder.

Left, two views of the P.A. installation in the Welsh coal mine, showing the phonograph equipment for sending safety talks, and one of the speaker installations in the shaft.

Below, Dr. Compton with his cosmic ray unit.

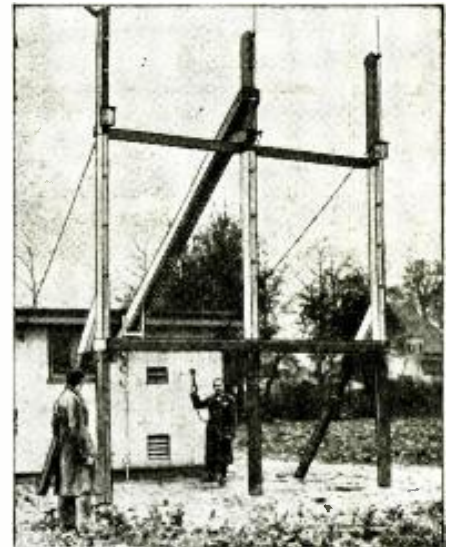
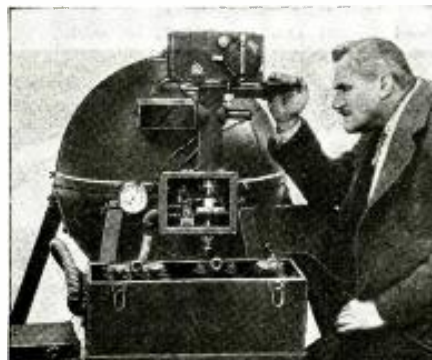

Engineers testing the Heston blind-landing rig.

## "BLIND LANDING" IN BRITAIN

THE first "blind landing" equipment at a British airport was installed, last month, at Heston Airport. The landing arrangement uses the system devised in Germany by the Lorenz Company and originally installed at Templehof Airport in Berlin.

This system consists of two radio beacons at either end of the airport. Each sends out constant call signals and information to guide the pilot to a safe landing.

## EUROPEAN RADIO HAPPENINGS

DURING the past month, several interesting radio news items have been received from various parts of Europe.

It is expected that within the year television will be inaugurated in England. The Post Office authorities also announced that *telephone-television* service probably will be established between London and Birmingham, using a new type of cable (presumably a coaxial cable) which enables television views to be sent over nearly 100 miles of land lines.

The Postal Ministry in Berlin announced that arrangements had been made to send television views of the Olympic games over the Berlin television station. This is the first time that such an important outdoor gathering has been televised. In addition to the television views, direct short-wave transmissions of the games will be made to at least 19 different countries from the new "radio-house" which has been  
(Continued on page 678)

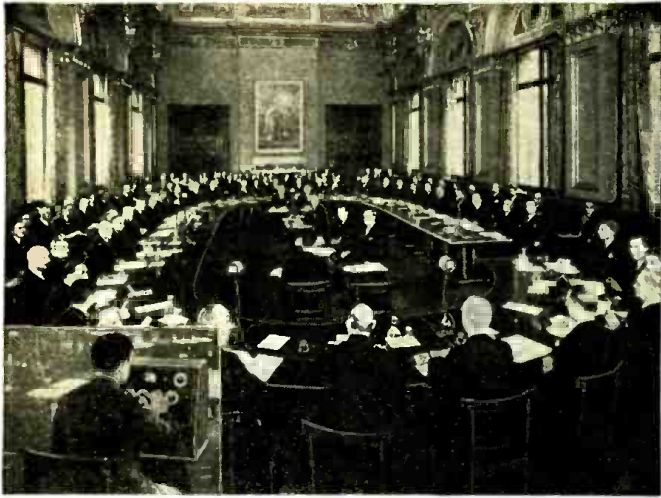

Above, P.A. in use at the Locarno conference.

Below, public address in a life-saving role.

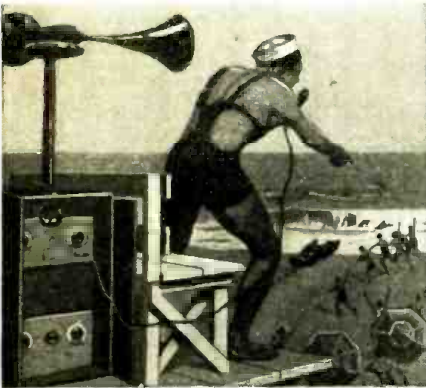

**C**UPID, even, has uses for P.A. equipment, it seems! According to recent newspaper accounts, Marie Almonte, beautiful night club chanteuse, made the mistake of voicing an "aside" in front of a sound-system microphone that suddenly was put into operation. Whereupon, the patrons of the Club Deauville in New York City heard Marie's whispered remark to Lucien Riviere, master-of-ceremonies at that club, "I don't see why people should know yet that we're engaged!" After the "whisper" had clarified throughout the big hall there was nothing the pair could do but gracefully come to the floor's center and acknowledge the classic "P.A. faux pas"!

"P.A."—which is short for "public address"—deserves a more comprehensive designation. In fact, we secure a better appreciation of the public-address field by consideration of the audio frequency topics covered by the more em-

Wurlitzer Organ Studios sends music to . . .



bracing term, "radio" (in which we readily include such extra-radio audio activities as deaf-aid services, call systems, automatic-phonograph installations, etc.). For, we must remember that new uses for P.A. are daily developing, while the old uses for P.A. are constantly expanding. In Table I are shown outstanding directions which this development and expansion of sound are taking. (Additional, important information on the subject appeared in the Public Address number of *Radio-Craft* that appeared this month last year.)

TABLE I

- (1) Increasing appreciation of sound facilities, in sacrosanct circles;
- (2) The use of super-power P.A. equipment;
- (3) High-fidelity recorded sound;
- (4) Mobile public address;
- (5) Appearance;
- (6) Controlled Sound;
- (7) "Talk-back" P.A. installation.

The manner in which sound equipment is usurping time-hallowed procedure is well indicated in recent word from Europe that the 5-power naval conference being held in London is being speeded through the use of sound equipment.

The equipment in operation in the Locarno room at the Foreign Office is here illustrated; the insert pictures one of the B.B.C. engineers making preliminary tests on the amplifiers at one end of the conference table.

#### SUPER-POWER P.A.

Of course P.A. will have a short-lived hey-dey this fall when the Demo-



# THE TREND OF PUBLIC ADDRESS

"New uses for P.A. are daily developing, while the old uses for P.A. are constantly expanding," states the author. The truth of this assertion is confirmed by illustrations and descriptions of systems and apparatus of interest to everyone in the field of public address.

R. D. WASHBURNE

cratic, Republican, and other political parties start blasting away—and we use the word advisedly—with sound trucks and every other conceivable type of loud and louder sound equipment. However, it must not be considered that all public address is a matter of projecting only voice.

There is, for instance, the recently-completed project of "humanizing" the Grand Central Terminal in New York  
(Continued on page 683)



Above and below, a mobile system publicizes the manufacture and sale of ice cream cones. The truck contains complete refrigerating equipment for the purpose. Generators supply electric power.

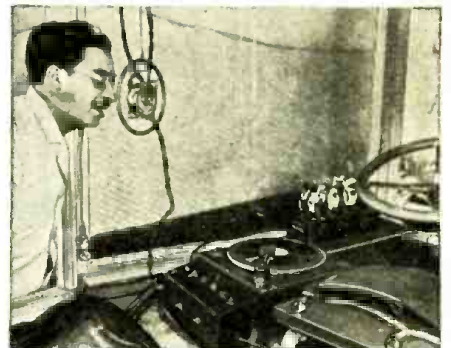

below, speakers reproduce the organ program.



# HOW DO WE HEAR?

The subject of hearing is primarily a biological study—but it is a study every worker in the P.A. or radio fields must make before he may consider himself seriously engaged in either field. The human ear is such an important part of both subjects that a real understanding of high-quality reproduction is unattainable without a knowledge of its action! The newest interpretation is given.

N. H. LESSEM

PART I

IF A GROUP of people happened for some reason to be on an island, at the time when, for example, a coconut fell, their ears immediately would have “perked up” and they would have exclaimed—probably in unison, having been taken by surprise—“What was that?”

“Sounded like a *shot* to me,” perhaps one would venture. “No, couldn’t have been. Sounded like a *thud* of some kind,” might reply another.

“Sounded like something fell,” yet another remarks, “it was sort of a *sharp knock*.”

Each person might respond to or interpret the disturbance (sound, or sound waves) differently; depending upon the physical and biological construction of his particular set of ears.

The same is true in far greater degree with “music,” which is nothing more than sound waves of a highly complex nature. When the strings of a violin are caused to vibrate, either by plucking or drawing a bow over them, they in turn cause the air in the immediate vicinity to vibrate at the same fundamental frequencies and overtones as the strings. These vibrations, in the form of sound waves, spread in an ever-widening circle, in all directions. *Now, no one will deny that these sound waves are the same for all people “listening” to them.* Yet, is it not logical to assume that in each person’s brain these sound disturbances might be interpreted differently? Some persons perhaps would express the opinion that “the instrument lacks high frequencies.” Others might say, “It does not go down quite far enough.” Nevertheless, some others might go into ecstasies over the perfection of the instrument. So there you are!

## STRUCTURE OF THE “OUTER EAR”

All of this brings us to the intended subject matter of this article—the mechanics of hearing—or, how we hear, and why we all do not hear alike. To discuss this subject intelligently we must first acquaint ourselves with the physical construction of the ear. Refer to Fig. 1.

The hearing mechanism is divided into three main por-

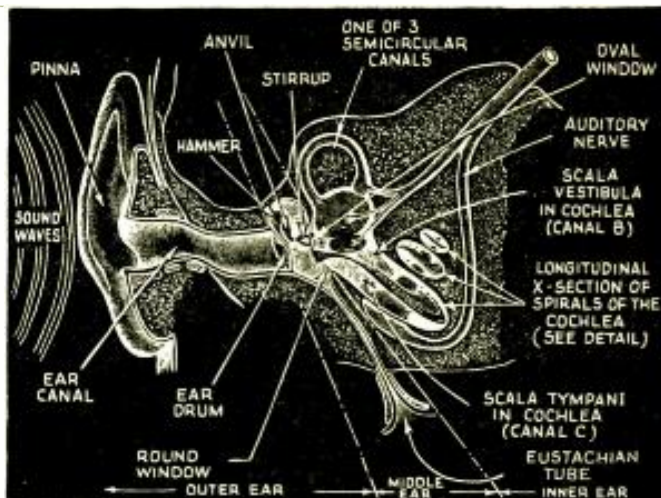

Fig. 1, above. A semi-diagrammatic section (from Czermak) through the right ear. A detail of the cochlea is enlarged in Fig. 2.

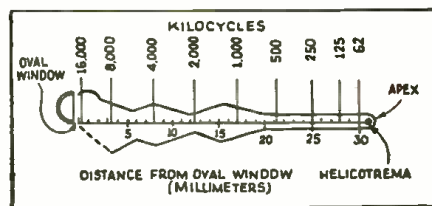

Fig. 4, right. The frequency characteristics along the length of the basilar membrane.

tions, namely: (1) the outer ear; (2) the middle ear; and (3), the inner ear. The outer ear is the *pinna*, which acts merely as a collector of sound and the ear canal. In animals the *pinna* is considerably more versatile than in the human being. However a cupped hand, held over the *pinna*, can considerably improve its sound-collecting function.

At the base of the *pinna* is an opening which penetrates the head for a short distance and terminates at the “ear-drum.” This is the *ear canal*.

## THE “MIDDLE EAR”

This eardrum is a flexible membrane or diaphragm, of approximately 1 centimeter (0.4-in.) in diameter, dividing the outer ear from the middle ear. On the inner side of this membrane are located three peculiarly-shaped little bones in a lever arrangement. The bone closest to the eardrum is called the “*hammer*”; the middle bone is known as the *anvil*, and the end bone as the *stirrup*.

These little bones or *ossicles* were named for their likeness to those familiar articles. The lower end of the stirrup terminates in a flat portion which rests against another flexible membrane approximately 1/20 the diameter of the eardrum—hardly larger than a pin hole. This membrane is stretched across an opening in the bony structure known as the “oval window.” Thus, contact is made, through these bones, from the outer ear to the inner ear. A tube (called the *Eustachian tube*) opening from the middle ear extends

(Continued on page 680)

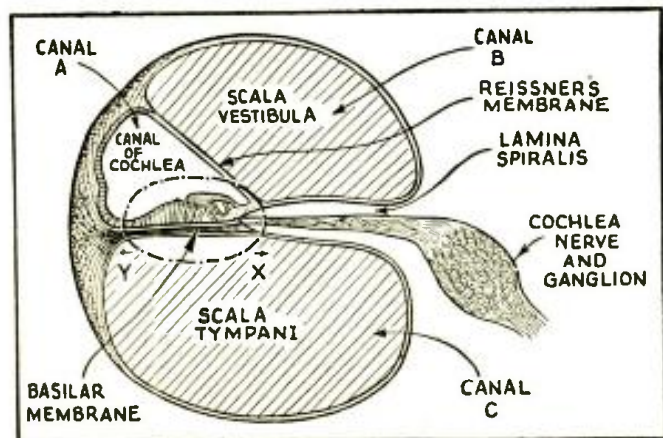
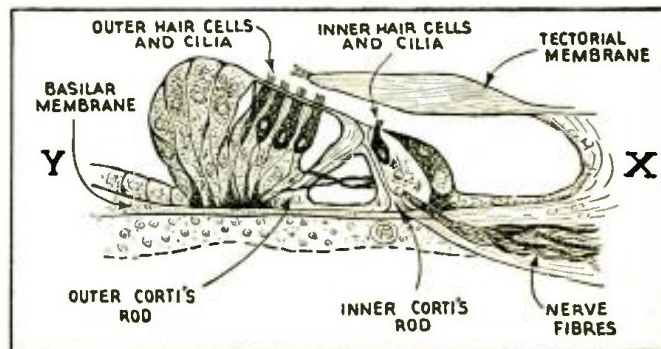

Fig. 2, left. A cross-section detail of the cochlea showing the three canals. The dotted portion is enlarged in Fig. 3.

Fig. 3, below. Corti's organ, showing the termination of the nerves in hair cells and hairy cilia.



# INTERNATIONAL RADIO REVIEW

RADIO-CRAFT receives hundreds of magazines from all parts of the world. Since the cost of subscribing to each of these would be prohibitive for most radio men, we have arranged with technical translators to prepare reviews for our readers.

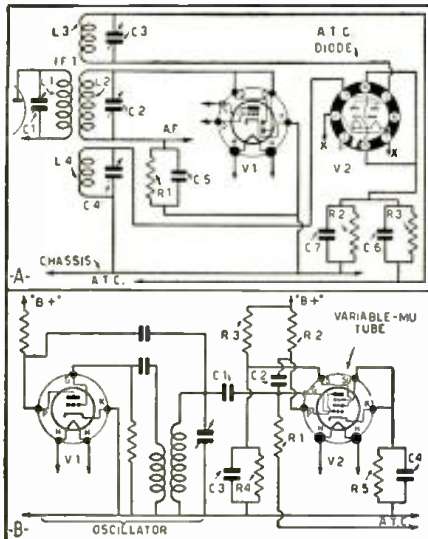

Fig. 1. The two parts of the A.T.C. unit. At A is the tuning control voltage supply circuit and at B is the bias-tuned oscillator, which compensates for mis-tuning.

## AUTOMATIC TUNING CONTROL

**A**UTOMATIC tuning compensation or A.T.C. as it is called, has taken Europe by storm. Since we first mentioned this new system in the January, 1936, issue of *Radio-Craft*, page 408, a practical, electrical method has been devised for replacing the meter-type compensator!

The new system which was described in *Wireless World* (London) recently can be described most readily by dividing it into two parts as shown in Figs. 1A and 1B.

The circuit at Fig. 1A shows the usual diode second-detector found in most superhet. receivers. In addition, the I.F. transformer has two additional windings, L3 and L4, which are tuned, one slightly higher than the I.F. and the other slightly lower. These two windings are so connected to a second diode tube that if the signal from the frequency-changer circuit is *above* the I.F., a positive voltage will be applied to the wire marked A.T.C. while if the signal applied is *below* the I.F. resonant point, by an equivalent amount, an equal voltage but of opposite polarity will be applied to wire A.T.C. by the second diode plate. This action is caused by the connections of resistors R2 and R3 connected to the cathode of V2 and the circuit of the diode plates of this same tube.

The second part of the A.T.C. action is found in the oscillator of the superhet. receiver. By an action known as the "Miller" effect, it is possible to vary the frequency of an oscillating tube circuit by varying the grid bias. If the tube used has an appreciable grid-plate capacity and it is operated with a resistance or capacity load in the plate circuit, its effective input capacity depends upon the amplification, which can be controlled by the grid bias. Since the input capacity of the tube shunts the tuning capacity, the oscillator frequency can thus be varied over certain limits by adjusting the "C" bias.

The voltage generated by the unit shown in Fig. 1A is used to control the bias of the oscillator at Fig. 1B which automatically varies the oscillator resonance point and corrects faulty tuning.

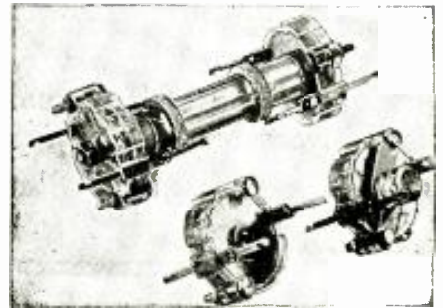

Fig. 2, above. A record grooving guide. Fig. A, below. The sign pillars in Berlin have been given a voice—via P.A.



Fig. 3. This insulating material looks like glass, but can be machined and molded.

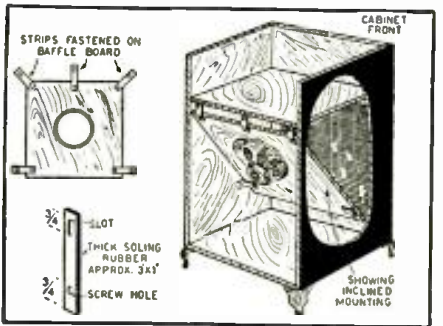

Fig. 4. By inclining the baffle, the high frequencies are thrown up where they can be heard and where they are not absorbed.

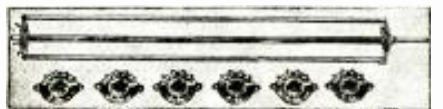

Fig. 5. A flexible way to make multi-point multi-throw switches for various needs.

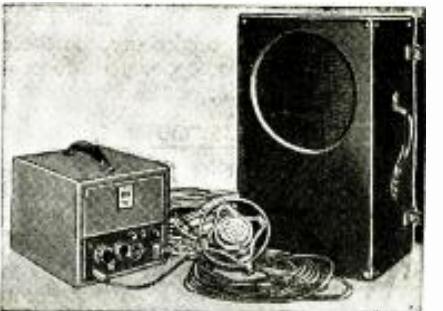
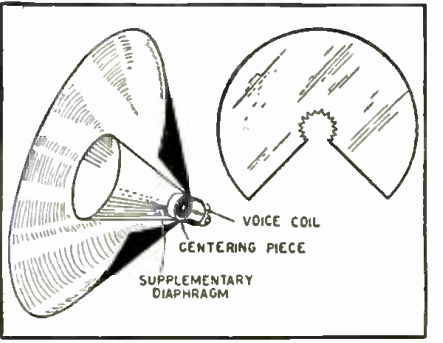

Fig. 6. An English portable P.A. outfit. A permanent-magnet speaker is employed.

Fig. 7. Improving high-note response.



## HOME-RECORDING GROOVING GUIDE

**I**N making home recordings, either pre-grooved or plain records can be used. While it has become almost universal practice in this country, because of the simplicity in the apparatus needed, to use pre-grooved aluminum or acetate record discs, there are some advantages in using the plain discs and cutting grooves at the time of recording.

(Continued on page 677)

# MAKING A BEGINNER'S 2-TUBE MIDGET ALL-WAVE SET

Here is an A.C.-D.C. all-wave set that will fit into a coat pocket! The beginner will find it easy to construct.

H. G. CISIN

**T**HE ultra-midget set here illustrated is a development made possible by the new metal tubes. It weighs less than a pound and takes up less room than a camera! It brings in on headphones the programs of short-wave and broadcast stations both near and far, and in comparison operates just as efficiently as its big brother radio sets. While its main feature is its small size, its efficiency is comparatively high. Basically, it consists of a 6C5 tube used

as a rectifier and another 6C5 tube employed as a regenerative detector. These midget-size new metal tubes (they are slightly over 1 in. in height) certainly pack a terrific punch.

The use of the A.C.-D.C. circuit has eliminated many bulky parts and even the necessary voltage dropping resistor is relegated to the line cord, so that essentially all that remain are a compact variable condenser, a small potenti-

(Continued on page 679)

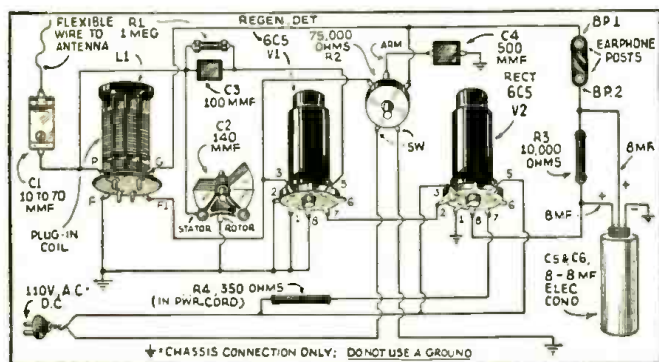
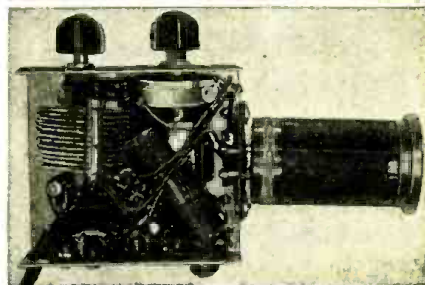
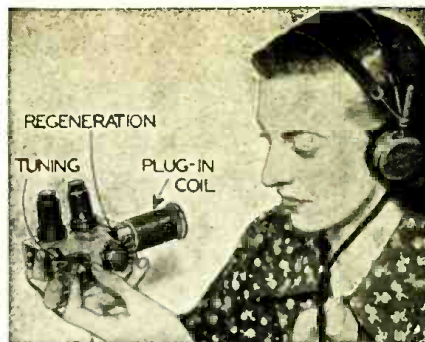
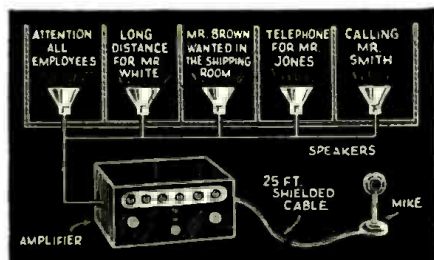
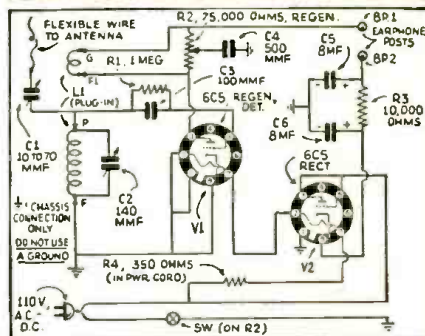

Fig. A, top right. The tiny A.C.-D.C. set.

Fig. B, center-right. The under-chassis appearance of the set with the coil in place. Note the midget tuning condenser, and the regeneration control resistor, R2.

Fig. 1, lower-right. The schematic circuit of the receiver with values — for those who prefer this type of wiring diagram.

Fig. 2, left. The picture wiring diagram for the use of the beginner in radio.



The application of P.A. in a factory.

## HOW TO MERCHANDISE P.A. EQUIPMENT

The way in which you go about "hunting up" business determines your success in the P.A. selling field.

R. M. GRAY

**I**T IS NOT difficult to show the vast field open to the sale of P.A. equipment, nor to point out the fact that the gross sales in this branch of the industry are jumping ahead by leaps and bounds. Instead, the startling fact the retail organizations of the radio industry today must recognize is that there are so many prospective buyers ready to be convinced of their need for sound equipment—and that *there are far too few P.A. men actively engaged in developing such markets!*

I do not know whether it is fear of the complications (which, after all, are not so serious; and knowledge is fast gained with a few experiences in demonstrating and installing such equipment), or whether it is merely a lack of ambition or lack of foresight in realizing how big a business this sound equipment is fast becoming, which is holding it back.

### P.A. MERCHANDISING

Perhaps it is a matter of finances! One attractive part of the P.A. business is its high "unit of sale" (sale price, as a complete unit) and resultant large gross profit. Fortunately, the wholesale set and parts jobber is now appreciating the possibilities of sales and necessity for quick delivery, and is stocking at least one of each of the more popular items and systems of the particular sound equipment line he is handling. *And he will allow the responsible dealer or Service Man to take a unit out for demonstration to a prospect. This is good sales logic, since in most cases not only is it impossible to sell without a demonstration, but the demonstration of equipment built by a reputable sound-equipment manufacturer results in completing the sale.*

A gratifying fact is that P.A. sales come the nearest of anything connected

with radio to being a 12-month business, and thus offers sales activities and income when the radio set business is in  
(Continued on page 681)

Parishoners of St. Columbkille's R. C. church, Cleveland, who are hard-of-hearing enjoy the facilities of a hearing-aid installation wired from pulpit to pew-backs, and (shown) inside the confessional.



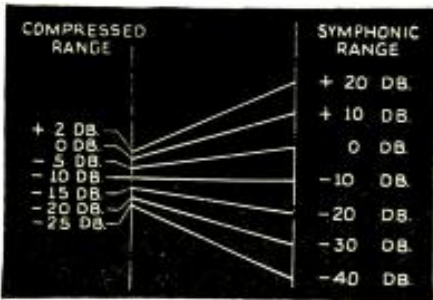
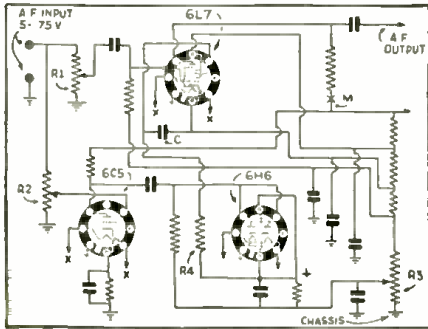

Fig. 1, above. The compression of the volume range in broadcast transmission.

Fig. 2, below. A practical expander using metal tubes.



**A** REAL STEP to realism in phonograph-record reproduction has been made by the introduction of *volume expander* circuits. While these circuits are extremely simple in conception and operation, it is really surprising that more work along these lines was not done at an earlier date. However, better late than never, and let the reader beware, because if he ever hears a good orchestral record played through good reproducing equipment, utilizing a volume expander, he will never be happy until he has one for himself!

It is well known that the record manufacturer has been handicapped in the recording of orchestras, with their large volume changes which could not be handled without "compression" in the volume range. This compressing is done in the recording studio by careful monitoring before the signal is fed to the cutting head. Until the present time, it was impossible to expand the signal during reproduction so that some compensation could be made for the necessary compression at the time of recording.

Thus, the volume expander brings new life to records, and phonograph reproduction moves ahead toward a newer standard of high fidelity. Before going further into the action of the volume expander in conjunction with phonograph reproduction, it will be interesting to note the possibilities of its use in radio reception.

A study of Fig. 1 illustrates roughly the compression of the volume range in broadcast transmission. As in the case of record recording, there are limitations which cannot be ignored without causing serious distortion.

#### SOURCES OF VOLUME DISTORTION

For example, if the volume level on the telephone line carrying a broadcast program to the transmitter proper is

# WHEN AND HOW TO USE THE VOLUME EXPANDER

The compression of certain frequencies in making phonograph records is counteracted by this "expander" unit.

C. E. DE RUNDEAU

of such a high power level as to overload the repeater amplifier, then there will be distortion in the signal even before it reaches the transmitter. Thus it will be seen that it is impossible to preserve the original ratio existing between the maximum and minimum volumes of the actual music or sound during the process of transmission. So when the program is received, it is apparent that this compression has taken place, and some of the naturalness of reproduction must necessarily be lost.

Another angle of importance when considering volume expanders, would be the effect of *noise* on the program. It is apparent that if a very wide volume range is being transmitted, then the pianissimo passages may be of such a low power level as to be practically destroyed at the receiver by hum, carrier noise, etc. The Bell Telephone Company has a volume contractor and a volume expander. In this case, they do not attempt to transmit a very wide volume range but limit the volume range transmitted at high volume levels so that it will not over-modulate the carrier. Then, they bring up the low-volume-level passages so that they will override the noise level. In such a case, the low power levels are amplified to a greater degree than the high-level-signal passages.

In receiving such a transmission it becomes necessary to put a volume expander working in the same ratio of expansion as the compressor works to contract the range. This, of course, operates under a reverse process, where the loud music is amplified more than the weak music, with a resultant improve-

ment in naturalness of transmission and reproduction.

#### PHONOGRAPH VS. RADIO "EXPANDERS"

Although one manufacturer in Europe has brought out a radio receiver using a volume expander, we find that its application here in the United States is being limited to phonograph record reproduction with greater success. In general, broadcast stations have an unfortunate habit of not watching the volume levels very closely and under ordinary conditions one could expect very peculiar ratios of maximum to minimum volume during the rendition of an orchestral number. Of course, this fault will not be so apparent when an expander is used in phonograph records, because the record is very carefully monitored in rehearsal and a very close check is kept on the volume level at all times during the actual cutting of the record.

#### PRACTICAL "EXPANDER" DATA

A very simple volume expander circuit using the new metal tubes is shown in Fig. 2. The heart of the volume expander circuit lies in the function of the 6L7 tube, which incidentally will be used in many of the high-quality radio receivers this year, as a mixer tube. The characteristics and mechanical make-up of the 6L7 tube were discussed in *Radio-Craft*, October, 1935, page 204.

The dual function of this tube, as far as grid characteristics are concerned, permits development of a very simple volume expander circuit. A signal from the phonograph pickup is fed to the

(Continued on page 681)

Fig. 3. A complete phonograph amplifier using the volume expander shown in Fig. 2.

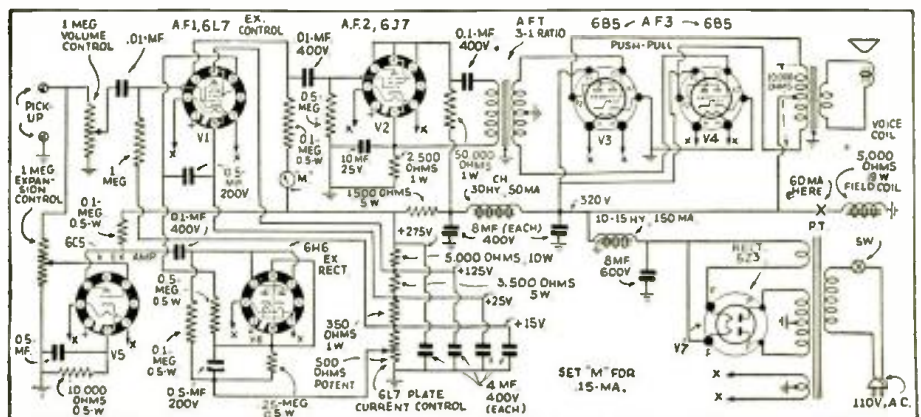

# HOW CONTROLLED SOUND AIDS A STUDENT

The man who is interested in P.A. sales and installation will find some interesting facts in this story.

ANDREW HALBRAN

**A** NEW idea in "controlled" sound which, because of its fundamental simplicity and possibilities offers great promise, has just been perfected by Samuel T. Coombs, a Columbia University (N. Y.) senior. An expert in high-fidelity reproduction, Mr. Coombs has paid his way through Columbia entirely through earnings in the sound field—his equipment supplying prac-

tically all of the music for dances and other affairs at the University as well as many places outside. The revenue derived from this "service" has also supported his research work in "controlled sound." (See the article by Prof. Burris-Meyer, in Sept., 1935 *Radio-Craft*.)

Stated simply, Coombs' idea involves the use of a "control" track on the film which, when reproducing film in theatres where loudspeakers have been installed in a certain fashion, will cause the reproducers to "follow" the performers about, the audience listening to these performers from their exact position on the screen rather than from a central point as is the case today. The result is very realistic and life-like. Mr. Coombs achieves similar effects in regular sound work such as his dance programs, etc., where, through clever placement of the speakers and a potentiometer-like control, he almost makes people believe they are listening to a



Fig. A, above. Students in John Jay Hall enjoying the high-quality P.A. phonorecording. Fig. B, below. An A.C. amplifier in operation.



real orchestra or real singers instead of reproduced music.

All of the sound effects are produced with but one control when operated manually and the amplifiers are both compact and efficient. On D.C. work  
(Continued on page 679)

Fig. C. Correct placement of speakers has important effects on the fidelity.

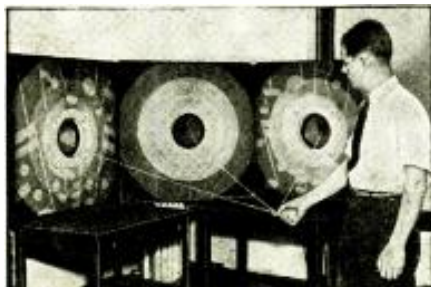

## A.C.-D.C. SOUND RECORDING AMPLIFIER DESIGN

Here are many kinks concerning an 11-W. push-pull—double-push-pull A.C.-D.C. P.A. amplifier, of humless, 6-stage type!

E. A. DENNIS

**I**N LARGE CITIES the operation of P. A. amplifiers, from both the A.C. and D.C. power lines is a great convenience, if not an absolute necessity. Especially for those small jobs where a great amount of output is not necessary and the operator does not want the trouble of lugging around a heavy converter.

Another demand on modern-day amplifiers is that they operate from the various crystal, velocity, and other low-output, high-quality microphones without the use of battery-operated preamplifiers, or in fact without external preamplifiers of any kind. To do this with a straight A.C. amplifier has proven comparatively simple.

The writer will describe a 6-stage, high-gain, high-fidelity amplifier (that he has had in operation for the last 6 months) which has almost no hum at any volume level, and incorporates an input transformer on the same chassis (which measures 10 x 18 ins.). The total gain of this amplifier is 124 db. Hum level is 107 db. below full-gain. While the writer does not feel that this is anything unusual in amplifiers, he does feel that it is very unusual in the "universal-current" type of amplifier.

### REDUCING HUM

First let us consider the question of hum—heretofore, the "snag" in such "universal" amplifiers, and after about 18



The portable sound recorder in use.

months' work, the writer has come to the conclusion that there are 2 convenient cures. The first idea, as the reader will of course know, is to use push-pull tubes throughout (if a gain of more than 100 db. is desired). The second fact, not commonly known, is that the return of all "B—" or common circuits should be made to one point, to a lug mounted within 1 in. of the filament prong of the input tube (or tubes).

This input tube should be the low end of the A.C. line, and this line should be brought directly to the lug and not to the tube socket. This method of returning all "B—" leads is very important, and a separate wire should be run for each connection that returns to this common lug. Furthermore it is necessary to be careful not to run any live A.C. leads connecting the various tube sockets parallel to this common wiring. Also make the leads from filter condensers separate from those of the isolating condensers. If this is done correctly each isolating condenser will have its own minus lead,  
(Continued on page 684)



Fig. A. The external appearance with reproducers.

# A MODERN SOUND TRUCK

Here is a "modern" and "complete" sound truck which should interest any up 'n' coming P.A. worker.

J. E. SEIDEL AND C. D. KIEBACH

**T**HE DESCRIPTION here of a modern sound-truck installation will be of interest to anyone who contemplates the construction of such a truck. This particular installation was made by two independent Service Men, in Reading, Pa., who were looking about for an additional source of income to augment their servicing business. The completeness and convenience of their installation might well serve as a guide to others.—*Editor*

Figure A shows a 3,000 lb. Chevrolet truck equipped with a 30-W. Lafayette sound amplifier. The 4 trumpet-type speakers can be rotated at will to any desired angle. They can be detached in a few minutes and hung on trees or other supports for better coverage at park outings, etc.

Figure B shows the interior of the truck. The gasoline engine driven generator at the left delivers 300 W. power. The fader box in the center permits the control of voice and music. On the top

of the rack is a radio tuner. This receiver is a Lafayette T.R.F.-type, equipped with a remote control unit. The sensitivity is exceptionally fine due to the use of pentode tubes and high-gain litz-wound R.F. coils. The detector output circuit is so arranged that it

may be connected to the amplifier input tube control-grid with a single lead. It has a built-in filament supply and requires 250 V. of well filtered "B" supply which is obtained from the amplifier.

Below the radio tuner is the power—*(Continued on page 679)*

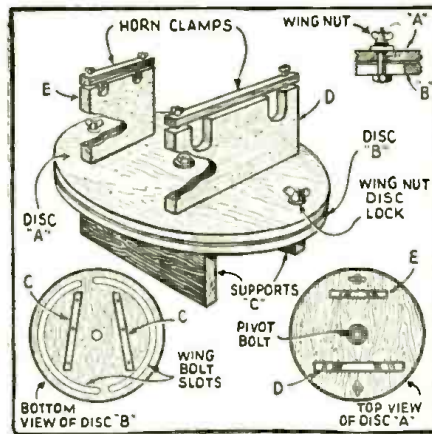

Fig. 1, left. An arrangement used for mounting and swiveling "trumpet" speakers.

Fig. B, below. The interior of the sound truck.

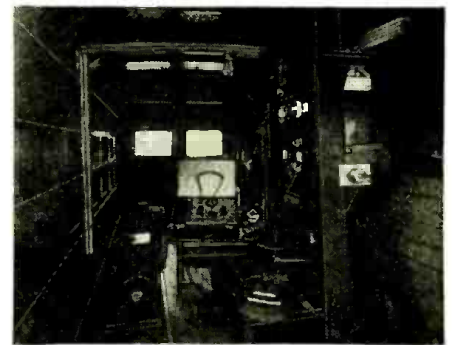

Fig. 1. The factors involved in db. gain and level.

## DECIBEL LEVEL VS. DECIBEL GAIN

Do not miss this lucid explanation!

S. L. CANTERBURY

**A**MPLIFIERS are rated according to the number of watts output they can handle without distortion. The output depends upon the size and design of the amplifier. This output tells what volume of sound will come from a system and the area that can be covered with the installation.

The amplifier performs but one important function: to receive the voice of the speaker or music and raise the volume to a much higher level so that the sound energy may be heard by many people over a fairly large area.

### BASIC RATINGS

Before the gain (amplification) of an amplifier can be measured it is necessary to select some unit of measurement. As the output of the amplifier is rated in terms of *watts* it would be logical to measure the input in terms of watts also. Now the effect of sound energy on the ear is not a direct (arithmetic) function but varies in an exponential way. Therefore, the gain of an amplifier is expressed in the same way, by means of logarithms. The expression is given

by the formula:  $db. = 10 \log_{10} \frac{W_o}{W_i}$  where

db. represents the unit of transmission or amplification—the *decibel*;  $W_o$  is the power output; and  $W_i$  is the power input. The formula states that the "decibel gain" is equal to ten (10) times the logarithm of the efficiency of the amplifier. Efficiency is here used in connection with *sound energy* and does not mean the electrical efficiency which is usually very low. The above formula will hold at all times in rating amplifiers.

Amplifiers can also be rated in terms of currents and impedances. Referring to Fig. 1, the formula is

$$db. = 10 \log_{10} \frac{I_o^2 R_i}{I_i^2 R_i} \text{ or}$$

$$db. = 20 \log_{10} \frac{I_o}{I_i} + 10 \log_{10} \frac{R_i}{R_i}$$

If the resistance of the input impedance equals the load resistance, the

last term becomes zero and the first term gives the decibel gain. In some designs, however, the second term may be considerable and must not be neglected in such cases.

The gain may also be rated in terms of input and output voltages, provided the input and output reactances are equal to zero; that is, when both impedances are *resistance* only. The formula is:

$$db. = 10 \log_{10} \frac{E_o^2}{E_i^2} \text{ or}$$

$$db. = 20 \log_{10} \frac{E_o}{E_i} + 10 \log_{10} \frac{R_i}{R_i}$$

Again the last term equals zero, if the input and output resistances are equal.

*(Continued on page 682)*



# INTRODUCING "WIRED AUDIO" ENTERTAINMENT

A new system of sending music, news and sports flashes over telephone lines at audio frequencies and selling this service to restaurants, clubs and hotels is described here for the first time in any radio publication. Read how the programs are sent out.

C. W. PALMER

**Q**UIETLY, without fanfare, an entirely new type of reproduced entertainment, *exclusive to subscribers*, which we have named "wired audio" for want of a better title, has been expanding since its inception over a year ago, until it now has 12 studios in as many cities, including New York, Chicago, Boston, Buffalo, Cleveland, Baltimore, Washington, Philadelphia, Cincinnati, Pittsburgh, San Francisco and Newark!

The Teleflash Company which has set up this service supplies news items, racing and sports flashes, music and other information to its customers. The service is being supplied to restaurants, clubs, bars, etc., and in the New York area, alone, some 2,000 subscribers are receiving this unique service! Static,

fading, cross-talk, and practically all the other ills of ordinary radio set operation are absent in this new system!

The charge for this service, from 7 A.M. to 3 A.M., is about \$20 per month, in the city—and correspondingly higher in outlying districts where telephone toll charges are higher.

**FOR THE  
FIRST  
TIME  
IN ANY  
RADIO  
PUBLICATION**

## TECHNICAL CONSIDERATIONS

The system operates entirely at voice or audio frequencies. Bell System telephone lines, which are specially balanced to 5,000 cycles are used for distributing the service to subscribers. It is interesting to note in passing that even though telephone wires are used for distribution, they are not the lines used for telephone service; instead, they are carefully balanced in order to supply high-quality musical reproduction.

The central-office equipment in each city includes a studio provided with a high-fidelity phonograph that serves as the source of a continuous musical program. Musical selections are played constantly, being interrupted only for news flashes or other features.

These news flashes are of two types. (1) The regular news items are received over the teletype lines and other  
*(Continued on page 684)*



Halbram Photo

Important news items are realistically dramatized.



The subscriber's unit contains an amplifier, reproducer and combined switch and volume control.



Above. Phono. music is interspersed with news.

Below. The remote unit; note the new type W. E. dynamic microphone.

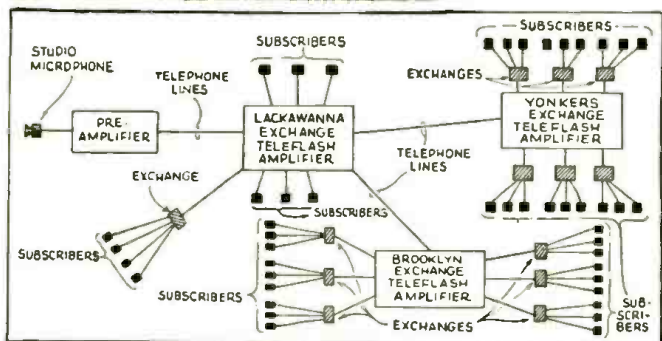

Fig. 1, left. The layout of the distribution system used in the New York area. The amplifiers are located in the telephone exchange offices.

Left, above. News items from the teletype system and news tickers are immediately sent out to subscribers by news announcers.

# RADIO PICTORIAL

An extensive sound system; a highly realistic robot; and a new phonograph which uses film.

**HUGE P.A. SYSTEM.** This apparatus is installed at the California-Pacific Exposition. The control-room view shows one man monitoring a program, while another is tending the main control panel. A radio receiver is also available for pick-up work.

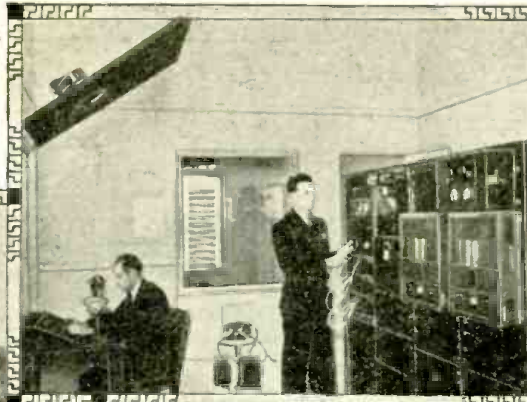

Left, a group of speakers in the Better Housing Building. All photos shown here were taken with the screens removed from the speakers. The W.E. installation is very extensive, as may be seen from the view at right, which shows another group of speakers. Both high- and low-frequency units are visible. The whole system includes 2 complete broadcast studios with input equipment and monitor amplifiers. There are 7 audio stations, 5 of which are equipped for wide-range reproduction. The other 2 are used mainly for individual P.A. at the organ amphitheatre and the Ford Bowl. The installation at the Foods and Beverage Building is at the right. The low-frequency speakers are in the enclosed structures below, the interiors of which are acoustically treated.



At the left are shown 2 busy fishermen, but they are not twins—one is Mr. Tenenbaum's robot. This emphasizes the lifelike appearance.

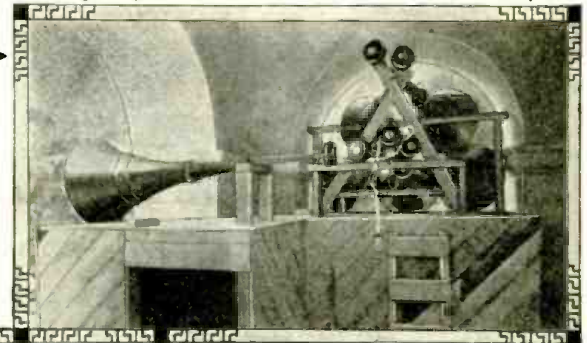

**LIFE-LIKE ROBOT.** Built by Milton Tenenbaum, this "man" can talk, smoke, cross his legs, etc. His owner is at the controls, which are hidden in actual practice. The amplifier gives the robot a strong voice.

Halbran

**THE PHONO.-REEL.** Below left, is a view of the latest musical machine for the home. It is designed to take the place of the phonograph, and is said to give very good reproduction. The present cost in Germany is about \$90.00, but this will doubtlessly drop with mass production. The 3 round boxes at the front of the case hold 150 ft. of film, which is sufficient for 2.4 hours of continuous playing. Standard 16 mm. film is used in the form of a continuous ribbon.

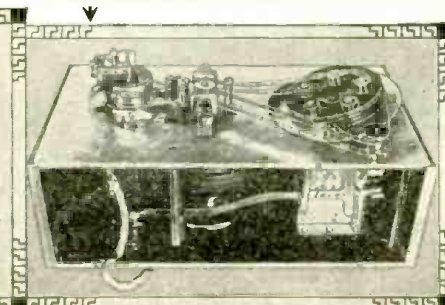

The 10 tracks are reproduced one after another by a photoelectric cell. An automatic device shifts the pickup from one track to the next as the film moves. There is a total absence of needle scratch, improving reproduction.

10  
SOUND  
TRACKS

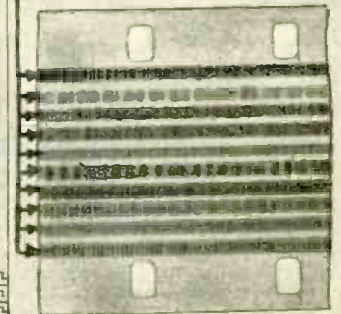



LOUDSPEAKER PORTS

THIS PLANE FIRES WORDS. Huge loudspeaker carrier is used by British to control savage tribes. It is found to be more successful than guns or bombs in many cases. The encased speakers may be seen in the bottom of the fuselage, while at the right, is the interior of the cabin. Note the microphones and speaker units.

(World Wide)



A GERMAN TELEVISION RECEIVER. A huge cathode-ray tube is used in this equipment. The image size is 10 x 7 1/2 ins.; an image of 180 lines and 25 frames per second is shown. Note the simplicity of controls.



INCLINED FRONT



Above, another view of Nelson Eddy, here shown recording his lines on a disc, upon which he has already impressed the voices of the other artists, with spaces left for his own lines. At the extreme left, THE "DIORAMA," a device of Marconi's, which demonstrates to the public the use of radio communication between airplanes and ground. A record is used, the sound coming from the grille at the bottom of the cabinet.

(RPS)

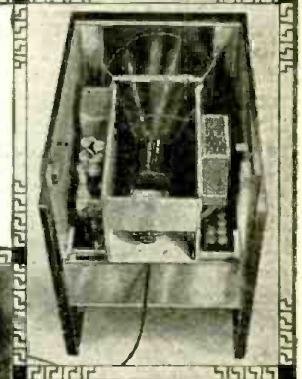

SOUND MOVIES OPERATOR

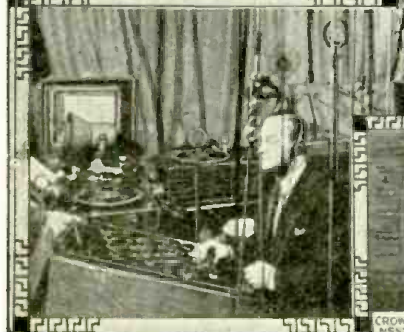

P.A. SYSTEM IN A MUSICAL CIRCUS. Amplified sound plays an important part in the new production, "Jumbo," at the New York Hippodrome. Above is the sound expert at his controls, which include not only electrical apparatus, but others, such as ropes controlling microphone position. At the right is an artist's view of the mechanism of the show. Note the position of the sound control room.

(Western Electric)

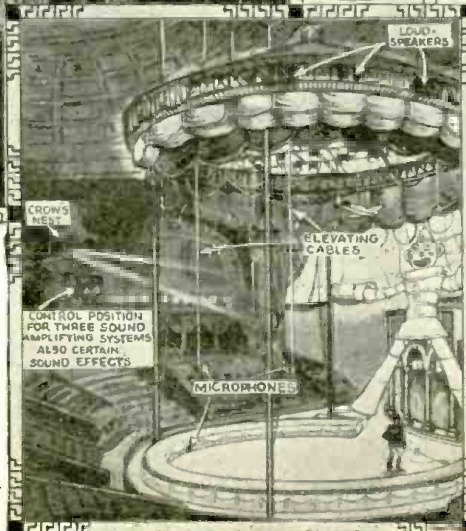
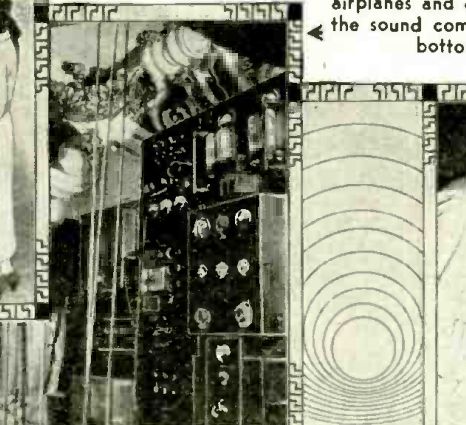

CONTROL POSITION FOR THREE SOUND AMPLIFYING SYSTEMS ALSO CERTAIN SOUND EFFECTS

LOUDSPEAKERS

ELEVATING CABLES

MICROPHONES



NELSON EDDY RECORDS OWN PROGRAM. Nelson Eddy, prominent movie star, records his lines and then plays back, to time speech and check on tonal qualities, etc. Loudness of voice is checked by a db. meter. Above he is timing lines.



Interior of the new Telefunken television receiver, pictured at the top of the page. The 5,000 V. power supply is at the upper right in a shielded box; a safety switch is incorporated. Below this is the receiver power supply. On left are tuning chassis for both sound and image, and the sweep circuit.

# HOW TO MAKE YOUR OWN TRANSFORMERS AND CHOKES

In response to an insistent demand by our readers this third (and concluding) part of a series of articles on the title subject has been prepared. It covers the design of chokes and transformers for Class A prime (AB) and B amplifiers. (The author of parts I and II was unable to conclude the series.)

JERRY KRIZ

PART III

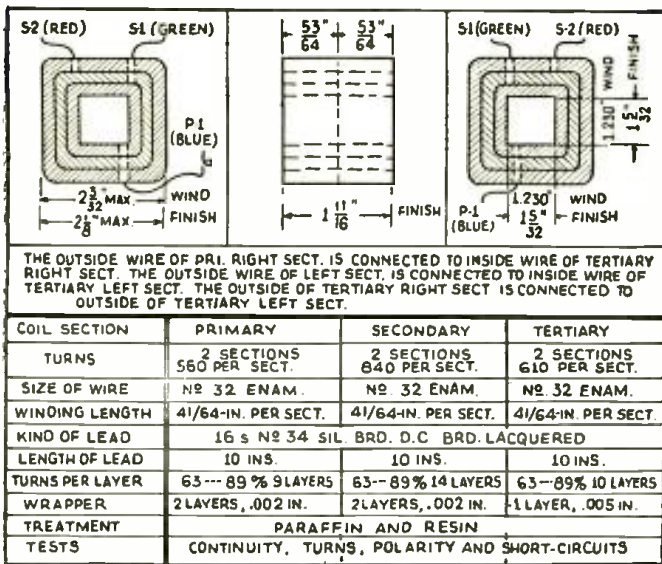

Fig. 1. Specifications for an input transformer for class B.

FULL DETAILS were given in the November, 1933 and January, 1934, issues of *Radio-Craft* concerning the design and construction of power and audio transformers in general. This concluding article will deal essentially with class A prime (AB) and class B audio and power components.

A perfectly erroneous conception that class B operation is invariably accompanied by an excessive amount of distortion is quite prevalent. The truth is that class A prime and class B units, power packs and amplifiers are difficult to construct in such way that the resultant A.F. distortion is negligible. But notwithstanding this fact great strides have been made in designing and perfecting class B power and A.F. systems to the point where practically all large broadcast stations employ nothing else but class B operated power output stages.

Class A prime and to a greater extent class B operation are ideal if economical operation is desired (as in, for instance, car-radio sets, portable, and battery-powered receivers), because for a given output power the use of a considerably lower plate voltage is made possible with the result that correspondingly smaller filter condensers and other associated components are needed. The initial installation cost is thereby considerably decreased while, in addition, the proportional power consumption is appreciably reduced.

## POWER SUPPLY

In order to get the best results from a class A prime (AB) or class B ampli-

fier system, it is essential that the power supply unit deliver a constant voltage to the amplifier. In other words, the power supply must be capable of delivering the same voltage under full-load as under no-load conditions, which is commonly expressed as "good voltage regulation." Not only does the amount of voltage regulation affect the total power that may be derived from an AB or B system, but it also controls the total harmonic distortion as well.

The heart of the power supply is, of course, the power transformer, which should have a voltage regulation close to 2 per cent, which means that in the case of a unit supplying 400 V. A.C. plate volts the value should not vary more than about 8 V. This is easily accomplished by using a relatively heavy wire in the primary and the high-voltage windings, and by employing a 50-cycle core for 60-cycle operation. Thus it was found that the class AB circuit employing type 45 tubes in the output stage delivers 13.2 W. of A.F. power with a maximum of 5 per cent total harmonic distortion, utilizing a power pack of a low internal resistance; but only 12.6 W. with a power pack having a total resistance of 1,000 ohms. Table I gives full specifications for a power transformer of a 50-W. class B amplifier using 4-6A6 tubes in the output.

Next in importance is the filter system. It is essential to use choke input to obtain a relatively constant output voltage. This input choke should have a relatively low resistance—the lower the better. A choke of not more than 100 ohms should be employed for a 20 W. class B amplifier and not more than a

50-ohm choke for a 50-W. amplifier. This choke input not only reduces any peak voltages and surges from the power-supply output, but also greatly reduces the strain on the filter condensers. The first filter condenser should be about 16 mf. for best results. The input choke itself, however, should have enough inductance so that the "B" voltage for the output tubes can be taken directly after this first choke. This inductance should be 20 hys. or more at the maximum current drain.

The selection of the rectifier tube itself is quite important, and wherever possible the use of a mercury-tube rectifier is recommended as its terminal voltage drop is not only very small (in the neighborhood of 16 V.) but it remains constant and is independent of the load while the rectifier tubes such as the type 80 rectifiers vary between 320 V. and 180 V. with a corresponding load of 0 to 150 ma. In other words, the type 80 rectifier tube has very poor voltage regulation while the mercury vapor tube, such as the 83, 866, etc., has excellent voltage regulation.

## INPUT TRANSFORMERS

In order to design and build a satisfactory (A.F.) transformer for class AB or B operation, it is important to realize that grid current is drawn by the output tubes, which in the case of a type 46 class B tube, for instance, is about 10 ma. at full-load. To prevent this grid current from introducing a degenerative voltage into the transformer, it is essential to keep the D.C. resistance of the secondary winding at

(Continued on page 685)

TABLE I

Class B Power Transformer for 4-6A6 tubes in a 50 W. Amplifier	
Core Stack: 1 1/2 x 2 ins.	
Winding Space: 2 1/4 x 3/4-in.	
Primary: 113 V. 60 cycles; 245 turns No. 20 enameled wire. Secondary Shield.	
Secondary winding: 360-360 V. at 210 ma.: 825 x 825 turns No. 30 enameled wire.	
Rectifier winding: 5 V. at 3 A.: 5 1/2 x 5 1/2 turns No. 16 enameled wire.	
6.3 V. at 8 A.: 7 x 7 turns No. 13 enameled wire.	

TABLE II

Input	Plate Volts	Pri. to 1/2 Sec. Ratio	Output Tube Set-up	Power Output Watts	Total Harmonics (per cent)
1-56	250	5.0	1-6A6 B	10.5	9
1-59	250	4.0	2-6A6s B	20	10
1-46	800	2.2	2-46s B	16	5
1-59	400	3.0	2-59s B	21.5	4.8
2-56s	250	3.33	2-45s AB	17.2	5
1-56	250	1.43	2-45s AB	11.5	5

# NEW — HUM-FREE TRANSFORMERS AND CHOKES!

Balancing the windings and correctly shaping the core reduces the leakage flux and hum. Cast alloy shielding also helps.

LEON J. LITTMANN

IN A RECENT issue of *Radio-Craft* (August, 1935) the writer pointed out some effective ways and means of reducing inductive hum pick-up. Among the methods outlined, the simplest and most effective one is to house the unit that picks up the hum in a high-permeability casting. However, sometimes the hum pick-up is sufficiently reduced by moving the unit in question from its original position and by placing it at such an angle with relation to the hum source that the hum pick-up is reduced to a minimum. Still another procedure is to replace the A.F. unit picking up hum by one that is symmetrically constructed in a humbucking fashion as outlined in the article mentioned above.

In cases of extremely high-gain amplifiers all three methods just described may be employed at one time by using an A.F. unit that has (a) the double "L" core hum-balancing construction, (b) housed in a high-permeability casting, and (c) placed at an angle with reference to the hum-inducing source so that hum pick-up is at a minimum. Thus amplifiers have been built with self-contained power packs and with enough gain to handle a low-impedance ribbon microphone (for instance) without any noticeable hum emanating from the loudspeaker.

In passing it might be well to mention here, that both the

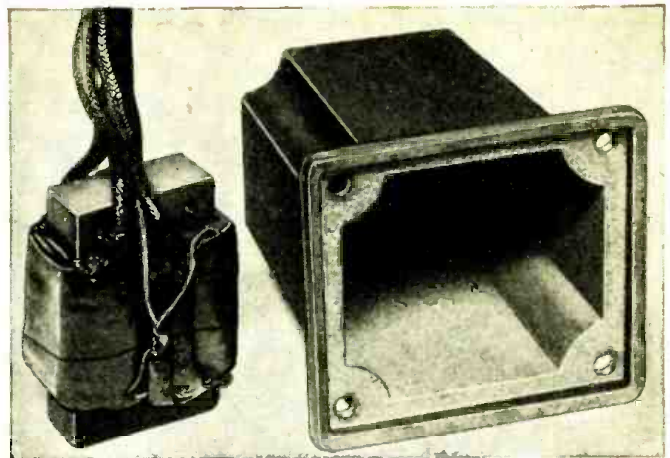
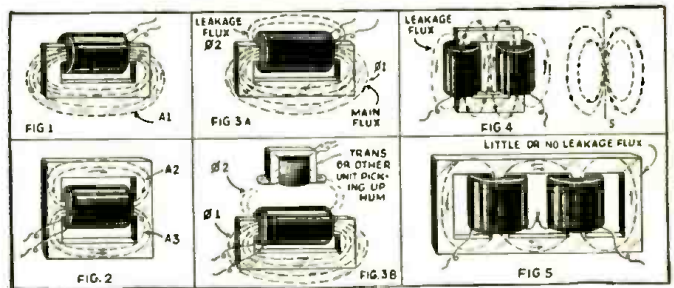

Fig. A, above. The new type transformer and casting. Fig. 1, below. Details of leakage-flux reduction.



placing of electrostatic shields on A.F. transformers and the use of push-pull circuits often help further in reducing hum pick-up.

Despite the fact, however, that much has been said and (Continued on page 685)

# NEW TUBE DEVELOPMENTS

The latest crop of tubes includes a dual-purpose metal tube, several 2.V. tubes and a high-power P.A. amplifier.

IT HAS become an almost unbroken rule among tube manufacturers to introduce at least 2 new tubes each month—whether from a desire to keep new products ever before bewildered set and amplifier designers—or because of new and urgent needs for tubes having different characteristics than those previously produced. The introduction of

the line of metal tubes, of course, spurred the efforts to produce new tube types—and in spite of early statements to the effect that dual-purpose metal tubes would not be made, we now have 2 metal tubes which combine the purposes of 2 individual tubes.

Type 6R7. The first dual-purpose metal tube was the 6Q7 (described in *Radio-Craft*, March, 1936, page 554). This tube duplicated the results obtained by the type 75 glass tube. The second dual-purpose metal tube, just introduced, is known as the 6R7 and is similar in characteristics to the glass type 85 tube. It will be noted that both of the above types are double-diode triode tubes.

Several differences exist between the characteristics of the 85 and the 6R7. The 6R7 has a higher mutual conductance and higher amplification factor than the 85. This necessitates corrections for grid bias, load resistance, etc., if the 6R7 is used in an attempt to replace the 85 in an existing design. Unless the "iron" 6R7 is thus operated under its optimum conditions it cannot perform as efficiently as the glass 85.

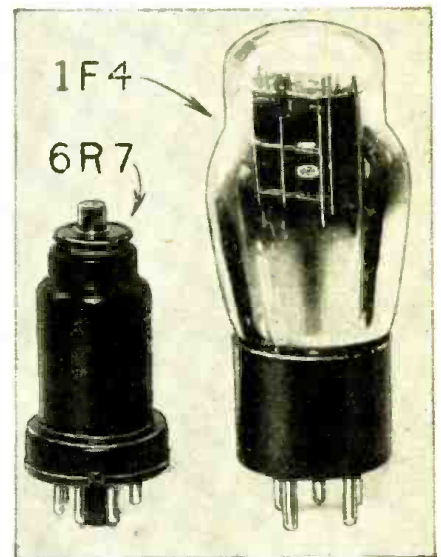

Fig. A. The appearance of 2 of the tubes.

Type 6R7 Characteristics—Triode Section

Heater Voltage (A.C. or D.C.)	6.3 V.
Heater Current	0.3-A.
Plate Voltage	250 V. (Max.)
Grid Voltage	-9 V.
Plate Current	9.5 ma.
Plate Resistance	8,500 ohms
Mutual Conductance	1,900 mmhos
Amplification Factor	16
Load Resistance	10,000 ohms
Undistorted Power Output	275 milliwatts

(Continued on page 686)

Fig. 1. Socket connections for 4 new tubes.

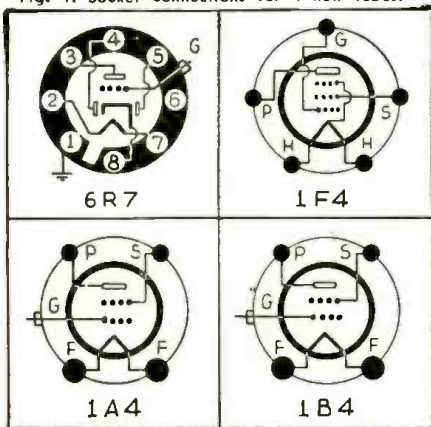

# HOME-MADE MICROPHONES

The high quality and directional qualities of the ribbon mike are well known—make this one! A cigarette-foil ribbon is used.

A well-known carbon mike can be easily converted into a high-quality condenser mike of the "stretched-diaphragm" type.

G. E. FAULKNER

M. L. POWERS & J. E. ABEL

## VELOCITY MIKE

OF ALL the various microphones, the *velocity* type is the easiest to construct. Furthermore, the average person can make an instrument that will give quality of tone comparable to that of the *finest* carbon microphone. The necessary parts are cheap and easily procurable, and there is no mystery in the manner of constructing the instrument.

### THE MAGNETIC SYSTEM

You will require two motorcycle-magneto magnets. These may be obtained from an automobile wrecker's store; they should measure 4½ ins. long, and 3 ins. wide, and they should be an exact fit when placed end-to-end. Each magnet should be provided with one or two holes through the end of each pole-piece. This is important, as it is almost impossible to drill holes through a good-quality magnet with an ordinary drill. You will also require two pieces of soft-iron bar, 5 ins. long and 1 in. x ½-in.—this last dimension does not particularly matter. These bars are the 2 pole-pieces which fit inside when the magnets are laid end-to-end. They should leave a gap of approximately ¼-in. It is in this gap that the ribbon is suspended.

Place the magnets end-to-end, alike poles together (opposing); place the bars in position and mark the places where holes must be drilled and tapped for the retaining bolts. Referring to the diagram, the two end ribbon supports are of shellaced wood and are fastened to the pole-pieces by means of "aluminum cement"—the kind that is sold in tubes. Tie string around, passing it about the end of each pole-piece, and leave it in place until the cement has quite set. By this method there is no need of drilling holes and using bolts to hold these pieces in place. This part of the microphone, once adjusted, is never touched, and hence will withstand whatever ordinary usage a microphone is supposed to stand.

### HOW TO MAKE THE RIBBON

Concerning the ribbon, much has been said in other articles of a more technical nature—that it must be very thin, that it must be properly hardened, etc.

(Continued on page 687)



Fig. A, left. The appearance of the complete velocity microphone with its "line" transformer all mounted in a neat case are readily seen.

Fig. I, below. The parts which make up the microphone are all labeled for the convenience of the constructor. Note particularly that the fixed magnets are placed with "like poles" together.

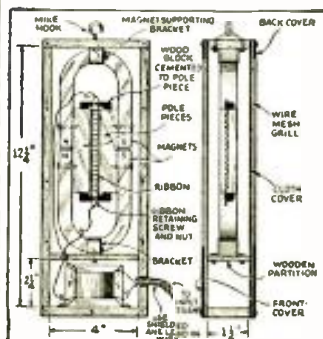

## CONDENSER MIKE

HAVING NEED for a new condenser head, we began to look about for something that would meet our requirements for a basic unit. We soon came across a Kellogg hand microphone which had been used in connection with several RCA Victor home-recording sets. As we found that this "mike" served our purposes very well we wish to describe its construction; and the alterations that transformed it from a carbon microphone to an effective unit of the *condenser* type.

Prominent among the good features of this microphone, is the fact that it may be obtained from almost any mail order house or large radio store; and, in some cases, may be found in an amateur's shack, or in a Service Man's junk box (where we found ours).

### THE STRETCHED-DIAPHRAGM "BASIC UNIT"

Note that the microphone, as first obtained, is a single-button, *stretched-diaphragm* type; the tension of the diaphragm being adjustable, thus makes it excellent for use as a condenser head. If we now suppose the reader has obtained one of these mikes, and is desirous of using it as a condenser mike, the following then are the necessary steps:

### DISASSEMBLY PROCEDURE

First, remove the 3 machine screws in the back-cover. This permits the cover and handle to be removed and the cord to be unsoldered. Now, put the mike in a vise, with the mouthpiece down, and punch out the 8 rivets around the flange; take care to cut only the rivets. Next, grasp the mike by its flange and front-cover, turn the mouthpiece upward, and carefully remove the front-cover; take care not to injure either the diaphragm or its 2 gaskets, as these later will be needed. It is now possible to empty the carbon cup of its granules. Keep the cup but discard the carbon disc (since it is of no further use).

Next, remove the 3 rivets in the front-cover; this permits the screen and mouthpiece to be removed. Cut away all excess metal. Now, the opening in the front-cover should measure 1 11/16 ins. Care should be taken, not to cut away too much metal, since the protecting screen must be soldered to the back of the remaining shoulder metal.

(Continued on page 688)

Fig. A, right. The re-made microphone closely resembles the carbon unit from which it was made. The rivets have been replaced by 6-32 machine screws according to instructions, in re-assembling it.



Fig. B, below. The parts which make up the condenser mike can be seen below. The "back plate" made from a washer and flat-head screw can be seen in the upper-left detail. The gaskets, and diaphragm-stretching ring are seen in the center, the front-plate in the lower-left detail, the diaphragm in the lower-right detail and the assembled unit in the upper-right detail.



## OFFICIAL RADIO SERVICE MEN'S ASSOCIATION, INC.

A department devoted to members and those interested in the Official Radio Service Men's Association. It is the medium for exchanging ideas, kinks, gossip and notes of interest to Service Men, or others interested in servicing.

### ALL-WAVE ANTENNA IMPROVEMENT

**RADIO-CRAFT, ORSMA Dept.:**  
The antenna shown in Fig. 1 is an installation recommended by one of the large manufacturers. We have found that the diagonal ropes have a tendency to twist around the horizontal portion of the antenna wire at each end which necessitates removal of the antenna and an untangling job.

Simply make a loop in the upper end of the diagonal ropes, the loop being made around the support ropes directly back of the insulators. The support ropes may then twist many times without affecting the 16 ft. drop ropes.

This tip saves much time—and plenty of bad language!

B. H. DAVIS,  
Calgary, Alta.

### A NEW "RACKET"?

**RADIO-CRAFT, ORSMA Dept.:**  
I picked up a copy of *Radio-Craft* (February issue), and on glancing through it I noticed an article that I read with a great deal of interest. It pertains to the so-called "racket" of the Actors and Authors Association, and their demands for reproducing their records (either by radio or on P.A. systems). I for one want to go on record as saying that they are very unfair in demanding a fee for advertising their numbers. In fact, they should pay any P.A. man for playing their records, for truly they are being advertised to the listening public, whether it be a radio listener or one of a public gathering.

There is no question in my mind that a great number of recordings are sold entirely because they were heard over a sound system or on the air. Therefore I feel that if enough operators of both types of equipment get together and show this association how unjust it is in its demands, and that the association members really gain through additional sales, more than they would by demanding a royalty, the problem could be adjusted to everyone's satisfaction.

Thank you for starting to champion a worthy cause.

RUSSEL C. NACE,  
Prckasie, Pa.

We are quite in accord with Mr. Nace's sentiment on this question. And it may be further pointed out that the composer of the music has already received his "cut" from the sale of the music or record, from which he gets a royalty.

### SERVICE MEN'S WEEK?

**RADIO-CRAFT, ORSMA Dept.:**  
Enclosed you will find a news release which I trust you will see fit to publish. The assistance of your

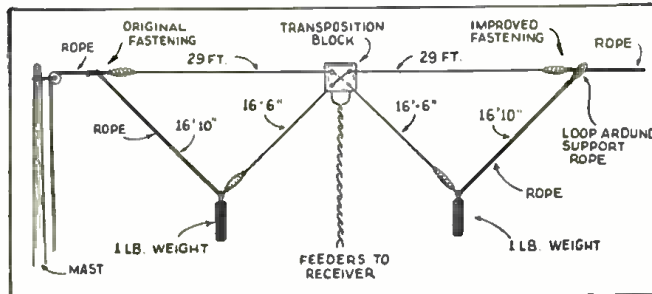

Fig. 1. A suggestion by Mr. B. H. Davis on the installation of an all-wave antenna which will not twist. Note the loop on the drop-rope.

journal in putting this over will be greatly appreciated.

NATIONAL RADIO SERVICE ASSO.,  
Galveston, Texas.

The news release referred to above reads as follows:

"The National Radio Service Men's Association has voted to set aside the 4th week of May of every year as 'Radio Service Men's Week.'

"This plan is being carried out with the thought of better acquainting the public with the virtues of all radio men and all radio men's associations.

"During this week, attention will be directed upon the Service Man and the important part he plays today in the life of John Public.

"All Radio Service Men and all branches of the radio industry are urged to participate in making this a success.

"Additional information as to how every branch of the radio industry may participate and derive benefits of this plan will be released each month.

"Those desiring additional information may write to The National Radio Service Association, 714 Anico Bldg., Galveston, Texas."

We would be pleased to hear from readers as to their reactions concerning this projected "week." We believe it would be a good opportunity for all Service Men to make a concerted effort to place themselves and their wares before the public.

### AN UNFAIR TAX ON SOUND TRUCKS

**RADIO-CRAFT, ORSMA Dept.:**  
In view of the present New York City tax of \$15.00 per day on sound trucks, which rate is much too ex-

cessive, I am writing to you in the hope that you may start a protest against such taxation.

I believe it to be detrimental to the welfare of the entire radio industry, and someone, preferably an organization such as ours, should start a protest.

VICTOR HASLO,  
New York City.

Before any concerted effort can be made in this direction, it would be desirable to know what other cities are similarly "affected." We will be glad to hear from other P.A. men who wish to cooperate "for the good of the order."

### "TOO MANY COOKS—"

**RADIO-CRAFT, ORSMA Dept.:**  
Since reading the letter of Mr. J. G. Sillak (March, 1936, *Radio-Craft* ORSMA Dept.) I've been wondering if you can help this town. Everyone who has built a crystal set, or soldered a wire or two on an old battery set, hangs out his shingle as a Service Man! Another trouble here is that the men who have a right to be in the business, by virtue of their study and work at their profession, tell each other how much they charge for service calls, but their customers claim the prices they pay are much lower!

There is enough work in this town for every legitimate Service Man in this locality, but not enough for us and the "radio mechanics" too.

If you think there is hope for us, send me the application blanks and I believe I can get a 100 per cent sign-up.

At the present time I can name 10 "would-be" Service Men in town. It isn't possible for a small town of 4,500 to support 13 or 14 of us.

I would appreciate it if you would not publish this until after we organize, because you may not realize it, but your magazine is very popular here. Thank goodness, I took advantage of your representative's propositions for men in the trade, and I certainly get my money's worth. *More power to you!*

WILBUR W. WELCH,  
Green Castle, Ind.

Mr. Welch also writes in no uncertain terms concerning some of the radio houses who will send their "wholesale" catalog to anyone. This is quite true, and we know of no other large industry where virtually anyone can get substantially wholesale prices. Of course, to correct this condition, it would be necessary for every wholesaler in the country to agree not to sell to any but those of certain qualifications, such as Service Men and Amateurs. But even the most rabid Service Man

(Continued on page 686)

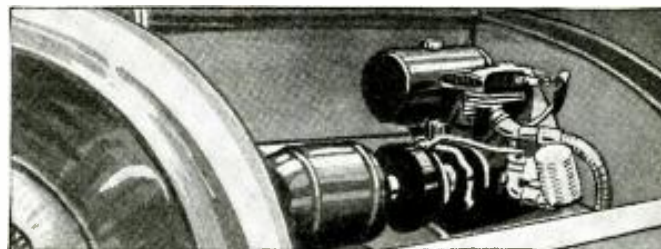
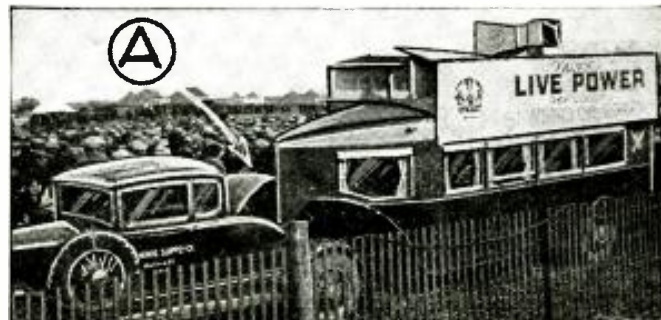

Fig. A, above. A close-up of the 450-W., gasoline-driven motor-generator unit, housed in the back of the coupe. The actual P.A. equipment is contained in the trailer. Fig. B, below. Four speakers are used.



# THE DESIGN OF MODERN TEST EQUIPMENT

A really comprehensive discussion of design problems relating to service instruments; Part II covers A.C. meters.

SAMUEL C. MILBOURNE **PART II**

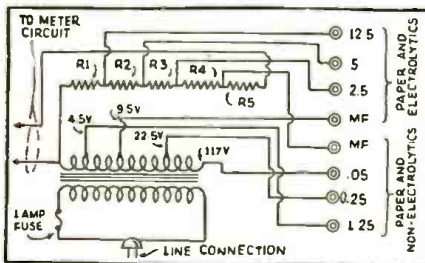
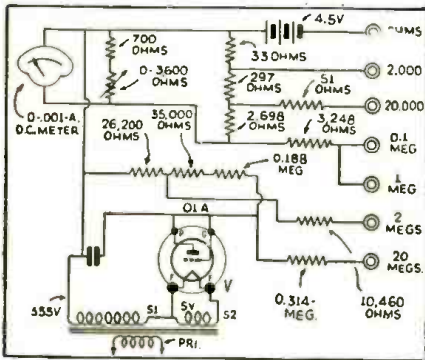
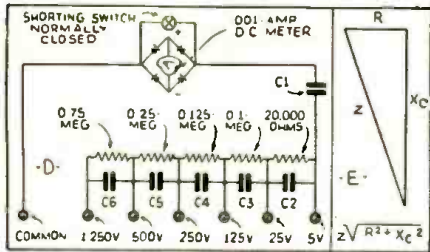

W. E. Co. Photo. A modern 2-channel hospital sound installation. It provides patients with radio-phono, entertainment. Unit also includes talk-back facilities—the speakers act as "mikes"; see page 688.

**P**ART I of this article dealt in great detail with elementary considerations of the foundation meter used in modern service equipment. The discussion started with an analysis of the D'Arsonval type of meter, and showed how this current-measuring type of instrument is adapted for voltage measurements, both A.C. and D.C. Now go on with the story.

Alternating current values, as measured by ordinary A.C. instruments, will not be indicated as having the same values when rectified and measured with a D.C. instrument. For example, an alternating potential of 100 V. as measured with an ordinary A.C. voltmeter will, after full-wave rectification, be indicated by a D.C. meter as having a value of only about 90 V.!

This is because the usual types of A.C. voltmeters, which are not sufficiently sensitive for many modern requirements, have the desirable characteristic of indicating *root mean square* (r.m.s.) values, whereas sensitive D.C.

instruments indicate *average* values which are lower than *root mean square* values by the ratio of 1 : 1.11. In other words, *average* values must be multiplied by 1.11 in order to obtain correct *root mean square* values. This condition is true for sine-wave forms which are approximated in commercial practice.

Therefore, the next item for consideration is "correcting for A.C. measurements." This suggests that some means must be provided for correcting

Fig. 4. Analyzer socket connections.

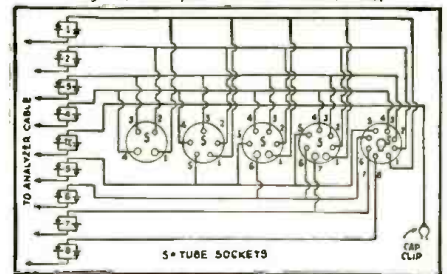

## CENTRALIZED P.A. FOR HOSPITALS

Though each P.A. installation offers new problems, a general idea of procedure is of great assistance.

W. S. PARSONS

**E**VERY public address installation is a problem in itself and can rarely be compared except in a very general way to any previous job which has been done along similar lines. Almost daily, problems come to our attention covering a wide variety of applications. Some of these are quite simple and others very complicated.

The other day a problem was presented, and its solution proved to be quite interesting. The installation under consideration was for a large hospital in which the majority of patients were

convalescent. Radio programs would undoubtedly provide the greatest amount of entertainment, but unfortunately, these patients occupied wards so that it was impossible for each patient to own or operate a radio set without disturbing his neighbors.

### A 3-CHANNEL SYSTEM

Since it was impossible for the individual patient to operate a radio receiver, it was decided to provide headphones and outlets whereby the patients

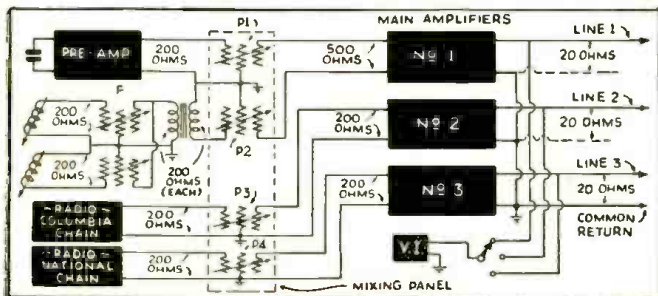
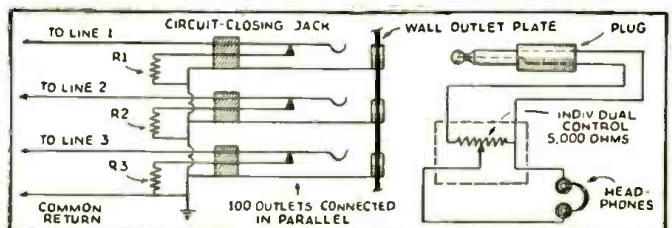

Fig. 1, left. The arrangement of the equipment in one hospital "job." Fig. 2, below. The program selection system for individual listening-in.





# ANALYSES of RADIO RECEIVER SYMPTOMS OPERATING NOTES

## NOTICE

Notes should exemplify repeated faults in particular set models; illustrations should be included. Operating Notes must be based on use of perfect tubes.

**Dynamic Speakers (Crosley, Gloritone, Apex, etc.).** Many Service Men have quite a time installing new voice coils and cone assemblies in Utah speakers, and also those in Crosley midgets with outside spiders. The holes where the nuts are located, see Fig 1A, are countersunk about 1/2-in. from the field casting, making it impossible to tighten; this condition is made more aggravating because the bolt heads are impossible to reach with a screwdriver. Put the bolts in casting side and nuts on the side of the spider. Then adjust the voice coil to the hole in the field casting, tightening the spider with a screwdriver where bolt heads are easily accessible. These types of speakers are found in the 4- and 5-tube Crosleys and in the 5- and 6-tube Gloritone and Apex midgets.

M. C. BIDDLE

**Kolster 6K.** A slight but annoying distortion was the complaint. Tubes were perfect, voltages all OK, excepting that the filament of the 71 tube had about 5 1/2 V. The 6 V. pilot which lights from same winding as type 71 tube is mounted with the push-pull A.C. switch, and its circuit comes in electrical contact with the frame of this switch. When disassembled, this switch revealed a resistance of about 10,000 ohms between line connections and frame. A direct short will cause the type 71 tube to blow if the A.C. line plug connection is right, and there is a ground on the set. We replaced the switch with a long-neck toggle.

**Fada Model "KU."** The complaint was intermittent distortion. We finally caught the plate current on one of the push-pull type-47 tubes increasing to about 48 ma. and replaced it. In about 15 minutes, more distortion! We checked the input A.F. transformer, which seemed OK. Resistors checked OK. We checked the transformer again, this time with 300 V. D.C. between primary and secondary. In a few minutes a high-resistance short between primary and secondary showed up. Replacement proved this to have been the trouble.

**Old Fada Sets.** On those models using a friction-driven dial, the casting which acts as a bearing for the driving cam gets out of shape just enough so that tuning becomes annoyingly difficult. An effective means of repair is to dismount this casting by unscrewing 3 mounting screws from underside, and slotting their holes with a round file toward the flange, as shown in Fig. 2. When remounting, press the casting

toward the flange before tightening the screws.

B. J. STERNBERG

**Noise in a Radiola 18.** The trouble in this set was reported as an intermittent crackling, spitting noise not unlike natural static except that it was sometimes very loud with no antenna or ground connected and with the volume control turned completely off. The machine would play perfectly for hours and then get so bad that it was almost impossible to listen to local stations. The set had then been taken to a shop but returned with the report that it was in perfect condition and that the noise must be due to local interference! Practically all the noise stopped when the 2nd R. F. tube was removed. The trouble finally was localized to a little coil (which eventually opened) in series with the primary. The circuit which contains this coil is shown in Fig. 3A; the details of its mounting together with the circuit-balancing condenser "C" which shunts it are shown in Fig. 3B. The first stage has the same type of coil but the connections are slightly different. The detector stage is like the second stage. It may seem impossible that this coil could make all the noise and still not show any variations in the plate voltage *but such was the case*. The set played perfectly as soon as the coil was shorted out and continued to do so after it was replaced with a small choke coil of similar design.

ROGERS SMITH

**Majestic Model 30.** The complaint was that the 80-type rectifier filament burned out. Upon examining the burned-out 80 tube, I found that only one filament was gone. By tracing from this filament connection of the tube socket, it will be found that the small orange wire leads into the filter pack, and connects to a 2 mf. filter condenser. (See Fig. 4A.) This condenser was shorted,

causing the 80 filament to burn out. The lead to the condenser should be cut and taped, and a 2-mf., 600 V. condenser mounted on the outside of the can.

**Atwater Kent Model 43-44.** If the tubes do not light it will almost always be found that the voltage-regulating resistor, shown in Fig. 4B, is burned out. Service Men should always see if this resistor is burned out before coming to the conclusion that the primary of the power pack is open.

**Majestic 20.** Having serviced quite a number of Majestic 20 superheterodyne receivers, I have found, in nearly every case, a shorted 0.1-mf. condenser which is housed in the I.F. cans, see Fig. 4C. Each can contains one condenser. The red wire leading from the can connects to the condenser. These condensers can easily be replaced by heating the can on a fire, removing the old condenser and replacing it with a new one of the small tubular type, preferably of not less than 400 working volts, D.C.

N. C. CURL

**Sparton Model 12.** The owner said this set would cut off and on, and that it would not "play" at the low-frequency end of the dial.

Giving the set the usual tests, it was found that all voltages were correct, but that by jarring the chassis, the set would play well over the entire band. The trouble was located in the variable condenser bank. It was found that the plates of several of the sections of the condenser could be moved slightly. A test revealed that there was a high resistance between the plates and the shaft. Since it was difficult to get a new unit, a repair was made by drilling holes in each rotor section and through the shaft, and inserting copper dowel pins. This cleared the trouble and a realign-

ment put the set in fine condition again.

P. T. SNOWDEN

**U. S. Radio and Television 25 Series, No. 500 Chassis.** This broadcast superheterodyne had a very annoying habit of mixing short-wave code signals in with the broadcast programs.

It occurred to me that the trouble was due to an over-production of harmonics by the oscillator, and these harmonics were heterodyning strong short-wave code signals. The broadcast stations heterodyned the signal at audio frequency and made them audible, as the only time they could be heard was when a station was tuned in. (I have noticed the same trouble on several other makes of small supers.) The remedy lies in increasing the value of the cathode bias resistor of the type 57 oscillator and first-detector. By putting a variable resistor in this circuit one can increase the bias to a point where all the code signals disappear without affecting the regular signals. When the proper value is found, a fixed resistor can be installed in place of the variable. I found that about 4,000 ohms was right, although it is not especially critical.

PAUL MCCOY

**RCA R-55.** This set made a low cracking static noise with the volume off. The trouble was found to be in the A.F. input transformer and replaced same. This seemed to remedy the trouble until the volume was turned up—then it was a bad as before. I then replaced the 1st I.F. coil, which corrected the trouble. My method in testing these coils is as follows: disconnect the primary from the original coil, put a flat choke coil in its place, close to the secondary of the I.F. coil, and change it to each coil until you find the noisy one.

(Continued on page 686)

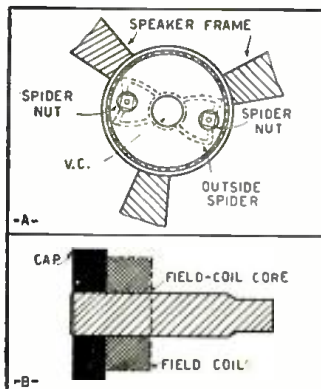

Fig. 1, above. Speaker modification.

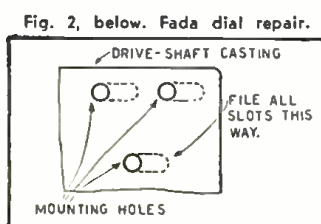

Fig. 2, below. Fada dial repair.

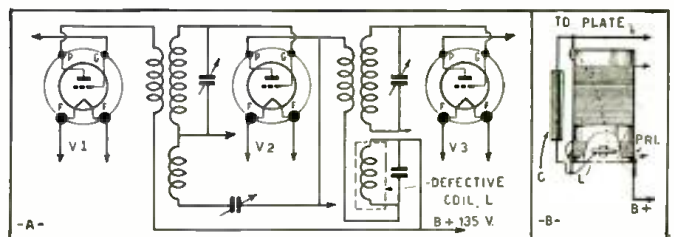
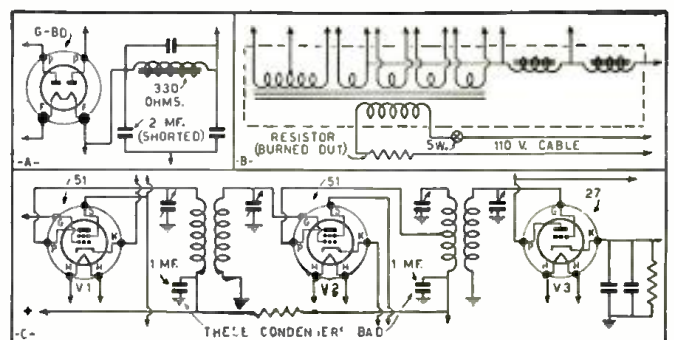
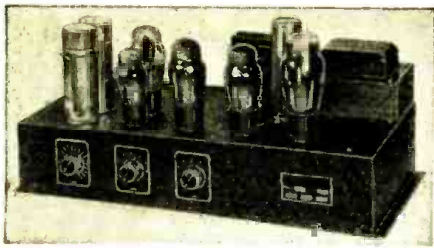

Fig. 3, above. Cause of noise in a Radiola 18. Fig. 4, below. Majestic Model 30, at A; A.K. Model 43, at B; and Majestic Model 20, at C.





# CRYSTAL-"MIKE" AMPLIFIER CONSIDERATIONS

The problems in using crystal mikes along with P.A. equipment are outlined for the installer and Service Man.

H. W. JOHNSON

**W**HEN BUILDING or buying an amplifier, one finds a staggering assortment of wares from which to choose. As descriptions of many amplifiers sound strangely alike, it is the intention in this article to point out some of the things which go to make an amplifier a good one.

In most cases, power output is a function of the output tubes. In general, the tubes preceding the output stage furnish voltage only, for swinging the grids of the power tubes. In class B amplifiers and, to a smaller extent, in class A prime amplifiers, a "driver" stage is required to furnish not only voltage, but power to the grids of the output tubes.

The power output of an amplifier cannot be determined from the tube manual ratings alone. These ratings are possible of achievement, but the conditions in most cases are exacting.

For example, type 2A3 tubes in push-pull will not put out 15 W. of clean audio power under just any old conditions. Plate, grid and heater voltages must be correct. Efficient driver and output transformers must be used, and impedances must be correctly matched. The power supply should have good regulation and the output-tube grids must be excited with enough voltage to produce full output. Class B tubes cannot produce the rated power output unless actual power is supplied to their grids. Ordinarily the necessary driver power can be considered to be 1/10 of the total power output. For example, class B tubes capable of 20 W. output will re-

quire 2 W. at the grids. This means that the class B tubes must be preceded by a tube or tubes which have a power output of 2 W. Push-pull driver stages are preferable.

Failure to meet one or several of the above-mentioned points, means reduced power output possibilities and explains why so many amplifiers from which we expect 15 W., act suspiciously like 6 W. jobs!

Of course great amounts of power can sometimes be obtained by overloading—running the plate voltage and cur-  
(Continued on page 692)

Fig. 1. The circuit of a "crystal" P.A. amplifier.

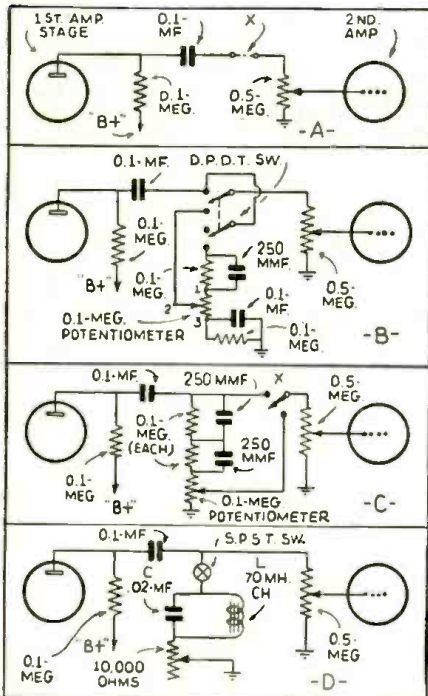
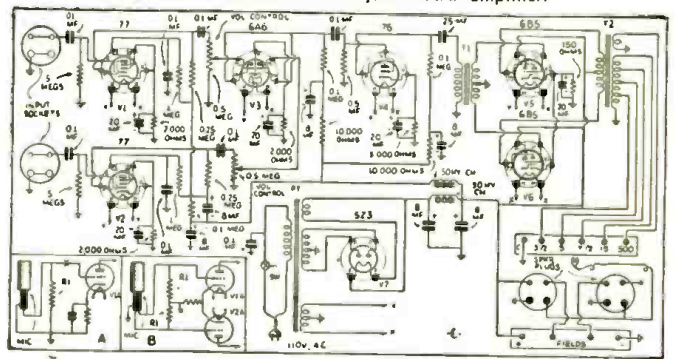

# CHECKING PUBLIC ADDRESS FIDELITY

Practical, dependable methods for checking and varying the response of P.A. systems are given.

PAUL H. THOMSEN

**T**HE FIDELITY of reproduction obtained from any P.A. installation is extremely difficult to determine without special instruments. We cannot hope to establish a standard of fidelity by using our ears as an indicator, for the human ear can be "fooled," or trained to accept reproduction which differs from the original.

Needless to say, measurement of the over-all frequency response of a P.A. installation is of vital importance to those operators who are interested in furnishing and maintaining a high

standard of fidelity. In the method outlined here, the number of instruments required is reduced to a minimum by making the P.A. microphone "listen" to its own loudspeaker, and the acoustical deficiencies of the microphone and the loudspeaker are automatically compensated-for by changing the frequency response of the amplifier. This method will apply to any P.A. installation, regardless of its size.

Good amplifier units will have an overall response which does not vary  
(Continued on page 693)

Fig. 1, below. Set-up for frequency check.  
Fig. 2, right. Frequency response curves.  
Fig. 3, left. Circuits for equalization.

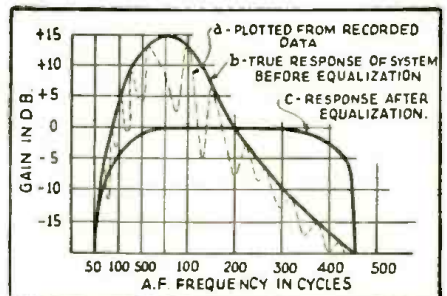
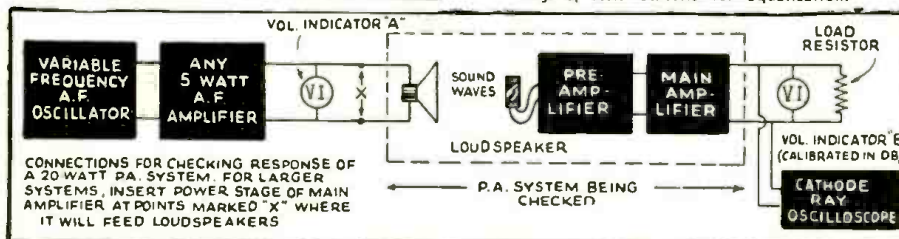

# ELECTRONIC MUSIC FUNDAMENTALS

Some practical instruments for the experimenter are described here. Why not try your hand at making one?

## EDWARD KASSEL PART II

**I**N PART I of this resumé of the subject of making musical instruments operating by electronic means, we covered some of the history of the subject, outlining a few of the methods which had been found successful as well as their characteristics and shortcomings.

In Part II, we will stick more closely to the practical side of the subject. The circuits and details for making several types of electronic instruments will be given.

### THE EREMEEFF "SYNTHESIZER"

Figure 3 represents an Eremeeff synthesizer (1924), consisting of a group of vacuum-tube tone-generating units as 1, 2, and 3, etc., for the generation of electrically-produced tones of pure sine-wave form (without partials).

Anyone having a small amount of radio experience can build 12 separate oscillators (1, 2, etc.), completely shielded, and each having its own reproducer (4, 5, etc.). Each oscillator as shown in the simplified diagram has tuning elements (7 and 9); 1 individual element for producing predetermined pitch (7), and another (9 and 10—both

of which are commonly connected by rod 8) for actuating all the common tuning elements.

The dotted lines indicate a common line pick-up, so that a complex sound is emitted from reproducer (11). By tuning the oscillator (1) for example, to the frequency of the tone which is to be the fundamental (A, in Fig. 3B), and tuning the oscillators (2, 3, etc.) each to their own frequencies, to correspond to the waves (B, C, D, etc.) in Fig. 3A, a complex tone is heard from the reproducers (4, 5, etc.) or from speaker (11) with a tone quality as represented by wave (X). By turning the knob (Y of rod 8) to and fro, all the oscillators are simultaneously raised and lowered in their frequencies, in order to raise and lower the complex tone (represented by X) while retaining its waveform and the number of its partials.

Each element (9, 10, etc.) has a compensating cam action for the purpose of having a mathematically-correct multiplying factor.

### THE TUNING-FORK PIANO

A very interesting electrical instrument. (Continued on page 695)

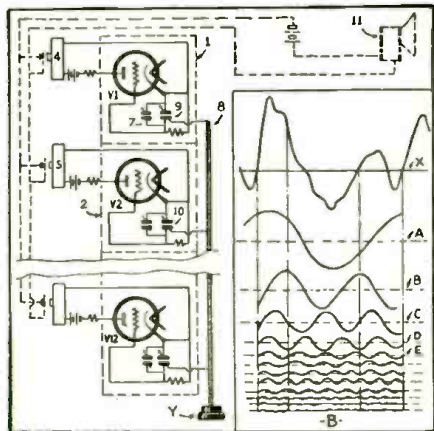

Fig. 3, above. Individual oscillators produce the tones. Fig. 4, below. The tuning-fork piano.

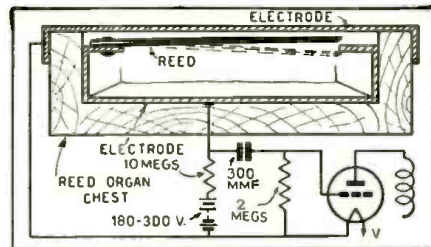
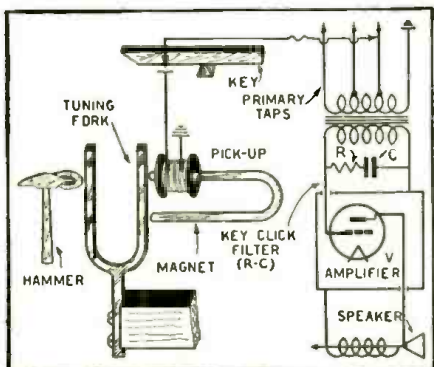

Fig. 5. The vibrating-reed instrument.

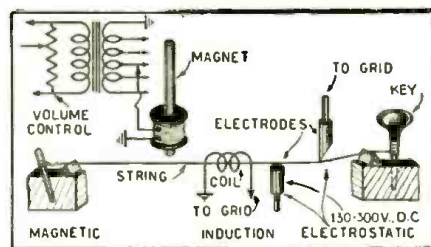

Fig. 6. Methods of pick-up from strings.

Fig. 7. Pick-up by piezoelectric crystal.

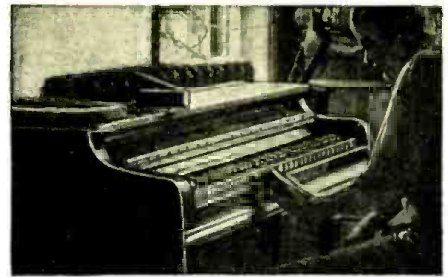
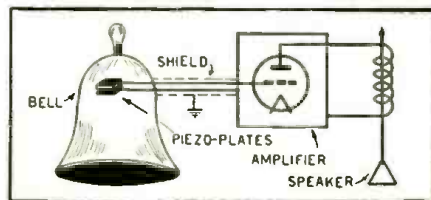

Fig. A. A standard piano, cut down, is the starting point in making an "organ."

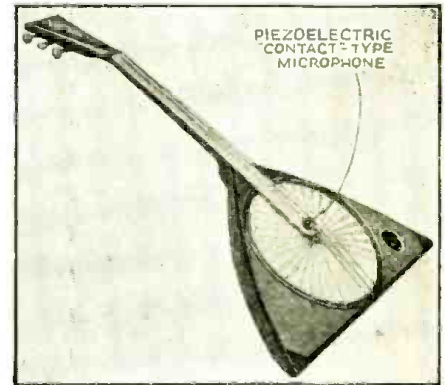

Fig. B. Mechanical amplification by means of a rocking "bridge" driving a diaphragm.

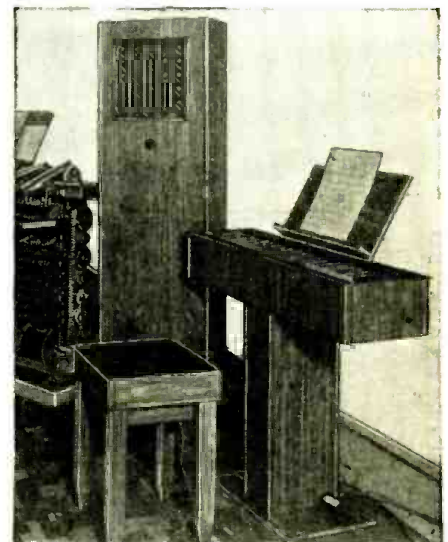
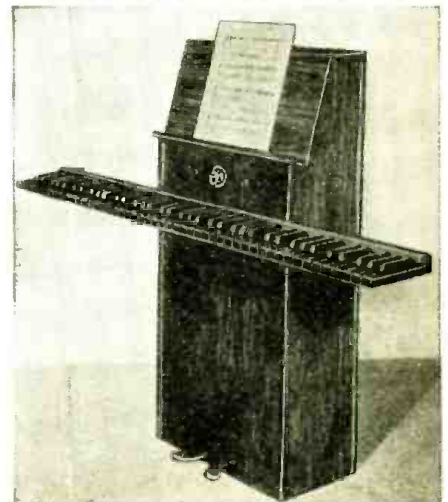

Fig. C. One form of home-made electrical organ.

Fig. D. An entirely self-contained electronic organ made from a standard piano keyboard.



# RADIO-CRAFT'S INFORMATION BUREAU

## SPECIAL NOTICE

Those questions which are found to represent the greatest general interest will be published here, to the extent that space permits. (At least 5 weeks must elapse between the receipt of a question and the appearance of its answer here.) Mark such inquiries, "For Publication."

Inquiries to be answered by mail MUST be accompanied by 25c (stamps) for each separate question; answers are subject to subsequent publication if considered of exceptional interest.

Enclose only a STAMPED and self-addressed envelope for names and addresses of manufacturers; or, in connection with correspondence concerning corrections to articles, as this information is gratis.



Fig. Q.362A. Sound pick-up remains constant.

## LAPEL VELOCITY MICROPHONE

(362) George L. Roman, Berwyn, Md.

(Q.) I have tried using an ordinary carbon microphone as a lapel type, but the results were not very satisfactory. Are there any microphones designed for this purpose?

(A.) Figure Q.362B shows a tiny velocity microphone designed especially for lapel use. The transformer is slipped in a pocket, and a long cord runs to the preamplifier. As shown in Fig. Q.362A, this unit is designed to have a change of less than 1.5 db., even though the speaker turns his head as much as 45 deg. to either side.

## P.A. AMPLIFIER (A CORRECTION)

(363) H. M. Greenwood, Austin, Texas.

(Q.) On page 682 of the May, 1935 issue of *Radio-Craft*, there is a diagram of an amplifier in connection with the article, "A Versatile Portable P.A. Amplifier." I do not understand the coupling between V2 and V3. It appears that there is a high positive potential on the grid of V3. Also, there does not seem to be any connection for high-voltage supply to V3. Will you please clarify this?

(A.) The lead from the grids of V3 should connect between the 1. mf. condenser and the 0.5-meg. resistance directly below it. This takes the high voltage off the grids of V3 and the 1. mf. condenser then acts as the usual coupling condenser.

There should be a lead from the center-tap of T3 to the same lead that supplies high voltage to the center-taps of T4 and T5. All these connections are shown in Fig. Q.363.

## TUBE TESTER

(364) E. C. Burr, Summit, N. J.

(Q.) I have constructed a tube tester that works on the usual grid-shift principle and is



Fig. Q.362B, above. Appearance of lapel-type velocity microphone, Fig. Q.364, below. Change in tube tester.

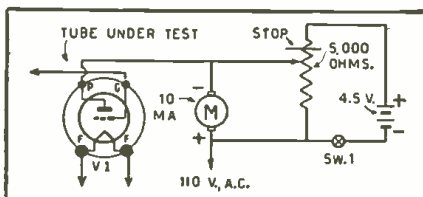

## OUR ADDRESS

(365) Everett E. Collins, Capron, Ill.

(Q.) Where should I address *Radio-Craft* for information: New York, Chicago, or Springfield, Mass.?

(A.) All editorial matter, including questions, should be sent to our New York office, where our editorial staff is located.

## TYPE 2A3H VS. 2A3 TUBES

(366) Herbert M. Isaacson, Buffalo, N. Y.

(Q.) I have been servicing a Colonial Model 602 receiver and find that the power tubes are designated 2A3H. Can you tell me what these are and how and why they differ from the 2A3?

(A.) Either the 2A3 or 2A3H may be used in this set; the 2A3H is a heater-type tube that is used simply because it heats up at the same rate as the rest of the tubes in the set. The base connections of both tubes are the same, since the cathode of the 2A3H is connected to the filament prongs. The type 83 (mercury vapor) rectifier in the 602 set requires delayed application of the load, hence the use of an indirect-heater output tube (the 2A3H).

(Continued on page 692)

Fig. Q.363. Dotted lines indicate corrections.

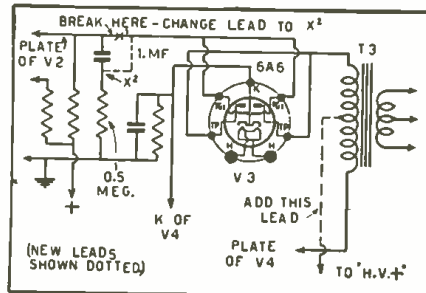

## P.A. QUESTIONS & ANSWERS

Conducted by  
CHARLES R. SHAW

Here is a department for the Radio Dealer, Service Man and Sound Technician who requires general information and help in P.A. work. This department will furnish valuable aid for the asking. Address all questions to *Radio-Craft's* Public Address Forum. Only those questions of general interest will be published.

## MIKE FEEDBACK

(34) W2HQW, Brooklyn, New York.

(Q.) I replaced my ribbon microphone with a crystal microphone and preamplifier and I now encounter much more feedback when I use it in a hall than I used to have with the ribbon microphone. What is the cause of this?

(A.) Feedback is essentially due to the sound of the loudspeaker reaching back into the microphone, and being in turn amplified in the amplifier, the output of which is fed into the loudspeaker. This complete cycle constitutes *feedback*. If, now, the microphone is peaked to a frequency to which the loudspeaker responds, then the feedback will take place at that particular frequency. You will find that by using a microphone which has a flat overall response curve together with an amplifier system of a similar response curve, you will be able to turn up the volume control much further without any feedback.

## AMPLIFIER HUM

(35) Sam Tortman, Bridgeport, Conn.

(Q.) There is considerable hum in my amplifier unless I connect it to a ground. How can I eliminate this condition?

(A.) Simply connect a 0.1- or .25-mf. paper condenser (300 V. peak) between one side of the primary of the power transformer and the chassis itself.

## HIGH- AND LOW-IMPEDANCE MIKES

(36) Jack Miller, Portland, Ore.

(Q.) What is the difference between a high- and low-impedance microphone, and when should they be used?

(A.) A low-impedance microphone permits the use of long extension lines. This practice is not recommended with high-impedance microphones because the longer the extension cord used the more the attenuation and corresponding loss at the higher frequency end of the range.

(Continued on page 691)

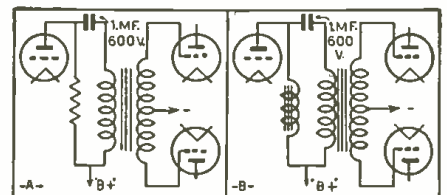
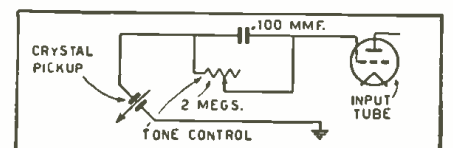

Fig. Q.37, above. Parallel feed systems. Fig. Q.38, below, reducing low-frequency response of a pickup.



# METAL TUBES IN A MODERN PREAMPLIFIER

Metal tube type P.A. amplifier requirements, and valuable data on mixers and pads are given.

I. A. MITCHELL

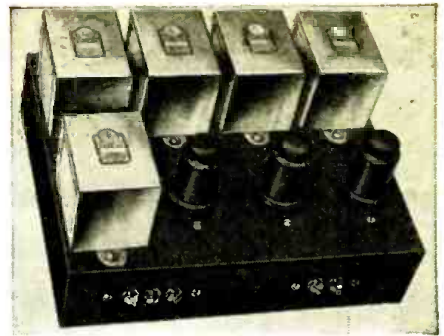

Fig. A. The appearance of the amplifier.

THE LAST few years have seen a very great increase in the frequency range of audio equipment, from microphone to loudspeaker. However, there has been practically a proportional decrease in the sensitivity of input devices requiring additional gain in the amplification circuits. This is readily

apparent when a number of modern types of microphones are compared. A fairly accurate check on modern input devices indicates the average output levels given in Table I. Only average values are indicated, as there is quite a difference in output level for the same type microphones as manufactured by

different organizations. Another factor to consider is the variation in output of microphones due to distance from the sound source and directional effects.

Considering the above as a whole, the necessity for preamplification becomes evident. To allow sufficient range in gain control, an amplification system should have at least 10 db. greater gain than the difference between normal input and output powers. For comparison, let us now consider (see Table II) the output of a number of power amplifiers, commonly used.

Based on this method of determining required amplifier gain, the gain required between a dynamic mike and the output of a pair of 2A3s would be  $34 + 88 + 10$ , or a total of 132 db. If (a) the power amplifier has a gain of 80 db., it is seen that (b) an additional gain of

(Continued on page 696)

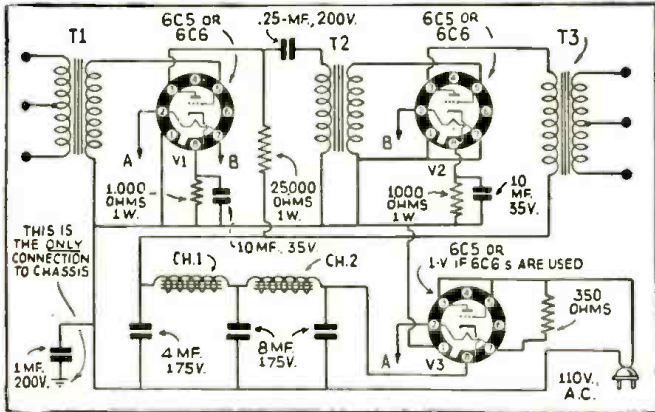

Fig. 1. The schematic circuit showing how a 6C5 triode, V3, is used as a rectifier for the pre-amplifier. Transformer T1 is the mike or phono pickup matching unit. Transformer T2 is the interstage coupling unit while T3 is the output coupling transformer for matching into a transmission line or amplifier input circuit.

# INSTALLING INDOOR AND OUT-DOOR P. A. SYSTEMS

Acoustic considerations in auditoriums are explained for the practical P.A. installer.

E. L. RICHARDS AND J. P. HANAN

EVERYWHERE one turns today he will find P.A. systems in use, satisfactorily serving many purposes. This advanced phase of "radio" is almost unlimited in its possible applications.

Outdoor installations such as ball parks, athletic fields, open theatres, picnics, in motor trucks roving the streets, or airplanes sailing the sky (see the P.A. Pictorial pages in this issue), advertising some commodity, business house, or giving amplified support to the voice of some election campaigner; indoor installations such as hotel, apartment buildings, schools and colleges, churches, railroad depots, ocean liners, and inter-call systems in factories and large office buildings are but a few of the places where P.A. systems are in use today. Yet the application of P. A. systems is only in its infancy. For example, for each church where a system is installed, there are hundreds of others (there are more than 200,000 churches—total, for all denominations—in the U. S.—Editor) waiting for competent trained men to install some form of P.A. system. What is said about the church is also true for many other phases of P.A. equipment application.

The nature of installations will vary according to individual requirements. Sound units will vary from equip-

(Continued on page 697)



Fig. A, above. Student P.A. work. Fig. 1, below. Charts and circuits.

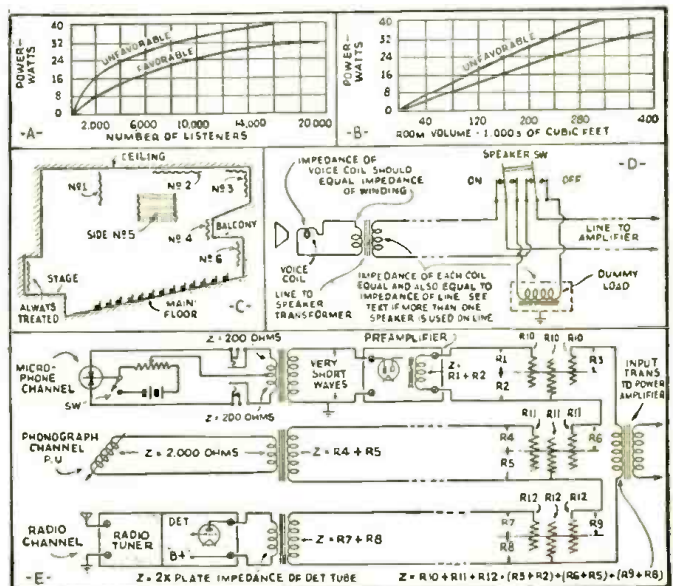
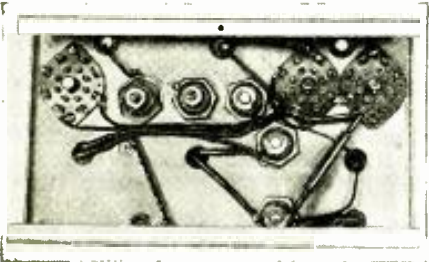



Fig. A, above. The amplifier in its case.

Fig. C, below. The partly-wired under-chassis.



**M**ANY P.A. systems are now in use which have been designed only with sufficient gain for carbon microphones. When the owner of one wishes to use the newer type "mikes," he is faced either with the prospect of extensive rebuilding or of purchasing a new high-gain amplifier.

The preamplifier unit here described is designed to have sufficient gain to allow the use of a "condenser head" (condenser-type microphone) with any amplifier which has sufficient gain to operate with a carbon microphone. It is compact and self-contained, and the output can be connected directly to the microphone transformer of the regular amplifier, or it can be fed into a 500-ohm line.

The power supply is built-in, and uses a type 25Z6 tube in a "voltage doubling" circuit. The series filament circuit employs a regulation line-cord resistor such as is used on many midget receivers. All the electrolytic filter condensers are of the 1-in. diameter type, so the total capacity used is very high, about

# HOW TO MAKE A PREAMPLIFIER

This P.A. unit uses metal tubes—voltage doubling—special hum-free chokes and complete shielding.

H. G. McENTEE

50 mf. The 2 filter chokes and the output transformer are housed in special cast alloy cases to minimize hum in the output.

The metal tubes offer the advantages of compactness and good shielding, and so are used in preference to the glass type.

## USES NEW "BIAS CELL"

A volume control is provided as a convenience. The arm connects to the grid of the 6C5, which is biased with the usual cathode resistor. The bias system of the 6F5 is quite different. Here, one of the new 1V. bias cells is used and proves very effective and simple. This cell in its holder, together with all other components in the input circuit, are mounted directly on the input terminal strip, which may be seen in Fig. B, attached to one end of the case.

## SPECIAL INSULATION PROCEDURE

As is usual with this type circuit, all components in the circuit are insulated from the chassis and metal case. Thus, even the electrolytic condensers *must* be insulated. The *only* connection to the chassis is the 0.25-mf. condenser between "B—" and the chassis.

There are 2 pilot lights, one burning whenever the heaters are lighted, and the other only when the high-voltage switch is operated. This second lamp is shorted by the same switch which opens the high-voltage lead. Since 3.2 V. bulbs are used, this slight change in total voltage cannot be noticed. Be certain the bulbs used are 3.2 V. and 0.3-A., as these can be used without a parallel re-

sistor. The 10,000-ohm resistor which precedes the 2 filter chokes serves to drop the high voltage to about 150 V., which is sufficient for all needs, and which is as high as should be applied to most condenser mikes. The resistor also serves as additional filtering.

The microphone cable enters at the bottom of the front panel, while the output is at the upper rear of the case, although the arrangements may be changed to suit individual requirements.

## GENERAL DATA

Construction of the unit is almost self-explanatory. The case comes knocked down, and is assembled with self-tapping metal screws. Since some constructors will wish to use parts that are on hand, other than those specified, no dimensions are given. However, the placement of parts should be followed as closely as possible to secure proper operation.

The wiring is very simple. It should be remembered that there are extra unused contact prongs on most of the metal tube sockets and these may be used to advantage to support small condensers, resistors and the like. This adds to the neatness of the set and prevents possible shorts between these parts.

There are no adjustments needed, and after a careful check of all wiring, the power may be turned on and the performance tried out. The preliminary tests may be made with a pair of low-impedance headphones connected to the output transformer, or high-impedance phones used in series with 0.1-mf. condensers in each lead and connected

(Continued on page 694)

Fig. B, left. The amplifier removed from its metal case. Note the bias-cell and the numerous filter condensers.

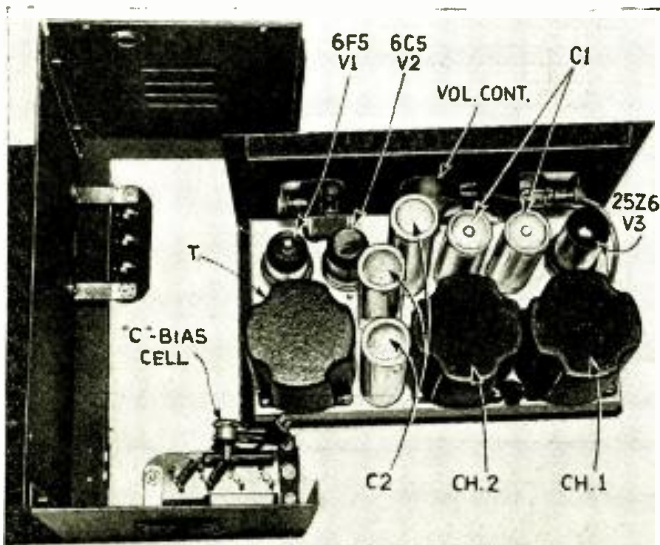
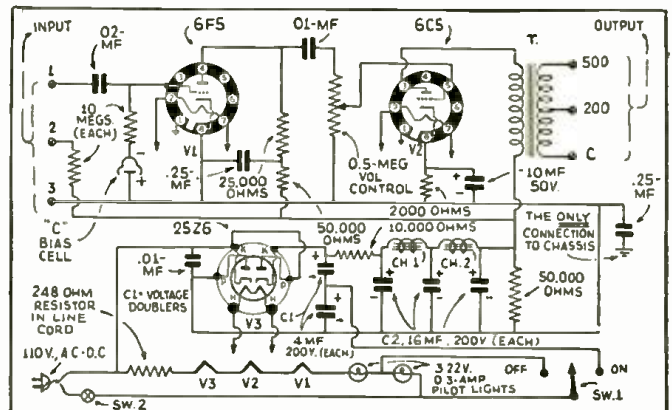

Fig. 1, below. The schematic circuit of the metal-tube amplifier with its voltage-doubling power supply unit.



**AWARDS IN THE CONTEST**  
**FIRST PRIZE** ..... \$10.00  
**SECOND PRIZE** ..... 5.00  
**THIRD PRIZE** ..... 5.00  
**Honorable Mention**

# USEFUL CIRCUIT IDEAS

Experimenters: Here is your Opportunity to win a prize for your pet circuit idea, if it is new, novel, and useful.



Fig. A. The code practise neon oscillator in actual use. All parts are contained in the inverted cup-shaped case. If desired, the batteries and other parts can be built into one compact box. This unit may be used to modulate a service oscillator and for many other purposes as well.

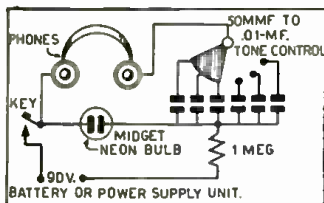

Fig. 1. Circuit of above unit.

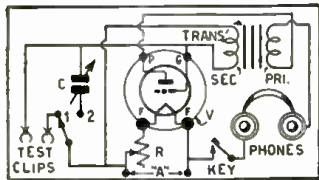

Fig. 2. A capacity bridge.

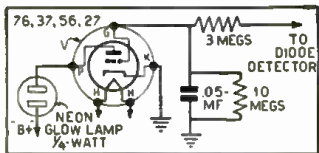

Fig. 3. Neon tuning indicator.

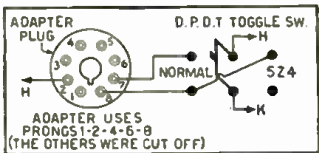

Fig. 4. Useful rectifier adapter.

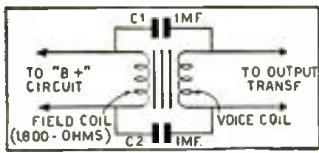

Fig. 5, above. Tone-improving Circuit.

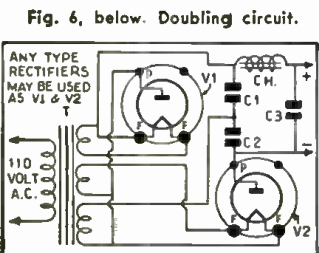

Fig. 6, below. Doubling circuit.

## FIRST PRIZE—\$10.00

**A VARIABLE-TONE CODE-PRACTICE OSCILLATOR.** The neon tubes which can be purchased for a few cents from radio stores have other applications than as pilot lights, output indicators, and the other services to which they have been put. They make really fine audio oscillators, and therefore can be used for service work or for code practice.

When combined with suitable variable resistors or tapped condensers, the tone can be shifted at will across the entire A.F. band. For varying the tone, though, perhaps the most convenient method is the use of the "condenser-type tone control" (which is a group of small fixed condensers and a switch in a small bakelite case, the assembly looking like a variable resistor).

The circuit, Fig. 1, shows the use of a 90 V. "B" battery to operate the oscillator. The battery can be replaced with a small "B" eliminator or the voltage can be obtained from the radio set (if the unit is used for service work).

When the unit is used for code practice, a key is connected to one of the two sets of tip-jacks on the side of the case and as many pairs of phones as needed are connected to the second set of tip-jacks, as shown in Fig. A. When used as a service A.F. oscillator, the "key" jacks are shorted with a piece of wire.

J. DUNCAN

## SECOND PRIZE—\$5.00

**A CAPACITY BRIDGE.** This simple arrangement, shown in Fig. 2, may be made up in portable form as a handy piece of test equip-

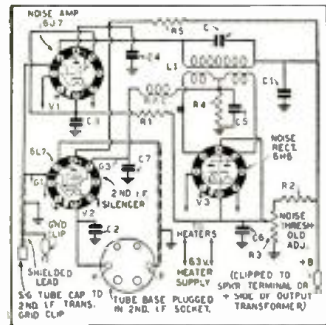
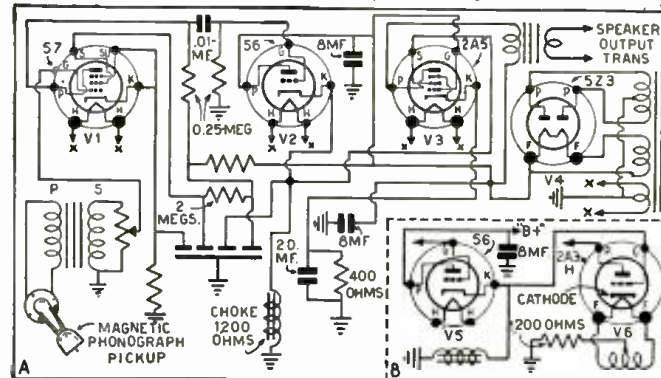

Fig. 7. Amplifier improvement made by substituting a 2A5 for a 2A3H.



ment. The tube, V, may be of any battery type, such as a 99 or 30. The filament is adjusted to the correct value by R. The transformer is a regular 3-to-1 audio unit. Condenser C may be of any size, but its range must cover the capacity of the unknown condenser under test. In operation, the test clips are connected to the unknown, and the test key pressed. Then the switch is shifted to position 2 and the variable condenser turned until the same tone is obtained. The dial of the variable condenser may be calibrated by means of known values.

RUSSELL M. RICHNER

## THIRD PRIZE—\$5.00

**TUNING INDICATOR.** This very sensitive circuit, shown in Fig. 3, may be used where other types of indicators do not give sufficient change to be of any use. For use on high-fidelity sets, receiving strong locals, a 2-meg. resistor in place of the 10-meg. unit shown will give extremely sharp resonance indication.

The neon lamp may be used as a pilot bulb or as any other sort of indicator desired.

GORDON W. CLARK

## HONORABLE MENTION

**RECTIFIER ADAPTER.** I am using a free-reference-point analyzer, and when I put in an 8-prong socket for the new tubes, I found that the heavy current of the 5Z3 would be carried by one of the small wires of the cable.

In order to overcome this, and yet have the same connections for the other tubes, I added a D.P.D.T. switch connected as shown in Fig. 4.

This allows the heater to be switched from prong 7 to prong 8 but when the switch is set for nor-

EVERETT R. BOLANDER

## HONORABLE MENTION

**IMPROVING TONE.** The circuit of Fig. 5 may be used to improve the tone of sets using dynamic speakers. The condensers will have to be experimented with in order to obtain satisfactory results, but the value indicated will be approximately correct. This hookup was used on a receiver using a single 42 output tube.

FORREST HARRIS

## HONORABLE MENTION

**HIGH-VOLTAGE SUPPLY.** The voltage-doubling circuit is well known in A.C.-D.C. sets, but experimenters often do not realize it can also be used with a transformer. The circuit is shown in Fig. 6, and it will be seen that a separate filament winding is needed

(Continued on page 698)

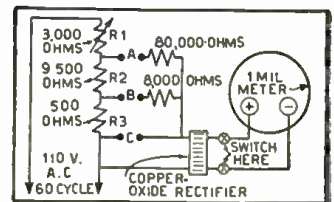

Fig. 11. Calibrated capacity meter.

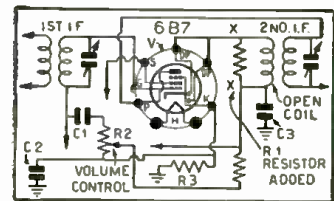

Fig. 10. Temporary I.F.T. repair.

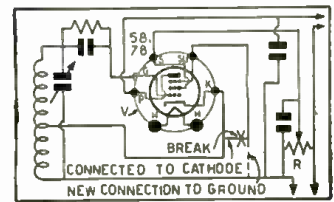

Fig. 8, below. A 32-type A.F. tube.

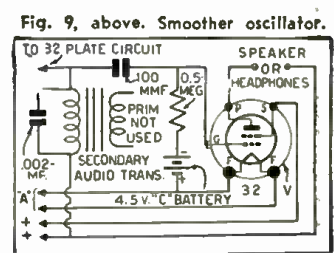

Fig. 9, above. Smoother oscillator.

## HETRO AIR-ACE SERIES M 9-TUBE 4-BAND SUPERHET.

(Range, 140 kc. to 20 mc.; metal tubes; 6B5 output tubes; 1 iron core I.F.T.)

Voltages, as measured with a 1,000 ohms-per-volt meter, are as follows:

Tube	Cath.	S.G.	Plate
V1	3 to 4	90	240
V2*	3 to 4	90	240
V3, V4	3 to 4	90	240
V5	2 to 3	..	..
V6	2 to 3	..	165
V7, V8	..	365*	340
V9	365	..	..

\*Grid 2, 145 V. All readings taken to ground. About 125 V. drop in speaker field. Power output is 15 W.

Band switch allows phono. operation when in extreme left position. Note that I.F.T.1 is of the iron-core type. Use a series resistance of 400 ohms when aligning bands 1 and 2, and a condenser of 250 mmf. for other bands. Alignment frequencies are 18 and 9 mc. on band 1, 6 and 2 mc. on band 2, 1,500 and 600 kc. on band 3, and 350 and 150 kc. on band 4. The I.F. amplifier is aligned with a series condenser of 250 mmf. between the service oscillator and the control grid of V2. I.F.T.1 is the last transformer to be lined up. A ground connection should always be used between service oscillator and set.

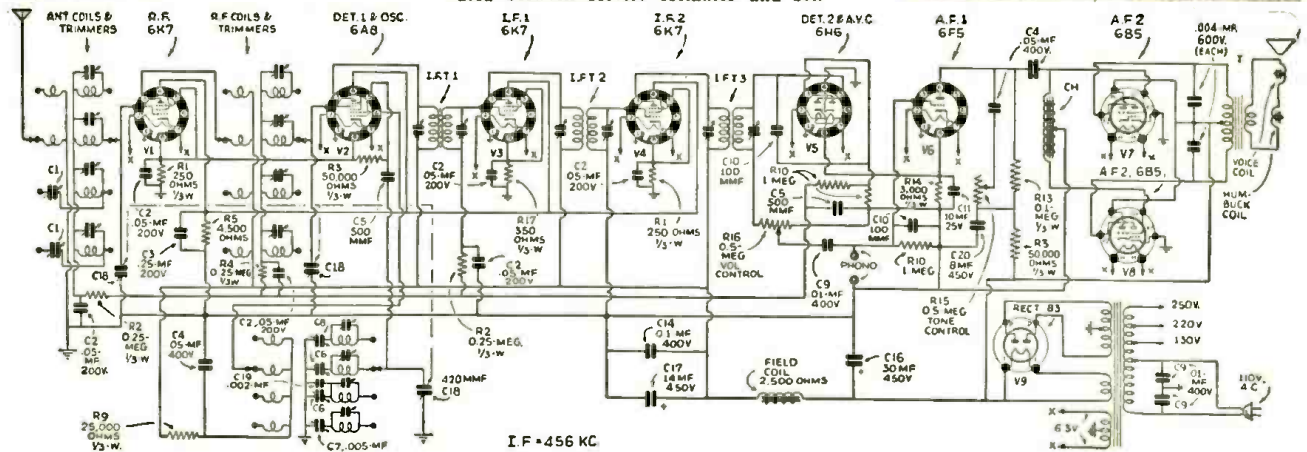
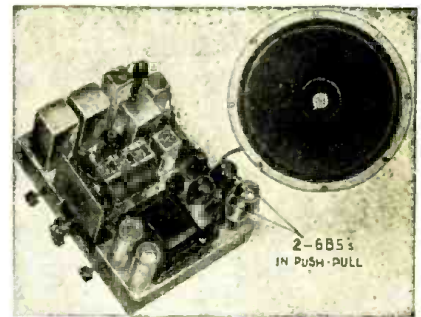

## CROSLY MODEL 1155 11-TUBE 4-BAND SUPERHET.

("Auto-expressionator"; range, 150 kc. to 19 mc.; triple-tuned I.F.T.s; tuning meter.)

Socket voltages are as follows, from tube to ground, using a 1,000 ohms-per-volt meter:

Tube	Plate	S.-G.	Sup.-G.	C.-G.	Cath.
V1	238	100	3	0	3
V2*	230	100	..	0	3.5
V3	140	..	-5 to -30	..	..
V4	230	95	3	0	3
V5	..	..	..	..	..
V6	155	..	..	0	2
V7	210	210	..	0	17
V8, V9	360	235	..	0	17
V10, V11	360	..	..	..	..

\*Grid 3, -5 to -30 V.

The power output is about 15.5 W., and power input 140 W. Speaker field drop, 125 V. The I.F. alignment is accomplished by con-

necting the service oscillator first to the grid cap of V4, and then through a .02-mf. condenser to the grid cap of V2. The adjustment is made by turning the middle trimmer, never the top or bottom trimmers. Do not touch the latter.

R. F. alignment on the Blue, Red, and Green bands is accomplished with a 250 mmf. condenser connected between the service oscillator and the receiver ANT. post. A 400-ohm carbon resistor is used in place of the condenser on the Violet band. Shunt alignment frequencies are, 400, 1,700, 6,000 and 18,000 kc. Series alignment frequencies are 150, 600 and 2,500 kc.; none for Violet band.

The "auto-expressionator" is entirely auto-

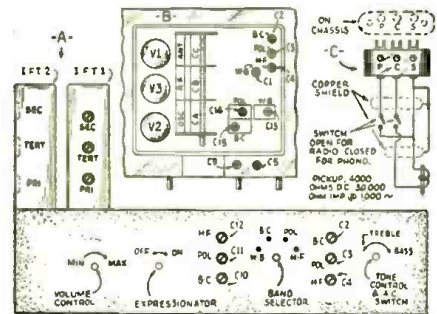

matic and needs no service, except a check to make sure the special bulbs are good.

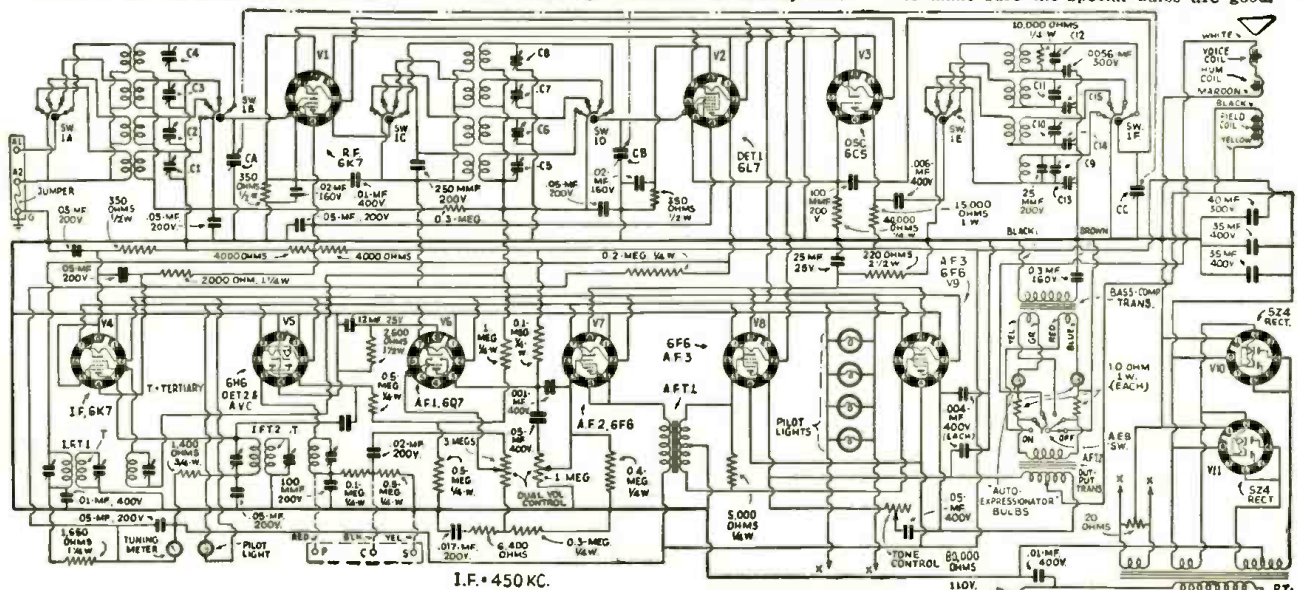



CANADIAN WESTINGHOUSE MODEL 175 7-TUBE DUAL-RANGE SUPERHET.

(6 metal tubes; Air Pilot; tone-flow cabinet; ranges 530-1720, 5,500-18,000 kc.; tone compensation; manual tone control.)

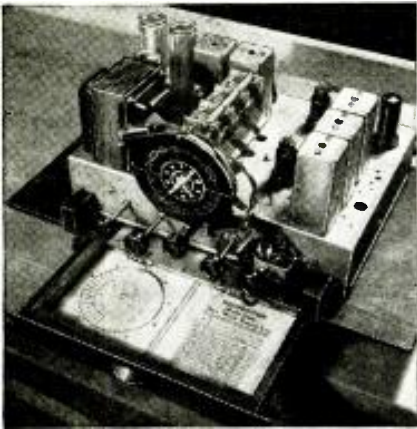

This set is similar to the Canadian Westinghouse Model 275, except that only 2 bands are provided on the Model 175. All the voltages are given on the trimmer

layout drawing. The D.C. readings are taken with respect to chassis. The R.F. line-up frequencies are 1,500 and 600 kc. for band A; 17,000 kc. on band C. Range B on the model 275 is aligned at 5,160 kc. The receiver is designed to allow the Service Man to make use of a tuning wand, and this tool should be used before any alignment is attempted. The I.F. stage is aligned at 460 kc. Before actual R.F. adjustments are started, the dial pointer must be set at the correct position. This is done by turning the tuning condenser to maximum, and setting one end of the pointer exactly to the horizontal line at the low-frequency end of band A, while the other end should be within 1/64-in. of the line at the high-frequency end.

The power consumption of these sets is 72 W., while there is 2 W. undistorted, and 4 1/2 W. maximum output.

Automatic tone compensation is provided on the manual volume control, by means of a resistance-capacity network, which increases the low-frequency response at low-volume levels.

The Air-Pilot is a combination of features which are said to enable accurate tuning of

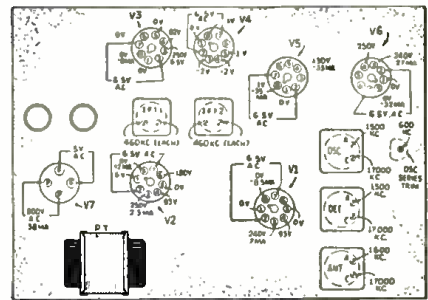

the receiver by even the most inexperienced owner. A world time map is provided in an illuminated drawer. This is fitted in both console and table models.

The console receiver uses a 12 in. speaker, while an 8 in. unit is used in the table model.

The variable condenser is mounted on a special shock-proof support, which prevents microphonic howl due to acoustic feedback from the loudspeaker.

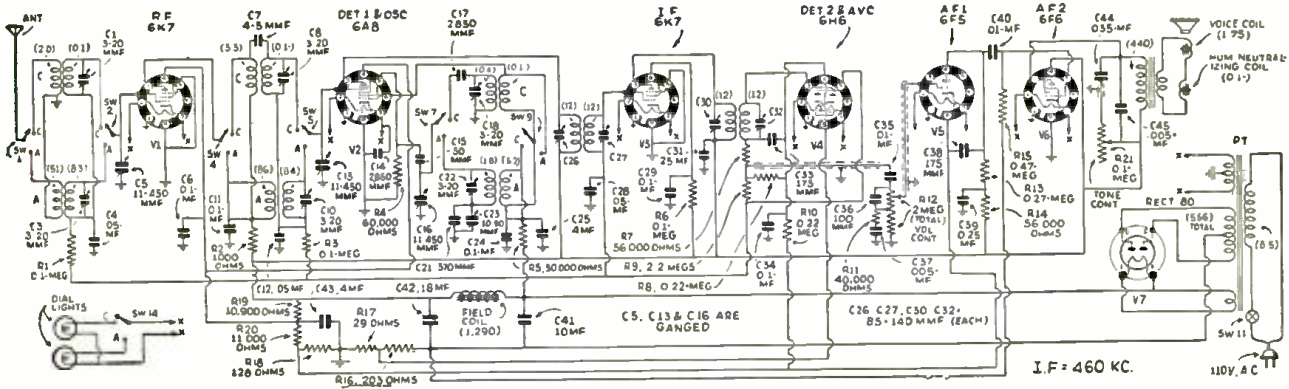

These receivers are designed for ease of motor-noise elimination. In rare cases certain cars may be especially hard to work with. In such cases, the Service Man may solder a 3 1/2 in. length of shielding to the underside of the condenser pulley mounting bracket, directly between the 2 6/32 screws

ARVIN MODEL 35 8-TUBE CAR-RADIO RECEIVER

(Push-pull output; tone control; highly filtered against noise.)

which hold the Bowden-wire housing clamp onto this bracket. The other end of this shielding is then hung over the edge of the chassis case on top of the copper-case ground shim, so that when the cover is put on, the condenser pulley assembly is bonded to the outer case. The usual suppressors will then be found to eliminate all trace of noise.

It will be noted that there are terminals provided for use of an external speaker, which may be of the electro-magnetic or permanent-magnet dynamic type.

A table is herewith given of voltage

measurements as taken with a 1,000 ohms-per-volt meter;

Tube	Plate	S.-G.	Cath.	Sup.-G.	C.-G.
V1	250	60	1.6	1.6	2.0
V2	250	60	2.2	2.2	2.2
V3	250	60	1.6	..	1.4
V4	135	..	1.6	..	1.6
V5, V6	245	250	18	..	18
V7	60	..	..	..	6
V8	275 A.C.	..	255	..	..

C.-G. voltages are measured with a V.-T. volt-meter. Plus or minus 20 per cent is acceptable on all voltages.

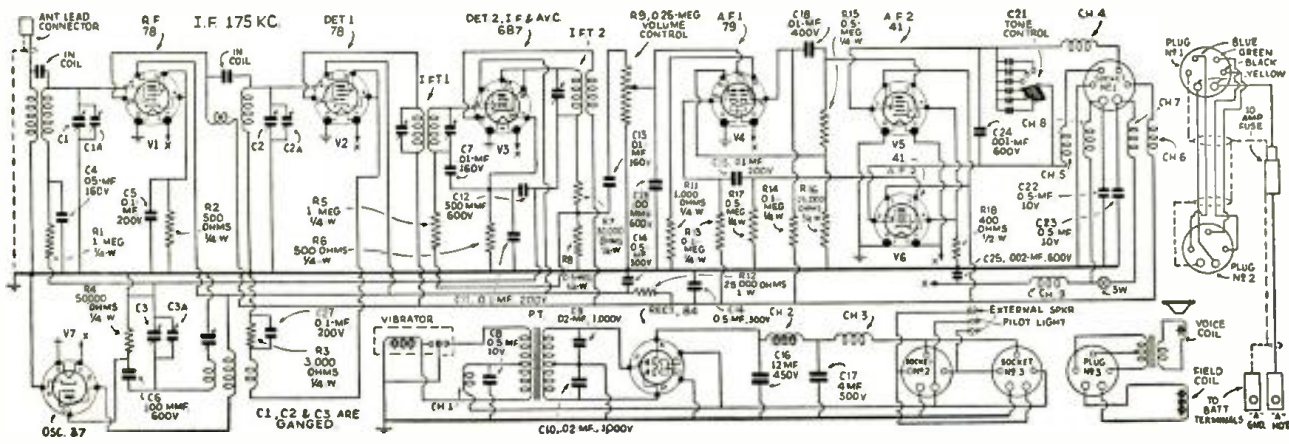



**S**CHOOL EXECUTIVES are rapidly becoming conscious of the value of sound equipment for use in modern education and administration. Because educators demand perfect tonal quality in their school sound equipment, class A and "modified" class A amplification should be used.

The controlling factor in quality am-

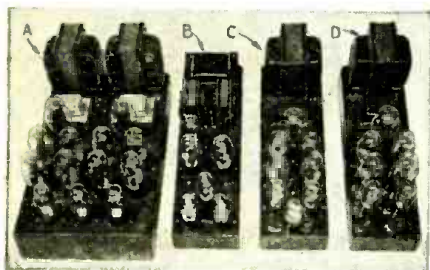

Fig. A, upper left. A typical school room equipped with a P.A. reproducer for announcements, lectures, etc.  
 Fig. B, left. The 4 units of a school installation, described here.  
 Fig. 1, right. The schematic of a class A, 11 W. amplifier used in the school installation.

# IMPORTANT FACTS ABOUT SCHOOL SOUND SYSTEMS

The technical requirements for P.A. systems designed for use in schools and similar institutions are given.

R. H. VON LIEDTKE PART I

plification is *true waveform reproduction*. This includes the following 5 conditions:

(1) The circuit used must reproduce, in the case of sound, absolutely *at pitch*. This means that if we induce a frequency of 256 cycles into a microphone this frequency must be reproduced in the speaker at 256 cycles.

(2) The frequency of 256 cycles must be reproduced in the speaker with the original amount of harmonic content, in

other words, the circuit must be of such a design that it is able to amplify the harmonics as well as the fundamental. If harmonics are not amplified proportionately to the same degree that the fundamental is amplified, bad tonal quality will result. The fullness of the tone will be missing. (It would be a good idea to look up a reference on tonal structure.)

(3) The amount of harmonic distortion  
*(Continued on page 701)*

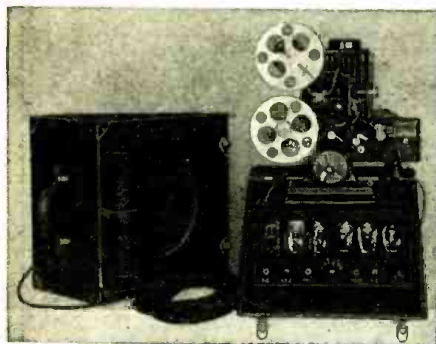
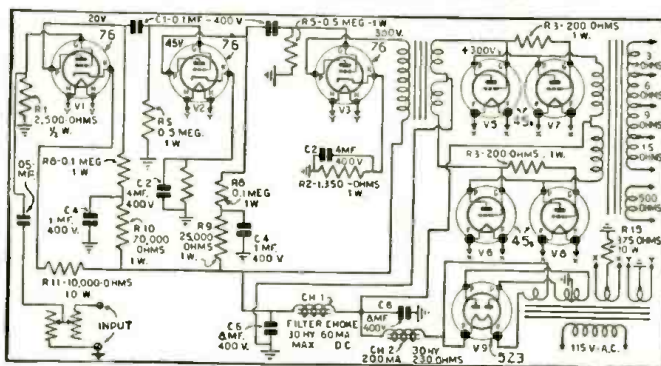

Fig. A. A representative 16 mm. talkies projector, amplifier and portable reproducer.

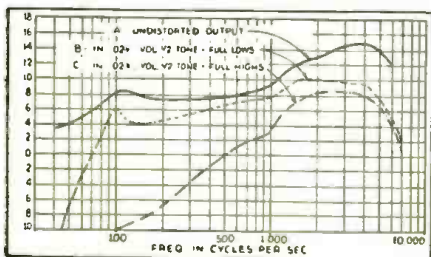
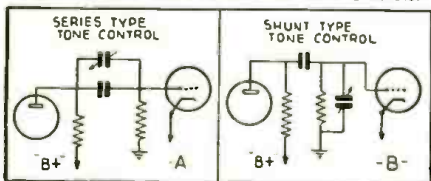

Fig. 1, above. Variation in response with bass tone control variation. Note the peak in the high frequencies.

Fig. 2, below. Series and shunt tone controls.



# SERVICING 1/4-MILLION 16-MM. TALKIES UNITS

Have you questioned the tremendous sales and service possibilities of "home movie" equipment? Here is the answer.

J. J. BRESSLER

**T**HE OFTEN-HEARD cry of "If I could only get into a game in which I could make money!" seems to be louder among men in the radio-service field than in any other so-called profession. Frankly, there is no need to forsake radio. Equipment maintenance, repair and modernization in associated electrical lines should make it possible for a radio Service Man to have an all-year job.

Not one in a thousand (mind you) radiomen have ever given sound-on-film a thought. Yet, there are over 250,000 silent 16 mm. projection machines in use! These equipments are in a stage similar to that of battery radio receivers in the days of battery eliminators. *Modernization* is a fairly long word, but a sweet money-getter. There are one-quarter million projectors which are fairly crying to be converted for sound or even traded-in for sound projectors! (It is difficult to make technicians realize the extent of this virgin field.)

## TALKING "TALKIE"

To get an idea of the rapid rise of "16 mm.," let us analyze a few facts. First, we have the Department of Commerce, Bureau of Foreign and Domestic Commerce, Specialties, Motion Picture Division estimated figure of 100,000 professional 35 mm. projectors in use in theatres, schools and auditoriums. Think of it! Only 100,000 units in use since the inception of motion pictures in 1895. Yet 300,000 16 mm. silent equipments have been sold in less than 7 years! 16 mm. sound-on-film outfits are now being sold on almost the same basis as radio sets. It isn't hard to conceive a need for men who are far-seeing enough to get a start in this newest field. These ambitious men in another five years will be reaping a rich harvest.

Each manufacturer supplies a detailed description of the mechanical parts and operation, also a wiring dia-

*(Continued on page 699)*

PHILCO MODELS 39 AND 39A 6-TUBE DUAL-RANGE BATTERY SUPERHET.

(Ranges, 550 to 1,720 kc., 5,500 to 16,000 kc.; class B output; A.V.C.; low battery drain; dynamic speaker.)

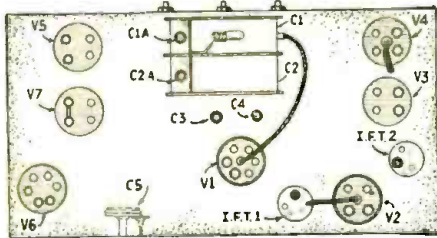

Voltages in this set are as follows:

Tube	Plate	S.-G.	Osc. plate
V1	130	66	112
V2	130	66	...
V3	...	...	...
V4	45	30	...
V5	130	...	...
V6	130	...	...

These readings are taken with a high-resistance voltmeter, and all are measured to ground.

The model 39 is operated from a 2-V. storage cell, while the model 39A is operated from a dry "A" battery, and requires the use of a type 6 ballast tube, V7. The socket for V7 is also on the 39 chassis, but is shorted out with a jumper.

The power consumption is 19 ma. from the high-voltage supply, and 670 ma. from the filament supply.

An output meter is needed for alignment and is connected to the plate terminal of V6. Locations of all trimmers are shown in the detail drawing, with the exception of C6, which is located on the underside of the chassis. The I.F. is aligned with the dial of the receiver set at 600, and the lead from the service oscillator connected to the cap of V1, the regular grid-cap connection having been removed. With the service oscillator still set at 460 kc., and the leads connected to the antenna and ground terminals of the receiver, adjust the wavetrap condenser, C5, for minimum response. The alignment frequencies for the broadcast band are 1,500 kc. and 600 kc.

For short-wave trimming, the maker recommends the use of a special, "crystal"-type service oscillator which has a frequency of 3.6 mc. With the wave-band switch turned to the right, and the crystal oscillator connected to the antenna and ground posts of the receiver, the 4th harmonic of the service oscillator should be picked up at about halfway between 14 and 15 mc. on the receiver dial. With the dial at a little more than 7 mc. the 2nd harmonic of the crystal service oscillator will be picked up, and at this point C3 is adjusted for best response. Although an ordinary service oscillator without the crystal feature may be used on the short-wave bands, the results are not so accurate.

A detail of the battery plug is given on the main diagram. It should be noted that the "A" leads do not come out of this plug, but are brought out of the cable separately just above it. This plug is made for connection directly to the special "B" and "C" battery unit, no connection wires being needed.

A special, low-drain pilot lamp is used.

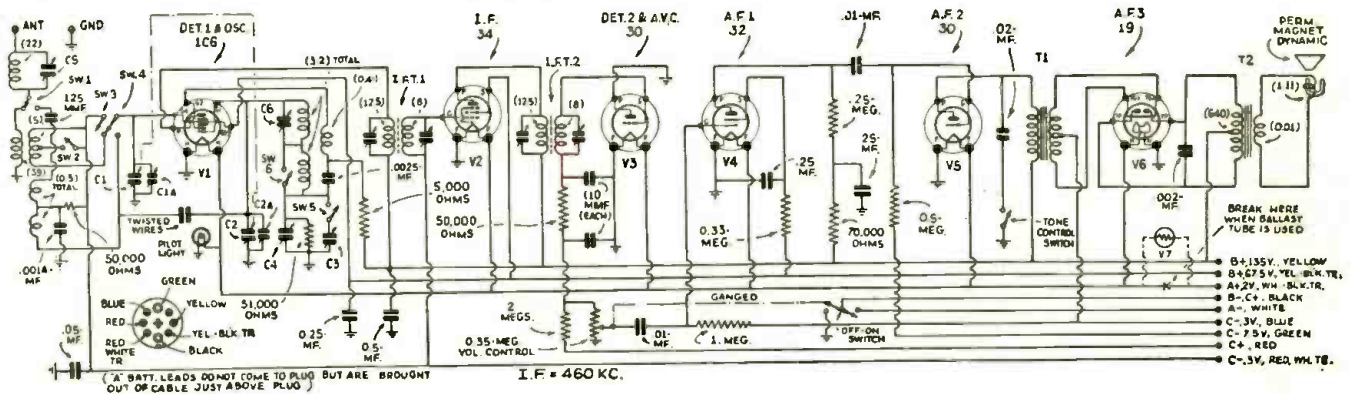

PHILCO-PACKARD DELUXE 7-TUBE SUPERHET. CAR RADIO

(Iron-core I.F.T.s.; both volume and sensitivity controls; automatic tone compensation; manual tone control; non-polarized "A" leads.)

A fully-charged heavy-duty battery must be used when attempting to align this set. An output meter is connected to the output tube, V6, by means of an adapter. The trimmers are very carefully adjusted at the factory and ordinarily no adjustment is needed.

When the receiver is adjusted while installed in the car, the regular car antenna should be connected and a wire run from the service oscillator close to, but not connected with the lead-in. In this manner the R.F. stage may be adjusted under conditions of actual operation.

When working on the I.F. amplifier, the service oscillator should be connected to the

grid cap of V3 and then V2 through a 0.1-mf. condenser. The same condenser is used for R.F. alignment. High-frequency adjustment is made at 1,500 kc. with the plates of the tuning condenser all the way out. A piece of thin paper is placed between the rotor and stator plates and the former turned out until they come to the paper. Alignment at this position of the plates will give the true setting for 150 on the dial. Low-frequency adjustment is made with the dial turned to 580 kc. Alignment of the R. F. stage is made with the service oscillator connected in series with a 0.1-mf. condenser, a 200 mmf. condenser and the antenna lead of the re-

ceiver. The alignment frequency is 1,400 kc. This completes the receiver adjustments.

The color code of the I.F. transformers is as follows: Plate, white; "B", red; grid, lead from top; grid-return, green. Replacements must be made with a complete new unit, since parts are not furnished separately.

There are no voltages given for this set, since the maker feels that, due to wide variation in battery voltage, any receiver voltages would tend to be misleading.

Note the use of a sensitivity control, which is needed because of the high gain of the receiver.

The output operates in class B.

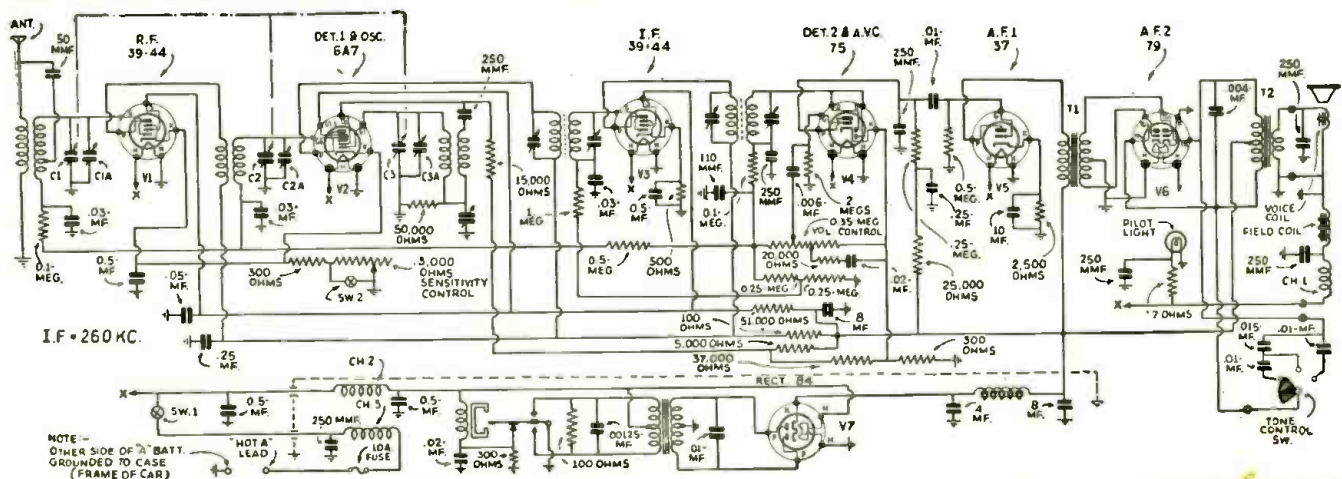

# THE LATEST RADIO EQUIPMENT



Small mantel receiver. (969)

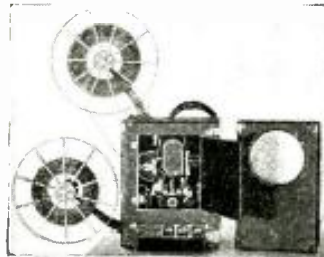

Portable sound movie machine. (976)



High-gain, portable amplifier for crystal equipment use. (977)



Table set, with "magic eye." (978)

## A.C.-D.C. SUPERHET. (969)

MODERN design is stressed in the 7-tube, small-size receiver shown here. There are 2 bands, 550 to 1,600 kc., and 5.5 to 15.5 mc. The dial is illuminated in 2 colors and has a planetary vernier drive. All coils are impregnated for tropical use, and individual inductances are used for each range. There is no resistor in the power cord, a ballast tube being used instead.

adjustments for changing both vertical and lateral angularity, and extremely fine adjustments of pressure on the stylus may be made. There is also a micrometer adjustment used for changing the angle of the actual cutting point of the stylus, to eliminate groove noise such as whistles, hiss and so-on.



Special P.A. analyzer. (970)

## P.A., TALKIES, AND RADIO SET ANALYZER (970)

(Supreme Insts. Corp.)

IT IS no longer necessary to struggle along in P.A. service work with an inadequate analyzer, for this one is specifically designed for the job; these facilities are applicable in other fields, too, as the heading indicates. Rotary switches are used and point-to-point or selective analyzing methods may be used. A self-contained power supply enables high-range resistance measurements. The multiscale meter includes besides all other ranges, 6 for db. measurements. Many other special features make this an invaluable instrument for the P.A. engineer and theatre projectionist.

## Disc Recorder

THE DEMAND for fine quality has been met in this instrument. It was engineered to secure the maximum results on aluminum records up to 12 ins. Recording head is of 4-pole, double-coil construction, and has a magnet of cobalt steel. Turntable is lathe-turned and heat treated. Tension screws permit adjustment of the weight on the stylus.



Audio beat oscillator. (979)



Midget electrolytic condenser. (971)

## TINY ELECTROLYTICS (971)

(Sprague Products Co.)

THE SMALL size of these units is emphasized in the illustration. The unit shown has a capacity of 8 mf., and measures  $1\frac{1}{4} \times 1\frac{1}{4} \times 2\frac{1}{2}$  ins. long. Made in all popular sizes up to dual 8 mf. with separate leads for each section; working voltage 450 V.

## PORTABLE PHONO. AMPLIFIER (973)

(Aalloy Transformer Co.)

RECORDS up to and including 12 ins. may be played on this compact unit. The amplifier is an A.C.-D.C. type; phonograph motor is switch-controlled for universal-current operation. The pickup is so mounted that vibrations from the speaker and motor will not affect it. Six tubes are used: 2-6C5c, 2-25A6s, 2-25Z6s. The power output is about 3 W. The use of a double-button carbon microphone is possible by the simple addition of a small unit which will fit into the case.

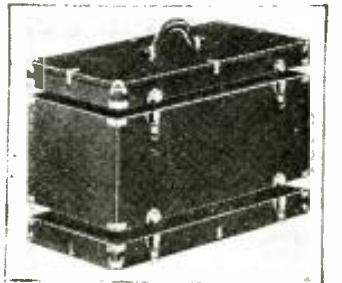

Amplifier carrying case. (980)

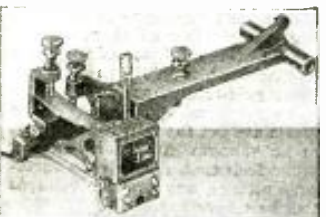

Above and below, recording units. (972)

## NEW SOUND RECORDING UNITS (972)

(Universal Microphone Co.)

### Floating Head

RECORDING may now be made on coated discs regardless of irregularities or rough surfaces on the disc. This "floating head" has

## NEW JAPANESE-STEEL PICKUP (974)

HERE is a pickup that may be used with both 33 1/3 and 78 r.p.m. equipment. The high-permeability (Japanese-steel) magnet is said to be  $2\frac{1}{2}$  times stronger than the so-called 36 per cent cobalt-steel type. Arm is  $11\frac{1}{4}$  ins. over all.

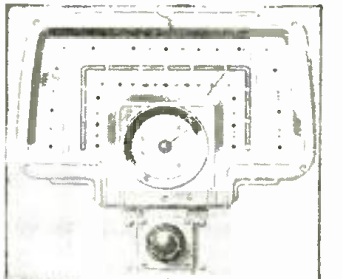

Above, a new style in dials. (981)



Portable electric phonograph. (973)

## GAS-ENGINE DRIVEN GENERATOR (975)

THE TWO units of this power plant are mounted on a steel base. Plant operates 3 1/2 hours on a quart

(Continued on page 702)

Below, a compact oscilloscope. (982)



Phonograph pickup. (974)

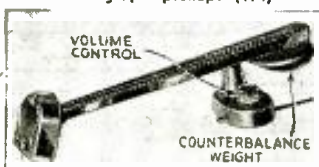

VOLUME CONTROL

COUNTERBALANCE WEIGHT



Gasoline-driven generator. (975)

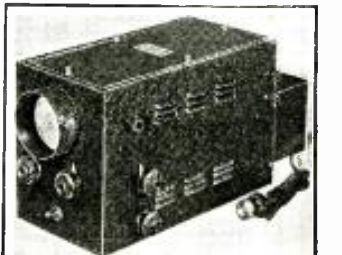

Name and address of any manufacturer will be sent on receipt of a self-addressed, stamped envelope. Kindly give (number) in above description of device.

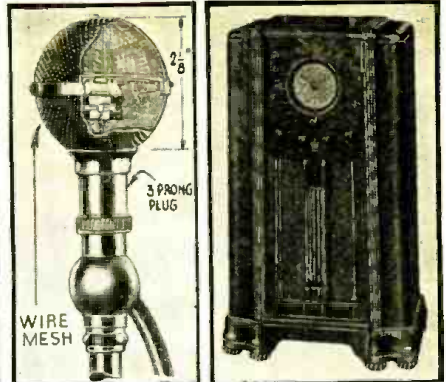
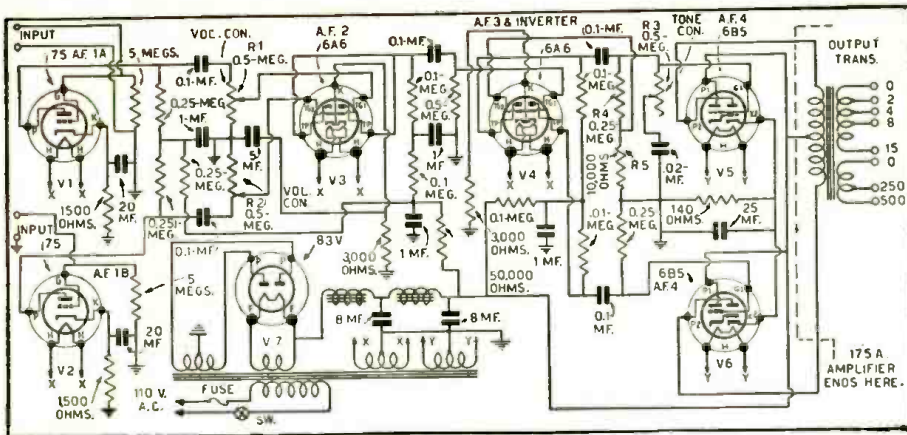

Above. "Cue ball." (993) Above. New set. (991)  
Left. A high-gain amplifier using 6B5s. (992)

### NOVEL "EXPANDER" SET (991)

ALTHOUGH the receiver containing this system (designated, by the manufacturer, as the "auto-expressionator") is described in a DATA SHEET on page 670, this portion of the circuit was deemed to (Continued on page 703)

### HIGH-GAIN, "6B5" AMPLIFIER (992)

(Wholesale Radio Service Co.) CRYSTAL and ribbon microphones in the general P.A. field require the use of compact amplifiers that will give their rated output on such low gain mikes without (Continued on page 703)

### "CUE-BALL" CRYSTAL MIKE (993)

(The Brush Development Co.) SPHERICAL microphones are the latest development; the black, or "B ball" (as engineers call it) having been introduced to our readers (Radio-Craft, Jan., 1936, (Continued on page 703)

### "LADDER" ATTENUATOR (994)

(Electrad, Inc.) GREATER attenuation, true logarithmic attenuation, and lower noise level, are provided by this new, compact unit, which is built on a new principle. The attenuation (Continued on page 703)

### 15-W. AMPLIFIER (995)

(General Transformer Corp.) THE OUTWARD appearance of a new 15-W. class AB amplifier is

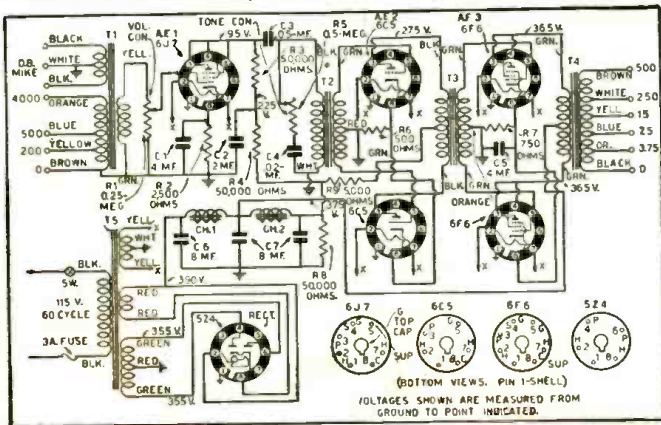

shown in the photo; its circuit is given. This unit uses a separate "C"-bias (Continued on page 703).

### 3-TUBE P.A. AMPLIFIER (996)

(Thor Radio Co.) PORTABILITY and utility are the main features of this inexpensive apparatus. A simple resistance-coupled circuit is used, with 3 tubes. 1-57 or 6C5, 1-2A5 or 42, and 1-80. (Continued on page 703)

### A "METER KIT" (997)

(Triplett Electrical Inst. Co.) ILLUSTRATED is a universal meter which may be made with this kit. All the parts are supplied except the case. There are 2 separate meters in one bakelite case; an A.C. (Continued on page 703)

### NEW PHONO.-RADIO SET (998)

(General Electric Co.) THIS 8-metal-tube radio and automatic phonograph combination embodies the latest in all-wave radio development and design, plus a perfected automatic record-changing (Continued on page 703)

### 30-W. SOUND SYSTEM (999)

(Allied Radio Corp.) A POWERFUL sound system suitable for use in large auditoriums and outdoor gatherings is shown. The amplifier unit is capable of (Continued on page 704)



Above and below. "Expander." (991)

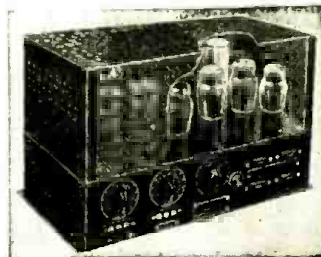
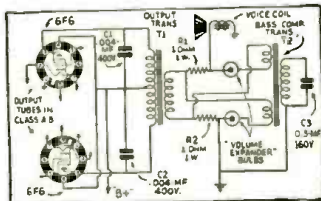

Above. High-gain amplifier. (992)

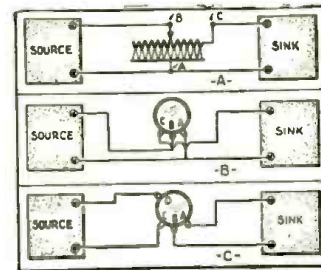

Above. Attenuator circuit. (994)

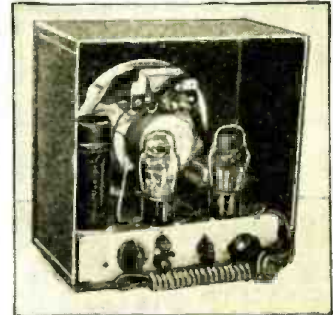

A compact 3-tube amplifier. (996)

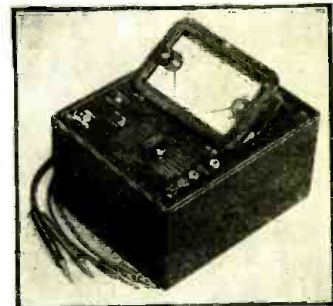

Test set made from a kit. (997)



Above. Phono-radio combination. (998)

Left. A 15-W. class AB amplifier which uses a fixed bias supply. (995)  
Below. A 30-W. amplifier with a view of the mikes supplied. (999)

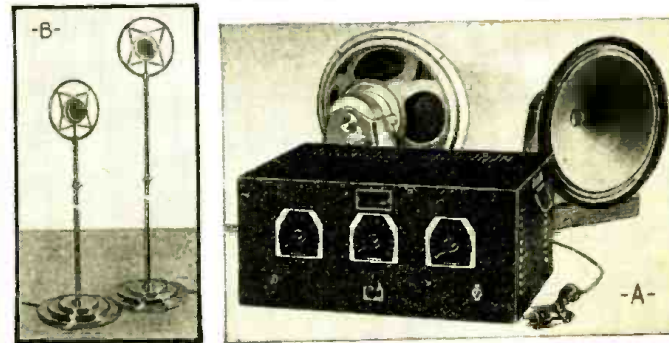

# READERS' DEPARTMENT

A department in which the reader may exchange thoughts and ideas with other readers of RADIO-CRAFT.

## ONE SOLUTION TO THE PRICE PROBLEM

Ontonagon, Mich.:

READ with great interest, the article published in the June 1935 issue of *Radio-Craft*, and written by Mr. C. Golenpaul blaming the Service Man for losing business by telling the customer what is wrong with his set, and I agree with him. But when he says not to show the customer your wholesale catalogue and protect your profits, that's different. Evidently Mr. Golenpaul does not know that of the hundreds of radio wholesale houses there are only a mere handful who will not send their catalogue to anyone who can write his name and address.

When a customer has his set checked over and asks what is wrong, and you tell him a bypass condenser and a resistor need replacing, he usually asks how much they cost. When told the job will be \$3.50, he wants to know how much the parts cost, and when you say the condenser is 35c and the resistor 25c he says "Why I can get them from such and such a company for 5 or 6c apiece, you're a robber." The same thing has happened to all of us, but here is my plan. We all know that the real job in servicing is finding the trouble and when found it is usually a matter of a few minutes or so to replace the offending part. So why should we give an estimate free? I don't. Also I never tell the customer what is wrong, unless it is some major defect, such as a power transformer or a field coil. And it is seldom I quote a list price on any parts other than tubes.

I hope you will find room to publish this in your wonderful magazine.

JACK WATT.

## NOISY A.F. TRANSFORMERS

South Haven, Mich.:

In your April issue is described a method for easily testing audio transformers and realizing how hard it is to find a noisy transformer, I discovered a method which works 100 per cent if care is used, so I will pass it on to others.

Take a screwdriver or piece of wire, and short the plate side of the suspected transformer to ground: this causes one of two things to happen, either the noise increases due to the increased plate current flowing through the winding or it may cease entirely, in which latter case the winding will probably be found open. If the noise continues the same with or without short, that particular winding is in good shape. If the noise ceases for a moment and then starts again, it is



usually because the heavy current has fused the ends of the break together slightly, after which they open again.

Very often such a noise as is made by a poor transformer winding will be found to be caused by a defective bias shunt condenser. This latter trouble is quite often found in the Sparton model 931, especially in the extra audio added to some of these old model Spartons.

OTTO I. KIRBY.

## ALL-WAVE SET I.F.

Galt, Ontario:

Regarding the circuit diagrams published in the Aug. 1935 issue of *Radio-Craft* on pages 100 and 101, I notice that the I.F. of the RCA-Victor model 281 is given as 175 kc., and the service note I have gives it as 460 kc.

Also I note that the Grunow 11A is listed as having a 262 kc. I.F. Please advise if this is correct as I have always understood that for use in supers of the all-wave type an I.F. of around 460 kc. was standard.

These 2 diagrams appeared on the above pages in the form of data sheets numbers 143 and 144.

E. J. KUJANIK.

The service note of Mr. Kujanik is correct in that the I.F. of the RCA-Victor model 281 is 460 kc.

However, a check-up reveals that the I.F. of the Grunow model 11A is 262 kc. as shown on the data sheet.

We apologize for the error in the first instance and wish to thank Mr. Kujanik for calling this to our attention. We hope other Service Men will note the correction.

## "DISTANCE GETTER FOR \$1"

Salt Lake City, Utah:

Enclosed is a circuit for the "Distance Getter For a Dollar" with many changes. It received 12 stations the first night. These stations were received on a common broadcast plug-in coil.

The advantage of this hook-up is that no "A" batteries are needed, and so it is much less expensive to operate.

You will notice that I do not use the plate, so no screen-grid voltage is needed, the screen being used as the conventional plate.

RADIO-CRAFT READER.

We do not know whether the circuit, as given, would be more sensitive, or whether it would work better with the plate and screen-grid tied together. However, here it is for the experimenters to play with.

At left:—Imagine a fire sweeping a mountain forest. A forest ranger from some high spot directs by radio the activities of many squads of men deployed over a wide area. The ability to talk to these scattered squads means the saving of hundreds of acres of trees and greatly increased safety of the men. Likewise in mine-rescue work, in fighting fires in large buildings, etc., seconds are precious. The new pack-type radio that is no larger than a soda-cracker box and weighs but 4 lbs. means the saving of these seconds. This tiny radio receiver uses a single tube and is equipped with batteries for several hours of continuous service. The range is several miles.

The circuit on the right shows the "Distance Getter for a Dollar" in its revamped form. Note that the plate of the tube is not used. The experimenter should try connecting the plate to the screen-grid. The set can be made all-wave by the use of plug-in coils.

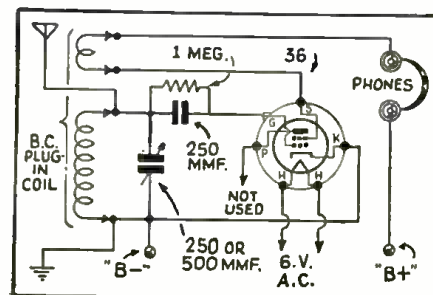

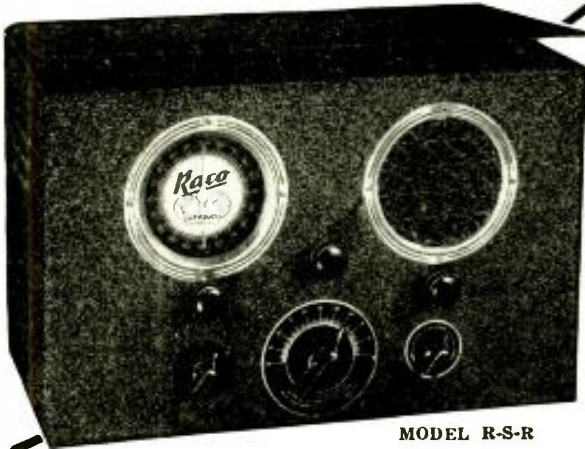

MODEL R-S-R

# HAYNES R·S·R·

5-TUBE RECEIVER

2 1/2 TO 555 METERS

REGENERATION PLUS SUPER-REGENERATION

Combined for the first time in a single receiver having the greatest tuning range ever incorporated in one set.

- ⊗ Self contained power supply.
- ⊗ Multi-band switching (no plug-in coils) down to 15 meters.
- ⊗ High efficiency plug-in coils below 15 meters with super-regeneration.
- ⊗ Electrical plus mechanical band-spread.
- ⊗ Dual regeneration control.
- ⊗ Hiss control on super-regeneration.
- ⊗ Perfect logging and absolute stability on super-regeneration.
- ⊗ Dynamic speaker and earphone reception.
- ⊗ Tubes used—2 6G6's, 1 6G5Z5, 1 6G4, and 1 76.

A. J. Haynes, who designed the first regenerative kit set (1922) and the first superheterodyne kit set (1924) chose RACO to build the final model of his new R-S-R receiver—another first AND DOES IT PERFECTLY!

The R-S-R is not only a remarkably fine DX receiver for all of the short wave and broadcast bands but it is the smoothest super-regenerator we have ever seen, giving exceptionally efficient reception on the 5 and 10 meter bands.

Come in and see us; operate the R-S-R yourself and look over our special U.H.F. equipment—transceivers, 5 meter M.O.P.A.'s, etc., all at direct laboratory built prices.

ORDER DIRECT FROM THIS AD

Complete R-S-R set; wired, tested, with 5 tubes, speaker, and cabinet. Ready to plug in and operate .....	<b>\$24.65</b>
Complete kit; unwired, including dynamic speaker, power supply and wired switch-coil assembly (less cabinet and tubes) ..	<b>\$14.95</b>

### One Tube (19 Tube) Transceiver



An inexpensive 1-tube 5 and 10 meter transceiver. This extremely efficient transceiver is recommended for the short-wave enthusiast who is interested in exploring the fascinating 5 and 10 meter bands.

This circuit utilizes the type 19 two volt twin tube, and is exceedingly sensitive since the super-regenerative principle is employed, when the receiving position is switched on. Batteries required are two 1 1/2 volt dry cells and 90 to 135 B supply. Complete kit with (2) 5-meter coils and dial, less batteries .....

**\$4.75**

- Cabinet, 75c. ● 10 meter coil, 50c ● Wiring, assembly, \$1.60. ● Tube, 65c.

### NEW! POWERFUL A. C. 3-TUBE TRANSCEIVER



Here is a 5 and 10 meter transceiver that is in a class by itself. Take it with you this Summer and plug it in anywhere that 110 V. A.C. is available. The way it punches through the Q.B.M. will surprise you. Uses 2 1/2" and an 80, 20 Watts input to plates on 5 meters. Operates direct from 110 volt A.C. power line. Separate regeneration and volume controls on reception; gives maximum sensitivity and minimizes receiver radiation. Smooth, stable super-regenerative reception operates either speaker or earphones. Self contained power supply using large 30 H. smoothing choke and two 8 mf. filter condensers. Works on both 5 and 10 meters with interchangeable plug-in coils.

Complete kit, less tubes and Cabinet **\$11.50**  
Wired and tested 33.50 extra. Cabinet \$1.50 Kit of 3 tubes \$1.60

### Portable Transceiver

Completely self contained unity coupled 5 meter transceiver using two 19 tubes and one 30. An unusually powerful, long range battery transceiver possessing excellent stability and good modulation. Push-pull 19 oscillator with two stage push-pull class B audio in both sending and receiving positions giving true 5 tube performance. Batteries used: 3-45 V.B and 2 No. 6 dry cells.



Complete **\$10.95**  
Kit **3.00**  
Assembled, wired **1.50**  
Cabinet **1.50**  
Matched tubes **1.65**

## RADIO CONSTRUCTORS LABS.



136 LIBERTY STREET  
DEPT. RCH NEW YORK CITY  
EXPORT DEPT.—105 HUDSON ST.

### INTERNATIONAL RADIO REVIEW

(Continued from page 650)

In Europe, the latter method has found much use, and according to a recent issue of *La T.S.F. pour Tous* (Paris) a new device for the purpose has just made its appearance. As shown in Fig. 2, it consists of a guide which is fastened to the side of the turntable and clips onto the centering pin of the phonograph. A worm gear carries an arm across the face of the record as it revolves. This arm holds the cutting needle guide and moves the latter uniformly across the record, thus cutting the groove in the smooth-faced disc.

### P.A. IN BERLIN "ADVERTISING PILLARS"!

A FORM of advertising which has gained some favor in Berlin is the use of columns or pillars in the busy sections of the city which are covered with small advertisements. These take the place, to some extent, of the billboards used in New York and other American cities. These advertising pillars have just been made much more effective by the addition of loud-speakers mounted on the top and automatic phonograph devices inside by means of which it is possible to add audible advertising to the signs pasted on the circumference.

### NEW INSULATION MATERIAL

A NEW form of insulation having advantages in low leakage and ease in moulding was announced by *Radio Industria* (Milan) recently. This material is useful for making coil forms, condenser insulation, trimmers and terminals of various types. A few samples of coils and trimmer condensers made of the material are shown in the photo, Fig. B. Note that the insulation is transparent and resembles glass!

### INCLINED Baffle MOUNTING

A NOVEL way to mount a dynamic speaker at the optimum incline for reproducing high frequencies (which are quite directional in their characteristic) was shown in an issue of *Practical and Amateur Wireless* (London), recently. See Fig. 3. In console cabinets which have a grille covering the entire front of the speaker compartment (so that cabinet resonance is not set up) the baffle of celotex or other material on which the speaker unit is mounted can be tilted back and supported on strips of live rubber.

### A WAVE-CHANGE SWITCH

A RECENT issue of *Radio-Vente* (Paris), showed a new type of switch for all-wave radio receivers, etc., which can be made in any desired number of circuits and positions by means of the correct contact discs and revolving

Please Say That You Saw It in RADIO-CRAFT

contactors which are mounted on the 3 metallic supports shown in the photo, Fig. C.

### ENGLISH PORTABLE P.A. UNIT

THE photo at Fig. D shows an English version of an 8-watt portable P.A. system which operates from the A.C. line.

This amplifier uses a heavy-duty permanent magnet dynamic speaker, in place of the electrodynamic type used in most P.A. amplifiers, and a piezoelectric microphone.

The unit may also be operated in a car by the addition of a rotary converter which can be obtained. This amplifier was described in *Wireless World* (London), recently.

### IMPROVING THE HIGH NOTES

A N interesting hint for increasing the high-frequency radiation of a radio set appeared in *Practical and Amateur Wireless* a short time ago.

This consists of adding a supplementary small free-edge cone to the regular dynamic reproducer. As shown in Fig. E, this is made in the form of a narrow frustrum, the smaller diameter of which matches the voice coil. It is cemented to the apex of the regular cone or to the end of the voice coil, depending on the mechanical construction of the speaker.

For those experimenters who wish to try this kink, we would suggest that flexible cement (known as "speaker cement") be used.

Send for Your Copy

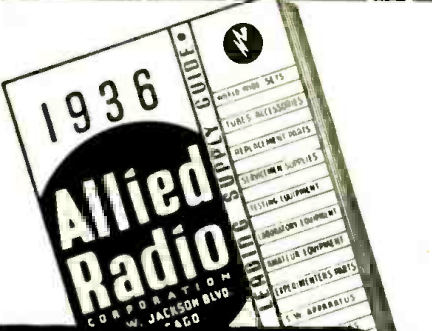

IT'S GREAT!  
**FREE**

FOR SERVICE MEN, DEALERS, AMATEURS, RADIO BUILDERS.

Everyone in Radio is talking about the new ALLIED catalog. It will pay you to send for your copy of the most complete Radio Supply Guide ever published. A full-sized 136 page catalog completely covering everything you need in radio equipment. The most complete, accurate and thorough Profit Guide available today—a real directory to radio progress. Packed with full-size sections on every field in radio. Up-to-the-minute on newest developments. Filled with outstanding values. This new book is Radio's Leading Supply Guide—geared to everything new in radio. It will still be up-to-date months from now.

**136 PAGES** All value-packed. Not a short-lived skimpy seasonal circular which constantly needs supplements and is soon discarded. Here is a solid 136 page luxuriously printed book. Covers everything in radio. Logically arranged for quick reference. Features big new sections in beautiful Rotogravure. Every page is loaded with outstanding new values.

**A Full Sized Catalog**

The new Spring and Summer ALLIED Catalog is full-sized in every way. Complete sections on every radio field. Offers you full-sized listings, full-sized values and fuller profits.

**NEW** The fullest, finest array of new, improved 1936 radio receivers. Modern in every detail. Models from 4 to 11 tubes housed in rich, artistic cabinets. Sets featuring the miraculous "Telev" visual tuner; perfected metal tube sets. De Luxe radio-phonograph combinations. Auto sets using all metal tubes. And for the rural areas—latest 6 volt battery sets. Also—exclusive—the startling new FarmPower units.

**NEW** An elaborate section on Public Address—page after page of new Sound developments. Mobile and portable systems of high versatility to meet every need. Amplifiers and complete P.A. systems ranging in size from 4 to 50 watts. Nothing has been overlooked. Your Sound problem can be solved easily, thoroughly, economically with ALLIED'S entirely new equipment. And Prices are excitingly low!

**NEW** Greatly enlarged Amateur section—a diversified selection of receivers and transmitters for every Ham need. Dozens of newest set-building kits for the experimenter and home-builder. Complete lines of standard, first class testing equipment for Servicemen and laboratory. Famous brands on every page. Thousands of replacement parts, gadgets, accessories. Tools, books, manuals. A truly endless directory to absolutely everything in radio.

**Allied Radio**

833 W. Jackson Blvd. Dept. D.  
Chicago, Ill.

Send me your FREE 1936 Spring & Summer Catalog.

Name .....  
Address .....  
City ..... State.....

**TECHNICIANS' DATA SERVICE**  
JOSEPH CALCATERRA DIRECTOR

A special arrangement between RADIO-CRAFT magazine and the publishers of this literature, which permits bulk mailings to interested RADIO-CRAFT readers, eliminates the trouble and expense of writing to each individual organization represented in this department.

2. **HAMMARLUND 1936 CATALOG.** Contains 12 pages of specifications, illustrations and prices on the new line of Hammarlund variable, mid-gect, band-spread and adjustable condensers; trimming and padding condensers; R.F. and I.F. transformers, coils and coil forms; sockets, shields, chokes and miscellaneous parts of ultra-short-wave, short-wave and broadcast operation.

3. **HOW TO GET A HAMMARLUND 1936 SHORT-WAVE MANUAL.** A circular containing a list of contents and description of the new 16-page Hammarlund Short-Wave Manual, which contains construction details, wiring diagrams, and list of parts of 12 of the most popular short-wave receivers of the year.

4. **THE "COMET PRO" SHORT-WAVE SUPERHETERODYNES.** Describes the outstanding features of the standard and crystal-type Hammarlund "Comet Pro" short-wave superheterodynes designed to meet the exacting demands of professional operators and advanced amateurs for a 15 to 250 meter code and phone receiver, but which can be adapted by anyone for laboratory, newspaper, police, airport and steamship use.

5. **ELECTRAD 1936 VOLUME CONTROL AND RESISTOR CATALOG.** Contains 12 pages of data on Electrad standard and replacement volume controls. Truvelt adjustable resistors, vitreous wire-wound fixed and adjustable resistors and voltage dividers, precision wire-wound non inductive resistors, center-tapped filament resistors, high-quality attenuators, power (50- and 150-watt) rheostats and other Electrad resistor specialties.

57. **RIBBON MICROPHONES AND HOW TO USE THEM.** Describes the principles and operating characteristics of the Amperite velocity microphones. Also gives a diagram of an excellent humless A.C. and battery-operated preamplifier.

59. **THE EVOLUTION OF TUBE TESTING.** This interesting booklet, published by the Supreme Instruments Corp., traces the development of tube testing equipment and gives a complete technical description, with wiring diagram and discussion of the technical points involved in the design and use of the Model 89 Supreme Radio Tester for testing all tubes, and also paper and electrolytic capacitors.

62. **SPRAYBERRY VOLTAGE TABLES.** A folder and sample pages giving details of a new 300-page book, containing 1,500 "Voltage Tables" covering receivers manufactured from 1927 to date, published by Frank L. Sprayberry to simplify radio servicing.

64. **SUPREME No. 385 AUTOMATIC TESTER.** A technical bulletin giving details, circuits and features covering this new Supreme development designed to simplify radio servicing. In addition to the popular features of Supreme analyzers and tube testers it contains many direct-reading features which eliminate guesswork or necessity of referring to charts or tables.

67. **PRACTICAL MECHANICS OF RADIO SERVICE.** Information, including cost, features and outline of lessons of the Frank L. Sprayberry course in Radio Servicing, and list of Sprayberry Data Sheets for modernizing old radio equipment.

73. **HOW TO ELIMINATE RADIO INTERFERENCE.** A handy folder which gives very complete information on how to determine and locate the sources of radio noise by means of the Sprague Interference Analyzer. A description of the analyzer and method of using it is included, together with data on how to eliminate interference of various kinds once the source is located.

74. **SPRAGUE 1936 ELECTROLYTIC AND PAPER CONDENSER CATALOG.** Gives specifications, with list and net prices on a complete line of wet and dry electrolytic, and paper condensers made by the Sprague Products Co. for radio Service Men, set builders, experimenters and engineers. Information on the Sprague Capacity Indicator, for making capacity tests on condensers and in servicing receivers, is included.

75. **SPRAGUE TEL-U-HOW CONDENSER GUIDE.** A valuable chart, compiled by the Sprague Products Co. which tells the proper types, capacity values and voltages of condensers required in the various circuits of radio receivers and amplifiers, and how to locate radio troubles due to defective condensers. Includes data on condenser calculations.

76. **FACTS YOU SHOULD KNOW ABOUT CONDENSERS.** A folder, prepared by the Sprague Products Co., which explains the importance of various characteristics of condensers, such as power-factor, leakage, capacity and voltage in determining the efficiency or suitability of a given condenser to provide maximum filtering and safety in operation.

Radio-Craft Technicians' Data Service  
99 Hudson Street,  
New York City, N. Y. RC-536

Please send to me, without charge or obligation, the catalog, booklets, etc. the numbers of which I have circled below.

2	3	4	5	57	59	62
64	67	73	74	75	76	

My radio connection is checked below:

- Service Man operating own business.
- Service Man for manufacturer.
- Service Man for jobber.
- Service Man for dealer.
- Service Man for servicing company.
- Dealer.
- Jobber.
- Experimenter.
- Professional Set Builder.
- Amateur Set Builder.
- Short Wave Work.
- Licensed Amateur.
- Station Operator.
- Radio Engineer.
- Laboratory Technician.
- Public Address Worker.
- Manufacturer's Executive.
- Student.

I am a:

Subscriber  Newsstand reader  
I buy approximately.....of radio material a month. (Please answer without exaggeration or not at all.)

Name .....

Address .....

City ..... State.....  
(Please print name and address)

Avoid delay. The catalogs and booklets listed are now in stock and will be sent promptly as long as the supply lasts. Please use this coupon in ordering. The use of a letter causes confusion and delay.

**THE RADIO MONTH IN REVIEW**

(Continued from page 647)

erected for the purpose. In Russia, installations are being made of 5 radio searchlights or beacons over the air lane between Moscow and Vladivostok. These are intended to aid fliers in fog and night flying.

Extensive plans are being made to broadcast daily from the liner Queen Mary during her maiden voyage to New York. A squad of technicians of the B.B.C. will install microphones at strategic points throughout the huge ship, from the engine room to the crew's nest, to convey impressions of the multifarious activities of passengers and crew.

A rumor was received that in order to finance the expensive television experiments in Paris, the French Post Office Department would accept publicity or advertising. The nature of the advertising was not mentioned.

Please Say That You Saw It in RADIO-CRAFT



## MAKING A BEGINNER'S 2-TUBE MIDGET ALL-WAVE SET

(Continued from page 651)

ometer which also contains a switch and a few small fixed resistors and condensers. Even the filtering system requires only a small resistor and two electrolytic condensers, both of the latter being incorporated within a very compact cartridge container.

Plug-in coils are used to cover the band from 17 to 560 meters.

The regeneration control and station selector control are mounted on the front chassis wall. A short length of flexible wire is provided at the rear for the antenna connection. The socket for the plug-in coils is mounted on the right-hand side by means of two small right-angle brackets. After these parts are secured in place, the set is well on its way to completion.

The other parts, such as grid leak and grid condensers, electrolytic condensers, filter resistor, etc., are soldered in place during the process of wiring.

### LIST OF PARTS

- One Hammarlund antenna trimmer, type IBT-70, C1;
- One Hammarlund variable tuning condenser, type SM140, C2;
- One Aerovox 100-mmf. mica grid condenser, C3;
- One Aerovox 500-mmf. mica condenser, C4;
- One Aerovox dual-section, cartridge-type electrolytic condenser, 8 mf. each section, C5, C6;
- One I.R.C. metallized resistor, 1 meg., 1/2-W., R1;
- One Electrad potentiometer, 75,000 ohms, with switch, type 202, R2;
- One I.R.C. metallized resistor, 10,000 ohms, 1/2-W., R3;
- One 350-ohm, 50-W. resistor in line cord, R4;
- One kit of 5 Hammarlund plug-in coils covering the wavelength range of 17 to 560 meters, L1;
- Two Sylvania Radiotron, Raytheon or National Union, type 6C5 metal tubes, V1, V2;
- One metal chassis, size 3 1/4 x 3 3/4 x 1 3/4 ins. high;
- Two brackets (for coil socket);
- One 4-prong socket (for coil L1);
- Two octal sockets (for the type 6C5 tubes);
- Two knobs;
- One roll of hook-up wire;
- Two phone connection posts, BP1 and BP2.

## HOW CONTROLLED SOUND AIDS A STUDENT

(Continued from page 653)

using 4 type 18 tubes and 1 type 80 tube, the amplifier delivers 15 W. of power with a quality that is amazing. The unit fits into a small portable case.

The use of decorated celotex baffles also adds a decorative touch to the "sound" programs. Coombs has found that they produce a certain psychological effect on the dancers when speakers are exposed. The photos, Figs. A, B and C, show how these baffles are decorated.

A demonstration of how speaker placement gives 3-dimensional effects when used in conjunction with either manual- or film-controlled sound is shown in Fig. C. Speakers in a theatre would be placed at such an angle that the sound waves would come to a focal point just beyond the last row of seats. This is illustrated by the 3 pieces of string in Fig. C.

## A MODERN SOUND TRUCK

(Continued from page 654)

control panel. In the rear of this unit is the exciter unit for the speakers and the automatic relay.

The phonograph is an automatic record changer (with dual speed—33 1/3 and 78 r.p.m.) for playing 10 and 12 in. recordings.

The amplifier (not shown in the picture but located below the record changer on the rack) is a 30 W. Lafayette class B auditorium model unit, consisting of a 57 pentode tube directly coupled to a 59 driver tube driving a pair of 59 tubes in class B, and a type 83 mercury-vapor rectifier tube which supplies the plate current for the tubes. The average gain is 83 db. and the maximum variation from 60 to 10,000 cycles is less than 4 db. It has a power output of 28 W., with a peak output of 32 W.

# UNIVERSAL RADIO SERVICING INSTRUMENT



### MODEL 1200 VOLT-OHM-MILLIAMMETER

Accuracy guaranteed within 2%

Reads D.C. 10-50-250-500-1000 volts at 2,000 Ohms per volt; 1-10-50-250 Milliampere; 1500 Ohms; 1.5 and 3 Megohms; A.C. 10-50-250-500-1000 volts.

### DEALER PRICE

**\$21<sup>67</sup>**

(Now in ALL-METAL Case)

**NO SERVICEMAN CAN PROPERLY BE WITHOUT THIS ONE INSTRUMENT**

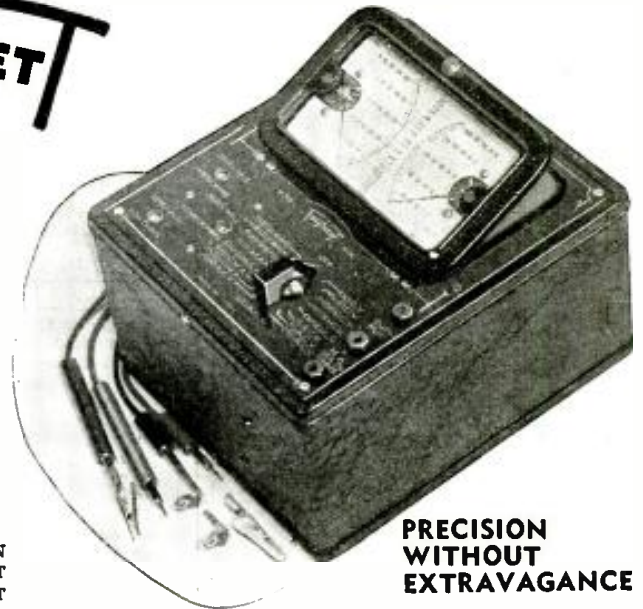

**PRECISION WITHOUT EXTRAVAGANCE**

### MODEL 1200 HAS THESE FEATURES:

- SEPARATE A.C. AND D.C. METERS
- TILTING FOR ACCURATE READING
- OHMS SCALES SEPARATELY ADJUSTED
- LOW LOSS SWITCH
- ALL METAL CASE

MODEL 1200 meets every need for measuring Volts A.C. and D.C., Milliampere A.C. and D.C. and Ohms. It is durable and compact and built in an ALL-METAL case.

This is one of the TRIPLET MASTER UNITS. Other units are:

- Model 1210-A Tube Tester Dealer Net \$20.00
- Model 1220-A Free Point Tester Dealer Net ..... 8.33
- Model 1231 All-Wave Signal Generator D.C. .... 26.67
- Model 1232 All-Wave Signal Generator A.C. .... 26.67
- Model 1204 Letherette Carrying Case with Demountable Cover .. 6.00

## TRIPLET MANUFACTURES

a complete line of all sizes and styles electrical measuring instruments for radio, electrical and general industrial purposes both standard and custom built. See them at your jobbers. If you have an electrical instrument problem write to TRIPLET.



TRIPLET ELECTRICAL INSTRUMENT CO.  
165 Harmon Drive, Bluffton, Ohio

Please send me more information on Model 1200  
 Model 1210-A  Model 1220-A  Model 1231   
 Model 1232  Model 1201  Please send new  
 1936 Catalogue

Name .....

Address .....

City ..... State .....

# WANTED 20,000 AUTHORIZED RADIO SERVICE MEN

Millions will be paid authorized service men this year for installing Winchargers, the wind-driven battery charger that enables farmers to operate their radios for 50c per year. Wincharger is new, beneficial and profitable to the service man. Each installation charge varies from \$5.00 to \$15.00, plus material. Tens of thousands of these units are already in use—more being installed every day. Get your share of this profitable business right now—write for your service manual today.

## WINCHARGER CORPORATION

MANUFACTURERS OF 32-VOLT EQUIPMENT SINCE 1927  
 2702 Hawkeye Drive Sioux City, Iowa



Please Say That You Saw It in RADIO-CRAFT

*I'll train YOU QUICKLY*  
for **Good FULL-TIME**  
and **SPARE-TIME Jobs in**  
**ELECTRICITY**



**Get Into a Big Pay Field for a Big Pay Future**  
*Train in your Spare Time*  
by PRACTICAL Shop Methods

**WITHOUT LEAVING HOME**  
Now, Electric Institute brings—**TO YOUR VERY DOOR**—practical training necessary for the rich rewards in Electricity. Keep your present job—no need to leave home—now you learn **ELECTRICITY** easily, practically—**RIGHT AT HOME**—in your spare time.

**Prepare for Jobs Leading to Salaries of \$30, \$40, \$50 a Week**

Get into a real money making field for a big pay future. There is no better way to succeed than to **TRAIN** for work in an industry that is expanding. New Electrical projects constantly mean more jobs for men with practical training. Almost every industry uses **TRAINED ELECTRICAL MEN**. Or you can own and operate an electrical business of your own.

**Opportunities to Earn Up to \$5, \$10 a Week or More While Training**

With this amazingly easy, fascinating method of **HOME SHOP TRAINING** it is possible to start **EARNING MONEY** almost at once. Do not confuse E. I. Training with dry, theoretical text book courses. Electric Institute tells you exactly **WHAT** to do—**THEN YOU DO** the **ACTUAL JOBS** with **ELECTRICAL EQUIPMENT** and **APPARATUS** which comes with your training at no extra cost.

Become a **TRAINED** man without leaving home or your present job—then be ready to step into a **REAL ELECTRICAL JOB**.

**Money Back If Not Satisfied**

You must be satisfied. I give you an agreement to return every cent you pay on tuition if, after completing my training, you are not satisfied in every way with my instruction, equipment or other services given you.

With my training, my graduates receive life time consultation service, employment service and many other features to help them succeed in Electricity.

Electric Institute is ready to show you the way in the great, growing field of **ELECTRICITY**—where trained men are **ALWAYS NEEDED**. Mail coupon **TODAY**—for big, free book of facts about this revolutionary **Practical Home Shop Training** and the tremendous opportunities in **ELECTRICITY**.

**DIESEL ELECTRIC POWER, RADIO and REFRIGERATION**

**FREE** Take advantage of the opportunities awaiting trained men in these and many other branches of Electricity, with **ELECTRIC INSTITUTE** practical training. Mail coupon for complete facts about **ELECTRIC INSTITUTE**—it may be the turning point in your life.

**RUSH THE COUPON—TODAY—BIG BOOK FREE**

H. W. Petersen, President  
Electric Institute, Inc., Dept. 156E.  
5840 Addison St., Chicago, Ill.

Send Free Book with all facts about E. I. Home Shop Training.

Name.....Age.....  
Address.....  
City.....State.....

**HOW DO WE HEAR?**

(Continued from page 649)

down into the back of the mouth. The purpose of this tube is to equalize the atmospheric pressure on both sides of the eardrum so that it will maintain a natural tension.

**THE "INNER EAR"**

The inner ear consists of a cavity or *labyrinth* surrounded by a solid bone wall. There are two distinct sets of organs in this inner ear; the first part is of a soft, membranous type, out of which project three "semi-circular canals" or tubes; these control the maintenance of equilibrium (balance) and take no part whatever in the mechanics of hearing.

The other part, sometimes referred to as the "bony labyrinth," is the *cochlea* (or snail-shell). It is in this organ that the vibratory energy of sound is finally expended in the process of conveying the impression of sound to the brain.

**CONVERTING SOUND WAVES INTO NERVE IMPULSES**

In order to fully understand how sound waves are converted into sound impressions in the brain, it is necessary to study this *cochlea* in detail.

This organ comprises three parallel canals (see Fig. 2.), namely: the *scala vestibula*, hereafter referred to as B; the *canal of cochlea* (A), and the *scala tympani* (C). This group of parallel canals is coiled approximately 2 3/4 times, assuming a shape similar to that of a snail's shell. (See Fig. 5A.) If you can picture three conically-shaped rubber tubes, all held firmly at the base and coiled 2 3/4 times into the shape of a pyramid, you will have a pretty good picture (Fig. 5B) of the *cochlea*.

The lower end of canal B is in close proximity to the oval window. The lower end of canal C terminates in the "round window" (which is another opening) between the inner ear and the middle ear, covered over by a flexible membrane. The *canal of cochlea* (A) is a "blind alley" between the other two, with no openings at either end. Canals B and C join each other at the apex through a hole known as the *helicotrema*.

The entire inner ear is filled with a fluid which is free to surge forward and backward from the oval window, up through canal B, through the *helicotrema*, down canal C, and finally to the round window with its flexible membrane. The fluid in canal A, the *canal of cochlea*, receives its vibratory motion through *Reissner's membrane* explained below. It is in this chamber—the *canal of cochlea*—that the actual wave motions of sound make "contact" with a complex maze of nerves, thus producing nerve impulses that result in the sensation of sound.

Canals A and B are separated throughout their entire length by a very thin flexible membrane (*Reissner's membrane*) which readily passes any sound wave; so that, from a dynamic point of view, these two canals may be considered as a single chamber. In further discussion we shall refer to this combination chamber as canal AB.

Canal AB then, is separated from canal C along its entire length by a fibrous elastic membrane known as the *basilar membrane*. On one side of this membrane (the side facing canal AB) is the complex organ of Corti, which contains the nerve terminals in the form of numerous sensitive structures known as "rods." It is estimated that there is a total of more than 24,000 such rods along the entire 31-millimeter (1.22 ins.) length of this *basilar membrane*.

At the end of each rod there is a hair cell, from which project into the liquid of the cochlea canal 12 to 15 *hairy cilia* (a hair-like fringe or process possessing vibratory movement). Lying loosely over these hair cells but in intimate contact with them and the rods, is another soft membrane known as the *tectorial membrane*. The details of this portion of the *cochlea* are made clearer in the greatly magnified cross-section of the two membranes illustrated in Fig. 3.

Now this *basilar membrane* is a wonderful accomplishment of nature; its elastic texture is of such a construction biologically, that different areas, from bottom to top, respond or vibrate at different frequencies.

A relatively large portion of the membrane, near the apex, responds to the lower frequencies of the audio spectrum. As we go down the membrane it gradually responds to the middle and higher frequencies until, at the very base, a very tiny portion responds to the extremely high audio frequencies.

However, the elasticity of the *basilar membrane* is not alone responsible for the differentiation of frequencies. In this function it is aided by the varying mass or weight of the liquid at various frequencies.

**HOW FREQUENCY RESPONSE IS ATTAINED**

Thus, for a low-frequency note, (about 20 or 30 cycles) the vibrations start at the bottom of canal AB and rise until they hit that portion of the membrane near the apex which is naturally resonant to that frequency. In effect, however, at this low note the entire column of liquid is moved up bodily; and therefore the mass of the liquid at the area of the membrane which is resonant to that note is relatively high. This explains very nicely why the low frequencies are "detected" at the upper end of the *basilar membrane*; since it requires comparatively great mass and low elasticity to create a low-frequency sound (witness the size of the cello and the low elasticity of its strings). The sensitive rods and hair cilia attached to that area would then send their "nervous discharges" to the brain at regular intervals depending upon the time and intensity of the note.

A 1,000-cycle note, on the other hand, would travel about half the distance up the canal before it reached a portion of the membrane with a natural period of 1,000 cycles. The mass of the column of liquid, which the 1,000-cycle note "pushes" ahead of it, is not so great nor is the area of the membrane which responds to this frequency so large; all of which, added together, gives us a suitable medium for the detection of a 1,000-cycle note. The rest is simple. The sensitive rods and hairy cilia, which are attached to the stimulated portion of the membrane, send "nervous discharges" at regular intervals (depending upon the time and intensity of the note) to the brain; there to give the impression of a 1,000-cycle sound. (The vibration of the membrane is communicated to the liquid in canal C and finally dissipated in the elasticity of the diaphragm stretched across the oval window.) Figure 4 illustrates diagrammatically, the characteristic frequency regions on the *basilar membrane*.

(Part II will conclude this description, with a complete synopsis of the mechanism of hearing. —Editor)

(The writer is indebted to Bell Telephone Labs. Inc., and to Western Electric Co., for courtesies extended in the preparation of this article.)

Fig. 5A, below, shows a cut-away view of the ear. Note how the sound waves, impinging on the eardrum, are transmitted by the three bones in the middle ear to the liquid of the inner ear. Fig. 5B shows, diagrammatically, the positions of the cochlea canals. It will be noticed that canals A and B are inter-connected, while canal C is closed at both ends.

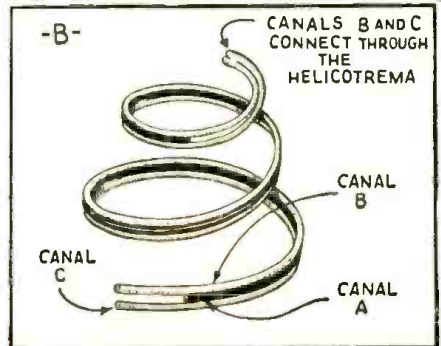
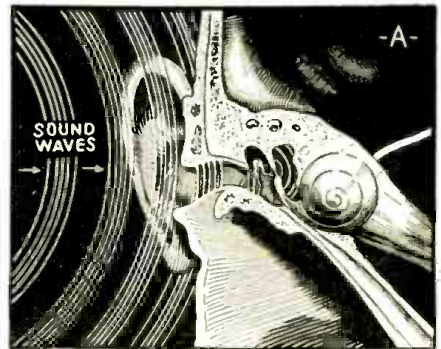

Please Say That You Saw It in RADIO-CRAFT

## HOW TO MERCHANDISE P.A. EQUIPMENT

(Continued from page 651)

a slump, or when a "business booster" is needed. The possibilities for the sale of P.A. equipment are becoming greater every day, and seem to be limited only by the imagination of the particular individual looking for prospective business. Not only are there plenty of prospects, but when you are trying to sell them sound equipment you are showing them how they can increase their revenue by one means or another. You are talking cold business facts to close your sale, which, believe me, is a big wedge as compared to selling a radio set or other luxury—usually, with a trade-in angle.

Now as to prospects; the old adage frequently used among advertising sales organizations that "the more you tell the more you sell," is equally applicable to P.A. sales.

The National Cash Register Co. at one of their sales meetings in Dayton, presented each one of their salesmen with a door knob and a membership card in the "Door Knob Pullers Club." The membership card in the club stated that the more door knobs pulled, the more sales over a period of time.

It also behooves the P.A. sales organization to get out on the street as much as possible, and to lose no opportunity to identify themselves with all that pertains to sound installations.

An interesting example in Green Bay, Wisconsin, recently came to our attention. An automobile dealer was suffering from an overdose of used cars. It was decided to put on a campaign directed toward disposal as quickly as possible of the merchandise that had proven so distressing in a financial way. A beauty contest was arranged. Through the medium of mobile P.A. equipment and the newspapers, this contest was brought to the attention of Mr. John Public.

In order to more effectively handle the crowds incidental to the show, a complete P.A. system was set up in the used-car lot where the contest was held. The results obtained—due to the completeness of the arrangements, and the use of a P.A. system large enough to adequately handle the crowds—were so gratifying to the dealer in question that he practically cleaned out his stock of used cars.

We have another field that is opening up, and one that has scarcely been scratched: that is, installation of hearing aids in theatres, churches (as illustrated) and other public places.

Rupert Hughes once submitted a statement that over 10 per cent of the people in the United States were afflicted in some degree or other with the handicap of impaired hearing; consequently, the sale of amplification equipment which will ameliorate this condition in even small measure, is not only remunerative, but constitutes a real public service, as well.

### CALL SYSTEMS

Another avenue of sales that has scarcely been opened is factory and warehouse call systems. For the progressive factory, the installation of the call system means greatly improved organization efficiency, and because of this, increased efficiency and more complete contact with the personnel—and therefore material reduction in the number of trunk lines necessary to conduct business.

In the early days of radio, the practice of building sets was indeed a large part of radio activity. With the improvement of tubes, consequent circuit complications and the general demand for better-performing equipment this practice has proven to be unsound economically and today it is seldom indulged in (except as more or less of a pastime—and an avocation is something to which no successful radio organization can devote any time).

This article has been prepared from data supplied by courtesy of The Webster Company.

## WHEN AND HOW TO USE THE VOLUME EXPANDER

(Continued from page 652)

remote cut-off (variable- $\mu$ ) control-grid (G1), of the 6L7. (Fig. 2). The signal volume level on the grid G1 is controlled by means of potentiometer R1. The same signal is also applied to the control-grid of the 6C5 triode amplifying tube at the same time, and at some point in the circuit before R1, thus making the signal level

on the control-grid of the 6C5 independent of the signal level on the control-grid (G1) of the 6L7. Potentiometer R2 then functions as the "expansion control" and should be placed at some point on the control panel where it can be readily adjusted.

The signal voltage developed due to amplification in the 6C5 is then rectified by the 6H6. This rectified voltage is fed to the sharp cut-off grid (G3) of the 6L7 by means of resistor R4 and condenser 31. Note that resistor R4 connects to the positive side of the rectifier output circuit.

As G3 is in the electron stream between G1 and the plate, any variation in the grid potential on G3 will affect the mutual conductance of the tube and will cause an increase or decrease in the voltage amplification, depending on the voltage supplied to G3. In normal operation, G3 is operated at a high negative bias (minus 10 V.) with the result that the mutual conductance of the tube is left at 50 micromhos. Under these conditions, the signal applied to G1, and with R2 cutting the 6C5 out of the circuit, there will be no rectified voltage appearing across the diode load of the 6H6, with the result that the normal negative 10 V. bias on G3 will be effective and the gain will be low—roughly:

$$\text{Voltage Gain} = \frac{G_m \times R_2}{1,000,000} = \frac{50 \times 100,000}{1,000,000} = 5$$

However, let the arm of the potentiometer R2 be advanced so that the signal is amplified by the 6C5 and rectified by the 6H6. Then a voltage will develop across the diode load that will buck the minus 10 V. bias applied to G3, thus reducing the effective negative bias voltage on G3 to minus 3 or 4 V. With this decrease in the negative bias, there will be an increase in the mutual conductance. Therefore, the voltage amplification of the stage (6L7) will increase.

$$\text{Voltage Gain} = \frac{G_m \times R_2}{1,000,000} = \frac{350 \times 100,000}{1,000,000} = 35$$

In practice, the increase in amplification will be nearly proportional to the voltage rectified by the diode.

It is recommended that (a) a 0 to 1 ma. milliammeter be included at the point marked "X" in the plate circuit of the 6L7 tube and (b) the initial bias on G3 be adjusted (by means of R3) for that particular tube, so that the plate current is approximately .15-ma.

Another important consideration is the amplitude of the voltage supplied to the input of the 6L7. It must be remembered that the 6L7 (G1) grid has a remote cut-off characteristic and if distortion is to be avoided, the maximum signal input should be kept as low as possible.

### "TIME CONSTANT" AND FIDELITY

Resistor R4 and condenser C not only serve as a coupling means between the positive point of the diode load resistor to the sharp cut-off grid of the 6L7 (G3), but also serve as a "time-constant control." It is found that speech is far from satisfactory if the time constant is too short, and if the time constant is too long, there will be an objectionable lag which should be avoided. For general purposes in speech and music, it is generally considered that a time constant of .25- to 0.5-second will be quite satisfactory. However, if it is desired to change the time constant, then R4 could consist of a 0.5-meg. resistor and a 1. meg. potentiometer connected in series and varied manually so that proper timing could be obtained between .25- and 1.5 seconds.

### CIRCUIT OF EXPANDER

In Fig. 3, is a complete circuit diagram of a modern phonograph amplifier, including volume expander, in a combination utilizing both metal and glass tubes, which is capable of delivering very high-quality output at volume levels that are more than satisfactory for home use.

The output of the 6L7 is resistance-capacity coupled to a triode-connected 6J7. This tube is transformer-coupled to a pair of 6B5s with the primary of the A. F. transformer (A.F.T.) parallel-fed. The plate load of the 6B5 should be 10,000 ohms plate-to-plate. This amplifier is capable of giving a power output of better than 15 W. with a very low percentage of over-all harmonic distortion.

As stated in the opening paragraph, volume expanders add new enjoyment to phonograph record reproduction. Why not try it for yourself and get a real thrill!

Please Say That You Saw It in RADIO-CRAFT

# SYLVANIA ANNOUNCES . .

## THE NEW TECHNICAL MANUAL!



**BIGGER . . . BETTER . . . MORE COMPLETE IN EVERY DETAIL. NO WIDE AWAKE RADIO MAN WILL WANT TO BE WITHOUT IT!**

● It's half again as big as the old one. A new index. New appendix. It's improved in a dozen different ways. Here are a few of the subjects covered by this valuable book:

1. A 50% increase in contents.
2. 141 tube types will be listed with important circuit application information given on each type.
3. Characteristics on all types will be the very latest. In other words, our book will be up to date including all the standard types of metal tubes.
4. A section on circuits has been increased to include 13 typical radio receiver and amplifier circuits which show proper use of the most popular types of tubes now being employed.
5. Curve data on ballast tubes for battery sets.
6. The convenient pocket size has been retained in spite of the large increase in material.

Send 15c for this new Technical Manual now! It will mean cash in your pocket.

Hygrade Sylvania Corporation, makers of Sylvania Radio Tubes and Hygrade Lamps. Factories at Emporium, Pa., Salem, Mass., and St. Mary's, Pa.

# SYLVANIA

Hygrade Sylvania Corporation Emporium, Pa.	RC-56
Please send me the new Sylvania Technical Manual. I enclose 15c in stamps.	
Name .....	
Address .....	
City .....	State .....

Here's **"BIG" News**



**THE NEW 1936 CENTRALAB VOLUME CONTROL GUIDE**

is off the press—more listings—way ahead—and up to the minute including 1935 data never before shown. All listings "checked and double checked" and will be found extremely accurate. Keep abreast with this new Guide—and keep abreast with CENTRALAB Volume Controls and Fixed Resistors for ALL replacement jobs. Get a FREE copy from your jobber.

**NEW! Up-to-the-minute!**



Every Radio Service Man should be a member of the Institute of Radio Service Men

**Centralab**  
MILWAUKEE WIS.  
RADIOHMS SUPPRESSORS  
FIXED RESISTORS  
WAVE CHANGE SWITCHES

## DECIBEL LEVEL VS. DECIBEL GAIN

(Continued from page 654)

### THE "ZERO LEVEL"

Sound and noise levels are usually expressed in decibels and not in watts, therefore, a reference level of zero decibels must be set. For convenience, engineers have arbitrarily taken the output of a common-battery telephone transmitter (when spoken into with a loud voice) as zero level. This equals 0.01-watt or 10 milliwatts. The output of a standard transmitter, used by telephone engineers is also 10 milliwatts. Thus in telephone work zero level has been set at 10 milliwatts, but in radio work it will be noticed that the articles in the past have always mentioned the reference level and is not universally standard. The tendency among radio engineers is to refer the system to a zero level of 0.006-watt or 6 milliwatts and throughout this article all levels will be with respect to 6 milliwatts. It is of very little importance whether the level is 10 or 6 milliwatts as long as one or the other is taken as standard!

By using 6 milliwatts as zero level, amplifiers may be rated at an energy level of a certain number of decibels. This is desirable because the ear responds to sound in a logarithmic manner. This can be illustrated by the following example. If an amplifier delivers 6 watts output it has a level of:

$$\text{db.} = 10 \log \frac{6}{0.006} \text{ or db.} = 10 \log 1,000 \text{ or db.} = 30.$$

Now, if the output is doubled, the ear will notice an increase in volume but not twice as great as the 6 watts output because the ear will respond as the increase in decibels and not as the increase in watts output. Thus,

$$\text{db.} = 10 \log \frac{12}{0.006} \text{ or db.} = 10 \log 2,000 \text{ or db.} = 33.0$$

The ear did not detect the increased volume in a direct ratio, but as the logarithm of the ratio. Therefore, if this zero reference level were not used, the amplifier control set at 30 db. gain would not give any indication of the volume of the output unless the input were known. With the control marked in decibels above zero level, the 30 db. setting would indicate an output of 12 watts.

A commercial amplifier rated at 26 watts output has an energy level, at full output, expressed in decibels equal to:

$$\text{db.} = 10 \log \frac{26}{0.006} \text{ or db.} = 10 \log 4,333 \text{ or db.} = 10 \times 3.64 \text{ or } 36.4 \text{ db.}$$

Now it is stated in the catalog that this amplifier has a gain of 96.4 db. Where do the extra 60 decibels come from? The answer to this question will become evident after the microphone output has been considered.

### ALLOWANCE FOR MIKE "LEVEL"

Different types of microphones have different energy output levels, but most commercial-type carbon-button microphones give an energy level of -50 to +80 db. When the speaker (source of sound) is near the mike, a good average is the -60 db. level. The mike, therefore, lowers the energy level that it receives and it is the function of the amplifier to raise the voice level from -60 db. back to zero level and still higher in order to have appreciable output at the loud-speaker. After the sound has passed through the mike, it is at a very low level and has very little energy. The actual power impressed on the amplifier input, after passing through the mike, can be found as follows: -60 = 10 log R; where R is the ratio of mike output to mike input, and here it is assumed that zero level is impressed upon the mike. 40.0000 = 100 = 10 log R or 4.0000 = 10 = log R or

$$R = 0.000001 = \frac{W_o}{0.006}. \text{ Therefore } W_o = 0.006\text{-micro-watt.}$$

Thus the input of zero level to the mike is lowered to -60 db. in passing through the mike and the power that the amplifier begins with is very small. The entire gain is therefore 96.4 db. as the amplifier ends up with a 36.4 db. level. In amplification work it is desirable to know what level above zero the amplifier will raise the sound of the speaker's voice, and, therefore, the maximum reading on the control should be 36.4 db. and not 96.4 db. A high-gain amplifier

when used with a very poor mike may give but little amplification. For example, suppose the mike had a loss of 76.4 db. This would leave a gain of 20 db. above zero. The output would be far below the rated 26 watts and would be equal to:

$$20 = 10 \log R \text{ or } 2.0000 = \log R \text{ or } R = 100 = \frac{W_o}{0.006}$$

or the output  $W_o$  equals 0.6-watt. After all, the decibel gain is not so important. It is the decibel level above zero that counts. It is well to point out here that there is a limit to the over-all gain that an amplifier may have, as explained in *Radio-Craft* July 1935, page 10.

The energy required to operate the amplifier is 90 watts, while the output is but 26 watts. The efficiency is therefore

$$\frac{26}{90} \times 100 = 28.8 \text{ per cent.}$$

This may be expressed in decibels as would be done if used in connection with telephone work.

$$\text{db.} = 10 \log \frac{26}{90} \text{ or db.} = 10 \log 0.288 \text{ or db.} = 10 \times (9.4594 - 10) \text{ or db.} = 94.594 - 100 \text{ or db.} = -5.4, \text{ which represents a loss.}$$

The accompanying, Table I lists the efficiency for certain decibel gains or losses. The table's use can be demonstrated by means of the following examples. It is well to point out that the table may be used for any value of decibel gain. Suppose the efficiency at 15 db. gain is to be found. Fifteen decibels equal 10 db. plus 5 db. but the resulting efficiency is the product of the efficiencies at 10 db. and 5 db. A 15 db. gain gives an efficiency of  $10 \times 3.16 = 31.6$  or 31.60 per cent.

### A DB. GAIN IN—DOLLARS!

Let us now use this 15 db. gain in a problem. A man starts out with \$2 and at the end of two weeks he has a 15 db. gain which is an efficiency of 3.160 per cent. Therefore, at the end of two weeks the man has \$63.20. The man's son also has a decibel gain of 15 at the end of two weeks but he started with 50 cents. His efficiency is also 3.160 per cent but instead of having \$63.20, like his father, the boy has only \$15.80. Again it is seen that the db. gain is not as important as the db. level above a certain reference point. Suppose the reference point chosen by the two is \$5.00, and this is zero db. level. The man at the end of 2 weeks, has a level of:

$$\text{db.} = 10 \log \frac{63.20}{5} \text{ or db.} = 10 \log 12.64 \text{ or } 10.0 \text{ db.}$$

The boy has a db. level of:

$$\text{db.} = 10 \log \frac{15.80}{5} \text{ or db.} = 10 \log 3.16 \text{ or } 5 \text{ db. level}$$

level which shall be called a 5 db. level. With the level above, as the reference point, it is at once evident that the father has more money than his son. Both still have the same gain, however. In this case the man began with a -5 db. level and finished with 10 db., a gain of 15. The boy began with a -10 db. level and ended with a 5 db. level which is also a 15 db. gain.

TABLE I

Per cent eff. for a db. gain	Number of Decibels	Per cent eff. for a db. loss
100	0	100
112	1/2	89.1
126	1	79.4
158	2	63.1
200	3	50.1
251	4	39.8
316	5	31.6
398	6	25.1
501	7	20.0
631	8	15.8
794	9	12.6
1,000	10	10.0
10,000	20	1.0
100,000	30	0.1
1,000,000	40	0.01
10,000,000	50	0.001

### FREE 20-PAGE WINCHARGER MANUAL

Due to the rapidly increasing interest in wind-driven generators for all types of service a detailed instruction book by the Wincharger Corp. has been prepared for radio dealers and Service Men. Ask for Publication No. 986.

## Consider First! The "SUPER-PRO"

### Amateur-Professional Receiver

THE finest receiver ever to bear the Hammarlund name—the receiver that outperforms all preceding standards of sensitivity, selectivity and tone.

Write Dept. RC-5 for Complete Details  
HAMMARLUND MANUFACTURING CO.,  
424-438 W. 33rd St., New York.



**P.A. Systems** **BELL SOUND SYSTEMS**

**FOR EVERY PURPOSE**

Refill Public Address Systems lead the "parade." They're more efficient—portable—simple to operate . . . and compared to their high quality are surprisingly economical. With outputs from 5 to 30 watts there's a model for every job.

You can "cash-in" on the growing demand for P. A. Equipment—on either sales or rentals—with Bell Systems. Start now to get your share of this business.

**WRITE TODAY for COMPLETE DETAILS**

**BELL SOUND SYSTEMS Inc.**  
61-62 East Goodale St.  
COLUMBUS, OHIO

Please Say That You Saw It in RADIO-CRAFT

## THE TREND OF PUBLIC ADDRESS

(Continued from page 648)

City. In this triumph of sound engineers, sound apparatus was used to reproduce pipe-organ music (originating in another part of the city, and transmitted to the Terminal by specially balanced lines).

Previous attempts to pump sufficient sound energy from an actual organ into the vast structure of the New York Central Railroad were quite unsuccessful, due to the peculiar acoustics of the building. The new installation overcame the acoustic difficulties by judicious placement of the reproducers. Organ tones are now heard with adequate volume and remarkable fidelity—even including the deep pedal notes down to 30 cycles.

Another and more practical use of super-power is illustrated on the cover of this issue of *Radio-Craft*. Here we see a lifesaver instructing a person outside the lifelines and apparently in difficulties, as to "what to do until the lifesaving boat arrives." Through the use of an ultra-high power P.A. amplifier and weatherproof, heavy-duty directional trumpet reproducer system he is able to overcome the din of breakers, etc., and cut through to the consciousness of panic-stricken individuals to make them realize that help is near.

There are a great many more possible uses for audio systems operating at power output levels far beyond our present average ranges, but time is required in which to develop them. There is, for instance, the "voice from the sky," or airplane P.A. One such system in use by England's Royal Air Force, for use in quelling riots, and for addressing native tribes, etc.

### HIGH-FIDELITY RECORDED SOUND

The newest "trick," that of using ultra-violet light instead of ordinary light, as described elsewhere in this issue has nearly doubled the frequency range that may be handled by sound film.

Finally, new circuits and means have been developed for restoring the volume level, which in recording must be made disproportionate across the frequency range, and which must be varied to allow for extremes of level during rendition by the original sound source (an orchestra, etc.). In general, these are known as "volume expanders," and make a "daylight and darkness" difference in the acoustical beauty of the reproduction.

"Wired audio" is one of the immediate outlets for such high-quality records of good music, etc., as described elsewhere in this issue of *Radio-Craft*. Clubs, hotels, restaurants and fine homes are in the market for equipment of this nature.

As an example, if a phonograph of the "automatic record changer" type is used it will be observed that not all those in the regular run of "electrically recorded" phonograph records can be used. For instance, not all records are similarly recorded as to volume level. Consequently, when the automatic record changer brings a new record into operation, the volume expander may cause the sound to be reproduced at far above normal volume—or far below, as the case may be—and thus require the services of an attendant to maintain normal volume.

One means for overcoming this condition would be to use some sort of "pilot track" on each record which would serve to start all records at a particular reference level.

A discussion of sound equipment and installations would be quite incomplete without mention of *mobile P.A.*—sound on wheels, in the air, etc.

Sound trucks are the P.A. man's attempt to "bring the mountain to Mohammed," and how successfully this can be accomplished is illustrated in the view here shown of the combined manufacturing-vending sound truck of an ice cream merchant.

Traveling from park to park in this fashion during the summer has enabled one ex-Service Man to beat hard times; in fact, he now employs 4 regular-salaried men operating daily and nightly!

### CONCLUSION

Appearance. Modern sound equipment is hardly to be compared in appearance with the apparatus of a few years ago. The "talk-back" equipment housing shown elsewhere in this

(Continued on page 684)

# These Splendid Books FREE!

Think of it! 2 books full of invaluable information, to be had for just the mailing costs! One with 20 complete transmitter designs including 12 tested transmitter RF section designs and 8 modulator and speech amplifier designs. Circuits, complete parts specifications, inductances, etc. all included.

Ten complete designs for public address amplifiers in the other book. It includes one for every purpose, from 3 Watts to 30 Watts output, with complete parts lists for each.

These books should be in every amateur's technical library. They are invaluable for reference purposes. Just 22 cents in stamps, to cover postage, brings them both to you, or get them from any Standard Distributor. Send for your copies today.

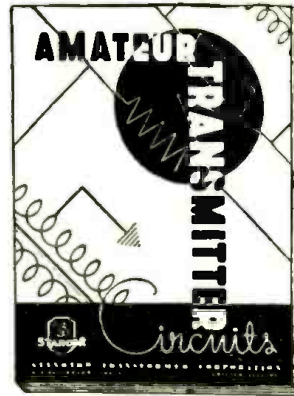

## STANDARD TRANSFORMER CORP.

856 Blackhawk Street,

Chicago, Illinois

### MAIL THIS COUPON!

STANDARD TRANSFORMER CORPORATION,  
Dept. C, 856 Blackhawk Street, Chicago, Ill.  
I am enclosing 12c for Transmitter Manual,  
I am enclosing 10c for Amplifier Manual.

Name .....

Address .....

City .....

State .....



## NEW EXPONENTIAL HORN

by OXFORD

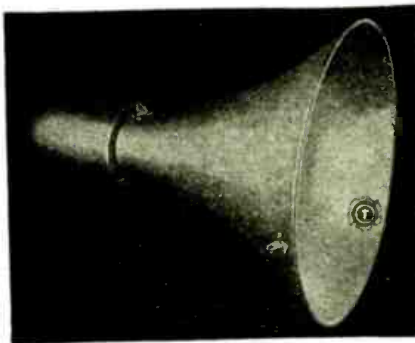

This is the dynamic horn you'll want for more than one P.A. job this season! Marvelous reproduction and projective power. Patented fabricated acoustic material. Waterproof and Weatherproof. Scientifically designed for use with electrodynamic cone type trumpet unit. Heavy cast supporting lugs. Back cover properly designed to give minimum of

ASK YOUR JOBBER  
or WRITE TODAY  
for BULLETIN 362M

back pressure. 23" bell diameter. 27 1/2" long. Weight 12 lbs. Attractive and serviceable silver finish. List price \$25.



## OXFORD-TARTAK RADIO CORP.

915 W. VAN BUREN ST.

CHICAGO, U. S. A.

### BUILD IT YOURSELF

Can be built by anyone, failure impossible. Total cost approximately \$385.00 for all materials. Our large sized blueprints and construction sheets make it a pleasure to build this smartly designed Trailer. Sleeps four—all conveniences beautifully appointed. Factory job would cost over \$1,000—build it yourself and save 75%. Plans sheet, completely illustrated and detailed for 25c stamps or coin.



The Trailer Plan Shop, 510-919 N. Michigan Ave., Chicago

### RADIOS..SAVE UP TO 50%



DEAL DIRECT. Factory Prices. Many models to select from: AC-DC, All wave, Farm, Car and new Metal Tube Models. Your name and address on postcard brings you NEW 16-page 1936 Bargain Catalog in colors FREE. Get details of 30-day TRIAL plan and Agent-User proposition. Goldentone Radio Co. Dept. 270 8780 Grand River, Detroit, Mich.



Please Say That You Saw It in RADIO-CRAFT

**WANTED** —Fully experienced Radio Service Expert. "Screw driver mechanics" need not apply. Must be fast, accurate and thoroughly familiar with all types of modern radio work. A real opportunity for the right man. State qualifications in detail. Box 101, c/o Bulletin.

## Could You Fill This Service Job?

Under improved business conditions, dozens of good-paying opportunities will soon be popping up in radio. Your future depends on whether or not you are qualified to grasp them. Will they go to other fellows—or will you MAKE them come to you!

Sprayberry Training is designed NOT for beginners but for men already in the service business who recognize the need for keeping up-to-date. It is for men who know that, to get better - than - average jobs, they have to be better - than - average workmen. It is sound, practical business and technical training—at a price within the reach of all. Investigate!



**"LET ME HELP YOU BUILD A REAL SUCCESS!"**

**F. L. SPRAYBERRY**, 2548 University Pl., N. W., Washington, D. C.

Without obligation, send me details on your advanced Service training.

Name .....  
 Street .....  
 City ..... Ra' 5/36

**SPRAYBERRY'S PRACTICAL MECHANICS OF RADIO SERVICE**

# POLITICS PAYS PROFITS

Sound trucks . . . portable P.A. systems . . . permanent P.A. installations . . . are all in greater demand this year because it is a presidential campaign year!

Political organizations of all parties are going to rent, or purchase outright, various types of public address equipment. Lafayette has prepared a special LIST PRICE catalog to help YOU sell P.A. equipment. And most important of all Lafayette engineers have spent months in the development of new, finer P.A. equipment. Send for your free copy of Lafayette's complete P.A. list price catalog No. 64. Get on the political bandwagon with Lafayette for profits in P.A.!

**LAFAYETTE RADIO MFG. CO., INC.**  
 100 SIXTH AVENUE ••• NEW YORK, N.Y.

Dept. LRC-56. Gentlemen:  
 Send me your P.A. Catalog No. 64

Name .....  
 Address .....  
 City ..... State .....

## THE TREND OF PUBLIC ADDRESS

(Continued from page 683)

issue for instance shows just what can be done to beautify such apparatus by giving it the modernistic touch.

The "Talk-Back" P.A. System. In conclusion the author wishes to call to the particular attention of sound specialists a development which bids fair to introduce a new technique in the installation, maintenance and service of sound systems. We refer to the new "talk-back" idea illustrated elsewhere in this issue, in connection with a commercially-available installation; and previously illustrated in the April issue of *Radio-Craft*, in discussing a new prison sound installation.

## A.C.-D.C. SOUND RECORDING AMPLIFIER DESIGN

(Continued from page 653)

although filter condensers may have one common lead.

Another departure from standard practice is the use of four 48 tubes in the output stage.

If 48s of the shielded cathode type are used, no extra precautions need to be taken to balance out hum, and no necessity exists for extra care in matching them.

A third important fact: Do not be afraid to use plenty of filter and isolating condensers. Because of the low voltage it is not possible to use high-resistance values in the isolation of the various stages. Therefore it is necessary to use large capacities, if high gain with low hum is to be achieved.

In the first stage of the amplifier (if a pentode-type tube is used, such as the 6J7) the isolating resistor should be from 40,000 to 75,000 ohms, while the condensers should be at least 16 mf. The second stage will depend a lot upon the type of tube used (the writer prefers 6F5s in both the 2nd and 3rd stages).

Now for the 4th stage (and contrary to a lot of beliefs) this stage may cause you as much trouble as the 1st stage. This is due first to the fact that the output of the 1st 3 stages may be so great as to overload the control-grid of this tube; 2nd, to the fact that coupling may take place between this stage and the 1st, 2nd or 3rd stage, causing degeneration at the higher frequencies. The writer encountered motor-boating in the amplifier, due to this coupling, where the beat note occurred about once every 1½ seconds. At this frequency it was not audible to the ear, but the moment a signal was applied it made "hash" of the signal. Therefore, the 4th stage was isolated with a 20,000-ohm resistor and a 10-mf. condenser. In the 5th stage, no isolation other than that furnished by push-pull tubes was used. This combination gave an output of 11.3 W. with an actual harmonic distortion of 8.7 per cent.

Using the ordinary way of rating the distortion content of amplifiers this would have showed less than 2 per cent distortion on this amplifier, however the check was made up to and including the 11th harmonic.

This article has been prepared from data supplied by courtesy of *Dencose, Inc.*

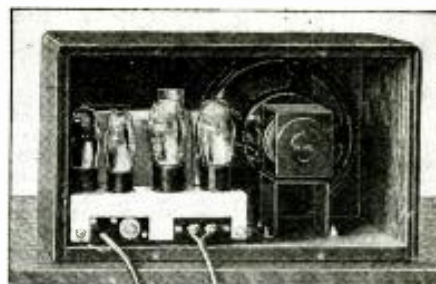

The rear view of the receiver unit.

## INTRODUCING "WIRED AUDIO" ENTERTAINMENT

(Continued from page 655)

wire services. As fast as they are received, they are sent out by the news announcers.

(2) On especially interesting news items, the news is dramatized by a trained cast which presents the story in such a vivid manner that listeners actually feel that they are hearing the actual event taking place.

Each of the 12 studios is equipped with a studio, control room, high-fidelity phonograph equipment, amplifiers, monitors, teletype and ticker news recorders, sound effects equipment and a complete staff of announcers, technicians and artists who take part in dramatizations.

The frequency range of the amplifiers as well as the telephone lines which distribute the programs are balanced flat from 50 to 5,000 cycles with a gradual tapering off to 8,000 cycles.

Since the entire system of program distribution is accomplished at audio frequencies, the receivers supplied to subscribers are quite simple, and consist merely of small cabinets in which are mounted A.F. amplifiers, speakers and volume controls.

The amplifier sections of these receivers operate on either A.C. or D.C. Four type 25Z5 tubes are used, two in parallel as rectifiers and two 43s in push-pull. The maximum signal strength is fixed so that it never exceeds 30 db. This is done because signals of greater strength would introduce cross-talk or interference from the telephone lines on which the programs are carried.

## PROGRAM DISTRIBUTION

To give some idea of the complexity of the distribution system required to send programs to all parts of a city, the block layout in Fig. 1 is given. This shows in detail the parts which make up the New York system. First, there is the studio with its preamplifier, microphones and other equipment, mentioned before. This is fed to the *Lackawanna* telephone exchange, where a special power amplifier for use only on this entertainment system is located. From this amplifier, the signals are distributed over balanced telephone lines to the subscribers, in that part of the City.

In addition, the output of the *Lackawanna* amplifier is fed onto telephone lines directly to the *Yonkers* and *Brooklyn* exchanges where additional amplifiers bring the sound level up to the required point for distribution to the subscribers in those sections of the city.

The circuit diagram of the complete amplifier showing hum treatment.

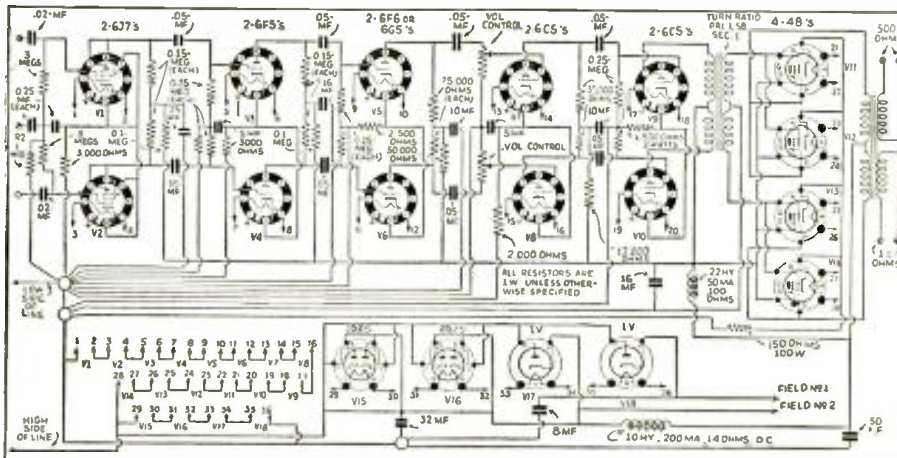

Please Say That You Saw It in RADIO-CRAFT

## NEW—HUM-FREE TRANSFORMERS AND CHOKES!

(Continued from page 659)

written about hum, very little thought or description has been given to methods of reducing or of restraining the troublesome magnetic interference at its very point of origin. Truly, successful recourse was often taken to building a separate power pack and placing it far from the rest of the A.F., I.F. or R.F. systems. But such procedure was not always very practicable and is hardly necessary, today.

### HUM FROM A FILTER CHOKE

Whenever inductive hum is encountered in an amplifier, the blame is often erroneously put solely upon the power transformer instead of on a filter choke, because the common conception is that the total strength of the magnetic field alone is the basis of comparison. The truth is that other factors are at times much more important.

Inductive hum is due mainly to the "leakage flux" which represents the magnetic lines produced by a filter choke, a power transformer, phono, motor, etc., which, instead of being concentrated completely within the unit under question is permitted to escape from it and to roam about, thus causing inductive interference. Thus the simple conclusion is reached that it is but necessary to "concentrate" or to reduce the total magnetic flux by means of one or more of the several methods outlined below, in order to minimize or to eliminate hum pick-up:

The main flux, simultaneously with the leakage flux, may be reduced simply by enlarging the core or by increasing the number of turns.

In Fig. 1, which may represent either a choke or a power transformer, although this construction is seldom used any more for power transformers, all the magnetic flux represented by dotted lines travels essentially through one relatively large area (A1), while in Fig. 2 only half the flux (magnetic lines) travels through the same area (A2). In the second case, there are two areas (A2 and A3) through which the total flux travels, but they are much smaller and more "concentrated." Therefore, a power transformer or filter choke will induce much less hum if the construction shown in Fig. 2 is employed than if Fig. 1 construction is used.

Another way of looking at it is this: The magnetic lines like electric currents or like the flow of water are always choosing the path of least resistance. Thus if any object such as an A.F. transformer or a casting is brought near the flux lines  $\Phi$  they will concentrate within that object as offering less resistance to their flow than air, as shown in Fig. 3B.

### HUM-FREE CONSTRUCTION

A filter choke, a power transformer, an A.F. choke, etc., can also be built in such a way that they have a negligible external radiating field. This is accomplished by splitting up the unit in two and mounting each half onto one leg of the core, as illustrated in Fig. 4.

Thus for every set of magnetic lines traveling in a certain direction produced by one of the coils there is a similar set of magnetic lines, generated by the other coil, traveling in the opposite direction. Thus the magnetic lines will balance each other out wherever they meet, and there will be absolutely no magnetic field set up along the plane S-S and in all other points the magnetic field is much smaller than if a stand-type (ordinary) power transformer or choke were employed.

It might be worthwhile to mention here that this type of dual coil construction lowers the D.C. resistance of a given inductance; in a choke coil this is very often a most desirable feature.

Figure 5 illustrates a construction that is still more effective as the leakage fluxes here have been still further reduced, besides having the advantages of the humbucking arrangement. However, this procedure is seldom employed as it proves too costly and the additional advantages are therefore not warranted.

Leakage flux can be further concentrated and kept within a short distance from the unit itself by placing it within a housing that offers a low reluctance (resistance to the magnetic lines) such as a high-permeability alloy casting. This type of casting is far more effective than

ordinary cast iron. Such a casting need not necessarily have more than 5 sides as the addition of a cover to form the 6th side adds very little to the total shielding effect of the castings and is relatively too expensive to warrant having dies made for this special bottom plate.

The best solution then will be a transformer or a choke, etc., having (a) the smallest mechanical dimensions, (b) the hum-hucking construction, (c) a core operated at a low flux density, and (d) a housing of high-permeability cast alloy.

This article has been prepared from data supplied by courtesy of Alloy Transformer Co., Inc.

## HOW TO MAKE YOUR OWN TRANSFORMERS AND CHOKES

(Continued from page 638)

a low value. (In the case of the transformer specifications given in Fig. 1 the resistance of the total secondary is only about 300 ohms.)

This grid current has a tendency to drive the driver tube (plate voltage, either up or down) if the latter hasn't enough driving power by itself or if the step-down ratio from the driving tube to the output tubes is not large enough. The greater the step-down ratio and the greater the undistorted output power of the driver tube, the greater the maximum undistorted output that may be obtained from the output tubes. Thus in the case of one 53 tube as a class B output stage, from 8 to 13 W. may be obtained from it with the same maximum harmonic distortion, by using different driver tubes.

It should also be noted that when D.C. flows through the primary winding, the transformer core should be assembled in such fashion that a small air-gap is provided, as the D.C. might easily saturate the core and thus produce harmonic distortion. Table II gives some of the recommended transformer step-down ratios for various applications.

As you see from the specification diagram, Fig. 1, the transformer is made up of 2 separate coils. This construction results in an identical resistance, capacity and inductance in each grid circuit, and by reducing the distributed capacity thereby the losses at the higher frequencies are automatically decreased.

### OUTPUT TRANSFORMERS

The primary consideration in the design of class A prime (or AB) and class B output transformers is the insulation between winding, winding and core, etc. If the load is accidentally disconnected from the secondary winding of the output transformer such high voltages may be induced at full-load that breakdown might occur between the output leads, between the windings, between the windings and core, or, if the transformer is well insulated, there might be arcing between the tube terminals (resulting in the breakdown of the tube socket or of the tube itself).

Naturally, the transformer should not only handle the output power without overheating, but also without appreciable losses. This again makes it necessary to use the heaviest possible wire in all windings. As pointed out above under "Power Supply," any resistance introduced into the plate circuit of the output tubes will cause a decrease in the maximum available undistorted output. Thus the D.C. resistance and the total primary winding in the output transformer should also be kept as low as possible and should not be more than about 300 ohms in the case of 246s or two type 59 tubes in class B. Table III gives full specifications for an output transformer employing 2-6A6s in the output stage of a 20-W. output class B amplifier.

TABLE III

CLASS B OUTPUT TRANSFORMER
Plate-to-Plate Load Impedance: 5,000 ohms
Core: 1 1/2 x 1 1/2 ins.
Window: 1 11/16 x 9/16-in.
Primary: 2 windings side-by-side, 1,300 turns (each) No. 32 enameled.
Secondary: 500-ohm winding: 865 turns No. 27 enameled.

Please Say That You Saw It in RADIO-CRAFT

## Again..MIDWEST STARTLES THE RADIO WORLD

with a Marvelous New

# 14-TUBE

FIVE WAVE BAND  
WORLD-WIDE RADIO

\$49.50

with New Auditorium-Type SPEAKER (1500-7000)

30 DAYS FREE TRIAL



TERMS AS LOW AS 15¢ A DAY

Buy Direct from MIDWEST Laboratories..SAVE UP TO 50%



EVERYWHERE, radio enthusiasts are praising this amazingly beautiful, bigger, better, more powerful, super selective 14-tube 5-band radio. Out-performs \$150 to \$200 radios on a side-by-side test—and will thrill you with its glorious Acousti-Tone, crystal-clear "concert" realism—and magnificent foreign reception. Never before so much radio for so little money! Before you buy any radio, write for the FREE 40-page 1936 catalog.

**50 Advanced 1936 Features**

Scores of marvelous features, many of them exclusive, explain Midwest super performance and thrilling world-wide reception...and prove why nationally known orchestra leaders like Ted Weems, Fred Waring, etc., use Midwest in preference to more costly makes. This advanced 5-band set enables you to switch instantly from American programs to Canadian, police, amateur, airplane and ship broadcasts—to the finest and most fascinating programs from Europe, Asia, Africa, Australia, and South America.

**DEAL DIRECT WITH LABORATORIES**

No middleman's profits to pay—you buy at wholesale price direct from laboratories...saving 30% to 50%. Increasing costs mean higher prices soon. Take advantage of Midwest's sensational values. As little as \$5.00 down puts a Midwest in your home on 30 days free trial. You are triply protected with Foreign Reception Guarantee, Parts Guarantee, Money-Back Guarantee!

**MAIL COUPON TODAY for**

Free 30-DAY TRIAL OFFER and 40-PAGE FOUR-COLOR Free CATALOG

MIDWEST RADIO CORPORATION  
Dept. 12M, Cincinnati, Ohio

Without obligation on my part, send me your new FREE catalog and complete details of your liberal 30-day FREE trial offer. This is NOT an order.

Name \_\_\_\_\_  
Address \_\_\_\_\_  
Town \_\_\_\_\_ State \_\_\_\_\_

Check  if interested in a Midwest All-Wave Battery Radio

User-Agents Make Easy Extra Money Check Here for details.

In the Electrad Volume Control—  
the shoe is in direct friction contact  
with the carbon resistance element

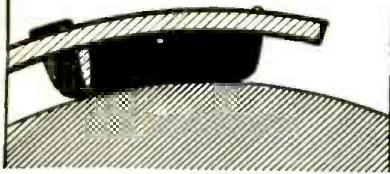

### Not FRICTION-LESS but FRICTION-RIGHT

The resistance element of the Electrad Carbon Volume Control is permanently baked to the outer rim of a warp and wobble proof bakelite ring. On this element the contact shoe moves in direct friction contact.

This contact provides a smooth stepless graduation of volume, with no gaps to cause stuttering or noise. It is mechanically smooth and electrically quiet, self-cleaning and self-polishing. The more an Electrad Volume Control is used the quieter it gets! Try an Electrad on your next replacement job. Every Electrad Volume Control is noise tested at the factory and fully guaranteed. Write Dept. RC5 for catalog.



Quiet Carbon Volume Controls. Vitreous Resistors. Truvalt Resistors. Power Rheostats.

## WRIGHT-DECOSTER Port-A-Case



Model 1440

Port-A-Case complete with large Model 790—10" Wright-DeCoster Speaker—

For only \$14.40 list

Our low prices for the different model Port-A-Cases, complete with speakers, enables users of Wright-DeCoster Reproducers to obtain this handsome, strongly built Port-A-Case at a price far below what a much inferior Case would cost.

There is plenty of room in the Port-A-Case for a small Wright-DeCoster field supply and any medium sized amplifier.

Write for catalog giving full description and our astonishing prices for the Port-A-Case Complete with the different 12" Speakers.

Buy through Wright-DeCoster distributors. They are always anxious to cooperate.

### WRIGHT-DECOSTER Inc.

2251 University Ave., St. Paul, Minn.  
Export Dept.—M. Simons & Son Co., New York  
Cable Address: "Simontree"  
Canadian Office, Wright-DeCoster, Inc., Guelph, Ont.

## NEW TUBE DEVELOPMENTS

(Continued from page 659)

It is interesting to note that the 6R7 is available also in the metal-glass type of construction and is then known as the 6R7MG.

**Type 1F4.** This tube is a power-output pentode of the glass variety designed for battery (air cell) or rural receivers. This tube has a high power sensitivity and will deliver considerable power output (when the low filament and plate current consumption are considered).

This tube ordinarily is resistance-coupled to the previous tube in the receiver and is operated as a class A amplifier. It can, however, be transformer-coupled to a suitable driver, thus permitting additional power output, in class B, or A prime operation. It can be used either single-ended or in push-pull circuits.

#### Type 1F4—Characteristics

Filament Voltage	2.0 V.
Filament Current	0.12-A.
Plate Voltage	135 V.
Screen-grid Voltage	135 V.
Control-grid Voltage	-4.5 V.*
Plate Current	8.0 ma.
Screen-grid Current	2.6 ma.
Plate Resistance	0.2-meg.
Mutual Conductance	1,700 mmhos.
Amplification Factor	340
Load Impedance	16,000 ohms
Power Output	340 milliwatts**
Distortion	5 per cent

\*Grid-return to negative filament.

\*\*With 3.5 V. r.m.s. signal on grid.

**Type 1A4.** This tube, also, is designed for sets using dry-cell or air-cell filament supplies. It is a variable-mu R.F. tetrode with characteristics somewhat similar (though greatly improved) to the type 34. However, the amplification factor is considerably higher and the size of the envelope is smaller which makes it a much more desirable tube for rural and portable sets.

#### Type 1A4—Characteristics

Filament Voltage (D.C.)	2.0 V.
Filament Current	0.06-A.
Plate Voltage	180 max. V.
Screen-grid Voltage	67.5 max. V.
Control-grid Voltage	-3 min. V.
Plate Current	2.3 ma.
Screen-grid Current	(Approx.) 0.7 ma.
Plate Resistance	0.96-meg.
Amplification Factor	720
Mutual Conductance	750 mmhos.
Mutual Conductance (At -15 V. bias)	15 mmhos.
Grid-Plate Capacity (With shield-can)	0.007-(max.) mmf.
Input Capacity	4.6 mmf.
Output Capacity	11 mmf.
Overall Length	4-9/32 to 4-17/32 ins.
Maximum Diameter	1 9/16 ins.
Bulb	ST-12
Cap	Small Metal
Base	Small 4-Pin

**Type 1B4.** This tube is a companion to the 1A4 just described. It is a screen-grid (normal cut-off) tube designed for detector or R.F. circuits. Its characteristics are similar to the type 32 tube, though it is smaller in size and the interelectrode capacity is somewhat lower than the 32. Use the 1B4 in all-wave sets.

#### Type 1B4—Characteristics

Filament Voltage (D.C.)	2.0 V.
Filament Current	0.06-A.
Plate Voltage	180 max. V.
Screen-grid Voltage	67.5 max. V.
Control-grid Voltage	-3 V.
Plate Current	1.7 ma.
Screen-grid Current	(Approx.) 0.4 ma.
Plate Resistance	1.2 meg.
Amplification Factor	780
Mutual Conductance	650 mmhos.
Grid-Plate Capacity (With shield-can)	0.007-(max.) mmf.
Input Capacity	4.6 mmf.
Output Capacity	11 mmf.
Overall Length	4-9/32 to 4-17/32 ins.
Maximum Diameter	1 9/16 ins.
Bulb	ST-12
Cap	Small Metal
Base	Small 4-Pin

## ORSMA MEMBERS' FORUM

(Continued from page 661)

will agree that this is a very large order.

We believe that the situation in Mr. Welch's town can be improved by having the legitimate and qualified Service Men form an organization or join an existing one, and, by means of advertisement in the local papers, can place themselves before the public and convince the latter that only the members of the organization are well qualified to service their receivers. Of course, other Service Men could join the association upon taking and passing a test which would prove their knowledge. Such organizations have been formed in other communities, both small and large, and if properly handled, will greatly improve the service situation.

Thanks for your kind compliments concerning *Radio-Craft*.

### HOME WORK?

RADIO-CRAFT, ORSMA Dept.:

Regarding Mr. Al Holtz's letter in the January, 1936, issue of *Radio-Craft*, I am absolutely in favor of the policies he advocates.

It is not often that I would give an estimate of the probable service charges in the home of a customer. In my opinion they are unfair.

Recently I was called to service an old Pierce-Airo A.C. 171 receiver. In my shop I gave it a thorough check, and found the following troubles: an open output transformer, an open input transformer, a bad power tube, an open R.F., 450-ohm resistor, and a shorted electrolytic condenser, and an interstage transformer "shot." How any Service Man can determine these faults, and make an accurate estimate in a short time is beyond my reasoning!

WILLIAM C. SANTORA,  
Jersey City, N. J.

This question has come up many times, but we believe it is of sufficient interest and importance to the Service Man to publish another letter on the same subject.

## OPERATING NOTES

(Continued from page 663)

**RCA R-7.** The set will lose its volume and the circuit will oscillate. The trouble is usually found in the 14,300-ohm resistor between high-voltage and screen grids. This resistor will often get as low as 5,000 ohms, causing high voltage on the screen-grids, and the 8,000-ohm resistor between the screen-grids and cathodes increases resistance. Renew these resistors and clean the springs on the condenser rotor, rebalance the set and it works like new.

WILCOX RADIO SERVICE

**Apex Model 8 Superheterodyne.** Distortion was found to be caused by type 27 second-detector tube, although this was not all. The volume was found to be below normal if the volume control was turned on full. This would cause a rumbling sound similar to motor-boating. The 8 mf. electrolytic condenser across the output of the filter had apparently dropped in capacity. Replacement effected a complete cure.

**RCA Model 66 Superheterodyne.** This was a case where everything tested OK but still the set would not play! After all voltages and resistance tests were made the oscillator was put to use, and here I found that my signal could not get through the second-detector.

This circuit has a 7,000-ohm resistor connected in parallel with the primary coil and for this reason the fault could not be found with an analyzer, the trouble being an open primary coil.

This was found after taking the coil out and shield off and testing the coil and resistor separately.

**Crosley 40.** Here is one that was found by close questioning of the owner; the trouble: "distortion" after a few minutes' operation. After questioning the owner, I found that a type 45 tube had burned out and she had placed another tube in the socket but instead of a type 45 it was an 80. Before she realized her mistake, the owner smelled smoke coming from the set. That was when the above trouble started. The 750-ohm resistor on the resistor strip was found burned completely off the wire and hanging between the two terminals. This wire would heat up, expand, and short against the chassis, causing little or no bias on the 45s.

EGIE M. NORKUS

Please Say That You Saw It in RADIO-CRAFT



## HOME-MADE MICROPHONES VELOCITY MIKE

(Continued from page 660)

microphone, once adjusted, is never touched, and hence will withstand whatever ordinary usage a microphone is expected to stand.

### HOW TO MAKE THE RIBBON

Concerning the ribbon, much has been said in other articles of a more technical nature—that it must be very thin, that it must be properly hardened, etc. I have used the ribbon-material manufactured expressly for the velocity microphone and have not been satisfied with the result. After much comparing and testing, I have determined that for excellent results one cannot do better than to use tinfoil of the kind that is brittle and thin. It can be obtained from cigarette-packing in the small boxes. Care should be taken in smoothing it out; avoid wrinkling or putting cuts in it through creasing. Determine the maximum permissible width of your ribbon, allowing about 1/16-in. clearance between the pole-pieces; use a stiff piece of cardboard for a straight-edge and cut the foil with a keen safety-razor blade. The result should be a ribbon not over 1/4-in. wide, and about 6 ins. long—allowing for the succeeding steps of crimping and fitting. To obtain the necessary corrugations in the ribbon, which makes the device non-resonant, run the ribbon in a straight line through a small pair of gear-wheels (Meccano gears will do nicely).

Use small brass screws with brass battery-terminals over the ends for fastening the ribbon in the air gap. This is a job that requires patience, as the ribbon is quite fragile. Fasten one end first, then, with a pair of tweezers, draw the other end to the anchoring screw-hole and fasten it firmly. There should be very little tension on the ribbon when in place. It should move freely when you blow on it gently.

Mount the completed mike in a case, such as the one shown. In the openings at the front and back of the microphone-case, use only copper screen, and place one or two layers of cotton mesh between each screen and the case.

### MATCHING TRANSFORMER

A line transformer, from the mike to the pre-amplifier, is best, when it is desired to get the maximum transfer of energy. Get any good-quality core from an A.F. transformer (the better ones have thin laminations) and wind 60 turns of No. 22 enameled wire for the primary, tapping at 30, 40, 50 and 60 turns. For the secondary, wind 390 turns of No. 30 enameled wire. When your mike is assembled, test for best response and volume using the different taps to the ribbon side of the mike. Generally, one will give decidedly better results than any of the others, thus indicating a close match of the primary-to-ribbon impedances.

For this matching unit from the input (ribbon) to the preamplifier, I have used a regular double-button mike transformer, connecting the entire primary to the line.

Use ordinary shielded antenna lead-in wire for the line from the mike to the preamplifier. One connection goes to the center wire, and the other connection, being grounded, connects the primary and secondary of the ribbon-to-line transformer, and the primary and secondary of the input transformer; hence use the sheath.

I have used this mike in a P.A. system at an exposed dance pavilion, for an entire summer. In this same location it was impossible to make use of a condenser mike due to excessive feedback.

The position of the ribbon is shown.

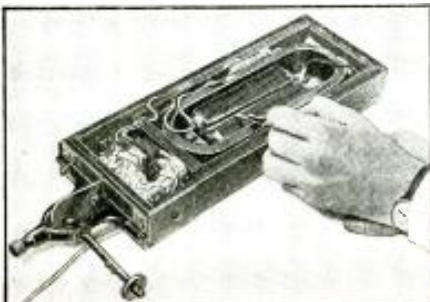



MR. E. H. RIETZKE      President, CREI

## TO SERVICE MECHANICS . . .

### Who want to become *SERVICE ENGINEERS!*

New 48-Page  
Illustrated  
Booklet

FREE!

Right now—WRITE NOW for this interesting catalog that fully pictures and describes our courses, school, faculty and equipment. Yours for the asking.

Actually it is not a case of "wanting" to become an engineer . . . it is a necessity! Rapid changes in receivers and equipment make it urgent for you to train yourself. Are you capable of testing, servicing and adjusting the latest receivers with all their modern refinements? Very few are . . . and men who lack training are eliminating themselves by failing to keep pace with radio!

"SERVICE AND PUBLIC ADDRESS ENGINEERING"

A new home-study course for experienced servicemen. Practical right from the beginning and priced within the reach of all. This course teaches theory plus the principles of design, so that the trained serviceman does better work in less time and earns more. It costs you nothing but a stamp to hear our complete story.

## CAPITOL RADIO ENGINEERING INSTITUTE

14th and Park Road, N. W., Dept. RC-5, Washington, D. C.



## PORTABLE, EFFICIENT, HI-GAIN, HI-FIDELITY PUBLIC ADDRESS SYSTEMS AND RECORDING and REPRODUCING EQUIPMENT

Sole and Exclusive Licensees

UNDER U. S. LETTERS PATENT NOS. 1,421,045—1,444,960  
CANADIAN NO. 232,922

for  
ALUMINUM RECORDING DISCS



1650 BROADWAY, NEW YORK, N. Y.

*"If it pertains to sound—see DENCOSE"*

## THOR'S "BABY GRAND" AMPLIFIER

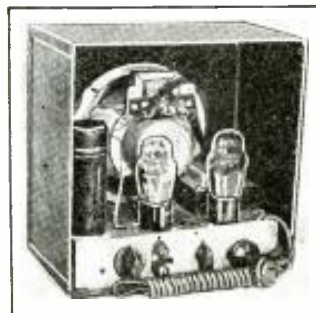

The gain of this unit is over 70 dB, with excellent frequency response. May be fed directly by any high impedance pickups, or by a carbon microphone in conjunction with a microphone transformer and battery.

This inexpensive amplifier has excellent performance! A simple resistance coupled circuit is used, employing 3 tubes 1-57 (1) 2A5 and 1-80. With built-in tone control. Excellent frequency response from tuner, pickup, or mike. An ideal unit for inter-office communication work and home record or radio reception. All apparatus housed in a steel case 10x10x5 deep, with black crackle enamel finish. Complete with Raytheon tubes **\$10.95** and dynamic speaker. . . . .

Order direct from this ad.

MAIL ORDERS PROMPTLY FILLED



Also available in AC-DC using **\$11.95**  
(1) 43 (1) 2525 and 6C6, complete.

167 GREENWICH ST.

NEW YORK, N. Y.

Please Say That You Saw It in RADIO-CRAFT

## BRUSH Spherical Microphone

For remote pickup, "P. A.," commercial interstation and amateur use. Low in price... but built to Brush's traditionally high mechanical and electrical standards. Wide frequency response. Non-directional. No diaphragms. No distortion from close speaking. Trouble-free operation. No button current and no input transformer to cause hum. Beautifully finished in dull chromium. Size only 2½ inches in diameter. Weight 5 oz. Output level minus 66 D.B. Locking type plug and socket connector for either suspension or stand mounting at no extra cost. Full details, Data Sheet No. 13. Free. Send for one.



## BRUSH Lapel Microphone



For after dinner and convention speakers, lectures, etc. Gives great mobility. The smallest, lightest microphone on the market. Size 1½ x 1¼ x ¾. Weight with coat attachment less than 1 oz. Special internal construction and rubber jacketed outer case insure quiet operation. No interference from breathing noises, etc. Typical Brush sound cell response and trouble-free operation. Details on request.



**YESSIR! THE NEW JR SERIES! "FITS THE BILL!"**

After more than a year of continuous tests in the laboratory, C-D engineers, release the Type JR series of electrolytics, as a fitting member of the Cornell-Dubilier family of hi-formation **ELECTROLYTICS, PAPER, MICA, and DYKANOL** condensers.

Their exceptionally compact and sturdy construction, convenient soldering leads, and stable electrical characteristics makes them ideal for small AC-DC midjet service work. Complete capacity range in 200 and 450 volts ratings.

Available at all C-D distributors. Don't forget to write for your copy of Catalog 128 on the complete Cornell-Dubilier line of capacitors.

**CORNELL-DUBILIER CORPORATION**  
4347 BRONX BOULEVARD  
NEW YORK

## CENTRALIZED P.A. FOR HOSPITALS

(Continued from page 662)

might listen to one of 3 programs. One source was planned as a recorded program with announcements originating in the office of the hospital. The remaining two would consist of the CBS and the NBC programs. All three would terminate in outlets conveniently located near the patients' beds. Each line was to accommodate 100 headphones.

In order to supply the 3 individual lines, it was necessary to have 3 individual main amplifiers of sufficient power output to operate the required number of headphones. Figure 1 illustrates the arrangement of these amplifiers. A volume indicator is also provided which can be switched to any one of 3 lines to indicate the level of that line during operation.

Now let us consider the equipment which must be worked into the 3 amplifiers. This equipment consists of a condenser microphone with preamplifier, a dual turntable for recorded programs, and 2 radio sets—one for the Columbia program and one for the National program.

### THE CONTROL PANEL

To properly control the source of signal an adequate control panel was essential whereby the individual sources could be mixed and distributed to their respective main amplifiers. Again referring to Fig. 1, the dotted line surrounds the controls which are to be mounted in the mixing panel.

There are 4 variable T-pad attenuators in this panel, P1, P2, P3, and P4, controlling respectively the output of the condenser microphone preamplifier, the dual turntable installation, the Columbia program and the National program. Attenuators P1 and P2 are connected as a 2-channel mixer, balanced to ground. Each channel has a terminal impedance of 200 ohms and since they are connected in series, the total impedance is 400 ohms. The output of this 2-channel mixer is fed into the primary of the transformer in main amplifier No. 1. Now, in order to correctly match the impedance of the 2-channel mixers the input transformer of amplifier No. 1 should have an impedance value of 400 ohms. Such a value, however, is not standard and for that reason a 500-ohm transformer is selected.

To centralize the control operations, attenuators P3 and P4 are also located in the mixing panel. These attenuators are fed from the 200-ohm secondary of a transformer which is provided in each of the radio sets. The radio sets themselves have no further A.F. amplification beyond the detector. This tube connects to an output transformer having a secondary impedance value of 200 ohms.

The fader, F, for the 2 pickups has been purposely disregarded up to the present moment. This fader has no place in the mixing panel and is usually placed adjacent to the dual turntable for convenient operation as the program is faded from one record to another. In the present case this is a 200-ohm fader which matches the pickup. This is fed into a transformer of 200 ohms input to 200 ohms output, thus providing the proper isolation of the pickups themselves which must be adequately grounded from the 2-channel mixer which is balanced to ground.

### TERMINATING THE LINES

With the input system arrangement completed, the arrangement and termination of lines 1, 2, and 3 must be considered. The general specifications for the installation required provision for 100 outlets adjacent to the patients' beds. From the individual outlets it must be possible for the listener to select any one of the 3 programs. Figure 2 illustrates the manner in which this is accomplished.

Each of the 3 lines terminates at a wall outlet plate in a circuit-closing jack. Resistors R1, R2, and R3 are connected to the jacks so that when the receiver plug is removed from any one of the 3 jacks, the resistor acts as a dummy load and maintains constant impedance upon the line. These resistors, R1, R2, and R3, are 2,000 ohms in value and need not exceed a rating of 1 W.

The headphones supplied to the listener are pairs having an impedance value of 2,000 ohms. (For an installation such as that under present consideration it is most convenient for the listener to use a pair of headphones rather than

the single instrument.) The volume control for each pair of headphones is a small unit located in the cord between the plug and the headphone and has a resistance value of 5,000 ohms. (During operation, then, the resistance of an individual line may vary, due to operation of an individual volume control, between 5,000 ohms (headphones out of circuit) to about 1,400 ohms (headphones in circuit and shunted by 5,000 ohms).—Editor

In final consideration of the entire installation, we come to main amplifiers 1, 2, and 3. These amplifiers should be of good quality with a gain of at least 60 db. and an output of 15 to 20 W.

This article has been prepared from data supplied by courtesy of Centralab.

(At the heading of this article is shown an illustration of a new development referred to by the manufacturer as a "program sound system." We will gladly forward inquiries.

One feature of the system is that it provides "talk-back" facilities. Sound not only may be sent out for reproduction over distant loudspeakers but the same loudspeakers may in turn be used as microphones for picking up sound which is transmitted back to the central point!

In the modernistic cabinet—which establishes new standards for appearance in P.A. equipment—are centered all controls, the flexible switching arrangements, a multi-wave radio receiver, a 2-speed electric phonograph, high-fidelity amplifying equipment, and a combination loudspeaker and microphone device capable of either individual or multiple operation.

This program sound system is especially suitable not only for hospital installations [doctors may be paged, radio programs and recorded selections may be sent to wards, etc.], but also for schools, hotels, department stores, factories and large office organizations.—Editor

## HOME-MADE MICROPHONES CONDENSER MIKE

(Continued from page 660)

After this, ream the holes in the front-cover until they will take size 6-32 machine screws. Tap to size 6-32, corresponding holes in the rear flange. Tap the carbon cup to take a 6-32 machine screw, replace the cup in its proper place, and tighten the set-screw.

The next move is to obtain a steel washer, 1 in. in dia., by 1/16-in. thick. Countersink the center hole and tap it for a 6-32 flathead machine screw, 1¼ ins. long. Mark off the resulting plate evenly, and drill 20 or 25 1/32-in. holes through it, as shown at upper-left, Fig. B.

Polish this "back plate" by using fine sandpaper, or emery dust and oil on glass. Important—use a circular motion in order to keep the plate as flat as possible. Thread this backplate into the carbon cup (previously threaded for this purpose).

Next, enlarge the 8 holes in the diaphragm and gaskets sufficiently to pass the 6-32 machine screws. Then, replace the tension ring (for stretching the diaphragm) that fits on the 6 screws in the back chamber; and the gaskets, diaphragm, and front-cover. Draw up the screws evenly.

### A CRITICAL ADJUSTMENT

You are now ready to make the necessary adjustments. First, tighten the 6 screws that stretch the diaphragm. Next, adjust the backplate by turning the 1¼ in. machine screw that was placed on this plate and threaded through the carbon cup. This stage of the adjustment is critical, as the space between the diaphragm and the backplate should be .005-in. When this distance is attained (as indicated by maximum sensitivity and tone quality), a 6-32 lock nut may be run up on the set-screw in order to make the adjustment permanent.

As a final touch, you may replace the 3 screws that held the back-cover and handle, or you may fill the holes; this will make an appreciable difference in the quality of the "head" (microphone). Whichever method is applied will depend upon the construction of your head amplifier (preamplifier).

If the head amplifier is a cylinder, you will wish to use the back-cover for mounting and appearance. If it is constructed in box-like form (as a good many are) you will not need the back-cover on the head, as, ordinarily; space is at a premium. In either case, the 3 holes should be filled.

Please Say That You Saw It in RADIO-CRAFT

# Moto-tool

only \$9<sup>85</sup>

for Shop... Home... School... Profession

The D.E. Moto-tool grinds, drills, engraves, sharpens, routs, carves, sands, cleans, polishes and does hundreds of jobs quicker, better and with greater precision. Handles easily as a pencil—weighs 6 oz. Powerful and sturdy as similar tools twice as heavy. 110% univ. motor—about 29,000 R.P.M.—oilless, self-lubricating & ball-thrust bearings. Handy built-in switch. Easily replaceable brushes. Universal collet chuck. Efficient cooling system. Shock-proof bakelite housing. You must see and use it to appreciate its tremendous value.

## 10 Day TRIAL

Money refunded if not more than satisfied. Write TODAY for free illustrated 16-page booklet.

**DREMEL MFG. CO.**  
455 Ct. Racine, Wis.



# This New 1936 Model Genuine SOUTH BEND LATHE

No down payment—3 years to pay. Write for details on this 9 x 3 ft. Workshop Precision, back-gear, gear-cutting Lathe. Made in 8 different drives, bed lengths, 88 practical attachments. Catalog Free!

**\$75<sup>00</sup>**  
LESS MOTOR DRIVE

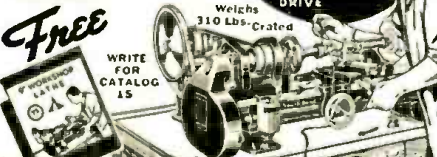

**SOUTH BEND LATHE WORKS**  
366 E. MADISON ST. SOUTH BEND, IND. U.S.A.

# SEND FOR THIS FREE CATALOG

Check full of BARGAINS in RADIO SETS, Long and Short Wave Apparatus, Servicemen's Repair and Replacement Parts, Electrical Appliances and hundreds of Miscellaneous Specials at TREMENDOUS SAVINGS. Get this big new Bargain Book. It's absolutely FREE without obligation—just send us your name and address on a post card.  
**RADIO CIRCULAR CO., INC.**  
915 Broadway, Dept. R. C., New York, N. Y.

QUALITY recommends

# Condensers

by **SOLAR**

WET... DRY  
PAPER  
MICA... TRIMMER

Please Write for Details  
**SOLAR MFG. CORP.**  
599-601 Broadway  
New York City

**NEW!** THE LARGEST AND FINEST CATALOG OF THEATRE SOUND AND PUBLIC ADDRESS EQUIPMENT EVER ISSUED!

**FREE ON REQUEST**

Hundreds of new items, valuable charts, data, etc., amazing money-making BARGAINS TO SELL!

**S. O. S. CORP.** 1600 B'way, N. Y. C. cable "SoSound"

# PUBLIC ADDRESS

Write for Complete Catalogue

**INTER-WORLD TRADE CORP.** 315 5th Ave., N. Y. C.

# THE DESIGN OF MODERN TEST EQUIPMENT

(Continued from page 662)

the sensitivity of the meter between measurements of A.C. and D.C. values, so as to provide for this ratio between root mean square and average values. In the circuit under discussion, the correction is effected by means of a series and of a parallel condenser, which together have the effect of reducing the total impedance of the circuits for measuring A.C. values, so that more current is permitted to pass through the meter movement than is the case when using the circuit for D.C. measurements.

In this connection it may be well to state that the ratio of 1 : 1.11 may be modified by the electrical characteristics of the rectifier unit or of other circuit elements. It might also be well to mention that the condenser which is used in place of the 4,700-ohm resistor and also the parallel condensers will vary somewhat according to the rectifier used and the frequency of the applied A.C., but will approximate the values shown in Table I, and should be individually matched for greatest accuracy.

TABLE I

A.C. Freq.	C1	C2	C3	C4	C5	C6
	Mf.	Mf.	Mf.	Mf.	Mf.	Mf.
60 cycles	0.73	0.077	0.0285	0.0185	0.008	0.0025
50 cycles	0.9	0.067	0.0215	0.014	0.0014	0.002
40 cycles	1.3	0.08	0.0271	0.022	0.0103	0.002
25 cycles	1.85	0.14	0.04	0.0335	0.0175	0.0065

## "CURRENT DENSITY" CHARACTERISTICS

The "current density" characteristic of instrument rectifiers is another matter which must be taken into consideration in the design of a universal test circuit. This characteristic manifests itself in the form of an increase in the rectifier resistance with a decrease in the electrical load. This accounts for the departure from a linear scale in the usual rectifier type A.C. meter. The current density characteristic may be better understood by a tabulation of resistance values corresponding to current values, based on a typical rectifier unit which has an internal resistance value of 500 ohms, with a load of 1 ma., as shown in Table II.

TABLE II

Ma.	Ohms	Ma.	Ohms
1.0	500	0.5	760
0.9	530	0.5	870
0.8	560	0.3	1,030
0.7	620	0.2	1,300
0.6	685	0.1	2,000

The effect of the current density characteristic is reduced, however, by the usual multiplier resistors as used in A.C. voltmeters of the rectifier type. For example, a rectifier having the above-tabulated resistance values, when used with a multiplier resistor for a 5-V. measuring range with a meter such as that described herein, would require a total circuit resistance of 4,500 ohms, this value being obtained by dividing 5,000 by the form factor of 1.11. At half-scale meter needle deflection, the total resistance of the circuit will increase about 260 ohms, as indicated in the above-mentioned table, so that the increase in the total resistance of the circuit is about 5.8 per cent. as contrasted with an increase of about 52 per cent if the meter was used without a multiplier for measuring a current value corresponding to half-scale deflection.

In the design of the circuit under discussion, it was found advantageous to minimize the effect of the current-density characteristic of the instrument rectifier by utilizing a series condenser (C1) for the low range as a multiplier reactance instead of utilizing a multiplier resistor. This arrangement constitutes an impedance circuit wherein the potential developed across the capacitive reactance is 90 deg. out of phase with the potential developed across the meter and rectifier resistance, so that the impedance elements may be represented by a right-angled triangle in which the resistance of the circuit is represented by a short leg of the triangle and the capacitive reactance by a long leg; the resulting impedance is, of course, represented by the hypotenuse of the triangle. This condition is graphically represented in Fig. 1E in which the resistance is shown as a value of 800 ohms, obtained by adding the resistance of the meter to the resistance of the rectifier unit with

(Continued on page 690)

# Learn RADIO from REAL RADIO ENGINEERS!



Mendall Clough  
Chief Engineer,  
Clough-Brenko Co.

E. E. Gramer  
Chief Engineer,  
Standard Tr. of T. Co.

Karl E. Hassel  
Chief Engineer,  
Zenith Radio Corp.

H. C. Fittle  
Chief Radio Engr'n,  
Grunow Radio

F. D. Whitten  
Service Mgr., Philco  
Radio & Telev. Corp.

Dr. C. M. Blackburn  
Radio Engineer  
P. R. Mallory & Co.

Train Now at Home for Good Pay Spare-Time and Full-Time Jobs that Pay Up to

# \$75 a Week

If you're dissatisfied with small pay—and an uncertain future—here's an opportunity that's too good to miss. Get my big FREE book, "RADIO'S FUTURE AND YOURS." This book tells how you can learn at home under the supervision of factory engineers, to make more money almost at once in Radio—how to make Radio your life's work, or use it to pick up \$5 to \$20 a week extra in your spare time.

## MORE OPPORTUNITIES THAN EVER BEFORE

Radio is still forging ahead. 1935 was its biggest year. Over 5 million new sets sold. Over 30 million dollars paid for service alone in 1935. Where only a few hundred men were employed a short time ago, thousands are employed today. And where a humdrum job paid up to \$75 a week—there are thousands of such jobs today—many paying even more. New full time jobs and spare time jobs are being created all the time. Get my book and see how easy you can get started.

## "SHOP TRAINING" FOR THE HOME

R-T-I Training is different. It comes to you right from the heart of the Radio Industry—right out of the factories where Radio sets and other vacuum-tube devices are made. It was planned and prepared and is supervised by big radio engineers. In these factories—by men appointed for the purpose, R-T-I will train you as the Radio Industry wants you trained.

## TELEVISION, PHOTO ELECTRIC CELLS, PUBLIC ADDRESS SYSTEMS INCLUDED

Radio service work is plentiful but it's only the starting point in R-T-I Training. From there you'll go through the whole field of Radio and Electronics. You will learn about every new development, including Television so you'll be ready when Television breaks.

## MAKES \$600 IN ONE MONTH

Herbert B. Thomson, Gorman, Texas, started making money with 12 lessons finished. He says, "Because of my R-T-I Training I made \$450 in September and over \$600 in October 1935. It pays to be R-T-I Trained."

## BIG MONEY IN AUTO AND POLICE RADIO WORK

W. H. Carr, 402 N. 18th St., Kansas City, Kans., R-T-I student, has charge of 35 radio equipped Police and Fire Department cars. He gets \$250.00 a month and free auto, gas, oil, etc. He says, "If I had not taken your course I would not be able to hold this job."

## 4 WORKING OUTFITS FURNISHED

Start almost at once doing part time radio work. I furnish 4 outfits of apparatus that you build into test equipment with which you can do actual jobs and earn extra money. My Training pays its own way and you get your money back if not satisfied. Age or lack of experience is no handicap.

## FREE BOOK

Find out why "R-T-I Trained" men get "Quick Results" and "Big Results." Send for "Radio's Future and Yours" today. It tells about Radio's amazing opportunities. It describes my approved training—what R-T-I students are doing and making. It gives the names of 50 firms who endorse and recommend R-T-I. It's FREE.

**RAY D. SMITH,**  
President  
**RADIO AND TELEVISION INSTITUTE**  
Dept. 225  
2150 Lawrence Ave.  
Chicago



## MAIL COUPON FOR FREE BOOK

**RAY D. SMITH, President**  
Radio and Television Institute (R-T-I)  
2150 Lawrence Ave., Dept. 225, Chicago, Ill.

Dear Mr. Smith: Without obligating me, send FREE Book about spare-time and full-time Radio opportunities and how I can train for them at home.

Name .....

Address .....

City ..... State .....

Please Say That You Saw It in RADIO-CRAFT

## Decade Resistance Box

The circuit below is the most economical decade resistance box which can be made. Only four semi-precision CONTINENTAL Carbon insulated resistors are required per decade! Two decades are illustrated.

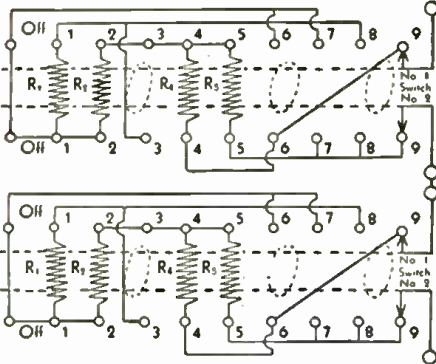

Decade	R <sub>1</sub>	R <sub>2</sub>	R <sub>4</sub>	R <sub>8</sub>	Resistance Range of Decade
1	100	200	400	500	100-900
2	1000	2000	4000	5000	1000-9000
3	10,000	20,000	40,000	50,000	10M-90M
4	100,000	200,000	400,000	500,000	100M-900M
5	1 meg.	2 meg.	4 meg.	5 meg.	1 meg.-9 meg.

List Price, 4 CONTINENTAL semi-precision insulated resistors, per decade ..... \$1.20

At all CONTINENTAL Distributors

Send for Engineering Bulletins 103-104.



13914 LORAIN AVE., CLEVELAND, OHIO  
and TORONTO, ONTARIO

**Announcing a 50 WATT P.A. AMPLIFIER**

**6 VOLTS & 110 VOLT A.C. MODELS AVAILABLE**

**SPECIAL OFFER:** 50 Watt Dual Channel 500-15-8-4-2 Ohms Output, 2 Channel Input Mixer, Hi-&Lo Equalizer, complete with \$40 Ribbon or \$37.50 Crystal Mike, two Rola G-12 AC Speakers, Crystal Pick-up. Special offer \$89.00 for the entire system .....

**COLUMBIA SOUND CO., Inc.**  
135 Liberty Street, New York

**Power Transformer**  
Universal Type  
In Alloy Hum Proof Casting 425-350-0 350-425 V. at 125 in a. 5A 3A...  
ALTA. Net price, \$4.50. 30-13 000 cycles 1 I D.B. Multiple Coil, Hum Free Balanced construction. **AUDIO TRANSFORMERS in Hum Free Castings. Each set, \$3.75. CHOKE in Alloy Hum Free Castings, \$1.75.**

**ALLOY TRANSFORMER CO., Inc., 135R Liberty St., N. Y. City**

**Filament Return Selector**  
the only answer to "Roaming Filaments"  
On Supreme Instruments Exclusively  
Supreme Instruments Corp., Greenwood, Miss.

a full-scale deflection load of 1 ma. The capacitive reactance is shown as having a value of 3,490 ohms, which is the reactance of a 0.76-mf. condenser. The resulting impedance is 3,590 ohms, as determined by the solution of the impedance formula. These values were taken from a typically-constructed analyzer so that the form factor of the rectifier unit is about 1.39 in this case, determined by dividing 5,000 by 3,590.

It will also be observed from Fig. 1E that slight variations in the length of that side of the triangle which represents the resistance will have comparatively little effect on the length of the hypotenuse, whereas the variations of the rectifier resistance would be considerable if the elements of the circuit impedance were additive; that is, capable of being represented by a straight line instead of by a triangle such as that described.

### RESISTANCE MEASUREMENTS

For resistance measurements, the meter is used primarily as a voltmeter, with the current passing through the meter calibrated on an "ohms" scale instead of being calibrated on a "volts" scale. In the multi-range ohmmeter circuits, however, shunts are used to enable the different sensitivities required for each range and, to this extent, the ohmmeter circuits resemble current-measuring circuits in which shunts are usually required. It will be observed in Fig. 2, that, for the lowest or 2,000-ohm range, the 33-ohm unit is a shunt resistor, while the 297-ohm and the 2,723-ohm resistors act as multipliers to the meter with its 700-ohm shunting resistor made up of a fixed 700-ohm resistor and a variable 3,600-ohm rheostat for accommodating battery potential variations. For the 20,000-ohm range, the 33-ohm and the 297-ohm resistors, totaling 330 ohms, act as a shunting resistor, with the 51-ohm and 2,723-ohm resistors functioning as multipliers. For the 0.2-meg. range, the 33-ohm, 297-ohm and 2,723-ohm resistors act as a shunting resistor, and a 3,269-ohm resistor acts as a multiplier resistor.

### PRIMARY REQUISITES

In the course of the design of the ohmmeter functions of this circuit, it was necessary to take into consideration the fact that (1) the meter required a current value of 1 ma. (.001-A.) for full-scale deflection, (2) a small amount of current must be allowed for passage through the variable "zero adjustment" rheostat to compensate for the natural depreciation of a new battery, (3) these 2 current values, when added together, constitute the "load" for the highest resistance measuring range which can be enabled by the available battery potential (which, in this case, is 4.5 V.), (4) in order that all resistance-measuring ranges fall on the same "ohms" scale, with the same set of scale divisions, the next lower range must carry 10 times the current load of the highest resistance-measuring range, and (5) the lowest resistance-measuring range must carry a current load which is 100 times that of the highest range. This means that, if 1/5-ma. should be passed through the variable meter shunt (zero-adjustment rheostat) with a new battery the total load for the highest resistance-measuring range would be .0012-A., the total load for the next lower range would be .012-A., and the total load for the lowest range would be .120-A., which is about as much load as should be taken from a small flashlight battery.

### THE NETWORK RATIO

However, since a fixed potential value, 4.5 V. in this case, is used for all ranges up to the 2 and 20 meg. ranges (powered by a high-voltage rectifier) which is not necessarily the case with the current-measuring functions of the meter in which the potential drop is not the same for all ranges, it becomes necessary to so arrange the network of the ohmmeter circuits that the effective internal resistance of each range be related to the effective internal resistance of each other range by the same ratio as that which exists between the current loads of the different ranges.

In other words, if the effective internal resistance of the lowest resistance-measuring range be 35 ohms, then the effective internal resistance of the next higher range must be 10 times as high, or 350 ohms, and that of the highest range enabled by the battery must be 100 times that

of the lowest range, or 3,500 ohms, so that all 3 ranges will follow the same scale distribution. Actually, the value of 35 ohms, and the decimal multiples thereof, were found most suitable, so that the center-scale calibration of the "ohms" range of the meter represents a value of 35 ohms, or a multiple thereof when one of the higher measuring ranges is used.

Taking the values indicated in Fig. 2 and assuming an average battery potential of 4.25 V., which is half-way between the new value of 4.5-V. and a discardable value of 4 V., we can determine, by different applications of Ohm's Law, that the variable shunt rheostat should be set at a position such that the used portion of the rheostat combined with the 700-ohm fixed resistance value totals 1,400 ohms when the rheostat is adjusted for "zero ohms" with the lowest range terminals short-circuited.

### ANALYZING "INTERNAL RESISTANCE"

The joint resistance of 1,400 ohms in parallel with the meter resistance value of 300 ohms is 247 ohms. This value of 247 ohms, added to 2,723 ohms and 297 ohms, gives a total value of 3,267 ohms. This value of 3,267 ohms for the lowest resistance-measuring range may be considered as being in parallel with the shunt value of 33 ohms for the lowest range. The joint resistance of 3,267 ohms in parallel with 33 ohms is 32.67 ohms which, when added to an internal battery resistance value of 2.33 ohms gives a total internal resistance value of 35 ohms for the lowest resistance-measuring range; that is, the 2,000-ohm range. For the 20,000-ohm range, the 247-ohm joint resistance value of the meter and its variable shunt, is added to 2,723 ohms, giving a value of 2,970 ohms which is in parallel with the value of 330 ohms made up of the two sections of 33 and 297 ohms. The joint resistance of 2,970 and 330 ohms is 297 ohms, which, when added to 51 and 2.33 ohms gives a value for the 20,000-ohm range, of 350 ohms, which is 10 times the resistance of the 2,000-ohm range. For the 0.2-meg. range, the joint meter and rheostat resistance value of 247 ohms are in parallel with 3,053 ohms (made up of the 33-ohm, 297-ohm and 2,723-ohm sections). The joint resistance of 247 and 3,053 ohms is 229 ohms. The total of 229, 3,269 and 2.33 ohms is 3,500 ohms for the internal resistance value of the 0.2-meg. range.

The resistance-measuring ranges beyond 0.2-meg. are powered from a miniature "power pack," so that the internal resistance of the rectifier tube must be taken into account when determining the multiplier resistance values required for the 2-meg. and 20-meg. ranges. Since the internal resistance value of the tube is not a constant value, but changes with varying loads, it cannot be expected that the 2-meg. and 20-meg. ranges will be as accurate as the lower ranges which are powered with the 4.5-V. battery.

### CAPACITY MEASUREMENTS

When a meter is used for capacity measurements, the resistance value of the meter and of the shunt and multiplier resistors associated with the measuring circuit constitutes one leg of an "impedance triangle" similar to that heretofore discussed for A.C. potential measurements. The reactance of a condenser of unknown value, which may be connected into the measuring circuits for the purpose of determining its value, constitutes another leg of the same impedance triangle. It is obvious that the resistance value of the meter and of its associated shunt and multiplier resistors is a constant value for any particular capacity-measuring range, regardless of the capacitive value of any condenser which may be connected to that range, and that the capacitive reactance, in every case, is determined by the capacitive value of the condensers which may be subjected to the measurement; therefore, the capacitive leg of the triangle is the variable element. It is further obvious that the meter current is related directly to the hypotenuse of the impedance triangle and will not, therefore, have a linear relationship to capacitive values.

For example, let's assume that we have an impedance triangle in which a full-scale meter current corresponds to a certain hypotenuse length and in which the reactance leg corresponds to a capacitive value of 5 mf. If we remove the 5-mf. condenser and put in its place a 2.5-mf. condenser, the length of the reactive leg of the triangle will be doubled, but the length

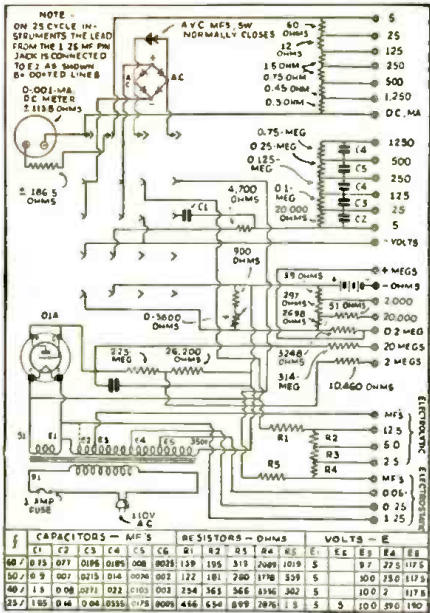

Fig. 5

The complete analyzer circuit diagram with values. of the hypotenuse will not be doubled and, therefore, the meter current will not be reduced to one-half of its former full-scale value.

In other words, a linear or evenly-divided scale cannot be used on the basis of fixed resistance values for the meter and its associated shunt and multiplier resistors.

For the measurement of electrostatic (paper) capacitive values, comparatively high A.C. potentials are used. It is necessary, however, to use comparatively low A.C. potential values for the measurement of electrolytic capacitive values, so as not to puncture the electrolytic film around the electrodes. Actually, the A.C. potential applied to electrolytic condensers in the 0.1-25-2.5-12.5 mf. ranges is about 9 V. The capacity-measuring circuits are shown in Fig. 3.

**ANALYZER CABLE CIRCUITS**

To enable the Service Man to test radio sets directly from the radio set's sockets, an analyzing circuit was developed, which is terminated at one end by one each of the 4-, 5-, 6-, 7- and the new 8-pin octal sockets, and at the other end by an analyzer plug having 7 pins therein and on which can be placed adapters for testing 4-, 5-, 6-, and 8-pin sockets.

As shown in Fig. 4, the 5 sockets are connected in parallel, with their terminals connected through 9 circuit-breaking switches into the analyzing cable which is terminated with a "top-cap" lug; and an analyzing plug with 7 pins and 1 receptacle contact for the 8th pin of an 8-pin analyzing plug adapter.

**SUMMARY OF ANALYZING CIRCUITS**

Our discussion has, so far, dealt individually with analyzing circuits. By reference to Fig. 5 we see the completed "master" circuit combining the component circuits discussed herein and utilized in the commercial analyzer.

In Part III of this article, we will take up the development of the modern tube testing circuit and the combination of analyzer and tube tester into a compact portable laboratory.

This article has been prepared from data supplied by courtesy of Supreme Instruments Corp.

**P.A. QUESTIONS & ANSWERS**

(Continued from page 666)

**PARALLEL FEED**

(37) W. Watson, Chicago, Ill.

(Q.) I would like to use a push-pull input transformer that I have on hand to drive two type 50 tubes with a 45, but I am afraid that the plate current of the 45 will burn out the transformer. Is there any way that I can get around it?

(A.) Very good results may be obtained if parallel feed, shown in Figs. Q.37A and Q.37B, is employed.

**RTL TUBE TESTERS**

**BUILT LIKE THE FINEST OF LABORATORY INSTRUMENTS**

Here's precision engineering carried to its highest degree. Every RTL Tube Tester is a laboratory built instrument—not a rush production job—designed and built like the finest of electrical instruments so that it can be unconditionally guaranteed for a full year.

Simpler to operate. Demonstrates tube defects clearly and positively in glass or metal tubes. RTL Testers actually help sell tubes! Write for complete details. Unconditionally guaranteed.



**RADIOTECHNIC LABORATORY**  
WILMETTE ILLINOIS

**NEW REPLACEMENT SPEAKERS**

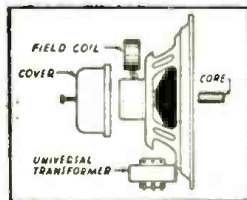

by **OXFORD**

with *Interchangeable Field Coil Feature!*

● A completely new and improved type of Electro-Dynamic Replacement Speaker by Oxford! Permits quick, easy change of field coil to give you the proper combination of transformer and field for the job *when you need it*. Universal transformer matches any tube. *Voice coil remains centered!*

Available in 5", 6", 8", 11" and 12" Models.

Ask your Jobber—or Write Today for Bulletin 361M



**OXFORD-TARTAK RADIO CORP.**

915 W. Van Buren Street

Chicago, U. S. A.

**To Readers of RADIO-CRAFT**  
FREE POST CARDS MAY BE HAD UPON WRITING TO PUBLISHERS

These post cards make it easy to answer advertisements which appear in RADIO-CRAFT, without cutting valuable data which you may wish to save.

Many times manufacturers request you to "clip the coupon" when answering their ads. Often this means destroying part of an article on the reverse page you may need later for reference. Save your RADIO-CRAFT issues complete. If you should ever want to see bound volumes, or certain copies of RADIO-CRAFT, the resale value of uncut issues is very much higher than that of mutilated ones. So send for a supply of these free post cards and use them in answering all RADIO-CRAFT advertisers.

**SERVICEMEN**

Look up October RADIO-CRAFT page 215

**ALL-WAVE SERVICE OSCILLATOR**



SAVE \$15.00 on this ALL-WAVE SERVICE OSCILLATOR

ALL GENUINE PARTS FURNISHED AT LOWER THAN WHOLESALE PRICES

**BLAN** THE RADIO MAN, Inc.  
8177 Greenwich St., New York, N.Y.  
NO CATALOGUE—BUT LOWEST PRICES

Please Say That You Saw It in RADIO-CRAFT

## "NOISE SILENCER"

### • ELIMINATES "MAN-MADE" STATIC

The noise "check valve", a development of James J. Lamb, editor of QST, has been acclaimed as one of the greatest discoveries in radio! Attached to any superheterodyne receiver, it eliminates noises caused by any sparking motors (oil burners, vacuum cleaners, fans, etc.) automobile ignition, high tension lines, dial telephones. Reduction of noise as high as 1,000 to 1 in power on sharp interference.

Just attach the "Noise Silencer" to rear of your receiver, make three single connections. A few simple adjustments as outlined in the instructions and you enjoy real noise-free reception. Works on all wave-lengths. Draws only a few milli plate current from receiver.

#### DEALERS!

Add to your income by selling these sensational "Noise Silencers"! 25% discount in quantities of six (6) only!

Mention make and model of superheterodyne when ordering so we can supply the correct pronged attachment plug.



#### COMPLETE KIT

of parts, drilled chassis and cabinet, less tubes, with complete instructions. ....

**\$3.85**

Three Sylvania Metal Tubes ..... **3.00**  
Wired and tested, ready to operate .. **8.55**

**12 West Broadway  
New York City**

**HARRISON RADIO CO.**

**Dept. R-5**

or noise pick-up at this point will be amplified through the entire system.

Two popular types of crystal microphone connections are shown at Figs. 1A and 1B.

#### PUSH-PULL INPUT

This arrangement has the advantage that the microphone cable acts as a balanced transmission line and any disturbance that affects one conductor will affect the other—and in phase, due to their position and proximity. Hence long lines can be run without appreciable noise pick-up. This system requires more amplification because the resistor network R1 acts as a voltage divider, one-half the output of the crystal microphone being supplied to each grid. For this reason a microphone connected push-pull can be considered lower in level than the single-grid type.

It might be well at this point to indicate the requirements of a good crystal microphone cable. They are:

(1) **Extremely low leakage.** This is important. A leakage of 1. meg. from conductor to shield will result in reduced low-frequency response.

(2) **Low capacity.** The conductor in the cable in conjunction with the shield forms a condenser. The greater this capacity, the greater the loss in the line. To overcome this, a very small conductor is used with much filler between it and the shielding.

(3) **Absence of mechanical noise.** The cable should not create any noise when moved. Many cables are susceptible to this defect.

(4) **Good shielding.** The shielding on suitable cables is woven. If the construction is not tight, that is, if the shielding does not cover the conductor 100 per cent, noise will be picked up.

Figure 1 shows the schematic of a carefully-built crystal amplifier. Its characteristics are:

- 20 W. output, undistorted.
- 23 W. output with 7 per cent distortion.
- 134 db. gain, measured.
- Hum level so low as to be of no consequence.
- Mixes 2 microphones electronically.
- Mixes 1 microphone and 1 phono. pickup.
- Universal field-supply connections provide field current for 2 dynamic speakers of most any resistance.
- Proper relation of parts.
- Proper voltage and impedance relations.

Figure A shows the layout of parts of an amplifier constructed around the schematic, Fig. 1.

The writer will be glad to answer questions regarding the construction of the above amplifier.

Our Information Bureau will gladly supply manufacturers' names and addresses of any items mentioned in Radio-Craft. Please enclose stamped return envelope.

## INFORMATION BUREAU

(Continued from page 666)

### TREASURE LOCATOR

(367) Mr. A. Garcia, Laredo, Texas.

(Q.) I have built the treasure locator which appeared in the Oct., 1935 issue of Radio-Craft on page 214. The circuit works and oscillates well, but is not sensitive enough for my purpose.

(A.) The following hints were received from Mr. R. D. Burchard, Jr., author of the original article: "There are several ways of increasing the power of the No. 5 Metal Locator. One is to increase the size of wire of the transmitting coil. Another way is to increase the number of turns in the same coil, remembering to increase the capacity of the receiving circuit at the same time, so that the latter may be tuned to the transmitter. Still another way is to raise the "B" voltage of the transmitter.

### WHY CERTAIN TUBES ARE USED

(368) H. N. Henningsen, Christian, Fla.

(Q.) I've noticed that in circuits using 6.3 V. tubes, the types 41 and 42 tubes are used, while the type 79 does not seem very popular. Is there anything wrong with the 79?

(A.) There are several reasons why the type 79 is not more widely used at present. One of the main reasons is probably the fact that another tube of somewhat the same characteristics, the 6A6, has been brought out. This tube has all the connections on the base, while the type 79 has one grid connection on the cap, which is an unhandy arrangement in most A.F. amplifiers.

## ★ NEWS! ★

From AMPLIFIER HEADQUARTERS

### HIGH FIDELITY ADVANCED DESIGN 16 WATTS—CLASS "A"

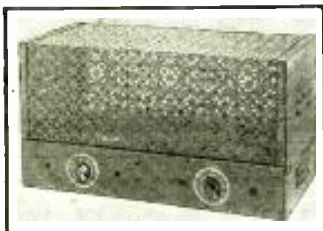

2 GAIN LEVELS 85 D.B.s AND 122 D.B.s  
USES CRYSTAL OR RIBBON MIKES DIRECT  
NO PRE-AMP. NECESSARY

- Separate Inputs for all Types of Mikes—Phono, Pick-Up and Tuner.
- Field Current for 2 Reproducers Independent of Filter Circuit.
- Built-In Acoustic Compensator.
- Built-In Multi-Tap Output Transformer.
- Oversize Power Transformer and Filters.
- 6 Tubes Including 6CS-6A6 + 685s Utilized in Exclusive Electronic Circuit Developed By Walter A. Carter.

PRICE NET ..... **\$15.75**

Less Tubes and Speakers

COMPLETE WITH INSTRUCTIONS

2 ROLA 12" HI-FIDELITY SPEAKERS **\$6.95**  
FOR ABOVE ..... Each

**GILLETTE RADIO CORP.**

160 DUANE STREET NEW YORK, N. Y.

## CRYSTAL-"MIKE" AMPLIFIER CONSIDERATIONS

(Continued from page 664)

rent excessively high—by overbiasing and running the grids excessively positive. However, the result looks very discouraging on an oscilloscope and it is terrifically hard on tubes.

### FREQUENCY RESPONSE

Here is something that is much talked about. It is impossible to judge accurately the frequency characteristics of an amplifier by listening to it. Of course it is possible to form a general idea as to whether the lows are "off" or the highs are "up" by a mere listening test, but it is not dependable.

The importance of the higher frequency has been much overestimated. It is not economical to build an amplifier flat to 15,000 cycles when a tone control must be provided to cut off these high frequencies.

For broadcast and P.A. work, where both speech and music are handled, a response flat from 60 to 7,000 cycles is quite sufficient. For amateur transmitter use, where voice alone is used, the low frequencies are not of importance.

### HARMONIC CONTENT

Here again, the temptation is to copy the tube manual ratings. Harmonic content has not been stressed so much in the past because few have had the facilities for measuring it. An output signal with a total harmonic content of 5 per cent is considered to be "undistorted" because it is not noticeable to the average ear.

This rating means that the total of the 2nd, 3rd, 4th, etc., harmonics comprise 5 per cent of the fundamental frequency. This distortion shows up worst in single-ended amplifiers and is higher in pentode and class B arrangements than in the class A circuits. Push-pull stages tend to eliminate the "even" harmonics and are always preferable.

Overloading of tubes and transformers, and improper impedance relations result in a tremendous increase in harmonic generation. Ordinarily, measurements of harmonic content are made at 400 cycles and may be higher or lower at other frequencies.

### GAIN AND HUM LEVEL

In so many words, "gain" means the amount by which the amplifier increases the minute bit of power supplied to the input grid. After all, if speaking into the microphone results in enough voltage at the grids of the power tubes to drive them to full output, the job can be considered well done.

### CRYSTAL MICROPHONE CHARACTERISTICS

These are becoming well known. Chiefly, their advantages are ruggedness and the fact that no input transformer is required. Eliminating the input transformer removes the possibility of hum pick-up from this source and the frequency discrimination a transformer is bound to introduce.

Crystal microphones in general, are lower-level devices than those of the carbon type; therefore more amplification is needed, either in the form of a separate amplifier or a built-in preamplifier. Ordinarily, this can be a pentode input tube of the high-gain variety such as a 57, 77 or similar type. Here great care must be taken. Any hum

Please Say That You Saw It in RADIO-CRAFT



YOU WANT YOUR OBSOLETE  
SET ANALYZER OR  
TUBE CHECKER

Modernized

WRITE FOR OUR PLAN

MENTION MODEL  
NUMBER OF YOUR  
OLD INSTRUMENT

MODERNIZATION  
DIVISION  
DEPT. "C"

**PRECISION**  
APPARATUS CORPORATION  
121 EAST NEW YORK AV., BROOKLYN, N. Y.

# TYPEWRITER BARGAIN

FREE HOME TYPING COURSE

10-DAY FREE TRIAL OFFER



ONLY 10¢ A DAY

BRAND NEW MODEL No. 5

## REMINGTON PORTABLE

● A brand new Remington for only 10¢ a day. An easy, practical Home Typing Course FREE. With it anyone quickly becomes expert on this machine . . . the most rugged, dependable portable made. Not used or rebuilt. Standard 4-row keyboard. Standard width carriage. Margin release on keyboard. Back spacer. Automatic ribbon reverse. *Every essential feature of big office typewriters.* Carrying Case FREE. Try it for 10 days without risking a cent. If you don't agree it is the finest portable at any price, return it at our expense. Don't delay. Without obligation, write now.

REMINGTON RAND, INC.,  
Dept. 189-5,  
205 East 42nd Street, New York, N. Y.

### EVEREADY RADIO REPAIR CEMENT

"THE ORIGINAL SPEAKER CEMENT"  
Used for replacing speaker cones, mending old, rattling, or torn cones, sealing adjustments, cementing loose tube bases, grid caps, coils, leads etc. Dries fast. Vibration proof, waterproof, insulating. Available to Service Men. See your jobber, if he cannot supply you, write us. List price 50¢ for large bottle. Send for FREE circular of complete line. GENERAL CEMENT MFG. CO. (Radio Div.) Rockford, Illinois



### HAVE YOU SOME SPARE ROOM

a basement or garage where you can do light work? We can offer you a profitable proposition for 1936 casting 5 and the Novelties, Airrays, Toy Automobiles, etc., as Branch Manufacturer for a firm of many years standing. No experience necessary and small outlay starts you so if you mean strictly business and are interested in devoting your spare or full time to profitable work write at once for full details.  
METAL CAST PRODUCTS CO. Dept. 26  
1696 Boston Road New York, N. Y.

### JENSEN 8" SPEAKER

1800 or 2250 ohm field, . . . . .ea. \$219  
TRF KIT: Includes 1 Ant. coil, 2 RF coils, Dejur 3-gang variable condenser. . . . . \$125  
Write for FREE RADIO PARTS Circular  
ARROW SALES CORP., 631 Washington Blvd., Chicago, Ill.

### SAVE \$\$\$ on RADIOS

BUY DIRECT 30 day trial FREE CATALOG

Buy at factory prices. 30 models to choose from. AC-DC. All-wave. Farm, Car and Metal Tube models. Send postcard for NEW 1936 Bargain Catalog FREE. Get details of 30 day TRIAL plan and Agent User proposition. Also ask for our NEW Parts Catalog  
ZEPHYR RADIO CO.  
11702 Livernois, Detroit, Mich. DEPT. 223



## CHECKING PUBLIC ADDRESS FIDELITY

(Continued from page 664)

more than plus or minus 1. db. between 50 and 7,500 cycles; the average P.A. microphone is guaranteed to respond within plus or minus 2 db. between 30 and 7,500 cycles; reproducers are trouble-makers, however, their response often varying as much as 15 db. Equalization may be introduced, changing the amplifier response to offset the faults of the loudspeaker and improve overall fidelity.

### CONNECTIONS OF EQUIPMENT

The equipment used in making this test is shown connected in Fig. 1, the P.A. system under test being enclosed by dotted lines. Note that the output of the main amplifier is fed into a special load resistor instead of to the regular loudspeaker; this resistor should be of the wire-wound type, capable of handling the power output of the main amplifier. Its resistance should, therefore, be equal to the output impedance of the main amplifier.

A variable beat-frequency A.F. oscillator, feeding into any 5-W. A.F. amplifier which happens to be at hand, is used to drive the loudspeaker of the P.A. system being tested. Two copper-oxide, rectifier-type volume indicators are used, one connected across the primary of the loudspeaker input transformer to measure the input, and the other, which is calibrated in db., connected in parallel with the load resistor to measure the output of the P.A. system. These meters should be free from frequency discrimination and each should have a 0-3 V. scale, with multipliers for measuring voltages up to 150 or 300 V.

A cathode-ray oscilloscope with a variable sweep frequency is connected across the output of the main amplifier to indicate when distortion due to overloading is present.

The set-up shown in Fig. 1 is satisfactory for checking all P.A. systems delivering less than 20 W. of power. With larger systems, simply change the line-up to insert the power stages of the main amplifier between the input volume indicator and the reproducer, at the points marked X.

### REPRODUCER AND MIKE PLACEMENT

The loudspeaker (or loudspeakers) used with the P.A. system should be placed outside, projecting away from any buildings. Place the microphone about 10 ft. away from the loudspeaker, facing toward and directly in line with the reproducer. Choose a location where the loudspeaker will not project sound toward a building or wall which might cause feedback of strong echoes.

### PLOTTING THE RESPONSE CURVE

Choose either a 500 or 1,000 cycles as the reference frequency. The cathode-ray oscilloscope (or "C.R.O.") is connected to the output of the main amplifier throughout this test; when any part of the P.A. system is overloaded, the sinusoidal wave appearing on the oscilloscope screen will become irregular or distorted in shape. With the A.F. oscillator set at the reference frequency, adjust the main amplifier controls until this amplifier is delivering all the power it can without causing overloading to be indicated on the oscilloscope screen. Note the reading on volume indicator B, then adjust the controls on the main amplifier until this reading drops 3 db. Now swing the frequency of the A.F. oscillator over the entire range from 50 to 10,000 cycles, and note whether overloading shows on the C.R.O. at any frequency. Reduce the gain in the preamplifier sufficiently to prevent this overloading.

You are now ready to secure data for the response curve. It is obvious that the power input to the loudspeaker must be constant throughout the test and should be at least 5 W. Note the reading of volume indicator A when the A.F. oscillator is set at the reference frequency, and adjust the oscillator after each change in frequency to maintain the power input at this value if necessary. Take readings of volume indicator B for points about 100 cycles apart down to the lower frequency limit of 50 cycles. Take readings about 500 cycles apart from the reference frequency up to about 10,000 cycles, and plot these points on graph paper to

(Continued on page 694)

These are unquestionably the OUTSTANDING AMPLIFIER VALUES EVER OFFERED!



Operate DIRECTLY with Crystal and Ribbon Microphones . . . requires NO EXTERNAL Pre-Amplifier!

● SEMI-ASSEMBLED KITS . . . OR FACTORY WIRED MODELS

OUTSTANDING FEATURES:

● FIELD CURRENT SUPPLY (self-contained) for 1 to 3-12 in. ROLA 2500 ohm (110 volt D.C.) Dynamic Speakers.

● PHONO-PICKUP (high impeded.) or "mike" (operation choice readily optional).

● SHIELDED AND POLARIZED PLUGS furnished for mike and phono. inputs.

● SPEAKER FIELD and output transformer connections made through a polarized plug-socket furnished.

● CIRCUIT employed is completely modern—complete absence from hum is guaranteed!

● TONE QUALITY matches performance of 8 to 10 tube amplifiers selling for many times the cost of these models!

● COMPACT—measures only 13½ in. long, 10 in. wide, 6½ in. tall. Its light weight also permits its use as a portable!

● KIT MODELS are furnished completely assembled . . . no holes to drill! Detailed instructions and photographs furnished will enable even a novice with no previous experience to quickly and successfully complete the utterly simple wiring that remains to be done.



Note simplified "MIKE-PHONO" CONTROL Panel—also speaker outlet socket, and shielded input connection plugs.

7½ Watt RIBBON "MIKE" Amplifier  
OVER-ALL GAIN: 120.7 Decibels  
Tubes Used: 2-6C6, 2-42, 1-5Z3

15 Watt CRYSTAL "MIKE" Amplifier  
OVER-ALL GAIN: 97 Decibels  
Tubes Used: 1-6C6, 1-75, 2-6B5, 1-5Z3

KIT MODELS || WIRED MODELS

**\$10.95** || **\$12.95**

Matched RCA Tubes (7½ Watt Model) \$2.84  
Matched RCA Tubes (15 Watt Model) \$1.18  
ROLA 12 in. 110 volt D.C. 2500 ohm  
Dyn. Speaker with output transf. . . . \$6.95  
PIEZO CRYSTAL MICROPHONE . . . \$13.23  
AMPERITE RIBBON "MIKE" . . . . . \$17.64

**YOUR MONEY REFUNDED**  
If on their receipt you are not pleased with your purchase, return same to us.

Ventilated Metal Cover  
Handsomely crystalline finished. Fits both models—provides access to tubes.  
**\$1.95 ADDITIONAL**



WRITE FOR OUR LATEST FREE CATALOG  
We SPECIALIZE in the design and construction of AMPLIFIERS . . . deal direct with the mfr. and save money!

AMPLIFIER MFG.' DIVISION Of The

# Remington

RADIO & ELECTRIC CORP.  
565-R 6th Ave., New York, N. Y.

Please Say That You Saw It in RADIO-CRAFT

# FREE

VALUABLE NEW CATALOG  
Filled With The Latest  
**RADIO PARTS**  
**AMATEUR SUPPLIES**  
**P. A. EQUIPMENT**

SAVE at SEARS  
Send for YOUR Copy TODAY

NEW DEVELOPMENTS!  
NEW APPARATUS!  
NEW LOW PRICES!

Every Radio Man Will Need New Equipment for Servicing the NEW METAL TUBES. You'll Find It in This New Catalog.

**Famous Testing Equipment  
SOLD ON EASY TERMS**

The Latest Triplett—Readrite—Supreme—R.C.A.—Clough Brengle and Triumph Instruments are All Included.

Write for Catalog RC653L  
**SEARS, ROEBUCK & CO., Chicago**

# EBY

Specializes in  
Quality

Binding Posts  
Tip Jacks  
Male Plugs  
Female Plugs  
Low-Loss Sockets  
A-C Switches  
Tap Switches  
Terminal Strips  
Short Wave Switches  
Moulded Sockets  
Electric Eyes

Write for Latest Bulletin

**HUGH H. EBY Inc.**

2066 Hunting Park Ave.  
PHILADELPHIA, PENNA.

## RADIO ENGINEERING

RCA Institutes offers an intensive course of high standard embracing all phases of Radio. Practical training with modern equipment at New York and Chicago schools. Also specialized courses and Home Study Courses under "No obligation" plan. Catalog, Dept. RT-36.

**RCA INSTITUTES, Inc.**

75 Varick St., New York 1154 Merchandise Mart, Chicago

Recognized Standard in Radio Instruction Since 1909

# RAYTHEON

TRADE MARK

**4-PILLAR RADIO TUBES**

Write for FREE 1936 Tube Chart  
RAYTHEON PRODUCTION CORP., Dept. E-5.  
30 East 42nd St., New York, N. Y.

## CHECKING PUBLIC ADDRESS FIDELITY

(Continued from page 693)

give you the over-all response curve of the P.A. system.

Undoubtedly you will find that this response curve has many hills and valleys, some more than 30 db. deep; and some about 100 or so cycles apart. These hills and valleys may be more pronounced at certain frequencies. Sound waves are reflected easily, and these reflected waves will cancel and reinforce the projected waves, thus producing these irregularities. Fortunately, it has been found entirely satisfactory to use only the peak values in drawing the actual response curve of the system. The response within any valley can be checked by moving the microphone a few inches to the right or left of its former position.

### TYPICAL RESPONSE CURVES

The response curve obtained for a typical P.A. system (not of high-fidelity type) is shown in Fig. 2. Curve *a* is the actual response with the microphone in one position throughout the test, and shows the peaks and valleys discussed before. Curve *b* is drawn only through the peaks and represents the true response of the system. Note that the response is more than 15 db. up, at 700 cycles. This response is typical of an amplifier being operated with a velocity microphone.

### EQUALIZING TO IMPROVE RESPONSE

Poor response in one part of a P.A. system, such as in the loudspeaker, can be compensated for by adjustment (equalization) of another part of the system. There is, of course, a definite limit to the amount of equalization which can be introduced if a definite amount of power is required from the P.A. system, for equalization necessarily reduces the peak of the response curve as it builds up the low parts. Uniform amplification over the entire frequency range can be obtained only at the expense of reduced power output.

The first stage of a typical resistance-coupled amplifier is shown in Fig. 3A. One type of equalizer circuit is inserted by cutting the leads at the point marked X, and inserting a double-pole double-throw switch which will cut the equalizer in and out at will. The new circuit containing an equalizer is shown in Fig. 3B. The values of the parts selected may be used as a guide in improving the frequency response of an amplifier combination. Better results can be obtained with some amplifiers if the two 100,000-ohm resistors which are connected in parallel with condensers are omitted. The position at which the equalizer control potentiometer is set determines whether the equalizer circuit will have a maximum impedance to higher or lower frequencies. (It is the impedance the equalizer circuit introduces at the various audio frequencies which determines the voltage applied to the grid of the succeeding stage.)

When the D.P.D.T. switch in Fig. 3B is in the up position, the equalizer is cut out of the circuit. With the switch in the down position, the A.F. signal enters the equalizer circuit through the 0.1-mf. coupling condenser; it then passes through the network made up of 3 resistors and 2 condensers.

The position of the contact arm of the 0.1-meg. potentiometer determines the relationship between the high- and low-frequency response of the amplifier. (Although this potentiometer has some control on the voltage supplied to the succeeding tube, the 0.5-meg. potentiometer is the real grid-voltage control. This potentiometer does not affect equalization, but simply regulates the gain introduced in the amplifier. It is thus used as a volume control.) If the arm, 2, of the 0.1-meg. potentiometer is set near point 3, the low frequencies will predominate in response curves, because the capacitive reactance of the 0.1-mf. condenser increases as the frequency is lowered. This in turn causes a greater voltage drop to occur across the lower 0.1-meg. resistor, thus giving greater amplification at the lower frequencies.

Good high-frequency response is obtained when the pointer is near terminal 1 of the potentiometer, because here the 0.1-meg. resistance of the potentiometer is now almost entirely in series with the 0.1-mf. condenser, reducing its effect upon the circuit. The 250 mmf. condenser carries practically all of the high-frequency sig-

nals around the upper 0.1-meg. resistor. Remember that "equalization" is a lowering of the voltage gain at those frequencies which are reproduced easily by the P.A. system. The greater the equalization required, the greater must be the amplification introduced, by adding an extra stage, to bring the P.A. system up to its original gain, but with high fidelity.

Another method of equalizing for the lack of high frequencies, which was first developed and successfully used by the writer, is given in Fig. 3C. The peculiar arrangement of resistors and condensers is in reality an automatic voltage divider, dividing the voltage in exactly the desired ratio to obtain the right response. The two condensers do not affect the circuit at low frequencies, but as the frequency is increased, the voltage drop across each of the condensers decreases, thus placing more and more voltage across the 0.1-meg. potentiometer. This potentiometer may be used as the volume control, for it has little effect upon the amount of equalization which is introduced. By selecting different values for the two condensers and resistors, it is possible to obtain a tremendous reduction in low-frequency amplification in comparison to that received at the higher audio frequencies.

The use of resonant circuits as a means of equalizing should not be overlooked, for they are simple, efficient and effective in improving the frequency response of a circuit. In the arrangement shown in Fig. 3D the values of the coil and condenser which are connected in parallel are selected to resonate at a high frequency, perhaps at 4,500 cycles, to improve high-frequency response. The greatest voltage drop will occur across the combination at this resonant frequency. The 0.1-meg. variable resistor controls the degree of equalization; an S.P.S.T. switch cuts it in and out at will.

The sales and business of any radio organization interested in P.A. work will increase tremendously if it can continuously guarantee good fidelity. A high-quality service is insured by using the method outlined here, because the human ear, having a variable-frequency response, has no part in the measurements. If necessary, the over-all response can be guaranteed to within a certain value to meet exacting specifications of given customers.

This article has been prepared from data supplied by courtesy of National Radio Institute.

## HOW TO MAKE A PREAMPLIFIER

(Continued from page 668)

directly across the primary of the output transformer. There should be no detectable hum in the phones with the volume control on full, and even a low-level condenser head should give a good loud signal.

### LIST OF PARTS

One National Union type 6F5 tube, V1;  
One National Union type 6C5 tube, V2;  
One National Union type 25Z6 tube, V3;  
Three I.C.A. 8-prong sockets;  
One I.C.A. steel cabinet 5x6x9 ins. long;  
One I.C.A. S.P.S.T. toggle switch;  
One I.C.A. S.P.D.T. toggle switch;  
One I.C.A. dial plate with knob;  
One I.C.A. 4-post terminal strip;  
One I.C.A. 3-post terminal strip;  
Five I.C.A. name plates;  
One Electrad volume control, 0.5-meg;  
One Aalloy output transformer (in case), T;  
Two Alloy filter chokes in cases, Ch. 1, Ch. 2;  
One Blan power cord, 248 ohms;  
Two Blan pilot lamp sockets with 3.2 V., 0.3-A. bulbs;  
Two Solar electrolytic condensers, 4 mf.;  
Three Solar electrolytic condensers, 16 mf.;  
Two Solar paper condensers, 0.25-mf.;  
Two Solar mica condensers, .01-mf.;  
One Solar electrolytic condenser, 10 mf., 50 V;  
\*One "C"-bias cell with holder;  
Two I.R.C. 10-meg. carbon resistors;  
Two I.R.C. 50,000-ohm carbon resistors;  
One I.R.C. 0.25-meg. carbon resistors;  
One I.R.C. 3,000-ohm carbon resistors;  
One I.R.C. 10,000-ohm carbon resistor.

(\*Name of manufacturer will be sent upon request; kindly enclose a stamped and self-addressed envelope.)

Please Say That You Saw It in RADIO-CRAFT



**MAKE YOUR OWN RECORDS**



**From radio or VOICE**  
We specialize in complete recording devices for professional and amateur work. We manufacture all types of home and professional recording apparatus and cutting devices for any malleable or non-malleable disc material. Write for details on your needs.

Specially designed Amplifier! With switching panel, including output meter. Contains throwback switches for recording play-back, public address, etc. We suggest sending for circular and technical details on this amplifier, before buying elsewhere.

**SOUND APPARATUS COMPANY**  
Manufacturers of Disc Recording Apparatus  
150 West 46th St. New York, N. Y.



**UNIVERSAL Velocity and Carbon Microphones**  
Universal's latest achievement—ideal for stage use—Not affected by temperature or humidity—Flat frequency response curve from 40 to 10,000 c.p.s.; Output-63 D.B.; Low impedance or direct to grid types. Compact, 2 3/4 x 4 3/4 in. by 1 1/2 in. thick—Weight, less than 18 oz.—Readers to any desired angle—Beautifully finished in black enamel and artistic chrome plate—ask for new catalog sheet describing models RI, RP, RH and CR—List \$22.50—Latest model music type seasonal stand for above microphone—List \$10.00.

**UNIVERSAL MICROPHONE CO., Ltd.**  
424 Warren Lane Inglewood, Calif., U. S. A.

*The world over*



IS ACKNOWLEDGED THE WORLD'S MOST ORIGINAL AND PROGRESSIVE MANUFACTURER OF ELECTRICAL TESTING EQUIPMENT  
4017 W. Lake Street Chicago, Illinois

Send today for your copy of new 16-page booklet crammed full of valuable and vital information on

**"AERIALS AND HOW TO USE THEM"**

Contains diagrams and complete information for eliminating noise on all bands, improving foreign reception, use of antenna couplers, balanced line filters, ultra high frequency transmission and reception, ham operation, and multiple installations for apartment houses and store demonstration hookups.

Sent postpaid for a dime  
Arthur H. Lyoch, Inc., Dept R., 227 Fulton St., N. Y. C.

**RADIO ENGINEERING,**

broadcasting, aviation and police radio, servicing, marine radio, telegraphy and telephony, Morse telegraphy and railway accounting taught thoroughly. Engineering course of nine months duration equivalent to three years of college radio work. All expenses low. Catalog free. School established 1874.  
Dodge's Institute, Hudson St., Valparaiso, Ind.

**ANY CARBON MIKE REPAIRED**  
Includes replacement of damaged diaphragms and repacking of both buttons with best grade of granular carbon. Both buttons are scientifically matched for like impedance! Genuine gold-leaf gold spot contacts furnished. 24 hour service!

Postpaid In U. S. **\$3.00**

**MICROPHONE REPAIR SPECIALISTS**  
559 6th Ave., New York, N. Y.

Prepare for the Big P. A. Season!  
Get Miles New P. A. Catalog

Amplifiers, Microphones, Trumpets, Complete Sound Systems for Indoor and Out. Your Mike Repaired Equal to New Only \$4.50. Catalogue Free. Miles Repro. Co., 114 W. 14th St., N. Y.

**NEON** Fascinating home-study course prepares you quickly for today's biggest opportunity—NEON—"gaseous tube" lighting—most widely used medium of lighted displays, the future's greatest source of illumination. Treatise men included in every locality! Start now while the industry is still new!

FREE Booklet describes NEON'S opportunities, complete data on C. L. home-study course. Enrollment fee amazingly low. Write for FREE BOOK!  
Commercial Laboratories, Box 47-R, Omaha, Neb.

**ELECTRONIC MUSIC FUNDAMENTALS**

(Continued from page 665)

ment can be made by using a number of tuning forks in place of piano strings. The forks, of various sizes for different pitches, are made of flat steel on a milling machine. The size, thickness and length of the prongs govern the pitch of each fork. Adjustments in pitch are easily accomplished by shortening the tips of the prongs (to raise the pitch), or by grinding their sides at a point about 10 per cent of the distance from arc to tip (to lower the pitch).

The experimenter can easily obtain a second-hand piano action and console, which he can cut down to the desired size (see Fig. A). Each of the hammers which is ordinarily used to strike a string is now made to strike a tuning fork, as shown in Fig. 4. Individual pick-up magnets are connected independently to contacts of the key action. The output of all pick-up magnets is connected to a primary tap of the output transformer. It is noted that the movement of the key closes the contact and also actuates the action of the hammer.

The amplification of metal reeds is accomplished in two ways: (1) electromagnetically for steel reeds, and (2) electrostatically for reeds of bronze, silver, etc.

Anyone familiar with a condenser-type microphone will find a resemblance between it and the diagram shown in Fig. 5, where one electrode is connected to a reed and another near it, so that when the reed vibrates by the movement of air from the reed chamber, alternating current is induced between the two electrodes, then amplified and converted into sound energy, the pitch being of the frequency at which the amplified reed vibrates.

The amplification of strings mechanically is accomplished by placing a metal bridge with knife edges under the strings, so that when a string is struck the vibrations rock the metal bridge which is securely connected to a large diaphragm by which the air is set in motion, as shown in Fig. 6.

Mechanical amplification is very simple, but does not have the power, flexibility and sound distribution such as is accomplished by electrical amplification of strings, several methods of which are shown in Fig. 6.

The Magnetic Pick-up Method of amplifying strings is accomplished in many ways, depending on design and requirements. The fundamental diagram shown in Fig. 6 illustrates a permanent bar magnet with a coil of No. 40 wire, one side of which is grounded and the other connected to the primary of the input transformer.

Anyone with a slight knowledge of electricity can clearly see that a coil winding on a magnet functions like an A.C. generator of fixed voltage and frequency (cycles) when the steel string is set in motion.

The primary winding of the transformer is made to match the winding of the coil on the magnet. Taps are provided in the primary winding for transforming the A.C. from the coil at a predetermined voltage. The output transformer is made with a secondary winding to match the grid of the tube. The winding of the primary of the transformer with or without taps is especially suitable when made at an impedance step-up ratio as: primary equals 1/10 or less; secondary equals 1.

The Induction Method of string amplification consists of a coil of wire around a stretched steel string. The motions of the string in all directions always are picked up by the coil.

The Electrostatic Method of amplification of strings uses the well-known principle of the condenser microphone, where a high potential is applied to one electrode, and another electrode is connected to the control-grid of the amplifying tube. The vibration of the string will induce an A.C. voltage in the string which is connected to the grid of the amplifying tube.

The contact-type piezoelectric pickup consists of 2 small plates of crystal (Rochelle salt) encased in a bakelite plate approximately 3/4 x 3/4-in. square, and secured tightly to any vibrating surface such as bells, chimes, the body of a musical instrument, or the sounding board of a piano, etc. (see Fig. 7).

(Part III of this article will discuss the construction of the units shown in Figs. C and D. —Editor)

Only  
**\$18.00**  
for this TUBE TESTER



MODEL 430

- ★ Tests all type tubes—Metal, Glass, Glass-Metal.
- ★ Line voltage adjustment.
- ★ Leakage and Short Test.
- ★ Triplett Direct Reading Instrument (GOOD-BAD Scale)

An up-to-the-minute 1936 Tube Tester. Five flush mounted sockets provide for all type tubes. The tester operation is very simple and indicates condition of tube for dealer and customer on Direct Reading GOOD-BAD Triplett colored meter scale. The Tester is designed to indicate all inner element shorts and make leakage tests. Complete in attractive, sturdy quartered-oak case. Attractive sloping panel of silver and black. Suitable for portable and counter use. Model 430. Dealer Net Price \$18.00 Model 431—same as 430 except has Readrite GOOD-BAD meter.  
Dealer Net Price ..... \$14.40

*Readrite*  
TESTERS AND METERS

**MAIL COUPON NOW**

READRITE METER WORKS  
516 College St., Bluffton, Ohio  
Without obligation please send me more information on  Model 430  Model 431  Send complete catalogue.

Name .....

Address .....

City ..... State .....

Please Say That You Saw It in RADIO-CRAFT

**Now... an ALL-AROUND MICROPHONE**  
*Ideal for All Conditions!*

The Amperite Velocity, when in vertical position, has widest angle of pickup without frequency discrimination.  
 • Permits 360° pickup when lowered and tilted until parallel to floor.  
 • Same position provides narrow angle (X in diag.) which can be used to eliminate undesirable noises.  
 • Eliminates Feedback in P.A. work.  
 Note: High impedance model operates directly into grid.  
**NEW!**  
 Positive, smooth-action stands.  
 Write for Bulletins PA-2

• Diagram shows angle of pickup without frequency discrimination of various types microphones.

**AMPERITE Co.**  
 561 BROADWAY NEW YORK

**AMPERITE Velocity MICROPHONE**

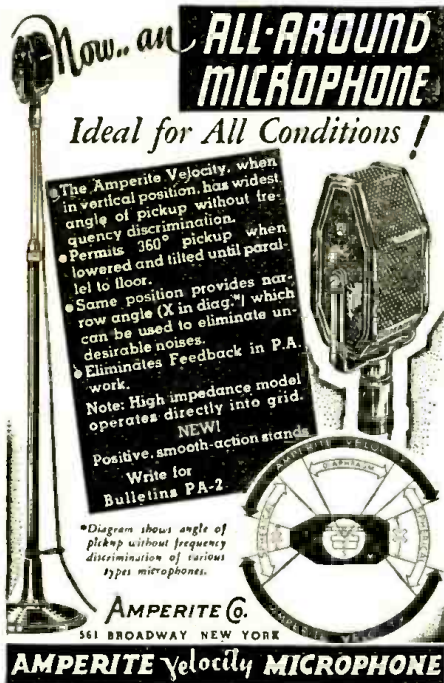

**METAL TUBES IN A MODERN PREAMPLIFIER**

(Continued from page 667)

52 db. is required in the preamplifier. Using the above method of attack, the required amplifier gain for any input device and output power can be quickly approximated. Until about 2 years ago, practically all preamplifiers were battery operated. Continuous research has changed this condition, so that now an all-A.C. operated preamplifier is practicable. There is no doubt by this time that metal tubes eventually will replace glass tubes in most radio receivers. While the cost of metal tubes is at present somewhat above that of comparable glass tubes, the several valuable performance characteristics of the former have caused "iron" tubes to take the radio industry by storm. This does not mean that glass tubes should be retired to obsolescence, but merely that the use of iron tubes reflects the general progressiveness of the radio field as a whole. The advantages of metal tubes in P.A. work are here enumerated.

1. Reduction in tube noise and microphonics.
2. Compactness, which lends itself to the modern trend toward simplified equipment.
3. Positive self shielding.
4. Simplified self-aligning base plug.
5. Increased strength.

Increased tube strength is of great importance in P.A. work due to the great abuse tubes normally receive in such service. In addition to the unbreakable shell, these tubes have a more rugged internal structure as the elements are supported by at least 7 short leads that go directly to the base pins. The psychological effect of metal tubes and the obvious "latest" effect on the ultimate purchaser or user of P.A. equipment, also play important roles.

Keeping in mind all the aforementioned metal-tube advantages, the low-level preamplifier described below was designed and developed to form a unit which would be ideal from the engineering standpoint and at the same time inexpensive.

Five major factors determined the design of this amplifier, as follows:

1. Adaptability to metal, metal-glass, and glass tubes.
2. High efficiency.
3. Low harmonic distortion and phase shift.
4. Low hum level.
5. High power output.

1. Adaptability. The circuit is designed to accommodate either metal, metal-glass, or glass tubes. If metal tubes are used, three 6C5s are employed. Two serve as voltage amplifiers while the third is used as a half-wave rectifier. In this way there is no possibility whatever of misplacing tubes. The same applies for metal-glass tubes. If glass tubes are used, two 6C6s connected as triodes serve as the voltage amplifiers, and a type 1V is used as the half-wave rectifier.

The input and output terminations are arranged to accommodate either 200- or 500-ohm lines.

2. Efficiency and Gain. The use of the 6C5 metal tube triode makes high efficiency possible in this circuit. The use of a transformer for interstage coupling, in place of resistance coupling makes possible a 100 per cent (6 db.) greater voltage amplification. Additional gain can readily be obtained by the use of an audio choke in place of the resistor for parallel feeding the interstage transformer primary. The overall gain of the amplifier is 55 db.

3. Harmonic Content. The harmonics in a class A amplifier may be attributed to both transformers and tubes. The harmonic content is small in transformers where the core materials are operated at proper flux densities. The phase shift is also maintained at a low value under these conditions. The amplifier can be operated up to an output of 30 milliwatts (+ 7db.) without exceeding a negligible value of total harmonics.

4. Hum Level. The amplifier is complete on a single chassis. It might be thought that the advantage gained in compactness (the complete amplifier is only 8 3/4 x 7 ins. wide and when using the metal tubes has an overall height of 4 1/2 ins.) would be completely offset by increased hum. However proper design and placement of parts (see the photos) has reduced the hum

**Westinghouse Power Generator**

Manufactured for U. S. Signal Corps

200 Watt.

110 V. AC

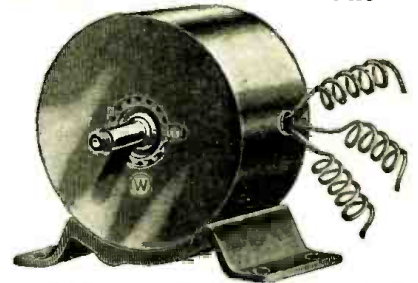

**A. C. ELECTRICAL POWER**

from a Windmill, from available Waterpower, from your Automobile, from your Motorcycle, from your Bicycle, Foot-pedals or Handcrank (for transportable Radio Transmitters, Strong Floodlights, Advertising Signs); do you want to operate AC Radio sets from 32 V. DC farm light systems; operate two generators in series to get 200 V. AC; obtain two phase and three phase AC, etc., etc.

**There Are Over 25 Applications**

Some of which are:

A.C. Dynamo Lighting from eight to ten 20 Watt 110 Volt lamps, Short Wave Transmitter supplying 110 Volts AC for operating "Ham" transmitter, Operating 110 V. AC 60 Cycle Radio Receiver in DC districts, Motor Generator, Public Address Systems, Electric Sirens on motor boats, yachts, etc. Camp Lighting, Short Wave artificial "fever" apparatus, Television, Pelton Waterwheel for lighting or other purposes, Airplane for lighting strong search lights or electric signs, Laboratory work, etc., etc.

1/4 to 1/2 H.P. needed to run generator.

BLUE-PRINT 22 x 28 in. and Four-Page 8 1/2 x 12 in. INSTRUCTION SHEETS FREE with Generator.

Generator, as described, including four replacement carbon brushes, Blue-print and instructions \$7.90

Send \$2.00 deposit balance C.O.D. Shipping weight 18 lbs.

(Replacement carbon brushes bought separate \$1.50 per set of four. Set of instructions, bought separate \$1.00.) MONEY-BACK GUARANTEE

**WELLWORTH TRADING COMPANY**

560 West Washington Blvd., Dept. RC536, Chicago, Illinois

**The NEW ATLAS ALL ALUMINUM BAFFLE**



The Original, Aluminum Parabolic Reflector Baffle will solve your problem of effective sound distribution. It will increase your speaker efficiency, and minimize feedback difficulties. This baffle accommodates all 10, 11, and 12-inch cone speakers. Bell opening, 17 inches; length, 20 inches. 100% weatherproof.

**BAFFLE—\$5.40**  
 (Model AM-10)

NET TO DEALER

Adjustable 6 ft. Floor Stand, and Baffle \$17.40 Net  
 Adjustable Floor Stand (Only) \$12.00 Net  
 Mounting Bracket (Only) \$5.40 Net

Send for free catalogue. Jobbers and representatives—Write for sales plan

**ATLAS SOUND CORPORATION**  
 1453-39th Street Brooklyn, N.Y.

**Sound Projection at its best!**

WITH THE NEW, SCIENTIFICALLY DESIGNED

**LIFETIME**

**SOUND PROJECTION BAFFLES**

Today's advances in sound reproduction are made possible by this new development, resulting in more effective sound distribution and a minimum of feedback. Model No. 32 has a 32" bell—will take any 12" speaker and comes complete with weatherproof speaker housing and adjustable mounting bracket. List \$40.00.

Special Introductory \$16.95

Price to P.A. Men.....

No. 20 P.B. for 8" Speaker \$12.95

Net.

No. 15 P.B. for 6" Speaker \$7.95

Net.

Prepaid on receipt of remittance.

**LIFETIME CORP.**

1006 MADISON AVE. TOLEDO, OHIO

MANUFACTURERS: Carbon, condenser, crystal, electrostatic and velocity microphones—electro dynamic speakers, aluminum trumpets and sound projectors.

Send for descriptive literature.



Please Say That You Saw It in RADIO-CRAFT

**Have You Seen the New Magazine?**



Telling you how to go about:

WHEN YOU ARE TACKLING THE JOB OF FINDING A JOB;

WHEN YOU ARE PLANNING A CAREER;

WHEN YOU WANT TO BETTER YOUR POSITION.

The new magazine giving you every month a digest of articles from magazines and newspapers all over the country

**HOW AND WHERE TODAY**

Alert, resourceful men and women have succeeded, where others, WHO DID NOT KNOW, have failed.

PRESENT-DAY JOB COMPETITION IS INTENSE, ONLY THE INFORMED MAN OR WOMAN CAN STAY IN THE RACE AND WIN.

**"JOBS & CAREERS" IS YOUR GUIDEBOOK OF OPPORTUNITY.**

On all Newsstands 25c

If your dealer cannot supply you, send a quarter and we will forward a copy at once.

**JOBS & CAREERS**

Dept. RC-536

520 North Michigan Avenue Chicago, Illinois.

level to an extremely low value.

The hum level in an amplifier can generally be charged to filament supply, plate supply, inductive pick-up and electrostatic pick-up. The filament hum introduced by modern cathode-type tubes is very small. The plate supply employs a highly effective 2-stage condenser input filter. Hum due to inductive and electrostatic pick-up is eliminated by proper transformer shielding and judicious placement of parts.

5. Power Output. The + 7 db. output available from this amplifier makes possible the use of direct monitoring with a pair of headphones or a standard db. meter where the preamplifier is located at some distance from the main amplifier. This high output also gives us latitude in gain to compensate for losses between the preamplifier and main amplifier and any losses that may be caused by equalization or tone control.

Certain applications, such as recording on film or record, require power outputs not exceeding 1 W. For such application the output of this preamplifier can be used to directly drive a 48 output tube.

**MIXING**

It has always been somewhat difficult to mix microphones, pickups and tuners of widely different output. In many of the less expensive sound systems a single gain control is used with a switching arrangement to throw in mike, pickup or tuner. It is evident that if such a gain control is designed to properly operate with an average microphone, it will have to be turned almost to the off point to control a pickup or tuner input. Furthermore, most inexpensive gain controls show a marked frequency discrimination at the maximum attenuation point. To compensate for this effect, a fixed attenuator can be inserted between the pickup or tuner and the input to the variable gain control. This attenuator will bring the pickup level down to the same output as a microphone, so that the original gain control will cover the entire volume range.

An ideal attenuator must maintain proper impedance on both input and output termination and must show no frequency discrimination throughout the A.F. range. It is customary to use either a T- or H-type pad to obtain the above results. With the chart shown in Table III any person can make a pad of either of these types.

**PADS**

Inasmuch as the most common impedance for transmission lines is 500 ohms, this chart has been plotted for 500-ohm input and output termination. The method of application is very simple. The value of attenuation desired is read on the left side. This value is then carried across to the corresponding resistance values. These values, which are read directly in ohms, are inserted in the circuits at the top of the chart. If it is desired to attenuate a circuit of an impedance other than 500 ohms, both A and B values should be multiplied by the ratio of the desired impedance to 500 ohms.

For example, let us assume that our preamplifier is designed to operate from an input level of -80 db. with a gain control covering a working range of 40 db. It is desired to operate into this amplifier, a 200-ohm pickup with an output level of -20 db., and it is evident that the original gain control would not be effective. However, by using a fixed attenuator of 40 db. between the pickup and amplifier input, proper volume control can be obtained. The chart indicates that for 40 db. attenuation, resistance values of A=245, B=10. Inasmuch as these values are based on 500 ohms, to reduce the impedance to 200-ohm values, both A and B are multiplied by  $\frac{200}{500}$ . This gives us corrected

values of approximately 100 ohms and 4 ohms. The H-type attenuator is generally used only where it is necessary to maintain perfectly balanced lines. Inasmuch as in most cases balance is not of prime importance, a T pad is suitable. Referring to the T-pad circuit, it is found that we need but 3 resistors: 2 of 200 ohms (each), and 1 of 4 ohms.

The preamplifier described, and the simplified fixed pad construction, make possible truly inexpensive low-level equipment.

TABLE I

Carbon Microphone	—34db.
Condenser Microphone	—82db.
Dynamic Microphone	—88db.
Velocity Microphone	—97db.
"Diaphragm" Crystal Microphone	—60db.
Magnetic Pickup	—25db.
Crystal Pickup	—15db.
"Sound-Cell" Crystal Microphone	—90db.

TABLE II

TUBES	CLASS	GAIN
1 45	class A	plus 24 db.
1 50	" A	" 28 db.
2 45s or 1 53	" B	" 32 db.
2 50s	" A	" 33 db.
2 2A3s	" A	" 34 db. (Fixed Bias)
2 WE800As	" A	" 35 db. (Fixed Bias)
2 46s or 59s	" B	" 36 db.

TABLE III

ATTENUATION NETWORK DATA				
NOTE: Z <sub>1</sub> (LINE IMPEDANCE) = 500 OHMS; f = 11513				
ATTENUATION	A = $\frac{Z_1}{2} \times \frac{10^{(N/20)}}{10^{(N/20)} - 1}$	B = $\frac{Z_1}{10^{(N/20)} - 1}$	C = $\frac{Z_1}{2} \times 5 \times 10^{(N/20)}$	D = $\frac{Z_1}{10^{(N/20)} - 1}$
NO. DB.	A	B	C	D
.1	1.440	43420	2.879	86850
.2	2.878	21720	5.755	43440
.3	4.318	14480	8.635	28950
.4	5.758	10850	11.52	21710
.5	7.193	8685.	14.40	17380
.6	8.635	7232.	17.29	14480
.7	10.07	6198	20.17	12420
.8	11.51	5421.	23.06	10870
.9	12.95	4818.	25.95	9656.
1.0	14.38	4333.	28.85	8690.
2.0	28.65	2152.	58.08	4364.
3.0	42.75	1420.	88.05	2925.
4.0	56.58	1049.	119.3	2209.
5.0	70.03	822.4	152.0	1785.
6.0	83.08	669.4	186.8	1505.
7.0	95.65	558.0	224.0	1308.
8.0	107.7	473.1	264.3	1162.
9.0	119.1	405.9	308.0	1050.
10.0	129.9	351.3	355.8	962.5
15	174.5	183.6	680.8	756.3
20	204.5	101.0	1238.	611.2
25	223.5	56.40	2216.	559.5
30	234.7	31.65	3949	532.7
35	241.3	17.79	7027.	518.0
40	245.1	10.00	12500	510.1
45	247.2	5.624	22230	505.7
50	248.5	3.163	39530	503.2
55	249.2	1.775	70300	501.8
60	249.5	1.0	125000	501.0
65	249.8	.5623	222300	500.5
70	249.8	.3163	395400	500.4
75	249.9	.1779	703000	500.2
80	249.9	10	1250000	500.1
85	250.0	.05620	2223000	500.1
90	250.0	.03161	3954000	500.0
95	250.0	.01879	7027000	500.0
100	250.0	.010	12500000	500.0

This article has been prepared from data supplied by courtesy of United Transformer Corp.

**INSTALLING INDOOR AND OUTDOOR P.A. SYSTEMS**

(Continued from page 667)

ment costing only a few dollars (and utilizing only a simple microphone, amplifier and speaker), to very elaborate systems such as used by the new Waldorf-Astoria Hotel in New York City, where provisions are made to distribute 6 programs to 1,940 guest rooms and to several public rooms located throughout the hotel. These programs may consist of entertainment from broadcasting stations, or music originating in the hotel. Arrangements are made for showing sound motion pictures and for sending programs originating in the hotel over transmission lines to broadcast stations. Such comprehensive installations cost several thousand dollars.

Every P.A. installation has its own particular problem that can be solved only after a careful study of all the factors that make it differ from other installations, but there are certain rules and requirements applying to all types of installations that will be discussed in Part II.

This article has been prepared from data supplied by courtesy of Coyne Electrical and Radio School.

Please Say That You Saw It in RADIO-CRAFT



- 17 WATTS UNDISTORTED OUTPUT
- SYNCHRONIZED COMPONENT PARTS
- FLOOR CRYSTAL MICROPHONE 25 FOOT CABLE
- FIELD EXCITATION FURNISHED FOR 2 SPEAKERS
- SYSTEM AVAILABLE ONE OR TWO 12" SPEAKERS



MODEL PX-417

Strict Dealer Policy. Time Payment Plan. Fully Licensed.

This equipment makes an ideal system for permanent installations in halls, churches, schools, etc., where crowds not exceeding 3,000 people are to be handled. Like all WEBSTER-CHICAGO sound systems it is completely synchronized and all parts are properly matched to deliver the ultimate in results.

Model PX-417 consists of the following units: The new WEBSTER No. 1242 dual diaphragm crystal microphone, which is unquestionably the ultimate in the diaphragm type of microphone, mounted on a floor stand with 25 feet of cable. Two No. 2601 speakers with connecting cords and cables. These speakers are 12" electro-dynamics with specially designed cones and heavy voice coils for public address systems. They have wide range reproductions to handle the amplifier range.

H.G.-417 Amplifier is a four-stage advanced design using the following tubes: 1-57, 1-53, 3-2A5, 1-523. Mixes two inputs. Gain at 400 cycles 105 DB, the hum level 25 DB below zero level. Tapped output transformers.

System is also available with one speaker. Can be purchased as a portable unit in carrying case.

Prices are surprisingly low. Write for details. See your jobber.

**FREE**

"A Short Course in Sound Engineering"

Webster-Chicago is now preparing a limited edition on the above. Every sound man, jobber, dealer, service man will want one of these up-to-date pamphlets covering engineering and sales details. If you wish one, send in your name. Printing will be limited to those desiring this information.

**WEBSTER-CHICAGO**

manufactures a complete line of synchronized public address systems, sound equipment amplifiers and accessories of all kinds.

**WRITE FOR CATALOGUE**

THE WEBSTER COMPANY  
 Section MY-10, 3825 W. Lake St.  
 Chicago, Illinois.

Please send me more information on Model PX-417..... Please enter my name for copy of "Sound Engineering".....

Name .....

Address .....

City ..... State .....

# DON'T!

## BUY ANY AMPLIFIER OR P. A. SYSTEM

until you read our circular describing a new line of advanced design amplifiers incorporating such revolutionary features as,

- Automatic Feedback Suppression
- Volume Level Expander
- Automatic Tube Noise Suppression
- Simultaneous Class "A" and Class "B" Amplification
- Cathode Ray Control Indicator
- Automatic Audio Volume Control

Our Amazingly Low Prices, **FREE TRIAL OFFER**, and Usual **FIVE YEAR GUARANTEE** Make It Well Worth Your While to Write To-Day for Free Circular No. PA 436

**AMPLIFIER Co. of AMERICA**  
20 West 22nd St., New York, N. Y.

### 5 WATT 6B5 POWER AMPLIFIER



A well designed amplifier suitable for most any small indoor public address installation. INPUT: to grid. Output 6 watts peak. Undistorted output 5 watts. Uses 1-6J7 metal tube; 1-5Z4 metal tube and 1-6B5 Tube. New resistance coupled circuit. No. 101. Your Cost, **\$8.75** less tubes **\$2.50** Matched Sylvania Tubes

### SERVICEMAN'S UTILITY KIT

Well worth many times its cost. Each part will be found useful to servicemen. Selling at this low price to clear our shelves. Sold complete with all metal utility tool chest. No. 761B. **\$1.25** Your Cost



### PUBLIC ADDRESS and S. W. MANUAL

Contains valuable data in the construction of power amplifiers. Installations of systems, microphone care, short-wave hookups; and many other interesting subjects. Send for your copy now. **10c**

Send for new 1936 Catalog  
**TRY-MO RADIO CO., INC.**  
85 Cortlandt Street New York City

### AUTOCRAT

## Tuning Indicator ELECTRON-EYE TUNING

for any set!

Provides simple, inexpensive means of modernizing any set by adding electron-ray feature for **PRECISE VISUAL TUNING**.

A self contained unit arranged for ready mounting on wood or metal panels.

Installed in any A.V.C. set using 2½ V. or 6 V. tubes. Complete instructions.

List price \$3.00 Complete. A good profit-maker over the counter or on service call.

Regular discounts apply. See it at your jobber, or write to

**AUTOCRAT RADIO CO.**  
3855 N. Hamilton Ave., Chicago, Ill.

**LEE** Correspondence Courses in **RADIO and ELECTRICAL ENGINEERING**

**ELECTRICAL ENGINEERING** covers complete electrical field. Most modern course. So simplified anyone can grasp quickly. **LOW COST!**

**RADIO ENGINEERING** Ultra-modern course in radio, public address, photo-electric work. Trains you to be super-service man, real vacuum tube technician. Diploma given. Tuition only \$25, either course. Deferred payment plan. **WRITE TODAY** for free copies of school catalogs, student magazines, etc. **SEND NOW!**

**LINCOLN ENGINEERING SCHOOL** Lincoln, Neb.  
859-G So. 37th St.

### USEFUL CIRCUIT IDEAS

(Continued from page 669)

for each tube. The latter may be 80s, 81s, 83s, or any other rectifiers. Condensers C1 and C2 should be about 8 mf. (depending upon the current to be drawn), and may be of the electrolytic type. The remainder of the filter is quite normal.

C. BORKOWSKI

### HONORABLE MENTION

**AMPLIFIER IMPROVEMENT.** While working on an amplifier which had a Loftin-White circuit, similar to that in Fig. 7, I replaced the 2A3H tube with a 2A5. The new tube gave much better power output and higher sensitivity, these characteristics having been rather poor before the change was made. The few new parts needed—a tube with its socket, and the bias resistor and condenser—made the change very inexpensive.

WILLARD MOODY

### HONORABLE MENTION

**OUTPUT TUBE.** The use of a type 32 tube as an output amplifier, as shown in Fig. 8, is quite effective for use in a low-current-drain receiver. Not wishing to use a 33 because of the relatively high current drain and since I know a 30 would not have high enough gain for the purpose, the 32 was hooked up as shown. The use of impedance coupling was necessary, since the detector was also a 32, and transformer coupling caused bad distortion. The 4½ V. "C" battery also aids in reducing distortion, and as a result, the tone quality is quite good.

RAY BOSSEN

### HONORABLE MENTION

**IMPROVED OSCILLATOR.** The use of a variable- $\mu$  tube such as the 58 or 6D6 in the so-called electron-coupled circuit often leads to instability due to the remote cut-off characteristic of this type tube. The connections may be slightly changed however, as shown in Fig. 9, so that the circuit will be much more satisfactory. The change is simply to remove the suppressor from the cathode, the usual connection, and return it directly to ground. With this hookup, the tube forms a very stable and smoothly-working detector.

ROBERT SANFORD

### HONORABLE MENTION

**TEMPORARY REPAIR.** I use a G.E. model T-B-52 radio set for interference location work, and when I needed it recently in a hurry it was inoperative due to a defective transformer. Since the set had to be used immediately, and no replacement could be had, the circuit was patched up as shown in Fig. 10. Resistor R1 was shunted directly across the open coil, and the set played at almost full volume.

RALPH SCOTT

### HONORABLE MENTION

**CONDENSER METER.** This is a direct-reading instrument. A 1 ma. meter is used in conjunction with a copper-oxide rectifier. By opening the circuit at the switches shown on Fig. 11, the meter may be used for other purposes. Condensers of known capacity are used for calibration. In use the test leads are shorted, and R1 adjusted for zero reading the same as in an ohmmeter. Resistor R1 is an ordinary volume control, while R2 and R3 are 10-W. wire-wound units. The 80,000 ohm unit, R4, is a 2-W., while R5 is a 10,000 ohm resistor with a clip for adjustment. This will be set at about 7,500 ohms. This meter is useful mainly for testing paper condensers, but electrolytics may be tested if they are first formed by applying D.C. to them. If condensers are tested in a set, the line plug should be removed from the socket, to prevent trouble from a grounded line.

Impedances may be calculated from capacity calibrations, since 1 mf. equals 3,000 ohms at 60 cycles, 2 mf. equals 1,500 ohms, ¼-mf.-12,000 ohms, etc. The capacity ranges of the various jacks are: A—.001- to .25-mf., B—.01- to 8-mf., C—.25- to 20-mf.

RICHARD T. SCHULTZ

### NOISE ELIMINATOR

The following circuit—reproduced by special permission of QST Publishing Co.—was developed by J. J. Lamb of QST magazine. This is one of the most successful methods so far developed.

# SPRAYER OUTFIT

ELECTRICAL—PORTABLE

Complete with Gun, ready for service **\$32.50**

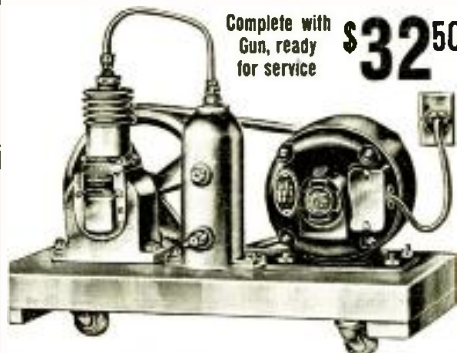

This is the ideal outfit for all around spraying work wherever current is available. Sprays everything: Lacquers, Oil, Cold Water Paints, Enamels, Varnish, Insecticides, Disinfectants, Shoe Dyes, etc. The Unit is compact, completely self-contained. Ideal for spraying Furniture, Radiators, Screens, Machinery, and other maintenance paintings in Homes, Schools, Clubs, Hospitals, Stores, Factories, and Office Buildings.

The Gun, furnished with this Unit is of Pressure Cup type, requires but 2 cu. ft. of Air per minute. Has Bleeder type construction which assures uniform pressure at all times without clogging the Air Passage which is easily cleaned. Furnished with 3 Nozzles which produce Fan, Round, and Right Angle Spray respectively.

Complete Unit consists of Air-cooled Compressor with machined Fan-cooling Pulley, V-Belt Drive; Pressure type Gun with 1 quart Aluminum Paint Cup; 3 Tips; ¼ H.P. Heavy Duty Motor, 110/120 volt, 60 cycle, AC; 15 ft. rubber covered 2 Ply Air Hose; 8 ft. Cord & Plug; Filter Tank; Entire Unit mounted on Base with Ball Bearing Casters.

A low priced Power Sprayer: the kind of Machine that usually sells for \$50.00 to \$60.00.

Price of complete outfit, shipping weight, 60 lbs.	<b>\$32.50</b>
Price of outfit complete, less Motor, shipping weight—35 lbs.	<b>\$25.50</b>
Price of Gun only with 3 nozzles, shipping weight, 7 lbs.	<b>\$7.50</b>
Price of Compressor only, shipping weight 15 lbs.	<b>\$9.50</b>

Our Old Customers Know That Our Merchandise Is Sold on a Strict Money-Back Guarantee

All Shipments will be forwarded by Express Collect if not sufficient postage included with your order.

## WELLWORTH TRADING CO.

560 W. Washington Blvd., Dept. RC-536, Chicago, Ill.

## Something NEW!

WEATHER FORECASTER AND HUMIDITY TESTER



### "HYGROSCOPE"

The Ace of Weather Forecasters

When placed in a well-ventilated room or in the fresh air, the HYGROSCOPE foretells coming weather conditions from eight to twenty-four hours in advance. It also accurately records outdoor humidity, and when placed inside it gives the humidity within the house or room.

The HYGROSCOPE is automatic self-adjustable, simple American-precision made. It cannot get out of order at any time. The dial measures 2¾", is enclosed in a 6" round hardwood case, with either walnut or mahogany finish. It is attractive for desk or living room.

### OUTSIDE DIAL FORECASTS WEATHER

Fair—rain—or changeable is indicated on the outer dial when the HYGROSCOPE is placed in a well-ventilated room or out-of-doors. If indoors, place the instrument near an open window.

### INNER DIAL SHOWS HUMIDITY CONTENT

The HYGROSCOPE also acts as a hygrometer. Numbers on the inner dial indicate the degree of humidity present in the air and in artificially heated rooms.

**SEND YOUR ORDER NOW!** Get your HYGROSCOPE today. Your remittance in form of check or money order accepted. If you send cash or unused U. S. Postage Stamps, be sure to register your letter. Also specify if you prefer the HYGROSCOPE in Walnut or Mahogany. **\$2.00**

Postpaid

## GRENPARK COMPANY

Dept. RC-536  
99 Hudson St. - New York, N. Y.

Please Say That You Saw It in RADIO-CRAFT

# SPECIAL OFFER

## Complete Public Address System

AS ILLUSTRATED  
Immediate Service

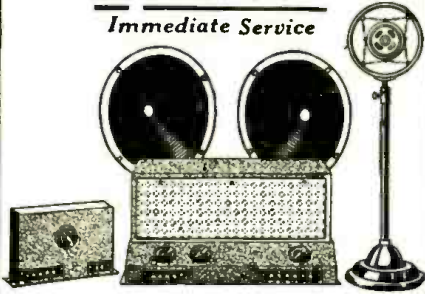

**20 WATTS**  
YOUR PRICE **\$59.95**  
less Tubes

Here's what you get:

- 1—20-Watt High-Gain 6B5 Push-Pull Amplifier using 1—6A6, 2—76's, 2—6B5's and 1—5Z3. Input to grid of first tube. Output to 2-1-8-15 ohm voice coils and 500 ohm line. Power consumption 85 watts. For use on 115 volts, 60 cycles. A.C. Can be used with velocity mike.
- 2—12 1/2" A.C. Dynamic Speakers matched to amplifier.
- 1—Fader Mixer Input Box for carbon microphone.
- 1—7 1/2" Adjustable Floor Stand, chromium plated stem, black crystalline base.
- 1—High Quality Double Button Carbon Microphone. All necessary connecting Plugs and Cables.

All components are perfectly matched to each other. Ship. wt. of Complete System, 75 lbs. Ship. wt., Amplifier Alone, 33 lbs.

Complete Set of Matched Tubes .....\$7.00  
\$5.00 for complete system with velocity mike on special offer.

## 5-WATT AMPLIFIER

No. R-2B6A  
**\$8.75**  
less Tubes

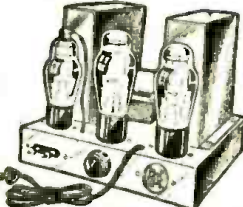

Gain 85 d.b. Input 250,000 ohms to grid of 57; output for 5000 ohm output transformer primary. Tubes: 1—57, 1—2B6, 1—5Z3. Consumes 50 watts. Operates on 115 volts, 60 cycles, A.C. Size: 8 1/2" x 6" x 7 1/2". Provides field current for 1—1500 ohm speaker or 2—3000 ohm speakers in Parallel. Ship. wt., 15 lbs.

100% Satisfaction Guaranteed. Send Money Order or Certified check. C.O.D. shipments require a 20% deposit. Immediate Service—No Waiting.  
**HUDSON SPECIALTIES CO.**  
40 West Broadway New York City

### CLASSIFIED ADVERTISEMENTS

Advertisements in this section are inserted at the cost of twelve cents per word for each insertion—name, initials and address each count as one word. Cash should accompany all classified advertisements unless placed by a recognized advertising agency. No less than ten words are accepted. Advertising for the June, 1936, issue should be received not later than April 6, 1936.

### A.C. AUTO GENERATORS

TURN SCRAP INTO MONEY. AUTOPOWER SHOWS you how easily and economically auto generators can be converted into A. C. or D. C. generators and D. C. motors. 2 to 1000 volts; for sound, radio, power, light, or welding. No previous experience necessary—complete information all in new book, with simple instructions and illustrations. Endorsed by thousands. Only \$1.00 postpaid. Autopower, Inc., 414-C S. Hoyne Ave., Chicago.

### RADIO

RADIO ENGINEERING, BROADCASTING, AVIATION and police radio, servicing, Marine and Morse Telegraph taught thoroughly. All expenses low. Catalog free. Dodge's Institute, Pine Street, Valparaiso, Indiana.  
INSTRUCTIONS 18 DISTANCE CRYSTAL SETS—record 2100 miles; "Radiobuilder" year. 25c. Laboratories, 151-B Liberty, San Francisco, Calif.

When properly constructed it is particularly effective in reducing "man-made" static, such as auto noise, and that made by electrical apparatus. The diagram given in Fig. 12 is for the unit used as an attachment to any modern superheterodyne, and in such receivers is connected into the I.F. circuit. (The more complicated set-up required for T.R.F. sets is not yet available.) The parts used are as follows:

- C1, 0.01-mf., 400 V.;
- C2, 0.1-mf., 200 V.;
- C3, 0.1-mf., 200 V.;
- C4, 0.1-mf., 400 V.;
- C5, 250 mmf., midget mica;
- C6, 0.1-mf., 200 V.;
- C7, 50 mmf., midget mica;
- R1, 600 ohms, 1/2-W.;
- R2, 20,000 ohms, 1 W.;
- R3, 5,000 ohm potentiometer;
- R4, 0.1-meg., 1/2-W.;
- R5, 0.1-meg., 1/2-w.;
- L1, diode-type I.F. transformer;
- RFC, 20 mh. R.F. choke.

The unit may be plugged into an existing receiver or it may be built into a new one. In the latter case the clips and plug naturally will be omitted. (More detailed data appears in QST.)

## SERVICING 1/4-MILLION 16-MM. TALKIES UNITS

(Continued from page 672)

gram of the amplifier. Servicing the audio system should be an easy matter. However, the sound end's optical section (described in the preceding, and other issues of *Radio-Craft*) will need study if the Service Man is going to do a good job of maintaining high-fidelity sound in these 16-mm. talkies systems.

### HIGH-FIDELITY TALKIES REQUIRE SPECIAL TONE CONTROL

The audio system of a sound film equipment differs from radio or P.A. systems in two respects. One is the source of signal, and the other is the frequency-response curve. The signal is generated from the impressed light variations on the plate of the photoelectric cell. This in turn is converted to electrical impulses and fed through a resistance-capacity network to the control-grid of the first tube. The low-level output of the photo-cell necessitates an amplifier with an overall gain of between 95 and 110 db.

The other item requiring special consideration is the response characteristic. The frequency response of 16 mm. sound amplifiers (see Fig. 1) has a peak at about 4,000 cycles. This is purposely put there to correct a corresponding drop in the sound track of the film itself. In order to retain this peak, a different type of tone control had to be designed. Figure 2A shows a series-type tone control, and Fig. 2B the shunt-type usually used in radio or P.A. equipment.

Use of this type of tone control permits variations in the low-frequency end of the spectrum only, the upper register remaining fixed at all times. "Graininess of the film" and "printing light losses" cause losses equal to 10 db. from 4,000 cycles up; grain of the film itself and the small area do not allow (with present practices) recordings higher than 5,500 or 6,000 cycles. However, film laboratories are working overtime to get a finer-grain film which will allow frequency recordings to 10,000 or even 15,000 cycles.

### CONCLUSION

In closing it can only be repeated that those of you who now apply some time and thought to this newcomer in the electronic field, will greatly profit in the very near future.

Large industrial organizations such as Coca Cola, Chevrolet Motors, Buick, Ford, power utilities, food stuff manufacturers and many others are now using 16 mm. intensively for advertising and good-will. The equipments will need a local service station just as any other mechanism.

Where formerly hundreds of equipments were sold annually, now thousands are sold monthly!

This article has been prepared from data supplied by courtesy of S.O.S. Corp.

Please Say That You Saw It in RADIO-CRAFT

# DEPENDABLE

## DOUBLE DUTY TUBE & SET TESTER

Ready to Operate

**\$21.95**

KIT —  
**\$17.85**

UNUSUAL VALUE



Model 305

A most efficient, practical test instrument, indispensable to the up to date service man. Takes all glass and metal tubes and roving filaments. Also tests shorts and leakages with neon indicating lamp. Makes capacity and ohm-meter tests, also tests all types of condensers. Separate line voltage meter. 5" fan-type full view "Good-Bad" meter. Simple to operate, needs no adapter. A remarkable buy at the price. Also available in portable-combination and de luxe models.

## DEPENDABLE OHMMETER

only **\$9.95**



Model 405A

Remarkably accurate double range instrument reading from 0-1000 and 0-100,000 ohms. 12 ohms is at middle of scale. Can measure less than 1/4 ohm. D'Arsonval moving coil meter has guaranteed accuracy of 2%. Has voltmeter scales of 0-2.5; 0-25; 0-125 and 0-750. Milliampere ranges 0-2.5 and 0-125. Neat, compact case, self-contained batteries. Size 7 1/2" x 4" x 3", weight 1 1/2 lbs. An instrument every service man needs, at an unusually low price. Sold through leading jobbers.

Write Dept. RC-5 for newest bulletins

**RADIO CITY PRODUCTS CO.**  
88 Park Place, New York City

## THE PERFECT CODE TEACHER!

### NEW MASTER TELEPLEX

For beginners, experienced operators, and schoolroom. The sure easy way to learn code and to step up your speed. This amazing new instrument will record your own sending on double row perforated paper and repeat it back to you at any speed you desire. 10,000 words can be recorded on one tape.

No Batteries

No Winding  
All Electric

Buy It or Rent It

It is the same in principle; and in operation it is equal to the Wheatstone Perforator and Transmitter, which cost over \$1,000.

Send for Folder A5, which tells you how to get the use of this instrument without buying it. No obligation. We furnish complete course and personal instruction with a money back guarantee. Low cost, easy terms. Write today for information.

### TELEPLEX CO.

72 Cortlandt St. New York City  
The New Master Teleplex—The Choice of those who Know

# Be Prepared to Meet All Radio Servicing Emergencies

## WITH GERNSBACK OFFICIAL RADIO SERVICE MANUALS



Just as we say—"Be prepared to meet all radio servicing emergencies with the Gernsback Official Radio Service Manuals." You never know when a service job requires that "extra" special attention. It might mean the difference between doing the job or losing it. You're safe if you have on hand the GERNSBACK MANUALS—either for regular service work or for servicing auto-radios. Get your copy today! No other radio book is comparable to the new 1935 OFFICIAL RADIO SERVICE MANUAL. In contents, in style of printing, in grade of paper, in illustrations, there has never been published such a comprehensive volume. This Manual contains over a thousand pages—yet it is only 1¼ inches thick because it is printed on a special Bible stock which is an exceptionally good stock, yet one of the thinnest and most durable papers. This 1935 Manual is the most authentic and elaborate service guide ever used in the radio industry.

### Contents of the 1935 Manual

Over 1,000 pages full of diagrams and essential information of manufactured receivers—only data of real use in servicing is included. This new Manual is really portable since it is extremely thin and light as well. ● Volume V, continues where the preceding manual left off. ● Many circuits of old sets are included. ● Service Men know every set has certain weak points which are really the cause of trouble. Wherever the information could be obtained, these weaknesses with their cures are printed right with the circuits. This is an entirely new and valuable addition to the Manual. ● All the latest receivers are included—all-wave sets, short-wave sets, auto-radio sets, midget and cigar-box sets, etc., as well as P.A. Amplifiers and equipment, and commercial serv-

icing instruments. ● The cumulative index is even more complete than before; including cross-references to sets sold under different names and type numbers. ● Volume V includes resistance data; socket layouts; I.P. data; and voltage data. ● Tube data on latest tubes. ● Free question and answer service—as included in our last three manuals.

### OVER 1000 PAGES

Over 3,000 Illustrations  
Size 9" x 12"—only 1¼" thick  
Flexible, looseleaf leatherette cover

**SET SERVICING**  
Service information found in the Manuals covers all types of radio receivers. The material is extremely valuable to Dealers and Service Men. On many diagrams appear voltage readings of tubes, socket connections, transformer data, alignment details, and other service notes.

**PUBLIC ADDRESS**  
The pages on P.A. Installation will be helpful to Service Men and P.A. specialists. Such prominent features as class A and B amplifiers—single and dual channel systems—attenuators, and mixers—super-power stages—pre-amplifiers and other commercial devices for P.A. work are included.

**ALL-WAVE RECEIVERS**  
Information relative to short-wave receivers have found their way into the Manuals. For these standard manufactured sets, wherever possible, complete aligning details for all wave bands are included in addition to the service material listed for other sets.

**AUTO-RADIO RECEIVERS**  
All available service information on new auto-radio sets has been included. From this data alone Service Men could derive sufficient knowledge to venture in a specialty field—that of servicing only auto-radios.

**\$7.00 LIST**

### Which of These GERNSBACK RADIO SERVICE MANUALS

Do You Need to Complete Your Files

- 1934 Official Radio Service Manual**  
Over 400 Pages. 9x12 Inches  
Over 2,000 Illustrations  
Flexible, Looseleaf. Leatherette Cover  
List Price \$3.50
- 1933 Official Radio Service Manual**  
Over 700 Pages. 9x12 Inches  
Over 2,000 Illustrations  
Flexible, Looseleaf. Leatherette Cover  
List Price \$5.00
- 1932 Official Radio Service Manual**  
Over 1,000 Pages. 9x12 Inches  
Over 2,000 Illustrations  
Flexible, Looseleaf. Leatherette Cover  
List Price \$5.00
- 1931 Official Radio Service Manual**  
650 Pages (Including Supplements)  
9x12 Inches  
Over 1,500 Illustrations  
Flexible, Looseleaf. Leatherette Cover  
List Price \$4.50  
(Including Supplements)
- 1933 Official Auto-Radio Service Manual (Volume I)**  
Over 200 Pages. 9x12 Inches  
Over 500 Illustrations  
Flexible, Looseleaf. Leatherette Cover  
List Price \$2.50

—for the real auto-radio servicing "dope," you can't find a better book!

### The 1935 Official Auto-Radio Service Manual

Every radio man connected in any way with the booming auto-radio business needs a copy of the new OFFICIAL AUTO RADIO MANUAL. It contains only auto-radio service "dope."

#### HERE ARE HIGHLIGHTS OF THE 1935 AUTO-RADIO SERVICE MANUAL

240 pages crowded with diagrams, service material and other essential data required for proper servicing of new auto-radio receivers. Included are diagrams of sets which appeared during 1931, and which were not included in the supplement to the first edition. Complete schematic diagrams, chassis layouts, voltage tabulations and servicing instructions are included for practically all sets. "Under-side" tube symbols are also included to facilitate the job of servicing the sets. Instructions are included with many sets telling how to suppress stubborn cases of ignition interference. This includes the newest "suppressorless" sets—and what to do when interference is encountered with this type of set. Details on how to make installations in "turrot-top" cars are included. The different methods used by car makers and set manufacturers are listed with the individual circuits and service information. The index contains the listing of sets which were published in the first edition, as well as the sets which appear in the new volume. This information helps the Service Man to locate the circuit and details for any receiver that has been made. The book is bound in a handy, flexible leatherette cover. To be sure the pages are sturdy, to withstand constant use, the book is printed on a special "bible" stock. This is a very durable, but thin paper. The book printed on this paper can be easily rolled to fit into your pocket or slipped in the service kit.



**240 Pages**

Over 500 Illustrations  
Size 9 x 12"

Flexible, Looseleaf Leatherette Cover

**\$2.50 LIST**

### MAIL COUPON TODAY FOR ANY MANUAL!

GERNSBACK PUBLICATIONS, Inc. RC-536  
99 Hudson Street, New York, N. Y.

Enclosed you will find my remittance of \$..... for which please send me promptly, POSTPAID, the OFFICIAL RADIO SERVICE MANUAL indicated.

- |  |  |
|--|--|
| <input type="checkbox"/> 1935 Edition @ \$7.00                         | <b>AUTO-RADIO MANUALS</b>                      |
| <input type="checkbox"/> 1934 Edition @ \$3.50                         | <input type="checkbox"/> 1935 Edition @ \$2.50 |
| <input type="checkbox"/> 1933 Edition @ \$5.00                         | <input type="checkbox"/> 1933 Edition @ \$2.50 |
| <input type="checkbox"/> 1932 Edition @ \$5.00                         |  |
| <input type="checkbox"/> 1931 Edition @ \$4.50 (Including Supplements) |  |

Name .....

Address .....

City ..... State.....

(Send remittance by check, money order, or registered letter if it contains cash, currency or unused U. S. Postage Stamps.)

**GERNSBACK PUBLICATIONS, Inc.**  
99 Hudson Street New York, N. Y.

**OVERSEAS READERS!**  
These books can be obtained from the following houses:

**GREAT BRITAIN**  
Gorrings, 9a, Green Street, Leicester Square, London, England

**FRANCE**  
Editions Radio, 42 Rue Jacob, Paris

**AUSTRALIA**  
McGill's 183-195, 218 Elizabeth St., Melbourne, C. I

Please Say That You Saw It in RADIO-CRAFT

## IMPORTANT FACTS ABOUT SCHOOL SOUND SYSTEMS

(Continued on page 672)

tion introduced in the circuit must be carefully watched as this will materially affect the amount of output and introduce many objectionable features.

(4) The circuit must be free of peak frequencies which greatly interfere with the blending of the different instruments being reproduced.

(5) The ideal circuit must cover a frequency range from 30 to 12,000 cycles and up to 16,000 cycles if possible. The extreme high range is necessary not for the reproduction of fundamentals but for the reproduction of harmonics that are necessary for the recreation of the tonal structure of the higher-range fundamentals. This is termed ordinarily under the phrase, "flat characteristic from 30 to 12,000 cycles."

We have proven that all the above characteristics can be realized in fact so that the reproduction can be *absolutely natural and faithful in every respect.*

### A 4-CHANNEL SCHOOL SYSTEM

In Fig. 2 we show a schematic and block layout of a 4-channel school sound system with 2 radio receivers, phonograph pickup and lines together with microphone lines other than in the offices.

From Fig. B you will see that the system is built in units as the front panels indicate. All programs are fed to the program control panel where the main gain controls as well as the channel switches are located. We might say here that all switches used must be of a special design to accommodate impedance and channel switching.

In Fig. 2 you will note that 4 amplifiers are used. The microphone as well as phonograph can be switched into any one of the 4 amplifiers whereas the radio receivers can only be switched into their respective banks of 2 amplifiers. The output of amplifiers Nos. 1 and 2 can be paralleled to cover the complete school. It isn't necessary that all amplifiers have sufficient power to

cover the complete school as generally only certain classes are interested in a particular program.

A schematic of the amplifier is shown in Fig. 1 and is explained in the text. The output can be fed as suitable impedances but great care must be taken that load, lines and speaker impedances are properly balanced-out so that when rooms are switched in and out the quality does not change. The room switches are again of special design and in this case have 20 contacts. Great care must be taken in the design as well as construction of all the apparatus so that in the ultimate results no objectionable features, including cross-talk, occur. Absolute fidelity in voice and music must be the result of the equipment. Throughout this maze of equipment at no time are there impedance-correcting devices used. All circuits must be properly matched in impedances as well as in their proper voltage and current relations.

The room control panel must be so designed that it is absolutely individual. Rooms do not have to be grouped as the system will operate just as well with only one room switched in as it will when the complete school is switched in.

Phonograph and microphone lines may be brought in from any part of the building so that these services may be established throughout the school.

In connection with this 1-way communication we have designed other systems which provide for 2-way communication. These systems will be explained in a later article.

From the foregoing it can be seen and understood that school sound equipment cannot be constructed from a lot of miscellaneous parts. All parts used throughout this equipment must be so designed and constructed that they not only will match the circuit, but so that their flexibility and efficiency will bring about perfect mechanical and electrical operation.

(This description will be concluded in Part II in the forthcoming issue.—Editor)

\*Copyright 1935 by R. H. von Liedtke. All rights reserved. Not to be reproduced in whole or in part in any form whatsoever without written permission of the copyright owner.

This article has been prepared from data supplied by courtesy of Radio Research Labs.

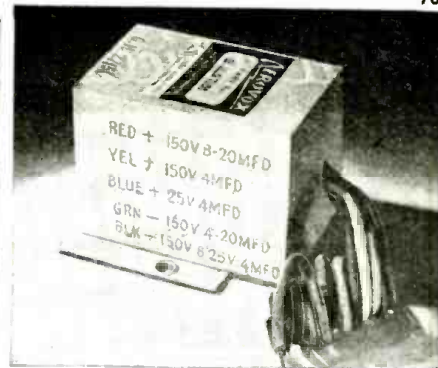

## Better Servicing Lower Costs



Here's a typical AEROVOX Exact Duplicate Replacement Condenser. Four sections. Precisely matches original unit. Slips in place on chassis. Functions as set designer intended. Why improvise? Why use a mess of separate units? Especially when this exact duplicate costs less! That's why AEROVOX offers a line of exact duplicates.

Write: New 1936 catalog contains four pages of exact duplicate replacements. Copy on request, together with sample of monthly Research Worker.

# AEROVOX

CORPORATION

77 Washington St. : : Brooklyn, N. Y.

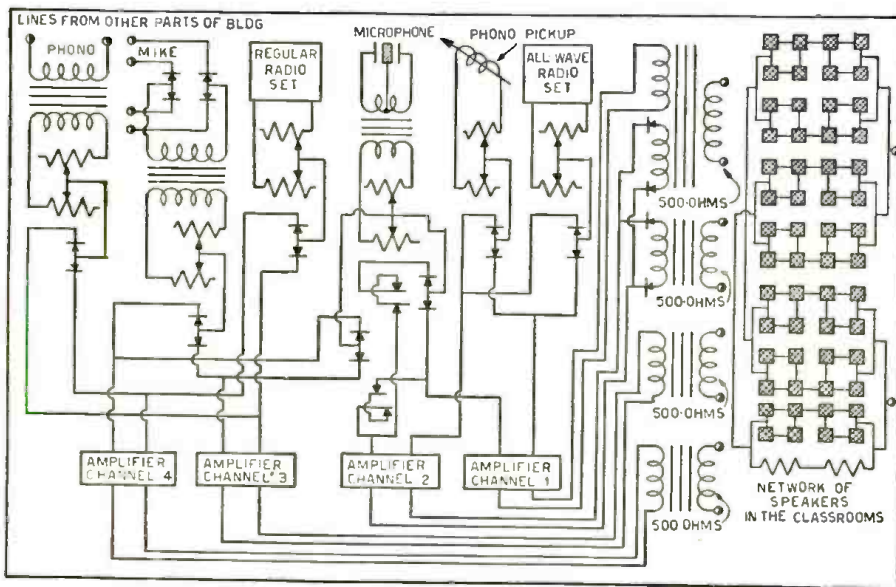

Fig. 2. Block and schematic layout of a 4-channel P.A. system.

## "AN A.C.-D.C. ELECTRONIC RELAY"

(A Correction)

Several changes in this interesting and practical article (which appeared in the preceding April issue of *Radio-Craft*, pg. 589) have been recommended by the author. These changes, either as additions, deletions or new wordage, are given below in italics; the line to which reference should be made is given in parentheses.

Col. 1: (line 14) the diagram. It operates on the change in output of an oscillator, caused by a change in the .....

Col. 2: (line 5) hand is brought close to the

antenna, capacity  $C_1$  is increased and the output of the oscillator falls.

Col. 3: (line 2) tations. When the oscillations are at full strength a negative bias is applied to the control-grid of the 25A6, which makes the plate current of the 25A6 fall. When someone in front of the window places a hand close to the antenna, the output of the oscillator is diminished and the voltage applied to the control-grid of the 25A6 is less negative. This causes the plate current of the 25A6 to rise sufficiently .....

Please Say That You Saw It in RADIO-CRAFT

## NATIONAL UNION OFFERS

ANOTHER WAY TO CREATE MORE SERVICE JOBS!

RADIO INTERFERENCE ANALYZER FREE

You can have this new business builder free with National Union tube purchases. Small deposit. Don't miss it. Get details.

...and Another Chart To Help Service Specialists

Chart of Radio Receiver Peak Frequencies. More than 2500 models. Real help for service experts. Get your copy free. Send coupon.

## SEND COUPON FOR DETAILS

NATIONAL UNION RADIO CORPORATION of N. Y.  
570 Lexington Ave., New York, N. Y. RC536

Send details on Interference Analyzer and new Peak Frequency Chart.

Name \_\_\_\_\_  
Street \_\_\_\_\_  
City \_\_\_\_\_ State \_\_\_\_\_

# Cut Prices on Many Popular Radio Books

**IMPORTANT—All prices have been drastically reduced—many new books included!**

We herewith present a selected collection of recent important radio books. We have, after an exhaustive study, selected these volumes because they represent the foremost radio books of their kind in print today. There is such a great variety that we are sure it will satisfy any taste as well as any requirement that the student of radio might have.

We publish no catalog and ask you to be kind enough to order direct from this page. Prompt shipments will be made to you direct from the publishers. We merely act as a clearing house for a number of radio publishers and **OUR PRICES ARE AS LOW OR LOWER THAN WILL BE FOUND ANYWHERE.** Remit by money order or certified check. Register all cash.

**SHORT WAVES.** by C. R. Lutz and H. B. Gable. Silk Covers. Size 6x9", 284 pages, 258 illustrations. Price was formerly \$2.98. **NEW PRICE NOW, \$1.15** prepaid

The biggest and most complete book on short waves. Covers every imaginable phase, including S. W. Superheterodynes, Television, Aircraft Radio, Ultra Short Waves, Directional Antennae, etc. The authors are famous short-wave authorities. This is the best book on Short-Waves in print today.

**PRACTICAL TELEVISION.** by E. T. Larner. Cloth covers, size 5 1/2 x 8 1/2", 223 pages. **\$3.69** 127 illustrations. Price

This book explains television in full, including elementary principles, photo-electric cells, and all important types of television sets as well as basic principles of optics, images, mirrors, lenses, etc.

**ELEMENTS OF RADIO COMMUNICATION (Second Edition).** by John H. Morecroft. Cloth covers, size 6 x 9 1/2", 286 pages, 241 illustrations. **\$2.98** Price

An introductory volume, written in easily understandable style, to the more comprehensive, "Principles of Radio Communication."

**OFFICIAL SHORT-WAVE RADIO MANUAL.** Volume 1, by Hugo Gernsback and H. W. Seror, with 352 pages, illustrations, flexible, looseleaf leatherette binder, size 9x12". Price **\$2.00** Prepaid

The one and only short-wave manual published. Contains construction information on the most important Short-Wave Receivers, sections on S.W. Transmitters, Ultra Short Waves, S.W. Beginner's section, coil winding, A.C.-S.W. Power Packs, kinks, etc., for S.W. Experimenters, sections on S.W. Converters, Antennae, Superheterodynes, Amateur Phone Transmitters, Super Regeneration in S.W. Receivers, S.W. Therapy, S.W. Physics, etc.

**SHORT WAVE WIRELESS COMMUNICATION.** by A. W. Ladner and C. R. Sizner. Cloth covers, size 6 1/2 x 9 1/2", 200 illustrations, 12 plates. Price **\$3.46**

Short wave experimenters who have grown out of 1-tube sets will revel in this book, which tells the "how come" of short-wave operation. A good portion of the volume is devoted to the amateur and commercial aspects of S. W. transmission.

**THE RADIO AMATEUR'S HANDBOOK.** (New Revised Edition), by a Frederick Collins. Cloth covers, size 5 1/2 x 7 1/2", 394 pages, 116 illustrations. **\$1.97** Price

If you wish to become a radio amateur (radio ham) this book tells you how. Everything in receiving and transmitter sets and how to build them.

**RADIO THEORY AND OPERATING.** by M. T. Loomis, 5th revised Edition. Cloth-bound; size 5 1/2 x 8 1/2" thick; 1,000 pages; over 800 illus.; 450 review questions and answers. **\$4.38** Price

Written in textbook style, a tremendous amount of useful information has been crammed into this thin paper, compact reference work. Radio transmission and reception have been covered, "from soup to nuts." A truly great book.

**MODERN RADIO ESSENTIALS.** by Kenneth A. Hathaway. Cloth covers, size 8 1/2 x 5 1/2", over 200 pages, and over 100 illustrations. Price **\$1.95**

**NEW!** Unlike most books dealing with radio fundamentals, Hathaway's new book is arranged for quick use by the practical technician. In addition, it brings the reader right up-to-date on essential radio theory.

**RADIO RECEIVING TUBES.** by Meyer and Westral. Cloth covers, size 7 1/2 x 5 1/2", 298 pages, 181 illustrations. **\$2.47** Price

One of the finest books on vacuum tubes. Everything worthwhile on the subject treated in a masterful manner.

**PHOTOCELLS AND THEIR APPLICATION.** (Second Edition), by V. K. Zworykin and S. D. Wilson. Cloth covers, size 5 1/2 x 8 1/2", 332 pages, 180 illustrations. Price **\$2.88**

Does this book tell you why and how to use light-sensitive cells? The answer is that the first edition was a "sell out," and the second edition, brought right up to date, is even a better volume. Enough said.

**ELECTRONICS.** by R. C. Hudson. Cloth covers, size 6x9", 134 pages, 45 illustrations. **\$1.95** Price

"This book is written for the reader who may wish to know something about what is going on and who has not heretofore given the matter much attention," says the author. Read it and learn how dry rectifiers, vacuum tubes, batteries, television tubes, and other apparatus work; get the "low down" on electrons and atoms.

**SHORT WAVE RADIO HANDBOOK.** by Clifford E. Denton. Paper covers, size 6 1/2 x 8 1/2", 128 pages, 150 illustrations. **\$1.00** Price

Coll data, circuit data, testing data, R.F. and A.F. amplifier data—in fact, let us say, "data of every imaginable sort—in connection with short-wave radio reception."

**PRINCIPLES OF RADIO.** by Keith Lenney, M. A. Cloth covers, size 8x5 1/2", 478 pages. **\$3.46** Price

A marvelously written textbook with the latest radio principles, including screen grid and pentode, amplifiers, etc.

**HOW TO ORDER**  
We cannot ship C.O.D. Our prices are net, as shown. Some of the books sent prepaid (in U. S. only). Those that are not thus listed will be shipped by express collect if sufficient postage is not included by you.

**NEW LOW PRICE RADIO BOOKS**

Here are new, up-to-date books on every conceivable radio subject, just published. Modern in every sense. ALL BOOKS UNIFORM from 61 to 72 pages; 50 to 120 illustrations. All books written by well-known radio authors.

- HOW TO BECOME AN AMATEUR RADIO OPERATOR **45c**
- HOW TO GET BEST SHORT-WAVE RECEPTION **45c**
- 101 SHORT-WAVE HOOK-UPS **45c**
- HOW TO BUILD AND OPERATE SHORT-WAVE RECEIVERS **45c**
- THE SHORT-WAVE BEGINNER'S BOOK **25c**
- 10 MOST POPULAR SHORT-WAVE RECEIVERS AND HOW TO BUILD THEM **25c**
- SHORT-WAVE COIL BOOK **25c**
- HOW TO BUILD FOUR DOERLE SHORT-WAVE SETS **10c**
- HOW TO MAKE THE MOST POPULAR ALL-WAVE 1- and 2-TUBE RECEIVERS **10c**

**RADIO PUBLICATIONS**

**99A HUDSON STREET**

**NEW YORK, N. Y.**

**THE LATEST RADIO EQUIPMENT**

(Continued from page 674)

of gasoline; requires no external exciting current. Weight is 79 lbs.; power output, 3,000 W. at 110 V. A.C. (60 cycles). Also generates 7 1/2 V. D.C. at 5 A. for use in charging storage batteries.

**PORTABLE SOUND-MOVIE MACHINE (976)**

**M**ANY new and exclusive features are included in this simple, compact machine. A motor-driven blower provides cooling. The special projection lamp also provides light for the high-quality sound reproduction! Model illustrated projects an 8 ft. picture.

**PORTABLE P.A. OUTFIT (977)**  
(The Webster Co.)

**H**ERE is a complete single-case portable P.A. system. The undistorted, high-fidelity output is 8 W.; total weight, 27 lbs. The input provides for a crystal microphone and a high-impedance phono. pickup. A tone control is provided.

**SMALL TABLE SET USES "MAGIC EYE" (978)**  
(RCA Mfg. Co.)

**M**ETAL tubes are used exclusively in this new receiver, except of course for the 6E5 "magic eye" tuning tube. There are 8 tubes; power output is 5 W.; tuning range is 540 to 18,000 cycles. Has 8-in. speaker and a tone control. The colorband dial has 2-speed tuning. The cabinet measures 21 1/4 x 15 1/4 x 9 1/4 ins. deep.

**BEAT NOTE OSCILLATOR (979)**  
(Clough-Brengle Co.)

**A** PURE sine wave is generated by this apparatus! Very useful for testing the audio systems of P.A. amplifiers, talkies, and radio receivers for fidelity over the complete range. The output is 27 V. at 5,000 ohms and is uni-

form within 2 db. over the (continuously-variable) range from 50 to 10,000 cycles.

**AMPLIFIER CASE (980)**  
(Radolek Co.)

**T**HIS case may be fastened permanently to the amplifier or may be detached; everyone interested in amplifier equipment will be glad to know that a case of this sort can be secured. The bottom tray makes all controls and connections available. The top tray has room for cable, microphones, and the smaller type of stands. This case will fit a 30 W. amplifier, with or without shield. Plywood construction is used with strong reinforcement on all corners. Finish is black fabrikoid.

**NEW RECTANGULAR DIAL (981)**

**E**XTREMELY fine bandsread is afforded by this 2-pointer dial. The scale measures approximately 3 x 6 ins. long and is calibrated 0-100. Entire face of dial is covered by a glass crystal. The planetary drive has 2 speeds: is used with slow (about 100-to-1 ratio), and fast (about 18-to-1) ratio, in 360 degrees.

**OSCILLOSCOPE (982)**

**T**HIS unit is entirely self-contained, with the power supply and all controls built-in. May be used with an external linear sweep. It is intended for all types of work including transmitter checking, audio work, receiver alignment,

etc. Only 2 tubes are used: a cathode-ray, type 906 (3-in.), and a type 80 rectifier.

**CAR P.A. UNIT (983)**  
(Remington Radio & Elec. Corp.)

**H**ERE is an ultra-compact P.A. unit measuring only 10 1/4 x 7 1/4 x 7 1/4 ins. high. The "A" drain is only 6.5 A., total; an ingenious switch disconnects "B" dynamotor during quiet periods, thus reducing the "A" drain to 4.1 A. The gain is 91 db. Tubes: 1-79 (used as A.F.1 and 2), 1-79 (A.F.3), 2-79s (A.F.4). Weight, 15 lbs.

**PORTABLE P.A. UNIT (984)**  
(Bell Sound Systems, Inc.)

**T**WIN speakers are used with this system; T output terminals provide for a total of 6. Power output: 15 W.; gain, 94 db., flat (within 2 db.) from 35 to over 10,000 cycles. Incorporates a crystal mike; uses: 3-53s; 2-2A3s; 1-523.

**SPEAKER HOUSING (985)**  
(The Lifetime Corp.)

**F**INISHED in rough satin silver. The design has been engineered to eliminate previous faults in this type of dynamic speaker housing. Insert illustrates a mounting variation.



Please Say That You Saw It in RADIO-CRAFT



**NOVEL "EXPANDER" SET (991)**

(Continued from page 675)

be of sufficient interest to be gone into more in detail here. The special bulbs used are shown in one of the photos, while a simplified circuit of the unit without the on and off switch is shown in the "breakdown" diagram. The circuit is somewhat similar to the Wheatstone Bridge in connection. The current is divided into 2 paths, and 2 small, variable-resistance bulbs with special filaments having a lag of 1/5- to 1/10-second cause more current to flow through one path than through the other as the volume increases. This restores to the reproduction the greater changes in volume which were, for various reasons, levelled off during transmission. The device also lowers the volume when a weak passage comes through.

**HIGH-GAIN, "6B5" AMPLIFIER (992)**

(Continued from page 675)

recourse to preamplifiers. Such an amplifier is here shown by photo and by diagram. Resistance coupling has been used throughout, resulting in a comparative lack of hum, frequency response within about 2 db. from 50 to 7,000 cycles. The gain is measured at 120 db., which is sufficient to work at top output with even the low-gain ribbon mikes.

Two separate input channels, allow the simultaneous use of a phono. pickup and a microphone, with individual gain control of each. The mixing is done in a 6A6 tube while another of the same type provides phase inversion and additional gain. The two 6B5 output tubes provide the gain of 2 ordinary stages, and in addition very fine quality.

While the peak power output of the unit is 24 W., the output into a 500-ohm line (the condition of actual service) is a full 15 W. The hum level is -45 db., which for practical purposes, is no hum at all.

The size of the amplifier is only 8½ x 15½ x 9½ ins. deep.

**"CUE-BALL" CRYSTAL MIKE (993)**

(Continued from page 675)

pg. 410), we now present the new dull-chromium (plating, on a fine-woven brass screen), non-directional "mike."

The output level is -66 db. and the impedance is similar to that of a capacity of .005-mf. The length of the connecting leads has no effect on the frequency response; only the output will drop (slightly).

**"LADDER" ATTENUATOR (994)**

(Continued from page 675)

is afforded by an infinitely variable ladder network consisting of a series element on which the contact rides, and which has a shunt element connected to it along its entire length. Referring to the circuit, A shows the effective circuit; B, connection for impedance values over 50 ohms; and C, for impedance values below 50 ohms. The unit is made in 9 sizes from 15 to 10,000 ohms; rating is 1½ W. signal energy.

**15-W. AMPLIFIER (995)**

(Continued from page 675)

rectifier to enable the most effective performance. The adjustable resistor, R7, permits the builder to vary the 'C' bias between the two 2A3 output



No. 995, left. 15 W. amplifier.  
No. 992, below. 6B5 amplifier.  
No. 998, right. Phono-radio.

**UTC PRESENTS A NEW AC-DC CK-7 METAL TUBE PREAMPLIFIER KIT**



The CK-7 preamplifier kit has been designed specifically for use with the new metal tubes. While the circuit is equally well suited for glass tubes, the low microphonic effects and excellent shielding of the metal tubes make them exceptionally well suited for operation at the low levels encountered in preamplifier work. A specially designed rectifier circuit and careful placement of component parts is responsible for the extremely low hum and noise level in the CK-7 preamplifier. Three identical tubes are used, one being connected up as a rectifier; so that no fear need be had regarding misplacement of tubes in the uniform 8 prong sockets. The preamplifier has a gain of 55 D B.

Overall Amplifier Dimensions—8½ x 7 x 4¼

For further details on seven types of UTC CHROMSHIELD Power Amplifier Kits write for CSB Bulletin

CK-7 Transformer kit including chassis	List \$16.00	Net \$9.60
CK-7 Accessory Kit—includes all necessary resistors, condensers, sockets, line cord and plug, hardware—ready to wire	6.00	3.60

**UNITED TRANSFORMER CORP.**  
78 SPRING STREET NEW YORK, N. Y.  
EXPORT DIVISION - 15 LAIGHT STREET, NEW YORK, N. Y.

tubes, in order to obtain the proper balance in this circuit.

Tone control and volume controls are used. Both the input and the output transformers are provided with plenty of taps to assure universal adaptability.

**3-TUBE P.A. AMPLIFIER (996)**

(Continued from page 675)

Either type tubes may be used, depending upon whether the U.T.C. type UH1 or UM0 transformer is used. All apparatus is housed in a steel case 10 x 10 x 5 ins. deep, and finished with baked black crackle enamel.

The gain of the unit is over 70 db., with excellent frequency response. The amplifier may be fed directly by any high-impedance pickup.

**A "METER KIT" (997)**

(Continued from page 675)

meter, and a 2,000 ohms-per-volt D.C. meter. The ranges of the complete instrument are: 10, 50, 250, 500, 1,000, D.C. and A.C. volts; 1, 10, 50, 250 D.C. ma.; 3 megs., 1.5 megs., 1,500 ohms. All voltage and current ranges are guaranteed accurate to 2 per cent.

Some of the uses to which the completed unit may be put, are: Measurement of A.C. supply and secondary voltages; checking leakage of electrolytic and paper condensers; tracing poorly soldered joints; locating open chokes and other components; and, measurement of current drain of all tubes. Many other checks and measurements of which the above are representative may be made.

**NEW PHONO-RADIO SET (998)**

(Continued from page 675)

phonograph installation. Special treatment of the A.F. amplifier results in full tone reproduction on both radio and phonograph. Automatic bass compensation is provided.

Electrical specifications are as follows: Tuning frequency range: band "A," 140-410 kc.; band "B" 540-1,750 kc.; band "C," 1.75-6.0 mc.; band "D," 6.0-19.5 mc. Tuning control drive ratio: fast tuning, 5½ to 1; vernier tuning, 55 to 1. Power output: undistorted, 5 W.; maximum, 8-W. dynamic speaker, 10¼ ins.: cone coil im-

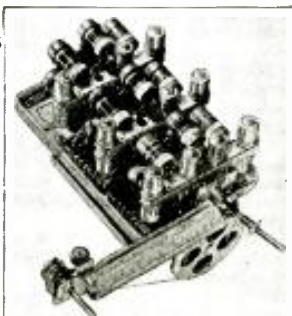

**Train Now for New RADIO Opportunities**

**Get Into a Line Where There's Action—Every Day—And a Payday Every Week—You Be the Boss!**

**Analyzer & Resistance Tester—Latest Design—YOURS Without Extra Cost**

Right now while hundreds are looking for work where there isn't any, the radio service field can use trained men. With the proper training and the necessary equipment, you can enter this field and make a comfortable living. We include with our course this modern set analyzer and trouble shooter without any extra charge. This piece of equipment has proved to be a valuable help to our members. After a brief period of training you can take the set analyzer out on service calls and really compete with "old timers." We show you how to wire shortwave receivers—analyze and repair all types of radio sets—and many other profitable jobs can be yours. Teaching you this interesting work is our business and we have provided ourselves with every facility to help you learn quickly yet thoroughly. If you possess average intelligence and the desire to make real progress on your own merits, you will be interested.

**ACT NOW — MAIL COUPON**

Start this very minute! Send for full details of our plan and free booklet that explains how easily you can now cash in on radio quickly. Don't put it off! Write today. SEND NOW!

**RADIO TRAINING ASSN. of AMERICA**  
Dept. RC-65, 4525 Ravenswood Ave., Chicago, Ill.  
Gentlemen: Send me details of your Enrollment Plan and information on how to learn to make real money in radio quick.

Name .....

Address .....

City ..... State .....

**UNBREAKABLE P. A. TRUMPET**

A radically new type of sound projector made of the specially processed RACON ACOUSTIC STORMPROOF material, with full-length bell reinforcement. Demountable in three sections, with cast aluminum throat and section couplings, with loose coupling for unit attachment. Unquestionably the strongest, most durable trumpet available, with characteristic RACON high acoustic efficiency.

Racon Electro-dynamic Units and Horns are manufactured under 14 exclusive Racon Patents.  
Write Dept. RC536 for catalog.

**RACON ELECTRIC COMPANY, INC.**  
52 East 19th St., New York, N. Y.

Please Say That You Saw It in RADIO-CRAFT

# SHALLCROSS AKRA-OHM RESISTORS

Shallcross wire wound resistors are especially adapted for:

- Voltmeter Multipliers
- Shunts
- Electrical Equipment
- Telephone Equipment
- Attenuators
- Fading Controls

Bridges for measuring Resistance, Capacity and Inductance

- Resistance Amplifiers
- Burglar Alarm Equip.
- Broadcasting Station Eq.
- Fire Alarm Equipment
- Television Equipment



Type 100



Type 190

AKRA-OHM Resistors are manufactured in any value from 0.01 ohms to 10 megohms to any accuracy from 0.1% to 1%.

Send us your resistance specifications and we will quote you on the proper type for your work.

**SHALLCROSS MFG. COMPANY**  
Electrical Measuring Instruments  
and Accurate Resistors  
700 MAC DADD BOULEVARD  
COLLINGDALE, PA.

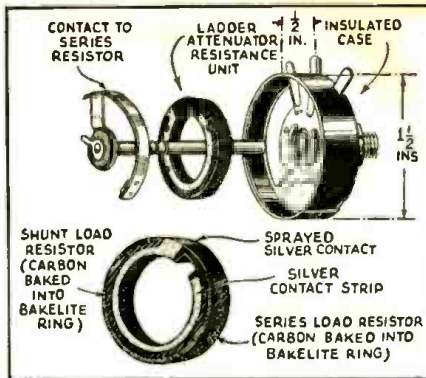

No. 994. Details of ladder attenuator.

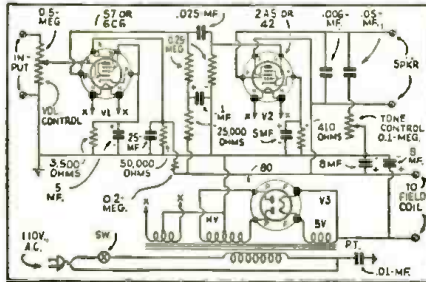

No. 996. Circuit of 3 tube amplifier.

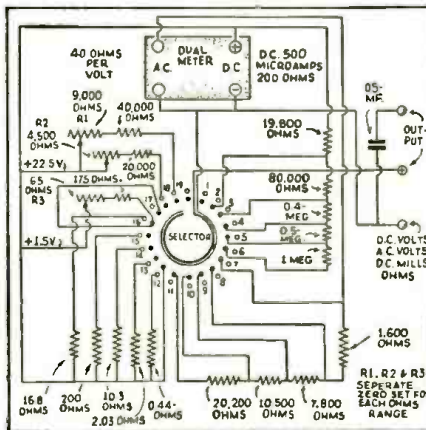

No. 997. Circuit of the meter kit.

pedance. 5 ohms at 400 cycles. Phonograph pickup: viscoloid damped; pickup coil impedance. 4.6 ohms at 1,000 cycles. Record changer: record ejector type; capacity. 9-10-in. records or 8-12-in. records; turntable speed. 78 r.p.m.; time to complete record-changing cycle. 4 1/2 seconds.

The "Sentry Box" utilized in this receiver is, as illustrated, a completely-shielded assembly of the R.F. wiring and associated parts, and may be removed as a single unit. Each coil is mounted on the soldering lugs of its respective band-change switch. Such construction eliminates long wiring and facilitates servicing.

## 30-W. SOUND SYSTEM (999)

(Continued from page 675)

an output of 30 W. with only 5 per cent distortion. A 3-channel input is provided for the use of 2 crystal microphones and a high-impedance pickup of any type. The input connections are such that absolute flexibility results. The overall voltage gain is 106 db., and the frequency-response curve is flat within 2 db. from 45 to 10,000 cycles. The amplifier is housed in a black crystalline finished steel case 17 x 12 x 8 ins. high. The output transformer has taps for 4, 8, 16, and 500 ohm lines.

The two 12-in. auditorium speakers employed obtain their field current by being connected in series directly across the output of the power supply, where they act as bleeders and help to stabilize the voltage.

There are 10 tubes needed, as follows: 2- 57s, 1- 53, 1- 2A5, 4- 2A3s, 1- 80, and 1- 83. The type 80 is used to supply fixed bias to the four type 2A3 tubes of the output stage, the latter working under class AB conditions.

## Index to Advertisers

<b>A</b>	
Aaloy Transformer Co., Inc.	690
Aerovox Corp.	701
Allied Radio Corp.	678
Amberite Corp. of America	696
Amplifier Co. of America	698
Arrow Sales Corp.	693
Atlas Sound Corp.	696
Autocrat Radio Company	698
<b>B</b>	
Bell Sound Systems, Inc.	682
Blau, the Radio Man, Inc.	681
The Brush Development Co.	688
<b>C</b>	
Candler System Company	682
Capitol Radio Engineering Inst.	687
Central Radio Laboratories	682
Classified Section	699
Columbia Sound Co., Inc.	690
Commercial Laboratories	697
Continental Carbon, Inc.	690
Cornell-Dubilier Corp.	688
Corno Elec. School	641
<b>D</b>	
Denmore, Inc.	687
Dodge's Institute	695
Dremel Mfg. Company	689
<b>E</b>	
Hugh H. Eby, Inc.	694
Electrad, Inc.	686
Electric Institute, Inc.	680
<b>F</b>	
Federal Engineering Company	695
<b>G</b>	
General Cement Mfg. Co.	693
General Electric Company	Back Cover
Gillette Radio Corp.	692
Goldentone Radio Company	683
Greenpark Company	697
<b>H</b>	
Hammarlund Mfg. Company	682
Harrison Radio Company	692
Hygrade-Sylvania Corp.	681
<b>I</b>	
Inter-World Trade Corp.	689
<b>J</b>	
Jobs & Careers	696
<b>L</b>	
Lafayette Radio Mfg. Co., Inc.	684
The Lifeline Corporation	696
Lincoln Engineering School	698
Arthur H. Lynch, Inc.	695
<b>M</b>	
Metal Cast Products Co.	683
Midwest Radio Corp.	685
Miles Reproducer Co.	685
<b>N</b>	
National Radio Institute	643
National Union Radio Corp.	701
<b>O</b>	
Oxford-Tartack Radio Company	683, 691
<b>P</b>	
Popular Book Corp.	697
Precision Apparatus Corp.	692
<b>R</b>	
Racon Electric Company	703
Radio & Technical Pub. Co.	Inside back cover
Radio & Television Institute	689
Radio Circular Company	689
Radio City Products Company	689
Radio Constructors Labs.	677
Radio Publications	702
Radrotech Laboratory	691
Radio Trading Company	689
Radio Training Association	703
Radolek Company	704
Rt'A Institutes, Inc.	694
Raytheon Production Corp.	694
REA Mfg. Co., Inc.	Inside front cover
Readrite Meter Works	695
Remington Radio & Elec. Corp.	693
Remington Rand, Inc.	693
<b>S</b>	
S. O. S. Corporation	689
Sears, Roebuck & Company	694
Shallcross Mfg. Company	701
Solar Mfg. Corp.	689
Sound Apparatus Corp.	693
South Bend Lathe Works	685
F. L. Sprayberry	684
Standard Transformer Corp.	683
Suifrene Instruments Corp.	690
<b>T</b>	
Teleplex Company	689
Thor Radio Company	687
Triplet Elec. Instrument Co.	679
Triumph Mfg. Company	695
Try-It Radio Company, Inc.	698
<b>U</b>	
United Transformer Corp.	703
Universal Microphone Company	695
<b>W</b>	
The Webster Company	697
Wellworth Trading Company	694, 696
Wineharber Corporation	670
Wright-DeCoster, Inc.	686
Zephyr Radio Company	693

(While every precaution is taken to insure accuracy, we cannot guarantee against the possibility of an occasional change or omission in the preparation of this index.)

THE  
SPOT  
TO



SAVE  
MONEY!

## Just Off The Press!

The Radolek New 1936 Profit Guide is the most complete Radio Parts Catalog ever published. Completely revised—right up to the minute, bringing you everything in Radio—at the right prices. Every page brings you extra profits! Contains over 10,000 Individual Radio Repair Parts—hundreds of new items—a complete new selection of receivers, Amplifiers, Tools, Tubes, Books and instruments. Everything you need—always in stock... ready for prompt shipment to you. You need this Big Radio Parts Catalog—it's FREE. Send for it! Rely On Radolek For Radio.

# RADOLEK

588 W. RANDOLPH—CHICAGO  
Send the Radolek Profit Guide Free.

Name .....

Address .....

Serviceman?  Dealer?  Experimenter?

Please Say That You Saw It in RADIO-CRAFT

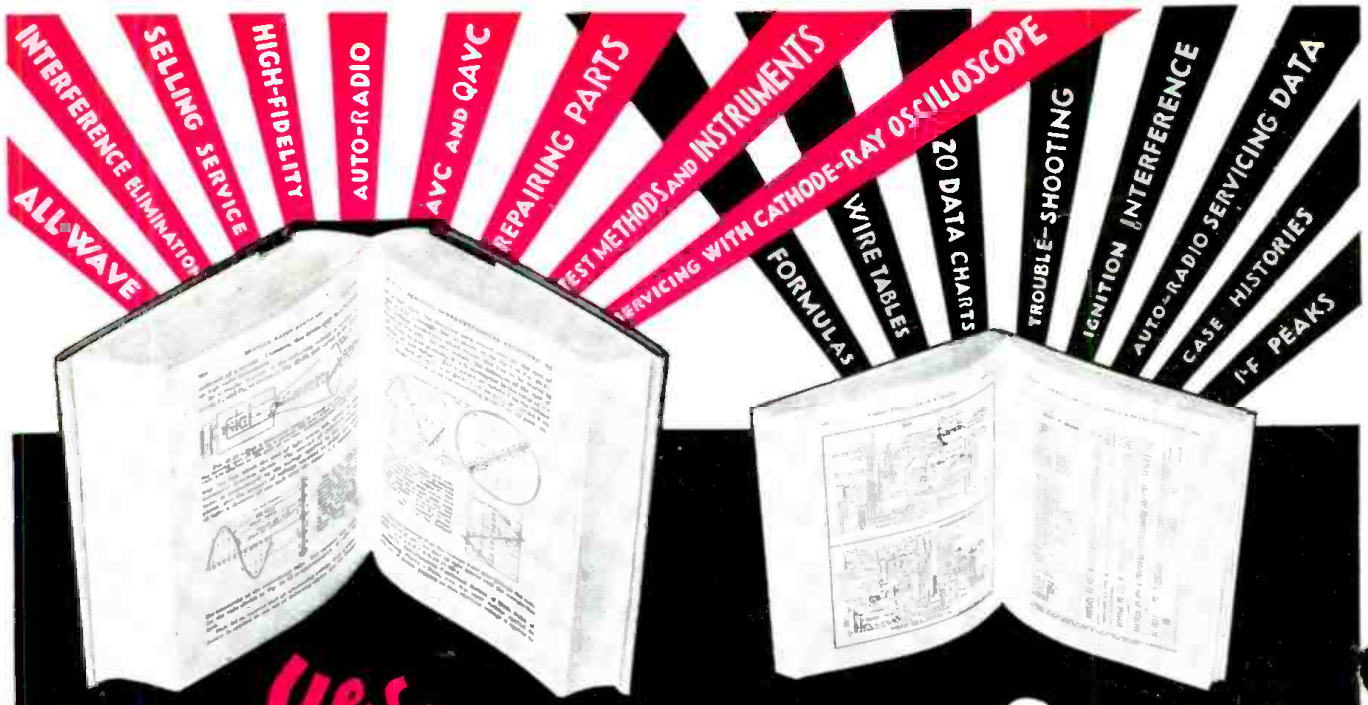

*Yes.* it's all here in these **2** books -  
 the whole field of **RADIO SERVICING**

**I**N this huge book and its supplement you have at your fingertips the same "inside information" that has been profitably used by the most successful servicing organizations in the country. A large part of it was supplied by them themselves! Thousands of time-saving tricks of the trade . . . Thousands of money-making ideas and tips. Editors, experts, service men and students all over the world acclaim this new Ghirardi masterpiece as the one book they have all been waiting for. You too will make more money after you make use of this complete and convenient source of knowledge on every phase of radio service work. It is the only book published that gives you "so much for so little." *Free circular upon request.*

*Just a few of the 417 different subjects covered in this huge storehouse of practical facts and data*

- |  |   |  |
|--|---|--|
| <p><b>TEST INSTRUMENTS</b><br/>       Full details about all types of measuring and servicing instruments—their principles of operation, their construction, and their use to best advantage in radio service work today. Full descriptions of all commercial instruments, including the very latest models. Construction data for building your own if you wish to.</p> | <p><b>INTERMITTENT RECEPTION, ETC.</b><br/>       How to track down to their sources, and then eliminate, intermittent reception, hum, distortion and other annoying receiver troubles.</p> | <p><b>HIGH-FIDELITY RECEIVERS</b><br/>       You'll save yourself a lot of experimenting by using this valuable dope that others have learned about servicing High-Fidelity receivers.</p> |
| <p><b>LATEST TEST METHODS</b><br/>       121 illustrated pages of time-saving test and servicing short-cuts you can use right away.</p>  | <p><b>ALIGNING RECEIVERS—CATHODE-RAY OSCILLOSCOPE</b><br/>       The whole story on alignment of T-R-F and superhet receivers, including use of the Cathode-Ray Oscilloscope.</p>           | <p><b>SALES AND ADVERTISING</b><br/>       Tested tips on how to sell, advertise and merchandise your service—how to build up your business and make more money out of it.</p>             |
| <p><b>LATEST REPAIR METHODS</b><br/>       The world's greatest compilation of money-making methods for making quick but effective repairs on all kinds of receiver parts.</p>   | <p><b>AUTO-RADIO</b><br/>       Every phase of auto-radio installation and servicing, together with dope on ignition systems and interference.</p>  | <p><b>INTERMEDIATE FREQUENCIES</b><br/>       For alignment work, the supplement gives you a complete list of 1-f peaks for over 3,400 different superhets.</p>                            |
| <p><b>AVC AND QAVC CIRCUITS</b><br/>       Complete study of all types of A.V.C., Q.A.-V.C. and resonance indicator circuits, with all their characteristics and troubles thoroughly explained.</p>  | <p><b>ALL-WAVE RECEIVERS</b><br/>       Special construction features, troubles and servicing problems.</p>   | <p><b>CASE HISTORIES</b><br/>       Actual Trouble Symptoms and Remedies conveniently tabulated for 750 common American receivers. (Supplement)</p>  |
|  | <p><b>NOISE AND INTERFERENCE</b><br/>       129 pages of short-cuts in tracking down and eliminating all kinds of noise and interference effectively.</p>                                   | <p><b>AUTO REFERENCE DATA</b><br/>       All kinds of special automobile ignition-circuit adjustment data for all makes of American cars including 1936 models. (Supplement)</p>           |

**A.A. Ghirardi's  
 MODERN  
 RADIO  
 SERVICING**  
 and its supplement  
**RADIO FIELD  
 SERVICE DATA**

**1540 pages  
 749 Illustrations  
 BOTH BOOKS  
 \$5**

*Gamble Nothing!*  
**Read the Guarantee—then  
 MAIL THIS COUPON**

**RADIO & TECHNICAL PUBLISHING CO.**  
 45 Astor Place, New York City, Dept. RC-56.

Enclosed please find \$5 for your Introductory Combination Offer of both books, postpaid. (Foreign \$5.50)

Enclosed please find \$1 for Ghirardi's "MODERN RADIO SERVICING." (Foreign \$1.50)

Enclosed please find \$1.50 for "LAD(1) FIELD SERVICE DATA." (Foreign \$1.75)

Please send PRICE descriptive literature.

NAME .....

ADDRESS .....

CITY .....

Occupation .....

**GUARANTEE:** If you are not entirely satisfied with these two books, return them undamaged within 5 days and your money will be promptly refunded.

**Everything a Service Man needs to know**

**GENERAL ELECTRIC RADIO**



# SERVICE NOTES

1930—1935

**FREE . . . to Service Men**

UPON THE RECEIPT OF  
10 "V-DOUBLET"  
ANTENNA CARTON LABELS

● Here's an opportunity for radio service men to get a free copy of service notes on all radio receivers sold by General Electric during the past six years. This practical, 887-page volume, just released, is sold at the regular price of \$2.00. Every radio service man, who sells 10 G-E "V-doublet" All-wave Antennas, may have a copy free. Just return CARTON LABELS FROM 10 G-E "V-DOUBLET" ANTENNA KITS, to your G-E Radio Distributor, and this valuable new book will be yours.

This Offer Expires  
May 30, 1936

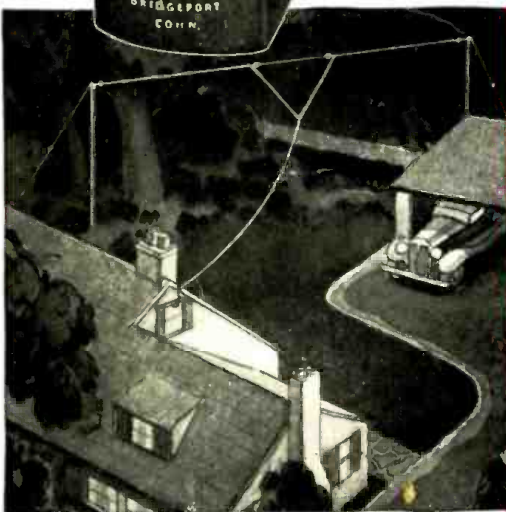

## THE GENERAL ELECTRIC "V-DOUBLET" ALL-WAVE ANTENNA Points the Way to Make Money

Do you want to cash in on radio's most neglected market? Then, sell and install the G-E "V-doublet" All-wave Antenna System. You'll find it pays big dividends in sales and profits. Canvass for prospective buyers every chance you get. Insist that a G-E "V-doublet" All-wave Antenna be included with every set. Get your share of this large and profitable market. Tune in on its profit possibilities.

*For complete information see your nearest  
General Electric Radio Distributor.*

# GENERAL ELECTRIC

**The Original Metal-tube Radio**

**APPLIANCE AND MERCHANDISE DEPARTMENT, GENERAL ELECTRIC COMPANY, BRIDGEPORT, CONN.**