



May  
25 Cents  
Canada 30c

# Radio-Craft

HUGO GERNSBACK Editor

How to Make This  
**1 TUBE LOUDSPEAKER SET**  
See Page 656

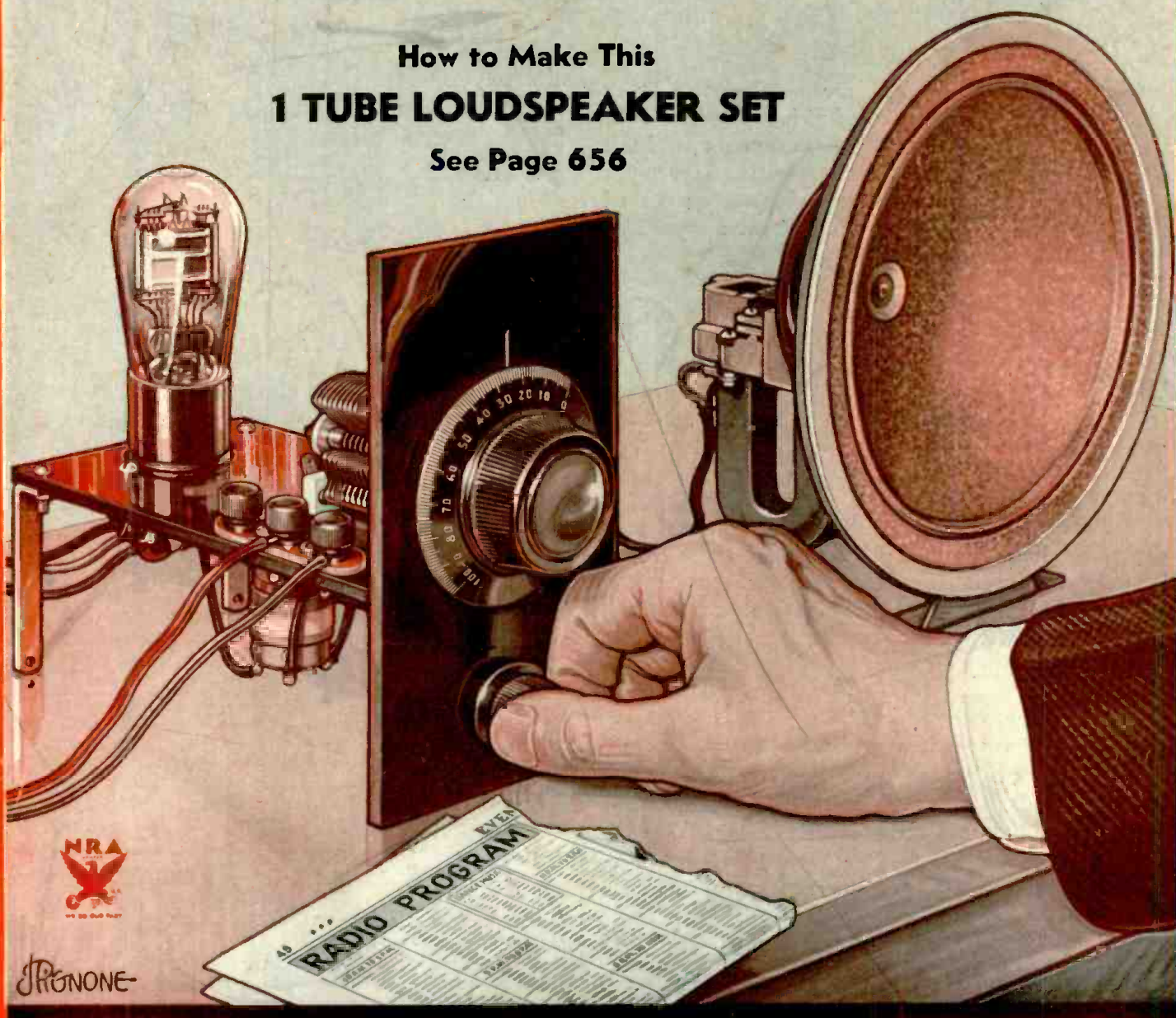

J. PRONONE

Third Dimension in Music – The Polytone New Photo-cell Music  
Party Tricks with Radio – Adjusting Soundhead Optical Systems

# TRAIN with R.T.A. for RADIO SERVICE WORK.

This precision Analyzer and Point to Point Resistance Tester included with our training. It is of the latest design and construction, will test all circuits equipped with latest six and seven-pin tubes, and cannot become obsolete or out of date. Equipped with an improved type 2% D'Arsonval Meter, etc.



## Learn at home to fill a **GOOD PAY RADIO JOB!**

**SKILLED SERVICE MEN  
ARE NEEDED**

Skilled service men are needed now more than ever to service the modern all-electric radio receivers. The day of the tinkerer is gone. By becoming a certified R.T.A. Radio Technician you can make bigger money, full time or spare time, and fit yourself for the big-pay opportunities that Radio offers.

### **TRAIN AT HOME—NOW**

Now is the time to get ready for these better pay radio jobs. Our training will qualify you quickly. In addition we furnish you, *free of extra charge*, a high grade Precision Analyzer and Point to Point Resistance Tester. This remarkable instrument, together with our training, will enable you to do expert work in a short time.

### **\$5 to \$15 A WEEK—EXTRA**

Our training is practical and designed to help you make extra money at the very start. With the first lesson I give you a series of over thirty spare-time Money Making Plans that will enable you to make from \$5 to \$15 a week extra, and more.

RADIO TRAINING ASSOCIATION OF AMERICA  
Dept. R-5 4513 Ravenswood Ave. Chicago, Ill.

**ALL THE LATEST CIRCUITS  
ARE INCLUDED**

Our training is up-to-the-minute and thorough in every detail. All late subjects are covered—automatic volume control, R.F. pentodes, diode detection, delayed and amplified A.V.C., automatic noise suppression, dual channel audio amplification, all-wave superheterodynes, acoustically compensated volume control, etc.

### **ENDORSED BY LEADERS OF THE INDUSTRY**

Our modern training is endorsed by Leaders of the Radio Industry. We have in our files over thirty letters from them recommending our training to those who want to make good quickly in radio.

### **Mail Coupon—Now**

RADIO TRAINING ASSOCIATION OF AMERICA  
4513 Ravenswood Ave., Dept. R-5  
Chicago, Ill.

Gentlemen—Please rush me more details of your practical endorsed training course in Radio.

Name \_\_\_\_\_  
Address \_\_\_\_\_  
City \_\_\_\_\_ State \_\_\_\_\_

# OPPORTUNITIES

*are many*

## for the Radio Trained Man



Don't spend your life slaving away in some dull, hopeless job! Don't be satisfied to work for a mere \$20 or \$30 a week. Let me show you how to get your start in Radio — the fastest-growing, biggest money-making game on earth.

### Jobs Leading to Salaries of \$50 a Week and Up

Prepare for jobs as Designer, Inspector and Tester—as Radio Salesman and in Service and Installation Work—as Operator or Manager of a Broadcasting Station—as Wireless Operator on a Ship or Airplane, or in Talking Picture or Sound Work—HUNDREDS OF OPPORTUNITIES for a real future in Radio!

## Ten Weeks of Shop Training

### Pay Your Tuition After Graduation

We don't teach by book study. We train you on a great outlay of Radio, Television and Sound equipment—on scores of modern Radio Receivers, huge Broadcasting equipment, the very latest and newest Television apparatus, Talking Picture and Sound Reproduction equipment, Code Practice equipment, etc. You don't need advanced education or previous experience. We give you—RIGHT HERE IN THE COYNE SHOPS—the actual practice and experience you'll need for your start in this great field. And because we cut out all useless theory and only give that which is necessary you get a practical training in 10 weeks.

# TELEVISION *and* TALKING PICTURES

And Television is already here! Soon there'll be a demand for THOUSANDS of TELEVISION EXPERTS! The man who learns Television now can have a great future in this great new field. Get in on the ground-floor of this amazing new Radio development! Come to COYNE and learn Television on the very latest, newest Television equipment. Talking Picture and Public Address Systems offer opportunities to the Trained Radio Man. Here is a great new Radio field just beginning to grow! Prepare NOW for these wonderful opportunities! Learn Radio Sound Work at COYNE on actual Talking Picture and Sound Reproduction equipment.

## PAY FOR YOUR TRAINING After You Graduate

I am making an offer that no other school has dared to do. I'll take you here in my shops and give you this training and you pay your tuition after you have graduated. Two months after you complete my course you make your first payment, and then you have ten months to complete your payments. There are no strings to this offer. I know a lot of honest fellows haven't got a lot of money these days, but still want to prepare themselves for a real job so they won't have to worry about hard times or lay offs.

I've got enough confidence in these fellows and in my training to give them the training they need and pay me back after they have their training.

If you who read this advertisement are really interested in your future here is the chance of a life time. Mail the coupon today and I'll give you all the facts.

## ALL PRACTICAL WORK At COYNE in Chicago

ALL ACTUAL, PRACTICAL WORK. You build radio sets, install and service them. You actually operate great Broadcasting equipment. You construct Television Receiving Sets and actually transmit your own Television programs over our mod-

ern Television equipment. You work on real Talking Picture machines and Sound equipment. You learn Wireless Operating on actual Code Practice apparatus. We don't waste time on useless theory. We give you the practical training you'll need—in 10 short, pleasant weeks.

## MANY EARN WHILE LEARNING

You get Free Employment Service for Life. And don't let lack of money stop you. Many of our students make all or a good part of their living expenses while going to school and if you should need this help just write to me. Coyne is 33 years old. Coyne Training is tested—proven beyond all doubt. You can find out everything absolutely free. Just mail coupon for my big free book!

H. C. Lewis, Pres. RADIO DIVISION Founded 1899

## COYNE ELECTRICAL SCHOOL

500 S. Paulina St., Dept. 54-8H Chicago, Ill.

Mail Coupon Today for All the Facts

H. C. LEWIS, President

Radio Division, Coyne Electrical School

500 S. Paulina St., Dept. 54-8H Chicago, Ill.

Dear Mr. Lewis:—Send me your Big Free Radio Book, and all details of your Special Offer, including your "Pay After Graduate" offer.

Name .....

Address .....

City..... State .....



HUGO GERNSBACK, Editor-in-Chief

J. T. BERNSELY, Managing Editor

C. W. PALMER  
Associate Editor

R. D. WASHBURNE  
Technical Editor



## CONTENTS OF THE MAY, 1934, ISSUE

VOLUME V

Number 11

|   |                 |     |
|---|-----------------|-----|
| Editorial: Revolutionary Radio Inventions.....    | Hugo Gernsback  | 645 |
| The Radio Month in Review.....                    |                 | 646 |
| Radio Pictorial.....                              |                 | 648 |
| International Radio Review.....                   |                 | 650 |
| The Latest Radio Equipment.....                   |                 | 652 |
| Third Dimension in Music.....                     | R. D. Washburne | 654 |
| How to Make a One Tube Loudspeaker Set.....       | W. P. Chesney   | 656 |
| The Polytone.....                                 | F. M. Sammis    | 657 |
| Party Tricks With Your Radio Set.....             | C. W. Palmer    | 658 |
| A Fundamental Analyzer.....                       | O. W. Caldwell  | 660 |
| More Summer Sales in Radio.....                   | C. K. Moon      | 661 |
| A Four Tube Short-Wave Converter.....             | Herman Cosman   | 662 |
| Telephotophone.....                               | D. R. M. Sutton | 663 |
| Soundhead Optical Systems.....                    | J. T. Bernsley  | 664 |
| Servicing the "Talkies," Part VII.....            | Aaron Nadell    | 665 |
| Applications of the Voltage Doubling Tube—25Z5    | H. K. Bradford  | 666 |
| A.C.-D.C. Booster Pre-Amplifier.....              | L. J. Littmann  | 667 |
| Wire-less P.A. Installation.....                  | J. M. Kuhlik    | 667 |
| A "Double Super" All-Wave 12 Tube Set.....        |                 | 668 |
| Operating notes.....                              |                 | 669 |
| <b>RADIO SERVICE DATA SHEETS:</b>                 |                 |     |
| No. 113—Radio-Craft Table of Bias Resistor Values |                 | 670 |
| No. 114—(Continuation).....                       |                 | 671 |
| Short-Cuts in Radio.....                          |                 | 672 |
| Information Bureau.....                           |                 | 674 |

## IN OUR NEXT FEW ISSUES:

**AMPLIFIED CHIMES FOR SCHOOL OR CHURCH.** Here is a novel idea for Public Address and Service Men, or for the general reader who is looking for something new in radio or sound work. Chimes that can imitate those of famed Westminster, or with which melodies may be played—very useful for churches or schools, or for the home for that matter. The associated equipment of amplifier, mike pick-up, and sound projecting systems are all described.

**UPLIFTING THE SERVICE PROFESSION.** Mr. F. E. Colt, a Service Man himself, discusses some of the salient factors in conducting an efficient and well paying service shop. And incidentally, he includes some very pertinent remarks about the problems that confront the Service Man of today, particularly in regards to whether radio servicing is in the "job" class, or a profession.

RADIO-CRAFT is published monthly, on the fifth of the month preceding that of date; its subscription price is \$2.50 per year. (In Canada and foreign countries, \$3.00 a year to cover additional postage.) Entered at the post office at Mt. Morris, Ill., as second-class matter under the act of March 3, 1879.

Text and illustrations of this magazine are copyright and must not be reproduced without permission of the copyright owners. We are also agents for WONDER STORIES and EVERYDAY SCIENCE AND MECHANICS. Subscription to these magazines may be taken in combination with RADIO-CRAFT at reduced Club rates. Write for information.

Copyright 1934. Continental Publications, Inc.

HUGO GERNSBACK, President

I. S. MANHEIMER, Secretary

Published by Continental Publications, Inc. Publication office: 404 N. Wesley Ave., Mount Morris, Illinois. Editorial and Advertising Office: 96-98 Park Place, New York City. Chicago Advertising Office: L. F. McClure, 919 North Michigan Avenue, Chicago, Ill. Western Advertising Office: Loyd B. Chappell, 511 So. Alexandria St., Los Angeles, Calif.

London Agent: Hachette & Cie., 3 La Belle Sauvage, Ludgate Hill, E.C. 4  
Paris Agent: Hachette & Cie., 111 Rue Reamur  
Australian Agent: McGills Agency  
179 Elizabeth St., Melbourne

# I'll Send My First Lesson **FREE**



*Here's Proof*

It Shows How Easy it is to Learn at Home to fill a **GOOD JOB** in Radio

Clip the coupon and mail it. I'm so sure that I can train you at home in your spare time for a good job in Radio that I'll send you my first lesson free. Examine it, read it, see how clear and easy it is to understand. Then you will know why many men with less than a grammar school education and no technical experience have become Radio Experts and are earning two to three times their former pay as a result of my training.

**MANY RADIO EXPERTS MAKE \$40, \$60, \$75 A WEEK**

In less than 15 years, the Radio industry has grown from a few million to hundreds of millions of dollars. Over 300,000 jobs have been created by this growth, and thousands more will be created by its continued development. Many men and young men with the right training—the kind of training I give you in the N. R. I. Course—have stepped into Radio at two and three times their former salaries.

**GET READY NOW FOR JOBS LIKE THESE**

Broadcasting stations use engineers, operators, station managers and pay up to \$5,000 a year. Manufacturers continually employ testers, inspectors, foremen, engineers, servicemen, buyers, for jobs paying up to \$7,500 a year. Radio operators on ships enjoy life, see the world, with board and lodging free, and get good pay besides. Dealers and jobbers employ servicemen, salesmen, buyers, managers, and pay up to \$100 a week. My book tells you about these and many other interesting Radio jobs.

**MANY MAKE \$5, \$10, \$15 A WEEK EXTRA IN SPARE TIME ALMOST AT ONCE**

The day you enroll with me, I send you instructions which you should master quickly for doing 28 Radio Jobs common in most every neighborhood, for spare time money. Throughout your training, I send you information for servicing popular makes of sets! I give you the plans and ideas that have made \$200 to \$1,000 a year for N. R. I. men in their spare time. My Course is famous as the Course that pays for itself!

**TELEVISION, SHORT WAVE, LOUD SPEAKER SYSTEMS INCLUDED**

There's opportunity for you in Radio. Its future is certain. Television, short wave, loud speaker systems, police Radio, automobile Radio, aircraft Radio—in every branch, developments and improvements are taking place. Here is a real future for thousands and thousands of men who really know Radio—men with N. R. I. training. Get the training that opens the road to good pay and success.

**YOU GET A MONEY BACK AGREEMENT**

I am so sure that N. R. I. can train you satisfactorily that I will agree in writing to refund every penny of your tuition if you are not satisfied with my Lessons and Instruction Service upon completion.

**FREE 64-PAGE BOOK OF FACTS**

Mail the coupon now. In addition to the sample lesson, I send my book, "Rich Rewards in Radio." It tells you about the opportunities in Radio; tells you about my Course; what others who have taken it are doing and making. This offer is free to any ambitious fellow over 15 years old. Find out what Radio offers you without the slightest obligation. ACT NOW! Mail coupon in an envelope or paste it on a 1c post card.

**J. E. SMITH, President**  
National Radio Institute, Dept. 4EX, Washington, D. C.

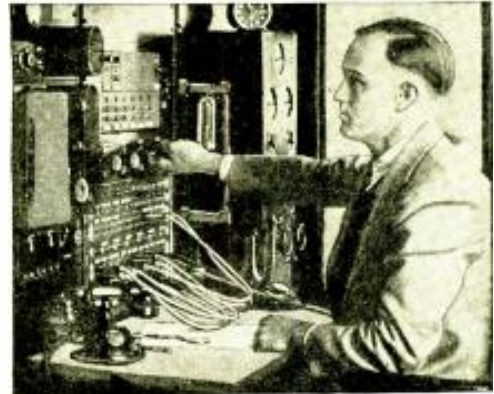

**SPECIAL Radio Equipment for Broad Practical Experience Given Without Extra Charge**

My Course is not all theory. I'll show you how to use my special Radio Equipment for conducting experiments and building circuits which illustrate important principles used in such well-known sets as Westinghouse, General Electric, Philco, R.C.A., Victor, Majestic and others. You work out with your own hands many of the things you read in our lesson books. This 50-50 method of training makes learning at home easy, interesting, fascinating, intensely practical. You learn how sets work, why they work, how to make them work when they are out of order.



Training like this shows up in your pay envelope—when you graduate you have had training and experience—you're not simply looking for a job where you can get experience.

**I have doubled and tripled the salaries of many. Find out about this tested way to BIGGER PAY**



**FILL OUT AND MAIL THIS COUPON TODAY**

**J. E. SMITH, President**  
National Radio Institute, Dept. 4EX  
Washington, D. C.

I want to take advantage of your offer. Without obligating me, send me your Free Sample Lesson and your book, "Rich Rewards in Radio." (Please print plainly.)

Name ..... Age .....  
Address .....  
City ..... State ..... **"R"**



**CLEAR \$4,500 IN 18 MONTHS**

"Before taking your Radio Course I was making \$18 a week. I came here three years ago and in the past months I made about \$4,500 in Radio. I cannot say too much for the wonderful help I have received from N.R.I."

Noel W. Ray,  
American Natl. Bank Bldg.,  
Gadsden, Alabama.



**SPARE TIME WORK PAYS \$18 A WEEK**

"I only do spare time Radio work and average \$18 a week. People who in good times would buy a new Radio, now have the old one fixed."

Stephen J. Drapachy,  
407 Wunderlich Avenue,  
Barberton, Ohio.



**CHIEF OPERATOR IN THEATRE**

"When I enrolled with N. R. I., I worked on a farm. I am now Chief Operator at the Majestic Theatre. I have all the Radio work I can do on the side. Your Course is the best I have ever seen. It is so easy anyone can learn by it."

W. A. Martin,  
Box 601,  
Artesia, N. Mex.

**The Famous Course That Pays For Itself**

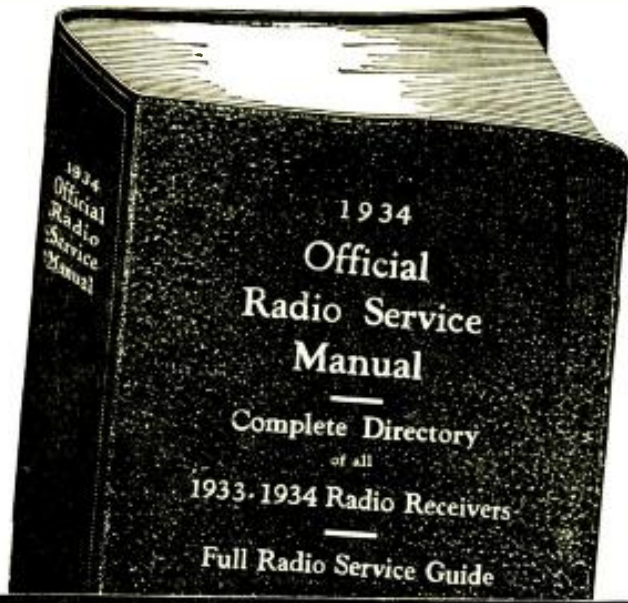

\$3.50

Reg. List Price

400 Pages
Over 2,000 Illustrations
9 x 12 Inches
Flexible, Looseleaf
Leatherette Cover

There's plenty of Servicing Material
in the NEW 1934 Manual

THE necessity of GERNSBACK Manuals in the radio field has been shown by the fact that the total sales of the first three OFFICIAL RADIO SERVICE MANUALS, including the new CONSOLIDATED EDITION, now exceed 80,000 copies.

In preparing this new edition many of the outstanding problems of the Service Men have been considered—methods of servicing, the new equipment constantly needed to cope with new tubes and sets, and the other fields of radio, such as public-address systems, short waves, auto radio and others.

The illustrations in the 1934 Manual are more explicit than before; inasmuch as the diagrams are not limited to the schematic circuit, but other illustrations show the parts layout, positions of trimmers, neutralizers, etc.

As in previous years, the 1934 Manual also includes a FREE QUESTION AND ANSWER SERVICE. In each book will be found 25 coupons, which entitle you to free consultation on any radio service topic.

It is quite evident that the 1934 Edition of the OFFICIAL RADIO SERVICE MANUAL is a decided improvement over previous volumes.

ORDER YOUR COPIES NOW

It is important to every Radio Service Man and Dealer to get his copy of the 1934 OFFICIAL RADIO SERVICE MANUAL now.

No need to delay sending us your order—the 1934 MANUAL like its predecessors, is a necessity in your business.

GERNSBACK PUBLICATIONS, INC.
96-98 Park Place New York, N. Y.

Contents of the 1934 Manual in Brief

- Diagrams and service notes, more complete than ever before in any MANUAL.
Voltage readings for practically all sets, as an aid in checking tubes and wiring.
All values of intermediate-frequency transformers used in superheterodynes, with the manufacturers' own suggestions as to correct balancing.
Detailed trouble-shooting suggestions and procedure as outlined by the manufacturers' own engineers—in other words, authentic "dope" right from headquarters.
Values of all parts indicated directly on all diagrams.
Section for reference to A.C.-D.C. cigarbox midgets.
Section for reference to public-address amplifiers.
Section for reference to short-wave receivers.
Section for reference to remote-control systems.
A complete compilation of radio tube data, covering both the old and the many new types.
Section devoted to test equipment, analyzers, etc., with full diagrams and other valuable information.
A complete list of American broadcast stations with their frequencies in kilocycles; extremely useful in calibrating and checking test oscillators and in calibrating receivers.
Free Question and Answer Service, the same as in our last two Manuals.
No theory; only service information in quickly accessible form.
Absolutely no duplication of any diagrams; nothing that appeared in any of the previous Manuals will appear in the 1934 MANUAL. This we unconditionally guarantee.
A handy, easily-consulted master index making it easy for you to find almost anything pertaining to your service problem instantly. This index includes all the diagrams published in all the previous GERNSBACK Manuals, as well as the 1934 diagrams. A big convenience and time saver!

Clip — Mail This Coupon Today

GERNSBACK PUBLICATIONS, Inc.
96-98 Park Place, New York, N. Y.
Gentlemen: Enclosed you will find my remittance of \$3.50 for which you are to send me. Postage Prepaid. One Copy of the 1934 OFFICIAL RADIO SERVICE MANUAL. [Send remittance by check or money order; or register letter if it contains cash, currency or unused U. S. Postage stamps.]
Name
Address
City State
RC-534



**"Takes the Resistance Out of Radio"**

Editorial Offices: 96-98 Park Place, New York, N. Y.

HUGO GERNSBACK, Editor

Vol. V., No. 11, May, 1934

# REVOLUTIONARY RADIO INVENTIONS

An Editorial by HUGO GERNSBACK

**T**HE fable still seems to prevail, in many minds, that revolutionary radio inventions, which will at once junk present-day radio sets, are always just around the corner.

Particularly in the lay mind, the idea persists that the ideal radio set is about to be invented; that something revolutionary is just about to be sprung on the public, and that it will be best not to buy a set this season, but wait until next year. These ideas are on a par with automobile developments where people at the beginning of a season refuse to buy cars, because they think something new and revolutionary will come about next year; only to see such ideas prove without foundation.

Evolution does not work in this manner. The radio set, in its gradual evolution, is not different from an automobile or a mousetrap. Once an art has reached a certain level, it is most unlikely that everything that has gone before will be swept overboard, in favor of some revolutionary new idea. Of course, this is not impossible; nothing is impossible, but most of the ideas along these lines are highly improbable.

The reason for these remarks is that, every so often, I am in receipt of letters, not only from laymen—but from radio people who should know better—asking whether there is any truth in a "tubeless radio set" which has been featured in the newspapers. The tubeless radio set is one of those myths which has been paraded before us ever since 1920, and is difficult to down. Every once in a while, some young budding genius "invents" such a tubeless radio set and creates no little stir in his own community. Photographs of the set are shown; interviews are given; prominent local business people give their opinions; would-be scientists and radio engineers are quoted—but, invariably, thus far the thing peters out. There have been reported a number of such "phantom" tubeless sets, but nothing much has ever been heard of them afterward. Whether these tubeless sets are deliberate fakes foisted upon a credulous public, or whether they are delusions of some budding inventor, it is difficult to say. The fact is, that it is highly improbable that such a set—that is, a practical one—has been built to date; though it is, of course, possible that it can be invented in the future. At the present stage of the art, however, it is quite impractical. Of course, we can easily picture in our minds a tubeless radio set. As a matter of fact, our first radio sets worked by crystals were of that description, but no loudspeaker operation was possible, unless the set was in the shadow of a broadcast station. It is true that there are still possibilities in the crystal detector that perhaps we, today, do not appreciate, and it is conceivable that in the future, tubeless loudspeaker sets, with some sort of crystal detector, may come into use.

The whole matter of efficient radio detection is still somewhat shrouded in mystery. Every once in a while we hear reports of some housewife getting radio music out of a kitchen pan, which is not even connected to an aerial and

ground. Water faucets have also been known to give off radio music and, recently, the newspapers reported an automobile that produced radio music somewhere under the hood, although it had no automobile radio installed nor, for that matter, any radio. It is conceivable that these freak conditions may be worked out in the future into something that we today do not know. When additional research has been made, and these laws are better understood, perhaps then we may have a tubeless radio; but my private guess is that, for many years to come, we shall worry along with the present-day tubes.

Then there is a sort of revolutionary invention in the tubes themselves. I refer to the radio tube that requires no filament current—a cold radio tube requiring no "A" power. Some advances have been made in an electronic tube of this kind; and it is conceivable that, within the next ten or fifteen years, our radio sets may have filamentless or cathodeless tubes. Again, this is an evolutionary process, and the change is certain not to come over night. It will take many years of research and, after the theoretical points have been covered, it will take another few years before the tube becomes commercially available.

For years there has also been reported another phantom radio set, supposedly sponsored by one of the big radio corporations. This particular variety of radio set is imagined to be secretly operated. The alleged plan behind it is that the company will rent you a radio set at so much a month; new and super-broadcast stations are to be put up, which will admit no radio advertising. An ordinary radio set will not work from such a super-station, and cannot be made to receive these super-programs; only those sets for which you pay rent can bring them in. This is another fable, imagined by some fertile writer, most probably as a joke. There is, of course, no basis for such a set, and it is not conceivable why any radio manufacturer, at present, would wish to put out such a receiver. The idea of emitting programs without advertising, engineered especially for such sets, is not an economical one, and is not likely to come about.

Coupled with this idea, we have a supposed new radio set which, automatically, eliminates all radio advertising, for the benefit of those listeners who object to advertising. The set itself is supposed to remain silent while radio advertising is going on.

Again, this idea is not impossible. Indeed, patents have been granted on this very idea; but the trouble in the present stage of the art is that the set will remain silent when *anyone* talks, irrespective of whether the talk is advertising or not. In other words, the automatic robot inside of the set will not know how to distinguish between an announcer dispensing a raw advertising talk and, let us say, President Roosevelt giving one of his important radio addresses.

Twenty years hence, this problem may have been solved, although personally, I have my doubts that it will ever come about.

# THE RADIO MONTH

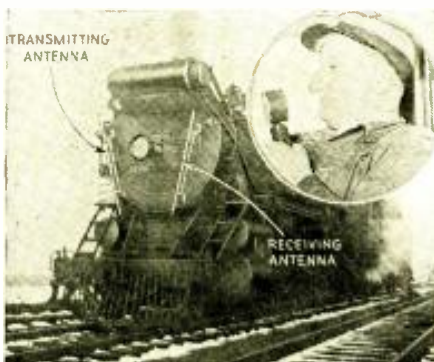

**THE RADIO FREIGHT TRAIN**  
To ease the difficult job of the engineer and brakeman on those mile-long trains.

## ULTRA-SHORT-WAVE RADIO FOR THE FREIGHT TRAIN

It isn't all "glamour and romance" in the lives of a brakeman and engineer of a freight train. Besides going places and running a fast train, there's that business of manipulating and pulling a string of box cars that sometimes covers a mile of territory. To facilitate co-ordination between these aforementioned two gentlemen, who hold a tremendous responsibility in keeping the long length of cars together—up and down hill, the Westinghouse Electric and Manufacturing Company has designed a small, efficient transmitter that permits communication between the engineer in the "cab" and the brakeman, who is generally in the "caboose" or last car on the train.

The radio transmission is done at five meters, which is considerably below the lowest wavelength possible on the average broadcast set.

As a matter of fact a regularly run freight train on the New Haven Railroad Company lines has just been completely equipped with 5 meter transmitting and receiving equipment, and it has been definitely established that the engineer and brakeman may communicate at all times without difficulty.

This is a distinct advantage over previous methods of signalling, especially for long trains which are often a mile or more in length.

A few brief points about the technicalities of the phone transmitters and receivers might not be amiss. The equipment, which operates from a 6 V. storage battery, consists of an ultra-

short-wave transmitter and receiver with microphone and loudspeaker located in the engine cab and duplicate equipment located in the caboose. Separate aerials are used for transmitting and receiving, and are located in the front end of the engine. The aerials for the rear end of the train are located on the two sides of the caboose.

## RADIO—THE ENEMY OF THE KIDS

AND now it may be told—of all the mean, low-down tricks! Out Des Moines, Iowa, way, it appears that the public schools were closed for an extra week after the usual New Year holiday was over, so that repairs might be made.

The children naturally welcomed this as a week of pure joy—just think of it, one more week without school. But they had not counted on the up-to-the-minute heads of the Des Moines board of education. Lessons were sent out over a local radio station twice a day.

Couldn't the rascals play truant? No, not even one. For it was announced that examinations on the radio lessons would be held after the week was passed.

We would be willing to wager that there is more than one Des Moines boy or girl who has had a change of heart about the family radio receiver, following this incident!



**LESSONS BY RADIO**  
The Des Moines kids did not enjoy their extra week of New Year's vacation.

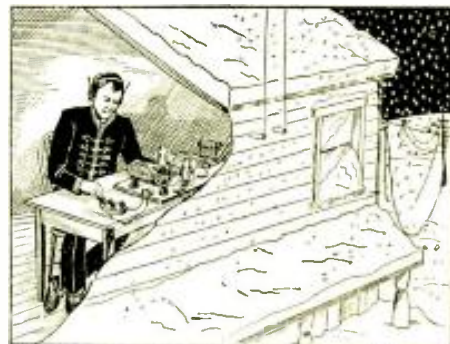

**LETTING THE BOSS KNOW**  
John Cook used his short-wave transmitter when he was snowbound.

## SNOWBOUND WORKER USES RADIO TO REACH BOSS

JOHN COOK, a suburbanite who travels from his home on Long Island to Manhattan, found himself in the same spot as thousands of others in one of February's heavy snow falls in the New York area—that is, snowbound and unable to get to work. Friend Cook tried to get out but could not even open the door; it was frozen fast. And no cars or busses were moving on the street. Then he went to the telephone, his first thought being to notify his boss that he would not be in, not today and probably not for a week the way things looked outside. But the telephone wires were down, and after jiggling the hook for some time, Mr. Cook gave it up as a bad job.

What to do?—jobs still being scarce—and the boss likely to misconstrue his absence (we suppose) when he suddenly thought of his short-wave radio sending outfit. No siree!—the day wasn't lost yet—if he could only get a message through.

Resourceful John sat down at the set, put on his headphones and turned on the "juice." Out over the air waves went the following message—"I am snowbound. Long Island Railroad not running since midnight. Telephone lines are down. Will be in when trains start running. Telephone Triangle 6000. Ask for Mr. Warren."

Within a short time, Cook picked up this message: "Office excuses you . . . will expect you when they see you . . . Warren says good work . . . signing off W2CSE."



# IN REVIEW

Radio is now such a vast and diversified art it becomes necessary to make a general survey of important monthly developments. RADIO-CRAFT analyzes these developments and presents a review of those items which interest all.

Over in Jersey City, New Jersey, Charles N. Dahlinger, another amateur operator, had been sitting idly listening to the various amateur messages permeating the ether and had picked up Cook's appeal—called up the New York office by phone and relayed the boss' message, via his station, W2CSE.

## THAT RADIO CONTEST SITUATION

**W**ELL, well, well!! The "miracle of all miracles" may happen after all. No more (maybe) will we have to "take the spinach with the meat" in radio broadcasting. We may, after all these years, be permitted to listen contentedly to some excellent programs without fear of having inflicted that nausea of most programs, "subtle advertising" by means of contest announcements.

With the inauguration of the NRA, business codes in most cases have included provisions against the use of any premiums as inducements to buy a particular product.

These rules, however, have not stopped radio advertisers from conducting prize contests until now. We have had word building, slogan, lucky number, product naming, and story contests, in fact, every possible type of contest that advertising agents have been able to devise.

However, when the Standard Oil Company of New Jersey announced the

"Babe Ruth" contest recently, in which the winners were to receive a trip to the "King of the Swat's" training grounds, Secretary Ickes, the oil administrator, brought suit against them. Later, the Standard Oil Company agreed to discontinue the contest and the suit was dropped.

This action on the part of Oil Administrator Ickes will probably cause all radio advertisers to discontinue this form of radio advertising, which should be a relief for those radio fans who resent the way in which many manufacturers try to force their products on gullible John Public.



A TYPICAL POLICE CAR  
One of the patrol cars which are causing the New York police to have headaches.

## AN INGENUOUS RADIO CABINET

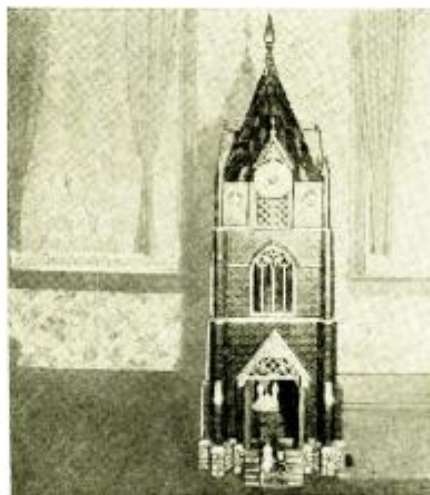

RADIO IN THE CHURCH

This model contains a complete radio set as well as a clock and chimes.

## THE NEW YORK RADIO COPS' HIDEOUT?

**M**UCH has been said about the efficiency of police radio systems, especially in the larger cities, such as New York. But even with their reputed efficiency there are still some "bugs" to be eliminated before they are perfected.

For example, it has just become known that right next door to the Elizabeth Street Police Station in New York, there is a spot where the police broadcasts cannot be heard—in fact the radio patrol cars in passing through this particular section hear entertaining musical programs from local broadcast stations instead of the usual "Calling all cars," etc.

The newspapers in New York were quick to pick up this news item. In an interview with police officials, one witty reporter suggested that: "it might have been the Tombs Glee Club you heard."

Police officials are at wits' end looking for a solution of the problem, and so eager are the policemen to assist, that there have been 97 requests for transfers to the Elizabeth Street station within the past few weeks.

Possibly the answer to the riddle will be found in the fact that there are three new steel-frame buildings, under construction or recently constructed, right at the point of difficulty. They are the new Federal Building, New York State Building and the Board of Health Building. These new structures probably effectively shield the radiations from the police transmitter WPEG, and one or more of them acts as a radiator of harmonics for stations within the broadcast band.



NO MORE CONTESTS

Secretary Ickes performed a humanitarian act when he stopped the "Babe Ruth" contest.

**T**HE style of radio receiver cabinets has undergone considerable revision in the past few years, but even with the advances made to beautifying the sets, they are still lacking in appeal to some, and very seldom is one found that completely fits in with its surroundings.

The cabinet shown in the accompanying photo shows a serious attempt to disguise "the mechanics" of the set completely.

It was constructed by a St. Louis cabinet maker, and contains over 10,000 small pieces, consisting of 12 varieties of wood. The cabinet houses not only a complete radio receiver, but also contains a clock and chimes.

# RADIO PICTORIAL



**P**OLICE RADIO has made many advances in recent months. Special transmitters have been designed and constructed to fit the particular needs of the police officers in charge of transmission. The patrol car receivers and installations have been improved so that constant communication is assured.

And now we have another development which represents a great stride forward in the field of crime prevention. As shown at 1, it consists of a radio receiver built as an integral part of the patrolman's Sam Browne belt. Equipped with one of these sets, every police officer will know every fact broadcast from headquarters, and instead of a police car with two men arriving alone at the scene of trouble, they will in all probability be aided by others on foot.

The photo of 2 shows a demonstration of an equipment devised by Prof. L. S. Palmer of Hull University, England, which permits radio communication on ultra-short waves in water. The development of this apparatus should open up a new field of communication, especially if it is found that the waves have a tendency to follow the surface of the water—as this would permit long distance communication on these waves; a thing not possible at present.

At 3 is shown the radiating system of the new micro-ray teleprinter at St. Inglevert, France, which is one part of the new radio typewriter communication system, on the extremely low wavelength of 17.4 centimeters, which provides two-way communication between the airports of St. Inglevert in France and Lympe in England.

This is the shortest wavelength used for regular commercial radio work at this time. The stations are arranged for duplex transmission, that is, simultaneous transmission from each station. While the present use is the sending of typewritten messages, provisions are made to permit radio telephony as well.

The photo of 4 represents a form of commercial portable communication used by the Forest Service of the U. S. Department of Agriculture. These portable radio-telephone transceivers operate on a frequency of about 3,445 kc., in fire fighting work.

The individual police receiver shown above heralds in a new era in police radio. The instruments shown at the right demonstrate how ultra-short radio waves can be transmitted through water. If experiments verify the expected results, it will be possible to increase the range of transmission on these waves which are limited now to a maximum of about 100 miles. The towers at the lower left support the parabolic reflectors of the 17.8 centimeter transmitter and receiver. The portable transceiver in the lower right is used for fire fighting.

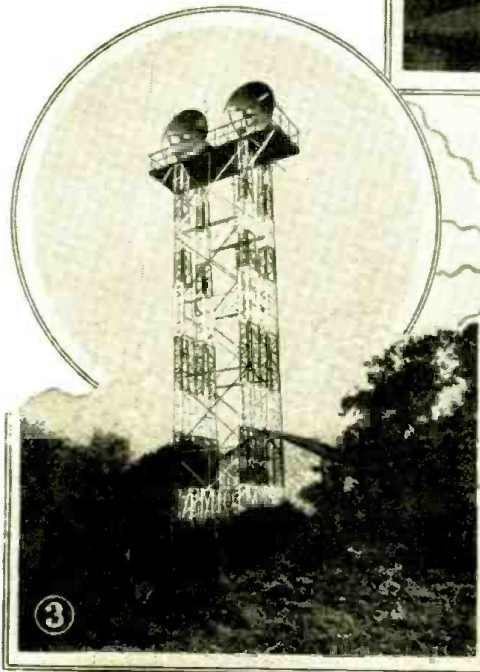
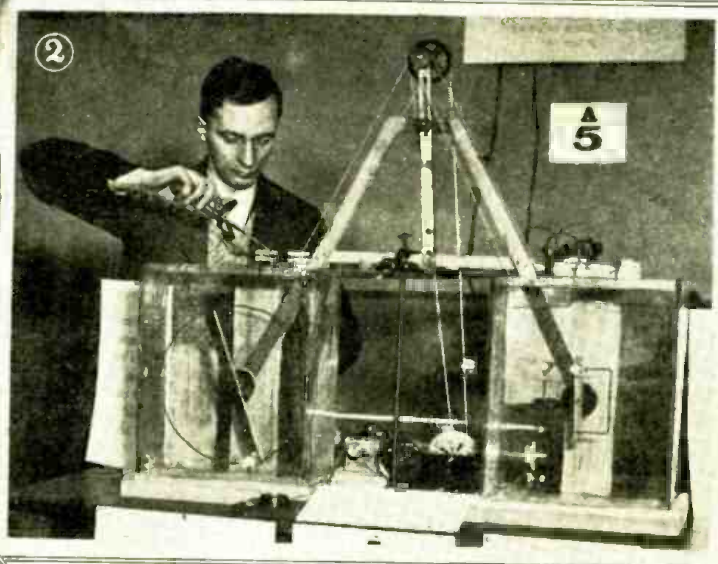

Photo courtesies:  
1, Int'l News; 2,  
Press Photos; 4,  
Dept. Agriculture.

**RADIO FANS** who have become used to seeing the common type of control panels used in broadcast stations, with their many meters and protruding control boxes, etc., should be interested to see the latest type of board used by the British Broadcasting Corporation. The unit is shown at 5, and as you can readily see, it is modernistic in design. The various meters and controls are mounted on a small slanting panel while a large horizontal shelf makes the job of controlling the output of the transmitter much easier for the operators.

The three photos at 6, 7 and 8, show the details of a new television receiver made in England for the reception of the regular television signals from the "Midland Regional" station. Photo 6 shows the heart of the set—a Kerr cell of the nitrobenzene immersed type. The scanning is accomplished by a commercial type of mirror scanning drum containing 30 mirrors and synchronization is attained by the use of a special synchronous motor with a synchronizing gear attached. Two nicol prisms are used with the Kerr cell. Light from a projection lamp is focused by the condenser lens through the first nicol or analyzing prism. The mirror then reflects the beam through the focusing lens, via the mirror drum on to the screen.

Photo 9 shows a portion of one of the studios of the radio station at Budapest. This is the only station in Europe at which an orchestra conductor hears the music just as it comes to the listener. A conductor is shown in his sound-proof cabinet with the speaker from which he hears the music at the right of the photo.

The illustration at 10 shows how the operators watch the modulation at station WJZ—the revolving mirror indicated shows the percentage of modulation.

Photo courtesies: 5, B. B. C.; 6, 7, 8, E. J. & J. D. Holmes; 9, J. Soprunge; 10, NBC.

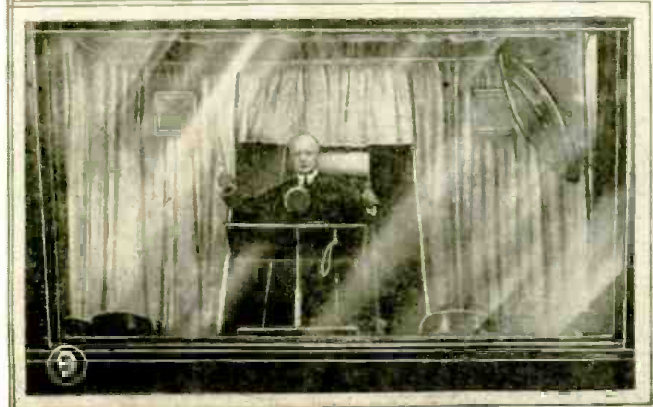
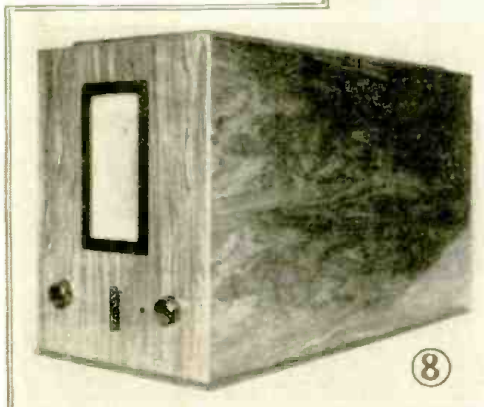
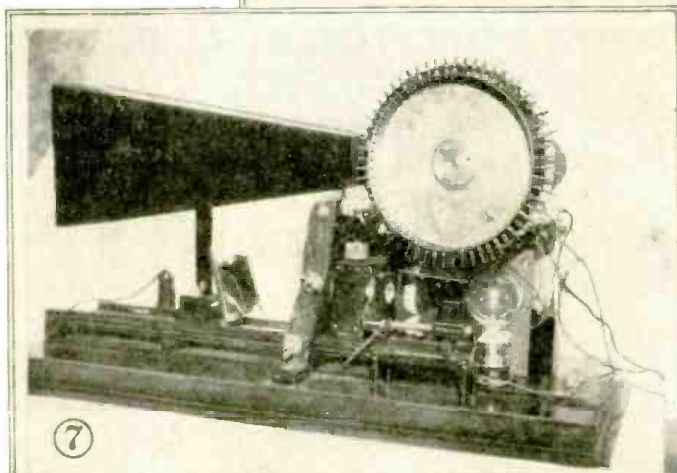
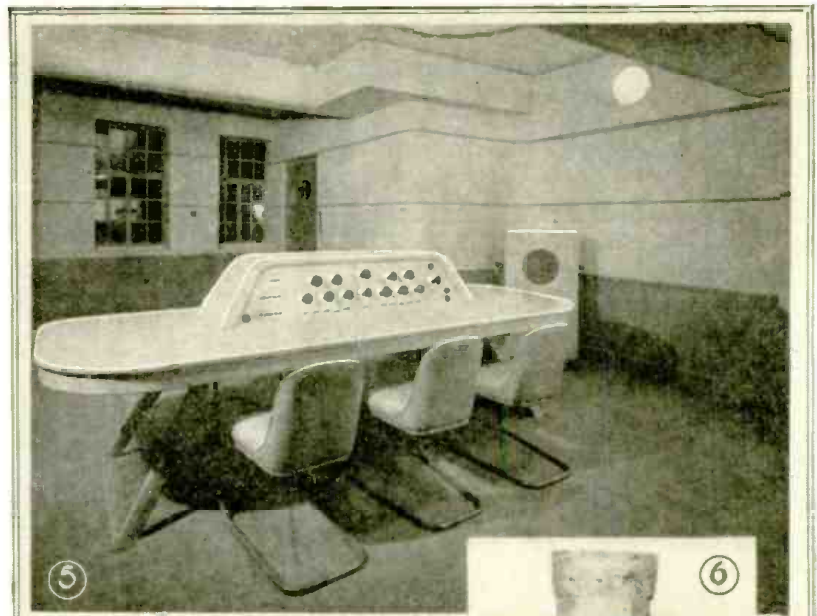

# INTERNATIONAL RADIO REVIEW

## AN UNUSUAL SHORT-WAVE RECEIVER

RECENT issue of WORLD RADIO, the official publication of the British Broadcasting Corporation, contained the details regarding a most unusual short-wave receiver—one that had been designed by the engineers of the B.B.C. for their listeners the world over.

The unique part of the set is in the detector circuit and in order to explain the action clearly, we are reproducing here two illustrations that appeared in the original article. The first, Fig. 1, shows the theoretical circuit of the detector.

"When a push-pull detector is used the R.F. currents in the two plate circuits flow in opposite directions and cancel out as far as the external plate circuit is concerned; consequently they are not passed on to the A.F. stages. This is shown in Fig. 1. A further advantage of this cancellation of the R.F. currents in the common plate circuit is that they do not impose any damping on the tuned input circuit connected to the grids of the two detector tubes. Hence the selectivity is much greater than with an ordinary single grid leak detector. Another point is that no grid condensers are required and fairly high values of grid leaks can be used to give good rectification without at the same time causing loss of high notes."

As comparatively narrow bands cover all the short-wave stations of the B.B.C., a simple switching arrangement permits all the stations to be included. It will be noticed by an examination of Fig. 2, that a 5 pole double-throw switch makes the necessary coil changes.

The method of controlling regeneration will be seen also from the simplified schematic diagram, Fig. 1. By using a regeneration winding with its center connected to the plate resistance common to the two detector tubes, the R.F.

HERE is what the radio experimenter has been wanting for a long time—a semi-technical review of the thousands of new ideas which are continually appearing in overseas publications. Each month there are received at the offices of RADIO-CRAFT hundreds of daily, weekly and monthly magazines originating from every point on the face of the globe.

SINCE the cost of subscribing to each of these would be prohibitive for most radio men, we have arranged with technical translators to prepare for our readers reviews of all the really important, new developments illustrated and described each month in these international radio periodicals.

NOTE that the only available information is that which is published; the experimenter must adapt the ideas to whatever equipment he has on hand.

currents flowing through the plate circuits of the two tubes assist each other as far as the regeneration winding is concerned, but cancel out in the common plate resistance. The regeneration control condenser is connected across the regeneration winding to control the amount of current flowing through the winding.

The coils, covering the wavelengths from 15 to 55 meters are made as follows:

15—35 meters

Aerial winding 2 turns;  
Grid winding 4 turns (2 turns in each half);  
Plate winding 2 turns (1 turn in each half).

25—55 meters

Aerial winding 2 turns;  
Grid winding 8 turns (4 turns in each half);  
Plate winding 2 turns (1 turn in each half).

The forms are 2 $\frac{3}{8}$  ins. in diameter and the turns are spaced  $\frac{1}{8}$ -in. apart. Number 16 enameled wire is used. The aerial winding is in the middle of the form and the grid winding is split into two parts and wound on each side of the grid winding, with the regeneration winding split on each side of the latter. It can be noticed that the end of the regeneration winding which goes to the plate of one tube is in the opposite half of the coil form to the end of the grid winding which connects to the same tube. This has the effect of reversing the coil so that the regeneration effect is in the correct phase.



Fig. A  
"Paying-off" on the radio, in Germany.

## RADIO ON THE INSTALLMENT PLAN

AND now comes news from Germany that radio sets can be bought on the installment plan by the use of a small

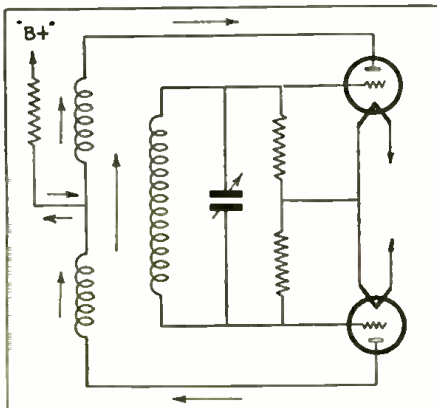

Fig. 1  
The theoretical circuit of the detector.

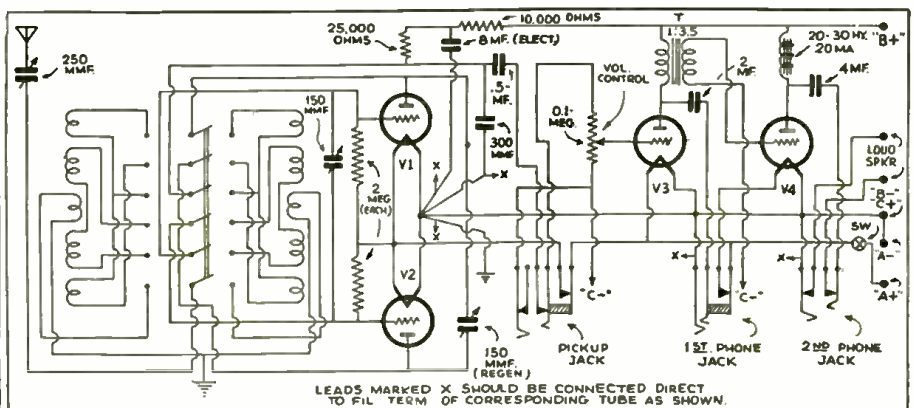

Fig. 2  
The actual wiring of the set showing the push-pull detector circuit.

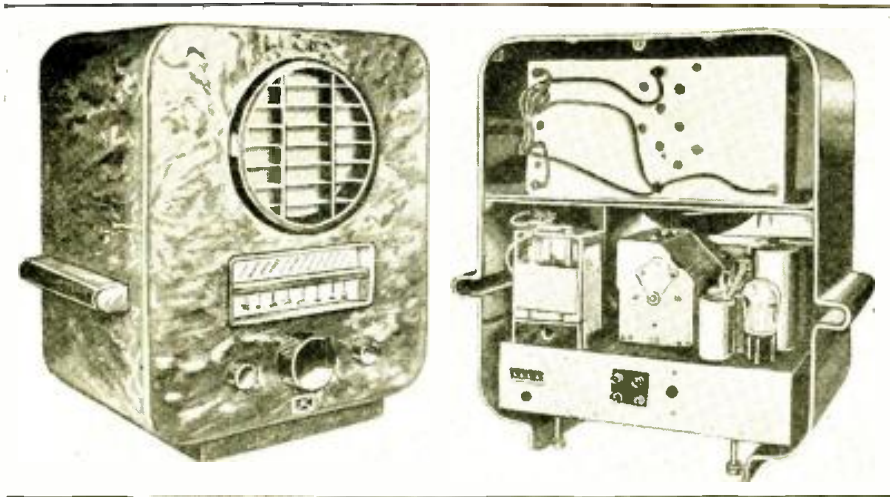

Fig. B

An attractive battery operated set which is available in England.

slot machine—as shown in Fig. A. A deposit of about 20 per cent secures the set and the remainder is then paid so much per hour of listening; very much on the order of the old quarter in the slot gas meters. The rate per hour amounts to about 2 cents.

### A MODERN BATTERY SET

FIGURE B shows the front and rear views of the cabinet of a modern English battery operated superheterodyne set. The cabinet is made of bakelite, and is both unusual and attractive in appearance, as can be seen. The rear view shows how the "B" battery fits behind the speaker, while the 2 V. storage cell rests in a special receptacle on the left side of the chassis.

Shadow tuning is used on the dial which is, by the way, calibrated in wavelengths. One section of the dial is also marked with 36 of the best European stations to facilitate tuning. Like most European sets, this one covers both the broadcast band and the long wave broadcast waves.

### A SOUTH AMERICAN TEST UNIT

THE MULTI-METER shown in Fig. 3 was described in an issue of RADIO POPULAR, a magazine published in Buenos

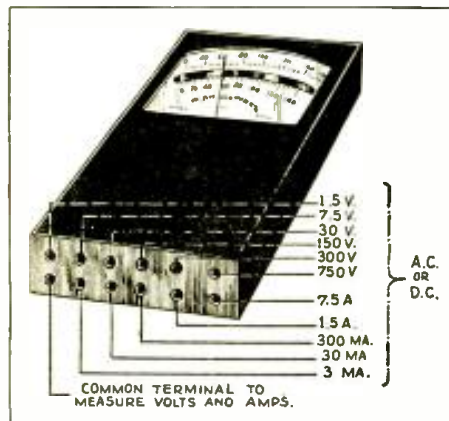

Fig. 3

A multi-meter with pin jacks.

Aires. As you can see, it covers practically all the current and voltage ranges needed for radio experimentation or repair. It is also interesting to note that it covers these ranges for both alternating and direct current.

The interesting part of the meter and a fact that is not clearly shown in the illustration, Fig. 3, is that a series of pin jacks on the base of the instrument permit any desired change from one scale to another. The test prods are equipped with insulated phone tips and are simply inserted in the correct jacks. This procedure eliminates the need for complicated switching systems and makes all of the current and voltage scales instantly available. The indicating scale is the mirror type which aids in obtaining accurate readings.

### CONVENIENCE PLUS

WIRELESS WORLD magazine, an English publication, recently requested their readers to send in ideas or designs to improve the appearance or convenience of radio receivers. In the group of suggested designs printed, the one shown in Fig. 4 was shown.

You will notice that the set and re-producer are both housed in the heavily upholstered chair.

(Continued on page 679)

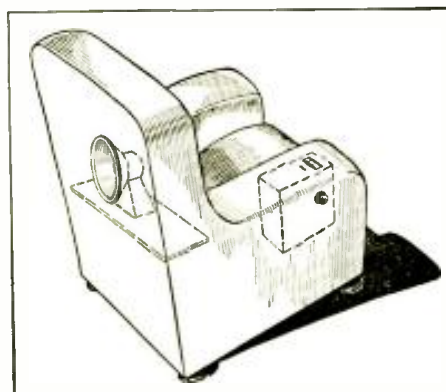

Fig. 4

A receiver installation which is both unique and practicable.



Fig. C

A European version of the airplane-type dial. And a tuning chart drawer.

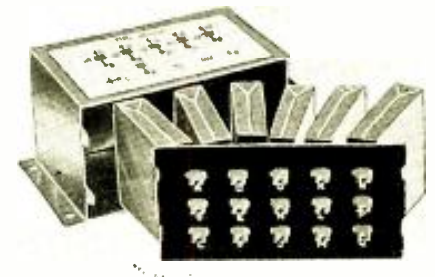

Fig. D

The Service Man will appreciate this type of condenser block construction.

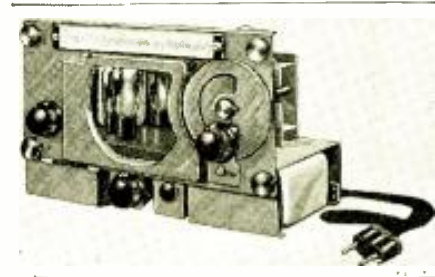

Fig. E

A French A.C.-D.C. midget which uses tubes of American origin.

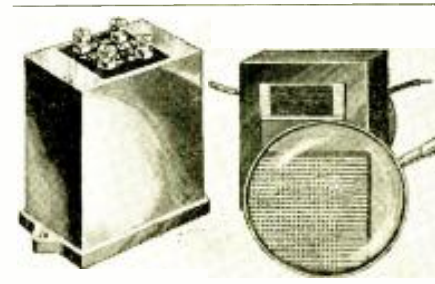

Fig. F

Here is a cut-away view of a new Australian A.F. transformer described here.

# THE LATEST RADIO EQUIPMENT



14 tube set with parallel push-pull A.F. (No. 430)

## DUAL-RANGE, 14 TUBE SUPER.

MODERN sets put to shame the older models. Consider the following features of the set illustrated above. Dual-range reception (broadcast range, 540 to 1,675 kc.; police, amateur and aviation range, 1,675 to 4,300 kc.); meter tuning; static control; A.V.C.; continuous (stepless) tone control; inter-station noise suppression; class A parallel push-pull output; large, auditorium-type dynamic reproducer. Set uses five type 58 tubes; three type 56's; one 55; four 45's; and one 5Z3. Although highest priced in a new line of receivers comprising 13 models, this superheterodyne falls slightly under the \$100 class. The cabinet design has appeal to those who admire modern art.

## A "1934" VOLUME CONTROL

THE volume control shown as item No. 431 measures only 1 in. (over switch) x 1 1/8 ins. in dia. Improved contact is made over a resistor area of 1.025 sq. ins.; humidity does not affect the resistor.

## NEW 16 MM. PORTABLE TALKIES

ONE unit of a 2 case talkies set-up is shown in item No. 432. The 5 tube amplifier output is 15 W. Tone and volume controls are provided; also, jacks for phono. pickup and mike.

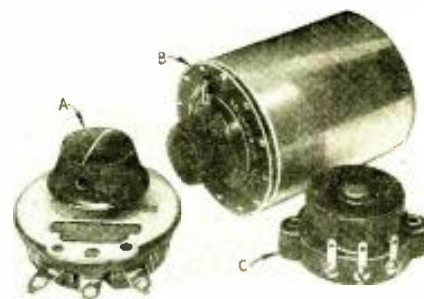

Three new radio components (No. 433).

## THREE NEW ITEMS

IN ITEM No. 433 are shown three new products of one manufacturer. At A, a vitreous enameled rheostat for 50 W. circuits; resistance ranges from 1 to 5,000 ohms. At B, an 8 W. T type attenuator with wire-wound resistor elements; impedance values, 200 to 500 ohms, with total attenuation of 44 db. At C, a small, fixed T type attenuator for fixed matching into P.A. equipment; 5, 10 and 15 db. attenuation in either 200 or 500 ohm impedance.

## A VARIABLE-VOLTAGE ADJUSTER

A HIGH-QUALITY unit for securing an output of 110 V., A.C., with an input of 85 to 145 V., A.C., or vice-versa, is shown in item No. 434.



A variable-voltage adjuster (No. 434).

## UP-TO-DATE TESTER

ALL sets having 4, 5, 6 and 7 prong tubes, automatic volume control, inter-station noise suppression, compensated tone controls, etc., may be tested in item No. 435, a modern ohmmeter, set analyzer and tube tester.



A modern test unit (No. 435).

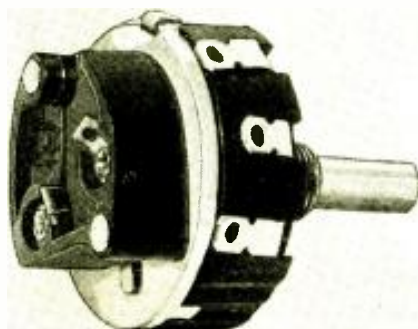

The newest design in volume controls (No. 431).



"Sound-on-film" (speaker not shown) (No. 432).

Name of manufacturer of any device will be sent on receipt of a self-addressed, stamped envelope. Kindly give (number) in description under picture.



An illuminated-dial crystal set (No. 436).



A D.C. to A.C. converter and filter (No. 440).

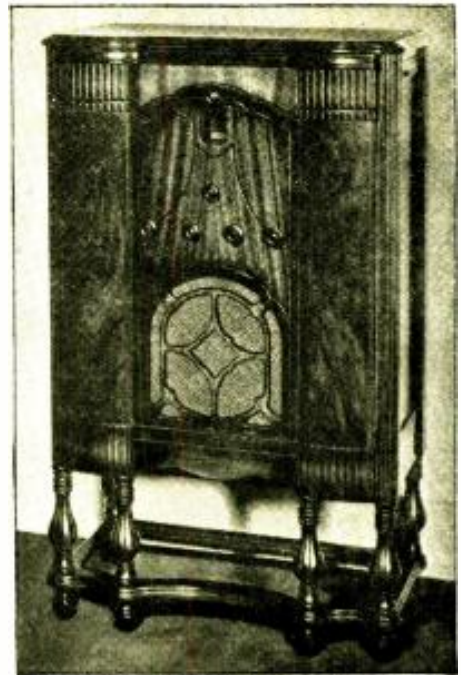

"Tone compensated" 10 tube super. (No. 442).

### NEW CRYSTAL SET

IN ITEM No. 436 is illustrated a novel crystal set housed in a molded bakelite case. The crystal contact is adjustable. The dial is illuminated when the set is in operation.



"Wide range" film talkies sound head (No. 437).

### "WIDE RANGE" SOUND HEAD

SERVICE MEN who have been following the series, "Servicing the Talkies," in RADIO-CRAFT, will be interested in item No. 437. It is a sound head for adapting talkies projectors to use the new "wide range" (high fidelity) sound film. Sound heads are available complete with optical systems, photoelectric cells, exciter lamps, brackets, endless woven belts, pulleys and all necessary projector attachments.

### HIGH-VOLTAGE CONDENSERS

IN ITEM No. 441 is shown a paper-insulated, oil-immersed condenser only 1/6th the bulk of average units available in equivalent capacity and voltage rating. The units are impregnated and filled with "vegetol." Capacity ranges: 1 to 5 mf., 600 V.; 1 to 3 mf., 1000 V.; 1 and 2 mf., 1,500 V.; 1 mf., 2,000 V. For filter use in high-power amplifiers.

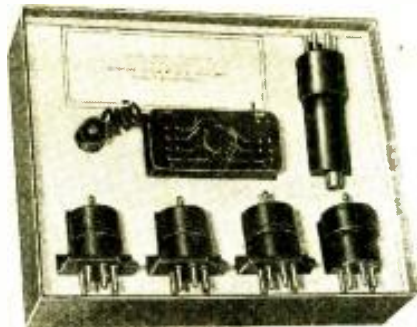

Newest type "selective analyzer" kit (No. 438).

### NEW SELECTIVE ANALYZER KIT

THE "selective analyzer" (Item No. 146, RADIO-CRAFT, October, 1933) has been considerably improved, as reference to item No. 438 will indicate. A single 7 prong plug and cord with special adapter combinations reduces from 7 prongs to 6, 5 or 4.

### 10 TUBE TONE-COMPENSATED SUPERHET.

A WELL-KNOWN set manufacturer just announced three new receiver models; the most pretentious one of the (Continued on page 694)



High-efficiency photoelectric cell (No. 439).

### "HEADLIGHT" PHOTOELECTRIC CELL

THE light-sensitive cell shown as item No. 439 is made like an auto headlamp bulb. Vacuum-type photoelectric cells are very stable; gaseous types, very sensitive. The new tube combines the features of both; and is 10 times as sensitive to infra-red rays.

### 32 OR 110 V. D.C. TO A.C. CONVERTER

THE standard model converter shown in item No. 440 delivers 1 A., at 110 V., A.C.; the heavy-duty model, 1.5 A. Ball bearings; lifetime lubrication; self-ventilating; built-in filter, are features.



A small-space high voltage condenser (No. 441).

# THE THIRD DIMENSION IN MUSIC

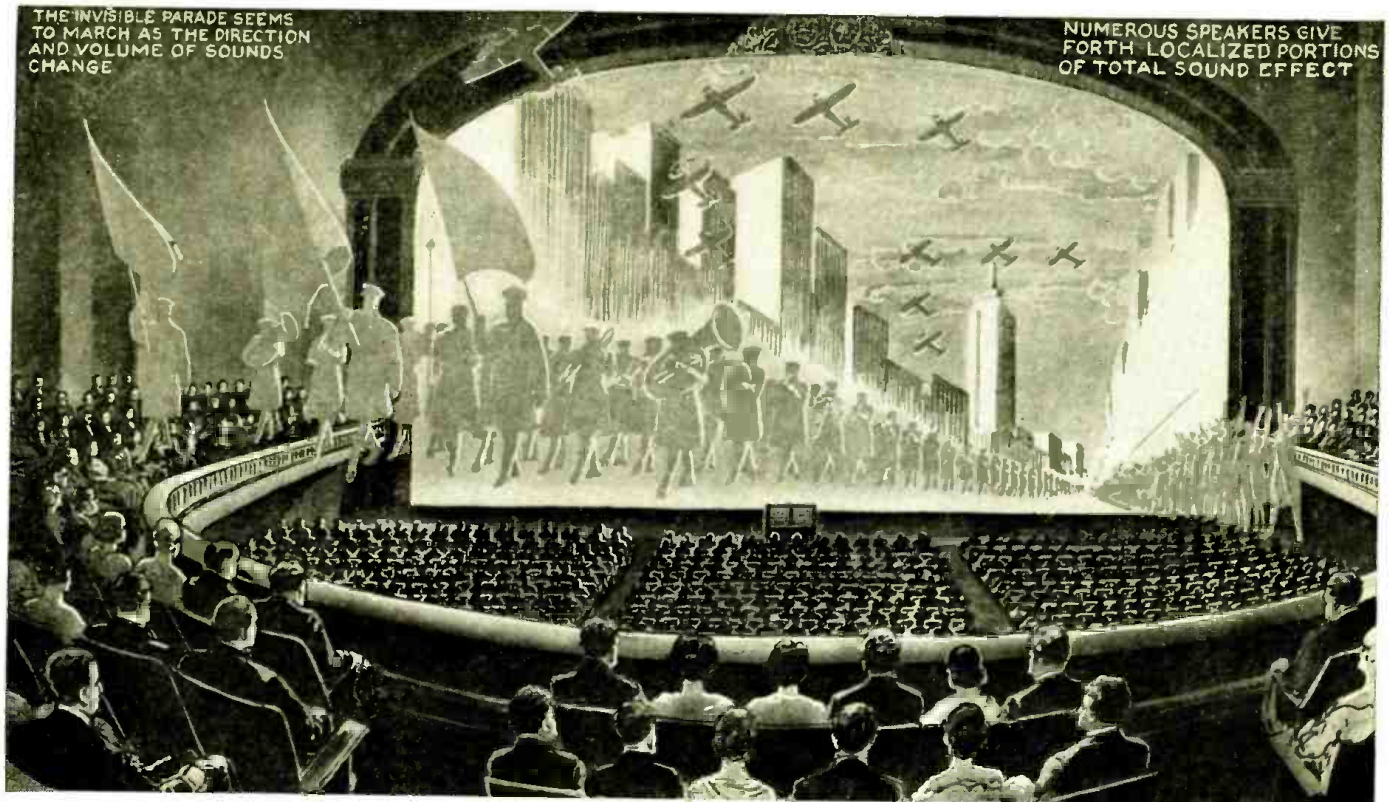

**T**HIRD dimension, auditory perspective, solid or sculptured music, directional audio, binaural reproduction, stereophonic sound—call it what you will, the effect achieved in the sound system recently demonstrated before members of the American Institute of Electrical Engineers and Institute of Radio Engineers, at the Engineering Societies' Building, by the Bell Telephone Laboratories, was *naturalness* of sound reproduction in the complete sense of the word.

It is impossible to point a finger at any one part of the system and say, "there is the 'secret' of the true-to-life sound reproduction." Rather, it is necessary to accept as the explanation, the entire ensemble—every component of which has been designed to meet a specific demand.

## Auditory Perspective

"Sound," whether it is vocal or instrumental, is generally divided into only two components: (1) volume, which gives "height" to sound; and (2), frequency, which gives "width." There is, however, a third component, more physiological than physical, without which no sound seems to be "natural"—this is the "sense of distance and direction" or "depth" (the third dimension—"perspective").

Although volume and frequency are thus shown to be fundamental considerations in discussing sound, apparatus designs to enhance the characteristics of one or the other present little that is new (See, "A Super-Power and -Quality P.A. System," *RADIO-CRAFT*, December, 1933). Reproduction in auditory perspective, however, introduces a more modern technique, the design, construction and operation of equipment for which bids fair to open to sound technicians a field

## R. D. WASHBURNE

of activity perhaps as lucrative as have been "P.A." and the "talkies."

The practical results that can be secured with a system designed to reproduce (or even accentuate) all the elements of sound reproduction in perspective are amazing; only by actually experiencing them can they be fully appreciated. If the listener closes his eyes *apparent* effects seem to be *actual* ones.

Thus, the audiences of trained engineers that critically listened to demonstrations in the Engineering Societies' Building found it difficult to distinguish between the two.

## Novel Effects of Sound Perspective

Apparently a man on the stage of the auditorium, near the right proscenium and in back of a curtain, sawed through a thick piece of wood; the clatter as the piece of wood hit the floor was unmistakable. All heads turned to the left as, in answer to a request for a hammer, a second person voiced acknowledgement! The succeeding sounds of nails being driven into the board, the hammer banging to the floor, and left- and right-stage conversations between the two men were "true to life." A bugler appeared in front of the curtain, raised a bugle to his lips, and started to play. After playing a few bars he removed the bugle from his lips and walked off the stage; the bugle continued to play, however, seemingly at the exact spot on the stage he had previously occupied! A tap dancer next appeared, moving his feet in rhythm with music. In the middle of the "act" he ceased all motion—but the dance went on! And, when our visible performer walked off the stage the "ghost artist" continued with the show, seemingly traveling back and forth across the stage!



"Depth," the "third dimension," is introduced in sound perspective by Bell Telephone Laboratories engineers. The author discusses many of the factors involved in the new system; advanced technicians may wish to set up equipment experimentally duplicating some of the sound effects he describes.

A dramatic sketch was enacted with invisible participants. As they seemingly changed their positions on the stage, the audience, almost as one person, turned their heads accordingly! Orchestral music was more enjoyable due to the seeming position of the artists, the groups being identified by their instruments. A singer apparently walked about the stage.

However, the most dramatic effect was reserved for the finale. The effect to be produced was that of a person shooting a firearm, the projectile whistling through the air in transit from left-stage to right, and the target being hit. Although it was amusing to seemingly hear a shot, follow the bullet across-stage and hear it smack the target, it was more amusing and even bewildering when the tables were turned—the target was struck, the bullet whistled across-stage from right to left, and then the "starting" shot was fired! (Of equal interest to the technician was the duplication of these William Tell activities—first produced *mechanically* — by *electrical* means.)

An amazed audience now watched a curtain of theatrical gauze rise, to reveal—not a soul! There were to be seen only three reproducers ("loudspeaker") assemblies, one of which is illustrated in Fig. A; a rear view is Fig. B.

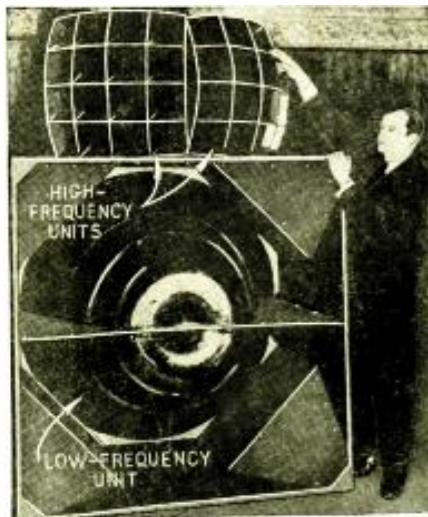

Fig. A, above

Front view of the reproducer assembly. The high-frequency units comprise two 16 section trumpets.



Fig. B, right

Rear view. Note the very great diameter of the low-frequency voice coil. The reproducer assembly is designed to deliver an output of 100 db!

These effects of auditory perspective were accomplished by employing three independent microphones connected by three amplifying channels to three of the "loudspeaker" assemblies, as shown in Fig. 1. (For the demonstration the orchestra, performers and microphones were located in an auditorium on the 5th floor of the building; the amplifying, monitoring and reproducing equipment, in the auditorium on the second floor.)

#### Additional Sound "Tricks"

In order to fully demonstrate the capabilities of this ultra-modern sound system the apparatus was designed to deliver 1000 W. of audio power to the loudspeaker assemblies, each of which is reported as having the remarkable efficiency of 50%; and the frequency range was designed to cover, without appreciable distortion, from 40 to 15,000 cycles!

Such wide extremes of power and frequency makes possible many unusual effects. Thus, for instance, it was interesting to watch the audience crane their necks in an effort to follow a phantom airplane as it rapidly approached from an imaginary horizon, circled "overhead," and then disappeared in the distance. The sound of an ordinary door signal buzzer was raised in volume until it resembled a miniature trip-hammer. The tap dancer, previously mentioned, was made to sound like a noisy giant. The volume of a 30 piece orchestra was increased until it equaled the "acoustic size" of a 300 piece orchestra (and thus demonstrating super-orchestral effects). At the same time, the volume of a vocal soloist was raised with each increment of orchestral volume so that the singer was never drowned out.

(Continued on page 676)

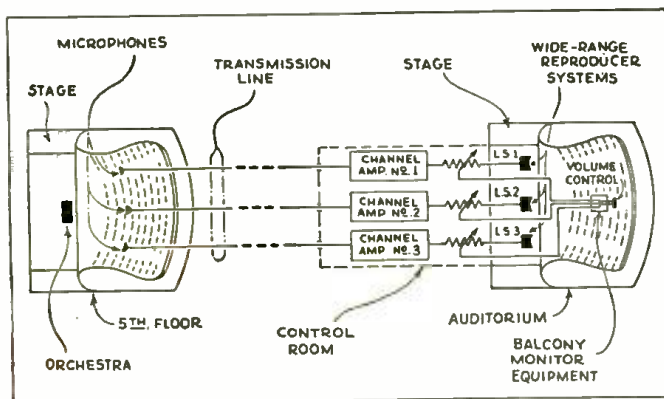
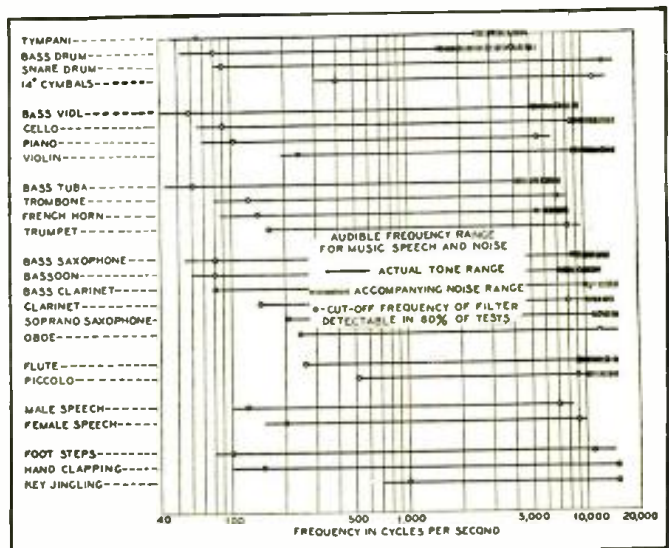

Fig. 1, above

The equipment for "three dimension" sound requires three microphones, amplifiers and speakers.

Fig. 3, right

Frequency, and noise ranges in music, etc.; figures which indicate the need for a 40 to 15,000 kc. sound system range.



# HOW TO MAKE A ONE TUBE LOUD-SPEAKER SET

Contrary to the belief of many constructors, it is entirely possible to build a one tube set that will satisfactorily operate a loudspeaker on many stations. Such a set has been developed by one of our readers, who employs a Flewelling super-regenerative circuit in a form that is very stable and simple to operate.

W. P. CHESNEY

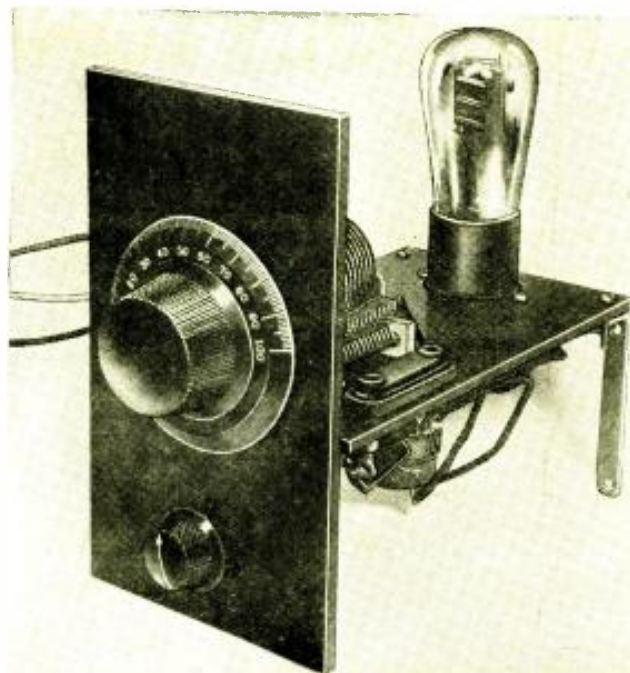

Fig. A  
The receiver is small and simple to operate.

YEARS ago, when radio was being developed by the experimenter and the amateur, a one tube loudspeaker set was the ultimate goal of every constructor. Various types of circuit combinations and forms of receivers were tried and built, and in a good many cases actual loudspeaker results with one tube were obtained. In favor of other fads or fancies interest in developing maximum efficiency from one tube waned. The constructor became caught in a maelstrom of other intriguing possibilities of radio which took his attention away from this most interesting and worthwhile work. But now, with interest being resumed in small receivers, as evidenced by the increasing popularity of the midget set, and since more highly developed tubes—(from an angle of sensitivity and power output) are available—the constructor and experimenter is once more focusing his attention in this direction.

To the uninitiated, it is not desired to convey the impression that it is possible to construct a one tube set that will duplicate the efficiency of a five or six tube set. What is emphasized is that no machine or electrical device is anywhere near 100 per cent efficient. Particularly is this true in the case of a vacuum tube. And since there is room for improvement in this case, through careful study of the problems involved and careful construction of the receiver, it is more than possible to make one tube operate a loudspeaker (with fair sensitivity) to the satisfaction of the user.

Since only one tube is employed, its function is limited to that of detection, or rectification as some term it, essentially because the high-frequency signals fed to the tube by the

tuning coil and condenser arrangement must be converted to D.C. (of a pulsating nature) so as to operate the loudspeaker. Some means of boosting the strength of the signal must be provided for, since no further stages of amplification are permissible. In earlier models of one tube loudspeaker sets, regeneration in various forms was employed for increasing the output from the tube. Because regeneration returns any excess R.F. energy that exists in the plate (or output circuit) of the tube back to the grid or input side to be amplified and rectified, we can readily see why this form of circuit minimizes any dissipation of energy and therefore increases the efficiency obtained from the tube.

The parts can be found in any radio shop for a very small sum and with the exception of the batteries and tube the cost usually runs around \$1.75 including a low-priced speaker. The total cost for the complete outfit only runs around \$5.00. For the man who has no electrical supply in his home and wishes a battery radio set that will work well with a speaker and, above all, the cost of material not to exceed five dollars, I believe this simple set will prove most interesting. The first cost is low and the upkeep is far below the average radio receiver.

To obtain even more amplification and real loudspeaker results, the circuit employed in this one tube set is of the "super-regenerative" type. But, lest the reader be frightened by what he has heard about so-called "supers," let me emphasize that this set is not the least bit critical, unstable, or in any way temperamental in its operation. Upon careful consideration of the schematic wiring circuit, shown in Fig. 1, it is noted that it is in reality a "Flewelling" super, one of

(Continued on page 678)



Fig. B  
Underside of receiver illustrating the location of parts.

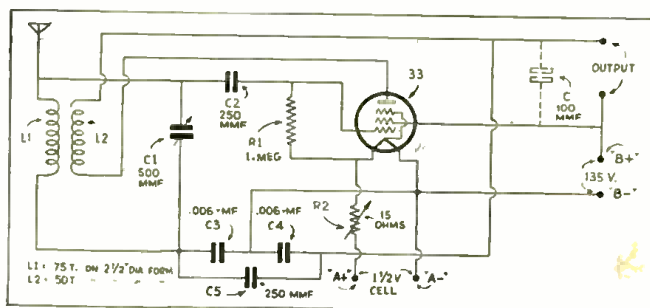

Fig. 1  
Connect the ground to the lower end of L1.

# THE "POLYTONE"

F. M. SAMMIS

An entirely new and different electronic musical instrument. A light beam focused on a photocell is modulated by frequency slits in a record. These slits are wave shapes of various frequencies obtained by means of an oscillograph or synthetically reproduced. Some very interesting musical notes may be obtained with this arrangement, in addition to simulating the tones of pipe organs, flutes, etc.



The "Polytone" is operated similar to the piano.

**W**HAT WILL the musical world say when pipe organs are made without pipes, pianos without strings, bands without brass instruments and the woodwinds without either the wood or the wind? Well—it had better steel itself for a pleasant shock for these things have come to pass.

Imagine being able to sit down in your living room or den and to command an orchestra to play what you will, or to play your own piano and to have this new instrument add orchestral accompaniments and effects, or pipe organ tones or tone colors which you yourself may invent on the spur of the moment and change them this moment and the next and almost forever without tiring of this new world of tone magic.

But you say, I know nothing about music and I can't play. Very well; one form of this instrument will be played automatically. For a few cents a paper player roll or disk will be available which will play the notes but leave to

your individual taste the matter of tone selection.

The Nuttall photoelectric musical instrument which has been tentatively dubbed with the rather inelegant name of "POLYTONE," after years of work has been developed into a commercial product. Few have realized that the same elements that made talking pictures possible may now be harnessed with other elements and into a different arrangement to produce marvelous new musical tones. In addition to producing musical qualities that are entirely new, this unique device faithfully produces the qualities of the usual musical instruments with which we are familiar.

Figure 1 illustrates an important and practically the only moving part of the Polytone. The light rotor or frequency disk which is here shown has only two octaves of what may be called light slits. A few additional rows of experimental frequencies have been added. This is the form in which one of the earlier models was made though subsequently

a three manual instruments was constructed with five octaves and many beautiful tone colors. The light rotor which determines the frequency of the emitted notes, may be of glass or of some opaque material which may be pierced with minute light slits. In the finished instrument this member may contain one or more octaves of slits as physical requirements demand. The function of the rapidly whirling light slits is to cause a series of minute shafts of light to pass over tone patterns as shown in Fig. 2. If the tone pattern is that of a flute and the number of light

(Continued on page 678)

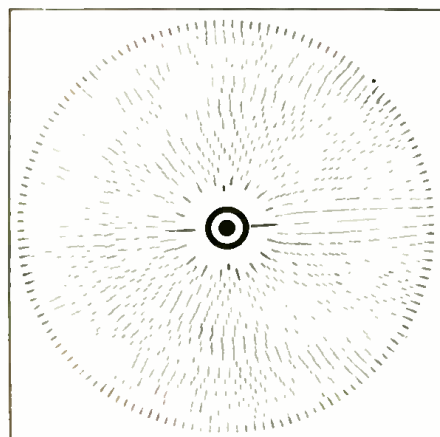

Fig. 1

Frequency disc with 2 octaves of light slits.

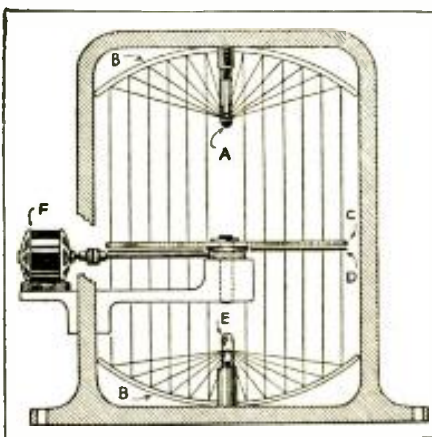

Fig. 2

(A) Light source. (B) Reflectors. (C) Freq. disc. (D) Mat and wave pattern. (E) P.E. cell.

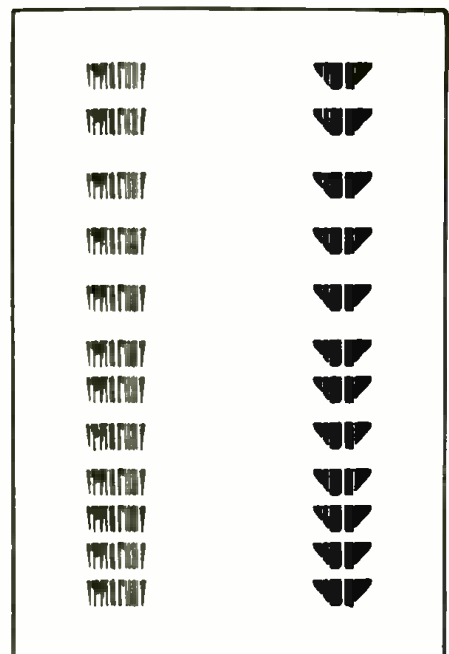

Fig. 3

Wave shape of various sounds or tones.



Fig. B—Extending the speaker without wires.

# PARTY TRICKS WITH THE RADIO SET

C. W. PALMER

THE RADIO fan who thinks that the only pleasure obtainable from his radio receiver is listening to radio broadcasts, is missing a good deal of enjoyment from his set. For example, there are an infinite variety of fun producing kinks that can be worked out in conjunction with the radio set and radio parts for house parties. When the usual run of games has been exhausted, there is danger of the enjoyment being marred by a sudden attack of the "what shall we do next" malady. With a little ingenuity, you can save the day with the aid of your radio receiver.

With little work previous to the party, and the aid of an accomplice you can make a mystifying Oracle such as the one shown in Fig. A, who can answer the most intimate of questions to the discomfort of your "victim" and the delight of the other guests.

The secret of the Oracle is evident from the illustration, Fig. A. The dynamic speaker is shown open in the back, for illustration purposes—actually it would be completely closed and the wires carefully concealed.

The schematic circuit, Fig. 1, shows the principle of operation. The dynamic speaker serves as a microphone when the switch is thrown in one position, and projects enough sound to the headphones so that your accomplice, who is

sitting in another room with the apparatus, can hear all that goes on in the room. Then at the appropriate time, he simply throws the switch and makes witty comments or answers questions, at which time the dynamic speaker acts in its correct capacity as a reproducer.

The parts for the Oracle are all commonly found in the radio experimenter's "shelf of gadgets"—the amplifier can conveniently be the A.F. amplifier of a broadcast receiver; connections being made by the use of adapters plugged into the detector socket and power tube base socket.

## Phonograph Tricks

For those who are fortunate enough to have either a combined radio-phonograph console or a separate electric phonograph which uses a vacuum tube amplifier to magnify the sounds picked up from the record, there are additional tricks that are both amusing and instructive. For example there is the old trick of playing records backwards. This has a never-ending appeal and can always be depended upon to induce merriment.

There are several ways in which the record can be reversed. If the phonograph motor is one of the cheap non-self starting synchronous type, the task is simple. In this type of motor, you

have to give the turn-table a push to make it start rotating. If you push it the opposite way, it will continue to rotate that way. Then, you simply have to move the pickup to the other side of the center pin and place it at the center of the record instead of the outer edge. This is usually quite simple, as most electric pickups are arranged so that the arc of rotation of the pickup arm can be adjusted.

If the phono. motor is an inductive type of unit, operated from some D.C. source, the connections to the armature can be reversed to change the direction of rotation. As a last resort, if you cannot reverse the motion in any other way, you can hold the record on the top of a pencil held vertically and press the edge of the record against the edge of the turn-table. If the motor is a strong one, it will rotate the record by friction drive, and the pickup can be shifted over to cover the correct arc.

The effects produced by reversing a record are quite entertaining, especially if the records are chosen carefully. For example, if a record of a piano is played backwards, the music resembles a cross between a violin and an accordion. Each individual note is heard as a sharp "ping" followed by the tone slowly decreasing in volume.

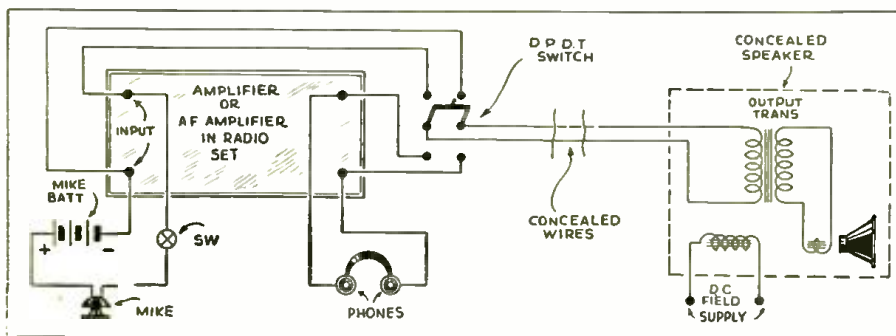

Fig. 1

Here are the details for making the Oracle which will mystify and entertain your friends. The amplifier may be either the A.F. amplifier from a radio receiver or a P.A. unit. The dynamic speaker works both as a mike and as a reproducer unit.



Fig. C

Programs can be heard without a speaker in this simple way.

How much do you use your radio set—several hours in the evening? If so, you are missing much entertainment from it. Listening to radio broadcasts is only one part of the possible amusement that you can get from your set. Why not enjoy it to the full? One way to increase its usefulness is described here.

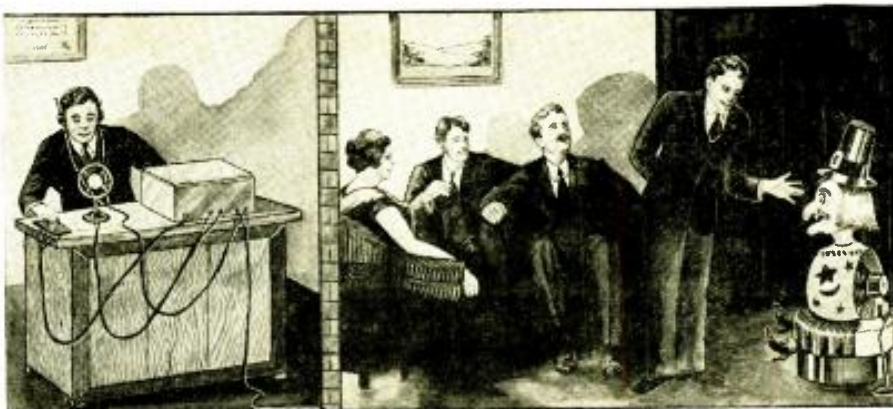

Fig. A  
The complete set-up for the Oracle, showing the concealed dynamic speaker.

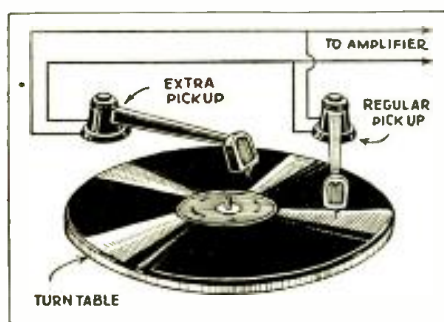

Fig. 2  
One way to produce echoes with 2 pickups.

#### Extending the Speaker Without Wires

Another trick that is quite amusing, especially to the young ladies present, who invariably have to be persuaded to participate, is the old stunt of extending a remote speaker from the radio set, without the use of wires. This is accomplished as shown in Fig. B, by the linked hands of the guests. A magnetic speaker is most convenient for this trick, as no field current is needed. Two members of the party touch wires which have previously been connected to the output of the set (more on this presently) and the other guests arrange themselves in two lines and the last two touch the remote speaker terminals. In connecting the wires to the set, if the last stage is a push-pull type of circuit, the wires can be connected directly to

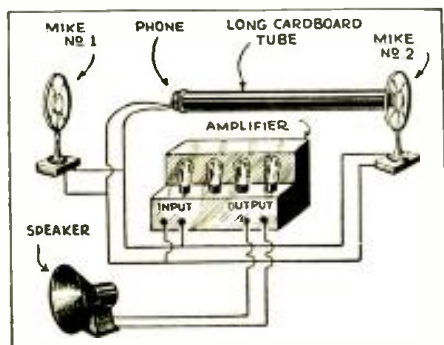

Fig. 3  
Echoes can be produced also in this way. Mike No. 1 can be replaced by the radio set if desired. The tube makes the echo.

the plate prongs on the power tubes. If a single power tube is used in the set, connections should be made to each side of the output transformer primary, and a condenser of about 2 mf. should be connected in each wire, between the set and the wires to be held, to prevent the guests from receiving a shock from the "B" voltage passing through them.

#### Reception Without a Speaker

The above experiment was originally described many years ago by Hugo Gernsback, in one of his magazines. Another one which was particularly popular at the time is shown in Fig. C. This is the stunt of hearing without a loudspeaker, phones, or any reproducing device. Three people participate. Two wear a kid glove on one hand, or hold a piece of thin paper between their hand and the ears of the third person who hears the music. Each of the other two persons hold one wire from the output of the radio receiver, connected as described for the previous stunt. The answer to the question "how does it work" is found in the theory of the electrostatic loudspeaker or condenser phone which is familiar to most people.

#### Radio Echoes

Many interesting effects can be obtained by echoes. This trick was originally suggested to the writer by a not-too-selective radio receiver, which picked up programs from two stations at one time. It happened that two of these stations happened to be connected with the same broadcast network, so that the same program was often heard from both stations. The peculiar part of this incident is in the fact that the local station was the key station from which the program was originated, while the distant station received its program by land lines. In the balancing of inductive and capacitive effects in these lines, a lag occurred, which produced a very amusing echo effect. Every speaker apparently had a heated argument with himself, while music from a trio appeared like that from a large orchestra. In attempts to duplicate this effect, at

will, several methods were worked out which can be used at the house party to amuse the guests. The first is with an electric phonograph. As shown in Fig. 2, a second electric pickup is connected in parallel with the original one, and is mounted at another convenient part of the circumference of the record. Then, by careful placement of the pickup needles various echo effects can be produced.

Another method which is useful for either the radio set or for "home broadcasting" is shown in Fig. 3. In this case, a long cardboard tube produces the echo. Input mike, No. 1, can be replaced by the radio or phonograph. The longer the tube, the greater will be the lag.

#### Magnetic Personality—Plus!

Quite a bit of fun can be had by perpetrating a hoax on your guests. The parts needed are an old voltmeter or milliammeter. (Use one that you do not intend to employ for radio work again, as it will probably be out of calibration after the experiment.) Most of these instruments are contained in bakelite cases, although a few are enclosed in

(Continued on page 680)



Fig. 4  
The magnetic personality meter.

# A FUNDAMENTAL ANALYZER

O. W. CALDWELL

A switchless, push-buttonless, fool-proof servicing instrument. Ordinary plug-in type jacks are employed so that either point-to-point testing can be easily accomplished, or measurements taken of any portion of the circuit without removing the chassis.

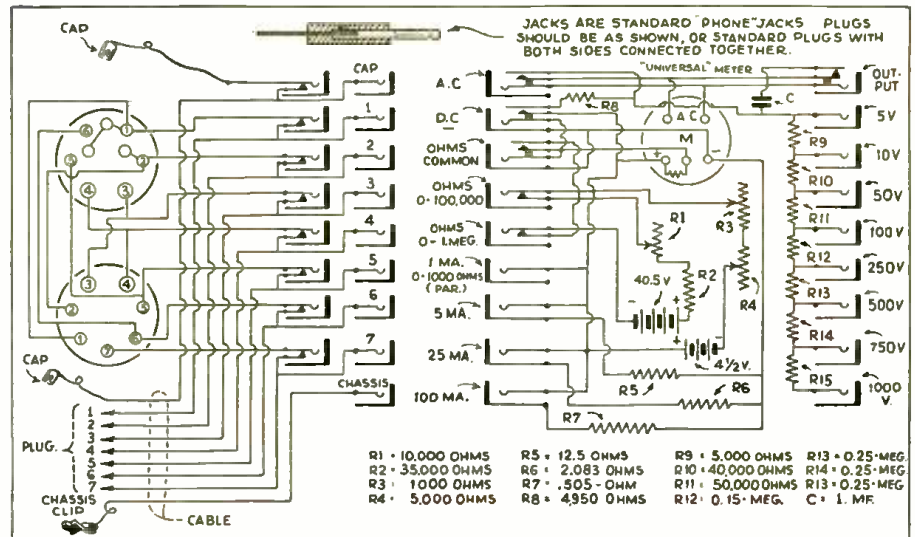

Fig. 1  
Schematic wiring diagram of the Fundamental Analyzer.

WE have seen the evolution of set analyzers over a period of years, and watched them develop into splendid instruments by which a complete analysis of all tube circuits could be made by manipulation of the switches and push-buttons on the panel. Then, all of a sudden, came the flood of new tubes, with six, then seven prongs, and the elements brought out in unusual places. The analyzer manufacturers tried bravely to extend the use of rotary switches, push-buttons, and other gadgets to keep up with these swiftly changing requirements, until the analyzer of that type is quite an expensive, and in some cases, a complicated instrument. In the opinion of the writer, the situation calls for a "New Deal."

The purpose of this article is to present an instrument that goes all the way back to the fundamental principles and starts over, from a different angle—the "switch-board" method—which allows thorough and complete analysis of circuit conditions without need of switches, push-buttons, toggles, rotaries, or other complicated machinery. All this without sacrificing any advantage that should be offered by the modern analyzer, or slowing up the operator's technique.

It is possible with this instrument to break into, bridge across, or isolate for external input or output, any circuit, or

circuits, at the tube socket. It is possible to test tubes by the reliable grid-shift method. Voltage measurements may be made with the set chassis or any tube element as the reference point. The ohmmeter section is highly developed, and offers new points not before offered, and the analyzer offers every available point-to-point resistance analysis at the tube sockets.

Ranges available for external use as well as in the analyzer, are 0-5, 10, 50, 100, 250, 500, 750, 1000 V., A.C. or D.C.; 0-1, 5, 25, 100 ma., D.C.; 0-1000 ohms; .1-meg; 1 meg. A.C. voltage measurements are used for output measurement through a separate jack which includes a blocking condenser to isolate the meter from D.C. plate current. An outstanding advantage over the standard analyzer is that all of the tube circuits are available *simultaneously*, so that by the use of extra meters more than one reading can be made at one time, and parts can be temporarily inserted in circuits without unsoldering the wiring or even pulling the chassis.

### General Description

The tester consists of two separate circuits entirely, as shown in the wiring diagram, Fig. 1. The universal meter comprises the meter, ohmmeter resistance network, and the two right hand columns of jacks. The analyzer section con-

(Continued on page 680)



Fig. A  
Appearance of the analyzer. Note the amazing simplicity of this unit.

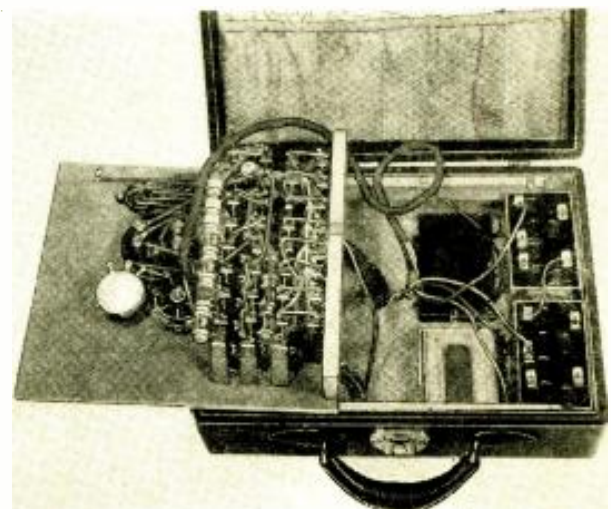
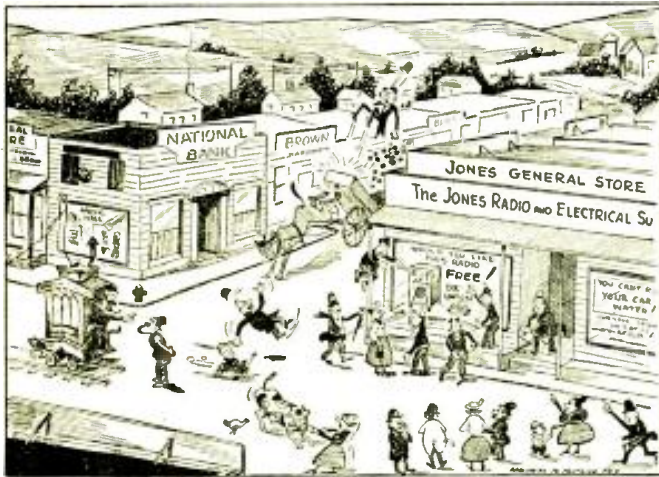

Fig. B  
Internal view. All batteries are mounted inside. This design makes all the tube circuits available simultaneously.

# MORE SUMMER SALES IN RADIO



Author's note: "Too many radio men today have become 'order takers' instead of salesmen. As an advertising man I investigated the field, and during a trial period of a new sales plan, worked in a small up-state community, it brought such results as to warrant it being passed on to others in the industry." What do you think of it?

C. K. MOON

SUPPOSE I belong to that group of radio experimenters commonly referred to as "pests" by accomplished Service Men. I repair radios (gratis) for some of my friends, guide them in purchasing new sets, and generally am on hand to offer criticisms whenever Service Men do inefficient jobs. Since 1920 I have been constantly in touch with the field. I've witnessed the advent of new apparatus, new transmission systems and all the lot, but not until last summer did I discover—to my sorrow—that radio Service Men were by no means covering the field to the best of their ability.

My folks live in a small town. Pottstown we'll call it. Located on the shores of Lake Ontario, it has always been said to have the best DX location in the country. I arrived in Pottstown in August, the dullest month in the radio year and immediately started my campaign.

In the first place I noted the radio used by my folks. An Atwater-Kent, vintage of 1928, it had not had a tube replaced since installation. Volume was weak on all stations. The original aerial installed by myself in 1925 had been discarded and instead the local Service Man had rigged one on the opposite side of the house, run the lead-in wire through a cellar window, across the cellar and through a hole in the living room floor to the set. Why he ignored the thirty-foot mast in the back yard I don't know.

Through my father I learned the name of the local Service Man and the following day I visited him. His establishment was located on the main street. His business covered not only radio sets but refrigerators, electrical appliances and used automobiles. I opened the door of the store and entered.

Mr. Jones was seated at a bench at the rear of the show-room, obviously servicing a radio receiver. After introducing myself I watched him work. In the particular set he was replacing a transformer. After much prying I found that he would profit by two dollars when

the job was finished.

"That's not much profit for two hours work," I told him.

"Maybe not," said Mr. Jones, "but the radio business isn't what it used to be. Once in a while somebody comes in and buys a set of tubes, but I haven't sold a new set since last Christmas."

Somehow it got under my skin. Mr. Jones was, obviously, an "order-taker." He answered the telephone, replaced a tube, serviced a set, and waited for customers to storm his place of business. In the company for which I work, we cannot tolerate this kind of salesman, and it is the business of the advertising and sales departments to make every salesman a "salesman."

Out of a clear sky I shot a question to Mr. Jones—"Would you like to make radio the biggest paying of your three enterprises?"

"I couldn't," he said promptly.

It was a nervy thing to do, but I reached up and snapped off the soldering iron. "Mr. Jones," I said, "maybe you couldn't, but we can. I've got an idea."

He took it very well, just leaned back in his chair and said—"Shoot."

For two hours we talked. I fought for every point, downed his arguments with a burst of new ideas, and at the conclusion he admitted that he would try the plan.

The next day we started. A local show-card artist made us a window sign to be placed atop of a console model radio which had graced Mr. Jones' window for six months. It read:

WOULD YOU LIKE THIS RADIO  
FREE  
?

From the local bank we borrowed a mimeograph machine. On it we printed the following message:

"For years Pottstown has been noted for having the best radio location in the country. Back in the old days a great many DX (distance) reception records were hung up in the city.

"The Jones Radio and Electrical Supply Company is determined to see that Pottstown maintains its old record for radio reception. The beautiful General Electric radio set displayed in our window will be given, free of charge, to the person submitting the best list of broadcast-band broadcasting stations received by any inhabitant of the city living within a radius of ten miles, during the month of September.

"Rules of the contest:

1. All stations must be located more than two hundred and fifty miles from Pottstown. Do not submit reception reports of stations nearer than that.

2. An official verification, received from each station, will be necessary. Simply send to the station received a post-card or letter noting the programs heard during a certain period, and ask for a verification, enclosing a 3 cent stamp for return reply. If stations heard are units of a chain, listen for special announcements at the close of chain programs. Due to delay in mails and answering letters, entries will be accepted up to and including October 31.

3. Copies of "White's Radio Log" may be obtained from the local stationery stores for ten cents. Check all calls carefully before sending for verifications. Verification cards may be purchased, in printed form, from the Pottstown Press offices for 25 cents a hundred.

4. Additional information may be had by applying at this establishment:

JONES RADIO AND ELECTRICAL  
SUPPLY COMPANY  
Pottstown, N. Y.

Telephone 933  
Service Sets Tubes

The next day was Saturday. Farmers, in a farming community, visit the town in droves on that day. Townspeople too make Saturday a big day for shopping and Mr. Jones' window display (dusted off and redecorated for the occasion) caused no little comment. Through the

(Continued on page 686)

# A FOUR TUBE SHORT-WAVE CONVERTER

A 4 tube short-wave converter, which will work into any set, either T.R.F. or superheterodyne. It will increase the range of the broadcast receiver from 200 down to 15 meters, permitting complete short-wave and broadcast reception.

HERMAN COSMAN\*

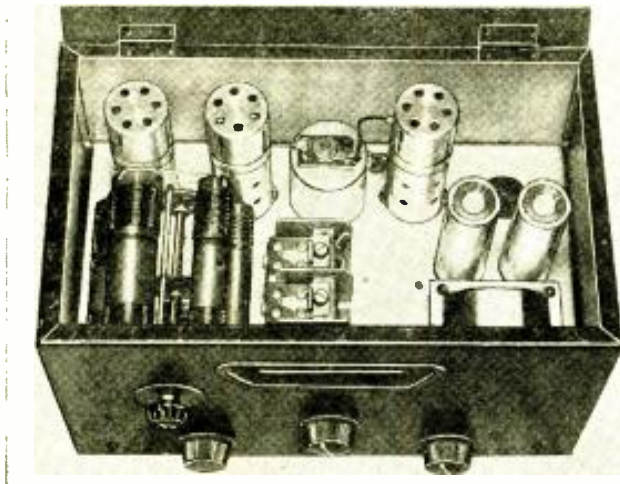

Fig. A—Front panel view.

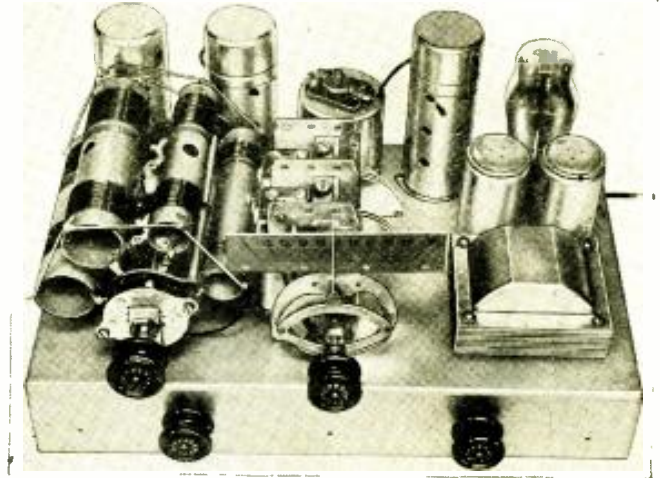

Fig. B—Top view illustrating parts layout.

**M**ANY LISTENERS of broadcast reception who have an efficient radio receiver, and who have heard so much about short-wave radio reception (possibly made a half-hearted attempt to rig up something that would permit them to get the lower wavelengths—only to be discouraged by the results) should consider the construction of this converter. The thrill of obtaining police calls, airplane communication, short-wave broadcasting, amateur telephone conversations, all over the country (and other countries too), may be yours very easily, and without impairing the present efficiency of your receiver. The unit has been designed very carefully, from an angle of efficiency, and also simplicity—since it is realized that not all short-wave enthusiasts, or would-be enthusiasts, are in a position to understand or manipulate complicated apparatus.

The converter employs a principle similar to that in super-

\* Chief Engineer Tri-Mo Radio Co.

heterodyne receivers, namely a first-detector and oscillator—since it is essential that the short waves (higher frequencies) be heterodyned and brought into the receiving range of the broadcast receiver. Four tubes are used, a 58 as first R.F. amplifier, a 56 as oscillator, and another 58 in the I.F. amplifier stage. An 80 or 5Z3 tube is employed for rectification for "B" supply so that no external batteries are necessary.

The wiring diagram for this converter is shown in Fig. 1. Note that no tapped coil arrangements are employed, but instead a complete multi-coil unit with a simple switch system for selecting any wave band from 200 meters to 15 meters. The tuning of the set is accomplished in a manner that is slightly different from that of the average broadcast receiver. The receiver is first set at any desired position of the scale. Then the two gang condenser unit in the converter is tuned until the signal of the desired station is heard, after which the 140 mmf. trimmer is em-

(Continued on page 690)

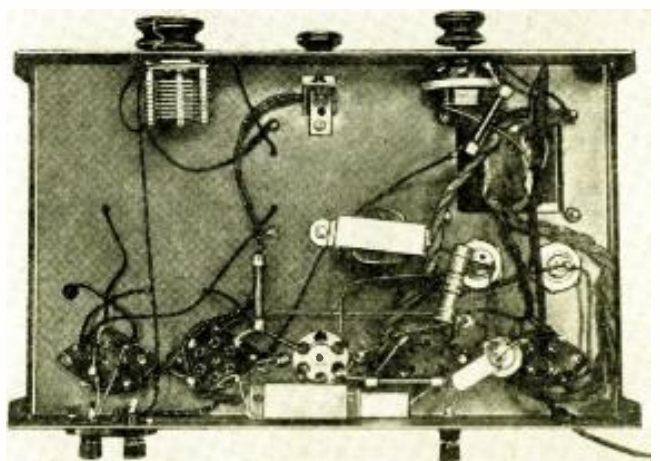
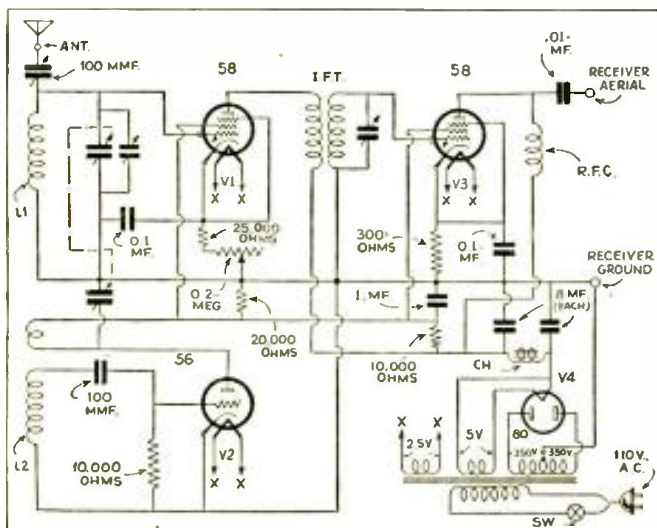

Fig. 1, left—Schematic wiring diagram of converter. Fig. C, above—Underneath view of chassis.





# "TELEPHOTOPHONE"

This title has been employed because it applies to the transmission of optical telephony. Much has been read of "light beam" transmission of sound, but few experimenters realize that they can build equipment that will permit them to imitate the results of the more complex devices. In this article a simplified light gate for talking on a light beam is described.

DR. R. M. SUTTON



Fig. A  
Construction of "light gate."

Additional descriptive data regarding "talking beam" transmission and reception will be found in the April, 1933 issue of RADIO-CRAFT, page 593, and in the Feb., 1933, issue. Another type of mechanical shutter device for modulating a light beam is described in the latter issue, and which information might give the constructor additional hints that may aid him in building this unit.

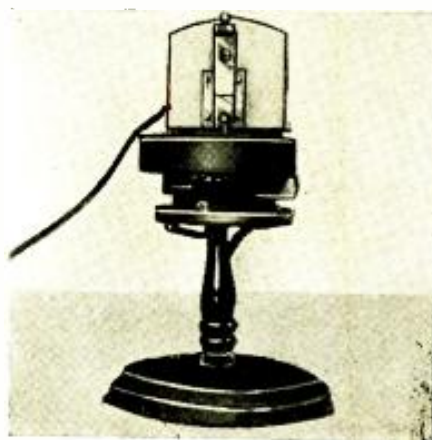

Fig. B  
"Light gate" ready for operation.

THERE have been numerous successful experiments in recent years which have demonstrated the possibility of "talking over a beam of light" in strictly point-to-point communication. The secrecy of such transmission of messages is as good as the optical system, and this method of talking across space can be made precisely into "beam narrow-casting." Communication by light beam is limited to optical paths a few miles in length. It presents certain advantages and disadvantages over short-wave and ultra-short-wave radio transmission. On the credit side stand complete secrecy, the absence of R.F. oscillators and generators, low cost, and ease of operation. On the debit side stand interference from atmospheric conditions, the necessity for a completely

clear optical path from sender to receiver, and the requirement of a strong, steady light source.

Many of the past experiments utilize a beam of light which is modulated by the varying output of a neon glow tube. The author describes here a peculiarly simple and effective method of light modulation which presents certain advantages. For such light values applied to the transmission of optical telephony, the name "Telephotophone" seems appropriate. In this particular apparatus, the voice or music currents from an A.F. amplifier are passed into a magnetic loudspeaker unit, such as the type used in cone-loudspeakers. Coupled directly to the armature of the unit is a vane which forms one side of a slit (see Figs. A and B). Thus the width of the

slit varies in accordance with the currents flowing through the speaker unit, and it is thus possible to vary the intensity of light which passes through the slit. This varying light beam is focused by lenses or by parabolic mirrors upon a distant photoelectric cell, where the variations in light intensity cause varying currents to flow in the light-sensitive cell. The cell is coupled to a high-gain A.F. amplifier and the output of the amplifier activates a loudspeaker to reproduce the original message. The accompanying diagrams will show the schematic arrangement of the necessary apparatus. (Figs. 1 and 2).

(Continued on page 686)

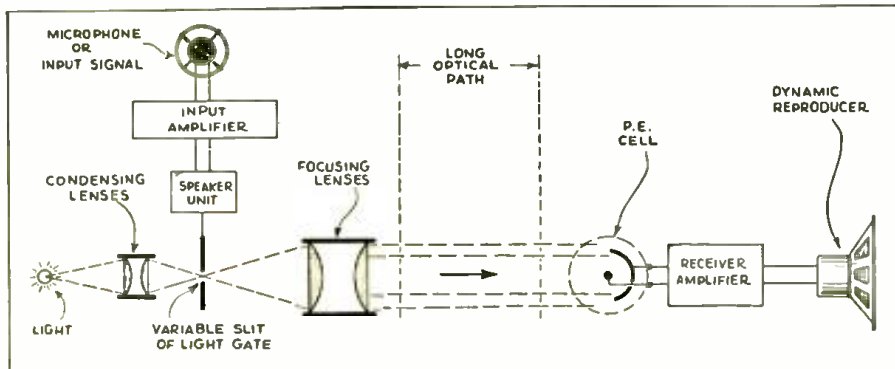

Fig. 1  
Illustrating equipment set-up for light-beam transmission and reception.

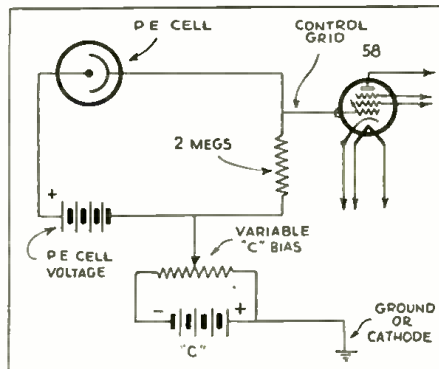

Fig. 2  
High-gain stage connects to P.E. cells.

# SOUNDHEAD OPTICAL SYSTEMS

J. T. BERNSELY

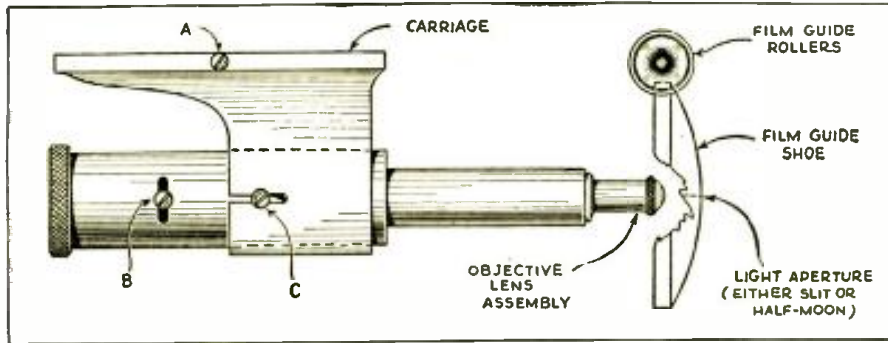

Fig. 3

Optical lens barrel, adjustments A, B, and C are explained in text.

The adjustment and care of optical systems and associated equipment in soundheads are thoroughly outlined in this article. Service Men who are interested in the "talky" field will find this information interesting and necessary.

**A** CONSIDERABLE number of Service Men have become interested in the servicing of sound equipment, probably due to the change in policy of the larger sound equipment manufacturers in regards to compulsory service of their equipment. This is, probably, applicable only to new "sales" of equipment, since the installations that were made some few years ago were obtained on a "lease" basis and included service inspection for a period varying anywhere from two to ten years. At the present time, it is understood, "talky" equipment (particularly the small theatre type) is being sold outright, with service inspections and maintenance by company's engineers being optional with the exhibitor. In cases of this sort, or where equipment manufactured by independent manufacturers exists, it is entirely possible for the local Service Man to arrange for the proper servicing and maintenance of the equipment. This may be done either on a weekly or semi-monthly basis, or only in cases of emergency (at times of breakdown), depending on the choice of the theatre manager—or in most cases the selling ability of the Service Man. It is needless to say that the more often periodic inspections of the equipment are made, the less likelihood of a breakdown—since worn or defective parts may be replaced in time to prevent such a catastrophe and thus save the management considerable money in the long run.

While the service procedure of any theatre equipment is somewhat varied and involved, depending upon the type of equipment installed, the theory concerning the adjustments on optical systems is practically the same for all of them. The position of the various adjusting screws in different makes will, of course, vary but their importance, relation and proper manipulation are identical for all makes of

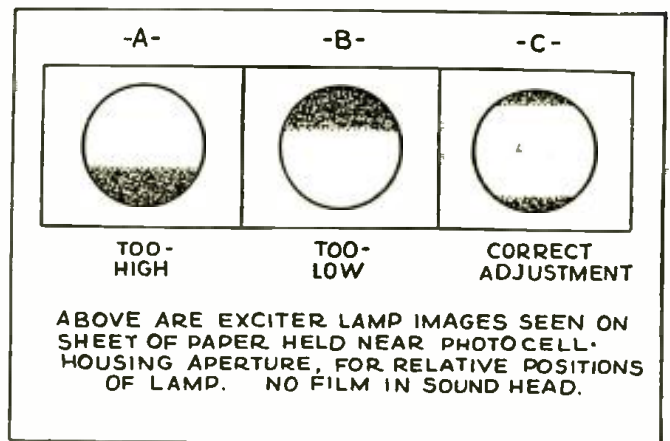

Fig. 2

Proper adjustment of exciter lamp is shown in "C."

sound heads. Then again, the reasons for discussing the adjustment of this mechanism in the sound head in preference to other parts is partly due to letters requesting this information, and due also to a consideration of the general store of knowledge that the average service technician has on hand. This generally includes amplifier circuits and theory, which is the chief requisite of any "talky" Service Man, speakers, power supply units, and "faders"—which is nothing more than a potentiometer type of variable resistance for changing from the output of one machine to the second. However, most of the radio-technicians have no knowledge  
(Continued on page 682)

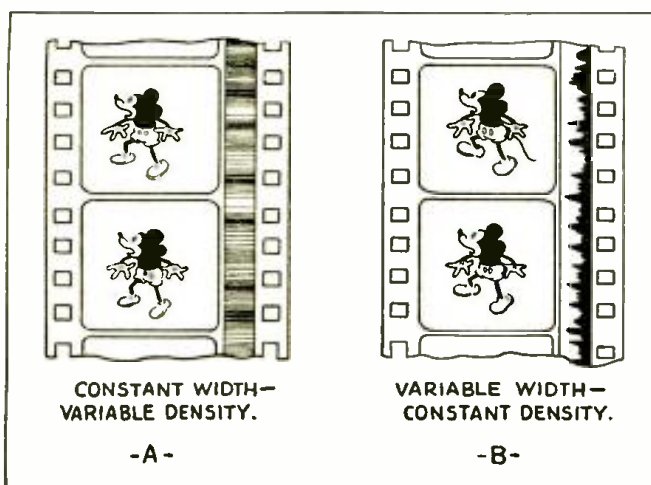

Fig. 1

Illustrating the two most popular types of film recording.

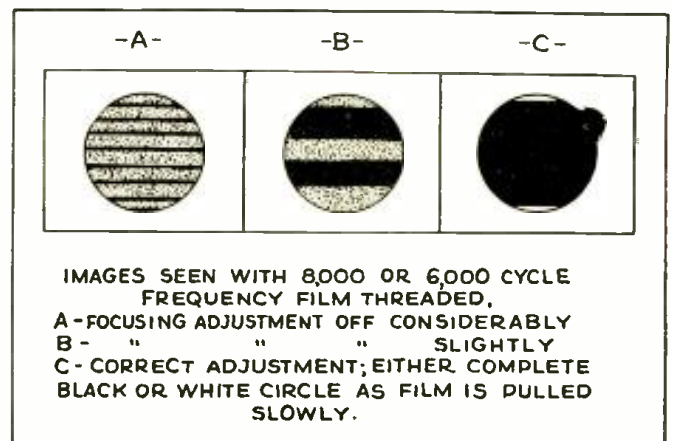
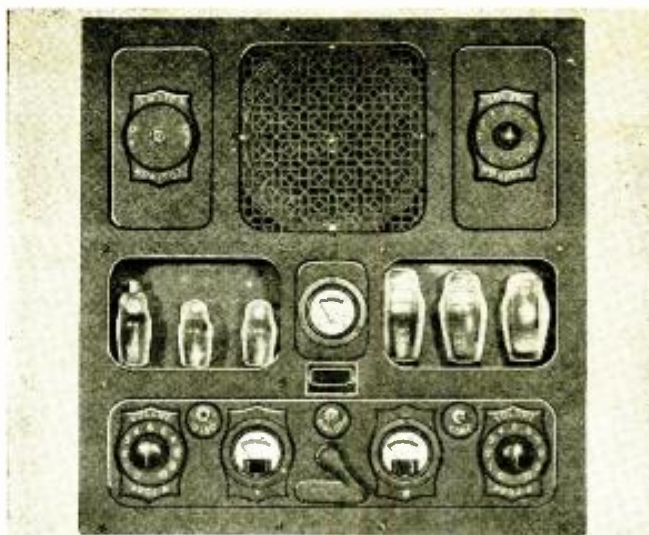

Fig. 4

Focusing adjustments, best when image shown at "C" is obtained. A and B show two degrees of mal-adjustment.

# SERVICING THE "TALKIES"

In this, the final installment, the author describes in detail methods for obtaining information regarding the equipment in a theater, and how to best obtain replacement parts. Also some valuable hints on service procedure, defining the projectionist's part as it ties in with the Service Man's duties. Further information is given on just how much work the Service Man may possibly get from various types of theaters.



A complete theater-type amplifier.

## PART VII

AARON NADELL

**R**EADERS who have followed previous articles of this series are now ready to consider definite and detailed plans for contacting local theatre personnel and arranging with them to service talking picture equipment and sell supplies for the same. Many concrete suggestions follow. But everything that will be said below is qualified and limited by those circumstances of theatre business, and by the nature and problems of theatre personnel, which were outlined in the course of the previous discussion and cannot be repeated here. *The detailed suggestions given below cannot be seen in their proper light, and may not prove in the least helpful, unless the preceding discussions of the peculiarities of show business, the psychology and special interests of showmen, and the labor union and other problems of the projectionist have been thoroughly digested and understood.*

### How to Contact the Manager

The simplest and most direct method of securing theatre business is of course to go up to the manager and ask for it, but if the manager is not disposed to

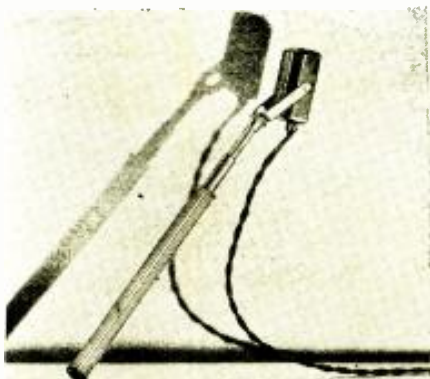

A hard-of-hearing aid that the Service Man might interest the theater in.

place full confidence in a stranger (perhaps acquainted with "talkies" equipment) who casually asks leave to intervene in the service of the theatre's most precious asset, the sound system, it may be necessary for the Service Man to suggest some profitable ideas not a part of the regular sound system. Thus, the Service Man can:

(1) Give the manager a radio set, to be awarded in one of his prize contests, in return for permission to display other radio sets in his lobby, or to advertise radio receivers and servicing from his screen;

(2) Sell, rent or lend the theatre a P.A. system to be used under the marquee, in front of the theatre, for ballyhoo. (If lent without cash consideration, secure lobby or screen advertising in return.);

(3) Sell, rent or lend the theatre a P.A. system to be used in a ballyhoo truck (if without cash consideration, secure lobby or screen advertising in return);

(4) Rent or sell (perhaps on trial) a set of ear-phones, or the more modern "bone-conduction." aids for patrons "hard of hearing."

In the course of conversation along these lines it is logical to express interest in the sound system of the theatre, and ask permission to visit it. This is especially true because three of the above four suggestions lend themselves readily to electrical connection with the regular sound installation. If a radio set is given away, a program received by it may be coupled (either directly, or through the announcing microphone if the manager is hesitant about permitting small changes in his sound system) to the theatre's amplifier, and played through the stage speakers. Conversely, radio receivers displayed in the lobby may be coupled directly, or through microphones, to play part of the sound of the show. A P.A. system under the marquee may also be coupled to the

show, or it may be wired to switches that will allow its amplifier to serve as an emergency amplifier in case of trouble with the regular system. Hard-of-hearing aids may be coupled directly to the theatre's sound equipment or may pick up the sound through a microphone concealed in the theatre. Thus, conversation about any of these business angles leads directly to discussion of the sound system proper.

### How to Study the Sound System

First of all, do *not* touch any part of the equipment without permission of the man who is in charge of it. Secondly, even after he grants you leave to "look it over," *never* open any panel cover or door while the show is running without his express consent. You may stop the show and be escorted to the street as an incompetent bungler, since much sound equipment is made with safety switches that cut off all power when a panel is opened.

You will find that the sound system is essentially an audio frequency amplifier, with little in it the radio man has not met many times before in the course of his ordinary radio and P.A. work. The photoelectric cell seems puzzling to some Service Men. It is simple and easy to deal with; its action having been explained in outline earlier in this series; it is described in detail in any number of reliable text books and in any large, modern encyclopedia. The rest of the sound system is mostly switches. Most Service Men are equipped with tables or boards for testing, on which they have mounted numerous meters and test leads, all operating by means of switching arrangements. Now the world's most competent electrical engineers would not understand at first glance the switching system the Service Man happens to have in his own test panel as well as it is understood by the man who built that panel, but there is nothing complicated

(Continued on page 683)

# APPLICATIONS OF THE 25Z5 VOLTAGE DOUBLING TUBE

H. K. BRADFORD\*

Not many of our technical readers fully realize the versatility of the 25Z5 rectifier tube. It is a tube that can be put to a number of varied uses, due to the flexibility permitted by its design. It may be used as a simple half-wave rectifier; full-wave rectifier; voltage doubling device—that is, to produce twice the voltage input in the output, where A.C. is employed; or as a combination power speaker supply device for A.C. and D.C. lines. The many applications possible are explained clearly, and in detail, in this article.



REFERENCE is made to that very ingenious tube of recent design, the 25Z5. Because of its revolutionary principle of operation it has invited considerable discussion and comment. Not only is its operation as a full-wave voltage-doubling rectifier of particular interest but also its adaptability to universal equipment (receivers, transmitters, oscillators, speakers, etc.) These indicate its wide application. It is with these applications of the tube that we are concerned.

To enable the simplest possible discussion of this tube's operation as a voltage doubler an analysis diagram is given in Fig. 1. To further aid in its understanding we will consider it from the viewpoint of "electron-analysis" rather than current flow.

During the entire half cycle in which terminal A is negative with respect to B electrons will flow from cathode 2 to plate 2, into condenser  $C_2$  and they will be drawn from the plus plate of  $C_2$  to B, charging  $C_2$  to a potential of 155 V. This is the peak voltage of 110 V. R.M.S. Condenser  $C_1$ , also has the opportunity of charging through R and  $L_1$  from plate 2, but we assume that R is much larger than the tube drop and thus  $C_1$  will receive a smaller charge. Its polarity will oppose  $C_2$  with reference to the output circuit. It will be opposite to the polarity indicated on the diagram.

When B is negative with respect to A electrons will flow into the lower plate

of  $C_1$  out of the top plate, through section 1 of the tube (cathode to plate) and hence to A. This not only dissipates the existing reverse charge on  $C_1$  as just mentioned, but also tends to lower the charge on  $C_2$  through the circuit  $L_1R$  in a manner outlined in the charging cycle for  $C_2$ . If we temporarily omit R we find that the two reverse actions due to the continuity furnished by R will be entirely eliminated and the potential across  $C_3$  as well as  $C_4$  will be 310 V. or the sum of the fully charged voltage of  $C_1$  (155 V.) plus that of  $C_2$  (155 V.).

It may be interesting to note in passing that when R is replaced by a number of plate and screen-grid circuits, there being no appreciable leakage and no bleeder current in the load, the reverse action can exist during both half cycles. At all times these reverse voltages are correctly polarized through the load.

The time constant of the tube drop and  $C_1$  and  $C_2$  is so extremely small as to be entirely negligible allowing both condensers to reach full peak charge with no load. Within the conductivity limits of the tube the voltage to which each condenser ( $C_1$  and  $C_2$ ) will charge depends on the ratio of the load resistance to the tube resistance (one half that of one rectifier section). As the load current increases the tube drop increases in almost direct proportion. The proportionality is so good that a "regulation factor" may be obtained for con-

stant values of  $C_1$  and  $C_2$  which will yield pertinent information as to the output voltage which may be expected at any load current.

This factor is obtained as follows:

$$(1) \quad K = \frac{E_2 - E_1}{I_2 - I_1}$$

Where  $E_1$  is the lowest voltage intersecting the curve.

Where  $E_2$  is the highest voltage intersecting the curve.

Where  $I_1$  is the lowest current intersecting the curve.

Where  $I_2$  is the highest current intersecting the curve.

Example—

Then the voltage to be expected for any current I up to and including maximum is:

$$(2) \quad E = 310 - KI$$

Where K is the regulation factor and I, the current assumed. Suppose we would like to know what current we can obtain at any specified voltage:

$$(3) \quad I = \frac{310 - E}{K}$$

Where the same factors are involved and the characteristic curve for the tube with our basic formula (1) we can obtain K for any value of capacity for  $C_1$  and  $C_2$ .

(Continued on page 687)

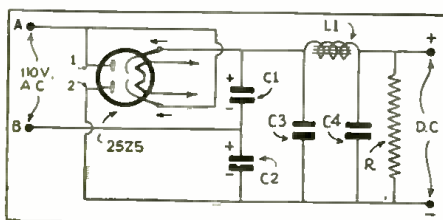

Fig. 1  
The 25Z5 as a voltage doubling device.

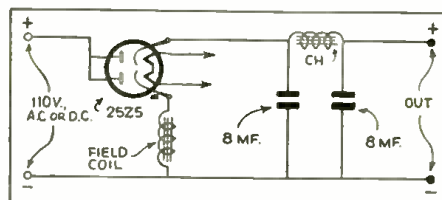

Fig. 2  
A split half-wave rectifier circuit.

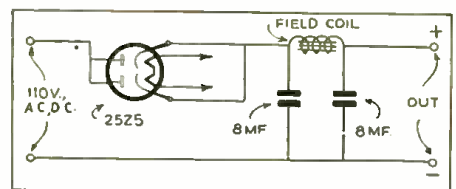

Fig. 3  
A paralleled half-wave voltage supply.

# AN A.C.—D.C. AUDIO PRE-AMPLIFIER

L. J. LITTMANN\*

Here is a self-powered pre-amplifier that will operate on either alternating or direct current. It has many uses as explained in this article.



**H**ERE is an item that has valuable appeal to every P.A. amplifier man and to every radio set owner. although primarily it was designed to serve in the P.A. amplifier field. Briefly, its purpose is to "pre-amplify" or to "boost" any A.F. signal produced by such input devices as phono. pickups, carbon microphones, crystal microphones, condenser microphones, dynamic microphones, ribbon microphones, photoelectric devices, etc. Such input devices are at-

\* Chief Engineer, Coast-to-Coast Radio Corp.

(Continued on page 691)

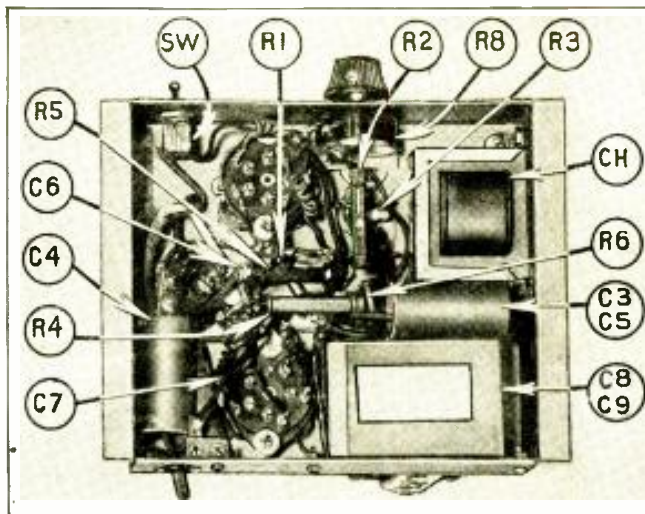
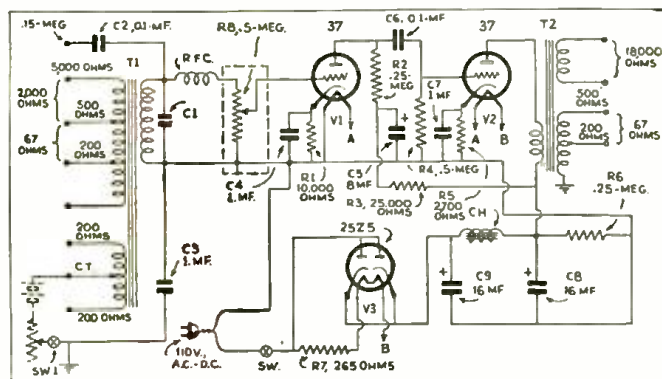

Fig. 1, left

Schematic circuit of the A.F. pre-amplifier for P.A. and experimental use.

Fig. B, above

Sub-chassis layout of the pre-amplifier. Important units are identified.

Fig. A, top-right

Note the neat appearance of the completed unit. Gain control R8 is on front.

## "WIRE-LESS" P. A. INSTALLATIONS

J. M. KUHLIK\*

The "transmitter" of this "wire-less" P.A. system energizes a building's entire lighting system with sound that may be "picked off" by any radio set; or, the special "receiver."



The transmitter.



The receiver.

**E**VER since the article, "A Wired-Radio Public Address System," appeared in the November, 1933, issue of RADIO-CRAFT, interest in this new and novel P.A. design, and extremely convenient method of P.A. installation and operation, has been rapidly increasing. The features that are exclusive to this system have found emphasis in commercial operation. Two units comprise the complete commercial "wire-less" P.A. system. Units Z and R, the transmitter and receiver, respectively, are illustrated.

The transmitter is often referred to as a "socket mike," since it plugs into the wall socket like a vacuum cleaner or any other appliance, and incorporates a mi-

crophone. The "socket mike" functions as a diminutive radio station; the "program" of this "station" as picked up by the microphone being fed into the wall receptacle (from which the unit receives its current supply) as "wired radio."

This "wired radio" program is then taken from any wall receptacle in the building by means of a radio set (connected to the light line through a small fixed condenser); or, merely by plugging into the wall socket the specifically designed "socket amplifier" or "receiver"—which also receives its current supply from the same outlet.

It is not necessary to run wires from point to point (often impossible in modern, steel-and-concrete buildings). Fur-

ther, the complete apparatus may be set up and ready for operation, at gatherings of every sort, in a few minutes.

### Novel Applications

Although there are a great many places where a wire-less P.A. system finds application, we will only discuss five new uses that have been brought to the attention of the writer, and which may suggest to technicians and prospective customers still other uses.

These applications are listed as follows: (1) traveling theatre ballyhoo service; (2) department store program relay and call system; (3) hospital call service; (4) remote alarm indicator; (Continued on page 692)

\* Miles Reproducer Co.

# A "DOUBLE SUPER" ALL-WAVE 12 TUBE SET

This receiver incorporates innovations in circuit design that make it a super-sensitive and selective radio set.

THE radio chassis in this 12 tube all-wave receiver uses a double super-heterodyne circuit. Through the use of a multi-section range switch, any one of four tuning ranges extending from 15 to 565 meters may be used.

By means of this range switch, radio signals are made to follow one of two general circuit paths, depending on their wavelength. If the signal is in the broadcast band, it is fed directly to the tuned input circuit of the R.F. tube, and from there on amplified in the usual way. During broadcast reception the short-wave section is rendered inoperative by

applying a very high negative bias on the short-wave oscillator tube.

When the set is switched over to any one of the three short-wave ranges, the received short-wave signal passes through the short-wave detector, where it is converted to 1,540 kc. by the action of the short-wave oscillator and it is then amplified at this frequency in the broadcast section of the receiver.

By the use of a separate A.V.C. tube, input to the second-detector is kept practically constant regardless of variation in signal strength. Volume is controlled by a potentiometer in the diode circuit of the 55 second-detector tube. This volume control feeds any desired portion of the A.F. signal to the triode section of the tube which acts as an audio amplifier.

This amplified A.F. signal is then fed into a resistance-coupled push-pull stage. The resistance-coupled push-pull stage with its necessary phase reversal tube, not only eliminates the distortion which would be produced by an input transformer but also increases the low-fre-



Fig. A

A simplified calibrated tuning scale is used.

quency response, and greatly improves the tone quality.

The type 56 phase reversal tube as used in the resistance-coupled push-pull circuit, functions as follows: By means of a voltage divider arrangement (resistors 51 and 52) one-sixth of the audio output voltage of the 55 is impressed on the grid of the 56 which reverses the phase, amplifies the signal to its original value, and applies it to the grid of one of the 2A5 output tubes. The other 2A5 receives its signal direct from the 55. Thus the two output tubes receive signals of equal strength but in opposite phase relation, giving a true push-pull effect without the use of a transformer.

### Local-Distance Switch

The local-distance or "quiet" switch, which is operated by an in-and-out motion of the tone control knob, makes the following circuit changes. In the "in" or local position, the primary of the R.F. coil is shunted by a fixed condenser, thus

(Continued on page 688)



(All photos—courtesy Stewart-Warner Corp.)

Fig. B

Power pack and receiver chassis are separate.

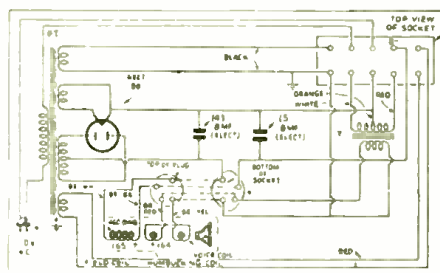

Fig. 1

Wiring diagram of power pack.

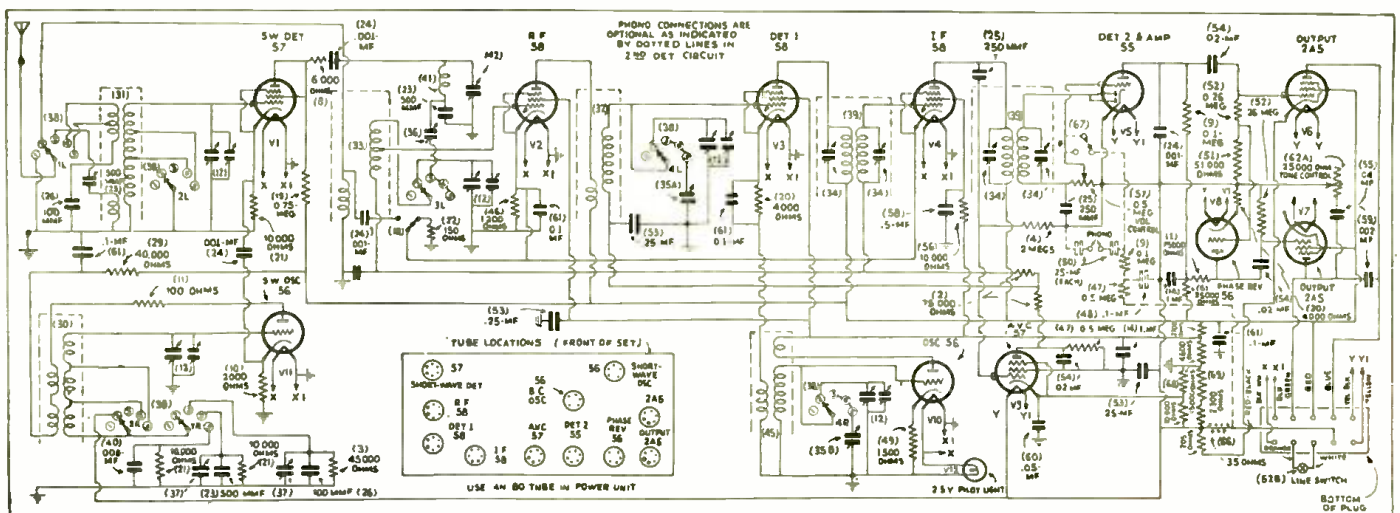

Fig. 2

Schematic circuit of complete receiver chassis.

# THE ANALYSIS OF RADIO RECEIVER SYMPTOMS

## OPERATING NOTES

### WHAT THIS DEPARTMENT IS FOR

It is conducted especially for the professional Service Man. In it will be found the most unusual troubles encountered in radio service work, written in a practical manner, by Service Men for you.

Have you, as a professional man, encountered any unusual or interesting Service Kinks that may help your fellow workers? If so, let us have them. They will be paid for, upon publication, at regular space rates.

### A.C.-D.C. RECEIVER TROUBLES

THE advent of the "cigar box" universal-current type of receivers has no doubt been partly responsible for the present trend of the radio industry in putting out small, low-priced sets, which naturally demands low service and repair charges. While this may be disadvantageous to the Service Man, the frequency with which these sets have to be serviced, more than balances the low service charges. This is to be expected for, besides the cramped quarters in which they are housed, which get real hot after a few minutes operation, they are subjected to more severe usage. While the 75 lb., 10 tubers of pre-A.C.-D.C. days may stand in the same corner for months at a time, the present-day cigar box type changes position almost as often as its owner leaves his flat or apartment.

### INTERNATIONAL KADETTE

SEVERAL cases of no reception in this receiver have been traced to the failure of the 75 ohm resistor in the plate lead of the KR-1 rectifier. A check-up usually shows no plate and screen-grid voltage on all tubes. While it may be suspected that the cause is a bad rectifier, or shorted filter condensers, it has been found in many cases that this resistor is at fault. A 10 W. wire-wound resistor is usually sufficient for replacement (or, if necessary, it can be shorted altogether, but this is not good practice). See Fig. 1.

The KR-1 rectifier, however, has been the cause of a good many failures in this receiver. There are times when the set will perform right on D.C., but not on A.C., due to a bad rectifier. When this happens, the rectifier brightens up like a lamp when the set is plugged into an A.C. outlet.

One frequent cause of complaint in this model is squealing at the high-frequency end. This develops after a few months of operation and on sets that have been carried around a lot. The effect is caused by the short projecting wire from the control-grid of the 36 detector being too close to the R.F. coil. (See Fig. 2.) Due to the fact that when the set is carried around the aerial wire is tucked into this compartment of the set, the feed-back wire is often bent out of position when the aerial is pulled out again and again. A little trimming and adjustment always stop the oscillations.

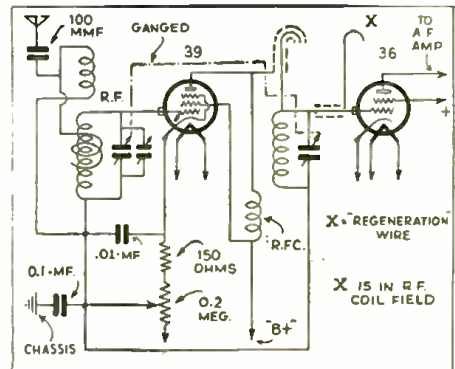

Fig. 2

Circuit oscillation in International "Kadette" sets may be traced to the feed-back wire.

### PHILCO 53 UNIVERSAL COMPACT

A VERY interesting case was a Philco 53 universal compact. The complaint was very low volume. A check-up showed all plate and screen-grid voltages low. The rectifier, a 12Z3 and all tubes were checked, and all seemed O.K. A short was presumed, and an investigation of all suspected parts was made with this in mind. This, however, did not disclose the fault. Finally, a new rectifier was substituted and the set played very well; and the voltages then read were "normal." The rectifier, though it checked "good" happened to be at fault.

Examination has shown that this particular tube when in the set does not get the right heater voltage. Actual measurement shows only 5 V., when this tube is rated at 12 V. Incidentally, we have run into a lot of these tubes with faulty heaters. The most common ones that develop this trouble are mostly the 38; a few 36's and 39's, and the 12Z3.

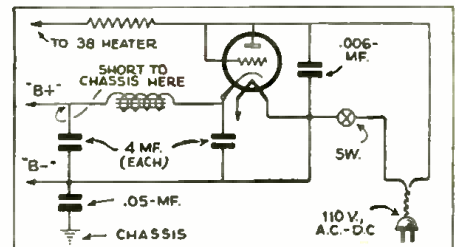

Fig. 4

Emerson 20A and 25A. Don't blame all crackling noises on tubes—check the other contacts.

### CLARION A.C.-D.C. 5 TUBE SET

A COMMON cause of complaint in this very sensitive set is low volume after a few months of operation. It has been found that in most cases this is due to the detector plate load resistor. The only remedy is replacement. One particularly baffling case came to our at-

(Continued on page 696)

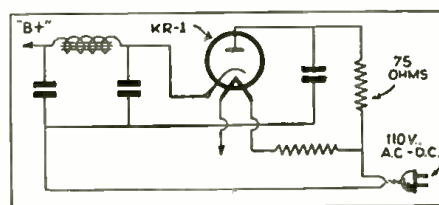

Fig. 1, above  
Fault-finding in International "Kadette."

Fig. 3, right  
Lack of sensitivity in Clarion set.

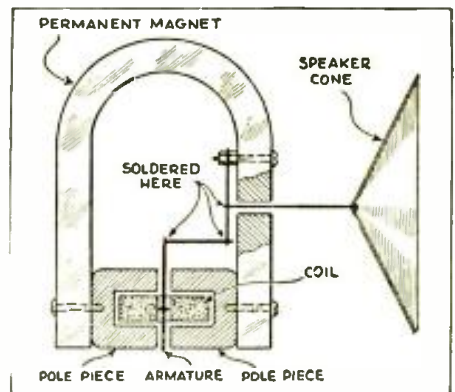
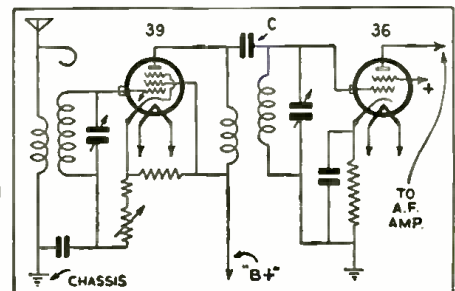

Fig. 5

De Champs sets. A recalcitrant reproducer may be cured easily—if you know how.



# RADIO-CRAFT TABLE OF BIAS RESISTOR VALUES

In this tabulation RADIO-CRAFT presents something entirely new and extremely valuable for the Service Man. All of the standard types of tubes are listed, and the bias resistor values for differing circuit conditions are enumerated. On the opposite page is a complete description of the procedure in applying this useful tabulation.

| —TUBE— |                |           |      | —VOLTAGE— |        |          |      | —OHMS— |           |      |       | Misc.     | —TUBE— |      |     |           | —VOLTAGE— |       |      |           | —OHMS— |         |           |     | Misc. | —TUBE— |       |      |     | —VOLTAGE— |     |       |      | —OHMS— |  |  |  | Misc. |  |  |
|--------|----------------|-----------|------|-----------|--------|----------|------|--------|-----------|------|-------|-----------|--------|------|-----|-----------|-----------|-------|------|-----------|--------|---------|-----------|-----|-------|--------|-------|------|-----|-----------|-----|-------|------|--------|--|--|--|-------|--|--|
| Type   | Use            | Plate S-G | C-G  | Plate     | Bias   | Notes    | Type | Use    | Plate S-G | C-G  | Plate | Bias      | Notes  | Type | Use | Plate S-G | C-G       | Plate | Bias | Notes     | Type   | Use     | Plate S-G | C-G | Plate | Bias   | Notes | Type | Use | Plate S-G | C-G | Plate | Bias | Notes  |  |  |  |       |  |  |
| 1A6    | C              | 135       | 67.5 | —         | 3.0    | —        | 27   | A      | 90        | —    | 6.0   | —         | 2,225  | E-11 | 50  | A         | 400       | —     | 70.0 | —         | 1,275  | N       |           |     |       |        |       |      |     |           |     |       |      |        |  |  |  |       |  |  |
| 1A6    | C              | 180       | 67.5 | —         | 3.0    | —        | 27   | A      | 135       | —    | 9.0   | —         | 2,100  | E-11 | 50  | A         | 450       | —     | 84.0 | —         | 1,530  | N       |           |     |       |        |       |      |     |           |     |       |      |        |  |  |  |       |  |  |
| 2A3    | APP            | 300       | —    | —         | 45.0   | —        | 27   | A      | 180       | —    | 13.4  | —         | 2,850  | E-11 | 53  | BDA       | 200       | —     | 4.0  | .25-meg.  | —      | —       |           |     |       |        |       |      |     |           |     |       |      |        |  |  |  |       |  |  |
| 2A3    | APP            | 300       | —    | —         | 62.0   | —        | 27   | A      | 180       | —    | 6.9   | 45,000    | 3,450  | E-11 | 53  | BDA       | 250       | —     | 3.0  | .2-meg.   | —      | —       |           |     |       |        |       |      |     |           |     |       |      |        |  |  |  |       |  |  |
| 2A4    | A              | 180       | —    | —         | 62.0   | —        | 27   | A      | 250       | —    | 7.3   | 70,000    | 3,325  | E-11 | 53  | 2A        | 250       | —     | 3.0  | .25-meg.  | —      | —       |           |     |       |        |       |      |     |           |     |       |      |        |  |  |  |       |  |  |
| 2A4    | A              | 180       | —    | —         | —      | —        | 27   | A      | 250       | —    | 21.0  | —         | 4,100  | H    | 53  | 2A        | 250       | —     | 3.0  | .25-meg.  | —      | —       |           |     |       |        |       |      |     |           |     |       |      |        |  |  |  |       |  |  |
| 2A4    | BD             | 250       | —    | —         | —      | —        | 30   | LD     | 45        | —    | —     | —         | —      | —    | 53  | A         | 250       | —     | 5.0  | —         | —      | 835     | 13        |     |       |        |       |      |     |           |     |       |      |        |  |  |  |       |  |  |
| 2A5    | AP             | 250       | —    | —         | —      | —        | 30   | BD     | 180       | —    | 11.0  | .25-meg.  | 44,000 | H    | 53  | A         | 300       | —     | 6.0  | —         | —      | 790     | 13        |     |       |        |       |      |     |           |     |       |      |        |  |  |  |       |  |  |
| 2A6    | TA             | 100       | —    | —         | 13.5   | —        | 30   | BD     | 180       | —    | 16.0  | .1-meg.   | 80,000 | 11   | 53  | B         | 250       | —     | 0.0  | —         | —      | —       |           |     |       |        |       |      |     |           |     |       |      |        |  |  |  |       |  |  |
| 2A6    | TA             | 100       | —    | —         | 1.05   | .25-meg. | 30   | A      | 90        | —    | 4.5   | —         | 1,800  | E    | 53  | B         | 300       | —     | 0.0  | —         | —      | —       |           |     |       |        |       |      |     |           |     |       |      |        |  |  |  |       |  |  |
| 2A6    | TA             | 145       | —    | —         | 1.05   | .25-meg. | 30   | A      | 135       | —    | 9.0   | —         | 3,000  | E    | 55  | TA        | 135       | —     | 10.5 | —         | —      | 2,840   | —         |     |       |        |       |      |     |           |     |       |      |        |  |  |  |       |  |  |
| 2A6    | TA             | 180       | —    | —         | 1.25   | .25-meg. | 30   | A      | 180       | —    | 13.5  | —         | 4,300  | E    | 55  | TA        | 180       | —     | 13.5 | —         | —      | 2,250   | —         |     |       |        |       |      |     |           |     |       |      |        |  |  |  |       |  |  |
| 2A6    | TA             | 250       | —    | —         | 1.3    | .25-meg. | 30   | A      | 180       | —    | 3.5   | 50,000    | 1,700  | E    | 55  | TA        | 180       | —     | 14.0 | .1-meg.   | —      | 23,000  | —         |     |       |        |       |      |     |           |     |       |      |        |  |  |  |       |  |  |
| 2A6    | TA             | 250       | —    | —         | 1.35   | .5-meg.  | 30   | A      | 135       | —    | 22.5  | —         | 2,800  | B    | 55  | TA        | 250       | —     | 11.0 | .25-meg.  | —      | 17,600  | —         |     |       |        |       |      |     |           |     |       |      |        |  |  |  |       |  |  |
| 2A7    | C              | 100       | 50   | —         | 1.5    | —        | 31   | A      | 180       | —    | 30.0  | —         | 2,450  | B    | 55  | TA        | 250       | —     | 20.0 | —         | —      | 2,500   | —         |     |       |        |       |      |     |           |     |       |      |        |  |  |  |       |  |  |
| 2A7    | C              | 150       | 75   | —         | 2.2    | —        | 32   | LD     | 100       | 35   | —     | .25-meg.  | —      | —    | 56  | LD        | 45        | —     | —    | —         | —      | —       |           |     |       |        |       |      |     |           |     |       |      |        |  |  |  |       |  |  |
| 2A7    | C              | 250       | 100  | —         | 3.0    | —        | 32   | LD     | 100       | 35   | —     | .25-meg.  | —      | 9    | 56  | BD        | 135       | —     | 10.0 | —         | —      | 50,000  | H         |     |       |        |       |      |     |           |     |       |      |        |  |  |  |       |  |  |
| 2B7    | PR             | 100       | 100  | —         | 3.0    | —        | 32   | BD     | 135       | 45   | 4.5   | .1-meg.   | 18,000 | —    | 56  | BD        | 180       | —     | 12.0 | .15-meg.  | —      | 60,000  | H         |     |       |        |       |      |     |           |     |       |      |        |  |  |  |       |  |  |
| 2B7    | PI             | 180       | 75   | —         | 3.0    | —        | 32   | BD     | 180       | 67.5 | 6.2   | .1-meg.   | 27,000 | 11   | 56  | BD        | 250       | —     | 16.0 | .25-meg.  | —      | 80,000  | H         |     |       |        |       |      |     |           |     |       |      |        |  |  |  |       |  |  |
| 2B7    | PI             | 250       | 100  | —         | 3.0    | —        | 32   | A      | 135       | 67.5 | —     | —         | 1,425  | E    | 56  | BD        | 250       | —     | 20.0 | —         | —      | 100,000 | H-11      |     |       |        |       |      |     |           |     |       |      |        |  |  |  |       |  |  |
| 2B7    | PI             | 250       | 125  | —         | 3.0    | —        | 32   | A      | 180       | 67.5 | —     | —         | 1,400  | E    | 56  | A         | 135       | —     | 6.5  | —         | —      | 1,860   | H         |     |       |        |       |      |     |           |     |       |      |        |  |  |  |       |  |  |
| 2B7    | PA             | 100       | 20   | —         | 2.0    | .25-meg. | 32   | A      | 180       | 30   | 1.0   | .1-meg.   | 1,150  | E    | 56  | A         | 250       | —     | 9.0  | .1-meg.   | —      | 8,150   | H         |     |       |        |       |      |     |           |     |       |      |        |  |  |  |       |  |  |
| 2B7    | PA             | 180       | 25   | —         | 2.1    | .25-meg. | 33   | A      | 135       | 135  | 13.5  | —         | 770    | H    | 56  | A         | 250       | —     | 13.5 | —         | —      | 2,700   | H         |     |       |        |       |      |     |           |     |       |      |        |  |  |  |       |  |  |
| 2B7    | PA             | 250       | 50   | —         | 4.5    | .25-meg. | 34   | A      | 135       | 67.5 | —     | —         | 800    | E    | 56  | O         | 90        | —     | 0.0  | —         | —      | —       | 12        |     |       |        |       |      |     |           |     |       |      |        |  |  |  |       |  |  |
| 2B7    | PA             | 250       | 50   | —         | 5.0    | .5-meg.  | 34   | A      | 190       | 67.5 | —     | —         | 775    | E    | 56  | BD        | 250       | 33    | 1.7  | .5-meg.   | —      | 8,000   | I         |     |       |        |       |      |     |           |     |       |      |        |  |  |  |       |  |  |
| 6A4    | A              | 100       | 100  | —         | 6.5    | —        | 34   | M      | 180       | 67.5 | —     | 7.0       | 4,100  | E    | 57  | BD        | 250       | 50    | 2.0  | .25-meg.  | —      | 3,000   | I         |     |       |        |       |      |     |           |     |       |      |        |  |  |  |       |  |  |
| 6A4    | A              | 135       | 135  | —         | 9.0    | —        | 34   | A      | 180       | 30   | 1.3   | .1-meg.   | 1,700  | E    | 57  | BD        | 250       | 100   | 3.9  | .25-meg.  | —      | 4,000   | I         |     |       |        |       |      |     |           |     |       |      |        |  |  |  |       |  |  |
| 6A4    | A              | 165       | 185  | —         | 11.0   | —        | 35   | A      | 140       | 90   | —     | 3.0       | 410    | I    | 57  | BD        | 250       | 100   | 6.0  | .25-meg.  | —      | 23,000  | I-9-11    |     |       |        |       |      |     |           |     |       |      |        |  |  |  |       |  |  |
| 6A4    | A              | 180       | 180  | —         | 12.0   | —        | 35   | A      | 250       | 90   | —     | 3.0       | 410    | I    | 57  | A         | 180       | 90    | —    | 3.0       | —      | 1,675   | H         |     |       |        |       |      |     |           |     |       |      |        |  |  |  |       |  |  |
| 6A7    | (Same as 2A7.) | —         | —    | —         | —      | —        | 35   | M      | 250       | 30   | —     | 7.0       | 1,800  | H    | 57  | A         | 250       | 100   | —    | 3.0       | —      | 1,200   | H         |     |       |        |       |      |     |           |     |       |      |        |  |  |  |       |  |  |
| 6B7    | (Same as 2B7.) | —         | —    | —         | —      | —        | 35   | A      | 180       | 25   | 3.0   | .1-meg.   | 3,750  | H    | 57  | A         | 250       | 60    | 1.8  | .125-meg. | —      | 1,500   | H         |     |       |        |       |      |     |           |     |       |      |        |  |  |  |       |  |  |
| 6C6    | A              | 250       | —    | —         | —      | 1,200    | 35   | A      | 250       | 30   | 3.0   | .15-meg.  | 3,000  | H    | 67  | A         | 250       | 60    | 2.0  | .2-meg.   | —      | 2,000   | H         |     |       |        |       |      |     |           |     |       |      |        |  |  |  |       |  |  |
| 6C6    | BD             | 250       | —    | —         | —      | 60,000   | 36   | A      | 100       | 55   | 1.5   | —         | 600    | H    | 58  | A         | 180       | 90    | 3.0  | —         | —      | 310     | I         |     |       |        |       |      |     |           |     |       |      |        |  |  |  |       |  |  |
| 6D6    | BD             | 250       | —    | —         | —      | 300      | 36   | A      | 180       | 90   | 3.0   | —         | 860    | H    | 58  | A         | 250       | 100   | 3.0  | —         | —      | 295     | I         |     |       |        |       |      |     |           |     |       |      |        |  |  |  |       |  |  |
| 6F7    | TA             | 100       | —    | —         | 3.0    | —        | 36   | A      | 250       | 90   | 3.0   | —         | 810    | H    | 58  | A         | 180       | 30    | 3.0  | .1-meg.   | —      | 3,300   | I         |     |       |        |       |      |     |           |     |       |      |        |  |  |  |       |  |  |
| 6F7    | PR             | 250       | 100  | —         | 3.0    | —        | 36   | A      | 180       | 40   | 1.5   | .1-meg.   | 850    | H    | 58  | A         | 250       | 35    | 3.0  | .15-meg.  | —      | 2,500   | H         |     |       |        |       |      |     |           |     |       |      |        |  |  |  |       |  |  |
| 6F7    | CTO            | 100       | —    | —         | —      | 290      | 36   | A      | 250       | 40   | 1.5   | .125-meg. | 775    | H    | 58  | M         | 250       | 100   | —    | 10        | —      | 2,700   | H         |     |       |        |       |      |     |           |     |       |      |        |  |  |  |       |  |  |
| 6F7    | CPM            | 250       | 100  | —         | 10.0   | —        | 36   | LD     | 135       | 30   | —     | .1-meg.   | —      | —    | 59  | AT        | 250       | —     | 28.0 | —         | —      | 1,075   | A         |     |       |        |       |      |     |           |     |       |      |        |  |  |  |       |  |  |
| 90A    | LD             | 45        | —    | —         | —      | —        | 36   | BD     | 100       | 35   | 3.6   | .15-meg.  | 18,000 | F-9  | 59  | AT        | 250       | —     | 28.0 | —         | —      | 1,075   | A-13      |     |       |        |       |      |     |           |     |       |      |        |  |  |  |       |  |  |
| 90A    | LD             | 90        | —    | —         | 1-meg. | —        | 36   | BD     | 180       | 50   | 5.0   | .15-meg.  | 31,000 | F-9  | 59  | AP        | 250       | 250   | —    | 18.0      | —      | 410     | A-13      |     |       |        |       |      |     |           |     |       |      |        |  |  |  |       |  |  |
| 01A    | LD             | 45        | —    | —         | —      | —        | 36   | BD     | 180       | 60   | 6.0   | .25-meg.  | 40,000 | F-9  | 59  | BT        | 300       | —     | —    | —         | —      | —       | —         |     |       |        |       |      |     |           |     |       |      |        |  |  |  |       |  |  |
| 01A    | LD             | 90        | —    | —         | 1-meg. | —        | 36   | BD     | 250       | 80   | 8.0   | .25-meg.  | 45,000 | F-9  | 59  | BT        | 400       | —     | —    | —         | —      |         |           |     |       |        |       |      |     |           |     |       |      |        |  |  |  |       |  |  |



REFERENCE DATA AND GENERAL CONSIDERATIONS ABOUT GRID BIAS RESISTORS

Tube bias resistor values ordinarily are a matter of "cut and try." Of course, if laboratory equipment is available, such as the microammeter and V.T. voltmeter, the procedure is simplified. At best, however, the process of selecting the correct value is a time-consuming one. Therefore, the data here given will be welcomed as a starting point for determining optimum values in tube circuits.

To anyone who has attempted to use present-compiled tube bias resistor data tables the woeful short-comings of these tables needs no comment. In order to supplement the inadequate information heretofore available, the RADIO-CRAFT Table of Bias Resistor Values has been compiled. It is recognized to begin with that no table of this order, short of an actual, complete manual, will meet all requirements. However, the necessity for a tabulation which would meet the majority of needs, and which would be many times as useful as any now available, is generally conceded. The table given will meet the average demands of Service Men and experimenters.

Current and plate-prong voltage values are not given since the operating figures in many cases (as for instance in resistance-coupled bias-detector circuits) would require the use of a microammeter and V.T. voltmeter, respectively—instruments not available to the average technician. Instead, the figures given in the tabulation may be used as references where necessary for checking circuit constants, and for interpolations.

Where the actual supply voltage is but 10% plus or minus, variations in resistor values will normally not be needed. Where the deviation is greater than this tolerance interpolation between values is usually necessary in direct ratio to voltage difference. In several cases but one set of voltages and resistor values for that type tube has been specified. This has been done where the normal resistor value (bias or otherwise) remains close to a constant value over widely varying supply voltage values.

Power ratings for R1, Fig. 1, may be obtained from the formula  $E^2 \div R$ , where E equals "C-G. Volts" and R, "Bias Ohms," in the table.

Item R2, Fig. 1, is the maximum allowable grid resistance value. It is the sum of all resistance in the grid circuit of a tube—and equals the values designated by capital letters under "Misc. Notes" in the table. The value of R2 should be as high as possible to secure maximum gain but must not exceed the maximum recommended for the tube type. (Greater stability is obtained for lesser values.)

In the listing "Miscellaneous Notes" (Numerals), references to tube elements (prongs) for resistor values are as follows: 1, anode grid; 2, osc. grid.

In the listing, "Cut-Off Voltages," are given the maximum C-G. negative bias values for minimum volume.

An explanation of the table headings is given below.

TABLE HEADINGS

"Tube Use"—functional classifications, such as class A amplifier (used in place of special classifications, such as screen-grid R.F. or A.F. amplifier, etc.). This listing better indicates the suitability of R.F. tetrodes and pentodes in A.F. impedance and transformer circuits.

A, class A amplifier; 2A, 2 stage amplifier; AT, class A triode; ATT, class A power tetrode; AP, class A pentode; APP, class A push-pull; BD, bias-detector; BDA, bias-detector and 1 stage amplifier; BPP, class B push-push; BT, class B triode; C, converter; CPM, converter pentode mixer; CO, converter triode oscillator; LD, leak-detector; M, mixer; O, oscillator; PA, pentode section as A.F. amplifier; PI, pentode section as I.F. amplifier; PR, pentode section as R.F. amplifier; TA, triode section as A.F. amplifier.

"Plate Volts"—voltage measured from A to "+1" in Fig. 1. The supply voltage is measured from "-" to "+1."

"C-G. Volts"—voltage measured from A to C in Fig. 1; more accurately measured from A to "-" where the value of R2 is high.

"Bias Ohms"—the value of R1 for self-bias; not given where commonly "fixed-bias" will be used. "Fixed-bias" may be obtained from "C" battery (see "C-G. Volts") or voltage divider. Self-bias with D.C. operated filaments is in general inapplicable. Bias resistor values for tubes with D.C. on the filaments are given for such use (as for instance in making a "1 tube" set) where possible.

"Misc. Notes"—operational data, and references to values for R2 and R4.

"MISC. NOTES" (NUMERALS)

- (1) Prong 1, 135 V. max.; 2, 50,000 ohms.
- (2) Prong 1, 100 V.; 2, 15,000 ohms.
- (3) Prong 1, 100 V.; 2, 35,000 ohms.
- (4) Prong 1, 200 V.; 2, 70,000 ohms.
- (5) Osc. grid leak, 0.1-meg.; ret. to cath.
- (6) Grid return to neg. fil.
- (7) Grid return to pos. fil.
- (8) Fixed-bias only.
- (9) Plate resistor shunted by 500 hy. choke coil.
- (10) Transformer coupling only.
- (11) Directly feeding output stage.
- (12) Grid leak, 30,000 ohms to 1. meg.; ret. to cath.
- (13) For class B driver service.
- (14) Grid bias secured from "C" battery.
- (15) Plate and S-G. connected at socket, for ATT use; unless overall voltage ("—" to "+," in Fig. 1) equals 135 V., an external "C" battery is required.
- (16) For two tubes.

"MISC. NOTES" (CAPITALS)  
(RESISTANCE VALUES FOR R2)

|                  |               |                   |           |
|------------------|---------------|-------------------|-----------|
| <i>Self-Bias</i> |               | <i>Fixed-Bias</i> |           |
| A                | 0.5-meg. .... | .....             | 10,000    |
| B                | 1. meg. ....  | .....             | 0.1-meg.  |
| C                | 1. meg. ....  | .....             | 0.5-meg.  |
| D                | 0.5-meg. .... | .....             | 50,000    |
| E                | 2 megs.       |                   |           |
| F                | 3 megs.       |                   |           |
| G                | 0.5-meg.      |                   |           |
|                  | 1. meg.       |                   |           |
| I                | 1.5 meg.      |                   |           |
| J                | 1,000         |                   |           |
|                  |               | <i>Self-Bias</i>  |           |
|                  |               | K                 | 1,500     |
|                  |               | L                 | 0.4-meg.  |
|                  |               | M                 | 0.25-meg. |
|                  |               | N                 | 10,000    |
|                  |               | O                 | 50,000    |

CUT-OFF VOLTAGES

| Tube Type | Plate Volts   | S.-G. Volts | Cut-Off |
|-----------|---------------|-------------|---------|
| 1A6       | 135           | 67.5        | -25     |
| 1A6       | 180           | 67.5        | -25     |
| 2A7       | 100           | 50          | -20     |
| 2A7       | 250           | 75          | -30     |
| 2A7       | 250           | 100         | -45     |
| 2B7       | 100           | 100         | -17     |
| 2B7       | 180           | 75          | -13     |
| 2B7       | 250           | 100         | -17     |
| 2B7       | 250           | 125         | -21     |
| 6A7       | (same as 2A7) |             |         |
| 6B7       | (same as 2B7) |             |         |
| 6F7       | 250           | 100         | -35     |
| 34        | 135           | 67.5        | -22.5   |
| 34        | 180           | 67.5        | -22.5   |
| 35        | 180           | 90          | -50     |
| 35        | 250           | 90          | -50     |
| 39/44     | 90            | 90          | -45     |
| 39/44     | 180           | 90          | -45     |
| 39/44     | 250           | 90          | -45     |
| 58        | 180           | 90          | -50     |
| 58        | 250           | 100         | -50     |
| 78        | 100           | 90          | -52     |
| 78        | 180           | 75          | -52     |
| 78        | 250           | 100         | -52     |
| 78        | 250           | 125         | -52     |

Miscellaneous Information

The use of plate resistance-capacity filters will, due to the IR drop, result in lower plate voltage than the table here given contemplates. It is therefore noted that the column "Plate Ohms" specifies for the accompanying voltage the sum of the plate coupling and filter resistors. Where higher gain is desired and the use of resistor-capacity filters is essential, the plate supply voltage should be accordingly increased slightly.

As a general rule, where the overall plate circuit resistance is increased by a given percentage, the plate supply voltage figure should be increased by one-half the percentage of the increase in the plate circuit resistance value.

In audio frequency amplifiers with tetrodes and high-gain pentodes the plate resistors are much smaller than the value essential to secure a large measure of the inherent gain in these tubes. Higher plate resistor values are possible, with increased voltage gain but, in general, such gain is accompanied by instability, and the distortion that is coupled with unstable operation. It is of course essential to both increase the plate voltage and, perhaps, the screen and control-grid voltages to secure this maximum gain. For guidance in this, the experimenter should check against the plate current and control-grid voltage curves as given in any standard tube manual.

Maximum resistance values for R2 are given for the following reasons. In R.F. amplifiers, to increase these values would tend to result in circuit oscillation. In A.F. amplifiers, strong signal swings may result in a loss of bias on the control-grid of the tube. In the case of power tubes, such bias loss may easily damage the tube, or the associated output transformers and power supply devices. Therefore, where control-grid circuit resistance-capacity filters are essential the filter resistor value must be included in the sum, R-2.

In several cases it will be noted in the table that, for a given plate supply voltage, the control-grid voltage varies. This is necessary because differing values of plate circuit resistance, due to the IR drop, make the actual plate voltage different than the plate supply voltage here given. (Tube data sheets ordinarily are compiled only for the voltage actually available at the tube prongs.)

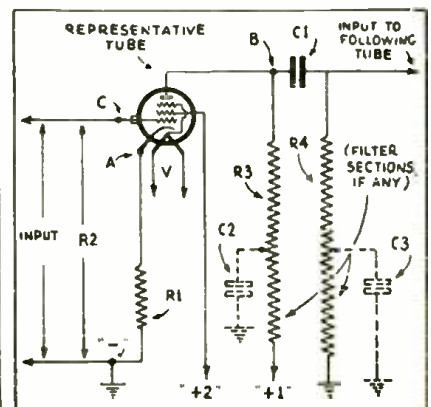
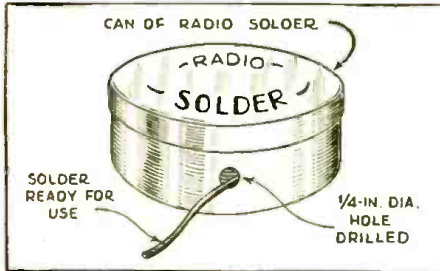
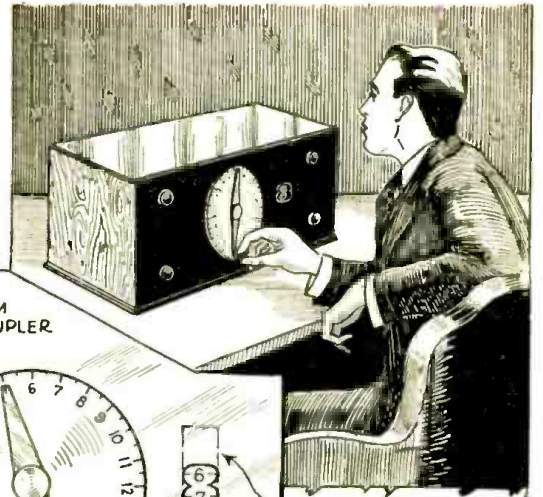
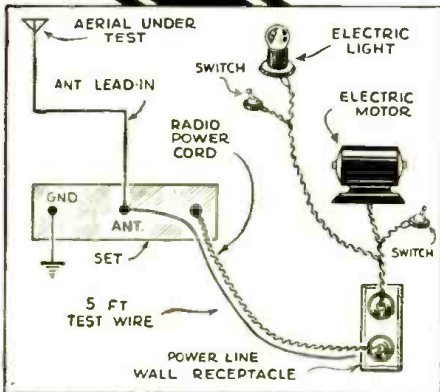

Fig. 1

# SHORT-CUTS IN RADIO



A TIME saver and a great convenience is illustrated at the left. A hole is drilled in the side of the can in which solder is packed. By threading the solder through this hole, as shown, it is more handy.—R. ROSEN



ANTENNA efficiency is conveniently determined in the manner shown at the left. A 5 ft. length of wire parallels the A.C. or D.C. power lines; one end connects to the antenna post of the radio set. Motors, switches, etc., establish a "noise reference level." Upon connecting the regular antenna to the set the relative strength of programs and this "static" will be in proportion to the efficiency of the regular antenna system.—WILHO G. MULLYKANGAS.

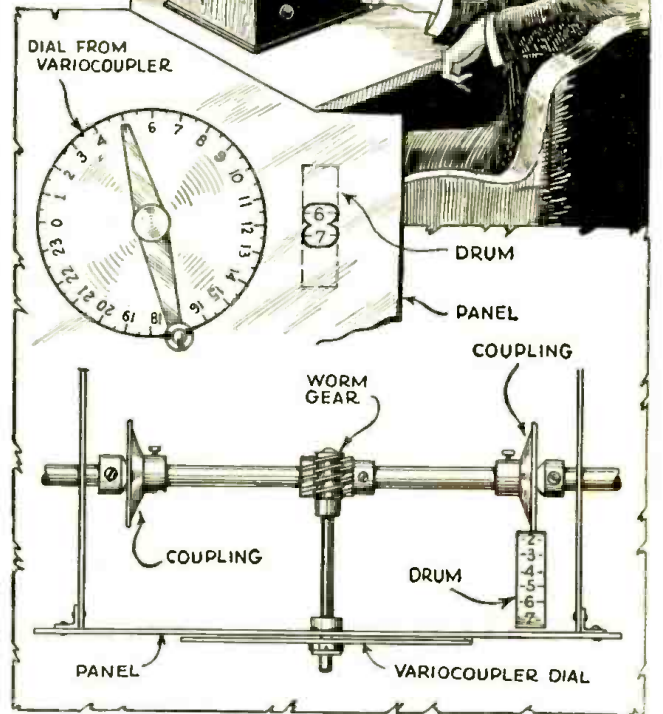

AN INEXPENSIVE and attractive vernier dial is made from the gears of a mechanical construction toy, and the dial and crank from, for instance, an old variocoupler. Graduate the dial for 360 degrees; graduate the drum so that successive numbers indicate one turn of the crank. Ratios of 18:1, 36:1 and 50:1, with only 1/2-degree backlash, are usual in these toy gears.—LEO ROSEN.

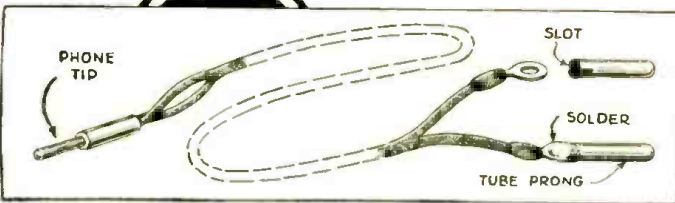

GOOD socket contact for resistance and continuity tests is shown above. A large and a small prong from a tube are soldered to a twin-conductor cord, ending in a single phone tip.—FRANK A. OREMUS.

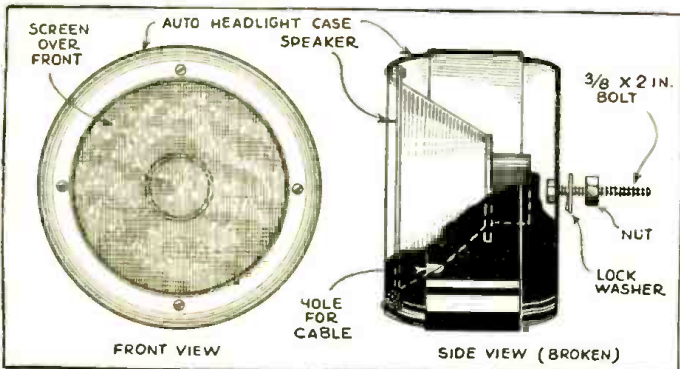

A "CHEVY" drum-type headlamp artistically houses a 6 in. dynamic reproducer for car radio use. Remove the reflector and lamp socket, and file or drill off the rivets that hold the side brackets. Use a shielded 4 wire cable; ground the case to the shield.—R. L. JOHNSON.

CONTINUOUS dots from the speed key are obtained by connecting it as a buzzer, as shown above. Mechanically hold the knob in the dot position. Useful for testing remote apparatus, "breaking" a "tough" amateur operator, small flashing attractions, etc.—VINCENTE ESPINOSA.

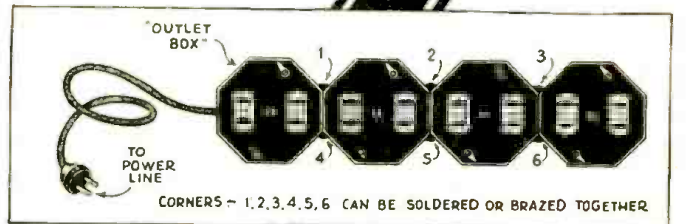
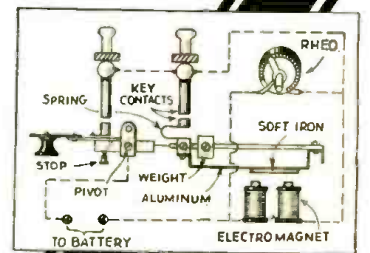

MULTIPLE receptacles may be obtained by fastening together a number of "double"-type "outlet" boxes, as shown above. Knock out holes in the boxes and run the wires through them for parallel connection of the outlets. Suitably fuse the line.—HOWARD BLACKBURN.

## 17 CAPACITIES FROM 3 CONDENSERS

J. N. Kessler

IN FIG. 1 is shown a switching device for connecting 3 condensers in series, parallel, or series-parallel combinations to secure 17 capacities for use in determining the best values to be used in filter circuits, etc., in radio receivers.

Units Sw. 1 and Sw. 2 are 3 point, single gang sectional rotary tap switches; units Sw.3 to Sw.8 are S.P.S.T. toggle switches. Connect tip jacks J1 and J2 to test prods. Care must be taken to close the switches in the correct combination as shown in Table 1 in order to prevent a direct short; (X indicates a closed switch).

TABLE I

| Sw. No. | Capacity in Mf. |   |   |                 |   |   |                 |
|---------|-----------------|---|---|-----------------|---|---|-----------------|
|         | 7               | 6 | 5 | 4 $\frac{1}{2}$ | 4 | 3 | 2 $\frac{1}{3}$ |
| 1       | 4               | 4 | 4 | 4               | 4 | 2 | 2               |
| 2       | 1               | 4 | 1 | 4               | 4 | 1 | 1               |
| 3       | X               | X | X | X               | — | — | X               |
| 4       | X               | — | — | —               | — | X | —               |
| 5       | X               | — | X | —               | — | — | —               |
| 6       | X               | — | — | X               | — | X | X               |
| 7       | —               | X | — | X               | — | — | X               |
| 8       | —               | X | — | —               | — | — | —               |

| Sw. No. | Capacity in Mf. |      |      |   |     |     |     |
|---------|-----------------|------|------|---|-----|-----|-----|
|         | 15/7            | 13/7 | 11/3 | 1 | 6/7 | 4/5 | 2/3 |
| 1       | 4               | 4    | 4    | 1 | 2   | 2   | 2   |
| 2       | 1               | 2    | 2    | 1 | 1   | 1   | 1   |
| 3       | —               | X    | —    | — | X   | X   | —   |
| 4       | X               | —    | —    | — | —   | —   | —   |
| 5       | —               | X    | —    | — | —   | —   | —   |
| 6       | X               | —    | —    | — | —   | —   | —   |
| 7       | X               | X    | X    | — | X   | X   | X   |
| 8       | —               | —    | —    | — | X   | —   | X   |

## PLASTIC WOOD IN RADIO

P. M. Ohlinger

IN FIG. A is shown one useful application of "plastic wood"—that putty-like material (obtainable in most hardware stores) which, when it hardens, can be molded by hand and, when dry, may be sanded and stained or varnished.

In the illustration are shown radio receiver control knobs that had pieces broken off and which the writer made "as good as new" by using plastic wood. Radio cabinets that have been damaged or scratched, in shipment or handling, usually can be made presentable by molding plastic wood to conform with the cabinet design; a "touch-up" kit will come in handy when re-finishing the repair. The experimenter can use plastic wood to fill unused holes in panels. En-

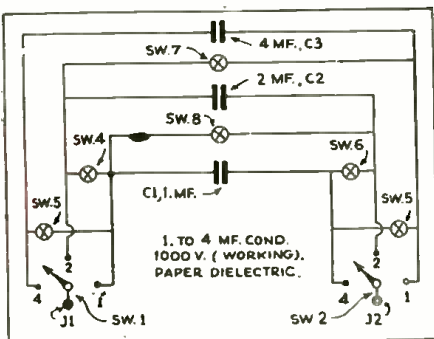

tire knobs can be molded to meet individual requirements and ideas.

When set, plastic wood can be cut, sawed, planed, drilled, whittled, tapped, and finished. It will hold nails, tacks or screws, thus making it useful in fixing knobs that have been worn by shafts so that they will again "stay put" on the shafts. The foundation of wood, metal, or other material must be clean and dry. Press and shape plastic wood with the finger (or a suitable tool) to the desired conformation and permit to dry. Thick sections are best built up of thin layers, permitting each layer to dry. Warmth hastens drying, but do not put too near a naked flame. Sandpapering, polishing, etc., should only be done when the wood has hardened. If plastic wood dries in the can, add a few drops of "plastic wood solvent" to soften it; also, use the solvent to remove the "wood" from your hands.

## A BEAD-INSULATED 3 CIRCUIT TUNER

F. W. Rinkowsky

CREDIT my 8 year old boy for the novel idea illustrated in Fig. B. This view shows a tuning unit having the usual primary, secondary and tickler coils, but wound with wire on which has been strung hundreds of colored glass beads of uniform size. These beads serve both to insulate and space adjacent turns; the resulting coil is quite efficient. A person with artistic leanings could make these coils exceedingly decorative.

The idea of bead insulation is an old one to short-wave fans but in the unit illustrated is given a new application. Bead-covered wire may be used for that inside aerial; any part in the length of the bare copper wire may be soldered to, by breaking off a few of the beads; short-wave plug-in coils wound with "beaded" wire appear to be equally as efficient and more decorative than commercial types; try wiring your next set with "beaded" wire.

## A CONDENSER TESTER

Otto L. Groff

IN FIG. 2 is illustrated a condenser tester that does a real job of weeding out the good from the bad small fixed condensers encountered in radio service work.

In operation, the meter needle will show deflections as follows: open con-

(Continued on page 689)



Fig. 1, left  
A 3 condenser, 17 capacity test unit.

Fig. A, above  
Plastic wood repairs and makes knobs.

Fig. B, right  
Bead-covered wire on a 3 circuit tuner.

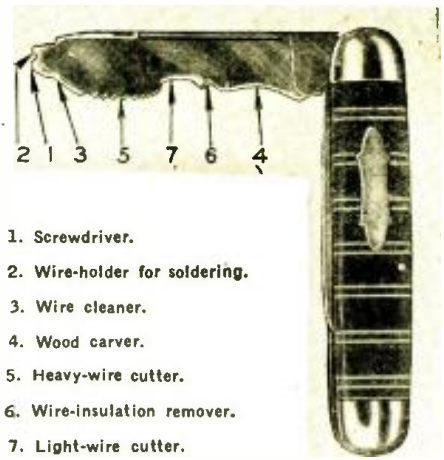

Fig. C  
The knife a versatile radio tool.

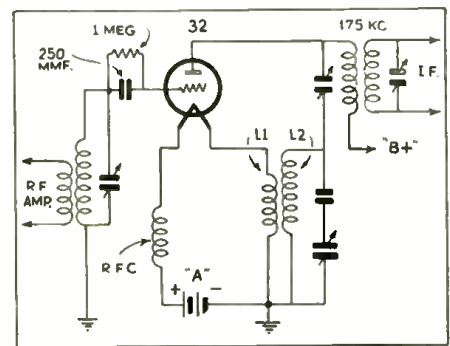

Fig. 4  
How to use the 32 as "det. 1 & osc."

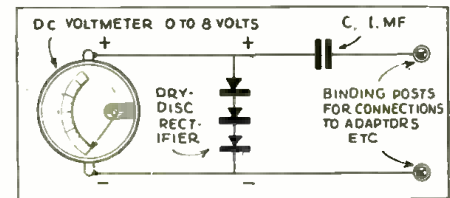

Fig. 3  
Trickle charger rectifier in output meter.

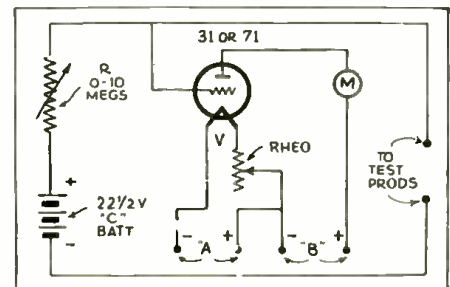
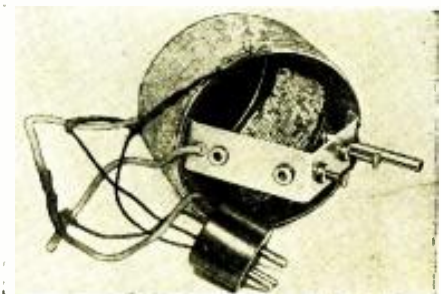

Fig. 2  
Small fixed condensers may be tested.



# RADIO-CRAFT'S INFORMATION BUREAU

**SPECIAL NOTICE TO CORRESPONDENTS:** Ask as many questions as you like, but please observe these rules:

Furnish sufficient information, and draw a careful diagram when needed, to explain your meaning; use only one side of the paper. List each question. Be SURE to sign your name AND address.

Those questions which are found to represent the greatest general interest will be published here, to the extent that space permits. At least five weeks must elapse between the receipt of a question

and the appearance of its answer here.

Replies, magazines, etc., cannot be sent C. O. D.

Inquiries can be answered by mail only when accompanied by 25 cents (stamps) for each separate question; answers are subject to subsequent publication, if considered of exceptional interest.

Other inquiries must be marked "For Publication."

## CURRENT IN A WIRE—GENERATOR "NO LOAD"

(256) Mr. C. E. Howard, Bradshaw, Neb. (Q.1) In Radio Library book No. 9, "Automobile Radio and Servicing," there is a statement concerning which I would like a little enlightenment. Referring to the illustration on pg. 25, what causes the polarity to change when the direction of rotation of the armature is reversed?

(A.1) This figure is reproduced as Fig. Q.256A. Three conditions are necessary in order that a wire generate a voltage: (1) the wire must be in motion; (2) the wire must be in a magnetic field; (3) the wire must move at right angles or across the field. It is the latter factor that is of special interest to you. When the wire is moving up, Fig. Q.256A, detail A, the voltage generated in it is in one direction; when the wire moves down, an equal voltage is generated in it, but in the opposite direction. If the wire rotates in (cuts across) the magnetic field, as shown in detail B, one end must go "up" (refer to the view) once and then down (the entire action taking place in the field shown by dashes); consequently, the polarity generated changes, as the wire rotates in the field. This will be made a little more clear by reference to Fig. Q.256B.

When the wire *a*, *b*, in detail A, Fig.

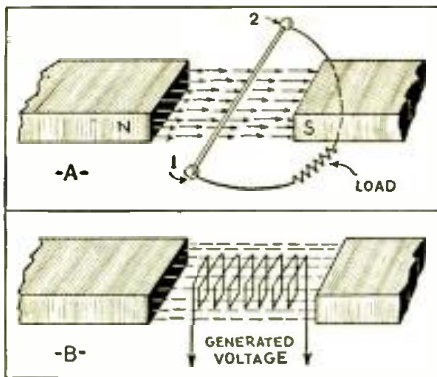

Fig. Q.256A

Generating voltage in a wire, A; or wires, B.

Q.256B, cuts across the magnetic-flux field of a permanent magnet as indicated by the solid-line arrow at (a) the direction of the inducing flux will be downwards, as shown by the arrowheads on the dotted vertical lines. An electromotive force is set up in the conductor in such direction that the current established will always produce a conductor flux which will agree in direction with the inducing flux on the side of the conductor that first comes in contact with the inducing flux and is opposite in direction on the other side of the conductor. (This is true regardless of whether the conductor or the flux is the moving element.) The direction of the conductor flux is indicated by the arrowheads on the bent lines. The direction of the electromotive force, as well as that of the current in this case, is from *a* to *b* in the conductor, as indicated by the arrowheads on the circuit wires that attach to either end of *a*, *b*. The flux is more dense ahead of the conductor than behind it because of the relation between the direction of the inducing flux and that of the conductor flux.

The direction of the induced electromotive force in any case where the relative direction of the movement of the flux and of the conductor is known may be determined by considering which side of the conductors has the denser flux. The direction of the circular conductor flux on that side agrees with the direction of the inducing flux, and the direction of the induced electromotive force is determined from the relation of the conductor current and its flux.

At (b) in detail A, in the same figure, we find the conductor, *a*, *b*, to be moving toward the left, in which case the induced electromotive force is from *b* to *a*.

Referring now to detail B, at (c) the conductor is represented as moving to the right in a field in which the direction of the flux is vertically upwards. The direction of the induced electromotive force is from *b* to *a*. In (d) the conductor is moved toward the left in the same field, and the direction of the induced electromotive force is from *a* to *b*.

Note that when either the direction of the motion of the conductor or the direction of the flux is reversed, the direction of the electromotive force is reversed, as indicated in details A and B; but, when both the direction of the flux and the direction of motion of the conductor are reversed, the direction of the induced electromotive force remains unchanged as in A (a) and B (b); or in A (b) and B (c). (The straight dotted arrows re-

late to the direction of the movement of the conductor when considered as a moving conductor.)

(Q.2) On the following page of the previously-mentioned book the statement is made that the type of generator being described should not be operated unless it is connected to a battery as damage would result to the generator. I cannot see why this should be true, since there would not be any field current or no current generated by the machine.

(A.2) In generators designed to charge car batteries, provision is made to reduce the voltage generated in the machine by means of "armature reaction," which is adjusted by the third brush on the machine. If the load were removed, there would be very little "armature reaction," and the voltage generated might be sufficiently high to puncture the insulation.

## A.V.C. IN A.C.-D.C. SETS

(257) Mr. Arthur Fischer, Bayonne, N. J.

(Q.1) In the Latest in Radio department of the March, 1934 issue of RADIO-CRAFT the statement is made that a resistor is used, in a superheterodyne, item No. 412, to prevent overloading. Please explain this action in greater detail.

(A.1) The schematic circuit of this receiver, the Tom Thumb A.C.-D.C. ultra-midget set, is shown in Fig. Q.257. The resistor in question is R5, in the grid-return circuit of second-detector V3. In case the detector control-grid is forced positive, the control-grid bias of I.F. amplifier V2 is increased. While this is not as effective as full A.V.C., it does prevent blocking which is an annoying characteristic in many sets due to the strength of a local-station carrier.

The following additional, interesting information is available. This set has a sensitivity (Continued on page 675)

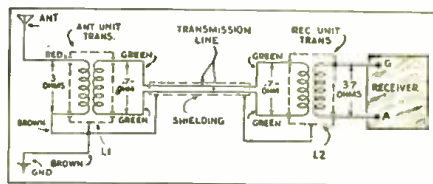

Fig. Q.258

The A.K. "interference eliminator" equipment.

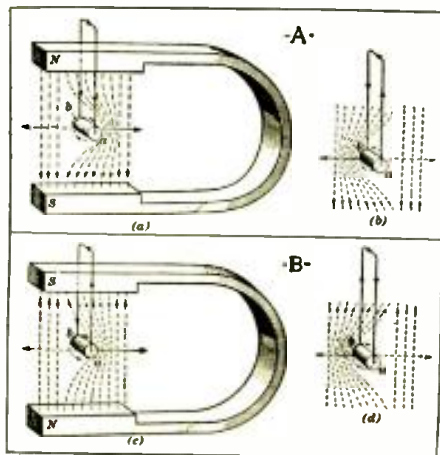

Fig. Q.256B, left

Showing why the direction of current reverses with the direction of motion. (Courtesy I.C.A.)

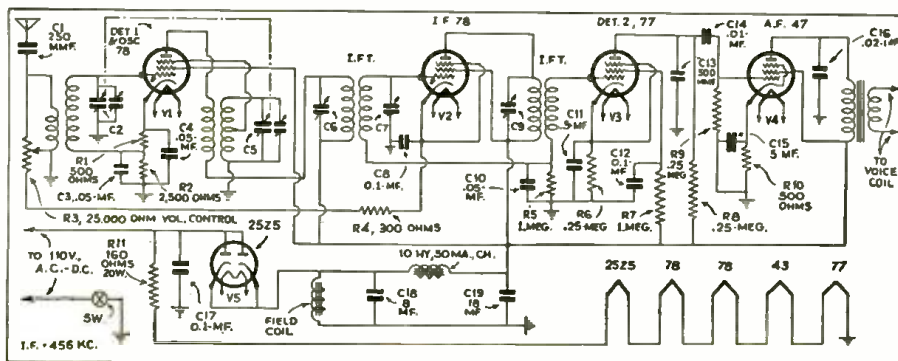

Fig. Q.257, above

Schematic circuit of the Tom Thumb A.C.-D.C. ultra-midget 5 tube superheterodyne.

sitivity of 10 microvolts at 1,400 kc.; and 20. at 600 kc. The wavelength range is 550 to 1,760 meters. The field coil, which acts as a bleeder resistor, shunts the output of the 25Z5; its resistance is 3,000 ohms.

### A.K. "INTERFERENCE ELIMINATOR"

(258) Mr. J. A. F. Pryor, Hyattsville, Md.  
(Q.) How is the Atwater Kent "interference eliminator" connected?

(A.) The schematic circuit of this instrument is shown in Fig. Q.258. (Winding data on this particular unit is not furnished by the manufacturer as this is a commercial device.) Units of similar type have been described in past issues of RADIO-CRAFT; they are more generally referred to as "R.F. transmission lines."

### "MAKING A 9 TUBE HOME-BUILT A.C., T.R.F. SET" (A Correction)

(259) Carroll E. Mapes, Chicago, Ill.

(Q.) Are there any errors in the List of Parts in the article, "Making a 9 Tube Home-Built A.C. T.R.F. Set," as published in the February, 1934 issue of RADIO-CRAFT? It does not seem correct that condensers C20 and C21 should be 100 V. units, when they connect across the 300 V. output of the rectifier.

(A.) Following are corrections to this List of Parts, as furnished by the author after making a further check of the components listed: C20, C21, two 8 mf., 500 V. electrolytic condensers in one can (positive and negative leads insulated from can); C22, 0.1-mf., 200 V. paper condenser; C23, 10 mf., 100 V. electrolytic condenser. Resistor R4, .15-meg., 1/4-W.; R5, 5,000 ohms, wire wound; R7, R9, R10, 25,000 ohms, 1/4-W. carbon; R18, 1,500 ohms, 1/2-W. carbon; R19, 0.4-meg., 1/4-W. carbon; R21, 15,000 ohms, 1/2-W. carbon; R22, 85,000 ohms, 1/2-W. carbon.

### AUTO SET FROM OLD A.K. 35

(260) Mr. Ellis G. Jeffery, LeRoy, Ohio.

(Q.) I wish to build an auto radio set using the chassis of an old battery receiver. Can it be done; and how?

I believe that it would be a good idea for you to show how to do this in some issue of your magazine. The set in question is an Atwater Kent model 35 which does not take up very much space; in addition, it could be conveniently cut into two sections and mounted one above the other where additional compactness was required.

(A.) It is always advisable to use equipment only in the specific service for which it was designed. An outstanding example of this is the use of the Atwater Kent model 35 battery receiver (the circuit of which appeared in RADIO-CRAFT Data Sheet No. 17, May, 1930) as a car radio set.

The sensitivity of this receiver, one of the most efficient of its "day," is only about 300 microvolts-per-meter at an output of .05-W. Compare this with, for instance, the Atwater Kent models 636 and 756 receiver chassis, the diagram of which appeared on page 728 of the June, 1933 issue of RADIO-CRAFT; this chassis has a sensitivity of approximately 1 microvolt-per-meter at an output of 3W!

For use in a car, build a real car set, such as the one described in the article, "How to Make a Modern Car Radio Set." This two-part article started in the December, 1933 issue of RADIO-CRAFT, on page 340.

### BROAD TUNING IN A.C.-D.C. COMPACTS

A WORTHWHILE discovery was made by us regarding the broad tuning of certain A.C.-D.C. compact radio sets of independent manufacture. After all the routine tests for such an ailment were applied to the set we discovered the antenna and R.F. coils were transposed, having been assembled this way at the factory. When placed in their correct positions the station selection was found to be quite normal. On the majority of these 4 tube sets the primary of the R.F. coil is wound on the outside of the form, and the antenna winding is a small choke coil placed on the inside.

LAWRENCE L. MORFORD

# PAUL WHITEMAN solves a mystery and gives a clue to finer radio music

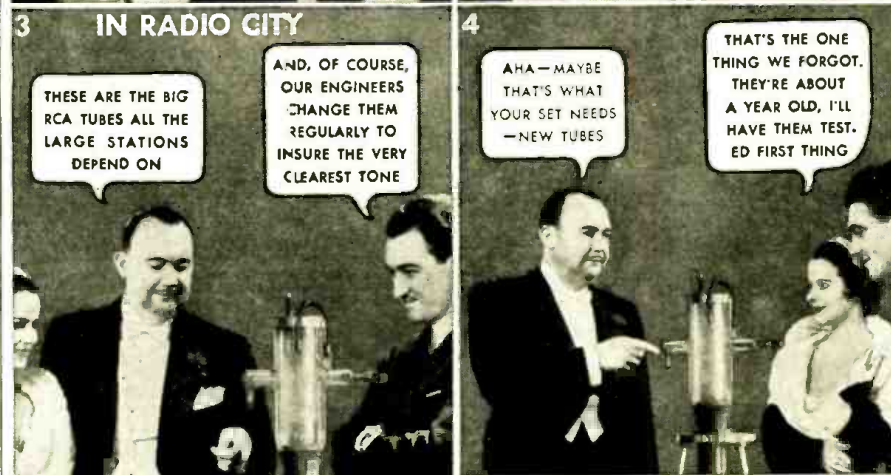

## NEW LIFE FOR OLD RADIOS!

Quicker start! More power! Better tone! It really means *new life* for your set when you replace old, worn radio tubes with these new Micro-Sensitive tubes by RCA. These are the only tubes guaranteed by RCA Radiotron Company to give you 5 important improvements. Have your dealer test your tubes today. Insist on RCA Radio Tubes—and bring back the thrill of radio.



- NEW MICRO-SENSITIVE RCA RADIO TUBES GIVE YOU:**
- 1 Quicker Start
  - 2 Quieter Operation
  - 3 Uniform Volume
  - 4 Uniform Performance
  - 5 Every Tube is Matched



# SPRAYBERRY'S

## Practical Advanced Training Course for Practical Servicemen

At last—a sound, how-to-do-it course by a man who, for years, has been in unusually close touch with servicemen and service work. No bunk—a bare minimum of theory—no mathematics—no fancy and costly bindings. Just a real, carefully written course which will prove invaluable to every serviceman who will study it. Best of all, the introductory price is so low you'll pay for it by your increased earnings on the first few jobs. For instance, E. J. Bureau of (Halhouse, N.B., Canada, writes: "I am well satisfied with your course. In fact, I can now service a radio in about half the time I could six months ago.")

## Where Will YOU Be Tomorrow?

Times change. Radio is a fast moving business. Servicemen must move with it. Otherwise tomorrow will find them sitting by watching the best jobs go to competitors. Constant study and improvement are essential. Thus, in "PRACTICAL MECHANICS OF RADIO SERVICE" F. L. Sprayberry gives you the latest, handiest dope in the most compact, readable style. It costs less and, being more practical, is easier to understand.

**ONLY \$10** For a total of \$10.00 you get 28 lessons on Modern Radio Service. Terms as low as \$2.00 down and \$2.00 a month. Your money absolutely refunded if you are not satisfied.

You Get the Latest Information on

### 1. SET TESTING

by means of the Analyzer Method; Voltage Method; Point-to-Point Method; Stage-by-Stage Method; Oscillator Method and Hand and Observation Method.

### 2. REPAIRING

Superheterodyne Circuits; Automatic Volume Controls; Public Address; Auto Radio, Battery Operated and 32-Volt and 110-Volt D.C. Sets.

### 3. PARTS TESTING

Including Practical Methods for Testing Condensers, Resistors, Transformers, Tubes, Loud Speakers and Antenna and Input Circuits.

### 4. TROUBLE SHOOTING

How to locate and eliminate Receiver Hum, Internal Receiver Interference, Intermittent Reception, Poor Quality Reception and Poor Sensitivity and Selectivity.

### ALSO . . .

A SPECIAL SECTION ON TUBES, including all the latest types, and 6. A SPECIAL SECTION ON SET ANALYZERS including information on modernizing and repairing all types.

**MAIL TODAY!**

**F. L. SPRAYBERRY** 132 Bryant St., N.W., Washington, D.C.

Please rush complete details of your new 28-lesson course "PRACTICAL MECHANICS OF RADIO SERVICE." These, of course, are free.

Name .....

Address .....

City..... State..... C-5/4

## NEW! SENSATIONAL!

## 110 VOLTS AC FOR AUTOS

The new AUTONATOR Generates 110 Volt A.C. Current in motor cars, aeroplanes and from all types of engines and motors—direct from fan belt. Costs nothing to operate. No service—no brushes, collector rings, commutator or wire wound armature. Ideal for operating PORTABLE Sound Equipment, A.C. Radio Sets, Neon Signs, Electric Lights, Searchlights. Send for complete details.

AUTONATOR LABORATORIES, INC.  
8440 South Chicago Ave. Dept. A Chicago, Ill.

## YOUR OPPORTUNITY—

### THEATRE SOUND EQUIPMENT

Buy From the World's Largest Suppliers Exceptional Bargains in New, Used and Rebuilt Motion Picture Apparatus Recent Government Surplus and Liquidation of other manufacturers such as PACENT, ROYAL AMPLIFONE, POWERS CINEPHONE, TONE-O-GRAPH, BIOPHONE, RCA PHOTOPHONE and others now offered to our trade.

Write for Our New Illustrated Catalogue

### S. O. S. CORPORATION

Dept. RAC 1600 Broadway, New York, U.S.A.  
EXPORT: 120 Liberty St., New York  
CABLE ADDRESS: "SOSOUND" New York. All Codes.

# THIRD DIMENSION IN MUSIC

(Continued from page 655)

A violin soloist was given a gigantic violin. The effects, and additional ones involving the use of frequency cut-off filters, were at all times under the full control of a monitor operator centrally located in the balcony.

For example, the previously-mentioned experiment of a bullet shot, its passage through the air and its striking a target, was achieved by having an assistant slap two boards together in front of the left microphone (on the 5th floor of the building) for the "shot"; a second assistant rapidly ran across-stage from left to right, blowing a whistle, to indicate the sound of the bullet in slow motion through the air; a third assistant hit a gong to indicate that the target had been struck. However, the monitor operator very cleverly simulated this effect with the performers in front of only one microphone by the simple process of "fading" the microphone output into the individual audio channels, feeding each speaker assembly as required; thus, with a twist of his wrist he reproduced the effect of the bullet whistling across-stage, yet without any of the assistants moving!

A very satisfactory degree of auditory perspective may be obtained with only two independent channels ("binaural" operation), but the presence of the third channel considerably enhances the effect, and is of very great advantage when a soloist accompanies the orchestra. With reproductions in auditory perspective, the center channel (connected to a special microphone in front of the singer) allows her voice to be amplified independently of the orchestra, and thus always to be kept at a slightly higher level.

The factors involved in attempting to simulate at a remote point the esthetic effects of original sounds should be learned by everyone interested in good sound reproduction. For this reason the following explanation is given of some of the factors involved in the design of the new sound system.

### Frequency and Power Requirements

For high-grade reproduction of sounds the range of frequencies that the system must transmit is determined by the range of hearing rather than by the kind of sound that is being reproduced.

Persons having normal hearing can hear pure tones ranging in frequency from 20 to 20,000 cycles. However, note that in order to sense the sounds at either end of this range the sounds at these extremities of the frequency range must have very high intensity. In music these frequencies usually are at such low intensities that the elimination of frequencies below 40 cycles and those above 15,000 cycles produces no detectable difference in the reproduction of symphonic music. However, the elimination of frequencies above 13,000 cycles produced a detectable change in the reproduced sound of the snare drum, cymbals, and castanets; and the elimination of frequencies below 40 cycles, of the bass viol, the bass tuba, and particularly of the organ.

Besides these requirements of frequency response the system must also be capable of handling sound powers that vary through a very wide range. For the type of symphonic music now produced by the large orchestras, for example, this range would be about 10 million-to-1, or 70 db. However, since the orchestra is limited in its power range it becomes desirable to design a system that will permit this power to be augmented by amplification in order to obtain enhanced sound effects. An ideal transmission system should, therefore, be capable of reproducing a sound as faintly as the ear can hear and as loudly as the ear can tolerate.

### Directional Characteristics

An audience, when listening directly to an orchestral production, senses the spatial relations of the instruments of the orchestra as a result of their ability to localize the direction, and to form some judgment of the distance from a sound source. This spatial character of the sounds gives to the music a sense of depth and of extensiveness which, for perfect reproduction, should be preserved.

The music which we hear comes to us in part directly, and in part by reflection from the walls; both contribute to the esthetic value of the music. However, inasmuch as many of the tones of a musical selection are of short duration, the direct sound is of great importance—it is this sound alone which enables us to localize the source. In general, instruments of lower register are less directive than those of higher register.

For efficiently radiating frequencies as low as 40 cycles a horn of large dimensions is required; the "folded" type of horn is preferable, but it transmits high-frequency tones very inefficiently. Therefore, the reproducer "assembly" was constructed of two units, one of the folded type, for the lower and the other, of trumpet type, for the high frequencies, as shown in Figs. A and B, with an electrical network to divide the current into two frequency bands, the point of division being about 300 cycles.

Each of the high-frequency horns shown in Figs. A and B has 16 separate divisions, each with an exponential taper. This design "sprays" the audience with the higher frequency sounds which, being highly directive, give the sense of direction.

The output frequency characteristics of the combined low- and high-frequency reproducers is shown in Fig. 2.

### Frequency Ranges

That the wide frequency range of this system is essential to natural reproduction is evident by reference to Fig. 3, which shows the audible frequency ranges for a number of different sounds; this graph differs from others in that it shows the "accompanying noise range" of sounds that tend to produce the illusion of naturalness. These sounds include lip noises, key clicks on musical instruments, "buzz" of reeds, and hissing of air. The short, heavy portions of the line indicate the frequency ranges thought to convey the "tone quality" of the instruments; and the short, vertical lines define the ranges of noise. In some cases noise and tone seem inseparably blended. This is a factor that previous designers of sound amplifiers and reproducers do not seem to have taken into account. Of course, in the case of radio program reception the point is not brought up, since the frequency range of the transmitter, operating on 200 to 550 meters, is only 5 kc. (new, experimental transmitters have recently been licensed to transmit an audio band 10 kc. wide, on three wavelengths below 200 meters—this is, indeed, good news for those who want to enjoy high-fidelity radio programs).

The qualitative observations made on various sounds by a number of trained observers, as frequency-range filters were cut into and out of circuit, are summarized in Table 1; in this tabulation, "L.F." means "lowest fundamentals." This table, and the previous discussion show, further, the necessity for an amplifier and reproducer frequency range of 40 to 15,000 cycles, for "natural" reproduction. It is of interest to note that the dynamic reproducer used in the ordinary domestic radio set is seldom capable of efficiently reproducing sounds lower than about 100 cycles or higher than about 6,000 cycles!

Now that we have been given a "taste" of what may be accomplished toward natural reproduction in audio perspective we look forward to a new day in sound technique. It

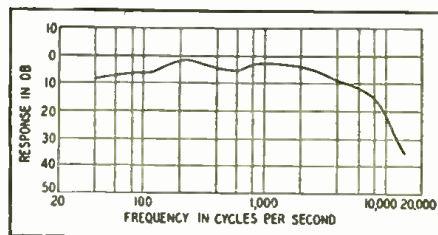

FIG. 2

Average over-all reproduction-ratio characteristics of the reproducer system. It departs from uniformity only about 2.5 db. plus or minus, between 40 and 15,000 cycles. Measurements were made by supplying "warbling" frequencies to the voltage amplifier and measuring the sound pressure in the "listening area" of a room.

will be only a matter of time until public address systems, talkies, radio sets and sound re-enforcement systems incorporate "three dimension sound."

The writer extends credit to Bell Telephone Laboratories, the Acoustical Society of America, American Institute of Electrical Engineers, and the Institute of Radio Engineers for the use of material and illustrations incorporated in this article, which has been written partly to describe a new development in sound reproduction; and partly to show the limitations and possibilities of existing sound systems of all types.

TABLE I

- Tympani**—No important frequencies below 65 cycles. (Drum tuned to 96 cycles.) Actual tone range ends around 2,000 cycles. Prominent drum rattle and beating noises to around 5,000 cycles.
- Bass Drum**—No important frequencies below 70 cycles. Actual tone range ends around 1000 cycles. Prominent drum rattle and beating noises to around 5,000 cycles.
- Snare Drum**—No important frequencies below 100 cycles. Actual tone consists of rattle extending to very high frequencies.
- 14" Cymbals**—No important frequencies below 350 cycles. Low frequencies prominent when one cymbal is struck with a hard stick. High frequencies prominent when two cymbals are clashed together.
- Bass Viol**—L.F. fairly important, slightly more on plucked than on bowed notes. Considerable bowing noise.
- Cello**—L.F. fairly important. Tone very rich in harmonics. Moderate bowing noise.
- Piano**—L.F. unimportant for first octave. 100 cycle high-pass filter only slightly noticeable. Upper notes practically pure tones.
- Violin**—L.F. important. Tone rich in harmonics. Noises and tone blended.
- Bass Tuba**—L.F. fairly important. "Pedal" notes—fundamentals around 20 cycles—contain fewer very low frequencies than regular notes. Moderate blowing and key noises.
- Trombone**—L.F. not very important below 130 cycles. Middle register has greatest harmonic content. Inappreciable noise.
- French Horn**—L.F. unimportant below 130 cycles. Middle register has most volume and harmonics. High register gives rather pure tones. Harmonics least prominent of any instrument tested.
- Trumpet**—L.F. fairly important. Lowest register has greatest high-frequency "blatt." Tones purer at higher pitches. Inappreciable noise.
- Bass Saxophone**—L.F. not very important below 90 cycles. Highest register rather unmusical and unpleasant. Considerable blowing and key noise.
- Sassoon**—L.F. fairly important. Prominent reed noise on lower register. Moderate key slap.
- Bass Clarinet**—L.F. very important. Tone goes to very high frequencies on upper register. Prominent reed noise on lower register becoming blended with tone on upper register.
- Clarinet**—L.F. very important. Medium range has largest harmonic content. Highest range gives much purer tones. Moderate blowing and reed noises at very high frequencies.
- Soprano Saxophone**—L.F. very important. Powerful harmonics making very harsh tone. Moderate reed noise above 10,000 cycles, less than that of clarinets.
- Oboe**—L.F. important. Most "reedy" tone of all tested. Tone extremely rich in harmonics of high order, especially middle register. Noises blended with tone.
- Flute**—L.F. very important. Middle register has most harmonics. Highest register produces almost pure tones. Much blowing and mechanism noise on highest register.
- Piccolo**—L.F. very important. Middle range most musical and free from noise. Highest few notes are very powerful but are practically pure tones. Much blowing noise and rumble on all registers.
- Footsteps**—No important frequencies below 100 cycles. High frequencies up to about 10,000 or 12,000 cycles required.
- Handclapping**—No important frequencies below 150 cycles, but requires the entire audible range on the high frequency end. Sounds fairly natural with 8,500 cycle cut-off.
- Key Jangling**—Bunch of 22 keys shaken on 4" wire loop—No important frequencies below 500 cycles but requires entire audible range on the high-frequency end. Tone very unnatural with 8,500 cycle cut-off.



Dealers Net Cash  
Wholesale Price  
**\$39.50**



Dealers  
Net Cash  
Wholesale  
Price **\$39.95**

We challenge you to find ANY instrument costing 50% or 60% more than the Model 333 Analyzer that will do what the 333 will do . . . that will have the range, speed, flexibility, and exclusive advantages of the "Free Reference Point System of Analysis" . . . or a tube tester that will tell you as much as the Model 85 . . . an individual leakage test between each and every element of EVERY tube, quickly revealing the faults of those troublesome tubes that test "Good" on ordinary testers . . . or a tube tester approaching the value of the new Model 35, just announced, with such simplicity of operation, and directly indicating "Good" and "Bad" tubes based on accurate calibration. . . . We confidently believe that these are the best engineered instruments ever offered the service profession . . . that they are truly "Supreme by Comparison" . . .

Supreme started something when the Model 333 Analyzer was announced . . . setting a new standard of value and engineering perfection awaited by the industry . . . with the result that in a few short months nearly 5,000 of the world's best radio technicians discarded their old testers in favor of Supreme's new Model 333 and "Free Reference Point System of Analysis" . . . No greater tribute can be paid this instrument than the enthusiasm of its owners . . . and then the Model 85 Tube Tester . . . as radically different from other tube testers as the 333 is different from other analyzers . . . and being accorded the same reception because service men know GOOD instruments . . . the Model 85 makes available for the first time a complete ANALYSIS of a tube . . . now the announcement of the new Model 35 Tube Tester in the lower price bracket . . . developed in close co-operation with leading tube engineers and "tried out" under actual service conditions . . . large English reading scale directly indicating the true quality of all tubes based on transconductance emission . . . and at a price heretofore believed impossible . . . all three of these revolutionary instruments are now in stock at the leading jobbers . . . see these new Supremes today and you'll say, as have thousands of others, "There's the equipment I've always wanted" . . .

\*Write us for a magazine reprint (with diagrams) giving a technical discussion and complete explanation of "Free Reference Point System of Analysis."

SUPREME INSTRUMENTS CORP.,  
493 Supreme Bldg., Greenwood, Miss.  
Please send me full particulars on

(Here indicate instrument or instruments interested in)

Name \_\_\_\_\_  
Address \_\_\_\_\_  
City \_\_\_\_\_ State \_\_\_\_\_  
Jobber Preference \_\_\_\_\_

SEE YOUR  
JOBBER  
NOW

SEND THE  
COUPON

Only Supreme can improve on Supreme's achievements. Each of these three instruments bearing the "Supreme" label is worthy of the name; each passed the confines of our laboratory only after definitely demonstrating Supreme features of engineering excellence, construction and performance. Here are new values-- new instruments that are, more than ever before, "Supreme by Comparison."



## “the LONG AND SHORT of it”

The next time you replace a volume control . . . use a **CENTRALAB RADIOHM** and begin to take inventory of the “satisfied customers” . . . **RESISTOR B** of annular shape, has long been the standard type. Current concentrates around the **INNER** edge, i. e., the shortest path.



**RESISTOR A** used in the new Radiohm, has the same length path across its entire width giving greater effective area for good volume control.

Your Jobber has the new 1934 Volume Control Guide. **ASK FOR IT!**

# Centralab

CENTRAL RADIO LABORATORIES  
MILWAUKEE WISCONSIN

Be sure to read the announcement on the Inside Back Cover which gives important information about the new **OFFICIAL AIR CONDITIONING SERVICE MANUAL** now being published.

*Dependable Sensational Performance!*

## BUD

Laboratory-Built  
**P. A. Equipment**

**5 DAYS FREE Trial**

Try **BUD** Sound Equipment For Five Days Absolutely Free!

**ELECTRO-DYNAMIC UNITS  
CARBON AND CONDENSER  
MICROPHONES • 4 & 6 FT.  
ALL ALUMINUM TRUMPETS  
FIELD EXCITERS • AIR COLUMN  
HORNS • LOW AND HIGH  
FREQUENCY UNITS FOR WIDE  
RANGE THEATRE USE**

We invite careful, critical inspection of our entire line of **BUD** laboratory-built sound equipment. We suggest that you conduct your own comparative test. We **CHALLENGE** you to duplicate **BUD** performance and **BUD** **DEPENDABILITY AT ANY PRICE!** Write today for descriptive literature and prices and details of our **FREE FIVE DAY TRIAL** offer.

**BUD SPEAKER CO.**  
1103 JACKSON ST.  
TOLEDO, OHIO - U.S.A.

## THE POLYTONE

(Continued from page 657)

shafts passing over it are 435 per second, then a “flute” will sound the note “A” as long as the key is pressed and the light reaches the photoelectric cell through the flute wave pattern.

The number of openings in any one of the concentric rings of the frequency disk when multiplied by the number of revolutions per second will give the musical frequency of that particular ring. It will be obvious that arrangements of the proper number of slits rotated at the proper speed will thus correspond to the chromatic scale common to keyboard instruments.

The method by which the player may selectively cause any note to sound may be accomplished in several ways. He may touch the keys which open and close mechanical light shutters between a common light and the photoelectric cell or he may elect to have each key light an individual lamp at each desired note and tone color. The same ring of slits or any of the rings may simultaneously play any number of tone qualities. Auxiliary stop shutters are used to shut off tone qualities not desired.

### Component Parts

Right here let us retrace our steps for a moment to explain that Polytone has the following parts: (A) the light source; (B) two reflectors; (C) the rotating light rotor or frequency disk previously described and illustrated in detail in Fig. 1; (D) an accurate matt or opening carefully dimensioned so that each opening always corresponds to the distance between the centers of any two adjacent light slits in the same ring. Under this matt is located the wave shape of the sound it is desired to produce. These wave shapes may be actually recorded oscillographs or their equivalent, or they may be synthetically produced; (E) a light sensitive photoelectric cell which will transduce the delicately shaded and rapidly fluctuating light impulses into electric currents and then in turn to sound through the medium of the usual amplifier and loudspeaker.

Figure 2 illustrates a schematic arrangement of the parts mentioned in the previous paragraph together with the driving motor and the reflectors which verticalize the light and collect it for the photoelectric cell.

Figure 3 represents two forms of the stationary wave shape or tone pattern. In practice these wave shapes may be arranged radially under the light source; these wave shapes may be of the type known to talking pictures as variable area or variable density or they may consist of nothing more than ink lines on a bit of transparent material or again just a few opaque ribbons which are radially grouped with various spacings and with either their edge or flat sides turned toward the light and thus produce a myriad of shadow patterns, each in turn producing a different tone color or quality.

The variations in Polytone construction may range all the way from a kit of parts which the amateur may assemble into a keyboard or player type of instrument, to multi-manual keyboard instruments with beautiful tone qualities not previously heard by the human ear. What a storehouse of treasure the amateur would find such an assembly of parts. The frequency disk and wave shapes and perhaps a few other parts all assembled would make a real musical instrument.

For the more ambitious instruments let us consider what they may do. The best pipe organ made can not actually produce sounds resembling closely the human voice but must resort to a bulky set of pipes for a poor imitation. Polytone would use an actual recording of a voice and within a few cycles of that recorded quality the whole keyboard will respond to that timbre and tone quality. With a group of such recordings, of perhaps some of the famous voices of the operatic world, it simply requires the pulling of stops and we have a solo, a quartet, or a grand choir of voice qualities with which we may conjure into being all the beauty of the human voice with the volume of a huge pipe organ.

Upon first thought it may appear that Polytone is limited to sustained tones like those of the pipe organ and the wind and reed and percussion effects may be had by proper

instruments, but very beautiful plucked string selection of tone quality and the method of bringing them into action and damping their duration. Such apparently difficult tones as a bell or chimes, bowed violins and cellos, banjos and steel string guitars and mandolins, have all been produced on the models that have been built. Sufficient data has been accumulated to warrant the assertion that pianos, harps, carillons and many new instrumental qualities may be had.

And so I might go on but enough has been said to present an idea of the accomplishments of this new versatile electronic unit.

(See “The Radio Organ of a Trillion Tones,” by Arnold Lesti, in the January, 1931, issue of **RADIO-CRAFT**, page 402.)

## ONE-TUBE LOUDSPEAKER SET

(Continued from page 656)

the most stable and easily built super-regenerative receivers that has as yet been devised. The receiver is built around a 33 tube which is a power pentode that requires only 2 V. of “A” battery for filament supply, and either 90 or 135 V. of “B” batteries. The latter voltage, when used, will give slightly more volume, but average results may be obtained from 90 V.

### Constructional Data

With the exception of the coil, which has two windings, all other material can readily be obtained. The coil must be especially made by the constructor, and is wound on a 1 in. diameter form, about 3 ins. long. The secondary, L1, consists of 110 turns of No. 32 enamel covered wire. The primary, L2, or plate coil winding consists of 45 turns of No. 36 D.S.C. wire wound below the grounded end of the secondary. The suggested layout and construction are shown in Figs. A and B.

The following are the other parts with given values necessary:

### List of Parts

- One 23 plate variable condenser, C1;
- One mica fixed condenser, 250 mmf., C2;
- Two mica fixed condensers, .006-mf., C3, C4;
- One fixed condenser, 250 mmf., C5;
- One resistor, 1 meg., R1;
- One 15 ohm rheostat, A2;
- Miscellaneous parts, such as 5 prong socket, hardware, chassis base, binding posts, 33 tube, and magnetic type loudspeaker.

### Adjustment and Tuning

If the set seems to be insensitive then the trouble is possibly due to the connections to the coil winding L2 being reversed. This winding must be in proper phase relationship to L1 or else regeneration will not take place. Fixed condensers, C3, C4, and C5, must be exactly as specified and mica-dielectric type is recommended to reduce the losses and inconsistencies that occur in the paper type. It is through these condensers that the super-regenerative action is obtained. A 100 mmf. fixed condenser may be connected across the output terminals, but will not be necessary in all cases. Its inclusion will be necessary if a persistent whistle takes place—but in some cases will also help to actually increase the volume. R2 controls the volume and stability of the receiver, by regulating the filament temperature of the tube. Stations are obtained by simply tuning the variable condenser, C1.

To obtain good loudspeaker volume, a high impedance magnetic type loudspeaker is recommended. It should preferably be of a “close” gap construction, which feature makes the unit highly sensitive, though it might tend to chatter a little on extreme volume.

Too large an antenna for this receiver should not be used. It may dampen the sensitivity of the set instead of increasing its efficiency. An approximate total length of 75 feet will be found to be ideal.

In Fig. 1 are given optional coil winding data.

A ground is not always necessary; it should be tried, though. Connect it to the end of L1 opposite the antenna connection (or, the junction of L1, C1, C3 and C5).



## INTERNATIONAL RADIO REVIEW

(Continued from page 651)

provided with a "thumb drive" on the right arm of the chair for tuning.

A dynamic speaker on a baffle is mounted in the back of the chair. A well-upholstered back on the chair gives a box baffle effect and prevents the occupant of the chair from feeling as if he were sitting on top of the speaker.

### MODERN SET TRENDS IN EUROPE

THE INTRODUCTION of the wavelength changes for most of the popular broadcasting stations across "the big pond" has caused no end of trouble with radio fans, as most of their sets were calibrated directly with the station calls or locations. This is much more common in Europe than in the U. S., as they seldom have more than one station in a given city, and they identify the stations by the city rather than the official call letters. Short-wave fans who have picked up foreign stations are familiar with this fact.

The result in changes in wavelength has caused a change in design of modern sets. The one shown in Fig. C is a typical example. This A.C. superhet. is calibrated in wavelengths, and a shallow tray is provided in the base of the cabinet to permit station charting. Then if further changes are made in the wavelength allotments, it is only necessary to change the station chart and not the entire dial.

### A SERVICING CONVENIENCE

A CONVENIENCE that will interest Service Men recently appeared in *THE BROADCASTER AND WIRELESS RETAILER*, an English trade publication.

It consists of a condenser block, for filtering, bypass and other services, in which the individual condensers are mounted separately in such a way that if one blows out or becomes otherwise defective, the entire block does not have to be discarded. As shown in Fig. D, any one of the condensers can be taken out of the can and replaced, without dissolving tar or other impregnating compounds.

### A FRENCH A.C.-D.C. SET

UPON RUNNING through a number of French magazines recently, the editor took particular interest in a French version of the popular A.C.-D.C. midset receivers which have flooded the American market. This set appeared in *MACHINES PARLANTEES ET RADIO*.

The appearance of the unit is shown in Fig. E, and as you can see it differs mechanically from the stereotype layout found in the American sets. A flat scale across the length of the cabinet, with a running pointer serves as the tuning dial. The speaker is mounted in the usual position at the center of the front panel, and the set is equipped with a tone control, a novelty of which American ultra-midgers do not boast.

It is interesting to note that the set employs American type tubes—the 6A7, 6DG, 75, 43 and 25Z5. These tubes have evidently been imported.

### A NEW A.F. TRANSFORMER

A *MATEUR WIRELESS* magazine recently contained a description of a new audio transformer with an unusually flat characteristic curve. A frequency curve, plotted against db. gain shows an almost perfectly flat characteristic.

The transformers are made in two types, one designed for parallel feed in which no direct current flows through the primary, and the other for direct connection in the plate circuit of the A.F. tubes. The uniform amplification is obtained by spaced layer windings impregnated with a non-hygroscopic material of very low specific inductive capacity, and the use of special nickel iron alloy core material of very high permeability.

These transformers are available in two types—the first for parallel feed, in which there is no direct current flowing through the transformer winding; and the second, for series feed in which the direct current for the plate bias passes through the transformer winding. Different types of cores are used for the two types.

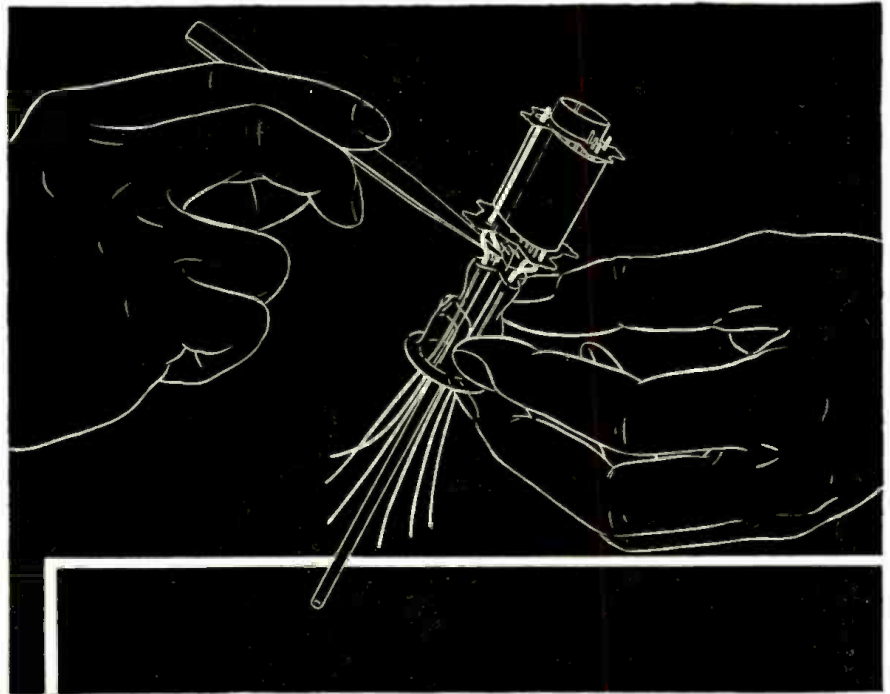

## BEHIND THE FINGERS, THE PURPOSE

FINGERS can be skilful and yet fashion nothing of practical importance. They must be guided by a purpose—a vision of perfection, the desire to create something better.

It is such a purpose that guides the many manual operations in the assembling of Raytheon 4-pillar Radio Tubes. For these tubes are made by workers steeped in the watchmaker's tradition of precision. Even the machines, employed in several stages of their manufacture, are fashioned for an express purpose—the construction of the 4-pillar principle of support which holds the vital elements in a Raytheon secure from damage through vibration.

Every operation through which the raw materials for these tubes pass, reflects that guiding purpose. The result is a tube that performs to perfection under the most rigorous circumstances. That is why police departments, air transportation companies, polar expeditions and millions of set owners everywhere, use Raytheon 4-pillar Tubes and nothing else. When you put a Raytheon 4-pillar Tube in a set, you are assured of perfect tube performance and customer satisfaction.

## RAYTHEON 4-PILLAR RADIO TUBES

RAYTHEON PRODUCTION CORPORATION



30 E. 42nd St., New York City  
445 Lake Shore Drive, Chicago

55 Chapel St., Newton, Mass.  
555 Howard St., San Francisco

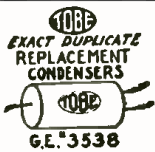

## AC-DC Midget Replacement Condensers



R.C.A. VICTOR  
#6487



GE. #7589



CROSLY #W27488



EMERSON  
HC.31



KADETTE  
A407



ATWATER-KENT  
#24955



MOTOROLA  
#48200



APEX #6201

Exact duplicates of the originals including physical dimensions, color and length of leads, capacity, etc. Higher peak voltage ratings of each TOBE condenser assure a superior product.

The following condensers are carried in stock by all TOBE distributors:

| Radio            | Model       | Mfd.    | Volts | List Price |
|------------------|-------------|---------|-------|------------|
| GE R.C.A.-Victor | K40A        | 4-4     | 140   | \$1.00     |
| GE R.C.A.-Victor | 27.         |         |       |            |
| GE R.C.A.-Victor | K40A        | 5-5     | 35    | .75        |
| GE R.C.A.-Victor | 27A         |         |       |            |
| GE R.C.A.-Victor | L50         | 6-8     | 250   | 1.55       |
| GE R.C.A.-Victor | 228         |         |       |            |
| GE R.C.A.-Victor | L50         | 10      | 35    | 1.60       |
| GE R.C.A.-Victor | 228         |         |       |            |
| GE R.C.A.-Victor | K63         | 4-4     | 175   | 1.00       |
| GE R.C.A.-Victor | 120         | 10      | 150   | 3.10       |
| GE R.C.A.-Victor | K62         | 4-4     | 460   | 1.75       |
| GE R.C.A.-Victor | 110         |         |       |            |
| GE R.C.A.-Victor | L50         | 8       | 140   | .75        |
| GE R.C.A.-Victor | 228         |         |       |            |
| Crosley          | Travette    | 8       | 25    | 1.10       |
| Crosley          | Fiver 167   | 8       | 25    | 1.10       |
| Crosley          | Fiver 167   | 8       | 300   | 1.10       |
| Crosley          | Dual Trans. | 6       | 25    | .90        |
| Emerson          | 20A         | 5-5     | 35    | .75        |
| Emerson          | 20A         | 4-4     | 200   | 1.00       |
| Emerson          | 250         | 8-8     | 200   | 1.25       |
| Emerson          | 250W        | 4-8-16  | 175   | 1.80       |
| Kadette          | Standard    | 4-4     | 175   | 1.00       |
| Kadette          | Standard    | 5-5     | 35    | .75        |
| Kadette          | A and B     | 4-10-10 | 175   | 2.10       |
| Motorola         | 44          | 4-8     | 250   | 1.15       |
| Motorola         | 44          | 8-12    | 250   | 1.40       |
| U. S. Radio      | Apex 5      | 4-4-12  | 175   | 2.10       |
| Simplex          | "V"         | 20-4    | 175   | 1.40       |
| Atwater-Kent     | 155(1st)    | 8-8-8   | 150   | 1.50       |
| Atwater-Kent     | 155(2nd)    | 8-8-8   | 150   | 1.50       |

40% discount to servicemen and dealers from the above list prices. If your local distributor does not carry these condensers in stock, send us your order direct along with his name. Send for free latest bulletin.

**ToBe Deutschmann Corporation**

CONDENSER DIVISION  
CANTON, MASSACHUSETTS

## A NEW AUTO REMOTE CONTROL

Build your own auto radio using this auto remote control. Fits any car. Eliminates mechanical controls with backlash and internal friction. This tuner connects to your speaker-amplifier unit by means of a 7 wire cable only. The small aluminum housing contains all the parts associated with the tuning section of a standard super.



### OUTSTANDING FEATURES

Uses the new pentagrid converter tube, type 6A7. Furnished complete from shielded lead-in to 456KC output transformer (less tube). Has illuminated vernier aeroplane dial calibrated KC. Selective, sensitive, high gain. Completely shielded. Compact. Rugged. Tube mounted in shock-proof construction. Adjustments made from the outside. Covers the broadcast band. Size only 3 1/2 x 4 1/2 x 3 1/2. Regular list price—\$15.00.

**SPECIAL PRICE TO SERVICE MEN \$8.50**  
(Less Tube)

Send a stamp to Dept. RC for our pamphlet showing different uses of this remote control.



**DELTA RADIO MFG. CO.**  
33d AVE. and TALMADGE AVE. S.E.  
MINNEAPOLIS, MINN.

## PARTY TRICKS

(Continued from page 659)

metal. The latter instruments must be taken from their cases to work as desired. Mount the meter in a box with a number of gadgets to make the entire unit more pretentious in appearance, as shown in Fig. 4, and put a new scale over the old one calibrated in any desired number of units. The idea is simply to disguise the meter.

Next obtain two magnets (from old headphones, meters, magnetic speakers, etc.), one stronger than the other. Place the stronger of the two in your vest pocket. A little maneuvering of the meter will show that in one position the magnet will cause the needle to deflect. The stronger the magnet, the greater will be the deflection.

Now, armed with this box, which you call a personal magnetism indicator, you can proceed to tell your guests what a wonderful thing it is to have this personal magnetism. Then to demonstrate you can show how the needle fluctuates when the box is placed near your body—that is the vest pocket. Of course, similar attempts with the other guests prove that they do not have this wonderful gift—that is, with the exception of your accomplice who has been given the weaker of the two magnets.

This hoax can be carried out with much success, depending on your ability as an orator and whether or not there are any bright little boys present who will proceed to find the source of your magnetism. In any event it will provide much merriment at the party.

The tricks and experiments mentioned here are only a few of the many that can be worked out to keep up the interest at home parties. No doubt you will be able to think of many new ones or variations and improvements over the ones mentioned. However, the examples given will serve to illustrate what can be done in this line.

## A FUNDAMENTAL ANALYZER

(Continued from page 660)

sists of the cable and plug, with its adapters, the two composite sockets, and the two left-hand columns of jacks. These jacks are identified by the R.M.A. number code to make the location of circuits easy. If the operator is familiar with this numbering and the arrangement of elements in the tube under test.

The links between these two separate sections are two patch cords, about 12 ins. in length, terminating in plugs similar in size and shape to standard 'phone plugs, but turned from solid brass rods, and set in short fiber handles. The writer has used regular 'phone plugs with the two terminals shorted together, but the special plugs are not difficult to make, have a much better appearance, and give much more positive contact in the jacks, as the insulating insert in the regular 'phone plug sometimes interferes with good contact. Standard test prods, terminating in the same kind of plugs, are used to work directly from the panel into the wiring, when necessary.

Figure A shows the external appearance of the finished tester, including the patch cords, test prods, analyzer cable, and adapters. The carrying case allows room for all of the accessories, as well as a few small tools, making a self-contained service unit. Note the absence of controls on the panel. The knob and bushing below the meter face are the zero adjuster and its trimmer, the latter being arranged for adjustment only at long intervals, with a screwdriver, as described later in this article. The white sheet forming a background for the jacks is typewritten with the titles and punched to match the drilling of the panel. This is shown in Fig. A. This is overlaid with clear celluloid, punched with the same holes which results in a clean, non-smearing job, easily read.

Figure B shows the wiring and the placement of the batteries and the blocking condenser in the case. The wiring job is not difficult, and can be done by the novice with safety. Due to the difficulty of mounting the condenser on the panel, it was placed in the case and contact is made through lugs on the edges of the panel and case. The bat-

teries are connected through a four-wire cable. The dual potentiometer, R1-R3, is mounted directly against the panel, and the trimmer R4 is mounted back about 3/8-in. with a bracket, to arrange for slotting the end of the shaft and placing the bushing through the panel. The bracket and bushing are made from the frame of a telephone jack like the ones in the analyzer.

### The Universal Meter

The heart of the universal meter, which includes a rectifier, is the 0-1 milliammeter. The switching of the shunts and multipliers and blocking condensers is accomplished entirely by the jacks, there being nothing to do but plug into the proper jacks as indicated on the panel. The D.C. jack is the common negative connection for all D.C. voltage and current ranges. The A.C. jack is the common terminal for all A.C. voltage ranges, the same set of jacks in the extreme right-hand column serving the selection of voltage ranges, both D.C. and A.C. The "Output" jack is used with these same jacks for various output ranges. Referring to Fig. A again, we see the patch cords in place for the 5 V. A.C. range, inserted in the analyzer section for measurement of heater voltage.

### The Ohmmeter

The ohmmeter section of this tester offers two advantages not found in most ohmmeters. First, zero adjustment without the necessity of shorting the test prods together; and second, the zero trimmer, which makes one zero adjustment suffice for all three resistance ranges.

The standard series circuit is used on the 0-1-meg, and 0-1 meg ranges, and the standard parallel circuit is used for the 0-1000 ohm range. This insures that not more than 1 ma. of current is drawn from the batteries at any time. Moreover it is impossible to inadvertently leave the batteries connected, as the circuits are opened when all plugs are withdrawn, and the case can not be closed with plugs in place.

To operate the ohmmeter, insert one plug in the "Ohms Com." jack, which automatically closes the circuit, and the zero adjustment can be made without shorting the test prods together, which saves a great deal of time. Then, if the other plug is inserted in the "1 ma." jack, for the 0-1000 ohm range, the circuit remains closed and the resistor under test is shorted across the meter. When the second plug is inserted in the "100M Ohms" jack, only the 4 1/2 V. battery is included in circuit, and when the "1 Megohm" jack is used the entire 45 V. is included. The jacks automatically switch in the necessary fixed and variable resistance for each range.

The purpose of the variable resistor R4 is to make the zero adjustments of the 4 1/2 V. and 45 V. circuits track. An adjustment of this resistor, with a screwdriver, once in a very long time, makes it possible to plug into the "Ohms Com." jack, as stated above, make the necessary zero adjustment with the other hand free, and then skip back and forth over all three ranges at will, measuring any resistor, from 1 ohm to 1 megohm, without having to touch the zero knob between ranges. This is a big time-saver in the popular method of resistance analysis for which this tester is particularly adapted.

Another interesting point to notice is that the system of multipliers is isolated from circuit except when the "D.C." or "A.C." jacks are in use. Thus, when the ohmmeter is in use, this set of 1% precision resistors can be used as a sort of resistance box, for comparison and calibration, by plugging into the different voltage jacks in the right-hand column.

### The Selective Analyzer

The two left-hand columns of jacks, in connection with the cable and plug, and the tube sockets, form the analyzer unit. The two sockets admit all tubes now on the market, including both types of 7 prong bases. As stated before, the R.M.A. numbering code is used to label the jacks, and a working knowledge of this code and the arrangement of elements on the tube under test makes the arrangement of the patch cords for analysis an easy matter.

For voltage, resistance, and most output measurements, the two plugs need only be used in the second, or right-hand column of jacks. The "reference point" is not restricted to any point; it is possible to measure be-

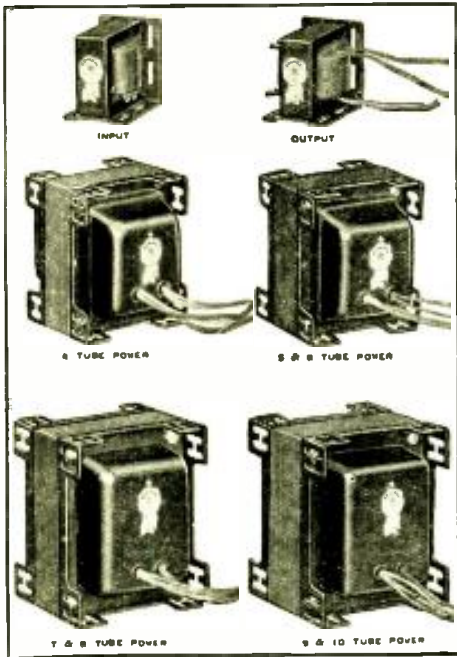

*"Multi-Tap"*

(Trade Mark)

**POWER TRANSFORMER**

(Patent Applied For)

The wide range of adaptability of only four models "Multi-Tap" Universal Power Transformers is made possible thru various taps in these units which may be used singly or in combinations. The required current values can be delivered to each of the several leads in the set with any combination of tubes, as accurately as by the original power units.

**Here Is a Great Opportunity!**  
**RADIO DISTRIBUTORS--SERVICEMEN**  
**KIT OF SIX (6) TRANSFORMERS**

*Exact duplicates*  
**ELECTRICALLY**

Provides immediate renewal of original performance in case of trouble in the power transformer (the heart of the radio) in any of more than 90% of all models—"orphaned" or current.

*Universally adaptable*  
**PHYSICALLY**

AC-110-120 V., 50-60 Cy. 220-240 V., 50-60 Cy. or 115 V., 25-40 Cy.

**THE "MULTI-TAPS" are Your SAFEST LEADER!**

for winning the replacement trade. Small stock investment—all staple items—quick turnovers—no slow movers or dead stock at any time, and—

**YOUR PROFITS ARE FULLY PROTECTED!**

Patent application claims now allowed insure "MULTI-TAP" Distributors the profit to which they are entitled—and may make it costly for dealers in infringements.

**Universal Input Audio**

Can efficiently feed any straight or push-pull audio stage on either A.C. or D.C. sets.

**"Multi-Tap" Output**

The Universal primary and the tapped secondary, from 2 to 30 ohms in 2 ohm steps, makes it possible to feed practically any straight or push-pull output stage to any dynamic speaker.

*Free for the Asking!*

Send for "Multi-Tap" Bulletin No. 3-D, showing complete data on each model, and listing of 1498 models of radios with required "Multi-Taps."

*Easily Installed!*

FULL DIRECTIONS WITH EACH UNIT

Furnished in dull satin black finish unless otherwise ordered. All units are fully shielded, and meet specifications of radios having Underwriters Laboratory approval, now required in many localities to protect fire insurance policies.

Complete set of units illustrated packed individually and in a carton as standard package for Service Engineers' initial stock. Additional stock of any unit may be had in any quantity.

**MAIL THIS COUPON NOW!**

**GENERAL TRANSFORMER CORP.**  
 504 S. Throop St., Chicago, Ill.

Please send free Bulletin No. 3-D of "Multi-Tap" Universals and list of Radios on which they can be used for replacements.

Name .....

Address .....

City ..... State .....

tween any two points. The "Chassis" jack, in this column, is useful in measuring voltages with respect to the chassis.

For current measurement, one jack in each column is used, the best procedure being to insert the right-hand plug first, then carefully insert the left-hand plug, watching the meter for overload, as these left-hand jacks automatically break the circuit as the plug is inserted, to include the meter in series.

These two columns of jacks can accomplish a number of useful purposes beside the usual analysis procedures, some of them entirely beyond the ability of the standard type of analyzer.

If the set under test supplies the proper voltages at the tube sockets, a grid-shift voltage can be introduced in the control-grid circuit of a tube, with the test prods, while the milliammeter is inserted in the plate circuit, the shift in the plate current being a function of the mutual conductance of the tube. This is admittedly the most reliable tube test for general servicing.

In many instances, trial resistors and condensers can be temporarily inserted while listening to the set. This is practicable in most cases in A.F. circuits only, as the capacity between wires in the cable would unbalance or detune R.F. circuits.

For instance, if a grid-bias resistor is found to be open, in a 27 first A.F. stage, a replacement can be inserted into the "Chassis" jack and No. 5 right-hand jack, making the circuit operative and locating the trouble without "pulling" the chassis. If, in this same stage, the resistor and its bypass had shown a dead short, indicating a defective bypass, the trial resistor and condenser in parallel could be inserted in "Chassis" and No. 5 left-hand jacks, which would throw the defective parts out of circuit at the same time it inserted the trial parts in circuit. This saves a lot of time unsoldering defective parts, or parts suspected as defective, and allows the whole trouble to be located, and replacements intelligently selected, before having to pull the chassis. This, in turn, allows the Service

Man to make a set price to the customer without having to pull the chassis in the customer's home or take it to the shop to locate the trouble.

Output measurements can almost always be made directly on the analyzer panel. For instance, let us consider the case of a single 47 output tube. The voltage across the plate load, which is the primary of the output transformer, can be measured by plugging into No. 2 and No. 5 right-hand jacks with an output meter. For single triode output tubes, the output meter can be connected between plate, usually No. 2 jack, and the "Chassis" jack. This same method will usually give a satisfactory reading on push-pull output tubes, connecting to the plate of one tube, and chassis. For output measurements on the new dual class B tubes (79 and 19 for instance) the connection would be to the two plates, No. 2 and No. 5 right-hand jacks.

An A.F. oscillator or phonograph pickup can be fed to the input of the A.F. channel of a set by plugging into chassis and grid jacks. If the left-hand grid jack is used, the normal control-grid circuit is disconnected and the grid fed only by the external signal. If the signal generator output is fed through a condenser, or if for some other reason the normal grid return should be retained, the right-hand grid jack is used. Still further, if an extra stage is desired, or if the detector stage is desired to be tested along with the audio stages, plug in on the detector input, and make an amplifier out of the detector by plugging in a new cathode resistor in parallel with the normal high-value one, through "Chassis" and No. 5 right-hand jacks for most tubes. The use of a little ingenuity will show the Service Man many other uses for this "switchboard." If extra meters are at hand, many measurements can be made at the same time. This is not permissible on most analyzers of conventional design.

While quality and accuracy were first considerations in the design and choice of parts for this tester, it is quite economical to assemble, and gives about as much value for

the investment as possible. And the investment is a safe one, as the principles on which it is based are "fundamental" and it can be easily extended to take care of the prophesied 8- and 9-prong tubes.

**List of Parts**

- One ClaroStat DP-58 dual potentiometer 1000 and 10,000 ohms, R1, R3;
- One ClaroStat P-58 potentiometer 5,000 ohms, R4;
- One I.R.C. type P-1 metallized resistor, 35,000 ohms, R2;
- One I.R.C. type WW4 precision resistor, 12.5 ohms, R5;
- One I.R.C. type WW4 precision resistor, 2,083 ohms, R6;
- One I.R.C. type WW4 precision resistor, 0.505-ohm, R7;
- One I.R.C. type WW3 precision resistor, 4,950 ohms, R8;
- One I.R.C. type WW3 precision resistor, 5,000 ohms, R9;
- One I.R.C. type WW3 precision resistor, 40,000 ohms, R10;
- One I.R.C. WW3 precision resistor, 50,000 ohms, R11;
- One I.R.C. type WW4 precision resistor, .15-meg., R12;
- Three I.R.C. type WW4 precision resistors, .25-meg., R13, R14, R15;
- One paper condenser, 1. mf., C;
- Four phone jacks, filament control type;
- Ten phone jacks, closed-circuit type;
- Twenty-one phone jacks, open-circuit type;
- One Na-Aid 907WICA analyzer plug with 8-wire cable, and adapters No. 974D8A, 975D8A, 976D8A, and 977D8A;
- One Na-Aid 4-, 5- and 6-prong composite socket type 456;
- One Na-Aid 7-prong composite socket type 477;
- One Na-Aid control-grid clip, type 91;
- One phone tip jack and phone tip;
- One pair test prods;
- Six or more plugs described in text;
- One clip on 5-ft. lead;
- One panel 9 x 11 ins., any suitable material;
- One carrying case.

## Build Your Own Wheatstone Bridge

For \$41.50

A simple, rugged, wide-range Wheatstone Bridge for resistance measurements. Operation identical with best laboratory instruments. Sensitive, accurate. Low cost. Kit easily assembled.



**SHALLCROSS No. 630 Kit \$41.50**  
Assembled \$49.70

Built around a highly sensitive galvanometer and Shallcross Resistors. Range .01 ohms to 11.1 megohms. Send 6c in stamps for Bulletin 630-P.

**SHALLCROSS MFG. COMPANY**  
Electrical Measuring Instruments  
and Accurate Resistors  
700 MAC DADD BOULEVARD  
COLLINGDALE, PA.

## The SHURE TECHNICAL BULLETIN

is valuable in your library.

Devoted to the advancement of microphone technique, this monthly publication of Shure Brothers Company, *Microphone Headquarters*, contains authoritative and useful information on technical phases of broadcast and sound engineering, design data, new applications of microphones.

These back issues are available at 6c per copy:

- No. 1 Condenser vs. Two-Button Microphones
- No. 2 Field Problems in Microphone Placement. Part 1—Broadcasting
- No. 3 Field Problems in Microphone Placement. Part 2—Public Address
- No. 4 Mixing Circuit Design Data
- No. 5 The Microphone—An Electric Ear. Noise Measurements—Binaural Transmission
- No. 6 Field Problems in Microphone Placement. Multiple Microphone Systems
- No. 7 Electro-Acoustic Measurements of Microphone Performance
- No. 8 High Quality Sound Reproduction. An Outline of Factors Affecting Fidelity
- No. 9 The Truth About Microphone Response Characteristics
- No. 10 Transformers for Speech Input Circuits.

**SHURE BROTHERS COMPANY**  
215 W. Huron Street, Chicago, Ill.

Send me postpaid the following issues of the SHURE TECHNICAL BULLETIN:

... No. 1 ... No. 2 ... No. 3 ... No. 4  
... No. 5 ... No. 6 ... No. 7 ... No. 8  
... No. 9 ... No. 10 (6c per copy)

Enter my subscription for one year.  
(Price 50c)

I am enclosing  c. in stamps  
 cash  money order.

Name

Address

City and State  RC-534

## SOUNDHEAD OPTICAL SYSTEMS

(Continued from page 664)

whatsoever of the mechanisms of either sound-head or projector head. And since it is impossible to describe the complete mechanical arrangement employed, in one article—we will deal only with a discussion and explanation of the optical system which is, next to the amplifier, the most important unit in the equipment. Faulty adjustment or improper care of this most delicately sensitive arrangement will result in unintelligible sound, or muffled and distorted reproduction.

Before going into detailed explanation of the component parts and adjustment of an optical system—a brief description of the operation of this and associated mechanisms will help the reader to obtain a better picture of this unit, in addition to the reasons for the certain required routine service procedure to obtain the highest possible efficiency from it. There are, in use, two methods for sound synchronization with motion pictures. One—the disc method, which is now practically obsolete, employs a constant speed turntable which is coupled to the projector head, and by means of a pickup and special starting precautions, produces synchronized talkies and sound effects. The other method is known as the "sound on film" system, which has all of the voice and music recorded on a small width of the film adjacent to the picture frames. There are two types of recording in general use at the present time, constant width-variable density (more commonly known as Western Electric recording) which consists of shaded lines of various thickness (see "A"—Fig. 1), and the other variable width-constant density (Phonophone recording) which when inspected seems to be a facsimile of an oscillograph curve (see "B"—Fig. 1). In either case of recording, a definite narrow beam of light, created by an intense light from an "exciter lamp" which is passed through an optical lens arrangement so that it has the required dimensions, is concentrated on the sound track of the film. A photoelectric cell is mounted in an especially built chamber (with the exception of a round opening to permit this light to reach the photo-cell) behind the film. As the film runs through the sound head the shaded areas on the sound track modulate the beam of light which pass through it on its way to the photoelectric cell. These light variations cause the P.E. cell to generate corresponding electrical fluctuations which, in turn, are passed on to the amplifier and then to the speakers behind the motion picture screen.

To get proper reproduction, assuming that the amplifier and tubes are working correctly, it is essential that:

1. The position of the light "slit" or beam be centered on the sound track properly. This is referred to as the "horizontal adjustment." The length of this beam is such that it will clear the sprockets and the picture frames if correctly centered. If the light were to enter the sprocket holes a loud hum would result, similar to a 60 cycle hum that emanates from an A.C. battery charger. Or if the light were to enter the picture frames, a staccato noise similar to a riveting machine would be heard.

2. The light slit must lie in an exactly horizontal plane across the sound track, in other words it must be at right angles to the edge of the film, so that it is parallel with the recording on the film (particularly Western Electric type). This adjustment is referred to as the "rotational" adjustment—and is also very important, since if incorrect will cause poor reproduction.

3. The light "slit" must be as thin (narrow) as possible, its focal point existing exactly (as possible) at that point where it strikes the film. This is referred to as the "focusing adjustment." If the beam is out of focus, it will be broad and cover a large area of recorded frequencies, resulting in poor definition and, consequently, poor reproduction.

4. The exciter lamp must be properly set in its socket so that full illumination is obtained from it. Most lamps are "pre-focused" and require only to be properly set in the socket. By holding a white sheet of paper in the front portion of the sound head to

intercept the light (no film threaded in the machine), images such as that shown in Fig. 2 will be seen. The lamp will be set properly when an image such as is shown in "C" of Fig. 2 is obtained.

Of all the necessary adjustments mentioned above, the one most likely to prove the most difficult for the layman is the one pertaining to the focusing of the optical system. Since the definition or quality of the output is seriously affected if this system is not set correctly, in addition to the volume being impaired—it is always advisable to inspect and service this item at least once every two weeks. Not only does the vibration of the machine sometimes throw the adjustment off—but an accumulation of oil and film emulsion on the front lenses will have the effect of considerably reducing volume. For that reason it is best to make a thorough check of this unit as often as aforementioned, remove all lenses, then replace and make all necessary adjustments. It should be emphasized at this point, that not all optical systems require this attention since some are hermetically sealed and the front and rear lenses are accessible for cleaning without removing the whole unit. Whether this construction is preferable or not is open to argument, but the point is that attention should be given to the cleanliness of all lenses that can be possibly reached. Where there is no provision for adjusting the unit, it should be checked with frequency film to see that it is still efficient. Should tests show that it is "off," it will be found that some portion of the lens barrel has worked loose.

### "Sound" Optical System

In Fig. 3 is diagrammatically illustrated a complete optical arrangement and portion of the sound gate, such as will be found in RCA Phonophone sound heads. "A," at the top of the carriage is the adjustment that regulates the "horizontal" adjustment of the light beam on the sound track. The adjustment shown at "B," Fig. 1, is for "rotational" adjustment. The procedure is generally facilitated by the use of a dental mirror with magnifying characteristics, placed so that it intercepts the light beam on its way to the photoelectric cell, with 5,000 or 6,000 cycle frequency film threaded in the sound head. The horizontal and rotational adjustments can be easily checked with this aid, even with the film running through both projector and sound heads, by placing the mirror slightly to one side of the beam so that reflected rays are caught by it without directly obstructing the light. The adjustment shown at "C," Fig. 3, is for focusing the light beam. This screw is nothing more than a locking screw to hold the lens barrel tightly in position. When this is released it is possible to move the entire assembly back and forth, until the correct focal point is obtained. Refer to Fig. 4, for illustration on ascertaining when this condition is reached. A piece of white paper is placed before the photoelectric cell so that the image of the frequency film is clearly seen on it. Complete black and white should only be seen when the exact focus is obtained. If a great many frequency lines appear, then the optical barrel is considerably out of adjustment. The film should be run through the sound head, at least a few feet of it, so that it may set itself properly on the sprockets. If further motion of the film is desired, especially a slow motion so that the adjustments in action can be checked, this may be secured by turning the flywheel or motor drive-gear slowly. After this adjustment is made the locking screw should be tightened, and the adjustment checked once more to determine whether the rotation of this screw affected the position of the barrel. Some optical systems have an adjustable objective lens assembly, which is employed for focusing the light beam. The procedure for adjusting this type is similar to the aforementioned, excepting that the locking screw is omitted, adjustment being obtained by rotating this assembly one way or the other—until the proper image effect is obtained on the white sheet.

Some sound heads employ a principle of shifting rollers above the film guide shoe for varied seating of the film so that the horizontal position of the light beam can be changed. In this type of sound head the sound gate generally employs flat springs for tension



## 10 DAY TRIAL

Masterpiece II, with its new 2B6 tubes is ready to give you the thrill of a lifetime and to show you, at no risk to you, precisely why Admiral Byrd chose it for 10 to 570 work in the Antarctic. You can order Masterpiece II with the unconditional understanding that it is yours to try for 10 full days . . . you to be the sole judge . . . your money back instantly if you want it. My new book tells all about this offer and gives full technical details of the new, improved Masterpiece II.—Send coupon.

**McMurdo Silver, Inc.**  
1735 Belmont Avenue, Chicago, Illinois

# NEW POWER TUBES

## GIVE 17 WATTS UNDISTORTED OUTPUT TO

# MASTERPIECE II



**Admiral Byrd's choice now gains even more distinction thru addition of sensational new audio system.**

Masterpiece II is now equipped with two of the new 2B6 power tubes in three stages of Class "A" dual push-pull. This feature, plus a totally new system of tone control even further improves Masterpiece II's already excellent signal to noise ratio . . . and actually yields tonal possibilities utterly unattainable with any other receiver.

cuit, eliminating all necessity for forcing tubes on even the weakest signals. But now . . . with the 2B6 power tubes, and the new tone control, Masterpiece II has placed an entirely new meaning upon brilliance and satisfaction in long range reception. Results are unbelievable, until you hear them yourself.

**Greatly Helps  
10,000 Mile Reception**

Masterpiece II has, since its inception, been noted for extreme clarity on short-wave transoceanic reception . . . the power resulting from absolute precision in every part and cir-



McMurdo Silver, Inc., 1735 Belmont Ave.,  
Chicago, U. S. A.

Send me full technical information on Masterpiece II.

Name.....

Street.....

Town..... State.....

shoes to hold the film tightly against the film guide. These springs must not be too tight or they will cause the film to weave, resulting in sprocket hole noise one instant and "frame" noise the next. The rear spring is generally made a trifle tighter than the front for best results.

### Conclusion

It is inadvisable to attempt these adjustments if the equipment is being serviced by an engineer representing the manufacturer. Nor is it proper or feasible to attempt to persuade the theatre manager to discontinue such service in favor of your own. Where the theatre can afford to pay for such service they would, in most cases be better off, since the men that service the equipment are much more experienced and capable, particularly in cases when an emergency or severe trouble arises. Then again, some equipment complements have been sold on a lease basis, with service covering a period up to ten years, which does not permit outside men to adjust the equipment. Where the service contract is about to expire, and the theatre does not expect to renew it, it would be advantageous to obtain data from the projectionist ahead of time concerning the type of equipment employed, and to secure all other available information possible on this equipment, so that absolute confidence is felt in regards to your competence to service the equipment.

There are, of course, other important adjustments in sound heads that must be reckoned with, in addition to the optical systems. However, they do not require the study, nor do they present the frightening, complicating appearance to the newcomer in this field as do adjustments outlined in this article. The adjustments referred to, and which may be described in another issue, if the readers so desire it, pertain to the constant speed mechanisms in various sound heads. This item rates next in importance to the optical system as regards adjustments that are essential to obtaining good reproduction in "talkies."

## SERVICING THE "TALKIES"

(Continued from page 665)

or mysterious about it. One has to know how it works, or trace the circuits until he finds out—that's all. Precisely the same is true of the switching and powering arrangements of a theatre sound system, which may strike the Service Man, when he first encounters them, as being as difficult and troublesome as his own test board might seem to some outsider who studied its connections for the first time.

The projectionist will know all about the switching and metering of his sound system, but he may not always be able to trace the connecting wires, which often run through pipe conduit and tie together on connecting blocks mounted inside of cut-out boxes.

### How to Obtain Information About Any Sound System

General information about sound equipment was outlined briefly at the beginning of this series, and as explained before it is available in greater detail in a number of text-books on the subject, and can be found in some electrical handbooks of the useful type that describe everything from motors to door-bells, and from vacuum tubes to lightning arresters. Such books can be found in any large public library, they can be bought through any good book store, they are advertised in radio magazines. Or one can write to any large publisher of technical books.

Detailed information is harder to obtain, and often must be pieced together, against a background of general knowledge, by adding the Service Man's observations to the projectionist's knowledge, and calling upon certain special sources of information, to be described, for further detail.

These special sources include, first of all, printed information available in the projection room.

Most manufacturers give some sort of instruction pamphlet with their apparatus: if the projectionist has lost it he can always write for another. Some sound equipments include wiring diagrams inside the panels. Sometimes these panels cannot be opened without releasing the safety switches previously described, and so stopping the show, but often a projectionist who is familiar with them can open them and instantly close the safety switch with his hand, holding it closed while the drawing is examined briefly. The interruption will last less than a second in such cases, and except in de luxe houses will not be objectionable (if it does not come at the crisis of the plot). Cut-out boxes containing connection blocks sometimes are supplied with wiring drawings, or with a list of numbers corresponding to the connection points, and a description, beside each number, of the wire that is fastened to the corresponding stud. Where such information is lacking, or has become lost, some manufacturers will furnish it, others will not.

There are a few books about sound apparatus that go into considerable detail about the wiring and connections of the more common makes and types of theatre equipment.

When all these possible sources of information have been exhausted, and there still remain some points to clear up, then there is no other resource but to trace out circuits precisely as one would with a home-made radio receiver brought in for repairs. That must be done on a basis of sound and thorough general knowledge of what theatre equipment is all about. If the Service Man does not feel perfectly certain of his background in A.F. amplifiers, photoelectric cells, microphones, phonograph pickups, switch keys, volume control potentiometers (including ladder, L, T and H pads), and elementary electrical theory in general, he should improve his background before tackling a sound system or he won't know what the apparatus is all about when he looks at it, or a drawing of it. Assuming that background (which, as said at the beginning of this series, is as-

# See the new 4-TUBE ALL-WAVE in the

## REMARKABLE New CATALOG OF SENSATIONAL RADIO VALUES BY FORDSON

It operates on any current, any where—home, car, boat, farm, foreign. Only in our new catalog is this set available and completely described. Try it for 30 days FREE. Get this catalog of Fordson guaranteed Radios at rock-bottom prices. Many models: AC-DC; dual wave; all-wave; 6 & 32 volt; approved Air Cell battery sets; consoles. Wonderful new 6-Tube Auto Radio! Thousands of enthusiastic owners. All newest features. \$9.45 up

ANY SET  
30-DAY  
FREE TRIAL

**FREE** Send today! New catalog sent free. Shows what you want in radio at amazingly low prices. Direct and save up to 50%.



**MAKE MONEY**—Our agents without previous experience make real money selling Fordson guaranteed Radios. Free samples. Write!

**FORDSON RADIO, INC.**  
Dept. 5-38, Robt. Oakman Bldg.,  
Detroit, Mich.

Send me free catalog and agent's proposition. (This is not an order.)

NAME .....  
ADDRESS .....  
CITY ..... STATE .....

## CLAROSTAT

since 1920 The Profit Line

Replacement Volume and Tone Controls  
Standard Volume and Tone Controls  
with an Ad-A-Switch consisting of  
wire wound (Series "W"), composition  
element (Series "C")

Replacement Line Ballasts  
Automatic Line Voltage Regulators  
Flexible Pig Tail Resistors  
Center Tap Resistors  
"L" Pads, "T" Pads, Series Mixers



Clarostat Ad-A-Switch Controls



Clarostat  
Line  
Ballast

Clarostat Ad-A-Switch line  
comprises the maximum utility  
with minimum stock investment.

Write for New Replacement  
Control Guide

**Clarostat Mfg. Co., Inc.**  
287 N. 6th St., Brooklyn, N. Y.

sumed in the case of the readers! The Service Man is faced with the job of collecting all the information he possibly can from the sources just mentioned, and then using his own eyes, hands and meters in the projection room to find out as much more as he needs to know about any particular circuit that is causing trouble.

(In tracing trouble in a sound system you begin by isolating the circuit or panel that is causing it; you don't tear the whole system apart. The method of isolation is described later on.)

### How to Service Sound Equipment

**Servicing**—a special function—must be distinguished from **operating**—the day by day routine. Now, these two functions overlap. Inspection is one detail of servicing, but it is also a detail of operating. If the projectionist is accustomed to careful daily, weekly or monthly inspection of his equipment, servicing would necessitate a semi-annual inspection at the most. If the projectionist performs only a perfunctory daily or weekly inspection, weekly or monthly examination of the equipment assume the status of a service detail. The same reasoning applies to repairs. If the projectionist is accustomed to finding and soldering a chance loose connection, servicing as such may be restricted to more serious troubles; in other theatres it may include even replacing a worn-out tube. In nearly every case, however, improvements to the sound equipment, addition of voltage control or power supply panels, extension of the range of frequency response, and so on, are service rather than operating matters.

**Inspection**—To be thorough, inspection is best carried out with the help of a pre-arranged form, covering every detail of the apparatus that needs examination. Such forms can be typewritten and, if desired, mimeographed. For "political" reasons, inspection responsibilities may advantageously be divided with the projectionist, leaving him the mechanical and the Service Man the electrical sections of the apparatus.

The Service Man will find it helpful to himself, helpful in doing a good job and in sparing him headaches, to make out an inspection form for every sound system he studies at the time he studies it. Such a form, together with other notes made at the time, will avoid possibility of confusing one theatre's arrangements with another's.

Among matters to be ascertained in the course of studying any system are correct meter readings, and normal voltages and currents at the terminals of the different panels. The projectionist will know what the meters should read, and the panel binding posts are often marked, as, "750 V. line; 350 V. line," etc. Where such markings are not shown, and the data is not within the knowledge of the projectionist nor covered in drawings or other information accompanying the system or obtainable from the manufacturer, a few test-meter readings noted down when everything is operating normally will be of great help later on in time of trouble, and always useful in the course of inspection.

Such routine but vital matters as focusing the exciter lamp, lining up the optical assembly, or testing take-up tension, together with a host of others, cannot be covered in detail here for lack of space. Full information concerning them is available in books on the subject, and the projectionist will know about them, too.

**Repair**—Trouble is isolated, then repaired. A preliminary step of isolation is applied by the projectionist, which is to examine all meter readings and check all signal lamps. Next, different parts of the system are tested. The theatre has two projectors. See if the trouble appears on both, or is confined to one. If it is not so confined, it exists in neither, but in some part of the system common to both sources of sound. If there are two amplifying channels, see if the trouble shows up on both. If there is one amplifying channel, consisting of more than one amplifier, jump one, if possible; if not, listen to the output of each with headphones. Such procedure, which isolates the trouble rapidly and unmistakably to some one panel, or to some one connecting line between panels, applies not only to complete loss of sound, but to poor quality, to noises and hums, and even to loss of volume if experience makes a headphone search for volume useful. However, if

the trouble-shooter is not familiar with what the volume from any one panel ought to be, his headphone tests may prove of doubtful value.

Some troubles are isolated and defined merely by listening to them. Many noises come under this category. The experienced ear recognizes flutter, sprocket-hole noise, and so on, as soon as they are heard. The Service Man, until he himself acquires more experience, will find the experienced projectionist of the greatest help in identifying many troubles merely by the sound of them.

The trouble having been isolated to some one part of the equipment, or to some one connecting line, that part or line is searched for the precise difficulty in just the same way a radio receiver or any electrical circuit is searched for trouble. Wherever possible, they are jumped or replaced in advance of such search, to save time in restoring the show.

The essentials of theatre repairs are good general background, detailed knowledge of the system under inspection if possible (but this is not indispensable since it can be acquired in the course of trouble-shooting, with some sacrifice of time), systematic and orderly procedure, and a cool head.

It is extremely helpful, in studying any sound system, to plan just how to look for and find troubles of various kinds. A skeleton trouble-shooting routine, drawn up in advance, will save invaluable time while an audience is waiting, and in every way enable the Service Man to do a far more competent job.

### How to Obtain Parts and Supplies

The radio man should find it profitable to sell supplies to the theatre, and if he is doing repairs he must be able to find replacement parts when the repair requires them. Some sound systems are so like radio apparatus that the parts in question, and their sources of supply, will be familiar at a glance to any radio man. Some sound systems do not use radio-type equipment. In such cases tubes and all other parts can always be bought from the manufacturer of the equipment, and very often, but not always, from independent suppliers. How to find the independent suppliers? Well, some companies advertise that they make this type tube, or that type gear, for such-and-such make system. Their salesmen or sales literature will have reached the theatre manager and the projectionist; or, the Service Man may write inquiries to the appropriate magazine, which will be able to direct him to sources of supply.

Again, some parts, although not specifically designed for such-and-such make of sound equipment, will fit that equipment. All that is necessary is to know the specifications of the part to be replaced. The specifications of all makes and types of tubes are public property and have been printed many times. The capacity and voltage limits of a condenser are often printed or stamped upon its case, or sometimes are shown on the manufacturer's blue-print accompanying the amplifier in which that condenser was used. Transformer and inductance specifications are less easy to obtain, but it should always prove helpful to write to a half-dozen transformer manufacturers and ask if they can supply an interchangeable unit; for example: to replace the 7-A autotransformer in a Western Electric type 200-A speaker impedance-matching panel. The inquiries very often will result in opening a new source of supply. Few if any sound manufacturers make all the parts used in their apparatus. The parts may bear their name plates, but not infrequently are made to specification by some well-known manufacturer of transformers, condensers, etc. This is true even of the largest and best-known sound systems.

Where a part is needed for emergency replacement, and the specifications are not known, not marked on the part, and not shown on any manufacturer's data, they can always be found if the panel or box in trouble is duplicated in the projection room. Any apparatus associated with either projector of course exists in duplicate—there are often two amplifying channels, and very often more than one speaker. By applying the usual electrical measurements for resistance, impedance at 1000 cycles, inductance, capacity, etc., to the duplicate part, the Service Man will know precisely what he needs in the way of replacement. But not all Service Men are

equipped to measure 1000 cycle impedance, inductance or even capacity. Where the specifications cannot be measured, or where no duplicate part exists to measure (the bad one being burned out or otherwise so defective as to be useless as a standard), there is no remedy but to "haywire" repairs, and wait for a replacement from the system's manufacturer, or from some source of supply the Service Man has investigated and lined up in advance of the emergency.

If the part needed is one that is commonly kept in spare stock in the theatre, such as a tube, exciting lamp or photoelectric cell, inquiry among neighboring theatres that may have similar sound equipment should uncover a spare that can perhaps be borrowed until the regular replacement arrives.

In extreme cases, it may be necessary to install temporarily an emergency amplifier, speaker or volume control, matching impedances if at all possible, until replacements are received, and this is one of the greatest services the radio man can render a theatre, since he has such equipment on hand, and no one else in the community is at all likely to have it.

#### What Should the Radio Man Charge the Theatre?

What price should the radio man set on the supplies he sells, or on the service he renders?

He can find out what the theatre has been paying for both, and what both will cost him, and set a price sufficiently low to be really attractive to the manager, yet high enough to be decidedly profitable to himself. In the case of a very large number of theatres he will find this possible without any very close figuring; in the case of some he will have to figure and shave with greater care; he will find a few theatres with which it will not be profitable to deal. Mostly, these will be houses in which the projectionist has already taken over the functions here recommended to the Service Man. In the case of such theatres, the radio man is limited to the value of his spare parts inventory (as being always available), and of his test meters (which are commonly not part of projection room equipment); and, to the P.A. systems and hearing aids which were mentioned in the previous article; and to the improvements in the sound system mentioned below.

#### Improvements in the Apparatus

Most theatres that need line-voltage controls (and this includes perhaps the majority of American theatres) don't have them; many theatres still use storage batteries and should replace them; the great majority of theatres still cannot reproduce sound frequencies below 50 or above 5,000 cycles (and many cannot do that well). Unless a sound system is very new, there is probably room in it for improvement, and the manager has doubtless been approached by salesmen or sales literature seeking to sell him improvements. The radio man who has become thoroughly familiar with sound equipment, and who has won the confidence of the manager and projectionist, can sell such improvements much more easily than can a circular coming through the mails, or even a visiting salesman. He will find his sources of supply in the same way he finds all sources of sound supply—a matter covered a few paragraphs back. And, because of the above, he must always keep in sufficiently close touch with the industry to know what improvements are matters of current interest.

#### Existing Contracts

In not a few theatres (not the majority, but a fair percentage) the Service Man may find a contract arrangement for service and parts, entered into with the manufacturer of the sound system.

Anyone can now sell parts to American theatres. A larger number of theatres, although they can buy parts from the radio man, are still under contract for service, and will not pay twice for it. In the case of such theatres, as mentioned earlier in this series, the radio man must pay himself for any services he may render by the profits of his parts business with the theatre.

In practice, even though a theatre is under contract for service, and paying for it, anyone can service the equipment.

Many theatre chains employ sound engineers for this purpose, and some do all their own servicing in spite of the fact that they



## YOU'LL PAY FOR IT—WHETHER YOU BUY IT OR NOT!

The New Model IRC DUAL RESISTANCE INDICATOR is one of those instruments that every serviceman and amateur *wants it to himself to own*. It will increase your efficiency—make you money by saving your time—and it will mean better business by insuring better work.

Of course you can get along without one. But the time and effort you waste through not having one may mean many times the \$2.70 that the Indicator costs. It is a real money-saving investment.

Just connect the Indicator in place of ANY questionable resistor. Move the ball-bearing slider until proper rating



\$2.70 NET TO SERVICEMEN  
List \$4.50

**Fuse Protected**—This new IRC DUAL RESISTANCE INDICATOR is fuse-protected. Thus, a frequent source of Indicator failures is eliminated, the fuse protecting resistance strips from damage caused by accidental overloads. Indicator may also be used as a calibrated rheostat, variable resistor, potentiometer, temporary standard resistor, voltage divider, etc. Sold by leading jobbers. Don't miss it!

*You'll Use it More Than Any Tool in Your Kit*

INTERNATIONAL RESISTANCE CO.

2100 ARCH STREET

PHILADELPHIA, PA.

(In Canada, 74 Wellington St. W., Toronto, Ont.)

• A NEW PRODUCT BY THE MAKERS OF IRC RESISTORS •

# PUBLIC ADDRESS

Special for May Only!



"BF" Microphone 2-Button, Heavy Duty, Chromium Plated Microphone, similar in appearance and performance to mikes listing at \$25.00. Size 3 1/2" x 2 1/4". Wt. 1 1/2 lbs.

\$11.00

Lists at .....



ED5 Desk Stand, High luster Chrome Finish, 7 1/2" high, 6" Ring

\$2.45

Lists at .....



P10—C25 Amplifier, 3 1/2 Watt self contained for mike and phone input. Incorporated volume control, 8" electro dynamic speaker. Beautiful leatherette case. Size 18" x 18" x 8"

\$26.00

Lists at .....

THE ABOVE THREE ITEMS COMPLETE WITH 25 FT. OF MIKE CABLE, 8 MIKE SPRINGS, AND TUBES, READY FOR OPERATION

SPECIAL NET PRICE \$34.80

20% with order, shipped C. O. D.

Send 3c for 1934 catalogue listing hundreds of items of public address equipment

RADIO AND AMPLIFIER LABORATORIES

291 EAST 137th STREET

NEW YORK, N. Y.

## FREE 1934 WHOLESALE RADIO CATALOG

Radio Replacement Parts, Sets, Tubes and Electrical Appliances at great savings.

WholesaleMerchandisers, Inc.

626 C. Broadway - New York City

**3 1/2 yrs FREE SERVICE**

Send post card for catalog of NEW remarkable CRESTONE RADIOS. Buy direct from us! 30 day FREE TRIAL. Money refunded if not satisfied.

AGENTS WANTED. Make money, demonstrate and sell in your own home. No experience needed, these radios sell themselves.

CRESTONE RADIO MFG. CO. 1454 BROADWAY DETROIT MICH.

# WEBSTER CHICAGO

## Three-Stage 3-Watt Microphone and Phonograph Amplifier



Type S A 2

Provides Microphone Current  
Master Gain Control  
Is Completely Enclosed  
SEND FOR BULLETIN!

**The Webster Company**  
3830 WEST LAKE ST., CHICAGO, ILL.

THE WEBSTER CO. Use This Coupon  
3830 W. Lake St., Chicago, Ill.

Gentlemen:—I am a [ ] Dealer, [ ] Serviceman,  
[ ] P.A. Specialist and want all information on your  
S.A.2 Amplifiers.

Name .....  
Address .....  
City ..... State .....

# RADIO for 1934

NO SERVICEMAN DEALER  
OR SET BUILDER CAN AFFORD  
TO BE WITHOUT THIS BOOK

Send for the most valuable book in Radio. Packed with quality and value. Lists the most complete line of radio replacement parts for any service requirement.



Features latest type set-building kits, test instruments, Long and Short Wave Radios, Sound Systems, etc.

Write for this Catalog today!

# FREE

## ALLIED RADIO CORP.,

Dept. D, 833 W. Jackson Blvd.  
Chicago, Illinois.  
Please send me FREE your New 1934 Radio Book.

Name .....  
Address .....  
City ..... State .....

# Allied Radio

are paying the electrical manufacturer for service—they pay for it, but do not use it. Other theatre chains pay for it, use it to some extent, and to some extent supplement it by the efforts of their own employees. Still others rely upon the manufacturer entirely.\*

The radio man is free (at least, if the precedent of these leaders of theatre industry is any guide) to do anything to any sound system the manager and the projectionist will allow him to do, regardless of other contracts. The point is stressed here because a number of readers have inquired about it. Such contracts limit the Service Man only this far—that if the theatre is already paying a service charge he may have to compensate himself, in part or entirely, by selling parts, as just said. But he should remember that these servicing contracts expire at some time unless renewed. What the theatre people will see fit to do about renewing them should depend to a very large extent upon how much of their confidence and respect the Service Man has won by the service he rendered in return for the privilege of selling them supplies. In a few theatres—less than 10% of all American theatres—contracts existing limit the parts a theatre will buy from the Service Man to certain items.

But in the majority of existing theatres the Service Man will find no hindrances of any kind whatever, if he can give the theatre what it wants—good parts and reliable service at smaller cost than it is accustomed to paying.

\* Among the larger theatre chains paying for manufacturer service but doing their own servicing in part or entirely are Paramount, Warner, Fox and Loew.

# MORE SUMMER SALES IN RADIO

(Continued from page 661)

Pottstown Press, which consented to print the QSL cards, we inserted a news item about the contest in the Pottstown Courier which was to be printed the following Monday.

I consented to work in the Jones establishment that day. During the afternoon we distributed some fifty of the mimeographed sheets and in the evening we handed out fifty more. Very carefully we explained the rules and Mr. Jones was agreeably surprised when I sold a complete set of tubes to an old settler who "liked to putter around the radio" and thought he might have a chance in the contest.

During the following week we worked up another slant on the contest. In the window we placed an abandoned Ford gas tank with a funnel in the funnel pipe and a pail of water beside it. A sign bore the words—"You can't run your car on water!" On the opposite side of the window we showed a radio with a very poorly constructed aerial cutting across the front window. For this aerial we used some very corroded wire, and a pair of insulators covered with grease and grime. The radio bore the sign "Run your car on good gasoline—your radio on a good aerial."

## "The Aerial Makes a Difference"

A small show-card in the center of the window bore the words:

"The Aerial makes a difference. Ask us."

We mimeographed some sheets that explained how bare copper wire corrodes within a few months and loses considerable of its efficiency. The statement also mentioned the fact that a majority of aeriels had been installed some years before and were, for the most part, of very little value in actual reception.

The last paragraph of this sheet read:

"Authorities agree that enameled copper wire, size 14 to 12, is the best to use for a broadcast aerial. Insulators should be of glazed porcelain, or pyrex glass, and two should be used at each end of the aerial. Transposed feeder aeriels, developed within the past year, are slightly more expensive, but are a great deal more efficient where sensitivity is an important factor.

"During the period of the Jones DX Contest, we are making a special offer to our friends. Modernize your old aerial, give your present set a boost, by installing a new aerial. "L" type aeriels can be installed for as low as \$2.00. Lynch or Philco aerial prices are slightly higher. If you prefer to install your own, parts are available at our establishment."

Friends began to drop in after that stunt. Our window display had attracted considerable attention and our little explanatory notes on aeriels were nearly exhausted by the following Saturday. At my suggestion Mr. Jones posted a small bulletin board in the window with notes like the following:

"J. B. Stiles of Prospect Street heard KFI—Los Angeles, Wednesday night on an At-water-Kent."

After a few days of posting these notices we obtained a blackboard and wrote the reception noted on it in chalk.

Unfortunately I left town—my vacation was over—before the September contest ended. However, I received a letter from Mr. Jones during the last of October. It read, in part, as follows:

"Doctor Nash won the September contest. His log contained reports from six West Coast stations, two stations in Salt Lake City, one in Idaho, one in Calgary and six stations in Texas, besides XER in Mexico. I presented him with the General Electric last week but he wouldn't part with the old set that he used. Fred Hampton won the special prize (a set of tubes) for the furthest station reported by logging a station in Long Beach, Cal. Three people won aerial installations for logging the most New York stations.

"I am more than satisfied and intend to continue the contest indefinitely, with a grand prize for the best record for the year. I probably will award some very high priced set for if business improves as I had I can afford it. In the first contest I sold, during the

# "TELEPHOTOPHONE"

(Continued from page 663)

Light from a bright source such as a carbon arc running on D.C. or an automobile headlight bulb is focused upon the slit of the light-gate. Variations in width of the slit cause corresponding variations in the transmitted intensity of the light. The slit is placed at the focus of another lens, or at the focus of a parabolic mirror, so that a narrow beam of light is transmitted across space to the receiving photoelectric tube. For moderate distances, this tube may receive the light from the source without a reflector; but for longer distances it is necessary to collect a larger amount of the original light beam to bring the signal strength up. The photo-cell is connected to a high-gain A.F. amplifier which turns the variations of feeble current from the photo-cell into audible signals in the loudspeaker.

The author has used the gate over one thousand feet without any parabolic reflector for the photo-cell. Some idea of the effectiveness of this type of light gate may be had from the fact that audible signals were detected at this distance by intercepting less than one-thousandth of the original light coming from the gate. With an improved optical system and a parabolic reflector at the receiving end, it should not be difficult to extend the range to several miles.

The simplicity of this type of light gate makes it peculiarly adapted to demonstration work, for the student can readily see the actual part played by the changing slit in modifying the light, whereas the neon glow tube conveys no such definite idea and shrouds the method of communication in greater mystery. For lecture room purposes, an ordinary automobile headlight bulb is sufficient for sending strong signals over distances of a hundred feet, from one end of a building to another.

The author has used sunlight for the transmission of signals, focusing the light of the sun directly on the slit of the apparatus by means of a heliostat and lens system. The intensity thus acquired is enormous and enables one to extend the distances traversed by the beam to great lengths. In fact, this type of gate allows the use of far greater intensity signals than are possible from neon glow tubes, with a corresponding increase in range of this type of point-to-point communication across space.

(The heliostat is an instrument consisting principally of a mirror and clockwork mechanism to focus sunlight in a fixed direction).



period, some four hundred tubes, six receivers, and Jerry (the youngster who installed aeri-als) was kept busy from morning to night for the whole month and is still going strong. We have replaced nearly one hundred aeri-als in town. . . . I was compelled to add a Service Man, hired in Syracuse."

During October Mr. Jones uncovered another kink. The contest that month was won by an old farmer who lived six or seven miles from town, who used a battery model Grebe Synchronphase. Mr. Jones was a bit dismayed at this and asked me what slant he could take on this winning. I suggested selling battery sets to farmers—most of the farms either make their own electricity or use kero-sene for lighting. As a result he sold ten battery receivers in the territory.

His "reclaimed set" department is doing very well. A great many of the older model sets have figured prominently in the contest and as a result the old sets taken in trade move rapidly. With the advent of short-wave attachments Mr. Jones has offered a special prize for short-wave acknowledgements.

To cut this story short, Mr. Jones is making money. At the close of the year he figured his profits more than two hundred per cent above 1932 and they're still on the upward trend. Any Service Man or radio dealer can appreciate that item. It purely and simply indicates that what the radio business needs is more salesmanship and less "order taking."

## VOLTAGE DOUBLING TUBE

(Continued from page 666)

These condensers must have the same value for minimum ripple. The information obtained is only approximate because the curves are not perfectly straight lines. It is usually good to better than 5%.

The filtration incident to the use of these condensers ( $C_1$  and  $C_2$ ) is very effective. The total capacity from output plus to minus is of course one-half that of  $C_1$  or  $C_2$  alone, that is if  $C_1$  and  $C_2$  are 16 mf. each; in addition to supplying a voltage doubling circuit they will have an 8 mf. filter value. Condenser  $C_3$  may or may not be used as desired. It is not essential. The output filter condenser  $C_4$  however is recommended.

### Other Applications of the 25Z5 Tube

Figure 2 illustrates its use as a combination power-speaker supply for A.C. and D.C. lines. For A.C. use, the input current is half-wave rectified and for D.C. the plate circuits of the tube are simply used as low-value resistors completing their respective circuits. With a continuous voltage applied, a continuous current will flow in these plate circuits.

Although a filter system required for D.C. alone need not be as complete in the way of high values of elements it must be effective as there is usually some line ripple. While more than adequate for D.C. its efficiency is high, thus requiring no changes in the circuit at all for A.C. or D.C. use.

In some cases the plates are tied together (see Fig. 3) and the cathodes are also tied together using both plate-cathode circuits in parallel as a half-wave rectifier. Inasmuch as there are several half-wave rectifiers having rectifying characteristics just as desirable as the 25Z5 with but one plate and one cathode, we may wonder why the 25Z5 should be used in this way.

The filament characteristics of the tube give us the answer. With this high voltage filament electrical power which would ordinarily be wasted in a "cordohm" or power resistor is made useful and the efficiency of the set is greatly improved.

Several manufacturers have provided switching systems so that in one operation the circuit in Fig. 2 may be changed into that of Fig. 1. Having a higher voltage for A.C., the receiver employing such a circuit will usually operate much better on A.C. This connection is considered better than the universal use as in Fig. 3 alone because full advantage is taken of the A.C. available. The circuit in Fig. 3 is less expensive and entirely fool-proof.

NATIONAL UNION TUBES  
 .. excellent performance .. give  
 satisfactory service .. we make  
 full margin of profit on all  
 tubes sold .. have satisfied  
 National Union users

## Service Men!

National Union policies are vital to you. The objectives of National Union, in addition to producing the finest radio tubes that science can devise are to aid and assist the serviceman in building a better and more profitable business for himself. You can't afford to ignore these policies:

**PROFIT:** 10 Cent Higher List Prices . . . Highest profit margin on your tube sales.

**SERVICE AIDS:** Charts, Data, Information at no cost . . . Cannot be duplicated from any other single source.

**SUPERIOR QUALITY:** Strict adherence to closer manufacturing limits makes National Union tubes consistently superior.

**FULL LIST PRICES - GOOD WILL:** Sold everywhere at full list price . . . no need to fear customer ill-will.

**FREE SHOP EQUIPMENT:** Testers, Analyzers, Service Manuals and Service Tools given with National Union tube purchases. Alert dealers everywhere are equipping themselves this easy way. Don't delay, write for full details about National Union free shop equipment.

**National Union Jobber Stocks Are Complete.**



WALTER BIEHLE, Manager,  
Perryville Electric Company.

NATIONAL UNION RADIO CORPORATION OF N. Y., 400 MADISON AVE. N. Y. C. RC-5  
 Send me details about free shop equipment.

Name .....  
 Street .....  
 City ..... State .....



## A New Kind of Short-Wave Radio the SKY-RIDER Another FIRST by the HALLICRAFTERS



This set is NOT with Byrd  
 —but it brings Little America  
 to Capt. Bartlett daily

Though the HALLICRAFTERS SKY-RIDER had not been released from its intensive laboratory and field tests before the Byrd Expedition sailed, it is serving to keep Capt. Bartlett, the highest ranking survivor of Admiral

Peary's famous dash to the Pole, in constant daily touch with his friends at Little America. You, too, can have the thrill of hearing Little America direct if you own the new SKY-RIDER Short-Wave Receiver.

An all-wave receiver development that makes possible the most dependable short-wave reception ever known.

A new circuit employing entirely different units and construction. Offered at lower cost than any other modern short-wave receiver.

No other receiver, regardless of price, offers all these features:

Low-loss wave change switch, modified band spread, 200 to 12 meter tuning range divided into 4 bands, micro-vernier tuning control, 18 to 1 ratio, dual gain controls—and many more, all described in the new HALLICRAFTERS "SKY-RIDER" booklet. Write for your copy today!

SKY-RIDER Receiver, with dynamic speaker and power pack, 5 tubes. Net to dealers and servicemen, \$39.95.

Mail Coupon Today  
 SILVER-MARSHALL MFG. CO.,  
 417 N. State St., Chicago, U. S. A.

Dept. A Name ..... Address .....

# HOW TO BUILD, TEST AND REPAIR RADIO SETS



## Radio Construction Library

Including Television, Short-Wave Receivers and Auto Radios. 3 Volumes, 6x9—1177 pages, 561 illustrations. This practical Library includes: PRACTICAL RADIO—The fundamental principles of radio, presented in an understandable manner. Illustrated with working diagrams. PRACTICAL RADIO CONSTRUCTION AND REPAIR—Methods of locating trouble and reception faults and making workmanlike repairs. Discusses modern Short-Wave Receivers and installation of automobile radios fully. RADIO RECEIVING TUBE—Principles underlying the operation of all vacuum tubes and their use in reception, remote control and precision measurements. Helps you to understand modern type receiving sets—full of construction data and practical kinks for the experimenter—a training course for service men.

10 Days' Free Examination  
Easy Terms

McGraw-Hill

### FREE EXAMINATION COUPON

McGraw-Hill Book Company, Inc.,  
330 W. 42nd St., New York.

Gentlemen—Send me the new RADIO CONSTRUCTION LIBRARY, all charges prepaid, for 10 days' Free Examination. If satisfactory I will send \$1.50 in 10 days, and \$2.00 a month until \$7.50 has been paid. If not wanted I will return the books.

Name .....

Home Address .....

City and State .....

Position .....

Name of Company.....RC-5-34

# THE NEW Model E 36 TUBE TESTER

Read these excellent features which give complete details about the new Model 36 Tube Tester.

- (1) Direct Reading.
- (2) Mutual conductance test.
- (3) Line voltage regulation both Plate and Filament on separate A.C. meter.
- (4) No obsolescence due to new 36 point, 6 pole rotary switch—Provisions for new sockets.
- (5) Complete short test of all elements. Diode test—cathode leakage test.
- (6) Rapid and accurate.
- (7) Filament voltage range for all tubes.
- (8) Portable, hand some leatherette covered case.



DEALERS NET PRICE \$37.50

Sold on 10 day trial or money refunded.  
Circular on request.

L & L ELECTRIC COMPANY

Dept. 8-A  
338 MADISON AVE. MEMPHIS, TENN.

# SAFE Resistors! TRUVOLTS

Have 1,000-Volt Insulation

Also patented spiral, air-cooled winding, with adjustable, sliding clips, and full-length protective fibre guard. All standard sizes.

Write for New Catalog RC-5

175 Varick St., New York, N.Y.  
**ELECTRAD**

# ALL-WAVE SUPER

(Continued from page 668)

bypassing part of the signal to ground and reducing the signal input into this circuit. In this position the R.F. and I.F. tubes are operated at a high negative bias to reduce their amplification. In the "out" or distance position, the bias voltage is reduced.

## Explanation of Range Switch

The range switch consists of eight independent switch sections, each section being provided with five contacts. Only seven sections of the eight, and only four contacts of the five per section are used.

In the circuit diagram these different switch sections are labelled 1R, 1L, 2R, etc., and for the sake of simplicity are shown in different locations in the diagram, although they are all parts of the master range switch assembly located in the center of the chassis. With the chassis bottom-side up and controls pointing toward you, 1R is the front right hand section, 1L is the front left hand section, 2R is the second right hand section counting from the front of the chassis, and so on.

As the range switch is rotated in a clockwise direction the following circuit changes are effected.

**Position 1.** Switch 1L grounds the aerial, preventing any reception.

**Position 2.** Broadcast Band. In this position switch 2R biases the short-wave oscillator to stop it from oscillating so that the short-wave section cannot cause interference when receiving stations on the broadcast band. Switch 1L connects the aerial to the primary of the R.F. coil. Switch 3L connects the third section of the variable condenser gang across the secondary of the R.F. coil. Switch 4L connects the fifth section of the variable condenser gang across the secondary of the first-detector coil. Switch 4R connects the fourth section of the variable condenser gang across the secondary of the broadcast oscillator coil. Switch 1R is open.

**Position 3.** 185 to 78 Meter Short-Wave Band. In this position switch 1L connects the aerial to one of the two primaries of the short-wave detector. Switch 3L connects the output of the short-wave detector to the secondary of the R.F. coil, and also connects an adjustable trimmer condenser across the secondary of this coil to tune it to 1,540 kc. Switch 4L connects an adjustable trimmer across the secondary of the first-detector coil to tune it to 1,540 kc. Switch 4R connects a variable trimmer across the secondary of the broadcast oscillator to tune it to 1,717.5 kc, thus giving an I.F. of 177.5 kc. Switch 1R connects an adjustable padding circuit in series with the secondary of the short-wave oscillator coil, thus permitting proper tracking of this circuit in this short-wave band.

**Position 4.** 80 to 33 Meter Short-Wave Band. In this position switch 1L connects the aerial to the second of the two primaries of the short-wave detector coil. Switch 2L shorts out a portion of the secondary of the short-wave detector coil, thus enabling it to tune to the 80 to 33 meter band. Connections to switches 3L, 4R, and 4L remain the same as in position 3, tuning the R.F. section to 1,540 kc. Switch 1R connects a different adjustable padding circuit in series with the secondary of the short-wave oscillator coil, thus permitting proper tracking of this circuit in this short-wave band. Switch 2R shorts out part of the secondary of the short-wave oscillator coil so that it will tune to wavelengths between 80 and 33 meters.

**Position 5.** 33 to 14.5 Meter Short-Wave Band. In this position switch 1L connects the aerial through a tap to the second primary of the short-wave detector coil. Switch 2L shorts out a larger section of the secondary of the short-wave detector coil so that this circuit can be tuned from 33 to 14.5 meters.

Connections made by switches 3L, 4L and 4R remain as in positions 3 and 4 since three points on each switch are connected together. Switch 1R connects a non-adjustable padding circuit in series with the secondary of the short-wave oscillator coil. Switch 2R shorts out another portion of the secondary of the short-wave oscillator coil, thus permitting this tuned circuit to cover the 33 to 14.5 meter band.

# WATCH OUT

FOR NEXT MONTH'S FULL PAGE AD COMPLETELY DESCRIBING NEW TEST ACCESSORIES

A COMPLETE SYSTEMATIZED LINE OF Improved Laboratory Sockets, Tip Jacks, Connectors and Plugs, Expanding Pressure Plugs, Jacks and Connectors, Extension and Junction Connectors, Test Probs, Universal Terminal Sockets, etc.

New Molded Handles in three styles: Small Space-Side Contact and Long or Short Testing, all interchangeable with the pointed Phone Tips, Expanding Pressure Plugs and Silver Plated Needle Points. Sockets with Universal Terminals for soldering, binding, plug-in and tap-off connections.

Why be handicapped with an ancient analyzer when in two hours you can easily modernize it with one of these kits and a pair of composite sockets? Directions and diagrams included with all outfits.

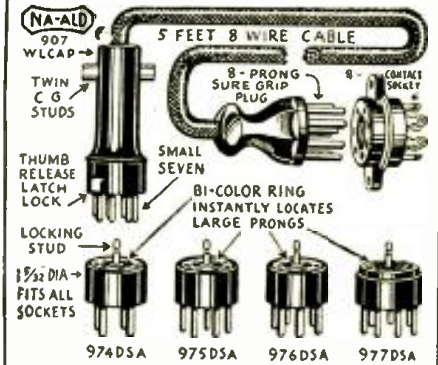

| 907WLCAP Small 7 prong Latch Lock Analyzer Plug, 8-wire Cable, Plug and Socket as shown above | List Price |
|---|------------|
| 974DSA Latch 7 to 4 prong Adapter   | 1.25       |
| 975DSA Latch 7 to 5 prong Adapter   | 1.25       |
| 976DSA Latch 7 to 6 prong Adapter   | 1.25       |
| 977DSA Latch 7 to 7 prong large Adapter   | 1.25       |

Here is the set for those who want the lowest possible cost. Does not have means for locking the adapters to the plug but is serviceable in every way, the wired adapters having the necessary small base for fitting shielded sockets. C. G. stud supplied.

| 877P 7-prong Plain-Type Analyzer Plug | List Price |
|---------------------------------------|------------|
| 974W 7 to 4-prong Wired Adapter       | .65        |
| 975W 7 to 5-prong Wired Adapter       | .65        |
| 976W 7 to 6-prong Wired Adapter       | .65        |
| 977WA 7 to 7A-prong Adapter           | .65        |
| 877P KIT Complete as shown            | \$2.00     |

| SERVICEMEN'S REQUIREMENTS  | List Price |
|--|------------|
| 8-wire Analyzer Cable as shown above   | \$10.10    |
| 456 4-5-6-contact Composite Socket   | .50 ea.    |
| 477 7-7A-contact Composite Socket  | .50 ea.    |
| 457 5-7-contact Composite Socket   | .50 ea.    |
| 567A 5-6-7A-contact Composite Socket   | .50 ea.    |
| 988S 8-prong Plug as shown above   | .50 ea.    |
| 438S 8-prong Socket as shown above   | .35 ea.    |
| 967DSA 6-hole to 5H, 7 Latch Adapter   | 1.25 ea.   |
| 955PSC Speaker-Phones Switching Adapter 2.50 ea.                                 |            |
| See page 522 March and page 606 April issues                                     |            |
| 450 50-watt Transmuting Tube Socket  | 1.00 ea.   |
| UX-50 50-watt to UX-base Adapter   | 3.50 ea.   |
| 50-7AS 50-watt to 50-watt Latch Adapter  | 3.50 ea.   |
| 950XYLA 120-in-1 Tubechecker Adapter   | 6.00 ea.   |
| 950TR Transformer Adapter for checking 10-12.4-14-17-25-30 volt tubes in 24 skt. | 6.00 ea.   |
| Laboratory Style Sockets 4-5-6-7-A holes   | .35 ea.    |
| Rubber Handle Plugs 4-5-6-7-A prongs   | .25 ea.    |
| Rubber Handle Connectors 4-5-6-7-A holes   | .40 ea.    |
| Sure-Grip 2-piece Molded Plug any no. pins                                       | .35 ea.    |
| Sure-Grip 2-piece Mold. Conn. any no. holes                                      | .50 ea.    |

**HERE'S THE DATA YOU WANT**  
Send two 3c stamps for new booklet showing illustrated tube socket connections of 268 different tubes, data and diagrams on rewiring any obsolete set analyzer or tube checker and information on using the new tubes in place of old types. Include catalog pages of all kinds of sockets, speaker plugs, connectors, wound and unwound coil forms, coil winding data, S-W receiver references, etc.

Servicemen's Discount 35%  
On orders amounting to \$10.00 List. 40%

**NA-ALD ALDEN PRODUCTS CO.**  
Dept. R-5, 715 Center St.  
BROCKTON, MASS.

**SERVICEMEN!**  
THE MOST COMPLETE LINE OF CONDENSERS AND RESISTORS FOR EVERY RADIO USE  
Write for our new 10-page Catalog folder free of charge

**AEROVOX CORPORATION**  
76 Washington Street Brooklyn, N. Y.

## SHORT CUTS

(Continued from page 673)

denser—needle perfectly still at maximum scale deflection; shorted condenser—needle kicks to zero and remains there; intermittent-contact or leaky condenser—needle kicks to zero, then climbs back to a fraction of the maximum scale value; good condenser—needle kicks to zero, then returns to a  $\frac{3}{4}$ -scale reading (on small condensers, the needle may only dip and then return to maximum scale reading—this will be determined mainly by the particular resistance value selected for R). The range of meter M will depend upon the tube selected; the actual reading in *milli-amperes* has nothing to do with the instrument in operation.

### A HOME-MADE OUTPUT AND CAPACITY METER

D. W. Pickett

IN FIG. 3 is illustrated a simple circuit for using that old D.C. voltmeter. The rectifier used by the writer was a dry-disc unit which would not function as a rectifier on a trickle charger. The meter and rectifier polarities must match as indicated.

For operation as an output meter connect the instrument across the voice coil or, by means of adapters from plate-to-plate or plate-to-ground, of the output tube circuit.

(Experimenters may be interested to know that the device may be connected across the secondary of an A.F. transformer, the primary of which is connected to a 110 V. A.C. supply, through a small series condenser, for checking transformers that seem to have noise due to an open primary winding that does not check open when testing with a continuity tester.)

To check condenser capacities from about 0.1 to 2.5 mf., use the 110 V. A.C. supply and check against a chart made by using condensers of known capacities; condenser C is always in the circuit as a safety device.

### A 2 V. FIRST-DETECTOR AND OSCILLATOR

Arthur Z. Smith

BECAUSE the cathode of the 32 is a grounded filament, the tube has been regarded as not adaptable to superheterodyne combined first-detector and oscillator hookups which require a feedback coupling coil inserted between cathode and ground. (One tube manufacturer, recognizing this, has produced a 2 V. heater-type tube, but it requires three times as much filament current as the 32.)

However, the 32 can be used if the coupling coil is in one filament lead, and an R.F. choke coil is in the other, as shown in Fig. 4. This is similar to the method used by many experimenters in adapting filament-type tubes to use in electron-coupled oscillators.

Unit R.F.C. is a 40 turn choke coil wound with No. 24 D.C.C. wire on a form 2 ins. in dia. It is not critical, and it is not coupled to anything else. Inductance L1 is a 20 turn feedback coil wound with No. 24 D.C.C. wire over the grounded end of the oscillator tank coil, L2; both coils are wound on a form 2

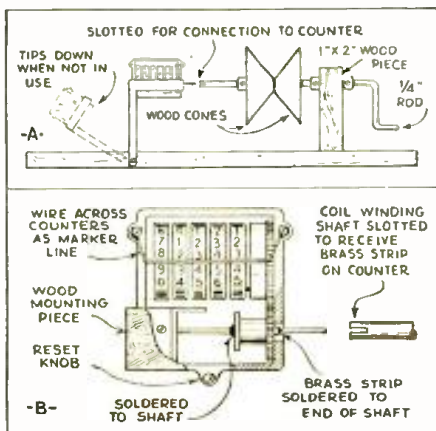

ins. in dia. If the circuit does not oscillate, reverse the leads to L1. If the circuit oscillates with an audio howl, slightly reduce the number of turns in L1, or slide L1 further from L2 until the howl stops.

The remainder of the circuit elements are conventional and are the same as found in many type 24 tube circuits. Grid-leak operation seemed better than bias operation. If no R.F. amplifier is used, the input circuit should be double-tuned to reduce oscillator radiation to the antenna, and to reduce image-frequency interference.

### AN EXPERIMENTERS' KNIFE

John Grummisch

THE AUTHOR has found that by "rebuilding" a good-quality knife as illustrated in Fig. C it is seldom necessary to carry any other tool than a pair of pliers for the average run of requirements in radio work.

Recommended dimensions of this knife are as follows: 1,  $\frac{1}{4}$ -in.; 2,  $\frac{1}{8}$ -in.; 3,  $\frac{3}{4}$ -in. (from the beginning of 5 to 1,  $\frac{3}{4}$ -in.); 5,  $1\frac{1}{2}$  ins.; 7,  $\frac{1}{2}$ -in.; 6,  $\frac{1}{4}$ -in.; 4, 1 in.

This 7-purpose tool is sharpened as follows: 1, like a screwdriver; 2, like a screwdriver  $\frac{1}{4}$ -in. in diameter; 3, like a knife; 5, like a saw; 7, like a knife; 6, like a knife; 4, like a knife. The actual use of each section is given alongside the illustration.

### A HANDY COIL-TURN COUNTER

Francis S. Stebbins

BROTHER Service Men may be interested in the manner in which the writer used an old speedometer to make a simple and effective coil-turn counter, illustrated in Fig. 5.

Disassemble the speedometer by removing the framework that holds the mileage and 3 trip counters; the shaft that carries these counters also supports the drive gear which is meshed to the total mileage counters in a 1 to 1 ratio. Solder this gear to the shaft and to a strip of brass to protrude through the frame in order to fasten the newly-born coil-turn counter to the coil winder (by means of a slot cut in the end of the shaft holding the coil form, as shown in Fig. 5A); the turn counter is to be mounted on a wooden frame, pivoted at one end, as shown in Fig. 5B.

### DEFECTIVE VOLUME CONTROLS

R. F. Lambert

WHEN a person is ill the Doctor prescribes medicine for his patient, not as a cure, but as a temporary relief. Many of us have followed the same idea when confronted with a noisy volume control. It has been "doctored" with "Nujol," "graphite" obtained from a lead pencil, "sandpaper," "alcohol" rub down, or what have you.

The majority of radio receivers employ wire-wound volume control resistors. Examine noisy units under a magnifying glass. Generally, the wire will be corroded or rusty, and at the edges, where contact has been made with the slider arm, it will have been worn or flat, or may even be cut through.

Explain to your customer that complete replacement of the volume control will eliminate what otherwise will be a "call back."

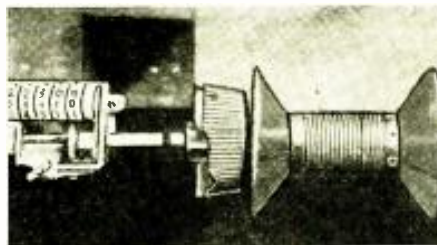

Fig. 5, left

The mechanical make-up of the coil-winding counter which is made from an old automobile speedometer mileage counter. A simple hinge couples the counter to the winding device.

Fig. D, above

The appearance of the writer's coil winder made as illustrated in Fig. 5, at the left.

# 150

## "Crack" Service Men Wrote This Book For You!

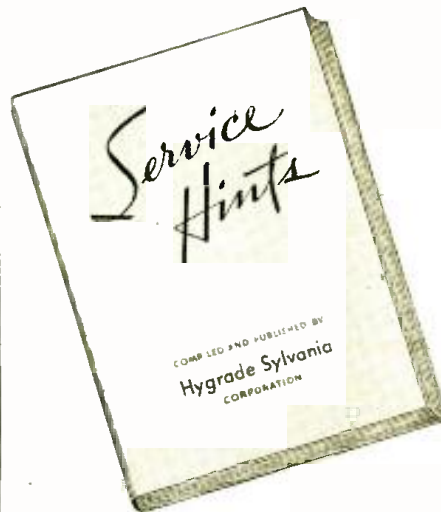

### GET IT FREE . . . learn their short cuts to better servicing, better profits

Sylvania's 64-page booklet "Service Hints" contains the pick of all the servicing tips and methods that hundreds of successful service men have sent to us. Inside dope on the special problems of more than 200 set models . . . and other valuable information.

All you do is mail the coupon below and we'll send you your copy! We'll also put your name on the mailing list for "Sylvania News," a free monthly bulletin that gives additional hints . . . keeps you up-to-date on news of the industry . . . and tells how your suggestions can win FREE TUBES!

### HYGRADE SYLVANIA CORP.

Makers of SYLVANIA TUBES HYGRADE LAMPS ELECTRONIC DEVICES

Factories EMPORIUM, PA. ST. MARYS, PA. SALEM, MASS. CLIFTON, N. J.

© H. S. Corp., 1934



# Sylvania

THE SET-TESTED RADIO TUBE

HYGRADE SYLVANIA CORPORATION B-10 Emporium, Pa.

Please send me your free booklet "Service Hints" and your free monthly Service Bulletin.

NAME .....

ADDRESS .....

CITY ..... STATE .....

# Check Shorts! RADOLEK'S "Build It Yourself" New A.C. Tube Short Checker

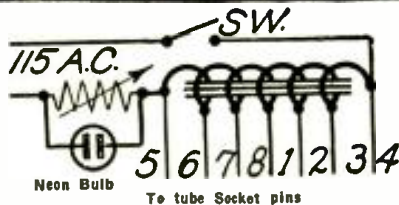

- For 4, 5, 6 and 7 prong tubes
- Catches all Interelement Shorts

Essential Parts Supplied by Radolek: 1—Tapped Choke, 1—Special Variable Resistor, 1—Neon Bulb, 1—4, 5, 6 Hole Tube Socket, 1—7, 7 Dual Seven Socket, 1—Neon Bulb Socket, and Plans for Building. Regular Value of Parts \$4.55.

**YOUR SPECIAL PRICE.....\$4.00**

Theory: A shorted Tube Element will cause a circulating current in one portion of the tapped choke which acts as an Auto-Transformer, changing its impedance from that which balanced the Variable Resistor to a negligible quantity, thus causing a high voltage across the Neon Bulb—indicating a shorted tube.

**RADIO DEALERS AND SERVICEMEN:** Write for your copy of the New 1934 RADOLEK PROFIT GUIDE! Kindly enclose your business card or use your letterhead when requesting our Catalog.

**The Radolek Co.**  
DEPT. 137 601 W. RANDOLPH  
CHICAGO, ILL.

## Try this FORMULA

WHEN you design or build that new Set Analyzer, Decade Box, Bridge, Ohmmeter or High Resistance Voltmeter why not try this FORMULA:  $Q+A+MD = PwWR$

L.C. When Q equals QUALITY and A equals ACCURACY MD equals MODERN DESIGN and L.C. equals LOW COST and LAST COST then PwWR is always PRECISION WIRE WOUND RESISTORS. RESISTANCE RANGE: .25 Ohm to 1 Megohm

**TYPE "F"**  
Normal Rating Watt  
Maximum Length 1"  
Maximum Diameter 5/8"  
Length of Leads 1 1/2"  
Furnished with No. 18 Tinned Copper Leads.



**TYPE "D"**  
Normal Rating Watt 1/2  
Maximum Length 3/4"  
Maximum Diameter 3/8"  
Length of Leads 1 1/4"  
Furnished with No. 18 Tinned Copper Leads.

Free Booklets and Price List  
Precision Custom Built Wire Wound Resistors, Mfg. by  
**PRECISION RESISTOR CO.**  
334 Badger Ave. Newark, N. J.



## UNIVERSAL

2-Button Hand-Mike \$15.00 List

Maximum volume, minimum hiss, scientifically damped. Truly natural tone. No delicate parts to be damaged. For announcing, transmitting or home recording. New catalog covers twelve models from \$5.00 up.

UNIVERSAL MICROPHONE COMPANY, Ltd.  
424 Warren Lane  
Inglewood, Calif. U.S.A.

## SHORT WAVE CONVERTER

(Continued from page 662)

played as a vernier for increasing the volume or sensitivity. It does not function as a volume control, since a volume control is included in the design of this instrument, but rather as a padding or trimming condenser, for finer adjustment.

The output of this set connects to the aerial and ground terminals of either T.R.F. or superheterodyne receivers through a coupling condenser in the plate circuit of the converter's output tube. This coupling condenser is employed for isolating the plate voltage from the antenna coil of the receiver to prevent any consequent damage that may occur if this high voltage were to go through it. The antenna, which ordinarily connects to the antenna post on the receiver, is connected instead to the converter. A common ground is employed for both receiver and converter. An antenna condenser is included in the aerial circuit of the converter for the purpose of adapting the regular broadcast antenna to short waves. It also serves to improve the selectivity of the unit somewhat.

The converter, as shown in Fig. 1, operates only on alternating current. Either a 5Z3 or 80 type tube is employed as the rectifier. A power transformer is also used for stepping up the 110 V. A.C. to the required high voltage necessary for the plates of the various tubes.

A front view illustrating the panel layout is seen in Fig. A. The parts layout for the chassis base can be seen in Fig. B. It is suggested that this layout be adhered to—since it has been ascertained that shorter wiring leads, an essential requisite for maximum efficiency on short-wave work, are possible with this plan of locating parts. A special I.F. transformer is employed, and can be seen located between two tubes in Fig. B. The padding or trimmer condenser for this unit is mounted on top where it is accessible for adjustment. Layout of parts underneath the chassis and wiring are shown in Fig. C.

### List of Parts

- One metal chassis and cabinet;
- One slow-motion tuning dial;
- One 2-gang special S.W. condenser (6 plates—each unit);
- Two 6 prong sockets;
- One 5 prong socket;
- One 4 prong socket;
- Three tube shields;
- One special power transformer;
- Two 8 mf. dry electrolytic condensers;
- Two 100 mmf. equalizing condensers;
- One 140 mmf. variable condenser;
- One special I.F. coil shielded;
- One .2-meg. volume control and switch;
- One 1. mf. condenser;
- Two .1-mf. condensers;
- One .01-mf. condenser;
- One B.R.L. special S.W. coil unit with switch;
- Three Eby binding posts;
- One filter choke (Powertest);
- One A.C. cable and plug;
- Four knobs;
- Two screen-grid clips;
- One 20,000 ohm resistor, 1 W.;
- One 25,000 ohm resistor, 1 W.;
- Two 10,000 ohm resistors, 2 W.;
- One 300 ohm resistor, 5 W.;
- One Powertest special R.F. choke;
- One type 56 tube;
- Two type 58 tubes;
- One type 80 tube;
- One kit of assorted hardware.

The number of stations that may be received, while augmented considerably by this efficient converter, is also dependent upon the efficiency of the receiver into which it works. This is only to be expected since further amplification (which occurs in the receiver's stages) is contingent upon the number of stages of amplification that the receiver employs. However, with an average set it should be possible to receive all short-wave transmission from 15 to 200 meters in this country, although the model described and illustrated in these pages has received many foreign short-wave signals, including VE9JR—25.6 meters, Winnipeg, Manitoba; FYA—25.6 meters, Pontoise, France; 31.5 meters—Daventry, England; and DJC—49.8 meters, Berlin, Germany.

# NOW FREE

## 48-Page Supplement to the Auto-Radio Service Manual!

To everyone who now purchases the OFFICIAL AUTO-RADIO SERVICE MANUAL this big 48-page Supplement is issued FREE. Practically all of the latest sets, together with servicing information will be found in these new pages. The new Supplement does not increase the cost of the book to you, but gives you an Auto-Radio Service Manual that is right up-to-the-minute with service notes.

If you are overlooking servicing auto radios, then you're missing a great deal of business. The auto-radio business had its greatest boom last summer and thousands of sets were sold. By this time many of these same sets require servicing and with hundreds of them right in your own community, you can build up a good auto-radio servicing business. In a short time you can easily add 25% or more to your regular servicing business.

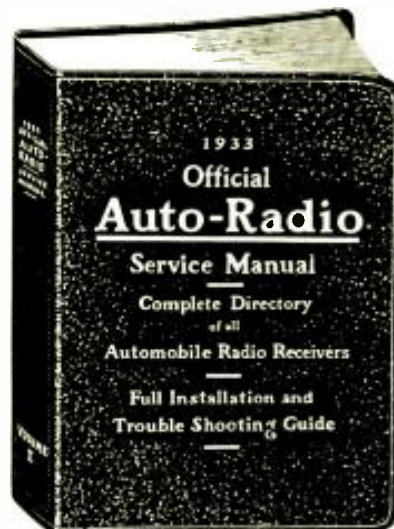

**\$2.50** The Copy

The OFFICIAL AUTO-RADIO SERVICE MANUAL devoted exclusively to auto-radio service "done" contains schematic diagrams, chassis layouts, mounting instructions, and trouble shooting hints on all 1933 and many older model auto-radio receivers. This Manual contains a "gold-mine" of information.

### List of Sets Covered in the Manual

|                           |                            |
|---------------------------|----------------------------|
| Atwater Kent Mfg. Co.     | Chas. Hoodwin Company      |
| Autocrat Radio Company    | Montgomery Ward & Co.      |
| Carter Genemotor Corp.    | National Co., Inc.         |
| Chevrolet Motor Company   | Philco Radio & Tel. Corp.  |
| Crosley Radio Corp.       | Pierce-Alro, Inc.          |
| Delco Appliance Corp.     | Premier Electric Co.       |
| Emerson Electric Mfg. Co. | RCA-Victor Co., Inc.       |
| Federated Purchaser, Inc. | Sentinel Radio Corp.       |
| Fada Radio & Elec. Corp.  | Sparks-Wilmington Corp.    |
| Ford-Majestic             | Stewart Radio & Tel. Corp. |
| Franklin Radio Corp.      | United Amer. Bosch Corp.   |
| Galvin Mfg. Corp.         | United Motors Service      |
| General Electric Co.      | U. S. Radio & Tel. Corp.   |
| General Motors Corp.      | Wells-Gardner Company      |
| Grigsby-Grunow Co.        | Zenith Radio Corp.         |

Over 200 Pages  
Over 500 Illustrations  
9 x 12 Inches  
Flexible, Loose-Leaf Cover

### Mail This Coupon Today!

GERNSBACH PUBLICATIONS, Inc. R-534  
96-98 Park Place, New York, N. Y.

Enclosed you will find my remittance of \$2.50 for which please send me One Copy of the 1933 OFFICIAL AUTO-RADIO SERVICE MANUAL. Send remittance in check or money order. Register letter if it contains cash or currency. WE PAY POSTAGE.

Name .....

Address .....

City ..... State .....

# AN A.C.—D.C. BOOSTER PRE-AMPLIFIER

(Continued from page 667)

tached directly to the input post of this pre-amplifier and the output signal (which of course has been pre-amplified) is then fed into the input binding posts of any conventional A.F. amplifier.

In the case of employing this device in conjunction with a radio receiver, the detector plate output is fed into the input of this booster, and its output is then fed into the power output stage of the radio receiver. The only occasion wherein this booster will be employed with a radio receiver is with an external input device, such as a phono, pickup or microphone, as the A.F. systems of most radio receivers are not designed to properly amplify such external input devices. The use of modern tubes in the R.F. circuits of radio receivers has made possible the production of larger detector output signals, which has accordingly caused the elimination of 1 or 2 stages of A.F. amplification, heretofore necessary in order to reproduce radio broadcast signals to full intensity.

By employing this device with such a receiver, any phono, pickup or microphone is connected, as stated before, directly to the input posts and its two high gain A.F. stages build up a powerful signal which when fed into the power output tube of the receiver proper is more than sufficient to produce maximum undistorted output up to the full rating of the power tube employed, even though the input signals emanate from a very weak input device, such as a crystal microphone or velocity ribbon microphone.

## The Unit

Up to the present time, practically all pre-amplifiers in use were battery operated. This made them not only relatively large, heavy and costly, but also quite unreliable. They were usually intended for limited applications and required continuous attention as to the proper filament voltage adjustment and condition of the batteries, rendering their upkeep quite expensive.

With the advent of the D.C.-A.C. rectifier systems, such as described by the author in the July, 1933, and the March, 1934, issues of RADIO-CRAFT, it became possible to construct this pre-amplifier with self-contained power pack. Heretofore, the only alternative to the battery box was a power transformer, whose electromagnetic field introduced a strong A.C. component into some of the pre-amplifier components, and usually even strategic placement of parts or heavy shielding of the essential units was not effective enough to prevent this hum, unless, of course, a separate external power pack was employed. The pre-amplifier and self-contained power pack described here measures only 6 1/2 x 6 1/2 x 6 ins. high, and weighs 9 1/2 lbs. It may be operated directly from any 25-60 cycle A.C., or D.C. 105-120 V. line or from any 220-240 D.C. or A.C. power line by means of a 385 ohm 35 W. series resistor, the total power consumption at 115 volts being only 35 watts. It employs two 37 heater type tubes, which are practically independent of line voltage fluctuations. It is provided with a universal input transformer, T1, having the following primary impedances: 200-200 ohms (or 100-100 ohms) for any double button or for one or two single button carbon microphones, and 67, 200, 500, 2,000, 5,000 ohms, which covers practically all impedances of various input sources commonly utilized.

Should a pair of earphones be placed across the corresponding winding on the output transformer, T2, the pre-amplifier may be employed as a "detecto-phon" to listen to what is going on in another room, cellar, office, garage, etc. The microphones and low impedance earphones may be placed many hundred feet away from the amplifier and interconnected with ordinary bell wire without introducing appreciable distortion or losses.

In a similar manner one or two microphones and earphones (or magnetic units) may be used at the same time and simultaneous conversations carried on. In other words it constitutes in reality an inter-office communication system, and if each set of ear-

phones (or magnetic units) and corresponding microphone are equipped with D.P.S.T. toggle switches an unlimited number of them may be connected to such a system, and then any one or two of them may be cut in and out at will. This amplifier constitutes also an excellent hearing aid for those hard of hearing; the only accessories required are the usual earpiece and any microphone.

It is interesting to note that many Service Men who could not get much sound out of a loudspeaker on microphone work, thought at one time or another that he required a more powerful amplifier, when all he needed was a "booster" such as this pre-amplifier. This unit will build up the electrical voltages generated by practically any device to a sufficient extent to permit full loudspeaker output to be delivered by the amplifier used in conjunction with it. Among such input sources are the ribbon, velocity, carbon, dynamic, crystal and condenser microphones, any type of photoelectric cell, an all-purpose or telephone transmission line, the crystal and other low voltage output phono, pickups of various impedances. It further permits the use of multiple volume controls, mixer circuits, control boxes and attenuator systems or other loss incurring devices, as it will build up the voltage available to such a high degree as to make their use with low gain amplifiers possible. This means that it will make a highly efficient 4 or 5 stage high-gain unit out of any low-gain amplifier.

It might be well to point out here that those who had to put up with the continuous and disagreeable background and hissing noises generated by carbon microphones will find in this "booster" a "new deal," in that it will permit them to successfully use other microphones that not only are free of all noises produced by carbon granules but have as a rule a much wider and more even frequency response.

All the input signals just referred to are now fed into the universal input transformer, T1, the secondary winding of which is connected to a series R.F. choke, RFC, and a small bypass condenser, C1 (both contained in the casing of T1) to prevent interference by R.F. signals and disturbances with resultant tube rectification and amplification. This R.F. choke is connected through a .5-meg. potentiometer, R8, to the grid of the first 37 tube V1. The shield of this input transformer houses also a .1-mf. coupling condenser C2 for connection to high impedance input sources, such as a crystal microphone, crystal pickup, and high impedance secondary windings of any other external matching transformers. The plate circuit of V1 is resistance-capacity coupled to V2. Two watt resistors are employed in their cathode, grid and plate circuits, and the condensers in their cathode circuits are 1 mf. paper condensers.

The second tube, V2, has an output transformer T2 in its plate circuit with secondary windings of 18,000 to 500, 200 and 67 ohms. This last winding of 67 ohms permits perfect matching of two additional 200 ohm output lines (three in all) to a common input winding of 200 ohms, which latter is the most common input impedance encountered in P.A. work today. The two A.F. amplifier tubes as well as the rectifier tube, V3, have their filaments placed in series with a line ballast resistor R7, which is incorporated in the line cord. This being practically the only heat dissipating source besides the tubes themselves, which are of course placed on the top of the chassis, the bottom of the chassis housing the various filter and bypass condensers remains absolutely cool. This is a very important consideration when continuous successful operation is desired, and is only too often neglected in universally powered modern receivers and amplifiers.

Although only half-wave rectification is employed, absolutely humproof and noiseless operation is obtained, due mainly to the fact that the total current rectified and filtered is only about 5 ma. The first tube, V1, draws only a fraction of a milliampere plate current, while the second tube, V2, has a normal plate current of 3 ma. Under these operating conditions, the tubes may be expected to last indefinitely.

Another important reason for the total absence of hum and noise from the amplifier output is the fact that the input and output transformers are heavily shielded and separated from the rest of the amplifier circuits, being housed in thick metal castings, and

# AMERICA TURNS TO MIDWEST!



## AMAZING NEW

### Super Deluxe

# 16-TUBE ALL-WAVE RADIO



**9 TO  
2,000  
METERS**  
13 MEGACYCLES  
TO 150 KC

**WORLD-WIDE  
RECEPTION**

**BEFORE** you buy any radio, write for big new **FREE** Midwest catalog printed in four colors. It has helped thousands of satisfied customers save from 1/3 to 1/2 on their radios by buying direct from the Midwest Laboratories. You, too, can make a positive saving of from 30% to 50% by buying a Midwest 16-Tube Super Deluxe ALL-WAVE radio at sensationally low direct-from-laboratory prices. They bring in broadcasts from stations 10,000 miles and more away... and give complete wave length coverage of 9 to 2,000 meters (33 megacycles to 150 KC). These bigger, better, more powerful, clearer toned, super-selective radios have FIVE distinct wave bands: Ultra-short, short, medium, broadcast and long... putting the whole world of radio at your finger tips. Now, listen in on all U. S. programs, Canadian, police, amateur, commercial, airplane, and ship broadcasts.

**\$59.50**  
NEW LOW PRICE  
WITH NEW DELUXE AUDITORIUM TYPE SPEAKER

(less tubes)  
**TERMS AS LOW AS \$5.00 DOWN**

## 30 Days' FREE Trial

Try this Midwest radio for 30 days before you decide. New four-color catalog pictures a complete line of beautiful, artistic consoles and chassis. See for yourself the 30 new 1934 features that insure amazing performance. These features include Automatic Select-O-Band, Amplified Automatic Volume Control, 16 New Type Tubes, Balanced Unit Superheterodyne Circuit, Automatic Tone Compensation, 29 Tuned Circuits, 7 KC Selectivity, etc. These and many additional features are usually found only in sets selling from \$100 to \$150! Write for FREE catalog.

## DEAL DIRECT WITH LABORATORIES

**TERMS AS LOW AS \$5.00 DOWN** Increasing costs are sure to result in higher radio prices soon. Buy before the big advance—NOW!—while you can take advantage of Midwest's amazing, low prices. No middlemen's profits to pay. You save from 30% to 50% when you buy direct from Midwest Laboratories—you get 30 days FREE trial—as little as \$5 down puts a Midwest radio in your home, satisfaction guaranteed or your money back.

**SAVE UP TO 50%**



**MIDWEST RADIO CORP.** (Est. 1920)  
Dept. 504, Cincinnati, O., U.S.A.  
Cable Address: Miraco, ABC, 5th Edition

**RUSH THIS COUPON FOR AMAZING 30-DAY FREE TRIAL OFFER, AND NEW 1934 CATALOG**

**MIDWEST RADIO CORP.,**  
Dept. 504,  
Cincinnati, Ohio.

Without obligation on my part send me your new FREE 1934 catalog, and complete details of your liberal 30-day FREE trial offer. This is NOT an order.

Name \_\_\_\_\_  
Address \_\_\_\_\_  
City \_\_\_\_\_ State \_\_\_\_\_

**AGENTS! Make Easy Extra Money**  
Check Here for Details



**NEW SECOND EDITION**  
**Modern**  
**Up-to-Date**  
**Convenient**

## PRINCIPLES of RADIO

*With a Section on Television*  
 By KEITH HENNEY

Associate Editor of "Electronics"  
 491 pages, 5 1/4 x 7 7/8. \$3.50.  
 This widely accepted book has been completely rewritten and a large amount of new material has been added, including short-wave receiver design; police two-way systems; iron core r.f. components; practical facsimile; cathode ray technique; technical status of television; industrial applications of tubes. Written in language simple and easy to understand, in "non-mathematical treatment," this book leaves out nothing that is worthwhile in radio.

### ON APPROVAL COUPON

JOHN WILEY AND SONS, Inc.,  
 440 Fourth Avenue, New York.  
 Gentlemen: Please send me Henney's "Principles of Radio" for ten days' approval. I agree to remit the price of the book (\$3.50) within ten days or return it postpaid.

Name .....

Address .....

Position .....

Employed by.....RC-534

### A new SERVICE TECHNIQUE!

ALPHABETICALLY INDEXED  
 RADIO SERVICE NOTES

We have expertly prepared in alphabetical arrangement and carefully indexed, specialists' service notes which give pertinent facts about sixty-five different standard receivers. This material, conveniently arranged with diagrams, enables you to quickly select from your files, cards which tell how to correct intermittent reception, hum, distortion, oscillation, superheterodyne alignment, speaker trouble, cross modulation, balancing, power pack failures, poor DX reception and dozens of other common radio faults. Our Consultation Bureau gives you FREE authoritative information of all radio service problems. In addition, it provides for sales promotional ideas, advertising—everything to make the servicing business profitable.

For complete details about these "Indexed Service Notes," write today for circular RC-5.  
 Capitol Radio Research Laboratories, Inc.  
 711 Barr Building Washington, D. C.

### the "M. J."

a revelation in  
**ALL-WAVE** reception  
 will be announced  
**SHORTLY**

Write for preliminary technical details and price of this FINE 12-tube receiver.

### PIONEER SOUND LABORATORIES

135 Liberty St.  
 New York, N. Y.

### CONCOURSE

Dry Electrolytic  
 Wax Paper  
 "Peewee" Paper Tubular  
**CONDENSERS**

389-409 WALES AVENUE, NEW YORK  
 Write for 1934 Catalog

that all input as well as the cathode and the common return connections of the first tube, V1, are all either very short, shielded or are made out of heavy busbar wires. Note also that although the common input and output windings of the amplifier are connected to chassis and should be grounded, they are in themselves, isolated from the rest of the amplifier circuit. This is necessary to prevent hum and noise pickup. Both amplifier tubes are mounted on double spring sockets to render them non-microphonic and all connections to them are made in spring like fashion. Otherwise the slightest vibration of the amplifier would be transmitted to the tube elements themselves, and be amplified as an audio howl and a consequent disturbance.

All component parts are consistently identified on the schematic diagram, Fig. 1, the front and bottom views, Figs. A and B, and List of Parts to enable anyone to build this pre-amplifier in a simple and foolproof manner.

#### List of Parts

- One Const-to-Const drilled chassis 6 3/8 x 6 7/8 x 2 3/4 ins. with a bottom plate;
- One Remington universal input transformer, type D-3567E, T1;
- One Remington universal plate to line transformer, type D-3580A, T2;
- One Remington filter choke, 30 hy., 500 ohms, 50 ma., Ch.;
- One Polymet 250 mmf. mica condenser, C1;
- Two Polymet .1-mf. 300 V. tubular condensers, C2, C6;
- Three Polymet 1 mf. 300 V. tubular condensers, C3, C4, C7;
- One Polymet 8 mf. 175 V. electrolytic condenser, C5;
- One Polymet dual 16 mf. 175 V. electrolytic condenser, C8, C9;
- One Centralab 10,000 ohm, 2 W. resistor, R1;
- One Centralab .25-meg., 2 W. resistor, R2;
- One Centralab 25,000 ohm 1/2-W. resistor, R3;
- One Centralab .5-meg., 2 W. resistor, R4;
- One Centralab 2,700 ohm, 2 W. resistor, R5;
- One Centralab .25-meg., 1/2-W. resistor, R6;
- One line cord and plug with 265 ohm 25 W. ballast resistor, R7;
- One Centralab .5-meg. tapered potentiometer, R8;
- Two 5 prong double spring sockets;
- One single-pole single-throw toggle switch, SW.;
- Miscellaneous mounting strips, hardware, wire, etc.

### "WIRE-LESS" P.A. INSTALLATIONS

(Continued from page 667)

(5) school call and P.A. systems.  
 The methods these systems employ are described in greater detail as follows:

(1) TRAVELING THEATRE BALLYHOO SERVICE. In the United States there are nearly 1000 traveling shows, groups of Thespians, who travel from place to place, entertaining the populace as they go. These troupes, some of them, constitute part of the larger circuses, while the majority of the shows operate quite independently of other organizations. In most cases, they are continually in need of equipment suitable for inter-communication, public address, sound re-inforcement, and ballyhoo.

Since, as previously described, point-to-point operation is obtained merely by plugging the transmitter and receiver into a convenient light socket, it is seen that an inter-communication service for use in the theatre or between two points or "the lot" is available at a moment's notice. Various sound effects and announcements may be made to the audience or assemblage by placing the receiving unit at any convenient point (for instance, on the stage) and operating the transmitter wherever the sound effects or speech conveniently originate.

Further, if it is desired to use the receiving unit for purposes of sound re-inforcement, it is only necessary to place the transmitting unit at the place of action. In this manner, too, it becomes convenient to address audiences beyond the capacity (about 500 people) of a single receiver used for public address.

In nearly every instance, these traveling

## FREE! Choice of One or More of These Popular Short Wave Books

Here's money put right into your pocket—here's a saying you never gave a thought to. You get absolutely FREE any one or more of the regular 25c and 50c short wave books with a year's subscription to SHORT WAVE CRAFT, the Radio Experimenter's Magazine. A one year's subscription brings you one fifty cent book or two twenty-five cent books; a two-year subscription brings you two fifty cent books and any one twenty-five cent book. Decide NOW what books are most necessary to you—then send us your subscription by return mail. The books will be sent to you immediately.



No. 1 50c No. 2 50c No. 3 25c No. 4 25c

THIS popular short-wave magazine interests the great army of "hams," broadcast listeners, and general radio students who are interested in experimental as well as scientific angles of short wave development and application. In each monthly issue appears the largest and most correct short-wave station call list, and important construction articles on receivers and transmitters, including "picture" diagrams easily understood by anyone, a big feature "originated" by SHORT WAVE CRAFT. You'll also find the latest news about short-wave physics, micro- and ultra-short waves and other applications of this newest branch of radio.

### Many Short Wave Sets to Build

Many excellent short-wave sets with complete construction details with "picture" diagrams, are found in every issue—these sets vary from simple one- and two-tube sets to those of more advanced design, five and eight tubes.

### Big Silver Trophy FREE!

Recently inaugurated by Mr. Hugo Gernsback, Editor, was the "Short Wave Scout Contest." To the Short-Wave "fan" who has logged and obtained verification of the largest number of short-wave stations from all over the world, during one month, will be awarded a magnificent silver Short Wave Scout Trophy.

25¢ The Copy 4-Color Cover 9" x 12"—Over 200 Illustrations



On All Newsstands

SHORT WAVE CRAFT, Dept. RC-534  
 96-98 Park Place, New York, N. Y.

Gentlemen: Enclosed you will find my remittance for a subscription to SHORT WAVE CRAFT for  
 One Year @ \$2.50 (Canadian and foreign \$3.00)  
 Two Years @ \$5.00 (Canadian and foreign \$6.00)  
 Send me FREE books which are circled below.

1 2 3 4

Name .....

Address .....

City ..... State .....

(Send remittance in check or money order. Register letter if it contains cash or unused U. S. Postage Stamps.)

MAIL COUPON TODAY

# BIG DISCOUNTS TREMENDOUS SAVINGS!

Get Our Monthly Bargain Bulletin



## FREE

IT'S CHOCK-FULL OF  
BARGAINS FOR YOU

You can't afford to be without this book. It offers marvelous buys in Radio Sets, Long and Short Wave Apparatus, Servicemen's Repair and Replacement Parts, Electrical Goods, Sporting Goods—hundreds of miscellaneous bargains.

Be among the first to have the pick of great bargains. Latest issue just out. Act quick. Send coupon and receive your copy by return mail.

RADIO CIRCULAR CO., INC.  
225 Varick Street  
New York, N. Y. Dept. RC-534

Please send me free of charge and without obligation, your latest catalog.

Name .....

Address .....

City ..... State .....

## ACTUAL TROUBLES in Commercial Radio Receivers

by BERTRAM M. FREED

The author's nine years' experience. In an excellent capacity in the service department of one of the largest radio chains in the country, qualifies him as an authority on all that pertains to radio service and repair. His extensive notes on unusual, but actual troubles repeatedly found in commercial radio sets, as encountered in actual field experience, are concisely described in this 200 page book (includes 43 diagrams). Spare does not permit a fuller description, but we will be glad to send you the service data on any one radio free of any charge—or examine this book at your leisure. Money back within ten days if not satisfied. We pay postage.



**\$1** POST PAID

Ten Days' Free Trial

**SERVICEMEN'S PUB. CO.**  
136C LIBERTY ST., NEW YORK CITY



## SHORT WAVE AND ALL-WAVE ANTENNA SYSTEMS

9 1/2-217 meters

The ICA S.W. Doublet antenna (illustrated) enables you to pick up weak signals ordinarily lost due to man-made static. Complete kit comprises: 15 ICA transposition blocks, 8 special Insulex Antenna Insulators, 1 ICA Doublet Coupler, 2 100 ft. Collis special enameled wire, No. 659. **\$4.75**

List Price.....**\$4.75**  
ALL WAVE JOJBLET ANTENNA

9 1/2-550 meters

For use on all makes of all wave receivers. Kit comprises: 15 ICA transposition blocks, 1 Universal all wave doublet coupler, 8 special Insulex Antenna Insulators, 2 Collis special S.W. enameled antenna wire, 100 ft., each No. 660. **\$5.25**

Your jobber or favorite M.O. House can supply you at 40% discount . . . or write direct.

16 wiring Diagrams FREE with catalog. Shows all latest S.W. equipment. Write today to

INSULEX CORP. OF AMERICA  
23-25 Park Place Dept. C-54 New York, N. Y.

shows arrange to present part of their program at the change booth in order to attract the attention of the passers-by. In many instances, this procedure is inconvenient and it is here the R.F. P.A. system fits in especially well. A receiving unit is located at the change booth, being plugged into the same power outlet that supplies the lights to the booth. The transmitting unit is then located on the stage and picks up the action of either a pre-show program or part of the regular performance, as desired. The effect produced is then much more spectacular since the program of the full cast is available.

(2) DEPARTMENT STORE PROGRAM RELAY AND CALL SYSTEM. Many department stores, including some of the biggest in New York and Philadelphia, are now using wire-less P.A. installations. One company places a transmitter ("socket mike"), plugged into a wall receptacle, near one of their better radio broadcast receiving sets and thereby energizes the entire lighting circuit of their building. The radio program as thus put on the power lines is taken off, at each floor level, where it "addresses" the patrons.

Another store, finding that it was too expensive and inconvenient to run individual wires for calling and communicating with the heads of various departments throughout the building, did not give the idea serious consideration, until the advent of the wire-less P.A. system. This store now uses both transmitters and receivers at strategic points throughout the building, for purposes of communication and call, and receiving units at still other points used for purposes of summoning employees to desired offices.

(3) HOSPITAL CALL SERVICE. Hospitals are now "taking to the idea" of using R.F. P.A. installations as an added service to their patients. A "socket mike" is installed at the bedside of every patient who may require emergency attention. A single receiving unit is kept operating in the office of the head nurse who thus may be instantly advised when a patient requires attention.

(4) REMOTE ALARM CALL SYSTEM. Still another use for the wire-less or radio frequency ("R.F.") P.A. system is in operating it as an alarm device to draw attention to action taking place at a remote point. For instance, a transmitting unit may be placed within a radius of 50 ft. from Baby Jones, and receiving units at one or more points throughout the house. If the "king" should even start to turn over in the crib, Mother will immediately hear him moving about, as long as she stays within range of one of the receiving units.

(5) SCHOOL CALL SYSTEM. Still another application has been found in connection with school work. The Principal has a transmitter connected to the power line outlet in his office. Receiving units in each classroom enable the Principal to call his teachers or any one of the students; or, to address the entire faculty and student body in a single operation. Too, in cases of emergency, the head of the institution is enabled to give pertinent instructions throughout the building.

### Technical Considerations

In the event that radio receiving sets are operating within the same building and therefore on the same power system, it may be necessary to tune the "wired radio" P.A. system to a wavelength beyond 550 meters in order to be outside the ordinary broadcast band. Where the apparatus is operated within the broadcast band it is seldom that signals can be picked up more than 300 ft. beyond the building in which it is operated, since the power transformer that supplies the building prevents the R.F. signal going beyond.

Transmitting unit Z incorporates a microphone; 3 tubes, as follows: a type 45 oscillator, a type 56 modulator, and type 80 rectifier; and, the accessory units for obtaining tube power and circuit oscillation. The output impedance is 200 ohms. The unit measures 8 x 12 x 12 ins. high and weighs 10 lbs. Receiving unit R incorporates a dynamic reproducer; 4 tubes, as follows: a type 57 power detector, type 56 A.P. driver, type 2A3 power A.F. amplifier, and a type 5Z3 rectifier; and, the necessary R.F. tuner and tube power supply equipment. The input impedance is 200 ohms; the power output, 3 1/2 W. The unit measures 8 x 12 x 17 ins. high and weighs 30 lbs. Both units are available for individual operation on either A.C. or D.C., as required.

# Put No. 710 ON YOUR PAYROLL



No. 1179—Free Point Test Set

HERE'S a quicker-acting, easier-operating tester that enables you to make more calls at the lowest possible cost! Here's a tester that thousands of service men prefer because it makes each day's work net them a bigger income. Put No. 710 on your payroll—NOW!

The No. 710 Tester tests all types of radios . . . both new and old—and easily handles the most advanced circuits and newest tubes. This better tester is equipped with a practical selector switch which makes it easy to check all parts of tube circuits by connecting to the set sockets. Selection for testing voltage of plate, grid, cathode, suppressor grid and screen grid is quickly and accurately done. Plate current, filament volts, line and power supply volts, resistance and continuity are measured also. A battery is furnished for continuity testing of transformers, chokes, etc.

The No. 711 Tester is the same as the No. 710 . . . except that it is equipped with the new Triplett D'Arsonval Volt-Ohmmeter. This instrument has 1000 ohms per volt resistance. Its easy-reading scale makes it possible to accurately read up to 3,000,000 ohms. **YOUR JOBBER CAN SUPPLY YOU . . . with these advanced testers at low Dealer's net prices. The No. 710 Tester is only \$16.50. The No. 711 Tester is only \$24.75**

**READRITE METER WORKS**  
110 College Ave. Bluffton, Ohio



Literature is FREE! Write today.

READRITE METER WORKS,  
110 College Ave., Bluffton, Ohio

Gentlemen: Send me catalog on Readrite Testers No. 710 and No. 711 . . . and complete line of servicing equipment. Also send "Proof" folder, which illustrates letters from service men.

Name .....

Street Address .....

City ..... State .....

# SHORT WAVE Reception

on any BROADCAST RECEIVER

**ADAMS Super-hot Short Wave**



## CONVERTER

Designed by HERMAN COSMAN

ANYONE interested in short waves will find a great deal of interest in this new converter unit. Can be connected to any broadcast receiver, utilizing the high amplification and fine qualities of the receiver.

On the first trial the following stations were heard on the loud speaker: WGBL, Winnipeg, Manitoba, and FVA, Pontoise, France.

The unit supplies its own power, so a power transformer and a type '80 tube are included for this purpose. Other tubes used are two '58's and a '56.

The unusual points in the design of the "Adams" are the use of an intermediate frequency amplifier in the converter unit—and use of a tuned-plate oscillator. The first assures plenty of amplification, as well as adding a tuned circuit to the complete receiver-converter arrangement. The second provides a stable oscillator system which is essential in a successful short wave super-heterodyne.

Model SW-4809 Kit of Parts..... **\$17.95**

Model SW-4809-W Wired and Tested.... **22.95**

Set of matched Sylvania tubes..... **2.75**

With every purchase of an "ADAMS" Converter we will give a Handy Servicemen's Manual absolutely FREE. The Manual contains 128 pages of invaluable service and short wave data.

Our New Handy-Sized Catalog is Now Ready SEND FOR YOUR COPY TODAY!

**TRY-NO RADIO**  
85 Cortlandt St., Dept. C5, New York, N. Y.

## LATEST IN RADIO

(Continued from page 653)

line is shown as item No. 442. This set incorporates dual automatic volume control and inter-station noise suppression. The A.F. output is in push-pull. In this connection it is of especial interest to note that the new type 2A5 power tubes are used in the output circuit of this receiver. The tube complement is as follows: four type 58 tubes; three type 56's; two type 2A5's; one type 80. The other two sets in the new series are modernistic in appearance; the one illustrated, however, is of early English design. Although the electrical circuit by which tone compensation is secured is an involved one, the action is simply explained. Whereas, in most receivers, the low notes rapidly disappear as the volume is reduced, in the set illustrated automatic compensation takes place in the circuit as the volume is reduced so that, at low sound levels, bass reproduction suffers but little attenuation.

### TUBE-PRONG ADAPTER

THE little device shown as item No. 443 permits connection to be made to either the large or small prong of a tube, without breaking the circuit. Excellent for connecting an extra reproducer, output meter, experimental equipment, etc.

### AERIAL ADJUSTER-SPRING

SERVICE MEN interested in good antenna installations will find merit in item No. 444. This "aerial spring adjuster" is especially useful where the antenna is to be used with a short- or all-wave receiver.

Most antennas sway with the wind, thus tending to cause them to break; or, to come in contact with high-tension lines, or other antennas. Doublet antennas, too, will sway in the wind, with undesirable effects when listening to short-wave stations.

The aerial spring illustrated, corrects this condition by keeping the wire taut. It is constructed of heavy, cadmium-plated steel. Two hooks interlock with the tension spring, making it impossible for the aerial to fall if the spring or its insulators should fail. The spring is exceptionally rugged and long lived to take care of the strain placed upon it. Porcelain eyes placed in the hooks at either end insulate the spring from the antenna.

## HERE'S A BOOK RADIO MEN WILL REFER TO MANY TIMES EACH DAY



### A Valuable, All-round Radio Book!

HERE is one radio book that answers every conceivable question on interference. It contains 76 pages, 8 1/2 x 11 inches, chock full with wiring diagrams, drawings and photographs showing where interference originates—how it is distributed, and how to eliminate it. This is a wealth of information needed by every radio listener, dealer and Service Man.

Send 50 cents in stamps or check for this book

**RADIO-CRAFT MAGAZINE**  
96-98 Park Place, New York, N. Y.

## CLASSIFIED ADVERTISEMENTS

### A.C. GENERATORS

TEN Practical and inexpensive changes converting Dodge 12-V., Ford T. A., Chevrolet Delco 6-V generators into 100-500 watt capacity A.C. generators, or into 32-110-V., D.C. motor or generator. Dodge is 500-W self-excited. All in one book illustrated with complete simplified instructions and drawings for only \$1. Auto-power, 410 S. Hoyne Ave., Chicago.

### INSTRUCTION

AVIATION—Airminded young men interested in entering the field of aviation as apprentices. Write, enclosing stamp, Mechanix Universal Aviation Service, Dept. K—12883 Mansfield, Detroit, Michigan.

RADIO HOME STUDY COURSE—FAMOUS Radio Doctors Course; 58 lessons, over 500 illustrations with supplementary service data and genuine blue prints. Hundreds sold for \$79.50. Complete course shipped prepaid \$7.50. Examinations included, but not corrected. Order now, supply limited. Liquidating Agent, Eugene Parker, Pierce Ave., Salem, Mass.

### RADIO

DO You want—anything built for you? We design or construct any radio or electrical apparatus to your satisfaction. Equipment Builders Co., Dept. 3G, 945 East 163rd Street, New York City.

SERVICEMEN—Here's money! Modernize obsolete Majestics. Victors to superhets with A.V.C., short waves or tone control optional. Necessary parts, blueprints, instructions, \$9.80. New set performance. Other specialties. S-O Laboratories, 740 N. Main, Decatur, Ill.

TUBELESS Crystal Set—something new. Separates all stations. Operates speaker. 1800 miles verified. Blueprint, 6 others. 25c coin. Modern Radiolabs, 151-B Liberty, San Francisco, Calif.

### SONGWRITERS

SONGWRITERS! Poems, melodies, Amazing opportunity. Hibbeler, D153, 2104 Keystone, Chicago.



A small-space tube-prong adapter (No. 443).



An inexpensive aerial spring (No. 444).

## PRACTICAL RADIO ENGINEERING

An opportunity for RADIO MEN to enlarge their scope of training.

Whether elementary radio principles or advanced subjects, sound applications or practical radio engineering, RCA Institutes is prepared to give you the instruction you need.



RESIDENT SCHOOLS NEW YORK AND CHICAGO with modern standard equipment

EXTENSION COURSES FOR HOME STUDY under convenient "no obligation" plan.

Illustrated Catalog on Request

**RCA INSTITUTES, INC.**

Dept. RT-5

75 Varick Street, New York  
1154 Merchandise Mart, Chicago

## BUILD Better Radio

For efficient short-wave receivers and transmitters use world-famous Hammarlund Condensers, Coils, Chokes, Sockets and Shields. Backed by 33 years of engineering leadership.

Write for new FREE CATALOG "RC-5"  
HAMMARLUND MFG. CO.  
424-438 West 33rd Street  
NEW YORK CITY

For Better Radio  
**Hammarlund**  
PRECISION  
PRODUCTS



## DETERMINING TRANSFORMER VOLTAGES UNDER LOAD

W. B. Thompson

It is frequently useful for Service Men and experimenters to be able to calculate what voltage a certain power-pack transformer will be capable of producing when a certain load is applied. This is an easy matter for one who possesses an elementary knowledge of mathematics, inasmuch as the relationship of the various factors in the circuit is expressed by the simple equation

$$(1) \quad E = e - \frac{eR}{RL + R}$$

where:

E = voltage supplied by the transformer when the load is RL.

R = A.C. impedance of the secondary winding.

e = voltage supplied by the transformer without load.

RL = the A.C. impedance of the load.

As an example of how this equation can be used in practice, take the case of the transformer shown in Fig. 1. The value, e, measured at points AB without load, is found to be 320 V. The value, R, as measured with an ohmmeter, is 400 ohms, which is its D.C. resistance; however, it was found that at 60 cycles, the difference between this value and the A.C. impedance is negligible and hence the error introduced was of no consequence. Resistor RL is a voltage divider of 6,000 ohms resistance. What we want to know is: what will be the transformer voltage with this 6,000 ohm load? Substituting the above values in equation (1) gives —300 V.

The same method may be applied where the current is rectified and applied to the plate circuits of various tubes.

We now consider the application of this method to step-down filament transformers: it is almost impossible to accurately determine the winding resistance with an ohmmeter (in fact, with transformers of high power rating a Wheatstone Bridge is incapable of measuring such low resistance values). Therefore an auxiliary equation (2) is used.

$$(2) \quad R = \frac{e - E}{I}$$

Example: A receiver employs 4 tubes drawing 4 A. on the filament; Fig. 2 shows the circuit. What will the filament voltage drop to, with 6 tubes drawing 6 A.? The voltage, e, without load, is 2.7 V. and E, with load, is 2.25 V. These values should be substituted in equation (2):

$$R = \frac{2.7 - 2.25}{4} = \frac{.45}{4} = 0.112\text{-ohm.}$$

Having obtained R, the calculation for a 6 A. drain is readily made by use of equation (3):

$$(3) \quad E = e - IR \\ E = 2.7 - (6 \times 0.112) = 2.03 \text{ V.}$$

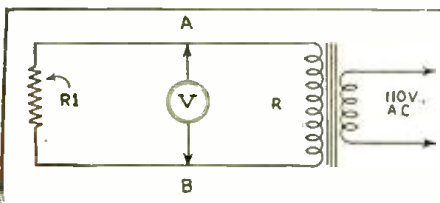

Fig. 1  
The value, e, is measured at A-B.

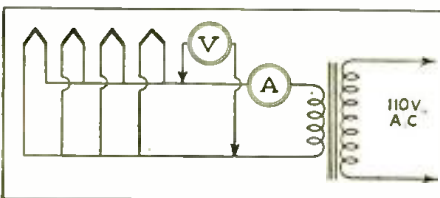
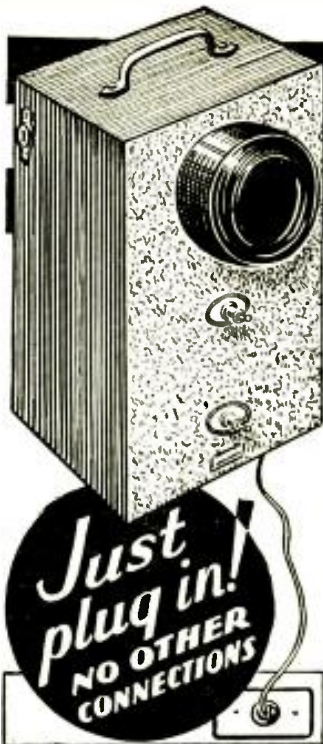

Fig. 2  
The method of filament circuit measurement.



Just plug in!  
NO OTHER CONNECTIONS

## A New Socket Operated SOUND SYSTEM

### Transmits Over House-Wiring!

Just plug-in the MILES SOCKET MIKE to any lighting socket and transmit music or speech to one or more amplifier-speakers connected to the lighting circuit anywhere in the same building. No other sound system has this patented "WIRE-LESS" feature.

Saves installation time, labor, cost, and avoids mistakes.

The amplifier-speaker of a radio set can be used as the outlet for the MILES SOUND SYSTEM, with perfect results. Full, clear, noiseless transmission assured for every private or public-address need.

### Big Profit-Maker

Sound amplifying is the big money-maker of 1934. Increase your profits! Sell or rent the sensational MILES SOCKET-OPERATED SOUND SYSTEM to your customers.

Write for new Illustrated Folder "RC-5," giving complete data, prices and uses.

HENRY GOLDSMITH CO., INC.  
225 WEST 34th STREET NEW YORK CITY

# HEADQUARTERS FOR PUBLIC ADDRESS AMPLIFIERS

BUY DIRECT from MANUFACTURER and SAVE BIG MONEY!

**JUST OFF THE PRESS!**

SEND FOR THIS FREE Radio and Amplifier CATALOG

**100 PAGES OF BIG MONEY SAVING VALUES**

You Can Not Possibly Afford to Be Without This Really Valuable Book — Send For Your Copy Today.

WE ARE HEAD-QUARTERS FOR P.A. SYSTEMS. Buy direct from the manufacturer and Pay Only One Profit!

SEND FOR FREE CATALOG

**OFFICIAL PUBLIC ADDRESS AMPLIFIER MANUAL**  
AND SOUND SYSTEM TREATISE  
THE ONLY BOOK AVAILABLE OF ITS KIND!

Devoted Exclusively to the Problems Involved in Purchasing, Designing, Measuring, Testing, Installing, Operating, Trouble Shooting, Maintaining, and Money Making Possibilities of Public Address Systems.

AVAILABLE with a VALUABLE SUPPLEMENT SERVICE

LOOSE LEAF contains 100 64 Pages, 8x10 OVER 150 DIAGRAMS CHARTS AND ILLUSTRATIONS

WRITTEN IN PLAIN CLEARLY UNDERSTANDABLE LANGUAGE

A Vital Necessity to Everyone Connected in Any Way With Sound-Systems—Public Address Work—or Amplifiers and Associated Equipment! Complete and Authoritative!

Coast-to-Coast-Radio-Corp. logo

**COAST-TO-COAST-RADIO-CORP.**  
123 K-WEST 17TH STREET . NEW YORK, N. Y.

BACK ISSUES OF RADIO-CRAFT which you might need to complete your files, can still be had at the price of 25c per copy. Send us your requirements, together with your remittance in check or money order. RADIO-CRAFT, 96-98 Park Place, New York, N. Y.

## WANTED!

Jobbers—Mail Order Houses and Representatives in all Territories

### TWO FAST MOVERS

Free Edge Cone and Voles And—Field Cells for all Coil Assemblies Dynamic Speakers We also Manufacture Various Types of Magnetic Speakers

We can Supply and Remedy Your Speaker Needs. Speaker Mfrs. Since 1921

LEOTONE RADIO CO., 63 Day St., New York, N. Y.

## "PERFECTED" ALL-WAVE SET

12,500 MILES ON ONLY TWO TUBES!

Simple to build—easy to operate—World-wide reception range—and extremely inexpensive! We have sold thousands of these remarkable short-wave kits and novices and "old-timers" alike have marveled at the amazing results obtained.

These kits contain every necessary part to construct the entire receiver. The coils, which tune from 15 to 200 meters, are wound on polished bakelite forms. The attractive crystal finished metal chassis and panel comes with all holes necessary to mount the apparatus and this, together with our complete, detailed, clear instruction sheets greatly simplifies construction.

DRY CELL OR AC MODEL \$4.75  
Two Coils 200 to 625 Meters \$1.25  
Deposit required with all orders.

**HARRISON RADIO CO.**  
142 LIBERTY ST., Dept. R-5, NEW YORK CITY

# SUPREMACY IN PERFORMANCE



**ROUGH** going this past winter—through mountains in New York State, this 6-tube Super-heterodyne proved a mighty sturdy Auto-Radio. Hard bumps, slippery roads, hills never interrupted reception during a long steady drive.

**FEATURES**  
Automatic volume control—Interstation noise suppression—New Pentagrid converter tube—8 tube performance—but uses only six 1/6A7 1/41 1/75 2/78 1/84 tubes—Humid rated vernier airplane dial—Power lock switch—Dyna-mic speaker—Only 2 wires to connect—Quickly installed—190 to 550 meters—Use any type aerial—Draws only 4 amperes—Size 8 3/4" x 6" x 6 1/2" high. Write immediately for our Free Circular and Special Low Prices on Auto Sets, Air Cell Supers and Long and Short Wave Receivers.

**STATES RADIO LABS.** 137R Liberty St. New York, N. Y.

## METAL - WORKING LATHE ...



New designs and mass production methods make this amazing bargain possible. Complete metal working lathe with compound slide-rest, improved three-jaw chucking device, 6-in. swing, 24-in. overall length, 20 lbs. Send postcard for catalog and 10-day trial offer, or save time and send \$1. balance plus express C. O. D. Wood-turning lathe \$1.50. Extra bed-lengths, 50c per foot. Attachments for milling, grinding, sanding, saw table, etc., available at low prices.

**AMERICAN MACHINE & TOOL CO.**  
200 Broadway Dept. J New York

## BACK ISSUES OF RADIO-CRAFT

which you might need to complete your files, can still be had at the price of 25c per copy. Send us your requirements, together with your remittance in check or money order.

**RADIO - CRAFT**  
96-98 Park Place New York, N. Y.

## OPERATING NOTES

(Continued from page 669)

tion lately. A set was brought in with a bad 25Z5 rectifier. After replacement and a thorough check the set was pronounced O.K. A few days later the set was back again and the owner volunteered the information that this was the third time he had a rectifier replaced—continuing, he said: "Don't tell me it is a rectifier again." But it was! We therefore made a thorough check of all parts that might contribute to its failure. The trouble was finally traced to the small condenser that couples the R.F. plate to the detector grid. This condenser consists of two 1/2 x 1/4-in. metal plates with mica dielectric. A single insulated rivet passes through the center. This condenser, somehow, started shorting after operating a few hours, thus shorting the power supply. After replacement the set performed as good as ever. This condenser, C, is indicated in Fig. 3.

### GEM A.C.-D.C.

VERY peculiar is speaker failure in Gem receivers. About half of these sets that have come to our attention have open speaker coils. This set uses speakers with a stamped aluminum frame that is folded over the edge of the paper cone. The magnet and moving parts are all inside and once out of order can't be inspected for repairs. The only solution is replacement.

### EMERSON 20A AND 25A

A STRANGE case that came to our attention was an Emerson model 20A. The complaint was a very loud cracking noise after about an hour of operation. The set had been serviced twice before, but each time the same trouble recurred. A thorough check failed to disclose the trouble. Since a leak or an intermittent short was indicated, all tubes were checked for voltages while the cracking noise was on. This did not locate the fault, however. Then all suspected parts were replaced but to no avail. After this a check of all soldered connections was made, re-heating with a hot iron all suspected parts. Finally, the fault was located on one lug of the filter choke.

A big lump of solder was clearing the chassis by only a few thousandths of an inch. Hot as the set is during operation, it takes some time before the flux strip on which the lug is mounted to give way and short to the chassis. While it can be seen in Fig. 4 that

the chassis has no direct connection to the rest of the circuit, except through a .05-mf. condenser (the variable condensers are mounted through insulated bushings) an intermittent short at the point indicated can create a racket.

The filter condensers are another weak point in these sets. These condensers (two 4 mf. in one case) give way quite frequently.

### R.C.A. VICTOR R-27

WHEN this set loses volume and behaves as if it has an open grid circuit, the trouble can usually be traced to the magentic speaker. The armature gets out of center after a short time. Adjusting the three screws provided for the purpose usually puts it in good order again.

### DE CHAMPE MODEL

LIKE the R.C.A. this set is afflicted with the same speaker trouble. It is "some job" to center the armature of this speaker, though. The armature has to be unsoldered from the pin that connects it to the supporting lever, centered, and soldered again. See Fig. 5. A good many minutes may be spent here. It is a cut and dry proposition.

R. GASPOR

### STEWART-WARNER 201

I HAVE found that reception in Stewart-Warner No. 201 superhet, short-wave converters can be greatly increased and improved by replacing the dropping resistor incorporated in the converter itself. I have replaced this resistor, which dropped 300 volts down to 50 with load, with a 10,000 to 20,000 ohm (preferably wire wound). The exact resistance will depend upon the value of the available "B" supply. (I wish to add that the writer has not experienced any trouble with the 2 mf. bypass condenser mentioned in this same column in the October, 1933, issue of RADIO-CRAFT.)

Many old sets, operating with the old 71 or 71A output tubes can be improved, both in decreasing hum and increasing distortionless output, by replacing the 26 first A.F. with a type 37, 6.3 V. general purpose tube; and the final output, by a 38 pentode, lighting both of them from the 5 V. winding, which will furnish sufficient voltage for both tubes.

RICHARD O. LAMB

### SPARTON SERVICE

I HAVE recently had to service a few Sparton T.R.F. 6 tube chassis (Sparton models 9-A and 410), the circuits of which oscillated very badly over the entire dial. An investigation of this trouble showed that the grounding contacts on the rotor shaft of the variable condensers were making poor contact, due to accumulations of dust and dirt. However, I further found that cleaning these contacts proved to be only a temporary cure.

For permanent repair, remove the original contacts entirely and install two phosphor bronze clips. These clips are made of strips of phosphor bronze about 3/8 x 1/2-in. Slots are cut in each end of the strips large enough to fit over the rotor shaft. The strips are then bent at the middle and installed as shown in Fig. 6. Be sure that the ends of the clips bear, with tension, against the hub of the rotor plates in a lateral direction. Complete the installation by soldering each clip in place at the edge of the shield over which it passes.

J. E. BEEZER

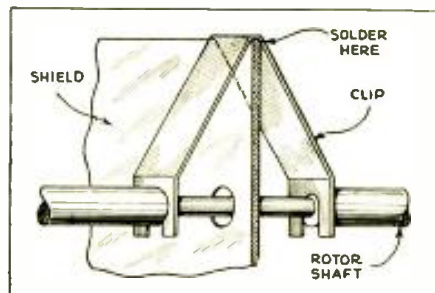

Fig. 6

Improving the Sparton 6 tube set.

# Are you looking for more business?

Do you want to add an extra

## \$1000.00

to your income this year? Write for details on how you can do it with a U-19 Portable Public Address System!



## UNITED SOUND ENGINEERING COMPANY

Manufacturers of Specialized Sound Equipment

2233 UNIVERSITY AVENUE

ST. PAUL, MINNESOTA

# RADIO ENGINEERING COSTS LESS IN CANADA

The Engineering Course is written by Mr. Florian J. Fox, B.Sc. (Yale), Chief Technical Adviser to the Radio College of Canada. Mr. Fox is well known throughout America in the Radio Industry, having held many responsible engineering positions with such companies as the American Bosch Corporation, Grimes Corporation, Utah-Carter Radio. At present he is Engineer in charge of design for the Rogers-Majestic Corp., Toronto, Canada.

In addition to the Engineering Course the Radio College gives instruction in all the subjects listed below. Whether you are a resident in the U.S.A. or Canada, it will pay you to return the coupon for further information.

- Practical Radio and Television, (Junior Engineering Course)
  - Broadcast Engineering
  - Sound Engineering
  - Aviation Engineering
  - Aviation Radio Operating
  - Practical Flying Instruction
- I am interested in  Home Study  School Study

**Radio College of Canada, Ltd.**  
**863 Bay Street, Toronto**  
 Authorized Agents for British Columbia and Alberta:  
**SPROTT - SHAW SCHOOL**  
 815 West Hastings St., Vancouver  
 School approved by leading manufacturers and government officials.

## DIAMOND TUBES at BARGAIN PRICES

All tubes are R. C. A. Licensed and are Guaranteed for 90 days. Dealers and service men let us show you how you can increase your profits on tubes sales. Our tubes will improve the quality and tone of any set.

| Type | Price | Type | Price | Type | Price | Type  | Price |
|------|-------|------|-------|------|-------|-------|-------|
| 201A | .25   | 234  | .65   | 58   | .45   | 125N1 | .85   |
| 226  | .27   | 236  | .50   | 59   | .55   | 401   | 1.10  |
| 227  | .27   | 237  | .40   | 75   | .65   | 403   | 1.25  |
| 245  | .28   | 239  | .45   | 77   | .60   | 485   | .50   |
| 171A | .28   | 239  | .50   | 78   | .60   | 182   | .55   |
| 240  | .28   | 41   | .50   | 79   | .75   | 183   | .65   |
| 224A | .45   | 42   | .50   | 281  | 1.10  | 210   | 1.25  |
| 235  | .45   | 43   | .75   | 82   | .40   | 250   | 1.10  |
| 251  | .45   | 44   | .50   | 83   | .45   | 247   | .75   |
| 247  | .45   | 46   | .50   | 84   | .65   | 287   | .85   |
| 112A | .40   | 48   | 1.75  | 85   | .50   | 6A7   | .75   |
| 230  | .50   | 49   | .65   | 89   | .55   | 6B7   | .85   |
| 231  | .50   | 55   | .50   | X99  | .45   | 25Z5  | .65   |
| 232  | .65   | 56   | .35   | V99  | .45   | 2A5   | .65   |
| 233  | .65   | 57   | .45   | 222  | .85   |       |       |

No order accepted for less than \$3.00. Order from this ad. All prices F. O. B. factory. 20% deposit with all orders. Dealers ordering 100 Assorted Tubes or more, allowed 10 percent discount.

**Radio Tube Exchange of America**  
 160 Washington St., New York, N. Y.

## 10¢ A DAY BUYS A NEW REMINGTON PORTABLE TYPEWRITER Special 7-Day Free Trial Offer

Think of it! You can buy a new standard Remington Portable Typewriter for but 10c a day. Standard keyboard. Small and capital letters. Beautiful finish. Carrying case included free. Exceptional money-making opportunities. Write today. Say: Please tell me how I can get a new Remington Portable typewriter on your special 7-day free trial offer for but 10c a day. Remington Rand Inc., Dept. RC-10, Buffalo, N. Y.



## MAJESTIC 130

I WAS called upon recently to service a Majestic Model 130. On questioning the owner I learned that the 80 tube had given up after a long and useful life, whereupon he had purchased a new one (a well-known make) and placed it in the set. The set performed well for possibly a quarter-hour, then went "dead." Finding that a fuse had "gone West" he replaced it only to have the same thing happen again.

I diagnosed the case as a dead short in the filter system—examination, however, proved that this was not the case. I then tested the transformer which showed correct voltage both with and without load. Not having any spare fuses with me I wasn't very keen about shorting the fuse block and watching the smoke roll in the customer's home, so I removed the set to the shop.

Here all filter and bypass condensers were tested for high-voltage breakdown, but without a fault developing. All tubes had previously been tested for shorts and proved O.K.

I then placed the set in working order again and bridged the fuse. After placing a voltmeter between the high side of the filter and the ground, to give a visual indication of the beginning of the show, I sat back to await results. After about half an hour of good entertainment in the way of music, the voltage started dropping.

At this point the 80 tube was so hot that the sticker on it was smoking. At the same time there was a fine display of fireworks in the tube. "What did you say Watson?" No, it wasn't the filament and the plate—it was between the leads in the base of the tube. A thermionic short in the base. I never heard of such a short but needless to say another 80 did the trick. Upon testing the defective tube it showed no traces of a short, and actually tested pretty fair in spite of the overload.

FRANK F. BABB

## ATWATER KENT 81

SEVERAL Service Men had worked on an Atwater Kent 81 installed in a Buick roadster and gave it up. While driving along the noise was like a bad case of static, but on stopping or turning a corner the noise would disappear. After some hunting and testing, we found that by disconnecting the right front brake rod the noise would not stop when the brakes were applied when traveling as it did when the rod was connected. This showed the noise to be coming from the front wheel. A thorough inspection of the wheel did not reveal a single thing to cause the trouble. However, when an ohmmeter was connected from the spindle to the hub of the wheel and the wheel turned, it was found that as the wheel was turned increasingly fast the resistance increased to about 50,000 ohms; the wheel was floating free.

The noise being a static discharge set up between the hub and the spindle, I then made the brush shown in Fig. 7, and installed it; since then the car has traveled about 7,000 miles and the brush is not showing any wear.

NORMAN A. REYER

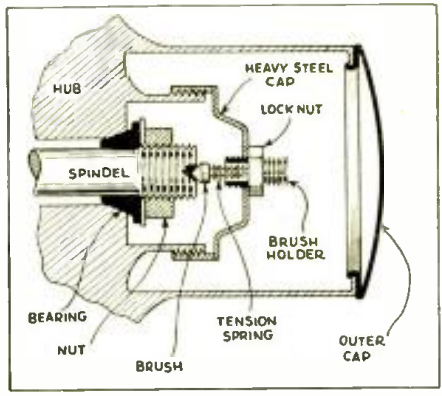

Fig. 7

Interference was set-up between hub and spindle.



## Make Quicker, More Accurate Tests with this NEW No. 1167



DEVELOPED by some of the industry's outstanding engineers, the new Triplet No. 1167 instrument is arousing widespread interest. While simply designed and easily operated, the extreme accuracy and completeness satisfy the most exacting requirements of the professional service man. With this new instrument, you can quickly and accurately measure voltages, current, resistances and continuities without removing the chassis from the cabinet . . . using the cable and plug to make the connections between the set socket and the tester.

The 1167 unit incorporates a direct-reading Ohmmeter, Output Meter, AC-DC Voltmeter and a Milliammeter. All readings are controlled by a selector switch. The single meter has 1000 ohms per volt resistance. Voltage readings range from 0 to 750—Milliamperic readings from 0 to 150—Ohmmeter readings from 0 to 3,000,000.

Four sockets take care of all tubes now in use. These sockets can be easily and economically replaced whenever other sockets with added connections are required. It is no longer necessary to carry additional cables, plugs, etc.

**YOUR JOBBER CAN SUPPLY YOU**  
 . . . at the dealer's net price of \$25.00

**THE TRIPLET ELECTRICAL INSTRUMENT COMPANY**  
 54 MAIN STREET BLUFFTON, OHIO



Mail Today For Details

THE TRIPLET ELECTRICAL INSTRUMENT CO.  
 54 Main St., Bluffton, Ohio

Gentlemen:  
 Send me catalog on Triplet Instrument No. 1167, and your complete line of radio servicing instruments.

Name .....

Street Address .....

City ..... State .....

## PHILCO DETECTOR-RECTIFIER AND AMPLIFIER

THE purpose of this article is to make clear the functions of each of two tubes, the detector-rectifier and the detector-amplifier, as used in many of the newer radio sets—the Philco in particular which is being used as an example.

Many have asked, why and how is it possible to get signal output from the ground side of the grid circuit, and why are the plate and cathode of the detector-rectifier tube grounded? How can a tube connected in such a fashion work, add quality to a set; and, what are the advantages of this system?

First, let us refer to a schematic detail of the Philco 91, Fig. 8. In the conventional set the detector tube acts as a detector and amplifier, that is, the R.F. currents are rectified and amplified. Each tube has only one function to perform. One tube acts as a diode rectifier and the other tube amplifies these feeble rectified impulses.

Let us forget the complicated circuit a moment and refer to Fig. 9A, a simple half-wave rectifier. Consider S as the secondary of an R.F. transformer and we have a simple half-wave or diode detector. The R.F. trans-

former secondary connects to the plate and to the filament through resistor, R. With A.C. flowing through S, during the positive cycle, current flows through it, during the negative cycle, no current flows, thus it may be seen, it becomes a half-wave rectifier.

Now let us look at Fig. 9B, in which the cathode and plate are tied together and grounded, thus corresponding to the filament terminal 2 of Fig. 9A; and lead 1 of Fig. 9B corresponding to lead 1 from the plate in Fig. 9A. In this case the grid is used as the plate of the tube, and the plate and cathode are tied together to cut down the internal resistance.

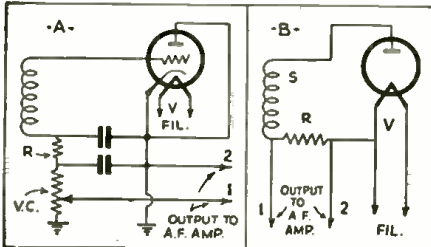

Fig. 9

The diode connection.

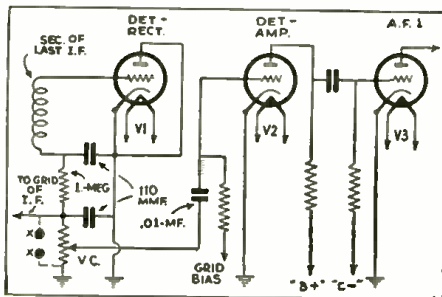

Fig. 8

The Philco 91 detector circuit.

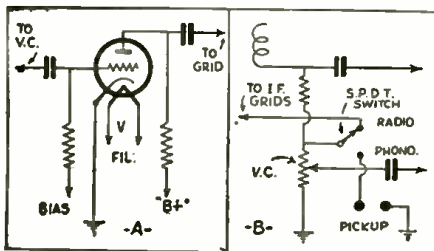

Fig. 10

A pre-amplifier connection.

In Fig. 10A we see a resistance-coupled amplifier used as a pre-amplifier for the A.F. By taking each unit separately and analyzing it, we can readily see that it is composed of two simple parts.

Any signal impressed upon this diode rectifier is directly proportional to the output. The advantage of this system is, when receiving a given signal and the modulation is increased, the A.F. output will go up in direct proportion. This is an important feature that is very hard to obtain except by using a diode type detector.

Incidentally it may be a little confusing to some to connect a phonograph pickup or microphone transformer in this circuit. A high-impedance pickup may be connected from X to X as shown by dotted lines in Fig. 8; or, the secondary of a microphone or phonograph pickup transformer may be similarly connected. When using either pickup or microphone transformer in this circuit it is advisable to put in an S.P.D.T. switch in the circuit as shown in Fig. 10B.

CHARLES M. CONLEY

## SEXOLOGY

### THE MAGAZINE OF SEX SCIENCE

SEXOLOGY, foremost educational sex magazine, is written in simple language and can be read by every member of the family. It is instructive, enlightening—not a risqué book—contains no jargon. Devoted to Science of Health Hygiene.

Contains 25 important articles on Sex Science, 68 pages, with attractive two-color cover. Here are a few of the more important articles:

Editorial—"Sex Determination"; The Cause of Caesarean Operations (Illustrated); When and How to Have Children; Cure for Homosexuals?; Where the Sex-Cells Meet (Illustrated); Sexual Anxieties; Sex and Insomnia; The Chemicals of Sex (Illustrated); Sex Impulses of the Country Child; How to Stop Masturbation; Education for Marriage; Venereal Disease Prevention (Part III); Advice to Young Unmarried Women; Scientific Sex Notes.

Get a copy of SEXOLOGY on any newsstand, or, if your dealer cannot supply you, send 25c in stamps for a copy of the current issue. SEXOLOGY 25R West Broadway New York, N. Y.

## Another Big Boom In Radio . . .

# PUBLIC ADDRESS INSTALLATION

## It's a Money-Making Field

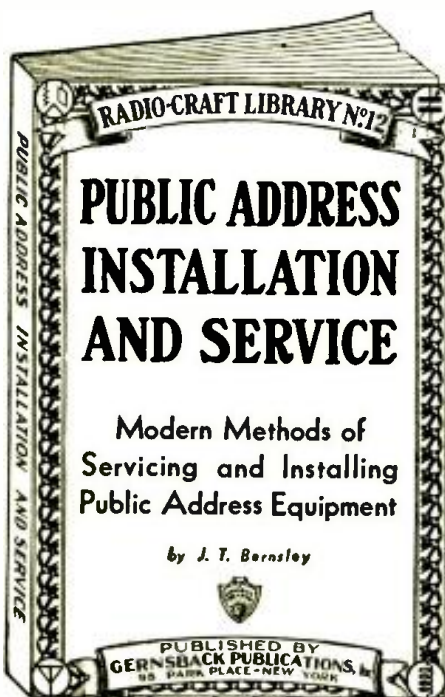

Here is a new edition to the RADIO-CRAFT Library Series—it's a book which shows radio men how to really make extra money in a fast-growing field, allied to radio. In public address work unlimited opportunities arise—it's practically a rejuvenation in radio. Know the facts about public address equipment and get your share of business. Get a copy of **PUBLIC ADDRESS INSTALLATION AND SERVICING**, by J. T. Bernsley—it covers modern methods of servicing and installing public address equipment.

### A BRIEF SUMMARY OF THE CONTENTS

**AUDIO AMPLIFIER FUNDAMENTALS**—Introduction; Discussion on types of amplification—transformer coupling, resistance coupling, impedance coupling, push-pull and miscellaneous; New Terms and Theory—Class A amplification, Class B amplification, Voltage amplifier; Power amplification; Pre-amplifier; Carbon microphone, Condenser microphone, Ribbon or velocity microphone; Power Supply Requirements—For Class A, For Class B.

**PUBLIC ADDRESS AMPLIFIERS**—Standard Installation—4 1/2 watt amplifier, 7 watt amplifier, 10 watt amplifier, 15 watt amplifier, 20 watt amplifier, 30 watt amplifier, 40 watt amplifier, 50 watt amplifier; Special Installation—Portable—6 volt operated amplifier; Mobile-use amplifier, 26 watt (Radio-Craft), AC-DC—and 6 volt amplifier, Pre-amplifier (1 stage, 2 stage, 3 stage).

### INSTALLATION INSTRUCTION

Analyzing Requirements; Best methods for installing—indoor, outdoor; Methods for minimizing "howl" or audio oscillation present after installing; Speaker installation (horn type, baffle type); General Instructions and Hints.

### ACOUSTICS

How to survey and analyze an auditorium for reverberation time—with formulas, and correct method for treatment; chart with absorption coefficients of standard treating material.

### SERVICING—FORMULAS

Amplifiers; Power Supply devices; Speakers; Microphones (carbon, condenser, ribbon or velocity); Formulas—decibel, meaning and use, calculation overall audio gain, distortion in amplifier; Conclusion.

64 PAGES — 6 x 9 INCHES — OVER 50 ILLUSTRATIONS

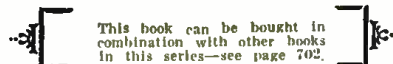

GERNSBACK PUBLICATIONS, Inc. 96-98 Park Place, New York, N. Y.

GERNSBACK PUBLICATIONS, Inc. 96-98 Park Place, New York, N. Y.

Gentlemen: Enclosed you will find 50 cents, stamps, checks or money order accepted, for which send me postage prepaid. One Copy of the new book, **PUBLIC ADDRESS INSTALLATION AND SERVICING**.

Name .....

Address .....

City ..... State ..... RC-534

● Index to Advertisers ●

|   |     |
|---|-----|
| <b>A</b>  |     |
| Aerovox Corporation.....                                  | 688 |
| Alden Mfg. Company.....                                   | 688 |
| Allied Radio Corp.....                                    | 686 |
| American Machine & Tool Co.....                           | 696 |
| Autonator Laboratories.....                               | 676 |
| <b>B</b>  |     |
| Bud Speaker Company.....                                  | 678 |
| <b>C</b>  |     |
| Capitol Radio Research Labs.....                          | 693 |
| Central Radio Laboratories.....                           | 678 |
| Claroostat Section.....                                   | 694 |
| Coast-to-Coast Radio Corp.....                            | 695 |
| Concourse Electric Company.....                           | 692 |
| Coyne Electrical School.....                              | 641 |
| Crestone Radio Mfg. Co.....                               | 685 |
| <b>D</b>  |     |
| Delta Radio Mfg. Co.....                                  | 680 |
| Deuschmann Corp., Tobe.....                               | 680 |
| <b>E</b>  |     |
| Electrad, Inc.....  | 688 |
| <b>F</b>  |     |
| Fordson Radio Mfg. Co.....                                | 684 |
| <b>G</b>  |     |
| General Transformer Company.....                          | 681 |
| Greensmith Company, Inc., Henry.....                      | 695 |
| Greenpark Company.....                                    | 701 |
| <b>H</b>  |     |
| Hammarlund Mfg. Company.....                              | 694 |
| Harrison Radio Company.....                               | 695 |
| Hygrade-Sylvania Corp.....                                | 689 |
| <b>I</b>  |     |
| Insuline Corp. of America.....                            | 692 |
| International Resistance Co.....                          | 685 |
| <b>L</b>  |     |
| L & L Electric Company.....                               | 688 |
| Leed's Radio Company.....                                 | 695 |
| Leotone Radio Company.....                                | 695 |
| Lynch Mfg. Company.....                                   | 699 |
| <b>Mc</b>   |     |
| McGraw-Hill Book Co.....                                  | 688 |
| <b>M</b>  |     |
| Midwest Radio Corp.....                                   | 691 |
| <b>N</b>  |     |
| National Radio Institute.....                             | 643 |
| National Union Radio Corp.....                            | 687 |
| <b>P</b>  |     |
| Pioneer Sound Laboratories.....                           | 692 |
| Popular Book Corp.....                                    | 692 |
| Precision Resistor Company.....                           | 690 |
| <b>R</b>  |     |
| Radio & Amplifier Labs.....                               | 685 |
| Radio Circular Company.....                               | 693 |
| Radio College of Canada.....                              | 697 |
| Radio City Products Co.....                               | 699 |
| Radio Trading Company.....                                | 704 |
| Radio Training Association of America, Inside front cover |     |
| Radio Tube Exchange.....                                  | 697 |
| Radolek Company.....                                      | 690 |
| Rytheon Production Corp.....                              | 679 |
| RCA Institutes, Inc.....                                  | 694 |
| RCA Radiotron Co., Inc.....                               | 675 |
| RCA-Victor Co., Inc..... Back cover                       |     |
| Readrite Meter Works.....                                 | 693 |
| Remington Rand, Inc.....                                  | 697 |
| <b>S</b>  |     |
| S. O. S. Corp.....  | 676 |
| Service Men's Pub. Co.....                                | 693 |
| Sexology.....   | 698 |
| Shalleross Mfg. Company.....                              | 682 |
| Shure Brothers Company.....                               | 682 |
| Silver-Marshall Mfg. Co.....                              | 687 |
| McMurdoo Silver, Inc.....                                 | 683 |
| Sprayberry, F. L.....                                     | 676 |
| States Radio Labs.....                                    | 696 |
| Supreme Instruments Corp.....                             | 677 |
| <b>T</b>  |     |
| Triplett Electrical Instrument Co.....                    | 679 |
| Try-Mo Radio Corp.....                                    | 694 |
| <b>U</b>  |     |
| United Sound Engineering Co.....                          | 696 |
| Universal Microphone Co.....                              | 690 |
| <b>W</b>  |     |
| Webster Company.....                                      | 686 |
| Wellworth Trading Company.....                            | 703 |
| Wholesale Merchandisers.....                              | 685 |
| Wiley & Son, John.....                                    | 692 |

(While every precaution is taken to insure accuracy, we cannot guarantee against the possibility of an occasional change or omission in the preparation of this index.)

**AUTO RADIO INTERFERENCE**

TWO rather unusual causes of interference in radio-equipped autos have recently come to the writer's attention.

In the first case the cause of a whirring noise could not be pinned down until it was noticed that with the ignition cut off and the car coasting in neutral the noise still persisted. A thorough inspection of the running gear disclosed dry front wheel bearings in which the rollers could be heard to click as the wheel was turned. Greasing eliminated the trouble.

The second trouble occurred in the form of a hissing, crackling noise which would disappear when the brakes were applied. Inspection of the brakes revealed that the lining used was of the type which is interwoven with brass wire. Replacement with a non-metallic lining cured the trouble.

These two instances seem to indicate that it would be wise to cast a critical eye over the mechanical parts of the auto when an "incurable case" of interference cannot be definitely charged to the electrical system.

R. E. BERRY

**BATTERY-OPERATED SUPER.**

THE set was a battery-operated super.—2 V. tubes; push-push class B A.F. output; the trouble—volume control inoperative; the set would not "turn down." The owner couldn't tell us whether the trouble had developed suddenly or not. Turning the volume control knob up or down made absolutely no difference in the volume. The control was noiseless, suggesting that our first guess, a burned-out control, was wrong. We took out the chassis and noted that when "full up" the moving arm was at ground potential. "Shorted somewhere" was our conclusion. The condenser across the control checked O.K. No accidental ground contact elsewhere so far as we could see. So we checked back. It was a bias control. "O" battery? we tested it. Gone from 22½ to 3 V.! A new battery restored the volume control action. Seems simple no doubt to some of the fellows, but who would have thought of testing batteries when the set operated with full volume and perfect quality? Those familiar with push-push battery receivers may have had the experience but the other fellow may be glad to know of this.

(Moral: Don't "think"—know! Tech. Ed.)  
D. & W. HOYLE

**CONDUCTIVE INTERFERENCE**

SOME time ago we encountered a most unusual source of trouble that may be of benefit to other Service Men. The symptoms were not such as to be called man-made static from make and break contacts or motors of any kind but an appreciable loss of volume that occurred at various times. This of course would lead the Service Man to believe such a trouble to be in the radio set itself or a poor antenna or ground system; or, possibly, line fluctuation. With various testing equipment all those checked O.K.

Finally, we started checking all conduit BX and radiators in this location with a portable interference locator using headphones. By tapping these with a piece of metal such as a large coin, our trouble was located by variation in volume. In the headphones, at different points on the premises. We found that two BX cables were in close proximity acting peculiarly like a condenser so as to affect tuning of a set station. The remedy was of course to separate the BX properly.

We have found that a great deal of this trouble exists, since in a lot of electrical fixtures there can be cause for a great many poor mechanical contacts, therefore we are calling such trouble "conductive interference."

AKRON AUTO & ELECTRIC COMPANY, INC.,  
Edward Schiavone,  
Radio Service Manager.

BACK ISSUES of RADIO-CRAFT prior to December, 1932, are available at 50c per copy. Succeeding issues are still available at the regular price of 25c per copy.

**Again! IMPORTANT NEW DEVELOPMENTS IN TEST EQUIPMENT by Radio City Products Co.**

Once more, the new Radio City products "scoop" all competition. The instruments listed below are only a part of the complete line of simplified and improved test devices for radio servicing, developed by the originators of the "free reference point-automatic selection" system of analysis.

The new test devices announced for 1934 are years ahead in simplicity of design, ease of operation, accuracy and economy.

**NEW MULTITESTER**—A combination voltmeter, ohmmeter and milliammeter. 2,000 ohms per volt, sensitivity. Accuracy within 2 per cent.

New Low Price **\$18.75**

**"DEPENDABLE" SHUNTS AND MULTIPLIERS**—Accuracy guaranteed within 1 per cent. Multipliers available in all popular ranges. Shunts in various ranges for standard makes of meters. Convenient in Size. Easily Mounted.

**"DEPENDABLE" MULTIMETER**—A remarkable new instrument for shop and laboratory or wherever economy and convenience are of importance. This single unit has flexibility equivalent to 30 different individual meters.

**"DEPENDABLE" SELECTOR SWITCH**—Single and multiple gang, up to 8 gang non-shorting types. Contacts per gang—from 3 to 12. Improved Wiping Surfaces—Positive Contacts—Low Capacity—Insulated Contact Arm. Excellent for long and short wave work. Furnished complete with dial plate and knob.

Write for descriptive literature and prices on complete new 1934 line of test equipment.

**RADIO CITY PRODUCTS CO.**

Dept. RC

48 WEST BROADWAY NEW YORK CITY

**HEY!**



**MUST WE LISTEN TO THAT SHAM-BATTLE?**

"Whaddaya mean 'sham-battle'? That's one of London's best orchestras."

Ed retorted, with snap: "Sounds like a boiler factory to me. Where'd you get the noise-maker, anyway—five and dime?"

"Go 'way, dope, that'll take, all-wave radio set cost a couple of venturies and it's guaranteed to bring in all the 'foreigners' the way you get locals on your outfit."

Followed a Bronx cheer. "It'll be thrown out, pronto, if you don't choke it off. It's lousy, now, but it could be made to work."

"Okay, wise guy, I'll ask the question—How can it be fixed up?"

"The gink who stuck you with it probably didn't tell you, but no radio, even if you pay a grand for it, is better than the serial you took it to. Even yours would be okay if you gave it a chance... now, do we play cards or what?"

"No Radio Can Be Better than its Aerial!"

Lynch All-Wave Antenna System Complete Kit (with instructions). **\$6.50** Less

At Radio and Department Stores; or by mail, C.O.D., or postpaid upon receipt of price. Write TODAY for amazing FREE Booklet that explains how you can cut out radio noise.

**LYNCH RADIO LABORATORIES, Inc.**

51 Vesey Street New York, N. Y.

# Service Men's Essentials for All Members of the

# ORSMA



No. 14—50c each  
(Plus 10c for Postage)

No. 3—60c per pad of 50  
\$3.00 per ten pads, each of 50



No. 5—50c each

## SERVICE MEN'S ESSENTIALS

THE OFFICIAL RADIO SERVICE MEN'S ASSOCIATION has made arrangements to supply a number of "Service Men's Essentials" for the use of its members and associate members. Only members and associate members can buy these items; they are not sold to others.

These essentials are priced at cost, plus a small additional fee which is the only source of income that the Association has. No one obtains any profit or benefit, except the Association itself. Whatever profit accrues, is reinvested for the furtherance and enlargement of the Association.

By using the letterheads, billheads, etc., you present the business-like appearance to your customer, so essential to successful servicing. In addition, the Association has made arrangements with most of the prominent manufacturers to allow special discounts to members, providing ORSMA letterheads are used when ordering.

### No. 1 ORSMA LETTERHEADS

These letterheads, shown on the right, are furnished with your name, address and telephone number, printed on excellent paper. They are sold in lots of 100 or multiples thereof, with a distinct saving for single orders of 1,000 or more. You would have to pay many times more if you ordered small lots from your local printer. Per 100, 60c; per 1000, \$3.00.

### No. 2 ORSMA ENVELOPES

These are furnished to match the letterheads, printed with your name and address and seal of the Association. They go hand-in-hand with the letterheads and are usually ordered in the same quantity. Per 100, 60c; per 1000, \$3.00.

### No. 3 ORSMA SERVICE RECORD CARDS

They serve a double purpose; whenever you complete a job you fill out the report-form and hand it to the customer; this is the "psychological moment" to collect. By the use of carbon paper a permanent record is kept which is a valuable asset to your business. They are furnished with your name, address and telephone number. Per pad of 50, 60c; per 10 pads, each of 50, \$3.00.

### No. 4 ORSMA INSPECTION LABELS

The label is to be filled in with the proper dates, and pasted inside the set or cabinet where the customer will see it. It is a continuous reminder to him that, when service is needed, he can call you again. The advantage is apparent. Per 100, 50c; per 1000, \$3.00.

### No. 5 ORSMA LAPEL BUTTON

At the suggestion of many members a handsome lapel button bearing the name and emblem of the Association has been designed. It identifies to your fellow members that you belong to the same Association;—and in addition it gives your customer a better appreciation of the professional nature of your work. 50c each.

### No. 6 ORSMA BUSINESS CARDS

These are furnished on a fine grade of paper in two colors with a blotter back. Thus they present an added incentive to your customer to keep them in a prominent place, where they will do the most good. They are printed with your name, address and telephone and bear the official seal of the Association. Per 100, 75c; per 1000, \$4.00.

### No. 9 & 10 ORSMA EMBLEM CUTS

These cuts for printing, advertising, etc., are furnished in two styles and sizes. They may be used for newspaper or telephone-book advertisements or for printing of any kind. Large size, 1 1/4 x 1 1/4 in., \$1.35 each; small size, 3/4 x 3/4 in., \$1.20 each.

### No. 11 ORSMA MEMBERSHIP SIGN

A set of three of these signs, printed on heavy cards, and having holes punched in order to hang in your office or store, and are sold in quantities of 25 or more and is ideal for hanging in stores, offices, etc., for advertising purposes. Set of 25 cards, \$3.00.

### No. 12 ORSMA ADVERTISING DISPLAY SIGN

A two color sign printed in large letters with your name, address and telephone, with the seal of the Association. This sign is sold in quantities of 25 or more and is ideal for hanging in stores, offices, etc., for advertising purposes. Set of 25 cards, \$3.00.

### No. 13 RADIO SERVICE MEN'S ASSORTMENT PACKAGE

This includes one gold filled lapel button, 100 letterheads, 100 envelopes, 50 service record cards, and 100 labels printed with your name and address as described above. The whole assortment costs only—\$3.00—a worth-while saving. Complete, \$3.00.

### No. 14 ORSMA MEMBER CERTIFICATE

A handsome diploma-like certificate engraved on stiff vellum-bound. The certificate is personally signed by the President and Executive Secretary and the corporation stamp of the Association is impressed on a red seal attached to it. Your name, certificate number and date of registration are lettered by hand and the certificate is mailed in a cardboard tube to insure safe delivery. Each 50c, plus 10c for postage.

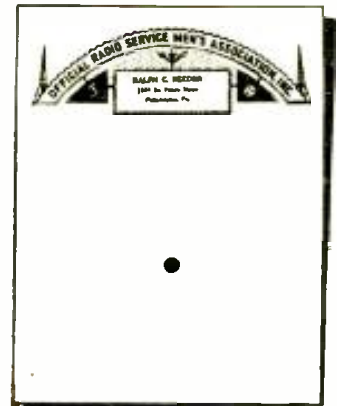

No. 1—60c per 100  
\$3.00 per 1000



No. 2—60c per 100  
\$3.00 per 1000



No. 6—75c per 100  
\$4.00 per 1000



No. 4—50c per 100  
\$3.00 per 1000

Mail This Coupon Today!

## Application for Membership in ORSMA

Executive Secretary, ORSMA  
98 Park Place, New York, N. Y.

Kindly send an application blank for

- Full Membership  
 Associate Membership

Name .....

Street or Box.....

City ..... State .....

RC-534

## OFFICIAL RADIO SERVICE MEN'S ASSOCIATION

RC-534

98RC Park Place, New York, N. Y.

Please send me the following RADIO SERVICE MEN'S ESSENTIALS which I have selected from this advertisement. My remittance for \$..... is enclosed. Send remittance in form of check or money order. Register letter if it contains cash remittance or unissued U. S. Postage Stamps.

.....  
.....  
.....

Name ..... ORSMA No. ....  
Address ..... City and State .....

# Follow the crowd — they're going "Short-Waves"

## THE OFFICIAL DOERLE Short-Wave RECEIVERS 15-200 Meters



**Y**ES, the crowds are going "wild" over short-waves; and the Doerle receivers are making them even wilder. Many have built their own and have obtained miraculous results. Others have purchased them already built and have obtained even better results. And why shouldn't they? These receivers, fundamentally, are so simple that they are **absolutely fool-proof**. As a result, they work **ANYWHERE**—not only in this country—but in any location. Day after day, night after night and with amazing regularity, they pull in stations from the far corners of the earth—**REGULARLY**—always on the same points of the dial.

Only parts of the highest quality, such as Hammarlund variable condensers, etc., are employed; for we fully appreciate that "a short-wave receiver is no better than the poorest part going into its construction." All fancy gadgets and embellishments have been entirely removed, only the most fundamental parts necessary for successful operation are employed. You will be impressed with their simplicity. You will be even more impressed with their operation. These receivers will convince you that foreign reception **CAN** be obtained—and with uncanny regularity—whenever they are on the air.

The Doerle receivers are available in two types, each type consisting of two models. The Electrified Doerle, both the 2-tube and 3-tube models were designed for those households where electric service is available. They must be used in conjunction with a specially designed hum-free A.C. power pack. The 2-volt battery types were designed for the rural districts. They, too, may be had in 2 and 3-tube models.

It may be possible for you to purchase similar receivers or parts for such receivers at greatly reduced prices elsewhere. We admit this at once. But unless you, too, wish to join the ranks of the disillusioned and skeptical short-wave fans you will insist upon the Official Doerle Receivers—Receivers which contain only highest quality parts. All Doerle receivers are built on beautiful, crackle-finished chassis and bear the official name-plate of the only recognized Doerle manufacturer. All 2-tube models measure 9" x 6" x 4½"; 3 tube models 10½" x 7" x 8".



- No. 2140 2-Tube 12,500 Mile Doerle Receiver Completely Wired and Tested. Shipping Weight 5 lbs. **YOUR PRICE \$9.88**
- No. 2142 Complete Accessories. Shipping Weight 22 lbs. **YOUR PRICE \$5.38**
- No. 2143 3-Tube Doerle Signal Gripper Completely Wired and Tested. Shipping Weight 7 lbs. **YOUR PRICE \$12.84**
- No. 2145 Complete Accessories. Shipping Weight 32 lbs. **YOUR PRICE \$7.19**
- No. 2174 Electrified 2-Tube 12,500 Mile Doerle Receiver Completely Wired and Tested. Shipping Weight 5 lbs. **YOUR PRICE \$10.44**
- No. 2176 Complete Set of Tubes for Above; Either 1-57 and 1-56 for A.C. operation or 1-77 and 1-37 for battery operation. **YOUR PRICE \$1.60**
- No. 2177 Electrified 3-Tube Doerle Signal Gripper Completely Wired and Tested. Ship. Wt. 7 lbs. **YOUR PRICE \$15.29**
- No. 2179 Complete Set of Tubes; Either 1-58; 1-57 and 1-56 for A.C. operation or 1-78; 1-77 and 1-37 for battery operation. **YOUR PRICE \$2.50**
- No. 2149 Special Hum-Free A.C. Power Pack including an Rectifier Tube. **YOUR PRICE \$7.25**

### Just Imagine! — 2-TUBES in one GLASS BULB — that's the "TWINPLEX" 15 to 200 Meters



The new type 53 tube makes possible this Twinplex "double-action" receiver. This tube actually contains 2 separate tubes in the same glass envelope. Just imagine what this means! It means that a 2-tube receiver can now be built for the price of a 1-tube set. This is exactly what has been done in the Twinplex receiver. A comparison of prices with the Doerle 2-tube receivers listed above will immediately substantiate this statement. And what's more, it actually performs like a 2-tube set. The circuit is practically the same as the 2-tube Doerle—extremely simple and therefore entirely fool-proof. You will receive stations which you never knew even existed before. We have received many letters from satisfied users of the Twinplex receiver praising it to the skies. And justly so, for it is a wonderful little set. It affords full band coverage of from 15 to 200 meters which includes the amateur bands, police and airplane calls, foreign reception and numerous code stations.

Only the finest quality parts such as Hammarlund variable condensers, Kurz Kasch high-ratio vernier dials, etc., are employed. All these parts are mounted in a beautiful, crackle-finished metal chassis which entirely does away with "hand capacity."

The receiver is universal in operation which means that it may be operated either with batteries or with an A.C. short-wave power pack. 180 volts is required for the plates of the tubes and 2½ volts, either A.C. or D.C., for the filaments. For a fan who is first starting in the short wave game, the Twinplex is the most economical receiver with which to begin.

No. 2115 Twinplex "Double-Action" Short-Wave Receiver Completely Wired and Tested, including diagram but less tubes. Shipping Weight 9 lbs. **YOUR PRICE \$5.00**

### FAMOUS Oscillodyne 1-TUBE WONDER SET 15-200 Meters

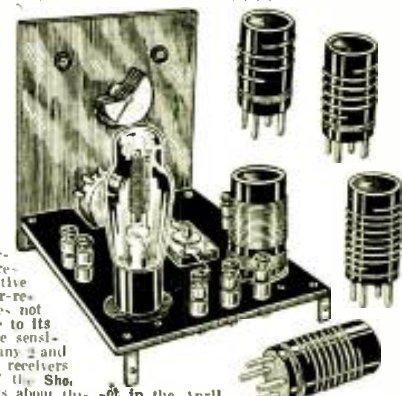

And a wonder set it is at that! Although the circuit of this unique little receiver is of the regenerative type, it acts like a super-regenerative set; yet it does not belong in that class. Due to its peculiar circuit it has the sensitivity and selectivity of many 2 and even 3-tube short-wave receivers. Read what the editor of the Short Wave Craft Magazine says about this set in the April, 1935, issue: "We are pleased to present to our readers an entirely new development in radio circuits—the Oscillodyne. This circuit which is of the regenerative variety, acts like a super-regenerative set. Its sensitivity is tremendous. The editor, in his home on Riverside Drive, New York City, in a steel apartment building, was able to listen to amateurs in the midwest, USING NO AERIAL AND NO GROUND. With the ground alone, a number of Canadian stations were brought in, and with a short aerial of 40 feet, many foreign stations were easily pulled in."

Here then is a set which brings in stations thousands of miles away; a set which frequently brings in Australia, loud enough to rattle your phones and with power to spare; a set which if you do not wish extreme distance will bring in stations several thousand miles away without aerial or ground. And the many hundreds of testimonial letters from short-wave fans who have either built their own or have purchased them, fully substantiate these remarkable results. The receiver may be used either with batteries or A.C. power pack. Requires a 237 tube for battery operation and a 227 for A.C. operation. Available either completely wired ready to use or in kit form. Four pages of detailed instructions and diagrams are included with each set. The aluminum panel is high x 4½" wide. The bakelite base is 7½" long x 1¼" wide. Shipping Weight 3 lbs.

- No. 2146 Official One-Tube Wonder Set, completely wired and tested. **YOUR PRICE \$7.20**
- No. 2147 Official One-Tube Wonder Set, in kit form, with detailed construction plans. Shipping Weight 3 lbs. **YOUR PRICE \$6.35**
- No. 2148 Complete Accessories, including the following: one 37 tube; set of standard headphones; four No. 6 dry cells; two 45-volt "B" batteries. Shipping Weight 22 lbs. **YOUR PRICE \$5.50**

WE ISSUE NO CATALOG All orders are F. O. B. New York. Terms: A deposit of 20% is required with every order. Balance may be paid on delivery. Deduct 2% if full amount is sent.

**GRENPARK COMPANY**  
245 Greenwich St. Dept. RC New York, N. Y.

# The Radio-Craft Library Series covers accurately every branch of Radio—and thoroughly, too

Presented on this page are the new books of the RADIO-CRAFT LIBRARY—the most complete and authentic set of volumes treating individually, important divisions of radio. Each book has been designed to give radio men the opportunity to specialize in one or more of the popular branches of the industry. The material contained

in these books will increase your knowledge; you will find them a real help in your work and they will contribute to your money earning capacity. Read these books during your spare time at home.

The authors of these books are well-known to everybody. Each one is an expert radio man; an authority on the subject—each is thoroughly

familiar with the field which he represents.

This is perhaps the first real opportunity that you have ever had to build a radio library of books that are authentic, right-up-to-the-minute and written so that they are easily digested and clearly understood. Mail coupon below for your books.

## TO THE RIGHT WILL BE FOUND A SHORT RESUME OF EACH BOOK

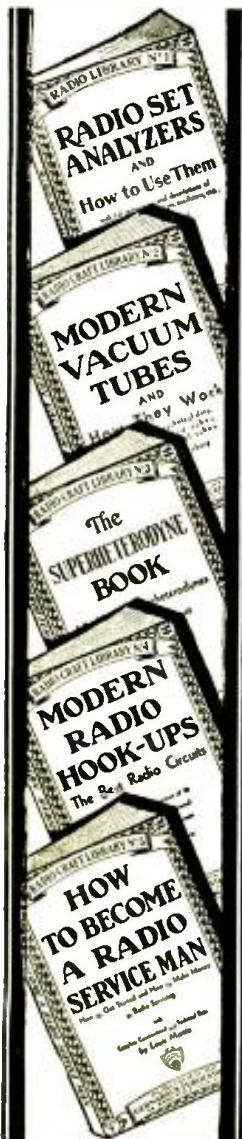

### Book No. 1 Radio Set Analyzers

And How To Use Them  
With Full Instructions and Descriptions of Set Analyzers, Tube Checkers, Oscillators, Etc.  
By L. VAN DER MEL

This book explains thoroughly the operation of set analyzers, tube checkers, oscillators and other testing equipment. For every radio man this book is extremely helpful. It covers every phase of testing and gives you valuable short cuts; completely illustrated with photographs and diagrams to facilitate the use of modern testers. Recently reprinted.

### Book No. 2 Modern Vacuum Tubes

And How They Work  
With complete Technical Data on All Standard and Many Special Tubes  
By ROBERT HERTZBERG

MODERN VACUUM TUBES describes the fundamental electron theory which is the basis of all vacuum tube operation, and goes progressively from the simplest two-element tubes right up to the latest pentodes and thyatrons. It is written in clear, simple language and is devoid of the mathematics which is usually so confusing. Valuable reference charts and characteristic curves of standard and special tubes are to be found, also diagrams of sockets and pin connections.

### Book No. 3 The Superheterodyne Book

All About Superheterodynes  
How They Work. How to Build and How to Service Them  
By CLYDE FITCH

There is no more fascinating a subject in the large array of radio circuits than the famous superheterodyne circuit. Whether you are a Service Man or experimenter, first-hand knowledge about the construction of superheterodyne receivers is very important. The book on Superheterodynes gives underlying principles of their construction, right from the very first set made.

### Book No. 4 Modern Radio Hook-Ups

The Best Radio Circuits  
A Complete Compendium of the Most Important Experimental and Custombuilt Receivers  
By R. D. WASHBURNE

It is fascinating to the experimenter, or even to the up-to-date Service Man, to take a commercial set and to change it into one using a famous hookup that is not found in any manufactured set. Many excellent circuits have never been commercialized, but limited only to home set builders. Thousands of these popular circuits have been requested from time to time, and in this book we have included over 150 circuits, which include the famous Peridyne, Cash-Box, A.C.-D.C. Set and others.

### Book No. 5 How to Become a Radio Service Man

How to Get Started and How to Make Money in Radio Servicing  
By LOUIS MARTIN

The ambition of many men in radio today is to become a first-grade Service Man. It is not as difficult as one might believe, but it cannot be done in a few short months. Following very carefully the advice of Mr. Martin, who has dealt with the problems of thousands of Service Men, this book deals very carefully with the essential stages in the preparation for qualifying as a Service Man.

### Book No. 6 Bringing Electric Sets Up to Date

With Pentodes, Multi-Mus, Dynamic Speakers—Complete Information How to Modernize A. C., D. C. and Battery Operated Receivers  
By CLIFFORD E. DENTON

In this country there are over ten million electrically operated receivers that could be modernized—by placing in them new type tubes, new speaker equipment and other modern improvements. This business of improving old sets can go to the experimenters and Service Men if they will quickly jump into action.

### Book No. 7 Radio Kinks and Wrinkles

For Service Men and Experimenters  
A Complete Compendium on the Latest Radio Short-Cuts and Money-Savers  
By C. W. PALMER

It often becomes necessary for experimenters and Service Men to call upon their memory for some short cut or radio wrinkle that will solve a problem quickly. In business, "short cuts" mean time and money saved, and to the Service Man "time saved" means money earned.

### Book No. 8 Radio Questions and Answers

A Selection of the Most Important of 5,000 Questions Submitted by Radio Men During the Course of One Year  
By R. D. WASHBURNE

There have been collected a wide variety of questions which have come into our editorial offices during the past two years, and only those whose answers would benefit the majority of men engaged in radio have been incorporated in this amazing question and answer book. A tremendously long list of topics is treated.

### Book No. 9 Automobile Radio and Servicing

A Complete Treatise on the Subject Covering All Phases from Installing to Servicing and Maintenance  
By LOUIS MARTIN

Automobile radios are up and coming, and someone has to service them properly. It therefore behooves you to read this immensely important new book on the art of Automobile Radio. The book is concise, and full of illustrations, photographs, diagrams and hookups.

A few of the really interesting chapters: Introduction; Automotive Radio Installations; Complete Descriptions of Commercial Automotive Receivers; Servicing Automotive Receivers; The Ignition System; General Service Considerations; Effects of Temperature on Power Supply; Conclusion.

### Book No. 10 Home Recording and All About It

A Complete Treatise on Instantaneous Recording, Microphones, Recorders, Amplifiers, Commercial Machines, Servicing, etc.  
By GEORGE J. SALIBA

If there is one subject that is fascinating to every radio man, it is that of Home Recording. Of course, this volume is not all on "Home recording," but the information contained therein is important to commercial radio men, studio operators, engineers and others interested in this phase of radio.

The art of recording and reproducing broadcast selections is becoming more important every day to radio men, experimenters and Service Men. Equipping dance halls, auditoriums, churches, restaurants and homes with public address systems and amplifiers brings many extra dollars and often an excellent income.

### Book No. 11 Point-to-Point Resistance Measurements

The Modern Method of Servicing Radio Receivers  
By CLIFFORD E. DENTON

Of the difficult problems which Service Men face today when repairing receivers, the greatest is that of replacing proper resistance values in sets. This task becomes even more difficult when the values of resistors are unknown; and manufacturers of many standard sets do not pass this information on to Service Men. In this new book radio men will find the information needed to quickly place a receiver in normal operating condition. This book cuts in half the time usually required to adjust the average set. Sufficient space has been devoted to the elementary problems and the theory of electricity as it is applied to resistance measurements so that the Service Man will have a comprehensive idea as to how to overcome this problem.

Below you will find a partial list of the contents which will appear in this new book. INTRODUCTION. Advantages of Resistance Measurement Method of Servicing for Radio Work; Basic Principles; Methods of Resistance Measurement; Resistors in Radio Receivers and Amplifiers; Point-to-Point Resistance Measurements in Typical Radio Set using Ohmmeter; Resistance Measurements using Modern Tester; Routine Testing where Circuit Diagram is Available and where Resistances are Known; Routine Testing where Circuit Diagram is Not Available and where Resistances are Unknown; The Relation of Voltage Testing Methods to Resistance Measurement; APPENDIX. Resistance Charts etc.

## ALL BOOKS UNIFORM

The books in the new RADIO-CRAFT LIBRARY are all strictly up-to-date, and written by men who know their subjects. The volumes are all uniform size, 6x9 inches, and contain on an average of 50 to 120 illustrations. Each book is printed on fine book paper and no expense has been spared to make it an outstanding value, for its editorial contents as well as from the mechanical standpoint.

## Clip Coupon and Mail Today!

GERNSBACK PUBLICATIONS, INC., 96-98 Park Place, New York, N. Y.

I have circled below the numbers of books in the RADIO-CRAFT LIBRARY, which you are to send me, and have deducted 20% for ordering five (5) books or more. I have included my remittance in full, at the price of 50c each, when less than five books are ordered.

The amount of my remittance is.....(stamps, checks or money orders accepted.)  
Circle numbers wanted: 1 2 3 4 5 6 7 8 9 10 11

Name ..... Address .....

City ..... State ..... RC-6-34

## Big Discount to You

In order to make it possible for everyone to buy these books, the fifty (50) cent price has been made uniform for all volumes. You can buy these books separately, but you should take advantage of our special offer:

**When Five (5) Books or More Are Ordered**

**Deduct 20% from Your Remittance**

Simply fill in the coupon at left, and mail it to us together with your remittance. Checks, stamps or money orders accepted.





# ORIGINAL

All Parts Used in Majestic Receivers Have  
Been Known to Be of the Highest Quality

# Majestic

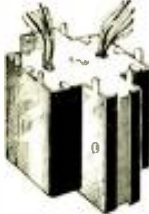
## REPLACEMENT PARTS

|  |  |  |  |  |
|--|--|--|--|--|
| <p><b>POWER TRANSFORMER</b><br/>Chassis 130A—Model 130—131—132</p> <p>Primary 115 Volt 60 Cycle<br/>Secondary to anode center tapped<br/>Secondary 5 Volt 2 Amp.<br/>Secondary 2.5 Volt 7 Amp.<br/>Secondary 2.5 Volt 3 Amp., center tapped<br/>Weight 16½ lb.<br/>Original Majestic Part No. 891</p> <p>MAJESTIC DEALER'S NET PRICE <b>\$5.67</b></p> <p>YOUR PRICE <b>\$3.45</b></p>  |  | <p><b>POWER TRANSFORMER</b><br/>Chassis 25—Model No. 251—253—254</p> <p>Primary 115 Volt 60 Cycle<br/>Secondary to anode center tapped<br/>Secondary 5 Volt 2 Amp.<br/>Secondary 2.5 Volt 7 Amp.<br/>Secondary 2.5 Volt 7 Amp., center tapped<br/>Weight 13 lbs.<br/>Original Majestic Part No. 5883<br/>We can also supply this for 25 cycle</p> <p>MAJESTIC DEALER'S NET PRICE <b>\$5.36</b></p> <p>YOUR PRICE <b>\$2.95</b></p>  |  |  |
| <p><b>POWER TRANSFORMER</b><br/>Chassis 230A<br/>Model 233 Comb.</p> <p>Primary 115 Volt 60 Cycle<br/>Secondary to anode center tapped<br/>Secondary 5 Volt 2 Amp.<br/>Secondary 2.5 Volt 7 Amp.<br/>Secondary 2.5 Volt 3 Amp., center tapped<br/>Weight 20 lbs.<br/>Original Majestic Part No. 2156</p> <p>MAJESTIC DEALER'S NET PRICE <b>\$5.67</b></p> <p>YOUR PRICE <b>\$3.65</b></p>  | <p><b>POWER TRANSFORMER</b><br/>Chassis 10<br/>Model 58—204—294</p> <p>Primary 110 Volt 50-60 Cycle<br/>Secondary to anode center tapped<br/>Secondary 5 Volt 2 Amp.<br/>Secondary 2.5 Volt 3½ Amp.<br/>Weight 4 lbs.<br/>Original Majestic Part No. 6414</p> <p>MAJESTIC DEALER'S NET PRICE <b>\$5.67</b></p> <p>YOUR PRICE <b>\$3.65</b></p> | <p><b>BROAD-BAND TRANSFORMER</b><br/>Chassis No. 130A<br/>BROAD-BAND TRANSFORMER<br/>Chassis No. 110 Auto Radio</p> <p>MAJESTIC DEALER'S NET PRICE <b>98c</b></p> <p>YOUR PRICE <b>69c</b></p>   | <p><b>PICKUP INPUT TRANSFORMER</b><br/>Chassis No. 130A<br/>Model No. 101<br/>Weight 3 lbs.<br/>Original Majestic Part No. 468</p> <p>MAJESTIC DEALER'S NET PRICE <b>\$1.89</b></p> <p>YOUR PRICE <b>89c</b></p> |  |
|  <p><b>PICKUP INPUT TRANSFORMER</b><br/>Model No. 155<br/>Weight 3 lbs.<br/>Original Majestic Part No. 5532</p> <p>MAJESTIC DEALER'S NET PRICE <b>\$1.89</b></p> <p>YOUR PRICE <b>89c</b></p>  |  | <p><b>PUSH-PULL INPUT TRANSFORMER</b><br/>Model 181<br/>Weight 4½ lbs.<br/>Original Majestic Part No. 628</p> <p>MAJESTIC DEALER'S NET PRICE <b>\$1.39</b></p> <p>YOUR PRICE <b>89c</b></p>  | <p><b>CONDENSER BANK</b><br/>For No. 100B and 90E<br/>Original Majestic Part No. 1585</p> <p>MAJESTIC DEALER'S NET PRICE <b>\$3.75</b></p> <p>YOUR PRICE <b>\$1.95</b></p>                                       | <p><b>CONDENSER BANK</b><br/>..Contains 3—2 mfd...<br/>Original Majestic Part No. 1258</p> <p>MAJESTIC DEALER'S NET PRICE <b>\$3.50</b></p> <p>YOUR PRICE <b>\$1.95</b></p>                        |
| <p><b>PUSH-PULL INPUT TRANSFORMER</b><br/>Model No. 30<br/>Weight 4½ lbs.<br/>Original Majestic Part No. 3624</p> <p>MAJESTIC DEALER'S NET PRICE <b>\$1.89</b></p> <p>YOUR PRICE <b>89c</b></p>  | <p><b>PUSH-PULL INPUT TRANSFORMER</b><br/>Model No. 102—103<br/>Weight 4½ lbs.<br/>Original Majestic Part No. 1551</p> <p>MAJESTIC DEALER'S NET PRICE <b>\$1.89</b></p> <p>YOUR PRICE <b>79c</b></p>   | <p><b>PUSH-PULL OUTPUT TRANSFORMER</b><br/>Model 51—52<br/>Weight 3 lbs.<br/>Original Majestic Part No. 3053</p> <p>MAJESTIC DEALER'S NET PRICE <b>\$2.27</b></p> <p>YOUR PRICE <b>89c</b></p>   | <p><b>CONDENSER BY-PASS ASSEMBLY</b><br/>Model No. 393<br/>Original Majestic Part No. 9167</p> <p>MAJESTIC DEALER'S NET PRICE <b>89c</b></p> <p>YOUR PRICE <b>69c</b></p>  | <p><b>BY-PASS CONDENSER AND TERMINAL STRIP ASSEMBLY</b><br/>Chassis No. 200<br/>Original Majestic Part No. 6298</p> <p>MAJESTIC DEALER'S NET PRICE <b>49c</b></p> <p>YOUR PRICE <b>39c</b></p>     |
|  <p><b>CONDENSER BANK No. 7B1P3</b><br/>6 Tap. No. 716<br/><b>CONDENSER BANK No. 7P3</b><br/>7 Tap. No. 712<br/>Used on Chassis 70B<br/>Weight 6½ lbs.</p> <p>MAJESTIC DEALER'S NET PRICE <b>\$3.95</b></p> <p>YOUR PRICE <b>\$1.49</b></p>   |  | <p><b>FILTER CHOKE UNIT</b><br/>Chassis No. 50<br/>Weight 5 lbs.<br/>Original Majestic Part No. 3051</p> <p>MAJESTIC DEALER'S NET PRICE <b>\$2.43</b></p> <p>YOUR PRICE <b>99c</b></p>   | <p><b>DOUBLE CHOKE FOR 90 SERIES</b><br/>9P3-9P6 power pack<br/>Weight 8 lbs.<br/>Original Majestic Part No. 281</p> <p>MAJESTIC DEALER'S NET PRICE <b>\$2.80</b></p> <p>YOUR PRICE <b>99c</b></p>               | <p><b>SINGLE CHOKE FOR 70 SERIES</b><br/>7P6-7P3 power pack<br/>Weight 5 lbs.<br/>Original Majestic Part No. 640</p> <p>MAJESTIC DEALER'S NET PRICE <b>\$1.57</b></p> <p>YOUR PRICE <b>79c</b></p> |
| <p><b>CONDENSER ASSEMBLY</b><br/>Model No. 25 and 25B<br/>Weight 3¼ lbs.<br/>Original Majestic Part No. 5608</p> <p>MAJESTIC DEALER'S NET PRICE <b>91c</b></p> <p>YOUR PRICE <b>69c</b></p>  | <p><b>BY-PASS CONDENSER ASSEMBLY</b><br/>Chassis No. 35<br/>Weight 1 lb.<br/>Original Majestic Part No. 5792</p> <p>MAJESTIC DEALER'S NET PRICE <b>99c</b></p> <p>YOUR PRICE <b>69c</b></p>  | <p><b>CONDENSER ASSEMBLY</b><br/>Chassis 340<br/>Original Majestic Part No. 9043</p> <p>MAJESTIC DEALER'S NET PRICE <b>64c</b></p> <p>YOUR PRICE <b>49c</b></p>  | <p><i>Do Not Write for Catalog</i></p> <p><b>WELLWORTH TRADING CO.</b><br/>111 W. Lake St. Chicago, Ill.</p>   |  |
| <p>WELLWORTH TRADING CO., RC-5<br/>111 W. Lake St., Chicago, Ill.</p> <p>Enclosed find \$.....for which ship to address below the following MAJESTIC parts:.....</p> <p>Name .....</p> <p>Address .....</p> <p>City .....State .....</p>   |  |  |  |  |
| <p><b>ORDER FROM THIS PAGE</b><br/>No orders for less than \$2.00 accepted. No C. O. D.'s. All shipments will be forwarded by express collect if not sufficient postage included with your order.</p>  |  |  |  |  |

# SPRING SPECIALS

**YOUR DOLLAR  
— IS WORTH MORE  
When You Buy From Us**

Is the dollar inflated? These days everybody is speaking of inflation but why worry about it, whether the dollar is inflated or not it is worth more when you buy from us. The prices shown on this page are so radically low that no one can possibly undersell them. Our consistent advertisements present to you each month, on this page, certain STAR (\*) items which are not listed in our regular catalog. These are all specials of which the small quantity on hand does not permit us to catalog them. **ONCE SOLD OUT NO MORE CAN BE HAD AT ANY PRICE. ORDER TODAY—NOW.** Order direct from this page and save money. 100% satisfaction guaranteed on every transaction. Take advantage of these special offers while they are still available. **STOP SHOPPING—WE SHOP FOR YOU AND GIVE YOU THE LOWEST PRICES.**

We are a wholesale house and cannot accept orders for less than \$3.00. If C.O.D. shipment is desired, please remit 20% of the total amount of your order. Balance will go forward C.O.D.

If full cash accompanies your order deduct 2% discount. Send money order, certified check or U.S. stamps.

Be sure to include sufficient extra remittance if order is to be shipped via parcel-post; any excess will be refunded.

## COLONIAL \*Remote Control ATTACHMENT

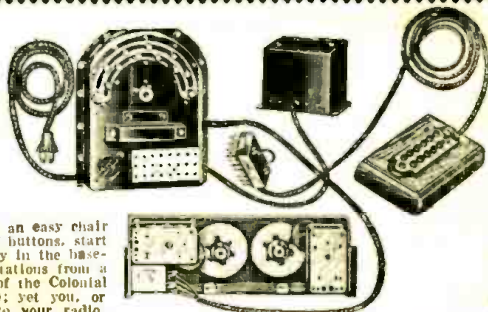

Imagine the convenience of just sitting back in an easy chair or lying in bed and merely by pressing a series of buttons, start the radio located in a far off room or hidden away in the basement. Not only that, but selecting one of ten stations from a remote point. This attachment was used on one of the Colonial remote control sets which sold for about \$300.00; yet you, or anyone at all handy with tools, can attach it to your radio.

You can then hide the radio in some out-of-the-way place and extend wires to any number of speakers strategically located in various parts of your apartment. Imagine the surprise of your friends, or guests, at dinner or at special gatherings, when, by merely pressing a button, the room is gradually flooded with beautiful music or other entertaining programs.

### RADIO SERVICEMEN AND CUSTOM SET BUILDERS—HERE IS YOUR OPPORTUNITY

You need not mention the words "remote control" to your customer and immediately you command his entire attention. You are able to do this because the idea, to him, is new and because it immediately implies expensive equipment. However, when he is properly informed that his receiver too can be adapted for remote control operation for just a few dollars, his interest will certainly materialize into an order.

### Extremely Simple to Operate

The outfit comprises two small motors: one for turning the tuning condenser and the other the volume control, a ten-position commutator switch for selecting ten different stations, a step-down transformer for energizing the motors and a thirteen-button control board (ten buttons for the ten stations, two for increasing or decreasing the volume and the last for silent tuning). A pilot light in the control board indicates when the receiver is operating.

If the shafts of the tuning condenser and volume control of your present receiver are at the correct distances apart, then you can slip this attachment on **DIRECTLY**—without any further changes. With some sets it may be necessary to remove the volume control entirely from the chassis and mount it directly on the rear of the volume-control motor. Shipping Weight 18 lbs.

No. 1789 Colonial Remote Control Attachment.  
YOUR PRICE, Only

**\$5.85**

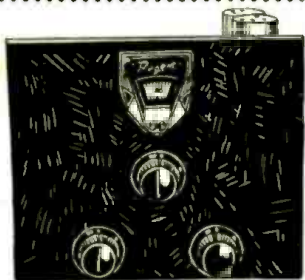

## "REGENT FOUR" TWO-VOLT Equi-Regenerator SHORT-WAVE RECEIVER

- NEW TYPE S-30 TUBES
- ECONOMICAL OPERATION
- PHONES OR LOUD-SPEAKER
- LOW-LOSS PLUG-IN COILS
- COMPLETELY SHIELDED
- RANGE 15 TO 200 METERS

The short-wave fan who has been troubled by lack of oscillation on certain parts of the wave-band covered by plug-in coils will welcome this new receiver. It employs the new S-30 tube which has similar characteristics to the regular 30, except for a much lower internal capacity. This is accomplished by brinking the plate terminal out of the top of the glass bulb. This reduction in internal capacity, facilitates oscillation on the very low wave lengths and also makes the regeneration control much smoother. Another outstanding feature of this receiver is that it automatically stabilizes regeneration at all times keeping the set below the point of oscillation—at which point it is most sensitive.

Uses four tubes, namely, one 34 R.F. pentode, two S-30's and one 233 power pentode output tube. In actual performance it will equal and in many cases even surpass five and six tube receivers. Three 45 V. "B" batteries and two No. 6 dry cells are employed. These dry cells will last a long time because of the low current consumption characteristic of the tubes. High-ratio vernier dial. Four plug-in coils tune from 15 to 200 meters are furnished with the set. All component parts are of the highest quality including Hammarlund variable condensers. These parts are all mounted on a metal base, the front panel of which is beautifully finished in black crystalline. Measures 7½" x 8½" x 7". Shipping Weight 15 lbs.

No. SW-252 4-Tube Regent Short-Wave Receiver Completely Wired.  
YOUR PRICE \$11.95

No. SW-253 Set of Matched Tubes 1—34; 2—S-30's; 1—233.  
YOUR PRICE \$3.70

No. SW-254 Set of Batteries 3—45 Volt Standard "B," 1—22½ Volt "C," 2 No. 6 Dry Cells.  
YOUR PRICE \$4.34

## Absolutely Free! RADIO and Short-Wave TREATISE



Every time a new edition of our Radio and Short Wave Treatise comes off the press, it is an event—an event of importance to tens of thousands of our customers and friends who have been receiving them regularly for many years.

**YOU TOO WILL FIND IT INDISPENSABLE.** This completely revised and enlarged 1934 edition contains 108 solid pages of useful radio information, diagrams, illustrations, radio kinks and real, live radio merchandise. It contains more valuable radio information—**MORE REAL LIVE "MEAT"**—than many text books on the subject.

**Partial List of Contents**  
Chapter Two of "Fundamental Principles of Radio for the Beginner"—The New Tubes, Their Uses, and Their Fundamental Circuits—How to Make Money with Public Address Systems—How to Build the "R.T." Beginner's Transmitter—How to Build the Famous "Twinplex" Short-Wave Receiver—How to Construct an Amateur Radio Transmitter—A Most Modern and Complete Tube Chart, Including Socket Connections for all Tubes—Numerous Free Offers, etc.

**Write To-day** Enclose 4c for postage. Treatise sent by return mail.

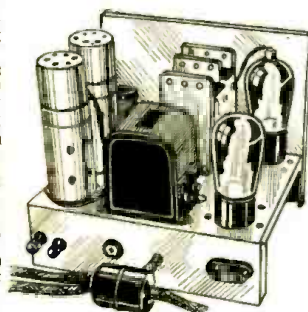

## A REAL "GO-GETTER" 5-TUBE A.C. SHORT-WAVE RECEIVER

One has to go a long way to obtain another receiver which will match this one both in price and performance. Although it is completely A.C. from start to finish, there is absolutely no trace at all of A.C. hum—an accomplishment which already speaks well for the receiver.

All stations come in with real, loud-speaker volume—on a 6" dynamic speaker which is furnished with the receiver. Dual regeneration for C.W. reception is one of the many features. The receiver employs 1—38 high gain, R.F. stage followed by a type of screen-grid detector. The detector is then resistance-coupled to the 56 first audio tube and hence to the powerful 2A5 power output tube. It is the use of this latter tube which affords dynamic speaker operation.

Only the best of parts are employed; for instance, octagonal-shaped plug-in coils (2 sets, 4 coils per set), genuine Hammarlund variable condenser, special vernier variable condenser, Hammarlund R.F. chokes, R.M.A. color-coded resistors, etc. The R.F. and detector tubes are fully shielded as is the specially-designed short-wave power pack which is enclosed in a handsome black, crackle-finish metal housing. The receiver itself is constructed on a beautiful black, crackle-finish chassis. All tuned circuits are controlled by high-ratio Kurz-Kirsch vernier dials. The small vernier condenser aids materially in the separation of crowded stations inasmuch as it affords extremely precise tuning. Set measures 8" deep x 10½" wide x 7" high. Power pack measures 6½" deep x 9" wide x 7¾" high. Shipping weight 20 lbs.

No. SW-220—Five Tube "Go-Getter" A.C. Short Wave Receiver  
Including Power Pack and Speaker but Less Tubes.....**\$23.50**

YOUR PRICE  
No. SW-221—Set of Six Months' Guaranteed Tubes Comprising 1—58;  
1—57; 1—56 and 1—2A5.  
YOUR PRICE **\$3.40**

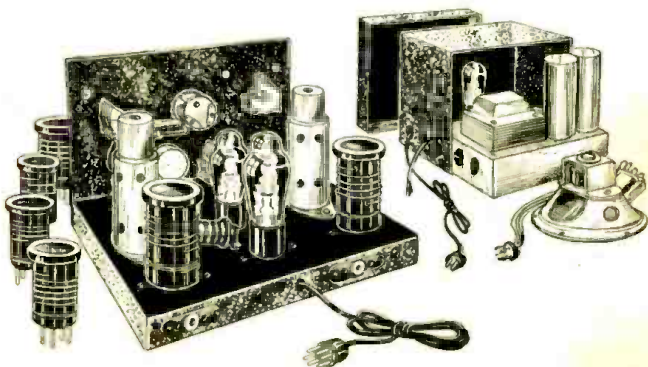

**RADIO TRADING COMPANY, 102 Park Place, New York City**

# ANNOUNCING

A GOLDEN OPPORTUNITY  
FOR ALERT RADIO MEN IN

## THE NEXT GREAT INDUSTRY

THE idea of electricians, radio service men and other mechanically inclined men, servicing Air Conditioning and Refrigeration Units is self-evident and the thought has occurred to some untold thousands ever since air conditioning equipment has been installed in public auditoriums, theatres, studios, department stores, office buildings and manufacturing plants. The tremendously broad possibilities in this new industry are bound to give employment and success to men far-sighted enough to see its advancement and development. We quote an excerpt from Mr. Hugo Gernsback's editorial which appeared in a recent issue of *Everyday Science and Mechanics*:

*"I advise young and progressive men to go into the air-conditioning business during the next few years; because, this, without a doubt, is the coming industry in this country. Thousands of small firms will spring up, undertaking to air-condition private houses, small business offices, factories, etc. We are not going to tear down every building in the United States immediately. It will be a gradual growth; yet small installation firms will air-condition small houses, and even single offices in small buildings."*

This is only partial proof of the certain success of this new field. Further assurance is that engineering schools have already added many important courses on air conditioning to their regular curriculum. Architects and building contractors are giving considerable thought to installation of this equipment in structures which are now being planned and built. The beginning of this business will probably be similar to the auto and radio industry, but in a few short years it will surpass these two great fields.

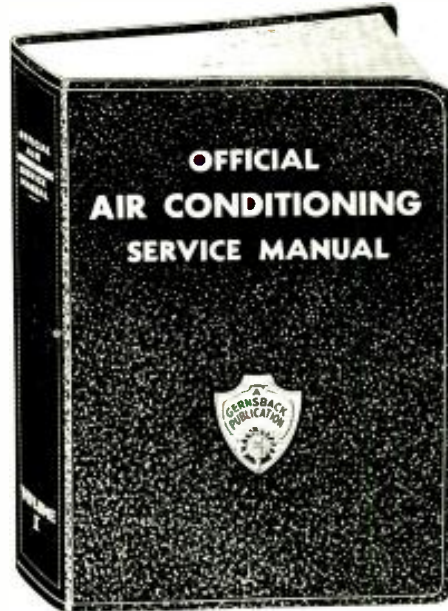

PRE-PUBLICATION OFFER  
**\$4.00**

## Official Air Conditioning Service Manual

The OFFICIAL AIR CONDITIONING SERVICE MANUAL is being edited by L. K. Wright, who is an expert and a leading authority on air conditioning and refrigeration. He is a member of the American Society of Refrigerating Engineers, American Society of Mechanical Engineers, National Association of Practical Refrigerating Engineers; also author of the OFFICIAL REFRIGERATION SERVICE MANUAL and other volumes.

In this Air Conditioning Service Manual nearly every page will be illustrated; every modern installation and individual part carefully explained; diagrams furnished of all known equipment; special care given to the servicing and installation end. The tools needed will be illustrated and explained; there will be plenty of charts and page after page of service data.

Remember there is a big opportunity in this new field and plenty of money to be made in the servicing end. There are thousands of firms selling installations and parts every day and this equipment must be cared for frequently. Eventually air conditioning systems will be as common as radios and refrigerators in homes, offices and industrial plants. Why not start now—increase your earnings with a full- or spare-time service business.

You have the opportunity to get your copy of the OFFICIAL AIR CONDITIONING SERVICE MANUAL today—at a saving of ONE DOLLAR. When the book comes off press, which will be March 15th, the price will be \$5.00 a copy. YOUR ORDER TODAY BRINGS YOU A COPY FOR \$4.00, POSTAGE PREPAID. This is our usual courtesy, pre-publication offer which enables us to determine the approximate print order for the first press run. Send us the coupon today, together with a deposit of \$2.00. When the book reaches you, you pay the other \$2.00.

Here are some of the chapter heads of the AIR CONDITIONING SERVICE MANUAL:

### Contents in Brief

History of Air Conditioning; Fundamental Laws; Methods of Refrigeration; Ejector System of Refrigeration; Compression System of Refrigeration; Refrigerants; Lubricating Oils; Liquid Throttle Devices; Servicing Expansion and Float Valves; Servicing Refrigerating Systems; Control Devices; Thermodynamics of Air Conditioning; Weather in the United States; The Field of Air Conditioning; Insulating Materials; Heat Transmission Through Walls; Complete Air Conditioning Systems; Estimating Requirements for the Home, Small Store, Restaurant; Layout of Duct Systems; Starting Up a System; Operating and Servicing Air Conditioning Systems; Air Filtration, Ventilating and Noise Eliminating Devices; Portable Electric Humidifiers and Room Coolers; Automatic Humidifiers; Air Conditioning Units for Radiator Systems and Warm Air Systems; Central Conditioning Units, etc.

**GERNSBACK PUBLICATIONS, INC.**  
96-98 Park Place New York, N. Y.

352 Pages

Over 600 Illustrations

9" x 12" in Size

Flexible, Loose Leaf

Leatherette Cover



## MAIL COUPON TODAY!

GERNSBACK PUBLICATIONS

Dept. RC-534

96-98 Park Place, New York, N. Y.

Gentlemen: Enclosed you will find my remittance of Two Dollars for which you are to send me One Copy of the OFFICIAL AIR CONDITIONING SERVICE MANUAL, postage prepaid, as soon as it comes off the press. I am to pay the additional Two Dollars to postman when it is delivered. It is understood that the regular price of the book will be FIVE DOLLARS when it comes off the press, and I am now paying only a pre-publication price of Four Dollars.

Name

Address

City

State

(Send remittance in form of check, money order or unused U.S. Postage Stamps. Register letter if it contains stamps or currency.)

# This set—by actual count—picked up 39 foreign and 171 domestic stations

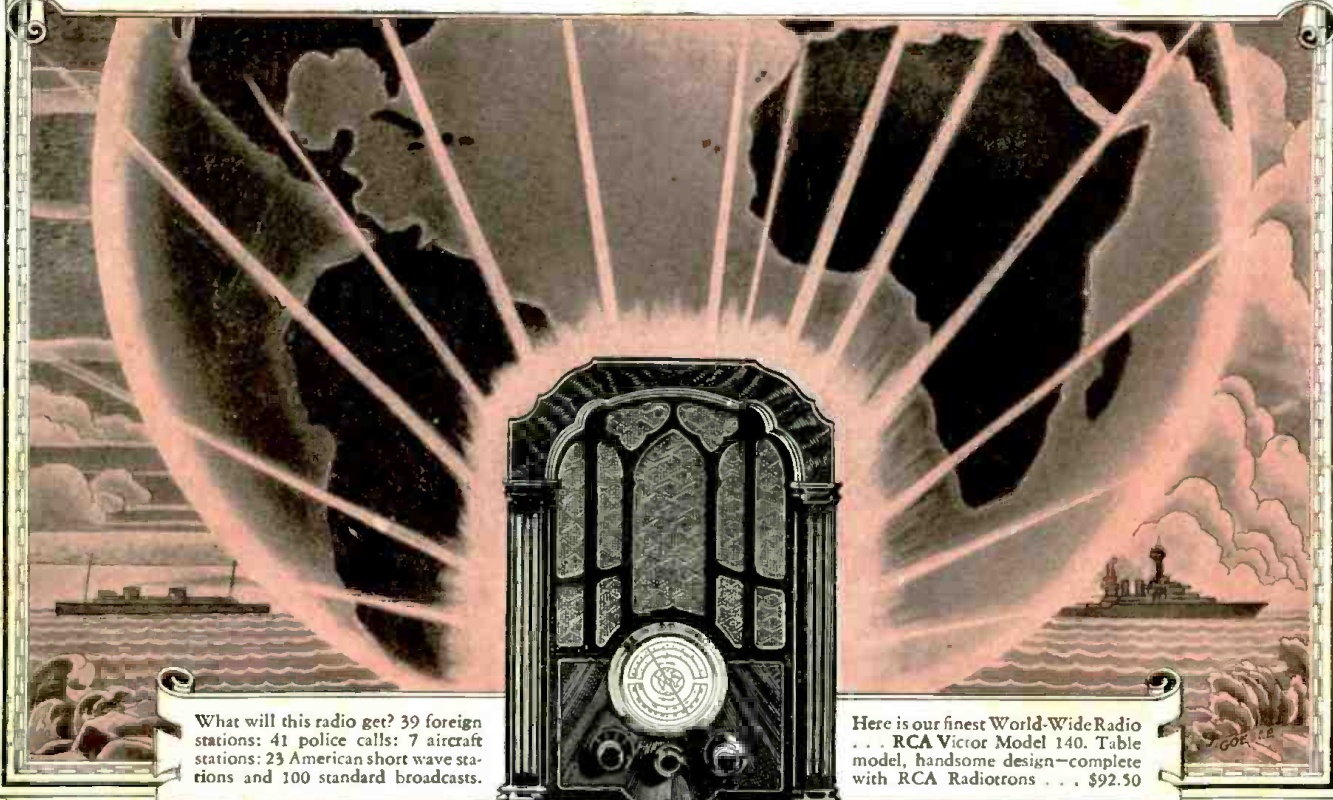

What will this radio get? 39 foreign stations: 41 police calls: 7 aircraft stations: 23 American short wave stations and 100 standard broadcasts.

Here is our finest World-Wide Radio . . . RCA Victor Model 140. Table model, handsome design—complete with RCA Radiotrons . . . \$92.50

IS there anything more fascinating than foreign travel? The lure of far away lands thrills everyone. Now, you—by the miracle of World-Wide radio—can travel around the globe at will. Let's see what a day offers . . .

You can drop in on gay Paris . . . with its night clubs, sidewalk cafes, opera and museums. Then, on to Berlin. Hear the martial music of a military band. Now comes a political speaker, or delightful operatic music. Next . . . it's time to roam to Rome. Italy's rich heritage of music manifests itself in a dozen delightful programs. Perhaps the Pope addresses the faithful throughout the world. Or Mussolini speaks. Now, on you go . . . to the other end of the world. To Sydney, Australia. Here's that station using the startling cry of the "Kookaburra" bird as a signature. Perhaps you'll want to linger a while "way down under" in Australia!

But, faster than it takes to tell it, you travel

It's a new RCA Victor Globe Trotter World-Wide Radio . . . on which you can get the same fascinating programs.

back to New York. The Great White Way, blazing in lights, cheerful with laughter, aglow with rhythm, calls. You've traveled around the world in just a few hours!

Does this sound unbelievable? It's true. The new RCA Victor World-Wide Radio you see above is the instrument that brings you this amazing new entertainment.

This set has, by actual checked count, picked up clearly and with sufficient volume, more than 39 foreign stations and 171 domestic stations (which include airplane, police and amateur signals). Here is a set which performs the way it should! Remember, when reception from abroad may not always be

available because of variation of time, or because of atmospheric conditions, you still can enjoy domestic broadcasts.

The RCA Victor World-Wide Radio is a set made with all the masterful skill of "Radio Headquarters". It comes as a result of long experimentation, careful study. It is right! See one . . . get one at your RCA Victor dealer's today. With it an entire world of entertainment opens up before you. *There are other RCA Victor World-Wide Radios* from . . . **\$58.50**

Here's the "World Dial" that brings you everything



On this full-vision airplane type dial, extra large in size . . . are marked the four broadcast bands that bring you all the radio ranges, short wave and standard. On its face is a miniature map of the world, symbolic of "His Master's Voice" around the globe.

Prices (F.O.B. Camden) subject to change without notice



## RCA VICTOR *World-Wide Radio*



RCA VICTOR COMPANY, INC., Camden, N. J. • "Radio Headquarters" • A Radio Corporation of America Subsidiary