

RADIO'S LIVEST MAGAZINE



March
25 Cents
Canada 30¢

Radio-Craft

HUGO GERNSBACK Editor

How to Build the
"TRAUTONIUM" —
Musical Instrument

See Page 522



Filamentless Tubes—Useful V. T. Voltmeters—Tube Reference Index
How to Make a New Tube Tester—Constructing a Simple Pentode Set

ALL-WAVE RADIOS

at *NEW LOW PRICES*

[15 to 560 Meters]

Up goes the quality!
Down goes the price!
Midwest has scored another tremendous hit by bringing the ALL-WAVE radio within reach of every buyer. For only \$18.50, radio fans can buy this 8-tube LONG and SHORT wave super-heterodyne chassis, completely assembled with electro-dynamic speaker. Never before such sensational value. Never before so much radio for so little money. Six months ago, such quality and such prices would have been impossible. Think of it! SUPER POWER, four distinct wave bands, 15 to 560 meter tuning range, coast-to-coast reception, police calls, foreign reception . . . all for as little as \$18.50. Only Midwest radio engineering skill backed by the engineering talent of R.C.A. and Am. T. & T. could produce such sensational radio value. Mail the coupon or write us a postal. You'll be amazed when you get full details.



30 DAYS FREE TRIAL

8-TUBE
Long and Short Wave
SUPER HETERODYNE
now only **\$18.50**
COMPLETELY ASSEMBLED with LARGE SPEAKER



What Midwest Owners Say

J. S. Kline, McGeehee, Ark.—“Listened to a set costing \$150.00 but would not swap my Midwest for the higher priced one.”

A. Edwards, 2125 North A St., Elwood, Ind.—“We wouldn't trade our Midwest for any of the numerous more costly sets.”

Emmet Berry, 222 29th St., Ashland, Ky.—“The Midwest cannot be beaten by any other radio that costs twice as much.”

Milton T. Lyman, 2525 Merwin St., Shreve-

port, La.—“Just as good as sets selling for double Midwest prices.”

Walter Fahrig, 1304 Highland Ave., Alton, Ill.—“Midwest is the best. Friends think I paid about \$300 for it.”

H. R. Peper, 436 Ferry St., New Haven, Conn.—“A neighbor of mine who recently purchased a \$200.00 radio went home very much dissatisfied after listening to our Midwest.”

only **\$5.00 DOWN**
PUTS THIS RADIO IN YOUR HOME

Deal Direct With Factory — Save UP TO 50%

Midwest sweeps aside the costly old-fashioned way of selling through distributors and dealers. You buy direct from the Midwest factory. You save the middlemen's profits.

Investigate! Mail the coupon. Get the Midwest catalog. Learn the facts about the new Midwest 8-tube ALL-WAVE sets—also 6-tube sets, Battery sets and new Automatic Record Changing Radio-Phonograph at an extremely low price. Learn about our sensationally low factory prices, easy payment plan and positive guarantee of satisfaction or money back. Get a bigger, better, more powerful, better toned radio—at a positive saving of 30% to 50%!

MIDWEST RADIO CORP.

(Est. 1920)

Dept. 194 Cincinnati, Ohio

NEW CONSOLE MODELS AS LOW AS \$21.95

Also amazing new long wave console radio at a sensationally low price. Six new type tubes, dynamic speaker, automatic volume control and other new up-to-the-minute features found in sets selling for \$75.00 to \$100.00. Don't buy any radio until you get all the facts. Mail the coupon or write us a postal now.

COMPLETE WITH TUBES



MAIL

THIS COUPON NOW!

Midwest Radio Corp.
Dept. 194
Cincinnati, Ohio

Without obligation on my part send me your new 1933 catalog, complete details of your liberal 30-day free trial offer. This is NOT an order.

Name

Address

Town State

LEARN RADIO IN 10 WEEKS!

PAY FOR YOUR TRAINING **PAY** AFTER YOU GRADUATE

I am making an offer that no other school has dared to do. I'll take you here in my shops and give you this training and you pay your tuition after you have graduated. Two months after you complete my course you make your first payment, and then you have ten months to complete your payments. There are no strings to this offer. I know a lot of honest fellows haven't got a lot of money these days, but still want to prepare themselves for a real job so they won't have to worry about hard times or lay offs.

I've got enough confidence in these fellows and in my training to give them the training they need and pay me back after they have their training.

If you who read this advertisement are really interested in your future here is the chance of a life time. Mail the coupon today and I'll give you all the facts.



A scene in the big, busy Radio Shops at Coyne. Here you see fellows working on real Radios—not reading about them from books or lessons. This is THE way to prepare for the big-money field of Radio!

TELEVISION *and* TALKING PICTURES

Television is already here! Soon there'll be a demand for THOUSANDS of TELEVISION EXPERTS! The man who learns Television now can have a great future in this great new field. Get in on the ground-floor of this amazing new Radio development! Come to COYNE and learn Television on the very latest, newest Television equipment. Talking Picture and Public Address Systems offer opportunities to the Trained Radio Man. Here is a great new Radio field just beginning to grow! Prepare NOW for these wonderful opportunities! Learn Radio Sound Work at Coyne on actual Talking Picture and Sound Reproduction equipment.

PREPARE NOW and be ready for Radio's many opportunities

Forget pay-cuts—lay-offs—unemployment! Don't be tied down to an untrained man's future. You NEED TRAINING IN A FAST-GROWING MONEY-MAKING TRADE. Here's your chance of a lifetime to get it! Hundreds of opportunities now open in Radio. My sensational offer, explained below, makes it possible for you to START AT ONCE!

The right way to learn Radio is the Coyne way—not by books, but by actual, practical work on actual Radio, Television and Sound equipment. Here at Coyne you'll service and operate scores of modern Radio receivers, huge Broadcasting equipment, late type Television apparatus, Talking Picture machines, Code transmitters and receivers, etc. In 10 weeks you can step into a REAL JOB, leading to a salary of \$50 a week and UP!

ALL PRACTICAL WORK At COYNE in Chicago

ALL ACTUAL, PRACTICAL WORK. You build radio sets, install and service them. You actually operate great Broadcasting equipment. You construct Television Receiving Sets and actually transmit your own Television programs over our modern Television equipment. You work on real Talking Picture

machines and Sound equipment. You learn Wireless Operating on actual Code Practice apparatus. We don't waste time on useless theory. We give you the practical training you'll need—in 10 short, pleasant weeks.

MANY EARN WHILE LEARNING

You get Free Employment Service for Life. And don't let lack of money stop you. Many of our students make all or a good part of their living expenses while going to school and if you should need this help just write to me. Coyne is 33 years old. Coyne Training is tested—proven beyond all doubt. You can find out everything absolutely free. Just mail coupon for my big free book!

H. C. LEWIS, Pres. RADIO DIVISION Founded 1899
COYNE ELECTRICAL SCHOOL
500 S. Paulina St., Dept. 33-8H, Chicago, Ill.

Mail Coupon Today for All the Facts

H. C. LEWIS, President
Radio Division, Coyne Electrical School
500 S. Paulina St., Dept. 33-8H, Chicago, Ill.

Dear Mr. Lewis: Send me your big FREE Book; details of your FREE Employment Service; and tell me all about your special offer of allowing me to pay for training on easy monthly terms after graduation.

Name.....
Address.....
City.....State.....



HUGO GERNSBACK, Editor-in-Chief

LOUIS MARTIN
Associate Editor

R. D. WASHBURNE
Technical Editor

CONTENTS OF THE MARCH, 1933, ISSUE

VOLUME IV

NUMBER 9

EDITORIAL:

Electronic Music.....Hugo Gernsback 521

NEW DEVELOPMENTS IN RADIO:

How to Build the "Trautonium" Musical Instrument
Clifford Denton 522

The Latest Radio Equipment..... 525

And Now—The Filamentless Tube..... 528

New Crosley Midget Sets..... 531

SERVICE MEN'S DEPARTMENT:

A Tube-Reference Index..... 532

Building the Shallcross 651 Set Tester.....Paul Shallcross 534

The Why and Wherefore of Low- and High-Resistance Ohm-
meters.....Arthur H. Lynch 535

Service Men's Forum..... 538

Improving Home Recording in RCA, G.E. and Westinghouse
Sets.....Fred H. Pitzer 539

Short Cuts in Radio Service..... 540

RADIO SERVICE DATA SHEETS:

No. 85 Capehart Models 200 and 300 DeLux Automatic
Phono-Radio..... 542

No. 86 Howard Model M "Triplex Control" 14-Tube Super-
heterodyne..... 543

TECHNICAL RADIO TOPICS:

The Pentode "Four".....H. G. Cisin 530

Constructing a 40-Watt, Class AAA, P.A. Amplifier
Leon J. Littmann 536

A Survey of the Vacuum-Tube Voltmeter Field
C. H. W. Nason 544

Radio-Craft Kinks..... 546

The Radio Craftsman's Page..... 548

Information Bureau..... 549

Over-the-Counter Suggestions.....Jack Grand 553

Book Review..... 561

Home Experiments.....John B. Brennen, Jr. 563

Atoms and Electrons.....576A

IN OUR NEXT FEW ISSUES:

HOW TO BUILD AN UP-TO-THE-MINUTE TUBE TESTER. Complete information which will enable the Service Man and experimenter to construct a tube tester which, without the use of adapters, will enable the technician to determine the characteristics of all the tubes which have so far been manufactured.

CONVERTING RCA AND ATWATER KENT RECEIVERS. In a series of descriptions as simple as A-B-C, the author describes the exact steps to be followed in modifying certain older set models to achieve improved operation.

POINT-TO-POINT CAPACITY TESTING. We are all familiar with "resistance testing," whereby effective resistance values in a receiver circuit are determined by measuring between tube terminals and the chassis-ground. Now, a Service Man offers his directions for making a "capacity testing" device which follows the same general operating procedure.

RADIO-CRAFT is published monthly, on the fifth of the month preceding that of date; its subscription price is \$2.50 per year. (In Canada and foreign countries, \$3.00 a year to cover additional postage.) Entered at the post office at Mt. Morris, Ill., as second-class matter under the act of March 3, 1879. Trademark and copyright by permission of Gernsback Publications, Inc., 98 Park Place, N. Y. C. Text and illustrations of this magazine are copyright and must not be reproduced without permission of the copyright owners. We are also agents for WONDER STORIES and WONDER STORIES QUARTERLY. Subscription to these magazines may be taken in combination with RADIO-CRAFT at reduced Club rates. Write for information.
Copyright 1933. GERNSBACK PUBLICATIONS, INC.

HUGO GERNSBACK, President J. M. HERZBERG, Vice-President
S. GERNSBACK, Treasurer I. S. MANHEIMER, Secretary

Published by TECHNI-CRAFT PUBLISHING CORPORATION. Publication office: 404 N. Wesley Ave., Mount Morris, Illinois. Editorial and Advertising Office: 96-98 Park Place, New York City. Chicago Advertising Office: 737 North Michigan Avenue, Chicago, Ill. Western Advertising Office: 220 No. Catalina St., Los Angeles, Calif. L. F. McClure, Chicago Advertising Representative. Loyd B. Chappell, Western Advertising Representative.

London Agent: Hachette & Cie., 3 La Belle Sauvage, Ludgate Hill, E.C. 4
Paris Agent: Hachette & Cie., 111 Rue Reaumur Australian Agent: McGill's Agency
179 Elizabeth St., Melbourne

ONLY SCOTT *Laboratory Technique* GIVES SUCH RECEPTION~

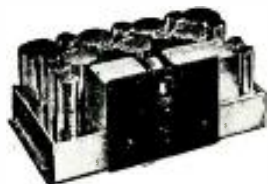

The chassis of the SCOTT ALL-WAVE DELUXE is a thing of beauty. Finished in gleaming chromium plate it is dust-and-weather proofed to keep its tremendous power always ready for service. Within this chassis is the perfection resulting from tests such as the one shown at the right—which matches exactly within the third of a turn of wire.



The New IMPERIAL GRANDE Console

Fittingly this newest addition to the group of distinctive SCOTT Consoles offers the most exquisite console for the world's finest receiver.



Of both Foreign and Domestic Stations

SCOTT Laboratory Technique begins with advanced engineering design . . . follows exacting specifications for every component part . . . includes custom construction by specially trained technicians who test and retest to assure the degree of perfection that gives SCOTT ALL-WAVE DELUXE Receivers the right to the title of "World's Finest Radio Receiver."

And how the SCOTT ALL-WAVE DELUXE lives up to its title! A twirl of its single dial brings magic music and the sounds of foreign tongues from stations 10,000 miles away as readily as it gives superior reproduction of familiar programs from homeland stations. Utter simplicity in changing from one wave band to another . . . just the turn of a switch—no plug-in coils, tapped coils or bothersome connections.

Tone . . . Sensitivity . . . Selectivity? What would you expect from a receiver known as "the world's finest"? Millions of words from us would bear less weight than the enthusiastic praise of SCOTT owners. More than 19,000 logs of foreign receptions have come to us from them within a year. In trial after trial SCOTT receivers continue to break all records for distance reception . . . for needle point selectivity . . . for gorgeous tone richness unrivalled in radio.

Before you buy any radio receiver learn all about the finest one . . . that is warranted to give true world-wide reception and every part of which (except tubes) is guaranteed for five years. You will be pleasantly surprised to find that, in spite of its custom-built superiority, a SCOTT ALL-WAVE DELUXE may be purchased for no more than many models of ordinary receivers.

E. H. SCOTT RADIO LABORATORIES, Inc.
4450 Ravenswood Avenue Dept. C-33
CHICAGO, ILLINOIS

The 15-550 METER **SCOTT**
ALL-WAVE Deluxe
Mail THIS COUPON FOR NEW BROCHURES

E. H. SCOTT RADIO LABORATORIES, INC.,
4450 Ravenswood Ave., Dept. C-33, Chicago, Ill.

Send me, without obligation, complete information about the new SCOTT ALL-WAVE DELUXE, including your new Brochures, "PROOF" and "The Creation of a Masterpiece."

Name.....
Address.....
Town.....
State.....

5. CLAROSTAT CONTROL HANDBOOK. A large 32-page book containing detailed specifications of volume controls, attenuators, constant-impedance controls, phonograph pickup faders, tone controls, line ballasts, rheostats, potentiometers and fixed resistors of various kinds, together with valuable circuit-design data. Contains many diagrams and charts, and a guide of replacement volume and tone controls for many commercial receivers. *Clarostat Manufacturing Company, Inc.*

6. MEASURING RESISTANCE BY THE DEFLECTION METHOD. The conventional method for the measurement of resistance involves the use of the Wheatstone bridge, a costly piece of apparatus. However, there are other methods which provide a fair degree of accuracy, enough for all practical purposes. The least expensive is the deflection method, which makes use of popularly priced milliammeters and fixed resistors. This bulletin describes the method completely, and should be very useful to Service Men and experimenters with limited meter equipment. *Shallcross Manufacturing Company.*

11. SUPREME INSTRUMENTS. Contains lengthy descriptions of the Supreme service instruments, including the AAA1 Diagonometer, which is five instruments in one, the model 90 analyzer, the model 40 tube tester and the models 60 and 70 oscillators. Interesting to the Service Man because it tells how his work is facilitated by ingeniously-designed test equipment that indicates the condition of an entire set in a few minutes. New test apparatus to take care of the new tubes is also described. *Supreme Instrument Corporation.*

19. A BAPTISM OF FIRE. Centralab fixed resistors are made by forcing a carefully calibrated resistance material through a plastic ceramic material, and then baking both under terrific heat. This booklet describes the manufacturing process in detail, and lists the advantages claimed for fixed resistors of this type. It is interestingly written and illustrated, and makes good reading. *Central Radio Laboratories, Inc.*

21. READRITE RADIO INSTRUMENTS. This sixteen-page pamphlet contains some valuable hints on the testing of electrolytic condensers, as well as descriptions of the full line of popular-priced Readrite instruments. Worth having. *Readrite Meter Works.*

22. HOW TO TEST PENTODES. This is a reprint of an article of the same name that appeared in the September, 1931, number of RADIO-CRAFT, accompanied by descriptive matter on the adapters specified for the purpose. If you missed the original article study the reprint; it contains much useful data for owners of testers or analyzers not already equipped to test pentodes. *Alden Manufacturing Company.*

28. HAMMARLUND PRECISION PRODUCTS. Midget variable condensers and their numerous applications in short-wave and broadcast receivers are discussed in a folder accompanying the complete catalog of Hammarlund variable condensers and coils. Some excellent circuit kinks are given. The catalog contains dimensional drawings of the popular Hammarlund midgets which may be of assistance to constructors designing small receivers. *Hammarlund Manufacturing Company, Inc.*

55. PHILCO PARTS CATALOG. This catalog will undoubtedly be of great help to all radio Service Men because it contains the only official, complete list of the more common replacement parts used in every Philco receiver from the very beginning of the company to the present time. The manufacturers are anxious to cooperate with Service Men and offer this catalog to all who want it. *Philco Radio & Television Corp.*

64. SYLVANIA RADIO TUBES. So many new tubes have appeared during the past several months that tube charts printed as recently as the Fall are incomplete and therefore of little value for reference purposes. Readers desiring new and complete charts for their shop will find the new Sylvania chart very desirable. It measures 11 by 17 inches when unfolded and shows bottom views of the tube bases in addition to full average characteristics of old tubes dating back to the 199 and 200A and all the new tubes including the latest 6.3 and 2.5 volt types. Special mention is made of the 56, 57, 58, 46 and 82 tubes; complete data are also given on the 38, 41, 69, 42 and 44. *Hygrade Sylvania Corporation.*

66. WHOLESALE RADIO SERVICE CATALOG. The 1933 Radio Catalog of the Wholesale Radio Service Company is the kind of catalog the radio Service Man and experimenter will carry around with him all the time in his back pocket. Measuring 7 by 10 1/4 inches and containing 144 pages, it is one of the most complete catalogs we have ever seen. It includes everything from soldering lugs to all-wave combinations, and is of particular value to the Service Man because of its handy lists of replacement parts for standard receivers. *Wholesale Radio Service Company, Inc.*

READERS' BUREAU

On this page are listed manufacturers' catalogs and booklets, chosen because they are of interest to readers of RADIO-CRAFT. You can obtain copies FREE by using the coupon below.

76. THE COAST-TO-COAST "BROADCAST." The "Broadcast" is the Fall 1932 edition of a 100-page mail order catalog that is a veritable encyclopedia. Its listings are very varied, and run from soldering lugs to complete 100-watt public address amplifiers. Every article is well illustrated and described for the benefit of radio dealers and Service Men, for whom the volume is specifically intended.

A large amount of space is also given to replacement power transformers, condensers and resistors for ordinary service work. This catalog is well prepared and is worth saving. *Coast-to-Coast Radio Corporation.*

80. FLECHTHEIM CONDENSERS. A wide variety of fixed condensers, ranging from tiny midgets, the size of postage stamps, to heavy transmitting units a foot high, are described and illustrated in the latest Flechtheim catalog. This is very useful for reference in design and service work, as it gives the mechanical dimensions and electrical characteristics of all models in minute detail. *A. M. Flechtheim & Co.*

81. I. R. C. RESISTOR CATALOG. This sixteen-page catalog describes a very complete line of fixed resistors for radio purposes. It includes full performance characteristics, so that a Service Man or an experimenter with a particular requirement in mind can select exactly the right unit for his purpose. A section in the back contains valuable data on the conversion of milliammeters into ohmmeters and voltmeters, and on the extension of voltmeter and ammeter ranges. This catalog is well worth saving. *International Resistance Company.*

86. YAXLEY AND ELKON CATALOGS. The Yaxley catalog is valuable for the Service Man because it lists numerous rheostats, potentiometers, volume controls, replacement controls and resistances for service work. Detailed dimension drawings are included; this feature will be appreciated by every Service Man who has been called on to install replacement units in cramped receivers. Two pages of volume control replacement information are included, along with fourteen diagrams showing different circuit positions for such controls.

The Elkon catalog is devoted exclusively to dry electrolytic high voltage condensers for filter and bypass purposes. It also includes valuable replacement data on commercial receivers. *P. R. Mallory & Co.*

89. MICROPHONES. A complete line of microphones and accessories for amateur, public address and broadcast station use is described and illustrated in a handy four-page pamphlet. The "mikes" range from small hand units to large condenser models containing two stages of amplification. *Sound Engineering Corporation.*

93. DUBILIER CONDENSERS. The 1933 catalog of Dubilier condensers is a large 16-page booklet describing fixed condensers for every conceivable application. These range from little mica units for receiving circuits to man-high assemblies for transmitting work. A useful catalog to all radio men. *Dubilier Condenser Corporation.*

94. ELECTRAD PRODUCTS. The newest and latest catalog of Electrad products contains twelve pages and lists many types of fixed and variable resistors and five different kinds of amplifiers for public address purposes. The popular Truvolt resistors have been improved by the addition of insulating shields and heat radiating covers, and a number of new sizes have been added to the line. The catalog also contains some valuable data on the application of resistors to radio receivers, transmitters, amplifiers and sound systems, and suggestions on how to compute the value of resistors. A handy and useful catalog. *Electrad, Inc.*

95. CARDWELL CONDENSERS. This is a condensed four-page catalog of the well known Cardwell "Midway" variable condensers for transmitting and receiving. These are small but not "midget" size instruments designed for purposes where extremely light weight and reduction of bulk are desirable. Complete and detailed specifications are included for the assistance of constructors. *Allan D. Cardwell Mfg. Corp.*

96. TOBE FILTERIZER AND CONDENSERS. The Tobe Deutschmann company is now catering to the Service Man with an extensive line of filter, by-pass and line condensers and radio noise eliminators. Their latest catalog, describing the complete line, has just come off the press. A full page is given to the new "Filterizer" noise eliminating antenna system, an item of particular interest to Service Men because of the money-making opportunities it offers. *Tobe Deutschmann Corporation.*

97. ARCO TUBE BULLETIN. A descriptive folder giving full technical characteristics on the complete line of Arco radio receiving and transmitting tubes, photo-electric cells, television lamps, hot and cold cathode tubes, cathode ray tubes, rectifiers and charger bulbs. This can be posted for easy reference. *Arco Tube Company.*

98. HOW TO USE NOISE REDUCING ANTENNA SYSTEM ON BROADCAST WAVES AND SHORT WAVES is the title of the latest booklet on this important subject. In addition to covering the theory, the practical application of the various noise-reducing systems available for broadcast and short wave use, is described also.

A section of the bulletin is devoted to the interest of the Service Man and dealer. It tells how to set up demonstration installations which show the comparison of the new systems and the older systems by simply throwing a single pole, double throw switch and makes important suggestions for increasing sales and service profits through the sale of these devices to new receiver buyers as well as the person who already owns a set. *Lynch Mfg. Co.*

RADIO-CRAFT 5-98

Readers Bureau
96-98 Park Place, New York, N. Y.

Please send me free of charge the following booklets indicated by numbers in the published list above:

No.
.....
Name
Address
City State.....

(Please check the following)

I am
(1) Service Man (2) Experimenter
(3) Dealer (4) Jobber
(5) Radio Engineer
(6) Licensed Amateur
(7) Professional or Amateur Set Builder

This coupon will not be honored unless you check off your classification above.

I will train you at home

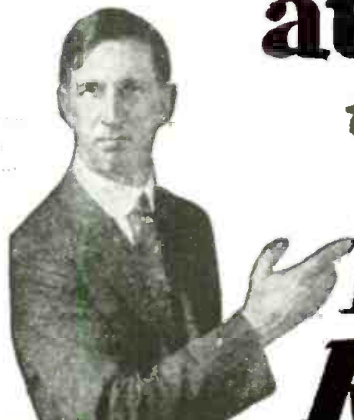

to fill a
BIG PAY
Radio Job!

Here's Proof



Made \$10,000 More in Radio

"I can safely say that I have made \$10,000 more in Radio than I would have made if I had continued at an old job."

Victor L. Osgood,
St. Cloud Ave.,
West Orange, N. J.



Jumped from \$35 to \$100 a week

"Before I entered Radio I was making \$35 a week. I earned \$100 in one week servicing and selling Radios. I owe my success to N. R. I. You started me off on the right foot."

J. A. Vaughn,
Grand Radio & App. Co.,
8107 S. Grand Blvd.,
St. Louis, Mo.



\$500 extra in 6 months

"In looking over my records I find I made \$500 in my spare time in six months. My best week brought me \$107. I have only one regret regarding your course—I should have taken it long ago."

Hoyt Moore,
R. R. 3, Box 919,
Indianapolis, Ind.

If you are dissatisfied with your present job, if you are struggling along in a rut with little or no prospect of anything better than a skinny pay envelope—clip the coupon NOW. Get my big FREE book on the opportunities in Radio. Read how quickly you can learn at home in your spare time to be a Radio Expert—what good jobs my graduates have been getting—real jobs with real futures.

Free Book Tells How Mail Coupon!

Many Radio Experts Make \$50 to \$100 a Week
In about ten years the Radio Industry has grown from \$2,000,000 to hundreds of millions of dollars. Over 300,000 jobs have been created by this growth, and thousands more will be created by its continued development. Many men and young men with the right training—the kind of training I give you in the N. R. I. course—have stepped into Radio at two and three times their former salaries.

Get Ready Now for Jobs Like These

Broadcasting stations use engineers, operators, station managers, and pay up to \$5,000 a year. Manufacturers continually employ testers, inspectors, foremen, engineers, service men, buyers, for jobs paying up to \$6,000 a year. Radio Operators on ships enjoy life, see the world, with board and lodging free, and get good pay besides. Dealers and jobbers employ service men, salesmen, buyers, managers, and pay up to \$100 a week. My book tells you about these and many other kinds of interesting Radio jobs.

Many Make \$5, \$10, \$15 a Week Extra in Spare Time, Almost at Once

The day you enroll with me I send you instructions which you should master quickly for doing 28 jobs common in most every neighborhood, for spare-time money. Throughout your course I send you information on servicing popular makes of sets! I give you the plans and ideas that have made \$200 to \$1,000 a year for N. R. I. men in their spare time. My course is famous as the course that pays for itself.

Television, Short-Wave Radio, Talking Movies, Money-Back Agreement Included

Special training in Talking Movies, Television, and Home Television experiments, Short Wave Radio, Radio's use in Aviation, Servicing and Merchandising Sets, Broadcasting, Commercial and Ship Stations are included. I am so sure that N. R. I. can train you satisfactorily that I will agree in writing to refund every penny of your tuition if you are not satisfied with my Lesson and Instruction Service upon completion.

64-Page Book of Information FREE

Get your copy today. It's free to all residents of the United States and Canada over 15 years old. It tells you where Radio's good jobs are, what they pay, tells you about my course, what others who have taken it are doing and making. Find out what Radio offers you without the slightest obligation. ACT NOW!

J. E. SMITH, President
National Radio Institute Dept., 3CX
Washington, D. C.

Our Own Home
Pioneer and World's Largest Home-Study Radio training organization devoted entirely to training men and young men for good jobs in the Radio industry. Our growth has paralleled Radio's growth. We occupy three hundred times as much floor space now as we did when organized in 1914.



Special Free Offer



Act now and receive in addition to my big free book, "Rich Rewards in Radio," this Service Manual on D.C., A.C., and Battery operated sets. Only my students could have this book in the past. Now readers of this magazine who mail the coupon will receive it free. Overcoming noises of all kinds, fading signals, broad tuning, howls and oscillations, poor distance reception, distorted or muffled signals, poor Audio and Radio Frequency amplification and other vital information is contained in it. Get a free copy by mailing the coupon below.

SPECIAL Radio Equipment for Broad Practical Experience Given Without Extra Charge

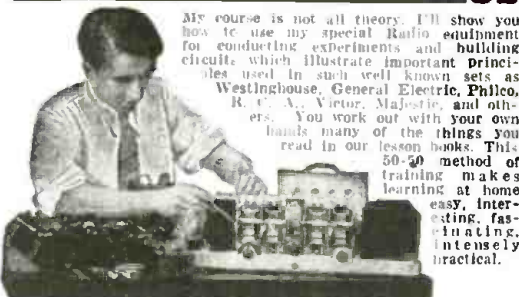

My course is not all theory. I'll show you how to use my special Radio equipment for conducting experiments and building circuits which illustrate important principles used in such well known sets as Westinghouse, General Electric, Philco, R. C. A., Victor, Majestic, and others. You work out with your own hands many of the things you read in our lesson books. This 50-50 method of training makes learning at home easy, interesting, fascinating, intensely practical.

I have doubled and tripled the salaries of many. Find out about this tested way to BIGGER PAY



Get a Job with a Future

FILL OUT AND MAIL THIS COUPON TODAY

J. E. SMITH, President
National Radio Institute, Dept. 3CX,
Washington, D. C.

Dear Mr. Smith: I want to take advantage of your Special Offer. Send me your manual "Trouble Shooting in D.C., A.C. and Battery Sets" and your book "Rich Rewards in Radio," which explains Radio's Opportunities for bigger pay and your method of training men at home in spare time. I understand this request does not obligate me.

Name.....
Address.....
City.....State.....

The Famous Course That Pays For Itself

It's taking the country by storm—

20^c The Copy

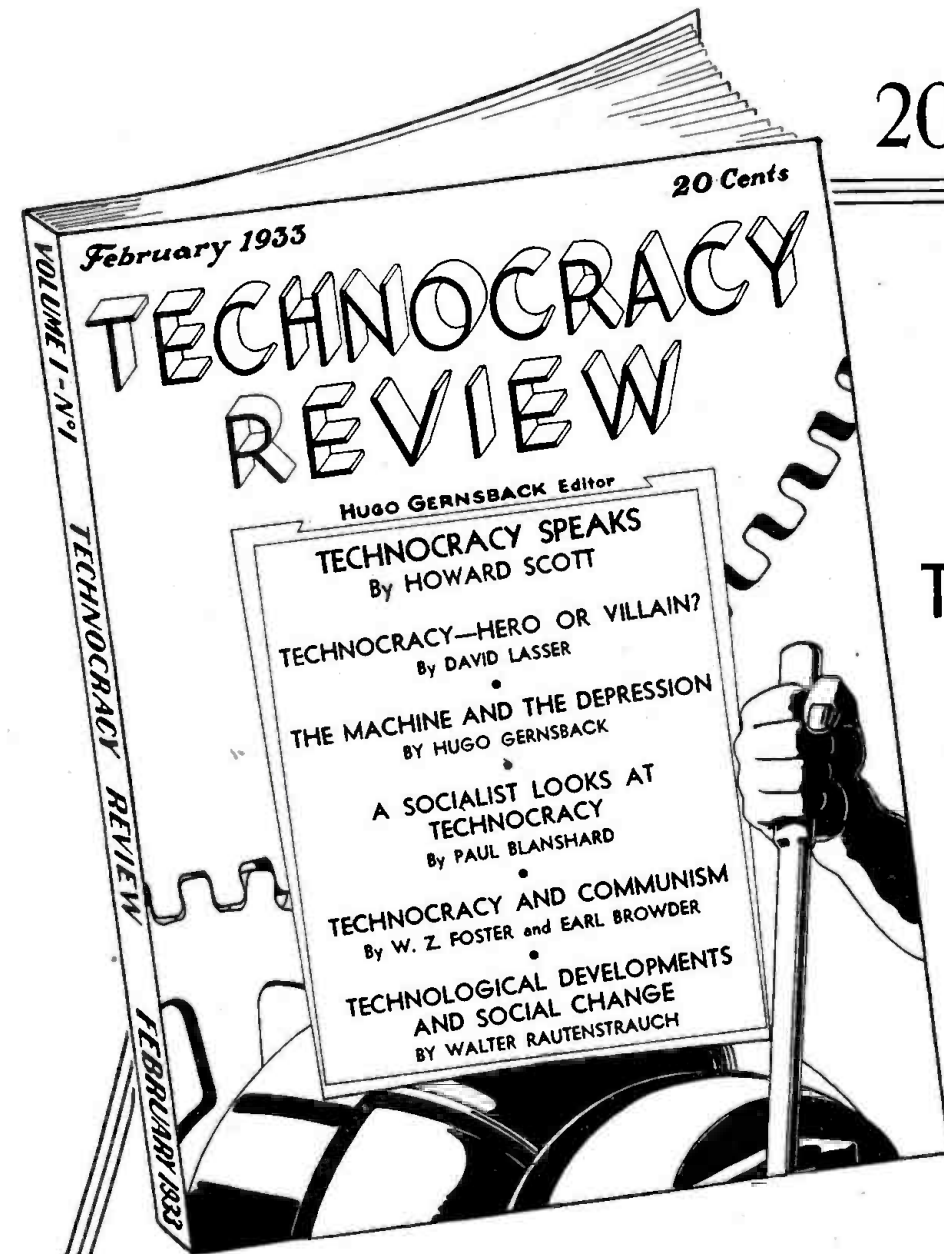

ARE THE
TECHNOCRATS
GENIUSES
OR
FRAUDS
?

● THEY HAVE BEEN
HAILED AS BOTH. Do
they plan merely to change
over our economic system, or
are they trying to set up a
soviet of engineers? How far
will they go; can they go?

IS THE MACHINE RESPONSIBLE FOR UNEMPLOYMENT?

Should we have more machines or less? Is the price system played out?
Should we have electric dollars or gold? Do we need a "new deal" or a
revolution? Where is it coming from?

The whole gamut of these social, economic and political problems
OPENED BY TECHNOCRACY are discussed
WISELY—PUNGENTLY—CLEARLY—in this and future
issues of

ON
ALL
NEWS-
STANDS

TECHNOCRACY REVIEW

NEW ways for the **SERVICEMEN** and Dealers To make **MONEY!** *Year in....and year out*

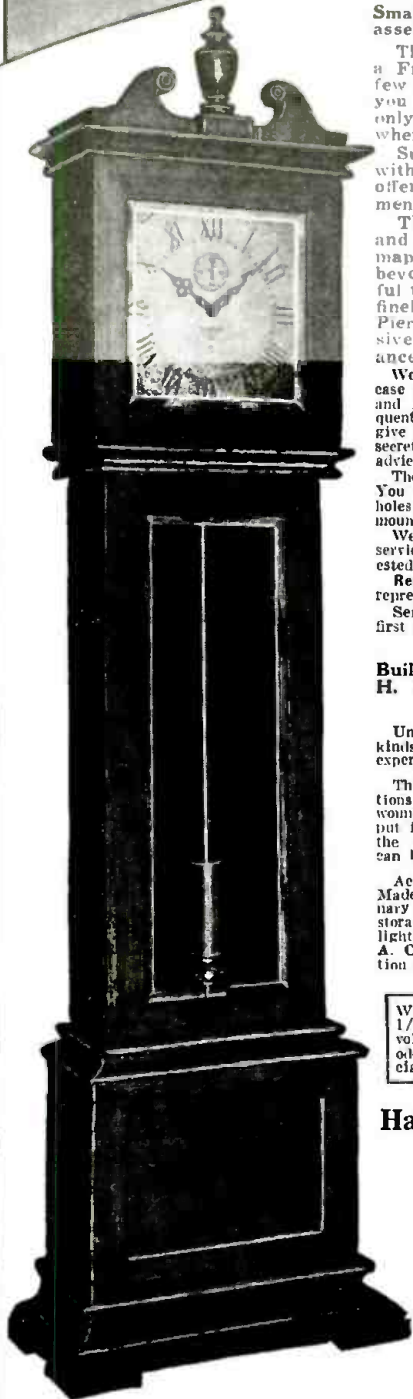

BUILD YOUR OWN GRANDFATHER'S CLOCK MOST ACCURATE AND FINEST OBSERVATORY TYPE

Small installment payments—Clock can be easily and quickly assembled—we supply all parts—no special tools necessary

The invention of the Hartford Electric Clock first made a Free pendulum clock available—electrically driven—at a few hundred dollars. Now, with our "build your own" plan, you can assemble such a master of Horological accuracy for only \$55. Complete, on payments of only \$2 each week or whenever you need more parts to continue your work.

Such a Grandfather model as illustrated on this page, even with an ordinary hand wound movement, has never been offered at less than \$250. With a Hartford Electric movement it is worth much more.

The Hartford Electric Grandfather Clock stands over six and a half feet high—is of genuine mahogany, walnut, hard maple or quartered oak—whichever you desire. Finest beveled plate glass in both upper and lower doors. Beautiful two tone antique silvered dial—over a foot square—with finely etched numerals and rich raised ornamentation. Pierced hands of exquisite design. A magnificent and massive Grandfather's Clock of purest Colonial design, appearance and finish.

We furnish everything—tell you how to do everything. No special tools necessary. The case wood is shipped to you in sections, all pieces cut, shaped and ready for you to assemble and glue together. We ship a section each week, or if desired we will ship at more frequent intervals to enable you to continue your work with greater speed. Our instructions give you full information on how to get any color or gloss of finish desired. All workshop secrets are given in great detail with complete explanations. You cannot go wrong. Special advice gladly given if ever needed.

The clock movement is shipped to you with all machine work and tool operations completed. You only have to assemble and mount in the case which is already prepared with mounting holes in place. Or if desired, we will assemble, test the movement and ship ready for mounting.

We will show you how you can establish your own business—the making, repairing and servicing of time apparatus. When you send for your book and parts, tell us you are interested in establishing such a business for yourself—we will send you complete information.

Remember, you are dealing with an old and reputable firm. We guarantee everything as represented. Send your order today and get started on this important and fascinating work.

Send your order for your first shipment of parts and enclose the first payment of \$2—the first section of the case parts will be sent at once.

Build Your Own Fractional H. P. Electric Motor for \$1.00

Unexcelled for winding clocks, running all kinds of toys, model trains, boats, and for experimental work of all kinds.

The parts cost but \$1. Complete instructions and blue prints, 25c; field coil already wound, 25c; armature coils wound ready to be put in armature slots and soldered, 25c. Or the complete motor, assembled and tested, can be purchased for only \$2.

Actual size of motor is 3" x 2" x 1 1/2". Made for 1 to 1 1/2 volts, to run on the ordinary dry cell, 6 volts to run on an auto storage battery, 32 volts to run on farm lighting plants, 110 and 220 volts, either A. C. or D. C., to run on any Central Station current.

We also supply all types of motors from 1/100th H. P. up to any size for any voltage or kind of current. Special and odd voltages and frequencies our specialty. Let us know your requirements.

Our Patented Electrical Winding Mechanism Converts any clock into an Electrically Wound Clock.

The striking and chiming mechanisms, as well as the time movement (either weight driven or spring clocks) are energized electrically. No hand winding of any kind required.

Electrifying a fine antique clock by our method does not spoil it as an antique—you simply add our mechanism.

Headquarters for synchronous, electrically wound, spring and weight driven movements of every kind and type. Everything in clocks and clock controls.

Start Your Own Business

Build and sell various types of electric clocks and repair and service time apparatus. Write for details of our attractive proposition, working arrangements, and how we can help you get orders and work, and the profits you should be able to make.

Send your order TODAY for what you need, or let us know what you are interested in.

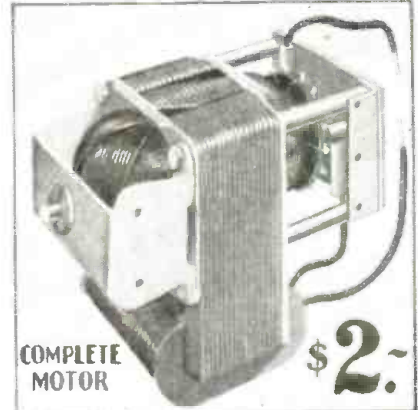

COMPLETE MOTOR

\$2.00

TURNTABLE FOR WINDOW DISPLAY

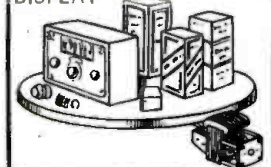

TOY LOCOMOTIVE

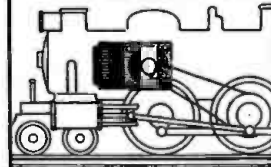

ELECTRIC MOTOR-BOAT MODELS

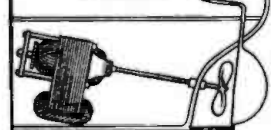

AQUARIUM PUMP

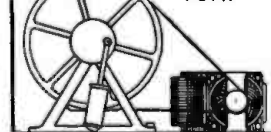

Hartford Clock Co., 202 Central Ave., Jersey City, N. J.

HARTFORD CLOCK COMPANY 202 Central Avenue, Jersey City, N. J.

Enclosed you will find \$..... for which please send me,

- () Parts for motor with instructions, \$1.00
- () Complete motor as illustrated, \$2.00
- () First shipment of parts to construct **ELECTRICAL GRANDFATHER'S CLOCK**, \$2.00
- () Mahogany () Walnut () Maple () Oak finish.

Name

Address

City..... State.....

(Send remittance in form of check or money order; register letter if it contains stamps or currency.)

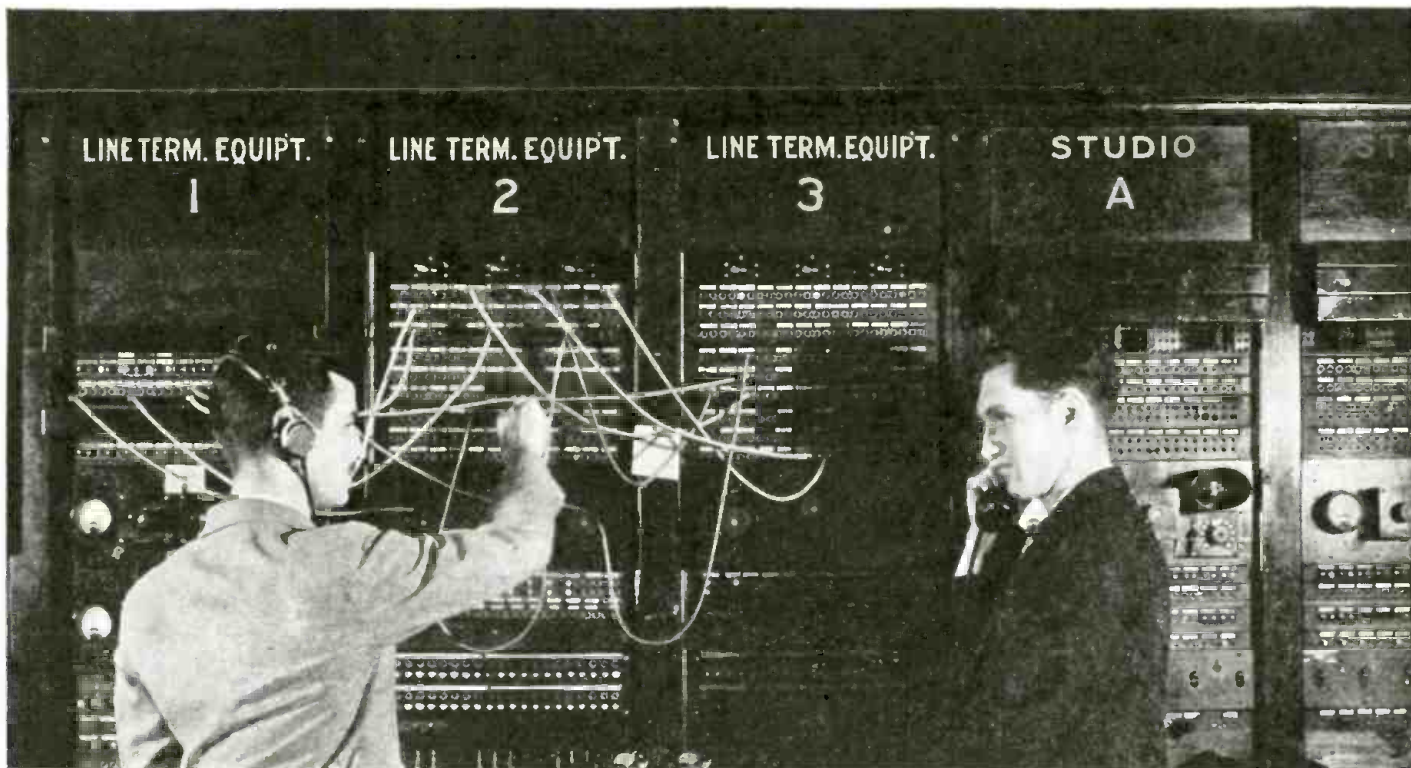

Courtesy of the National Broadcasting Company

WHAT YOU NEED TO SUCCEED IN RADIO

RADIO is a highly specialized business. As it develops it is becoming more exacting in its demands. But radio is the modern field of opportunity for those who keep step with its progress and pioneer in its opportunities!

There is a great need for *trained* men in the radio industry. There is no place for *untrained* men. Experience must be accompanied by technical knowledge.

A pioneer in home study, the International Correspondence Schools have kept pace of the times and offer courses prepared by authorities, which give practical instruction in fundamentals and latest developments alike. The courses are revised regularly.

Up to date in every respect, the Complete Radio Course is designed to give thorough instruction in the whole field of radio. The I. C. S. Radio Servicing Course was prepared specially for men who wish to become service experts. Study of it makes possible leadership over competition. The I. C. S. Radio Operating Course is vital to mastery of operating and transmitting.

We will be pleased to send you details of any or all of these subjects. Just mark and mail the coupon—the information will be forwarded without delay. Why not do it today — *now!*

INTERNATIONAL CORRESPONDENCE SCHOOLS

BOX 6679, SCRANTON, PA.

Without cost or obligation, please tell me all about the NEW RADIO COURSE

Name _____ Age _____

Street Address _____

City _____ State _____

If you reside in Canada, send this coupon to the International Correspondence Schools Canadian, Ltd., Montreal, Canada



"Takes the Resistance Out of Radio"

Editorial Offices: 96-98 Park Place, New York, N. Y.

HUGO GERNSBACK, Editor

Vol. IV, No. 9, March, 1933

ELECTRONIC MUSIC

An Editorial by HUGO GERNSBACK

A NEW type of radio instrument will make its appearance within the next few years. It will doubtless be sold by the millions, and it is well that all those now interested in radio should be prepared for what is coming. I refer to electronic musical instruments, whereby an entirely new type of music is produced that anyone, who has knowledge of music, can play. These instruments will be quite small, and so will take up little room; in most cases they will connect with your radio set so the music will issue from the radio loud-speaker. Others will be more elaborate: probably in the form of pianos or other furniture design, with amplifiers and loudspeakers incorporated in the instrument itself. These instruments will be played by means of the usual piano keyboard, or by touching a wire-string, or even by running one finger over a resistance, similar to the instrument for the first time described in this issue of RADIO-CRAFT.

Electronic music is not new—indeed, it was invented by Dr. Lee de Forest. The first public account of such an instrument appeared in my former publication, the *ELECTRICAL EXPERIMENTER*, of December, 1915, when Dr. de Forest wrote an illustrated article for me entitled, "Audion Bulbs as Producers of Pure Musical Tones." The article contains the original diagram whereby the tones were produced by depressing keys, much as we do today. Due to the imperfection of vacuum tubes, at that time, nothing much came of the idea. Years later, in *PRACTICAL ELECTRICS* for March, 1924, when vacuum tubes had been greatly improved, I described an instrument of the electronic music variety which I termed the "Staccatone." This instrument I played publicly for the first time in November, 1923, over WJZ of New York. The same instrument was also used in a theater, in April, 1924, when I loaned it to Dr. Hugo Riesenfeld, who had one of his musicians play it in the *Rialto* Theater in New York. So much for the history of electronic music.

Last summer, in Berlin, I witnessed the performance of the first commercial instrument, the "Trautonium," invented by Prof. Trautwein of Berlin. The Germans have made great headway in electronic music, and many of their instruments have already been exported to this country. I understand on good authority, that a number of American manufacturers are about to produce small and low-priced musical instruments of this kind, which may be used as an adjunct to any radio set; I am certain that we shall witness an avalanche of such instruments in the very near future.

These new electronic musical instruments are exceedingly interesting from many angles: In the first place, they may be played by anyone who can play a keyboard; second, and more important, by the mere turn of the knob (which controls resistances), it is possible to imitate anything from a piccolo down to a bass drum, all in the self-

same instrument. It is possible with such instruments to obtain the pure tones resembling an oboe, saxophone, cello, and other tones which have not yet been heard on mechanical musical instruments.

The construction of these instruments is ridiculously simple; as a matter of fact, simpler than the usual radio set. Then, too, the price is within reason, and there are some interesting experiments that may be performed that I am convinced will soon take the country by storm, once experimenters and others have taken up this new and intensely interesting art.

Indeed, it is certain that electronic music will revolutionize the entire musical art, including the musical instrument field, during the next decade. The vistas opened to experimenters and serious constructors are tremendous. There seems to be no end to what may be accomplished by means of electronic music, inasmuch as the surface has not as yet been scratched.

Entirely new musical effects will be produced which we cannot now foresee. The production of double and triple tones, all produced in the same manner as single tones, is but one of the interesting possibilities; and, of course, by means of electronic music, all the tricks of all other musical instruments can easily be performed, namely sustained tones for any length of time, *vibratos*, echoes, and many other effects not as yet demonstrated, but which are sure to be perfected once a few real musicians get together with a few good technicians.

Then, too, we have the most interesting, and from a utilitarian and practical standpoint, most important point that all these electronic instruments can be played without annoying anyone. You cannot practice on a saxophone or play a piano today without disturbing other people within the house, not to say anything about your neighbors. By means of electronic music, all this is a thing of the past, because the player only has to wear a pair of headphones, and play to his heart's content from sunset until dawn without anyone, even a foot away from him, being aware that any music is going on.

But most important for the radio industry, at the present time, is the fact that these instruments can be sold for very little money. They may be attached to the owner's radio set in order to give people of small means a real musical instrument which far surpasses the piano, and has the tremendous advantage of low cost on the one hand, and takes up very little space, on the other. It can, if necessary, be stored in a closet, out of sight, if not required.

And as for experimenters who are taking up this new electronic music, they will be in a paradise of their own, because there will be no limit to the number of new and novel sound effects which they will create in the very near future.

THE TRAUTONIUM: A NEW MUSICAL INSTRUMENT

A description of a simple musical instrument easily built at home by anyone. Costing but a few dollars to build, this instrument constitutes a complete unit in itself—nothing elaborate, nothing expensive. One may learn to play it in a short time, even though one is not a musician. Complete construction data is given here.

CLIFFORD E. DENTON

EVER since the vacuum tube has been used for the generation of oscillations, many experimenters have been trying to develop new musical instruments. Most readers are familiar with the developments of Theremin, who changes the pitch of his instrument by changing the capacity in an oscillatory circuit. In this instrument the pitch change is accomplished by moving the hand further from or closer to a metal rod provided for the purpose.

The accepted forms of instruments used for the production of musical tones have been with us for many years, and the major changes in them have been merely mechanical ones. Such changes have given the performer greater control of pitch, greater speed in note production, richer tone, and greater volume. New devices for the production of musical tones must offer a new conception of tone quality, scale range, and ease of tone production.

If a new instrument is to be successful and accepted as a standard, several qualities must be incorporated in its design. First, it must be easy to play; the mechanical process necessary for tone production must be as simple as possible. Secondly, the tone must be pure. Purity of tone in this case will depend upon the character of the producing device and the skill of the performer. Another angle to the requirement of tonal purity is the desire to create tones of such quality as could be easily recognized and defined by the listener. Every one knows when a violin is being played because of its individuality. Third, the amount of volume which the instrument can produce must

be ample to permit its use in an orchestra. The volume should be under continuous control of the performer so that the proper values of sound intensity may be obtained for true musical expression. Fourth, the tone color must be changeable at will (as in the organ), so that by means of color variation, the instrument will give tones with characteristics similar to the various instruments in the orchestra. By changes in the tone color, it should be possible to

emulate the bass viol, trumpet, French horn, piccolo, and so on through the modern orchestra. Fifth, it should be possible to play the standard scales of full-tones and half-tones plus the tone intervals, which, up to now, have been neglected in modern instrument development. Sixth, the instrument should produce all of the commonly accepted tone colors, but should be capable of new ones of pleasing sound. Seventh, the cost of the complete instrument should not exceed that of any other good

musical instrument. Eighth, the instrument must not be so developed that there would be no incentive for the artist. The instrument should offer ample opportunity for the creation of pleasing tone pictures in the hands of a capable performer.

These eight requirements may seem to impose restrictions on the development of a new musical instrument, but the Trautonium seems to incorporate so many of the features desired that it may possibly be the real new musical instrument.

Oscillation generation in a vacuum tube can be influenced and synthesized by the association of the proper equip-

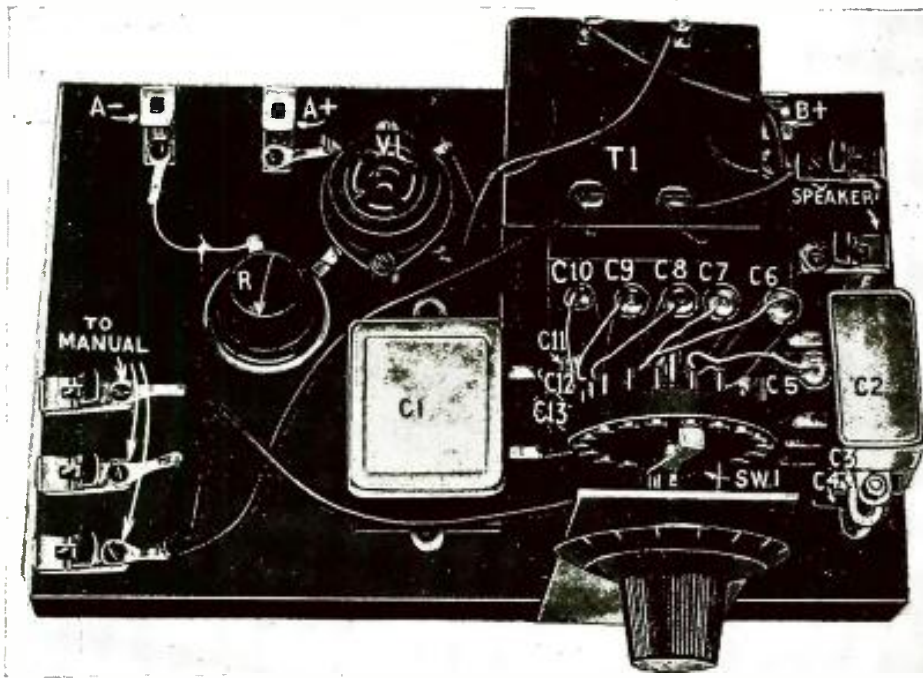

Fig. A
View of the tone generating device showing the location of all parts.

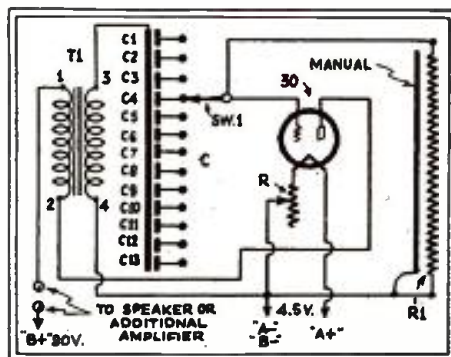

Fig. 1
Complete schematic circuit of the Trautonium. It's simple, isn't it?

ELECTRONIC MUSIC

The production of tones by vacuum tubes has been recognized as one of the outstanding methods of producing music. In presenting this description of the Trautonium, RADIO-CRAFT wishes to emphasize the tremendous possibilities for making money by building and selling such devices. They are simple, do not cost much, and represent a new idea in musical production. This is the first of a number of articles on this subject.

ment. These tones, when generated, are then capable of producing tones of varied pitch and color. These considerations have led to a new theory of "Sound Designs" which was introduced by Dr. Trautwein, of Berlin, Germany, who invented the instrument described here.

(The instrument described here is a modified form of the original Trautonium. The original has been changed so as to accommodate American tubes and American apparatus. The name "Trautonium," however, has been retained to give credit to the original designer. —Editor.)

Electrical Circuit

A study of the circuit of Fig. 1 reveals the simplicity of design. A standard feedback circuit using an audio transformer, T1, for the coupling device as a means of oscillation production is employed. The frequency of the oscillations generated depends mainly on the time constant of the resistance used in the playing manual and the particular condenser switched into the circuit. Many experimenters have built audio oscillators following the circuit of Fig. 2. This is the same circuit as Fig. 1, only simplified, and is used for the generation of one frequency only. The frequency of this circuit is dependent on the time constant of C and R for the determination of the frequency of oscillation. In Fig. 2, with the value of capacity left constant and resistor R varied, there will be a change in the pitch or frequency of the oscillation generated. This change in generated frequency is caused by the varying time constant due to changes in the value of R.

Every one is familiar with the fact that a variable condenser connected across a coil will permit the combination to resonate at various frequencies. The same condition is found here, only the coil is replaced by a resistance.

In the case of the completed musical instrument, the condenser corresponding to C is variable over a wide range

by means of the tapped switch (Sw.1 in Fig. 1), and R is varied by the changing value of resistance of the manual, R1. Thus, by the proper selection of the condenser C and the audio transformer, tones of various colors can be produced, ranging from impact tones such as from a drum beat, to the sustained tones of a bowed violin. Tone colors of the trumpet can be obtained using small values of capacity, and the simple change to a condenser of greater value produces tones similar to that of the bass viol.

Any type of tube can be used in a circuit of this kind, but the choice must be limited to any of the triode types. This selection gives the best results, and gives sufficient power output to drive a magnetic loudspeaker directly. In the model shown in Fig. A, a 30 type tube is used; and with 90 volts of "B" supply, satisfactory power output can be obtained except for the very low frequencies. If the tube is of the battery type, a rheostat should be used in series with the filament to limit the current flowing in the "A" circuit. Of course, A.C. or cathode-type tubes operating from a filament-

supply transformer will not need this rheostat.

As a precaution, if the tube will not oscillate, reverse the connections to the plate feed-back coil of the audio transformer. The connections for the audio transformer are shown in Fig. 1, in which the transformer terminals are indicated in the drawing as they are marked on the transformer shell, i. e., the markings are 1, 2, 3, 4 on the diagram and the transformer.

The Playing Manual

The instrument is played by means of a manual, or key board, as shown in the photographs. This may be constructed in several ways; a simple method is shown in Fig. B in which five resistors are connected in series and held in place by means of a metal rod running through the hollow core to

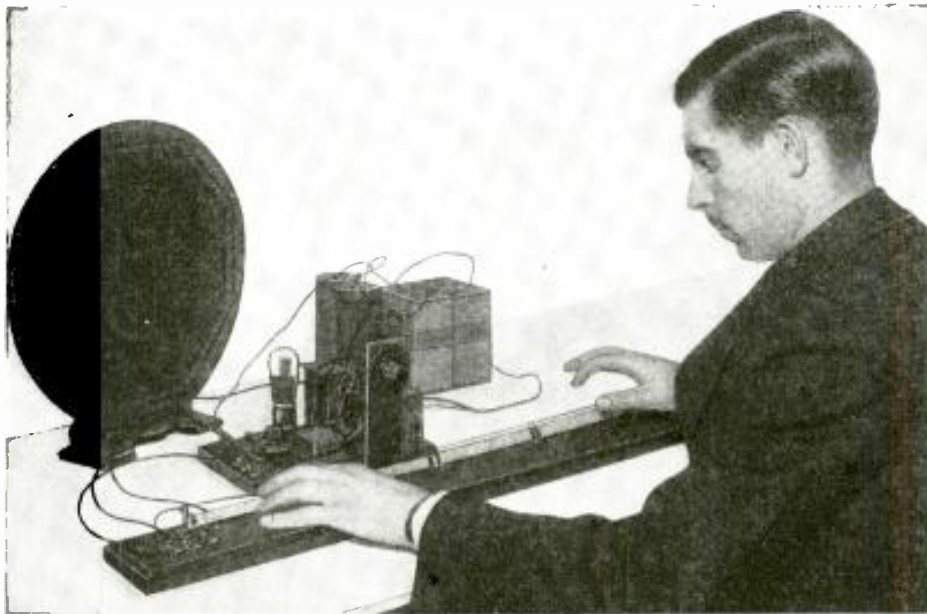

A photograph of one of the Editors testing the Trautonium. Tones are generated by moving the index finger of either hand along the manual.



Fig. B
Photograph of the manual. This unit is shown in more detail in another view.

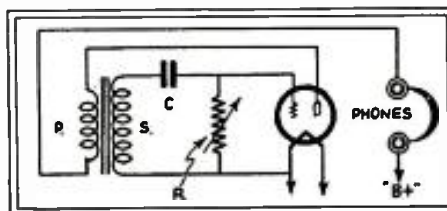

Fig. 2
A simple oscillator circuit illustrating the connection of Fig. 1.

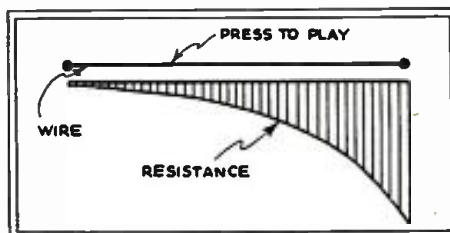

Fig. 3
The manual may be wound on a logarithmic form, as suggested in this figure. However, it will work fine without a logarithmic calibration.

hold them in place. A metal wire is held directly over the long resistance bank by means of metal brackets screwed to the base at the ends. The pressure of a finger causes the wire to make contact with the resistance strip, which, in turn, will cause a tone to be produced. The pitch of the tone depends on the resistance in the circuit and the particular choice of condenser connected into the grid circuit of the oscillating tube. Variations in the value of the resistance caused by moving the finger along the wire will cause the pitch or frequency of the oscillation to vary. A little experimentation with the placement of the finger on the wire will show the constructor how it is possible to play a musical scale.

A playing manual of this type will not give equal spacing between tones. If a playing scale is desired that will give equal spacing between notes, then the resistance wire will have to be wound on a special form that will provide a logarithmic taper. The form of such a taper is indicated in Fig. 3.

Constructing and Wiring

Little need be said for the construction of such an instrument as illustrated in the pictures. Everything is fastened to a baseboard by means of wood screws; Fahnestock clips are used for the battery connections; and all of the parts can be assembled before the wiring is started.

It is a good idea to leave the mounting of the small panel, holding the tapped switch, until the end. This procedure will simplify the wiring, and all of the tubular condensers can then be soldered to the common connecting wire running to the terminal marked 3 on the audio-frequency transformer. After all the condensers are soldered into place, mount the panel with the switch, and solder the remaining connections.

Be sure to follow the circuit as shown in Fig. 1, as there will then be no trouble in making the instrument work. The circuit and the construction are so simple, that no one should have trouble in getting results.

The instrument as shown does not include a volume control. When the Trautonium is used with an amplifier, it will be necessary to have some means of controlling the output of the instrument or the amplifier. Most amplifiers are already equipped with a volume control of some kind, and that should suffice. If possible, the volume should be controlled by the movement of the foot, using a device as sketched in Fig. 4. Here, the volume control, suitable for the amplifier used, is mounted on a bracket. On the shaft of the volume control is fastened a wheel about three inches in diameter. This wheel is wound with cord of sufficient length, so that, as the cord is

pulled down by means of the foot pedal, the volume control will rotate from the maximum to the minimum position. A spring is necessary to pull the wheel around to the minimum position again. The control should work in such a manner that with the foot removed from the control, there will be no sound.

Possibilities

Electronic devices applied to the production of musical sound should provide a new meaning to music. Sadly enough, no instrument will ever be accepted until the complete possibilities have been demonstrated in the hands of a capable performer. Time and study is necessary to develop such an individual. Study of the limitations, advantages, and the mechanical details of individualistic tone production are most important.

Though the vacuum tube has been studied for many years, little creative work has been done along the lines of musical note generation. Dr. Trautwein, in the development of the Trautonium, has taken a real step forward. His theory of sound designs or sound patterns, called *Hallformant* in German, opens a new field for the development of an interesting musical instrument.

There are several circuits that may be used, none of which are as simple as that shown in Fig. 1. One of the most interesting circuits uses a neon tube as the oscillation generator and incorporates an amplifier with a power output of about three watts.

A simple circuit was chosen for the first presentation of this new device in America. If there is enough interest

in this new device, RADIO-CRAFT will present the full details of one of the more elaborate designs which are capable of still more interesting tone colors and greater flexibility.

Parts List

- One Silver-Marshall audio transformer, type 240, T1;
- One 4-prong tube socket;
- Twelve Fahnestock clips;
- One 20-ohm rheostat for filament control, if necessary, R;
- Five Electrad, type D resistors, 100,000 ohms each, R1;
- One Flechtheim condenser, type GB-100, 1.-mf., C1;
- One Flechtheim condenser, type

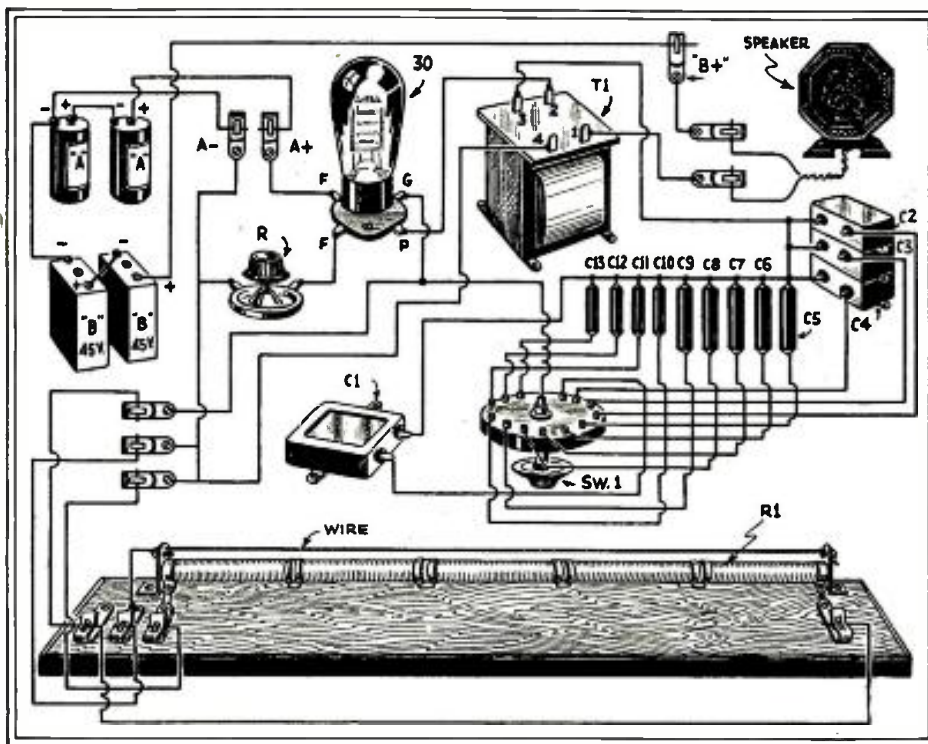

Pictorial view of the Trautonium showing the wiring, not only of the parts, but of the connections between the different units.

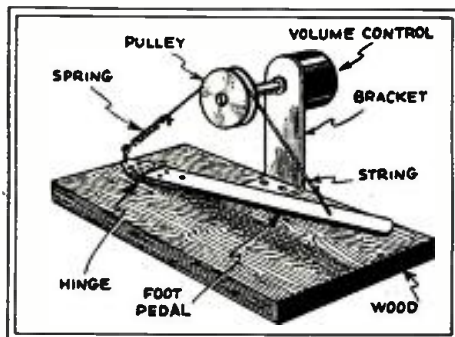
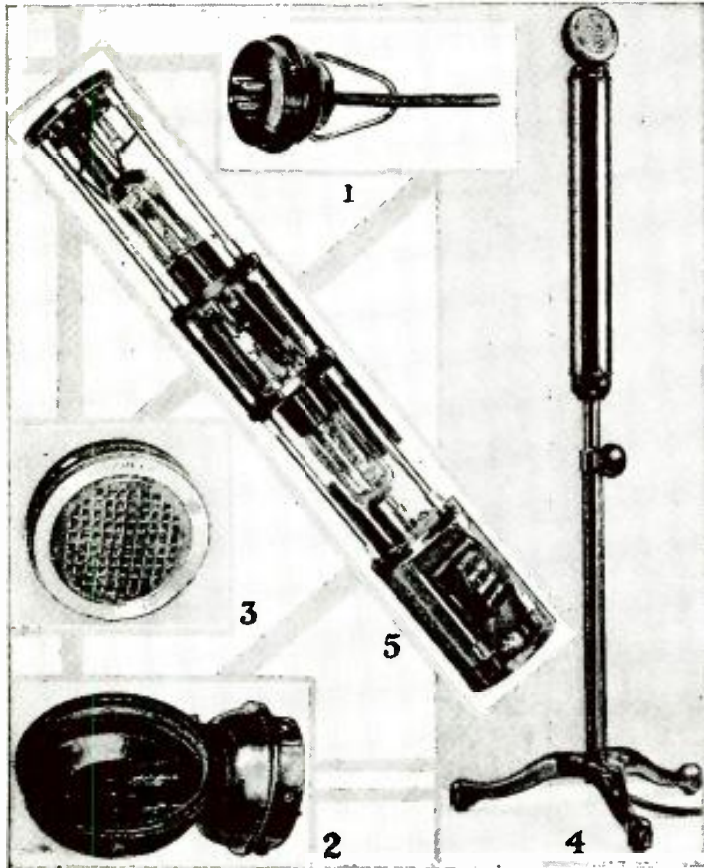

Fig. 4
View of the foot-operated volume control which may be used, if desired.

- GB-50, .5-mf., C2;
 - One Flechtheim condenser, type GB-25, .25-mf., C3;
 - One Flechtheim condenser, type GB-10, .1-mf., C4;
 - One Flechtheim tubular condenser, type AZ-23, .05-mf., C5;
 - One Flechtheim tubular condenser, type AZ-20, .025-mf., C6;
 - One Flechtheim tubular condenser, type AZ-18, .015-mf., C7;
 - One Flechtheim tubular condenser, type AZ-17, .01-mf., C8;
 - One Flechtheim tubular condenser, type
- (Continued on page 572)

THE LATEST RADIO EQUIPMENT



Left, components of the Remler microphone; and right, complete assembly.

NEW REMLER CONDENSER MICROPHONE

A NEW condenser microphone of radically new design has been produced by the Remler Company, Ltd., and is illustrated in the photograph to the left. The completed unit comprises, in addition to the microphone, a complete amplifier in the same housing to facilitate its use. The parts of the unit are as follows: the connection block, known as the suspension converter, is indicated at (1); the head housing at (2); the front view of the transmitter head at (3); the complete assembly at (4); and the pre-amplifier between microphone and line at (5).

The completed unit has a response which is substantially flat between 40 and 10,000 cycles per second, and is equipped with a combination 50- and 200-ohm output unit.

FLECHTHEIM DRY ELECTROLYTIC CONDENSER

A NEW line of condensers suitable for replacement work has been announced by A. M. Flechtheim & Co., one of which is reproduced below. The unit shown is of the electrolytic type, has a screw-type base, and is either of the insulated or non-insulated type. Of course, they are made in all standard sizes. The non-insulated type is shown in the illustration.



Photograph of one of the new Flechtheim electrolytic condensers.

WEBSTER MIXING PANEL

THE Webster No. 104 mixing panel illustrated below provides facilities for mixing the output of either carbon or condenser microphones, and low-impedance pickups for program work. An integral part of the equipment is a two-stage battery-operated amplifier having an overall gain of 40 DB. Space is also provided for the necessary "A" and "B" batteries. The amplifier is normally equipped with type 30 tubes, but as optional equipment the type 864 may be had.

The unit is equipped with a master gain control; individual gain and current control for each circuit; and a master "on" and "off" switch.

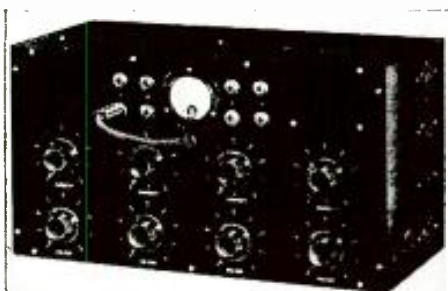

Panel view of the Webster mixing panel.

YAXLEY FIVE-SECTION SWITCH

THE Yaxley Manufacturing Co. now has available a new type of section switch illustrated below. Features of the unit are that as many sections as desired may be used, and a low-capacity insulated arm is employed. This latter feature, in conjunction with low-resistance contacts, make this switch specially adaptable for S. W. work.

PHOTOMATIC EQUIPMENT

A SIMPLE and compact photoelectric unit designed to operate from standard A. C. lines, and known as the Photomatic Equipment has been produced by the Western Electric Co.

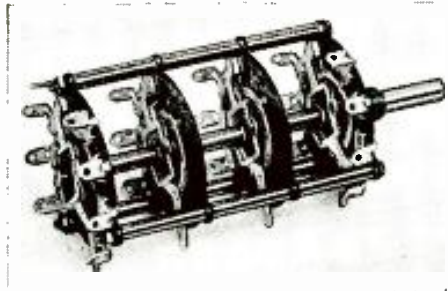

The five-section switch by Yaxley.

This unit, which, in reality, consists of two parts, is adaptable for the many uses to which the P. E. C. may be put. Details are shown below.

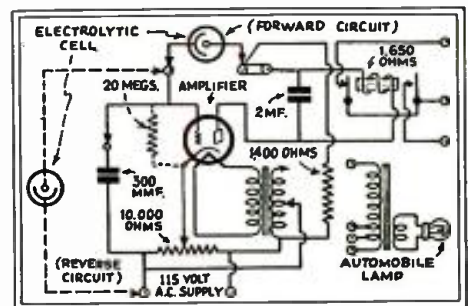

Schematic circuit of the P. E. C. unit by W. E.

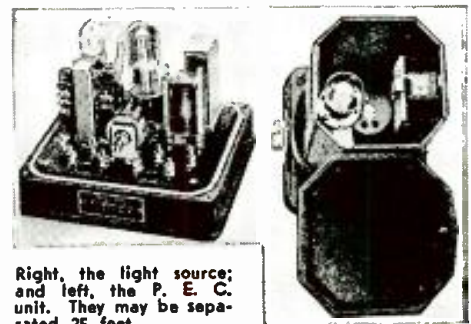

Right, the light source; and left, the P. E. C. unit. They may be separated 25 feet.

PHILCO REMOTE SPEAKER

THE Philadelphia Storage Battery Co. has just made available an extension speaker which enables reception in any locality remote from the set. The speaker, shown below, is equipped with a volume control, and has an impedance of about 20,000 ohms, thus making it adaptable for most of the output circuits now being used. It is as large as the usual mid-get.



New Philco remote speaker.

MECHANICAL RECTIFIER

A NEW mechanical vibrator-type rectifier suitable for operating standard transformers is now available from the American Radio and Television Corp. Among the features of the device are: (1) small space; (2) quiet operation; (3) rugged and long life.

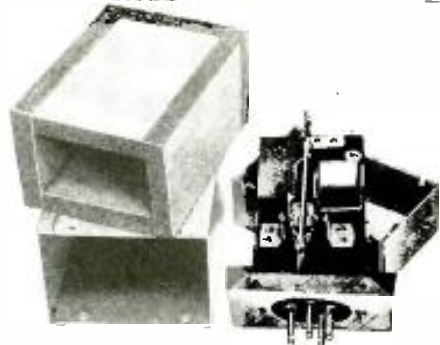

Full-wave mechanical rectifier.

LIGHT-WEIGHT PHONES

TELEPHONE receivers are used by many, outside of the transmitting amateur. The phones illustrated below, a product of the Acme Specialty Co., are light-weight, and are made in two types: 2,000 ohms, for the crystal sets; and 4,000 ohms, for tube receivers. Reports from users say that background noise is considerably reduced, declare the makers.



Acme light-weight phones.

A NEW CONTROL PANEL

THE Oliver Hotel officials decided to incorporate a paging system along with their Centralized Radio systems. To accomplish this, a 20-watt amplifier was built and mounted on the panel board, front and back views of which are shown below.

By means of the switches, either the radio or microphone may be connected to the vital points in the hotel, at will. This panel is now available through the RCA Victor Co.

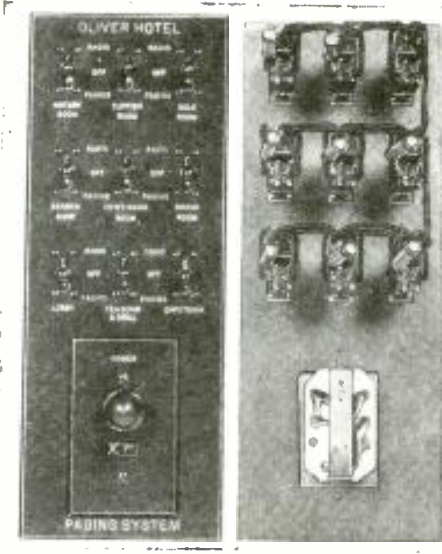

A unique paging control panel.

RADIO TIME SWITCH

THE New Haven Clock Co. has made available a new combination clock and time switch shown below. A red flag, seen to the right, indicates automatic operation. Referring to the left photograph, (1) is the A.C. line plug to an outlet; (2) is the hand set; (3) is the radio or appliance plug; (4) red flag lever; (5) red flag lever in operating position; (6) time "on" set; (7) time "off" set.

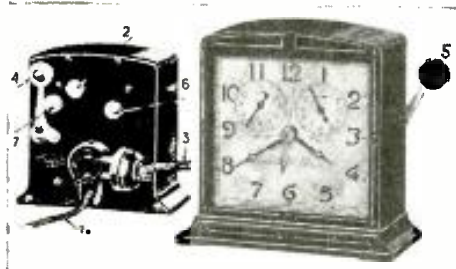

The New Haven radio time switch.

RADIO CHASSIS SET

A FIVE-TUBE receiver using the latest tubes available has just been marketed by Radio Chassis Inc. The receiver is very small, but has been placed in a small console cabinet shown below. The chassis, known as the Model A.C. 25, is shown immediately below the cabinet, and the circuit diagram of the receiver is depicted below, at the bottom of this page. A 58 tube is used in the first R.F. stage, a 57 in the detector stage, a 56 as the first audio amplifier, and a 47 in the output stage. This receiver has unusual selectivity and sensitivity. The cabinet measures about 10 x 18 x 30 ins.



Cabinet of the Radio Chassis A.C. 25.

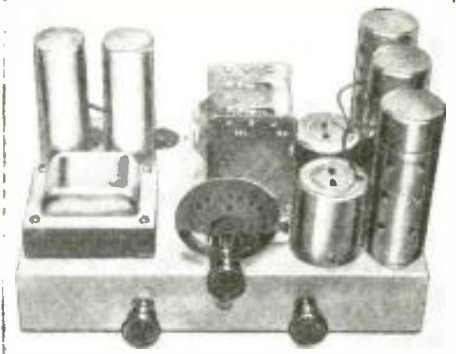

View of the chassis of the A.C. 25 receiver.

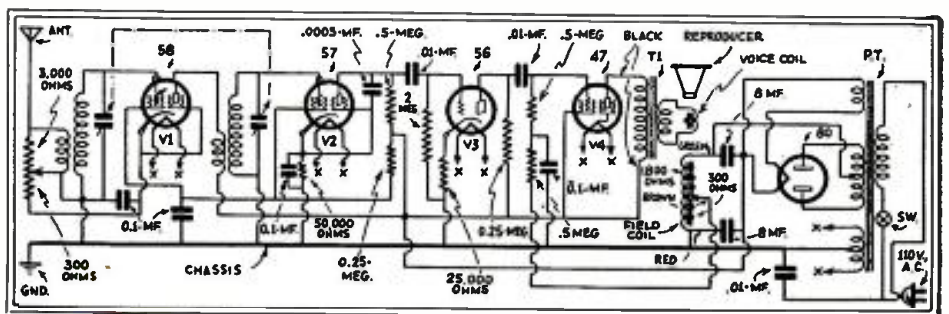

Complete schematic circuit of the A.C. 25 Radio Chassis receiver. All values are shown.

ALDEN CODE PRACTICE SET

THE Alden Manufacturing Co. announces a new code practice set containing a key and buzzer on a single mounting, as shown to the right. The pitch of the note may be adjusted at will, and the screw adjusting the pitch used as a binding post for the connection of headphones. The code is engraved on the base for convenience when practicing. A fountain pen flashlight battery may be used, and the entire unit slipped in the pocket.

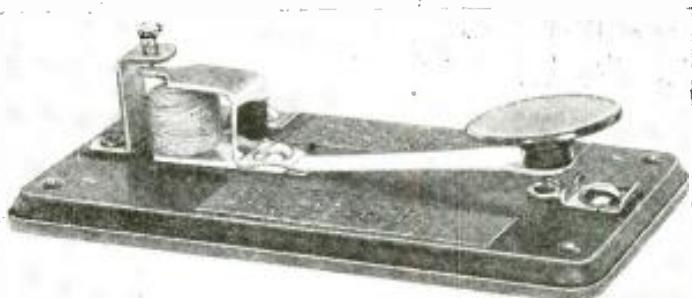

Photograph of the new Alden code practice set.

"PIX," THE NEW VARIABLE CONDENSER

POSTAL Radio now has available a unique type of variable condenser having a minimum capacity of .000005-mf., and a maximum capacity of .000157-mf., a ratio of about 40 to 1. As may be seen by referring to the illustration to the right, the unit consists of two sliding metallic tubes about three inches in length, each tube terminating in a binding post. The uses for this unit are as follows: (1) as a wave trap or volume control; (2) when one Pix is connected in series with each leg of a loop aerial, better results are obtained; (3) as an inside aerial when connected in series with a fixed condenser to one side of the A. C. line; (4) as a means of sharpening the tuning.



"Pix," the new sliding variable condenser.

EMERSON MIDGET SET

A COMPACT midget receiver, not much larger than a hand, has just been announced by the Emerson Radio and Phonograph Corp. Employing one 36, one 37, one 38, and one 39, this receiver is so designed as to operate from either A.C. or D.C. without the manipulation of any switches. The general principles of operation of receivers of this type have been described in RADIO-CRAFT.

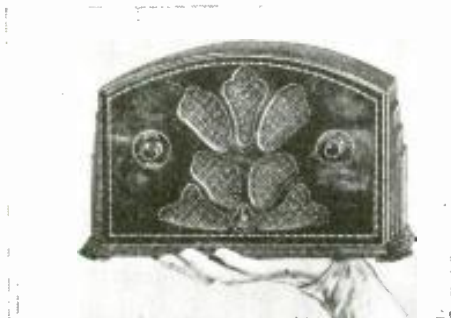

The Emerson midget—a handful.

NEW VOLTAGE REGULATOR

HAVING an absorbing power of twenty-five, compared to fifteen of its older brother, the new Amperite shown to the right is now available to all. One of the new features is the screw-type base, which allows the unit to be used in a standard incandescent base. When ordering, be sure to specify the model number of set.



New Amperite.

UNIVERSAL TORPEDO MICROPHONE

BELOW is illustrated the new Universal Torpedo Microphone, a product of the Universal Microphone Co., Ltd. These microphones are completely protected, compact, and readily demountable. Connection is made via spring jacks into which telephone pins are inserted. The case is of heavy brass, chrome-plated for durability.

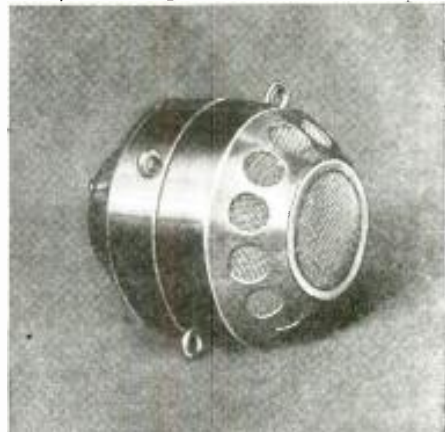

The Universal Torpedo microphone.

LYNCH ANTENNA SYSTEM

PAST issues of RADIO-CRAFT contained articles on the relative merits of antenna systems with and without antenna matching transformers, one type of which is illustrated below. Such units, when properly installed, eliminate about 90% of man-made static. This percentage decreases slightly as the frequency increases—in the short-wave band—until at about 15 meters, only about 20% of the noise is eliminated. At such low wave lengths, however, it is recommended that the transposed lead-in be used.



New Lynch antenna kit, complete.

NEW DUBILIER CONDENSERS

TWO new types of Dubilier condensers, shown below, are now available. The unit in the large sardine can, known as the "Pyranol," is made in 4 and 2 mf. sizes, and rated at either 1,000, 2,000 or 3,000 volts. They are especially designed for transmitting purposes. The small paper unit above the can is a dry electrolytic condenser of the two-in-one type.

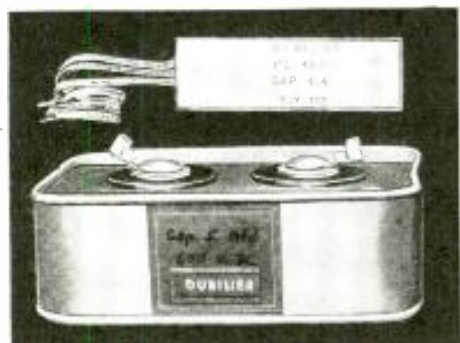

Dubilier's condensers; the lower, a sardine can.

DUMONT AERIAL ELIMINATOR

THE Dumont Electric Co. have developed a combination noise reducer and aerial eliminator for radio receivers, shown below. The A.C. line from the set is plugged into the eliminator, the plug from the eliminator into the line, one of the two "EXT.GND." wires to a radiator, and the other two to the aerial and ground of the set.



The Dumont aerial and noise eliminator.

AND NOW— THE FILAMENTLESS TUBE

Tubes of various types and classes have been described in this and other publications since the latter part of the nineteenth century; but, in nearly every case, the tubes described employed a filament as the primary source of electrons. Ionization of gas has been suggested as a means of securing electron emission, and a great deal of work has been done along this line in Germany. We herewith present the first complete description of an American filamentless tube, recently demonstrated in New York.

AFUORE was created at the January, 1933 meeting of the Institute of Radio Engineers when Dr. August Hund, a member of the research staff of Wired Radio, Inc., discussed the development and demonstrated the operation of filamentless ("cold-cathode"), or ionized-gas, tubes. (Based on the fundamental experiments of Dr. Lee DeForest, nearly thirty years ago, as mentioned in the article, "Soon—The Cold-Cathode Vacuum Tube," in the May, 1931, issue of RADIO-CRAFT.—*Technical Editor.*) Over 1,000 engineers listened to every word of this well-known scientist and pioneer in the development of ionized-gas discharge devices. In a short address, just before the discussion of Dr. Hund's paper by members of the Institute, Mr. R. D. Duncan, Jr., chief engineer of Wired Radio, Inc., stated that the primary interest of his company in new tube developments was in long life, because of the tremendous cost it would be for his company to service burned-out tubes in the rented receiver system they plan to install shortly in Cleveland, Ohio.

Uses of Filamentless Tubes

The experimental tubes demonstrated by the Doctor were put through the paces of oscillation, detection (or demodulation, as the Doctor chose to call it), voltage amplification, and power amplification. The tubes of the power class operated as class B, push-push devices. Oscillations were produced by feedback circuits.

A four-tube set (contained in a cabinet of conventional design) demonstrated beyond a doubt, when music and speech of excellent quality filled the packed auditorium, that *the filamentless tube can rival the filament*



Fig. 1

Illustration of one type of filamentless tube along the lines suggested by Dr. Hund at his recent lecture in New York. This tube is drawn approximately to scale, and the location of all the elements is clearly indicated.

tube in performance! (A beautiful lavender glow; sufficiently strong to permit the reading of newspaper print a short distance away, emanated from the ends of the tubes' cathodes.) A one-tube set gave loudspeaker volume that would be sufficient for any hotel room.

An experimental tube design shown and described is illustrated in Fig. 1; a schematic circuit of a "1-tube loudspeaker set," designed in accordance with the engineering data given verbally and via the blackboard by Dr. Hund, is shown in Fig. 2; a theoretical amplifier circuit is Fig. 3. It must be remembered that although experimental work is still continuing, commercial tubes are not yet available, and hard and fast figures cannot be given.

Two general types of tubes have been developed, one of which is a five-electrode tube that makes use of the conduction of negative ions, while the other is a two-electrode tube operating on the negative resistance principle involved in the operation of the Poulsen arc. Both types of tubes have been made to function as oscillators, amplifiers, modulators and demodulators, and several forms of amplifier tubes working on both the ionization and negative resistance principles were described, but the design of greatest interest to the average radio man is the former or "ionization" type.

The "Uniode" Filamentless Tube

In Fig. 4 we have the first blackboard illustration sketched by the Doctor. In this elementary form of tube, we have the basis of many already commercialized devices. A globe with about 10 or 20 mm. of some inert gas encloses two electrodes, a cathode A and an

anode B; a high-voltage battery and limiting resistor R complete the circuit. This resistor limits the current through the tube, which current otherwise would reach an excessive value due to the low resistance of the ionized gas.

With the battery current adjusted to a value that is not critical, we have a glow between the electrodes. The color is pink for neon, and lavender or purple for helium. This glow is thought to be caused by the collision of positive ions and electrons dissociated by the highly charged electrodes A and B.

This "uniode" tube can be made to detect, oscillate and amplify; also, relaxation oscillation has been produced from low audio frequencies to 30,000 kc. (10 meters), according to Dr. Hund. However, these two-element tubes have serious limitations when compared to the orderly working thermionic class used in our present receivers, and, therefore, it was found necessary to modify the design in order to more closely approximate the performance of filament-type tubes. At the same time, the feature of unlimited life was obtained. This modification, Fig. 5, is the introduction of a third element marked C.

How the Diode Cold-Cathode Tube Operates

The dissociation of electrons and positive ions from the rare-gas atom, as explained, makes it possible to pull great quantities of negatively charged ions and electrons to the third electrode, which is charged "plus plus" (the Doctor's terminology), or at a higher voltage than electrode B. We now have one stream of electrons and ions between A and B, and another to C. In a hot-cathode type diode tube the filament may be likened to the path A-B, and the internal plate circuit as the electron stream to C.

So far, the talk had only reviewed the work of previous investigators, continuing with the remark that as soon as a grid was put between the arc and the plate C, the grid becomes charged with positive ions and causes it to become inoperative. This was the starting point for the description of the structural changes which made the filamentless triode practical.

ADVANTAGES OF THE FILAMENTLESS TUBE

The type of tubes described in this article are not pipe dreams, but actually have been constructed and successfully demonstrated. While the total power required to work the tube is slightly greater than a corresponding filament tube, the extremely long life it enjoys more than compensates for this slight increase in power. Then again, the necessity for filament transformers is not present. Of considerable manufacturing importance is the comparative leeway in gas pressure allowed, and the tube may even function with about 10 mm. of air alone! The materials used as the elements are not critical, both as to type and purity; a plate, for instance, may be of iron, and this iron may be either clean or rusty—the results are the same. It is expected that commercial tubes may be available in about one year.

RADIO-CRAFT takes pride in presenting a description of one type of American filamentless tube.

Construction of the Filamentless Triode

The next blackboard sketch, Fig. 6, showed the introduction of a perforated electrode in place of C in Fig. 5; the introduction of a grid D and plate E completed the representation of a triode which may be designed for any service.

The action was explained as follows: Electrons and positively charged ions from the arc between A and B are accelerated through the perforated cylinder; for purposes of explanation, only one of the small holes is shown. (See Fig. 1.)

The shielding effect of this positively charged cylinder slows the speed of the positively charged ions so that there is practically no trace of this trouble maker in the electron stream between the cylinder and plate. A grid in the electron stream now affords complete control of the operation of the tube, similar to any triode.

In order to obtain power from the tube, the entire surface of this cylinder, or "cathode," must be perforated, as shown in Fig. 3. (These holes measure about 40 mils in diam.) This gives us an electron stream second to none, not even the best of filament or hot-cathode emitters. Once the electrons are drawn through this cathode, the operation of the tube is exactly analogous to the operation of hot-cathode emitters, and the glass envelope, therefore, may contain all the additional electrodes necessary to produce a diode, triode, screen-grid quadrode, pentode, and, if the tube industry finds need for such, a septode or heptode.

By placing the grid and plate all the way around the cylinder it was found possible to take advantage

of the electrons coming through all the holes; this is the controlling factor which enabled the Doctor to design almost any kind of a tube, be it for voltage or power amplification, or detection or oscillation. The corrugated appearance of the plate electrode (which very much resembles a biscuit-cutter) is explained when it is recalled that if it were not corrugated the electrons would tend to be drawn to that point on the surface of the plate which is nearest the cathode—because of mechanical assymetry—and corru-

(Continued on page 570)

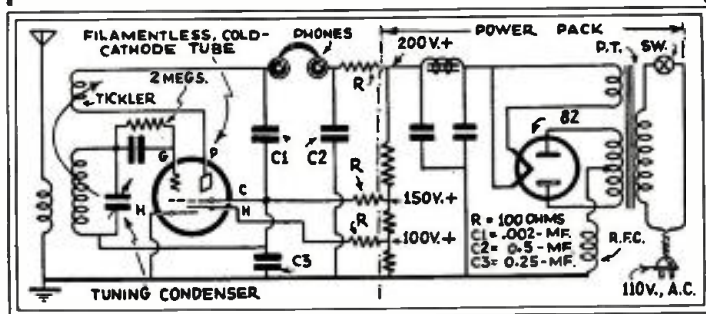

Fig. 2
Schematic circuit of a one-tube receiver using the filamentless tube described in this article.

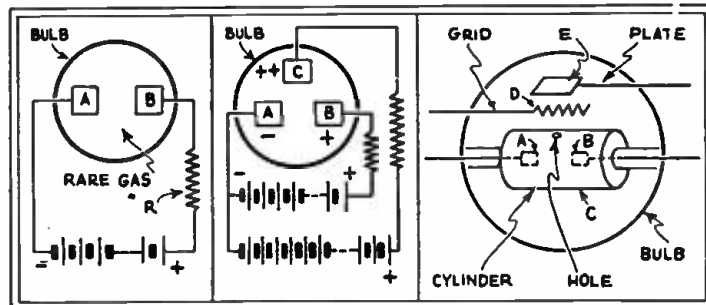

Fig. 4 Simple circuit of an elementary gaseous two-element tube.
Fig. 5 Same as Fig. 4, with a third element, C, inserted and charged.
Fig. 6 Simple schematic of the filamentless tube showing the use of the holes.

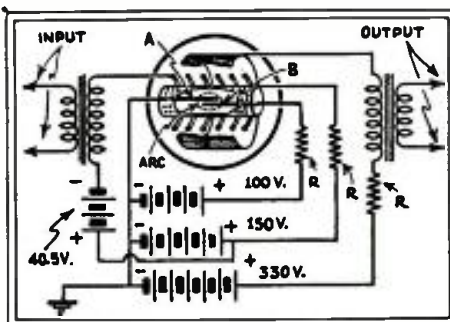

Fig. 3
A theoretical circuit illustrating the use of the filamentless tube as an amplifier.

THE PENTODE "FOUR"

A description of a four tube receiver of novel design using the latest tubes. A 58 is used in the R.F. stage, a regenerative 57 as the detector, impedance coupled to a 56.

H. G. CISIN, M. E.

ONCE more ingenious engineers have added to the efficiency and performance of the marvelous "talking bottles," otherwise known as vacuum tubes. A number of these tube developments are included in the new Pentode "Four," described in this article. The circuit used is a simple one—a single tuned R.F. stage, a regenerative detector, and two audio stages. The first audio stage is coupled to the detector by resistance coupling, while the output stage is coupled to the first audio by a transformer.

One of the new 58 tubes is used in the R.F. stage. This tube is a variable mu, R.F. pentode, employing a uni-potential cathode with an A.C. heater. It is very efficient because its long "cut-off" feature effectively reduces cross-modulation. Modulation distortion is also reduced to a minimum, and the use of this tube eliminates the necessity for "local-distance" switches. Correct screen voltage is obtained by means of a series resistor in the high voltage (plate supply) circuit. The variable cathode-resistor method of volume control is used in

order to obtain full advantage of the remote "cut-off" characteristic. A potentiometer (8) is employed for this purpose.

The regenerative detector stage utilizes one of the new 57, non variable-mu pentode tubes. The shield arrangement in the dome of this tube is an important development, in that it allows a decided reduction in output capacitance. Other advantages are the high transconductance, and plate resistance, and the sharp plate current, grid bias "cut-off," desirable and necessary for sensitive detection. In this circuit, grid-leak detection is employed, the 57 tube being connected to take the utmost advantage of its high sensitivity. Resistance coupling with the first audio stage permits the attainment of best fidelity. Regeneration is controlled by means of the potentiometer (17).

A two-gang variable condenser takes care of the two tuned circuits. In the broadcast receiver, an antenna coupler is used at (3), while a standard screen-grid R.F. coil is employed at (11), with the secondary used as the tuned impedance and the primary as the tickler. The new 56 tube is ideal for use in the first audio stage. Instead of using a fixed resistor for the resistance coupling at (23), a potentiometer is substituted, thus permitting the inclusion of a means of tone control.

Transformer coupling is used between the first and second audio stages in order to eliminate any tendency towards "motorboating." The output tube is a pentode, having a power output of 2.5 watts. The advantages of using this tube, with its high mutual conductance and high power sensitivity, are universally recognized by set designers. A standard 80 rectifier is used, and the filter system incorporates dry electrolytic condensers. An automatic line-voltage control amperite is specified as an important adjunct to the attainment of excellent performance under all conditions of supply voltage.

The construction of the receiver will now be described. The holes are drilled for the sockets and power transformer, preferably before chassis material is bent. The wafer sockets and binding posts are mounted on the finished chassis. Mounting holes are drilled in the front chassis wall for the

(Continued on page 554)

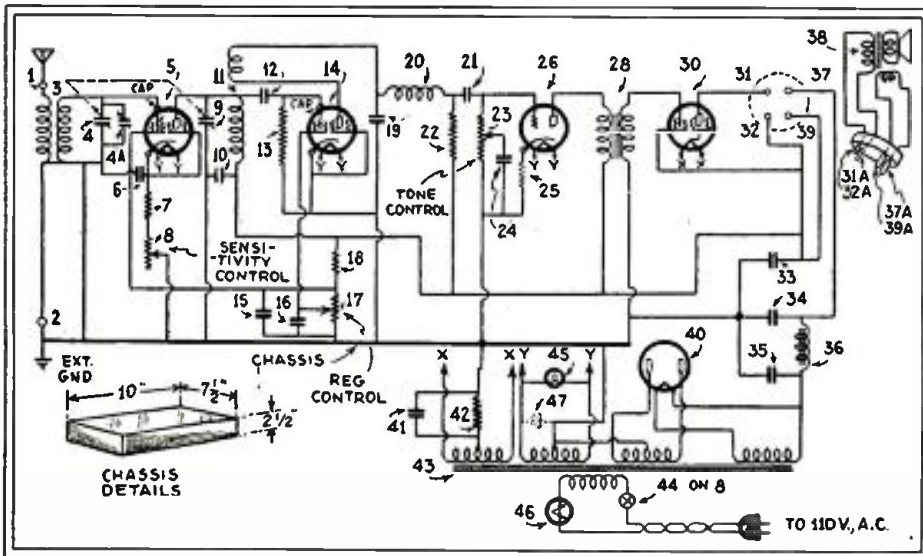

Schematic circuit of the Pentode "Four" described by the author. All values are given in the List of Parts.

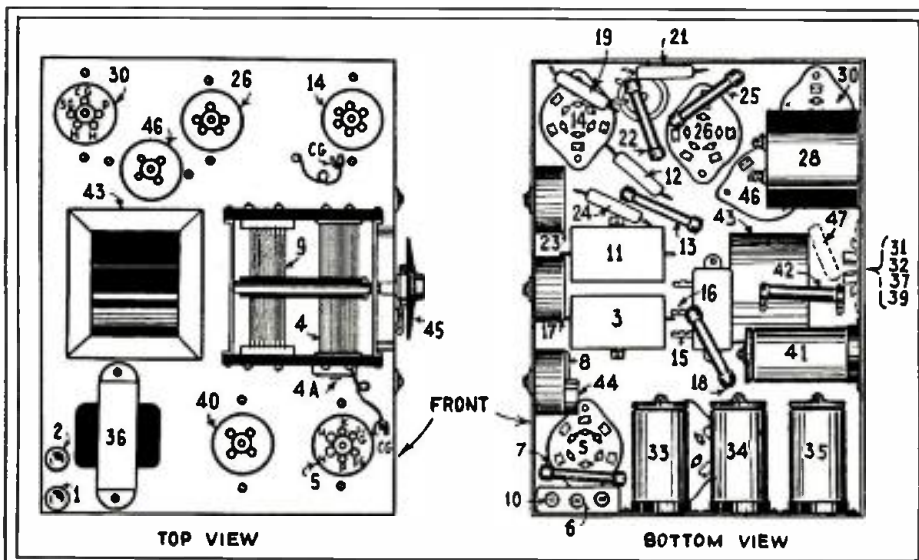

Left, top view; and right, bottom view of the chassis. The numbers refer to those given in the List of Parts.

NEW CROSLLEY RECEIVERS

A description of three different models of midget receivers featuring unusual cabinet designs.

WHEN the automobile industry had perfected the mechanical features of its cars to a high degree, it turned its attention towards beautifying and modernizing the car bodies. The radio industry has followed in the footsteps of the automobile industry. The avalanche of new tubes that has made its appearance during the past year has stimulated the engineering departments of set manufacturers to a point where they now produce very sensitive and selective receivers heretofore impossible with the same number of tubes. Now that the electrical and mechanical features have been somewhat stabilized, attention has been turned toward unique cabinet design.

Crosley has been the pioneer in this respect, as exemplified by their Book Case Model receiver illustrated in Fig. A. It takes but a glance at the upper part of this photograph to realize that even an expert can be fooled by its appearance. To all intents and purposes, it appears as a beautiful set of books; but, on closer examination, and by an inspection of the lower part of the figure, it is seen to be a little radio set, camouflaged so as to present a unique and dignified appearance.

The schematic of this receiver is illustrated in Fig. 1, and it is seen to be a five-tube superheterodyne—five tubes including the rectifier—of rather unusual design. It is operated from the conventional 110-volt, 60-cycle line, and employs the following tubes: a 24 as an oscillator—first detector, V1; a 58 as an I.F. amplifier, V2; a 57 second detector, V3; and 47 output tube. The 80 rectifier is seen at the extreme right of the diagram. Using this tube arrangement, it is possible to secure the high gain which is char-

acteristic of superheterodynes, and, at the same time, obtain excellent selectivity by means of the efficient tuning circuits.

Coil L1 is the antenna coil, which is connected in series with another small coil acting as a cathode coupler to the oscillator portion of the tube. The set of coils L2 are the conventional oscillator inductances common to some types of dynatron oscillators. A feature of particular note is its inclusion of an R.F. choke in series with the control-grid lead of the 58 tube. This choke prevents parasitic oscillations from taking place, and also assists in blocking out any high-frequency oscillations from V1. The 57 second detector is resistance-coupled into the 47 output tube, which, in turn, has its conventional output transformer connected to the speaker.

The following filament voltages exist: all tubes but the rectifier, 2.2 to 2.6 volts; rectifier, 4.3 to 5.3 volts. First detector and I.F. plate voltages, 230 to 270; second detector, 30 to 50; output tube, 230 to 260; rectifier, 340 to 380. The screen-grid voltage of the first detector and I.F. tubes are 80 to 110; of the second detector tube, 30 to 50; of the output tube, 225 to 265. The bias voltage of the first-detector tube is 8 to 10; of the I.F. tube, 3.1 to 3.9; of the second-detector tube, 8 to 12; of the output tube, 16 to 21 volts. The above voltages are valid when a Voltmeter with a sensitivity of 1,000-ohms-per-volt is connected in the circuit with the return lead of the voltmeter to the emitter contact. Bias voltages are measured from cathode to chassis.

The Model 148

Another type of Book Case Receiver, known as the Model No. 148, is a five-
(Continued on page 571)

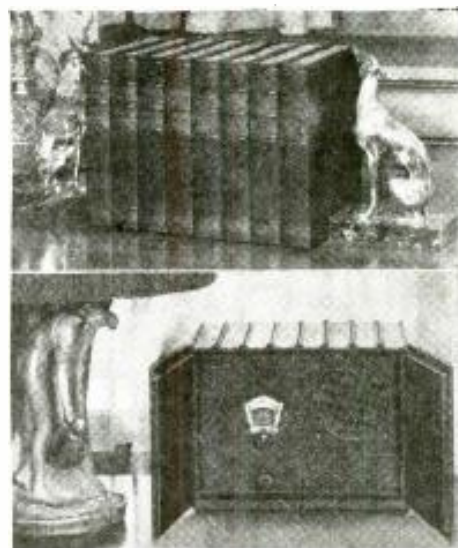

Fig. A

Above, the Book Case receiver closed. Does it fool you? Below, the "books" are opened and the set is ready for operation. This is only one example of how receiver manufacturers may attempt to increase their sales by appealing to the public eye rather than to their ears, which are rather worn out by this time.

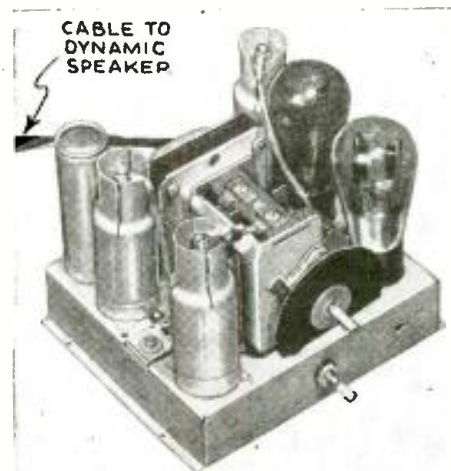

Fig. B

Chassis view of the Model 148 Crosley Book Case receiver. The circuit of this set is different from that shown for the model in Fig. A, above and Fig. 1. A description of this receiver appears in the text.

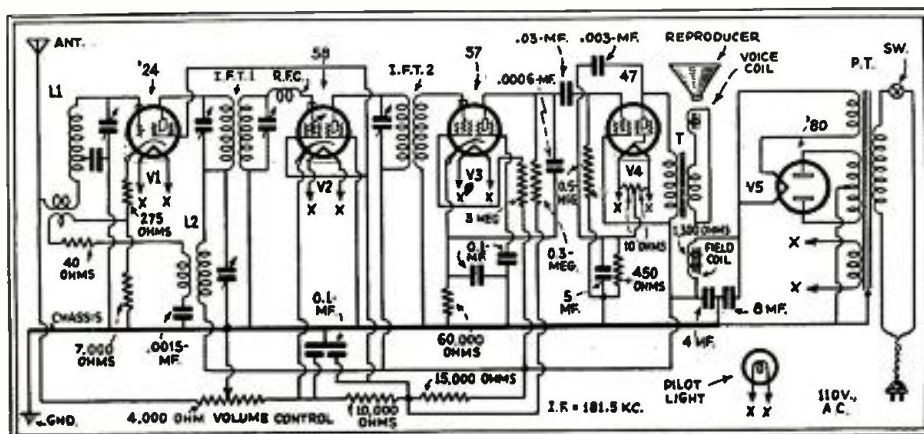

Fig. 1

Schematic circuit of the Crosley Book Case Receiver pictorially illustrated in Fig. A.

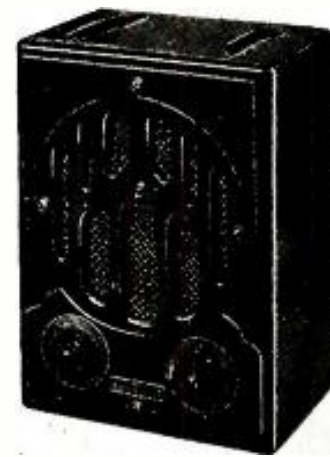

Fig. C

The latest model of Crosley. Known as the "To-tem," this receiver, also a midget, while of rather conventional design, presents a striking appearance.

TUBE REFERENCE INDEX

A description of a tube chart which enables one to tell at a glance the purpose for which tubes are designed. This chart covers over one hundred tubes in common use in receiving sets today, and will be expanded as new tubes arrive.

Type Tube	Fil. Volt.	Reference Letters	Socket Key	Type Tube	Fil. Volt.	Reference Letters	Socket Key	Type Tube	Fil. Volt.	Reference Letters	Socket Key	Type Tube	Fil. Volt.	Reference Letters	Socket Key
00A	5.0	dT	4-1	41	6.3	oP	6-3	83	5.0	fmR	4-5	*A28	15.0	T	4-1 (A)
01A	5.0	T	4-1	42	6.3	oP	6-3	85	6.3	dD2+T ³	6-4	*A30	15.0	oT	4-1 (A)
10	7.5	oT	4-1	43	25.0	oP	6-3	89	6.3	oTP	6-1	*A32	15.0	T	4-1 (A)
11	1.1	T	4-1 Obs.	44	6.3	vP	5-5	X99	3.3	T	4-1	*A40	15.0	oT	4-1 (A)
*X12				45	2.5	oT	4-1	*181	3.0	oT	5-1 (SP)	*A48	15.0	T	4-1 (A)
12A	5.0	oT	4-1	46	2.5	oDG	5-4	182B	5.0	oT	4-1	*AD	6.3	hmR	4-6 (A)
*14	14.0	SG	5-2 (P)	47	2.5	oP	5-3	183	5.0	oT	4-1	*AE	12.6	oP	6-3 (A)
*15	2.0	P	5-5 (S)	48	30.0	oP	6-3	*205D	4.5	oT	4-1 (T)	*AF	safety	(see 82)	
*17	14.0	T	5-1 (P)	49	2.0	oDG	5-4	*257	5.0	oP	5-3 (TS)	*AG	rectifi	ers (see 83)	
*18	14.0	oP	6-3 (P)	50	7.5	oT	4-1	*291	12.0	T+oT ³	5-7 (C)	*BA	none	gas fR	4-8 (ER)
*19	2.0	oT2 ¹	6-6 (S)	51	2.5	vSG	5-2	*293	6.3	T+oT ³	5-7 (C)	*BH	none	gas fR	4-8 (ER)
20	3.3	oT	4-1	*52	6.3	oDG	5-4 (ER)	*295	2.5	T+oT ³	5-7 (C)	*BR	none	gas hR	4-8 (ER)
22	3.3	SG	4-2	55	2.5	dD2+T ³	6-4	*401	3.0	T	5-1 (SP)	*BA	5.0	oP	5-3 (A)
24A	2.5	SG	5-2	56	2.5	T	5-1	*401	3.0	T	4-10 (K)	*KR1	6.3	hmR	4-6 (KR)
26	1.5	T	4-1	57	2.5	TP	6-1	*403	3.0	oT	4-10 (K)	*KR5	6.3	oP	5-4 (KR)
27	2.5	T	5-1	58	2.5	vTP	6-1	*482A	5.0	oT	4-1 (SP)	*KR20	2.5	dDG	6-2 (KR)
*29	2.5	dDG	6-2 (S)	59	2.5	oTP	7-1	482B	5.0	oT	4-1	*KR22	6.3	dDG	6-2 (KR)
30	2.0	T	4-1	*84	6.3	SG	5-2 (NU) Obs.	483	5.0	oT	4-1	*KR25	2.5	oP	6-3 (KR)
31	2.0	oT	4-1	*85	6.3	SG	5-5 (NU) Obs.	484	3.0	T	5-1	*LA	6.3	oP	5-3 (ER)
32	2.0	SG	4-2	*87	6.3	T	5-1 (NU) Obs.	*484A	3.0	T	5-1 (SP)	*PA	6.3	oP	6-3 (A)
33	2.0	oP	5-3	*88	6.3	oP	6-3 (NU) Obs.	485	3.0	T	5-1	*PZ	2.5	oP	5-3 (A)
34	2.0	vP	4-2	*89	6.3	dDG	6-2 (S)	*486	3.0	T	4-1 (SP)	*PZH	2.5	oTP	6-3 (A)
35	2.5	vSG	5-2	*70	6.3	dDG	6-2 (SP)	884	1.1	T	4-1	*T1	6.3	hmR	4-6 (T)
36	6.3	SG	5-2	71A	5.0	oT	4-1	888	2.5	hmR	4-6	*WUND	2.5	dDG	6-2 (A)
37	6.3	T	5-1	*79	6.3	T2 ¹	6-5 (S)	*985	5.0	fmR	4-5 (J)	A			
38	6.3	oP	5-5	80	5.0	fR	4-5	*985	5.0	fmR	4-5 (J)	*WUND	6.3	dDG	6-2 (A)
39	6.3	vP	5-5	81	7.5	hR	4-6	*A22	15.0	SG	4-2 (A)	AUTO "A"			
40	5.0	T ²	4-1	82	2.5	fmR	4-5	*A26	15.0	T	4-1 (A)	*Ballast	none	series with	line (AC)

PREFIXES

d special detector
f full wave
h half wave

m mercury vapor
o output
v variable mu

T triode; T2, Double triode
SG screen grid tetrode
DG Double grid tetrode

CAPITALS

P pentode (suppressor grid tied to cathode)
D diode; D2 double diode

TP triple grid pentode (suppressor grid free)
R rectifier

NUMERALS

¹ Two Triodes in a single envelope for complete class B operation.
² These tubes are voltage amplifiers only.
³ Two Diodes plus a Triode (Duplex-Diode Triode).

⁴ Triode plus Output Triode (Triple Twin).
Obs. Obsolete.
The letter A after 24A and 27A means quick heater

TUBE MANUFACTURERS

*These tubes are not made by all manufacturers. The particular manufacturer is given a key letter in () under Socket Key; the manufacturers corresponding to the keys are given below:
(A) Areturus (J) Johnsonburg (NU) National Union
(C) Speed (K) Kellogg (McCullough) (P) Philco
(ER) Eveready Raytheon (KR) Ken-Rad (S) Sylvania
(SP) Sparton (Cardon)
(T) Triad
(TS) Tung-Sol
(AC) Arco

If no prefix is shown, the tube is a detector-amplifier.

CLASSIFICATION OF TUBES

DETECTORS AND AMPLIFIERS			OUTPUT TUBES			RECTIFIERS			
Common Use	Filament Voltage	Tubes	Common Use	Filament Voltage	Tubes	Common Use	Filament Voltage	Tubes	
Battery	1.1	X12, 864	Battery	2.0	19, 31, 33, 49	A. C.	none	BA, BH, BR, Ballast	
	1.5	26		3.3	20		2.5	82, 866, AF	
	3.3	22, 29		A. C.	2.5		45, 46, 47, 59, 295, KR25, PZ	5.0	80, 83, 985, 986, AG
	2.0	15, 30, 32, 34			3.0		403	6.3	KR1, T1, AD
	5.0	00A, 01A			3.3		181	7.5	81
A. C.	2.5	24A, 27, 29, 35, 51, 55, 56, 57, 58, KR20, PZH, Wunderlich A, Wunderlich Auto "A"	Auto and A. C.	5.0	12A, 71A, 182B, 183, 257, 482A, GA	Automotive, 6.3 volts; Battery, 1.1, 1.5, 2.0, 3.3, and 5 volts; A.C. Operated, 2.5, 3.0, 5 (output), 6.3, 7.5, and 15 volts;			
		3.0		401, 485, 486	D. C. Power	6.3	38, 41, 42, 52, 67, 68, 79, 89, 293, KR5, LA, PA	D.C. Power, higher than 7.5	
5.0	40, 112A, 71A	7.5	10, 50						
Auto and A. C.	6.3	36, 37, 39, 44, 64, 69, 70, 85, KR22, Wunderlich A, Wunderlich Auto "A"	12.0	291, AE					
			14.0	18					
			15.0	A30, A40					
D. C. Power	14.0	14, 17	25.0	43					
	15.0	A22, A26, A28, A32, A48	30.0	48					

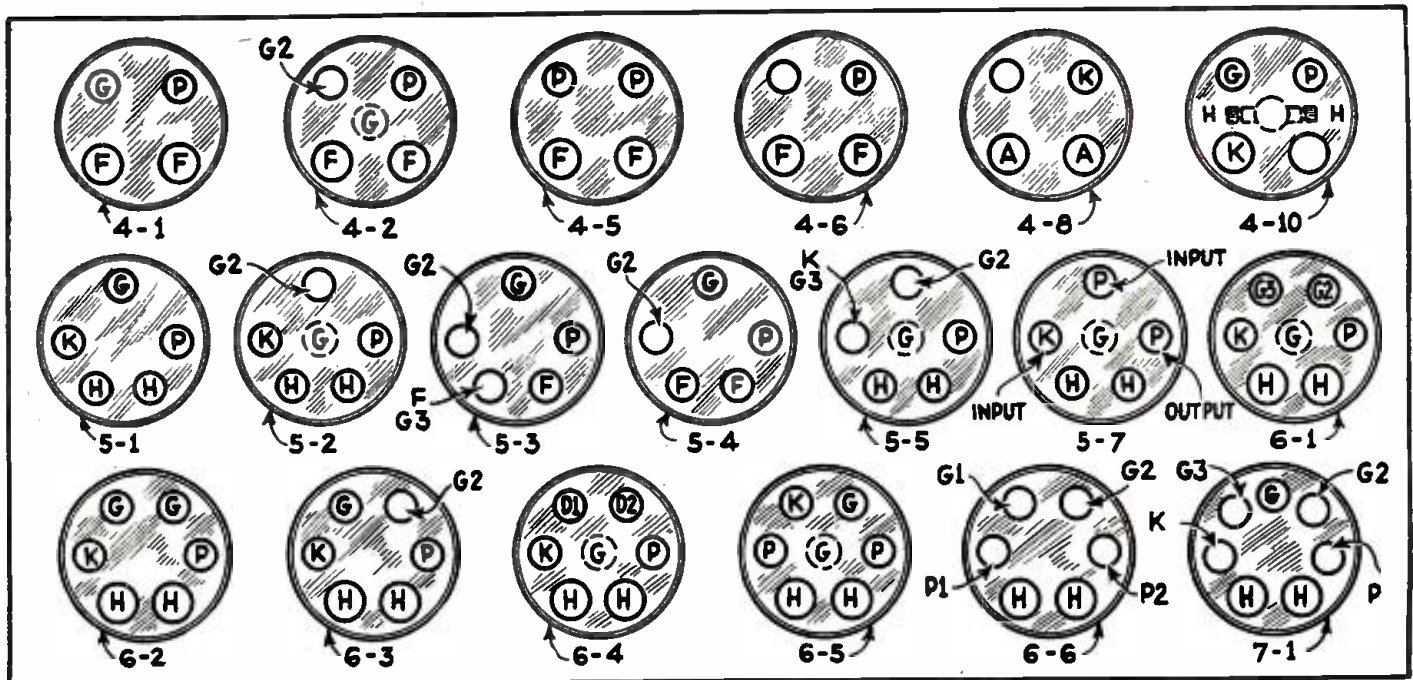

EXPLANATION OF TUBE INDEX

The chart listed on the opposite page has been compiled and tabulated in order to assist those in the radio industry in determining the filament voltage, purpose, and socket connections of the numerous tubes now available for receiving sets. The chart is divided into two sections: the first, shown in the upper part of the chart, is divided into four columns: Type Tube, Fil. Volts, Reference Letters, and Socket Key. The "Type Tube" column lists, of course, all the tubes in numerical sequence that are in common use. The second column, labeled "Filament Volts" states the filament voltage of the tubes listed in the first column. The third column is labeled "Reference Letters," and here is where the real value of the chart lies. The letters (or designations) are referred to the bottom of the chart and interpreted. The use of this column is better shown by an example:

Referring to the type 35 tube, we see by the second column that it is a 2.5-volt tube, and is designated vSG. Now, looking at the bottom of the chart, we see that the prefix v means variable mu, and that the capitals SG mean screen grid tetrode. The 35, therefore, is a variable-mu screen grid tetrode. The socket connections for this tube are given above as 5-2, as stated in the fourth column alongside the 35. In a similar manner, the 85 is seen to be a 6.3 volt, diode plus an output triode, a Duplex-diode triode; the d tells us that it is a special detector. The socket connections are given in 6-4, above.

Another example: What is the 79? By referring to the first table, the 79 is seen to be a 6.3 volt double triode (the *double* triode being indicated by the numeral 2 following the letter T.) The socket connections of this tube are shown

at 6-5, and it is a special tube made by (S), which, it can be seen, stands for Sylvania. With a little practice, many of the symbols can be memorized.

The second half of the chart under the heading "Classification of Tubes" is especially useful in determining the proper tube to use with regard to filament voltage. For instance, if you want to know what tubes *can* be used for D.C. power operated receivers, look under the column "Common Use" until the sub-head D.C. Power is reached, and, alongside, there are listed the tubes suitable for such service, tabulated according to filament voltage. The tubes are further classified according as to whether they are detectors and amplifiers, output tubes, or rectifiers. By cataloging the tubes in this manner it is possible to determine exactly what tube may be used for a specific purpose.

Another valuable feature is the listing of the standard filament voltages in terms of the type of power they *may* be used with. This data is listed just under the heading "Classification of Tubes." Heater tubes are indicated by a cathode in the socket connections.

To use the chart properly, it is necessary that you carefully examine every part of the chart and make sure that you understand the details specified.

Tube reference indices have been prepared before, but the one presented here has been designed especially for men who want to find information quickly, and who are not concerned with the technicalities of tube production dates, and the like. *Once again, be sure you study the chart carefully.*

BUILDING THE SHALLCROSS 651 SET TESTER

A description of a simple, efficient set analyzer suitable for all of the new tubes now available. All construction data are given.

PAUL SHALLCROSS*

THE advent of 6- and 7-prong tubes has made much radio servicing equipment obsolete, and has taxed the ingenuity of the Service Man to provide himself with modern test apparatus. To assist the

Service Man to meet this problem, a new radio-set tester has been designed and is now offered to the field. This instrument employs only one meter, and yet provides all the necessary D.C. voltage and current measurements for all radio tubes now in general use, including the new 59, etc.

The device is pictured in Fig. A and its schematic circuit is shown in Fig. 1. This same circuit is used in the Shallcross models 651 and 652 testers, the only difference being that in the type 651, an 0-1 ma. meter is used; while in the type 652, an 0-1.5 ma. meter is employed. The values of resistors used for either type are given in the List of Parts at the end of this article.

For the model 651 tester, four ranges of voltages are available: 0-10, 0-100, 0-250, and 0-1,000. Three ranges of current measurements are also available: 0-2.5, 0-10, and 0-100 ma. For the type 652 tester, four voltage and four current ranges are possible: voltages, 0-7.5, 0-30, 0-150, and 0-750 volts. Current ranges of 0-3, 0-15, and 0-75 ma.

The instrument, as described and shown here, may easily be assembled in a short time by the average Service Man. The result will be a light-weight and compact unit. The panel dimensions may be obtained from Fig. 2.

Switching Arrangement and Operating Data

The system of switching is so arranged that damage to the instrument is impossible if the switches are set correctly. The wiring is also so arranged that short-circuits are not possible—

(Continued on page 554)



Fig. A
Panel view of the set tester described by the author.

OPERATING CHART

Tubes	4 Prong				5 Prong (Fig. A)			6 Prong		7 Prong
	964 DS				Left Sockets		Right	No Adapters		90788
	A	B	C	D	E	F	G	H	I	J
Adapters (Na—Ald)										
Group										
Plate Voltage	V-P	V-P	V-P	V-P	V-P	V-P	V-P	V-P	V-P	V-P
Plate Current	MA-P	MA-P	MA-P	MA-P	MA-P	MA-P	MA-P	MA-P	MA-P	MA-P
Screen-Grid Voltage	V-G1	V-G1*	V-G1	V-G1	V-G1	V-G1	V-G1
Screen-Grid Current	MA-G1	MA-G1*	MA-G1	MA-G1	MA-G1	MA-G1	MA-G1
Heater to Cathode Voltage	V-H	V-H	V-H	V-H	V-H
D. C. Heater Voltage	V-H
Control Grid to Cathode Voltage	V-H	V-H	V-G2	V-G2	V-G2	V-G2	V-G2
Control Grid to Heater Voltage	V-G1	V-G2
Suppressor to Cathode	V-G3	V-G3

*Second Plate

00A-A	13-C	26-A	32-B	37-F	42-I	47-G	52-G	59-I	69-I	82-C	93-E	985-C	PZH-I
01A-A	18B-D	27-F	33-G	38-E	43-I	48-G	53-H	64-E	70-I	83-C	95-E	986-C	Wunderlich
10-A	20-A	29-I	34-A	39-E	44-E	49-G	54-F	65-E	71A-A	85-H	97-A	98A-A	A
12A-A	22-B	30-A	35-E	40-A	45-A	50-A	57-F	67-F	80-C	89-H	98A-A	98B-A	6 Prong I
WX12-A	24A-E	31-A	36-E	41-I	46-G	51-E	58-H	68-E	81-D	91-F	98A-A	98C-G	B-II

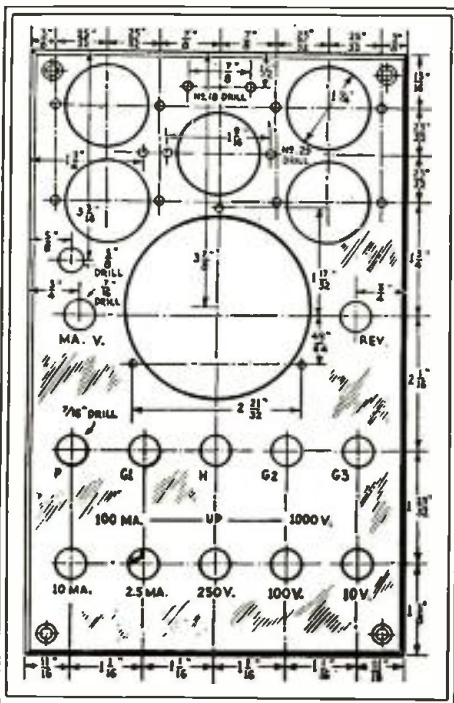
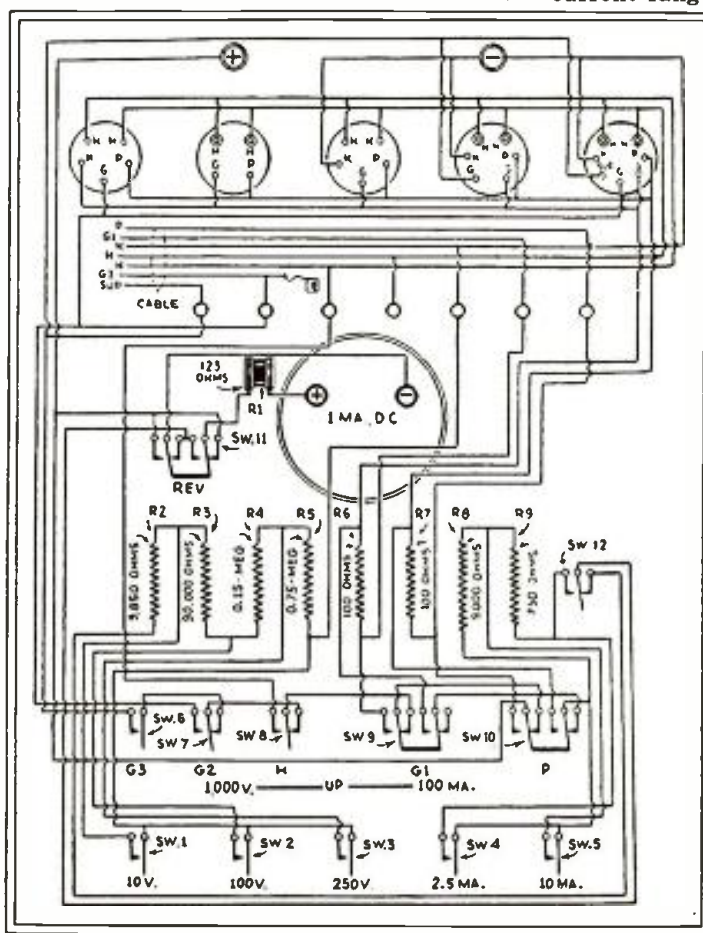

Fig. 1, right
Complete schematic circuit of the model 651 and 652 set testers. The values of resistors shown in the diagram are for the model 651 tester, but the values for the model 652 may be obtained from the List of Parts; (this list includes sockets V1 to V5, from left to right).

Fig. 2, above
Panel layout for the tester. The markings shown are the same as the photograph, shown in Fig. A, above.



THE WHY AND WHEREFORE OF LOW AND HIGH-RESISTANCE OHMMETERS

A comprehensive description of the fundamental principles governing the choice and calibration of ohmmeters suitable for low- or high-resistance measurements.

ARTHUR H. LYNCH*

It is generally appreciated by the Service Man and experimenter that the various forms of direct-current meters used in radio measurements are fundamentally the same, and vary principally in the values of the resistors used with them and the manner of connection. However, considerable confusion seems to exist in reference to the application of the principle involved.

The fundamental unit is a sensitive galvanometer—the more sensitive, the greater the elasticity of ranges. Series resistors are used to increase the voltmeter range; shunt resistors to extend the ammeter range; and either the voltmeter or ammeter, in conjunction with a known voltage source, can be calibrated to read in ohms. The interrelation of voltage, current and resistance—volts, amperes and ohms—is expressed by Ohm's Law, and if the principle is understood, any meter, regardless of type or manufacturer, may be converted for current, voltage, or resistance measurements within the limits of sensitivity of the instrument.

(A complete treatise on the use of multipliers and shunts appeared in a series of articles entitled "Magic in Meters," by Clifford E. Denton, which appeared in the November and December, 1931, and January, 1932, issues of RADIO CRAFT.—*Editor*)

The fundamental circuit of voltmeters is essentially the same as the circuit for ohmmeters. In the voltmeter arrangement, resistors are inserted in series with the meter and the applied voltage connected between the other terminal of the meter and the remaining terminal of the series resistor, or multiplier. In the ohmmeter arrangement, the same mode of connection is used, but the applied voltage is fixed, and the series resistance varied—this resistance being the one under test. Accordingly, it is best for the reader to review, if necessary, the fundamentals of voltmeter and ammeter connections before attempting to make his own apparatus. With the above idea in mind, the question of ohmmeters will now be discussed.

Ohmmeters

Figure 1 shows the fundamental ohmmeter circuit. GIVEN: E, 1.5 volts and I, .5-milliamperes. REQUIRED: resistance of Rx.

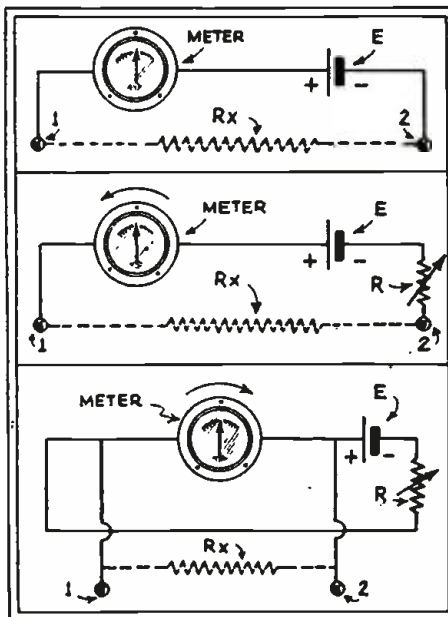

Fig. 1, above
Fundamental circuit of the ohmmeter.
Fig. 2, center
Schematic of the "series" type ohmmeter used for the measurement of high resistors.
Fig. 3, below
Schematic of the "shunt" method of measuring small resistors. A combination of Figs. 2 and 3 should be ideal for resistance measurements.

$$R_x = \frac{E}{I} = \frac{1.5}{.0005} = 3,000 \text{ ohms}$$

When using the circuit of Fig. 1, care must be taken that the resistor being tested is sufficiently high so that no more than the maximum current will be passed through the meter. This precaution generally resolves itself into the circuit of Fig. 2, where R is a variable limiting resistor. It is usual to choose R so that the meter will just read maximum current with the test terminals, 1 and 2, shorted. For instance, with an 0—1 milliammeter and a 1.5-volt flashlight cell:

$$R = \frac{E}{I} = \frac{1.5}{.001} = 1,500 \text{ ohms (max.)}$$

This circuit is easily calibrated by calculation. Suppose, for instance, that with a value of 1,500 ohms at R, the meter reads full scale, indicating zero external resistance at Rx. Now if Rx is made equal to 1,500 ohms, the current through the meter will be reduced to half its value (since the resistance of the circuit is doubled and the voltage, E, is constant) and the meter will read half scale. The total circuit resistance is now 3,000 ohms. If Rx now be increased to 3,000 ohms, the meter will again be reduced to half its value, or read one-quarter of full scale; the total circuit resistance is now 6,000 ohms. If the value of Rx is now increased to 6,000 ohms, the meter will read one-eighth of full scale, etc. In this manner the meter may be calibrated to read values up to about 20,000 ohms. For values of resistances below 50

ohms, this mode of connection is not recommended, as the change in reading from full scale will be too small to permit accurate estimation.

When values of resistances below 50 ohms are to be accurately measured, the circuit of Fig. 3 is recommended. Once again, the value of R is so chosen as to cause the meter to read full scale with the test leads, 1 and 2, open—equivalent to closed in the other connection. The value of R, then, is about 1,500 ohms.

An examination of this circuit will reveal an interesting fact. If the terminals 1 and 2 are short circuited, the meter reads zero, although the current throughout the circuit remains substantially constant. Now as the size of the resistor connected across the meter—that is, Rx—is increased, the meter reading increases, which is opposite to the effect produced with the standard method of connection

(Continued on page 555)

*President, Lynch Mfg. Co.

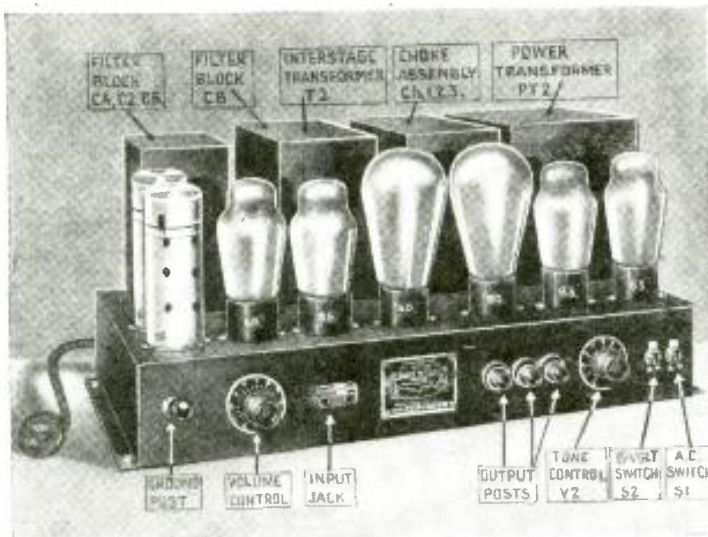

Fig. A

Photograph of the Coast-to-Coast 40-watt amplifier which employs Class AAA amplification. See Fig. 3, lower right.

THERE is a substantial demand for public-address audio amplifiers producing undistorted outputs of 40 to 50 watts. But, due to the almost prohibitive cost involved in purchasing or in constructing such an amplifier, its general use has been previously limited. Some of the draw-backs offered by the present series of power amplifiers producing 40 to 50 watts are as follows: (1) very high initial cost of the component parts; (2) very high tube cost; (3) large power consumption; (4) relatively large physical dimensions; (5) the necessity for use of high and dangerous plate voltages, etc. Furthermore, the use of previous 40- to 50-watt amplifiers on sound trucks was practically prohibitive in view of the fact that such amplifiers consume anywhere from 400 to 550 watts, thereby necessitating elaborate and expensive generator systems. The dominant thought, then, in the design of the amplifier described herein, was to eliminate all of the faults enumerated above, and, at the same time, attain an undistorted output power of at least 40 watts.

The system to be described in this article is entirely successful and can be absolutely relied upon to perform just as satisfactorily as did its considerably more expensive and bulkier predecessors with a drastic saving in tube and parts cost, etc. Let us, for a moment, compare the old and new systems, side by side, not in a spirit of "knocking" the old system, but rather to show the advancing trend in amplifier design.

System A uses two 845's, two 66's, two 45's, one 56, and one 80; system B, to be described in this article, uses two 50's, two 83's, two 59's, and two 56's; the list price of the tubes for system A is \$84.90, while that for system B is \$23.10; the approximate wholesale cost of parts for system A is \$150.00, while that for system B is \$45.00; the power consumption for system A is approximately 500 watts, while that for system B is 150 watts; the approximate over-all dimensions for system A is 18 x 18 x 10 ins., while that for system B is 18 x 9 x 8½ ins.; the approximate weight of system A is 90 pounds, while that of system B is 42 pounds; the rectifier plate voltage for system A is approximately 1,000 volts, while that for system B is 500 volts.

From the above comparative information, it can be readily seen that the sound-truck industry will certainly welcome the advent of this new amplifier, for it solves the problem of greater sound coverage with a minimum investment of capital. By employing relatively low plate voltages, the danger of filter condenser break-down is proportionately minimized.

The attainment of 40 watts output can, of course, also be obtained by employing six type 50 tubes accompanied by four to six type 81 rectifiers. However, it can be logically observed that there is really no merit in this procedure, for the results do not justify the means. The new 40-watt

CONSTRUCTING A 40 WATT CLASS AAA, P. A. AMPLIFIER

Featuring a low cost, economically-operated, high-power amplifier in a new circuit arrangement.

LEON J. LITTMANN*

amplifier to be described may be built by any Service Man, radio technician, and amateur, and, due to its absolutely fool-proof construction and perfect stability of operation, it is especially preferable for installations where the operators have no radio or technical knowledge, as in dance halls, restaurants, stadiums, skating rinks, public schools, stores, etc. It might be well to also stress the fact that because of the comparative light weight of the equipment involved, and because of the low power consumption,

(Continued on page 560)

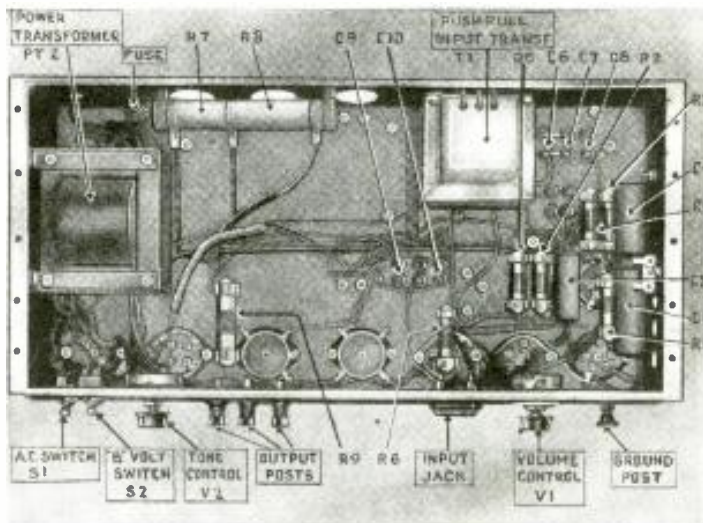

Fig. B

Under-view of the amplifier discussed in the article.

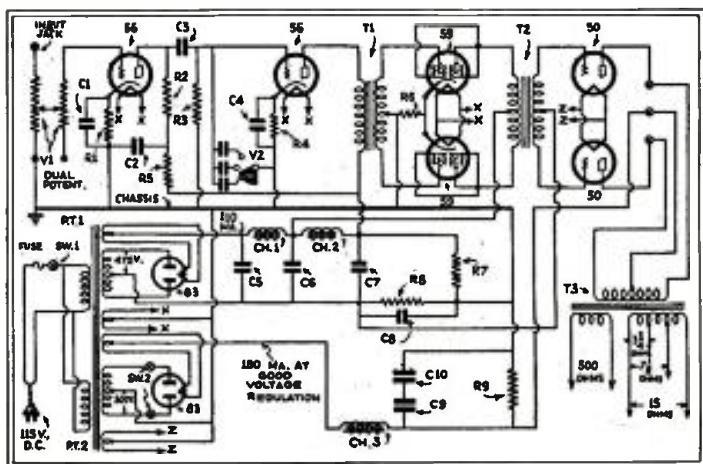

Fig. 3

Schematic circuit of the P. A. amplifier using two 59's feeding two 50's in the new, class AAA circuit.

*Chief Engineer, Coast-to-Coast Radio Corp.

THE ANALYSIS OF RADIO RECEIVER SYMPTOMS

OPERATING NOTES

W. H. MYLLKANGAS

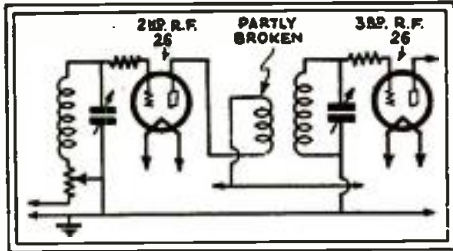

Fig. 1
Detail of the Stewart Warner model 801.

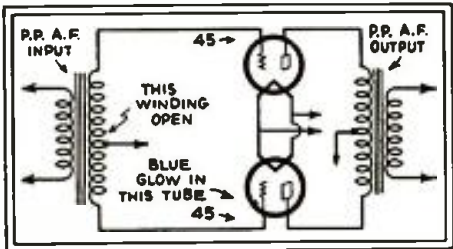

Fig. 2
Schematic of the Philco model 77.

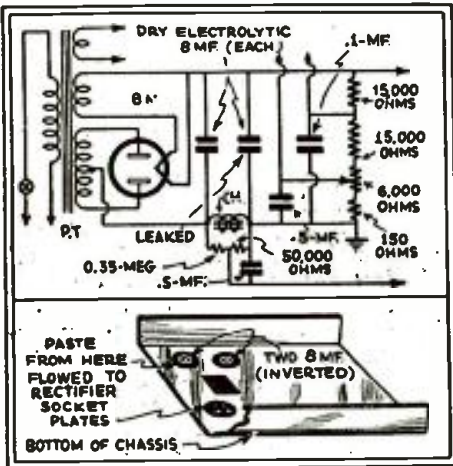

Fig. 3
Lower unit of the Tom Thumb model P45.

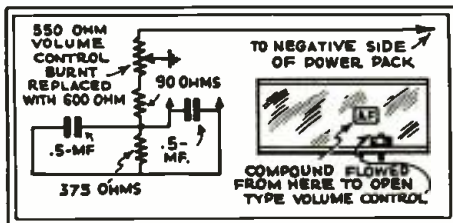

Fig. 4
Trouble in the Graybar model 600.

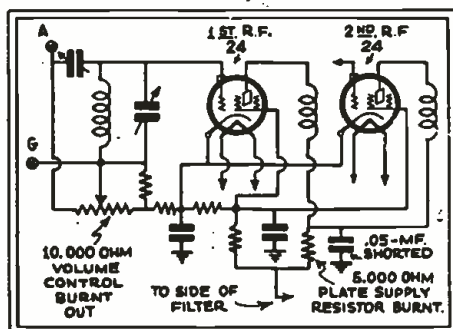

Fig. 5
Resistor arrangement in the Bosch model 133.

WHAT THIS DEPARTMENT IS FOR

It is conducted especially for the professional Service Man. In it will be found the most unusual troubles encountered in radio service work, written, in a practical manner, by Service Men for you.

Have you, as a professional man, encountered any unusual or interesting Service Kink that may help your fellow workers? If so, let us have them. They will be paid for, upon publication, at regular space rates.

SPECIALIZING in servicing radio-noise interference, I have listed a few radio noise cases and other radio troubles I have serviced. I read the Operating Notes section each month, and they have come in handy many times. That is why I am reporting the following radio trouble shooting cases taken from my service files.

Reception of local stations only, and plenty of static on a Victor R35, was traced to the lead-in wire being grounded to the nail on the nail knobs. A similar complaint was reported on a Crosley 124, and the customer had been advised to move! On inspection I noticed that the antenna consisted

of only a lead-in wire 25 feet long along the side of the house. In both cases, after installing the antenna properly, the customer was satisfied. Many times I have traced intermittent noisy reception to a broken window lead-in strip.

In another case, every time a Zenith model 52 was turned on, there would be a loud hum, drowning out all reception for about 15 minutes. After that the set would work satisfactorily. All readings on the analyzer were correct; however, on turning over the unit containing the power transformer and 80 rectifier, I found a mouse across the A.C. power input terminals. After removing the mouse, the trouble was eliminated.

The tone of a Zenith model A was reported distorted and noisy. On inspection, I noticed a blue glow in one of the 45 power tubes, and on test the other 45 power tube proved to be shorted.

Noisy reception on a Spartan 63 (this set uses the overhead heater tubes) was found to be caused by the heater prongs at the top of the tubes being loose.

Noisy, weak, and intermittent reception on a Stewart-Warner 801 was traced to a partly broken wire in the primary of the third R.F. coil, as shown in Fig. 1.

I had a Tom Thumb P45 which had a faint spluttering sound when the aerial and ground wires were disconnected. The noise would increase with the aerial and the ground wires connected to the set, drowning out reception. The detector plate R.F. choke coil was found to be corroded. I have also found cases where leaky filter condensers have had the same symptoms.

A Rola model F dynamic speaker had a tendency to rattle. This was diagnosed as a corroded voice coil. A loose voice-coil winding on the dynamic speaker of a Zenith model 77 was responsible for distortion and rattle.

Low volume and a blue glow in one
(Continued on page 556)

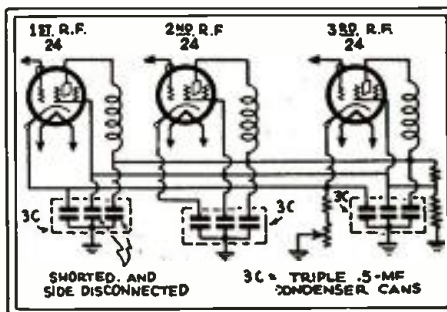

Fig. 6
Bypass condensers in the Eveready model 50.

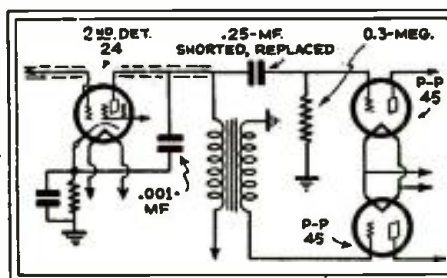

Fig. 7
Input arrangement of the Silver Marshall 36A.

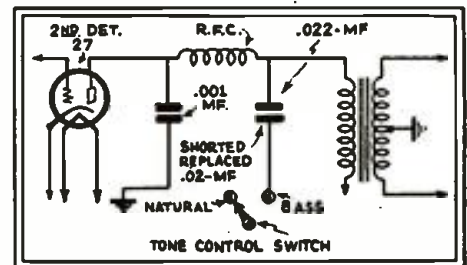

Fig. 8
Output detector circuit of the Majestic 20.

THE SERVICE MAN'S FORUM

Where His Findings May Benefit Other Radio Technicians

AN OPEN LETTER TO SERVICE MEN

Editor, RADIO-CRAFT:

I have been experimenting for several years on various systems for the elimination of man-made static, power transformer, and power line noises. I have designed an antenna system which may be built by any radio Service Man without buying expensive transformers, etc. By the use of this system, I have been able to sell radio receivers where a dozen others have not, because of the noise. I would be glad to send any radio Service Man details of design of this new system if they will send me a stamped, self-addressed envelope.

WILLIS JUDD,
Bear Lake, Mich.

(We do not promise anything fellows, but we give you Mr. Judd's (a member of the O. R. S. M. A.) story without comment, since he has not taken us into his confidence (!)—Editor.)

A CANADIAN SERVICE SHOP

Editor, RADIO-CRAFT:

A picture of my radio repair shop may be of interest to other readers, as I like to see those of others. I am a member of the Official Radio Service Men's Association and greatly appreciate RADIO-CRAFT for the practical material which I get from it. The part I like best is the "Forum."

J. A. BELLEMARE,
173, 4e Rue,
Shawinigan Falls, Que., Canada.

(Mr. Bellemare exhibits his pride in being an authorized representative of Stromberg-Carlson by indicating this authority on his letterhead (*Représentant Autorisé du "Stromberg-Carlson"*). We appreciate his commendation of our magazine and we are sure service contributors to this department will be equally pleased to know of his interest in their letters.—Editor.)

ELECTROLYSIS TROUBLE

Editor, RADIO-CRAFT:

Several months

THE Official Radio Service Men's Association, sponsored by RADIO-CRAFT, invites all Service Men who are not members of the Organization to write for an application blank. It is the official service organization of this magazine and is main-



Official lapel button of the O. R. S. M. A.

tained solely for the interests of Service Men. Membership cards are issued upon passing a written examination which is forwarded by mail. Write for yours today. The O.R.S.M.A., 98 Park Place, N. Y.

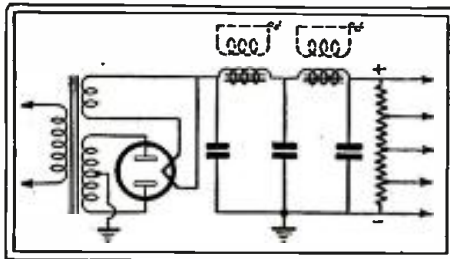

Fig. 1
Read this, boys, it's good.

ago I found it necessary to twice replace the A.F. transformers of a Motorola radio receiver which was being used on a Puget Sound fishing boat. Of course, electrolysis had caused the primary copper to deteriorate. While the windings had been impregnated with paraffin—which should have been satisfactory—this process proved inadequate. The second batch of transformers, however, I

impregnated with Marine - "Spar" Varnish. (Pratt and Lambert "61" Spar Varnish.) No further trouble from electrolysis has been experienced to date.

R. L. WOOLLEY,
3008 15th Ave., S.
Seattle, Wash.

ONE ON "RESISTANCE SERVICING"

Editor, RADIO-CRAFT:

I am passing this on to other Service Men as I think it is the strangest experience I've had in servicing radio. I was called to service a home-built radio which had excessive hum. I was told that the set had been serviced by two Service Men prior to me, but after trying everything they had turned the job down as incurable. The tubes were of the 201-A type with 171's in a push-pull arrangement and used "A" and "B" eliminators. I first started with the "A" eliminator as I thought the circuit was overloaded or in need of a high-capacity condenser across the output. When this check-up was completed the set was no better. After trying everything without eliminating the hum, I was about to pass the verdict of the Service Men and say "incurable," when I noticed that the chokes were of the unshielded type, and were wrapped with friction tape—which didn't look like a factory job! The owner said he put it on to strengthen it, but on taking it off I found the real trouble; the coils had been wrapped securely with a layer of bell wire and the protruding ends twisted and soldered together! On clipping the ends, the hum disappeared entirely.

It was a perfect job mechanically but not electrically. The extra winding, shown dotted in Fig. 1, acted as a shorted winding of a transformer, thus greatly reducing the choking effect of the chokes.

W. MARSHALL,
38-29 27 St.,
Long Island City,
N. Y.

(Again the Radio Detective "clicks"; and the moral: "Don't take anything for granted." This fault, reported by Mr. Marshall, although very unusual, serves as an interesting ex-
(Continued on page 556)

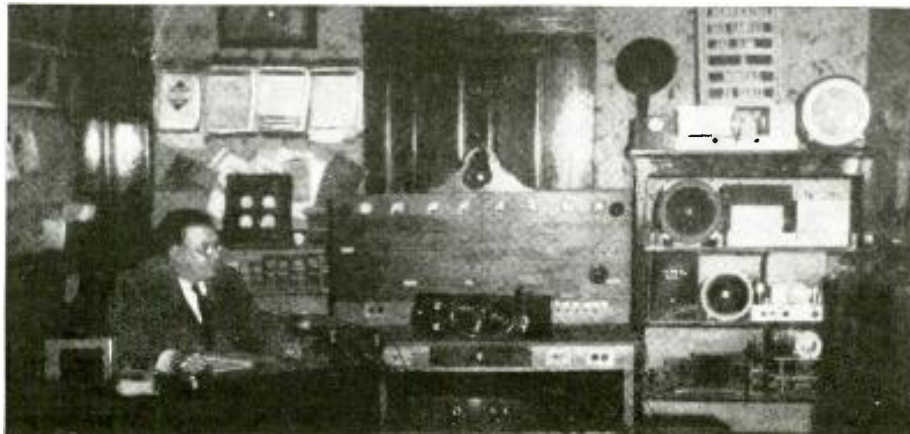

Service bench of Mr. Bellemare. Such a neat bench is indicative of good work.

IMPROVING HOME RECORDING IN RCA, G.E., AND WESTINGHOUSE SETS

Thousands of RCA, G. E. and Westinghouse receivers have been sold which have home-recording facilities as part of the receiver. Many owners of such sets are not satisfied with the results of the recordings. In this article, the author describes the changes which should be made to improve the quality of reproduction.

H. FRED PITZER

WHILE home recording has been featured on many radio sets for the past two years, there are certain faults, the correction of which will result in a gain in sensitivity and fidelity. The original home recording instruments of two years ago were very deficient in these qualities, and the comparatively poor home-recording matrices added to their inefficiency. In those days home recording was considered as a toy; today, however, recording has passed this toy stage, as is proved by the widespread use of these instruments.

The main differences between the old instruments and the new and the best methods of adapting the newer microphones to the older radio sets are outlined below. The machines of two years ago, incorporating home-recording, were the RCA 86, the Victor 57, and the G.E. and Westinghouse sets, all of which used a single-button microphone. The first improvement which should be made upon these sets—all basically the same—is the substitution of a two button microphone for the single button. Referring to Figs. 1A and 1B remove the old microphone transformer and replace it with one of the newer type (RCA part No. 7312). Fig. 1B should require little explanation as it is made sufficiently clear in the diagram. The two outside ter-

minals of the primary of this new transformer are connected to the two microphone buttons; to one of these outside terminals is also connected the *ungrounded* lead from the pickup (the other terminal is grounded), since this transformer acts as a phonograph input transformer. Return leads for the microphone and pickup are provided by connecting the center of the primary to ground as shown in Figs. 1A and 1B. It is possible, and in some cases necessary, to ground this center terminal directly instead of by means of a jumper as shown, and to connect a one megohm resistor between the grounded shields of the *secondary* and ground. Means of providing connections for the new mike may be obtained by replacing one of the needle cups with a three prong socket, which being done, it follows that some method of disconnecting the mike current must be provided when the mike is not in use. In the case of the RCA 86, 6-90, the Victor 57, and their corresponding models, this is easily accomplished by removing the wire from terminal No. 9 on the control switch. This wire, the only black-with-yellow-tracer wire connected to this switch, is the fifth one below the shaft end of the switch. Investigation shows that with this wire removed, the switch will make the same

(Continued on page 557)

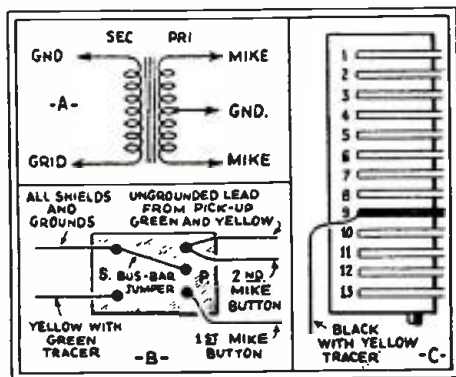

Fig. 1
At A, schematic and at B, pictorial view of the new microphone transformer. At C, the terminal block.

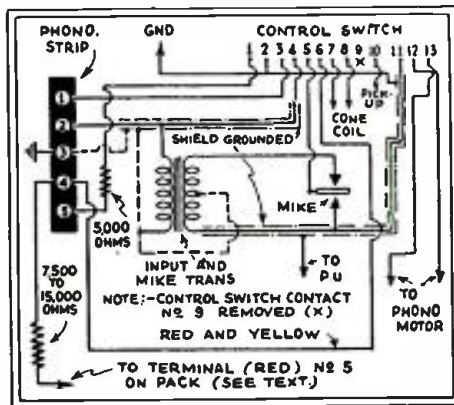

Fig. 3
Diagram showing the completed change to facilitate the use of a two-button microphone.

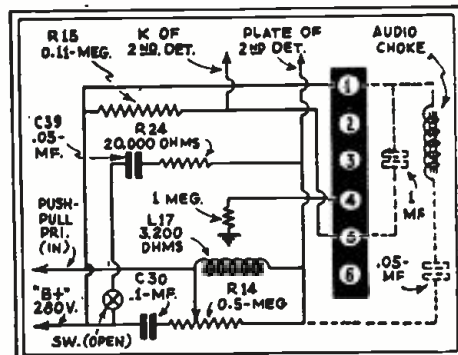

Fig. 5
Schematic circuit of the fone-control circuit used in the RCA, G.E., and Westinghouse receivers. The circuit may be opened at the point indicated and the additional control circuit, shown dotted, inserted for better quality.

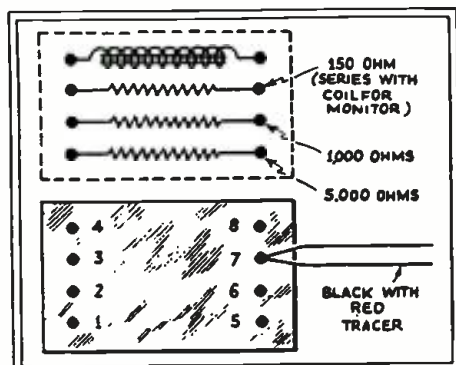

Fig. 2
Connections showing how to remove the monitor speaker.

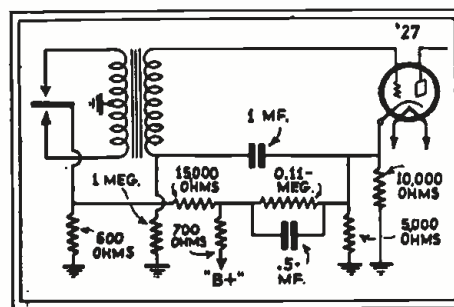

Fig. 4
Schematic circuit of the system without the presence of the switches. This circuit shows the connections when the switches are thrown for microphone use.

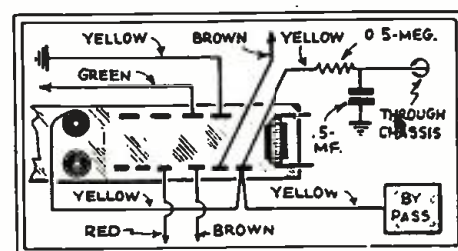

Fig. 6
The resistor and condenser shown may be connected in the circuit to obtain better quality on low volume in these receivers. This change was brought about by complaints that the set distorts on low volume. Incidentally, some of the changes recommended will also improve reception when used on "radio."

SHORT CUTS IN RADIO SERVICE

Prize Award

D. C. SETS ON A. C.

J. H. Blanche, Jr.

IN the past few months I have had a number of D. C. sets to service, and not having D. C. at my disposal, I decided to make my own outfit. The schematic circuit is Fig. 1. Although this outfit does not furnish enough current to test the D. C. sets that have a heavy current drain, it has, however, served my purpose for the majority of the D. C. sets I have serviced lately.

Another use for this outfit, which has been of even greater advantage to me, is the testing of noisy transformers, R. F. coils, choke and field coils, resistors, and condensers. Often, sets have parts which are breaking down and cause static-like noises when the set is in operation, although when these parts are tested with a continuity test meter the defect is not located.

The following test has never failed me, using this outfit, which I use as a continuity tester by simply placing a good grade phone and a pair of test leads in series with the 110 volts D. C. The slightest breaking down of a transformer, for instance, will not show up with a battery and meter test, but will show up in the earphones in my D. C. test as a crackling, static-like noise.

I constructed this outfit at absolutely no cost to me, as I used only spare parts that I had in the shop. The average repair shop will, likewise, in many instances, have enough spare parts to make this outfit.

The parts used in making this D. C. outfit are as follows: Two rectifier units from RCA model 106 speaker; one (choke coil) filter reactor from RCA model 18 power pack; one 20 mf. condenser from RCA UP972 "A. C. Package" condenser bank; three 2 mf. condensers in parallel (RCA 20, 25 or 28 bypass condenser); one A. C. receptacle (to plug in D. C. sets); four binding posts for test leads and phones; one A. C. input cord and plug; one mounting panel, a few feet of wire, a few screws and bolts.

Note that the RCA 18 power pack filter reactor is composed of two choke coils. I found that the hum is practically eliminated and the purpose best served by using only the one with the highest resistance. However, any good audio choke coil should serve the same purpose as well as other parts such as those mentioned above. All the parts can be mounted on a board. An A. C. switch can also be placed in the A. C. line if necessary. A D. C. 150-volt range meter can be used instead of

the earphones for average continuity and low-resistance tests.

HOME MADE ANALYZER CABLE

Mike Fedorchak

NOT having on hand a six wire cable, and not being able to buy one in town, I improvised one for my analyzer by using a pair of high top shoe laces in the manner illustrated in Fig. 2.

By cutting off the tips, it is possible to work the lace over six lengths of No. 18 stranded insulated wire, each lead being about 30 inches long.

DYNAMIC SPEAKER CONE REPAIR

S. E. Atcheson

CONES of dynamic speakers of the type using a solid piece of fabric for the center support often become so flimsy at this "spider" that not only is the tone quality impaired but the centering screw will no longer hold the cone in a central position. This may be remedied by removing the cone and voice coil from the speaker and applying a small quantity of any celluloid-base household cement, as shown in Fig. 3, being careful to get the cement in the seam between the voice-coil form and the fabric of the cone. A small quantity of the cement may also be smeared over the whole center supporting section. This cement dries quickly and leaves the center of the cone strong and flexible. It is also a good idea to use a felt washer under the supporting screw and washer, and between the cone center and the center pole-piece. (Some manufacturers supply these to their dealers without cost.)

IMPROVING THE FAULT-FINDING ADAPTER

Louis B. Sklar

MOST Service Men are familiar with the fault-finding adapter which opens the plate circuit of a tube and connects a pair of headphones in series; to obtain detection, most of these adapters use a switch for connecting a grid-leak and condenser in the grid circuit of the tube. As this

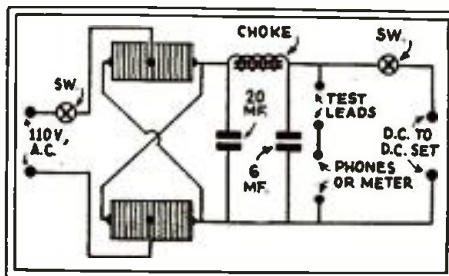

\$10 for Prize Service Wrinkles

Previous experience has indicated that many Service Men, during their daily work, have run across some very excellent Wrinkles, which would be of great interest to their fellow Service Men.

As an incentive toward obtaining information of this type, RADIO-CRAFT will pay \$10.00 to the Service Man submitting the best all-around Radio Service Wrinkle each month. All checks are mailed upon publication.

The judges are the editors of RADIO-CRAFT, and their decisions are final. No unused manuscripts can be returned.

Follow these simple rules: Write, or preferably type, on one side of the sheet, giving a clear, description of the best Radio Service Wrinkle you know of. Simple sketches in free-hand are satisfactory, as long as they explain the idea. You may send in as many Wrinkles as you please. Everyone is eligible for the prize except employees of RADIO-CRAFT and their families.

The contest closes the 15th of every month, by which time all the Wrinkles must be received for the next month.

Send all contributions to the Editor, Service Wrinkles, c-o RADIO-CRAFT, 98 Park Place, New York City.

introduces a considerable change in the operation of the tube, particularly as regards the tuning of the circuit, the writer submits the stunt illustrated in Fig. 4. Thus, the plate circuit of the tube, whether it is an R. F., detector, or A. F. unit, is controlled, as regards the plate voltage for detection, by the adjustment of resistor "R."

IMPROVING THE ANALYZER PLUG-ADAPTER

Walter H. Price

HERE are two ideas which may be applied to increase the usefulness of the Na-Ald analyzer plug and adapter used on the Weston 566-3 and other set analyzers. Every Service Man having trouble with this type of analyzer plug separating from the adapter when being removed from a UX socket will welcome the first idea as it makes the lock positive in action, saving much time and inconvenience.

A small fiber bushing is made to fit snugly into the hole molded in the base of the plug to receive the prong on the adapter, as shown in Fig. 5. (A small amount of "radio" cement may be used in addition to the snug fit to hold the bushing permanently in place in the analyzer plug base.) The bushing is drilled for a loose fit on the adapter prong and should be as long as the base is thick at the hole. The bushing should not be pushed in so

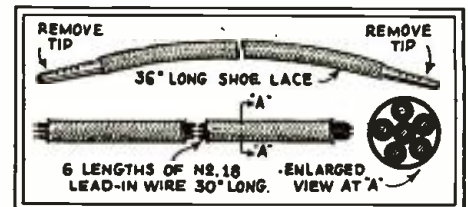

Fig. 1, left
Schematic circuit of the "B" eliminator.

Fig. 2, above
Six wires in a single shoelace.

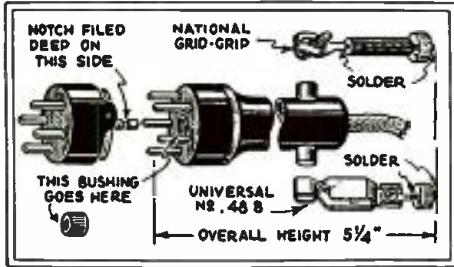

Fig. 5, above
Construction of plug described by the author.
Fig. 6, right
An adjusting screw driver for all Service Men.

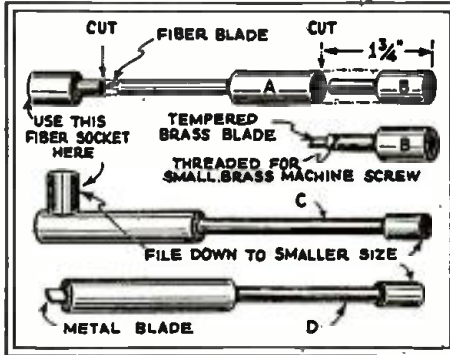

Fig. 7
Another meterless tube tester.

far that it will bind the lock. A three-cornered file is used to make the groove on the adapter prong slightly deeper on the side the plug lock engages.

In many sets the control-grid lead is not long enough to reach either cap on the analyzer plug, especially when analyzing UY tube circuits. To replace this "missing link" I have made a simple extension from a length of threaded brass rod, a length of fiber tubing, a brass binding-post base and a National Grid-Grip. As an alternative, a similar extension may be made from a screen-grid tube cap, a short length of wire or rod, and a Universal clip.

THE PERFECT ALIGNING TOOL

M. J. Rebennack

BALANCING wrenches and fiber screwdrivers to fit the various makes of radio sets are rather expensive and hard to secure. However, you can, with a little careful work, make four tools which will take care of almost any set now in use.

Secure four large Sparton fiber wrenches, cut as illustrated in Fig. 6. Fiber screwdriver A contains no metal and is used in aligning the oscillator section of Silver-Marshall and other superheterodynes (It is also used to adjust the antenna trimmer on all Spartons.), while B is a handy size for aligning gang condenser trimmers and, on RCA 60 series, the antenna compensating and oscillator trimmers.

Wrench C is for Majestics and Spartons. The reason for filing down C and D is that the Majestic has a rather small hole in the condenser shield and the chassis.

Tool D, with its long shaft, can be used on almost any other sets.

ANOTHER METERLESS TUBE TESTER

P. J. Fracchia

FOR the beginner or Service Man who wishes to make all of his equipment, here is a suggestion whereby he can test power tubes and rectifiers.

By referring to Fig. 7, the simplicity becomes apparent.

Tubes plugged into the socket will give the following indications if they are good:

Tube Type	Lamp No. 1	Lamp No. 2
10	Dull Red	Dull Orange
80	Dull Orange	Dull Orange
81	None	Dull Orange
45	Dull Red	Dull Orange

The lamp filament in tube should glow cherry-red; if the tube is shorted, lamp No. 1 will be bright. Other tubes may be tested in this manner after a few experiments and tests.

The following parts are necessary: One 6-volt battery or suitable D. C. source; one 2.5 amp. power rheostat; one UX socket; two 110 V., 10 W. lamps; two lamp sockets; two 45 V. "B" batteries or an eliminator.

CONTINUITY TESTING BY SOUND

John Melicharek

MUCH time can be saved when testing for continuity and shorts, by having a foolproof "sound" indicating device, as illustrated in Fig. 8, making it unnecessary to look at the meter each time a test is made.

A relay unit taken from a discarded Philco "A-B" unit, or other old eliminators, is rewound to about 2,000 ohms, and is wired in series with the test prods, "B" supply source, and milliammeter. The other circuit is made by using only one set of contact points

(Continued on page 558)

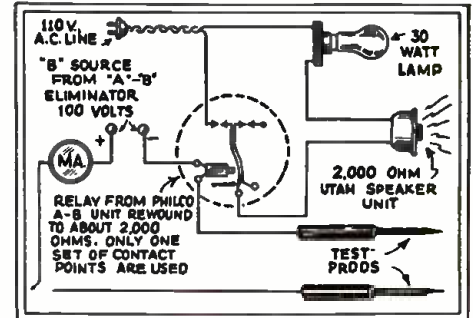

Fig. 8
This idea may be used in a number of places: testing for leaky transformers is one idea.

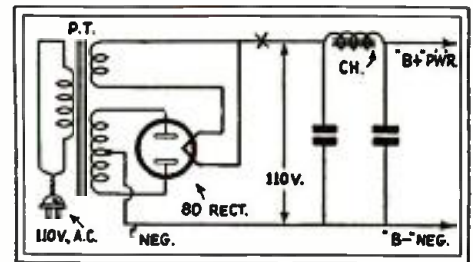

Fig. 9
A simple rectifier and filter circuit which may be used to test D. C. sets on A. C.

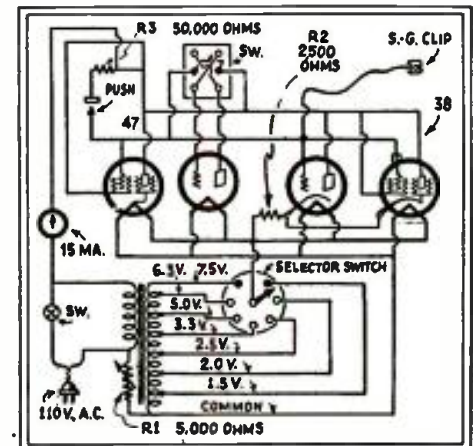

Fig. 10
Diagram of the simplified tube tester which may be made from "spare parts."

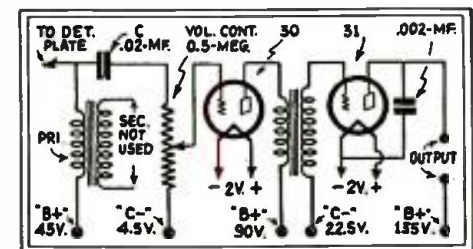

Fig. 11
A simple method of controlling volume on some 2-volt receivers. A change easily made.

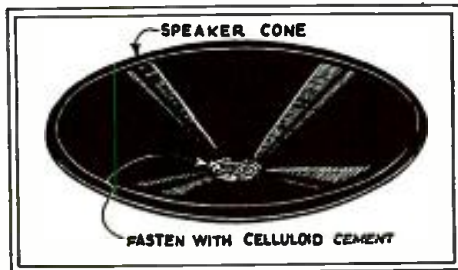
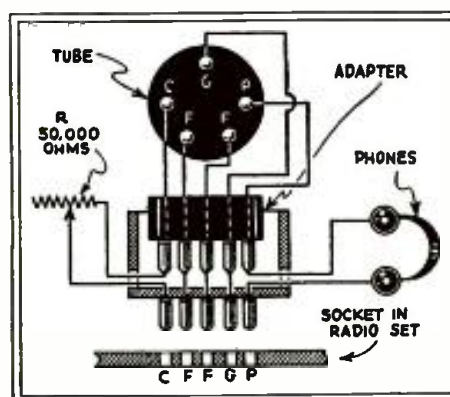

Fig. 3, above
Here's how to repair that speaker cone.

Fig. 4, right
By means of the resistor R and the headphones, the adapter shown is very useful for testing the individual stages of the R. F. end.



CAPEHART MODELS 200 AND 300 DE LUXE 11-TUBE AUTOMATIC PHONO-RADIO

(Visual tuning meter; phono. pickup pre-amplifier; tone control; silent-tuning control; automatic record-changer; delayed A.V.C.; superheterodyne circuit.)

The Model CK chassis incorporated in this automatic record-changer phonograph and superheterodyne radio receiver combination, manufactured by The Capehart Corporation, is produced by Howard Radio Corp. as their Model K chassis, the "C" designation indicating that the circuit has been modified by the Capehart concern to include a separate tube, V10 in the diagram, as a phono. pickup pre-amplifier. The "200" uses a Jensen 12 in. D-9 speaker and the "300" a 14 in. "Mastodon," and the cabinets and record changers are different. The sensitivity is 6 microvolts-per-meter; undistorted power output, 5 W., and; power consumption, 142 W. (set, 115 W.; motor, 17 W.; cabinet light, 10 W.).

Tube No.	Fil. Volts	Cath. Volts	S.G. Volts	Sup. G. Volts	Plate Volts
1.....	2.5	3	90	3	180
2.....	2.5	7	90	7	180
3.....	2.5	7	—	—	90
4.....	2.5	3	70	3	180
5.....	2.5	70	—	—	180
6.....	2.5	95	180	—	180
7.....	2.5	95	180	—	180
8*	2.5	—	—	—	—
9**	2.5	—	85	3	32
10.....	2.5	7	—	—	160
11.....	5.0	—	—	—	300

Voltagages indicated at a line potential of 115 V. All readings taken between tube element and chassis, with R3 in the least effective position. *No data available for a 56 as V8; for a 57 [used in late models], the following figures are given: C.G., 90V.; Cath., 115V.; S.G. [grounded], zero V.; Sup. G. [tied to C.G.], 90V.; Plate, 3V. **The C.G. of V9 is 3V.

Condensers C1 to C3, tuning units shunted by trimmers; C4, padding condenser; C5 to C8, I.F. trimmers; C9, C15, C17, C18, C19, C20, 0.1-mf.; C10, C11, C12, C13, C14, 1.2 mf.; C16, C21, .001-mf.; C22, C23, 1.4-mf.; C24 to C26, 8 mf.; C27, 1. mf.; C28, .01-mf.

Resistors R1, R2, .125-meg.; R3, 10,000 ohms; R4, .25-meg.; R5, R8, R13, R16, R17, 0.2-meg.; R6, R20, 3,000 ohms; R7, R14, 500 ohms; R9, 2 megs.; R10, 2,500 ohms; R11, R12, .15-meg.; R15, R23, 10 ohms, center-tapped; R18, 30,000 ohms; R19, 0.1-meg.; R21, 4,150

ohms; R22, R25, 2,000 ohms; R24, 210 ohms. Choke coil section A 2,575 ohms, section B 170 ohms; phono pickup 40,000 ohms (at 1,000 cycles); field coil Ch. 220 ohms.

The Model 10-12-C automatic record changer used in this phono-radio combination operates at 78 r.p.m. To adjust the pickup change lever for playing 10 in. records, loosen the forward lever stop and hold it in such a position that the needle will come down onto a 10 in. record exactly 4 11/16 ins. from the edge of the center pin. When the correct location of the pickup change lever has been ascertained the front stop may be set snug against this lever and the screw tightened, which will allow the lever to always be thrown over to that exact position when playing 10 in. records. To adjust the playing for 12 in. records, loosen the back lever stop and hold the lever in such a position that the needle will come down exactly 5 11/16 ins. from the edge of the centering pin.

Adjust the weight of the pickup with only one record on the turntable. With a delicate pair of scales, having a range of 0 to 12 ozs., catch the needle screw and lift the pickup from the record until the A.F. quality breaks, at which time a reading of 5 1/2 to 6 ozs. should be indicated.

There are five steps in adjusting the oscillating and spiral trip lever and the pickup silencer. (1), Turn the master cam until the large timing mark is exactly above the timing mark on the tone arm lifting lever; (2), Hold the switch lever and cam assembly against the driven clutch so that the radius of the cam will center against the clutch; (3), Set the pickup silencer switch against the casting bearing so that the shaft of the cam cannot be moved further toward the automatic switch; (4), Hold the tail of the cam against the lug on the inside of the master cam and adjust the trip lever until it is 1/16-in. beyond the catch in the oscillating trip lever; (5), Adjust the pickup silencer switch so that a good contact is made on the pickup short-circuiting switch when the needle is on the record and the automatic switch has been tripped.

Failure to correctly adjust the spiral trip cam, so that the automatic trip operates when

the needle is 1 49/64 ins. from the edge of the turntable spindle, will cause the instrument to change records before the music is finished, or not to change records automatically.

The correct clearance for the needle to feed into the music groove, between the cork insert and the tone arm base is .015-in.

The record magazine pin must be so placed that the offset at the bottom extends directly away from the record support shelf, and the pin must have a clearance of exactly 4 7/8 ins. between the back center of the offset, and the extreme right and left corners of the record support shelf, with the magazine in the 10 in. record playing position.

Adjust the record weight (at the bearing pivot) so that the lower edge clears the record slide shelf while in the 10 in. position but holds one record in correct position for the slide plate to unload it onto the turntable.

The receiver chassis incorporates a special A.V.C. circuit so that at low signal levels the A.V.C. is inoperative, due to the high bias on the grid of V10, and only when the received signal exceeds 50 microvolts input does the A.V.C. circuit operate, after which point it holds the output of the receiver substantially constant up to an input as high as 4 volts.

During the condition of "no signal," there is no current flow through R11, R12, and therefore the control-grid of V9 has zero potential, causing a large current to flow through R16, producing a blocking potential on the control-grid of V5. During the condition of "signal," V8 operates and develops a voltage across R11, R12, applying a negative potential on the control-grid of V9, reducing its plate current to zero and thus restoring the control-grid potential of V5 to normal. (For more positive noise suppressor action the control-grid and suppressor-grid of V9 are tied together.)

Use a low value of service oscillator output in realigning the circuits to counteract the apparent detuning effect due to the action of the A.V.C. circuit. Padding condenser C4 is accessible through a hole in the upper part of the variable condenser shield can.

Transformer color code: winding X, X, (3.5 A.) blk. & maroon; Y, Y, (1 A.) and Z, Z, (5 A.) yel.

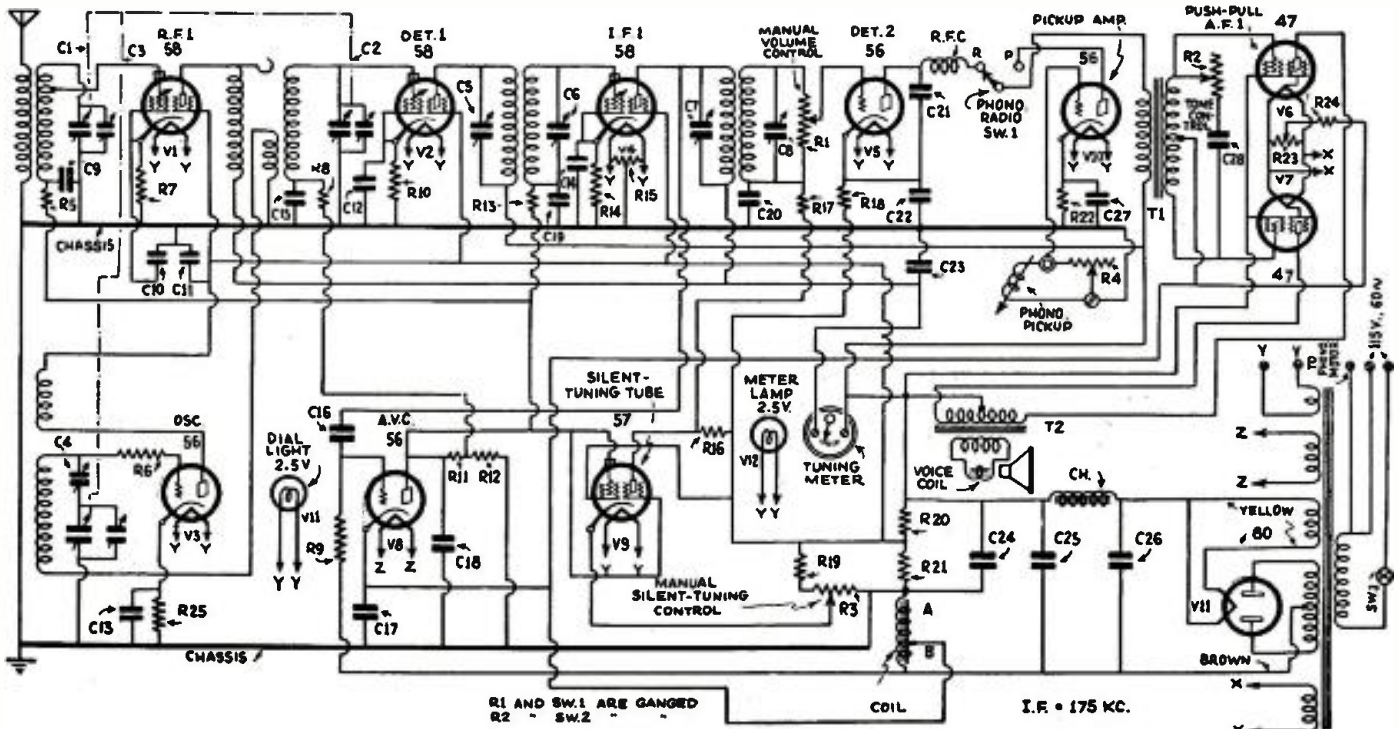

HOWARD MODEL M "TRIPLEX CONTROL" 14-TUBE SUPERHETERODYNE

(Parallel push-pull A. F. amplification; visual tuning meter; A.V.C.; silent-tuning control; twin 80 rectifiers; duodeiode silent-tuning tube; tone control.)

In the Howard Model M 14-tube superheterodyne, manufactured by Howard Radio Co., are incorporated several new circuit details with which the progressive Service Man must acquaint himself. Use of a "triplex control" circuit in this set results in improved performance in the reduction of station background noise, and sensitivity and inter-station noise suppression, over the "duplex control" Model K chassis.

The following tube voltages are used in this set:

Tube No.	Fil. Volts	Cath. Volts	S.G. Volts	Sup. G. Volts	Plate Volts
1	2.5	2.7	80	2.7	190
2	2.5	4.4	80	—	190
3	2.5	7.5	—	—	190
4	2.5	2.8	80	—	80
5	2.5	87.0	—	—	188
6	6.3	16.5	280	—	267
7	6.3	16.5	280	—	267
8	6.3	16.5	280	—	267
9	6.3	16.5	280	—	267
10	2.5	15.0	80	—	188
11	2.5	12.0	—	—	70
12	2.5	—	—	—	—
13	5.0	—	—	—	374**
14	5.0	—	—	—	374**

(Voltages indicated at a line potential of 115 V. *Switch Sw. 2 closed. **Read between V13, V14 filaments and chassis.)

The values of the components used in the Howard model M receiver chassis are given below.

Resistor R1, tone control, 1½ megs.; R2, manual silent tuning control, .25 meg. (liner taper); R3, manual volume control, .25-meg.; R4, R6, R8, R10, R11, R13, 0.2-meg.; R5, 2,000 ohms; R7, 1,100 ohms; R9, R12, 500 ohms; R14, R17, R28, 30,000 ohms; R15, 105 ohms; R16, 2 megs.; R18, R19, R27, 0.1-meg.; R20, 50,000 ohms; R21, R25, 10 ohms, center-tapped; R22, .15-meg.; R23, 8,000 ohms; R24, 3,000 ohms; R26, 30 ohms, center-tapped; R29, R30, R31, 2,200, 3,730 and 3,900 ohms, respectively, and on one resistor unit. The field coil has a resistance of 300 ohms.

Condensers C1 to C3, tuning units; C1A to C3A, trimmers; C4 to C7, C16, C18, I.F. trimmers; C8, C11, .001-mf.; C9, 1. mf.; C10, .002-mf.; C12, C13, C17, C24, C25, C27, C28, C29, C31, C32, C33, C35, 0.1-mf.; C14, C15, C19, C20, .05-mf.; C21, C22, C23, 8 mf.; C26, .000153-mf., padding condenser; C30, 0.5-mf.

Pilot lights V15, V16 connect to winding X, X on the power transformer, PT.

A red-lead 0.5-mf. condenser, in the same can with the blue-lead unit, C9, but not shown in the schematic circuit, bypasses the plate current supply to V5. An 11-section condenser block includes the following condensers: C12, C13, C14, C15, C17, C19, C24, C28, C30, C31, C32. The color code is as follows: brown leads, 0.1-mf.; green, .05-mf.; red, 0.5-mf.; all are rated at 200 V., as are condensers C25, C27, C29, C33.

To gang the I.F. circuits, disconnect the control-grid cap on V2 and connect the 175 kc. oscillator between the control-grid and ground (chassis); then, by means of either the ear or a meter connected across the voice coil or plate circuit output stage, adjust trimming condensers C4 to C7 for greatest output. Make the input signal as small as possible in order to eliminate the apparent detuning condition met with due to the operation of the A.V.C. system.

Due to the fact that the silent-tuning circuit (S.T.C.) and the automatic volume control (A.V.C.) system constitute a tuned unit, it will be necessary to tune the plate circuit of the type 58 "triplex control amplifier," V10, and also the tuned circuit which is associated with the type 55 tube, V12. This circuit can be readily tuned to correct resonance by use of the 175 kc. oscillator operated at the low input to the first-detector V2. All that is necessary is to first tune the plate circuit of the "triplex control amplifier," V10, until the tuning meter needle swings the greatest distance to the right. Next, tune the suppressor or type 55 tube, V12, circuit until the meter swings to the greatest distance toward the right. It may be possible that both circuits are exactly in tune so that any additional adjustment of these two tuned circuits will not effect the meter swing.

Be sure, when making this adjustment, that you snap on switch Sw.2, associated with resistor R2. If this switch is not thrown to the "on" position, the meter will not operate because switch Sw.2 opens the cathode circuit of V12 and no plate current will flow (unless V12 is gassy).

If it is not possible to obtain a sufficiently low voltage in the oscillator to "gain" this "triplex control" system, you can rotate the knob of R2 further to the right, when you will note that the meter needle swings away from

the zero or maximum right position, and when this condition is obtained, you can again check the tuning of the two circuits in order to obtain the maximum right swing of the needle on this meter. If your input signal from the oscillator is excessive, as previously stated, with the minimum right rotation of R2, you will note that when tuning to a station or to your service oscillator, the tuning meter swings to the full right position, and in such a position you cannot tune the noise-control circuits. Be sure, when tuning these circuits, that either your input signal from the oscillator is as small as possible, or if this is not obtainable, rotate R2 to the right until the meter swings away from the zero or maximum right position. The tuning of these two circuits is simple if you take precautions referred to above, and if these two circuits are properly tuned, you will note that by snapping Sw.2 the inter-station noise will disappear and you will have quiet operation between stations. This tuning operation, when correctly done, increases the apparent selectivity of the receiver and provides a beautifully operating receiver which embodies the latest development of the "duplex control" feature of previous Howard set models.

The output of V5 is fed to the parallel push-pull circuit through a step-up transformer T1 with a ratio of 2-to-1.

Associated with the plate circuit of the "triplex control," or S.T.C. and A.V.C. pre-amplifier tube V10, are three coils, L4, inductively coupled to each other. The first coil, A, is merely a coupling primary in the plate circuit of the pre-amplifier, V10; the second, B, provides voltage for the rectifier system of V11 in the A.V.C. circuit; the third coil, C, provides the noise-suppressor voltage on the control-grid of second-detector V5, through the medium of the voltage drop across resistor R23 in the plate circuit of the S.T.C. tube V12.

In the event that it is necessary to realign the R.F. circuits, connect the service oscillator to the antenna and ground post of the set and tune the oscillator to 1,400 kc. Adjust the set dial to this setting and align the trimmers, starting with C3A, then C1A and then C2A. If it is necessary to align the padding condenser C26 at 600 kc., it will be necessary to go over the adjustments of the high-frequency trimmers again. Condenser C26 is accessible through a hole in the upper part of the container which shields the variable condensers

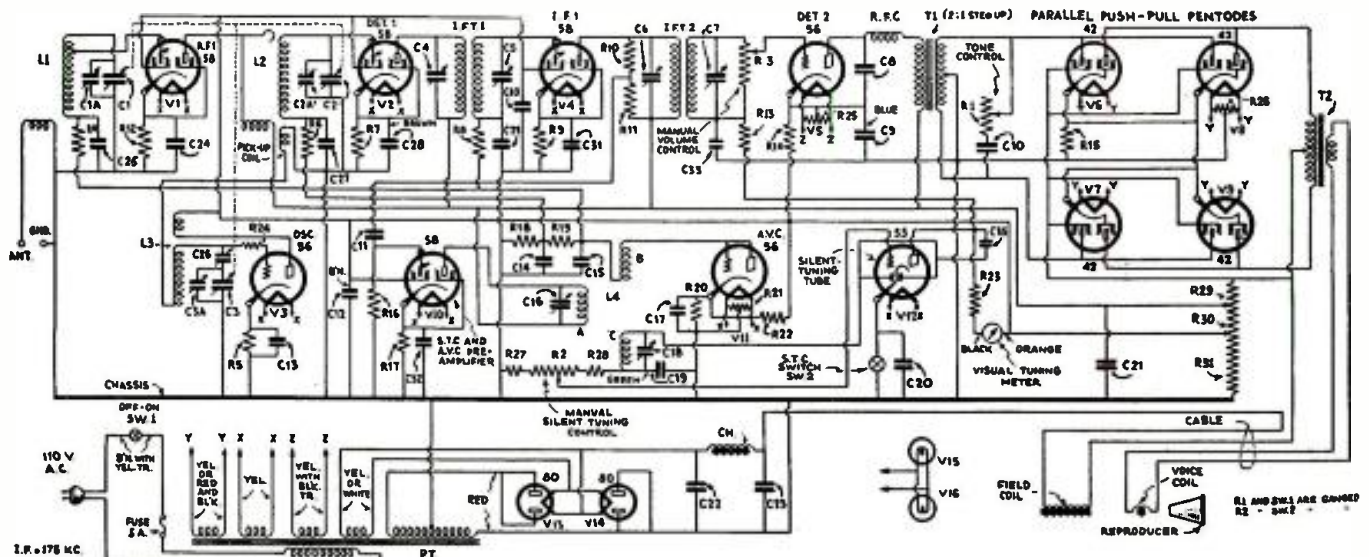

A SURVEY OF THE VACUUM—

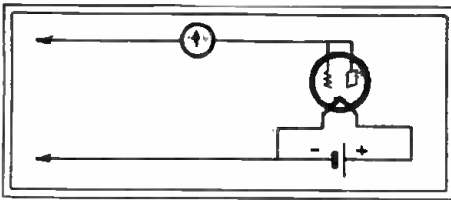

Fig. 1
A simple V.T. voltmeter circuit suitable only for low-impedance circuits. It is illustrative, however, of the fundamental principles.

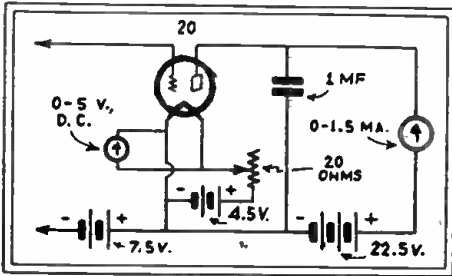

Fig. 2
A simple, practical V.T. voltmeter. A tube, a few batteries, a meter are all the apparatus required to complete this versatile unit.

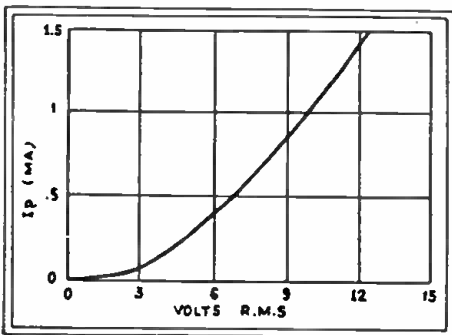

Fig. 3
A calibration curve of the V.T. voltmeter illustrated in Fig. 2. This meter will read voltages up to about 15, very easily. A 20 is used.

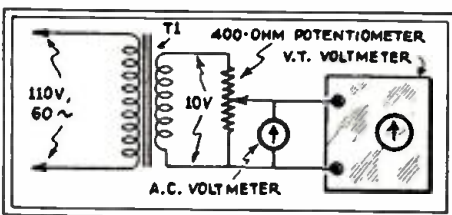

Fig. 4
A simple circuit for calibrating the V.T. voltmeter. For every reading of the A.C. meter, a corresponding reading of the V.T. voltmeter is taken.

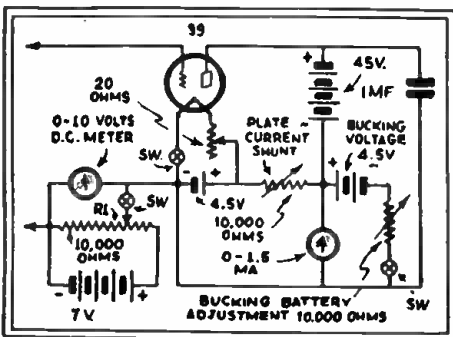

Fig. 5
Schematic circuit of the "peak" or "slide-back" V.T. voltmeter. The peak voltage is determined by the change in bias required to maintain a steady deflection of the milliammeter.

A detailed article dealing with the construction of various types of vacuum-tube voltmeters suitable for various classes of service. An important article for the up-to-date Service Man. V. T. Voltmeters may be used as output meters in lieu of the more general types of rectified meters. A comprehensive review of the applications of vacuum-tube voltmeters was contained in a series of articles which appeared in the May, June, August, 1932, and the January, 1933, issues of RADIO-CRAFT, by Beryl B. Bryant.

C. H. W. NASON

THERE is probably no instrument better adapted to the uses of the radio technician than the vacuum-tube voltmeter. It is a device which can—when understood thoroughly—be flung together hurriedly for some shop measurement when a special instrument is required; when made up in portable form, it can be used as an output meter by measuring the voltage developed across a known resistance, or to accurately measure the source of overloading in a radio receiver.

The simplest form of tube voltmeter is that shown in Fig. 1, where a simple diode, made by connecting together the grid and plate of a three-element tube, may be employed to measure the voltage input to the tube in terms of the plate current passed. Such an instrument is of value only in cases where the loading effect of the tube input circuit does not affect the circuit under measurement; that is to say, the device shown could well be used as an output meter, but could not be employed across the input of a vacuum tube because of the loading effect which would destroy the accuracy of readings.

A Simple Tube Voltmeter

As an example of the simplicity with which a device of this character can be made and calibrated, refer to Fig. 2. Here a 20 tube—the old output tube which was companion to the 99—is used in conjunction with two inexpensive meters to form a simple, accurate, and effective measuring device having negligible loading effect in all audio-frequency circuits. For R.F.

measurements, a more complex device is required. The meter shown has been used by the writer without variation for the past few years in some hundred or more measuring arrangements. It has done duty in conjunction with a standard signal generator in the laboratory, and as an output meter or resonance indicator on the test benches in a number of manufacturing plants where a compact instrument with a fair degree of accuracy was required. The calibration chart in Fig. 3 comes from the writer's notebook and is characteristic of the device. Without doubt, it will serve quite accurately for a similar instrument should the reader not be in a position to obtain an accurate calibration. This is the simplest form of V.T. voltmeter for use in all-around measurements in service, repair, and test of radio receivers. A pair of 4.5-volt "C" type batteries in parallel will serve for filament supply over a long period, while the "B" and "C" batteries will last indefinitely. A periodic check of the calibration is, of course, necessary when it is desirable to have accurate readings. Where the device is required only as a resonance indicator in the alignment of receivers, no such periodic check is required.

R.M.S. and Peak Voltmeters

The average A.C. instrument gives R.M.S. readings; that is, the values read are the root mean square values of the sine wave. Calibration of such meters is carried out with a potentiometer and a transformer in conjunction with an A.C. voltmeter of known ex-

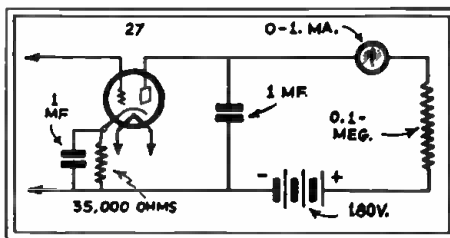

Fig. 6
A V.T. voltmeter suitable for the measurement of high voltages. This meter is known as a "Reflex" voltmeter, and is good to about 25 volts.

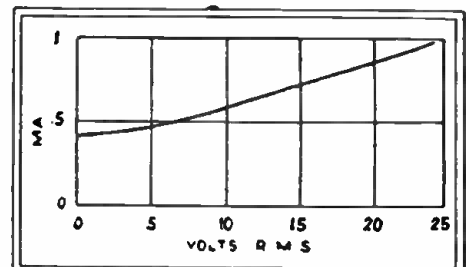

Fig. 7
Calibration curve of the Reflex voltmeter illustrated in Fig. 6, to the left.

TUBE VOLTMETER FIELD

cellence. Although such an ordinary voltmeter, itself, cannot be used across high impedance vacuum-tube circuits, the calibrated V.T. meter may be used in such high-impedance circuits. In Fig. 4 there is shown the set-up for calibration of a tube voltmeter from a standard A.C. meter.

The peak values of the A.C. wave are 1.414 times the R.M.S. readings, and can be mathematically estimated by the application of this factor. Conversely, the R.M.S. values are .707 times the peak values. As we probably have had pointed out to us before, it is the *peak value* of the signal which "slops" over the bias and causes overloading of a tube. In many cases—some of which we shall later analyze—the peak readings are desirable, and the fact that the D.C. and the peak values of the A.C. voltage are interrelated is used in the direct measurement of peak voltages.

A "peak" or "slide-back" meter is shown in schematic form in Fig. 5. Here we have a simple vacuum-tube circuit in which the biasing potential is made variable by means of a potentiometer R1. A key switch, Sw., should be provided so that the filament and biasing voltage may be switched off together with the bucking voltage which is used to bring the plate-current reading exactly to zero. In operation the input terminals are first shorted and the initial grid bias and the "bucking" battery adjusted to reduce the plate-current reading exactly to the zero line of the meter. The signal is then applied and the short-circuiting wire removed from the terminals of the meter. A reading will now be apparent on the meter. This does not give an indication of the peak voltage applied, for the meter is uncalibrated. In order to ascertain the peak voltage of the signal, we again adjust the biasing potential in a negative sense until zero plate current is reached. The increment in voltage as read directly on the D.C. meter is equal then to the "peak" value of the signal voltage.

The Reflex Voltmeter

As we may have already noted, the tube voltmeter is nothing more nor less

than a grid-bias detector, consequently, much of our knowledge of detector theory can be applied to the design of the V.T. voltmeter. The "automatically biased" detector is known for its long straight characteristic, and for its inherent immunity to overload. This type of detector is found in modern broadcast receivers where a high plate voltage is used and where the biasing resistance between cathode and ground has a high value. One of the greatest advantages of the automatic-bias detector when used in a voltmeter circuit is its availability for double-range purposes.

It is quite a simple matter to so proportion the voltages and resistances as to obtain a wide range of readings. The circuit shown in Fig. 6 is that of a "Reflex" voltmeter employing a 27 tube; this meter will cover a range of from 0 to 25 volts with a 1 ma. meter in the plate circuit. The calibration chart shown in Fig. 7 is typical of this type of meter, but an individual calibration should be made in the manner already shown, before attempting to use the meter. The steady deflection of the meter due to the failure of the plate current to fall exactly to zero may be removed by simply backing off on the zero adjustment of the meter until the reading is zero with no signal input. This is not really necessary, as we may accept the slight reading as our zero point when reading the meter.

A Highly Sensitive Dynatron Voltmeter

The meters shown above will be seen to cover ranges involving readings of several volts. A more sensitive meter may be constructed using an initial voltmeter tube with a second tube operating as a D.C. amplifier. It is possible, however, to construct an exceedingly simple and sensitive meter by using the dynatron characteristic of the 24 tube. The circuit arrangement and calibration shown in Fig. 8 are indicative of the extreme sensitivity of the device when used with a simple 0-1.5 ma. meter in the plate circuit. In operation the input terminals are short circuited and the plate voltage varied until the meter reads zero. The device

(Continued on page 558)

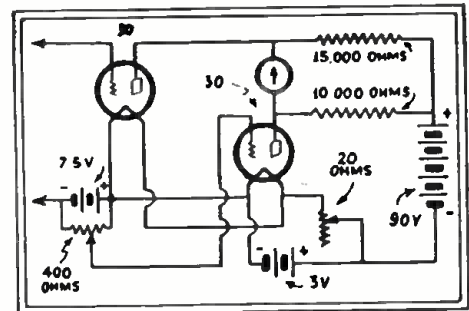

Fig. 12

Complete schematic circuit of the Hoare V.T. voltmeter. This is a bridge arrangement using two tubes and a type 30 tube. Balance for zero reading of the meter in the circuit.

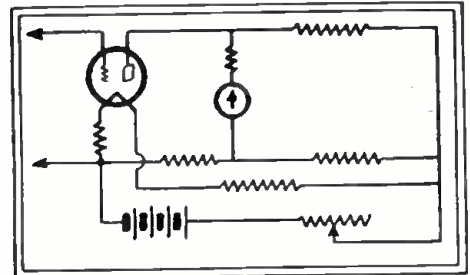

Fig. 11

Fundamental circuit of the Hoare V.T. voltmeter. Details and circuit constants appear in the complete schematic circuit of Fig. 12, above.

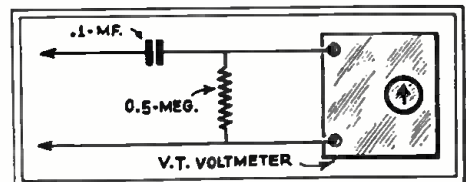

Fig. 10

The coupling device used in conjunction with a V.T. voltmeter for eliminating the D. C. present in a circuit. The condenser may be short-circuited by a switch, if so desired.

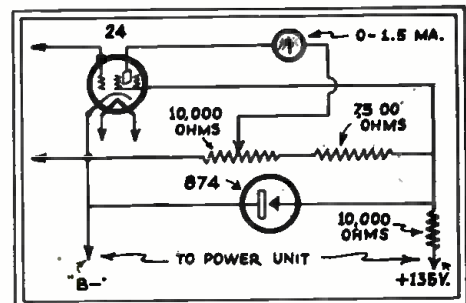

Fig. 9

Connection of the voltmeter illustrated in Fig. 8 for use with an A.C. power pack. A pack may be made, or an old "B" eliminator used.

The Vacuum-Tube Voltmeter In Service Work

Many Service Men use the V.T. voltmeter in lieu of output meters. Thus, it becomes one of the most useful test instruments available. It has the added advantage of being able to measure voltage across high-impedance circuits—something the output meter cannot do. It is economical and reliable.

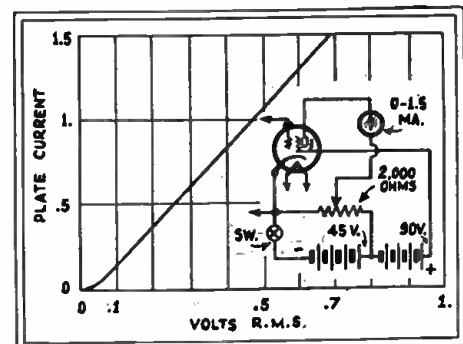

Fig. 8

Calibration curve and circuit of a highly sensitive dynatron voltmeter. You may have to use an old type 24 for this circuit.

RADIO-CRAFT KINKS

Practical Hints From Experimenters' Private Laboratories

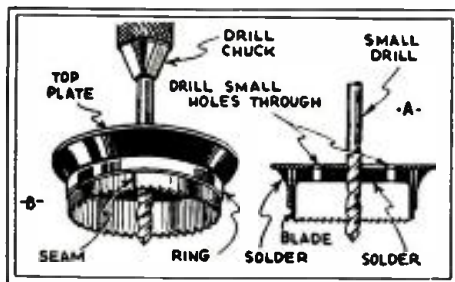

Fig. 1

This very versatile circle cutter may easily be made at home with the aid of the few parts specified by the author. It's handy, too.

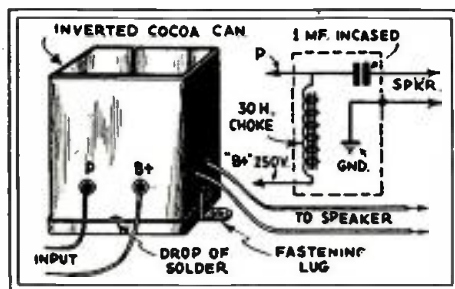

Fig. 2

A new use for a cocoa can. This idea ought to help the cocoa industry; a good excuse to drink cocoa, too. (Free advertisement.)

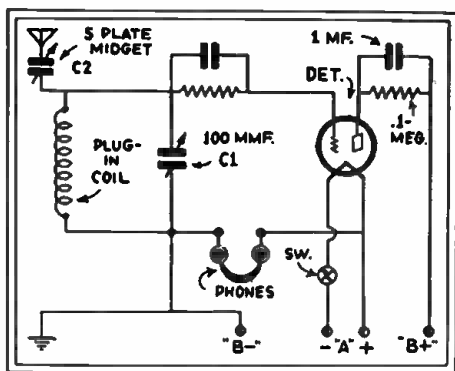

Fig. 3

Well, experimenters, try this on your radio set. The author claims it's good. What say?

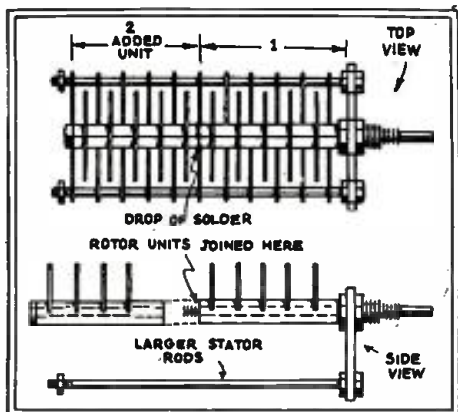

Fig. 4

Separately controlled condensers made by Pilot may be ganged as described here.

Prize Award

A HOME-MADE PANEL CUTTER

E. F. Houser

EXPERIMENTERS often have use for a circle cutter. As it is rather difficult to make an adjustable circle cutter, the simplest solution is to make up "fixed" cutters of various sizes, as they are required, until a complete kit of assorted sizes is available. A very satisfactory design for a home-made tool is illustrated in Fig. 1.

Cut a piece of heavy gauge iron, $\frac{1}{2}$ -in. larger in dia. than the size of the desired hole. Now, determine the exact center of this sheet and scribe a circle exactly the size of the hole to be cut, and then drill a $\frac{3}{8}$ - or $\frac{1}{4}$ -in. hole in the center for the cutter-guide. Finally, solder a strip of light-gauge iron $\frac{1}{4}$ -in. wide to form a complete circle on the line scribed as the desired hole size, flowing the solder from the outside surface of this strip to the periphery of the heavy plate. The result will be as shown at "A" in Fig. 1.

Next, cut a hack saw blade the exact length necessary to fit tightly inside the "cup" made by the $\frac{1}{4}$ -in. strip; the edges of the blade must butt tightly. The teeth of the blade must point in the direction of rotation.

Now fit the cutter-guide (a small drill) snugly into the center hole, permitting it to extend $\frac{1}{4}$ -in. below the level of the hack saw blade; leave sufficient length in the other direction for the drill chuck to grasp firmly. Accurately align this cutter guide so that it is at right angles to the heavy plate and flow solder into the cup so blade and guide are held firmly in position. Now drill two or three holes in the heavy plate for removing the discs due to cutting circles, and the tool is complete. However, some constructors may wish to cut a circle from a thin piece of fibre, permitting this disc to remain inside the blade where it may be held in position with flat head bolts to act as a re-enforcement and anchor of the blade.

"DRESSING UP" THE COUPLING CHOKE

J. K. Holloway

LAST year an article was published in RADIO-CRAFT entitled, "Pentodes and Their Use." Since then I have had occasion to couple magnetic speakers to pentodes. Although in all cases

a 30 hy. choke has furnished the proper reactance, the greatest difficulty encountered was to find some way to attach the choke. The chokes were generally from old eliminators and looked pretty bad when stuck up on a neatly arranged sub-panel.

I solved the problem by placing the choke and uncased condenser in a cocoa can, and filling the remainder of the can with "compound" as shown in Fig. 2. (The can had been drilled to allow an opening for the four leads.) This makes an output unit that may be painted to match the chassis, with choke and condenser enclosed in one container. Attachment lugs may be soldered to the can in any position.

AN IMPROVED REGENERATIVE CIRCUIT

Irving Gottlieb

IN constructing a short-wave set, I found it difficult to make it oscillate smoothly over the entire band when using the conventional tickler coil for regeneration. As a remedy to other fans who are troubled in this respect, I suggest the circuit in Fig. 3, which will oscillate smoothly over the entire band providing the phones or primary of the audio transformer are not bypassed.

This circuit is a good basis for an all-wave set because there is no critical tickler inductance to be tapped.

(Here you are, fellows. A simple regenerative circuit which at first glance presents no new feature; however, here is where Mr. Gottlieb, who is only 12 years of age, puts one over on the fellow who jumps to conclusions. Since the headphones [or the primary of a transformer] form the necessary common coupling between the grid and plate circuits, thus producing regeneration, the author does not require a tickler coil or variable condenser method of control, instead, he uses a resistor. Then, by coupling the antenna through a condenser C2 in the usual manner, he is able to accomplish two results. First, even regeneration over a very wide tuning range; and second, a tuning circuit which requires only one inductance. We are sure that many experimenters will want to apply this idea in the construction of all-wave receivers, A. F. modulated R. F. oscillators, and other devices where it is desired to operate with a minimum number of coils.—Technical Editor).

\$5 for a Practical Radio Kink

As an incentive toward obtaining radio hints and experimental short-cuts, "Radio-Craft" will pay \$5.00 for the best one submitted each month. Checks will be mailed upon publication of the article.

The judges are the editors of "Radio-Craft" and their decisions are final. No unused manuscripts are returned.

Follow these simple rules: Write, or preferably type, on one side of the sheet, giving a clear description of the best radio "kink" you

know of. Simple sketches in free-hand are satisfactory, as long as they explain the idea. You can send in as many kinks as you wish. Everyone is eligible for the prize except employees of "Radio-Craft" and their families.

This contest closes on the 15th of every month, by which time all the Kinks must be received for the next month.

Send all contributions to Editor, Kinks Department, c/o "Radio-Craft," 98 Park Place, New York City.

GANGING PILOT MIDGET CONDENSERS

E. C. Stevens

WHILE using two Pilot midget condensers in parallel, it was decided to gang them in order to eliminate one control. It was found that the rotor plates could be removed from their shaft in a single unit by simply holding them and turning the shaft counter-clockwise. It will be seen from Fig. 4 that the rotor unit is threaded at just one end.

Now in order to gang the condensers, the end nut of condenser No. 1 is removed, and the rotor unit of condenser No. 2 is screwed on in its place, and a drop of solder used to hold them tight. (It may be necessary to file the ends slightly in order to make the plates line up.) Next the stator plate screws of condenser No. 1 are replaced by screws long enough to hold the added plates of No. 2. In this way it is possible to make a very neat condenser of almost any capacity.

It would also be possible to tune two separate stages by using a suitable tapped and threaded insulating shaft between the two rotor units and using insulating washers between the stator sections.

"A NUTTY" TOOL

D. Barry

THE writer is so well pleased with the little tool illustrated in Fig. 5, that he is passing on a description of its construction.

Just solder little fins of spring brass to a piece of hexagonal brass rod (countersunk to accommodate the screw ends). It will be necessary to file down two of the surfaces at one end to hold the smaller size nuts. This is certainly a great little jigger for holding nuts until they engage a screw thread.

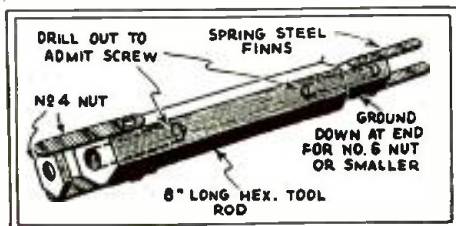

Fig. 5
Just a "nutty" tool, that's all.

A LEAD PENCIL TEST PROD

A. R. Eggensperger

HERE, fellows, is a chance to use that old lead pencil that has been parking in the way; just solder a wire to one end of it as shown in Fig. 6 and you have a very nice test prod.

Some experimenters may prefer to solder a phone tip to the end in place of the needle, thus making it convenient for connection into tip jacks.

AN S.-W. COIL MOUNTING

Doyle Witgen

PERHAPS some "wind your own" fans have had difficulty with the problem of mounting short-wave coils on tube bases in such manner that they may easily be changed without disturbing the windings. A good form of construction used by the writer is illustrated in Fig. 7.

SPEAKER KINK

By R. L. Woolley

RECENTLY found it necessary to widen the armature gap of a Philco balanced-unit speaker. The unit was being used as an extra extension on a very powerful set, and, for this reason, the armature chattered. Fig. 8 illustrates this speaker kink. This is all you need to do: place a piece of cellophane between each pole-piece spacer, as shown; this permits a greater armature swing.

AN EMERGENCY TAP SWITCH

M. C. Clapp

SOME time when you feel a creative urge and lack a tap switch, dig into your scrap box and resurrect a rheostat, remove the resistance wire, notch the fibre strip, and re-wind with copper wire, in the manner illustrated in Fig.

(Continued on page 559)

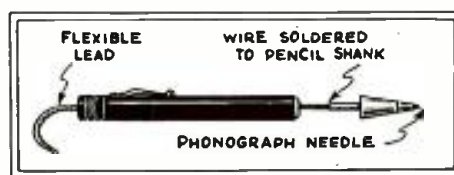

Fig. 6

Many of you, we are sure, have some of the automatic pencils on hand that may be used to good advantage as test-prods.

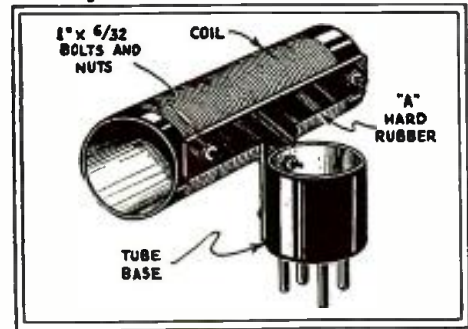

Fig. 7
A novel S. W. coil mounting.

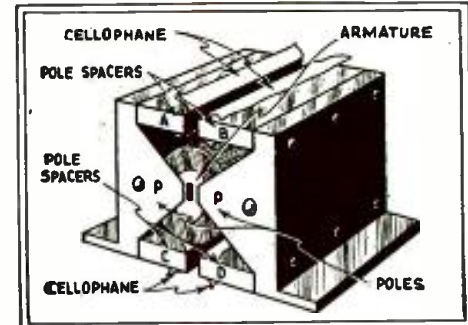

Fig. 8
A simple idea that looks complicated.

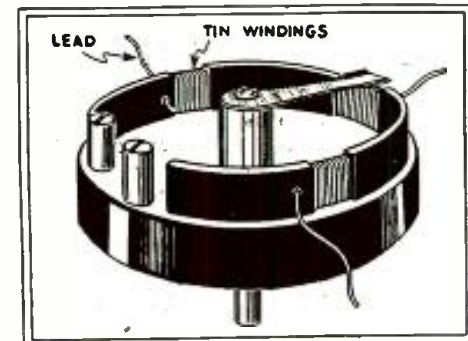

Fig. 9
Truly, a brilliant tap switch.

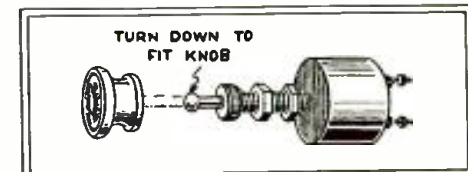

Fig. 10
This simple knob may be used on many switches.

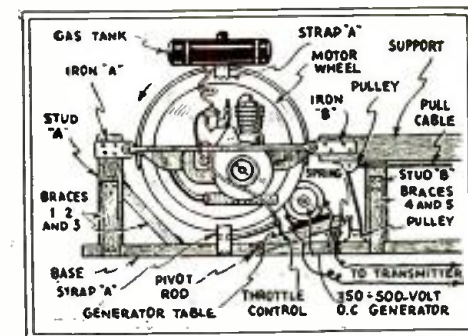

Fig. 11
A good "high powered" eliminator.

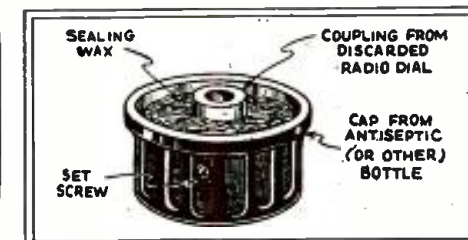

Fig. 12
An inexpensive knob, if you have the time.

THE RADIO CRAFTSMAN'S PAGE

The Bulletin Board for
Our Experimental Readers

A SEQUEL TO "MORE NEW TUBES"

Editor, RADIO-CRAFT:

Since the publication of my letter, suggesting the need for a line of heater-type tubes, designed for use on 1½-volt circuits, (See page 238 of the October, 1932 issue of RADIO-CRAFT.) I have received considerable correspondence pertaining to this subject. Inasmuch as it is impossible to answer all who have expressed interest in the subject, I will do the next best thing, and respectfully submit the following, trusting that this statement will clarify the situation in the minds of many who are interested but who do not quite grasp the situation.

There are three groups of people who have expressed themselves with regard to my suggestion; one group, and it leads in numbers, includes those who are experimentally inclined, and also numerous amateurs who operate short-wave stations, who are forever investigating and learning something new from time to time. This group has expressed itself as being decidedly for the proposal.

A second group includes a number of men engaged in service work who wonder why any more tubes should be thrust upon the market. Their viewpoint seems to quite overlook the fact that there are thousands of persons engaged in experimentation, research, and investigation (the very people, in fact, who have made radio what it is today) who have, undoubtedly, a very definite use for such a line of tubes. These Service Men recognize the fact that there are altogether too many voltages for which receiving tubes are designed, and I thoroughly agree with them; but, even so, many "servicers" could use some 1½-volt tubes.

The third group of people represent the minority in number, however, their inquiries indicate a considerable amount of interest in the subject and many asked for further information as to just why a 1½-volt line of tubes, instead of some other voltage, was outlined. By way of directly answering them, and also to make my own point clearer, I desire to say that the most common, and easiest to obtain, source of power for filament heating is the good old 1½-volt dry cell. It can be obtained anywhere that any kind of filament supply can be obtained, as a rule; and one such cell would supply the heater of a low-drain, 1½-volt tube for many hours. Such tubes could

IMPORTANT NOTICE

In the interest of those readers who do not like to mutilate this magazine, we have asked some of our advertisers not to place coupons in their advertisements.

Instead of the usual coupons, you will find a number of convenient post cards inserted between the last page and the back cover of this magazine.

This new service will save you time and work. No need to cut coupons, nor is it necessary to hunt for and address envelopes. Moreover the space for your name on a coupon is usually so small that the advertiser is often not able to make out your writing and then you wonder why you do not get the literature sent for.

Then, last but not least—the postage for a postal card is only 2c whereas a letter now costs 3c.

Read the advertisements and then turn to the page containing the special postal cards. Detach, fill out and mail the card of the advertiser whose literature or offers you want to have sent to you.

Mail your card today! Show the advertisers that you appreciate their cooperation and thoughtfulness.

RADIO MANUFACTURERS, NOTICE

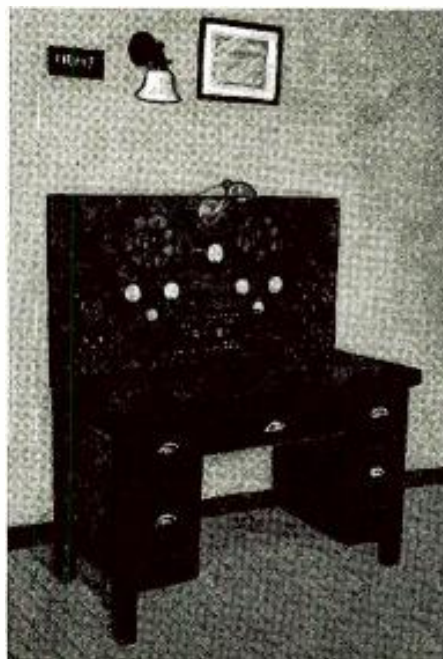

A neat test bench, eh, wot?

also be used on 1½-volt A. C. filament supply when such a source of power might be at hand. The experimenter, then, would have a tube which would immediately adapt itself to two different, yet very common, sources of power; moreover, four such tubes could be operated with their heaters in series

on the standard 6-volt storage battery, thus making a third common form of filament supply usable in those cases where series operation of the heaters might be permissible! Of what other tube, placed at the disposal of the American public, can as much be said as to flexibility of heater supply?

Personally, the writer has for some time been using type 32 tubes in circuits designed to supply type 26 tubes; in fact, he is operating type 32 tubes in parallel with type 26 tubes. (However, it goes without saying that such a procedure cannot obtain under all conditions of operation to which it may be desired to subject these particular tubes.

By way of conclusion, the writer desires to direct the attention of all who may be interested, to the Sylvania type 15 tube, a 2-volt tube of the heater type, described in the January, 1933, issue of RADIO-CRAFT. This tube is quite along the line of the tubes suggested in my previous letter, and it occurs to the writer that perhaps the tube manufacturers may already be in a position to put before the public a 2-volt, heater-type tube with characteristics, as to heater flexibility, which will permit the operation of either 1½ or 2 volt circuits, or circuits whose rated supply voltages are multiples of 1½ volts, as is the case of a circuit powered by a 6-volt storage battery.

May we not hear from the tube manufacturers in connection with the subject under consideration? Also, let us hear more from those who may be interested, both pro and con.

C. M. DELANO,
Lincoln, Nebr.

WORLD WIDE RADIO RECEPTION

Editor, RADIO-CRAFT:

You ask for DX results, here are some. I might remark that location is not so "hot" as too many code stations are located within a few miles. And don't they break through, even unto the 125th harmonic!

On the broadcast band, we receive rather regularly a station in San Juan, Porto Rico on about 1250 kc. Also all Cuban, and most of the Mexican stations. KFI, KSI, and KOA come in like locals as soon as the other stations on the same channels say good-night. But the prize catch is LR3, Buenos Aires, on about 970 kc., which

(Continued on page 560)

RADIO-CRAFT'S INFORMATION BUREAU

SPECIAL NOTICE TO CORRESPONDENTS: Ask as many questions as you like, but please observe these rules:

Furnish sufficient information, and draw a careful diagram when needed, to explain your meaning; use only one side of the paper. List each question. Those questions which are found to represent the greatest general interest will be published here, to the extent that space permits. At least five weeks must elapse between the receipt of a question

and the appearance of its answer here. Replies, magazines, etc., cannot be sent C. O. D. Inquiries can be answered by mail only when accompanied by 25 cents (stamps) for each separate question. Other inquiries should be marked "For Publication," to avoid misunderstanding.

PARALLEL RESISTORS—RESISTOR POWER RATING

(185) Mr. Stanley Moscovitz, Boise, Ia. (Q. 1.) Is there available any "abac" or chart which would make it possible to determine the effective value of three (or more) resistors in parallel, without using the usual formula?

(A.1) The graph illustrated in Fig. Q.185A (reprinted by courtesy of Ohmite Mfg. Co.) will meet this demand. (It is possible to obtain 15,006 combinations of resistance values from 123 different stock resistors listed in Ohmite Stock List No. 8, the manufacturers state.)

(Q.2.) What would be the power rating of a 1,000-ohm filter resistor in the plate circuit of a type 24 tube with 250 volts plate potential?

(A.2.) The correct rating for any value of resistor operating with any current load may be determined by reference to the chart of Fig. Q.185B. (Reprinted by permission of Modern Radio Publishing Co.)

Using the example furnished by our correspondent, we find that a 1-watt resistor is quite adequate to the demand. Taking as another example a 1,500-ohm resistor to carry 50 ma., travel along the R line until a value slightly higher than 50 is reached (or 55), under "5W." Thus, a 5-watt resistor will do, but the unit will be operating at full rating, or "hot." To run "warm," continue to the right until a figure about 1½ times the load current is reached; in this case 80, which is in the "10W" column. To run "cool," select a current figure twice that of the current to be handled, in this case, 112, in the "20W" column.

In general, for a particular resistance value, doubling the current will require four times the power rating in watts, and tripling will require nine times the rating. One-half the current calls for one-quarter the power rating, and cutting the current to one-third will reduce the power rating to one-ninth its value.

For a given resistor power rating in watts, twice the resistance drops the current capacity to 0.7, and three times the resistance drops the capacity to 0.6 of the original value. One-half the resistance allows 1.4 times the current, and one-third the resistance allows 1.7 times the current.

ACOUSTIC NOISE METERS—ELECTRIC NOISE METERS

(186) Mr. Carlton Parkside, Burlington, Vt. (Q.1.) Some time ago there was demonstrated at a meeting of the N. Y. Electrical Society a "noise meter" which demonstrated the relative noise levels of Times Square, N.Y.C., and the loop district of Chicago. What is the circuit employed in such devices?

(A.1) The demonstration in question was the result of a special long line set-up between the two cities, terminating in a sound meter or "audiometer." A general circuit of one type of noise meter is illustrated in Fig. Q. 186A (Electrical values are governed by individual designs); a block view of a noise meter set-up is shown at B; the tabulation at C indicates the relative sound intensities of a few of the sounds and noises we encounter in our everyday life. (Figures B and C are reproduced from "Indicating Meter for Measurement and Analysis of Noise," by Castner, Dietze, Stanton, and Tucker.) The "zero noise level" of C was determined as the threshold of audibility for certain common types of noise.

Some makes of noise meters comprise only a calibrated microphone, A.F. amplifier and indicator system while others include a local oscillator (see Fig. 186A) for setting up a reference sound level. The level of a sound is taken as the level of this oscillator tone which gives a meter reading equal to that given by the sound under test, and is expressed in decibels above this reference point. The advantage of this reference point is that it is definite and re-

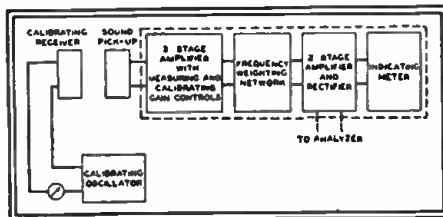
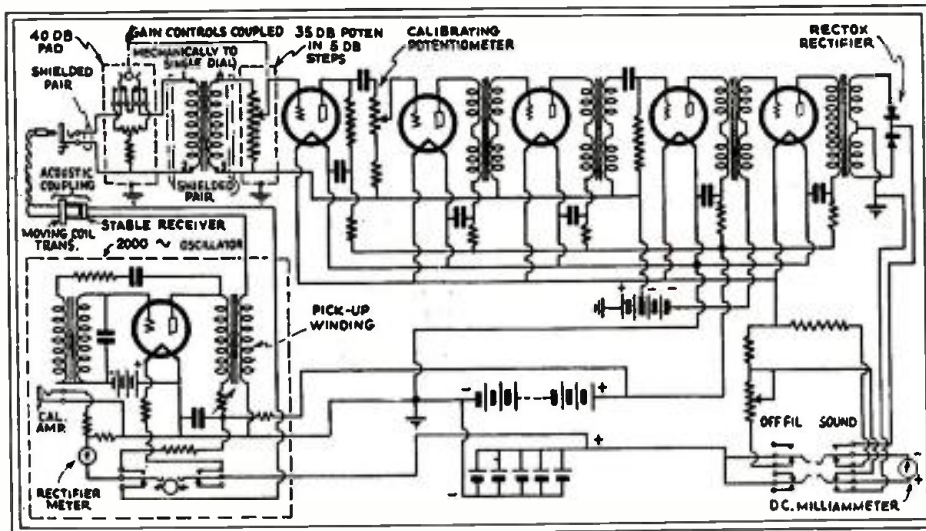

Fig. Q. 186A, top. Schematic circuit of a laboratory-model sound meter. Sound differences are read directly on the decibel output meter connected to the dry-disc rectifier.

Fig. Q. 186B, above. Block illustration of a sound meter set-up. The weighting circuit is an electrical network for weighting energies at different frequencies in a manner similar to that in which they are weighted for loudness by the ear.

Fig. Q. 186C, right. An illustration of the levels of some commonly encountered noises.

OUTDOOR NOISES IN NEW YORK CITY		DB ABOVE ZERO NOISE LEVEL	OTHER NOISES
DIS. FROM SOURCE (IN FEET)	SOURCE OR DESCRIPTION OF NOISE		SOURCE OR DESCRIPTION OF NOISE
55	RIVETER	100	SUBWAY - LOCAL STATION (WITH EXPRESS PASSING) ①
15-20	ELEVATED ELECTRIC TRAIN ON OPEN STRUCTURE	80	
15-25	VERY HEAVY STREET TRAFFIC WITH ELEVATED LINE	80	SUBWAY CAR AT FREE-RUNNING SPEED, INTERIOR OF CAR ①
15-20	MOTOR TRUCK	70	
15-25	BUSY STREET TRAFFIC PASSENGER AUTOMOBILE	70	AVERAGE OF 10 FACTORY TELEPHONE LOCATIONS ①
15-300	RATHER QUIET RESIDENTIAL STREET, AFTERNOON	60	LARGE HALL WITH AUDIENCE TALKING ②
	MINIMUM NOISE LEVELS	50	AVERAGE BUSINESS LOCATION ①
15-100	WRECKING (10-20 MINUTE AVERAGE)	40	AUDIENCE NOISE DURING PERFORMANCE IN LARGE AUDITORIUM ②
15-100	WRECKING (10-20 MINUTE AVERAGE)	40	AVERAGE RESIDENCE LOCATION ①
		30	
		20	
		10	OBTAINABLE IN SOUND PROOFED ROOMS ③

ABOVE DATA FROM REPORT BY NEW YORK CITY NOISE ABATEMENT COMMISSION

① DATA OBTAINED AT TELEPHONE LOCATIONS BY JOINT SUBCOMMITTEE ON DEVELOPMENT AND RESEARCH, NATIONAL ELECTRIC LIGHT ASSOCIATION AND BELL TELEPHONE SYSTEM.

② DATA OBTAINED BY ELECTRICAL RESEARCH PRODUCTS, INC.

producible, and does not depend upon the personal equation. It can be related to the threshold of audibility, as accurately as the latter is known. The systems described are those of acoustic noise meters; electric noise meters are discussed in the article, "Sleuthing for Static," in the February, 1933 issue of RADIO-CRAFT.

Noise meters have proved useful for city noise surveys, for the use of health departments or other legal officers in inspecting alleged noise nuisances, for measuring noise in offices or other rooms before and after noise-reducing treatment, for the use of salesmen selling noise-reducing materials, for factory or field inspection of fans, motors or similar mechanical equipment and for the majority of other problems of practical noise engineering. The modern recommendation that builders' or buyers' specifications for fans, refrigerators and similar equipment no longer should guarantee "noiseless" or "quiet" operation, but should specify noise production less than so many decibels, as measured on a reliable noise meter, opens a new field for the progressive Service Men technically equipped to sell, install and service these devices.

The range of the meter illustrated in Fig. Q.186A is determined by the setting of the 35db.

potentiometer; more accurate adjustment is then obtained by operation of the calibrating potentiometer. The output of the pick-up microphone is fed into the amplifier by means of the jack connection J.

In connection with the tabulation of C it may be mentioned that interesting observations in restaurants show that the peaks of many noises, above the general noise level, have the following values: dishes on tray, 8 db.; chairs, 6 db.; dishes on table, 7 db. These peaks recur at the following rates, respectively: 0.2 per minute; 0.5; 1.2.

(Q.2.) Please show the connections of an interference locator.

(A.2.) The data requested appears in the schematic circuit published in connection with the article, "Sleuthing for Static," in the February, 1933, issue of RADIO-CRAFT. The components have the following values: Resistor R1, 50,000 ohms; R2, 10 ohms; R3, 3 mega.; R4, 0.3-meg.; R5, R6, R7, 0.1-meg. Condensers C5, C6, .05-mf.; C7, C13, 250 mfm.; C8 to C12, 0.1-mf. Condensers C1 to C4 are ganged.

(Continued on page 552)

Radio's *Greatest*

The most
**Complete Directory of Radio Circuit Diagrams—
in ONE VOLUME of over 2,300 Pages
with Extra Heavy Cover—Looseleaf Bound**

Buy this Big Volume on our New
DEFERRED PAYMENT PLAN

Here are two of the most surprising announcements that we have ever made to the radio trade and we know that it is such good news that every radio man will be greatly enthused.

FIRST—that the three editions of the **OFFICIAL RADIO SERVICE MANUALS** have now been combined into one big volume of over 2,300 pages.

SECOND—that this new single volume of consolidated radio circuit diagrams and complete radio servicing course can be bought on a deferred payment plan—and at a big saving for you.

It is needless to say how valuable the **OFFICIAL RADIO SERVICE MANUALS** have been to members in every branch of the Radio Industry, and how many thousands of each edition have been sold to manufacturers, jobbers, dealers, Service Men and experimenters. But we must emphasize this one fact: Service Men now realize that they are tremendously handicapped without the full set of Gernsback Manuals. So much so, that those who have purchased only one or two volumes, are **NOW ORDERING THE MISSING BOOKS**. They want their files to be *complete*.

The complete book gives you a volume of over 2,300 pages with over 5,500 diagrams, charts and photos. There are absolutely no pages or illustrations or diagrams duplicated.

There is no radio book published today which is so modern, up-to-the-minute, and which contains so much useful information as is to be found in this single volume. It is a book that will outlast any other radio book in print. Look carefully at the photograph of the complete edition on the opposite page. It measures 9" wide, 12" long, 4½" thick.

Included in this volume is a complete radio servicing course. This course covers every step needed to learn the servicing business . . . from starting in business . . . materials needed . . . and how to go about servicing receivers and repairing other radio equipment. This course in itself, is actually worth the price of the entire book.

Our new plan now enables every radio man to get this single volume—a Complete Directory of all Circuit Diagrams, of over 2,300 pages, on deferred payments. You can order this book immediately—get it in a few days, and use it while you are doing servicing work. You can make the first few calls pay for the entire cost of the book.

For you to get this book is quite simple and it is sent to you as soon as your order is received. You pay for it in small monthly amounts which can be taken from your earnings. If you were to buy the three volumes separately, the total cost would be \$17.00, including the supplements.

Now you can get the

1931 **OFFICIAL RADIO SERVICE MANUAL**, with Supplements,
1932 **OFFICIAL RADIO SERVICE MANUAL**, with Supplements,
and the 1933 **OFFICIAL RADIO SERVICE MANUAL Complete**

at a big saving.

THE SPECIAL NEW PRICE FOR ALL THREE MANUALS, WITH SUPPLEMENTS, IN ONE VOLUME, WITH HEAVY BINDER IS ONLY

\$14.00

You buy this book this way—

Send \$3.00 with order—

Pay \$5.00 to Express Company upon receipt of book.

Send \$3.00 thirty days after receipt of book.

Send \$3.00 sixty days after receipt of book.

Total \$14.00.

IF THE ENTIRE AMOUNT IS SENT WITH YOUR ORDER, WE WILL ALLOW YOU A 10% DISCOUNT. THIS CAN BE DEDUCTED FROM YOUR REMITTANCE.

IMMEDIATE SHIPMENT

Mail Coupon Today!

GERNSBACK PUBLICATIONS, Inc.,
96-98 Park Place, New York, N. Y.

Gentlemen:

In accordance with your Special Offer, I enclose herewith \$3.00 as first payment toward the One-Volume Radio Manual. Please forward it to me promptly. Upon receipt of the book, I shall pay express company \$5.00. Thirty days later I shall send you \$3.00, and sixty days after receipt of books, I shall send you my last payment of \$3.00.

If you want to take advantage of the Special Discount of 10%, remit only \$12.60 with this coupon.

Name

Address

City State RC-338

Over 2,300 Pages

Over 5,500 Illustrations

**THIS IS THE GREATEST SINGLE
VOLUME RADIO BOOK IN PRINT TODAY**

GERNSBACK PUBLICATIONS, Inc.

96-98 Park Place

New York, N. Y.

Servicing Book!

Over
2,300 pages

Over
5,500
Illustrations

Consolidated
Official Radio
Service Manuals

Consolidated Official Radio Service Manuals

Complete Radio Servicing Guide

Up-to-date Directory
of all
Commercial Radio Receivers

OHMS	WATTS RATING (W) OR SIZE									
	1W	2W	3W	5W	10W	25W	35W	50W	100W	100W
100	100	100	100	100	100	100	100	100	100	100
200	20	98	120	134	225	315	350	400	500	1000
300	20	91	112	123	208	291	325	355	450	690
500	41	67	75	81	141	197	220	236	280	440
1000	82	34	38	41	282	394	440	500	670	1100
1500	123	25	28	30	423	591	660	750	1000	1500
2000	164	18	20	21	564	786	880	1000	1300	2000
2500	205	14	15	16	705	981	1100	1250	1600	2500
3000	246	11	12	13	846	1176	1320	1500	1900	3000
4000	328	8	9	10	1128	1568	1760	2000	2600	4000
5000	410	6	7	8	1410	1960	2200	2500	3300	5000
7500	615	4	5	6	2115	2940	3300	3750	5000	7500
10000	820	3	4	5	2820	3920	4400	5000	6700	10000
15000	1230	2	3	4	4230	5880	6600	7500	10000	15000
20000	1640	1	2	3	5640	7840	8800	10000	13000	20000
25000	2050	1	2	3	7050	9800	11000	12500	16000	25000
30000	2460	1	2	3	8460	11760	13200	15000	19000	30000
40000	3280	1	2	3	11280	15680	17600	20000	26000	40000
50000	4100	1	2	3	14100	19600	22000	25000	33000	50000
75000	6150	1	2	3	21150	29400	33000	37500	50000	75000
100000	8200	1	2	3	28200	39200	44000	50000	67000	100000
150000	12300	1	2	3	42300	58800	66000	75000	100000	150000
200000	16400	1	2	3	56400	78400	88000	100000	130000	200000
250000	20500	1	2	3	70500	98000	110000	125000	160000	250000
300000	24600	1	2	3	84600	117600	132000	150000	190000	300000
400000	32800	1	2	3	112800	156800	176000	200000	260000	400000
500000	41000	1	2	3	141000	196000	220000	250000	330000	500000
750000	61500	1	2	3	211500	294000	330000	375000	500000	750000
1000000	82000	1	2	3	282000	392000	440000	500000	670000	1000000

Fig. Q. 185A, right. A nomograph (and formulas) for determining the effective value of one or more resistors in parallel.

Fig. Q. 185B, above. A tabulation for determining resistor power ratings.

UTAH AUTOMOTIVE "B" UNIT—MULTIPLE-RECEIVER INSTALLATIONS

(187) Mr. A.B.C. Pabos, O. K., Kentucky.

(Q.1.) What are the connections, etc., of the Utah "B" eliminator described on page 397 of the January, 1933, issue of RADIO-CRAFT?

(A.1.) The schematic circuit of this device is shown in Fig. 187A; at B is shown the manner in which this instrument connects to the associated radio receiver, etc.; various models are available, depending upon the required drain, as shown at C which also indicates the regulation of the respective models.

The current consumption from the storage battery is 1.5 A. for an output of 25 ma. at 135 V. The interrupter is of full-wave type; it feeds a special Utah type P-861 mercury-vapor, cathode-type rectifier made by Ken-Rad. The "A" relay is an externally-connected shunt-type unit which may be added to automatically control the "B" portion of the instrument by the operation of an existing off-on switch at the set. When installing the eliminator in place of "B" batteries, do not change the connections from the car battery to the set. However, when replacing an eliminator using a series type relay, remove the relay and connect the "hot" lead from the set to the "hot" terminal of the battery; if replacing an eliminator not using a relay, (as in the case of "B" batteries), it is not necessary to change the connections from the set to the battery. The figures of graph C were taken at 6.2 V. input.

(Q.2.) Is it possible to use a number of "set" couplers in conjunction with a single antenna and "antenna" coupler, together with the usual shielded R.F. transmission lines, for operating a number of remote radio sets?

(A.2.) A copyright view, Fig. Q. 187D, reproduced by permission of Amy, Aceves & King, Inc., illustrates the manner in which a plurality of "Akaformer" units ("antenna" and "set" couplers) may be connected to obtain the desired result. At A in this figure is shown a connection system which is recommended for use in cases where it is convenient to use two shielded downleads (R.F. transmission lines), to operate two radio receivers. The circuit of B is suggested for operating up to four radio receivers from a single downlead.

WELDING TRANSFORMER

(188) Mr. Robert Crowley, Mobile, Ala.

(Q.1.) How can I make a transformer for electric "lead burning," which will enable me to

(Continued on page 572)

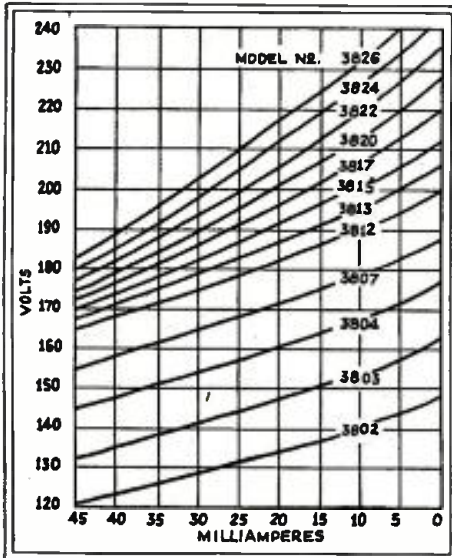
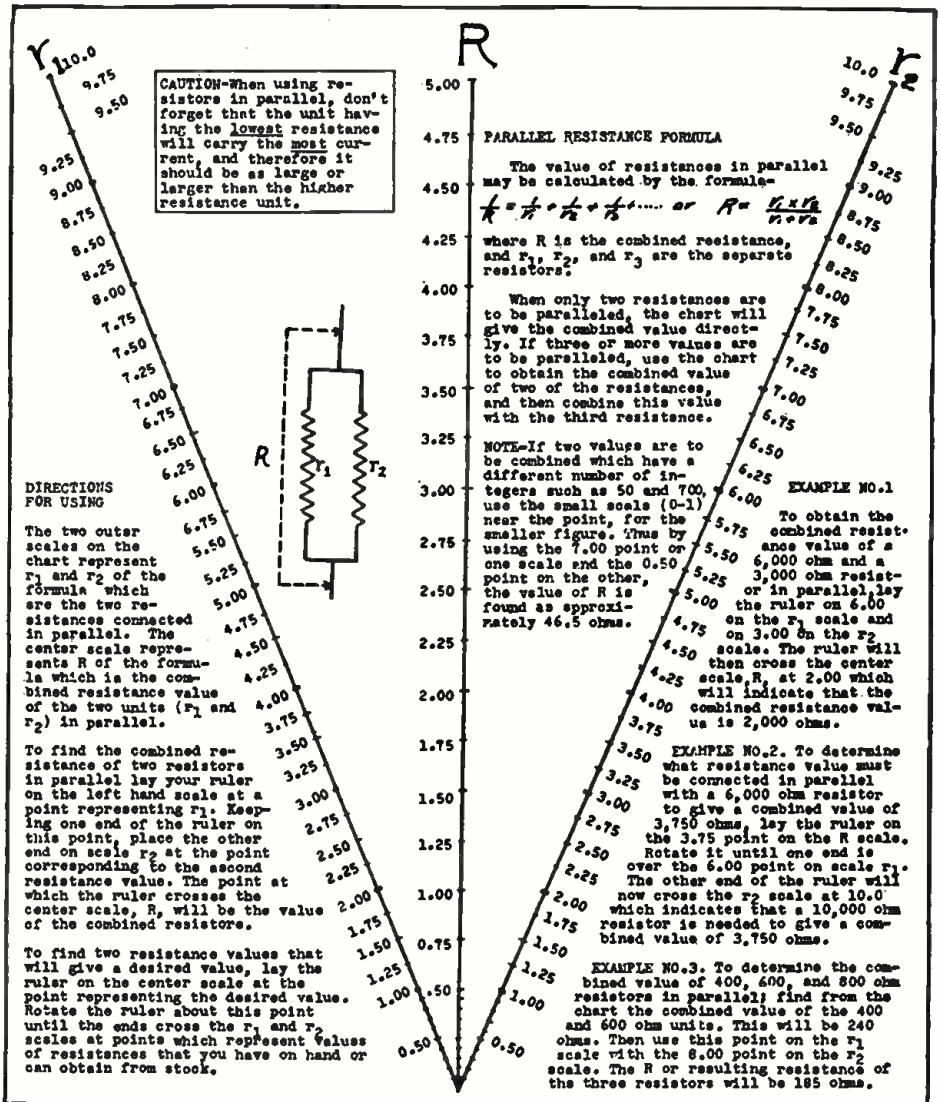
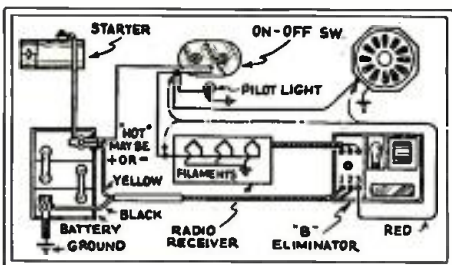
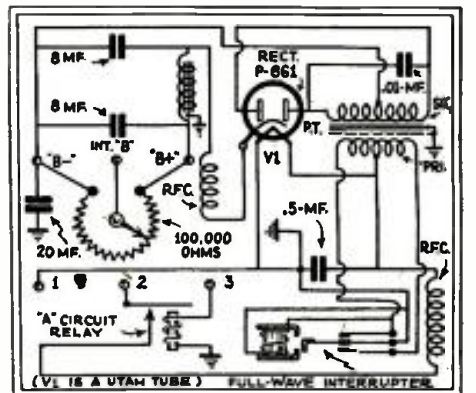
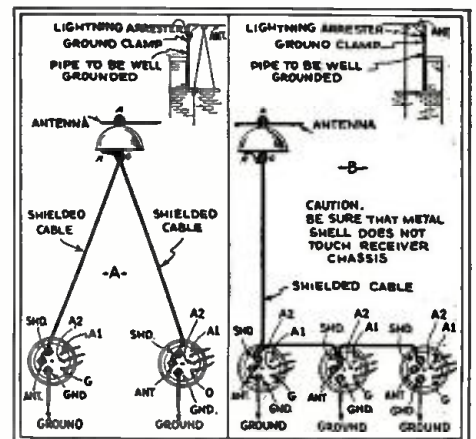

Fig. Q. 187A, right. Schematic circuit of the Utah full-wave car-radio "B" unit.

Fig. Q. 187B, left. Block illustration of the "A" connections to the car-radio units.

Fig. Q. 187C, above. Graph of the regulation of various car-radio "B" unit models.

Fig. Q. 187D, upper right. Methods of connecting several radio receivers to one antenna while still retaining the advantages of the shielded R.F. transmission line. At A, connections where the location permits the use of two downleads; at B, the next best arrangement.



OVER-THE-COUNTER SUGGESTIONS

Jack Grand

We get calls here, and we get calls there, in fact, we get service calls everywhere, But, the thing that worries us most and always will, is how to make the results show in the fill.

Meeting countless radio men in the course of a year, it finally has dawned upon yours truly that one of the biggest evils in radio is the slipshod antenna installation that the average Service Man, through one reason or another, installs for the poor unsuspecting customer. Maybe said technician must get in a certain number of "units" per day in order to feel sure he will get his check when the ghost walks; maybe the boss is one of those tight-fisted fellows that can't see any further than his nose, and doesn't know what it is all about; or maybe the installer couldn't "see" trekking back to the shop for more material when he had on hand 50 feet of antenna wire to complete a first-floor set-up in a 25-story building! At any rate, all too many "antennas" are undeserving of the name. How about your jobs? Are you putting in antennas that are so short that the noise-to-signal ratio is very high? Why not put in a good R. F. transmission line, such as Kolster is now advertising, under the name "Rejectostat"?

There is a good scheme one automotive radio service shop employs, for testing this type of set—I mean the "automotive" antenna they use. It is a screen with an area of 9 sq. ft., permanently strung in the shop.

"So he took the 60 cycles—" and applied 50 volts of it to the primary of the output transformer, to check the dynamic reproducer voice coil. It seems that a "sandpaper" sound indicates that the voice coil is rubbing; however, if the coil is floating clear, the hum will be "pure."

Don't try to use an ordinary transformer for your amplifier using type 46 tubes; remember that the input transformer must be step-down.

If you want to save a little cash here and there, watch your expenditures for bypass and filter condensers. Some constructors tend to recommend values that are extremely high, for circuits which are not at all critical in respect to condenser values. Of course, high-gain circuits often require the stipulated ratings, but careful placement of apparatus will often effect a saving in the number and size of parts required.

Set builders and Service Men do not seem to be aware that fused plugs are now on the market. Their use will save much cussing for, when Willie jabs a piece of metal into the "works," it doesn't put the house in darkness while the family goes into conference to find matches and the fuse-box. Explain this to your customer and watch him shell out—and like it!

It's a bit easier to sell your automotive sets when you point out to Mr. Prospect that by arranging the reproducer to plug into a mounting on the car, it is convenient to arrange a similar socket in the house; thus, the car speaker may be used for dual operation as a remote unit or a supplementary same-room set-up inside the rooms (for dancing, improved tone quality, etc.). The usual "output tube plate-to 1. mf. condenser-to speaker-to ground" is usually satisfactory; the field coil, if used, must be energized in a manner determined by the design.

Also, an extension-cord sale will be made if you point out that where the bungalow lacks a radio set, the car radio may be put into service by extending the speaker connections to enable the reproducer to be brought into the house.

These ideas will be appreciated on rainy days, when everyone is a "stay-at-home."

(Continued on page 555)

The House of Coast to Coast is Justifiably Proud to Offer The MOST SENSATIONAL SCOOP of these 12 past years of RADIO. A Flat-fee—Testimonial and Offer to Our Many Purchasing Resources.

THREE-CAR-LOADS OF

RADIO CORPORATION - Westinghouse - Victor

TWO STAGE 250 SUPER-POWER AUDITORIUM-SOUND TRUCK and PUBLIC-ADDRESS-AMPLIFIERS

Excellent adapted for

\$8.95 Complete with TUBES \$12.00

ABSOLUTELY BRAND NEW! Shipped in Original Cases!

Here is the amplifier that was designed for the VICTOR ELECTROLA No. 12-15C and RCA No. 108 Speaker that sold for \$850.00 to \$1,000.00. Due to "quick-heater" action of tubes employed (1-250, 1-250, 2-250) this amplifier is excellently adaptable for INTER-OFFICE CALL SYSTEMS. Can furnish D.C. FIELD CURRENT to either one or two 1000 ohm (100 mil.) RCA PHOTOPHONES—OR—two to four 2500, ohm D.C. Dynamic Speakers. Can also provide Radio Tuner voltages. Equipped with an OUTPUT TRANSFORMER that can MATCH from one to eight 10 to 15 ohm VOICE COILS! Also equipped with a PHONO-INPUT TRANSFORMER. Built to last a LIFE-TIME. Actual weight, 68 lbs. Size—17 1/2 in. long, 12 1/4 in. wide, 7 1/4 in. tall. This amplifier is excellent for MULTI-CHANNEL INSTALLATIONS, each amplifier "feeding" its own bank of dynamic speakers, and all such amplifiers operating from a common INPUT source. For 110 Volts, 50-60 cycles A.C.

AGENTS—DEALERS—MAKE BIG MONEY RENTING OUT THESE AMPLIFIERS!

Within a few rentals, you can make back your nominal investment cost of these amplifiers—and accordingly show you a handsome profit over a short period of time! Thoroughly tested before shipment... ready for IMMEDIATE USE!

SOLD ON AN ABSOLUTE GUARANTEE OF COMPLETE SATISFACTION BASIS!

RCA AP-736 TWO STAGE 250 P. A. AMPLIFIER... **\$8.95** SPECIAL Amplifier, Tubes and Two Special Wright De Coster Dynamic Speakers... **\$22.50**

COMPLETE WITH TUBES... **\$12.75**

COMPLETE RCA 250 AMPLIFIER P. A. INSTALLATION

One RCA 250 AP-736 Amplifier	\$12.75
One Set of Tubes	15.00
One Double Button Carbon Microphone	15.00
One Microphone Stand and Ribs	7.95
One "Mike-Phone-Radio" INPUT CONTROL BOX, Mixer and FADER	10.65
One 110 P.M. Phono. Pick-up	9.75
One 33 1/2 and 78 it.P.M. Phono. Motor	9.75
FOUR JENSEN 1 1/4 in. Diameter, or SPECIAL WRIGHT DE COSTER DYNAMIC SPEAKERS	20.40
TOTAL	\$92.65

Special Offer - - - \$75.00

SUPER-QUALITY DOLLAR SERIES AUDIO TRANSFORMERS

Originally Manufactured by **Westinghouse**

These transformers and chokes are all designed on a 1/4 in. square core of high Silicon steel. The core is securely held in an aluminum finished strap. Designed in accordance with the latest technique; they can be depended upon to give very satisfactory results. The 6 inch leads are made of heavily insulated wire and bear the R. A. A. standard color coding. The coils are scientifically treated to be impervious to all atmospheric—a very valuable and necessary feature. The overall measurements of all the units below are 2 5/8 in. long, 2 in. wide, 2 in. tall.

5 to 1 Audio, 3 to 1 Audio, 2 to 1 Audio, Push-Pull Input Transl., Split Secondary, Push-Pull Input, Low Impedance Phono, Pick-up Input, High Impedance Phono, Pick-up Input, Single Button "Mike" Input, Push-Pull 171-245 to 8 to 15 ohm Voice Coil, Push-Pull 250 to 8 to 15 ohm Voice Coil, Single Pentode (247, Etc.) to 8 to 15 ohm Voice Coil, 500 Ohm Line to Grid, Plate to 500 Ohm Line, Control Box to 500 Ohm Line, 4000 Ohm-Primary, 10 to 15 Ohm Voice Coil-Secondary.	
--	--

All One Price - - - \$1.00 each

VICTOR R-32, 45, RC-42, 75 Radio-Microphone and Phono. 245 OR 247 PUSH-PULL POWER AMPLIFIERS

A latest design RCA transformer enables use of new Tubes... Such as 56, 57, 224-A, Etc. Wiring diagrams furnished show how these amplifiers can be connected for using the following Tube Combinations: 1-250, 2-245 (or 2-247 or 59), 1-250 (or 1-53), 4000 Ohm-Primary, 10 to 15 Ohm Voice Coil-Secondary.

Can furnish D.C. Field Current to any 2500 Ohm 110 Volt D.C. Dynamic Speaker. An output transformer is included that matches the voice coil impedance of any 7 to 15 Ohm rating Dynamic Speaker. All the component parts are of the HIGHEST QUALITY; here are the manufacturers whose products are employed: WESTINGHOUSE, GENERAL ELECTRIC, Etc. 13 1/4 in. long, 10 1/4 in. wide, 6 1/4 in. tall. For 110 Volt, 50-60 Cycle A.C.

We furnish a complete Kit of all the necessary parts—any Radio man can very easily wire up one of these really remarkable Amplifiers!

8-TUBE, 40-WATT UNOIS OUTPUT P. A. AMPLIFIER WITH TWO 250 TUBES!

Employing Highly Efficient, Improved and "Modified CLASS A PRIME" CIRCUIT TUBES EMPLOYED: 2-56, 2-59, 2-250, 2-83

SPECIFICATIONS: at full load 155 WATTS, 110 Volts 50-60 Cycle A.C.; STAGES: FOUR C-156 Resist. coupled to 1-56, then Transformer coupled to 2-56 Drivers which is in turn in push-pull push-pull 250 output Tubes; MAXIMUM VOLTAGE EMPLOYED: 500 Volts; GAIN: 92 D. B.; INPUT: Into GRID universal Potentiometer of FIRST PRE-AMPLIFIER TUBE (self-contained); OUTPUT: 500 Ohms, 15 Ohm, 10 Ohm, 5 Ohm, and 3 1/2 Ohm; SIZE: 18 in. x 8 in. x 8 1/4 in. tall.

Ideal for SOUND TRUCKS due to MINIMUM POWER CONSUMPTION REQUIREMENTS! Furnished with detailed instructions and blue prints.

COMPLETE KIT \$45.00 **FACTORY Assembled and Wired \$59.50** **Set of RCA Tubes \$13.60**

Write for this FREE VALUABLE BOOK TO-DAY!

COAST TO COAST RADIO CORPORATION

Contains Thousands of Listings from a Lug or Screw to a 100-watt Dual Channel Rock and Panel Amplifier.

COAST TO COAST RADIO CORPORATION

123-R West 17th Street, New York City.

The Biggest Scoop In Radio History

Jewell & Weston Instruments



Jewell 536—Tube Seller. Just look at this perfect job. List price \$150. You'll wonder how we can sell 'em for only **\$39.50**

Jewell 538—Tube Seller. This is the one that every dealer wants. Now you can afford to buy two or more at this special price. List \$160. Our price only **\$39.50**



Jewell 214—Tube Seller. Finished in cast aluminum. 9 inch 3 color dial meter. A wonderful unit for any shop. List \$125. Special... **\$37.50**

Jewell 534—Very impressive appearing unit. Always attracts attention. List \$164. Our special price. **\$55.00**

Jewell 540—Ideal for House or counter use. List \$75. Special... **\$29.50**

Jewell 444—Set Analyzer: complete with 6 and 7 prong adapters. List \$112. Our special price... **\$55.95**

Weston 566—Set Analyzer: complete with 6 and 7 prong adapters. List \$112. Our special price. **\$55.95**

Don't ask WHY these special prices

All instruments are brand new—in original sealed cartons and carry the factory guarantee. Quantity limited—first come, first served. Write for folder on any instrument that you may be interested in.

By remitting in full you save extra C. O. D. charges. On C. O. D. shipments—Deposit required with all orders. All prices F. O. B. New York.

LEEDS
The Home of RADIO

45D Vesey St.
New York
City

The Voltage "POLICEMAN" in Your RADIO

Less than one hour of high line voltage overloads vital radio parts—causing crackly noises. AMPERITE automatically regulates voltage—prevents noises and burnouts.

AMPERITE makes replacement regulators for Majestic, Brunswick and all other sets.

Send \$1.40 to Dept. RC-3 for sample and sales help.

AMPERITE Corporation
501 BROADWAY, NEW YORK



AMPERITE
VOLTAGE CONTROL

THE PENTODE "FOUR"

(Continued from page 530)

three potentiometers; in the side wall for the condenser (6, 10), and the three condensers (33, 34, 35); in the rear wall for condenser (41) and audio transformer (28). These parts are then fastened in place. The dual variable condenser is mounted on top of the chassis as shown. The chassis is then turned upside down and condenser (15, 16) is mounted. Then, the coils (3, 11) and the R.F. choke (20) are fastened in place. The chassis is then turned right side up and the power transformer and audio choke are mounted.

Wiring the Set

Starting the wiring, the filament circuits are wired in first, a separate 2½-volt winding being provided for the output tube. Grid circuits are wired next, with control-grid connections to the caps of tubes (5) and (14) made as indicated on the schematic diagram. The various socket terminal connections are plainly indicated on the top view layout. In the case of both (5) and (14), the suppressor grid is the one which is grounded to the cathode.

Plate circuits are wired next. If the primary of coil (11) (here used as a tickler coil) is reversed, there will be no regenerative whistle. In this case, it is simply necessary to reverse the connections at the primary (P,B) terminals. Cathodes are then wired, and next, by-pass condensers and negative returns to the chassis. Antenna and ground connections are completed. The primary circuit of the power transformer is wired through the amperite socket, the latter being in series in this circuit. The rectifier and filter circuits are then put in, completing the wiring to the four-prong speaker socket (31, 32, 37, 39). This socket is mounted at the rear chassis wall.

List of Parts

Two Trutest binding posts, 1, 2;
One Premier "Conoid" shielded antenna coupler, 3;
One Cardwell .00035 mf. (each section) two-gang (Dual) variable condenser, type 217-C, 4, 9;
One Trutest equalizer, capacity 2 to 35 mmf., 4A;
One Trutest No. 4B four-prong plug for speaker connection, 31A, 32A, 37A, 39A;
One type 58 tube, 5;
Two Trutest six-prong wafer-sockets, type 2M13071, 5, 14;
Two Aerovox .1-mf., each section, double-section metal case condensers, type 260-21, 6, 10, and 15, 16;

One Electrad Truvolt 200-ohm flexible resistor, type 2G200, 7;
One Electrad potentiometer, 10,000 ohms, type RI-240P, 8, with switch 44;
One Premier "Conoid" shielded screen grid R.F. coil, 11;
One Aerovox .0001-mf. mica condenser, type 1450, 12;
One I.R.C. 2 meg., 1 watt, metallized resistor, type MF4, 13;
One type 57 tube, 14;
One Electrad potentiometer, 50,000 ohms, type RI-205, 17;
One I.R.C. 20,000 ohm, 1 watt, metallized resistor, type MF4, 18;
One Aerovox .001-mf. mica condenser, type 1450, 19;
One Trutest R.F. choke, 20;
Two Aerovox .025-mf. mica condensers, type 1450, 21, 24;
One I.R.C., 200,000 ohm, 1 watt metallized resistor, type MF4, 22;
One Electrad potentiometer, 500,000 ohms, type RI-203, 23;
One I.R.C. 2,000 ohm, 1 watt metallized resistor, type MF4, 25;
One type 56 tube, 26;
Two Trutest five-prong wafer sockets, type 2M13070, 26, 30;
One Trutest audio transformer, 3 to 1 ratio, type 2C 1550, 28;
One PZ pentode, power output tube, 30;
Three Trutest four-prong wafer sockets, type SA-176, 31, 32, 37, 39, 40, 46;
Three Aerovox 4 mf. dry electrolytic condensers, type E5-4, T1 can, 33, 34, 35;
One Trutest 30-henry choke, 75 ma., type 2C, 1571, 36;
One '47 type output transformer, 38;
One 180-type full-wave rectifier tube, 40;
One Aerovox 25 mf., 25-volt dry electrolytic condenser, type E25-25, 41;
One Electrad Truvolt 400-ohm flexible resistor, type 2G400, 42;
One Trutest power transformer, flush mounting, type 2C 1492, 43;
One Trutest full-vision, high ratio dial, complete with escutcheon plate and pilot light socket, type 2H9815, 45;
One Amperite self-adjusting line-voltage control, type 5A-5, 46;
One aluminum chassis, 12 to 14 gauge, 10x7½x 2½ ins.;
One Wright-DeCoster dynamic speaker, Infant Model with 2500-ohm field;
One .006-mf. mica condenser, 47.

THE SHALLCROSS 651 SET TESTER

(Continued from page 534)

provided that the elements in the tube under analysis are clear.

An operating chart is included to facilitate operation. This chart contains a list of the switches that must be set for any particular tube under test. In using this chart, the particular tube under test is associated with a letter which classifies the tube into a group. For instance, a type 34 tube is under test. At the bottom of the chart, a list of tubes is given from which the letter associated with this tube is found to be A. Then, referring to the data above the tube listing, it is seen that a type 964DS Na-Ald adapter must be used on the cable plug, and that the following voltages and currents may be measured: plate voltage, by turning switch MA-V to the V position and turning the P switch to the left, or P position; plate current, by turning switch marked MA-V to the MA position, and the P switch to the left, or P position; D.C. heater voltage, by turning the MA-V switch to the V position, and the H switch to the H position; control-grid to heater voltage, by turning the MA-V switch to the V position, and by turning the G1 switch to the G1 position.

If the switches are thrown in any of the above-mentioned positions for a particular reading, any of the voltage or current buttons may be depressed in order to secure a convenient deflection on the meter. For reversed readings, a reversing switch is included on the panel. An examination of the chart shows that approximately 70 different types of tubes may easily and conveniently be tested with this device. The view showing the loca-

tion of all holes on the panel is given in Fig. 2. No adapters are required for this tester, as it is equipped with 4-, 5-, 6- and 7-prong sockets. The diagram of Fig. 1 is self-explanatory, and no further comment concerning it is necessary. The cable uses a 6-prong plug with a control-grid clip on the side; thus, adapters for the plug are only required when testing 4-, 5- or 7-prong tubes.

List of Parts

The following list of parts is required for either the model 651 or 652 tester:
Five Yaxley type 2001 push buttons, Sw.1 to Sw.5 inclusive;
One Yaxley type 720 switch, Sw.6;
Three Yaxley type 730 switches, Sw.7, Sw.8, Sw.12;
Three Yaxley type 760 switches, SW.9, SW.10, Sw.11;
Two Na-Ald type 425, five-prong sockets, V1, V3;
One Na-Ald type 424, four-prong socket, V2;
One Na-Ald type 426, six-prong socket, V4;
One Na-Ald type 427, seven-prong socket, V5;
One Na-Ald type 906WL plug with cable;
One Na-Ald type 964DS adapter;
One Na-Ald type 965DS adapter;
One Na-Ald type 965GGDS adapter;
One Na-Ald type 967SS adapter;
Two Eby binding posts;
One carrying case.

The following parts, in addition to the above, are required for the type 651 tester:
One drilled and engraved panel;

(Continued on page 559)

OHMMETERS

(Continued from page 535)

in which the meter reading decreases—pointer moves to the left—with increasing values of Rx.

The reason why this mode of connection is capable of reading low values of resistance is best illustrated by an example. The resistance of a standard 0-1 ma. meter of the D. C. type is about 30 ohms. Thus, if the value of Rx (in Fig. 3) is made equal to 30 ohms, the meter reads half scale, because only half the total current flows through the meter: the other half flows through the resistor Rx which now acts as a shunt. Now, the point to keep in mind is that half the meter scale is used for only 30 ohms, while in the circuit of Fig. 2, half the scale is used with an external resistance of 1,500 ohms!

That's why the shunt method is good for small resistors.

Calibration Data

Both types of ohmmeters may be calibrated by calculation, using the following formulas:

For the series type ohmmeter (suitable for high resistances, Fig. 2)

$$R_x = \frac{E}{I} - R,$$

where E is the voltage of the battery—usually 1.5 and/or 3 volts; I is the reading of the meter in amperes; and R is the value of limiting resistor.

For the low-resistance ohmmeter illustrated in Fig. 3

$$R_x = \frac{R_m}{(n-1)}$$

where Rm is the resistance of the meter (about 30 ohms) and n is the ratio of the full-scale current reading to the actual current reading. For instance, with the meter under discussion, what resistance is being measured when the reading of the meter is .75-ma.7 Substituting in our formula, we obtain:

$$R_x = \frac{30}{(1.33-1)} = \frac{30}{.33} = 90 \text{ ohms.}$$

The above is valid so long as the resistance of R is large compared to the meter resistance, almost always the case.

Circuit 3 may also be calibrated against low-value standard resistors. As a matter of fact, all mathematical calculations should be checked this way at three or four points. A few "spot" points on the proper cross-section paper will greatly facilitate calibration. Using D.C. meters, circuits 2 and 3 will plot a straight line only on logarithmic paper.

Special scales can be prepared and placed over the milliammeter scale for direct reading.

In Conclusion

All equations given in this paper are based on volts, amperes and ohms. Considerations involving megohms, millivolts, milliamperes, or any other subdivisions or multiplications of the fundamental units should be converted accordingly before computations are undertaken.

The power requirements of the resistors used in these circuits are usually well under two watts—with the exception of high-range voltage multipliers. The dissipation can be easily calculated by multiplying the current in amperes squared, by the resistance in ohms—i.e., $W = I^2R$.

OVER THE COUNTER SUGGESTIONS

(Continued from page 553)

The old stunt of shorting the posts provided for a reproducer field coil, to check operation against the speaker, doesn't always work—the voltages throughout the set go "off the handle," due to the lowered resistance in the filter circuit. Instead, use a heavy-duty Bradleyohm or Clarostat variable resistor, adjusted by means of your ohmmeter to the value of the field coil, connected to the field coil terminals; if the value for the setting is not known, it may be necessary to pick out a portion of the circuit the voltage of which is known, and then vary the resistor until this voltage is obtained.

SQUIRE

Wins Again!

FIRST AC-DC RECEIVER

on market using a 3 Gang Condenser

5 Tubes (New C43 and C25Z5; 2-C39, 1-C36)

Rola Dynamic Speaker

Will operate in country as well as city

C25Z5 tube actually used as a voltage doubler in a practical new circuit providing results equal to those obtained from transformer receivers

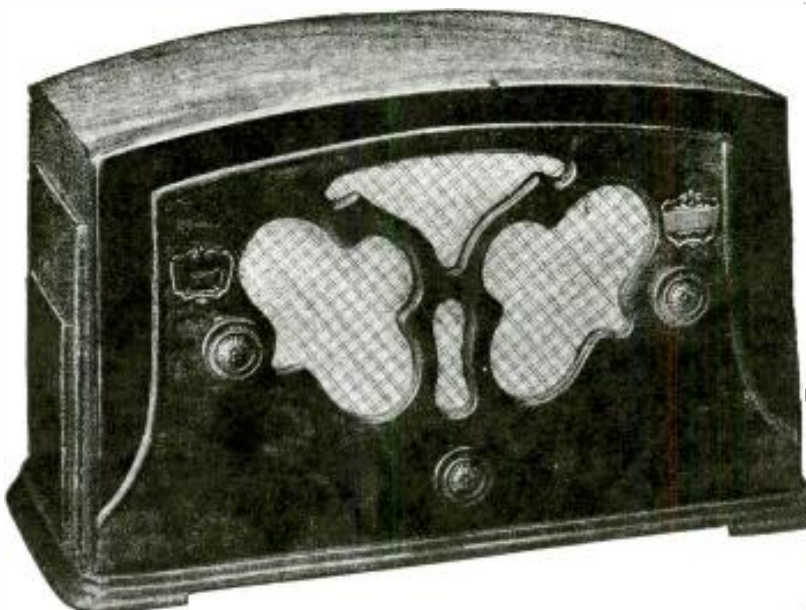

Price Complete with 5 Cunningham Tubes

1-C43 & 1-C25Z5
2-C39 1-C36

LIST PRICE \$29.50 COMPLETE

This beautiful cabinet is made of fine grained cured figured butt walnut. Hand rubbed, highly polished, with two toned effect on front panel. We know of no other receiver with a similar beautiful appearance. Width 11 inches, height 8 in., depth 5 1/4 in., shipping weight 9 1/2 lbs.

This receiver, designed by Mr. Squire employs all the latest engineering developments. We have purposely refrained from trying to put a model of this type on the market until seasoned experience had been given all of our suppliers based on the mistakes made by most of the portable models on the market at the present time. Now, in

co-operation with engineers of the Cunningham-Radiotron Co.—Dubilier—Rola—Aerovox—General Instrument—Centralab Companies and several laboratories such as Hazeltine Radio Corporation—American Telephone & Telegraph Companies, we feel that our receiver is the last word in engineering and are sure that the results received by those purchasing them will justify these claims and make us many new friends and boosters.

WRITE FOR CIRCULAR. WE MANUFACTURE 52 DIFFERENT MODEL RECEIVERS AND CHASSES. TAKE ADVANTAGE OF OUR 15 DAY TRIAL OFFER

DEALERS! Write for Exclusive Territory.

Licensed under patents granted
RADIO CORPORATION OF AMERICA—GENERAL ELECTRIC—WESTERN ELECTRIC—
AMERICAN TELEPHONE & TELEGRAPH COMPANY—WESTINGHOUSE ELEC. & MFG. CO.
AND THE HAZELTINE CORPORATION

RADIO CHASSIS, INC.

(Formerly Marquette Radio, Inc.)

112-116 West 18th Street

Dept. C

New York, N. Y.

Export Department: 1457 Broadway, New York, N. Y.

TRAIN WITH R.T.A. TO BE A

Professional RADIO MAN

THE TINKERER'S DAY IS DONE!

It's vital that you become a Radio technician through R. T. A. teaching NOW! New, complicated circuits . . . new tubes . . . the approach of popular television . . . all require professional service men. Their future is secure—their opportunities to make good money are unlimited. And R. T. A. can place you in their ranks quickly—easily—and surely through interesting home study that's understood by anyone who can read English.

SET ANALYZER— AT NO EXTRA COST

Included with R. T. A. Training is this excellent set analyzer and trouble shooter. After a few lessons you will know how to use it, and it becomes an immediate means of earning as you learn. Many R. T. A. students make far more than enough to pay for their training by spare time service work, using this analyzer. In addition, R. T. A. gives you life membership in a great radio service men's association with the privilege of consultation on "tough" problems at any time, and an employment service that works to keep you at work.

WONDERFUL OPPORTUNITIES NOW!

You don't have to wait for a dim and distant future as an R. T. A. professional Radio Technician. Even though there was never another receiver built—even though all the tremendous progress in this gigantic industry stopped—there would be enough work in conditioning and reconditioning the sets now in operation to assure you a good living. Look into this great field of professional radio service work. Learn, too, of the many other glowing opportunities open to true Radio-technicians in this field. Fill out and mail the coupon—it will bring you FACTS that will surprise you—and that may open up for you a permanent way out of depression and job-fear.



FILL IN-MAIL TODAY

RADIO TRAINING ASS'N. OF AMERICA,
Dep't. RCA-3, 4513 Ravenswood Ave., Chicago, Ill.

Send me the FACTS about R. T. A. professional training, together with information about the opportunities in the radio service field, without obligation to me.

NAME.....

ADDRESS.....

Sprayberry's RADIO DATA SHEETS

Act at once—start making
more extra profits now!

F. L. Sprayberry has inaugurated a unique DATA SHEET SERVICE for Radio Service Men. Each month, SPRAYBERRY DATA SHEETS are mailed out to thousands of Radio Service Men all over the United States and Canada.

These Data Sheets tell in concrete words how to rewire old, obsolete receivers for new, modern tubes and circuits. For instance, instructions are given for rewiring the Majestic 70 Series for '58, '57, '56 and '45 tubes; instructions are also given for rewiring the Sparton 931 series for '56 and '55 tubes with AVC. Wiring directions also given for making a superheterodyne from a tuned radio frequency receiver. Other older receivers will be covered in a like manner. Actual wiring directions are given with diagrams in each case. Mr. Sprayberry has opened up a vast source of profit for the service man—a source where no profit is being made at present.

This unique service assures the Service Man a steady income each month. The cost is trifling—less than thirty-five cents a month.

PLANS FOR REWIRING ANY
SET ANALYZER OR TUBE
CHECKER ARE ALSO AVAIL-
ABLE FOR \$1

Send for a complete FREE list of subjects
to be covered in this Data Sheet Service.

F. L. SPRAYBERRY
132 BRYANT STREET, N. W.,
WASHINGTON, D. C.

OPERATING NOTES

(Continued from page 537)

of the 45 power tubes was reported on a Philips 77. This trouble was caused by one side of the input push-pull transformer secondary being open. Illustrated in Fig. 2.

A Little Giant five-tube set was brought in with the remark that the power transformer was smoking and that the plates of the 80 rectifier tube were red. This radio had been left on over night. The transformer stopped smoking after I had replaced the two 4 mf. dry electrolytic filter condensers which were shorted.

When a Tom Thumb P 45 was turned on, smoke would come from somewhere in the chassis. On inspection I noticed that one of the 8 mf. dry electrolytic condensers had leaked. Some of this paste had made its way to the 80 rectifier socket and caused a short across the two plate prongs. The socket was replaced and a temporary repair was made by melting some wax from a defective paper condenser onto the leak. Later, both 8 mf. condensers were replaced with new dry electrolytic condensers. Figure 3 shows location of dry electrolytic condensers and 80 rectifier socket at the bottom of the chassis.

A Graybar 600 kept blowing out the rectifier tube each time it was replaced, and smoke with a strong odor came from the receiver chassis. I went about locating this trouble by smelling the parts inside the chassis until I came to the volume control. This 550-ohm open type case volume control was burnt. See Fig. 4. The heat radiated from this unit caused the compound from the A.F. transformer case to flow on the volume control winding. This was repaired by replacing it with a new 600-ohm enclosed type.

No control of volume and sometimes no reception was called to my attention on a Bosch 133. I found the 5,000-ohm plate supply resistor of the first and second R.F. stage

burnt, and the .05-mf. bypass condenser of the same circuit shorted, as shown in Fig. 5. Also, the volume control winding was burned out.

While servicing an Eveready model 50, I located a shorted .5-mf. bypass condenser in the first R.F. plate and screen-grid circuit. I disconnected them, but did not replace them as the customer could not afford the extra expense. Looking at Fig. 6, you will notice that there are still two left in each circuit. After rebalancing the set, it worked satisfactorily with this omission.

A Silver-Marshall 36A was found dead. The set tested satisfactorily on the analyzer voltage readings; but when the tubes, with the exception of the 80, were removed, 200 volts were read on the voltmeter to one of the 45 grids. The grid of this 45 power tube is connected to the second-detector plate by a .25-mf. coupling condenser, as shown in Fig. 7. This condenser would not show a direct short with all the tubes in the sockets.

In another case, a Majestic model 20 would die out when the tone control was moved to the bass side, as illustrated in Fig. 8. The .02-mf. tone control condenser was shorted.

An Atwater Kent model 40 was reported dead, caused by a probable burned power transformer. I found the A.C. plug on the power input cord defective, and replaced it.

I had occasion to service a Victor R32 in which the type 26 R.F. tubes would not light. When all these tubes with the exception of one were removed, this one remaining R.F. tube would light. This trouble was traced to a shorted filament winding in the power transformer.

A customer complained that their Crosley Showbox 706 was dead and that the 80 rectifier plates were red. This trouble was caused by the cover of the Mershon condenser.

THE SERVICE MAN'S FORUM

(Continued from page 538)

ample of an instance in which fault-determination by the "resistance measurement" method will not solve the problem. However, it is interesting to note that an A.C. measurement would have indicated the fault. Now, we may look forward to the appearance of a test unit which will make dynamic as well as static resistance measurements.—Technical Editor.)

THE RECTIFIER TUBE A FAULT FINDER

Editor, RADIO-CRAFT:

Not every Service Man is aware that the new mercury-vapor type of tube may serve as a current trouble finder. By using the 83 in place of an 80, for instance, the Service Man may determine in an instant whether certain troubles are present. (Better use one of the commercial adapters which connect limiting resistors into each half of the high-voltage circuit, thus preventing a burned out power transformer.—Technical Editor.) If there is a glow in one plate and not in the other, one-half of the high-voltage secondary is open. If there is no glow within both plates, this is usually an indication of an open high-voltage winding, or perhaps a burned out choke coil. If the blue is unusually intense, this indicates a short-circuit somewhere. If the glow varies in time with the signal volume, this means that the power tubes (except when they are operating in class B or push-push) are consuming excessive current or are over loaded. Only experience will enable the Service Man to apply just the right interpretation to the glow.

ANDREW P. PLATCO,
264 South St.,
Brooklyn, N. Y.

"TALKIES" AS A REMOTE P. A. SYSTEM

Editor, RADIO-CRAFT:

HERE is a stunt that will gain the Service Man plenty of free publicity and enable him to realize a handsome profit at the same time. The theatre manager desiring an added attraction for his Kiddie Klub matinee suggested the idea.

As a juvenile movie star was making a per-

sonal appearance in a nearby large city, arrangements were made to have her talk from her dressing room over the long distance phone to the local audience. Permission having been obtained from the telephone company, a line was run from the telephone to the operator's booth. Here, two, 2 mf. condensers were inserted in series with each side of the line and connections made in the fader control-box to screws intended for the attachment of phonograph pickups. (Since most theatres use sound-on-film, these screws are left vacant.)

On this particular outfit, a DeForest Phonofilm job, a double-throw switch is incorporated for changing from sound-on-film to disk; this switch was commandeered to change to the telephone connection. A test call was made and both sides of the conversation were clearly audible. The regular fader was used as a volume control. The final trial worked to perfection and gave a thrill to the audience.

This idea can be worked with ease and when run with previous publicity excites plenty of interest.

No doubt many Service Men will find the theatre manager more than glad to arrange for a similar stunt.

EARL L. WELLER,
224 Van Buren St.,
Litchfield, Ill.

(What other unusual applications of sound equipment can Service Men report. Let's hear how the next fellow used his "bean" to capitalize his technical knowledge.—Technical Editor.)

AMRAD PARTS

Many radio men have old Amrad sets or parts and desire to secure information concerning them. It might interest men to know that Mr. J. A. Ricard of the Ricard Radio Service Co., in Roxbury, Mass., former service manager of Amrad, is in a position to supply information concerning parts from this manufacturer by merely writing to him.

Mr. Ricard kindly forwarded some information to us about the old S tube.

The First COMMERCIAL PHOTO-ELECTRIC Burglar Alarm System



The JUNIOR control UNIT is enclosed in a handsome aluminum case, finished in black optical-instrument enamel. No adjustments.



A. The Intellect-A-Ray Generator is a very high grade optical type of instrument. Its operation requires 50 watts, and plugs directly into any lighting outlet.
B. This Intellect-A-Ray Optical Cell Housing is complete with The Photo Cell. The ball-and-socket joint, with set screws, furnishes an easily adjustable mounting for perfect alignment with The RAY.

THE INTELLECT-A-RAY (Invisible Ray System)—Control Unit, Invisible Ray Generator, Photo-Cell, Cell Housing and other allied equipment—is the First *Complete* Photo-Electric System that can be installed by any electrician or radio service man.

INTELLECT-A-RAY is commercial. There are no adjustments to be made for changing exterior light values, there are NO Vacuum Tube amplifiers, and it cannot be paralyzed. NO adjustments whatever.

TO RADIO DEALERS AND SERVICE MEN EVERYWHERE, INTELLECT-A-RAY offers an unparalleled opportunity to be first in This Great Field; to Cash in on the enormous demands that are developing for Photo-Electric Devices.

INTELLECT-A-RAY JUNIOR

The JUNIOR shown here is complete in every detail. It is the first time that a complete SYSTEM has been available—not just another UNIT—but a complete SYSTEM ready to be installed. The generator furnished with The JUNIOR has an effective fifty foot range, and when installed the interception of the INVISIBLE RAY



INTELLECT-A-RAY JUNIOR installed in prominent jewelry store, in Pasadena, California

closes a mechanically locked switch capable of carrying in excess of 2,500 watts non-inductive load.

WRITE FOR SPECIAL PROPOSITION TO FIRST DEALER IN EACH COMMUNITY

INTELLECT-A-RAY carries a very liberal discount to all established dealers and service men, but to get quick representation in every section of the country, we have a special proposition to offer the first dealer in each city.—WRITE TODAY.

THE INTELLECT-A-RAY CORPORATION

251 SINGER BUILDING ♦ ♦ ♦ PASADENA, CALIFORNIA

HOME RECORDING

(Continued from page 539)

connections as before, but in a slightly different manner. This contact is indicated in FIG. 1C.

Since it requires power—taken from the audio end—to run the monitor speaker, and since a monitor is not actually necessary after a little experience in recording, it seemed good policy to disconnect the monitor entirely. When this is done as indicated in Fig. 2, a material increase in fidelity will be noted. The lack of a monitor was not found to be a drawback, inasmuch as the cutting head and record acted as a soundboard, reproducing the program sufficiently loud to be used as a monitor.

In order to eliminate the monitor from the above models, proceed as follows: on the control switch, removal of terminal No. 9 disconnects the choke across the speaker cone coil to ground. To disconnect the series resistance in the cone coil, locate the resistor and reactor assembly, fastened to the left side of the cabinet, and remove both black-with-red tracer wires from terminal No. 7, but leave these two wires connected to each other. See Fig. 2. This resistor and reactor unit contains the disconnected choke, the 150-ohm series monitor resistor, the 1,000-ohm paralleling resistor around the old mike, and the 5,000-ohm resistor used to parallel the 10,000-ohm resistor in the cathode circuit of the second detector when it becomes an audio amplifier. Now it will be necessary to obtain microphone current.

Figure 3 shows the completed change to two-button mike use. Notice the red and yellow wire connected to terminal No. 4 on the phonograph strip. This red and yellow wire is one of five coming out of a cable running to the control switch. Remove this wire from the screw contact and solder another wire sufficiently long to reach down to the power pack, taping the newly made connection. In series with this wire connect a resistance of sufficient size to allow 10 ma.

through each button of the mike. This value will be in the neighborhood of from 7,500 to 15,000 ohms. Connect the other end of this resistor to power pack terminal No. 5 which already has a red wire connected to it. You are then ready to record. Note, on Fig. 3, that the center connection of the mike runs to contact No. 5 on the control or change-over switch. This contact closes the current supply to the mike.

1932 Models

On the 1932 models of the RCA Victor, G. E., and Westinghouse sets, there are several slight changes which result in improved quality and increased volume, both on audio and radio operation. First, we will take up the home recording unit. Cleared of the accumulation of switches, etc., the microphone connections are approximately as shown in Fig. 4. Incidentally, this diagram shows the use of the one-megohm resistor referred to previously. It will be noted that this circuit retains all the fundamentals of the changes outlined above, but has certain acquisitions which particularly apply to the De Luxe machines.

Figure 5 is a rough diagram of the tone control system employed on these receivers. If the trap circuit containing C39 and R24 is opened at the point indicated, there will be a noticeable increase in volume. It is recommended, however, that this disconnection be made only when playing records or making home recordings, since there will be a noticeable peak at high frequencies. This peak can be flattened out by the addition of the items shown dotted, without loss of volume. These items comprise an audio choke in series with a condenser of such size as to smooth out the "highs." The audio choke indicated was an old audio transformer. Be sure the choke end is connected to terminal No. 1. Also, insert the 1 mf. condenser across terminals 1 and 5 as shown.

As an additional kink, the tone may be still further varied by experimenting with the values of condenser C39 and resistor R24,

some individuals preferring a combination such as 20,000 or 30,000 ohms for R24 and .025 mf. for C39.

In many of the series 50 and 55 chassis, as well as their corresponding models in G. E. and Westinghouse, there has been an objection raised regarding the tone quality at low volume. It seems that when low volume is used, there is an apparent fuzziness and roughness to the reproduction. This may easily be cured by removing the chassis, locating the yellow lead which leaves the end contact of the resistor and condenser terminal board and goes to the first R. F. tube in the chassis. In series with this yellow lead, insert a .5-megohm resistor. Now, from the tube end of this resistor, connect a .5-mf. condenser to ground. This will effectively cure distortion on low volume. See Fig. 6.

Long-Playing-Record Attachment

The long-playing record has been developed to a stage of perfection that is amazing to the writer. But what is more amazing to him is the apparent apathy with which the radio Service Man regards this record. Here is a field absolutely new—a method whereby most of the objections to a record are overcome, and yet the Service Man cannot, or will not, sell his customer a simple device which instantly converts his old phonograph to a "long playing" phonograph. This device, called the Sr. 1, 2, or 3 is a turntable for replacement of the old turntable, and by means of a ball-bearing arrangement, successfully reduces the turntable speed from 78 to 33½ R. P. M.

ADDRESS CHANGE

We have just been advised by the Sun Radio Co. that, because of the erection of a new Post Office building on their location, they have moved to new quarters at 227 Fulton St., New York City. They were formerly at 64 Vesey St.

AERO INTERNATIONAL

ALL WAVE 11-TUBE SUPER-HETERODYNE DE LUXE



Completely Assembled
With 2 Matched Full
Dynamic Speakers **\$29.75**

At last! World wide reception at a sane price. 15 to 550 meters. Besides the regular broadcast band, it brings in foreign programs, amateurs, police calls, ships at sea and aeroplanes. One dial control. No plug in coils. Latest super-phononic tubes.

AERO 4-TUBE MIDGET

\$10.95 less tubes
2.95 kit of tubes



The lowest priced quality Midget Receiver on the market today. Very selective, brings in long distance like local stations.

AERO 5-TUBE MIDGET... **\$11.90**
AERO 6-TUBE MIDGET.... **\$18.50**

AERO WORLD WIDE



1-Tube SHORT WAVE
SET for Head-
phone Operation
\$5.95

Listen in DIRECT to London, Paris, Berlin, Buenos Aires and other broadcasting stations throughout the world via short waves. Your ordinary receiver cannot tune in these low wave stations. **WORLD-WIDE RECEIVER** gets 15 to 500 meters. Aero 2-Tube Short Wave Set **\$8.75**. The same as above set but it has 1 stage of Audio Frequency added to it.

Write for Complete Catalogue.

CHARLES HOODWIN CO.

4240 Lincoln Ave., Dept. C-150 Chicago

Here is the INSTRUMENT you have been waiting for! The E33 Tube Checker

Modern in performance—Moderate in price. Tests all tubes without adapters, 4, 5, 6 and 7 prong, giving Short Test; Grid Change Test; Oscillation Test and Total Filament Emission Test. Voltage regulation 90-130 volts. Nine sockets and selector switch gives flexibility that takes care of all present and Future Type Tubes. Simple to operate—Material and workmanship guaranteed. Lettered backelite panel—Imitation leather carrying case with handle provided—Light and portable.



ONLY \$19.80

ORDER DIRECT OR WRITE FOR TRIAL OFFER.

L. & L. ELECTRIC COMPANY
336 Madison Ave. Memphis, Tenn.

SERVICEMEN MAKE MORE MONEY

Transformers Rewound

or built to order. **50¢**
Speaker Field Coils wound for all types of Speakers

GRAPHITE VOLUME CONTROLS REBUILT
Guaranteed like new. 25% to 50% saving

5 Hour Service
Prices on request

PEMBLETON LABORATORIES
921 Parkview Ave. Fort Wayne, Indiana
17 years in design of coils and transformers

SHORT CUTS IN RADIO SERVICE

(Continued from page 541)

on the relay in series with a 30 watt light, a 2,000-ohm speaker unit (Utah or other make), and a 110-volt A.C. line.

AN A.C.-D.C. CHANGE-OVER DEMONSTRATOR

Fred Westerkam

HERE is a wrinkle that will be used over and over to save lots of work (and argument) when you get an A.C. radio set to change for operation on D.C. You can let the customer hear exactly how the job will sound after the change, and he will then know what to expect.

Simply break the "B+" lead at X as shown in Fig. 9, insert a Bradley-ohm resistor, vary the voltage until you have 110 volts (which may be taken as the D.C. line potential) and you have a good idea "what is what" after the change. Don't touch any other wiring.

A SIMPLIFIED TUBE-TESTER DESIGN

Robert C. Reinhart

A TUBE-TESTER that I happened to discover while experimenting is illustrated by diagram in Fig. 10. It is made of "junk-box" parts, which almost any experimenter or Service Man will have in his shop. The meter is a 15 ma. Readrite which is obtainable for less than a dollar. The unit is direct-reading, and is calibrated by inserting tubes of known quality and value. If desired, a new paper scale may be inserted and the various tube values recorded directly. The tester tests all present-day tubes, including both types of pentodes. The new type 51 and 35 tubes, while having different calibration points are tested in the same manner as the type 24.

Note that the filament transformer used must be able to supply the necessary 1.75 to 2.0 A., and all filament wiring must be of heavy wire. The "D.P.D.T." switch is used for switching plates in testing type 80 tubes.

This circuit looks a bit complicated on paper, but when actual construction is started, it becomes very easy. Of course, if the constructor so desires, the number of sockets can be cut down and the various filament voltages obtained by the use of a tapped switch. This would result in a more compact job, but as I had the sockets and not the switch, I used the former.

VOLUME CONTROL FOR 2-VOLT RECEIVERS

O. D. Elder

THERE is considerable profit to be made by the Service Man in rewiring battery sets to accommodate the new low-drain tubes. The saving in battery current, alone, is usually argument enough to convince the rural set owner that it is a good investment.

The writer has worked over several of these older sets in the past few months with very good success using type 30 and 31 tubes except where the mechanical arrangements made it feasible to use the 32 screen-grid in the R.F. stages (replacing the 22's or 01A-type originally used). It is a very simple matter to rewind the primary of the R. F. coils so that they will handle the 32 in place of the 01A, or in some cases I have left the primary unused and inserted an R. F. choke within the coil form, and in series with the R. F. plate lead.

The principal difficulty lies in the volume control which, in the majority of the older battery sets, is a rheostat in the filament circuit, a system that just won't work with the new tubes. The plan sketched in Fig. 11 is the best method so far discovered by the writer, for sets such as the Atwater Kent 33, 35, 49, Kolster 6-D, etc. It consists of merely placing a 1/2-meg. potentiometer on the front panel, and wiring it into the circuit in place of the first A.F.T. secondary.

VACUUM-TUBE VOLTMETERS

(Continued from page 545)

may be calibrated from 60 cycles A.C. as previously shown. By an arrangement such as is shown in Fig. 9, the device may be operated directly from A.C. with but a slight loss in accuracy.

Operating the V.T. Voltmeter Where D.C. is Present

The meters, so far shown, have been devised for operation across sources carrying A.C. only. When it is necessary to obtain a reading across a device also carrying D.C., such as the primary of an A.F. transformer, a resistance-capacity coupling device may be used. This is shown in Fig. 10. The resistance may be several megohms if desired, and the size of the condenser depends for its value upon the lowest frequency at which measurements are to be taken. For readings as low as 20 cycles, the values given in the figure are suitable.

The Hoare Voltmeter

The Hoare Voltmeter is essentially the same as the meter supplied by the General Radio Company. In this meter the single battery serves to both light the filament, and to provide the necessary plate voltage. The rheostat shown in Fig. 11 is employed as the zero adjustment. The simplicity of the meter and the fact that with no signal input, and with the resistances properly proportioned no current is drawn through the indicating meter is a decided advantage. The meter holds its calibration indefinitely and it is only necessary to replace the battery every time its voltage falls so low that the zero setting can no longer be obtained. It will be seen that the meter is nothing more than a Wheatstone Bridge with a microammeter as an indicator. Two arms of the bridge are simple resistances of equal value, while the other two are the plate resistance of the vacuum-tube itself and a third resistance of value equal to the R_p of the tube. Variation in the applied voltage serves to balance the bridge by varying the R_p of the tube over a narrow range. Any signal applied across the input then serves to un-

balance the bridge and provide a reading on the microammeter. The values are not given in the figure; but for a 30 tube, and a voltage of 90 across the bridge, resistances of about 15,000 ohms all around, and a suitable biasing resistance in the lead from filament to ground should serve. A more readily constructed balanced-bridge type of meter is shown in Fig. 12, together with a rearrangement of the circuit in which the bridge arrangement is more clearly seen.

This meter is ideal because of its freedom from inaccuracy due to variations in the voltages applied. With a 0-200 microampere meter, a range of from zero to two volts is obtained; the range can be increased by increasing the plate and grid voltages and by so shunting the meter as to have it read approximately half the actual current values passing.

Where it is desired to make readings of voltages in excess of the meter range, it is always possible to construct a potentiometer of high resistances such as grid leaks, and to measure the voltage drop across any portion of the divider thus formed.

CLASS A', CLASS B

So many receivers are now using class A' amplification, and so many men are confusing the properties of this type of amplification with that of ordinary class B operation, that perhaps a little explanation would be in order. In class B operation, the tube is so biased that no plate current flows when no signal is applied, but the current rises to a high value when signals are applied. In some tubes, as for instance, the 46, this cut-off point is obtained with zero bias, and therefore the grid draws considerable current during the positive peaks of the signal. In the class A' arrangement, the grid is not biased so negative, so the grid current is not so great, although the heavy signal may be applied for large output.

RADIO KINKS

(Continued from page 547)

9. Tin these "contact turns" and take a lead wire from each section.

Some of these old style rheostats may be conveniently ganged.

MODERNIZING OLD SWITCHES

F. J. Wylie

A SIMPLE way of improving the appearance of an off-on switch is by the simple process of filing off or turning down, on an emery wheel, the little bump on the end of the switch until a standard wooden knob, to match the panel, can be slipped onto the shaft. This idea, illustrated in Fig. 10, may be applied to both the push-pull and "side-swiper" switch types.

A MOTORWHEEL "B" UNIT

L. B. Robbins

BY following the design illustrated in Fig. 11, the writer succeeded in developing a very successful "B" unit for the operation of a high-power P. A. system, for use in the "sticks," where it is not always convenient to charge batteries. Although this wheel could also have been used to drive a low-voltage generator to furnish "A" potential, we found it more convenient to use "automotive" tubes and a six-volt filament battery.

A HOME-MADE KNOB

H. Newkirk

EXPERIMENTERS may be interested in the following description of a home-made knob.

The center bushing of the knob was obtained from a discarded radio dial, the cap was obtained from a bottle which had contained Pepsodent mouth wash. After drilling a hole in this cap in line with the set screw in the coupling, a screw of sufficient length to extend from the coupling to the outside of the cap is then threaded into place, after which the coupling is fixed in the position illustrated in Fig. 12 by means of sealing wax. Then the long screw was removed and the regular set screw placed in position.

THE SHALLCROSS 651 SET TESTER

(Continued from page 554)

- One Weston model 301 D.C. 0 to 1 ma. meter;
 - One Shallcross resistor type 170, 123 ohms, R1;
 - One Shallcross resistor type 6T, 9,850 ohms, R2;
 - One Shallcross resistor type 6T, 90,000 ohms, R3;
 - One Shallcross resistor type 6T, 150,000 ohms, R4;
 - One Shallcross resistor type 6T, 750,000 ohms, R5;
 - Two Shallcross resistors type 6T, 100 ohms, R6 and R7;
 - One Shallcross resistor type 6T, 9,000 ohms, R8;
 - One Shallcross resistor type 6T, 750 ohms, R9;
- The following apparatus, in addition to that listed at the beginning of this section, is required for the model 652 tester:
- One drilled and engraved panel;
 - One Weston model 301 D. C., 0 to 1.5 ma. meter;
 - One Shallcross resistor type 170, 82 ohms, R1;
 - One Shallcross resistor type 6T, 4,900 ohms, R2;
 - One Shallcross resistor type 6T, 15,000 ohms, R3;
 - One Shallcross resistor type 6T, 80,000 ohms, R4;
 - One Shallcross resistor type 6T, 400,000 ohms, R5;
 - Two Shallcross resistors type 6T, 100 ohms, R6 and R7;
 - One Shallcross resistor type 6T, 4,000 ohms, R8;
 - One Shallcross resistor type 6T, 800 ohms, R9.

Watch forthcoming issues of RADIO-CRAFT for a description of a real tube tester. It tests all tubes without the use of any adapters.

RADIO-CRAFT for MARCH,



Pat. Pending

FREE

I R C

RESISTOR INDICATOR

with each order for
I. R. C. Combination Kit No. 6

Two new service helps that have made a ten-strike with repair men! Both now for the price of the Kit alone!

The Indicator tells instantly the replacement value of any damaged unit. Pocket size. Can be purchased alone—list price \$4, net \$2.40.

The Combination Resistor Kit is a permanent steel cabinet—with the most popular sizes and types of resistors. Compartments for screws, nuts and tools. Net \$16.50.

With them we send the famous I. R. C. Resistor Guide and Color Code Chart. A \$23.55 value for only \$16.50 (higher in Canada) or less than regular cost of resistors alone! Send check or money order to

INTERNATIONAL RESISTANCE CO.

2006 Chestnut Street, Philadelphia, Pa.
71 Wellington St., West, Toronto, Ontario.



WHOLESALE LEADS AGAIN WITH A COMPLETE LINE OF PUBLIC ADDRESS SYSTEMS!



When it comes to PUBLIC ADDRESS systems there is no finer equipment obtainable at any price than the famous LAFAYETTE OUTFIT with LOFTIN WHITE "250" push-pull Amplifier. I'll tell you that the price is so low that it will astonish you . . . and talk about tremendous power and wonderful tone!

Of course Wholesale Radio Service Co. carries other equipment—a complete line. 3 and 4 Stage Amplifiers, Microphones, Dynamic Speakers and Speaker Units. Their prices are LOW on everything. I know because I've been doing business with them for 11 years.

And talk about SERVICE! If you have some special requirements on sound equipment, WHOLESALE will put their engineering staff at your disposal. Just ask them!

NEW 1933 SPRING CATALOG 152 Pages of BARGAINS!

The greatest Catalog in the Radio Industry is ready—just off the press! WHOLESALE RADIO SERVICE COMPANY'S new, 54th Edition 1933 Catalog describes the most sensational BARGAINS in Radio. Words can't begin to tell the amazing values that are packed between the covers of this Big 152 Page Wonder Book!

The Service Man's Headquarters

Service men know that WHOLESALE leads the field. They insure values for themselves by buying from the Catalog that guarantees "HIGHEST QUALITY AT LOWEST PRICES."

You can buy anything you want in Radio from the world's largest company of its kind through this BIG BARGAIN BOOK. Here is assembled an amazing array of SETS, TUBES, SPEAKERS, REPLACEMENT PARTS, KITS, SHORTWAVE RECEIVERS AND APPARATUS, AMPLIFIERS, etc. Then there are featured sections on LAFAYETTE RECEIVERS, TRUST PARTS, PUBLIC ADDRESS, etc. ANYTHING AND EVERYTHING in Radio at the lowest WHOLESALE prices in our history!!

Buy Direct from this great organization which in its 11 years of constant service has become a nationally known Institution.

MAIL THE COUPON FOR THIS CELEBRATED CATALOG—IT'S FREE

WHOLESALE RADIO SERVICE CO.
100 Sixth Ave., New York, N. Y., Dept. C33
Send me your New, 1933 Spring Catalog.

WHOLESALE RADIO SERVICE CO.
100 Sixth Ave., New York, N.Y.

Name _____
Address _____
City _____ State _____

1933

559

SERVICEMEN!

DEALERS!

YOUR PROFIT GUIDE
FREE!
EVERYTHING NEW!

Send Today for this
BIG CATALOG

If you haven't a copy of the **RADOLEK 1933 PROFIT GUIDE** you are without the biggest and most complete catalog of Radio Merchandise ever compiled by a house catering exclusively to Radio Servicemen and Dealers.

NEW MERCHANDISE AT LOWEST WHOLESALE PRICES

Attach this ad to your letterhead or enclose your business card and mail to

THE RADOLEK CO.
121 Canal Station. CHICAGO, ILL.

SUN RADIO CO.

announce their removal to
227 FULTON ST.
COR. FULTON AND GREENWICH STS.
NEW YORK CITY

"If It's Radio—We Have It."

TREMENDOUS stock of parts and accessories at LOWEST PRICES

WE ARE OFFICIAL HEADQUARTERS for
Weston, Jewell & Supreme Meters
Set Testers and Tube Testers

MIDGETS

Mr. Serviceman and Dealer

Midgets of High Quality

4 Tube 2 Circuit with tubes.....\$11.00
5 Tube 3 Circuit with tubes..... 13.00
5 Tube Super with tubes..... 15.50
110 Volt, 60 Cycle, A.C.

5 Tube Auto-Radio with tubes, dynamic speaker, suppressors (6 cyl.) and B-Eliminator (aerial if specified)\$21.00
Regular 90 day guarantee.

TRUMAN RADIO SHOP
7443-C Stewart Ave. Chicago, Ill.

Free Descriptive Literature on Request

ALAN

KITS IN ALL MODELS

SHORT WAVE RECEIVERS

When You Buy the Alan S.W. Receiver — YOU GET —

Unequaled flexibility and ease of control. Multi-Mu Sensitivity. Low Background noise. Super-smooth oscillation control.

Full A.C. or D.C. operation. Absolutely harmless A.C. operation. Impedance audio for quality phone signals. Microlite insulation throughout.

12 models from the A-11, a 2-tube battery receiver using the 54 R. F. Pentode and the 33 A. F. Pentode, built in a beautiful black metal can, with standard parts thru-out. A real buy at \$7.75—in kit form, \$6.45.

To the A-1V A.C. a 5-tube AC model using two 58's, a 56, a 59 Pentode and an 80 in a new circuit, complete with 4 coils, and self-contained power supply, in black crackle-finished metal cabinet. 1250 tubes—\$26.20.

ALAN-RADIO 83 Cortlandt St. New York, N. Y.

THE RADIO CRAFTSMEN'S PAGE

(Continued from page 548)

has been received many a night with sufficient field strength to cut through the other stations on the same channel.

On S. W. we have had stations from all over the world. Saigon, Sidney, etc., have been received pretty well, also most of the European stations. But the best S. W. station is DJB on 19.73 meters, which is received all year 'round with the quality and volume of a local. This station is on the air from 8 to 9, and 10 to 11:30 A. M., E. S. T., daily. There is interference, sometimes, from stations in Japan. On 19.70 m. is FYA which is also on the air every morning from 8 to 10, but the programmes are punk. Just talky—talky propaganda, *Francaise*.

Equipment used: An 11 tube Ozarka and an S-M converter.

(If you are interested in checking up on DJB, call Bayport 1543 any Sunday morning around 10:30 A. M.)

FREDERICK G. HEHR,
P. O. Box 875,
Sayville, L. I.

A NEAT RADIO WORK BENCH

Editor, RADIO-CRAFT:

I have just built the A.C. rejuvenator published in your October issue of RADIO-CRAFT. Thanks to Mr. Shaw, it is working fine. I owe your book many compliments for the very valuable information published each month.

I am sending you a snap-shot of a switch-board and outside service box I built from many of your ideas.

Here's hoping you keep the good work up in your valuable book.

THOMAS BOYD,
41 Cherry Grove,
Ecorse, Mich.

(As is evident by reference to the photographic illustration, Mr. Shaw has built a very

neat appearing test bench. Note the close resemblance between this bench and the one described in the March, 1930 issue of RADIO-CRAFT, in which appeared an article entitled, "The Construction of a Radio Work-Bench."—*Technical Editor.*)

"THE DECLINE OF RADIO SETS"

Editor, RADIO-CRAFT:

It is with genuine desire for an expression of intense satisfaction, that I decided upon writing you this letter, and wish it to convey to you my sincere wishes for success in your enterprise.

The cause—your editorial, "The Decline of Radio Sets," in the November 1932 issue of RADIO-CRAFT.

Every word and argument expressed in your article is hitting the historical nail right on its head, and brings out those facts which for a long time have been felt by radio customers and Service Men alike who are stoically supporting manufacturers' extravagances.

The general applause should convince you of the appreciation given your enterprise in bringing about a change in the practices of set manufacturers, and I wish you the greatest success ever. Service Men and public, I am sure, will stand behind you and insist that manufacturers take into account the ultimate customer, whose satisfaction must be obtained if the industry is to benefit by this buying force.

Here is "Good Luck" and "Best Wishes" for your efforts.

G. MORAL,
C. Alvaro Obregon,
Tabasco, Mexico.

(Your comments are appreciated, and we are sure that you express the interest of a good many readers of RADIO-CRAFT, judging by our correspondence.—*Editor.*)

40-WATT, CLASS AAA AMPLIFIER

(Continued from page 536)

this amplifier is particularly adaptable to all aeroplane "advertising-in-the-air" installations.

Determining Amplifier Output

It might be well to compare for a moment, and outline briefly, how the undistorted power output ratings of any amplifier system are determined. The undistorted power output of any one particular type of power tube is dependent solely upon the particular audio circuit used, and upon the accompanying voltages and currents employed. (The latter causes the tube to dissipate actual heat which should not exceed a certain maximum safe value.) For instance, the 50 type of tubes can be used in the four following amplifier circuits: the conventional class A; class A prime (also known as class A double prime, class A triple prime, and increased class A); class B; and class C.

Refer to Fig. 1 which shows the plate-current grid-voltage curve of a single type 50 tube with a filament voltage of 7.5 and plate voltage of 500. Inspection of this curve shows the conventional straight-line portion labeled class A. Under this condition, the average D.C. plate current remains at a constant value when a sine-wave voltage is impressed upon the grid of the tube, and the maximum undistorted power output of 13 watts may be obtained when using two such tubes in a conventional push-pull class A circuit.

In the class C circuit, the tubes are placed under such operating voltages—necessitating an unusually high bias—that the tubes only draw plate current during a very small lapse of time; for this reason the tube draws an amount of current which may be much larger than in a standard class A circuit; the total heat dissipation now being concentrated into the corresponding small lapse of time.

This type of circuit has been found only satisfactory when applied to radio-frequency and to audio amplifiers for code transmitters, as its application in audio-frequency amplifiers for receiving sets would produce an output with far too great a distortion factor.

In class B circuits, the tubes draw plate current only during one-half of the cycle and can, accordingly, dissipate at least twice the amount of heat that it would if it were forced to dissipate

this heat continuously. In other words, the type 50 tubes in class B circuits are biased just enough to reduce the plate current to practically zero with no grid excitation; no plate current flows over the negative half-cycle of an impressed sine wave. This decreased bias permits power outputs of 10 to 20 times that obtainable in a conventional class A circuit. Theoretically, it is possible to obtain 10 times the normal power output from any tube when employing same in a class B circuit, solely due to the fact that heat control has been attained.

Unless painstaking care has been exercised on the design of class B circuit amplifiers, and the very finest of component parts employed, the quality of its output might not be entirely satisfactory; it is inadvisable to attempt to employ type 50 tubes in a class B circuit because of objectionable characteristics of the tubes themselves for this particular type of service (large grid current, etc.).

However, in employing two 46, two 59, or similarly designed tubes in a class B circuit, you can obtain the virtually undistorted outputs as stated in the tube data charts prepared by the leading tube manufacturers.

The 40 watt class A prime amplifier, herein described, employs a circuit that has all the advantages of a standard class A circuit, as well as the feature of enormous power output due to the incorporated class B principles of operation. *It can thus be rightly called a happy compromise!* This circuit is variously called class A prime, class A double prime, class A triple prime, as stated before. They all refer to a power output circuit in which the heat dissipation of the output tubes is considerably below normal with no signals impressed upon their grids. *It can also be considered as a combination push-pull and push-push circuit.* However, the successful performance of such a circuit employing two type 50 tubes depends upon whether or not the following recommendations are closely followed:

(1) The driver tubes should be capable of producing by themselves an undistorted power output of at least 5% of the total output desired—in the herein described amplifier, this amounts to more than 2 watts.

(Continued on page 562)

BOOK REVIEW ●

"THE PRINCIPLES OF OPTICS," by Arthur C. Hardy, M.A., associate professor of optics and photography, and Fred H. Perrin, S.M., instructor in physics, both of the Massachusetts Institute of Technology. Published by the McGraw-Hill Book Co., Inc., 330 West 42nd Street, New York, N. Y. 6 x 9 inches, 600 pages, cloth; 150 illustrations. Price, \$6.00.

This text combines a purely mathematical treatment of optics with a practical consideration of the subject. Thus, it not only provides a solid foundation for those who intend to select optics as a career, but also furnishes an adequate knowledge of the subject, in comprehensive form, for those who intend to specialize in other branches of engineering. Although designed chiefly as a college textbook for students of physics and optometry, it may also be used as a reference work for specialists in the fields of illumination, motion pictures, television, optical instruments manufacture, etc. R. H.

RADIO ENGINEERING, by Frederick Emmons Terman. Published by the McGraw-Hill Book Co., New York, N. Y. 6 x 9 inches, 700 pages, 425 illustrations, cloth. Price, \$5.00.

In these days of pentodes, band-pass tuners, automatic volume control, diode detectors, etc., etc., there is a demand for a textbook which sidesteps the fundamentals just a little and devotes itself to the problems of modern radio design. *Radio Engineering* performs this function admirably.

The fundamentals of radio have been treated in so many different aspects already, that it was with a somewhat prejudiced attitude of boredom that this book was opened. After the first few pages, however, the real purpose of the book became apparent: it brings before the reader a comprehensive treatment of the factors governing the design of modern vacuum tubes, amplifiers, speakers, oscillators, etc., in a manner that makes it difficult to lay the book down. For instance, all derivations of formulae are given in footnotes rather than in the body of the book itself. In this manner the reader is saved the trouble of wading through a lot of mathematics that may not be desired; or, if the reader is mathematically inclined, reference may be made to the footnotes for a more detailed analysis. Algebra is sufficient for most of the derivations, but the calculus is helpful for many, especially those requiring the expansion of a power series. Of particular note is the use of several convenient charts and working rules which are of invaluable assistance to the practical design engineer.

The method of treatment is simple: The fundamental principles of the subject are given briefly, stressing the high-lights; the reader is then launched into a description of the application of the fundamentals, with the problems of modern radio receiver design in mind.

It is recommended, therefore, that the reader acquaint himself with a good knowledge of radio before reading this book, as it is not intended for a beginner in radio or electricity.

A partial list of the contents follows: circuit constants, properties of resonant circuits, fundamental properties of radio circuits, triode amplifiers, oscillators, detectors, special vacuum tubes, modulation, sources of power for the operation of vacuum tubes, transmitters, receivers, antennas, propagation of radio waves, aids to navigation, radio measurements, sound and sound equipment. L. M.

PHOTOCELLS AND THEIR APPLICATION, by V. K. Zworykin, E.E., Ph.D., and E. D. Wilson, Ph.D. Second Edition. Published by John Wiley & Sons, Inc., New York. 331 pages, 5 1/2 by 8 inches, cloth covers. Numerous illustrations. Price, \$3.00.

This is an authoritative and exhaustive work on the photocell, written by two well-known research workers who have specialized in this field. Zworykin is especially noted for his development of the cathode-ray tube for television purposes, and for other notable achievements in the science of photoelectricity.

The book is intended as a general introduction to the "electric eye," and strikes the happy medium of being simple enough for the untrained man and yet not too shallow for the specialist. It makes interesting and instructive reading for the radio man.

Starting with the history of photoelectric effects, the book covers radiant energy, photo-emissive effects, photosensitive films, material and apparatus for making photocells, and cells of the vacuum, gas-filled, photo-conductive and photo-voltaic types. Subsequent chapters deal with the problems of amplification, special light-sensitive devices, the photocell in photometry and colorimetry, the photocell in sound movies, television and facsimile transmission, miscellaneous applications, and photocells in the future. We can recommend this book very highly to all radio men.

PHOTOELECTRIC PHENOMENA, by Hughes and DuBridge. Published by the McGraw-Hill Book Co., New York, N. Y. 6 x 9 inches, 500 pages, 300 illustrations, cloth. Price, \$5.00.

This book is a most complete survey of the field of photoelectricity. It is mathematical, concise, and accurate. For the engineer interested in obtaining a complete analysis of photoelectricity, this book is recommended without any hesitation.

The field of photoelectricity changes so rapidly, that it is almost impossible to attempt to look up all the back references on the subject in order to actually know its present status. This book has been prepared in order to supply a treatment that may be looked upon as authentic. Its completeness is apparent at the outset. Starting with the fundamental laws of photoelectricity, the reader is taken, expertly and smoothly into the photoelectric threshold, energy and spectral distribution of photoelectrons, the selective photoelectric effect, theories of photoelectric emission, ionization of gases and vapors by ultra-violet light, photo-conductivity, photovoltaic effects, etc. Truly an important and much needed contribution to the field of photoelectricity. L. M.

AUTO INTERFERENCE

A very interesting experience with automobile radio receivers has been reported by a number of different Service Men. It seems that in certain cars the sets give forth a great deal of noise of the kind usually due to static. This interference is not caused by the ignition systems, as it persists even with the engine completely shut off and with the car merely coasting under its own momentum.

One man reports that the trouble is most noticeable when the car is driven over dry cement pavements and that it disappears when two of the wheels are allowed to run off the pavement on to the dirt shoulders of the road.

This interference is undoubtedly caused by frictional electricity generated by the rubber tires in contact with the cement pavement, which is a rather good insulator when dry. Since the entire metal body of the car is quite effectively insulated from the ground by the rubber tires, the discharges are quite likely to make themselves felt in a sensitive radio receiver. You undoubtedly have noticed that gasoline tank trucks invariably have a length of iron chain hung from the rear axle, merely dragging along the ground. Its purpose is to prevent an accumulation of static charges, which naturally are very dangerous in a vehicle of this type. That such static discharges can build up to an appreciable extent is well known to owners of automobiles.



"Look to your Resistors!"
has made set owner
and service-man alike
OHIOHM CONSCIOUS

1932 marked the first year that resistors were popularized, 1933 points to greater strides in this direction. The makers of OHIOHMS lead the country in aggressiveness and greater profits for its tradesmen. Keep in pace with this progress by tying up with OHIOHM.

PROTECT-O-PACKING

has been a
protection
to the man
selling OHIOHMS

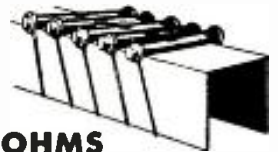

No kinks or bent wire-leads with OHIOHMS far protect-o-packing has made installations easier and quicker—likewise adding to the attractiveness of the kit or display package.

NO Guesswork—
VALUES STAMPED ON
EACH UNIT and
guaranteed CORRECT!

Each OHIOHM has the resistance value stamped thereon. You can't go wrong with an OHIOHM for in addition the resistance value is guaranteed to be correct within 10% tolerance.

Write for the OHIOHM Resistor proposition and also the OHIOHM Spark Suppressor story.

OHIOHMS

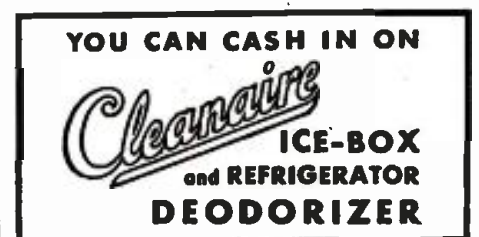

THE OHIO CARBON CO.
12502 BEREA ROAD CLEVELAND, OHIO

OHIOHMS are made in Canada by
C. C. Meredith & Co., Ltd., 639 Bay St., Toronto

BETTER CONDENSERS AT LOWER PRICES



Yes, and we can prove it! Never was such quality offered in condensers. Never such low prices. Because never were such engineering efforts, new materials, novel production methods and rigid inspection placed behind such products. Dubilier—world's largest and oldest condenser specialist—offers you electrolytics, paper, mica, receiving, transmitting, industrial, laboratory and other condensers for the most reliable, longest and most economical service.

free CATALOG

is yours for the asking. Just issued. Covers entire line. Write for your copy today.



DUBILIER CONDENSER CORPORATION
4377 Bronx Blvd., New York

UNIVERSAL 3-PIECE ADJUSTABLE COMBINATION STAND



This full utility, all-purpose, adjustable banquet and floor stand out-sells any stand on the market—three telescoping sections—collapsible for easy transportation—can be extended to full standing height—honest, solid construction—snappily finished in highly polished nickel plate—lowest price in history—only \$10.00 list, including 8 suspension springs.

Universal Microphone Co., Ltd.
424 Warren Lane, Inglewood, Calif., U.S.A.

FREE!

INFINITE VARIETY & VALUES

Here is what you have been waiting for! Every Dealer and Serviceman will find our Catalog replete with values on every type of radio part imaginable. We stock all items catalogued, thus assuring you PROMPT DELIVERY. Send for your copy today.

TRY-MO RADIO CO., INC.
Dept. C3, 85 Cortlandt Street, NEW YORK, N. Y.

Study RADIO in CANADA

A start in Radio Guaranteed or your money back. Course covers Radio, Television, Sound Amplification and Telegraphy. Practical work material supplied. Preparation for Government and Service examinations. Home Study, Day or Evening Classes. Write for booklet.

RADIO COLLEGE of CANADA
Limited

310 Yonge Street Toronto, Canada

Sensitivity **SHURE** Tom Quality

MICROPHONES

SHURE BROTHERS COMPANY

337 WEST MADISON ST. CHICAGO, ILLINOIS

40-WATT AMPLIFIER

(Continued from page 560)

(2) Improved voltage regulation is probably the most important factor, and is only obtainable with perfectly designed power transformers, input filter choke, and mercury vapor rectifier tubes. (The 81 rectifier tubes are poorly fitted for this purpose, as their large internal voltage drop usually amounts to about 65 volts and varies with the current passing through them, while the 88 mercury vapor full-wave rectifier tubes have a corresponding voltage drop of only 16 volts, and are independent of current variations. Besides remaining much cooler in operation, each 88 tube can supply 250 ma. as against 85 ma. for the 81 tube.)

(3) The total power consumption should be kept at a minimum to avoid excessive and expensive damaging heat accumulation, and to avoid the need of larger power supply equipment.

(4) The bias voltage required for the output tubes must be obtained from a power source that is not affected by the large current variations of the output tubes.

(5) All parts should be especially designed for this circuit, and no attempt should be made to employ standard class A, 13 watts output parts. Thus, full constructional details are given for the push-pull input transformer in Fig. 2A, and all circuit constants are given in the schematic diagram, Fig. 2B.

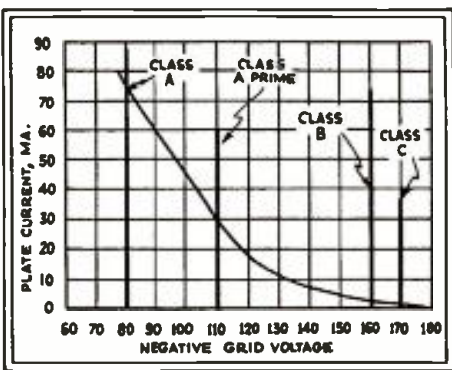
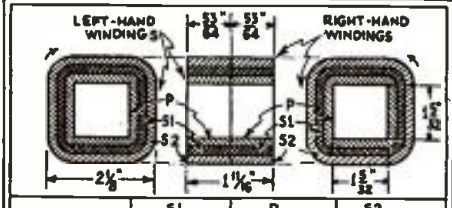

Fig. 1



	S1	P	S2
NO. OF TURNS	2 SECTIONS 740 PER SECTION	2 SECTIONS 110 PER SECTION	2 SECTIONS 814 PER SECTION
TURNS PER LAYER	74 (10 LAYERS)	74 (15 LAYERS)	76 (11 LAYERS)
SIZE OF WIRE	35 ENAMEL	55 ENAMEL	35 ENAMEL

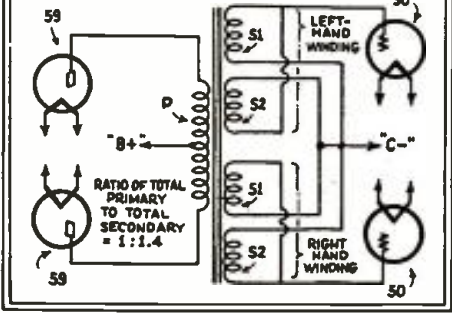

Fig. 2

Figure A is a front view of the "40 Watter," and Fig. B shows the bottom view of same. The placement of all parts is clear, and each item is properly identified. The schematic diagram is given in Fig. 3. Although the first three stages are built in accordance with standard three-stage power amplifier design, it should be noted that the power supply used has a relatively heavy bleeder, R7-R8, from which the operating "C" bias voltage is obtained for type 50 output tubes. This circuit arrangement makes it possible to use two 88 full-wave rectifier tubes, as

(Continued on page 573)



FUNDAMENTAL PRINCIPLES OF RADIO

Radio Simply Explained—Its Origin, Nature and Functions
By LOUIS MARTIN
Prepared with special consideration given to young members in the radio profession, and those who have gained their experience in a haphazard fashion. This radio primer is a handy fundamental aid for "checking up" and systematizing your knowledge of radio. Regardless of how much you know about the subject, you should read this book.

PARTIAL CONTENTS:
Chapter I—Fundamentals of Radio: Electricity, Resistance, Batteries, The Magnetic Circuit, The Magnetic Field, Inductance, Condensers, A.C. Circuits, Propagation of Radio Waves; Chapter II—The Simple Radio Set, Single, Two, and Three-Circuit Tuners, The Battery Set, Vacuum Tubes, Electric Sets, Loud Speakers; Chapter III—Diagrams, How to Read Them; Chapter IV—Amateurs and Broadcast Stations, Talking Pictures, Television.

FORMULAS and RECIPES

For the Practical Man
By S. GERNSBACK
An extremely helpful book showing you how to save money by making in your own home, at a fraction of the regular cost, the hundred and one preparations which you now buy for use at home or business.

PARTIAL CONTENTS:
1. Adhesives; Glues, Cements. 2. Cleansing: Stain Removers, Bleaches. 3. Metal Craft: Coloring, Oxidizing, Pickling, Polishes. 4. Paints: Colors, Stains, Varnishes. 5. Glass-Working: Cutting, Drilling, Boring, Etching, Engraving. 6. Wood-Craft: Fireproofing, Acid-proofing, Waterproofing, Furniture Polishes. 7. Inks: Sympathetic, Invisible, Hectograph. 8. Photography: Developers, Emulsions, Fixers. 9. Antidotes for Poisons, Remedies for Burns and Scalds, Disinfectants. 10. Preparation, Manipulation, Handling, Mixing, Tables of Weights and Measures, Useful Tables.

ELEMENTARY MATHEMATICS

for the Technician and Craftsman
By C. SHAINMARK

This manual has been especially prepared for the man who wishes to acquire a working knowledge of the elementary principles of mathematics. A complete treatment of the subject is given by the author, Mr. C. Shainmark, with special attention to the use of mathematics in Radio and other technical work for those who employ its formulas daily.

PARTIAL CONTENTS:
I—Arithmetic: Addition, Multiplication, Subtraction, Division, How to Use Decimals; II—Fractions, Percentages, Ratio and Proportions; III—Powers and Roots; IV—The Metric System; V—How to Measure Surfaces and Volumes; VI—Mathematics for the Manual and Technical Craftsman; VII—Special Mathematics for the Radio Technician; VIII—Commercial Calculations, Short-cut Arithmetic, Interest Calculation, Discounts; IX—Weights and Measures; X—Useful Tables.

All our books are of uniform size, 8 x 9 inches, and contain 84 pages. The books are printed on strong paper with stiff colored covers.

PRESS GUILD INC., 16 Murray St., New York, N. Y.
ANY TWO BOOKS FOR 85¢
ALL THREE BOOKS FOR \$1.25 (postpaid)

Enclosed find \$..... for which mail me postpaid the following books:
No. 1 No. 2 No. 3
Single copy 50¢ Postpaid

Name

Address

City and State

HOME EXPERIMENTS

DURING the several months in which this series of articles on quasi-optical home experiments have been appearing in *RADIO-CRAFT* magazine, a number of simply built pieces of light-sensitive apparatus have been described and their uses explained. In this month's department we digress for a time to take a look at what is going on about us in the commercial world on the progress and development of light-sensitive equipment.

In the laboratories of the country's leading electrical houses, experiments have been and are being conducted to determine the further commercial uses of this modern Aladdin's lamp, the photocell and its associated apparatus. In looking over the technical bulletins issued by these firms, the editors felt that much of the technical material received was of particular moment to the followers of this department, and for that reason much of it is presented here, in a boiled down fashion, to be sure, but nonetheless instructive and interesting.

Thief Catchers

From the Intellect-A-Ray Corporation comes the technical information concerning three of their latest light-sensitive devices; the relay cell, the sound cell, and the NO Op cell. The first named is used in a most complete burglar alarm system, the second in sound heads of talking picture projectors, and the third is especially designed for use with the 16 mm. home movie outfits so as to provide home talkies.

A most unusual and practical thief catcher system, known as the Intellect-A-Ray Junior, is illustrated in the photograph. The pieces of apparatus shown, when connected together in the manner described in a simple set of directions which accompany each outfit, provides a most efficient burglar alarm system. An invisible ray is generated and projected by the unit No. 2 which is appropriately designed for wall mounting on a swivel joint. This ray generator is composed of a special system of high transmission quality lenses and filters using an incandescent filament and gas tube requiring fifty watts at 110 volts. The ray is projected so as to impinge on the active surface of the relay cell No. 3, which is housed, in actual operation, in the cell mounting, No. 4. If it be required to reflect the invisible ray onto the relay cell in other than a straight line then the special ray mirror, No. 5, is used for the purpose. The lock-box, No. 1, the brains of the installation, is the terminus of the various connecting cables and also contains the control mechanism.

Light-Beam Narrowcasting

From the News Bureau of the General Electric Company at Schenectady, New York, comes the following release concerning the successful transmission of the human voice on a beam of light over a distance of twenty-two miles.

"The human voice has been carried 22 miles on a beam of light; the previous record was about six miles. The successful spanning of the much greater distance was accomplished on the evening of November 22, 1932, when Heywood Broun, newspaper columnist and radio speaker, stood before a microphone in one of the buildings of the General Electric Company at Schenectady. Beside him was a 24-inch reflector, concentrating into a narrow beam the light from an electric arc. The light appeared constant but in reality it was very rapidly varying in intensity, being modulated by the voice of Mr. Broun. Through a closed window the light beam was pointed northward to the foothills of the Adirondacks.

"High up on a hillside near Lake Desolation, at a crow-flight distance of more than 22 miles were John Bellamy Taylor and other scientists of G.E. They had a 36-inch reflector, at the focus of which was mounted a light-sensitive phototube. Accurate adjustments of the beacon and receiver established the contact. The phototube equipment, responding to the light variations changed the impulses into electrical waves and then into sound.

"The principle used in this broadcasting was the same as that brought into play last spring on the occasion of the visit of the U. S. Navy dirigible Los Angeles to Schenectady. At that time the dirigible, with Mr. Taylor aboard, circled the roof of one of the laboratory buildings

and kept up constant communication by means of a similar but less powerful beam of light."

Check and Double Check

One of the simplest uses of the photocell in commercial work is in the preselecting and counting of manufactured objects in the production department of a manufacturing concern. Interruption of a light beam focused on a photocell by the progress of the manufactured object along a conveyor enables one to keep tab on the products as they are turned out.

Seeing Through Fog

Within recent months at least two new inventions in which the principles of use of light-sensitive apparatus have been applied have been announced to the public. Both were somewhat alike although used in different ways for different purposes.

It is a well known fact that mariners on the ocean obtain their bearings by "shooting the sun" with a sextant and then mathematically computing their exact position in terms of latitude and longitude. On overcast or foggy days or during storms, when the face of the sun is obscured, they are out of luck, so to speak, since they are unable to "shoot the sun." Or so it would seem until science stepped in and surmounted this very serious difficulty.

Although at times invisible to the human eye, the sun's rays, to a certain extent, do penetrate the intervening layers of clouds and atmosphere. So much so, in fact, that on the foggiest of days an electrical sextant, utilizing the properties of the photoelectric cell, when aimed in the general direction of the sun will respond immediately; and, by means of appropriate meters it is possible to ascertain exactly when the electrical sextant is accurately aimed at the sun by the maximum deflection of the meter indicator.

The second practical use to which the phototube has been put is in the detection and location of airports obscured from a plane in flight by reason of the existence of fog. When the plane, on which is mounted a light sensitive apparatus, enters the influence of a beam of light projected upward from a neon beacon, the pilot is made aware of his proximity to the landing field and can come in for a landing.

If you have any particularly good photographs of the light sensitive apparatus you have constructed and wish to let others know about it, send them to this department, with a short description of the equipment. If you desire to have such photos returned to you be sure to include the necessary stamped addressed envelope.



Photograph of the Intellect-A-Ray apparatus described by the author. The unit is shown divided into five different parts, as follows: (1) the lock box, brains of the equipment, is the terminus of the various connecting equipment and also contains the control apparatus; (2) the projector for the invisible ray; (3) the photoelectric cell proper, upon which the invisible ray is impinged; (4) housing of the Intellect-A-Ray, shown in (3); (5) a special mirror used only when the light beam cannot be focused directly onto the cell.



Make More Money WITH THIS BETTER TESTER!

\$33.00
NET TO DEALERS
List. \$55.00

Readrite

Tester No. 1000

NOW you can test automatic volume control, diode, resistance coupling, phase shifting, automatic noise suppression, automatic tone control and the many variations of these circuits. Until this new, exclusively Readrite method appeared, it was necessary to pick your way through the circuits by the laborious and confusing prod contact method. The fact that voltage tests are inadequate and that they lead to gross errors compels testing of modern set circuits by the *resistance method*.

Quoted At a Popular Price

All parts are carefully assembled in a strong, fine leatherette case with a removable cover. Handy instructions on the panel, show in detail the circuit and tube socket connections for each position of the selector switch.

This precision tester is quoted at \$33.00 net to dealers—a price so low that you can afford to own it immediately. Besides, it will do work that you would not expect from more expensive units.

If your jobber cannot supply you, we will ship the No. 1000 Tester directly to you—when remittance accompanies your order at dealer's net price of \$33.00.

READRITE METER WORKS
44 College Ave., Bluffton, Ohio

MAIL COUPON NOW

Readrite Meter Works,
44 College Ave., Bluffton, Ohio

Gentlemen:

Please send me information about Readrite No. 1000 Resistance, Continuity and Capacity Tester. Also catalog of other servicing instruments.

Name.....

Street Address.....

City..... State.....

RCA INSTITUTES

(A Radio Corporation of America Subsidiary)

Resident Schools

at

NEW YORK and CHICAGO

Technical training courses in radio and associated electronic arts.

PRACTICAL RADIO ENGINEERING.

SOUND TECHNICIANS' COURSE embracing Television Fundamentals, Public Address Systems, Recording, Sound Motion Pictures. Electronic Tube Applications.

BROADCAST TRANSMISSION in all its aspects including Studio and Control Room Operation.

RADIO SERVICING including Broadcast Receivers, Home Talkies, Rudiments of Television.

RADIO OPERATING—Aircraft, Marine and Police Alarm Systems.

EXTENSION COURSES for HOME STUDY under new "no obligation" plan, with privilege upon graduation of 2 weeks' intensive practical training without charge at either Resident School.

Mail Coupon for Illustrated Catalog.

RCA Institutes, Inc.,
Dept. RT-3
New York School and Headquarters:
75 Varick Street, New York, N. Y.
Chicago School:
1154 Merchandise Mart, Chicago, Ill.

Radio Corporation of America Subsidiary

Please send with no obligation to me:

() Full information on the New General Course in Radio.

() Illustrated catalog and information about specialized resident school courses in radio and allied arts.

() Information about extension course for study at home, together with illustrated catalog.

Name..... Age.....
Address.....
City..... State.....

D. X. SPECIAL

CUT OUT INTERFERING STATIONS & ENJOY FOREIGN PROGRAMS

Just Fix a Pix in the aerial terminal and increase the range and selectivity—permits knife-edge tuning—two million European "users." Once "Pixed" you're fixed to bring in Distant concerts.



FIX A PIX IN YOUR AERIAL

POSTAL RADIO
133-35 Liberty St., Dept. C., N. Y. City

Modern Radio Reception
Is Noise-Free
Even at Full Volume

Different Noise Reducing Systems
Are Required for Broadcast
And Short Wave Use

A Full Range of Products
For All Waves
Can Be Had
ONLY
From the
LYNCH MANUFACTURING CO.
711A General Motors Bldg., New York, N. Y.

FREE Booklet on Request

THE SERVICE CHARGE

In "The Federated Microphone" we find the following interesting information which is obtainable as the result of a survey.

This survey shows that 93 per cent make a minimum charge for inspection calls ranging from 50c to \$2.50, the average being \$1.25. In 88 per cent of the cases, the actual service work is based on a fixed charge per hour.

Average, fixed charges for replacement of major parts, labor, material, are as follows:

Part	Charge	Range
Power transformer	\$11	\$4 to \$22
Filter Condenser	8	3 to 22
Volume control	4	1 to 10
Voltage divider	4	1 to 8
Audio transformer	5	1 to 10
By-pass condenser	3	1 to 7

Methods of charging vary, but most service organizations appear to work on a time basis, charging from \$1 to \$2.50 per hour plus the list price of necessary parts. Where parts bear no list price, it seems customary to add from 30 per cent to 50 per cent when billing the customer. Several shops have established flat rate charges for labor on common repairs. Some admit that they charge whatever they think the traffic will bear.

A surprising number of Service Men make all repairs in their shops. Fully 61 per cent state that they invariably remove the chassis from the home wherever it is necessary to install a new part. About 24 per cent repair either in the home or in the shop depending upon the nature of the "grief." Three per cent work exclusively in the home.

Eighty-eight per cent of the shops surveyed charge full list price for replacement tubes. And 81 per cent make some attempt to sell such accessories as line filter, antenna eliminators, tone controls, etc., when in the field. Where sets are over two years old, and where service charges are considered high in proportion to the original cost of the equipment or present worth, 76 per cent advise the purchase of new models. Twenty-four per cent, on the other hand, specialize in service only, and make no sales recommendations to the service customer unless specifically asked.

KONAL FILAMENTS

Demand for an alloy which retains useful strength at higher temperatures led to the development of Konal, according to Howard Scott of the Westinghouse Research Laboratories. Konal is a nickel base alloy, consisting, for example, of about 18 per cent cobalt, 6 per cent iron and 2.5 per cent titanium. When aged after quenching, it hardens to approximately 300 Brinell. When so treated it has a tensile strength of 75,000 lbs. sq. in., with an elongation of more than 20 per cent at 600° C.

One virtue of this alloy resides in the fact that its use as a core for oxide-coated emissive filaments enhances the electron transmission so that lower filament temperatures can be used. On the basis of this ability it has successfully replaced platinum alloy as the filament material in many radio tubes, making them a low priced commodity.

How to build an up-to-the-minute Tube Tester

Converting RCA and Atwater Kent Receivers

Point-to-Point capacity testing

Coming in future issues of Radio-Craft

CLASSIFIED ADVERTISEMENTS

Advertisements in this section are inserted at the cost of ten cents per word for each insertion—name, initials and address each count as one word. Cash should accompany all classified advertisements unless placed by a recognized advertising agency. No less than ten words are accepted. Advertising for the April, 1933, issue should be received not later than February 9th.

CHEMISTRY

BECOME A TRAINED CHEMIST. Thousands of opportunities—fascinating career. Learn at home. Complete experimental laboratory outfit given. Write for big free book. Chemical Institute, 19 Park Place, Dept. RC, New York.

DOGS

BEAUTIFUL Registered bull pupa, \$15. Bull-dogs. 501-RC, Rockwood, Dallas, Texas.

INVENTORS

PATENTS—SMALL IDEAS may have large commercial possibilities. Write immediately for free book, "How to Obtain a Patent" and "Record of Invention" form. Delays are dangerous in patent matters. Free information on how to proceed. Clarence A. O'Brien, 533-B Adams Building, Washington, D. C.

MISCELLANEOUS

CABINETS, GRANDFATHER CLOCK style, 5 ft. high, walnut veneer, \$3.50. Midget cabinets \$1.25. All brand new, limited quantity. Send money, or dollar deposit for C. O. D.'s Don R. Stevenson Co., 161 Champlain St., Rochester, N. Y.

RADIO

TRANSFORMERS REWOUND, varnished, baked, guaranteed, reasonable cost. SPEAKER REPAIRING, magnetic \$2.00-\$2.50; dynamic, voice coils, fields, etc., reasonable charges. Clark Bros. Radio Co., Albia, Iowa.

GUARANTEED "Pocket Radio," \$2.00. Catalog, 10c. Neil Tasker, Shamokin, Pa.

MAGNETIC Speakers adjusted, coils rewound, \$1.25. Radio Service, Flora, Indiana.

REPAIRING, rewinding, phono and fractional horsepower motors. Deemer, Elysburg, Penna.

DRUM DIAL CABLES—Special Low Price: Majestic, Bosch, and any similar cable, 8c each; DIAL WIRE—Heavy, 2c per foot; Light, 1½c per foot; Braided, 1c per foot. Send for samples. PEERLESS RADIO PARTS CO., Box 264, WILKES-BARRE, PENNSYLVANIA.

In ST. LOUIS

THE AMERICAN HOTEL
275 ROOMS WITH BATH
\$2.00 UP

THE ANNEX
226 ROOMS WITH BATH
\$1.50 UP

The AMERICAN HOTEL MARKET AT SEVENTH

The AMERICAN ANNEX MARKET AT SIXTH

Our food has made our Reputation
COFFEE SHOP OPEN UNTIL MIDNIGHT

COBALT ALLOY FILAMENTS

A new type filament for practical two-volt battery tubes, and for future application to other types of tubes, is announced by the Engineering Department of the DeForest Radio Company. This cobalt alloy filament is said to overcome the handicaps heretofore experienced with the 30, 31, and 32 types of tubes in which a finely drawn nickel filament is employed. With a diameter of .001-inch, the usual nickel filament provides uncertain emission, is subject to premature burn-outs, and makes for a short-lived tube.

The cobalt alloy filament developed by DeForest engineers has a much greater hot tensile strength. Furthermore, the increased diameter for a given resistance makes for maximum efficiency of emission. A relative comparison between the nickel filament and the cobalt alloy filament is as follows:

	Ni Fil.	Co Fil.	In- crease
Weight in milligrams per 100 millimeters.....	9	15	75 %
Diameter	10	13	33 %
Area	25	43	70 %
Tensile Cold Strength.....	1	4	300 %

The 30, 31, and 32 tubes produced with the new filament have a service life consistently over 1,000 hours. The new filament makes for a tube one-third as microphonic as when the usual nickel wire is employed. The cobalt alloy filament is stronger, easier to handle, and the tension is more accurately secured, making for greater precision in stem mounting. The operating temperature is the same as for nickel.

The cobalt alloy filament offers a promising field for development because of its low thermal emission. It is entirely probable that the development work on this filament will be extended to other types of tubes by DeForest engineers.

A.C. AND D.C. RESISTANCE COMPARISONS

In certain applications in a radio set it is highly important that the resistance should be independent of frequency. For example, a 1 megohm unit which may be employed as a grid leak between the last R.F. stage and the detector tube should retain its resistance value at radio frequencies, for otherwise the amplification may be materially altered. In most resistors, particularly those employing a large mass of resistive material, the resistance value varies greatly on D.C. and A.C. at different frequencies due to the skin effect of surface conduction of A.C. of higher frequencies. A resistor employing a thin resistive coating on an insulator base, such as the metallized resistor, is free from any marked variation between D.C. and A.C., since the conducting medium is practically the same under any condition.

On actual test, the usual solid conductor type of resistor shows a wide difference in resistance between D.C. and A.C. of varying frequencies. For example, a 1 megohm unit when measured at 750 K.C. shows a resistance of anywhere from 1/2 megohm to 300,000 ohms.

In the latest type of metallized resistor employing the newly developed "K" filament, the resistance variation is extremely small for D.C. and radio-frequency applications. If there is any difference at all, the radio frequency resistance is but slightly higher than the D.C. resistance, and therefore the amplification might rise rather than fall, although only by a negligible amount.

It is therefore possible for definite resistance values to be obtained in a radio circuit irrespective of whether D.C. or A.C. of different frequencies is employed.

● GENERAL DUNWOODY DIES ●

Brig. Gen. Henry Harrison Chase Dunwoody, former chief signal officer of the United States Army, died at Interlaken, near Ithaca, N. Y., January 1, at the age of 90.

For 26 years he was in charge of the forecasting division of the weather bureau. A radio research engineer, he is best remembered in radio circles as the inventor of the crystal detector.



Why TRUVOLTS are PREFERRED

- 1—Patented construction permits air-cooling, larger wire, greater radiation and longer life.
- 2—Spiral winding permits better electrical contact.
- 3—Sliding clips permit accurate adjustment. 1,000 volt insulation.
- 4—Full-length fibre guard prevents injury from contact with tools or hands.

Replacement VOLUME CONTROLS ALUMINUM Shafts—Snap-on SWITCH

Long ALUMINUM shafts, easily cut to desired length. Standard end cover may be instantly replaced by power-switch assembly, without disturbing control connections. Two new features, which save service time, labor and money.

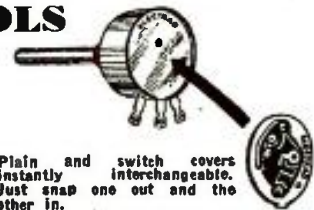

Plain and switch covers instantly interchangeable. Just snap one out and the other in.

Ready March 1st—New HAND BOOK

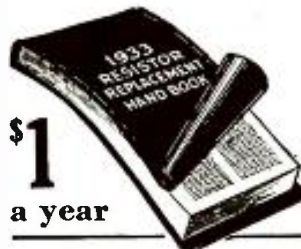

\$1 a year

Although the 1932 ELECTRAD Hand Book was considered the last word by its more than 10,000 users—the new 1933 edition is BIGGER, BETTER, MORE COMPREHENSIVE. It lists in easy readable form, full data on all resistors (including carbons) and volume controls—indispensable information for the busy service man. The \$1 subscription includes three supplements, as issued during the year. Send your dollar NOW!

Write Dept. RC-3 for
New General Catalog

175 Varick St., New York, N.Y.
ELECTRAD

PATENTS TRADE MARKS COPYRIGHTS

Consult us about how to protect your ideas. Send today for our FREE book—"How to Obtain a Patent" and FREE "Record of Invention" blank. We have successfully served thousands of inventors. Highest references—prompt service—reasonable charges—deferred payments.

VICTOR J. EVANS & CO.

Registered Patent Attorneys—Established 1898
650CC Victor Building, Washington, D. C.



TRICKS WITH ELECTRICITY

Make things spin, jump, kick, shoot, shock, flash, buzz, mystify—all by electricity. Make lights obey voice, window noelities, trick lights, floating rings, spirit rapping—all kinds amusing, practical devices. Book tells how to do 200 stunts with 110 volts A.C. Postpaid \$1. Experimenters catalog free.
Cutting & Sons 33 L St. Campbell, Calif.

TAU-REX CONVERTS

Any D. C. Milliammeter Into a Sensitive A. C. Meter A New Copper-Oxide Rectifier—MADE FOR METERS—Size 4 in. by 1/2 in. FULLY GUARANTEED.

Can be used in set testers, analyzers and for many other purposes. See Jack Grand's article, "The Specialty Tester" in the November issue of Radio-Craft.

Tau-Rex will be shipped postpaid promptly upon receipt of \$3 (check or money order)—or order C. O. D. and pay postman. Furnished Complete with Diagrams and Instructions

Leo Taussig, 3245 37th St., Long Island City, N. Y.

Get Started In Radio

Resident courses in

RADIO SERVICING RADIO OPERATING

Practical instruction on different types of circuits including testing with analyzer, ohmmeter and oscillator. Material supplied. Prepares for government and service examinations. Write for booklet "Opportunities in Radio"

Educational Department
WEST SIDE Y M C A
7 West 63rd Street, New York

A NEW REVOLUTIONARY STATIC AND AERIAL ELIMINATOR



Illustration shows eliminator with leads and plug attachments

Here, at last, is a device made to eliminate, completely, man-made static, the type of noises that so often causes discomfort to radio listeners. Quickly it reduces to a minimum, disturbances caused by electrical appliances, and brings in reception with excellent results. With the DUMONT STATIC AND AERIAL ELIMINATOR, the possibility of lightning striking the receiver is impossible—aerials are entirely eliminated.

Service Men and Dealers add this money-making radio device to your line—install the Dumont Eliminator in every home where you call to service the set. A lifetime of service is guaranteed for every Dumont Eliminator. Write for full details today—just

Clip—Mail Coupon Today!

DUMONT ELECTRIC CO., Inc., Dept. RC
453 Broome Street, New York, N. Y.

Enclosed herewith you will find check or money order for \$2.10 for which you are to send me, postage prepaid, one Dumont Static and Aerial Eliminator, with complete instructions for operating.

Name
Address
City..... State.....

2

USEFUL RADIO BOOKS WHICH EVERY EXPERIMENTER NEEDS IN HIS LIBRARY

There is not a radio man in the field, experimenter, service man or dealer, who will not want to read these two books. Right up to the minute with outstanding developments in short-wave radio—new methods and apparatus for quickly learning how to become a practical radio operator. Each book is authoritative, completely illustrated and not too highly technical. The text is easily and quickly grasped.

How to Become An Amateur Radio Operator

We chose Lieut. Myron P. Eddy to write this book because his long years of experience in the amateur field have made him pre-eminent in this line. For many years he was instructor of radio telegraphy at the R.C.A. Institutes. He is a member of the I.R.E. (Institute of Radio Engineers), also the Veteran Wireless Operators' Association. If you intend to become a licensed code operator, if you wish to take up phone work eventually, if you wish to prepare yourself for this important subject—this is the book you must get.

Partial List of Contents

Ways of learning the code. A system of sending and receiving with necessary drill words is supplied so that you may work with approved methods. Concise, authoritative definitions of radio terms, units and laws, brief descriptions of commonly used pieces of radio equipment. This chapter gives the working terminology of the radio operator. Graphic symbols are used to indicate the various parts of radio circuits. General radio theory particularly as it applies to the beginner. The electron theory is briefly given, then waves—their creation, propagation and reception. Fundamental laws of electric circuits, particularly those used in radio, are explained and typical basic circuits are analyzed. Descriptions of modern receivers that are being used with success by amateurs. You are told how to build and operate these sets. Amateur transmitters. Diagrams with specifications are furnished so construction is made easy. Power equipment that may be used with transmitters and receivers, rectifiers, filters, batteries, etc. Regulations that apply to amateur operators; the International "Q" signals, etc.

How to Build and Operate Short Wave Receivers

is the best and most up-to-date book on the subject. It is edited and prepared by the editors of SHORT-WAVE CRAFT, and contains a wealth of material on the building and operation, not only of typical short-wave receivers, but short wave converters as well.

Dozens of short-wave sets are found in this book, which contains hundreds of illustrations; actual photographs of sets built, hook-ups and diagrams galore.

The book comes with a heavy colored cover, and is printed throughout on first-class paper. No expense has been spared to make this the outstanding volume of its kind. The book measures 7½x10 inches.

This book is sold only at such a ridiculously low price because it is our aim to put this valuable work into the hands of every short-wave enthusiast.

We know that if you are at all interested in short waves you will not wish to do without this book. It is a most important and timely new radio publication.

**Each Book Contains Over 150 Illustrations
72 Pages 7 x 10 inches Not Sold on Newsstands**

Mail Coupon at Left for Books!



50¢
EACH

SHORT WAVE CRAFT
96-98 Park Place,
New York, N. Y.

Gentlemen: I enclose herewith \$..... for which please send me, prepaid a copy of the book checked.

- () HOW TO BUILD AND OPERATE SHORT-WAVE RECEIVERS—50c.
() HOW TO BECOME AN AMATEUR RADIO OPERATOR—50c.

Send money order, check, cash or new U. S. stamps. Register letter if it contains stamps or currency.

Name

Address

City State

REFRIGERATORS!

In your community there are dozens of electric refrigerators to be serviced. Many need immediate repairs which can be made quickly with little expense—and which you can repair with the aid of this authoritative Refrigeration Service Manual. Make many extra dollars, together with other repair work. Electric refrigeration servicing is a well-paying business—start in your spare time—before long you will devote full time to it. One or two jobs pays the small cost of the OFFICIAL REFRIGERATION SERVICE MANUAL.

96 Pages of New Data Have Been Added to the OFFICIAL REFRIGERATION SERVICE MANUAL

To bring this useful service manual right up-to-date, Mr. L. K. Wright, the editor of the OFFICIAL REFRIGERATION SERVICE MANUAL, has added a wealth of material on new electric refrigerators, and older models as well. As usual every refrigerator has been accurately described from the viewpoint of servicing—diagrams to illustrate the essential parts, so simplified that repairs can easily be made. The addition of these new pages will not increase the cost of the book to those who order their copy now.

Here Are Some of The Important Chapters:

- Introduction to the Refrigeration Servicing Business.
- History of Refrigeration.
- Fundamentals of Refrigeration.
- Description of All Known Types of Refrigeration.
- Motors.
- Trouble Shooting.
- Units, Parts, Valves and Automatic Equipment.
- Makes and Specifications of Units.
- Manufacturers of Cabinets.
- Refrigerants and Automatic Equipment and Many Other Important Chapters.

**Over 1,200 DIAGRAMS
450 PAGES
Flexible Looseleaf Binder
Complete Service Data**

Mail Coupon Today!

GERNSBACK PUBLICATIONS, Inc. RC-333
96-98 Park Place, New York, N. Y.

I enclose herewith my remittance for \$5.00 (check, stamps or Money Order accepted) for which you are to send me, postage prepaid, one copy of the OFFICIAL REFRIGERATION SERVICE MANUAL, together with the extra 96 pages of new material at no extra cost.

Name

Address

City State

Here's a book every Radio Man will refer to dozens of times every day—

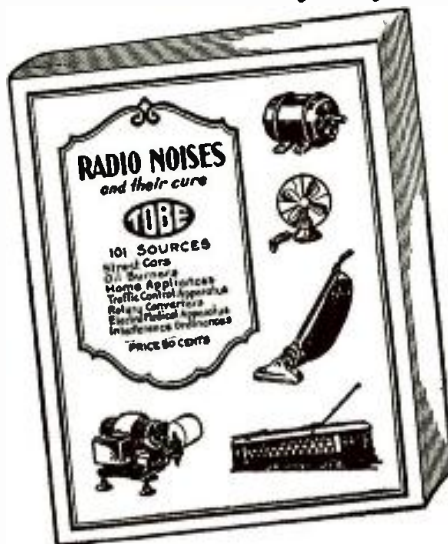

A Valuable RADIO BOOK!

HERE is one radio book that answers every conceivable question on interference. It contains 76 pages, 8½x11 inches, chock full with wiring diagrams, drawings and photographs showing where interference originates—how it is distributed, and how to eliminate it. This is a wealth of information needed by every radio listener, dealer and Service Man.

Send fifty cents in stamps or check for this book.

RADIO-CRAFT MAGAZINE
96-98 Park Place New York, N. Y.

RADIO IN TECHNOCRACY

Present conditions compel the thinking technician to visualize the future in order that he may best apply his knowledge in the "better times" ahead. Consequently, the following remarks by Gen. James G. Harbord, during his talk before the engineering society, are of more than ordinary interest.

"Nothing has brought within the reach of so many, so varied and wide-sweeping a realm for adventure as swings open to the magic of the wireless," General Harbord declared.

"Radio is most democratic, (he continued). It brings joy alike to the classes and the masses; to the youngster and the oldster; to the serious-minded and the frivolous. The ether is neither selective nor critical.

"What will electricity be doing to man in twenty years from now? The future possibilities of electricity as expressed in terms of radio communication, television, broadcast programs, photo and fac-simile transmission, sound pictures, sound recording and reproducing, and many other variations in these related marvels of our time, are perhaps less of interest as mere achievements than in their effect upon our everyday lives, our habits, our customs, our laws—and perhaps our morals.

"One needs little imagination as to the actual devices by which such a change may be brought about, for they are already in existence or being hatched in the laboratories. The imagination may assist in a forward glance as to their effects in twenty years from now. As we now have the combination radio and phonograph, we shall eventually have a combined radio, phonograph, sound picture projector, fac-simile and television receiver, a sound recorder, and an electrical piano or other purely electrical musical instrument. Living rooms will soon be built with an eye,—or perhaps I should say, an ear to acoustics. Interior decoration will provide an effective but unobtrusive screen for the picture panelled in the wall, if this is desired. Architects, in designing homes, will specify the wiring to receive and carry the necessary currents. Already modern apartment houses in New York City are built with aerials in the roof, and plug-in connections in every room. The social effect of these agencies will equal the change wrought in the western world by the printing press, the reformation and the invention of the steam engine.

"Electrical science has discovered and is rapidly perfecting new musical instruments which will arouse the interest and challenge the talents of countless thousands who no longer attempt the violin and the piano. The novelty of these new instruments will compel attention. Their greater range of frequencies and the variety of tone characteristics which may be evoked will practically put the player in command of a whole symphony orchestra in the one instrument. The degree of manual skill required will be somewhat less and this may enlist deserters from the older forms, blasé and indifferent as they are, to much that attracted former generations. The production of creditable musical performance from one or more of the wonderful new instruments may yet become fashionable.

"Radio in none of these forms requires preliminary education for its enjoyment. These devices destined to play so important a part in our lives will yet move multitudes, beyond the sea, who could not read a newspaper if they saw one. The dead level monotony of countless Asiatic villages will be relieved by these new agencies. The psychological gulf between the Occident and the Orient will be spanned by the electrical impulse. Whatever the East can translate into the spoken word will be heard in the west."

LAW OFFICE "TALKIES"

Noting the rapid strides which have been made in sound recording, a phase of radio development which has received considerable impetus through the publication of many interesting technical articles in RADIO-CRAFT, we cannot help but recall part of a broadcast by O. H. Caldwell. In view of the increasing interest in sound-film records, such as wills and testaments, the Service Man will soon find himself hurrying out on a new type of service call, since it is possible that "every lawyer's office of the future may be equipped with a sound-picture camera, just as every modern doctor's and dentist's office has an X-ray machine."

Announcing the

BULLETIN

THE BIGGEST NEWS-MAGAZINE IN
THE RADIO INDUSTRY

Issued Monthly for Radio
Service Men

This new magazine is filled with interesting service information; plans of the Association; Service Men's experiences; answers to inquiries about servicing; hints on making extra money in the servicing field, in short, it is a magazine written for and by members of the O. R. S. M. A. It is the voice of the Association in which the problems and suggestions of the individual members are presented for review and discussion among the fraternity. It is a magazine for, of and by the Service Man, edited by the staff of RADIO-CRAFT Magazine, sponsors of the OFFICIAL RADIO SERVICE MEN'S ASSOCIATION.

In appearance this BULLETIN is made up in the style and size of a tabloid newspaper. It contains up-to-the-minute service information. A partial contents of the first issue is found below:

Editorial:—The purpose of the O. R. S. M. A. BULLETIN.
Messages from Service Managers of large Radio Set manufacturers to O. R. S. M. A. members.
Servicing experiences—unusual service cases and their method of handling.
Descriptions of service equipment—by members.
What the Service Man should charge—various angles of this vital question.
A sermon to set owners—Beginning the War on free service "Gyps."
The Service Man's Own Forum—Letters on all subjects pertaining to the Association
Electrifying and Modernizing old receivers as a source of income to the Service Man.
Making Money at Servicing—the ways in which established Service Organizations advertise and otherwise extend their sources of income.
The Question Box—questions and answers of servicing, questions of general interest.
Employment Service—ads inserted by members looking for employment and companies looking for men.

Subscription Rates for the O. R. S. M. A. BULLETIN

O. R. S. M. A. Members		Non-Members
50c	one year	\$1.00
\$1.00	two years	\$1.75
\$1.50	three years	\$2.50
\$2.00	four years	\$3.00
\$2.50	five years	\$3.75

Price of Single Copy 10c

Subscription Blank

Executive Secretary O. R. S. M. A.,
98 Park Place, New York, N. Y.

Enclosed find my remittance of \$..... for which please enter my subscription to your BULLETIN for years.

I am a member of The Association and my Membership Certificate number is.....

I am not a member, but would like to receive your application blank to join the O. R. S. M. A. (no fees—no dues to be paid by me).

Name

Address

City..... State..... "A"

AUTO-MOTIVE RADIO DATA

The following interesting information has been compiled by Magnavox Company Ltd., makers of automotive radio reproducers: careful consideration of this information should thoroughly squelch the cry of those who insist that there is no business to be had in the radio field and who pick on the "saturation point" as a couple of handy words with which to end their arguments.

Dealing in round figures, states the report, there are 25 million passenger cars in this country. It is generally agreed that there are about a half million auto radio sets in use. On that basis this market is 2% saturated. For every two cars with radio there are ninety-eight without.

The sale of household radio receivers is based upon 27 million families, which indicates the importance of the automobile market. Perhaps some of us haven't given as much thought to the potentialities in this field as it deserves. Each successive year shows an increase in auto radio sales over the preceding, and 1933 will not be an exception. Think it over.

Operating conditions of auto radio make rugged construction one of the most vital factors in design. Auto radio sets made today are in every way far advanced over the first ones. (Magnavox has helped in pioneering this field with a dynamic speaker that "stays put". It must have good tone, be sturdy and rugged, dust-proof, and quickly and easily installed.)

TEMPLE RADIO SETS

Editor, RADIO-CRAFT

Dear Sir:

I am writing you relative to the service manual on the Temple Radio.

Temple Radio, prior to the time they were forced into bankruptcy, made only two models of electric sets one using 2-224's, 4-227's, 2-245's and 1-280; the other uses 4-227's, 2-245's and 1-280. These sets were both tuned radio-frequency circuits.

When Temple was sold to the new company composed of Len Welling of New York, Wexler of New York and Izenstark of Chicago, together with others, the Temple set became a trade name only, and during the time they sold the Temple they were made with Columbia chassis or any chassis that was handy to put into a cabinet and sold under the name of Temple.

At the present time Transformer Corporation of America, Keeler Ave. and Ogden here in Chicago, are making a Temple set for a holding company in New York, so the set you have in question is either a Columbia, or a what have you, or possibly a Clarion.

We are very happy for this opportunity of giving you any information that we may be able to offer and will be happy to help you at any time on problems of Temple.

Yours truly,

L. BOLDEN AND J. STAUFFENBERG.

Temple Radio Service Station, 2515 West 59th Street, Chicago, Illinois.

BRUNSWICK AND BREMER-TULLY

Of special interest to all radio Service Men and also to many dealers and distributors, is the announcement regarding the establishment of a national headquarters in New York City for Bremer-Tully radio parts and Brunswick radio and phonograph replacement parts and service.

Hereafter, these parts can be obtained from the Brodco Radio Corporation, 142 Liberty Street, New York, N. Y. This concern has been organized to act as an authorized central source of genuine replacement parts for these two makes of receivers, and, also, to perform actual servicing in instances where highly specialized aid is imperative.

Servicing and replacing activities, formerly handled exclusively through the Brunswick service department at Muskegon, Michigan, will henceforth be transferred to the New York offices of the Brodco Radio Corporation. Brunswick has turned over the entire factory replacement parts inventory to the new organization, including parts for all phonograph models, for Brunswick Radiola and Panatropé Radiola models, for all Bremer-Tully models, for all instruments incorporating RCA units and for all Brunswick radio receivers, with the exception of the "D" and "E" models.



—when
Centralab Quality costs so little?

Use Centralab resistors in your replacement jobs . . . they cost so little more that they put to shame the usual "bargain type" products. Centralab products are baptized in fire at 2700 degrees to insure permanent, perfect performance. Play safe . . . use only CENTRALAB Resistors.

10 fixed resistors—in carton—(choice of values) list at \$2.50, your price, special. **\$1.25**

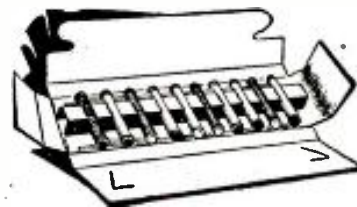

Centralab
CENTRAL RADIO LABORATORIES
930 E. Keefe Ave. Milwaukee, Wis.

BACK ISSUES of RADIO-CRAFT can be had at the price of 25c each. Address RADIO-CRAFT, 98 Park Place, New York City.

Voltage and Resistance Measurements

95% of radio-set troubles can be located quickly and accurately with the



SHALLCROSS
No. 681
Quick-Change
Volt-Ohmmeter

10 - 100 - 500 - 1000 volts
1 ohm to 3 megohms

This instrument is very easy to build.

The important parts required are a 1-milliamperé D.C. meter and the SHALLCROSS Resistor Kit No. 681.

Send 6c in stamps for Bulletin 681-P, describing the service man's most useful test instrument.

Shallcross Mfg. Company
ELECTRICAL SPECIALTIES
700 PARKER AVENUE
Collingdale, Pa.

SILVERTONE MODEL III

Abnormal hum in the Silvertone Model III receiver, a Sears-Roebuck product, usually may be traced to the three electrolytic condensers in the power supply unit; like an electric light bulb, they screw into sockets, and it is the power contact of the spring at the bottom of the socket which causes the condensers to become ineffective.

WIRED RADIO

The largest number of subscribers to "wire radio" is in Holland, with a list containing 170,000 names, states a short item in "Radio-Television Retailer and Jobber." In Europe the public telephone lines are usually employed as the carriers, and the systems are frequently tied in with the space broadcasting programs. That is, the "wire radio" stations pick up the broadcast programs and relay them over the wires to the subscribers.

In the United States it is proposed to use the power lines as carriers, and the system will be worked in competition with space broadcasters. In order to provide adequate service, it is necessary for the sponsoring company first to acquire patent rights for devices used and then to obtain dependable sources of broadcast material.

RADIO AS A SOCIAL FORCE

The influence of radio, as a social force, has become most pronounced in the linking up of all human activities instantaneously. Except for the barrier of language it is now possible for human beings in all parts of the earth to learn of great events almost as soon as they occur and to respond to them instantaneously.

This was marked very well in the nomination

of Franklin Roosevelt as president on the Democratic ticket last summer. The whole country, at least, was able to follow the balloting from the moment it started; it knew, as soon as the delegates in the hall did, that Roosevelt had been nominated; it was as well posted as the delegates on the dramatic trip by Roosevelt to the convention hall by plane; it was able to follow closely the reactions of the delegates as Roosevelt addressed them. The country becomes a living breathing organism responding at once to world events.

How different this is from events in colonial days when days were necessary before a candidate knew of his nomination or election. The time lag then must have been terrific. Even the telegraph did not remedy this entirely, because people in rural sections still had to wait until news was telegraphed to newspapers, the papers were printed and sent to subscribers.

The radio speeds up the life processes and enables us to live more quickly; to crowd more events into a lifetime.

Should another war come, it is quite possible that radio audiences will be able to keep in instantaneous touch with campaigns, events and personalities on the field of battle. Unless censoring becomes too harsh, the victors in the war will feel more elation as events progress, and the defeated more despair. Psychologically, therefore wars should end quicker than they did in pre-radio days.

Since the whole world will be tuned-in in the future, and possibly translators will be on hand to translate international hookups on events as they occur, people will become more interested in international events. Great international crises that provoke war, will now get an immediate public reaction. Leaders who respond to the public will, will be able to get an im-

mediate judgment on a course of action to pursue.

Rural prejudices may be expected to fade out as the suburbanite gets the urban point of view through the radio, and vice-versa. The farmer can tell us of his troubles and get a personal sympathetic hearing through the air; while the city worker will have an audience of farmers, on city problems.

Great disasters will provoke immediate response from sympathetic people the world over, and help for the stricken will be sent quicker. This too will help to promote international goodwill. It might be a good question to ask, what the events of 1914 would have been had present day radio service been in existence at that time.

The effect of radio is only beginning; it is sure to change many of our habits and thoughts and to create far-reaching social changes. It has already gone far to create new educational and artistic outlets. If properly handled it should be a means for constructive propaganda never before possible.

Of course improperly or unwisely used it can become as great a menace as it might be a boon. It is vital therefore that it be kept from becoming a weapon in the hands of those in power to maintain themselves. The radio, above all, should be open to all parties and all social and political opinions. An enlightened policy on the part of broadcasting companies will do much toward this.

For example, when Technocracy became a household word, Howard Scott appeared quickly on a national hookup. This gave the people of the country a chance to get into immediate and personal contact with the Great Technocrat; and it is possible that the radio talk might have been responsible for the break in the group that later occurred. Events must move quickly in this radio world.

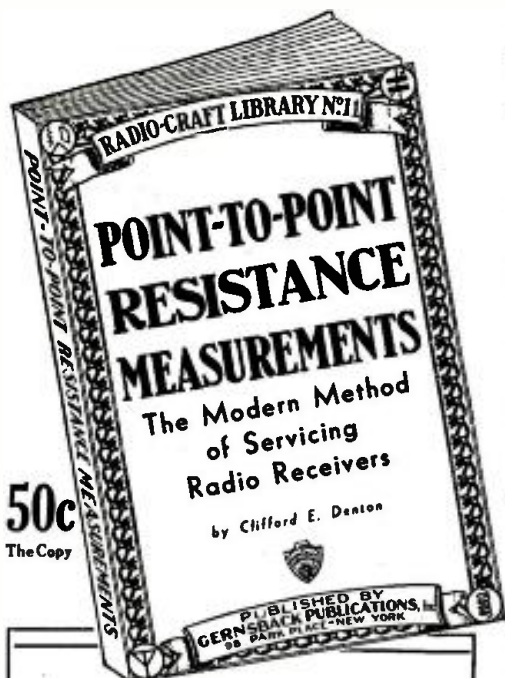

GERNSBACK PUBLICATIONS, Inc. RC-333
98-98 Park Place, New York, N. Y.
Enclosed you will find my remittance of Fifty Cents (check, stamps or money order accepted), for which you are to send me One Copy of POINT-TO-POINT RESISTANCE MEASUREMENTS, by Denton.

Name
Address
City State

"Cliff" Denton has written Point-to-Point Resistance Measurements

The Modern Method of Servicing Radio Receivers

—ANOTHER VALUABLE BOOK FOR SERVICE MEN

Of the difficult problems which Service Men face today when repairing receivers, the greatest is that of replacing proper resistance values in sets. This task becomes even more difficult when the values of resistors are unknown; and manufacturers of many standard sets do not pass this information on to Service Men.

In this new book, "RESISTANCE MEASUREMENTS," radio men will find the information needed to quickly place a receiver in normal operating condition. This book cuts in half, the time usually required to adjust the average set.

Sufficient space has been devoted to the elementary problems and the theory of electricity as it is applied to resistance measurements so that the Service Man will have a comprehensive idea as to how to overcome this problem.

Below you will find a partial list of the contents which will appear in this new book . . . prepared by one of radio's foremost service writers, Clifford E. Denton.

- Partial Contents of POINT-TO-POINT RESISTANCE MEASUREMENTS**
- CHAPTER 1—INTRODUCTION. Advantages of Resistance Measurement Method of Servicing for Radio Work.
 - CHAPTER 2—Basic Principles.
 - CHAPTER 3—Methods of Resistance Measurement.
 - CHAPTER 4—Resistors in Radio Receivers and Amplifiers.
 - CHAPTER 5—Point to Point Resistance Measurements in Typical Radio Set using Ohmmeter.
 - CHAPTER 6—Resistance Measurements using Modern Tester.
 - CHAPTER 7—Routine Testing where Circuit Diagram is Available and where Resistances are Known.
 - CHAPTER 8—Routine Testing where Circuit Diagram is Not Available and where Resistances are Unknown.
 - CHAPTER 9—The Relation of Voltage Testing Methods to Resistance Measurement.
 - CHAPTER 10—APPENDIX. Resistance Charts, etc.

64 PAGES — OVER 100 ILLUSTRATIONS
6x9 INCHES

THIS BOOK IS A NEW ADDITION TO THE RADIO-CRAFT LIBRARY SERIES

GREATEST MAGAZINE ON SHORT WAVES

NOW 25c A COPY

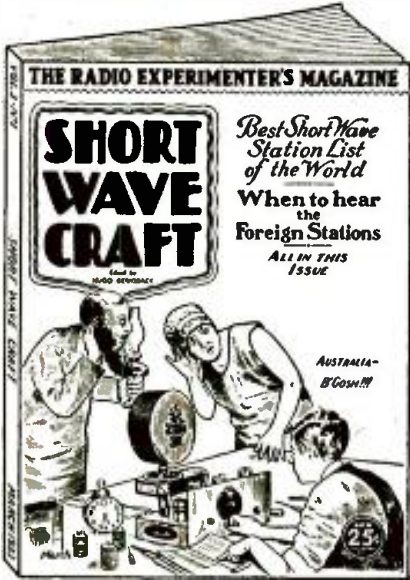

At All Large Newsstands
4-Color Cover
9"x12" in Size
Over 200 Illustrations

RAPIDLY increasing each day are the number of experiments in the Short-Wave field—developments which are bringing to this branch of radio thousands of new "thrill seekers." Experimenters, as in the early days of Radio, again have the opportunity to bring about stirring new inventions. Read, in **SHORT WAVE CRAFT**, the Experimenter's Magazine, how you can build your own Short-Wave Sets, both transmitters and receivers. **SHORT WAVE CRAFT** is exclusively a short-wave magazine—the kind you have wished for so long.

Interesting Articles in the Current Issue

Will Short-Wave Heat Effects Cure Human Ills?, by Dr. Willis R. Whitney, Vice-President and Director, General Electric Company.
Short Waves Control Model Ship.
2-Tube Portable All-Wave Receiver, by Clark Kunej, Jr.
Pentodes in Low-Power Transmitters, by Dr. W. Moller.
The A.C. Super-Wasp Brought Up-To-Date, by A. A. Deild.
Short Wave Receiver Built in A Cigar Box.
Two-Tube A. C. "Band-Spreader" Works Loud Speaker, by George W. Shuart, W2AMN-W2CBC, Winner of \$20.00 Contest Prize.
A 5-meter S. W. Superheterodyne, by A. C. Matthews, Radio Consultant.
Cislín 4-Tube Pentode Receiver—The Utmost in Signal Strength From Four Tubes, by H. G. Cislín, M. E.
Improving the Short Wave Antenna, by Everett L. Dillard.
"... Picked Up and Relayed," (S. W. Fiction) by A. D. Middleton, W8UC.
The Comet "Pro" Superheterodyne—with all coil, condenser, and resistor values "for the first time," by Lewis Martin.
The Short-Wave Beginner, by C. W. Palmer.
SHORT WAVE STATIONS OF THE WORLD.
Complete List.

SPECIAL OFFER COUPON

SHORT WAVE CRAFT RC-333
98 Park Place, New York, N. Y.

GET ACQUAINTED OFFER

As per your Special Offer, I enclose \$1.00 (Canada and foreign \$1.20) for which enter my subscription to **SHORT-WAVE CRAFT** for 3 months. (I understand that your regular rate for a year's subscription is \$2.50).

Mail me a sample copy of **SHORT WAVE CRAFT** for which I enclose 15c (U. S. Stamps or coin accepted).

Name
Address
City State

"TRY THIS ON YOUR—"

Scanning, a common term in television, believed by many people to be something new, is really as old as man, states Hollis Baird, chief engineer of Shortwave and Television Corp.; for the human eye has always scanned and always will. As few people realize how simple it is to prove this (one of the fundamentals of television) the continuation of Mr. Baird's remarks will be of general interest.

Without thinking definitely or analytically about it, we would think that when we look at a picture or a scene we see it all at once, but the fact is that we see only a tiny spot. What happens is that our flexible, efficient eyes rapidly travel across and up and down a given scene, registering the various points so rapidly that a complete picture seems to be seen.

It is easy enough to test this. Hold your hand out straight in front of you and then look at the thumb nail. Now without shifting your eye in the slightest try and see how much else you can see clearly, not just suggested, but vividly. You will find that the area comprising the end of your thumb is about all that is sharp.

Now open your hand and decide you want to see all of it. As you do, notice carefully what your eyes are doing and you will see that they are swinging back and forth in various cross directions until they have covered every bit of your hand. Now you have a very definite picture of what your hand looks like—yet it was obtained piecemeal.

Taking something more concrete, more nearly like what a television camera must pick up, let us look at a motion picture. As the action goes on, you seem to see what is happening on the whole screen but if you will pick out a single spot on the screen and look at it without moving your eyes, as you did when looking at your thumb nail, you will find you are actually seeing but a small part of the picture clearly, the rest being in sort of out-of-focus relation to the main spot of vision. The human eye, however, moves so quickly that it takes in the whole picture in a series of rapid glances and the memory retains these pictures, each piece in its proper place, and the effect seems to be a whole, complete picture. In television the same thing takes place: the television camera rapidly scanning a scene which, in turn, is reproduced in the same order by the television receivers. Of course, this scanning is much more rapid than the human eye, as the scanning spot cannot pick up as much detail as the human eye will register correctly at one instant, and so must travel faster to get in all the points.

Another point of difference is that the human eye needs no definite routine to follow in scanning a scene, for it may move across the top, then down to the bottom and across there, then up at an angle from the lower left to the upper right corner, etc. In television, as in anything mechanical or electrical, an accurate pattern must be followed to be repeated in rapid succession, in order that at the receiver the same pattern may be followed and a picture reproduced which will be the same as the picture picked up at the transmitter.

Thus, while television may seem to be a far cry from any human parallel it actually follows the human eye more accurately in its procedure than does a camera which takes in all at once a complete picture. Eye scanning is a fascinating thing to experiment with and should offer a lot of fun for the person who likes to contemplate television problems. Since the apparatus is already part of one's body there is no cost involved. A study of the human methods of taking in a scene is indeed interesting.

"SPLIT" PROGRAMS

The "split" program, possible only where long- and short-wave stations are available.

The musical part of the program is simultaneously transmitted from both the long broadcast-wave of KDKA and the short wave of W8XK, as is usually done with ordinary station programs. However, when reaching the spoken part of the program, which is to be "split," one part of the program (for instance, a conversation in English) going over KDKA and other part (for example, a talk in Spanish) going over short-wave station W8XK, it requires a switch in lines.

P. A. OPERATORS! On the output end of your amplifiers—



FOX
electro-
dynamic
UNITS
and
Aluminum
HORNS—

—mean better and more dependable performance. All precautions have been taken to insure that FOX is the most dependable. Even the diaphragm is guaranteed for one year and as a P.A. Operator or user of heavy duty units, you cannot afford to overlook a product with such a positive guarantee on it.

FOX Aluminum trumpet horns too. They are constructed in four and six feet sizes, sturdy, beautiful in tonal quality and will withstand all weather conditions.

Service also—we repair any make or type of units or microphones. Work guaranteed, prices reasonable and return shipment prompt.

ATTENTION TO ALL

Write for complete descriptive information about the new FOX portable P. A. system. It is the smallest, most convenient you've ever seen, only 7x8x10 inches, entirely self contained and gives more than enough volume to distribute speech throughout most any show-room or store or banquet hall.

Priced net at \$49.00, including a first class double button hand speech microphone. Send in your order now.

Write for descriptive bulletins and permit us to quote trade discounts.

THE FOX ELECTRIC & MFG. CO.
3100 Monroe Street, Toledo, Ohio



CONDENSER CONTEST Has Started!

Will you be one of
the winners?

100 PRIZES worth over
\$2,000.00 Given away to
Dealers, Amateurs, Ex-
perimenters and Service-
men. Enter Today—See
Your Jobber for Contest
Rules or write Contest
Editor.

Tobe Deutschmann Corp.
Canton, Mass.

AND NOW—THE FILAMENTLESS TUBE

(Continued from page 529)

gating the plate tends to result in the electrons being drawn through all the holes in the cathode and distributed over the entire area of the plate (provided the elements are symmetrically positioned with the usual commercial tolerances).

Characteristic Data

Although it is regretted that curves of the static and dynamic characteristics of the experimental tubes described by Dr. Hund are not available at the present time, considerable information may be obtained from the figures given and from known data regarding the operation of gas discharge devices.

A potential of 100 volts is shown in Figs. 2 and 3 as the value required to produce ionization between the two over-lapping electrodes; this figure, however, will depend entirely upon individual tube design. The current required to produce sufficient ionization for operation in the desired service is another variable factor; in one tube model this figure was 60 ma. The "power" consumption of this ionized path (equivalent to the more usual "filament") is, therefore, 6 watts. In both Figs. 2 and 3 the cathode is shown placed at a potential 50 volts above that required for normal ionization, or 150 volts; the cathode current consumption will vary with tube design.

The grid and plate voltages, shown in Fig. 2, are those usually employed for grid-leak detection using certain types of hot-cathode triodes (zero grid bias, and 50 volts on the plate with equivalent plate current drain). The grid and plate voltages, and plate current of Fig. 3 parallel the figures for operation of a type 71A tube used as an amplifier. As Fig. 2 indicates, it makes no difference whether the operating potentials for a filamentless tube are obtained from batteries or a "B" eliminator, provided correct bypassing is secured in the latter instance.

Grid input impedances may run as low as 30,000 ohms and as high as present tubes. Output impedances can be made to match present

tubes so that present transformers can be used. The power transformer must be designed to accommodate the additional 150 volts required by the ionizing and cathode circuits at the current drain of the particular tube types.

At the conclusion of the reading of Dr. Hund's paper, it was not necessary for the President of the Institute to ask for a rising vote of thanks as the audience showed their appreciation of this amazing development by long and loud applause. The discussion which followed brought to light several interesting points.

The Discussion

For instance, it was brought to light that some heat is developed by electron bombardment of the electrodes; however, this heat is carried off through the stem of the tube by conduction, and does not reach a temperature high enough, for instance, to burn the hand.

In answer to another question, it was explained that the material used for the electrodes did not make much difference. In some tubes the electrodes were made of iron, while in others aluminum and nickel. The iron could be rusty, oily, and dirty; clean electrodes were no better than dirty ones.

The kind of gas used did not seem to make any differences; combinations also did not exhibit any differences in operation. Chemically pure gas reduced the ionizing potential from about 100 volts, which was not considered too high, to as low as 35 volts. The amount of gas was usually between 10 and 20 millimeters, but Dr. Hund said he obtained quite satisfactory operation by using only ordinary air exhausted to 10 mm., and without the addition of any other gases. (Apparently occluded gases cause little trouble in a tube of this type, and since high evacuation on expensive pumps is one of the most costly procedures in the manufacture of present-day hot-cathode tubes, it follows that a marked saving should be affected in the procedure of manufacturing cold-cathode tubes.) The doctor explained to another engineer that

the insulation within the tube was carried right up to the electrodes by extending the glass to the point of contact with the electrodes. This is done in order to prevent "sputtering" or uncontrollable sparking from point to point which otherwise occurs in gas-filled tubes.

Although the inquiries of four engineers and the impromptu calculations of another tended to indicate that the over-all power consumption of a tube of the filamentless type exceeded that of the filament type, it was pointed out that the practically "lifetime" longevity of the tube, its low cost of production, its freedom from variations in characteristics with relatively large changes in gas pressure, the absence of a filament winding on the power transformer, the ease of reproducing tubes having a given characteristic, and the simplification of receiver wiring, far more than off-set the added cost of the increase in high-voltage output necessary to supply the ionization and cathode potentials and currents. Undoubtedly, this talk by Dr. Hund has done more to stimulate nation-wide interest in the cold-cathode or filamentless type of tube than any other publicity so far.

COMING IN FUTURE ISSUES
How to build an up-to-the-minute tube tester
Converting RCA and Atwater Kent Receivers
Point-to-Point Capacity Testing

NOW READY

The RADIO-CRAFT INDEX

It contains a thorough, alphabetical and topical arrangement of EVERY article and subject which has been published in all the issues of RADIO-CRAFT from July, 1929 to June, 1932

Radio Men have conclusively proved to us the need and practicability for a book which has included in it, a comprehensive and complete listing of every article which has thus far been published in RADIO-CRAFT. A book which has each topic so sub-divided and cross-indexed that a mere glance at a subject will give you any number of classifications and uses of it. For example, if you look at tubes, you find under this topic, various sub-titles, general, power, transmitting, photo-cells, testing of tubes, thyratrons, etc. Every article or notice in the book has been considered so deeply important that when you refer to a certain classification, listed below the main topic, you will find perhaps a dozen or more articles treating the subject from different angles. The author in each case is given—the exact issue in which the article appeared, and on what page it is to be found. So accurately compiled, by C. W. Palmer, one of radio's foremost writers, that in less than two minutes you can turn to any article—needless to waste through all

the issues of RADIO-CRAFT which have been published during the past three years. The RADIO-CRAFT INDEX is exactly the same size as the monthly magazine—it has 24 pages. It can be conveniently kept on file with the copies of the maga-

zine—ready for quick reference. The index is printed on good paper with self covers. This book is sold only by the publishers at 25c the copy. Mail coupon below for your copy of the RADIO-CRAFT INDEX.

Briefly outlined below appears only a partial contents of the book

AMPLIFIERS— General Audio Frequency Intermediate Frequency Power Radio Frequency	NOVELTIES— PATENTS— PHONOGRAPH REPRODUCTION AND RECORDING— POWER SUPPLY AND BATTERIES— RECEPTION— General Airplane Automotive Broadcast D.X. Short-Wave	TONE AND VOLUME CONTROL— TOOLS— TRANSFORMERS— General Audio Frequency Intermediate Frequency Power Radio Frequency
ANTENNA SYSTEMS— CABINETS— CIRCUITS— Commercial Experimental	REMOTE CONTROL— SELLING AND MONEY MAKING SERVICING— General Equipment Operating Notes Service Men's Data	TRANSMISSION— General Airplane Beam Broadcast Short-Wave
CODE— COILS AND TUNING— COMPONENTS— COOPERATIVE LABORATORY— DETECTORS AND RECTIFIERS— EDUCATION— INTERFERENCE AND HUM ELIMINATION— KINKS— MANUFACTURING— METERS AND TESTING EQUIPMENT— MISCELLANEOUS— MOTION PICTURE RECORDING AND PROJECTION— MUSICAL INSTRUMENTS— NEUTRALIZING—	SET CONSTRUCTION— All-Wave Automotive Broadcast Short-Wave	TRANSMITTERS— General Airplane Amateur Broadcast
	SPEAKERS AND REPRODUCERS— TELEVISION— General Reception Transmission	TUBES— General Pentode Photo-Cells Testing Thyratrons
		LIST OF BROADCAST, SHORTWAVE AND TELEVISION STATIONS—

ABSOLUTELY NOTHING WHICH HAS APPEARED IN RADIO-CRAFT HAS BEEN OMITTED FROM THIS VALUABLE COMPILATION

Clip and Mail Coupon Today!

Publishers of RADIO-CRAFT, RC-333
96-98 Park Place, New York, N. Y.

Enclosed you will find my remittance of 25c (check, stamps or money order accepted) for which you are to send me, postage prepaid, one copy of the RADIO-CRAFT INDEX.

Name.....

Address.....

City..... State.....

25c
the Copy

THIS BOOK CANNOT BE BOUGHT ON THE NEWSSTAND—ONLY DIRECT FROM THE PUBLISHERS

1-Volume RADIO Encyclopedia

Double the size of the
First Edition!

This 2nd Edition, S. Gernsback's Radio Encyclopedia is by far the most useful book in Radio Literature. It is designed for practical use and gives you instant information on everything in Radio.

The fact that 30,000 Radio Men have one or the other edition of S. Gernsback's Radio Encyclopedia in their homes, proves that it is an absolute necessity in the Radio Trade. **EVERY RADIO MAN SHOULD OWN THIS VALUABLE VOLUME.**

What the New, Second Edition Radio Encyclopedia Gives You

The explanations—or, rather, definitions are not in brief outline form like those of an ordinary dictionary, but they give in fullest detail, and at considerable length, the meaning and application of every word, phrase, general and special term used in the science of radio. Every topic is written in plain, everyday English, easily understood by anyone.

Hundreds of definitions in the book are illustrated by drawings, photographs, diagrams, or charts. Just look up as you would in a dictionary, the word or phrase about which you are seeking information. Every page is key-indexed for convenience and speed in locating any definition. All the subject matter is arranged in alphabetical order.

This greatly enlarged Second Edition Radio Encyclopedia should be used by everyone in radio. It answers all radio questions,—increases your knowledge and saves time. It covers every known radio problem. It is a gold-mine of facts for every radio man.

**2,201 RADIO DEFINITIONS; 1,253
TECHNICAL ILLUSTRATIONS;
34 TABLES AND CHARTS; 24
PAGES OF APPENDIX; Red Mor-
occo-Keratol Flexible Covers;
Printed on strong ledger paper,
loose-leaf arrangement.**

NEW SELLING PLAN

In order to allow you to inspect the volume and really appreciate what you are buying, we will send it to you with the privilege of inspection. When the express man brings you the book, look it over. If you like it, pay him the purchase price of the book, plus postage. If you do not like it just tell the express man to take it back. You won't be out one penny.

352 pages
9x12 inches
Weight 3 lbs.

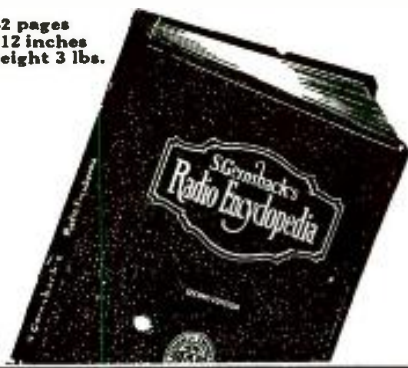

Mail Coupon for this Book!

RC-333

S. GERNSBACK CORPORATION,
88 Park Place, New York, N. Y.

Send me one copy of the new Second Edition S. Gernsback's Radio Encyclopedia with the privilege of inspection. If I like the volume, I will pay Expressman \$3.98 plus shipping charges.

Name

Address

City..... State.....

CAR AERIAL COSTS

Now that people are taking a greater interest in car-radio installations, Service Men will be interested in the following information furnished to Transitone Distributors.

Frequently we hear that "so and so" is charging ten dollars or more for an antenna. And they feel justified in charging this because they have to pay some outside top man from five to ten dollars for the work.

There is still a lot of hokum connected with installing an antenna. You could do it. I could do it, practically anybody except the extremely careless person could do it—and do a good job of it. And it wouldn't take more than two or three hours to do it, either. That top man or upholsterer is certainly getting the cream.

Here are some actual figures. There is a service station not far from here where they do their own antenna work from the Ford to a Lincoln limousine. They have a young chap who knows enough to keep his hands clean when working with the headlining for which they pay him twenty-two dollars a week. In addition to installing the antenna, he also helps with the rest of the installation and motor interference suppression. They average about eleven cars a week and in case installations are not so frequent, he is used for other work.

Not considering the other work, he installs eleven antennae per week at an average cost of \$2.00 each for labor. The actual cost of this labor figured out over a period of several months however, is well under \$1.50.

The cost of copper screen is approximately \$1.00 per car where used. Inasmuch as copper screen is not required in 50% of all installations, the average cost of the screen is only \$.50. The actual cost of installing an antenna at this service station is \$2.00, including labor and material. This certainly is a lot better than paying an outside man five to ten dollars for each job and never knowing in advance just when you can get him to work.

CROSLY RECEIVERS

(Continued from page 531)

tube superheterodyne for operation from standard A.C. circuits, and having an intermediate frequency of 456 kc. This receiver uses a 58 oscillator-detector; a 58 I.F. amplifier; a 57 second detector; a 42 output tube; and an 80 rectifier.

A photograph of the chassis of the Model 148 is indicated in Fig. B. The compact arrangement of the parts of the completed assembly, and their complete accessibility, is readily apparent from an inspection of the photograph. Of particular note is the fact that while the Model 141, described here, has an intermediate frequency of 181.5 kc., the model 148 has an I.F. of 456. In view of this fact, care should be taken in attempting to line up the Crosley Book Case Receivers. *Be sure you know the model number you are working with.*

The Totem, Model 147

Public fancy has turned towards the ultra compact receiver, and to satisfy this craving, Crosley has announced their Model 147, better known as The Totem. It is a four-tube tuned R.F. receiver designed for operation from 110 volts, either 25 or 60 cycles, or from 110 volts D.C. An inspection of the photograph (Fig. C) shows that the off-on switch and volume control are combined at the lower left-hand side of the panel, while the station selector, or tuning dial, is located on the right. The loudspeaker grille is placed directly above the control knobs, as is evident. The two openings on the top of the cabinet provide space for ventilation, and also act, in a measure, as additional outlets for loudspeaker output.

The complete circuit and additional views of this receiver will appear in a forthcoming issue of RADIO-CRAFT.

**How to build an up-to-the-minute
Tube Tester**
Converting RCA and Atwater Kent
Receivers
Point-to-Point capacity testing
Coming in future issues of
Radio-Craft

SERVICE MEN!

Your own business depends upon the wholesale house backing you. Thousands of service men throughout the country have built up their own business by coming to us for supplies. Our tremendous stock and efficient organization serves them promptly and accurately.

Quality Only

When you deal with us you get the very best and latest in radio equipment . . . no orphan brands . . . no job lots from defunct companies that can't make good.

Money-Back Guarantee

We stand back of all merchandise we sell. Very seldom does anything go wrong because of the quality tests before we sell . . . but if it does, we make good or refund your money in full cheerfully and promptly . . . no stalling or excuses.

Lowest Wholesale Prices

Send for our new 1933 Catalog



Just Off the Press everything in replacement parts, tubes, batteries, latest sound systems, and electrical supplies. Send us a trial order and let us prove to you how rapidly and accurately we can serve you.

FREE CATALOG

Allied Radio Corp.
835 W. Jackson Blvd., Chicago, Ill.
Please send me **FREE** your new 1933 catalog.

Name

Address

City State.....



MILLIONS of Sets including MAJESTIC and other standard lines need ballast Replacement **NOW**.

JOBBERS AND SERVICE ORGANIZATIONS—

Send for our plan outlining Ballast Replacement Market and Money Making Plan. Also Volume Control Replacement Data Book.

CLAROSTAT MANUFACTURING CO., Inc.
285 N. 6th St. Brooklyn, N.Y.

NEW ADAPTER AND ANALYZER EQUIPMENT



950X YL

SPECIAL 40 IN 1 ADAPTER

Here's what you have been looking for—nothing like it—highgrade tube checking adapter—tests over 40 tubes. No leads—no jacks or plug—no complicated directions. Resistances and toggle switch for instant reading of both plates of dual plate tubes—beautifully and ruggedly made—a typical Na-Ald product. List \$6.00. Servicemen's postpaid price \$3.75. Orders filled in sequence received. Do not delay—send order today. Tubes it will check in practically any checker are 19, 20, 33, 36, 37, 38, 39, 41, 42, 44, 46, 47, 49, 52, 55, 57, 58, 59, 64, 65, 67, 68, 69, 70, 80, 82, 83, 85, 88, 89, 93, 95, 985, 986, G-2, G-4, LA, PA, PZ, PZH, Wunderlich A and B. No. 950X YL, Servicemen's price \$3.75 postpaid

NEW 7-Prong Analyzer Plug



907WL Na-Ald 7-Prong latch-lock analyzer plug. List Price.....\$3.50



907WLC Above plug with five feet of EIGHT wire cable. Eighth wire insures adaptability to possible future developments. List Price.....\$5.50



This new plug has a seven prong base which is reduced to a 6, 5 or 4 prong base by locking on the following adapters:



976DS 7-hole to 6-prong adapter with locking stud. List Price.....\$1.25



975DS 7-hole to 5-prong adapter with locking stud. List Price.....\$1.25



974DS 7-hole to 4-prong adapter with locking stud. List Price.....\$1.25

It's the Contact that Counts

That's why we are announcing a new improved line of sockets using a special steel reinforced contact clip—and at no increased cost. The modern multi-contact socket demands this improved contact and Na-Ald is, as usual, keeping up with the times.



456E 4, 5 and 6 contact socket List 60c
437E 7 contact socket List 40c
436 6 contact socket List 25c
425 5 contact socket List 25c
424 4 contact socket List 25c

LAST MINUTE SPECIALS

8PL—New Universal Output-Meter Adapter. Connects the plate-prong of 4, 5, 6 or 7 prong tubes whether small or medium based. Insulated for use in new shielded sockets and provided with five foot lead. List price \$1.00
977M—Adapter for changing a medium 7 prong plug to the new small base 7 prong plug. List price \$1.00
977BM—Adapter for use in a regular medium 7 hole socket to take the new small base 7 prong tubes, \$1.00



New Speaker-Silencing Phone-Connecting Adapters
For use in pentode output stage. Connects phones safely in the screen grid circuit—silences loud speaker with plate drawing its required normal current. Renews interest in late hour DX.
955PGT for single 6 prong pentode.....\$1.25 (33, 47, GA, PZ, etc.)
955PGW for p. p. 5 prong pentodes..... 2.50
966PGT for single 6 prong pentode..... 1.25 (41, 42, 43, 46, etc.)
966PGW for p. p. 6 prong pentodes..... 2.50
Twin adapters

Send 10c for 26-page NA-ALD Adapter data sheets showing 300 diagrams, tube connections, etc.

Servicemen's Discount.....35%
On orders amounting to \$10.00 List.....40%

Na-Ald Adapter Data Sheets listing 300 new adapter diagrams, tube connections, etc., are supplied free with all orders.



ALDEN PRODUCTS CO.
Dept. R3, 715 Center St.
BROCKTON, MASS.

CAR "B" BATTERIES

We print below some interesting information which, although furnished to a Transitone Service Station, is of sufficiently general interest to warrant the attention of every radio automotive Service Man who wishes to make and keep a good reputation in his chosen field.

"A Transitone owner recently drove into one of our service stations," states the release, "with a request for service. A new model 7 had been installed in his car a few weeks before, in a distant city. After a few days the receiver stopped playing.

"An examination revealed that the "B" batteries were dead. The batteries were replaced and the "B" drain checked. Everything appeared normal. A few days later the customer was back for new batteries. This time the trouble was found. When the receiver was installed, the battery cable had been carelessly looped over the exhaust pipe.

"It wasn't long before the insulation was burned through and the batteries discharged. Six "B" batteries and a battery cable, to say nothing of the inconvenience and dissatisfaction to the customer, and service expense to another service station are the price of this rare bit of carelessness.

"It shouldn't be necessary to warn service stations to keep clear from exhaust manifolds and pipes—the results from such negligence are so apparent. Every day, however, we see cases that are as bad and even worse than this, so you had better instruct all your service stations."

- (1.) Don't locate the battery box beside the muffler where the batteries will become hot and dry out, causing short life.
- (2.) Don't hang cables or wires on exhaust pipes.
- (3.) Every cable or wire should be fastened securely to prevent it from interfering with any mechanism of the car.

THE TRAUTONIUM

(Continued from page 524)

AZ-14, .005 mf., C9;
One Flechtheim tubular condenser, type AZ-8, .001-mf., C10;
One Flechtheim tubular condenser, type AZ-6, .0005-mf., C11;
One Flechtheim tubular condenser, type AZ-4, .00025-mf., C12;
One Flechtheim tubular condenser, type AZ-2, .0001-mf., C13;
One Blan 16-contact inductance switch, Sw1;
Two small baseboards, wire, wood screws, etc.;
One type 30 tube.

INFORMATION BUREAU

(Continued from page 552)

replace broken terminals on storage batteries?

(A.1.) Electric "lead burning" is nearly obsolete, practically all work in battery houses being done by the use of the oxy-acetylene torch.

Where electrical welding is occasionally employed, the operator in nearly every instance will use a storage battery as a source of current supply, two to four cells outputting the four to eight volts required. Instead of using an auxiliary battery to supply this voltage, it will be possible to use the storage battery upon which work is being done (where this work involves the welding of storage battery terminals).

If it is desired to employ A.C. for the operation, it is possible to use a standard steel-welding transformer. This device may be built by winding 10½ lbs. or 344 turns of No. 10, B. & S. gauge D.C.C. wire for the 110 V., A.C. primary. Wind this coil over an iron core 5 ins. long, 8½ ins. wide, and 2 ins. thick. The low-voltage secondary is made by winding 31 turns of No. 0, B. & S. gauge wire (or, two No. 3, or four No. 6, wires in parallel) over the primary.

It will be necessary to use a husky carbon rod as one contact; this rod may have a diameter of about one or two inches, connection being made to it by means of a heavy clamp. This rod must be sharpened to a point in order that any part of the work may be reached. The circuit is completed by connecting the other secondary lead to a large, strong clamp which is to be clamped onto the work.



Publisher's Samples and Bindery Rejects.

We have on hand a few hundred copies of the SECOND EDITION S. GERNSBACK RADIO ENCYCLOPEDIA, which we are going to sell as quickly as possible at a marvelous bargain price.

We are going to call it a sale of "shop-worn" books. These books are actually, however—every one of them—new books, and for all practical purposes as good as any copy you could buy. They are copies that have been used by the publisher as display and salesman's samples, as in bookstore windows, exhibitions, etc. Some were set aside because of bindery imperfections, such as a slight defect in the gold-stamping, or a small irregularity in the texture of the cover—most of these blemishes being so slight as to be scarcely noticeable on ordinary inspection. The text pages are perfect. The books are not in any way marred, but merely not fresh enough to be sold as new books.

This Second Edition Radio Encyclopedia consists of 352 pages, weighs 3 lbs., bound in red Keratol flexible binder, size 9x12", contains 2,201 Radio Definitions; 1,253 tech. illustrations and 34 tables and charts.

We are disposing of these very fine books at the ridiculously low price of

\$2.00 per copy

New books of regular stock are selling currently at \$3.98 This offer of course will hold only so long as our special stock holds out—first come, first served!

We have also on hand a few hundred remaining copies of the unbound volumes of the FIRST EDITION of this encyclopedia, which we have been selling out very rapidly, at the close-out price of

69 cents a copy

The size of the book is 9 by 12 inches. It contains 168 pages, and is printed on the finest book paper obtainable, it contains over 1,930 definitions, 549 photo reproductions, drawings, and diagrams.

Don't send any money. Delivery will be made to you on the following plan:

ISKOR PRESS, Inc., 19 Park Place, New York, N. Y. RC Please send me

SECOND EDITION, S. Gernsback Radio Encyclopedia, of your special "shop-worn" sale lot, at.....\$2.00

FIRST EDITION, S. Gernsback Radio Encyclopedia, of your unbound special lot, at.....69c

I will pay the postman the amount indicated above on delivery of my order, plus the small postage charge.

Name.....

Address.....

City..... State.....



MACHINE STETHOSCOPE

Gives inside information on all running machinery **Build it yourself**

All you need is an old Flashlight, a SKINDERVIKEN Button and a phone receiver.

Full details of instruction and blueprint showing where and how to listen, also chart indicating character of noise in automobile chassis and motor.

OTHER USES FOR SKINDERVIKEN TRANSMITTER BUTTONS:
RADIO AMPLIFIER PHONOGRAPH AMPLIFIER
DETECTOGRAPH TELEPHONE AMPLIFIER
(Dictograph) LOUD SPEAKER AMPLIFIER
HOME RECORDER CRYSTAL SET AMPLIFIER
LAPEL MIKE

16 PAGE INSTRUCTION BOOKLET containing suggestions and diagrams for innumerable uses, furnished with each Skinderviken Button

95c ONLY

Our Microphone Transmitter is the original SKINDERVIKEN Button; it is the smallest microphone made, measuring only ¼ inches in diameter. It is filled with the finest polished carbon grains obtainable.

—ULTRA SENSATIVE—

USE COUPON—SEND NO MONEY When the postman delivers your order you pay him for whatever you have ordered, plus postage.

PRESS GUILD, Inc. RC-333
16 Murray St., New York, N. Y.

Please mail me at once as many of the following Skinderviken Microphone Buttons as I have indicated.

One for 95c; Two for \$1.75;
 Three for \$2.50 Four for \$3.20

I will pay the postman the cost of the items as specified, plus postage.

Name.....

Address.....

City..... State.....

Build a TREASURE FINDER!



We supply all Parts for Building Electrical and Radio TREASURE LOCATORS

Radio, Audio, Ground Potential Measurements, Hughes Induction Balances and other types; including Oscillators and amplifying systems.

We supply all materials needed for building and operating any of the recognized treasure finders.

The following standard circuits are described in our bulletin:

- No. 1. Ground Potential, Leap-Frog Method.
- No. 2. Hughes Induction Balance Type A.
- No. 3. Hughes Induction Balance Type B.
- No. 4. Sensitive Hughes Induction Balance.
- No. 5. Simple Super-Sensitive Hughes Balance Circuit.
- No. 6. Radio Frequency Oscillator Circuit.
- No. 7. Audio Oscillator Circuit.
- No. 8. Single Search Coil Hughes Induction Balance with Audio Amplifiers.
- No. 9. Combination Radio Transmitter and Receiver circuit.

Also accessories such as High Frequency Buzzers, Audio Oscillators, Differential Current Transformers, Two Stage Audio Amplifiers, etc.

With any one of these systems you can locate buried treasures, metal war relics, mineral deposits, subterranean water veins, buried gas and water pipes, and lost objects, tools and treasures sunken in water, etc.

Write for pamphlet giving history and theory on this interesting subject. All above circuits and systems are described and explained. List of parts and prices included. (Price of pamphlet 10c.)

Mail Coupon TODAY!

GREN PARK COMPANY Dept. RC
245 Greenwich St., New York, N. Y.

Enclosed find 10c for which kindly send me pamphlet on Treasure Finders.

Name

Address

City

State

40-WATT AMPLIFIER

(Continued from page 562)

the applied R.M.S. plate voltage never exceeds 500 volts. This permits the use of low cost electrolytic condensers almost throughout.

One of the two rectifier tubes is used in conjunction with its corresponding power transformer, PT1, and associated filtering equipment to supply the three-stage voltage amplifier (two 56's, and two 59's) with the required voltages, as well as the bias voltage for the two type 50 output tubes. The other type 83 rectifier and its associated power transformer, PT2, are used solely to provide the filament and "B" voltages for the two type 50 tubes.

The primary of the output transformer T3 has a plate-to-plate impedance of 8,000 ohms. The secondary windings are suitable for 500 and 15 ohm-outputs, tapped at 7.5 and 3% ohms.

List of Parts

- One Coast-to-Coast chassis and four removable cans, type 5767 C;
- One Lynch Metallized resistor, 10,000 ohms, 1 watt, R1;
- One Lynch Metallized resistor, 200,000 ohms, 1 watt, R2;
- One Lynch Metallized resistor, 250,000 ohms, 1 watt, R3;
- One Lynch Metallized resistor, 2,700 ohms, 1 watt, R4;
- One Lynch Metallized resistor, 25,000 ohms, 1 watt, R5;
- One Lynch Metallized resistor, 525 ohms, 2 watts, R6;
- One Coast-To-Coast wire-wound resistor assembly, 6,000 ohms, 11 watts, type 5767, R7;
- One Coast-To-Coast wire-wound resistor assembly, 1,500 ohms, 15 watts, type 5767, R8;
- One Coast-To-Coast wire-wound resistor assembly, 100,000 ohms, 3 watts, R9;
- One Coast-To-Coast modified L pad, 500,000 pot., type 6516-B, V1;
- Two Coast-To-Coast electrolytic condensers, 10 mf., 50 volts, type 5225, C1, C4;
- One Coast-To-Coast electrolytic condenser, 2 mf., 500 volts, type 5219, C2;
- One Coast-To-Coast paper condenser, .02-mf., 400 volts, type 6713B, C3;
- One Coast-To-Coast paper condenser, 1. mf., 1000 volts, type 2890B, C5;
- One Coast-To-Coast electrolytic condenser, 3 x 8 mf., 500 volts, type 6884, CA-C6, C7, C8;
- One Coast-To-Coast electrolytic condenser, 2 x 16 mf., 500 volts, type 6885, CB-C9, C10;
- One Coast-To-Coast variable condenser tone control, type 6515, V2;
- Two Coast-To-Coast filter choke, 15 Hy., 200 ohms, type E625CH, CH2, 3;
- One Coast-To-Coast filter choke, 15 Hy., 60 ohms, type E625CH, CH2, 8;
- One Coast-To-Coast push-pull input transformer, type 6153, T1;
- One Coast-To-Coast interstage push-push transformer, type 526T2, T2;
- One Coast-To-Coast push-push output transformer, type 526T3, T3;
- One Coast-To-Coast power transformer, type E625PT1, PT1;
- One Coast-To-Coast power transformer, type E625PT2, PT2;
- One Hart & Hegeman D. P. S. T. toggle switch, type 6351, S2;
- Miscellaneous hardware, wire, etc.

FEDERAL SETS

Judging from our correspondence with Service Men all over the country, considerable confusion exists in regard to the Federal, Brandes and Kolster receivers. The following letter from J. H. Schmidt, factory service manager of Kolster Radio, Inc., of Newark, N. J., should help to clear some of this misunderstanding:

"The Federal line of radio sets was manufactured by the Federal Telephone and Telegraph Company of Buffalo, N. Y., who we believe are no longer in existence. At the time C. Brandes, Inc., and the Federal Telegraph Company of Palo Alto, Calif., merged and were manufacturing Kolster sets, the organization became known as Federal-Brandes, Inc. However, there is no connection between the Federal Telephone and Telegraph Company of Buffalo and the Federal Telegraph Company of Palo Alto, nor has the Federal Telephone and Telegraph Company at any time been affiliated with this organization."

Lowest Wholesale Prices!!!

DEALERS! SERVICEMEN!

Buy from us and
save MORE MONEY!

Ohmite Resistance Decade Box—handy for servicemen	\$ 8.82
Victor ABC Pr. Transf. G-220; 1-227; 2-45's and 1-80....	1.39
Victor Filter Choke—30 Hy. 150 m.a. 200 ohm....	.39
Majestic Filter Chokes.....	1.19
Majestic Plate and 80 Fil. Transf.....	1.25
Majestic P.P. Output Transf.....	1.19
Victor Ist. Audio for Models R-32, RE-45, etc.....	.39
Victor P.P. input and output Transf. for above models..	.59
Victor Condenser Blocks for above models.....	.79
Victor Power Amplifiers: 1-28; 1-80; 2-45's P.P.....	7.50
Readrite No. 710 set analyzers.....	14.70
Readrite No. 406 Counter Tube Testers.....	14.70
Supreme Counter Tube Checker model 18.....	25.98
Supreme Diagonometer Model AAA1.....	144.55
Stranded Aerial Copper Wire—90 ft. coils.....	.15
De Forest types 410, 450 and 481—new and guaranteed, each.....	1.69
Mershon Elec. Conds. (wet), single 18 mfd.....	.55
Mershon Elec. Conds. (wet), double 8 mfd.....	.69
Mershon Elec. Conds. (wet), 5-15 mfd (Spartan type)..	.89
Mershon Elec. Conds. (wet), 9-0-18 mfd. (Zenith type).	1.89
Mershon Elec. Conds. (wet), Triple 8 mfd.....	1.15
Sprague Elec. Conds. (wet), single 8 mfd.....	.39
Elkon Dry Elec. Conds., single 8 mfd.....	.35
1/4 mfd. tubular 300 volts d.c. uncase'd conds.....	.15
1 mfd. uncase'd condenser—300 volts d.c.....	.19
Tubes!!! Types: 80, 47, 45, 27, 71a.....	.39
Philco type P.P. Input transf. small size No. 3242.....	.89
Philco type P.P. Input transf. large size.....	1.45
Thordarson P.P. Input transf. large size.....	.95
Thordarson P.P. Output transf. large size.....	.95
Audio Transformers, 3 1/4 to 1.....	.44
CA-Victor hand mikes with cord.....	1.75
Carbon Resistors—1 watt size, dos.....	.72
Wafer Sockets, 4-5-6-7 prong types, each.....	.06
10 watt Ohmite wire wound—cement coated, 1 to 25M ohms, each.....	.20
20 watt Ohmite wire wound—cement coated, 30M to 75M ohms, each.....	.38
Electrad, Clarostat, Xaxley and Centralab volume controls in stock.	
Copper tubing cut to any length.	

We ship anywhere in the world. Orders under \$1.00 accepted. 20% deposit must accompany C.O.D. orders—balance C.O.D. You pay postage or express charges. Write for prices on any item that you are interested in. "Ham" parts stocked.

Maurice Schwartz & Son

710-12 Broadway Schenectady, N. Y.

Your copy is ready

88 Pages—over 3,000 items, including many "hard-to-get" replacement parts.

FREE!

Send for it today

Baltimore Radio Corp.
225 Broadway, New York City

BACK ISSUES of RADIO-CRAFT can be had at the price of 25c each. Address RADIO-CRAFT, 98 Park Place, New York City.

NEW Autocrat Jr.

New Super Phonic Tubes

1-258, 1-257, 1-247, 1-250, R. C. A. (Lic'd) Build-up Kit, 110 Volt, C, 60 cycle, \$10.95

Size 12 1/2" x 7 1/4" x 9 1/4"—weighs 12 lbs. Easily assembled—Full instructions. Walnut Cabinet Dynamic Speaker. Complete with all parts. Direct from Mfr. Send \$4 deposit, balance \$6.95 C. O. D. Completely assembled, \$12.95. Agents build and sell these radios. Send for circular on 6 Tube Auto Radio.

AUTOCRAT RADIO CO.
3655 N. Hamilton Chicago, Ill.



SERVICEMEN-DEALERS
Send for our Handbook and Catalog
Complete Stock of NEW Radio
Replacement Parts
Hard to Get Parts in Stock
Power Packs and Speakers Repaired
Grant Radio Laboratories
6521-C South Halsted St., Chicago, Ill.

The Radio-Craft Library is now complete!

Presented on this page are the new books of the RADIO-CRAFT LIBRARY—the most complete and authentic set of volumes treating individually, important divisions of radio. Each book has been designed to give radio men the opportunity to specialize in one or more of the popular branches of the industry. The material con-

tained in these books will increase your knowledge; you will find them a real help in your work and they will contribute to your money earning capacity. Read these books during your spare time at home.

The authors of these books are well-known to everybody. Each one is an expert radio man; an authority on the

subject—each is thoroughly familiar with the field which he represents.

This is perhaps the first real opportunity that you have ever had to build a radio library of books that are authentic, right-up-to-the-minute and written so that they are easily digested and clearly understood. Mail coupon below for your books.

**TO THE RIGHT
WILL BE FOUND
A SHORT RESUMÉ
OF EACH BOOK**

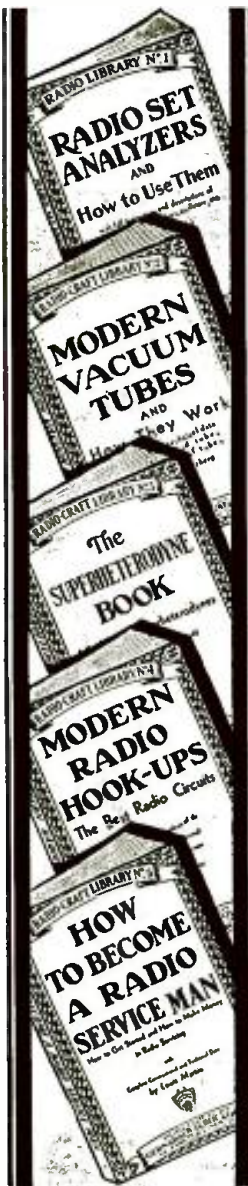

Book No. 1

RADIO SET ANALYZERS

And How To Use Them

With Full Instructions and Descriptions of Set Analyzers, Tube Checkers, Oscillators, Etc.

By L. VAN DER MEL

This book explains thoroughly the operation of set analyzers, tube checkers, oscillators and other testing equipment. For every radio man, this book is extremely helpful. It covers every phase of testing and gives you valuable short cuts; completely illustrated with photographs and diagrams to facilitate the use of modern testers.

Book No. 2

MODERN VACUUM TUBES

And How They Work

With complete Technical Data on All Standard and Many Special Tubes

By ROBERT HERTZBERG

MODERN VACUUM TUBES describes the fundamental electron theory which is the basis of all vacuum tube operation, and goes progressively from the simplest two-element tubes right up to the latest pentodes and thyatrons. It is written in clear, simple language and is devoid of the mathematics which is usually so confusing. Valuable reference charts and characteristic curves of standard and special tubes are to be found, also diagrams of sockets and pin connections.

Book No. 3

THE SUPERHETERODYNE BOOK

All About Superheterodynes

How They Work, How to Build and How to Service Them

By CLYDE FITCH

There is no more fascinating a subject in the large array of radio circuits than the famous superheterodyne circuit. Whether you are a Service Man or experimenter, first-hand knowledge about the construction of superheterodyne receivers is very important. The book on Superheterodynes gives underlying principles of their construction, right from the very first set made.

Book No. 4

MODERN RADIO HOOK-UPS

The Best Radio Circuits

A Complete Compendium of the Most Important Experimental and Custombuilt Receivers

By R. D. WASHBURNE

It is fascinating to the experimenter, or even to the up-to-date Service Man, to take a commercial set and to change it into one using a famous hookup that is not found in any manufactured set. Many excellent circuits have never been commercialized, but limited only to homeset-builders. Thousands of these popular circuits have been requested from time to time, and in this book we have included over 150 circuits, which include the famous Perlyne, Cash-Box A.C.-D.C. Set and others.

Book No. 5

HOW TO BECOME A RADIO SERVICE MAN

How to Get Started and How to Make Money in Radio Servicing

By LOUIS MARTIN

The ambition of many men in radio today is to become a first-grade Service Man. It is not as difficult as one might believe, but it cannot be done in a few short months. Following very carefully the advice of Mr. Martin, who has dealt with the problems of thousands of Service Men, this book deals very carefully with the essential stages in the preparation for qualifying as a Service Man.

Book No. 6

BRINGING ELECTRIC SETS UP TO DATE

With Pentodes, Multi-Mus. Dynamic Speakers—Complete Information How to Modernize A. C., D. C. and Battery Operated Receivers

By CLIFFORD E. DENTON

In this country there are over ten million electrically operated receivers that could be modernized—by placing in them new type tubes, new speaker equipment and other modern improvements. This business of improving old sets can go to the experimenters and Service Men if they will quickly jump into action.

Read in this book by Mr. Denton, how easily you can modernize any obsolete set, and with little additional costs.

Book No. 7

RADIO KINKS AND WRINKLES

For Service Men and Experimenters

A Complete Compendium on the Latest Radio Short-Cuts and Money-Savers

By C. W. PALMER

If often becomes necessary for experimenters and Service Men to cull upon their memory for some short cut or radio wrinkle that will solve a problem quickly. In business, "short cuts" mean time and money saved, and to the Service Man "time saved" means money earned.

This book is a compilation of important radio kinks and wrinkles and discusses only such items as are constantly used today.

Book No. 8

RADIO QUESTIONS AND ANSWERS

A Selection of the Most Important of 5,000 Questions Submitted by Radio Men During the Course of One Year

By R. D. WASHBURNE

There have been collected a wide variety of questions which have come into our editorial offices during the past two years, and only those whose answers would benefit the majority of men engaged in radio have been incorporated in this amazing question and answer book. A tremendously long list of topics is treated.

Book No. 9

AUTOMOBILE RADIO AND SERVICING

A Complete Treatise on the Subject Covering All Phases from Installing to Servicing and Maintenance

By LOUIS MARTIN

Automobile radios are up and coming, and someone has to service them properly. It therefore behooves you to read this immensely important new book on the art of Automobile Radio. The book is concise, and full of illustrations, photographs, diagrams and hookups.

A few of the really interesting chapters: Introduction; Automobile Radio Installations; Complete Descriptions of Commercial Automotive Receivers; Servicing Automotive Receivers; The Ignition System; General Service Considerations; Effects of Temperature on Power Supply; Conclusion.

Book No. 10

HOME RECORDING AND ALL ABOUT IT

A Complete Treatise on Instantaneous Recordings, Microphones, Recorders, Amplifiers, Commercial Machines, Servicing, etc.

By GEORGE J. SALIBA

If there is one subject that is fascinating to every radio man, it is that of Home Recording. Of course, this volume is not all on "Home" recording, but the information contained therein is important to commercial radio men, studio operators, engineers and others interested in this phase of radio.

The art of recording and reproducing broadcast selections is becoming more important every day to radio men, experimenters and Service Men. Equipping dance halls, auditoriums, churches, restaurants and homes with public address systems and amplifiers brings many extra dollars and often an excellent income.

**BIG
DISCOUNT
OFFERED**

In order to make it possible for everyone to buy these books, the fifty (50) cent price has been made uniform for all volumes. You can buy these books separately, but you should take advantage of our special offer:

**When Five (5) Books
or More Are Ordered
Deduct 20%**
from Your Remittance

Simply fill in the coupon below, and mail it to us together with your remittance. Checks, stamps or money orders accepted.

**ALL BOOKS
UNIFORM**

The books in the new RADIO-CRAFT LIBRARY are all strictly up-to-date, and written by men who know their subjects. The volumes are all uniform size, 6x9 inches, and contain an average of 50 to 120 illustrations. Each book is printed on fine hook paper, and no expense has been spared to make it an outstanding value, for its editorial contents as well as from the mechanical standpoint.

Clip Coupon and Mail Today!

GERNSBACK PUBLICATIONS, INC., 96-98 Park Place, New York, N. Y.

I have circled below the numbers of books in the RADIO-CRAFT LIBRARY, which you are to send me, and have deducted 20% for ordering five (5) books or more. I have included my remittance in full, at the price of 50c each, when less than five books are ordered.

The amount of my remittance is.....(Stamps, checks or money orders accepted.)

Circle numbers wanted: 1 2 3 4 5 6 7 8 9 10

Name Address

City State RC-3-33

On page 568 of this issue will be found an important announcement about the new book which has been added to the RADIO-CRAFT LIBRARY SERIES.

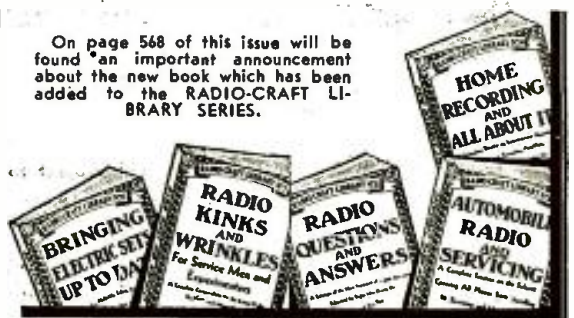

MARCH SPECIALS!!

EVERY month we list on this page certain **STAR** items, which are **NOT LISTED IN OUR CATALOG**. These are all specials of which the quantities on hand are not sufficient to catalog them. **Once sold out, no more can be had.** First come, first served. **ORDER NOW, TODAY.**

STOP SHOPPING. The lowest prices are right on this page. **No one undersells us.** We meet any price on ANY NEW Merchandise. Order direct from this page and save money. **100% satisfaction on every transaction.** Take advantage of these special offers. **ORDER NOW, TODAY.**

Only
\$10.85

Greatest Buy In America!

Only
\$10.85

***"PEERLESS" 8-TUBE SCREEN-GRID T.R.F. RADIO RECEIVER**
Complete with Full Dynamic Speaker

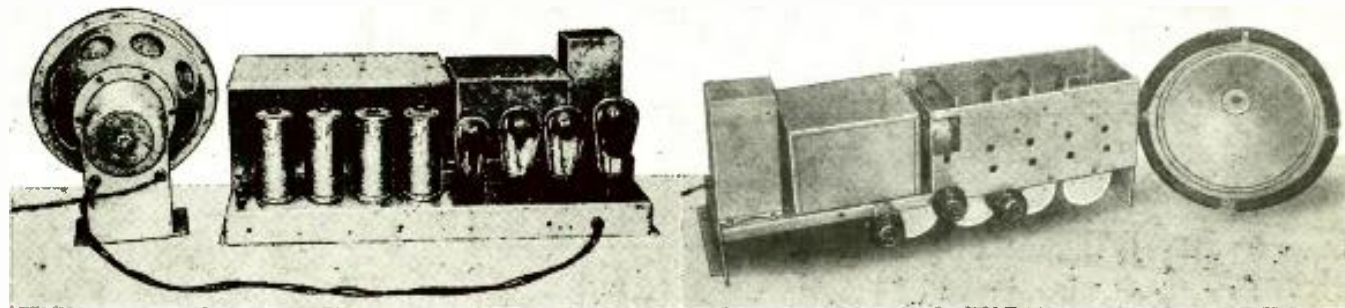

Back View

Front View

Limited Supply—Only as Long as They Last—Order Today

IF EVER there were a greater value than this offered before, we have yet to see it. The selectivity and sensitivity of this 8-tube receiver (due to its four tuned stages) are just as sharp as those of an expensive 11-tube Superheterodyne receiver. The construction of this receiver is best described as "standard." Its circuit is none other than the "good old standby" TRF type which is the most reliable and the most foolproof ever designed. It incorporates three stages of tuned R.F. amplification using type "24" Screen-grid tubes; the power detector is a "21"; a single stage of AF voltage amplification utilizing the type "27" tube, feeds a pair of "45's" in push pull, the full wave rectifier is an "80." All provisions are made for supplying field power for the 9 inch TCA (Transformer Corporation of America) full dynamic speaker. Both cone and spider of this excellent reproducer are made of Duxet to improve the high note response (brilliance) without impairing the low note production. Tuning is extremely simple, the tuned circuits being controlled by a single central knob; a variable dium-type illuminated tuning dial is employed. The second knob controls the on-off switch and the third, the one on the right, volume control. Coils, tuning-condenser-rank, filter condenser bank, output choke and by-pass condenser bank are all individually shielded. The chassis itself is made of non-magnetic aluminum. The use of four tuned circuits, employing screen-grid tubes and high gain R.F. transformers, together with careful wiring, and by-passing, result in high sen-

sitivity. Many of our satisfied customers inform us that a good variety of distant stations come in like local. Tone quality, too, is extraordinarily fine. Despite the maze of new tubes recently thrown upon the market, it is generally conceded that for average home use push pull '45's supply adequate power with the least distortion. Why build a set when a complete receiver, wired and ready to use, and complete with speaker, can be bought at this phenomenally low price? Here is an excellent opportunity for wide-awake service men to "clean up." There are little more than 100 of these receivers left and at this low price, they are bound to give out in very short order. Experimenters will find in this chassis the laboratory "monitor" they have been waiting to buy "when things get cheaper." Remember that the supply is limited. Hence, "first come, first served." The moral is don't delay, order today. Overall size 21" x 8" x 8 1/2" (set only). Ship. wt. 45 lbs.

List Price \$75.00

NO. SP-2000 Peerless 8-Tube TRF Receiver
YOUR PRICE with speaker but less tubes .. \$10.85
LIMITED SUPPLY—ORDER TODAY—TOMORROW MAY BE TOO LATE

Official Doerle 2-Tube 12,500 Mile Short Wave Receiver

THERE have never been produced short-wave receivers which have taken the whole country by storm as much as the now famous DOERLE Receivers. Mr. Doerle described this receiver, the now famous TWO-TUBE 12,500 MILE RECEIVER in the December-January issue of **SHORT WAVE CRAFT**. You have seen the many letters published in **SHORT WAVE CRAFT** lauding this receiver to the skies, and for a good reason. It is a low-priced receiver, yet, built in short-wave stations from all over the world, **REGULARLY**, in practically any location, not only in this country, but anywhere. Thousands of experimenters have built their own, and have obtained miraculous results, as hundreds of glowing testimonial letters from radio fans testify.

In the course of the year, we have received many requests for this receiver, and have sold a great many parts for it, but not until recently have we concluded our tests which now places us in a position to supply it in either kit form or completely wired and assembled, ready to use.

It took a lot of labor, and much ingenuity to collect the correct parts to make sure that this receiver would work under all circumstances. This means that all the usual "hugs" have been ironed out by us in such a way that you may order every receiver with full confidence, that in practically every location, anywhere, "it will do its stuff."

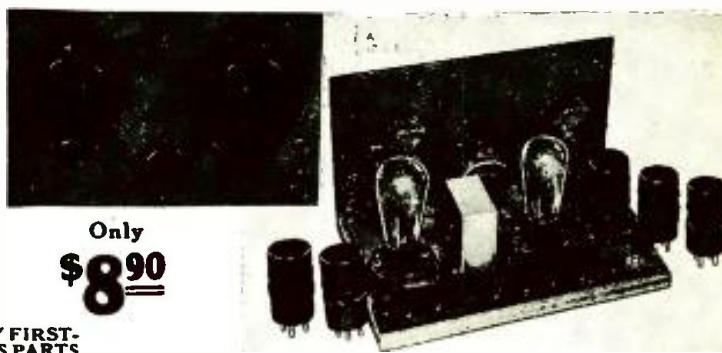

Only
\$8.90

FREE RADIO AND SHORT WAVE TREATISE



The new Winter, 1933 edition of our Radio and Short-Wave Treatise, No. 26 has just come off the press—104 solid pages of useful information, radio items, diagrams and illustrations. Positively the greatest book in price—**NOT JUST ANOTHER CATALOG**. Contains a large editorial section with valuable information not found anywhere else. Special consideration has been given to the radio beginner in this issue. Among the new technical information listed are the following:

HERE IS A PARTIAL LIST OF CONTENTS
Fundamental Principles of Radio—Grim's Law—Discussion of New Tubes—Constructing a "Twin-Tone" Amplifier—About Superheterodynes—Eliminating Man-Made Static—Constructing a Two-Tube Short-Wave "Globe-Trotter" Receiver—\$3.00 Prize Suggestions—Radio Hints, etc., etc.

WRITE TODAY. Enclose 4 cents for postage. Treatise sent by return mail.

Over 100 New Hook-Ups, Etc. 1000 Illustrations.

WE ARE A WHOLESALE HOUSE AND CANNOT ACCEPT ORDERS FOR LESS THAN \$3.00. If C.O.D. shipment is desired, please remit 20% remittance, which must accompany all orders. If full cash accompanies order, deduct 2% discount. Send money order—certified check—U. S. stamps.

ONLY FIRST-CLASS PARTS USED

It may be possible to buy the parts of the completed set at a lower price. We admit this at once. But if you will look over our parts list, you will find that **only first class material is used.** We have done away with all losses. There is no "hand capacity" IN THIS SET—**ONLY THE BEST CONDENSERS—AND THAT MEANS HAMMARLUND—ARE USED.** The set could be produced for a considerable less amount if we used cheaper condensers. We have refrained from doing so because we wanted a first-class product. And this goes for everything else in the set. They are low in price, yet the quality is excellent, considering the low price. Thus, for instance, we are using Kurtz-Kasch dials because we found them excellent for their

purpose, and as everyone knows, they are really first class vendors. The baseboards are of laminated well-seasoned veneer wood that will not warp. Panels are polished aluminum, on which the condensers and other parts are mounted. These panels do away with hand capacity. The plug-in coils are of Bakelite, wound with enamel wire for low losses. In short, despite the amazingly low price of these sets, we give you quality. Bakelite sockets only are used. Even the aerial condensers are of the Miconoid Equalizing type. We have even included pin-tip jacks, rheostats with switches and binding post strips of Bakelite to keep down losses. In short, you will be pleased not only with the business-like appearance, but with the performance as well.

Only by making these sets in quantities can we afford to sell them at the extremely low prices quoted.

This receiver is exactly as illustrated in our photograph. Size of aluminum panel is 9 3/8 inches base by 5 1/2 inches. List of material used: 2 Hammarlund 00014 Condensers; 1 Carter 20 ohm Rheostat and Switch; 1 Peerless Audio Transformer; 2 Kurtz-Kasch Vernier Dials; 3 Bakelite Low Loss Sockets; 1 Miconoid Equalizer Antenna Condenser; 1-0001 Aerovox Fixed Condenser; 1-5 megohm Carbon-dium Grid Leak; 2 Telephone Pin Jacks; 1 Aluminum Panel; 1 Veneer Baseboard; 1 Bakelite Rheostat Knob; 1 Bakelite Binding Post Strip; 1 set of 4 Bakelite Short Wave Plug-in Coils; Instructions for Operation; 1 Set of Hardware, Wire, etc. Complete shipping weight 5 lbs. No. 2140. **TWO TUBE 12,500 MILE DOERLE SHORT WAVE RECEIVER, completely wired and tested as per above specifications. YOUR PRICE \$8.90**

No. 2141. **TWO TUBE 12,500 MILE DOERLE SHORT WAVE RECEIVER KIT**, with all parts as specified above, but not wired, with blueprint connections and instructions for operation. Complete shipping weight 5 lbs. **YOUR PRICE \$7.70**

No. 2142. **COMPLETE ACCESSORIES**, including the following: 2 six months guaranteed Neontron type No. 230 tubes; one set of No. 1678 Brandes Matched Headphones; 2 No. 6 standard dry cells; 2 standard 45-volt "B" batteries. Complete shipping weight 22 lbs. **YOUR PRICE \$5.40**

Radio Trading Co.
102 Park Place
New York, N. Y.

ORDER FROM THIS PAGE. You will find special prices from time to time in this magazine. Get our big **FREE** catalog for the greatest Radio Bargains. Should you wish goods shipped by parcel post, be sure to include sufficient extra remittance for same. Any excess will be refunded.



PROTECTION



In their own secluded laboratory, these engineers, with slide rule, meter and microscope are always making improvements and double checking Certified Triad production.



Hundreds of skilled young ladies find interesting and profitable employment, making "small parts" for Certified Triads.



Many "batteries" of sealing machines controlled by highly skilled co-workers make Triads great production possible.



At the end of every production line, the tubes are given their first check. Ten characteristics are checked here. Even this is more than is done with the average tubes, but it is not enough for "Double-Checked," Certified Triads.

for SERVICEMEN

CERTIFIED TRIAD TUBES are the result of many years' experience. All the guesswork has been eliminated. They are designed, manufactured and tested by the most modern machinery. They are produced by skilled operators. No better tubes can be bought.

A complete study of the proper method of merchandising tubes, in order to protect the seller as well as the buyer has resulted in the adoption of an entirely new form of distribution. The CERTIFIED TRIAD SERVICEMAN is the key stone. You can become one of the agents, who are taking a handsome profit from these tubes, by filling in the coupon. The whole interesting story will come to you by return mail.

If you are selected to represent TRIAD, we will protect your territory, for you. Every Tom, Dick and Harry will not be competing with you.

Write for full information



This is a reduced facsimile of the Triad Radio Tube Certification Coupon, which is sealed in the box with tube to which it refers.

and EXPERIMENTERS

Even a good radio receiver will sound like "nothing at all" if it is equipped with poor tubes. Most people realize that the radio tube is the heart of their receiver. Ordinary tubes can be bought for a song, but you usually get what you pay for. No one expects to get Caçillac or Lincoln service from an Austin. No one looks for custom-made shoes for three dollars. Those who expect the very best performance from inferior tubes are not logical and they are sure to be disappointed. No form of entertainment is as inexpensive as radio. Isn't it good business to keep it working at its best? You can be sure of doing so by insisting on CERTIFIED TRIAD TUBES. A line to us will enable us to send you the CERTIFIED TRIAD SERVICEMAN, we have selected to serve your vicinity.

The TRIAD LINE is complete. It includes all types of standard Tubes as well as Photo-Electric Cells and Television Tubes

TRIAD TELEVISION & MFG. CO.
Pawtucket, R. I.

Gentlemen:

Please send me full information and prices on the complete line of Certified Triad tubes. Check shows my field of interest in Short Waves and Television.

- Experimenters
- Dealer
- Serviceman

Name

Address

City..... State.....

BY POPULAR DEMAND • We Announce

9 to 200

METERS

The LINCOLN R-9 COMMERCIAL TYPE

A SUPER POWERED RECEIVER DESIGNED FOR STRICTLY SHORT WAVE RECEPTION



Repeated requests from commercial operators, communication systems, broadcasting stations and hundreds of individuals prompted us to put months of work on the new R9 commercial type receiver. A STRICTLY SHORT WAVE RECEIVER FROM ANTENNA POST TO SPEAKER JACK. Capitalizing on our years of experience in designing high powered receivers and utilizing the tremendous advantage of the new Litz wire duplex tuned amplifier of DeLuxe SW-33.

The short wave fan today wants short wave world-wide reception with a bang. He wants his receiver in his private den, figuratively speaking, thousands of miles away from the humdrum of chain advertising. The R9 is the

most powerful receiver for S.W. reception; the most selective and sensitive—not forgetting its marvelous tone—ever developed. It has everything the DeLuxe SW-33 has, minus the broadcast band, and plus every feature desirable for commercial voice and code reception. YOU have asked for this receiver in many letters and by personal request; so here it is—in a heavy satin finished case, a beautiful crackle leather finish 1/8" aluminum panel, and silver finish appointments.

Tubes used are 4—'58; 3—'56; 1—6P Wunderlich; 2—'45 and 1—'80.

- Band spread all frequencies
- C W Beat Oscillator
- Two Stages Push Pull
- Three High Gain Stages
- Intermediate amplifier
- 10 Tuned Circuits—I. F.—Litz wire
- Perfect Automatic Volume Control
- Visual Signal Indicator
- Instantaneous Band Selection—5 groups
- Double rectifying detector
- Silent Tuning

And — NOW YOU CAN BRING THE WORLD OF RADIO RIGHT INTO YOUR HOME WITH THE NEW & Improved LINCOLN DeLuxe SW-33

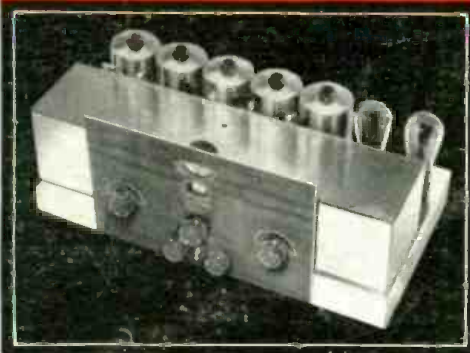

with even more amplification, more selectivity and sensitivity than we ever hoped to attain. Foreign stations are daily rolling into our laboratory, located in the heart of Chicago, with undistorted volume. Powerful locals are cut dead with fractional movement of the dial controlling the twelve tuned circuit.

Like everyone who first hears the DeLuxe SW-33, you will marvel at the heavy undistorted register and fidelity, as the result of the new balanced grid, double rectifying detector. Once you hear the tremendous power of this new model, you will under-

stand why it so far outperforms the average receiver.

Prove this in your home, as many have done, in comparison with any other receiver, for 10 days, with the privilege of return for full cash refund.

REMEMBER—Lincoln receivers grace many of the finest homes in this country.

Equipment is composed of chassis, power equipment, and giant M-20 Jensen, or Wright DeCoster speaker.

Write today for full information. New York Territory write to Valentine G. Hush, Division Drive, Dobbs Ferry, N. Y.

LINCOLN DeLuxe Receivers

LINCOLN RADIO CORP.
Dept. RC-3, 329 S. Wood St., Chicago, Ill.
Please send information on R9 SW-33

Name
Street
City State