

RADIO'S LIVEST MAGAZINE



May  
25 Cents

# Radio-Craft

HUGO GERNSBACK Editor

How to Build the  
**TETRADYNE**  
ALL-WAVE  
Radio Receiver

See Page 650



Cash in Car Radio—Using the V. T. Voltmeter—Filter Design  
The A. C.-D. C. "Cash Box" Set—Constructing a Set Analyzer

# SPEED

## Symbol of Advanced Design

Radio Tubes, Foto-Lectric Tubes, Television Tubes  
 sold under the **SPEED** brand represent  
 the last word in Tube Engineering at all times.

### NEW TYPES



SPEED 234, a radio frequency pentode in the 2 volt, low wattage series. Because of the outstanding characteristics of this tube, it will eventually supplant the type 232, except for detector use.

SPEED 282, a mercury vapor rectifier, fills the demand for increased power, smaller envelope dimensions, improved regulation. It will eventually supplant the type 280 in the new receivers.



SPEED Triple-Twin, an exclusive development of the SPEED laboratories, illustrated in last month's issue. Type 295 AC; type 291 DC; type 293 for automobile use.

### REGULAR TYPES

#### Receiving Tubes

General AC Series	General DC Series	Automobile Series	Sparton Set Series
224	201A	236	S82B
235	199	237	S83
551	WD11	238	S84
226	WD12	239	S85
227	120		
245	140	Low Wattage Series	Rectifier Series
247	112A		
171AC	171A		
	200A	230	280
Triple-Twin Series	222	231	281
	Special Amplifier Series	232	282
291		233	
293		234	
295	210		
	250		

Other new important types will shortly be announced.

#### Foto-Lectric Tubes

Five types with several different basing arrangements. For use with DeForest Phonofilm, Kinoplay, Weber, Platter, Holmes, DeVry, RCA Photophone, Powers, Pacent, Royal, Universal, Gries, Western Electric and many other types of equipment.

Standard gas-filled types, red sensitive, caesium on caesium-oxide, silver-oxide base. Guaranteed against defects.

#### Television Tubes

One inch plate, Wall Electrode type for operation in plate circuit of type 171A tube and with plate current limitations in circuit of types 245 or 247.

Crater type, in standard diameters of .015", .020", .030", .040". Other sizes available on special order.

Send Coupon for Current Bulletins

CABLE RADIO TUBE CORP.:

Mail current bulletins on items checked:

- Radio Tubes       Foto-Lectric tubes  
 Television Tubes

Name .....

Address .....

City and State .....

**CABLE RADIO TUBE CORP.**  
**230-240 NO. NINTH ST. BROOKLYN, N.Y.**

# BEAT PAY CUTS

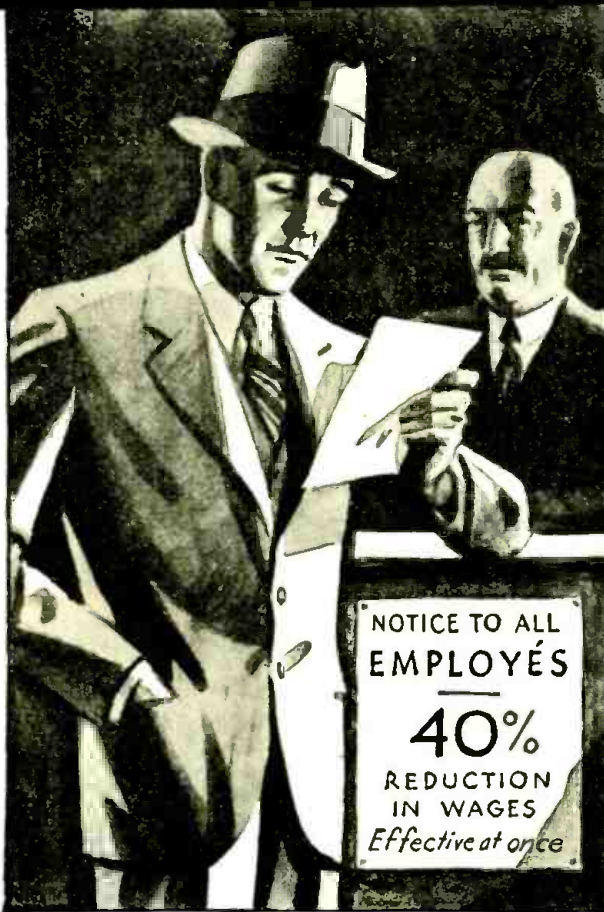

"You bet I can fix it but I have 3 jobs ahead of yours. I'll be over in an hour!"



*This excellent set analyzer and trouble shooter included with our course of training*

## WORK FOR YOURSELF

If they've cut your pay—go to work for yourself! Put in as many hours as you like. Set your own prices. Name your own pay. Be independent! You can, if you're an R. T. A. Certified Radiotechnician engaged in the highly profitable business of servicing all kinds of radio sets and equipment. Here is a field that actually *needs* trained men, and R. T. A. has made it possible for you to break in and make money almost at the very start.

### A Wonderful, Practical Plan

The Radio Training Association of America is not just a school that merely gives you a certain amount of radio fact, then leaves you to shift for yourself. Indeed not. You really become a lifetime member of the great R. T. A., and with your course you get the fine R. T. A. Set Analyzer and Trouble Shooter illustrated here. With this equipment and your R. T. A. training you'll be able to locate the trouble in any set, *quickly*, and get a good big price for the few minutes needed for the repair. That's what makes the R. T. A. plan so practical; you begin making real money almost immediately after joining. As a member of R. T. A. you should be the most popular radio service man in town—your income limited mainly by your willingness to work. Up to \$20 a day is easy.

### NO-COST MEMBERSHIP PLAN

We have worked out a truly wonderful plan whereby R. T. A. membership, the R. T. A. Course, and the R. T. A. Set Analyzer and Trouble Shooter need not cost you a cent. The coupon will bring you full particulars. Clip—fill in—mail now! Today!

RADIO TRAINING ASSOCIATION OF AMERICA  
4513 Ravenswood Ave., Dept. RCA-5 Chicago  
Send me full particulars of your No-Cost Membership Plan.

Name.....

Street.....

Town..... State.....

# RADIO TRAINING ASSOCIATION OF AMERICA

4513 Ravenswood Avenue

Dept. RCA-5

Chicago, Illinois

H. GERNSBACK, President  
 S. GERNSBACK, Treasurer  
 J. M. HERZBERG, Vice-President  
 I. S. MANHEIMER, Secretary



R. D. WASHBURNE  
 Technical Editor

LOUIS MARTIN  
 Associate Editor

VOLUME III  
 NUMBER 11

## Contents of This Issue

MAY  
 1932

	PAGE		PAGE
<b>EDITORIAL:</b>		<b>TECHNICAL RADIO TOPICS:</b>	
Modernizing Electric Sets.....By Hugo Gernsback	649	How to Build the Tetradyne All-Wave Receiver By Harry Hill	650
<b>NEW DEVELOPMENTS IN RADIO:</b>		The Theory and Construction of Volume Controls, Line Filters and Matching Transformers .....By Hy Levy	660
More New Tubes.....By Louis Martin	652	Using Crater Lamps.....By Clyde Fitch	662
The Latest in Radio Equipment.....	656	The A.C.-D.C. "Cash Box" Receiver.....By H. G. Cisin	663
Telektor—A Radio Robot.....	664	Cash in Automotive Radio.....By Arthur H. Lynch	665
<b>SERVICE MEN'S DEPARTMENT:</b>		The Craftsman's Page .....	674
Constructing a Simple Set Tester.....By Joseph Lech	659	An Ultra-Short-Wave Super-Regenerative 5-Meter Receiver.....By E. P. Hufnagel and Geo. J. Herrscher	675
The Service Man's Forum.....	666	Using the V. T. Voltmeter (Part I) By Beryl B. Bryant	676
Short Cuts in Radio Service.....	667	Radio Kinks .....	677
Operating Notes .....	668	RADIO-CRAFT'S Information Bureau .....	678
Servicing Modern "Supers".....By H. G. Cisin	670	Foreign Reviews .....	697
A Modern Tube Checker.....By B. J. R. Williams	671	Book Review .....	695
<b>RADIO SERVICE DATA SHEETS:</b>		RADIO-CRAFT Reader's Bureau .....	698
No. 65: Stromberg-Carlson No. 29, 9-Tube Super- heterodyne Receiver .....	672		
No. 66: Majestic Models Sheffield (201) and Fairfax (203) Superheterodyne .....	673		
Simplified Coil Calculations.....By C. H. W. Nason	683		

### In Forthcoming Issues

**PICTURES BY WIRE.** In this interesting article the author describes the processes involved in sending pictures, almost instantaneously, to remote points.

**A NOVEL SHORT-WAVE ADAPTER.** To eliminate the faults in powerizing previous designs of short-wave adapters, the author designed a novel and efficient system of connection which is described in detail.

**RE-RANGING METERS.** Numerous articles describing the procedure in re-ranging meters have appeared. None of them, however, have contained the technical "meat" that the Service Man will find in this treatment of an important subject.

**A SELECTIVE CRYSTAL RECEIVER.** Radio receivers which depend upon the "natural rectifier" for operation may be built with "band selection" as described in detail in this article.

RADIO-CRAFT is published monthly, on the fifth of the month preceding that of date; its subscription price is \$2.50 per year. (In Canada and foreign countries, \$3.00 a year to cover additional postage.) Entered at the postoffice at Mt. Morris, Ill., as second-class matter under the act of March 3, 1879. Trademark and copyright by permission of Gernsback Publications, Inc., 98 Park Place, N. Y. C.

Text and illustrations of this magazine are copyright and must not be reproduced without permission of the copyright owners. We are also agents for WONDER STORIES and WONDER STORIES QUARTERLY. Subscriptions to these magazines may be taken in combination with RADIO-CRAFT at reduced Club rates. Write for information.

Copyright 1932. GERNSBACK PUBLICATIONS, INC.

Published by  
**TECHNI-CRAFT PUBLISHING CORPORATION**

Publication Office: 404 No. Wesley Ave., Mount Morris, Illinois

Editorial and Advertising Offices  
 96-98 Park Place, New York City

Chicago Advertising Office  
 737 North Michigan Avenue, Chicago, Ill.

Western Advertising Office  
 220 No. Catalina St., Los Angeles, Calif.

L. F. McClure, Chicago Advertising Representative

LOYD B. CHAPPELL, Western Advertising Representative

London Agent: Hachette & Cie.,  
 3 La Belle Sauvage, Ludgate Hill, E.C. 4

Paris Agent: Hachette & Cie.,  
 111 Rue Reaumur

Australian Agent: McGill's Agency,  
 179 Elizabeth St., Melbourne

# OPPORTUNITIES *are many* for the Radio Trained Man



Don't spend your life slaving away in some dull, hopeless job! Don't be satisfied to work for a mere \$20 or \$30 a week. Let me show you how to get your start in Radio—the fastest-growing, biggest money-making game on earth.

**Jobs Leading to Salaries of \$50 a Week and Up**  
Prepare for jobs as Designer, Inspector and Tester—as Radio Salesman and in Service and Installation Work—as Operator or Manager of a Broadcasting Station—as Wireless Operator on a Ship or Airplane, or in Talking Picture or Sound Work—HUNDREDS of OPPORTUNITIES for a real future in Radio!

## Ten Weeks of Shop Training

We don't teach by book study. We train you on a great outlay of Radio, Television and Sound equipment—on scores of modern Radio Receivers, huge Broadcasting equipment, the very latest and newest Television apparatus, Talking Picture and Sound Reproduction equipment, Code Practice equipment, etc. You don't need advanced education or previous experience. We give you—**RIGHT HERE IN THE COYNE SHOPS**—the actual practice and experience you'll need for your start in this great field. And because we cut out all useless theory and only give that which is necessary you get a practical training in 10 weeks.

## TELEVISION *and* TALKING PICTURES

And Television is already here! Soon there'll be a demand for THOUSANDS of TELEVISION EXPERTS! The man who learns Television now can have a great future in this great new field. Get in on the ground-floor of this amazing new Radio development! Come to COYNE and learn Television on the very latest, new-

est Television equipment. Talking Picture and Public Address Systems offer opportunities to the Trained Radio Man. Here is a great new Radio field just beginning to grow! Prepare NOW for these wonderful opportunities! Learn Radio Sound Work at COYNE on actual Talking Picture and Sound Reproduction equipment.



## All Practical Work At COYNE In Chicago

**ALL ACTUAL, PRACTICAL WORK.** You build radio sets, install and service them. You actually operate great Broadcasting equipment. You construct Television Receiving Sets and actually transmit your own Television programs over our modern Television equipment. You work on real Talking Picture machines and Sound equipment. You learn Wireless Operating on actual Code Practice apparatus. We don't waste time on use'less theory. We give you the practical training you'll need—in 10 short, pleasant weeks.

## Many Earn While Learning

You get Free Employment Service for Life. And don't let lack of money stop you. Many of our students make all or a good part of their living expenses while going to school and if you should need this help just write to me. Coyne is 32 years old! Coyne Training is tested—proven beyond all doubt. You can find out everything absolutely free. Just mail coupon for my big free book!

H. C. Lewis, Pres. **RADIO DIVISION** Founded 1899  
**COYNE Electrical School**  
500 S. Paulina St., Dept. 52-8H Chicago, Ill.

## Mail Coupon Today for All the Facts

H. C. LEWIS, President  
**Radio Division, Coyne Electrical School**  
500 S. Paulina St., Dept. 52-8H Chicago, Ill.

Dear Mr. Lewis:— Send me your Big Free Radio Book, and all details of your Special Offer.

Name .....

Address .....

City.....State.....

# SEND NO MONEY--

Clip and mail to us the coupon below. We will send you either one or both books through the Express Company for your inspection. You have the privilege of keeping or returning them.

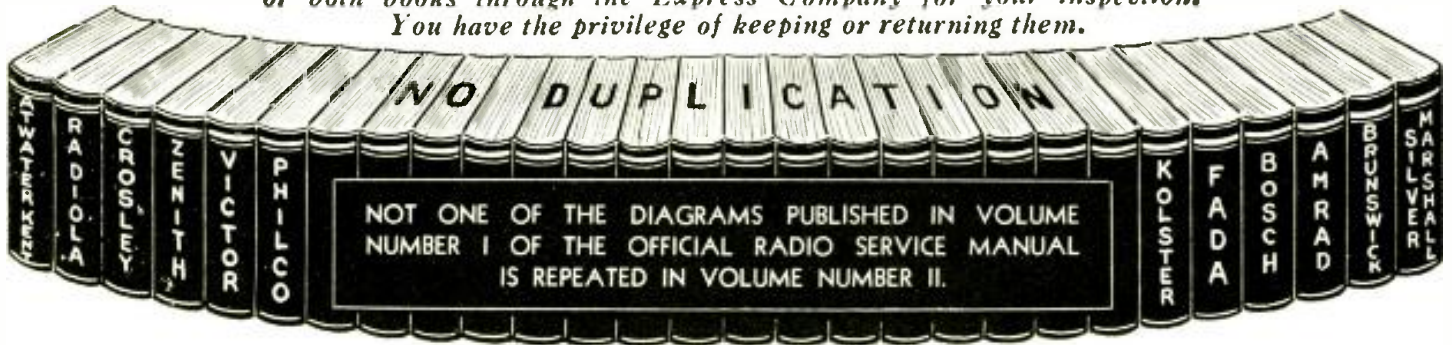

*If you want a complete set of  
al Radio Diagrams, you must  
have both volumes in your file*



Volume I, 1931 Edition

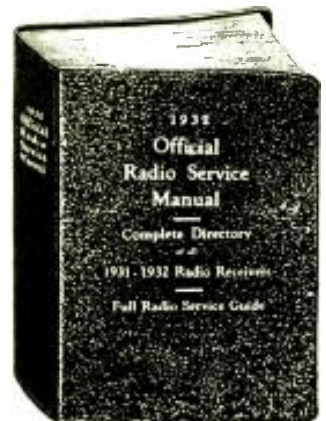

Volume II, 1932 Edition

Both volumes of the OFFICIAL RADIO SERVICE MANUAL will give you the most complete set of circuit diagrams ever published for the Radio Industry. Every Radio Service Man and Dealer should have them available for immediate use in his business. Professional set-builders and amateurs will find them instructive and helpful.

Briefly outlined below are the "high spots" that are to be found in the 1931 Manual—the first complete radio service manual ever to be published. Over twenty-seven thousand copies of this edition were sold to members of the radio industry. This assures you of its importance to those engaged in radio and how valuable it is to them.

**Partial Contents**

Wiring diagrams of radio sets manufactured since 1927, and many earlier ones of which there is any record elsewhere. 650 pages of helpful radio-servicing material.

Complete course of instruction for Radio Service Men, dealers, manufacturers, jobbers, set builders and amateurs.

(Here are but a few of the subjects covered in the special course of instruction).

- |                  |                            |
|------------------|----------------------------|
| Amplifiers       | Power-Supply Systems       |
| Antennae         | Radio Phonograph Equipment |
| Automotive Radio | Resistors                  |
| Condensers       | Short-Wave Sets            |
| Detectors        | Speakers                   |
| Eliminators      | Tubes                      |
| Meters           |                            |

**Get Supplements FREE with the  
NEW 1932 MANUAL**

There is so much new material in this Manual, that a Service Man or dealer would be lost without it when called to service a set. Information about new models which have been on the market only a few weeks are contained in this book. The 1932 Manual makes the service kit complete.

The 1932 Manual contains a Full Radio Service Guide and a Complete Directory of all 1931-1932 Radio Diagrams, also models of older design. Everyone in the Radio business should have a copy. Send for yours today!

**Partial Contents of Volume II**

A step-by-step analysis in servicing a receiver which embodies in its design every possible combination of modern radio practice; it is fully illustrated and thoroughly explained. It is the greatest contribution to the radio service field.

Chart showing the operation of all types of vacuum tubes, whether new, old or obsolete. An exclusive résumé of the uses of the Pentode and Variable-Mu Tubes and their characteristics.

Complete discussion of the superheterodyne and its inherent peculiarities. Also a special chapter on tools used on superheterodyne circuits. Schematic diagrams and circuits complete with color codings.

Important chapters on commercial aircraft radio equipment; new data on commercial short-wave receivers and converters. Servicing and installation of public address systems and talking machine equipment.

Standardized color-codings for resistors. Operation of old and new testing equipment; tube voltmeters, output meters, oscillators and aligning tools.

A full section on Midget radios—their design, circuits, and types. How to service them most economically.

Hundreds of schematic diagrams of older radio receivers which have never been published.

Blank pages for recording notes, diagrams and sketches; these pages are transferable to any part of the book.

Coupon page for free questions and answers.

**\$4.50 Complete with Supplements**

**Mail Coupon TODAY!**

**\$5.00 Complete with Supplements**

**650 PAGES**

(Complete with Supplements)

**Over 1,500 Diagrams, Charts  
and Illustrations**

**Flexible, Looseleaf Binder,  
9 x 12 inches**

GERNSBACK PUBLICATIONS, Inc. RC-5  
96-98 Park Place, New York, N. Y.

Please send me for FREE inspection the books I have checked below. I understand that I may examine them carefully, and should I decide to keep them, I will pay the full cost, plus the few cents for carrying charges. This offer is good only in the U.S.A.

- ( ) Volume I, 1931 Manual, with Supplements, \$4.50
- ( ) Volume II, 1932 Manual, with Supplements to be mailed Free every 60 days, \$5.00
- ( ) BOTH BOOKS FOR \$9.00

NAME .....

ADDRESS .....

CITY..... STATE.....

**OVER 1,000 PAGES**

(Including Supplements)

**Over 2,000 Diagrams, Charts  
and Illustrations**

**Flexible, Looseleaf Binder,  
9 x 12 inches**

# 815 Logs of 48 foreign stations

received in U.S. again Prove

## SCOTT ALL-WAVE

the One Round the World Receiver

JANUARY LOGS From Scott Owners	
Stations Received	Number of Logs
VK3ME	Australia.....122
VK3ME	Australia.....100
HKD	Colombia.....85
1210	Italy.....70
VFA	France.....69
HKM	Colombia.....50
HKA	Colombia.....49
CSW	England.....45
HKO	Colombia.....37
FCICD	Indo-China.....35
PONTOISE	France.....35
ZEESEN	Germany.....19
LSN	Argentina.....15
GBW	England.....11
HRE	Colombia.....10
GBU	England.....9
GBS	England.....8
HNC	Colombia.....7
PHADO	Ecuador.....7
RABAT	Morocco.....6
RAJ	Bermuda.....6
CMCI	Cuba.....5
HBF	Colombia.....4
CTIAA	Portugal.....3
FTV	France.....3
K6XO	Hawaii.....3
OKY	Denmark.....3
HQDR	Ecuador.....3
JAIA	Japan.....2
LEV	Java.....2
HV-15	Russia.....2
YRHM0	Venezuela.....2
Konigswater	Hausen.....1
CMK	Cuba.....1
CM2MK	Cuba.....1
DHA	Germany.....1
FAH25	Spain.....1
FTS	Spain.....1
FTF	Holland.....1
FTC	France.....1
SKH	Hawaii.....1
LSV	Argentina.....1
LSN-LSG	Argentina.....1
T-16-3RH	Cuba.....1
VV4V	Venezuela.....1
VFW	France.....1
ZJI	New Zealand.....1
VVA	New Zealand.....1

Send **COUPON** for full PARTICULARS

FROM NEW YORK AND SAN FRANCISCO—from Canada and the Gulf Coast—from everywhere in the United States—verified logs of foreign reception have poured in—815 in all—during the month of January. The most distant station was 10,500 miles away from the receiver! And most of the logs that came in were of stations over 6,000 miles distant.

These logs—this reception of foreign stations was accomplished with Scott All-Wave Receivers operating under all possible conditions. The results obtained are, therefore, AVERAGE—and represent the results YOU will get when YOU buy a Scott All-Wave for yourself. They constitute actual PROOF of the SCOTT ALL-WAVE'S ability to give daily 'round the world performance. Not just once in a while—but daily, summer and winter. And by reception, we mean loud, clear, reproduction—ample volume—clear, undistorted tone—thoroughly satisfactory in every way.

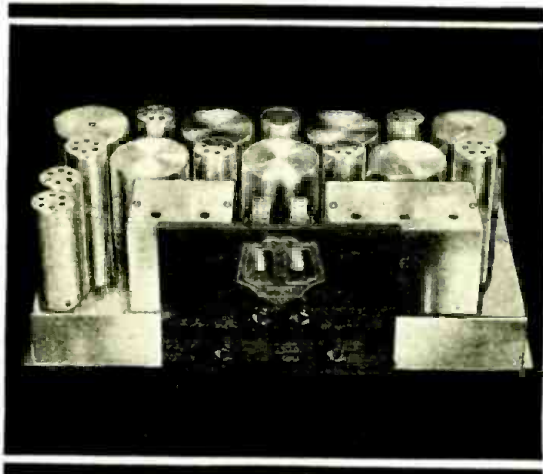

A radio that does not cover a range of 15-550 meters is completely out of date. But you want more than just a set that "dials" 15-550 meters. Even "promises" of foreign reception won't do. The set you want is the one that can PROVE its world-wide prowess BEFORE you buy it. That ONE receiver is the Scott All-Wave 15-550 Meter Superhetrodyne—a custom-built jewel of advanced design and precision engineering. The coupon will bring you full details—and you'll be happily surprised at the modest price. Clip—fill in—mail the coupon now.

The E. H. SCOTT RADIO LABORATORIES, Inc. (Formerly Scott Transformer Co.) 4450 Ravenswood Avenue Dept. C-52 Chicago, Illinois

# SCOTT ALL-WAVE 15-550 METER Superhetrodyne

The E. H. Scott Radio Laboratories, Inc. 4450 Ravenswood Ave., Dept. C-52 Chicago, Ill.

Send me full particulars of the Scott All-Wave, 15-550 meter Superhetrodyne.

DXER  SET BUILDER  DEALER

Name .....

Street .....

Town..... State.....

# BE THE BOSS OF YOUR OWN RADIO

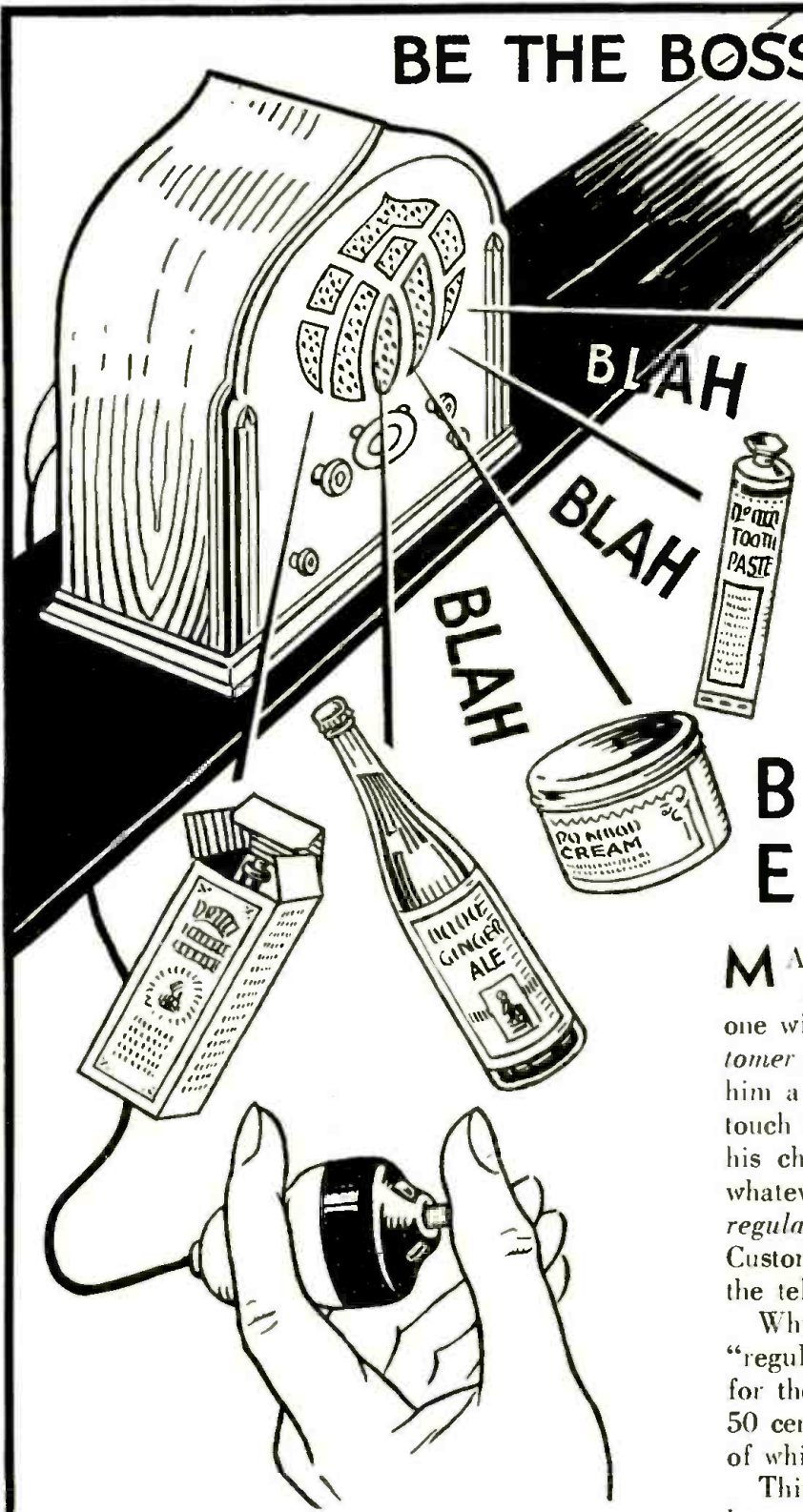

HERE'S  
THE  
SERVICE  
MAN'S BEST SELLER

Doubles the Enjoyment  
from Any Radio

## BLAH BLAH ELIMINATOR

**M**AYBE you think a "good" broadcast receiver is a sharp-tuning, sensitive one with good tone fidelity. But that customer of yours—*what does he think?* Show him a radio that he can "shut up" at the touch of a button, whenever it starts a volley of whatever *he* may call "blah." *There's a regular radio*—that's what Mr. and Mrs. Customer will think—and especially when the telephone rings!

Why not convert their old radio into a "regular" one, charging them only \$1.00 for the BLAH BLAH ELIMINATOR and 50 cents for your installation?—*over half* of which total represents *your profit*.

Think of the market—*everybody* that has a radio! Tell them in a minute what it will do—*demonstrate* it on any set *in another minute*. Sell only ten a day—install them on the spot, they're small and light to carry—and you have a mighty nice income, besides whatever else you take in. Send for your initial supply today—be the first in your community to offer this service that will be talked about at every gathering!

A slender silk-covered cord runs from antenna and ground posts (*no connection with power wiring*) to the neat, entirely insulated push button of the BLAH BLAH ELIMINATOR, which can be carried anywhere—to the customer's armchair, ironing board, or under the dining table. *One sample, to everyone* (note this protection) \$1.00 postpaid; to dealers and service men only, ½ dozen \$4.00, 1 dozen \$7.00 postpaid. Cash in advance; no accounts opened. *Money promptly refunded* on return of any sample in perfect condition within ten days.

COMPO MFG. CO.,

1255A S. Michigan Ave.,

Chicago



# LEGION offers SERVICE MEN and DEALERS

## Exclusive TERRITORIAL RIGHTS

Representatives everywhere are making big money with this most beautiful line of midget and console quality receivers. . . . The manufacturer protects your locality for you. **ALL BUSINESS FROM THAT TERRITORY IS YOURS.** . . . The line is the most complete ever offered and includes five and six tube T.R.F. sets, six tube superheterodynes, four tube short-wave adapters, and nine tube all-wave combination receivers. **EVEN A MOST COMPACT AND SIMPLIFIED AUTOMOBILE SET WILL SOON BE READY.** Our complete television model is now in the course of construction. No matter what others may offer, you can be in a position to present something for less. . . . Write on your business letter-head or send us your business card. Only one representative selected for each territory. Be the first in your locality.



**3 OTHER FEATURE MODELS**



**Model 5B (above).**  
Uses 2-35's; 1-21; 1-47; 1-80. 110 Volts AC. 50 to 60 Cycles. Height 16½". Width 11". Depth 9". Round arch model with two-toned American Walnut cabinet. Full-vision dial with traveling light indicator. Dynamic Speaker. AC Model, \$14.25 less tubes. COMPLETE WITH ARCTURUS TUBES \$16.75. DC Model also.  
**Model 5A** has same characteristics as 5B but cabinet is of pointed top design and dark American Walnut finish. AC Model, \$14.25 less tubes. COMPLETE WITH ARCTURUS TUBES \$16.75. DC Model also.



**4 Tube Short Wave Converter.**  
Uses 1-27; 1-24; 1-51; 1-80. Triple Switching Arrangement. No plug-in coils. Full-vision dial with traveling light. Special two-toned Walnut cabinet. Adapter connected to any receiver makes it a superheterodyne on short waves. Power supply is self-contained unit. Used on AC or battery operated receivers. Smooth tuning by means of high ratio tuning dial. Height 11½". Width 13¼". Depth 9¼". AC Model, \$14.25 less tubes. COMPLETE WITH ARCTURUS TUBES \$16.25.

**Model 6A (above).**  
Uses 2-24's; 2-35's; 1-47; 1-80. 110 Volts AC. 50 to 60 Cycles. Ultra-sensitive Dynamic Speaker. Tone Control. Hum Control. Full-vision Dial. Ball-bearing Condensers. Cabinet of selected art grained American Walnut. Height 18". Width 15". Depth 9". Weight 18½ lbs. AC Model, \$16.75 less tubes. COMPLETE WITH ARCTURUS TUBES, \$20.25. DC Model also.

**MODEL 6SA SUPERHETERODYNE.**

Uses 2-51's; 2-21's; 1-47; 1-80. Circuit design exclusively our own—sensitivity of any nine tube receiver. Ultra-sensitive Dynamic Speaker. Tone Control. Hum Control. Full-vision dial. Ball bearing condensers. Cabinet of selected art grained American Walnut. Height 18". Width 15". Depth 9". Weight 25 lbs. AC Model, \$18.75 less tubes. COMPLETE WITH ARCTURUS TUBES \$21.75.

**9 TUBE ALL WAVE COMBINATION.**

Uses 3-71's; 3-24's; 1-27; 1-47; 1-80. This Super Superheterodyne has two full-vision dials with triple switching arrangement. No troublesome plug-in coils. Everyone can enjoy simplified tuning on all wave bands. Even a child can operate successfully. Tuning by six variable condensers (1 midget). Can be had in midget type cabinet or consolette. Height 19". Width 13". Depth 10½". \$37.50 less tubes. COMPLETE WITH ARCTURUS TUBES, \$42.00. Weight 30 lbs.

**LEGION RADIO MFG. COMPANY**  
154 WEST 22nd ST. Dept. RC-5 NEW YORK, N. Y.

**TRIAL ORDERS ACCEPTED**

ALL SHIPMENTS MADE WITHIN 24 HOURS.  
All Prices Net. F. O. B. New York City. C. O. D. Orders must be accompanied by at least 20% of total amount. Balance on receipt of merchandise. Make all money orders or checks payable to Legion Radio Mfg. Co.

# only \$37.50 11-TUBE Super-Het!

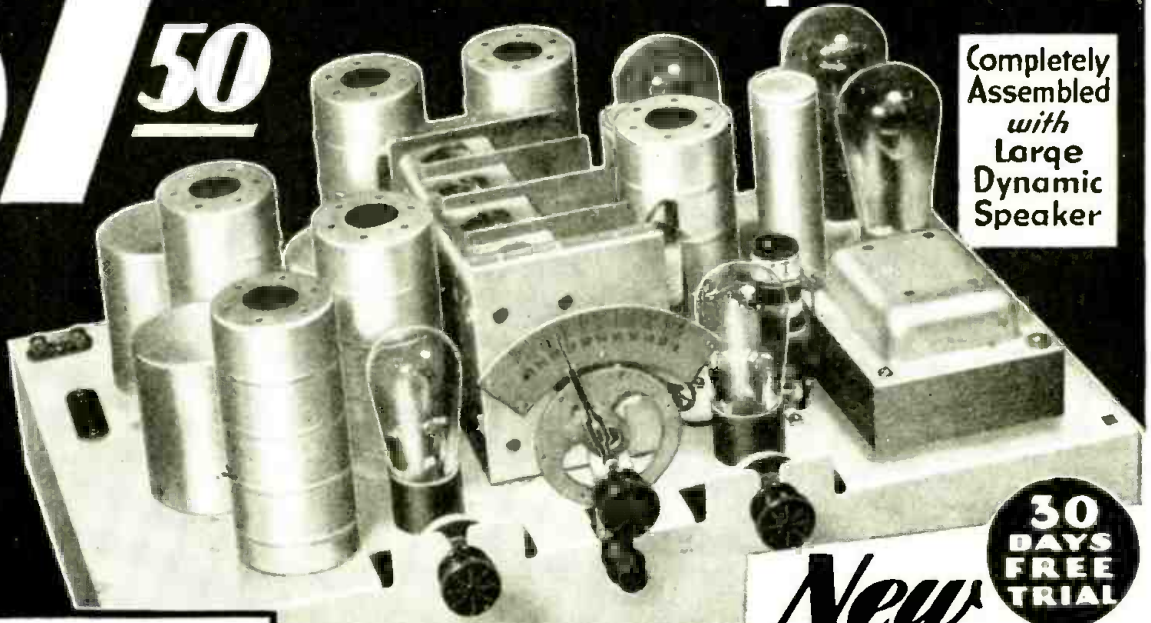

Completely Assembled with Large Dynamic Speaker

Pentode Variable-Mu and Real Automatic Volume Control

**30 DAYS FREE TRIAL**

*New*

## 13-Tube and 15-Tube ALL WORLD-ALL WAVE COMBINATIONS!

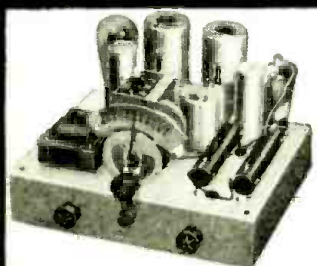

### MIDWEST 4-TUBE SHORT WAVE CONVERTER

### WORLD-WIDE SHORT WAVE RECEPTION

Converts any A.C. set of adequate sensitivity into a short-wave receiver for reception of police calls, airplane conversations, ships at sea, and, under conditions, broadcasts from foreign stations. This amazing new short-wave converter employs 4 tubes and is self-powered. It uses one 280, one 224, and two 227 tubes. In combination with a 9-tube Super-Het, it gives you a 13-tube ALL-WORLD, ALL-WAVE combination. When used with the very latest model Midwest 11-tube super-heterodyne, shown above, it gives you a total of 15 powerful tubes, and ALL-WORLD, ALL-WAVE reception unbeatable even in receivers costing several times as much. Don't confuse this 4-tube self-powered converter with cheap one and two-tube converters that are not self-powered. The Midwest Converter actually gives better performance than many converters costing twice as much.

Now you may get SHORT WAVE broadcasts—airplane calls—police signals—standard long wave broadcasts—all with one combination set. Hear U. S. stations from coast to coast, and from Canada to Mexico. Hear the Canadian stations, Mexico, Cuba, South America, ships at sea, foreign stations! A Midwest 13-tube or 15-tube combination gives you ALL that's desirable in radio. These wonderful new combinations are sold at amazingly low direct-from-factory prices. When you receive our big new catalog and note the low prices, 30 days free trial offer, terms as low as \$5.00 down, you'll be positively amazed. Mail the coupon right now—get the surprise of your life.



### Deal Direct with Factory SAVE UP TO 50%

**TERMS**  
as low as  
**\$5.00 DOWN**

Never have such powerful sets been offered at Midwest's amazing low prices. You save the middlemen's profits. Your outfit will reach you splendidly packed, rigidly tested with everything in place ready to plug in. No assembling! Entertain yourself for 30 days absolutely FREE—then decide. And don't forget—every MIDWEST outfit is backed by an absolute guarantee of satisfaction. You take no risk. Mail the coupon now!

### Read This Letter!

This is but one of many letters received from delighted Midwest buyers:  
"During the past week I logged the following: FYA Pontoise, France; GBW Rugby, England; HVJ Vatican City, Italy; NDA Mexico City; VK2ME Sydney, Australia; VE29GW Bowmanville, Canada; 12 RO Rome, Italy; G5SW Chelmsford, England; CGA and VE2DR Drummondville, Canada. Also picked up many amateur and airport stations from all over United States. Numerous ship, shore and transatlantic phones from both sides and an Hawaiian Test Station came in clear and sharp. Several Spanish and German speaking stations have also been received but not yet identified. Have received every broadcast from FYA, morning and afternoon, for over a week with wonderful tone and volume. The Midwest Combination Set is certainly one to be proud of."  
Wm. S. Teter, Winterpark, Fla., Mar. 2, 1932



Complete Line of Consoles

The big FREE catalog beautifully illustrates the complete line of gorgeous Midwest Consoles. "Deluxe," "High-boy and Lowboy models.

### Mail this Coupon for Complete Details and Big FREE Catalog!

Midwest Radio Corp.  
Dept. 72  
Cincinnati, Ohio.

( ) Send me SPECIAL USER AGENT'S PROPOSITION

Without obligation send me your new 1932 catalog and complete details of 13 and 15-tube All-World, All-Wave Combinations, 4-tube Converter, 9 and 11-tube Super-Heterodynes, low factory prices, easy terms and liberal 30-day free trial offer. This is NOT an order.

Name .....

Address .....

Town..... State.....

**MIDWEST RADIO CORP.**  
Dept. 72 (Est. 1920) CINCINNATI, O.



**"Takes the Resistance Out of Radio"**

Editorial Offices, 96-98 Park Place, New York, N. Y.

# MODERNIZING ELECTRIC SETS

By HUGO GERNSBACK

**S**INCE the advent of the electric set in 1927, approximately 15,000,000 of such sets have been produced.

Of these, 10,000,000 may be said to be antiquated because they operate with old-fashioned equipment, and are still utilizing the magnetic type of speaker instead of the modern dynamic type.

The old sets have no tone control, and as a rule, compared to a modern receiver, they have little power, or as it is said in the vernacular, they have "no pep."

Yet, millions of such sets are in use every day for various reasons. One reason, perhaps the main one, is the present economic depression; the owners have a real investment in their sets, (having bought them when high prices prevailed, at an average of over \$100.00 apiece) and are, therefore, loth to throw out the set which, after all, still gives some service.

Another reason is that some of the sets of the vintage of 1928-29 were housed in very expensive cabinets; the latter often representing more than 50% of the total cost. The cabinet that now houses an antiquated radio is a piece of furniture that the owners are not willing to discard immediately, and for that reason they put up with the admitted deficiencies of the old radio.

Although these are excellent reasons, they should not deter the aggressive Service Man from selling efforts, because they open up a hitherto-untapped gold mine.

It probably has not entered into the head of the present owners, of these antiquated sets, that these may be modernized and brought up to date for a very modest sum of money. The changeover of such sets to dynamic speakers, pentodes, variable-mu tubes, etc., is not a difficult one; and it enables the Service Man to reap a real harvest, if he only knows how to go about it.

If the Service Man who has serviced such sets in the past knows what he is about, the situation reveals itself as one of comparative simplicity. All he needs to do is to call the attention of the owner to it by personal visit, telephone or letter, telling him that his set is now woefully antiquated, and that it needs to be brought up to date. If you once get "under the skin" of the owner, and make him realize that he has an antiquated radio set (which may be compared to a Model "T" Ford car) the owner will usually be persuaded to consider the proposition of having the set modernized.

Of course, the owners of fine cabinets, nine times out of ten, fail to realize that a changeover will not mar or affect the appearance of their prized cabinets, and this point should be pressed with due emphasis.

Naturally, no two cases will ever be exactly the same, so it is possible only to give general advice on the subject; but,

as a rule, it has been found in practice that a little salesmanship properly applied works wonders with the average set owner.

Most important, however, from the standpoint of the Service Man, is the fact that once the job has been done, it will be found that the owner's attitude towards the set has entirely changed. The improvement has, so to speak, put new life into him, speaking from a radio standpoint. He will use the set more; he will be more likely to show it to his friends, because he can again feel proud of the set, just as when it was new. It can, indeed, be described by him as an "up-to-date set," because that is exactly what it is.

Just as an operation has made a new man out of many an invalid, so a "set operation" makes a new receiver out of an antiquated "wheeler," and will be a source of more business for the Service Man. Once the set owner has been shown that a Service Man has done him a real turn, he will call the same Service Man in again when the need comes, either for servicing or if he finally decides to buy a new set. And we know of many cases where Service Men have closed a number of nice set sales in this way.

And have you, as a Service Man, ever considered the multiple-speaker installation?

Practically every set owner has use for more than one speaker. Whether he lives in an apartment or in a house, the case remains the same. As a rule, the radio set will be found in the living room. What about the dining room? What about the children's room? What about the bedrooms?

If the owner can be convinced that, for a moderate sum of money, speakers can be installed all over the house, with switches and volume controls so that they may be turned off and on at all outlets; many attractive sales can thus be made. We know of a number of Service Men who have worked this as a specialty, and found it exceedingly profitable; particularly in suburban or country houses, where the need of extra speakers is acute.

Of course, in this instance too, an old set operates poorly, because more power is required to supply a number of speakers. The extra speaker, as a rule, need not be a dynamic; it may be of the magnetic type, as the wiring is simpler and the power demand less. With the coming of the summer, loud-speaker installations on summer porches is a worth-while undertaking for Service Men who complain of poor business.

One Service Man always carries an extra speaker with him, to demonstrate on the spot the advisability of extra speakers. He reports that six out of eight owners order at least one extra speaker.

# How to Build the TETRADYNE ALL-WAVE RECEIVER

●  
By  
HARRY  
HILL  
●

**T**HE writer has always had a liking for the superheterodyne receiver ever since building the Ultradyne designed by the late R. E. LaCault. With the advent of screen-grid tubes, however, he has always felt that the extra grid could be put to good use by using one tube as a combined oscillator and modulator (first-detector). Consequently, about a year ago, the writer set about designing a receiver, using the superheterodyne principle, that incorporated the idea mentioned above. As a result, the set pictured in Figs. A, B, and C was developed. It is called the "Tetradyne" Model 112 merely because the combined oscillator—first-detector is a four-element tube.

## The Oscillator—First-Detector

Figure 1 shows a detailed schematic circuit of the first tube. It will be seen that one side of the oscillator tuning condenser C2 is

250,000 ohms. The cathode bias resistor (R2 in Fig. 2) may have a value of from 500 to 1,000 ohms; it is not very critical—in fact, in one case, the writer used 1,500 ohms with very good results.

A further examination of Fig. 1 will show that the input to this tube is tuned in the conventional manner, even though the plate circuit is a little out of the ordinary. There is about 30 percent coupling between the screen and plate circuits, the exact amount depending upon the value of plate voltage used. This value has nothing to do with the construction of the receiver; it being given for the interest of certain "technically-minded" men.

A particular point of interest is the fact that the screen-grid is used as the output element. This grid has its current modulated (varied) by the plate current fluctuations; it being in this manner that the coupling is secured.

The voltages on the screen-grid and plate are not at all critical, but, as a general rule, the plate voltage should be about one-third the value of the screen voltage—which is the same for any dynatron oscillator. However, the voltages specified on the diagram have been found best for all practical purposes.

The writer has found one feature that may be of interest. Using one particular tube with 180 volts on the screen, the plate-voltage supply lead could be disconnected entirely from the set, and the tube would keep on functioning as usual. Once the set was shut off by means of the power switch, the tube would not oscillate again when the set was turned on unless the 180-volt lead were momentarily applied. This may be food for thought for some detailed experimenter.

The two circuits (first-detector and oscillator) are prevented from "pulling in" by the plate resistance of the tube. Thus, under no conditions do the oscillator

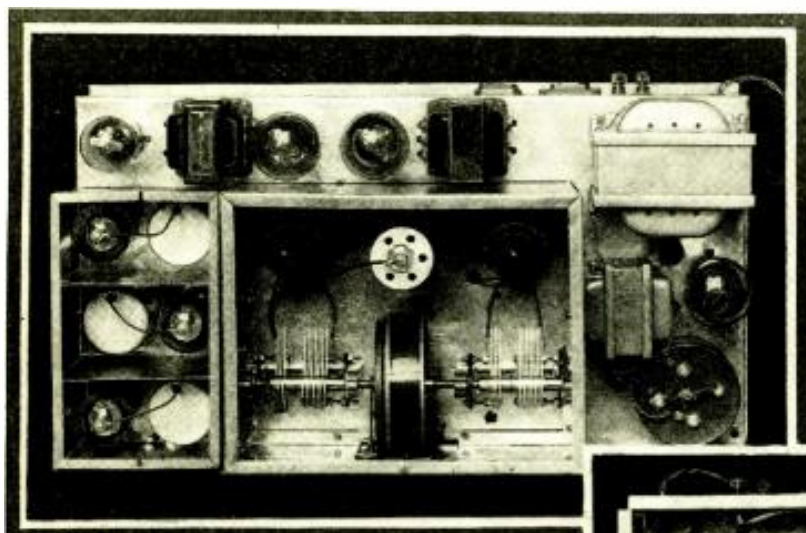
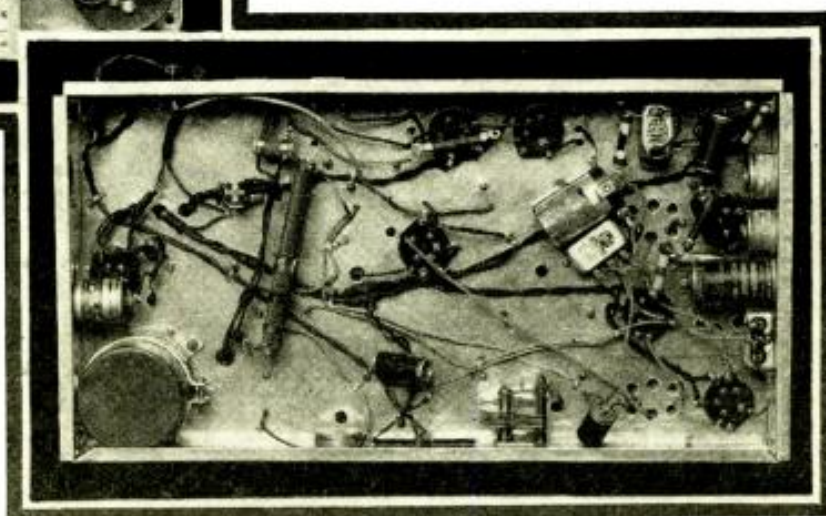

Fig. B, above. Top view of the Tetradyne's chassis.  
Fig. C, right. Under-chassis view of the receiver.

connected to the positive side of the high voltage through the oscillator coil L3, which is connected in the plate lead of the tube. Since the other terminal of the condenser is grounded, the high voltage is applied directly across the condenser. This may not be regarded as "good engineering" practice, but the writer has operated this receiver for eight months without any harmful effects. It will be noticed, by reference to the schematic diagram of the completed receiver shown in Fig. 2, that a small Christmas-tree lamp is connected in the high-voltage line; if a short should occur, the lamp will burn out, thus protecting the "B" supply unit from possible danger.

Referring again to Fig. 1, it will be seen that a grid leak and grid condenser is used in the input circuit. This is optional, as the circuit works very well without it; it does, however, seem to add a little sensitivity to the receiver. If it is used, the grid condenser should have a value of 150 mmf., and the grid leak a value of



and broadcasting station mix at any but the I.F. frequency.

It will now be instructive to discuss the tubes used in the set and then proceed with its construction.

Both the '24 and '35 (the latter a variable-mu type) tubes have been tried in the oscillator—first-detector stage. From the writer's

Many all-wave receivers have been described heretofore; but the Tetradyne, discussed by the author, has some very novel features that warrant the close attention of set-builders, Service Men, and Experimenters.

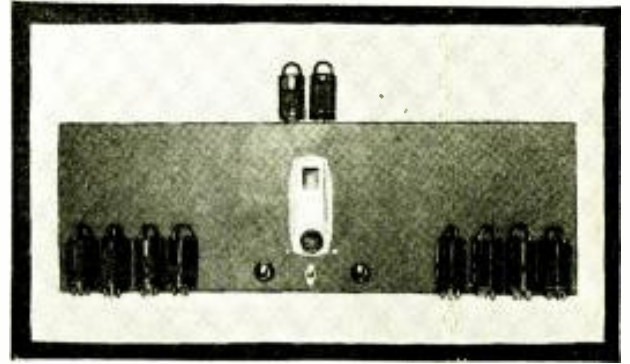

Fig. A  
Front view of the Tetradyne Model H2 receiver.

experience, the '35 has been found to give better results on the lower waves while the same reception was secured on the broadcast band. For this reason the '35 type tube was selected for this purpose as well as for the two stages of I.F. A '24 was used as the second-detector which is resistance-coupled into a '27 first audio which, in turn, feeds into two '47 pentodes connected in a push-pull arrangement.

**The Tuning Condensers**

Now, referring to Fig. 2 and also to the photographs, it will be seen that the tuning condensers are of the two-stator type. They are National type E.C. 4 which originally had a capacity of .0004-mf. However, several plates have been removed from each section so that now the smaller section is composed of three plates and has a capacity of .0001-mf. (Condensers C2 and C5 in Fig. 2.) The larger section has seven plates and a capacity of .0002-mf. (Condensers C1 and C4 in Fig. 2.) This results in a total capacity of .0003-mf. in each section, which is used to tune the broadcast band. The smaller sections are used only for the short-wave bands, and are automatically connected in the circuit by means of the plug-in coils illustrated in Fig. 3.

Condenser C3 is shown in Fig. 2 as connecting directly across the entire tuning unit; but, in reality, it is connected only across the smaller or .0001-mf. section; this connection also being shown in the coil data of Fig. 3.

The main tuning condensers are ganged on one dial and C3 is manipulated by means of a separate knob on the front panel. Its use on the broadcast band is not at all necessary; but on the shorter waves, it helps to tune in the weak stations. Condenser C6 is an equalizing condenser of about 50 mmf. and is permanently connected to the broadcast-band coil; once adjusted, it should not be touched again.

This condenser is also shown in the coil-data illustration of Fig. 3. It should be studied very carefully.

One thing that will be noticed in examining Fig. 2 is the absence of R.F. chokes and complicated filter systems in the plate and

screen-grid leads. They may be used if so desired, but the writer does not see the necessity of them—in this set, at least. Nothing is used that does not improve results at the loudspeaker, for that is where the merits of a set are judged. They were tried and, while they may be theoretically O.K., the writer did not notice any improvement with their use, and consequently discontinued them.

It will be noticed that the second-detector, while it is a '24 type tube, has its screen-grid and plate connected together—it being used as a regular three-element tube. In this manner, greater amplification is secured than if a '27 were used.

Different set-constructors have their own ideas on how a set should be shielded. I have found the following to be successful.

Shielded wire is used on this receiver; the shield being grounded. It was found necessary to completely shield the first I.F. transformer and tube from the rest of the set, so all three I.F. transformers and the two I.F. tubes were enclosed in a separate three-section shield. The modulator-oscillator tube, the tuning condensers and coils are all placed in one large shield-box; and contrary to the usual custom, the coils and condensers are *not* shielded separately. However, the '35 tube is shielded separately. None of the leads from the coils to the control-grid caps are shielded—just plain rubber-covered wire is used.

The complete receiver, including the power supply, is mounted on a sheet of 14-gauge aluminum, 11 1/4 ins. wide, 21 ins. long, and 2 1/2 ins. high. The modulator-oscillator tube, the coils, tuning condensers, and dial are mounted in an 18-gauge aluminum shield-box, 10 1/4 ins. long, 6 ins. high, and 8 1/4 ins. wide.

The shield-box for the I.F. and second-detector is 8 1/4 ins. long, 5 ins. wide, and 6 ins. high. It is divided into three equal compartments, the material also being No. 18-gauge aluminum.

Home-built tuning coils wound on commercial forms have been used throughout as they have been found to be inexpensive.

Figure 3 illustrates the manner in which the tuning coils are to be wound. While Pilot coil forms were used, they may be con-

(Continued on page 682)

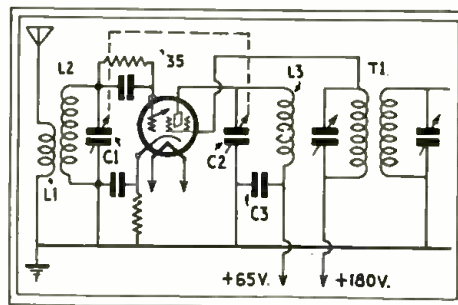

Fig. 1  
Detailed diagram of the oscillator.

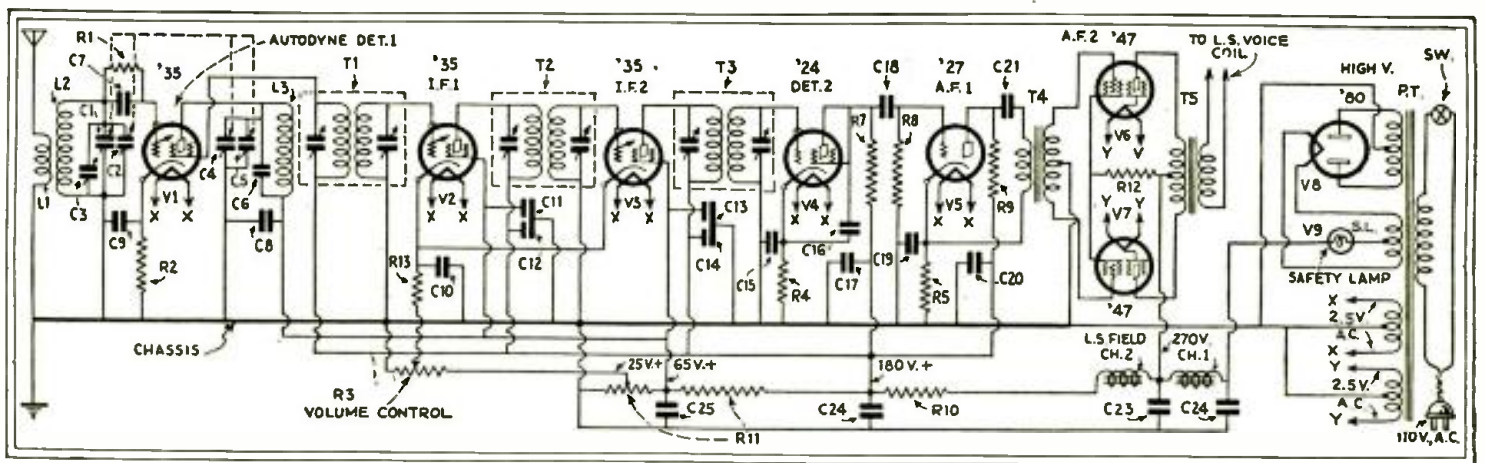
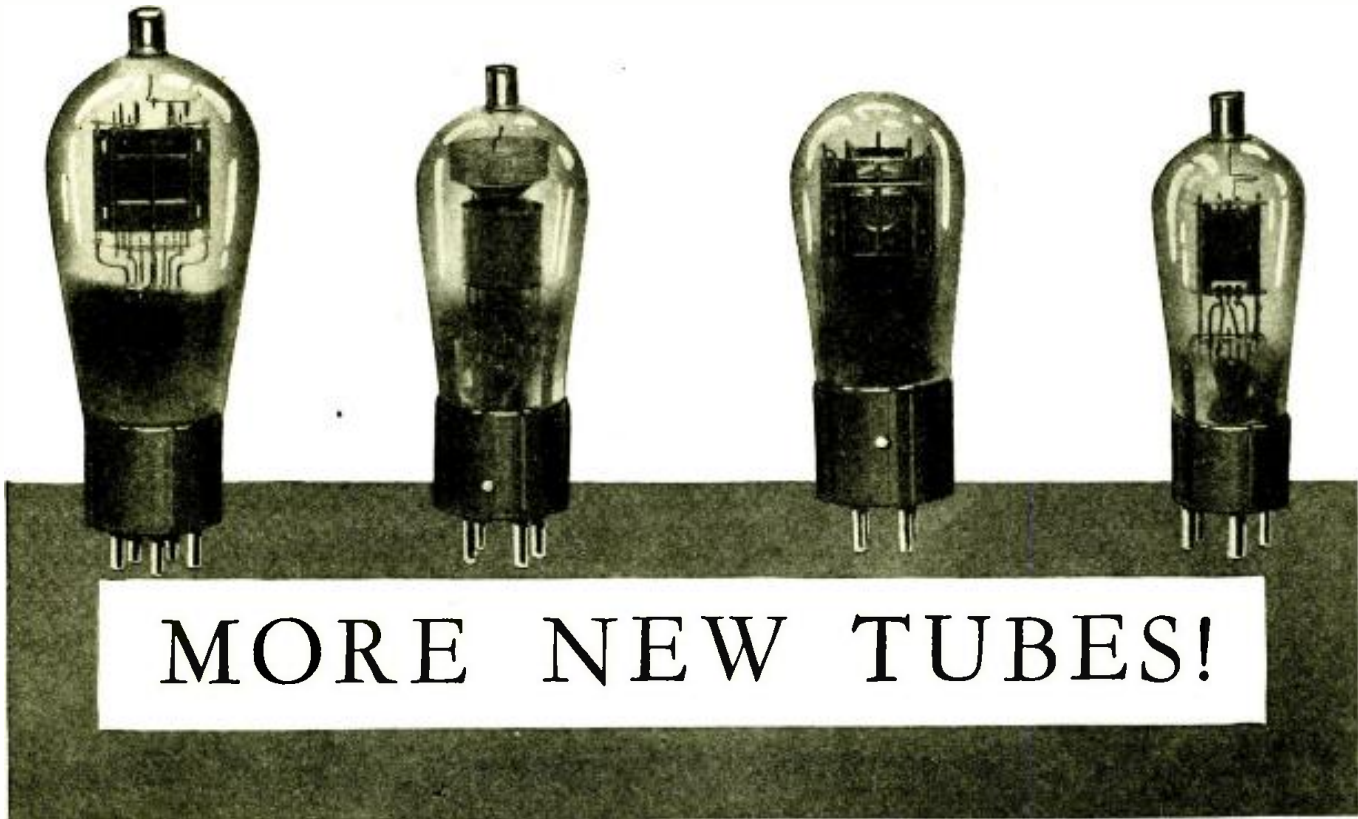

Fig. 2  
Complete schematic circuit of the Tetradyne receiver. The exact connections of the input tuning circuit is shown in Fig. 3.



**H**ERE we are again this month with a line of eight new tubes; each one being prematurely announced in these pages so that the set builder, experimenter and Service Man may be in a better position to formulate any plans he may have had for the future. It might be well to state that it is impossible at this time to specify the type-number of these tubes inasmuch as they have not yet been established at this writing.

It is probable that even one of the tubes discussed in this article will have its physical construction changed slightly, but this should not hamper the reader inasmuch as the electrical characteristics will be identical with those given here.

#### A New Type Output Pentode

In Fig. 1 we have shown a new type of output pentode which is capable of delivering 3.5 watts of undistorted output with a load resistance of 7000 ohms. Probably the unique feature about this tube is the fact that, unlike other output tubes, it has a heater; in other words, it has a cathode emitter which is similar to the '27 type tube. This new feature results in a much lower hum output than has been heretofore possible in power output tubes. For instance, consider Fig. 1.

This curve shows the hum-voltage output when the grid and plate-return-leads are not brought to the center tap of the filament. In other words, the '47 type tube has a hum

output of one volt when the center tap is but 1.5 percent off center; the new pentode has an output of but one-tenth of a volt with the return leads 1.5 per cent off center. An examination of this latter curve will readily show how quiet this new pentode is expected to be.

Figure 2 shows the relation between plate voltage and plate current. The vertical line at the 250-volt mark is the rated plate voltage of the tube. As with other pentodes, the familiar "bump" at low plate voltages is absent. This, of course, is due to the insertion of the fifth element in the tube. The curves in Fig. 2 are each taken with different values of grid biases; at the rated bias of -16.5 volts, the plate current is seen to be approximately 33 milliamperes.

Figure 3 is a very interesting curve; it

---

**F**OR the fifth consecutive month, RADIO-CRAFT is scooping the field by being FIRST to announce new and vital radio tubes. In practically every case, these new tubes have been published several months ahead of any other radio publication in the country.

Because new tube developments are considered important, and inasmuch as every new radio development is fully dependent upon new and better tubes, RADIO-CRAFT has always taken the initiative to be the FIRST to bring the latest developments along these lines to its readers.

The present article is a climax in this respect, as the developments of the entire radio industry, during the next twelve months, will revolve around these tubes.

---

shows the relation between the load resistance and the power output of both the second and third harmonics. The small scale to the right indicates the percent distortion. The second-harmonic output is a minimum with a load resistance of 7000

By LOUIS

ohms; it is for this reason alone that the value of 7000-ohms for the load resistance was chosen.

Figure 4 illustrates the variation of amplification factor, mutual conductance, and plate resistance of the tube with various grid biases. As in the other curves, the vertical line indicates the rated bias of this new tube.

It may be well to remark that the curves as given above have been supplied by the manufacturer of the tube.

The following are the characteristics of the tube; heater voltage, 2.5; heater current, 1.75 amperes; plate voltage, 250; screen voltage, 250; grid bias, -16.5; load resistance, 7000 ohms; amplification factor, 100; internal plate-impedance, 31000 ohms; mutual conductance, 3300 micromhos; plate current, 34 ma.; output power, 3.5 watts.

It is seen that the characteristics of this new tube are very similar to that of the '47. In fact, it may directly replace the '47 tube; the only circuit change necessary is the rewiring of the socket as per the diagram, Fig. 5.

The addition of this tube to any receiver will result in a greater power output with less distortion than could be secured with the '47. In fact, the author predicts that this new tube will completely replace its older brother within a short time after it

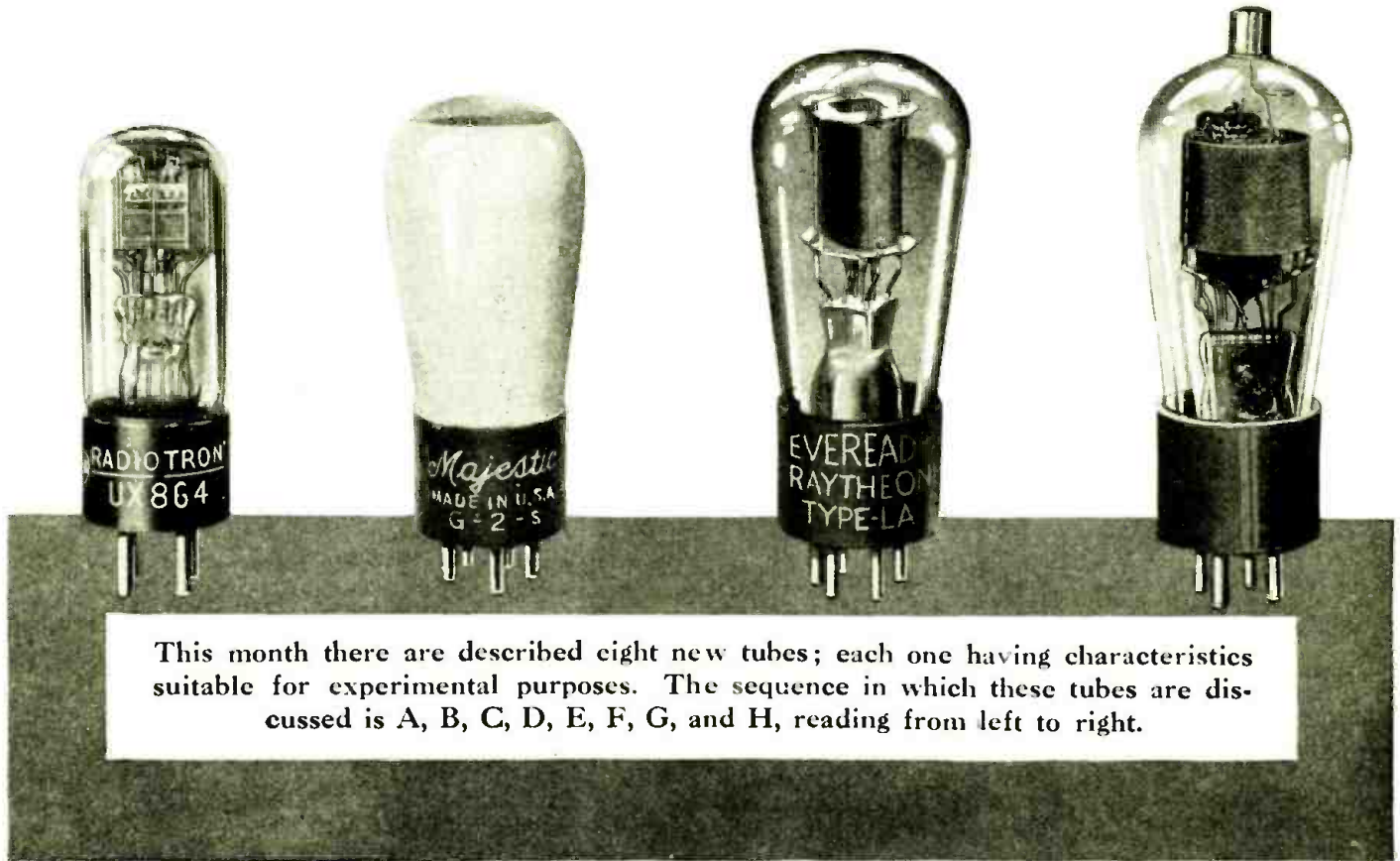

This month there are described eight new tubes; each one having characteristics suitable for experimental purposes. The sequence in which these tubes are discussed is A, B, C, D, E, F, G, and H, reading from left to right.

MARTIN

is obtainable in the open market.

A Combination Oscillator First Detector

Very few people deny the fact that the superheterodyne is the most popular circuit in use today. The only possible objection that one could have to its use is the necessity for having an *additional* (oscillator) tube. While circuits have been designed that have combined the oscillator and first detector, they have not proved very satisfactory, especially when made on a production basis, so that almost every one who has designed such a circuit has eventually changed it so as to use the additional tube.

Figure B shows what the author considers a tube of radically new design—a combination oscillator and first-detector built into a single glass bulb.

The diagram of Fig. 6 shows the rather unique mode of connection. As may be seen, the tube has two plates, a pentode-grid, a screen-grid, a control-grid, a cathode, and a heater. While physically it has seven elements, nevertheless colloquial use will probably change it to a *sextode*, inasmuch as the cathode and the heater may be considered as a single element.

The operation of this tube is not unlike that of the familiar dynatron oscillator. Refer to Fig. 6. The coil L1 and condenser C1 constitute the oscillator tuning circuit; the coil L2 and condenser C2 the secondary circuit of a standard R.F. transformer. Circuits L1 C1 and L2, C2 are detuned by an amount equal to the intermediate frequency. The transformer and condensers shown within the dotted outline to the right of the diagram is the first I.F. transformer. For convenience in explaining

the operation of this circuit, the elements of the tube have been labeled in the diagram as P1, P2, G1, G2 and K which corresponds

to the socket connection given in Fig. 7. All voltages shown in Fig. 6 are obtained from batteries in order to simplify the diagram. The theory of operation, however, is the same when operated from a power unit.

Condensers C3, C4 and C5 are the familiar control-grid, screen-grid and plate bypass condensers. C6 is used as a bypass condenser for the plate-voltage supply of P2.

Referring to Fig. 8, it may be seen that the tube operates on the portion of plate-resistance curve which changes very rapidly. Thus, any change in grid-bias will result in a very large change in plate resistance. Now when a signal is applied to the control-grid (G1), the plate currents of both P1 and P2 vary in accordance with this signal voltage, while at the same time, the plate current of P2 is varying at a frequency determined by the size of L1 and C1. The result is that the change in the control-grid voltage is determined not only by the signal voltage but also by that induced in the grid coil L2 from plate coil L1. Here is where plate P1 comes into use: Its current is the result of both voltages, whose frequency is the *difference* between the two; that is, equal to the intermediate frequency. It is for this reason that the I.F. transformer is connected to P1. Stated in another way, the tube has two plates; through one (P2), the oscillating current flows, and through the other, the resultant of both the signal and the oscillator plate current.

The relation between control-grid voltage and plate current is also shown in the same figure. A peculiar fact, as may be seen by referring to Fig. 9, is that the plate of P2 is at a potential of but 30 volts and that of P1, 250 volts.

This tube has some very interesting possibilities, and it would be well for the ex-

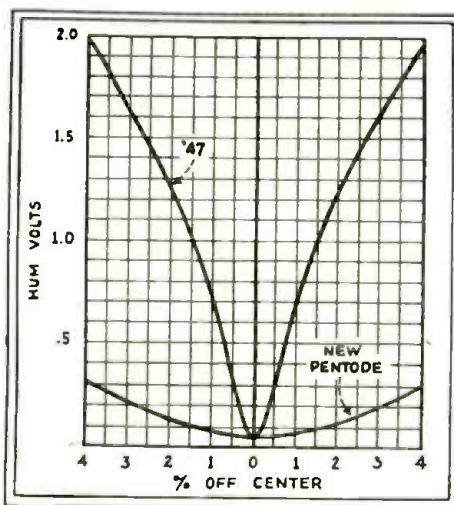

Fig. 1  
Hum-volts output of the '47 compared to the new heater-type output-pentode tube, as position of center-tap is varied.

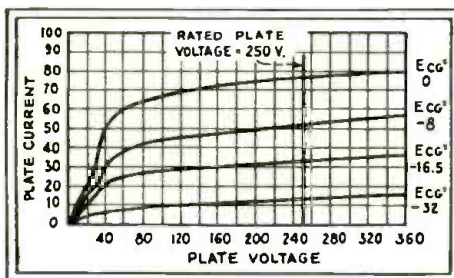

Fig. 2  
Curves showing the relation between plate-current and plate-voltage of the new heater-type pentode.

such happenings as insulation in or near the electron path, irregular filament emission, gas, positive-ions emitted by the filament, and insulating foreign deposits on grid wires. The construction of this new tube is such as to minimize these disturbances to an extent that will permit the measurement of the small voltage mentioned above.

The characteristics of this new tube are as follows: Filament voltage, 5; filament current, .25-amperes; plate voltage, 135; plate current, .45-ma.; control-grid voltage, -.5; amplification factor, 30; internal plate resistance, 10,000 ohms; mutual conductance, 3000 micromhos; grid-plate capacity, 9.6 mmf.; grid-filament capacity, 4 mmf.; plate-filament capacity, 2.3 mmf. For a resistance coupled amplifier, the following constants should be used: "B" voltage, 180; grid voltage, -3; load resistance, 500,000 ohms. With the above, the plate current will be .1-ma. and the amplification factor 20.

as shown in C Fig. 11; when the cycle reverses, G1 causes a decrease in plate current while G2 hardly rises at all. The resultant plate current flowing through the resistor R of Fig. 10 is shown at D of Fig. 11. In other words, full-wave rectification is secured, and the voltage drop across this resistor may be taken in order to obtain A.V.C. action. The elements of the grid as labeled in Fig. 10 are connected to the socket as shown in Fig. 13.

This tube was designed by Dr. Wunderlich, and is undergoing production at the present time.

**A New Two-Volt Pentode**

At this time, tube manufacturers announce a new super-control pentode in the two-volt series for use as an R.F. or I.F. amplifier or as a first detector in superheterodyne circuits. It corresponds to the '35 or '51 in the A.C. series and the '39 (which was described in the February, 1932 issue of RADIO-CRAFT) in the automobile series).

The characteristics of this new tube (which is designated as the '34) are as follows: Filament potential, 2 volts D.C.; filament current, .06-ampere; plate voltage, 180 (max.); screen-grid voltage 67.5 (max.); control-grid voltage, -3; plate current, 2.8 ma.; screen-grid current, 1 ma.; internal plate-resistance, 1,000,000 ohms; amplification factor, 620; mutual conductance, 620 micromhos.

This tube is ideally suited to short-wave use, especially for portable receivers. When used with the '32 screen-grid tube as a detector, and a '33 tube as an output tube, a higher degree of sensitivity and volume are obtainable.

The socket connections of this tube, as shown in Fig. 14. Fig. 15, shows the control-grid voltage—plate-current curve of the tube and also the mutual conductance curve. Fig. 16 shows a family of plate-current—plate voltage curves. See Fig. H.

**A Detector-Amplifier**

As the sixth tube on the list we present a new detector-amplifier designated

Fig. 6, left.

Diagram of connections of the oscillator—first-detector.

Fig. 8, below.

Variation of negative plate-resistance and plate current with grid voltage for the oscillator—first-detector tube.

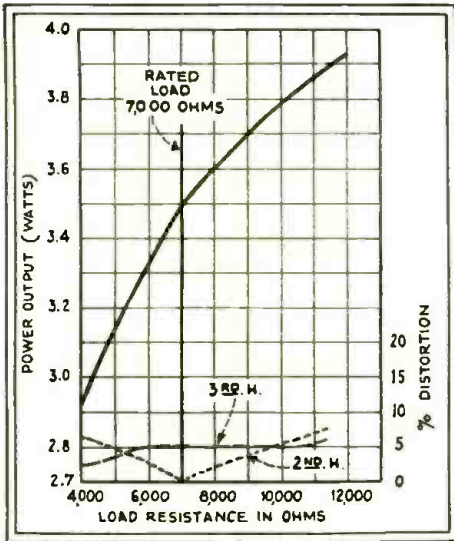

Fig. 3

Power output and percent harmonic-distortion curves of the new output pentode.

perimeter and set builder to obtain one and see what can be done with it.

**The P. J. 11 Plotron**

A vacuum tube more sensitive than its predecessors in the measurement of minute voltage was announced recently by the vacuum-tube engineering department of the General Electric Company. This new "low noise" vacuum tube, illustrated in Fig. C, is technically designated as the type "P. J. 11 Plotron," differs particularly from the usual tube in the degree of vacuum that has been attained. In the ordinary tube, the gas pressure is of the order of a millionth of an atmosphere (an atmosphere being 14.7 pounds per square inch); the new tube has been exhausted to a billionth of an atmosphere!

The "low noise" tube makes it possible to detect voltages of the order of 1/10,000,000 of a volt. It has been possible to do this at radio frequencies for some years, but when attempts were made to amplify voltages whose frequencies were less than 1000 cycles per second, it was found that voltages of less than 1/10,000 of a volt were completely masked by large random disturbances. When these disturbances are made audible by a loudspeaker, they appear as a loud crackling noise. Because of the fact that this new tube reduces this noise between a hundred and a thousand-fold, it is possible to measure voltages as small as a millionth of a volt and to detect voltages ten-times smaller at all frequencies up to about one-million cycles per second.

Laboratory investigations show that random disturbances are caused by any or all

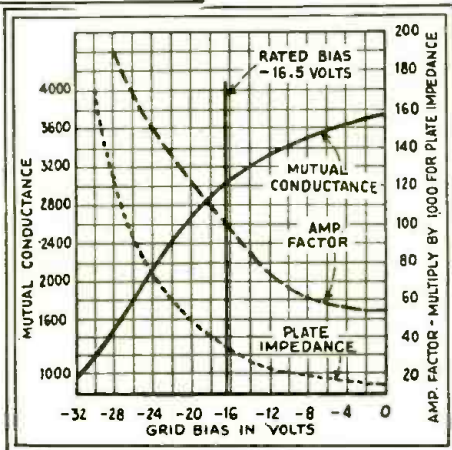

Fig. 4, above.

Variation of amplification factor, mutual conductance, and plate impedance with grid bias.

Fig. 5, right.

At the left (A), socket connections of the new heater pentode.

Fig. 7, right.

At the right (B), socket connections of the new oscillator—first-detector.

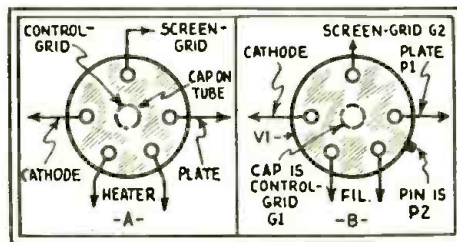

and the diagram of its connections in Fig. 10.

As may be seen by an inspection of this figure, there is no bias on the tube itself. The coil L1, and capacity C1, is the usual secondary circuit that feeds the second-detector (of course, if the receiver is of the T.R.F. type, the second detector is the only one there is, and consequently the information given regarding this tube is valid for such receivers also). Its theory of operation is relatively simple. Consider Fig. 11. The signal voltage shown as A is impressed across grids G1 and G2 of the tube; one (G1) being positive and the other (G2) negative. The plate current, due to G1, does not rise very much even though the grid is positive because of the unusual shape of the plate-current—grid-voltage curve shown in Fig. 12. The grid G2 being negative causes a large decrease in plate current

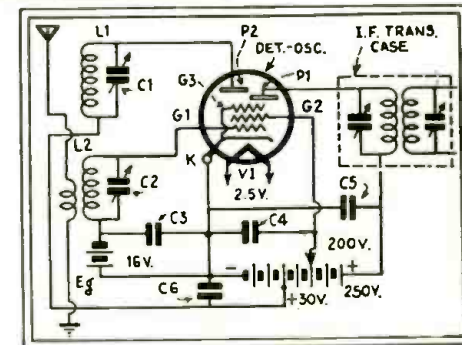
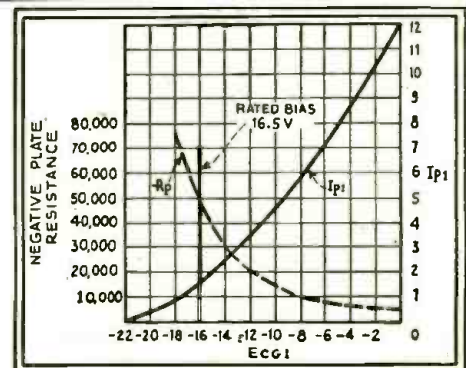

Diagram of connections of the oscillator—first-detector.





as the '61. It is designated as a three-electrode tube of general-purpose type construction for use under conditions where freedom from microphonic disturbances is required. It is specially applicable as a detector-amplifier or oscillator to battery-operated equipment which may be subjected to either impact or continual vibration. This tube is illustrated in Fig. E and has the following ratings and characteristics: Filament voltage, 1.1 (D.C.); filament current, .25-ampere; plate potential, 90 volts (max.); grid voltage, -1.5; plate current, 2.9 ma.; amplification factor, 8.2; internal plate-resistance, 13500 ohms; mutual conductance, 6.10 micromhos; plate-grid capacity, 2.3 mmf.; grid-filament capacity, 5.4 mmf.; plate-filament capacity, 3.5 mmf.

**The "G-2S" Duodiode**

For several years past, the detector-circuit of the radio receiver has received less technical attention than any other circuit from the standpoint of fidelity and overload characteristics.

The earliest type of vacuum-tube detector—the diode—consisting simply of a thermionic cathode and a plate, was discarded chiefly because of its lack of gain; or, in other words, due to the fact that it was not particularly sensitive. It has become increasingly more apparent, during the last few years, that the two-element tube, or diode, has several advantages as a detector which more than compensate for its low gain and lack of sensitivity, and several modern circuits have appeared in which the usual triode, or three-element tube with two of the elements electrically connected, have been used as a diode detector. It is well known that it is practically impossible to overload such a detector, since it has the ability to handle any amount of power up to the point of destruction of the tube itself without overload distortion. The circuits associated with this use have frequency characteristics which are inherently better adapted to detectors than are the common detectors in use today. In fact, the diode detector is often known as the "linear detector" as contrasted with the more usual "square-law" type.

The advantages of "push-pull" operation are well understood in the radio art today. The great advantage of push-pull lies in the fact that this mode of operation auto-

matically cancels out the objectionable even harmonics.

It has remained for Grigsby-Grunow engineers to incorporate in an entirely new tube and a new circuit, the combination of these two developments, that of the diode or linear detector, and at the same time the push-pull operation.

The "G-2S" is constructed with a standard heater type cathode operating at a heater terminal potential of 2.5 volts and a heater current of 1.75 amperes (average). It utilizes two small plates, concentric with the cathode, with a spacing of about one millimeter between them at the center of the cathode. The two plate leads are brought out separately to the stand-

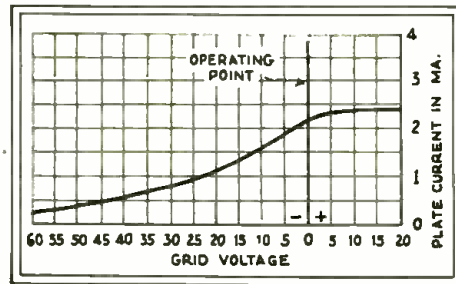

Fig. 11, left.

Action of the detector tube.

Fig. 12, above.

Plate-voltage — plate-current curve of the new detector.

Fig. 13, upper left.

Socket connections of the detector tube.

Fig. 14, lower left.

Socket connections of the '34.

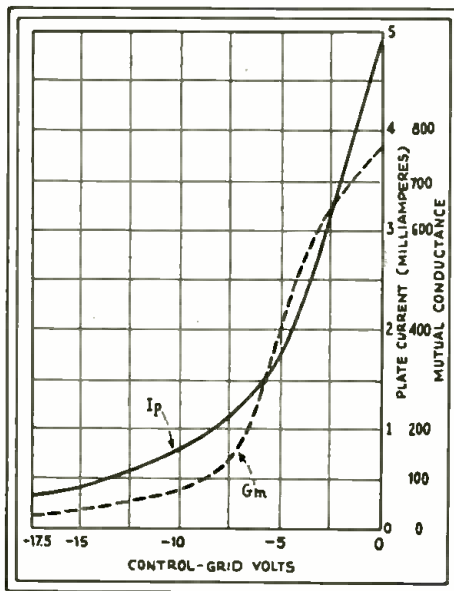
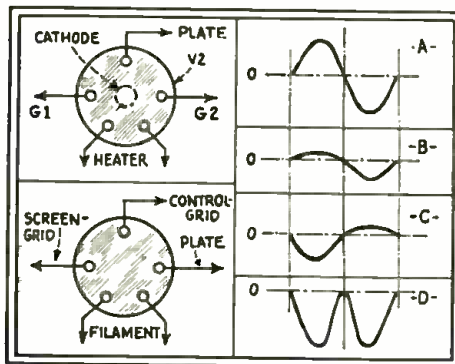

Fig. 15

Curves showing the variation of plate-current and mutual conductance with grid-bias. The former is represented by the solid and the latter by the dotted curve. It should be noted that with the rated grid voltage of -3 volts, both the plate current and mutual conductance vary considerably with grid bias. This tube cannot be used in the output stage.

duced with the courtesy of Dr. C. Marvin Blackburn of the Grigsby-Grunow Co. A photograph of the tube is reproduced in Fig. F.

**A New Output Pentode for Automobile Receivers**

One of the most important problems in automobile receivers is that of supplying sufficient audio output. The signal level should be high enough so that driving noises will not interfere. The first sets employed fairly sensitive magnetic speakers so that an output of a few-hundred milliwatts was sufficient. However, with the recent trend to small dynamic speakers of poor efficiency, the power tubes are required to give a much higher output.

The plate-supply power is very limited. Dry batteries of 135- and later of 180-volts have been generally used as "B" supply. Also the "B" eliminators introduced recently are designed to give only 30-35 ma., because they operate on the car battery already loaded up to maximum capacity. Allowing about 10 ma. for the other tubes in the set, this leaves a maximum of 25 ma. for the output tubes. After subtracting the bias voltage, about 4 watts "B" power remain and must be used economically. It is easy to see that 2 watts of audio power is the highest possible output under these conditions.

Another requirement imposed on the output tubes as well as on all the other tubes in the set is that of maximum sensitivity. Conventional triodes are, therefore, practically eliminated, pentodes being far superior in this respect.

There are some tubes for this purpose on the market already; the '38, for instance, having been designed especially for automobile receiver operation, has proven quite satisfactory. In some cases, a tube with higher power output and power sensitivity is desirable. The plate dissipation, however, at 165 volts on the plate is rather high for the size of the tube.

The '33" would be quite suitable for this application in some respects. However, the

(Continued on page 683)

Fig. 9, below.

Plate-voltage — plate-current of the detector-oscillator.

Fig. 10, right.

Circuit diagram of the new detector. Condensers C2 may be made equal to .00025-mf.

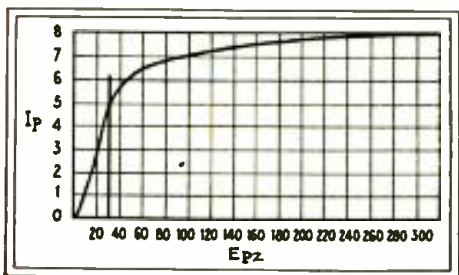
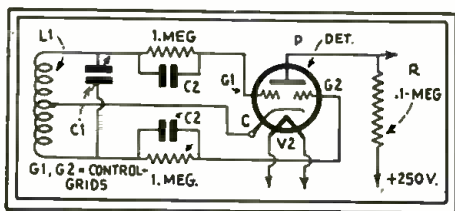

An important feature of the "G-2S," when operated under these conditions, lies in the fact that an extremely long life may be expected. At the present time, it is impossible to say what the actual life may be, but it is certainly safe to say that it will be far in excess of any of the commercial triodes or tetrodes now standard in the industry.

The information given above is repro-

# The Latest in RADIO EQUIPMENT

## A PORTABLE SOUND REPRODUCER

A NEW portable and completely self-contained unit for reproducing records through radio sets and power amplifiers has been recently announced.

Housed in the leatherette carrying case are an electric phonograph motor and turntable, and a sensitive electro-magnetic pickup. A carrying case in the cover provides for storage of several records without danger of breakage.



The Operadio reproducer.

This unit is adapted for use with all radio sets and amplifiers having provision for connection to either high or low impedance pickups. Adapters are available

for connections to most other radio sets. Available with either high or low impedance pickup, and with 78 or 33-1/3 R.P.M. motors, for 25 or 60 cycles, 110-volt power supplies. It is a product of the Operadio Mfg. Co.

## A NEW BATTERY RECEIVER

IN THE accompanying illustration is shown a new 8-tube superheterodyne (Model KOC) designed to operate from a 110-volt D.C. source. It uses four type F-236-X variable-mu tubes for the R.F. stage, first-detector and two I.F. stages; two type F-236 tubes for the second-detector and oscillator; and two type F-257 tubes for the A.F. stage. It has a band-pass input circuit and a small dry battery for "C" bias.



The Fada Model KOC.

It is manufactured by F.A.D. Andrea, Inc.

## A SMALL DRY RECTIFIER

THE H. T. 8 rectifier shown in the illustration is suitable for supplying the plate current of receivers consuming 60 ma.



The voltage doubler.

It may also be used for battery charging and for supplying field-current for dynamic speakers.

It is manufactured by Westinghouse, Brake and Saxby Signal Co.

## A SMALL METER RECTIFIER

THE use of output meters for testing purposes is becoming increasingly popular. The small rectifier shown below

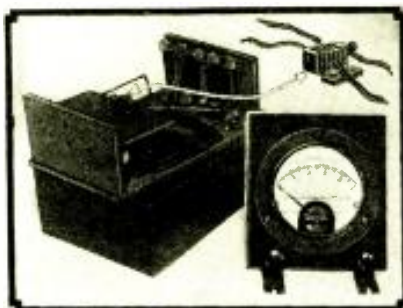

A set-up using the rectifier.

was designed to work in conjunction with a 0-1 ma. D.C. meter. For voltage measurements, the series resistor necessary may be

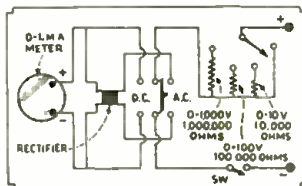

Left, manner in which multipliers are connected. Right, Calibration curve.

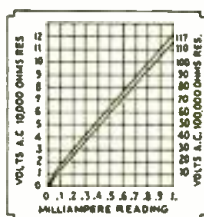

determined by merely multiplying the range by 1000. Thus, shown below is the connection of a meter for three ranges, 0-1,000 volts, 0-100 volts and 0-10 volts. A calibration curve is also shown.

This unit is manufactured by the Taussig Research Laboratories.

## BULOVA RADIO SETS

RADIO sets and electric clocks go together like hand and glove, but the newest models have a degree of utility not obtained in earlier models of such "combination" instruments. One of these newer radio receivers is illustrated below.

A particularly interesting new feature is the Bulova electric clock which is built into the set. Besides giving the correct time, the clock (together with its time relay) automatically turns the radio "on" and "off" at any desired time. Just pick out the program you desire to hear, set the clock, and when the time comes the radio automatically turns itself on and starts to play.



The Bulova "midget."

There are five models in the Bulova line: a five-tube

T. R. F. midget (illustrated here); a seven-tube superheterodyne midget; a seven-tube console; a seven-tube Grandfather Clock; and a ten-tube deluxe console.

The dynamic speaker has been set back from the front of the cabinet a number of inches and a shorthorn introduced, acting as an acoustic load. This greatly improves the quality of reproduction from the midget models.

The clock operates continually, always indicating the correct, electrically perfect, synchronized time. The radio set can be operated either automatically by the clock or manually in the ordinary manner.

These sets are the first to be put on the market by the Bulova Watch Company.

Its diagram of connections will be published in a future issue.

## AN A.C. AUTOMOTIVE RECEIVER

THE New York and Chicago Automobile Shows occasion the announcement of a new superheterodyne motor car radio receiver. It is manufactured by the American Bosch Corp. and is designated as the Model 9:20, because of 20 outstanding features, 9 of which are engineering features combined for the first time in automotive radio.

One of the features is the Magmotor, an instrument used for the elimination of "B" batteries. This device is a single armature, double-commutator machine, with a permanent magnet field and operates from the car battery. The receiver may be operated either from the Magmotor or from 135 volts of "B" batteries.

Seven of the new automotive tubes are used including one used as a "diode-triode." Full automatic volume-control regulates the signal level to counteract the varying field strength as the car moves along the road.

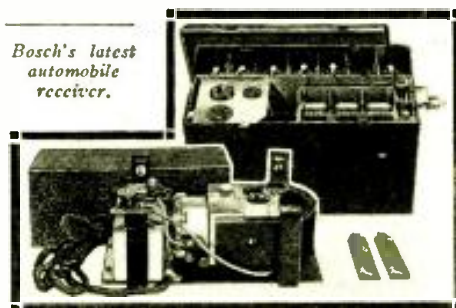

Bosch's latest automobile receiver.

The receiver utilizes the roof type antenna now being installed at the factory, or it may be operated with a new plate antenna designed by the Bosch company. It is suspended to the under-side of the car frame parallel to the road.

## A Complete Television Receiver

At last, with the announcement of a television receiver shown at the left and right, the public is beginning to get a glimmering of the particular corner around which television has been hiding for the last few years.

The set is a product of the Hutton Television - Radio Corp. and bids fair to find an excellent market. It incorporates, aside from the television receiver, a broadcast receiver so that the reception of sound and image may be made simultaneously.

The set has two main features: First, the disc is stamped from a single sheet of metal, and is slotted radially, so that each section between two slots may be bent at different angles; second, the crater lamp is so placed with respect to the screen that a long beam-length

is secured in a very short space.

These two points are illustrated in the drawing reproduced here. In each of the sections mentioned, a concave indentation is stamped and its surface polished. The crater lamp is so focused that the diverging beam of light from the lamp strikes the disc and is reflected to the screen. Thus, all of the light is utilized and a picture 5 x 6 inches is secured in a cabinet whose depth is only 11 inches.

The photograph at the right shows the 60-line disc removed from its motor in order to illustrate the respective location of the crater lamp and its associated parts.

Sound is emitted from the loud speaker at the top of the grandfather type console illustrated. Clyde Fitch is the inventor.

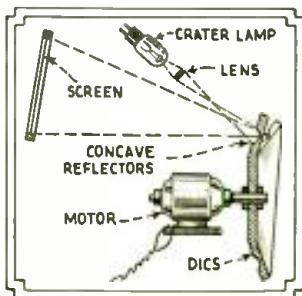

Schematic of lens system.



The television receiver

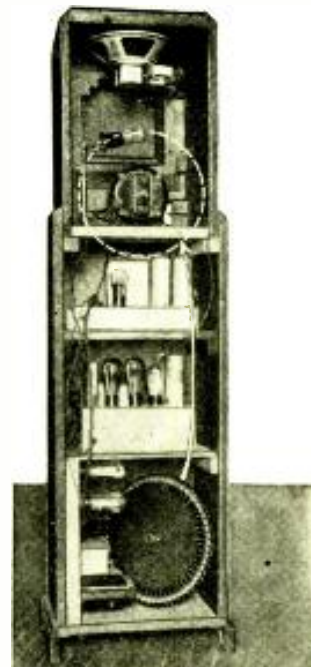

Rear view of the combination television and broadcast receiver.

**NEW PORTABLE "P.A." SYSTEM**  
 THE latest thing in portable public-address equipment is illustrated here. The complete unit is carried in a single, balanced carrying case, the front of which is utilized as a baffle for the self-contained dynamic speaker. Complete with tubes, microphone, and all accessories, the weight is only 40 lbs.



The portable P.A. system

The input from the two-button microphone that is supplied, or from any 200-ohm phonograph pickup, is raised by the three-stage amplifier to a volume level sufficient for addressing a group of people

that may be assembled in a room 1,000 feet square. The amplifier operates from 110 volts 60 cycles, A.C., and supplies power for all accessories including the dynamic speaker and two-button microphone.

A control panel is provided with separate volume controls for microphone and phonograph input, and a changeover switch for shifting the amplifier to either input. The cover provides stowage for a 50-foot rubber-covered microphone lead and a 25-foot A.C. line cord. A jack is provided that allows from one to four additional A.C. dynamic or magnetic speakers to be operated without affecting the output of the main speaker.

This type of unit finds wide application for use at meetings and luncheons where overflow crowds are located in a second room, and as a paging system during conventions. They are often carried by speakers on tour who wish to make certain that they are easily heard by their whole audience.

This instrument is manufactured by The Operadio Mfg. Co.

### NEW REPLACEMENT CONDENSER BLOCKS

THERE have recently been announced replacement units for the Majestic "9-P-6" and "7B-P-6," and Atwater Kent models "37" and "38" power supply units.

The replacement unit for the Majestic "9-P-6" power supply consists of three 2-mf. sections of 400, 500 and 600 D.C. working voltages and 1-mf. section of 300 D.C. working voltage with a choke connected in series with the latter.

The replacement unit for the Majestic "7B-P-6" power supply consists of two 2-mf. sections of 300 and 600 D.C. working voltages, and two 3-mf. sections of 300 and 400 D.C. working voltages.

The condenser sections used in the construction of these blocks are non-inductively wound, thoroughly impregnated and dehy-

drated and use high grade materials. They are mounted in metal casings, fully sealed with moisture-proof filling compound and provided with convenient soldering terminals on an insulating strip through the top of the unit as shown.



Replacement unit for Atwater Kent Models 37 and 38 power units.

The replacement units for Atwater Kent models "37" and "38" power supply units consist of two .5-mf. sections, two 1-mf. sections, two filter chokes and a speaker choke. The condenser sections and chokes are mounted in heavy metal containers filled with sealing compound and provided with colored wire leads.

The above units are products of the Aero-vox Wireless Corp.

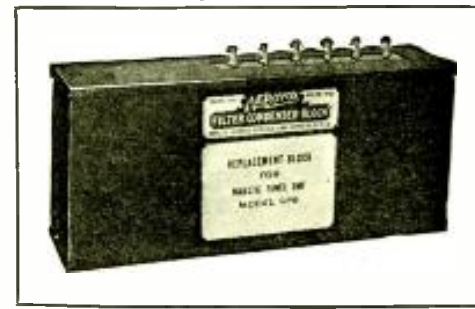

Replacement unit for the Majestic Model 9-P-6 power supply. It consists of three 2-mf. sections and a 1-mf. section with a choke.

**A 5-TUBE SUPERHETERODYNE**

By the use of the "autodyne" principle of operation, it has been possible to produce a 5-tube superheterodyne, the Crosley "Littfella," illustrated.

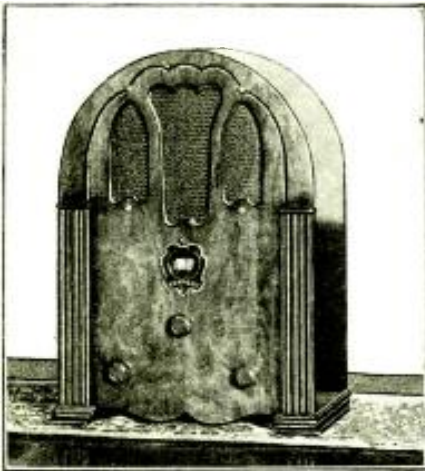

The Crosley "Littfella."

**A "QUICK-SERVICE" ANTENNA**

The "Tennacord" illustrated has been developed by the Holyoke Co., Inc., to meet the demand for simple antenna equipment suitable for modern, high-power receivers.

This device incorporates a 25-ft. "antenna" lead, 10 ft. of which is capacity-coupled to a light-line lead 10 ft. long (one end of which plugs into the power outlet, while the other receives radio set's plug); the remaining 15-ft. length is permitted to dangle conveniently as added pickup.

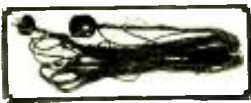

The antenna.

**"SOUND-ON-FILM" HOME TALKIES**

A PRODUCT of RCA Photophone, Inc., the 16 mm. Photophone Junior Portable now makes available for home, office and shop a complete little "theatre,"—and without recourse to the machinery required for turntable-and-disc operation. The equipment weighs 43 lbs.; it measures 14 1/2 x 13 1/2 x 8 1/4 ins.; it is complete with loudspeaker and 110 V., A.C. power equipment and is reproduced below.

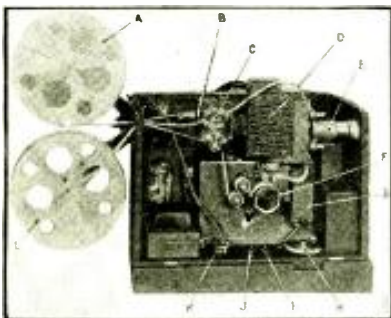

Above, A to L, feed reel, takeup, feed, proj. lamp, optical system, sound drum, exciter, proj. sec and amp. vol. control, amp. sec., compensator sec., speaker plus, takeup reel. Right, normal size of 16 mm. film and enlarged sound track.

**REFLECTOR-LENS TELEVISION**

NEWEST in television is the "prismatic reflecting lens" system of television developed by William Hoyt Peck. Light, instead of going through the scanning disc, is reflected by the mirrored back of the lens and thence to the screen; the resulting focal length makes convenient, in small depth a picture 12 ins. square, or more. In the cabinet shown are the usual sound and sight units.

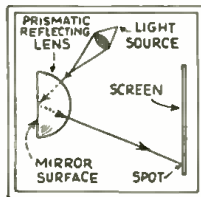

Above, Peck television receiver (and in back, enlarged view of inset prismatic reflecting lenses). Left, arrangement of the Peck optical system. Light from the neon crater lamp "light source" passes to the mirrored plane surface of the special lens.

**NEW ELECTROLYTIC CONDENSERS**

SMALL-SPACE electrolytic condensers now being manufactured by Dubilier Condenser Corp. are particularly suited to the requirements of high capacity and low impedance; and D.C. working voltages of 25 (available in units of 8, 10, and 20 mf.); 50 (4, 6, and 8 mf.), and 125 (10 and 15 mf.). Metal-container type measures 3 1/4 x 2-3/16 x 1 1/4 in.; cartridge type, 2 1/4 x 1 in. in diam. for 125 V. units, and 2 1/4 x 5/8-in. in diam. for the lower voltage units.



Above, Dubilier type, and, right can type of compact electrolytic condensers.



**A LIGHT-OPERATED RELAY**

AN inexpensive light-operated device is the new LuxTron supersensitive selenium cells and relay which operates from a 22 1/2 volt current source. The manufacturer is Lux-Tron Devices Co.



The light operated relay.

**POLICE RADIO SETS**

THE new types D-2175 (1712 kc. band) and D-2166 (2110 kc. band) Stromberg-Carlson Police Receivers illustrated below are manufactured by Stromberg-Carlson Tel. Mfg. Co. These superheterodynes incorporate A.V.C. and pentode A. F.



The Police Radio Set.

**METER SHUNTS**

SHUNTS of special alloy wire for multiplying meter readings are illustrated below. Manufacturer, D. L. Van Leuven. Circuits, and multi-scale dials for standard meters are available.



Above, Van Leuven meter shunts; and right, measuring 100,000 ohms; 0-5, 0-25 and 0-100 ma.; and, 0-5, 0-10, 0-50, 0-250, and 0-1,000 volts.

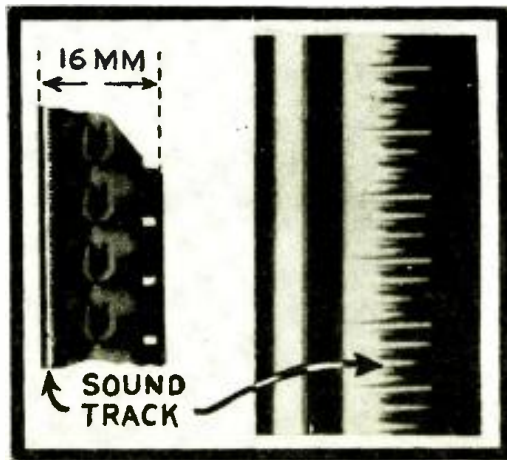
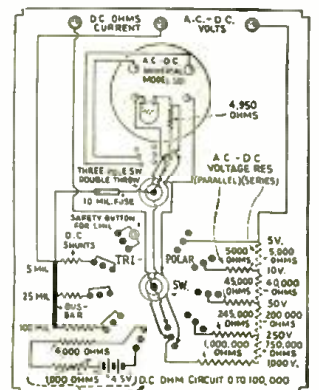

# Constructing a SIMPLE SET TESTER

By JOSEPH LEEB, E.E.

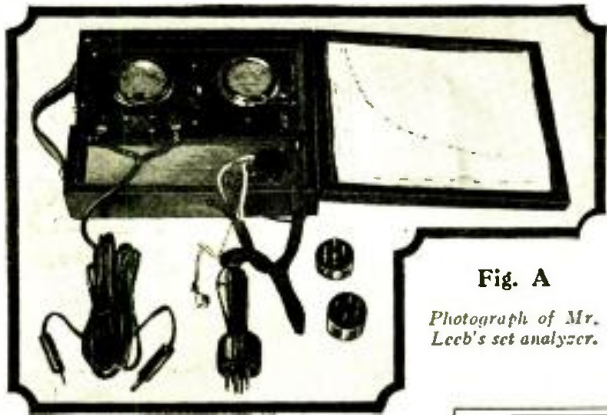

Fig. A

Photograph of Mr. Leeb's set analyzer.

EMERSON once said, "If eyes were made for seeing, then beauty is its own excuse for being." This bit of philosophy can be applied to articles describing set analyzers as well as flowers. The test set illustrated in Fig. A was built because of its extreme compactness, simplicity and low cost, although it is not lacking in symmetry.

The size of the instrument panel is only 4 1/4 inches by 8 inches, while the outside dimensions of the carrying case are 8 1/2 inches long by 6 3/4 inches wide by 2 1/2 inches deep. A sewing machine tool box was pressed into service to house "the works." These boxes may be obtained for almost nothing at any sewing machine dealer's. If a box of this type cannot be obtained conveniently, any other case of suitable size may be substituted.

### Description of Analyzer

Figure 1 shows the panel layout. As will be observed, only two meters are used; a D.C. voltmeter and a D.C. milliammeter. The A.C. voltmeter was purposely omitted, for two reasons. A third meter would add considerably to the bulk of the test kit, and is not used often enough to make it absolutely essential. The most important readings are obtained on the two D.C. instruments. If A.C. readings are desired, the Service Man can carry a separate portable meter in his tool kit.

A five-prong flush-mounted socket is placed as shown. The use of a four-prong adapter obviates the necessity for a four-prong socket on the panel, tending further toward conservation of panel space. Tip jacks are used for the tube-socket terminals, screen-grid clip, and external posts of the voltmeter and milliammeter. This procedure brings all parts of the circuit right out on the panel, where the tests can be made directly. Complicated switching arrangements are thus done away with.

The meters used in this tester are of the two-inch flush-mounting type. Weston Model 506 was the make selected. The voltmeter in this case had two scales, 0-8 and 0-200. A 0-400 scale was added by the inclusion of a multiplier in the circuit. The resistance of the multiplier is equal to the resistance of the meter at the 200-volt range, in this case 25,000 ohms. The milliammeter is a 15 ma. instrument with an additional shunt connected through a toggle switch for the 150 ma. range. The shunt is easily made by connecting the milliammeter in series with another milliammeter (of about 150 ma. range), a variable resistance, and a battery. Various lengths of resistance wire (from an old rheostat) are connected across the terminals of the 15 ma. meter until its reading (multiplied by 10) corresponds to the reading of the higher-range meter. When the proper length of wire has thus been determined experimentally, a piece of spaghetti tubing is slipped over it and lugs carefully soldered to the ends. We now have our shunt for the "111" range of the meter. The toggle switch takes this shunt out of the circuit when the "1.0" range is required.

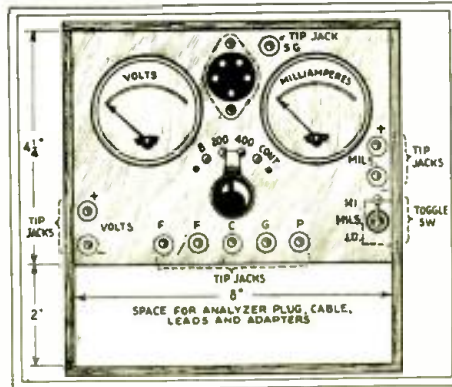

Fig. 1

Suggested panel layout for the tester. Miscellaneous material may be kept in the side compartment.

Associated with the voltmeter circuit is a four-point selector switch for 8, 200, or 400 volts, or for continuity testing. Reference to the wiring diagram (Fig. 2) will show how this is accomplished. It will be noted that with the testing battery connected as shown, it is impossible to short-circuit it, should the switch happen to rest upon two adjacent points. The worst condition possible is a short through the two external multiplier resistances—49,000 ohms—which is not very serious. This condition occurs when the switch lever happens to rest upon the two right-hand points.

The handle of a round "stippling" brush, together with the base of a burnt-out '27 tube, serves admirably as an analyzer plug. One end of the cable connects to the socket prongs and the screen-grid cap on the side of the handle. The other ends of the wires go to the respective tip jacks on the panel.

A pair of flexible leads should be made with phone tips on one end and test prods on the other. The positive lead may be marked with some red thread or other device. For testing screen-grid tubes, a short lead is made with a phone tip at one end, a screen-grid clip at the other. The tip of this lead is plugged into the tip

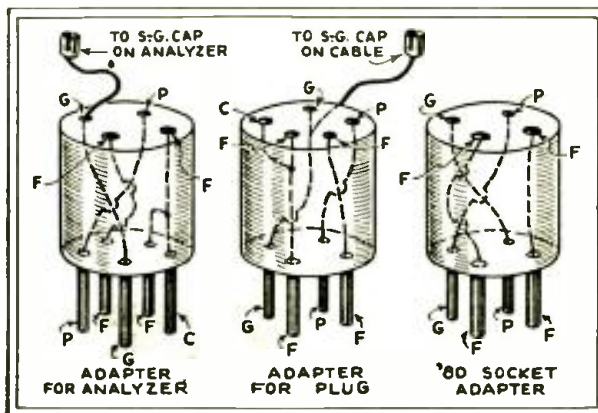

Fig. 3

At the left, an adapter for the plug-end of the analyzer cable; center, the adapter for the socket in the analyzer; and right, an adapter for testing '80 rectifiers.

(Continued on page 691)

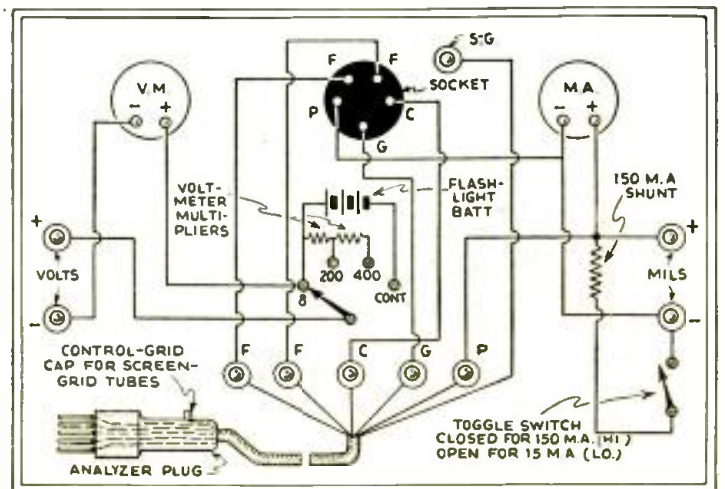

Fig. 2

Complete schematic diagram of the tester. Voltage measurements are made at the socket terminals of the analyzer by the voltmeter leads which are inserted in the left-hand terminals.

# The Theory and Volume Controls, Matching

(PART

By

Fundamental frequency in c. p. s.	Harmonics		
	2 <sup>nd</sup> leng. miles	3 <sup>rd</sup> leng. miles	4 <sup>th</sup> leng. miles
40	583	388	291
100	233	155	117
500	47	31	23
1000	23	15	11.5
2000	11.5	7.7	5.8
3000	7.8	5.2	3.9
4000	5.8	3.9	2.9
5000	4.7	3.1	2.3
6000	3.9	2.6	1.95
7000	3.3	2.2	1.66
8000	2.9	1.9	1.45
9000	2.6	1.7	1.3
10000	2.33	1.65	1.17

IN ANY well-designed voice transmission circuit, such as telephone lines, radio-broadcast speech equipment, public-address systems, "talkie" apparatus, etc., will be found resistance networks, or attenuators, more commonly called "pads." The proper use and design of these pads make for an efficient transmission system, from which the maximum output of energy with the least distortion may be obtained, and which, if these pads were not used, could not be realized. It can be said that pads find their way into practically every phase of voice transmission where quality reproduction is the prime requisite.

It is the purpose of this article to make clear the methods by which these pads are designed, to show their application in transmission circuits, and to discuss the problems encountered in transmission circuits where pads are used.

## Purpose of Pads

In voice-transmission circuits, where energy is being transmitted over a line to a load located at the far end of the line, it is necessary that some means be employed to control the magnitude of the energy entering the load. It is for such purposes that pads are used. These networks are always used between a source of energy and a load. The source of energy might be any of the following:

- (1) Output of a speech amplifier, such as a normally high-level amplifier which is feeding another amplifier located at a remote point;
- (2) Output of a high-level amplifier (power amplifier);
- (3) Output of a low-level amplifier, such as a condenser-microphone amplifier, which is feeding a speech amplifier located at some distant point;
- (4) Output of microphone circuits, etc.: The load may consist of a transmission line carrying the energy and terminating in an impedance located at the far end of the line. This load impedance might consist of any of the following:
  - (a) Primary side of a line-matching transformer (line to line transformer);
  - (b) Input circuit of a speech amplifier;
  - (c) Loud speakers located at distant points from an amplifier;
  - (d) Mixing circuits, etc.

The attenuator imposes a constant impedance upon the transmission line, thereby controlling the level (magnitude) of the energy being transmitted into the far end of the line. The attenuator or "pad" maintains this level by introducing a loss in energy between the source and the load, at the same time causing no impedance mismatch to the impedances between which it is working (source impedance and load impedance).

To illustrate the statements given in the preceding paragraphs, a typical case showing the use of such networks will be given. The complete design and calculation of the pads will be shown, and the problems arising in circuits in which these pads are used will be discussed. It is hoped that by obtaining a complete understanding of the subject matter given in these papers, any problems relating to the design and use of pads in voice transmission circuits will be materially lessened.

Let us assume we have a radio amplifier whose output voltage is 1.5 (effective value of alternating current). This voltage is to be fed over a transmission line, at the far end of which is located the primary side of an input transformer, whose secondary is in the input circuit of an amplifier (see Fig. 3). Let us also assume that it is also necessary to reduce the voltage impressed across the primary side of the transformer to approximately .15 volts (R.M.S.). It can be seen, therefore, that it is necessary to interpose a network of some sort between the input source of 1.5 volts and the primary side of the input transformer in order that the voltage will be reduced to the desired value, at the same time introducing no impedance mismatch between the source and the load.

In voice transmission circuits, this network is composed of non-reactive resistances so arranged that they will cause the desired loss between the input and output terminals of the pad. By "non-reactive" is meant resistances whose impedance remains practically constant to alternating current. This is accomplished by constructing the resistances so that their inductance and capacitance is negligible throughout the frequency band in which they function. (The construction of the resistances for use in the pads will be given in a forthcoming article).

For most purposes, this frequency band can be taken as the audio spectrum of 40 to 10,000 cycles per second. The resistances used in networks must be non-reactive in order that

the attenuator maintain constant impedance characteristics throughout the audio band to the impedances between which it is working, so that straight line frequency attenuation will be obtained without frequency distortion in the transmission circuit, which would hinder the intelligibility of the signal.

The change in voltage between the source and the load is expressed as the logarithmic ratio between the two voltages. At this point a brief resumé on the transmission unit or decibel will be given, so that those not familiar with this unit will have a clear understanding of how it is used in transmission circuits.

In electrical circuits carrying energy which is either being amplified or attenuated, the question arises: What is the relationship between voltage, current, and power on the input side of an amplifier or an attenuator, to the voltage, current, and power on its output side? The engineer signifies this ratio between two voltages,

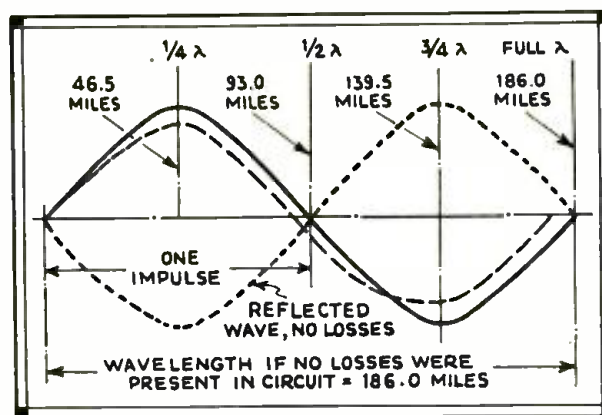

Fig. 4

Initial and reflected waves in a circuit with and without losses.

# Construction of Line Filters and Transformers

I)  
HY LEVY, B.S.

two currents, or two powers, by the number of decibels change taking place between the input and output terminals of the amplifier or the attenuator.

### The Decibel

In any electrical circuit carrying energy, the product of the common logarithm of the power ratio multiplied by ten, or the product of the common logarithm of the current or voltage ratios multiplied by twenty determines the change in decibels.

As an example of this principle, let us assume that in a certain circuit the voltage has been decreased from 3.0 volts to 1.0 volt, or to one-third of its original value. Then from the definition as given above, the voltage ratio is 3 to 1, or 3. The common logarithm of three is 0.4771 (which may be obtained from a table of common logarithms). This means that 0.4771 is the power to which ten must be raised to give three. Then, multiplying 0.4771 by twenty, we get .9542 decibels change:

$$\begin{aligned} \text{i. e., decibels change} &= 20 \log \frac{V_1}{V_2} \\ \text{where } V_1 &= \text{input voltage} \\ \text{and } V_2 &= \text{output voltage} \\ &= 20 \log \frac{3.0}{1.0} \\ &= 20 \log 3.0 \\ &= 20 \times 0.4771 \\ \text{decibels change} &= 9.542 \end{aligned}$$

The above simply means that if the voltage in the circuit has been decreased to one-third of its original value, we have caused a change of 9.542 units or decibels to have taken place. (See table in November, 1931 issue of RADIO CRAFT—Editor.) This change in decibels is expressed as a *loss*, as the voltage has been *decreased*. Similarly, if the voltage had been *increased* to three times its original value, the resultant change in decibels would also be 9.542, only in this case the result would be a *gain*. Therefore, if the voltage has been increased or decreased to three times its original value, the resultant change in decibels is the same in both cases, or 9.542. The only difference in the two cases is in the method of expressing the results obtained.

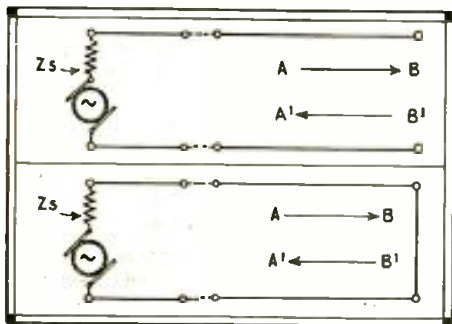

Fig. 5, above. Open-end transmission line.  
Fig. 6, below. "Shorted" transmission line.

When using the formulae shown below, the change in decibels obtained depends on the type of circuit involved. In an amplifying circuit, the relationship between the voltage, current, or power ratios is expressed as a gain in decibels. In an attenuator, the relationship between the voltage, current,

or power ratios is expressed as a loss in decibels. In the circuits to be taken

up, attenuators (resistive networks) will be discussed, and a decrease in energy will be incurred between the terminals of the pad, and therefore all results will be given as a *loss* in decibels.

Thus by expressing current, voltage, and power ratios in decibels, one has an accurate description of the changes in energy taking place in the circuit.

From the definition of the decibel as given above, we can write the following formulae:

$$\begin{aligned} \text{Change in decibels} &= 10 \log_{10} \frac{P_1}{P_2} \\ &= 20 \log_{10} \frac{V_1}{V_2} \\ &= 20 \log_{10} \frac{I_1}{I_2} \end{aligned}$$

where  $P_1$  = input power  
 $P_2$  = output power  
 $V_1$  = input voltage  
 $V_2$  = output voltage  
 $I_1$  = input current  
 $I_2$  = output current

This is shown in Fig. 1.

Also if we *know* the number of decibels change, and it is desired to determine the voltage, current, or power ratios, we can write:

$$\begin{aligned} \frac{P_1}{P_2} &= \text{antilog} \frac{\text{change in decibels}}{10} \\ \frac{V_1}{V_2} &= \text{antilog} \frac{\text{change in decibels}}{20} \end{aligned}$$

$$\frac{I_1}{I_2} = \text{antilog} \frac{\text{change in decibels}}{20}$$

To illustrate this method, assume we wish to introduce a 15 decibel loss into the circuit, and it is desired to know what voltage ratio will give this loss. Then from above:

$$\begin{aligned} \frac{V_1}{V_2} &= \text{antilog} \frac{\text{change in decibels}}{20} \\ \frac{V_1}{V_2} &= \text{antilog} \frac{15}{20} \\ \frac{V_1}{V_2} &= \text{antilog } .75 \\ \frac{V_1}{V_2} &= 5.62 \end{aligned}$$

which means that if the voltage ratio is equal to 5.62, a 15 decibel loss will be maintained in the circuit.

Returning now to our own problem, it was determined that a network is required to cause a loss in voltage between its terminals,

(Continued on page 690)

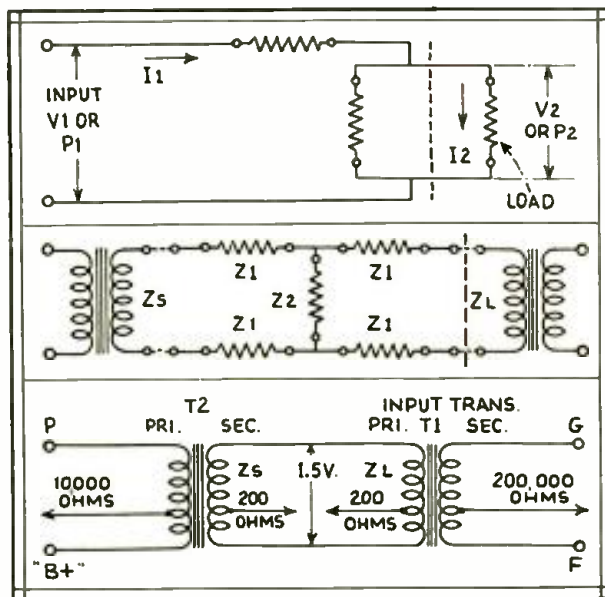

Fig. 1, above. Circuit illustrating current distribution.  
Fig. 2, center. Schematic diagram of an "H"-type pad.  
Fig. 3, below. Impedance relations in a typical line.

Fundamental frequency in c.p.s.	Length of circuit in miles to produce resonance
40	1165
100	465
500	93
1000	46
2000	23
3000	15.5
4000	11.6
5000	9.3
6000	7.8
7000	6.7
8000	5.8
9000	5.2
10000	4.7

# USING Crater Lamps

Because crater lamps will undoubtedly displace the flat-plate neon lamp for television work, the author discusses their methods of connection.

**W**HILE the following circuits were used with a crater-type neon lamp and a projection set using a concave mirror disk, it is quite possible that they could be used equally well with a flat-plate neon lamp and a pinhole disk. Therefore, they should be of interest to all television fans. Lacking definite electrical characteristics of the various lamps, such as A.C. and D.C. impedances which manufacturers fail to supply (lamps of the same make and type varying considerably), it is impossible to give exact data on the best circuit for a given lamp. The following circuits were tried by using ordinary radio parts such as will be found in the average experimenter's laboratory. While excellent results were obtained with some of them, improvements could still be made by proper design. For the present, the "cut and try" method will suffice; and any one who has patience is bound to obtain better reception.

We may start with the information generally supplied by the tube manufacturers. As a rule, parallel output tubes, such as two type '45's, are recommended as they more nearly match the impedance of the neon lamp. The lamp is then usually placed directly in the plate circuit, as in A, Fig. 1, and nature left to take its course.

A simple comparison between the lamp circuit for picture reception and a loud-speaker circuit for sound reception will show how ridiculous it is to expect good images from such a circuit. In the plate circuit of the tubes, both D.C. and A.C. (from the received signal) are flowing. When a loud-speaker is used, only the A.C. component produces a response; the D.C. is silent, and no matter how strong it is, no sound is produced. Furthermore, no matter how weak the A.C. is in proportion to the D.C., it produces an effect on the loud-speaker diaphragm and can be heard.

When a neon lamp is connected as in A of Fig. 1, the results are entirely different. In this case, the direct current as well as the alternating current produces light, which can be seen. Therefore, when the received signal is weak and the A.C. component small in comparison with the D.C. component, the light caused by the D.C. is so strong that the faint picture can hardly be seen. Only the strongest of stations can be tuned in properly. In other words, to obtain the best images, the lamp must be 100 per cent modulated. This means that we must have a method for controlling the amount of D.C. passing through the lamp so that it can be adjusted to be

By CLYDE FITCH

in the proper proportion to the A.C. signal. Before trying any of these circuits, it is well to add a switch to the detector circuit for changing from positive to negative images; some of these circuits give negative images, and to obtain an accurate comparison of the various circuits the detector switch should be thrown to reverse the image. The simple method of reversing a transformer winding will not reverse the image. The best method is to connect the detector switch so that either grid-bias detection or grid-condenser-and-leak detection may be used.

Since the simple circuit at A is not satisfactory for general use and is only good when the incoming signal is very strong, we will discard this together with various versions of it employing combinations of series and parallel resistors, and look for something better.

### Description of Circuits

We have shown that the circuit of A, Fig. 1, is only good for receiving very strong signals; weak images being blinded out by the intense light caused by the D.C. component of the plate current. Note that two output tubes connected in parallel are shown in this circuit. Two parallel output tubes are recommended in all of the following circuits but are left out of the illustrations for clearness.

Figure 1B shows one method of controlling the amount of D.C. flowing through the crater lamp. The resistor R is placed in the output circuit and should be of a value equal to the impedances of the output tubes (depending upon the type of

tubes used) so as to give maximum power output. The crater lamp is connected between the plate and ground—the amount of D.C. passing through the crater being regulated by the variable resistor R2, which is shunted by the Lmf. condenser C to allow for the passage of the alternating current. The resistor R1 may or may not be used. Its purpose is to increase the load impedance so as to more nearly match that of the resistance R. As a rule, the A.C. impedance of a crater tube is only a few hundred ohms, although its D.C. impedance may be a few thousand ohms. Resistor R1 may have a range of from 0 to 10,000 ohms and, once adjusted, may remain fixed. Resistor R2 may have a value of from 0 to 50,000 ohms and should be mounted on the front of the receiver panel so as to be accessible, as its adjustment varies with each

(Continued on page 688)

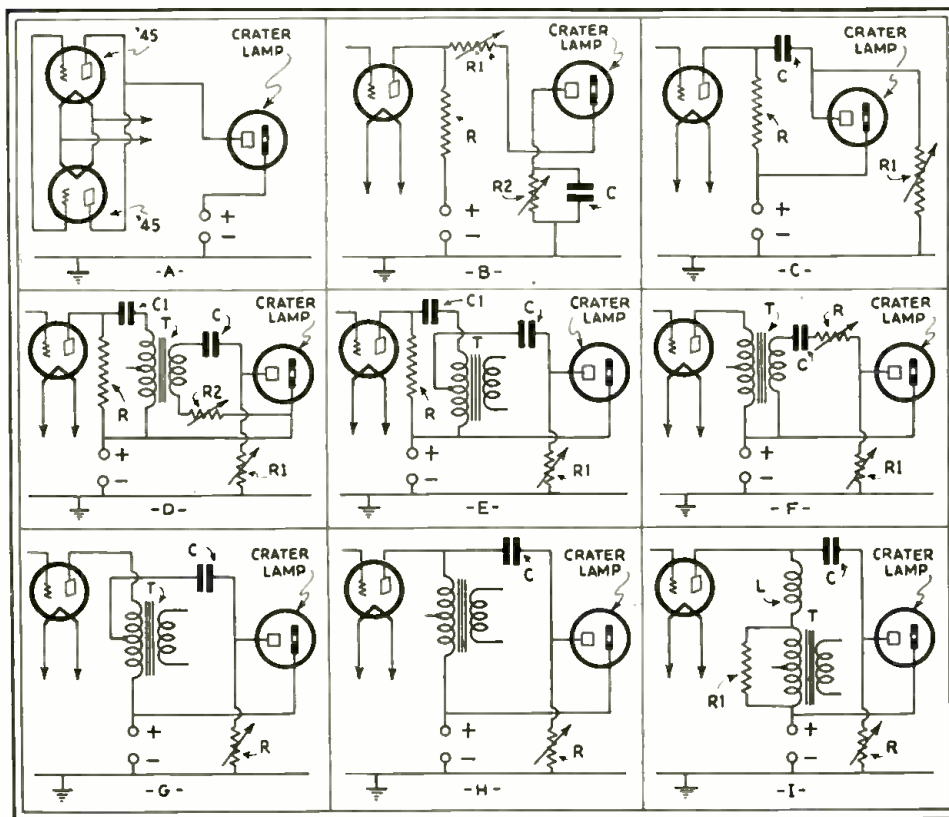

Fig. 1  
Circuit diagrams of crater-lamp circuits. They are discussed in detail by Mr. Fitch.



# The A.C.-D.C. "CASH BOX" Receiver

By H. G. CISIN, M.E.

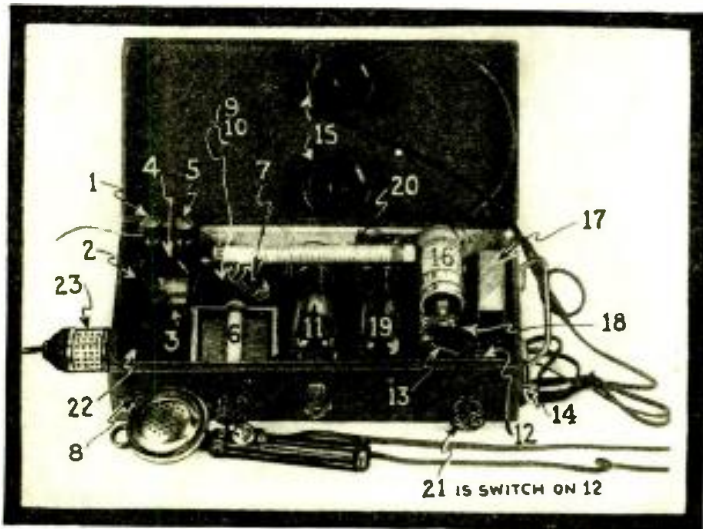

Fig. A

The numbers above correspond to those given in the diagram below.

**H**ERE'S a little radio set that's a true "pal." This A.C.-D.C. portable is possibly the smallest, lightest power-operated portable in the world. It has surprising volume, is fairly selective and still, it fits into a case only a bit larger than a camera.

The portable, which is illustrated in Fig. A, makes a splendid traveling companion. It is also ideal for sick-bed use, for convalescents in hospitals, and for other shut-ins. It is admirably suited to the use of people who are hard of hearing. In fact, by plugging a microphone in terminals 8, it serves as an excellent "hearing aid" when not being used for radio reception. Those who like to listen to radio late at night can do so with this set, without disturbing the neighbors, or without even bothering anyone sleeping in the same room. Used in conjunction with a new type of short-wave converter (police adapter), this portable set will bring in exciting police messages and also other interesting programs and calls on the short-wave band between 80 and 200 meters. No change in wiring is necessary to use the S.W. adapter.

This versatile receiver may be plugged-in any place where electric lights are used, regardless of whether the current is alternating or direct. This universal feature adds to the desirability of the little receiver. Incidentally, this circuit, which is shown in Fig. 1, may also be made available for battery use, and hence for automotive work, with only a few small changes.

No aerial is necessary, although provision has been made for the use of one when distance-reception is desired. The circuit employed is ingeniously simple. In reality, the "Cash Box" receiver is essentially a one-tube set, since the second tube is used merely as a rectifier. The new Arcturus "M" filament, quick-heating, cathode-type 137A tubes are used. These are especially designed for interchangeable use on either A.C. or D.C. and they are the only tubes available for use in this circuit, which will give the desired degree of humless operation.

### Discussion of Circuit

The filaments of both tubes are in series and a wire-wound resistor is also in series with the same circuit, so that the 115 volts supplied by the line is reduced to the 12.6 volts (6.3 volts per tube) required by the two tubes. The first tube 11 acts as a combination detector and amplifier. Tube 19 serves to rectify A.C. to D.C. for use on the plate of tube 11. Filtering is accomplished by means of the audio-choke 17, which is bypassed by the electrolytic condensers 16 and 18. A "conoid" antenna coupler is used at 3. A tickler coil has been added, not only to increase the distance range, but especially to improve the selectivity of the set, so that broad-tuning local stations may be separated through

the use of the regeneration control. The tickler coil is wound on a small cardboard form and placed within the shielded case of the "conoid" coil. The secondary of this coil is tuned by means of a featherweight variable condenser. Conventional grid-leak detection is used, employing resistor. The small fixed condensers 2 and 4 serve to protect the tubes from short circuits through the ground connection to the power line. Condenser 7 isolates the metal box from the line, while condenser 13 helps to prevent hum.

An automatic line-voltage regulator constitutes an important feature in the design of this set. It protects tubes, 'phones and other components against damage due to voltage fluctuations and surges, thus prolonging the life of the tubes and stabilizing the operation of the set. It also acts as a fuse in the event of a short circuit.

### Construction Details

In order to make the set as compact as possible, every available bit of space within the carrying case is utilized. Most of the parts are mounted on a wood strip which fits against the inside rear wall of the case. Before fastening the components on the board, variable condenser 6 and choke 17 are placed in the approximate positions they are to occupy. The board is then put against the rear wall of the case and the locations of coil 3 and of the two tube-sockets are noted. The coil must clear the condenser on one side and the socket must clear it on the other. The two electrolytic condensers are located, one above the other, between socket 19 and choke 17. The conoid coil, the tube sockets, and the electrolytic condensers are then mounted on the baseboard in their proper positions. The coil is mounted vertically by means of a small right-angle bracket fastened to its cover. Resistor 20 is next mounted on the baseboard as indicated. The grid condenser 9 and grid leak 10 are mounted on the board between the conoid coil and the socket. A composition binding-post strip, carrying posts 1 and 5, is fastened to the edge of the board, at the left, by means of three small wood screws.

Mounting holes are drilled in front of the carrying case at the left for the variable condenser, which rests on the bottom of the case. Holes are also drilled at the left front for mounting the twin jack 8. At the right front, a hole is drilled for mounting the Electrad combination regeneration control and switch. Holes are drilled at the right side for mounting the twin jack 14 and at the left side for the outlet 22. Holes are also drilled at the bottom of the case for fastening the choke 17, and at the back, for bolting the wood base securely to the case. All parts which mount on the case are then fastened in position.

It is preferable to start wiring  
(Continued on page 692)

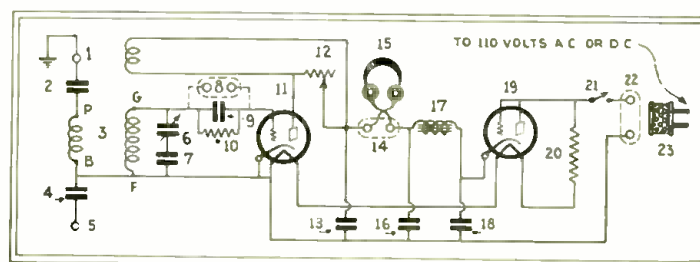

Fig. 1

Circuit diagram of the "Cash Box" receiver.

# TELEKTOR—The Radio Robot

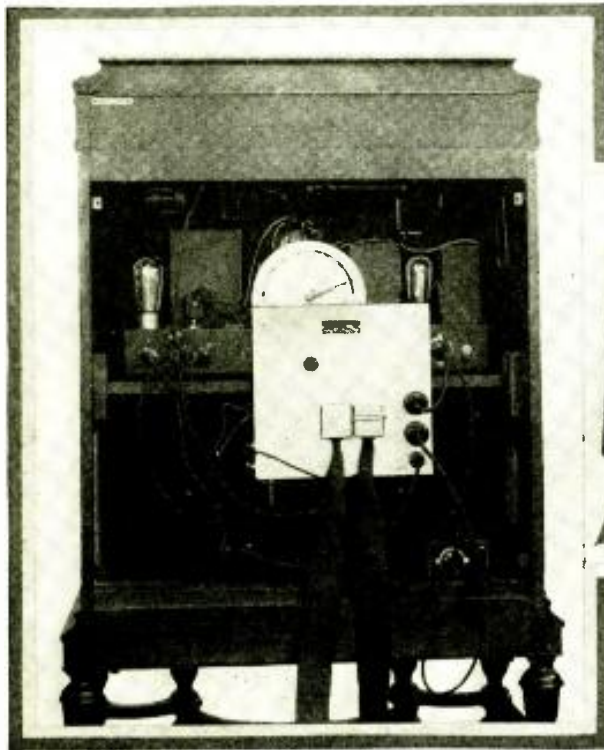
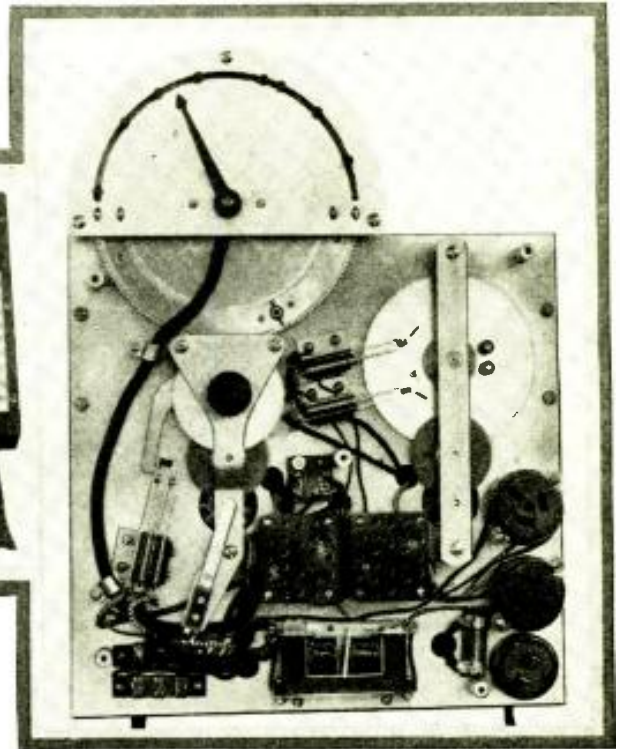

Fig. C. below.  
The remote tuning  
box of the "Telektor."



Figs. A and B,  
left and right.  
The motor unit of  
the "Telektor"  
system.



An interesting description of the manner in which "Stromberg-Carlson" obtains complete remote control operation of modern radio receivers.

**B**Y the very nature of his existence, man is lazy. From time immemorial, he has continually striven to minimize his daily work. Our scientists call this type of advancement "progress," although the definition of the word "progress" is relative. Whether laziness is a desirable characteristic or not depends entirely upon the individual.

In the early days of radio broadcasting, a man would return from his daily labors, turn on his radio receiver, test his storage battery, turn three or four dials until a desirable station was tuned in, and then listen quietly to a conglomeration of noise which, at that time, was called music. However, we have "progressed;" there are few batteries in use today, and receivers have but a single dial, making the tuning-in of distant and local stations a relatively simple matter. But still man is not satisfied. He not only finds it desirable, but at times necessary, that he completely control the tuning and adjusting of his radio receiver from many convenient points distributed about his home. This latter refinement marks another step in the "progress" of radio.

The device to be described is manufactured by the Stromberg-Carlson Telephone Manufacturing Company, and although it is designed to work in conjunction with their own receivers, it may easily be applied to any other receiver having somewhat similar characteristics.

This device, called the "Telektor," consists of a combination of motors and relays mounted at the rear of a radio receiver, as indicated in Fig. A; a detailed view of the Telektor is shown in Fig. B. This Telektor motor unit may be removed from a receiver at any time without affecting the operation of the radio set. It must always be used with a "Telektor Box." When so used, it performs remote starting or stopping of the radio receiver, remote control of volume, and remote control of the tuning dial. Certain Telektor systems are also designed to control, in addition to the above, an automatic record-changing phonograph and four loud-speakers which may be used in a sound distributing system. As stated previously, each of the above may be controlled from any of the remote points selected.

As noted from the Telektor Box, illustrated in Fig. C, twenty push-buttons are available. Eight of these control relays and the remaining twelve control motors. The buttons that control relays need only be pressed for an instant, as the relays operate immediately the circuit is closed. These buttons are the six nearest the pilot lamp and the two at the bottom; that is, there are four speaker buttons, the radio button, the records button, and off and on buttons. (See Fig. C.)

#### Operation of the Telektor

The operation of these relay-controlled push-buttons is as follows: When the "ON" button is depressed, the system automatically connects to the A.C. line and is ready for operation. It should be remembered that pressing the "ON" button will also turn on any loud speaker in the system that is connected for use as a "Master" speaker. You may, of course, press the proper push-button to start any of the extension speakers you may care to use, provided none of them is connected at the time.

You will then hear a program of radio or phonograph music, depending upon whether the radio or records button was last pressed. If you are not sure whether you are hearing a program of records or radio music, then press the button for whatever type of entertainment you wish at the moment. The set, however, is usually installed in such a manner that all the extension speakers will turn off automatically whenever the "OFF" button is pressed, which, of course, turns off the radio receiver as well.

Thus, suppose it is desired to shift the program from one extension speaker to another. The sequence of operation is to press the "OFF" button. This turns off the speaker to which you have been listening and also turns off the radio receiver. Immediately press the "ON" button, and then press the button labeled for the particular speaker you wish to place in operation. This procedure is necessary because in certain installations all the extension speakers draw current from the A.C. line, and it is therefore necessary to disconnect this speaker from the line in order to

(Continued on page 689)

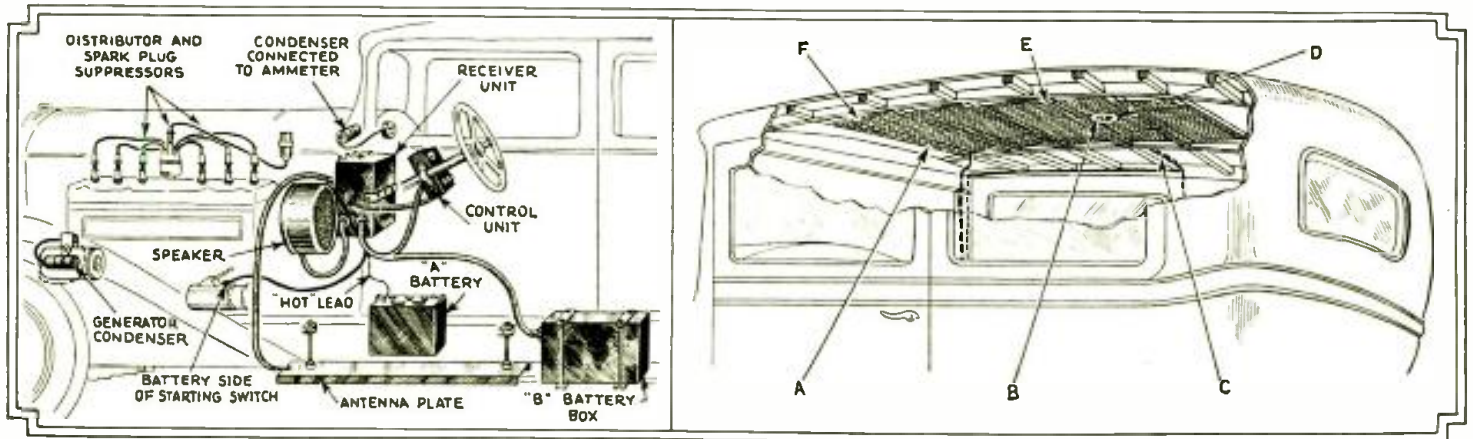

At the left is shown a typical car installation and at the right is shown a typical car antenna. At A are shown stagger tacks to permit listings on head lining, to be tacked over screen; at B, dome-light; at C, dome-light wiring; at D, a hole which is cut to clear the dome-light—the edges of the screen are soldered; at E, the antenna screen—use bright copper or bronze wire only; at F, edges of screen—they must be soldered.

# CASH in Automotive Radio

Here's an analysis of a new field, right at your backdoor, where the grazing is very good now, and will get better as summer comes.

**J**UST a few short years ago, a meeting of important radio manufacturers was called in New York City to consider the possibilities of making a profit from the sale of automobile radio receivers and accessories. That was before Crosley and National and Atwater Kent had given the subject any more than the most casual consideration. It was before Transitone was taken over by Phileo and before the R.C.A., or any of the tube manufacturers, gave any consideration to the manufacture of special tubes, batteries, cables and the like, for automobile-receiver use. There was a live interest shown at that meeting; but there were plenty of misgivings, as there always are when anything off the beaten track of radio merchandising is up for consideration.

By **ARTHUR H. LYNCH**

But the purpose of this article is not so much to review auto-radio's history as it is to indicate that there is a market for receivers of this nature right at this minute. It is increasing by leaps and bounds, and it is bringing an entirely new field of effort and profit into existence for the Service Man. Before you read another paragraph, may I suggest that you give the idea a bit of thought from this point of view.

Regardless of the size of your town, I'll wager that there are at least three automobile dealers in it. In all likelihood, two of them are kicking about business being poor, and they are the two who are doing nothing about it other than waiting for something to happen and for things to take a turn for the better. Have any of them ever thought of the idea of giving a good auto radio with every car? Did you ever talk this over with them? Business is to be had—plenty of it—if you will use your head for something in addition to making a satisfactory resting place for your hat. You may be interested to know what other fellows are doing along this very line. It may give you a hunch or two and enable you to rake in a lot of the loose "shekels" which are just waiting around for you. Furthermore, if you handle the job properly, it can be made of great advertising value to your regular service business.

### Service Systematized

Unlike the ordinary type of radio business, auto-radio servicing does not begin after the receiver has been in operation some time and begins to require attention. Auto-radio service begins when the dealer makes the sale. The installation of an auto-radio receiver is no mean job. It is usually different for every make of car as well as for every different model of every make. It is not easy, except for the Service Man who specializes in it. For the man who does, there is a virgin field with much more than the ordinary amount of profit waiting.

Just think this over: At the last radio show in New York, the Chief Engineer of a very large company told me that his company made and sold about five thousand auto receivers this year—not counting short-wave receivers sold to various police departments—and the company is now working on a production schedule of five thousand a week! Even supposing it did not carry on that type of production for a long while, it is an indication of the business already at hand. When the meeting of manufacturers was held in New York there were only five makers of auto-radio receivers. Now there are more than sixty. At that time, there were no makers of special tubes for auto-radio use. Now there is not a single tube maker of any importance who does not include these tubes in his line. There were, at that time, practically no batteries made especially for this service, and the ordinary type of storage battery did not give a very suitable account of itself when the drain of several tubes was added to the drain caused by the starter and so forth. Nor did the "B" batteries, designed to sit quietly in some place or other until they were exhausted, perform too well when they were bounced over hundreds of miles of rough roads.

There arose a howl for service—and a new kind of service—which required a very fair knowledge of automobiles and their engines. Automobile companies were not too slow to realize the importance of auto radio—after some of them went so far as to suggest that the radio would be a menace to driving, only to have it proven to them that they were cutting off their noses to spite their faces. Then the manufacturers of receivers and tubes began to wake up to the fact that here was a market which they had been ignoring. Then some of them went into it blindfolded. Sales managers saw millions of dollars in it and sold the idea to their directors; and printers' ink and radio-advertising time were devoted to this new venture with more than ordinary prodigality. Then the kittens came home to the mama cat. There was weeping and gnashing of teeth. This was not true of all the auto-radio manufacturers, but there were very few exceptions.

Then it became recognized that systematized service was an absolute necessity, if auto radio was to give the customer satisfaction. And there are still a few receiver manufacturers who hold the opinion that it is good business to deliver a customer at least a portion of the claims made for their products. Where were the Service Men who could save the day for them? They were few and very, very hard to find; in most instances they have not been able to find half enough of them. In the final analysis, no auto-

(Continued on page 693)

# The Service Man's Forum

Where His Findings May Benefit Other Radio Technicians

## "RADIO SERVICE—CODE"

Editor, RADIO-CRAFT:

I have read with interest your article, "Radio Service and the Electric Code." Let me say that when a reliable radio set is sold and properly installed as a rule the Service Man's battle is over. I have seen quite a few "Handymen's" installations and the result was—numerous service calls!

Each state should require an examination of Service Men and, license the men who pass this test. It goes without saying that a man must have good tools to do good work.

A Service Man should refuse to make an installation which would not conform with the National Electric Code, simply because the customer wants a "cheap job."

What do you say fellows? Lets hear from you.

PAUL J. SILAFFER,  
Terra Alta, W. Va.

## RADIO CRAFT AND THE SERVICE MAN

WE are in receipt of the following bit of interesting data from Mr. Omer Benson of Willis, Kan., and the illustration we reproduce in this issue.

As can be seen by reference to the figure, the main part of our service bench is a Supreme 400-B Series N Diagonometer with Shop Test Panel; the other service instruments are built around this unit. To the right is a small panel, and a test oscillator; the small panel at the left is part of a direct-reading ohmmeter and output meter combined. It is built up with a Jewell 0-1 ma. milliammeter, using the scale published in the July, 1931 issue of RADIO-CRAFT (pg. 51) for the ohmmeter, together with a resistance and dry cell to give full-scale readings. This scale matches the other meter scales so closely that it is almost impossible to tell that it has been replaced with the new paper one. This makes an ohmmeter always ready for use without disturbing the Diagonometer and without disconnecting the radio receiver under test from the light socket.

The output meter has an audio transformer and fixed crystal to rectify the output current of a radio set, and a variable resistor to vary the needle reading; it also has large fixed condensers in the circuit to protect the meter.

Other instruments on the bench are set analyzers, tube testers, etc., for portable use.

On another work bench not shown in the picture is a stand for the electric drill, together with a buffing wheel, grinding wheel, and special tools for holding the work.

I live in a small town but have a large amount of service work brought in as I have been in this field since the start of broadcasting. I have every copy of RADIO-CRAFT on file, from Vol. 1, No. 1, and they are not for sale! Of course, I have my copy of the Official Radio Service Manual; I

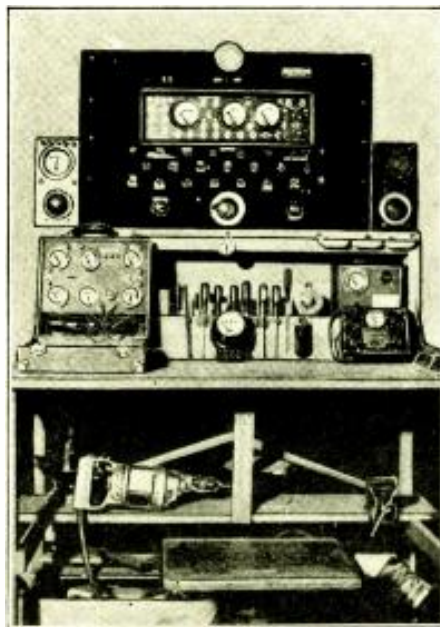

could not do without it.

We are of the opinion that a better job can be done at less cost and in less time at the shop than it can at the customer's location; consequently, we believe that it is only a matter of time until nearly all radio repair work is done in well-equipped service shops.

## BIG BUSINESS IN TOONERVILLE TOWNS

Editor, RADIO-CRAFT:

I read with interest Ralph J. Whitter's letter in December RADIO-CRAFT and I agree with him that there do not seem to be very many letters from Service Men in small towns and cities.

I am located in a small "town" of about 700 population. Within 10 miles there are seven other towns of about the same population as the one I work in. I also maintain an office in a village of 4000 people, 15 miles away. I have worked in this territory for about eight years and I would advise Mr. Whitter not to get discouraged with his first two months business. Better try it for about 1½ years before making any decisions. I have found that there are more jobs and profit in small towns than in large cities, also that one can give lower prices due to lower overhead.

In order to get business in small towns, it is necessary to advertise. I cover all my territory at least every two months with different forms of advertising. Most of my copy is the result of reading other service concerns' advertising and arranging to suit my needs.

Consistent advertising plus good work will bring all the work you want. It will take time, of course, but you will get it.

Most small cities and towns have their local newspapers. A single column, one-inch ad is usually enough, for it keeps your name before the public's eye just as well as a larger one.

Let's hear from some other "small city" men now and see what they have to say.

FREDERICK E. BARBER,  
Camillus, N. Y.

(Due to Mr. Barber's frankness, we are able to find out why he has been able to make his radio business pay, even though he lives "in the sticks." He studies the publicity and advertising material of foremost organizations, and applies the best parts of each to his particular requirements.—Technical Editor.)

## A "GROUND-ANTENNA" IN THE MOJAVE DESERT

Editor, RADIO-CRAFT:

We would be very glad to hear from any Service Man or technician who may have experienced the peculiar difficulty which we find in our locality—an increase of signal strength when we connect aerial and ground to the ground and antenna posts, respectively!

We have found that in 85% of our installations this is true.

You will understand that we are located in the center of the Mojave Desert. The summers are very hot—with no rain and lots of static; the winters have quite a bit of rain, no snow, and the temperature seldom goes below freezing. Altitude, 485 feet, and mountains on all sides, ten to fifty miles away; very sandy soil.

We have been building and servicing sets in this town for eight years. Have had good reception as far north as Regina, Sask.; south to Cuba, and, east to New York and Atlantic City. We might add that we never experienced the above trouble with a battery set.

We have a rather small power plant here, generating 2200 volts; poor voltage regulation, and considerable disturbance at times due to leaky insulators and other troubles too numerous to mention. Santa Fe telegraph causes lots of disturbance, due to radiation from points on their repeaters.

In connection with the above question, we might add, we recently built an aerial for a customer owning a Crosley "Band Box" which we overhauled for him, giving him daylight reception (which he never before had experienced), using the ground only, on the aerial post. He was very much pleased and wanted us to build an aerial immediately. We built him an aerial as follows: Forty-foot poles built from 2 x 3 inch pine lumber and then painted. One pole is located directly at the window where the set is; the other, on the back of the lot. The aerial wire is seven-strand, enameled, with no joints between the distant end and the

(Continued on page 696)



# Operating Notes

## The Analysis of Radio Receiver Symptoms

By D. C. McCALL

### Sparton 210

I HAVE caught up with all outside jobs, but have plenty to do in the shop. The first machine to draw my attention was a Model 210 Sparton Midget, which performed well until it had heated thoroughly, and then it broke into oscillation. The usual check of voltages and a new set of tubes failed to show anything wrong. I then checked the resistor values with the set "cold" and also after it had thoroughly

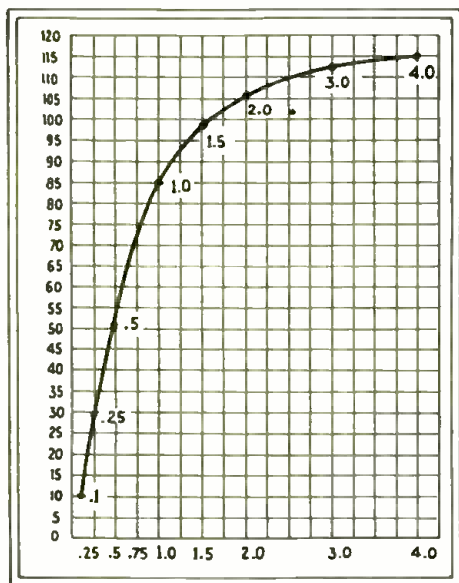

Fig. 1

Calibration curve of the A.C. voltmeter used in the Jewell 199 set tester for capacity measurements.

heated. Frequently resistors change values considerably after heating, and the voltage rises surprisingly. However, this set uses wire wound resistors of good quality that did not change appreciably.

Finally I checked the bypass condensers for open circuit, but they all gave a deflection on a D.C. meter. Then I began to add more capacity to the various points. The oscillation stopped immediately when a tenth microfarad condenser was placed so as to bypass the cathode bias resistor to ground. Although there was already a condenser in this position, evidently it was not quite sufficient and the set would break into oscillation on strong signals.

This experience taught me the value of having some method of measuring capacity so I determined to calibrate my A.C. voltmeter (Jewel pattern 199) for values commonly used in filter and bypass condensers. I measured the line voltage first and found it to be 118 volts. Then I took a number of condensers of known value and read the

voltage with a condenser in series with the meter. The following values were obtained:

- 4 mf. 115 volts
- 3 mf. 112 volts
- 2 mf. 106 volts
- 1.5 mf. 98 volts
- 1.0 mf. 85 volts
- .5 mf. 50 volts
- .25 mf. 30 volts
- .1 mf. 10 volts

These values were plotted on graph paper and the curve drawn with the aid of a French curve. (Both the graph paper and the French curve can be obtained at most five-and-ten stores). See Fig. 1.

In the future when I have a set that is erratic and oscillates at irregular intervals, the first thing I shall check will be the bypass condenser values. (R.F. bias resistors and plate leads should have capacity bypasses of .1- to .25-mf. and screen-grid leads .5- to 2 mf.).

### Majestic 20

The next set needing attention was a Model 20 Majestic. This set had a short in the plate circuit of the R.F. end. By the process of elimination this short was found in the second I.F. transformer. This transformer may be removed and replaced without taking off the bottom of this set entirely, which saves quite a bit of time, as much of the power pack, etc., is fastened to the bottom plate of the chassis. Simply remove the end section near this transformer and loosen the drive screws in the bottom section so that it may be pulled open a little. Take out the two screws holding the transformer and unsolder the four leads.

Invariably I have traced the short in this unit to the .1-mf. condenser bypassing the plate lead. To repair this unit cut the rivets holding the I.F. unit in the metal can and pull the leads out of the holes in the can. Carefully warm this can until the wax softens; then the assembly may be lifted out. The shorted condenser can then be cut out and a midget type bypass put in its place or it may be left out of the can and a larger size condenser put outside the can and under the chassis. Then the set is aligned with a 175 kc. oscillator.

### Clarion Midget Model 40

The third number coming up for attention was a Clarion Model 40 Midget. This set behaved erratically when the volume control was moved. (Since then I have had several of this model with bad volume controls and they all seem to be affected differently according to what defect was in this unit. Hence it is well to check this unit when servicing this model.) This control is rated at 4,100 ohms and is used as a part of the voltage divider. The potentiometer arm is

used to vary the bias on the grids of the variable-mu tubes. In substituting here it is well to use a value of resistance as close as possible to the value mentioned, but 5,000 ohms can be used. I found it a good idea to put a small resistor (100-200 ohms) between this unit and ground so that the voltage applied to the grids never goes to zero. See Fig. 2.

### Audiola Jr.

The next "pain in the neck," was caused by an Audiola Jr. which failed to function at all. The circuit in this set is the prize puzzler of the past season, namely, direct-coupled. The resistors in this set have given me plenty of trouble and the first thing to check in this model is these resistors. In Fig. 3 a pictorial drawing shows the location of the different resistors and their value. In different sets I have found defective resistors of each value, but the one that goes bad most frequently is the 400-ohm section on the black unit. Notice the 50,000 ohm tap (green) used as a series resistor for the R.F. screens. I have cured several complaints of the set "having no pep and no volume" by cutting this resistor out and substituting one of lower value, thereby raising the screen-grid voltage.

### Apex Midget

The last one on the bench is an Apex midget of the 26P series. Many complaints have been registered by customers about the volume control "jumping" from loud to soft or vice-versa. I determined to locate this trouble and brought this set to the shop for that purpose. All tests and visual examination show these units in good shape but they do justify a complaint that their regulation of volume is not smooth. So with

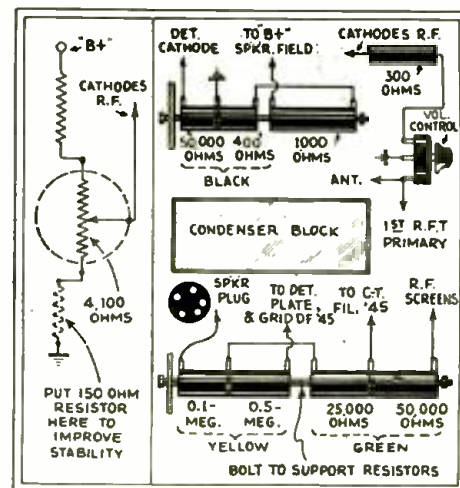

Fig. 2. left. Diagram showing location of additional 150 ohm resistor.

Fig. 3. right. Diagram showing the location of the resistors in the Audiola Jr. receiver.

a strong magnifying glass and a strong light on the unit I proceeded to play the set and watch what happened. Suddenly I found the explanation!

This volume control was wire-wound with a spring slider that made contact on the inside of the resistance circle. The magnifying glass showed that as the slider pushed around the resistance strip the turns of wire were loose and the slider pushed a number of turns together. This continual movement had worn out the enamel insulation between turns and the result was that as the slider pushed around it forced a number of turns together and shorted out an appreciably large amount of resistance suddenly. Replacement of this type with one having a carbon strip and smooth acting contact relieved this complaint. This volume control is rated at 8,000 ohms.

So finished a typical day in the shop.

**ZENITH MODEL 52**

By Joseph Leeb

THE writer was recently confronted with the problem of removing hum from a Zenith Model 52 radio. After checking the set over, it was decided that the cause of the trouble was in the electrolytic filter condenser. With the set turned on, each terminal of the condenser was momentarily shorted to the chassis by means of a metal screw driver. This procedure completely removed the hum. The same method was tried on sets of various other makes, with great success.

**PHILCO MODEL 112X**

By Joseph Reily

A FEW of the early production of the model 112X Philco receivers had an input transformer with the letter "A" after the part number on the terminal board. These transformers should have a .0008-mf. condenser connected across the entire secondary. Later production models have the input transformer without the letter "A." These should be equipped with a 49,000 ohm resistor across the secondary.

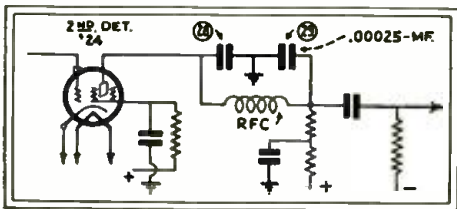

Fig. 5

The .00025-mf. condenser in the detector circuit causing the howl.

On some of the first production model 112X receivers, the wires from the plates of the pentodes to the two lower terminals of the speaker socket in the chassis were wired as shown dotted in Fig. 4. This "dressing" tends to produce a high pitched whistle if the tubes are slightly unbalanced. This condition is readily eliminated, however, by changing the dressing of the wires as shown by the full lines in the same figure. All new production models are now wired in the same manner. If it is found necessary to make this change, be sure that the polarity of the wires after reconnection is the same

as before. In present production, red and black wires are used, but in earlier models two red wires were used.

In some few cases in this model receiver, a slight whistle may be heard. This may be eliminated by moving the two plate wires away from the compensating condenser.

**CROSLLEY MODELS**

By R. P. Haviland

IN most of the Crosley models, the various filament center-tap resistors are arranged in tiers. In damp weather these strips sometimes buckle, producing a short that causes a bad hum.

Many sets have the volume control connected as a potentiometer from B+ R.F. to ground. Carbon-strip resistors in this position soon become noisy. Only wire-wound resistors should be used.

Some sets have the chassis built in two parts. A faulty connection between these two parts will cause the set to stop operating.

When reproduction from phonograph pickups becomes bad, it is probable that the damping rubbers between the armature and the pole pieces have become hard. Replacing these with new rubber dampers will better the quality.

**CROSLLEY MODEL 124**

By James R. Garcia

IN servicing the new Crosley Model 124 receivers, considerable trouble has been encountered with the "biasing" of these new sets; the trouble usually showing up after 30 to 90 days of operation with high control-grid bias on the R.F. and I.F. tubes.

The biasing of all tubes, excepting the pentodes, is accomplished by resistors in the emitter circuits. The pentodes obtain their bias by returning their grids through the ground to a flexible resistor which connects to their filament center taps. The volume control varies the biasing resistance in the emitter circuits of the R.F. and I.F. amplifier tubes and also varies the resistance between antenna and ground.

The correct control-grid voltages on the R.F. and I.F. stages is 1.5 to 2.5 volts negative. Various 1/4-watt resistors are used in these sets and it seems their value varies slightly after being placed in service. To overcome this, and also to "pep-up" these receivers, place a 400 to 750 ohm resistor on the volume control to ground, placing it on the opposite contact arm from the antenna and first R.F. coil.

Check all quarter-watt resistors very carefully, as they are a continual source of trouble. When touching the antenna post with the aerial lead and plenty of loud "clicks" are going through the speaker, and yet there is no reception, check your 2000 ohm flexible resistor across the oscillator-tube cathode to ground, as this is the usual trouble, being open.

**PHILCO MODEL 70**

By R. L. Young

WHEN the tone control on a Philco Model 70 receiver is turned to the right-hand position, that is, the modified tone position, the set will function properly; but, when turned to the left-hand position,

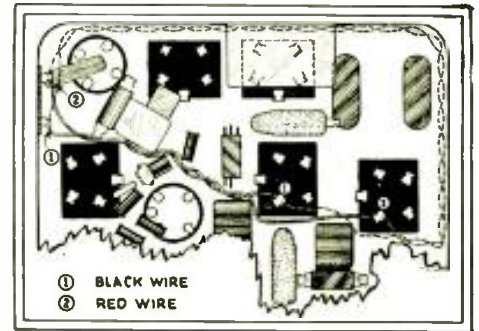

Fig. 4

Suggested changes in wiring of the Philco Model 112X.

the set will have a distorted tone something like a loud howl or a microphonic noise. In most instances, this noise will be noticeable even when the set is not tuned on a station. At first thought, the tone control was suspected, but glancing at the diagram, it can be seen that when the tone control is turned to the left-hand position, it is not connected in the circuit.

Referring to the diagram of Fig. 5, it can be seen that there is a phone condenser of .00025-mf.-capacity, identified by having a yellow dot on one side, connected to the plate lead of the second-detector next to the choke coil. Should this condenser become open or change in capacity, the above mentioned trouble will be noticeable in the receiver. Therefore, replacing this condenser with one having the correct value will remedy the trouble.

**CROSLLEY "BUDDY" AND "CHUM" MODELS**

By Lloyd R. Brown

IN the Crosley "Buddy" and "Chum" receivers, the 10,000 ohm wire-wound resistor that furnishes voltage to the screens and R.F. plates may register continuity and still be open, if you make the test with a meter and battery.

If time is valuable, a 10,000 ohm carbon resistor can be shunted across the present wire-wound unit without taking the old one out, as it is braided to the chassis. But shunting a resistor across another is not to be practiced, unless the open one is certain never to make contact again while the receiver is in operation.

**Brunswick A.C.-10—Columbia C-31**

THE Brunswick A.C.-10 and Columbia C-31 are midget receivers of the same design, but placed in different cabinets. If you have a call on one of these receivers, and after taking analyzer readings no fault is revealed, but when the set is in operation you get just faint reception, you can look to the speaker for the trouble. A good way to tell where the speaker is defective is to remove it from the cabinet and, with the receiver in operation, press lightly on the cone with the fingers. If reception becomes normal, there is an open in the voice coil. This coil can be repaired, but extreme care must be used, since both the field coil and cone are braided to the speaker case.

It will be necessary to take a cold chisel and hammer, and knock off the braids holding the cone; which may then be repaired.

# SERVICING MODERN "SUPERS"

In masterly fashion the author takes his readers through a series of tests representing actual conditions encountered by radio Service Men

By H. G. CISIN, M.E.



Fig. A  
The Readrite No. 550 Service Oscillator.

**T**HE rapid march of progress in radio receiver design, calls for constant study on the part of the radio Service Man. Having mastered the technique of servicing the tuned-radio-frequency receiver, he finds himself facing newer and more difficult problems in connection with superheterodynes.

A receiver of this type that needs balancing and readjustment will lack selectivity; it will not bring in the distant stations that it should; and its dial readings in kilocycles are generally off more than 20 k.c. Quite often, there will be squealing and howling on certain sections of the dial, indicating that adjustments are necessary. Weak reception and poor selectivity at the high-frequency end of the dial, indicate incorrect adjustment of the oscillator "high-frequency trimmer"; at the low end of the dial, the need for "low-frequency trimmer" adjustment. It is useless to attempt to readjust a superheterodyne without correctly designed, accurate equipment.

Fortunately, the modern Service Man has at his disposal up-to-date, versatile test instruments, capable of handling any type of receiver no matter how complicated or advanced in design.

Those who have never used the modern equipment now available for this purpose will be amazed at its utter simplicity and at the ease with which all necessary readings and adjustments may be made. In performing the tests outlined in this article, using one of the new Readrite No. 550 audio-modulated R.F. oscillators (with panel output-meter), it was found possible to realign all the tuned circuits of a 9-tube Philco superhet. in but seven minutes,—from start to finish, including the removal and replacement of the chassis.

The tuning control of this service oscillator operates over two separate scales, which results both in wide divisions, and in accuracy. One scale is provided for the broadcast range, 550 to 1500 kc.; the other scale, for the I.F. band, 120 to 175 kc. Other intermediates, such as 260 kc., 262 kc., etc., are obtained by using the second-harmonic; and 475 kc. (for "all-wave" superheterodynes) is obtained by means of the third-harmonic. These harmonics give just as sharp signals, in this instrument, as the fundamentals. When testing 260 kc., using the I.F. band, the service oscillator selector switch is set at the "intermediate" reading of 130, resulting in a sharp second-harmonic signal.

### Re-calibrating the Oscillator

To re-calibrate the No. 550 service oscillator, a procedure that may at times become necessary (due to mechanical jars, etc.), set its selector switch to the "broadcast" position, and tune to the wavelength of a signal from a crystal-controlled station previously selected on the radio receiver. If the reading of the oscillator dial does not check with the known figure for the station, make corrections on the auxiliary scale which is furnished especially for such comparison purposes. Proceed with other stations and settings of the oscillator, making notations of any changes. Should there be any appreciable changes in the broadcast range, it may be possible to determine the cause by comparing the hand-drawn

scale with the one on the oscillator. (If the control knob has moved slightly on the shaft, this can be determined readily by comparing the hand-drawn and oscillator scales.)

After finding the correct calibration for the broadcast band, proceed to adjust the service oscillator's trimmer-condenser for the intermediate frequencies.

The first step is to select, on the radio set, a broadcast station of known frequency,—say, 700 kc. Next, turn the service oscillator selector switch to the "intermediate" position and again prepare to adjust its trimmer condenser.

With the radio receiver thus set at 700 kc., adjust the service oscillator pointer to an I.F. of 175 kc.; this will produce the fourth-harmonic of 175 kc. at the receiver setting for the broadcast station selected. Adjust the service oscillator trimmer condenser

until the oscillator signal is received strongest with the oscillator pointer set at exactly 175 kc.; then proceed to make the same check with the receiver set for stations at 875 kc. and 1050 kc., these being exactly 175 kc. apart. The dial will now track when the oscillator knob is moved over the "intermediate" scale.

The Harmonic Chart may be referred to in calibrating at other intermediate frequencies. Thus, for calibrating at 260 kc., a broadcast station on 650 kc. is selected; this is the fifth-harmonic of 130 kc.

### Adjusting a Philco Superheterodyne

The procedure to be followed in adjusting a Philco superheterodyne is representative of all superheterodyne receivers of the same general type.

The first step is to check the service oscillator and if necessary recalibrate it as outlined above, (especially at 175 kc. and 260 kc.), a fibre wrench is required.

The adjustment of the I.F. compensating condensers in this type of superheterodyne is performed as follows:

(1) Connect the G jack of the service oscillator to the GND terminals of the radio set;

(2) Connect the A jack of the service oscillator to the grid of the first-detector tube, with the tube shield in place and first-detector grid clip removed;

(3) Connect the output meter jacks to the primary of the receiver output transformer. (A Philco plug-in adapter may be used at the speaker socket to obtain this connection. Two tipped wires are furnished with the output meter for these connections);

(Cont. on page 695)

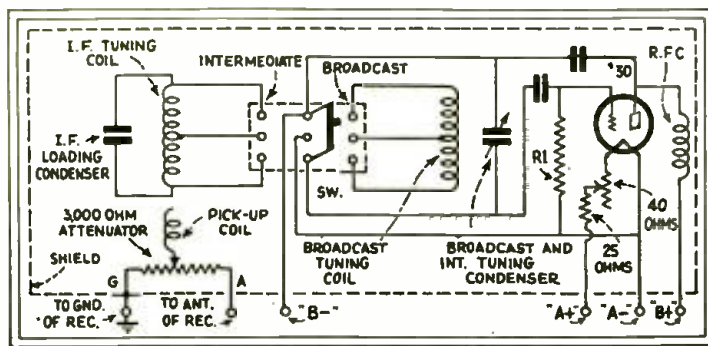

Fig. 1  
Schematic circuit of the "No. 550" service oscillator. The value of R1 determines the frequency of the A.F. modulation

Harmonic	Frequencies						
	130	140	150	160	170	175	180
(1)	130	140	150	160	170	175	180
2	-	-	-	-	-	-	-
3	-	-	-	-	-	-	-
4	-	560	600	640	680	700	720
5	650	700	750	800	850	875	900
6	780	840	900	960	1020	1050	1080
7	910	980	1060	1120	1190	1225	1260
8	1040	1120	1200	1280	1360	1400	1440
9	1170	1260	1350	1440	-	-	-
10	1300	1400	1500	-	-	-	-
11	1430	-	-	-	-	-	-

Fundamental (1) and harmonic frequencies, in kc. Additional harmonics may be similarly calculated.



# The Design of a New TUBE TESTER

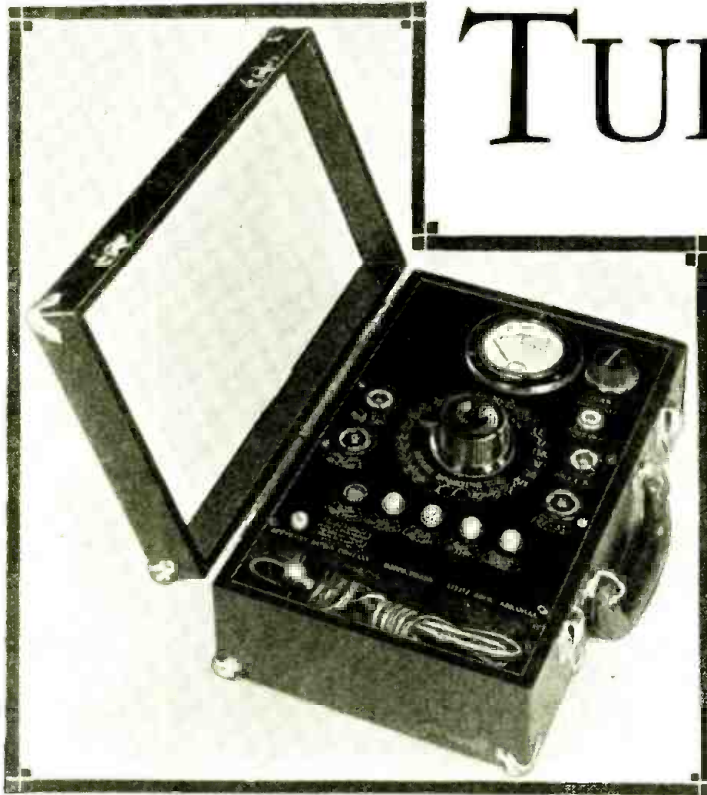

Fig. A  
The Confidence "English-reading" Tube Tester

First published description and diagram of the newest type of tube tester. It indicates directly in words the relative merit of every type of tube on the market.

By B. J. R. WILLIAMS\*

to the multi-shunt switching mechanism necessary for successively applying the correct potentials to each type of tube solely by rotating a single knob.

### One Meter—Four Sockets

In this type of instrument four sockets are used, into which all known tubes are inserted according to their connection requirements. This means that all 4-prong UX tubes such as '10, '50, '81, '71A, '12A, '01A, '00A, '20, '99, '45, '31, '30, '26, '82B and '63 are inserted in one socket; and other types in the remaining three sockets.

Assuming it is desired to test a '99 tube, the one selector knob of this multi-shunt device, is turned to the position marked '99," and the tube placed in the UX socket. Two buttons are pressed; one reading "Grid Action" and the other "Plate Action." If the

(Continued on page 689)

UNIQUE in the field of test equipment is the tube checker illustrated in Fig. A. A schematic diagram of the instrument, simplified for easy reference, is shown in Fig. 1. Its outstanding feature is its "English-reading" indication of the worth of a vacuum tube in terms of "good," "bad," or "gas." To better appreciate the superiority of this type of test unit, let us gloss over past history.

Early types of tube checkers met the requirements of five or six years ago by furnishing only a "plate current" indication; the meter indications were checked against a table of evaluations for satisfactory characteristics. Increased public interest in the tube's inherent bearing on tone, volume, sensitivity, and selectivity resulted in the development of "oscillation" testers which gave a better indication of merit. Lately, "mutual conductance" (zero set) tube checkers have been offered as portable equipment for the Service Man; and as "counter" models for the mutual reference of the radio dealer and his store trade,—still, however, requiring the use of a reference table for correlating meter readings and desirable tube characteristics.

To most of the tube-buying public, these figures were just so much Greek; and while impressive, they were not convincing. It was to provide a more simple device that would be "plain English" to the customer, that the "Confidence," Direct-Reading Tube Tester was developed; its single meter scale indicates the suitability of a tube in words,—"good," "bad," or "gas."

Although design work on the "Confidence" tube tester was started in 1928, it was some time before all the "bugs" could be ironed out;—since there is considerable complexity

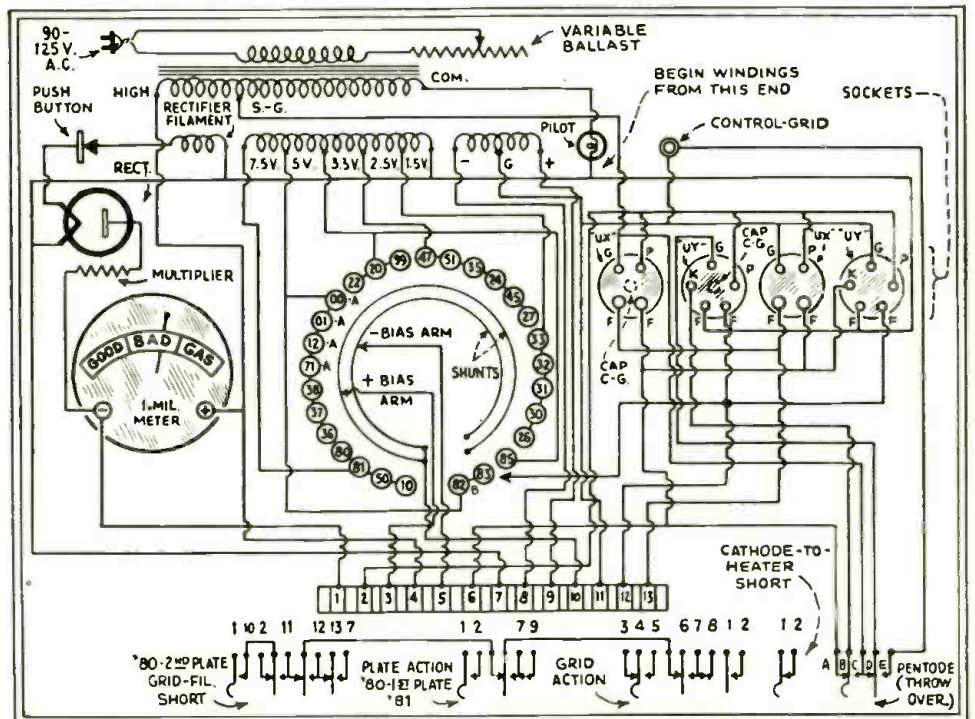

Fig. 1

Schematic circuit of the "Confidence" Tube Tester. Two sets of resistors, represented by the lines marked "shunts," adjust the circuit for correct test of any type of tube.

\*Chief Engineer, Apparatus Design Co.

**STROMBERG-CARLSON No. 29, 9-TUBE SUPERHETERODYNE RECEIVER**

What is probably the first receiver to derive its designation from the number of its design features is the "29" receiver of Stromberg-Carlson Telephone Mfg. Co., Rochester, N. Y. These features, as furnished by the factory, are listed below (where their position in the circuit is not evident from the wording, a more detailed description of the nomenclature is given):

1. Optosynchronous (Visual) Tuning, with sensitive meter for accurate setting of the station-selector dial;
2. Mono-Vision Dial and Tuning Meter, for quick, accurate tuning;
3. Large Baffle Area Cabinet, for full, smooth range of musical and voice tones;
4. Manual Volume-Control, for pre-setting to desired audio volume and for increasing sensitivity on extreme distance;
5. Level-Action Automatic Volume-Control, to maintain the predetermined volume over an extremely wide range of signal strength;
6. Detectomatic (Duo-Diode) Detector, for most efficient demodulation action;
7. Adjustable Automatic Clarifier, to allow hand adjustment of high-frequency reproduction to meet receiving conditions; (R15-C27);
8. Antenna Aligner, for obtaining maximum results with any particular size of antenna;
9. Image Suppressor, for giving a very high discrimination cover 100,000 to 1) against "cross-talk"; (C1-C2-C3, L1-L2-L3);
10. Isolated Oscillator Tube and Circuit, for correct control of sensitivity;
11. Bi-Resonator Radio-Frequency Tuning System, for better selectivity; (C1-C2, L1-L2, C);
12. Tri-Resonator Intermediate Amplifier, providing high selectivity;
13. Triplex Audio System, employing screen-grid first audio, and push-pull output;
14. Variable-Mu (Super-Control) Screen-Grid Tubes, for long range of action;
15. Triode Push-Pull Output, for best audio quality;
16. Four-Gang Tuning Condensers, for super-selectivity;
17. Non-Glare Dial, with wide-spaced markings for easy and accurate tuning;

18. Phonograph Key, for switching from radio to records;
19. Telephone Cabling, grouping of wires in neat, insulated cables for quiet operation;
20. Full-Size Chassis, avoids crowding units and provides accessibility for servicing;
21. Highly Efficient, Large Size Electro-Dynamic Speaker, to give ample undistorted sound output;
22. Karvart Panel of Airplane Fuselage Construction, giving ornamental carved design of real wood;
23. Precision-Selected Tubes, sealed in sockets, the style of tubes used having been picked for best over-all results;
24. Non-Radiating, avoids disturbing, with heterodyne squeals, neighboring radio receivers;
25. Super-Sensitivity, the highest compatible with clarity of reception;
26. Flexibility of Volume, from a whisper to auditorium volume;
27. Oscillograph Aligned, Tested and Sealed, to assure laboratory performance in every set;
28. Telephone-Built, by a manufacturer with more than 37 years experience;
29. Heavy Genuine Walnut Veneer Cabinet, for beauty and permanence.

Taking these points in their numerical order, the following comments are made in further explanation. Number 6 refers to the new type detector circuit by which a single type 27 tube is made to function approximately similar to two separate two-element, or diode tubes; here the grid and cathode of V5 function as a diode type of second-detector (or "demodulator"), while its plate and cathode function as a diode type of automatic volume-control detector. Since V5 must serve a dual purpose, it is essential that exceptional care be given to the selection of a tube for this position; for the tube must possess characteristics which will meet the requirements of dual service. The audio output of V5 appears across load resistor R7; the degree of input to the audio system is under control by variation of the setting of the arm of potentiometer R1, the manual volume-control ("No. 4").

The antenna aligner, No. 8, is variable condenser C5 in the diagram; its control knob is located on top of the R.F. coils' shield can, and close to the front edge of the chassis, between the tuning knob and the off-on switch and tone-control combina-

tion knob. Tune in a weak signal at the high frequency (1500-ke.) end of the dial, and adjust this antenna condenser knob (marked E in the diagram on the label in the rear of the receiver) until maximum volume is obtained. Leave this knob set at the position of maximum response. If the antenna or ground wires are changed at any future date, this knob must be readjusted. For this purpose a very weak signal should be used, in order to obtain the best over-all sensitivity. If the signal is strong enough to operate the visual tuning meter, adjust the knob E, for greatest swing after tuning the station selector for best reception. The I.F. is 175 kc., peak-tuned.

All resistor and condenser values are as follows: Resistor R1, variable, 0.5-meg.; R2, R4, R18, R19, 0.1-meg.; R3, R6, R9, 600 ohms; R5, 3 ohms; R7, R10, R11, 0.25-meg.; R8, R15 (tone control); R17, 0.5-meg.; R12, hum balancer (center-tapped), 400 ohms; R13, 750 ohms; R14, 10 ohms; R16, R23, 10,000 ohms; R20, 2,174 ohms; R21, 2,080 ohms; R22, 340 ohms; R24, 6,500 ohms; R25, 4,000 ohms; R26, 500 ohms.

Condensers C1 to C9 include the tuning, coupling, and trimming condensers; C10, C19, .04-mf.; C11, C13, C30, C31 .05-mf.; C12, C14, C15, C17, C28, 0.3-mf.; C16, C27, 0.1-mf.; C18, C20, C29, 100 nmf.; C21, C24, C25, C26, C37, .01-mf.; C22, C35, 1. mf.; C23, .45-mf.; C26, C32, C34, 2 mf.; C33, 6 mf.

Operating current and potential values are taken with a line potential of 110 volts and the fuse in the "EO" position. It is necessary to use the meter scales specified (in parentheses) for each reading: (1), 0-4 V., A.C.; (2), 0-8 V., A.C.; (3), 0-10 V., D.C.; (4), 0-250 V., D.C.; (5), 0-750 V., D.C. Filament potential, V1 to V8, and V10, 2.48 V., (1); V9, 4.9 V., (2). Cathode-to-chassis potential, V1, V4, V6, 3 V., (3); V3, 16 V., (4). Control-grid bias, V7, V8, 50 V., across R13, (4). Plate-to-chassis potential, V1, V2, 170 V., (4); V3, 87 V., (4); V4, 220 V., (4); V6, 192 V., (4). Plate potential, V5 (measured as the voltage drop across resistor R22), 12.5 V., (4). Plate potential, V7, V8 (measured between either tube plate and the center-tap of resistor R14), 250 V., (5). Screen-grid potential, V1, V2, V3, 87 V., (4). The potential across the field coil is 127.5 V., (4); the A.C. plate-to-chassis potential of V9 is 340 V.

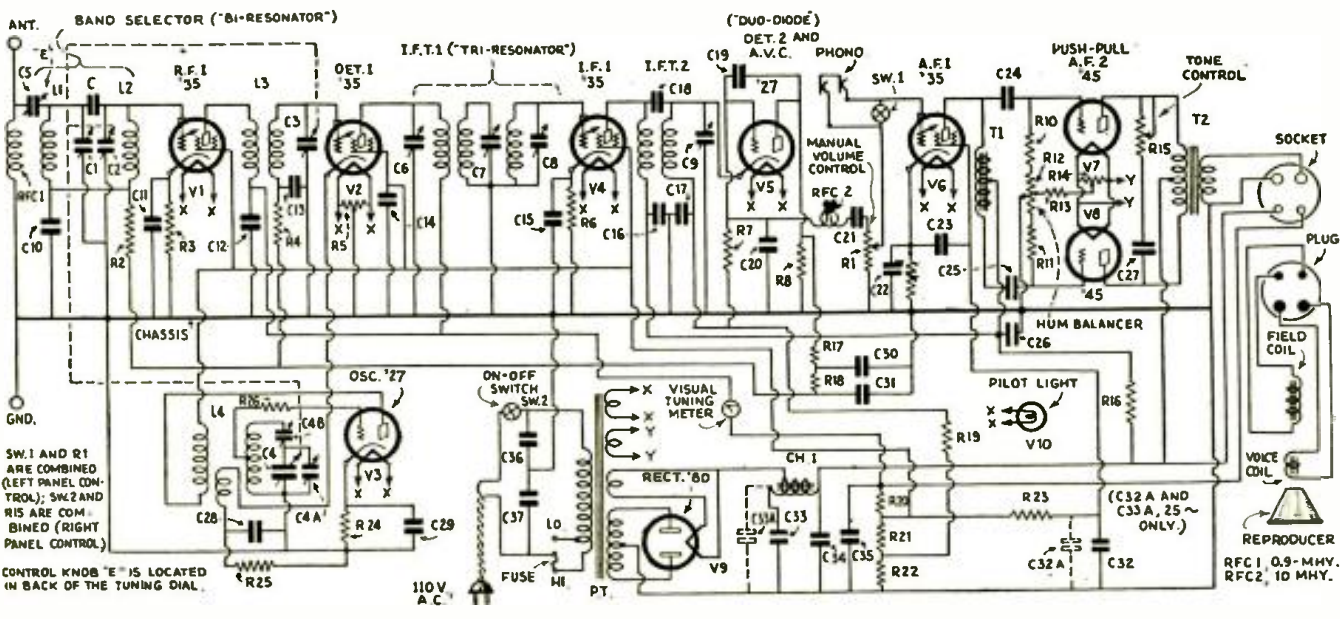

## MAJESTIC MODELS FAIRFAX AND SHEFFIELD 8-TUBE SUPERHETERODYNES

(Model 200 Chassis; with automatic volume control and duodiode detector)

New radio receivers are adding responsibilities to the Service Man, but if he knows his business he will experience no difficulty in clearing the normal troubles he may find in such sets. He must merely acquaint himself with the design variations of each new model. For instance, the Grigsby-Grunow Company's Majestic Model 200 chassis uses a new type of tube in the dual role of second-detector and automatic volume control. This is indicated in the schematic circuit.

The parts values are: Resistor R1, 7,000 ohms; R2, 3,500 ohms; R3, 3,000 ohms; R4, 110 ohms; R5, 180 ohms; R6, R8, R13, 0.1-meg.; R7, R9, 0.25-meg.; R10, R11, R12, R18 (manual volume control), 0.5-meg.; R14, 0.3-meg.; R15, 1. meg.; R16, 0.2-meg.; R17 (hum balancer), 20 ohms; R19 (tone control), 50,000 ohms; R20, 700 ohms.

Condensers C1, C4, 0.1-mf.; C2, C3, C5, .25-mf.; C6, C11, .05-mf.; C7, C8, C12, C-13, C14, C15, .01-mf.; C9, .03-mf.; C10,

necessary to readjust this unit unless pentode V7 is replaced.

The length of the antenna recommended for various receivers varies with the design of each model; the Model 200 chassis is designed to work best with an antenna of about 30 to 40 feet, for normal urban localities, and a somewhat greater length, up to 100 feet, in rural sections.

Due to the fact that the diode second-detector V5 also forms part of an automatic volume-control circuit, the tube ordinarily required for this service is eliminated. Since there is an A.V.C. circuit in the Model 200 chassis, and a visual tuning meter has not been provided, it is essential that stations be tuned in for maximum volume and clarity; if the tuning is slightly off the correct point, noise and poor tone will result. In fact, it is best to carefully note the dial marking while tuning in a desired program, to rock the dial back and forth until the signal drops out at equal points on either side of good reception, and then to leave the dial at a position halfway between these two settings.

Looking at the front of the set, the knob on the left controls the combined tone control ("static modifier and acoustic control") R19 and on-off switch SW-1, and the one on the right varies the manual volume control, R18. Note that the automatic volume-control action is independent of the other portions of the circuit, being adjusted to operate at a volume level pre-determined in the design of the chassis. The manual volume control only varies the audio input

to the voltage-amplifier V6, and the succeeding power-amplifier pentode V7.

The duodiode full-wave rectifier V5 is used specifically because of its increased sensitivity over the diode (or "two-element") half-wave connection ordinarily employed. Its sturdier construction, better fidelity, better definition on the higher frequencies, and its ability to handle more power. The duodiode is a full-wave rectifier, as compared to the diode, which is a half-wave rectifier.

A tone control is included in the instrument, not as a means of correcting faults in the receiver design, but to accommodate variations in conditions external to the radio set. For instance, as a means of matching the acoustic properties of the room, in order to obtain the most realistic reproduction; also, to reduce the proportion of static and background noise during local electric storms or when receiving distant programs.

The output of the oscillator is coupled into the cathode circuit of first-detector V2 by means of a small coupling coil which forms part of inductance L3.

The Model 200 chassis is used in the Sheffield Model 201 receiver and the Fairfax Model 203 receiver. The power consumption is 85 watts.

Line-filter condensers C7 and C8 prevent clicking sounds in the loud speaker when electric lights on the same circuit are turned on or off, and also reduce noises incidental to the operation of other electrical devices on the same line.

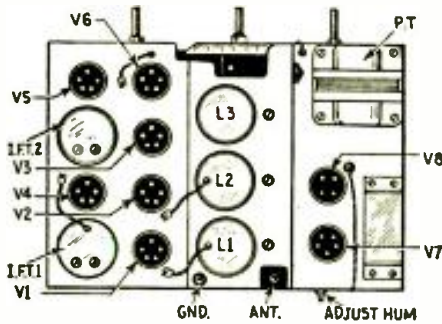

.005-mf.; C16, 50 mmf.; C17, C19, 4 mf.; C18, 500 mmf.; C20, 8 mf. Condenser C is the oscillator padding component.

The tubes specified for this receiver carry the following Majestic numbers: Type G-35-S spray shield multi-mu screen-grid tube, as R.F. amplifier V1; Type G-35-S spray shield multi-mu screen-grid tube as first-detector V2; Type G-27-S spray shield tube as oscillator V3; Type G-35-S spray shield multi-mu screen-grid tube as I.F. amplifier V4; Type G-2-S spray shield duodiode tube as second-detector and automatic volume control V5; Type G-35-S spray shield multi-mu screen-grid tube as first A.F. V6; Type G-47 pentode as second A.F. power tube V7.

To obtain correct balance in the filament circuit, to reduce hum, there is provided a hum balancing potentiometer R17. Adjust this, right or left, by means of a screw-driver, for minimum hum. It is seldom

MODEL 200 CHASSIS

TABLE OF VOLTAGE AND CURRENT READINGS

All D.C. Voltage Readings are to Ground.

Tube Purpose	Type Tube	Filament Voltage A.C.	Plate Voltage D.C.	Filament To Ground F.C.	Cathode To Ground D.C.	Plate Current M.A. - D.C.	Screen Voltage F.C.	Screen Current M.A. - D.C.
R.F. Amp.	G-35-S	2.5	255	.5	3	5.	96	1.
1st Det.	G-35-S	2.5	255	.5	11	4.	96	.4
Oscillator	G-27-S	2.5	98	.5	0	9.5	—	—
I.F. Amp.	G-35-S	2.5	255	.5	3	1.	96	.8
2nd Det.	G-2-S	2.5	0	.5	0	0	—	—
1st Audio	G-35-S	2.5	100	.5	2	2.	44	.4
Power Amp.	G-47	2.5	250	.5	—	25	260	6.
Rectifier	G-80	5.	—	290	—	75 Total	—	—

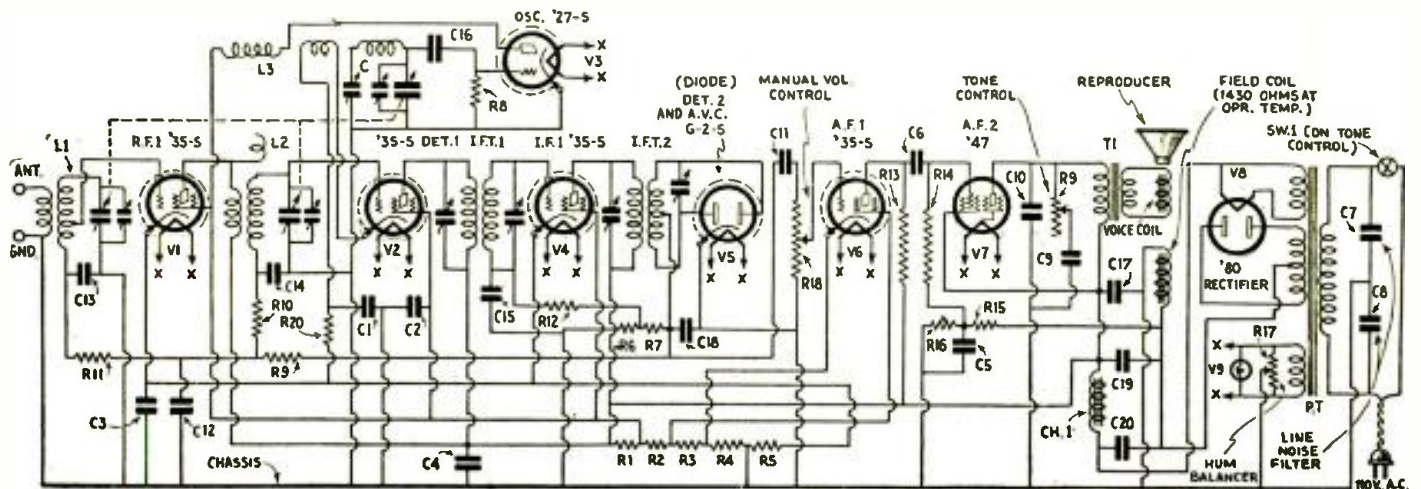

# The RADIO CRAFTSMAN'S

Page

The Bulletin Board for Our Experimental Readers

## COMMENTS ON THE CONDENSER-RECTIFIER

Editor, RADIO-CRAFT:

Our attention has been called to the article in your December, 1931 edition of RADIO-CRAFT, on the use of an electrolytic-condenser-rectifier. We find that, on using the hook-up shown, with a transformer intended for use with a BH tube (and which, with an Elkon "BH" type dry tube-substitute, supplies actually about 240 volts no-load rectified D.C. voltage across the terminals of the voltage divider, and "B" current enough for a set using three, type '26 tubes; one '27 tube; one '24 tube; and one '71-A tube), the no-load D.C. voltage (measured with a 1000 ohms per-volt meter) is about 75 volts, and no more.

The transformer, moreover, instantly heats up to the point where the insulating wax begins to flow upon switching on the supply current, when the condenser is used as a rectifier, though the condenser seems to operate O.K. in the conventional power pack hook-up.

A discussion of this data in your columns would no doubt interest others who perhaps are obtaining similar unsatisfactory results with the published hook-up.

C. M. DELANO,  
Box 663, Lincoln, Nebr.

(This article, "A Novel Power Pack Design Including Only a Transformer and Electrolytic Condensers," created considerable attention. As pointed out by Mr. Jarowey, the idea at the present time is recommended particularly for the attention of laboratory workers; later, the scheme may be perfected for commercial use. Following, we print the explanation for the effects noted by Mr. Delano.—Technical Editor.)

### MR. JAROWEY REPLIES

Editor, RADIO-CRAFT:

There are several interesting points in your letter, Mr. Delano, concerning your difficulties with the condenser-rectifier.

To begin with, the present conventional sizes of electrolytic condensers are too large to be used with a transformer that has been

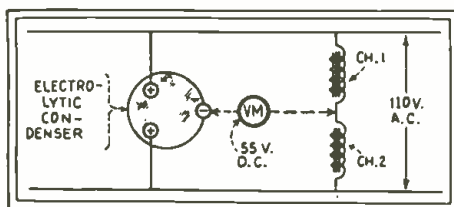

Fig. 1

Circuit illustrating Mr. Jarowey's theory.

designed to operate with a thermionic or a gaseous rectifier tube. The size of winding in such a transformer would operate well with about 2 mf. per section, and to prove it we will examine the reactance (A.C. resistance) of the condenser: the reactance—the reciprocal of  $6.28 \times 60 \times .000008 = 331$  ohms, which will prove that the heating of the transformer was due to this overloading charging current, and hence the drop in D.C. voltage.

Now, I will illustrate an ideal design verbally as follows: Let us suppose that we need 170 volts of D.C. Therefore, we will wind the transformer secondary to have maximum voltage across the outside terminals equal to the rated condenser voltage, that is,  $180 \times .707$  (the effective value of A.C.) = 339.6 volts; to this value the drop due to the load may be added, by actual test, you will find that you can obtain the required 170 volts D.C.; provided, however, that the electrolytic-condenser capacity does not exceed the current capacity of the transformer. On the other hand, if you have 25-cycle current, the A.C. resistance, or rather impedance, of the condenser will increase tremendously. That is, the frequency plays a very important part in A.C. circuits, whether they be R.F. or A.F.

To prove that this idea is correct, you may make a test for yourself any time as follows: If you have access to a 110- or 220-volt A.C. line, connect the two positive terminals of the condenser sections to the line, and connect the two filter chokes or bellringing transformer primaries in series also to the line (that is necessary to obtain an inductive neutral point); then connect a good D.C. voltmeter of suitable range between the two chokes and the negative side of the condenser, and you will have a D.C. voltage of one-half of the value you may apply to the condenser; no filter is necessary to this arrangement, Fig. 1, for the current is non-pulsating.

I hope that this will explain the behavior in your case; and those of others who may have experimented with this extremely simple and radically new power pack design.

P. M. JAROWEY,  
815 Merchant Street, Ambridge, Pa.

### A BUDDING INVENTOR

Editor, RADIO-CRAFT:

While reading about the "Autoverter" in the January, 1932 issue of RADIO-CRAFT, I got a few ideas; here are three of them.

I looked through my automobile junk-box and found a Dodge high-tension transformer, a distributor head with a six-point cam, and an old electric horn.

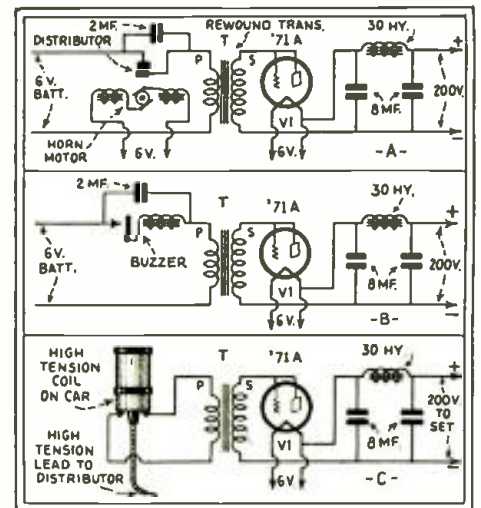

Fig. 2

The circuit diagram after Mr. Palmer's ingenious changes.

The transformer I rewound—100 turns of No. 22 D.C.C. wire for the primary and about 4000 turns of No. 32 enamel-covered wire for the secondary. The horn I dismantled, throwing away the horn bell, diaphragm and cam. Onto the shaft of the remaining horn motor I fastened the shaft of the distributor. (I used four pieces of strap iron to hold these two contrivances rigid.) The six-point cam makes and breaks the electrical circuit six times per revolution. Across the breaker points I soldered a 2 mf. condenser. The resulting circuit is Fig. 2A.

Another method is to use the same Dodge transformer, same primary and secondary winding, and then connect a buzzer in series with the primary and a 6-volt battery, as shown in Fig. 2B.

I have a six-cylinder Chevrolet, and when I connect the above transformer to the primary binding posts on the high-tension coil in my car, I get the same results as in the first wrinkle, excepting that I use the distributor in the car. It is exactly the same idea as the first wrinkle; the circuit, however, is as shown in Fig. 2C. The car distributor already has a condenser shunted across the breaker points. The only drawback to using this system is that the car must travel at least 20 miles-per-hour in order for the circuit to be broken enough times per minute to maintain the required high voltage.

FRANK C. PALMER,  
1472 Jay Street, Edgewater, Colo.

(The ideas tried by Mr. Palmer are very interesting. If these were de-  
(Continued on page 699)

# An Ultra-Short-Wave Super-Regenerative 5-Meter Receiver

By E. P. HUFNAGEL (W2BUK) and GEO. J. HERRSCHER (W2APW)



**U**LTRA-SHORT-WAVES, first investigated in the classic manner by one Heinrich Hertz, have crashed the commercial field with both the installation of 3- to 8-meter transmitting equipment as stations W2XF and W2XK atop the Empire State building in New York City, (which towers 110 stories into the air), and with the manufacture of compact receiving sets of suitable design for operation at these "quasi-optical" wavelengths.

The foremost characteristic of 5-meter radio reception is that its waveform, like that of light ("quasi-optical"), travels in a straight line and, so far as known, is not deflected in the manner we are accustomed to associate with the propagation of the higher wavelengths: instead, reception is limited by the curvature of the earth, while hills have shielding effects which tend to reduce volume. Thus, the "DX" range of W2XF-W2XK may be only about 80 miles (unless later experiments show that under certain conditions reflection or refraction may take place, and thus increase this figure; incidentally, many amateurs' 5-meter transmitters are heard in *cellars*); with the result that the millions who reside within this theoretical radius of sight may be able to have reliable reception—since fading is not experienced in this, the "graveyard" end of the wavelength spectrum.

### Frequency and Wavelength

It is interesting to note that the frequency range encompassed by "all-wave" or 15- to 545-meter radio sets, lies between 20,000 kc. and 550, or a total frequency band of 19,450 kc. Figuring on the basis of 10 kc. as the required "foot-frontage" (to borrow a term of the realtor) of a broadcast station, or 100 kc. for television requirements we find that, by simple division, in the former case there would be (theoretically, at least) provision for 1,945 broadcast stations, and in the latter 194 television stations; which leads us to the following step.

Between 3 meters (100,000 kc.) and 8 meters (37,500 kc.), there is a frequency band width of 62,500 kc. Applying the same principle of arithmetic as previously, we make the startling discovery that in this relatively small *wavelength* range it is possible to fit 6,250 broadcast stations, or 625 television stations! In other words, our entire and supposedly enormous "all-wave" tuning range of 15- to 545 meters, would fit into the "3- to 8-meter" band, and leave

Fig. A, above. Panel view of the receiver.

Fig. B, right. Inside view of the 5-meter receiver. L1 and L2 are the tuning coils. (Refer to Fig. 1.)

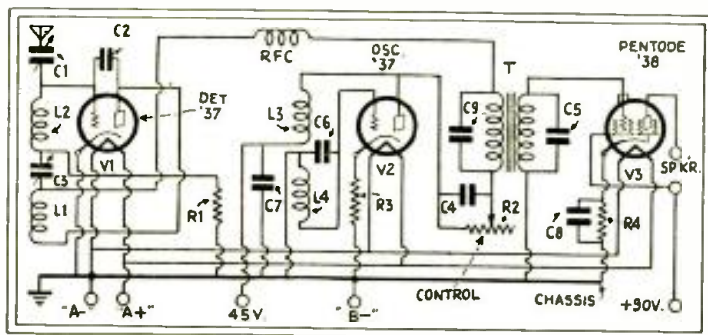
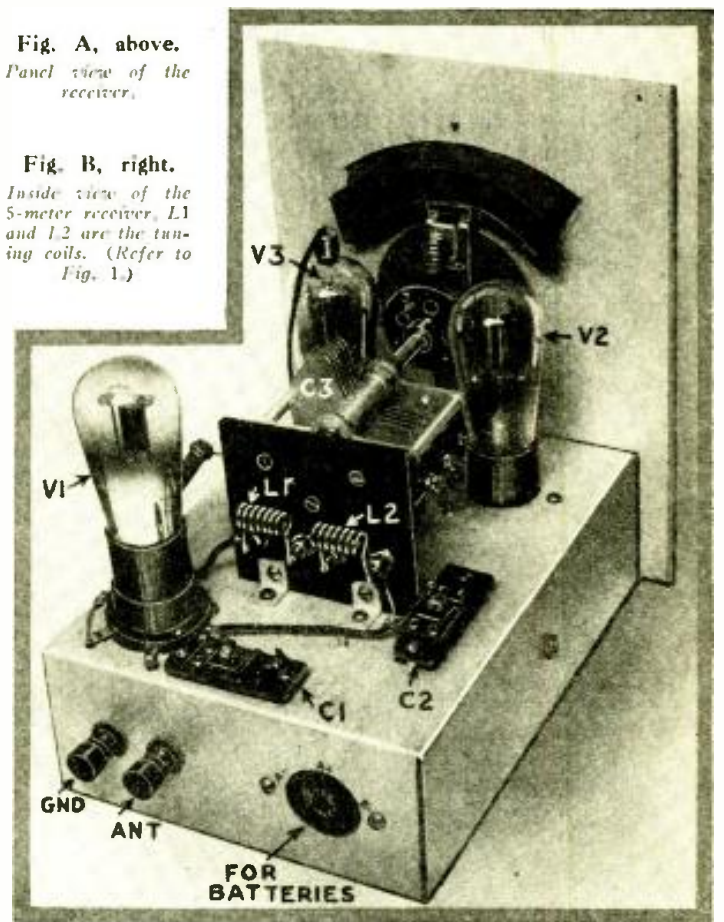

Fig. 1

Schematic diagram of the receiver which operates in the quasi-optical frequency band.

enough room to fit in about two more bands just like our present one! No wonder the "big boys," who know what it is all about, are gobbling up all the little wavelengths in sight—and the smaller they are the better they like 'em!

Although transmitters operating at these ultra-high frequencies are few and far between, it would seem that in a fairly short time the countryside will be dotted with them; duplicating in other centers of population the coverage now offered by W2XF-W2XK nearly a quarter-mile in the air, in New York's Empire State building.

And, the power requirements are astonishingly small, to wit: experiments (which have proven the value of this type of operation) between fire towers in northern New Jersey indicate that reliable communication can be maintained with powers as low as 0.8-volt (input, to two 2-volt '30's; the entire transmitter) supplied by two dry cells and three "B" batteries.

Since the length of the best possible aerial used in the reception of a 5-meter signal would not exceed 8 ft., the adaptability of  
(Continued on page 684)

# USING the V.T. VOLTMETER

(PART I)

By BERYL B. BRYANT

In a series of articles, of which this is the first, the author will discuss the various uses of vacuum-tube voltmeters, with particular reference to radio servicing and measurement.

**I**N response to the many requests received by the Editors of this magazine for information concerning the use of vacuum-tube voltmeters, such as the gooseneck V.T. voltmeter described in the February, 1932 issue of Radio-Craft, the writer has been asked to prepare an article setting forth the methods of measurement and procedure in which the instrument may be employed.

As in all measurements, the accuracy of the measured result depends upon the accuracy with which the instrument has been calibrated, and the care with which the measurements are conducted.

### Radio-Frequency Measurements

To conduct measurements by which the gain of an R.F. amplifier of one or more stages may be determined, a modulated R.F. oscillator, having the frequency range over which the amplifier is to be measured, is required. It is customary to modulate the R.F. signal with an audio signal of 400 cycles at 30 percent modulation. The signal from the modulated oscillator is induced into an artificial antenna of known constants; the set-up of the oscillator, the artificial antenna, and the amplifier to be measured is shown in Fig. 1. The mutual inductance between the coupling coil  $L_0$  of the oscillator and the 20-microhenry inductance  $L_a$  of the artificial antenna is determined by a method to be described in a later paragraph. Having determined the mutual inductance between  $L_0$  and  $L_a$ , the current through  $L_0$  may be measured by connecting the V.T. voltmeter across the 500-ohm resistance in series with  $L_0$ ; this is shown in Fig. 1 at R.

The resistance  $R_1$  may be a 200-ohm potentiometer, and is used to control the output of the oscillator.

Having determined the voltage drop across  $R$  and knowing the resistance of  $R$ , the current may be determined by the application of Ohm's Law. The peak-voltage drop across  $R$  must be converted to effective volts by dividing the peak-voltage by 1.4. The voltage (effective) induced in the artificial antenna may now be determined by the formula:

$$E_a = 6.28 \times I \times M \times f$$

Where  $E_a$  is artificial antenna voltage,  $I$  is the calculated current through  $L_0$ ,  $M$  is the mutual inductance between  $L_0$  and  $L_a$ , and  $f$  is the frequency in cycles.

The R.M.A. standard artificial antenna consists of a coil of 20-microhenries inductance in series with a 25-ohm resistance and a .0002-mf. condenser. This, during the measurements, is connected directly across the antenna and ground binding posts of the receiver or R.F. stage to be measured.

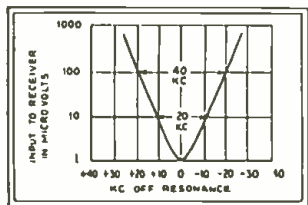

Fig. 2 Typical selectivity curve.

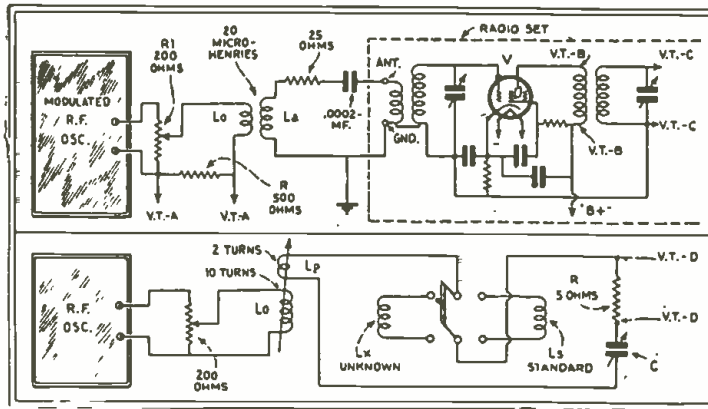

Fig. 1, above. Oscillator, dummy antenna, and V.T. voltmeter. Fig. 3, below. Substitution method of measuring inductance.

### Gain Measurement

Having provided a means of knowing the exact voltage input into an R.F. stage or amplifier, the gain may be measured by placing the V.T. voltmeter terminals across the plate-load of the single stage or the output of the amplifier whose gain is to be measured.

If the voltmeter is applied across the plate primary as shown at V.T.-B in Fig. 1, it is necessary that care be taken to insulate the V.T. voltmeter at all points from the chassis of the receiver; otherwise, a short will exist, as the V.T. voltmeter in this position is above ground potential by an amount equal to that of the plate-voltage of the amplifier stage.

In measuring the gain of tuned R.F. amplifiers, the induced voltage into  $L_a$  must be constant for all frequencies. It is therefore necessary to adjust the input to a predetermined peak value before each frequency measurement is made.

The gain of a single stage, or of the entire amplifying system is the ratio of the output voltage to the input voltage, and is determined by dividing the output by the input voltage. These voltages should be in effective values.

If it is desired to plot sensitivity and selectivity response curves of an R.F. amplifier, the measurements should be made in conjunction with the A.F. amplifier of the receiver. The sensitivity curve is the input in microvolts plotted against the radio frequency in cycles. The output of the receiver is kept constant at .05-watt, with the input frequency varying from 1500 to 600 kc. The R.F. oscillator is adjusted to 400 cycles at 30 percent modulation during these measurements.

The sensitivity of a receiver is determined by a signal (input) that will produce a standard output of .05-watt from the receiver (a 10-ohm resistor connected in place of the voice coil of a dynamic speaker should have .707-volt across it for .05-watt output.) When plotted as a curve this is interpreted as follows: An input signal at any frequency will produce a standard output

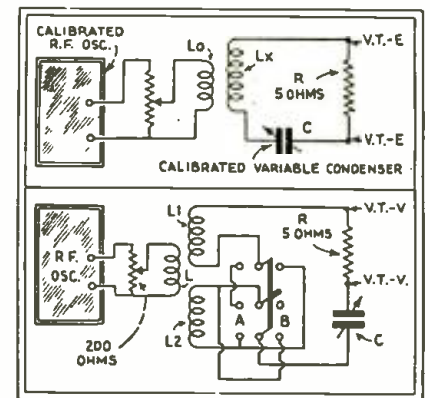

Fig. 4, above. Measuring distributed capacity. Fig. 5, below. Another measuring circuit.

(Continued on page 686)

# RADIO-CRAFT KINKS

*Practical hints from experimenters' private laboratories.*

## (PRIZE AWARD)

### MEASURING SMALL CAPACITIES

By Edgar J. Smith

**T**HE set builder, as well as the Service Man, never knows when he may be called upon to determine with fair accuracy the capacity or capacity range of a condenser. The method used by the writer for checking the capacity of small units, between the values of 50 and 1,000 mmf., may be of interest to the readers of RADIO-CRAFT.

Since most Service Men possess a grid-dip oscillator which covers the broadcast frequencies it is possible to construct this rig out of parts from the junk box.

The condenser C1 and C2 shown in the schematic circuit, Fig. 1A, is a double condenser having two sections of 500 mmfs. each. This condenser must be of the *straight-line capacity* type and of good construction. The two rotors are connected to a S.P.S.T. snap switch so that the condenser may be used as a 500 or 1000 mf. unit.

The tapped coil is not of critical construction and any coil at hand similar to it will be satisfactory. A pick-up coil, wound over or at the common end, is necessary for coupling to the oscillator.

A S.P.D.T. snap switch is provided for changing from CX (unknown capacity) to the calibrated condenser (C-1 C-2).

The process of checking a condenser is as follows: Place the condenser between the clips at CX. The snap switch is thrown to "TEST" position. The pickup coil on the inductance is connected to the pickup coil on the oscillator. With the oscillator turned on, the oscillator condenser C3 is varied until a dip is noted in the milliammeter MA; or, if no dip is noted, the inductance switch is changed to another tap and the operation is repeated until a dip is noted. The S.P.D.T. switch is then thrown to the

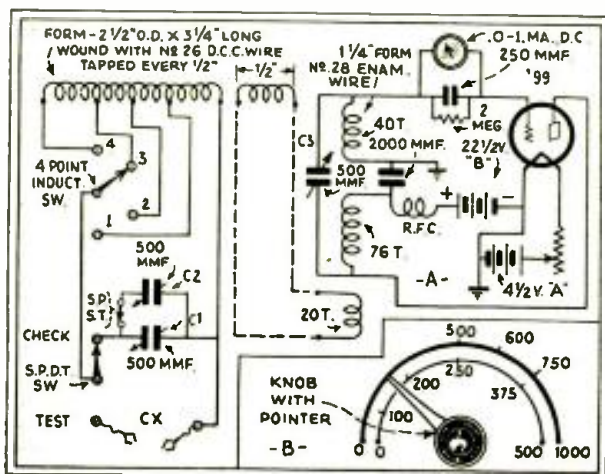

Fig. 1

Circuit for measuring capacities from 50 to 1,000 mmf.

### \$5 FOR A PRACTICAL RADIO KINK

As an incentive toward obtaining radio hints and experimental short-cuts, RADIO-CRAFT will pay \$5.00 for the best one submitted each month. Checks will be mailed upon publication of the article.

The judges are the editors of RADIO-CRAFT and their decisions are final. No unused manuscripts are returned.

Follow these simple rules: Write, or preferably type, on one side of the sheet, giving a clear description of the best radio "kink" you know of. Simple sketches in free-hand are satisfactory, as long as they explain the idea. You can send in as many kinks as you wish. Everyone is eligible for the prize except employees of RADIO-CRAFT and their families.

This contest closes on the 15th of every month, by which time all the Kinks must be received for the next month.

Send all contributions to Editor, Kinks Department, c-o RADIO-CRAFT, 98 Park Place, New York City.

"CHECK" position and C1 is turned until a corresponding dip is noted on the milliammeter; if CX is larger than 500 mmf. it will be necessary to use C1 and C2 by closing the S.P.S.T. switch.

When the dip is found on C1 note the dial reading; if, for instance, the reading is 10 degrees, you will have 10% of 500 mmf.; that is, CX will equal 50 mmf. If it reads 50 degrees, you have 50% of 500 mmf. or 250 mmf., and so on. If C1 and 2 are used and you obtain a reading of 0 degrees, you will have 60% of 1000 mmf. or 600 mmf.

By substituting a pointer in place of the dial, and shel-lacing a white paper onto the panel, a direct reading may be plotted on the paper as shown in Fig. 1B; the outer circle being used for the 1000 mmf. condenser and the inner for the 500 mmf. No markings are made on the outer circle between 0 and 500 mmf., as these readings may be obtained more

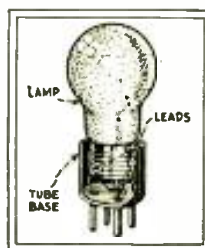

Fig. 2

A convenient lamp mounting.

accurately on the 500 mmf. condenser. One word of warning—do not make the test leads to CX any longer than necessary, to insure as much accuracy as possible.

The range of capacities may be increased by using fixed condensers of known value in either series or parallel connection with the unknown capacity.

The limiting factor of this device is the requirement that the unknown capacity across the inductance, or any section of the inductance, must have a resonant frequency within the range of the grid-dip oscillator.

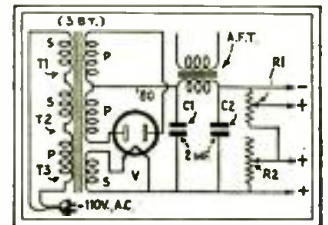

Fig. 3

An emergency "B" eliminator

### SPARK COIL TONE GENERATOR

By Cal Brainerd

**E**XPERIMENTERS who wish to practice the telegraphic code may be interested to know that an ignition coil from an automobile may be very conveniently used to obtain the high audio frequency that is so pleasing when heard in a pair of head phones connected to the output of a smooth-operating, vibrator-brake type of current generator system.

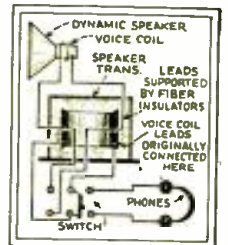

Fig. 4

Connecting head-phones.

The schematic diagram is Fig. 5. In this circuit, transformer T may be an ignition coil of the type used in Model T Fords. By bending the lower vibrator bracket to increase the tension on the armature, fairly high-speed interruption of the primary circuit may be obtained.

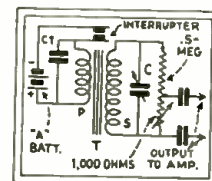

Fig. 5

A code practice unit.

With a 4-volt "A" battery, the secondary voltage will be from 5,000 to 10,000 volts; to handle this potential a book-type condenser is easiest to make and use.

The natural period of the secondary coil is in the audible frequencies, it will be found that a small capacity as C will give considerable range in tone. An ordinary variable condenser in series with two metal plates about 6 x 8 in. square, separated about 1/4-inch can be tried.

(Continued on page 685)

# Radio-Craft's Information Bureau

**SPECIAL NOTICE TO CORRESPONDENTS:** Ask as many questions as you like, but please observe these rules:

Turnish sufficient information, and draw a careful diagram when needed, to explain your meaning; use only one side of the paper. List each question.

Those questions which are found to represent the greatest general interest will be published here, to the extent that space permits. At least five weeks must elapse between the receipt of a question and the appearance of its answer here.

Replies, magazines, etc., cannot be sent C. O. D.

Inquiries can be answered by mail only when accompanied by 25 cents (stamps) for each separate question. Other inquiries should be marked "For Publication," to avoid misunderstanding.

## ZENITH MODEL 103—CROSBLEY MODEL 127

(155) Mr. Carlson J. Parker, Owosso, Mich.  
(Q. 1) In the March, 1932 issue of RADIO-CRAFT, page 541, Data Sheet No. 61, is described the Zenith Model 103 receiver, and

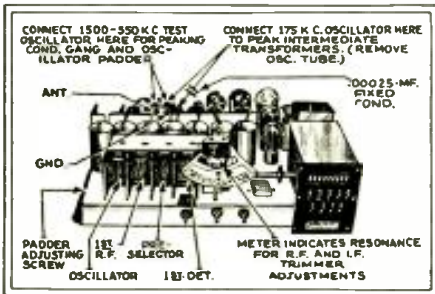

Fig. Q.155A

Chassis layout of the Zenith 103 receiver.

mention is made of a "chassis layout," but it does not appear on the page. Please show this parts layout, if it is available.

(A. 1) The parts layout for the Zenith "Hyperheterodyne" receiver mentioned is shown in Fig. Q.155A.

(Q. 2) In the same issue, page 550, appears the diagram of the Crosbley Model 127 "Happy

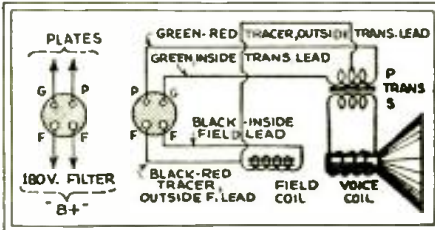

Fig. Q.155B

Dynamic speaker plug and socket connections.

Hour" and "Tenstrike" receiver, as Fig. Q. 151, but only the socket for the dynamic reproducer is shown. What are the lead connections from the dynamic reproducer to the plug which fits into this socket?

(A. 2) The plug connections of the dynamic reproducer used in this chassis is shown in Fig. Q. 155B.

## RCA-VICTOR MODEL M-30 CAR RADIO—MUTUAL CONDUCTANCE METER

(156) Mr. Barrington Fox, Needles, Ariz.  
(Q. 1) What are the antenna requirements for the RCA-Victor car radio set?

(A. 1) Considerable detail, including the schematic circuit, is given in RADIO-CRAFT Data Sheet No. 64, which appeared in the April, 1932 issue.

A roof antenna for the Model M-30 receiver is required only in districts where the average signal-intensity level is very low. For an antenna installation the following equipment may be required: Long-nose, gas, and diagonal pliers; small Crescent, and No. 4 Spintite wrenches; small, large, and thin-shank 6-in. screw drivers; tin shears; medium and heavy-duty soldering irons; resin and acid-core solder; electric drill (with set of drills up to 1/2-in.); reamer (3/8-in. max.); seat and door protectors; sheet copper; and a supply of 1/2-in. Belden Braid.

(Q. 2) Can you suggest any way of reducing interference, in addition to the use of spark-plug circuit series resistors? The use of these does not entirely eliminate interference from the motor.

(A. 2) Apparently bypass condensers have not been applied to the several radiating circuits of the ignition wiring in the car.

Two bypass condensers, one on each terminal, at the ammeter may reduce certain forms of car interference. The receiver should not be located near the car's ignition coil, due to its strong field. Interchanging its primary connections may reduce interference. Whether the antenna lead-in shield should be grounded to reduce interference should be determined by test.

(Q. 3) What is the schematic circuit of the Sterling direct-reading mutual conductance meter?

(A. 3) Several models of this type of instrument were manufactured by the Sterling Mfg. Co. The Model R-517 Meter is illustrated and described in detail in the book, "Radio Set Analyzers," by L. Van der Mel. The "Bridge" of the same manufacture is illustrated in Figs. Q. 156A and B. The meter is calibrated 0-3000 mhos., 0-30 ma., and 10-60 ma.; available data appears in this diagram.

The "A," "B," and "C" voltages for the tube to be tested are adjusted first, and the reading of the meter balanced out by means of the lower left-hand knob. The mutual conductance value is then obtained by reading the meter, which is graduated directly in micromhos; this is the rate of change in plate current for a given grid voltage change.

This device is equipped with four sockets, one for pre-heating and three for testing.

## MAJESTIC MODELS 25, 25B, AND 35

(157) Mr. Harry Sauterine, Kenosha, Wis.  
(Q. 1) I have a Majestic Model 25 super-

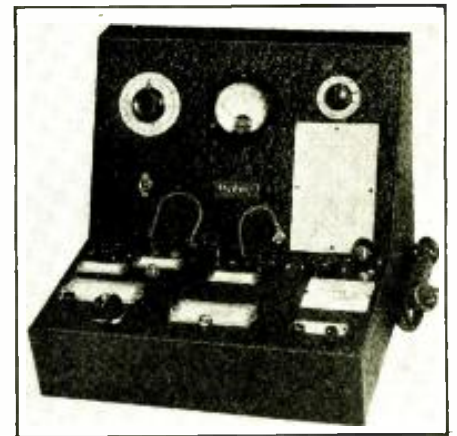

Fig. Q.156A

The Sterling R-517 mutual-conductance meter.

heterodyne which does not seem to be connected the same as diagrammed in Data Sheet No. 59, which appeared in the February, 1932 issue of RADIO-CRAFT.

My set incorporates automatic volume control; tapped-choke input to the push-pull pentodes, instead of transformer coupling; a potentiometer controls the audio input to the push-pull pentodes. There is also a "local-distance" switch which is not shown. Please explain this.

(A. 1) The chassis in the receiver described was changed at the factory, and does not carry the number, "Model 25"; the correct number is the "Model 25B"; and in the Collingwood and Abbeywood cabinets the chassis is "Model 35."

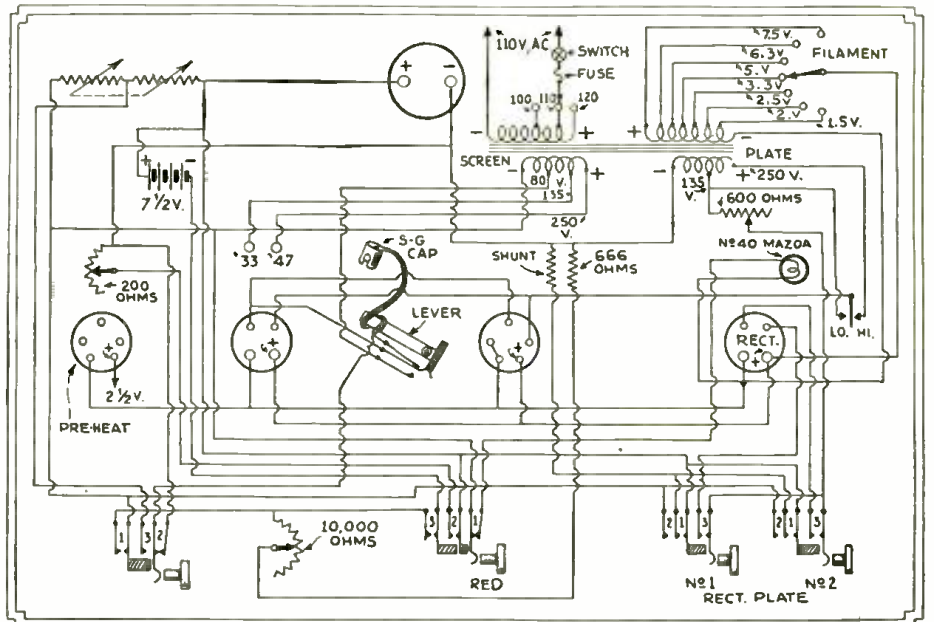

Fig. Q.156B

Schematic circuit of the Sterling Model R-517 mutual-conductance meter.



**SM**

**FROM THE OTHER SIDE  
OF THE WORLD—**

**A 727SW WILL KEEP YOU  
IN TOUCH WITH YOUR HOME**

**SHORT - WAVE  
LONG-WAVE  
ONE DIAL  
ONE CHASSIS**

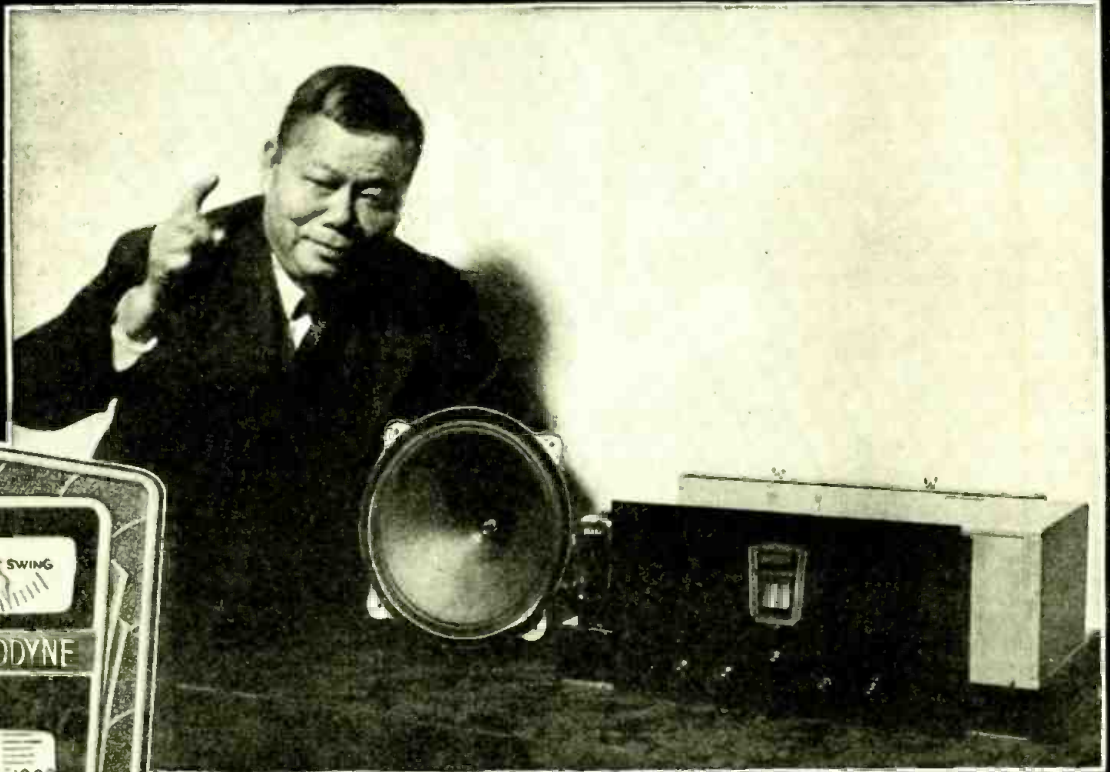

**COLOR TUNING**—calibrates each short-wave band on the dial with the same accuracy as the broadcast band. You will find it **ONLY** in the Silver-Marshall 727SW. It makes finding foreign stations easy.

**ONE DIAL—CALIBRATED  
NEW PATENTABLE CIRCUIT  
AUTOMATIC VOLUME CONTROL  
METER-TUNING  
FRACTIONAL  
MICROVOLT SENSITIVITY  
ABSOLUTE 10KC SELECTIVITY  
PENTODE-VARIO-MU TUBES**

**SILVER-MARSHALL, Inc.**

**6419 W. 65th St.**

**CHICAGO, U. S. A.**

**SILVER-MARSHALL, Inc.  
6419 W. 65th St.  
Chicago, U. S. A.**

Enclosed find 2c. Please send all the 727SW details.

Name .....

Address .....

# Announcing the

# RADIO-CRAFT

Presented on these two pages are the new books of the RADIO-CRAFT LIBRARY—the most complete and authentic set of volumes treating individually, important divisions of radio. Each book has been designed to give radio men the

opportunity to specialize in one or more of the popular branches of the industry. The material contained in these books will increase your knowledge; you will find them a real help in your work and they will contribute to your money earning

## RADIO SET ANALYZERS

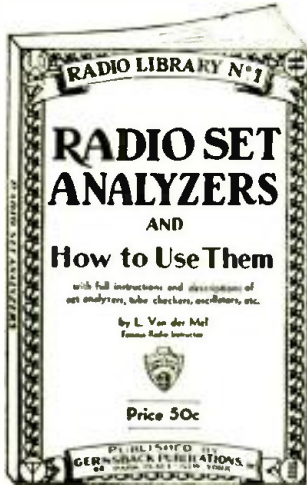

64 PAGES. Size, 6 x 9 inches  
Over 50 Illustrations  
Bound in stiff board covers

**And How To Use Them**  
With Full Instructions and Descriptions of  
Set Analyzers, Tube Checkers,  
Oscillators, Etc.

By L. VAN DER MEL

This book explains thoroughly the operation of set analyzers, tube checkers, oscillators and other testing equipment. For every radio man, whether junior grade or expert, this book is extremely helpful. It covers every phase of testing and gives you valuable short cuts; completely illustrated with photographs and diagrams to facilitate the use of modern testing equipment.

The following chapters briefly outline the contents: INTRODUCTION; THE ANALYZER; Fundamentals, Switches, A.C. and D.C. Voltmeters, Calibration and Design; TROUBLE SHOOTING WITH THE ANALYZER; Classification of Trouble, Analysis of Electrical Troubles, Features and Uses of Various Analyzers, Care and Maintenance; CONCLUSION; Summary.

## MODERN VACUUM TUBES

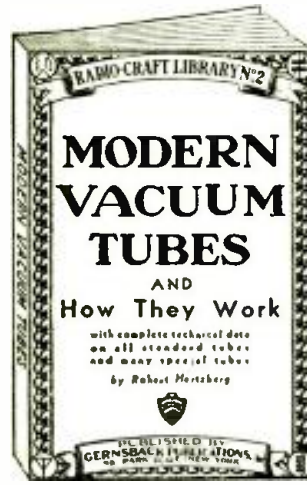

64 PAGES. Size, 6 x 9 inches  
Over 100 Illustrations  
Bound in stiff board covers

**And How They Work**  
With Complete Technical Data on All  
Standard and Many Special Tubes

By ROBERT HERTZBERG

MODERN VACUUM TUBES describes the fundamental electron theory which is the basis of all vacuum tube operation, and goes progressively from the simplest two-element tubes right up to the latest pentodes and thyratrons. It is written in clear, simple language and is devoid of the mathematics which is usually so confusing. Valuable reference charts and characteristic curves of standard and special tubes are to be found, also diagrams of sockets and pin connections.

Here are some of the chapters: The Edison Effect and The Electron Theory; Electron Emitters and the Ionization Effect; The Three-Electrode Tube; Vacuum Tube Characteristics; Four- and Five-Element Tubes; Light Sensitive Cells and Other Special Tubes.

## HOW TO BECOME A RADIO SERVICE MAN

How To Get Started and How To Make  
Money In Radio Servicing

By LOUIS MARTIN

The ambition of many men in radio today is to become a first-grade Service Man, with a business that is flourishing. It is not as difficult as one might believe, but it cannot be done in a few short months. Following very carefully the advise of Mr. Martin, who has dealt with the problems of thousands of Service Men, this book deals very carefully with the essential stages in the preparation for qualifying as a Service Man. The Chapters of the book are so divided that each element is thoroughly covered.

Here are the chapters: The Small Independent Service Man; Advanced Commercial Aspects; The Radio Set; Semi-Technical Considerations; Advanced Service Data. Each chapter is again subdivided to bring out in minute detail every point of importance.

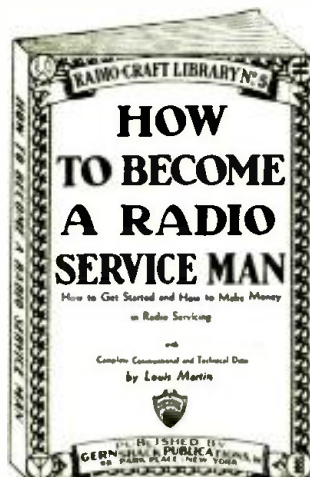

64 PAGES. Size, 6 x 9 inches  
Over 55 Illustrations  
Bound in stiff board covers

## BRINGING ELECTRIC SETS UP TO DATE

With Pentodes, Multi-Mus, Dynamic  
Speakers—Complete Information How to  
Modernize A.C., D.C. and Battery Operated  
Receivers

By CLIFFORD E. DENTON

In this country there are over ten million electrically operated receivers that could be modernized—by placing in them new type tubes, new speaker equipment and other modern improvements. This business of improving old sets can go to the experimenters and Service Men if they will quickly jump into action.

Read in this book by Mr. Denton, how easily you can modernize any obsolete set. Your clients can retain their expensive cabinets and still have a receiver that is right-up-to-the-minute, and with little additional costs.

Here are the high lights of this book: Tubes Available for Replacements; Electrifying Battery Receivers; Use of the New 2- and 6-Volt Tubes; Operating Sets with Single Control; Conversion of A.C. Sets into D.C., and D.C. into A.C.; Replacing Output Tubes with Higher Output Tubes; Improving Old Supers; Loftin-White Amplifiers; Adapters and Their Use.

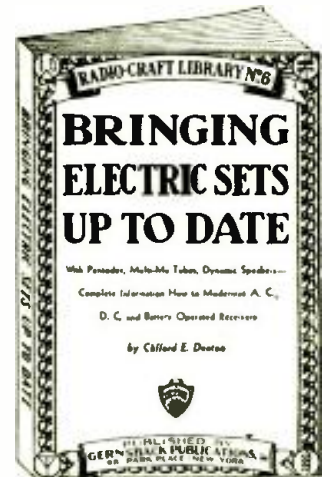

64 PAGES. Size, 6 x 9 inches  
Over 80 Illustrations  
Bound in stiff board covers

## AUTOMOBILE RADIO AND SERVICING

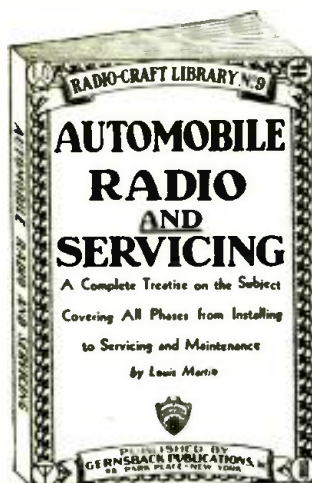

64 PAGES. Size, 6 x 9 inches  
Over 65 Illustrations  
Bound in stiff board covers

A Complete Treatise on the Subject Covering  
All Phases from Installing to Servicing  
and Maintenance

By LOUIS MARTIN

Automobile radio is up and coming, and someone has to service them properly. It is certain that one of these days your turn will come, whether you are an experimenter or Service Man. It therefore behooves you to read this immensely important new book on the art of Automobile Radio. There is no better book in print and none as concise. The book is full of illustrations, photographs, diagrams and hookups.

Here are only a few of some of the really interesting chapters: Introduction; Automotive Radio Installations; Complete Descriptions of Commercial Automotive Receivers; Servicing Automotive Receivers; The Ignition System; General Service Considerations; Effects of Temperature on Power Supply; Conclusion.

## HOME RECORDING AND ALL ABOUT IT

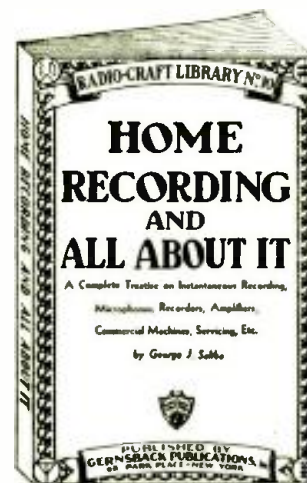

64 PAGES. Size, 6 x 9 inches  
Over 70 Illustrations  
Bound in stiff board covers

A Complete Treatise on Instantaneous  
Recording Microphones, Recorders, Amplifiers,  
Commercial Machines, Servicing, etc.

By GEORGE J. SALIBA

If there is one subject that is fascinating to every radio man, it is that of Home Recording. Of course, this volume is not all on "Home" recording, but the information contained therein is important to commercial radio men, studio operators, engineers and others interested in this phase of radio.

The art of recording and reproducing broadcast selections is becoming more important every day to radio men, experimenters and Service Men. Equipping dance halls, auditoriums, churches, restaurants and homes with public address and amplifiers brings many extra dollars and often an excellent income.

In this book are found such topics as: Short History of the Art; Microphones; Recording Amplifiers; Cutting Heads; Types of Records; Commercial Machines; Adding Recorders to Receivers; Studio Layouts; Mechanical Filters for Turntables.

# LIBRARY > > >

capacity. Read these books during your spare time at home.

The authors of these books are well-known to everybody. Each one is an expert radio man; an authority on the subject—each is thoroughly familiar with the field which he represents.

This is perhaps the first real opportunity that you have ever had to build a radio library of books that are authentic, right-up-to-the-minute and written so that it is easily digested and clearly understood. Mail the coupon below for your books.

## THE SUPERHETERODYNE BOOK

All About Superheterodynes  
How They Work, How to Build and How  
to Service Them

By CLYDE FITCH

There is no more fascinating a subject in the large array of radio circuits than the famous superheterodyne circuit. It has taken the world by storm, and today practically all modern receivers employ this principle of design. Whether you are a Service Man or experimenter, first-hand knowledge about the construction of these receivers is very important. The book on Superheterodynes gives underlying principles of their construction, right from the very first set made. Mastering the fundamentals of this circuit will enable you to build or service any receiver.

The following is a short list of contents: Basic Principles of the Superheterodyne; The Oscillator; First Detector; Single Dial Tuning Systems; Intermediate Amplifier; Second Detector, Audio Amplifier and Power Supply; Commercial Superheterodyne Receivers; Servicing Superheterodynes.

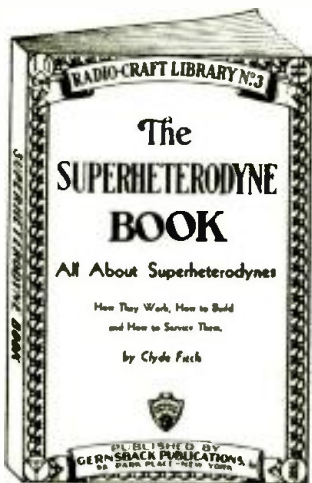

64 PAGES. Size, 6 x 9 Inches  
Over 60 Illustrations  
Bound in stiff board covers

## MODERN RADIO HOOK-UPS

The Best Radio Circuits  
A Complete Compendium of the Most Important  
Experimental and Custom-  
built Receivers

By R. D. WASHBURNE

It is fascinating to the experimenter, or even to the up-to-date Service Man, to take a commercial set and to change it into one using a famous hookup that is not found in any manufactured set; and it is usually worth the trouble because results are far superior than in the original. Many excellent circuits have never been commercialized, but limited only to home-set builders. Thousands of these popular circuits have been requested from time to time, and in this book we have included over 150 circuits, which include the famous Peridyne, Cash-Box A.C.-D.C. Set and others.

The circuits cover the following: BROADCAST RECEIVERS, ALL-WAVE RECEIVERS, SHORT-WAVE RECEIVERS, CONVERTERS AND ADAPTERS, TELEVISION RECEIVERS, HOME RECORDING APPARATUS, AUTOMOBILE RECEIVERS, AUDIO AND POWER AMPLIFIERS, POWER UNITS and MISCELLANEOUS EQUIPMENT.

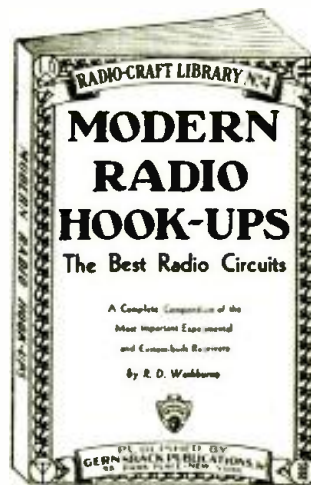

64 PAGES. Size, 6 x 9 Inches  
Over 120 Illustrations  
Bound in stiff board covers

## RADIO KINKS AND WRINKLES

For Service Men and Experimenters  
A Complete Compendium on the Latest  
Radio Short-Cuts and Money-Savers

By C. W. PALMER

It often becomes necessary for experimenters and Service Men to call upon their memory for some short cut or radio wrinkle that will solve a problem quickly. In business, "short cuts" mean time and money saved, and to the Service Man "time saved" means money earned.

This book is a compilation of important radio kinks and wrinkles; the entire contents of the book has been selected with great care in order to discuss only such items as are constantly used today.

Here are some of the more important chapters: Introduction; Servicing Short-Cuts; Testing Equipment and Meters; Vacuum Tubes and Circuits; Volume-control Methods; Amplifiers and Phonograph Reproducers; Power Supply Equipment; Coils and Tuning Circuits; Short Waves; Loud Speakers; Tools and Accessories.

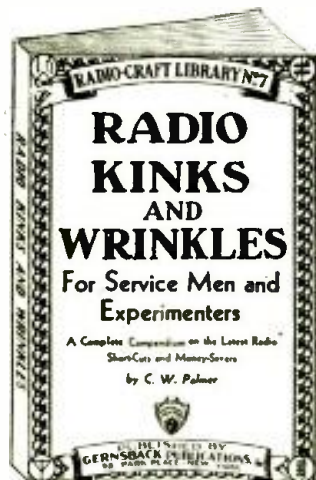

64 PAGES. Size, 6 x 9 Inches  
Over 78 Illustrations  
Bound in stiff board covers

## RADIO QUESTIONS AND ANSWERS

A Selection of the Most Important of 5,000  
Questions Submitted by Radio Men During  
the Course of One Year

By R. D. WASHBURNE

There has been collected a wide variety of questions which have come into our editorial offices during the past two years, and only those whose answers would benefit the majority of men engaged in radio have been incorporated in this amazing question and answer book.

The tremendously long list of topics better explains the subjects which are treated. Here are the titles:

Radio Servicing; Receiver Design; Theory; Home Recording; Television; Sound Equipment; Short Waves; Antennas; Operating Notes; Test Equipment; Vacuum Tubes; Engineering; Ultra-Short-Waves; Police Radio; Reproducers; Graphs; Superheterodynes; Automotive Sets; Power Packs; Automatic Volume Controls; Remote Control Devices; Aligning Procedure; Photoelectricity; Tone Control; Coil Construction; Adapters; Measuring Apparatus; Band-Selectors; Meters; Symbols; Microphones; Converters; Definitions; Public Address Equipment; Modernizing Methods; Set Analyzers; Midset Sets; Oscillators; Phonograph Pickups; Tube Testers; Diagrams.

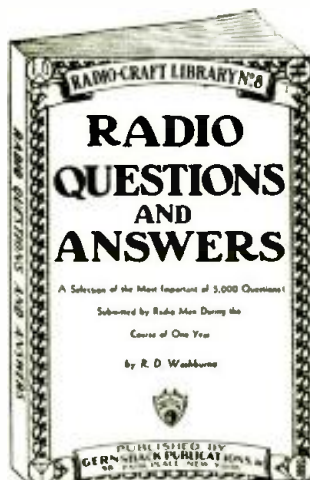

64 PAGES. Size, 6 x 9 inches  
Over 80 Illustrations  
Bound in stiff board covers

## BIG DISCOUNT OFFERED

In order to make it possible for everyone to buy these books, the fifty (50) cents price has been made uniform for all volumes. You can buy these books separately, but you should take advantage of our special offer:

WHEN FIVE (5) BOOKS OR MORE ARE ORDERED  
DEDUCT 20% FROM YOUR REMITTANCE

Simply fill in the coupon below, and mail it to us together with your remittance. Checks, stamps or money orders accepted.

### All Books Uniform

The books in the new RADIO-CRAFT LIBRARY are all strictly up-to-date, and written by men who know their subjects. The volumes are all uniform size, 6 x 9 inches, and contain on an average of 50 to 120 illustrations. Each book is printed on fine book paper, and no expense has been spared to make it an outstanding value, for its editorial contents as well as from the mechanical standpoint.

CLIP  
COUPON  
AND  
MAIL!

GERNSBACK PUBLICATIONS, Inc.		96-98 Park Place New York, N. Y.								
I have circled below the numbers of books in the RADIO-CRAFT LIBRARY, which you are to send me, and have deducted 20% for ordering five (5) books or more. I have included my remittance in full, at the price of 50c each, when less than five books are ordered. The amount of my remittance is ..... (Stamps, checks or money orders accepted.)										
Circle numbers wanted:	1	2	3	4	5	6	7	8	9	10
Name.....	Address.....									
City.....	State.....									
RC-532										

# STUDY RADIO RADIO SERVICING COURSE

by Alfred A. Ghirardi and Bertram M. Freed  
Contributing Editor,  
Radio Craft Servicing  
Department.



**\$1.50**

Postpaid in the U. S.  
192 Pages, Over 100  
illustrations!

# RADIO PHYSICS COURSE

Nobody in Radio can afford to be without these two great books. Written by two of Radio's foremost authorities, they cover every phase of the subject up to the present moment. These are financially profitable books to own! They will give you a complete radio education—in your spare time at home!

By Alfred A. Ghirardi  
The Radio Physics Course now running in Radio News—complete in one book!  
**\$ 3.50**

Postpaid in the U. S.  
992 Pages, Over 500  
illustrations!

## MAIL THIS COUPON AT ONCE!

RADIO TECH. PUB. CO., Dept. R.C. 5  
80 Fifth Avenue, New York City.

Enclosed find check, cash or money order for .....  
copies of Radio Physics Course at \$3.50 each, and  
..... copies of the Radio Servicing Course at \$1.50  
each. Check here for FREE circular.....

Name .....  
Address .....  
City ..... State.....

# LISTENERS OFFICIAL RADIO LOG

World Short Wave Stations—Police—  
Aeronautical—Relay and Telephone Stations also Aeroplane and Amateur Bands—  
Cross Tabulated by Call, Frequency,  
Location and  
Time of Broadcast.

An accurate up-to-date call book. Regular and short-wave broadcasting stations of the world—U. S. map and short wave World map—Special illustrated short-wave features—contains just the information your customers demand—good for advertising or resale.

Jobbers, Dealers, Mfrs., Service Men—write today on letterhead for sample and quantity prices. Others send 25c.

ALL AMERICAN SERVICE  
5707 N. Clark St.  
CHICAGO, ILL.



# AERO WORLDWIDE SHORTWAVE RECEIVER \$6.45

Listen in DUBLIN, Paris, London, Paris, Berlin, London, Mires and other broadcasting stations throughout the world via short waves. Your ordinary receiver cannot tune in these low wave stations. WORLD-WIDE RECEIVER gets 14 to 550 meters.

**AERO SHORT WAVE CONVERTERS**  
Convert Your Present Set Into a Short Wave Super-Heterodyne

A. C. MODEL \$12.50—D. C. MODEL \$11.50

AT LAST: The Perfect Auto Radio—ONLY \$20.00

Built by pioneers in the manufacturing of Auto Radio. We guarantee 1000 miles radius of reception. A masterpiece of Radio Engineering. Latest model G Tube Aero Pentode Auto Radio. Price of set only \$20.00. Set complete with tubes, batteries, dynamic speaker, antenna equipment and noise suppressors. \$39.50. Send for complete Catalog.

CHAS. HOODWIN CO. 4240 LINCOLN AVENUE, Dept. 5-15, Chicago, Ill.

# THE TETRADYNE RECEIVER

(Continued from page 651)

structed at home by winding the coils on a tube 1 1/2 ins. in diameter. The following specifications are given:

The 200- to 550-meter broadcast band: L1, 20 turns; L2, 98 turns; L3, 66 turns. L1 and L2 are wound on the same form (on all the different wave-band coils), are separated by 1/16-in., and are wound with No. 28 D.S.C. wire.

The 80- to 205-meter band: L1, 14 turns; L2, 57 turns; L3, 58 turns. L1 and L2 are separated by 1/8-in., and are wound with No. 24 D.S.C. wire.

The 40- to 85-meter band: L1, 10 turns; L2, 22 turns; L3, 21 turns. L1 and L2 are separated by 1/4-in., and are wound with No. 24 D.S.C. wire.

The 20- to 15-meter band: L1, 8 turns; L2, 10 turns; L3, 10 turns. They are separated by 1/4-in., and are wound with No. 24 D.S.C. wire.

For wave lengths up to 25 meters: L1, 4 turns; L2, 6 turns; L3, 6 turns. L1 and L2 are separated by 1/4-in., and are wound with No. 24 D.S.C. wire. The lowest wavelength that is received is determined by the capacity of the wiring and the internal capacity of the tubes. The writer has been able to tune in stations as low as 15 meters without any trouble.

Figure 3 shows complete construction details of the coils. The left-hand coil is the first-detector or modulator, and the right-hand coil is the oscillator coil L3. The connections of the coil to its prongs are shown above, while the socket connections are shown below. Notice that the .0001- and .0002-mf. condensers are connected together in the broadcast coil only, thus leaving only the .0001-mf. section of the tuning condensers for the short-wave band. The same method is used for the oscillator coil.

## The I.F. Transformers

Any good 175-ke. transformer may be used for the I.F. stages. However, for the man who desires to construct them himself, the following data are given: Refer to Fig. 4. The primary is "jumble" wound, having 152 turns of No. 28 enameled wire; the secondary is spaced from the primary by 3/8-inch, and is wound with 213 turns of No. 28 enameled wire. The spacing and sizes of the windings are shown in the diagram.

It is desirable to first enclose the I.F. transformers in a shield and then mount them on the chassis. For more details on I.F. transformer design, the reader is referred to the article by Clifford E. Denton in the April, 1932 issue of RADIO-CRAFT, Editor.

With the information as given, together with

the diagram of connections, the constructor should have no trouble in making this set work to his complete satisfaction.

## Results

This receiver has great sensitivity, good selectivity, very good tone quality, and is capable of giving enormous volume which may be easily controlled by the resistor R5. The writer would like to say that for real quality, he prefers a good, long, air-column horn with a dynamic speaker. It is true that a 9- or 10-foot horn, when coiled up, takes more room than a standard dynamic unit, but it is the writer's choice for real quality.

If the constructor is located very close to a powerful broadcasting station, then it may be desirable to connect R3 to a 40-volt tap on the bleeder resistor R11 rather than on the 25-volt tap as it now is. This change will allow

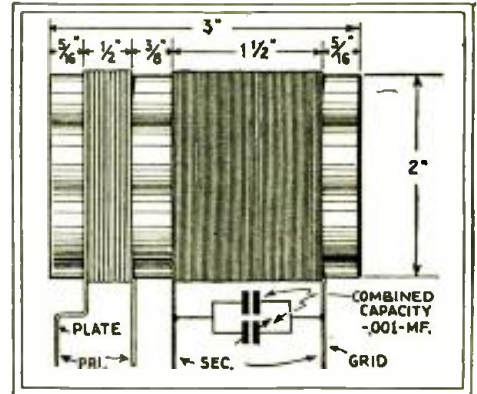

Fig. 4  
I.F. transformer coils.

the sensitivity of the receiver to be lowered to a sufficient extent to reduce interference to a minimum.

The writer lives in a section of high noise level and poor-reception conditions, but has had some very good results on both the short-wave and broadcast bands; short-wave stations having been received from halfway around the world. As for the broadcast band, 100-watt stations have been received from California and 500-watt stations from Mexico (the writer is located in Wisconsin).

Short waves are very erratic, so do not expect too much from them and you will not be disappointed. The number of turns for the lower wavelengths may vary a turn or so, especially on the 25-meter coil.

## Parts List

- Two National Type E.C. special 2-stator condensers, C1 and C2, C4 and C5;
- One 50-mmf. trimmer condenser, C3;
- One Hammarlund equalizing condenser, 4 to 70 mmf., C6;
- One Aerovox .00015-mf. mica condenser, C7;
- Three Aerovox 0.1-mf. bypass condensers, C8, C9, C10;
- Two Polymet 0.1-mf. condensers, C11 and C12, C13 and C14;
- Two Concourse 5-mf. dry electrolytic condensers, C15, C19. (These are the 35-volt type.)
- One Aerovox .0005-mf. mica condenser, C16;
- Two Concourse 4-mf., 400-volt dry electrolytic condensers, C17, C20;
- One Aerovox 0.1-mf., 400-volt condenser, C18;
- One Aerovox 0.25-mf. condenser, C21;
- One Aerovox filter type 1-mf., 600-volt condenser, C22;
- One Aerovox 8-8.8 mf., 475-volt dry electrolytic condensers, C23, C24, C25;
- One Lynch 250,000-ohm pigtail resistor, R1;
- One Electrad 1,000-ohm grid resistor, R2;
- One Carter 5,000-ohm potentiometer, C. P. 5 M., R3;
- One Lynch 25,000-ohm pigtail resistor, R4;
- One Lynch 6,000-ohm pigtail resistor, R5;
- One Electrad 200-ohm resistor, R6;
- Two Lynch 0.5-megohm pigtail resistors, R7, R8;
- One Lynch 100,000-ohm pigtail resistor, R9;

(Continued on page 694)

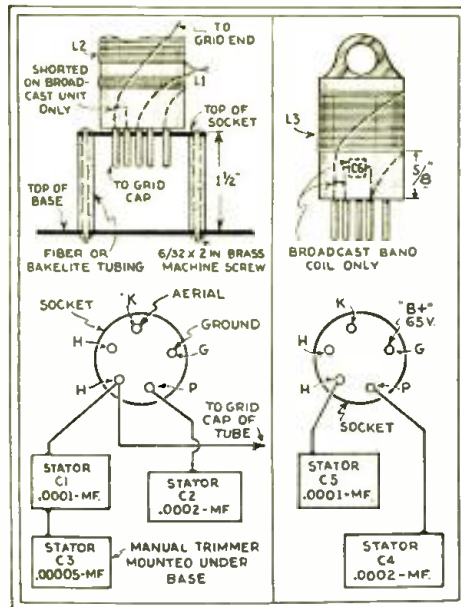

Fig. 3

At the left, the tuning, and at the right, the oscillator coil and socket connections.

## MORE NEW TUBES

(Continued from page 655)

low-wattage 2-volt filament in this tube is not rugged enough to stand the rough treatment of an automobile tube, nor would it give good life performance with the high current drain at 165 volts. Its power sensitivity is somewhat better than that of the '33.

A new tube called "ER-LA" has been designed to meet the very severe requirements of automobile output-tubes, outlined above, combining the advantages of the '47 and '33 with the filament rating of the '38 and has proven very suitable for this service.

A filament type had been selected because of the better mutual conductance obtainable. Previous experiences with '71A and '21A tubes had proven that a coated filament of similar rating may be used successfully in automobile receivers.

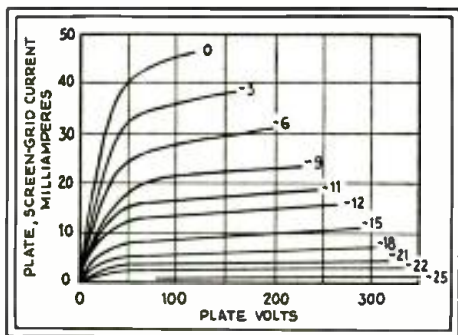

Fig. 16

The rating and characteristics of the ER-LA are as follows: Filament voltage, 6.3 (D.C.); filament current, .30-ampere; plate and screen-

grid voltage, 135 to 165 volts (max.); control-grid voltage -9 to -14 volts; plate current, 12 to 17 ma.; screen-grid current, 2.5 to 3.5 ma.; amplification factor, 100; mutual conductance, 1900 to 2100 micromhos; power output 700 to 1200 milliwatts; load impedance, 9500 to 8000 ohms, overall dimensions: Length, 4-11/16 inches; diameter 1-13/16 inches; base, 5 prong.

It was found that the most economical and distortionless operating conditions resulted from the use of two tubes in push-pull with a self-bias higher than normal (class B amplifier) though the total power is somewhat less than from two tubes with normal bias. Two equal tubes will balance their even harmonic distortion due to the push-pull arrangement. By selecting proper values of bias resistor and load impedance, the curvature of the dynamic (plate-current—grid-voltage) curves will balance also, and the third-harmonic distortion disappears much the same way as the second-harmonic does in a single pentode. The self-bias eliminates a difficulty usually encountered in class B amplifiers; the plate-current fluctuations are not very much higher than in ordinary class A amplifier.

The distortion balance is maintained with all input voltages up to the value at which grid-current starts. It will be noted that the "ER-LA" under these conditions, gives much better sensitivity than the '38 and approximately the same power as a '47. Remarkable under these conditions is the value of 70 percent for the efficiency of the plate circuit of the "ER-LA," not counting the screen-grid current and grid bias losses. Taking these into account, the efficiency is of the order of 45 percent. These values compare favorably with plate circuit efficiencies of 40 to 45 percent in pentodes under normal operating conditions.

## SIMPLIFIED COIL CALCULATION

By C. H. W. NASON

THE archaic method of calculating inductances involves a formula taking into account, not only the actual dimensions of a winding and the number of turns of wire, but a form factor "K" dependent upon the ratio of length to diameter of the form on which the coil is wound. (See page 109, August 1931 issue.) While these formulas are no doubt, accurate to a minute degree in capable hands, the errors possible are manifold; and rarely, if ever, does a coil so designed come within a reasonable degree of the desired inductance.

A considerable simplification of the design problem was evolved several years ago by Harold A. Wheeler of the Hazeltine Laboratories, who is responsible also for the multiplex detector and automatic volume control used by Philco, Fada, and other Hazeltine licensees.

In the illustrations, herewith, three types of windings, which cover practically every case within the needs of the experimenter or Service Man in his daily work are shown. First, we have a multi-layer winding, such as might be employed in the intermediate-frequency transformers of a superheterodyne receiver. Second on the list is a simple solenoid of the type used in the tuned circuits of broadcast receivers. The last is a helical (spiral) winding such as might be used either as a coupling

coil in a band selector, as an antenna coupling coil, or as a primary winding for an R.F. transformer. The equations for calculating the inductance are given with each sketch. All dimensions are to be taken in inches and the answer will be obtained directly in microhenries.

The method compares quite favourably with Nagataki's formula as to accuracy, and is many times easier to use than the older method, in which the form factor had to be taken into account. Accuracy to 1% is obtainable in the case of the multi-layer coil, when the three terms in the denominator (below the line) are nearly equal. The accuracy in the case of the simple solenoid is also to 1% when the length of the winding is greater than four-fifths times the diameter. In the third case, this degree of accuracy is obtainable when the dimension "c" is greater than one fifth the dimension "a".

In no case will the error be greater than is possible with the more tedious method formerly used, when the most exacting care is taken. All that is necessary for the calculation of inductance values is a ruler, a pencil and a copper wire table giving the diameter of various wire sizes, so that the space occupied by a given winding may be known. (See page 185, September 1931 issue).

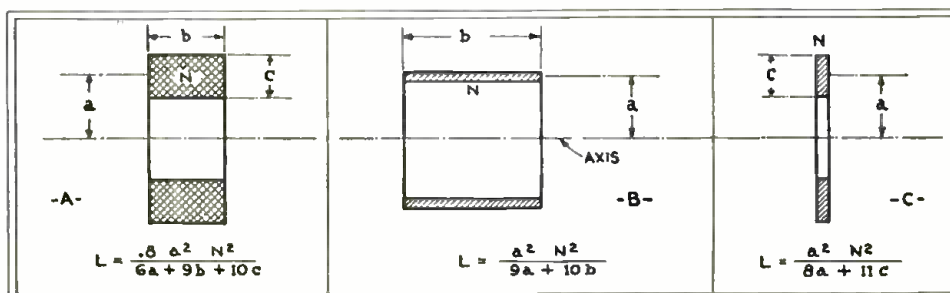

## YOUR FIRST LINE OF DEFENCE AGAINST SUMMER SLUMP

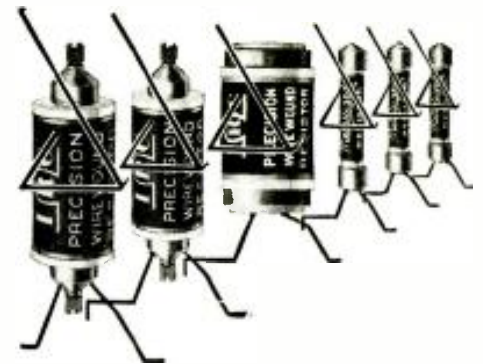

I.R.C. Resistors insure summer PROFITS.

Metallized Resistors for replacements. Wire Wound Resistors for meters and test equipment.

Make for yourself valuable apparatus which will speed up your service work, build your reputation and add satisfied customers.

Mail coupon today for FREE charts. They will save you hundreds of dollars in equipment.

INTERNATIONAL RESISTANCE CO.  
PHILADELPHIA TORONTO



Metallized and Precision Wire Wound

## RESISTORS

International Resistance Co. C-5  
2006 Chestnut St., Philadelphia.

( ) Please send your money-saving charts.  
( ) I am interested especially in making the apparatus below. (Name the equipment you wish below coupon.)

Name .....

Address .....

City ..... State .....

**SERVICEMEN**  
**Save TIME MONEY**  
 with **CLAROSTAT ad-a-switch**  
**VOLUME CONTROLS**

Don't lose service business. You need never be stuck in an emergency if your bag contains AD-A-SWITCH. You can convert from plain to switch control in a jiffy. Snaps on without tools. Ask your jobber or write us direct.

**FREE!** Write for your copy of the most complete handbook on every type of variable resistance—from tiny Center Taps and Volume Controls up to Heavy Motor Speed Controls.

Every experimenter, service man and engineer should have a copy of the CLAROSTAT Control Handbook.

**CLAROSTAT Mfg. Co.**  
 285-287 N. 6TH ST. BKLYN. N.Y.

## 5-METER SET

(Continued from page 675)

such a receiver to moving vehicles becomes evident.

After noting one more technical consideration, that of sensitivity, we will be ready to proceed with the discussion of a practical receiving set design.

Experimenters who have specialized in work below 200 meters are familiar with the difficulty which exists in obtaining "pep" at the lower wavelengths. Now, it so happens that a phenomenon of "super-regeneration" is its increasing efficiency, as a "sensitizing" agency, with decreasing wavelength. In fact, a super-regenerative receiver may be made to operate very nicely at 1 meter.

### A Practical Receiver

In Figs. A and B are illustrated United Radiobuilders' custom-constructed super-regenerative receiver, which covers a wavelength range of roughly 3 to 8 meters (more nearly, 3.7 meters to 7.2); its schematic circuit is Fig. 1. In Fig. 2 are shown two details of construction; at A, the coils of the suppressor-frequency inductance L3-L4, and; at B, the end-plate which serves to hold the short-wave inductances L1-L2 and at the same time support one end of the tuning condenser C3. By plugging in a different inductance unit as L1-L2, the minimum wavelength pickup may be reduced to 1. meter; adjustment of C1 and C2 will increase the maximum wavelength pickup.

Following are the electrical values of all the parts used in this receiver: Condensers C1, C2, 30 mmf. (each), "compensator" type; C3, Cardwell Type 404-B, 105 mmf.; C4, 0.5-mf.; C5, .00025-mf.; C6, .0025-mf.; C7, 0.1-mf.; C8, 1. mf.; C9, .005-mf. Resistor R1, 2 megohms; R2, variable, 50,000 ohms; R3, R4, 2,000 ohms (carbon). Radio frequency choke R.F.C. is spaced-wound with 40 turns of No. 36 S.S.C. wire on a form 1/4-in. in diameter. Coils L1, L2, each consist of 6 turns of No. 16 bare copper wire air-wound to a diameter of 5/8-in.; L3, 800 turns of No. 40 S.S.C. wire; L4, 1,500 turns, No. 40 S.S.C. (core diameter, 1/2-in.). Transformer T has a ratio of 3 1/2 to 1.

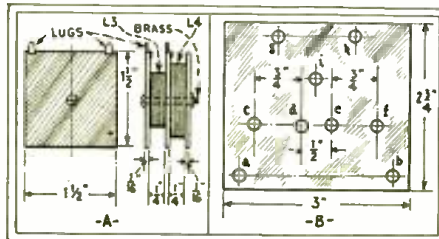

Fig. 2

Parts construction data.

In Fig. 2B, holes A and B are for the angle brackets; holes C, D, E, and F for General Radio tip-jacks; and G, H, and J, mounting holes for the end-plate of the tuning condenser.

An Acme 30 kc. I.F. transformer may be used in place of a home-constructed unit for L3-L4.

Batteries are connected to this set by means of a battery cable, one end plugging into the 5-prong socket which appears in the illustration. The chassis measures 6 x 8 x 2 1/2 in. deep; the front panel, 7 x 9 in.

Super-regeneration contributes the greater proportion of the sensitivity in this type of set, the receiver illustrated developing a gain of about 80 dB; consequently, volume and sensitivity control may be combined in the operation of a single knob to vary the value of resistor R2. (Further information on this type of reception is contained in the article, "The Short-Wave Superregenerator," by Clifford E. Denton. This description appeared in the August, 1931 issue of RADIO-CRAFT. See also the July, 1931 issue of QST magazine.—Technical Editor.)

The design of suppressor-frequency coils L3-L4 is not critical; except that the frequency must be kept outside of the broadcast band, and near as possible to the audio end of the

(Continued on page 694)

## GODSEND for Radio Service Co.

Dear Sir:

After having used all of your publications in our work during the past seven years, we desire to compliment you on your new second edition Radio Encyclopedia.

This certainly is the most comprehensive and complete book we have as yet seen on the subject of Radio, and for anyone who really wants to know the why and wherefore of Radio phenomena, it is a godsend.

Wishing you continued success, and in anticipation of your future works, we are

Very sincerely yours,  
**DEPENDABLE RADIO SERVICE CO.**

Milton D. Nelson,  
 New York City.

### What the New Second Edition Radio Encyclopedia Gives You

It gives you an explanation of every word used in radio. These explanations—or, rather, definitions—are not brief outline information like those of an ordinary dictionary, but they give in fullest detail, and at considerable length, the meaning and application of every word, phrase, general and special term used in the science of radio. They are written in plain, everyday English, easily understood by anyone.

Practically every definition in the book is illustrated by drawings, photographs, diagrams, or charts. All you need to do is to look up as you would in a dictionary, the word or phrase about which you are seeking information. Furthermore, each page is key-indexed, for greater convenience and speed in locating any definition. All the Subject-Matter is Arranged in Alphabetical Order.

This greatly enlarged Second Edition Radio Encyclopedia is an absolute necessity to everyone interested in Radio. It answers all radio questions, increases your knowledge and saves your time. It covers every known radio problem, and is a goldmine of practical information for every radio man.

**2,201 RADIO DEFINITIONS**  
**1,253 TECHNICAL ILLUSTRATIONS**  
**34 TABLES AND CHARTS**  
**24 PAGES OF APPENDIX**  
 Red Morocco-Keratol Flexible Binding  
 Printed on strong ledger paper, Loose-Leaf Arrangement

352 pages  
 9 x 12 inches  
 Weight 3 lbs.



**S. GERNSBACK CORPORATION,**  
 98 Park Place, New York, N. Y.

Send me one copy of the new Second Edition S. Gernsback Radio Encyclopedia. I enclose herewith \$3.98, check or money order preferred. (Foreign and Canada, add 35c extra for postage.) Money refunded in full if not satisfactory.

Name .....

Address .....

City..... State.....

RC-532

**New Low List Prices**  
 1 Watt 30c; 2 Watt 40c; 3 Watt 50c

**LYNCH RESISTORS**  
 Metallized Precision Wire Wound  
 1, 2, and 3 Watts

Servicemen—

**FREE!**

**New LYNCH RESISTOR Replacement MANUAL**

with purchase of 10 LYNCH Metallized Resistors, of Manual alone may be bought for \$1.00.

Covers more than **200 Receivers**

Send order today for Manual, new reduced price catalog and R. M. A. Color Code Card.  
**LYNCH MFG. CO., Inc., 1775RC B'way, N. Y. City**



**EFFICIENT PHOTO CELLS**  
 CAN NOW BE BOUGHT AT **LOW COST**

**COMPLETE KIT \$9.50**  
 (Never Before Sold For Less Than \$5.00)

INCLUDES: 5T TYPE LUXTRON CELL  
 R1 RELAY CONTROLLING R.I. RELAY CIRCUIT  
 110-V. CIRCUIT COMPLETE SET OF INSTRUCTIONS & DIAGRAMS  
**SEND \$1 FOR INTERESTING INSTRUCTIONS LUXTRON DEVICES COMPANY**

330 BERRY STREET, DEPT. 3-W, BROOKLYN, N.Y.

Write for full details about the OFFICIAL REFRIGERATION SERVICE MANUAL. Gernsback Publications, Inc., 98 Park Place, New York, N. Y.

## RADIO DECOUPLING FILTERS

**N**O doubt you are all familiar with the methods shown in Fig. 1 for the purpose of eliminating coupling between stages by means of filters composed of chokes and condensers or resistance-condenser combinations. The question often arises as to what values these components should have and as to the relative merits of the two systems.

An empirical rule may of course be given in which we state that the condenser should be of such value as to offer a short path to ground for all currents involved as compared with choke or resistance. Of course, in circuits carrying current there will be a voltage drop through the filtering resistors, and where this current is high it is most economical of voltage to employ R.F. or A.F. chokes as the circuit may dictate. For an example: in a

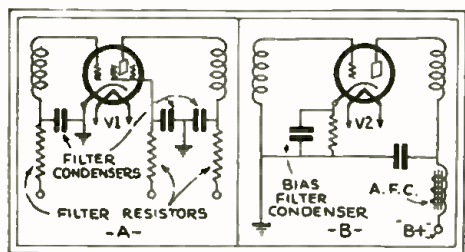

Fig. 1

ircuit employing 71A tubes in the output, the maximum voltage available is not much in excess of 200 volts, and should we require a plate voltage of 180 for an R.F. amplifier tube, the drop created through a high filter resistance would be prohibitive. If we are using 45 output tubes we have 300 volts available and can waste 120 volts in the filtering resistance if desired. The filter then can act in the double capacity of filtration and voltage reduction. The value will now depend upon the resistance required to drop the plate voltage of the R.F. amplifier tube to the required value and the filter bypass condenser will be chosen so that it effectively short circuits all stray currents to ground.

### Resistance Filter in R.F. Circuits

There is a reason for employing a resistance type of filter in R.F. circuits employing the screen-grid tube which has escaped the attention of most writers and which really pro-

hibits the use of R.F. chokes in this connection. Let us suppose that two filters are to be compared. The first employs a resistance of 100,000 ohms in conjunction with a .1-mf. condenser, which has a reactance of about 1.6 ohms at 1000 kc. This condenser will effectively short circuit the resistance at all frequencies within the broadcast band and also will be effective as far as any harmonics present in the plate circuit of the tubes are concerned. Let us assume that the other filter has an R.F. choke in place of the resistance which has a reactance of the order of 100,000 ohms at all frequencies involved. The efficiency of these two systems is about equal so far as normal conditions are concerned, the only difference lying in the fact that the resistance of the R.F. choke will be but a few ohms and the voltage drop across it will be negligible.

Filtration with the resistance remains effective at all frequencies at which the reactance of the condenser is substantially smaller than the resistance employed. Thus with a resistance of 100,000 ohms and a 1-mf. condenser, which has a reactance of 16,000 ohms at 100 cycles, the filtration would still be quite effective. It is thus evident that, except in the case of the new variable-mu tubes, it is essential that the resistance-capacity type of filter be employed to avoid interaction due to coupling between stages in the power supply circuits.

In A.F. circuits it is much cheaper to employ resistance filters than to use A.F. chokes of equal filtering ability. In most cases the maximum voltage available for the power tubes is sufficient to absorb the voltage drop entailed. It might be noted that no decoupling filters are required in push-pull circuits, as the signal voltages do not appear in the common circuits. There is a certain amount of second harmonic present, but not enough to make necessary the use of filter circuits or a condenser to bypass the biasing resistance. In push-pull amplifiers employing 50 tubes it is sometimes necessary to employ a small choke in series with the common "B" supply, as these tubes are gassy and oscillation is likely to take place. Such an attempt at oscillation on the part of the tubes is easily suppressed by the use of a small choke in the plate supply lead.

(The reader is referred also to the article, "The Effective Use of Bypass Condensers and Resistors," by P. M. Greeley, which appeared in the August, 1930 issue of RADIO-CRAFT.—Tech. Ed.)

## RADIO KINKS

(Continued from page 677)

It is important to remember that an ordinary condenser of low capacity will offer more resistance and develop a higher voltage across its plates than a larger condenser.

The primary coil will have two audio frequencies of its own, at times; also, the vibrator may be set at from 300 to about 1000 cycles. There is a 2 mf. condenser across the primary coil, which will resonate it at high audio (or low radio) frequencies.

It will be seen that, ordinarily, the secondary can be tuned, so that a harmonic of its frequency will be the same as the fundamental of the primary. Also, that the period of the vibrator can be some fraction of the secondary fundamental.

The 5 meg. and 1000 ohm resistance, are used to load the secondary; and also, as a voltage divider and output connection.

Either headphones or the input of an audio amplifier system may be connected to the posts marked, "output."

### EMERGENCY "B" UNIT

By Chas. A. Schuldt

**I**HAD an emergency need for some high voltage D.C. and not having a "B" eliminator handy, I built one in a short time from "junk box" materials, consisting of the following: three, 110V.-to-4V. bell ringing transformers T1, T2, T3; a 4-prong socket and an '80 tube, V; an old audio transformer, T4; and two "Telephone" condensers, C1, C2. The diagram of connections shown in Fig. 3, was very satisfactory.

This unit might be made as a shop "B" elimi-

nator, by inserting a few variable resistances, R1, R2, across the plus and minus, to obtain the several voltages needed.

### A NEAT BALLAST TUBE

By C. L. Small

**T**O mount a lamp bulb on a panel with an ordinary socket looks very cumbersome, so the writer evolved the kink illustrated in Fig. 2.

The lamp bulb was fastened in an old tube base and wires run out to the prongs. This, then, could be placed in a sub-panel socket, and used as filament ballast for a tube in an oscillator.

A sealing compound held the lamp securely in the (ex-) tube base.

### HEADPHONES REPLACE THE DYNAMIC REPRODUCER

By Alvin C. Porter

**H**OSTILITIES will cease for the late listener if headphones are used instead of the speaker; here's how.

Disconnect the voice coil leads from the output of the speaker transformer. The output is then wired to the center terminals of a small, D.P.D.T. switch, as shown in Fig. 4. The voice coil leads, which should be fastened to the fiber insulators for support, are connected to two of the switch terminals. Connect the phones to the two remaining terminals.

In operating, the switch is thrown in one position for the speaker; the other, for the phones. The switch is mounted in the set, together with the necessary binding posts.

## WHAT DOES RADIO OFFER YOU TODAY?



... and how you may get the correct training at . . . .



**T**HRILLS . . . excitement . . . adventure . . . and advancement. That is what you have a chance to win in radio. For this great industry has many different branches—each with a great future.

Consider a few. There is aviation radio, television, broadcast station and studio operation, the talkies, and many others. But no one—no one—can ever hope to get ahead in radio without the proper training.

Such training is offered at America's oldest radio school—RCA Institutes—founded nearly a quarter century ago. There are now four big resident schools, in New York, Boston, Philadelphia and Chicago. Each has modern equipment. Each has a large corps of expert teachers with practical experience. You may take either elementary or advanced courses of practical radio. New classes begin about every six weeks. For those who cannot attend these resident schools, RCA Institutes has prepared a complete series of extension courses for home study. As part of many of these courses special home laboratory is available. Both type of study benefit, too, from our association with radio's largest research laboratory.

RCA Institutes has more than 23,000 graduates, many of whom hold responsible positions in radio. So delay no longer, if you would enter radio. Mark and mail the convenient coupon now. In a few days our general catalog and complete information about RCA Institutes will be in your hands.

A Radio Corporation of American Subsidiary

**RCA INSTITUTES, INC.**

Dept. RT-5, 75 Varick Street,  
New York City.

Please send me your General Catalog. I am checking below the phase of radio in which I am interested.

<input type="checkbox"/> Aviation Radio	<input type="checkbox"/> Talking Pictures
<input type="checkbox"/> Microphone Technique	<input type="checkbox"/> Servicing Home Entertainment Equipment.
<input type="checkbox"/> Broadcast Station or Studio	<input type="checkbox"/> Television
<input type="checkbox"/> Radio Operating	

Name \_\_\_\_\_

Occupation \_\_\_\_\_ Age \_\_\_\_\_

Address \_\_\_\_\_

## CONVERT OLD SETS INTO DOLLARS!

Replace worn-out condensers at little cost and put those old sets back into service. It's profitable business if you use the Special Dubilier Service Kit—a useful package containing 25 assorted sections for by-pass and filter block repairs, ranging from .1 to 2 mfd., 200 to 400 volts.

List Price, \$10.50.



**ORDER NOW!** Carry the kit in your service bag and start cashing in on the profitable business of repairing old radio sets. Write for free copy of new General Catalog No. 121.



**DUBILIER**  
Condenser Corporation  
4377 Bronx Blvd New York

Radio Service Men:—

## What 24

Resistor Values  
do YOU use most?



Out of 100 values made—only 24 found a place in the EX-STAT kit. This original resistor kit for service men covers 95% of replacement calls. It puts the right value instantly at your finger-tips. "Original-equipment" quality, now priced 40% lower than 1931. Just send postcard for list of values and special introductory offer.

**TILTON MFG. COMPANY**  
15 East 26th Street  
(Dept. RC) NEW YORK

Headquarters for  
EX-STAT specialties  
DESIGNED for  
radio service men.

## Power Generator

FOR SHORT WAVE BROADCASTING  
Reg. Price Was \$75

While They Last!  
**\$4.95**

U. S. Gov. power generator for radio transmitting made by Westinghouse. Ideal for Amateur Broadcasting. Built strictly purchased from U. S. Gov. Signal Corps, 250 to 500 meters, 200 watts, 110 Volt R.P.M. 4500. Can be connected direct, belt driven or wind propelled for Aeroplanes. Guaranteed new and perfect. Worth \$75.00, but while they last, only \$4.95, plus shipping charge. Send check or money order.

**NATIONAL JOBBING & EXPORT CO.**  
109 W. Lake St. Dept. 185 Chicago, Ill.

## NEW 1932 HAND-LAPEL MIKES

- No. 306—Single Button \$5.00
  - No. 501—Single Button 10.00
  - No. 503—Two Button 15.00
- and 15 other types for every occasion.

Also Direct Manufacturers of Amplifiers, Horn Units, Trumpets and All P. A. Accessories

Send for Catalogue RC Now  
**MILES REPRODUCER CO.**  
26 East 22nd St., N. Y. C.



## THE V. T. VOLT-METER IN RADIO

(Continued from page 676)

from the receiver when this input signal has a local field strength equal to the input in microvolts, as indicated on the curve directly above the frequency of the signal; thus, to determine the sensitivity of the receiver in *microvolts-per-meter* at any point (assuming an antenna 4 meters in height as standard), a selected point along the curve (in microvolts) is divided by 4.

The selectivity curves are plotted with field-strength ratios (input microvolts) as the ordinates, and the kilocycles off resonance as the abscissas. The first quadrant of the graph (to the right of the center or zero line) is plotted in minus kilocycles off resonance, while the second quadrant (to the left of the center resonance line) is plotted in plus kilocycles off resonance.

The field strength ratio at any frequency is the input in microvolts compared to the input at resonance. The *selectivity* rating of a receiver is defined as the width of the resonance curve when the input signal strength is both 10 and 100 times that at resonance. Thus, in Fig. 2, the selectivity is 20 kc. at 10 times normal and 40 kc. at 100 times normal. (Normal being the input to the receiver at resonance.)

### Measurement of R.F. Inductance

The measurement of inductance cannot be accomplished directly with the voltmeter. The instrument is used as an indicating device only.

Two dependable methods are given in the following paragraphs. The set-up for the substitution method is given in Fig. 3, while that of the known frequency-capacity method is given in Fig. 4.

In the substitution method, the only known factor necessary is the calibration of the variable-inductance standard. The condenser C need not be variable. The coupling between L<sub>o</sub> and L<sub>p</sub> should be very loose. The oscillator is tuned to a frequency which need not be known, but must be in resonance (indicated by the maximum deflection on the V.T. voltmeter) with the oscillatory circuit formed by the unknown inductance, the 2-turn pickup coil L<sub>p</sub>, the condenser C, and the resistance R which should be about 5 ohms. When the maximum indication is obtained on the V.T. voltmeter, connected at V.T.-D, the standard inductance is substituted for the unknown inductance. A convenient means of doing this is with a D.P.D.T. switch as shown.

Care should be taken that the settings of the oscillator, pickup coil, or any portion of the wiring are not disturbed. When the standard inductance has been substituted for the unknown, it is then varied until maximum indication is obtained on the V.T. voltmeter. The calibration of the standard inductance at the maximum indication is now determined. This value is the exact inductance of the unknown coil.

In the known frequency-capacity method shown in Fig. 4, the oscillator is adjusted to some known frequency; coupling between the oscillator inductance L<sub>o</sub> and the unknown inductance L<sub>x</sub> is made as loose as possible.

The calibrated condenser is then varied until the circuit is brought into resonance with the known frequency of the calibrated oscillator as indicated by the maximum deflection of the V.T. voltmeter which is connected across the 5-ohm resistance R (shown at V.T.-E).

By calculation, the inductance L<sub>x</sub> may be determined by the following formula:

$$L_x = \frac{L_c}{Cf}$$

Where L<sub>c</sub> is the oscillation constant of the frequency, and C<sub>f</sub> is the capacity in microfarads of the calibrated condenser C.

The oscillation constant for the frequency may be obtained from the L<sub>c</sub> table given by Mr. Denton on page 55 of the July 1931 issue of *RADIO-CRAFT*.

If the operator does not have access to such a table the inductance may be calculated by the formula given below:

## Experimental Equipment Given FREE to Every Student!



Size of Cabinet: Height, 22 1/2", Length, 17 1/2"; Weight 25 lbs.

We give to every student without additional charge his chemical equipment, including fifty pieces of regular standard laboratory apparatus and supplies and forty-two different chemicals and reagents.

### Opportunities in Chemistry



Dr. T. O'Conor Sloane

Chemistry offers those who are ambitious and willing to apply themselves conscientiously, the greatest opportunities of any vocation today. Industrial firms of all kinds pay tempting salaries to get the right men. Opportunities abound on every hand.

You can study Chemistry under the well-known instructor, T. O'Conor Sloane, A.B., A.M., Ph.D., LL.D.

### You Can Learn at Home

Your home study course, written by Dr. Sloane himself, is practical, logical and remarkably simple. It is illustrated by so many experiments that are performed right from the start that anyone can thoroughly understand every lesson. Dr. Sloane will, in addition, give you any individual help you may need in your studies.

### Easy Monthly Payments

The tuition is very low, and includes your laboratory outfit—there are no extras to buy with our course. You can pay in small monthly amounts, and we show you how to earn the course of the whole cost as you go along.

## CHEMICAL INSTITUTE OF NEW YORK, Inc.

HOME EXTENSION DIVISION

19 Park Place New York, N. Y.

Mail the Coupon NOW!

CHEMICAL INSTITUTE OF NEW YORK,  
Home Extension Division

19 Park Place, New York, N. Y.

Please send me at once, without any obligation on my part, your Free Book "Opportunities for Chemists," and full particulars about the Experimental Equipment given to every student. Also please tell me about the latest reduction in tuition price and your easy plan of payment.

NAME .....

ADDRESS .....

CITY ..... STATE.....

R.C.-532



$$Lx = \frac{\left(\frac{V}{f}\right)^2}{K^2 \times C}$$

Where V is the velocity of propagation (299,800,000 meters per second), f is in cycles per second, C is the capacity in microfarads, and K is 1882 (if the inductance is expressed in microhenries).

**Measuring Mutual Inductance**

The set-up for the measurement of mutual inductance is given in Fig. 5. As in the case of measuring other inductances, this cannot be measured directly.

The resistance R is of 5 ohms and the condenser C may be fixed or variable although the variable is preferable. The inductances L1 and L2 are arranged in the exact manner in which they are to be coupled in the receiver. If possible, they are attached together as, for instance, the primary and secondary of the ordinary R.F. tuned transformer. The triple-pole double-throw switch is convenient although not necessary. In any event, the inductances are first connected so that their fields aid or add. The true inductance of the combination is then measured. This corresponds to position A of the switch. The inductances are then arranged so that their fields oppose or subtract; this corresponds to position B of the switch. The true inductance of the combination with the fields opposing is now measured.

From the formula following, the mutual inductance M may be determined:

$$M = \frac{L_a - L_s}{4}$$

Where La is the inductance of L1 and L2 adding; Ls with their inductance subtracting; and M is the mutual inductance in microhenries.

**True Inductance**

It is thought pertinent at this time to describe the determination of true inductance, although this has no direct bearing on V.T. voltmeter measurements. However, to determine mutual inductance it is necessary that the true inductance of the coils be known.

All inductances have distributed capacity which in reality is in shunt with the inductance of the coil. The true inductance and the distributed capacity give us the apparent inductance of the coil.

When the apparent inductance of a coil is known (the latter measurement is described in a following paragraph), the true inductance may be determined with the following formula:

$$L_t = \frac{L_a}{\left(1 + \frac{Cd}{c}\right)}$$

Where Lt is the true inductance in microhenries, La is the apparent inductance, Cd is the distributed capacity, and C is the tuning capacity with which the apparent inductance of the coil was determined.

**Distributed Capacity of Inductances**

Distributed capacity of inductances may be determined by either of the two methods described here. Both will give accurate results. The setup in each instance is the same as that given in Fig. 4.

The inductance, of which the distributed capacity is to be determined, is connected as Lx in the figure. A minimum of four readings at different frequencies with different capacities of the calibrated condenser C are made. These readings of the calibrated condenser are plotted as abscissas, against the wavelength squared as ordinates, on cross-section paper. The result will be practically a straight line. This line is continued to the negative value of capacity which is on the left of the zero capacity point. The distance between the point of intersection with the horizontal line and the zero point will be the distributed capacity of the coil.

The second method is somewhat easier. The condenser C is adjusted to about 75 per cent of its total capacity. The coil to be measured is again Lx; call this capacity C1. The oscil-

lator is now brought into resonance by using the V.T. voltmeter as previously described. The capacity of the calibrated condenser C is now reduced to a value about one-quarter of its total capacity, until a maximum indication is obtained on the V.T. voltmeter at resonance with the second-harmonic of the oscillator. The oscillator is not disturbed from the original setting. The capacity of the standard condenser at this setting is designated as C2. The distributed capacity Cd is determined by calculation from the formula:

$$Cd = \frac{C1 - (4 \times C2)}{3}$$

**Measurement of Variable and Small Fixed Capacities**

The measurement of variable and small fixed capacities up to approximately .001-mf. is easily accomplished using the same set-up of apparatus as given in Figs. 3 and 4. The positions of the standard inductance and the standard variable capacity C are interchanged; the unknown capacity being placed in the position formerly occupied by the inductance under test. The maximum indication on the V.T. voltmeter is obtained in the same manner as for the inductance tests. The oscillator is brought into resonance with the oscillatory circuit which is tuned by the unknown capacity. The calibrated standard capacity is next substituted for the unknown after which the oscillatory circuit is brought into resonance with the oscillator by its use. The capacity of the calibrated condenser will then be the same as the unknown capacity, the value of which is determined from the condenser calibration curves.

When the set-up given in Fig. 4 is used for the determination of unknown capacities, a standard fixed inductance is used. This is placed in the circuit with the unknown capacity as shown in the figure and the calibrated oscillator brought into resonance with the oscillatory circuit as indicated by the maximum deflection of the V.T. voltmeter. Knowing the value in microhenries of the standard inductance and the frequency of the calibrated oscillator, the capacity may be determined by calculation from the following formula:

$$Cx = \frac{LC}{L1}$$

Where LC is the oscillation constant of the frequency, L1 is the inductance in microhenries, and Cx is the value of the unknown capacity in microfarads.

If the LC table is not handy, the capacity may be determined from the following formula:

$$Cx = \frac{\left(\frac{V}{f}\right)^2}{K^2 \times L}$$

Where V is the velocity of propagation (299,800,000 meters per second, f is in cycles per second, Cx is the capacity in microfarads, and K is 1882 (a constant), and L is the inductance in microhenries.

**ELECTRICIAN ADDS CAT TO KIT**

RADIO-CRAFT reproduces below a little yarn that might well be applied to Service Men attempting to install an antenna in a rough spot.

Paul Long, Kingston electrician, recommends that every electrician carry a cat!

Long had the job of running a cable through the top of a house, but between the roof and ceiling there was hardly room for him to squeeze in and the distance was eighty feet.

Then he had an idea. He cut a hole in one end just under the roof, tied a string to a cat's tail and shoved it in. Then he closed the hole, leaving an inch-wide opening and cut another hole where he wanted the other end of the cable. He had a long wait, but the cat finally appeared at the second hole. Long tied his cable to the string and completed the job.

**SERVICE MEN!**  
**FREE OFFER!**

National Union is making an extraordinary offer to all service men and dealers—a high quality tube tester, an oscillator and output meter, and a visometer. Three valuable pieces of radio service equipment . . .

All absolutely free. You can have any one or all of these pieces of equipment. Simply, easily and absolutely without charge.

This offer by National Union lasts for a short while only. Act at once!



The oscillator and output meter. An absolute necessity for all the modern service men to tune super sets.



The visometer. A new and unusual tube tester. Noise test an exclusive feature. A real big volume builder.



The readrite tube tester . . . efficient, compact, easily carried. An illuminated dial! Just think, service men. No more squinting in dark corners.

SEND FOR DETAILS TODAY. MAIL COUPON NOW!

**NATIONAL UNION RADIO CORP.**  
400 MADISON AVENUE, N. Y. C.  
Please tell me how I can have any one or all of the above equipment free.

NAME \_\_\_\_\_ R. C.  
ADDRESS \_\_\_\_\_  
CITY \_\_\_\_\_ STATE \_\_\_\_\_

### ROYAL SHORT WAVE RECEIVER Screen Grid—Power Pentode

SPECIAL PRICE

\$14.95

Set of Tubes \$2.20  
Batteries \$5.45



Royal Model RP List Price \$25

#### WORLD WIDE RECEPTION GUARANTEED!

This new super-sensitive receiver works on any antenna and tunes from 11 to 200 meters. (530 meter coil 75c extra.) It is sturdily constructed on a heavy metal chassis and enclosed in a neat crackle-finished cabinet. A full-volt an dial and a combination regeneration-volume control (with automatic switch) makes tuning remarkably easy. Use of a UX-232 screen-grid detector and a UY-233 power pentode amplifier gives extreme sensitivity and tremendous volume.

Send your order (with a small deposit) NOW for immediate delivery and enjoy a NEW THRILL!

Distributed by

### HARRISON RADIO CO.

111 Liberty St., Dept. R-5 New York City  
Dealers Wanted—Write Now for Details!

## NEW

### Radio Handbook

and Wholesale Catalog

Sent postpaid anywhere for only

25 Cents

Hard to Get Parts—We have them.

Send us your Repair work for estimate.

### Grant Radio Laboratories

611 C South Halsted Street, Chicago, Ill.

## TAU-REX CONVERTS

ANY D.C. MILLIAMMETER INTO SENSITIVE A.C. METER

TAU-REX is a new copper-oxide rectifier which can be applied to any d.c. Milliammeter to convert a.c. to d.c. Size 1/4" x 3/8".

FULLY GUARANTEED

Will be shipped postpaid promptly upon receipt of \$3.00 (check or money order). Price Complete with Diagrams and Instructions.

### LEO TAUSSIG

3245 - 37th St. Astoria, L. I., N. Y.

## G.E. PHONOGRAPH MOTOR

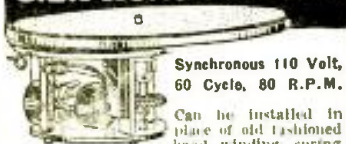

Synchronous 110 Volt, 60 Cycle, 80 R.P.M.

Only \$3.95  
1/2% VALUE

Can be installed in place of old fashioned hand winding spring motors. Also many other uses. These G.E. motors are all brand new in original factory cartons. Fully guaranteed \$12.00 value only \$3.95 including 12 in. cartons. Shipped Prepaid. Manufacturers and dealers write for Special quantity price. NATIONAL JOBBING & EXPORT CO., 109 W. Lake St., Dept. 175 Chicago, Ill.

**SAVE SERVICE TIME and MONEY**

**TRUVOLT RESISTORS**, with adjustable clips, mean quicker service and fewer parts to stock. All standard sizes.

Write Dept. RC-5 for Folder

175 Varick St., New York, N.Y.  
**ELECTRAD**

## CRATER LAMPS

(Continued from page 662)

station. Note that this and the following circuits are so arranged that the variable resistor is always connected on one side to ground. Thus, no high-potential parts are placed on the control panel.

The disadvantage of this circuit is that variations in the control resistor (R2) vary the voltage drop across the plate resistor R, and hence change the plate voltage and alter the tube's characteristics. Furthermore, the maximum amount of D.C. voltage available for the crater is only that between the plate of the tube and ground; and is less than the value supplied by the power pack, due to the drop across the resistor R. One way of overcoming this disadvantage is to use an iron-core choke coil in place of the resistor R. Even then, the total current passed through the choke is large and may affect its characteristics by saturating the core.

In the diagram of Fig. 1C, the disadvantages of the one of Fig. 1B are overcome by making the D.C. supply to the crater tube independent of the output tube. The D.C. for the crater is obtained directly from the plus "B" power supply, and the amount of current is controlled by the 0- to 50,000-ohm variable resistor R1 mounted on the front of the receiver panel.

The A.C. signal current obtained from the load resistor R passes through the 1-mf. condenser C to the crater lamp.

This simple circuit gives unusually good results with most crater lamps and is highly recommended. The use of resistors throughout gives faithful response over a wide frequency range, resulting in good picture definition.

While the A.C. impedance of a crater lamp varies with the size of the crater, it is usually much lower than the impedance of the usual power tube. For this reason the output tubes are connected in parallel instead of in push-pull. Even with this connection the impedances do not match, and the efficiency of the circuit is low.

Because of the wide frequency response necessary for good picture definition, iron-core matching transformers have been considered impractical by television authorities and consequently few have tried them. But when we consider that the lowest frequency required at 20 pictures per second is 1,200 cycles, it is well within the realm of possibility to design a very efficient transformer having sufficiently flat characteristics between 1,200 and 40,000 cycles for excellent picture detail.

In the circuit of Fig. 1D, an ordinary dynamic loud-speaker output transformer, having a center-tapped primary (for push-pull connection) and a secondary to match the usual voice coil, was employed; and amazingly good results were obtained. This circuit is in other respects the same as that shown in Fig. 1C, the transformer being inserted to match the impedances more nearly and obtain brighter images. And it works. Condensers C and C1 are each 1-mf. capacity; T is the transformer; R1 the 0- to 50,000-ohm control resistor; and R2 a 0- to 10,000-ohm resistor which usually is not required in the circuit, but helps to prevent flickering of the lamp in some cases. It will be noted that no D.C. flows through the transformer windings.

The circuit of Fig. 1E is similar to that of D, except that the primary of the transformer is used as a center-tapped choke, giving a 2-to-1 step-down ratio. It works better than that in D with some crater lamps.

In these transformer circuits, negative images were at first obtained. These were reversed by changing the method of detection, as previously explained.

Figure 1F is somewhat similar to that shown in D except that the matching transformer is connected directly in the plate circuit of the tube. The advantage is that the tube gets a higher plate voltage, and the disadvantage is that the transformer core may become saturated. A push-pull output circuit, with the proper transformer, may give excellent results. Resistor R1 controls the D.C., and R the A.C. through the lamp. In most cases, it may be eliminated.

(Continued on page 696)

## NOW

### A MONTHLY MAGAZINE AT

# 25c

## A COPY

GREATEST MAGAZINE ON SHORT WAVES



At All Large Newsstands

4-Color Cover 9"x12" in Size Over 200 Illustrations

RAPIDLY increasing each day are the number of experiments in the Short Wave field—developments which are bringing to this branch of radio thousands of new "thrill seekers." Experimenters, as in the early days of Radio, again have the opportunity to bring about stirring new inventions. Read in SHORT WAVE CRAFT, the *Experimenter's Magazine*, how you can build your own Short Wave Sets, both transmitters and receivers. SHORT WAVE CRAFT is exclusively a short wave magazine—the kind you have wished for so long.

#### Interesting Articles in the Current Issue

- New 2-R.F. Pentode Short Wave Receiver. Building an S-W Super-Ilet.
- The Denton S-W "Stand-By" Receiver—Works Loud-Speaker on 3 tubes.
- A 17 to 300-Meter S-W Receiver. Heinrich Hertz Institute (Berlin) 4.9-Meter Receiver.
- Experiments with 3-Meter Transmitter.
- A Practical 5-Meter Transmitter.

#### SPECIAL OFFER COUPON

SHORT WAVE CRAFT 98 Park Place, New York, N. Y. RC-5  
GET ACQUAINTED OFFER

- As per your Special Offer, I enclose \$1.00 (Canada and foreign \$1.20) for which enter my subscription to SHORT WAVE CRAFT for 3 months. (I understand that your regular rate for a year's subscription is \$2.50).
- Mail me a sample copy of SHORT WAVE CRAFT for which I enclose 15c (U. S. Stamps or coin accepted).

Name .....  
Address .....  
City..... State.....

# TELEKTOR—THE RADIO ROBOT

(Continued from page 664)

prevent wasting power while the speaker is not in operation.

The twelve push-buttons that control motors are a little different in operation, as they must be pushed down and held down until the desired condition is attained. The operation of these motor-controlled buttons is relatively simple. These buttons are divided into two sections, a "LOWER CHANNEL" and an "UPPER CHANNEL." The lower channel push-button turns the dial continuously toward the 550 kc. (No. "55" on the dial) end of the scale, as long as the push-button is depressed. The "HIGHER CHANNELS" push-button likewise turns the dial continuously toward the 1500 kc. (No. "150") end of the dial. These two push-buttons may be used for cruising or hunting for stations. When a desirable station is located, the finger is immediately removed from the button; for instance, in tuning toward the shorter wavelengths, the "HIGHER CHANNELS" button is depressed until a desirable station is located, at which time, as stated above, the finger is removed. If closer tuning is desired, then the "LOWER CHANNELS" button is depressed which turns the dial in the reverse direction. With a little practice, however, it is a relatively simple matter to tune in an unknown station by means of these two buttons. It is convenient to figure that the motor unit, driving the tuning dial of the radio receiver, travels at an average rate of six channels per-second when operated on a 110 volt, 60 cycle line, or about five channels per-second on a 50-cycle line. (A channel is 10 kc. wide.)

The "INCREASE VOLUME" button, when held down continuously, increases the volume until a maximum point is reached. The "REDUCED VOLUME" button continually lowers the volume as long as the button is depressed, until minimum volume is reached.

These buttons operate the same for the phonograph as for the radio, provided a phonograph relay has been installed.

## Tuning of Favorite Stations

Every person has a number of stations to which he listens more than others. To make the tuning of these stations more convenient, the remaining eight buttons are used. It is really here where the Telektor is a true Radio Robot. Each of these eight buttons controls a contact which is mounted on a commutator arrangement in the motor unit. Suppose, for instance, that one of these buttons has been set by the installation engineer for 800 kc. In other words, one of your favorite stations is operating on a frequency of 800 kc. When this particular button is depressed and then released, the dial continuously rotates until the station is tuned in, and then it stops. Thus, it is possible to control the tuning of eight different stations at any of the remote points that were wired during the installation.

## Different Systems

There are three different Telektor systems available. The type "X" is for wiring in walls to extension Telektor Boxes and controlled outlets in which there are no relay-controlled extension speakers. The type "Y" system is for wiring in walls to loud speaker outlets and built-in dynamic speakers when there are no extension control positions. The type "Z" system is for wiring in walls for extension loud speakers and control position. In all of these systems, a visual tuning meter is located on the Telektor Boxes, as shown, so as to provide accurate tuning without actually listening to the station itself.

It might also be mentioned at this time that the radio set may be controlled manually even though the Telektor Motor Unit is attached. In fact, the manual operator may take control of radio tuning radio and phonograph volume and "ON-OFF" switch functions away from Telektor Boxes so that he retains sole or "Master" control of the system, although persons in distant rooms are still free to turn on and off the loud speakers that are controlled by relays.

## A MODERN TUBE CHECKER

(Continued from page 671)

tube is normal the meter reads in the center of "GOOD" for both tests. If one or the other button test reads in the "BAD" section or in the "GAS" section, it indicates the tube may have misplaced elements, incorrect plate impedance, incorrect emission, incorrect space-charge properties, or ionization from the presence of gas. This same interpretation will be given for a 50 or any other UX tube placed in the same socket, the only operation required being the turning of the selector knob to point to "50," or any other number that corresponds to any other type of tube under test.

Tubes having high mutual conductance will read higher in the "GOOD" section, until a point is reached where the tube is not high mutual conductance, but has gas content. The meter then reads in the "GAS" section.

This instrument will also indicate on one jeweled pilot lamp all plate or screen-grid to control-grid, filament or heater shorts immediately the tube is inserted in a socket. If the test buttons should be pressed when such a shorted tube is in the test socket, or if the tube is shorted from plate or screen-grid to cathode, it will not injure the indicating meter, (but the pilot lamp will light or remain lighted).

Rectifier tubes such as the '80 and '81 and all screen-grid and pentode tubes are tested in the same manner.

### Voltage Ballast

To secure this simplicity it was first necessary to design an electrical circuit for placing separate meter shunts and tube voltages in proper relation when the one selector knob was moved; to provide means for adjusting the transformer to different line voltages; and to indicate the proper setting, and all at minimum cost in apparatus. These conditions were met by using a rectifier tube and marking the meter scale at a determined point. Thus, when

the input voltage is to be adjusted, a button is pressed, connecting the rectifier into the meter circuit and if the needle of the meter does not point to the mark, the ballast control knob is to be adjusted.

The transformer output current at certain voltages at times reached high limits, due to short circuited tubes creating a completely closed circuit, which, if the current was not held within definite limits, would destroy the shunts, burn out the current-limiting pilot and injure the meter. Also, the transformer current and voltages had to be held to close limits in order to maintain constant values on the 56 different meter shunts; and to control the meter calibration.

The main problem encountered in this respect, after transformer design, was the effect on the input current by use of the usual variable resistance or "ballast" in series with the primary. With the definite output limitations, a variation of line voltage would necessitate adjustment of the ballast, which in turn would alter the amount of resistance in the series circuit. This variation of resistance would effect the current input and in turn effect the output current—a "vicious cycle."

To overcome this defect, the ballast was discontinued and the transformer primary tapped to a rotary adjustment switch, but the same mechanical operation was retained. That is—the adjustment of line voltage requires pressing a button to throw the rectifier in circuit and then turning the small knob to bring the meter needle to the mark. This operation is required only where line voltages vary. (For convenience, the "ballast" type of control is illustrated in Fig. 1.—*Technical Editor.*)

It was then found necessary to slightly alter the shunting system to make any variation in tube test reading correspond proportionately only to the variation in line voltage,



"I find it Pays to use JEWELL professional equipment"

Experienced radio servicemen find that the high degree of accuracy, convenience, and thoroughly dependable operation of Jewell Service Instruments result in profits that more than offset any saving to be gained by using obsolete or inexpensive make-shift equipment.

These instruments enable servicemen to work more rapidly and more accurately—saving time on jobs, thus doing a greater number of jobs each day and also reducing complaints and repeat calls to a minimum.

## Jewell 444 Set Analyzer



Socket current and voltage tests on all sets, including those using output and r.f. pentodes. Twenty-four measuring ranges for use with test leads. Triple range output meter. Two range capacity test. Non-shatterable meter glasses. Test cord detachable at analyzer panel. Simplified switching system separates A.C. and D.C. tests. Large easy-to-read meter with 2.5 inch long scales. Panel and over fifty other parts molded of bakelite to assure permanence.

## Jewell 563 Test Oscillator



Three frequency bands: broadcast 550 to 1,500 K.C.; low intermediate 125 to 175 K.C.; and high intermediate 160 to 280 K.C., covered by fundamental waves. Calibration curves carried in cover. Entire unit, including batteries, shielded by heavy metal carrying case. Separate output for neutralizing. Furnished complete with shielded output lead, batteries, and one '30 type tube.

Jewell Electrical Instrument Co.,  
7 Haynes Ave., Newark, N. J.

Please send me literature on the Jewell Instruments checked below:

- |  |  |
|--|--|
| <input type="checkbox"/> Jewell 441 Set Analyzer             | <input type="checkbox"/> Jewell 540 Portable Tube-Seller |
| <input type="checkbox"/> Jewell 563 Test Oscillator          | <input type="checkbox"/> Jewell 538 Counter Tube-Seller  |
| <input type="checkbox"/> Jewell 531 Professional Combination | <input type="checkbox"/> Jewell Panel Instruments        |

Name .....

Address .....

# THEORY AND CONSTRUCTION OF ATTENUATORS

(Continued from page 661)

from 1.5 volts, on the input side, to .15 volts, on the output side. This loss expressed logarithmically is as follows:

$$\begin{aligned} \text{loss in decibels} &= 20 \log \frac{V_1}{V_2} \\ &= 20 \log \frac{1.5}{.15} \\ &= 20 \log 10.0 \\ &= 20 \times 1.0 \\ \text{loss in decibels} &= 20.0 \end{aligned}$$

or, a 20 decibel loss is to be incurred between the input and output terminals of the network to be designed. This is the same as saying that by reducing the voltage from 1.5 volts to .15 volts, or in the order of ten times, a loss of twenty decibels has taken place.

The first problem to be considered is what type of network shall be used to cause this loss in voltage.

In communication circuits, two types of networks used for this purpose are:

- (1) "H"-type pad
- (2) "T"-type pad

The H-type pad will be discussed first, and a complete discussion will be given showing the method of obtaining the desired twenty decibel loss by the use of this pad in our own problem.

The H-type pad is so called because it is composed of five resistances taking the form of the letter "H". This pad is designated as a balanced network, in that an equal number of resistances (Z1) are used in the series arms on both sides of the line as shown in Fig. 2. In some circuits, the shunt arm Z2 may be divided into two equal parts, with the mid-point grounded. This balances the entire network with respect to ground.

At this point an investigation of certain factors which must be considered in transmission circuits will be given in order that

an understanding of the problems encountered in voice transmission will be had. It is of the utmost importance that a general knowledge of the circuit characteristics be obtained, so that when the design of the pads is taken up, maximum efficiency may be obtained from the transmission line in which the pad is to be placed.

In Fig. 3 is shown the output circuit of an amplifier feeding a transmission line, at the far end of which is located an input transformer T1.

The transformer (T2) used in the output circuit of the tube is called a tube-to-line transformer or output transformer, in that it transfers energy from the tube to the transmission line. The secondary side of this transformer is called the source impedance of the line, for the energy induced in this winding is the energy transmitted along the line. This transmission line, we can assume, terminates in the primary side of an input transformer (T1), whose secondary side is in the grid circuit of a vacuum tube. This transformer is called a line-to-tube transformer or input transformer, as it transfers the energy from the line into the tube. The primary of this transformer is known as the load or terminating impedance, as the transmission line can be considered as ending at this point, for the primary side completes the transmission line, and the secondary side is considered in another circuit.

In communication circuits the source and load impedances of the transmission line have been standardized in most cases to 200, 500, and 600 ohm lines. Therefore, if Zs, the source impedance, equals 200 ohms, then the load impedance ZL must also equal 200 ohms in order to prevent so-called "reflection" losses from being set up in the circuit. It is these reflection losses that will now be discussed.

## Reflection Losses

The speed with which electromagnetic waves travel is the same as that of light, or approximately 186,000 miles per second. This speed is attained only in a circuit having zero losses, which of course is not obtainable in practice. All circuits have some losses, and in transmission lines these losses increase as the frequency increases. The speed of the transmitted waves is retarded slightly by the losses of the line, and by what is known as "skin effect" of the line conductors. (Skin effect is the forcing of the current to flow along the outer surfaces of the conductors.) As the frequency increases, the inductance inside the conductor (mostly in the center) increases, thereby offering a greater opposition to the flow of current within the conductor, and consequently the current is forced to travel along the outer surface of the wires. The relationship which exists between inductance, capacitance, and the velocity of light is:

$$LC = \frac{1}{V^2} \text{ or } V = \frac{1}{\sqrt{LC}}$$

where V = velocity of light in miles per second  
L = inductance in henries  
C = capacitance in farads

If a frequency of 100 cycles per second is impressed upon a circuit of infinite length (no end), at the end of  $\frac{1}{186000}$  of a second the wave will have traveled  $\frac{186000}{100}$  or 186 miles. A part of such a wave is shown in Fig. 4. This circuit is said to have a full wavelength for the frequency of 1000 c.p.s. (cycles per second). In this circuit, when the first part of the waves arrives at a point 186 miles distant from the start of the transmission line, the

## THREE NEW 50c BOOKS



FORMULAS AND RECIPES For the PRACTICAL MAN

**CONTENTS**

1. Adhesives; Glues; Cements; Gums; Lubricants
2. Cleansing; Stain Removers; Bleaches; Cleaning Fluids
3. Metal Craft; Coloring; Oxidizing; Plating; Repairing; Welding; Polishes; Alloys; Solubility; Paints; Colors; Stains; Varnishes; Enamels; Laminous; Paints; Washable Paint; Paint-Removing; Waterproofing; Fireproofing
4. Wood-Craft; Fillers
5. Glass-Working; Cutting; Drilling; Boring; Bending; Blowing; Etching; Engraving; Frosting; Silvering, etc.
6. Fireproofing; Acid-proofing; Waterproofing; Furniture Polishes
7. Inks; Eradicators; Ink Stain Removers; Sympathetic; Invisible; Hectograph
8. Photography; Developers; Emulsions; Fixers; Sensitizing; Toning; Printing; Photographic Paper; Blueprint Paper
9. Antidotes for Poisons; Remedies for Burns and Scalds; Disinfectants; First-Aid in Accident; Home Remedies
10. Preparation; Manufacturing; Handling; Mixing; Emulsifying; Use of Hydrometer; Use of Thermometer; Tables of Weights and Measures; Decimal System; Useful Tables.

FROM the table of contents, it will be seen that the book contains only such material as is constantly needed and can be practically applied by the man who is doing or making things.

Every formula has been selected with a view to its usefulness to the experimenter and practical technical man.

Not only that.—This book is intended to serve directly for the use of the man who wishes to work out desirable preparations for practical home manufacture, as a means to earning spare-time money.

It is well known, in the case of innumerable preparations that have become household standbys and whose production now runs into millions of dollars of profit—and if the truth were known, this would be found to be the origin of nearly all such successful enterprises—that the biggest manufacturers, who have built up tremendous factories making all these things which you use in your own home, shop, and business, started on the road to success with just such a small beginning as you, perhaps have been dreaming about.

This book will be useful also in helping you to save money by showing you how to make in your own home at a fraction of their usual cost the hundred and one preparations which you now buy ready-made for use in your home or business.

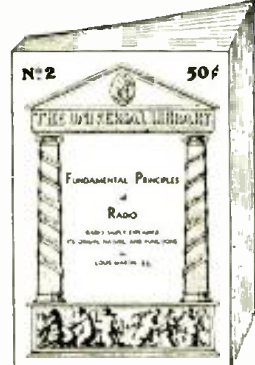

FUNDAMENTAL PRINCIPLES OF RADIO

Radio Simply Explained—Its Origin, Nature and Functions

THIS BOOK is intended as a handy fundamental aid for "hooking up" and systematizing your knowledge of radio, no matter what stage of the art you have thus far mastered by study or experience.

It is intended for those who may have had to get their first working knowledge of radio through experience in a haphazard fashion and now want to get a more solid grounding in its principles and theory.

**CONTENTS**

Chapter I—Fundamentals of Radio: Electricity, Resistance, Batteries, The Magnetic Circuit, The Magnetic Field, Inductance, Condensers, A.C. Circuits, Propagation of Radio Waves; Chapter II—The Simple Radio Set, Single, Two, and Three - Circuit Tuners, The Battery Set, Vacuum Tubes, Electric Sets, Loud Speakers; Chapter III—Diagrams, How to Read Them; Chapter IV—Amateur and Broadcast Stations, Talking Pictures, Television.

It is intended for the practical man, the technician who wants to get a practical comprehensive knowledge of the principles underlying the HOW and WHY of Radio.

The book has been prepared with special consideration for the young members of the profession; and one of the main objects has been to state in plain English the few important elementary principles which the authors of most books on radio envelop in such a haze of technical mystery as to keep their explanations beyond the understanding of the ordinary man.

THIS MANUAL has been written especially for the man who wishes to acquire a working knowledge of the elementary principles of mathematics for his own every-day use. To provide a complete treatment, the author starts from the beginning of the subject, explaining the first principles of arithmetic in simple, clearly understandable language, and from these, takes the reader by easy steps through all the rules and processes of arithmetical calculation.

A good technician is not always a good mathematician, but the art of computation by figures is easy to acquire. If you are guided by some one who knows how to direct your way and make it easy.

That is the object of this book. Mr. Shainmark, who is an instructor in practical sciences, knows how to explain things in plain English, and his one purpose in this book is to make clear, in terms of daily application, the important basic principles of mathematics which everyone ought to know, whether he be a working man, a merchant, or a professional man.



ELEMENTARY MATHEMATICS For the Technician and Craftsman

**CONTENTS**

I—Arithmetic: Addition, Multiplication, Subtraction, Division, How to Use Decimals; II—Fractions, Percentages; III—Ratios and Proportions; IV—The Metric System; V—How to Measure; Surfaces and Volumes; VI—Mathematics for the Manual and Technical Craftsman; VII—Special Mathematics for the Radio Technician; VIII—Commercial Calculations, Short-cut Arithmetic, Interest, Calculation, Discounts; IX—Weights and Measures; X—Set of Tables.

All our books are of uniform size 6x9 in. containing 64 pages printed on strong paper with stiff colored covers.

PRESS GUILD INC., 16 Murray St., New York City, Itc 5

Enclosed find \$..... for which mail me post-paid the following book(s):

No. 1 }  
No. 2 } 50c each, Postpaid.  
No. 3 }

Name .....

Address .....

City and State .....

end of the same wave is at the start of the circuit. This is assuming zero losses in the line. The actual wave would be slightly retarded due to the losses of the circuit. This is shown in the dotted lines of Fig. 4.

If now an alternating-current wave is impressed upon a transmission line, it will travel along the line with the speed of light, until it reaches the far end of the line, where, if the far end is open (infinite impedance), the wave will be reflected back to its origin with the same velocity, but will gradually decrease in magnitude as it approaches the starting point of the line, due to the losses of the line which it encounters. If at the moment this wave reaches the starting point another wave is sent into the line, that which was left of the first wave adds itself to the second wave and therefore increases the second wave. If, at the moment that the returned second wave reaches the starting point, a third wave is sent into the circuit, that which was left of the second wave adds itself to the third wave and so on as the number of waves increases; with the result that an accumulative effect of energy is developed in the circuit. The magnitude to which this reflected energy can rise is determined by a characteristic of the line conductors known as the "surge impedance."

The surge impedance of a conductor is the impedance which the conductor offers to these free oscillations of energy at the high frequency limit. (This condition is greatest at the highest frequency that the circuit passes.) This building up of reflected energy in the circuit is known as "quarter-wave resonance," or merely as the resonant frequency of the line. To produce such a condition, it is necessary that the alternating-current impulses occur at intervals of time equal to the time necessary for the energy to travel the length of the line and back. In other words, for one complete cycle (two impulses) the energy would have to travel the length of the line four times between successive impulses in order to create resonance. Expressed as a formula:

$$\text{frequency} = \frac{46587}{\text{length in no. 1}}$$

$$\text{or; length in miles} = \frac{46587}{\text{frequency}}$$

It can be seen, therefore, that as the frequency increases the length of the circuit becomes shorter in order to produce the resonant condition. In table 1 is given the length of circuits in miles to produce resonance throughout the audio band.

At this condition of resonance, the magnitude of the reflected energy reaches a maximum, and abnormal voltages and currents are set up in the circuit. This reflected energy, if present in a circuit in which vacuum tubes are employed, will cause incorrect voltages to be applied to the grids of the tubes, which in turn will cause distortion of the wave-form of the original signals, with the result that harmonics will be generated in the circuit. As these harmonics increase, the resonant period of the circuit is decreased. This is

shown in table 2, where the resonant periods of circuits due to harmonics being set up in the line are given. It can readily be seen that as the harmonics increase, the length of the line necessary to produce resonance is decreased.

Now in practical circuits, such as the transmission lines encountered in everyday sound work, the resonant condition may not be theoretically reached as the fundamental frequencies used are not high enough to produce resonance for the length of the lines ordinarily used, which in most cases are comparatively short. Nevertheless, if the lines are not properly terminated, the reflected energy which is set up produces distortion of the wave-form of the original impulses, which in turn will create harmonics. These harmonics are multiples of the fundamental frequencies, and as these harmonics increase, the frequency of the circuit increases, thereby approaching the resonant frequency of the line. Consequently, as the resonant period of the line is approached, extreme distortion of the signals arises, with the result that the quality is atrocious.

#### Mechanical Analogy

The analysis of reflected electrical waves is analogous to that of water flowing in a canal. If the near end of a canal is struck a blow, a water-wave will be set up which will travel to the end of the canal, where it will be reflected back to the origin. As it travels back toward the starting point, its amplitude will decrease slowly, due to resistance encountered in the canal. If, at the instant the wave reaches the origin, another blow is struck, a second wave will flow to the end of the canal and return. This second wave will be composed of itself, plus that which was left of the first wave. This effect increases as the number of waves is increased, and reaches a maximum when the losses due to resistance prevent the amplitude of the waves from increasing further.

If a gate or obstruction of some sort is inserted at the end of the canal, any waves traveling down the canal will strike the wall and bank up to a height determined by the potential energy of the wave. When the potential energy equals the kinetic energy impressed on the wall, the wave will have reached its maximum height. It can be shown that in certain cases the waves will rise to a height twice that of the original wave striking the wall, and then will be reflected back at a slowly decreasing amplitude as the starting point is approached.

Similarly, in electrical circuits, when an electromagnetic wave reaches the end of a transmission line, and the line is open at the far end as shown in Fig. 5, the wave is reflected back to the source; the current is zero, and the voltage at the load reaches a value equal to twice the peak value of the original voltage.

Also, if instead of open circuiting the far end of the line, it is short circuited, the wave is reflected with a current value twice the value of the starting current, and the voltage becomes zero. This is shown in Fig. 6.

## A SIMPLE SET TESTER

(Continued from page 659)

jack marked "S.G.," and the screen-grid clip, of course, on the cap of the screen-grid tube. The voltmeter leads can be used on the milliammeter, if it is desired to use that instrument externally.

The milliammeter, being connected in the plate circuit of the tube, gives plate current readings directly. The voltmeter, however, must be applied to the various points in the circuit by means of the test prods on the ends of the voltmeter leads. As mentioned above, this arrangement eliminates the necessity for a complicated mess of switching devices. It also makes possible tests between otherwise inaccessible points of the circuit.

In order to realize the full usefulness of the test set, several socket adapters will have to be made, or purchased. The most important are a 4-to-5 prong adapter for the panel socket and a 5-to-4 prong adapter for the end of the analyzer plug (Fig. 3). The current delivered by the second plate of an '80 rectifier

tube can be measured by using a special socket adapter constructed as shown in Fig. 3. It will be noted that the grid and plate wires are reversed; that is, the grid connects to plate, and the plate to the grid. This arrangement connects the milliammeter into the second plate of the rectifier tube, enabling the user to determine if the tube is delivering a balanced output. A bad case of hum can often be traced to an unbalanced rectifier tube.

Besides being useful for continuity tests, the voltmeter can easily be calibrated to read directly in ohms. Many external uses can also be found for the milliammeter.

#### A "BARBEROUS" ENTHUSIAST

A radio experimenter of Newcastle (England) was not satisfied with the selectivity of his simple one-tube receiver. He installed small variable condensers made of ordinary razor blades, and reports that the tuning is now very sharp! Keen young man, what?

# CROSLEY

## 7 TUBE SUPERHETERODYNE At an Amazingly Low Price



**\$45<sup>00</sup>**  
COMPLETE WITH 7 TUBES  
AND TENNABOARD

### The Crosley FORTYFIVE

The Crosley FORTYFIVE is the last word in radio design and performance. The beautiful front panel is finished in Adam brown. A pleasing two-tone effect is accomplished by an overlay of stump walnut veneer which decorates the front panel. Fluted pilasters support the arch of "V" matched rose wood. The top and sides are finished in Adam brown.

The 7-tube superheterodyne chassis incorporates pentode output and variable mu tubes, continuous (stepless) tone and static control and on-off switch, illuminated dial, volume control. Full floating moving coil dynamic speaker is used. Never was there a greater radio value.

Prices subject to change. Any Federal or State taxes which may be levied must be added to this price.

Montana, Wyoming, Colorado, New Mexico and west, prices slightly higher.

THE CROSLEY RADIO CORPORATION  
Powel Crosley, Jr., President  
Home of "the Nation's Station"—WLW  
CINCINNATI

YOU'RE THERE WITH A CROSLEY  
**CROSLEY  
RADIO**

# DEALERS and SERVICEMEN

Give to your customers the advantage of buying first-class licensed R.C.A. tubes at prices that are exceptionally low. We carry the largest variety of tubes in the world, many for special purposes, and every tube is replaceable within 30 days. We either have the tube you require or we will make it for you.

### COMPLETE STOCK ALWAYS READY FOR IMMEDIATE SHIPMENT

Order from this page—Remit 20% with order, balance C.O.D. All prices are F.O.B. FACTORY, Newark. Shipments go through express or parcel post. No order for less than \$5.00 accepted.

<b>.30 Cents</b>		<b>.60 Cents</b>	
UX-201A	UX-226	UX-230	WD-11
UX-227	UX-171A	UX-231	WD-12
UX-171		UX-232	
		UX-247	
<b>.40 Cents</b>		<b>.85 Cents</b>	
UX-210	UX-120	UY-233	UY-236
UX-198	UX-199	UY-235	
UX-112	UX-112A	UY-237	UY-238
UX-200A	UY-224	UY-551	
UX-215	UX-280		
Standard Base 199			
		<b>\$1.10</b>	
UX-210	UX-222		
UX-250			

Ballast tube to prevent tube life set from blowing out ..... .60  
 Special super-sensitive 200A detector tube ..... .60  
 Special super-sensitive RF 201A..... .60  
 Special super-sensitive AF 201A..... .60  
 Special 1 1/2 AC 1/2 amp. extra coated filament—good for electric sets..... .60  
 T-14 (201A High Mu) high emission Switch tube, 201A or 112 or 171 double life ..... .60  
 Adapter tube 226, 227, 171A, to convert bat. sets to AC, each ..... .60  
 UY-227A—AF amplifier or detector, same as 227 (but quick heater)..... .60  
 UY-224A—AC screen grid amplifier, same as 224 (but quick heater)..... .60



Photoelectric Caesium Type cell.

<b>RECTIFIER AND CHARGER BULBS</b>		
125 MH. rectifying tube (H. H.) (Rathcon Type) .....		1.25
6/10 amp. trickle charger bulb (Tungar Type) .....		2.00
2 amp. old and new type charger bulbs (list \$1.00) (Tungar Type) .....		2.00
5 and 6 amp. charger bulbs (list \$8.00) (Tungar Type) .....		3.75
<b>PHOTO CELLS AND TELEVISION TUBES</b>		
Tellon Television Tube, 1" Cathode Square Type X .....		3.85
Tellon Television Tube, 1 1/2" Cathode Square Type V .....		3.85
Photoelectric cell, "Potassium" Type O .....		3.85
Photoelectric cell, "Caesium" Type A .....		7.90
Photoelectric cell, "Caesium" Type R .....		5.90
15 amp. charger bulbs (Tungar Type) .....		7.50
Rectifying Tube especially designed for use with Freshman Master "B" Eliminators UV brass base, limited quantity .....		30
UX-866—Mercury Vapor Half-Wave Rectifier (Heavy Duty) .....		2.75
UX-280—Mercury Vapor Full-Wave Rectifier or UX-288 .....		1.40
UX-281—Mercury Vapor Half-Wave Rectifier .....		2.75
UX-182—Sparton Type .....		.85
UX-183—Sparton Type .....		.85
UX-484—Sparton Type .....		.85
UX-585—Sparton Type .....		2.10
UX-686—Sparton Type .....		.85
UX-401—Kellogg Type .....		1.50

**DISCOUNTS:** 50 Tubes and Over 10%  
500 Tubes and Over 10% and 10%

**ARCO TUBE COMPANY, 38-40 Park Place, Newark, N. J.**

## SERVICE MEN! IMPROVE YOUR BUSINESS

BY KEEPING YOUR NAME BEFORE YOUR CUSTOMERS EVERY DAY

Most people forget the day, the station, the dial number and hour of their favorite programs and will appreciate Radiominder Cards with spaces to record such information. They will be kept for the longest time in any home. Give Radiominder Cards with your ad printed on to your customers or place a few in every home in your neighborhood and they will constantly remind the people of you and thus think and talk about you.

*There's No Better Way To Make People Think of You Every Day*

These cards are far superior to business cards and their cost insignificant considering the benefits you will derive. Trial orders accepted for as little as

**100** Radiominers with your Ad of 5 Lines Printed for **\$1.25** Each additional 100 Cards 50c Postpaid

Card size 3 1/4 x 5 1/2 inches. Ad space 1 x 3 inches. Printed attractively on heavy Golden Rod Bristol Card. Use ink and handprint your copy and mail today with remittance to

Dept. F—ROTH PRESS, 846 Sutter Ave., Brooklyn, N. Y.

FRONT **RADIOMINDER**

BACK

COURTESY OF Your Ad will appear here

## "CASH-BOX" SET

(Continued from page 663)

the parts on the baseboard. Connect the filament terminals (heaters) in series with the resistor 20 and connect the other end of the resistor to the plate of socket 19. Then connect the plate terminal to the grid terminal. Make all conoid coil connections, soldering the fixed condensers 2 and 4 in position. Wire in the grid leak and grid condensers. After the wiring of the parts on the baseboard has proceeded as far as possible, rest the baseboard on the lower inside portion of the carrying-case cover and complete the wiring between the parts on the board and those in the case. The tickler coil is wound according to the directions given in the list of parts. It is placed within the shield of coil 3. The two ends are brought out through holes drilled in the coil-shield cover. Great care should be taken to avoid short circuits at these points. The stator of the variable condenser 6 is connected to the "G" terminal of the coil. One side of fixed condenser 7 is soldered to the grounded rotor and the other side is connected to the "E" terminal of the coil and also to the cathode terminal of socket 11 and to one of the heater terminals. The three condensers 13, 16 and 18 are also connected to the same negative return lead, which goes to one side of the outlet. The wiring is then completed to the tickler coil, regeneration control, choke, switch, twin jacks, etc. The baseboard is finally slipped into position and fastened to the back of the case.

Before making the connection with the 160-volt line, check over all wiring carefully. If possible, test the set on A.C. first. Use the Chromostat at all times. It will save plenty of money in case of trouble. It will probably be found more convenient to use it at the baseboard lamp outlet, instead of at the set. Turn the current on and rotate the variable condenser and regeneration control. If no regenerative whistles are heard, it will be necessary to reverse the tickler-coil connections. If the set does not play on D.C., reverse the plug at the outlet. Tube 11 should show a plate voltage of about 57 volts on A.C. and about 100 volts on D.C. To use the Police Thriller, simply remove tube 11 from its socket and insert the plug of the Thriller in its place.

- One Electrad regeneration control, type RT-232P, 12, with Power Switch, 21;
- One Electrad Truvolt wire-wound resistor, 75-watt, type D-4, 20;
- One Cardwell .000365-mf. "Midway" Feather-weight variable condenser, type 107-B, 6;
- One Aerovox .00025-mf. mica condenser, type 1460, 9;
- Two Aerovox .0005-mf. mica condensers, type 1460, 2, 13;
- One Aerovox .006-mf. mica condenser, type 1460, 4;
- One Aerovox .01-mf. tubular condenser, type 280, 7;
- Two Aerovox 1-mf. dry electrolytic condensers, type E-51 small, 16, 18;
- One shielded "conoid" antenna coupler with special tickler consisting of 70 turns of No. 29 enameled wire-wound on 1-in. dia. cardboard tubing, 3/4 in. long;
- One I.R.C. 2-meg. metallized resistor (Durham), type M.F. 4, 10;
- One Trutest Lightweight "Super-Sensitive" headset, 15;
- Two Trutest twin jacks, type SA-196, 8, 14;
- One Trutest 30-henry choke (small) type 1892-A, 17;
- Two five-prong Eby sockets, type SA-178, 11, 19;
- Two 137-A Arcturus Universal A.C.-D.C. Tubes, 11, 19;
- Two binding posts, type SA-187, 1, 5;
- One Hubbell 115-volt depressed outlet (prongs are on outlet instead of on plug), 22;
- One special plug for Hubbell outlet, 6 ft. lamp cord, one attachment plug;
- One metal box (inside dimensions of box, 11 3/4 x 5 3/4 x 2 1/2 ins.; inside dimensions of cover, 11 3/4 x 5 3/4 x 1 1/2 ins.);
- One 3-ply wood strip 11 3/4 ins. long, x 2 3/8 ins. high x 3/4-in. thick;
- One Clarostat automatic line-voltage regulator, type "50-Watt," 23;
- One Universal single-button "Handi-Mike," model No. 50;
- One Bud Police Thriller, model No. 2701.

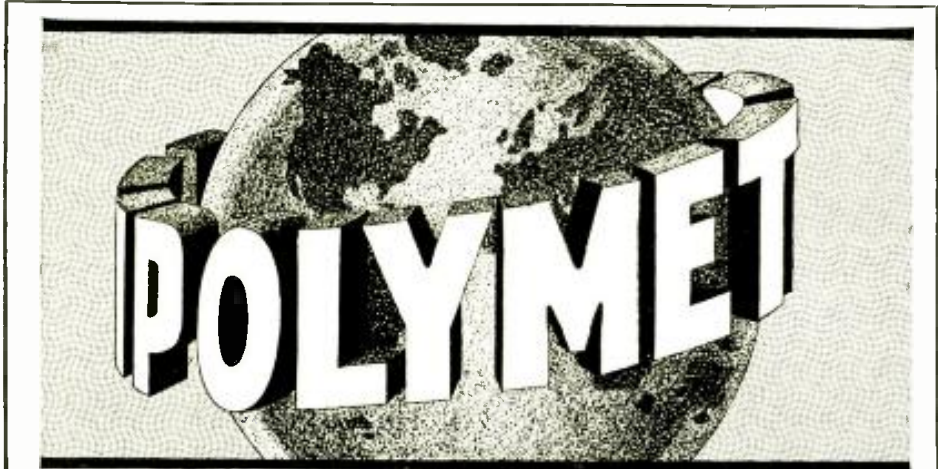

## POLYMET PRODUCTS World—Known World—Accepted

**POLYMET MFG. CORP.**  
834 E. 134th St., New York City

Send me your new and valuable catalog of quality replacements parts.

Name .....

Address .....

City .....

State .....

Jobber  Dealer  Service-Man

The new 1932 Polymet Catalog gives complete dimension data and electrical specifications of the parts used by leading receiver manufacturers. You can purchase identical parts from your local jobber, and give "guaranteed" service work—a sure way to increase your business and your reputation.

**MAIL COUPON FOR YOUR FREE COPY**

# CASH IN AUTO RADIO

(Continued from page 665)

radio receiver will stay sold unless it is properly installed and properly watched by the Service Man. The regular Service Man can learn to handle the job but, in most instances, he has failed to do so.

How much do you know about the requirements for installing any type of auto radio on a Buick Eight, 1932, five-passenger sedan, for instance? Do you know the difference in the performance of the same receiver when properly installed in a Ford De Luxe Phaeton? I'll bet that more than eighty-five percent of the men who read this article couldn't answer those two questions satisfactorily. But that only emphasizes the opportunity there is for you.

Several of the leading manufacturers have gone about the installation and service job in a systematic manner and the results have been very gratifying. For instance, Philco, the maker of Transitone Radio, has made an arrangement with suitable auto-battery and ignition-service stations all over the world, which assures them the proper type of installation and upkeep at a modest charge to the purchaser. The same thing is true of Crosley and one or two others. In some instances, these manufacturers have made arrangements with organizations of national or even international proportions, but in others they find it advisable to utilize the services of a local specialist. It is this phase of the situation which should be so very profitable to the man who is already recognized in his neighborhood as a radio Service Man of more than ordinary ability.

## A Premium for Service

In New York City, and the same thing is true in other places to a proportionate degree, several of the large department stores offer auto radios for sale at regular intervals. Instead of permitting the customer to have his pet "expert" make the installation, the store sets a flat figure for the installation charge, or includes it in the price of the receiver, and insists upon having it installed in one of the several authorized service stations with which it has working arrangements. In this way, the customer is well protected; and there is an increasing amount of this business being turned over to the service stations which have had the foresight to make a thorough investigation of the special requirements which this type of installation demands. There is still plenty of room, at the top. Even though there may be a very satisfactory station in your town (and investigation among the manufacturers indicates that this is not likely to be true), there are always reasons for the establishing of competition.

A radio installation on a good car should bring the service organization at least ten dollars, when it is done on a contract basis for the radio or automobile dealer. It should bring more, if it is a single job being handled for an individual. Do you happen to know of any other service job which is brought right into your shop, which brings you that much money? There are exceptions, of course, but at least ten "bucks" a throw is a pretty fair average. And no consideration has been given to the repeat business which is becoming less and less in connection with ordinary receivers.

"B" batteries are still fairly high in price, and there is almost as much profit in a set of them as there is in the sale of a complete midget receiver and a set of tubes to go with it. Then, too, you know that the batteries are not going to last as long as the midget. Give your auto-radio customer the proper kind of attention, and you will be amazed at the rapidity with which you will be developing business which should be yours and which has been slipping through your fingers. The manufacturers want you, the sales organizations want you, and the customer certainly wants you. And all three are willing to be more than ordinarily liberal.

## A Few Examples

You may want some concrete examples of just how all this can be made to fit into your business. All I can do is let you in on the backstage operations of several service organi-

zations which are typical. From them you will have to draw your own conclusions.

In a western city, a young friend of mine was in the employ of a large radio dealer. He ran the service department and his salary was fifteen dollars a week. When radio was on the increase, the dealer was doing a "land-office" business and was making a pile of money. Then things began to happen; several cut-rate stores opened up on the same block. The dealer would not cut his prices, nor would he utilize some of the sales devices which are now generally recognized as necessary to meet competition. He said he would go broke before he would cut the prices of his high-class lines. He did; I mean he went broke. My young friend was out of a job. He tried sending out post cards to the clientele of the store, letting it be known that he would service receivers for the store's old customers. For some reason or other, the idea did not "click" and the business he was getting was not enough to meet his modest demands for a livelihood.

Then he went to a company which specialized in auto-ignition and battery repairs. He told the manager that he wanted a job where he could learn about ignition systems. He got the job, with very little pay. He let it be known that he was able to take care of the installation and servicing of auto-radio receivers. The result was a deal between the proprietor and himself, where he was to get a commission on all the jobs of that nature which the ignition station would take care of. Some small ads were placed in the local papers and it was not long before the man who was taken on to learn the ignition business was the manager of the radio department. Within a short time, the representative of one of the radio manufacturers visited the station and arranged a contract which brought all the installation and service work from three large stores right into the ignition shop, and it became necessary to put on additional Service Men and take more space. Now this company is doing a fine bit of work and has been able to make special arrangements with a local automobile upholsterer who takes care of the antenna installation. By this method, the inside roof is taken off, the antenna wires put in place and the covering replaced without the antenna being visible; and the job is so well done that there is no appearance of the covering having been removed.

There is a great deal of conjecture about this sort of thing and there is but one real way to get at the facts and that is to get right into the job. There is no branch of service work which is so highly specialized and in which there are so many loopholes. For instance, a great many auto manufacturers are now advertising provisions for radio. You would imagine—and a great many dealers have been fooled, from the manner in which they tell their story—that all you have to do is to get any auto-radio receiver and that the car has been made ready to drop the receiver in. It is not as easy as that, not by a deuce of a shot. Experience with quite a number of such cars indicates that, in many instances, it is necessary to cut the top of the car open, take the so-called aerial out altogether and put a new one in. In other instances, the wire netting which is used comes so close to the metal sides of the body that the pickup is terrible. In further instances, it has been found that some of this wire is actually short-circuited to some part of the body frame.

## Easy When You Know How

In this business, just like all others, the fellow who knows what he is about can be away in the lead; while the fellow who undertakes auto-radio installation and service without knowing his "book" is likely to lose a lot of time and money, to say nothing of the confidence of his patrons. But the bright spot in the whole picture is the fact that this is the time to get on the job and find out what it is all about. If you don't think this is true, just drop around to some of the service stations in your neighborhood and ask a few questions about the installation of these receivers. You will find that in nearly every

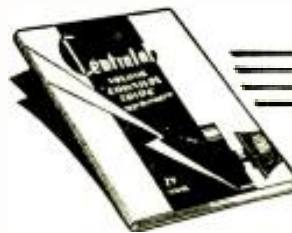

Two  
Important  
Books



Send for them  
today

These two important books should be on every serviceman's bench.

The new VOLUME CONTROL GUIDE tells how to service all old and new sets with but a few CENTRALAB VOLUME CONTROL REPLACEMENT UNITS. Filled with circuits and valuable data. Priced at 25c.

The other—"A Baptism of Fire," tells the dramatic story of how Centralab Fixed Resistors are made. It is handsomely illustrated and is mighty interesting reading. It is free for the asking. Send for it.

**Centralab**  
CENTRAL RADIO LABORATORIES

930 E. Keefe Ave., Milwaukee, Wis.

Mail the Coupon Today

CENTRAL RADIO LABORATORIES  
930 E. Keefe Ave. Milwaukee Wis.

Please send me your Free Booklet "A Baptism of Fire"

Am enclosing 25c for your VOLUME CONTROL GUIDE

Name \_\_\_\_\_

Address \_\_\_\_\_

City \_\_\_\_\_ Province \_\_\_\_\_

Radio Craft

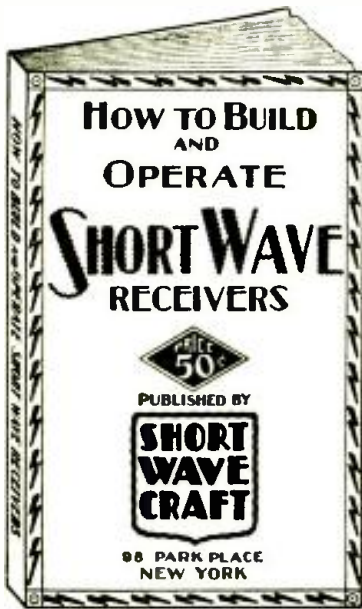

*I received your book, "How to Build and Operate Short Wave Receivers." I am very pleased with it, as I believe it is the best book that has been printed on short wave work. It is invaluable to builders of Short Wave receivers. Worth many times the price, my candid opinion.*

**E. H. BLADES,**  
Radcliff, Alberta, Canada.

**T**HE greatest book of its kind ever published. **HOW TO BUILD AND OPERATE SHORT WAVE RECEIVERS** is the best and most up-to-date book on the subject ever put between two covers.

The book has been edited and prepared by the editors of **SHORT WAVE CRAFT**, and contains a wealth of material on the building and operation, not only of typical short wave receivers, but short wave converters as well.

Dozens of short wave sets will be found in this book, which contains hundreds of illustrations; actual photographs of sets built, hook-ups and diagrams galore.

**WE SAY—AND REPEAT IT—THAT NOTHING LIKE THIS HAS EVER BEEN PUBLISHED BEFORE.**

The book comes with a heavy colored cover, and is printed throughout on first-class paper. No expense has been spared to make this the outstanding volume of its kind. The book measures 7½ x 10 inches.

This book is sold only at such a ridiculously low price because it is our aim to put this valuable work into the hands of 50,000 short wave enthusiasts during the first few months of 1932.

Published by the publishers of **SHORT WAVE CRAFT** magazine. This alone will be your guarantee that it is a really worthwhile publication.

We know that if you are at all interested in short waves you will not wish to do without this book. It is a most important and timely new radio publication. 76 Pages — 250 Illustrations — Stiff Paper Covers

**NOT SOLD ON NEWSSTANDS**  
*Mail Coupon At Left!*

**SHORT WAVE CRAFT** RC-5  
96-98 Park Place, New York City.

I enclose herewith fifty (50c) cents for which please send me a copy of your new book **HOW TO BUILD AND OPERATE SHORT WAVE RECEIVERS**. (Send money order, check, cash, or new U. S. Stamps. Register letter if it contains currency or stamps.)

Name .....

Address .....

City and State .....

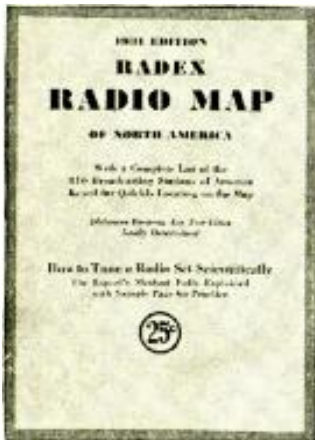

## A RADIO MAP OF NORTH AMERICA

Nearly five times the size of this page. Shows location of every broadcasting station in Canada, United States, Mexico, Central America and West Indies. Scale for quickly computing distances. Time zones accurately shown. All stations listed geographically with key for instant location on map.

Explains scientific method of tuning with examples for practice. *Adopted as official Newark News DX Club as basis for awarding*

*medals for distance.* At newsstands everywhere or postpaid on receipt of

**THE RADEX PRESS**

5005 EUCLID AVENUE CLEVELAND, OHIO

**25c**

BACK ISSUES OF RADIO-CRAFT can still be had at the regular price of 25c per copy. If you are in need of any issues to complete your file, send us your remittance in check, stamps or money order, together with the months and year, and we shall forward your copies to you immediately. Address: RADIO-CRAFT, 98 Park Place, New York, N. Y.

**SHORT WAVE Converter**  
**SUBMARINER \$12.50**  
**ACROCYCLE**  
**OSCILLATOR \$17.50**  
**AUTO-DIAL**

SEND FOR FREE CIRCULAR  
**J-M-P MANUFACTURING CO., Inc.**  
3354 Fond du Lac Ave. Milwaukee, Wis.

**The TRANSMITTER UNIT**  
*with 100 Uses ~*  
**SKINDERYKEN MICROPHONE BUT-TON**—Powerful Speech and Phonograph Amplifier—Detector, etc., etc. One unit 95c—two, \$1.75, with 12-page booklet of experiments. Sent C O D. In U. S. foreign—cash with order. **PRESS GUTH, INC.**, 16 Murray St., Dept. D-332, New York, N. Y.



case, there is little or no system and that the installation is put in on a "cut and try" basis. Here's what can happen when you know what it's all about.

I was in a shop, on Long Island, where they specialize on auto-radio installations. The one in my own car needed a new set of batteries and they were being supplied. A lady drove in and said that she was having trouble with her receiver. It did not seem to get the distance she thought it should. A few questions brought out information to the effect that local stations came in beautifully, but just as soon as she turned the volume control up high enough to get the distant stations—she could get many of them if she did not have the motor running—the stations seemed to fade out and there was a continuous roar in the loud-speaker. The Service Man lifted the hood and made a few passes over the generator. A few minutes later he had installed nothing more than a single fixed condenser. The whole operation took less than five minutes and the "special" ignition condenser brought a dollar and a half. If the same sort of condenser had been dropped into an ordinary receiver, it would have brought one third that amount. Furthermore, the lady got a bargain.

It transpired during a chat that I had with her afterward, that she had taken her car to a number of places and had paid quite a little, at each of them, for the assurance that "there would be no more trouble now," only to find that nothing much had been accomplished. A radio dealer, some few miles from the shop in question, had told her of the service station where I met her and she had driven past more than a hundred similar stations on her way to the Long Island place. The receiver she had was a very good one. The mechanical installation was excellent and nearly every other detail was satisfactory, but the receiver was not doing its stuff. What was needed was a working knowledge of the solution of ignition problems.

### Business Building

While I was at the station, three other cars came in and there was a total of more than fifteen dollars' worth of business in considerably less than half an hour. It was all happening in a shop where just one man was doing this particular work and he told me that they were not always so busy, but he counted that day as poor when he did not take in seventy-five dollars. He also told me that he had a very good idea of his operating costs and, from his figures, it was easy to see that he was making a profit of more than thirty dollars after all his expenses had been paid. And all his business was on a cash basis, with one exception. The exception was one of the best auto dealers in the territory who had taken on a line of auto-radio receivers which he was having installed in all the cars which were traded in for new cars, as well as making sales of receivers with the new ones. By installing the receivers in the old cars, he was able to get a much better price for them and was able to get a great deal of publicity which would not have been possible otherwise.

### 5-METER SET

(Continued from page 684)

frequency spectrum. In fact, when the set is operating correctly it is usual to hear a "hiss"; this disappears when the station carrier is fully tuned in, and by the use of certain reproducers, such as the Radiola Model 100, it may be entirely eliminated.

Stations W2XF and W2NK together constitute the pioneer high-power ultra-high-frequency transmitter in greater New York. Pictures (sight) go out on one frequency band, and the accompanying sound on another; simultaneous experimental transmissions sometimes go out on the 40-to-43 megacycle (about 8 meters) band, and the 60-to-80 megacycle (about 4 meters) band, sight and sound being interchangeable. Television with 128 lines per inch is readily accommodated on either band.

The writers will be pleased to hear from experimenters interested in developing ultra-short-wave operation; and will be glad to answer any inquiries concerning the ultra-short-wave (5 meter) superregenerative receiver.



## SERVICING MODERN "SUPERS"

(Continued from page 670)

(4) Connect the power cord of the receiver to the electric power outlet, after all other connections have been completed;

(5) Turn on the radio set and the switch on the service oscillator, adjusting the tube filament power of the latter to about one-third normal;

(6) Turn the service oscillator switch to the I.F. band (making certain the switch is turned all the way);

(7) For Philco models of the "70" and "35" series, set the control knob of the service oscillator to the "130 kc." position (this being used for testing 250 kc.). For models of the "111," 11A (see RADIO-CRAFT Data Sheet No. 45, in the July, 1931 issue), "112," "90" and "51" series, the control knob of the service oscillator should be turned to the "175 kc." position. When adjusting sets with a "Normal-Maximum" switch, the switch should be placed at the "Normal" position;

(8) Turn the radio set volume control to maximum, and set the dial between 60 and 65 on the Philco scale. For maximum sensitivity the indicating needle of the output meter should not be allowed to go much beyond the center of the scale. To keep the output needle at this point, make use of the "attenuator" knob on the service oscillator;

(9) By means of the fibre wrench adjust the various I.F. condensers, one at a time, to obtain maximum reading on the output-meter. It is desirable to start with the last I.F. compensating condenser in the circuit (second I.F. secondary, in the model "112") and finish with the first. It may be necessary, while the adjustments are being made, adjust the attenuator from time to time, to keep the output meter readings within the scale range. After these adjustments have been completed, remove the service oscillator connection from the grid terminal of the first-detector tube and restore the grid clip connection to the terminal.

The "coupling condenser," in the model "51" is adjusted at 175 kc. in the same manner as the I.F. condensers.

### Balancing the Receiver's Oscillator

In adjusting the "high-frequency" trimmer condenser, in the set's oscillator circuit, make connection from the A jack of the service oscil-

lator to the ANT terminal of the radio set, leaving all other connections the same as for the I.F. adjustments. The control knob on the service oscillator is set at "1400," with the switch turned from "intermediate" to broadcast. The dial on the receiver is set exactly at 140 (1400 kc.), with the volume control set at maximum. The service oscillator is turned on and its attenuator is again adjusted until a one-half scale reading is obtained on the output meter; if the receiver is badly out of adjustment this may be difficult to obtain, requiring the use of headphones in place of the output meter. The high-frequency trimmer condenser in the set is carefully adjusted for maximum reading on the output meter; or for maximum volume in the 'phones. After making the adjustment, turn the station selector slightly, noting whether any increase in volume can be obtained by this procedure. If so, then the R.F. and first-detector trimmer condensers must be adjusted (as described below), followed by a final readjustment at 1400 kc. of the set's oscillator high-frequency trimmer condenser.

The set's oscillator "low-frequency" or "padding condenser" adjustment is made with the same connections as when making the "high-frequency" adjustments. In this case, the Philco dial is set at 70, and the oscillator control knob at 700 kc. The low-frequency padding condenser is now adjusted for maximum reading in the output meter. If the service oscillator signal comes in stronger at a position off 70 on the set scale, adjust the padding condenser for maximum output on the meter at this "off kc." position of the set dial. Now retune the set slightly to obtain any further possible increase, adjusting the padding condenser and retuning the set dial each time so as to bring the point of maximum output as near 70 as possible. Then reset the set dial to exactly 140 and readjust the set's high-frequency trimmer condenser, since it is possible that the adjustment of the low-frequency padding condenser has affected the high setting of the dial, somewhat.

The adjustment of the R.F. and first-detector trimmer is done at 140 on the receiver dial, exactly as for its oscillator high-frequency trimmer adjustments.

## BOOK REVIEW

TELEVISION, by Edgar H. Felix. Published by McGraw-Hill Book Company, Inc., New York, N. Y. 5 x 7 1/4 inches, 272 pages, cloth.

Television has been made the subject of so much hysterical writing that it is a pleasure to read a sane, unbiased book that contains digestible information instead of disguised publicity. The author has refrained from smothering existing difficulties in the art with rosy predictions and expressions of blind enthusiasm, but rather treats them with the utmost frankness in the belief that they will be overcome through accurate understanding and comprehending research. His purpose in writing this book has been to develop a clear understanding of how existing television systems work, the basic processes involved, the standards of performance essential to a commercial service, the limitations of certain features of existing methods standing in the way of the attainment of commercial performance standards, and the nature of the developments still necessary to bring performance of public-service quality.

Mr. Felix has written an admirable book in clear, understandable language. Parts of it are technical, but still well within the knowledge of radio constructors and Service Men. After reading it, one can give intelligent answers to the numerous questions that people everywhere are asking about the new wonder of the radio industry. R. H.

RADIO SERVICING COURSE, by Alfred A. Ghirardi and Bertram M. Freed. Published by Radio Technical Publishing Co.,

New York City. Cloth bound, 182 pages, 124 illustrations, size 5 x 7 1/2 in.

A practical, concise text on the use of modern radio service instruments; and the rapid and systematic attacking of radio service problems.

This book is admirably suited to the need of those who wish to have a handy reference for radio service procedure under practical demands. Even the beginner in the field need not feel a bit uneasy about delving into its pages; since it has been prepared in textbook fashion, with numerous review questions closing all but the last chapter.

These chapters are: (1), Introduction; (2), Electrical Measuring Instruments; (3), Simple Electrical Tests; (4), The Set Analyzer and the Receiver; (5), Trouble-Shooting the Receiver; (6), The Service Test Oscillator; (7), Interference, Noise, and Its Elimination; (8), Vacuum Tube Checkers; (9), Useful Information for Service Men. An exceptionally fine index closes the book; there are about 360 separate listings.

Particular note should be made that there are 28 circuits of test instruments included in this volume,—which is one of a series constituting a "course."

The amount of technical "meat" which the authors in collaboration have succeeded in cramming into this relatively small space is considerable. Most Service Men will possess a certain proportion of the knowledge contained in "Radio Servicing Course," merely as a result of study and practical experience in the field; nevertheless, much of the book will be new to practically every Service Man, due partly to the wide experience of the authors and their diversified viewpoint of the Service Man's requirements.



# Readrite

No. 550

## OSCILLATOR

Licensed by A. T. & T. Co.

\$18 Net to dealer  
\$30 list

\$21 Net to dealer  
with output meter

If not at your Jobbers we will ship direct when remittance accompanies order.

A sturdy modulated instrument carefully made. Completely shielded with separate battery compartment. Furnished with 22 1/2-v. and 3-v. batteries and one '30 tube. Direct reading broadcast band (550-1500 kc.) and intermediate band (120-185 kc.). Sharp 2d and 3d harmonics for 260 and 475 kc. Operating instructions attached in case cover with shielded wire leads. Very compact. In leatherette case, 6x11 1/2x5 1/2 in. Weighs but 8 pounds. Built to high standards. Every serviceman should have the No. 550 oscillator to align r.f. gang condensers, locate defective r.f. transformers, adjust i.f. transformers, check oscillator stage and determine sensitivity of a receiver. A necessary instrument. Get yours today. Write for catalog of servicing instruments.

Readrite Meter Works  
17 College Ave.  
Bluffton, Ohio

Please send all information about Readrite Oscillator and other service instruments.

Name .....

Address .....

City..... State.....

Readrite Meter Works

Established 1904

17 College Ave., Bluffton, Ohio

**Make a PROFIT**

Service men make \$90 extra per month installing AMPERITE. Send \$1.62, to Dept. RC-5, for dealers' sample AMPERITE and sales helps.



**AMPERITE Corporation**  
561 BROADWAY, NEW YORK

**AMPERITE**  
Self-Adjusting  
LINE VOLTAGE CONTROL

**UNIVERSAL**

**2-BUTTON HANDI-MIKE**

**LIST \$15.00**

Maximum volume, minimum hiss—scientifically designed. Truly natural in tone and the most rugged microphone yet devised. No delicate parts to be damaged if dropped, jarred or roughly handled. For announcing, transmitting or home recording. Our Engineering Department is at your service. New outgoing covers twelve models from \$3.00 up.

**UNIVERSAL MICROPHONE CO., LTD.**  
424 Warren Lane, Inglewood, Calif., U.S.A.

**DEALERS—AGENTS WANTED**

EVERYWHERE, to handle the fastest selling radio attachment on the market today.

**THE POLICE LOWWAVE CONVERTER**

A new invention that is easily attached to any radio by means of which anyone can tune in, at any time on local radio broadcasting and get such thrilling exciting—and often sensational—news as headquarters talk on the air for Radio Police squads. Simple instructions are furnished.

**SELLS FOR ONLY \$3.00**

Send \$1.79 for sample, no stamps. Or if you wish, send 10¢ in stamps for C.O.D. order and pay postage the balance of \$1.99.

**POLICE LOWWAVE LABORATORIES**  
1460 Huron St. Dept. 12 Toledo, Ohio

**UNITED SHORT WAVE CONVERTER**

Range 15-210 meters, using special coil and switch assembly. Two tubes, fitted to take power supply from the pentode socket. Handsome metal container, finished in walnut crystal-line finish, most compact converter on the market.

Write for descriptive circular.  
List price \$23 (less tubes).

**THE UNITED RADIO LABORATORIES**  
27 HOWARD STREET ARLINGTON, MASS.

**ALUMINUM BOX SHIELDS**

Genuine "ALCOA" stock, silverplated finish, 7 1/2 x 9 x 6, \$1.89; 10 x 6 x 7 Monitor size \$3.25; 5 x 5 x 5 Coil Shield (like picture on right) \$1.00. Any Size to Order. Skindervikn Button, 95c.

**"BUDDY" TEST PRODS.**

Always sharp pointed, using phonograph needles, 1-ft. wires. Colored nipples identify each lead, \$1.50 pair.

National 2-Strator condensers, \$2.45; Hammond Equalizer 1-75, 15c; Pilot Tube Shield, 48c; Belden shielded wire, 2c per foot.

We specialize in radio parts exclusively.

Carrying Cases for Set Testers, Analyzers, Portable Sets.

**BLAN, THE RADIO MAN, Inc.**  
89 Cortlandt St. Dept. RC-532 New York, N. Y.

**SERVICE FORUM**

(Continued from page 666)

set, and one stand-off insuli or hobling it well out from the house, and glass insulators on each end of the aerial.

The ground is No. 14 rubber covered, clamped to the cold-water pipe, near the lead-in end and tied in with a galvanized iron pipe driven in the ground six feet for the lightning arrester. It keeps the ground wet around this pipe. As above stated, the volume decreases when he uses the aerial. We have tried to give you all the information possible regarding the above question.

"RADIO LOUIE"

Box 716, Needles, Calif.

**THE TETRADYNE**

(Continued from page 682)

- One Electrac 15,000-ohm Type D resistance, 75-Watt, R10 and R11;
- One 2,000-ohm resistor, R12;
- One Electrad 200-ohm grid resistance, R13;
- Three 175-ke. transformers, T1, T2, T3;
- One Thordarson input push-pull transformer Type 2408, T4;
- One Thordarson output push-pull transformer Type 4831, T5;
- One Polo power transformer, 745 type, PT.;
- One Polo 30-henry choke, CH. 1;
- (Choke coil No. 2 is field coil of dynamic speaker.)
- One 110-volt A.C. switch, SW.;
- One National Type II drum dial with knob;
- Two knobs 1-in. diameter for C3 and R3;
- One miniature lamp and socket, S.L.;
- Three sliding clips for R10, R11;
- One aluminum base, size 2 1/4 x 1 1/4 x 2 1/2 ins.;
- One aluminum shield-box, size 10 1/4 x 8 1/4 x 6 ins.;
- One aluminum shield-box, size 8 1/4 x 5 x 6 ins., with two partitions;
- One Pilot tube shield for modulator—oscillator tube;
- Ten ft. of Belden shielded wire;
- Five ft. of Belden rubber-covered wire;
- One molded-bakelite twin jack marked "Field";
- One molded-bakelite twin jack marked "Speaker";
- Two Eby binding posts, "Aerial" and "Ground".

**CRATER LAMPS**

(Continued from page 688)

The circuit of Fig. 1G resembles that of Fig. 1E and, like Fig. 1E, the transformer is connected directly in the plate circuit of the output tube. Only one variable resistor R is required in this circuit. As in the other circuits, its value should range between 0 and 50,000 ohms. Excellent results are obtained with this circuit.

One of the best and simplest of circuits is shown in Fig. 1H. Here the transformer primary is used as a choke and the lamp is independently fed with D.C., controlled by the variable resistor R (ranging up to 50,000 ohms). Condenser C is of 1-mf. capacity. For all-round work with crater tubes up to 100-in. in diameter and up to 100-ma. capacity, this circuit is highly recommended.

In the circuit of Fig. 1H, the frequency response may not be flat enough over the whole range to give the theoretical ideal desired. Therefore Fig. 1I has been arranged to overcome any defects which may exist in Fig. 1H. The basic circuit is the same. It has in addition, however, a resistor (about 5000 ohms) R1 connected across the choke to flatten its characteristic curve. The choke may be peaked at 8000 or 10,000 cycles, and the resistor has the effect of cutting off the peaks.

Another point is that the choke may not respond to the highest frequencies due to distributed capacity. For this reason, an air-core choke L is connected in series. This should resonate or be peaked in the neighborhood of 30,000 cycles. A winding from an old audio transformer (removed from the core) may be employed; or a number of large honeycomb coils, tuned with a large variable condenser, might improve results.

**Classified Advertisements**

Advertisements in this section are inserted at the cost of ten cents per word for each insertion—name, initial and address each count as one word. Cash should accompany all classified advertisements unless placed by a recognized advertising agency. No less than ten words are accepted. Advertising for the June 1932 issue should be received not later than April 9th.

**AGENTS WANTED**

**BRAND NEW OPPORTUNITY** for salesmen with cars. Call on radio dealers, service men and jobbers. Popular low-priced specialty every service man needs and wants. Men now making \$25 to \$40 weekly as sideline. Write today. Give details and territory you can cover. Box TM, Radio-Craft, 98 Park Place, New York, N. Y.

**CHEMISTRY**

**BECOME TRAINED CHEMIST.** Thousands of opportunities—fascinating career. Learn at home. Complete experimental laboratory outfit given. Write for big free book, Chemical Institute, 19 Park Place, Dept. RC, New York.

**INVENTORS**

**PATENT YOUR INVENTION:** Send for FREE book, "How to Obtain a Patent," and "Record of Invention" blank. Consult us about how to protect your ideas. Victor J. Evans & Co., 620 E. Victor Bldg., Washington, D. C.

**RADIO**

**RADIO SERVICE MEN Attention—**Power transformers rewound or built to your requirements. Meyke Radio Service, 2140-A Stansbury, St. Louis, Mo.

**FORCED TO SELL—\$90** Weston oscillator (with output meter). Only two months old—perfect. Seventy dollars. M. W. Gleckler, Metamora, Ohio.

**SERVICE MEN, ATTENTION—**Speakers rewound, magnetized, repaired, \$2.00 to \$2.75. Complete Power Pack Service—Transformers rewound, condenser blocks repaired, resistors duplicated. Guaranteed. Clark Brothers Radio Co., Albia, Iowa.

**SERVICE MEN and shops.** Transformers (power) rewound, also special types made. Supreme Radio Laboratory, 16 Fulton Ave., Rochester, N. Y.

**RADIO INSTRUCTION**

**LEARN** Radio, television and talking pictures in Canada. Day, evening and home study classes. Free scholarship and trip to Toronto, all expenses paid. Booklet on request. Radio College of Canada, 310 Yonge St., Toronto.

**TELEVISION NEWS**

Now 25c a Copy  
On All Newsstands

**\$5,000 WILL BE PAID TO PROVES THAT THIS IS**

not the actual photo of myself showing my superb physique and how the Ross System has increased my own height to 6 ft. 3 3/4 inches. Hundreds of Testimonials. Clients up to 45 years old gain from 1 to 6 inches—in a few weeks!

**First in 1907 First To-day**

**No Appliances—No Drugs—No Dieting. ROSS SYSTEM NEVER FAILS. Fee Ten Dollars Complete.** Convincing Testimony and Particulars in first stamp. "Allow time for return mail; a rush the Atlantic." **G. MALCOLM ROSS, Height Specialist,** Scarborough, England, (P. O. Box 15).

**Tube Checker Blueprint**

and complete instructions for making tube tester. Tests all types, including 15 volt, both plates of -80, the new double diodes and triodes. Flexibility which insures tester against becoming obsolete. Sent postpaid upon receipt of \$1.00 cash or money order.

**DAVID L. FORDE, Jr., USMC.**  
P. O. Box 212 Quantico, Va.

## SERVICE SHORT CUTS

(Continued from page 667)

rent models, in which it is difficult to detect any trace of this former annoyance.

If the Service Man can inform the owner of such a set that the hum can be "balanced out" at a small cost, he is quite likely to be "old to go ahead." Most independent Service Men have long since learned that these little extra jobs often make his work far more profitable. However, eliminating hum that is due to the original design of the set is not a simple matter, but the solution of the problem as presented here has proved successful and practical of application to a large variety of sets.

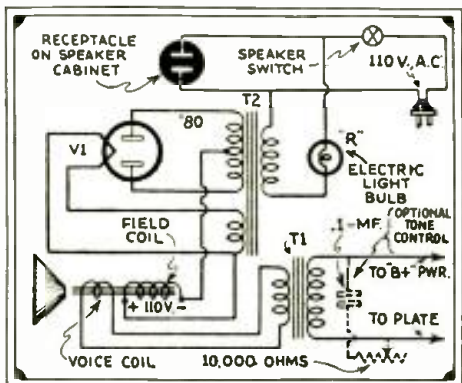

Fig. 4

It is particularly suited to the type of receiver most likely to give trouble of this kind: the conventional T. R. F. receiver, having a '26 or '27 first audio and a single '71 or '45 output tube. The writer has also applied it to other types such as screen-grid sets having push-pull output circuits, with satisfactory results. The method is simple and practical and does not require any changes in the set or its wiring. Despite its simplicity, however, it was only evolved after a great deal of experimental work based on the idea of introducing "bucking hum" into the audio circuit.

In brief, the idea consists of coupling the grid of the first audio tube to the "C" bias circuit of the power output tube through a high resistance, as indicated at the left of the diagram, Fig. 3. It does not affect the grid bias of the first audio tube, as might appear at first glance, and has only a slight effect on the tone quality, the result being a little lower pitch in the music.

If it is a strong hum that is to be reduced or eliminated, it may be necessary to lower the resistance R to the point where the volume will be slightly reduced. Ordinarily, however, the hum will entirely disappear without producing any noticeable effect on the volume. The method will prove effective in most cases on sets on which all of the usual remedies have been tried without reducing the hum to a satisfactory level. It should not be necessary to add, however, that the method is not recommended as a cure all for poor tubes or defects in the set. It is, particularly recommended for use on sets that have plenty of volume and a normal amount of hum, which it is desired to reduce to the level of the best of the new sets. It is also very useful in battery sets that have been converted to electric operation and that have an excessive amount of hum which cannot be reduced otherwise.

Owing to the simplicity of the device, no directions for its installation are necessary other than the diagram. For most sets the variable resistance should have a value of about 100,000 ohms.

A note on hum reduction that is worth mentioning here, since many Service Men may not be familiar with it, is the effectiveness of a variable resistance used to reduce the line voltage going into the set. A 150-ohm heavy duty rheostat connected in one side of the A. C. supply line, as shown at the right of Fig. 3, will often work wonders not only in reducing hum, but many line noises and disturbances that originate in the lighting circuit as well. As most of the more experienced Service Men know, a certain line voltage will give the best results and any increase above this value results in a large increase in hum, line noise, and noises within the set without any gain in performance.

## FOREIGN REVIEWS

BRITISH radio constructors are evincing considerable interest in the "Autotone," a new receiver sponsored by and described in *The Wireless World*. The basis of the arrangement consists in extremely high selectivity regardless of loss of quality due to side-band cutting, followed by correction in the audio-amplifier circuit to reconstitute the missing frequencies in their proper proportion. This idea seems to bear a close resemblance to the Stenode receiver of Dr. James Robinson, which was the subject of heated controversies in technical circles on both sides of the Atlantic.

The essential circuit of the "Autotone" is shown in the accompanying diagram. The desired high degree of selectivity is obtained merely by the use of a very loosely coupled two-stage band-pass tuner, which feeds directly into the detector tube. If the absence of preliminary R.F. amplification seems strange

to Americans, please remember that broadcast conditions in Great Britain and Europe are altogether different from what they are in the United States. Great sensitivity in receivers is not necessary, as the transmitting stations are powerful and numerous. In fact the entire British broadcasting system is designed to provide satisfactory results in even the simplest crystal sets!

The audio "correction" is obtained by a simple control consisting of a 3-henry choke and a 5,000-ohm variable resistance connected in the grid circuit of the second tube of a three-stage amplifier. The set certainly looks interesting, and seems to accomplish the purpose of the much-disputed Stenode with less apparatus. American radio experimenters who want to bite into a real design job might adapt the circuit to domestic parts and tubes.

—R. H.

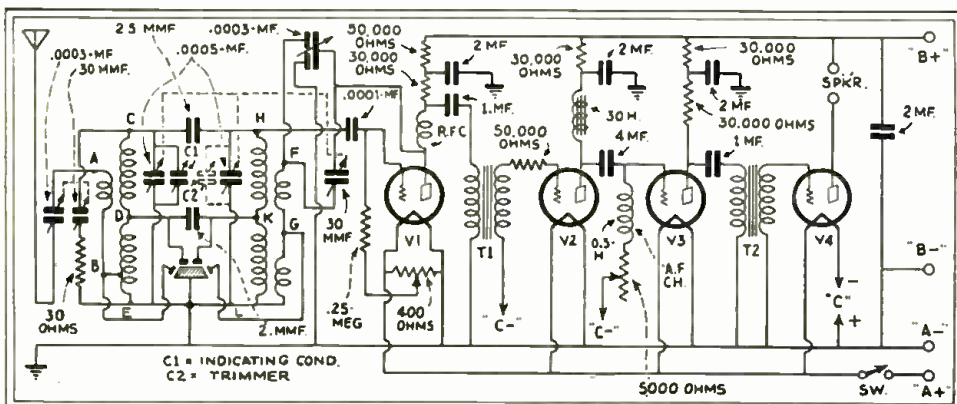

## Start Your Career Today

In the world's fastest-growing industry—

You can, if you will, start your career today in the world's healthiest and fastest-growing industry—RADIO. The biggest and most talked-of building project in the world—RADIO CITY—is but an advance sign of the future this industry holds for the man who gets started in it today, while the industry is still young. The first move is up to you. Read this advertisement carefully and then send in the attached coupon. But do it now. Get started.



The three volumes of this library cover the entire field of building, repairing and "troubleshooting" on modern radio receivers. The Library is up-to-the-minute in every respect and is based on the very latest developments in the design and manufacture of equipment. The rapidly-growing interest in short-wave and television reception is thoroughly covered in a complete section which deals with the construction of this type of apparatus.

## Radio Construction Library

INCLUDING CONSTRUCTION OF SHORT-WAVE AND TELEVISION RECEIVERS

By JAMES A. MOYER and JOHN F. WOSTREL

Faculty, University Extension, Massachusetts Department of Education

Three Volumes — 1087 Pages, 6x9  
605 Illustrations

**VOLUME I:** presents the fundamental principles of radio so clearly and simply that anyone of average training will be able to read, understand and apply them. It gives actual working drawings and lists of materials for the construction of many typical sets.

**VOLUME II:** fully discusses all of the elementary principles of radio construction and repair. An explanation of the necessary steps for "troubleshooting," repairing, servicing and constructing radio sets successfully. Practical data is also given on antenna systems, battery eliminators, loud speakers, chargers, etc. This volume includes complete instructions for the construction and operation of short-wave and television receivers.

**VOLUME III:** covers the essential principles underlying the operation of vacuum tubes in a non-technical a manner as is consistent with accuracy. It discusses the construction, action, reactivation, testing and use of vacuum tubes; and an interesting section is devoted to remote control of industrial processes; and precision measurements.

### EXAMINE these books for 10 days FREE

This Library is not only a thorough home-study course, but a handy means of reference for the more experienced radio experimenter, repair man, and radio shop-owner. To these men, as well as to those who desire to advance in the radio profession, this offer of a 10 days' Free Examination is made.

Simply clip, fill in, and mail this coupon

McGRAW-HILL  
FREE EXAMINATION COUPON

McGRAW-HILL BOOK COMPANY, INC.,  
330 W. 42nd Street, New York.

Gentlemen:—Send me the new RADIO CONSTRUCTION LIBRARY, all charges prepaid, for 10 days' Free Examination. If satisfactory I will send \$1.50 in 10 days, and \$2.00 a month until \$7.50 has been paid. If not wanted I will return the set at your expense.

Name .....

Home Address .....

City and State .....

Position .....

Name of Company..... RC-5-32

(WRITE PLAINLY AND FILL IN ALL LINES)

# Radio-Craft READERS' BUREAU

## A NEW FREE SERVICE

These booklets, pamphlets, etc., are obtainable FREE by mailing the accompanying coupon.

22. **HOW TO TEST PENTODES.** This is a reprint of an article of the same name that appeared in the September, 1931 number of RADIO-CRAFT, accompanied by descriptive matter on the adapters specified for the purpose. If you missed the original article study the reprint; it contains much useful data for owners of testers or analyzers not already equipped to test pentodes. *Alden Manufacturing Company.*

23. **YAXLEY REPLACEMENT CONTROLS.** Printed on heavy cardboard, 9 by 12 inches, this chart is intended to hang in the service shop as a handy source of information on replacement volume controls. Fourteen different circuit positions for such controls are shown in blue-and-white diagrams, and specific units for various commercial receivers are listed. Normally this chart costs twenty-five cents, but through the kindness of the Yaxley company copies will be sent free to readers of RADIO-CRAFT who make use of the coupon on this page. *Yaxley Manufacturing Company.*

24. **HARTMAN SCANNERS.** This is a catalog of supplies for television experimenters and constructors. It describes particularly a scanner with semi-automatic synchronization, which is put out in convenient kit form for home assembly. Other special items are rigid disc-mounting stands, framing levers, magnifying glasses, taper-face synchronizing pulleys, blank and drilled discs, and motors. *Dieuett & Eisenhardt, Inc.*

25. **AEROVOX 1932 CONDENSER AND RESISTOR MANUAL AND CATALOG.** This 48-page booklet is worth having and saving. In addition to very complete specifications on the full line of Aerovox paper, mica and electrolytic condensers, and vitreous enamel, carbon and wire-wound resistors, it contains a great deal of information and data on condensers and resistors in general which the Service Man and experimenter will be able to apply to his everyday problems. *Aerovox Wireless Corporation.*

26. **CATALOG OF POLYMET PRODUCTS.** Arranged especially for radio dealers and Service Men, and includes detailed descriptions of paper, electrolytic and mica fixed condensers, resistances, volume controls, power transformers, audio transformers and filter chokes. The very complete specifications of all the parts will be appreciated by Service Men, as they eliminate costly guesswork and uncertainty in replacement work. *Polymet Manufacturing Corporation.*

27. **DUBILIER CONDENSERS.** The name Dubilier being synonymous with condensers in the minds of many people, the latest catalog of Dubilier condensers is sure to be of interest to all classes of radio users. This 16-page booklet describes the entire line of receiving condensers and tells something of the historical background of the company. The special service kit and replacement units are recommended to the attention of

On this page are listed booklets, catalogs, pamphlets, etc., of Manufacturers, Schools, Institutions, and other organizations, which may be of interest to readers of RADIO-CRAFT. The list is revised each month, and it will be kept as up-to-date and accurate as possible. In all cases the literature has been selected because of the valuable information which the books contain. If you are interested in subjects not listed on this page, write us and we will try to serve you.  
*This Service is absolutely free to all Readers of RADIO-CRAFT.*  
Fill in and mail the coupon below; make sure that your name and address are included and are plainly written. Order by number only.

Service Men. Included with the catalog is an instructive technical article dealing with electrolytic condensers. *Dubilier Condenser Corporation.*

28. **HAMMARLUND PRECISION PRODUCTS.** Midget variable condensers and their numerous applications in short-wave and broadcast receivers are discussed in a folder accompanying the complete catalog of Hammarlund variable condensers and coils. Some excellent circuit kinks are given. The catalog contains dimensional drawings of the popular Hammarlund midgets which may be of assistance to constructors designing small receivers. *Hammarlund Manufacturing Company, Inc.*

29. **REL SPECIFICATIONS.** There is much in this catalog to interest the transmitting amateur. High-grade transmitters ranging in power rating from 10 to 250 watts are described and illustrated, and several circuit diagrams given. Band-spreading short-wave receivers and many special accessories are also included. For the man who "rolls his own" there are coil forms and receptacles, band-covering variable condensers, special tube sockets, wavemeters, transmitting inductors and motor-generators. *Radio Engineering Laboratories, Inc.*

30. **UNIVERSAL MICROPHONES.** Carbon-granule microphones of all types from midget "Baby" units to broadcasting studio models are described and their frequency response curves published in this interesting catalog. Thirteen diagrams show how single- and double-button "mikes" are used for different purposes. Other data are given on "mixers" and "faders" for combinations of microphones and phonograph pick-ups, and for hooking "mikes" into radio receivers. *Universal Microphone Company, Ltd.*

31. **B-I. SOUND MOTION PICTURE RECTIFIERS.** A four-page folder describing several power packs designed to convert ordinary line A.C. to direct current for the operation of sound-motion picture equipment of either the film or disc type. These units make use of dry metallic rectifiers rather than tube rectifiers of the gaseous type. *B-I Electric Manufacturing Company.*

32. **BUD RADIO DEVICES.** This is a handy and very complete catalog of radio parts and accessories for the Service Man and set constructor. The short-wave adapters and "police thrillers" in the front section are of particular interest to short-wave fans. Replacement power transformers are listed in convenient reference form, with their terminals marked and numbered for the assistance of Service Men who use them in repair work. *Bud Radio, Inc.*

33. **GARDNER RADIO TRANSFORMER.** This folder deals exclusively with power transformers and filter chokes coils for radio receivers and transmitters. Several dozen units are catalogued, and their input and output characteristics described. The available models take care of practically any radio outfit, from the smallest to the largest. *Gardner Electric Manufacturing Company.*

34. **MACY EXPONENTIAL HORNS.** Microphones, voice amplifiers, loud speakers, horns and other equipment for public address systems are illustrated and described in this catalog, which is punched for use in a standard three-ring, loose-leaf binder. *Macy Manufacturing Corporation.*

35. **SHURE CONDENSER MICROPHONE.** A very complete description of a high-grade microphone of the condenser type, designed for radio broadcasting, sound recording, public address and sound measurement purposes. The frequency response of the instrument is said to be comparatively flat from 40 to 10,000 cycles. *Shure Brothers Company.*

36. **INSTALLING SHIELDED LEAD-IN WIRE.** In locations where interference from outside sources is unusually bad, the use of a high aerial with a shielded lead-in helps alleviate the trouble considerably. This folder discusses the problem and tells the correct methods of installing both the aerial and the lead-in. *Belden Manufacturing Company.*

**RADIO-CRAFT Readers Bureau**  
96-98 Park Place, New York, N. Y.  
Please send me free of charge the following booklets indicated by numbers in the published list above:  
No. ....  
.....  
Name .....  
Address .....  
City..... State.....

Whatever  
your **HOBBY!**  
you'll find it in

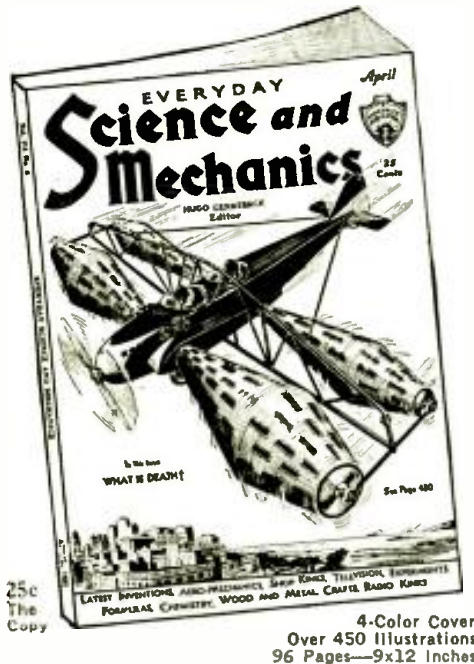

**M**R. HUGO GERNSBACH's latest magazine contains the most important and recent developments in Science, Mechanics, Radio, Television, Aviation and Chemistry. For everyone, regardless of age, EVERYDAY SCIENCE AND MECHANICS will be found to be useful and instructive. Thoroughly illustrated with scientific events from all parts of the world, and helpful to thousands of high school, university students and instructors who wish to advance their scientific knowledge.

Many excellent pages for the home workshop man who finds pleasure in building things; experiments in electricity, chemistry and formulas of all kinds.

- Just to Mention a Few Departments
- LATEST INVENTIONS
  - AERO-MECHANICS
  - SHOP KINKS
  - TELEVISION
  - EXPERIMENTS
  - FORMULAS
  - CHEMISTRY
  - WOOD AND METAL CRAFTS
  - RADIO KINKS
  - AND OTHERS

**Special Offer!**  
**8 Months for \$1.00**  
**ON ALL NEWSSTANDS**  
*Mail Coupon Now!*

EVERYDAY SCIENCE AND MECHANICS  
100 Park Place, New York, N. Y. RC-5

I enclose herewith One Dollar for which you are to enter my subscription to EVERYDAY SCIENCE AND MECHANICS for the next Eight Months.

Name .....

Address .....

City ..... State .....

### CRAFTSMAN'S FORUM

(Continued from page 674)

veloped further, and work started at a much earlier date. It is probable that any one of the three would have contained patentable features! As it is, several similar instruments, now in laboratories, will be put on the market in a short time; at least two of these will incorporate the buzzer idea, shown in a general way in Fig. 2B. It is interesting to note that by using T as a transformer with a secondary potential of about 110 volts, it becomes possible to operate a standard 110 volt A.C. receiver; rectifier V1, the choke, and the condensers are then unneeded.—*Technical Editor.*

### CONCERNING "UNEXPLORED RADIO"

*Editor, RADIO-CRAFT:*  
I was glad to see in the March RADIO-CRAFT your editorial mentioning the crystal. This depression has stimulated interest in this "natural detector," more there in the country where I live than there was in 1922 when I built the prize-winning "Radio Gem" circuit, described in "Radio News" magazine, as my first set, and could, on occasion, hear a station in San Francisco, 400 miles.

I think you were too modest in placing the crystal range at only 300 miles. On my new DX crystal set, I have in the last three months received KFI, Los Angeles, distance 750 miles, with good headphone volume on an average of 5 nights a week; and at least hear them every night. I also hear KXX about three or four nights a week; KSL, (600 miles), the same as KGW (120 miles), daylight every day; and many others, (always several each night). Also, I have heard XER, Mexico, once this winter (1,570 miles). I have had KFI on two separate nights on a speaker so loud as to be understood anywhere in a 16 x 14 ft. room; crystal only, (no extra power amplification); I used a Baldwin unit and an exponential horn. Also have had KOAC, 1000 watts, on a speaker, audible 10 feet in line of horn; (distance 40 miles), *daylight*, too!

A friend duplicates these distances with another crystal set in Eugene.

J. M. NIGHTSWANDER

Route 3, Box 289, Eugene, Ore.

(As pointed out by Mr. Gernsbach, in the editorial to which our correspondent refers, the usual range of a crystal is only about 15 to 25 miles, yet under certain conditions this may be extended to 300 miles. It is quite natural to suppose that under still other conditions all of the elements necessary to long-distance reception would, infrequently, conspire to hang up a nice, long air-miles range of reception from a certain group of stations. It is evident that Mr. Nighswander has given exceptional attention to the problem of obtaining the last bit of sensitivity from crystal detectors, since he has been working with them for over ten years. He is certainly to be congratulated in having obtained such remarkable results from "ye olde crystal."—*Technical Editor.*)

### INDEXES

*Editor, RADIO-CRAFT:*  
Here is a suggestion which I am sure will be welcomed by Service Men, engineers, and anyone who has need of radio magazine articles for future reference. The suggestion is to include in every issue a perforated table of contents with stick-on the back. This would enable the reader to file away, in his own system of indexing, each article he desired; service hints and helps should have a perforated title for each hint. It would only be necessary to tear out this index along the perforations and paste it in his index-book, scrap-book, or what have you.

Hoping this suggestion may be of value to you, I am,  
H. W. MALMSTROM  
2511 East Grand, Everett, Wash.

(As pointed out some time ago in this department, it is extremely difficult to index some of the departments, particularly, "Operating Notes." However, stronger deterrents are the regulations of the U. S. Post Office Department, and the mechanics of magazine makeup. Admittedly, an extensive index would interest many readers.—*Technical Editor.*)

## MICO TUBE TESTER

Tests All Tubes Accurately



The MICO TUBE TESTER is an essential instrument which every serviceman and dealer should have. Its simplicity in operation makes it extremely desirable for counter tube testing or as a portable tester for service calls.

The MICO Tester employs the use of a high quality ammeter with Jewell bearings. Pointer does not oscillate thus permitting quick and accurate readings.

Attractive in appearance and weighs only 3 1/2 lbs. Measures 9" x 5" x 5".

COUNTER Model \$9.95 Net to dealers and servicemen.  
PORTABLE Model \$10.95 Net to dealers and servicemen.  
Upon receipt of check, we will send tester for 3 days' trial and will refund money if not satisfactory.

MADSEN INSTRUMENT CO.  
98R PARK PLACE NEW YORK, N. Y.

## SERVICE MEN!

YOUR RESISTOR PROBLEM SOLVED  
with the  
**RADISTOR KIT**  
CONTAINING EVERY  
**Resistor That You Need!**

Always on Hand for Quick Use  
Contains a Resistance Value for Any Service Job



Be sure to get your \$2.75 net  
copy of our New Free Wholesale Radio Supply Catalog.

Twenty-four of the finest quality, 1 watt, R. M. A. color-coded Carbon resistors that take care of practically every replacement need. Kit contains one, each, of the following resistances: 100; 250; 400; 500; 800; 1,000; 2,000; 5,000; 10,000; 15,000; 20,000; 25,000; 30,000; 50,000; 60,000; 75,000; 100,000; 250,000; 500,000; 1,000,000; 2,000,000 ohms. Can be hooked in parallel or series to provide great range of resistances. GUARANTEED accurate to within 10% plus or minus, most of them are within 5% plus or minus. Fine quality that insures a first class repair job and a satisfied customer.

FREE COLOR CODE CHART included. Always valuable to a serviceman. No ohmmeter is needed to determine the value of resistors. GREATEST VALUE. Nothing ever before offered equals this value. You cannot afford to risk your reputation or waste your time using "odd-lot" resistors when you can get 21 of the very finest, select quality, carbon resistors obtainable for only \$2.75.

Place your order NOW. For the small purchase price of \$2.75 you will receive the finest kit of resistors ever offered. At no extra cost to you we will include the necessary simple formulas you need to find the value of resistors when hooked either in parallel or series.  
**DON'T WAIT — SEND FOR THEM NOW!**

Order direct from this Advertisement!  
CASH WITH ORDER OR C.O.D.  
**FREE! The RADOLEK CO.**  
601 W. RANDOLPH ST.  
CHICAGO, ILL.

Please send me \_\_\_\_\_ RESISTOR KITS at \$2.75 Net, Plus Postage.  
Copy New 1932 Serviceman's Wholesale Price Guide (Attach your professional card).

Name .....

Street .....

City ..... State .....

**THE RADOLEK COMPANY**  
105 CANAL STATION CHICAGO, ILL.

# Hotel Directory of the Radio Trade

The Hotels on this page are Patronized by the Radio Trade.  
Make them your Headquarters.



## Unusual Facilities For Small Meetings Too!

THE DRAKE . . . renowned for successful Conventions . . . also provides facilities particularly adapted to small-group meetings. Special accommodations . . . in room arrangements . . . an extra Conference Room without extra charge . . . dining service fitted to your needs . . . and our experienced staff will relieve you of detail . . . obtain reduced railroad rates . . . plan registrations . . . suitable entertainment, etc. Costs are moderate. Write for further information.

THE  
**DRAKE**  
HOTEL, CHICAGO  
*Under Blackstone Management*

*"The Gathering Place  
of  
Cosmopolitan New Yorkers."*  
The **RUSSIAN VILLAGE**  
100 West 57th Street  
New York City  
Dining, Dancing, Russian and Gypsy  
Entertainment.  
LUNCH — TEA — DINNER  
No cover charge at any time.  
Broadcasting WOR Circle 7-9434

THE SENSATIONAL  
**HOLLYWOOD**  
RESTAURANT  
B'WAY. at 48<sup>ST.</sup> N.Y.C.  
**NT.G.** and his  
NEW REVUE  
Presents  
the great-  
est cabaret entertainment  
the world has ever seen.  
Broadway's Best Dinner  
\$1.50 \$1.75 \$2.00  
AFTER  
THEATRE  
Popular Prices.  
NO COVER CHARGE

**THE  
NEW  
FLANDERS**  
THE HOMEY HOTEL  
Finest Hotel in Times Square  
Right in the Heart of Everything  
Times Square, 47th to 48th Sts.  
East of Broadway  
NEW YORK CITY

Rooms with Private Bath  
1 person ..... \$1.50  
Rooms with Private Bath  
1 persons ..... 2.50  
Rooms with use of Bath  
1 person ..... 2.00  
Rooms with use of Bath  
2 persons ..... 3.00  
Large Comfortable Suite—2 or  
3 people ..... 5.00  
*Special Weekly Rates*  
FRED W. BIZEL, Resident Manager

### • Index to Advertisers

<b>A</b>	
All American Service .....	682
Amperite Corporation .....	696
Arco Tube Company .....	692
<b>B</b>	
Blan the Radio Man, Inc. ....	696
<b>C</b>	
Cable Radio Tube Corp. ....	Inside front cover
Central Radio Laboratories ..	693
Chemical Institute of N. Y. ..	686
Clarostat Mfg. Company .....	684
Classified Section .....	696
Compo Mfg. Company .....	646
Coyne Electrical School .....	643
Crosley Radio Corporation .....	691
<b>D</b>	
Drake Hotel .....	700
Dubilier Condenser Corp. ....	686
<b>E</b>	
Electrad, Inc. ....	688
<b>F</b>	
Flanders Hotel .....	700
Forde, Jr., David L. ....	696
<b>G</b>	
Gernsback Corp., S. ....	684
Grant Radio Laboratories .....	688
Grenpark Company .....	701
<b>H</b>	
Harrison Radio Company .....	688
Hollywood Restaurant .....	700
Hoodwin Company, Chas. ....	682
<b>I</b>	
International Resistance Co. ....	683
<b>J</b>	
JMP Mfg. Company .....	694
Jewell Electrical Instrument Co. ....	689
<b>L</b>	
Legion Radio Mfg. Co. ....	647
Lincoln Radio Corp. ....	Back cover
Luxtron Devices Company .....	684
Lynch Mfg. Company .....	684
<b>Mc</b>	
McGraw-Hill Book Company .....	697
<b>M</b>	
Midwest Radio Corp. ....	648
Miles Mfg. Company .....	686
<b>N</b>	
National Jobbing & Export Co. ....	686, 688
Narional Radio Institute .....	704
National Union Radio Corp. ....	687
<b>P</b>	
Police Lowwave Laboratories .....	696
Polymet Mfg. Co. ....	692
Popular Book Corp. ....	688, 694
Press Guild, Inc. ....	690, 694
<b>R</b>	
Radex Press .....	694
Radio Technical Pub. Co. ....	682
Radio Trading Company .....	703
Radio Training Assoc. of America ..	641
Radolek Company .....	699
RCA Institutes, Inc. ....	685
Readrite Meter Works .....	695
Malcom Ross .....	691
Roth Press .....	692
Russian Village .....	700
<b>S</b>	
Scott Radio Labs, Inc., E. H. ....	645
Silver-Marshall, Inc. ....	679
<b>T</b>	
Taussig, Leo .....	688
Tilton Mfg. Company .....	686
Triad Mfg. Company .....	Inside back cover
<b>U</b>	
United Radio Laboratories .....	696
Universal Microphone Co. ....	696

### IMPORTANT ANNOUNCEMENT!

On pages 680 and 681 will be found a very important message telling of the new RADIO-CRAFT LIBRARY. Be sure to turn to these pages NOW and learn of the new and interesting books which are being published.

(While every precaution is taken to insure accuracy, we cannot guarantee against the possibility of an occasional change or omission in the preparation of this index.)

## \$100,000 SPEAKER SALE!

Included in this tremendous speaker sale are the products manufactured by leading speaker makers. Every speaker is brand new and shipped in original factory sealed cartons. They are sold far below their regular list price because they were bought in exceedingly large quantities and our purchase price permits us to give you the benefit of low cost.



### DUO MAGNETIC

Duo Magnetic Speaker **\$3.95**  
 Duo Inductor Dynamic Chassis **\$3.95**  
 Similar to Farrand Inductor.

### JENSEN

A.C.—D.8 Dry Rectifier **\$14.95**  
 A.C.—D.7 Jr. Audit Tube Rect. **\$12.95**  
 A.C.—D.15 Concert Jr. Tube Rect. **\$8.50**  
 D.9—2500 OHM D.C. Field **\$7.50**  
 D.7—2500 OHM D.C. Field **\$8.50**  
 D.15—Midget Concert Jr. 2500 OHMS **\$4.75**

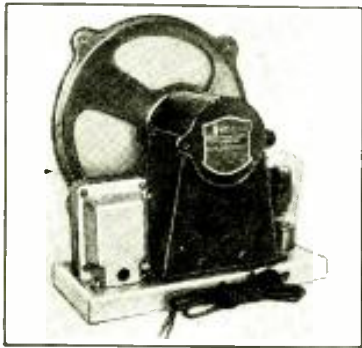

### ROLA



A. C. Models  
 Model O-90-C A.C. using 280 Rect. **\$9.95**  
 Model K, Midget A.C. using 280 Rect. **\$8.50**  
 D. C. Models  
 2500 ohm P.P. Output Trans. **\$4.25**  
 1000 ohm P.P. Output Trans. **Each Model**  
 2500 ohm Single Pentode  
 2500 ohm Push Pull 238.  
 1000 ohm Single 238.  
 1800 ohm Single Pentode 300 ohm Tap for Bias.

### BALDWIN

A. C. using 250 Tube Rect. **\$7.50**  
 D. C. 2500 OHM—110 Volts **\$5.50**  
 D. C. 2500 OHM—110 Volts Field Less Stand **\$4.00**  
 D. C. 2500 OHM—110 Volts Field Less Output Trans. **\$3.25**

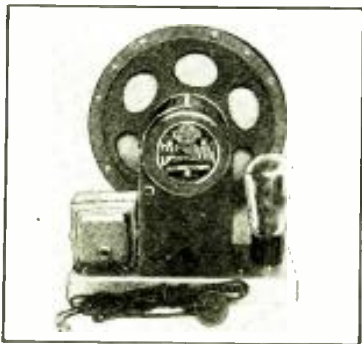

### SANGAMO TRANSFORMERS



Sangamo transformers are offered to the public for the first time at these reduced prices.  
 Sangamo A. X. Audio Transformer. Price **\$1.75**  
 Sangamo B. X. pp Input Transformer. Price **\$1.95**  
 Sangamo H. X. pp Output Transformer. Price **\$1.95**

## Do Not Write For Catalog!

All offers are F.O.B. New York, and subject to prior sale. Terms: A deposit of 20% is required with every order. Balance may be paid on delivery. Or, deduct 2% if full amount is sent with order.

## HEADQUARTERS

for

Materials and Parts

for building

## Treasure Locators

Radio. Audio. Ground Potential measurements. Hughes Induction Balances and other types.

Oscillators and amplifying systems are included.

*We can supply all materials needed for building and operation of any of the recognized treasure finders.*

WITH this apparatus you can locate buried treasures, metal war relics, mineral deposits, subterranean water veins, buried gas and water pipes, and lost out-board motors, tools and treasures sunken in water.

Write for our pamphlet (price 10c) giving instructions on how to assemble parts for building treasure finders. Parts list and prices included.

Mail  
 Coupon  
 TODAY!

GREN PARK COMPANY Dept. R.C.  
 245 Greenwich Street, New York, N. Y.

Enclosed find 10c for which kindly send me pamphlet on the building of Treasure Finders.

Name: .....

Address: .....

State: .....

GREN PARK CO., Dept. R.C., 245 Greenwich Street, New York, N. Y.

# Build Your CUSTOMERS THE Revolutionary STENODE

## The Receiver That Is **NOISE FREE** on **SHORT WAVES** or **BROADCAST**

A STENODE demonstration will create more new custom set prospects than any radio receiver ever did before. People listen in amazement when they hear stations free of background noises and absolute silence between stations. When you tune out heterodynes and whistles and stations STAY IN strong and crystal clear, owners of all other sets gasp in astonishment. The former chief of wireless research of the British Royal Air Force, Dr. James Robinson has given an entirely new principal to radio in STENODE.

By the STENODE principal the highest selectivity ever attained as well as unprecedented tonal range is now made possible. All engineers agree that it is impossible with ordinary superheterodynes.

STENODE amplifies signals most and static least. That's why YOU want to build an 11 tube STENODE to work with a SHORT WAVE adapter when it is not used to log and listen with enjoyment to more broadcasters than can be heard on any other type of radio. STENODE selectivity is 5 to 1 greater than that of so called 10KC Supers. The noise does not get in along with the high audio frequencies, and the STENODE reproduces perfectly higher frequencies than ever heard on any other receiver giving

**500% BETTER SELECTIVITY**  
**1000% MORE FREEDOM FROM NOISE**  
**INFINITELY BETTER QUALITY**



STENODE selectivity curve makes 10KC selectivity, so-called, look like broad tuning.

STENODE selectivity is compared, at left, to that of ordinary receivers. All background noise is contained in outer curve. Stenode's curve, shaded, contains but 1-10 the total noise.



STENOTUBE. Only one required in each Stenode. This heart of the Stenode circuit consists of a quartz crystal ground to 175KC frequency and mounted in tube form for easy handling. Standard UX socket base. Price \$15.

Made in England

None genuine without the inventor's signature.

*James Robinson*

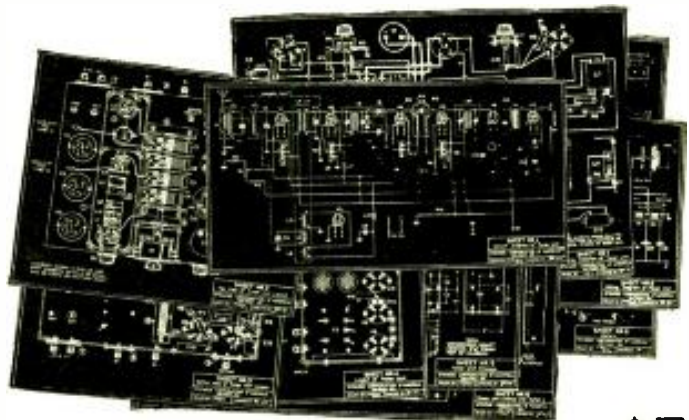

## 9 Blue Prints - Data Book - Direction Book Now \$5

Increased demand for Stenode Data Book, Instruction Book and Blue Prints permits our cutting former price in half. Those who have already sent in full price will receive our check for \$5. We are not interested in making profit from our engineering service. Our profits come safely from Royalties paid us by our licensees.

**GERNSBACK PUBLICATIONS, Inc.**  
98 Park Place, New York, N. Y.

Enclosed find  Money Order,  Check, for \$..... Please forward me  STENOTUBE,  BLUE PRINTS, DATA BOOK and DIRECTION BOOK for building STENODE.

(Make all checks payable to Gernsback Publications, Inc.)

Name .....

Street .....

City ..... State .....

The STENODE opens up new fields for short-wave and television work, as well as broadcasting. Full details of all sorts of applications are given in the STENODE Data Book. Nine full-sized diagrams show where to place every part. How to make every connection is clearly told in STENODE Book of Directions. Your finished STENODE will put you into a new field of radio. Fill in and mail the coupon with your money order for the biggest value ever offered custom set builders.

**STENODE CORP. OF AMERICA**  
GERNSBACK PUBLICATIONS, Inc.  
98 Park Place New York, N. Y.  
**SOLE SELLING AGENTS**

**IF IT ISN'T A STENODE IT ISN'T A MODERN RECEIVER**



# MAY SPECIALS !!

**NOTICE** our important New departure in announcing Special values. Every month we will show on this page certain **STAR** items, which are **NOT LISTED IN OUR CATALOG**. These are all specials of which the quantities on hand are not sufficient to catalog them. *Once sold out, no more can be had.*

**STOP SHOPPING.** The lowest prices are right on this page. *No one undersells us.* We meet any price on **ANY NEW Merchandise.** Order direct from this page and save money. 100% satisfaction on every transaction. Take advantage of these special offers. **ORDER NOW, TODAY.**



**NEW! "LITTLE GIANT" DYNAMIC SPEAKER**

Absolutely the smallest dynamic speaker that will withstand the strain of modern output power tubes, ever manufactured.

Suitable for use on midget, portable and automobile receivers. Measures but 6 1/4 in. long over-all, having a 1 1/2 in. diameter and weighing but 1 lb. The "Little Giant" has, under test, actually flooded a ten-room apartment with faithfully reproduced music of virtually original tone quality. Field winding has a resistance of 2500 ohms and may therefore be energized by using it as a filter choke in the power pack, thereby serving a double purpose. This last feature makes the "Little Giant" excellently suited for portable A.C. sets, since it does away with filter chokes and thus with considerable weight. Equipped with built-in output transformer to work from any standard output power tube arrangement. Specify the power tube or tubes used when ordering. Shipping weight 5 lbs. **List Price \$6.50. No. 1549. LITTLE GIANT DY. NOMIC SPEAKER. Your Price \$2.50**

**\*UTAH A.C. DYNAMIC SPEAKER—Only a Few Left**



110-volt, 60-cycle A.C. light socket supply for field excitation with Westinghouse dry rectifier. 9 in. high, 9 1/2 in. wide, 7 1/2 in. deep. Speaker comes packed in wooden crate. Weight 19 lbs. It is one of the most powerful as well as best reproducers in the market. 9-inch cone. **List Price, \$50.00. No. S.P. 1506—Your Special Price \$7.45**

**\*FARADON 4-MFD. FILTER CONDENSER**



Here is just the condenser for constructing noise filters. In some cases one condenser connected across the line or instrument will be sufficient. However, in most commercial filters there are two condensers connected in series; the center-tap being grounded and the two remaining leads connected across the line or the interference-producing apparatus. Put up in a neat, black-enamelled case with tuned lugs for soldering connections. 2" high x 3 1/4" wide x 2 1/4" deep. Working potential 600 volts D.C. Ship. wt. 6 lbs. **List Price \$7.50. No. S.P. 9062—Faradon 4 Mfd. Filter Condenser. Your Price \$1.50**

**World-Wide Short-Wave Set NOT A CONVERTER**



A perfect radio short-wave receiver for use between 18 and 200 meters. To put into operation, connect antenna, ground, 15 volt "B" and two No. 6 dry cell "A" batteries, and headphones to the posts provided. Plug in a 1 1/2" 350 tube, and tune in! An ingenious circuit makes possible a 1 coil single-winding plug-in design. This little instrument has the same sensitivity as many big, shielded short-wave receivers costing ten times as much. A power amplifier may be added for any degree of volume. Complete with 4 plug-in coils. Has fine vernier dial for precision tuning. **Never has a first class short-wave set sold for so little money.** This short-wave set measures 5 1/2" x 7 1/2" in. high, over all. Ship. weight, 3 lbs. **List price, \$12.50. No. 1666—World Wide S.W. Set. \$6.25 Your price.....**

**NEW! NEW! SYNCHROMATIC ELECTRIC CLOCK**



Never was such a first class electric clock sold at such a ridiculously low price! An electric clock using the famous **synchromatic movement.** Naval observatory time right from your light socket! No spring to wind, no batteries. Never out of order. Lubricated for a life-time at the factory. The entire movement with its white-enamelled dial and artistic numbering is enclosed in a dust-tight and shock-proof and milled Bakelite case. The case is of walnut brown finish with simple but catching design. For 110 volts, 60 cycle A.C. operation only. Complete with cord and attachment plug. Size 3 1/2" x 1 1/2" x 1 1/2". Weight 1 lb. Service men now sell these fine clocks by the hundreds. Be the first in your locality to handle them.

**List Price \$3.00. No. 1689—Synchromatic Electric Clock. Your Price \$1.00**

**FREE 76 Page Radio Treatise No. 24**



The new Winter edition of our **RADIO SERVICE TREATISE**, twice as large as our former one, has just come off the press. It is positively the greatest book in print. **NOT JUST A CATALOG**. It contains a large editorial section—a veritable book in itself—with valuable information **NOT FOUND ANYWHERE ELSE.** Among the wealth of new technical information listed in the editorial sections are the following: 1932 Complete Radio-iron Characteristics **SHORT-WAVE TUNERS AND PHONO-PICKUPS.**—Constructional Data of **SERVICEMEN'S TEST OSCILLATOR—ALL ABOUT TONE CONTROLS—SHORT-WAVE ADAPTERS AND CONVERTERS—CONSTRUCTING A 3-TUBE SUPER-HET SHORT-WAVE CONVERTER.**—**MODERNIZING OLD RADIO SETS—LATEST TYPE MULTI-MU AND PENTODE TUBES—ALL ABOUT DC RECEIVERS—VACUUM TUBES TREATISE.**—And dozens of new radio experiments, hints to Servicemen, valuable tables of useful data, etc., etc.

This book is not just another catalog but a veritable mine of radio information which will be of infinite and everlasting value to you.

**100 New Hook-Ups, etc. 675 Illustrations.**

**WRITE TODAY. Enclose 2 cents for postage. Treatise sent by return mail.**

**6 MONTHS GUARANTEED NEOTRON TUBES**

Sold in a 6 MONTHS FREE REPLACEMENT GUARANTEE BASIS, PROVIDING TUBE LIGHTS! All tubes are carefully meter tested before shipment, and carefully packed. Do not confuse these **HIGH QUALITY** tubes with any other "low priced" tubes—our low prices are possible because we do a **VOLUME** business!

Choice 226	Choice of 112A	Choice 245	Choice 222	Choice 231	Choice 232
227	290A-199X	280	210	232	234
171A	199U-V-120	171	250	236-37	351
201A	224		281		

60c ea. 69c ea. 70c ea. 1.58 ea. 1.08 ea. 1.08 ea.

**R.C.A. LICENSED TRIAD AND PERRYMAN TUBES**

These nationally advertised tubes are guaranteed UNCONDITIONALLY for six months. The prices are slightly higher than our **NEOTRONS** because these tubes are of much better quality. See listing above for tube numbers.

Choice Price 63c	Choice Price 80c	Choice Price 75c	Choice Price \$1.76	Choice Price \$1.15	Choice Price \$1.15
------------------	------------------	------------------	---------------------	---------------------	---------------------

**\*"POROX" 2-VOLT STORAGE CELL**

5 Ampere-Hours—For 2-Volt Tubes

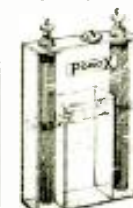

One such unit will light a two-volt battery tube for 75 hours continuously. Will handle two 2-volt tubes for 35 hours, etc. Put up in a transparent composition container with two non-corroding terminals clearly marked as to polarity. Easily recharged either directly from a 110 volt D.C. line in series with a 10 watt electric light bulb or from an "A" eliminator in series with a 12 ohm 2 watt resistor. Excellent for use in any circuit requiring a steady source of current. 3" wide x 4" high x 3/8" thick. Instructions included. Ship. wt. 2 lbs. **List Price \$4.50. No. S.P. 9060—Porox 2 Volt Storage Cell. Your Price \$8.00**

**NEW RESONANCE TUNING METERS**



This ingenious device **INDICATES VISUALLY** when a station is exactly "tuned-in—on-the-dial." Receiver is tuned to its most critical resonance point for any given station when needle swings to farthest position. Servicemen profit by installing these meters in sets which are not so equipped. Have only scales and pointers visible through an escutcheon plate. Used in new Stromberg-Carlson sets.

**EXCELLENT TUNING DEVICE FOR SHORT-WAVE RECEIVERS.** The extremely sharp tuning short-wave stations are very easily detected by this visual indicator when the ear usually misses them. Easily installed on any receiver by placing it in series with the plate of the meter tube. Shipping wt. 1/2 lb. Available in two styles.

**TM-103**—(Illustrated) Enamel finished dial-lighted from that side of the case over top of the dial. **Your Price \$90**

**TM-100**—Translucent dial—lighted from a rear window. **Your Price \$90**

Escutcheon Plate .....\$25 extra  
Pilot light and bracket .....\$30 extra

**\*VERSATILE PORTABLE PUBLIC ADDRESS SYSTEM**

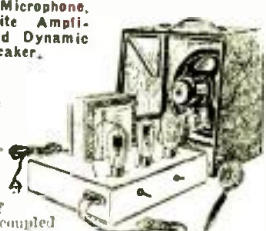

Comprises Microphone, Loftin-White Amplifier and Dynamic Speaker.

A recently completed all electric A.C. development incorporating all the features and advantages of the direct-coupled Loftin-White Amplifier principle. The amplifier is a high quality two stage job, having some **RADICALLY NEW IDEAS IN AUDIO FREQUENCY AMPLIFICATION** and employing 1-27, 1-15 power tube and 1-50 full wave rectifier. It is remarkably free from A.C. hum.

The design is adaptable to all purposes, i.e., microphone, radio, and phonograph. Has an undistorted power output of approximately 3 1/2 watts. **SUFFICIENT TO OPERATE FROM 2 TO 3 ADDITIONAL DYNAMIC SPEAKERS.**

The portable address system is solid **COMPLETE WITH THE NEW R.C.A.-VICTOR HAND MICROPHONE**—a sturdy constructed unit which will withstand a lot of rough handling.

Put up in a single compact and perfectly balanced carrying case, the front of which is utilized as a baffle for the self contained dynamic speaker. Complete with microphone and accessories the weight is only 30 pounds. For 50-60 cycles, 110-220 volts A.C. operation. Shipping weight 38 pounds. **List Price, \$75.00. No. S.P. 9063—Versatile Portable Address System. Your Price, complete \$25.50 with microphone.....**

**\*R.C.A.-VICTOR HAND MICROPHONE**



The most ruggedly constructed hand microphone ever manufactured. There is not another of its kind that is quite as sensitive. Designed especially for home recording and personal entertainment. Requires but a 2 1/2 volt battery to operate. Easily connected to any radio or amplifier in a few minutes. This unit is essentially a single button carbon microphone—a sensibly centered in a stout metal housing which serves the dual purpose of protection and noise shielding. Responds indiscriminately to all speech and music frequencies. Has a high D.C. resistance and may therefore be connected directly across the grid and cathode of the detector tube without employing a coupling transformer. Sold complete with 5 ft. connecting cable. Shipping weight, two pounds. **List Price, \$10.00. No. S.P. 9064—R.C.A.-Victor Hand Microphone. Your price \$2.75**

**Screen Grid Cap Connectors**

Newest SCREEN GRID CAP! Small, neat in appearance and exceedingly constructed. A sure necessity in service work. Sold only in lots of 12 or more. Shipping weight 1 oz.

**No. 1672—Screen Grid Cap Connector. Your price..... Dozen \$12**

**\*Guaranteed 8-Mfd. Electrolytic Condensers**



Indiculously used in many parts of any R.F. or A.F. circuits, in power packs, in dynamic speakers, they will perform miracles in eliminating any trace of objectionable A.C. hum or other incidental disturbances. These electrolytic condensers are particularly recommended for 250 power packs. Where the working voltage of the millifared A.C. is 800 volts, two electrolytic condensers in series will stand up indefinitely. Easily mounted through the use of a bayonet socket base which is equipped with a "positive contact" spring. Totally shielded and protected by a copper cap. Shipping weight—1 lb. **List Price, \$2.50. No. SP9054—Guaranteed 8 Mfd. Electrolytic Condenser. Your Price..... \$4.49**

**WE ARE A WHOLESALE HOUSE AND CANNOT ACCEPT ORDERS FOR LESS THAN \$3.00.** If C. O. D. shipment is desired, please remit 20% remittance, which must accompany all orders. If full cash accompanies order, deduct 2% discount. Send money order—certified check—U. S. stamps.

**Radio Trading Co.**  
23 West Broadway  
New York, N. Y.

**ORDER FROM THIS PAGE.** You will find special prices from time to time in this magazine. Get our big **FREE** catalog for the greatest Radio Bargains. Should you wish goods shipped by parcel post, be sure to include sufficient extra remittance for same. Any excess will be refunded.



# My NEW Book is ready for You

## IF you're in Radio now *spare time or full time -* it will show you how *my improved training* can help you make *still more money*



J. E. SMITH  
President, National Radio Institute, the  
man who has directed the Home-Study  
Training of more men for the Radio Industry  
than any other man in America.

If you're not in Radio /  
this book will show you how  
you can get in quickly!

Radio's continued development and new uses in Radio principles will open hundreds of new, good jobs for the well trained man. Broadcasting Stations, Radio Dealers, Jobbers and Manufacturers, Shipping Companies, Aviation, Talking Movies, Research Laboratories, and many other sources of good jobs employ men well trained in Radio. Besides, there are almost unlimited opportunities for a profitable spare-time or full-time Radio business of your own. Many have jumped from \$25, \$35, and \$40 a week to \$50, \$60, \$75 and even \$100 as a result of taking my Course. My book proves this.

### I Will Train You Inexpensively At Home in Your Spare Time

Hold your job until you are ready for another. Give me part of your spare time. I will give you the training that has raised the salaries of hundreds of men. I send you home experimental outfits that show you how to do experiments, build testing equipment and make tests that make clear the basic principles of whatever branch of Radio you enter—and show you how to service practically every type of set made.

### Many Have Made \$200 to \$1,000 In Spare Time While Learning

The day you enroll I will give you instructions, which you should master quickly, for doing 28 Radio jobs common in most every neighborhood. Nearly every one of the sixteen million Radio sets in use need \$2 to \$10 servicing a year. Get some of this money for yourself. I will show you how to do it. I will give you the plans and ideas that have made \$200 to \$1,000 for many of my students while they are taking my course. Read their letters in my book.

### Find Out What Radio Offers You GET MY NEW FREE BOOK

It tells you where the good Radio jobs are, what they pay, how you can fit yourself right at home in your spare time to get into Radio. It tells you about my Iron-clad Money-Back Agreement and the many extra services and materials N. R. I. gives its students and graduates. It shows you what others who have taken my course have done—are making—what they think of it. There is no obligation. Send the coupon today.

### I Help You Specialize Through My Five New Advanced Courses

My training not only gives you a thorough knowledge of Radio—all you need to get and hold a good job—but, in addition, you may take any one of my new advanced courses, without extra charge. They are:

1. TELEVISION  
Theory and Practice
2. AIRCRAFT RADIO
3. BROADCASTING  
Commercial and Ship  
Radio Stations
4. SOUND PICTURES AND  
PUBLIC ADDRESS SYSTEMS
5. ADVANCED RADIO SERVIC-  
ING AND MERCHANDISING

"Rich Rewards in Radio" gives you an outline of these courses. Get a copy. See how valuable this new idea in Home Study Training can be to you.

Have YOU read my new book giving an outline of National Radio Institute's improved training in Radio? If you haven't, send for your copy today—it's free. No matter what kind of a job you may have in the Radio industry now, unless you are at or near the top, I believe my training can help you get ahead—make still more money—get a still better job. However, I'll let you decide that for yourself after you have read my book—just let me show you what I have to offer. Many others in Radio—amateurs, spare-time and full-time service men, Radio dealers, fans, custom set builders—have found the way to more profit and more money through this course. You will find letters from them in my book.

### See What I Offer Those Who Are Now or Who Want To Be Service Men

While my course trains you for all important branches of Radio—I am also giving extensive, thorough, and practical information on servicing almost every type of receiving set made. The experiments I show you how to perform with the Home Experimental Outfits I send you make learning at home easy, interesting, practical. This information is of special help—real money-making value—to those who are now service men or those who want to be service men. This part of my training, however, is only one of the 18 features that I am offering men and young men who want to get good jobs in the Radio industry—or who are in Radio and want to advance. Even though you may have received information on my course before, unless you have gotten my newly revised book as pictured above, write to me again—see how N. R. I. has grown and improved, too. Hundreds of men in Radio owe their success and larger income to it. Send the coupon today.

J. E. SMITH, President,  
National Radio Institute, Dept. 2EX,  
Washington, D. C.

### 7 Years Previous Experience

"Dear Mr. Smith: Before taking your course, I had worked at Radio for over 7 years. But I realized I needed better training to succeed in the Radio game. Every part of the course has been very clear, teaching me what I could not have learned otherwise. In 9 months I made \$3,500."  
C. J. Stegner, 28 S. Sandusky St., Delaware, Ohio.

### Former Service Man Increased Salary

"Dear Mr. Smith: I had been doing service work before taking your course. Now I am serving in the capacity of Field Engineer for the Central Public Address Systems, a position I feel I can serve well, due to your thorough training. Compensation is expected to run about \$3,600 to \$4,000 per year."  
Paul E. Nelson, 3015 Regent Place, E. St. Louis, Ill.



CLIP  
AND  
MAIL  
THIS  
Coupon  
DO  
IT  
TODAY

J. E. SMITH, President  
National Radio Institute, Dept. 2EX  
Washington, D. C.

Dear Mr. Smith: Send me your free book, "Rich Rewards in Radio." I want the facts on the opportunities in Radio and your revised and improved course. I understand this does not obligate me and that no agent will call.

Name..... Age.....

Address.....

City..... State.....

# NEW Tubes and a NEW Service

TUBE CHARACTERISTICS have a direct relation to TUBE LIFE. If the characteristics (Figures which indicate the actual condition of the tube and which are understood by your serviceman) of radio tubes are kept within certain limits, it is possible to tell very definitely, just how the tube will perform, when it is used in a normal manner. Tube Characteristics are somewhat like air-pressure in an automobile tire. Other things being equal, the life of a tire will depend on the air-pressure which is KEPT at a constant, pre-determined figure. With every CERTIFIED TRIAD TUBE, you get an ENGINEERING DATA CERTIFICATE, signed by a Triad Engineer, which shows the essential figures, for that particular tube.

## CERTIFIED TRIAD TUBES

ARE DOUBLE-CHECKED,  
AGED, AND—

Long experience has taught Triad Engineers that the characteristics of an ordinary tube may vary greatly, even with new tubes. Therefore CERTIFIED TRIAD TUBES ARE AGED. They are also Double-checked: Once, when they are going through the production line and again, after a long period during which they are seasoned. The double-checking, which follows the aging process, insures against any changing of characteristics, after the tube has been made. This great care, in manufacturing makes it possible for the CERTIFIED TRIAD SERVICEMAN to bring you tubes, which he knows will give you more satisfactory service.

ARE SOLD BY CERTIFIED TRIAD  
SERVICEMEN EXCLUSIVELY

After a thorough survey of all radio tube sales and an analysis of the reason for service calls, we have found that more than ever before, is the serviceman being called upon for tube replacement and tube advice. We are thoroughly confident that there are thousands of intelligent servicemen, in all parts of the world, who understand the desirability of knowing just what the tube characteristics are, when the tube is put in your socket. Therefore, we are selecting and appointing CERTIFIED TRIAD SERVICEMEN in every corner of the globe, to enable you to get the performance you pay for. And we have decided to sell these special tubes through these reliable men, exclusively.

**TRIAD** MANUFACTURING CO.  
TELEVISION MFG. CO.  
Pawtucket, R. I.

Gentlemen:  
Please send me complete information about your new Sales Plan for servicemen.  
I have been a serviceman for..... years.  
I sell..... tubes per year.  
I belong to the..... Servicemen's Association.

Name.....  
Address.....  
City..... State.....  
My letterhead or card is attached.

# Super Power



insures

## World-Wide Performance- 15 TO 550 METERS-NO PLUG-IN COILS

If you have followed Lincoln's advertising, you will note we have never made statements of performance of our receiver. We have never claimed you can get foreign reception at all times as clear as a bell. As long as the atmosphere is used as a medium—subject to its varied conditions, and as long as radio is limited to local interference and absorption, *ALL RADIO EQUIPMENT* is handicapped.

Yet, in spite of these unavoidable conditions, Lincoln engineers have for years been the recognized leaders, and Lincoln receivers have been used by Arctic explorers, designing engineers of broadcasting equipment, for reception of press matter direct from the war zone of China and other special work where other receivers failed.

Lincoln owners are getting the full benefits of Lincoln's Super Power. Lincoln receivers, the world over, are known for what they actually do—just ask the Lincoln owner.

### Super Power to Amplify Signals Not Heard on Ordinary Receivers

If you have not heard a Lincoln, you have no conception of what high amplification will do. Tune in a station on any other receiver, tune in the same station on a Lincoln with equal volume with regulation in low power then snap the high power switch, the tremendous blast of volume will startle you. This is what you must have to get weak signals with local volume.

### Every Continent Logged in 2 Hours, 11 Minutes

QUOTE: "Sunday morning, Mr. Hollister, I logged every continent in two hours and eleven minutes. At seven AM, VK2ME came thru good, a few minutes later, GBU also Pontois, France, and at seventy-three F31C1) came thru with fair volume. At nine AM, LSN Buenos Aires and at nine eleven AM Rabat, Marroco, was tuned,—completely the five continents."

### Extra Power Invaluable States Texas Owner

A recent letter received from a man with wide experience in all short-wave receivers states: "The gain is unbelievable to persons who have heard other SW receivers. I usually run any North American SW station I hear on local switch and have all of the reserve power for fishing on SW. Best of all, sensitivity seems absolutely uniform on all frequencies which cannot be said for all receivers, in fact, no other SW I have tried. Believe me, that extra power is invaluable in SW work if one hopes to hear foreign stuff to amount to anything."

This man is telling you just what to expect in Lincoln high powered receivers. He is verifying what Arctic explorers, broadcast engineers, and hundreds of Lincoln owners have proved without a question of a doubt.

From the tropical jungles of Colombia, South America, comes the following report. "I take pleasure in writing you that the Lincoln receiver ordered from you last December arrived in excellent order and that no trouble whatever was experienced in installation. It is giving the most wonderful reception and I wish to congratulate you on having produced a masterpiece. It brings in stations from extreme distances, with great volume and clarity, both American and European. Have listened to VK2ME Sidney, Australia, on Sundays with excellent volume which is something around 6,000 miles distant from this point. It is without a doubt the finest battery operated receiver to be had and again let me express my appreciation for your prompt and careful attention to my order." This man is in the worst location in the world near the equator where radio reception is ordinarily impossible.

Built and actually tested on the air by competent engineers.

Finished in beautiful highly polished silver nickel.

You can own a high powered Lincoln—they do not cost as much as you think.

Write at once for new prices for demonstrator effective for the next thirty days.

Clip and Mail NOW!

# LINCOLN DE LUXE-SW-32

## LINCOLN RADIO CORPORATION

Dept. RC-5, 329 S. Wood St., CHICAGO, ILL.

Please send descriptive literature to NAME.....

ADDRESS.....

CITY.....

STATE.....