



Sept

25 Cents

Radio-Craft

for the
Professional-Serviceman-Radiotrician

HUGO GERNSBACK Editor

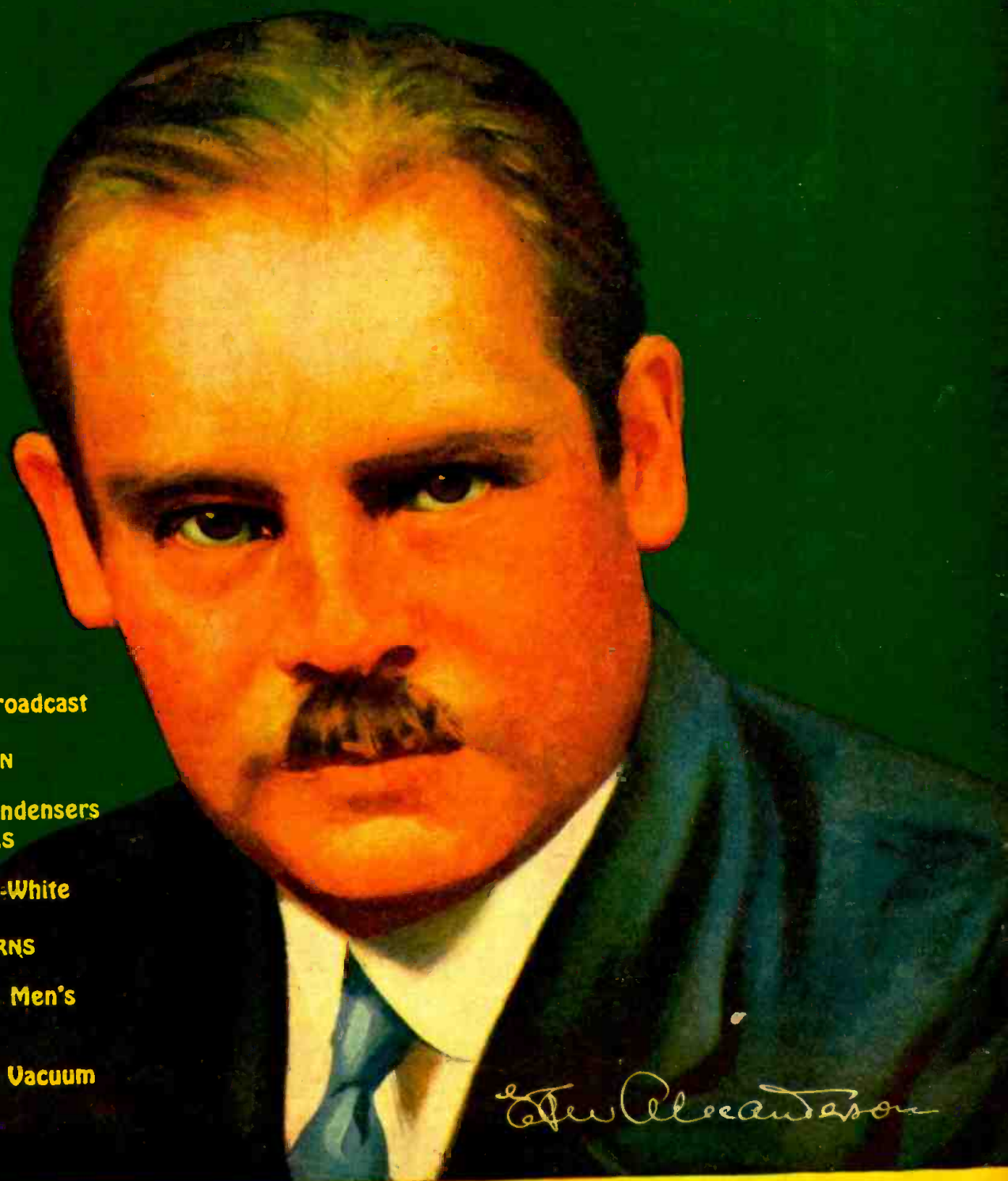

Short Waves on Your Broadcast
Receiver Dial
By WATSON BROWN

All About Electrolytic Condensers
By SYLVAN HARRIS

Constructing a Loftin-White
Amplifier
By MORTON W. STERNS

Leaves From Service Men's
Notebooks

The New "Thyratron" Vacuum
Tube

E.F.W. Alexanderson

Men who have made Radio: **E.F.W. Alexanderson**

R. T. I. R. T. I. QUALIFIES YOU TO MAKE MONEY AND ITS SERVICE KEEPS YOU UP-TO-THE-MINUTE ON THE NEWEST DEVELOPMENTS IN RADIO, TELEVISION, AND TALKING PICTURES **• R. T. I.**

RADIO
TELEVISION-TALKING PICTURES

BIG MONEY NOW!
More to Come

TUNE IN ON R.T.I.



Radio now offers ambitious men the greatest Money-Making Opportunity the world has ever seen! Hundreds of trained service

men are needed by radio dealers, jobbers, and manufacturers! A "trained" Radio "Service and Repair" man can easily make \$40 to \$50 a week, and it's very common for a trained man with experience to make \$75 a week and up.

BIG MONEY for Spare-Time Radio Work is easily made in every city and village. You can now qualify for this Big-Money work quickly through R. T. I. Get the Big Money Now and go up and up in this Big Pay field. The Radio industry calls for More Men, and R. T. I. supplies what the industry wants you to know.

No Experience Needed

ALL YOU NEED is ambition and the ability to read and write. The Radio industry needs practical trained men. Remember, R. T. I. makes it easy to earn spare time money while you learn at home.

More to come

THE MEN who get into this Big-Money field now will have an unlimited future. Why? Because this billion dollar Radio industry is only a few years old and is growing by leaps and bounds. Get in and grow with it. \$10 to \$25 per week and more is easily made in spare hours while you are preparing for Big Money. TELEVISION, too, will soon be on the market, so the leaders say. Be ready for this amazing new money-making field. Remember, R. T. I. "3 in 1" home-training gives you all the developments in Television and Talking Picture Equipment, together with the complete Radio Training.

Supervised by Radio Leaders

R. T. I. training is prepared and supervised by prominent men in radio, television and talking picture engineering; distributing; sales; manufacturing; broadcasting, etc. These men know what you must know to make money in Radio. You learn easily in spare time at home with the R. T. I. wonderful combination of Testing Outfits, Parts, Work Sheets, Job Tickets. It is easy, quick and practical, covers everything in Radio — includes Talking Pictures and the latest in Television. Get started in Big Money Radio work now.

Warning

Do not start R. T. I. training if you are going to be satisfied to make \$15 or \$20 per week more than you are now. Most R. T. I. men will make that much increase after a few weeks. There is no reason to stop short of the Big Money Jobs or the Big Profits in a spare time or full time business of your own. No capital needed. Get started with R. T. I. now. Make money while you learn at home.

R. T. I. Book Now

FREE

The thrilling story of Radio, Television and Talking Pictures is told with hundreds of pictures and facts — its hundreds of big money jobs and spare time money-making opportunities everywhere.

Send for your copy now. USE THE COUPON.



LET F. H. SCHNELL AND R. T. I. ADVISORY BOARD HELP YOU!

Mr. Schnell, Chief of the R. T. I. Staff, is one of the ablest and best known radio men in America. He has twenty years of Radio experience. First to establish two-way amateur communication with Europe.

Former traffic manager of American Radio Relay League. Lieutenant Commander of the U. S. N. R. Inventor and designer of Radio apparatus. Consultant Engineer to large Radio manufacturers.

Assisting him is the R. T. I. Advisory Board composed of men prominent in the Radio industry.

\$60-\$70-\$80. PER WEEK AND UP. That's what R. T. I. training leads to. Send for the R. T. I. Book and see for yourself.

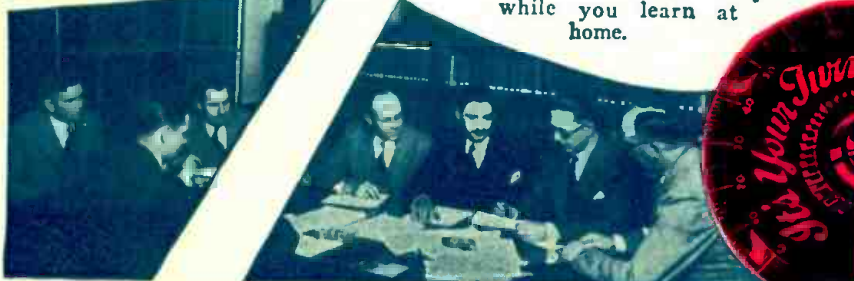

THE R. T. I. ADVISORY BOARD. These men are executives with important concerns in the radio industry — manufacturing, sales, service, broadcasting, engineering, etc., etc. They supervise R. T. I. Work Sheets, Job Tickets, and other training methods.

R. T. I. R. T. I. TRAINS YOU AT HOME FOR A GOOD JOB OR A PROFITABLE PART TIME OR FULL TIME BUSINESS OF YOUR OWN



RADIO & TELEVISION INSTITUTE
Dept. 766 4806 St. Anthony Ct., Chicago

RADIO & TELEVISION INSTITUTE
Dept. 766 4806 St. Anthony Court, Chicago

Send me Free and prepaid your BIG BOOK "Tune In On Big Pay" and full details of your three-in-one Home Training (without obligating me in any way).

Name.....
Address.....
City..... State.....

5,000



Radio Service Men Needed Now!

The replacing of the old battery operated receivers with all-electric Radios has created a tremendous country-wide demand for expert Radio Service Men. Thousands of trained men are needed quick!

30 Days of R.T.A. Home Training
... enables you to cash in on this latest opportunity in Radio

\$40 to \$100
a week
Full Time
\$3.00 *an hour*
Spare Time

Ever on the alert for new ways of helping our members make more money out of Radio, the Radio Training Association of America now offers ambitious men an intensified training course in Radio Service Work. By taking this training you can qualify for Radio Service Work in 30 days, earn \$3.00 an hour and up, spare time; prepare yourself for full-time work paying \$40 to \$100 a week.

hour spare time or \$40 to \$100 a week full time, this R. T. A. training offers you the opportunity of a lifetime.

More Positions Open Than There Are Trained Men to Fill Them

If you were qualified for Radio Service Work today, we could place you. We can't begin to fill the requests that pour in from great Radio organizations and dealers. Members wanting full-time positions are being placed as soon as they qualify. 5,000 more men are needed *quick!* If you want to get into Radio, earn \$3.00 an

We furnish you with all the equipment you need to become a Radio Service Man!

Radio Service Work a Quick Route to the Big-Pay Radio Positions

Radio Service Work gives you the basic experience you need to qualify for the big \$8,000, \$10,000 to \$25,000 a year Radio positions. Once you get this experience, the whole range of rich opportunities in Radio lies open before you. Training in the Association, starting as a Radio Service Man, is one of the quickest, most profitable ways of qualifying for rapid advancement.

If you want to get out of small-pay, monotonous work and cash in on Radio quick, investigate this R. T. A. training and the rich money-making opportunities it opens up. No special education or electrical experience necessary. The will to succeed is all you need.

Mail Coupon for No-Cost Training Offer

Cash in on Radio's latest opportunity! Enroll in the Association. For a limited time we will give to the ambitious man a No-Cost Membership which need not . . . should not. . . cost you a cent. But you must act quickly. Filling out coupon can enable you to cash in on Radio within 30 days, lift you out of the small-pay, no-opportunity rut, into a field where phenomenal earnings await the ambitious. You owe it to yourself to investigate. Fill out coupon NOW for details of No-Cost Membership.

The Radio Training Association of America
 4513 Ravenswood Ave. Dept. RCA-9, Chicago, Ill.

THE RADIO TRAINING ASSOCIATION OF AMERICA
 4513 Ravenswood Ave., Dept. RCA-9 Chicago, Ill.
 Gentlemen: Please send me details of your No-Cost training offer by which I can qualify for Radio Service Work within 30 days. This does not obligate me in any way.

Name.....
 Address.....
 City..... State.....

H. GERNSBACK, President
 S. GERNSBACK, Treasurer
 J. M. HERZBERG, Vice-President
 I. S. MANHEIMER, Secretary

R. D. WASHBURN, Technical Editor



HUGO GERNSBACK, Editor-in-Chief

JOHN F. RIDER, Editor Service Dept.

C. P. MASON, Associate Editor

VOLUME II
 NUMBER 3

Contents of This Issue

SEPTEMBER
 1930

	PAGE		PAGE
EDITORIAL:			
The Superheterodyne Cycle	By Hugo Gernsback 135	Men Who Have Made Radio (XII) — E. F. W. Alexanderson	151
SERVICE MEN'S DEPARTMENT:			
Leaves from Service Men's Notebooks	By RADIO-CRAFT Readers 136	New Radio Devices for Shop and Home.....	152
A Complete Tester for the Service Man.....	By Bert Deal 139	SHORT-WAVE CRAFT:	
Construction of Oscillators for Servicing	By A. Binneweg, Jr. 140	List of Short-Wave Broadcast Stations of the World....	153
Installing a Standard Receiver in a Car	By Ralph Manley 141	Short Waves on Your Broadcast Receiver Dial	By Watson Brown 154
Operating Notes for Service Men.....	By Bertram M. Freed 142	RADIO CONSTRUCTION AND DESIGN:	
Salvage Values in Old Radio Sets.....	By Clyde A. Randon 143	Constructing the Loftin-White Amplifier	By Morton W. Sterns 156
RADIO SERVICE DATA SHEETS:			
The Colonial "Model 31" and "Model 32" D.C.....	144	An Improved Neutralizing Circuit	By Sydney P. O'Rourke 157
The Fada "265A" and "475A".....	145	The Ultimate in Selectivity.....	By C. Sterling Gleason 158
All About Electrolytic Condensers.....	By Sylvan Harris 146	The Oscillating Crystal	159
AUTOMOTIVE RADIO:			
The Utility of Automotive Radio.....	By Morris Metcalf 149	Power-Supply Tubes for Radio Receivers	By C. Walter Palmer 160
An Extremely Compact Five-Tube Automotive Receiver	149	How "Static's" Picture is Being Taken	163
NEW DEVELOPMENTS IN RADIO:			
The "Thyratron"—An Addition to the Vacuum-Tube Family.....	By Joseph Riley 150	RADIO-CRAFT's Information Bureau	164
		Simple Mathematics for the Service Man	By Boris S. Naimark 168
		Schedule of Standard-Frequency Transmissions.....	184
		Correspondents Wanted	185
		RADIO-CRAFT's Opportunity Column.....	186

In Forthcoming Issues

THE "BETTER BOOSTER," by E. F. Henning. This device, incorporating a stage of tuned screen-grid amplification ahead of a standard receiver, will increase both its selectivity and its range. It is therefore something which many a set owner who wants better distance reception will hail with joy. Its construction from the data furnished will be an easy matter for the Service Man or constructor.

A REMOTE-CONTROL SYSTEM, by Joseph Attardo. The demand for more convenient and precise tuning methods is manifesting itself in the modern high-class receivers. The device described here was built to tune in automatically any

of 36 stations, selected by the pressure of a button. The principle and the method of its application will interest the experimenter and the radio man with clients for "built-in radio."

THE "STENODE RADIOSTAT," by Clyde J. Fitch. This English invention is hailed by all authorities as revolutionary in its implications; since it almost eliminates the necessity for a "channel" which has hampered the growth of broadcasting. How complete reception is obtained apparently without the need of sidebands will be explained here.

And many other articles on radio practice and theory.

RADIO-CRAFT is published monthly, on the fifth of the month preceding that of date; its subscription price is \$2.50 per year. (In Canada and foreign countries, \$3.00 a year to cover additional postage.) Entered at the postoffice at Mt. Morris, Ill., as second-class matter under the act of March 3, 1879. Trademarks and copyrights by permission of Gernsback Publications, Inc., 98 Park Place, New York City.

Text and illustrations of this magazine are copyright and must not be reproduced without permission of the copyright owners. We are also agents for WONDER STORIES, AMAZING DETECTIVE TALES and WONDER STORIES QUARTERLY. Subscriptions to these magazines may be taken in combination with RADIO-CRAFT at reduced Club rates. Write for information.

Copyright 1930, GERNSBACK PUBLICATIONS, INC.

Published by
TECHNI-CRAFT PUBLISHING CORPORATION

Publication Office: 404 No. Wesley Ave., Mount Morris, Illinois

Editorial and Advertising Offices
 96-98 Park Place, New York City

Western Advertising Office
 737 North Michigan Avenue, Chicago, Ill.

L. F. McCLURE, Western Advertising Representative

London Agent: Hachette & Co.,
 16-17 King William St., Charing Cross, W.C. 2

Paris Agent: Hachette & Co.,
 111 Rue Reaumur

Australian Agent: McGill's Agency,
 179 Elizabeth St., Melbourne

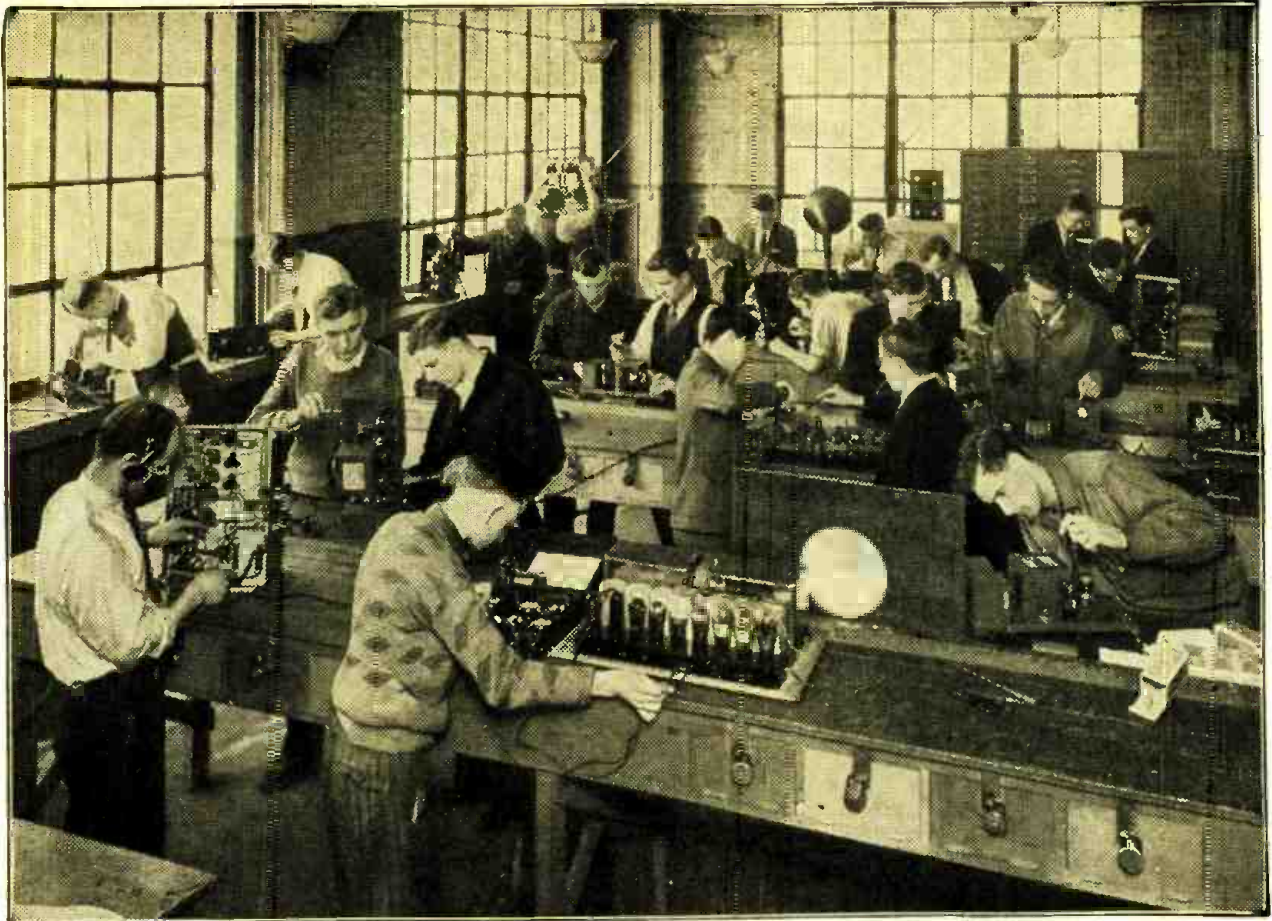

YOU Radio Men!

STATISTICS in the radio industry show that at the present time the ordinary radio man, either as a repair man or Service Man, makes an average of \$35.00 a week. Let us show you how you can quickly qualify for jobs leading to salaries of \$60.00, \$70.00, or \$100.00 a week and up—NOT by books or correspondence, but by an entirely new way.

We Teach You How—No Books—No Lessons—No Classes!

Coyne is not a correspondence school. We actually show you, by expert instructors, every phase of radio; which it is impossible to learn from books or from correspondence courses.

The majority of Radio Service Men and Radio Experts today do not earn what they should, because they have never been properly grounded in the fundamentals of radio—that is to say, in electricity.

Remember, you will never qualify as an expert radio man unless you know the fundamentals of electricity. All of this is taught by ACTUAL WORK on real equipment in our school.

From \$20.00 a Week to \$100.00 a Week

"Before going to Coyne, I had worked in a garage for five years at \$20.00 a week. I had no advanced education and didn't know a volt from an ampere. Yet I graduated in three months with a grade of 98%. Since I left Coyne, I have jumped from \$20.00 to \$100.00 a week, and am still going strong. I owe all my success to the practical training I got in the Coyne Shops."—Harry A. Ward, Iowa.

COYNE ELECTRICAL SCHOOL, H. C. Lewis, Pres. 500 S. Paulina St. Founded 1899 Dept. 60-85, Chicago, Ill.

Most self-taught radio Service Men fall utterly because their electrical education has been neglected; and, incidentally, they lose a good income because statistics show that radio alone cannot support the independent radio man all year around.

In the Spring and Summer time, particularly, radio is notoriously dull; and the radio man who is an electrical expert will make more money in the end.

Radio Training

The photograph above shows how men are actually trained in our big radio shop, where students are shown by experts how to take apart and put together the various modern radio sets. We will show you how to get at the root of servicing troubles; and within 90 days you can be a radio expert.

Most radio men today flounder around because they do not know the peculiarities of many sets, and have to puzzle these out, tediously, for themselves; whereas our instructors, with years of experience behind them, can show you how to locate any set troubles.

No Previous Training Necessary!

Remember, I do not teach you out of books. You are actually doing the work yourself, and get all the experience you need right here at Coyne.

I do not care whether you cannot tell a vacuum tube from a C-battery; whether you are sixteen years old or forty-five. It is my job to prepare YOU for a big-pay radio and electrical job in 90 days' time.

The Future of Radio

At the present time, there is a dire need for REAL and experienced Service Men, who

also know the ins-and-outs of electricity. Even though you may work on a good salary job for an employer at first, sooner or later you will wish to establish yourself in your community and start in business for yourself. The combination of radio and electricity cannot be beat; it is an all-year-round business.

Even if you do not want to go in business, there are more jobs today than good men to fill them. Coyne training settles the job question for life. Only recently one concern called on me for 150 graduates, and calls for more men are coming in daily. Coyne maintains an expert Employment Department, which will help you and back you as long as you live, WITHOUT ONE CENT OF COST TO YOU.

Special Offer!

In connection with the radio training, you are also given electrical training in all its branches—auto ignition and aviation electricity—WITHOUT ONE CENT EXTRA COST!

Get My Free Book

Mail the coupon today, and let me send you the big Coyne book of 150 photographs—facts—jobs—salaries. It costs nothing, and does not obligate you in any way. Just mail the coupon.

MAIL THIS COUPON—NOW!

Mr. H. C. LEWIS, President
COYNE ELECTRICAL SCHOOL, Dept. 60-85
500 S. Paulina St., Chicago, Ill.

Dear Mr. Lewis:
Without obligation send me your big free catalog and all details of Railroad Fare to Chicago, Free Employment Service, Radio, Aviation Electricity, and Automotive Courses, and how I can "earn while learning."

Name

Address

City..... State.....

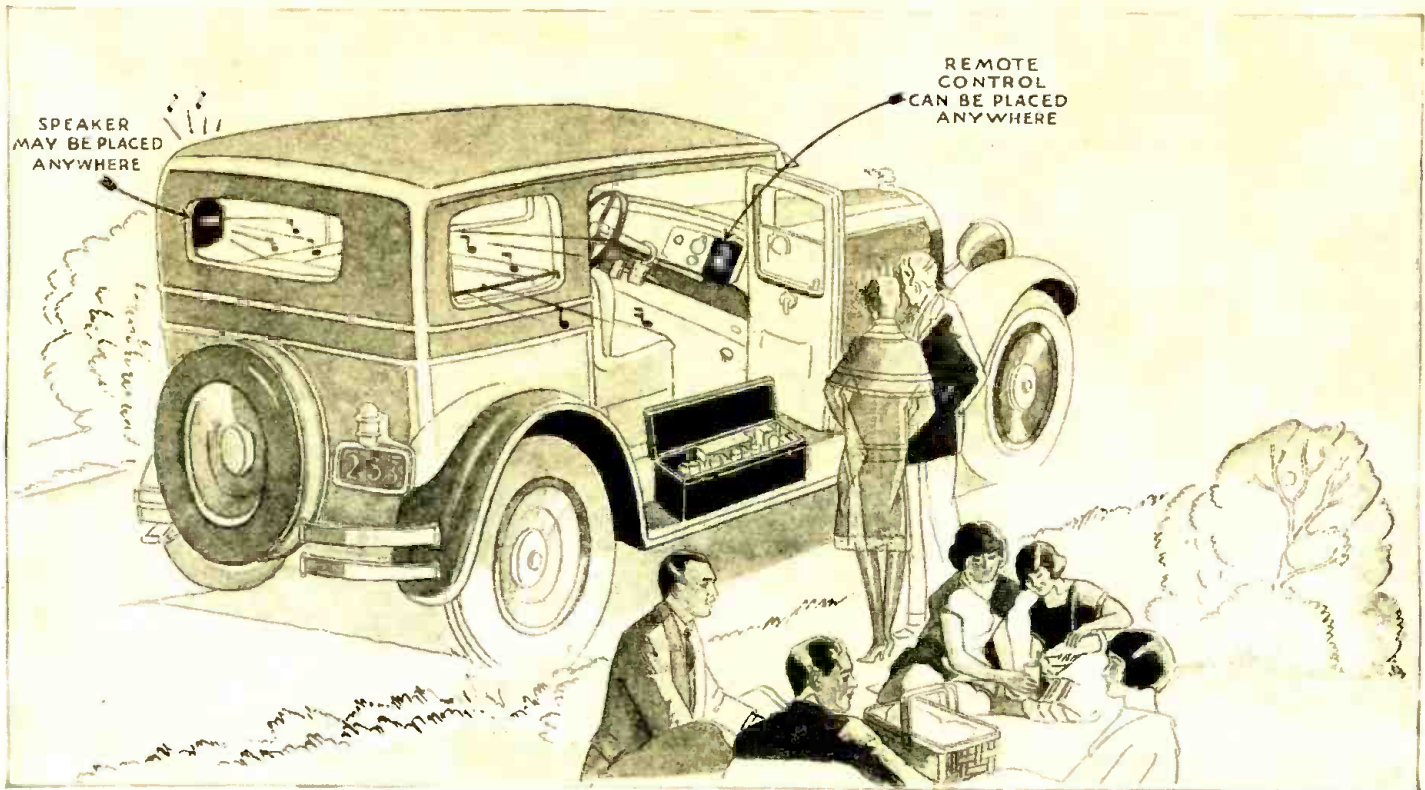

The "AUTO PILOT" goes on your running board and does not lessen the car's trade-in value when taken off to go on your next car

"Auto Pilot" Full Screen Grid Radio

LICENSED UNDER R.C.A. PATENTS

Increases Your Automobile Pleasure

Nobody will have a more up-to-date automobile than yours when you have assembled this powerful "AUTO PILOT" Screen Grid broadcast receiver kit, placed it on your running board in its attractive black japanned case and connected its remote control dial and speaker. Even the specially designed PILOT "undercar" aerial attaches between the axles without necessity for harming your car's exterior or interior.

This new and advanced "AUTO PILOT" not only has every up-to-date feature of radio to assure you distance, selectivity, tone quality and volume—but the welfare and future trade-in value of your car has also been a chief consideration of design. The New "AUTO PILOT" requires no mutilation of floor, instrument board or upholstery to make a solid installation—convenient to operate, taking up no foot or seat room.

You Can Install the "Auto Pilot" in Your Car in An Evening.

Four-224 A.C. Screen Grid Pilotrons comprising three stages of radio frequency and detector give the "Auto Pilot" tremendous pick-up and distance range. A. C. Pilotrons are operated from the car's battery instead of battery type tubes because they are rugged and non-microphonic.



Auto Pilot Kit 47⁵⁰
Complete with aerial lens
Pilotrons and Speaker

Thick sponge rubber mountings take up road shocks. The audio amplifier system gives enough volume for outdoor dancing, with tone quality of the highest order. Filament current drain from car's storage battery is only 4 amperes. Plate current is 20 milliamperes from three 45-volt "B" batteries.

Inquire of your local Pilot Radio Dealer or write direct to

PILOT RADIO & TUBE CORP.

323 BERRY ST., BROOKLYN, NEW YORK

Chicago Office: 234 South Wells St.

San Francisco Office: 1278 Mission St.

FACTORIES AT LAWRENCE, MASS.



PILOTRON RADIO TUBES

Endorsed by Professionals

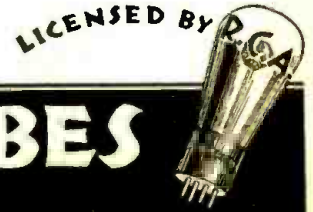

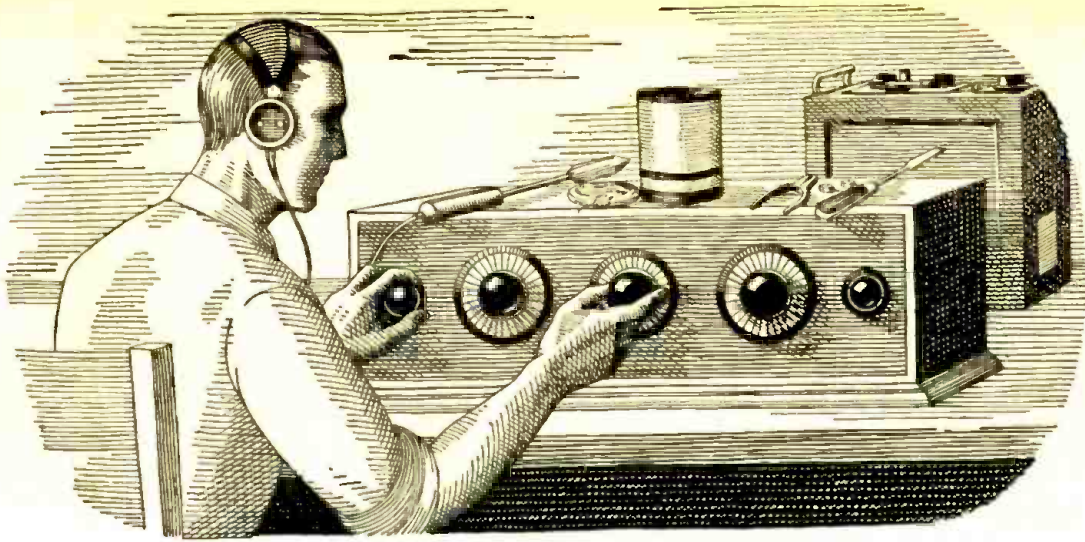

If all the Radio sets I've "fooled" with in my time were piled on top of each other, they'd reach about halfway to Mars. The trouble with me was that I thought I knew so much about Radio that I really didn't know the first thing. I thought Radio was a plaything—that was all I could see in it for me.

I Thought Radio Was a Plaything

But Now My Eyes Are Opened, And I'm Making Over \$100 a Week!

FIFTY DOLLARS A WEEK! Man alive, just one year ago a salary that big would have been the height of my ambition.

Twelve months ago I was scrimping along on starvation wages, just barely making both ends meet. It was the same old story—a little job, a salary just as small as the job—while I myself had been dragging along in the rut so long I couldn't see over the sides.

If you'd told me a year ago that in twelve months' time I would be making \$100 and more every week in the Radio business—whew! I know I'd have thought you were crazy. But that's the sort of money I'm pulling down right now—and in the future I expect even more. Why only today—

But I'm getting ahead of my story. I was hard up a year ago because I was kidding myself, that's all—not because I had to be. I could have been holding then the same sort of job I'm holding now, if I'd only been wise to myself. If you've fooled around with Radio, but never thought of it as a serious business, maybe you're in just the same boat I was. If so, you'll want to read how my eyes were opened for me.

WHEN broadcasting first became the rage, several years ago, I first began my dabbling with the new art of Radio. I was "nuts" about the subject, like many thousands of other fellows all over the country. And no wonder! There's a fascination—something that grabs hold of a fellow—about twirling a little knob and suddenly listening to a voice speaking a thousand miles away! Twirling it a little more and listening to the mysterious dots and dashes of steamers far at sea. Even today I get a thrill from this strange force. In those days, many times I stayed up almost the whole night trying for DX. Many times I missed supper because I couldn't be dragged away from the latest circuit I was trying out.

I never seemed to get very far with it, though. I used to read the Radio magazines and occasionally a Radio book, but I never understood the subject very clearly, and lots of things I didn't see through at all.

So, up to a year ago, I was just a dabbler—I thought Radio was a plaything. I never realized what an enormous, fast-growing industry Radio had come to be—employing thousands and thousands of trained men. I usually stayed home in the evenings after

work, because I didn't make enough money to go out very much. And generally during the evening I'd tinker a little with Radio—a set of my own or some friend's. I even made a little spare change this way, which helped a lot, but I didn't know enough to go very far with such work.

And as for the idea that a splendid Radio job might be mine, if I made a little effort to prepare for it—such an idea never entered my mind. When a friend suggested it to me one year ago, I laughed at him.

"You're kidding me," I said.

"I'm not," he replied. "Take a look at this ad."

HE pointed to a page ad in a magazine, an advertisement I'd seen many times but just passed up without thinking, never dreaming it applied to me. This time I read the ad carefully. It told of many big opportunities for trained men to succeed in the great new Radio field. With the advertisement was a coupon offering a big free book full of information. I sent the coupon in, and in a few days received a handsome 64-page book, printed in two colors, telling all about the opportunities in the Radio field, and how a man can prepare quickly and easily at home to take advantage of these opportunities. Well, it was a revelation to me. I read the book carefully, and when I finished it I made my decision.

What's happened in the twelve months since that day, as I've already told you, seems almost like a dream to me now. For ten of those twelve months, I've had a Radio business of my own. At first, of course, I started it as a little proposition on the side, under the guidance of the National Radio Institute, the outfit that gave me my Radio training. It wasn't long before I was getting so much to do in the Radio line that I quit my measly little clerical job, and devoted my full time to my Radio business.

SINCE that time I've gone right on up, always under the watchful guidance of my friends at the National Radio Institute. They would have given me just as much help, too, if I had wanted to follow some other line of Radio besides building my own retail business—such as broadcasting, manufacturing, experimenting, sea operating, or any one of the score of lines they prepare you for. And to think that until that

day I sent for their eye-opening book, I'd been wailing "I never had a chance!"

NOW I'm making, as I told you before, over \$100 a week. And I know the future holds even more, for Radio is one of the most progressive, fastest-growing, businesses in the world today. And it's work that I like—work a man can get interested in.

Here's a real tip. You may not be as bad off as I was. But think it over—are you satisfied? Are you making enough money, at work that you like? Would you sign a contract to stay where you are now for the next ten years—making the same money? If not, you'd better be doing something about it instead of drifting.

This new Radio game is a live-wire field of golden rewards. The work, in any of the 20 different lines of Radio, is fascinating, absorbing, well paid. The National Radio Institute—oldest and largest Radio home-study school in the world—will train you inexpensively in your own home to know Radio from A to Z and to increase your earnings in the Radio field.

TAKE another tip—No matter what your plans are, no matter how much or how little you know about Radio—clip the coupon below and look their free book over. It is filled with interesting facts, figures, and photos, and the information it will give you is worth a few minutes of anybody's time. You will place yourself under no obligation—the book is free, and is gladly sent to anyone who wants to know about Radio. Just address J. E. Smith, President National Radio Institute, Dept. OKY, Washington, D. C.

**J. E. SMITH, President
National Radio Institute
Dept. OKY, Washington, D. C.**

Dear Mr. Smith:

Please send me your 64-page free book, printed in two colors, giving all information about the opportunities in Radio and how I can learn quickly and easily at home to take advantage of them. I understand this request places me under no obligation, and that no salesman will call on me.

Name.....

Address.....

Town..... State.....

Occupation.....

Announcement!



NATIONAL RADIO SERVICE MEN'S ASSOCIATION

BOARD OF DIRECTORS

L. M. Cockaday

David Grimes

John F. Rider

Hugo Gernsback

Sidney Gernsback

I. S. Manheimer



EVER since the appearance of the commercial radio broadcast receiver as a household necessity, the Radio Service Man has been an essential factor in the radio trade; and, as the complexity of electrical and mechanical design in receivers increases, an ever-higher standard of qualifications in the Service Man becomes necessary.

The necessity, also, of a strong association of the technically-qualified radio Service Men of the country is forcing itself upon all who are familiar with radio trade problems; and their repeated urgings that such an association must be formed has led us to undertake the work of its organization.

This is the fundamental purpose of the NATIONAL RADIO SERVICE MEN'S ASSOCIATION, which is not a money-making institution, or organized for private profit; to unite, as a group with strong common interests, all well-qualified Radio Service Men; to make it readily possible for them to obtain the technical information required by them in keeping up with the demands of their profession; and, above all, to give them a recognized standing in that profession, and acknowledged as such by radio manufacturers, distributors and dealers.

To give Service Men such a standing, it is obviously necessary that they must prove themselves entitled to it; any Service Man who can pass the examination necessary to demonstrate his qualifications will be elected as a member and a card will be issued to him under the seal of this Association, which will attest his ability and prove his identity.

The terms of the examination are being drawn up in co-operation with a group of the best-known radio manufacturers, as well as the foremost radio educational institutions.

The following firms are co-operating with us:

- GRIGSBY-GRUNOW CO (Majestic), CHICAGO
- STROMBERG-CARLSON TELEPHONE MFG. CO., ROCHESTER, N. Y.
- CROSLEY RADIO CORP., CINCINNATI, OHIO
- COLIN B. KENNEDY CORP., SOUTH BEND, IND.

The schools who have consented to act as an examination board are:

- International Correspondence Schools, Scranton, Penna.; Mr. D. E. Carpenter, Dean.
- RCA Institutes, Inc., New York, N. Y.; Mr. R. L. Duncan, President.
- Radio & Television Institute, Inc., Chicago, Ill.; Mr. F. G. Wellman, Managing Director.
- Radio Training Association of America, Chicago, Ill.; Mr. A. G. Mohaupt, President.
- School of Engineering of Milwaukee, Milwaukee, Wisc.; Mr. W. Werwath, President.
- Rider-Goll Radio School, New York, N. Y.; Mr. John F. Rider, Director.
- Radio College of Canada, Toronto, Canada; Mr. J. C. Wilson, President.

Radio Division, Coyne Electrical School, Chicago, Ill.; Mr. H. C. Lewis, President.

We shall not attempt to grade the members into different classes. A candidate will be adjudged as either passing or not passing. If the school examining the papers passes the prospective member as satisfactory, we shall issue to him an identification card with his photograph.

If the candidate does not pass this examination the first time, he may apply for another examination three or six months later.

There is absolutely no cost attached to any service rendered by the Association to its members, no dues, no contributions.

If you wish to become a member, just fill out the coupon below and mail it to us. We will send you all the papers necessary to become a member.

N. R. S. M. A.,
c/o RADIO CRAFT,
98 Park Place,
New York, N. Y.

I wish to become a member of your Association. Please mail me the examination papers and application blanks.

Name

Address

Town..... State



"Takes the Resistance Out of Radio"

Editorial Offices, 96-98 Park Place, New York, N. Y.

The Superheterodyne Cycle

By Hugo Gernsback

RADIO, as I have said often before, is known to go through certain evolutionary cycles. It has done so from the start, and it can be expected to go on indefinitely in this manner. The radio industry has always been progressive enough to take hold of that instrumentality which it thought would give the best results. It was so, beginning with the coherer-spark-gap cycle; it was so during the crystal-detector cycle, the regenerative "blooper" cycle and, of late, in the so-called tuned-radio-frequency cycle.

Practically all sets in use today use some sort of tuned-radio-frequency circuit, or a modification of the principle. Regeneration has been severely left alone; because in the modern set, the old shrieking and whistling has been completely tabooed by radio engineers and the quiet set is the order of the day. During the last few years, few changes in the average radio set have been noted and, while we have changed our tubes from the old-fashioned "triodes" to "screen-grids," the circuits still remain fundamentally the same.

The superheterodyne cycle, into which we are now about to be launched, promises to change radio conditions enormously. It is true that the superheterodyne has been known for many years, and has been valued as one of the best and most sensitive circuits known. It has been, however, because of basic patents, the sole property of the Radio Corporation. This company steadfastly refused to license anyone else to use the superheterodyne patents until, very recently, the announcement was made that the R.C.A. will now license a number of companies to build superheterodynes for themselves.

This announcement is an important one and, in a way, it has created a sensation in the radio industry; particularly as the announcement of the decision was made so late in the season that it probably will affect few of the models that will come out during the remainder of 1930.

During 1931, however, the situation will be vastly different. There is not the slightest doubt in our minds, that practically every radio set manufacturer will immediately turn to superheterodynes, for a number of reasons. In the first place, there is no question but that the superheterodyne circuit is the best and most efficient circuit known to the radio art today. If one or two radio set manufacturers start to bring out superheterodynes, the rest of the industry must of necessity follow, or be left behind.

Of course, we will have many new variations of the superheterodyne and we may confidently expect that, if the entire radio industry is to stand behind the circuit, it will be greatly improved as time goes on. We will have screen-grid super-

heterodynes; we will have pentode superheterodynes; we will have all sorts of combinations of the circuit or adaptations of it; and there is little doubt that even the still more mysterious super-regenerative circuit will also, in the near future, be heard from.

In the past, there was one slight disadvantage in using a superheterodyne set, and that was the necessity of using two tuning controls. The modern radio set buyer demands a single tuning control; and the R.C.A. has finally produced one good model in which a single tuning control is used. There is no question in our minds that the standard commercial superheterodyne set, which will be put out by the radio industry during the coming year, is to be of the single-control variety.

Of course, one of the various advantages of the superheterodyne is that it requires no aerial. Under modern conditions, with a broadcasting system of the power we have today, much better reception can be obtained by means of a superheterodyne than with practically any other set. The reason is, that the superheterodyne tunes much sharper, and it is much easier to tune out an interfering station with a loop than with a set that uses an aerial.

The sales arguments, when recommending a superheterodyne to the prospective customer, are of course much stronger; because he need incur neither expense or worry about an aerial. Then there are still in this world some people who think of an aerial as a lightning danger; these people will naturally prefer a superheterodyne, which has no "aerial complex."

We, personally, welcome the idea that the superheterodyne is now to come into its own. We urge every reader of **RADIO-CRAFT** to brush-up on superheterodyne literature; and **RADIO-CRAFT**, during the coming months, will do its share by publishing every month superheterodyne data which in time will be most valuable, not only to the general reader, but to the Service Man, the radiotrician and the professional radio man as well.

It is certain that the superheterodyne will stimulate the radio trade to a marked extent during the next few years.

It will have a great and lasting effect on automotive radio; as the superheterodyne is certainly a most efficient set for use in a car.

The superheterodyne will also encourage the long-neglected radio experimenter; who will again be able, we hope, to buy low-priced kits for experimental purposes.

From whatever angle you look at the situation, the superheterodyne cycle looks distinctly hopeful for the radio industry during the next few years.

Leaves from Service Men's Note Books

The "Meat" of what our professionals have learned by their own practical experiences of many years

By RADIO-CRAFT READERS

TESTING BY EAR

By Michael Yanosko

THE visual method of testing is the most efficient; but the aural method has its compensations, and should be used. (By "visual," I mean the use of meters, and by "aural," that which depends on the Service Man's ear.) Somehow, when I listen-in

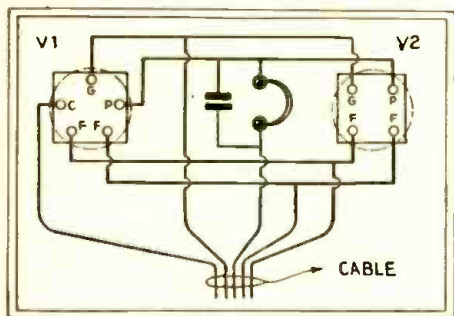

Fig. 1

The circuit of a device which enables the Service Man with a good ear to listen in on the circuits which he is testing and thus, frequently, save time.

on a set, I can more quickly find the cause of its ills. Perhaps I am "ear-minded." However, I am sure that the instrument described here will help others in solving their problems; and the method has not been described before, to my knowledge.

Its purpose is to cut into the detector plate circuit and tell at once whether the R. F. stages and detector are functioning correctly. If they are, the Service Man listens in on the audio stages, and can thus quickly locate the defect. The visual indicators then come into play. This method is extremely useful on public-address and talking-picture apparatus, where servicing time is at a premium.

The instrument consists of two tube sockets, a cable and plug, a phone by-pass condenser and a pair of phones. The cost is practically nil; the parts are: one UX socket, sub-panel type; one UY socket, ditto; a .001-mf. by-pass condenser; two tip jacks; a two-foot cable with UY plug and UX adapter; and a two-foot length of wire with two "peewee" clips. The assembly and the schematic circuit are shown.

It is very easy to work with this instrument. Remove the detector tube, insert the

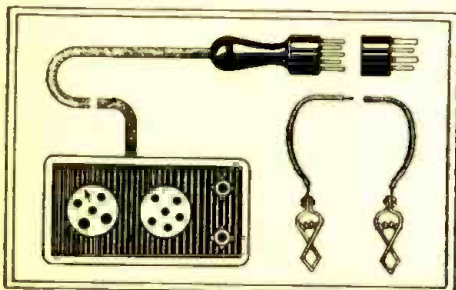

Fig. 2

The appearance of Mr. Yanosko's tester, which cuts a pair of phones into any tube's plate circuit.

cable plug, and place the tube in the proper socket of the tester. Then listen while you tune the set. With a screen-grid tube, the length of flexible wire is brought into play; one clip is attached to the control-grid cap of the tube, and the other to the tube clip in the set. Both screen-grid and space-charge detectors may be thus tested. The audio stages are tested in the same manner. The device is adapted to either A.C. or D.C. sets.

If the Service Man wishes, he may incorporate this method into his present tester, by opening the plate milliammeter lead and inserting two tip jacks shunted by a by-pass condenser. A switch should be connected across these to short them when the phones are not in use.

PHONOGRAPH PLUG CONNECTION

By Charles Marceu

THE method shown affords an inexpensive, as well as simple, way to connect a phonograph pick-up to any set using power detection. It does not introduce capacitative feed-back, or decrease the working efficiency of the set in any way.

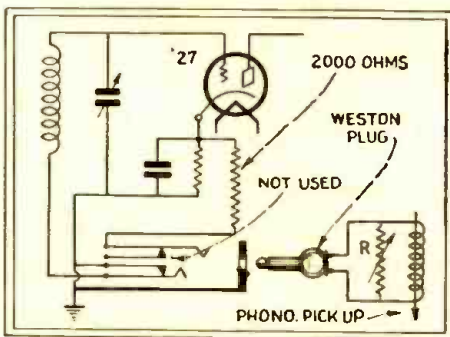

Fig. 3

Many modern sets are not provided with phonograph attachments. This method may be recommended for use with a high-impedance pickup.

VOLTAGE TESTS ON CONDENSERS

By Chas. L. Brown

ONE cause of scratching, popping, sputtering noise is a defective transformer in the first audio stage, even though a test may show that the transformer is neither grounded, open, nor shorted. Nevertheless, the substitution of a new transformer will cure the trouble.

Defective grid leaks and grid condensers are also a prolific source of extraneous noise. Usually, substitution is the only test that the Service Man can make.

Slightly-shortened by-pass condensers will cause noise (a completely -shorted condenser will run down the "B" batteries, on a battery set; and the set will give very poor reception or none at all). By-pass condensers may be tested with a battery and voltmeter in series; the battery used should give a voltage as high as that used in the set. The

needle of the voltmeter will kick slightly when contact is first made; but, if the condenser is good, no reading will be shown on a second contact.

All movable contacts, such as switches, volume controls, and battery connections should be clean; and they should be inspected to make sure of good contacts.

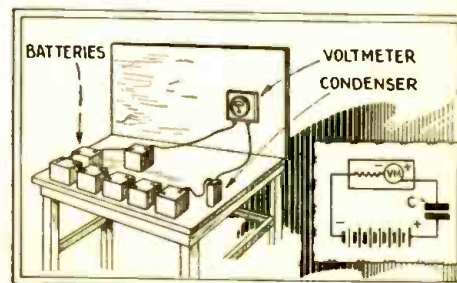

Fig. 4

Defects are found, by testing condensers under working voltages, which would perhaps otherwise escape notice.

VOICE COIL CEMENT

By C. F. McNulty

IN repairing dynamic speakers, I encountered the problem of fastening the voice coils to the cones. The solution of celluloid in acetone, used in self-supporting R.F. transformers, is inexpensive, and will be found especially satisfactory in securing the flanges, in Brandes and Kolster speakers.

SCREEN-GRID DETECTOR FOR AUTO RADIO

By Russell L. Woolley

THE value of the screen-grid tube as a detector is well-known to every Service Man; yet many constructors hesitate to take advantage of its high amplification for their pet auto receiver.

The accompanying diagram shows how the high plate impedance of the '24 screen-grid tube may be properly matched and, at the same time, the output fed directly into a push-pull output stage. No intermediate A.F. stage is required, and the output may work directly into an inductor dynamic speaker without any output transformer.

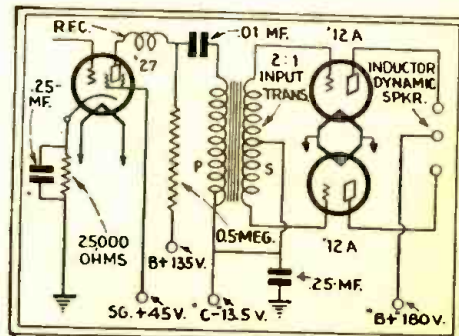

Fig. 5

Mr. Woolley's circuit for an automotive receiver gives the advantages of power detection, parallel-plate feed and push-pull operation.

LINE-POLARITY TROUBLES

By D. W. Pickett

LIKE Mr. Jones, who contributed a note on ground tests in the June issue of RADIO-CRAFT, I am accustomed to test the ground connection with an A.C. voltmeter between the house line and the ground. Because one side of the line is usually grounded, I should find a voltage reading between the other side of the line and the ground wire of the set, provided the lightning arrester is O.K. and the aerial not grounded.

In locating a bad hum for a local radio dealer, I obtained a reading of 35 volts on one side of the line, and 115 volts on the other. The house was served from a step-down lighting transformer, which delivers 110 volts from each end of the secondary, as measured from the "neutral wire" which leads to the center tap of the secondary. By the mistake of a lineman, one of the outer leads had been grounded at a house about a block away. During half the cycle, the set received 115 volts at the primary of its power transformer; but during the reversal the voltage was increased by 35, and the tube voltage correspondingly. After the error had been corrected, the hum ceased. If the ground had been less resistant, the voltage would have been still further increased. I therefore recommend checking up the line voltage frequently; since mistakes may happen.

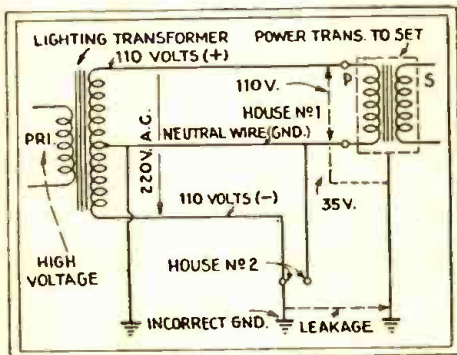

Fig. 6

One of the favorite questions in radio is "Where does the ground begin?" When there has been a mix-up in the power wires, such as Mr. Pickett found, the answer is in the negative.

VOICE-COIL LEADS

By A. Coblenz

AFTER an exhaustive series of tests on an Eveready "Series 50" had failed to show any fault, I turned to the only thing left—the speaker. Nine times out of ten, if a speaker plays at all, the fault is in the amplifier; however, I examined it under the distrustful glance of the customer, who had been assured by previous Service Men that it was O. K.

The field coil showed its normal resistance; but the voice coil, which should have been a few ohms at most, had an appreciable resistance. I dismantled the whole assembly, and found that the coil looked all right under a pocket microscope (laugh if you will) which I had brought along. I pulled at the leads from the coil to the terminal strip; they resisted the strain. There was nothing else to lay the blame on; I applied the soldering iron to one side—and the high resistance was gone! On reassembling, I found that I had to pull the leads from the

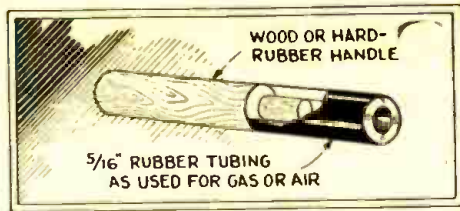

Fig. 7

This service kink is an ingenious one. While the rubber wrench is not recommended for heavy work, it will handle a small lamp bulb.

coil taut to put them on the strip. The mystery was solved. The wire had been taut and, as the coil moved back and forth, it was unable to swing freely; and the pull had gradually developed a high resistance at the joint, 300 ohms in fact.

When I hooked the speaker on again, the owner swore that the reproduction was better than it had ever been before. The lesson was a double one: first, the value of good joints; and secondly, the importance of plenty of slack in the leads.

A PANEL-LIGHT "WRENCH"

By Henry E. Sigles

ON some sets, such as certain Crosley and Majestic models, the dial light is so located that it is hard to make a replacement. To meet this difficulty, the wrench illustrated in Fig. 7 was designed.

The open end of the rubber tube is slipped over the end of the lamp bulb, and then the wrench is turned in the proper direction to remove or replace the tube.

AERIAL TESTING

By Edwin T. Phillips

DISCONNECT the aerial and ground from the set, and place the headphones in series between them; on making and breaking the circuit, you should hear a noise similar to that obtained when you "tickle" the catwhisker on a crystal set.

A quicker method is simply to put a shunt across the aerial and ground when the set is in operation. On making and breaking the circuit, a "keying" effect should be noticed. Either test will indicate a good antenna; and I venture to say that if every Service Man would make them, fewer sets would be taken back to the shop to look for trouble which is in the "location."

VOLTAGE TESTS ON '27s

By R. D. Wills

IN taking voltage measurements of a set employing type '27 tubes, it must be remembered that some older equipment takes the reading between plate and filament, even though a 4-to-5-prong adapter is used.

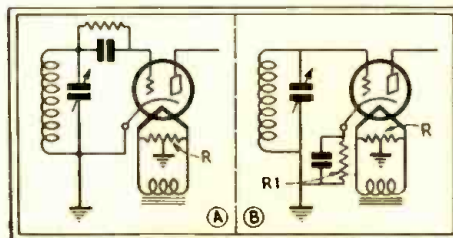

Fig. 8

While at A the filament and cathode are both at ground, there is considerable difference between them in a power detector (B). Then, too, late models are apt to have a positive bias instead of a ground tap at R.

Unless the equipment is arranged to show the condition of the cathode circuit, this circuit must be tested separately; since a correct plate-filament voltage is not enough to show how the tube is functioning. In tubes of this kind, the plate current must flow through the cathode return.

In most sets employing '27 type tubes, the volume control is inserted in the cathode circuit and, since moving parts are most subject to acquired defects, the volume control is always a good place to look for an open cathode circuit, as a short cut in trouble finding.

This article was inspired by knowledge of a case where half a day was spent by two Service Men looking for trouble with socket meters which did not show the open cathode.

DETECTOR TROUBLES

By J. N. Schwartz

THE commonest, most obnoxious and most elusive trouble in detector circuits is frequency distortion. It is also the most difficult to locate; since other portions of the receiver are more likely to be suspected and subjected to investigation. Frequency distortion creeps into the most efficient circuits, under the guise of all those highly-desirable features—"low loss," "high sensitivity," "sharp tuning," "wide tuning range," "good low-note reproduction," etc.—and the possibility of their contributing to distortion is seldom considered. For this

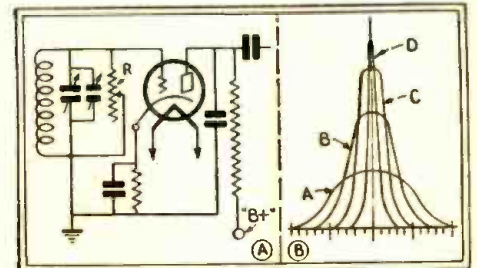

Fig. 9

Introducing R into the detector circuit prevents regeneration, but broadens tuning. However, in a super-selective set, cutting the tuning down from D to C may better quality.

reason, the radio- and audio-frequency sections receive more than their proper share of consideration in efforts to eliminate distortion.

Usually, every precaution is taken to insure good quality in the construction of receivers, whether of the commercial or the home-built types. The circuit, the components, and their placement, are given all due consideration. The result should be ideal reproduction; but this is rarely the case, as we can plainly hear in most commercial receivers. Using a regenerative detector, no distortion is evident on strong signals, so long as the detector and audio stages are kept below the point of overload; but as soon as weak signals are received, with the aid of regeneration, the tuning curve becomes so steep and narrow that serious distortion results from side-band cutting, and the accompanying attenuation of high frequencies. The more efficient the circuit, the worse this effect.

In modern T. R. F. receivers, with three stages ahead of the detector, the use of the grid condenser and leak is obviated, from the standpoint of available power. Using plate-bend detection, with its higher grid

bias, the tendency to regenerate, or oscillate, is at once increased. The resultant increase in the sharpness of tuning (not in itself undesirable, but here accompanied by other factors) results in frequency distortion of a serious nature. The signal frequency-band, already narrowed in the tuned stages, suffers. This effect will not be noticed, if the signal is kept below the point of overloading the tube; but, as before, it becomes evident on weak signals. One well-known set, one of the most expensive on the market (*the writer is a Canadian*), is such a serious offender that speech from stations moderately distant is almost unintelligible; yet many buyers select it because of its "absence of static and high-frequency noises."

Audio transformers of high primary inductance and impedance tend to aggravate this condition; since they respond very well to low notes, and the amplification curve falls off toward the high-frequency end. They have usually also a tendency to regenerate the detector slightly. For this reason, we often find a set using really high-grade transformers giving poorer reproduction than those with cheaper components.

The simplest and most effective cure for this condition, in a commercial set, is to shunt the detector tuning circuit with a resistor of such value as to stop the regenerative action. This will at the same time flatten and widen the tuning curve. The sensitivity will be somewhat reduced; but in most cases there is some to spare—at least that portion which is rendered useless by distortion. However, the manufacturer has a decidedly simple and effective means of getting around this in sets of the future; which will not only eliminate detector distortion, but at the same time increase sensitivity and volume without impairing selectivity.

FINDING HOME-MADE STATIC

By Duncan Salmund

MANY of the crashes and buzzes endured by owners of the latest receivers can be traced to electrical appliances and fixtures in the same home. A systematic method of tracing them begins by shutting off the power where it enters the house. Then remove the line fuses, one at a time, wipe them clear of all dust, and clean the sockets. Tighten up the screws that hold wires to the fuse blocks and switches. If the contacts are too black, a little sandpaper will brighten them. Be sure to screw the fuses in tight when replacing them.

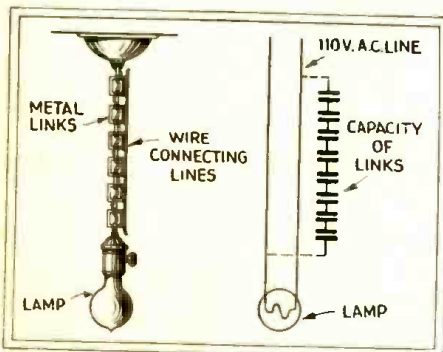

Fig. 10

The electric charge, accumulating on the metal of light fixtures, causes "static" noises; which are eliminated by the use of a jumper.

The next step is to start at one end of the house, and examine each electric socket to make sure that the connections are tight; don't be afraid to use sandpaper where it is necessary. The power may then be turned on.

Turn on your radio set with the volume at "full." Turn the selector away from any station until nothing can be heard but the usual noises.

Start with the first room, and turn on the light a number of times. Each time a click may be expected in the receiver. If the socket is of the chain-pull type, shake the chain vigorously, first with the light on and then off. If noise is obviously caused thus, the chain should be replaced by a non-metallic cord. If, on rapping the socket with the knuckles, noise is heard, it is probable that arcing has pitted the contacts; and the cheapest remedy is to replace the socket.

If a socket is suspended from the ceiling by a metal chain, a great deal of noise may be caused by the movement of the individual links as the chain swings. This may be cured by soldering a piece of fine flexible wire to each link from top to bottom, to prevent the accumulation of static charges.

If each socket in the house has been gone over, as described, the chances are that most interference will be eliminated. However, if noises continue, remember that your neighbor's fixtures may be as bad as ever, and that you as an individual have done a whole lot to help a good cause. Your electric-light company and radio dealer will probably be glad to help in tracing outside interference.

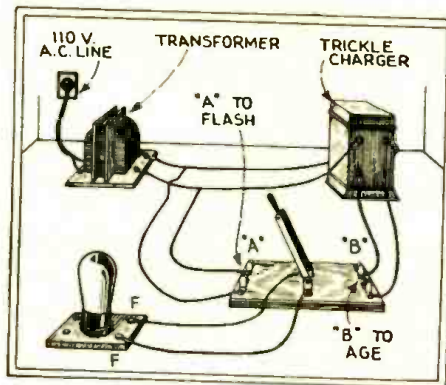

Fig. 11

A trickle charger and a D. P. D. T. switch may be quickly arranged as shown to assemble a tube reactivator. (The transformer need not be removed from the charger.)

REACTIVATION WITH A TRICKLE CHARGER

By F. E. Nolkemper

SOME D.C. tubes, such as the '99, '01A, '12A and '71A, can be brought back to activity by the simple method shown.

The switch is thrown to A for one minute, connecting the filament across the secondary terminals of the step-down transformer and "flashing" the tube; and then reversed to B, where the output of the rectifier is applied for ten minutes to permit the tube to "age." If emission is not then restored, the tube must be discarded.

SERVICE BUSINESS METHODS

By Albert A. Saddler

SINCE the publication of my letter in the May issue of RADIO-CRAFT, I have gone into business for myself. I have a store in

Date _____ N^o 597

Mr. _____

Address _____

Phone _____

Saddler Radio-Elect. Service
2300 6th S. W. Phone 22578
CANTON, OHIO
Service that pleases the Customer

Work promised _____

Tubes			
Aerial			
Set			
Speaker			
Labor			
Total			

Customer's
Claim N^o 597
Check

Saddler Radio Electric Service
2300 6th S.W. Canton, O. Phone 22578
Promised _____

The tag which Mr. Saddler attaches to each job, as a record and time sheet, is reproduced here.

a very good neighborhood and am doing nicely.

My two assistants are instructed to be courteous and neat. When we call on a customer, we do not give the impression that we are crazy to get the job done and collect. When making a service call, we arrive on time. The following questions are asked: what is the nature of the trouble? Is the set weak, noisy, does it cut out, or is it dead? After hearing the symptoms, we go to work. One man tests the tubes; while the other cleans the inside of the set with a brush, with long fine bristles, which I find very convenient for this purpose. This dust accumulates, and it is hard for the housewife to get out.

The set analyzer is then applied and the usual readings taken. We carry an A.C. oscillator with which to rebalance the set. If it is necessary to take it to the shop, we tag it properly with all the information required.

When work is completed, to the customer's approval, we come to the most important question—"How much do I owe you?" The only rule is, charge enough for your service, but do not overcharge. Your customer is your best advertisement.

FINANCING SERVICE EQUIPMENT

By P. F. Nugent

ALMOST every conceivable commodity can be procured on time payments, even articles costing but a trifle; why not radio instruments also on a partial-payment plan? Every Service Man worth his salt wants to be the owner of delicate precision measuring instruments and fine testers; but few of us are able to afford a hundred, or even fifty, dollars at one fell swoop. A Service Man

(Continued on page 175)

A Complete Tester for the Service Man

The apparatus shown here was designed for all-around service, to meet all the needs of radio work with modern receivers. The shunts and switches give it a high degree of efficiency when accurately used.

By BERT DEAL

THE tester described, and shown schematically in Fig. 2 was constructed, at a moderate cost, to replace one which had been found out of date and inadequate for the proper servicing of modern, complicated receivers. That

switches, permits reading all voltages and currents at the socket under operating conditions; it isolates the circuits so effectively that the same resistors are employed for all D.C. voltage measurements. These are read on four convenient ranges, and return to the

Control-grid and screen-grid voltages are read with the bipolar switch in position 4; grid bias with Sw2 in the normal position. As screen-grid voltage is positive, the reversing switch is used. Control-grid voltage, usually negative, can be read with the bipolar in position 3 and Sw2 in normal. If the meter tends to read backward, it appears that the tube is used as a space-charge amplifier, and the control-grid has a positive bias. Sw2 should then be reversed.

Cathode voltage is read with respect to the heater; Sw3 should be placed on the filament side for these readings. In an A.C. receiver, in which the cathode is grounded through the grid-bias resistor, and the heater also grounded, the cathode will read positive; in others, the heater is connected to some positive potential, and Sw2 is placed in reverse to read the cathode voltage. If the cathode is connected directly to the heater, no reading can be obtained.

Plate voltages are read in position 5 of the bipolar, with Sw3 on the filament side. In positions 6 and 7, the milliammeter is used to measure current. The unusual method of mounting the shunts on Sw4 and Sw5 permits its insertion in the grid and plate circuits, still retaining the continuity of these circuits from the previous voltage readings; thus obtaining all measurements under operating conditions.

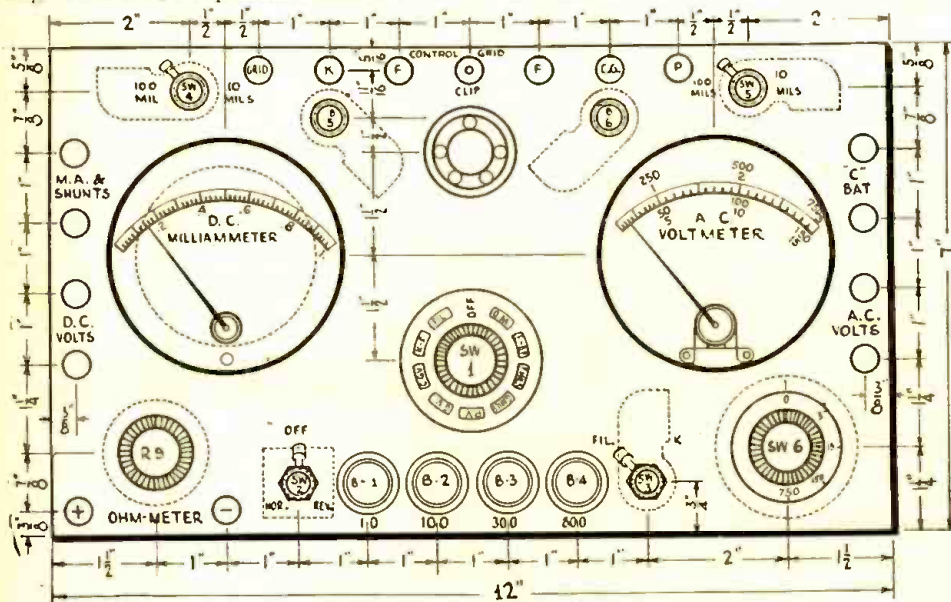

Fig. 1 The panel appearance of the very complete tester designed by Mr. Deal.

shown here is capable of making all the various voltage and current measurements at the socket terminals, measuring the filament emission of a full-wave-rectifier, testing continuity and condition of circuits, and testing all tubes, including the screen-grid type in use as either screen-grid or space-charge amplifier.

Two meters were available—an A. C. voltmeter and a 0-1-scale D.C. milliammeter. As the latter has an internal resistance of 27 ohms, a parallel resistance of 3 ohms was required to give a 10-ma. reading with the latter. Carter fixed filament resistors were used. Shorting about a quarter of the turns of an 0.4-ohm resistor (with solder) produced an 0.3-ohm shunt, to give a 100-mil. reading.

High resistors, guaranteed accurate within 1%, were obtained in values of 10,000, 100,000, 200,000 and 500,000 ohms. Using these in series with the milliammeter produced a high-resistance D.C. voltmeter, with ranges of 0-10, 0-100, 0-300 and 0-800 volts; sufficiently accurate for all practical purposes, with but 1-ma. current consumption for a full-scale reading.

An ohmmeter circuit was also provided; the "C" battery was isolated from the various circuits except through the push-button B5 and the bipolar switch. It is also available for use in the conventional grid-swing test, as used in several commercial analyzers.

The bipolar switch, with its auxiliary

S.P. D.T. switch Sw3, which determines the return to the negative filament or the cathode, as the tube under test requires.

In a D.C. receiver, where the filament voltage is read with Sw2 in reverse, the apparent grid voltage is the sum of filament and grid voltages, since the grid return is to the positive side of the filament.

Protection for the Meter

An element of safety is also introduced in this manner; with ordinary care, there need be no danger of overloading the instrument. However, if it is desired to use the 0-1-ma. scale in these positions, the wires

(Continued on page 179)

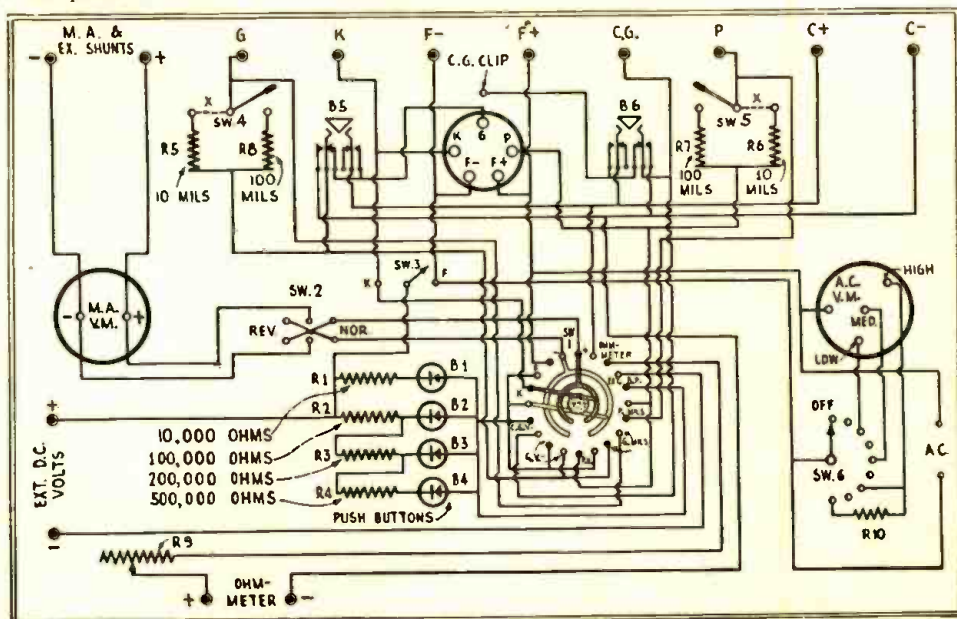

Fig. 2 The versatility of the meter at the left is obtained by the switches and resistors shown above.

Construction of Oscillators for Servicing

How old transmitting apparatus may be rearranged by the "ham," or the same principles utilized by the Service Man

By A. BINNEWEG, JR.

AMATEUR operators may come and go, but the oscillators they build are usually good enough to go on, with slight modifications, for servicing. Low-power tube transmitters can easily be revamped for servicing, thus saving time and usually considerable expense. Not only do most transmitters supply sufficient power for the ordinary run of tests, but they can be used for many purposes requiring more power. It is usually not difficult to locate one at a reasonable price.

Take, for example, the circuit of Fig. 1. It is not the last word in transmitting arrangements as used today, but it is easily modernized. It is provided with two clips, or tap switches, and some tapped turns at the end of the inductance for the counterpoise.

Rearrangement of Circuit

By a few simple changes, Fig. 2 results. Since most sets of this type were designed for 150-200 meters, or higher, it is possible in some cases to adapt them for operation in the broadcast spectrum with little change. Later sets require a different coil; others only a few extra turns in the inductance. The antenna and counterpoise leads are disconnected, and one tap switch is connected to the condenser C1 (for rough-frequency adjustment), the other being connected to the filament center-tap lead. This is a very convenient feature for adjusting the grid excitation and, to some extent, the output and wave-form. A plate blocking condenser (C3) must be added; this should be of proper rating to withstand the plate voltage used. Three additional binding posts are placed on the panel for current or voltage feed to the circuit under test, as indicated in Fig. 2.

A small R.F. choke, consisting of three or four hundred turns of fine wire on a cotton spool, connected in series with a 5000-ohm grid leak and a 0-25-scale D.C. milliammeter MA1, provides a sensitive resonance indicator. This meter can be mounted in the hole left by the antenna ammeter, which is removed. A plate milliammeter MA2 of lower reading is often necessary.

The outfit described was a telephone trans-

mitter, as may be seen from the diagrams. The modulator can be left as it was, usually; the set can then be used as a modulated oscillator. Various known frequencies can be employed for modulation, if desired; a buzzer can be used for some purposes. In a simple oscillator, a plate supply with a little ripple in it is usually sufficient for other purposes.

The above remarks apply to any of the usual amateur transmitters. The procedure described would also be followed by the amateur in adapting a transmitter for modern practice, as far as the circuit is concerned.

Simplified Circuits

The short-wave sets can often be revamped, with somewhat less difficulty, for servicing. Usually, it suffices to increase the values of the grid and plate-blocking condensers GC and C3, and the size of the inductance; although the choke may have to be changed. The later sets employ a large

requiring a minimum of apparatus and having facilities for all kinds of tests. A useful oscillator is shown in Fig. 3; this has all the advantages of ordinary equipment, with some additional advantages. The sensitive gridmeter is at ground potential; a shielded

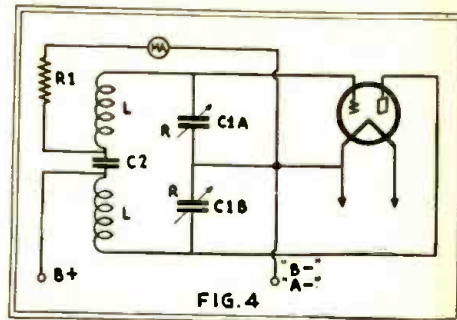

FIG. 4
This circuit, though it requires a special condenser unit, requires no grid condenser and avoids body-capacity effects. Its output is picked up just as in Fig. 3.

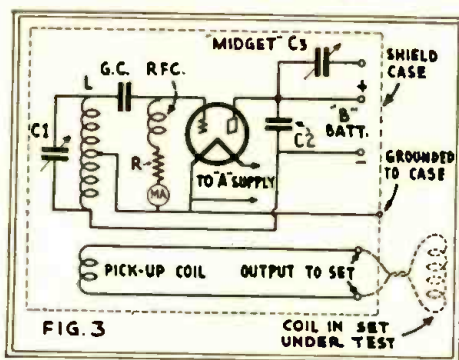

FIG. 3
This type of oscillator presents several advantages for the user. It must be shielded, as shown; the pick-up coil has external terminals for connection to a set.

value of capacity in the oscillating circuit, so it may not be necessary to replace the tuning condenser C1. A set designed for short-wave use works especially well at lower frequencies, if proper constants are employed.

Although much has been published on the general subject of oscillators, there is room for considerable improvement in outfits re-

case and a "B-" battery by-pass condenser C2 are also provided. It is also better to employ a small choke R.F.C. in series with the grid leak. Current or voltage feed is also provided. Circuit values are as usual for the broadcast band.

Every circuit has its own particular advantages. Fig. 4 requires no R. F. chokes; its gridmeter is at ground potential and no body effects will be noticed, since the condensers also are grounded. However, it requires a double-unit condenser C1A-C1B; which may be a disadvantage if one is not available. If plug-in coils L are to be used, four coil-connections are necessary. Both coils and both condensers are of the same values. Whether Fig. 3 or Fig. 4 is the more suitable depends upon the user and the parts available.

Since the meters are usually the most expensive parts, their number must be limited. Fig. 5 shows a convenient arrangement to provide versatility. A number of posts are provided on the panel, and shunts are used for the various tubes employed; each shunt R1, R2 has in series a push-pull switch Sw1, Sw2. When the meter is used externally for a vacuum-tube voltmeter, or in measuring

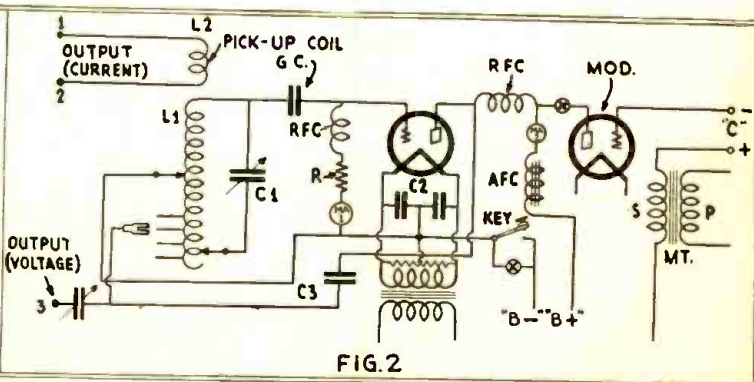
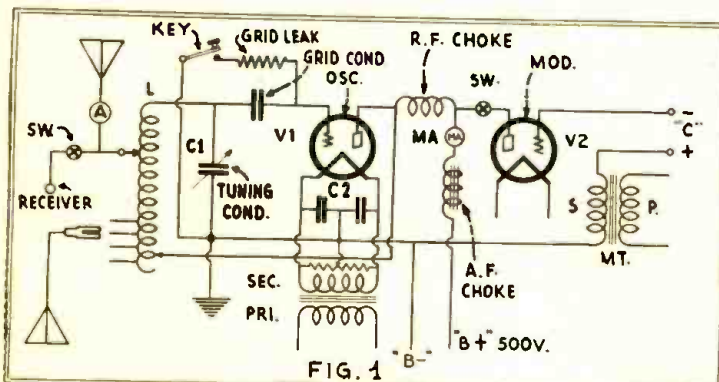

The circuit shown at the left introduces itself as a once-popular type of low-power transmitter, which will accommodate itself admirably to the purposes of the Service Man, who wants his own "broadcast station" for purposes of receiver testing and adjustment. As remodeled in Fig. 2, it will serve this purpose excellently.

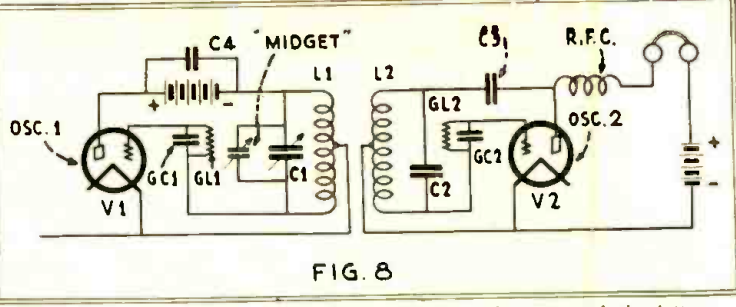
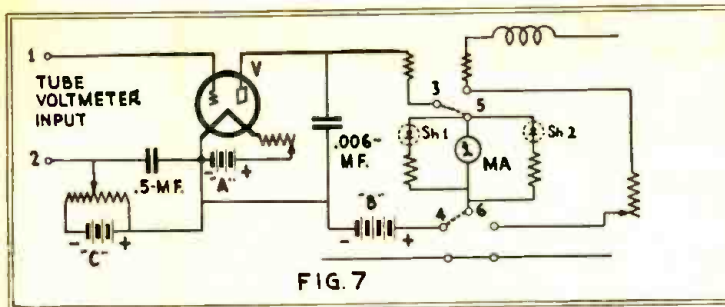

The vacuum-tube voltmeter shown at the left may readily be mounted in the same cabinet with the shop oscillator, and use the meter of the latter through the connection 3-5 and 4-6. At the right, the method of using two oscillators to provide an A.F. tone adjustable to any frequency.

plate currents, it has two ranges. This meter can be used externally, even though the oscillator is operating, by connecting to proper posts. By means of a variable resistor R3, it is possible, not only to provide an extra shunt, but to set the grid current at a definite value on the scale; which is convenient in some tests. The shunts R1, R2 consist of short lengths of resistance wire, adjusted to give 1/2, 1/3, etc. of full-scale deflection when this current value is passing through the combination. A complete diagram of connections decided upon should be glued to the case of the set.

By using in the oscillator two paralleled sockets, power outputs up to 15 watts may be obtained with the proper tubes and voltages. Ordinary condenser spacing will allow oscillator plate voltages of about 350 volts in ordinary arrangements; for "hi-C" amateur transmitters, 1000 volts is usually specified. For such a wide selection of outputs, the shunting arrangement of Fig. 5 is necessary. Since the filament voltages and currents will vary with the different tubes used, the rheostat connections of Fig. 6 are necessary. Two rheostats R1, R2 are connected in series; and a switch is provided to short either one or the other. Both may be calibrated for the filament voltages to be used in this way; so that no filament volt-

meter is necessary on the panel. One rheostat is of the carbon-pile type and the other of the power-tube variety.

Other Adaptations

The vacuum-tube voltmeter can be used for many purposes by the Service Man. Since it requires only limited space, it may be mounted in the same cabinet with the oscillator. A good size of meter to use for

any of the circuits described is the 0-11/2-milliamper scale. By providing two additional posts 5, 6 on the panel the meter can be used also for the tube voltmeter, as shown in Fig. 7.

The beat-frequency oscillator provides perhaps the simplest arrangement to obtain a good audio note over the entire audible range. One oscillator is fixed as to frequency; and the other is variable, as shown in Fig. 8. Although the audible beat can be picked up in an external circuit, if desired, one can listen in the plate circuit of either oscillator. The adjustable-oscillator tuning condenser C1 should be shunted by a small trimming (midget) condenser to give small changes in the beat-note. In some arrangements, a short extension handle on this condenser will be necessary for best results. The whole outfit should be mounted in a shield case, and proper posts provided for external connections. It can be used for many purposes at either radio or audio frequencies.

With his long experience with all kinds of circuits at long and short waves, an amateur makes an ideal Service Man. The fact that he owns a license is sufficient proof that he has unusual interest, often greater ability, and certainly more knowledge of radio regu-
(Continued on page 179)

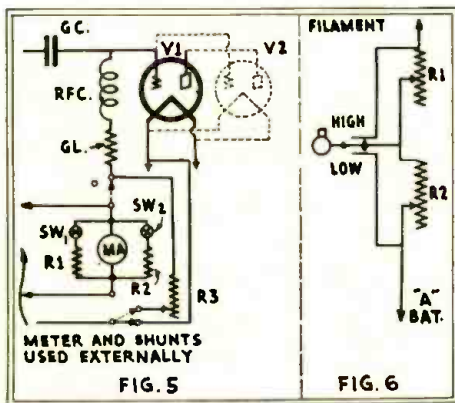

With a large output, it is desirable to provide button-controlled meter shunts, as shown at the left, which give a higher scale reading. The connections at the right adjust filament voltage for the tube in use.

Installing a Standard Receiver in a Car

By RALPH MANLEY

ABOUT a year ago I decided that I wanted radio in my car. I tried three sets which I made myself. All would work on a good outside antenna, but they were not satisfactory on a car antenna. I later decided to try a standard broadcast receiver—the Crosley screen-grid "Model 21." In contrast to the usual location of an automotive receiver, I mounted this on the shelf back of the seat in my coupé. The receiver was at the right, the dynamic speaker at the left; the "B" and "C" batteries were located under the rear deck; and the "A" supply was, of course, derived from the storage battery of the car.

To eliminate the interference from the engine, I used a 25,000-ohm resistor connected in series between each spark-plug and its ignition lead. Between the frame of the generator and the relay box from which a lead is taken to the ammeter, I shunted an 0.25-mf. condenser; this connection must be made on the generator side of the box, or the noise will interfere with reception when driving at a high speed. Between the ignition coil and the distributor cap, I inserted a 30,000-ohm resistor. The

lead-in is sheathed wire with the shielding grounded.

With this arrangement, and a copper-screen aerial in the top of the car, I have been able to receive, while driving, stations over a thousand miles distant with plenty of volume.

I find it very convenient to carry a small aerial wire with battery clips on each end. When the car is stopped, I can receive far distant stations with extreme volume by clipping one end of this wire to my aerial, and the far end to any extensive metallic object, such as a wire fence, a windmill, etc.

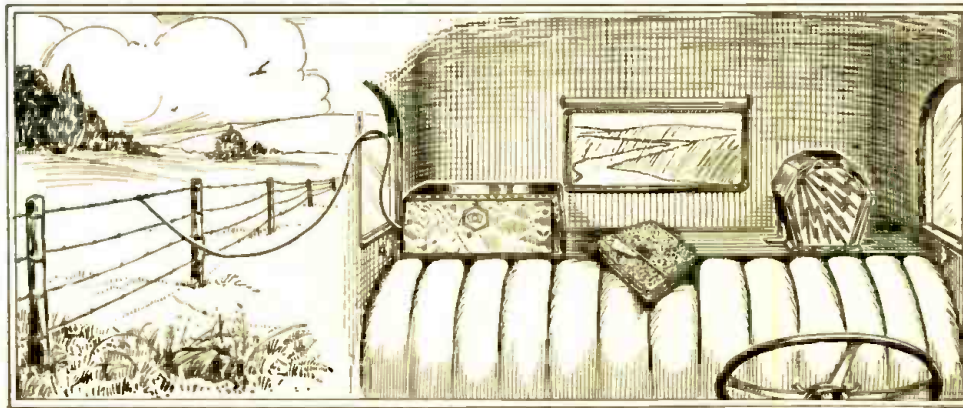

Here is another variation in the manner of mounting an automotive receiver, which permits the convenient use of a standard set. When the car is stopped, a temporary aerial enables greater distance to be obtained.

Operating Notes for Service Men

Mr. Freed follows the excellent idea of keeping a notebook and jotting down his experiences with sets of this and that model. Consequently, he has a "line" on many of them which saves time and worries.

By BERTRAM M. FREED

THE new Fada sets incorporate the "Flashograph," which lights a bulb when a station is reached on the tuning scale. To set this, when a station has been tuned to its highest peak, a key, furnished with the set, is pushed through the hole provided in the panel. The dial is thereby perforated at this point; and, every time the dial is set to the same point, the Flashograph operates. It is good policy not to use this key to perforate the dial until the set has been installed in the customer's house; for oftentimes the settings necessary there are different from those which would be found in the store. (Fig. 1.)

Points to Watch

Complaints of lack of power, or weak reception, on a Kolster "Model K" may be caused by a shorted vernier tuning condenser, which cuts out one stage, in effect. This condenser is located at the end of the tuning gang nearest the detector (Fig. 2); the trouble is caused by the mica falling out and allowing the plates to touch.

Several Federal sets, of a popular model, were returned to the shop because of failure of the power packs. After melting out the tar and pitch which sealed in the components of a number of these packs, and tracing the circuit, the trouble in each case was found in the "B—" return, a non-insulated wire which emerges from the compound and is

soldered to the metal container. When vibration breaks this wire loose from its moorings, no "B" voltage can be obtained. (See Fig. 3.)

A loud hum in the Radiola "17" or "18," which is not caused by a shorted filament winding or biasing resistor, may be attributed to a faulty volume control. This resistor has its movable arm connected to the grid lead of the first R.F. tube.

A source of noise and fading in a Freed-Eisemann "NR-80" was found in the volume control, after a thorough preliminary test of the tubes and aerial. This model uses a volume control of unusual type, and it must usually be replaced. Cleaning the resistor usually helps but little and for a short time.

When replacing the antenna tuning variometer in an Earl D.C. model, care must be taken that the shaft and the unit proper are shielded and insulated from the chassis. If the shaft shorts to the chassis, something goes! (Sometimes an R.F. coil, most likely a tube.)

An owner of a Grebe model (using four '26s, a '27, a '71A and an '80) complained of hum which was not present when the set was first operated. The hum control could not be found at the first search but, after the chassis was removed, it was discovered just behind the detector. Only a six- or eight-inch screwdriver is needed to make the adjustment. (Fig. 4.)

When fading or intermittent reception from a Zenith "Series 50" screen-grid model is reported, it is a good idea to pull on every wire; better still, sweat every soldered joint that is accessible. Loose or corroded connections may cause serious trouble. The same is true of Philcos; reheating corroded joints may correct intermittent reception.

On newer Philco models, the common can which shields the screen-grid tubes is held in place by four or five screws; if this shield is not tightened securely, oscillation results.

Lack of Control

If radio reception increases in a Colonial "Model 32" A.C. set when the phono-radio switch is turned to phonograph position, the trouble may be found in an open detector-cathode resistor. (The color is black.)

In the same model, a report of fading and noise not attributable to the three 0.1-mf. Sprague condensers has been traced to a broken porcelain bracket in the variable condensers. Vibration then causes the stator to shift, causing fading and, when the plates short for a moment, noise.

In replacing a Bosch chassis ("18," "48," "28," etc.) take care to place it in the cabinet in such a position that the shafts of the volume control and the tuning gang do not

short to the escutcheon plate. This will cut out the first R.F. stage and most reception, in the "28" or "29"; and in the screen-grid models, hand capacity or lack of reception results.

In some Peerless models, the detector grid connection is a lug, fastened to the bakelite strip directly back of the detector tuning condenser; it sometimes shifts and shorts to the shield can covering the detector tube. (Fig. 5.)

After changing speakers and overhauling the chassis, to remedy intermittent reception on the Fada "15," "25" or "35," the trouble was traced to poor tinsel connection to the speaker cord tips. Change the cord, or sweat the tips.

Few Service Men bother to adjust the antenna compensating condenser of every Sparton set. This should, however, be adjusted from time to time, as necessitated by climatic and seasonal conditions. (Fig. 6.)

Some have condemned the volume control of a new Stromberg Carlson A.C. because it had no effect on volume, without observing that the local-distance switch was in the distance position. In this receiver, this control is combined with the A.C. switch; the latter turns clockwise to turn on the set. When it is then pushed in, the set is employing the "distance" arrangement; when the switch is pulled out, it is set for locals.

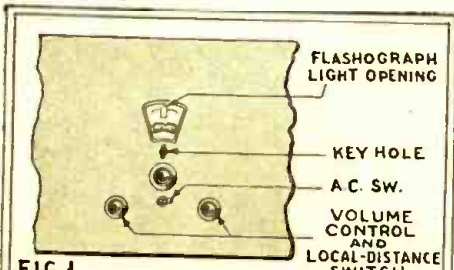

FIG. 1

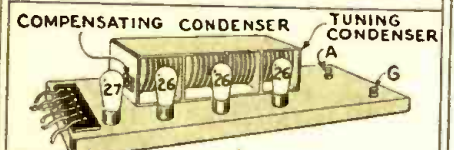

FIG. 2

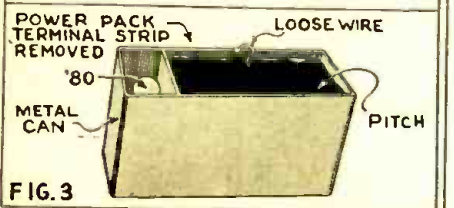

FIG. 3

Above, the arrangement of the "Flashograph" tuning indicator in Fada models; center, a compensating condenser position in the Kolster K; lower, the internal ground lead in a Federal power pack, which may require resoldering.

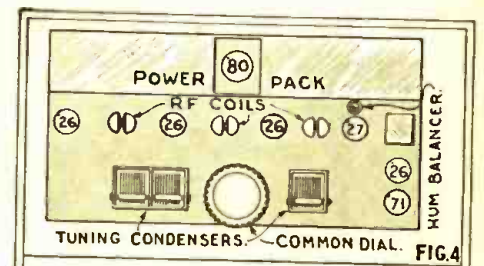

FIG. 4

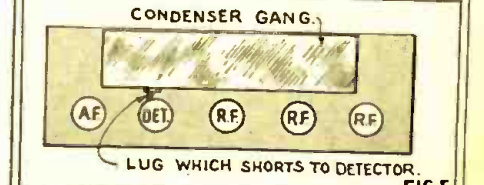

FIG. 5

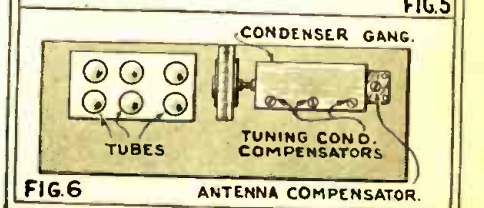

FIG. 6

ANTENNA COMPENSATOR.

The upper view shows where a hum control may be found in certain Grebe sets; center, a detector grid connection which may short to the tube shield in some Peerless models; lower, the antenna compensator of a Sparton set, which may require resetting.

Salvage Values in Old Radio Sets

Receivers of standard makes, in perfect working order, are nowadays cheaper than their component parts. A few hints as to their utilization are contained in this article.

By CLYDE A. RANDON

RADIO parts and sets which are no longer the "last word" can be obtained quite cheaply, and are valuable for many different purposes; among which is replacement in some types of sets. These parts are obtained easily in a variety of ways and often at a surprisingly small cost. Old regenerative receive-

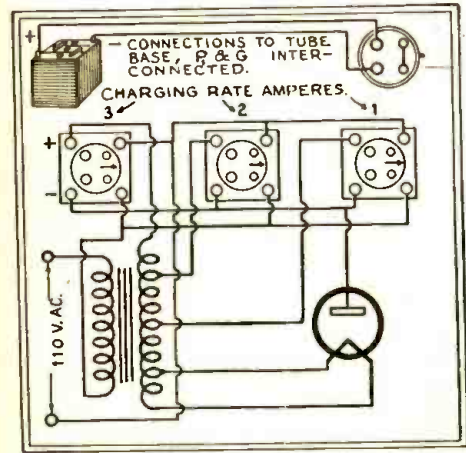

Fig. 1

The method of connecting a battery charger, shown here, gives flexibility in operation to meet varying demands.

ing sets, which can be purchased for a comparative "song," when slightly modified, are useful as service oscillators. Old sets of other types, after slight adjustments have been made, can easily be sold to some types of customers. D. C. sets, when made over into A.C. models, sell easily, and at a good profit. Methods of obtaining old parts and sets, and the uses to which they can be adapted, will be described.

There are, and always will be, radio owners who cannot afford the best in radio entertainment, and must use sets which are not as good as their more expensive A.C. counterparts. These set-owners are content with the usual quality and, often, with the use of batteries for plate supply; since the initial cost is less.

On the other hand, there are set-owners who must have the very best, and are constantly buying new models and discarding the old ones, although these are still in good shape. Moreover, it is usually the Service Man who advises the owner that better results can be obtained with a later model, and is thus in a position to offer the owner a price for the old set. Any set owner realizes that an out-of-date set which must be resold is not worth much, and will be content with a small allowance. If the Service Man sells new sets on the side, it is his part to install such a new set. Often it will be to his advantage to make a rather liberal allowance on an old model, in order to induce the prospective buyer to buy a new receiver. Any small amount, offered in excess of what the set would normally be worth, is easily absorbed in the profit made on the new set.

Market for Old Sets

If a D.C. set is received in a deal, or purchase, the Service Man can give it the "once over" and resell it to some listener at a reasonable cost. By using adapters, such a set can be equipped for '99 tubes so that a large storage battery is unnecessary. With all the batteries in the cabinet, the old set is more salable. Some listeners do not care particularly for extremely good quality; for example, college students away from home will often buy a cheap set simply to listen to boxing returns or football games in their own private room, or at the fraternity house. They do not expect an exceptional set for a small price, and are content to receive these sporting returns for the few months which they spend away from home.

Service Oscillator

Old D.C. models, if regenerative, can be used for servicing. For example, one of the small Crosley regenerative sets can be set up in the laboratory to function as a heterodyne wavemeter or for any of the many purposes which an oscillator serves. A small "B" unit eliminator which someone has discarded, because it no longer supplies sufficient current for a late model set, can be used to supply the plate voltage.

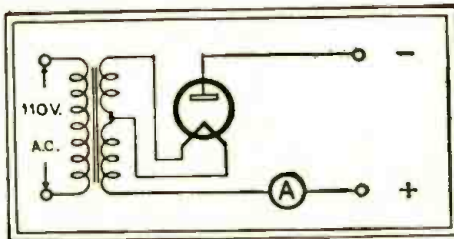

Fig. 2

Here is a very simple rectifier circuit which will be useful for various shop purposes, as well as for charging.

There are also many kinds of parts which can be obtained for practically nothing. UV sockets will serve many purposes; although they do not look as well, they will "take" the UX tubes, and can be used in experimental hookups of various kinds.

These sockets usually have good binding posts; if such a socket is mounted where power connections are required (for example in a battery charger; see Fig. 1), connections can be made in any desired order around these posts.

A Handy Charger Set-Up

In Fig. 1 is shown a very good use for some old sockets, and a tube base. The rate at which the charger charges, depends upon the transformer voltage; so various taps can be used for the different charging rates desired. By making connections to the sockets and connecting the tube-base as shown at the top it is possible to supply three or more charging rates by simply plugging into the proper socket. The grid and plate terminals on the tube-base are

shorted. When inserted into either of the sockets this plug serves to close one of the 110-volt leads connecting with the primary; thus turning the charger "on." Obviously, the price of a switch is also saved. One of the filament terminals on each of the sockets connects with the plate; the other filament terminal connecting to the various taps supplying the different transformer voltages. This system has been used with a "dry" type charging unit; but it will also work with a Tungar bulb, or other system.

Since battery chargers are very useful to the Service Man and can easily be constructed, one will be briefly described below. A simple rectifier constructed at a small initial cost is useful for the experimenter as well as the Service Man.

A Tungar rectifier is easily assembled. It consists of a two-electrode tube, or equivalent "dry" unit, and a step-down transformer. The circuit is shown in Fig. 2.

Construction of a Transformer

The core, which measures 8 by 5 inches, outside, has a cross-section 1 1/2 inches square, consisting of .016-in. silicon laminated steel. About 300 pieces are necessary. One can often secure an old core of the proper size, and the iron need not then be cut. If a right-angle box is constructed, with 8 in. inside measurement, one leg of the core may be built up by placing one strip first to the right, then another to the left. When compressed, the core should measure 1 1/2 inches thick; it should be squeezed in a vise and bound with tape. The other leg is built up in a similar way.

The primary winding consists of 400 turns of No. 18 D.C.C. wire, and should be wound on a slightly-tapered form to facilitate removal. Small, square pieces of wood should be fastened at each end of the form and a couple of wires laid lengthwise. Tape the primary, longitudinally.

The secondary winding consists of 100 turns of No. 14 wire, and this should be wound on the same form. A tap is taken off for the filament voltage at the tenth turn. If the windings are soaked in hot paraffin there will be less chance that the

(Continued on page 180)

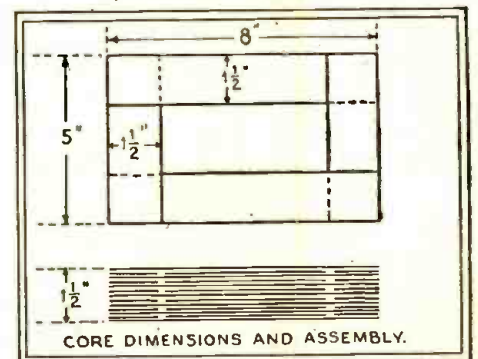
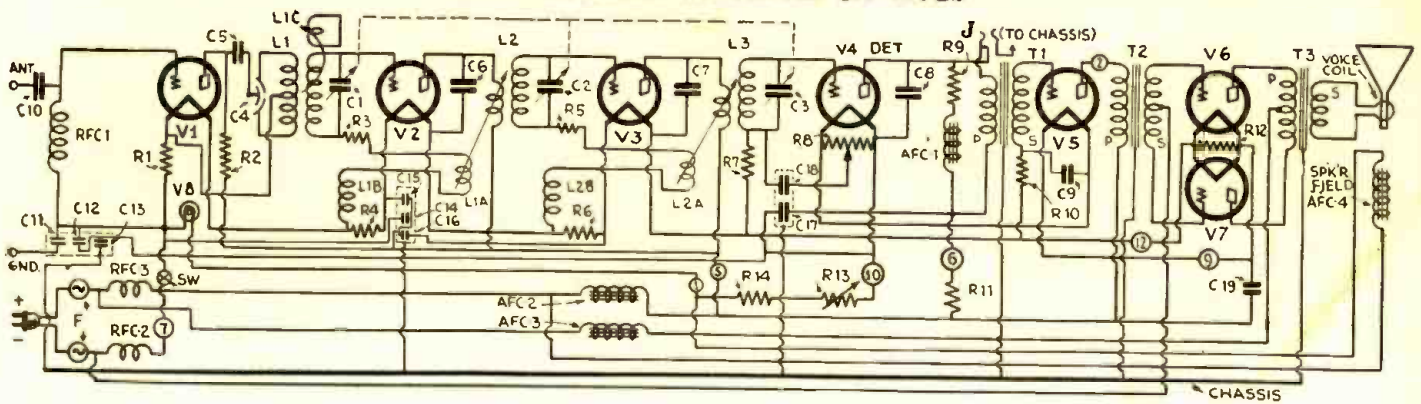

Fig. 3

The design of a transformer for use with a charger, as in Fig. 2, or any other purpose which may suggest itself to the radio worker.

COLONIAL 31 AND 32 D.C.



Complete schematic circuit of the Colonial 31 D.C. receiver. The filament wiring is shown in simplified form below.

The Colonial "31 D.C." which has had very wide distribution, incorporates a number of unusual design features. For instance, volume is controlled by varying condenser C4; with the middle plate centered the signal is balanced out. An absorption loop (L1C) improves the tuning characteristic.

The cable color code is as follows: 7, yellow; 1, maroon; 5, black; 2, blue; 6, red; 12, gold with black tracer; 9, black with red tracer; 10 red with black tracer; 3, green; 4, 8 and 11 are not used.

V1, V2, V3, V4 and V5 are '26 tubes; V6, V7, are '71As; while V8 is a 110 V. "miniature base" 15-watt lamp.

The following parts are contained in the power pack: F, 5-amp. fuses; C19, 2-mf.; AFC2, AFC3, 1½-henry chokes; T2, A.F. push-pull input transformer; T3, A.F. push-pull output transformer; AFC4, 18-ohm reproducer field; R11 100,000 ohms; R12 9.1 ohms; R13 20-ohm power rheostat; R14 60 ohms; radio-frequency chokes RFC2 and RFC3; and the tubes V6 and V7.

Following are the constants for the receiver chassis: RFC1, R.F. choke; C5, C6, C7, C8, C10, .002-mf.; C11, C13, 0.5-mf.; C9, C12, C18, 0.1-mf.; C14, C15, C16, 0.4-mf.; C17, 1 mf.; C19, 2 mf. R1, R4, R6, 2.5 ohms; R2, R7, R10, 100,000 ohms; R3, 200 ohms; R5, 100 ohms; R8, 30-ohm potentiometer; R9, 10,000 ohms. Jack J is the connection in the plate circuit of detector tube V4 for a phonograph pickup.

A variation of 25% from the following average operating current values is permissible: Grid potential, V1, V2, V3, V4, 3 volts; V5, 2.25 volts; V6, V7, 14 volts. Filament potential, V1, V2, V3, 1.5 volts; V4, V5, 1.4; V6, V7, 4.7 volts. Plate potential, V1, 70 volts; V2, 98 volts; V3, V6, V7, 95 volts; V4, 55 volts; V5, 85 volts. Plate current, V1, 3.5 ma.; V2, V3, 7.5 ma.; V4, 0.3-ma.; V5, 4 ma.; V6, V7, 14 ma.

The following are the values for the chassis parts of the Colonial "32 D.C." screen-grid receiver. Condensers: C1, C2, C3, C4, .00035-mf.; C5, .00025-mf.; C6, C7, C8, C9, 5 mmf.; C10, 0.2-mf.; C11, C12, C14, C15, C16, C18, C19, C21, C22, C23, C32, C33, C35, 0.1-mf.; C13, C17, C20, 0.25-mf.; C24, C25, .00025-mf.; C26, C34, 1.0 mf.; C31, .05-mf. Resistors: R2, 10,000 ohms (volume control); R3, 35,000 ohms (pink); R4, 65,000 ohms (orange); R7, R8, R9, R12, 750,000 ohms (red); R10, 10,000

200 ohms (black, wire wound); R13, 34.9 ohms ("chimney" type); R14, 1.43 ohms (vitreous); R16, 100,000 ohms (green); R17, 50,000 ohms (black); R18, R22, 100,000 ohms (green); R19, 2,000 ohms (red, wire-wound).

The chokes RFC7 and RFC8 are 930 microhenry; AFC1, AFC2, AFC3, AFC4, 50 henry; AFC5, 11.7 ohms. V8 is the pilot light. Fuses are 3- to 5-amp. rating.

The meter readings for the "Model 32 D.C." are approximately as follows: plate current, V1,

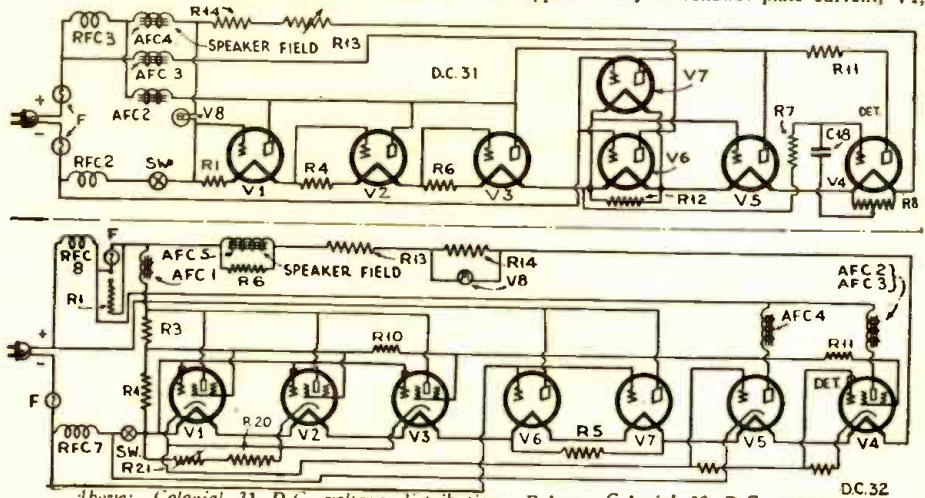

Above: Colonial 31 D.C. voltage distribution. Below: Colonial 32 D.C. sequence.

ohms (blue); R11, 250,000 ohms (white); R15, 50,000 ohms (black); R20, 200 ohms (black, wire-wound); R21, 75,000 ohms.

The following units are mounted in the power pack: condensers C27, 1.0 mf.; C28, C30, 0.5-mf.; C29, 0.1-mf.; resistors R1, 5.7 ohms, (vitreous); R5, 20 ohms (vitreous); R6,

V2, 1.3 ma.; V3, 1.2 ma.; V4, 0.15 ma.; V5, 3 ma.; V6, V7, 16 ma. Plate voltage, V1, V2, 91 volts; V3, 92 volts; V4, 81 volts; V5, 93 volts; V6, V7, 104 volts. Screen-grid potential, V1, V2, 32 volts; V3, 27 volts; V4, 5 volts. Control-grid potential, V1, V2, V3, V4, too low to read; V5, 2.25 volts; V6, V7, 5 volts.

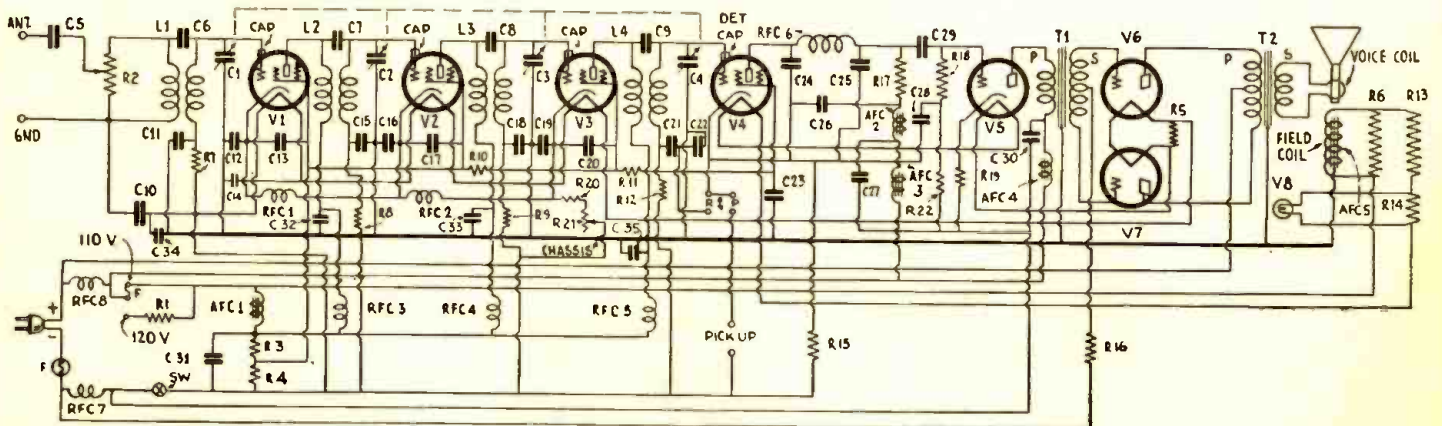

Schematic circuit of the Colonial 32 D.C. Note chassis is insulated from ground and aerial.

All About Electrolytic Condensers

The how and why of a radio component which has made great changes in filter design

By SYLVAN HARRIS

THE value of electrolytic condensers has been increasingly appreciated during the past few years; they have made it possible to obtain at a low cost capacities previously unheard-of, for filter systems, and thereby to handle increasingly large operating current with smoother output than ever before. A fundamental explanation of the subject will therefore be of interest to every Service Man. Before undertaking this, it should be said that the theory of the operation of electrolytic cells as condensers is so closely related to that of their operation as rectifiers, that a simultaneous discussion of both effects will materially aid in understanding either.

Elements of a "Cell"

The electrolytic cell consists of a so-called rectifying or "valve metal," which is immersed in an electrolyte together with an inactive electrode. The "inactive electrode" may be an additional bar or strip of metal, or it may be simply the container which holds the electrolyte. Its electrical function is merely to connect an outside circuit conveniently to the liquid active electrode, the electrolyte. Many metals under certain conditions, and with certain electrolytes, show "valve action"; which is to say they allow a current to flow only one way. The only elements which exhibit this rectifying action to a degree which is satisfactory for commercial purposes are aluminum and tantalum. Of these aluminum is the more widely used; for the reason that tantalum cells require an acid electrolyte, while aluminum cells operate satisfactorily with the less corrosive borates or phosphates.

The form of cell most widely used comprises an electrode of chemically pure aluminum, immersed in a solution of ammonium borate or phosphate, and an additional inactive electrode, which may be carbon, lead, copper, or any other metal which does not exhibit the valve action. Fig. 1 shows the elementary construction of an electrolytic

cell; at A the two electrodes are immersed in the electrolyte, which is held in a neutral container, while at B a copper can serves both as the inactive electrode and as a container for the electrolyte. Three active electrodes in a common electrolyte are shown at C; and the Mershon "individual electrolyte" design is illustrated at D.

Many theories, most of which are unsatisfactory and incomplete, have been proposed to explain the operation of these cells; the most plausible however, will be explained here. We will consider a cell with aluminum and copper electrodes immersed in a borax solution. Also, we will first suppose that the cell is connected to a battery;

leak through the pores and attack the aluminum, causing the formation of more oxide. The consequent flow of current "ionizes" the electrolyte, and negatively-charged oxygen molecules (or "ions") are liberated at the negative copper electrode. These are attracted to the positive aluminum electrode, where the electrons are neutralized; and oxygen gas is liberated, only to be entrapped in the aluminum oxide on the surface of the electrode. Then, because of the high resistivity of the gas, the current gradually decreases, as more and more gas is entrapped by the oxide; until finally the flow of current ceases entirely.

The process is called "forming" the cell.

Fig. 1

The evolution of the commercial electrolytic condenser is illustrated here. At A, we have the simple rectifier cell from which the condenser is derived; two metal electrodes are immersed in electrolytic fluid held in an insulating container. At B, the electrolyte is contained in a metallic can which serves as the negative or grounded electrode; and at C it is shown how three condensers in one case can be produced. At D, below, the Mershon method of separating the three positive electrodes into compartments.

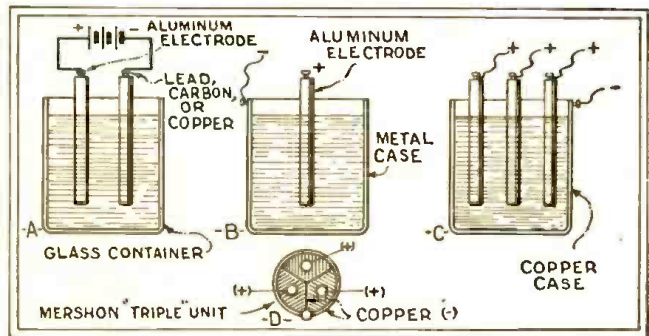

the aluminum electrode to the positive and the copper electrode to the negative terminal, as shown in Fig. 1A.

Why the Plate "Forms"

It is well known that, on the surface of aluminum, there is always a coating of oxide due to its exposure to the air. Although this aluminum oxide is a poor conductor of electricity, the coating is so very thin that it does not appreciably limit the flow of current through the cell. Consequently, when a voltage is first applied to the cell, there will be a large flow of current which may result in damage, unless regulated.

Again, because of the porosity of the oxide coating, some of the electrolyte may

An insulating medium (that is, the oxygen gas) is "formed" at the surface of the aluminum and prevents a flow of current from the aluminum into the electrolyte. It must be noted that all this requires that the aluminum electrode be charged positively in order that the negatively-charged oxygen ions shall be attracted to the aluminum electrode. When, however, by the reversal of current the aluminum electrode is negatively charged, the oxygen ions are attracted to the copper. Since the latter has no porous coating with which to entrap the gas, the oxygen escapes out into the air; and current is again allowed to flow through the cell.

This, in general, is the manner in which the electrolytic rectifier or condenser acts.

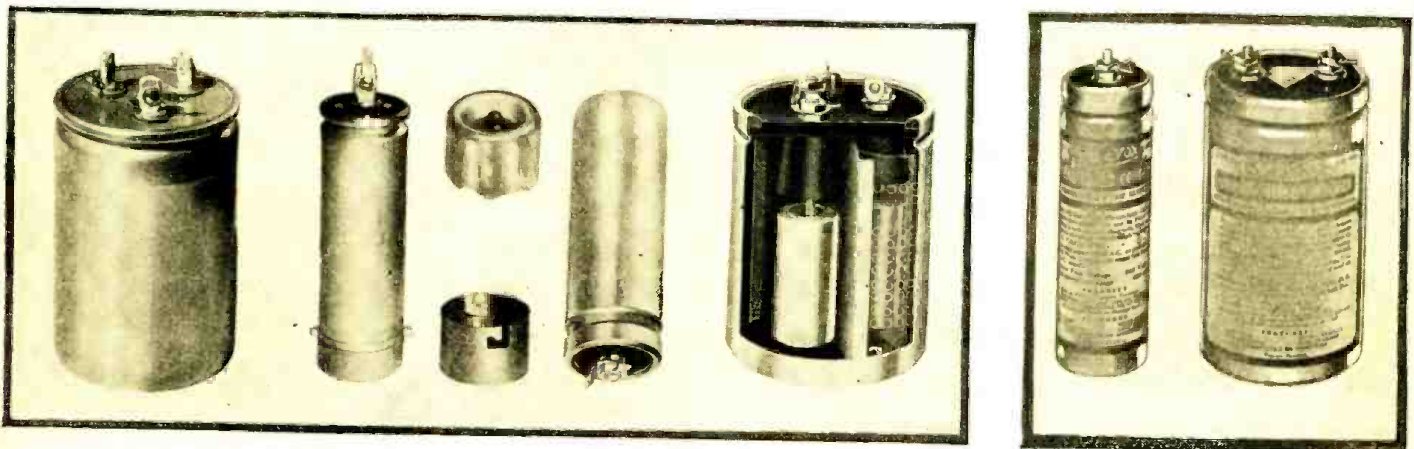

Fig. A

Various types of commercial electrolytic condensers, showing their design and construction. From left to right they are: a Polymet triple-8-mf. condenser; a Polymet single-8-mf. condenser, with its mounting cup at its right; a Mershon single-8 condenser, with a separate view of its upper end at the left, to illustrate the gas nipple; and a phantom view of the Mershon triple-8, to show its copper partitions and perforated contact-insulator. At the extreme right are single- and double-8 Aerovox condensers.

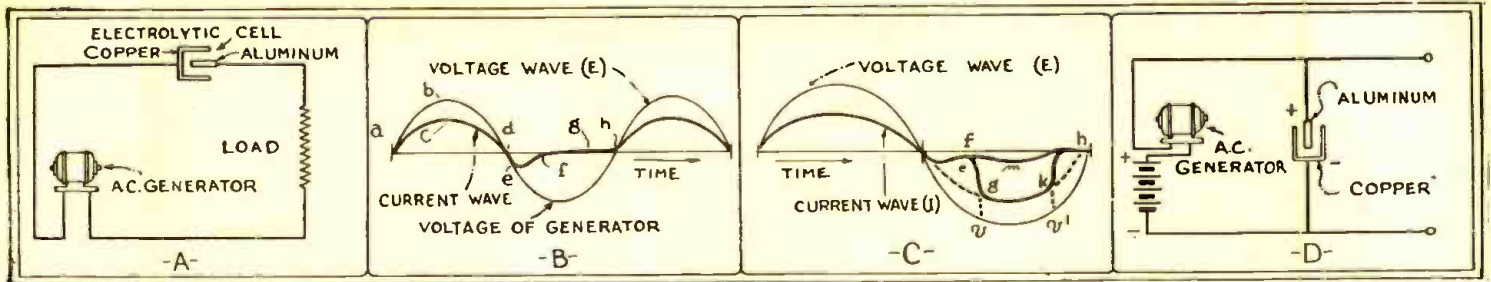

Fig. 3

At A and D, the schematic circuits of A.C. and a pulsating D.C. load, respectively, on an electrolytic condenser; the first is used when forming the plate. The curves of B show the current and voltage waves of the circuit A; and those of C, the effect of a breakdown in the line g-k.

Its great capacity is due primarily to the extreme thinness of the dielectric or gas (oxygen) layer—just as in a paper condenser; the thinner the paper, the greater the capacity. Increasing the size of the plates also increases the capacity.

Actions Inside the Cell

Now let us see how the cell works in an electrical circuit; of course, we know that its fundamental connections are about as shown in the standard filter circuit (Fig. 2A), which is used in many Crosley sets. A four-section unit is shown in Fig. 2B, as used in the Amrad Model 81 "Bel Canto."

However, let us first connect the cell into an A.C. circuit, such as that indicated in Figure 3A. Suppose that the copper electrode (or container) is charged positively during the first half of the cycle, and that this positive charge increases from zero to maximum; this is, from a to b, in the voltage wave shown at B. In accordance with the explanation given before, current will flow through the cell; and this current will increase with the voltage, as indicated at c on the heavier line. As the applied voltage decreases from its maximum value, the current in the circuit likewise decreases; until when the voltage is zero, the current is also zero, as shown at point d.

Then the polarity of the impressed voltage changes, and the aluminum becomes positively charged. At first there is no gas film on the surface of this electrode; so that, even though the applied voltage is small, the current transmitted through the cell may be appreciable—being limited mainly by the load resistance and the low impressed voltage—so that we may have a small current peak as indicated at e. (Fig 3B.) However, the gas film forms again very quickly, cutting down the current; so that it tapers off to zero, as indicated by the line e-f-g. This current, indicated below the horizontal line

a-d-h, is the "back-current," and detracts from the efficiency of the cell as a rectifier.

At h the cycle begins again. During the negative half of the first cycle, after the film has been formed, (between f and g) some current may be transmitted through the cell, because of its ability to act as a condenser. The magnitude of this effect is of course, dependent upon the capacity of the cell and upon the frequency as well as the value of the applied voltage; and it is likely to give peculiar shapes to the back-current wave, as for example, the curve f-m-h in Fig. 3C.

If the applied voltage is quite high, there is also danger of breaking down the film during the negative half of the cycle. Such an effect is illustrated by the wave f-g-k-h in Fig. 3C. After the film is formed, as at e, the applied voltage increases until, at v, the film breaks down. The back-current then increases from f to g; and from g to k it follows the curve we would have had if no film had been formed at all. Then, when the applied voltage drops to a sufficiently low value, at v' the film forms again, and the back-current drops quickly from k on.

Forming should, therefore, be begun with a small voltage, which is gradually increased up to the working voltage, or perhaps a little higher. A current indicator should be kept in the circuit, so that the voltage may be adjusted, to ensure that too much current shall not pass through the cells during forming; otherwise the electrolyte will heat, and the film may be destroyed. In aluminum cells this critical temperature is in the neighborhood of 120 degrees Fahrenheit. Sparking at the surface of the aluminum indicates too great a forming rate.

The Cell as a Condenser

Now let us connect the cell into a circuit which is supplied with a current which always flows in the same direction, as in the battery circuit of Fig. 1A. We have seen

that, if the aluminum electrode is always held positive, no current will flow through the cell; because the insulating film will always be maintained. Even if we slightly increase or decrease the battery voltage, slowly, no current will be transmitted by conduction; because we always keep the aluminum positive.

But if we increase and decrease the applied voltage very quickly, we have then a condition such as we obtain in rectifier circuits; an alternating voltage superposed on a constant voltage. The equivalent circuit is Fig. 3D, where we have a source of alternating voltage in series with a source of constant voltage. The alternating voltage is small compared with the constant voltage; so that the aluminum electrode is always sufficiently positive to retain the gas film at its surface.

Under these conditions there will be no conduction current through the cell. Actually, there will be a small leakage current; but this is usually so small (about 0.2-milliampere per microfarad) that it does not detract from the usefulness of the cell as a condenser. However, the large capacity of the cell makes it act as a large condenser, and it therefore offers little opposition to the flow of the alternating component through it. It is in this manner that the electrolytic cell acts as a condenser of large capacity in rectifier-filter circuits. Since the cell will not pass direct current when connected in this way, the D.C. component is not short-circuited; on the contrary, it may be used on any load, such as a radio receiver.

A well-formed condenser will remain formed indefinitely, even with only occasional use. A properly-formed aluminum electrode will not be shiny, like new aluminum sheet, but will have a dull whitish surface, which can be easily scraped off with a knife, showing bright aluminum beneath.

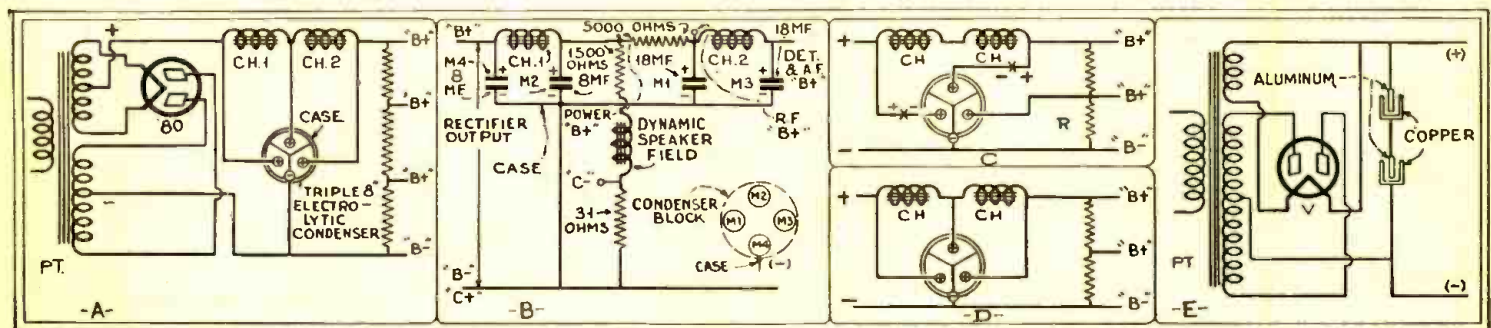

Fig. 2

The circuit A is that of a Crosley power pack using a Mershon triple-anode condenser; B that of an Amrad "81" with a four-anode condenser. In each case the negative connection is to the metal case, which serves as a cathode. At D, a standard connection which may be changed to that of "C" to prevent motorboating. Condensers inserted at X-X will reduce liability to breakdown, as shown also at E, in a high-voltage circuit.

Voltage Ratings

Aluminum condensers, employing ammonium phosphate as electrolyte, "break down" at about 360 volts; when ammonium borate is used, the breakdown voltage is about 500. Tantalum cells, using dilute sulphuric acid, break down at about 460 volts; using hydrochloric acid, they break down at about 210 volts. Commercial aluminum condensers, employing borate solutions, are rated at 400 volts maximum, or thereabouts.

Popular applications of the electrolytic condenser are found in D.C. and battery-operated receivers, where the voltages are always much lower than the breakdown voltage of the condenser.

It is possible, and perfectly practicable, to use electrolytic condensers at high-voltage points in the circuit by connecting several cells, in series, across the voltage to be filtered. For example, if it is desired to filter the output of a rectifier which delivers a peak of 700 volts, the arrangement indicated in Fig. 2E may be employed; this comprises two electrolytic condensers in series, connected across the output of a full-wave rectifier tube of the '80 type. With a maximum of 700 volts applied, the drop across the terminals of each electrolytic cell is only 350 volts, which is well below the breakdown figure. Actually, the two in series could stand a potential of 800 volts; since they are rated at 400 volts each. The capacity in combination of the two is of course, half the capacity of either alone—assuming them to have the same value. With a rated capacity of 8 microfarads each, the two in series would be equivalent to one of four microfarads.

There has recently been evolved the so-



Fig. B

In an Elkon 2000-mf. "dry" electrolytic condenser, two strips of heavy foil are separated by a cloth holding the electrolyte, and the cotton (lower left) prevents a short to the can.

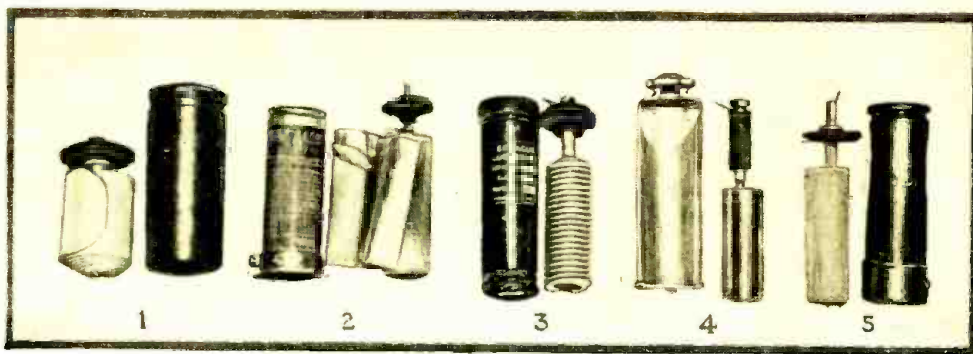

Fig. C

Electrodes of commercial condensers: 1, Mershon; 2, Acrovox "dry" unit; 3, Sprague; 4, Acracon, inverted, with rubber tube over anode post, showing gas vent below; 5, Polymet.

called "dry" electrolytic condenser. This is dry in the same sense that dry batteries are dry; that is to say, dry in the sense that the electrolyte cannot be poured out of the container. A strip of cloth, or similar material, is rolled up with the aluminum, the cloth being saturated with the solution and holding it much as a sponge holds water.

Ventilating the Cell

The objection to the liquid electrolyte has been overcome to a large extent by proper design of the containers, by the employment of rubber gaskets and by adding a gas vent. This vent is usually a small "nipple," which is inserted into the container at one end; it is made of rubber, and contains a minute hole. When the gas pressure within the container becomes great enough, by reason of either increased temperature or excessive evolution of gas, the nipple swells like a miniature balloon; the vent hole then opens and permits the gas to escape. When the pressure is relieved, the nipple contracts, thus closing the hole, and preventing evaporation or leakage of the liquid.

This is the sole purpose of the "nipple." Although some Service Men are of the opinion that it is necessary to remove it, in order to ensure the proper operation of the condenser, it is evident that the presence of the nipple has absolutely nothing to do with the operation of the cell except to prevent leakage and evaporation of the electrolyte. In fact there are known instances where the electrolyte has spilled through this hole, unnecessarily opened by a Service Man, and caused damage to the radio set, when the owner had need to move the set.

(However, this rubber may harden, as some Service Men have found, and require replacements; or salts may so solidly fill the tiny hole as to necessitate re-opening it with a needle. Another condition, which may be encountered in isolated instances, is lack of any opening, because the perforating machine failed to pierce the rubber.—Editor.)

Commercial Condenser Design

The capacity of an electrolytic condenser or of any condenser, for that matter, is proportional to the area of the active electrodes—in this type the aluminum electrode and the liquid electrolyte. Consequently, a large surface of aluminum is required in order to obtain a large capacity; so various ingenious arrangements are found in commercial condensers by means of which these large surfaces are provided. In most makes an aluminum sheet is coiled spirally about

a central post, or "riser," to which the sheet is welded. The arrangement is shown clearly in Fig. 4A. A cap of insulating material is mounted on the end of the riser, together with the required fastening nuts and soldering lug.

Another method of giving the anode a large surface is that of "extruding" the aluminum into the form shown in Fig. 4B. In any case, a sheet of insulating material around the anode is required; so that the

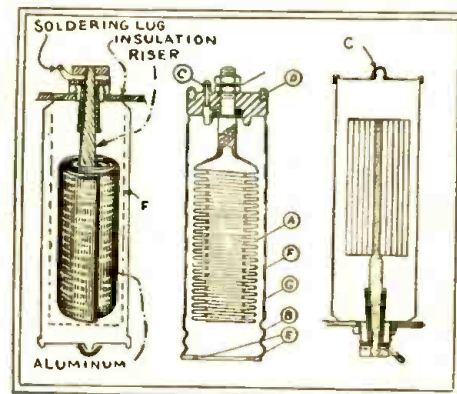

Fig. 4A Fig. 4B Fig. 4C

Left, general arrangement of condenser construction; center, Sprague unit (A, hollow extruded anode; B, base; C, vent; D, sealing ring; E, separator; G, cathode-can); right, cross-section of Acracon unit.

metal may not come into conductive contact with the surrounding container, which is a lead to the cathode or negative element. This insulator is generally a sheet of celluloid, which is perforated to permit good circulation of the electrolyte.

General Service Notes

A service hint for reducing motorboating in some amplifiers is to change the filter wiring as shown progressively in Figs. 2D and 2C. If the output is to feed the plates of tubes that require over 300 volts, such as the type '10 and '50, it is necessary to insert condensers in series with the high-voltage leads and poled as shown, at the points marked X. (This principle is incorporated in transmitter design.) Of course, only one negative post can be grounded, and care must be taken so to place the other series condenser units that the cases cannot make contact with each other or with the ground.

In one of the Amrad receivers incorporating type '99 tubes in a series-filament circuit, there is provided a single 60-mf. condenser across the high-voltage D.C. output

(Continued on page 180)

The Utility of Automotive Radio

The great new market which motor-car radio has opened for the industry depends, not upon novelty, but upon the service it will render the motoring public

By MORRIS METCALF *

THEORETICALLY we spend a third of our lives in bed; practically, hundreds of thousands people spend a third in automobiles. To many motor-car radio sets render a real service as a means of relieving the tedium of long trips, keeping the passengers amused and the driver awake, amusement in the evening while camping or resting. It is coming to be realized that it fills a long-felt want. Comparatively few people have yet ridden in a car equipped with a good radio set. It is one of those things that must be tried and heard to be appreciated.

There has been some talk on the part of public officials and others to the effect that radio in an automobile tends to distract the driver, annoy people on the sidewalks, etc., etc. Most of these criticisms arise from a false perspective.

It may be true in principle that any addition to the host of ever-present distractions is bad, but although there are a hundred things going on in and around a car that

may prove distracting or annoying, any driver deserving of a license does not take his attention off the business in hand unless conditions of traffic, speed, or the moment make it safe to do so.

However, it is not expected by its sponsors that the value of motor-car radio will be judged under conditions of crowded traffic, mid-day reception or suburban travel. After its novelty has worn off the owner will not use it under these conditions any more than he would drive down Main Street playing a portable phonograph, but for the person who is driving from Boston to New York, Chicago to St. Louis, San Francisco to Los Angeles, the pleasure, relaxation and freedom from the usual conversational effort will be well worth the cost. After an hour's steady driving conversation palls, and the radio provides a welcome respite. Waiting in a parked car becomes a pleasure. On picnics, camping parties, and at wayside hotels it provides amusement for the evening. Ability to get the news of the day,

the stock and commodity quotations, when he is alone and has time to think, will appeal to the business man.

I have talked with many people on this subject, including public officials and those interested in traffic and safety conditions, and of those who thought they were opposed to it or were not interested, ninety per cent of them were converted after one ride in a car equipped with a good set.

Primarily, motor-car radio was prompted by automobile manufacturers as a new and possibly appealing accessory. It begins to look as if they had uncovered a new and substantial radio market.

A novelty is short-lived unless it performs a worth-while service. To many people motor-car radio is just a novelty and nothing more. If this new product is to provide a steady volume of business which will be of interest to the manufacturers, it must be based on something more substantial than the mere thrill of listening to "Amos 'n' Andy" while riding in an automobile.

An Extremely Compact Five-Tube Automotive Receiver

FOR automotive installation—a term which covers motor boats and other vehicles as well as motor cars—a new receiver assembly has been developed by the United States Radio and Television Corporation of Marion, Indiana. The chassis is unusually compact, fitting into an aluminum shield case only 8 x 8 3/4 x 10 1/4 inches; a junction box, to which all electrical leads run, simplifies the task of connecting the control unit, receiver, speaker and power supplies.

The circuit, which is illustrated at the right, exhibits several differences from any of the other automotive designs which have been shown in the preceding issues of RADIO-CRAFT. It will be noted that a '26 tube, with its high thermal lag and lower filament requirements, is used as a detector, instead of the usual '27 type. The volume control is a 10,000-ohm resistor in the cathode return of the two R.F. screen-grid amplifiers, which regulates their control-grid bias.

As with most motor-car installations, it is assumed that the control unit which carries the tuning knob is to be attached to the instrument board of the car, and thus be accessible to the driver and to his companion; but the previous arrangement of the car's equipment will usually control in this matter. The locations of the shielded chassis and of the magnetic speaker are also optional; the standard place for the latter is at the left of the dash, and an extension cord is required for its mounting in the top or rear of the car.

The junction box receives the leads from the various units of the assembly; and is

the convenient place of application of a meter for the first service tests. Only the flexible drive shaft, which couples the control unit to the condenser shaft of the chassis, runs directly between the two last named. A 1:16-gear furnishes the connection at the receiver.

For the current supply, a shielded box is provided to hold a specially-designed dry-

cell combination, which provides at the same time 180 volts of "B" and 45 of "C," in place of separately-cased smaller blocks. The filament current, of course, is drawn from the storage battery of the car and, to avoid pick-up of ignition and other interference when the car is in motion, the usual suppressors must be used.

(Continued on page 174)

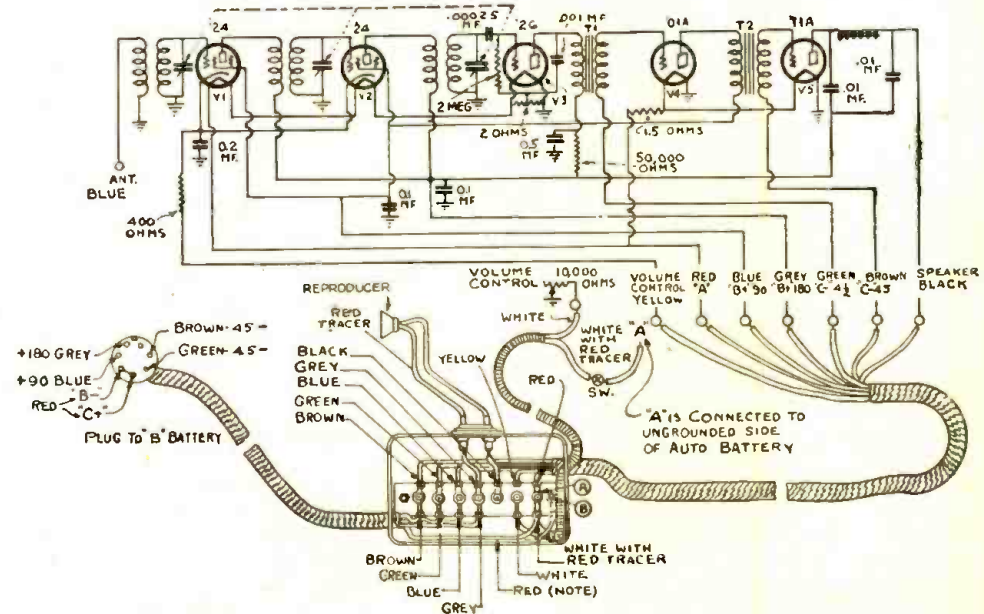

The schematic circuit and wiring connections of the U. S. Radio "Model 30" screen-grid automotive receiver. When the positive side of the car's storage battery is grounded, the red lead connects to terminal "A" of the junction box, from which one side of all voltage readings is then taken. If the battery's negative is grounded, the red lead connects to "ground" on the screw "B" which mounts the junction box.

* President, Radio Manufacturers Association.

The "Thyratron"—An Addition to the Vacuum-Tube Family

The remarkable achievements of a new type of tube which finds extensive use for many electrical purposes, as well as in radio circuits requiring power. It comes in a wide range of sizes to serve numerous purposes, many still being developed.

By JOSEPH RILEY

THE radio technician is now called upon to make the acquaintance of a new member of the growing family of tubes with classical names—the "Thyratron." This word is derived from the Greek, and signifies an "electron door." As with its relatives (Pliotron—"more electrons," Dynatron—"electron power," and Kenotron—"electrons in motion") the term is applicable to tubes of all sizes and structure.

Briefly, the thyratron is an arc rectifier (over 90% efficient) the starting of which can be controlled by its grid. After starting, however, the grid has no further control over the arc, which it can neither limit, modulate, nor extinguish. Modulation of this current flow, however, may be obtained conveniently through the plate circuit.

The range of sizes is enormous. Fig. B is reproduced from the photograph of a huge thyratron, designed to work in a circuit carrying 100 amperes at 20,000 volts; while Fig. A illustrates a small model closely resembling in appearance the standard type of vacuum tubes used in broadcast receivers. The interest of this tube for the technician lies in its application to radio transmission and photoelectric work.

It has, as may be seen, the fundamental electrodes corresponding to those of the

three-element receiving tube; but their design and proportions are different, and the tube contains a quantity of inert gas, or a drop of mercury to furnish vapor. While thyratron operation would be possible in a receiving tube of ordinary design the elements of the latter (Fig. C) are not advantageously disposed for this purpose; the grid is too short and close to the filament, and the filament voltage is too high. These difficulties are obviated in the thyratron by the design shown in Fig. A. The latter is designed for an alternating plate potential of 110 volts at 60 cycles; and will pass a plate current of 5 amperes.

Internal Action in the Tube

Briefly, the action of the thyratron is as follows:

(1) The grid is held at a high negative "C" potential (perhaps 15 volts) and repels the electrons or negatively-charged particles shot off the cathode. Therefore, no plate current flows (as indicated at A in Figs. 3 and 4.)

(2) If the "C" bias is reduced to a low negative value (perhaps $\frac{1}{2}$ -volt) or is made slightly positive, "grid emission" will start, and a few of the cathode electrons will succeed in reaching the plate. This completes the plate-to-cathode circuit and, within a

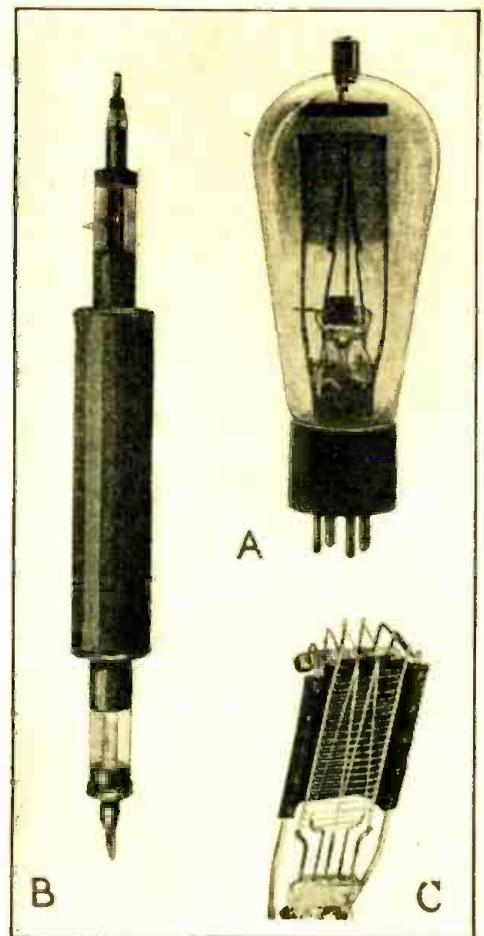

The long tube at the left is a large thyratron with a metal jacket which is also its grid; at the upper right is a small one, whose elements are visible and may be compared with ordinary receiving-tube design at C.

fraction of a "microsecond" (one millionth of a second) the plate current will jump to its maximum output, which may be five amperes, as shown at B.

For the remainder of the cycle the grid cannot exercise any control over the plate current, because the vapor in the tube is now ionized and forms around the grid a positive "ionic sheath" (shown dotted, in Fig. 3 at B and C); no matter how negative the grid is now made, its negative ions cannot break through this sheath of positive ions and exercise control of the plate current.

(3) However, by reducing the plate voltage, we can stop the arc in the ionized vapor, as shown at C; then, because of the drop in plate voltage, the positive "ionic sheath" around each grid wire expands until it touches that of the next wire. A sheath is thus formed which completely shields the cathode and insulates its negative electrons from the plate; and, as a result, the plate current again drops to zero.

If a D.C. plate supply, such as batteries, is used instead of the 60-cycle current applied in this demonstration, approximately 80 microseconds will be required to allow the positive ions to dissipate; for these ions represent a current, and even a fraction of a microampere is sufficient to start the arc.

The ratio of positive plate to negative voltage at which current will just start in the thyratron (corresponding in general to "amplification factor" in an ordinary tube) is its only constant; and for it a new term has been coined, the "grid-control ratio." An average figure is 100.

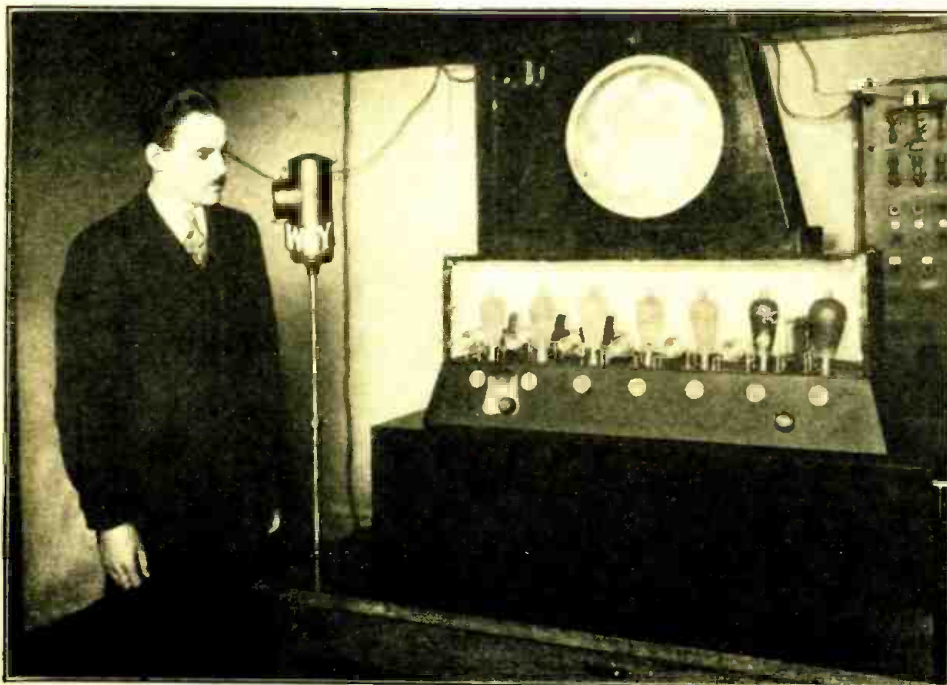
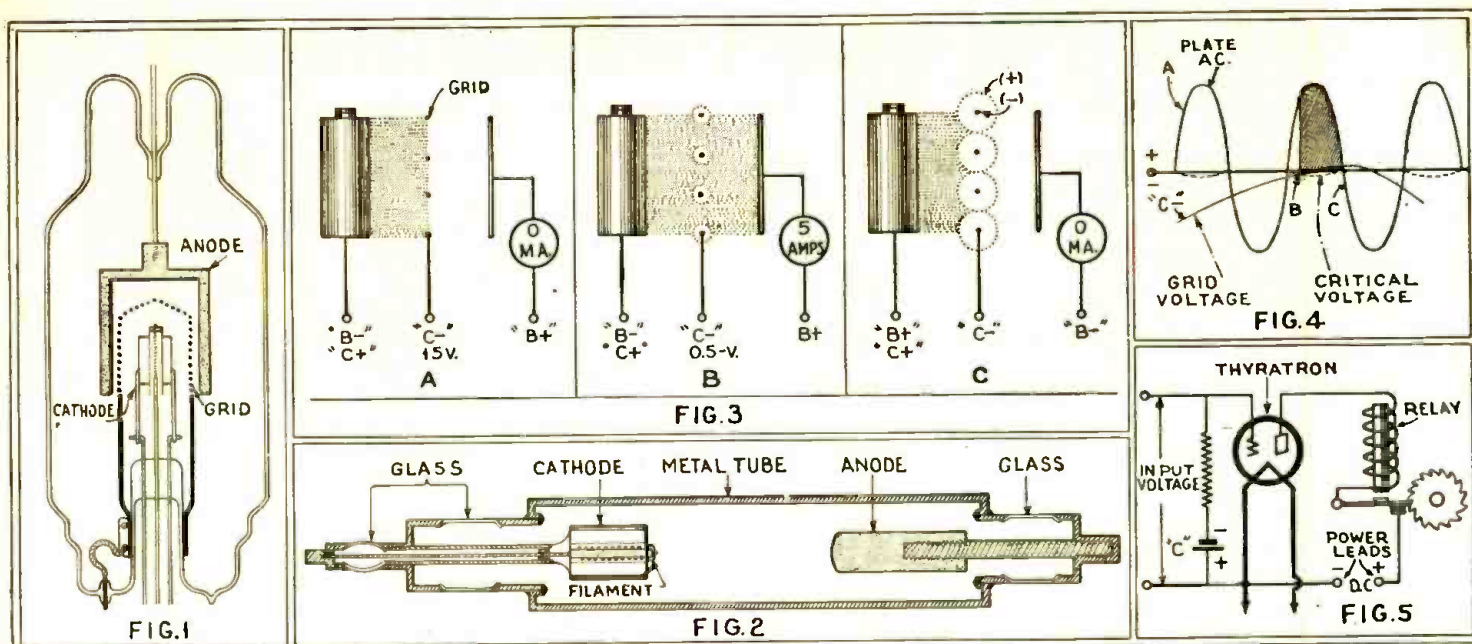

Fig. D

A huge model superheterodyne in which thyratrons serve as detectors and amplifiers, functioning in the ordinary manner. Their activity, however, is made visible by the varying brilliancy of the glowing colored gases with which they are filled. Even the loud speaker is replaced by a glow-tube.



At the left, a section (Fig. 1) through the elements of a typical small thyatron, such as that illustrated in Fig. A; in Fig. 2, below, the arrangement in a power thyatron like that of Fig. B, where the metal jacket is the grid. The internal action of a thyatron, shown in Fig. 3, is also indicated in the characteristic curve of Fig. 4; and a circuit using a low-power thyatron as a relay is given in Fig. 5.

It is characteristic of the thyatron that its output impedance is practically zero; hence, it must feed into a load which will limit the plate current to the requirements of the tube.

Numerous Applications

Industrial uses for the thyatron are as follows: to start, stop or control the speed of motor and generators; change D.C. to A.C. (with either a flat-top or a sine-wave characteristic); sort fruit according to color and size; measure or control pressures; control temperature of electric furnaces; control heavy-current circuits by use of light-

sensitive cells; and measure the transparency of liquids. A simple circuit showing the thyatron in use is Fig. 5.

At the recent show of the Radio Manufacturers Association in Atlantic City, the thyatron was ingeniously and spectacularly applied to a demonstration of the action of a superheterodyne at the booths of the General Electric Company. The apparatus, illustrated in Fig. D, replaced ordinary receiving tubes with thyratrons. When the set was tuned, each tube—including one which replaced the speaker in the power output, glowed with a distinctive color. When a station was tuned in and out, the

light increased and faded again; leaving only the oscillator tube in constant operation. The first two thyratrons, representing R.F. amplifier and first detector, glowed pink, being filled with helium; the oscillator, ingeniously, was arranged to vary in color as it was tuned from one end of the scale to the other. The intermediate amplifiers were filled with neon, and the dimness or brightness of their red glow showed the sharpness of tuning in these stages. The second detector and A.F. amplifier contained mercury, and the pulsation of the speech or music received could be observed plainly in the blue-green glow from these tubes.

Men Who Have Made Radio—E. F. W. Alexanderson

THE TWELFTH OF A SERIES

RADIO, beneath its innumerable applications, has the fundamental basis of electrical engineering. The latter term may have seemed, oftentimes, a trifle too stately when it was applied to the design of a device of power so low and mechanical structure so simple as that of the earliest radio receiving sets; but the problems of long-distance and commercial radio transmission involve tasks of consummate engineering as well as delicate electrical balancing. It is not enough to perceive clearly radio's fundamental principles; it is necessary to create machinery for their application. Such has been pre-eminently the work of the distinguished electrical engineer pictured here.

Ernst F. W. Alexanderson was born January 25, 1878, in the ancient city of Upsala, in Sweden. His early mechanical bent was encouraged by his father, a professor of classical languages, and he was sent to the Royal Technical University of Stockholm. After post-graduate technological work in Berlin, the young engineer determined to pursue his profession in America. Here, in 1902, he entered the drafting department of the General Electric works at Schenec-



tady; and after two years, won a place on the engineering staff, to the top of which he proceeded to climb rapidly.

Alexanderson soon made his impression on the whole field of electrical motor design and allied machinery. The New Haven railroad undertook electrification, and he

designed the single-phase motor for this work. For other purposes, he created the self-exciting alternator, high-voltage D.C. motors, high-voltage synchronous converters, variable-speed induction motors of great power, whose application to the battleship *New Mexico* marked a revolution in naval design.

Perhaps the best known, however, of his accomplishments in this type of machinery is the invention of the high-frequency alternator; the repercussions of which were more than nation-wide. For many years the spark method of radio transmission reigned, until it was threatened by the arc; yet neither of these met the rising demands of radio communication. The idea of creating a generator which should develop radio frequencies, as ordinary machinery does sixty-cycle current, had been more than once suggested. The problem of practicable design, however, seemed insoluble until Alexanderson was successful. A new and striking element was introduced into overseas communication; and to it the inventor added the magnetic amplifier and the multiple tuned antenna, the last perhaps the most important from

(Continued on page 180)

New Radio Devices for Shop and Home

In this department are reviewed commercial products of most recent interest. Manufacturers are requested to submit descriptions of forthcoming developments.

AUTOMOTIVE SERVICE METER

THE increasing vogue of automotive radio installations has created a demand for special devices adapted to their particular service needs. One of the latest of these is the "Model 489" D.C. volt-milliammeter illustrated in Fig. A together with a special leather case designed for its keeping. The instrument's weight is but 11 ounces; it has three ranges—0-200 volts and 0-8 volts, with resistances of 125 ohms per volt, and 0-2 milliamperes. These, it will be seen, meet the needs of all standard automotive radio receivers. The accuracy is guaranteed within 2 per cent; zero scale adjustment is provided for.

The pinjacks shown on the front of the instrument receive the ends of 30-inch flexible cables, equipped with test prods; and the choice of jack determines the scale used. The prods may be inserted in tube-socket openings. Plate or screen-grid current may be measured by connecting the meter in the proper "B" lead and inserting one tube

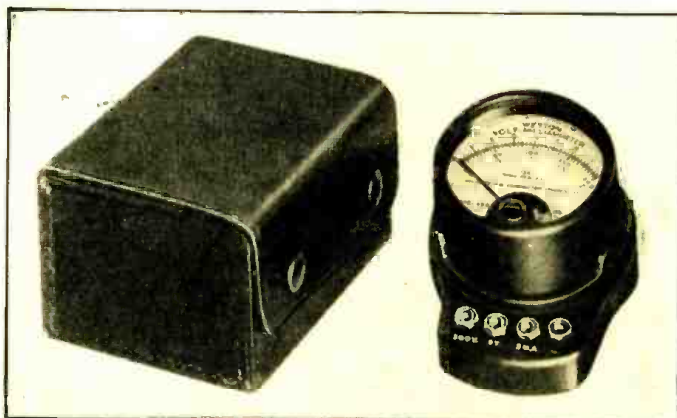

Fig. A

The Weston meter shown at the right has been designed especially for the increasing work of automotive radio servicing. The leather case at the left makes a very convenient carrier.

at a time into its socket. Continuity tests, condenser adjustments, and many other operations may be performed with its aid.

The meter is mounted in a case of molded black bakelite; the dial is silver etched. The instrument is manufactured by the Weston Electrical Instrument Corporation of Newark, N. J.

SOLDERING-IRON HEAT CONTROL

A SHOP device developed by the Clarostat Mfg. Co., Brooklyn, N. Y., has been placed in production, for the benefit of those who have occasion to use an electric soldering iron frequently at the bench. Any make of iron, up to 200 watts rating, can be used.

This instrument, which complies with underwriters' requirements, comprises a perforated iron box (as shown in Fig. B) with the necessary "knockouts" for BX or conduit wiring, a front metal panel carrying a snap switch, a variable "power Clarostat" of 100 ohms resistance, a pilot light, and a plug receptacle.

The switch has three position: "off," "full on" (for quick heating), and "current control on"; in the latter position, the power

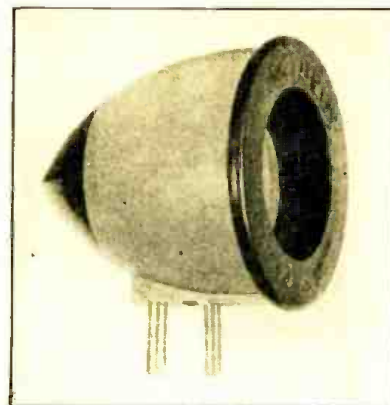
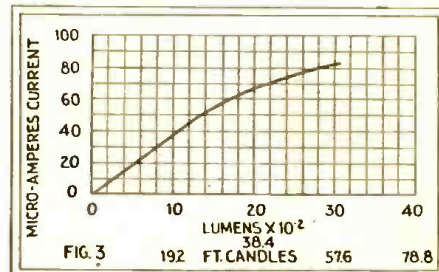

Fig. C

Appearance of the new Arcturus photolytic cell in its container, now available for practical applications.

big brother the storage battery. In the Arcturus cell, troubles hitherto experienced in its operation have been overcome by tinting the darkened plate.

Such a cell has a very low impedance, and will work well when connected to transformer primaries with the values between 600 and 5,000 ohms. An outstanding feature of the photolytic cell is that it needs no biasing voltage; this is clearly shown in Fig. 2, the schematic circuit of the "dynamic" hookup to be employed when using a modulated light source.



The characteristic curve, showing the response to light-intensity, of an average photolytic cell.

Since this cell does not contain ionized gas, there is no ionization "rushing" sound in the amplifier; while another advantage is the entire absence of all microphonic effects. A third consideration is the life of the tube; it is stated that, after about 1,000 hours' exposure to a light intensity of some 20 foot-candles, the "depreciation," or fatigue, was less than 10%. Its current output when subjected to light of varying intensity is shown in Fig. 3.

FUSE ADAPTER PLUG

INSTEAD of inserting a short-circuit device in sets equipped for regulator tubes (where these tubes, for some reason, are not being used, or have not yet been installed) the Fuse Adapter Plug illustrated in Fig. D may be used to complete the circuit.

This, a product of the Carter Radio Co., Chicago, Ill., is "polarized." It plugs into
(Continued on page 167)

resistor will control the temperature of the soldering iron "to a T" for any type of work. The lamp's brilliancy is the heat indication. It is claimed that this procedure will increase the life of an iron at least six times.

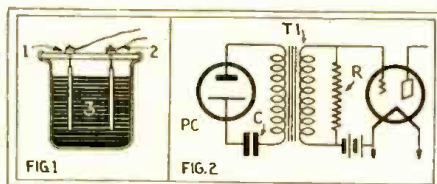

Left, the essentials of the photolytic cell, which resembles other voltaic pairs; right, a photolytic cell hooked up to a vacuum-tube amplifier.

LIGHT-SENSITIVE CELL

A "PHOTOLYTIC" or photo-voltaic cell (one with the property of generating current when light strikes one of two metal plates that are immersed in an electrolytic solution) developed by the Arcturus Radio Tube Co., Newark, N. J., is shown in Fig. C.

It operates by the physical effect discovered by Becquerel, whose general arrangement is Fig. 1; in this diagram 1 and 2 are pieces of copper foil which have been coated with cuprous oxide and immersed in a very dilute copper-sulphate solution 3. If one plate is illuminated while the other is kept dark, a current will flow; the cell has become a minute generator, akin to its



Fig. B

The box on the wall at the right is the new Clarostat heat control, regulating the electric soldering iron.

Short-Wave Stations of the World

All Schedules Eastern Standard Time: Add 5 Hours for Greenwich Mean Time.

Meters	Kilo-cycles	Station	Notes
4.97-5.35	60,000-56,000	Amateur	Telephony and Television.
8.57	35,000	W2XCU	Ampere, N. J.
11.55	25,960	G5SW	Chelmsford, England Experimental.
12.48	24,000	W6AQ	San Mateo, Calif. (Several experimental stations are authorized to operate on non-exclusive waves of a series both above this and down to 4 meters.)
13.04	23,000	W2XAW	Schenectady, N. Y.
13.97	21,460	W2XAL	New York.
14.06	21,320	DIV	Nauen, Germany.
14.50	20,680	LSN	Monte Grande, Argentina, after 10:30 p. m. Telephony with Europe. —FMB, Tamatave, Madagascar. —PMB, Bandoeng, Java.
14.62	20,500	W9XF	Chicago, Ill. (WENR).
14.89	20,140	DGW	Nauen, Germany. 2 to 9 p. m. Telephony to Buenos Aires.
15.03	19,950	LSG	Monte Grande, Argentina. From 9 a. m. to 1 p. m. Telephony to Paris and Nauen (Berlin). —DIH, Nauen, Germany.
15.07	19,900	...	Monte Grande, Argentina. 8-10 a. m.
15.10	19,850	WMI	Deal, N. J. —SPU, Rio de Janeiro, Brazil.
15.12	19,830	FTD	St. Assise, France.
15.40	19,460	FZU	Tamatave, Madagascar.
15.45	19,400	FRE	St. Assise, France.
15.50	19,350	...	Nancy, France, 4 to 5 p. m. —VK2ME, Sydney, Australia.
15.55	19,300	FTM	St. Assise, France. 10 a. m. to noon.
15.60	19,220	WNC	Deal, N. J.
15.85	18,920	XDA	Mexico City, Mex. 12:30 to 2:30 p. m.
15.94	18,820	PLE	Bandoeng, Java. Broadcasts. Tues. 8:40 to 10:40 a. m. Telephony with Kootwijk (Amsterdam).
16.10	18,620	GBJ	Bodmin, England. Telephony with Montreal.
16.11	18,610	GBU	Rugby, England.
16.30	18,400	PCK	Kootwijk, Holland. Daily from 1 to 6:30 a. m.
16.35	18,350	WND	Deal Beach, N. J. Transatlantic telephony.
16.38	18,310	GBS	Rugby, England. Telephony with New York. General Postoffice, London. —FZS, Saigon, Indo-China, 1 to 3 p. m. Sundays.
16.44	18,240	FTO	FTE, Ste. Assise, France.
16.50	18,170	CGA	Drummondville, Quebec, Canada. Telephony to England. Canadian Marconi Co.
16.54	18,130	GBW	Rugby, England.
16.57	18,120	GBK	Rugby, England.
16.61	18,050	KQJ	Bollnas, Calif.
16.70	17,950	FZU	Tamatave, Madagascar.
16.80	17,850	PLF	Bandoeng, Java ("Radio Malabar"). Works with Holland.
16.82	17,830	PCV	Kootwijk, Holland. 3 to 9 a. m.
16.88	17,770	PHI	Hilzen, Holland. Beam station to Dutch colonies. Broadcasts Mon., Wed., Thurs., Fri., Sat., 8:40-19:40 a. m. N. V. Philips Radio, Amsterdam.
16.90	17,750	HSIPJ	Bangkok, Siam. 7-9:30 a. m. 1-3 p. m. Sundays.
17.20	17,440	AGC	Nauen, Germany.
17.34	17,300	W2XK	Schenectady, N. Y. Tues., Thurs., Sat. 12 to 5 p. m. General Electric Co. —W6XN, Oakland, Calif. —W6AJ, Oakland, Calif. —W7XA, Portland, Ore. —W7XC, Seattle, Wash. —W2XCU, Ampere, N. J. —W9XL, Anoka, Minn., and other experimental stations.
18.00	16,900	G2GN	S. S. "Olympic." —G2IV, S. S. "Majestic."
18.10	16,560	G2AA	ship phone.
18.37	16,320	VLC	Sydney, Australia. Phone to England.
18.40	16,300	PCL	Kootwijk, Holland. Works with Bandoeng from 7 a. m. Netherland State Telegraphs. —WLO, Lawrence, N. J. —GBX, Rugby, England. —FRE, Saigon, Indo-China. —PLG, Bandoeng, Java. Afternoons. —F8Z, French phone to G2XN. —W2XAD, Schenectady, N. Y. Broadcasts Sun. 2:30 to 5:40 p. m. Tues., Thurs. and Sat. noon to 5 p. m. Fri. 2 to 3 p. m.; besides relaying WGY's evening program on Mon. Wed. Fri. and Sat. evenings. General Electric Company.
19.60	15,300	OXY	Langby, Denmark. Experimental.
19.63	15,280	W2XE	Jamaica, N. Y.
19.66	15,250	W2XAL	New York, N. Y.
19.71	15,220	W8XK	(KDKA) Pittsburgh, Pa. Tues., Thu., Sat., Sun., 8 a. m. to noon. —LSI, Monte Grande, Argentina.
19.99	15,000	CM6XJ	Central Toluca, Cuba.
20.00	14,900	TFZSH	Iceland.
20.70	14,480	W8XK	East Pittsburgh, Pa. —GBW, Rugby, England.
20.80	14,420	VPD	Sura, Fiji Islands.
20.90	14,310	G2NM	Caterham, England. Sundays 5-6 a. m. 12:00-2 p. m.
20.97-21.26	14,300-14,100	Amateur	Telephony.
21.50	13,940	...	Bucharest, Roumania. 2-5 p. m. Wed., Sat.
21.59	13,890	...	Mombasa, East Africa.
22.20	13,500	...	Vienna, Austria.
22.28	13,400	WND	Deal Beach, N. J. Transatlantic telephony.
22.97	13,050	W2XAA	Houlton, Me. Transatlantic telephony.
23.00	13,040	DBE	La Punta, Peru. Time signals 2 p. m.
23.35	12,850	W2XO	Schenectady, N. Y. Antipodal program 9 p. m. Mon. to 3 a. m. Tues. noon to 5 p. m. on Tues., Thurs. and Sat. General Electric Co. —W6XN, Oakland, Calif. —W2XCU, Ampere, N. J. —W9XL, Anoka, Minn., and other experimental relay broadcaster.
23.98	12,500	G2GN	"Olympic." —G2IV, "Majestic."
24.41	12,280	GBU	Rugby, England.

Meters	Kilo-cycles	Station	Notes
24.46	12,250	FTN	Ste. Assise (Paris) France. Works Buenos Aires, Indo-China and Java. On 9 a. m. to 1 p. m., and other hours. —KIXR, Manila, P. I. —GBX, Rugby, England.
4.63	12,180	Airplane	
24.68	12,150	GBS	Rugby, England. Transatlantic phone to Deal, N. J. (New York). —FQO, FQE, Ste. Assise, France.
24.89	12,045	NAA	Arlington, Va. Time signals, 8:55-9 a. m., 9:55-10 p. m.
24.98	12,000	FZG	Saigon, Indo-China. Time signals, 2-2:45 p. m. —Operto, Portugal.
25.10	11,915	KKQ	Bollnas, Calif.
25.21	11,880	W8XK	(KDKA) Pittsburgh, Pa. Tues., Thu., Sat., Sun., noon to 5 p. m., and Sat. night. Arab. programs. Television Mon. and Fri. 2:30 p. m., 60 lines. 12:00 p. m. —W9XF, Chicago (WENR). —W2XAL, New York (WRNY).
25.34	11,840	W2XE	Jamaica, New York (WABC).
5.36	11,820	KIXR	Manila, P. I., 5-6 p. m., 11:15 a. m.-12:15 p. m., 2-4 a. m., and (except Monday) 10-10:15 p. m.
25.40	11,810	IBRO	Rome, Italy (Tests)
25.42	11,800	UDR2	Vienna, Austria. Tues., 9-11 a. m.; Wed., 5-7 p. m.; Thurs., 5-7 a. m.
25.53	11,750	G5SW	Chelmsford, England. 6:30-7:30 a. m. and 1-6 p. m. except Saturdays and Sundays.
25.60	11,690	CJRX	Winnipeg, Canada. 5:30 p. m. on 11:00 Tu.; 8:30 Mon., Wed., Fri., 10:30 Tu.; 11:00 Thu.; midnight Sat. Sundays 11:30 a. m. to 1 p. m., 10-11 p. m.
25.68	11,670	KIO	Kahlun, Hawaii.
26.00	11,530	CGA	Drummondville, Canada.
26.10	11,490	GBK	Rugby, England.
26.20	11,440	KIXR	Manila, P. I., 11:15-12:15 p. m., 2-4 a. m., 5-10 a. m.
26.22	11,435	DHC	Nauen, Germany.
26.70	11,230	WSBN	S. S. "Leviathan" and A. T. & T. telephone connection. —IBDK, S. S. "Elettra," Marconi's yacht.

(NOTE: This list is compiled from many sources, all of which are not in agreement, and which show greater or less discrepancies; in view of the fact that most schedules and many wavelengths are still in an experimental stage; that daylight time introduces confusion and that wavelengths are calculated differently in many schedules. In addition to this, one experimental station may operate on any of several wavelengths which are assigned to a group of stations in common. We shall be glad to receive later and more accurate information from broadcasters and other transmitting organizations, and from listeners who have authentic information as to calls, exact wavelengths and schedules. We cannot undertake to answer readers who inquire as to the identity of unknown stations heard, as that is a matter of guesswork; in addition to this, the harmonics of many local long-wave stations can be heard in a short-wave receiver.—EDITOR.)

27.00	11,100	EATH	Vienna, Austria. Mon. and Thurs. 5:30 to 7 p. m.
27.75	10,800	GBX	Rugby, England.
28.20	10,630	PLR	Bandoeng, Java. Works with Holland and France weekdays from 7 a. m.; sometimes after 9:30.
28.00	10,710	VAS	Glace Bay, N. S., Canada 5 a. m. to 2 p. m. Canadian Marconi Co.
28.50	10,510	RDRL	Leiningrad, U. S. S. R. (Russia)
28.50	10,410	VK2ME	Sydney, Australia. Irregular. On Wed. after 6 a. m. Amalgamated Wireless of Australia, Pennant Hills, N. S. W. —KES, Bollnas, Calif.
29.00	10,340	...	Paris, France. 1:30-3 p. m. daily; 9 a. m. Sundays.
28.86	10,390	GBX	Rugby, England.
29.50	10,100	HS2PI	Bangkok, Siam. Sun., Tues., Fri. 8-11 p. m.
9.70	10,095	...	"Radio Experimental," Paris, France. From 5:45 p. m. daily; Sunday at 7 a. m. and 2 p. m.
29.98	10,000	CM2LA	Havana, Cuba.
30.15	9,940	GBU	Rugby, England.
30.20	9,920	W2XU	Long Island City, New York. —Psen, Poland.
0.30	9,890	LSN	Buenos Aires, phone to Europe.
30.61	9,790	GBW	Rugby, England.
0.75	9,750	...	Asen, France. Tues. and Fri., 3 to 4:15 p. m.
40.90	9,700	NRH	Heredia, Costa Rica. 10:00 to 11:00 p. m. Amado Cespedes Marin, Apartado 40.
...	...	WIXAZ	Springfield, Mass. Relays WHZ.
1.10	9,640	7LO	Nairobi, Kenya Africa. 11:00 a. m. to 2 p. m. Relays G5SW, Chelmsford, frequently from 2 to 3 p. m. —Monte Grande, Argentina, works Nauen irregularly after 10:30 p. m.
31.23	9,600	LGN	Bergen, Norway.
1.26	9,590	PCI	Hilversum (Eindhoven) Holland. Thu. 1-5 p. m. 6-10 p. m. Friday 1-3 p. m. 7 p. m. to 1 a. m. Saturday, N. V. Philips Radio.
31.28	9,580	VK2FC	Sydney, Australia. Irregularly after 4 a. m. N. S. W. Broadcasting Co. —W3XAU, Ryberry, Pa., relays WCAU daily. —VPD, Sura, Fiji Islands.
31.35	9,570	WIXAZ	Springfield, Mass. (WHZ).
31.38	9,550	...	Konigsbrunn, Germany. 10 to 11 a. m., 11:30 a. m. to 2:30 p. m. and 3 to 7:30 or 8:30 p. m. Relays Berlin. —KIXR, Manila, P. I.

Meters	Kilo-cycles	Station	Notes
31.48	9,530	W2XAF	Schenectady, New York. Mon., Tues., Thurs. and Sat. nights, relays WGY from 6 p. m. General Electric Co. —W9XA, Denver, Colorado. Relays KOA. —Helsingfors, Finland.
31.56	9,500	VK3LO	Melbourne, Australia. Irregular. Broadcasting Co. of Australia. —OZ7RL, Copenhagen, Denmark. Around 7 p. m.
31.60	9,490	OXY	Langby, Denmark. Noon to 3 p. m.
31.75	9,450	...	Rio de Janeiro, Brazil. 5-7 p. m. Testing 200 watts.
31.80	9,430	XDA	Mexico City, Mex. —Psen, Poland. Tues. 1:45-4:45 p. m.; Thu. 1:30-8 p. m.
32.00	9,375	EH90C	Berne, Switzerland. 3-5:30 p. m. —OZ7MK, Copenhagen, Denmark. Irregular after 7 p. m. —3UZ, Melbourne, Australia.
32.06	9,350	CM2MK	Havana, Cuba.
32.13	9,330	CGA	Drummondville, Canada.
32.40	9,250	GBK	Rugby, England.
32.50	9,230	FL	Paris, France (Eiffel Tower) Time signals 4:55 a. m. and 4:55 p. m. —VK2BL, Sydney, Australia.
32.79	9,200	GBS	Rugby, England. Transatlantic phone.
32.80	9,110	SUS	Calro, Egypt.
33.24	9,010	GBS	Rugby, England.
33.81	8,875	MRD	Caite (Manila) Philippine Islands. Time signals 9:55-10 p. m.
31.50	8,690	W2XAC	Schenectady, New York.
34.68	8,650	W2XCU	Ampere, N. J.; —W9XL, Chicago. —W3XE, Baltimore, Md. 12:15-1:15 p. m. 10:15-11:15 p. m. —W2XV, New York City. —W8XAG, Dayton, Ohio. —W4XN, Oakland. —W4XB, Miami, Fla. —And other experimental stations.
34.74	8,630	WOO	Deal, N. J.
35.00	8,570	HKCJ	Manizales, Colombia. —RB15, Khabarovsk, Siberia. 5-7:30 a. m.
35.02	8,560	G2GN	S. S. "Olympic." —G2IV, S. S. "Majestic."
35.54	8,440	G2AA	ship phone.
35.48	8,450	WSBN	S. S. "Leviathan."
36.00	8,330	3KAA	Leiningrad, Russia. 2-6 a. m., Mon., Tues., Thurs., Fri.
36.74	8,160	...	Mombasa, East Africa.
37.02	8,100	EATH	Vienna, Austria. Mon. and Thurs. 5:30 to 7 p. m. —HS4P, Bangkok, Siam. Tues. and Fri. 8-11 a. m., 2-4 p. m. Tuesdays.
37.36	8,030	NAA	Arlington, Va. Time signals 8:55-9 a. m., 9:55-10 p. m.
37.43	8,015	Airplanes	
37.80	7,930	DOA	Hobertz, Germany. 1 to 3 p. m. Telepostzentralamt, Berlin.
38.00	7,890	VPD	Sura, Fiji Islands.
38.30	7,830	PCK	Kootwijk, Holland. after 9 a. m.
38.60	7,770	FTC	St. Assise, France. —PCL, Kootwijk, Holland. 9 a. m. to 7 p. m. —Bremen."
39.70	7,550	...	S. S. "Bremen."
39.15	7,600	FTL	St. Assise, France.
39.98	7,500	TFZSH	Reykjavik, Iceland. —EK4ZZZ, Danzig (Free State).
40.20	7,460	YR	Lyons, France. Daily except Sun. 10:30 to 1:30 a. m.
40.50	7,410	...	Eberswalde, Germany. Mo., Thu. 1-2 p. m.
41.00	7,310	...	Paris, France ("Radio Vitus") Tests. —Moscow, U. S. S. R. 7-7:45 a. m.
41.16	7,290	DOA	Doerzbitz, Germany.
41.50	7,220	HBSD	Zurich, Switzerland. 1st and 3rd Sundays at 7 a. m., 2 p. m.
41.70	7,190	VK6AG	Perth, West Australia. Between 5:30 and 10 a. m.
42.12	7,120	OZ7RL	Copenhagen, Denmark. Irregular. Around 7 p. m.
2.70	7,020	EARI25	Madrid, Spain. 6-7 p. m.
42.80	7,000	FBKR	Constantin, Algeria.
3.00	6,980	EAR 110	Madrid, Spain. Tues. and Sat. 5:30 to 7 p. m., Fri. 7 to 8 p. m. —CTIAA, Santos, Portugal, Friday, 4-5 p. m. —IMA, Rome, Italy, Sun., noon to 2:30 p. m. —FBMC, Casablanca, Morocco. Sun., Tues., Wed., Sat. —Cathen, Germany. Sundays 4-6 a. m.; Tuesdays, Fridays, noon-2 p. m.; Thursdays 4-6 p. m.
44.00	6,820	XC 51	San Lazaro, Mexico. 3 a. m. and 3 p. m.
44.40	6,750	WND	Deal, N. J.
44.60	6,720	VRV	Georgetown, British Guiana. Wed. and Sun., 7:15 to 10:15.
45.00	6,690	...	Berlin, Germany.
35.20	6,630	WSBN	S. S. "Leviathan."
36.65	6,515	WOO	Deal, N. J.
46.70	6,425	W2XCU	Ampere, N. J.; —W9XL, Anoka, Minn., and others. —CT3AG, Funchal, Madeira Island. Sat. after 10 p. m. —VAS, Glace Bay, Canada. Tests. —VESAP, Drummondville, Canada. 4:15 p. m.
48.25	6,215	FRT	Port de France, Martinique.
48.30	6,205	LON	Buenos Aires, Argentina.
48.35	6,200	HKC	Buenos Aires, Colombia.
8.50	6,160	HRB	Tegucigalpa, Honduras. 9:15 p. m. to midnight, Mon., Wed., Fridays. From 11-12 p. m. Sat., Int. S. W. Club programs.
48.74	6,155	W9XAL	Chicago, Ill. (WMAAC) and Airplanes.
48.80	6,140	KIXR	Manila, P. I. 3-4:30, 5-9 or 10 a. m. 2-3 a. m. Sundays.
48.83	6,140	KDKA	East Pittsburgh, Pa. Tu., Thu., Sat., Sun., 1 p. m. to midnight. —Montala, Sweden. "Rundradio." 6:30-7 a. m., 11-4:30 p. m. Holidays, 5 a. m.-5 p. m. —ARI, Hongkong, China. —W2XE, New York City. Relays WABC. Atlantic Broadcasting Co. —FL, Eiffel Tower, Paris. 5:30-5:45 a. m., 5:45-12:30, 4:15-4:45 p. m.
49.15	6,100	W3XL	Round Brook, N. J. (WJZ, New York). 12 midnight on.

(Continued on page 188)

SHORT WAVE CRAFT

Short Waves on Your Broadcast Receiver Dial

By WATSON BROWN

THE short-wave frequency-changer described here was designed for both showroom and living-room use. It works in connection with any broadcast receiver, makes use of both R.F. and A.F. amplification, and is as free from A.C. hum on the short waves as the receiver on the broadcast band. Further, without tampering with your present set, it erases all the broadcast programs that now crowd the dial, and gives you instead scores of distant short-wave stations, which can be successively brought in by the same tuning controls.

There were two outstanding reasons for using the design pictured. First: the writer knows of many Service Men who want to make and sell short-wave sets at a profit during dull months. Since the profit from a short-wave set is less than from a broadcast receiver, the constructor can hardly afford to make several trips to his prospect's home to give demonstrations. The cost of the sale is greatly reduced when we have a set that is foolproof in connections and in tuning; so that we can insist on our customer's taking it home and trying out himself for a few days. Secondly, in the stores of thousands of radio dealers (especially in the small towns throughout the West and the South which have no local broadcast stations) there is urgent need for some way of demonstrating the tone, selectivity, etc. of their broadcast receivers during days when

THE equipment described here differs from the short-wave "adapters" which are well-known; since it utilizes the whole radio-frequency amplification of a broadcast receiver. In addition to this, the control dial of the broadcast receiver serves as an actual tuning control, giving the same vernier effect obtainable on the longer waves. With this converter, the radio-frequency stages of the receiver become an amplifier at an intermediate frequency which is easier to vary exactly than the oscillator frequency of the converter tube. However, the tuning of the aerial on short waves must not be too nearly aperiodic; or it is possible that interference will be caused by the sum- and difference-frequencies in the output of the converter. It is always desirable, with a short-wave device, to have the antenna tuning condenser control readily accessible.

As Mr. Brown observes, the sale of converters of this kind, especially if they are attractively housed like the model (illustrated here) which he submitted to RADIO-CRAFT, offers a very good summer opportunity to the radio man for pushing his sales.

the noise level is high. This can be done only by making use of the short waves through a good frequency-changer.

If reasonable care is taken in the building of the equipment described here, the builder will not be disappointed; since it will fill the above needs in a most satisfactory manner.

Electrical and Structural Design

The schematic circuit is Fig. 1. When short-wave signals are tuned in there are no whistles or howls; unlike most short-wave receivers, this frequency changer tunes into the signal exactly like a modern broadcast receiver. When using it, of course, the tone quality, selectivity, and sensitivity are dependent on the broadcast receiver used in conjunction with it. The writer will say here that the model illustrated has been tried on six popular makes, and works well on all.

A smoker's stand, to which one "plug-in" type flexible cable leads, houses the chassis. This feature makes the stand useful in more ways than as a cabinet. A UY socket re-

ceives the plug which, in turn, is made from a UY tube base. Five wires are necessary in the cable.

The base and subpanel are made from one L-shaped piece of 18-gauge metal. It's important that these parts be rugged, or there will be trouble from microphonic noises. The panel and base are braced by a piece of metal bent and drilled as shown in Fig. 2. This also supports the disc that carries the six short-wave coils.

No Plug-In Troubles

Fig. 3 shows the switching arrangement used for the coils. As can be seen, the prongs from the bases on which the coils are wound protrude through the holes in the bakelite disc; and, as the disc is rotated, they make contact with the eight springy copper strips. It is very important that the contact strips have plenty of spring and that they be bent in the manner shown; so that the disc can be turned in either direction.

The disc is made of ordinary panel bakelite, at least one-fourth inch thick, and should be 5½ inches in diameter. It can be turned out most easily on a lathe, but an ordinary circular panel cutter will do a good job.

Great care should be used when drilling holes for the UX base; because all must be the same distance from the center. If the holes that receive the prongs are drilled slightly too small at first, and then reamed out a little at a time, a tight fit can be secured; and it will not be necessary to use anything to hold the bases in place.

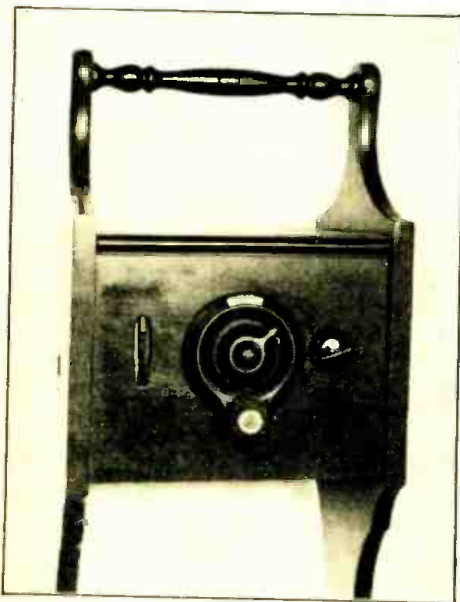

Fig. A

While the cabinet to be used for the converter affords room for choice, the smoking stand used by Mr. Brown is very convenient.

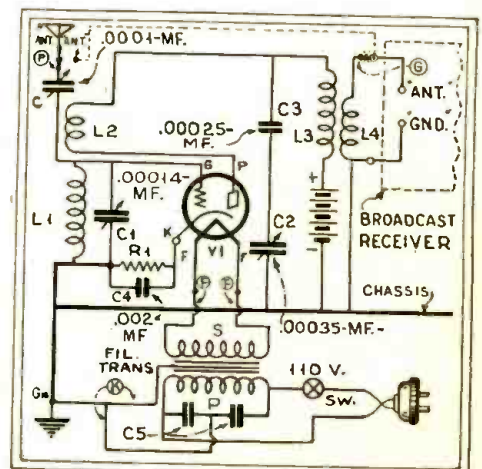
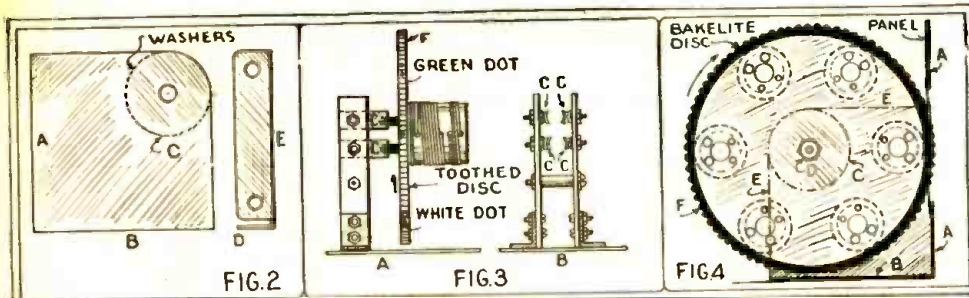

Fig. 1

The schematic circuit of the converter, illustrated in Fig. A, and its power unit, illustrated in Fig. C.



The method of mounting the revolving coil assembly. In Fig. 2, the 18-gauge metal coil support in front and edge views; side A is bent as at E, and B as at D. In Fig. 3, a side view, showing one coil in contact with copper clips C which are bent as at B, to permit rotation either way. Fig. 4 shows the positions of the six coils on their disc, held by washers C and nut D, with regard to the support E and panel A.

Otherwise it is best to drill and tap the disc from the edge; so that six small set-screws can be run in against the large outside prongs.

When the disc is mounted on its support (Fig. 2), several large washers should be used between them, to keep the disc from wobbling as it is turned. Six shallow holes should also be drilled in the edge of the disc at equal intervals. A different-colored crayon is melted and forced into each hole; so that the operator will be able to see which coil is in use.

Components Used

Fig. 1 shows two condensers connected in series between the plate lead and the chassis. The fixed condenser C3 is needed to protect the "B" battery should the plates of the variable condenser become shorted.

The setting of the .00035-mfd. condenser C2 isn't critical at all; an instrument of slightly more or less capacity will do as well. The tuning condenser C1 is of the usual short-wave type, a vernier dial controls it. The spiderweb R.F. transformer L3-L4, of the same type as those used in the tuned R.F. sets of a few years ago, is mounted under C2. It has a 65-turn primary and 12-turn secondary; but these figures may be varied a good bit without affecting the working of the set.

The tube biasing resistor R1, of 500 ohms, is wire-wound. One or two small 22½-volt "B" batteries may be used, since the plate drain is very small. Although any of a number of '27 tubes may be used, the writer has had best results from an Areturus.

The Power Supply

The transformer shown in Fig. C furnishes the filament current; with a switch, to change over from long to short waves, it is mounted on a 4 by 6½ inch bakelite base.

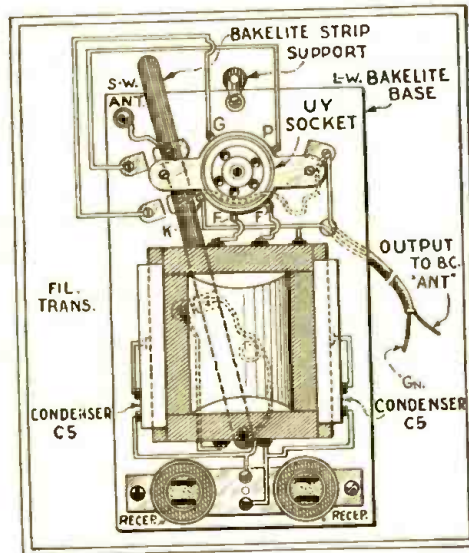

Fig. 5

The details of the power unit and switch.

The unit is made to be hung behind the broadcast receiver; so that the control lever will come about half an inch above the top of the cabinet. (Fig. 5). This insulating lever acts as a triple-pole, double-throw switch; it connects the aerial to the broadcast receiver or converter, as desired; in the

latter case replacing the connection to the receiver with the output of the frequency-changer.

The transformer is one of the bell-ringing variety, the secondary of which has been rewound to deliver 2½ volts. It isn't mounted flush to the base but, by using long screws, a space of half an inch is left. This is where the 110-volt switch goes, and where the lower end of the switch lever is pivoted.

The power-supply end of the cable plugs into the UY socket, which, like the transformer, is mounted half an inch above the base. One side of the base receptacle is used for the broadcast receiver; the other takes a 110-volt line plug. Two condensers, of 0.5-mf. capacity, are connected as shown to clear the line of strays. Another thing that helps to keep stray signals out is running all wires between the broadcast receiver and the change-over switch as short and direct as possible.

The cable consists of five wires. If the control stand is to be used near the broadcast receiver (not over four feet away) any well-insulated cable will serve. If it must be longer, the two antenna connecting wires should be of the shielded lead-in type; that's how to keep long-wave signals off the dial. This wire can be purchased for about five cents a foot, and the liberal use of it will completely erase the broadcast band from the receiver. This is important.

Coil Data

The coils are wound on the bases of discarded UX tubes. All the cement that holds the glass bulb in place should be chipped out, and the bases cleaned thoroughly. The wire used is No. 30, enameled and cotton-covered.

A list of the coils and their winding ratios follows:

Color of Dot	L1 Turns	L2 Turns
Green	3	7
Yellow	6	8
White	10	10
Red	17	11
Orange	28	15
Blue	60	18

After the first is wound, it should be
(Continued on page 182)



Fig. B

The internal arrangement of the short-wave converter, diagrammed in the upper part of Fig. 1. The tuning condenser is C1, the regeneration condenser C2; it will be noted there are no grid leak and condenser. C4 bypasses the cathode resistor, and C is the adjustable antenna condenser. The six-coil assembly is mounted at the right. C3 and L3-L4 are behind the B battery.

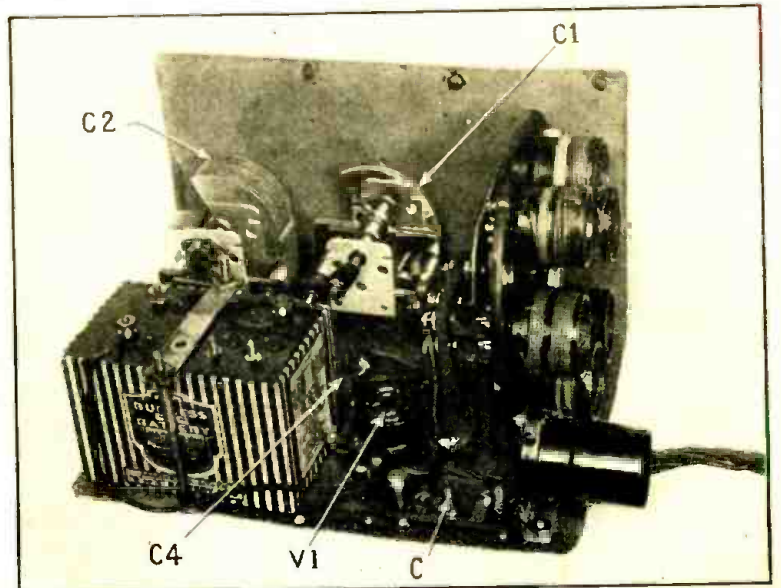

Fig. C

The illustration at the left shows the power transformer and short-long-wave switch, electrical and mechanical details of which are shown in Fig. 5. This unit is conveniently mounted behind the broadcast receiver, out of the way, and near the house receptacle.

Constructing the Loftin-White Amplifier

An interesting discussion of the problems affecting the design of a direct-coupled amplifier, and of the use of a meter to give the necessary data as to the action in various parts of the circuit

By MORTON W. STERNS

IT had been a long time since a new circuit caused as much of a furore as the Loftin-White amplifier. Coming at a time when everyone thought that the day of the home experimenter had passed, and parts were hard to obtain, this amplifier has taken the country by storm. The reason for this is apparent with a little thought: first, the quality is unsurpassed; and, secondly, the cost of parts is reasonable.

Let us examine the Loftin-White amplifier from an impartial point of view. (First let us understand that the inventors of this circuit call it a direct-coupled amplifier and that name is easier to handle, with all due respect to the inventors.) It has been generally understood that resistance-coupled amplifiers are the best for high quality and cost of construction. Transformers have improved wonderfully with proper engineering; but it must be understood that every winding on an iron core has a certain amount of inductance shunted by a small distributed capacity and must necessarily tune to some frequency. Also, since the drop across an inductance varies with the frequency, the gain of an amplifier where the transformers amplify some frequency better than another cannot be made uniform.

Resistance-coupled and direct-coupled amplifiers have been constructed, in which the gain has been uniform within two transmission units, from 30 to 10,000 cycles. Both direct- and resistance-coupled amplifiers have certain drawbacks which, fortunately, are fairly easy to overcome. The first is that there cannot be a voltage step-up, since no transformer is in use. We therefore can hope to get only about 90% of the amplification constant of the tube itself, per stage. This deficiency of course is overcome by using high- μ tubes or adding an additional stage to the amplifier.

MR. STERNS, a distinguished engineer, some years ago gave the radio practice of the day a new turn by his invention of the honeycomb coil, still the best for many purposes. In this article he takes up the new arrangement of the direct-coupled amplifier which has been popularized by Messrs. Loftin and White, and analyzes its working. Not only are values given here, but the reason for their adoption; and the ingenious method here explained makes it possible for the experimenter to calculate the constants for not merely this amplifier, but for others whose design may interest him.

Mr. Sterns invites readers who are interested in further articles on this subject to say so, and RADIO-CRAFT will be glad to hear from them on this, as on other subjects which they wish to see covered in constructional theory and practice.

From Fig. 1, we see that the resistance-coupled amplifier and the direct-coupled amplifier are inherently alike and that no mysterious improvement in gain can be expected simply because the latter is direct coupled. In Fig. 1A we assume a one-volt signal to be impressed upon the grid of the first tube and, since the amplification constant or " μ " of the tube is 8, 8 volts will be impressed on the plate circuit of the tube. Now, certain losses always appear in the coupling device, regardless of its nature, whether transformer or resistor; but experience has shown that 90% is a fair transfer. Therefore, we impress 7.2 volts on the grid of the

second tube; this, multiplied by the " μ " of the second tube, will impress 57.6 volts on the output.

A similar process of reasoning (Fig. 1B) will give the same results for direct coupling. Direct coupling has one marked advantage over resistance coupling, however; and that is, while with the latter we could always amplify voltage until we came to the last power tube, then, try as we would, the grid of the last tube would always choke up. This is accounted for by the fact that electrons stored in the coupling condenser must leak through the grid resistor to the filament of the tube. Since the resistance in the grid is high, an appreciable time is taken for the charge to leak off; and, if the grid resistor is reduced in value, then the last tube is shunted by a low resistance with a corresponding loss in amplification. In Fig. 1B (by certain circuit precautions which will be taken up later) the plate of the first tube is made positive with respect to its filament; while at the same time the grid of the second tube is negative with respect to its own filament. Thus there is no reason for the last tube to choke up and this accounts for the popularity of the direct-coupled amplifier.

The direct-coupled amplifier is also a good radio-frequency amplifier, and no doubt much will be done along this line in the future. A mass of information has been submitted regarding the Loftin-White amplifier which, while very interesting, did not help us in understanding the problem. It is my contention that the Loftin-White amplifier follows known engineering laws and, by the simple application of Ohm's law, the entire action of the amplifier can be predetermined on paper and the respective voltages arrived at; even without an instrument sensitive enough to measure some of the values. One important point that cannot be overlooked is that it is absolutely essential to use high-class resistors; for a component resistor that changes its resistance with different values of current flowing through it is useless for our purpose.

We will now analyze a two-stage Loftin-White amplifier and see just how it works. Fig. 2 gives the values of a two-stage direct-coupled amplifier that has worked out very well in practice. You will notice that a conventional power pack is used with separate windings to heat the two tubes; the single-stage filter comprises a No. 377 choke and two condensers to get rid of the hum. An extra 1-mf. condenser by-passes the resistor bank.

By tapping off a voltage and bringing it back to the cathode of the '24 tube through the 0.6-mf. condenser, the hum may be exactly "bucked out" when we find the proper point on the 200-ohm potentiometer. This is what allows us to use a single-choke filter instead of the conventional double-choke apparatus.

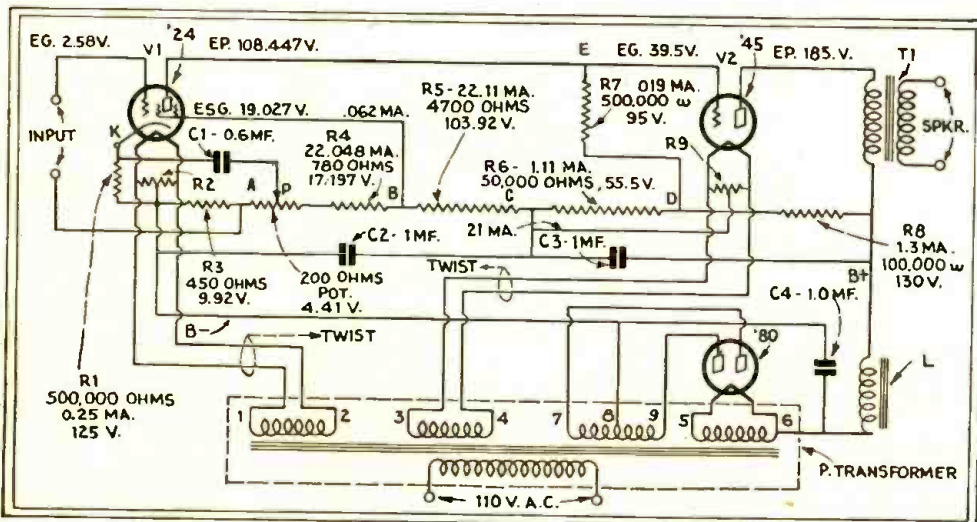

Fig. 2

This design shows the constants, voltages and current flow in an actual working amplifier. The resistors are of the Cresradio Corporation's manufacture; T1 is a Pilot No. 394 output transformer L is a No. 377 choke and PT a No. 411 transformer, of the same make.

Let us look at Fig. 2 again; it will be seen that all current must leave the pack at "B+" and return through "B-" to terminal 8 of the transformer. The voltage from the plate of the '45 tube and point C (which is the centre tap of the filament) can be readily measured by a voltmeter. Other voltages will be impossible to read; for the most sensitive voltmeters require at least 1 milliamperes for a reading, and that is more than some of the circuits draw. We have, however, inserted sensitive milliammeters in the circuit and the readings obtained are shown. By multiplying the current in amperes by the resistance in ohms, the voltage drop across any resistor can be found; it must be remembered that one milliamperes is .001-ampere.

Now let us trace the flow of current from "B+" back to "B-." A current of 1.3 milliamperes flows through the 100,000-ohm resistor R8; this current divides, 1.11 milliamps flowing through R6 to point C, and 0.19-milliamperes through the coupling resistor R7 to the plate of the '24 tube V1. The 21-milliamperes current drawn by the '45 tube V2 flows from the plate through to the center tap of the filament resistor R9, and then through the resistor bank to "B-." The current passing through R5, therefore, is 22.11 milliamperes (the sum of 21 and 1.11). At point B, .062-milliamperes leaves to flow to the screen-grid of V1; and 22.048 milliamps continue through the remaining resistors to "B-."

In the diagram, the current flowing through each resistor, the resistor's value, and the voltage drop through it are shown. It should be noted that the grid and plate voltages of V2 are measured from point C, the filament resistor's center tap; while those of V1 are taken from the cathode.

To obtain the grid bias of V2, we take the difference between the two voltage drops, C-D and D-E: that is, 95-55.5, or 39.5 volts.

In V1, whatever current flows to the

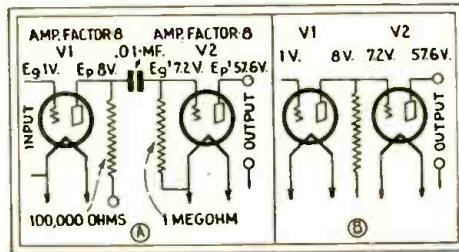

Fig. 1

The resistance-capacity coupling at the left does not put the full output of V1 on the grid of V2; neither does the direct coupling at the right!

cathode from the plate and the screen-grid must pass through R1; this makes the cathode 12.5 degrees positive with regard to "B-." The resistor bank is tapped at A, 9.92 volts positive with regard to "B-"; the difference gives a bias on the control grid 2.58 volts negative with regard to the cathode.

The voltages on the screen-grid and the plate are determined by adding the respective voltages between them and "B-"; not forgetting to deduct the 12.5 volts positive of the cathode.

On account of the construction of the '24 tube, it is not wise to have the cathode more than 15 volts positive with regard to the heater; or the leakage of electrons from the heater to the cathode will cause crackling noises.

Several peculiarities of this circuit will be noticed. In the usual set, "B-" is grounded; but, if this amplifier should be connected to such a set the 450-ohm resistor R3 would be

shorted, allowing the grid to become 12.5 volts negative and cutting off the plate current in V1.

If, for any reason (such as a loud signal) the plate current of V1 increases the grid bias on V2 increases and the plate current of V2 decreases. This causes the bias on V1 to increase, tending to keep the plate current in this tube constant. This is the automatic regulation of the amplifier.

Let us look at this regulation feature in another way. Suppose we have a certain grid bias on a tube; if the input signal ever exceeds the bias, distortion will occur. In this amplifier this effect is automatically compensated by keeping the grid of V1 at a low potential to be sensitive for weak signals, and automatically increasing the bias for strong signals. Thus the amplifier handles a larger range of input voltages than usual, by this differential grid bias.

It will be seen that it is hard to use this amplifier with a radio set; although it is an extremely good phonograph amplifier. The first tube would make an ideal detector, being kept in its most sensitive condition by means of the differential bias; but it would require another tube to give the desired volume. The writer, some time ago, constructed a three-stage amplifier which gives exceptional results and can be used with any radio set. If sufficient interest is aroused, more data will be forthcoming.

In the meantime, it must be admitted that the Loftin-White circuit is nothing more than a glorified resistance-coupled amplifier in which we are not limited by the choking of the last grid. It will be seen that the performance and design of such an amplifier can be calculated with engineering precision by following the method described in this paper.

An Improved Neutralizing Circuit

By SYDNEY P. O'ROURKE

TO prevent, or oppose, interelectrode coupling in R.F. amplifier tubes, we have numerous expedients all of which (except neutralization and the use of screen-grid tubes) attain our end by the simple yet unscientific process of reducing the efficiency of their associated circuits. It is well known that the screen-grid tube overcomes feed-back by reducing its grid-plate capacity to 1/200th that of an ordinary tube.

In neutralizing, we divert a small portion of the oscillations present in the plate circuit to the grid in such a manner that they should, theoretically, cancel each other at all frequencies and make the tube a perfect one-way amplifier.

The representative neutrodyne circuit uses the split primary shown in Fig. 1 at A; all forms of tapped-coil neutralizing arrangements work down to essentially the same form of Wheatstone bridge arrangement which is shown more clearly. It is well known that, in the Wheatstone bridge, the points P and D will be at the same potential if the impedances on either side of them bear a certain proportion; that is, if G-P:P-T::G-D:D-T (taking each pair of letters to indicate the total impedance between the points lettered in Fig. 1B). Since the

bridge represented by the neutrodyne circuit in Fig. 1A contains two capacities and two inductances, beside resistance, it must be evident how difficult it is to find the proper zero point; especially when we consider the additional couplings introduced by the transformer secondary L3, and the nearby condensers and shields.

The chief cause of trouble, however, is that the A.C. resistance and plate-to-ground capacity of the tubes are shunted entirely across one half (A) of the primary L2, the other half (B) being entirely inloaded. An exterior resistance and capacity across the winding have been tried and, indeed, work well; but they introduce more complications.

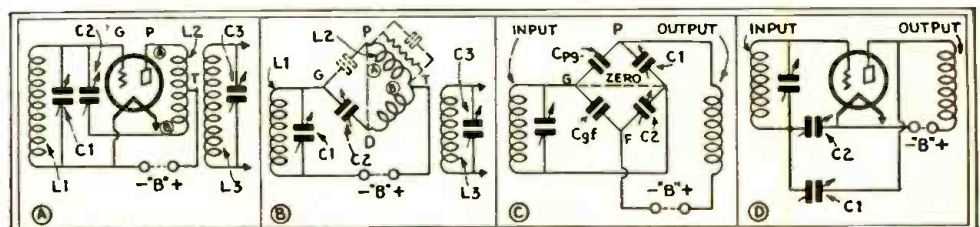

Fig. 1

The standard type of neutralization, following the lines indicated at A, may be represented in "Wheatstone bridge" form as at B; it balances inductance against capacity. In the ideal arrangement of C, this difficulty is overcome; the corresponding new circuit is outlined at D.

An All-Capacity Bridge

The new circuit to be described here, recently presented in England by its originator, Mr. C. P. Allison, provides a practically perfect bridge and permits several efficient R.F. stages to be constructed and operated—even from a loop aerial—with a stability difficult for the hardy fan to imagine. Its fundamental circuit is that of Fig. 1C; we have our bridge with its necessary input and output inductances connected by a bridge of four capacities—one of which, we know, must be that between the plate and the grid of the tube, marked here Cpg.

All previous neutralizing systems were de-

(Continued on page 183)

The Ultimate in Audio Selectivity

You have heard the old story of the man whose receiver was so selective he could tune in any instrument in the orchestra and hear a solo. Telephone engineers have accomplished just that with band-pass filters.

By C. STERLING GLEASON

COMBINATIONS of low-pass and high-pass filter networks can play surprising pranks with tone quality, and various permutations of these circuits can be used to stage a striking demonstration of what constitutes good and bad loud-speaker reproduction. Such an arrangement, designed and built by engineers of the Pacific Telephone and Telegraph Company, for use in a demonstration-lecture on "Sound and Voice Transmission," has been presented before numerous audiences in Southern California.

The apparatus can be made to exemplify in a striking way the qualities and defects of various types of amplifiers and loud speakers. The filters used in the demonstrations are mounted separately, each in a strong box equipped with carrying handles. By means of jacks to which leads from each filter are attached, the circuits may be patched together in any desired combination.

At demonstrations, the cabinets are stacked up side by side, with terminals at the back where they may be manipulated unseen by the audience. A long sign box, bearing a series of placards, is set upon this rampart and, as each combination is made, an operator manipulates a small switch panel, illuminating the proper signs by bulbs placed

behind the cards, and causing the frequency bands passed by the filters to be indicated in translucent, glowing numerals.

The output of a phonograph tone-arm microphone is passed through an audio amplifier terminating in a push-pull stage of UX-210's, and thence through the filters to the loud speaker. A large reflexed horn of exponential design is used for high-quality reproduction, as a standard of comparison with other types. By cutting off the uppermost and lowest frequency-ranges of the speech input, this excellent speaker can be made to sound like the poorest horns of 1922 vintage.

Tuning to Separate Instruments

Most interesting to the layman are the effects that can be produced upon musical reproduction. From orchestral selections, various groups of instruments can be picked at will. A record of a number scored for full symphonic orchestra—such as, for example, the second movement of Tchaikowsky's "Fifth Symphony"—is useful in this experiment. With only the range of 4000—5000 cycles being passed, a sharp frying sound like heavy static is heard. The next lower thousand cycles also consists mainly of harmonics. The band of 2000-3000 cycles carries the piccolo and the upper ranges

of the violin and flute. Another thousand-cycle drop brings in the upper woodwinds. Successive extensions of the range add in turn the violas, cellos, the brasses and, finally, as the lowermost two-hundred-cycle band is opened, these are joined by the kettledrums, double basses, bassoons, and bass clarinets.

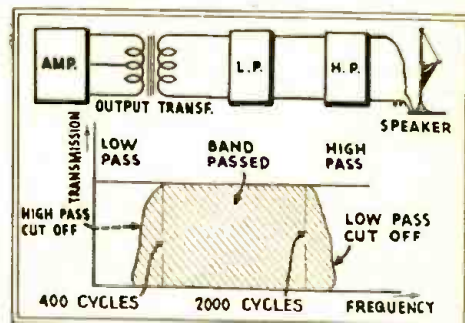

Fig. 1

A properly selected pair of filters, in series, cuts off the frequencies at both ends of the range; so that only the middle tones reach the reproducer.

A microphone is then substituted for the tone-arm pickup and a member of the audience is induced to read into it while the operators manipulate the jacks. When only the high frequencies are admitted to the loud speaker, the speaker's voice displays symptoms of an aggravated case of adenoids. Switching to the opposite extreme, the operators—much to the edification of the audience—visit upon their unhappy victim all the vocal manifestations of acute tonsillitis. Thus is forcibly demonstrated the acoustic maxim that, while the low notes carry the energy, the high frequencies make intelligibility. Another striking feat may be performed by using the record of a selection in which the melody and accompaniment are distinctly separated—for example, Moskowski's "Serenata," played by orchestra. By the use of a high-pass filter, the violin melody may be singled out from the rest; whereas a low-pass filter will reproduce only the oom-pah accompaniment of the low strings.

Arrangement of Filters

As built by the Bell engineers, the low-pass filters were designed with cut-off frequencies of 200, 400, 800, 1000, 2000, 3000, and 4000 cycles respectively; the high-pass sections cut off at 200, 400, 800, 1000, 2000, and 3000 cycles. Various ranges can be passed by series and parallel combinations of the filters. For example, if it is desired to admit only the band between 400 to 2000 cycles, a low-pass filter cutting off at 2000 cycles is connected in series with a high-pass section with cut-off at 400. (Fig. 1). If it is desired to pass only the extremities of the frequency range (cutting out the

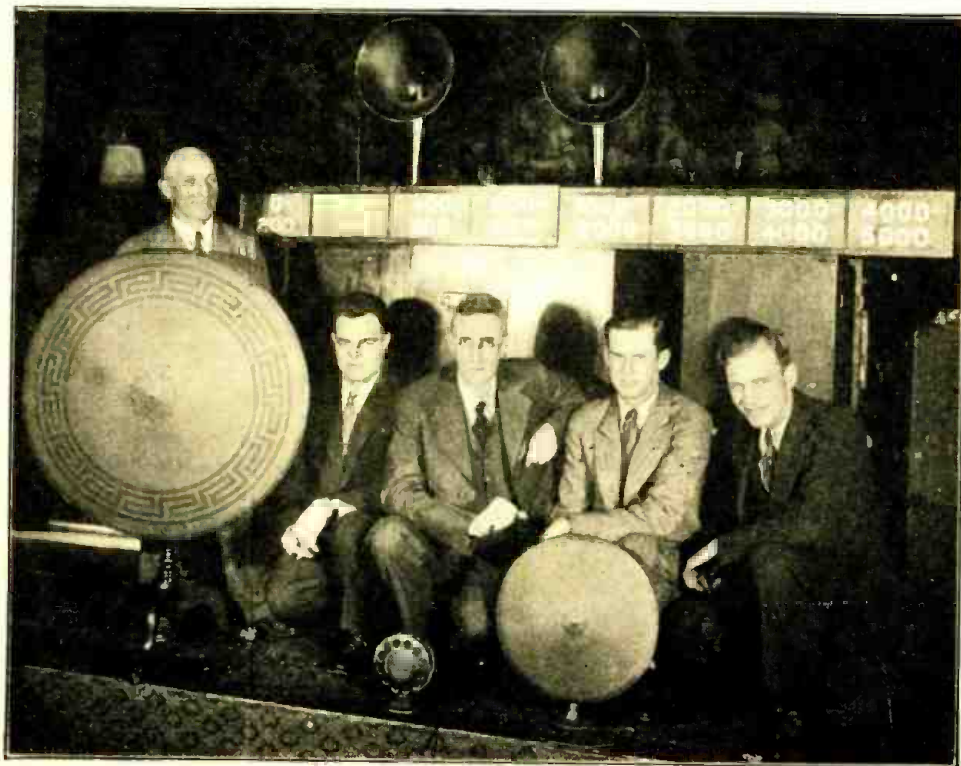

Engineers of the Pacific Telephone Company with the sound-analysis apparatus used for public demonstrations. The reproducers and microphone are easily identified; the panels above the filter apparatus are illuminated, at the proper times, to show the audience just what frequencies they are hearing at the moment.

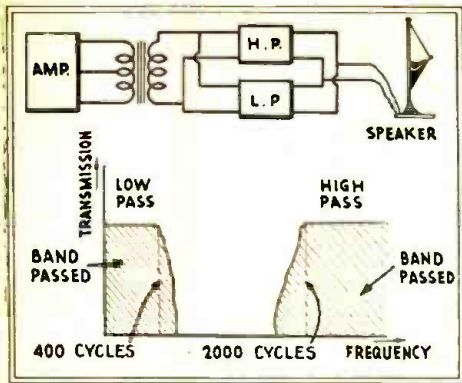

Fig. 2

When the two filters are connected in parallel, as indicated, the result is to cut out the whole middle range of sounds; and the effect of the combination of very high and very low notes is something unusual.

medium band), the two filters connected in parallel will yield a characteristic as illustrated in Fig. 2, where only the frequencies from zero to 400 and from 2000 upward, are transmitted.

Practical Value

A combination of filters of this type offers interesting possibilities to the experimenter and constructor. Setbuilders should find it valuable in demonstrations, as a means of illustrating in a graphic way the principles of tone quality; thus clinching sales arguments. As a means of testing loud speakers, it is useful also; for a good idea of the response characteristic of a loud speaker may be gained by experimenting with different band combinations until the quality of the speaker under test matches that of the filter-horn combination. Other uses will suggest themselves readily.

The only difficulty in the way of the construction of these filters by the average con-

structor is the problem of matching chokes and condensers to meet the requirements of design. However, if the builder is content to use whatever values are obtainable in the market, letting the cut-off frequencies fall where they may, he may assemble circuits which, although possessing characteristics not expressible in convenient round numbers, will nevertheless demonstrate the desired phenomena satisfactorily.

Designing the Filters

It should be emphasized here however, that accurate results demand exact values of inductance and capacity, and it is therefore imperative that only a grade of apparatus known to be reliable and highly accurate, should be used. For the lower values of inductance, Remler-Giblin honeycomb coils are very satisfactory, as they adhere closely to the specified values of inductance. If they are connected in series or parallel, however, it must be remembered that their combined inductance is not equal to their simple sum; since the mutual inductance of the two, resulting from the interaction of their fields,

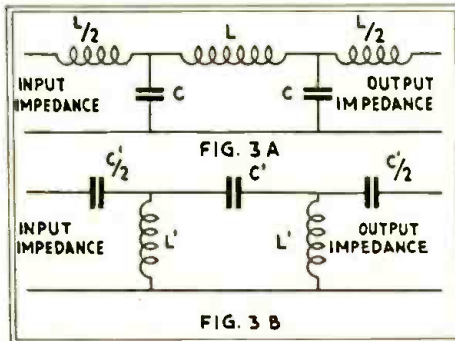

The arrangement of the low-pass filter is indicated above; the high frequencies are by-passed and do not reach the output. In the high-pass filter, below, the low frequencies instead are by-passed through the chokes.

will materially alter the value. If an impedance bridge is available, all trouble of this nature will of course be obviated.

Since condensers may be arranged conveniently in series-parallel to give any desired capacity, it is easier to decide upon standard values of inductances, and then arrange the capacity to suit the requirements. The design is simple; the following formulas only are required:

Low-Pass Filter Design

For a low-pass filter, the cut-off frequency (see Fig. 3A) equals the impedance facing the filter section, on both the input and output sides, divided by 3.14 times the inductance (in henries) of L.

So, if the output of a push-pull '10 amplifier is fed to the filter through a transformer (Amertran "No. 152") whose secondary has an impedance of 2,500 ohms, and the choke L has an inductance of one henry, the cut-off frequency is 2,500 divided by 3.14 x 1, or about 795 cycles. It will be observed that each of the inductances on either side of L is of just half the value of L.

Similarly, the capacity C in microfarads equals 1,000,000 times L, divided by the square of the impedance. In the above case this works out as 1,000,000 x 1 divided by 2,500 x 2,500; or 0.16-mf.; this capacity is conveniently obtained by paralleling a 0.1- and a 0.06-mf. condenser.

High-Pass Formulas

For the high-pass filter (Fig. 3B) the cut-off frequency (the lowest frequency passed) equals the impedance divided by 12.57 times the inductance L' (in henries). The capacity of C' in microfarads equals 1,000,000 times L' divided by the square of the impedance. Each of the series condensers on either side of C' has one-half the capacity of C'.

Oscillating-Crystal Amplification

WITHOUT the use of a tube, an oscillating crystal may be introduced into the circuit of a crystal detector, to increase the strength of reception. While such an expedient may seem rather old-fashioned, in this day of multi-tube sets, the possibilities of crystals for the experimenter are almost endless.

The crystal detector, as all should know, is a rectifying device; it allows current to flow much more freely in one direction than in the other. Its resistance is high, and it absorbs signal energy in the form of heat. Nevertheless, the purity of the tone obtained from a good crystal makes it still a favorite with many constructors who build their own; as proved by the continuing popularity of the Interflex circuits.

The oscillating crystal is, like a vacuum tube, a "generator" of current; that is, it takes direct current from a battery and converts it into alternating current.

An English experimenter, Mr. W. H. Grayling, has developed a circuit presenting many points of interest; in this, a detector crystal and an oscillating crystal are used together. The oscillator circuit may be used either in series with the antenna and the tuned detector circuit, or in parallel as shown. The choice would depend, doubtless, upon local conditions.

For the oscillating crystal O, zincite gives best results, with a hardened steel cat-whisker (No. 32 wire). For the detector crystal D, zincite-copper pyrites, which have high resistance, are recommended. The resistor R should be wound on an iron core, and have a resistance between 1000 and 1500 ohms.

The potentiometer P should be about 400 ohms. The battery voltages shown are 4 and 8; with dry cells, this figure would have to be changed slightly. Higher voltages, up to thirty, may be applied. The aerial condenser is between .0005- and .001-mf.; the tuning condenser about .00025-mf. with a suitable coil.

While this circuit is said to give the results of an R.F. stage used before a crystal detector—a combination still popular abroad—the warning is issued that extraordinary patience in its adjustment will be required.

The oscillation points on a crystal are fewer and harder to find than the points of good detection. The oscillating crystal should be cushioned with rubber against shock. The zincite crystals if not sufficiently sensitive, may be fused with an arc (which is obtained with low voltage between carbons, as experimenters know).

The oscillation of O is controlled by the potentiometer; different settings must be

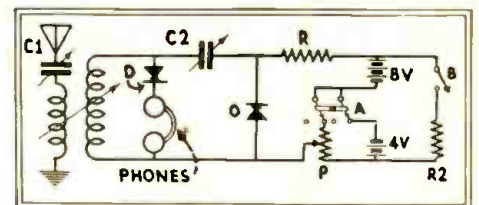

This unusual circuit uses an oscillating crystal O to sharpen reception, by increasing the sensitivity of the crystal detector D.

found for each wavelength, higher frequencies requiring higher voltage. While current is flowing (after a suitable oscillation point is found, by a slight flicking of the contact) the battery current must not be cut off sharply, or resetting will be necessary. For that reason, the switches shown are included in the circuit; to turn off the current, with A closed for normal operation, B is closed to bring the resistor R2 into circuit; and A is opened, then B. Operation is then resumed by reversing the process.

Reception at several hundred miles in this manner was reported; an amplification factor as high as 15, with special oscillating-crystal circuits, has been reported. It is obvious that much is left to the ingenuity of the operator, and values not given here he must work out for himself.

Power-Supply Tubes for Radio Receivers

An article for Service Men and constructors explaining the theory and practice of rectifier- and regulator-tube design and operation, with testing hints and some suggestions for amateurs

By C. W. PALMER

IN four former articles by the writer, there have been discussed and explained the "characteristics" of the vacuum tubes which are designed for purposes of amplification, at different frequencies, and detection in a radio receiver. The fourth article, in January, was devoted to the subject of the systems used to test tubes, on the large scale, as well as manual methods.

We now come to tubes which have been designed, not for reception in the strict sense of the word, but to provide to the receiving tubes, and regulate, a supply of electricity from more convenient sources than the chemical batteries originally used. Such tubes are classified into two principal divisions: Rectifiers, which convert alternating current into "pulsating" direct current; and regulators, which maintain a constant voltage across their terminals, or a constant flow of current through their circuits. The regulator tubes, being less essential to set operation, are not so familiar to the radio worker as the rectifier tubes; but the importance of the former is increasing, as the desirability of an unvarying electrical supply for a receiver becomes appreciated by the general public, as it always has been by the experimenter.

Rectifier Tubes

The rectifier tubes, used in radio reception, may be classified into three groups of types: The "thermionic" or filament-emission tubes, now in most general use; the ionized-gas, hot-cathode (filament) tubes; and the ionized-gas, filamentless, cold-cathode tubes.

In the first, or true "thermionic" type, are included all of the tube rectifiers which have filaments, except those of the Tungar type. The last-named, or hot-cathode tubes, as do the cold-cathode types, operate on a different principle—the "ionization" of the

gas in the bulb—which will be explained a little further on.

The tubes of the '80 and '81 type are classed as true "thermionic" types; that is, they depend on the emission from the filament of electrons which travel to the plate to produce their rectifying action. The electrons, having a negative charge, are attracted to the plate when the plate is charged positively; this occurs once during each "cycle" of the alternating current. When the current reverses its direction, so that the plate is negative, the electrons are repelled from the plate and many return to the filament. It can be seen very readily that the direct current at the output of the rectifier is fluctuating (Fig. 1A at C).

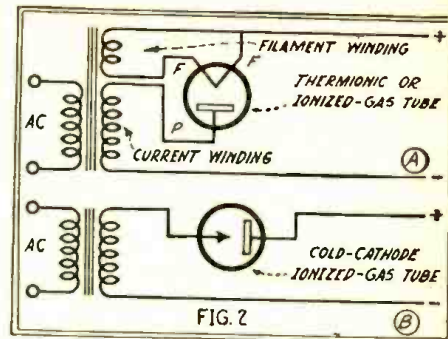

The circuit arrangement of a "filament" rectifier of the '81 type, is shown at A. Note the absence of a filament winding when the rectifier is of the "cold-cathode" type, as at B. "Half-wave" rectification is shown in both diagrams.

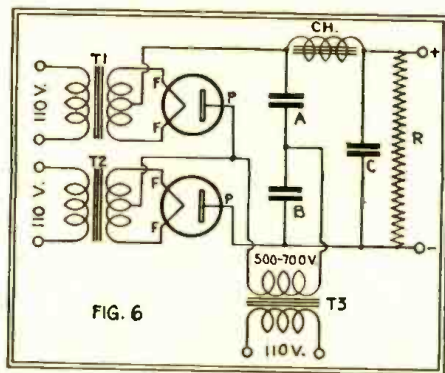

Schematic of a standard "voltage doubling" device. Each tube operates within its safe rating, but the combined voltage output exceeds this value.

Unilateral Conductivity

The operation of any rectifier depends on its "unilateral conductivity;" this formidable expression means only that it lets currents pass through it in but one direction. For example, let us consider a "cycle" of alternating current.

At the beginning of each cycle, a flow of current increases from zero in one direction to maximum value, and falls again to zero; this is the first half-cycle. A flow of current in the opposite direction then builds up to an equal maximum, and falls off again to zero, ending the cycle. In 60-cycle current, each half-cycle of current flow lasts 1/120-second.

The usual representation of a half-cycle will be found in Fig. 1A, at a. During the half-cycle when the line-current supply to the rectifier plate is positive, there is a heavy electron flow from filament to plate inside the tube, shown graphically at b. The conductive "bridge" permits the line-current to be measured as positive potential on the D.C. side of the rectifier. Incidentally, the voltage of this output c of the

rectifier is not as high as the input voltage, because of the internal resistance of the rectifier.

During the next half-cycle (Fig. 1B) the polarity of the alternating current has been reversed; though an A.C. voltmeter shows the same potential for this current, the polarities of the rectifier's electrodes have been reversed. But the filament emits no stream of electrons; and therefore the current will not pass through the rectifier; for there is nothing to conduct it. During this half-cycle d, therefore, no current is indicated at the output of the tube. We have 1/120-second of inaction, as at f; on the next half-cycle g, there is an output of current, and so on.

From "oscillograms" obtained by scientific investigators, it has been shown that the thermionic-tube rectifier is practically perfect in its "one-way" regulation of current.

Examining Fig. 1B more closely, we see that the rectifier supplies current to the power unit of a receiver during only one-half of the time; and the output current fluctuates in value. In order to make it useful, therefore, we must have a filter system to "smooth" out the inequalities, and give us an electrical supply of constant voltage and flow. The condensers used in a power pack serve the purpose of storing up the surplus energy passed by the rectifier while it is operating, and discharging their stored current while the rectifier is idle. The chokes add still more to the constancy of the flow, which should arrive at the voltage divider free from pulsations and "ripples."

The action we have described is that of a "half-wave" rectifier (so called for obvious reasons) like the '81-type tube. The '80 type, however, has two plates, which are so connected that when either one is negative with respect to the filament, the other is

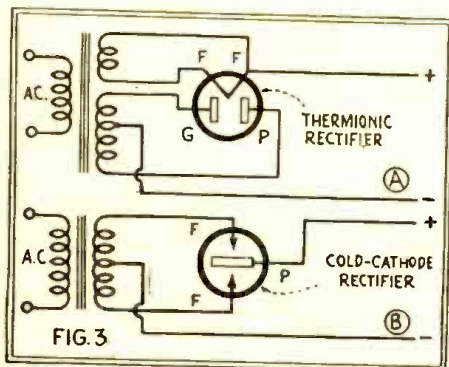

At A, the connections to the power equipment which result when a type '80 tube is plugged into the socket; at B, those resulting when a "cold-cathode" rectifier is similarly plugged into the receptacle for "full-wave" rectification.

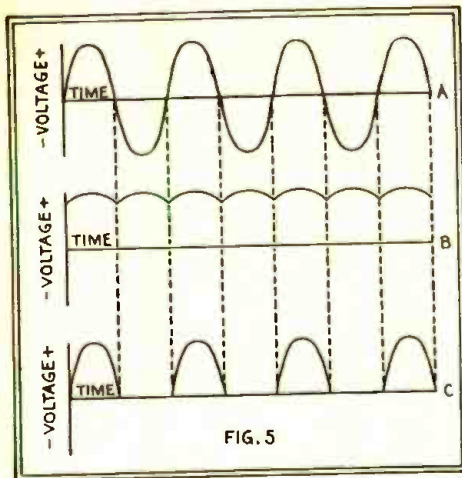

FIG. 5
The changes of voltage in an alternating-current circuit are shown at A; the pulsations of the direct current passed by a full-wave rectifier at B; and the output of a half-wave rectifier at C. It will be seen how much more "smoothing" is needed by the last.

positive, and therefore draws current. This is accomplished by the use of a tapped transformer in the A.C. input, as in Fig. 3. For this reason, the current has twice as many active pulsations between current "nodes," and it is not necessary to draw so high a current during the active half-cycles. This makes it unnecessary to store as much current in the condensers, or to use such large chokes for smoothing; and the arrangement is more economical. As to the advantages of "full-wave" over half-wave rectification, more will be said in connection with Fig. 5.

The ionized-gas, hot-cathode (filament) rectifiers include such types as the Tungar, Rectigon and similar tubes. Although these are similar in general appearance to the thermionic types, their principle of operation is entirely different. The glass bulb or "envelope" is filled with an inert gas such as argon, helium or neon (usually the first) to about 1/75th of atmospheric pressure. The filament emits electrons which, in turn, "ionize" or break up the molecules of gas by colliding with them in their race for the plate. The electrons freed by this "ionization" produce most of the conduction of current. This is in contrast with the thermionic type, which depends entirely on the electrons given off by the filament for its conduction.

That the filament is comparatively unimportant in the gas-filled tube is shown by the fact that under certain conditions, batteries can be charged with a cold, unlighted filament.

The third class of rectifiers is different from either of the others. It uses no filament, and the envelope is filled with gas, usually helium; although argon and neon have also been used. It contains several electrodes, different in size and shape. In operation, when alternating current of the correct potential is applied, a field is created between the electrodes and, at moments of correct polarity, the gas between the electrodes becomes ionized by the strong electric field. The molecules of the gas are changed in structure, resulting in conductivity between the electrodes.

The shape and size of the electrodes play an important part in the operation; because the "free electrons" from the gas can collect very easily on the large electrode, but com-

paratively few come in contact with the small electrode or electrodes. If the electrodes were all of the same size, a strong "back current" (one flowing in the opposite direction to the main flow) would limit the usefulness of the tube. In fact, this was one of the principal difficulties to be overcome by the engineers who designed the tube.

Each of the three classes of rectifiers described above has its own application in receiving sets. The thermionic and the cold-cathode types are best suited to high-voltage, low-current work, because of their inherent characteristics. These two tubes compete for popularity in "B" power units and other similar devices. The hot-cathode type is not very suitable for high-voltage operation but, since a great electron flow results from the combined filament and gas activities, a large amount of current can be handled. This type of tube, therefore, serves very well, as a rectifier for battery chargers and "A" power units.

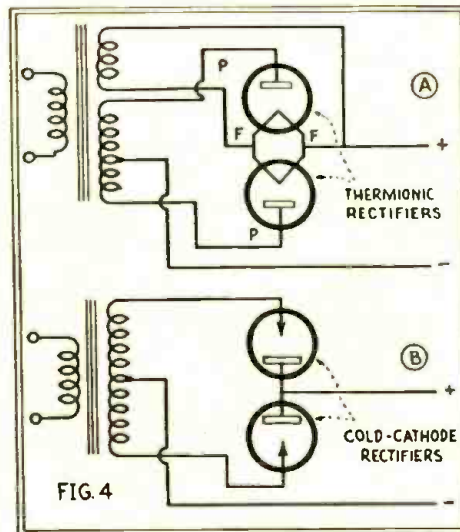

FIG. 4
The circuits above are utilized to obtain full-wave rectification with a pair of half-wave rectifier tubes; the thermionic type is indicated at A, and the cold-cathode type at B.

Half- and Full-Wave Rectifiers

We have explained above that tubes can be made to operate on either half of the cycle, or on both halves. The half-wave rectifier, which contains only two elements,

is connected as shown in Fig. 2. The full-wave rectifier contains three elements, as shown in Fig. 3. Full-wave action can be obtained, however, from two half-wave rectifiers with a single A.C. potential source, by the method shown in Fig. 4.

When the output from the rectifier must be extremely steady, as in the case of an "A" or "B" power unit, it is much better to use the full-wave system than the half-wave arrangement, because of the greater ease in filtering the rectifier output. As explained before, the number of fluctuations in the output of a full-wave rectifier is twice that of the half-wave rectifier. In other words, if the supply current is 60-cycle, the output will be direct current with 120 pulsations, similar to those shown in Fig. 5; A represents the "shape" of the alternating current supply; B the rectifier current from a full-wave rectifier, and C the rectifier current from a half-wave rectifier.

Importance of Design

The output from a rectifier of the thermionic type is directly dependent on the electron flow from the filament and the size and shape of the plate and the glass bulb or envelope. The use of a filament capable of a very high electron discharge, together with a large, heavily-constructed plate and a large envelope are the requirements for a high-current tube. The plate must be constructed in such a way that it radiates heat very quickly; and the glass envelope must be large, so that it will not overheat. In certain types of rectifier tubes, used for large transmitters, a water-cooling system is employed, to keep the plate from melting. However, for receiving purposes, correct design of the plate is sufficient.

In the tungar-type of tubes, the factors which control the current-handling ability are the size of the envelope, the size of the filament and the size of the plate. The envelope must be large, so that a considerable quantity of gas can be contained in the space between the elements; and, also, so that it will have sufficient surface to radiate the heat liberated in the process of rectification. The filament must be long and heavy; so that its electron emission will be considerable and that it will have a long life. The plate must be made so that it will not

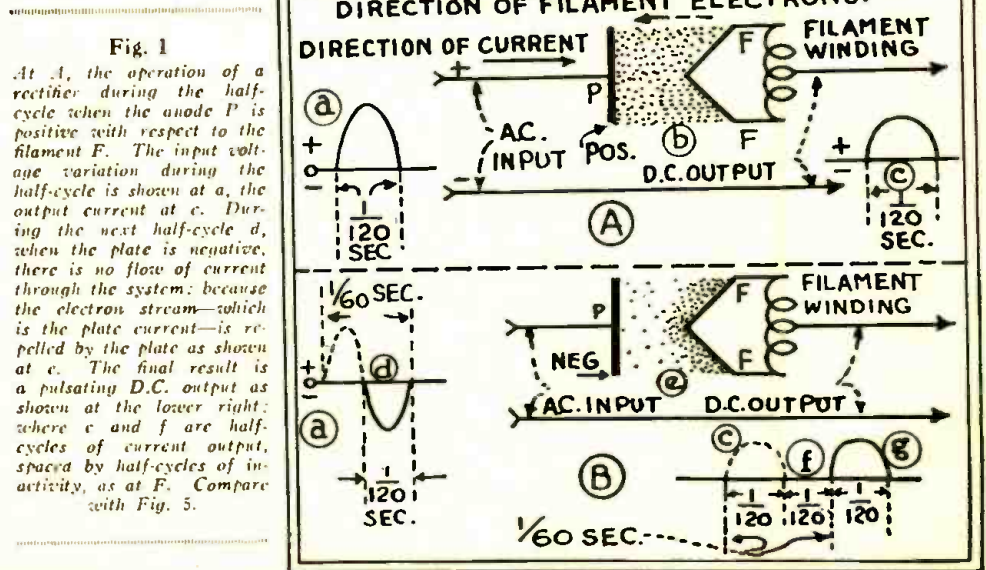

Fig. 1
At A, the operation of a rectifier during the half-cycle when the anode P is positive with respect to the filament F. The input voltage variation during the half-cycle is shown at a, the output current at c. During the next half-cycle d, when the plate is negative, there is no flow of current through the system; because the electron stream—which is the plate current—is repelled by the plate as shown at e. The final result is a pulsating D.C. output as shown at the lower right; where c and f are half-cycles of current output, spaced by half-cycles of inactivity, as at F. Compare with Fig. 5.

overheat. In some cases, a carbon plate is used; and at full capacity this heats to a red glow on the side nearest the filament.

In the cold-cathode types of tube, the factors controlling current output are the size of the envelope, the comparative size of the elements and the degree of gas pressure used. The large envelope is needed to dissipate heat; the correct pressure of gas is necessary to make the rectification most efficient; and the large difference in the size of the electrodes is needed to produce unilateral conductivity.

Why Rectifiers Break Down

It has been noticed, recently, that many rectifier tubes used in "B" power units have not had the long life that was customary in the past. One well-known tube engineer attributes this shorter life to the extra strain placed on these tubes in receivers of recent models, designed by many set manufacturers. The general use of the '45 tube, or even two of these tubes in push-pull, is taxing the rectifiers to the limit. In the past, the '71 tube was used and very few sets had a plate-current drain that approached the limits of the tube.

The authority mentioned above explains the situation as follows: "It would seem improbable that the current demands of the '45 tube should cause such an action; since the '45 tube requires but 250 volts on the plate and 50 volts on the grid or, in other words, a total of 300 volts. This, however, is not all that the rectifier tube is called upon to furnish. Since there is a voltage drop in the tube itself of nearly 100 volts, the rectifier must start with 400 volts; in order that the '45 tube or tubes may be supplied with the normal plate and grid voltages. When this unusual demand is made, the rectifier is quite unequal to the task, primarily on account of the filament."

The author of the above statement discussed the improvement of the filament, and also reduction of "back current" due to the plate becoming hot. When the plate cannot dissipate the heat, it becomes slightly incandescent and emits some electrons, which cause a current in the direction opposite to the desired flow. This back current not only reduces the output of the tube, but greatly shortens its life.

If the set constructor or designer uses more care to be sure that he is not overtaxing the rectifier tubes, longer life will result.

Voltage-Doubling Devices

The increased use for high-power amplifiers, comprising tubes which belong in the transmitting category, has caused a demand for some convenient way of obtaining the high voltage required for the plates of these tubes. The '81 tube is able to supply about 600 volts without injury but, by using several tubes of this type, we can obtain potentials up to about 1600 volts.

Fig. 6 shows one of these "voltage-doubling" circuits. Two individual filament transformers (T1, T2) are required, and a step-up transformer, T3, supplies about 500 to 700 volts. This particular unit is quite satisfactory, only for currents up to about 50 milliamperes. The two condensers A and B must have at least 1000-volt working rating—preferably more—and C should be a 2000-volt condenser. Each should have a capacity of 4 mf. The choke coil should have an inductance of 20 to 30 henries, under the required current load. A resistor R must be connected across the output. It should have a resistance of about 100,000 ohms; note that it must have a current-carrying capacity of 30 to 60 milliamperes.

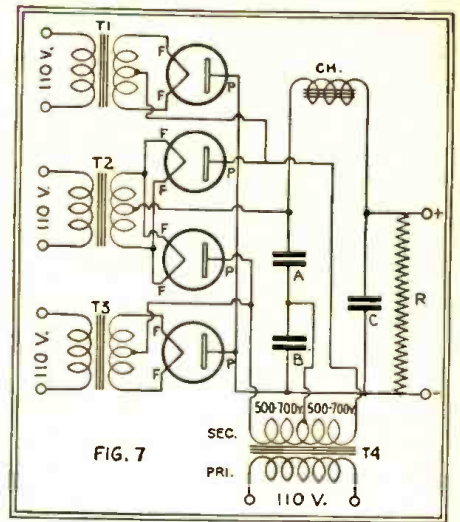

FIG. 7
A voltage-doubling system which will supply more current than that of Fig. 6. This is in use principally by amateurs for transmitting purposes.

to cause an "arc-over" inside a tube, or one of the tubes is liable to overheat.

A second arrangement, which will supply much more current than the first, is shown in Fig. 7; it required more apparatus than the first circuit, however. When it is operating correctly, currents up to about 150 milliamperes can be drawn from it. Three separate filament transformers (T1, T2 and T3) are required, as well as a transformer T4 with a tapped secondary, supplying a total output of 1000 to 1500 volts. The tap is at the center of the winding.

The filter system for this unit is the same as the first—each of the first condensers (A and B) must stand a working voltage of 1000 and condenser C at the output of the filter should have a working voltage rating of 2000 volts. The choke in this case must be made to carry more current than the one used in Fig. 6; for the output of the rectifier tubes is much higher.

When using a power unit of this type, extreme care must be employed to insulate all the parts and to employ the best possible apparatus; as a break-down in the condensers or the transformer would probably result in a fire.

Fuses should be placed in each of the connections from the transformer to the line; five-ampere size will be about right.

Note: It is necessary to use extreme care in approaching any of the parts of such a unit when it is connected to the line; as the high voltage is very dangerous. Before any changes are made, the power line should be entirely disconnected from the apparatus, and the condensers discharged.

Testing Rectifier Tubes

The Service Man often encounters the necessity of testing a rectifier tube, to determine whether it is the tube or some other part of the apparatus that is defective. The easiest way to determine whether the tube is at fault is to replace it with another one.

However, if the Service Man is equipped with several meters, he can make electrical tests to find whether the tube is working. The necessary apparatus comprises a high-voltage A.C. voltmeter, a high-voltage D.C. voltmeter, and a special plug to fit the rectifier-tube socket.

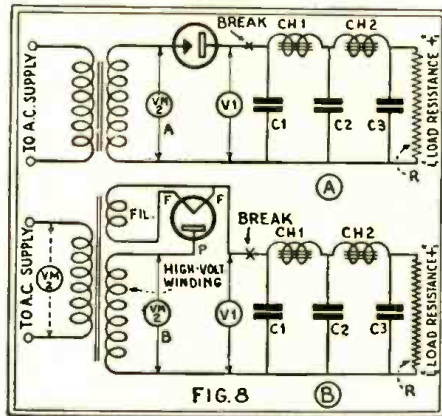

FIG. 8
To test the operation of a rectifier tube disconnect the positive side of the tube from the filter system, as shown at X; this is conveniently done with a special plug in the rectifier socket. Readings are then taken across the tube with the A.C. voltmeter VM2 and D.C. voltmeter V1, to show its action under no load.

When using any voltage-doubling system, the filament circuits of the tubes must be closed before the high voltage is applied. If this is not done, the initial surge is liable

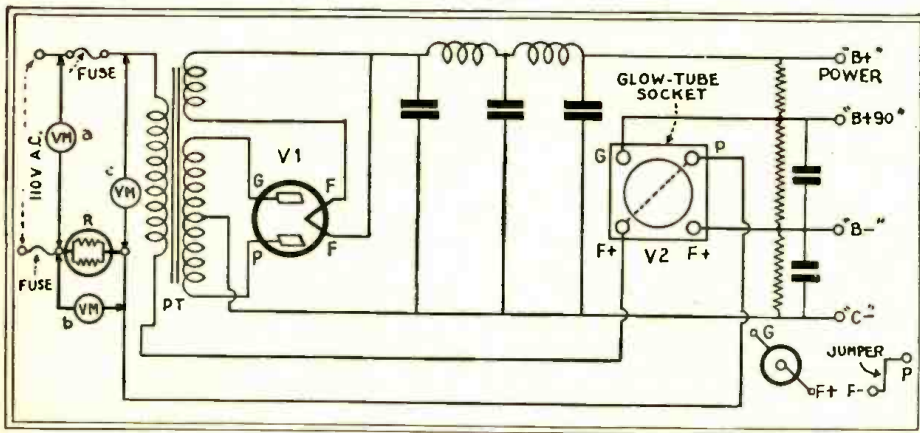

Fig. 9
The ordinary arrangement of a power unit with a voltage-regulator tube V2 across the detector and a ballast tube R in the circuit of its special power transformer. The jumper at the lower right connects two prongs of the glow-tube V2, and automatically breaks the power input when this tube is out of its socket.

The required range of the meters depends on the voltage produced by the power unit. For most units, meter ranges of 0-500 volts will be suitable, for both alternating and direct-current readings. The special plug consists of the base of an old tube, equipped with a four-prong socket to hold the rectifier tube, and a terminal strip with four contacts, one for each of the wires protruding from the base.

First, the output of the transformer should be checked, with the A.C. meter. To do this the rectifier tube is removed from the power unit, and the special plug placed instead in its socket. Then the A.C. voltmeter is connected between the anode (plate) prong and the negative terminal of the power unit. This connects the meter between the ends of the secondary winding. In the case of the '80 or any other full-wave tube, the same test should be made between each of the anode prongs and the negative terminal; in order to test the output of both sides of the secondary winding.

It will be noted that in the '81 tube the plate connects to the usual "P" prong on the socket, and in the '80, the two plates connect, respectively to "P" and "G." In the Raytheon gas-filled tubes, however, which operate on a different principle, the anodes (corresponding to plates) connect to the two "F" prongs of the socket. The cathode of a tube of this kind connects to the "P" prong. For this reason, the tubes are not interchangeable and cannot be tested without a change of external connection.

If the transformer is supplying the correct A.C. voltage (which must be somewhat higher than the D.C. output voltage of the unit) the rectifier tube should be placed in the socket mounted on the special plug. This connects it again into the unit, but allows external connections to be made to the tube circuits.

In the case of Raytheon gas-filled recti-

fiers, the matter of testing the operation of a tube is quite simple. The wire from the tube which leads to the first filter choke and condenser should be disconnected from the tube; this can be done by merely disconnecting the wire from the corresponding prong of the special plug which connects to the socket mounted on top.

Then, with the D.C. voltmeter, V1, the voltage between this prong on the tube (the "plate" prong for the Raytheon tubes) and the negative terminal of the power unit should be measured (Fig. 8A). If no voltage reading is obtained, the connections should be checked very carefully, to be sure that none are defective. If the voltage readings are very low, it is a "sure bet" that the tube is at fault.

With filament-type rectifiers, such as the '80 and '81, the wire connecting the filament winding to the first filter choke should be removed, to disconnect the rectifier from the filter system. This is more difficult than with the Raytheon gaseous type, but is essential; for the trouble might be located in the filter or voltage divider.

The D.C. meter, V1, is connected between the filament of the rectifier and the negative terminal of the power unit (Fig. 8B). The connection is sometimes made to a tap in this winding on the transformer, and sometimes to one side of the filament. The results are the same in either case. If the D.C. voltage is correct, it will be found somewhat higher than the output voltage of the unit; because of the resistance of the filter chokes, etc. If this voltage is very low, the rectifier tube is usually at fault. Before testing the secondary voltage of the transformer with the A.C. voltmeter VM2 it is well to test the line voltage at the input to the power unit; this can be done with the same meter. (See dotted connections.)

The requirements of the standard '80 type,

full-wave thermionic rectifier tube are as follows: filament supply, two amperes at five volts (A.C.); plate supply, 125 milliamperes at 350 volts, both maximum values. This gives an output whose D.C. voltage and amperage depend on the type of filter, one falling as the other rises. The base is the standard four-prong UX, as explained above.

The trade names and designations are Radiotron (Radio-Victor Corp.) UX-280; Cunningham, CX-380; Sonatron X80; Pilotron (Pilot Radio & Tube Corp.) P280; Speed (Cable Radio Tube Co.) 280; Champion, UX-280; Sylvania, SX-280; Gold Seal, GSX-280; Arceturus, 180; Ken-Rad, 280; Ray-O-Vac, RX-280; (French Battery Co.) CeCo, R80; DeForest, 480; Perryman, PR-280; Diatron (Diamond Vacuum Products Co.) 280; Eveready-Raytheon, X-280.

The half-wave, heavy duty thermionic rectifier, known as the '81, fits the same base, as explained above; although the grid prong is unused. The filament supply is 1.75 amperes at 7.5 volts; the plate supply 85 milliamperes at 700 volts.

Trade names are Radiotron and Champion, UX-281; Cunningham, CX-381; Sylvania, SX-281; Gold Seal, CSX-281; Ray-O-Vac, RX-281; Sonatron, X-281; Speed, Ken-Rad, Diatron, 281; DeForest, 481; CeCo, R-81; Perryman, PR281.

The cold-cathode, ionized-gas rectifier is the Eveready-Raytheon BH, with large standard UX base, to which the connections are special: it requires a plate supply of 125 milliamperes at 350 volts. A tube of this type is produced as SH85.

A larger size of this tube, the Eveready-Raytheon BA, takes 350 milliamperes, at 350 volts; its large current output makes possible series-filament operation of D.C. type tubes in a receiver.

(Continued on page 173)

How "Static's" Picture is Being Taken

SINCE the first attempts—no matter by whom—to establish radio communication, back in the nineteenth century, the existence of "atmospherics" or natural static has been annoyingly apparent. Much inventive ingenuity has been devoted by experimenters to the search for means of correcting the condition or overcoming the interference.

Since there are several billion cubic miles of atmosphere in which electrical disturbances are continually originating, it is impossible (certainly for the present) to overcome static at its source. More success has been obtained by various means which make receivers more sensitive to desired signals, and less sensitive to those received from other directions and at other frequencies. In radio telegraphy, moreover, some advantage has been obtained from systems which are designed to neutralize or cancel out atmospheric disturbances. In telegraphy, moreover, it is possible to receive a very sharply-timed impulse, with a sideband much narrower than that of a phone station; and it is sufficient to receive this at a single audio frequency, in contrast to the thousands of cycles required for good reproduction of speech or music. The methods useful in commercial work, therefore, cannot be applied to broadcast receivers.

Static is Complex

There are many radio fans who imagine static to be a simple interference which can be filtered out of a receiver by putting a coil, a condenser, or even—as we have seen in some cases—a tube of colored water in the aerial circuit. We may suggest to the "static-eliminator" enthusiast a comparison with a broadcast studio, in which an orchestra is playing. Someone drops in front of the microphone a pan full of dishes and glassware; the audible disturbance which would be broadcast would have something of the nature of atmospheric static. Now, while it is possible to create a filter which would allow practically none of the noise thus picked up by the microphone to go out on the air, it is not necessary to remark that the quality of the broadcast would be quite destroyed by such a filter in its audio amplifier. No static reducer can be made which will not take away some of a receiver's sensitivity; perhaps the best is the loop, which limits reception as much as possible to a given direction. The great multiple antennas used in transoceanic work serve the same purpose even more efficiently.

Recent elaborate researches on atmospherics have been made by British observ-

ers, with the aid of special measuring devices. By these the strength, the wavelength, and the number of impulses of static disturbances were automatically recorded.

(Continued on page 185)

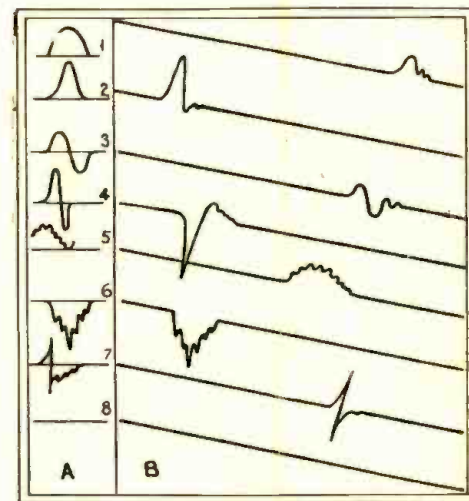

At A, single static impulses as recorded by an oscillograph; the lower three show the complex shapes given by the rapidity of tropical static. At B, each line is the static reception during .01-second. (Adapted from World-Radio.)



INFORMATION BUREAU

SPECIAL NOTICE TO CORRESPONDENTS: Ask as many questions as you like, but please observe these rules:

Furnish sufficient information, and draw a careful diagram when needed, to explain your meaning; use only one side of the paper. List each question.
 Those questions which are found to represent the greatest general interest will be published here, to the extent that space permits. At least five weeks must elapse between the receipt of a question and the appearance of its answer here.
 Inquiries can be answered by mail only when accompanied by 25 cents (stamps) for each separate question. Other inquiries should be marked "For Publication," to avoid misunderstanding.
 Replies, magazines, etc., cannot be sent C. O. D.

SCREEN-GRID NEUTRODYNE

(84) Mr. Warren T. Kellogg, New Bedford, Mass.

(Q.) What is the meaning of the term "screen-grid neutrodyne?" It is my understanding that a screen-grid circuit does not require neutralization. Please clarify this point. This term has been used in referring to the Crosley "Buddy" and "Chum" radio sets.

(A.) The "screen-grid neutrodyne" circuit is a development of the laboratories of the Crosley Radio Corp. and the Hazeltine Service Corp., the latter concern being the patent-holding organization for the Hazeltine interests. The feature of the development centers around the R.F. transformers. As shown in the accompanying diagram (Fig. Q84) of the receiver models mentioned, there is a small open-end winding L in the primary of each R.F. transformer. This adds a capacity coupling at the grid end of each secondary, which makes the tuning more uniform throughout the range. This desirable effect is improved by the method of winding the concentrated primary outside the secondary.

FADA "32" SELECTIVITY

(85) Mr. Geo. Beckerle, St. Louis, Mo.

(Q.) I have a "Model 32" Fada receiver (all-electric). I will appreciate it very much if you will public a diagram showing how to add a second tuning control, that will make it more selective; as this set now tunes very broad.

(A.) We have checked over the early and late models of the Fada "32," and find that the set in question requires only re-balancing. To add a tuning stage to this set is to detract from its efficiency.

Reference to the diagram of the first two tubes of this set (Fig. Q85) will show that there is already adequate provision for obtaining resonance in the tuned R.F. stages of this set. There is a trimming condenser for each tuned stage (two of the four are shown); and each R.F. inductor is individually shielded. Furthermore, there is provided a small fixed condenser (connected to post L.A.) which should be used for maximum selectivity. Proper use of the volume-control potentiometer should give an evident selectivity when powerful locals are operating on wavelengths near those of desired distant stations. Check the effectiveness of this

condenser; if its use makes no change in the selectivity, it is probably shorted and should be replaced. Dust the plates of the tuning condensers.

It will be noted that a step-down ratio between succeeding tubes is obtained by connecting the grid to a point on the secondary below that of highest voltage. The effect of this connection is to secure greatly increased selectivity, as compared with the more usual arrangement which proves adequate for a lesser number of stages of R.F. amplification.

It is probable that the receiver should be re-neutralized; two of the three neutralizing condensers are shown as C3 and C4. By using a dummy tube, or a neutralizing adapter with an open filament as described in previous issue of RADIO-CRAFT, the circuits may be balanced.

If exceptional interference is being experienced from a particular station, it is recommended that a wavetrap for this station be inserted in the antenna.

The Fada "32" receiver is tremendously sensitive and must be carefully balanced to obtain best results. Part of this sensitivity is due to regenerative feed-back, introduced by coupling a small amount of energy from the detector plate to that of the second R.F. tube through a resistance and condenser in series.

Incidentally, the main difference between the early and late models of the "32" is the use in the former of fixed R.F. "C" bias, and of a volume-control potentiometer in shunt with the primary of L1. In the latter there is a direct signal input to the primary of L1, and a variable R.F. "C" bias provides the volume control.

TRANSMITTER DATA

(86) Mr. Nelson Stover, York, Pa.

(Q.) (a) If a transmitter tuning condenser tunes best with plates all out, how can it be changed to work equally well with the plates partly meshed? (b) The filaments of the tubes in this transmitter are A.C.-operated; can a resulting hum be eliminated without destroying the power or strength of the power transformer? (c) Could I increase my output by paralleling the elements of my '10 with those of a '71? (And so on for fifteen questions. Mr.

Stover signs as operator of station W3BBV1—Editor.)

(A.) The answers to these questions, which have appeared in previous issues of RADIO-CRAFT, are here repeated in condensed form: (a) Increase the

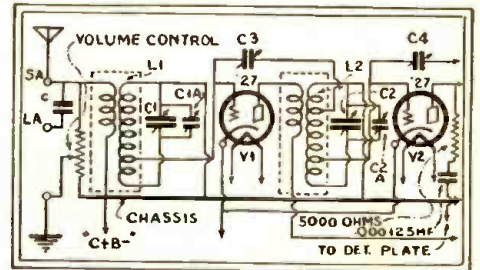

(Fig. Q85) The two first stages of the earlier Fada "Model 32." The receiver is designed for very high selectivity; but may require readjustment.

number of turns in shunt to the condenser, or remove condenser plates; (b) Return the leads to a hum balancer, with variable center tap, shunted across filament and keep grid leads short (and away from power transformer or chokes); (c) The type '71 tube is not designed to be operated with the same grid, plate and filament currents as the '10.

HOUCK "B" UNIT

(87) Mr. John Anderson, New York City.

(Q.) In the June, 1930, issue of RADIO-CRAFT, on pg. 643, Mr. L. H. Houck describes means of obtaining hum-free operation on short waves when using a "B" eliminator. Please clarify some of the points covered in this article, "Short-wave Operation from a "B" Unit." For instance, mention is made of variable Clarostats, but no value is given; what is the type of these units? Also, the manner of adding these resistors and the choke coil to the set is not clear.

(A.) In connection with this eliminator recom- (Continued on page 186)

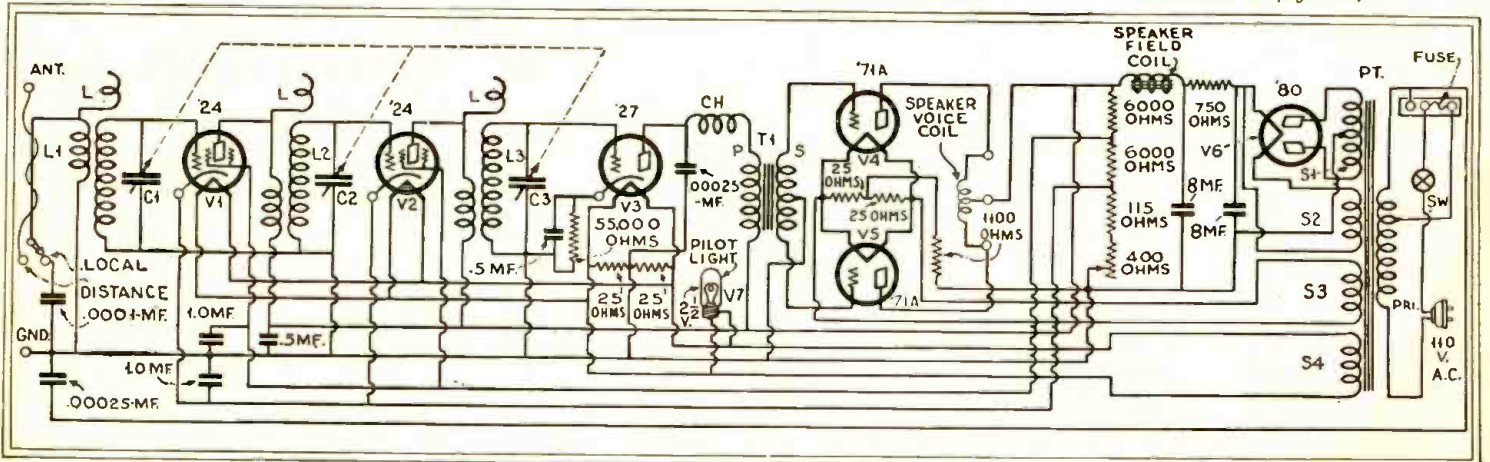

(Fig. Q84) The circuit of the Crosley "Buddy" and "Chum" receiver models, which utilize a new circuit called the "screen-grid neutrodyne." The old type of neutralization, used with three-element tubes, is not used here; but the special R.F. transformers, used to obtain better coupling at all wavelengths, were developed by the same interests as the original Neutrodyne.

FREE PROOF

you can make real money

in RADIO

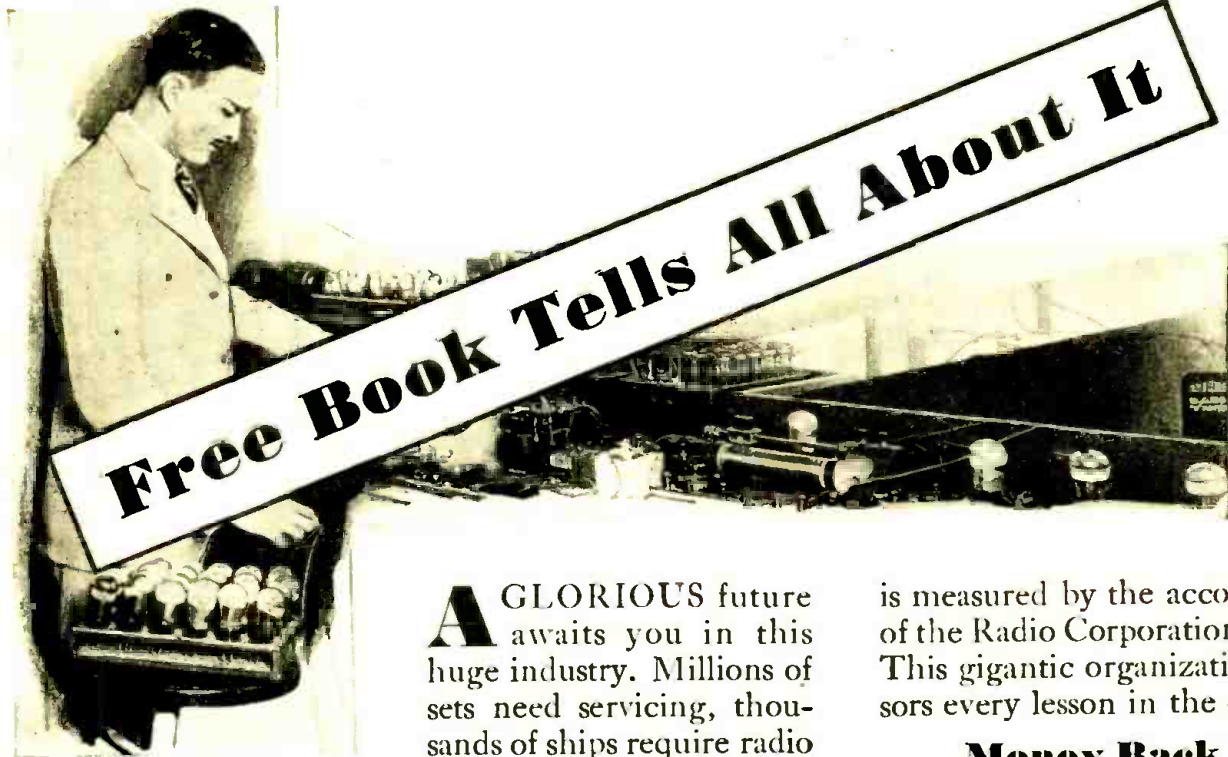

Radio Operator \$70—\$200
per month with all
expenses paid.



Broadcast Operator \$1,800
—\$4,800 a year.



Radio Repair Mechanic
\$1,800—\$4,000
a year.



Radio Inspector \$2,000—
\$4,500 a year.

A GLORIOUS future awaits you in this huge industry. Millions of sets need servicing, thousands of ships require radio operators... manufacturers and broadcasting stations throughout the land are eagerly seeking trained men... and now, nation-wide radio telegraph service, telephony, sound motion pictures, open up thousands of new and amazing opportunities.

Learn at Home

By means of this marvelous, simplified home-training course, sponsored by the Radio Corporation of America, you can now prepare for success in every phase of Radio. The remarkable outlay of apparatus given to you with this course enables you to learn by actual practice how to solve every problem in radio work. That's why you, too, upon graduation can have the confidence and ability to command good money.

Backed by RCA

Graduates of this school are always posted in newest developments in Radio. That's why they are always in big demand. The progress of Radio

is measured by the accomplishments of the Radio Corporation of America. This gigantic organization... sponsors every lesson in the course.

Money Back if not Satisfied

As a student you will receive an agreement signed by the president of this school assuring you of complete satisfaction upon completion of your training—or your money instantly refunded.

Free!

This fascinating book on Radio's glorious opportunities... written by one of America's well-known radio experts.

RCA INSTITUTES, INC.

A Division of
Radio Corporation of America

RCA INSTITUTES, Inc.
Dept. RC-9, 75 Varick Street, New York

Gentlemen: Please send me your FREE 40-page book which illustrates the opportunities in Radio and describes your home laboratory method of instruction.

Name

Address

Occupation

GREATEST Tube Sale of 1930

Never before has there been such an amazing tube sale as the present one which is being conducted

JUST AS LONG AS THE SUPPLY LASTS

All tubes are warranted to be perfect and all tubes that are returned within five (5) days will be exchanged for new ones free of charge.

This sale has been arranged especially for service men, radiotricians and radio dealers and no further sales will be held once this supply is sold.

These tubes represent over-production by one of the largest Eastern tube manufacturers and are sacrificed for ready cash.

This is a chance that you will never have again.

Order from this page and note particularly the following terms:

NO ORDERS ACCEPTED FOR LESS THAN \$5.00

NO REPLACEMENTS AFTER FIVE (5) DAYS.

IT IS NOT NECESSARY TO SEND THE FULL AMOUNT OF CASH WITH THE ORDER AS LONG AS YOUR ORDER IS ACCOMPANIED BY 20% OF THE VALUE.

SHIPMENT WILL GO FORWARD TO YOU BY EXPRESS OR PARCEL POST C. O. D.

ALL PRICES ARE F. O. B. NEWARK.

IMMEDIATE SHIPMENTS

ANY QUANTITY

TYPE	PRICE
UX-201A	.30
UX-210	.60
UX-226	.30
UX-227	.30
UX-240	.30
UX-250	.40
UX-171	.60
UX-171A	.30
UX-120	.30
UX-199	.40
UV-199	.40
UV-199 Standard	.40
Special Detector Tube 200A	.60
Special Audio Frequency 201A	.60
Special 171 A.C. 1/2 am. extra coated filament	.60
Special Radio Frequency 201A	.60
T-14 (201A High Mu)	.60
Switch Tube	.60
Adapter Tube 226-227-171A, each	.60
Quadrode 5-prong 201A	.50
All bakelite Shield Tube 201A	1.00
UX-222	1.10
Telion	3.85

RECTIFIER AND CHARGER BULBS

125 Mil Tube Rectifying Tube	1.40
2 amp. old and new type (List \$4.00) OUR PRICE	2.00
5 and 6 amp. old type (List \$8.00) OUR PRICE	3.75
UX-280	.40
UX-281	.60
UX-112	.40
UX-112A	.40
UX-200A	.40
UY-224	.40
UX-245	.40

DISCOUNTS:

50 tubes and over 10%
500 tubes and over 10% & 10%



Telion Television Tube \$3.85



Shielded 201A Tube, entirely covered with Bakelite shield—does a way with micro-phonous noises.



Switch Tube \$0.60
Switch is used when one filament burns out, tube therefore has twice normal life. With switch on acts as 171 or 112 Power Tube—with switch off it is 201A Tube.



5-Prong 201A \$0.50



All tubes come in an attractive carton.



High Grade (Hi Mu) 201A Type—better vacuum—works and fits in any set. \$0.60



A.C. Adapter Tubes to convert battery sets into A.C. Electric sets—furnished for 226, 227, 171A.

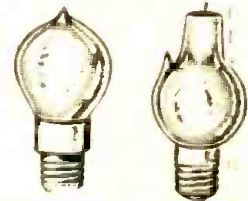

2-Amp. Charger Bulbs.



5 and 6-Amp. Charger Bulbs.

ARCO TUBE COMPANY

38-40 PARK PLACE . . . NEWARK, N. J.

New Radio Devices for Shop and Home

(Continued from page 152)

the standard regulator-tube receptacle and will blow if the line-voltage is extremely high; or when a power short develops in the radio receiver. The fuse supplied is



Fig. D

This cut-away view of the Carter fuse adapter plug shows the position of the fusible element, which is automatically connected by plugging the shell into a regulator-tube socket. The fuse is replaceable.

rated at 1 amp., 250 volts. An aluminum shell, with a bakelite base and a fiber cover-plate, encloses the fuse. (In the illustration, the cover plate is cut open to show the position of the fuse.)

REDUCED FILAMENT CURRENT

IN production, it is announced, the new UX-231 two-volt power tube described in this department two months ago will be made to operate on 130 milliamperes of filament current, instead of the 150 required by experimental models. This will effect added economy, in dry-cell operation of receivers incorporating it.

AN AIRPORT HORN

FOLLOWING the trend of design for reproducers capable of handling, in a single instrument, the audio output of high-power amplifiers, the Maey Manufacturing Company, Brooklyn, N. Y., has developed the multiple loud speaker shown in Fig. E, which has an effective radius of five miles.

The large end of the horn measures 3 x 5 ft., and the total length is 7 ft. Six dynamic units, each rated at 20 watts, are con-

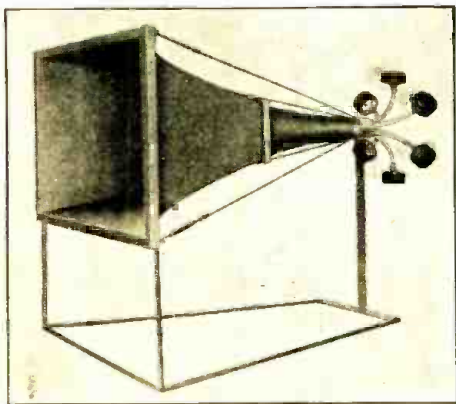

Fig. E

The multiple horn, illustrated above, with its six dynamic-reproducer units, is designed for a task greater than that of the public-address system; covering, as it must, a large airplane-landing field.

nected in series-parallel (three units in each series, and the two banks in parallel). This combination is rated to handle the output of two 50-watt tubes in push-pull. The assembly may be adjustably mounted, to project the sound in any desired direction.

Need for such equipment (one set of which is destined for the Newark airport) is well recognized at landing fields; it serves for issuing orders and warnings to pilots, paging and warning patrons of the "takeoff," and many other uses made possible by cutting a microphone into the circuit.

HANDY WIRE CONNECTOR

THERE are times when a "Western Electric" joint is necessary, and others that call for a "pigtail" joint. To increase the efficiency and speed of the latter connection, the Jiffy Wire Connector Co., Hackensack, N. J., is concentrating on the production of the little "SRK Wire Connector" shown in Fig. F.

In its design, comprising a bakelite cap containing a brass insert, with the inside taper-threaded, it much resembles an overgrown binding-post top.



Fig. F

This connector, screwed down tightly on such a pair of wires as shown at the left, will bind them in a good contact and effectively insulate and protect them.

The trick is to skin the leads to be joined (doubling them back, if necessary), jab the bared wires into the wire connector, and screw the connector down until the wires are held tightly. The cap prevents accidental contact with the pigtail leads.

GROUND CLAMP



CLAMPPIPE

Fig. G

This ground clamp will work in the close quarters found with many piping arrangements. A positive contact, with the ground wire, is made at the screw in the center above.

SERVICE MEN will be interested in a ground clamp developed by Mueller Electric Co., Cleveland, Ohio, makers of the well-known "Universal" battery clip.

The clamp (trade name, "ClampPipe"), illustrated in Fig. H, is so small and flat that it will fit on a pipe lying close to a wall. Its channel construction insures rigidity. The case-hardened screw is pointed to dig through corrosion; while the ground-lead wire from the receiver is to be clamped under the head of a screw in the center of the cadmium-plated clamp. The jaw spread is $\frac{3}{8}$ -in. to $1\frac{1}{4}$ -in.

The New Readrite Self-Contained OHMMETER

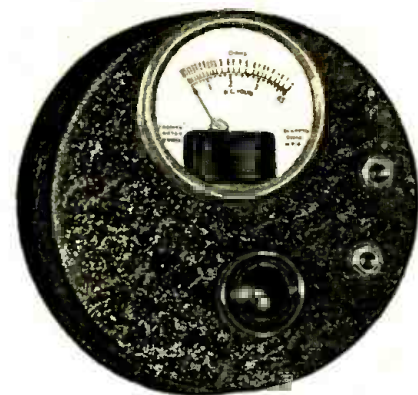

This No. 500 Ohmmeter will accurately test resistances and is also handy for making continuity tests in the shortest time. Complete with small $4\frac{1}{2}$ -volt battery in a convenient baked enamel steel case. Rheostat sets needle to zero. Tipped wires for connecting to jack terminals are supplied.

Reads directly to 10,000 ohms and $4\frac{1}{2}$ volts. Resistor may be had at \$1.00 list to be plugged into one of the jacks and used with external $22\frac{1}{2}$ -volt battery for testing to 60,000 ohms. No drain on battery.

Complete for 10,000 ohms

\$360 Net

Your jobber can supply. If ordered direct remittance must accompany order.

No. 501 Resistance Meter Only
\$1.50 Net

READRITE METER WORKS
Est. 1904

17 COLLEGE AVE, BLUFFTON, OHIO

EVERY
SERVICE MAN
SHOULD OWN
THIS BOOK!

THE BIGGEST SELLER IN
RADIO LITERATURE

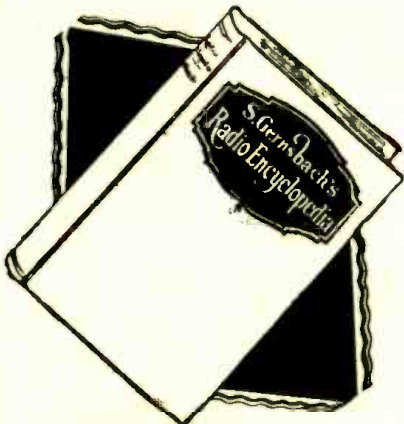

S. GERNSBACK'S
RADIO
ENCYCLOPEDIA

EDITED by SIDNEY GERNSBACK, Author of "Wireless Course in Twenty Lessons"—"One Thousand and One Formulas"—"Practical Electricity Course"—"The Radio Educator," etc.

S. GERNSBACK'S RADIO ENCYCLOPEDIA is the only standard work ever published in America attempting to classify alphabetically the countless words used in the highly specialized science of RADIO. The ENCYCLOPEDIA is written in plain English so that everybody can understand the definitions and descriptions.

No expense has been spared, covering over two years in compilation, to make it worthy a place in your library.

It is published in one volume—168 pages—size 9 x 12 inches, over an inch thick and nicely accommodates the beautiful illustrations and the large, easy-to-read type.

The work contains 1,930 definitions, 549 photographs, drawings and diagrams.

REMEMBER THIS IS A REAL ENCYCLOPEDIA — NOT A DICTIONARY — and very few of the things described and illustrated in this volume can be found in any dictionary, or any other encyclopedia.

The book contains as a supplement a classified cross index designed to bring together radio references under one heading, having relations in common.

All circuits new and old are described by word and picture and every part and apparatus used in Radio is explained and made understandable by means of photographs and drawings.

The volume is printed upon fine paper—bound in full black Keratol, marbled paper fly leaves and end sheets, with the title stamped in gold.

SEND NO MONEY

Just Pay Postman

(Canada or Foreign send Check or Money Order for \$2.35)

ISKOR PRESS, Inc. R-9-30
19 Park Place, New York, N. Y.
Send me one copy of Sidney Gernsback's First Radio Encyclopedia in one volume as advertised. I will pay postman \$2.00 plus postage on delivery.

Name

Address

Town and State

Simple Radio Mathematics for the Service Man

By BORIS S. NAIMARK

IT is generally believed that mathematics is a highly complicated science and that formulas, being mathematical expressions, are equally involved and complicated. There are consequently many radio men who have acquired a deep-rooted, though not very wise, aversion toward the mathematical end of the radio science. They may be termed "formula shy."

However, there is no royal road to knowledge, and, since radio is a mathematical science, the amateur and, particularly, the professional Service Man must admit that, without a thorough knowledge of at least the basic formula, he is "licked."

This article is intended primarily for Service Men who take their calling seriously. It comprises a discussion of formulas most commonly encountered or useful in the radio shop or practical laboratory. These are tabulated also in a form that permits quick and convenient reference.

Use this table as you would a vacuum-tube chart. The intelligent Service Man does not attempt to memorize all the facts found in the conventional tube chart. He first learns how to use it; he determines what information the chart contains that may be of interest to him. Thus, when a question presents itself, he knows that the tube chart contains the answer; and he consults it as frequently as he may find desirable.

Follow the same procedure with the formulas given. Of course, first read this article carefully and familiarize yourself with the possibilities for more intelligent and efficient application of theory to practice. Post the table where it can be consulted when need be; better yet paste it on a stiff cardboard and tack it to the wall of your workshop.

While it is not recommended that all the data be memorized outright, those who apply a little effort will be rewarded by a thorough knowledge of the formulas presented and as time goes on will actually know them by heart.

To begin with, let us understand that a formula is nothing but a statement of fact or facts. It is, of course, expressed in symbols and invariably is the most concise statement of the fact or facts it deals with.

Current, Resistance, Voltage

Let us consider Ohm's Law—the most fundamental of all electrical formulas. This law is basic, and finds application wherever potentials or voltages are involved. It is one of the few formulas that the Service Man should memorize outright. The basic form of Ohm's Law is

$$I = \frac{E}{R}$$

where I is current in amperes, E the potential difference in volts, and R the resistance in ohms. This formula simply expresses the fact that, in a D.C. circuit, the current is directly proportional to the voltage impressed upon the circuit and is inversely proportional to the resistance of

the circuit. In other words, the current within a circuit will increase as we increase the E.M.F. impressed upon it; and will decrease as we increase the resistance of the circuit. It therefore stands to reason that, if in a given circuit we increase both the E.M.F. and the resistance in the same ratio, the current flow remains unchanged.

The first modification of Ohm's Law tells us that the voltage drop across any two points of a circuit is proportional to just two factors; current and resistance.

$$E = I \times R$$

Thus this formula is particularly useful in the workshop.

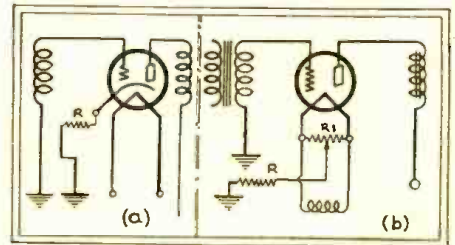

Fig. 1

In either circuit, multiplying the plate current of the tube by the value of the cathode (filament) return resistor gives the grid bias.

In Fig. 1, two extensively-used methods of obtaining "C" bias by the voltage drop across a resistor are shown. In practical service work, it is often desirable to determine what value of resistor to use, in order to obtain the desired value of biasing potential. For this calculation, the third modification of Ohm's Law is employed. In using the formula

$$R = \frac{E}{I}$$

R is the desired resistor value, E the voltage to be obtained, and I stands for current. This current (in the case of Fig. 1a) is the normal value in amperes of plate current for that tube. Quite frequently, as shown in Fig. 2, a single resistor is used to obtain biasing voltage for several tubes. When such is the case, in the above formula I represents the sum of the plate currents of the several tubes to be biased.

In the practical application of Ohm's Law in any of the basic forms, it should be understood that it can be applied equally well to the whole circuit or to any definite portion of a circuit. Care must be exercised

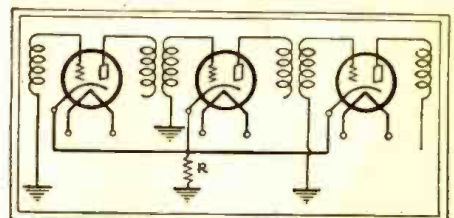

Fig. 2

The rule is the same here, except that the current of more than one tube passes through R. The sum of their currents is therefore used.

FACTORY TO YOU—SAVE to 50%—COMPARE WITH COSTLIEST OUTFITS BEFORE YOU BUY

Enjoy a powerful new Miraco 30 DAYS FREE

Latest 1931 SUPER Screen Grid Outfit (No obligation to buy)



NEWEST IN RADIO! TOP OPERATION

in this 1931 Miraco "Easy-Chair" model with magazine racks, each end. Place it anywhere in any room. Easily moved about. Small door in top conceals dial and controls when not in use. 26 in. high, 15 in. wide—yet it contains a complete full-size radio and Super-Dynamic speaker! No outside aerial or ground required. Many other new, clever models, obtainable nowhere else, shown in free literature.

Get Our "SEND NO MONEY" 11th Anniversary Offer!

Latest 1931 **Super Screen Grid** FULL YEAR'S GUAR.
lighted 1 dial steel chassis
Vari-Tone and Automatic Sensitivity Control
Also latest PUSH-PULL Amplification

Built like—looks like—performs like newest radios in many outfits much more costly. Latest, finest, heavy duty construction. Skillfully engineered to super-utilize a battery of "224" SCREEN GRID tubes—in addition to "245" PUSH-PULL POWER, "224" HUM-FREE long-lived POWER DETECTOR and AMPLIFIER and "280" A-C TUBES. Vari-tone feature gives any tone-pitch your ears prefer. Automatic Sensitivity Control reduces "fading," protects tubes. Phonograph pick-up connection. Built-in house wiring aerial and ground. Built-in plug for electric clock, lighter, lamp, etc. Super-sturdy power section. Razor-edge selectivity; Super-Dynamic Cathedral tone quality; marvelous distance-getter. Solid one-year guarantee if you buy! Wide choice of cabinets.

Easy Chair Model Only \$49.⁸⁸ (as illustrated less tubes) COMPLETELY ASSEMBLED
Values possible because you deal direct with big factory

MIRACO

TRADE MARK REGISTERED

CATHEDRAL TONED, SUPER SELECTIVE, POWERFUL DISTANCE GETTERS

You need not send us a cent! For its 11th successful year, America's big, old, reliable Radio Factory again sets the pace in high-grade, latest guaranteed radios *direct to you*. And now—at history's greatest savings. With this newest perfected SUPER SCREEN GRID, push-pull, super-powered and humless electric AC set in clever, beautiful new Miraco-Mastercrest consoles obtainable nowhere else—you are guaranteed satisfaction, values and savings unsurpassed. *Get Amazing Special Offer!*

Don't Confuse with Cheap Radios With Miraco's rich, clear Cathedral Tone, quiet operation, razor-sharp separation of nearby stations, tremendous "kick" on distant stations, Vari-Tone and automatic sensitivity control, and other latest features—be the envy of many who pay 2 or 3 times as much! Send for proof that delighted thousands of Miraco users cut through locals, get coast to coast, with tone and power of costly sets. Miraco's are built of finest parts—approved by Radio's highest authorities. Our 11th successful year!

EASY TERMS to reliable persons only

USER-AGENTS WANTED
Exclusive Territory—Try it at Our Risk!
Spare or full time. No contract, no experience required. Big money! Send coupon now!

At our risk, compare a Miraco outfit with highest priced radios 30 days and nights. Surprise, entertain your friends—get their opinions. Unless 100% delighted, don't buy! Your decision is final—no argument!

Deal Direct with Big Factory

Miraco outfits arrive splendidly packed, rigidly tested, to plug in like a lamp and enjoy at once. No experience needed. Entertain yourself 30 days—then decide. Liberal year's guarantee if you buy. Play safe, save lots of money, insure satisfaction—deal direct with Radio's big, reliable, pioneer builders of fine sets—successful since 1920. SEND POSTAL OR COUPON NOW for Amazing Offer!



MIDWEST RADIO CORP. 895-AS Miraco Dept., Cincinnati, Ohio

BEAUTIFULLY ILLUSTRATED LITERATURE, TESTIMONY OF NEARBY USERS, PROOF OF OUR RELIABILITY—

All the proof you want—of our honesty, fairness, size, financial integrity, radio experience and the performance of our sets—including Amazing Factory Offer—sent without obligation!

MIDWEST RADIO CORPORATION
Pioneer Builders of Sets—11th Successful Year
895-AS Miraco Dept., Cincinnati, Ohio

THIS COUPON IS NOT AN ORDER

- WITHOUT OBLIGATION, send latest literature, Amazing Special Free Trial Send-No-Money Offer, testimony of nearby users and all Proof. User. Agent. Dealer
- Check here if interested in an EXCLUSIVE TERRITORY PROPOSITION
- NAME..... ADDRESS.....

NEW LOW FACTORY PRICES SAVE to 50%

Similar Low Prices on Beautiful Variety of Latest Fine Consoles. Send Coupon!



30 DAYS FREE TRIAL
Electric Clock Model Medium-size "Hi-Boy." Built-in clock over dial. Latest drop-panel front. Rich design, fine woods, fine finish. Astonishingly low factory to you price.

Stylish small console with convenient magazine racks, each end. Another exclusive Miraco-Mastercrest 1931 design. Bargain factory to you price!



Full-size wall console with latest 1931 features. Beautiful design and woods. Priced very low, factory to you.

These Consoles are Equipped with **SUPER DYNAMIC CATHEDRAL TONE REPRODUCERS**

Also: built-in aerial and ground—and built-in extra light socket!



Magnificent new 1931 Miraco-Mastercrest creation. Send coupon for complete showing including Radio-Phonographs. Low factory-to-you prices.



Free!

◆ ◆ *Official*
RADIO SERVICE MANUAL

*and Complete Directory of
 all Commercial Wiring
 Diagrams of Receivers*

**PREPARED ESPECIALLY
 FOR THE
 RADIO SERVICE MAN !**



\$3.50 *Special Offer*

⌞
HUGO GERNSBACK
Editor

CLYDE FITCH
Managing Editor

WE ANNOUNCE the publication of the long-awaited **OFFICIAL RADIO SERVICE MANUAL.**

This manual is the first complete and most up-to-date book of this kind. Nothing else like it has ever appeared in print.

A tremendous amount of material has been collected, not only for the Service Man, but for everyone interested in radio. A complete directory of every radio circuit of commercial receivers is now possible, and not only do you get every circuit of every set manufactured, of which there is any record, but in addition, an entirely new idea makes it possible to keep the manual up-to-date.

The **OFFICIAL RADIO SERVICE MANUAL** is made in loose-leaf form—handsomely made of flexible leatherette—the entire book can be folded and slipped easily into your pocket or put in your bag.

Rarely do manufacturers supply information about receivers made before 1927—even 1930 service data are not always available because many manufacturers do not supply independent Service Men with such data. And, when you can get the material from some of the manufacturers, it is of little use to you because it is not uniform, and it is scattered in different places; difficult to get at.

Additional service data, for new receivers as they appear on the market will be published and supplied at trifling cost so that the **MANUAL** may be kept up-to-date at all times.

SERVICE INFORMATION

But that is not all. The **OFFICIAL RADIO SERVICE MANUAL** contains also a most comprehensive instruction

course for radio Service Men, giving practical information from every angle on how to service sets.

In short, the **OFFICIAL RADIO SERVICE MANUAL** is the biggest thing of its kind that ever came along in radio. It will be hailed by every wide-awake radio man throughout the entire industry.

The size of the **OFFICIAL RADIO SERVICE MANUAL** is 9 in. by 12 in. There are several hundred pages, printed on good paper, and the book contains hundreds of illustrations and diagrams.

NOW ON SALE!

A limited supply of the first printing are ready for distribution, and at the unusual low price of \$3.50 for this Radio Service Manual, every Service Man should have one at his disposal.

GERNSBACK PUBLICATIONS, INC.,
 96-98 Park Place, New York, N. Y.

RC-9

As per your special offer, I enclose herewith \$3.50 for which you are to send me postpaid, one copy of the **OFFICIAL RADIO SERVICE MANUAL.**

Name

Address

City..... State.....

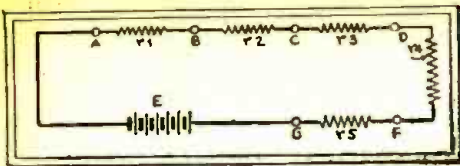

Fig. 3

While the voltage drop across any resistance in a circuit is equal to its value multiplied by the current passed, the wattage (which measures the heat generated) is equal to the resistance times the square of the current. Different wattage ratings may be necessary in a series of resistors.

that the known values are those of that particular section of the circuit, and not those of the entire circuit. Fig. 3 illustrates this point graphically.

Wattage Formulas

In electrical circuits it is not sufficient to know that, for a given purpose a resistor of a certain ohmage must be employed. We must also know what wattage rating the resistor must have, in order to carry safely the required current. The wattage may be easily determined from the expression

$$W = E \times I = I^2 R$$

where W is the power in watts, E the E.M.F. in volts, I in the current in amperes, and R the resistance in ohms. The same precautions must be observed when using this formula as in the use of Ohm's Law; that is, with regards to its use in entire or partial circuits.

It is quite customary, in radio design, to

employ resistors of a wattage rating several times greater than the calculations call for. This is a precaution against resistor burn-outs, where facilities for ventilation, are poor and the danger of burnout through overheating is correspondingly high.

The wattage rating of a resistor applies to the *entire resistor only*, and not to any section of the resistor. It is apparent that, in order to pass a certain amount of current through a given resistor of definite resistance and wattage, it is necessary to apply a certain definite potential across the resistor. If this potential, however, is applied across a section of the unit, the decrease in the resistance will cause a corresponding increase in the current, through the section employed, which will naturally be beyond the permissible safe value and the useful life of that particular section will be materially shortened if not suddenly terminated. Thus wattage ratings of units are applicable to the entire units *only*, and not to any section of them.

Commercial resistors are commonly marked as follows: "1,000 ohms—10 watts." It is frequently desirable to determine from such a rating the value of current that may be safely passed through the resistor without overloading. This (1/10-ampere, in the instance above) is obtained from the relation

$$I = \sqrt{\frac{W}{R}}$$

Series and Parallel Circuits

We need not devote much space to the formulas devoted to the determination of the resultant value of a combination of resistors or condensers, in series or in parallel. The formulas themselves are quite clear and require no special explanation. The wattage of the individual resistors is not affected by the series connection. It is clear, therefore, that the resulting resistor, consisting of several resistances in series, should not be permitted to carry more current than is permissible for the resistor of the series having the lowest wattage rating. When two or more resistors are connected in parallel, the resultant value of resistance is less than that of the smallest of the resistors used in the parallel connection. While the current-carrying capacity of the individual resistors remains unaffected the current permitted to pass through the parallel circuit may be as great as the sum of the current-carrying capacities of the individual resistors.

With regard to condensers, when two or more are connected in parallel, the resultant capacity is the sum of the individual capacities. When two or more condensers, however, are connected in series, the resultant capacity is smaller than the smallest of the individual capacities used in the series arrangement. Condensers of the higher capacities are, as a rule, rated for their working voltage. When voltages in excess of the rating are applied across the terminals of any one condenser its useful life is materially shortened, and, if the excess is great, its usefulness may be instantly terminated.

The question naturally presents itself, how this working voltage of the individual condensers is affected when two or more of them are connected either in series or in parallel. For a parallel connection, the voltage impressed across the parallel bank should not exceed the voltage rating of the condenser having the lowest working voltage rating in the parallel circuit. When

FREE PROOF you can make real money in RADIO

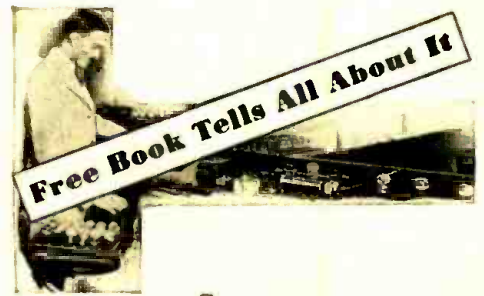

A GLORIOUS future awaits you in this huge industry. Millions of sets need servicing, thousands of ships require radio operators . . . manufacturers and broadcasting stations throughout the land are eagerly seeking trained men . . . and now, nation-wide radio telegraph service, telephony, sound motion pictures, open up thousands of new and amazing opportunities.

Learn At Home

By means of this marvelous, simplified home-training course, sponsored by the Radio Corporation of America . . . you can now prepare for success in every phase of Radio. The remarkable outlay of apparatus given to you with this course enables you to learn by actual practice how to solve every problem in radio work. That's why you, too, upon graduation can have the confidence and ability to command good money.

Backed By RCA

Graduates of this school are always posted in newest developments in Radio. That's why they are always in big demand. The progress of Radio is measured by the accomplishments of the Radio Corporation of America. This gigantic organization sponsors every lesson in the course.

Money Back If Not Satisfied

As a student you will receive an agreement signed by the president of this school assuring you of complete satisfaction upon completion of your training—or your money instantly refunded.

Free!

This fascinating book on Radio's glorious opportunities . . . written by one of America's well-known radio experts.

RCA INSTITUTES, INC.

(A Division of Radio Corporation of America)

RCA INSTITUTES, Inc., Dept. SRA-9
75 Varick Street, New York City

Gentlemen: Please send me your FREE 40-page book which illustrates the opportunities in Radio and describes your home laboratory-method of instruction.

Name.....

Address.....

Occupation.....

Radio Operator \$90 and up per month with all expenses paid. Broadcast Operator \$1,800 and up a year. Radio Repair Mechanic \$1,800 and up a year. Radio Inspector \$2,000 and up a year.

OHM'S LAW — RELATIONS BETWEEN VOLTAGE, RESISTANCE, CURRENT AND POWER

Direct Current

Where I is Current Intensity in Amperes, R is Resistance in Ohms
E is Electromotive Force in Volts and W is Power in Watts, then:

$$I = \frac{E}{R} = \frac{W}{E} = \sqrt{\frac{W}{R}}$$

$$R = \frac{E}{I} = \frac{W}{I^2} = \frac{E^2}{W}$$

$$E = I \times R = \frac{W}{I} = \sqrt{W \times R} \quad W = E \times I = I^2 R = \frac{E^2}{R}$$

Alternating Current

Where Z is the Impedance in Ohms, E is Effective Electromotive Force in Volts, and I is Current Intensity in Amperes, then:

$$I = \frac{E}{Z} \quad E = Z \times I \quad Z = \frac{E}{I}$$

Where L is the Inductance in Henries and C the Capacity in Farads.
f is the Frequency in Cycles (per second), then in ohms,

The Inductive Reactance $X_L = 6.283 \times f \times L$

The Capacitive Reactance $X_C = \frac{1}{6.283 \times f \times C}$

The Resonant Frequency is $f = \frac{1}{6.283 \times L \times C}$

The Impedance Z is:

In a Capacitive Circuit:	In an Inductive Circuit:	In a Circuit having Resistance, Capacity and Inductance:
$Z = \sqrt{R^2 + \left(\frac{1}{6.283 \times f \times C}\right)^2}$	$Z = \sqrt{R^2 + (6.283 \times f \times L)^2}$	$Z = \sqrt{R^2 + \left(\frac{1}{6.283 \times f \times C} - 6.283 \times f \times L\right)^2}$

A. C. Voltage and Power:

The Maximum Voltage E_m is 1.414 x the Effective Voltage E_e
The Effective Voltage E_e is 0.707 x the Maximum Voltage E_m
The Average Voltage E_a is 0.636 x the Maximum Voltage E_m
The Wattage of an A. C. Circuit $W = I \times E \times \frac{R}{Z}$

Where the Angle of Lag is ϕ , and the Power Factor $\frac{R}{Z} = \cos \phi$
Cosine ϕ , Sine $\phi = \frac{X}{Z}$, and Tangent $\phi = \frac{X}{R}$

Combinations of Resistances or Capacities:

The Effective Sum of a Combination of Resistances (R) or of a Combination of Capacities (C) is as follows:

In SERIES **In PARALLEL**

Resistances: $R = R_1 + R_2 + R_3 \dots$ $R = \frac{1}{\frac{1}{R_1} + \frac{1}{R_2} + \frac{1}{R_3} \dots}$

Capacities: $C = \frac{1}{\frac{1}{C_1} + \frac{1}{C_2} + \frac{1}{C_3} \dots}$ $C = C_1 + C_2 + C_3 \dots$

The above formulas are fundamental in radio work, and the Service Man who preserves them for reference will find them frequently useful.

This Free Book shows how you can get into AVIATION



Walter Hinton

First to pilot a plane across the Atlantic, first to fly from North to South America, first to use the plane in exploration, first world-famous flyer to give home-study students the cream of his knowledge. Get Walter Hinton's own message to you, his Free Book, "Wings of Opportunity."

HERE'S the book that tells just where your chances are in Aviation today. It gives definite answers to the questions you've been asking yourself— "What does Aviation offer me?" — "What must I do to get into Aviation?" — "What job can I hold?" It explains how Lieutenant Walter Hinton, through a remarkable personalized home-study course can give you— **RIGHT AT HOME** — the ground-work employers demand. This intensive home-study course in Aviation is getting cash results for Hinton's graduates in all parts of the country. He also backs you up with an active employment service when you are ready for a job. If you want to take up flight instruction, he arranges for special reduced rates at an accredited flying school.

Send for this book today. The time you now spend thinking about Aviation could be spent in training.

Mail Now for Facts

Walter Hinton, President
Aviation Institute of U. S. A.
1115 Connecticut Ave., Washington, D. C. 304-C

Please send me your Free Book showing how I can train right at home for a place in Aviation.

Name..... Age.....
(must be 18)

Address.....

City..... State.....

FREE! RADIO BARGAIN CATALOG

ALSO FREE RADIO GIFT

Send now for this new free radio catalog which saves you many dollars on radio outfits, kits, parts, tubes and accessories! Also **TIME CONVERSION CHART FREE**. Tells you instantly what time it is in any part of the world! Given free if your request for catalog reaches us this month.

20th CENTURY MAIL ORDER CORP.

202 JACKSON ST., CHICAGO, ILL.

Genuine **PILOT** Products

With **BYRD at the SOUTH POLE**

An album containing authentic views of the BYRD ANTARCTIC EXPEDITION. Each of the seventeen actual photographs present a thrilling story of the hazardous life at the far end of the world. Send twenty cents, stamps accepted, for your copy of this interesting album of the greatest expedition of all times.

GRENPARK COMPANY

245-R Greenwich St. New York, N. Y.

condensers are connected in a series circuit the voltage applied across the entire series may be greater than the working voltage specified for the individual condensers. When all of the individual condensers are of equal capacity and of equal voltage rating we may apply across the series a voltage equal to the sum of the individual working voltages.

The above is correct only if the D.C. resistances of the condensers are of like value. Such a condition very seldom obtains in practice and, in order to prevent uneven distribution of voltage, a resistor of 100,000 ohms is customarily shunted across each individual condenser of the series. This shunt resistance is sufficiently great and can not interfere with the normal functions of the condensers. When the condensers in the series are of unequal capacities, the voltage distribution is uneven; being affected by difference of capacity as well as by difference in the D.C. resistance of the individual condensers.

Voltages Across Condensers

Ignoring the effect of D.C. resistance it may be stated, with sufficient accuracy (especially where a reasonable factor of safety is allowed), that the voltage across the individual condensers in the series is inversely proportional to their capacities. The smallest of the condensers will have the highest voltage drop across its terminals. Thus if we have connected in series three filter condensers rated as follows—2 mf.-350 volts; 3 mf.-350 volts; 4 mf.-350 volts—and the voltage impressed across the series is 900 volts, the 4-mf. condenser will have approximately 225 volts drop through it. The 3-mf. condenser will have approximately 300 volts; and the 2-mf. condenser, approximately 450 volts. It can be seen at once that the 2-mf. 350-volt condenser is not suitable for the series; since the voltage drop through it is considerably greater than the specified working voltage.

It is frequently asked why it is that the A.C. rating of a condenser is lower than its D.C. rating. The explanation lies in the nature of alternating current, which does not possess the steady characteristics of direct current. The form of alternating current, usually assumed in A.C. theory is that of a "sine curve," shown in Fig. 4. It is apparent, then, that the value of either current or voltage in an A.C. circuit is continually changing; assuming successively all values from its positive maximum to its negative maximum. A vacuum-tube voltmeter indicates the maximum or peak values of an alternating voltage. A.C. voltmeters and ammeters, however, indicate the effective values; which, as the formula chart shows, are equal to only .707 of the maximum values.

A.C. voltages or currents generally employed are the effective or "root-mean-square" (R.M.S.) values. Thus, if an electric receiver is said to operate from 110 volts A.C., the effective value is referred to. Similarly, if a condenser is rated for 300 volts A.C., the effective value is meant. The very same condenser is probably rated for 450 volts D.C. The peak value of A.C. that may be impressed upon the condenser is also approximately 450 volts. Thus the A.C. voltage rating of a condenser is lower than its D.C. rating because the A.C. rating is in effective, and not maximum, value. If

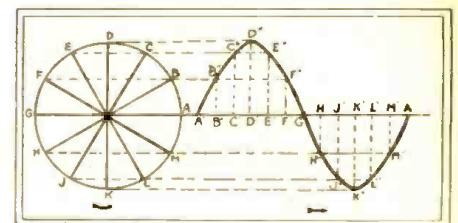

Fig. 4 The familiar "wave-form" at the right is not the picture of a real wave; it is merely a spreading out of the circle at the left, so that the time of each current value can be measured along the base line, instead of in an angle around the center of the circle.

the maximum value were used for A.C. condenser rating, it would be of the same value as the D.C. rating. If a condenser is rated for direct current only, and it is desired to determine the A.C. rating by calculation, assume the A.C. rating (in effective volts R.M.S.) to be equal to approximately seven-tenths of the D.C. rating.

A.C. Circuits

We now come to the subject of Ohm's Law for alternating current. When an A.C. circuit has resistance only, the formulas given for D.C. are equally well applicable to A.C. circuits. Where inductance and capacity are present, the term "impedance" takes the place of "resistance" in the formula. The value of impedance depends upon how much capacity and inductance are present in an A.C. circuit; and it can be easily determined from the formulas given in the chart. As with all other formulas, the terms of the expression

$$I = \frac{E}{Z}$$

may be transposed, to solve for either the voltage or the impedance.

Both capacity and inductance retard the current in an A.C. circuit. This opposition to the current flow is dependent upon the inductive and capacitive reactances, of the inductance and capacity respectively. Inductive reactance increases with the inductance value and the frequency. Capacitive reactance, however, decreases with both the capacity value and the frequency.

(To be continued)

ELECTRICAL STANDARDS OFF

FOR the student who has great confidence in the exactness of figures, it comes as a shock to find that all wavelengths are inaccurate. In America they are figured on a basis of 299,820,000 meters per second as the speed of radio; in Europe on 300,000,000; while the latest measurements indicate that the real figure is 299,780,000. The difference is seen in the last figure or two of a short wavelength, when it is tabulated.

Now comes the Bureau of Standards with the report that the international standards of electrical values are too large; the ohm by 5 parts in 10,000; the volt by 45 in 100,000; and the watt consequently by about 4 parts in 10,000. This should console the man who pays a \$25.00 light bill, to the extent of one cent. Practically, of course, these differences are invisible; but they illustrate at once the intensity of the search for absolute scientific accuracy and the impossibility of obtaining it.

Power-Supply Tubes

(Continued from page 163)

Voltage Regulation

One of the greatest bugaboos in A.C. receiver operation, especially in the outlying districts around cities, is the trouble caused by line-voltage fluctuations. Needless to say, these variations cause a great percentage of tube failures, due both to the excess filament voltages and to the high plate voltages applied to the tubes, as a result of periods of high line-potential.

Tubes are now being made with stronger and more rugged filaments than when they were first introduced; so that the number of "casualties" has been reduced considerably. The trouble, however, was so prevalent that several special tubes were developed to regulate, to a further degree, the potentials applied to the receiving set.

These tubes fall into two classes: The first is the D.C. output-voltage regulator, or "glow"-tube; and the other is the A.C. line-voltage regulator, or "ballast"-tube.

The glow-tube is made for service in "B" power units and insures proper voltage regulation of the D.C. output voltages. In addition to the voltage-stabilizing effect, the tube is equivalent to an extra filter condenser across the output; thus reducing the possibility of "motorboating" or other interstage-coupling effects in the receiver, and also tending to reduce the hum. Its effect has been compared to that of a 20-mf. condenser connected at the same position in the circuit.

Engineering Data



One point not very well understood about the regulator tube is the fact that additional current is required to operate it, and that this must be included in the total current consumption of the receiver. The current normally used amounts to about 30 milliamperes; so that a power unit operated close to its maximum output cannot be equipped with such a tube without overloading it. To attempt it would cause a reduction in the output voltage, and prevent the correct operation of both the power unit and the glow tube.

The "74" type glow-tubes are particularly valuable in power units where the current requirements are not constant; or are not known at the time when the unit is designed. The use of variable resistors of high current-capacity, in the voltage divider, for output-voltage regulation has not been entirely successful; since the resistors often become noisy or burn out. If a glow-tube (V2, Fig. 9) is connected between the negative "B" terminal and the 90-volt terminal, it will maintain this voltage constant under wide variations of output current. With a current flow from 10 to 50 milliamperes at the 90-volt tap this tube will keep the voltage constant. It must be used with a series resistor, in order to limit the current to about 50 milliamperes; otherwise it may be injured. If desired, two tubes may be connected in series and they will maintain a voltage of 180, as a single tube does a voltage of 90. The same precautions must be observed with two tubes in series as with a single tube.

In operation the tube shows a purple glow surrounding the cathode (the large circular plate) which accounts for its name

PATENTS INVENTORS

**Write for these
FREE BOOKS!**

**MY PATENT
LAW OFFICES
OPPOSITE
U.S. PATENT
OFFICE**

At the left is a view of my drafting and specification offices where a large staff of experienced experts is in my constant employ. All drawings and specifications are prepared in my offices.

Protect Your Ideas Take the First Step Today

If you have a useful, practical, novel idea for any new article or for an improvement on an old one, you should communicate with a competent Registered Patent Attorney AT ONCE. Every year thousands of applications for patents are filed in the U. S. Patent Office. Frequently two or more applications are made for the same or substantially the same idea (even though the inventors may live in different sections of the country and be entirely unknown to one another). In such a case, the burden of proof rests upon the last application filed. Delays of even a few days in filing the application sometimes mean the loss of a patent. So lose no time. Get in touch with me at once by mailing the coupon below.

Prompt, Careful, Efficient Service

This large, experienced organization devotes its entire time and attention to patent and trademark cases. Our offices are directly across the street from the U. S. Patent Office. We understand the rules and requirements of the Patent Office. We can proceed in the quickest, safest and best ways in preparing an application for a patent covering your idea. Our success has been built on the strength of careful, efficient, satisfactory service to inventors and trademark owners located in every state in the Union.

Strict Secrecy Preserved— Write Me in Confidence

All communications, sketches, drawings, etc., are held in strictest confidence in strong, steel, fire-proof files, which are accessible only to authorized members of my staff. Feel free to write me fully and frankly. It is probable that I can help you. Highest references. But FIRST—clip the coupon and get my free book. Do THAT right now.

No Charges for Information on How to Proceed

The booklet shown here contains valuable information relating to patent procedure that every inventor should have. And with it I will also send you my "Record of Invention" form, on which you can sketch your idea and establish its date before a witness. Such evidence may later prove valuable to you. Simply mail the coupon and I will send you the booklet and the "Record of Invention" form, together with detailed information on how to proceed and the costs involved. Do this NOW. No need to lose a minute's time. The coupon will bring you complete information entirely without charge or obligation.

Clarence A. O'Brien Registered Patent Attorney

Member of Bar of Supreme Court of the United States; Court of Appeals, District of Columbia; Supreme Court, District of Columbia; United States Court of Claims.
Practice confined exclusively to Patents, Trademarks, and Copyrights



Mail this Coupon Now

CLARENCE A. O'BRIEN
Registered Patent Attorney

3506 Security Savings and Comm'l Bank Bldg.,
Washington, D. C.

— or —
Suite 1106, Dept. K-2, Woolworth Bldg., New
York City

Please send me your free book, "How to Obtain a Patent," and your "Record of Invention" form without any cost or obligation on my part.

Name

Address

(Important: Print or Write name clearly
and address office nearest you)

RADIO Service Men!

Products listed below are made by leading radio manufacturers and offered at prices far below the manufacturing cost. Stocking them for future use will save you money.

VICTOR "ABC" POWER TRANSFORMER

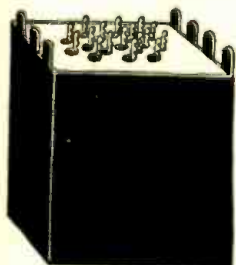

105-115 VOLT
60 CYCLE
Supplies voltages for
6—226 tubes
1—227 tube
1—280 tube
2—245 tubes
350 Volts "B, C"

Our Price
\$2.75

PUSH-PULL AUDIO TRANSFORMERS

FOR 245-171 TUBES

Flat characteristic curve obtained by using these transformers in a push-pull stage.

Finished in Bronze

\$3.00

Pair



COMBINATION "A B C" AIREX POWER PACK



Dealers
Price
Now
\$5.45

WIRED READY FOR USE

Built with high-grade parts. Supplies "A, B, C" Voltages for
5—226's 2—227's 2—171-A's 1—280
105-120 Volts — 50-60 Cycle

Delivers over 125 Mils and up to 300 volts "B" power. The Power Transformer is designed to take care of a D.C. DYNAMIC SPEAKER, two connections being provided on the pack for same. It need not be used if not wanted, but may come in handy at some future date.

280 Rectifier Tube **95c.**

All products shipped C.O.D. immediately upon receipt of order

Grenpark Tool Company

245 Greenwich St. - New York City

SIGNAL

Wireless PRACTICE SET



LIST \$3.40

For practicing the code. Equipped with high grade key and high frequency buzzer. Each set complete with booklet "Fundamentals of Wireless Telegraphy." If your dealer cannot supply you write direct—

SIGNAL ELECTRIC MFG. CO.
MENOMINEE, MICH.

of "glow"-tube. If the tube connections are reversed a bright glow occurs at the small electrode. Proper results are not obtained unless the connections are made as in the diagram (Fig. 9). The terminals from the "P" and "F—" socket prongs are connected together internally at the base of the tube and this "link" connection may be used as a line switch in the transformer primary. This insures that the power unit cannot be turned on until the '74 tube is inserted in its socket, and that V1 and V2 cannot be interchanged with resulting damage. If the rectifier tube is inserted in the regulator socket, the primary circuit is still open and no current flows in the unit.

The operation of the glow-tube depends on the variation of resistance between electrodes, separated by certain gases, when different voltages are applied. If the receiver draws more current (thus leaving less for the glow-tube) the voltage applied to the glow-tube is reduced and the resistance of the glow-tube *increases*; resulting in a greater amount of current being available at the output tap. (When the resistance of the glow-tube increases, it consumes less current than normally, thus reducing the "load" on the eliminator.) On the other hand, if more current is available, the resistance of the glow-tube *decreases* and a greater current flows through it. A difference in the line-voltage affects the applied voltage, and has the same effect as a difference in the current used at the 90-volt tap. As the voltages at other taps are controlled to some extent by the current at this tap, all of them are affected by the tube, though not as greatly as the 90-volt output.

The Ballast-Tube

The ballast-tube type, of which the 876 is representative, is intended to regulate the input voltage to the primary winding of the power transformer in a power unit. Like an electric lamp, it has a screw base. The tube passes 1.7 amperes, at any applied voltage between 40 and 60. The *current* in the secondary winding of the transformer must be such as to bring the voltage on the ballast-tube to 50, under normal line-voltage. For example, if the line-voltage averages 115 volts, (VM at a, Fig. 9), the transformer should be designed to take 1.7 amperes at 65 volts under normal load, (VM at c); the remaining 50 volts are required for the operation of the ballast-tube (VM at b). For completeness, 5-amp. fuses are shown.

While the line-voltage varies, up to 10 volts on either side of 115 volts, then the voltage applied to the primary winding remains constant at 65 volts. It must be remembered that this tube cannot be used with an ordinary transformer. The primary must be made for a 65-volt input, for a 115-volt line; or a 60-volt input, for a 110-volt line.

(Another "ballast"-tube, of somewhat similar performance, was described in detail in the September, 1929, issue of RADIO-CRAFT magazine, on page 119.—*Editor.*)

The tube is equally serviceable on 25- or 60-cycle lines, when used with transformers designed for the available frequency. The tube becomes quite hot in operation and should be housed in a ventilated metal case, for safety in case of a defective tube.

Servicing Procedure

In the case of the glow-tube, if no glow is obtained, the voltage at the 90-volt tap should be measured. If it is lower than 90, the set should be disconnected temporarily from this tap, to reduce the load. The voltage should be measured again and, if the tube still does not flash even when the applied voltage is above 90, the connections to the tube should be examined carefully. If the wiring is correct, the tube is undoubtedly defective and should be replaced.

There is no direct method of testing these tubes, except placing them in a circuit which will supply normal conditions and observing the action. Occasionally, the glass will be found cracked, thus allowing some of the gas to escape. In other cases, if the tube has been subjected to excessive voltages for long periods, it will not glow.

In the case of the ballast-tube, if correct operation is not obtained, the applied voltage should be measured; and the primary winding of the power unit should be checked for an open circuit. The tube operates only when the load is correct; so that it is necessary to check the complete power unit to be sure that the trouble is not located elsewhere. If everything is apparently correct, and the tube still fails to supply the correct voltage to the transformer, it should be replaced by a new tube for comparison.

When operating at normal, the '76 ballast-tube, passing 1.7 amperes, heats considerably. The tube requires several minutes to heat up. The voltage increases rapidly for the first three minutes and then slowly for about seven minutes more; by which time it has reached its final temperature. During this interval the voltages on the tubes will be slightly high, but will not exceed safe values. Thereafter, the ballast-tube will maintain the voltage practically constant, so long as the device is in operation. This fact should be recalled when servicing sets that incorporate a '76.

The '76 passes sufficient current for most radio sets. However, some receivers demand a greater current input; and for these the 886-type (the '86) tube is available, with a current rating of 2.05 amperes at the same voltages as the '76.

Automotive Receiver

(Continued from page 149)

For the installation of an aerial, when one is not already provided in the car, the manufacturer's standard accessory is 1/4-inch metal-coated tape, to be applied to the car roof in the shape of a hollow U; and cemented down with wider adhesive tape. This avoids perforating the car top; care must be taken not to run the aerial tape too near to metal supports.

While there are optional methods of mounting the aluminum chassis case, that recommended is at the right of the dash, under the cowl, with the tubes inverted. For convenience in replacing tubes, the lid of the case is mounted at an angle.

The output stage, a '71A, is equipped with a tone filter, as shown in the diagram; which gives also the operating voltages. The ground connection depends on that of the car's storage battery.

Service Men's Notebooks

(Continued from page 138)

may be able to worry along on the cheaper instruments, making allowances for what his apparatus may be "off"; but the soul of the real technician revolts at those coarse-needled meters that seem to say: "You are only as good as I am." I hope this will start some manufacturer thinking.

I have found that most of my troubles in the screen-grid Steinite (except for tubes) came from the breakdown of the 0.5-mf. condenser by-passing the R.F. tube plates. There is no plate voltage and no reception, of course. Oscillation has always been due to bad contact of the springs wiping the rotors of the variable condensers.

In the Bosch 48, the right-hand knob, or clarifier, often will not peak. I find this due to the cup-shaped shield over the variometer being pressed in or pulled out too far. This will bear looking into in case of oscillation, also.

In the Bosch 28, putting a resistor across the secondary of the first A.F. transformer has stopped the howl which occurs while the 27 is heating up. The resistor value must be found by experiment; 100,000 ohms is a good figure at which to start.

KOLSTER AND SPARTON SETS

By George M. Robinson

FADING in a Kolster "Model 6-K" set, complicated with noise similar to static, was in a recent case traced to the volume control. Without any alteration of its setting, even local stations would fade and then come back on with great volume. The volume control, which in this model is a filament resistor in series with the 26-type tubes, had been cleaned and tightened about six weeks before to deal with this condition.

The second time, after cleaning all parts of the control with alcohol, as I had done before, I thinly coated them (even the resistance wire!) with Nujol. Since then this trouble has not been experienced again. The grating sound caused by moving the resistor arm is eliminated also.

As to the excess noises, I suspected the audio transformers, and replaced them. This did not eliminate the noise; so I tested the power pack. On temporarily shorting the resistor between the detector tap and "B+90" I found it stopped entirely. This indicated that the noise was in this unit, and it was accordingly replaced.

In the same model, I found a set which could not be turned off entirely. The tubes would dim, but would not go out. Even turning off the house switch would not entirely stop the flow of current; though detaching the ground wire, or reversing the plug would do so. The latter, however, was obviously improper, because the polarity had been marked before this trouble developed.

On testing the set switch, I found the little cone-shaped plunger was shorting to the frame, thus completing the primary circuit through the pilot-light wires to ground. A new Cutler-Hammer switch cured the trouble.

Some months ago, I received a call to service a late Sparton A.C. set which would not give sufficient volume on distant sta-

See for Yourself Why TRUVOLTS are BETTER

For
Eliminator
and
Power Packs

U. S. Pat. 1676869
and Pats. Pend.

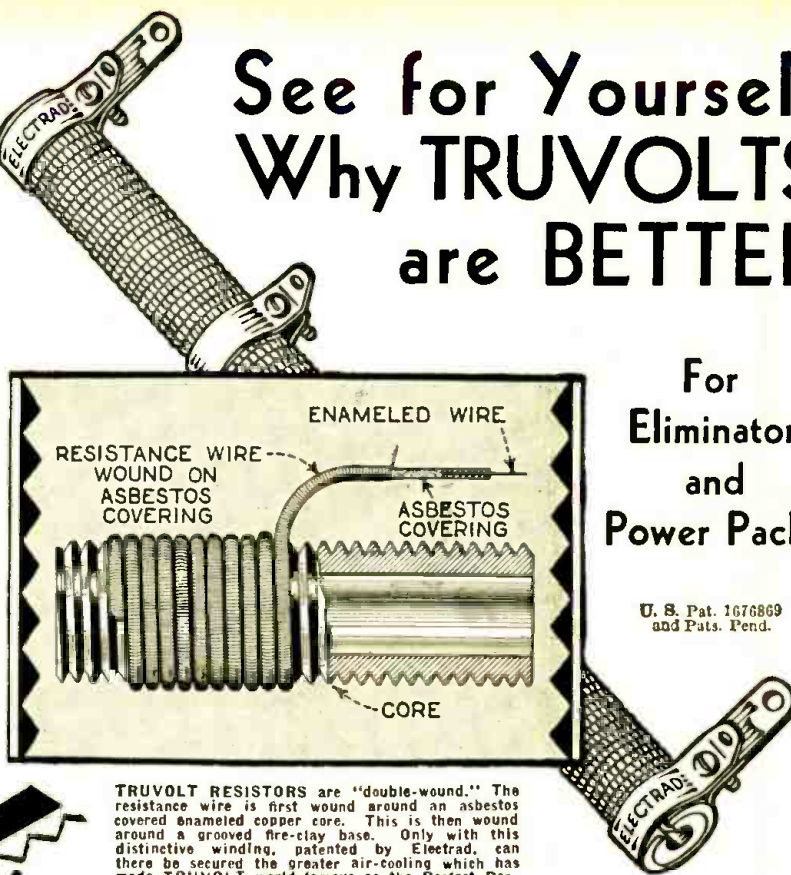

TRUVOLT RESISTORS are "double-wound." The resistance wire is first wound around an asbestos covered enameled copper core. This is then wound around a grooved fire-clay base. Only with this distinctive winding, patented by Electrad, can there be secured the greater air-cooling which has made TRUVOLT world-famous as the Perfect Performing Resistor.

TRUVOLT Resistors have long been the first choice of radio service men for replacement purposes because their experience proves that only the best is good enough. The open air-cooled winding (see illustration) insures lower operating temperature, more accurate values and longer life in battery eliminators and power packs. Fixed TRUVOLT Models (shown above) have a convenient sliding clip for exact adjustment of resistance value. This feature, found only on Electrad TRUVOLT Resistors, greatly simplifies service, installation and experimental work. It also cuts down the number of replacement units necessary in the service kit.

Made in all usual sizes and wattage ratings.

ELECTRAD manufactures a complete line of resistors and voltage controls for every radio and power supply requirement, including TELEVISION.

Intelligently standardized production and mass purchasing of raw materials effect large savings in Electrad's original manufacturing costs—savings which are passed on to consumers in Electrad's moderate prices for exceptionally high-grade products.

175 Varick St., New York, N.Y.
ELECTRAD
INC.

ADJUSTABLE TRUVOLT

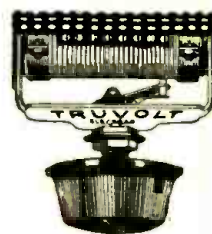

Distinctive TRUVOLT winding with knob variation and metal ventilating shield. Lasts longer owing to endwise travel of contact over resistance wire. One-hole panel mounting. 22 sizes. List Price \$2.50.

MAIL COUPON FOR TRUVOLT CIRCULAR
ELECTRAD, INC., Dept. R.C.-9, 175 Varick Street,
New York, N. Y.
Please send circular describing TRUVOLT RESISTORS.
 Check here for literature on complete Electrad Line.
Name.....
Address.....

FREE

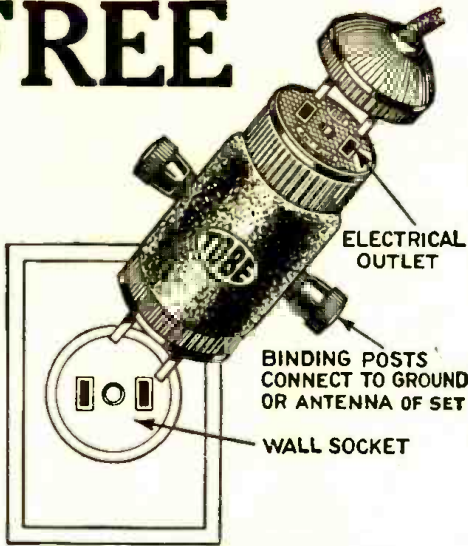

Mail this **TODAY!**
Coupon

for your promptness!

A TOBE 4-Way Purpose Light Socket Aerial with every radio convenience in one small unit—and given to you *free* with one year's subscription to RADIO-CRAFT.

This unit serves as a perfect indoor antenna, reduces static pick-up, and gives clear, pure tone reception, or—

A convenient and efficient ground without troublesome water-pipe connections or long wires, and—

A power-socket outlet which may be used for operating set, "B" eliminator, power pack, charger or any electrical apparatus, and—

A lightning arrester, protecting the set from all high-potential atmospheric discharges.

The most convenient of all radio antenna developments. TOBE SOCKET AERIAL is sold with a two-year guarantee. Complete instructions showing many combinations included with each aerial.

It had been returned to the distributor, who pronounced it O.K. The owner was advised by one of my customers to get in touch with me. I checked the antenna installation and set, and found voltages and tubes good. At our shop, the receiver was found to work as it had done at the owner's home; that is, with no volume on distance.

The condensers were checked for synchronization, and found satisfactory. On connecting the aerial to the R.F. amplifier input, signals came in loudly, but unselectively. This pointed to the tuning assembly. The inductances were tested, and found all right; but an ohmmeter showed a reading on the second condenser. Going along the insulation between rotor and stator on one side of the instrument with the test prongs, I found the approximate location of the leakage, but no discoloration. The condenser assembly was then put into an oven, and baked at a moderate heat for a couple of hours; after which a test showed no leakage, and the receiver worked wonderfully after being reassembled. The owner was delighted with this result, which seems to be permanent; he is again sold on his set, and also on our service.

I would like to say, at this time, that we wrote the manufacturers of Sparton for service manuals, and they informed us that these are supplied only to their authorized dealers. I believe that cooperation with Service Men by sending such data would not only help to give better satisfaction to the customer, but also aid the manufacturer in his effort to secure more sales.

VICTOR SETS—'24 DETECTORS

By Riley Jenks

IT is undesirable to operate the Victor R-32 or R-45 with a ground connection to the aerial post; this throws 110 volts across the condenser bank, which it is apt to damage. On these sets, the volume control may be treated with oil, instead of sandpaper, if it becomes noisy.

When replacing a speaker cone in the Victor models, if the centering-screw washer is flat, replace it with one of the new-style washers with turned up edges. The older washers wear through the cone much more quickly with their sharper edges.

When checking these sets without meters, it is well to inspect the terminal connections of the Jones plug to see that a soldered connection is not loose. Turning the tone control too far down will cut down the volume, as well as supply a deeper bass.

On '24 type screen-grid tubes, loose caps have defied discovery during trouble shooting for poor volume; these connections may be faulty on new tubes.

In the new Sonora screen-grid models, every '24 tube will not work satisfactorily as a detector. Try each of the '24 tubes in this socket, in turn, before looking further for trouble. There will be a noticeable improvement in the reception when the best detector is found, enough to make this trouble worth while. The other tubes will work well enough as amplifiers.

The simplest things cause the most trouble. This was impressed upon me when I found that the antenna line in one Sonora 9-tube console set (of 1929 model) was cut through where it passed under the chassis—thus grounding the signals and shutting out all

RADIO-CRAFT, Dept. D
98 Park Place, New York, N. Y.

I have enclosed \$2.50 for a year's subscription to RADIO-CRAFT. Please send me FREE Tobe 4-Way Light Socket Aerial.

Name

Address

City..... State.....

Hotel Dixie

42^d-43^d Streets West of Broadway

A New and Better Hotel for Times Square

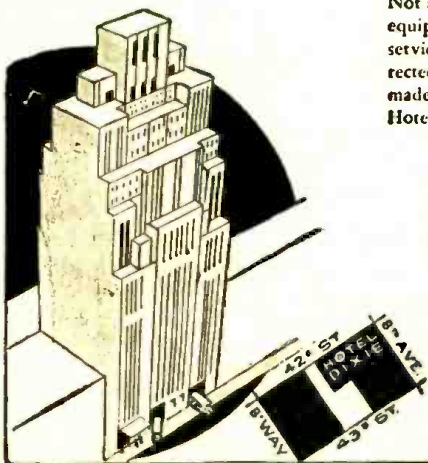

Not alone new in construction and equipment, but new in conception of service and comfort to its guests. Directed by S. Gregory Taylor, who has made such enviable successes of the Hotels Montclair and Buckingham.

Single Rooms
with tub and shower

\$3, \$4 and \$5

Double Rooms
with tub and shower

\$4, \$5 and \$6

A few terraced rooms and suites, exceptionally large closets, on an attractive monthly basis.

RADIO IN EVERY ROOM

Entrances on 42nd and 43rd Sts.

CENTRAL UNION BUS TERMINAL

LOCATED IN THE DIXIE HOTEL BUS CONNECTIONS FOR ALL POINTS IN THE UNITED STATES

Classified Advertisements

CHEMICALS

BOOKLET OF EXPERIMENTS and chemical catalog, 15c. General Chemical Company, Box 397, Reading, Penna.

DETECTIVES

DETECTIVES Earn Big Money. Excellent opportunity. Experience unnecessary. Particulars Free. Write, George Wagner, 2190B Broadway, N. Y.

INSTRUCTION

BE THE LICENSED RADIO DOCTOR of your community. Earn \$7.00-\$10.00 spare time evenings. Write now for free booklet, "Why the Radio Doctor?" Radio Doctors, Inc., Dept 1, 131 Essex Street, Salem, Massachusetts.

GET OUTDOOR GOVERNMENT JOBS; \$135-\$200 month; vacation. Patrol forests and parks; protect game. Details free. Write, Delmar Institute, B39, Denver, Colo.

LEARN TATTOOING. Instruction catalog, dime. Miller, N431 Main, Norfolk, Virginia.

INVENTIONS

INVENTIONS COMMERCIALIZED. Patented or unpatented. Write Adam Fisher Mfg. Co., 594 Enright, St. Louis, Missouri.

MISCELLANEOUS

LOCATING TREASURE UNDERGROUND by Radio—New, non-competitive business. Thrilling, profitable, exclusive. Details for Red Stamp Exchange, Box 607, El Monte, California.

OLD MONEY WANTED

\$5 to \$500 EACH paid for Old Coins. Keep ALL old money. Many VERY valuable. Get Posted. Send 10c. for illustrated Coin Value Book, 4x6. Guaranteed Prices. We buy and sell. COIN EXCHANGE, Room 10, Le Roy, N. Y.

PRINTING

100 OF EACH, Business letterheads and Envelopes, printed, your copy \$1.50. CRANE, Box 7622 Kansas City, Missouri.

RADIO

SPECIAL BARGAIN OFFER of Standard Radio Replacement Power Transformers to supply plate and filament for any combination of one to six 227 or 224 tubes; one or two 245 tubes; one 280 tube. Can be used in Loftin-White Circuit, transmitting station. Custom radio sets and amplifiers. Write for complete description and special low price offer. Radiart Corporation, 13220 Shaw Avenue, Cleveland, Ohio.

SERVICE MEN, ATTENTION — Speakers re-wound, magnetized, repaired, \$2.00 to \$2.75. Complete Power Pack Service—Transformers re-wound, condenser blocks repaired, resistors duplicated. Guaranteed. Clark Brothers Radio Co., Albia, Iowa.

Orders - Inquiries

60 pages
Send for FREE COPY

Can be Secured by MAIL

POLK'S REFERENCE BOOK and Mailing List Catalog

Gives counts and prices on over 8,000 different lines of business. No matter what your business, in this book you will find the number of your prospective customers listed.

Valuable information showing how to use the mails to secure orders and inquiries for your products or services is given.

Write for FREE Copy
R. L. POLK & CO., Detroit, Mich.
Largest City Directory Publishers in the World. Branches in Principal Cities
Mailing List Compilers—Business Statistics Producers of Direct Mail Advertising

reception. Several Service Men had been up to investigate this receiver; they tested it with meters, took it to the shop for a week, and could find nothing wrong. I doubt if I would have found it so easily if I had not asked the owner when the set was serviced, and heard about my predecessors. I then came to the conclusion that the circuit must be all right and the trouble exterior.

VOLTMETERS INTO MILLIAMMETERS

By George Lay

MOST Service Men have considerable use for D.C. milliammeters of various ranges. I have quite an assortment of them, and they have cost me little or nothing; and no doubt you have a number of good low-resistance voltmeters. If these are of reliable makes, they may be easily altered for use as milliammeters. They are very little use around the shop now; though still reliable for battery testing, but not suitable for modern all-around work.

Ordinarily, a voltmeter is a milliammeter with a series resistor added. To change it back to a milliammeter, remove the works from the case; you will find a small spool, connected between one of the terminals of the meter and the moving coil of the instrument. Carefully solder a small jumper across the terminals of this spool, thus shorting out the resistance; and your voltmeter is again a milliammeter. Its range will have to be checked, by means of another milliammeter of 0-10 scale, or higher, which you will probably have in the shop or can borrow for the purpose of checking.

This is done as follows: Connect the meter in series with the standard instrument, a 4½-volt battery, and a variable resistor of at least 500 ohms maximum. See that all the resistance is in circuit; failure to observe this may damage one or both meters. Complete the circuit, and gradually adjust the resistance until one meter shows full-scale deflection. Then, by comparing the checking milliammeter with the ex-voltmeter, it is easy to determine the correct scale or range for the latter. The new scale may be written in on the dial, if it is different from that originally used on the voltmeter.

I have found that an 0-10-scale Jewell voltmeter became a 0-25-scale milliammeter, and an 0-8-scale Weston voltmeter, an 0-8-scale milliammeter. Also, a 0-150-scale voltmeter may turn out to be an 0-15- or an 0-50-reading milliammeter. As soon as the ratio is determined, it will be possible to correct the scale.

SOME TROUBLES AND CURES

By Archie H. Klingbeil

ABOUT fifty per cent of our radio trouble shooting is undertaken at the request of set owners who have paid professional radio men without having their troubles corrected. Here are five such cases we have encountered.

An A.C. console, bought by mail, which developed a tinny rattle, apparently in the chassis, had a speaker suspended from the grill opening by a single screw, and its vibrating frame was not in contact with the front of the console. Additional wood-screws took out the metallic ring; and a good clear tone was obtained.

WE SPECIALIZE IN REPLACEMENT PARTS

BAL-RAD
Replacement Block for Atwater-Kent No. 37
This unit contains the broner chokes and high voltage condensers. All flexible wire colored leads identical to the original. Fully guaranteed. **\$4.95**
Each.....

BAL-RAD
Replacement Block for Majestic "B" Eliminator
The condensers in this block are composed of High Voltage Condensers. Guaranteed for 1 year. **\$2.95**
Each.....

R.C.A. CHOKE COILS
15 Henries
Impregnated in Rosin. Ideal choke for use in "B" Eliminators and A.C. Sets—D.C. Resistance 500 ohms. **35c**
Each.....

POLY-MET
1 Mfd. 200 Volts
By-pass Tubular Condenser
Can be used across Choke Terminals in Victor Sets to reduce hum. **\$1.00 Per Dozen**
Each \$3.60 Per Doz.

R.C.A. By-Pass Condenser
Part No. 5996
Comprising one ½ and three .1 mfd. condensers. **35c**
List \$3.00—Each.....

YAXLEY—2000 OHM VOLUME CONTROL
For Radiola 17, 18, 32, 42, 44 and practically all sets. Insulating strip (easily removed) for metal panels. **45c**
List Price \$1.95 Each.....

R.C.A. Power Transformer
FOR RADIOLA Nos. 17, 18, 33 and 51
This shielded power transformer can be used to convert your battery set to an A.C. set. Will supply all filament and plate voltages up to 7 tubes. **\$3.95**
Part No. 8335
Special, Each.....

BAL-RAD HY VOLTAGE SURGE-PROOF CONDENSERS
For General Repair and Power-Pack Work
We guarantee these condensers for 100 per cent. free replacement. Repair man should carry a few dozen in stock.

One Mfd.	600 Working Volts	30c
Two Mfd.	600 "	40c
Four Mfd.	600 "	60c
One-half Mfd.	300 "	25c

R.C.A. REPLACEMENT 600V CONDENSER BLOCK
FOR RADIOLAS Nos. 18, 33 and 51
Part No. 8333
Special, Each..... **\$1.50**

R.C.A. DOUBLE FILTER CHOKES
R.C.A. Replacement Part No. 8336 Contains Two 30 Henry 80 Mfd Chokes. Each choke insulated for 1,000 volts. **\$1.70**
Part No. 8336 Each

VICTOR 30 HENRY CHOKE
Will Pass 125 Mils.
For replacement in Victor, Edison and Radiola sets. Each **50c**

VICTOR PUSH-PULL TRANSFORMER
INPUT AND OUTPUT
Can be used with 17A—245 or 250 type tubes. Output matches moving coil on all dynamic speakers.
With Metal Jacket **\$2.50** Without Metal Jacket **\$1.75**

TERMS: 20% with order, balance C.O.D. 2% discount allowed for full remittance with order only. NO ORDERS ACCEPTED FOR LESS THAN \$2.50

BALTIMORE RADIO CO.
47-R Murray Street, New York City
Send for our latest Bargain Bulletin

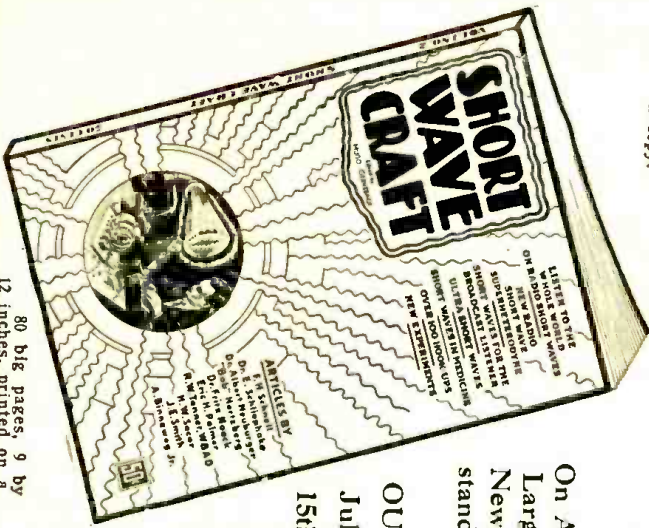

Contains more material than a \$2.50 book, yet the price is but 50c. a copy.

You have never seen anything like it in Radio

On All Large News-stands July 15th.

PARTIAL CONTENTS in SHORT WAVE CRAFT No. 2 Aug.—Sept. Issue

SHORT WAVE CRAFT, Mr. Hugo Gernsback's latest radio magazine, has been called his greatest achievement in radio magazine publishing.

SHORT WAVE CRAFT is the one and only real big magazine on short waves you have wished for so long. HERE IS PROOF!

NEW Short Wave Receiver with Push-Pull R.F. and Detector Stages, by F. H. Schnell, famous short wave expert

How to Build a Successful Short Wave Super-Heterodyne Receiver, by R. Wm. Tanner (W8AD), well known short wave amateur and author

Short Wave Operation Hints, by "Bob" Hertzberg

Short Wave Aerials, by C. H. W. Nason

Television Reception on Short Waves, by D. E. Replogle

Radio in Garisbad Cavern, by Eric H. Palmer Jr.

New Experiments in the Short Wave Field, by Dr. Ernst Basse (Germany)

Quasi-Optical Waves, by Kappelmeier

The High Power Short Wave Station Operated by WGY, by H. Winfield Secor

Experimenting with the Short Wave Regenerative Receiving Circuits, by Clyde A. Randon

Local Reception on the 20-meter band, by Carl Wurtz (DE939, Cologne, Germany)

Western Electric Airplane Short Wave Radio Equipment, with photos and hook-ups of the apparatus

Short Wave Antennae

Transmitting Newspaper Pages by Photo-Radio on Short Waves

Besides these features, SHORT WAVE CRAFT Number 2 contains a wealth of constructional experimental matter for short wave fans, including question and answer box edited by Mr. Tanner (W8AD), together with pictures and descriptions of all the latest short wave apparatus from the manufacturers' workshops.

Unlike other magazines, it does not contain purely technical matter of interest only to the advanced amateur and ham.

Quite to the contrary, SHORT WAVE CRAFT contains a tremendous wealth of short wave material of interest to everyone who wishes to get into short wave activities.

Over 250 illustrations, hookup, charts, circuit diagrams, dozens of actual photographs of receivers, transmitters, and a wealth of practical stuff.

MUSICAL FASHIONS BY SHORT WAVES

THE rapidity with which novelties travel by radio is becoming international, now short-wave receivers are coming into vogue. A secret is thus revealed by "Ariel" in *Popular Wireless* (London): "The manager of a certain famous broadcasting orchestra tells me that one of their number is a regular listener on the short waves, and specializes in observing the dance tunes which are played in America. It is a fine tribute to the alertness of these boys to record that on several occasions the melody of new "numbers" has been jotted down, harmonised, "orchestrated," and played to British listeners before the printed music was available here."

ANTI-NOISE ORDINANCE

ANOTHER step in the growing campaign against "man-made static" is indicated in an ordinance lately passed by the city council of Sacramento, California, prohibiting the operation between 2 p.m. and 11 p.m. of devices, appliances and equipment which interfere with radio broadcast reception, except for machines used by doctors, licensed radio stations, and public utilities.

SCENTED MOVIES

"SMELLIES" may be a new entertainment feature, adding to the problems of the projectionist. John H. Leavell, of Los Angeles, has been granted U. S. patent No. 1,749,187 for "an apparatus for supplying an olfactory impression in conjunction with a motion picture" which "expels an odor normally associated with said motion picture impression into the atmosphere breathed by the audience." Next!

PUBLISHED ON THE 15th OF EVERY OTHER MONTH

Extra Special Offer Void After September 15th

The regular subscription price to SHORT WAVE CRAFT is \$3.00 a year. But up to August 15th, we will accept \$1.80 for a full year's subscription (Canada and foreign, \$2.00) AND IN ADDITION will send you FREE the 1st number of SHORT WAVE CRAFT. This will give you in reality a subscription of one year and two months, value \$3.50, for \$1.80!

MAIL COUPON TODAY!

SHORT WAVE CRAFT
96-98 Park Place, New York, N. Y.
As per your special offer I enclose \$1.80, for which please enter my subscription for one year to SHORT WAVE CRAFT and send me also the first issue gratis.

NAME
ADDRESS
CITY
STATE

A Complete Tester for the Service Man

(Continued from page 139)

shown dotted as X and X may be omitted. Switches with neutral or off positions must then be provided. If the wires are omitted, the shunts would no longer be in position for the 100-ma. reading of Sw4 and Sw5; a new value of 0.27 ohms would then be necessary.

The screen-grid current and that of the second plate of a full-wave rectifier may be measured on position 6 of the bipolar; on position 7, the plate current of all other receiving tubes can be taken.

Grid-swing tests may be made on position 7; depressing push-button B5 connects the 4½-volt battery in the grid circuit of the tube, and alters the bias to that amount. The difference between the plate-current readings before and after determines the value of the tube. A screen-grid tube is tested by depressing B6. The meter may be inserted in the screen-grid and the plate circuits, respectively, and a measurement obtained in each. If the tube is used as a space-charge amplifier, B5 should be pushed.

External Measurements

On the eighth position of the bipolar switch, the voltmeter is available for external measurements; the desired range is selected by pressing the appropriate button. On the ninth and last position, the ohmmeter circuit becomes available. Readers of RADIO-CRAFT require no introduction to this or the A.C. voltmeter and their uses.

External shunts have been provided also; for a 5-ampere reading about 10¼ inches of No. 18 bell wire was used. Calibration is desirable, if not essential; supply houses are usually very accommodating in this way. A rough way of increasing the range of the milliammeter is to measure the filament current of a '99 tube; this should draw 63 milliamperes at 3.3 volts.

The operation of this tester, it will be seen, is simple, requiring only the care ordinarily used with any costly measuring instrument. Depressing a higher-range push-button first when taking voltage readings, and checking Sw4 and Sw5 before inserting the milliammeter in the grid or plate circuits, are precautions which will avert the danger of overloading or damaging the meter.

The general construction is indicated by the layout (Fig. 1) which is designed for the parts specified; but it may be altered to suit the constructor's available equipment. Those used by the writer were:

List of Parts

- One bakelite (or hard-rubber) panel, 7 x 12 inches;
- One Weston "Model 301" milliammeter, 0-1 scale;
- One Standard A.C. voltmeter, three-range;
- One Weston bipolar switch, Sw1;
- One Carter "No. 33" D.P.D.T. jack switch, Sw2;
- Three Yaxley "No. 730 Junior" S.P.D.T. switches;
- One Marco 9-point sub-panel-mounting inductance switch;

- Four "Super-Akraohm" or "Super-Davohm" resistors: 10,000 ohms, R1; 100,000 ohms, R2; 200,000 ohms, R3; 500,000 ohms, R4.
- Four Carter Type H fixed resistors; two 3-ohm, R5 and R6; two 0.4-ohm (see text) R7 and R8;

- One Pilot "Resistograd," R9;
- Four pearl push-buttons, B1-2-3-4;
- Two Yaxley No. 2006 D.P.D.T. push-buttons, B5-B6;
- One Na-ald No. 423 UY socket;
- One 4½-volt "C" battery;
- Seventeen binding posts, four pairs grid-leak clips, a six-wire cable, and the necessary adapters.

Oscillators for Servicing

(Continued from page 141)

lations and practice. Some of the best performing broadcast receivers are found in amateurs' homes. Friends and neighbors call frequently on the amateur for repairs and advice; so experience with late sets is not lacking.

Long experience, with apparatus which is much more difficult to adjust, has made the average amateur careful of small details which others overlook. Realizing that certain factors must be sacrificed in factory-built sets in order to make them salable and, also, that such design limitations do not necessarily apply to a home-made set, the amateur set builder can build (on the side) broadcast sets with greater over-all gain and selectivity; by providing, for example, better coils and more distance between parts. Instead of a small set with coils covered over with cans, there is a spacious affair (but with plenty of room in the console), 'a la breadboard,' to show the visiting radio friends. Few amateurs realize their servicing and set-building opportunities.

"TODAY IS THURSDAY"

LISTENERS have often complained that station calls are not given often enough. In Australia another important service is rendered by broadcasters. Station 3LO of Melbourne gives the day of the week in its announcements for the benefit of those who are so far in "the bush" that they may have lost track of the date.

LE JOLI ACCORDÉON

AFRENCH radio magazine recently held a contest to determine the instrument most popular with French listeners. The poll showed that the accordion headed the list with more than 1,100 votes. The violin was second, the 'cello third and the saxophone was at the bottom of the list with only 128 votes.

A NEGLECTED BY-LAW

THE city of Cleveland, Ohio, it is stated, has an ordinance requiring a permit and imposing a fee of fifty cents for the erection of a radio aerial, under a penalty of \$10 or more per day. However, the ordinance has been forgotten; and the majority of the citizens of Cleveland are lawbreakers in this regard, if no other.

BLAME IT on Wobbly Line Voltage

When tubes burn out prematurely, when power packs break down, when volume is weak and tone is poor—don't hasten to blame the set. Nine times out of ten, it's wobbly line voltage. In many sections, perhaps yours, the line voltage varies between 90 and 140. Low voltage means poor volume and tone. High voltage means short-lived tubes and power pack failures.

Don't take a chance: install the

Allen Watts Line Voltage Regulator
CLAROSTAT

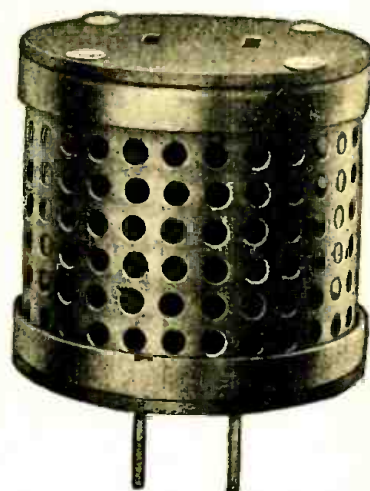

Operates with any set. Simply snaps between plug and outlet. Varies resistance according to fluctuating line voltage. Absolutely automatic. Provides maximum satisfaction—anywhere—any time **\$1.75**—any line voltage. And all for LIST

WRITE for data regarding this ingenious radio aid. And let us send you our literature on other resistors, volume controls and other radio aids.

Clarostat Mfg. Co., Inc.

Specialists in Aids to Better Radio
295 North Sixth St., Brooklyn, N. Y.



PATENTS TRADE-MARKS

DO NOT LOSE YOUR RIGHTS TO PATENT PROTECTION

Before disclosing your invention to anyone send for blank form "EVIDENCE OF CONCEPTION" to be signed and witnessed.

LANCASTER, ALLWINE & ROMMEL
(Registered Patent Attorneys)
475 Ouray Bldg., Washington, D. C.
Originators of forms "Evidence of Conception"

Reduced Rates at
CLEVELAND'S
Newest
HOTEL

AUDITORIUM

EVERY ROOM WITH BATH

\$2
\$2.50
\$3

300 Clean Modern Rooms



East Sixth St. & St. Clair Ave.
W. H. BYRON, Manager

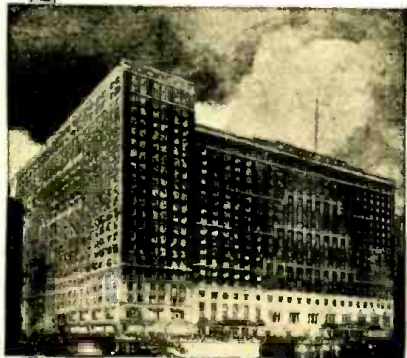

Famous

For courteous service, unexcelled food and comfortable rooms. The atmosphere prevailing is surprisingly home-like. Directly adjoining principal office buildings, shops and theatres. All dining rooms cooled.

Rooms, \$2.50 up—
with bath \$3.50 up

NEW BISMARCK HOTEL CHICAGO

Write for Booklet with city map

Be sure to read the announcement on page 176 if your subscription to RADIO-CRAFT expires shortly.

All About Electrolytic Condensers

(Continued from page 148)

of the rectifier (two 216B's in parallel), and also a dual unit having capacities of 15 and 30 mf. In connection with these units it may be noted that the electrodes are widely spaced, and can seldom short. Occasionally, the center electrode or negative terminal does not seat flat against the rubber gasket, and it may jar against the positive anode. If this occurs, the '99 tubes will not light and the "B" voltage between the black and brown, red or green wires will be zero. To locate definitely a short circuit in these units it is necessary to disconnect them entirely, as in testing a filter in which paper condensers are used. A short in these electrolytic condensers may be remedied by loosening the clamping nuts on the negative post (cathode) and straightening the post.

Instead of using one container and several anodes, the makers of the "Acrakon" unit recommend the use of individual single-anode condensers for each capacity required; this advice is based upon the contention that considerable cross-current leakage will exist between multiple anodes at different voltages in a common electrolyte.

The capacities commercially available may reach 72 mf., at 400 volts, as in the case of the Polymet "E." The capacity limit,

however, is almost solely a matter of convenience and necessity.

A service hint concerns the Crosley D.C. sets which are provided with a lamp socket on the attachment cord. If a lamp, placed in this socket, burns brightly, reverse the plug connection to the D.C. line; the lamp should then light dimly or not at all. When the set is thus connected properly, the lamp is to be replaced by a fuse.

The Amrad "Model 1-5" "B" eliminator uses a dual 4-8-mf. and a dual 15-30-mf. Mershon condenser. The following table should be filed by the Service Man as a reference for the electrolytic condenser capacities used in Crosley receivers:

Twin 8-mf. condensers: 608 A.C. ("Gembox"), 704A ("Jewelbox"), 705 D.C. ("Showbox"), 706 A.C. ("Showbox"), 609 A.C. ("Gembox," "Gemchest"), 610 A.C. ("Gembox," "Gemchest"), 41-A A.C., 42 A.C.

Triple 8-mf. condensers: 704B ("Jewelbox"), 40-S, 41-S, 42-S, 82-S, 30-S A.C., 31-S A.C., 33-S A.C., 34-S A.C. 60-S D.C., 61-S D.C., 62-S D.C., 63-S D.C.

Four 8-mf. sections: 804 A.C. ("Jewelbox").

Triple 10-mf. condensers: 704 A.C. ("Jewelbox").

Salvage Values in Old Radio Sets

(Continued from page 143)

wire will char in the event of excessive current. Small pieces of doweling between layers will allow plenty of air circulation, if desired, in some experimental arrangement. Fuses should be provided in the 100-volt leads, for safety. If a 5-amp. charger is desired, use No. 12 wire on the secondary instead of No. 14, which is for a 2-amp. outfit. The tube becomes quite hot, so that a porcelain socket (an ordinary porcelain lamp socket will do) is necessary. The elements of the tube will redden, but this is normal. The windings will run quite warm, but ordinary currents should not damage them. The ammeter must be properly connected, so that it will read in the proper direction. If the socket arrangement described is used, the transformer should have two additional taps. These will be left to the experimenter to work out for himself for the particular charging rates desired. The wire can be scraped slightly, at a given position on the winding, connection made, and the charging rate, when connected to a battery, measured. This is repeated until the desired rate is obtained.

To assemble, slide a core leg through each winding and then fit in smaller lengths of laminations at the ends to complete the core. The method of assembly is shown in Fig. 3. If the coils are placed on opposite legs, keep them close together for better efficiency. The end laminations are, therefore, shorter. The core is securely held together, and prevented from humming, by pieces of strap iron securely bolted to the core. These straps are slightly longer than the laminations and are bolted over the ends. The entire equipment can be mounted on a small slate panel if desired. The tube

should be covered over, as it gives a very disagreeable, and strong, light; and the ammeter (such as a Ford ammeter; accuracy is not so essential here), is placed where it can be easily read. An ordinary clip makes contact with the plate of the tube.

An interesting stunt can be tried with a burnt-out Tungar bulb. A spark coil is connected with the open filament and a spark allowed to pass inside the tube. If the filament can be made to glow, the charging current will start, and the charger will operate with a burnt-out tube! The spark-coil should then be disconnected. This is a very interesting experiment, its success depending upon how badly the filament is blown out.

E. F. W. Alexanderson

(Continued from page 151)

the standpoint of permanent addition to the radio art.

The rivalry between transoceanic communication systems reached the point when a consolidation of American electrical companies and "wireless" systems was formed, on the suggestion of the late Admiral Bullard, in order to maintain ownership of over-sea "ether lanes" in American hands. Dr. Alexanderson was appointed the first chief engineer of the Radio Corporation, to effect the systematization of its assembled constituents, and the extension of its facilities. "Radio Central," that marvelous linking of the communication offices in New York to the transmitters and receivers, some of them hundreds of miles away, was the result. Today telegraph, telephone, and

even pictorial messages go out to all quarters of the world, from controls a continent away from the sending aerial.

It was not alone on the large scale that the engineer worked, however. He had to make practical huge generators, and great antenna systems which multiplied the certainty of reception a thousandfold; but the same researches were to make their mark on home radio devices. Not only did he work on vacuum-tube amplification and modulation for transmission, but his system of tuned radio-frequency reception forms the fundamental patents for the modern radio receiver. By solving the problem of selectivity, it made broadcast reception possible in a zone where broadcasters by the score are competing for the public ear. One of his earliest studies in radio was the problem of the behavior of iron in a magnetic field alternating at radio frequencies and of dielectric hysteresis. One of the by-products of the invention of the alternator is that of the cored high-frequency amplifier.

Not only did the work of Dr. Alexander-son command the respect of his profession, but also the honors, first of the gold medal of the Institute of Radio Engineers, and then of the presidency of that organization in 1921.

In recent years, the most striking of his developments, as chief consulting engineer of the General Electric Company, have been those in the field of television, where he has been steadily building up a technique which seems now, for the first time, to bring sight-at-a-distance out of the laboratory and into commercial possibility. Two years ago, he took television apparatus out of the huge laboratories and set it down in the home; where representatives of the press and public were admitted to see moving images in the little screens of receivers which differed apparently in no other manner from those in their own houses.

This was followed by the public exhibition of television images, almost full size, to the thousands who visited the radio world's fair in New York that year. Those faint, flickering, but unmistakable shadow shapes seemed to bid their watchers wait yet a little longer, and television would be here.

The laboratory of such an inventor is no unobtrusive table in a corner; he who works on a huge scale must have adequate tools. A workbench ninety feet long, lining one side of a lofty room, down the center of which runs a traveling crane; dynamos, generators and the appliances of science on every hand; draftsmen and observers busy everywhere with measurements, sketches and calculations—so an eyewitness sees the sanetum where Dr. Alexander-son presides.

Out of this workshop, a few days ago, came another surprise for the world. The television projector (pictured and described in the previous issue of RADIO-CRAFT) threw upon the screen of a theater, in the view of thousands, moving figures far larger than life, in detail better than ever. The engineer, whose life task has been to make large bodies move faster, has accomplished the same feat with even those incorporeal, phantom reflections of distant actors which he threw into the ether, and caught from it again.

Television had at last turned the corner!

“Learn Electricity By Doing”

The N. Y. E. S. teaches pupils of all ages Practical Electricity by making them do actual work, such as Armature Winding; Building and Operating Motors and Generators; Wiring Homes, Automobiles, Boats and Planes; Wiring and Operating Switchboards, Signal and Communication Systems; also Electrical Drafting, Estimating and Contracting.

Thousands of our graduates are filling well-paying positions in every phase of electrical work. Enroll now in our day or evening classes. In a short time you will be earning wages in this profitable vocation. Write or phone for our 64-page illustrated catalog. CHELSEA 2633.



NEW YORK
ELECTRICAL SCHOOL
21 West 17th Street - New York City

Remarkable FREE OFFER!

With the purchase of 10 Durham Metallized Resistors (until October 15th, 1930) you receive our complete Resistor Replacement Guide free; or you may buy it for 50c.

This remarkable booklet shows service men clearly and concisely:

- (1) How to locate cause of trouble in radio sets.
- (2) Proper types and values of resistors to use in all popular types of radio receivers.

Every day, service men are finding this guide a most valuable aid in speeding up their work—you'll be able to do more repair jobs per day—easier, too!



DURHAM
Metallized
RESISTORS

INTERNATIONAL RESISTANCE COMPANY
2006 Chestnut Street Philadelphia, Pa.

“No other Resistor has all of Metallized's Advantages”

Send your order for 10 resistors—or 50c—today and get this valuable Resistor Replacement guide.

The TRANSMITTER UNIT
with 100 Uses ~ **95¢**

SKINDERVIKEN MICROPHONE BUTTON — Powerful Speech and Phonograph Amplifier — Dictaphone, etc., etc.
One unit for \$1.75, with 12-page booklet of experiments. Sent C.O.D. in U. S.; Foreign cash with order. PRESS GUILD, INC., 16 Murray St., Dept. D-930, New York, N. Y.

SONG WRITERS!

Substantial Advance Royalties are paid on work found acceptable for publication. Anyone wishing to write *either the words or music* for songs may submit work for free examination and advice. *Past experience unnecessary.* New demand created by "Talking Pictures", fully described in our free book. Write for it Today—Newcomer Associates
131 Earle Building, New York, N. Y.

EVERY Radio Service Man should read the interesting announcement of the OFFICIAL RADIO SERVICE MANUAL which appears on page 170 of this issue. This Manual is a complete directory of all commercial wiring diagrams of commercial receivers, and is indispensable to Service Men.

SEND FOR THIS

New! Radio Bargain News

Dealers and Service Men \$100,000 WORTH OF RADIO MERCHANDISE SUCH AS REPLACEMENT CONDENSER BLOCKS, TRANSFORMERS SETS, SPEAKERS, AND TUBES SOLD AT 75% OFF THE LIST PRICE. SEND FOR FREE COPY OF THIS BIG CATALOG JUST ISSUED

Federated Purchaser
22-A HUDSON ST., NEW YORK CITY

Short Waves on Your Broadcast Receiver

(Continued from page 155)

tried out. If no signals are heard, one of the windings should be reversed. If this is found correct all the other coils should be wound in this direction.

Operation of the Converter

For operation, the .00035-mf. condenser C2 is set about half-way in; the broadcast receiver dial is set at about 900 kc. (333 meters); and the volume control is turned nearly all the way on. Signals are tuned in on the vernier dial controlling C1. As stated before, there should be no squeals or whistles; if there are any, the circuit should be checked over carefully.

The regular aerial can be used, although the set will have plenty of pep without any aerial at all. If "frequency for dial setting" curves are plotted for all the short-wave coils, they will help greatly in fishing out the foreign stations. Your luck in this direction will depend also on the sensitivity of the broadcast receiver used; its regular volume control is used for control of the short-wave signal strength, too.

Don't think that anything is wrong when you find that short-wave signals can be tuned in on the broadcast dial; this is natural with the frequency-changer shown here.

From a commercial standpoint I believe this receiver offers the greatest value as a help to dealers in towns where there are no local stations, and where daytime reception is difficult on account of the high noise level.

When the Kentucky Derby was run, the writer was in a dealer's store in a small town in Alabama. A crowd had gathered to listen to the race. A typical Southern thunderstorm was approaching, and the static was terrific on the broadcast band; it was so loud we could hear absolutely nothing from a powerful chain station a hundred miles away. As a last resort, we turned on the short-wave converter here described. You can imagine everyone's surprise when the race report came through from WGY's short-wave station with a wallop that made me jump for the volume control; and there was very little static.

TELEVISION ON LARGE SCALE

TELEVISION broadcast studios, it is announced, will be one of the important features of the huge Rockefeller group of buildings, to be erected in the center of New York City to house a great entertainment center. In their magnitude, these will excel any previous single group of buildings; and the cost is estimated at \$250,000,000. Several years will be required for their completion, and in that time, it is believed, home television will have reached the stage of general acceptance.

SOUTH AMERICAN PROGRAM

ARGENTINE independence day was observed on May 25 with an international broadcast from the powerful telephone transmitter LSG at Monte Grande, near Buenos Aires. This station, on 15.02 meters, has often been heard directly by short-wave fans in the United States.



\$3.00
Per Day
and Up

800
Rooms
800 Baths

Old Fashioned Hospitality in a Modern Setting

In the Grand Central Section, 10 minutes from Penn. Station, near Times Square, Fifth Avenue shops and important commercial centres and theatres.

Radio in Every Room

Single Rooms \$3 to \$5 per day
Double Rooms \$4 to \$6 per day

S. Gregory Taylor, President Oscar W. Richards, Manager

HOTEL MONTCLAIR
49 TO 50TH STS.
AND LEXINGTON AVE
NEW YORK CITY

Book Lovers
Ex-Libris-Book Plates

LATEST series of OLD MASTERS book-plates, reproducing antique woodcuts and engravings. Unique creations for book-lovers who appreciate the unusual. Write for Illustrated catalogue and specimen, enclose 10 cents for mailing charge. ISKOR PRESS, INC., 19 Park Place, Dept. A-930, New York, N. Y.

WRITE FOR CATALOGUE

DO YOU WANT TO STOP TOBACCO?

Banish the craving for tobacco as thousands have. Make yourself free and happy with Tobacco Redeemer. Not a substitute, not habit forming. Write for free booklet telling of injurious effect of tobacco and dependable, easy way to relieve the craving many men have.

FREE BOOK

Newell Pharmaceutical Co.
Dept. 928 Clayton, Mo.

An Improved Neutralizing Circuit

(Continued from page 157)

signed on the assumption that the tuned input circuit is directly connected between grid and filament. Now, if this were not so, we might consider the usual ground or filament end of the tuning coil to form an "unknown" corner of the bridge; and in such a case, therefore, the four corners would follow automatically, namely—grid,

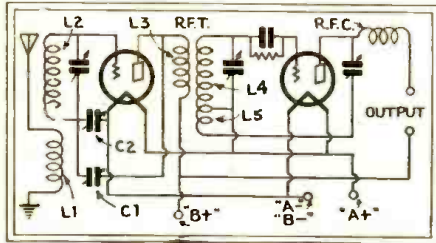

Fig. 2

A single stage of neutralized radio frequency.

plate, filament and an unknown. These four corners would then be separated by small capacities—two fixed and two variable. The two fixed are, obviously, plate-to-grid and grid-to-filament; the remaining electrode capacity (that between plate and filament) is immaterial since it is, in effect, across the output inductance.

The two variable capacities would be provided experimentally by two condensers and adjusted to a ratio equal to that obtaining between the two fixed tube capacities, so that $C_{pg}:C_{gf}:C_1:C_2$.

It might be reasonably thought that, to dispense with the usual direct connection, between tuning coil and filament, would make for very inefficient working. So it would if we were dealing with other than radio frequencies, or unless a large capacity connected these two vital points. In this case, however, one of the variable condensers serves this purpose, and is large enough for reasonable efficiency.

Hence we arrive at a perfect bridge circuit in which both interelectrode capacities of the tube are neutralized; no tapped coils are necessary, so that parasitic oscillations are impossible; and the bridge remains perfect, no matter what form the input and output inductances may take. (Fig. 1D.)

Application to Receivers

In Fig. 2, a two-tube circuit, using the new system in a single stage of R.F. amplification, is shown in detail. Here RFT is an ordinary detector coupler with a tickler winding L5. Note, however, that the bottom end of the antenna coupler secondary L2 is at a critical capacity, compared with the rest of the circuit. It is therefore impossible to couple the aerial to this coil either directly or through a large condenser, or even by a primary L1 wound directly over the secondary. A suitable close-coupler must be used here, with both primary and secondary wound on the same form, and separated by a suitable space. From 20 to 30 turns on the primary, and 50 to 80 on the secondary, depending on the size of the tube and the capacity of the tuning condenser, will be suitable.

In adding R.F. stages, the same method must be used; for part of each primary winding of an interstage coupler is at "B+" potential, as the antenna winding is at ground.

Theoretically, the neutralizing condensers may have any value, so long as the correct ratio between their settings is preserved. Practically, a small (.0001-mf.) variable with two sets of stators and one rotor is very satisfactory. In this type, as the capacity is reduced on one side, it is increased on the other; so that the correct setting can conveniently be found. The actual neutralization is performed in the customary manner.

A final circuit (Fig. 3) comprising four efficient tuned stages of R.F. amplification, completely undamped, and utilizing the full rated plate voltages, is claimed by its designer to be perfectly stable from 180 meters upwards. A grid-bias detector is almost essential, with such high amplification.

The resistors R1-2-3-4 are employed, between the tuning coils and ground, to make possible the application of proper grid bias and keep out line-voltage hum, which may often be picked up with sets having entirely "free" grids. They may have values of one or two megohms; and it is possible to use very much lower resistances before circuit instability appears.

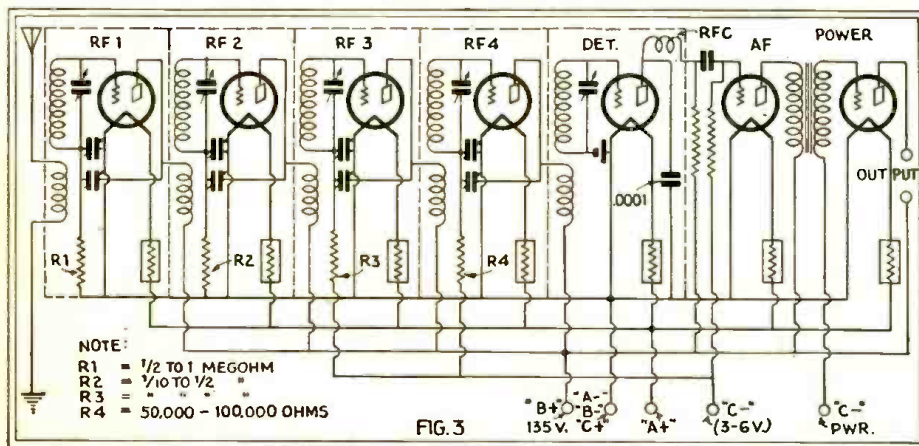

FIG. 3

A receiver with four stages of tuned radio-frequency amplification, designed by Mr. Allison to employ his new neutralizing circuit. It was constructed with British components, and no data as to values are available except as given in the article. The experienced constructor will undoubtedly be able to adjust the circuit to his own apparatus.

Learn Radio Telegraphy

This new library contains the essential information for the student who wishes to learn radio telegraphy. The books are especially written for home study work. Not only are all the essential facts concerning radio telegraphy given, but the questions and answers which are used for government examinations are all covered.

Library of Practical Radio Telegraphy

647 PAGES, 5 1/2 x 8, 314 ILLUSTRATIONS

VOLUME I—Practical Radio Telegraphy. The theory and practical operation of all types of modern commercial arc, spark, and vacuum tube transmitters. Complete data on all kinds of up-to-date radio receivers.

VOLUME II—Radio Operating Questions and Answers, Second Edition. This volume covers the advances since 1921 in the art of radio communication. It takes into account the new technique of broadcast-station operation and considers electrical, mechanical and physical improvements. Questions and answers on the leading problems of radio operation are most carefully worked out for the student preparing for his operator's license.

Examine these books—No money down

Examine these books—use them for 10 days free. Then, after you have seen them, decide if these books aren't worth five dollars in you. If you keep them you have only to remit \$1.00 in 10 days and \$2.00 a month for two months. If they are not satisfactory you have only to return them.

McGraw-Hill Free Examination Coupon

McGraw-Hill Book Company, Inc.,
370 Seventh Avenue, New York.

Gentlemen:—Send me the new Library of Practical Radio Telegraphy, 2 volumes, all charges prepaid, for 10 days' Free Examination. I will send \$1.00 in 10 days, and \$2.00 a month until \$5.00 has been paid, or I will return the books postpaid.

Name

Home Address

City and State

Position

Name of Company..... R.C. 9-30

For Exact Radio Tube Voltage IN A. C. RADIO

Only AMPERITE automatically insures stable line voltage for electric radio. AMPERITE saves trouble, saves tubes, saves service. No radio is modern without AMPERITE. Demand AMPERITE in the electric receiver you buy or build.

FREE—Useful AMPERITE Bulletin and list of AMPERITE-equipped radios. Write Dept. RC-9.



WE MATCH PANTS To Any Suit.

Double the life of your coat and vest with correctly matched pants, 100,000 patterns. Every pair hand tailored to your measure; no "readymades." Our match sent FREE for your O. K. before pants are made. Fit guaranteed. Send piece of cloth or vest today. SUPERIOR MATCH PANTS COMPANY, 115 So. Dearborn Street, Dept. 378, Chicago

Your CHOICE to One Year's Subscription of

WONDER Stories

Stories of scientific developments in the future combined with racy, action-filled adventures, are contributed to **WONDER STORIES**, by the foremost authors of scientific fiction. The greatest treat of your life is in store for you when you subscribe to **WONDER STORIES**, the magazine for the intelligent man and woman.

OR

AMAZING Detective TALES

Now you can read of Science and Crime in Arthur B. Reeve's own magazine, **AMAZING DETECTIVE TALES**. You can read how criminals make themselves invisible to human eyes. You will learn of the mysteries of **MIND MACHINES**, which control men's actions. You will be told what is happening today and what will happen in the next hundred years.

8 MONTHS OF \$1.00 EITHER

STELLAR PUBLISHING CORP., RC-9
98 Park Place, New York, N. Y.

Enclosed find \$1.00 for which enter my subscription for eight months to

- WONDER STORIES**
 AMAZING DETECTIVE TALES

check which.

Name

Address

City..... State.....

Become a Reporter!



Thousands of opportunities for young men to enter the Newspaper field. Fascinating work. You will meet interesting people; interview celebrities. A famous New York reporter with twenty years of practical experience has written a whole course of journalism and reporting in six easy lessons. He shows you the short-cut to success. He tells you what to do and what not to do, to become a successful reporter. Send today for the "PRACTICAL COURSE IN JOURNALISM," by Henry John Brockmeyer of *The New York Evening Post*. Just drop us a Postal Card—no need to send money. We will mail you the whole set of six books and you pay the Postman \$3.00 plus a few cents for postage. No more to pay. Money absolutely refunded if not satisfied.

PRESS GUILD
16 Murray Street, Dept. D-930 New York.

SCHEDULE OF STANDARD-FREQUENCY TRANSMISSIONS

WITH the increasing use of short-wave receivers, the standard-frequency signals of WWV, Washington, may be of interest to fans as well as to amateurs. The importance of having a suitably-calibrated instrument, preferably a wavemeter separate from the receiver, is very great in locating distant stations. While the announcements are made in telegraph code, the time may be checked by those who have an accurate timepiece. The general code call is given at the beginning of each twelve-minute period, as scheduled, on the dates listed below. After two minutes of this a series of long dashes with the code letters WWV (— — — — —) are transmitted for four minutes, and then an announcement of the frequency and the transmission to follow is given in code. There is then a four-minute pause for adjustments before the next transmission.

Information is furnished in Letter Circular 280 of the Bureau of Standards, Washington, D. C. (which may be obtained on application to that institution) about methods of using these transmissions for calibration. The schedule for the rest of the year is as follows (the times are those of the commencement of each transmission on the given frequency, and are Eastern Standard):

August 20 and November 20: 10 p.m., 4,000 kc. (74.96 meters); 10:12 p.m., 4,400 kc. (68.14 meters); 10:24 p.m., 4,800 kc. (62.46 meters); 10:36 p.m., 5,200 kc. (57.66 meters); 10:48 p.m., 5,800 kc. (51.69 meters); 11 p.m., 6,400 kc. (46.85 meters); 11:12 p.m., 7,000 kc. (42.83 meters); 11:24 p.m., 7,600 kc. (39.45 meters).

September 22 and December 22: 10 p.m., 550 kc. (545.1 meters); 10:12 p.m., 600 kc. (499.7 meters); 10:24 p.m., 700 kc. (428.3 meters); 10:36 p.m., 800 kc. (374.8 meters); 10:48 p.m., 1,000 kc. (299.8 meters); 11 p.m., 1,200 kc. (249.9 meters); 11:12 p.m., 1,400 kc. (211.2 meters); 11:24 p.m., 1,500 kc. (199.9 meters).

October 20: 10 p.m., 1,600 kc. (187.4 meters); 10:12 p.m., 1,800 kc. (166.6 meters); 10:24 p.m., 2,000 kc. (149.9 meters); 10:36 p.m., 2,400 kc. (124.9 meters); 10:48 p.m., 2,800 kc. (107.1 meters); 11 p.m., 3,200 kc. (93.69 meters); 11:12 p.m., 3,600 kc. (83.28 meters); 11:24 p.m., 4,000 kc. (74.96 meters).

'ROUND-THE-WORLD RELAY

RELAY broadcasts half-way around the earth and back have been followed by one which went all the way around, by means of four transmitters. On June 30 a talk which went out from W2XAD, Schenectady, was picked up and rebroadcast from PH1, Hilversum, Holland. PL5 at Bandoeng, Java, sent it on to Sydney, Australia; and VK2ME at Sydney sent it back to Schenectady, where the fifth transmission on longer waves was made by WGY. Oscillograph records measured the time of the program's travel.

As a matter of fact, the signals of any of these stations, if the skip-distance fell right, might be picked up after going completely round the world one way, if the interference from the original transmission were not too great.



The Crossroads of a Nation

THE DRAKE is admittedly one of the great hotels of the world... the stopping place of seasoned travelers. Rooms are spacious and smartly elegant... continental atmosphere. Available, also, is an experienced Travel Bureau... to relieve you of every travel detail. Rates begin at \$5 per day. Permanent Suites at Special Discounts.

THE DRAKE HOTEL, CHICAGO
Under Blackstone Management

"AN ADDRESS OF DISTINCTION"

The FORT HAYES HOTEL

Around the Corner from Everything

300 ROOMS EACH WITH BATH \$250 A DAY SINGLE — \$4 DOUBLE

Finest Hotel in

COLUMBUS

You'll enjoy the beautiful lobby with its \$150,000 worth of the 'ate Sarah Bernhardt's Furniture

PLENTY OF PARKING SPACE GARAGE IN CONNECTION

R. B. BUNSTINE—MANAGER

QUIT TOBACCO



No man or woman can escape the harmful effects of tobacco. Don't try to banish unaided the hold tobacco has upon you. Join the thousands of inveterate tobacco users that have found it easy to quit with the aid of the Keeley Treatment.

KEELEY Treatment For Tobacco Habit Successful For Over 50 Years

Quickly banishes all craving for tobacco. Write today for Free Book telling how to quickly Free yourself from the tobacco habit and our Money Back Guarantee.

THE KEELEY INSTITUTE
Dept. L-705 Dwight, Illinois

TURN TO PAGE 186

and read of the interesting announcement regarding technical, mechanical and home workshop magazine which is now published.

Taking "Static's" Picture

(Continued from page 163)

In addition to this, the operation of several stations at once made it often possible to determine the direction from which a strong impulse came.

It has long been known that "tropical static" is the worst. The operation of broadcast stations on intermediate wavelengths has been almost prohibited in the tropics by the smallness of the area in which they can overcome static; and not till lately has the problem been seriously attacked by the construction of short-wave stations. The unimaginable violence of this electrical disturbance is shown by the report that at Khartoum, in the Egyptian Sudan, *three thousand six hundred impulses of static per second* were counted on the oscillograph record. Such static caused, not separate cracks and crashes, but piercing high notes. In England, however, the average number of atmospherics is found to be about ten a second during the day, and about fifty a second during the night.

The conclusion was that, while these atmospherics varied in strength from a maximum (depending on the locality) to very feeble signals, there is no possibility of overcoming them by amplifying the signal; for, when the sensitivity of the receiver is increased tenfold, the number of atmospherics which it can detect is increased a hundredfold. Incidentally, while a strength of 1/250-volt per meter in the antenna was considered the basis for counting ordinary static impulses, one measured in Khartoum produced a voltage of 250 in the aerial.

Lightning Causes Static

The fact that the most intense static comes obviously from the center of storms has been especially well-known since the experience of the U.S.S. *Kittery* in the tornado of September, 1926, which swept Miami. The research of the British investigators show, at each hour of the day for which records were made, one predominant source of atmospherics; which was indicated, on a chart of the world which had been made on the inner walls of a cubical room, when directions from different receiving stations were plotted.

The average atmospheric lasts about one five-hundredth of a second; in the tropics, and regions of intense electrical disturbance, they come so fast that they are not cleanly separated, but appear in groups which create ragged outlines on the oscillograph, and send out harmonics down even to the ten-meter wavelength—usually quite static-free. As a matter of fact, most static discharges, created by strokes of lightning, have a very long fundamental wave, in which most of their energy is quickly dissipated; the disturbances heard in our broadcast receivers are largely their harmonics. The most convenient wavelength for a maximum of static records is thirty thousand meters; here it is found that the atmospheric, as described above, tends to give a very impure A.F. note, in the order of 500 cycles.

At two thousand miles the average lightning flash, with a current of ten thousand amperes at a height of a mile or more, creates a static signal of about 60 milli-

volts per meter at its peak—sufficient to interfere with a very strong local station. The estimate is made that, the world over, there are probably a hundred or two hundred lightning flashes every second. Each of these creates a whole chain of atmospheres, several hundred in fact, which produce an audio frequency.

In the reception of pictures transmitted from a single station, by the Fulton system, at various points, it was possible to measure the comparative times of arrival of a certain atmospheric. A record made in Spain was compared with one made in Belgium and another in England; each had the same static irregularities in the picture. Comparing the time of their receipt with the distance of the picture receiver from the transmitter, the difference in time (.006-second from Spain to England) could be measured. The disturbances were taking place, evidently, in a storm region in Africa or off its coast.

JUDGE CALLS WITNESS BY RADIO

THE broadcast appeal for a prodigal son to return and the description of a criminal sought by the police, are not unfamiliar to radio listeners in this country. In Saxony (Germany), however, a short time ago, a judge broadcast an appeal for the appearance of an important witness whose existence, but not his identity, was known; in order that the truth might be brought out in court. The unique attempt was successful.

HAM CORRESPONDENTS WANTED

I would like to communicate with some amateurs that operate a station, to get information on short-wave transmitters and a few other things regarding short waves.

EINAR NELSON,
Box 467, Burlington, Wash.

A similar request is received from Clayre E. Matz, Box 83, Delano, Pa.; and Irving Filderman, 8528 118th St., Richmond Hill, New York, asks advice on short-wave tuners.

CIVIL AND MEAN TIME

Editor, RADIO-CRAFT:

I would like to call your attention to the fact that Greenwich Mean Time is no longer in use. A number of radio magazines, including yours, quote schedules in Greenwich Mean Time which are twelve hours in error. Briefly, Greenwich Mean Time, which was discontinued in 1925 by the international astronomers, started at noon. Since 1925 time is counted from midnight; midnight at Greenwich being 0000 hours Greenwich Civil Time, also called Universal Time.

It seems to me unfortunate that many radio publications make this error; as it is apt to be confusing to anyone who has studied astronomy. I was quite confused by it myself, and wrote to the Mount Wilson observatory.

GEORGE LEANDER SMITH,
Los Angeles, California.

(It is true that before 1925 astronomers were in the habit of publishing their calculations in tables which began the mean solar day at noon; a habit which originated in the fact that noon was the natural time of observing the sun. However, in modern astronomy, this was no longer essential: the more so as actual noon and mean noon are not the same. Mean time, no matter what hour of the day it is reckoned from, is based upon the position of an imaginary "mean sun" revolving around the earth at a steady rate of speed. For that reason, the present Greenwich Civil Time is legitimately called "mean time," and it is still customary to abbreviate it as GMT; a form easily understandable by readers who are either familiar with astronomy or know nothing at all about it.—Editor.)

"The first mean sun is a son-of-a-gun,
But the second mean sun is worst:
When the first mean sun is half through his run,
The second mean sun is first."

—Old Naval Academy Ballad.

The New Protecto Voltage Regulator

The simplified Voltage Control is here. Compact and the only Voltage Regulator that sells for 50c and does the work of one that costs many times more.

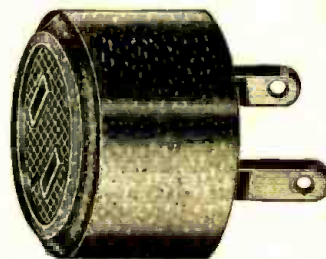

The "NEW PROTECTO VOLTAGE REGULATOR" saves your tubes from blowing out by regulating the current flow. It is an essential attachment enabling you to obtain the best results from your Radio set.

If your dealer cannot supply you, we will be pleased to fill your order.

50c

PROTECTO MANUFACTURING CO.

1157 Flatbush Ave., Brooklyn, N. Y.

Write for Information about the **NEW H-F-L MASTERTONE** LABORATORY MADE RECEIVER
The Year's Outstanding Radio Achievement
HIGH FREQUENCY LABORATORIES
3900 N. Claremont Dept. 80 Chicago, Ill.

ALUMINUM BOX SHIELDS

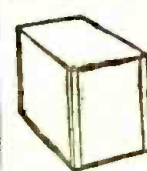

Beautiful silver dip finish, 5 x 9 x 6 inches, \$1.89. We make any size to order in 24 hours.

Shielded Choke Coil, 45c.
.01 Mica Condenser, 35c.

BLAN, The Radio Man, Inc.
89L Cortlandt St., New York, N. Y.

PATENTS Write for Free Guide Book, "HOW TO OBTAIN A PATENT" and Record of Invention Blank. Send model or sketch and description of your invention for our Free Opinion whether it comes within Patent Office Rules. **RADIO and ELECTRICAL Cases a Specialty.** Prompt, Efficient Service. **PAYMENT OF FEES IN INSTALLMENTS**
VICTOR J. EVANS & CO., 923 - 9th, Washington, D. C.



SOMETHING DIFFERENT
No Flint, No Friction,
MAKE UP TO

\$40 A DAY

Showing My Mystery Lighter to Men. What Makes It Light? All Guaranteed. No Flint or Friction. New Principle of Ignition. Sample with Sales Plan, 25c. Sample Gold or Silver Plated, \$1.00. Agents write for proposition. **NEW METHOD MFG. CO.**
Desk SF-9, New Method Bldg., Bradford, Pa.

EVERYDAY MECHANICS

Will Increase Your Earning Power

Whatever your job, you will find in EVERYDAY MECHANICS labor-saving kinks which will help you to get more work done in less time and will bring you recognition from your employers. If you do machine shop work of any kind, auto repairing, sheet metal work, electrical work, farming, concrete work, carpentering, tool making, poultry raising, painting, plumbing, masonry, building, glass work, welding, or general repairing, a yearly subscription to EVERYDAY MECHANICS will pay for itself a thousand times over.

Make Money in Your Spare Time

Hundreds and thousands of amateur mechanics and spare-time workers are making \$10 to \$100 a week EXTRA MONEY by servicing vacuum cleaners and washing machines, repairing automobiles, manufacturing book-ends, lamp-shades, tool chests, chairs, tables, unique ornaments, concrete articles, photo frames, flower boxes, ladders, tanks, garages, gliders and innumerable products in everyday use. EVERYDAY MECHANICS teaches you HOW to turn your spare time into MONEY. EVERYDAY MECHANICS is staffed by real engineers and practical mechanics who tell you about the latest ideas and inventions which you can CAPITALIZE to your OWN PROFIT.

Contents

SPACE DOES NOT PERMIT US TO PRINT THE 59 FEATURES IN THE CURRENT ISSUE OF EVERYDAY MECHANICS. But the following titles will give you some indication of the interesting and valuable contents:
 HOW TO BUILD A TREASURE FINDER
 BUILDING A MODEL AIRPLANE
 HOW TO BUILD A MODEL STEAM TURBINE
 NEWSPAPER CRAFT - NEW USES FOR OLD NEWSPAPERS
 TEST HOPPING AND FLYING A GLIDER
 SENSE, NONSENSE AND RELATIVITY and fifty-two other helps and fascinating features about Automobiles, Aviation, Chemistry, Construction Work, Electricity, Magic, Metal Work, Radio, Photography, Shop Work, Woodworking and new devices.

A Special Offer

In order that you may not miss any of the splendid features now appearing in EVERYDAY MECHANICS and opportunities for making money from the unique 'tips' that are published in every issue, the publishers will send this valuable magazine DIRECTLY TO YOUR HOME every month at a reduction of ONE-THIRD off the usual subscription price. But to take advantage of this offer you must act quickly. Tear off the coupon below and mail it today. YOUR FIRST COPY OF EVERYDAY MECHANICS WILL BE SENT YOU BY RETURN MAIL.

Mail Coupon Today

EVERYDAY MECHANICS PUB., Inc.
 96-98 Park Place, New York, N. Y. RC-9
 Please rush my first copy of EVERYDAY MECHANICS. I enclose

- \$1.00 for one year's subscription
 - 1.90 for two years' subscription
 - 2.70 for three years' subscription
- (Check one of the above)

NAME

ADDRESS

CITY STATE

NOTE: This special subscription offer may be withdrawn at any time.

Radio-Craft's Opportunity Column

TO make this magazine of additional benefit to Service Men, RADIO-CRAFT has instituted a new feature, of which advantage may be taken, free of charge, by any Service Man. We will print short notices of the same nature as those which follow; and will forward to the writer of any of them the replies which may be addressed to him (by the number given) in care of RADIO-CRAFT. We can undertake to publish the same notice only once.

We must reserve the right to condense all letters into their most essential details; and we urge all our correspondents who use this service to be as concise, though thorough, as they would be in the composition of a paid advertisement which would cost them several dollars.

Service Men seeking employment should give, at the beginning, the important details which an employer will first ask; and anyone offering employment to a Service Man should be equally specific.

It is desirable that references be given in all letters seeking employment, etc.—not for publication, but in order that RADIO-CRAFT may verify the statements made, if requested to do so, by parties interested in replying to the advertisement.

Please give all information for publication on a sheet of paper separate from the questionnaire, which is filed by us. Age, years' experience, domestic affairs, etc.; and do not forget to put your name and address on each sheet. We have several requests lacking these important details, which we cannot publish as yet. A period of at least one month must elapse between receipt of letters and publication; as the forms of RADIO-CRAFT close several weeks ahead.

We cannot publish under this heading any advertising of a commercial nature—for the sale of goods, or instruction, etc.; or for an employment agency. We cannot publish offers of general servicing for the public, or service representation of a manufacturer in a district. For the former, local advertising mediums are available, and as to the latter, a manufacturer requesting such information will be given it directly from the files of the NATIONAL LIST OF RADIO SERVICE MEN. Announcements seeking or offering regular employment, however, will be accepted under the conditions stated above.

The writers of any of these requests may be addressed as Opportunity No. (number

given below), in care of RADIO-CRAFT, 98 Park Place, New York City.

(Opportunity 78) R. T. A. graduate, one year's servicing experience, seeks position any branch of radio; salary unimportant if sufficient for expenses. Age 20. (Ohio.)

(Opportunity 79) Service Man, radio factory experience, seeks connection offering laboratory or sound projection experience. Has serviced theatre installations; taken courses in radio engineering. Work in Canada preferred. (Toronto.)

(Opportunity 80) Instrument maker and machinist, 10 years' experience in electrical and mechanical production, four years' independent radio service work, seeks position with manufacturer in plant, service or testing; can qualify as foreman in any branch from parts to testing. (New York City.)

(Opportunity 81) Service Man, four years' experience on all makes, high school education, wishes position with manufacturer or radio laboratory; free to move or travel, starting salary not important. Age 21. Single. (Detroit.)

(Opportunity 82) Service shop wants inside Service Man with some experience on both battery and electric sets. (Iowa.)

(Opportunity 83) Young man, N.R.I. graduate, wishes connection with laboratory or factory where he can work under experienced direction with chance of advancement. (Pennsylvania.)

(Opportunity 84) Service Man, seven years' experience, own business, has equipment, high school graduate, R. C. A. Institutes course, wishes to take charge of service department in good sized eastern city, and build up business on salary and bonus basis. (New York State.)

(Opportunity 85) Sound technician and projectionist, acoustical engineer, nine years' radio experience, former amateur, experienced in sound equipment and public-address work, desires position doing sound picture or acoustical correction work. Go anywhere. (Washington State.)

(Opportunity 86) Service Man, four years' experience on all types of sets, N. R. I. graduate, wishes position servicing for manufacturer or jobber. Will go anywhere. Married. (New York.)

(Opportunity 87) Service Man, working for self, N. R. I. student, amateur license, wishes position servicing or in laboratory. Has car, will go anywhere. Age 21. (Iowa.)

Radio-Craft's Information Bureau

(Continued from page 164)

mentation. Mr. Houck points out that the Claro-stats used in his set-up were the standard variable units, with a range from zero to about 500,000 ohms: such as are used in, for instance, the Majestic "Standard" and "Super B" eliminators for regulating the voltage at the "detector" and "intermediate" taps on these eliminators. Further, Mr. Houck states: "I would suggest that you place the (added) variable resistors outside of the eliminator" (which may be conveniently done by mounting them on a separate panel, or perhaps on a portion of the main panel—Editor) "and in each positive lead of the eliminator. Give this circuit a trial. If you have excessive hum or noise you can then add the choke coil in one of these positive leads if necessary; usually the 180-volt tap, outside the eliminator."

CLAYTON SHORT-WAVE RECEIVER

(88) Mr. Lionel Richardson, Vancouver, B. C., and Mr. Ray M. Holden, Cheshire, Mass.

(Q.1) (Mr. Richardson) I find that the metal case of the Sargent Seven receiver has exactly the dimensions specified in the article "A Triple-tuned R.F. Short-wave Receiver," by S. H. Clayton, in the June issue of RADIO-CRAFT.

Sorry to say, I have not been able to make the circuit oscillate; and after going over it backwards and forwards, must acknowledge myself beaten. All voltages test correct. A "G-10" condenser (.001-mf.) has been used as C11. Radio dealers say there is no such thing as a No. 227 R.F. choke in the Silver-Marshall line. Resistors R1 and R2 are indicated in the diagram as 1.0 meg. and in the list of parts as 0.1-meg.: which is correct? I have tried Aero and home-constructed R.F. coils with continued lack of success.

The symptoms are as follows: nothing is heard but a steady rumble; until the grid of the detector tube is touched, when the set goes entirely dead (instead of squealing, as most sets would). Reversing tickler connections does not help.

(A.1) The R.F. choke should be the "No. 277." Also, resistors R1 and R2 are 0.1-meg. Instead of a G-10 condenser, a G-5 (.0005-mf.) unit, as listed, will probably work best on the short waves; if this is leaky it may explain the effect that is described. Resistors R1, R2, R3 should be carefully tested for rated values under load. Also, all the by-pass condensers should be carefully tested for capacity; and to find whether there is the least bit of leakage (this is the most likely cause of the trouble).

Although it has been determined that all voltages are correct, it will be well to check the plate current of each tube and determine whether it is passing the rated amount.

Disconnect all leads to tubes preceding the de-

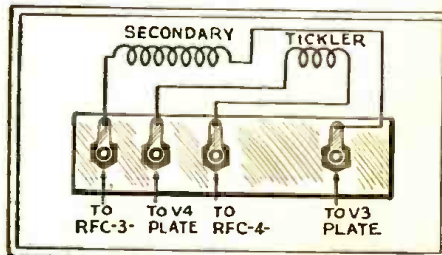

(Fig. Q88.) Proper coil connections to the General Radio mounting, used in the receiver previously described by Mr. Clayton.

Train for a better Job!

STUDY CHEMISTRY

The field with a future!

WHY should you spend your life in the hopeless rut of the untrained workman? You know that it holds no prospects for you, and some day when you realize that you have gained nothing for your years of labor, it will be too late to pull yourself out. NOW is the time to guarantee your future by getting into Chemistry—the one field that offers you boundless opportunities for a comfortable living, an enjoyable occupation, wealth and even fame.

Not an industry in the world—not a factory, mine, mill, ranch or plantation can get along without the services of chemists. Chemistry is utilized everywhere, and so many new lines of business involving Chemistry are springing up daily that there is an actual shortage of men sufficiently trained to fill the best positions.

No Previous Experience Required

Do not think that you are barred from this attractive profession by lack of education. THE CHEMICAL INSTITUTE has taught thousands of young men, many of whom had no previous schooling of any kind. We can train you thoroughly, and may even get you your first job. The celebrated course which we give is simplified to such a point that anyone can learn who is able to read and write English. All we ask is interest in the work and willingness to devote your spare hours to it conscientiously.

The course is simple to understand and enjoyable to study, but it does not skim over the essentials. You will get just as thorough instruction as if you took the same subjects in college, but it will be easier to grasp as well as far more convenient and inexpensive. No text-book could be as explicit and readily understood as our lessons. Many professional chemists use them in their own reference libraries. And in addition the personal services of able instructors will be yours at all times to help you, step by step, continually.

Learn at Home in Spare Time

But a Chemistry student has to get practical training with laboratory apparatus! So he does, but we furnish you with the equipment needed to do your experimental work at home. You do not have to give up your present work while learning or leave home to attend classes. All your study and experiments can be done in your spare time. If you have very little leisure, we can accommodate you anyway, as every student is taught individually and may take as much time as he needs to complete the course. Even then he is entitled to specialized training and to the free services of our instructors as long as he wishes.

Extra Laboratory Equipment Supplied Free

There is absolutely no extra charge for the comprehensive laboratory set which we furnish every student. This laboratory contains over one hundred pieces of apparatus and chemicals.

With this portable laboratory you can duplicate famous historical experiments. Think of all the pleasure it will give you! You will really be learning while playing.

Tuition Price Reduced

Effective this month we have reduced the tuition fee, so that this splendid course and equipment are within the means of every individual who is interested in following Chemistry, whether as a career or merely as a hobby. Fee can be paid on EASY MONTHLY TERMS. The one price covers everything. There are no extras to buy.

Plenty of Money in Chemistry

Why talk about hard times and lack of opportunities when Chemistry offers you a rich variety of ways to make a fortune? Every day the papers contain news of fresh discoveries in Chemistry, and for every one you read about, there are hundreds not recorded as news because their interest is purely technical. The manufacture of steel and other metals, of glass, isotery, soap, perfumes, fertilizers, dyes, drugs, celluloid and explosives—paper making, the tanning of leather, the refining of sugar, dairying, meat packing, preserving, sugar refining, and the preparation of hundreds of food products—all these and a multitude of other activities engage the skill of a chemical army. Don't you think there is room for you also?

Chemists are well-paid employees and each one has the opportunity of discovering new chemical secrets with a liberal fortune as his reward. Every one of the lines of business in any way connected with Chemistry—and you can see that there are thousands of them—has brought wealth to the many chemists who were associated with its development. Are you going to throw away your chances for the same reward, when schooling in Chemistry can be so easy and delightful as it is through our course?

No Exaggerated Claims

This Institute does not claim that every chemist makes millions; nor do we guarantee that you will immediately get a job paying \$10,000 a year. But many have done it and there is no reason why you cannot do it also.

Get a Start Today!

If you would like to know more about Chemistry, and if you are sincere in your desire to get out of the rut and if you have ambition enough to want to become a famous chemist some day, you will not wait until tomorrow to find out.



MR. CHARLES W. SUTTLE, of Forgan, Okla. (at left on top), is deeply interested in chemical research. He performs his experimental work in his well-equipped home laboratory.

MR. O. T. D. BRANDT, of Seattle, Wash. (center photograph), is an analytical chemist of demonstrated ability. In his home he has equipped a laboratory containing several thousand dollars' worth of equipment, bought entirely with earnings from spare-time work while he was taking our course.

MR. VIRGIL REIDGATE, of Hutchinson, Kans. (bottom right-hand photo), began doing professional analysis on commission, even before he completed his course. He is also the inventor of several devices and processes used in photography.

DIPLOMA AWARDED EVERY GRADUATE

Upon graduation every student is awarded our Diploma in Chemistry, verifying that he has successfully completed his studies. Your name on this certificate will be a source of pride to you all your life, as well as an aid in obtaining a position.

MAIL THIS COUPON

TODAY

FOR FREE BOOK!



CHEMICAL INSTITUTE OF NEW YORK, INC.

19 Park Place New York, N. Y.

CHEMICAL INSTITUTE OF NEW YORK, Inc.
Home Extension Division
19 Park Place, New York, N. Y.

Please send me at once, without any obligation on my part, your Free Book, "Opportunities for Chemists," and full particulars about the Experimental Equipment given to every student. Also please tell me about your plan of payment and the reduction in the tuition price.

NAME

ADDRESS

CITY STATE

RC-9-30



The MADISON

ILLINOIS AVENUE
Overlooking Boardwalk and Ocean

"A Hotel Distinctively
Different"

JUST COMPLETED IN
Atlantic City

Unexcelled Colonial
Hospitality

Now Ready for YOU

Fireproof — Showers and Baths
Throughout

From \$4.00 daily
European Plan

From \$7.00 daily
American Plan

FETTER & HOLLINGER, INC.
Eugene C. Fetter
Managing Director

Philadelphia
Your Choice Should Be
The

HOTEL MAJESTIC
BROAD ST. AND GIRARD AVE.

400 Large Rooms

Only Hotel in Philadelphia with a
subway entrance from main lobby

Most Moderate Rates!

Single Room, running water... \$2.00
For Two \$3.50
Single Room, private bath... \$3.00
For Two \$5-\$6

Garage Connected with Hotel

Wire at our expense for reservations

JNO. C. GOSSLER, Mng.-Dir.



tor and after connecting the aerial (through a small variable "midget" condenser) to the plate-end of L4, check over the apparatus until the detector circuit is functioning properly. (Make certain that there is no leakage in the insulation of the variable tuning condenser C9 or the regeneration condenser C12. Check RFC4 and RFC5 for short-circuits.)

Mr. Clayton makes the following observations: "Note that a screw hole in the base of the Aero coil is close to the end of L4. If the head of the screw touches this coil, and grounds to the chassis, it probably would cause the rumbling sound. Do not use ordinary lead paint on the receiver; but cover all woodwork with Duco or other celluloid paint to keep out moisture. Condenser C11 must be raised from the copper base-plate.

"My coils are made on celluloid forms. These are made by winding photograph film (cleaned of its light-sensitive emulsion) around a cardboard mailing tube four inches in diameter; and fastening it with cement made by mixing equal parts of amyl acetate, acetone and glacial acetic acid. Over the resulting tube wind the primary and, alongside it (spaced 1/8-in.), the secondary; they are then painted with a "dope," made with equal parts of acetone and amyl acetate, which has been brought to molasses consistency by adding celluloid cuttings. (Connect coil L4-L5 to the General Radio coil mounting as shown in the accompanying illustration.—Editor.) I have not had any luck with tube-base coils.

"To obtain rigid connections, bus-bar wiring should be employed. *Keep leads short.* Place the three R.F. sockets with "P" and "G" posts to the right; and next to the partition following. This will shorten leads. Place the coil sockets on 2-in. wood blocks, duco-ed, to exactly center the coil in the shield compartment.

"An improvement is to raise R2 from the base so that it is in a straight line from the control-grid cap of V3 to condenser C8; and keep C8 at a 45- or 90-degree angle to the partition,—not parallel. The socket for coils L4-L5 is raised about 1/4-in.; resistor R3 and the socket for V4 are raised about 1 inch. Placing the Cardwell condenser as shown in the photograph is important for good control."

(Q.2) (Mr. Holden.) In the coil data of the "Three-stage R.F. Short-wave Receiver," it is stated that the turns on the smallest coils, maroon and orange, are spaced 1/16-in., and the larger ones, 1/8-in. Measurements seem to indicate the required number of turns will not fit on the tube. Are not these dimensions reversed?

(A.2) The spacing between primary and secondary may be 1/8-in. for the maroon and orange coils; and 1/16-in. for the others. Further coil details are given above, in the answer to Mr. Richardson's inquiry.

USES INTERFLEX SYSTEM

Editor, RADIO-CRAFT:

I am looking for all the information I can get on short-wave work, and as for RADIO-CRAFT, I would not be without it. It has helped me in many ways with my work.

—You may remember my writing to you three years ago regarding your Regenerative Interflex. I want to tell you that I have built two or three sets of them for friends, and all have given wonderful results. I interflex all my sets; for I find the crystal in the place of the grid leak a wonderful improvement.

WILLIAM HENRY MAHON,
Radio-Trician,
Duncan, B. C. Canada.

Short-Wave Stations of the World

(Continued from page 153)

Meters	Kilo-cycles	Station Name	Location	Time
49.17	6,095	VE9GW	Bowmanville, Ontario, Canada.	Daily, 1:45-5 a.m., noon to 7 p.m. Sundays, 5 a.m. to 7 p.m. Gooderham & Worts, Ltd.
49.26	6,090	...	Copenhagen, Denmark.	
49.31	6,080	W2XCX	Newark, N. J. Relays WOR.	
		W9XAA	Chicago, Ill. (WCFL).	
		W6XAL	Westminster, Calif.	
49.40	6,070	UR2	Vienna, Austria.	5-7 a.m., 5-7 p.m. Tues. and Sat., 9-10 a.m. Thu.
49.46	6,065	SA1	Motala, Sweden.	6:30-7 a.m., 11 a.m.-4:30 p.m.
49.50	6,060	W8XAL	Cincinnati, Ohio. Relays WJW.	
		W9XU	Council Bluffs, Iowa. Relays KOIL.	
		W3XAU	Lyberry, Pa., relays WCAU.	
		HKC	Bogota, Colombia.	9:15-11:30 p.m., Monday to Friday. Later on Sat.
49.67	6,010	W9XAQ	Chicago, Ill. (WMAQ).	
		W2XAL	New York	
49.80	6,020	W9XF	Chicago, Ill.	
		W2XBR	New York, N. Y. (WRNY).	
49.97	6,000	ZL3ZC	Christchurch, New Zealand.	10 p.m.-midnight, Tuesdays, Thursdays and Fridays.
		EAR25	Barcelona, Spain.	Sat. 3 to 4 p.m.
		RFN	Moscow, Russia.	Tues., Thurs., Sat. 8 to 9 a.m.
		Eliffel Tower	Paris, France	Testing 6:30 to 6:45 a.m., 1:15 to 1:30, 5:15 to 5:45 p.m., around this wave.
51.40	5,933	HK2	Barranquilla, Colombia.	3:30 to 4:30 p.m. exc. Sun.
52.00	5,770	AFL	Bergerod, Germany.	
52.72-54.41	5,690-5,510	Aircraft.		
54.02	5,550	W8X1	Columbus, Ohio.	
54.51	5,500	W2XBH	Brooklyn, New York City (WBBC, W4G1).	
56.70	5,300	AGJ	Nauen, Germany.	Occasionally after 7 p.m.
58.00	5,170	OKIMPT	Praque, Czechoslovakia.	1 to 3:30 p.m., Tues. and Fri.
60.00	4,920	LL	Paris, France.	1,900 kc. Television.
61.22	to 62.50	W6XK	Pittsburgh, Pa.; W1XAV, Lexington, Mass.; W2XBU, Beacon, N. Y.; WENR, Chicago, Ill.	
62.56	4,795	W9XAM	Eldin, Ill.	
		W9XL	Chicago, Ill.	
		...	And other experimental stations.	
62.69	4,785	Aircraft.		
62.70	4,785	VZA	Drummondville, Canada.	
65.22	to 66.67	W6XC	Los Angeles, Calif.	Television.
		...	Los Angeles, Calif.	
67.65	4,430	DDA	Doberitz, Germany.	6 to 7 p.m., 2 to 3 p.m. Mon., Wed., Fri.
70.00	4,280	DKK2	Vienna, Austria.	Sun., first 15 minutes of hour from 1 to 7 p.m.
70.20	4,273	BB15	Khabarovsk, Siberia.	5-7:30 a.m.
71.77-72.98	4,180-4,100	Aircraft.		
72.87	4,116	WOO	Deal, N. J.	
74.72	4,105	NAA	Arlington, Va.	Time signals 3:55-9 p.m., 9:35-10 p.m.
80.00	3,750	F8KR	Constantine, Tunis, Africa.	Mon. and Fri.
		...	Rome, Italy. (Testing)	
82.90	3,620	DDA	Doberitz, Germany.	
84.24	3,560	O27RL	Copenhagen, Denmark.	Tuesday and Fri. after 6 p.m.
84.16-85.66	3,550-3,500	Amateur	Telemetry.	
86.50-86.00	3,490-3,460	Aircraft.		
92.50	3,250	W9XL	Chicago, Ill.	
		...	And other experimental stations.	
91.26	3,166	WCK	Detroit, Mich. (Police Dept.)	
93.48-97.71	3,142-3,070	Aircraft.		
96.03	3,121	WOO	Deal, N. J.	
97.15	3,088	W10XZ	Airplane Television.	
97.53	3,076	W9XL	Chicago, Ill.	
98.95	3,030	...	Motala, Sweden.	11:30 a.m.-noon, 4-10 p.m.
101.7	to 105.3	Television.		
		W2XK	Silver Springs, Md.	8 to 9 p.m. except Sunday; WPY, Allwood, N. J.; W2XR, New York, N. Y.; W3XL, Bound Brook, N. J.
104.4	2,870	...	Milan, Italy.	After 2 p.m.
105.3	to 109.1	Television.		
		W2XBA	Newark, N. J.	Tues. and Fri. 12 to 1 a.m.; W2XCL, Brooklyn, N. Y.; W8XAU, Pittsburgh, Pa.; W1XB, Somerville, Mass.; W7XAG, Portland, Ore.; W9XAP, Chicago, Ill.; W2XAP, Jersey City, N. J.
		W2XCR	Jersey City, N. J.	8:15 and 9 p.m.
109.1	to 113.1	Television.		
		W2XBR	Long Island City, N. Y.	
		W9XR	Chicago, Ill.	
110.2	2,722	Aircraft.		
113.5	2,645	W2XBO	New York Central R.R. train.	(Excs.)
124.2	2,410	W7XP	Seattle, Wash.	Police and Fire
125.1	2,398	W9XL	Chicago, Ill.	W2XCU, Ampere, N. J.—And other experimental stations.
128.0-129.0	...	Aircraft.		
129.0	2,325	W10XZ	Airplane Television.	
135.0	2,220	...	Stockholm, Sweden.	
131.2	2,285	W2XBO	N. Y. C. R.R. (Exp.)	Television.
136.4	to 142.9	Telemetry.		
		W8XAU	Pittsburgh, Pa.	W1XB, Somerville, Mass.; W2XCV, Schenectady, N. Y.; W1XAV, Boston, Mass., 6 p.m.
		W8XAV	Pittsburgh, Pa.	60 holes, 1200 r.p.m. 1:30-2:30 p.m. Minn., Wed. Fri. Westinghouse Electric & Mfg. Co.
142.9	to 150	Television.		
		W2XCL	Brooklyn, N. Y.	Mon., Wed., Fri., 9 to 10 p.m.; W9XAA, Chicago, Ill.; W2XBS, New York, N. Y., frame 60 lines deep, 72 wide, 1,200 R.P.M.; W1XAE, Springfield, Mass.; W8XAV, Pittsburgh, Pa.; W6XAM, Los Angeles; W2XBU, Beacon, N. Y.; W3XAK, Bound Brook, N. J.; W3XK, Washington, D. C. Daily except Sun., 8 to 9 p.m.; WPY, Allwood, N. J.; W10XU, Airplane.
150	2,000	W2XBO	Long Island City, N. Y.	
149.9-174.8	2,000-1,715	Amateur	Telemetry and Television.	
175.2	1,712	WKDU	Cincinnati, Ohio. (Police Dept.)	
		WMP	Framingham, Mass.	11 a.m., 1 and 5 p.m. daily. Music and police reports.
		WRH	Cleveland, O. (Police Dept.)	
		KGIX	Pasadena, Calif. (Police Dept.)	
		...	St. Quentin, France.	
		F8FY	Cannes, France.	5 p.m. Wed.; 4 a.m. Sunday.
176.5	1,700	...	Orly, France.	
178.1	1,631	WCK	New York, N. Y. (Police Dept.)	
180.4	1,662	...	Michigan State Police.	
186.6	1,608	W9XAL	Chicago, Ill. (WMAC) and Aircraft Television.	
		W2XY	Newark, N. J.	
187.0	1,604	W2XCU	Wireless Radio, Ampere, N. J.	
		W2XCD	DeForest Radio Co., Passaic, N. J.	8-10 p.m.
		...	Ornskoldvik, Sweden.	
		...	And other experimental stations.	
187.9	1,596	WRBC	New York, N. Y. (Fire Dept.)	
190	1,530	...	Karlskrona, Sweden.	
187.9	1,596	WKDT	Detroit, Mich. (Fire Dept.)	

Brand New Merchandise

At Unheard Of Prices

All articles shown on this page are brand new merchandise in original cartons, sold at prices never attempted heretofore. Inasmuch as the supply is limited, we reserve the right to return

deposits if items have been sold out. Every article is fully guaranteed, although all merchandise shown here is sold below actual manufacturing cost.

Utah Dynamic A.C. Power Speaker—Model 33A

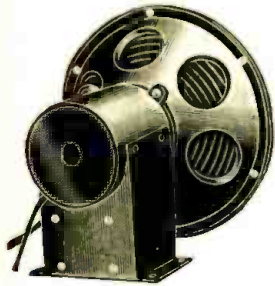

110-volt Alternating Current light socket supply for field excitation using Westinghouse dry rectifier. 9 in. high, 9 1/2 in. wide, 7 1/2 in. deep. Speaker comes packed in wooden crate. Weight 19 lbs. It is one of the most powerful, as well as best reproducers in the market.
List Price, \$50.00
YOUR SPECIAL PRICE
\$7.50

Peerless D.C. Dynamic Speaker

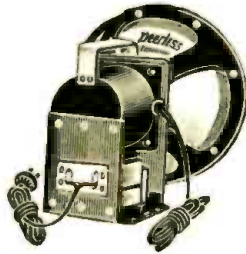

The ideal speaker for cabinet installation. Field resistance of 2500 ohms—90-120 volts with input transformer. This speaker can be used with A.C. receivers that are equipped to supply the "B" current to speaker field. Speaker comes to you packed in factory-sealed cartons.

YOUR SPECIAL PRICE..... \$6.50

Peerless A.C. Dynamic Mantel Cabinet Speaker—Model 19A



Size: 16 3/16 in. high at center; 11 1/2 in. wide at base; 10 3/16 in. deep at base. Diameter of cone, 9 in. Chassis specifications: Extremely solidly built. Power transformer and rectifier assembled as a unit with chassis. Each reproducer equipped with 8 feet of silk-covered power cord with plug and switch, and 8 feet of silk-covered speaker cord with phone tips. Equipped with power transformer and rectifier to operate on 110-volt, 50-60 cycle, A.C. current.

List Price, \$75.00
YOUR SPECIAL PRICE..... \$14.50

R.C.A. 100B Loud Speaker

A modern design loud speaker which will fit the modern trend in any home, yet harmonizes well with any set. Reproduces tones faithfully over a wide range and possess great sensitivity. Handles a substantial volume of tone with remarkable clarity. Magnetic unit. Corrugated cone. Height, 10 1/2 in.; Width, 10 in.; Depth, 6 1/2 in.

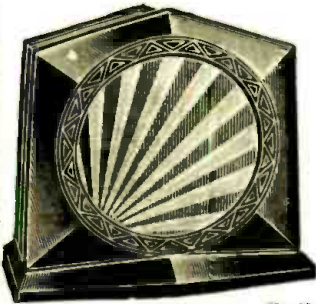

List Price, \$17.50
YOUR SPECIAL PRICE..... \$5.20

R.C.A. Loud Speaker 103

A beautiful speaker in appearance. Superb in its ability to reproduce music and speech most faithfully. The frame and pedestal are mounted to resemble hand-carved oak, while the beautiful tanestry medallion conceals the mechanism and completes the decorative design of the instrument. Magnetic unit. Corrugated cone. Height, 15 in.; Width, 13 1/2 in.; Depth, 6 1/2 in.



List Price, \$22.50
YOUR SPECIAL PRICE..... \$5.25

Utah Magnetic Speaker Model X-35

Utah Power Motor used in Utah Speaker, with its natural-like valve coil an exclusive Utah feature—a lasting source of dependable radio speaker power. 6 to 12 volts. Direct Current for field excitation. Operates from "A" battery. Current consumption .5 to 1 ampere. Packed 1 to wooden crate. Weight, 1 1/2 lbs.



List Price, \$35.00
YOUR SPECIAL PRICE..... \$3.75

Atwater Kent Approved Dover, Model 133 Cabinet



Made from selected Veneers of Walnut with a two-tone routing and other attractive decorations on the front with a heavy, full-bodied, hand-rubbed and polished varnish finish. Size: Top, 16 x 25 1/2 in.; Height, 38 in.; Width, 21 1/2 in.

YOUR SPECIAL PRICE
\$7.70

Berkey & Gay, Model 106 Cabinet



Walnut, Oak, Bird's-eye Maple and Gunwood combination. 26 in. wide; 38 1/2 in. high; 16 1/2 in. deep. Finest hand-rubbed finish.

YOUR SPECIAL PRICE
Without Speaker —
\$9.90
\$13.75
With R.C.A. 100A Speaker

SPECIAL! Equipped with Peerless Speaker Cavalier, Model 159 Cabinet

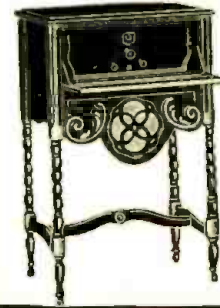

This beautiful and distinctive cabinet is sold with the built-in Peerless Speaker. It is designed to provide a maximum cabinet at a minimum price. Veneers of figured Walnut with attractive carvings and unusual turnings. Set compartment, 21 1/2 in. wide x 10 1/2 in. deep x 8 in. high. Height, 38 in.

Complete with Speaker
YOUR SPECIAL PRICE
\$7.15

Chesterfield, Model 120 Table

Table with speaker compartment. Top and front Walnut Veneer. Balance Gunwood. Antique Walnut finish. Top size, 15 1/2 x 24 in. Height, 30 in.

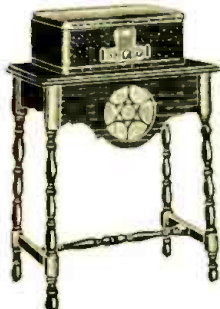

Model 122
Same as Model 120, except that top size is 15 1/2 x 31 inches. Packed two in a carton. (Not sold singly.)
PRICE OF EITHER MODEL
\$3.30

Kreeg-Mellen, Model 22 Cabinet

Walnut finish. Maple overlay. Front door drops. Solid panel for receiver. 21 1/2 in. wide; 38 in. high; 15 in. deep



YOUR SPECIAL PRICE
\$7.15

Kreeg-Mellen, Model 1 Cabinet

Walnut, Oak, Bird's-eye Maple and Gunwood combination. 21 1/2 in. wide; 38 in. high; 16 1/2 in. deep. Finest hand-rubbed finish.

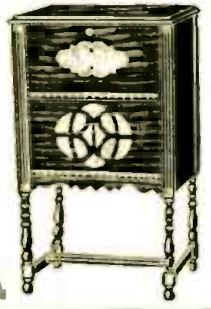

YOUR SPECIAL PRICE
\$7.15

We are a wholesale house and cannot accept orders for less than \$5.00.

If C. O. D. shipment is desired, please remit 20% remittance, which must accompany all orders; balance on delivery.

If the full cash amount accompanies the order, you may deduct 2% discount.

Radio Trading Co.
246 Fifth Avenue
New York, N. Y.

Should you wish goods shipped by parcel post, be sure to include sufficient extra remittance for same.

Any excess will be refunded.

We have no catalogue but you will find special offers from time to time in this magazine. Prompt shipments will be made.



JUST OUT A TONE TEST DEMONSTRATION RECORD

Enables You To Make Comparative Tone-Tests
of sets . . . phonographs . . . amplifiers and pick-ups . . .
INCREASE YOUR SALES! Let your prospective customers
judge the reproducing qualities of different sets by means of
this Record.

A SIX-MINUTE demonstration—ORIGINAL
—INSTRUCTIVE and ENTERTAINING—
of the effects of the high, intermediate and low notes—individually
and in groups—of the flute, piccolo, cello, violin, bells, trombone,
drums, and orchestral effects of the full organ. Short, snappy talks
are made between each rendition—telling the listener what each
demonstration means. Play this record and give the prospect a REAL
demonstration. Play it on one set—then on another. Judge the re-
producing qualities of ANY instrument. Every dealer, every sales-
man, every service man should have one of these records. Manu-
facturers and engineers will find many uses for it.

Recorded and produced for the publishers of "RADIO"
and sold to you on a money-back guarantee.

Only \$ **1.00**
POSTPAID
IN THE U.S.

SPECIAL INTRODUCTORY OFFER
Buy a standard package of 6 of these records and
give one to each of your salesmen. **SIX RECORDS
FOR \$5.00, postpaid.**

—Shipments made
on same day your
order reaches
us . . .

RADIO
Pacific Building,
San Francisco, California.

Send _____ Demonstration Records
to me immediately upon receipt of this order.

I enclose \$ _____ in full payment.
(Prices: \$1.00 each, or \$5.00 for six)

G

CHECK HERE IF C. O. D. SHIPMENT IS WANTED

Name _____
Street and Number _____
City _____
State _____



Surplus Sale of Nationally Advertised Radio Merchandise

SEND NO MONEY!

All merchandise listed on this page is sent to you by express, C.O.D., WITH FULL PRIVILEGE OF INSPECTION. You risk absolutely nothing and the express agent will allow you to open the package so you can satisfy yourself that the merchandise is as represented. We do not require a deposit from you—WE TRUST YOU. Prices are F.O.B. New York, express charges to be paid by you. C.O.D. privilege is good only in continental United States.

Allen A.C. Phono. Motor

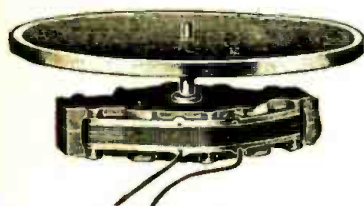

WITH TURN-TABLE

Reg. \$35.00 **\$4.45**

Most Compact Made

A sturdy SYNCHRONOUS, compact motor, ONLY 1/4 IN. THICK, with dependability and stamina that make it a marvel of engineering. REVOLVES EXACTLY 80 TIMES IN ONE MINUTE, which is standard, REGARDLESS OF VOLTAGE FLUCTUATIONS! CAN FIT INTO MOST ANY AVAILABLE SPACE. COMPLETE WITH TURN-TABLE. FOR 110-VOLT A.C. Shipping weight, 10 lbs.

SM 250 Power Amplifier



Contains two stages of power a. f. amplification. Ideal for theatres, dance halls, schools, lecture halls, hospitals, auditoriums, outdoor gatherings, etc., etc. The gigantic power output is at all times within control—FOR THAT MATTER IT CAN BE USED IN ANY HOME, AS THE VOLUME CAN BE THROTTLED DOWN TO AMAZING FIDELITY OF REPRODUCTION. WORLD RENOWNED SILVER-MARSHALL LABORATORIES. Can be used with ANY RADIO TUNER—PHONOGRAPH PICK-UP—MICROPHONE ARRANGEMENT. SUPPLIES ALL "A B C" CURRENT TO ITS OWN TUBES—all self contained. Uses ONE 250—ONE 226—TWO 281 TUBES (not included—\$5.00 additional). 21 x 5 3/4 x 5 1/2 inches—shipped express collect.

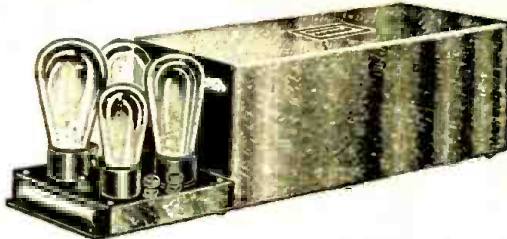

Reg. \$125.00

\$22.50

AMAZING FIDELITY OF REPRODUCTION. WORLD RENOWNED SILVER-MARSHALL LABORATORIES. Can be used with ANY RADIO TUNER—PHONOGRAPH PICK-UP—MICROPHONE ARRANGEMENT. SUPPLIES ALL "A B C" CURRENT TO ITS OWN TUBES—all self contained. Uses ONE 250—ONE 226—TWO 281 TUBES (not included—\$5.00 additional). 21 x 5 3/4 x 5 1/2 inches—shipped express collect.

Reg. \$15.00
375



Pacentic Pk-up

Note that this tone arm rests on its own base — on the end remote from the unit itself, there is a considerable weight which "counterbalances" the weight beyond the pivot. Weight on record is only about three ounces, greatly reducing scratching, and increases the life of all records. Due to construction of tone arm, the unit is always set at the correct angle, with reference to the surface of the record. Pacentic does not have to be screwed down to the phonograph platform. For use with either A.C. or D.C. sets. Shipping weight, 4 lbs.

SEND NO MONEY!
WE SHIP C.O.D. WITH PRIVILEGE OF INSPECTION

FREE RADIO BOOKLET
FULL OF BARGAINS
SEND FOR IT TO-DAY

WE MAKE FREQUENT MAILINGS OF SPECIAL BULLETINS — IT WILL PAY YOU TO BE ON OUR MAILING LIST

RCA SPEAKER CHASSIS

\$3.75

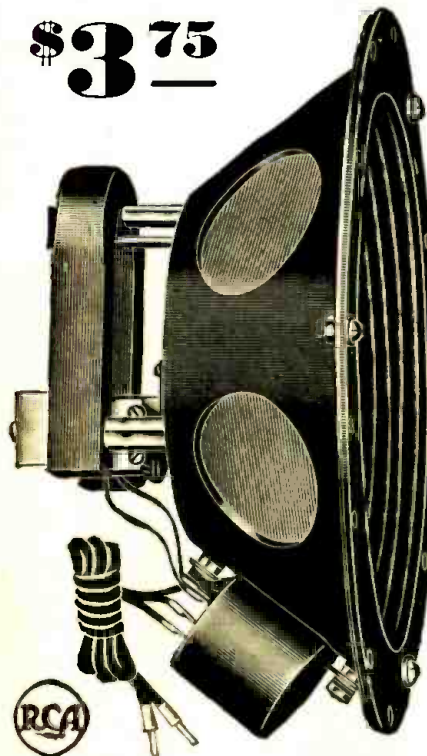

TWO OF THE GREATEST ORGANIZATIONS IN THE RADIO INDUSTRY, GENERAL ELECTRIC COMPANY AND RADIO CORPORATION OF AMERICA, ARE SPONSORS OF THIS PRODUCT! This chassis is the identical one used in the RCA Model 100A and 100B Speakers, WHICH LIST FOR AS HIGH AS \$35.00.

Note built-in OUTPUT TRANSFORMER—this enables the speaker to be used with voltages applied to it as high as 450 volts, without any trace of distortion, rattling or blasting. Equipped with GENEROUS OVER-SIZED MAGNETS. The thick armature is ACCURATELY CENTERED. The STURDY METAL FRAME IS LINED WITH A SELF-BAFFLING FABRIC, greatly improving the acoustic properties of this sensational speaker! NOTE THE CORRUGATED SURFACE OF THE CONE, AN EXCLUSIVE FEATURE—ENHANCES PERFECT TONAL REPRODUCTION QUALITIES CONSIDERABLY. MOST COMPACTLY MADE: 9 INCHES OUTSIDE DIAMETER, 4/8 INCHES DEEP OVER-ALL.

IDEAL FOR AUTOMOBILE RADIO SPEAKER INSTALLATION — CAN BE MOUNTED IN ANY RADIO CONSOLE, or against any baffle arrangement. Complete with durable 5-foot cord. Shipping weight, 5 lbs.

SPEAKER CHAMBER FOR ABOVE CHASSIS
This speaker can be installed in this special ACOUSTICALLY PERFECT BAFFLE CHAMBER in a few moments. Front baffle board included.

OUR SPECIAL PRICE85c.

FARRAND DYNAMIC CHASSIS
Here is not only true Dynamic operation and performance at a popular price, but opportunity to enjoy Dynamic reception from every type of radio receiver. Outside diameter, 8 3/4 in. 7 in. Cone. Depth, 7 1/2 in. Shipping weight, 10 lbs.

REG. \$18.00

\$8.49

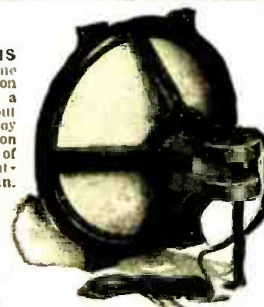

BBL GIANT ELECTRIC MOTOR SPEAKER CHASSIS

12 IN. OVER-ALL DIAMETER

The motor (unit) used in this speaker is approximately 4 times the size of the original BBL unit, or most any other unit—therefore, is capable of handling terrific power. Due to its extremely large permanent magnet, its efficiency surpasses that of all other magnetic speakers, and some dynamos. Use a n y fidelity of reproduction. Equipped with tapped impedance winding, enables you to select any of 3 impedances, to properly match your amplifier, and thereby give you the most realistic tone! An exclusive feature! Ship. wght., 10 lbs.

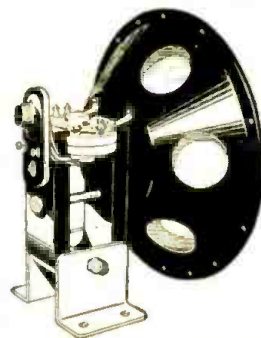

Reg. \$22.00 **\$6.95**

LOFTIN-WHITE LICENSED DIRECT COUPLED AMPLIFIERS



A most remarkable and inexpensive amplifier for use in electrical reproduction of phonograph records and public address systems in halls, schools, churches and auditoriums. Very compact! Modernize any tuner! Shipping weight, 15 lbs.

Model 245 \$16.50
Model 250 29.50

THORDARSON SPECIALS

2 1/2-volt, 12-ampere P1L Transformer.....\$3.15
R17) or R210 Compact 4.89
(Power Transformer and 2 Chokes in one case)
250 Push-Pull Power Transformer, for 2-250.
2-281, 2-227 Tubes 4.50
S-M 251-255-250 Audio Transformers..... 2.45
Webster 2A Phono. Pick-up..... 8.75

Note post office department does not allow inspection of parcel-post shipments. If cash accompanies order for full amount deduct 2% discount. Include postage allowance if parcel-post shipment is desired—any excess will be refunded. Send check, money order, cash (registered mail) or U. S. stamps, any denominations.

Radio Surplus Corp.

56 R VESEY ST. . NEW YORK, N. Y.

ALL MERCHANDISE IS BRAND NEW AND COMES IN ORIGINAL SEALED CARTONS

WE GUARANTEE YOU 100% SATISFACTION—YOU RISK NOTHING

WE MAKE SHIPMENTS SAME DAY ORDER IS RECEIVED!

A REVELATION *in* RADIO VALUES

FREE
168
PAGE BOOK

Get This Catalog

All the Latest
RADIO ATTRACTIONS



A wonder book of remarkable money-saving bargains—168 pages and over 500 illustrations—all your radio needs priced so low it will startle you.

The latest radio devices—the last minute improvements in sets, accessories, parts and kits.

New, 1931 Screen Grid, Tone Control A. C. Humless All-Electric Sets

remote control, public address, phono-combinations, all dynamic speaker equipped. Beautiful Consoles. Bed-rock prices and unusual values on all sets, parts and appliances.

You must have this catalog—whether owner or dealer—to tune in on the newest and greatest values in radio merchandising—made possible by the tremendous buying power of this great corporation. The catalog of catalogs. Brimful of bargain information. Money-saving values on every page. *Send for it TODAY.* It's **FREE.**

*The House of
Outstanding Values*

Sets, Parts,
Kits and
Everything
In Radio

**ALLIED RADIO
CORPORATION**
711 W. Lake Street Dept. 0 Chicago

Resources
Over
Three
Million

WHAT EVERY ELECTRICIAN WANTS TO KNOW!

JUST OUT!—Latest Exact Information from A to Z!

We take pleasure in announcing: **"AUDELS NEW ELECTRIC LIBRARY"**

New and More Uses for Electricity offer great opportunities to men who can handle this power correctly. Modern electrification of industry calls for trained men who know how to handle electricity accurately.

Simple as A. B. C.—"Audels New Electric Library" gives latest, exact information from foundations of electrical practice to latest modern applications. This is a NEW practical and theoretical course in electricity for home study and ready reference.

Here are the answers to your questions, giving you the real dope that every electrician must know. They chart your knowledge, taking away the uncertainty of guess work.

NEW!

As Easy As ABC



Latest information, fully illustrated, covering:—

Fundamental Principles and Rules of Electricity, Magnetism, Armature Winding, Repairs, Dynamos, D-C Motors, Construction, Installation, Maintenance and Trouble Shooting, Tests and Testing Instruments, Storage Battery, Construction and Repairs, Alternating Current Principles and Diagrams, Power Factor, Alternators, Transformers, A-C Motors, Windings, Reconnecting, Converters, Switches & Fuses, Circuit Breakers, Relays, Condensers, Regulators, Rectifiers, Motors, Switchboards, Power Station Practice, House Light & Power Wiring, Circuits, High Tension, Transmission, Plans, Calculations, Code, Electric Railways, Signals, Elevators, Hoists & Cranes, Gas Engines, Auto & Aero Ignition, Starters, Radio, Telephone, Telegraph, Bells & Signals, Motion Pictures, Talks, Lighting, Illumination, Electric Refrigeration, Heating, X-Ray, Plating, Welding, Pumps, Compressors, Domestic & Farm Appliances, An Electric Calculator for Engineers and Mechanics, Practical Mathematics for Ready Reference, A New Electric Dictionary & Encyclopedia of Words.

7 Books Now on Sale 5 in Preparation

The Library contains 12 books—the first 7 books containing 3600 pages with thousands of diagrams and illustrations are now ready; the remaining 5 books are in preparation. A pocket-size, flexibly bound series that is valuable wherever electricity is used.

Beautiful, timely books for service—pocket size; completely illustrated with diagrams and charts; simplified, easy to read and understand. No electrical man can afford to pass up this opportunity. Extremely low price; buy on your own terms.

QUESTIONS AND ANSWERS
AUDELS NEW ELECTRIC LIBRARY ILLUSTRATED

NEW!

SATISFACTION GUARANTEED! "Audels New Electric Library" is backed by our 50-year record as helping hand publishers. Satisfaction always guaranteed.

Beautiful, Timely Books



Read for Profit

BUY ON YOUR OWN TERMS

- PLAN 1—ONE BOOK A MONTH**
Please enter my subscription to "Audels New Electric Library" to consist of twelve volumes, price \$1.50 a volume (\$10.50 for the seven volumes now ready). Mail one volume each month and as they are received, I will mail you \$1.50 promptly.
- PLAN 2—PAY 50¢ OR MORE A WEEK**
Please ship me for one week's free trial the first seven volumes of "Audels New Electric Library." \$1.50 each (\$10.50 for the seven volumes now ready). The remaining five volumes to be mailed as issued at \$1.50 a volume. If satisfied, I will mail you 50¢ or more each week as payment for the first seven books and I will pay for the last five numbers as I receive them at \$1.50 each.
- PLAN 3—CASH PRICE \$9.98**
Please ship me postpaid "Audels New Electric Library" for which I enclose remittance \$9.98 in full payment for the seven volumes now ready. You are to ship me on one week's trial the remaining five volumes as they are issued for which I will either pay \$1.50 each as received or return to you. This price is based on 5% cash discount.

THEO. AUDEL & CO.,
65 West 23rd St., New York, N. Y.

Please ship me the NEW "Audels Electric Library" on the plan marked (X).

NAME

ADDRESS

OCCUPATION

EMPLOYED BY

HOLD EVERYTHING, SERVICE-MEN,

'til you can see and check this



REVOLUTIONARY SET ANALYZER

A one meter instrument more complete and with greater range and elasticity than any other set tester or analyzer, *regardless of the number of meters employed.*

SUPREME SET ANALYZER MODEL 90

25 TESTING INSTRUMENTS IN 1

BE sure to have your jobber show you this new wonder-instrument. Its marvelous range and elasticity, its multiplicity of tests and functions will prove astounding. To those accustomed to other set testers and analyzers it will prove a revelation in *completeness, thoroughness, simplicity and beauty.*

And still it is available at the cost of ordinary Set Testers—Priced only \$78.50 Net to Dealer. Note just a few of its features:

79 Distinct readings and ranges available—as compared with a maximum of 20 in nearest approaching competitive instruments.

22 Distinct ranges for external use—against a maximum of 13 in other instruments—and obtained with only 3 connections compared with 7 to 16 connections required in other set analyzers.

All Pentode, screen grid and overhead heater type analyses and tests made **WITHOUT ADAPTERS OR EXTRA LEADS.**

Measures screen grid current and Pentode current.

Tests helium non-filament rectifier tubes.

Measures resistances and capacities.

Measures reactance of choke coils from 2 to 100 henrys.

May be used as output meter on any type of radio, meter adaptable for output impedances ranging from 1,000 to 35,000 ohms.

Provides high and low resistance continuity tests.

READS GRID TO PLATE VOLTAGES.

Meter measures alternating voltages at 1,000 ohms per volt.

ONLY SET TESTER OR ANALYZER PROVIDING READINGS OF ALTERNATING CURRENT IN MILLIAMPERES.

Supreme analyzer plug eliminates the need for extra leads and adapters.

Battery for continuity testing enclosed and protected, preventing accidental shorts and loose connections. Ordinary flash light cells, readily obtainable everywhere, employed.

PARTICULARLY ADAPTED FOR TESTING AUTO RECEIVERS

METER RANGES

- A. C. Voltage 0/3—0/9—0/30—0/90—0/300—0/900.
- D. C. Voltage 0/3—0/9—0/30—0/90—0/300—0/900.
- A. C. Milliamperes 0/3—0/9—0/30—0/90—0/300.
- D. C. Milliamperes 0/3—0/9—0/30—0/90—0/300.

All scales read with utmost ease—no complication—no guesswork.

Twice the efficiency of any other set analyzer with greater speed and simplicity.

"ONLY ONE METER TO READ"

Most good distributors carry the complete line of Supreme Instruments in stock. If yours cannot supply you, use inquiry coupon to right, being sure to specify which "Supreme" instrument you are interested in.

SUPREME INSTRUMENTS CORP.
Greenwood, Miss.

Distributors in all principal cities

Service Depots in New York, Philadelphia, Pittsburgh, Chicago, Kansas City, Seattle, Toronto, San Francisco.



Size 4 1/4 x 9 1/4 x 1 1/4, Weight 6 lbs. Dealers Net Price, F. O. B. Greenwood, Miss. **\$78.50**

"SUPREME BY COMPARISON"

Simplify your choice of testing instruments—assure "Supreme" results—standardize on "Supreme" Instruments.

SUPREME DIAGNOMETER.....	\$139.50
SUPREME SET ANALYZER.....	78.50
SUPREME TUBE TESTER.....	98.50
SUPREME TUBE CHECKER—Model 17.....	21.75
SUPREME TUBE CHECKER—Model 19 Counter types.....	26.95
Portable types.....	29.95
SUPREME OHMMETER.....	18.50

SUPREME INSTRUMENTS CORP.,
376 Supreme Bldg.,
Greenwood, Miss.
Please give full particulars on

Name.....
Firm Name.....
Street Address.....
City..... State.....