

MAR. 1925 **RADIO** 35 CENTS
BROADCAST



A GOOD FOUR TUBE RECEIVER
Choosing a B-Battery Eliminator
Who Is To Pay for Broadcasting and How



Selections from Carmen

says the broadcasting announcer, and in a moment you are transported to old romantic Spain, to enticing, sunny Seville. That is but one of the endless joys of radio owning. For the full enjoyment of modern life, radio has become a necessity. For full enjoyment of radio, you will find Cunningham Tubes essential.

Since 1915—Standard for all sets
Types C-301A C-299 C-300 C-11 C-12

In the orange and blue carton



Cunningham ★ **RADIO TUBES**

Home Office: *E. J. Cunningham Inc.*
182 Second St.,
SAN FRANCISCO

CHICAGO
NEW YORK

Patent Notice: Cunningham tubes are covered by patents dated 2-18-08, 2-18-12, 12-30-13, 10-23-17, 10-23-17, and others issued and pending. Cunningham 40-page data book fully explaining care and operation of Radio Tubes now available by sending 10c in stamps to San Francisco Office

★ Tested and approved by RADIO BROADCAST ★

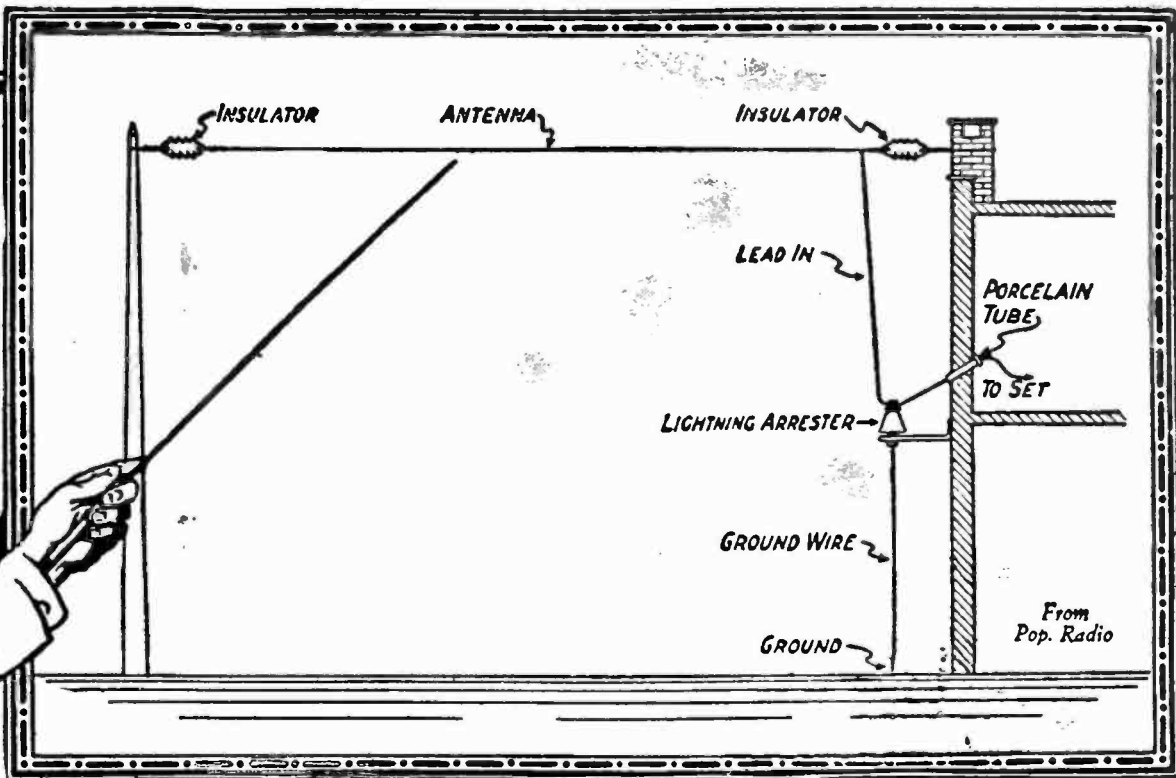

The Secret of a Good Aerial Is the Protective Enamel Coating

RAUDIO AUTHORITIES agree that ordinary bare aerial wire deteriorates rapidly when exposed to atmospheric fumes and moisture. High-frequency currents in the aerial always flow along the surface of the wire, and when this surface becomes corroded, the aerial current encounters great difficulty in reaching the radio set. This means considerable loss of range and volume.

Beldenamel Stranded Aerial Wire is made of bright, clean copper strands, each covered with a protective, baked-enamel coating. Atmospheric exposure, even for years, has no effect on Beldenamel and corrosion cannot take place to reduce signal strength. Follow the advice of acknowledged radio authorities, and replace your aerial with Beldenamel Aerial Wire. Do it now, and hear the difference.

For Best Results

the aerial and lead-in should be a continuous length of Beldenamel Aerial Wire. Use a 150-foot length furnished in standard Belden carton and avoid all joints.

Free Booklet



Belden Manufacturing Company
2312A S. Western Ave., Chicago

I want a *real* aerial for my set. Please send me your booklet describing Beldenamel Aerial Wire and other Belden Radio Products.

Name.....

Address.....

Results will be better anyway. Power lines in close proximity to an antenna cause a shadowing effect or an absorption effect and sometimes both.

Corroded Antenna Wire Causes Weak Signals

If your antenna has been up for a year or more the chances are that the surface of the antenna wire has become corroded due to the action of the weather. Radio frequency currents travel on the surface of the wire and often the weakening signals carried by them is due to this corrosion. This trouble is particularly prevalent in large cities where the atmosphere is contaminated with sulphur fumes and other chemicals from manufacturing plants.

Enamelled wire is excellent for antennas as the enamel protects the surface of the copper from the gases and other corrosive elements in the atmosphere

Clipping from Popular Radio



Belden

Manufacturing Company
2312A S. Western Avenue • Chicago

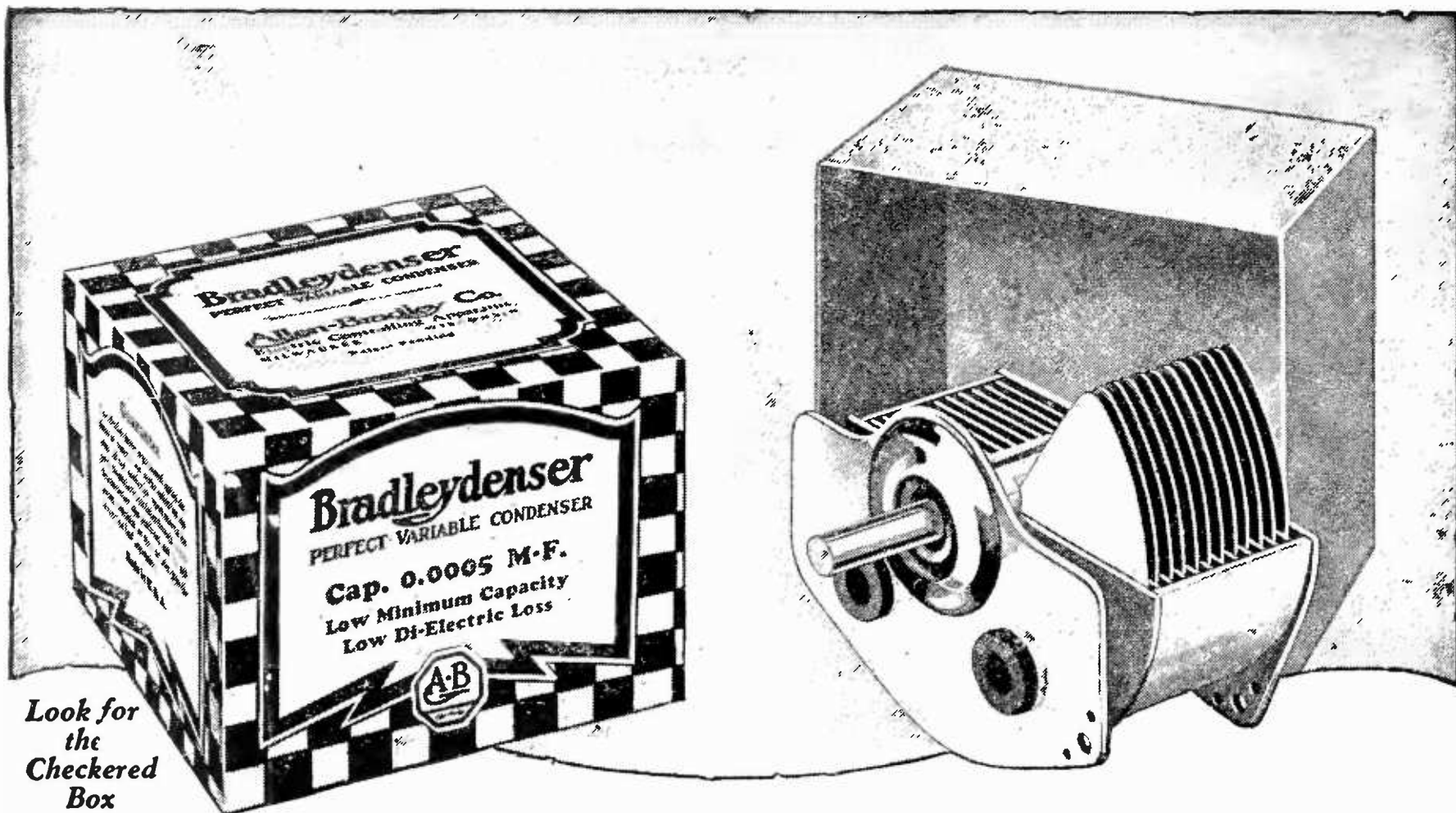

Look for
the
Checkered
Box

Brass Plates — Soldered Joints — Grounded Rotor Are Standard Features of the Bradleydenser

The Bradleydenser is a low-loss condenser with many distinctive features that insure long life and high efficiency. For instance, the brass stator and rotor plates are soldered at all joints. The plates cannot become loose, corrode at the joints or work out of alignment. The rotor is mounted on a long sleeve bearing that supports the rotor plates without the use of an outer end-plate. Therefore, the di-electric material is reduced to two small buttons. This means low loss and sharp tuning.

The stator plates are protected with a dust cap that can be detached without tools. The minimum capacity is extremely low, and body capacity effects are greatly reduced. The entire design makes for the highest efficiency in radio receivers.

*Build for
Efficiency*



Allen-Bradley Co.
Electric Controlling Apparatus
278 Greenfield Ave. Milwaukee, Wis.

*Use the
Bradleydenser*

This filter tuner with resistance-coupled audio amplifier is equipped with Bradleydensers. The tuning is very sharp and selective.

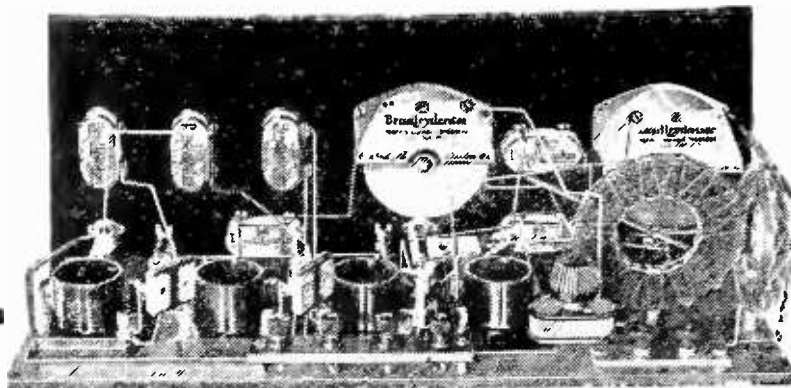

Send for the latest information on the Bradleydenser. It will pay you to know about this remarkable low-loss condenser before planning your next radio set.

★ Tested and approved by RADIO BROADCAST ★

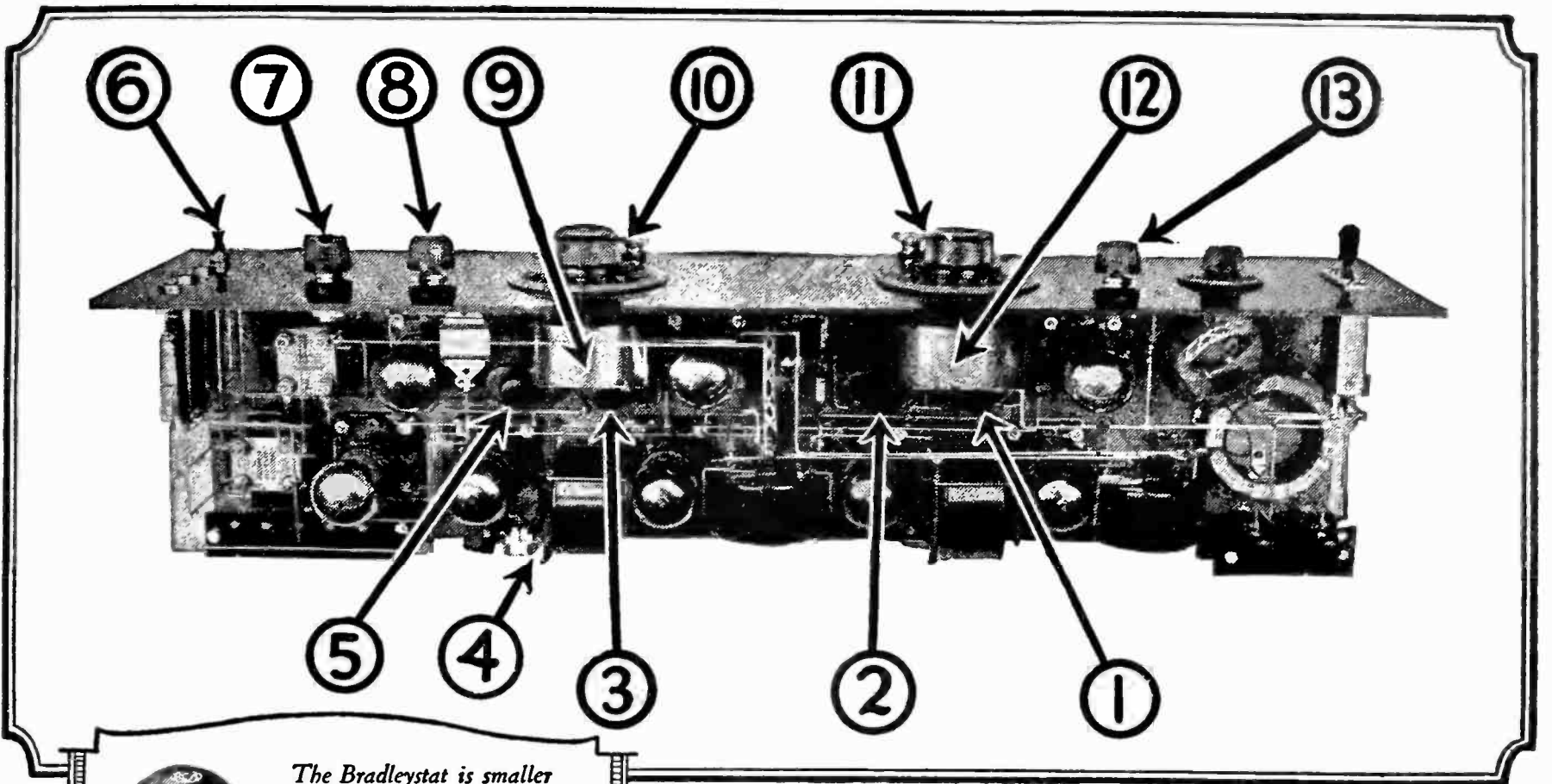

The Bradleystat is smaller than the UV-199 or C-299 tubes. It is much smaller than the 6-volt tube.

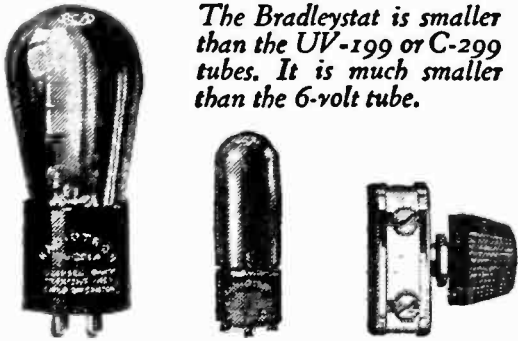

Bradleystat

PERFECT FILAMENT CONTROL

For All Sets and Tubes

Graphite Discs provide smooth control

Observe the compact construction of the Bradleystat, shown below. Note the two columns of graphite discs, the pressure screw and the internal switch. Only two terminals, and yet the range is from approximately 1/4 ohm to 100 ohms. The entire range is stepless and noiseless.

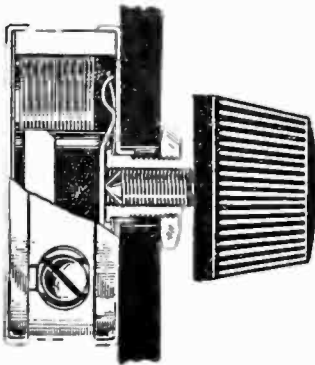

The new Bradleystat has taken the radio world by storm. Thousands of radio fans have replaced their old wire rheostats, even in ready-built sets, with Bradleystats to get noiseless, stepless control, so essential in every radio set. The new Bradleystat is so compact, and the "one-hole" mounting so simple and convenient, that it is but a moment's work to install the new unit. Furthermore, a Bradleystat-equipped set can use any tube without change of rheostats or connections.

The super-heterodyne receiver, shown above, is equipped with Bradleystats at 1, 2, 3, 5, 8, and 13. Within the set, they are mounted on the baseboard; the others are on the panel. A Bradleyleak is used at 4, a Bradleyswitch at 6, and a Bradleyometer at 7. Bradleydensers are used at 9 and 12, and micrometer dial control is obtained with Bradleyniers at 10 and 11. This Allen-Bradley-equipped set is typical of thousands of multi-tube sets using the new Allen-Bradley line for maximum efficiency. Build for better radio by following this example.



Allen-Bradley Co.

Electric Controlling Apparatus

278 Greenfield Ave.

Milwaukee - Wisconsin

Mfrs. of Graphite disc rheostats for over 20 years

ALLEN-BRADLEY CO.
278 Greenfield Ave., Milwaukee, Wis.

Please send me the latest literature, describing the entire Allen-Bradley line of superior radio devices.

Name.....

Address.....

.....



★ Tested and approved by RADIO BROADCAST ★

THE NEW MODEL C-7

"The Rolls-Royce of Reception"



MODEL C-7 SUPER-HETERODYNE

Wave-length Range, 200 to 575 meters. Dimensions, 40 in. x 8 in. x 8 in.
 Tube Arrangement: Regenerative Detector, Oscillator, 2 Stages Radio, Detector, 2 Stages Audio

Important To-day

THE EXPERIMENTERS INFORMATION SERVICE, Inc., has been recommending the Super-Heterodyne method of reception since the early part of 1922. In February, 1923, a Super-Heterodyne of our design was installed on the *S.S. Western World*, pier 1, Hoboken, N. J., in the cabin of Dr. Horatio Belt. On the voyage to Rio de Janeiro, Brazil, at a distance of 3,000 miles, southeast of New York, the entire Greb-Gardner fight was received from WJZ, with sufficient audibility for the entire cabin full of passengers to hear the bout, blow by blow, plainly. At 3,300 miles southeast of New York, an entire evening church service was received from Pittsburgh. At that time there was not another single firm advertising or advocating the Super-Heterodyne. Since then Mr. A. Ancieux, Engineer, Trarivia Elec de Arequipa, Arequipa, Peru, has reported consistent reception from KDKA, WDAP, WEAJ, WGY, and others, a distance of over 5,000 miles, using a Model "C" Super-Heterodyne. The Pratt & Brake Corp., of New York City, sent a Model C to Rio de Janeiro which received American broadcast stations at a distance of over 7,000 miles.

Practically all concerns now featuring Super-Heterodyne have copied our original Model C design, and to prove again that we are far in advance of competition, we present this Improved Model C-7 Super-Heterodyne as the *Most Sensitive, Most Selective*, and finest reproducing Broadcast Receiver that can be built.

7 Tubes Give the Results of 10

The Reason—When regeneration is added to a one tube non-regenerative receiver, the increased amplification is about equal to adding two stages of tuned radio frequency amplification. Heretofore it has been impossible to add regeneration in the 1st Detector of a Super-Heterodyne and accordingly this has been a big loss.

The new Model C-7 Super-Heterodyne has a special 1st Detector circuit with a split antenna inductance so arranged that normally the detector would oscillate continually. However, in addition, a neutralizing condenser is inserted in the circuit, which gives absolute control of the oscillations to such an extent that the circuit can be adjusted to just below the oscillating point, as this adjustment gives the maximum regenerative amplification. The new circuit has a bias potential on the 1st Detector grid, in place of the usual grid leak and condenser, and this allows infinitely weak signals to be regenerated and heterodyned through the radio frequency amplifier, which an ordinary grid leak and condenser would block. On a weak signal the difference in sensitivity is very noticeable. Using a 22-foot indoor antenna in the suburbs of New York loud speaker reception has been obtained from KGO, Oakland, California. A normal range of 2,000 miles is easily obtained on an average small antenna at night under average conditions.

Original Blue Print showing all data, diagrams, circuits, details, etc., \$1.00, postpaid

EXPERIMENTERS INFORMATION SERVICE, Inc.

476 Broadway, New York City



Designers of the Highest Class Radio Apparatus in the World

New Book, "Modern Radio Reception," by Charles R. Leutz, 325 Pages, 200 Illustrations, \$3.00 Postpaid

★ Tested and approved by RADIO BROADCAST ★



TRADE MARK REG.

"The Perfect Broadcast Receiver"

A New Superior Broadcast Receiver

Simple—Long Range—Highest Quality
Non Radiating—Non Regenerative

*Two Stages Tuned Radio Frequency-Detector
and Three Stages of Audio
Frequency Amplification*

\$60.00

Completely Constructed
Without Accessories



PLIODYNE 6
Front View Showing Simplicity of Control

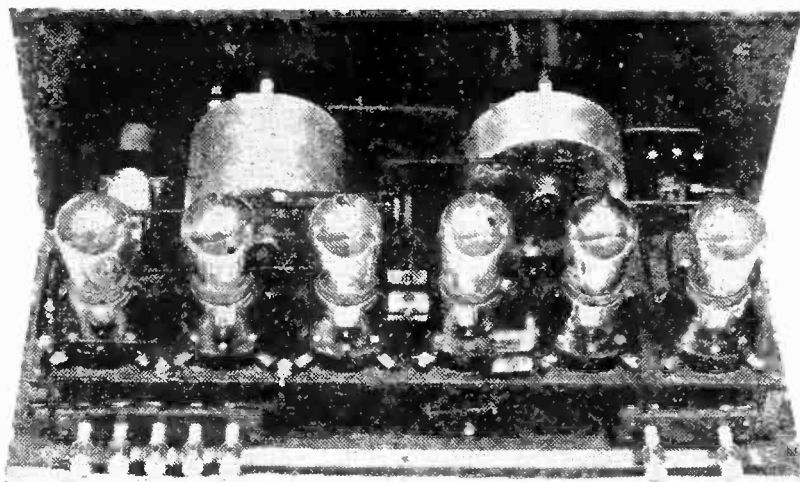

PLIODYNE 6
Interior View Showing Compact and Efficient Design

Sold Direct From Manufacturer to Consumer Only

Sent C. O. D. Subject to Examination

Our Guarantee

We guarantee every GOLDEN-LEUTZ "Pliodyne 6" to be the finest broadcast receiver that can be manufactured using 6 tubes or less and to be satisfactory to you in every way and to reach you in perfect condition.

You take no risk whatever in sending us your order, for unless you are completely satisfied with the receiver and with your saving you may return the receiver to us and we will refund your money.

GOLDEN-LEUTZ, Inc.

476 BROADWAY

NEW YORK CITY

LICENSED UNDER FARRAND AGREEMENT AND HOGAN PATENT NO. 1,014,002

★ Tested and approved by RADIO BROADCAST ★

Somerset

QUALITY

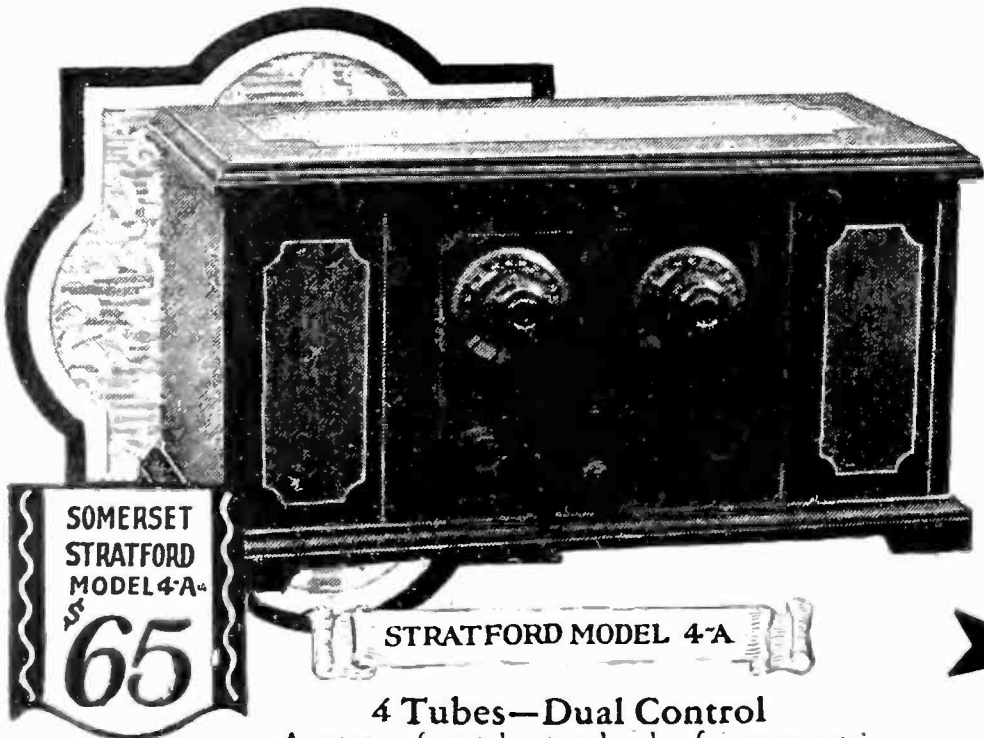

SOMERSET
STRATFORD
MODEL 4-A

\$65

STRATFORD MODEL 4-A

4 Tubes—Dual Control

A superior four tube, tuned radio frequency receiver—two dial control—operates on storage battery or dry cells. Automatic filament control insures long life of tubes. The finest "low loss" condensers and the famous SOMERSET Calibrated Transformers are features. "A" and "B" battery space is provided in the handsome two-toned mahogany finish cabinet. Size 21"x15"x11".....List \$65



SOMERSET Radio Receivers have leaped into popularity immediately because they bear unmistakable evidence of superior quality, design and value—the most for the money that has ever been offered in radio. Remarkably sensitive and selective, they reach far out to get broadcast programs from incredible distances, reproducing them with precise fidelity and rich mellow tone. Infinite care with the "tremendous trifles" which are essential to fine reception has placed Somerset Radio Receivers in a class by themselves.

Make the Acid Test Yourself

COMPARE these big beautiful instruments of precision, feature for feature, with any other radio receivers at or near their price—*bar none*. The Somerset line

consists of four models—Stratford Model 4-A, 4 tube set, 2 dials \$65; Mars Model 5-A, 5 tube set, 3 dials, \$75; Shelbourne Model 4-B, 4 tube set, 1 dial, synchronized control, \$85; Standish Model 4-C 4 tube set, 1 dial, synchronized control, built-in loud speaker, \$150.

SHELBOURNE MODEL 4-B

4 Tubes—Single Dial Control

Our perfected tuned radio frequency circuit with single dial synchronized control. Storage battery or dry cell operation, automatic filament control, the finest "low loss" condensers, and the famous SOMERSET Calibrated Transformers are features. Compartments for large sized storage "A" and dry cell "B" batteries. Mahogany finished cabinet hand rubbed two-tone effect. Size 27"x15"x12" List \$85

SOMERSET
SHELBOURNE
MODEL 4-B

\$85

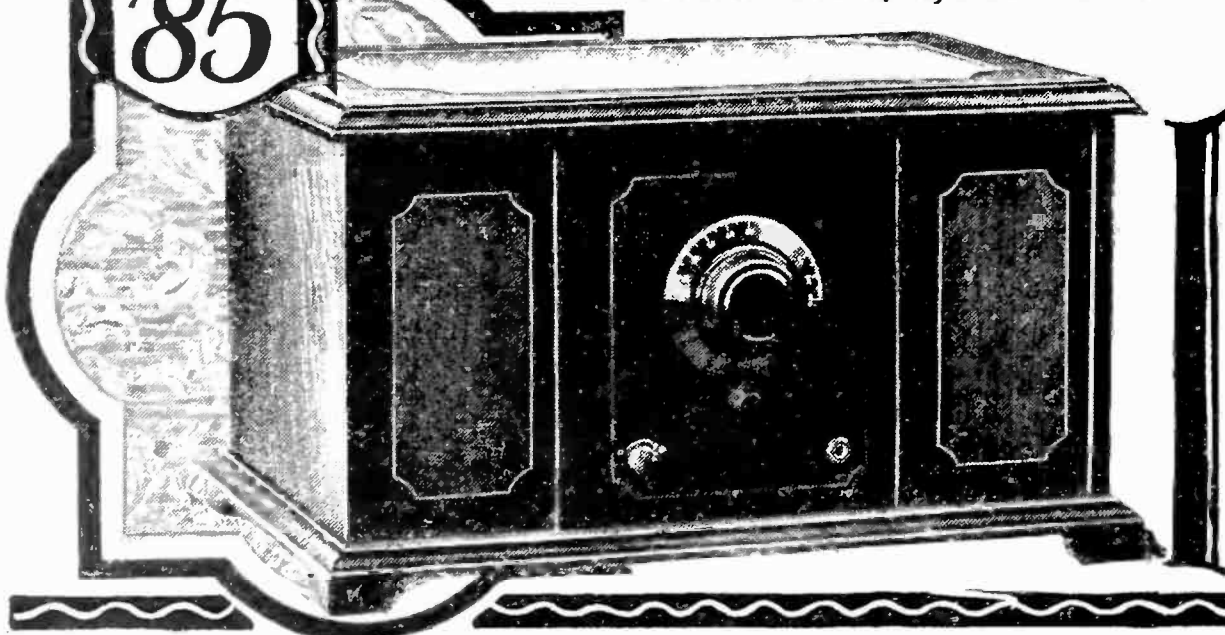

Real Values

Somerset Prices are
Honest Prices

Each Somerset Radio Receiver represents the best that can be produced for the money—the utmost in results and permanent satisfaction to the owner. Compare them, feature for feature, with any other at or near their price range—*bar none*. Fill out and mail the coupon for full information about these splendid instruments. Don't put it off—send today.

Low Prices

Somerset Radio Receivers

Radio

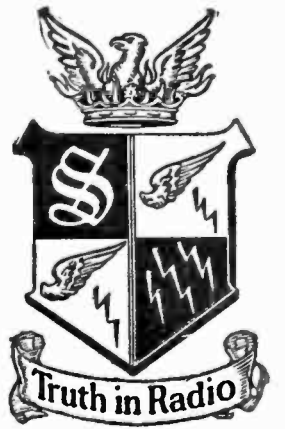

at a Price!

SOMERSET Radio Receivers are unique—in cabinet design, mechanical features, and technical superiority. In simplicity of operation, range, selectivity and tone they have set a new standard. The single dial synchronized control, featured on the Shelbourne and Standish models is made possible only by the most painstaking selection and matching of coils, condensers and transformers. Somerset cabinets in artistic two-toned hand rubbed mahogany finish are equally notable. And every Somerset Radio Receiver bears a tag certifying that it has been thoroughly tested by the Somerset Engineering Laboratories.

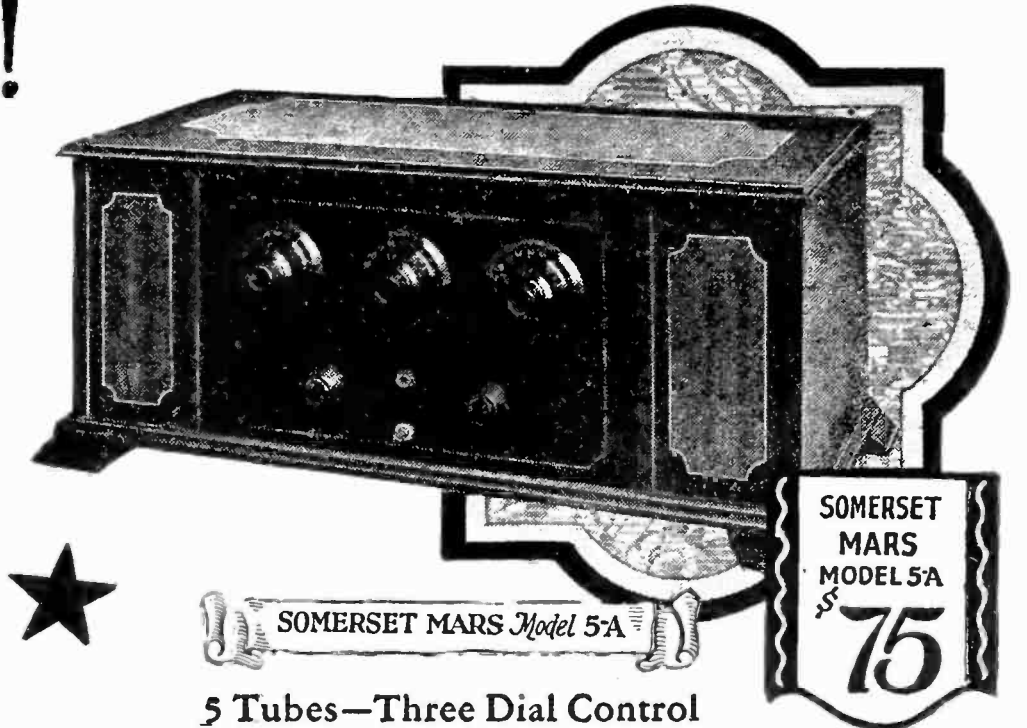

SOMERSET MARS Model 5-A

SOMERSET MARS MODEL 5-A \$75

5 Tubes—Three Dial Control

Two stages tuned radio frequency, detector, and two stages audio frequency Storage battery or dry cell operation, automatic filament control, highest quality "low loss" condensers and the famous SOMERSET Calibrated Transformers. Artistic cabinet hand-rubbed mahogany finish, providing space for "A" and dry cell "B" batteries. Size 29"x14"x12". List \$75

The Famous Somerset Guarantee

“YOU must be satisfied with your Somerset Radio Receiver or we do not want you to keep it. If for any reason you feel that it is not exactly as represented or that it has not the quality and value which you have the right to expect, we want you to return it for exchange or for refund, whichever you prefer. We will cheerfully and promptly make good any Somerset product which does not fully measure up to your expectations.”

4 Tubes—Single Dial Control with built-in loud speaker

Combining a built-in loud speaker of the highest type and the four tube tuned radio frequency circuit with single dial synchronized control—all the latest and best in radio Storage battery or dry cell operation, automatic filament control, highest quality "low loss" condensers, and the famous SOMERSET Calibrated Transformers. Ample space is reserved in this cabinet for standard size high ampere hour storage "A" batteries and dry "B" batteries. Exquisite cabinet, antique mahogany finish. List \$150 Size 29"x13"x14".

STANDISH MODEL 4-C

SOMERSET STANDISH MODEL 4-C \$150

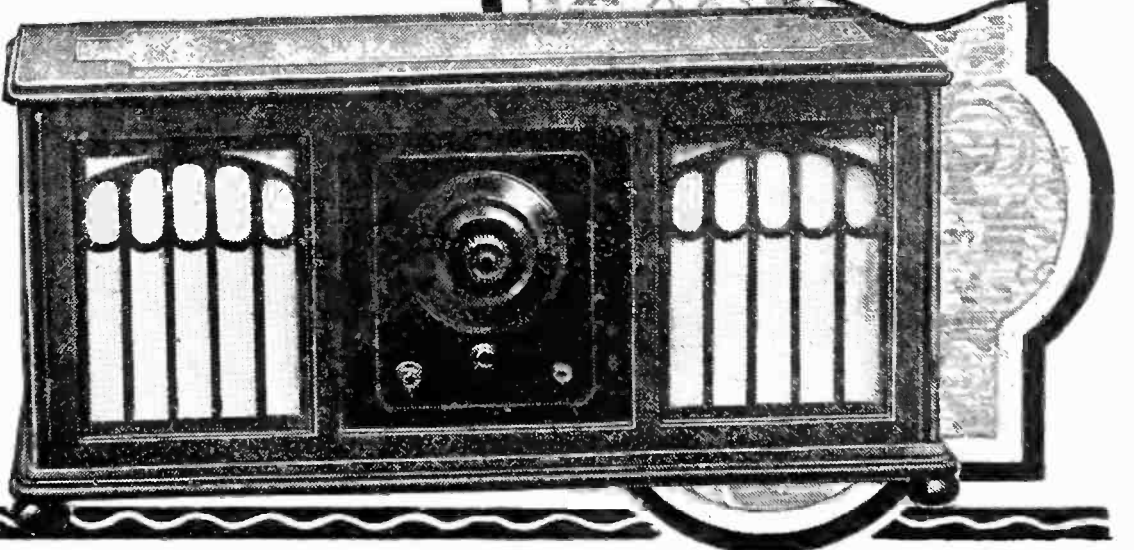

Fill Out

National Airphone Corp.
16 Hudson St., N. Y. City
Without any obligation to me, send me the Somerset Radio Primer and full details of Somerset Radio Receivers.
Name
City
State.....

Mail Today

MFD. by **NATIONAL AIRPHONE CORP.**

16-22 Hudson St.
New York City

Prices subject to change without notice.

Prices West of the Mississippi—add 10%

★ Tested and approved by RADIO BROADCAST ★

Earn \$75⁰⁰ to \$200⁰⁰ a Learn at Home

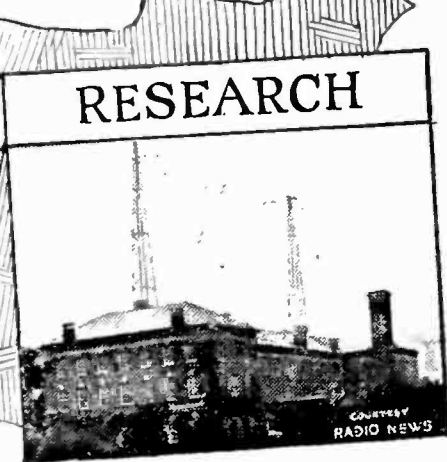
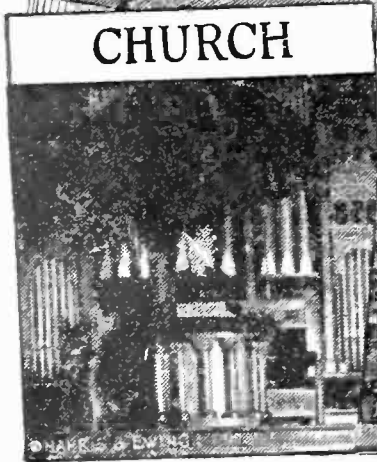
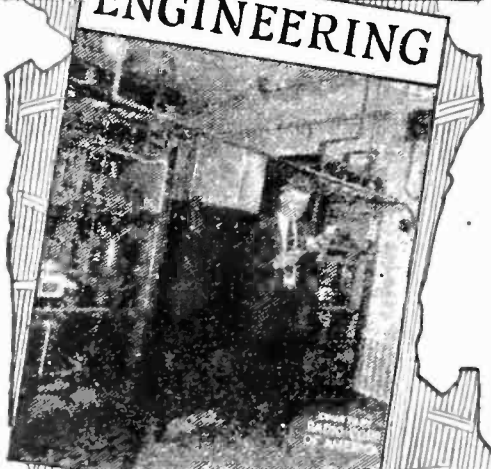
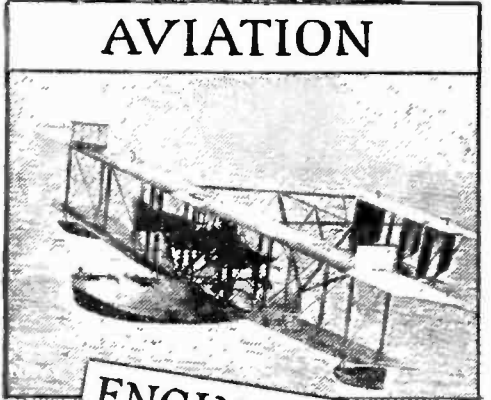
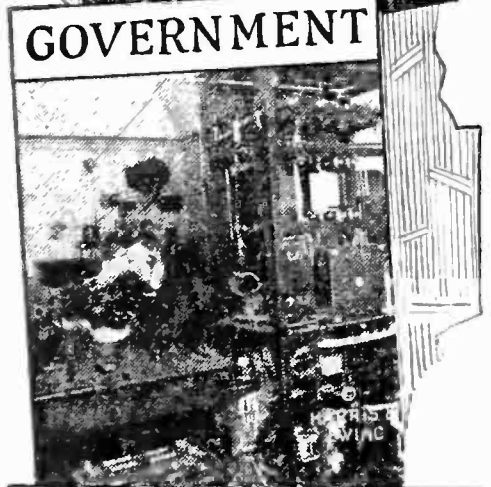
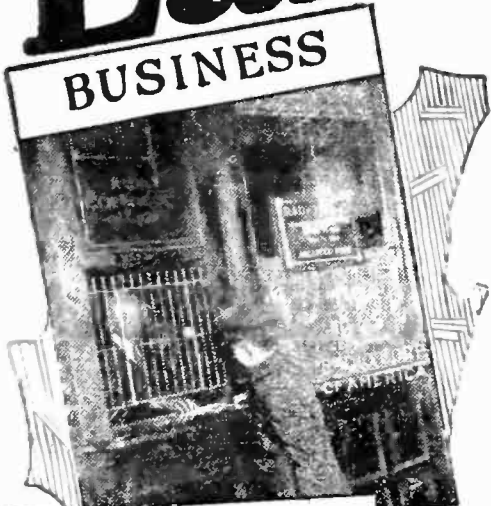

The astounding growth of Radio has created thousands of wonderful opportunities for earning big money. Millions upon millions of dollars are being spent every year since broadcasting has become so popular. Radio is indeed sweeping the world like a forest fire!

A few years ago only a very small number of men were actively engaged in Radio. To-day, with but few exceptions, these men are holding key positions in this marvelous new industry. In the same way, the young men and ambitious boys who get into Radio now will be the leaders a few years hence. The opportunities right now are a hundred times greater than they were ten years ago.

Recognized Radio Experts In Urgent Demand

Trained experts—not just half trained amateurs—are needed for the many big paying positions which have developed as a result of the tremendous expansion of Radio. Broadcasting stations are constantly needing operators, stores are sadly in need of trained experts as salesmen, installers, repair men, demonstrators. Factories need inspectors, assemblers, testers, and executives.

These are just a few of the opportunities. Radio operators on board ship travel all over the world without one cent of expense, see historically important places, meet prominent people on board ship, mingling with the passengers and earning salaries equal to \$200 a month in any land job.

Hundreds of Big Paying Positions Open Right Now - in Radio !

Hardly a week goes by without our receiving calls for our graduates. This is how some of them read: "We need the services of a competent radio engineer"; "We want men with executive ability in addition to radio knowledge to become store managers"; "We require the services of several resident demonstrators."

PROOF!

Pay Increases Over \$100 a Month



I am averaging anywhere from \$75 to \$150 a month more than I was making before enrolling with you. I would not consider \$10,000 too much for the course.

(Signed) A. N. Long,
Greensburg, Pa.

Doubles Salary

I can very easily make double the amount of money now than before I enrolled with you. Your course has benefited me approximately \$3,000 over and above what I would have earned had I not taken it.



T. Winder,
Grand Junction, Colo.

\$3500 First Year



When I enrolled with you I was a "buck private" in the army. No sooner had I received my discharge than I opened a Radio Shop of my own in my home town.

I made over \$3,500 in one year working for myself. Now that I have the N. R. I. course beneath my hat, I wouldn't have missed it for a million dollars.

John P. Zinno,
Corona, L. I.

Week as a Radio Expert in Spare Time

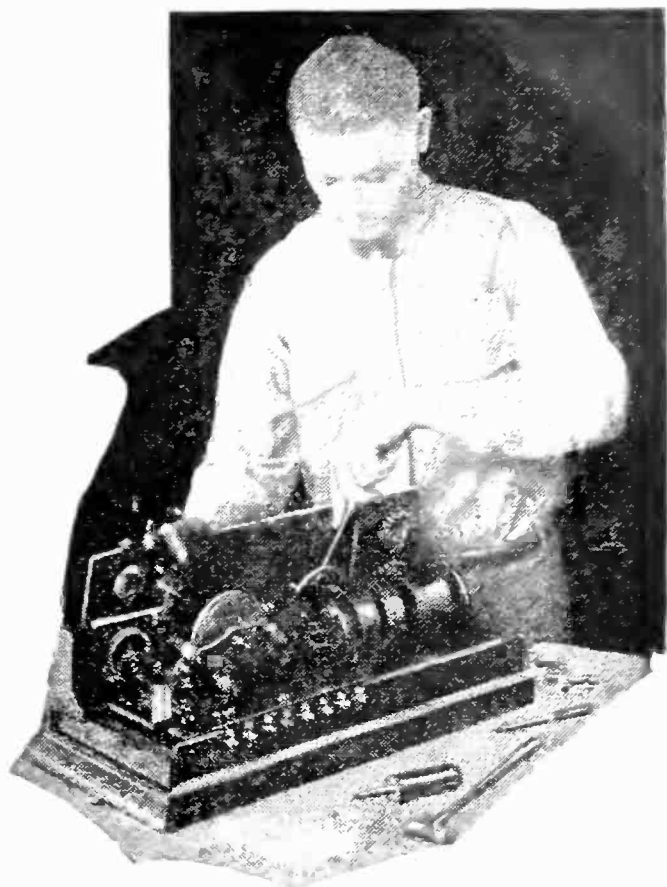

MORE PROOF!

\$405 In One Month

I cleared up \$405 in one month recently. Not so bad—is it—for a fellow who just completed your course a short time ago. I sure have been coining the dough. I never will regret the money I paid for your course.



Emmet Peculiar, Mo.

From \$15 to \$80 a Week



Before I enrolled with you I was making \$15 a week on a farm. Now, I earn from \$2,080 to \$4,420 a year and the work is a hundred times easier than before. Since graduating a little over a year ago.

I have earned almost \$4,000 and I believe the course will be worth at least \$100,000 to me.

(Signed) George A. Adams, Tamaqua, Pa.

Triples Salary

I am earning three times as much as before enrolling and I have clean interesting work that takes me to all parts of the globe. I tell you, boys, it's Radio for me.



Arthur Herke, Vancouver, B. C.

The big radio firms are coming to us for their men—they call on us first because they know that our graduates are one hundred per cent. trained experts—they are Recognized Radio Experts.

Earn Big Money While Learning

No matter if you know nothing at all about radio or electricity, you can easily and quickly become an expert. Age is no drawback. Our method of teaching makes it fascinating and interesting to learn the mysteries of this new science. Instruments for practical training given FREE with this course are shown at the bottom of this page.

Scores of our students earn big money during their spare time after finishing the first few lessons. Mathew Waldron made \$150 in one month—Fred W. Sullivan, of Fall River, Mass., made \$84.60 in three weeks. Many students more than pay for their course in this way—while they are studying.

The National Radio Institute, which has been established since 1914, guarantees to refund every cent of your money if you are not satisfied when you finish the course.

Send for FREE BOOK

We will gladly send you Free, without any obligation on your part, our book, "Rich Reward in Radio," which gives you more facts about the big pay opportunities in Radio, tells you how we prepare you at home in spare time, and about how we are asked to fill hundreds of fine positions every year. No matter what you are doing now—no matter what your plans for the future are—send for this Free Book of wonderful opportunities. Mail the coupon NOW.

NATIONAL RADIO INSTITUTE
Dept. 31EB, Washington, D. C.

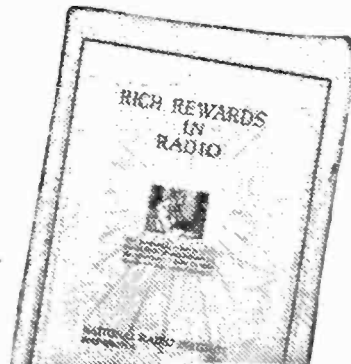

NATIONAL RADIO INSTITUTE
Dept. 31EB, Washington, D. C.

Without any obligation on my part, send me your money, "Rich Rewards in Radio," which tells all about the big-money opportunities in Radio, how spare time study will qualify me as a recognized Radio Expert and also how your Employment Service will help me get a good position.

Name..... Age.....
Street..... Occupation.....
City..... State.....

FREE—for practical training at home

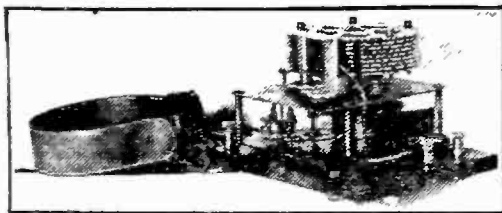

At Left—This is the world-famous Natrometer—one of the three instruments given for scientific and practical home training in mastering the code.

At Right—These parts with instructions are given for experience



and practical training in making and operating regenerative receiving apparatus.

At Left—These parts with complete instructions are given for practice in building a receiving set of the more simple kind.



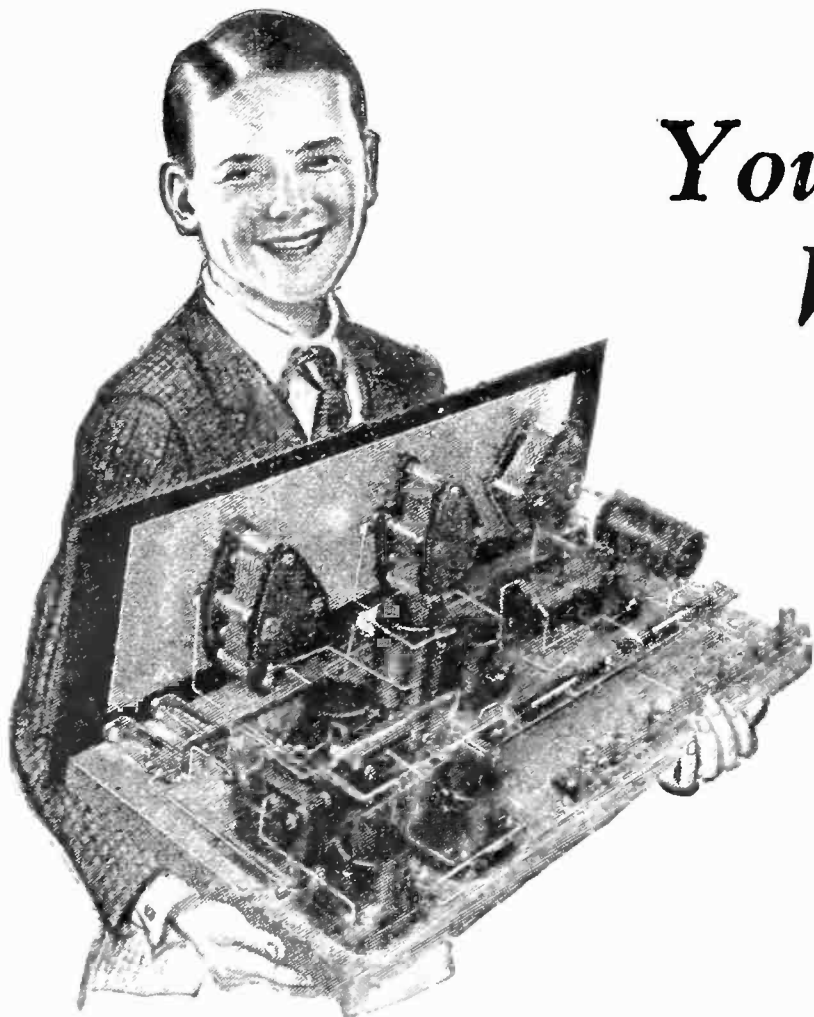

*You Like it Better
When You Build it
Yourself* ★

THE 5-TUBE
THOMPSON
NEUTRODYNE

KNOCK-DOWN SET
LICENSED TYPE K-40

THE American boy is a natural-born builder. His imagination—his inherited constructive spirit—craves a worthy objective.

There is nothing that so satisfies the natural creative ability of American boys—young and old—as the building of a radio set; for when a radio is finished it brings to the boy the world's best entertainment and education from far and near.

Many of the achievements in modern radio reception have been made by young men who a few years ago built radio sets, listened to code messages, and were the first to listen in when speech and music were first broadcast.

Building a radio receiver is a happy event in *any* boy's life.

The Thompson Knockdown Licensed Neutrodyne Set contains parts that have been developed by famous radio engineers of many years experience. The perfectly designed and perfectly matched Thompson parts are in no way similar to ordinary parts. Thompson neutroformers and audio transformers, that have made the Thompson quality of tone reproduction famous, cannot be bought separately.

The Neutrodyne circuit, which was designed since present-day broadcasting was perfected, plus Thompson experience of many years in radio, make the results from Thompson Knockdown Set superior to any Knockdown Set on the market. It is easy to assemble.

*All Parts included in Case
No drilling necessary*

All parts, (except batteries and tubes) needed to assemble the Thompson 5-tube Neutrodyne Knockdown Set are packed in a case with the Thompson 16 page instruction booklet.

This booklet contains easily understood building directions together with photographs, diagrams and actual size blueprints—everything to make building a Thompson Knockdown Set about the easiest thing you have ever tried.

The Thompson Knockdown Set is only \$72 at good radio stores.

**R. E. THOMPSON
MANUFACTURING CO.**

Maker of Thompson Neutrodyne Radio Receivers and the Thompson Speaker.

30 CHURCH ST., NEW YORK, N. Y.

"Experience is the Vital Factor in Excellence"

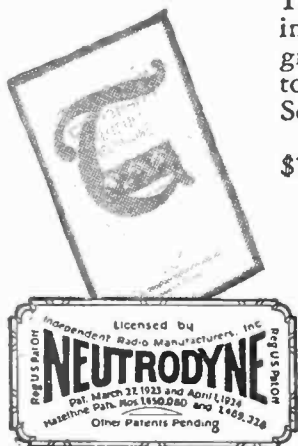
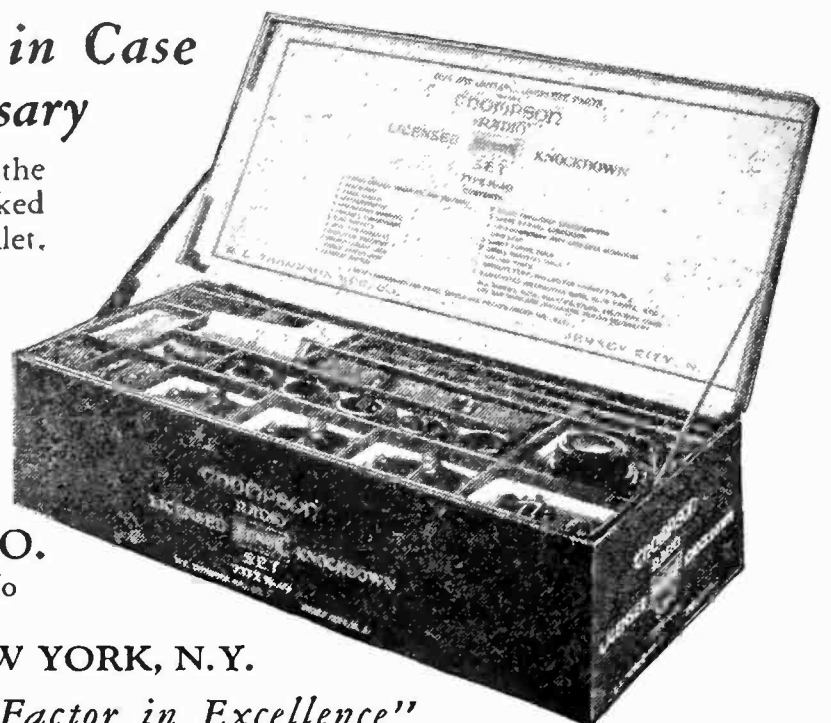

★ Tested and approved by RADIO BROADCAST ★

DE FOREST
Leads again

Another jump ahead!
Just out—First in 1925

DE FOREST'S greatest triumph. A truly remarkable advance in ease of operation—beauty of tone—selectivity—distance range. It uses tube detector instead of crystal.

You should see and test this instrument before you buy any set. Its refinements and improvements are too many to tell here.

Ask your nearest De Forest dealer to bring it to your home and show you how simply and perfectly it operates. It will be hard for you to let him take it away.

Price range, \$125 to \$200

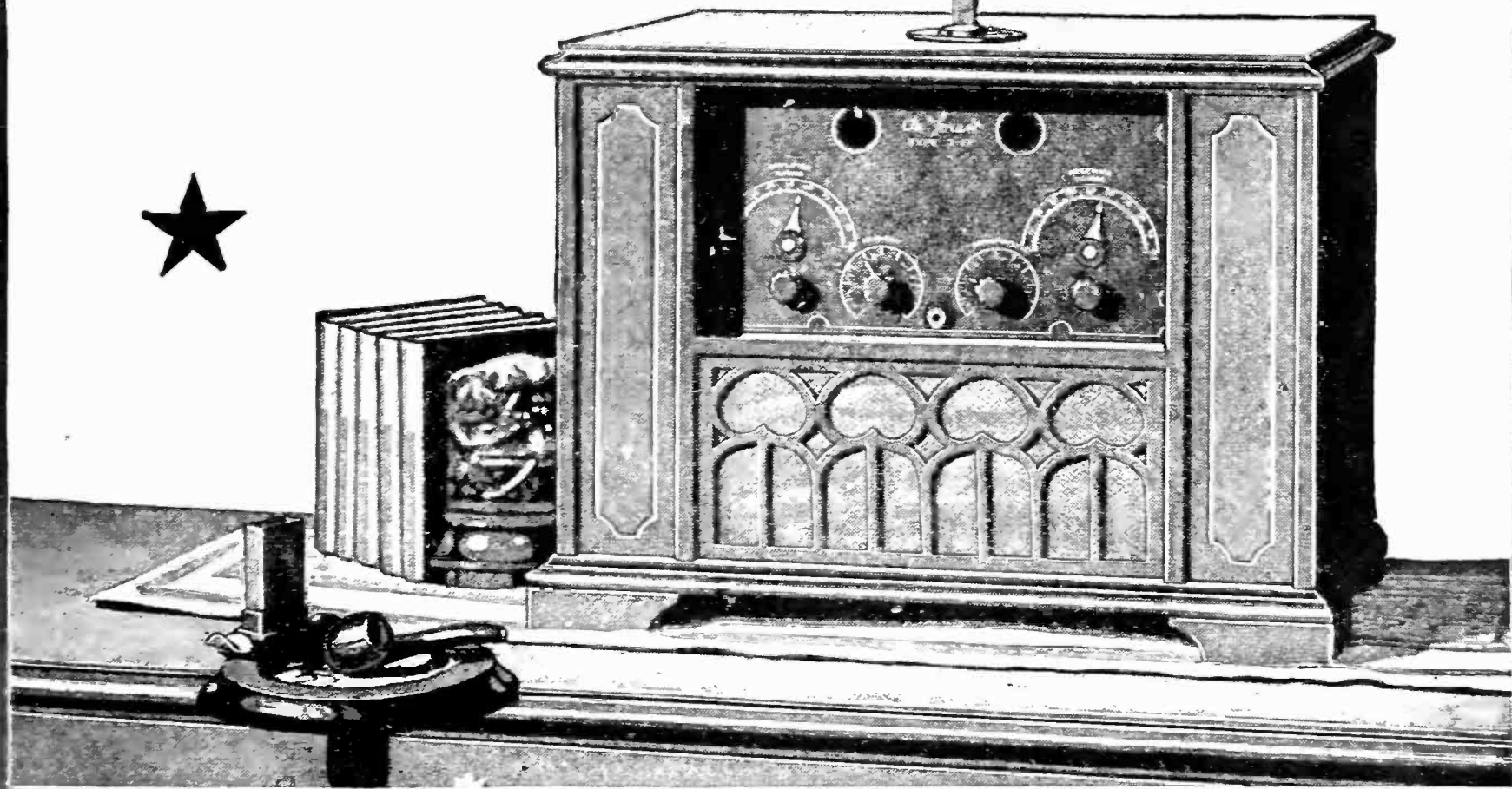
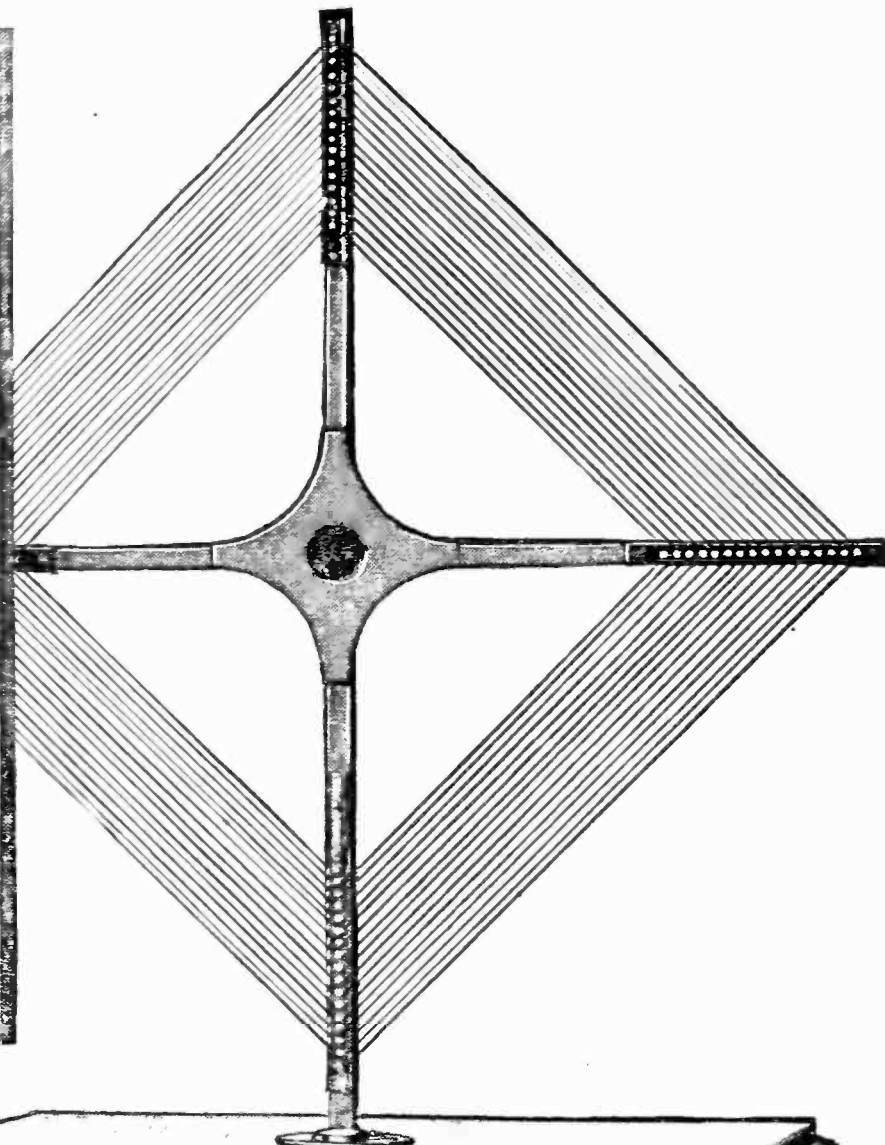

THE NEW
DE FOREST D-17

REG. U.S. PAT. OFF.

De Forest Radio Company, Jersey City, N. J.

★ Tested and approved by RADIO BROADCAST ★

New Model Tungar charges all batteries

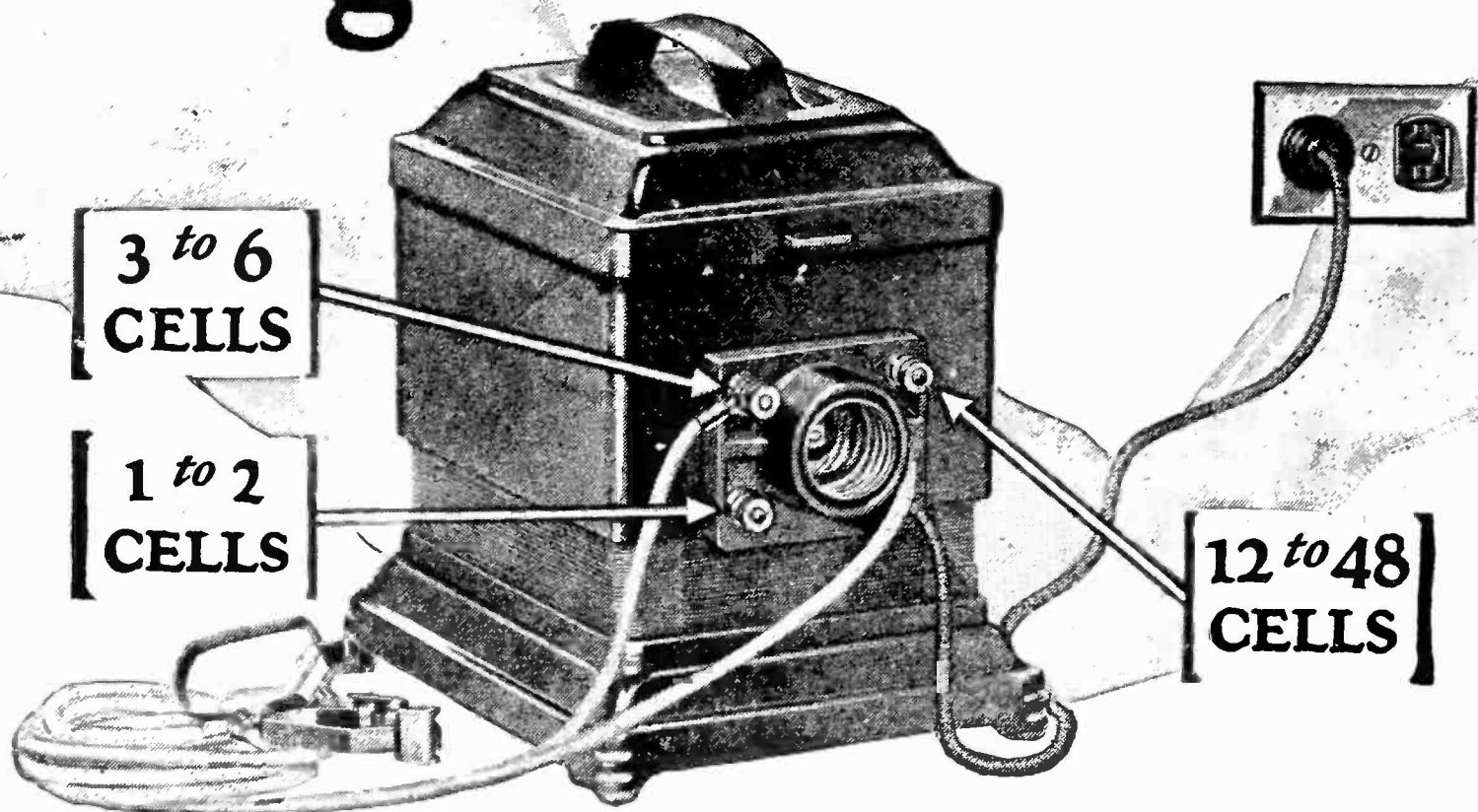

On the back of the Tungar, there are three terminals. Slip the wire into one and charge your radio "A" battery, 2 or 4 volt size. Use the second to charge your radio "B" battery, 24 to 96 volt size. Or the third will charge a 6 volt "A" battery or 6 to 12 volt auto battery.

Just clip on the Tungar, and plug it into any electric outlet in the house or garage. Then leave it overnight to charge while you sleep. Very simple.



The Tungar is a G-E product, developed in the great Research Laboratories of General Electric.

The New Model Tungar charges radio A and B storage batteries, and auto batteries. Two ampere size (East of the Rockies) \$18.00

The Tungar is also available in five ampere size (East of the Rockies) . . . \$28.00

60 cycles—110 volts

Tungar
Reg. U. S. PAT. OFF.
★ **BATTERY CHARGER**

Tungar—a registered trademark—is found only on the genuine. Look for it on the name plate.

Merchandise Department
General Electric Company
Bridgeport, Conn.

GENERAL ELECTRIC

★ Tested and approved by RADIO BROADCAST ★

GENERAL RADIO

Rheostats and Sockets mean higher tube efficiency

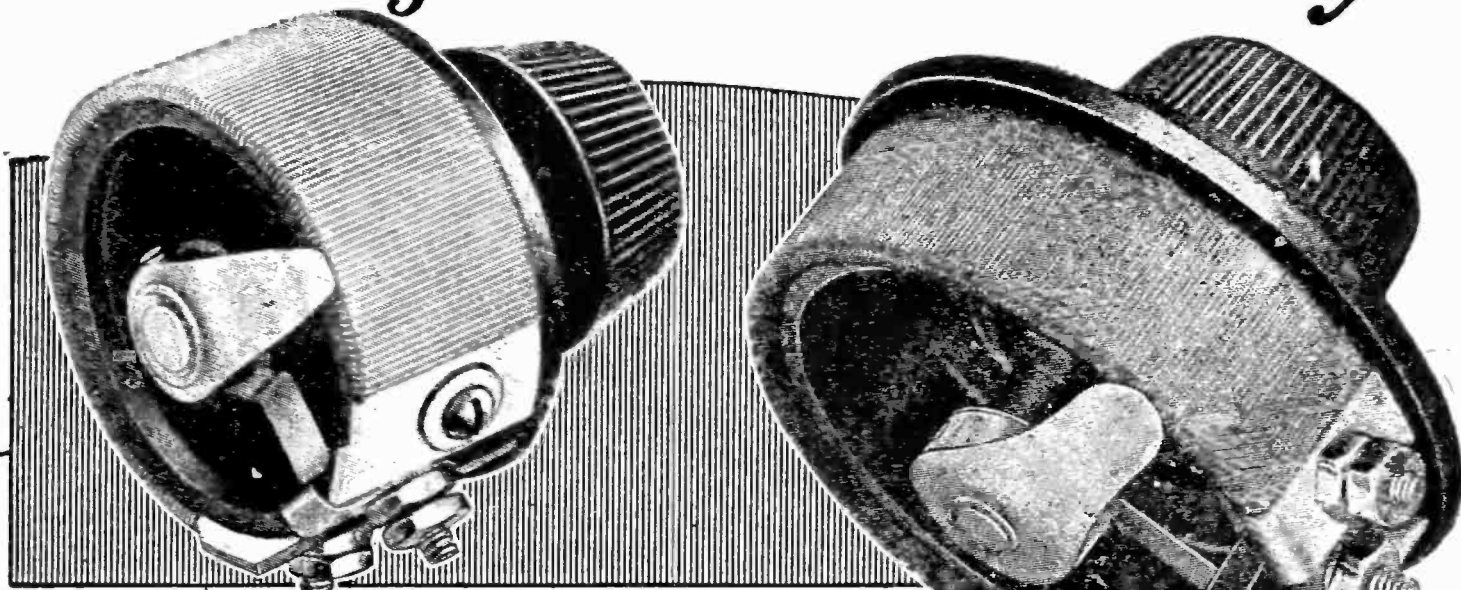

Type 301
10 and 30 Ohms
Price \$1²⁵

Type 214
2-7-20
and 50 Ohms
Price \$2²⁵

General Radio Rheostats Are Smooth Running and Uniform

THERE is only one way to operate tubes at their peak of efficiency—by the use of properly designed rheostats and sockets. In building your set, remember that vacuum tubes are important factors in successful radio reception, and require rheostats which provide a gradual and uniform resistance control over the filament.

General Radio Rheostats are smooth running, uniform, and capable of very minute variations. Many of the well-known manufacturers of receiving sets have chosen General Radio Rheostats and Sockets as standard equipment because of their high efficiency in tube operation. Why not use them in the next set you build, and get more out of your tubes?

Sold at all good radio stores
Write for New Radio Catalog 920



The red cartons with the General Radio label are your unfailing assurance of satisfaction.

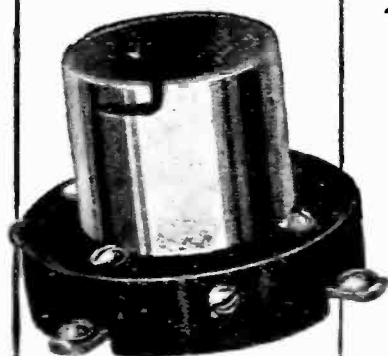

Type 156

For all standard base tubes. A positive wiping contact is made to the side of the tube prongs by double spring terminals. These terminals hold the tube firmly and prevent vibrations. Price \$1⁰⁰

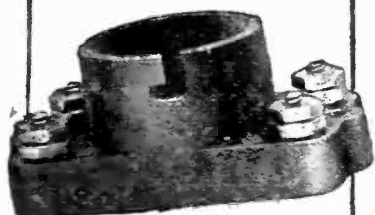

Type 299

For UV-199 Tubes. This socket is a particularly high-grade socket of moulded bakelite. Contact is made to tube prongs by phosphor bronze terminals with double leaf blades. Price 50c.

GENERAL RADIO Co.

Cambridge, Mass.



★ Tested and approved by RADIO BROADCAST ★



IMPROVE YOUR SET!

The sure way to do it is to rebuild the audio side and use a pair of AmerTran. Do this, and the utmost in volume, clarity and tone quality will result.

AmerTran is the product of over twenty-four years' specialized experience in transformer building.

Increasing appreciation of its quality comes with continued use.

AmerTran is made in two types, one quality—
A F 6—ratio 5:1 and A F 7—ratio 3½:1

Buy them by the pair!

AMERICAN TRANSFORMER COMPANY

181 EMMET STREET, NEWARK, N. J.

"Transformer builders for over twenty-four years"



Price either model
\$7.00
at your dealer's

AMERTRAN
TRADE MARK REG. U.S. PAT. OFF.

Send for leaflet
giving useful
amplifier information

★ Tested and approved by RADIO BROADCAST ★

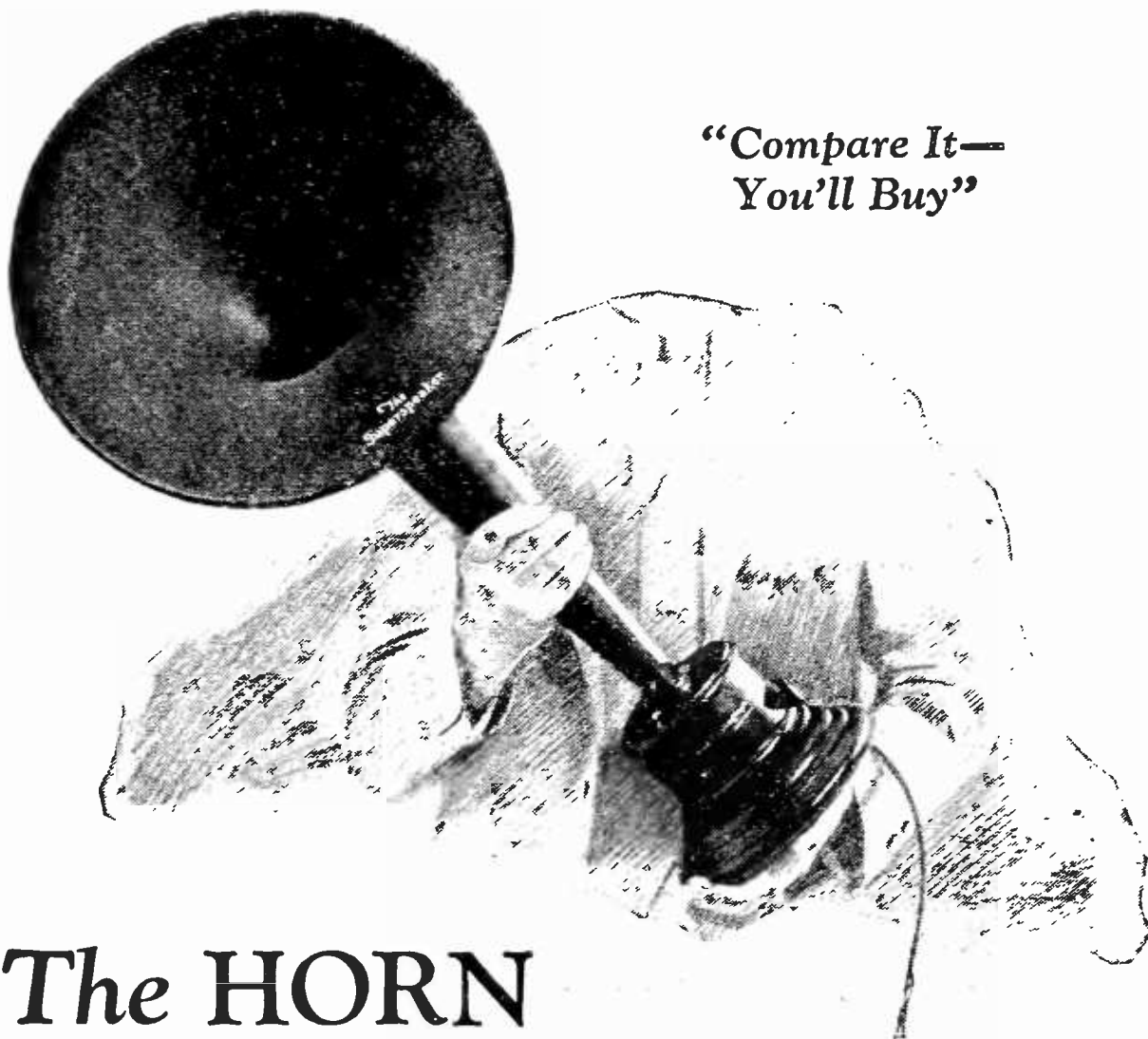

“Compare It—
You’ll Buy”

The HORN with the “WHY”

When you first hear Radio through the Jewett Superspeaker, you marvel at the amazing accuracy and volume of the reproduction.

Yet there is no mystery in Superspeaker performance; it is based on laws you yourself can easily understand.

One could never jam the massed harmony of a full brass band through the eye of a needle. So the Superspeaker horn is ample in size for the work it must do.

Also sound, as you know, moves in a direct line. The Superspeaker throat is therefore straight as an organ pipe, avoiding the bugling effect due to the crooks or curves. And its inner surface is smooth and glossy, never tripping or confusing the waves of music or voice.

Just listen to The Superspeaker! Compare its performance with that of any other loud speaker in the world! The difference will amaze you.



No extra batteries—Exclusive air-gap adjustment to modify results from nearby stations, and increase strength of those from far away—A true musical instrument, built and guaranteed by the million-dollar company whose name it bears. Sweep the ether with a Superspeaker!

JEWETT RADIO & PHONOGRAPH COMPANY
5672 TWELFTH ST., DETROIT, MICH.

The
Superspeaker
Trademark
Registered

★ Tested and approved by RADIO BROADCAST ★

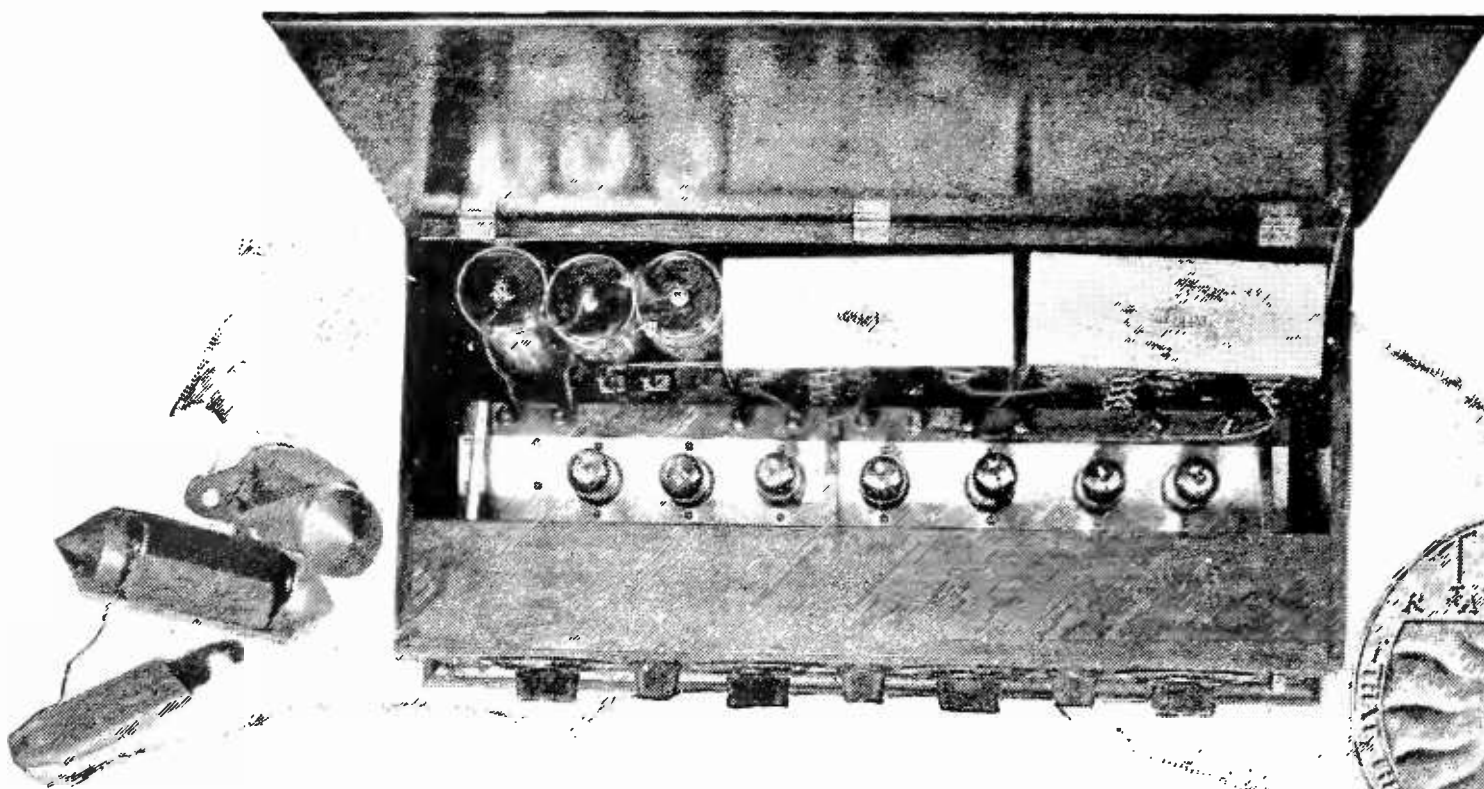

Interior view of a typical set you can build with the new Telos KIT.



With all its amazing power and range—this set costs less to operate than most sets of half its size!

IT need not cost you a fortune to construct and own a set that out-performs any factory-made receiver on the market.

For the 5, 6 and 7 tube sets you can easily build with the new Telos Kit are designed for *dry cell* use. By superimposing (re-flexing) the A. F. on the three stages of Telos tuned R. F., far less equipment is needed—and you save money there. In the set pictured above, full efficiency

is secured, with one-half the plate current of any other of its size! Tubes and batteries last twice as long!

If you have hesitated to build the set you dream about, then this Telos economy is something you should investigate. Use the coupon below for your copy of "The KIT of a Thousand Possibilities." It's free, but the edition is limited to sincere seekers for better *radio!*

Telos ★ Radio

Danziger-Jones, Inc.,
Dept. B, 25 Waverly Place,
New York, N. Y.

Send me at once your booklet "The KIT of a Thousand Possibilities."

Name

Address

★ Tested and approved by RADIO BROADCAST ★

Two Big Radio Thrills

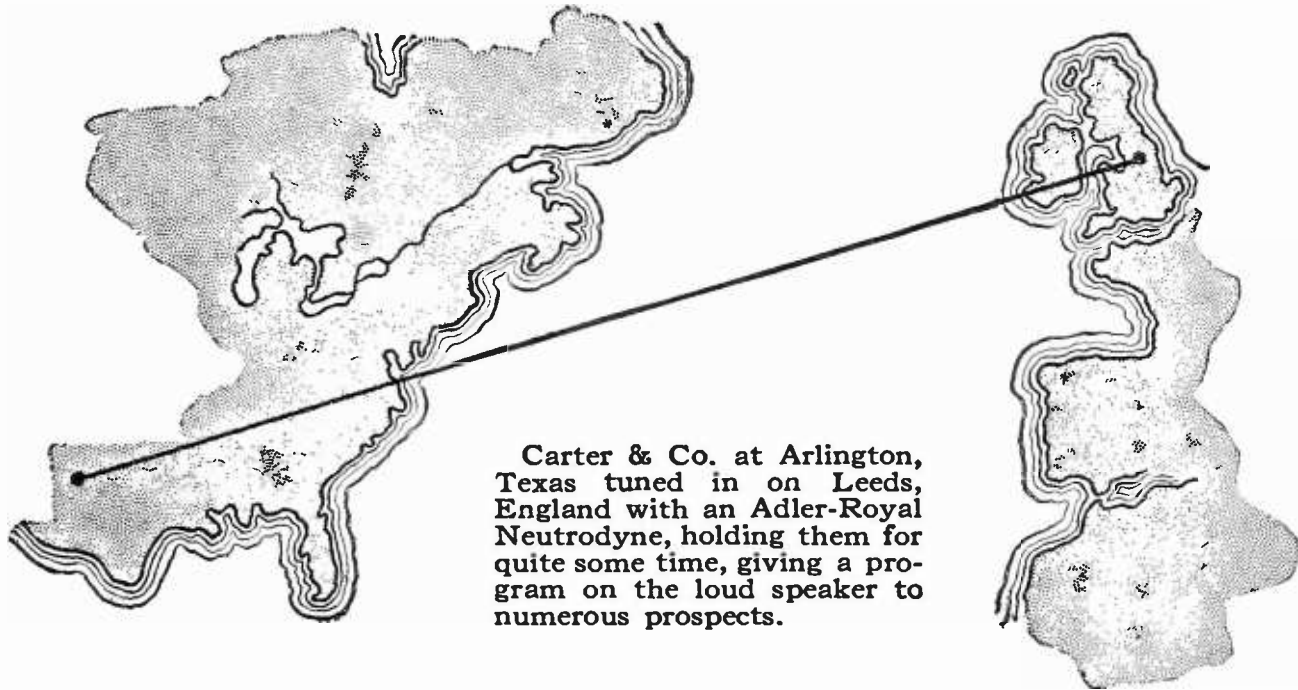

Carter & Co. at Arlington, Texas tuned in on Leeds, England with an Adler-Royal Neutrodyne, holding them for quite some time, giving a program on the loud speaker to numerous prospects.

YOUR first thrill with an Adler-Royal neutrodyne will be the magic spell of D.X. as station after station comes in clear as a bell with the slightest change in dial settings. No matter how much you know about radio, the performance of Adler-Royal will be a remarkable radio experience for you. The selectivity you had hoped for has really been accomplished.

Then, as your own log grows, you will be more discriminating about the quality of what you hear. You will begin to appreciate what

Adler-Royal really is and this will be your biggest thrill. Your daily paper will be your program. You will learn to depend on Adler-Royal absolutely.

The Neutrodyne principle is so far perfected in Adler-Royal that even in the hands of a novice its selectivity and pure tone qualities are almost automatic. Its operation is as simple as setting a clock. There are no squeaks, squeals or howls to ruin radio enjoyment. Adler-Royal has conquered the mysteries of the air.

Seek a Service Dealer

THE dealer from whom you buy a radio set is quite as important as the set you buy. On his service to you, much of your enjoyment of a radio set will depend. It will pay you to turn the corner into Main Street to find the Adler-Royal dealer. He is appointed by us on his pledge to give purchasers the best of every service. On Adler-Royal, you get the guarantee of a high-class dealer to back up ours.

ADLER MANUFACTURING COMPANY, Inc.
 General Sales Office: Dept. C3, 881 Broadway, New York City
 Factories: Louisville, Ky.

ADLER-ROYAL

Phonograph and Radio



ADLER-ROYAL NEUTRODYNE
 Model 199 Table Type used with dry cells. Batteries concealed in cabinet. 5 tubes (199), Cabinets walnut or mahogany. Price \$165.

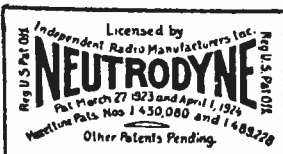

Send this coupon to-day for your free copy of Adler-Royal Book and Log

ADLER MANUFACTURING COMPANY
 Dept. C3, 881 Broadway, New York City

Please send me my copy of the Adler-Royal Book and Log.

Name.....

Address.....

★ Tested and approved by RADIO BROADCAST ★

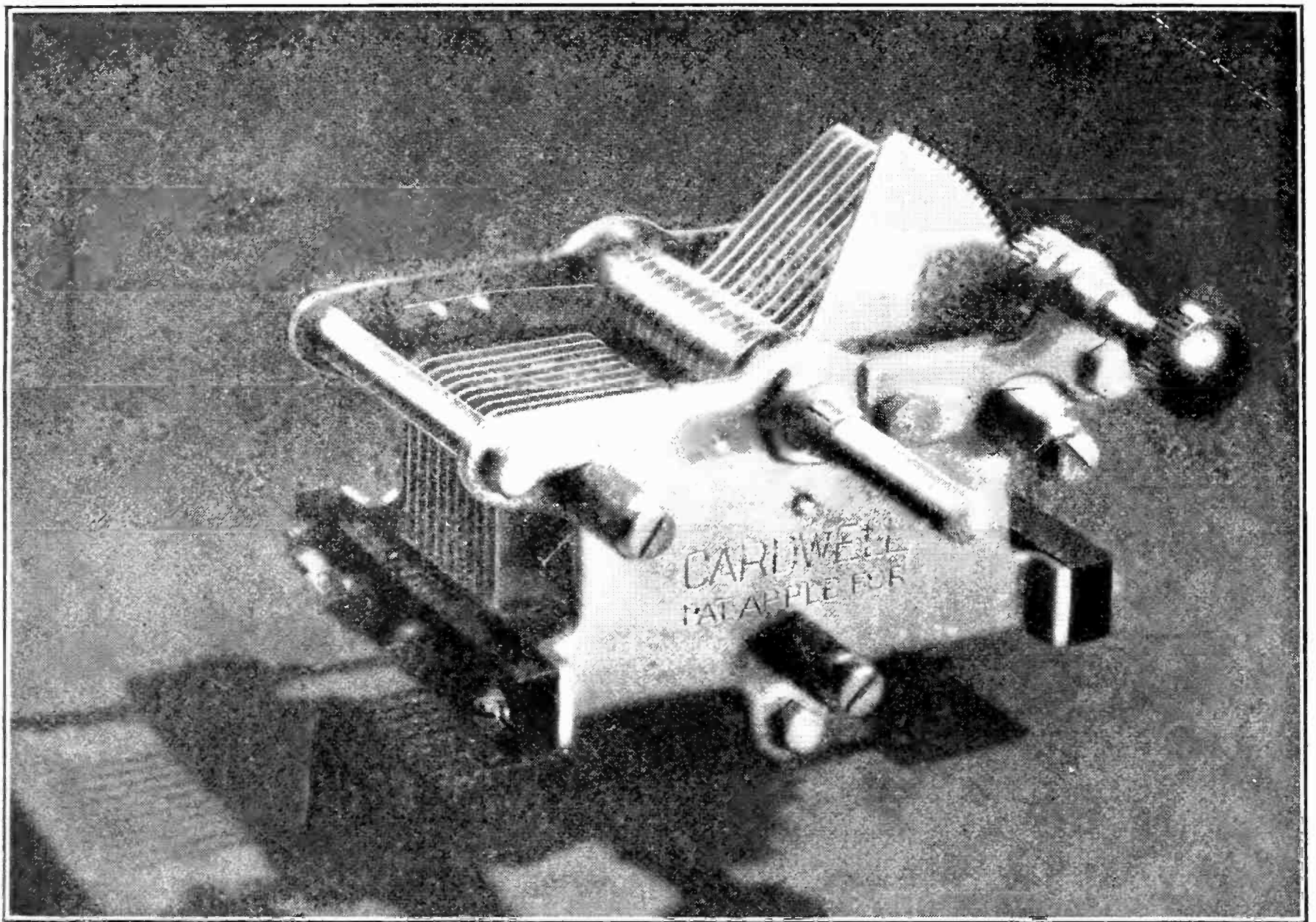

“No fancy gewgaws to attract the eye and cause trouble in the end”

SO writes Mr. Henry M. Neely, Editor of RADIO-IN-THE-HOME. Mr. Neely adds:

“The present-day low-loss condenser approaches more nearly to a perfect instrument, the more nearly it approaches the design and workmanship of the Cardwell.”

Simplicity is a distinctive characteristic of the Cardwell. There is no excessive bulk or weight—no intricate parts or complicated assembly.

Other points of merit have been praised by many different experts. In fact, Cardwell condensers have received the universal approval of radio editors and engineers everywhere.

Cardwell condensers are rugged, free

from play, noiseless and remarkably smooth in action. And there is nothing to work loose or get out of adjustment.

Cardwell invented the first “low-loss” condensers—a name originally applied only to Cardwells to distinguish them from ordinary varieties. Cardwell now makes seventy-six different types—a condenser for every requirement. Ask your dealer to show you his assortment.

A postcard brings you an education on condensers. Write today for the new Cardwell Condenser booklet.

The Allen D. Cardwell
Manufacturing Corporation
81 Prospect Street, Brooklyn, N. Y. ★

CARDWELL
(RADIO UNITS)

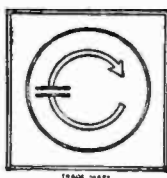

UNITRADS
(OF MERIT)

CONDENSERS — INDUCTANCES — TRANSFORMERS

★ Tested and approved by RADIO BROADCAST ★

Volume and Clarity

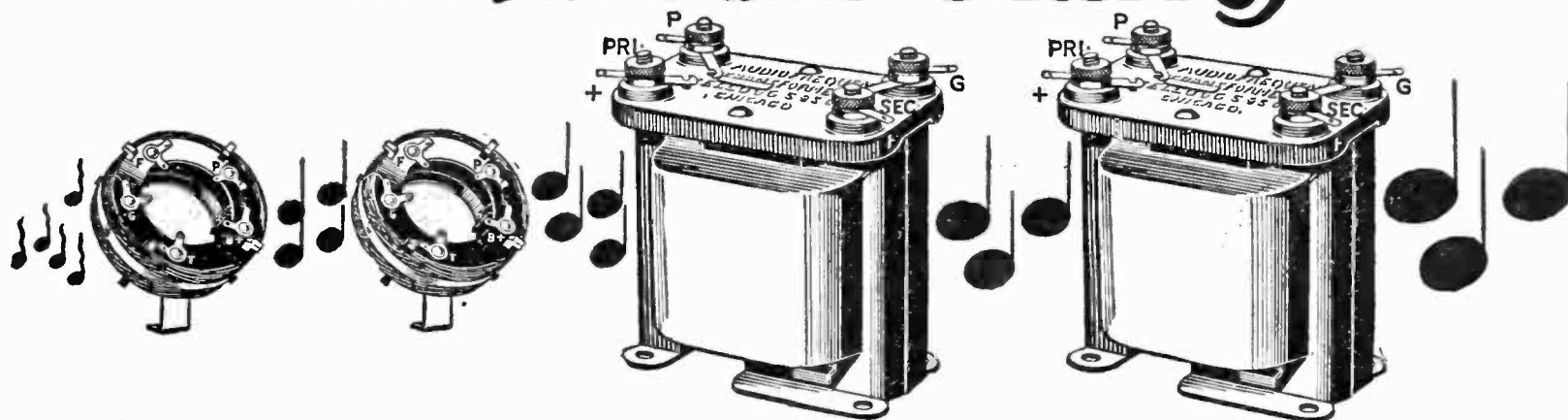

with Kellogg Transformers

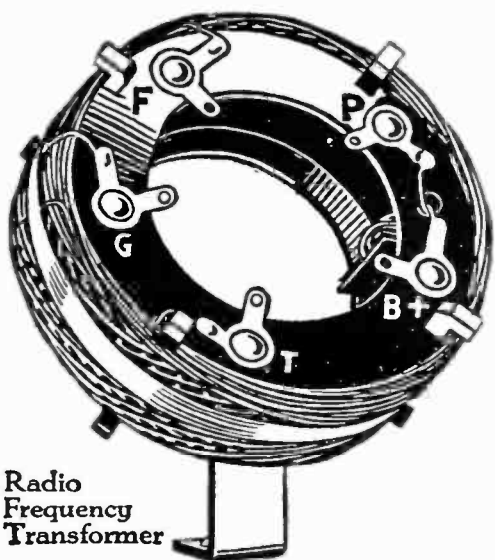

Radio Frequency Transformer

A Radio Frequency Transformer of the aperiodic type suitable for all sets with which tuned radio frequency is desired. Also used for one stage of radio frequency amplification ahead of regenerative sets to prevent re-radiation.

Consider these points of superiority:

- No dope to hold windings in place.
- Soldered connections.
- Mounting bracket holds coil at correct angle.
- Minimum rubber used in form.
- Lowest possible loss, with greatest transfer of energy.
- Works with any .0005 condenser.
- Secondary arranged with suitable taps for biasing features.

This transformer makes the construction of a radio frequency set an easy matter, assuring best possible reception with widely varying types of circuits, including reflex.

Built and guaranteed by Kellogg Switchboard and Supply Co.

No. 602 Radio Frequency Transformer at your dealers for \$2.35 each.

Kellogg Audio Frequency Transformers are the "stepping stones" of modern amplification.

Clear, accurate reproduction assured over the entire range of the musical scale.

Plainly marked, accessible terminals.

It is acclaimed by test to be the best.

No. 501 Audio Frequency Transformer Ratio 4½ to 1—

No. 502 Audio Frequency Transformer Ratio 3 to 1—
\$4.50 each

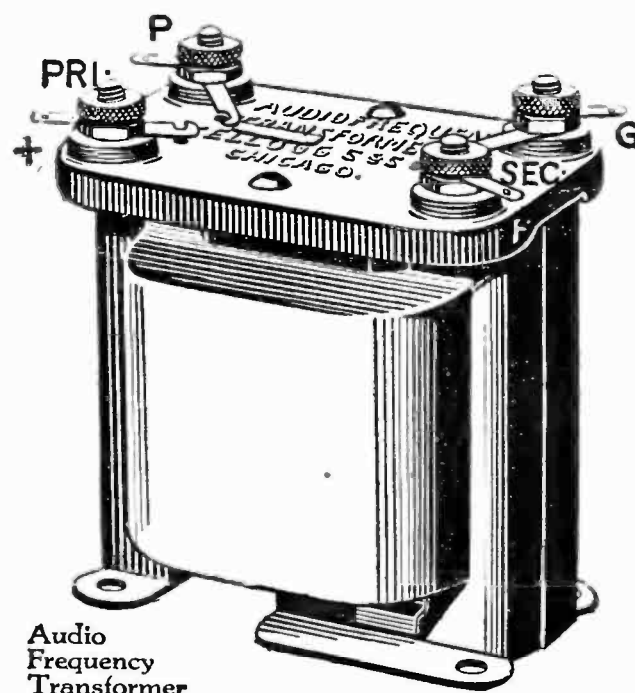

Audio Frequency Transformer

KELLOGG SWITCHBOARD & SUPPLY CO.

1066 WEST ADAMS STREET, CHICAGO

★ Tested and approved by RADIO BROADCAST ★



What Reliable Radio Means to You

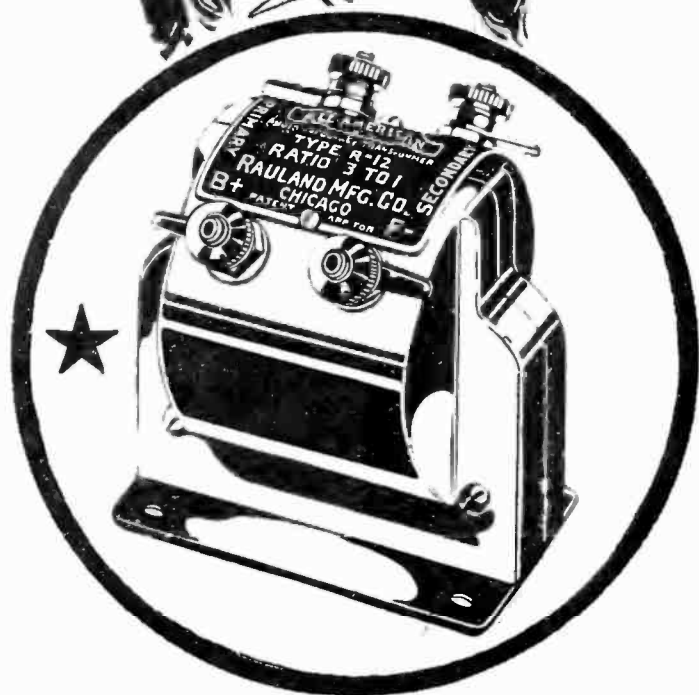

AN assurance that, when you try out a hook-up, you can rely on your instruments to give you a *fair test*. **Q**A knowledge that each part has been put to such searching tests that its proper performance, *under any conditions*, is assured. **Q**In short, a conviction that each individual part *will continue* to do its work *year after year*.

The RADIO KEY BOOK will acquaint you with the essential facts of modern reception. Ten cents—coin or stamps—brings the KEY BOOK

RAULAND MFG. CO.

Pioneers in the Industry

2652 Coyne St.

Chicago

ALL-AMERICAN Guaranteed Radio Products

Standard Audio Transformers
3 to 1 Ratio, type R-12... \$4.50
5 to 1 Ratio, type R-21... 4.75
10 to 1 Ratio, type R-13... 4.75

Power Amplifying Transformers
(Push-Pull)

Input type R-30..... \$6.00
Output type R-31..... 6.00

Rauland-Lyric
A laboratory grade audio
transformer for music
lovers. R-500..... \$9.00



Universal Coupler
Antenna coupler or tuned r. f.
transformer. R-140..... \$4.00

Self-Tuned
R. F. Transformer 
Wound to suit the
tube. R-199 \$5.00. R-201A \$5.00

Long Wave Transformer
(Intermediate Frequency)
(15-75 kc.) R-110..... \$6.00

10,000 Meter (30kc.)
Transformer 
Tuned type (filter or
input). R-120.. \$6.00

Radio Frequency Coupler
(Oscillator Coupler). R-130 \$5.00

Super-Fine Parts
Consisting of three R-110's, one
R-120 and one R-130.... \$26.00

All-American Reflex Receivers
(Mounted but not wired)
All-Amaz Junior (1-tube) \$22.00
All-Amaz Senior (three-tube)
\$42.00

ALL-AMERICAN

Largest Selling Transformers in the World

★ Tested and approved by RADIO BROADCAST ★



Newport Owners Know What Tonal Quality is!

The Tonal Quality of the Newport brings to them the ineffable thrill of good music.

They have experienced those delightful little runs, fine gradations, and double stop work in Kreisler's "Caprice Viennois" which are so clear, well defined, and ungarbled in the Newport. The thunder of the organ as it runs the gamut of its mighty diapason is not new to them. They parade across the theatres of their minds every evening all the brilliance and charm of the virtuosi. They catch with ease those slight inflections of the voice that often mean so much when famous men speak. They make their Newports perform the acid test of Tonal Quality. They dial into the militant swing of Sousa's "El Capitan" or the "Stars and Stripes Forever." That they can distinguish the high trebles, the deep bass, the various instruments that go to make the action-stirring whole of this famous orchestration, is not novel to them.

They know what Tonal Quality is!

*The Newport is a Good Receiver
Built in a Piece of Fine Furniture*

★ *Newport Radio Corp.*
 1250 West 54th Street,
 New York City



★ Tested and approved by RADIO BROADCAST ★

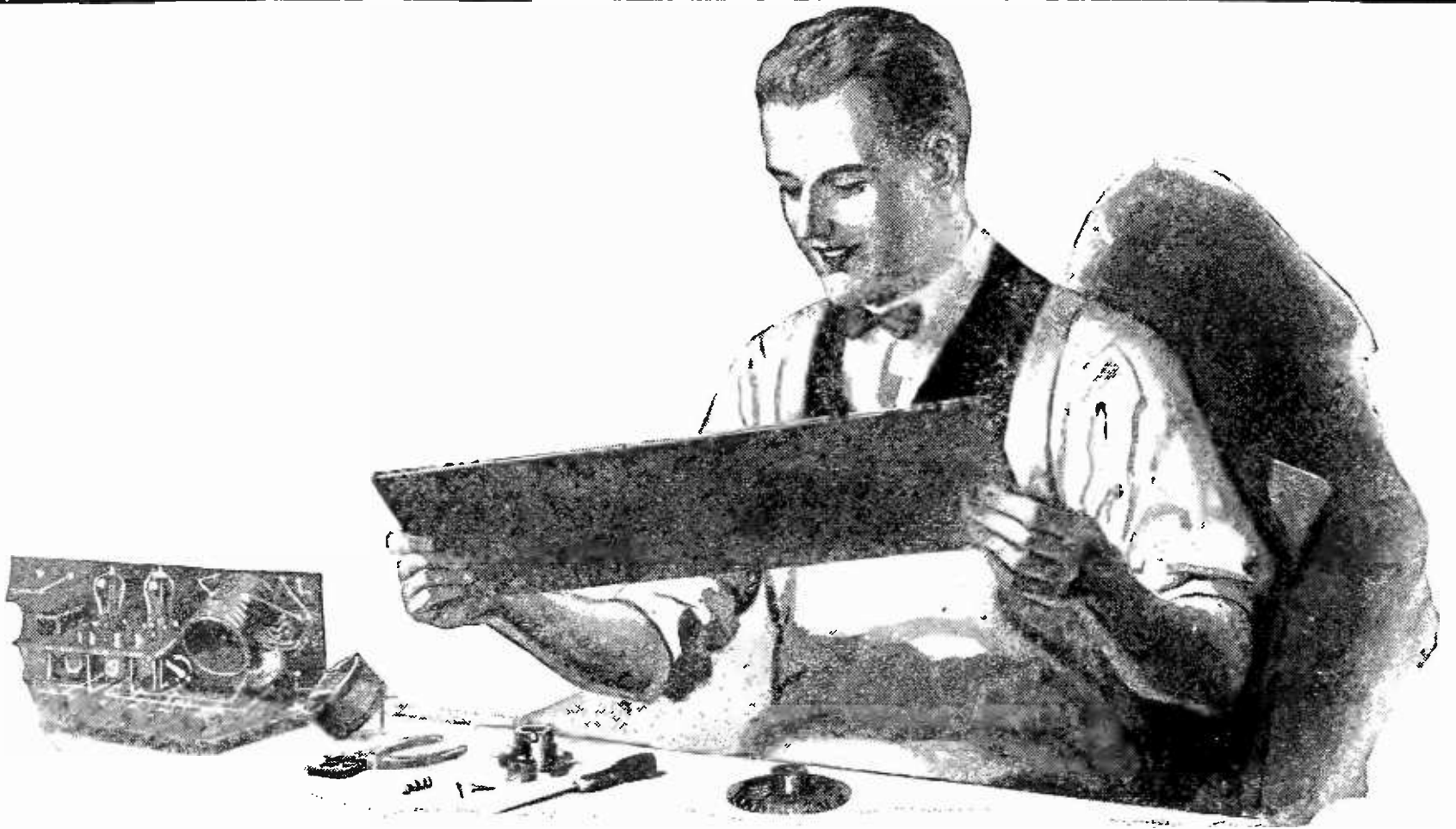

Notice the rich finish on this panel —built to order for radio

A SURFACE that is good-looking and useful, too. That was one of the demands we made of the engineers who developed Radion especially *to order* for Radio purposes.

The high-polished, satin-like finish of Radion Panels does more than add to the beauty of your set. It keeps out dirt and moisture, thus preventing the possibility of causing short circuits from this source and reducing good reception.

Lowest losses and greater efficiency

But the worth of Radion is not just on the surface. Authoritative laboratory tests give it the highest rating as radio-frequency insulation. It reduces surface leakage and leakage noises. This means lowest losses and greater efficiency,

Other Radion Products

The same qualities of low-loss insulation and attractive appearance characterize Radion dials (to match panel), binding post panels, insulators, knobs, etc.—also the new Radion Built-in horn.

especially noticeable in super-sensitive circuits.

Radion Panels resist warping. It's the easiest material to cut, saw or drill. It comes in eight stock sizes and two kinds, Black and Mahoganite.

Better performance will make it worth your while to ask for Radion by name and to look for the stamp on the panel and the name on the envelope. Radio dealers have the exact size you want for your set.

Send for booklet "Building Your Own Set"

Our new booklet, "Building Your Own Set," giving wiring diagrams, front and rear views, showing a new set with slanting panel, sets with the new Radion built-in horn, lists of parts and directions for building the most popular circuits—mailed for ten cents. Mail coupon to-day.

AMERICAN HARD RUBBER COMPANY, Dept. C-3, 11 Mercer St., New York City

Chicago Office: Conway Building

Pacific Coast Agent: Goodyear Rubber Co., San Francisco—Portland

RADION ★

The Supreme Insulation

PANELS

Dials, Sockets, Binding Post Panels, etc.

AMERICAN HARD RUBBER COMPANY
Dept. C-3, 11 Mercer St., New York City

Please send me your new booklet, "Building Your Own Set" for which I enclose 10 cents (stamps or coin.)

Name.....

Address.....

City.....State.....

★ Tested and approved by RADIO BROADCAST ★

MELCO SUPREME

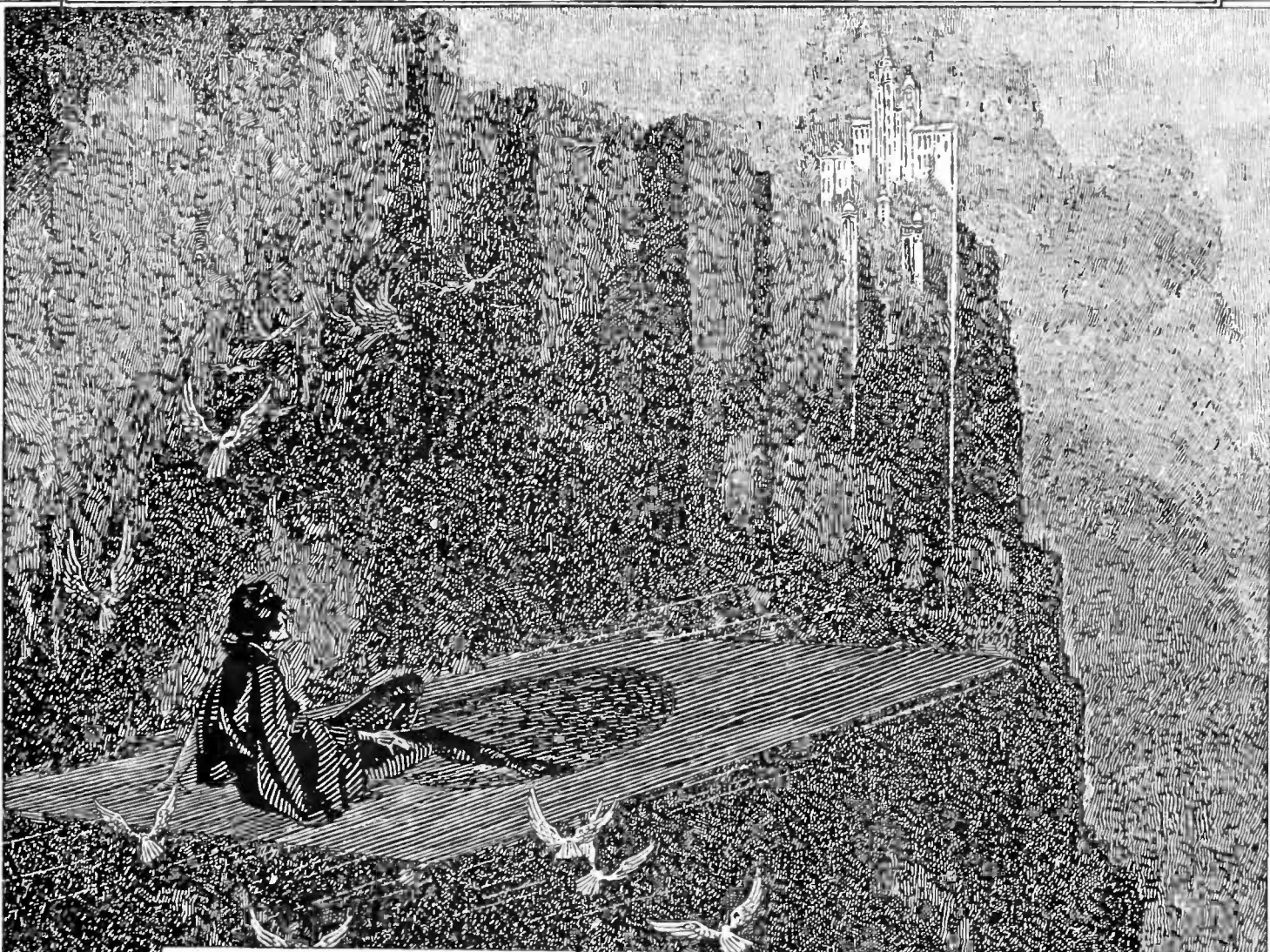

"THE MAGIC CARPET"

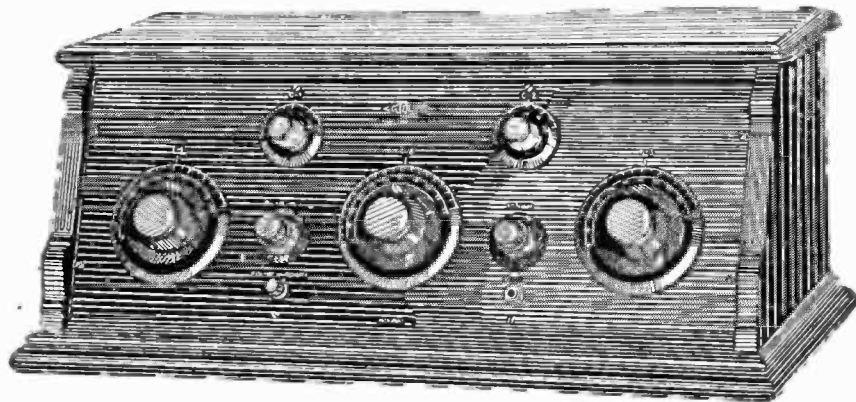

YOU tour the world in a night with your MELCO Supreme—a five tube tuned radio frequency Receiver with a unique low-loss Amsco chassis.

Tuned by inductance—not capacitance—it is without parallel for purity and precision of reception. Write for literature.



AMSCO PRODUCTS INC. BROOME & LAFAYETTE STREETS, N.Y.



★ Tested and approved by RADIO BROADCAST ★

Be sure ~ that your transformers are giving you Amplification without Distortion

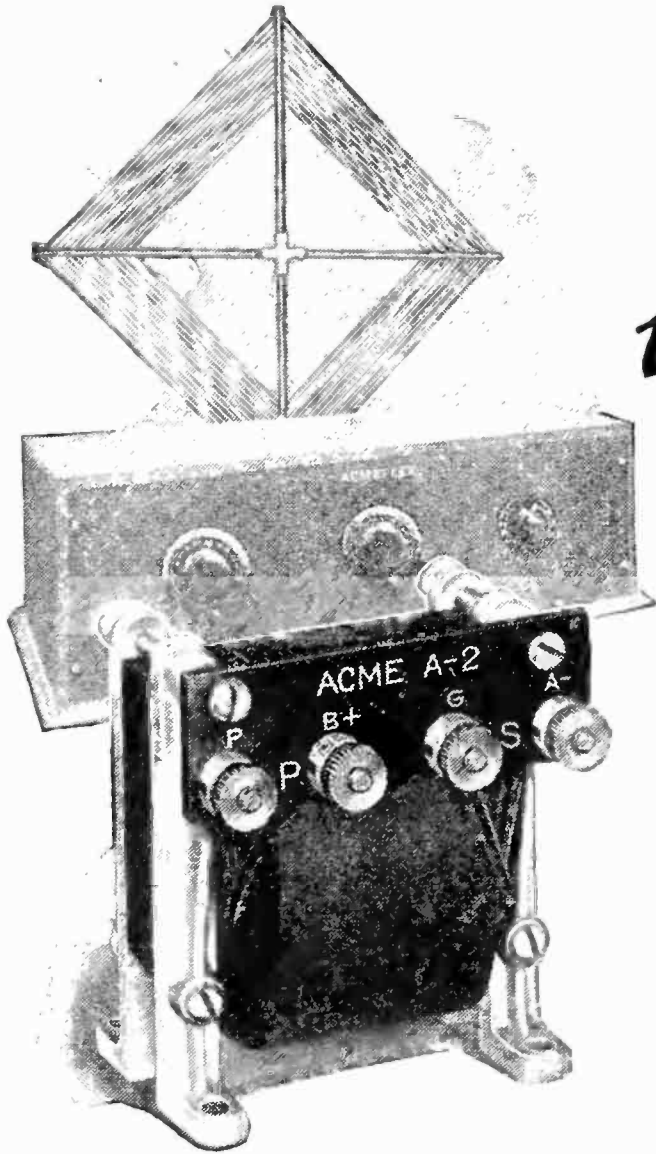

Acme Transformers give maximum volume of sound, clearly and distinctly

WHEN you put a lot of time and money into a radio set you want to be sure that it will give the best results. You want to know that your set will bring in the stations so that you can enjoy listening and be proud to call in your friends. You want Amplification, but above all you want Amplification without Distortion. Be sure to use amplifying transformers that increase the sound without spoiling the quality.

The Acme A-2 Audio Amplifying Transformer is the result of 5 years of research and experimenting. It gives amplification without distortion to any set. Whether you have a neutrodyne, superheterodyne, regenerative or reflex the addition of the Acme A-2 will make it better.

If you are not getting loud clear radio try Acme Transformers and note the difference.

Each transformer is tested and carries a guarantee tag. If you want Amplification without Distortion use Acme Transformers in the set you build and insist on them in the set you buy. (That's one of the big reasons why the Acmeflex Kitset gives such good results—it uses Acme Transformers.) Send for our 40-page booklet which explains how to get the best results by proper amplification and also contains a number of valuable wiring diagrams. It will help you build a set. Mail the coupon with 10 cents.

“For Amplification Without distortion” use ACME Transformers in the set you build. Insist on them in the set you buy and enjoy all the year long Radio

The Amplifying Transformer is the Magnifying Glass of Radio



ACME APPARATUS COMPANY
Transformer and Radio Engineers and Manufacturers
Dept. F2 Cambridge, Mass.

Have the fun of making your own radio set

ACME

~ for amplification

ACME APPARATUS COMPANY,
Dept. F2, Cambridge, Mass.

Gentlemen:

I am enclosing 10 cents (U. S. stamps or coin) for a copy of your book, “Amplification without Distortion.”

Name

Street

City..... State.....

★ Tested and approved by RADIO BROADCAST ★

Daily Broadcasting Programs

<p>WEAF-NEW YORK CITY-492. 7:45 P. M.—Play by play description Yale-Harvard football game, Graham McNamee announcing. 8:00 P. M.—Clifford Lodge Dance Orchestra. 8:30 P. M.—Waldor Astoria Orchestra. 7:30 P. M.—Thrilling adventure story for boys, Fred J. Turner. 7:50 P. M.—Genevieve McKenna, dramatic soprano, Anna Daly, violinist, and Anita Fontana, pianist. 8:15 P. M.—Redfern Hollishead, tenor. 8:50 P. M.—Genevieve McKenna, dramatic soprano; Anna Daly, violinist, and Anita Fontana, pianist. WOR-NEWARK-443. 7:00 A. M.—WOR morning gym class. 2:30 P. M.—Argyle Trio. 2:45 P. M.—Anne Tindale, piano. 3:00 P. M.—"Mysticism of Marie Corelli," John Romiser. 2:15 P. M.—Argyle Trio. 2:50 P. M.—Anne Tindale, piano. 8:15 P. M.—Hasty Lafayette's Orchestra. 8:00 P. M.—Broadway Baptist Church Choir. 8:45 P. M.—Dr. Harvey W. Wiley, "How You Can Add Years to Your Life." WRW-TARRYTOWN-273. 8:00 P. M.—Services, Second Reformed Church. 9:00 P. M.—Police reports. 10:20 P. M.—Musical program. WVY-CONNECTICUT-34. 11:00 A. M.—St. Peter's Church. 1:45 P. M.—St. Anthony's Church. 7:00 P. M.—Musical program. WIS-CHICAGO-345. 8:00 P. M.—Trip to Japan with F. Glenn, Saturday night band. 10:00 A. M.—Timely talks by Terence. 12:00 A. M.—Music. 12:20 A. M.—Ethel Perser, "Straight Music." The Rev. Lynn</p>	<p>WHAR-ATLANTIC CITY-375. 2:00 P. M.—Seaside Hotel Orchestra. 7:30 P. M.—Gordon Williams, "Real Estate." 8:00 P. M.—Seaside Hotel Orchestra. WDAE-PHILADELPHIA-32. 2:00 P. M.—Arcadia Concert. KDKA-PITTSBURGH-32. 11:00 A. M.—Services, the Point Lighthouse Presbyterian Church. 2:45 P. M.—Concert. 4:00 P. M.—Organ recital. 4:45 P. M.—Vesper services. 6:30 P. M.—Dinner concert. 7:30 P. M.—Services, the Calvary Church. WJAR-PROVIDENCE-360. 7:20 P. M.—Musical program, State, New York city. 9:15 P. M.—Organ recital. WDBE-WORCESTER-265. 11:30 A. M.—Musical program. 12:00 Noon.—WBRE. 3:00 P. M.—WBRE. 5:30 P. M.—WBRE. 7:45 P. M.—Charles, director of the "Thanksgiving Day program." 8:15 P. M.—Concert. 9:15 P. M.—Musical program. WLS-CHICAGO-345. 8:00 P. M.—Trip to Japan with F. Glenn, Saturday night band. 10:00 A. M.—Timely talks by Terence. 12:00 A. M.—Music. 12:20 A. M.—Ethel Perser, "Straight Music." The Rev. Lynn</p>	<p>WRAS-LOUISVILLE-460. 5:00 P. M.—The Alamo Orchestra. Just Among Home Folks. 3:30 P. M.—Louisville State Club. WSB-ATLANTA-429. 1:00 P. M.—Ed and Grace McConnell. 3:00 P. M.—Bodine story. 9:00 P. M.—Ed and Grace McConnell. 11:30 P. M.—Hired Help Skylark. WMC-Memphis-500. 11:00 A. M.—Musical program. 11:30 A. M.—Public health report. WFAA-DALLAS-476. 7:00 P. M.—Radio Bible class. 8:30 P. M.—Westminster Presbyterian Church. 10:00 P. M.—Sacred songs. 10:20 P. M.—Dick Richardson's Orchestra. WOC-DAVENPORT-484. 1:00 P. M.—Chimes concert. 8:00 P. M.—Chimes concert. WFAA-DALLAS-476. 7:00 P. M.—Radio Bible class. 8:30 P. M.—Westminster Presbyterian Church. 10:00 P. M.—Sacred songs. 10:20 P. M.—Dick Richardson's Orchestra. WOC-DAVENPORT-484. 1:00 P. M.—Chimes concert. 8:00 P. M.—Chimes concert.</p>	<p>WEAF-FORT WORTH-476. 12:00 M.—Services, First Methodist Church. 3:00 P. M.—Concert. 12:00 P. M.—Midnight Frolic. WWJ-DETROIT-317. 8:00 A. M.—Setting up exercises. 9:30 A. M.—To-night's dinner. 9:45 A. M.—Public health bulletin. 2:00 P. M.—The Detroit Orchestra. 7:00 P. M.—The Detroit Orchestra, T. Stanley Perry, tenor. WDAP-KANSAS CITY-411. 7:00 P. M.—Program Mus. Phi Epsilon Musical Society. WFAA-DALLAS-476. 1:30 P. M.—Dr. J. B. Grandfill, "How Can Two Walk Together?" 9:30 P. M.—Musical recital. 12:00 Midnight—Adolphus Hotel Orchestra. WCAT-NORTHFIELD-360.</p>
--	--	---	---

NEW!

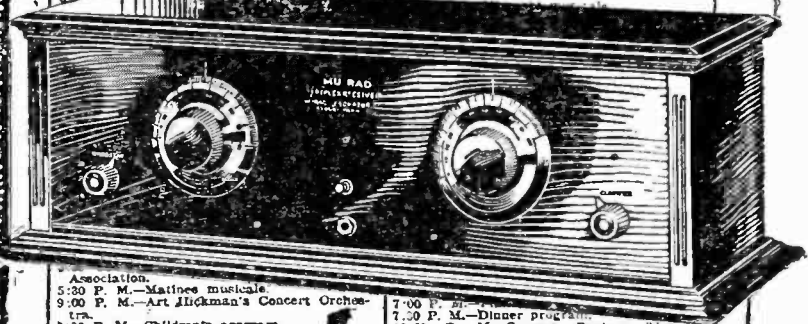

Mu-Rad Triplex 3 Tube-Dry Cell Receiver \$75

4-TUBE EFFICIENCY

Although only 3 tubes are used, all the efficiency of 4 tubes is attained by reflexing one tube. The circuit is one stage of radio frequency, two stages of audio frequency, and detector.

DISTANCE and SELECTIVITY
 Real distance right through the strongest local interference with very simple tuning.

CAN BE LOGGED
 Only two dials, the readings of which are always the same for each station, so that tuning is practically automatic.

NON RADIATING
 Your set cannot interfere with your neighbors'.

CONVENIENT
 All power from dry cell batteries, contained in the handsome mahogany cabinet. Easily portable.

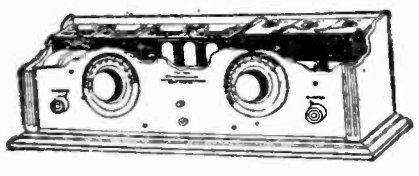

NEW—not just in price, because there are plenty of low priced radio sets—but **NEW** in the value represented by the radio treasures it unfolds, and the sterling character of instruments and workmanship. A MU-RAD Receiver in every detail that has made the name MU-RAD trusted and respected everywhere.

Write for Literature



MU-RAD LABORATORIES, INC.
 803 FIFTH AVE ASBURY PARK, NEW JERSEY

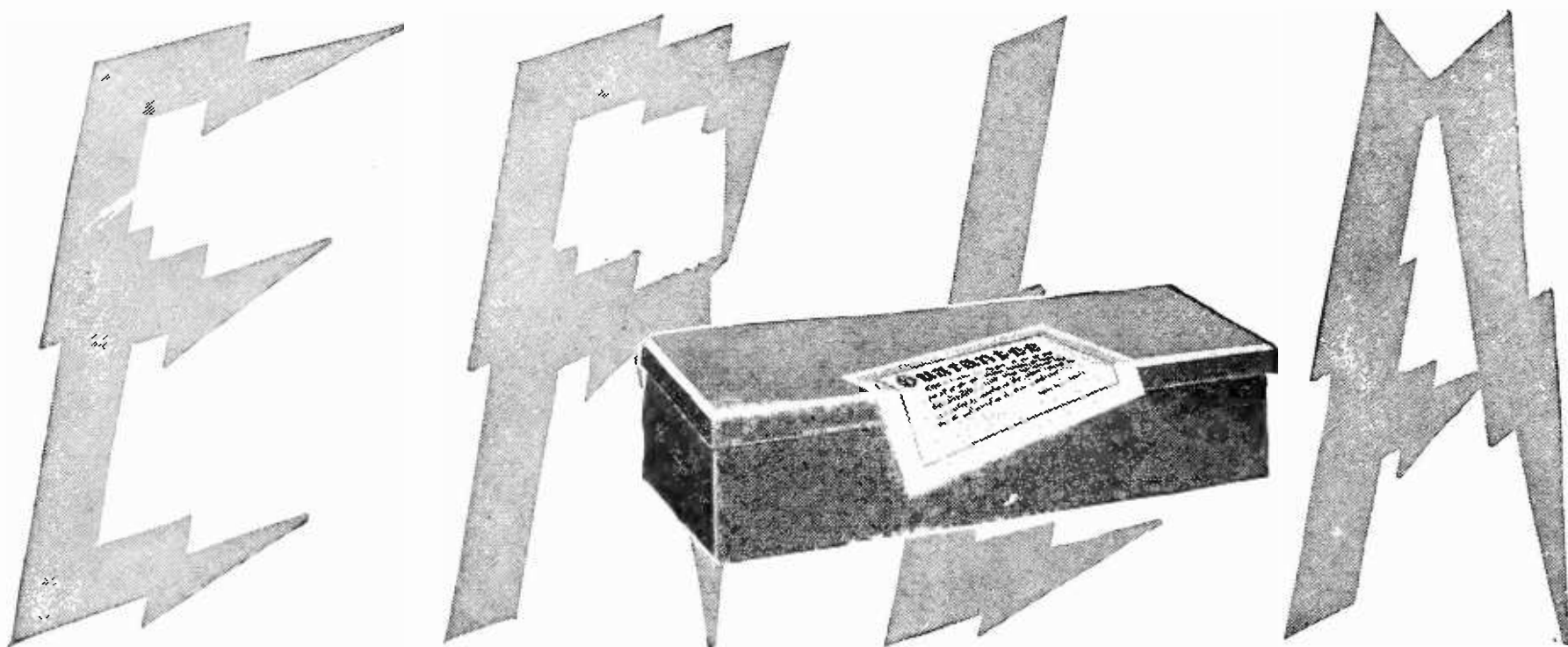

Supereflex Means MORE POWER PER TUBE

Erla Supereflex makes tubes do triple duty. One tube actually does the work of three that would be needed otherwise. Three tubes do the work of five, unquestionably! That is why simple, compact, inexpensive Erla Supereflex receivers equal or surpass the performance of costliest, temperamental multi-stage radio sets.

More power, tube for tube, is basic in Erla Supereflex. Nothing else can "make up for it." Greater power in Erla Supereflex just simply means finer radio, which you can afford.

For you yourself can confidently build these matchless Erla circuits with Erla Supereflex *CIR-KIT*.

CIR-KIT is a complete array of Erla Scientific Precision Apparatus, especially created to make Supereflex possible. *CIR-KIT* provides clear, simple instructions for perfect assembly. Blueprints are full size. The panel is pre-drilled for you. The baseboard is marked to locate every unit accurately. The famous Erla Solderless Connectors do away with soldering entirely.

With screwdriver, pliers and *CIR-KIT* you are sure of a set that will make you proud, both for appearance and performance. The cost is very moderate. Yet the range, volume, selectivity AND TONE PURITY are rarely equaled at any price, because Supereflex does give you more power, tube for tube.



Electrical Research Laboratories
Department B 2500 Cottage Grove Avenue, Chicago

CIR KIT

★ Tested and approved by RADIO BROADCAST ★



The Heart of the Radio

We shall be glad to send new circuits with complete working diagrams. Grimes 3XP Inverse Duplex, Jefferson Baby Grand 6 Tube Superheterodyne, Jefferson 8 tube Superheterodyne, and many others. Any of these will be sent upon receipt of five cents in stamps to cover postage.

F AINT, trembling impulses are caught from the air and amplified thousands upon thousands of times. Finally transformed into audible sounds by your loud speaker, they are either painfully distorted or lifelike in purity of tone. Which it will be, depends largely upon your transformer.

For the transformer is of the utmost importance in your radio set. Each minute sound vibration coming from the detector is magnified and reissued with a stronger pulse—lending volume and clarity to your radio reception.

Jefferson Super Sensitive Transformers are designed to receive over the entire musical range without howling or distortion. Radio authorities the world over recognize the excellent performance of these wonderful transformers and specify their use in new circuits.



Handled by the better dealers and jobbers. A superior transformer at a price attractively low.

Jefferson Electric Manufacturing Co.
501 South Green Street CHICAGO, ILLINOIS

Manufacturers of

Radio Transformers
Bell Ringing Transformers
Sign Lighting Transformers
Automobile Ignition Coils
Jump Spark—Make and Break Coils

Auto Transformers
Testing Instruments
Toy Transformers
Furnace and Oil Burner Transformers
Oil Burner Ignition Coils

Special high and low voltage transformers

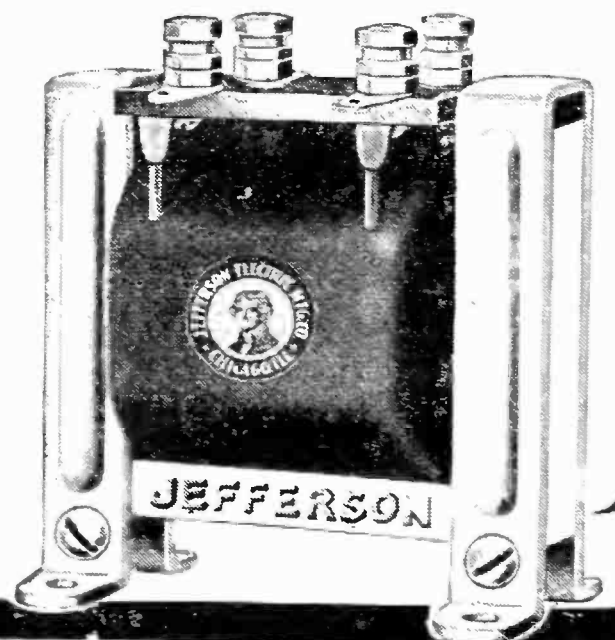

Jefferson Transformers

★ Tested and approved by RADIO BROADCAST ★



Here it is!

Hommel Broadcasting: *listen!*

“Business static hurts your cash register as much as weather static hurts reception.”

Now, listen in carefully.

The HOMMEL Dealer Service Department was developed for the one particular purpose to help alleviate business “static.” That Department is vitally concerned in furthering your interests—as a Hommel Dealer.

We work shoulder to shoulder with our dealers—not in competition with them. We wholesale only and carry only the most reputable radio equipment. All user inquiries and orders resulting from our national advertising are forwarded *promptly* to our local dealer.

In our new six-story building we carry larger stock, and have better facilities for serving you than ever before.

listen!

DISTRIBUTORS FOR
Radio Corporation of America

 Westinghouse General Electric

Baldwin Brandes Burgess
 Cardwell Crosley
 Cutler-Hammer
 Dubilier Fada Freed-Eisemann
 Freshman Frost
 General Radio Grebe
 Haynes-Griffin Magnavox
 Remler Rhamstine
 U.S. Tool Western Electric
 And other
 leading manufacturers

We can't help you unless you ask us to. Write to-day for Hommel's Encyclopedia of Radio Apparatus 266-B. It's free and will help you.

WHOLESALE

EXCLUSIVELY

LUDWIG HOMMEL & CO

929 PENN AVENUE



PITTSBURGH, PA.

★ Tested and approved by RADIO BROADCAST ★



The Trans-Atlantic CUP WINNER

Mrs. Edna M. Smith, of Springfield Gardens, Long Island, is the winner of the handsome silver cup, awarded for being the first to report reception of European broadcasts on a FREED-EISEMANN RECEIVER during the recent trans-Atlantic tests.

The winner was selected by "Radio Broadcast" Magazine, which was in charge of the arrangements, and verified the reports of reception.

Scores of other participants in the tests heard the following European stations on FREED-EISEMANN RECEIVERS:—

Paris, Petit Parisienne	Glasgow	5SC
Madrid . . . PTT	Aberdeen	2BD
London . . . 2LO	Brussels	SBR
Bournemouth 6BM	Liverpool	6LV
Newcastle . . 5NO	Birmingham	5IT

For full sworn statement and
fac-simile letters, write —

Freed-Eisemann Radio Corporation
MANHATTAN BRIDGE PLAZA, BROOKLYN, N. Y.



FREED-EISEMANN

RADIO RECEIVERS

★ Tested and approved by RADIO BROADCAST ★

It Has The Full Sweet Resonance Of Our Upright Horn

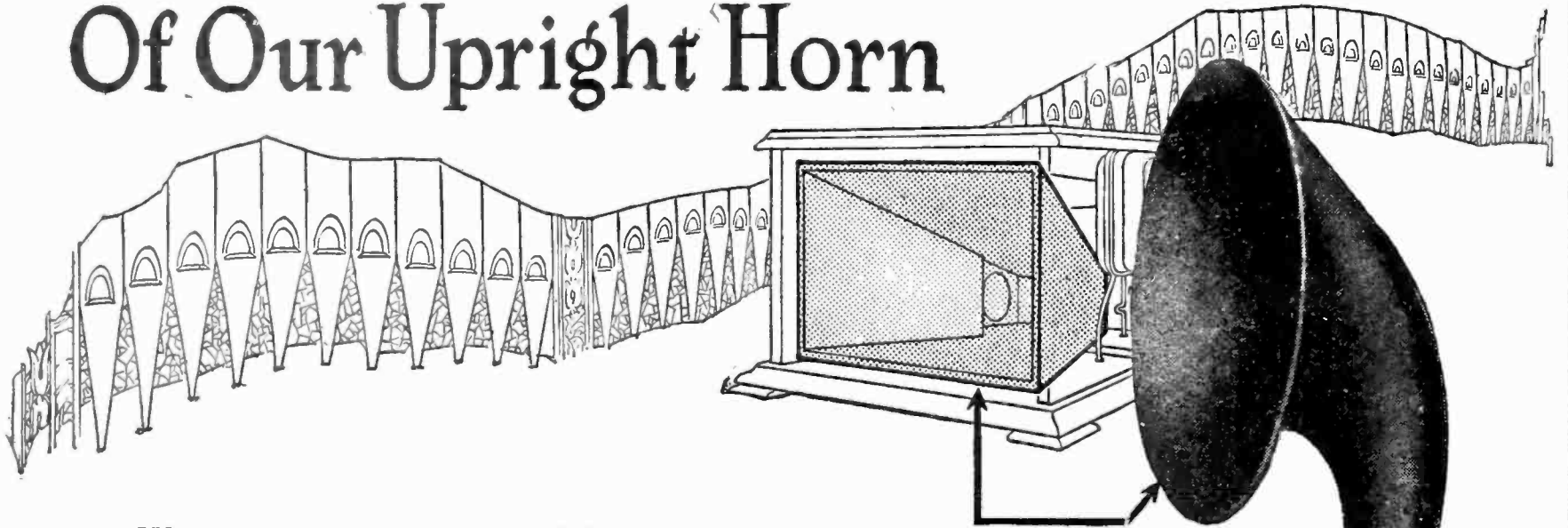

The new cabinet model has a seasoned wood horn which is "full floating"—the outer end, or bell, does not touch the cabinet. This, together with a long expansion chamber, gives it that same freedom of vibration which goes to make the Bristol horn type Loud Speaker such a resonant, sweet-toned instrument. It also has the same high-grade electromagnetic sound mechanism. It is not only a handsome piece of furniture, but a speaker worthy of the best radio set that money can buy.

Both Horns are Free to Vibrate Like the Open Diapason of the Organ.



Model S Audiophone \$25.00

Rubber horn 14½" in diameter. Cast metal throat. Velvet mat finish of mottled bronze and gold.

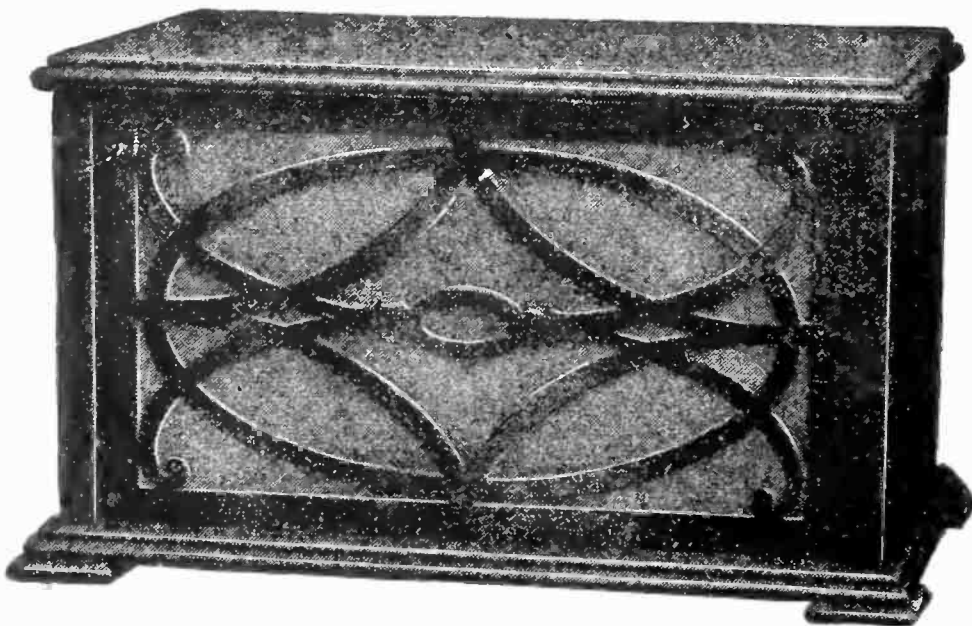

Cabinet Model \$30.00

Beautifully finished mahogany. Full floating wooden horn and cast metal throat. Musically, a companion to the finest set ever built; size 17 x 10 x 10¼".

There are five Bristol Loud Speakers, priced from \$12.50 to \$30.00. If not at your dealer's, write for Bulletin No. AH-3020.

Bristol TRADE MARK AUDIOPHONE REG. U.S. PAT. OFF. Loud Speaker

The Bristol Company Waterbury, Connecticut

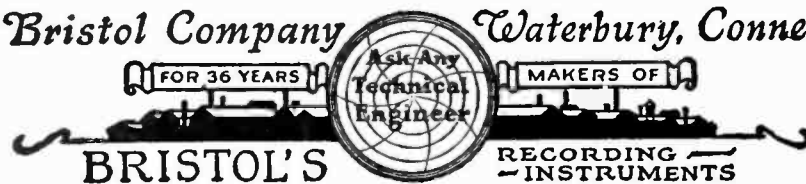

★ Tested and approved by RADIO BROADCAST ★

TOWER'S Scientific

\$2⁹⁵



Two Towers

As the Eiffel Tower stands as a monument to skilled engineering construction so TOWER'S Scientific phones stand as a monument to supreme radio achievement. Each phone is carefully tested and approved before it leaves the factory by a Government Licensed Radio Operator thus guaranteeing perfection in tone quality with a positive uniformity of volume.

TOWER'S Scientific Headsets are guaranteed to be made of the best materials money can buy—highest test enamel, insulated magnet wire, best grade five-foot tinsel cord, unbreakable caps, polished aluminum cases—using the famous scientific headband constructed for maximum comfort.

If your dealer cannot supply you, order direct, we will ship immediately Parcel Post C. O. D.

THE TOWER MFG. CORPORATION

98 BROOKLINE AVE. Dept. 7 BOSTON, MASS.

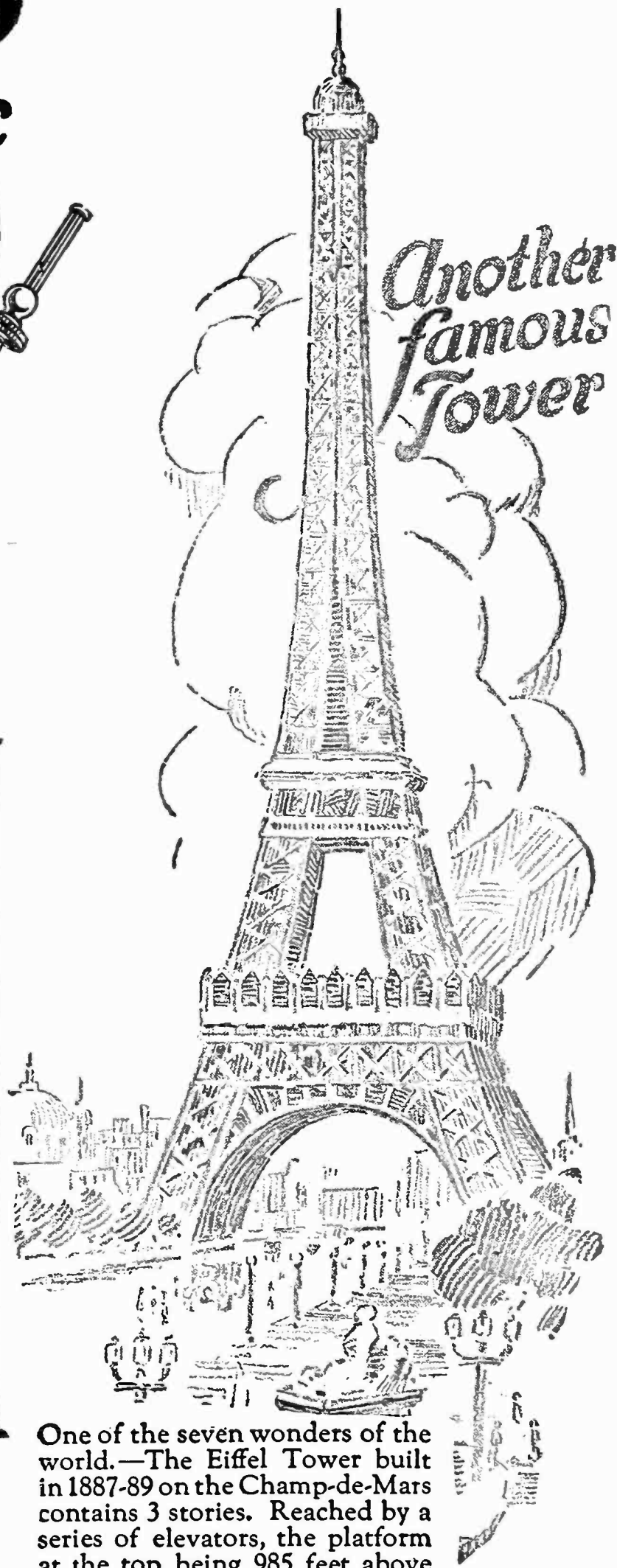

One of the seven wonders of the world.—The Eiffel Tower built in 1887-89 on the Champ-de-Mars contains 3 stories. Reached by a series of elevators, the platform at the top being 985 feet above the ground. In the top story is located the powerful Broadcasting Station FL.



The World's Greatest Headset Value

★ Tested and approved by RADIO BROADCAST ★

Radio Broadcast

ARTHUR H. LYNCH, EDITOR

MARCH, 1925

COVER - - - - -	<i>From a Painting by Henry J. Peck</i>	
THE PRINCIPALS IN A BIT OF HISTORIC BROADCASTING - - - -	<i>Frontispiece</i>	
NEW FIELDS FOR RADIO - - - - -	<i>D. C. Wilkerson</i>	851
SELECTING A B-BATTERY ELIMINATOR - - - - -	<i>Phil Fay</i>	857
WHO IS TO PAY FOR BROADCASTING—AND HOW - - - -	<i>H. D. Kellogg, Jr.</i>	863
“AS THE BROADCASTER SEES IT” - - - - -	<i>Carl Dreher</i>	867
RADIO HEAVEN VIA THE ROBERTS CIRCUIT - - - - -	<i>W. R. Bradford</i>	875
THE LISTENERS’ POINT OF VIEW - - - - -	<i>Jennie Irene Mix</i>	880
HOW TO WIRE YOUR HOME FOR RADIO - - - - -	<i>James Millen</i>	887
THE MARCH OF RADIO - - - - -	<i>J. H. Morecroft</i>	890
A GOOD FOUR-TUBE RECEIVER - - - - -	<i>McMurdo Silver</i>	900
IN THE R. B. LAB - - - - -		907
Applying the Regenerative Loop to any Super-Heterodyne		
Low Loss Coils and the Roberts Set		
A Short Wave Low Loss Set		
How to Connect Your Tickler Coil		
Laboratory Hints		
SHALL WE SPECIFY PARTS? - - - - -	<i>Arthur H. Lynch</i>	913
HOW WIRELESS CAME TO CUBA - - - - -	<i>Frank E. Butler</i>	916
THE FACTORS GOVERNING RADIO RECEIVING - - - - -	<i>Walter Van 'B. Roberts</i>	926
“NOW, I HAVE FOUND . . .” - - - - -		928
IMPROVING THE STORAGE BATTERY FOR RADIO - - - -	<i>James M. Skinner</i>	933
WHAT OUR READERS WRITE US - - - - -		937
THE GRID - - - - -		939
Body-Capacity Effects		
Antennas		
A Stage of Radio Frequency for the Roberts Receiver		
Tuning to the Lower Wavelengths		
A By-Pass Condenser for the Loud Speaker		
Resistance and Capacity Formulas		
Charging Storage Batteries with 110 Volts D. C.		
NEW EQUIPMENT - - - - -		946
AMONG OUR AUTHORS - - - - -		948

Copyright, 1925, in the United States, Newfoundland, Great Britain, Canada, and other countries by Doubleday, Page & Co.
All rights reserved. TERMS: \$4.00 a year; single copies 35 cents.

F. N. DOUBLEDAY, *President*
ARTHUR W. PAGE, *Vice-President*

NELSON DOUBLEDAY, *Vice-President*
RUSSELL DOUBLEDAY, *Secretary*

S. A. EVERITT, *Treasurer*
JOHN J. HESSIAN, *Ass't. Treasurer*

Doubleday, Page & Co.
MAGAZINES

WORLD'S WORK
COUNTRY LIFE
GARDEN MAGAZINE & HOME BUILDER
RADIO BROADCAST
SHORT STORIES
EDUCATIONAL REVIEW
LE PETIT JOURNAL
EL ECO
THE FRONTIER

Doubleday, Page & Co.
BOOK SHOPS

NEW YORK: LORD & TAYLOR BOOK SHOP
PENNSYLVANIA TERMINAL ARCADE
LONG ISLAND TERMINAL ARCADE
38 WALL ST. AND 55 LIBERTY ST.
ST. LOUIS: 223 NORTH 8TH STREET
4914 MARYLAND AVENUE
KANSAS CITY: 920 GRAND AVENUE
TOLEDO: LASALLE & KOCH
CLEVELAND: HIGBEE CO.
NEWARK: 34 PARK PLACE

Doubleday, Page & Co.
OFFICES

GARDEN CITY, NEW YORK
NEW YORK: 120 WEST 32ND STREET
BOSTON: PARK SQUARE BUILDING
CHICAGO: PEOPLES GAS BUILDING
SANTA BARBARA, CALIFORNIA
LONDON: WM. HEINEMANN, LTD.
TORONTO: OXFORD UNIVERSITY PRESS

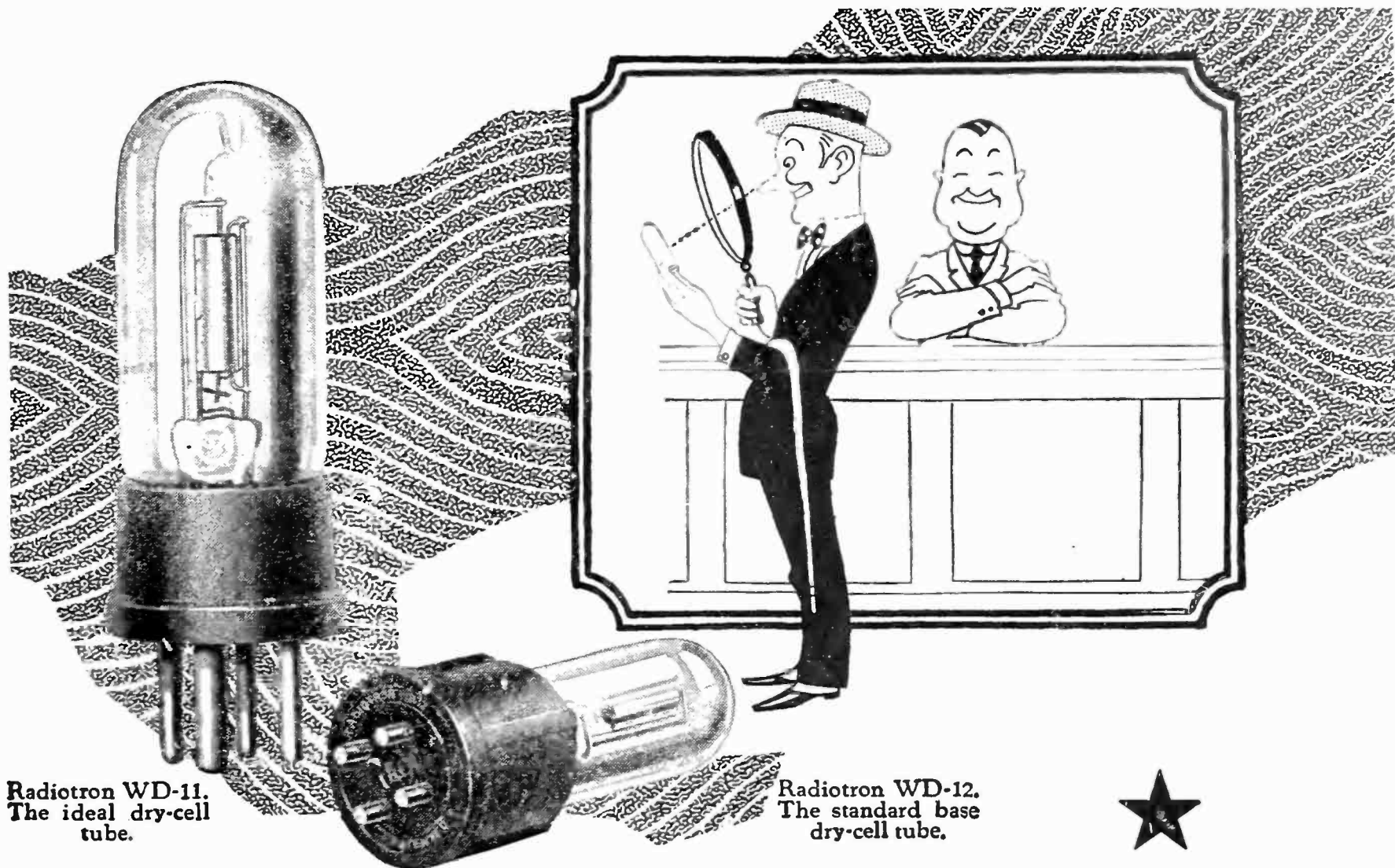

Radiotron WD-11.
The ideal dry-cell
tube.

Radiotron WD-12.
The standard base
dry-cell tube.



For *Distance* ~ the *tube* is important

Radiotrons WD-11 and WD-12 are the same except for the base.

Radiotron WD-12 has a standard navy type base. Use it to change your set to dry battery operation. Ask your dealer today.

Radio reception is not only a question of power, but of sensitivity to weak signals—and *clear* amplification. Radiotrons WD-11 and WD-12 are sensitive to the extremely feeble signals from distant stations—are silent in operation—and economical. They are famous for radio frequency amplification as for audio frequency—and detection. Get *genuine* WD-11's or WD-12's. Look for the name Radiotron and the RCA mark.



This symbol of
quality is your
protection

Radio Corporation of America

Sales Offices:

233 Broadway, New York

10 So. La Salle St., Chicago, Ill.
28 Geary St., San Francisco, Cal.

Radiotron

REG. U. S. PAT. OFF.

★ Tested and approved by RADIO BROADCAST ★

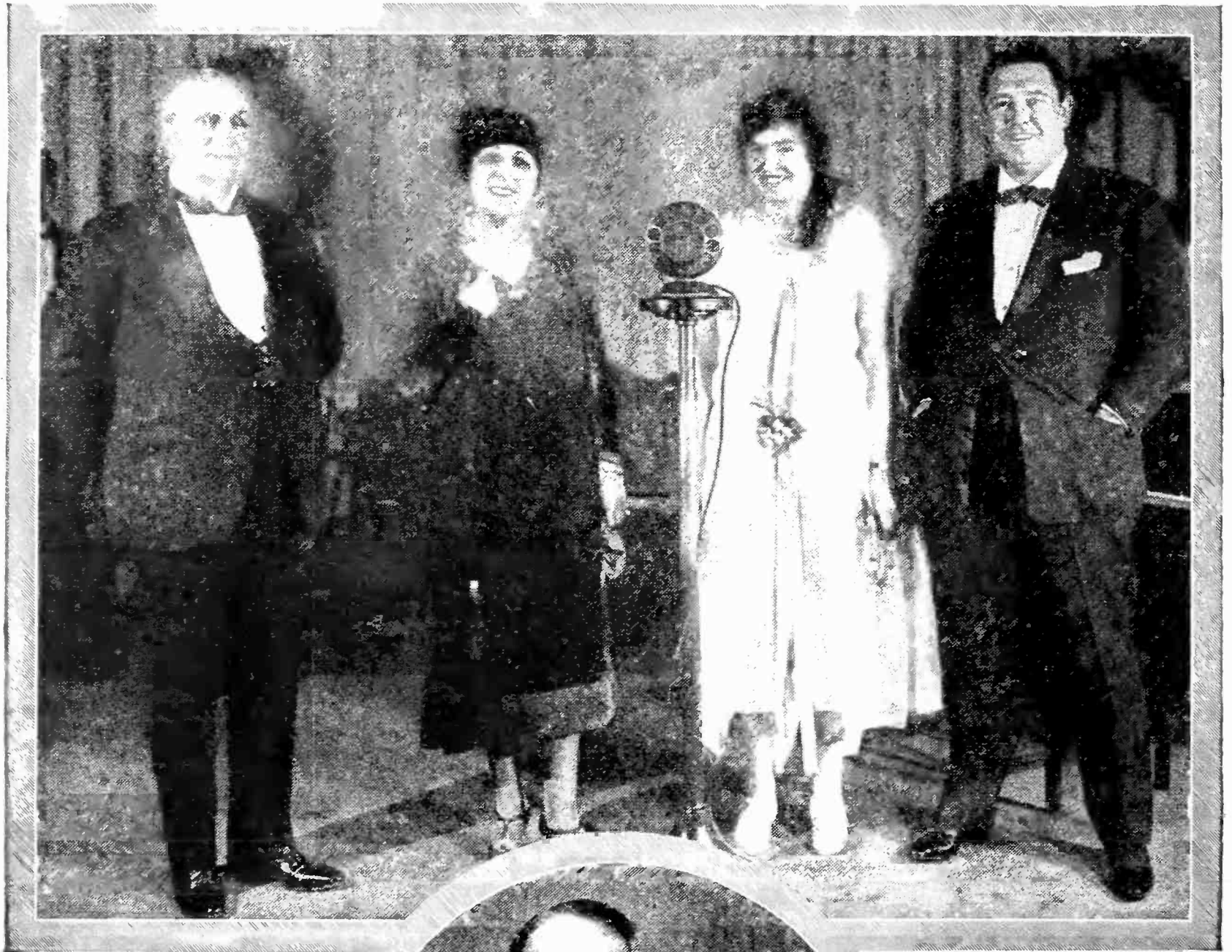

THE PRINCIPALS IN A BIT OF HISTORIC BROADCASTING

The top photograph was taken in the studio of WEAf, New York, on the evening of January 1 when two recording artists of the Victor Talking Machine Company, broadcast through a chain of eight stations. The Victor Company, through its New Year's night broadcasting, is the latest of the large phonograph companies to allow its stars to broadcast. Several weeks before, the Brunswick Company allowed a number of its own recording artists, members of the Metropolitan Opera Company, to broadcast. Calvin Childs of the Victor Company, Lucrezia Bori of the Metropolitan Opera Company, Gwendolyn McCormack, (daughter of John McCormack), and John McCormack are in the upper photograph. The insert shows Graham McNamee who capably announced the event

RADIO BROADCAST

Vol. 6, No. 5



March, 1925

New Fields for Radio

The Next Will Be a "War in the Air"—A Consideration of the Possibilities that Radio Has Brought About

BY D. C. WILKERSON

IT WAS almost inevitable that such an art as radio—for so is the science of radio now classified—with so many new and undeveloped channels for expression, would carve a way into the rank of indispensable resources for national protection and aggression.

In the late World War, the pressure of combat was so tremendous and immediate that a leisurely investigation of the possibilities of radio was impossible, and it was only during the latter days of the war that the full measure of its advantages were practically realized.

At the beginning, there were few vacuum tubes in use by either of the Allied or Central Power field or naval forces. This De Forest invention had not received the attention nor had it been developed enough through experiment to make it a worth-while adjunct to military intelligence. The two-electrode Fleming valve up to 1914 had enjoyed considerable vogue, but it was

unstable, and was regarded more as a laboratory toy than a practicable work-a-day device.

The French, Italian, German, and English electrical engineers, under the incessant demands for better and more reliable means for establishing and maintaining radio communication in the surges and stress of the battle front, started developing the vacuum tube with a vengeance, and by the time that the United States entered the war in 1917, had covered considerable ground in the development of the vacuum tube. Parallel with foreign efforts in this direction, the Western

Electric, General Electric, Westinghouse, De Forest, and Bell Telephone engineers were beginning to produce real results with the three-element tube and they had made for the United States Government a fairly stable and reliable product.

The vigorous plunge of our forces into the front line trenches rekindled the enthusiasm of

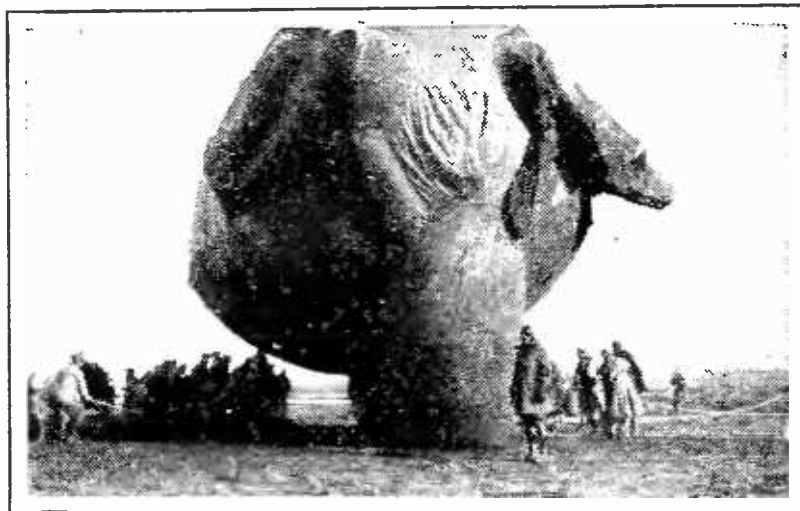

—Photograph Courtesy U. S. Air Service

CLUMSY AËRIAL ELEPHANTS

Such as this "blimp" will be easy prey for the radio-controlled airplane, equipped with incendiary bombs or bullets

the Allies, and the liaison established between the practical engineers of the above mentioned companies and those of the nations aligned against the Central Powers, brought about quick changes and some real advances.

At the close of the War, the reputation of the vacuum tube had advanced to a high plane. As a means for radio reception it had proved its excellence, and its use as an oscillator and a transmitting agent had begun in earnest. Its use as a generator enabled many of the front line engineers to "get the jump" on many a zero-hour attack by the Germans, and it also served as an excellent "scrambler" for the German attempts to maintain radio communication at the front.

Following the rapid development of the vacuum tube itself came the circuits designed to use it. Some of these were the reflex, the super-heterodyne, the super-regenerator, and the neutrodyne. All of these helped attain greater selectivity, hence a greater degree of secrecy in communication. Later, have come the circuits of Meissner, the junior Hammond, and Senator Marconi.

PEACE-TIME ADVANCES AID WAR

IN EVERY case where peace-time advances are being made in the radio art, that development has a place among the resources for war. For ten or twelve years a tremendous amount of laboratory and experimental work has been done toward achieving a practical

control of distant mechanisms by means of radio waves. In the United States Patent Office are anywhere from two to three hundred patents all bearing on this branch of the art, and probably three or four times as many applications not yet passed upon by the government staff of experts, as patentable.

The proposition of distant control has many peace time uses. Railroad train cab-signal and control mechanisms can be operated by means of radio. Great unit powerplants located at distant points from the zone of power delivery are going to require some means of radio communication and control. Our coast-line lighthouses and beacons are going to figure in a radio control development. In the near future, the transcontinental air mail will require radio tell-tales, showing positions of mail carrying units at some central point, as the volume of business by air mail requires a more complex control and intelligence system than its present incomplete development allows. In the event of aërial passenger and freight movement of any consequence there will be an immediate need for practical intelligence and control mediums.

Certainly in time of war, the nation which is able to keep in the air, and control the flight of mechanical engines of death will be able to sway the tides of combat in its favor.

A recent dispatch from England told that the Royal Aircraft Forces there are making

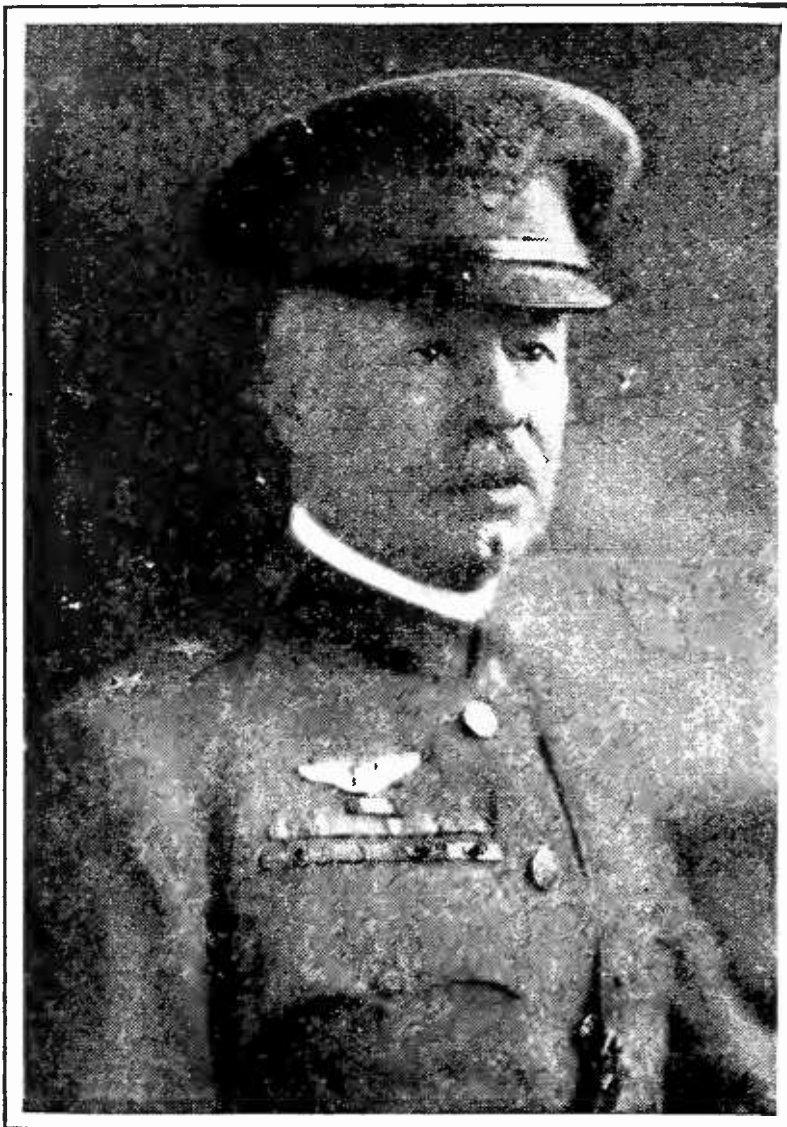

MASON M. PATRICK

Major General, United States Army,
Chief of Air Service

Since the War, the great advance in the development of radio has been followed with interest by the Army Air Service. It affords a rapid and accurate means of communication between forces behind the guns, on the land, sea, and in the air. Experiments have proved that airplanes can be operated by radio without pilots on board them. It is believed to be possible that a number of airplanes may thus be directed and controlled from a single plane or from a control station, guided on their course and that from them bombs may be dropped when the attacking plane is over its target. Aërial torpedoes may likewise be made to find their mark. While great progress has been and continues to be made in this method of distant control of war machines, there seems to be likewise a further large field for experiment in hampering or preventing the radio operation of these engines of destruction and it is possible that this may tend to a still further radio development.

I am interested and glad to note the stimulative effect of the publication of articles and data of this character by such magazines of the excellent quality of RADIO BROADCAST.

great progress in the control of pilotless planes controlled by wireless waves. In the same dispatch it was stated that the launching of aerial torpedoes or "winged bombs" was being attempted and that some measure of success in control of their flight over a limited distance was accomplished.

These military developments are naturally shrouded in mystery, protected with every artifice of secrecy available. Without doubt, every modern nation is participating in experimental work of this class, for the overwhelming tactical advantage of success in this field would weigh heavy should another international war break out once more.

ARMY OFFICERS ARE SANGUINE

MAJOR-GENERAL MASON M. PATRICK, Chief of the U. S. Army

Air Service, in an address before the Franklin Institute at the occasion of the recent celebration of the centenary of that organization stated to that distinguished assembly that the Army already had an "automatic pilot" device which flies airplanes without anyone aboard. He added that the step toward radio control was but a short one. He also said that he expected within a short time to see our military forces flying whole fleets of these planes, operated by a few men in a central control station. These fleets could be maneuvered to carry on attack against enemy cities and military units.

At the same meeting, Major-General George O. Squier, late Chief Signal Officer of the Army expressed his belief that within a short time, "manless planes" carrying sleep-producing gases sufficient to put to sleep a whole nation for forty-eight hours, could be sent into action as a means for stalemating war.

Such startling predictions by conservative military men are most worthy of consideration,

but thus far none have touched upon the further developments which must follow the practical achievement of radio control of mechanical flight. The success of the radio-controlled aerial torpedo guarantees the parallel success of the radio-controlled bombing plane, the gas spreader, the reconnaissance camera plane, and the combat plane. The operating technique of the one lends itself readily to the control of the other.

With the development of lighter-than-air gases of poisonous nature, for repelling aerial reconnaissance and attack, and with the proper development of anti-aircraft barrage fire, the predicted mortality of flyers and pilots will be higher than in any previous war.

In addition to the estimated government investment loss of \$25,000 for every pilot killed while flying, the lost benefits of his services

amount to even larger figures. A live, trained pilot is worth considerably more than the cost of his training. The perfection of radio-controlled mechanical flight means a saving of seasoned flyers for more important uses, which cannot be furnished by automatic pilots.

Entirely aside from the Army developments, the Navy is

working with radio-control. The Navy needs the automatic pilot and the controlled-flight airplane for a hundred different purposes.

WHAT THE NAVY NEEDS

IT WILL have to protect its battleship and battle cruiser fleet without which there are no bases from which to conduct flights. It will have to produce aerial smoke-screens, to conduct raids against attacking lighter-than-air and heavier-than-air bombing fleets, and to serve as the extended "eyes" of the fleet, to guarantee against inefficient position maneuvering. The latter can prove very disastrous, as the battle of Jutland so clearly demonstrated.

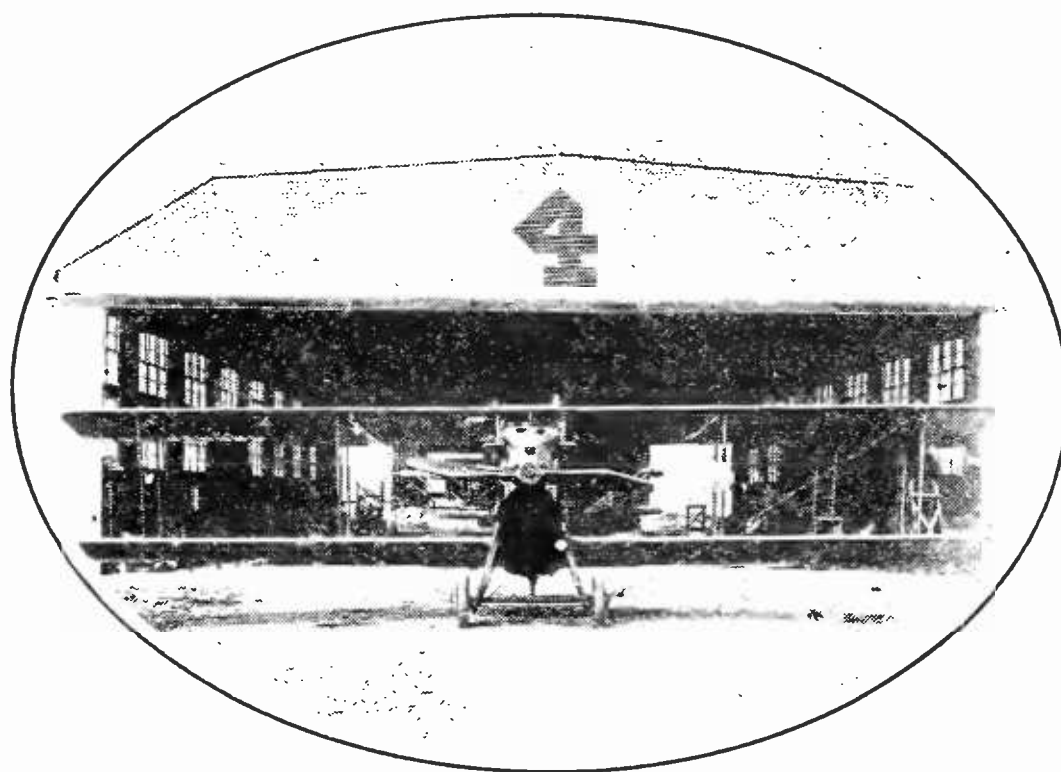

— Photograph Courtesy U. S. Air Service

WILL PLANE SUCH AS THIS, RADIO-CONTROLLED, MAKE FRONT LINE TRENCHES UNTENABLE?

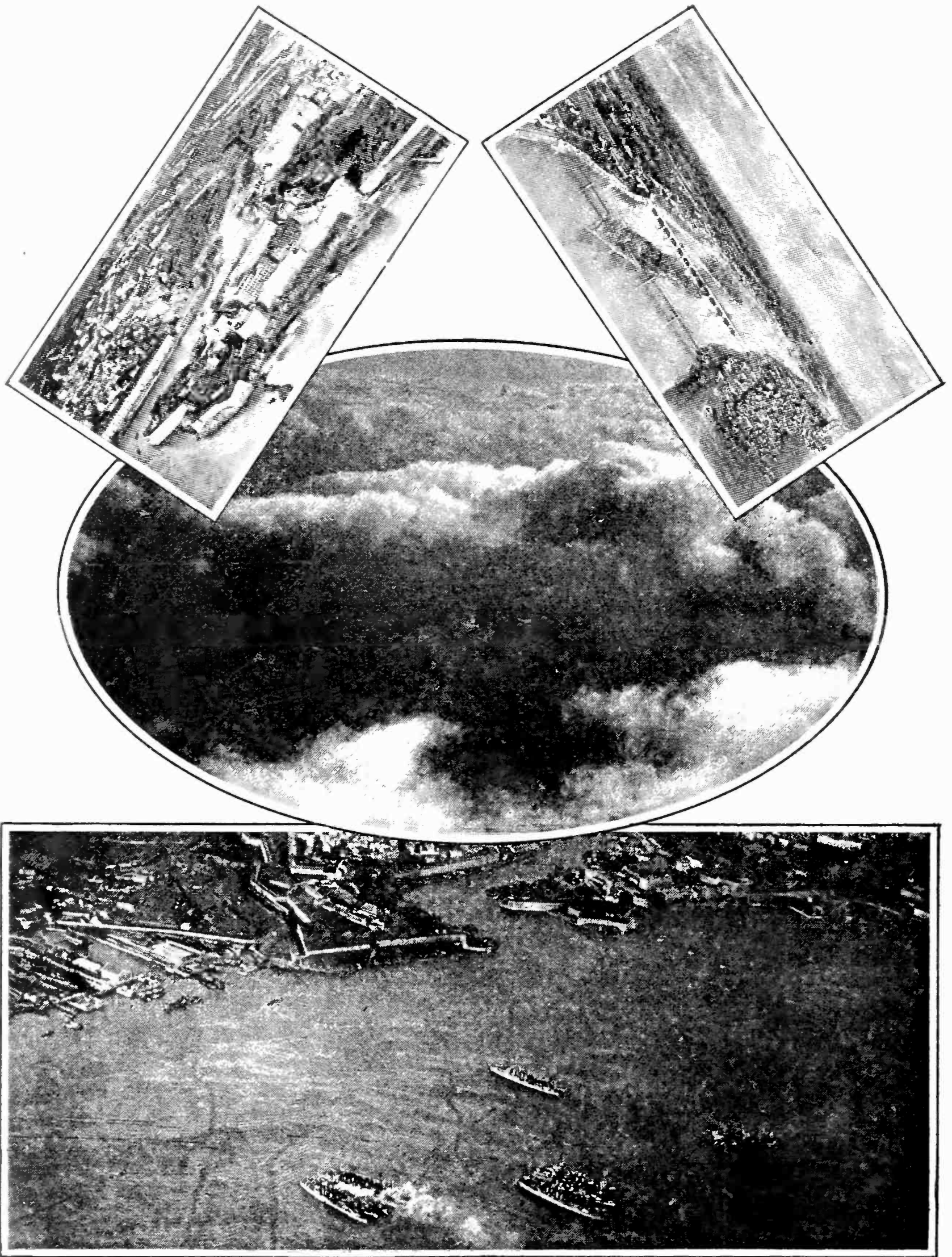

—Photographs Courtesy U. S. Air Service

CLOUD BANKS CAN HOLD NO TERRORS FOR THE RADIO-CONTROLLED PLANE

The radio-controlled camera plane could be utilized to take aerial photographs such as these and return them safely to headquarters with valuable data on enemy forces. These shown here were all taken in the regular manner by the Army Air Service photographers in France during the War

Radio-controlled mechanism can be called on to conduct underwater attack, to maneuver torpedoes to their destination, and to make whole mine fields "live", when, for instance, a fleet retreat is required to be "covered," by newly sown mines.

Another new use of the radio control mechanism will be its application in penetrating enemy mine fields. During the late war there was devised and used by the British Navy an invention known as the "paravane," or "otter gear." A ship thus equipped was able to steam right through an enemy mine field, and provided it did not strike a mine bow-on, the otter gear, swinging out from its side, armed with huge steel jaws, snipped the anchor cable of any mine encountered. The mine, then released from its anchoring weight, bobbed harmlessly to the surface, where it was detonated by watchful guards placed along the decks with rifles.

Steel underwater sharks, entirely radio-controlled, could easily be equipped with "otter gear,"

and can cut swaths through a mine field so that attacking ships can steam to enemy ports. An enemy zone can be placed in such condition that no enemy ships can maneuver there because of the danger from their own mines to their own ships.

IMPORTANT APPLICATIONS OF RADIO CONTROL

NOT the least important among the developments hinging upon the successful completion of the distant control of mechanisms by radio, is the handling of decoy aerial fleets, and decoy battleships. It is a known fact that the British Admiralty completely fooled the German scout submarine commanders when they built facsimile copies of the superstructures of the Grand Fleet on the discarded hulls of pre-dreadnaught ships,

and operating these decoy ships in waters far removed from the location of the Grand Fleet in Scapa Flow. There will always be a need for decoy vessels of the sea as well as of the air, and their operation will adapt itself quite well to radio control mechanisms. The U. S. S. *Iowa* was maneuvered by rudimentary radio control apparatus in battle evolutions three years ago.

With radio-control, it will be quite feasible to deploy great squadrons of tanks in concentrated battle front, to batter a hole in a dangerous sector.

Mechanical land mines, underground gas bombs, incendiary flares, and short-distance

catapulted detonating devices containing all three of these elements lend themselves to control by radio. An occupied area about to be abandoned, can be rendered absolutely untenable for long periods of time by intermittent explosions controlled by radio from a distant point.

At recent frequent intervals, some very interesting stories of ammunition

magazine explosions and disastrous fires caused by radio waves have appeared in the press. Many of the soundest scientists refuse to credit theories of that sort. People in general have ceased to wonder at the miracles of radio, and expect much greater marvels than the art to-day is capable of attaining. This blasé attitude has restrained radio-progress to some degree. It may be that powerful transmitting stations, broadcasting radio waves of high frequency, can cause currents to flow in external circuits in such a way that sparks are produced of sufficient strength to do damage. However, when one considers the thousands of circuits, telephones, telegraph wires, and house-lighting, immediately adjacent to these powerful transmitting stations it is not hard to assume that

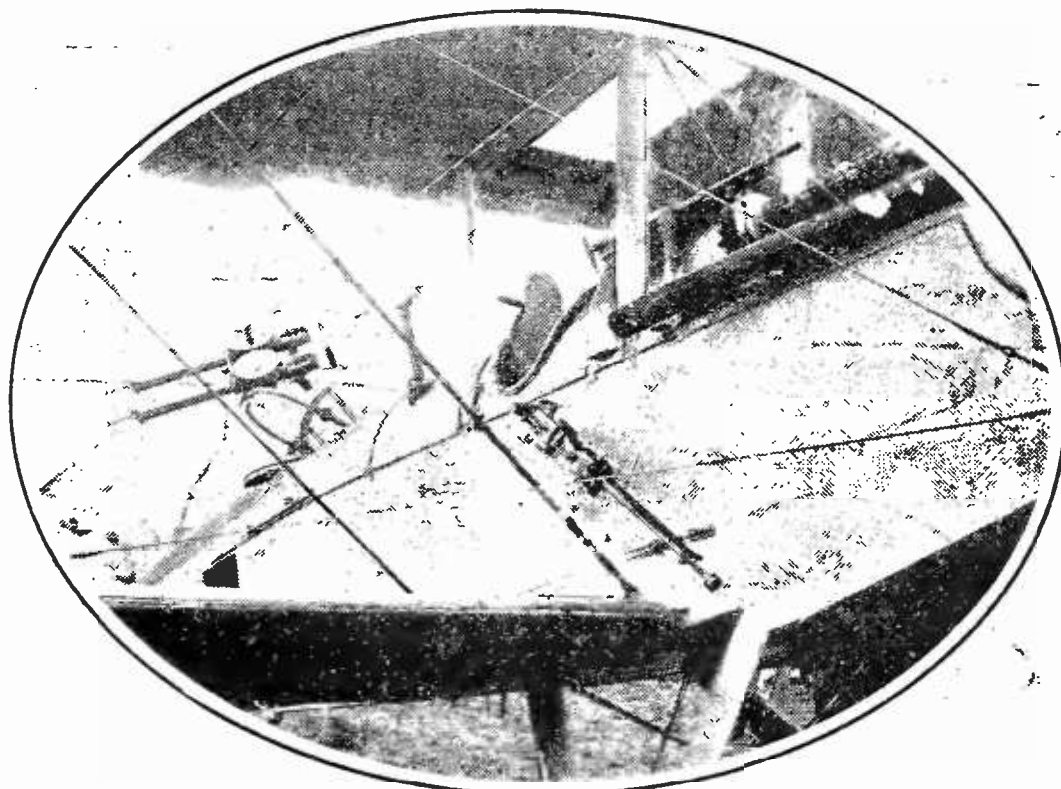

—Photograph Courtesy U. S. Air Service

THE PROMISE OF A THREAT

Is dimly concealed in the armament of this airplane. It is theoretically possible to control the firing of the guns and releasing of bombs as well as to guide the flight of an airplane equipped for radio control

radio energy, picked up from some powerful transmitting station, would burn out such circuits, or else seriously disturb their normal operation. This does not seem to be the case, and it can be inferred, if no better proof is available, that these stories of ammunition explosions are purely imaginary.

More to the point, and far closer to realization, is the imminent completion of successful aërial flight controlled by radio and mechanical means as outlined and as noted by the authorities quoted here. Whether or not these means now being developed will find their first practical use in the arts of

peace or in the arts of war remains a question that only the future can answer. We only know that the means are available, that the energies of governments and of many private individuals are being directed toward the rapid solution of the problems presented, and that so far a fair measure of success has rewarded these efforts.

The wonders and mysteries wrapped in the radio art are gradually, but nevertheless surely, being unfolded, and the hand and mind of man are making use of their solution in ever widening circles of industrial, economical, social, and military activity.



OBSERVATIONS OF THE RADIO LIFE: NO. I

Selecting a B-Battery Eliminator

What to Consider in Buying a B-Battery Substitute—A Helpful Discussion of Moot Points of Economy, Operation, and Value

BY PHIL FAY

SO MANY different kinds of current tap devices, widely varying in price and operating characteristics, have been offered the public, that a prospective purchaser, uninitiated in the technical phases of radio and electrical engineering, finds it difficult to make a choice. The usual recourse—that of consulting a friend who has one—is rarely available in the case of the current tap devices because few or none of the manufacturers have yet reached a volume of production which is very great.

To secure satisfaction, it is absolutely necessary to select a B-battery eliminator which is adapted to your particular set and power circuit. A current tap device suited for use with a three-tube set frequently gives about as good service with a five-tube receiver as a bicycle tire with a Ford car.

A further complication is added to the situation by reason of the fact that radio salesmen are not yet sufficiently experienced with these devices to make sound recommendations. If the binding post on a current tap device reads 100 volts, they unhesitatingly state that its output is 100 volts, while as a matter of fact, with some current tap devices it may vary between 40 and 275 volts, according to the set with which it is used. Hence the prospective purchaser will do well to make a little study of the subject before making an invest-

ment as large as one for the average receiving set, lest he find his purchase a liability rather than an asset.

In general, there are four qualities to consider, which determine the value of a current tap device to its user. They are:

1. The degree of silence with which it operates
2. The life of rectifier tubes and their upkeep cost
3. Its adaptability to different types of receiving sets, and
4. Its safety with respect to shock and fire.

SILENCE IS GOLDEN
AND DESIRABLE

THE first quality of a current tap device which you must verify is the silence with which it operates. At first sight, this may appear to be a simple matter—a few moments of listening at a radio store. A purchaser may conclude that a certain device is silent because it was demonstrated to his satisfac-

tion, but upon connecting it up at his home, he may find it extremely noisy. Often the dealer or manufacturer is then accused in the mind of the purchaser of having a demonstrator superior to the product sold to purchasers. But this is quite unfair to dealer and manufacturer. A current tap device which may work perfectly in one electric circuit may be entirely unsatisfactory in another because of difference in its electrical qualities. The general impression that all 110 volt 60 cycle alternating current is

Batteries and Battery Eliminators

The storage battery has been in use for a long time in lighting the filaments of radio receiver tubes. This secondary source of energy in fact has been used for that purpose ever since the vacuum tube was invented. More recently, however, the storage battery has been used as a source of plate potential with considerable success. The storage batteries which were used with tubes were for a long time simply those designed and used for lighting and automobile ignition purposes, but such batteries have their shortcomings. New storage cells have been designed especially for radio circuits and are to be had on the open market.

The public has heard much and so far seen little of the devices designed and sold to replace batteries. Most prospective users are timid about purchasing these devices because they are not sure that they will perform as well as batteries. Mr. Fay's article is of genuine interest and contains facts which have been found after actual test of the various methods of voltage supply for tubes.

—THE EDITOR.

electrically identical, no matter where secured, is unfortunately erroneous.

There are many differences between one power circuit and another. First, there are wide variations in voltage at different hours of the day and night ranging between 100 and 120 volts. These are not noticeable in the brilliancy of electric lights or in the operation of ordinary household equipment, largely because this apparatus unlike radio equipment, is not especially sensitive to voltage variations of this amount. In a current tap supplying a radio set line voltage differences are of the utmost importance.

Another factor, which enters into the matter of successful current tap operation in one's particular location, is the voltage wave form delivered by the generating system supplying the alternating current. The theoretical sine wave, with its smooth variations, is a laboratory product only; alternators supplying power lines have individual characteristics which cause humps of differing intensity, to occur in the voltage at harmonics of the 60 cycle frequency. Engineers state that no two generators have ever been built that have precisely the same voltage curve and that an expert can recognize the wave form of a particular generator with the same degree of accuracy that a detective identifies the criminal by his finger print.

Such variations in wave form have no effect upon the ordinary loads, such as motors and electric lights, but a vacuum tube rectifier is so highly responsive to these digressions from the sine wave, which often assume proportions larger than the voltages induced in the antenna system by strong incoming signals, that satisfactory reception with the current tap may be impossible. Consequently, one current tap device, silent when supplied from one light socket, may be objectionably noisy in another.

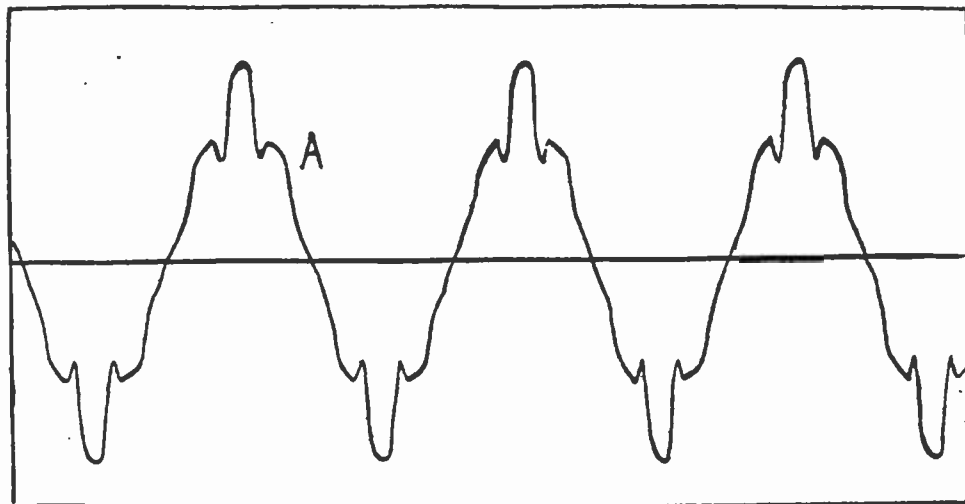

THE OUTPUT OF A COMMERCIAL ALTERNATOR

Installed in the average power house which furnishes the alternating current used for house lighting and power purposes

POWER TRANSFORMERS AFFECT CURRENT

ANOTHER important cause of changes in wave form are those due to saturation of the iron core of transformers placed along the line to step down the line voltage to the value required by consumers. At certain loads, this effect may accentuate harmonics to a surprising degree, while at other hours and loads, they may fall to a point where they are not annoying. Hence a discriminating purchaser will not only test a current tap in his own home but will continue it over a sufficiently extended period to make certain that it will give satisfaction at all loads and conditions of his power circuit. Because of the newness of current tap devices, many dealers are willing to permit such a test and to refund the purchase price if satisfaction is not secured in your home.

These considerations with respect to variations in power supply should not lead the reader to conclude hastily that a current tap device cannot be made to work. If it is provided with suitable adjustable inductances, capacities and resistances, its characteristics may be adapted to these constantly changing conditions.

In judging the effectiveness of a current tap device in your particular location, it is also necessary to remember that power lines are excellent conductors of currents of radio frequency, as evidenced by the successful development of antenna plugs for use in place of aerials, and the transmission of radio programs over power lines, by the "wired wireless" method.

Those who live in or adjacent to buildings having elevators or electric motors have frequently heard the annoying hum which is radiated from the power lines and picked up by the antenna system. In some cases, it is necessary to wait for the offending elevator to complete its trip before satisfactory reception, even from local stations, can be secured. When using a current tap device you make a direct connection with the power conductors supplying such elevator motors, amplifying the resulting noises through vacuum tubes and feeding them to the most sensitive circuits of your receiving set. The interfering noises from such sources are therefore tremendously increased. Every time a light is switched on and off in the building, a decided click is heard, although noise from

this source is not nearly as annoying as that from high speed motors.

DISTORTION ON HARMONICS OF POWER SUPPLY

WHEN loud speaker reception is attempted, the faint residual hum heard with the current tap device is not annoying. Usually the signals from local stations are considerably stronger than the residual hum. Quality of reception is affected only upon harmonics—that is, in the case of 60 cycle current, 120, 180, 240, 300 cycles, and so on. At these frequencies, the volume is somewhat louder than normal because the signal is reinforced by the pulsations in the power line. Thus if a scale is played at the same intensity at the broadcasting station, your receiver will respond at the same intensity, excepting at these harmonic frequencies, which will be increased in proportion to the residual hum and the amplification applied. The difference between this distortion and that produced by a poorly designed amplifying transformer is that the resonant points in the former case are very sharp, while with the latter they are quite gradual and cover wider frequency bands.

Even the best of current tap devices, entirely satisfactory for local reception, cause considerable noise where the amplification level is raised. Since local reception is the principal use to which receiving sets are put, a slight residual hum is not serious. But as soon as the amplification level is raised for the reception of distant stations, the hum increases. When a device is demonstrated connected to a receiver, it is advisable to increase tickler coupling or filament brilliancy so that maximum amplification is obtained. This will protect you against a device which is only suitable for reception from near by high power stations.

UPKEEP EXPENSE WITH THE CURRENT TAP

INASMUCH as the current tap device is purchased in order to eliminate B battery expense, the purchaser must be certain that the current tap device will prove an economy. If a current tap is suited to the load for which it is used, there is no reason why it should not be economical. On the other hand, tube renewals, with a poorly designed current tap device, may be several times the cost of B bat-

teries of good quality and of the current capacity for your receiver.

Overloading a vacuum tube is fatal to its life. Life tests have shown that a 5 per cent. overload in filament voltage may cut in half the life of a tube, which practically doubles the cost of maintenance. This condition can be overcome in a current tap, if means be provided to control the filament voltage of the rectifier tubes. By all means select a current tap device which is equipped with means of controlling the filament voltage, for without it economy is quite impossible. It may appear that a properly designed current tap supplies the tubes with the correct filament voltage without requiring adjustment, but this, unfortunately, is not the case.

Assume that you have a current tap designed to furnish exactly five volts to the rectifier at 110 volts of current supply. In the early evening hours when there is the heaviest drain on power supply, it is usual that the supply drops to 105 volts and consequently, the rectifier filaments are being furnished with only 4.56 volts—a considerable underload. This permits of maximum filament life. But by 10.30 P. M., the voltage of the power line is likely to increase to 120 volts, because the load upon it has decreased. It is characteristic of power systems that as the load falls the voltage increases. Consequently there are constant fluctuations in line voltage at all hours of the day and night.

At 120 volts, the filament supply is 5.45 volts, or approximately 10 per cent. overload, sufficient with most tubes to cut their

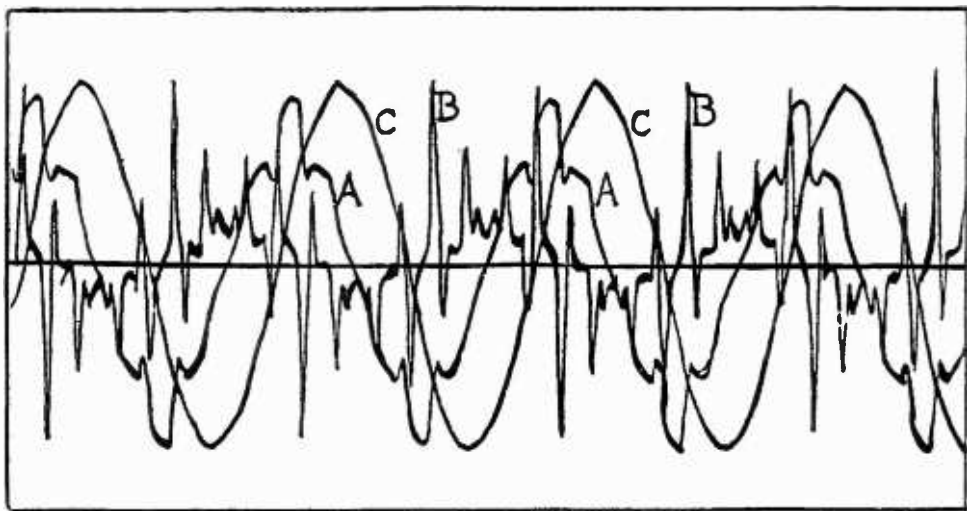

THE EFFECT

Of inductive and capacity loads on the regulation curve of a typical commercial power house alternator. These loads are such demands as are ordinarily made by normal power-consuming devices. The variation in voltage is clearly indicated. These varying demands result in an uneven voltage being delivered to the power-consuming device. This effect is not serious with the incandescent lamp and the usual household device, but the accompanying article shows its effect on a radio receiver using battery eliminators

life to one fourth. Hence, no matter how conscientious the manufacturer, he cannot make a current tap suitable to all conditions, unless it is equipped with a filament voltmeter and means of regulating the voltage supplied to the rectifier tube filaments. A device which works perfectly under laboratory conditions may in your service completely belie all life and silence tests. In order to increase output, many current taps are so designed that even with normal voltage the filaments are considerably overloaded and operation on increased voltages, which obtain late at night, make tube life a matter of hours instead of hundreds or thousands of hours.

OVERLOADING FILAMENTS IS EXPENSIVE

THESE are the conditions which permit the elimination of certain current taps without further investigation by reason of the fact that their tube equipment is such that it is under no circumstances economical. A current tap equipped with UV-201-A tubes has a definite limit to economical output. To quote John F. Rider, a radio writer in "The Laboratory Scrap Book," New York *Sun* Radio Section, Oct. 18, 1924:

The 201-A tube has often been recommended for the rectifying medium in B battery eliminators. Unfortunately, however, while it does function as a rectifier and may be utilized as such, its current output is so limited that its application to this type of work is very poor—that is, if one is desirous of utilizing the unit in conjunction with a multi-tube receiver.

In order that the B battery eliminator may be a success, it is necessary that its current output be at least twice the total possible current drain of the tubes used in the receiver with the maximum plate voltage applied. Having both equal is impractical, as a strong signal will increase the drain beyond the normal value, and the moment the drain is in excess of the supply the voltage of the latter will undergo a considerable drop.

The current output of the average 201-A tube when used as a rectifier and arranged so as to supply about 120 volts is about 20 to 22 milliamperes. With several tubes which were tested the maximum rectified current was only 18 milliamperes. In addition, it was necessary to maintain the filament brilliancy above the value specified by the manufacturer, thus greatly decreasing the life of the tube. To attempt to use a rectifying arrangement of this type with a receiver that draws 30 or more milliamperes is out of the question, hence it is necessary somehow to increase the current output of the B battery eliminator.

It may appear at first sight that the use of two tubes (as is done on practically all devices)

may double the output. But indeed this is not the case, for one tube functions during one half of the cycle and the other tube during the other half. A five-tube set, for instance, may draw as high as 25 milliamperes, and consequently a supply of 18 milliamperes, which is the maximum output, even with considerable overloading, that UV-201-A tubes can be expected to deliver, it is quite out of the question that satisfactory results may be had. The total output must be at least 30 milliamperes, or else there will be distortion in the received signal.

Another type of tube which is sometimes used by experimenters, is the Tungar rectifier, familiar through its use in battery charging devices. This device is designed to supply a heavy current at low voltages. It is not a high vacuum tube but filled with a gas that is easily ionized so that it can become a conductor of considerable current. Consequently when it is used with excessive voltages it has the unstable characteristics of gas tubes and the effect on the life of the filament is disastrous.

"S" tubes do not have any of these disadvantages. However, they are designed for use with radio transmitters to deliver high voltages and small currents. A current tap made with s tubes is likely to overload the receiving set unless extraordinary precautions are used. A very high voltage is necessary to make these tubes work and it is not wise for the novice to wear headphones so intimately associated with an s tube requiring 750 volts as plate potential. Damage to the set may be repaired but ear drums are irreplaceable.

ADAPTABILITY OF THE CURRENT TAP DEVICE

SO FAR, we have seen that a current tap device must be suited to power line conditions and that the tubes must be able to supply the necessary output. These conditions can be met through the selection of a current tap device of the proper characteristics. The third condition—adaptability to your particular set—can be met in the same way. But the user must keep in mind the fact that the same device will not work with the same satisfaction with all other receivers. Inasmuch as there is a comparatively large investment involved in the purchase of a current tap, it is essential it give service over a period of years. For instance, an economical five-tube receiver used 500 hours a year can be supplied with B batteries for five years for \$75.00 if heavy duty batteries be used. A current tap costing \$50.00 suited to the load so

that the tubes last fully a year, would require 4 renewals at \$8.00 each, or \$32.00, making a total cost for equipment and tubes for five years of \$82.00. Hence, assuming economical upkeep for the current tap, five years must pass before the expenditure for the eliminator becomes less than that necessary for B batteries. You must be sure that your present receiving set with the present type of tubes will satisfy your requirements for a period of at least five years. Otherwise B batteries will serve you better than a current tap device.

The reason that a B battery eliminator is not adapted to different kinds of sets is that its voltage output varies with *the load which is drawn from it*. For instance, a certain current tap device was measured under varying conditions of load, without change of the voltage in the current supply from the power mains. At 1 milliamperes it furnished 180 volts of plate current; as the load increased to 15.5 milliamperes, the voltage fell to 90; at 25 milliamperes, the average drain of a five-tube set, the voltage furnished was but 40 and at 32 milliamperes, the voltage was zero. On the second stage of amplification, the voltage was too low to give the best results and the load so near the peak output that the distortion was noticeable.

This particular device gave 100 volts plate supply at 13 milliamperes which is a good output for an economical four-tube set using UV-201-A tubes.

In selecting a current tap device, therefore, measure its voltage when supplying the plate current needed for your set. If this falls somewhat below the rated voltage of the device, select another make of current tap which is better suited to your requirements.

FACTOR OF SAFETY

NATURALLY, there is a little hesitancy on the part of those not accustomed to dealing with high power electric mains to connect a pair of headphones, directly or indirectly, with a source of kilowatts of energy. A well designed current tap device having insulated bind-

ing posts and concealed wiring, exposes its user almost to no danger, except when one turns the lighting current on and off. If you turn off the filaments of your receiving set with the current tap device still in operation, all load is of course removed from it. The output of the rectifier tubes is merely supplied to the condensers and inductances which form the filter of the current tap device and high voltages are quickly built up, unless the output terminals of the tap are short circuited by a resistance through which these voltages may leak off. Some devices are so equipped; others are not. If, after having turned off the tubes of the receiving set, your next act is to turn off the electric light switch supplying the current tap, this charge remains in the filter condenser, seeking a place to discharge. Then, if you proceed to change the wiring of your receiving set or touch the B battery binding posts, you will have an excellent opportunity to test the effect of a high voltage upon your system.

A simple precaution, however, will practically eliminate this danger. First, always turn off the current tap from the power mains *with the receiving set in operation*. Be certain that you and all the members of your family understand this. Second, short circuit the output mains, *after turning off the supply mains*, before you touch the wiring of your set. In

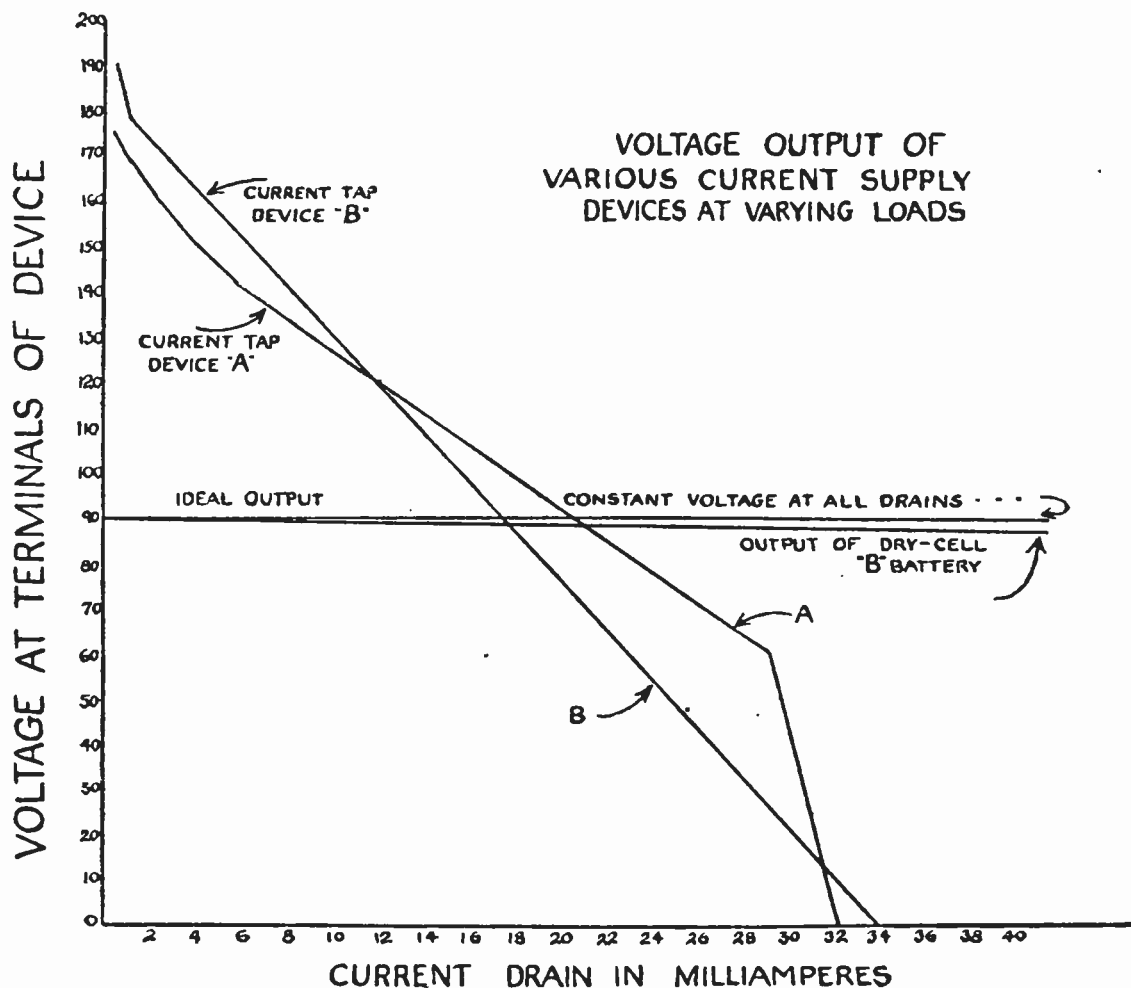

A CURVE

Which shows the voltage output of various current supply devices (B battery eliminators) plotted against the current drain caused by a receiver in milliamperes

this way, you will avoid the danger of shock.

Another source of danger in the current tap is fire due to overheating. Never operate a current tap device without someone in the room. When current taps were first placed on the market, life tests were made at a laboratory and one of these devices was left on all night. A fire which did several thousand dollars damage resulted. Had someone been there, warning through fusing wires would have been given in time to turn off the device.

A well designed current tap device presents none of these dangers. You can determine this for yourself by looking for the stamp "Approved by the Board of Fire Underwriters" on the device which you select. This mark appears on every piece of apparatus which has been inspected and approved by the board as safe for household use. There are scores of well-known manufacturers of household apparatus. Select a current tap

made by one of these, for they have learned the results of placing unsafe apparatus on the market by painful experience.

The convenience of having plate potential always available is certainly worth a little care in the selection of a current tap device.

Satisfy yourself on these points and you will find your investment justified:

1. Is the current tap device silent when connected with *my* receiving set *in my own home*?
2. Does it use tubes capable of furnishing the current which *my set* requires with economy in tube renewal?
3. Is there means of regulating the voltage input of the device so as to compensate for the variations in power supply?
4. What voltage does the current tap device supply to *my set* and is it sufficient to give good results and not too high to be a source of danger when connected with headphones?
5. Is the current tap device approved by the Board of Fire Underwriters?

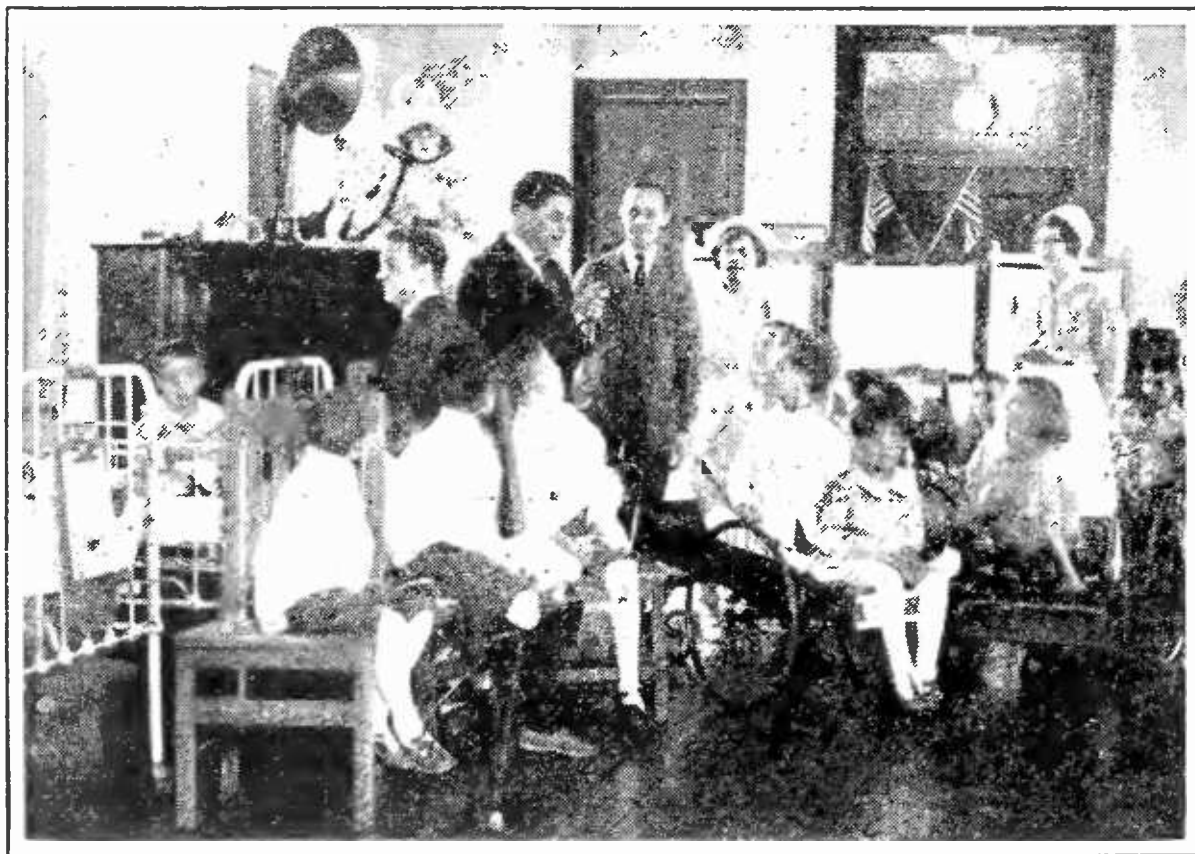

RADIO PERFORMERS IN PERSON

At a children's hospital. The Radio Franks, who are well known to radio listeners went to perform in person for these crippled children, who before had only known them as voices over the air

Who Is to Pay for Broadcasting—and How

The Plan Which Won RADIO BROADCAST'S Prize of \$500 Offered for the Most Practicable and Workable Solution of a Difficult Problem

BY H. D. KELLOGG, JR.

RADIO broadcasting, to be placed on a sound economic basis, must pay its way as do other forms of entertainment. It should be paid because of, and in proportion to, the value of the entertainment provided. And the payment should be made by the consumer, that is, the owner of the receiving set.

Under present conditions, what is entertainment for the radio fan is a subtle source of advertising, in the great majority of cases, for the broadcasting station. And advertising foots the bill. This inconsistency between the purpose of the broadcaster and the radio listener, and the differential between the source of payment and the actual consumer, has led to recognition of the fact that the economic foundation for broadcasting must be rearranged.

While it is apparent that a certain proportion of the expense of present-day broadcasting can continue to be borne by appropriations for the advertising received, and that artists who wish to receive the advertising that their performances bring them will perform free, still the highest type of broadcasting cannot be financed indefinitely on this basis. To secure the utmost excellence in talent, talent which

needs no advertising, the performers or artists must be paid. And further to insure that program directors shall secure the best entertainment possible, untrammelled by any commercialism or advertising for the broadcasting station, the operating expense of the station should be paid directly by the radio audience.

A YEARLY CHARGE—TO THE RECEIVER

A CHARGE, then, must be collected from each owner of a radio set, on a yearly basis, sufficient to pay the annual expense of the broadcasting received. The fair and equitable way to apportion the sum each owner shall pay is on the basis of the value and range of his set and the amount it is used. We would not expect the owner of a crystal set with its limited range and sensitivity to pay as much to the broadcasting fund as the owner of a many tube super-heterodyne.

The amount paid by the radio owner should be compulsory—in other words, it should be the equivalent of a box office charge. No theatre could support the cost of regular performances open to the public in a sound and business-like way through voluntary contributions. A fixed and definite amount must be collected from each individual in the audi-



H. D. KELLOGG, JR.

Of Haverford, Pennsylvania, winner of RADIO BROADCAST'S \$500 Prize Contest. A tax of \$2 on each tube and \$.50 on each crystal used in a receiver is proposed by this plan, and the funds so raised to be administered by a Federal Bureau of Broadcasting

ence before entering the theatre. And likewise the owner of a radio receiving set, with his power to tap in on many sources of entertainment, should be made to pay his share of the entertainment received, commensurate with the range of his set and the amount it is used.

Probably the best index of the range and cost of a set lies in the kind and number of its tubes. In a crystal set it is difficult to pick out any one satisfactory index of its value or use. The crystal should no doubt be taken as the index here. A charge, then, on the tubes or crystals purchased, and included in the purchase price paid by the owner of the receiving set, is the method here suggested for meeting the cost of broadcasting. Why these articles rather than any other should be taken as the criterion in laying the charge will appear from what follows.

THE TUBE IS THE INDEX OF THE SET

IF EXCEPTIONAL cases be excluded, it may be said that the tubes used in receiving sets to-day have a life closely commensurate with the service they render. Two similar tubes giving identically the same service may not last each as long as the other. But in the long run, tubes of reputable manufacture in ordinary service will last a time closely enough concurrent with their usage to serve as a basis for

the owner's share of the broadcasting he receives.

With crystals the relation between use and useful life is not so satisfactory. Crystals do in time lose their sensitivity as detectors and have to be discarded. But statistics will be needed to determine accurately how long the different crystals now in use for radio reception may be expected to give satisfactory service before requiring replacement. No doubt considerable data on this subject is already available. Although this mode of gauging "broadcasting consumption" for this type of set, which it is believed involves the majority of receiving sets of to-day, is not wholly satisfactory, still no better criterion is apparently available.

In a tube set, the number of tubes is an excellent index of the cost of the set and of the range over which it can receive. Thus a broadcasting tax on tubes will affect more the owner of the expensive set who should be required to pay more, because he is able to command a broader choice of program than the owner of the less expensive set, who is correspondingly less able to pay the larger tax. Crystal sets do not as a rule involve very expensive equipment and in any event their range is usually limited, and hence a sliding tax scale here is not particularly to be desired.

A Summary of the Plan

- I. Radio broadcasting must pay its way.
- II. Person who must pay is the consumer—the radio listener.
- III. Most satisfactory mode of payment is a definite charge applied to every owner of a receiving set in proportion to range, value and amount of use of set.
- IV. This charge must be compulsory—a "box office" charge.
- V. The best index of the range and value of a set lies in the kind and number of its tubes. In a crystal set, the crystal is the best apparent index.
 - A. Life of tubes and crystals represents with reasonable accuracy the amount of use set has.
 - B. Number of tubes is index of diversity of broadcasting programs at consumer's disposal.
 - C. Levy can be readily applied to tubes or crystals in form of stamp tax collected from manufacturer and paid by final purchaser.
 - D. Apportionment of tax greatly simplified and evasion minimized.
- VI. Yearly tax not excessive and should not harm the industry.
- VII. Only possible administrator of the super-broadcasting fund is the Federal Government.
 - A. Problem national in scope.
 - B. Private interests would require monopolistic powers.
 - C. Administration of broadcasting fund not particularly liable to political corruption.
 - D. Importance to Government of controlling broadcasting stations as means of directing public opinion.
- VIII. Concrete illustration shows how \$18,000,000 a year may be raised by stamp tax for super-broadcasting purposes.
- IX. Government will take over some existing stations and build others by bond issues amortized from broadcasting fund. Immediate fund obtained by collecting tax from sets now in use.
- X. Conclusion that super-broadcasting for, and paid by, the consumer places broadcasting on its rightful basis.

A TUBE TAX IS READILY APPLIED

THE most important feature of a broadcasting levy applied to tubes and crystals is the readiness with which it can be applied. A stamp affixed to the article, or applied as a seal to the package by the manufacturer lends itself to the requirements of a strict enforcement measure. A concurrent feature is that the work of supervision and apportionment of the tax is greatly simplified. It is difficult to apply a tax to a radio set, which may consist of antenna, ground, batteries, amplifier, loud speaker, and innumerable other components or accessories. To levy a tax on all of these articles would be a clerical task of unnecessary magnitude that would make the expense of collection excessively high.

Since the manufacturers of tubes is so nearly a monopoly, under the existing patents on these important products of the radio industry "bootleg" manufacturing or evasion of the tax would be difficult. Conversely, the tax on tubes would be simple and easy of application and enforcement. With crystals, however, the situation is not so simple. The production of these articles might be made into a monopoly, thus facilitating the application of the stamp tax at the point of manufacture. Or a few large wholesaling houses might be given control of the entire supply and the stamp tax applied there. It is not inconceivable that the requirement be laid down for the affixing of a stamp representing the tax at the time of sale to the ultimate consumer. But a tax collected from the manufacturer, pro-

vided there are not too many manufacturers, could be more readily enforced and is therefore most desirable.

The effect of a tax as outlined upon the radio industry is problematical. It would depend largely upon the additional cost of tubes and crystals to radio fans. In a later paragraph,

the yearly budget needed for broadcasting purposes is briefly discussed, and the amount required from each owner of a receiving set does not seem excessive. The economic stability accorded to broadcasting by the plan outlined should soon carry the industry farther forward than ever before.

THE GOVERNMENT SHOULD ADMINISTER THE FUND

THE most practicable administrator of the broadcasting levy outlined is obviously the Federal Government. It is inconceivable to require manufacturers and producers of tubes and crystals to collect a stamp tax and turn it into a pool or fund held as a monopoly for and by private interests. The problem is clearly national in scope. It is outside the control of individual states and if run by private interests would require the granting of

dangerous monopolistic power. The work of administering a national broadcasting service is not particularly susceptible to political corruption. With full publicity of all accounts, mishandling of the funds in trust would certainly be difficult. And the public would be a daily judge of the quality of entertainment provided. The tremendous value to the Government of having broadcasting stations continuously under its control in times of

Is This the Solution?

This plan of Mr. Kellogg's, which received the prize of \$500 offered by RADIO BROADCAST, won over some thousand others which were submitted. The judges were, Professor J. H. Morecroft, president of the Institute of Radio Engineers (1923-4); Major J. Andrew White, formerly editor of the *Wireless Age* and well-known descriptive broadcaster; Harry Chandler, publisher of the *Los Angeles Times* and owner of KHJ; Frank Reichmann, a Chicago radio manufacturer and an old-timer in the field; Dr. Royal S. Copeland, United States Senator from New York, representing the public point of view; A. S. Lindstrom, chairman of the Pacific Radio Trade Association; Zeh Bouck, one of the best known radio authors in America; and Charles H. Porter, Chicago, secretary of the Radio Manufacturers' Association.

The officials of the American Radio Association, under whose auspices the contest was conducted, do not feel that this plan is the final word in the matter of "who is to pay?" and neither do the editors of this magazine. The broadcasting problem cannot be settled as easily as this plan proposes, although without doubt there is much to be said for Mr. Kellogg's plan. One of the chief stumbling blocks is the setting up of a federal bureau of broadcasting which seems to be contrary to the entire trend of radio development. We believe that anything which smacks of too centralized federal control or censorship would be resisted as much by the public as by all those administering radio to-day. Next month we shall print an interesting discussion on the entire subject.

—THE EDITOR.

emergency, or even in ordinary times, to crystallize and direct public opinion and thought, cannot be overemphasized.

Broadcasting under this plan would then be conducted from twenty-five or fifty high power stations throughout the country. How these may be financed can be indicated by a brief illustration. Tubes and crystals should be rated according to their quality, durability and service. A stamp purchased from the Government Division of Broadcasting should be affixed by the manufacturer to the article or its container. The amount of the stamp should be set, in accordance with statistics compiled, such that each tube will bear \$2 of the broadcasting budget for the year. Similarly, the tax on each crystal sold may be apportioned so that each crystal will bear 50 cents of the broadcasting budget for the year. If we assume 4,000,000 tube sets with an average of two tubes each and 6,000,000 crystal sets in operation, the returns from taxes set at this rate would be \$19,000,000. Taking \$1,000,000 as the cost of collection, \$18,000,000 would remain to be distributed among some twenty-five or fifty stations, allowing each \$720,000 or \$450,000 respectively, per year.

It will no doubt be found desirable, in installing super-broadcasting, to take over many existing stations, though no attempt should be made to prevent present stations from broadcasting on the same basis as heretofore. New stations which may later be installed can be

financed by bond issue amortized from the general broadcasting fund. A sizeable amount of the initial expense of taking over existing stations can conceivably be collected from the present owners of receiving sets as a retroactive inclusion under the collection of the stamp tax on later sales, though the payment could not be enforced without popular support. This would greatly hasten the advent of super-broadcasting, however, which otherwise would have to wait for sufficient accumulation of returns for the normal sales of tubes and crystals before it could be instituted.

It should be understood that while super-broadcasting will place before the public daily, the best talent, entertainment, lectures and concerts available, in a way that is now largely impossible, still the payments to artists for broadcasting service should not be as high as for public performances. There is not the expense involved for the performers in the broadcasting of a concert, either at the time of a public performance or at other times, that accrues for the public performance alone. In the case of many lectures or addresses, the only expense should be that of transmission. The important feature of super-broadcasting paid by the radio listener-in is that it places broadcasting on the firm foundation of direct, paid service to the consumer and insures every day the best possible programs from well-equipped stations, unencumbered by advertising or other irrelevant considerations.

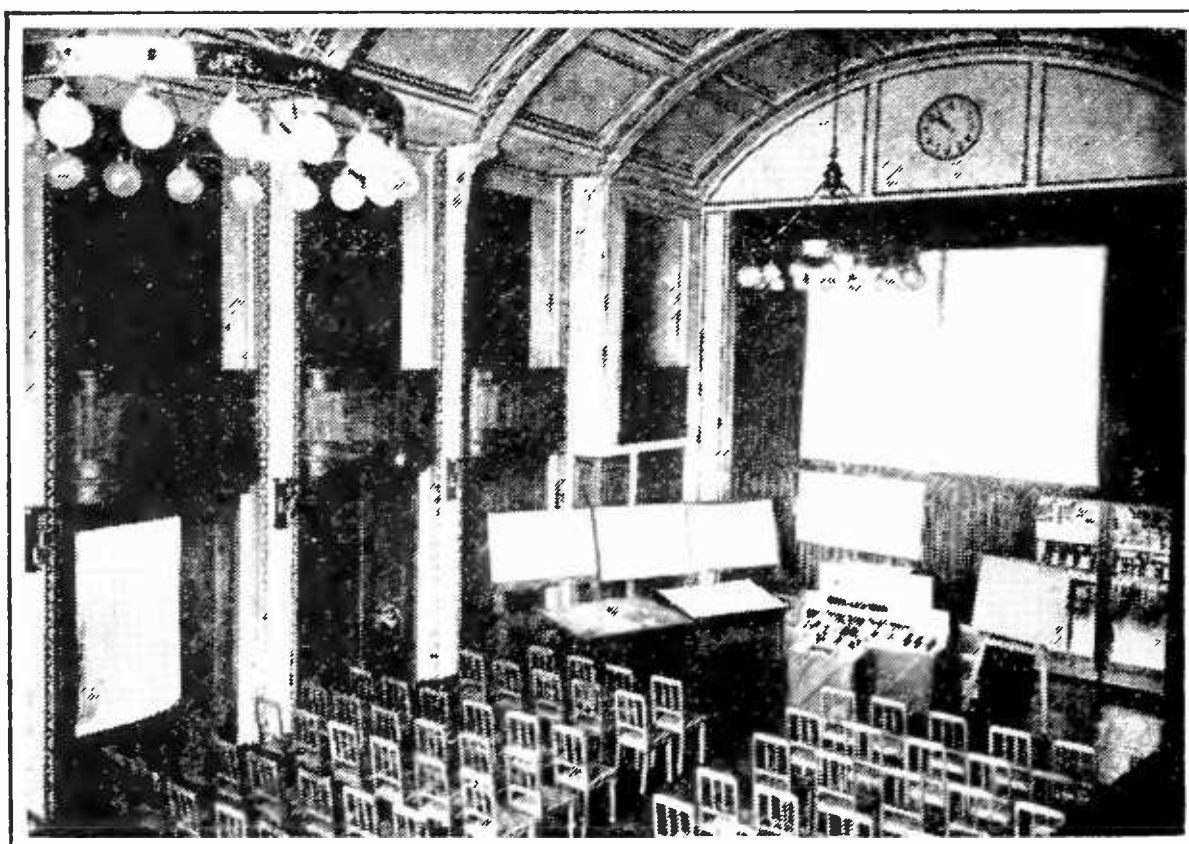

THE LARGEST GERMAN RADIO STUDIO
At Nauen, near Berlin

“As the Broadcaster Sees It”

BY CARL DREHER

Drawings by Franklyn Stratford

The Rising Tide of Microphones

WE ARE proud to present the first article in Mr. Dreher's series, "As the Broadcaster Sees It." For some time the great number of engineers and others interested and responsible for broadcasting have needed a place where their problems could be presented and discussed—perhaps even solved. The broadcasting field is getting so large and varied that intelligent comment, help, and suggestion should be of great interest to those in the field, those who are thinking of entering it, and those who are simply watching from the outside. The listening public will discover that Mr. Dreher has gathered together information which is highly interesting and essentially worth reading and also presents criticism of great value. The series will not be too technical nor too popular. We hope this series sets up some sympathetic oscillations among our readers.—THE EDITOR.

IN BROADCASTING a speaker from a public auditorium, how high should the microphones be placed? It is a grave question, my masters.

The accompanying photograph, showing President Coolidge delivering an address in Baltimore, is an extreme case. The two microphones were placed almost head-high, and must have obstructed the view of many persons in the space below the speakers' stand. From the broadcaster's angle the situation is an ideal one. It is possible to obtain decidedly better quality and naturalness of speech, in the case of a quiet and restrained orator like the President, with the microphones at head-level and fairly close to the speaker's lips. In this way the higher tones of the voice, the harmonics which are so important in the pro-

duction of consonant sounds and delicate inflections, but whose energy is comparatively small, are retained and passed on to the amplifiers. These higher frequencies are easily lost. Generally speaking, with the microphones waist-high, quality of transmission will be slightly inferior. A fair compromise would seem to be at about the level of the speakers' chests. The pick-up is good enough for all

practical purposes, and there is no interference with a clear view of the face of the man on the platform. Both the physically present part of the audience and the radio listening portion will be satisfied.

The opposite extreme to the case discussed above is in theatrical broadcasting. Usually the only pick-up permissible is in the footlights, ankle-high. The speakers are distant from the mi-



IDEAL PLACING FOR THE MICROPHONE

Few broadcasters are able to arrange as favorable a placing of the microphone as was arranged for this speech of President Coolidge. Where the microphone is so favorably placed, excellent speech quality results

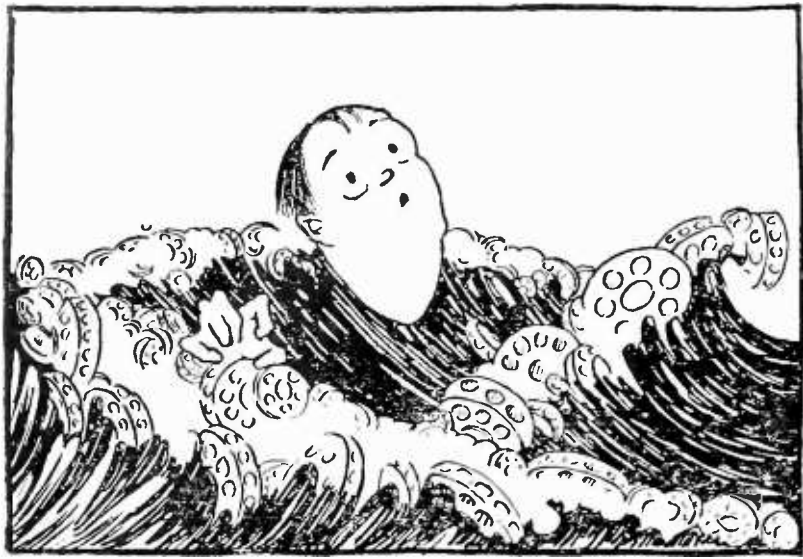

the rising tide of microphones

crophones, and they move around as they talk. To obtain perfect quality under these conditions is out of the question; to do a reasonably good job is an achievement. In spite of the transmission difficulties, broadcasting from the stage is one of the most popular program features that a station can handle. The prerequisite, however, is careful selection of the shows to be broadcast. Generally speaking, the more music the play contains, and the less dialogue, the better it will broadcast. But the engineers will never be really happy, in broadcasting from the stage, until microphones the size of a dime, suspended on No. 30 steel wires, can be placed all over the proscenium. And we are a long way from that, with high quality microphones $3\frac{1}{2}$ inches in diameter, and weighing $2\frac{1}{2}$ pounds apiece, without the housings. We may admire, without attempting to emulate, the bold Baltimore broadcasters who set their transmitters before Mr. Coolidge's nose, and we may pray to be delivered from pick-ups where nothing is seen—and little heard.

Radio Transmitters for All

A FAVORITE subject of newspaper writers and cartoonists and prophets in general is the coming day when radio telephone transmitters will be carried about, as umbrellas are now. Portable sets like these will make possible continuous communication between individuals, and release them from dependence on restricted means of contact at a distance like the present-day wire telephone and telegraph. An example of this type of prophecy is the following excerpt from a recent editorial in the *New York Journal*:

“ . . . This writer has received . . . an excellent little receiving set contained in a matchbox. Using that set as a receiver,

President Coolidge's speech was heard distinctly. Soon each man's hat will contain an apparatus enabling him to talk to his wife at home—an excellent thing if it helps his wife to keep track of him.”

Leaving out of consideration the moot point brought up by the last clause in this quotation, we may point out that the whole contingency is very remote. The popularization of radio *reception*, and the development of highly sensitive portable *receivers*, have led many people to forget (if they ever knew) that there is a fundamental difference between transmitters and receivers. The receiver is a low-power apparatus, in the same class as a microscope or the human ear. Dealing only with small amounts of energy, it may in special forms be made small and inconspicuous. But a transmitter, in all known systems of radio, is power equipment, in the same class as a subway train or a rock crusher. In general, power means size.

Take the present 500-watt broadcasting equipment used by Class B broadcasting stations. The power of these sets is none too great for effective program distribution in a large city. Witness the considerable “dead” and weak areas which every urban station has in its own vicinity. Yet the motor required to drive such a set is a six horse power proposition, and the total weight of the transmitting equipment would tax the strength of an elephant. Carry it in your hat, indeed!

Then there is the limited traffic-carrying capacity of the luminiferous ether—bless it!—or whatever agency does carry radio messages from one place to another. The advent of

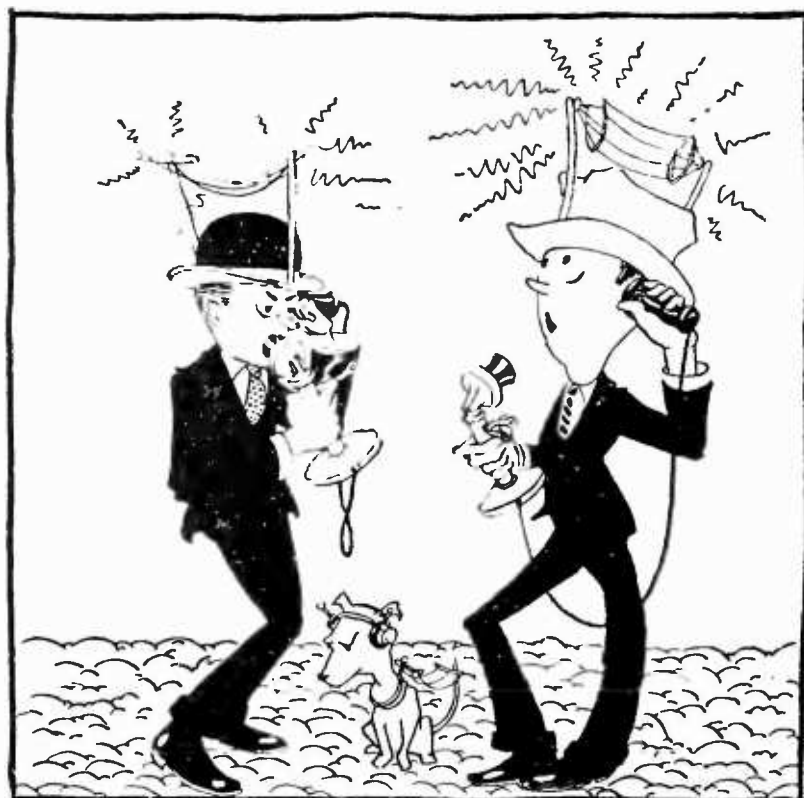

radio transmitters for all

broadcasting, as engineers know, has increased the already severe congestion in the ethereal highways. Marine radio is being forced down, amateur radio up, in the frequency scale. The art is not free from station interference in any of its branches; the problem is one which is taken up at every radio conference. What, then, would happen if every citizen got him a transmitter, when, even now, with one transmitter to about every sixty thousand persons in the United States, interference problems arise? We leave the answer to the feature writers, who are less troubled by such details than we are.

Of course, there is the development of short-wave transmission to be taken into account. Here a great supply of new wavelengths and traffic channels is opening up. And it may also be pointed out that, while power normally involves size, in the case of firearms, for example, great power is secured in very compact form by extreme concentration of force. Furthermore, radiation varies as the fourth power of the frequency, and thus one may view short wave, high frequency radio as a vaguely analogous concentration process, with the added factor that these short waves may be directed in a beam instead of being diffused in all directions. Admitting these arguments as interesting and pertinent, nevertheless, to the engineering sense, the transmitter-in-the-hat development is a thing almost as remote as the Milky Way. Universal radio communication between individuals, without the agency of corporate, public service facilities, may arrive some day, but that the communication companies, wire and wireless, will rake in dividends for a few centuries first, is a safe forecast. The development of a practical

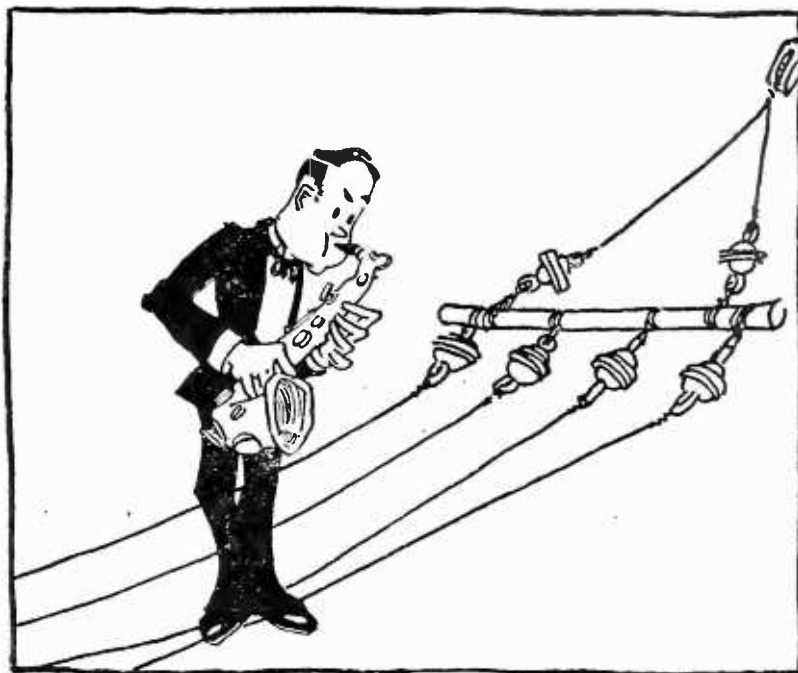

one station specializes in jazz

system of telepathy is just as probable, and telepathy is talked of glibly in much the same way, yet, to the writer's knowledge, no concrete demonstrations of the phenomenon have ever been given. It may exist, it may develop and supersede the laborious and costly forms of electrical communication which have been worked out in the last hundred years—but the vice-presidents and general managers of communication systems are not losing any sleep over that possibility. The possession by every individual of a radio *receiver*—that, of course, is another matter. That is already at hand.

The Differentiation of Broadcasting Stations

AT PRESENT all the broadcasting stations are trying to please everybody. This is not to say that all the programs are alike in point of quality, for as a matter of fact the large metropolitan stations are able to attract a better class of performers and to supplement these with out-of-the-studio broadcasting of a superior order. As yet, however, no station seems to have made a serious effort at specialization.

In the field of printed periodicals we find a great range of contents and policies, with each magazine creating its peculiar atmosphere and catering to a particular class of readers. There are the vendors of fluffy stories, the "quality magazines," critical periodicals, humorous papers, political reviews, and so on. Each is supported by a certain clientele with its special interests. Each has a reputation for presenting such and such material so and so, readers buy accordingly, writers market their

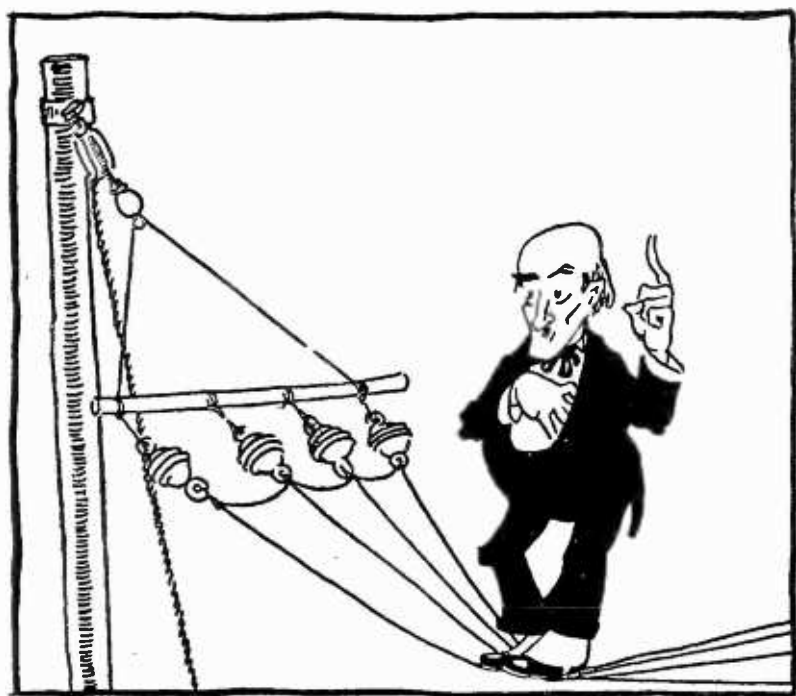

serious speeches are broadcast

output accordingly. You can tell a man by the magazines he reads. As yet there is no corresponding development among the broadcasters. There is some tendency in that direction, but it is only a tendency as yet. One station in New York City, owned by vaudeville and moving picture interests, caters mainly to vaudeville tastes; it specializes in jazz, popular songs, dance orchestras, and the like. Two other stations, run by large public service corporations, go after dignified banquets, informative talks, symphonic concerts, and the like. Still, the latter two stations broadcast many hours a week, and when summed up it is seen that they do distribute a large amount of popular material. The similarities of the various broadcasting stations, in the matter of program material, are more marked than are their differences.

We cannot say positively that broadcasting will take the same course as magazine publishing. There are obviously economic factors involved, and the economics of the radio business are not the economics of the publishing business nor of any other business. At present, in fact, the economics of radio might be termed *sui generis*—in a class by themselves. But there is in both fields the necessity of attracting a sufficiently large audience. One cannot print a magazine for a dozen readers (except perhaps in Greenwich Village), nor can one broadcast for two hundred listeners, generally speaking. And here the question of national (super-power or chain-station) as against local broadcasting is of interest. The cost of a national or section wide broadcast distribution, whether from a single high power station or a chain of smaller stations radiating the output of a single microphone, must be so high that a very large audience is essential. The program will have to appeal to a vast army of listeners, and a proportionately wide range of tastes. The general structure may be expected to resemble that of the magazines of large circulation, and undue specialization will hardly be feasible, owing to its effect in restricting the "circulation" of the station. The smaller local stations, on the other hand, especially those in metropolitan locations, may find it advantageous to narrow and concentrate their appeal. There are probably enough radio listeners in and around cities like New York and Chicago to support a station devoted to dramatic broadcasting, say, or chamber music, or some other particular field. Such a station might broadcast only once a week, or it might be used by special interests on certain recurring days, the plant being thus

fully utilized by a number of different broadcasting agencies, each with an individual cultural, political, or economic motive. It is probable that some such tendency will become more and more apparent as the art advances, and the importance of broadcasting as a medium of conveying entertainment and information is brought home to people as yet untouched by it.

Broadcasting and the sos

SHORTLY after 5 P. M. on December 17, 1924, a steamship, sight unseen, name unknown, poked her nose into the waters of New York Harbor and called a land station with her radio transmitter. The call letters she signed were sws, a combination which, with the changing of a single dot to a single dash, becomes sos, the international radio distress call which takes precedence over all other human agitations of the ether on land or sea.

Whether it was a slight stuttering of the key on the part of the operator of the good ship, or a trifling inaccuracy in reading on the part of the vigilant radio electrician at NAH of the Brooklyn Navy Yard, that sws *was* changed to an sos. NAH blared out a general QRT which, in the radio lingo, is a peremptory summons for everybody to shut up immediately or sooner. At 5.15 all the broadcasting stations went off the air in the middle of jazz selections, market reports, interviews with celebrated bootleggers, and advice to the lovelorn. A pall of silence hung over the harbor, and telephones were pressed to thousands of pairs of cauliflower ears while thousands of auditory nerves strained to hear who was sinking and where. The suspense was broken when the sws piped up to report that all was well and that her call was not a distress signal. NAH retired from the scene. Traffic was resumed at 5.21.

sws is the call, according to the books, of the Greek steamer *Chelatos*. Boy, page the King of Greece and ask him whether he can't find a less delicate combination of letters for his merchant fleet. sgs, sms, and a few others also would not be missed. Better still, why not introduce a little logic into the prevailing distress call routine, as regards taking the broadcasters off the air?

In some cases, that is a blessing. If a painless method could be found of keeping some broadcasters off the air until say, 2024, when we shall all be dead and beyond the reach of terrestrial loud speakers, that would be fine.

But there is no discrimination under the present system. Let an sos go out, or the alarm be raised that some one thinks he heard one, and all broadcasters, good and bad, are supposed to take their carriers off the air instantly. It does not matter what their wavelength is, nor where they are situated.

Actually, nothing of the kind happens. The inland broadcasters don't go off the air. I have listened during a number of Atlantic sos shutdowns, and heard about all the broadcasting stations west of the Alleghenies going full blast and modulating 120 per cent. In fact, as Professor Jansky pointed out at the Third Annual Radio Conference, most of the hinterland telephone stations don't even keep a 600-meter watch. They don't know when a ship sends out an sos, much less go off the air for it.

This may be most reprehensible, but it is none the less sensible. What chance has a 20 watt, 230 meter, peanut-roaster broadcaster in Cabbage Corners, Iowa, of interfering with the disposition of a distress call on the high seas, with all traffic relative thereto being handled on 600 meters? About as much chance as the whistle of the traffic cop on the corner of Fifth Avenue and 42nd Street, New York City.

The fact is that the present system is merely a hangover from the old marine days of radio. It has no more rationality than any other attempt to solve the radio problems of to-day with the Berne Convention of 1912. The idea was that sometime, somewhere, a broadcasting station might interfere with an sos. But the fact is that most of the broadcasters, owing to their wavelength and position, cannot conceivably interfere.

The officers of the Federal radio inspection service, have done their best under difficult conditions with insufficient appropriations. Furthermore, while the letter of the regulations covering sos calls remains unchanged at this writing, it is said that some modification of the existing system is being considered. If so, this article is in line with a widespread feeling that the rules should be better adapted to present-day radio.

Of course, compared to the safeguarding of life at sea, a task which is enormously facilitated by ship-to-shore radio, broadcasting is a luxury. Better that all broadcasting should cease for an hour or two, than that the life of a single seafarer or passenger should be jeopardized. But, if the two things have no connection, or if a formula can be worked out whereby all risk of interference with sos traffic

by broadcasters can be obviated, then it is nonsensical to interrupt a concert by a Chamlee or a Philharmonic Orchestra because a tramp steamer 2000 miles away has lost her rudder.

The most comprehensive scheme would be to separate the lower end of the frequency band devoted to broadcasting from the upper end of the frequency band assigned to marine traffic to such an extent that, assuming the use of decent tuning equipment, neither could interfere with the other. That will ultimately be accomplished. It will be a good thing for both services. The process is already well under way in the United States, where marine traffic has been removed from the 300 and 450 meter waves during the evening hours by regulation of the Department of Commerce.

Now, all sos calls are sent out on 600 meters. The Berne Convention provided for a 300-meter distress wave for small vessels, but in recent years no one ever heard of an sos signal on this wave, and no one listens for one. One has to look out for 600 meters only. That is one thing we know. We also know a few things about interference. We know what band of frequencies various types of tuners, from excellent to very poor, will admit. We know the effect of power on the strength of a signal. We also know the effect of distance—that the strength of the field, under the most favorable transmission conditions, apparently falls off inversely as the distance. What, then, is to stop us from developing an empirical formula which will separate the sheep from the goats, which will discriminate between stations which may conceivably interfere with sos traffic, and those which cannot possibly do so?

I have gone into the calculus and, after vast travail and figuration, brought back such a formula with me. Here it is—

$$I = \frac{(F-500)^2 (100+D)}{10 P}$$

Where I is the sos index of the broadcasting station. When I is less than 700, the station is required to keep a 600 meter log and to go off the air on hearing an sos.

F is the frequency of the station in kilocycles.

D is the distance in kilometers from the nearest coast station handling marine traffic. This includes the Great Lakes.

P is the power in watts delivered to the antenna.

As the wavelength of the broadcasting transmitter approaches that of marine traffic

(600 meters; 500 kilocycles), I becomes very small. If F is actually 500, I will be zero, even with a power of one watt in an antenna 2000 miles from seaboard. But in general, as D increases, and as the power decreases, I becomes larger. The formula discriminates against broadcasting stations using high wavelength and high power, and which happen to be close to the oceans or the Great Lakes, since these are the ones which are apt to interfere with distress signal traffic.

The table below gives the results of the application of this formula to a number of New York City broadcasters. As D , when small, has little effect on the result, it was taken uniformly as 10 kilometers (6.2 miles) in these calculations.

SOS INDEX OF SEVEN NEW YORK CITY BROADCASTERS

STATION	WAVE-LENGTH METERS	FREQUENCY KILOCYCLES	ESTIMATED POWER WATTS	SOS INDEX
WNYC	526	570	1000	54*
WEAF	492	610	1500	89*
WJZ	455	660	750	375*
WJY	405	740	750	845
WOR	405	740	500	1267
WHN	360	833	500	2440
WGBS	316	949	500	4455

The dividing line in New York City, it will be seen, lies between *wjz* and *wjy*, *wor*, the former requiring an sos watch, while the latter two broadcasters are absolved. The figures show the working of the formula quite clearly. With the same order of power in the antenna, and lower wavelengths, the likelihood of interference with marine traffic becomes even less and the value of the index increases sharply.

The effect of distance from deep water is illustrated in the second table:

SOS INDEX OF SEVEN INLAND BROADCASTERS

STATION	WAVE-LENGTH METERS	FREQUENCY KILOCYCLES	ESTIMATED POWER WATTS	DISTANCE KM.	FROM	SOS INDEX
KDKA	326	920	5000	480	Atlantic	2050
				190	Lakes	1025
WCAE	462	649	500	480	Atlantic	2575
				190	Lakes	1287
KYW	536	561	1000	10	Lakes	41*
KSD	546	549	500	820	Lakes	442*
WIP	509	589	500	60	Atlantic	253*
WWJ	516	581	500	10	Lakes	144*
KOA	323	928	1500	1300	Pacific	10000

A few remarks about the above table: *KDKA* and *WCAE* are both in Pittsburgh, Pennsylvania. *KDKA*'s power is assumed on the basis of

*These indices being below 700, the stations in question would be required to observe an sos watch.

a Class D development license. It will be seen that in spite of *KDKA*'s higher power, *WCAE* has somewhat the higher index, owing to the longer wavelength. The index was computed in the case of Pittsburgh for both the Atlantic coast and the Great Lakes.

In the case of *WIP*, Philadelphia, there is a question whether D should not be reckoned with reference to *NAI*, the Naval station in that city, rather than Tuckerton, New Jersey (*wsc*), the nearest marine station actually on the Atlantic. The U. S. Supervisor of Radio of the district would decide such questions.

KOA, Denver, Colorado, has the highest index of any of the stations figured. *KOA* could use 21.5 kw in the antenna, on 323 meters, and still keep his sos index below the dividing line; but if he put 22.0 kw into the antenna he would have to stand a watch. No matter how low the wavelength, any one who goes up in power indefinitely will come to a point where the formula requires him to watch out for sos calls.

The advantages of injecting order and intelligence into the sos-shutdown situation would be twofold. First, the broadcast listeners would always be sure of entertainment from at least some of the locals, even when an sos was abroad. That is of comparatively slight moment. What is of great moment is that with a reasonable system the law could be stringently enforced. Those broadcasters whose index numbers were below the required figure could be compelled to keep a *continuous* 600-meter watch; if, when an sos went out, they did not go off the air, the operators should have their licenses summarily revoked. The fellows in the Middle West, or on low waves and low power anywhere, would be let alone. The present regulation, requiring two minutes listening in every fifteen, and everybody in the whole United States to shut down when an sos is transmitted off the coast of Portugal, is ineffective, unenforced, and unenforceable; it's a joke.

This is not to say that the mathematical formula given above is worth anything. Perhaps the mystic line of demarcation should be, not at 700, but at 500 or 900. A committee of competent radio engineers could decide that soon enough. The formula may be shot full of holes; the fact will remain that the problems of radio should be settled, not by oratory, tradition, and fiat, but by the application of engineering intelligence. A formula with an adequate security margin can be devised, just as safe values are calculated for the iron girders of a bridge. If a committee of a few

men like Dr. Alfred N. Goldsmith, Mr. John V. L. Hogan, Dr. Louis W. Austin, Prof. J. H. Morecroft, and Mr. W. D. Terrell, should devise such a formula, or any equivalent system of classification, and, being put into practice, the same should cause interference with an sos message, the writer will gladly allow his friends in the marine service to conduct him to Seagate, immerse him in the Atlantic, and hold his head under water while he recites the last four books of *Paradise Lost*.

Zoölogical Note in Report of a Field Event at wjz

Everything O. K. except a dog barked during the announcements.



monthly prize for broadcasters

Our Announcers' Bulls Prize Contest

EACH month RADIO BROADCAST will offer a handsome prize to the announcer who makes the most original and startling bull on the air during the preceding thirty days. Many prizes have been awarded to the most virtuous, most handsome, and most popular announcers in various localities, but this is the first time in the history of broadcasting that a prize is offered for the great, glowing bulls which are constantly brought forth by members of the fraternity.

Our readers are invited to make a note of such horrible errors as come to their ears, and to send them to this department, giving station of origin and time of perpetration. All contributors whose reports are published will receive honorable mention. In case of a dispute between the announcer and the listener as to the wording of the alleged bull, or other facts, the parties in the controversy will be privileged to fight with broadswords on the Mall in Central Park, New York City, or on the tennis courts in Golden Gate Park, San Francisco,

according as to which terrain is most convenient. The conductor of AS THE BROADCASTER SEES IT will referee the duel and in every case take out the survivor to dinner.

In order to guard against an overwhelming avalanche of contributions, the contest is limited, until further notice, to announcers of broadcasting stations of 500 watts power or over. We regret that the bulls of midge or mosquito broadcasters cannot receive notice at this time.

The prize for the coming month will consist of a handsome leberwurst bologna, i. e., sausage, six inches long, two inches in diameter. We look forward to spirited competition between our most popular Lotharios of the air for this desirable possession. The prize will be changed every month. For the guidance of contributors the following sample bulls, all plucked from prominent New York stations, are placed on exhibition:

One talented young man called the Philip-pines a principality.

The same gentleman declared that a certain soprano, who was then holding forth in his studio, had "received many commendable criticisms." Read it again if you don't get it the first time.

Another announcer released this one—"In just a moment you will have the pleasure of listening to the last number played by the Flathead Orchestra."

Open the gates, let the toreadors descend into the arena. On with the bulls!

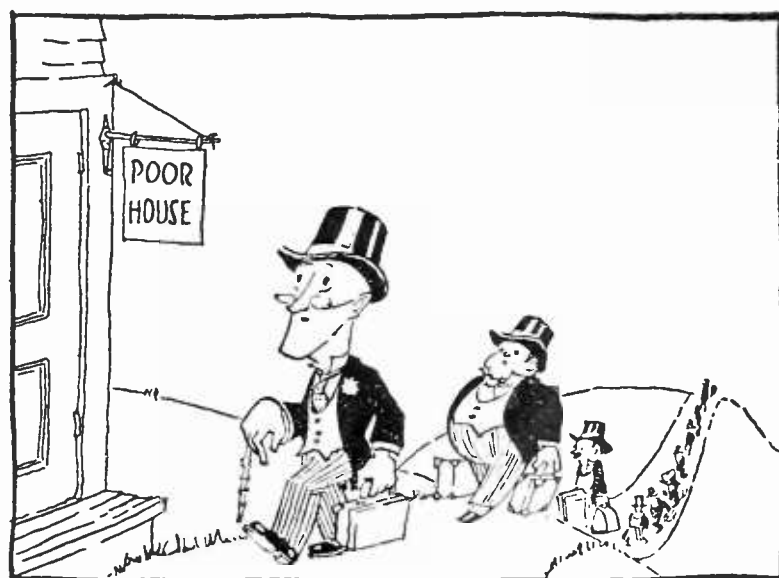

radio amateurs at the poor house?

Those Talented Amateurs

OUR worthy contemporary, *Popular Radio*, in giving the record of a young man who is going on a trip around the world as a wireless operator, informs us that he "has been actively identified with the

American Radio Relay League, the Radio Club of America, the Institute of Radio Engineers, and other groups of dyed-in-the-wool radio amateurs [Italics ours].

This is terrible. We are shocked to discover that Messrs. De Forest, Elwell, Hazeltine, Marconi, and Sarnoff, to mention only a few of the Fellows of the Institute of Radio Engineers, have been working all these years for nothing, as dyed-in-the-wool amateurs. How shall they provide evening gowns for their wives, and gasoline for their Packards? Will no one take up a collection for these gentlemen, and for us, and for all the members of the Institute? Will no one organize a relief expedition to take us over the hills to the poorhouse?

Progress

IN 1824, the introduction of steam railroads being proposed, many good citizens cried out in alarm, declaring that all vegetation would be destroyed along the right of way, that the passengers, whirled along at the dizzy speed of twenty miles an hour, would be unable to breathe, while persons and objects near the tracks would be swept under the wheels by the tremendous suction. Wasn't the stage coach, which had been good enough for their fathers, good enough for them? If steam carriages were introduced, they didn't know what would become of the country.

In 1924, the construction of higher powered broadcasting stations being proposed, many good citizens cried out in alarm, declaring that their receiving sets would become useless, that the local stations would be drowned out, that the ether would be monopolized, and that the radio industry, if not the Republic, would go down to ruin.

However, the viewers-with-alarm of 1924 ride behind steam locomotives, and the six remaining stage coaches are in the museums.

Item for Radio Critics

AT THE Metropolitan Opera performance of *Carmen* on the evening of Nov. 27, 1924, Mr. Martinelli, the Don José, tripped over his sword and fell full length; Miss Easton, singing Carmen, dropped her dagger while threatening one of the other cigarette girls; and in the third act a canvas mountain fell over and hit the gypsies.

Yet people expect radio to be perfect.

Text for Opponents of Broadcasting

And when he had opened the seventh seal, there was silence in heaven about the space of half an hour.

Revelation, 8:1.

Blame It On Radio!

VIENNA, Nov. 15 (Associated Press)—The establishment of a regular service of radio concerts and entertainments by the post office department has resulted in what is called the first case of radio insanity on record here.

A 46-year-old lithographer complained to the police that the whole world was talking about him. He said that he was connected with a radio receiver and could distinctly hear people in every part of the globe gossiping about him. He asked, pitifully, to be disconnected from the radio.

Radio had gone to his head, and he was placed in an insane asylum for observation.

—New York Times.



new short waves are being handed out



"I turned my desk into a radio family."

Radio Heaven Via the Roberts Circuit

The Cartoonist of the Philadelphia *North American* Finds Solace and Comfort in the Roberts Knockout Set—Confessions of an Artist Turned Radio Fan

BY W. R. BRADFORD

THE Roberts circuit?" asked my desk buddy: "You already have the Smith circuit, the Jones circuit, the Mackadoo circuit, and you'll find that any old circuit by any name will squawk the same. How many circuits do you want, you octopus?"

"Only one" I replied: "But that circuit must be the one I am looking for. My constant looking for that circuit has necessitated many trips to the oculist. Listen; they say that regeneration is the equal of two stages of

radio frequency. Now if one stage of r. f. can be added to regeneration, this ought nearly to equal three stages of r. f. If the howls of the lost souls that usually result from such an Old Home Week of these "Up-peppers" of radio, if these howls can be neutralized into giving the effect of a lion and lamb lying down-together why, that ought to be a ring-dingler arrangement, what?"

Desk buddy admitted it was so, but said: "Yes, but——"

"I don't care" I said: "I'll keep on running

radio hostel, and the first thing you know, I'll be entertaining an angel as a boarder, un-awares."

This silenced him. It likewise silenced the other sour-grapers in the art department.

A look around in my "laboratory"—an unused corner for which no other use could be found, disclosed most of the parts necessary for the trial. Any one who has wasted as much time in radio as I have, has enough truck lying around to flotsam anything that will jetsam up in radio for many moons to come.

Back of my desk stood a five-tube tuned r. f. set which was always resorted to when the many "wonder" circuits became "duds," which was almost always. The main wonder of these wonder circuits is that we keep on falling for them, with such loud and resounding thuds. Chumps, every one of us. (Little did that r. f. set know that it was to be ousted by the Roberts circuit!)

It seemed that everybody in the building had heard of the Roberts set. At the request of all hands, I turned my desk into a radio foundry where all could get an eyeful of the proceedings:

You can hear the snip of pliers
As their jaws bite into wire,
Hark! The charcoal pot is cracking—
Solder irons are in the fire;
But—a new condenser's needed—
Lack of funds a stumbling block?
No! By old Grandfather Gridleak,
We will hock the kitchen clock!

Everybody offered suggestions, from the Big Boss, down to the window cleaners. It was clear to see that this was considered a family affair.

THE ROBERTS ON A DRAWING BOARD

ONCE stung, the wise man looks out for wasps. In consequence I first hooked up the Roberts on the back of an old drawing board. Ten minutes later I was tearing it

down in feverish haste, and had started building it carefully.

I used the manufactured coils. Few of us can make such neat windings, and a sloppy looking coil is the nux vomica of radio land. However, I made a few changes in the taps of the primary coil, as follows: 17 turns of No. 22 enameled wire, with taps at turns 5, 7, 10, 13, and 17. This covered all the wavelengths I was interested in, and eliminated quite some dead end effect. I also increased the coupling between primary and secondary. It was $\frac{3}{8}$ " I made it $\frac{7}{8}$ ". This made a razor-like sharp-

ness in tuning that was as cheering as getting money from home. When you understand this set was to be used four miles from ol' woo, which has a roar like a dinosaur, you will understand my quest for the last squeak in selectivity.

A new form of base came out at this time in which the circuit leads were imbedded in the panel, in grooves. At convenient intervals are holes, to which connections are made with a machine screw and washer.

This makes an orderly manner of distributing wires, allowing short leads, so desirable in cutting down resistance. Well tightened, these connections make sure contact, something not always true in a soldered joint. The push-pull transformers were mounted underneath the base, thus making more breathing space up aloft. Some of our radio troubles are caused by crowding. Too many dogs in one manger—and nobody gets any rest. You know it.

I found in a small variable neutralizing condenser just the little touch that makes a radio fan glad he is alive. With this condenser, distant stations can be lifted up to the point of loudest audibility. As a matter of fact, one can go pretty far toward controlling regeneration with it. It is far more shipshape than the "Granddaddy Longlegs" arrangement of spaghetti and bus bar, and I am most emphatically for it.

The mounting that comes with the ready

Where the Cynics Gather

Is usually in a newspaper office, and since a lot of the fourth estate have become radio enthusiasts, much of their cynicism has been directed toward radio and some of its works. From the time that the Roberts Knockout receiver was first described in this magazine for April, 1924, we have received great numbers of letters telling of the experiences of many builders of this set—some serious, some humorous, but all decidedly interesting. As Mr. Bradford confesses in his article, he has lately managed to take some of his spare time and devote it to the compelling art of radio. His experiences with the Roberts Knockout receiver are so typical of others and his relating of them so interesting that probably more than one constructor whose hands often curl lovingly around pliers and soldering iron will chuckle an appreciative chuckle when he reads this.—THE EDITOR.

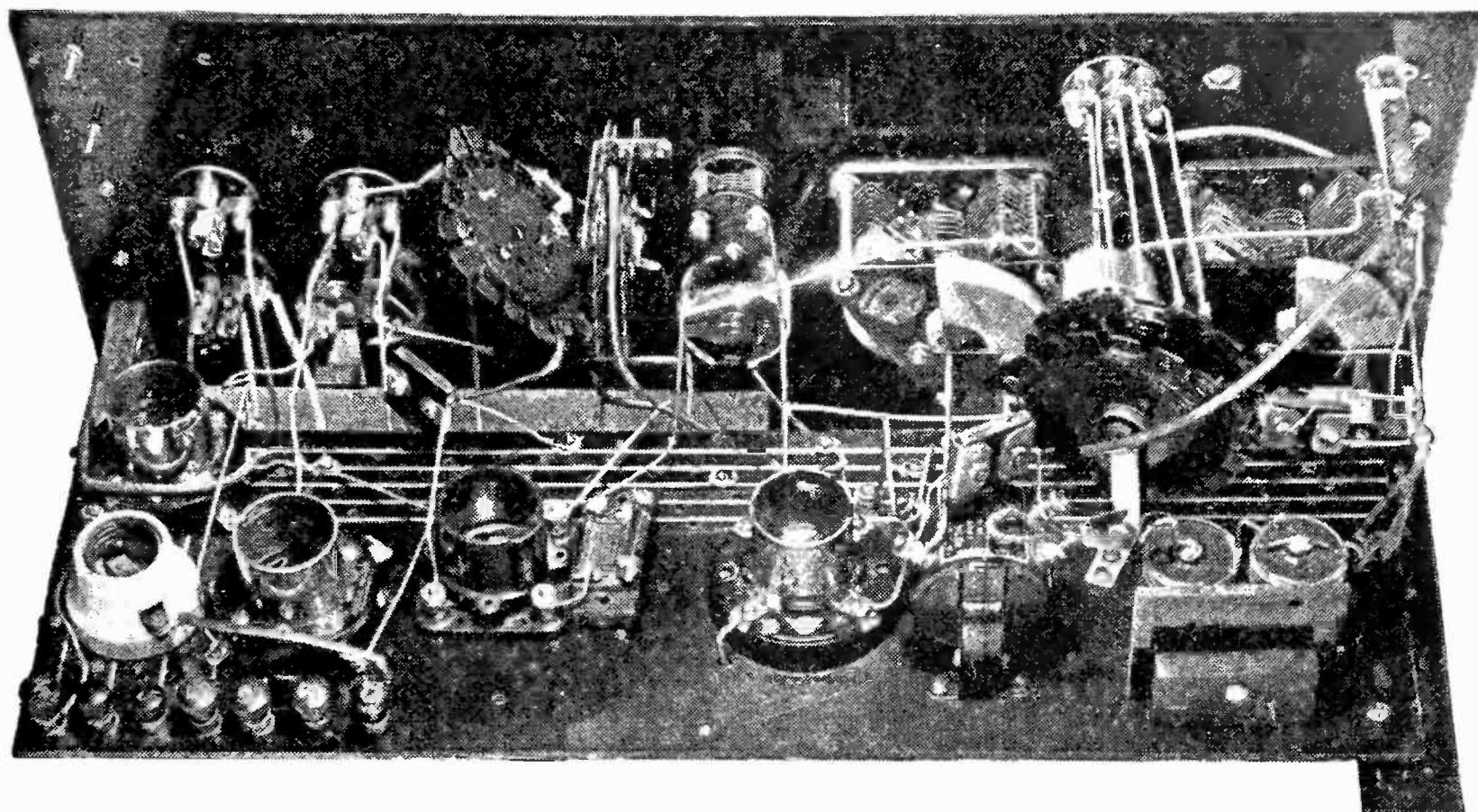

THE RECEIVER

Constructed by Mr. Bradford who has incorporated some interesting changes in the four-tube circuit originally described in RADIO BROADCAST for September, 1924

made coils is a bit amateurish, so I constructed a more manageable mounting, wherein space was saved, and better control effected. These are little details one will work out for oneself. The answer in radio seems to be—the desire for a certain thing is generally the father of the deed that gets it.

You will notice generous width of panel, nine and a half inches. This made the easiest hooked up set I ever worked on. As a matter of fact, I think I whistled "Buffalo Gals" most

of the time when assembling it. Thus, I am sure of a rebate from The Gods What Am, having made a record for profanity on all the other sets I ever constructed. (How many? —I'm ashamed to tell you!)

THE ROBERTS ON A LOOP

MY FIVE-tube r. f. set worked fine on a loop. I had an idea the Roberts would have something to say along this line, so I arranged a double jack that cut out the antenna

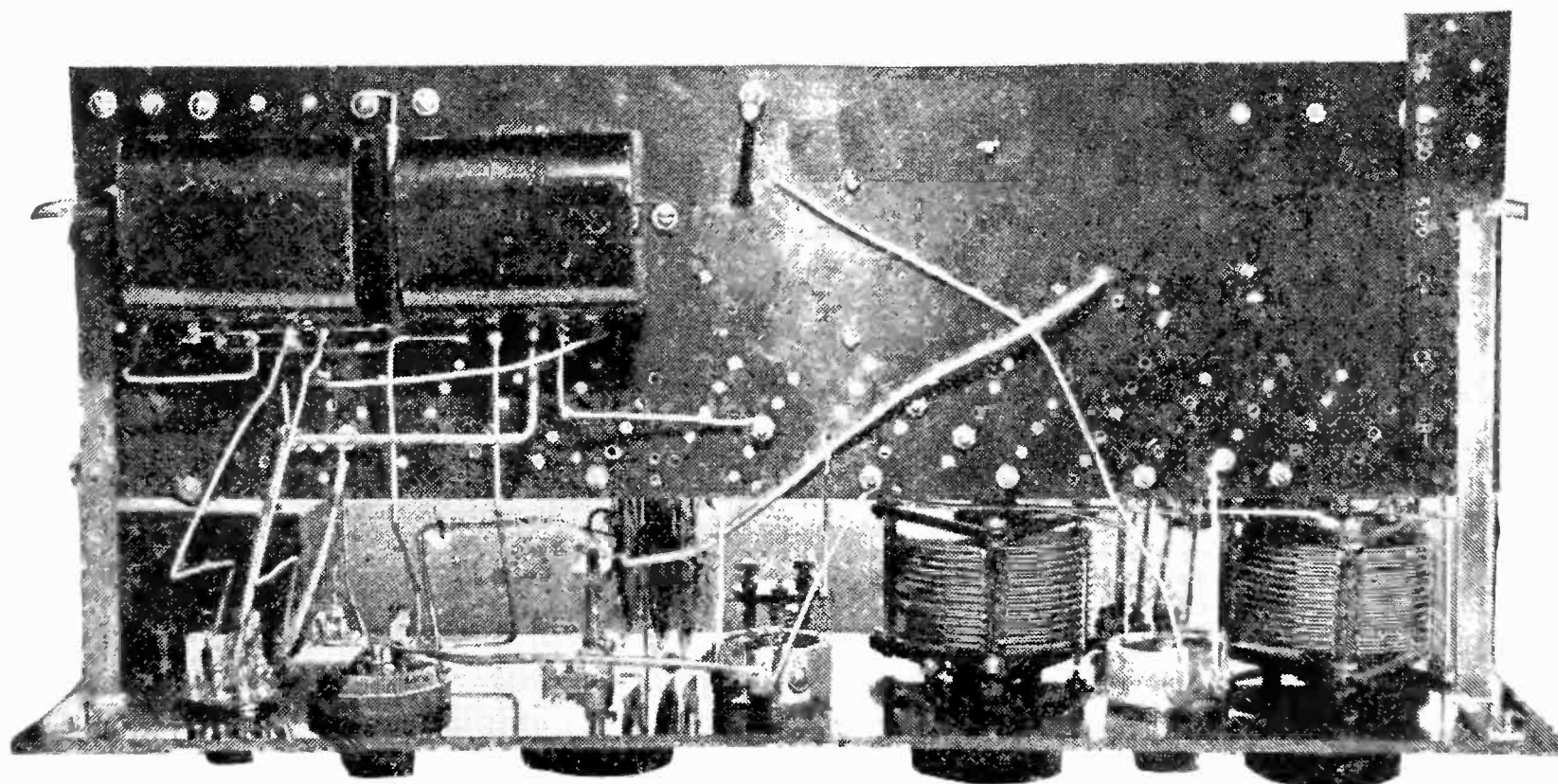

UNDERNEATH THE PANEL

Of Mr. Bradford's Roberts receiver. Push-pull transformers have been mounted underneath to save space on top

coils when the loop was plugged in. Our building is a twenty-one story affair, of steel girders, yet the Roberts has pulled in on the loop, WGY, WEA, and KDKA. WGY and WEA, could only be heard when the locals were not on, for our two local stations are not more than five blocks away from my window!

"Now" said everybody: "You have SOMETHING! For heaven's sake, leave it alone!"

Did I leave it alone? It was but natural that I should try to paint the lily. Ha! I would put one over, even on old man Roberts himself! Another stage of audio was added before the push-pull. Did you ever see a pup that bit into a hornets' nest? I was him. The result was a devils' chorus that would have warmed the heart of old Pluto himself. Squeals. Howls. Demoniack chuckles. All the red-faced hyenas of the infernal regions were using my Roberts for a speaking tube. (Fortunately, this attempt was made at my own home, otherwise, my stock in trade as a "radio expert" would have suffered in the estimation of my office mates.)

Still, in the opinion of cartoonists I am a "radio expert." In the opinion of radio experts I am—well, some kind of a cartoonist, probably. There you are.

I have tried the Roberts on all the tubes a fan would use. Works fine on all, with the biggest rumpus, on the 6-volters, of course. Clarity of tone is one of its biggest selling points.

Using a loop, at my home, in West Philadel-



THE HORRIBLE MIXTURE
Of cartoonist and one too many audio

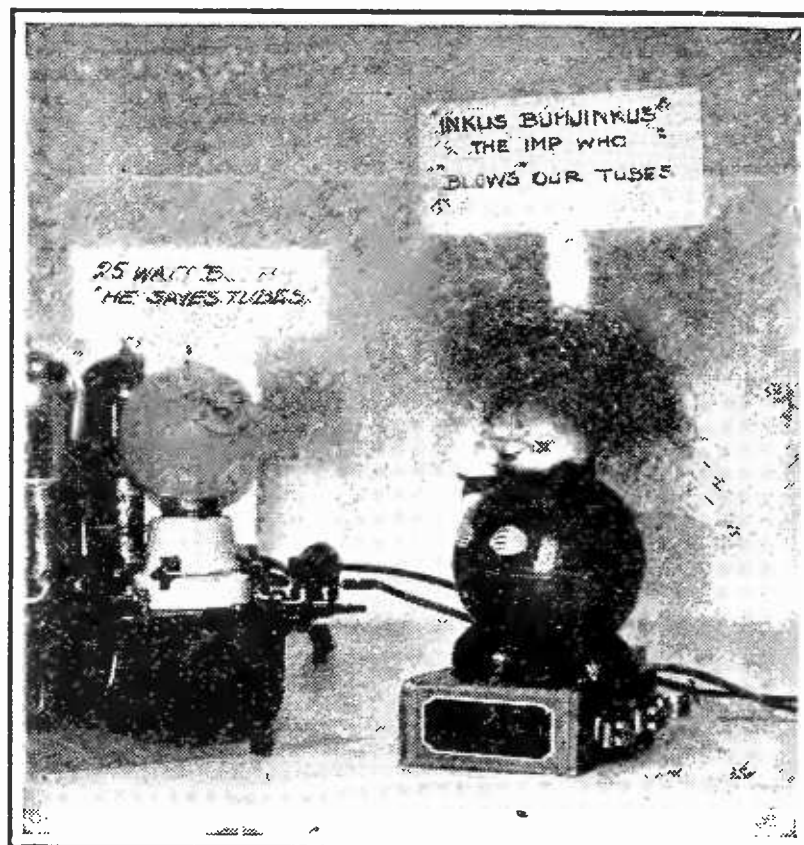

A RARE PHOTOGRAPH

Of a demon discovered and photographed by Mr. Bradford. This imp is seen in a particularly quiet pose, observing the personified device used by the author of this article guaranteed to destroy this menace

phia, WDAF, Kansas City, and WCAL, Northfield, Minnesota, have arrived on the Roberts, using phones. Nice, hm?

So far, it has not been tried on an outside antenna. When I get around to it, I shall chloroform the landlord and erect an outside antenna, whereupon, I expect to tune-in London, and get an earful of "How to Make Chow Chow by Radio" from Cross and Blackwell, in Soho Square.

In the accompanying photograph of my receiver, you will notice an ordinary electric light socket at the left on the base panel. When a 25-watt bulb is inserted in this socket, which is wired in series with the B minus lead, "Inkus Buhjinkus," the Eskimo imp, can jeshang around all he wants to. Tubes simply can't blow with this life saver in. This has saved the humble writer much spondulix, for tubular kohinors are worth in the neighborhood of \$4 per groan. (Note the photograph of Mr. 25 watt-er giving Inkus Buhjinkus the merry ha-ha.)

WHAT HAPPENED IN PHILADELPHIA

I PUBLISHED a short account of my experience with the Roberts in the Philadelphia *North American*, the paper I am tolerated on. I had to bribe one of the office stenographers to help answer the raft of correspondence that followed. To my knowledge, there has never

been a set that has caught on like the Roberts has done. Given good material, and care used in assembling and wiring, "success waits on radio appetite," so to speak.

One of my neighbors, aged 71, built a Roberts, and swears he is 10 years younger, through pure joy. (And I know a lady fan, who "rolls her own" who swears she will kiss Walter Van B. Roberts on sight—and were I Roberts, I shouldn't disguise myself on that threat).

And me? Oh, I have no time for anything but my Roberts. The battery charger is buzzing all the time, and the stockholders of the electric company have all bought fur overcoats.

Oh, faithful and willing set, you have warmed the cockles of my heart.

But—alas. There is always a ghost at the banquet. The cat and the canary mope in jealousy, and Betterhalf has gone in for the movies. It's a habit now.

Where is mother? At the movies.
Where is Dadah? At his set.
He is tuning-in for England
Which he hasn't gotten—yet;
Mother's lonesome—mother's frantic
And she threatens—a divorce!
But that's futile, for like nature—
Radio will run its course.

An obliging enthusiast bought my five-tube r. f. set. Good bye, ol' top, you were a good old wagon, but the Roberts—the Roberts is a Rolls Royce. *Pax vobiscum!*

Well, that's the end of that; Now for the fireworks.

Roberts, Roberts, you're a blessing,
For your set, in any dressing
Makes of radio, a heaven,
With your neutralizing "leaven."
Gone—is rumpus in the feedback—
(Due to demon's teeth, on hardtack?)

Amen. Do it with a Roberts.



IN THE CAR-
TOONIST'S LAB
The assembly is lis-
tening to the Roberts
Knockout "telling
'em"



At Last—Great Artists Over the Radio

THE expected happened when the phonograph companies began to feature their artists over the radio. Many who are equally familiar with the music and the radio game knew that in time the phonograph manufacturers would relax from their autocratic attitude in forbidding any of their artists to broadcast and would realize that in refusing to use the microphone as a means of advertising they were neglecting a rich opportunity.

Still, the change came rather suddenly. To the Brunswick-Balke-Collender Company goes the credit of taking the initiative in what is the most significant development in radio programs since broadcasting was started.

To be sure, the Brunswick firm had somewhat prepared the way by making records of the chief hits of some of the popular radio singers and players, and advertising them as radio favorites, thereby selling many of the records. But that was quite different when that company suddenly sprung on the public the news that Florence Easton, one of the leading sopranos at the Metropolitan, Mario Chamlee, who holds a position as tenor of equal prominence at the same house, Elly Ney, pianist, and the Cleveland orchestra, would be heard in the first of three programs to be given by Brunswick recording artists during December.

Then came the Victor Talking Machine Company with the announcement that on New Year's night they would present Miss Lucrezia Bori and John McCormack in the first of a series of radio programs to be given by their artists. One would have thought, in reading many of the papers after this performance that never before in the history of

radio had the great stars in the musical world broadcast. This was a deep injustice to the Brunswick Company and the artists they had up to that time presented before the microphone. The first program of the Brunswick artists in all respects equalled and in some ways excelled the first Victor program. But then, no intelligent person was beguiled by the newspaper reports into the belief that the Victor program was the first one of its kind broadcast. We have no issue to raise with the Victor people regarding this matter. Our complaint is against the press, which did not state the case completely. We believe in fair play.

There has been no end of discussion in the papers regarding whether these artists who have so far been heard on the Brunswick and Victor programs, are or are not paid. The Victor Company has announced that all of their artists are giving their services for these initial experiments. But this is a matter with which the public has no concern. It is a business question to be decided between the recording companies and their artists. For this entire scheme of the Brunswick and Victor companies in putting their singers and instrumentalists on the radio is a business proposition, and it is quite right that it should be. They are out to sell records, and let us hope that they will sell so many more of them than ever before that they will feel they can never desert the microphone as a means of advertising. If, on the other hand, they do not find that the returns justify the expense involved, a large public will have had the opportunity to hear artists they could never have heard in any other way.

True, with radio in its present uncertain

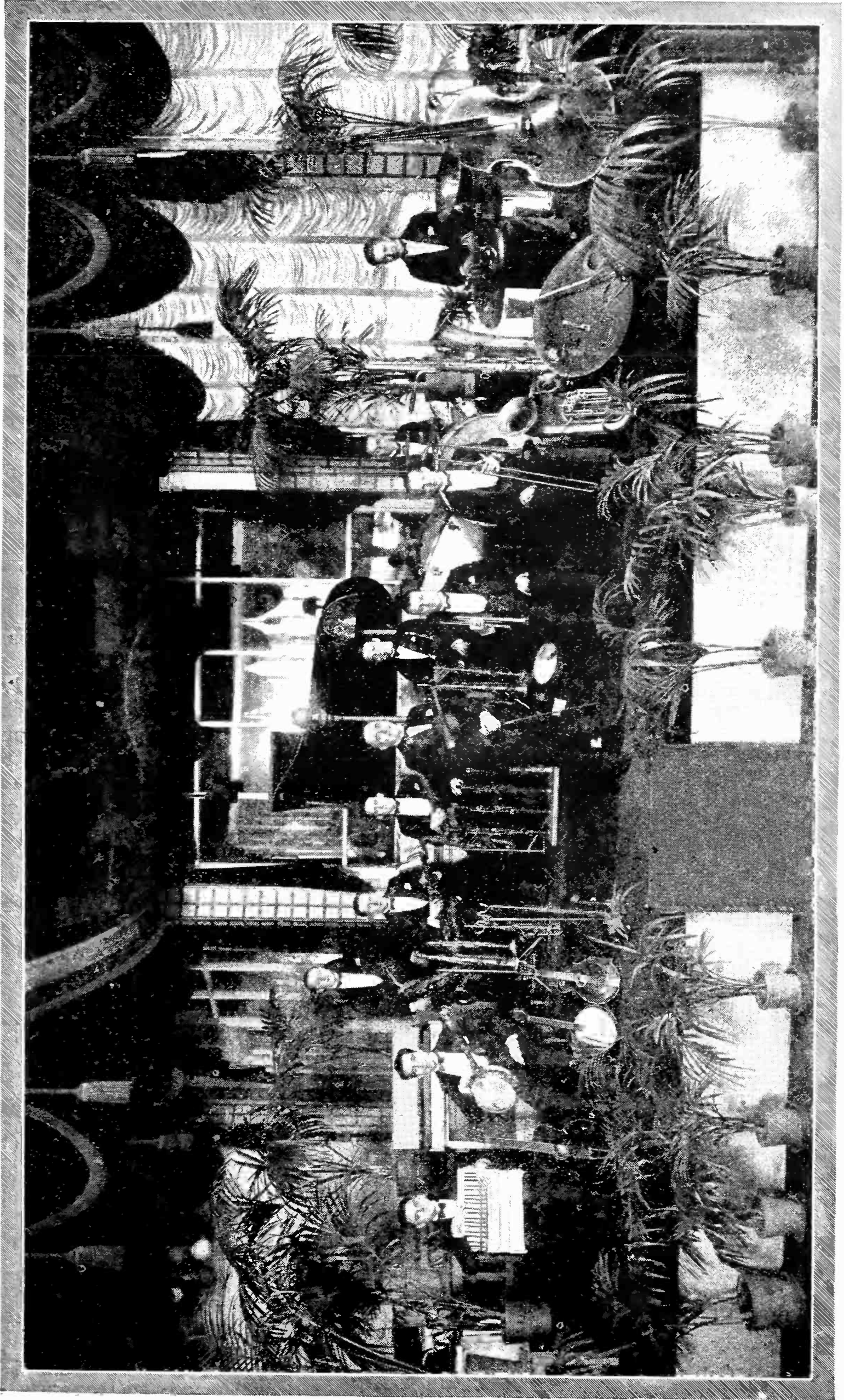

Bloom, Chicago

THE ORIOLE ORCHESTRA OF CHICAGO FREQUENTLY HEARD THROUGH STATION WEBB

state so far as good production is concerned, some may have failed in trying to hear the artists so far featured on these programs. But to one such person there are no doubt hundreds to whom the voice, the instrument, the interpretation, came through with a clearness that brought keen satisfaction.

But let us not lose our heads. It was amusing to read in the *New York Times* the day after this Victor program was broadcast, a wail from William A. Brady over the vacant seats in the theaters New Year's night. According to him, every one had stayed at home to hear this concert. The theater faced ruin. Even when great stars were not broadcasting, the theater crowd stayed at home to listen to the music broadcast!

If Mr. Brady thinks that any one who knows a good play when he sees it is going to stay away from the theater when a good play is on because he prefers to hear radio music, then Mr. Brady's knowledge of radio music is exactly equal to a cipher.

No, let us not lose our heads. These programs put on by the phonograph

companies are going to help radio music tremendously. But they are not going to dominate. Just as every city in the country of any musical ambition has a few concerts of superlative importance each season, with the remainder of the musical attractions of far more than average merit, so it will be with radio, even if all the phonograph companies go into the business of broadcasting. We need these great artists to sing and play for us, and equally, if not more, we need the near great, those who are also artists, but not of world fame. It is such as these who are going to raise radio music to a standard where it can command the respect of those with artistic ideals.

It must be borne in mind that not all the programs put on by the phonograph companies

will be given by famous concert and opera stars. Artists who make "popular" records will be heard as well—but then, when you are out to advertise your wares, if you are wise, you are going to advertise all of them and not just the *de luxe* variety.

When Talented Music Students Broadcast

ONE feature that is becoming conspicuous on the programs of some of the best conducted broadcasting stations, is the presentation, by a music teacher in the city where the station is located, of a program given by members of his or her master class.

Some excellent programs of this nature have been heard from wcx, Detroit, since that station moved to the Book-Cadillac Hotel while still keeping relationship with the *Detroit Free Press*. If a teacher's master pupils do him credit when heard over the radio he thereby has had at his disposal an advertising means more far-reaching than he

could attain in volumes of the written word. We are glad to record that wcx is not alone in having successfully featured such programs.

A Protest Against Bad Taste and Bad Judgment

MANY requests have been received by the conductor of this department to enter a protest in these columns against the campaign conducted by station wos, Jefferson City, Missouri, to raise money for Harry Snodgrass, "King of the Ivories," so that he might have a fund with which to start life anew after leaving the Missouri State Penitentiary.

Among these letters, all from strangers, was one that so completely covers the subject that

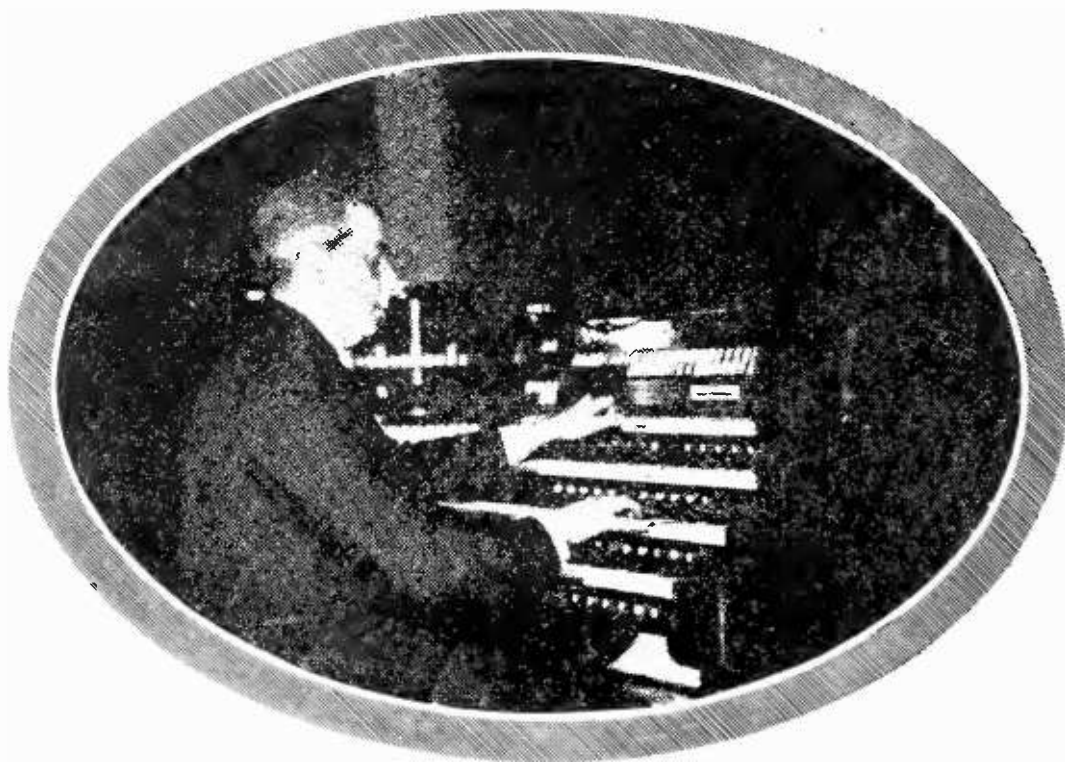

Underwood & Underwood, New York

MARCEL DUPRÉ

The great French organist who has been broadcasting from wjy and several connecting stations. He is here seen at the Wanamaker concert organ in New York where he played all his programs



Apeda, New York

MME. ELLY NEY AND FLORENCE EASTON

Mme. Ney, pianist, who in private life is the wife of Willem Van Hoogstraten, conductor of the New York Philharmonic Orchestra, was one of the star attractions of the radio program broadcast by the Brunswick Phonograph Company recently. Mme. Easton is a leading soprano at the Metropolitan Opera House and also appeared on the Brunswick program which was the first ambitious large scale broadcasting ever to be arranged by a phonograph company

it is here quoted in full as the best means to show the consensus of opinion of a large public. If wos knew just how large that public is, those in charge of that station might do some worrying.

The letter, which is from A. O. Weiss, of Copperhill, Tennessee, reads:

I have followed with interest your articles in RADIO BROADCAST. You represent, probably, the first effort in radio to keep it clean and on a high plane. God knows, your work is necessary and should be amplified.

I—or rather, we were listening to a program from wos, Jefferson City, to-night. It was a solo program, by Harry M. Snodgrass, a convict in the Missouri State Prison. It would seem that they are running a benefit for him, and his musical numbers were interspersed with announcements of letters and telegrams contributing money for his benefit. He is to be released shortly.

He collected, by this means, several hundred dollars. I have no fault to find with this. He is an entertaining chap on the piano, the Coney Island kind of an entertainer. There are plenty of him over the country. I will confess that I sometimes enjoy him myself. However, what I do find fault with is the exalting of a criminal over the radio, and the detrimental effect it must have on children. I have seven. They know that this man is a criminal, and they hear him called "The King," and hear of the money being sent in to him. This is absolutely

bad! I know nothing of his crime. I am no Puritan. I would gladly help him to regain his mental health. But I seriously object to such propoganda as wos has put forth in his behalf being broadcast into the homes of decent Americans. We need our moral foundations a sight more than we need Harry M. Snodgrass's music.

Such a letter needs no comment. It will inspire the respect and admiration of all those who give the matter intelligent thought.

How Much Jazz Is Enough?

BUT if this degradation of broadcasting brought protests to the present writer, they were exceeded in number and virulence by those that came soon after Christmas denouncing the jazzing by an orchestra at station WTAM, of "Silent Night, Holy Night." Some beneficent fairy kept us from tuning-in on that sacrilege, and for a time we hotly denied that such a thing could have occurred. But the evidence that poured in was irrefutable.

Jazzing "Silent Night, Holy Night"—to what base depths the mind of man can sink!

From all over the country come endorsements of the policy of this department in

fighting for good radio music. Note, these excerpts from a letter received from Captain W. C. Mahoney, Fort Benning, Georgia.

I believe I can speak for the average broadcast listener, for I am neither a highly educated musician, nor am I entirely ignorant of the effects of good music. Neither have I an objection to a reasonable amount of modern music in its place. I do however believe that if the broadcasting stations at large would adopt a plan of putting on programs that contained more high class music and eliminate so much jazz, that they and the entire public would benefit thereby.

There follows a warning that every radio manufacturer and dealer should take to heart:

The public is not only getting tired of so much jazz, but is getting disgusted, and the radio business at large is certainly going to see a marked reaction unless the broadcasters wake up to the fact that the general public is demanding programs of higher grade music.

Captain Mahoney then goes on to call attention to the fact that the Crosley Station at Cincinnati is making a feature of what, for a better term, we must call classical music. He also speaks of Zion City, that never puts on any jazz at all, every program being harmonious—whether classical, semi-classical, or

religious. With this we heartily agree. This station is always above the average in everything it does. Many of the religious programs are beautifully chosen and presented, while the secular programs might be taken as models by a dozen stations not far distant from Zion City.

Then, from Edgar Felix, who has been as close to broadcasting behind the scenes, as any man in this country, comes congratulations on our attitude toward radio programs. He was until lately publicity director for station WEAJ, the American Telegraph and Telephone Company, and is now with N. W. Ayer and Son. He writes:

During the last few weeks, in the course of some experimental work in receiving set design, I have had occasion to listen to the programs of scores of broadcasting stations all over the country. It is obvious that the average manager conceives the radio audience to be a most preposterous group of frivolous jazz enthusiasts. As station after station is tuned-in, we are treated to the painful strains of the weeping saxophone, or the tearful ballad entertainer. The preponderance of this type of program is well nigh overwhelming.

On the other hand, when I was with WEAJ, I remember that we felt the mail response to the programs of the Philharmonic Orchestra broadcast was

a decisive indication that there is a large element preferring classical music. And the response to the ballad programs . . . given during the Eveready Hour, brought numberless letters showing that the people prefer good ballads to the sentimental trash so often broadcast under the name of ballads.

You are no doubt by this time familiar with the new announcement form used by WBZ: "This is WBZ, New England." Regarding which the Springfield *Republican*, in an editorial, has this to say:

"The Springfield devotees of the radio are bound to consider it rather small business for the management of WBZ deliberately to omit from its announcements the fact that the broadcasting is actually done from this city. To say, 'This is WBZ of New England,' is not fair to

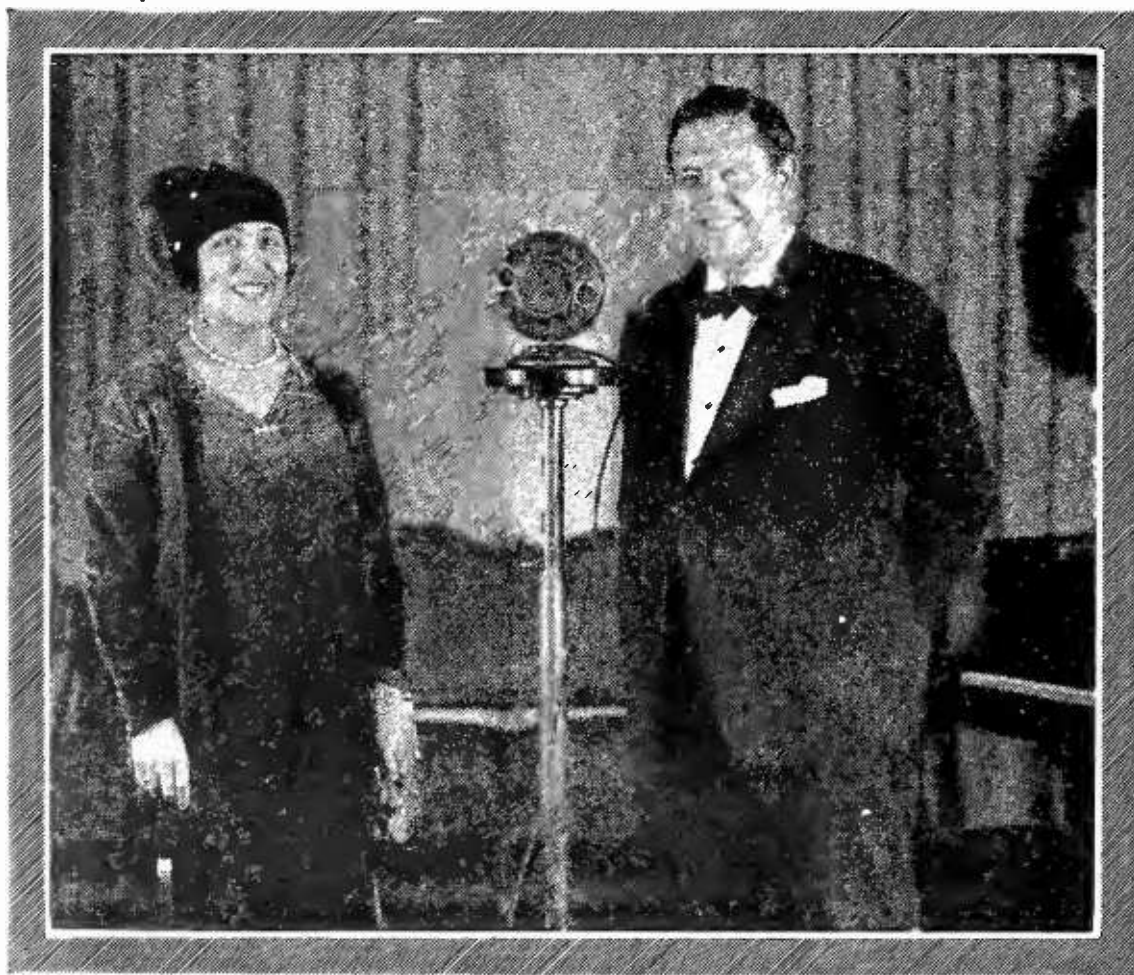

Bain, New York

LUCREZIA BORI AND JOHN MCCORMACK

Recording artists of the Victor Talking Machine Company, who broadcast through a chain of eight stations on New Year's night. Miss Bori is a member of the Metropolitan Opera Company and Mr. McCormack is the famous concert singer. The phonograph company announced that its entry into the broadcasting field was purely an experiment and if successful would be continued for its advertising value

proud Springfield, and it is not giving the listener-in elsewhere a bit of the essential information that seems to be given in the case of about every other broadcasting station in the country."

After agreeing that the Westinghouse Company may, from its point of view, have good reasons for thus slighting Springfield, the editorial concludes with the pointed comment:

"The broadcaster does not have to name the city in every other breath, as he has been accustomed to name the Westinghouse Company, but, in all fairness, it ought to be plainly stated, as is done in the case of other stations, that the broadcasting is done from Springfield."

To which we wish to add that, as it comes over the radio, "WBZ of New England," sounds plainly silly. One would think that WBZ was trying to claim that it had a broadcasting station in every city, town, village, and hamlet in New England, or else was the only station in Maine, New Hampshire, Vermont, Massachusetts, Rhode Island, and Connecticut. (Are the states all there? It's a long, long trail back to school days.)

In the radio column on the editorial page of this same edition of the *Republican*, the writer forecasts one of the phases of a radio Utopia when he says that at the time any really notable musical performance is being given over the radio all interfering stations should remain quiet. Whether a play, an opera, a symphony, or a string quartet is being given, it ought to be possible to hear it as a whole and with the minimum of mechanical interference and extraneous noise. "Such an experience," concludes the article, "once a month would be of more solid value than a surfeit of scraps from many tables."

Wait, five or six or seven years, and not only may such good things as this come to pass in broadcasting, but even greater things.

G. B. S. at the Microphone

ONE man reading a play to a radio audience is not a success even when that man is Bernard Shaw and the play is his own, according to the reports published in the London papers after Shaw had read his *Flaberty, V. C.*, from the London station of the British Broadcasting Company. Yet all acknowledged that he carried off his task with superb ability. The trouble was that

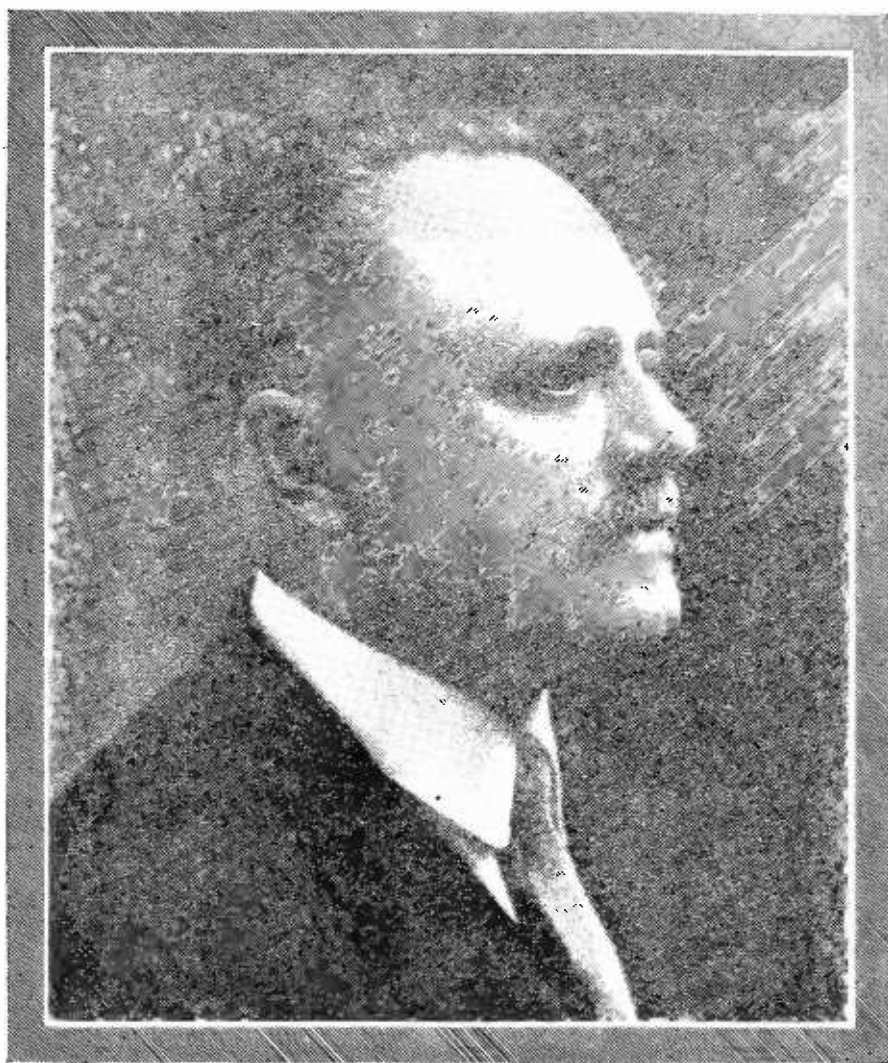

CLARENCE W. ALLEN

Director of the Church Community Chorus which broadcasts every Sunday from wjz. Mr. Allen often gets his listeners-in to sing with him, but how he does it is a mystery to many of us

the audience could not visualize all the people he tried to impersonate simply by a change of voice. Radio has its limits and it is not going to eat up the theaters and the concert halls and the opera houses as some alarmists would have us think.

Lopez at the Metropolitan

MR. Hurok, concert manager, and manager of the Lopez Orchestra, uttered a loud complaint against radio after a concert recently given at the Metropolitan Opera House by Vincent Lopez and his orchestra of forty pieces. The attendance was small. Mr. Hurok blamed it on the fact that the Lopez Pennsylvania Hotel supper-dance programs are broadcast.

It seems not to have occurred to Mr. Hurok, first that very few people would go to the Metropolitan Opera House, a place of vast expanse, to hear any orchestra of forty pieces. And second, that the public upon which he would draw for this concert could hear Lopez in his natural environment at the Pennsylvania any night. Perhaps they would go to the Metropolitan to hear Paul Whiteman—once. But from this Mr. Hurok should not

rush to the conclusion that they are going there to hear any other jazz orchestra of small numbers, and when they failed to patronize his concert he should not lay the blame on radio. It is more than likely that the majority of Lopez's radio admirers, and he has many, live far away from Manhattan Island. They would go to a public concert given by him because they would be eager to see him and his orchestra. But New Yorkers have no such incentive to patronize any paid public concert he may give.

They Talk Fast in Cuba

THE Cuban stations are asking that the stations in this country give their call letters in both Spanish and English. That would be a simple matter, and there seems no reason why the request should not be granted. But among the reasons that prompt this request, explain the Cuban stations, is that the American announcers talk so fast no one, not even a Spaniard who speaks English—can understand anything that is said.

But have you ever tuned-in on a Cuban station when some Spaniard was making a speech? His speed would put the most fluent announcer in this country to shame, even if the American announcer were trying to make a record for speed.

French Efforts to Pay for Broadcasting

THE United States is not the only country that is struggling with the question, "Who is to Pay for Broadcasting?" The *Compagnie Française de Radiophonie* of Paris recently sent out an appeal for financial support to those who previously had expressed interest in their programs. Prefacing a coupon which the contributor could fill out with his name and address and the amount to be contributed for the year 1924, was the following statement:

In England, the Broadcasting Company is remunerated indirectly by the listeners by means of rents, or dues, payable to the General Post Office.

In France the administration of P. T. T. asks for itself only one franc from the listeners for dues, so that the *Compagnie Française de Radiophonie*, which neither constructs nor sells any apparatus, must assume considerable expense in order to main-

tain five hours of broadcasting daily, to which tens of thousands in France and foreign countries listen. What you wrote us some time ago, and for which we thank you, makes us know that you appreciate our programs. If you wish to have a share in our expenses, and also coöperate in the improvements we have in view, we shall be greatly obliged to you.

Such a plan could be made to work more readily in France than in this country because over there the number of broadcasting stations is small as compared with the number on this side of the water. How this plan is progressing we have not yet heard. It is not new. It has more than once been brought up as a possible solution to the financial problems of broadcasters in this country, and has wisely been abandoned as impracticable, for the reason that the contributions would be but a temporary means of support with complete uncertainty as to what might be forthcoming in the future.

Credit and Appreciation for Radio Accompanists

ACCOMPANISTS for radio singers and instrumentalists get almost no credit for their work. The truth is that quite often the accompanist is better than the one he accompanies. It is a thankless job, even on the concert stage. It must be a discouraging job behind the scenes of radio, except in those cases where the accompanist is the official pianist of the studio, when this task comes as simply part of the day's work.

FROM Dorothy Doane Haynes, of Winfield, Kansas, comes a cheerful letter stating that, in her opinion, broadcasting is taking on a much more satisfactory aspect. One of the cases in point she cites to prove this is: "Why! KFKX doesn't even say 'radiocasting' any more!"

IT IS so long now since Christmas that probably few people can remember what gifts they received. But every one who listened-in to the Christmas carols must have rejoiced to have a radio set in his home. The highest praise is due all the leading broadcasting stations in the country for the carols and other forms of Christmas music they gave the public an opportunity to hear.

How to Wire Your Home for Radio

A Central Location for the Receiving Set and Proper Connecting Mains to the Various Rooms Is the Plan

By JAMES MILLEN

THE ideal location for the radio set in the modern home is difficult to find. Of course, there are "tea-wagon loop sets" which may be wheeled from room to room with only slight inconvenience. Some multi-tube ones are fairly portable, since a handle is attached to the cabinet. It is often inconvenient in the average home to attempt to take such an outfit to an upper floor at different times throughout the day as might be most desirable should some unfortunate member of the family be confined to the sickroom.

We don't generally put a handle or wheels on the furnace, coal bin, and ash cans and then take them from room to room in order to have heat where we most want it at any particular time. Why not, then, permanently locate the radio set in some convenient spot (not necessarily the cellar, of course) and "pipe" the output to the several places where its presence may at times be most desirable, such as the living room, front porch, dining room, den, or kitchen. As the cost of a half dozen or even fewer high grade loud speakers is in most cases prohibitive, neat and inconspicuous outlet boxes may be provided in their stead. Then it will merely be necessary to move one loud speaker about the house, plugging it in in much the same manner as an electric heater or other such appliance.

The location of the set itself could then be in some secluded

spot, which good engineering practice would proclaim as best suited for long distance reception or, if the owner prefer, the set might well be kept in his workshop where one set of batteries could supply any receiver or receivers he might have there.

How can it be done? Will the reception be just as loud and clear with the loud speaker so far removed from the set? How can the volume be changed without going to another room and re-adjusting the set? In the next few paragraphs an attempt will be made to answer these questions as well as some of the others which may have already come to the reader's mind.

HOW TO MAKE THE INSTALLATION

THERE are, no doubt, a few ambitious persons who will prefer to "snake" the wires between the walls and above the ceilings, but most of us will be satisfied to run the wires along the cellar ceiling and up through small

auger holes to the desired outlets. The wire may also be concealed behind the picture moldings or neatly tacked along the top of the base boards. Many good ideas about making this wiring may be obtained by examining your telephone installation. The main thing is not to run parallel too closely to exposed electric light wires or *un-grounded* BX cables, in which electric light wires are run. The best wire to use is a double No. 18 bell wire.

The Radio Mohammed

Is brought easily to the radio mountain if he wire his house according to the suggestions of Mr. Millen in the accompanying article. Very frequently it is inconvenient for a radio receiver to be taken from room to room in one's home and from one floor to another. If outlet wires be strung as this article outlines, only the loud speaker need be transported. Of course, the receiver has to be tuned and the variable voltage adjustments made before the outlets are used, but that, in general, is no especial hardship. If the experimenter is especially interested, it will not put him to much trouble to arrange a system so that when the loud speaker plug is removed from the outlet base the filament circuit of the receiver is opened. Some experimenters may even wish to arrange a distant control system so that the set may be tuned from a distant point.—THE EDITOR.

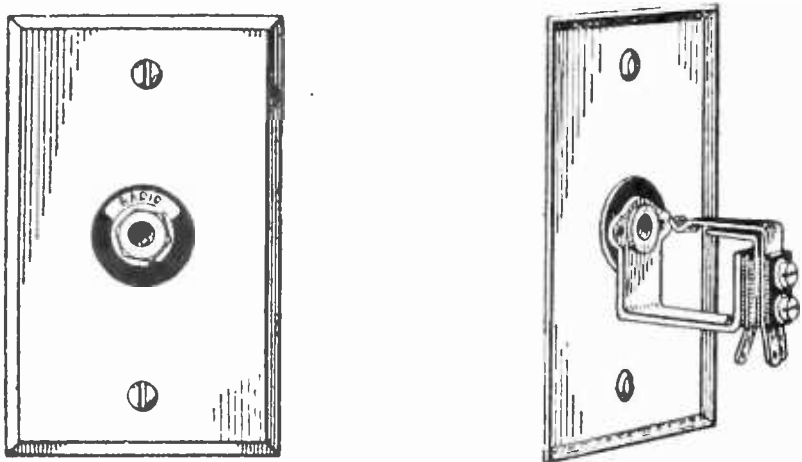

FIG. 1

One type of baseboard outlet box which can be used for connecting the loud speaker to the radio set which is located in a central spot in the home.

Front and back views are shown in the sketch

This wire comes with a fairly heavy insulation. It is not twisted and is contained in one cover so it is very easily pulled through small holes without excessive jamming.

PLACING THE OUTLETS

THE outlets may be rigged up in any number of ways, depending upon the individual tastes of the builder. Where a box is to be "sunk" into a wall, then a standard brass

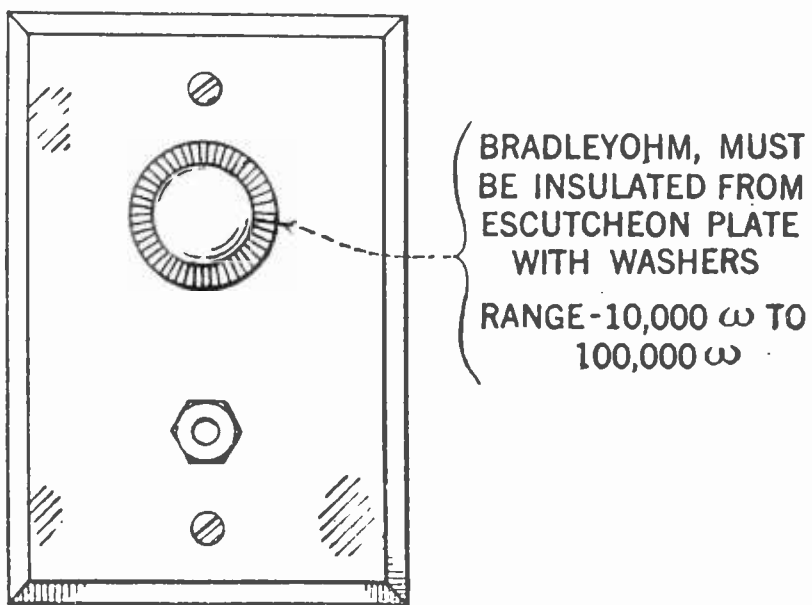

FIG. 2

An outlet which can be built up, containing a variable resistance to regulate the volume delivered to the loud speaker. Where a resistance is mounted in each outlet box, it is unnecessary to regulate the receiving set directly, once it is tuned to a given station

escutcheon plate with a jack as obtainable on the radio market (Fig. 1) may be employed. Otherwise a plain brush-brass escutcheon plate such as used with the ordinary two-button push switches may be fitted up with a jack and variable resistance for controlling the volume. (Fig. 2). The resistance is shunted across the line and should preferably be connected so as only to be active when the loud-speaker plug is in the jack. In order to ac-

complish this it will be necessary to re-arrange the contacts on the standard jack, or to use a series instead of parallel circuit. (Fig. 3). If no provision is made for automatically tak-

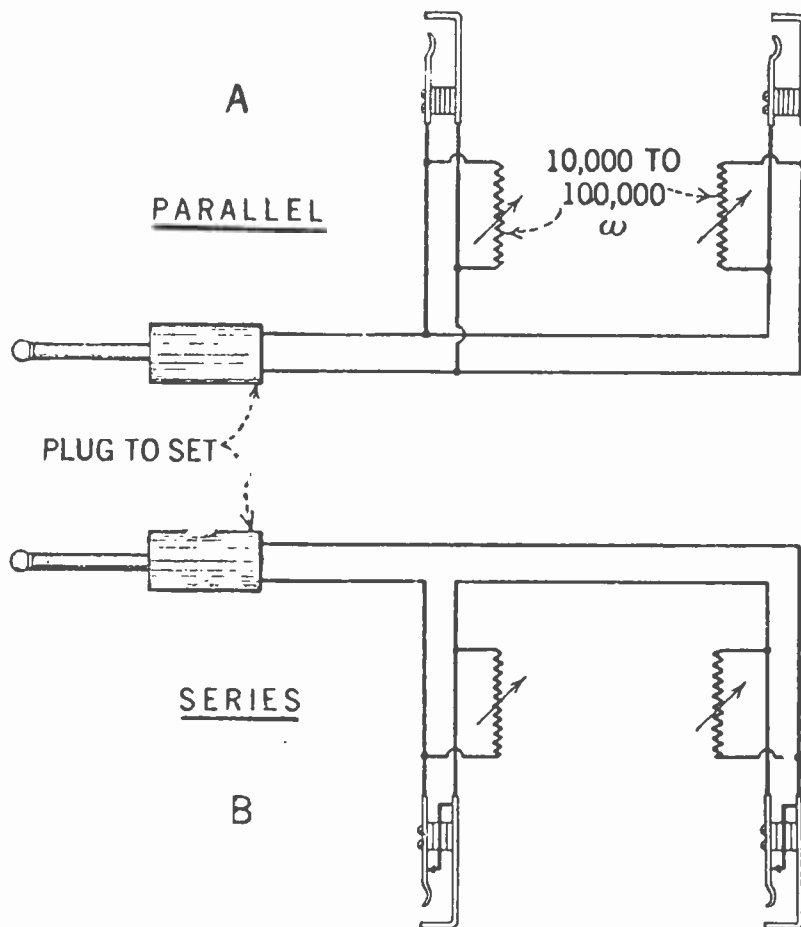

FIG. 3

Two ways of connecting the outlet feed wires to the radio set. A controlling resistance is necessary to regulate volume. The series connection in "B" is recommended because the extra blade on the jack automatically short-circuits the variable resistance in the circuit when the plug is out of the jack

ing care of the resistance connection, it may be necessary now and then to examine the connections in the radio-house-wiring to find what resistance is connected and which is causing the lack of volume. It is, however, always easily found.

A much more easily installed outlet consists of a small box with a flexible cord connection. This may be placed on a table, window sill, or even the floor. Should no volume control device be desired, then an enclosed jack of the type shown in Fig. 5 may be used.

TROUBLE ELIMINATION

SHOULD trouble due to whistling occur when the loud speaker extension line is being used, it may be rectified either by shifting the lines or using a low impedance speaker and installing the transformer at the receiving set end of the line.

REMOTE CONTROL

A CONSIDERABLE field for some interesting experimental work is available to the fan who cares to arrange a remote control so

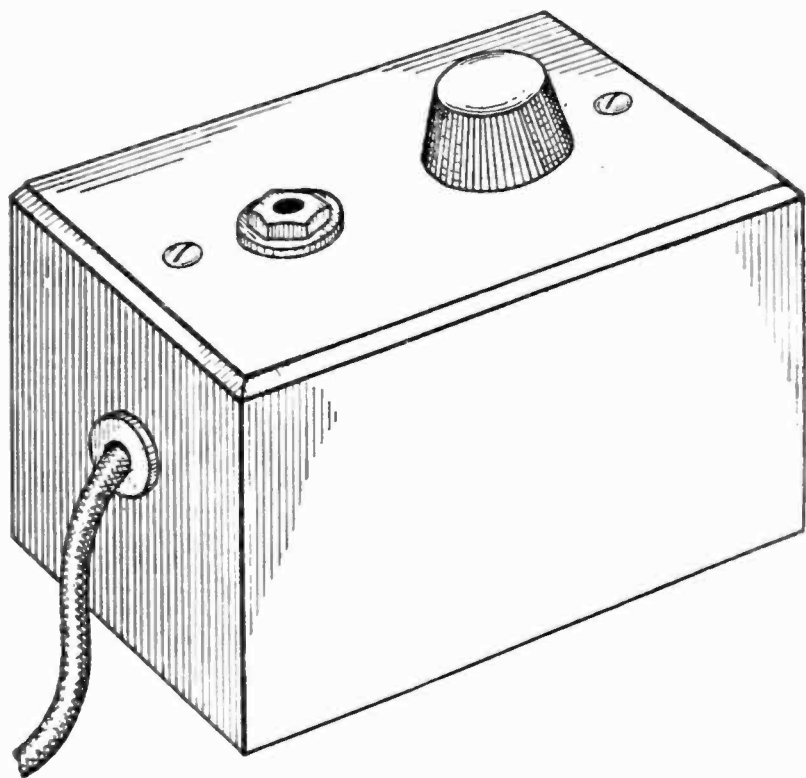

FIG. 4

A compact outlet box containing the variable resistance and jack, with a long flexible lead going to the output of the receiver. This arrangement can be used where the experimenter does not desire to install the baseboard feed circuit



B



C

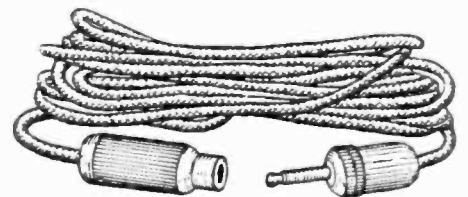

A

FIG. 5

A long cord with plugs, such as these sketched can be used by listeners who do not care to use any of the other methods suggested in the article

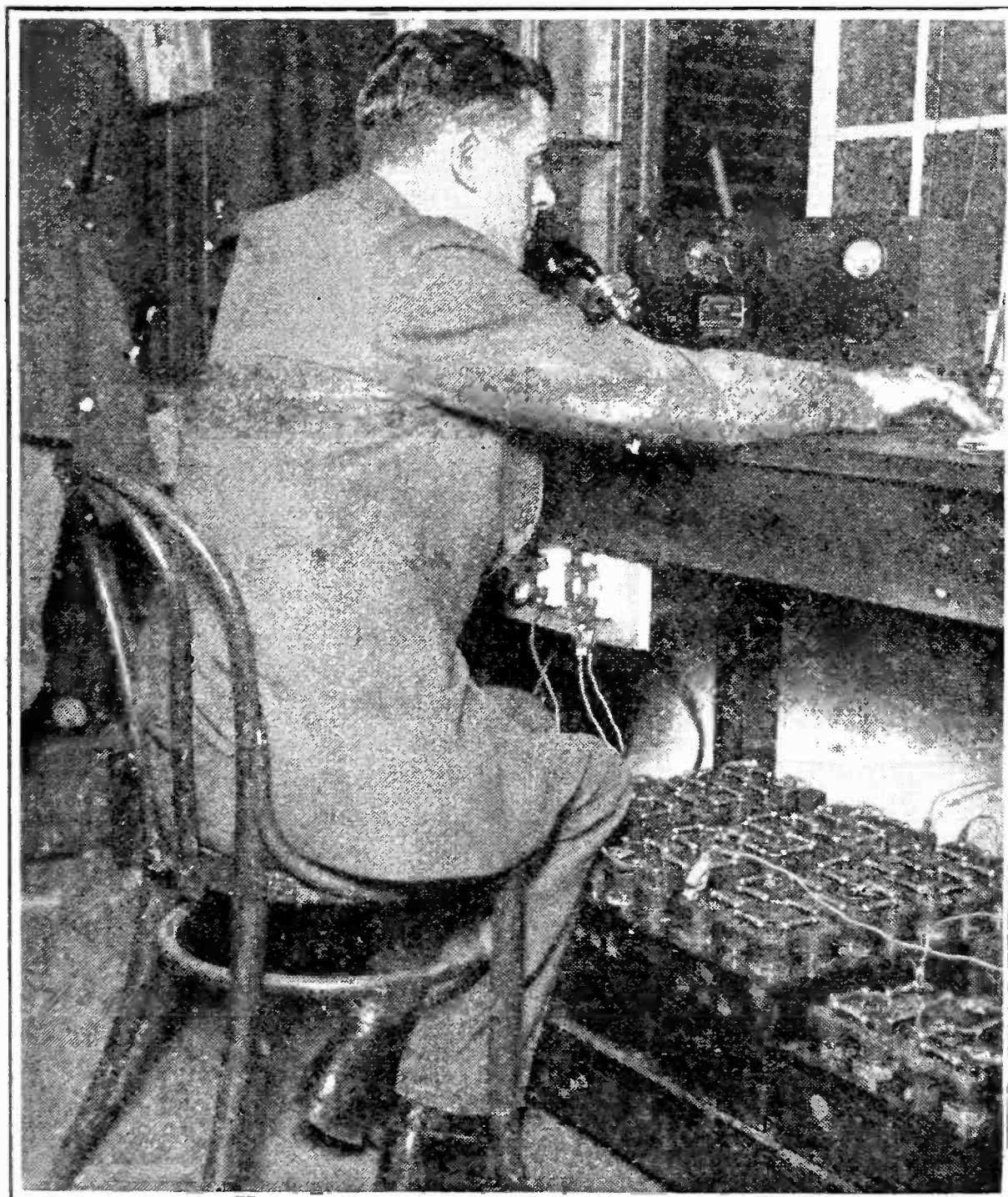

IN THE RADIO
BROADCAST LAB

The Radio Corporation twenty-watt tube transmitter whose plate supply is furnished by a three hundred and fifty volt bank of Presto-lite storage B batteries



MR. WINSTON CHURCHILL

Making a political address in England in which a public address system and radio broadcasting are being used to spread his voice over great distances. Political addresses are much the same the world over, and the microphone and loud speaker are now accepted as a necessary adjunct. Mr. Churchill is Chancellor of the Exchequer in the present English cabinet

THE MARCH OF RADIO

BY

J. J. Morecroft
Past President, Institute of Radio Engineers

Hoover's Suggestions for New Radio Regulations

APPARENTLY feeling that the power at present vested in him is not as well defined or as inclusive as he would like to have it, Herbert Hoover, Secretary of Commerce, has suggested to Representative White that he prepare a short

bill (the wording of which Mr. Hoover gives) instead of attempting any broad regulation of radio at this time. The bill Mr. Hoover suggests asserts that the people of the United States are entitled to the inalienable possession of the ether within the confines of their coun-

try, and then amends the Radio Act of 1912 to read:

The wavelength of every radio transmitting station for which a license is now required by law, its power, emitted wave, the character of its apparatus, and the time of transmission, shall be fixed by the Secretary of Commerce as in his judgment and discretion he shall deem expedient, and may be changed or modified from time to time in his discretion.

Such wording certainly relegates plenty of power to the Secretary of Commerce—far too much, in the opinion E. F. McDonald, Jr., President of the National Association of Broadcasters. Says Mr. McDonald: "I have unbounded confidence in him (Mr. Hoover) and would be in favor of putting this tremendous power into the hands of the Secretary of Commerce on one condition, and that is, that Mr. Hoover give to the radio broadcasting industry a guarantee that he will live for 100 years and that he will serve as Secretary of Commerce for that hundred years. In other words, Mr. Hoover, we don't know who your successor is going to be!"

Mr. McDonald's point is well taken. The actions and policies of Mr. Hoover during the last few years have given the radio broadcasters every confidence in his judgment, and all of them would cheerfully abide by his decision in any matter he deemed it wise to regulate, but to confer on any Secretary of Commerce such Napoleonic power as this brief paragraph would do, seems certainly unwise.

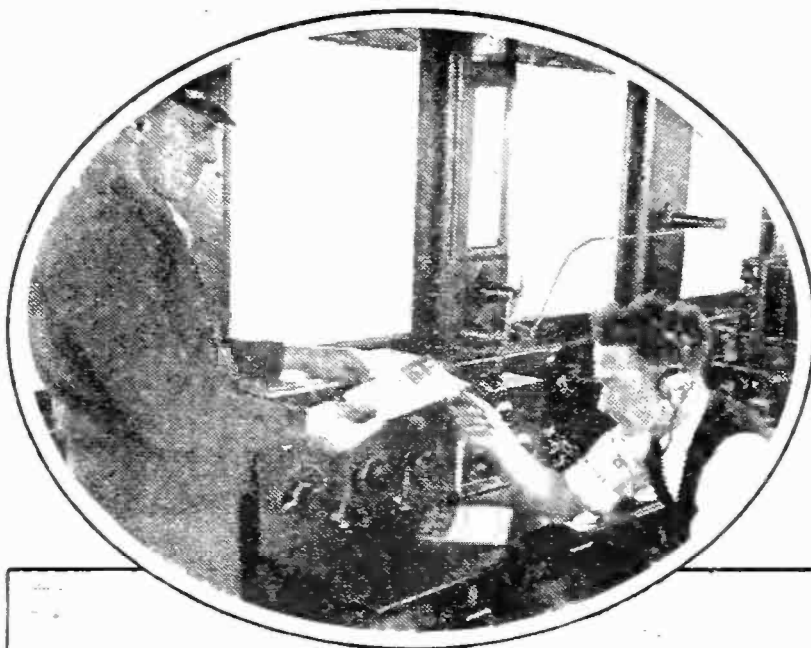

His word would be final. There would be no recourse or appeal from any decision he might make, as the bill is now worded.

Such powers are too sweeping and should not be granted.



DISPATCHING HARBOR TUGS BY RADIO

Is being tried by the New York Central Railroad in New York harbor. The Company anticipates saving much time by being in constant touch with the captain of each tug. The inset shows the radio cabin and tube transmitter which operates on 660 meters. Because of the small space available, the radio apparatus is installed in the pilot house

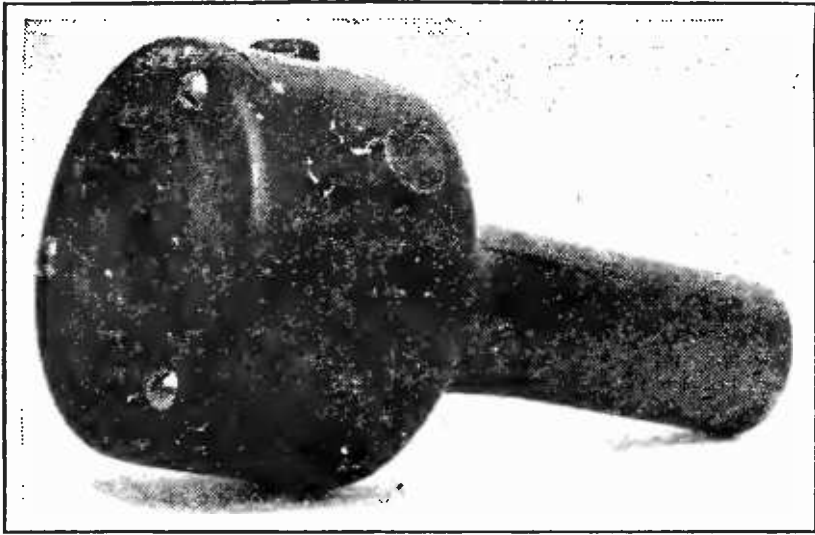

THE FIRST TELEPHONE RECEIVER WITH A PERMANENT MAGNET

The case is of wood. The diaphragm is made of an old tin-type with an iron magnetic core around which the wire coil was wound. This receiver was made by Professor A. E. Dolbear while he was a student in Ohio Wesleyan University at Delaware, Ohio. It was recently brought to light again in the University's physics laboratory

Mr. Hoover's letter covering the transmittal of his suggested bill to Mr. White shows how well he has grasped the essentials of the radio industry as it exists to-day. After reviewing the advances and changes during the past year, all of which indicate the inadvisability of governmental regulation at this time, he says: "I hope that another year's experience will show what direction of legislative course must be pursued. Meanwhile I feel that we would gain by allowing the industry to progress naturally and unhampered except by the maintenance of a firm principle of governmental control of the ether and the elimination of interference so far as possible."

An Epoch in Broadcasting

SETTING a rapid pace for 1925 broadcasting to follow, WEAf announced that through coöperation of the American Telephone and Telegraph Company, The Victor Talking Machine Company, and the various artists involved, January 1st and succeeding nights saw the inauguration of a great broadcast experiment. On that evening John McCormack and Lucrezia Bori, two of America's best-known operatic stars, gave a program of arias and favorite old songs which all radio listeners hailed with delight. These were exactly the type of programs which we have always visualized for broadcasting. To be sure, lots of folks can enjoy jazz and second-rate humor, but many of us prefer other than vaudeville programs. To suit a million people who are listening, a program of variegated character is

required, but in this program lovers of real music had their turn. It was suggested that if this experiment was successful, more programs of like quality would follow.

The artists who have agreed to assist in this new phase of broadcasting, all of them Victor artists, are Alda, Bauer, Bori, DeGogorza, DeLuca, Fleta, the Flonzaley Quartet, Gordon, Jeritza, McCormack, Martinelli, Matzenauer, Ponselle, Schumann-Heinck, Scotti, Whitehill, Paul Whiteman, Crooks, and the Shannon Quartet. There are still a number of well-known Victor artists who have not yet agreed to broadcast, but it is quite likely that if the quality of WEAf's transmission keeps up to its present high standard and the public show a real appreciation of the programs rendered by the artists who have already agreed to broadcast, the others may join in to give us, the "dead-beat" audience, broadcast entertainment to which we are not at all entitled by any right of payment, but which we shall welcome nevertheless.

Radio Dispatch for Harbor Tugs

WHERE other means of communication fail, let radio be used—seems to be a logical dictum by which to allot different communication tasks to the different possible mediums. Certainly contact with moving vessels can most conveniently be had by radio and we believe that the attempt of the New York Central Railroad Company to handle its harbor traffic by radio is justifiable. The company operates forty-three tug boats in New York harbor and undoubtedly this harbor traffic could be speeded up if the chief tug dispatcher could talk to his captains whenever he wanted to. Although the experiment is being started on a 660 meter wave, it seems as though a much shorter wave would have been preferable, much below the normal broadcast range. As the distances to be covered are small, probably a 5-watt set operating at, perhaps, 20 meters might do the work very well, certainly much better than the channel at present being used.

How to Calibrate Your Receiver

THE latest list of "standard frequency" broadcasting stations put out by the Bureau of Standards is well selected to help the radio enthusiast who wants to construct an accurate calibration curve for his receiving set. Of the following stations, whose frequencies reach right through the broad-

cast range, none has an average deviation from its specified frequency by more than two tenths per cent. This means an accuracy much better than that to which the dial of the ordinary receiver can be set. Here are the stations:

WWJ	Detroit	580	kilocycles
WCAP	Washington	640	"
WSB	Atlanta	700	"
WGY	Schenectady	790	"
WBZ	Springfield	890	"
KDKA	Pittsburgh	920	"

Of course for any one within hearing distance of the Bureau of Standards Station, wwv in Washington, or station 6x8m at Stanford University, their standard wavelength signals periodically sent out on a definite schedule, are even more useful for calibrating purposes.

A New Toll Broadcaster

TO ANY ONE having an interest in economics it is a puzzle to discover the raison d'être for some of our broadcasting stations. We are told by some news-

paper men that the use of their broadcasting station for the dissemination of news seems to have actually decreased their circulation, besides costing them at least \$25,000 a year for maintenance. There has been some talk that soon there will be no more broadcasting licenses issued and they don't want to be on the outside when such a situation arises. It may turn out that broadcasting will prove profitable at some time in the future. Why does a street railways system, for example, want to operate a broadcasting station? It is difficult to see how it will make people ride in the street cars any more, as a result of the operation of the company's station.

To the ordinary business man there is one type of station that might give a real reason for existing, that is, the station which attempts to pay its way by renting its facilities to clients who wish to have their name and products gently called to the attention of a shy public. It is very interesting nowadays to observe the advertising salaams and bows made to the broadcast listener before the brand of coffee or batteries is mentioned. It makes the listener quite appreciate himself to notice the deference

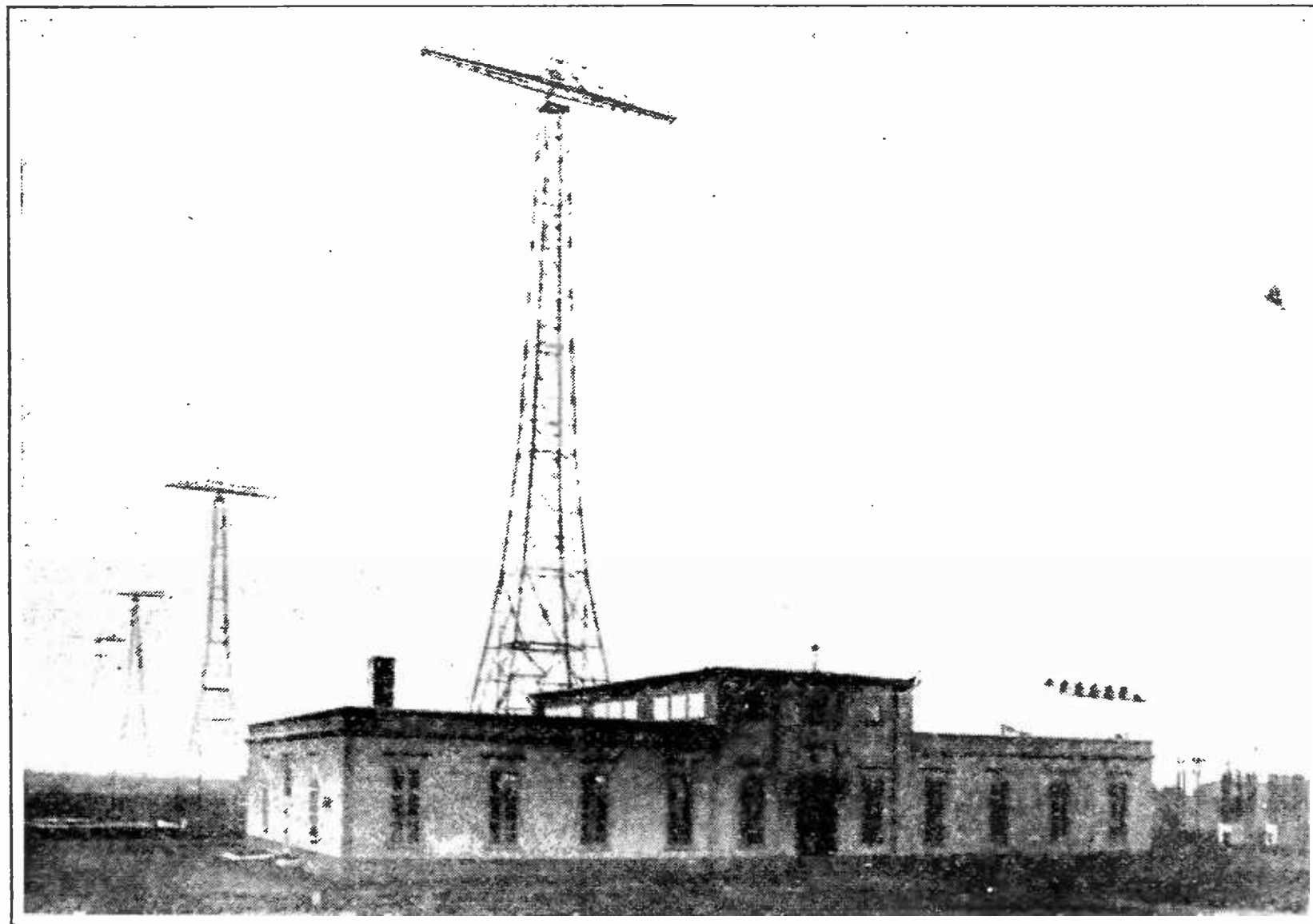

SWEDEN'S NEW RADIO TRANSMITTER

At Grimeton, near Gothenburg. The four hundred foot towers extend in a line for a mile and a half. This station is one of those in constant communication with Radio Central at Rocky Point, Long Island. All these stations use high power and a wavelength of approximately 17,500 meters (about ten miles long)

with which his attention is called to the antics of soapy twins or happiness vendors. It seems likely that a new brand of psychology will soon be offered in college curricula—that of the unseen audience.

New York has a station which thus endeavors to increase the sales of candy, cigarettes, soap and what not; Los Angeles has one, and now Chicago has started out on the great adventure. The *Southtown Economist* station, WBCM, is to make the attempt to become self-supporting by commercial advertising of the gentle sort referred to above. This new 500-watt station will be on the air every evening (and possibly daytime too) and will continue its progress until midnight and later. Their program staff will include skilled writers who will get up programs to attract the public's attention to the products they will be asked to buy.

These advertising stations are really not as bad as many listeners anticipated they would be. The quality of this advertising ma-

terial must continually improve because otherwise people will not listen. So we wish to WBCN success—which will be directly proportionate to the quality of the entertainment it associates with its advertising.

And Now Courtship by Radio

IF YOU can't get married by the regulation courtship methods, try radio. It may be that your voice has such a mellow and appealing quality that if not accompanied by the negative effect of an unattractive physiognomy, girls might fall in love with you. Then, after they've fallen, perhaps meeting you even in person might not be able to shake them free from their love-spell and the battle is thereby won. Then again, whereas one's voice might not be appreciated by the home-folks, in an audience of several hundred thousand there may be a susceptible Miss who falls for it. This seems to have been the case recently when the dulcet tones of Mr. Thomas

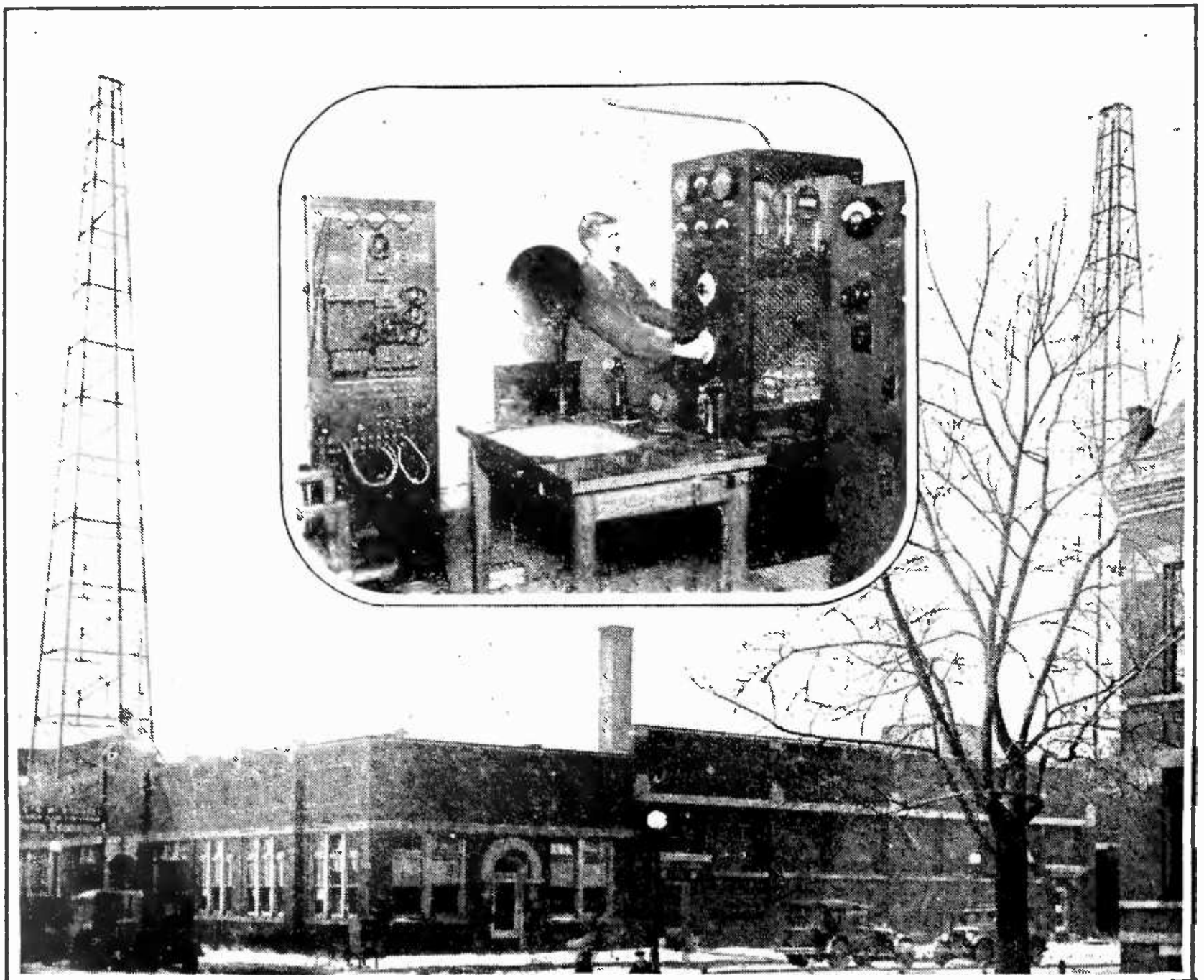

A NEW CHICAGO BROADCASTER

Station WBCN, operated by the *Southtown Economist*. The owners of this station plan to attempt toll broadcasting, such as is done by WEAJ and other stations

Malies (of Pittsburgh) penetrated the New York apartment of Miss Dorothy Hess (of Chicago). A short time afterward they met and were married, and lived happily ever after, we suppose.

Canadian Stations Joined by Wire

WE KNOW with what success the broadcasting network in the United States is gradually being extended. At first it was only a Presidential address, or event of similar national importance that seemed to warrant the use of a large wire network to tie in several broadcasting stations, but continually increasing interest in broadcasting and continually increasing excellence and utility of programs makes it a foregone conclusion that the association of wire networks and radio stations will be of ever increasing occurrence.

Canada has now entered into this field and for the first time three of her stations were recently tied together to radiate the same program. In Canada, it appears that the railways have been most influential in forwarding radio broadcasting. The Canadian National Railway has offered much of the best material which has been broadcast in Canada including musical, educational, and utilitarian subjects. The railways have also installed receiving equipment in their best trains, so that travelers are kept reasonably well in touch with national events as they speed across the continent.

This first tie-in experiment involved stations in Montreal, Ottawa, and Toronto, and the program was sent out from CNRM in Montreal, when an able address was made by Sir Henry Thornton, president of the company.



HOW RADIO RESISTANCES ARE WOUND

This precision machine which was in operation at the recent Chicago radio show made strips of resistance varying from three to seven hundred ohms. Like other components in radio receivers, most resistances are wound by machinery, very accurately and quickly

Radio and the Church

A NEW YORK newspaper recently printed an interview with three of the best known ministers there who had been preaching over radio channels for the last year or two. The interviewer sought their views as to the effect of radio on church attendance. The final answer to that question has not yet been given. The best known radio preacher in America, Dr. S. Parkes Cadman, made the interesting comment that his father, who preached continuously for sixty years, did not reach during his whole lifetime as many listeners as the son reaches by radio in a single Sunday afternoon. All three of the preachers interviewed spoke of the vast increase in their congregations, as certified by the thousands of letters received from every part of the country. Wherever these three speak the church is filled to overflowing and many cannot get in to hear them. And because of their eloquence, religious conviction, and sincerity of appeal, radio can never decrease church attendance as far as they are



C. H. MURCHLAND

Telegraph operator for the United Press at the Dayton, Ohio, *Herald* receiving press dispatches by radio broadcasting during a recent storm which struck down press wires. Broadcasting has frequently come to the aid of newspapers in an emergency caused by a storm since it was first used in this connection by the *Detroit News* in 1921

concerned. People come to their churches not so much to get religion as to get the speaker's view on religious questions—they want their religious convictions to be deeply rooted in their inner consciousness and appreciate consciously or unconsciously that these magnetic and powerful speakers can bring this about much more thoroughly than would result from any analysis and study of their own. So that if the evidence of such men is to form the basis of our judgment, we must admit that radio is a great assistant to the church—thousands and thousands who cannot get into the church do nevertheless hear these scholars discourse on Christ's philosophy and examine critically the question as to what things are really worth while in our modern complex life.

Many meetings are held outside of the church doors, says one of the ministers interviewed, to listen to his sermon over the radio at points far distant. Do these radio listeners also attend their own church services? or have they forsaken their own comparatively mediocre leader to listen to one of much greater power? Before we can really tell what effect radio has on church attendance we must interview many of these less gifted preachers whose congregations may have fallen off as rapidly as the metropolitan preachers' have increased. So let's interview the country pastor whose flock can listen every Sunday to S. Parkes Cadman or Harry Emerson Fosdick over the radio channels, what the effect of

radio on church attendance has been, and see if his views agree with theirs.

Another Antiquated Transmitter Scrapped

THERE is no doubt that broadcasting is making progress; only last month we spoke of the spark signals from the United States Mail tug *President* in the port of New York carrying on its sometimes heavy traffic by means of a spark set which spilled its energy promiscuously throughout the broadcast range. During the past month the Government has decided, after pressure brought by the American Radio Association, to scrap this outfit and install a vacuum tube transmitter in its place. A 200-watt tube set, which will send out practically all of its energy on one wavelength, will be used to replace the one kilowatt spark set at present used. Orders for the purchase and installation of the tube transmitter have already been placed by the Post Office Department.

Wavelengths Will Not Be Changed

THE recent National Radio Conference recommended to the Secretary of Commerce certain changes in the assignment of wavelengths to the various broadcasting stations. It was the opinion of the conference members that interference could thereby be lessened. Soon after the conference disbanded, it became evident to officials of the Commerce Department that the suggested plan had already become obsolete, because of the rapidly increasing number of broadcasting stations, and the consequent demands for wavelength assignments. The present "rush to broadcasting" will not continue very long according to the ideas of some of these officials, and any change in wavelength assignments had better wait until that time.

The complete upset of the re-allocation plan has apparently convinced those responsible for radio regulation that the art is changing so rapidly that a general re-assignment at this time would be useless and should not be attempted until the conditions in the broadcasting world have become more stable. We are inclined to agree with one official who expressed the opinion that many people are getting broadcast licenses who don't want them, and that as the art progresses the number of stations will decrease rather than increase, thereby automatically eliminating

much of the interference which caused the recent radio conferees to suggest the wavelength changes.

The High-Power Arc Loses Favor

AFTER the General Electric Company secured the contract for the installation of a high-powered tube telegraph transmitter at Mare Island, California, it seems sure that the day of the high-powered arc station has gone. There have been available two methods of getting large powers (in hundreds of kilowatts) for continuous wave telegraphy: the high frequency alternator developed by Fessenden and Alexanderson, and the oscillating arc developed by Poulson and Pedersen and built in America by the Federal Telegraph Company. The Navy Department has installed large arcs for its principal transmitter, and they have proven very effective and reliable in their operation.

The arc is not, however, a very efficient generator of high frequency power, feeding into the antenna, as it does, less than half as

much power (in the form of alternating current) as is delivered to the arc itself in the form of continuous current power. Because of its low efficiency, great quantities of water must be circulated around the arc and through the electrodes to keep it sufficiently cool. This defect, of course, doesn't worry the broadcast listener at all, but another characteristic of the high-powered radio arc is very obnoxious to those radio listeners who happen to live within a few miles of such a station. Besides sending out its own wavelength (and another one quite close to it called the compensating wave) the arc sends out an appreciable amount of power at all kinds of wavelengths some of them right in the broadcast channels. These stray wavelengths do not come in the broadcast receiver as pure notes but as noise or "mush". So exasperating is this interference that the great Navy arc at Annapolis shuts down two hours each evening so that radio listeners in that part of the country can avail themselves of the entertainment sent over the broadcast channels.

It has been known for two or three years



BROADCASTING THE MAKING OF A MOTION PICTURE

In a New York studio. Vincent Lopez is at the left with the baton and Ann Pennington is dancing atop the piano. The dance music, is used in the scenario and it was broadcast by wjz. The announcer made appropriate explanations while the action for the camera was going on

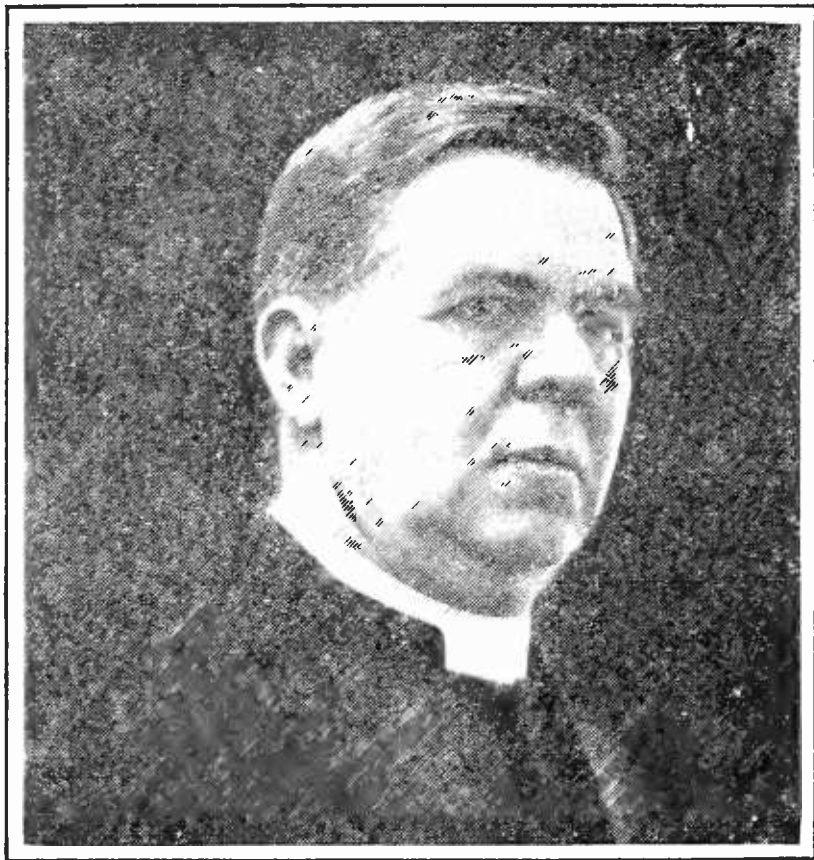

DR. S. PARKES CADMAN

Pastor, Central Congregational Church,
Brooklyn

"The scope of my Sunday broadcasting has been greatly extended. . . . Thousands of letters of appreciation come to me from the Eastern States. And when I visit the cities, towns, or villages throughout this vast region I not only meet people who listen regularly to my sermons but who are familiar with my voice.

"We are coming to understand more fully the possibilities and limitation of broadcasting. It is a fascinating problem which well repays study and analysis. If one uses the radio merely to preach special doctrinal views he will fail. On the other hand, if he uses radio to broadcast the great basic principles of religion and of the welfare of the world, he finds in it an agency of unprecedented value."

© New York Times.

now that large water-cooled triodes could effectively replace the arcs, and now this change is actually going to take place. Four 20-kilowatt triodes operating in conjunction with each other to feed power into the antenna will replace a 300-kilowatt arc and will permit more satisfactory and reliable communication, according to the engineers responsible for the new installation. But from our standpoint, the beauty of this new triode outfit to replace the arc is due to the absence of "mush". The oscillating vacuum tube is practically free of those spurious oscillations which are responsible for the great interference which the arc causes, and for this alone the radio listeners are truly grateful that the Government is to scrap its antiquated arc transmitters and to keep in line with the march of radio.

Hoover Not For a Radio Sales Tax

RECENTLY a Washington dispatch, which at once received wide publicity, stated that in an interview Secretary Hoover had proposed a two per cent. sales tax to support radio broadcasting. Such a proposal at once brings up all sorts of difficult questions, such as, how to enforce the collection of the tax, and still more difficult, how equitably to distribute it. So it seemed that the eminent engineer-Secretary was becoming more of a theorist than an engineer. The truth was, however, that the Secretary did not make the suggestion attributed to him, neither was he in favor of agitation in behalf of such legislation. We believe that a sales tax or a licensing scheme is not the way that the cost of broadcasting is to be met in America. We have yet to find it.

Interesting Things Interestingly Said

WILLIAM A. BRADY (New York City; theatrical producer, speaking about the recent broadcasting by stars of the Metropolitan Opera Company, and others): "Radio constitutes the greatest menace the theatre has ever faced, and so far as I know, the theatre is doing nothing whatever about it. I am seated now in a room with a group of people and we are listening free of charge to a concert which I can only describe as gorgeous. Why should any one be foolish enough to go to a theatre under such circumstances? The trouble is not with those who sit at home and hear McCormack and Bori; the fault is entirely with men who control the theatre.

"We engage these various artists and pay them to work for us. Why should they be permitted to ruin our business by giving free radio entertainments on the side?"

DAVID SARNOFF (New York City; vice-president and general manager, Radio Corporation of America, speaking about coming events in radio): "Within a reasonably short period of time it will be possible for people in New York or London, or people in the United States and England to converse with each other by radio telephony across the ocean. . . . We know how to build sending machines that will send messages and carry the human voice. We also know how to build receiving apparatus which will receive these waves on the other side. We know how to perform stunts in radio photography and the like, but we don't know much about what happens between the send-

ing and receiving machines in the great outdoors that separates them. There's where we must look for additional information."

JOHN McCORMACK (New York; phonograph recording artist and concert star, speaking of his impressions after broadcasting for the first time): "I like it. You know I have had plenty of experience in making records, but this beats it. Somehow you seem able to visualize an audience better in broadcasting and you can sing to them directly. After you get the hang of it, it's easy."

LUCREZIA BORI (New York; Metropolitan Opera Company, speaking of her first broadcasting experience): "Oh, I just thought of those 6,000,000 people out there somewhere listening and I was scared to death. I generally sing to four or five thousand and it's very different. It's odd what a feeling you get when you see that little instrument in front of you. I had to fight to keep myself from tightening all up, but after I got well started I forgot all about it."

JUDGE S. B. DAVIS (Washington; Department of Commerce): "The short wave has found its place in commercial and amateur transoceanic communication and in transmission both at home and to places across the seas. In domestic use it is a rival of wire interconnection. I consider interconnection, in whichever mode effected, almost essential to the future of broadcasting if we are to look at radio as a means of service to all our people all the time. It ultimately means national programs, nation-wide utterances, more valuable subject matter and that great happenings in which our people have so vital an interest will be available to everybody. . . . It is transforming broadcasting from a local to a national service."

S. O. MARTIN (New York; president, Sonora Phonograph Company, Inc.): "There has recently come an increasing demand for phonographs and radio-phonographs. We believe that phonograph companies must make a proper connection with the radio industry, since the situation in regard to radio is not at all a question of whether or not the phonograph business will be extinguished by radio, but on the contrary how far the phonograph business can safely ally itself with radio. . . . Now that radio is being dressed up in appropriate cabinets, it is becoming a drawing room feature instead of an attic experiment."

A. H. SCOVILLE (Cleveland; vice president of the Union Trust Company, coöperators with the Goodrich Rubber Company, owners of station WEAR): ". . . In establishing our broadcasting station, we have attempted to demonstrate that radio broadcasting to-day is an important cog in the



GEORGE C. FURNESS

New York: Chairman Battery Committee, Associated Manufacturers of Electrical Supplies

"The responsible manufacturers of dry B batteries have made such marked improvement that to-day's dry B battery operating costs are at least fifty per cent. lower on the average than those of a year ago. The reduction is greatest on those sets with a heavy B battery drain. Here the costs are often only one third of the former figures. A year ago it was sometimes necessary to renew B batteries after two or three months' use. To-day, under the same conditions, they will last from four to six months. These developments resulting in lower operating costs for the radio public have come about in several ways. There has been a real improvement in the design of the regular size B batteries which has brought about greater uniformity and longer life. In the second place, extra large batteries, that is, those constructed with extra large cells, have been developed for use with the increasingly popular multi-tube sets and power amplifiers. Finally, the price of batteries has been reduced."

industrial machinery of our country. I really feel that broadcasting, in its importance, is second only to the introduction of rural free delivery for the farmer, and I make that statement advisedly because without our own broadcasting station we have placed the farmer in the position of a man with a private bond ticker in his office. . . . We look on our station as a means of knitting together the Fourth Federal Reserve District with all its banks and all its people together into a compact whole. We try to keep them thoroughly informed at all times of the major news of the financial world."

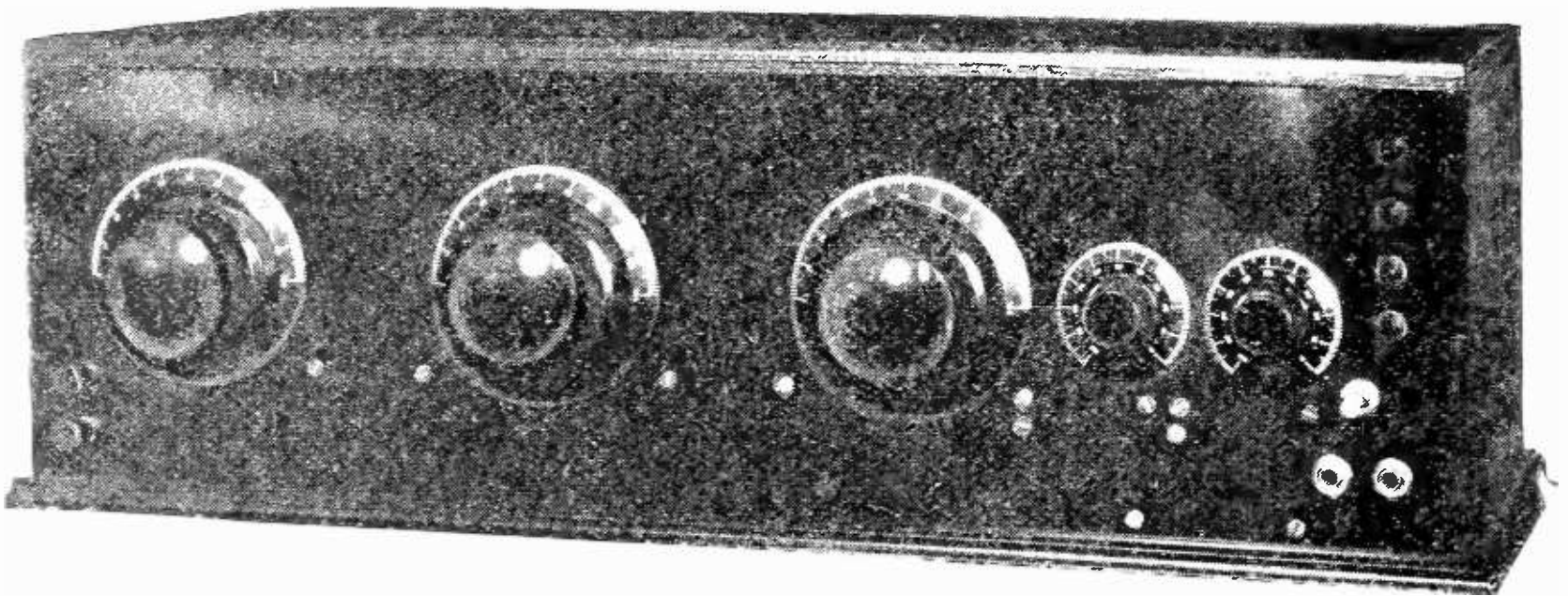

FIG. 1

A panel view of one of the first test models. The final form is practically the same with the exception that one rheostat instead of two controls all the tubes

A Good Four-Tube Receiver

Employing Neutralized Radio Frequency-Amplification, a Controlled Regenerative Detector, and Two Stages of Audio Amplification—An Efficient and Simple Receiver Using Cylindrical Inductances Which Can Easily Be Built

BY McMURDO SILVER

THIS receiver is no great innovation in the point of circuit design, for it employs the tried and true principles of radio-frequency amplification and controlled regeneration. As Mr. Silver brings out, his receiver is quite like the one known as the Knockout Roberts receiver, but this set uses cylindrical coils which, for some constructors, may be somewhat easier to build. The receiver produces results, for those in our laboratory on test, quite came up to the promises made by the author. The set has also something in common with that described by G. H. Browning in RADIO BROADCAST for December. Every part of the Silver receiver can be purchased in the open market and built and assembled by the constructor.—THE EDITOR.

DURING the last year and a half, there is no question but what the super-heterodyne receiver has been at the top of the list, from the point of view of the more experienced set-builders, but for those experimenters who desire "super" results on a small antenna, there have been only two other really satisfactory receivers to turn to, until the advent of the Roberts Knockout Reflex. These receivers were the neutrodyne, or those using some form of tuned radio-frequency amplification, and that good old stand-by, the now almost prehistoric regenerative receiver. The neutrodyne, after the "super", was the next most sensitive receiver, and with these two at the head of the list, the

regenerative circuit has suffered a gradual decline in popularity. Now, however, there is a tendency to combine regeneration and r. f. amplification, and receivers built along these lines may in time, supplant both the straight regenerative receiver and the neutrodyne.

The reasons for this are very excellent ones. Tuned r. f. amplification offers many advantages, but the sensitivity of a receiver employing this type of amplification is not as great as it might be if the set itself is to be kept in a stable operating condition. This is because regeneration, unless it be controlled to some extent cannot be used. The sensitivity of such a circuit depends in a very large measure

upon the amount of regeneration used. The obvious thing to do is to combine some form of variable regeneration with stable radio-frequency amplification. If the r. f. amplifier is neutralized and the regeneration take place in the detector circuit, the result is an extremely sensitive, non-radiating receiver. In the more congested centers, the effect of the "bloopers" or radiating receivers is not becoming a menace, but *is* one, and most seriously interferes with satisfactory reception of broadcast programs.

The set to be described herein presents nothing radical nor does it incorporate any wild or so-called new ideas. It is, on the contrary, merely an application of sound design principles in an endeavor to produce a receiver which would embody all the advantages of the neutrodyne plus those of the regenerative receiver and with none of the draw backs of either type. Certain definite requirements were laid out before development was started:

1. The receiver must, when using a 75-foot outdoor antenna give results equivalent to a good seven-tube super-heterodyne when operating on a loop, with respect to sensitivity, selectivity, quality of reproduction, ease of control and simplicity of assembly.
2. The set must employ a minimum number of tubes operating at maximum efficiency.
3. It must be non-radiating.
4. The equipment used must be as efficient as it is practically possible to make it.
5. The construction and assembly must be simple enough for any one to build.
6. The parts cost must be kept within reasonable limits.
7. An extensive course of "trouble-shooting" must be absolutely unnecessary. In other words, the set must work, if it is assembled properly, without trouble and experimenting on the part of the builder.

The general design is shown in Figs. 1 and 2. It will be noticed that the mechanical require-

ments come up entirely to what was planned for it. As for results, with the set located in Chicago operated with a 75-foot out-door antenna, stations on either coast may be brought in with loud speaker volume on the four tubes while all the locals are operating. Practically all tests of the receiver were conducted in a location midway between WEBH and WQJ, located approximately one-half mile apart. It was entirely possible to bring WGY operating on 380 meters through WEBH operating on 360, with no interference and it was possible to bring several 440 meter stations through WQJ operating on 448 with only a slight amount of back-ground interference. On the lower waves the selectivity was sufficient to separate KFNX, KFKX, WJJD, WTAY, and WTAS, all operating within a very narrow wave band. The selectivity was almost up to that of a seven-tube super-heterodyne and the volume with the outdoor antenna was equivalent to that obtained with the "super" on a loop.

WHAT THE SET DOES

ADDITIONAL tests were then made to determine what the set would do on a 20-foot indoor antenna, and most satisfactory results were obtained—stations throughout the country being brought in with ease and in the case of all the more powerful ones, with loud speaker volume. The set was also tested for radiation and it was found that with the detector oscillating and beating on a given station that the same station could be picked up on a super-heterodyne about 25 feet away with no evidence that the four-tube set was oscillating.

The circuit employed consists of one stage of tuned r. f. amplification followed by a regenerative detector and two stages of audio amplification. The r. f. amplifier is neutralized to prevent oscillation and radiation, although where 199 tubes are used it is often

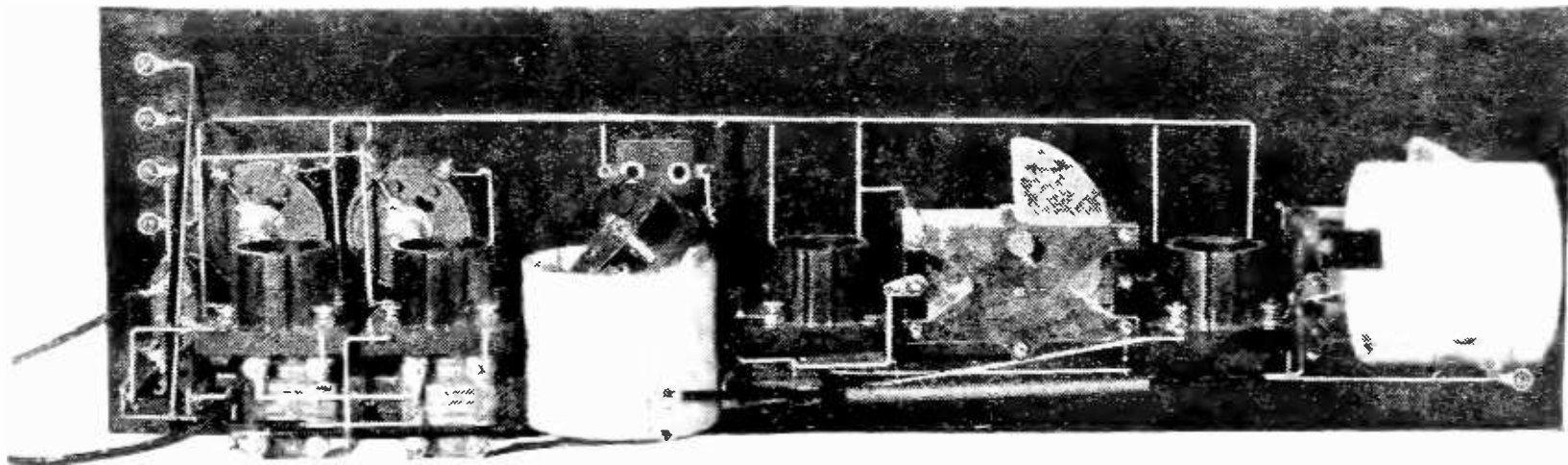

FIG. 2

The "works" of the four-tube set built by Mr. Silver. Note the connection of the neutralizer to the tap off of the vario-coupler secondary coil. All the parts are mounted on the panel and no baseboard is used

unnecessary to neutralize the set. The quality of reproduction was all that could be desired, either with storage battery or dry cell tubes and the difference in volume between 199's and 201-A's was only about 10 per cent., the sensitivity remaining substantially the same. See Fig. 3.

The tuning inductances used in the set are very efficient. I believe they have about the lowest losses of any coils at present used for broadcast reception. They are supported entirely on air with the exception of the two bakelite strips which are approximately $\frac{1}{2}$ inch wide. The turns are held in place by means of five strips of adhesive tape which introduce practically no additional losses. Some tests were run off using the coils with and without a bakelite supporting tube and it was found that the sensitivity to weak signals using the air core coils was decidedly superior to that obtained when coils wound upon a bakelite tube were used. The coils are so located that a minimum of loss from surrounding material is introduced. Some question might arise in the mind of the reader when it is seen that one of the audio transformers is very close to the second detector grid circuit coil, but the losses introduced here are negligible, however. This would not be the case if the transformer were located at one of the open ends of the coil.

The entire assembly of the set is on a 7 x 24 bakelite panel. No sub-base is used. All parts are screwed directly to the panel itself which is extremely substantial and simple. At the left end of the panel is the r. f. tuning condenser which tunes the grid circuit of the r. f. amplifier. Next is the detector tuning

condenser controlling the grid circuit of the detector tube. These two controls function in exactly the same manner as the first two controls on a neutrodyne receiver and may be logged in exactly the same fashion. The third control, or tickler, is what accounts for the extreme sensitivity of the set as it provides a means of varying the amount of regeneration used in the detector circuit.

THE PARTS REQUIRED

THE material used by the author to construct the set is as follows:

- 2 .0005 low loss condensers (Silver, Cardwell, or Duplex)
- 1 Low Loss coupler
- 1 Low Loss Antenna coil
- 4 Hoosick Falls panel mounting sockets.
- 1 Howard $6\frac{1}{2}$ Ohm rheostat
- 2 Thordarson $3\frac{1}{2}:1$ Transformers
- 1 Carter 102-A Jack
- 1 Carter 101 Jack
- 1 On-Off Switch
- 1 .00025 Mica condenser with leak clips
- 1 .002 Mica condenser
- 1 .0075 Mica condenser
- 1 2-Megohm grid leak
- 6 Insulated top binding posts
- 3 4" moulded dials
- 1 7 x 24 x $\frac{3}{16}$ " bakelite panel
- 1 5" length $\frac{1}{4}$ " brass tubing, spaghetti, lugs, bus bar, solder, etc.

Tools: Screw driver, pliers, soldering iron and hand drill with drills and counter-sink.

If the builder wishes, he may substitute other parts than those specified in the construction of the receiver, bearing in mind that they must be of as good quality as those specified and of approximately the same size and values.

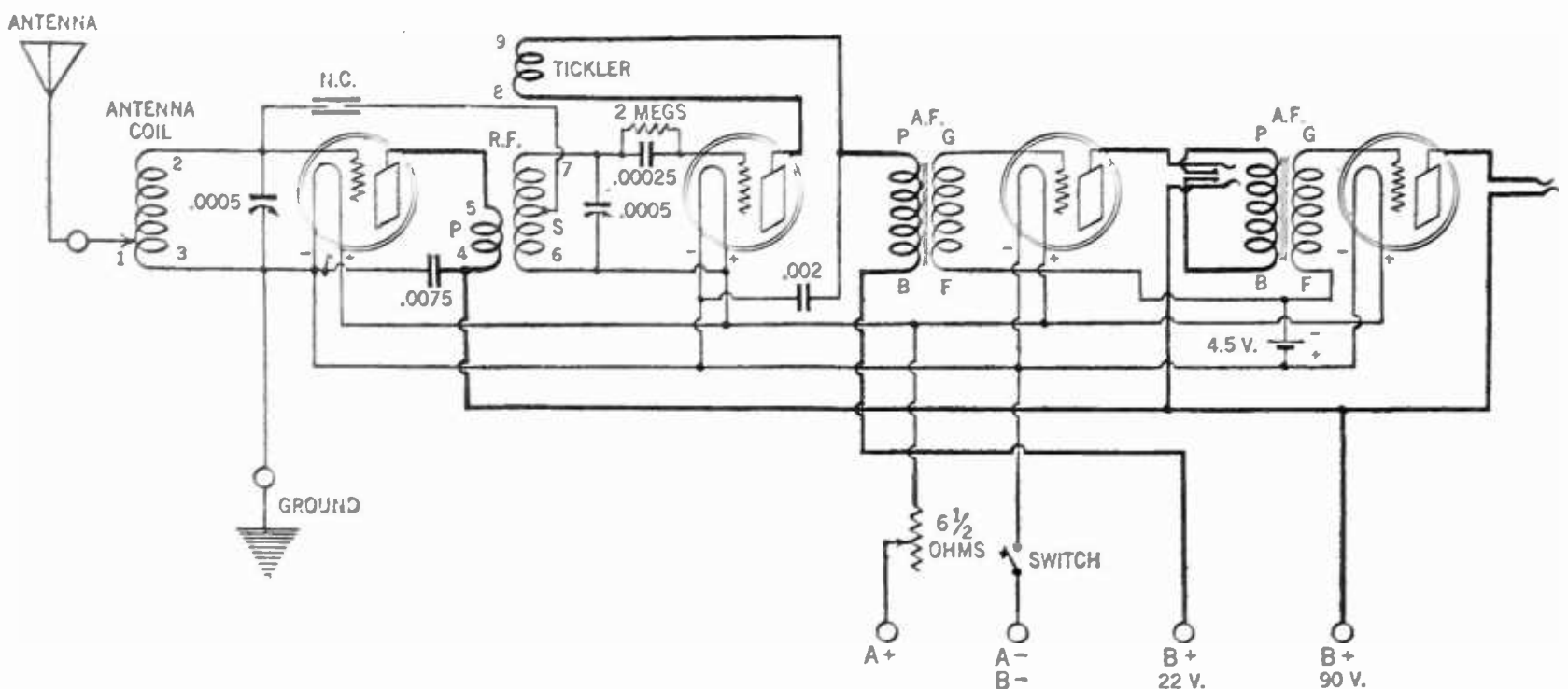

FIG. 3

The schematic circuit diagram. The various coil terminals are numbered for ease in identification of wiring. Direct reference may be made to the numbers in this plan and those in Fig. 4

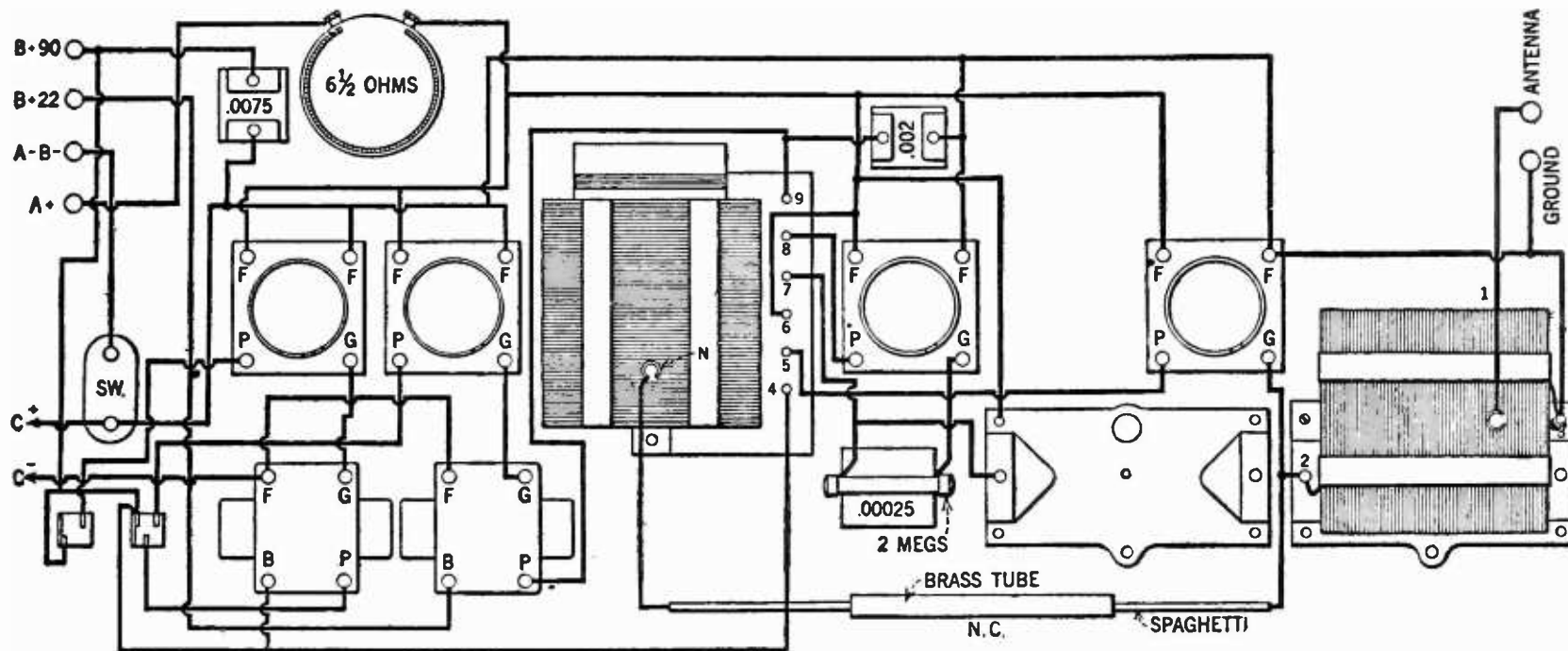

FIG. 4

A picture layout of the wiring. The parts are in relatively the same position as shown in Fig. 2

Before starting with the assembly and immediately after the purchase of parts, they should be carefully checked and inspected to see that they are in first class condition. All bolts, screws, and springs should be tightened up so that no trouble will be encountered further on in assembling the set.

The panel should be laid out with a scribe and square following the diagram given in Fig. 5 if material as specified in the parts list is used.

After all holes have been located they should be drilled and counter-sunk where necessary. If desired, the panel may then be given a sanded finish by rubbing in one direction only with fine sand paper and oil until all traces of the original polish have disappeared.

DETAILS OF CONSTRUCTION

IF THE builder decides to wind the coils used in the set, the simplest method of doing it is to wind them upon a bottle approximately 3 to 3 $\frac{1}{8}$ " in diameter and then break the bottle away from the coil. The method of doing so is to place five strips of adhesive tape lengthwise along the bottle, these strips being held down by two rubber bands at either end, the sticky sides up. Sixty turns of No. 20 double cotton-covered wire should be wound in place for the antenna coil with a tap taken at the fifteenth turn, the rubber bands may be removed and the ends of the adhesive tape, each strip of which should be approximately 6 inches long, may now be bound back over the coils to hold the turns in place. This will leave five bands of tape, each one running around both inside and outside of the coil

and touching each turn on the inside and on the outside of the winding.

The stator coil of the vario-coupler is wound in exactly the same manner except that at one end of the tube fifteen turns of No. 30 d. c. c. wire are first wound on the bottle and then sixty turns of No. 20 wire put on over this. These fifteen turns are wound single layer, as close together as possible, and the 60 turn winding of No. 20 d. c. c. is put on starting directly over the first turn of the No. 30. When fifteen turns of the stator-secondary winding have been put in place, a tap is taken as on the antenna coil and 45 more turns then put in place. The tickler consists of a small bakelite tube approximately 2 inches in diameter and 1 inch long arranged so that it may be rotated at the end of the last coil made which is the farthest from the tap. The tickler should consist of between fifteen and twenty turns of No. 30 d. c. c. wire.

A more satisfactory way of supporting the coils would be to paint them with a good grade of insulating dope. In order to keep the losses low, however, an extra good grade of dope should be used. If the coils are made in this manner, 55 turns in the grid windings will be sufficient, instead of 60 turns, as the insulating compound increases the distributed capacity slightly.

For the vario-coupler two strips of bakelite may be used to clamp the stator coil together and they may project somewhat at one end. These two projecting ends may have a hole drilled through them which will accommodate a shaft to which the tickler coil is attached. Terminals may be machine screws run through one of the pieces of bakelite strip

which should be wide enough to project to about the edge of the coil whereas the strip inside the coil will be only $\frac{1}{2}$ inch wide.

ASSEMBLY

THE assembling may then be started by placing lugs on all instrument binding posts and mounting the parts themselves upon the panel following the scheme of Fig. 4. No wiring should be attempted before the builder has first studied the lay-out carefully and has turned the lugs in the directions which will permit of the shortest possible connecting wires. After this has been done, the variable condenser, coupler, and rheostats should be removed from the panel and the filament wires put in. These wires should be run along the panel at a point about two inches above a line passing through the socket bases. Small lengths of bus bar should be soldered to the main lines and carried down to the lugs on the sockets. It is advisable to cover this wiring with spaghetti. The antenna coil which has been previously wound should now be placed between two thin strips of bakelite about $\frac{1}{2}$ inch wide and $3\frac{3}{4}$ inches long. In the end of each of these bakelite strips a No. 18 hole should be drilled, placed $3\frac{5}{16}$ inches between centers and arranged so that when one strip is placed over the other the holes at either end will coincide. If $1\frac{1}{4}$ inch round head $\frac{6}{32}$ machine screws are put through these mounting strips at each end with a nut on the far side of the second strip, it will be possible to clamp the coil between the strips which rest on the winding at a point directly above one of the lengths of adhesive tape.

It will be noticed on the condenser that there are two holes used for small mounting screws on the back plate which are approximately on a line which would run through the rear shaft bearing. These screws should be removed, and after a second nut is placed on each of the $1\frac{1}{4}$ inch screws running through the coil mounting strips, these two new screws should be inserted in the holes in the condenser from which the original ones were removed. They may then be tightened up, care being taken to keep the nuts loose upon them until they have been entered at least $\frac{1}{4}$ inch into the condenser end supports. One nut on each screw may then be tightened up against the condenser end plate, and the second nut on each screw tightened up in the opposite direction against the bakelite strip. This will leave the coil clamped firmly between the two bakelite strips and mounted on the back of the condenser. In connecting

this coil to the condenser, the end near the tap should go to the frame of the condenser if it is of the grounded rotor type and the end farthest from the tap should go to the stator plates, which will in turn go to the grid of the r. f. tube. The tap itself leads to the antenna binding post.

It is very much simpler to purchase the coupler completely built up than to endeavor to build it, since its construction will involve the turning out of a special shaft, bearings and lock washers. For this reason it will not be taken up, although the winding data has previously been given, and if the constructor feels confident of his ability to build it, he will have sufficient knowledge to supply the mechanical coupling arrangement details suitable for his needs.

The r. f. condenser with its coil is then mounted at the left end of the panel and the detector condenser placed in the next position to the right, followed by the coupling unit which is located between the detector and first audio tube. The rheostat is also put in position and wired with one of its terminals to the positive A battery binding post and the other to the line connecting the positive filament terminals of all sockets. The balance of the set wiring presents no particularly difficult features and if care is used, a very neat job can be made of it. The stator plates of both condensers should be connected to the grid sides of their respective circuits.

TESTING THE SET

AFTER the wiring and assembly has been completed, the set is ready for test. If 201-A tubes are used, a 6-volt storage battery will be required and a 90-volt B battery tapped at either 22 or 45 volts for the detector. A $4\frac{1}{2}$ -volt C battery will also be required for the audio amplifier. If UV-199 tubes are used, the B battery will remain the same, but the A battery should consist of three dry cells connected in series or if extra life is desired, six dry cells connected in series parallel.

The batteries should be connected to the set, and as they are connected no sparking should be noticed. If sparking is noticed it indicates that there is a short circuit in the wiring, which should then be very carefully checked. After the batteries are connected, a single tube should be inserted in the right hand socket and the rheostat just barely turned on. If the phone plug is inserted in the right hand jack a click should be heard and if a finger is placed on the grid terminal of this last tube either a click or squeal should result. If this

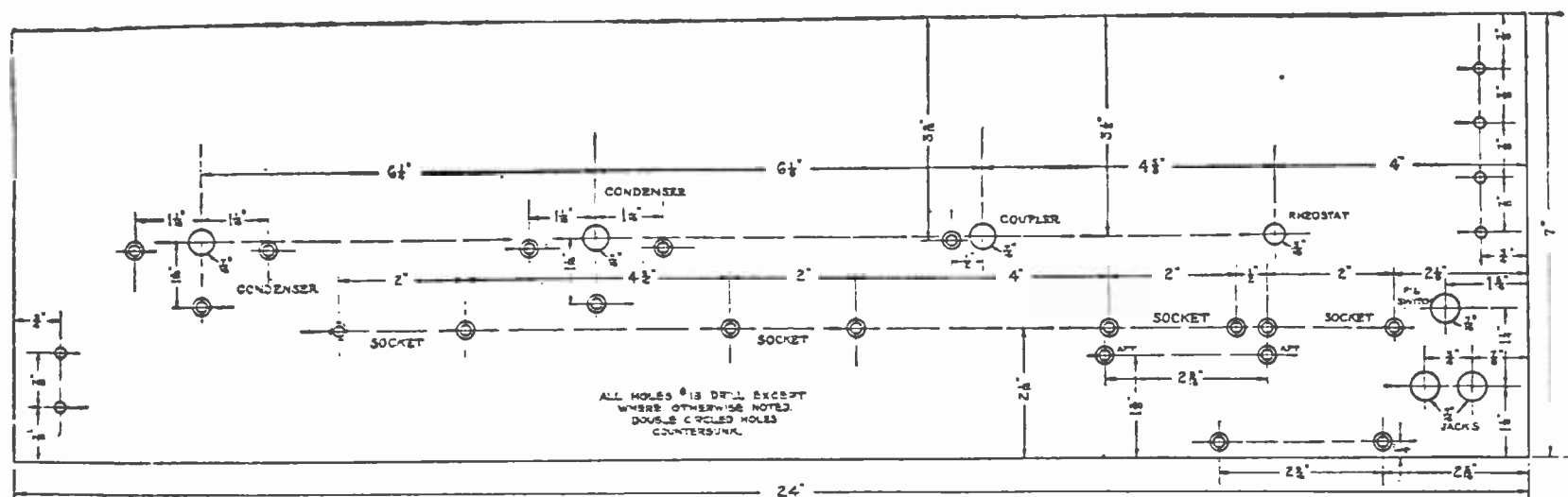

FIG. 5

The panel layout. Where other parts are to be used, it will be necessary to provide other mounting holes. The center holes then may remain as shown

is the case, it indicates that the wiring in this circuit is correct and the second tube should be inserted in the next socket. A click will be heard as it goes in and if its grid terminal is touched, a click or squeal will also be heard. The 2-megohm grid leak should be placed in the clips of the grid condenser and the detector tube inserted in its socket. Then with the detector condenser set at about 50, the tickler should be rotated and as it goes from 0 to 100, at some point along its scale a "plunk" should be heard. If, after this plunk has been heard the grid condenser is touched with the finger, a thud or squeal should result if the detector is oscillating. If the tickler is then set at zero, nothing but a click or squeal should be heard as the grid condenser is touched. If the thud is not heard at all, it is due to failure of the detector tube to oscillate. This may be corrected by reversing the leads to the rotor or tickler coil of the vario-coupler.

Now connect a ground to the ground binding post and an antenna to the small tap located on the stator winding of the coupler which also goes to one side of the neutralizing condenser, which will be connected later. This leaves out entirely the r. f. amplifier tube and gives a straight regenerative detector and two stages of audio amplification. For test purposes, the tickler may now be moved up beyond the point where a plunk is heard and the detector tuning condenser rotated until a "tweet" or squeal is noticed. This indicates a station and if the tickler is then set just below the oscillating point the signal will be heard with its true modulation.

ADJUSTING THE NEUTRALIZER

AFTER these tests have been made, the neutralizing condenser should be connected to the grid terminal of the first tube

socket and to the tap on the stator winding of the vario-coupler. The neutralizing condenser consists of nothing more than two pieces of bus bar of equal length and so arranged that when soldered to the tap and grid terminal referred to and running in the same direction their ends will fail to meet by approximately $\frac{1}{4}$ inch. Both ends are inserted in a length of spaghetti which will, when run from the tap up to the grid terminal, serve to hold these two pieces of bus bar firmly in position. Before they are finally soldered in place, a small 5-inch length of brass tubing should be placed over the spaghetti and left entirely unconnected so far as the balance of the wiring goes. This completes the neutralizing condenser.

An antenna should now be connected to the antenna binding post of the set and the first or r. f. tube inserted in its socket. The rheostat should be approximately three-quarters on. The tickler should be set at zero and the tuning condenser at a position where a station was previously heard. The 5-inch brass tube should be pushed up toward one end of the spaghetti tube on which it slides and the r. f. tuning condenser varied around approximately the same setting as that of the detector condenser, when the station should be heard again. Stations should now be tuned-in over the entire range of the receiver, with the tickler at zero.

If the r. f. amplifier oscillates, the small piece of brass tubing should be slid down the spaghetti $\frac{1}{4}$ inch at a time until all tendency toward oscillation is eliminated. If it cannot be eliminated by moving this tubing along, this indicates that the primary of the r. f. transformer is improperly connected and the leads to it should be reversed. This primary is the small 15-turn coil located inside one end of the vario-coupler stator coil.

Another method of neutralizing the set would be to tune-in a fairly strong signal and then remove the first r. f. tube from its socket. A piece of paper should be placed over one of the filament pins and the tube replaced in its socket. Then, with the tube unlit, the signal will come through weakly and the brass tube should be slid along until the signal does not come through at all or at best with very poor intensity.

The receiver having been neutralized, there is nothing more to do, and in tuning it may either be operated with the tickler set at zero and the first two dials handled in the same manner as when tuning a neutrodyne, or the tickler coupling may be increased until the detector oscillates and a signal located by rotating the detector condenser until a whistle is heard. The detector condenser should be left set on the whistle and the r. f. condenser moved to a point where the whistle is strongest. If the tickler coupling is then reduced to just below the oscillating point and the two condensers readjusted very slightly, the signal will be heard with maximum intensity.

De Forest DV-3 tubes, which have the same characteristics of 199's may be used and will work in very nicely as they have standard bases and do not require adapters. WD-12's will also work in very well as they also have standard bases. It is probable that the neutralizing adjustment will not be at all critical if 199's or WD-12's are used.

TROUBLE SHOOTING

THERE is very little that can go wrong with the receiver or that might cause failure to function, and if it is assembled properly, there is no reason why it should not work. However, it is possible gradually to improve it slightly by following some of the suggestions outlined below:

Selectivity: If the detector tuning condenser is broad, it indicates the use of an insufficient amount of tickler coupling. It should be possible to make this control very selective indeed by bringing the tickler up to just below the oscillating point. If the r. f. tuning condenser is broad, this may be overcome by inserting a small fixed condenser, say .00025 or .0005 mfd. in series with the antenna which will, in effect, reduce the resistance of this circuit and sharpen its tuning very much. This will not be necessary except with a very long antenna, say over 125 feet.

Volume: If the detector can be made to oscillate and the receiver to tune sharply, poor volume may be attributed to trouble in

the audio frequency amplifier and should be looked for in this section. Improper connections or misplaced C battery, would account for this. Individual location conditions will more probably be to blame, however.

Hand Capacity Effect: This will not be experienced if the stator plates of the condensers are connected to the grid sides of the circuit and if all by-pass condensers are wired in. The by-pass condensers are very important. The .002 mfd. by-pass condenser is quite important and should be connected from the plate terminal of the first audio transformer to either minus or plus side of the filament line.

Squealing: This would be due either to too high a value of tickler coupling, failure to neutralize the r. f. amplifier, or more probably to the audio amplifier. If in the audio amplifier, it may be overcome by reversing the leads to the primary of the audio transformers or shunting the secondary of the audio transformers with a .00025 mfd. condenser or $\frac{1}{4}$ megohm grid leak, or both.

Noise: Noise in the set should be traced by first disconnecting the antenna. If it disappears it is picked up on the antenna and probably cannot be eliminated. If it persists, the first r. f. tube should be removed and so on down the line until it stops. If it stops upon the removal of some tube other than the last one, the noise is probably in its circuit. If it persists throughout the entire set it is due to some faulty common wiring, such as B battery, or A battery, rheostat, or socket contact.

Grid Leaks: A 2-megohm grid leak will be satisfactory for practically all tubes used, although it may be found that a 3- or 5-megohm grid leak will give a little better result on weak signals.

Tickler: The detector circuit should not oscillate until the tickler has been advanced to about 50 to 70 degrees on its dial. If it oscillates at some point below this, turns should be removed from the tickler coil until the oscillation point is brought within this range, if the builder wishes to do so, although this is not very important. If the detector fails to oscillate, reversing the tickler connections will correct matters.

Neutralizing: If the r. f. stage cannot be neutralized so that it does not oscillate, the leads to the primary of the r. f. transformer should be reversed. If this fails to correct matters, one or two turns should be removed from the primary, although this would be an extreme case.

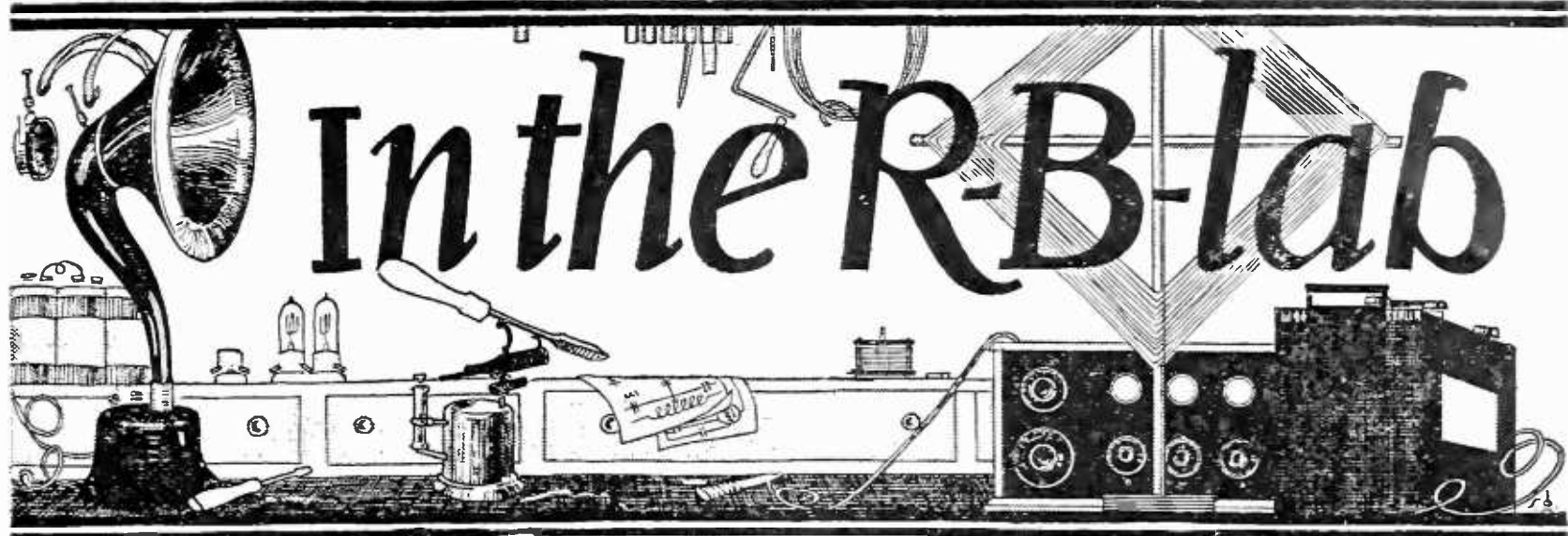

APPLYING THE REGENERATIVE LOOP TO ANY SUPER-HETERODYNE

THE principle of the regenerative loop can be applied to practically any type of super-heterodyne receiver without altering the interior connections of the set. The "regenerative loop" is, as the name implies, a method of introducing regeneration into the first detector tube. This results in all the desirable characteristics of the regenerative circuit—i. e., increased sensitivity and response to distant stations, and greater selectivity. (Under certain conditions, such as operating in closed quarters as imposed by steel apartment houses in a large broadcasting center, the selectivity of the super-heterodyne operated in the usual manner falls short of its possibilities. This is due to distortion of the wave front by the surrounding walls and semi-conducting or refracting mediums. As a result, the loop is extremely unreliable as an indication of direction, the plane of the loop often being approximately 90 degrees to the expected angle, and most stations, regardless of direction, are received best at this one position.)

Regeneration in the loop can be effected in several ways. A somewhat common system, though not altogether satisfactory, employs a tickler coil situated within the loop. The adjustment of the tickler, however, affects the tuning of both the plate circuit

(which inputs to the intermediate-frequency amplifier) and the grid circuit, when coupling is sufficiently close to secure satisfactory regeneration. A more common and satisfactory method is to alter the loop circuit into a regenerative system. This is a simple matter and quickly accomplished.

It is first necessary to add more turns of wire to the loop, say from one third to twice the number of turns used for normal tuning. A tap is brought out where the new turns connect to the old. The additional turns are wound in the same direction as the loop proper.

In many cases it will be found that the loop the experimenter is utilizing for straight reception has more turns than are necessary to cover the desired wave band and that the tuning condenser is only active up to about two thirds maximum capacity. Where this is true, it will probably be possible to tap the loop so that sufficient turns of wire are left on one side for regeneration. As before mentioned, from

one third to one half the number of turns used in the tuning section are required in the additional or regenerative section.

The completed loop will have outlets for three connections, the upper terminal, the near-center tap, and the lower terminal. For simplicity in the

In the R. B. Lab This Month—

—How to apply the regenerative loop principle to any super-heterodyne.

—Using standard low-loss coils in the Roberts Knockout circuit.

—A receiver operating from 45 to 200 meters using the Roberts circuit and low-loss coils.

—A method for pre-determining how to connect the tickler coil in a regenerative circuit.

—Short laboratory notes of value and interest to the constructor and the experimenter.

following explanation, designate these respectively, as A, B, and C. "A" connects to the posts or jack prong on the super which leads through to the grid of the first detector tube, either directly or through the pick-up coil. A short inspection of the receiver will identify this lead. In the case of loop binding-posts, it is generally the upper one. "B" runs to the remaining loop post or prong. The connection leads through to the filament of the first detector tube. The upper part of the loop is now connected in the usual manner, exactly as the whole loop was before the change was considered.

"C" is now connected to one side of a variable condenser having a capacity not less than .00035 mfd. This will be sufficient, though if more convenient a larger condenser may be used. The condenser shown in the photograph (Fig. 1) is a Freshman mercury condenser, capacity .0005 mfd. The other and remaining side of the condenser is connected to the plate of the first detector tube. These connections are shown diagrammatically in Fig. 2, where A indicates the usual loop connections in the Haynes and other super-heterodynes, and B the regenerative system.

The experienced reader will immediately identify the resulting circuit as the Hartley system, which becomes an oscillator as the condenser, C_2 is turned above the spilling over point. This system of producing oscillation is used in many transmitting stations. However, the receiving operator, utilizing regenerative loop reception should not permit the detector tube to oscillate. In this condition it is a radiator of interfering waves, which, though they are effective only over short distances, may still bother reception on another receiver located in the same building. Fortunately there is absolutely nothing to be gained by maintaining these oscillations, reception being impossible until condenser C_2 is turned down.

Tuning the "super" is only slightly more complicated with the regenerative loop. As regeneration is built up, a slight retuning of the loop or oscillator dial will be required. Regeneration will be most effective on distant stations.

Fig. 1 shows this system adapted to the Haynes simplified super-heterodyne, described in the March, 1924, RADIO BROADCAST.

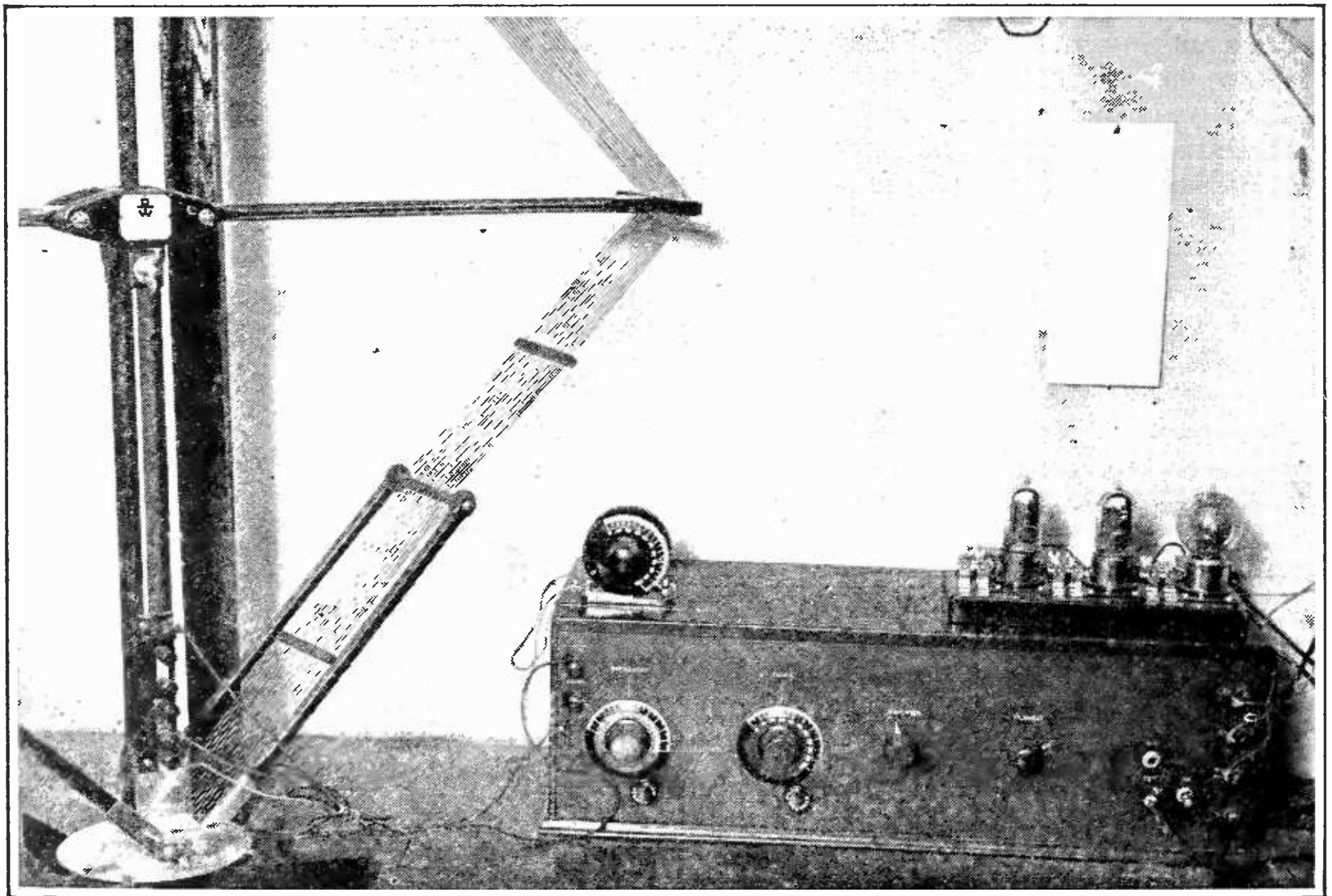

FIG. 1

The regenerative loop in operation. Note the three leads from the loop. The control condenser is above the oscillator dial. Three stages of resistance coupling are plugged in on the detector tube of this super-heterodyne. See January, February, and March, 1924, RADIO BROADCAST

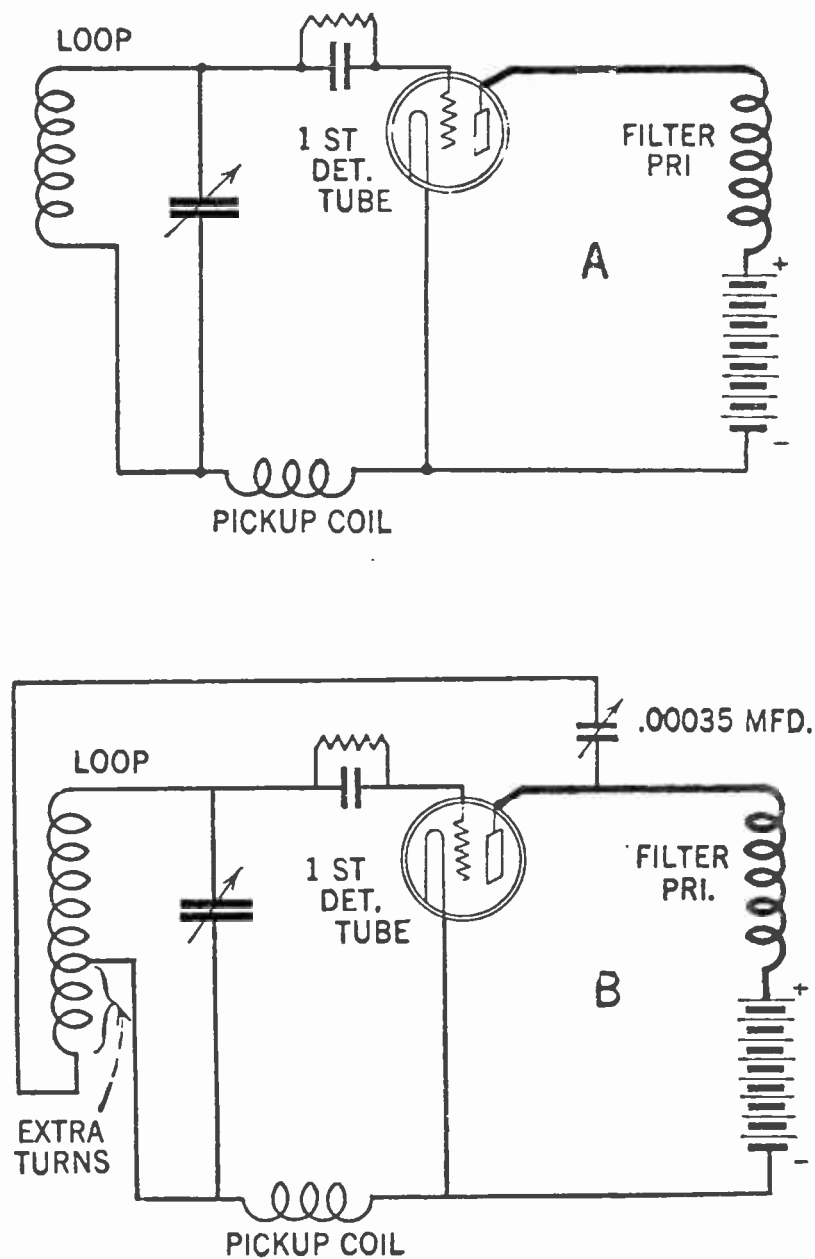

FIG. 2

"A" shows the usual loop connection in most superheterodynes. "B" indicates the additional turns and condenser which cause regeneration in the first detector tube. This arrangement is particularly advantageous on DX reception

LOW LOSS COILS AND THE ROBERTS SET

FIGURES 3, 4 and 5 illustrate the manner in which standard three-circuit low loss coils can be adapted to the Roberts Knockout circuit. In principle, the adaptation consists merely in supplying a neutralizing winding to the radio frequency output circuit. Either one or two low loss tuning units can be employed. If one set of coils is obtained, the substitution is effected only in the r. f. and tickler circuit, the usual spiderweb or similar antenna coupler being unchanged. With two units the complete system is made low-loss, from the antenna through to the audio output.

The units employed in experiments in The R. B. Lab were the "Lopez Low Loss Tuners." The same directions and manner of procedure hold good for other types.

USING ONE UNIT

IN SUBSTITUTING a single set of coils for the usual "N, P, S, and tickler" inductances, the primary of the low loss tuner arrangement is used as the transformer primary (P) and is placed in the plate circuit of the first tube. However, it is first necessary to wind either alongside or on top of the primary coil, the neutralizing winding. This consists of one more turn than the primary, wound in the same direction, with any convenient wire, such as No. 24. The beginning of the neutralizing winding is connected to the end of the primary, thus giving a common tap to the two coils, which is connected to the plus side of the B battery. The remaining terminal of the primary is wired to the plate of the r.f. tube and the end of the auxiliary winding to the neutralizing condenser. The secondary and tickler coils are connected in the usual manner.

USING TWO UNITS

WHEN a duplicate set of coils is employed, the procedure is slightly different. The antenna coupler is formed by removing the tickler coil from one of the units, thus leaving primary and secondary. These two remaining coils may be remounted in numerous ways that will suggest themselves to the experimenter. The tickler that has been eliminated from the first unit, is now substituted for the primary of the second unit, and a neutralizing winding wound upon it as already described. The number of turns on the tickler are generally more suited to the transformer primary requirements, than the primary designed for the antenna circuit.

Using these coils, the primary taps are eliminated, as the antenna primaries are generally of the semi-aperiodic type. The ground, in addition to running to the lower end of the primary, should be connected to the minus side of the A battery.

Figs. 3, 4, and 5 show how the coils used in this laboratory were mounted. Low loss coils are generally more bulky than the less efficient inductances, for which reason their disposal on the panel presents more of a problem. The shaft to the transformer primary (the upper coil in Fig. 4) has been removed, as there is no occasion for varying the coupling between the primary and secondary, and it is secured permanently by means of a metal strip. Other forms of winding, such as the diamond weave and spiderweb may be satisfactorily substituted for the basket weave coil illustrated.

A SHORT WAVE LOW LOSS SET

BY SIMILARLY utilizing short wave low loss coils, a highly efficient short wave receiver, similar to that described in the August number of RADIO BROADCAST can be had. A receiver of this type is operating successfully in the R. B. Lab on wavelengths between 45 and 200 meters. It was used in intercommunication work with amateur stations for checking up on European reception during the International Radio Broadcast Tests.

On the short wave set, the tickler should be so arranged that 180 degree variation is possible. It is, of course, impossible to secure satisfactory reception of short wave telephone broadcasts with the detector oscillating, and on the extremely high frequencies reversed feedback is generally necessary to stabilize the receiver. The tickler coupling must not merely be loosened but the coil must be turned around over ninety degrees.

It is somewhat contrary to expectations, and therefore interesting to note, that the Roberts circuit employing low loss coils, responds more readily to adjustments of the neutralizing condenser, and little or no experimenting is required to stabilize the system. Operating and other instructions remain the same as those suggested for the standard receiver.

For detailed information concerning the Roberts circuit and parts other than those just described, the reader is referred to any of the articles dealing with the set, or the "Knock-Out Book" published by RADIO BROADCAST.

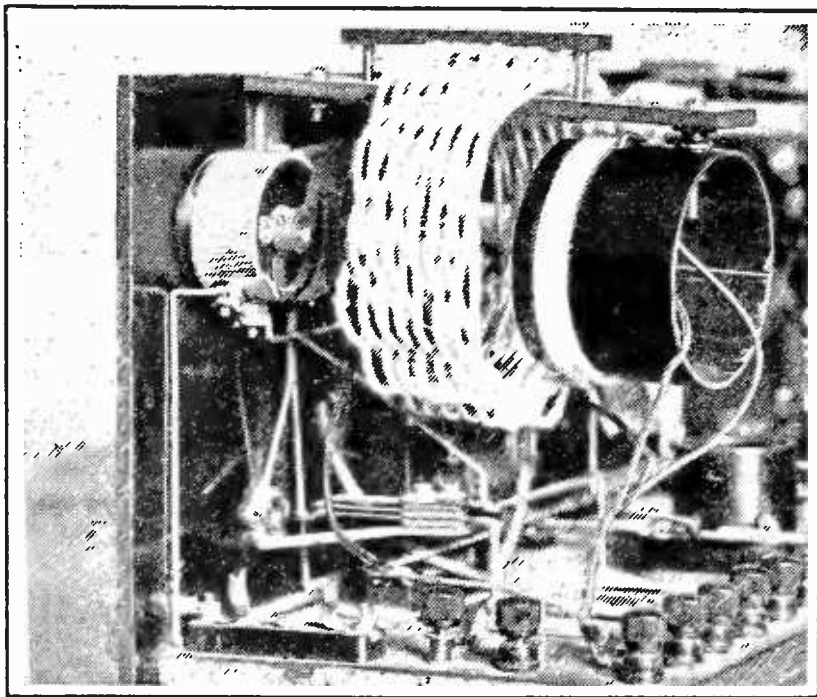

FIG. 3

Primary and secondary low-loss coils for the antenna coupler. These have been remounted from a standard three-coil unit

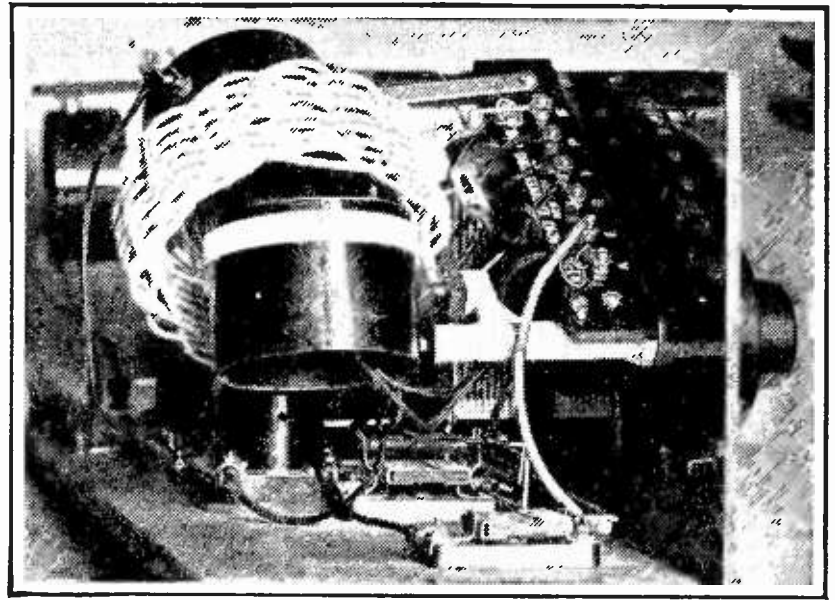

FIG. 4

The r. f. transformer and tickler coil. The primary shaft has been removed, and the coil mounted on the frame by a metal strip

HOW TO CONNECT YOUR TICKLER COIL

ARTICLES on the wiring and operation of tickler-feedback regenerative receivers are almost invariably accompanied by rather indefinite instructions as to the proper connections to the feedback coil. The reader has doubtless run across a phrase (which the writer has often written) explaining that if the set failed to regenerate the connections to the tickler were to be reversed. Thus the wiring of the regenerative apparatus was a fifty-fifty chance which, in consideration of a permanent job, was decidedly inconvenient.

There is really no reason why the exact manner of connecting the tickler coil should not be stated, for all doubt can be eliminated by a simple rule.

Regeneration is secured by tickler feedback when energy is fed back from a coil in the plate circuit of a vacuum tube to a coil, generally the secondary of a vario-coupler, in the grid circuit, in such a manner that the returned impulse is in the same or assisting direction of the existing grid impulse. When the directions are reversed, that is, when the feedback impulse is in a direction opposing the grid impulse, the effect is naturally reversed, and instead of regeneration we have a very noticeable weakening of the signal.

To one familiar with the laws of induction, these considerations will throw light on the situation. Let us assume that the incoming signal places a momentary positive charge on the grid. This will, of course, cause an increase in the plate current, with an expansion of the magnetic field about the tickler. This

motion of the flux will induce an appreciable e.m.f. in the secondary coil if the coupling is sufficiently close. If regeneration is desired, this e.m.f. must be such as to place an additional positive charge on the grid which assists the original charge. However, we know that an induced current is always in a direction opposite to that of the original or inducing current at moment of induction. This brings us to the very simply rule which may be relied upon to guide tickler connections rightly.

Take any regenerative circuit, and consider two distinct currents as flowing from the tube, one from the grid, through the grid coil or secondary to the filament, and the other from the plate, through the plate coil and battery to the filament. (These conditions, in an electronic analysis, often exist during reception). The drawings in Fig. 6 illustrate this conception of the two individual currents flowing from the grid and plate of the tube, the arrows indicating the direction of flow as we have suggested. The rule is (bringing the coils close together) that these two currents must flow in opposing directions—i.e., one set of arrows must point up and the other set point down.

The rule is further qualified as follows: When the coils are wound in the same direction (A) either clockwise or counter clockwise, the grid must connect to the beginning of the grid coil and the plate to the end of the tickler or, of course, vice versa. When the coils are wound in opposite directions, the grid and plate should connect both to either the beginnings or ends of their respective coils.

B, in Fig. 6, shows two coils wound in the

same direction in which the requirement for regeneration has not been filled. The effect of this coupling, as explained, will be the opposite of regeneration.

LABORATORY HINTS

THE capacities of condensers used in radio circuits are generally given in microfarads, which means one millionth of the unit of capacity, the farad. The abbreviation for microfarad is "mfd." Thus, we often run across condenser specifications such as .001 or .0005 mfd. There has been a recent tendency to eliminate the decimal, and to consider these small capacities in micro-microfarads, or millionths of a microfarad. The abbreviation for this term is mmfd. Condensers having capacities of .00025 mfd., .00035 mfd. .0005 mfd. and .001 mfd. can be respectively described as 250 micro-microfarads, 350 micro-microfarads, 500 micro-microfarads, and 1000 micro-microfarads condensers.

AN EXCELLENT reamer for working panel material is a round file, $\frac{3}{8}$ inch in diameter at the large end. Enough of the tang is broken off so that the file can be grasped in a brace. Any hole in which the point of the file can be inserted can be reamed up to $\frac{3}{8}$ inch by turning the brace

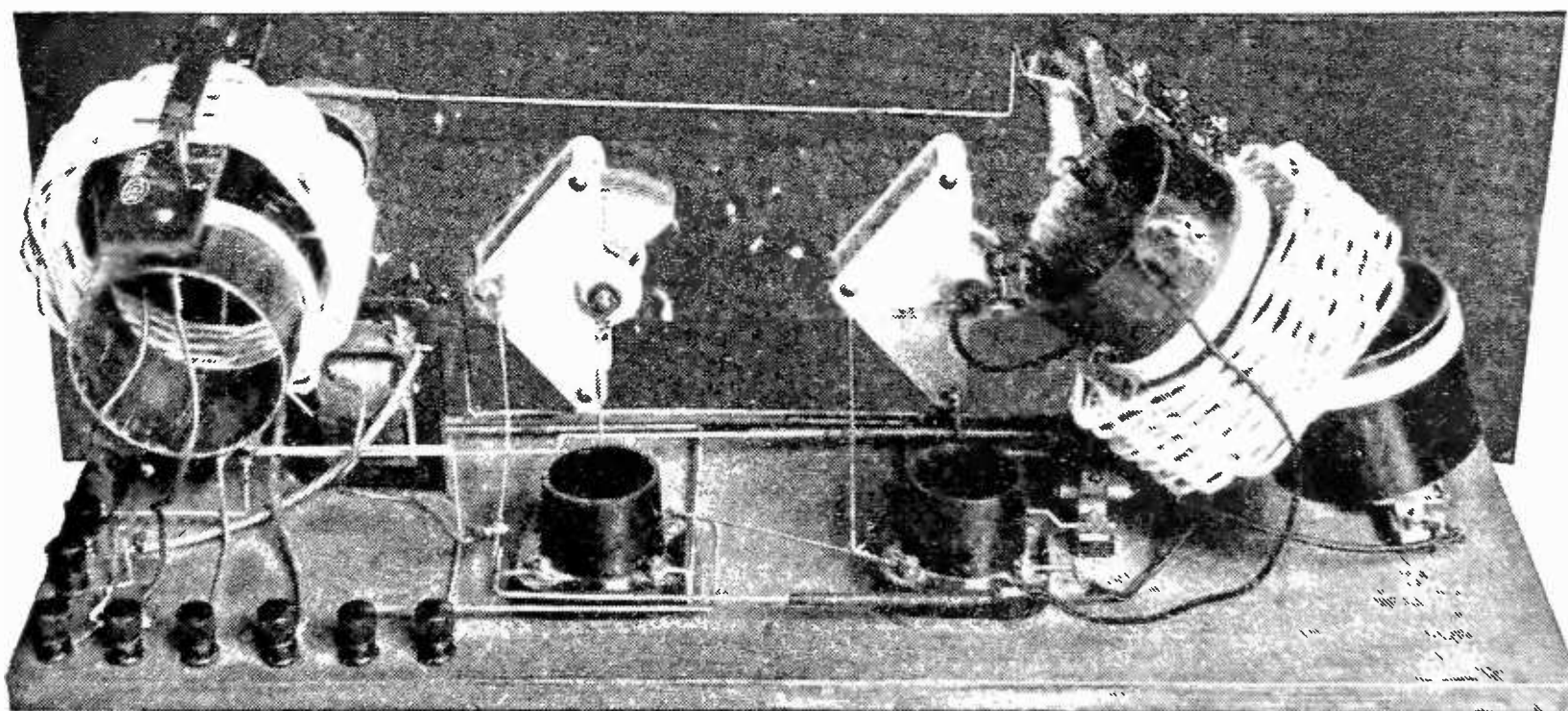

FIG. 5

Rear view of the low-loss Roberts, using adapted Lopez Tuners. This set is particularly easy to neutralize

counter-clockwise. If turned clockwise it will jam.

Holes reamed in this manner are very smooth and have little taper.

IN THE article on charging storage B batteries in the June RADIO BROADCAST, mention was made of the discrepancy between a hot wire meter and a d.c. meter in a common charging circuit. The a.c. meter will always give the higher reading, and a statement was advanced that this reading was to be preferred as being the more nearly correct value of the current flowing. This is erroneous. The hot wire meter registers the root mean square or heating value of the current, and the d.c. meter the average value of the current. An electrolytic process, such as that functioning in a storage battery during charge, varies with the average current. That is, a two ampere charge applied for one hour, off for one hour, on for one hour, etc., is equivalent in electrolytic effect to that obtained by applying a one ampere charge continuously for the total length of time of the intermittent charge. It can be shown that in a pulsating current, the r.m.s. value is always higher than the average value.

In almost every other case where measurements are desired of a pulsating current, it is the r.m.s. value that should be observed.

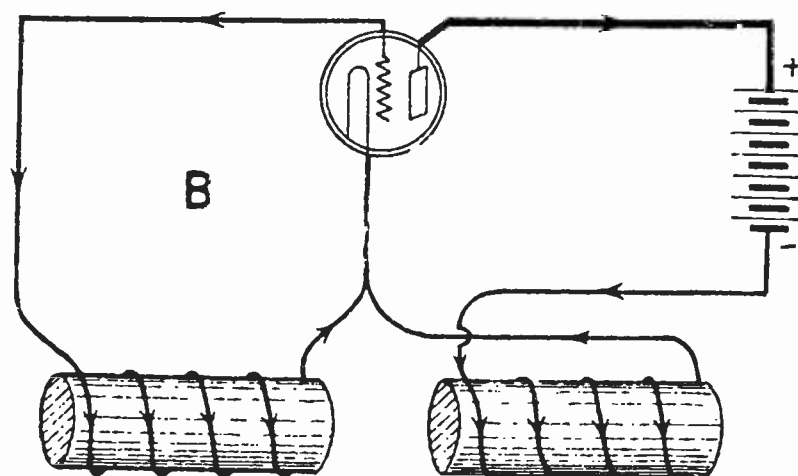
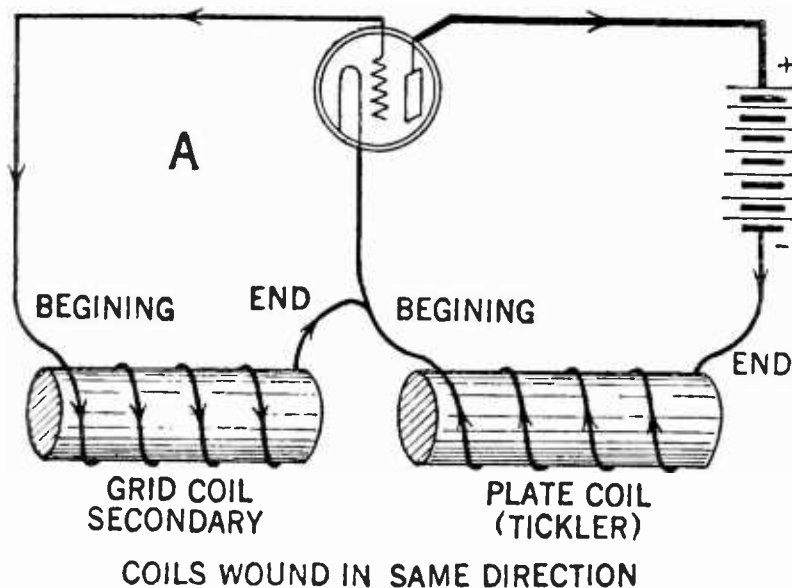

FIG. 6

How to connect your tickler coil for regeneration, in accordance with simple rules set forth in this article. "A" will regenerate. "B" will rot.

THE material appearing in this magazine is fully protected by copyright, and editors of periodicals are advised that unauthorized publication of circuit diagrams, technical descriptions, and parts or the whole of articles, without due permission and credit, is an infraction of the law. Those who wish to reprint material appearing in these pages are asked to communicate with the editor.

Shall We Specify Parts?

The Policy of This Magazine in Publishing Construction Articles—A Note on Radiating Receivers

BY ARTHUR H. LYNCH

FOR some little while we have given a great deal of thought and consideration to the interesting subjects discussed in the letter we publish below. Similar questions to Mr. Musladin's have been asked us time and again. The answer is not easy, nor can it be made without reservations. We try to have the articles appearing in our magazine as near correct technically, practically, and ethically as human effort permits. You will find Mr. Musladin's letter of interest, and we will consider it below.

Editor, RADIO BROADCAST,
Doubleday, Page & Co.,
Garden City, L. I.

DEAR SIR:

The writer has been observing construction articles in radio publications and feels that there should be a general movement toward broader specifications of parts.

It is no secret, to be sure, that exact specifications are causing both dealers and jobbers considerable trouble. The layman in reading the articles justly believes that good results can only be obtained by following exact specifications, if exact specifications are published; and while it may or may not be the writer's intent to press that idea, nevertheless the ultimate result is that both dealers and jobbers receive hundreds of requests for materials not stocked in jobbing centers away from manufacturing centers, because of the fact that the particular item is not a nationally recognized standard.

From a personal standpoint I might say that we are very proud of the fact that we carry practically all nationally recognized standards. There is hardly a need of publishing a list of them, but it will suffice to say that such a listing would prove that it is our desire to serve the public in this particular territory with parts to which they should be entitled.

By way of detailed explanation, one might take the variable condenser situation. Is it not a generally accepted fact that the substitution of any of the wonderful examples of condenser construction now on the market will produce like results?

The audio transformer presents another case. Jacks, rheostats, binding posts, and similar items are certainly not subject to exact specifications. In cases where a company has succeeded in producing a very good patented item, and which will prove popular when presented to the public, the right of that company to subsidise, or themselves publish,

an article is not questioned. In cases of this kind winding data or construction data should be given.

To come down to the real point of my letter, would it not be possible for editors to adopt some standard expression for use in terminating all such articles? My suggestion is as follows:

The above items were used in the author's described set, but substitutes of equally good materials will produce like results.

You are, of course, in better position to promote such an idea, and I believe you would have the thanks of those engaged in the radio business, and those who desire to see the business as a whole put on a strictly ethical basis.

Very truly yours,

ALEXANDER AND LAVENSON ELECTRICAL SUPPLY
COMPANY, San Francisco, Cal.

By C. P. Musladin, Sales Manager

We try to give the reader every possible assistance in building receivers from the articles we publish. Wherever possible we name the parts used in building the receivers, and where similar units of other makes can be employed with equal satisfaction we say so. We try, as far as possible to describe only such receiving circuits as include parts of reputable manufacture, which may be purchased in all parts of the country. Where special parts, such as the coils for the Roberts circuit and the intermediate-frequency transformers of certain super-heterodynes are recommended, we insist upon authors supplying us with data concerning their construction as well as the names of units which may be substituted wherever possible. We cannot insult the intelligence of our readers by mentioning all the condensers which could be used in a given circuit, for instance. There are a great many good variable condensers on the market any of which—if of proper capacity—would work well in a circuit where a particular brand is mentioned. This is true of audio-frequency transformers, tube sockets, jacks, rheostats, panels, and similar products. As a general rule, any good parts designed for the same purpose may be interchanged in a well designed circuit.

We quite agree with Mr. Musladin. This magazine will continue to print construction

articles, specifying particular parts when necessary, and wherever possible indicating the use of standard products. But, for the time being, we must remember that the market is pretty well flooded with useless and poorly designed parts which we hope to save our readers from buying.

It is true that certain manufacturers subsidize writers to specify their units. Sometimes, perhaps, they are justified in doing so. Such articles are usually taken with a grain of salt by the reader and though they may make some temporary friends for the publication among those whose parts are specified, the usual result is unfavorable reaction on the part of other advertisers. In many instances the periodicals in question do not acquaint themselves with the performance of the receivers described and, as a result, many utterly useless purchases, and general dissatisfaction will result. As an instance of this: an experimenter sent us a very well written and very well illustrated article, describing a five-tube, single-control receiver some few months ago. The work was excellent. We asked for a demonstration. When the receiver came to our laboratory we were delighted with its appearance. Then we tried to make it work. Then we called for assistance from the designer. He tried to make it work. Then he began to make apologies. Imagine our surprise on seeing the description of this wonder appear on the front page of a certain newspaper radio section for which we had come to have a feeling of friendship because of the technical accuracy of the articles it published.

There are occasions, when the subsidized writer—usually signing his articles with a self-imposed “Radio Engineer”—really does describe something worth while and, even if he does load his literary efforts describing it with publicity which is supplemented by price lists and space in the advertising section, the intelligent reader will take it for what it is worth. We are quite certain that advertising contracts, secured by the offer of a certain amount of editorial comment per dollar are hard to renew. We want none of them. On the other hand it is equally unfair to the reader, who, in the final analysis pays the piper, for any periodical to withhold a description of a valuable addition to the radio field because it is not to be accompanied by advertising.

Our policy is governed by the value we believe the article under consideration will be to our readers. If it happens to stimulate

the sale of reliable products, we believe it does the reader and the manufacturer a service, by bringing to the former a good product and the latter a customer. In doing this work, however, we try to maintain a perfectly fair stand in connection with products of a competing nature. It is only by such procedure we believe the industry will prosper.

THE BLOOPERS ARE AT IT AGAIN

IT IS rather significant that all of the letters considered here were received in the same mail. If we get many more, requiring such lengthy comment we may have to abandon the magazine and devote all our time to correspondence.

Mr. Guy M. Chase of Elizabeth, N. J., is responsible for the letter which follows, which, with our reply, seems to require no further comment.

*Editor, RADIO BROADCAST,
Doubleday, Page & Co.,
Garden City, L. I.*

DEAR SIR:

On page 280 of the December issue of RADIO BROADCAST in an article by A. H. Lynch, there appear statements which are, to me, interesting.

Speaking of the absence of “squealing receivers” at the Radio Fair, the article lists, “all manner of tuned radio frequency receivers, reflexes, and super-heterodynes,” with the intimation that they do not squeal.

I know of a certain factory-built five-tube tuned radio frequency receiver in this city, operated on a 100-foot outside antenna which is *always tuned by the squeals*, even on locals. With 90 volts on the plate, is not that a squealer?

Super-heterodynes operated on outside antennas, with a constantly oscillating tube as a part of the working of the set, seem to me to fall in the squealer class, with a vengeance. I know of improperly tuned neutrodynes likewise tuned by the squeals.

I read most of the radio magazines published and I set up and try out a great many circuits. There are few which will not squeal when improperly operated or improperly adjusted, at least, that is my experience.

My point is this. I have been impressed with the fact that most radio magazines are obsessed with the idea that only regenerative circuits *can* squeal. I have often heard a salesman tell a buyer that a neutrodyne set or a tuned r.f. set could not squeal. I think that is sheer fraud.

True, regenerative circuits can be so operated as to be a pest to all for miles around. Those who have recently listened for Europe can swear to that. But not all the squeals come from regenerative sets. (I except the single-circuit from any consideration, as it is, by all odds, the champion squealer.)

Using two coupled regenerative sets, of the so-

called Ambassador type, another person and I have used two antennas which are parallel and two feet apart for 40 feet, one being 40 feet long and the other 100. We tuned all over the scale and neither one of us heard a squeal from the other set. The other operator used a loud speaker and I phones and one a.f. stage. Coupled regenerative sets, like any other, can be operated without squeals.

I ask consideration of this point:

Any set, regardless of name, type, or price, which will produce a squeal in its own speaker or phones, also produces a squeal in near-by speakers and phones.

Very truly yours,

GUY M. CHASE, Elizabeth, New Jersey.

Mr. Guy M. Chase,
Elizabeth, N. J.

DEAR SIR:

Thank you very much for your interesting letter. We have not overlooked the very important matters that you discuss, but Rome was not made in a day and it is impossible for us to do much at one time.

One of the principal reasons for our International Tests was to demonstrate conclusively to the radio listeners that squealing receivers should be abolished. It makes no difference to us whether they be single-circuit or improperly balanced neutrodynes or super-heterodynes hooked up to an antenna.

Thank you for your coöperation.

Very truly yours,

ARTHUR H. LYNCH
EDITOR, RADIO BROADCAST

Then, along with Mr. Chase's letter and several thousand of a similar nature we have one from an old-timer—a man who was for some time a radio inspector for the Marconi Wireless Telegraph Company of America. We felt that editorial expression concerning this letter is a waste of time. No doubt ninety per cent. of you folks listened for Europe during our international tests and it is quite likely that most of you heard the racket to which Mr. Collison refers and no additional reference to the subject is necessary at this time.

Editor, RADIO BROADCAST
Doubleday, Page & Co.,
Garden City, L. I.

DEAR SIR:

On Monday, Wednesday and Thursday nights of the International Test week, friend wife and I aided by a nine-tube super-heterodyne that has just been calibrated by Tyler, Rossiter, and MacDonald of New York City, deprived (and that's just what I mean to say), ourselves of sleep and almost ruined our sense of hearing not to mention our dispositions, in an attempt to pick up some of the European Stations.

And what did we hear?

Promptly at eleven o'clock, four million assorted squeals, whistles, whines, yowls, grunts, rattles, buzzes, ships working with spark sets with a decrement of something more than ten times what is allowed, chirping and twittering amateurs with little five-watt bottles (I dare any member of the A. R. R. L. to deny that his fellow members kept within bounds), and enough static to fill in the weak spots.

It's an outrage—I don't mean the static,—that's sent to us either from Heaven as punishment for our sins, or from Hades to plague us and must be accepted along with Income Tax Publicity, Near Beer, and Subway Rush Hour Riots.

But this oscillating receiver business is something that does not have to be endured. Newspaper publicity has not helped, because the average B. C. L. does not care a tinker's damn about the other fellow. Of what use is it for any person to invest several hundred dollars in a laboratory model super-heterodyne if some hi-jacking neighbor with a "one-tube-marvel" is going to smear the ether with noise.

Although the range of my super-heterodyne with a loop is considerably less than when used on an out-door antenna I would not think of putting it on an antenna because I know it would ruin reception for my immediate neighbors. I live in an apartment with several other B. C. L.'s and none of us annoy each other. That is because we have used our brains in a manner courteous to each other.

There is no way of getting under the skin of those who persistently sell parts which when assembled will cause radiation. They are of the same moral fibre as a bootlegger.

Every receiving set manufactured in the United States should be of a design approved by the U. S. Department of Commerce. All commercial radio apparatus must be so approved, so why not every other kind? This would remedy one source of trouble. Every installation connected to an outdoor antenna should be licensed by the Radio Inspector of that District and subject to his restrictions and orders. A one dollar license fee would not be a hardship and would more than pay for the cost of the extra inspectors needed. Periodic inspections might be arranged to check up the installations.

No doubt there will be many objections to this plan because it will curtail some "personal liberties." On the other hand I defy any person to defend the radiating receiver or the rights of any individual to use it.

The other remedy would be "super-powered" transmitters that would make the construction of such delicate and highly efficient receiving sets unnecessary.

No, I did not hear any European Stations.

Cordially,

PERCE B. COLLISON, Brooklyn, N. Y.

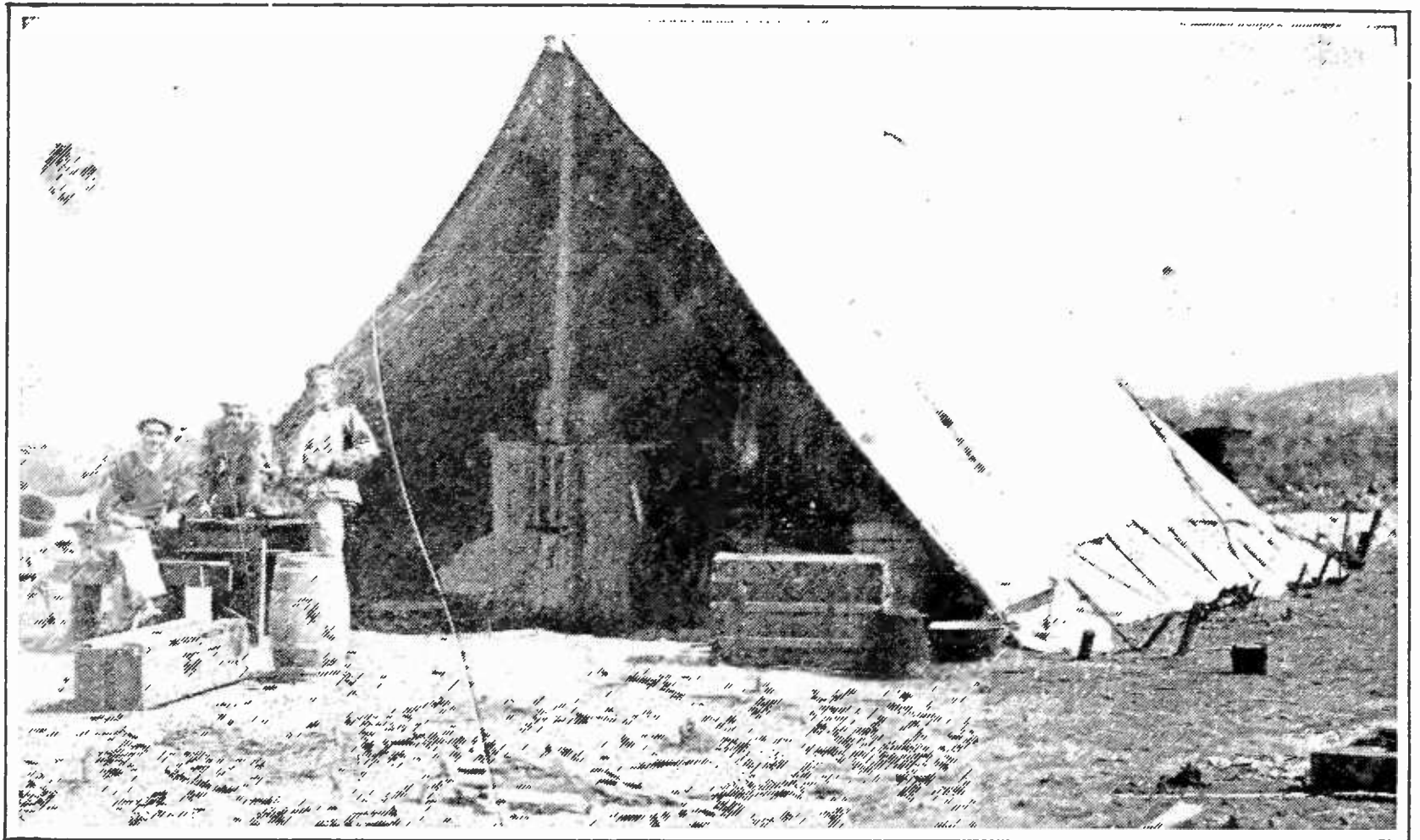

ON CUBAN SANDS

The party which installed the station had to live in tents for some time before other buildings could be put up to house them

How Wireless Came to Cuba

The Drama and Struggle of Strenuous Radio Times in the Jungle—
Hitherto Unpublished Memoirs of High Technical and Human Interest
—What Really Happened in the Early Days of Wireless Telegraphy

BY FRANK E. BUTLER

Former Chief Assistant to Dr. Lee De Forest

THE way we went about building a wireless telegraph station in 1905 was an entirely different procedure from that followed to-day when the modern radio engineer starts out to construct a broadcasting or any other type of radio station.

Instead of blue prints to guide us in those pioneer days we used only past "experience," and our stock of that was mighty limited. If past "experience" failed as a means of attaining further satisfactory results, then we relied upon patience and determination. These unscientific assets were all we had to help us in the working out of each new problem.

Up to this time, three high powered stations had been erected by Dr. Lee De Forest, one at the St. Louis World's Fair, one at Pensacola, and the third at Key West, Florida. These stations, while practically of the same

design and construction, had presented in their building individual problems which had to be worked out. These experiences had somewhat tempered our conceit as to what we thought we knew about installation. We began to realize the uncertainty of any set radio laws, and to expect anything to happen, or fail to happen.

This was the situation when I went to Guantanamo, Cuba, to erect the next in the series of five powerful stations to be built by Dr. De Forest for the United States Navy Department.

I sailed from Key West early in the spring of 1905 for Havana from whence I was to take a train overland to Santiago and from there embark once more by boat to within a few miles of my destination.

A brief stay in the delightful city of Havana

enabled me to form an idea of the difficulties I would have in a country whose language I didn't know and where buying facilities were very inadequate. My stay there was during the celebration of the first Cuban Independence Day, which resembled our own Fourth of July. The city was full of natives from all over the island, and when the train left Havana that evening I was mixed in with the most motley lot of passengers I ever met. I was the only white man.

A great quantity of wire, instruments, etc. had been shipped to me at Havana from New York. Having been forewarned of the advisability of not checking this material as baggage or shipping it via express on account of the unreliability and slowness of these methods, I decided to take it all in the car with me. As a result, my seat in the so-called, "sleeper," resembled a baggage car.

EN ROUTE TO GUANTANAMO

THE train dragged along slowly all night and seemed to stop at every sugar plantation. In the morning we stopped thirty

minutes at a town for breakfast which was served in a large room adjoining the depot. The passengers swarmed in there like a lot of cattle. There were no chairs, just long benches to sit on. Everybody grabbed, and so did I. They all talked Spanish, and they all talked at once. I was the only American in the crowd. The only Spanish I knew was "agua" but as they did not have any water, this one-word proficiency in the language was useless. Everybody was drinking wine, so I drank it, too, the while I sat in amaze as I watched the others empty glass after glass until they were stopped only by the call that the train was ready to move on.

At each station I hoped that some one would come aboard who could speak English. But all that I heard from the new passengers as well as the old, was Spanish. During the stop for lunch I was sitting rather disconsolate by myself when I noticed a dapper young Cuban army officer, who had, apparently, been to Havana for the recent celebration. He appeared very popular with the entire crowd. Just before leaving the station to board the

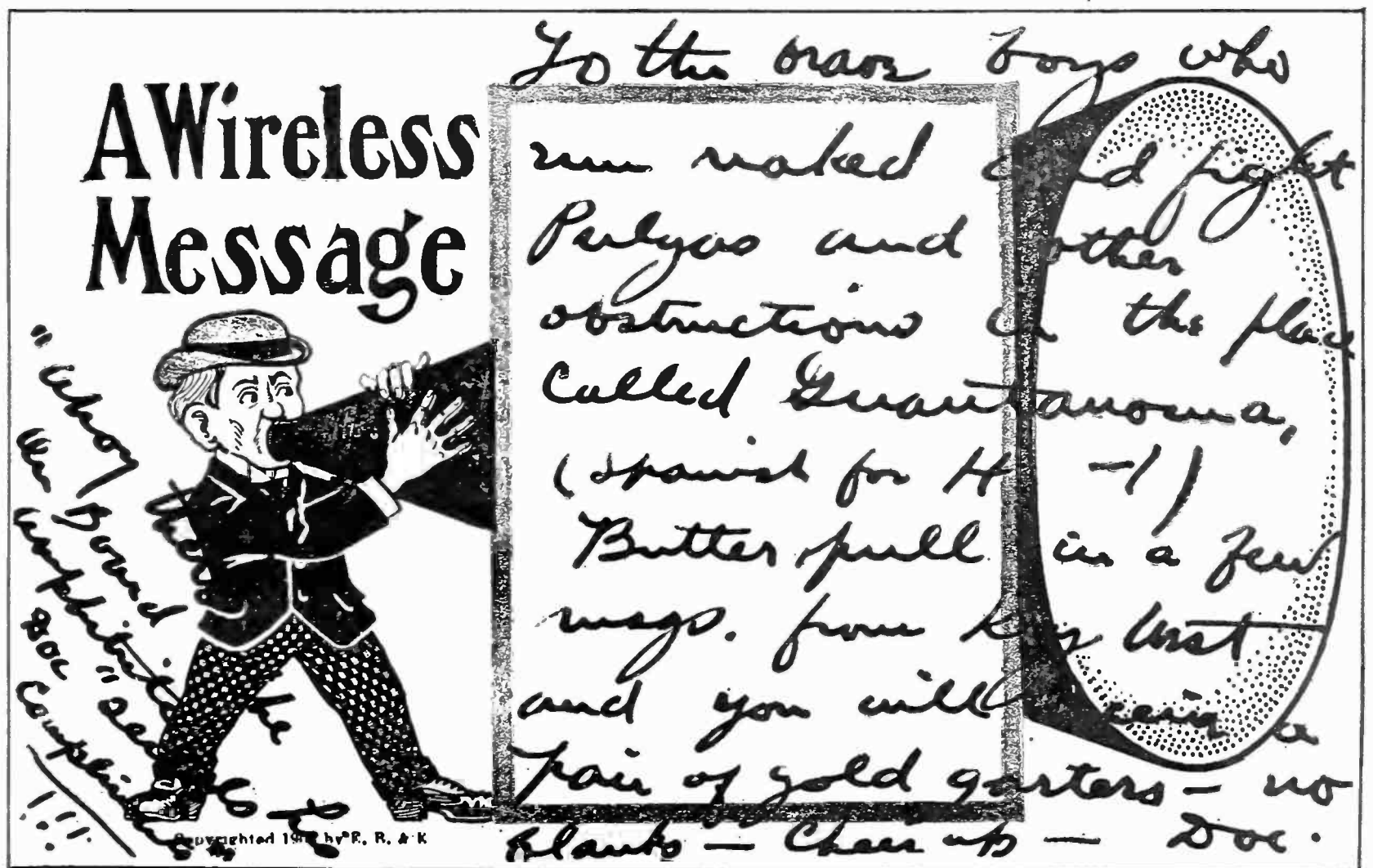

"DOC" DE FOREST TO MR. BUTLER—

The postal card was mailed in St. Louis on June 14, 1905. He writes: "To the brave boys who run naked and fight pulgas and other obstructions in the place called Guantanamo (Spanish for h-l) Better pull in a few msgs. [messages] from Key West and you will receive a pair of gold garters—no blanks—cheer up—Doc." And along the side: "'Ahoy there on board the *Amphitrite*—Doc sends his compliments'" The pulgas are small insects, almost invisible. They swarmed about the station in clouds, and their bite, while not poisonous, was very annoying. Since these insects chose to hover under clothing, the radio pioneers at Guantanamo often took the easiest way and removed most of theirs, hence Dr. De Forest's remark about the "boys who run naked"

train he came over to me and said, in perfect English, "Hello, John. Are you going to Santiago?" Every stranger in Cuba in those days was called, "John."

When I replied in the affirmative, the dashing young officer told me that he, also, was going there. From that moment the aspect of the trip was changed. I had found a companion, and a delightful one he proved to be!

About three o'clock the train stopped at what appeared to be a railway terminal. I stepped out to the platform for a little exercise while engines were being changed. After about ten minutes everything was in readiness, yet the train did not move. Fifteen, twenty, thirty minutes passed, and still we stood there. I noticed a little crowd by the baggage car so I strolled up to investigate the trouble. Imagine my surprise to find the entire crew circled around a large coil of wire which had been taken from my seat while I was away. All were talking excitedly and casting suspicious glances at me. I couldn't understand the situation. I hurried back to the "sleeper" to seek the assistance of my English-speaking Cuban friend. He came forward with me and asked what the trouble was. They explained that it was against the rules of the company to carry such kind of "baggage" in the sleeping car unless the express charges on it were paid. I had visions of a hold-up which would either mean most of my money for carrying charges or the confiscation of my tools and material. So I asked my interpreter to inquire the amount of the charges. The excited gestures and the combined talking of the crew increased my fears and I expected the worst. Imagine my surprise, however, when I was told I would have to pay the railroad company thirteen cents in American money to release the wire so that the train could proceed with my baggage in the sleeper. Upon payment of this sum I had to wait for several receipts and then the train again started on its journey.

✓ We arrived at Santiago about nine o'clock that evening after a twenty six hour drag. It was dark and the town was lighted with old fashioned kerosene street lamps. Through the officer I engaged several Cuban boys to assist me to the dock with my luggage as there were no conveyances about. From here I boarded a small steamer enroute to Boqueron, located on the interior shores of the Bay of Guantanamo.

The boat steamed out of the bay and past old Morro Castle over the spot where, a few

years before, Hobson had sunk the *Merri-mac*. We skirted the southern shore of the island and could see, as we passed by, the dim outlines of some of the hulls of the Spanish fleet which Admiral Sampson beached during the Spanish war.

THE SCENE OF ACTION

EARLY the next morning we arrived at the little group of huts which was called Boqueron. This hamlet port was the nearest point to the site of the contemplated government wireless station, which in Spanish was called telegrafo sin hilo.

It will be remembered that it was only a few years previous to this time that the Spanish-American war occurred which resulted in the freedom of the Cuban people. The United States Government had only very recently completed the arrangements of the formal turning over of the island to its natives, and it was the jollification at Havana which I saw only a few days before which had been held in honor of the event. In this transaction it was agreed that the United States should retain a small spot in Cuba as a naval base and coaling station. The site selected was the Bay of Guantanamo and its surrounding land consisting approximately of thirty-six square miles. About half of this was land and half water. The entrance from the sea was through a narrow inlet with high hills on either side extending along the coast. It was an ideal land-locked harbor, and big enough to accommodate all the navies of the world at once.

The sight of the harbor was inspiring, and the sight of Boqueron was depressing in proportion. The principal building was at the dock. A few native huts, a store and a saloon, housed the entire population of, perhaps, twenty-five people. The loungers around the dock were a tough looking lot, mostly negroes or half-breed Spaniards, just the kind you see in blood and thunder plays. I learned later that a few of them were fugitives from justice, and two were wanted in the United States for murder.

As I needed assistance to get overland to my destination I engaged a Jamaican negro, George Morehead, who spoke English, to go as my guide. We strapped the luggage across the backs of two horses and started afoot on the hike through the jungle to the government "lines" beyond which was the continuance of the jungle to the point where the wireless station was to be built. Government surveyors were the only white men who had pre-

ceded me through this wilderness, and the marks of their hatchets as they hewed the trail through the underbrush, were the only signs that any one had ever been there before. The land on this entire reservation, and for miles beyond, was in its virgin state. All was a dense undergrowth and jungle, interspersed with low, arid, sand flats: a paradise for mosquitoes, snakes, horned toads, scorpions, tarantulas, wild cats, and all other kinds of tropical creatures, flying and crawling.

I found George an intelligent fellow, entertaining and thoroughly trustworthy. This in itself was a godsend, as one would hardly expect to find anything like honor in surroundings such as these. As we journeyed he asked me if I had a pistol and I told him I had. He advised me to carry it always in my belt whether or not I ever had occasion to use it, as the many bad Negroes down there behaved only when they knew that the white man had a gun. I later found this advice valuable.

ONE THRILL OF MANY

ONE of my first thrills happened on this pathfinder trip. As we emerged from the jungle trail onto a wide level stretch of sand flats, I noticed that far ahead of us the earth looked bluish white, while beneath us it was hard packed salty sand. Nearing the blue patch I noticed this "land" moving. Slowly the bluish white part was separating in the middle with a wide swath and making a path showing the earth underneath. The negro, noticing my amazement, smiled and told me that this was a large army of land crabs scampering away to avoid us. They were there by the millions—ugly, worthless, destructive creatures with glaring, protruding eyes and wicked claws, some of them as big as human hands. In their cowardly nature they scurried and scampered away from us. But had we fallen helpless by the wayside they would immediately have returned to devour us.

A short time previous to my arrival the U. S. monitor, *Amphitrite*, had anchored in the harbor with officers and men to break ground for the construction of the new Naval Station. This ship was the Naval headquarters of the entire reservation and its commanding officer was the acting Commandant of the Navy Yard. Three Navy electricians from the ship were assigned ashore with me. They were: John Watts, Chief Electrician, of New York, Roscoe Kent of St. Paul, and V. Ford Greaves of Minneapolis.

First we lived in a tent and got our food



A TYPICAL NATIVE HUT

supplies from the ship. The initial general work to be done was the clearing of the dense growth of mango bushes which grew profusely along the shores around the station site. This made sport for the mosquitoes. Next a small dock was made so as to land supplies for the engine house and other necessary material. Finally, the engine house was completed to the extent that we could move in there until our regular living quarters were finished. Mosquitoes by the millions abounded and they made life miserable for us both day and night until we were able to obtain the necessary fine mesh netting to protect our tent and house.

It was not uncommon to be awakened in the night by the sound of a wildcat outside, for the animal was attracted there by the smell of food. Once we failed to close the flap of our tent and were awakened in the middle of the night by a suspicious but familiar sound inside. We switched a flashlight in the direction of the sound. Instantly a huge cat sprang completely across three of our cots to the tent opening and escaped with our next day's quota of meat.

Any one who has ever witnessed a southern sky can understand our enjoyment in watching the southern constellations which are so different from those at home. Huge fireflies as big as bumblebees emitting a bright green light filled the air at night. Small deer were plentiful and once we shot a fine specimen from our door. In the nearby inlets were the beautiful pink plumed flamingo birds so free from the haunts of man as not to fear our approach. In the waters all about us were gold fish, star fish, sea urchins, cow fish, and scores of other tropical wonder fish, besides many of the edible variety.

But enjoyment of the scenery had to take

second place to work. Heavy concrete abutments were constructed for the huge towers. These were in triangle formation three hundred feet apart. The towers were made of eight inch timbers, about three feet square at the base and tapering to one foot square at the top. They were two hundred and eight feet high. Suspended from the cross cables at the top was a big fan antenna from each of the three sides of the triangle. Heavy, seven-strand phosphor bronze wire was used and each triangle consisted of about 15,000 feet of wire or a total of 45,000 feet for the entire cage. This immense amount of wire weighed over a third of a ton, or the equivalent to the amount used to-day by radio fans in building five hundred sets of antennas. The huge cage resembled a giant gold fish globe two hundred feet high, and months afterwards, when the station was in operation, the mesh of wires would emit a bluish brush discharge at night which was beautiful beyond description and always proved of unending awe to the natives who would stand off from afar and gaze in open mouthed wonder.

QUARTERS

THE main building consisted of six rooms, which included living quarters. About 100 feet distant was the engine house which contained a 50-horsepower gasoline driven dynamo that furnished the electrical power. The station was rated at 20 kilowatts. One room contained the operating instruments, another the huge condenser trays, the spark gap and helix. So many wires from the antenna came into the one point of the bottom apex that it was necessary to build a gibbet to hold them on account of their weight before running them into the station.

It so happened that the site of the station was selected by Navy officials who instead of first considering its location from the point of its adaptability for perfect wireless work, selected it because that particular space was down on the blue print as the place, just as every other building planned for the reservation. As a result, a worse location could not have been chosen. The little peninsula upon which the station stood was wholly of coral formation, entirely dead as far as moisture or good ground facilities were concerned. This condition gave us no end of trouble in getting the station to function properly.

The days were hot and dry and the insects bothered us so much that work progressed slowly in the erection of the buildings and the installation of the apparatus. Many times

it was necessary to tie a towel around one's face, neck, and head, leaving only opening enough to see and breathe, wearing overalls and shirts saturated in kerosene was another method used to ward off the pestering insects.

Hard luck seemed to follow every move. High winds often blew down our antenna, and the station was struck by lightning three times. Once we experienced a slight earthquake shock, but aside from frightening us it did no damage.

An outcast Frenchman by name of Émile was our cook. He spoke broken English, poor Spanish, and never ceased telling us of his acquaintance with Sarah Bernhardt. He was a chef by courtesy only, but was the best we could procure in that godforsaken land. Another interesting member of our family was Marianna Binega, a Cuban Negro, black as the ace of spades, but loyal to the last degree. He was a general roustabout; but did everything in his power for us. He watched over our health and comfort always, once saving me from the bite of a scorpion by quickly cautioning me not to put my arm in the sleeve of a coat which had been hanging for some time in the closet without being worn. Excitedly he told me in Spanish (which by this time I had begun to grasp) to shake the garment. Sure enough, out from the sleeve dropped the wicked insect which Marianna quickly surrounded with an oiled wick, then lighted it so that the scorpion would commit suicide—which it did—thus giving me, as Marianna had designed—another souvenir, which I still possess. To Marianna, I was, "Mistah Fraang." Kent was "Mistah Kee." Watts was "Mistah Gwaa" and Greaves was "Mistah Greavo." He was as faithful as Friday to us.

GOVERNMENT INSPECTION

FOR some reason, unknown to me, a so-called government inspector was sent there for the purpose of watching me and my work. I will not mention his name here, but Marianna called him "Mistah Sinka-Walla" and that name stuck with him till he left after I did. He stayed on the job religiously for eleven long months, every day, Sunday included, from 8 A. M. till 5 P. M. He watched me constantly and said nothing. Never a word of encouragement or suggestion, but whenever anything went wrong he was always there with his familiar, "I thought so."

As we had no fresh water supply on account of the dead ground formation, we made a cement cistern to hold our drinking water.

To obtain this water it was necessary for the Government tug to steam up the Guantanamo River to where the supply was fresh, there fill its tanks, and then run down to our dock

and fill the cistern. Usually it required half a day to do this and of course was of some expense to the Government, so naturally we tried to be as saving with the water as possible.

One day after this filling was done, we forgot to place the cover over the cistern hole and that night a big wildcat, smelling the fresh water, went to the opening, fell overboard, and was drowned. The next morning Mr. Watts notified the officer on the ship of what had occurred, and requested that the water

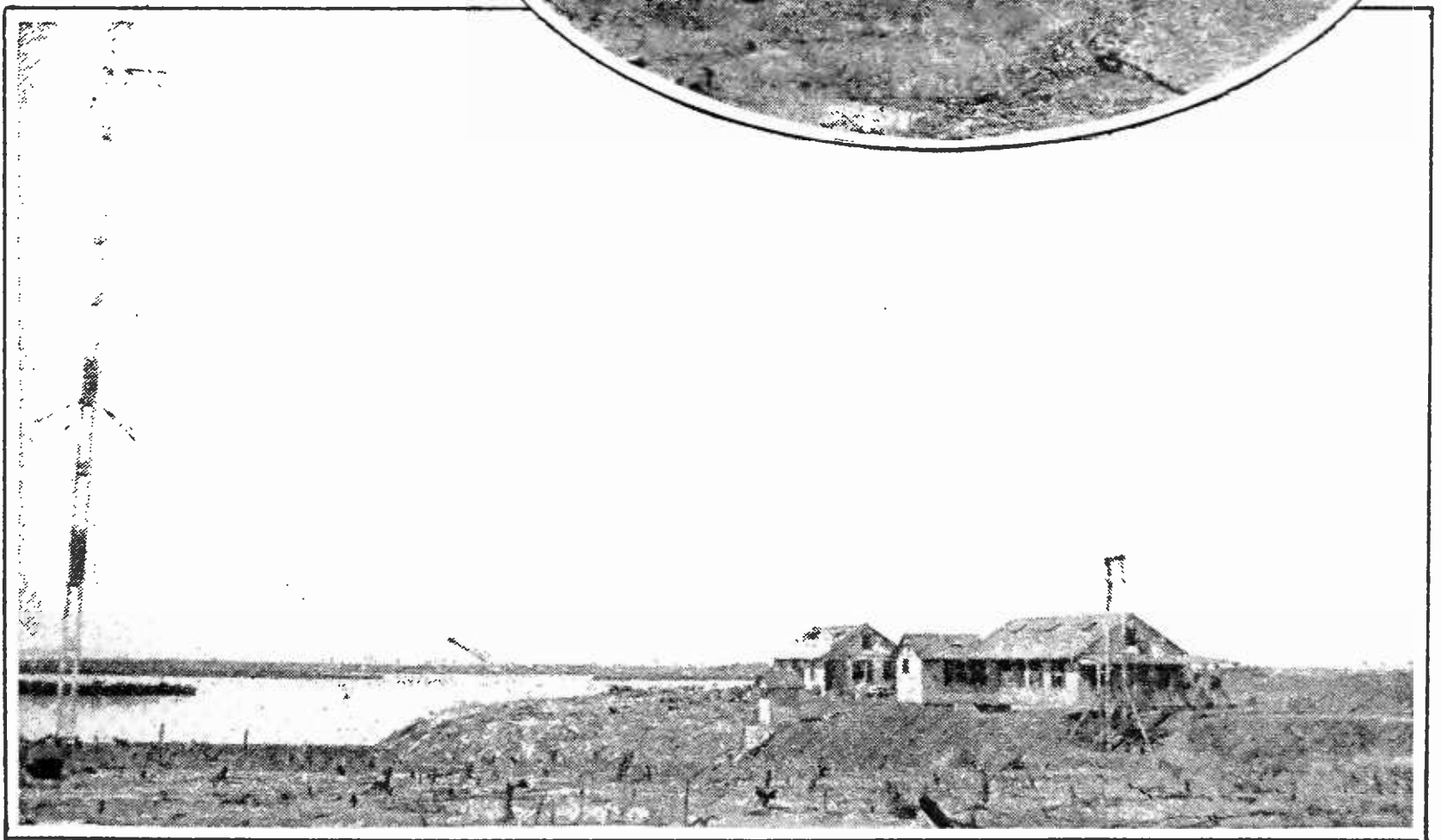
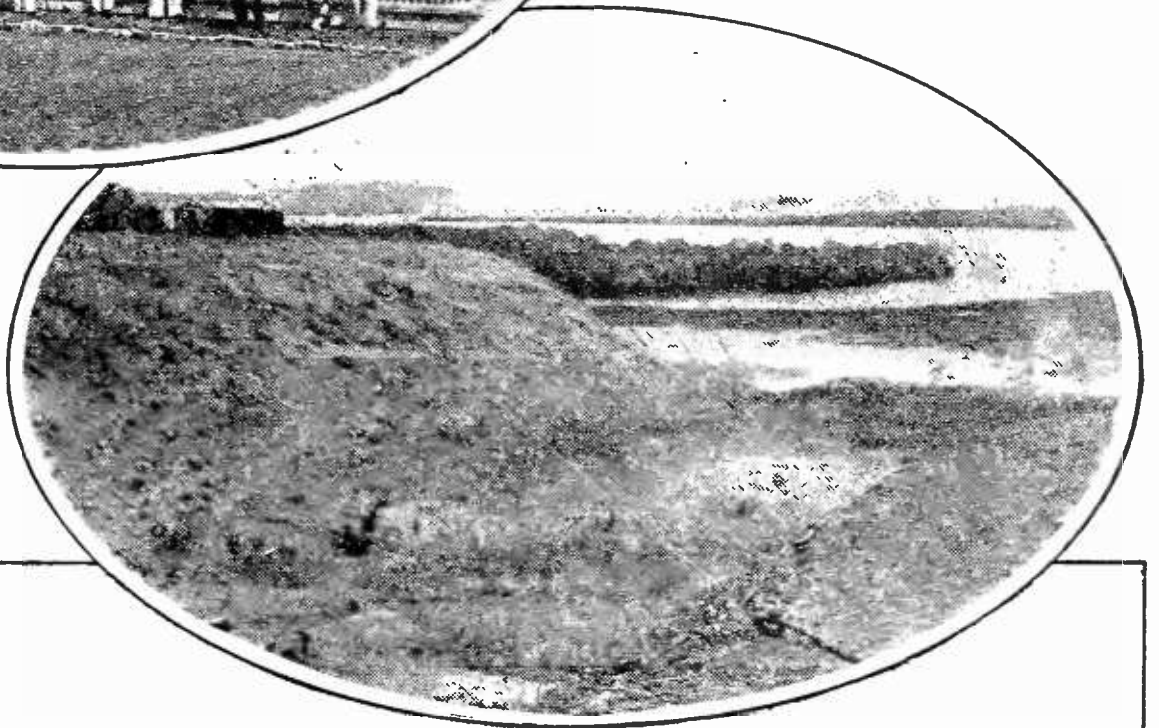
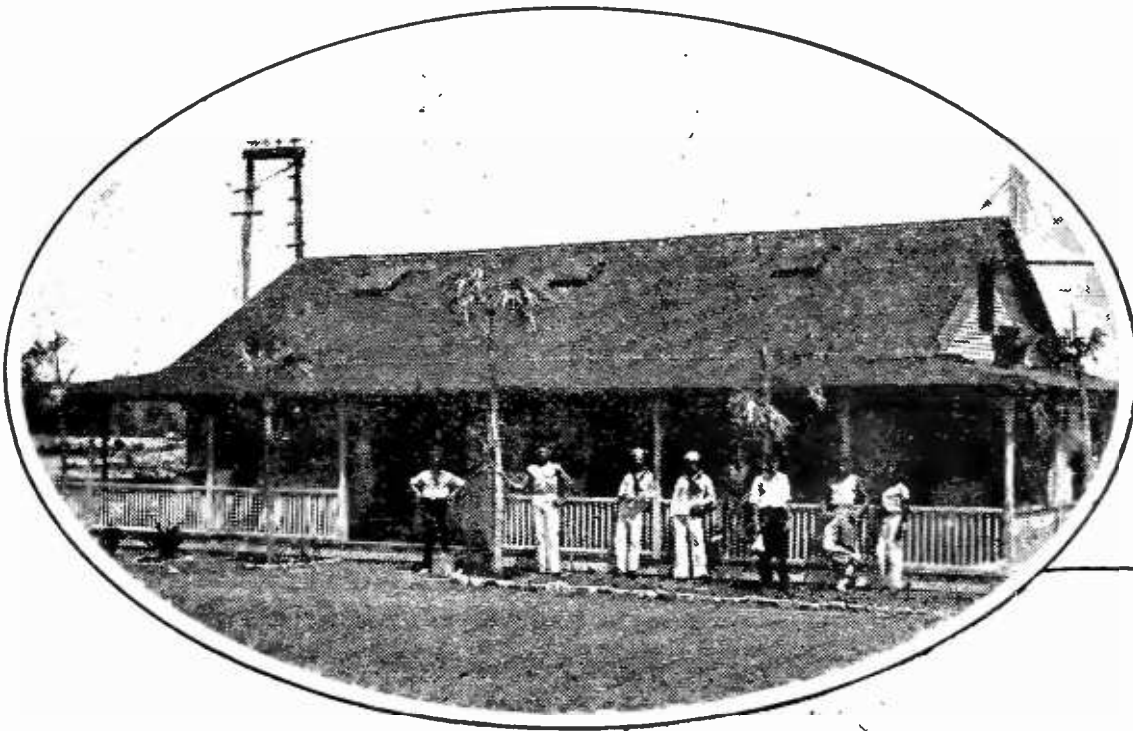

IN AND AROUND THE WIRELESS STATION

Which was installed by Mr. Butler, working for Dr. De Forest's American Wireless Telegraph Company at Guantanamo, Cuba, for the United States Navy. The lower photograph shows the station house and the masts. The oval next above it shows the view of the Cuban landscape, on which the operators could feast their eyes. The top oval is taken outside the operating shack and shows a part of the staff then attached to the station

be pumped out and the cistern refilled with fresh water. A prompt, curt refusal was the result. Such an order coming from their superior officer had to be obeyed, of course. I then sent a similar request and received the answer that the matter had been taken care of through Mr. Watts. Here, then, was the first time it was necessary for me to use the special letter I had from the Secretary of the Navy which requested all officials where I operated to assist me in every possible way. Without further argument I cabled Washington. Within a few hours an answer came and we got what we asked for. A short time afterwards a case of yellow fever broke out in the laboring camps near by and my three Navy companions were ordered to vacate the station and come aboard ship until the disease subsided. This inhuman action left me helpless and alone at the station with an imminent danger near. I again sought recourse from the Navy department with instant and satisfactory results.

In reviewing my old diary I find under date of Tuesday, November 14th, 1905, that I employed a Negro by name of Joe Francis to repair a parted main antenna cable which spanned the space of 300 feet between two masts. To repair this was not only a difficult task but an extremely dangerous one because most of the splicing work had to be done 200 feet above the ground. No one but Francis could be found who was daredevil enough to risk it. He was a notorious bad man and had a price on his head for a murder alleged to have been committed in the United States. I dickered with him to do the job for \$40.00 and he accepted.

However, after he had nearly finished the work, and while sitting up there swaying between heaven and earth, he called

down and declined to proceed unless I doubled the amount of pay. This I flatly refused to do and he still maintained his strike until I drew my pistol and threatened to shoot him down from his perch unless he completed the job as he had contracted to do. To this threat he promptly replied: "I guess you'd do that all right, Mistah Frank. I'll finish the job." I kept him covered while he continued the work because he continually looked down at me to see if I still meant business. He afterwards told others he was going to get me for that trick.

One night about nine o'clock, a few days later, one of the station boys and myself were returning with fruit from "the halfway house," a tent shack, not far away where native fruits and vegetables could be bought.

The night was starlit and the journey was three miles over a zig-zag path through the jungle. We had to walk single file. Some of the spots on the way were so dense with overhanging moss and tropical foliage as to entirely cut out the view of

the sky. There were comparatively few snakes here, but there were plenty of horned toads, tarantulas, land crabs, mosquitoes, and wildcats, so we always carried a pistol. At a spot, such as this, one third of the way home we met Joe Francis, the Negro. He spoke coolly and slunk by us like a panther, looking over his shoulder as he passed. Fortunately I was ahead of my partner and I think this was what saved me. We were suspicious of his designs, so the instant he left our view we turned off the trail and penetrated the jungle, deciding to attempt to feel our way home through the uncharted underbrush. This, in itself was dangerous, but we thought it the lesser of the two evils. Scarcely had we left the path and fallen to the ground than we heard Francis retracing his steps stealthily. Not having

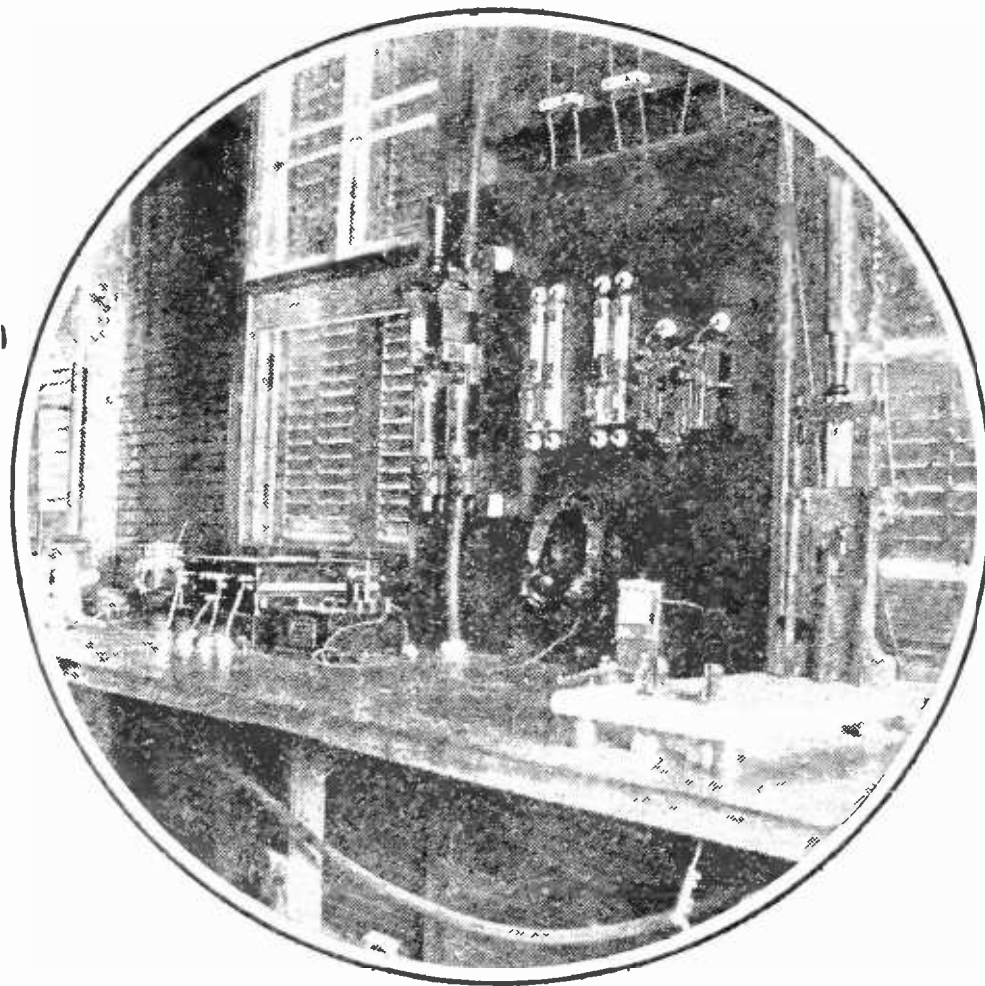

THE OPERATING ROOM AT GUANTANAMO

The huge contrivance on the right is the antenna switch; next is the power-control panel. An electrolytic detector and slide tuning coil receiver completed the installation

a compass with us we selected, before moving, a group of stars which we figured was above the wireless station. Then, instead of starting directly for the station we doubled back further toward the way we had come and planned on a wide circle around so as to enter the station from the other side, thus avoiding that trail entirely. We encountered bogs, marshes and everything imaginable, but after several hours of maneuvering we reached home safely and without further adventure.

About a week later, Castro Frerrar, a Spanish surveyor with whom I was well acquainted, was stabbed and killed on this lonely trail a short distance from the wireless station. No one ever knew who did the deed or for what purpose. He was about the same size as I and might easily have been mistaken for me. The singular coincidence was that Joe Francis left a few days later and was never seen or heard of afterward.

TESTING THE STATION

FINALLY after many months the station was completed and the long series of tests began. Static was terrific. It was a continual rumble. Our principal tuning device was a two-coil slider which to-day would not be considered worth anything by a nine-year-old school boy with a crystal set. Realizing the immense importance of developing the receiving end of wireless, Dr. De Forest left Key West and went back to New York to study out this problem.

I firmly believe it was our gruelling experience with these southern stations that turned the doctor's attention so strongly toward this subject that he never gave it up until he later perfected the heart of radio—his three-element audion bulb, without which present day broadcasting and receiving would be impossible.

His immediate work, however, after going north was to perfect a tuning device which would handle static better. This led to his invention of the pancake tuner which consisted of fine insulated wire wound spirally on glass with variable adjustments. This we found more efficient than anything used previously and it became one of the principal elements in the success of these installations.

In reviewing the many letters which passed between Dr. De Forest and me during these trying days it is gratifying and interesting to note his keen appreciation of our difficult work—his determination to succeed, and his constant belief in ultimate success. Too much credit cannot be given to Dr. De Forest for what he has contributed toward the de-

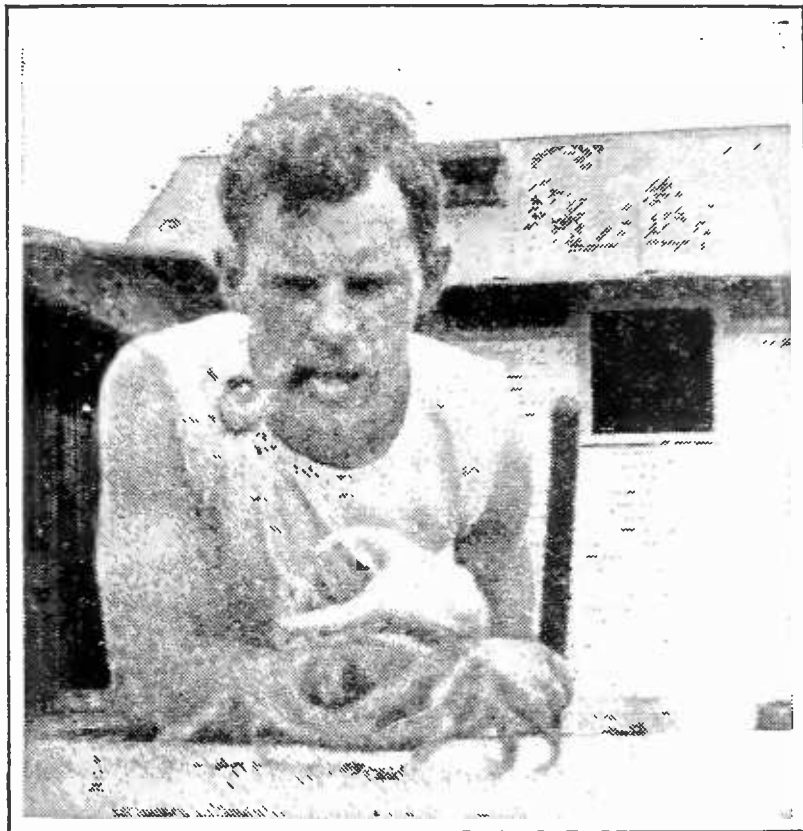

A LAND CRAB

Which was caught in the act of carrying away a pair of overalls belonging to one of the workmen at the station. His claws are about the size of a man's hand. These bluish white molluscs crawling across the bare wooden floor of the porch at night sounded like people walking across the creaking spaces

velopment of wireless and radio. His dominant persistence, patience and ability were as prominent two score years ago as they are to-day. Had this development been left in the hands of a less determined or less capable man than he, it would probably not be in the advanced stage it is to-day. I firmly believe this, because during the twenty years I have watched the progress of radio I have seen many experimenters who started with great expectations but soon fell by the wayside, not strong enough at heart or in ability to stand the test of constant disappointments.

Here are a few excerpts from some of the De Forest letters:

July 28th, 1905: Your very interesting letter concerning the lightning storm received. It was a very graphic account of a frightful experience. I appreciate your devotion to the cause in taking the risk you did and am glad so little damage to our apparatus occurred.

August 9th, 1905: You certainly are the star martyr to the wireless cause at present and have our fullest sympathies—if those will do you any appreciable good. None of us are too happy or enjoying flowery beds of ease. It is a tough problem and I can't tell what "ist los," but will keep on trying new stunts until it is solved. "Never say die," and "You can't stop a Yank," are the two cardinal mottoes of the wireless bunch, you know.

October 4th, 1905: "I am enclosing plan for

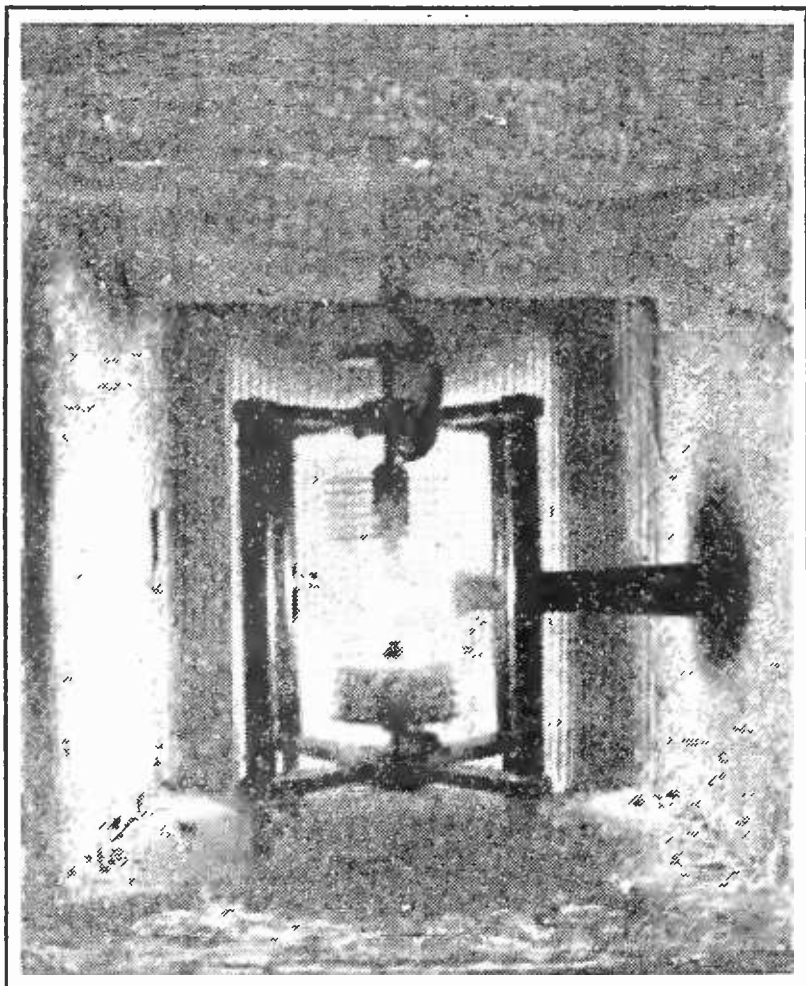

THE SPARK-GAP AT GUANTANAMO

The electrodes were encased in an asbestos-lined muffer box. The spark jumped a one-inch gap, shunted by four large condensers

connecting up the six condensers. The tinfoil has been shipped from the lab. You can put this on with paraffin, as we generally do now, *building up the whole thing under oil*. (Imagine working for days with arms immersed in kerosene.)

November 8th, 1905: Glad to get your long letter of 30th, and regret it is so full of hard luck tales. Sincerely hope your big transformer (weighing a ton) won't blow up again and believe that the new ground plate will remedy your troubles. You show splendid grit as you always do in facing these difficulties.

November 20th, 1905: Your yellow feverish, earth quakish letter came to hand this morning. I am sorry your troubles are holding up so well, but do not get discouraged as we have ours here, and you have not succeeded in cornering the trouble market by any means.

December 26, 1905. I want to thank you most heartily for the very kind letter of Christmas greetings you wrote me. There is no one in our employ who has shown himself more loyal and determined in his efforts to hasten success of the system than yourself, and you may be sure that I appreciate it fully.

Then, in reviewing my diary of that year, the following few terse sentences graphically portray the unbroken schedule of daily mishaps we encountered:

June 5th, 1905: Big 50 H. P. motor generator blew up, damaging armature.

June 7th. Commenced taking off tin roof on building and substituting it with asbestos.

June 12th. Commenced repairing damaged trays in condensers.

June 14th. Lined condenser trays with portland cement.

June 26th. Killed an 8-foot Moha snake in back yard. This was the cause of so many of our chickens disappearing.

July 10th. Constructed plate glass condensers for motor and circuit breakers.

July 13th. Terrific storm 2:30 A. M. Lightning struck station bursting an entire room full of condensers—just finished after two weeks of hard work—throwing oil and plate glass all over the room and into the walls.

July 14th. Repaired damaged antenna wires.

July 26th. Changed all d. c. wiring throughout station 36 inches away from a. c. from engine house to station.

August 14th. Rained this evening during exceedingly bright moon which caused unusual phenomena of two bright rainbows at night.

August 21st. Small cyclone struck us.

August 31st. Lightning struck the station at 4:15 P. M. blowing up one set of condensers.

September 5th. No fresh water. Had to drink salt water all day.

Sept. 24th. Another entire span of 15,000 feet antenna wire blew down.

Sept. 27th. Touched off station again and blower motor blew up.

October 8th. Herd of horses from workmen's camp broke corral in night and demolished the guy wires on the entire aerial spans twisting wires badly.

October 15th. Earthquake at 4:43 P. M. while eating supper.

October 17th. Finished new ground to-day.

October 19th. Rewound blower armature.

November 7th. Secretary of Navy Taft visited us to-day.

November 17th. Heard Key West and Pensacola first time.

December 10th. Key West heard us first time. Blew up blower motor.

December 15th. Big two-ton transformer blew up.

I had almost begun to think I was waging a hopeless battle against nature as week after week a fresh burst of some new and unforeseen trouble presented itself.

MORE TROUBLE

ABOVE the door of our station we tacked a motto: "Abandon hope, all ye who enter here, for verily this *is* hell." It was there for months and was a grim way we had of joking with ourselves.

It was not until the following March that we finally overcame all our troubles and succeeded in establishing communication with

our distant stations to the entire satisfaction of the Navy Department.

When the end finally came, when my work was finished, I was more than overjoyed to get away from that place of trials, but I was sorrowful to leave my three faithful navy companions, Watts, Kent, and Greaves, likewise faithful Marianna, who so loyally stood by me through, perhaps, the most crucial period that any group of early wireless workers ever experienced.

In the meantime, Dr. De Forest had sailed for Europe and shortly after my arrival in New York I received the following letter from him, which I highly prize, because of the wonderful sentiment and appreciation it discloses.

London, E. C.
April 20th, 1906

Mr. Frank E. Butler,
New York City.

MY DEAR FRANK:

Upon the occasion of the final acceptance by the U. S. Navy of the five large stations, of which you have been in charge, I wish to extend to you on behalf of myself and of the American De Forest Wireless Telegraph Co., congratulations, hearty and sincere, and to felicitate you upon your safe return to God's country.

Too often it is the case that while the faults and blunders of men receive prompt and severe criticism, the merits of their work, the fidelity of their services pass unacknowledged, even if fully appreciated by their employers. I trust that this may never be the policy of our company.

All of the officials of this corporation have watched with intense pride the heroic efforts you have made, the great patience through long months of discouragement and difficulties which have necessarily preceded this success. I can deeply appreciate the nature of your labors, your trials, the hardships you have undergone, for it has been my good fortune to have been with you at your post and shared in, while directing, your work.

This work, these experiments, these long-drawn-out tests, carried on in the face of unforeseen and manifold difficulties have, I believe, not only achieved the wireless success intended, but have been the means of developing character, a determination to bear and achieve like good soldiers; have ripened a friendship and a loyalty to one another and to a worthy cause, which constitutes in life elements of even greater value than commercial success.

We do not, we cannot forget the obstacles you have had to face and which you have bravely overcome.

For tedious months away from home and friends, in climates scorching and unhealthy, deprived of all usual comforts of life, tormented night and day by insect pests, distressed but not baffled by static

unknown to any other wireless workers, delayed month after month by breakdowns of Navy apparatus, continually called upon to make repairs, often without proper tools, facing skeptical criticism, surrounded by hostility, open or concealed on the part of officials from whom we had every reason to expect cooperation and interest,—yet, you have stuck to your posts, have triumphed over one difficulty after another, have forced new secrets from Nature, and having by your tenacity, patience and skill accomplished your ends, you have won at last an acknowledgment of the success of the system from the entire Navy Department, and set a new standard in the art of Wireless Telegraphy.

In view of your services in this unexampled undertaking we wish to express, although in inadequate words, some portion of praise you so well deserve, and to express our confidence that this navy work is but the beginning of greater things we are yet to accomplish together in wireless.

Very sincerely yours,

LEE DE FOREST.
Vice Pres. and Scientific Director.

All the desperate trials of the Cuban experience seemed wiped out by this letter. For were they not worth it, those trials, when one was working for Dr. Lee De Forest?

RECEPTION		COMPAGNIE FRANÇAISE DES CABLES TÉLÉGRAPHIQUES	
Station de			
POUR		DE Pensacola	
N° d'origine 36	Indications de service	REÇU le 5 H 40 par	
Lo H 20	P	de Lee De Forest	
Nombre de mots		L'Employé.	
Butler naval wireless telegraph station			
Guantanamo			
listen five thirty to eleven thirty a.m.			
no night work check coming			
Lee de forest			

ONE OF DR. DE FOREST'S CABLEGRAMS
To Mr. Butler and his associates in Cuba. It was filed in Pensacola, Florida on August 3, 1905 and reads: "Butler Naval Wireless Station Guantanamo listen five thirty to eleven thirty A. M. no night work check coming Lee De Forest". Many messages of this sort had to be exchanged before the new Naval station in Cuba could be put in order

The Factors Governing Radio Receiving

Why Daytime Reception Is Less Than That at Night—
Why Signals Fade—How Selective Should a Receiver Be?

WHAT MAKES THE WHEELS GO 'ROUND: XI

BY WALTER VAN B. ROBERTS

THIS installment of Mr. Roberts's series of explanatory technical articles answers some of the questions most often asked by the broadcast listener. Many attempts have been made to explain the phenomenon of fading in radio, and still, although radio is more than twenty-five years old, we know but little definitely about it. Here the best-known facts have been gathered together, and every reader whose set has come to mean more to him than a box containing tubes and wires will be interested to read what an authority has written on the subject of radio reception. The next and last article in this series will appear soon. It deals with the operation and use of the various accessories of the radio receiver.—THE EDITOR.

THERE are three main factors governing the distance that can be satisfactorily covered between a given transmitting station and a given receiving set.

(1) The amount of interference.

(2) The inverse distance effect. As the radio waves spread out in all directions from the transmitting station their strength naturally decreases. At twice the distance their amplitude is halved, at four times the distance it is only one quarter, etc.

(3) The attenuation, which is quite a different thing. It acts simultaneously with the inverse distance effect to reduce the amplitude of the waves. Attenuation of the waves is due to their being dissipated in the form of heat. Whenever the waves strike any object in which they can produce electric currents, the currents are produced at the expense of the energy of the waves and heat up, to a minute degree, the material in which they flow. The result of this is that, independently of the inverse distance effect, every so many miles the strength is reduced by a certain fraction of what it was at the beginning of those miles.

Thus if the amplitude is cut down by attenuation to one half of its original value at the end of the first hundred miles, it would be only one fourth after two hundred miles, one eighth

after three hundred miles, one sixteenth after four hundred, etc. This is the same sort of thing as the compound interest law, and mounts up very rapidly. In the case of ordinary telephony over land wires, the attenuation is such that the current is about one third, at the end of every ten miles, of what it was at the beginning of those ten miles, and a little calculation shows that to talk across the continent without any amplifiers inserted along the line would require more power than is available in the whole world—in fact more power than the sun gives out. Yet by the insertion of a dozen or so amplifiers or relay stations along the line, the attenuation law is prevented from “getting well under way” and a ridiculously small power is enough for transcontinental telephony.

In daytime, the attenuation of radio waves (which is possibly due to the air being rendered slightly conducting by sunlight) seems to be fairly constant and reliable. At night, however, it may be anything between the daytime value and nothing at all. On especially good nights in winter when there is practically no attenuation, stations can be heard at great distances because the spreading out effect is all that is at work to weaken the signals. Thus, for example, a station that can be heard fifty miles in daytime could be equally well

heard, on one of these good nights, a thousand miles away by simply adding a stage of radio-frequency amplification which would amplify the received signal twenty times before supplying it to the detector.

The mere absence of attenuation is probably enough to account for the numerous cases of the simplest sort of receiving equipment sometimes hearing stations thousands of miles away, while the presence of the daytime attenuation accounts for these same sets failing to get equally powerful stations only a hundred miles or so away in daytime.

82. FADING

IN THE close vicinity of a transmitting station the inverse distance effect is the main factor in weakening the signals. Hence near-by stations come in about as well by day as by night. Above a few hundred miles the attenuation is the chief factor, but there is also another type of variation of signal strength called "fading." Every broadcast listener has noticed this, but many of them think it is due to improper tuning of their receivers. The phenomenon is as follows: suppose a distant station has been tuned-in and we are sitting listening to a speech. Suddenly we realize that the voice is rapidly becoming fainter and in the course of a few seconds it may drop out of hearing entirely. If now we do not touch the receiving set but wait a few seconds or perhaps half a minute, the voice will probably reappear and rapidly regain its original volume. If this happens often, it makes the reception very unsatisfactory. There is no proved explanation of it. Variations in the attenuation constant due to ionization of the air by "storms" of electrons shot out from the sun or interference effects due to some of the waves going from transmitter to receiver via a different path are two of a number of possible causes. The phenomena are so irregular that no law has been discovered governing them.

83. IDEAL SELECTIVITY AND SENSITIVITY OF A RECEIVING SET

THE ideal radio receiver will be as selective as is possible; that is, it will receive a channel of frequencies about 10,000 cycles wide (or only 5000 cycles in the case of single side band transmission) equally well, but will not

receive other frequencies at all. In this manner, the door is shut to all interfering wavelengths except those lying in the channel that we must receive. This is all that selectivity can do to reduce interference. (It is assumed that a loop or the most "directional" possible antenna is used to further reduce interference by responding less to interference coming, on the average, from all directions than to the signal which comes from the most favorable direction). The ideal receiver will not need to be any more sensitive than enough to bring in interfering noises with more than tolerable loudness under conditions of *least* interference. When interference is worse, the sensitivity should be cut down to keep these noises from becoming objectionably loud. In summer time the interfering radio waves manufactured by nature are the worst, and rarely stop.

84. MORE POWER NEEDED AT THE TRANSMITTER

AS THIS ideal in radio receivers is not attainable at the present time, there is only one way left to reduce interference with the present wavelengths and improve the distance over which satisfactory broadcasting is possible. That is to have the transmitting stations put out more power and still more power. If every broadcasting station put ten kilowatts into the ether for every one that they are radiating now, interference between stations would *not* increase and the "static" and other noises would be drowned out and the signal would be so powerful that receiving sets could be less sensitive and thus save much more money than would be required to increase the power of the transmitting station. However, just as in the case of land wire telephony we will probably never be able to put enough power into the ether to give good transmission across the continent in spite of bad interference with the daytime attenuation at work. We will more likely send the voice across country by land line to be shot out by radio from numerous broadcast stations so located that everybody will be somewhere near one of them. This system has the advantage that if something that is to be transmitted is of interest to only certain sections of the country, it can be broadcast only from stations in those sections, and thus not cause unnecessary interference in other sections.



“NOW, I HAVE FOUND. . .”

A Department Where Readers Can Exchange Ideas and Suggestions of Value to the Radio Constructor and Operator

FOR a long time, RADIO BROADCAST has felt the need of an outlet for the many excellent ideas dealing with various features of radio construction which reach our office. With this issue, we begin the department of good ideas from our readers, and invite the coöperation of all those who are interested.

If you have an idea about a valuable and useful new circuit, some new device, a construction or operating suggestion, we should like to have it. Payment of from two to ten dollars will be made for every idea accepted. The descriptions should be limited to three hundred words and typewritten. Accompanying sketches, drawings, and circuit diagrams should be as plain as possible.

We do not want simple, obvious suggestions. Material to be acceptable for this department must offer something of definite value to the constructor. Mere novelty is not desired. Address your manuscripts to this department, RADIO BROADCAST, Garden City, New York.—THE EDITOR.

AN ECONOMICAL B.C.L. ANTENNA MAST

MANY and varied have been the articles concerning the kind of apparatus to be used by the radio experimenter, while the descriptions of good auxiliary apparatus have been few. The writer believes that there is a definite need for the description of a mast especially suitable for the broadcast listener.

In designing this mast, the location and needs of the listener have been kept in mind. Simplicity of construction, neat appearance, stability, and ease of erection have been the prime considerations. Due to the number of good well distributed broadcast plants and the increase in sensitivity of the present-day receivers, great height is not required in a mast. Besides, many listeners live in the cities, near the big stations, and where apartments are the dwellings of the majority, so that there is a corresponding lack of room and facilities for the erection of any very high mast.

The mast described below is easy to make, easy to erect, mechanically strong, neat appearing (thus eliminating the objection of many property owners), and best of all it is inexpensive.

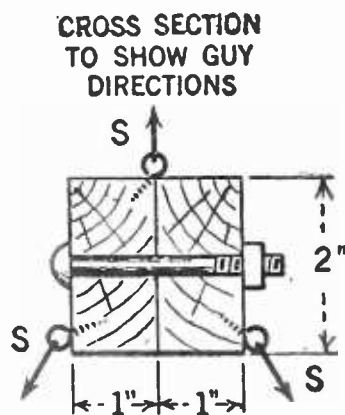

FIG. 2

MATERIALS AND ESTIMATED COST:

Two pcs. 2" x 1" clear surface pine, 16 to 24 ft. long . . .	\$1.00
One pc 1" x 1" clear surface pine, 5 ft. long20
Eight 3/16" diam. ordinary stove bolts, 2 1/4" long20

Twelve large screw eyes20
Pint can outside white paint.75
Guy wire (length to be calculated)50
TOTAL	\$2.85

In addition, several screws or nails, usually found in the home work box, and a pair of blocks or stakes will be required.

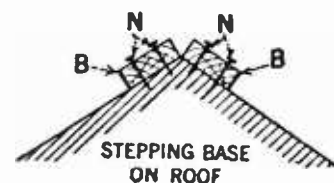

FIG. 3

This total is only approximate and will probably vary for different localities.

ASSEMBLY

CONSTRUCTIONAL work is much easier and very much facilitated if two old boxes are set up to hold the mast pieces while working.

Place the two mast pieces side by side, flat side (the 2" face) up. Then, starting a few inches from the end, mark drilling points every two feet, stopping at point C, which is five feet from the proposed lower end of the mast. The number of these drilling points will vary as some can get 24-ft. pieces, while others can only get 16-ft. pieces. Drill these holes so they will just take the 3/16" bolts snugly. Bolt the two mast pieces together, tighten nuts, and place the mast so the two one-inch faces are now up (bolts parallel to ground). See Fig. 7.

Now cut a one-foot length from the 1" x 1" and slip it in at a point a few inches from end of the unbolted portion of the mast (H in diagram). Fasten this in permanently with screws. Cut three more sections (J, K, L) and insert in the same way. Be sure to cut the

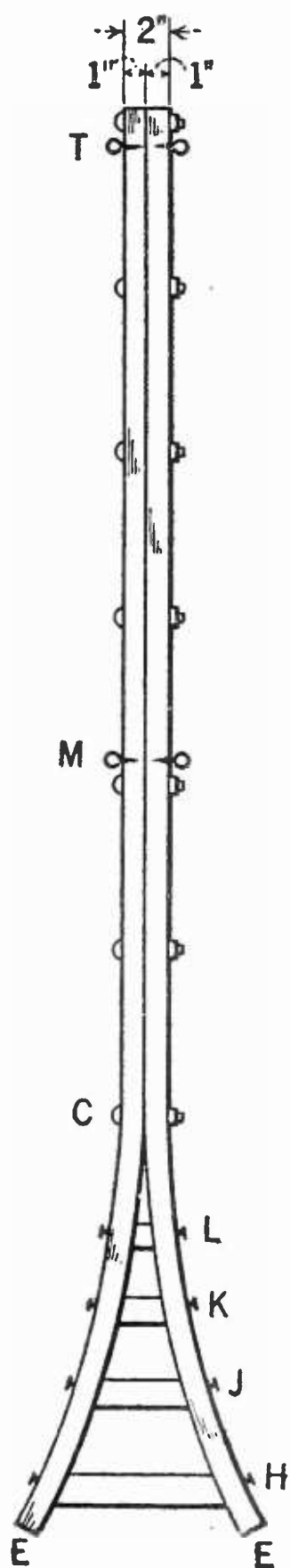

FIG. 1

ends of these at a slight angle so they will fit snugly into the slight curve in the wood. A mitre box is very useful if available. Ends E, E are to be sawed off at the proper angle to rest on roof or ground, Insert eyes at top (T) and at midpoint (M), so that two guys will pull backward and one forward (see sketch). Note that the forward eye is not to be put in the crack, but screwed in at an angle. The mast is now ready for painting, which is easily done on the double box rest mentioned previously. Apply *two* coats (one is insufficient and will wear off quickly), giving each a full twenty-four hours to dry, and applying the first thinly. See Figs. 2-5 and 6.

GUYS

IN THE small diagram, P represents perpendicular pole height, and B the distance from base to point at which you will anchor the guy, of length L. Square P, square B, add these together and take the square root. The result is the guy length L. Three are needed at the top and three more that are attached at M. Be

sure that P for the latter is measured from base up. Add at least a foot to each of the guy lengths to allow for twist when securing to pole and at the base. See Fig. 7.

STEPPING THE MAST

IF THE mast is to be on the roof, a stepping base should be built. This consists of two blocks of wood nailed to roof as an inverted V at point of rest (see sketch.) The mast is stepped against this in raising so that one man can raise it alone, as he would a

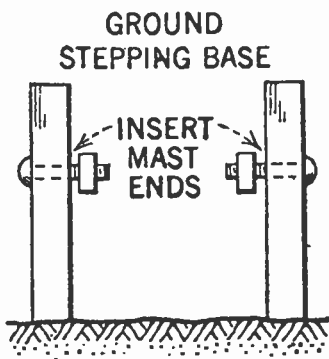

FIG. 4

long ladder. Tying in a couple of guys in advance assists materially. Block and tackle attached to a near-by tree or building may be used if available. This is shown in Fig. 3.

If the mast is to be raised from the ground, two stakes may be driven in and ends of mast bolted to these as swivel points in raising. See Fig. 4.

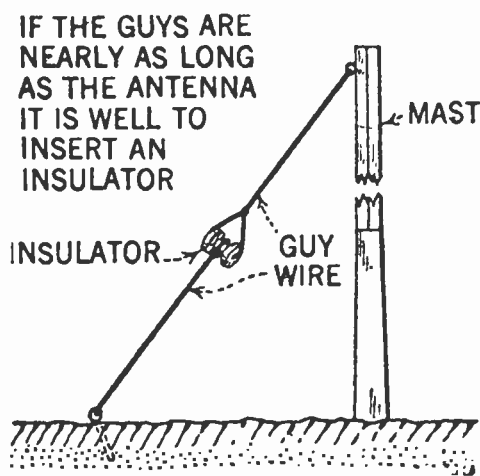

FIG. 5

ANTENNA

THIS mast will easily support an antenna of several wires with their spreaders. However, for most reception, one wire is sufficient. Furthermore, attaching a single wire to the mast permanently is highly recommended, as

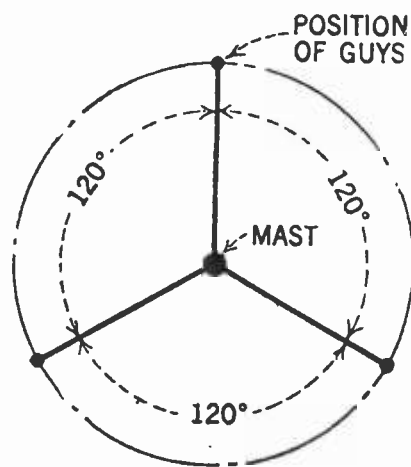

FIG. 6

trouble due to broken pulley ropes is thus entirely avoided.—CARLOS S. MUNDT, San Francisco, Calif.

A HANDY RADIO BATTERY WHICH USES FLASHLIGHT CELLS

THE block type B battery is not always the best investment according to the opinion of some radio users because when one or two cells go dead the entire block has to be thrown away and its usefulness is gone. If separate cells are utilized however, only the "dead" ones need be discarded. New ones may be inserted in their places and the battery will be as good as ever for considerable continued use. Assembling these, in the ordinary case, is more or less troublesome however when the various connections have to be soldered together. Consequently, the idea described here will be found of great advantage and by its

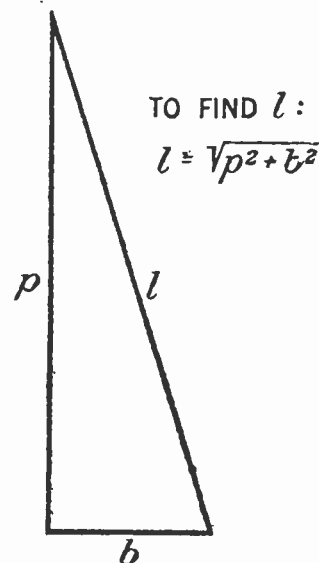

FIG. 7

use dead cells may be instantly removed and fresh ones inserted.

This article describes a $22\frac{1}{2}$ -volt outfit using flat flashlight cells of standard size with an e.m.f. of 3.8 volts each. Batteries of higher voltages may be computed from these measurements.

The constructional details are shown in Fig. 8.

Make a box of thin wood whose inside measurements are $4\frac{7}{8}$ inches long, 3 inches high and $2\frac{1}{2}$ inches wide. Shellac the inside to keep out moisture. Remove any projecting nails or metal that might cause a short circuit between two or more neighboring cells.

Next make five contact strips of sheet brass as shown in the little detail sketch. These must be at least $\frac{3}{4}$ inches wide and long enough to bend over and clinch on each side of the wood. Place the six cells in the box and note where their tabs come along the edge. Mark the spots and then remove the cells and fit three contact strips along one side in proper relation and two on the other side of box. Replace the cells, being careful to alternate the relation of the various tabs. The short or positive tab of one cell must be on the same side as the negative or long tab of its neighbor and so on. Thus the strips will connect, electrically negative to positive all through the six cells and build up the resultant voltage to about $22\frac{1}{2}$. As will be noted, the tabs originally bend inward but should be sprung out sufficiently to bear well against the contact strips when the cells are in position in the box.

To prevent the cells from rising from the box due to the springiness of the tabs, it will be necessary to make a top strip of thin wood which must be fastened across the box lengthways. This holds the cells down and makes contacts sure.

A spring clip on each B battery wire enables

one to tap in anywhere and secure any plate voltage desired. Such a battery will be found very handy and a considerable money saver.

To insure a positive contact at all times it is well to brighten the contact strips by rubbing with fine sandpaper.—L. B. ROBBINS, Harwich, Mass.

UN-BLOOPING BLOOPERS

LIVES there a man with soul so dead that he *wishes* to annoy the neighbors by running a blooper?

If so, the neighbors would be justified in making his body match his soul, and the whole town would rejoice, and the minister should refuse to bury him.

If you own a blooper and wish to avoid such a well deserved fate, and also wish to avoid the expense of a new panel and cabinet you can change it to a Roberts set, (which does not radiate), by mounting three of the spider web coils on the outside of the old cabinet. These are the coils NP, S2, and T, and unless you have a very good set with as many as three tubes it will also give you better reception.

This is not a fashionable arrangement as radio fashions go, but it works quite as well as with the knob-controlled coils, the only requirement being that there must be room in the old cabinet for two .0005-mfd. variable condensers with about four inches clearance between them.

The coil mounting consists of three cartridge fuses two inches long and six fuse clips to hold them. The clips are fastened to the bakelite shown in sketch by $\frac{8}{32}$ brass machine screws $1\frac{1}{4}$ inches long which project into the cabinet for the connections.

The fuse cartridges are drilled out for a $\frac{3}{16}$ inch hole at the ends and the fuses and filling shaken out. Three pieces of $\frac{1}{8}$ inch fibre are cut out as shown in Fig. 9 for the coil controls. These pieces and also the fuse cartridges should be boiled in paraffin for ten minutes to prevent them from absorbing moisture.

The brass rod should be softened by heating to a dull red and cooling in water, cut into pieces $1\frac{5}{8}$ inches long, bent in a vise with a hammer, $\frac{1}{2}$ inch from one end to shape a right angle. The other end should be flattened slightly to fit against the fibre and to drill easier. No. 14

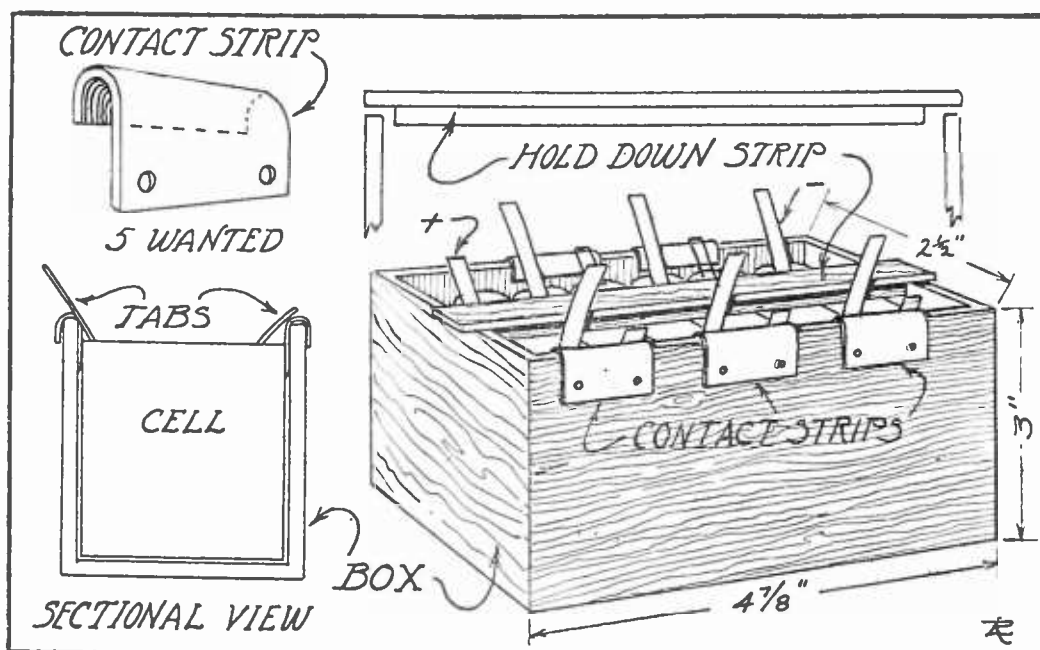
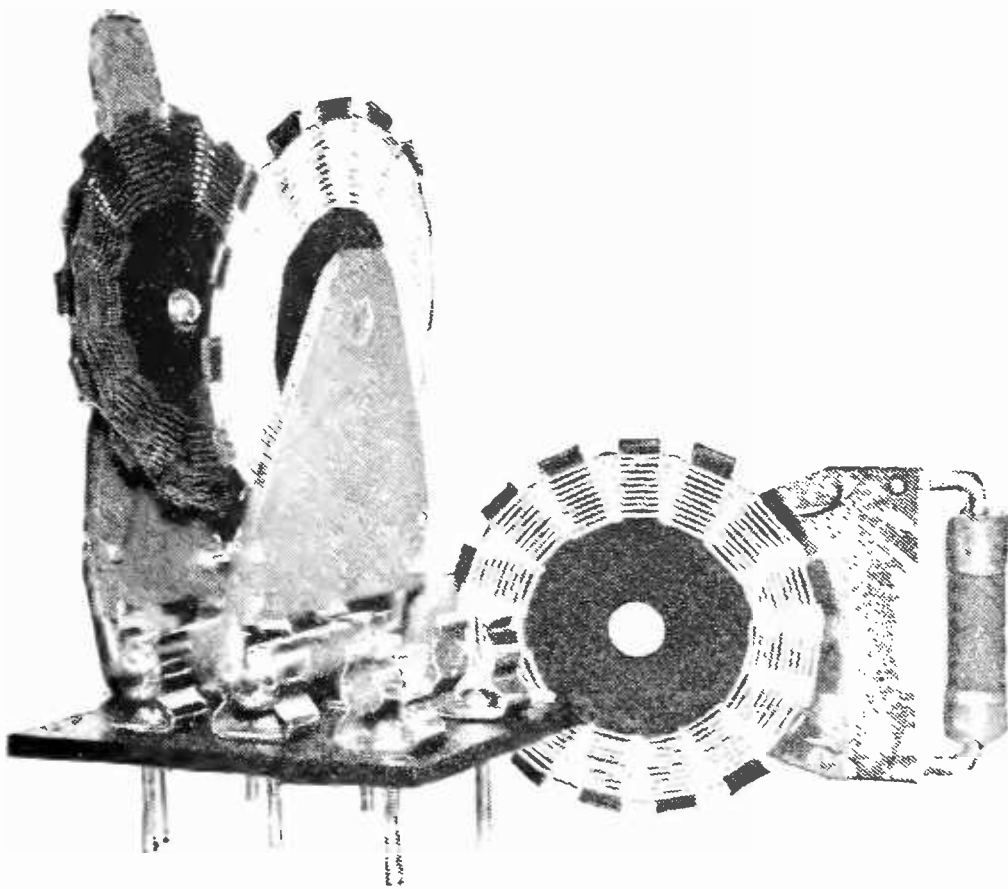

FIG. 8



HOME MADE

A simple and very efficient mounting for the Roberts circuit

distance, as this condenser is easily effected by body capacity. For this reason it should be placed at the back of the cabinet, high enough to adjust easily. A screw driver with a wooden handle will also serve to vary the capacity by inserting the blade in the screw head. Once this adjustment is made, for the tube used, it does not have to be altered. —HARDING GOW, East Sound, Wash.

NOTES ON THE ROBERTS CIRCUIT

IN BUILDING a receiver employing the Roberts circuit I have come across the following points which may be of help and interest to others who build a receiver of this type.

brass escutcheon pins are used for rivets in the No. 44 holes to fasten the bent rods to the fibre, with heads on the fibre side.

The construction of the coil forms has already been described in RADIO BROADCAST.

The leads of the coils are soldered to the rivet heads or rods. The tickler coil is on the right, coil S2 in the middle clips and coil NP at the left. The third terminal from the coil NP is soldered to a $\frac{6}{32}$ screw in the No. 27 hole in the fibre. Two inches of pig tail wire are soldered to the other end of this screw, a piece of shoestring is slipped over the pig tail for insulation and the free end connects to a small binding post in the hole X.

The coils A and S1 should be mounted on top of the left hand condenser in a horizontal position, using a bracket made of a strip of stiff brass bent at right angles. The three-coil mounting is located on the right hand end of the cabinet with the centers of the coils at the same height from the base board as the average height of A and S1. This may necessitate lowering the left hand condenser, but it is very important to prevent magnetic feedback. Only the right hand condenser which tunes S2 need have a vernier.

The small neutralizing condenser shown in the photograph is very easy to make, the plates being insulated from each other by a piece of thin celluloid or mica. The screw head is soldered to the movable plate and is turned by a piece of hacksaw blade tied in the split end of a stick which allows adjustment from a

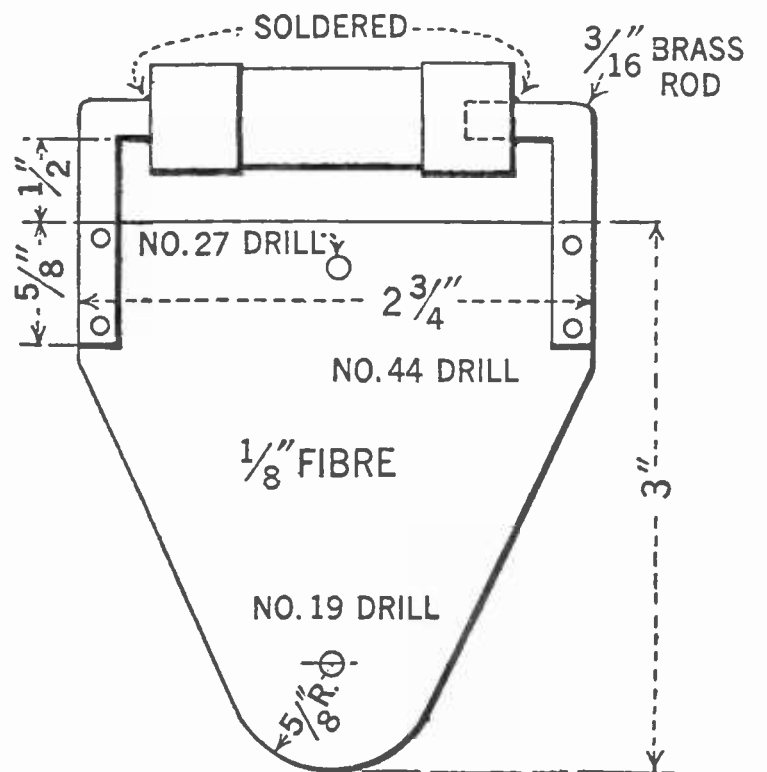
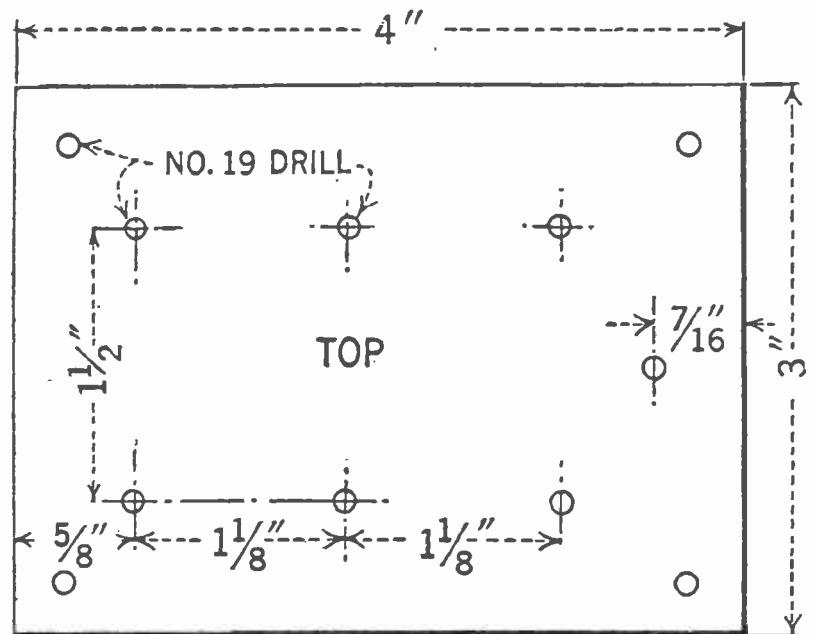

FIG. 9

If the components of the circuit are so arranged that the capacity of the first tube is more than neutralized due to capacity between parts of the circuit, it is impossible to balance



THE ANTENNA COUPLER

By means of a bolt and nuts the coupling between primary and secondary may be varied

the first tube capacity in the usual way. In order to avoid this condition, it is necessary to minimize any capacity between the grid circuits of the two tubes by the following precautions:

1. Mount the two variable condensers so that there is at least a 2-inch clearance between them.
2. Do not mount the audio transformer near the grid circuit of the detector tube.

If it seems impossible to neutralize the tube capacity in the usual way, the neutralizing condenser may be connected as shown in Fig. 10, and a balance obtained by adjustment in the usual manner. To arrange the neutralizing condenser for this connection, solder a

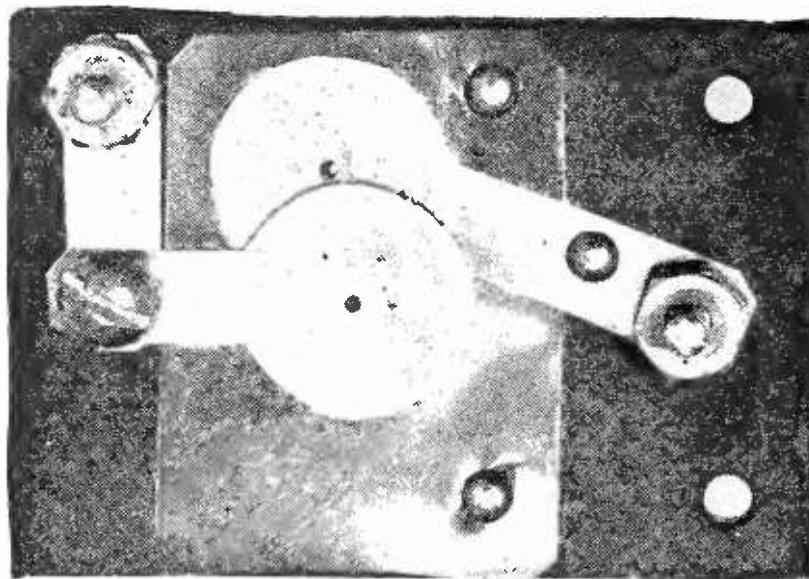

A GOOD NEUTRALIZING CONDENSER

For the Roberts circuit which can be made in the home laboratory

piece of wire, preferably braided, to the neutralizing condenser sleeve and connect this to the grid. Connect the two electrodes of the condenser as in Fig. 10. One to the end of the balancing winding and one to the plate of the tube.

Moving the sleeve towards A balances out the tube capacity as usual. Moving the sleeve towards B increases the capacity between grid and plate of the tube so that if, due to stray capacity as explained above, the tube capacity is neutralized, a balance can be obtained.

I have found that a vernier is unnecessary for tuning the circuit of the first tube, but the tuning of the detector tube circuit requires that a vernier be used.

Some means should be employed to prevent the neutralizing condenser sleeve from coming in contact with the condenser electrodes. A piece of string tied tightly around the glass tube at each end as in Fig. 11 will prevent the sleeve from touching the electrodes while adjustments are being made. —

JOHN B. CLOTHIER, JR., Landsowne, Pa.

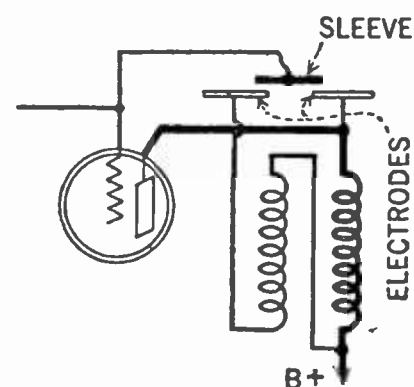

FIG. 10

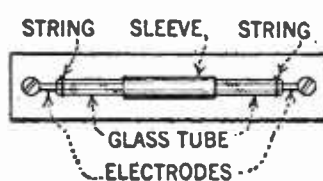

FIG. 11

Improving the Storage Battery for Radio

BY JAMES M. SKINNER

WE HAVE heard and read much concerning the recent developments in various systems of current production from the regular lamp socket as a means of doing away with batteries of all kinds for radio work. This work, as editorials and articles we have published heretofore certainly indicate, is in our minds both valuable and interesting—work which we have gone a long way off the beaten path to encourage. In the light of present-day enterprise an advance in any branch of industrial activity usually results in a necessity for rearrangement of existing methods which the more recent development is designed to improve or replace, rather than total abolition of older methods. The most efficient method of radio receiver operation, obviously, is the method which will produce the best results at the lowest cost. The estimate of cost should include purchase price and upkeep and in these days of luxury it would seem reasonable to include convenience as part of the service the device must render.

All of these much mooted questions have, to a certain degree at any rate, been glossed over by most radio editors while the manufacturers of storage batteries and current tap devices have to a marked degree been gnawing at each other's throats.

We are convinced that there is room in the field for all three systems of plate and filament supply and feel that the publication of articles like this one will let our readers know that the makers of our old friends, the dry and storage batteries, have not been entirely asleep. They have made radical improvements in their products which have made the storage battery a clean enough device to grace our living rooms and have developed a system of charging which is almost automatic. Batteries are still very important elements in radio, and it is very likely that they always will be.—THE EDITOR

HERE was a time when the radio enthusiast went to his favorite radio shop and bought merely a storage battery for his set. Now he is more critical, for he knows that the storage battery has been carefully and excellently adapted to the uses of radio by progressive manufacturers. When the vacuum tube first came into use and storage batteries were required to light their filaments, the only battery which could be had was the heavy and unwieldy and certainly unbeautiful battery then used for ignition purposes. The acid leaked through the vents in the sticky top of the cell and the wood case was itself often acid soaked. Then, the storage battery had to be carefully disposed indeed, for few carpets and rugs were proof against its acid invasions.

Now the storage battery has been modified and altered so that it is really suited for radio. It is essentially the same old storage battery and it works on the same tried and true chemical principles as before the battery got all dressed up for its radio uses.

With the new models of storage batteries recently brought out by several manufacturers, it is unnecessary to have any technical knowledge about the workings of storage batteries. It is entirely unnecessary to worry about such deep technical mysteries as current rates, overcharging, and reverse charging.

Many of these batteries are now manufactured with glass cases so that the complete condition of the cell can be seen at all times. Some contain a charge and discharge indicator, in the form of two colored indicator balls. These are so designed that they indicate the condition of the cells at all times. When both of these indicators are floating, the battery is charged. When one sinks and the other floats, the battery is partially discharged and when both sink, the battery is nearly discharged. During the charging process, this action is reversed. First one ball floats when the battery is more than half charged. Later, the other floats, which indicates that the recharging of the battery has been completed.

KEEPING THE ACID IN ITS PLACE

MODERN radio storage batteries are designed so that almost no spray escapes from the battery. Everybody knows that a mere trace of acid turns blue litmus paper red. One manufacturer claims that his storage battery for radio use stays so dry and free from acid on top that a piece of blue litmus paper placed over the vent cap will not turn red.

Of course, this all implies that the unit shall be properly charged, but here again, the radio user, no matter how inexperienced, has nothing to worry about. Chargers can now be purchased with a current rate so low that even if the battery remain on charge long after it is fully charged, no harm can result. The battery therefore cannot overheat.

CHARGING THE BATTERY

FOR small A batteries of about 15 to 18 ampere-hour capacity, such as would be used to supply the filaments of peanut tubes, a $\frac{1}{2}$ -ampere charger is sufficient. For a 30 to 50 ampere-hour A battery supplying standard 6-volt tubes, a one-ampere charger is satisfactory. A batteries whose capacity is from 80 to 100 ampere-hours, use a one- or two-ampere charger. For storage A batteries of size larger than this, a two- or five-ampere

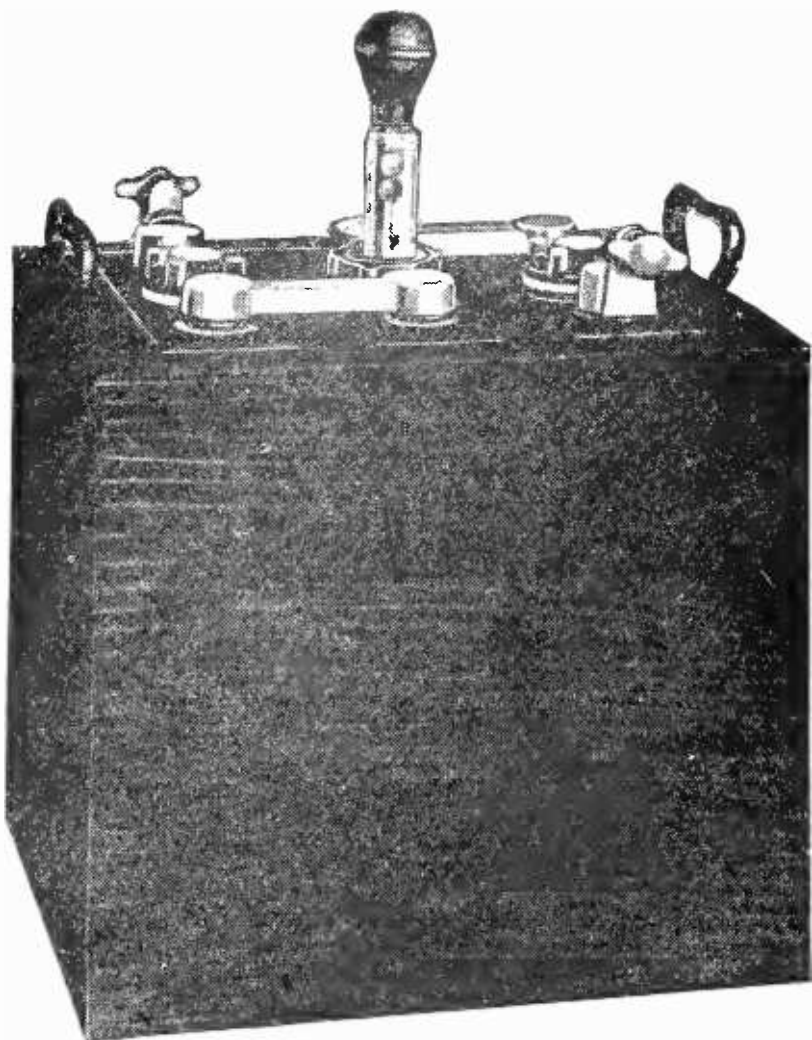

THE OLD TYPE

Of battery to which the name "radio" was applied by makers of auto lighting batteries when the demand for radio batteries came upon them. Though a perfectly good battery for other purposes, it does not fill the bill for radio as a comparison with the other illustrations will disclose

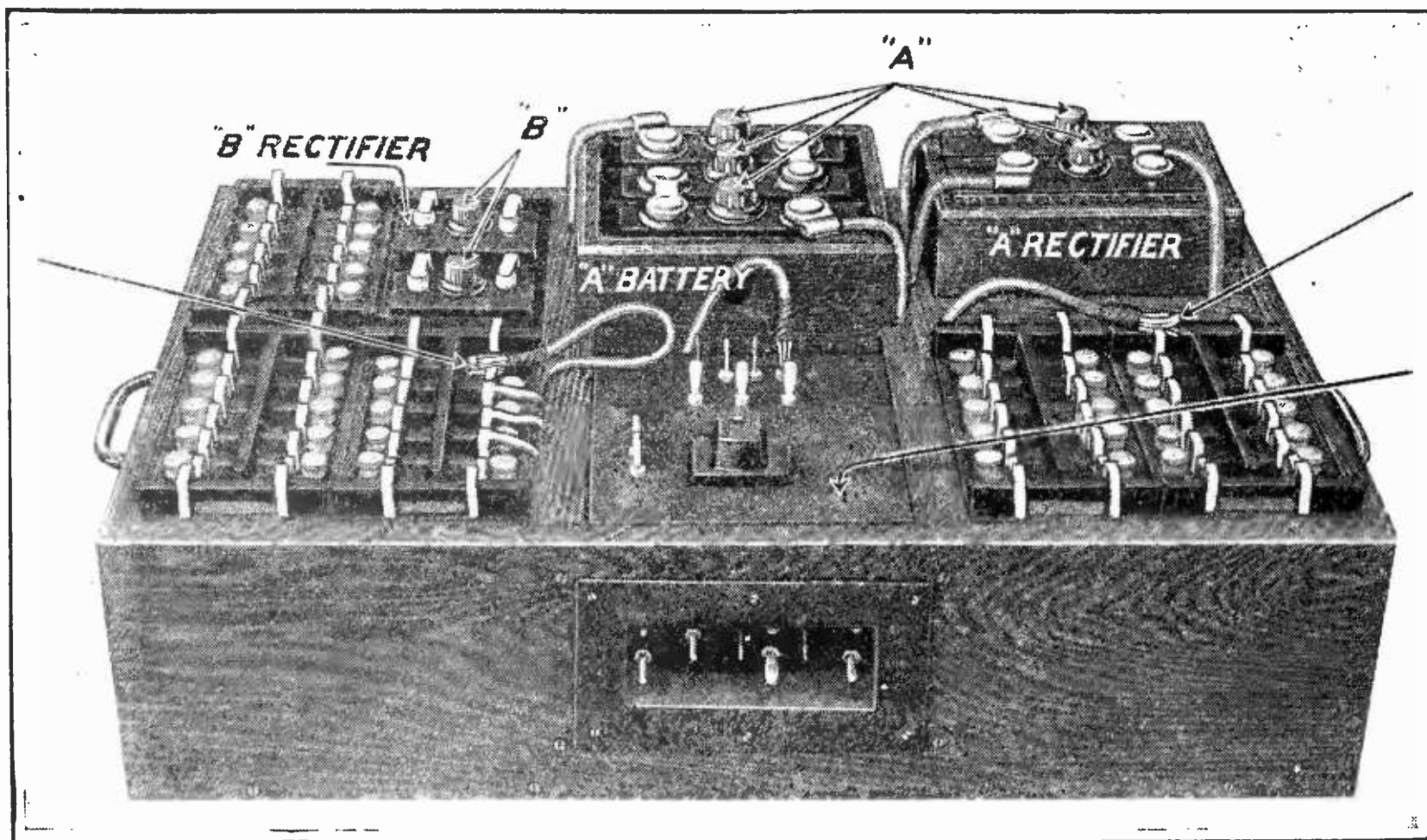

ALL IN ONE

Storage A, storage B batteries with plugs for varying the voltage at will. The A charger and B charger and switching device make it possible to use batteries with this unit and operate it directly from an alternating current light socket

charger will charge gently enough to insure against acid spray or overheating.

Since radio storage batteries have been so refined there is no reason why they cannot be charged as well as discharged in the same room in which the radio receiver is located. It is almost a waste of energy to carry one of the newer batteries to a service station for re-

charging when it is possible to perform that operation in the home at a minimum of expense. Separate chargers can be purchased

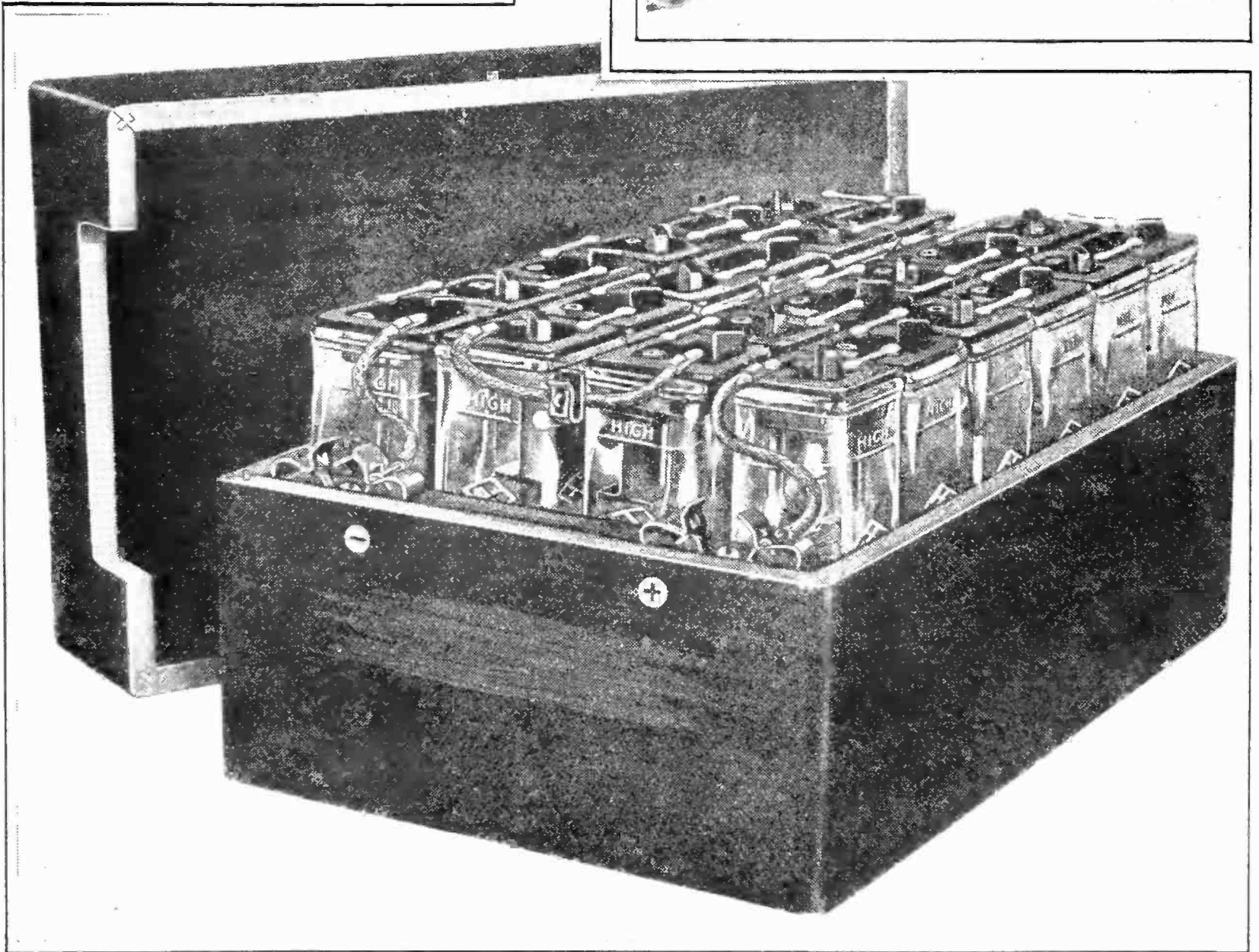
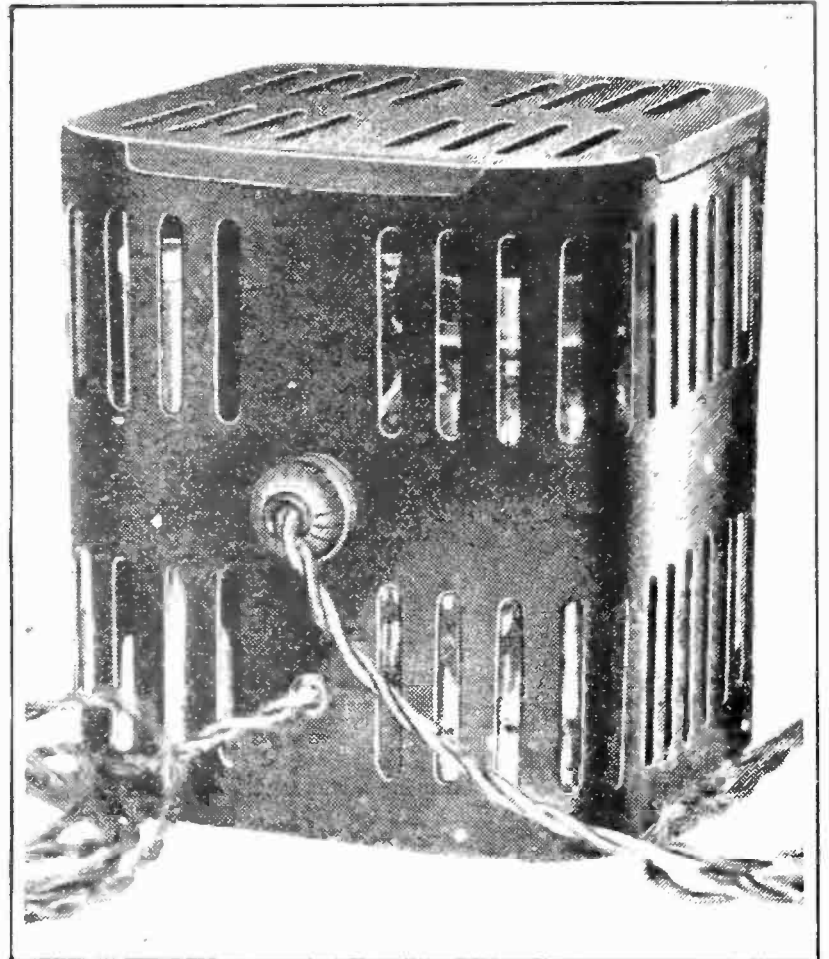
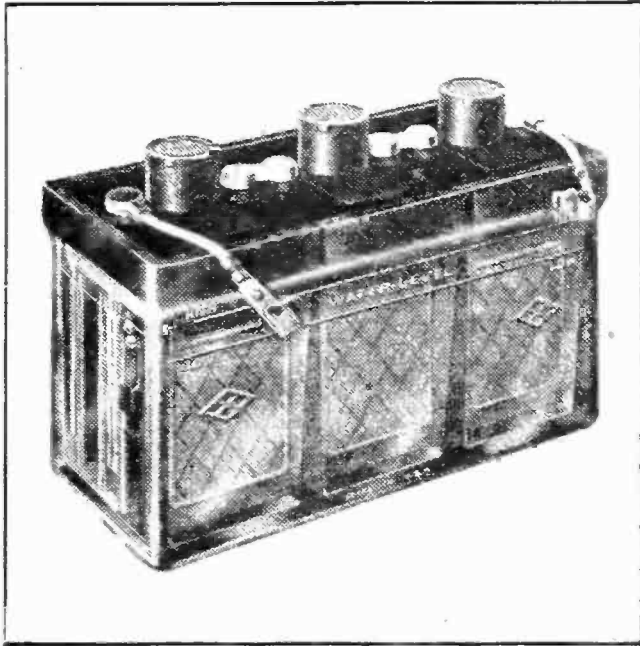

ANOTHER COMPLETE UNIT

Comprising storage A and B batteries with chemical low-rate charger and convenient switching arrangement for charging and operating. Here the manufacturer has made an effort to keep pace with the demands made upon him by discriminating purchasers. A radio supply system of this type is clean, easy to operate, and quite satisfactory

and wired so that when the battery is run down from continued use, a switch may be thrown and the battery charged. If the purchaser wishes, he may buy a complete storage battery and charging unit combined.

The glass case of most of the present radio storage batteries allows the user to see at all times the proper height of the electrolyte and a constant check can be kept on its condition. Because of the avoidance of overheating during the charging process and proper design of the vent caps in the top, the water in the solution evaporates quite slowly and refilling is necessary only at very infrequent intervals.

When a low-rate charger is used, the battery must obviously be charged at more frequent intervals than if the charging rate is high, say five amperes. With the charging unit connected so that charging and discharging is merely a matter of throwing a switch from one side to the other, frequent charging at a low rate is no especial hardship. Also, it actually costs less for current to charge slowly and easily at a low rate than fast and furiously at a high rate. When one overheats a battery by leaving it too long with a charger too big for it, one has to pay for the current which generates this utterly useless and harmful heat.

PLACING AND USE OF THE BATTERY

GLASS cased storage cells can very easily and neatly be placed inside radio cabinets, and some of the late models of complete cabinet receivers contain glass cased storage cells which are used for continuous service with no annoyance from spilled acid.

Storage batteries have the advantage of maintaining a quite constant, even voltage. This variation is not more than ten per cent. from the start to finish of a discharge, and less than five per cent. if the battery is kept pretty well charged at all times with frequent boost-

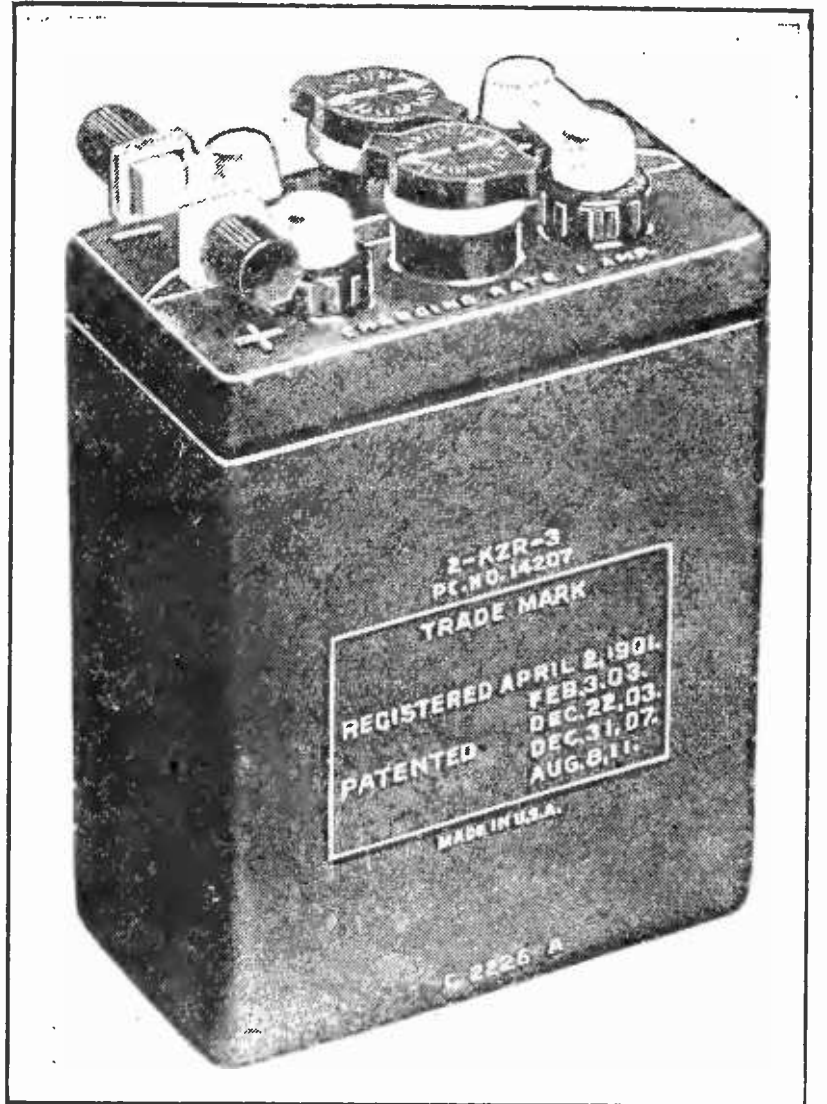

A SMALL STORAGE BATTERY

Made with a rubber case and a view to portability. Such a battery may well be used with the smaller tubes, requiring 3 volts for filament operation. It is rugged, clean, and not too expensive

ing with a low rate charger. In the A battery circuit of a receiver, uniform voltage minimizes the danger of shortening the life of tubes at first by overheating filaments, and against weak signals through underheating of the tube filaments later on. Uniform filament voltage also makes the filament rheostat settings on a receiver the same for any one station from one day to the next.

Steady voltage of the B battery circuit is even more desirable than in the A circuit.

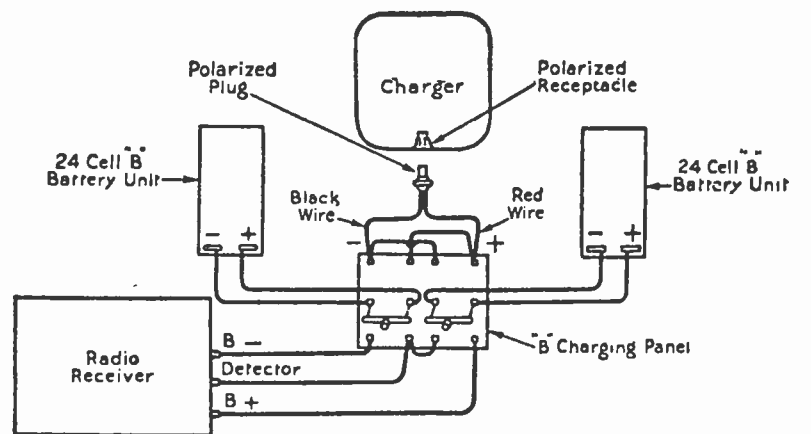
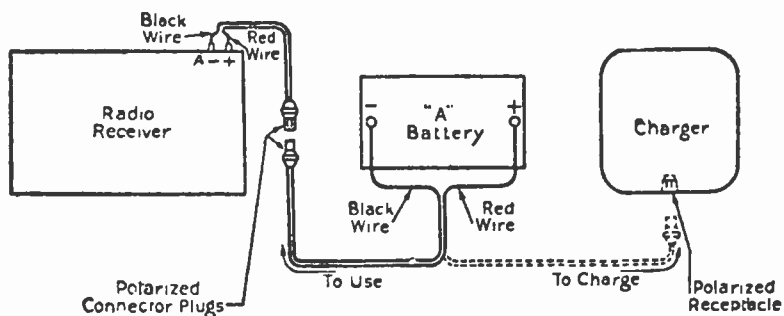

SWITCHING CONNECTIONS

For charging storage batteries used with radio receivers. The diagram on the left shows a convenient method for charging a radio A battery and the complete one on the right shows a method very generally used for B battery charging

Storage B batteries give steady, uniform voltage which is desirable.

Storage batteries are not overly expensive. A high grade A battery and charger (the filament supply for peanut tubes) including plugs and sockets for permanent switching connection costs about \$18. A larger size for standard 6-volt tubes can be bought for a little more than \$30, which also includes a charger and switches. A 96-volt B battery costs about

\$27.50 to \$40.00, according to its size and finish. Most A battery chargers are designed to charge B batteries as well, or they can be so adapted.

To charge a 96-volt B battery of 3000 milliampere-hours capacity costs about ten cents. The expense of keeping an A battery charged is very slight. And a properly built storage battery will last for years with practically no outlay for repairs.

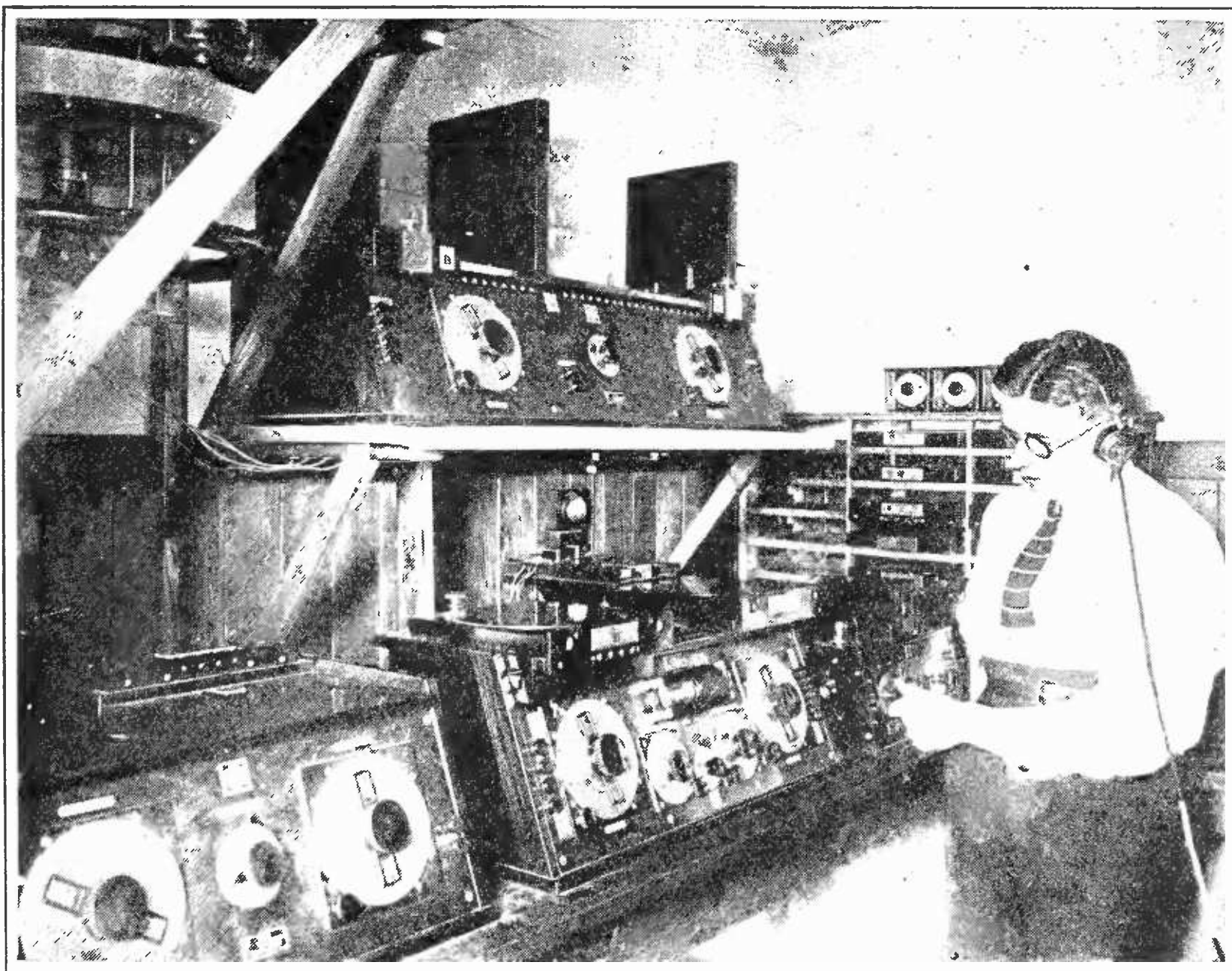

RECEIVING TRANSATLANTIC COMMERCIAL RADIO TRAFFIC

In the station at Nauen, near Berlin, Germany. Nauen, 90z, is the single most powerful station in that country and transmits commercial traffic directly to many countries. The handle of a large receiving loop is in the upper left corner



WHEN YOU WRITE THE GRID . . .

Don't fail to enclose a stamped, self-addressed envelope with your inquiry if you expect a personal reply.

Don't be impatient if you do not receive an immediate answer. Every letter is answered in the order of its receipt. Do not send a second letter asking about the first.

Look over your files of RADIO BROADCAST before asking a question which might have been covered in a previous issue.

Don't ask for a comparison between manufactured apparatus. The addresses of manufacturers of articles used in the construction of apparatus described in RADIO BROADCAST will be given on request.

Don't include questions on subscription orders or inquiries to other departments of Doubleday, Page & Co. Address a separate inquiry to The Grid.

Don't send us a fee for answering your questions. The Grid Department is maintained for the aid and convenience of readers of RADIO BROADCAST and there is no charge for the service.

QUERIES ANSWERED

WHAT IS BODY-CAPACITY AND HOW MAY IT BE ELIMINATED?

L. C. M.—Berkeley, Calif.

WHAT KIND OF AN ANTENNA DO YOU SUGGEST FOR ORDINARY RECEIVING PURPOSES?

F. E. C.—Kansas City, Mo.

MAY I HAVE A CIRCUIT DIAGRAM FOR ADDING A STAGE OF RADIO-FREQUENCY AMPLIFICATION TO THE ROBERTS CIRCUIT?

J. H. M.—Washington, D. C.

MY RECEIVER WILL NOT TUNE TO THE LOWER WAVELENGTHS. HOW MAY I REMEDY THIS CONDITION?

I. N.—Madison, Wisc.

WHERE MAY A BY-PASS CONDENSER BE ADDED TO ADVANTAGE IN AN AUDIO-FREQUENCY AMPLIFIER CIRCUIT?

S. P.—Nashville, Tenn.

WILL YOU EXPLAIN, IN DETAIL, THE APPLICATION OF FORMULAS GOVERNING THE CALCULATION OF RESISTANCE AND CAPACITY?

W. K.—Portland, Oregon.

MY HOME IS EQUIPPED WITH 110 VOLTS DIRECT CURRENT. HOW MAY I CHARGE MY STORAGE BATTERY WITH IT?

R. R. T.—New York City.

BODY-CAPACITY EFFECTS

HOW many people there are who have to be told that when there is trouble in a receiver it may usually be traced to some definite source!

The effects of body-capacity are no exception to the rule.

Generally speaking, body-capacity may be termed that effect which when the hand of the operator is brought near the tuning dial or other parts of the tuning circuit, causes the receiver to become detuned from the signal being received. It may be further placed as an electrostatic effect altering the inductance-capacity value of the tuning circuit.

Some receivers employ metal shielding fastened

ANTENNAS

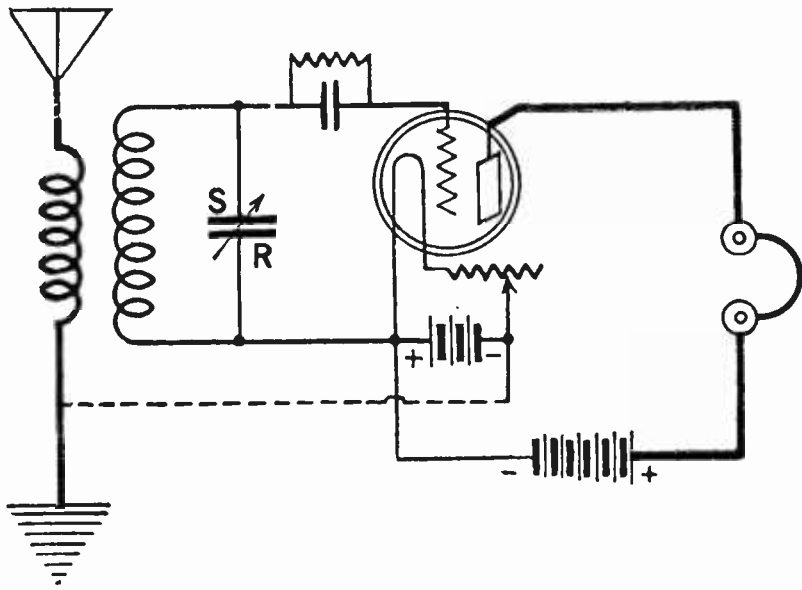

FIG. 1

on the panels behind the tuning dials as a remedy for this condition. That is only a remedy.

To put the receiver into proper operating condition it would be well to follow a logical troubleshooting plan. One should look to see if the stationary plates of the condenser are not tightly connected to the grid of the tube, and to see that the negative side of the filament is properly connected to ground. Grid and plate leads should be so arranged that they do not run parallel and close together.

The placement of the parts constituting the tuner circuit also adds to the possibilities of body-capacity effects and may be forestalled by a painstaking preliminary set-up and test of the circuit.

In all circuits it is advantageous to bunch the filament and B battery supply wires so that the grid and plate terminal leads may be as short and direct as possible.

In Fig 1 are incorporated the ideas as outlined here.

MANY times this department is asked about the advisability of erecting antennas of questionable design and makeup. The uni- and vari-directional types, multi-strand, and the new braid-ribbon arrangements all come in for their amount of querying.

The ordinary receiving conditions, which, in the

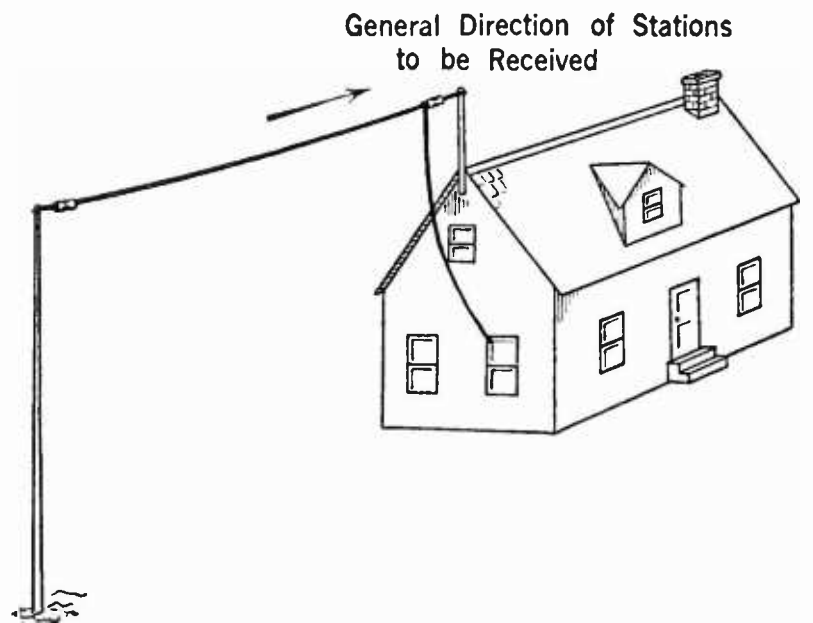
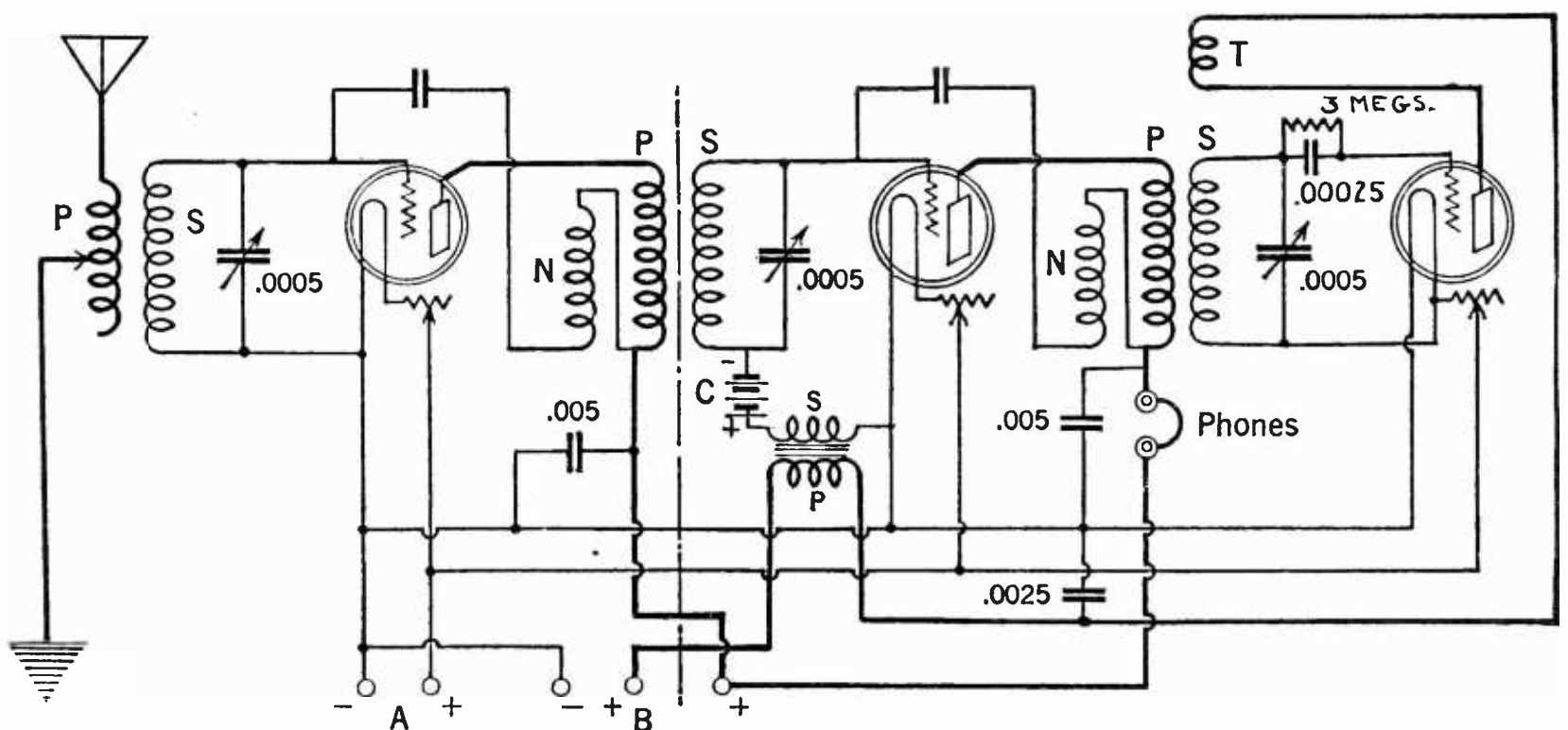

FIG. 2

end, interest the majority of broadcast listeners, require simply a single strand of antenna wire erected in as straight a line as possible.

It has been argued pro and con as to the special merits of the placement of the lead-in tap-off but we advise bringing the lead-in from the end of the antenna which generally points in the direction of the stations to be received. See Fig. 2.



ADDITIONAL STAGE OF R.F. (NEUTRALIZED) AMPLIFICATION

TWO TUBE ROBERTS KNOCKOUT CIRCUIT

FIG. 3

A STAGE OF RADIO FREQUENCY FOR THE ROBERTS RECEIVER

FOR those who wish to add a stage of neutralized radio-frequency amplification to the Roberts circuit we show the circuit in Fig. 3. From this circuit it will be seen that the antenna coupler which was previously connected before the tube No. 2 is now placed before tube No. 1. It then becomes necessary for us to provide the radio-frequency coupler between the first and second tubes. Like the other radio-frequency coupler it has a double wound primary constituting the plate coil and the neutralizing coil which is connected back through the condenser to the grid of the tube. The necessary parts for this addition are, the r. f. coupler (as explained), the neutralizing condenser, a socket, a rheostat, and a .005 mfd. fixed condenser.

TUNING TO THE LOWER WAVELENGTHS

WHERE, the condition exists in a receiver, that makes tuning at the lower wavelengths difficult or even impossible it is well to incorporate the improvement as outlined in Fig. 4.

By making a tap-off on the tuner coil and bringing

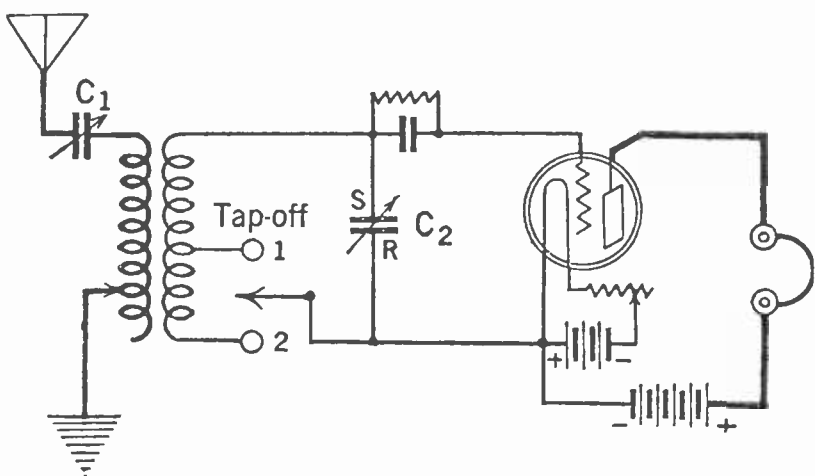

FIG. 4

the lead to a switch point it is possible to cut in or out, by means of the switch arm, a section of the entire inductance.

Naturally enough, when the switch arm is placed on tap No. 1 the lower section of the coil is cut out

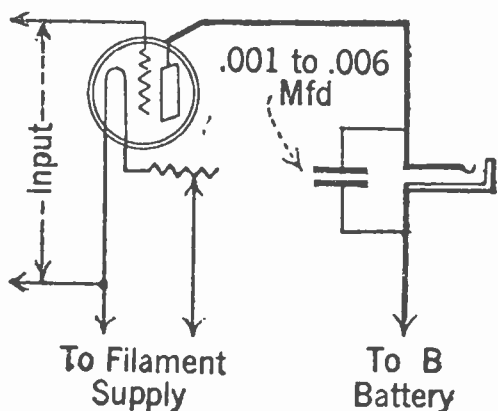

FIG. 5

of the circuit and the condenser C2 shunt only that part of the inductance between switch point No. 1 and the grid of the tube. The wavelength range of the receiver at this setting will be shifted down. That is to say at minimum capacity the wavelength

will be lower than if the whole coil were in the circuit. Similarly when the condenser is at a maximum capacity value the wavelength setting is lower than when the switch is on point No. 2.

It will also be noted that with the switch on point No. 1, the positions of stations transmitting on the comparatively low wavelengths will be spread out over the tuning dial which facilitates their reception.

The insertion of the variable capacity C1 offers a means for sharply tuning the antenna circuit to the incoming signal. However, its use is not absolutely necessary and may be required only where the antenna is exceptionally long.

A BY-PASS CONDENSER FOR THE LOUD SPEAKER

TO OBTAIN that fullness of tone so much desired of all loud speakers, it has been observed that a fixed condenser shunted across the output terminals of an audio-frequency amplifier will often do the trick.

The circuit showing the position of the condenser

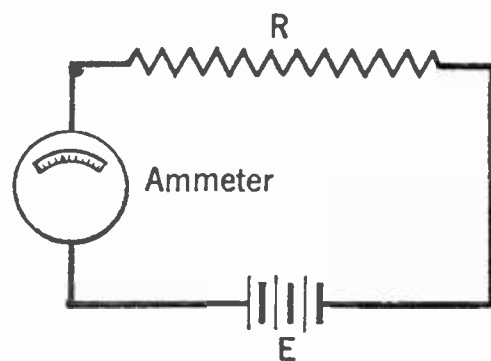

FIG. 6

is depicted in Fig. 5. The value of the condenser (better determined by test) usually varies between .001 and .006 mfd. In some instances that side of the by-pass condenser connected to the B battery is better situated on the negative than on the positive terminal of this battery.

RESISTANCE AND CAPACITY FORMULAS

NOW to digress and to go from the practical to the theoretical.

The computation of resistance, capacitance, and inductance values is of interest and importance to the experimenter who proceeds not along on hunches but on carefully laid plans.

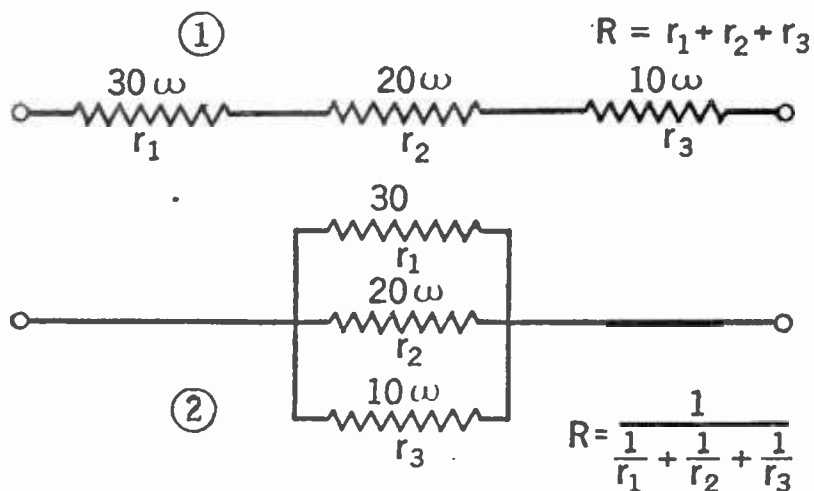

FIG. 7



The name to look for when buying radio equipment.



ONE hand on ONE dial for Tuning in!

Magnavox Receiving Sets

TRF-5 (as illustrated) encased in carved mahogany cabinet; price includes M4 Reproducer . . . \$125.00

TRF-50 in carved mahogany period cabinet with dust-proof doors and built-in Magnavox Reproducer \$150.00

Semi-dynamic Reproducer

M4—the most efficient unit ever designed to operate without external battery, \$25.00

Electro-dynamic Reproducer

The original radio reproducer, famous throughout the world. With Volume Control.

R3, \$35.00
R2, \$50.00



EVEN though the Magnavox single dial Station Selector has displaced the "old style" complicated tuning arrangements, this remarkable feature *alone* would not have merited the praise which every owner gives his Magnavox Set.

It is by its sheer *musical quality*, in addition to its unusual simplicity, that the Magnavox 5-tube tuned radio frequency circuit retains the user's lasting admiration.

As pioneers in the design and manufacture of radio reproducers, Magnavox engineers were thoroughly equipped to master the problem of beautiful tone.

If you already own a receiving set, a Magnavox Reproducer will wonderfully enhance its daily usefulness for family and friends.

Ask the nearest Registered Magnavox Dealer to demonstrate Magnavox Radio equipment

THE MAGNAVOX COMPANY, Oakland, Calif.

New York: 350 W. 31st St.

Chicago: 162 N. State St.

Canadian Distributors: Perkins Electric Limited, Toronto, Montreal, Winnipeg

MAGNAVOX Radio

3R

★ Tested and approved by RADIO BROADCAST ★

At a later time we will discuss the computation of inductance. Just now, let us consider the factors of resistance and capacity.

In computing the resistance of a coil of wire such as a rheostat it is necessary to make use of Ohm's Law which is expressed symbolically $R = \frac{E}{I}$ or, as written, the resistance in a circuit equals volts divided by amperes.

By transposing, it is possible to obtain a formula

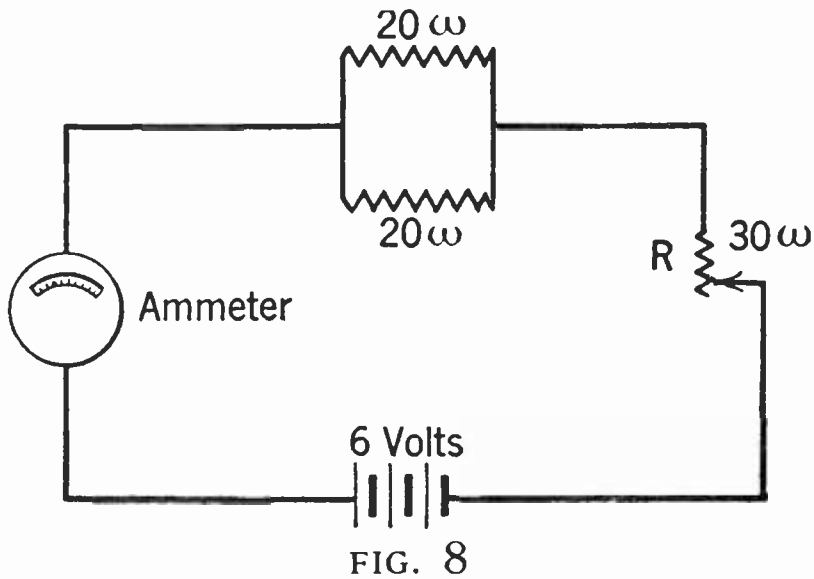

FIG. 8

for finding the other two values, namely E and I, as follows:

$$E = I \times R$$

$$I = \frac{E}{R}$$

Now in Fig. 6 we have a circuit containing the resistance R and the battery supplying the voltage, E. The ammeter will register the amperage of the circuit. Assuming that the battery delivers 6 volts and the resistance has a value of 30 ohms, then, substituting these values in Ohm's Law the formula would read $I = \frac{6}{30}$ or .2 amperes.

To determine the resistance of the filament of a tube the same law may be employed. For instance, in the UV-201-A the filament voltage as stated by the manufacturers is 5 volts and the amperage at which its best operation is obtained is .25 amperes.

Then substituting values in the formula $R = \frac{E}{I}$, $R = \frac{5}{.25}$ or $R = 20$. Therefore the resistance of a UV-201-A filament is 20 ohms.

Where several resistances are used in a circuit, their total resistance may be obtained by the application of other formulas depending upon the particular type of hook-up.

When resistances are connected in series (1, Fig. 7) the total resistance value equals the sum of all. The formula is expressed $R = r_1 + r_2 + r_3$.

For resistances in parallel another calculation is necessary. Here is the formula: $R = \frac{1}{\frac{1}{r_1} + \frac{1}{r_2} + \frac{1}{r_3}}$

Substituting the values as shown in 2 Fig. 7, $R = \frac{1}{\frac{1}{30} + \frac{1}{20} + \frac{1}{10}} = \frac{1}{\frac{1}{11}}$ or 5.4 ohms.

When the current in a circuit must pass through several resistances in series the amperage is less than if only one of the units were used.

However, from the formulas it may be seen that this is not true when the resistances are connected in

parallel. The reason here is evident. Due to the units being in parallel three paths are afforded to the flow of current. The same effect would be obtained by the use of a larger wire, the resistance of which is lower than smaller sizes.

In Fig. 8 we have the combination of resistances in series-parallel. The two 20-ohm resistances are in parallel while the resistance R of 30 ohms is in series in the entire circuit. To find the amperage of the entire circuit first compute the total resistance of the two parallel resistances (10 ohms), Then $10 + 30 = 40$ ohms total resistance of the circuit. Therefore $I = \frac{6}{40}$ or .15 amperes.

This will indicate that when all the resistance (if it be variable in the form of a rheostat) is included in the circuit .15 amperes of current will flow through. By reducing the value of resistance the amperage will vary to a maximum of .6 amperes.

To calculate the resistance of a rheostat necessary to control a tube circuit the following formula will prove helpful: $R = (\frac{E}{I}) - rf$

where R—resistance of rheostat
E—voltage of battery
I—current rating of tube
rf—resistance of the filament

Interpreted, this formula would be expressed thus: to obtain the value of resistance of the required rheostat divide the voltage of the battery by the current rating of the tube. From this quotient subtract the resistance of the filament.

By an inspection of the formulas and circuits as outlined in Fig. 9 it will be seen that they are similar to those for resistance computations with the exception that they apply to the opposite condition. That is to say, the total capacity of con-

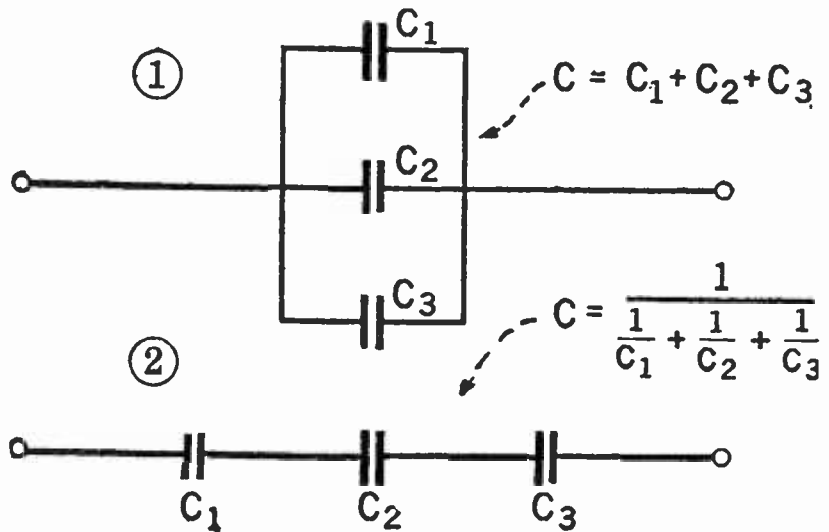

FIG. 9

densers in parallel as in 1, Fig. 9 is equal to the sum of all, while the total value of resistances in parallel is equal to the sum of the reciprocals.

As an example: 3 condensers, each of .002 mfd, in parallel would equal .006 mfd. Three condensers of .006 mfd. in series would equal .002 mfd.

CHARGING STORAGE BATTERIES WITH 110 VOLTS D. C.

HERE again the knowledge of Ohm's Law plus another formula, that of power equation, will prove of aid.

The power expended in a circuit performing a

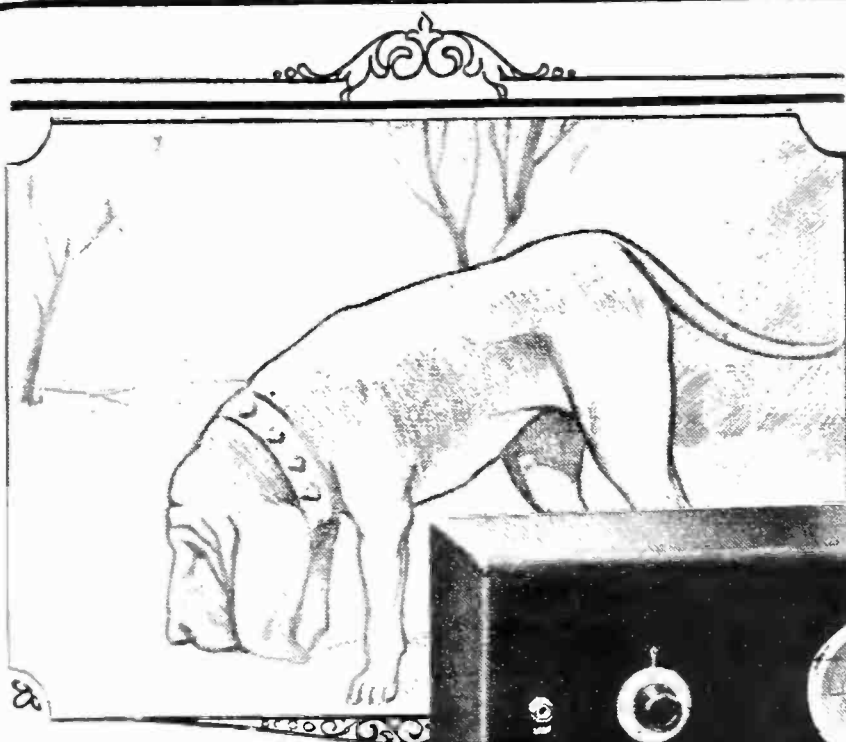

Sensitivity

The bloodhound, remarkable for the acuteness of its smell, can pick up a scent and follow a trail when all else fails.



-never before thought possible!

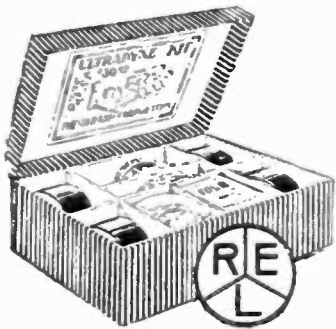

THE ULTRADYNE KIT

Consists of 1 Low Loss Tuning Coil, 1 Special Low Loss Coupler, 1 Type "A" Ultraformer, 3 Type "B" Ultraformers, 4 Matched Fixed Condensers.

To protect the public, Mr. Lacault's personal monogram seal (R.E.L.) is placed on all genuine Ultraformers. All Ultraformers are guaranteed as long as this seal remains unbroken. **\$30.00**



How to Build and Operate the ULTRADYNE

32-page illustrated book giving the latest authentic information on drilling, wiring, assembling and tuning the Model L-2 Ultradyne Receiver **50c**

With the extreme acuteness of the bloodhound's scent, the Model L-2 Ultradyne detects the faintest broadcast signals—signals that are "dead" to other receivers—regenerates and makes them audible on the loud speaker.

It's here, where the development of other super-radio receivers has halted, the Ultradyne forges ahead.

The unusual sensitivity of the Model L-2 Ultradyne is due to the successful application of regeneration, to the famous Modulation System of radio reception, recently perfected by R. E. Lacault, E.E., A.M.I.R.E., Chief Engineer of this Company and formerly Radio Research Engineer with the French Signal Corps Research Laboratories.

It's this development, an exclusive feature of the Model L-2 Ultradyne, that makes it possible to receive greater distance on the loud speaker.

Everything that the Model L-2 Ultradyne means in actual results and genuine satisfaction you will appreciate the first evening you operate it.

Write for free descriptive folder

★ ULTRADYNE

MODEL L-2

PHENIX RADIO CORPORATION
5-7 Beekman Street New York

★ Tested and approved by RADIO BROADCAST ★

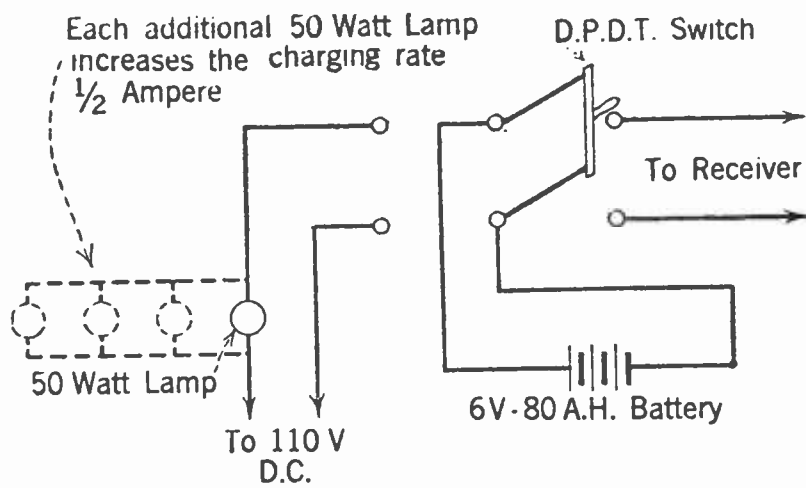

FIG. 10

certain work is equal to the voltage supplied multiplied by the amperage flowing through. This is expressed: power equals voltage times amperage. The designation of power in electrical and radio terms is watts. Symbolically the formula is expressed $W = E \times I$.

Now for the battery charging.

A storage battery must be recharged at a definite amperage rate. Usually the manufacturers of batteries designate this charging rate on the name-plate fastened on the battery.

Generally it does not exceed 8 amperes. Theoretically it is necessary to put back into the battery just as many "amperes of current" as were taken out by the discharge.

The capacity of a battery is rated in ampere hours. Explained, this means that an 80-ampere hour battery may be discharged at 4 amperes for 20 hours, 2 amperes for 40 hours or 8 amperes for 10 hours.

Therefore in recharging it is necessary to charge the battery for a certain period of time the length of which depends upon the amperage rate of charge. For instance, a fully discharged 80 ampere-hour battery must be recharged for 80 hours at 1 ampere; 40 hours at 2 amperes; 20 hours at 4 amperes and so on.

Ordinarily a battery is not completely discharged and only requires a short time charge or as is correctly termed, a trickle charge.

Fig. 10 shows a circuit for charging a storage battery at a trickle-charge rate.

To increase the rate of charge it is necessary to parallel additional 50 watt lamps to that shown. The addition of each lamp increases the charging rate one half an ampere.

Other charging rates with various sized lamps may be computed from the power formula as previously explained.

This power formula is given as an aid in determining the resistance values of various sized lamps. It may be transposed as follows: $I = \frac{W}{E}$, and $E = \frac{W}{I}$

Given the wattage of the lamp and the voltage of the line it is a simple matter by substituting values, to calculate the value of amperage.

Then, knowing the amperage and voltage, the resistance of the lamp filament may be computed. Therefore knowing the resistance and the voltage in the charging circuit it is a matter of calculation to determine the value of the current in amperes flowing through the charging circuit.

As an example, using a 75 watt lamp in a 110 volt charging circuit: $I = \frac{W}{E}$ or $I = \frac{75}{110}$ or .68 amperes.

Then $R = \frac{E}{I}$ or $R = \frac{110}{.68}$ or 162 ohms (approximately)

Therefore $I = \frac{E}{R}$ or $I = \frac{110}{162}$ or .68 amperes. The amperage of the charging circuit is equal to the computed amperage value of the lamp derived from the power formula.

This computation was carried through to its logical conclusion as a proof and also as an indication that the last calculation is unnecessary, the charging rate being determined by the current rating of the tube where only one is used.

HOW TO FIND TROUBLE

AS AN aid in determining and locating defects and trouble in any type of receiver the following list of trouble-shooting pointers will be found helpful.

Many of the tests to determine the causes of trouble require only a pair of phones and a battery, C, B, or A.

Continuity of circuits, short circuits, open circuits and leakages may be located by arranging a test circuit merely consisting of a pair of phones to which has been added a battery inserted in series with one side of the phone lead. The other lead and the remaining terminal of the battery are connected to pointer leads so that they may be touched to the terminals of units to be tested.

Trouble-shooting may be divided into several classes

1—Battery circuits

A—If the tubes light to full brilliancy the filament battery is O. K. This may further be determined by the use of a hydrometer.

B—B batteries may be tested for full life by noting the volume of the click when a pair of phones are momentarily touched to each of the output terminals of each block. This test is not recommended, but is merely suggested if a voltmeter is not available to register the voltage of the battery.

2—Tuning circuits

A—The antenna circuit of the coupler coil may be tested with the phone battery tester for continuity of the circuit.

B—Inspect antenna and ground connections.

C—Have antenna and ground leads insulated from other objects.

D—Secondary of coupler may be given circuit continuity test.

E—Condenser shunting the secondary should have the rotor connected to the filament and the stator should connect to the grid of the tube.

3—Audio-Frequency units

A—Try reversing the primary leads. Also the secondary leads.

B—Give each winding continuity test. Here the primary will click louder than the secondary.

C—Try grounding the metal cores to eliminate squealing.

D—Make use of by-pass condensers to round out the tone quality. They should be placed across the primaries or across the phone output.

EVEREADY HOUR

EVERY TUESDAY AT 9 P. M., E. S. T.

For real radio enjoyment, tune in the "Eveready Group." Broadcast through stations

WEAF	New York	WFI	Philadelphia
WJAR	Providence	WCAE	Pittsburgh
WEEL	Boston	WGR	Buffalo

Dry "B" Batteries are an economical, dependable and convenient source of plate current!

There's more life in Eveready Batteries

Buy Eveready "B" Batteries and you get electricity in its surest, safest and most compact form. They reduce your operating expense. New developments in the Union Carbide and Carbon Research Laboratories, Inc., have been converted into new manufacturing processes in the Eveready factories. Good as they always have been, Eveready "B" Batteries are much better today.

The Eveready achievement of giving you more hours of "B" Battery service for less money has cut the cost of running receivers in half, and in some cases to a third.

There is an Eveready Radio Battery for every radio use.

Manufactured and guaranteed by

NATIONAL CARBON COMPANY, INC.

Headquarters for Radio Battery Information

New York

San Francisco

Canadian National Carbon Co., Limited, Toronto, Ontario

EVEREADY Radio Batteries

-they last longer

No. 7111.
1½-volt
Dry Cell
"A"
Battery
for all
dry cell
tubes



No. 772.
45-volt
Large
Vertical
Price
\$3.75



No. 770.
45-volt
Extra
Large
Vertical
for heavy
duty
Price
\$4.75



No. 771.
4½-volt
"C"
Battery
improves
quality,
saves "B"
Batteries
Price 60c

★ Tested and approved by RADIO BROADCAST ★

New Equipment

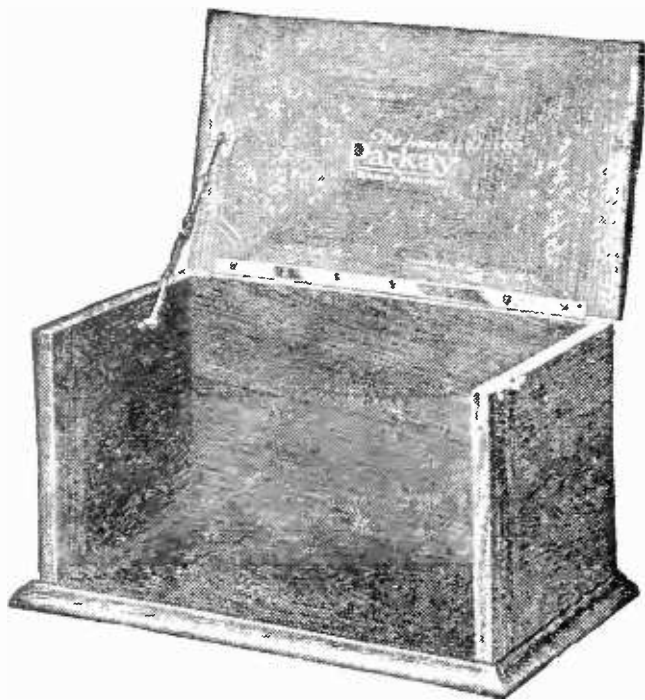

A CABINET

Of neat design and sturdy construction is presented in this Jewett Parkay cabinet. It is a well finished article which should please even the most particular. Made by The Jewett Radio & Phonograph Co., 5672 Twelfth St., Detroit, Mich.

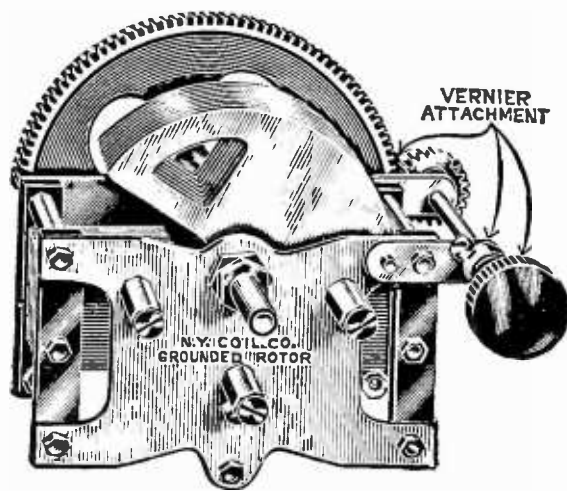

N. Y. COIL CO. CONDENSER

A condenser with cone type bearings insuring smooth action and long service. The grounded rotor eliminates hand capacity. "Straight line" capacity is obtained by cutting away a portion of the rotary plates. Made by the New York Coil Co., 338 Pearl St., New York City

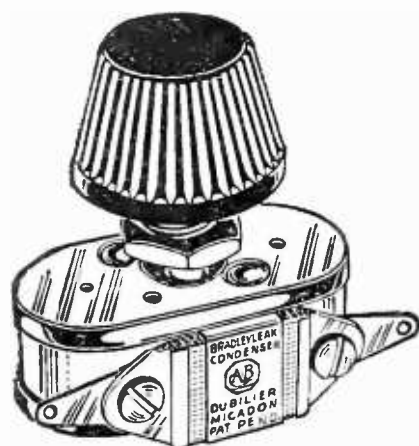

THE BRADLEYLEAK

This instrument combines a smooth action variable grid leak with a grid condenser in a compact and efficient manner. It is possible to mount this unit on a base board, sub-base, or panel without difficulty. Made by the Allen-Bradley Co., 278 Greenfield Ave., Milwaukee, Wis.



JONES MULTI-PLUG AND CABLE

A neat and efficient means of connecting batteries to the receiver. All leads are contained in a cable furnished with a keyed bracket which facilitates making connection or disconnection to the receiver by one operation. The design of the bracket makes it impossible to connect the leads wrong after once having the wires connected to the set. Made by Howard B. Jones, 614 South Canal St., Chicago, Ill.



TITAN B BATTERY

Here we have a 48-volt storage B battery designed to give long and satisfactory service. It is possible to tap off for any desired voltage. The cells are contained in heavy glass jars and as a unit have a capacity of about 6000 milliampere hours. Made by the General Lead Battery Co., Chapel St. and Lister Ave., Newark, N. J.



BESTONE RECEIVER

A five-tube receiver of interesting design which is encased in a cabinet with built-in loud speaker and battery compartment. This compactness should be an attractive feature. Made by Henry Hyman & Co., Inc., 476 Broadway, New York City

A Special Offer!

An opportunity for radio fans to save money in buying Celoron Panels and Vulcawood Cabinets

WE are making this special introductory offer to make new friends for our products and for the dealers who sell them.

Celoron is the standard insulating material among leading radio manufacturers and it is the choice of nearly a million radio fans. But there are many fans who never have had an opportunity to see and use this popular insulating material and others have never heard of the new Vulcawood Cabinet.

For a limited time, we offer you the privilege of buying these standard, well-known parts direct from our factory—at special introductory prices. Orders will be accepted subject to the conditions outlined below.

This offer expires on April 30, 1925.

Your money back if not satisfied

If your dealer does not stock and carry these parts, you may select a cabinet, and the panel to fit it, at the special introductory prices quoted.

In return for this privilege we ask you to send us your dealer's name and the names of three of your friends who are radio fans.

We shall refund your money without a whimper if you are not entirely satisfied with the goods when received.

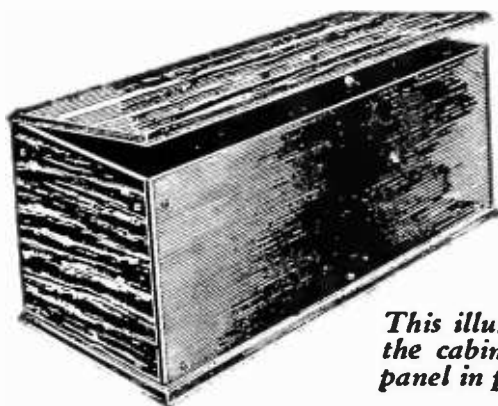

This illustration shows the cabinet—with the panel in place.

NEW VULCAWOOD CABINET the only bakelite cabinet made

This new bakelite cabinet insulates your entire set and it is grained and colored to match beautiful hand rubbed manogany.

Vulcawood Cabinet Prices		
Sizes	List Prices	Special Prices
(1) 7 x 7 x 10	\$ 7.95	\$4.50
(2) 7 x 7 x 12	8.10	4.50
(3) 7 x 7 x 14	8.10	4.50
(4) 7 x 7 x 18	9.40	4.50
(5) 7 x 7 x 21	10.40	6.50
(6) 7 x 7 x 24	10.40	6.50
(7) 7 x 7 x 26	10.55	6.50
(8) 7 x 7 x 30	11.15	6.50

DIAMOND STATE FIBRE COMPANY Bridgeport, Pa., and Chicago, Ill.

Branches in Principal Cities Toronto, Canada—London, England



CELORON RADIO PANELS universally endorsed by radio experts

Celoron will help you get better results from your radio hook-up. It will give your instruments thorough, leak-proof insulation.

A Celoron Panel will not soften with heat or deteriorate with age as do rubber and composition panels. It retains its beauty and its insulating properties indefinitely.

Celoron Panel Prices		
Sizes	List Prices	Special Prices
(1) 7 x 10 x $\frac{3}{16}$	\$1.09	\$1.00
(2) 7 x 12 x $\frac{3}{16}$	1.31	1.00
(3) 7 x 14 x $\frac{3}{16}$	1.53	1.00
(4) 7 x 18 x $\frac{3}{16}$	2.95	1.00
(5) 7 x 21 x $\frac{3}{16}$	3.45	2.00
(6) 7 x 24 x $\frac{3}{16}$	3.94	2.00
(7) 7 x 26 x $\frac{3}{16}$	4.25	2.00
(8) 7 x 30 x $\frac{3}{16}$	4.92	2.00

If your dealer does not carry Celoron, order by mail

In ordering please follow these simple directions:

1. Indicate on the coupon the size of the panel and the size of the cabinet you want.
2. Print in your name and address carefully.
3. Clip out the coupon and attach it to a plain sheet of white paper.
4. Mark on the white sheet the name and address of your dealer and the names and addresses of three friends who are radio fans.
5. Attach your check or money order to the white sheet.
6. Mail all papers to the Diamond State Fibre Co., Bridgeport, Penn.

DIAMOND STATE FIBRE COMPANY, Dept. 103 Bridgeport, Pennsylvania

Please send me prepaid the following items:

Celoron Panel Size No. Price \$.....
Vulcawood Cabinet (without panel)
Size No. Price \$.....
Check attached \$..... Total \$.....

Name.....

Street.....

City..... State.....

★ Tested and approved by RADIO BROADCAST ★

Among Our Authors

FOR a number of years Dan C. Wilkerson has been closely associated with the Army Air Service in Washington and has done considerable technical work with radio and airplanes. He is a resident of Washington and a quite frequent writer of radio articles.



D. C. WILKERSON

PHIL FAY built his first radio set in 1911 and has never since, like a lot of us, recovered from the first infusion of the radio virus.



PHIL FAY

He writes considerably for the newspapers on various radio subjects, but RADIO BROADCAST is the first magazine to have an article under his name. Mr. Fay is responsible for the design of many of the essential little

accessories for radio receivers which are familiar to every fan.

H. D. KELLOGG is a native Philadelphian and a graduate of Yale in the class of 1923. Although he won the prize of \$500 offered by this magazine for what the judges decided was the best answer to the problem of who is to pay for broadcasting, he is not actively occupied in radio. Mr. Kellogg says, however, "I have followed with great interest the development of radio communication, particularly the outstanding developments of the last few years which have come with the advent of broadcasting." He feels that there is a growing difficulty which broadcast station directors are facing in securing good talent to appear at stations without payment for their services.

CARL DREHER, in addition to being the excellent radio man that he is, writes articles which insinuate themselves into such

august covers as are found on Henry Goddard Leach's *Forum* and the expressive Mr. Henry L. Mencken's *American Mercury*. Mr. Dreher was a visitor at the offices the other day and outlined some of the plans he has for "As the Broadcaster Sees It." If he manages to put in print the ideas he has, life will certainly be more interesting for both the broadcaster and those who like to know what broadcasters are doing.

W. R. BRADFORD contributes one of his excellent radio cartoons and an article about his attack on the Roberts Knock-out receiver to the magazine this month. His method of attack is strangely more like an electrician's than a cartoonist's, but perhaps this is just another anomaly. The accompanying photograph is one of himself taken by himself—which certainly makes it a one-man affair.



W. R. BRADFORD
Self-photographed
as his grandmother



Montiero, Forest Hills
J. E. MILLEN

J. E. MILLEN is a senior at Stevens Institute of Technology at Hoboken but he finds some spare time occasionally to write about radio and experiment with it.

ALTHOUGH at present an enthusiastic Chicagoan, McMurdo Silver was born in Geneva, New York.

Now Geneva is otherwise famous for two things: it contains Hobart College and is not far from Cornell University at Ithaca. They also make cutlery there, if we remember the geographies correctly. Mr. Silver is designing, manufacturing, and selling radio equipment.

Philco Type DX "B" Battery with deluxe mahogany-finish case with cover (48 volts). Price—\$20.00

Type DXO, without cover—\$16.50

"B" Charging Panel, factory wired and ready for use—\$2.75

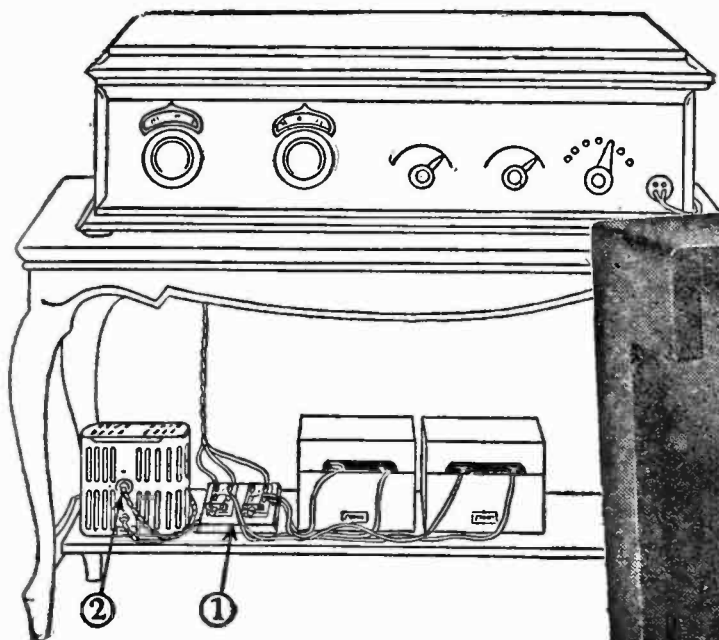

Philco "B" Batteries on Charge

To connect the batteries to your set, throw over switches on Charging Panel (1) and pull out plug (2) from the built-in receptacle on the Philco Charger. Simple as A B C.

Philco Single Charger for all "B" batteries and UD44 "A" batteries. Noiseless. Price—\$9.75

Philco Double Charger for all "B" batteries and UD86 "A" batteries. Noiseless. Price—\$15.00

Charger prices include plugs and receptacles.

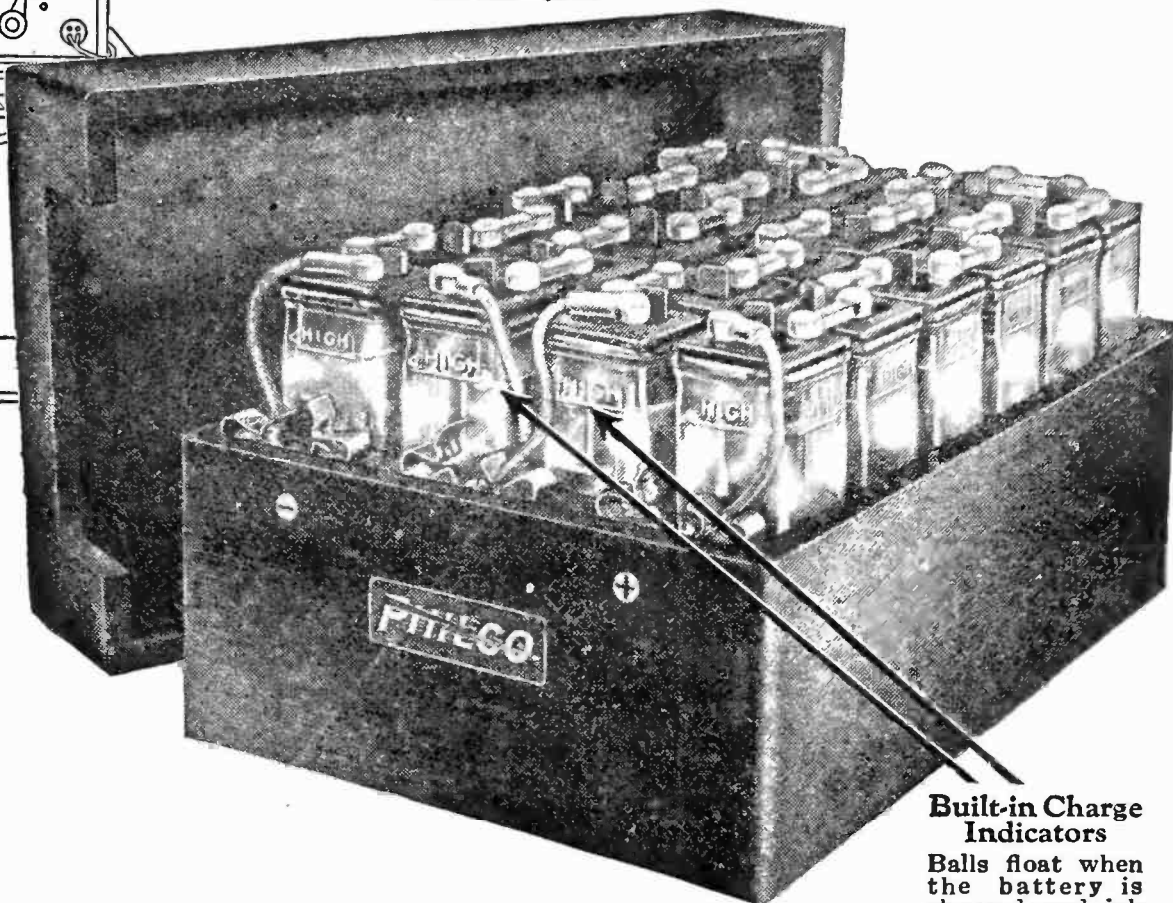

Built-in Charge Indicators

Balls float when the battery is charged, and sink as the battery becomes discharged.

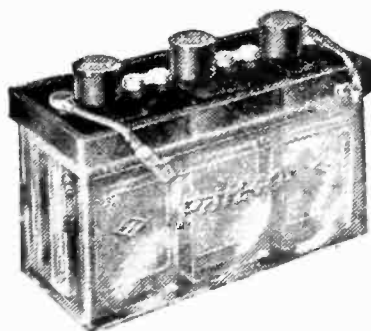

Philco Pressed-Glass Case "A" Batteries

Spray-proof. Stay dry and clean always. Built-in Charge Indicators. Type UD86 for storage battery tubes—\$16.00

Type UD44, "a dry cell replacement" enabling you to get better results out of dry cell tubes. Occupies less space than three dry cells and may be installed permanently in the radio cabinet. Price—\$8.00

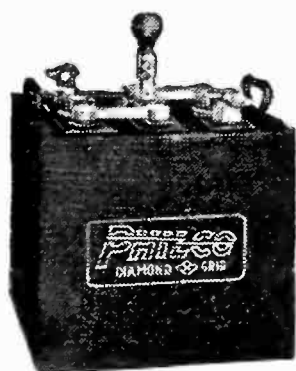

Philco Mahoganyized-Case "A" Batteries

Types RAR and RW for storage battery tubes. In beautiful Adam-brown mahogany-finish cases harmonizing with your radio cabinet. Price—\$14.50 up

Philco Charge Tester—permanently mounted in filler cap—avoids fussing with a hydrometer—\$1.00 extra.

Recharge in your living room without changing a wire!

YOU need storage "B" batteries because clear and distant radio reception depends on steady, non-drooping voltage and strong, hum-free current. Philco has made "B" storage batteries easy, convenient and economical to operate.

To Recharge—just throw the Charging Panel switches and insert the plug in the Philco NOISELESS Charger. Cost—five to ten cents. You don't move the batteries nor disconnect a wire. You avoid all danger of getting positive and negative mixed and burning out tubes.

Clean, Dry and Beautiful. The tightly sealed glass cells are assembled in Adam-brown mahogany-finish cases harmonizing with radio cabinets and furniture.

Built-in Charge Indicator. Tells you at a glance how much charge is in the battery at any time. Does away with the old-fashioned hydrometer.

Philco makes storage "A" batteries of similar convenience and economy. Also high-powered starting batteries for your automobile. Your Philco is sure to be new and fresh because, of course, Philco Batteries are shipped Drydynamic (dry-charged).

See your nearest Philco Service Station, Radio or Music Dealer.

Philadelphia Storage Battery Company, Philadelphia

PHILCO DRYDYNAMIC RADIO BATTERIES

JOBBERs and DEALERs—Philco has brought radio batteries out of the cellar and put them in the living room. Our new Radio Manual tells how. Fill out coupon below and we will mail you a copy.

Name.....
 Street..... City.....
 State..... Jobber Dealer

★ Tested and approved by RADIO BROADCAST ★

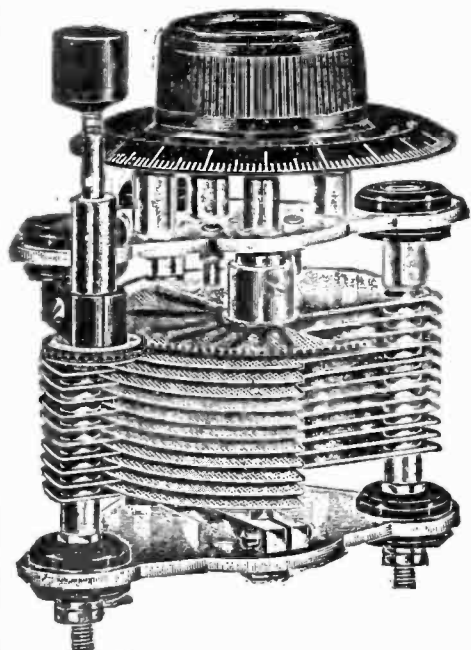

HEATH RADIANT NON-DIELECTRIC CONDENSERS

Contributing to the Popularity of the
SPLITDORF RECEIVER

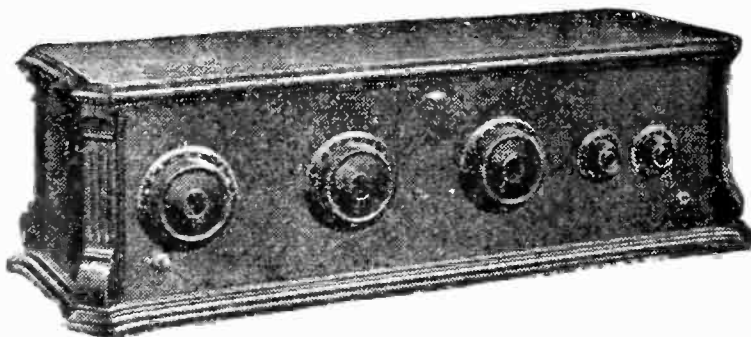

Prices:
WITH DIAL

No. 12AV 12 Plate
\$5.00

No. 24AV 24 Plate
\$5.50

No. 44AV 44 Plate
\$6.50

*Non-Vernier types in
all capacities*

Permanently Flat Plates

Stamped under huge presses to absolute flatness, tempered to prevent warping.

Micrometer Geared Vernier

We guarantee the Heath Vernier Condenser to be more highly selective than any condenser employing a vernier which actuates ALL of the plates.

THE choice by such an eminent manufacturer of *Heath Condensers* is convincing evidence of thorough-going quality of both materials and workmanship and also of superior design. This sort of evidence is your best guide in the choice of condensers.

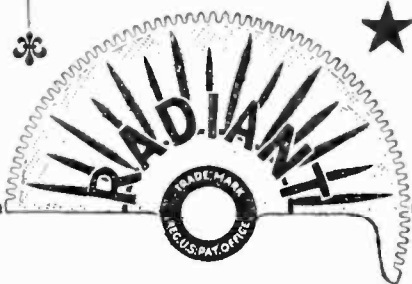

★ **HEATH RADIO & ELECTRIC MFG. CO.**
207 First Street Newark, N. J.

Canadian Distributors:
Marconi Wireless Telegraph Co., of Canada, Ltd.

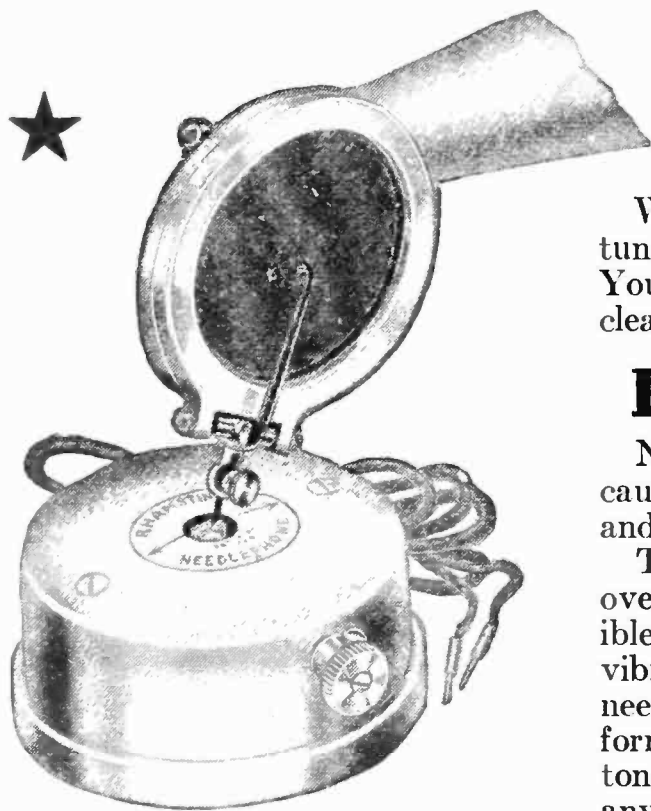

Rose-Marie

When your favorite radio orchestra is playing "Rose-Marie," tune in and bring it in on the Needlephone and your phonograph. You'll be surprised at the wonderfully sweet reproduction—the clear, tender strains—and the full rich notes that you will receive.

Rhamstine★ NEEDLEPHONE

No other speaking unit can possibly give equal reproduction because no other unit takes advantage of "magnified reproduction" and the perfection of the phonograph reproducer.

The Needlephone picks up the delicate impulses that come in over your radio and transmits them through vibrations of a flexible reed, to the point of the phonograph needle. These small vibrations at the point are then transmitted through the pivoted needle to the mica diaphragm where they are enlarged and transformed into sound. As a result, the most delicate variations of tone are enlarged and given fuller value. It may be used with any phonograph, including the Edison with Victor adapter.

Send No Money—Take No Risk

Send the coupon to-day, pay on delivery, and try the Needlephone on your own phonograph and radio. Try it with a soft needle and see what pleasures await you. Try it with a loud needle and see what volume you get without distortion or metallic noises. Then if you are not entirely satisfied—if you cannot say you get better reproduction, sweeter, clearer music—Rhamstine★ does not want you to keep it. Return it and he will gladly refund your money in full.

J. THOS. RHAMSTINE* 3
506 E. Woodbridge, Detroit, Mich.

Send me the *Needlephone*. I'll pay the postman \$10 upon its arrival. It is distinctly understood I may return it if I desire, within 5 days and receive a refund in full.

Name.....

Address.....

Mail this
Coupon
To-day

J. THOS. RHAMSTINE★
DETROIT MICHIGAN

★ Tested and approved by RADIO BROADCAST ★

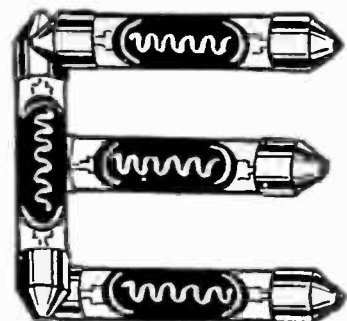
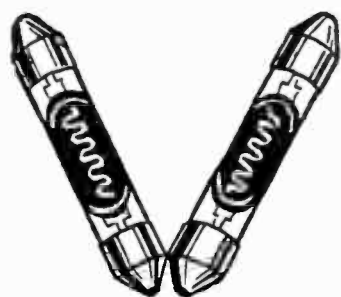
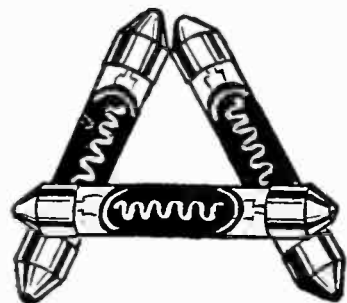

DAVEN is the real word for dependability when connected with Resistance Coupled Amplification. Daven engineers designed and built the first Resistance Coupled Amplifier offered the Broadcast fan—they were the pioneers and their devices have blazed the way for others to follow.

The Daven Resistance Coupled Amplifier Kits are highly perfected—their assembly is very simple—their output perfect. By adding this amplifier to your favorite tuner, you will have a worthy combination, hard to beat, and amplification that is perfect.

With Resistance Coupling the volume is adequate for all purposes while the tone quality is overwhelmingly superior to any other form of amplification. The name Daven is the “Sine of Merit” and your safeguard when you go out to buy.

The Daven Super Amplifier Unit is laboratory tested and comes ready to install. The base is of molded Bakelite and small enough to fit within any cabinet. All wiring is hidden beneath the base.



The Daven Kits are supplied for either three or four stages—sockets and mica fixed condensers are not included, but instructions are furnished giving complete information and diagrams.



You can buy the Daven Products at any good Radio Store.



TRADE MARK
DAVEN RADIO
“The Sine of Merit”
CORPORATION
Resistor Specialists

Newark

New Jersey

Obtain from your Dealer the “RESISTOR MANUAL,” our complete handbook on Resistance Coupled Amplification 25c. If your Dealer cannot supply you, we will send you one direct postpaid for 35c.

★ Tested and approved by RADIO BROADCAST ★



We Give Back

\$78

48%

of Your Money

Place a Resas Tone-A-Dyne Receiver side by side with any set selling for twice the price and compare them for performance, appearance, etc. You'll find this \$78.00 set will do everything the \$150.00 set will do—and it will enable you to put back into your pocket the \$72.00 difference in price.

Or indoor or outdoor antenna, the Resas Tone-A-Dyne will give unexcelled volume and clarity. In addition, the tone and volume can be regulated by simply turning a knob—an exclusive Resas feature.

It is easy to tune and works right through local stations; distant stations are always at your command.

The cabinet is Mahogany handsomely finished, 26½" x 8½" x 9½".

In everything except price, it's a \$150.00 set. It is fully guaranteed for one year.

Write for our interesting booklet

RESAS, Inc. ★

112 Chambers St. New York, N. Y.

Dealers: Write for name of distributor in your territory and our special proposition.



WHEN your set is equipped with Supertran audio transformers you are assured faithfulness in reproduction, clarity, and freedom from all distortion. The Supertran being shielded, is protected against damage to the coil while mounting.

At Good Dealers Everywhere

Distributed by

Philip Chandler & Co. - - Boston, Mass.
L. W. Cleveland & Co. - Portland, Me.
Gray Sales Co. - - - Philadelphia, Pa.
Waite Auto Supply Co., Providence, R. I.
The Beckley-Ralston Co. - Chicago, Ill.
Coast Radio Supply Co.

San Francisco, Cal.

Radio, Ltd. - - - - Montreal, Canada

Ford Mica Co., Inc., 33 E. 8th Street
NEW YORK



SUPERTRAN

REGISTERED U.S. PATENT OFFICE

AUDIO TRANSFORMER

**Be A Radio Expert !
Earn \$60 to \$200 Week**

Wonderful positions now open for ship operators & commercial radio experts. Travel & see the world.

Free RADIO BOOK tells how you can quickly qualify as expert in this new, fascinating, money-making profession. Actual training on amazing array of radio and electrical equipment. Write today for big FREE BOOK giving all facts.

NATIONAL ELECTRICAL SCHOOL
Division R, 4004 S. Figueroa, Los Angeles, Calif.

The New
CHELSEA
 SUPER-FIVE

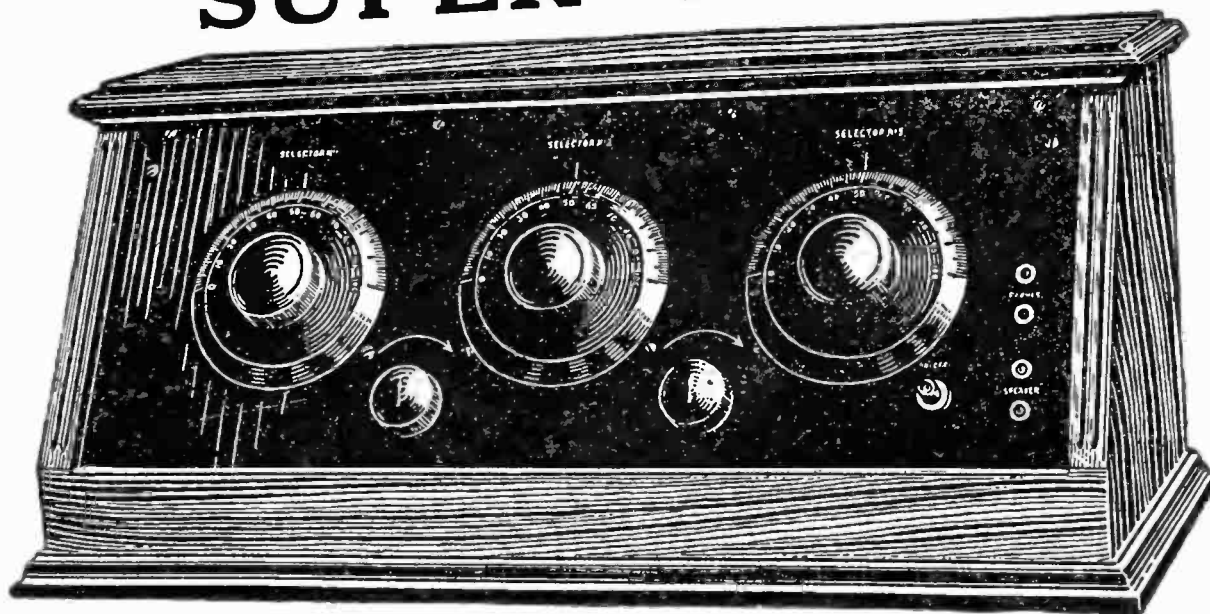

5 TUBE RECEIVER \$ **50.00**
 West of Rocky Mountains \$55.00

The **ULTIMATE** of **SELECTIVITY**

In thousands of homes the name CHELSEA is synonymous with good radio maintaining always a rigid standard of supreme quality. Now CHELSEA manufacturers have succeeded in embodying in a low price model—CHELSEA SUPER FIVE—the extraordinary receiving principles of the finest non-regenerator set. Distance! Volume! With selectivity, plus a cabinet finished in rich mahogany with shielded Bakelite, making the new CHELSEA the logical set to own.

On sale by all good dealers. Catalogue sent upon request

CHELSEA RADIO-COMPANY ★
179 SPRUCE STREET ~ CHELSEA, MASS.

Chicago

St. Louis

Seattle

Denver

Los Angeles

San Francisco

Cleveland



★ Tested and approved by RADIO BROADCAST ★



WINDING MACHINES
for
INDUCTANCE
and
RADIO FREQUENCY
TRANSFORMER
COILS

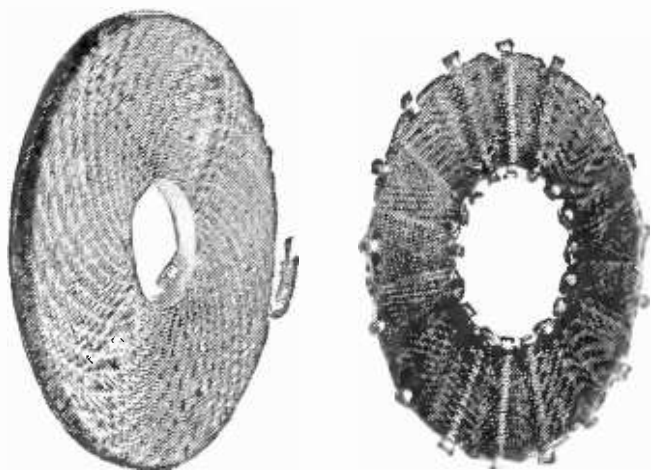

To successfully produce self-supporting cross-wound coils, it is essential that the wire be laid with extreme accuracy. The No. 84 Universal Coil Winding Machine, with its micrometer-like adjustment for different sizes of wire, admirably fulfills this condition, producing coils of maximum durability and efficiency.

Semi-automatic features facilitate the operation of this machine, permitting the use of unskilled labor and at the same time insuring coils of uniform characteristics.

The fact that leading manufacturers of radio equipment insist upon Universal Coil Winders, is undeniable proof of their superiority.

UNIVERSAL WINDING COMPANY

Manufacturers of coil winding equipment covering practically every phase of the electrical industry ★

MAIN OFFICE:
95 South Street
Boston, Mass.

PLANT OFFICE:
P. O. Box 1513
Providence, R. I.

5 TUBE RADIO SET \$38.50
COMPLETELY ASSEMBLED



10 DAYS FREE TRIAL

Coast to Coast

Direct from factory to you. Marvelous 5-tube radio set. Latest and most efficient TUNED RADIO FREQUENCY circuit. Approved by America's Leading Radio Engineers and the Institute of Standards. Easy to operate. Dials can be logged. Tune in your favorite stations instantly, on the same dial numbers every time. No guessing. Mr. Howard of Chicago said, "While 5 Chicago Broadcasting Stations were on the air, I tuned in 17 out-of-town stations from 40 to 1,000 miles away, on my loud speaker, very loud and clear as though they were all in Chicago."

Description: 5-tube set. Comes completely assembled in beautiful mahogany cabinet, size 25 x 7½ x 7½. Has 2 stages Tuned Radio Frequency, Detector and 2 stages Audio Frequency. Equipped with the highest quality, approved standard low-loss parts. Genuine Bakelite Panel, Bakelite dials. Use any standard tubes and batteries.

10 DAYS' FREE TRIAL

Don't miss this wonderful opportunity to obtain the marvelous METRODYNE SUPER FIVE direct from the factory. **REGULAR VALUE \$100.** Our factory price **ONLY \$38.50**, assembled in a beautiful mahogany cabinet that will add to the appearance of the room. Our liberal **FREE TRIAL OFFER** gives you an opportunity to try the set in your home for ten days before deciding to keep it.

Metro Electric Co.

400 N. Michigan Ave., Dept. 76, Chicago, Ill.

Send me further details of your Metrodyne Super-Five Radio set and Free Trial offer.

Name

Address

City..... State.....

Read RUDYARD KIPLING'S Books

For sale everywhere

Doubleday, Page & Co.

PEERLESS TWINAUD



Consists of *two* audio transformers combined in *one* unit. It may be substituted in *any* circuit in place of *any two* audio transformers with the absolute assurance that the result will be *greater volume and clearer reproduction.*

List Price \$9.50

AT ALL GOOD DEALERS

Buy a TWINAUD to-day

PEERLESS RADIO CORPORATION
Newton Lower Falls Boston, Mass.

Make This Test Yourself



ASK your dealer to let you hear an Adler-Royal Radio Speaker side by side with any speaker in his store. Operate its magic modulator yourself and see how it adapts its tones to your mood. Notice how free it is from the noises you have formerly associated with loud speaker reception. Whether it is the strident measures of a jazz band or the plaintive notes of a world renowned violinist, put yourself under spell of Adler-Royal tone quality.

Then Make the Hardest Test of All

TUNE in on a station that is broadcasting piano music, and observe how the Adler-Royal actually reproduces music that really sounds like a piano. The remarkable purity of tone in Adler-Royal is accomplished in two ways. The horn preserves pure tonal qualities. This, coupled with the tone modulator, easily accessible, gives you perfect control over tone volume and quality.

Two Exclusive Features

YOU tune in your radio set for maximum amplification so that every delicate overtone is caught and amplified and then by this modulator, you blend and soften this tone to your own mood.

The cabinet design of Adler-Royal Radio Speakers provides a setting that will grace the finest living room.

Our experience of 25 years in producing fine pianos, organs and phonographs enables us to offer this speaker at the extremely reasonable price of \$30.00. In two finishes, either duo-tone walnut or mahogany.

ADLER MANUFACTURING COMPANY

New York

Louisville



The secret of Adler-Royal natural tone



Adler-Royal Radio Speaker

ADLER MANUFACTURING COMPANY
Dept. C3, 881 Broadway, N. Y.

I should like to know the name of a dealer near me where I can compare an Adler-Royal Radio Speaker. Also please send me The Adler-Royal Catalogue and Log.

Name

Address

★ Tested and approved by RADIO BROADCAST ★



Super-Heterodyne C-7

Model C-7 the Long Distance Concert Receiver With a Telephone Range of 3,000 Miles

For any Circuit Prompt shipment can be made on tested, standard apparatus of the following manufacture:

- | | |
|-----------------------|----------|
| E. I. S., Inc. | |
| General Radio | Willard |
| Ultradyn | |
| Sangamo Electric | |
| Benjamin Electric | |
| Allen Cardwell | |
| Dubilier | Formica |
| Weston | Magnavox |
| Jewell | AmerTram |
| Western Electric | |
| Radio Corporation | |
| Music Master | Acme |
| CutlerHammer | Frost |
| Federal | Kellogg |

None of the so-called new "circuits" or modifications of standards approach the C-7 in efficiency—for long range, for high audibility, for selectivity. **Seven tubes give the result of ten** because this model allows signals to be regenerated and heterodyned through radio frequency amplifier.

E. I. S. Model--All material we furnish is endorsed and recommended by the designers. ★

Using the finest apparatus and building to Naval standards, Model C-7 has a telephone range of 3000 miles.

**PRESSLEY
CIRCUIT**
as described in
Popular Radio.
We furnish parts
as specified.

Norden-Hauck Price List Saves You Money

Free Information—Write for descriptive matter and price list. Our service is as near as your mail box. Special engraving to order.

Full Stock on Hand—We carry complete stocks of laboratory tested apparatus for immediate shipment.

Norden, Hauck & Co. Engineers • Office and Laboratories
1617 Chestnut St., Philadelphia

DeJUR

ONE HOLE MOUNT RHEOSTATS

- 1—Easiest to mount.
- 2—No back panel fussing.
- 3—Perfect contact always.
- 4—Genuine bakelite throughout.
- 5—Contact slider and shaft made in one piece.

At All Dealers

DEJUR PRODUCTS CO.
Broome and Lafayette Sts., New York

PATENTS APPLIED FOR

RADION

The Supreme Insulation ★

SOCKETS

RADION V-T Sockets, Improved Type, provide the utmost protection against possible leaks and losses. Spring contacts of tempered bronze alloy maintain continuous connection with tube terminals.

Write for catalogue of Radion Products.
Dealers: Write for our proposition

AMERICAN HARD RUBBER COMPANY
Dept. C-3, 11 Mercer Street,
New York City
Chicago Office: Conway Building
Pacific Coast Agent: Goodyear Rubber Co.,
San Francisco—Portland

Radion Built-in Horn

Radion Dial

★ Tested and approved by RADIO BROADCAST ★



Convenience—

Install an Electrad Lead-In

Five dollars worth of convenience for 40c—absolutely safe—made under specifications of the Board of Fire Underwriters. 3000 volt tested. Fahnestock clips. Soldered connections.

Does away with unsightly porcelain tubes—no damaging holes in window sash or frame. Made of pliable insulated metal that will bend into any desired shape. Fits under closed, locked windows. Price 40c.

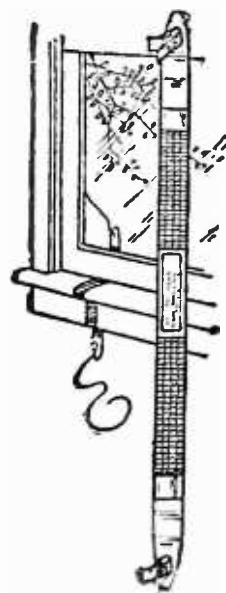

Electrad Guaranteed Parts Make Any Set Better

Variohms, Audiohms, Rheostats, Audio Transformers, Grid Leaks—a complete line of parts, every one fully guaranteed.

Foremost radio engineers have developed Electrad parts and to-day supervise their manufacture.

And under that supervision each individual part is scrutinized—the slightest imperfection, and the part is instantly thrown away—destroyed.

Nobody has ever bought an Electrad “second.” Every part is perfect and guaranteed so.

Save yourself time, money, and disappointment by insisting upon “Electrad.”

For sale at nearly all good radio dealers.

ELECTRAD

INCORPORATED

428 Broadway, New York City

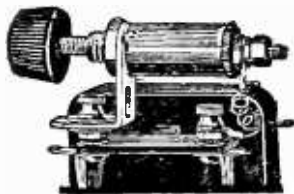

Use the Audiohm for clarity. Put one across the secondary of your transformer, Easily attached by anyone. Once set is permanent. Price, with adjustable bracket, \$1.50.

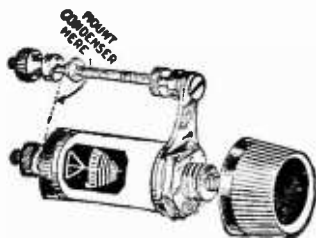

Electrad Variohm: A variable grid leak that will give exactly the correct grid resistance. Any resistance from $\frac{1}{4}$ to 30 megs.; gives that last hair's breadth tuning that adds so much to enjoyment of radio. Price \$1.25 for panel mount, \$1.50 for base mount.



★ Tested and approved by RADIO BROADCAST ★

BRANSTON RADIO

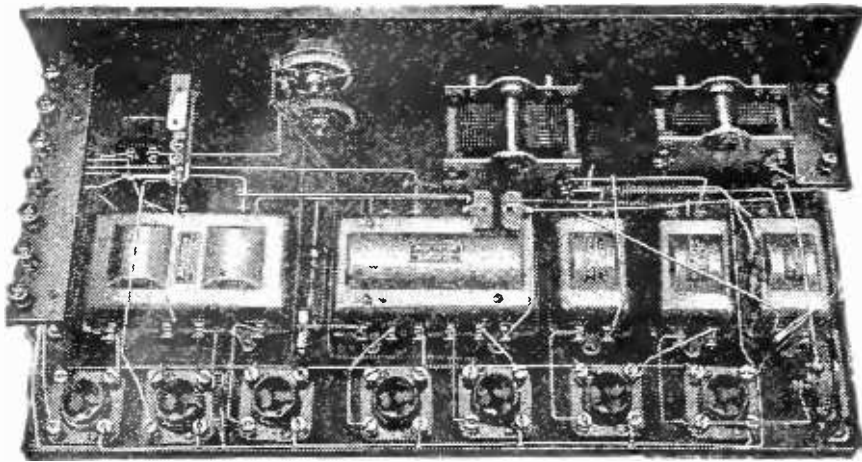

**Build Your Own Super-Heterodyne
Save \$100 or More—Have a Better Set**

Branston's Transformer Kit No. R-199 (\$35.00) contains eight matched transformers; Branston Accessory Kit No. R-199-A (\$50.00) contains panel, condensers, rheostats, wire, etc., etc. Partially assembled. Any amateur, in a few evenings, can easily build a reflexed Super-Heterodyne of coast-to-coast range, remarkable tonal quality, great volume, and hairline selectivity.

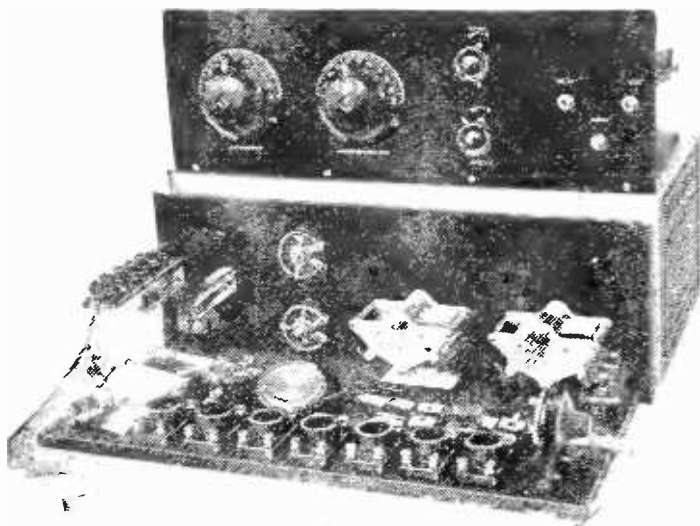

BRANSTON ACCESSORY KIT No. R-199-A
(partially assembled) contains

- | | |
|---|--|
| 1 7x21 Drilled and Engraved Panel | 1 3 Plate Vernier Condenser and Mountings. |
| 2 23 Plate Straight Line Low Loss Condensers. | 2.001 Tested Fixed Condensers |
| 1 60 Ohm Rheostat | 2 .005 " " " |
| 1 25 Ohm Rheostat | 1 .0001 " " " |
| 1 Battery Switch | 1 .00025 " " " |
| 1 Single Circuit Jack | 2 Grid Leak Mountings |
| 1 Two Circuit Jack | 1 Variable Grid Leak |
| 2 Branston Cam-Vernier Dials | 1 Fixed Grid Leak |
| 2 Sub Panels and Ten Binding Posts, assembled | Sufficient square bus bar, spaghetti, nuts, screws, terminals and rosin core solder to complete wiring of set. |
| 1 Baseboard 20"x9 1/2" | |
| 7 UV-199 Sockets | |

Be sure to state whether you intend to use UV-199 or UV-201-A Tubes

Send 25c for Super-Heterodyne, Radio Frequency, and Honeycomb Coil circuits and complete catalogue. Your dealer has Branston Kits or can get them for you. If not, write us.

CHAS. A. BRANSTON, Inc.
813 Main St., Buffalo, N. Y.

Manufacturers of Branston Violet Ray High Frequency Generators

In Canada—Chas. A. Branston, Ltd., Toronto, Ont.

POLY PLUG

75¢

With Polyplug you get maximum clearness from your set, because you can't mistake the positive pole. The positive pole is plainly marked on the sleeve contact.

Polyplug has no screws to tighten—no need to take plug apart. Wires are crossed under the tension slot—exclusive Polyplug feature—and plugged in. Pulling and jars do not disturb contact.

Permanent Positive Contact
Made of Genuine Bakelite

Send for Circular C
POLYMET Mfg. Corp.
70-74 Lafayette Street
New York City

POSITIVE POLE PLAINLY MARKED

★

MARCONI recommends ★
Short-wave reception

as being vital to the best results from radio. The design of Myers Tubes makes them adaptable for short-wave as well as long-wave reception. They achieve this result by having the grid and plate leads extend from opposite ends of the tube.

Amateurs using Myers Tubes get virtually every station on the continent. Three types for dry and storage batteries. Complete ready to mount. At your dealer's or sent postpaid for..... **\$4.99**
251 Craig Street, Montreal

Myers Tubes
Practically Unbreakable

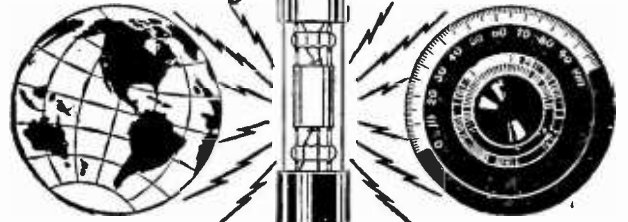

"The World On Your Dial"

Write for descriptive circular

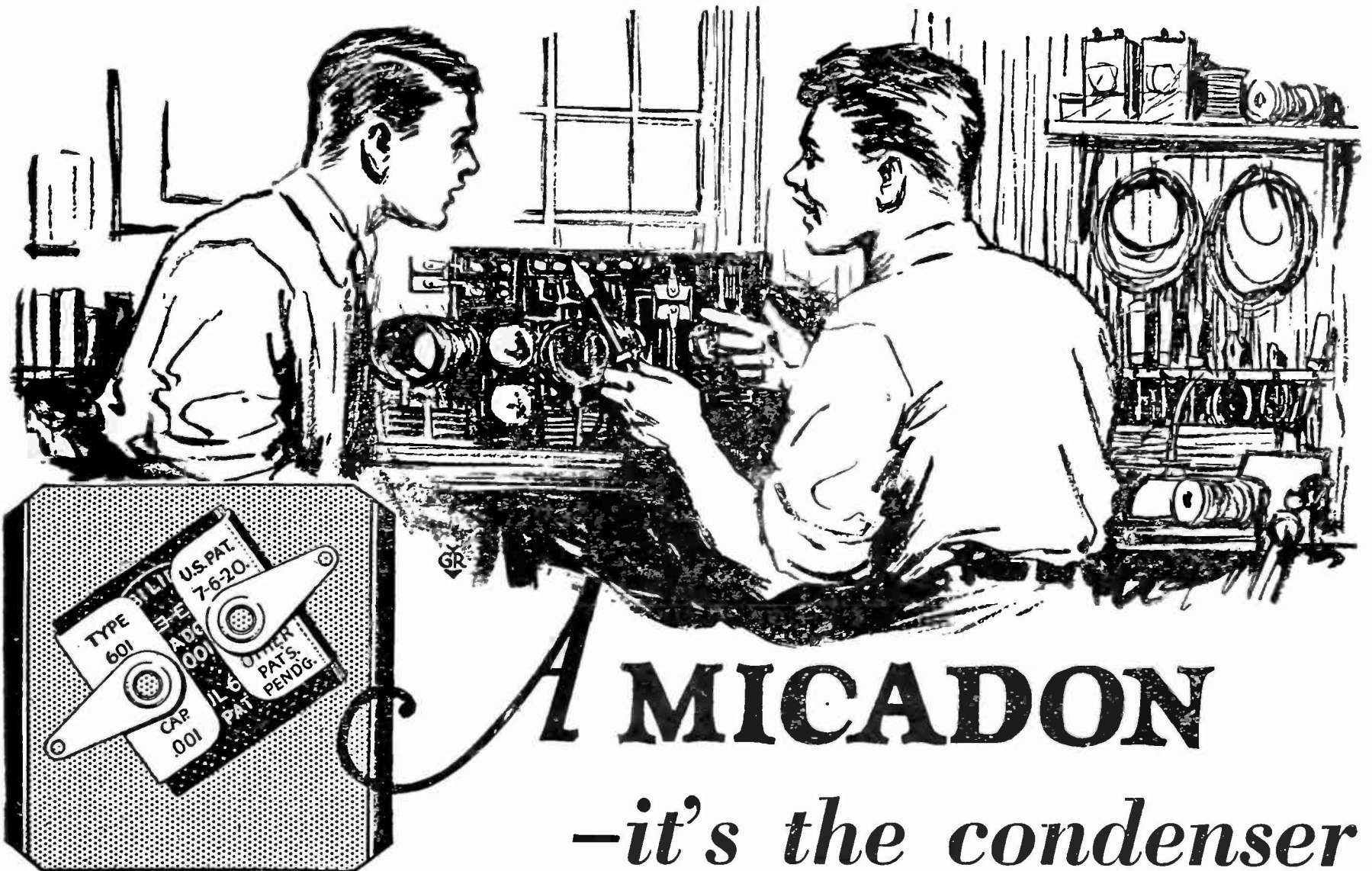

A MICADON

—it's the condenser

The Micadon is the standard fixed condenser of radio! Extremely accurate because only the very best materials are used and because Dubilier condenser craftsmen assemble and inspect them. Simple to install because equipped with extension tabs for soldering and eyelets for set screw assembly. Different capacities for different requirements. More than 90% of all sets made—by manufacturers and amateurs—use Dubilier Micadons.

The preference of all these fans and experts has made Dubilier Micadons the Standard.

Sold by all good Dealers

★
Dubilier

CONDENSER AND RADIO CORPORATION

★ Tested and approved by RADIO BROADCAST ★

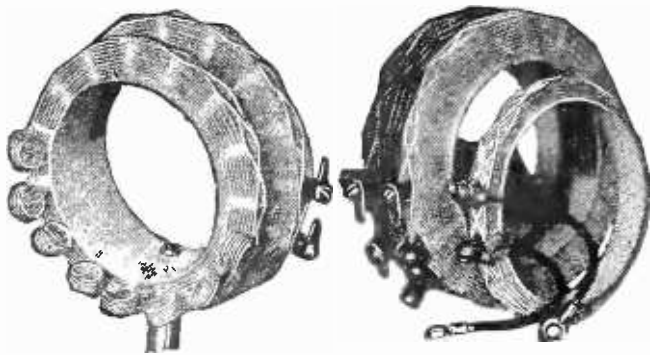

Coils for Roberts Circuit No. 18
Price \$8.00 a set

SICKLES DIAMOND-WEAVE COILS

Patented Aug. 21, 1923

For Craig, Roberts and Hoyt Circuits

Sickles Coils were chosen by Albert G. Craig in designing his remarkable new Reflex Receiver using the new Sodian detector, and are specified by him for this circuit in the February issue of Popular Radio. This coil set, No. 20, is priced at \$4.50.

For the very popular Roberts Circuit the Sickles Coil Set No. 18 (\$8.00) is standard equipment. Unit No. 1 has primary and secondary coils. Unit No. 2 has primary, secondary, neutralizing coil and tickler. Broad variation in coupling adjustments is provided for. Tickler is provided with 180 degree dial control.

Coils for the Hoyt Circuit at \$8.50 a set, for the Knockout Reflex Circuit at \$4.00 a pair, and the Tuned Radio Frequency coil at \$2.00 each are among the standard Sickles coils. We manufacture special coils also for manufacturers' requirements.

**An entirely new system of
Radio Reception**

Sickles Diamond Weave Coils have been specified for use in the Hoyt System of Signal Augmentation, by the inventor, Francis R. Hoyt. We have a limited number of blue printed copies of Mr. Hoyt's original laboratory notes on this new system of radio reception, together with nine circuit sketches, which will be sent free to you upon receipt of this coupon and four cents for postage.

The F. W. Sickles Co.
335 Worthington St., Springfield, Mass.
Please send information of Hoyt System.

Name

Address

Send for descriptive catalogue

★ **The F. W. Sickles Co.**

335 Worthington Street
SPRINGFIELD, MASS.

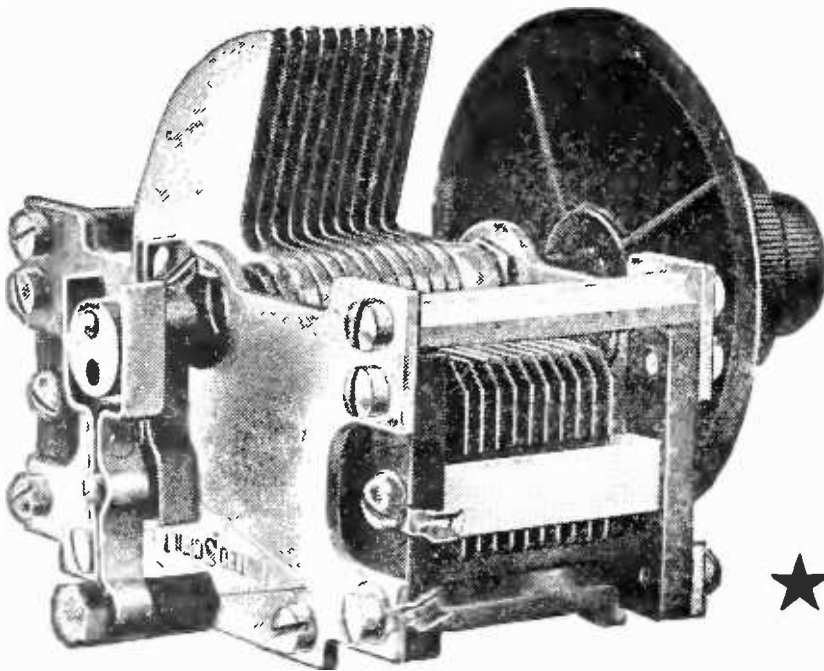

10 SUPERIOR POINTS
DUAL RATIO

★
GROUNDED
ROTOR



LOW

LOSS

CONDENSER

Plain and Vernier Type

Improved Type RHEOSTATS
and POTENTIOMETERS

All Sizes. Write for Full Information

United Scientific Laboratories, Inc., 92-94 E. 10th St., New York City

Praised by Experts!

Enjoyable volume and marvelous clarity are ensured with Airtron Tubes.

Every tube is a product of scientific skill and accuracy, and fully guaranteed. Bases are of Bakelite which insures highest efficiency. Tested and approved by Radio Authorities. Ask your favorite dealer for Airtron Tubes. All standard types \$4.00.

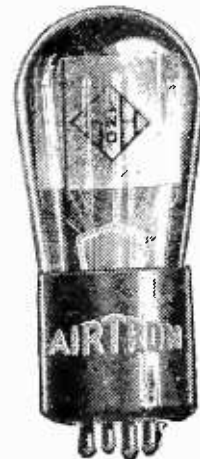

Dealers write for discounts

We repair all types of tubes \$2.50

H. & H. RADIO CO.

Dept. 109

514 Clinton Ave., Newark, N. J.

AIRTRON

RADIO TUBES

★ Tested and approved by RADIO BROADCAST ★

RASLA



\$1.75



RASLA for reflex." That slogan has become the "buyword" for reflex satisfaction both with radio fans and radio engineers.

RASLA Fixed Detectors are sensitive, remain so despite hard usage. They are tested with 10 times the current they will ever carry when used in a set. And everyone is a good one!

RASLA Lo-Cap Condensers are just the thing for compensating reflex circuits. If you examine one you'll realize why. Your dealer has them.

DAVIDSON RADIO CORPORATION

222 Fulton Street

New York

\$1.25



PRODUCTS

★ Tested and approved by RADIO BROADCAST ★

RASLA

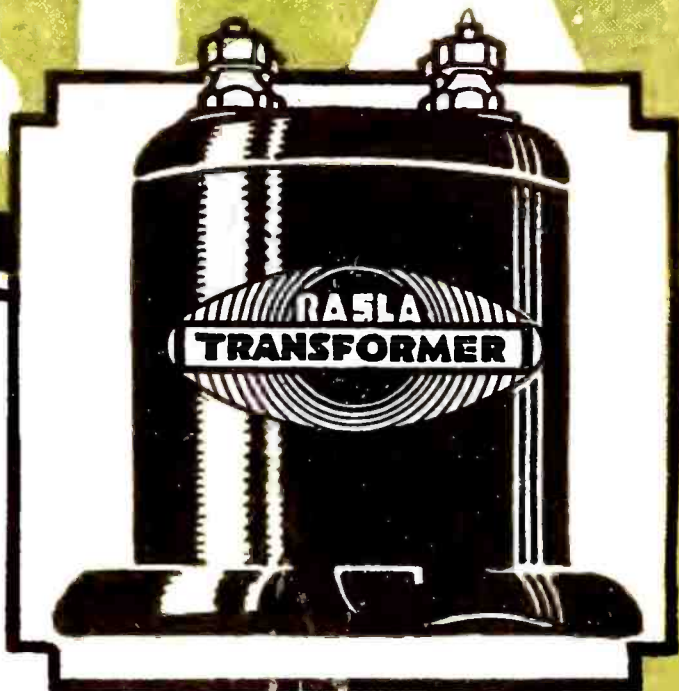

Price \$4.00



Best for Reflex!

RASLA Type CR Transformers have proven their right to leadership among reflex transformers. These transformers have been designed by reflex experts. For linking a tube and a crystal they have no equal!

RASLA Tuners mark an innovation in reflex circuits. They make sharp tuning possible—tuning so sharp that distance is possible through the locals. Your dealer has them.

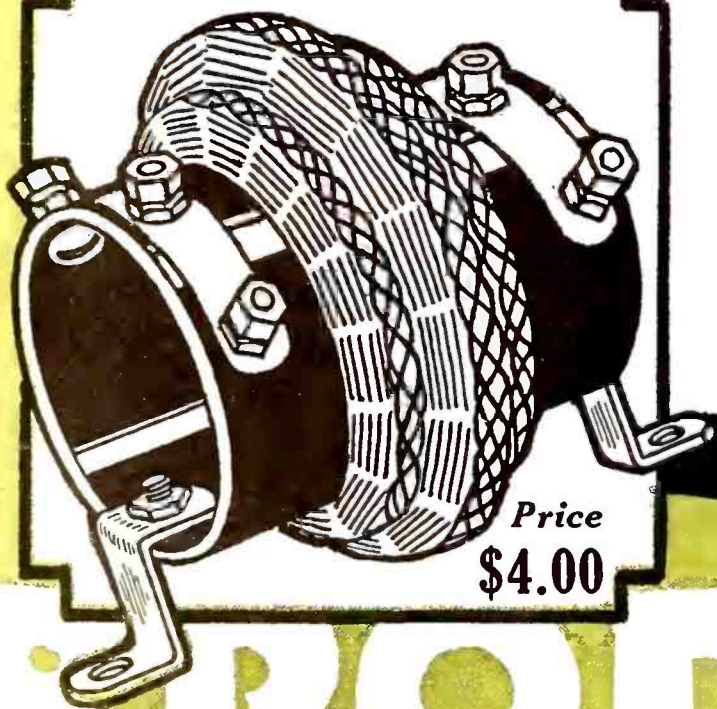

Price
\$4.00

*Write the Davidson Radio Corp.,
222 Fulton Street, New York,
for literature on these and other
RASLA Products.*

PRODUCTS

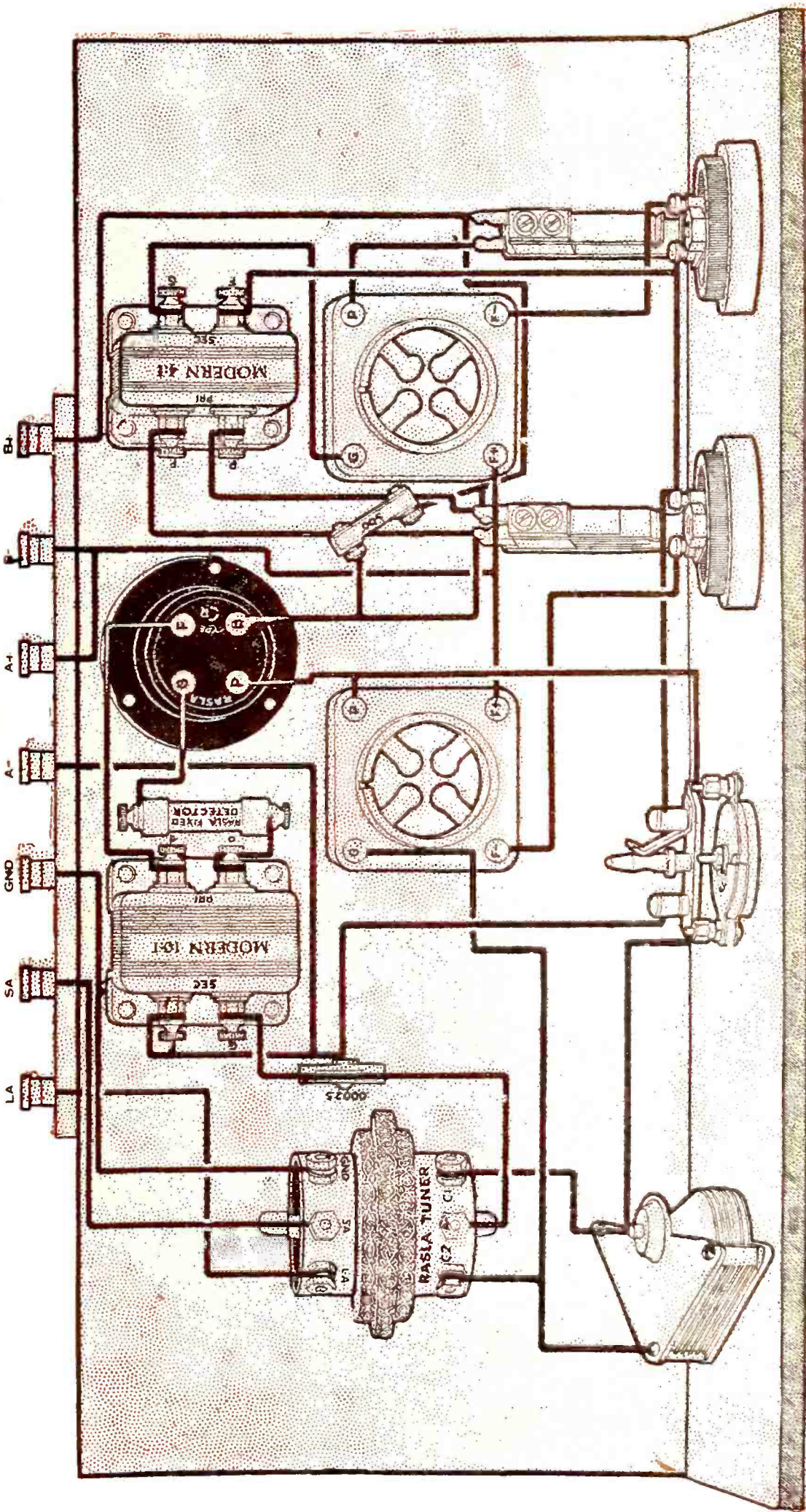

THIS is the Improved Rasla Reflex for Two Tubes as originally built by the well known reflex expert, John Clyde Davidson, and described by him in the February Radio Broadcast. It is unusually easy to build if you follow the detailed instructions available FREE by writing the Davidson Radio Corp., 222 Fulton St., New York.

RASLA REFLEX

for 2 tubes

★

★ Tested and approved by RADIO BROADCAST ★

MODERN

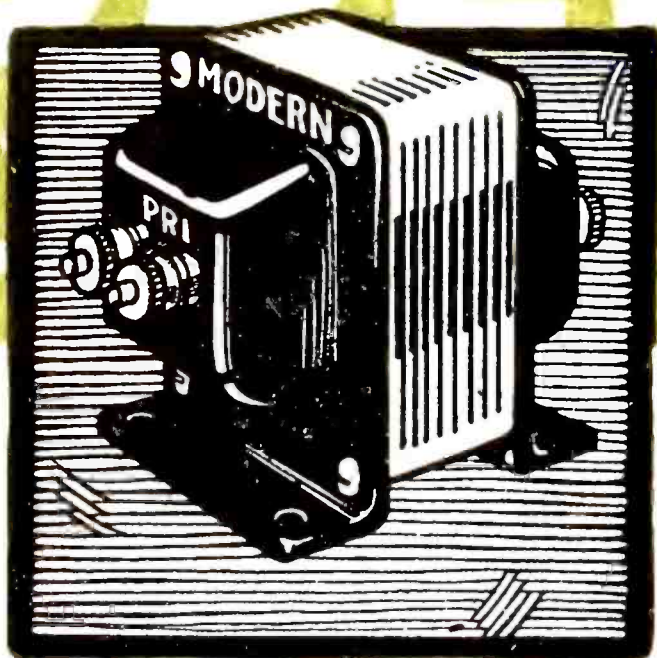

Prices
 4 to 1, \$5.00 Push-Pull
 10 to 1, 5.50 \$12.50 per pair

MODERN Transformers have always been synonymous with better reproduction. The set that "amplifies the MODERN way" is a set that will reproduce each note and each intonation of the broadcasting artist *exactly*.

MODERN Transformers have been chosen exclusively by Mr. John Clyde Davidson for the Improved Rasla Reflex for Two Tubes. After thorough tests, MODERN Transformers were found best.

Whether you build the Improved Rasla Reflex for Two Tubes, or any other set you will find MODERN Transformers your best bet. They are made in the Ten to One, Four to One, and Push-Pull styles.

MODERN ELECTRIC MFG. CO. - TOLEDO, OHIO



TRANSFORMER

★ Tested and approved by RADIO BROADCAST ★

Haynes-Griffin

RADIO SERVICE, Inc.

41 West 43rd St., N. Y. City

250 W. 49th St.,
New York

MAIL ORDER DEPARTMENTS

111 So. Clark St.,
Chicago

Complete parts for the Rasla One Dial Reflex Receiver

Described by John C. Davidson
in February 1925 "Radio Broadcast"

Haynes-Griffin is ready with a complete stock of parts for this remarkable one control reflex set—both the two and four tube models. Drilled and engraved bakelite panels also in stock.

Order what you need from the lists below. Haynes-Griffin Mail Order Service will give you immediate delivery on any of the apparatus called for by Mr. Davidson.

Parts for the 2-Tube Set

1 Rasla Radio Frequency Tuner	\$4.00
1 X Laboratory .00032 mfd Condenser	5.50
1 Rasla R. F. Transformer.....	4.00
1 Rasla Fixed Crystal	1.25
1 Modern 10-1 Audio Frequency Transformer	5.50
1 Modern 4-1 Audio Frequency Transformer	5.00
1 Rasla Balancing Condenser	1.75
1 Walbert Filament Control Switch.....	.50
2 Hoosick Falls Sockets, ea. .50	1.00
2 Haynes-Griffin 20 ohm Rheostats ea. .75...	1.50
1 Haynes-Griffin Double Circuit Jack.....	.60
1 Haynes-Griffin Single Circuit Jack.....	.50
1 National Vernier Dial 4".....	2.50
7 Eby Binding Posts, ea. .20.....	1.40
1 .00025 mfd. Dubilier fixed condenser35
1 .002 mfd. Dubilier fixed condenser40
1 .005 mfd. Dubilier fixed condenser60
1 7 x 18" Bakelite Panel, drilled and engraved	4.50
1 7 x 17" wood baseboard75
1 7 x 18" solid mahogany cabinet	7.25

Parts for the 4-Tube Set

With Push-Pull Amplifier

1 Rasla Radio Frequency Tuner	\$4.00
1 X Laboratory .00032 mfd variable condenser	5.50
1 Rasla Radio Frequency Transformer.....	4.00
1 Rasla Fixed Crystal Detector	1.25
1 Modern 10-1 Audio Frequency Transformer	5.50
1 Modern 4-1 A. F. Transformer	5.00
1 Rasla Balancing Condenser	1.75
1 Walbert Filament Switch.....	.50
4 Hoosick Falls Sockets, ea. .50	2.00
3 Haynes-Griffin 20 ohm Rheostats, ea. .75..	2.25
2 Haynes-Griffin Double Circuit Jacks ea. .60	1.20
1 Haynes-Griffin Single Circuit Jack.....	.50
1 National Vernier Dial 4 in.	2.50
9 Eby Binding Posts, ea. .20.....	1.80
1 C Battery 4½ volts.....	.60
1 Modern Push Pull Transformer No. 112 } 12.50	
1 Modern Push Pull Transformer No. 113 } pair	
1 .0005 mfd. Dubilier fixed condenser35
1 .006 mfd. Dubilier fixed condenser75
1 .005 mfd. Dubilier fixed condenser60
1 .00025 mfd. Dubilier fixed condenser.....	.35
1 Drilled and engraved bakelite panel, 7 x 24"	6.00
1 Solid mahogany cabinet 7 x 24"	7.50
1 Wood Baseboard 7 x 23"	1.00

Diagram and complete working directions with each set of parts
Parcel Post Prepaid, except on C. O. D. shipments

★ **HAYNES-GRIFFIN RADIO SERVICE, Inc.**

Mail Order Departments

250 West 49th St., New York, N. Y.

111 South Clark St., Chicago, Ill.

★ Tested and approved by RADIO BROADCAST ★

CROSLEY AGAIN LOWERS PRICES

Big Reduction in Famous Trirdyn and other Radios



CROSLEY
50
One Tube

\$14.50

The biggest selling radio in the world

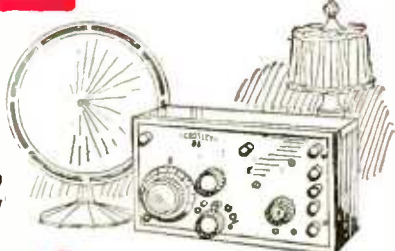

CROSLEY
51
Two Tube

\$18.50

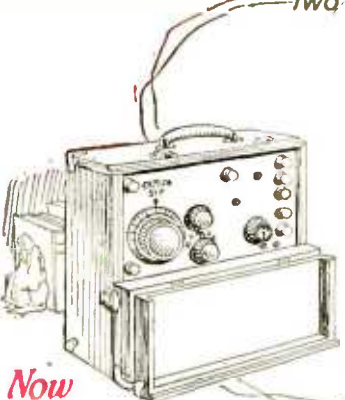

CROSLEY
51 Portable
Two Tube

Now

\$23.50



CROSLEY
52
Three Tube

\$30



CROSLEY
"TRIRDYN"

Now

\$50

THE biggest selling high grade receiver on the market—the Crosley Trirdyn—reduced from \$65 to \$50.

The Trirdyn Special—the beautiful Model with cabinet to house batteries—formerly \$75, now \$60.

The Crosley 51-P, a tremendous seller at \$25, reduced to \$23.50.

We unhesitatingly state that Crosley Radios represent the biggest values ever offered.

CROSLEY RADIOS JUSTLY POPULAR

Only the less expensive Crosley Radios have exceeded the Trirdyn in sales. This deserved popularity of the entire Crosley line is the result of extraordinary performance at a very low price.

Crosley Radios cost less originally, use fewer tubes and consume much less battery current. They give results not equalled by receivers costing a great deal more and using two or three additional tubes.

The unique Trirdyn circuit—a combination of Armstrong Regeneration, Radio Frequency Amplification and Reflexed Audio Amplification—has proven beyond a doubt that the features of selectivity, volume and ease of operation can be obtained with three tubes better than heretofore has been possible with five or even six.

Hundreds of voluntary letters have come to us, telling of the unparalleled foreign reception during international test week with Trirdyns and all other Crosley Radios; even the little one-tube Crosley 50 at only \$14.50.

It is this continued remarkable performance that has created such a tremendous demand for Crosley Radios. And it is this great popularity that now allows us to decrease our production costs and pass this large saving along to you.

NEW CROSLEY MODELS

In order to allow even a greater selection, three new Crosley Radios have been added to our extensive line. Taking its place with the well known Crosley 50 and Crosley 50-P is the leatherette covered, one-tube 50 Portable, a utility set in which the dealer can quickly make the necessary connections and allow you to carry it home complete.

The New Crosley 51 Special, a two-tube receiver similar to the Model 51, is housed in a cabinet large enough to hold the necessary batteries and has a sloping panel.

Similar to the Crosley 52, but with sloping panel and cabinet to house the batteries is the new Crosley 52 Special.

Most good dealers handle Crosley Radios.

You Will Make No Mistake in Buying One.

All Crosley Receivers contain the famous Armstrong Regenerative circuit, and are licensed under the Armstrong U. S. Patent No. 1,113,149

As is customary prices shown do not include tubes, phones, loudspeakers or batteries

Price West of Rockies—add 10%



CROSLEY
"50P"
One Tube

\$16



CROSLEY
"51" Special
Two Tube

\$23.50



CROSLEY
"52" Special
Three Tube

\$35



CROSLEY
"TRIRDYN" Special
Now

\$60

3 Tubes do the work of 5



In a CROSLEY Trirdyn

THE LOUD SPEAKER SHOWN IS THE WONDERFUL NEW CROSLEY LOUD SPEAKER THAT IS TO BE ANNOUNCED IN THE NEAR FUTURE

Write for Complete Catalogue

THE CROSLEY RADIO CORPORATION

POWEL CROSLEY, JR., President

320 Sassafras Street

Cincinnati, Ohio

Crosley owns and operates Broadcasting Station WLW

★ Tested and approved by RADIO BROADCAST ★

THE COUNTRY LIFE PRESS, GARDEN CITY, NEW YORK



and

Silver-Marshall

It is well known that John C. Davidson is one of the foremost authorities on reflex design—that Arthur H. Lynch, Editor of *Radio Broadcast*, never backed a loser. But SILVER-MARSHALL could not approve Rasla Reflex until their own engineers had stamped it with their approval—until they, too, had pronounced it the most powerful two-tube reflex circuit ever developed—until every claim made for it had been substantiated—extreme simplicity of design, amazing selectivity with one-dial control, tremendous volume, and splendid tone quality.

Then, and only then, it received the O. K. of McMurdo Silver, Assoc. I. R. E., designer of the famous SILVER SUPER.

Then came the S-M guarantee. And you know what that means—satisfaction or your money back. You are assured of parts of the best quality approved by Mr. Silver. You are assured that when you buy a set of S-M parts they are right, for behind them is the S-M Laboratory test of each individual item. And the famous technical information service is at your disposal—at no charge.

Parts for 1-Tube Rasla Reflex

1 Silver low-loss condenser, No. 302.....	\$4.00
1 Rasla Type CR Transformer.....	4.00
1 Rasla tuner.....	4.00
1 Rasla fixed detector.....	1.25
1 Rasla LoCap condenser.....	1.75
1 Modern 10:1 audio transformer.....	5.50
1 Howard 25 ohm rheostat.....	1.20
1 Hoosick Falls socket.....	.60
1 Carter 102A jack.....	.80
1 On-off switch, Cutler-Hammer.....	.60
7 Insulated top binding posts.....	.35
1 .00025 mica condenser.....	.35
1 .005 mica condenser.....	.60
1 4" Kurz-Kasch dial.....	1.00
1 7 x 18 x 1/4" drilled, grained and engraved bakelite panel.....	4.50
1 7 x 17 x 1/2" Oak baseboard, bus-bar spaghetti, screws, nuts, solder, lugs, etc.....	1.00
Total.....	\$31.50

Add for 2-Tube Receiver

1 Modern 4:1 Audio transformer.....	\$5.00
1 Howard 25 ohm rheostat.....	1.20

1 Carter 102A jack.....	.80
1 Hoosick Falls socket.....	.60
Total.....	\$7.60

Add to above for 4-Tube Receiver

1 Modern 112 Push-pull transformer.....	\$6.25
1 Modern 113 Push-pull transformer.....	6.25
1 Carter 101 jack.....	.70
2 Hoosick Falls sockets.....	1.20
Total.....	\$14.40

“How to Build the Simplified Rasla Reflex”

is Mr. Silver's own pamphlet telling you how to build the one tube set, how to add the second tube, and then the push-pull amplifier, without changing the original assembly. Its troubleshooting section insures perfect results, for each little kink is explained.

Dealers write for attractive discount

★ Silver-Marshall, inc.

105 South Wabash Avenue, CHICAGO, ILLINOIS

★ Tested and approved by RADIO BROADCAST ★

Answer!



T OWER Scientific Head Sets	Brandes Table Talkers Head Phones	Talking Tape	A. C. Dayton XL-5 Sets and Kits	M ODERN TRANSFORMERS
R AULAND ALL AMERICAN Trans-formers	Adapto Console Cabinets		Bright Star B Batteries	O PERADIO Receiving Sets
I MPROVED Jacks and Switches				N ATIONAL Airphone Receiving Sets
V OOD ARIAL'S Paramount Mathieser Duo-Spiral	Cardvell Condensers			T HOROLA Loud Speaker Phonograph Units
L OPEZ Low Loss Tuners				A CME Condensers Trans-formers Pot. Rhea.
I NSULATORS Fleron Brach Sensory	Gray Chargeable B Batteries			G RIMES Receiving Sets
N A-ALD Dials Sockets Adapters	Home Chargers and Kodak Sets			U NCLE SAM Low Loss Tuners
G ENERAL RADIO Condenser Rheostats etc.	Pacent Jacks Rheostats Sockets etc.	Western Electric Speakers Head-Sets Phonograph Units	Bradleystats Bradleyohms etc.	D RLA Trans-formers Detectors etc.

The Determining Factor To-Day!

Governing the success and expansion of the average retail radio store is the **Strength of the distributor behind your orders**

Our 1925 Catalogue is a valuable guide to every dealer—

IT IS FREE FOR THE ASKING

LARGEST EASTERN EXCLUSIVELY WHOLESALE RADIO DISTRIBUTORS OF NATIONALLY ADVERTISED LINES



Grow With Us

49 N. 7 Street Philadelphia, Pa.

★ Tested and approved by RADIO BROADCAST ★

Bakelite - Faultless servant of Radio's invisible audience

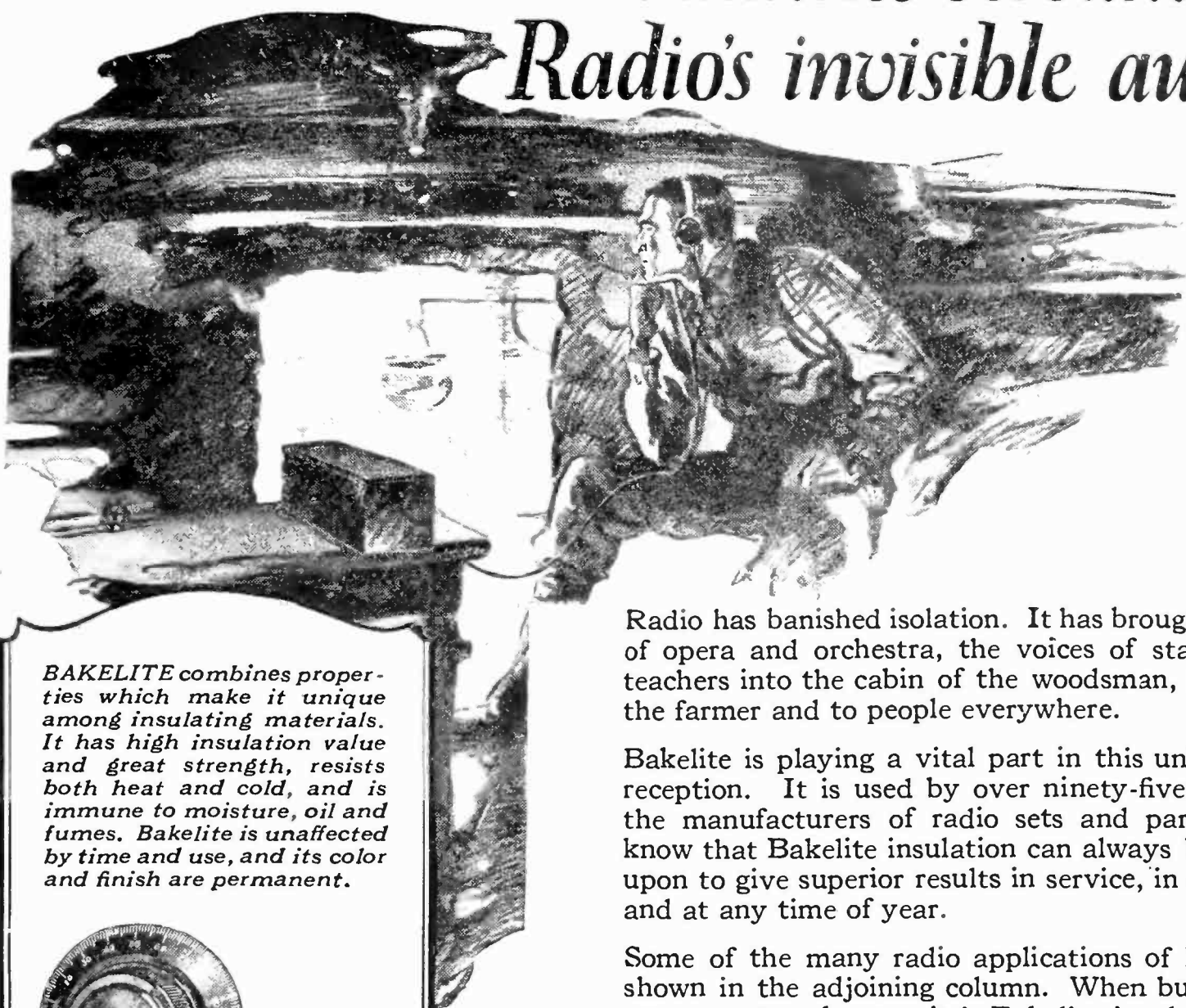

Radio has banished isolation. It has brought the music of opera and orchestra, the voices of statesmen and teachers into the cabin of the woodsman, the home of the farmer and to people everywhere.

Bakelite is playing a vital part in this universal radio reception. It is used by over ninety-five per cent of the manufacturers of radio sets and parts, for they know that Bakelite insulation can always be depended upon to give superior results in service, in any climate and at any time of year.

Some of the many radio applications of Bakelite are shown in the adjoining column. When buying a radio set or part make sure it is Bakelite insulated, for this is a definite indication of quality.

BAKELITE combines properties which make it unique among insulating materials. It has high insulation value and great strength, resists both heat and cold, and is immune to moisture, oil and fumes. Bakelite is unaffected by time and use, and its color and finish are permanent.



Na-ald Dial

Write for Booklet R

★ BAKELITE CORPORATION

247 Park Avenue, New York, N. Y.
Chicago Office: 636 West 22d Street

Rathbun Condenser

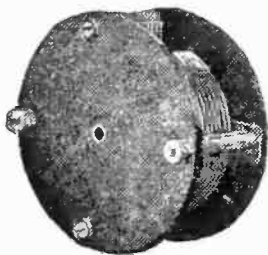

Na-ald Tube Socket

R. C. A. Tube Base

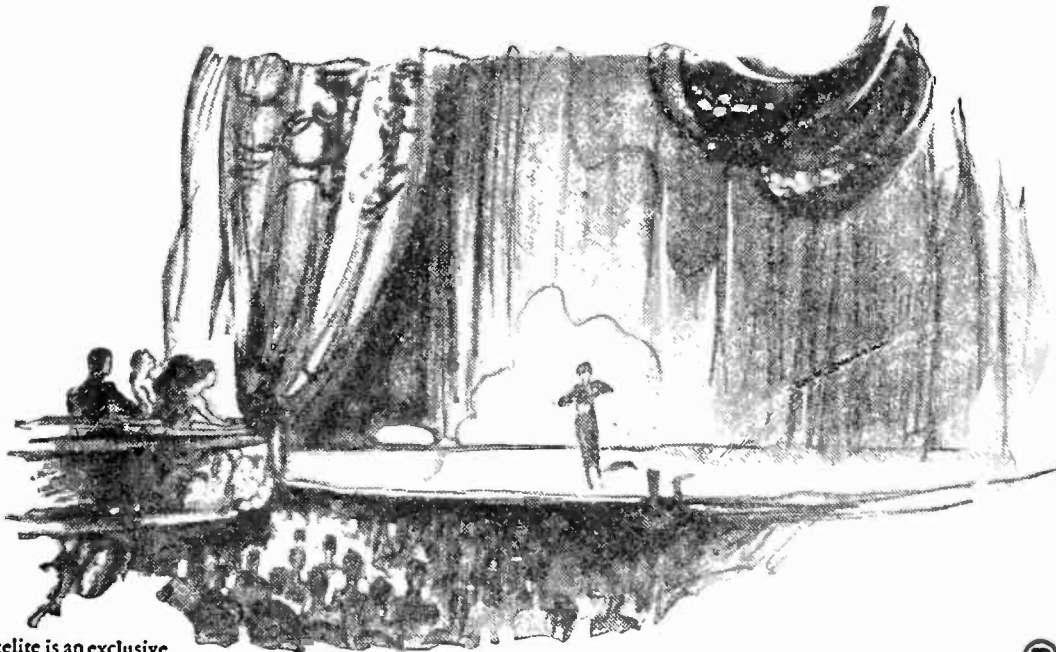

Bakelite is an exclusive trade mark and can be used only on products made from materials manufactured by the Bakelite Corporation. It is the only material which may bear this famous mark of excellence.

BAKELITE



BAKELITE is the registered trade mark for the phenol resin product manufactured under patents owned by the Bakelite Corporation.

THE MATERIAL OF A THOUSAND USES

3527-B

★ Tested and approved by RADIO BROADCAST ★

Do You Know

- how to construct a radio receiving set scientifically and the exact function of each part?
- how the wave length of radio signals may be measured by the maximum amplitude method?
- the Heterodyne principle of radio reception?
- how to calibrate a receiving set?

The men who thoroughly understand these things are holding good radio positions today as designers, salesmen, engineers and executives. And the field is broadening rapidly.

OPPORTUNITY IN RADIO FOR YOU

Prepare now for a big future—study radio at home in spare time. The Radio Institute of America, the world's oldest radio school, now offers a new, revised Home Study Course that covers every phase of modern radio.

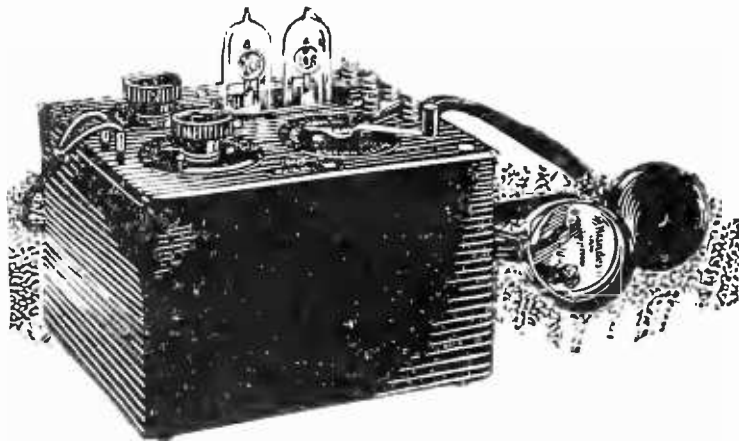

A Radiola III complete with two tubes and headset is only one of the four pieces of highest grade apparatus furnished with this course. Mail coupon today for more information on the opportunities which radio holds for you.

Radio Institute of America

(Formerly Marconi Institute)
Established in 1909

328 Broadway, New York City

CUT HERE

RADIO INSTITUTE OF AMERICA
328 Broadway, New York City

Please send me full information about your Home Study Course of radio instruction.

- I am interested in the complete course including code.
- I am interested in the technical course without code.

Name.....

Address.....

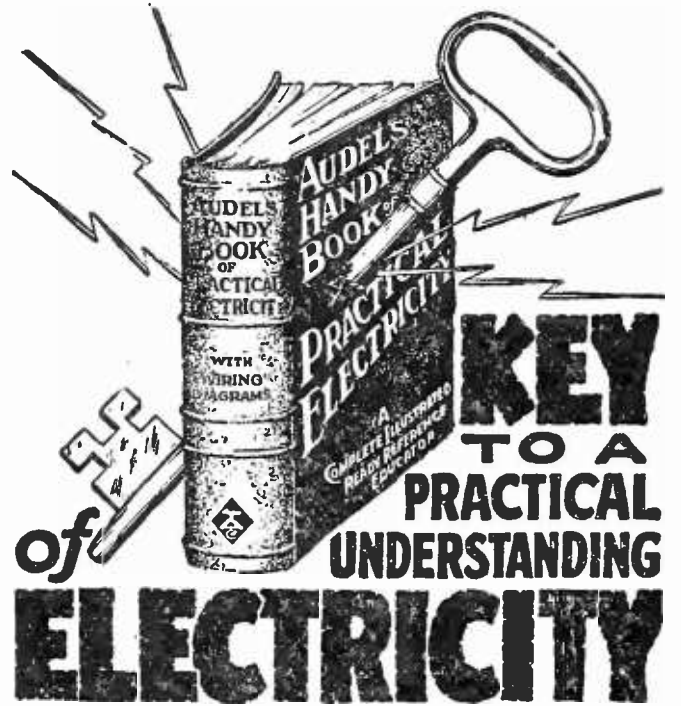

KEY TO A PRACTICAL UNDERSTANDING OF ELECTRICITY
Audel's Handy Book of Electricity, Price \$4.
A quick simplified ready reference, giving complete instruction and inside information. Handy to use. Easy to understand. For Engineers, Professional Electricians, Students and all interested in Electricity. A reliable authority and a handy helper for every electrical worker.

INFORMATION
The 1040 pages and 2600 diagrams give accurate, up-to-date and complete information on—Rules and Laws, RADIO, Storage Batteries, WIRING DIAGRAMS, Power and House Wiring, Automatic Phones, Auto Ignition, Motor Troubles, ARMATURE WINDING, Cable Splicing, Elevators and Cranes, Sign Flashers, Transformers, Practical Management, Modern Applications—READY REFERENCE on every electrical subject. *Pocket Size*, handsomely bound in flexible Red LEATHER. Easy Terms. Shipped for *Free Examination*. No obligation to buy unless satisfied.

FREE EXAMINATION COUPON The Audel Co, 65 W. 23 St, New York
Please send me Audel's Handy Book of Practical Electricity for free examination. If satisfactory, I will send you \$1 in 7 days, then \$1 monthly until \$4 is paid.

Name.....
Address.....
Occupation.....
Employed by..... 3F332



\$3.50
RADIO Storage "B" Battery
Lasts Indefinitely—Pays for Itself

Economy and performance unheard of before. Recharged at a negligible cost. Approved and listed as Standard by leading Radio Authorities, including Pop. Radio Laboratories, Pop. Sci. Inst. Standards, Radio News Lab., Lefax, Inc. and other important institutions. Equipped with Solid Rubber Case, an insurance against acid and leakage. Extra heavy glass jars. Heavy rugged plates. Order yours today!

SEND NO MONEY Just state number of batteries wanted and we will ship day order is received. **Extra Offer:** 4 batteries in series (96 volts), \$13. Pay expressman after examining batteries. 5 per cent discount for cash with order. Mail your order now!

WORLD BATTERY COMPANY
1219 So. Wabash Ave., Dept. 78, Chicago, Ill.
Makers of the Famous World Radio "A" Storage Battery
Prices: 6-volt, 100 Amp. \$12.50; 120 Amp. \$14.50; 140 Amp. \$16.00.
All equipped with Solid Rubber Base.

World FOR RADIO STORAGE BATTERIES



KDKA WEAF WGN WJS KHJ KGO KFAF WJY KOP

THESE BLUEPRINTS AND 16-PAGE INSTRUCTION BOOKLET

Help You to Make
the Receiver of
the Year

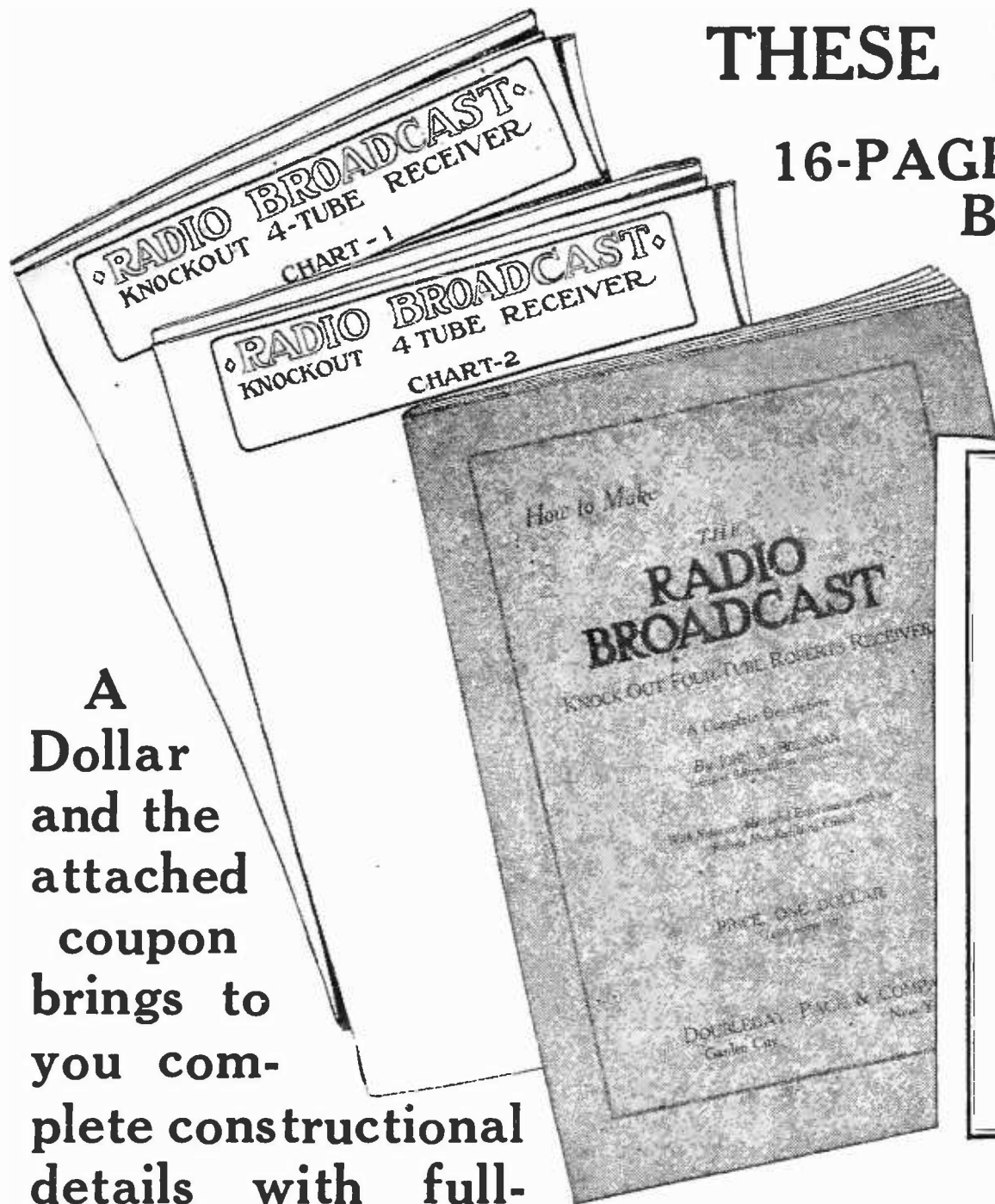

A Dollar and the attached coupon brings to you complete constructional details with full-sized blueprints for building this cracker-jack receiver.

What the set has done

During Radio Broadcast's International Tests the following stations were tuned-in with sufficient volume for a loud speaker, using the Radio Broadcast Knock-out Four-Tube Receiver.

- PTT—Madrid, Spain
- 2BD—Aberdeen, Scotland
- 5NO—Newcastle England
- 2EH—Edinburgh, Scotland
- 2LO—London, England
- 5IT—Birmingham, England

- ☐ It compares very favorably with any good super-heterodyne.
- ☐ RADIO BROADCAST'S pattern blueprints and sixteen-page instruction booklet make it easy for you to construct this receiver.
- ☐ This circuit combines tuned radio-frequency amplification, push-pull audio-frequency amplification, neutralization, reflexing, regeneration, ease of tuning, super-selectivity, and distortionless loud speaker volume.

DEALERS! We have a most attractive proposition for you. Will you let us aid you in selling stock parts for this Receiver? Make sales that stay sold.

Doubleday, Page & Co.
Garden City, New York

Enclosed find my dollar for the Blue Prints and sixteen-page Instruction Book for building RADIO BROADCAST'S Four-Tube Knock-out. It is understood that my dollar will be returned if the material sent me does not come up to my expectations.

Name.....

Address.....

RB—M

"MODERN RADIO RECEPTION"

A New Book

By
Charles R. Leutz

325 PAGES
200 ILLUSTRATIONS
FULLY BOUND

Partial List of Contents:

Radiola Super-Heterodyne Diagram

Western Electric 4B Receiver

Model C Super-Heterodyne

Model C7 Super-Heterodyne

Long Distance Reception

Short Wave Reception

Long Wave Receivers

Pliodynes and Super-Pliodynes

Laboratory Equipment

Broadcast Transmitters

High Efficiency Amateur Transmitters

Model L Super-Heterodyne
and

Everything of importance relating to Broadcast Reception

This supersedes Mr. Leutz's earlier book entitled "Super-Heterodyne Receivers"

Price **\$3.00** Postpaid

EXPERIMENTERS INFORMATION
SERVICE, Inc.

476 Broadway New York City

FREE Booklet and "Hook-ups"

Write
Today

See
Below

Price

90 Cents

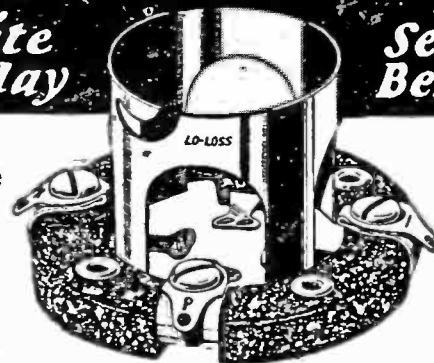

Premier

"LO LOSS" TUBE SOCKET

Checks Current Losses

What is it that saps current strength? Insulation leakage, poor contact and mutual capacity between parts. The Premier LO LOSS Tube Socket is specially designed to stop such losses. The bakelite cross section is thin to prevent phase angle losses between terminals. All metallic parts are arranged for minimum capacity. Positive contact is insured by cam action lock and self cleaning action of contact spring on tube prong. One-piece contact springs have twice ordinary deflection range. Skeleton barrel permits inspection of contacts at all times. Price 90 cents.

Send for Bulletin No. 94

showing complete line of Premier Quality Radio parts. Ask your dealer for Premier free hook-ups. If he cannot supply them, write us, mentioning his name.

PREMIER ELECTRIC COMPANY

3812 Ravenswood Avenue

Chicago, Ill.

PREMIER

Quality Radio Parts

— THE LAMBSKIN LIBRARY —

95 cents per volume

Doubleday, Page & Co.

Garden City, New York

New Long Distance Crystal Gives Remarkable Results

A recent invention in crystals is amazing Reflex and Crystal Set owners everywhere. It is stated that this marvelous Crystal Detector gets distant stations loud and clear and there is no disagreeable "hunting" for spots because the entire surface is sensitive. Many are finding it far superior for Reflex work and claim it the last word in mounted synthetic crystals.

A Trial Costs You Nothing

In order to introduce his invention, the owner, Mr. Hick, offers you two \$1.00 Crystal Detectors for the price of one. Sell one and put the other on your own set without cost to you. Just send name and address to Chas. M. Hick, Dept. 8, 1018 So. Wabash Ave., Chicago. Pay Postman \$1.00 (plus postage). Unless you are absolutely satisfied write Mr. Hick, and money will be cheerfully refunded.

A WONDERFUL RADIO ACHIEVEMENT!

The First All-Glass Socket

Countless tests have proven glass to be the most effective insulation available to radio. After exhaustive research, our engineers have developed a new-idea Socket made entirely of VIRALON—a special glass processed for 100% electrical efficiency.

VIRALON Glass is absolutely heat and moisture proof, and unaffected by those influences that commonly make rubber, rubber derivatives, porcelain and vitreous products so inefficient.

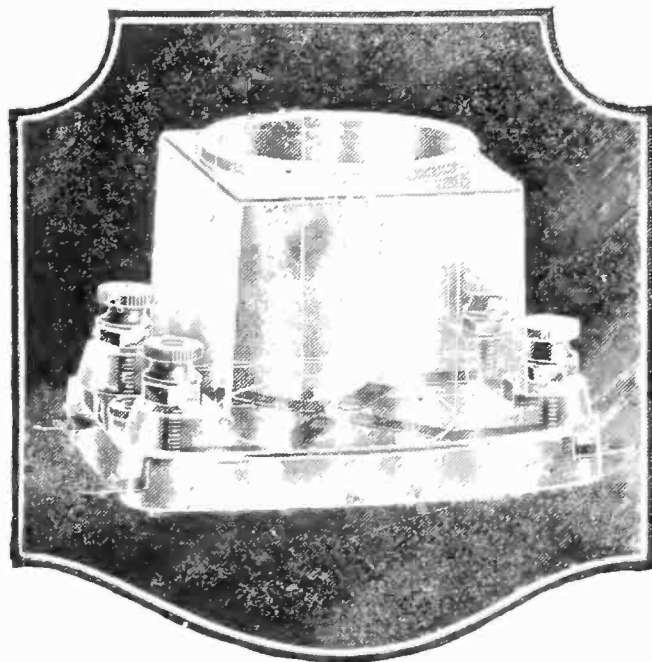

Duray All-Glass Sockets eliminate most of the so-called "tube noises"—cut down power losses—prevent short circuits—and eliminate radio frequency leakage.

DURAY RADIO CORPORATION

Dept. 12, 263 Washington Ave.

Newark, N. J.

DURAY
ALL-GLASS
VIRALON
SOCKET

You'll like all the exclusive Duray features—the all-glass construction—the one-piece contact strips—the knurled contact spots (corrosion proof)—the handy soldering terminals.

Price \$1.25 (standard size.)
Packed in attractive carton.

Until all dealers have been stocked, you can be supplied direct from the factory at the retail price, plus 10c for packing and postage.

GENUINE!

2 and 4-TUBE KITS

FOR THE ROBERTS

"KNOCK-OUT" SET

You can now obtain the same parts and panel layout used by Mr. Roberts from the Laboratory in which the first commercial Roberts set was constructed.

A NEW SYSTEM of wiring makes this kit simplicity itself to build; **ALL BINDING POSTS ARE MARKED WITH COLORED TAGS,—**You merely connect all tags of the same color. Blue prints are packed with each set.

THIS KIT COMES TO YOU MOUNTED IN A BEAUTIFUL MAHOGANY FINISHED CABINET. ALL NECESSARY TOOLS, INCLUDING ELECTRIC SOLDERING IRON, PACKED WITH KIT.

2-Tube Kit, \$55.00

4-Tube Kit, \$75.00

Kits shipped C. O. D.

MAIL OR WIRE DEPT. C-S

NASSAU RADIO CORP.

80 NASSAU STREET
PRINCETON, NEW JERSEY

BROWNLIE

VERNIER

DETECTOR

PATENT PENDING

FOR REFLEX OR CRYSTAL SETS

Best Reflex Crystal Detector

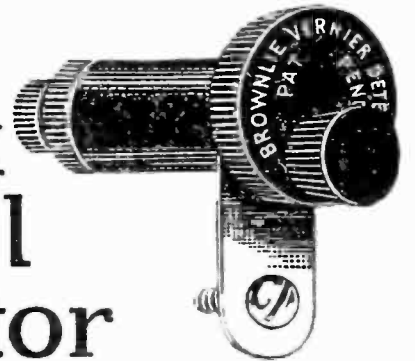

Says the **Acme Apparatus Co.**

No longer does the whisker scratch the crystal, or is the sensitiveness killed by heavy spring pressure—the Vernier Regulator takes care of that. It will surprise you to know how sensitive Crystal Detectors are when correctly made.

For Panel or Base Mounting **\$2.00**
including Crystal. Guaranteed

At your dealers, otherwise send purchase price and you will be supplied postpaid.

ROLAND BROWNLIE & COMPANY
20-24 Saunders Street Medford, Mass.

The Quiet NILES

Battery Charger

DELIVERS 72% OF CURRENT

The quiet Niles does a thorough job of charging—quickly and cheaply. Charging rate (8 to 10 amp.) automatically controlled. No bulbs to break or burn out. No liquids. No fumes. Crystallized black enamel finish. Model A for 6-volt batteries, \$19.00; Model AB for 6-volt and 24-volt batteries \$21.00. Add \$1 west of Rockies.

Write for Literature

NILES MANUFACTURING CO.
Dept. 83 Ypsilanti, Mich.

McCormack~More Clearly

on the

FRESHMAN MASTERPIECE

WHEREVER you are in this country you can easily tune in John McCormack, Bori, Alda and the host of other Metropolitan Opera artists, now broadcasting every other Thursday evening, from W E A F and other stations.

The Freshman Masterpiece assures true to life reproduction with real loud speaker volume. Brings out every single note distinctly, with matchless tonal qualities.

The easiest of all sets to operate.

A five tube tuned radio frequency receiver made of the finest low loss materials and in a beautiful genuine solid mahogany cabinet, that is attractive enough for the most pretentious room, and at sixty dollars, economical enough for the most modest. Combining all points essential to the perfect receiver, it is the greatest value ever offered in a radio receiving set.

Chas. Freshman Co. Inc.
Radio Receivers and Parts
FRESHMAN BUILDING
240-248 WEST 40TH ST.-NEW YORK, N.Y.



These artists broadcasting through courtesy of Victor Talking Machine Co.

★ Every genuine Freshman Masterpiece has the serial number and trade mark riveted on the sub-panel. Sets are not guaranteed if number has been removed or tampered with. Beware of imitations. Insist upon the genuine.

★ Tested and approved by RADIO BROADCAST ★

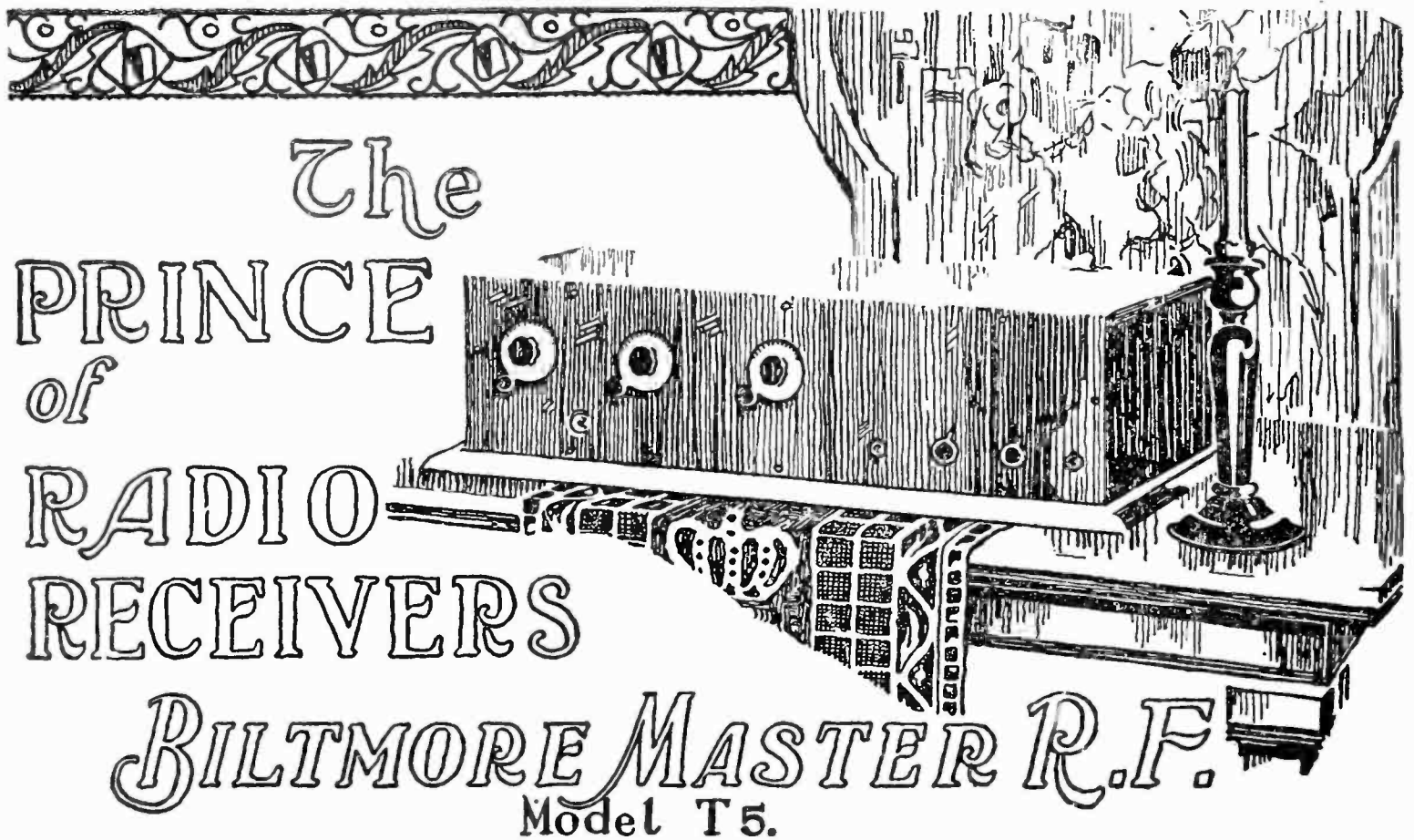

The
PRINCE
of
RADIO
RECEIVERS

BILTMORE MASTER R.F.
Model T 5.

A \$150.00 Receiver Selling For Only \$68.00

Here is as fine a five-tube receiver as was ever made. Fine in appearance, workmanship, materials and results. The circuit is the Biltmore improved Radio frequency type. All materials are the finest which it is possible to obtain. The variable condensers and R. F. Transformers are low loss especially designed.

The cabinet is heavy mahogany hand rubbed; The panel is mahogany and all metal parts are highly nickel plated.

The results match the appearance of the receiver. Its extreme sensitiveness, matchless selectivity and perfect tone have made for the Biltmore a host of highly enthusiastic owners. "Absolutely the best Receiver which can be had at any price" is an example of the hundreds of testimonial letters in our files.

Model T 5. Price, \$68.00

For Sale by all the better Radio Dealers. Write for descriptive literature, Department A.

The Biltmore Radio Company.
BOSTON 30 MASS.

**Keep your Radio set
Clean!**

You must have a NODUST to keep your set working its best! Each stroke of a NODUST forces a blast of compressed air into all the hard-to-get-at places and cleans out every speck of dust and dirt in a jiffy.



If your dealer has not received his NODUSTS yet, we will send you one on receipt of \$1.00. Satisfaction guaranteed.

PEIFFER & CO.
86 Liberty Street
Newark, N. J.

**AMBASSADOR
Low Loss Products**

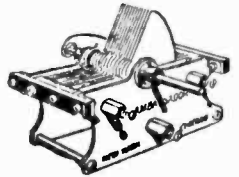

**Master Tuning Coil
Perfectly Balanced Head Phone
Low Loss Condenser**

High grade, standard radio products that will increase the efficiency of any set and add to the satisfaction of the user. Ambassador Low Loss Products have long been the choice of particular fans. See them—compare them, and you will choose them too.

At all good dealers. Write for FREE diagrams of circuits in which Ambassador products can be used.

AMBASSADOR SALES COMPANY
108 Greenwich St., New York
326 W. Madison St., Chicago





The Amber MARV-O-DYNE

The Spring Model Is Here!

MARV-O-DYNE—the set with the Filameter—has been improved. Many refinements have been added. The new spring model surpasses in performance even the records made by the original MARV-O-DYNE.

The Filameter, that exclusive device that saves both tubes and batteries, has been retained with its Weston meter. Haig and Haig Straightline condensers have been added, making tuning easier than ever. Coto-Coil's famous transformers are now used. And a Cutler-Hammer Lock Switch insures the set against tampering.

This MARV-O-DYNE Tuned Radio Frequency five tube receiver is exceptionally handsome and efficient. It is built into a genuine solid mahogany cabinet, by the way. Go to your dealer and have him show you a MARV-O-DYNE to-day!

Write for descriptive folder

Manufactured by

Amber Manufacturing Corp.

115 W. Broadway

New York, N. Y.

Don't fail to see the MARV-O-DYNE exhibit at the Amateur Radio Show. Pennsylvania Hotel, New York City. Week of March 2-7. Booth 36

Adapto

RADIO CABINET BY DONEHUE

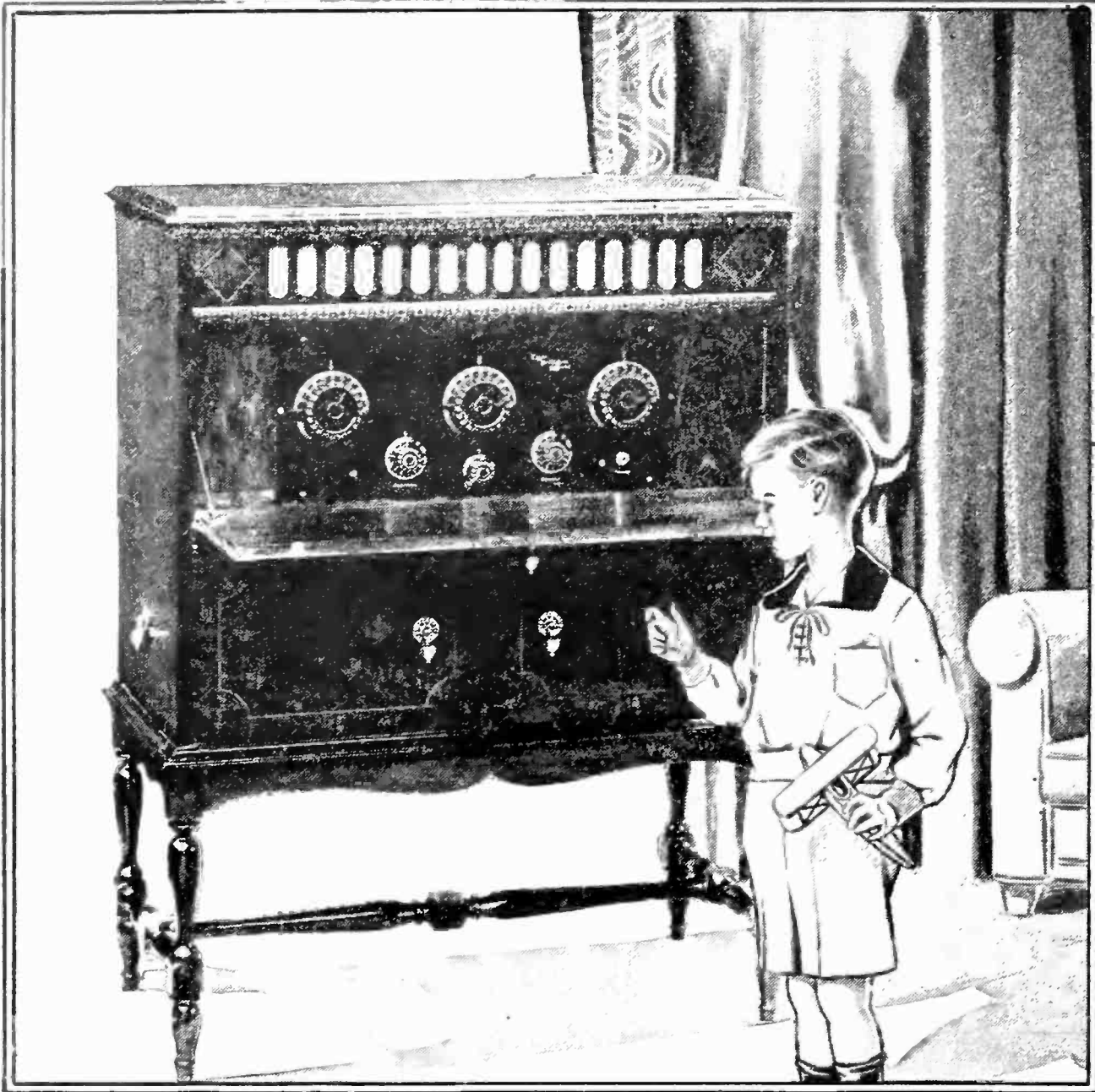

For Radio Beauty and Safety

TO-DAY'S Fashion says "Radio Console." And the most select environment bids gracious welcome to a distinctively paneled mahogany or walnut ADAPTO Radio Cabinet.

Encloses every radio accessory—*safely out of sight*, yet easily accessible when desired. A drawer on the side accommodates your battery, charger, distilled water and hydrometer. Batteries easy to inspect, easy to recharge. Simply throw a built-in switch which puts your charger in operation. Insert your own set—*adapt* it with the adapter frames. Horn inbuilt at top, needing only loud speaker unit. But read about it in detail.

Send — to-day — for circular.

★ L. R. DONEHUE COMPANY
Kant Building Perth Amboy, N. J.

★ Tested and approved by RADIO BROADCAST ★

INSULINE

**Frieze
Finish**



INSULINE PANELS and PARTS *Unanimously Elected!*

The way radio experts, fans and set manufacturers are turning to Insuline panels and parts proves that the long search for a dependable and perfect insulating material is at an end.

Insuline panels and parts have been subjected to the most rigid laboratory tests and have not been found wanting in a single quality necessary for perfect radio reception. Insuline is impervious to changing weather conditions, it does not chip or crack, does not soften or buckle, is thoroughly moisture proof and possesses great dielectric strength.

Insuline comes in three beautiful finishes—*black, black anti-capacity, mahogany* and the new frieze finish shown above.

Insuline panels may be obtained in ten standard sizes, in special sizes and drilled and engraved for nine well known circuits.

For panels, dials, tubing, sockets, and mounting strips, insist that your dealer gives you INSULINE.

RADIO PANEL and PARTS CORP.

(INSULATING COMPANY OF AMERICA)



Insuline Building, 59 Warren Street, New York City

Western Division
Insulating Co. of America
Madison, Wisconsin
538 So. Dearborn Street,
Chicago, Ill.



Sales Representative
F. A. Krue, Jr.
333 State Street,
Detroit, Michigan

Manufacturers, Jobbers and Dealers Write Our Nearest Branch for Booklet and Prices

★ Tested and approved by RADIO BROADCAST ★

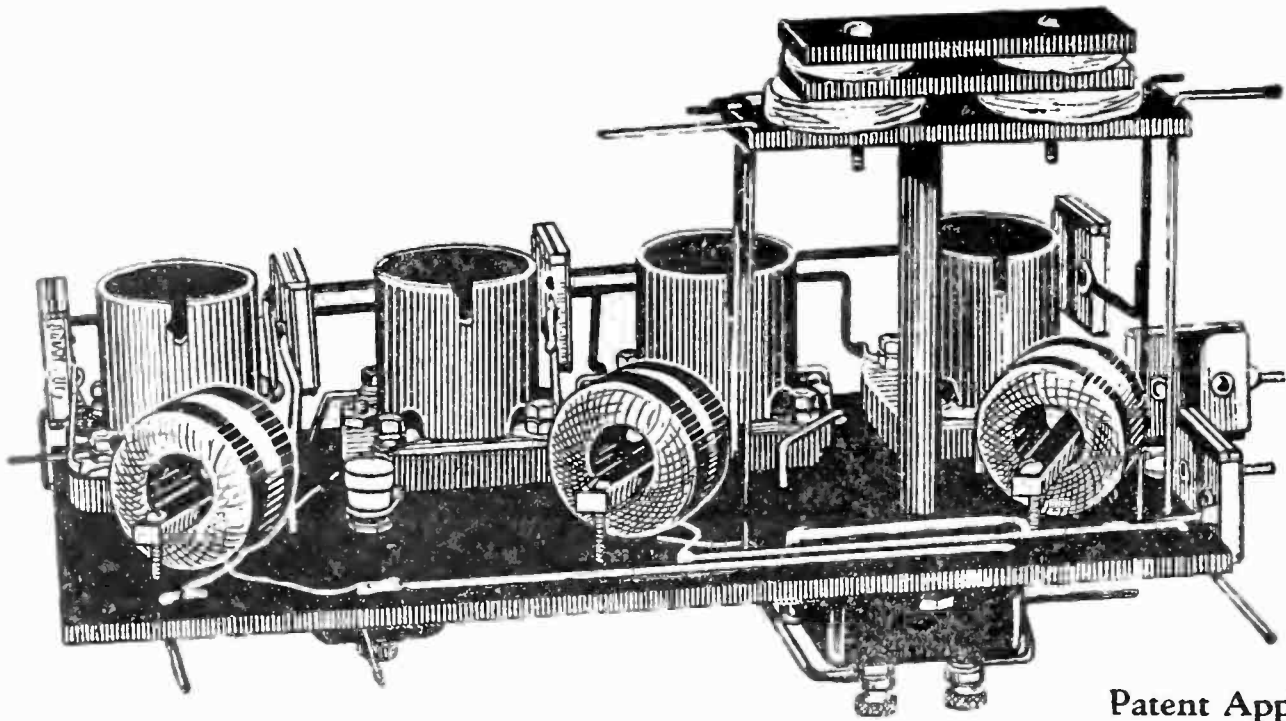

Patent Applied for

THE SUPERUNIT—

IT LOOKS EASY AND IT IS!

“Enclosed find check for the SUPERUNIT; also want to take this time to tell you what we think of your super. The writer has built about every set from a single to an eleven tube super and your circuit is the first I have that I really wanted for my own use, and believe me it is causing me to lose just too much sleep.

“Have orders for the three units that are on order at this time but would like to know about shipments on more. How soon can we have three more? Have sure got your set started here.”

(Name on request)

A complete assembly that needs only tuning condensers, rheostats, and audio frequency to build a six tube Superheterodyne that will surprise and delight its owner.

Each unit tested before it leaves the works and guaranteed to perform to your entire satisfaction.

Shipped anywhere for \$37.50. (Charges collect.)



ALLAN T. HANSCOM

WOONSOCKET, RHODE ISLAND, U. S. A.

★ Tested and approved by RADIO BROADCAST ★

WANTED

at \$3,000 to \$10,000 a year



Yes—\$3,000 to \$10,000 a year! These are the opportunities that exist everywhere today for big easy money in Radio. Radio is the fastest growing industry in the world. If you are in a routine job with poor pay and no future, here's the chance of a lifetime. Investigate! Look into the amazing money-making possibilities of Radio. In a few short months of training at home by mail, we can make you an expert representative of our Association. Learn to install, repair, build and sell high-

grade radio sets. Become the Radio expert of your neighborhood. Find out how the Radio Association of America now makes all this easy for you. Radio offers not only big-salary jobs, but is a business you can easily get into for yourself.

Become a Radio Expert

Train at Home in Three Months Get your share of the big money being made in Radio.

Mail the coupon for free information. Find out how in your spare time at home, without giving up your present position or losing a dollar of pay, you can become a Radio Expert in a few short months. No previous experience is necessary. For the man who prefers a salary, big-pay jobs are waiting with the U. S. Government, Steamships, Railroads, and thousands of corporations and business houses. For the man who wants to get into business for himself and be independent, Radio offers unlimited possibilities—either on a spare or full time basis. In no other line can ambitious men find the opportunities that Radio now offers. You can train under one of America's leading Radio authorities. Read Mr. A. G. Mohaupt's offer to train you personally in everything about Radio—construction, installation, repairing and selling. By enrolling with us now you get the benefit of the direct personal guidance of this well-known expert.



A. G. MOHAUPT, B. A., M. S.

Head of the Radio Association of America, Graduate Electrical Engineer, University of Wisconsin. Former Radio Instructor for U. S. Government. Author of "Practice and Theory of Modern Radio."

"I give my personal attention to every student taking my course. Your individual problems and questions are answered by myself. I work with you at every stage of the course, guiding you, directing you to your goal to be a Radio Engineer in the big-pay class. My course prepares you to successfully pass Gov't examination for Operator's License."

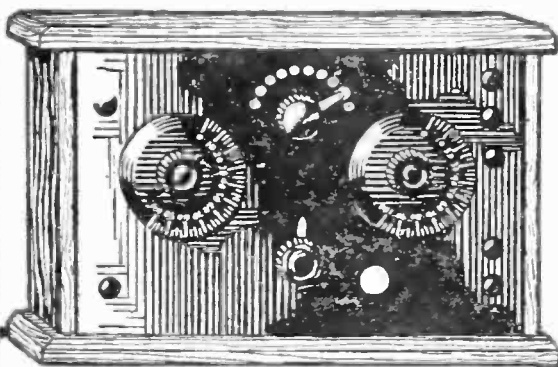

FREE—1000 MILE RADIO OUTFIT

This set when completed has a range of over 1000 miles. Right now we give it free to each member taking our course of training. Mr. Mohaupt's clear, simple instructions will show you how to build similar sets to sell at a big profit. When you have finished the course, you can sell this free set at a price that will practically pay the cost of your training.

Get The Facts—Mail Coupon

Radio knowledge is not only interesting and the means to the greatest form of entertainment the world has ever known, but is the most cashable knowledge a man can possess. Let us prove to you that there is nothing difficult about Radio—that any intelligent person can easily learn it right at home by mail under our simplified and approved methods. Mail the coupon now for all the facts. Let us prove that Radio is easier to learn and offers bigger money than any other business or profession you can get into. Don't wait—act while our Free Offer of a 1000 mile radio outfit is still in effect.

A. G. MOHAUPT, Radio Engineer
RADIO ASSOCIATION OF AMERICA
 4513 Ravenswood Avenue Chicago, Ill.

RADIO ASSOCIATION OF AMERICA
 4513 Ravenswood Avenue
 Dept. B-3 Chicago, Ill.

Please send me details regarding your Expert Home Training Plan and offer to representatives, also your offer of a 1000 mile Radio Set FREE.

Name.....

Address.....

City.....State.....

Why it is Better

Look at this illustration—see for yourself the eleven distinctive features in the construction of the Federal Condenser. Every feature is a distinct point of superiority—essential to clear, sharp tuning and clear reception.

You can get the outstanding advantages of Federal Tone and Federal Selectivity in your pet hook-up *only* by *insisting* on Federal Parts.

There are over 130 Federal Standard Radio Parts bearing the Federal iron-clad performance guarantee. Use them—for your own protection and enjoyment.

Federal Telephone and Manufacturing Corp.

Buffalo, N. Y.

Boston New York Philadelphia Pittsburgh
Chicago San Francisco Bridgeburg, Canada



Federal

Standard RADIO Products

Original three point suspension assuring perfect alignment which prevents buckling or short circuiting of plates and affords 7-16 inches air dielectric between condenser head and panel. Template furnished with each condenser.

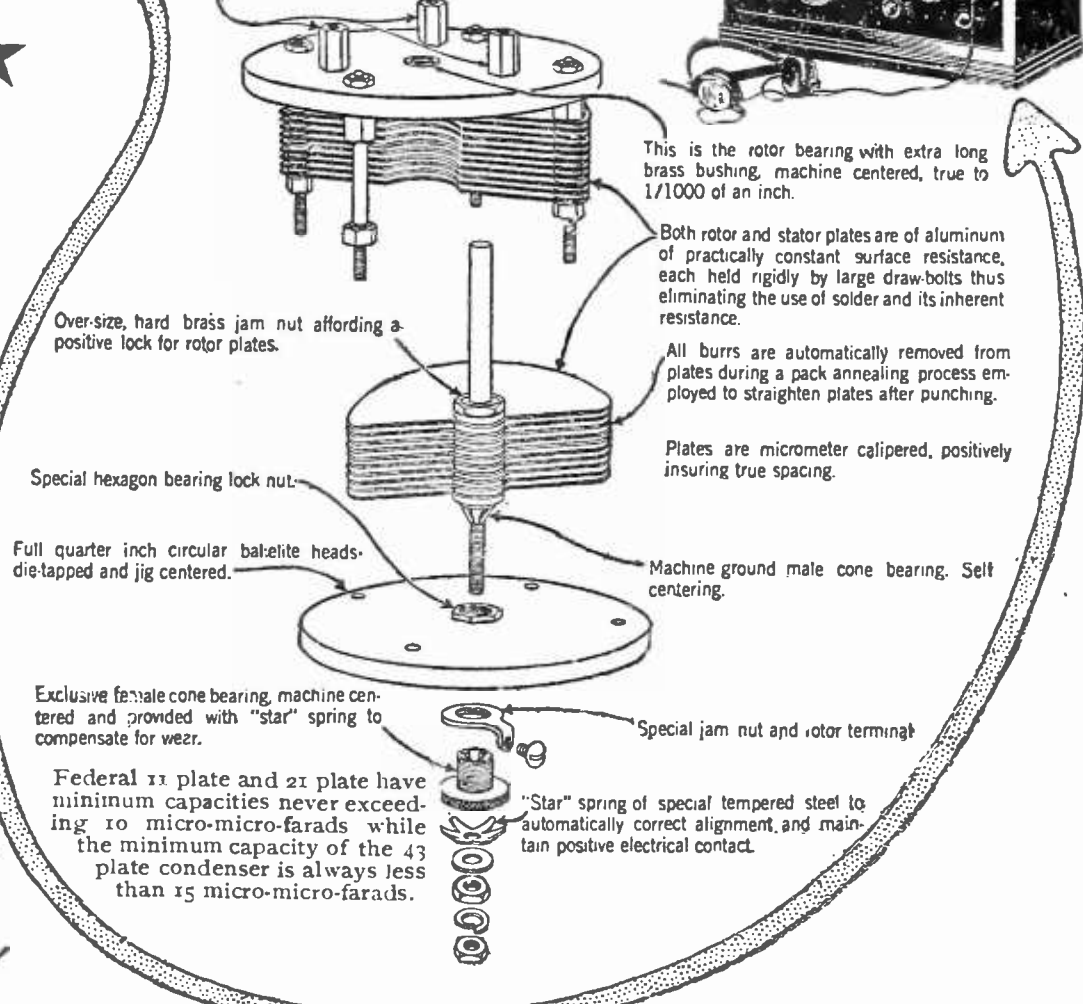
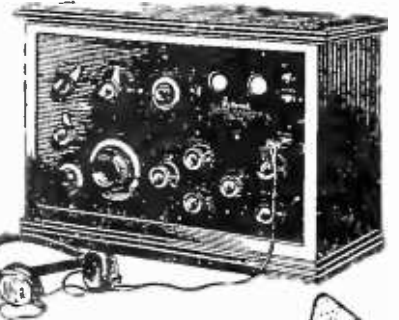

This is the rotor bearing with extra long brass bushing, machine centered, true to 1/1000 of an inch.

Both rotor and stator plates are of aluminum of practically constant surface resistance, each held rigidly by large draw-bolts thus eliminating the use of solder and its inherent resistance.

All burrs are automatically removed from plates during a pack annealing process employed to straighten plates after punching.

Plates are micrometer calipered, positively insuring true spacing.

Over-size, hard brass jam nut affording a positive lock for rotor plates.

Special hexagon bearing lock nut.

Full quarter inch circular bakelite heads—die-tapped and jig centered.

Machine ground male cone bearing. Self centering.

Exclusive female cone bearing, machine centered and provided with "star" spring to compensate for wear.

Special jam nut and rotor terminal

Federal 11 plate and 21 plate have minimum capacities never exceeding 10 micro-micro-farads while the minimum capacity of the 43 plate condenser is always less than 15 micro-micro-farads.

"Star" spring of special tempered steel to automatically correct alignment, and maintain positive electrical contact.

For Push-Pull Take No Chances! Use "Como Duplex"

The World's standard for Push-Pull amplification. Como Duplex Transformers are being specified continually by practically all leading Radio Editors and Authors of Radio subjects. This is because they know that the user will get results. Why not take their advice?

The new form of assembly takes up less room in your set.

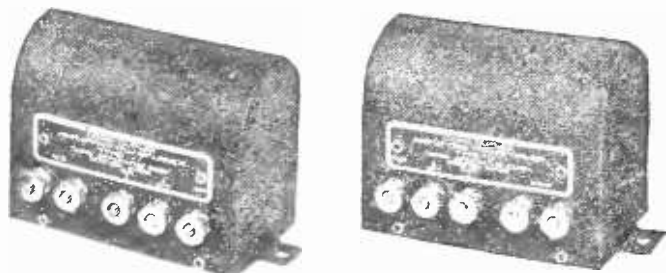

Price \$12.50 per pair

COMO APPARATUS CORPORATION
Manchester New Hampshire

DeForest License



Honeycomb Coils

Back and Front Panel Mountings Plain or Geared—Genuine Bakelite

The Universal all-wave inductance—accepted as standard in regard to superior construction and electrical units of measurement. Ask your "Old Timer" radio friend why sets using honeycomb coils are better; they give closer tuning, greater selectivity and range. No dead end losses, easy to operate 16 sizes, mounted and unmounted. Interchangeable with all mountings. Be sure the set you buy or build has them

Send 25c for Super Heterodyne, Radio Frequency and Honeycomb coil Circuits and Complete Catalogue. ★

Chas. A. Branston, Inc., Dept. 7, 815 Main St., Buffalo, N.Y.
In Canada—Chas. A. Branston, Ltd., Toronto



Send for Our Complete Radio Instrument Catalogue No. 15-A

ILLUSTRATING OUR

- No. 95 Radio Test Set
- No. 90 Wave Meter
- No. 20 Grid Leak Tester
- No. 55 Multiple Range Meters
- No. 84 "B" Battery Voltmeter
- No. 57 "A" and "B" Battery Voltmeter
- Transmitting Set Instruments
- Receiving Set Instruments
- Lightning Arrester

Order from Dealer

Jewell Electrical Instrument Co.
1650 Walnut St. - Chicago

Not Merely a Clear Receiver, but a Fine Musical Instrument

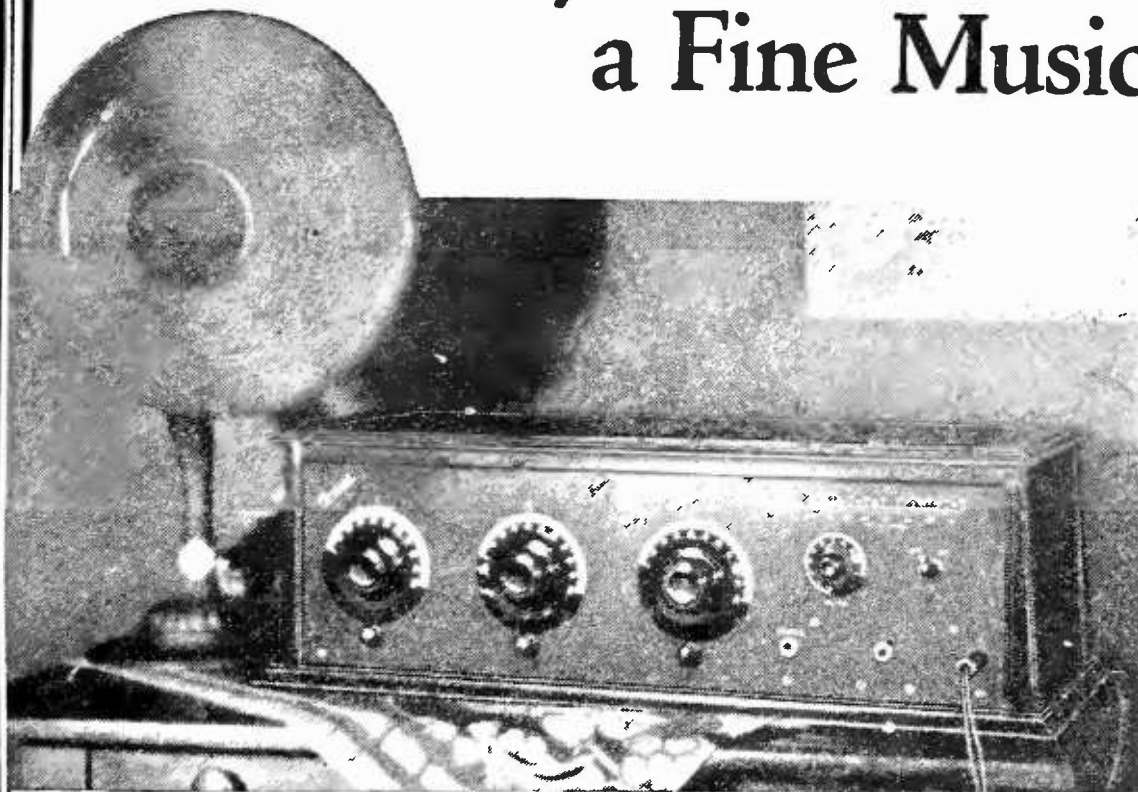

*Brings out the
Overtones—
the Rich Timbre
of both Music and
the Human Voice*

Radio is becoming as much of a household convenience as the telephone. It should be just as dependable and true. Quality of tone is the supreme test. Distance can always be obtained by sufficient amplification. The problem is to secure distance without distorting or blurring the tone.

For years radio engineers have realized this. While the public was going wild over reaching out for distance, they were quietly exhausting every resource in experimentation to overcome the internal noises which increased with every new stage of amplification. The same steps which amplified the tone also amplified the stray oscillations within the set itself, as a by-product.

Nobody knew how to prevent them. Various means were employed to choke them or neutralize them. Potentiometers, extra condensers, complicated wiring were employed with only partial success. They work only when perfectly adjusted, and their operation interferes with a perfectly pure, free, flexible tone. By absorbing the true signal as well as the stray energy, they lose or blur those delicate overtones which make real music. They cannot prevent the conflict which occurs in the circuit between the forward stream of radio energy and the feedback of stray energy, blotting out the overtones

The real trouble was this: No structurally correct long-distance radio system had been designed. All de-

signs up to date generated feedback of stray energy which chattered, howled and squealed unless choked down or neutralized; and radio reception, while accomplishing wonders, was still a makeshift.

A New Capability in Radio: Overtones Perfectly Reproduced

Pfanstiehl's big contribution to radio lies in his discovery of the real causes of oscillations and his complete elimination of them by a circuit system which **KEEPS THEM OUT**. No choking or neutralizing elements are any longer needed. No adjusting is required. The receiver is always at its best. Tuning and operation are absolutely quiet. The tone or voice comes in sweetly, in all of its natural richness. All of the overtones are perfectly reproduced, exactly as transmitted. This is true of long distance. High amplification doesn't distort. His invention has turned radio from a stunt device, for fans to play with, to a dependable, enjoyable and trouble-proof instrument in the home—the thing it should be and was destined to become.

See the new Pfanstiehl at your radio or music dealer's. If he does not have one to show you, we can quickly get it to him.

Dealers. Write for the Pfanstiehl proposition

PFANSTIEHL RADIO COMPANY

Dept. B

11 So. La Salle St.

Chicago, Ill.

Pfanstiehl



OVERTONE RECEIVER

A 5-tube Receiver using the new system of tuned radio frequency

★ Tested and approved by RADIO BROADCAST ★



Only
\$12.50

at your
dealer's

!

It's a
quality
loop! . .

None better
can be made

Patent
Applied
For . .

FOUR WAY CO. Folding Loop

Wires *always stay taut in any shape* The *only* folding loop that keeps its wires taut whether open or closed. Never gets tangled. Be sure to specify the **FOUR WAY CO. Folding Loop.**

The wonderful new **FOUR WAY CO.**

Loud Speaker Extension Unit

(COMPLETE)

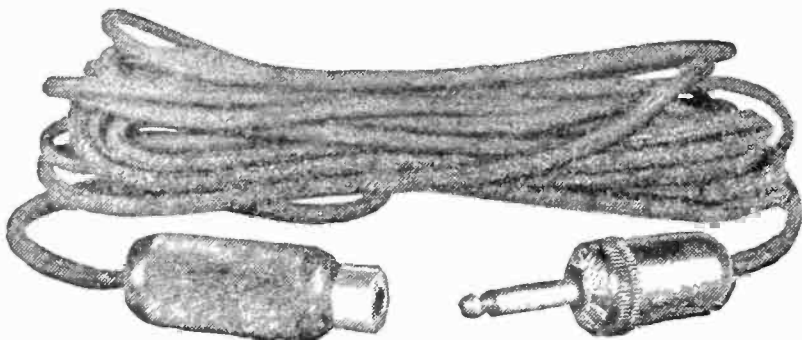

(Patent Applied For)

THIS COMPLETE UNIT enables you to use the loud speaker in other parts of the house without removing the set. Insert plug from loud speaker into jack; place plug on end of cord, into set. This can be done readily without the aid of tools or soldering iron! A wonderful convenience—get yours to-day.

PRICES, including Jack, Plug and Cord

10 foot cord.....	\$2.25	40 foot cord.....	\$3.00
20 foot cord.....	2.50	50 foot cord.....	3.50
30 foot cord.....	2.75	100 foot cord.....	5.75

The JACK sells separately at \$1.00

AT YOUR DEALER'S

Manufactured by

FOUR WAY CO. ★

Myrick Bldg.

Springfield, Mass.

**-the Panel
SUPER Fine**

★

Look for the
*Red
Stripe*

No other material known possesses the many combined advantages for radio paneling as does Dilecto. It has every endorsement of dealer and manufacturer, because it is practically indestructible.

The Continental Fibre Co.
Factory: Newark, Delaware

NEW YORK, Woolworth Bldg.
CHICAGO, Wrigley Building
PITTSBURGH, Farmers Bank Building
SAN FRANCISCO, 75 Fremont St.
LOS ANGELES, 307 S. Hill St.
SEATTLE, 1041 Sixth Ave., So.

Offices and agents throughout
the world

Dilecto

The Andrews ★
Deresnadyne
Radio Receiving Set

combines tone quality and selectivity with distance and volume. Price \$150 without accessories. Write for literature.

ANDREWS RADIO CO.
327 S. LaSalle St., Chicago



**FROST-RADIO
MUSETTE**

"The Stradivarius of
Radio"

Black finish Silver or gold
\$12.50 finishes \$20

For perfect reproduction of all instruments and the human voice *Musette* cannot be excelled. Hear it at your dealers.

HERBERT H. FROST, Inc.
314-24 W. Superior St., Chicago

★ Tested and approved by RADIO BROADCAST ★

Radio Without the Horn!

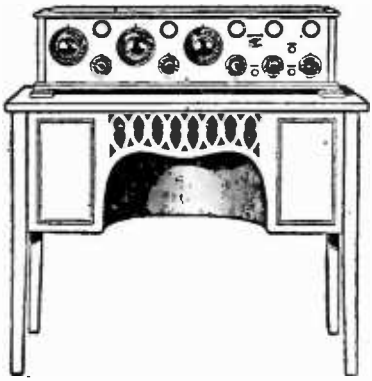

Goodbye to the Old-Fashioned Horn Speaker!

A Vastly Better Reproduction With this New Radio Console!

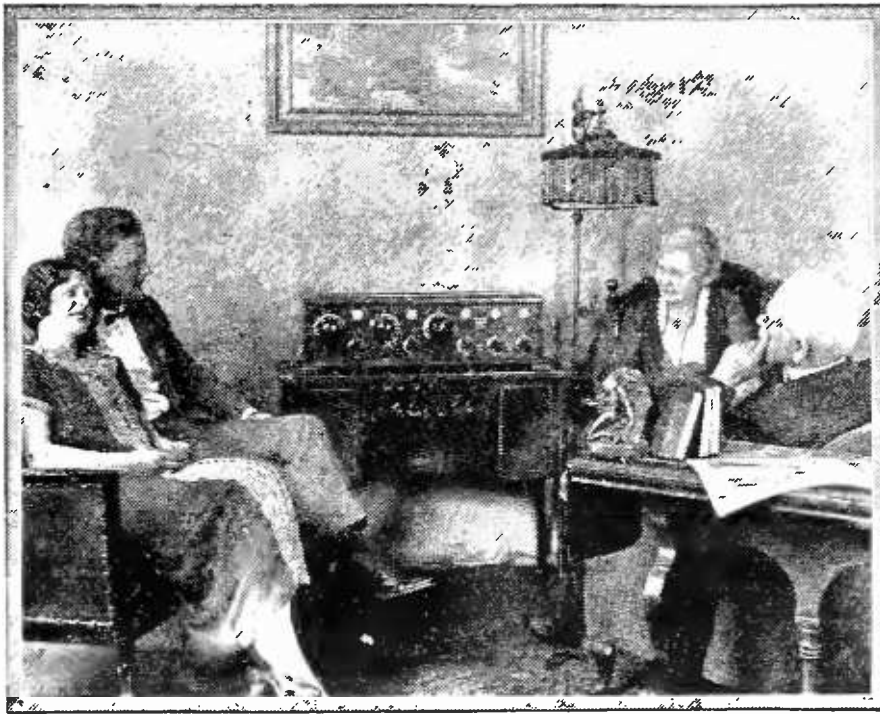

"Our old horn speaker never gave tones like this! An artistic addition to the living room—everything in its place—it's a joy!"

New Console Has Its Own Perfect Loudspeaker!

Ample Space for All the Rest of Your Outfit!

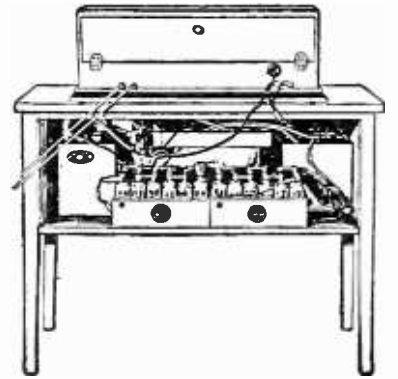

HERE is something that enables you to enjoy radio in the home without the clutter of unsightly apparatus that plays havoc in the decorative scheme of your living room! The horn speaker is out of date and out of place in radio for the home. This console, with its in-built loudspeaker, is scientific and sightly.

A Truly Wonderful Tone

It does a good job of reproducing, for it has a good unit and its sound-box is of resonant wood instead of metal, fibre, or composition.

The appearance of a Windsor loudspeaker console is a delight. Its convenience is a joy. A piece of real living room furniture of pleasing lines and finish—and it accommodates all the miscellany of equipment which hitherto had no place except on table tops, shelves or floor. Ample space on top for any set, with plenty of elbow room in front. Nothing in sight but the console and receiving set. Everything else goes inside—from behind—in spaces cleverly designed to hold the largest batteries and outfit for home use—besides the self-contained loudspeaker—all unseen and protected from dust or disturbance.

You Need This Console Whatever Your Present Outfit Is

It makes no difference what kind of radio outfit you have—this console was designed for your use. The graceful exterior of this console gives no hint of its inner utility, for it is a simple and effective piece of furniture in every line. But a glance at the interior reveals a most ingenious arrangement of the in-built loudspeaker with space either side and in back. These spaces are ample for the largest A battery, and the largest wet B batteries and the largest charging outfit for home use. It is 38 in. long, 18 in. deep, and 29 in. high. Notice the artistic grill that conceals sound-box, and the provision for "knee room" beneath. Made in mahogany or walnut finish, and the price is only \$40.00! (West of the Rockies, \$42.50.)

Dealers!

The sale of these consoles has already reached extraordinary figures. They are selling in surprising quantities in even smallest stores where there is one in the window or on the floor. It is a convenience and a value not to be duplicated.

Write us for discounts and particulars.

INVESTIGATE!

Dealers everywhere are now showing the Windsor loudspeaker console, and have them for immediate delivery to your home. If you haven't already seen this re-

markable contribution to radio enjoyment and convenience, write us now for the name of a nearby store where you may view it. We will also send you complete information. Remember, this console gives you not alone a reproducing unit and sound-box, but an altogether new beauty and utility in the provision for your entire radio outfit. Mail coupon or postal.

If you wish to use your own favorite unit, a deduction will be made for omission of unit.

WINDSOR FURNITURE COMPANY (15)
1422 Carroll Ave., Chicago

Please furnish pictures and full details, also name of nearest dealer who has the new Windsor loudspeaker console.

Name.....

Address.....



★ Tested and approved by RADIO BROADCAST ★

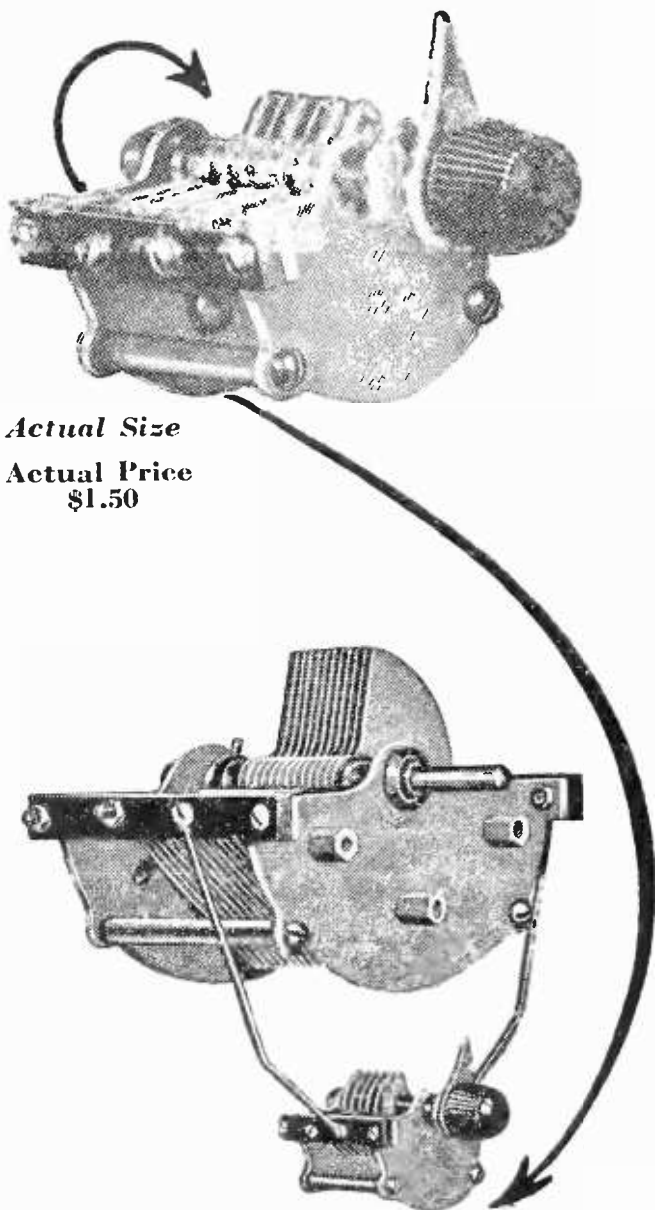

Actual Size
Actual Price
\$1.50

NOW A VERNIER WITHOUT LOSSES!

All existing vernier attachments become obsolete with the arrival of the instrument that has set a new standard for condenser performance.

CONTINENTAL LO LOSS JUNIOR

A radical departure from the inefficient geared, friction, or single-plate type of micrometric control. It is a miniature condenser with exactly the same low losses, rigid construction and precision workmanship of its big brother.

Two Condensers for the Price of One!

The Standard Continental Lo Loss is now sold with the new Junior condenser for exactly the same price you pay for any high-grade Low Loss Condenser. Two condensers for the price of one—and an added efficiency to your set that cannot be reckoned in dollars and cents.

ALL CAPACITIES ARE EXACT

- 13 plate capacity .00025 with Junior . . . \$5.50
- 18 plate capacity .00035 with Junior . . . 5.75
- 25 plate capacity .0005 with Junior . . . 6.00
- 45 plate capacity .001 with Junior . . . 7.00



If your dealer can't supply you, write us

GARDINER & HEPBURN, INC.

Sales Dept., 611 Widener Bldg. Philadelphia, Pa.

Building Better Service into RADIO PARTS

Aside from recognized radio uses in which no other metals can be substituted, COPPER and its alloys help you to make good radio sets *better* sets.

For instance, binding posts are superior posts, and battery nuts give best service and satisfaction when made of dependable free-cutting BRASS rod. *And—*



their speedier production makes labor costs lower.

COPPER & BRASS RESEARCH ASSOCIATION

25 Broadway - - New York

The Famous

BEL-CANTO ★ Loud Speakers NOW at your DEALER

- 10" Bell—22" High . . \$10
- 15" Bell—29" High . . \$15
(Goose Neck)

If your dealer cannot supply you, write us and we will advise where to purchase one.

BEL-CANTO RADIO & TEL. EQUIPMENT CO., Inc.
872 Broadway, New York City Tel., Stuyvesant 1921

HERCULES ★ AERIAL MAST

- 20 Ft. Mast.....\$10
- 40 Ft. Mast..... 25
- 60 Ft. Mast..... 45



All steel construction. Complete with guy wires and masthead pulley. We pay the freight.
S. W. HULL & CO., Dept. F-4
2048 E. 79th St. Cleveland, O.

Write for Literature and FREE Blueprint

RADIO ENCYCLOPEDIA

FREE! Thousands of radio bargains; standard sets, standard parts for sets, vacuum tubes, etc., at one-third less than regular prices, also latest information on all circuits, complete list of broadcasting stations and other valuable data. Send name and address, we'll send you 50c book FREE! **FREE SERVICE DEPARTMENT.** Mr. Decker of N Y Eve World will help you solve your radio problems, and furnish up-to-date information on set construction, operation improvement. This service FREE to our customers. Write today!

NORWALK RADIO CORP.

Dept. 57B 66 READE ST., NEW YORK

★ Tested and approved by RADIO BROADCAST ★

Dear Jim:

Here's something more important than has come out of your loudspeaker for a long, long time.

The leading broadcasting stations use Willards.

When a station broadcasts, voice and music must be amplified many, many times before the program can be put on the air.

The amplifiers used are like the ones in your set — only larger.

Quiet operation of the batteries employed to furnish this amplification is as essential to the broadcasting stations as it is to you.

You see, their requirements for a good sending job are the same as your requirements for a good receiving job.

And believe me, Jim, Willards have what it takes to do it.

Signing off,

Sam.

P. S. I have been looking at the map and there are 178 stations using Willards. That will tell you something, I guess.

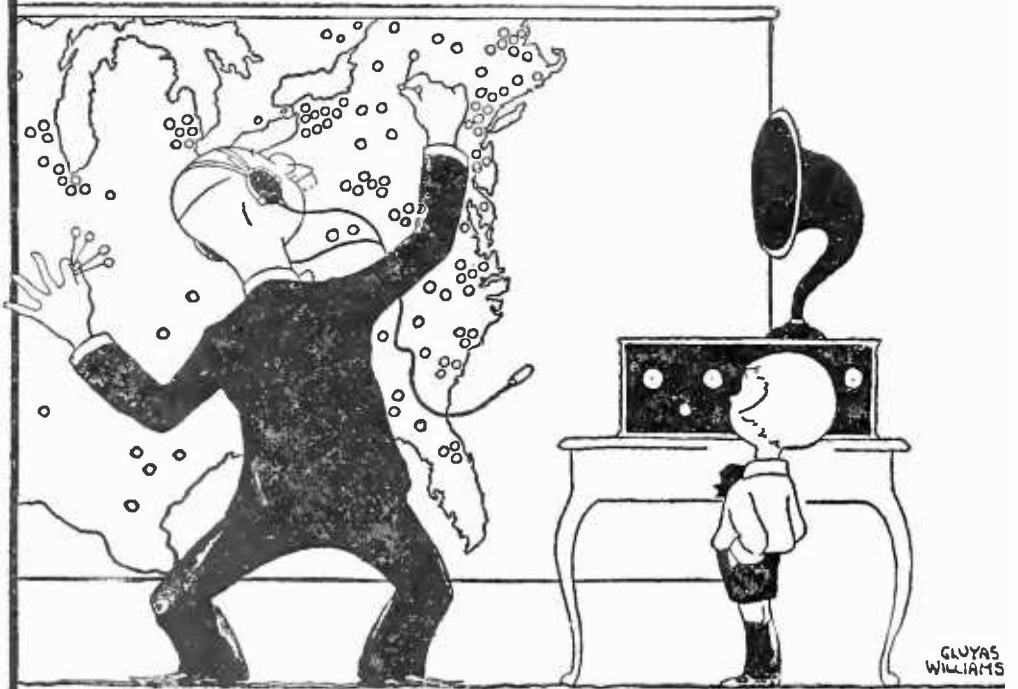

GUYAS WILLIAMS

178 BROADCASTING STATIONS USE WILLARDS

WILLARD RADIO BATTERIES

FOR SALE AT WILLARD SERVICE STATIONS AND RADIO DEALERS

These unusual batteries were developed by WTAM—the broadcasting Station and Radio Research Laboratory of Willard Storage Battery Company, Cleveland, Ohio.



Write to **WTAM** for this booklet
[The Voice of the Storage Battery]

Read how you can get greater distance, and added clearness from your set—how to get the longest life and greatest value from your batteries. It's all in the little booklet. Sent to you with our compliments. Just mail the coupon.



Mail me to WTAM. I'll bring you "Better Results."

.....
Name

.....
City and State

.....
Street Address

R. B. 7

★ Tested and approved by RADIO BROADCAST ★

When
the phone
rings

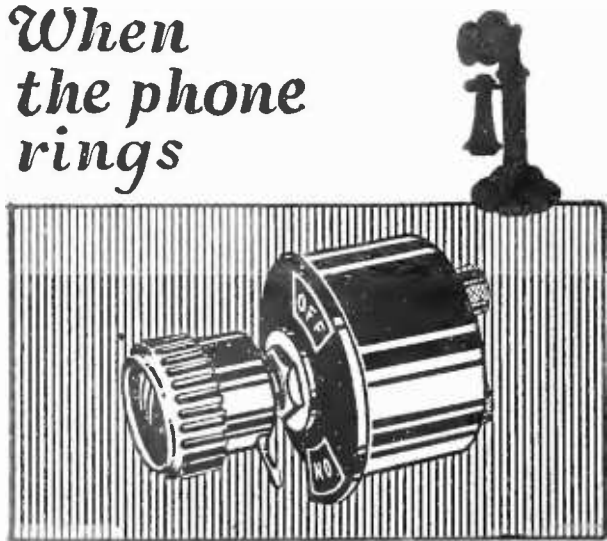

Snap ~
AND ALL IS SILENT
Snap again ~
AND THE PROGRAM
CONTINUES ~
without retuning

No modern set lacks the convenience of a MAR-CO filament battery throw switch. Its definite on and off positions make it far superior to any pull switch. Saves tubes and batteries—you don't forget to turn them off! Saves annoying interruptions when you only want to stop reception for a minute.

Make your set ★
convenient with a

MAR-CO



ON AND OFF
BATTERY
SWITCH **\$1.00**

ACH TUNING INSTRUMENT
Using Expensive WORM GEAR

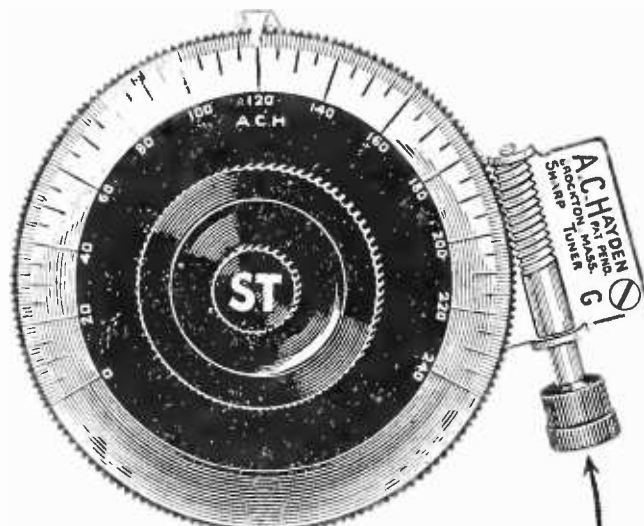

Why the A.C.H. is different

3 in. DIAL → ACH → 156-t0-1

4 in. DIAL → ACH → 215-t0-1

Price 3-inch size.....\$2.50 Price 4-inch size..... \$5.00
Regular fitting 5/16 shaft. 1/4 and 3/16.....5c each extra

The expensive worm gear is a type of gear in a class by itself. Ask for the

WORM GEAR

A new way to spell
SELECTIVITY—WORM GEAR

A WORM GEAR HAS NO SUBSTITUTE OR OTHER NAME

Mail orders—prepaid U.S.A.—if not at dealers

A. C. HAYDEN RADIO & RESEARCH CO.
BROCKTON, MASS., U. S. A.

CARTER



New Vernier Control Potentiometer
Smooth—Positive—Noiseless

Clock spring pig tail connections.
Vernier control all the way with but one knob.
One hole mounting.
Binding post terminals.
Complete with combination knob and pointer.

200 Ohms
400 Ohms

Any dealer can supply.

In Canada—Carter Radio Co., Limited—Toronto, Canada



VESCO SMILES AT MILES

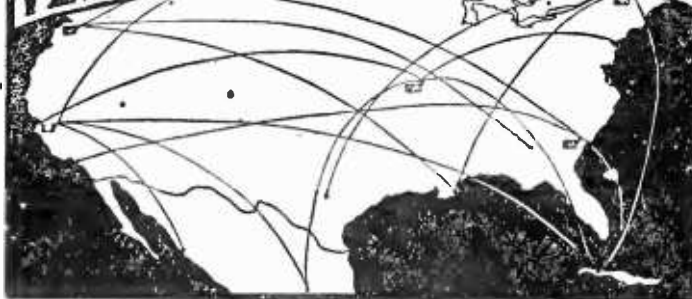

ON ONE TUBE

BIG FREE BOOKLET tells the story. California users of CROSS COUNTRY CIRCUIT hear Atlantic Coast. Canada, Cuba, Mexico, and Hawaii. Atlantic Coast users hear England to California. Our new plan makes this set easiest and cheapest to build. One hour puts in operation. One tuning control. No soldering. Any Novice can do it. BIG BOOKLET FREE or complete instructions for 25c stamps or coin.
VESCO RADIO CO. Box RB-117 Oakland, California

★ Tested and approved by RADIO BROADCAST ★

NEW YORK PRECISION MICA FIXED CONDENSER

Adds the real undistorted true tone quality to your receiver



TYPE A.

MORE UNIFORM CAPACITY and superior construction improves selectivity and distant reception with marked freedom from noise. Endorsed by leading radio engineers, and standard equipment with most discriminating manufacturers —yet they cost no more than the ordinary products.

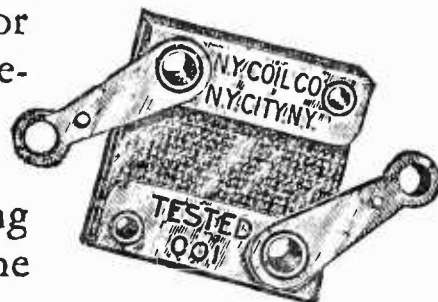

TYPE B.

The supreme pleasure of radio is secured only from a set constructed by yourself, but be sure to use reliable parts ★

OUR GROUNDED ROTOR CONDENSER is superlative in low loss construction—no other manufactured incorporates so many actual improvements.

PRICE .0005 (23. plate) without Vernier, \$4.50; 17 plate, \$4.25; Geared Vernier attachment, \$1.50.

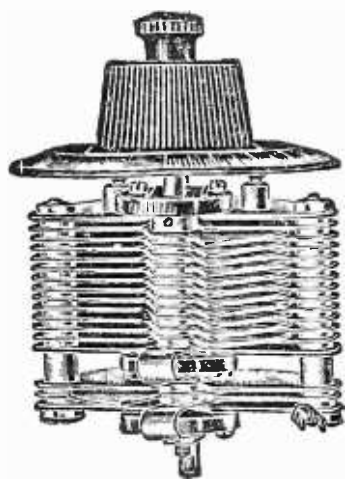
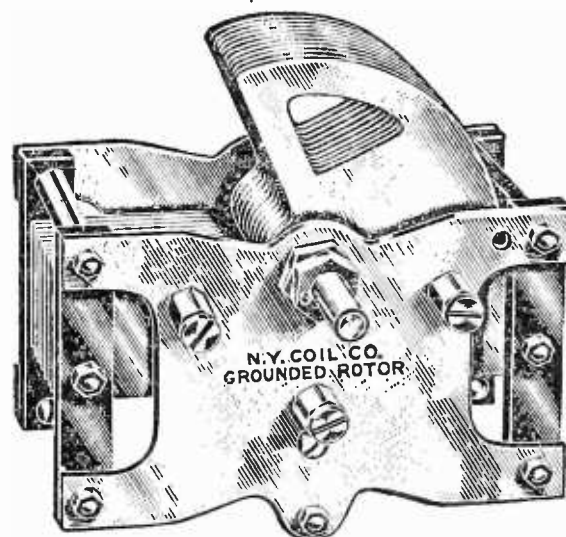

OUR STANDARD VARIABLE CONDENSERS are universally recognized for their efficiency, workmanship, DX reception and sharp tuning qualities. They equal many others selling at **double our price**—made possible by large production.

Price, without Vernier or dial -17 plate, \$1.80; 23 plate, \$2.00; 43 plate, \$3.00. Price with Vernier, including dial and knob, 23 plate, \$3.50; 43 plate \$4.50.

NEW YORK COIL COMPANY

338 Pearl Street, New York City, N. Y.

PACIFIC COAST—MARSHANK SALES CO., 926 Insurance Exchange Building, Los Angeles, Calif., also San Francisco, Portland.

★ Tested and approved by RADIO BROADCAST ★

New Model "C"

U.S. and Foreign Patents

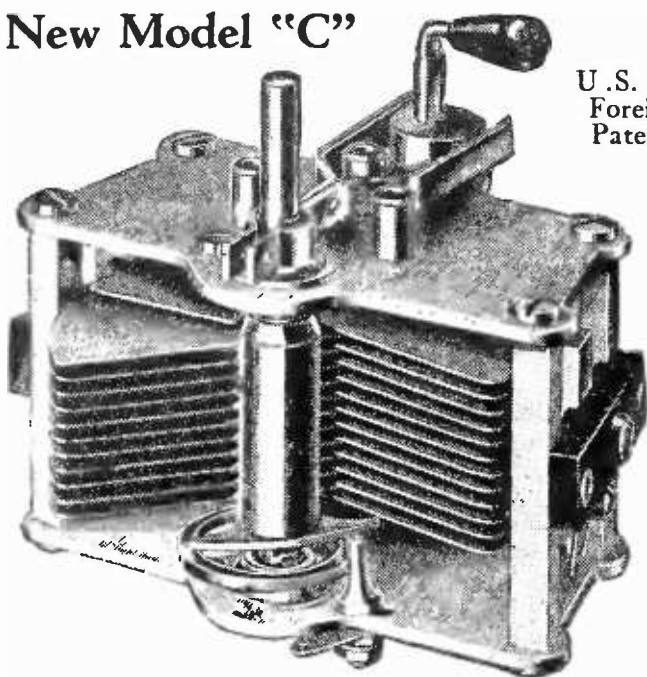

Keen as a Razor!

The sharpness of tuning you have vainly sought—the selectivity that was promised but never realized—the quality that should have come but didn't—they are yours when you tune your receiver with the new Model "C" Hammarlund Condensers.

When you find Hammarlund Condensers in the receiver you purchase, you will know that the manufacturer was determined to give you the best the radio world affords. Use only Hammarlunds in the receiver you build. All capacities; plain and vernier. Sold by the better radio dealers.

Write for descriptive folder.

9 points of Superiority

- 1—Soldered brass plates, chemically treated against corrosion; perfect alignment.
- 2—Stator plates specially shaped for easy tuning on low waves.
- 3—Adjustable ball-bearing rotor shaft, grounded through metal end-plates.
- 4—Soldered clock spring pigtail, with automatic stop.
- 5—Minimum dielectric; losses too small to be measured.
- 6—Rugged, compact construction; cannot warp.
- 7—Micrometer vernier moves all plates; no backlash.
- 8—Takes any size dial.
- 9—The product of 14 years' experience, making precision instruments.

HAMMARLUND MANUFACTURING CO.
424-438 West 33rd St., New York



Fidelity

Just as the rare old violin expresses the finest instincts of its master, so does the Pacent Improved Audio-former bring out the best in any radio set.

It gives faithful, pure and undistorted reproduction over the entire band of sound frequencies, with an unusually high amplification factor *throughout the entire range* rather than at one high peak.

You will be more enthusiastic than ever about your set when you hear it with Pacent Improved Audio-formers. Order a pair today from your dealer.

Write for complete catalog of Pacent Radio Essentials.

PACENT ELECTRIC COMPANY, Inc.
91 Seventh Avenue, New York City
Washington, Chicago, Buffalo, Minneapolis, Birmingham, Jacksonville, Boston, Philadelphia, St. Louis, San Francisco, Detroit

- PACENT Radio Essentials
- Adapters
 - Improved Audioformer
 - Autoplug
 - Coil Plug
 - Coil Plug Receptacle
 - Condensers, Low Loss
 - Detector Stand
 - Duojack
 - Duoplug
 - Duo Lateral Coils
 - Headsets, Everytone
 - Jacks
 - Jack Set
 - Radioloop
 - Loop Plug
 - Loop Jack
 - Multijack
 - Plugs
 - Potentiometers
 - Rheostats
 - Resistors, Laboratory
 - Sockets
 - Twinadapter, etc., etc.

★ **Pacent**
RADIO ESSENTIALS

DON'T IMPROVISE - PACENTIZE

★ **PYRATEK** TRADE MARK

PYRATEK Reg. U.S. Pat. Off. FIXED Crystal Rectifier

CARTRIDGE DETECTOR

Guaranteed to give utmost sensitive reception with absolute stability. Especially designed for REFLEX work. Tested and recommended for the "Knock-out" Reflex by "Radio Broadcast" Laboratory.

WITH MOUNTING CLIPS \$1.25

At your dealers or sent direct upon receipt of purchase price

THE ERISMAN LABORATORIES
3785 Broadway Dept. BX New York, N. Y.

FAHNESTOCK CLIPS

The Perfect Radio Connectors—are used by manufacturers of standard sets and parts—and makers of wet batteries and exclusive on Eveready Dry Batteries.



Their Sure Patented Grip is recognized universally by enthusiastic users.

FAHNESTOCK ELECTRIC CO. Long Island City

★ Tested and approved by RADIO BROADCAST ★

NEW!

"B" CURRENT FROM THE ELECTRIC LIGHT SOCKET

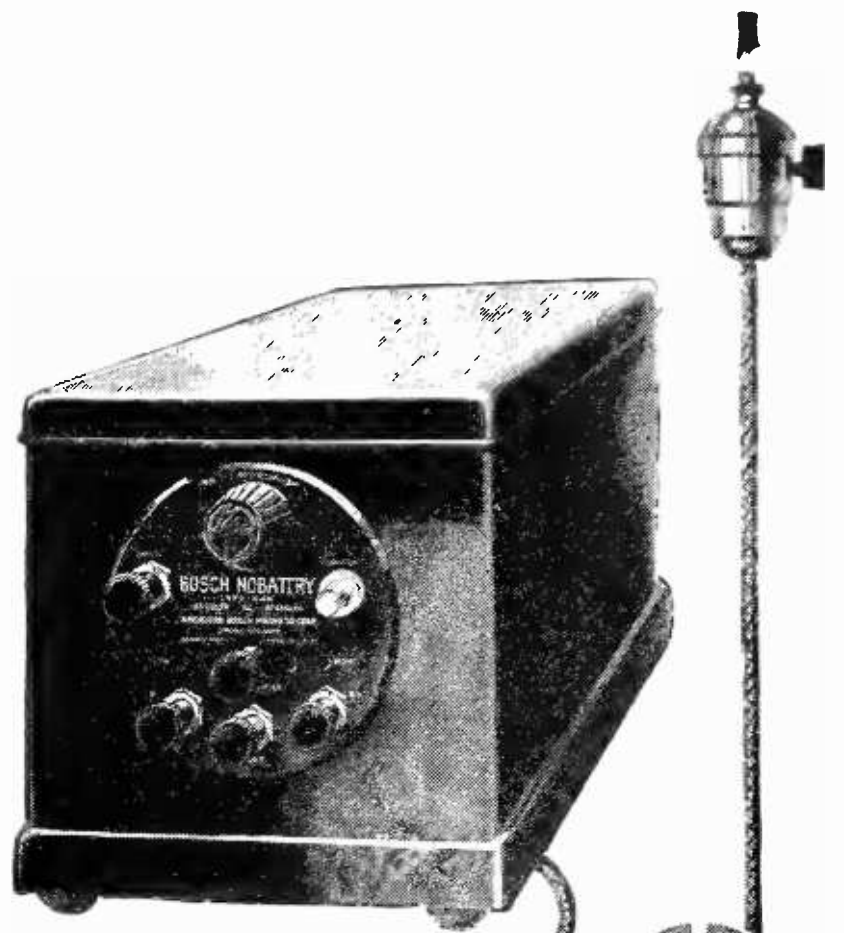

Switch it on! switch it off!

That's all you have to do. No "B" batteries to charge or replace—No bother or nuisance—No trouble or disappointments—No guess work about your plate voltage.

Here's a magic box that takes your ordinary AC house current and converts it into direct current of the proper voltage to operate your radio set at maximum efficiency—to-day or a year from now.

It doesn't run down or get weak—doesn't need attention or new parts. It's as easy to operate as an electric iron, and should last just as long.

It is absolutely dependable, too! The fact that it is built and guaranteed by the makers of the world-famous Bosch Magneto should establish complete confidence in its efficiency and reliability.

Do not confuse the Bosch Nobattery with other "B" battery eliminators. It uses no tubes, and is radically different in design and construction. It is the perfect "eliminator" which conservative radio users and dealers have been waiting for.

Learn more about it. Write to-day for illustrated folder, giving the name and address of your radio dealer.

Type BAN For alternating current.....\$49.50
 Type BDN For direct current.....\$30.00

DEALERS—Don't delay—the demand is sure to be enormous. Wire to-day for sales proposition and discounts. State whether you are a dealer or jobber, and give references to aid us in quick allocation of territories.

AMERICAN BOSCH MAGNETO CORP.
 Main Office and Works: Springfield, Mass.

Chief Points of Superiority

1. Suitable for any receiving set, using 1 to 14 tubes—will also take care of power amplifier.
2. Unlimited current supply.
3. Requires no attention.
4. Cannot burn out radio tubes even if wrongly connected.
5. Uses no tubes for current rectification.
6. Costs only a fraction of a cent to operate.
7. Detector voltage adjustable—from 15 to 50 volts.
8. Amplifier voltage adjustable, too—from 90 to 150 volts.
9. Constant voltage—plenty of pep.
10. Gives clear tone, greater volume and more distance.
11. It is NOISELESS—there's absolutely no hum or distortion.
12. Will operate low power transmitting sets.



BOSCH NOBATTERY

★ Tested and approved by RADIO BROADCAST ★

Now you can UNDERSTAND RADIO!

Take the mystery out of it—build and repair sets—explain the vacuum tube—operate a transmitter—be a radio expert!



1 VOLUME
514 PAGES
Leatheroid Edition

Compiled by
HARRY F. DART
E.E.

Formerly with the
Western Electric
Co., and U. S.
Army Instructor
of Radio.

Technically Edited by F. H. Doane
100,000 ALREADY SOLD

This practical and authoritative I. C. S. Handbook is considered one of the biggest bargains in radio today. Over 100,000 homes rely on the I. C. S. Radio Handbook to take the mystery out of radio. Why experiment in the dark when you can quickly learn the things that insure success? Hundreds of illustrations and diagrams explain everything so you can get the most out of whatever receiver you build or buy.

It contains: Electrical terms and circuits, antennas, batteries, generators and motors, electron (vacuum) tubes, many receiving hook-ups, radio and audio frequency amplification, broadcast and commercial transmitters and receivers, wave meters, super-regeneration, codes, license rules. Many other features.

A practical book. Written and edited by experienced engineers, in plain language. Something useful on every one of its 514 pages. The authority that covers every phase of radio, all under one cover in one book at a surprisingly small cost. Don't spend another cent for parts, turn a dial or touch a tool until you have mailed \$1.50 for this I. C. S. Radio Handbook.

Send \$1.50 at once and get this 514-page I. C. S. Radio Handbook—the biggest value in radio today. Money back if not satisfied.

-----TEAR OUT HERE-----

International Correspondence Schools
Box 8296-D, Scranton, Penna.

I am enclosing \$1.50. Please send me—post-paid—the 514-page I. C. S. Radio Handbook. It is understood that if I am not entirely satisfied I may return this book within five days and you will refund my money.

Name.....

Address.....

Check here and enclose \$1 if you wish the cloth-bound edition.

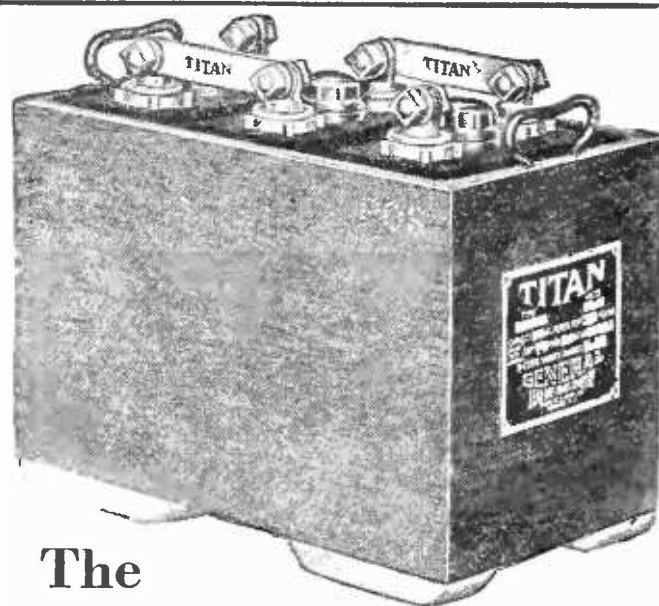

The U. S. Government gets 5 to 8 years dependable service from the Titan Radio "A" Battery.

The

TITAN

BOLTED "A" BATTERY

The Titan 6 volt "A" Battery has bolted connections across 3 cells (2 volts per cell). This is a decided advantage in that it enables you to easily and quickly adapt your battery voltage to any tube. When repairs are necessary, bolted connections remove all the ordinary difficulty and keep the expense at a minimum. These two features alone of bolted connections represent a real saving to you. The extra heavy plates in the Titan "A" Battery insure well over 5 years of dependable service. The Titan "A" Battery is especially suited to distance (DX) work.

It is assembled in a hard wood, mahogany finished case that is attractive in appearance and the larger sizes are mounted on porcelain skids.

Designs with burned connections as low as \$12.00 for 110 ampere hour capacity.

Carefully Packed. Shipped anywhere. Ready to use.

Write for circular on Titan 48 Volt 6000 M.A.H. "B" Battery.

GENERAL LEAD BATTERIES CO.
Chapel Street and Lister Ave. Newark, N. J.

Jobbers and Dealers: Write for Merchandising Information on Titan "A" and "B" Batteries

Get the program you want when you want it!

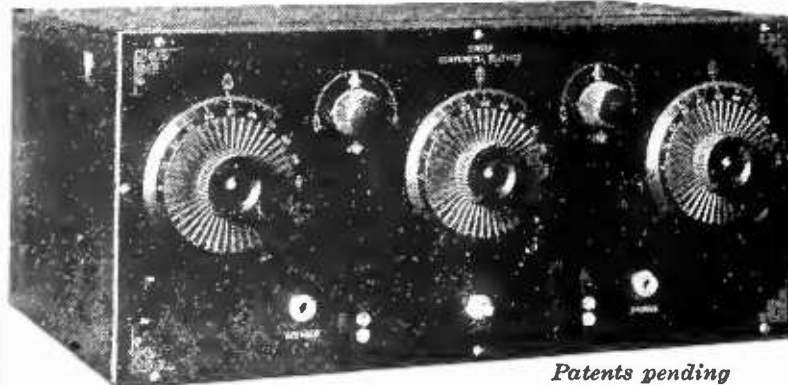

Patents pending

The SINGER Compendyne

The Compendyne* 5 tube tuned R. F. low loss receiver has brought in sixty-seven distant stations on the loud speaker, while powerful local stations were broadcasting. Squeals, howls and distortions are eliminated. You get great volume with sweet, pure tone. Have your dealer arrange for a demonstration.

Cabinet and panel are matched in mahogany, engraving and panel parts in gold finish; or black panel with engraving and panel parts in nickel finish.

Formerly \$95 NOW \$65.00

★ E. SINGER COMPANY
40 Hudson Street New York

★ Tested and approved by RADIO BROADCAST ★

RATHBUN

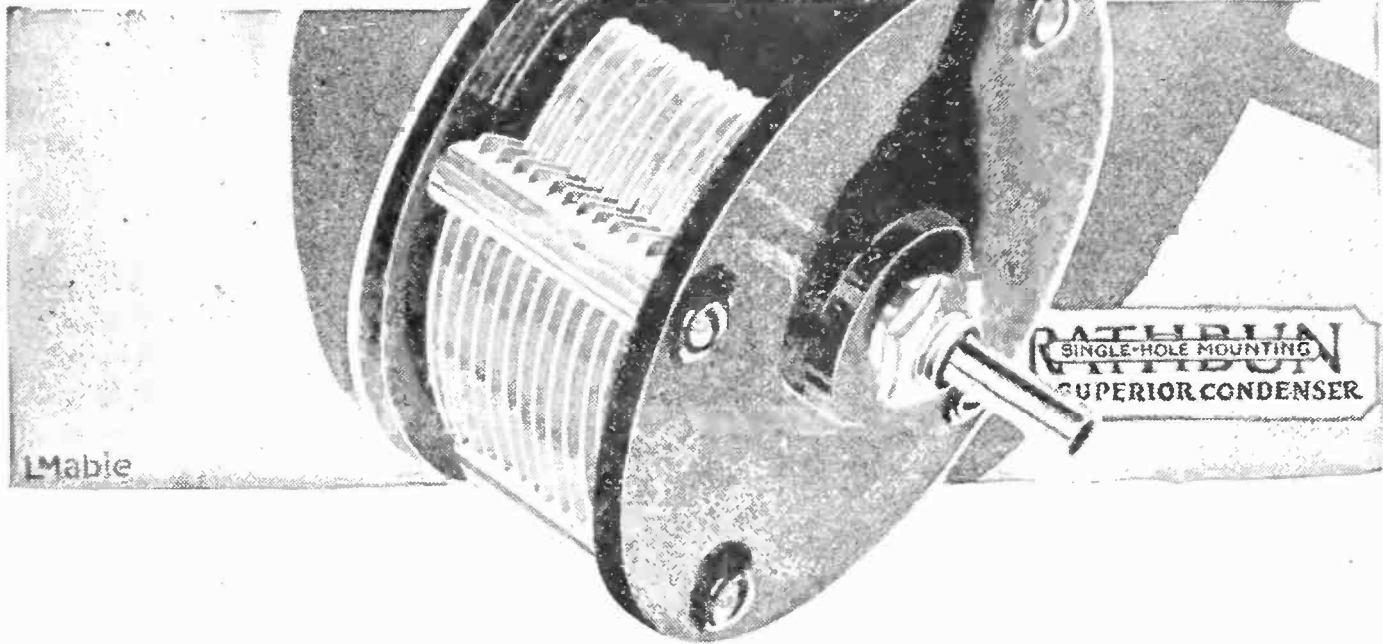

Don't be Fooled by "Low-Loss" Bunk!

RATHBUN CONDENSERS—with genuine Bakelite moulded end plates—will give results fully equal to any variable condenser on the market. None are more honestly made or more reasonably priced.

We are proud of our condenser — proud of the materials, the workmanship and the care put into it. It would be easy for us to make metal end plate condensers of the so-called "low-loss" type, but we are firmly convinced that our present methods of construction are right and that the radio public has been grossly misled as to the supposed advantages of the "low-loss" metal end plate types.

In order to prove our sincerity, and to justify our product—honestly made—in the face of much exaggeration and misleading propaganda, every Rathbun Condenser is sold with the following guarantee:

Rathbun Condensers are guaranteed satisfactory in electrical and mechanical construction — any proving otherwise will be replaced free of charge, or the purchase price refunded. If you can get longer distance, sharper tuning, better quality, or more volume with any other condenser on the market today — return ours and your money will be immediately refunded.



That's An Honest Guarantee For An Honest Product—And We Mean Every Word Of It!

We have prepared a little booklet giving in detail the story of so called "low-loss" condensers, including a tabulation of the losses, accurately measured, in over fifty standard condensers. You will find it interesting and instructive and it's free for the asking.

An Entirely New System of Radio Reception

Rathbun Single Hole Mounting Superior Condensers have been specified for use in the *Hoyt System of Signal Augmentation*, by the inventor *Francis R. Hoyt*. We have a limited number of Blue Printed copies of Mr Hoyt's original laboratory notes on this new system of radio reception, together with nine circuit sketches, which will be sent free to you upon receipt of this coupon and 4 cents for postage.

NAME _____

ADDRESS _____

RATHBUN MANUFACTURING COMPANY, INC.
JAMESTOWN, NEW YORK

Honest CONDENSERS

★ Tested and approved by RADIO BROADCAST ★

SUPORTENA

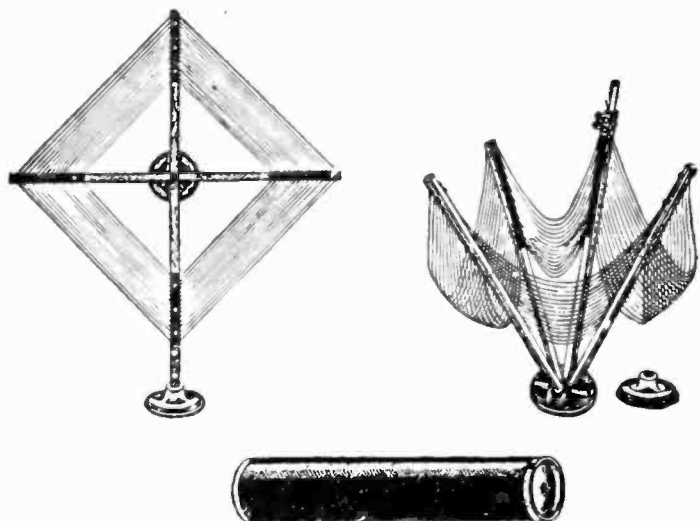

The ultimate in Folding Loop Development Inductance can now be varied at will, to suit the receiver.

An ingenious Slider on Upright Support equivalent to 16 different Taps!!

A Development especially adapted to Super-heterodyne receivers.

Tunes below 100 and over 600 meters!!
Increases the efficiency of any loop set.

PATENT APPLIED FOR

\$9.00 Construction Similar to the Popular PORTENA Loop, with Addition of The Slider Improvement



Manufactured by Radio's Master Loop Craftsmen.

J. NAZELEY CO.

571 HUDSON ST.

NEW YORK

Ingenious

The
"SELF ADJUSTING"
Rheostat



\$1.10

Write for FREE Hook-ups

everywhere

AMPERITE controls perfectly and automatically the current flow from battery to tube. No Rheostat knobs on panel to turn. No ammeter needed. No worry. One AMPERITE for each tube inside the set regulates current on thermo-electric principle. Simplifies wiring and operation. Facilitates tuning. Proven in use. Adopted by 50 set manufacturers. Be sure your set is equipped with AMPERITE.

RADIALL COMPANY

Dept. R.B-4, 50 Franklin St., New York

AMPERITE
"means right amperes"

Protects
Radio
Tubes

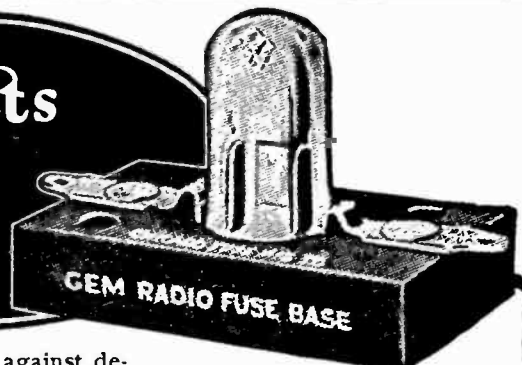

You can protect tubes against destruction from short circuits for a few cents by installing the "Gem" Radio Fuse. Then when there's a "short," the fuse blows and the tubes aren't injured. Easily installed. Sent postpaid for 60c with fuse block for attaching, if not at your dealers. Write for booklet.

CHICAGO FUSE MFG. CO.

1505 West 15th St., Chicago, Illinois

"GEM" RADIO FUSE

KESTER Radio SOLDER
(Rosin-Core)

If your dealer cannot supply you
send us 25c in postage

CHICAGO SOLDER COMPANY
CHICAGO, U. S. A.

Crescent Lavite Resistances Absolutely Non-Inductive

12,000 } Ohms
48,000 }
50,000 }
100,000 }

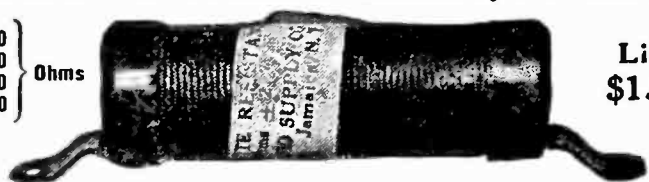

List
\$1.50

Special resistance to order. When better resistances are made Crescent will make them. CRESCENT RADIO SUPPLY CO., 5 LIBERTY ST., JAMAICA, N. Y.

★ Tested and approved by RADIO BROADCAST ★

NATIONAL

VELVET CONDENSERS VERNIER AND DIALS

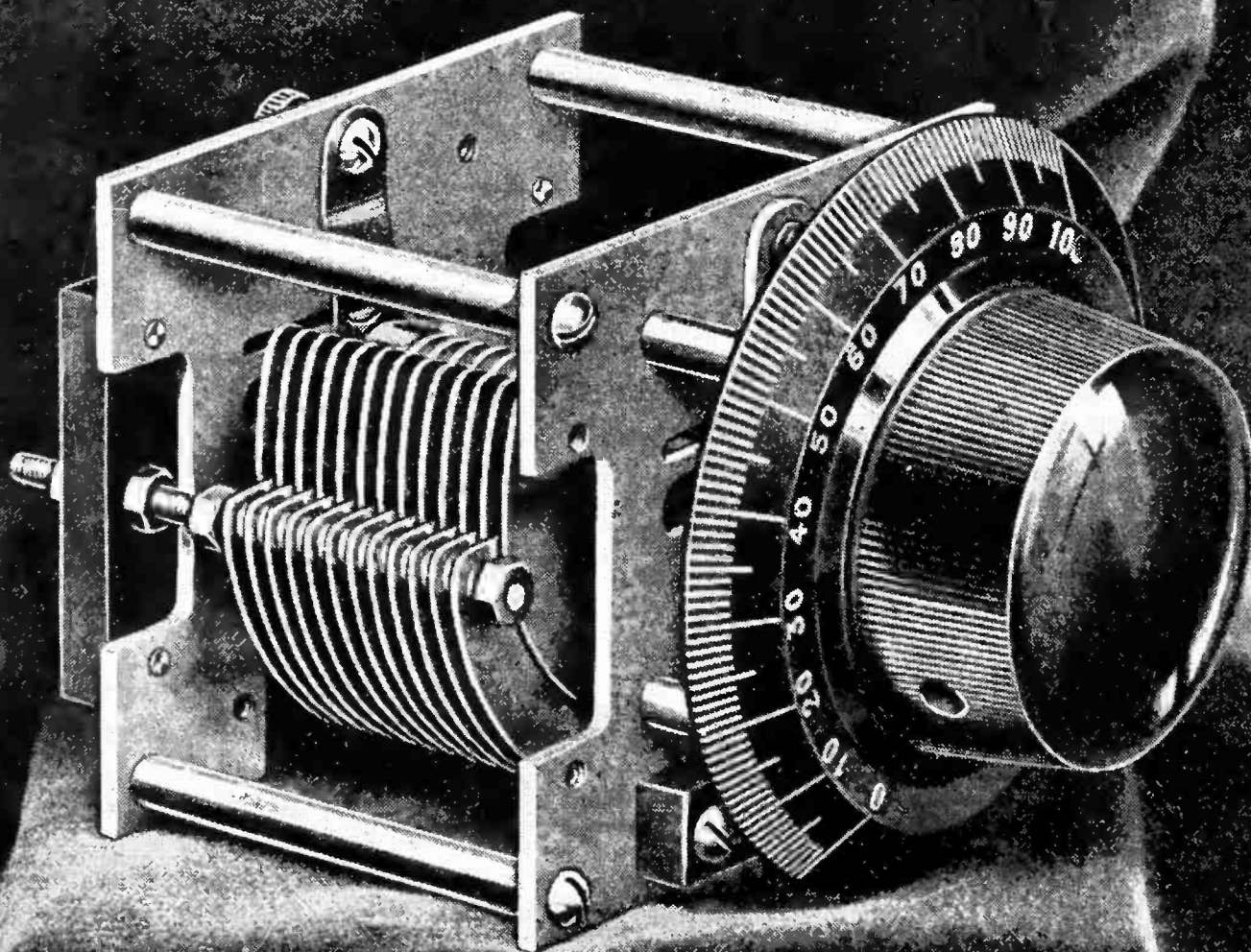

“What a Difference!—” ★

“Never had such perfect reception,” writes a delighted fan to the dealer who persuaded him to buy a National Condenser and dial for his new set. “The National does make a mighty big difference.”

Get a National for *your* set. If your dealer is not yet stocked, send us his name. We will see that you are supplied.

Send for Bulletin 104 RB

NATIONAL COMPANY, Inc., Engineers and Manufacturers
110 BROOKLINE STREET CAMBRIDGE, MASS.



★ Tested and approved by RADIO BROADCAST ★

Gets DX— SLOW MOTION Tuning



REMEMBER how the "slow-motion" picture helped you see details that were unnoticed in the usual running?

In a similar way the "slow-motion" (12-to-1 ratio) of the new UNIVERNIER helps you find dozens of stations that are missed if "searching" is done with the usual coarse adjustment (as you are compelled to do with many so-called vernier dials which merely duplicate the action of the obsolete vernier condenser.)

With its continuous "slow motion," the UNIVERNIER first finds the station you want—then clears it up. That's why it's such a record-breaker for locating those hard-to-get distant stations and bringing them in so easily, quickly, clear and loud. Promise yourself a real surprise—replace your dials with UNIVERNIER tonight! At your dealer's or sent postpaid on receipt of purchase price. (Please mention dealer's name.)

Mahogany Knob and Gold-plated dial . . . \$1.50

Black Knob and Silver-plated dial . . . \$1.25

Jobbers and Dealers: Write for Discounts

WALBERT MFG. CO.

927 Wrightwood Ave., Chicago, Ill.

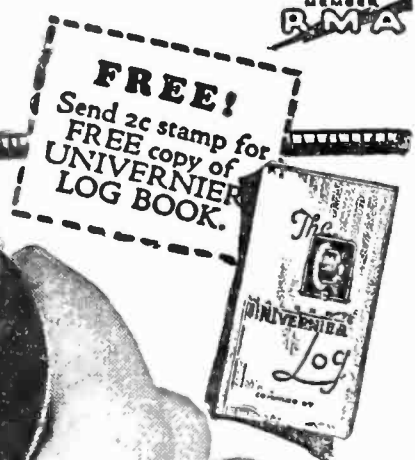

WALBERT
UNIVERNIER
Micro-Selective Tuning Control

**Out with the Old!
In with the NEW!**

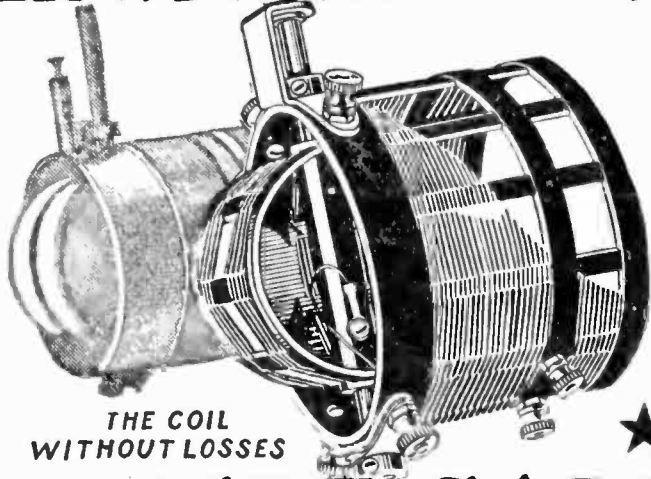

THE COIL
WITHOUT LOSSES

UNCLE SAM Master Tuning COIL

Replace your old Uncle Sam with a new type and increase your volume from 50% to 180%, also improve selectivity. If a five days trial does not prove this, your dealer will refund your money.

FREE Ask your dealer or send us four cents in stamps for wiring diagrams of circuits in which these remarkable coils can be used.

UNCLE SAM ELECTRIC CO.
219 E. Sixth Street Plainfield, N. J.

**PATENTS Secured
Trade Marks Registered
Radio Inventions A Specialty
Write Us**

MASON, FENWICK & LAWRENCE
Patent and Trade Mark Lawyers
Washington, D. C., New York, Chicago
ESTABLISHED OVER 60 YEARS

References: National Confectioners' Association, Chicago National Canners' Association, Washington, D. C. Life Savers Inc., Port Chester, N. Y. Bon Ami Co. and U. S. Cigar Co., New York City. Hershey Chocolate Co., Hershey, Pa. Stephen F. Whitman & Son, Philadelphia, Pa., and many others

DX "mushy"?

FREE

BOOKLET

On "Tube Control" tells how to bring in distant stations clear and loud. Just drop a postcard to

UNITY MFG. CO.
230 North Halsted Street
CHICAGO, U. S. A.

★ Tested and approved by RADIO BROADCAST ★



*Resonant Wood
insures
Tone Quality*

**“With the
Tongues of Men”**

HUMAN voices pulsating with life, vibrant with emotion, speak from **MUSIC MASTER** rich and clear, as in the church, miles or hundreds of miles away.

In the comfort of your own home—near or far—you hear the sermon, the organ, the singing, the entire church service, as though you were seated among the congregation.

The reproducing element of **MUSIC MASTER** responds to the faintest radio impulses; the heavy cast aluminum tone chamber eliminates blast and distortion; the amplifying bell of natural wood—like the violin and the cello—reproduces in tones that are full, resonant and life-like.

Your dealer will be glad to send **MUSIC MASTER** to your home to be tried and proved with your own set.

Dealers Everywhere

- | | | | |
|---|-----------------------------------|-------------|---|
| Connect MUSIC MASTER
in place of headphones. | MODEL VI
14-inch . . . | \$30 | |
| No batteries required. | MODEL VII
21-inch . . . | \$35 | |
| MODEL VIII Cabinet Type with “Full-Floating” Wood Horn | | \$35 | ★ |

Music Master Corporation

Makers and Distributors of High-Grade Radio Apparatus
S. W. Cor. 10th and Cherry Streets
Chicago PHILADELPHIA Pittsburgh

**Music
Master**
RADIO REPRODUCER

★ Tested and approved by RADIO BROADCAST ★

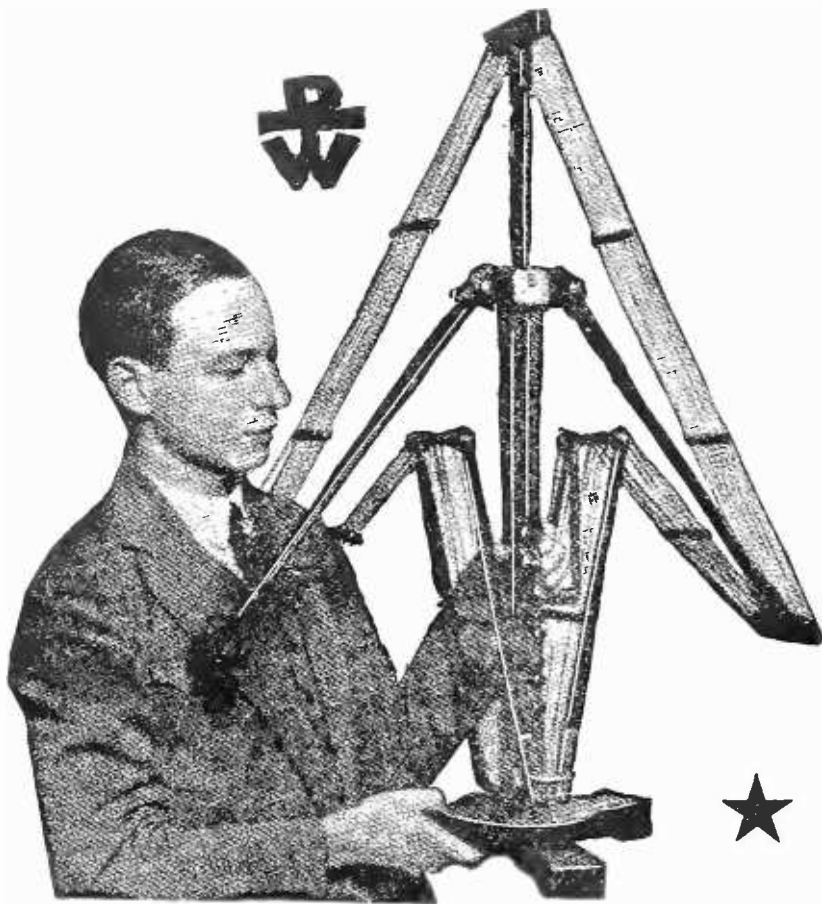

THE PERFECT IMPORTED GERMAN LOOP

Made by

Deutsche Telephonwerke & Kabelindustrie
Berlin, Germany

The D T W Loop is one of the finest examples of German technical and scientific skill. It stands 42 inches high by 40 inches wide. It is wound with fourteen turns of genuine Litzendraht cable, which is made up of sixty individual insulated and twisted strands covered with double green silk. The turns are sectionized and by unique design all "Dead end" effect is absolutely eliminated. The woodwork is solid mahogany, hand rubbed and all metal parts are highly nicked. A graduated metal table at the base of the loop accurately gives the station direction. It is tapped for various wave lengths and the center tap permits its use without modification for all types of superheterodynes. The loop is collapsible and may be used by its adjustable slide in tuning to wave length.

PRICE.....\$25.00

Fully guaranteed. Dealers and jobbers write or wire for exclusive territorial franchise.

Burns

Loud Speaker
of Distinctive Beauty
Generous Proportions

NATURAL TONES WITH VOLUME
A Reproducer that Satisfies

Aluminum Sound Column. 14 inch pyralin bell. Convenient adjuster.

No. 205B Polished Black Flare \$22.50
No. 205D Mahogany Tinted Flare 25.00

Manufactured by
American Electric
COMPANY

State and 64th Sts. Chicago

Six Tools in One

A radio socket wrench that fits every round and hexagon radio nut

\$1.25



Sockets ranging from 1/4" to 1/2"

How it works
Place socket of required size on end of shaft with slots not in line with lugs on shaft.

Buy it from your dealer or direct from us

THE PERRY-FAY COMPANY, Elyria, Ohio
Screw Machine Products

★ Tested and approved by RADIO BROADCAST ★

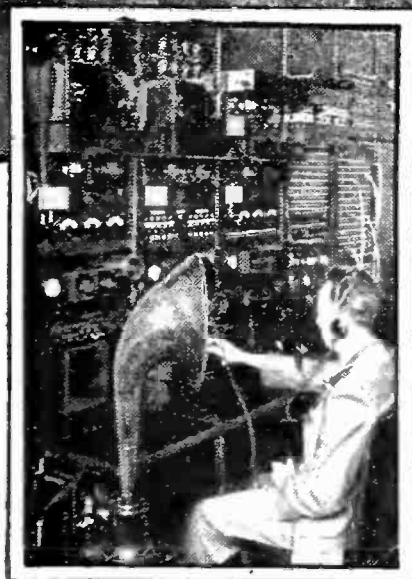

The Silvertown Cord Orchestra (above) under the direction of Joseph Knecht, has been delighting millions of lovers of good dance music in programs broadcasted every Tuesday night from 10 to 11 from WEA, N.Y.; WJAR, Providence; WFI, Philadelphia; WCAE, Pittsburgh; WGR, Buffalo; WEEL, Boston.

Better Reception

Science has established a big fact in radio—dielectric losses reduce range and selectivity.

Hard Rubber has the lowest dielectric losses of any practical panel material yet employed. Goodrich Hard Rubber Panels are distinctly superior in permanence of color and lustre, and freedom from warpage. Use them in your set and bring in those distant stations finer—get better reception and enjoy to a greater degree the big dance orchestras, soloists, orators, and other features.

For maximum selectivity and widest possible range use Goodrich Rubber Radio Products. Fifty-five years' experience is behind them—they represent highest rubber quality.

*Goodrich Hard Rubber Radio Panels.
Goodrich V. T. Sockets ✓ Goodrich
Variometers Unwound ✓ Radiophone
Ear Cushions ✓ Spaghetti Tubing
Battery Mats.*



THE B. F. GOODRICH RUBBER COMPANY
ESTABLISHED 1870
Akron, Ohio

Goodrich RUBBER
RADIO PRODUCTS

"Best in the Long Run"

★ Tested and approved by RADIO BROADCAST ★

Morrison

Loud Speaker Unit

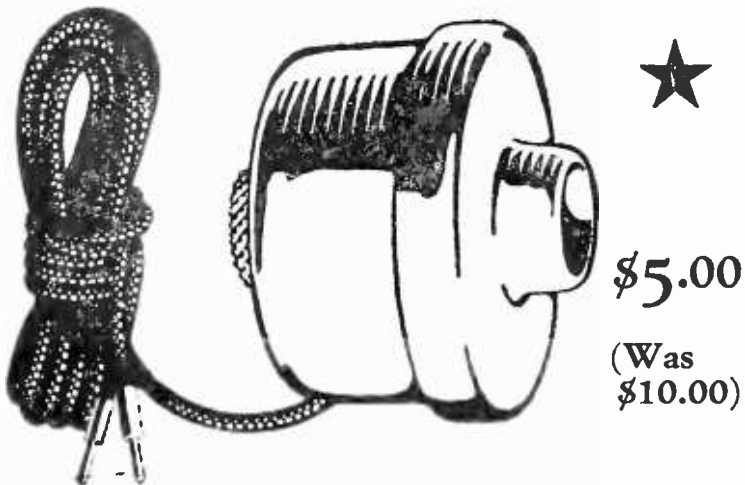

★
\$5.00
(Was \$10.00)

Standard of Radio

FOR three years—long before the days of Super-Heterodynes and many other splendid radio successes — Morrison has been the acknowledged leader among loud speaker units. To-day the most powerful sets, and the most sensitive, reproduce at their best through Morrison Loud Speaker Units. There is no problem when buying a unit for either phonograph or horn—buy a Morrison and be sure.

You can adjust it loud for distance and tone it down for local reception in a second's time.

On sale at all good radio and phonograph dealers. Mail orders shipped promptly from factory. Interesting Loud Speaker Facts free on request.

Morrison Laboratories, Inc.
347 E. Jefferson Ave. Detroit, Mich.

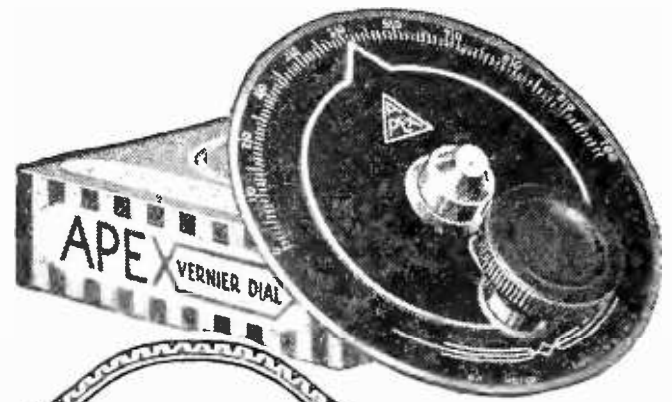

MORE DISTANT STATIONS

WITH THE **APEX VERNIER DIAL** ★

Greater range, bigger volume, finer selectivity, less interference. Lasts forever. The one big advance yet made in tuning. Ratio 12 to 1.

Quickly applied to any shaft.

For sale by all good Radio Dealers.

If unable to obtain from dealer, enclose

\$2.00 for
Royal Brass
Finish.

\$2.50 for
Satin
Silver
Finish.

\$3.50 for
De Luxe
Gold
Plated
Finish.

The Apex Super Five

is a tuned radio frequency receiver of the highest type. Built into a highly finished walnut cabinet—complete with Jones Multiple Battery Cable—all settings highly gold plated. List price \$95.00 complete.

7 Tube Microdyne Super-Heterodyne for \$97.50

Receive the parts complete to assemble your set. Coast to coast on an 18 in. loop-rodnyne Super-Heterodyne on a 7 x 18 in. panel in 3 hours. Parts complete. Price of cabinet, to fit, on application. If your radio dealer cannot supply, send check or money order and name of dealer.

Apex Electric Mfg. Co.

1410 West 59th Street, Dept. 304, Chicago

Read RUDYARD KIPLING'S Books

For sale everywhere

Doubleday, Page & Co.

ALL SHOT

That's the common expression of dry cell "B" batteries. Purchase the economy way and enjoy clearer reception, and greater volume. Put together an everlasting "HAWLEY" rechargeable "B" storage battery. Nickel-iron alkaline type. No former experience or soldering necessary. Put up in both assembled and knock-down types. The knock-down units contain all actual material for building battery and are put up in 90 volts at \$8.95; 100 volts at \$9.95; 120 volts at \$11.60; 135 volts at \$12.75; 150 volts at \$13.90; 200 volts at \$17.50. Guaranteed for 2 years with a 30 day trial offer of complete satisfaction or return of your money without any ifs nor ands. Complete sample cell 35c prepaid. 8 page illustrated folder of instructions showing simple putting together, making charger and charging free with all orders. Complete manufactured "B" battery charger \$2.75. Order direct or write for my literature, guarantee, and testimonials. Same day shipments. Address

B. F. SMITH

31 Washington Ave.

Danbury, Conn.

★ Tested and approved by RADIO BROADCAST ★

"NO-MOR B" POWER SUPPLY

Use Lighting Circuit—Throw Away Your "B" Batteries
INCREASED VOLUME & DISTANCE—LOWER OPERATING COST

Completely Finished Ready to Operate **\$29.90**

Gives 15 to 50 volts on Detector 75 to 130 volts on Amplifier

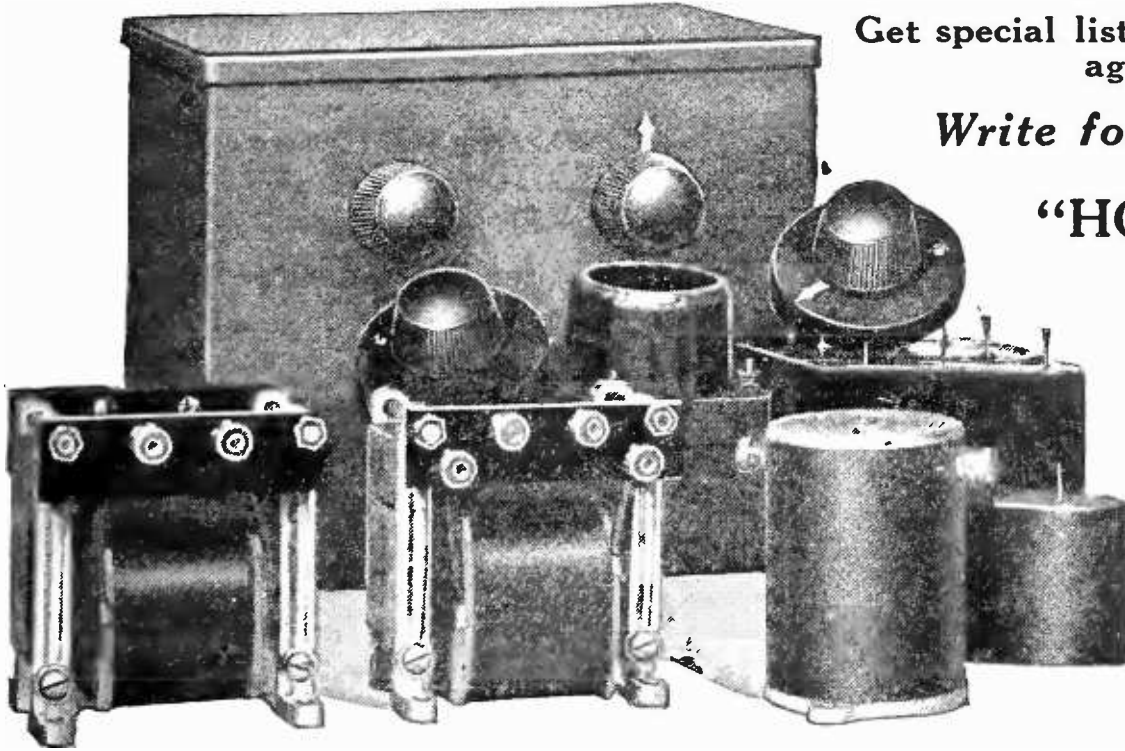

Get special list for 3 and 4 variable voltage connections

Write for special price of

"HOME ASSEMBLY KIT"

Which includes—Induction shielding cabinet with base and cover—power transformer—50 Henry choke—7 mf fixed condensers—socket—rheostat—detector voltage regulator—lead in bushings—screws, nuts and complete instructions.

60 CYCLE A. C. PARTS LIST

Power Transformer.....\$9.00	2 mf Condensers..... 1.65	Hi Voltage Socket..... .70
50 Henry Choke..... 6.50	Shielding Metal Cabinet..... 1.50	Lead in Bushing..... .05
Det. Voltage Control..... 2.00	Insulating Base..... .25	Set Screws & Nuts..... .25
1 mf Condensers..... 1.15	Controlling Rheostat..... .70	Instruction Booklet..... .25

Direct current—25 or 40 cycle A. C. power units—write for special list. High efficiency design—makes operating cost negligible—complete unit small and compact—clear reception without AC hum—fully tested with written guarantee.

"GLASS" or WOOD PANEL TOP CABINETS

Exquisite Design and finest cabinet obtainable

Clean, smooth, hand rubbed finish

Rich genuine walnut or adam brown mahogany style finish

Rubber feet—lid supports—nickel hinges



"DE LUXE" MODEL

THE ONLY CABINET WITH GLASS TOP

Panel	Deep	Adam Brown	Black Walnut	Panel	Deep	Adam Brown	Black Walnut
7 x 14	8	\$4.00	\$5.75	7 x 36	10	\$8.25	\$11.75
7 x 18	8	4.50	6.50	7 x 40	10	9.00	12.75
7 x 21	8	5.25	7.25	8 x 32	10	8.00	11.50
7 x 24	8	5.75	8.25	8 x 36	10	8.75	12.50
7 x 28	8	6.50	9.50	8 x 40	10	9.50	13.50
7 x 32	8	7.50	10.75				

For Low Cost Cabinets get "Richmond" Model list

Write for Dealers' and Distributors' Discounts

QUALITY RADIO SHOP

Richmond

Indiana

*Gee!
We've got 'em*



*Loud and Clear
with the*
Howe Radio Receiver

\$1.75

DO you know that you can listen to every radio broadcasting station in and around your city with a Howe Radio Receiver costing only \$1.75? Thousands of folks—young and old—all over the country are having many hours of solid enjoyment listening to the wonderful and varied programs—music, talks, sport and church services.

The Howe Radio Receiver is not a toy but a very sensitive, practical, radio set made of the best materials and furnished in a strong, steel case finished in a beautiful dark olive antique verde. It is fool and trouble proof. **No Batteries to Buy.** Guaranteed you can hear any broadcasting stations within 25 miles. One or more persons can "listen in" at the same time.

For perfect local reception use a Howe Radio Receiver crystal set.

For Sale by All Dealers

Howe Auto Products Co.

Radio Division
Chicago, Illinois

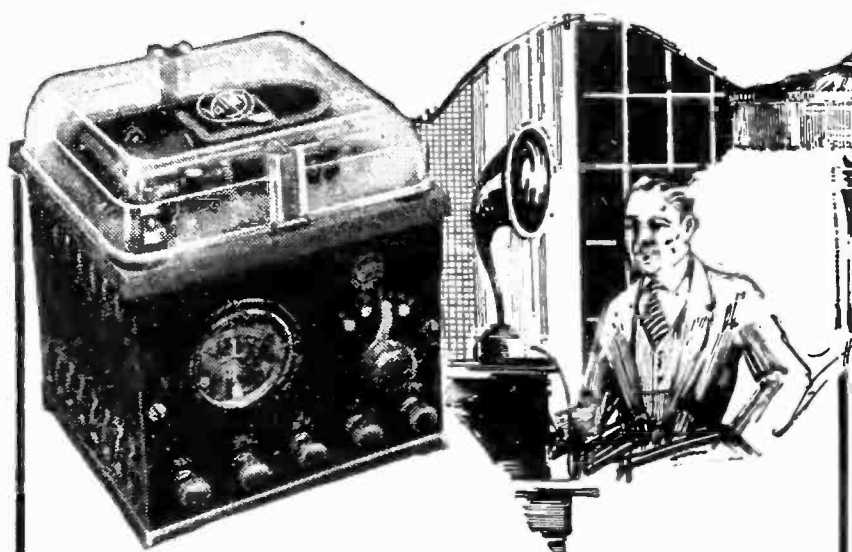

Don't Miss a Program

Sometime, haven't you wanted to hear a certain radio program . . . but could not because your storage battery was down?

Don't let it happen again. Add a **Valley Battery Charger**

to your radio set, and you can always be ready to listen in. With the Valley Charger you can completely recharge any radio battery at home overnight.

Quiet in operation.

Full 6-ampere charging rate.

No liquids. No bulbs.

The Valley Battery Charger recharges 2-volt peanut tube cells, 6-volt A batteries, and from one to four 24-volt B batteries. Takes about a dime's worth of current for a full charge.

Plugs into the ordinary light socket like a fan or other household necessity, and is just as easy to operate. It has a grained and engraved Bakelite panel which harmonizes with any radio set. Clear glass top shows the simple, patented working parts at all times.

At radio dealers everywhere.



VALLEY ELECTRIC COMPANY
3157 S. Kingshighway St. Louis, Mo.

No library complete without Kipling complete.

Radio Salesmen and Set Builders

We need you and you need us. If you are reliable and well known in your community, we will appoint you our representative and furnish you with standard well advertised sets and parts at prices that will enable you to sell at a handsome profit. Write at once for catalogue and sales plan. Waveland Radio Co., Div. 57, 1027 N. State St., Chicago, Ill.

RADIO

Big, complete stock. Standard prices. And you're sure it's reliable if it comes from Andrae.

Send for our catalogue

JULIUS ANDRAE & SONS CO.

112 Michigan Street

Milwaukee, Wis.

ANDRAE *In Business Since 1860*

★ Tested and approved by RADIO BROADCAST ★



Radio Headquarters

Why not buy your set or parts at Radio Headquarters? Only tested and approved radio equipment is sold. Every set sold by us is guaranteed to give satisfactory results.

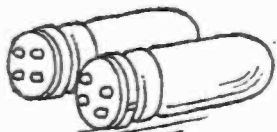

Ward's Radio Catalogue

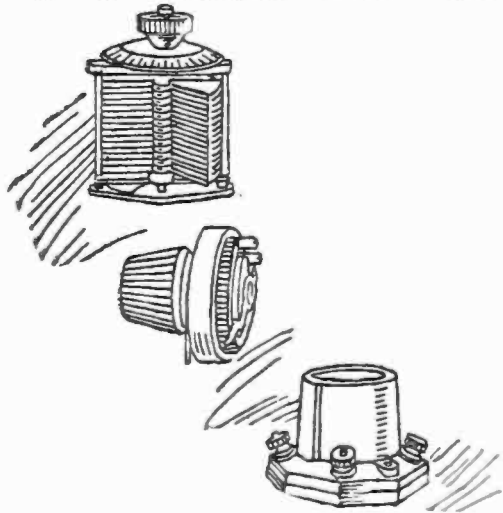

The best Radio Experts made this catalogue—men who devote their entire time to Radio—who are up to the minute with everything new, who tell you the best hook-ups, who have selected for you the best tested parts, who have chosen the best sets—so simple that you yourself can easily install them—so reliable that we guarantee them to give satisfaction.

Write for your copy of this Catalogue. See for yourself the

low prices. Buy your radio at Radio Headquarters.

Our 53 Year Old Guarantee Ward's has dealt with the American people for 53 years under a definite guarantee of "Money back if you are not satisfied." All our Radio sets are guaranteed to give satisfactory results and back of this guarantee is a proven reliability that for 53 years has not been questioned. Address our house nearest you. Dept.27-R.

ESTABLISHED 1872 Montgomery Ward & Co.

The Oldest Mail Order House is Today the Most Progressive

Chicago Kansas City St. Paul Portland, Ore. Oakland, Calif. Fort Worth

GENUINE NAZELEY ROBERTS UNITS
(TRADE MARK)

FOR
Radio Broadcast's Knock-out Receivers
2 and 4 Tubes

These are the Only Coils Designed and Approved by Walter Van B. Roberts, E.E., Ph.D.

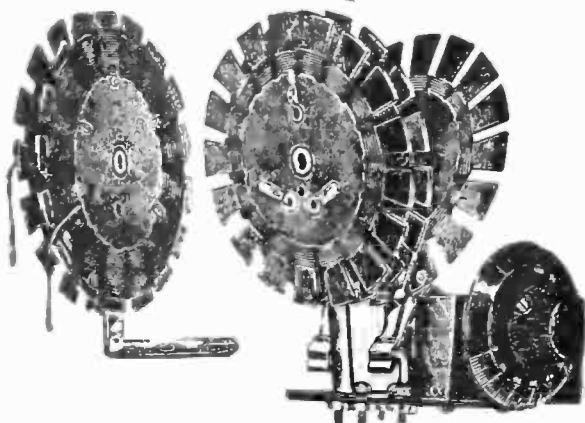

\$8.00

Endorsed by **RADIO BROADCAST**
In every issue since May, 1924
(When the circuit was born)

The Wonder of Radio To-Day

The Nazeley Roberts Units are wound on Genuine Bakelite Forms—strictly in accordance with Mr. Roberts' specifications—consisting of five coils in two units—ready for mounting, Neutralizer included, with Building Instructions by Mr. Roberts.

ROBERTS' KITS

Complete equipment of all high grade parts. Including genuine bakelite panel drilled
(Less cabinet, tubes, and batteries)

Two-Tube Kit, \$53.00 With Portena Loop, \$60.00 Four-Tube Kit, \$70.00 With Portena Loop, \$77.
(Loop only for local reception)

Note: We could supply cheaper parts, BUT WE WILL NOT!

J. NAZELEY CO.

Sole Manufacturers

571 Hudson Street

New York



Link Talking Machine
★ **Clearness to Radio!**

DULCE-TONE'S popularity is proven. The public have demonstrated that they *WANT* to use the fine amplifying unit they already own in their talking machine. *Dulce-Tone provides the only thoroughly successful link.* Retail price complete, \$10.00 (In Canada, \$14.00).

THE TEAGLE COMPANY, 1125 Oregon Ave., Cleveland, Ohio
Canadian Distributor: The Otto Higel Co., Ltd., Toronto

Dulce-Tone

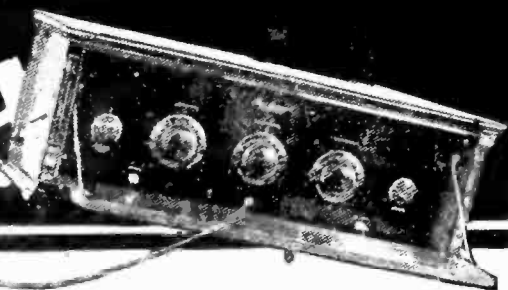

Retail price complete, \$10
(In Canada \$14)

★ Tested and approved by RADIO BROADCAST ★

BUILD YOUR OWN B-ELIMINATOR

No Technical Knowledge Required
Easier to Wire Than a 1-Tube Radio

Alternating Current 100 to 125 Volts, 50 to 70 Cycles.....	Parts \$16.25	Assembled \$21.25
<i>(Can also furnish Higher Voltage, and 40 and 25 cycles)</i>		
Direct Current	\$ 9.50	\$13.50

Uses regular 201 A or 301 A Tubes

Supplies constant current. Absolutely silent. No vibrators, magnets, crackling or static-like noises—to interfere with fine reception.

A. C. Outfit Consists of

- | | |
|----------------------------------|-----------------------------|
| 1 Variable transformer | 3 Engraved binding posts |
| 2 High capacity accumulators | 6 Insulators |
| 1 Inductance and resistance unit | 10 Ft. of Wire |
| 1 High voltage variable resistor | 10 Ft. gold brown lamp cord |
| *1 Pressed steel box (Japanned) | 1 Detachable plug |
| 1 Socket | Screws and nuts |

* Or Baseboard Panel Mounting

Diagram Showing Simplicity in Wiring

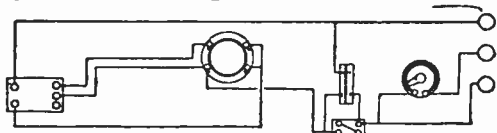

Weights only 4 1/4 lbs. Size 5 x 5 1/2 x 7

Absolutely Guaranteed to Work; or Your Money Back.

SEND NO MONEY

Pay Postman for item and postage on arrival. *If you send Cash with order, we pay postage.*

Send for descriptive matter. State kind of circuit and how many tubes

DEALERS—Order on your letterhead for trade discounts.

Send Your Order TO-DAY!

RADIO POWER UTILITY COMPANY
1272 Broadway New York City

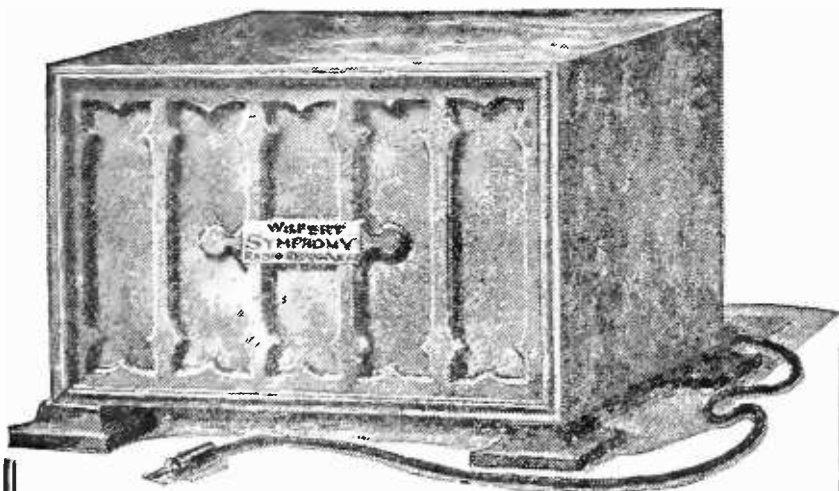

WILFERT SYMPHONY SPEAKER

The Wilfert Symphony is "a Speaker possessing exceptional refinement of tone.

Violin wood is used in chambers constructed to mellow and refine the sound as it is amplified.

A rich hand-rubbed mahogany case and tasteful design make the Wilfert Symphony a pleasing addition to any home.

Price \$35.00

★ We have an attractive proposition for dealers.

Wilfert Symphony Radio Reproducer
21 Cambria St. Boston, Mass.

Surprising!... the improvement this discovery can make in your radio set

IN THE electrical laboratory of a leading engineering university, a test has just been made which reveals some striking facts about sockets.

Out of 13 different makes of sockets, 12 showed losses higher than a good low loss condenser. Of these 13, only one—Na-Ald Sockets—showed losses lower than a good low loss condenser.

This means that many sockets are of such poor dielectric or insulating material that they nullify the efficiency of a good condenser. Na-Ald Sockets (of genuine Bakelite Alden-processed) have the qualities that enable a condenser to function efficiently.

The laboratory test also showed that Na-Ald Sockets have the lowest capacity of any socket. This is particularly important for short wave length reception.

Also most important is the "Clean-easy" feature of Na-Ald DeLuxe Sockets. You simply turn the tube several times and the tube terminals become bright and clean. The side-scraping contact (not merely side pressure) removes the film of corrosion that hinders the delicate minute current; this corrosion so often is the cause of disturbing noises in your set.

Use Na-Ald Sockets not only in the set you build but also install them in the set you buy, if not already adopted by the manufacturer. Sockets for all tubes. DeLuxe 75c; others 35c, 50c, 75c.

Send for free booklet and story of laboratory test.

Mail coupon for full particulars of the laboratory test; also free booklet "What to Build," giving tested, selected circuits.

ALDEN MANUFACTURING CO.

Also manufacturers of the famous Na-Ald Dials
Dept. B-4, Willow St. Springfield, Mass. ★

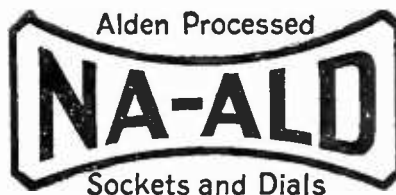

ALDEN MANUFACTURING CO.
Dept. B-4, Willow St., Springfield, Mass.

Please send me free booklet, "What to Build" and details of laboratory test.

Name.....

Address.....

A
vital
improvement!

hooked
terminals

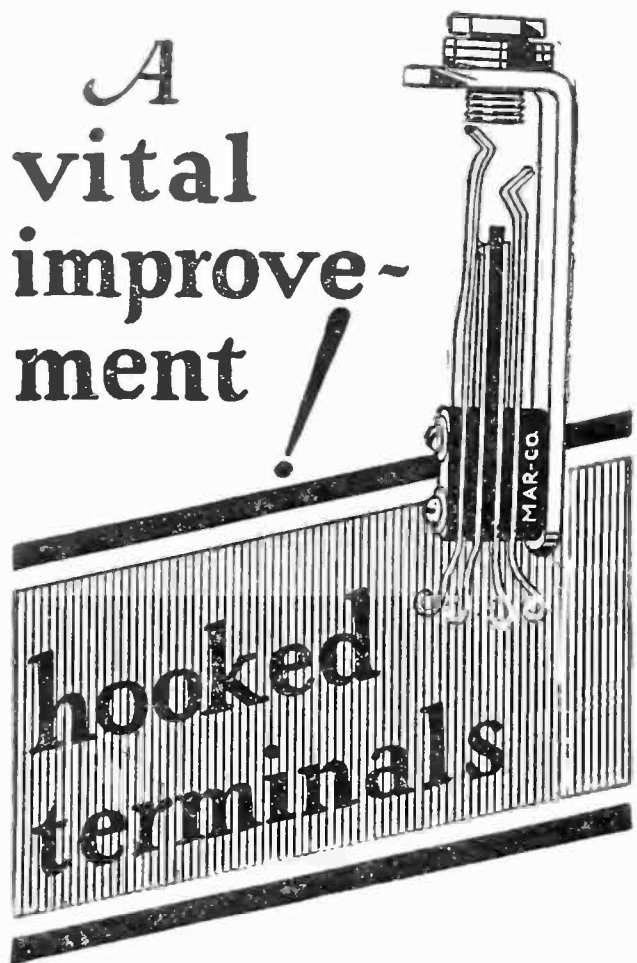

MAR-CO SHURE-GRIP jacks—with hooked terminals—make set construction easier—short circuits impossible—and leak-proof connections permanent!

Formica insulation thruout—heavily nickeled finish—sterling silver contacts—five types—60 cents to \$1.00—and mighty well worth the difference!



MAR-CO



SHUR-GRIP JACKS

Any MAR-CO plug, with a SHUR-GRIP jack, is ample assurance that all the energy in your set . . . actually gets to your speaker!



MURDOCK PHONES

are backed by 20 years of successful experience. There are over 1,000,000 in use to-day. Murdocks are famous for distinct reproduction and for their light weight. With the Murdock Multiple Plug you can use from one to four phones at the same time.

WM. J. MURDOCK CO.
511 Washington Ave. Chelsea, Mass.

Free Booklet

Write for our free booklet "The Ears of Radio." It contains important data on headphones.

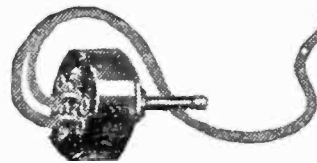

MURDOCK RADIO PHONES

Standard since 1904

VOLT-X
VARIABLE GRID LEAK

NEW!
A BALL-BEARING Grid Leak that stays put. Screw adjustment, expansion contact and resistance unit that cannot wear or tear.

Volt-X Grid Leaks are positive and smooth in action with an accurate range of from one-half to fifteen megohms. Balancing Resistances for Super-Heterodyne and other circuits 30,000—150,000 ohms. They fit any standard leak mounting, and get the absolute maximum from your tubes. They do not wear out.

Grid Leak \$1.00
Grid Leak Mounting .30

BURTON & ROGERS
MFG. CO.
755 BOYLSTON ST. BOSTON, MASS

★ Tested and approved by RADIO BROADCAST ★

BARKELEW

Attachments for Radiola III and III-A

Antenna Selector Switch

The full range of antenna adjustments can be made by simply turning the two knobs and without loosening a nut.

Remove the knurled nuts, slip the switch on the binding posts and replace the nuts. The antenna wire attaches to the one binding post on the rear.

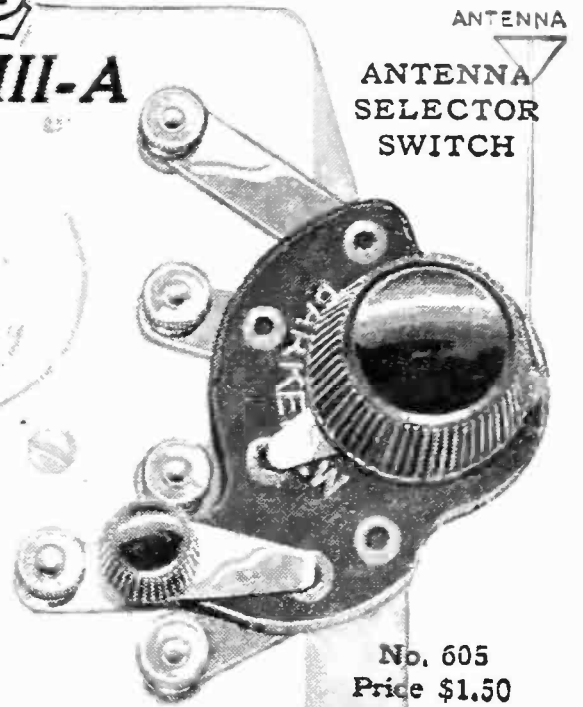

No. 605
Price \$1.50

FOUR
PHONE
POST

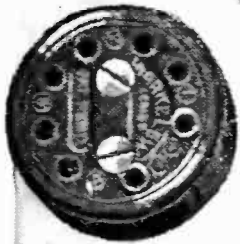

No. 624
Price \$1.00

Four Phone Post

This post will take any number of head sets from one to four and all in series. It is equipped with prongs that push through the phone holes in the face of the panel.

The Barkeley Electric Mfg. Co.

Middletown, Ohio. U. S. A.

NEW YORK, 157 Chambers St.
WASHINGTON, D. C., Mills Building
CHICAGO, 15 Clinton St. S
SAN FRANCISCO, 75 Fremont St.
SEATTLE, 1014 Sixth Ave., S.

LOS ANGELES, 443 S. San Pedro St.
DENVER, Denham Building
MINNEAPOLIS, 1017 Lumber Exchange
BOSTON, 31 Bedford St.
PITTSBURGH, Arrott Building



"ROBERTS SETS" "HANSCOM SUPER"

2-4 tube push pull and resistance coupled, built by us for this magazine as illustrated in past numbers are now available to the public—also six tube HANSCOM SUPER-HETERODYNE—THE REAL SUPER FOR DISTANCE.

Prices on Request.
ALL PARTS IN STOCK.

EXPERIMENTAL - RESEARCH - TEST - SERVICE
Mail Orders Solicited
SUPERS—ADJUSTED

Radio Research Laboratories

Schneider-Horneij, M. I. R. E.

154 Nassau Street New York

★ EBY BINDING POSTS

Twenty-five They Don't
Different Lose
Engraved Tops Their Heads



H. H. EBY MFG. CO.
Philadelphia



The HIGH QUALITY — LOW PRICE CLARITRON \$2.30 TUBE BY MAIL



OUR TYPE 499
Detector and
Amplifier

NOT CHEAP TUBES, BUT GOOD TUBES WHICH WE SELL CHEAPLY
You cannot get a better tube at any price—and why pay more? Our Price is low because we sell direct and are content with a fair profit.

We guarantee that CLARITRON TUBES measure up to the highest standards. The well known New York Testing Laboratories declared CLARITRON to be better than standard tubes selling for \$4.00.

We make all types of tubes including:

Our No. 501A—for same use as 201A

Our No. 112—for same use as WD12

We ship all orders as soon as received. Shipments made by Parcel Post, C. O. D., or Prepaid on Receipt of Express or Postal Money Order.

Our No. 499—for same use as 199

\$2.30 for any type

SUPERIOR RADIO COMPANY, Dept. 202
176 Shephard Ave. Newark, N. J.



OUR TYPE
501A—Tipless
Detector and
Amplifier

★ Tested and approved by RADIO BROADCAST ★



\$1.50
now
for the Ideal
Radio Rheostat

The old story of big demand and quantity production making for price reduction has worked out for the Marshall-stat, the ideal radio rheostat. Its new price is \$1.50 now.

For your money you get the smoothest accurate adjustment rheostat on the market. It gives vernier precision throughout its entire range from 100 to 0.2 ohms. Yet there is only one adjustment to make—only one dial to turn.

In addition, it is compact (illustration above full size), requires only one hole in panel, and can be used with any tube or combination of tubes.

You can't go wrong with the Marshall-stat.

★ **MARSHALL ELECTRIC CO.,**
3233 Locust Boul. St. Louis, Mo.



Get the Marshall-stat at radio dealers everywhere. Write us for descriptive literature.

BOB, SON OF BATTLE
"Is the greatest dog story ever written!"
ASK YOUR BOOKSELLER

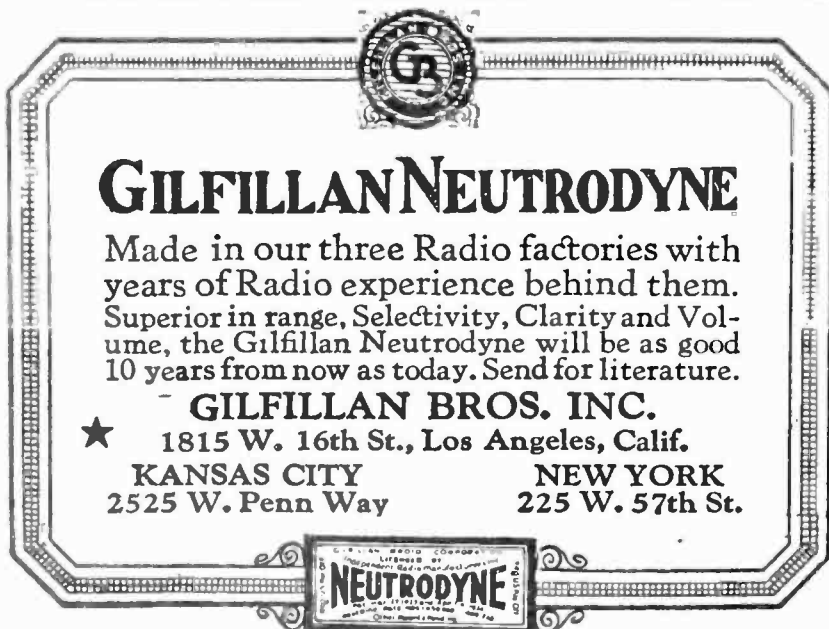

GILFILLAN NEUTRODYNE
Made in our three Radio factories with years of Radio experience behind them. Superior in range, Selectivity, Clarity and Volume, the Gilfillan Neutrodyne will be as good 10 years from now as today. Send for literature.
- **GILFILLAN BROS. INC.**
★ 1815 W. 16th St., Los Angeles, Calif.
KANSAS CITY NEW YORK
2525 W. Penn Way 225 W. 57th St.



FREE
To Each Purchaser of a **World Battery**

A 24-Volt "B" Storage Battery positively given FREE with each purchase of a WORLD "A" Storage Battery. The WORLD Battery is famous for its guaranteed quality and service. Backed by years of Successful Manufacture and Thousands of Satisfied Users. You save 50%.

AUTO BATTERIES		RADIO BATTERIES	
6-Volt, 11 Plate	\$12.25	6-Volt, 100 Amps.	\$12.50
6-Volt, 13 Plate	14.25	6-Volt, 120 Amps.	14.50
12-Volt, 7 Plate	17.00	6-Volt, 140 Amps.	16.00

Shipment Express C.O.D. subject to examination. 5 per cent discount for cash in full with order.
2-Year Guarantee Bond in Writing With Each World Storage Battery proves satisfactory World performance. Mail your name and address—we will ship battery day order is received; and give you your choice of "B" Storage Battery or a handsome nickel finish Auto Spotlite, FREE. Write TODAY

WORLD BATTERY COMPANY
1219 So. Wabash Ave. Dept. 24, CHICAGO, ILL.

This FREE "B" Storage Battery takes the place of dry cell "B" batteries. Can be recharged and will last indefinitely. To be sold retail for \$6.00. It is the only battery of its kind equipped with solid rubber case—and insurance against acid and leakage. Take advantage of this remarkable introductory offer NOW. (To those who prefer it, we will send FREE a handsome nickel finish Auto Spotlite, instead of the "B" Battery. Be sure to specify which is wanted.)

GIVEN FREE
To introduce this new and superior World "B" Storage Battery to the Public

THAT WONDERFUL SUPERDYNE CIRCUIT IS AMAZING RADIOISTS

Only one of the great features in

RADIO WORLD

The first national illustrated weekly and Superdyne Authority.

The 1925 Model Superdyne Explanation and Diagrams. Dealers everywhere. 15c per copy.

OTHER FEATURES: Full week's programs. Many Hook-ups. Great Question and Answer Dept. Articles for Novices and Experts by Authorities. Bring your radio troubles to RADIO WORLD. 15c per copy.

\$6 per year (52 nos.) \$3 six months
\$1.50 three months
SPECIAL: Ten weeks, \$1.

RADIO WORLD 1493 Broadway New York City

★ Tested and approved by RADIO BROADCAST ★

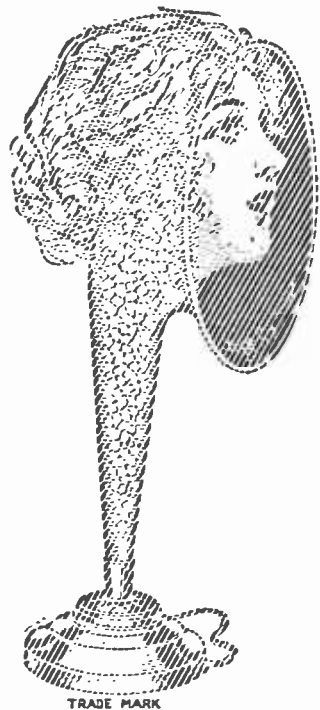

TRADE MARK



TRADE MARK

RADIO REPRODUCTION
Speaker



The ATLAS Unit with adjustment and compound diaphragm—the heart of the ATLAS Speaker. "It gives the best that's in your set."

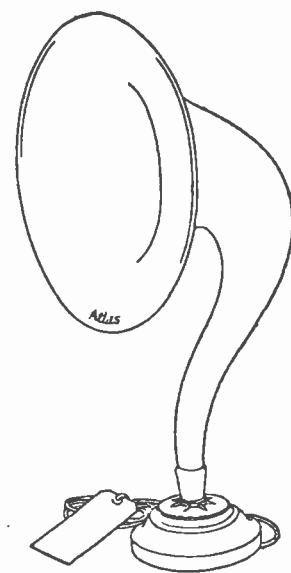
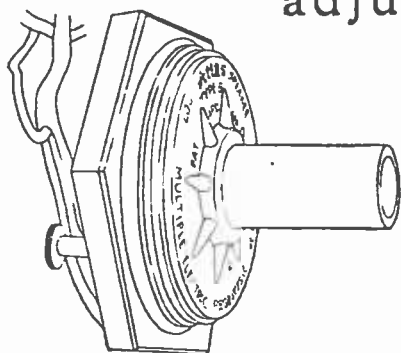

MULTIPLE ELECTRIC PRODUCTS CO., Inc.
365 Ogden St., Newark, N.J.
(Dept. A.)

New York Philadelphia
Boston Baltimore Detroit
Pittsburgh Chicago
St. Louis San Francisco

Marconi Wireless Telegraph Co.
of Canada, Ltd.
Sole Canadian Distributors

ATLAS Products are guaranteed

FOR BETTER RESULTS

You are always sure that the care and time you take in arranging or changing and wiring your set will not be misspent when you use

YAXLEY

Approved Radio Products

Examine any Yaxley Product. Take it apart. You will see many exclusive refinements in design and construction which make for better results in your receiving.



YAXLEY No. 10

Midget Battery Switch

Small and compact. One nut mounting in single panel hole. Quick and positive snap-break contact. **Each 60c**

Other Yaxley Approved Radio Products

Jacks, Jack Switches, Rheostats, Potentiometers, Plugs, Resistance Units, etc.



Fully Guaranteed and Protected by the Manufacturer.

Ask your dealer or send his name with your order to

YAXLEY MFG. CO.

Dept. B., 217 No. Desplaines St., Chicago

THE SILENT
FRANCE
MULTI-DUTY
SUPER-CHARGER

Speed and Economy

In speed and economy, as in numerous other ways, the France Multi-Duty Super-Charger sets a new standard in battery charging. 2, 4, 6, or 8 volt Radio "A" or Auto batteries are quickly charged at a 5 to 7 ampere rate, which tapers as the battery is charged. It also charges up to 120 volts of "B" battery IN SERIES, at varying rates as desired, without attachments—a remarkable achievement. The France Multi-Duty Super-Charger is noiseless, non critical, non-heating, and exceptionally efficient. And there are no bulbs to break and replace nor acids to spill and spoil clothing or woodwork.

Now is the time to put your batteries in order. Write for name of nearest dealer. Price \$22.00; West of Rockies \$23.00. Canadian prices upon request. Dealers and Jobbers:—Write us to-day for description and prices.

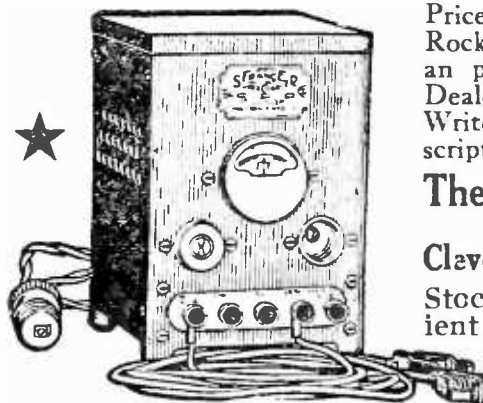

The France Mfg. Co.

10327 Berea Road
Cleveland Ohio

Stock carried at convenient points throughout the United States and Canada.

★ Tested and approved by RADIO BROADCAST ★

THE *Summit* TOROIDAL

used in exactly the same manner as the open radio frequency coils—they are self balanced and self neutralized. They have no stray fields nor leakages, nor can they feed back, thus assuring the radio set builder of correct operation without howling or squealing.

One builder using these Transformers in the Summit circuit received 54 stations in two nights, traveling West to Denver and south to Mexico City. This circuit with instructions for building enclosed with each set of transformers.

List Price (Set of 3 mated units)
\$10.00

*Distributors and Jobbers
Wanted*

**SUMMIT RADIO
MFG. CO., Inc.**

Dept. 21 481 Broad St.
Newark, N. J.

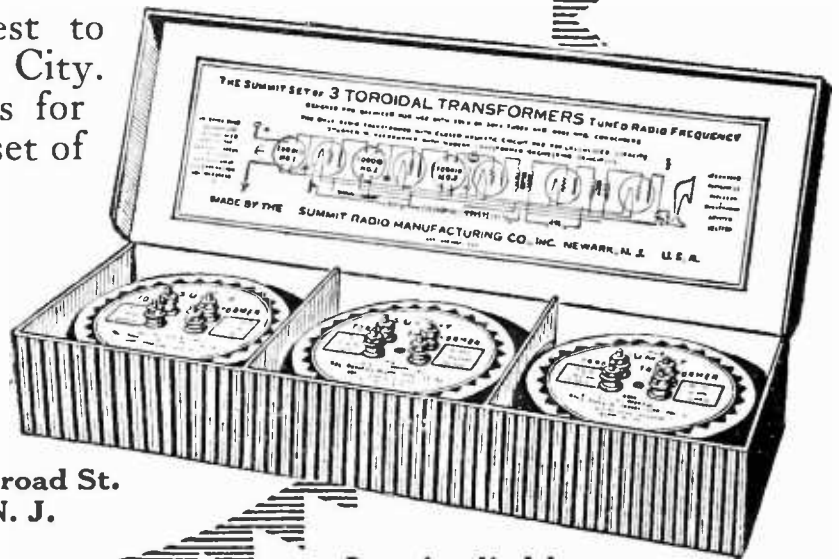

Pat. Applied for

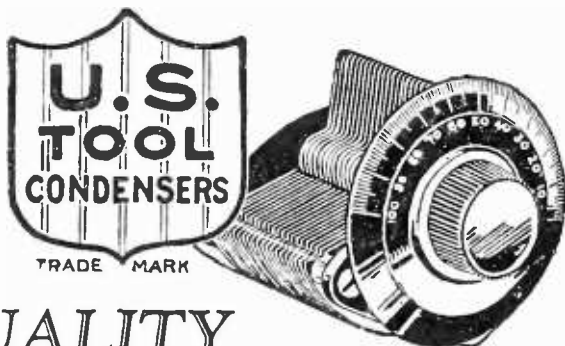

QUALITY
—Based on Perfection
of Parts

A CONDENSER is no more efficient than its weakest feature—a thought borne in mind in designing U. S. Tool Condensers. As a result, the perfecting of parts has led to the nearest approach to condenser perfection. Inquire about Type 6 with the micrometer dial.

FACTORY GUARANTEE

Write for Literature

U.S. TOOL COMPANY, Inc.

125 Mechanic Street NEWARK, N. J.

*Mfrs. of Special Tools, Dies, Jigs, Auto-
matic Machinery and Sub Presses.*

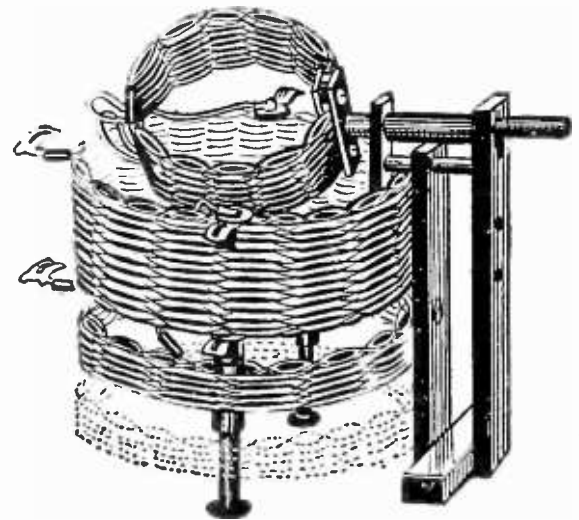

Reg. U. S. Patent Office

**For Sensitivity—
Selectivity—
Distance**

Transcontinental Low Loss Tuner

You love to labor—then make the most of it. To just build a radio set is not sufficient—the receiver you labor on should be the best.

Many radio fans using the Transcontinental Low Loss Tuner report having heard European Stations during the International Test Week. These remarkable 3-circuit tuners can be purchased at any good Radio Store.

List Price, \$7.00

Jobbers and distributors wanted

TRANSCONTINENTAL SALES CO.

241 Market St.

Newark, N. J.

★ Tested and approved by RADIO BROADCAST ★

Low-Loss
“Supercoils”
Fully Adjustable
For All Circuits

“Radio Broadcast’s ‘Knockout’ ”

Walter Van B. Roberts’ Circuit—
 Combining Radio Frequency,
 Regeneration and Reflex.

Endorsed by Mr. Arthur H. Lynch, Editor
 “Radio Broadcast”



“Superdyne” Circuit

For 2-3-4 tubes
 As described in “Radio World”

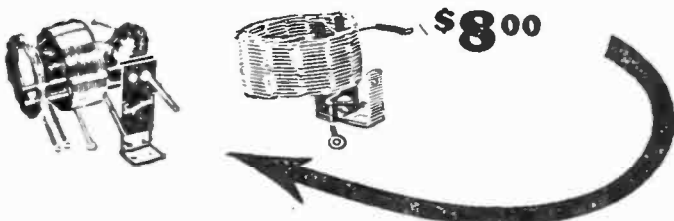

“Tuned Radio Frequency”

(Neutrodyne Type)

Supercoils for adjustable coupling and Low Losses
 \$8.00 for Set of Three

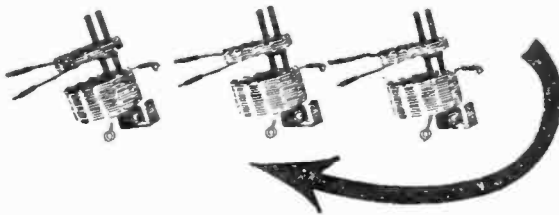

“Superheterodyne”



“Crystal Reflex”

“Harkness” Circuits

Loud speaker operation on one tube

Two Transformers—T1 and T2
 (Fixed Coupling)



At your dealer’s, or direct, plus p. p.

PERFECTION RADIO MFG. Co.

Office 316—1521 Chestnut Street
 Philadelphia, Pa.

Send 3—2c stamps for Low-Loss Bulletins and Hook-Ups

BURGESS
RADIO BATTERIES

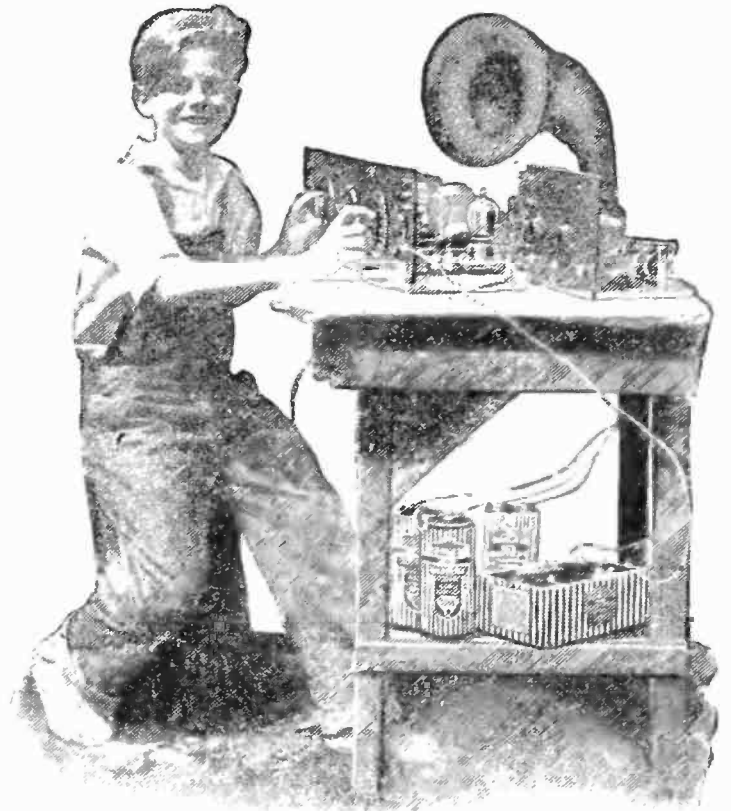

Radio Engineer
Extraordinary!

Old folks can take a tip from the family radio expert, for he and his gang constitute the last word in the choice of receiving set parts.

And when boys get together and talk Radio “A,” “B” and “C” batteries there’s only one brand that they’re strong for—BURGESS—because Burgess Batteries are quiet, serve longer, and they do everything a battery should do—better.



“Ask YOUR Boy”

BURGESS BATTERY COMPANY

Engineers DRY BATTERIES Manufacturers

Flashlight - Radio - Ignition - Telephone

General Sales Office: Harris Trust Bldg., Chicago

Laboratories and Works: Madison, Wisc.

In Canada: Niagara Falls and Winnipeg

★ Tested and approved by RADIO BROADCAST ★

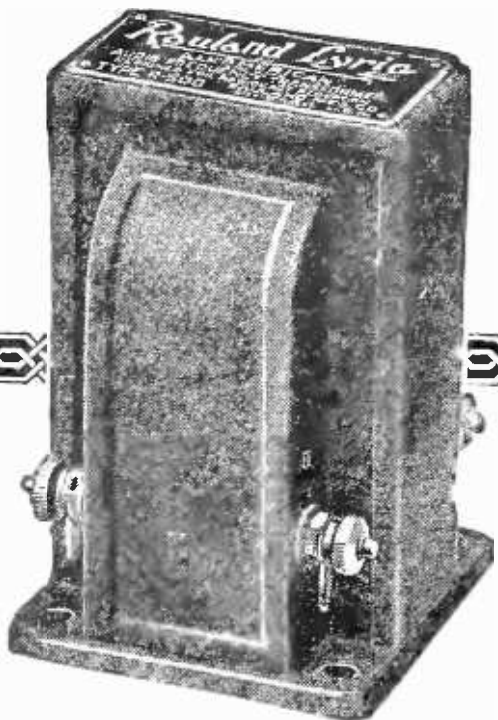

Tonal Beauty Lies Deeper than the Varnish

DEEPER even than the circuit diagram—chiefly, indeed, in the *audio transformer*.

All-American engineers, builders for years of the *largest selling transformers in the world*, have achieved another triumph, in the *world's finest transformer at any price*. Rauland-Lyric amplification, with an ordinary tuner and loudspeaker, has received the plaudits of musical authorities hitherto skeptical of all radio reproduction.

Perfect amplification makes of radio a joy unending. Who shall say that such a benefit is not worth the slight additional cost?

There is romance in the story of Rauland-Lyric. A request will bring it to you complete—from the original laboratory studies to the auditions with world-famous music critics. Rauland Manufacturing Company, 2652 Coyne St., Chicago.

The price is nine dollars

Rauland-Lyric
AN

ALL-AMERICAN
TRADE MARK
TRANSFORMER

The Choice of Noted Music Critics

BLUEBIRD RADIO TUBES

Distinctly New



AND EFFICIENT, satisfying every radio fan's wish in performance and price. Our direct sales plan enables us to sell at this low figure. "Bluebird" assures increased range and undistorted volume.

Type 400—5 Volts, 1 Ampere Detector Tube.

Type 401A—5 Volts, .25 Ampere Amplifier and Detector.

Type 499—3.4 Volts, .06 Ampere Amplifier and Detector.

Type 499A—3.4 Volts, .06 Ampere with Standard Base Amplifier and Detector.

Type 412—1½ Volts, .25 Ampere Platinum Filament Amplifier and Detector.

All Standard Types \$2⁵⁰

TYPE 402 5 WATT TRANSMITTERS . . \$3.00

EVERY TUBE GUARANTEED

to work in Radio Frequency. Especially adapted for Neutrodyne, Reflex and Super-Heterodyne Sets.

Shipped Parcel Post C. O. D.
When Ordering Mention Type

BLUEBIRD TUBE CO.

200 Broadway

New York City

ARROW BATTERY
SLASHES Prices

Prices Smashed!

Quality Not Sacrificed

TO CONSUMERS

ONLY

Here is real battery quality, guaranteed to you, at prices that will astound the entire battery-buying public. Order direct from factory. Put the Dealer's Profit in your own pocket. You actually save much more than half, and so that you can be convinced of true quality and performance, we give a **Written Two-Year Guarantee**

Here is your protection! No need to take a chance. Our battery is right—and the price is the lowest ever made. Convince yourself. Read the prices!

Special 2-Volt Radio Storage Battery, \$3.75
Special 4-Volt Radio Storage Battery, 6.00
6-Volt, 60 Amp. Radio Storage Battery, 7.00
6-Volt, 80 Amp. Radio Storage Battery, 8.00
6-Volt, 100 Amp. Radio Storage Battery, 9.50
6-Volt, 120 Amp. Radio Storage Battery, 11.50
6-Volt, 140 Amp. Radio Storage Battery, 13.00

We ask for no deposit. Simply send name and address and style wanted. Battery will be shipped the day we receive your order Express C. O. D., subject to your examination on arrival. Our guarantee accompanies each battery. We allow 5% discount for cash in full with order. You cannot lose! Act quick. Send your order today—NOW.

Arrow Battery Co.
1215 South Wabash Ave.
Dept. 10 Chicago, Ill.



★ Tested and approved by RADIO BROADCAST ★

• IN STOCK •

Ready for Immediate Delivery—

~
Complete Line of Radiolas

Radiola III	\$35.00
Radiola Balanced Amplifier	30.00
Radiola III A	90.00
Radiola Regenoflex	191.00
Radiola X	245.00
Radiola Super Heterodyne	269.00
Radiola Super VIII	425.00
Radiola Loud Speaker UZ 1325	25.00

~
 We can promise stock shipment because we are one of the largest RCA distributors and placed ample orders with the Radio Corporation of America to take care of our dealers.

Wire in your order now—we'll ship immediately.

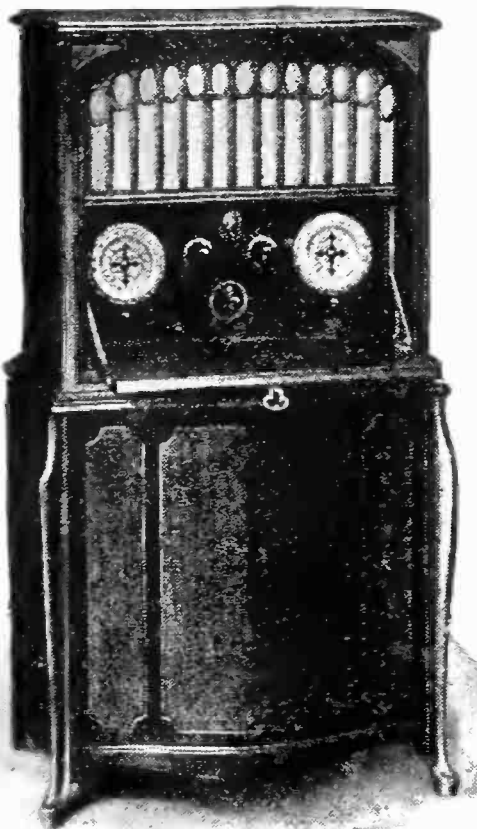
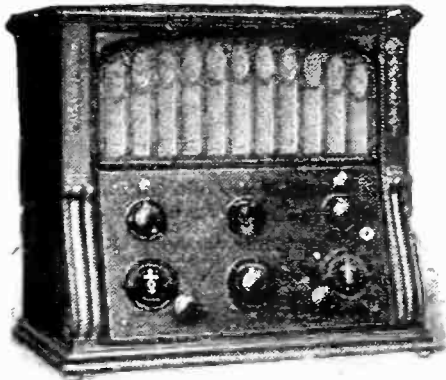

WHOLESALE

EXCLUSIVELY

LUDWIG HOMMEL & CO

929 PENN AVENUE



PITTSBURGH, PA.

Reflectone

COMBINED
Loud Speaker
and
Cigarette Box

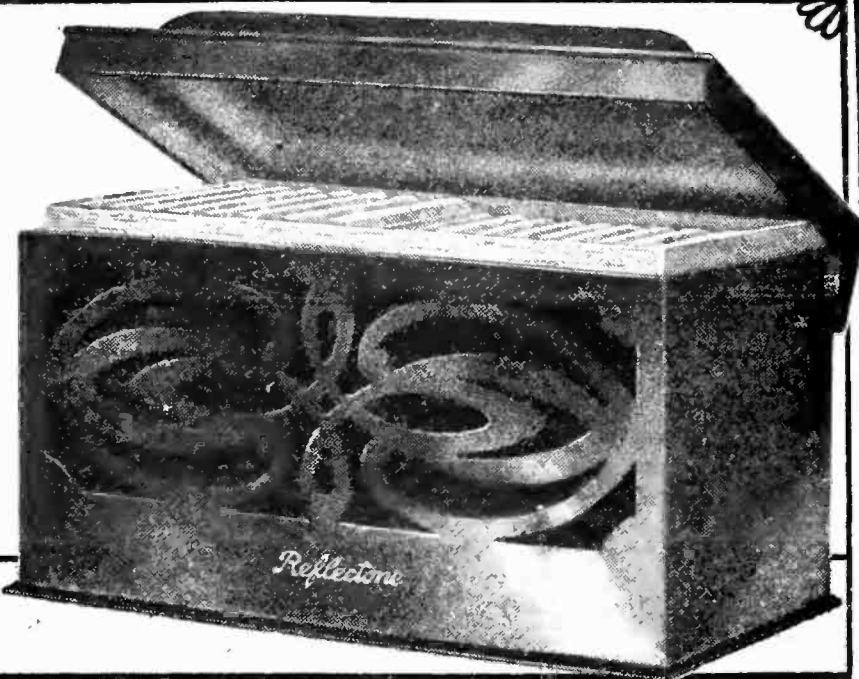

Only 4½ in high \$12.00

Place it on the smoking stand, or in your library. Tune in. Anything. Dance music, or a delicate solo. Each note will be heard as though you stood beside the performer—full, natural, beautiful.

This Model "C" Reflectone was created because the model "A," the first Midget Loud Speaker with a Giant voice, has

proven conclusively the home need for a small but efficient amplifier.

By a new scientific development, tone is reflected from one tonal chamber to another. Vibration is neutralized, the faintest sound reflected—no note is added, none destroyed.

At your dealers, otherwise send purchase price and you will be supplied postpaid. Write for descriptive circular.

★ **RICE & HOCHSTER, 132 Washington Place, New York City**

Daniel Boone: Wilderness Scout

by Stewart Edward White

An out-of-doors story for fathers and sons

At bookstores, \$1.75

Doubleday, Page & Co.

Spintite

For Round or Hex Nuts
It's great fun to build a radio set with Stevens Spintite Wrenches. They spin up the tough little nuts in a jiffy—tight as if soldered.

Set of 3 Round Spintites \$1
Set of 3 Hex Spintites \$1

Write for Radio Tools Booklet No. 22

STEVENS & CO.
Toolsmiths since 1899
375 Broadway New York

Let the non-directional

Thor Speaker Lamp

[Patents Pending]

bring in your Radio programs and furnish light at the same time. Many models—many styles—parchment or any color silk shades.

Table lamp models \$35.

At your dealers—or delivered.

★ **THOR Radio Division**
of the Golden Gate Brass Manufacturing Co.
1239-1243 Sutter St., San Francisco, Cal. (125)

THE FRENCH BINDERS

French binding—in America

Country Life Press Garden City, N. Y.

LEARN THE CODE AT HOME with the OMNIGRAPH

"Just Listen—The Omnigraph will do the teaching"

THE OMNIGRAPH Automatic Transmitter will teach you both the Wireless and Morse Codes—right in your own home—quickly, easily and inexpensively. Connected with Buzzer, Buzzer and Phone or to Sounder, it will send you unlimited messages. at any speed, from 5 to 50 words a minute.

THE OMNIGRAPH is not an experiment. For more than 15 years, it has been sold all over the world with a money back guarantee. The OMNIGRAPH is used by several Depts. of the U. S. Govt.—in fact, the Dept. of Commerce uses the OMNIGRAPH to test all applicants applying for a Radio license. The OMNIGRAPH has been successfully adopted by the leading Universities, Colleges and Radio Schools.

Send for FREE Catalogue describing three models. DO IT TO-DAY.

★ **THE OMNIGRAPH MFG. CO., 16K Hudson St., New York City**

If you own a Radio Phone set and don't know the code—you are missing most of the fun

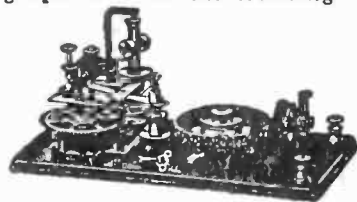

★ Tested and approved by RADIO BROADCAST ★

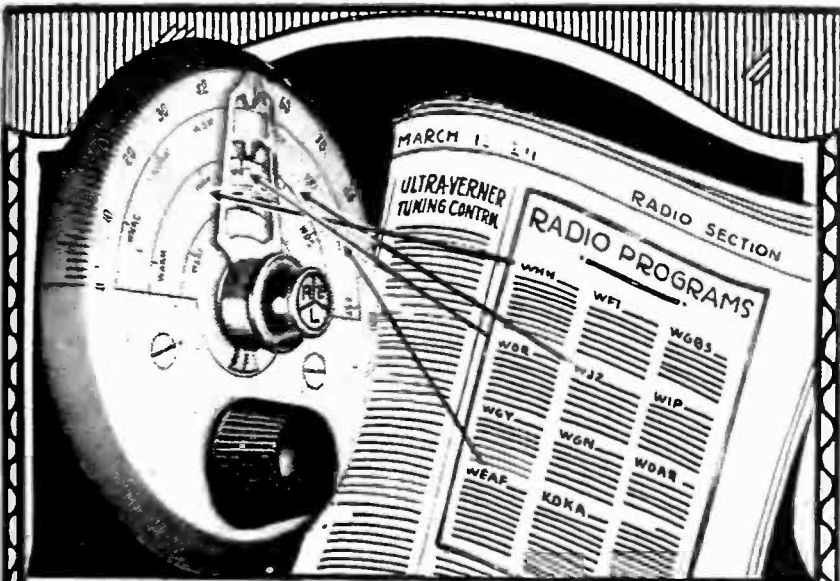

Tune by Sight



Designed by R. E. Lacault, E.E., A.M.I. R.E., inventor of the famous Ultradyne circuit. This monogram seal (R.E.L.) is your assurance of Lacault design.

\$2.50

Made by the Hammarlund Mfg. Co., your assurance of quality and dependability—produced solely for the Phenix Radio Corporation. At your dealer; otherwise send purchase price and you will be supplied postpaid.

Tune your favorite stations once, mark them on the Ultra-Vernier, then forget wavelengths. Tedious tuning, blind fumbling and guessing are over for all time.

Now it's possible to pick your entertainment from the radio program and turn the dial instantly, accurately, to your station and know your receiver is tuned with infinite precision.

The silvered Ultra-Vernier dial mounts fast to panel. Single control 20-1 ratio operates vernier for hair-splitting adjustment and governs station indicator. Replace your old dials with Ultra-Verniers. You've never known such tuning ease.

Write for descriptive folder.



**ULTRA-VERNIER
TUNING CONTROL**
PHENIX RADIO CORPORATION

5-7 Beekman Street
New York City

WIND YOUR OWN INDUCTANCE!

The **SEE-ESS** COIL WINDER

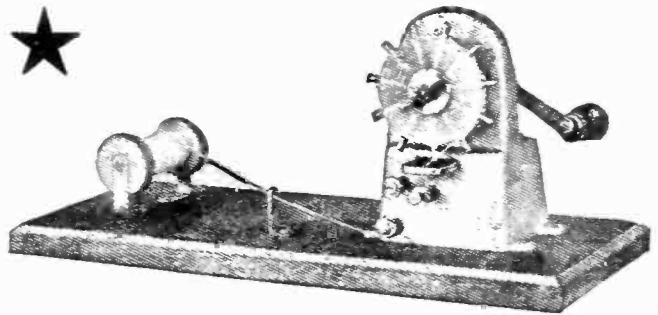

List Price Only \$10.00

THIS very simple device designed especially for the radio experimenter who understands the value of low loss, efficient inductance coils and who has tried this or that type of "patented coil" with no real improvement in selectivity or signal strength. With the See-Ess winder you can wind any size or type of coil, varying the turn ratio, placing the primary between the secondary winding or using two separate windings for the grid and plate circuit. The wire can be space wound, parallel wound or criss-cross, in fact any type of winding that may be desired. The See-Ess winder makes perfect coils, every one exactly like the other and the coils are entirely self-supporting. They require no pegs, lacing or forms to hold the wire in place. The finished coil may be boiled in paraffine or beeswax to exclude all air and moisture from the insulation. The finished product will be practically indestructible.



These coils may be used in Radio Broadcast Knockout Reflex, Roberts' Reflex, all low loss inductance, all self-neutralized tuned radio frequency circuits and all other circuits.

Jobbers Write

WIRELESS ELECTRIC ©

Sole National Distributors

204-206 STANWIX ST.
PITTSBURGH, PA.

MANUFACTURED BY COVEY-SNEDDEN

Not A Copper Aerial

Jiffy Ribbon Antenna is NOT a copper aerial, but is made of highest grade steel with a special plating that makes it absolutely immune to corrosion or oxidization. It has tremendous strength and is guaranteed not to snap, kink or curl.

Jiffy Ribbon Antenna stays bright, clean and efficient month after month—in all kinds of weather.

Jiffy RIBBON ANTENNA



Gives you longer range, greater volume and far more pleasure, service and satisfaction from your

set. Endorsed by thousands of users everywhere. Here is the *non-copper* ribbon aerial that will make your set 100% efficient.

Full 100 feet complete with two insulators, Ready for installation. **\$1.50**

If Your Dealer Cannot Supply You, Order Direct—TO-DAY!

APEX STAMPING CO.
Dept. 47, Riverdale, Illinois

Send me Jiffy Ribbon Antenna. I agree to pay postman \$1.50 each, plus few pennies postage.

Name

Address

.....

THE TAG

That Will Make History

The Curve Tells The Story

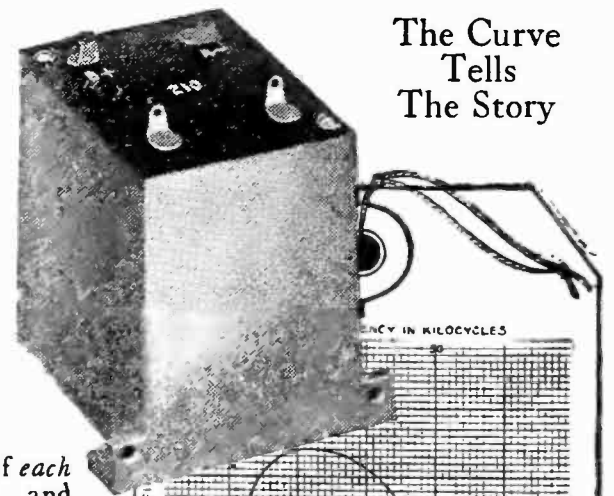

The curve of each TWO-TEN and TWO-ELEVEN Long-Wave Transformer is plotted in our laboratory—recorded upon a tag (as illustrated)—and tied to the transformer. It shows the peak—side-bands passed—amplification expected in any circuit. The Curve applies to *one transformer only*—the one which it accompanies. TWO-TEN—iron-core inter-stage. TWO-ELEVEN—sharply tuned filter for in or output. Both peak at 6000 Meters. Price either type \$8.00 Send for circulars.

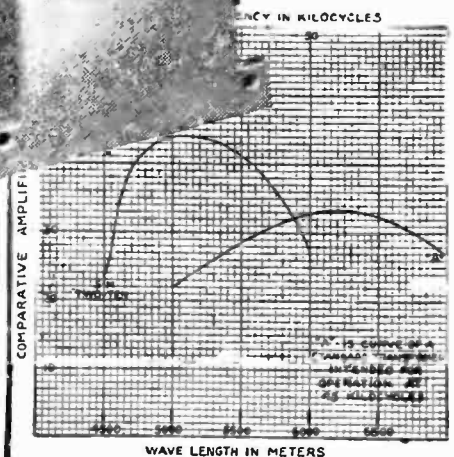

TWO-TEN OR TWO-ELEVEN LONG WAVE TRANSFORMER
Manufactured under the supervision of McMurdo Silver, Assoc. I. R. E. by **SILVER-MARSHALL, Inc.** 105 S. Wabash Ave. Chicago

A REVOLUTIONARY IDEA

It remained for SILVER-MARSHALL to produce long-wave transformers so uniform that *individual amplification curves* could be supplied with each instrument.

The idea is revolutionary. It establishes a new standard of excellence that every progressive manufacturer will be forced to adopt. And it demonstrates, once again, the well-known fact that S-M engineering methods are always years ahead of the industry.

Now you can build your super, as an engineer builds a bridge—after a definite plan.

Send for the "Why of Silver Supers."

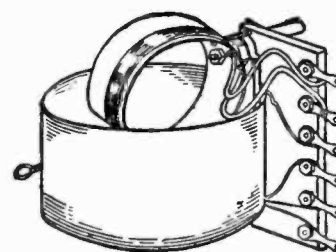

S-M Low Loss Parts

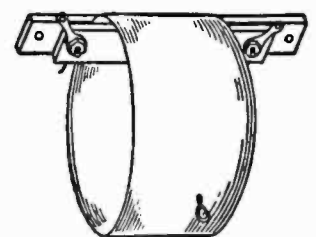

The SILVER-MARSHALL R.F. Coupler (left) and Antenna Coil (right) were designed by McMurdo Silver, Assoc. I. R. E. for use in the Four-tube Knockout, tuned R.F., and three-circuit sets. They show the lowest losses of any coils obtainable. Literature on these parts will be sent upon request.

Write for the book on the Four-tube Knockout. Price, 25c.

SILVER-MARSHALL, Inc.

★ 105 So. Wabash Ave., CHICAGO

I Will Buy for You!

A shopping service conducted for the convenience of Radio Broadcast readers.

AVAIL yourself of the services of an expert buyer in the great radio markets of New York and Philadelphia.

I will act as your representative in these markets without charge to you for my services and will buy any radio equipment mentioned in Radio Broadcast at its Regular Price plus only parcel post and insurance charges. I will buy for you the parts YOU want!

RASLA REFLEX

The Two, Three and Four-Tube "One Dial Receiver" described by J. C. Davidson in February Radio Broadcast with genuine Rasla parts, drilled and engraved panel, celatsite wire, base board, and complete parts all ready to build:

2 Tube Rasla Receiver, complete with all parts	\$36.00
3 Tube Rasla Receiver, complete with all parts	43.00
4 Tube Rasla Receiver, complete with all parts	50.00

I specialize in these circuits:

"Knock-Out" Two-Tube Roberts Receiver, complete with all parts	\$31.00
"Knock-Out" Three-Tube Roberts Receiver, complete with all parts	44.00
"Knock-Out" Four-Tube Roberts Receiver, complete with all parts	53.00

Write for information on

M & H Eight-Tube Super-Heterodyne, "The Real Super" complete with all parts	95.00
---	-------

Kits are composed of *only Highest Grade* apparatus.

Before building your receiver, consult me **FIRST**. I will do your complete radio shopping for you on any circuit.

You can depend on me for reliable radio apparatus.

Every **ORDER** is carefully packed and delivered to your door. You may remit with order or pay your postman.

E. M. Clarke Company
1523 Chestnut Street
Philadelphia Pennsylvania

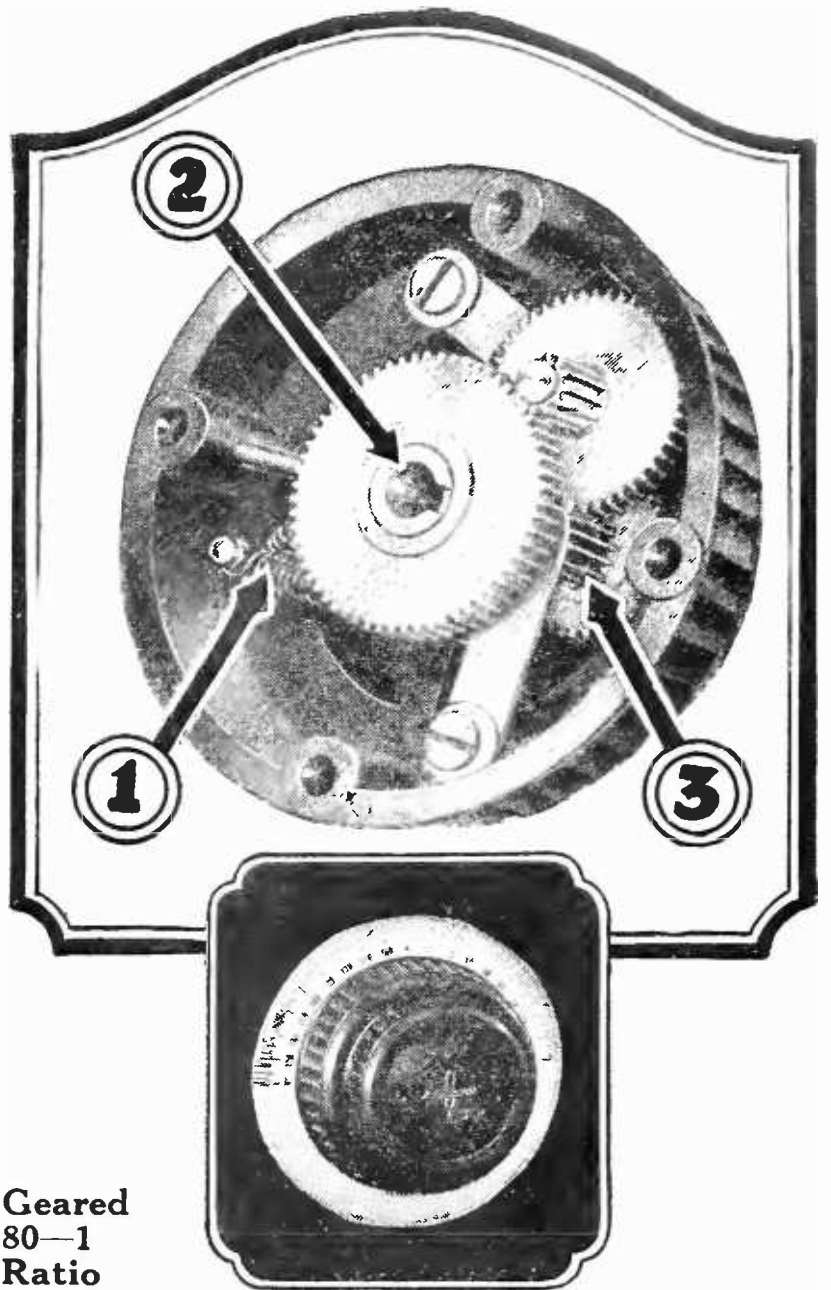

Geared
80-1
Ratio

Dominating Accuratune Features

- 1.—**No Back Lash**—A new principle takes up all lost motion and back lash and produces a very smooth operating instrument.
- 2.—**Long center bushing eliminates all dial wobble** and takes all standard condenser shafts. Permits dial mounting flush with panel. No cutting of condenser shafts.
- 3.—**Gear mesh and alignment perfected** to the same degree of accuracy as the mechanism of a watch.

You can change from ordinary dials to Accuratune Micrometer Controls in an instant, no set alterations necessary—a revelation in fine tuning.

Write for descriptive folder

MYDAR RADIO COMPANY
9-D Campbell St. Newark, N. J.
Canadian Representative: Radio Ltd., Montreal

ACCURATUNE
REGISTERED — GEARED 80to1 — U.S. PAT. OFF.
MICROMETER CONTROLS

INDEX OF ADVERTISERS

IN THIS ISSUE

A

Acme Apparatus Co., The.848H
 Adler Mfg. Co.848A, 955
 Alden Mfg. Co.1001
 Allen Bradley Co.834, 835
 Ambassador Sales Co.976
 Amber Radio Co.976A
 American Bosch Magneto Corp.987
 American Electric Co.994
 American Hard Rubber Co.848F, 956
 American Transformer Co.846
 Amsco Products Co.848G
 Andrae & Sons, Julius.998
 Andrews Radio Co.980
 Apex Electric Co.996
 Apex Stamping Co.1012
 Arrow Battery Co.1008
 Audel Co., Thos.970

B

Bakelite Corporation.569
 Barkelew Elec. Mfg. Co.1003
 Bel-Canto Mfg. Co.982
 Belden Mfg. Co.833
 Biltmore Radio Company976
 Bluebird Tube Co.1008
 Branston Co., Charles A.958, 978
 Bremer-Tully Mfg. Co.1015
 Bristol Company.848N
 Brownlie & Company, Roland974
 Burgess Battery Co.1007
 Burton & Rogers Mfg. Co.1002

C

Cardwell Mfg. Co., Allen D.848B
 Carter Radio Co.984
 Chelsea Radio Co.953
 Chicago Fuse Co.988
 Chicago Solder Co.988
 Clarke Co., E. M.1013
 Como Apparatus Co., The978
 Continental Fibre Co., The.980
 Copper & Brass Research Ass'n.982
 Corning Glass Co.990
 Crescent Radio Supply Co.988
 Crosley Radio Corp.Fourth Cover
 Cunningham, E. F.Second Cover

D

Danziger Jones Co.848
 Daven Radio Co.951
 Davidson Radio Co.961, 962, 963
 De Forest Tel & Tel Co.843
 De Jur Products Co.956
 Deutschmann, Tobe C.994
 Diamond State Fibre Co.947
 Donohue Lumber Co., L. R.976B
 Doubleday, Page & Co.971
 Dubilier Condenser & Radio Corp'n.959
 Duray Radio Corp.973

E

Eby Mfg. Co., The H. H.1003
 Electrad, Inc.957
 Electrical Research Lab.848J
 Erisman Laboratories, The.986
 Experimenters Info. Service.836, 972

F

Fahnstock Electric Co.986
 Federal Tel & Elect. Co.978
 Ford Mica Co.952
 Four Way Co.980
 France Mfg. Co.1005
 Freed-Eiseman848M
 Freshman Co., Chas.975

G

Frost, Inc., Herbert H.980
 Gardiner & Hepburn.982
 General Electric Co.844
 General Lead Battery Co.990
 General Radio Co.845
 Gilfillan Bros.1004
 Golden Leutz, Inc.837
 Goodrich Rubber Co., B. F.995

H

Hammarlund Mfg. Co.986
 Hanscom, Allan T.976D
 H. & H. Radio Company.960
 Harkness Radio Corp., Kenneth1010
 Hayden Radio & Research Co. A. C.984
 Haynes Griffin Radio Service, Inc.965
 Heath Radio.950
 Hick Co., Chas. M.972
 Hommel Co., Ludwig848L, 1009
 Howe Auto Products Co.998
 Hull & Co., S. W.982

J

Jefferson Electric Mfg. Co.848K
 Jewell Electrical Inst. Co.978
 Jewett Radio & Phonograph Co.847

K

Kellogg Switchboard & Supply Co.848C

L

Liberty Mail Order House.1003

M

Magnavox Co.941
 Marshall Elect. Co.1004
 Martin Copeland Co.984, 1002
 Mason-Fenwick & Lawrence992
 Metro Electric Co.954
 Midwest Radio Co.Third Cover
 Modern Electric Co.964
 Montgomery Ward Co.999
 Morrison Laboratories.996
 Multiple Electric Products Co.1005
 Mu Rad Lab.848I
 Murdock Co., Wm. J.1002
 Music Master Corp.993
 Mydar Radio Co.1013
 Myers Co., Ltd., E. B.958

N

National Airphone Corp.838, 839
 National Automotive.952
 National Carbon Co.945
 National Company991
 National Radio Institute840, 841
 Nazeley Co., J.1000, 988
 Newport Radio Inc.848E
 New York Coil Co.985
 Niles Manufacturing Co., The974
 Norden Hauck & Co.956
 Norwalk Radio Corp.982

P

Pacent Electric Co.986
 Peerless Radio Corp.954
 Peiffer & Co.976

Perfection Radio Mfg. Co.1007
 Perry-Fay Co., The.994
 Pfanstiehl Radio Co.979
 Phenix Radio Corp.943, 1011
 Philco Batteries.949
 Polymet Mfg. Corp.958
 Premier Elec. Co.972
 Prest-O-Lite Co.1016

Q

Quality Radio Shop.997

R

Radiall Co.988
 Radio Ass'n. of America977
 Radio Corp. of America849
 Radio Institute of America970
 Radio Panel & Parts Corp.976C
 Radio Power Utility Co.1001
 Radio Shop, The (Nassau Radio Co.)974
 Radio Specialty Co.990
 Radio World1004
 Rathbun Electric Co.989
 Rauland Mfg. Co.848D, 1008
 Resas, Inc.952
 Rhamstine, J. Thos.950
 Rice and Hochster1010

S

Sickles Co., F. W.960
 Silver-Marshall, Inc.967, 1012
 Singer, E.990
 Smith, B. H.996
 Stevens & Co.1010
 Summit Radio Corp.1006
 Superior Radio Co.1003

T

Teagle Company, The.1000
 Thompson Mfg. Co. R. E.842
 Thor Radio Department1010
 Tower Mfg. Co.848O
 Transcontinental Sales Co.1006
 Trilling & Montague968

U

Uncle Sam Electric Co.992
 United Scientific Lab., Inc.960
 Unity Mfg. Co.992
 Universal Winding Co.954
 U. S. Tool Company, Inc.1006

V

Valley Electric Co.998
 Vesco Radio Co.984

W

Walbert Mfg. Co.992
 Waveland Radio Co.998
 Wholesale Radio Service966
 Wilfert Symphony Radio Reproducer1001
 Willard Storage Battery Co.983
 Windsor Furniture Co.981
 Wireless Electric Co.1011
 World Battery Co.970, 1004

Y

Yaxley Mfg. Co.1005

TAKE THE GUESS WORK OUT OF RADIO—USE B-T PARTS



Radio is no longer a mystery. It is an exact science. Using B-T parts in a standard, proven circuit you are as certain of obtaining good results as the modern chemist when he mixes chemicals. Don't guess—use B-T.

READ WHAT OTHERS HAVE DONE

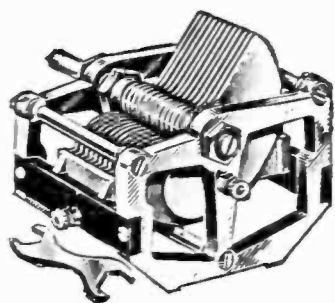

B-T Lifetime Condensers

Type	Capacity	Price
L-7	125 M.M.F.	\$4.25
L-11	250 M.M.F.	4.50
L-23	500 M.M.F.	5.00
L-35	750 M.M.F.	6.50

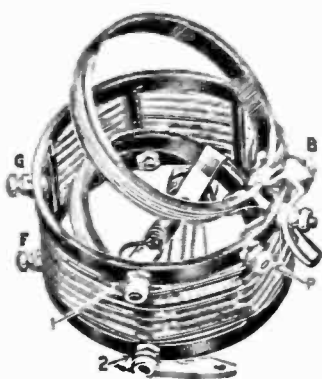

B-T Low Loss Tuner

Made in two types for Broadcast and Short Wave work. Ranges covered with an L-11, Lifetime Condenser.

Type B. .200 to 565. . \$5.00
Type SW. .50 to 150. . \$5.00

Tito Schipa the world's greatest tenor, praises "Nameless" set installed in his apartment at the Congress Hotel, Chicago, as follows:

"After using several other well known radio receivers and discarding same, to say that I am pleased with your set is putting it very mildly. The volume, selectivity and quality of tone, and ease by which distant stations were tuned in while other Chicago stations were radiocasting, was simply marvelous and almost beyond understanding. I suppose that you will hardly believe me when I tell you that I tuned in 42 stations my first night, Monday night, December 8th, 1924, including one Pacific coast station, KHJ."

Roanoke, Va., Dec. 23, 1924
I have just completed your No. 1, using your tuner and condenser. It is the most powerful regenerative set that I have ever heard.

C. F. K.

Denver, Pa., Dec. 23, 1924
Have just received my certificate showing that I have received European stations. I used your tuner and condenser.

E. F. B.

A REAL RADIO HELP

"Better Tuning," our 40 page booklet of hook-ups, construction, tuning and general information, has been a great help to thousands of set builders and operators. No radio library is complete without it. See your dealer, or send for postpaid copy.

B-T Kit No. 3
Contains three 3-Circuit Transformers; three L-11, Lifetime Condensers; one Control Condenser with Dial and complete Blue prints and Instructions. . . . \$26.50

B-T Kit No. 1
Contains three 3-Circuit Transformers only. . . . \$10.50

Nameless Blue Prints and Instructions \$1.



B-T Air Core Transformers

Type AC-3, with adjustable primary. . . . \$3.50

Type AC-1, with fixed primary. . . . \$2.50

BREMER-TULLY MFG. CO.

"Pioneers of Better Tuning"

532 S. Canal St.

Chicago, Ill.

★ Tested and approved by RADIO BROADCAST ★

Prest-O-Lite

RADIO CHART

Voltage of Tubes	No. of Tubes	Type of Tubes (see foot-note)	Total Rated Ampere Drain	Recommended Prest-O-Lite "A" Batteries		
				Order by following Types	Days between Chargings	
5-Volt Tubes C-300 and UV-200 are interchangeable C-301A, DV-2 and UV-201A are interchangeable	1	UV-200	1	69 WHR OR 67 WHR	22 16	
	2	UV-201A	1/2	67 WHR	33	
	4	1 UV-200 1 UV-201A	1 1/4	611 WHR OR 69 WHR	22 17	
	3	UV-201A	3/4	69 WHR OR 67 WHR	29 22	
	3	1 UV-200 2 UV-201A	1 1/2	611 RHR OR 69 WHR	22 14	
	1	UV-201A	2	69 WHR OR 67 WHR	22 16	
	4	1 UV-200 3 UV-201A	1 3/4	613 RHR OR 611 WHR	22 15	
	5	UV-201A	1 1/4	611 WHR OR 69 WHR	22 17	
	5	1 UV-200 4 UV-201A	2	613 RHR OR 611 WHR	19 13	
	5	UV-201A	1 1/2	611 RHR OR 69 WHR	22 16	
	4	UV-201A	2	69 KPR OR 67 KPR	21 15	
	For sets using current at a rate higher than 2 amperes.			2 1/4	69 KRL OR 67 KPR	22 13
				2 1/2	69 KRL OR 69 KPR	19 16

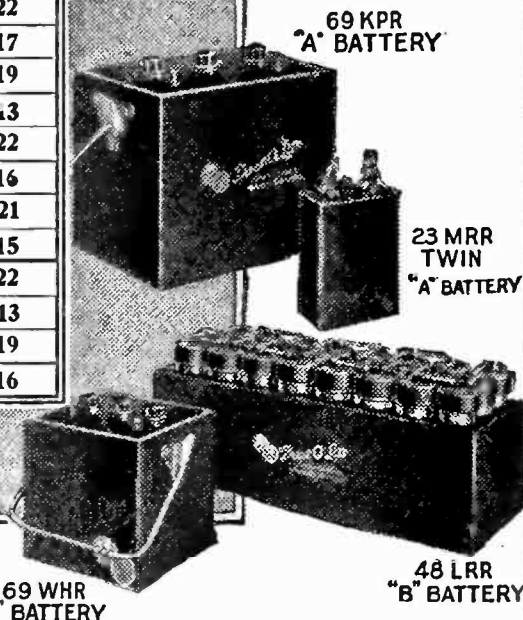

What size batteries will work best in your set?

THE Prest-O-Lite Radio Chart makes it easy for you to select the right storage battery for best reception, and also arrange the time between chargings to suit your convenience. Illustrated above is a section of the master chart showing Prest-O-Lite "A" Batteries for 5-volt tube sets. If your set has these tubes, you will find, in this chart, the Prest-O-Lite "A" Battery that fits it exactly. Two sizes are recommended, but the larger capacity battery will be found more desirable unless facilities for frequent and easy charging are provided. (The days between chargings are based on an average use

of your set of three hours a day.) Thousands of radio dealers have the complete chart, showing you also how to select "B" Batteries, as well as "A" Batteries for peanut tube sets. You'll prefer Prest-O-Lite Batteries because of their special features designed for better radio reception. Improved separators and plates insure steady, unvarying current and years of life. They're easy to recharge and priced to offer you remarkable savings at from \$4.75 up.

See the Prest-O-Lite Chart at your dealer's—or write for booklet, "How to fit a storage battery to your set—and how to charge it."

THE PREST-O-LITE CO., INC., INDIANAPOLIS, IND.

New York

San Francisco

In Canada: Prest-O-Lite Company of Canada, Ltd., Toronto, Ont.



★ Tested and approved by RADIO BROADCAST ★

Unsurpassed selectivity, sensitivity, range, volume and tone combined

Looks like—and performs like—a \$200 radio set

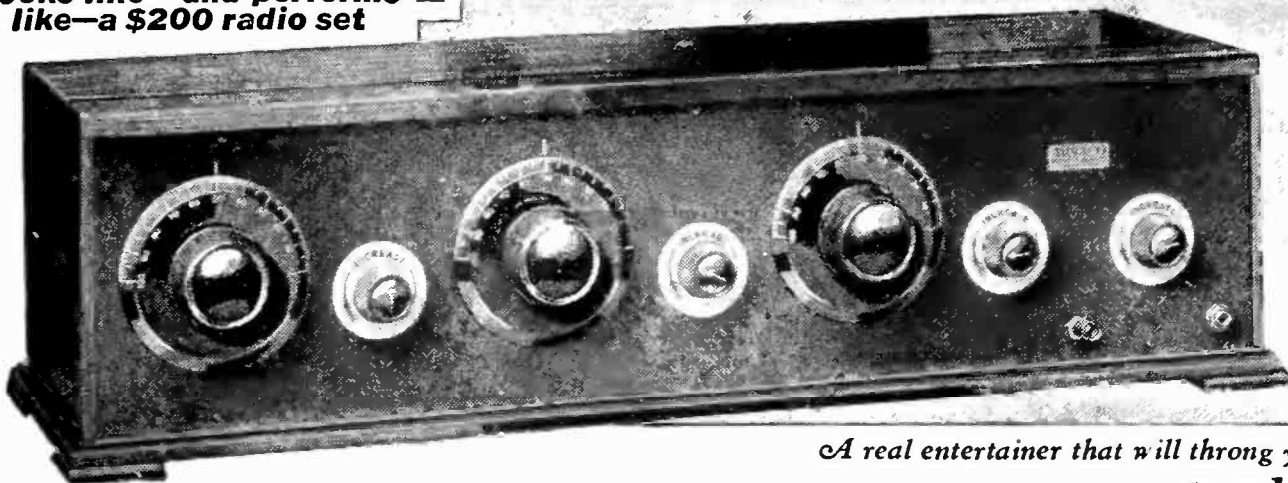

BUILT TO GIVE LOUD SPEAKER ENTERTAINMENT FROM STATIONS THOUSANDS OF MILES DISTANT WHILE LOCAL STATIONS ARE BROADCASTING

A real entertainer that will throng your home with friends!

"Coast to Coast" reception
verified by Miraco Users

Maryland Hears Europe
During International Radio Week I received European stations several times upon my Miraco. Who wouldn't be satisfied with results like this?—Jos. E. Cook, Owings Mills, Md.

California Hears East Coast
Miraco works fine. Last night I got Cuba on loud speaker. I also pick up East Coast programs in spite of local interference.—Clinton Elliott, Long Beach, California.

Illinois Hears London
Miraco operates wonderfully. Thursday night I heard the program from Hotel Savoy, London, for about 35 minutes.—Carl Mackey, White Heath, Ill.

Bermuda Hears California
On my Miraco I have received KGO at Oakland, Cal., a distance of over 3,000 miles, four times in last four weeks. Also five stations about 2,000 miles away and about twenty over 1,000 miles away.—I. O. L. Spurling, Spanish Pt., Bermuda.

Nevada Hears Cuba
Am able to get all Eastern Coast stations with my Miraco as well as Havana, Cuba, and Mexico City. Also all Canadian Stations. Had Havana loud enough to broadcast same over telephone a distance of 300 miles.—A. A. Ewing, Rox, Nev.

Vermont Hears Mexico
I have received stations as far as Mexico, Calgary, Can., Cuba and Texas on Miraco.—A. V. Little, Vergennes, Vt.

Mass. Hears Belgium
Nov. 27th at 11:25 P. M. I heard 2LO London, England, on the Miraco. Nov. 29th at 11:40 P. M. heard SBR, Brussels, Belgium. You can't get a better set for the money.—M. J. Discocoe, Pittsfield, Mass.

N. Y. Minister Hears Europe
I tuned in four different European stations last week on my Miraco. My guests and I heard 5NO Newcastle, England, very clearly—a piano solo from Rigolletto. Also heard voice in Italian announce IRO, Rome, Italy. Concerts from other stations came through but static crashed at conclusions—one was in Flemish.—Rev. Thos. E. Owen, St. Patrick's Rectory, Rosie, N. Y.

The Marvelous **MIRACO** Ultra 5

costs only \$ **75**

Send for free bulletins and **SPECIAL OFFER** today!

[FIVE TUBE OUTFIT IN BEAUTIFUL SOLID MAHOGANY CASE]

Completely built, thoroughly tested and factory guaranteed by one of America's oldest and most reliable manufacturers of quality sets! Years of experience and quantity production explain its almost incredible price. Users say that friends who see and hear it are amazed that it sells for less than \$150 or \$200. Radio experts, who know good construction and quality parts, are equally astonished. You, too, will be delighted, thrilled, amazed with your big five-tube Miraco Ultra 5 in its beautiful hand-rubbed solid mahogany cabinet!

Imagine getting all this for \$75—a beautiful sweet toned "coast to coast

loud speaker" set, composed of finest parts, equipped with the latest improvements, refinements and features found on costliest sets. An instrument approved by radio's highest authorities! A set anyone can connect and operate. Even beginners learn quickly to cut through the "locals," get distant stations loud and clear, log stations and return to them at will. (Full directions with each set.) It is non-radiating, non-distorting, non-howling. Has cut-out switch—and a first stage phone jack for tuning—on Bakelite panel. All wiring concealed under Bakelite sub-base. Works on storage battery or dry cells. Literature describes other newest features.



Other Miraco Long Distance Sets \$14³⁵ up

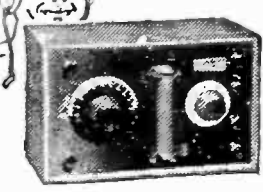

Miraco Model R justly deserves its title, "Radio's finest low priced quality receiver." One tube acts as a tuned radio frequency amplifier and detector combined. A great distance getter. Easy to operate and log. Covers all wave lengths 150 to 625 meters. Like all Miraco sets, it operates on a storage battery or dry cells. Never such value before at only \$14.35. Send coupon today!

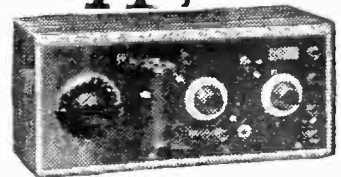

This wonderful new Miraco Model R-3 is the three-tube, long distance, loud speaker set that has created such a sensation. Easy to tune and log. Covers wave lengths 150 to 625 meters. Detector acts also as a tuned radio frequency amplifier. 2 stages audio frequency amplification. Has no equal for simplicity, volume, range or clearness at anywhere near its price of \$29.50. Use coupon!

All the Proof you want is waiting for You!

Reports from the many users in every state prove Miraco Tuned Radio Frequency Receivers—at rock bottom prices—have efficiency of sets costing up to three times as much. Remember that Miraco Sets are the product of a long established, reputable manufacturer—pioneer builders of sets. Send for further evidence that they are Radio's finest moderately priced receivers. All Miraco sets bear the endorsement of radio's highest authorities. Mail coupon now for latest bulletins, SPECIAL OFFER and plenty of additional testimony from users leaving no doubt that "Miraco Radio Gets 'em Coast to Coast."

Dealers! Jobbers! Agents!
Write for the new Miraco proposition.
The wonderful tone, volume and distance-getting ability of Miraco Sets makes them easy to sell. Send coupon for proposition; good territory open.

Send coupon for free bulletins or order direct from this ad

MIDWEST RADIO CORPORATION
Pioneer Builders of Sets, 406-W L. Eighth St., Cincinnati, O.
Send free literature, SPECIAL OFFER and all particulars regarding Miraco Sets. () Jobber () Dealer () Agent () User

NAME.....
ADDRESS.....
.....

★ Tested and approved by RADIO BROADCAST ★

CROSLEY AGAIN LOWERS PRICES

Big Reduction in Famous Trirdyn and other Radios



The biggest selling radio in the world



Now

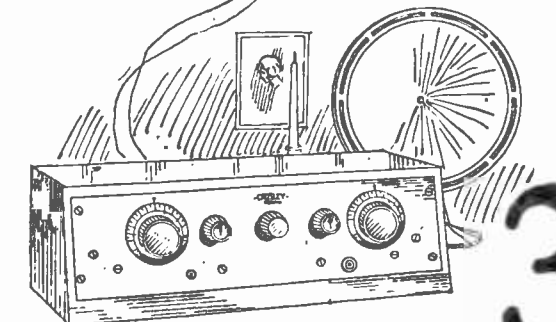
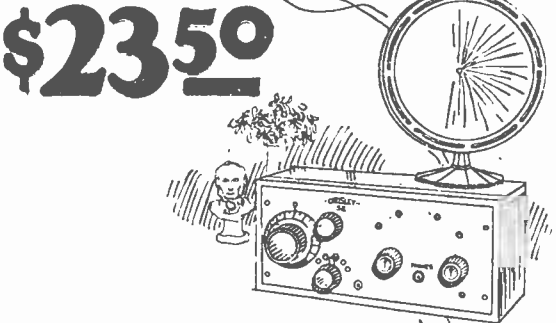

THE biggest selling high grade receiver on the market—the Crosley Trirdyn—reduced from \$65 to \$50.

The Trirdyn Special—the beautiful Model with cabinet to house batteries—formerly \$75, now \$60.

The Crosley 51-P, a tremendous seller at \$25, reduced to \$23.50.

We unhesitatingly state that Crosley Radios represent the biggest values ever offered.

CROSLEY RADIOS JUSTLY POPULAR

Only the less expensive Crosley Radios have exceeded the Trirdyn in sales. This deserved popularity of the entire Crosley line is the result of extraordinary performance at a very low price.

Crosley Radios cost less originally, use fewer tubes and consume much less battery current. They give results not equalled by receivers costing a great deal more and using two or three additional tubes.

The unique Trirdyn circuit—a combination of Armstrong Regeneration, Radio Frequency Amplification and Reflexed Audio Amplification—has proven beyond a doubt that the features of selectivity, volume and ease of operation can be obtained with three tubes better than heretofore has been possible with five or even six.

Hundreds of voluntary letters have come to us, telling of the unparalleled foreign reception during international test week with Trirdyns and all other Crosley Radios; even the little one-tube Crosley 50 at only \$14.50.

It is this continued remarkable performance that has created such a tremendous demand for Crosley Radios. And it is this great popularity that now allows us to decrease our production costs and pass this large saving along to you.

NEW CROSLEY MODELS

In order to allow even a greater selection, three new Crosley Radios have been added to our extensive line. Taking its place with the well known Crosley 50 and Crosley 50-P is the leatherette covered, one-tube 50 Portable, a utility set in which the dealer can quickly make the necessary connections and allow you to carry it home complete.

The New Crosley 51 Special, a two-tube receiver similar to the Model 51, is housed in a cabinet large enough to hold the necessary batteries and has a sloping panel.

Similar to the Crosley 52, but with sloping panel and cabinet to house the batteries is the new Crosley 52 Special.

Most good dealers handle Crosley Radios.

You Will Make No Mistake in Buying One.

All Crosley Receivers contain the famous Armstrong Regenerative circuit, and are licensed under the Armstrong U. S. Patent No. 1,113,149

As is customary prices shown do not include tubes, phones, loudspeakers or batteries

Price West of Rockies—add 10%

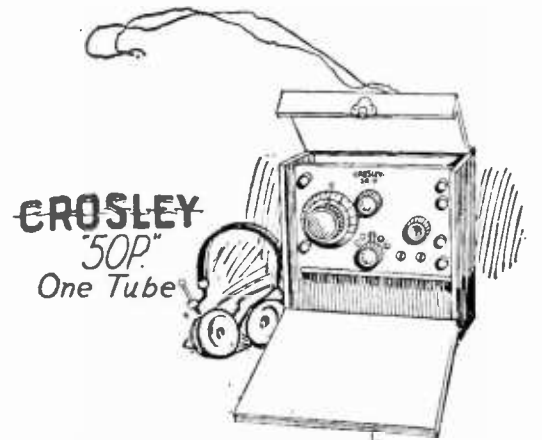

3 Tubes do the work of 5
In a CROSLEY Trirdyn

THE LOUD SPEAKER SHOWN IS THE WONDERFUL NEW CROSLEY LOUD SPEAKER THAT IS TO BE ANNOUNCED IN THE NEAR FUTURE



Write for Complete Catalogue

THE CROSLEY RADIO CORPORATION

POWEL CROSLEY, JR., President

320 Sassafras Street

Cincinnati, Ohio

Crosley owns and operates Broadcasting Station WLW

★ Tested and approved by RADIO BROADCAST ★

THE COUNTRY LIFE PRESS, GARDEN CITY, NEW YORK