

Popular Radio

NOVEMBER • 1927 ★

25¢



**How to Build the
LC-28 Unipac Amplifier
and the New Hammarlund
Hi-Q Receiver**

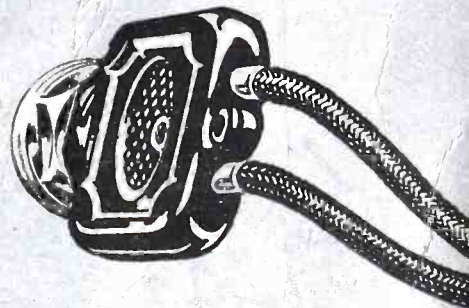

30^D FREE TRIAL

Battery or All-Electric OPERATION

HERE is the great value offer of the day. Test and try this powerful seven-tube RANDOLPH RADIO for thirty days. After it **brings in stations from coast to coast** with amazing clearness—**with easy one-dial tuning**—after it **easily equals any other radio** regardless of cost—after you are more than satisfied then you can buy it **direct at factory prices**. Every RANDOLPH must make good before it is sold.

The RANDOLPH SEVEN-TUBE CONSOLE illustrated here can be had for use with batteries or **connected direct to the electric light socket—absolutely batteryless—no batteries, chargers or acids—just plug in and tune in**. 100% efficient either way. Its construction and performance have been tested and approved by leading radio engineers and authorities—by leading radio publications and laboratories.

7 Tubes—Single Control Illuminated Drum

One drum dial operated by one simple vernier control tunes in all stations with easy selectivity to tremendous volume. No overlapping of stations. Illuminated drum permits operation in the dark. Volume control for finer volume modulation. This is a seven-tube tuned radio frequency receiver with power transformers and power amplification. Space wound solenoid coils. Full and completely shielded. A real receiver of the highest quality. Tremendous distance, wonderful tone quality, simple to operate.

Beautiful Walnut Console Built-in Cone Speaker

The Randolph Seven-tube Ampliphonic Console illustrated above is housed in a genuine burl-walnut cabinet with two-tone hand rubbed finish giving it unsurpassed beauty. The same expert cabinet work has gone into the making of these consoles as in the finest furniture. Has **built-in cone loud speaker that compares with any on the market**. Accurately reproduces complete range of musical notes from the highest to the lowest pitch.

What Users Say

I have logged more than 50 stations from coast to coast.—Lloyd Davenport, Littlefield, Texas. I have logged 52 stations from Cuba to Seattle, the set is a world beater.—J. Tamplinson, Detroit, Mich. Your set is a revelation, has all others tied to the post for distance and selectivity.—Waldo Powers, Vergennes, Vermont. On strength of its performance sold two more sets this week.—T. Scanlow, Orlando, Florida.



The Randolph \$ **99**
7-Tube Console Single Control
RETAIL PRICE
Completely Assembled

Sensationally Big Discounts to Agents
 Work either full or part time and make big money. Tremendous advertising campaign helps you sell. Regardless of whether you have ever sold before, be sure to get our proposition. The Randolph sells on first demonstration. Men and women both can make money this easy way. Get your demonstration set for thirty day's FREE TRIAL.



MAIL COUPON NOW!

The Senior Six
 Now you can have a new, modern, single-control, six-tube radio. Do not compare this set with old style 2-dial 6-tube sets selling for about the same price. The Randolph 1928 Senior Six has also been tested and approved by the leading radio engineers. Comes in a beautiful solid walnut cabinet of hand-rubbed finish. Single control. Illuminated Drum with space for logging. Absolutely dependable and very selective. **Sent for 30 Days' Free Trial. You test it before you buy.**

6-Tube \$55
Retail Price Single Control

The Randolph Radio Corporation are pioneers in the manufacture of radios. All of its vast and unlimited resources have been used in making and perfecting of the Randolph Receivers. Because of our long and successful experience in the radio business, we are perfectly confident in sending out a Randolph Radio on trial. We know what it will do. Mail us the coupon now for the greatest radio offer ever made.

Use This Coupon NOW!

Randolph Radio Corporation,
 711 West Lake Street, Dept. 228
 Chicago, Illinois.

Send me full particulars about the RANDOLPH Six and Seven-Tube All-Electric and Battery Table and Console Sets with details of your **30 Day FREE Trial Offer**.

Name.....
 Address.....
 City..... State.....
 Mark here if interested in Agent's proposition.

RANDOLPH RADIO CORPORATION
 711 West Lake Street Dept. 253 Chicago, Illinois

... Modern

10⁰⁰
COV

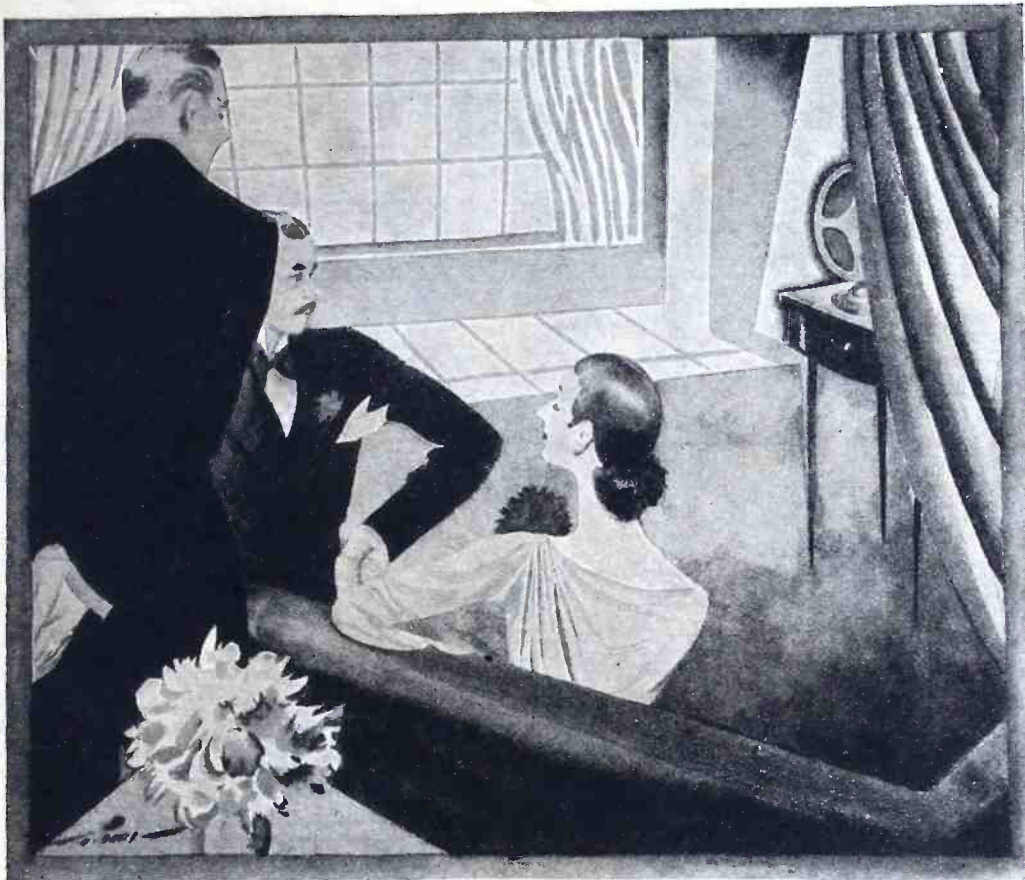

Here is the Eveready Layerbilt "B" Battery No. 486. Eveready's longest-lasting provider of Battery Power.

Radio is better with *Battery* Power

NOT because they are new in themselves, but because they make possible modern perfection of radio reception, batteries are the modern source of radio power.

Today's radio sets were produced not merely to make something new, but to give you new enjoyment. That they will do. New pleasures await you; more especially if you use Battery Power. Never were receivers so sensitive, loud-speakers so faithful; never has the need been so imperative for pure DC, Direct Current, that batteries provide. You must operate your set with

current that is smooth, uniform, steady. Only such current is noiseless, free from disturbing sounds and false tonal effects. And only from batteries can such current be had.

So batteries are needful if you would bring to your home the best that radio has to offer. Choose the Eveready Layerbilt "B" Battery No. 486, modern in construction, developed exclusively by Eveready to bring new life and vigor to an old principle—actually the best and longest-lasting Eveready Battery ever built. It gives you Battery Power

for such a long time that you will find the cost and effort of infrequent replacement small indeed beside the modern perfection of reception that Battery Power makes possible.

NATIONAL CARBON CO., INC.
New York  San Francisco
Unit of Union Carbide and Carbon Corporation

Tuesday night is Eveready Hour Night
—9 P. M., Eastern Standard Time

- | | |
|------------------|--------------------------|
| WEAF—New York | WOC—Davenport |
| WJAR—Providence | WCCO— <i>Minneapolis</i> |
| WEEL—Boston | <i>St. Paul</i> |
| WFI—Philadelphia | KSD— <i>St. Louis</i> |
| WGR—Buffalo | WDAF— <i>Kansas City</i> |
| WCAE—Pittsburgh | WRC— <i>Washington</i> |
| WSAI—Cincinnati | WGY— <i>Schenectady</i> |
| WTAM—Cleveland | WHAS— <i>Louisville</i> |
| WWJ—Detroit | WSB— <i>Atlanta</i> |
| WGN—Chicago | WSM— <i>Nashville</i> |
| | WMC— <i>Memphis</i> |
- Pacific Coast Stations—
9 P. M., Pacific Standard Time
- | | |
|-------------------------------|-------------------------|
| KPO—KGO— <i>San Francisco</i> | KFI— <i>Los Angeles</i> |
| KFOA—KOMO— <i>Seattle</i> | KGW— <i>Portland</i> |

EVEREADY

Radio Batteries

—they last longer

The air is full of things you shouldn't miss

Popular Radio

EDITED by RAYMOND FRANCIS YATES



FOUNDED 1911

VOLUME XII

November, 1927

NUMBER 5

CONTENTS

- A Radio "Still" that Evaporates Steel
FRONTISPIECE.....PAGE 310
- Roxy's Absorbing Theory of
"Radio Psychology"
America's outstanding broadcaster tells the secret
of his astonishing success
By "Roxy" (S. L. Rothafel)...PAGE 311
- The Hammarlund Hi-Q "Six"
Constructional details for a receiver with an
improved system of "cascaded" high-frequency
amplification
By Raymond Francis Yates....PAGE 314
- AC Rejuvenation for the Radiola 20
By Charles L. Davis.....PAGE 318
- Forced and Free Vibrations
The principles of the celebrated "N" circuit, as told
by one of radio's foremost pioneers—
Sir Oliver Lodge, F.R.S., D.Sc., LL.D....PAGE 319
- A Radio that Plays Watchman
By Walter E. Burton.....PAGE 322
- How to Build the LC-28 Unipac
Amplifier
A compact unit that furnishes low-frequency
amplification and "B" and "C" power for the
LC-28 high-frequency pack
By Laurence M. Cockaday....PAGE 324
- A Measurement Chart
A mathematical time-saver for the experimenter
and set builder
By Raoul J. Hoffman, A.M.E....PAGE 327
- A Circuit New in Principle and
Performance—The Octa-monic
"Harmonic" detection gives amazing results in this
latest advance in circuit design
By John Brennan.....PAGE 328
- How to Build the MagnaRay
Power-Pack
A snappy "B" power unit for use with the
Magnaformer 9-8 receiver
By Laurence M. Cockaday....PAGE 330
- The New High-mu 2-Grid Valve
By L. James.....PAGE 332
- The Phono-Radio Reproducer
No. 4 of a series of articles on combining radio and
the phonograph for all-round program reproduction
By James Millen.....PAGE 334
- What's New in Radio
By the Technical Staff.....PAGE 338
- How to Read the Autobiographies
of Vacuum Valves
By H. A. McIlvaine, E.E....PAGE 342
- How to Build and Operate the
Universal Tester
Experimenters and service men will find countless
uses for this radio "detective"
By Morris M. Silver.....PAGE 346
- The New Belin Televisor.....PAGE 347
- How to Build the Lynch "Five"
Receiver
A receiver of unique quality—within the reach of
every man's pocketbook
By S. Gordon Taylor.....PAGE 348

DEPARTMENTS

- Broadcast Listener.....Raymond Francis Yates.. 366
With the Experimenters.....S. Gordon Taylor..... 382

VOLUME XII

NOVEMBER, 1927

NUMBER 5

Published monthly by Popular Radio, Inc., 119 West 57th St., New York, N. Y.; telephone number, Circle 8180; Douglas H. Cooke, President and Treasurer; Laurence M. Cockaday, Secretary; Emma A. Harn, Asst. Treasurer. Price, 25 cents a copy; subscription, \$3.00 a year in the U. S., Canada and all countries within the domestic postal zone; elsewhere, \$3.50 a year, payable in advance. The International News Company, Ltd., No. 5 Bream's Bldg., London, E. C. 4, sole distributors in England. Entered as second-class matter April 7, 1922, at the Post Office at New York, N. Y. under the act of March 3, 1879. Additional entry at Jamaica, L. I., N. Y. Copyright 1927, and title registered as a trade-mark by Popular Radio, Inc. Copyright in Great Britain by Popular Radio, Inc., 6 Henrietta St., Covent Garden, W. C., London, England. For advertising rates, address Popular Radio, Inc., 119 West 57th St., New York; or 225 North Michigan Ave., Chicago.
Printed in U. S. A.

CHARLES L. DAVIS, *Managing Editor*

LAURENCE M. COCKADAY, *Technical Editor*

E. E. FREE, Ph.D., *Contributing Editor*

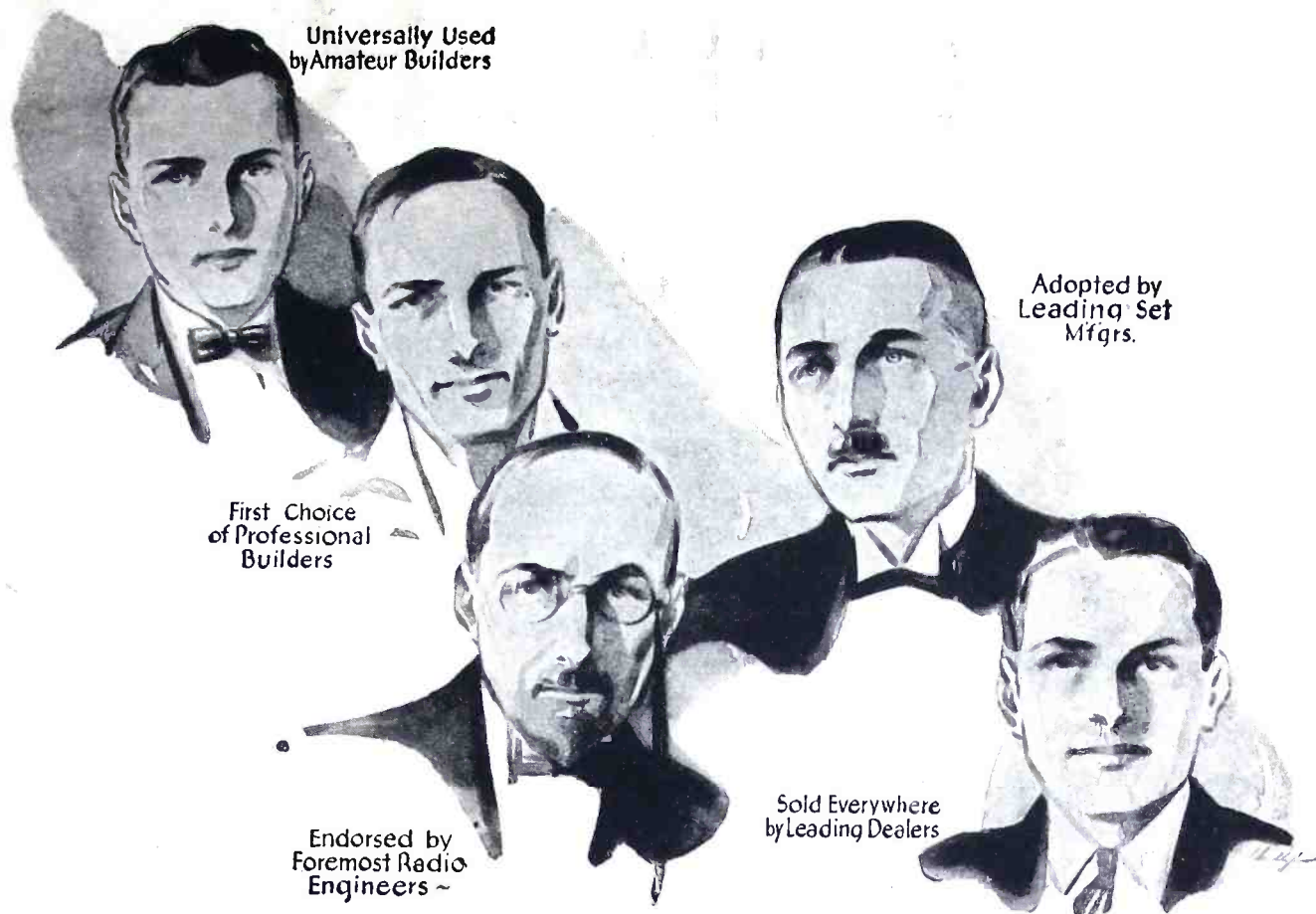

Universally Used
by Amateur Builders

Adopted by
Leading Set
Mfgs.

First Choice
of Professional
Builders

Endorsed by
Foremost Radio
Engineers ~

Sold Everywhere
by Leading Dealers

FIRST CHOICE of the Keenest Minds in Radio!



Durham standard resistors are made in ranges from 500 ohms to 10 megohms. Durham Powerohms for "B" Eliminators and Amplifier circuits are made in 2.5 watt and 5 watt sizes in ranges from 500 to 100,000 ohms.

Adopted by Leading Radio Manufacturers

| | |
|-------------------|---------------------|
| Philco | Kellogg Switchboard |
| A-C Dayton | Garod Radio Corp. |
| F.A.D. Andrea | Fansteel Balkite |
| Western Electric | Kokomo Electric |
| Sterling Mfg. Co. | Howard Radio |
| | Browning-Drake |

SPECIFIED FOR THE
KNICKERBOCKER 4 and
KARAS EQUAMATIC

FIRST CHOICE—because Durham was the first and original "metallized filament" resistor—because years of heavy production and the confidence of leading radio manufacturers have given us *time* to produce a perfect product.

Durham Resistors and Powerohms are the leaders in their field because their uniform, unfailing accuracy and absolute reliability have been proved time and time again.

This is why they are the first choice of foremost engineers, leading manufacturers, professional set builders and informed radio fans who demand quality results.

Like Durham Resistors and Powerohms, Durham Resistor Mountings are also the leaders in their field. The only upright mountings made; takes minimum space—made of high resistance moulded insulation—best quality tension-spring bronze contacts. Single and double sizes.

DURHAM

METALLIZED

RESISTORS & POWEROHMS

INTERNATIONAL RESISTANCE CO., Dept. A, 2½ South 20th Street, Philadelphia, Pa.

A PAGE WITH THE EDITOR

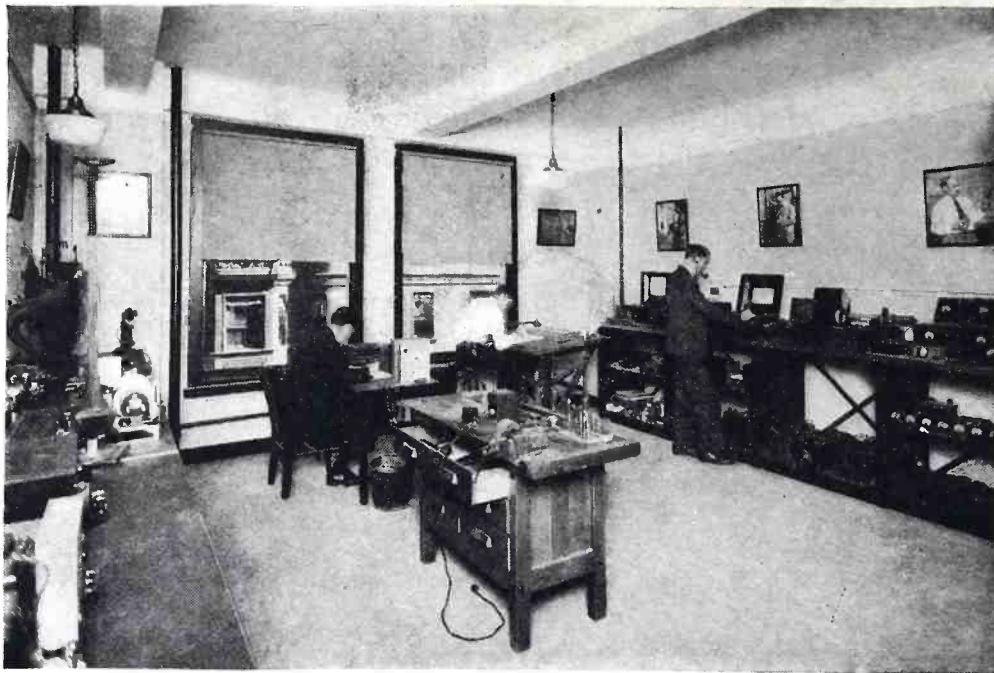

From a photograph made for POPULAR RADIO

POPULAR RADIO'S SPACIOUS NEW LABORATORY

The new POPULAR RADIO Laboratory is one of the most modern institutions of its kind in this country and is far the most commodiously equipped in the publishing field. Not only has the Laboratory new headquarters, but many new instruments as well. The Laboratory is located in the executive offices of the publishers at 119 West 57th Street, New York, N. Y.

THIS particular number of POPULAR RADIO is issued from the spic-and-span new headquarters at 119 West 57th Street, opposite Carnegie Hall. The new quarters afford greater space, more convenient accessibility and ideal conditions for the functioning of the publication's many departments. Nothing but growth and expansion necessitated the change.

It might be said that the latch-string cordially dangles from the door for those of our friends who were accustomed to calling at the old address.

STILL, the letters are filtering in from readers who wish to express their satisfaction with phonograph pick-up units used in connection with good low-frequency amplifiers. It seems as though POPULAR RADIO's active campaign to interest readers in this wonderful new device has borne luscious fruit. Incidentally, one manufacturer of pick-up devices has frankly confessed his inability to keep pace with the demand that this publication has created for these units.

MANY of those who do not contemplate the construction of new instruments are planning to modernize their old sets by installing new low-frequency equipment. All of which reminds us of a statement recently made by a radio engineer of national fame. Said he: "It's been years since I shaved with a

straight razor, and I can't understand those people who still insist on using antiquated low-frequency apparatus when the new stuff is so easily installed and the results so deliciously entertaining."

POPULAR RADIO has in store a wealth of new and interesting editorial material and several exceptionally absorbing articles all planned for the Christmas Number. Christmas comes but once a year, you know, and the editor will put forth every effort to make Santa Claus anything but parsimonious. Chief among the feature articles will be "The Radio Mystery House" which, incidentally, is not fiction. It is a—well, just a mystery.

THERE is still another important forecast for December. In this issue POPULAR RADIO will hit another high mark with the details of an A. C. operated superheterodyne of simple construction. Of all of the "wows" that P. R. has printed, this is one of the "wowest."

As these paragraphs are being written, a great wave of interest in set building is sweeping across the continent, and radio enthusiasts everywhere are scraping the rust from their tools in preparation for an active winter of receiver construction. The crop forecast for good receivers appears very encouraging, indeed.

LAWRENCE B. BATSON of the Department of Commerce comes forward with some absorbing figures showing that over 90,000,000 people throughout the civilized world are now listeners to radio programs. He further states that some 18,000,000 sets are in use and that 200,000,000 sets would be required to service the populace of this unimportant little planet of ours.

WHERE, oh, where, Dear Mr. Radio Statistics Man, are those gloomy brothers who talk so pessimistically about saturation? Saturation of what, the radio manufacturer's pocketbook?

ALONG with this talk about saturation, it's interesting to note that the Homeland is the largest exporter of radio equipment in the world. Canada is our best customer, with Argentina second. Evidently we don't have to tell the world where to shop for the best apparatus obtainable.

THIS recalls to mind a remark made by an appreciative English visitor to our own laboratory. "Our British Engineers," he said, "are still dreaming of the things that you Americans are doing."

Raymond F. Yates



ARCTURIZE YOUR RADIO

*Now you can have all the convenience and economy
of A-C operation — plus unfailing reception of
unusual tone quality with the reliable*

ARCTURUS A-C TUBES

With but a few simple changes in wiring, you can modernize the radio receiver you now own. The only A-C Tube on the market with but four prongs, the Arcturus A-C Tube fits present sockets, can be installed in any circuit without the addition of condensers, or potentiometers.

The changeover to Arcturus A-C Tubes does not take long or cost much. The uniform quality reception they give you is your assurance of complete satisfaction.

For Your New Set

When you are selecting a fine, new set, make sure that you will reap all the benefits of A-C operation, the absolute reliability, convenience and economy that can be yours only with Arcturus A-C Tubes.

ARCTURUS RADIO COMPANY

INCORPORATED

257 Sherman Avenue, Newark, N. J.

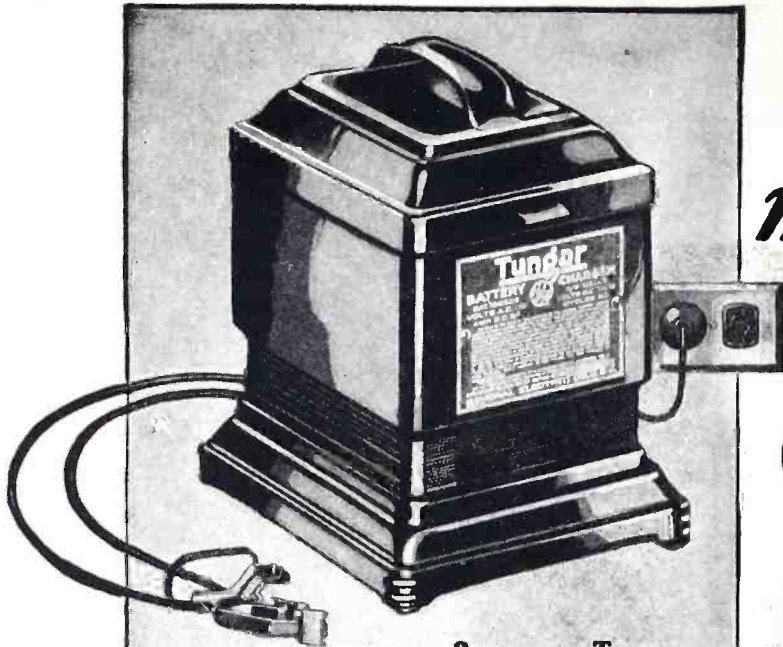

2-ampere Tungar



5-ampere Tungar



G-E Trickle Charger

New Low Prices
(East of the Rockies)

- 2-ampere Tungar . . . now \$14
- 5-ampere Tungar . . . now \$24
- G-E Trickle Charger . . . now \$10

Tungar causes no radio interference. It cannot blow out tubes.

An overnight charge costs about a dime. It is a G-E product developed in the Research Laboratories of General Electric. The 2- or 5-ampere Tungars charge 2-, 4- and 6-volt "A" batteries, 24- to 96-volt "B" batteries in series; and auto batteries, too. No extra attachments needed.

Battery Chargers

made and guaranteed by

General Electric

now \$10 - \$14 - \$24

When you buy a General Electric battery charger for your radio batteries, you get a thoroughly tested and proved product.

The Tungar [the name of the General Electric battery charger] was developed by a staff of technical experts in the experimental and testing laboratories of the world's greatest electrical organization.

More than 1,000,000 Tungars are in use today. For Tungar long ago established its reputation for dependable, trouble-free, economical service.

Just turn on a Tungar at night . . . in the morning your radio storage batteries are pepped up and ready for active duty.

Your dealer can help you. Ask him to show you the popular 2-ampere Tungar that gives both trickle and boost charging rates. It charges "A" and "B" radio batteries and auto batteries, too.



Merchandise Department
General Electric Company
Bridgeport, Connecticut

Tungar—a registered trademark
—is found only on the genuine.
Look for it on the name plate.

GENERAL ELECTRIC



POPULAR RADIO Keeps Its Readers "One Step Ahead
of the Other Fellow"

"The value of POPULAR RADIO is above par to the man who strives to be a little better acquainted with the latest and the best circuits. Technical information upon various radio subjects—especially reception—has always been presented in such an interesting way that the home builder feels that he should apply this knowledge to his own set; as a result, he produces a receiver which is the nearest to perfection in tone quality. With POPULAR RADIO as a guide, he is well equipped to follow the rapid radio improvements and is enabled to be one step ahead of the other fellow."

Henry F. Heins

PRESIDENT, HEINS & BOLET, INC.

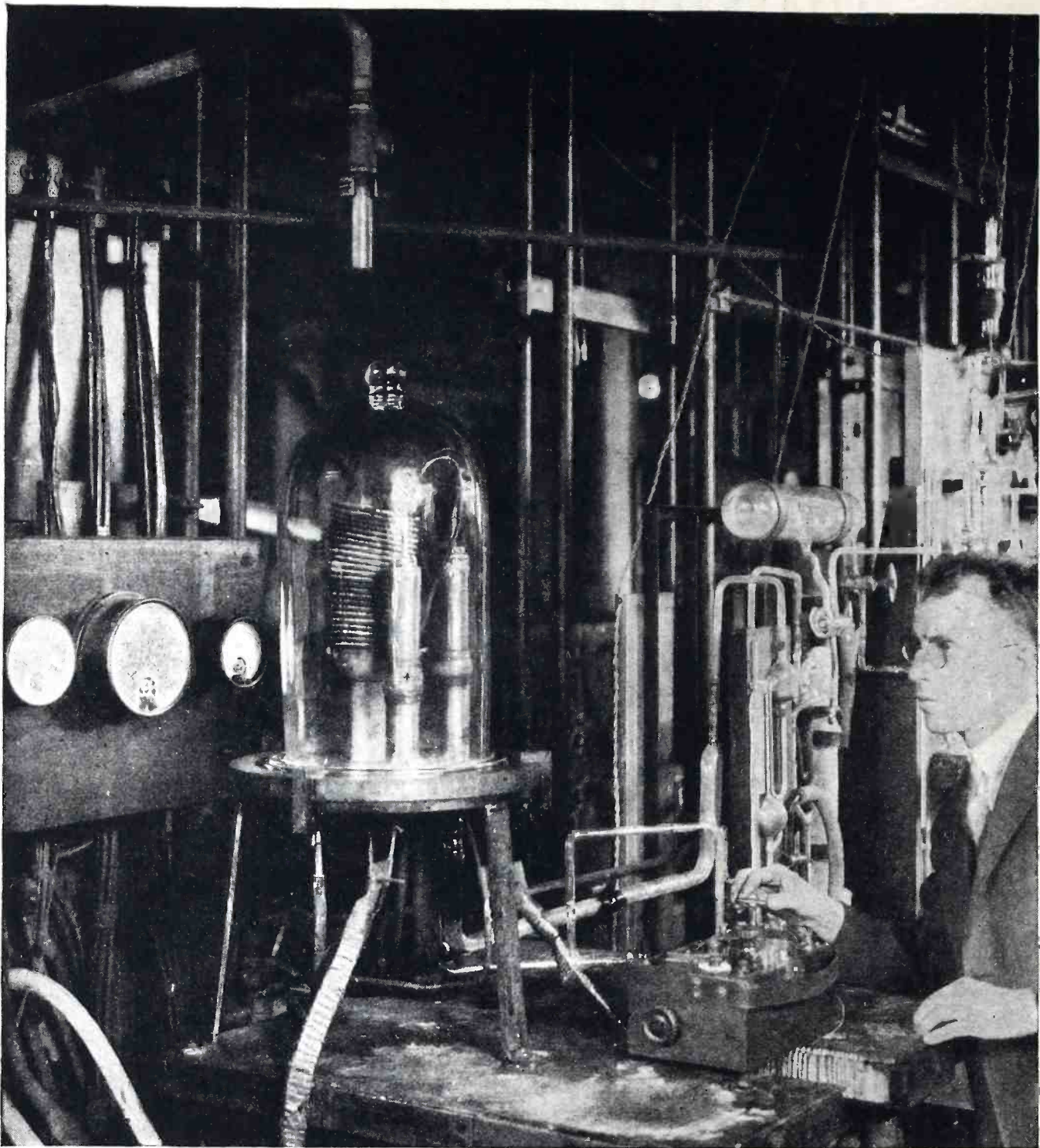

Westinghouse

A Radio "Still" That Evaporates Steel

Heat so great that steel and the noble metals evaporate as readily as alcohol in a still is generated in this high-frequency vacuum furnace, which utilizes the same electric currents as those employed in radio communication. Current of a frequency corresponding to a wavelength of ten thousand meters is sent through the coil inside the glass vacuum bell, creating a heavy oscillating magnetic field. If a metal is placed within the coil, so that it absorbs most of this energy, the frenzied atoms generate such frictional heat in responding to the changing magnetic field that the metal is liquefied and gasified in less time than it will take the reader to absorb the contents of this caption. P. H. Brace, of the Westinghouse Research Laboratory, is shown with the apparatus.

Popular Radio



VOLUME XII

November, 1927

NUMBER 5

ROXY'S ABSORBING THEORY OF

"RADIO PSYCHOLOGY"

Radio's greatest humanist and impresario tells how mass psychology knits the radio audience together and causes it to establish its own fancies and ideals, to which every successful broadcaster must appeal. Listeners automatically elect to popularity only those who are able to interpret their commonplace reactions to entertaining stimuli. Roxy says "Yes" to the question, "Is there an immutable psychological law that makes the radio audience always right in its choice of broadcast programs?"

By "ROXY"

(S. L. ROTHAFEL)

IF you have watched a flock of birds in flight, you will be better able to understand my attempt to explain what I believe to be the sound psychology of broadcasting—I might even say the "law of broadcasting." Birds in flight, it seems, obey some unexplainable law of mass suggestion which causes them to veer to the right or left, to dip or ascend, with perfectly unified and coordinated action. It is an uncanny sight to see thousands of our winged friends responding with delicate precision to this invisible, intangible "something" that makes its appeal only to their psychic selves.

In a measure, the radio audience responds to the work of its willing impresarios in much the same way as the birds respond to mass suggestion. There is a common, sympathetic understanding between its various members and there is a common response to the same

stimuli. And I'll tell you that I had to do a lot of broadcasting to find this out. For months after I began my work on the air, I worried and fretted over a plan whereby I might better understand the mood of the radio audience. It was like looking for the Philosopher's Stone of Radio: something that would make all hearts akin.

What was needed was an appeal that would knit the emotions of the audience together, and cause it to express itself as a unit. A universal stimulus had to be found that would win mass approval. To guide me, I had formulated a more or less roughly hewn idea of the functioning of the mind of the theatre-goer, but I feared that a knowledge of the psychology of the theatre was unavailable for use on the air. In the theatre you reach the mind of your audience through two channels, the eye and the ear. On the air, you must reach

out for emotional response through the ear alone.

The problem solved itself. After my first "gang" had appeared regularly for several weeks, mail began to sweep down on us in tremendous volume. Had I unknowingly struck the very thing that I was trying to find? Had I unwittingly found a means of tapping that psychic stuff that makes the birds fly in unison? Further experience proved that I had.

What was this secret of the air, if secret it could be called? It was sentiment. No matter what the philosophers tell you, I believe that when all is said and done it's sentiment that makes the whole world akin. If you can touch people's hearts, you've got them. Why? I don't know, but since the time when I was knocking about as a cash boy in a Fourteenth Street department store it's been my experience.

Why did the radio public become so entranced with "Gamby" and "Doug"? I'll tell you: because "mike" told the world, the whole wide world, about their love affair, and brought the romance of a charming ballerina and her handsome troubadour right to the humdrum fire-side of the listeners-in.

It wasn't dignified, you may say, but what has dignity to do with merriment? Aren't we all children at heart, anyway? On our birthdays don't we put on paper caps and hope to get the prize out of the frosted cake, just as we did when we were kids? Well, anyway, I do.

I get a tremendous kick out of the morning's mail after a broadcasting session. It's just like a big surprise bag to me. Just as "mike" reflects your own personality, whether you like it or not, so does the radio mail reflect

unerringly the opinion of the public. Well, no, it isn't always complimentary, but that doesn't matter. You can soon learn to boost yourself by the knocks, if you are determined to profit by your mistakes. Many an idea has come to me through a radio letter. Many a constructive criticism, too. They have a way of saying exactly what they think, these listeners-in, and, believe me, it is not only a revelation of the public's mind, but an inspiration to "carry on."

The controlling microphone of a chain of modern broadcasting stations such as we use in our weekly broadcasts is to-day a most powerful instrument for affecting mass psychology, providing a broadcaster has some inkling of the more subtle reactions of his listeners. Louis Satow, the psychologist, comments learnedly on this phenomenon in one of

his books. "Many of the ideas and conceptions," says Satow, "which the individual believes himself to have adopted independently and without constraint, are no more than the effect of the mass mind which manifests itself in manners, customs, and education. On the other hand, the individual mind, especially that of the leader or moralist, has a stimulating effect upon the mind of the crowd."

Unless you are a more eloquent orator than I, however, you cannot get the crowd to follow you in becoming enthusiastic about something that it is only mildly interested in. I'm not a Theodore Roosevelt or a Plato; I don't attempt to change opinions already formed. Sentiment was born with the race and it is appealed to perhaps more easily than any other human characteristic. When you strike at sentiment,



Roxy Masters the Baton as Well as the Microphone

Although not able to read music, Roxy directs his symphony orchestra with a genius that amazes the connoisseurs. His baton anticipates every note and he demonstrates an enormous capacity for memorizing the classics. Musicians who play under his direction say that they absorb just as much inspiration from him as they do under the guidance of directors of greater experience. When in the mood, Roxy often directs the great 110-piece symphony orchestra of the Roxy Theatre, in New York.



At the left is Roxy in an informal pose, snapped on his estate at Spuyten Duyvil, New York. The picture below shows the broadcasting studio of the new Roxy Theatre. The studio is large enough to accommodate a sixty-piece symphony, together with the hundred-voice Russian chorus. It is provided with a glass enclosed balcony from which visitors may view the microphone performers at their work.

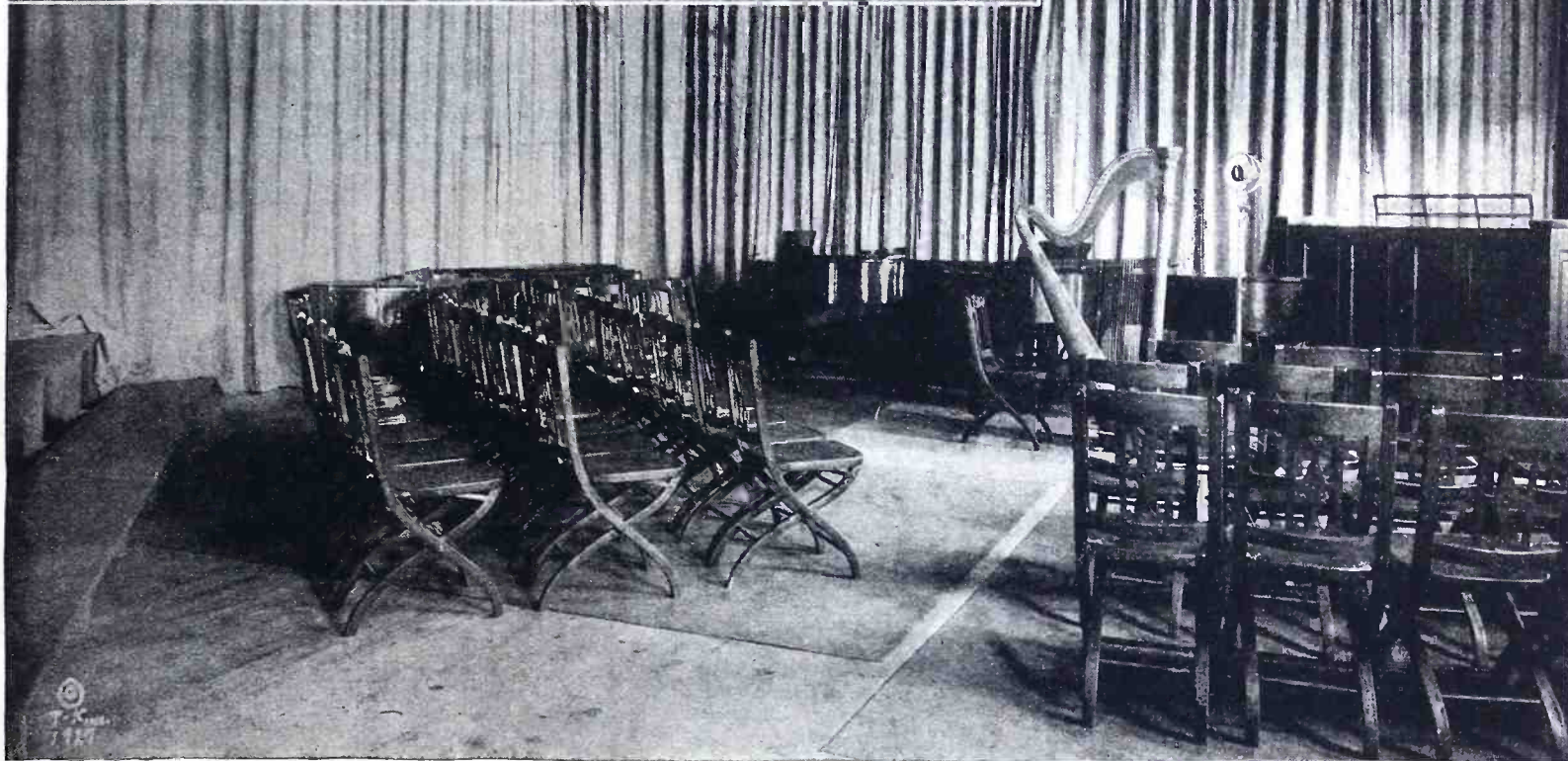

Tebbs & Knell

you are striking at something very fundamental.

I choose sentimental appeal for my programs and I have persisted in this, for once an impresario has hit a responsive note he must stick to it.

There is such a thing as suggestive compulsion, although I would not use it if I could, because I do not need to convince my audience. It already cries for the things that reach the heart; the things that temper life; the things that offer it even momentary escape from this materialistic life that is closing in on us more and more every day.

I must confess that I am a very sentimental person. This is really fortunate, since it does not make it necessary for me to humbug my way into the heart of my audience. Here again we deal with another phenomena of mass radio psychology—the imitative instinct, which, to quote an authority, “is innate in man and causes the crowd to play a much greater susceptibility to suggestion than the individual.” Bech-

terow says somewhere in his voluminous writings on the subject that “without really knowing it, we reach a certain level where we acquire for ourselves the emotions, superstitious ideas, opinions, tendencies, intentions, and even singularities of character of the individuals with whom we most commonly associate.”

Mass psychology will make men see red or white, it will make them love or hate, and in the radio we have one of the greatest instruments for use in making life more bearable and comfortable. My own programs try to emphasize the silvery side of things—try to make men and women see white, so to speak.

It's odd how, at times, we go wide of the mark in attempting to broadcast what we think should prove the most acceptable feature. Some of the numbers that are considered perfect bring in a distinctly hostile mail, and others that are considered doubtful bring in inspiring floods of approbation.

For a long time I was very doubtful as to the effect that poor Gamby would make with her little ditties, although she was very sincere about their rendition. I conferred with my most faithful associates and friends and a decision was reached to see what the effect would be of taking her off the air. The effect was nothing short of thunderous, and Gamby was quickly put back on the program to stay. Here was an interesting study in radio psychology that I was at a loss to understand, but it accounted for a potential following, a following that, by its sheer force of numbers, made a singer out of a dancer.

Upstairs in our theatre we have stored away over one million letters from radio fans, and I should indeed like to turn them over to the Psychology Department of some college that they might be carefully tabulated and studied. I think this might give us an entirely new insight into broadcasting. It would, I feel sure, vindicate my pol-

(Continued on page 353)

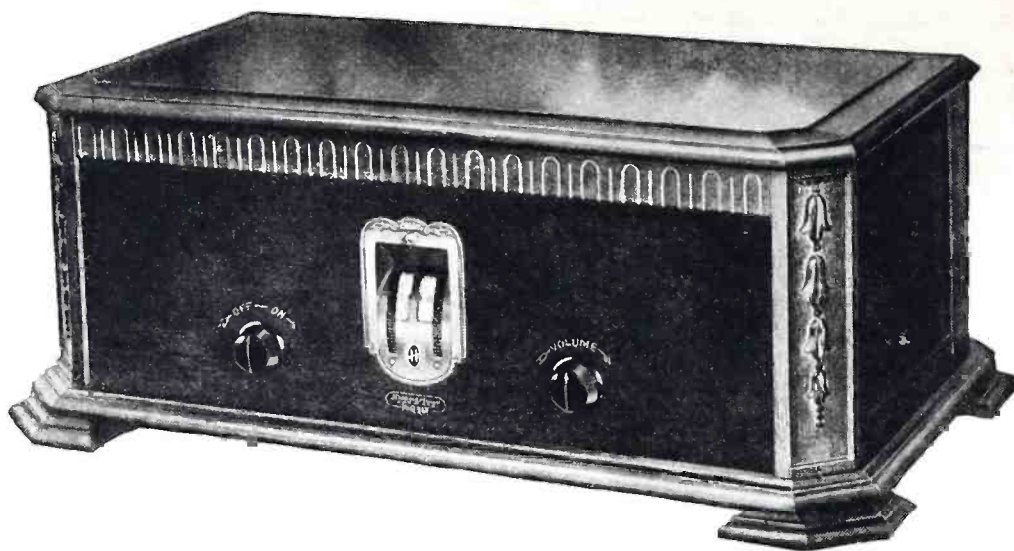

TO RADIO BUILDERS EVERYWHERE:

The new model of the Hammarlund Hi-Q Receiver is the result of eleven months of painstaking research, and represents the honest effort of its designers to supply set builders with all that is modern and efficient in radio design. The splendid performance of the receiver has been more than commensurate with its cost, and I firmly believe that the new Hi-Q takes its place beside the best that 1928 engineering will have to offer.

—LLOYD HAMMARLUND

Hi Quality, Hi Amplification and Hi Efficiency— **The Hammarlund Hi-Q "Six"**

By RAYMOND FRANCIS YATES

COST OF PARTS—Not over \$96.00

HERE IS A LIST OF INSTRUMENTS AND ACCESSORIES FOR BUILDING THIS RECEIVER—

- | | | |
|--|--|--|
| A—Samson symphonic transformer; | K—Carter Imp battery switch, type 2-A; | R—Hi-Q "6" foundation unit, containing: |
| B—Samson 3-1 transformer, type HW-A-3; | L—Durham metallized resistor, 2 meg-ohms; | R1—Drilled and engraved Micarta bakelite panel, 7 by 21 by 1/8 inch; |
| C1, C2, C3 and C4—Hammarlund Mid-line variable condensers, .0005 mfd.; | M2, M3 and M4—Acme Parvult by-pass condensers, .5 mfd., series A; | R2—Drilled metal chassis; |
| D1, D2, D3 and D4—Hammarlund auto-couple coils, HQ-64; | N1, N2, N3, N4, N5 and N6—Benjamin Cle-ra-tone vibrationless sockets, No. 9040; | R3 and R4—Two-stage aluminum box shields; |
| E1, E2, E3 and E4—Hammarlund chokes, type RFC-85; | O1, O2 and O3—Eby engraved binding posts, marked <i>Speaker plus</i> , <i>Speaker minus</i> and <i>Antenna</i> , respectively; | R5 and R6—Brass extension shafts for variable condensers; |
| F—Hammarlund illuminated drum dial; | P1 and P2—Amperite automatic filament adjusters, No. 1-A; | R7 and R8—Cam-operating assemblies; |
| G—Sangamo mica fixed condenser, .00025 mfd.; | P3—Amperite automatic filament adjuster, No. 112; | R9, R10 and R11—Grid-biasing resistors; |
| H—Sangamo mica fixed condenser, .001 mfd.; | Q—Yaxley cable connector and cable, No. 660; | R12 and R14—Grid suppressors (black); |
| I—Sangamo grid-leak clips; | | R13—Grid suppressor (red); |
| J—Carter Imp rheostat, 6 ohms, type 1-R-6; | | R15—Bakelite grid-leak mounting block; |
| | | R16—Bakelite binding-post strip; |
| | | Wires, screws, nuts, washers, spacing col-lars, etc. |

IN the last issue of POPULAR RADIO the salient features of the new Hi-Q "Six" were enumerated for the benefit of the radio set-builder and experimenter. The conditions of design were outlined for a receiver that would have adequate selectivity for modern broadcast conditions and, at the same time, satisfy the requirements of uniform amplification and realistic broadcast reception.

The set comprises three stages of

tuned-high-frequency amplification, with a tuned detector stage, and with a filter choke and condenser in the output of the detector circuit to exclude high-frequency currents from the low-frequency amplifier. The latter is composed of two stages of transformer-coupled amplification, using the highest quality apparatus and a power valve for reproducing the full scale of musical frequencies.

The outstanding features incorpo-

rated in this new receiver are here reviewed:

1. The entire receiver is mounted on a metal chassis with complete shielding for the four tuned circuits that comprise three stages of efficient high-frequency amplification and a detector stage.

2. The mechanical details of the new receiver have been worked out with a view to securing not only efficient operation, but a front panel layout that is

The list of parts given on page 314 includes the exact instruments used in the laboratory model of this receiver. The experienced amateur, however, will be able to pick out other reliable makes of instruments which have been approved by POPULAR RADIO and which may be used with good results. But we recommend that the novice follow the list, as the diagrams in this article will tell him exactly where to bore the holes and exactly where to place the connections. If instruments other than the ones listed are used, the only change that will be necessary will be the use of different spacings for the holes that are drilled in the sub-base for mounting the instrument. To any reader who has difficulty in obtaining any of the parts which are necessary in making up these model receivers, POPULAR RADIO SERVICE BUREAU, 119 West 57th Street, New York City, will gladly assist in seeing that his requirements are promptly supplied.

pleasing in appearance. The only tuning control appearing on the front panel is an illuminated drum dial, consisting of two separate controls which are, however, turned simultaneously by two fingers of one hand. Only two secondary adjustments appear on the front panel, the filament switch and the volume control.

3. An important feature employed is automatic variable coupling, a new idea in radio, which secures maximum and uniform amplification over the entire tuning range and exceptional selectivity and sensitivity with full volume on all frequencies, without the slightest possibility of oscillation.

4. Another feature of the set is the complete isolation of each of the four tuned circuits by means of chokes and by-pass condensers. This means that each stage operates independently and at highest efficiency without interaction

between any of the successive stages.

Furthermore, the construction of the set is so simple, and the wiring laid out in such an orderly manner, that anyone without previous radio experience can build it successfully from the diagrams and description given in this article.

How to Assemble the Instruments

The first job to perform is the mounting of the various instruments on the metal chassis. Reference to Figures 1, 2 and 3 will make the description perfectly clear. It will be advisable first to mount the six sockets. N1, N2, N3, N4, N5, N6, taking care to arrange them so that the arrows are in the position shown in Figure 1. Sockets N1, N2 and N3 are mounted with two machine screws and nuts; sockets N4, N5, and N6 have the negative filament binding posts removed and have

the machine screw inserted through the hole and through the spacing collars, with the nut on the bottom side of the metal chassis. R2. This connects the negative filament terminal in firm electrical contact with the metal chassis. These latter three sockets also have two machine screws and nuts holding them in position in the normal mounting holes.

Next attach one end of each of the three grid-biasing resistors. R9, R10, R11, to the negative filament terminals of sockets N1, N2 and N3, respectively. The other ends of the three resistors are connected directly to the metal chassis, R2, by means of a machine screw and nut.

Next attach the Sangamo grid-leak clips to the grid-leak mounting block, R15, by means of machine screws. This should be attached to the chassis next to the socket N4, in the position

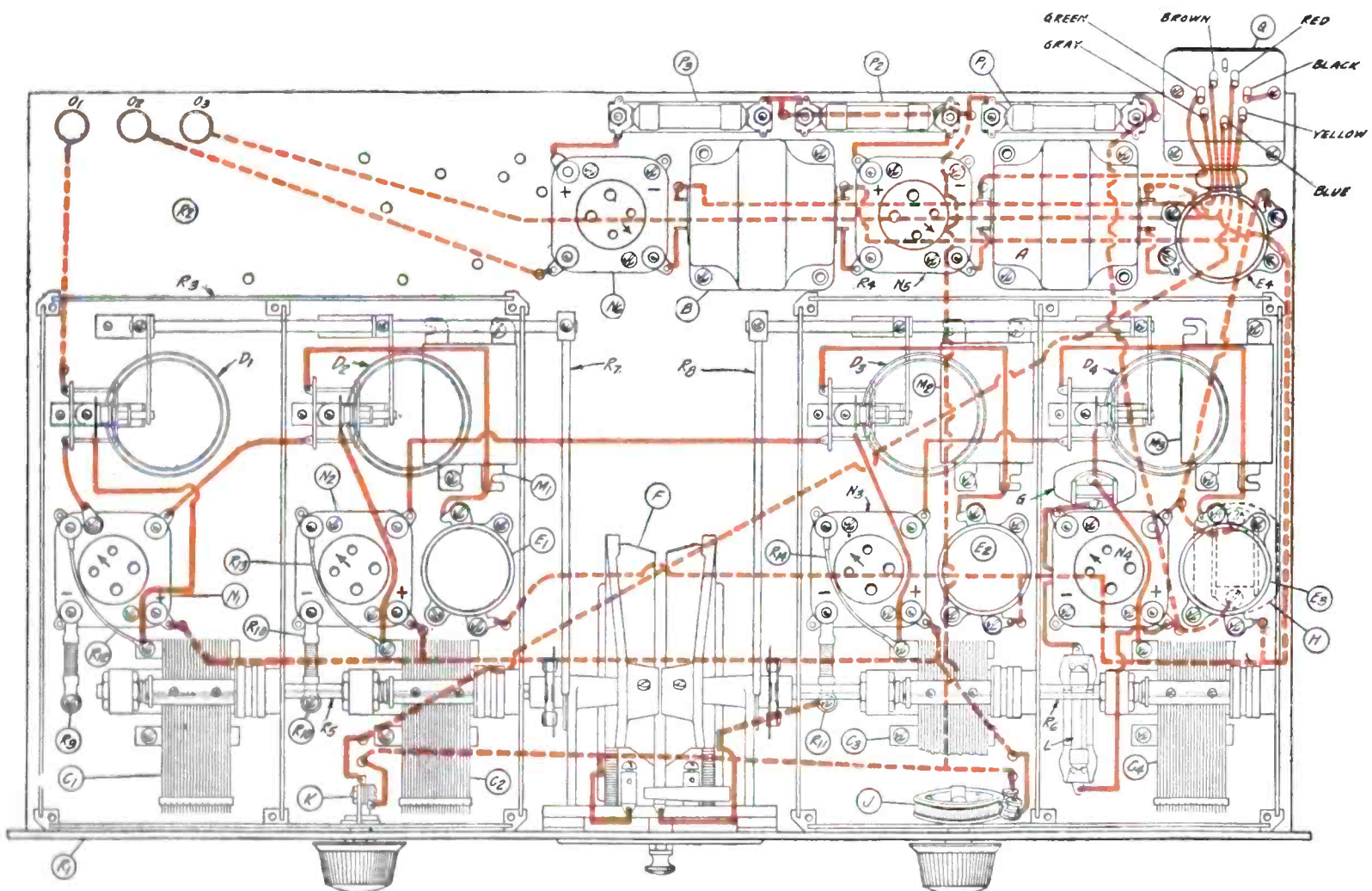

HOW TO WIRE THE SET

FIGURE 1: All the outlines of the instruments and parts are shown in solid black lines, except in the case of condenser H, which is shown in dotted black lines, to indicate that it is mounted underneath the chassis. The wiring that is run above the chassis is shown in solid red lines, while the wires that run underneath the chassis are shown in dotted red lines. The plug, Q, is shown tilted to expose the contact points.

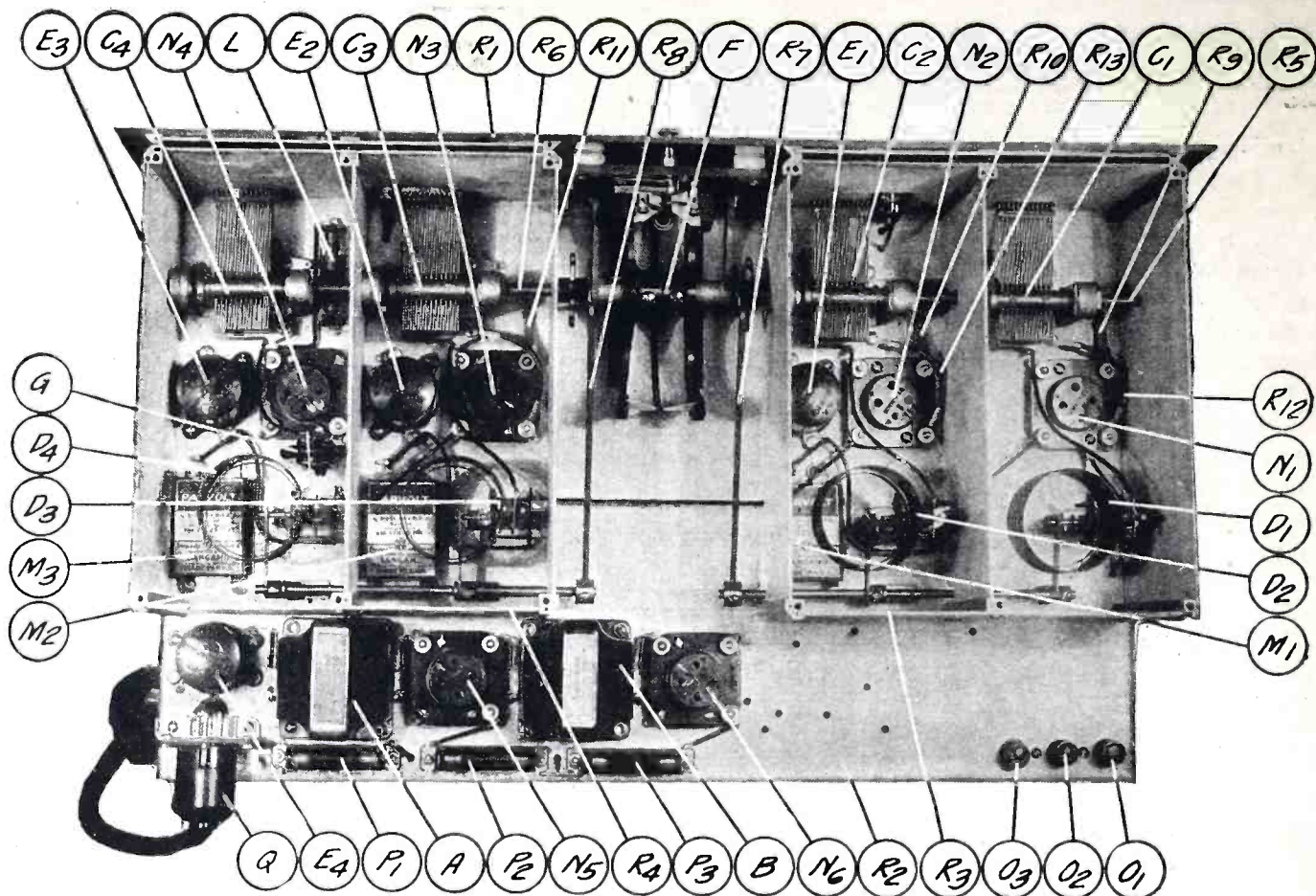

A VIEW OF THE RECEIVER FROM ABOVE

FIGURE 2: In this picture the general arrangement of all of the instruments and binding posts is clearly indicated. The position of the drum dial and the method of attaching the side walls of the shielding boxes is also shown.

shown in Figure 1. Insert the grid-leak, L.

Now mount the three by-pass condensers, M2, M3, and M4, by means of a machine screw and nut through one of the mounting lugs, and a machine screw and nut inserted through one left-hand electrical terminal lug, using a 1/8-inch spacing collar under the lug to make efficient electrical contact with the chassis, R2.

This completed, mount the four chokes, E1, E2, E3 and E4, by means of two screws and nuts fastened through the chassis. You are now ready to mount the binding post strip, R16, in position underneath the metal chassis by means of two machine screws and nuts. The three binding posts may then be mounted on the top side of the binding-post strip.

Now mount the three amperites, P1,

P2 and P3, and the cable connector, Q, along the back edge of the chassis as shown in Figure 2.

Next mount the four variable condensers, C1, C2, C3 and C4, with one machine screw from the under side of the chassis, in the position shown in Figure 1, so that the condensers mesh upwards and towards the back of the set. Before assembling, the shafts of the condensers should be removed, as well as the single-hole mounting nut and the two mounting screws. The friction band should be loosened, or taken off entirely.

The four auto-couple coils, D1, D2, D3 and D4, are now mounted in the positions indicated in Figure 1.

The four brass brackets of the cam operating-assemblies, R7 and R8, may now be fastened in a similar manner.

Then the 3/16-inch shafts of these assemblies can be inserted in the brackets, at the same time threading on the slotted arms which move the primaries of the auto-couple coils. These slotted arms should be attached so that the slots engage the sliding rod that moves the primaries, and so that the set screws which hold them to the 3/16-inch shafts are uppermost. The two slotted arms on each of the 3/16-inch shafts should be secured at the same angle, so that the primaries of the two coils they control are held in line.

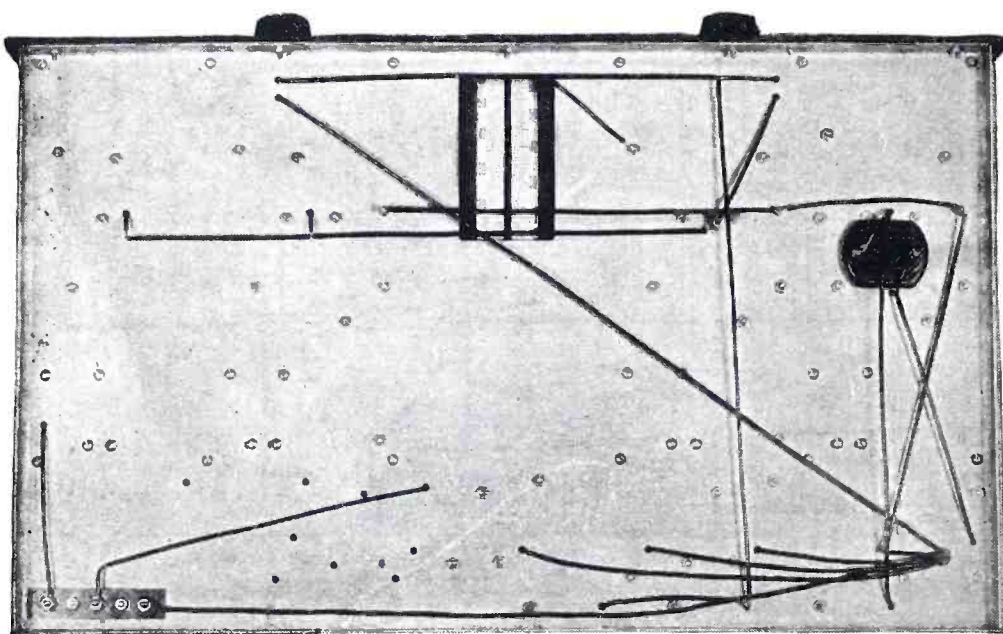

THE UNDER SIDE OF THE HI-Q "SIX"

FIGURE 3: This view of the receiver gives some idea of the simplicity of the wiring and the method of mounting instruments by means of machine screws fastened through the metal chassis.

The work proceeds with the mounting of the transformers, A and B, with their terminals turned as shown in Figure 1.

This completes the assembly of the chassis, R2, as far as should be done at this time, and the mounting of the instruments on the front panel, R1, should be begun.

First mount the switch, K, and the rheostat, J, in the two holes drilled for them, as shown in Figure 1. These are single-hole mounted and are attached by a single nut. Attach the two small knobs and adjust the pointers.

Now mount the dial, F, according to instructions packed with the dial, and as shown in Figure 1. We are now ready to start the wiring.

How to Wire the Receiver

The wiring of the receiver should be done exactly as shown in the picture wiring diagram in Figure 1.

First attach as much of the wiring as possible on the under side of the chassis, and then wire up the connections between the terminals and the instruments on the top side of the chassis, referring constantly to the picture wiring diagram for these connections. The holes in the chassis are indicated in the picture wiring diagram for wires that run through the chassis at various points. The wires that connect to the switch, K, and the rheostat, J, should be soldered to the terminals of these two instruments before the front panel is attached to the chassis. These wires may then be inserted through the four holes in the chassis and then the front panel may be fastened to the chassis by means of five flat-head machine screws and nuts. After this the wires may be connected to the proper parts of the circuit, as shown in Figure 1.

The three grid suppressors, R12, R13 and R14, should be connected in their

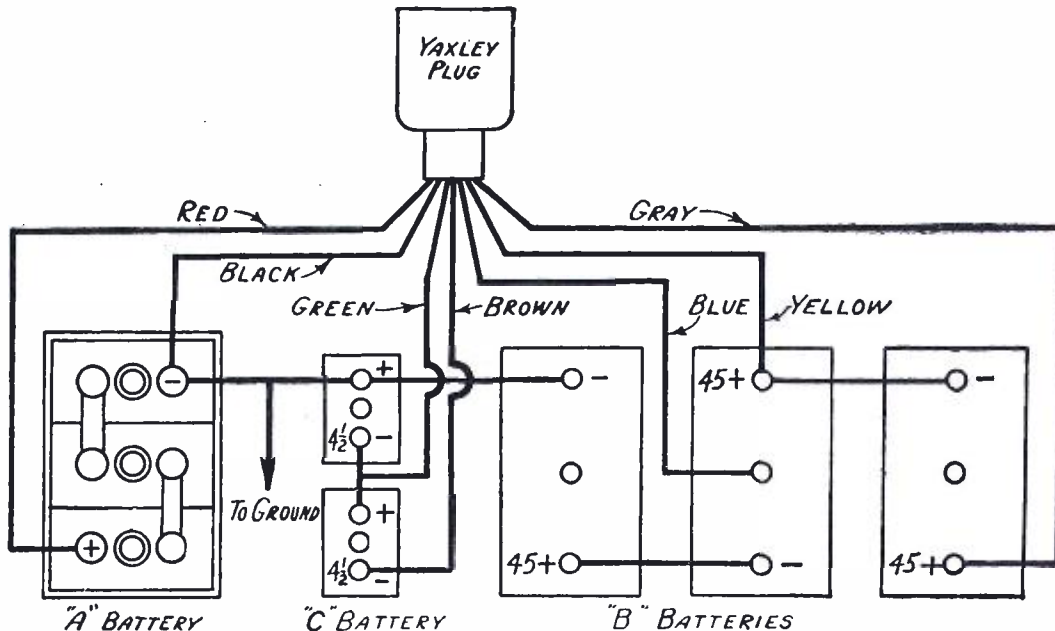

THE BATTERY HOOK-UP DIAGRAM

FIGURE 4: When the colored leads of the Yaxley cable have been connected to the batteries indicated in this diagram, and the cable inserted in the plug on the sub-panel, the receiver is ready for operation at the turn of the switch.

proper places as shown in Figure 1, between the stator or variable condensers C1, C2, and C3, and the grid terminals of sockets N1, N2 and N3, respectively, being sure that the red suppressor, R13, is placed in the second stage.

The grid condenser, G, is supported by the wiring and is mounted as shown in Figure 2. The mica fixed condenser, H, is mounted underneath the chassis, as shown in Figure 3. Be sure that the metal parts of the condenser, H, do not touch the chassis.

The pilot light of the drum dial should be connected in the circuit by two wires, as shown in Figure 1.

When the wiring is complete, the eight aluminum corner posts for the shields should be attached to the chassis with machine screws inserted through the chassis and threaded into the posts.

Next attach the four partition posts, one of them to each front and each back shield section, by means of two machine screws. The two front sections and the two back sections of the shield may then be slid in place in the proper grooves in the corner posts.

Now slide in the two extension shafts, R5 and R6, through the two sets of condensers, C1, C2, C3 and C4, and attach to the adjacent ends of the flexible couplings on the drum dial, F. These are held rigidly by two set screws on each of the coupling bushings.

The builder should now be ready to set the two sections of the drum dial at 100 and set the condenser plates all the way in, and tighten up on the two set screws in the rotor of each of the variable condensers.

Insert the six side sections of the
(Continued on page 374)

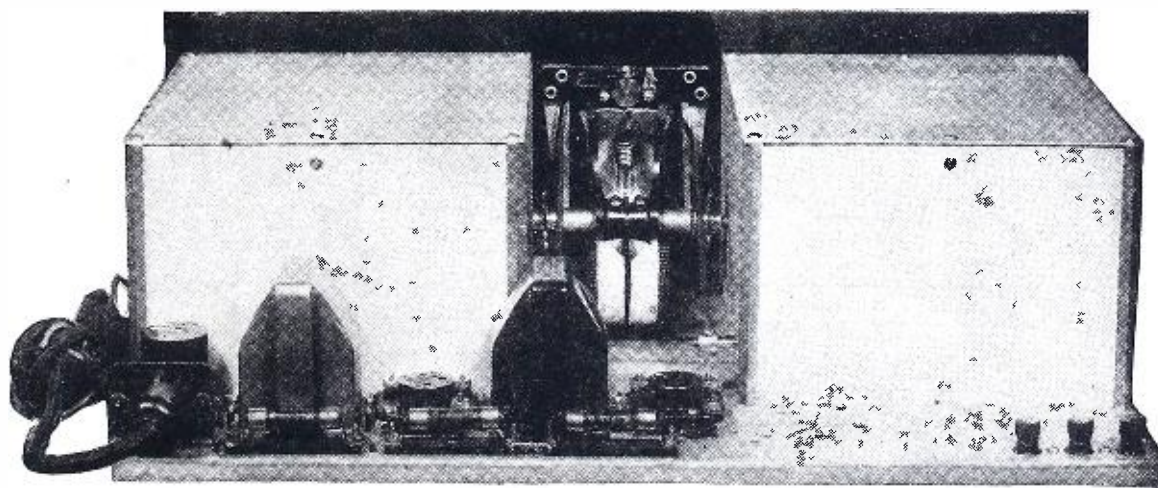

A REAR VIEW OF THE SET

FIGURE 5: In this view the shields are in place with the top covers screwed down. Note that the low-frequency amplifier, consisting of two stages of high-quality amplification, is mounted exterior to the shields that contain the high-frequency amplifying parts.

AC Rejuvenation for The RADIOLA 20

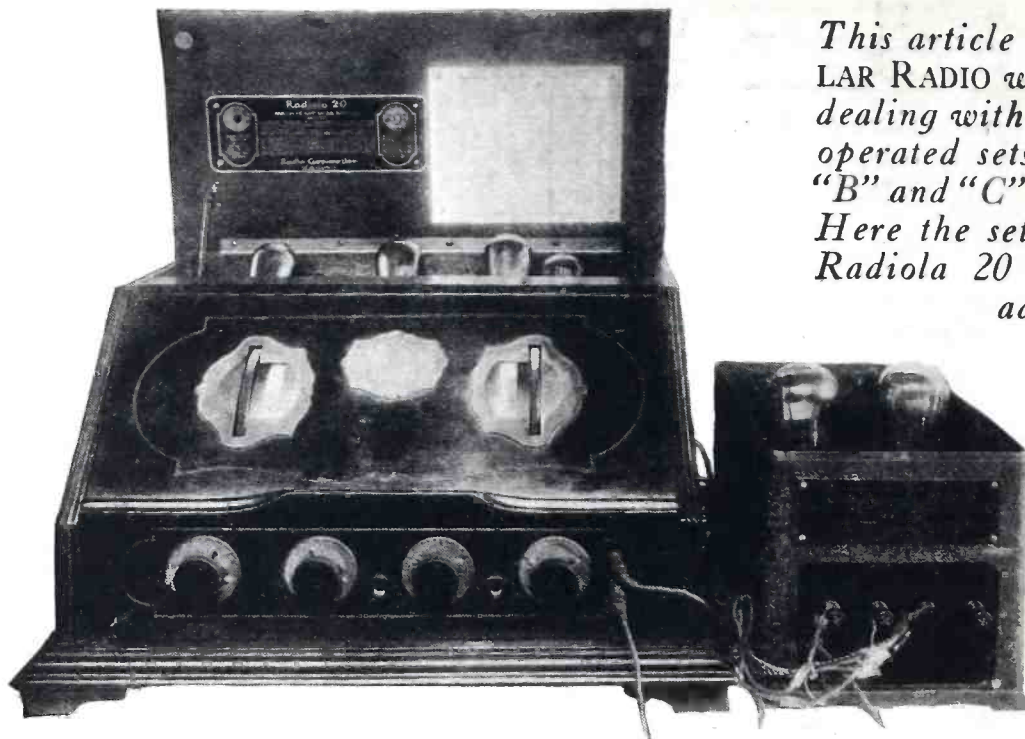

This article is the first of a series that POPULAR RADIO will publish from month to month dealing with the conversion of the old battery-operated sets into sets that obtain their "A," "B" and "C" voltages from the lighting mains. Here the set owner is told how to bring his Radiola 20 up to the minute by a slight additional expenditure.

By CHARLES L. DAVIS

READY FOR LIGHT-SOCKET OPERATION

FIGURE 1: This picture shows the Radiola 20 and the Powerizer ready for operation at the turn of a switch. AC valves have been installed and all batteries eliminated.

THERE are several general rules that should be followed in changing a receiver designed for operation with battery-operated valves so as to enable it to get its "A," "B" and "C" power from the lighting lines.

The old filament wiring will have to be revised to take care of the greater heating currents and, in cases where volume has been controlled through filament rheostats, a new volume control will have to be installed.

The first commercial receiver that has been revamped is the Radiola 20,

shown in Figure 1. This has been converted into a complete batteryless set by the use of three Ceco type M-26 AC valves and one Ceco type M-27 AC valve operating with a power-pack especially designed for this purpose and manufactured by the Radio Receptor Co. The power-pack itself contains a rectifier valve and a UX-210 power amplifier valve for the last stage of low-frequency amplification.

Special adapter sockets are furnished with the power-pack for holding the new valves. These are completely

wired for attaching to the set, and are furnished with complete cables that connect between the power-pack and the set itself.

In Figure 3 is shown the top view of the receiver after the changes have been made. Notice that in the third socket a plug is inserted. This plug connects to the amplifier valve of the power-pack.

In the wiring diagram in Figure 2 the original circuit of the receiver is given with the new additions shown in blue. Wires that are to be taken out are shown in dotted black lines. The receiver should be taken from its cabinet before the changes are made.

After the wiring has been changed according to this diagram, the AC valves should be placed in position and the power-pack connected up. All the terminals to the connection cords are marked so that they may be readily attached without fear of error.

No batteries are necessary once the changes have been made, and the set
(Continued on page 352)

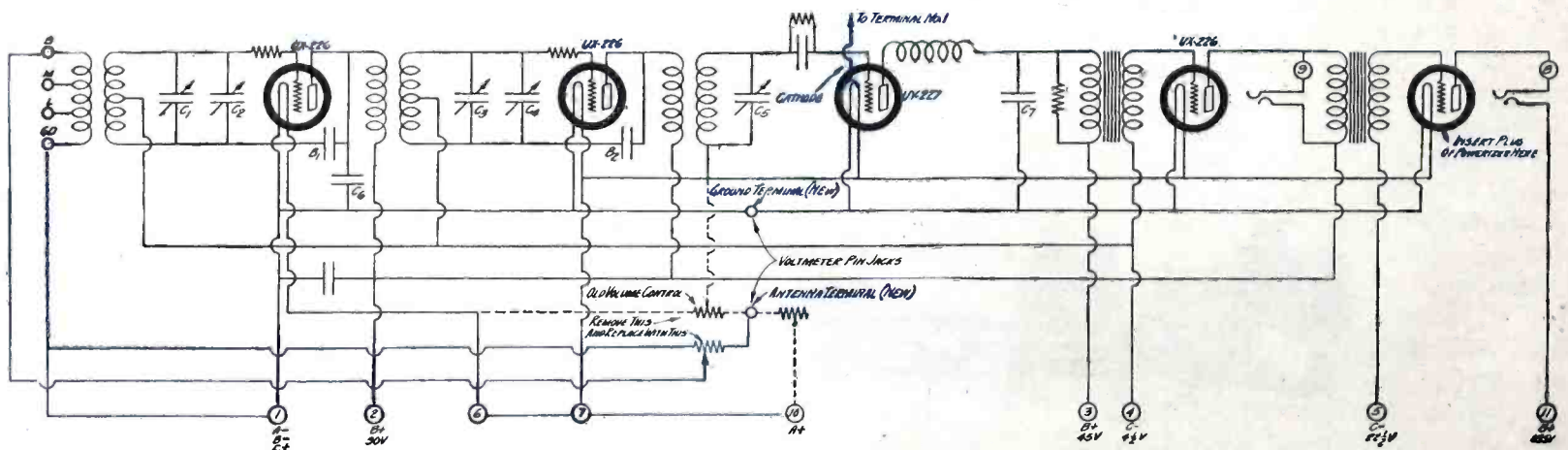

THE SCHEMATIC CIRCUIT SHOWING CHANGES AND ADDITIONS

FIGURE 2: In this schematic wiring diagram for the Radiola 20 the extra wiring and added parts are shown in BLUE. The parts of the original wiring that have been eliminated are shown in dotted BLACK lines.

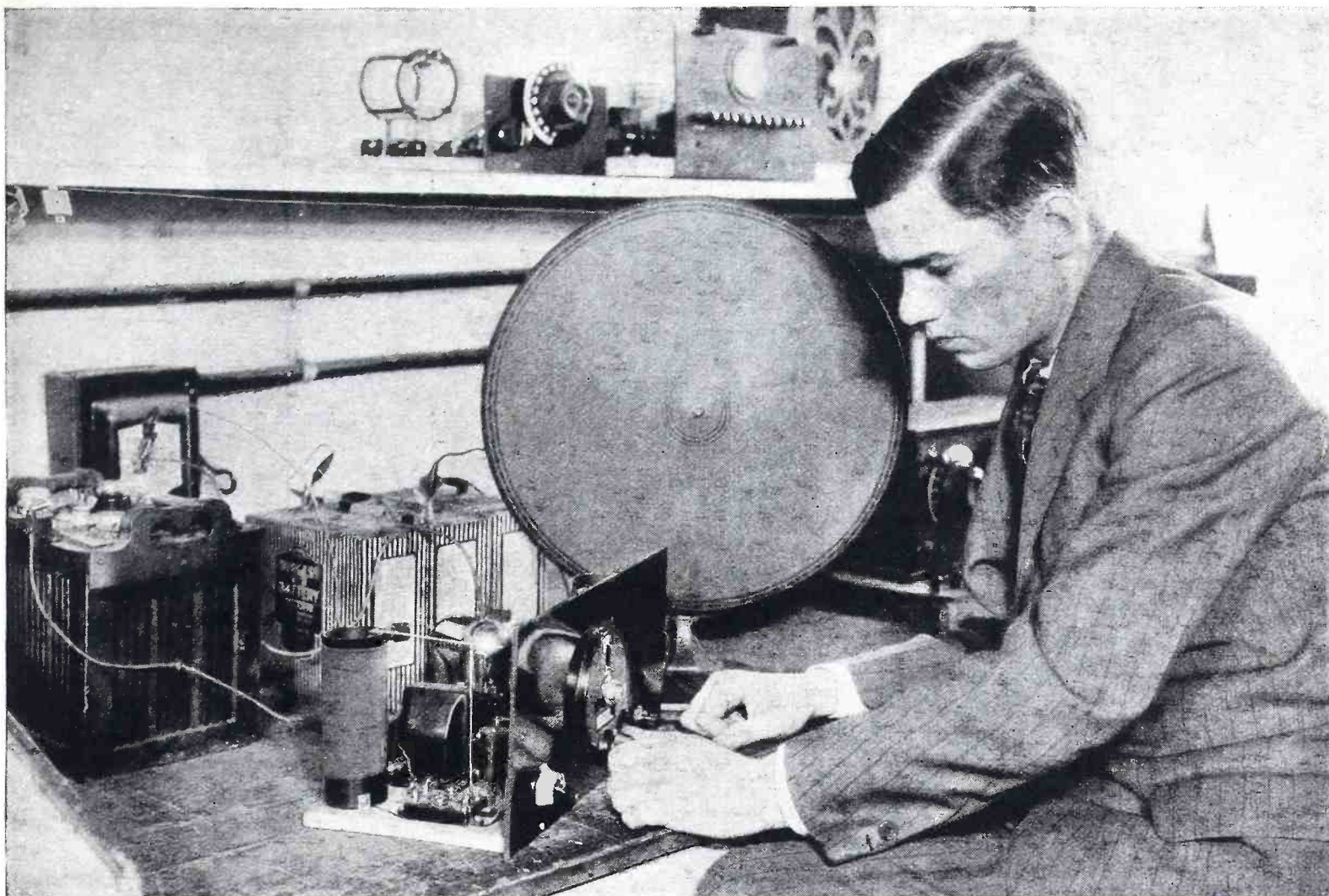

From a photograph made for POPULAR RADIO

THE "N" CIRCUIT AS DEVELOPED FOR AMERICAN USE WITH
AMERICAN PARTS

This small receiver incorporating Sir Oliver Lodge's "N" circuit was designed with the use of American apparatus by A. J. Haynes. It is sensitive, selective, easy to operate, and it employs a multiple vacuum valve.

Forced and Free Vibrations

From the principles here described, the author develops the theory of his famous "N" circuit as a free oscillator of exceptional selectivity.

By SIR OLIVER LODGE, F.R.S., D.Sc., LL.D.

ANY closed circuit that possesses inductance and capacity in series is a free vibrator, if there is nothing else near it.

A free vibrator is one which has a definite frequency of its own and is not coupled to anything; it cannot give continuous vibrations, for there is nothing to maintain it.

Once a free vibrator is excited, and then left to itself, like a plucked string or struck tuning-fork, and the vibrations gradually die away. They would be plotted as a sinuous curve of diminishing amplitude, the amplitude of the vibrations diminishing logarithmically or exponentially.

The resistance of an electrical oscillating circuit only affects the frequency in a subordinate manner; the main effect

of resistance or damping is on the amplitude or extent of the wave train; this may be measured either by the maximum potential to which the capacity rises, or by the maximum current through the circuit. The average current through such a circuit is practically zero unless it is rectified, for the positive and negative phases are opposite and almost equal.

A hot wire in such a circuit does not measure the average current, but the RMS value of current, which is independent of sign. Such a circuit can be used as a wavemeter if the resistance of the hot wire is not too great.

As soon as any circuit is tightly coupled up to something which is going to excite it, it is no longer a free vibrator; its vibrations are forced.

The difference between forced and free vibrations is important.

A radio receiving circuit is always a case of forced vibrations, and the amplitude of the oscillations excited in it depends on the accuracy of tuning and the resistance of the circuit.

Anything may be forced to vibrate by a sufficiently violent stimulus, irrespective of tuning. Provided the friction is small enough, a child might be able to set a church bell ringing by timing its impulses properly, though it would take him some time to work it up; an elephant might set it swinging by a single pull. Similarly a strong singer is said to be able to shatter a pane of glass or a bowl by accurately singing the note corresponding to the free vibration of that glass; a charge of dynamite could

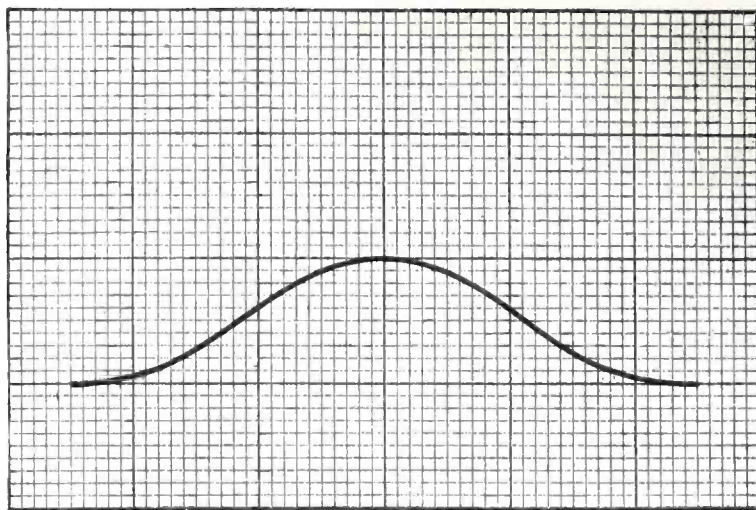

A CURVE ILLUSTRATING BROAD TUNING

This curve, which consists of amplitude plotted against frequency, gives a graphic illustration of a circuit that responds to a broad band of frequencies, due to damping from electrical resistance incorporated in the circuit.

shatter it without any adaptation. No receiver can be immune from a forced vibration of sufficient amplitude; but even if the vibration is continued for a long time, the response of an untuned vibrator will be only feeble. An equation can be written for a vibrator of any period or frequency excited by a forced vibration of some other period or frequency; and it would be found that unless they were in tune the effect would be small. The ultimate rate of vibration would depend not at all on the free rate, but on the forced rate; the discrepancy between the rates would merely keep the amplitude small.

When the tuning is improved, so that the two vibrators are nearly of the same pitch, a curious phenomenon happens at first. The free vibrator tries to vibrate in its own period, and does so until those vibrations have died away and the forced vibration takes control. During that period the two frequencies are superposed, and we get a kind of incipient

heterodyning and beats are produced. In a short time, however, the forced vibrations become dominant, and we then get a response of a certain amplitude. Improve the tuning still further, and the amplitude increases greatly in strength. The two are now in agreement. This is experienced during the operation of tuning in. The beats die away and disappear; the tone becomes smooth and continuous, with an amplitude depending on the resistance, or rather the conductance, of the circuit.

If the circuit is of low resistance, there is hardly any limit to the amplitude of the vibrations that can be thus produced when the tuning is perfect.

If the forced vibrations have the frequency p , and the free vibrations the frequency n , the resulting amplitude, when there is no resistance, is a definite fraction of E (the amplitude of the original disturbance), divided by $n^2 - p^2$. So that when n and p are in agreement, the resulting amplitude is infinite. This, of

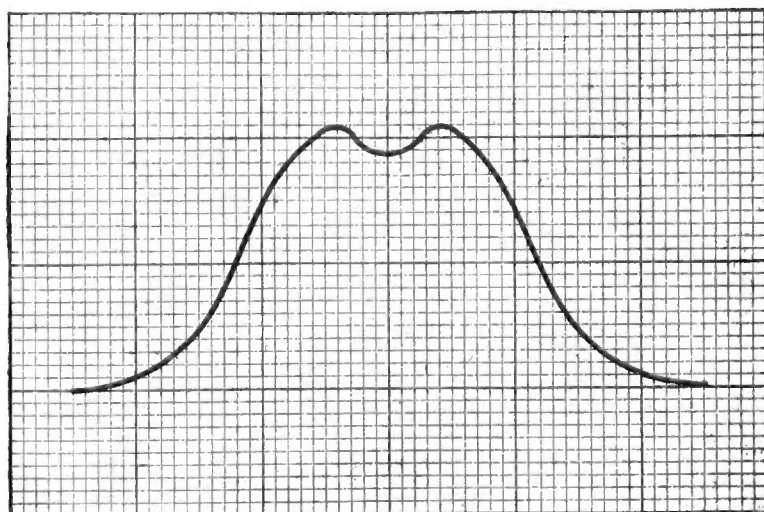

ANOTHER CONDITION OF BROAD TUNING

This curve, plotted in the same manner as the one shown at the top of the page, illustrates the resonance curve of a coupled resonator that has a double amplitude maximum, owing to reaction between forced and free vibrations.

course, in practice is not possible, for there must be some resistance. By making the resonating circuit a good conductor, however, its amplitude may be made almost as big as we please.

When two circuits are coupled together, neither of them are free. They interfere with each other more or less, and the combination cannot attain the energy of a really free vibrator.

To get big amplitudes in reception, therefore, the right plan is to use a circuit of low resistance, and arrange so that it shall be disturbed by the forced vibrations coming from a distant station in only a gentle or slight manner. However feeble the received disturbances are, they can be worked up to almost any amount, by resonance, in such a circuit; then they can overflow and give the desired signal through a coherer or valve or any other detector. The detector should not be in the circuit itself, but rather an appendage to it, so as not to interfere with the circuit until it responds, as the resistance of the detector circuit is, up to that time, practically infinite.

All this, it is needless to say, takes place in a minute fraction of a second with the rapid oscillations used in radio broadcasting.

Moreover, if such a circuit receives vibrations of many frequencies from different stations, being stimulated in this feeble manner by all, it will only respond to the one to which it is itself in tune. The others will be discarded or eliminated. Such a circuit acts as an admit-ter or responder to vibrations of one frequency and as an ignorer of all others.

If we use a circuit of large capacity and small inductance, it is analogous to a light pendulum or violin string which can easily respond to any disturbance, though it responds more fully to some than to others. But if instead of being a light thing, like a string or a wooden bob pendulum, it is a massive thing like a tuning fork or a pendulum with a heavy lead bob, then it will not be disturbed appreciably by anything except a synchronized disturbance of exactly the right frequency. The electrical analogy to big inertia and great stiffness is a circuit of high inductance and small capacity.

Such a circuit responds just as freely as any other to a periodic disturbance of exactly the right pitch, but takes no notice of those with wrong pitch. Such a circuit I will call an "N circuit."

An N circuit is one of high inductance, low capacity and resistance as small as it can be made, and it is to be stimulated by very feeble disturbances collected from the ether and communicated to it by the slightest connection possible. It is to be left almost free from the aerial;

it must be connected to it to some degree or it would not respond at all, but the slighter the connection the better. It is not to be coupled up in any ordinary way. Coupling, in fact, is to be avoided.

A single-wire connection, with a small capacity interposed, suffices to join the N circuit to the aerial.

The aerial should have no tune of its own, so that it can pick up any ether waves which exist. They are all equally transmitted, in the feeble manner described, towards but not to the N circuit; for it takes no notice of any of them except those of the right frequency, and to that particular kind it vigorously responds. The detectors are set into action by the oscillations thus worked up in the N circuit, and are not themselves connected to the aerial at all. The aerial is a mere collector; the N circuit is the responder.

After that come the detector, rectifier, magnifier and telephone arrangements as usual.

By this means one particular station may be listened to, while all the others are ignored. The tuning, however, has to be precise, so that the received stimulus shall always act in one direction and shall never oppose or destroy what it has begun to excite. The only limit to the selective response thus obtainable is that created by the resistance of the circuit.

It was shown by Kammerlingh Onnes that at a low temperature, approaching that of absolute zero, the resistance of metals became nothing. Some day I feel sure that an experimenter will immerse his receiving circuit in liquid hydrogen or helium, and thereby get a response far beyond anything which has as yet been attained. But such a method might not be good for reproduction, which requires a certain breadth of frequency. The lateral frequencies would be too much excluded if the resonating circuit were too sharply tuned. Meanwhile a device

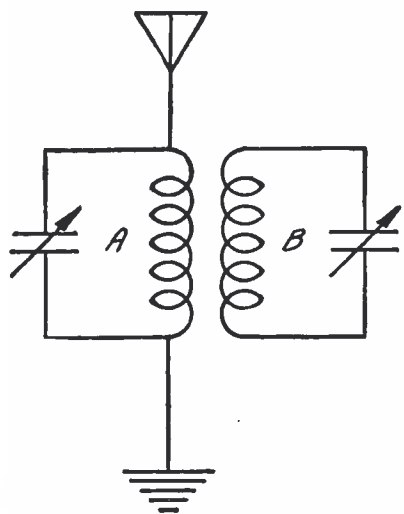

INDUCTIVELY - COUPLED CIRCUITS
This diagram shows an ordinary coupled resonating circuit in which B is forced to vibrate at the same frequency as A.

has come into use that has practically the effect of abolishing the resistance of a responding circuit, though at the same time it does not leave it as completely free as it should be. This is the device called regeneration. It cannot be applied with a crystal; but it can be applied by a tube, where the high-tension battery introduces fresh local energy into the circuit, so that the plate part of the circuit is vibrating in a forced manner with extra amplitude due to the introduced energy. These enhanced vibrations are usually made to react upon the input circuit, which is usually a tuned collector. This regenerative action sets up the extra stimulated vibrations of the same frequency as those received, and often causes the bad effect of howling. A circuit can, in fact, be made to excite itself in this way; just as a telephone speaking to its own microphone transmitter can set up a howl. The slightest initial disturbance is magnified by reaction or regeneration between the telephone and the transmitter; its own sound, however feeble, operates the mouthpiece, and thereby increases the response of the telephone, which again reacts on the mouthpiece by feeding back energy—and so on, until the disturbance is worked up.

When a circuit is thus on the verge of regeneration, it is exceedingly sensitive—almost, though not quite, as sensitive as a receiving circuit cooled to near absolute zero. In using regeneration the object of the experimenter should be to bring the circuit near to the sensitive condition, but not to over-pass it so as to get self-excitation. For self-excitation is a nuisance to all stations in the vicinity, since the self-excited howl cannot be tuned out if one is trying to receive signals on that particular wavelength.

To cure this there should be no radiation at all from the antenna circuit.

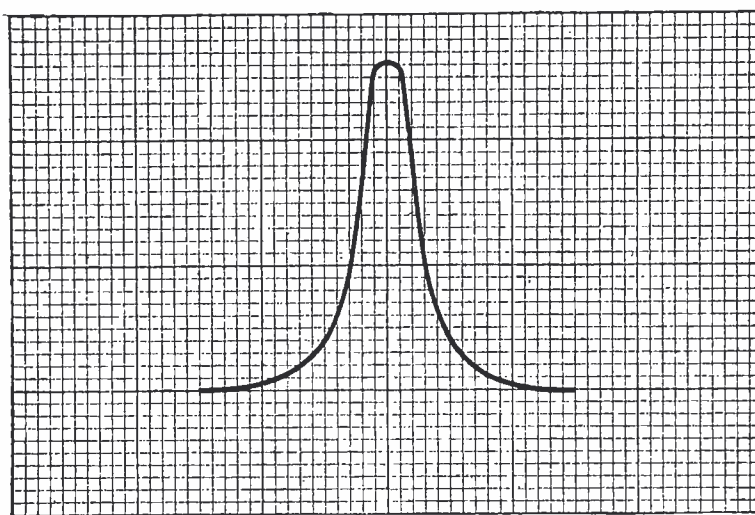

A CURVE ILLUSTRATING SHARP TUNING

This curve illustrates a resonating circuit that responds to only a narrow band of frequencies. However, the tuning curve may be made too sharp for good reproduction, so that the best results in selectivity are limited by the best results in tone quality.

Whatever regeneration there is should act upon the tube input circuit only. The antenna should not be in tune with it, and, moreover, it should be so feebly connected that it has no temptation to respond.

The antenna circuit must have some frequency of its own, since it is a conductor connecting two capacity areas, one the antenna, the other the ground; but if it is thoroughly out of tune, so as to respond let us say only to much longer waves, it will be stimulated only by forced vibrations, which, being of wrong frequency, produce hardly any amplitude of vibration. There is then no effective reradiation; the antenna is not acting as a transmitter.

This result is attained by an antenna circuit entirely out of tune and feebly connected to the circuit which it can excite only by continued vibrations of exactly the right frequency. In other words, the desired waves can be received only by the resonating circuit.

If the forced vibrations received by the antenna are exceedingly strong, as for instance those from a lightning flash in the neighborhood or some powerful station, it will not be possible

(Continued on page 353)

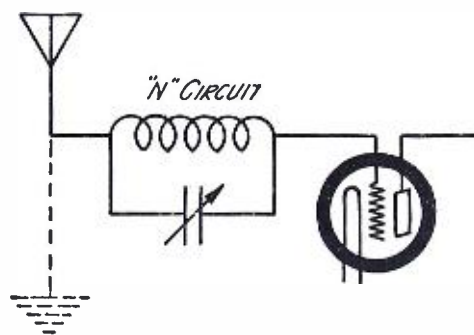

A FREE VIBRATOR

This drawing shows a free oscillating circuit incorporating the principles of "N" circuit. It is stimulated by an antenna system, which may or may not be grounded.

A Radio That Plays Watchman

Radio, that needs neither sleep nor vacation, is now doing guard duty that once required the services of several men, without any of the many errors incidental to the "human equation."

By WALTER E. BURTON

A RADIO watchman has been standing guard over the 20,000,000 gallon daily water supply of a quarter million people for nearly two years.

During this period it has made an hourly record, over a distance of fourteen miles and at great saving of expense and labor, of the water level in the reservoir which holds that city's reserve supply of water. Upon this hourly record the operation of a city's pumping station depends. It is important that this hourly record be rendered without fail; otherwise a shortage or excess of water supply would develop that would certainly involve cost and likely involve danger.

But the radio watchman has not failed.

The official name of this trustworthy sentinel is 8-OIC. And its post of duty is located outside of the city of Akron, Ohio.

Before the installation of the automatic radio system the reservoir patrolman led a hard and irregular life. It was his duty to telephone the pumping station two or three times a day to report the water level in the basin. This method was partially satisfactory when telephone lines were in working condition, but it often happened that storms, ice or other agencies interfered with the communication system. As is usual with such emergencies, the breakdowns usually occurred during the most disagreeable weather; it also happened that the reservoir would be either too full or nearly empty at the same time. The patrolman would then be forced to crawl out of his warm bed in the wee, small hours of the night, hop into his car and drive nearly 20 miles through a blizzard to tell the pump operators how to regulate the water flow.

So the waterworks department set about to find a more reliable means of communication.

The plan to build an underground telephone line along the water main right-of-way was discarded when it was



From a photograph made for POPULAR RADIO

THE RECEIVING END OF THE "RADIO WATCHDOG" SYSTEM

In a corner of the pumping station is this short-wave set that receives the automatic signals from the water reservoir transmitter. A part of the loudspeaker that broadcasts the signals is shown at the right. Above the set is the meter panel with the clock that turns the receiver "on" at seven minutes to each hour. The contact point may be seen above the figure XI. William A. Manfrass, the designer of the system, is manipulating the dial.

learned that the work would cost about \$20,000. The installation of an electrical recording system would be equally expensive.

Then William A. Manfrass, an elec-

trical engineer at the pumping station and an enthusiastic radio amateur, offered to solve the problem with a radio broadcasting and receiving system of his own design and construction.

His offer was accepted, and the first trials in January, 1926, proved entirely satisfactory. The most noteworthy feature of the system, from the water-works officials' standpoint, was that the cost of all equipment was less than \$500.

The sending set operates on 175 meters, is rated at 15 watts, and has a circuit of the coupled Hartley type. It is situated in the attic of the reservoir patrolman's home, several hundred feet from the automatic mechanism which operates it.

In the reservoir valve house is a float, operating in a vertical pipe; to this is connected a steel tape which passes over the wheel of a recording meter. On the end of this meter has been built a circular switch resembling a Ford timer. This is built up of alternate sections of brass and insulating material. A contact arm, rotating within the switch ring in accordance with the water level, determines which of the brass segments is "live."

A wire passes from each segment to a key-like device in another dust-proof case. There are ten keys in all, corresponding with an equal number of segments in the circular switch. The end of each key rests on a hard rubber disk, on the edge of which is a series of elevations and depressions arranged in the form of radio telegraphic signals. When the station is in operation, the entire set of disks revolves, but only the one operating the live key is functioning.

At five minutes to each hour, (except between eight and eleven o'clock each evening), a master clock turns on

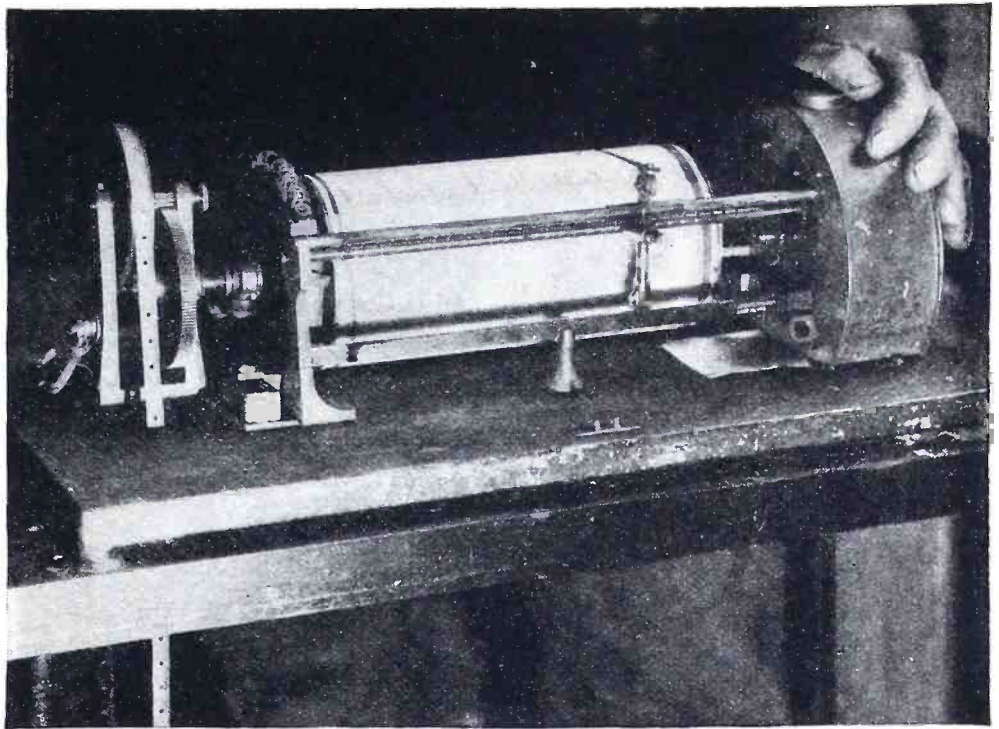

From a photograph made for POPULAR RADIO

THE RECORDING APPARATUS AT THE RESERVOIR

This apparatus is above the vertical pipe in the reservoir valve house. The float indicating the water level is attached to the metal tape shown at the left. The tape passes over a wheel that turns a drum covered with graph paper, shown at the center, thus making a record of the water level variation. The tape also controls the contact arm of the circular switch at the right, thus making "live" one of the metal fingers shown in the illustration below.

a relay, which switches the sending set "on." Another relay starts the 110-volt motor which operates the rubber disks. The station remains on the air for about 50 seconds, sending the combination of dots and dashes which reveals the water level. At the same time the water height is recorded on a meter chart for permanent record.

At seven and one-half minutes to each hour another clock at the pumping station turns "on" the receiving set, which remains in operation for five minutes. A red light lets attendants know when the set is "on." Signals are received on a short-wave, three-tube regenerative set, with two stages of low-frequency amplification. A loud-speaker makes it possible to hear the signals all over the station, above the noise made by the pumps. The building of an automatic recorder, operated by the signals, was believed impractical.

The information transmitted by the station is accurate to within one inch of water level. The closest reading is 1½ inch of the top, and the greatest is 9 feet 2 inches. The accuracy of readings increases as the water nears the top of the reservoir. When the maximum reading of 9 feet 2 inches is passed, the device repeats, the reservoir being about 30 feet deep. The repeating is not confusing, because it would require over four hours of pumping to raise the water level from 9 feet to the top of the reservoir.

During the operation of this radio sentinel the only expense for upkeep has been that resulting from the charging of batteries.

Considering the decreased cost of maintenance and the greater efficiency, it can be seen that radio is performing an invaluable service to the community in doing this work.

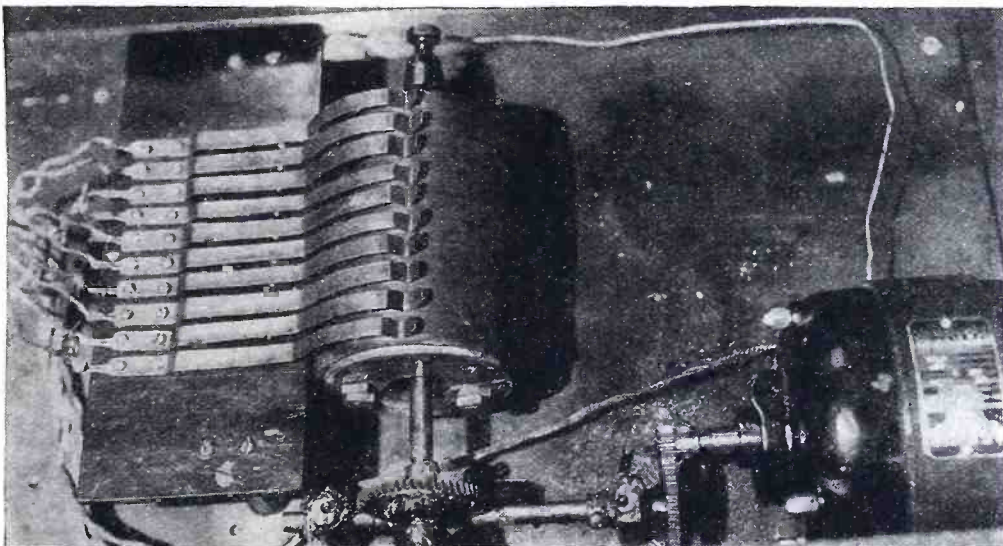

From a photograph made for POPULAR RADIO

THE METAL FINGERS THAT POINT OUT THE WATER LEVEL

At five minutes to each hour a relay starts the motor at the right; it rotates the ten hard-rubber discs in the center, each of which is engraved with metal code markings indicating a given water level. One of the metal fingers resting on the discs is made "live" by the contact arm of the circular switch in the illustration above. This completes the circuit to the transmitter and the message engraved on the disc under the "live" finger is sent through the ether to the receiver at the pumping station.

Quality amplification at low cost—High power with a few valves—Rapid construction with minimum labor—This summarizes the features of the Unipac.

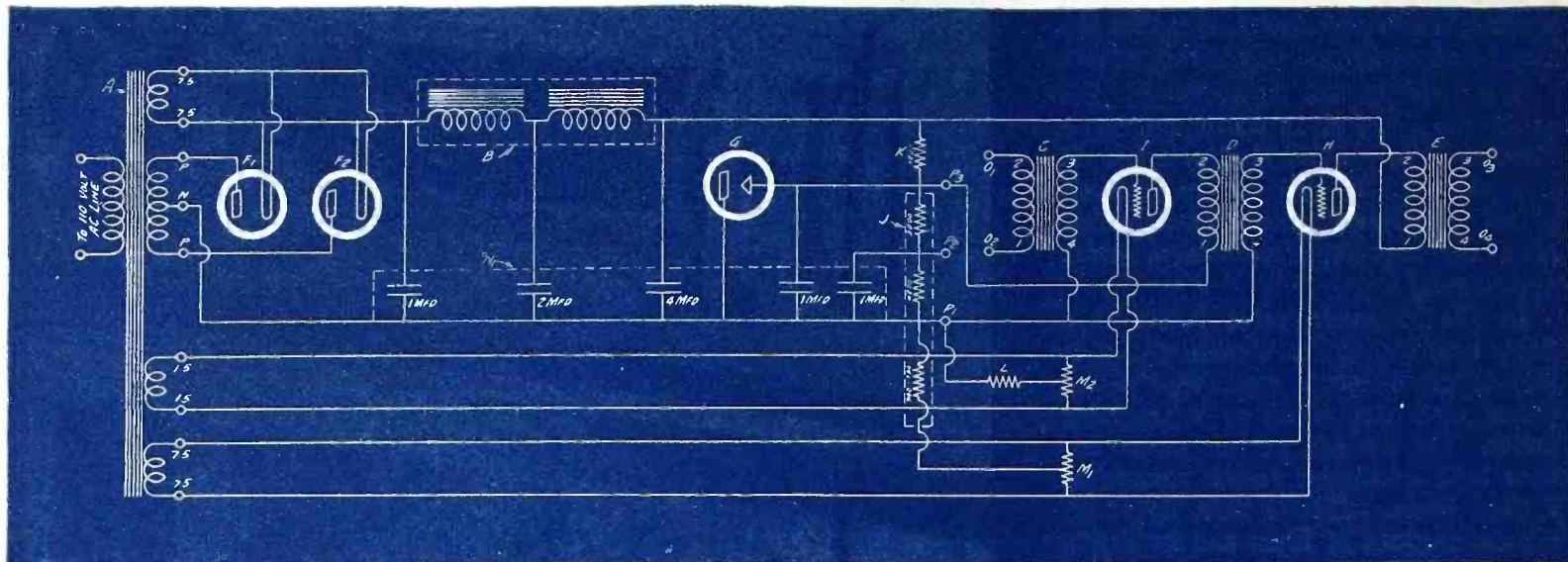

THE SCHEMATIC DIAGRAM OF THE POWER-PACK CIRCUIT

FIGURE 1: At the extreme left is shown the full-wave rectifier with the filter circuit and the voltage-regulator valve in the center. Next to it, on the right, is the voltage-dividing resistor bank, and, at the extreme right, two stages of low-frequency amplification and the output transformer.

REFRESHING QUALITY AND VIGOROUS AMPLIFICATION WITH

The LC-28 Unipac Amplifier

While affording an astounding volume, this new amplifier at the same time maintains a quality of tone that will caress the ears of the most discriminating listener. Although designed especially for the LC-28, the Unipac may be used in conjunction with receivers of practically any type.

By LAURENCE M. COCKADAY

COST OF PARTS—Not over \$82.00

HERE ARE THE INSTRUMENTS AND ACCESSORIES NECESSARY FOR BUILDING THIS UNIT—

- | | | |
|--|--|---|
| A—S-M full-wave, super-power transformer, No. 328; | F1, F2, G, H and I—S-M valve sockets, No. 511; | O1, O2, O3 and O4—Frost tip jacks, No. 253; |
| B—S-M Unichoke filter system, No. 331; | J and K—Ward-Leonard resistor kit, No. S-651; | P1, P2 and P3—Eby binding posts (marked B—, 45, 90); |
| C and D—S-M special low-frequency transformers, No. 240; | L—Frost resistor, No. F-1500; | Q—Van Doorn steel chassis and cabinet, with hardware (nuts, screws, washers); |
| E—S-M special output transformer, No. 241; | M1 and M2—Frost resistor, No. FT-64; | 20 feet of Kellogg hook-up wire. |
| | N1—Tobe condenser bank, No. 662; | |

IN previous articles in POPULAR RADIO the story of the development of the LC-28 broadcast receiving set has been told. The specialization of the various functions of reception into separate units is a feature that makes possible the building of a set that is scientifically correct and that

can be assembled to take care of the owner's exact needs.

In the October issue, complete details for constructing the high-frequency pack were given. This unit is used to pick up the broadcasting signals from the ether and to supply them to a low-frequency amplifier. The

LC-28 Unipac is the first of a series of amplifiers designed for use with high-frequency packs to be described in POPULAR RADIO, and it is designed especially for this purpose in connection with the LC-28 high-frequency pack. It may be placed in a console or radio table and connected and put

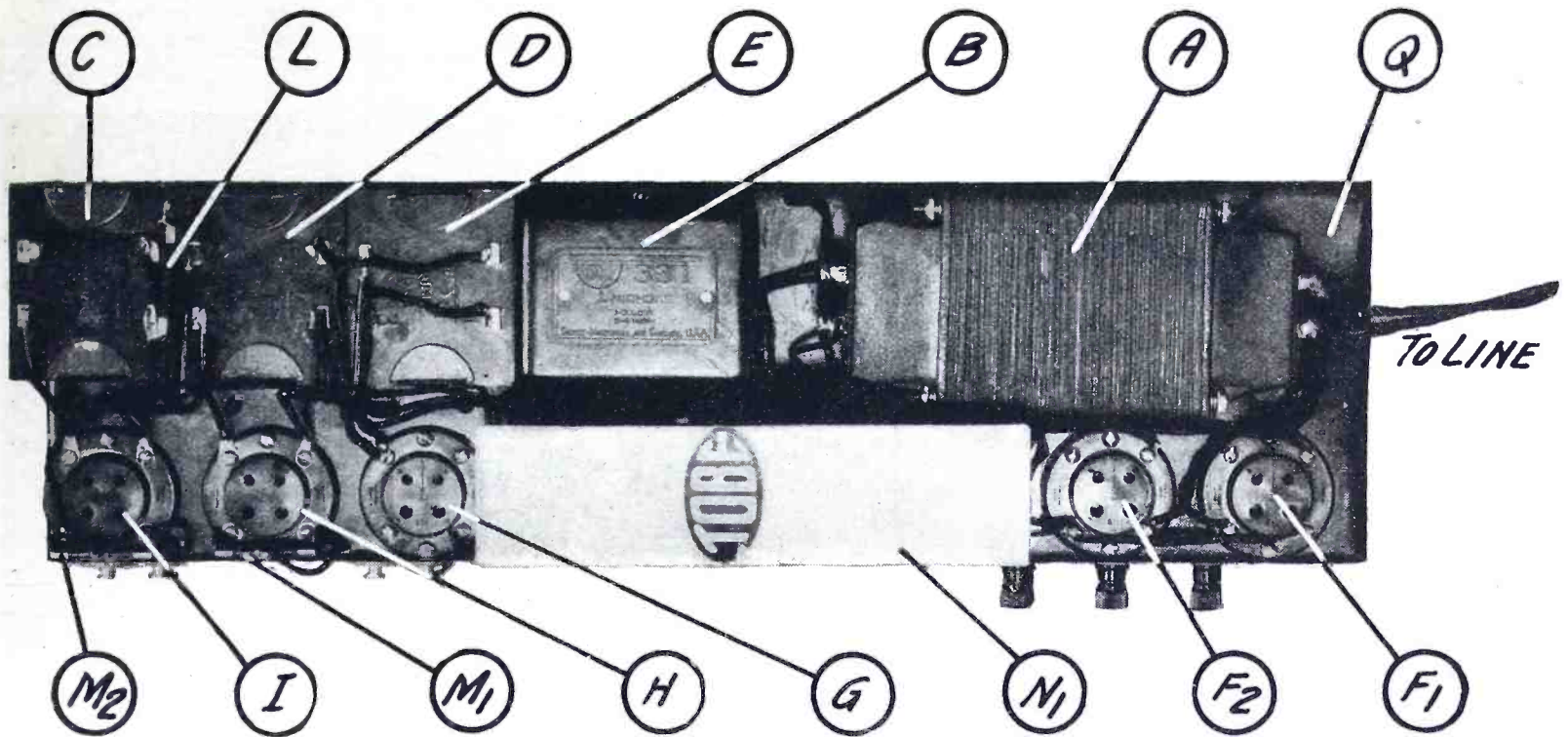

A TOP VIEW OF THE COMPLETE UNIT

FIGURE 2: This shows the wiring arrangement of the transformers, sockets, chokes, condensers, and the power transformer which are mounted on the metal chassis, with the binding posts and the small jacks fastened on the lower side.

into operation in a few minutes. The Unipac consists of two stages of low-frequency amplification with an output transformer, and it also contains a complete full-wave rectifier and filter as well as a supply for AC valve heaters. The outstanding features of the new Unipac are as follows:

1. Complete AC operation without batteries;
2. It contains the new type low-frequency transformers designed especially for the LC-28;

3. It gives full-wave, high-power rectification;
4. It utilizes the new AC valve;
5. It gives excellent tone quality;
6. It is capable of great volume without overloading;
7. It supplies complete "B" voltages for the high-frequency pack.

The Unipac is mounted on a metal chassis with the same general type of construction followed throughout as is the case in the high-frequency pack. It contains a single condenser bank

equipped with flexible leads for simplification in wiring and mounting. The unit is supplied with a cord and plug for attaching to the AC house-lighting lines.

The electrical circuit is shown schematically in Figure 1.

How to Construct the Unipac Amplifier

The metal chassis used for building up this unit may be obtained completely stamped and drilled, and the

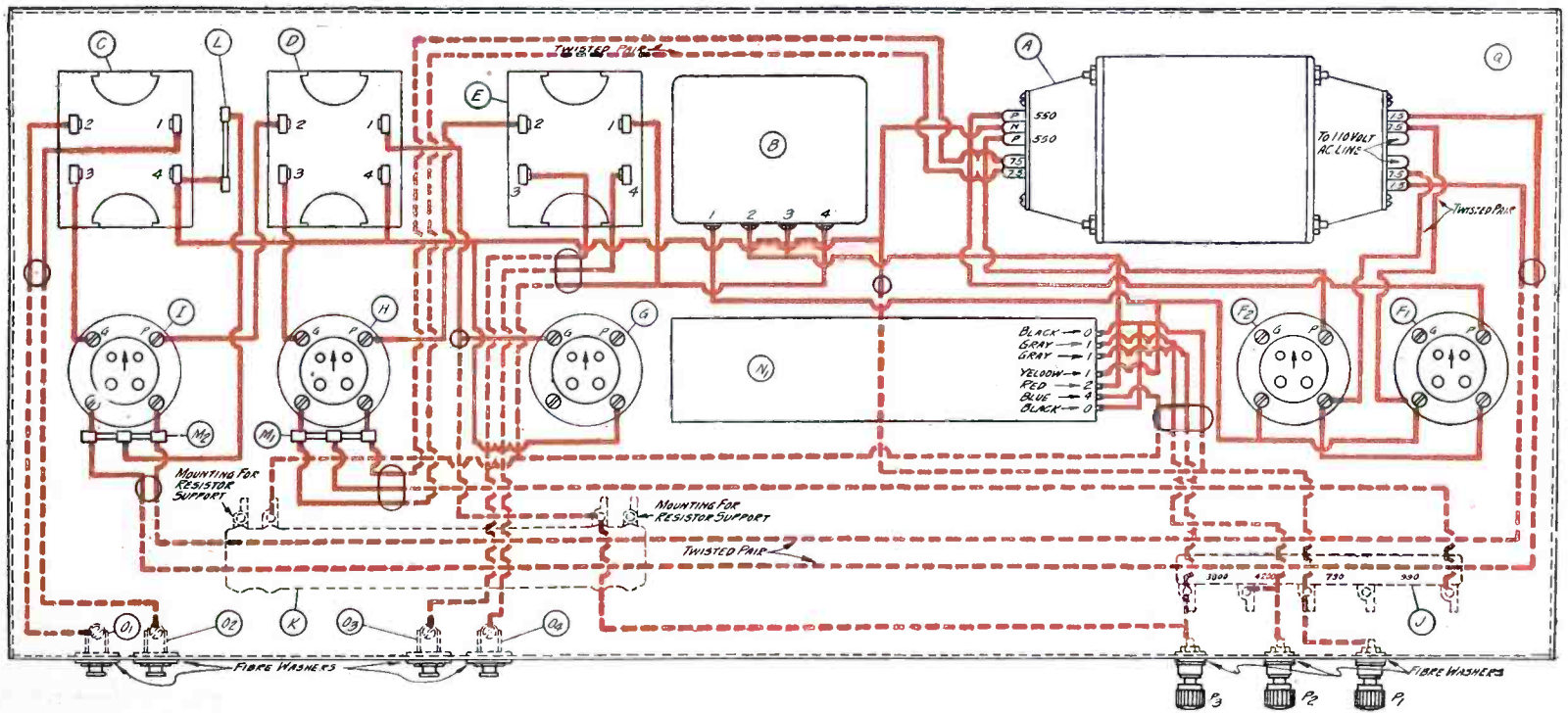

THE PICTURE WIRING DIAGRAM OF THE UNIT

FIGURE 3: In this drawing all the instruments mounted on the top of the metal chassis are shown in solid BLACK lines, while those parts that are mounted beneath are shown in dotted BLACK lines. All of the wiring is shown in RED lines. The solid lines indicate the wiring done on top of the chassis, while the dotted lines show the wiring done beneath.

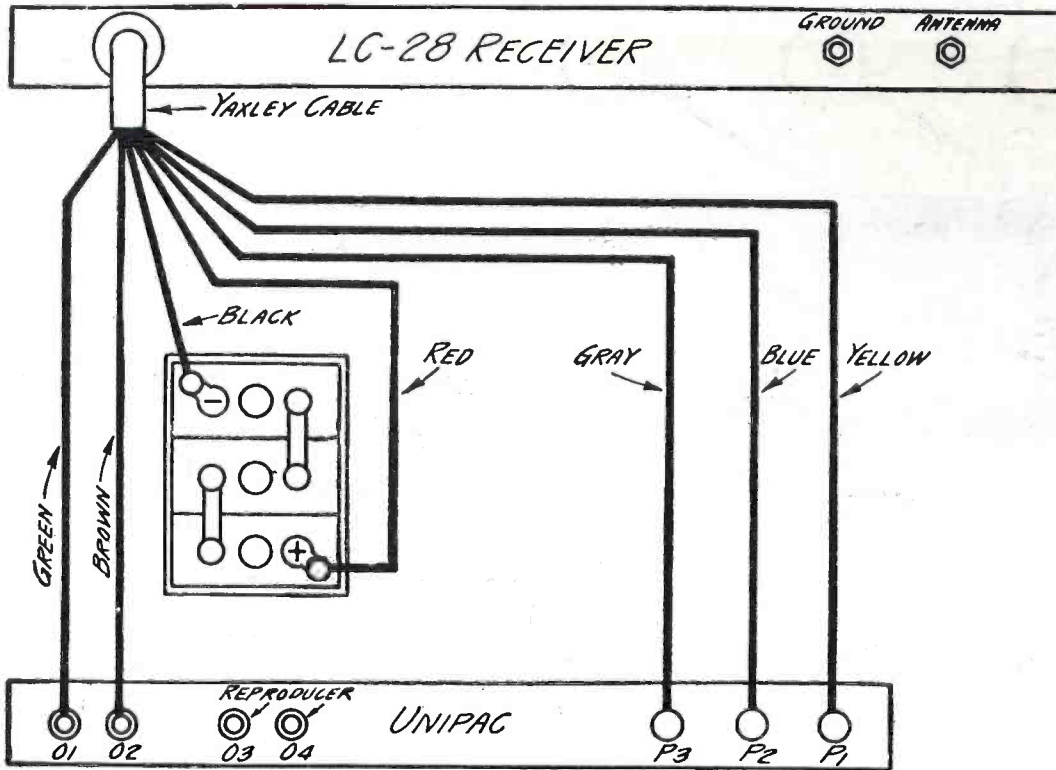

HOW TO CONNECT THE POWER-PACK TO THE LC-28

FIGURE 4: This shows the connection between the LC-28 high-frequency pack and the Unipac. The connections should be made with the Yaxley cable that comes with the high-frequency pack. The colors of the connecting wires are indicated.

parts should be mounted by means of screws and nuts in the positions shown in Figures 2 and 5.

There is no necessity for a complete description of the mounting, except that the precautions of position, as in-

dicated in Figure 3, for the sockets and for the transformers should be carefully followed.

A bottom view of the Unipac is shown in Figure 5, and this gives a clear idea of the mounting of the two

resistors, J and K, as well as the three binding posts and the four small jacks.

Be sure that all bolts for fastening down the instruments are tightened carefully; and the bolts on the large transformer, A, should be equipped with lock washers to prevent loosening.

This completes the constructional work, and the Unipac is now ready for wiring.

How to Wire the Unipac

The picture wiring diagram in Figure 3 shows the instruments in their correct positions and outlined in black lines. The units outlined in solid black lines are mounted at the top of the chassis, while those in dotted lines are mounted beneath the metal chassis. The same holds true of the wiring—the heavy red wiring runs above the chassis, while the dotted red wiring runs below. The connections are to be made with Kellogg flexible covered hook-up wire.

If the directions given in the diagrams are followed exactly, no trouble will be experienced in wiring, and the job will be a simple procedure.

How to Operate the Unipac

The new amplifier should be placed in the console or radio table underneath the LC-28 receiver and should be connected by means of the Yaxley

(Continued on page 355)

The list of parts given on page 324 includes the exact instruments used in the set from which these specifications were made up. The experienced amateur, however, will be able to pick out other reliable makes of instruments which have been approved by POPULAR RADIO and which may be used with good results. But we recommend that the novice follow the list, as the diagrams in this article will tell him exactly where to place the connections. If instruments other than the ones listed are used, the only change that will be necessary will be the use of different spacings for the holes that are drilled in the sub-base for mounting the instruments. To any reader who has difficulty in obtaining any of the parts which are necessary in making up these model receivers and power units, POPULAR RADIO SERVICE BUREAU, 119 West 57th Street, New York City, will gladly assist in seeing that his requirements are promptly supplied.

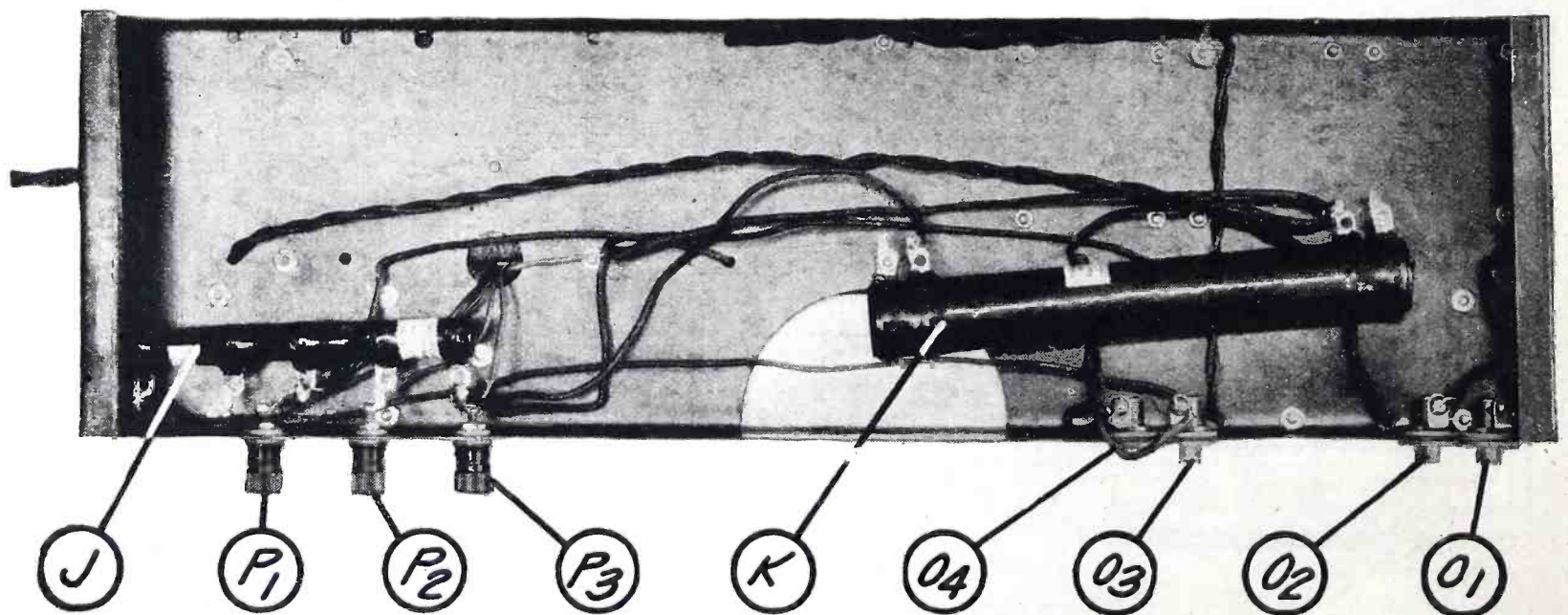

A VIEW OF THE UNIPAC FROM BENEATH

FIGURE 5: This gives a clear idea of the mounting of the resistances, the binding posts and the small tip-jacks on the under side of the chassis. It also gives a good idea of the method of wiring.

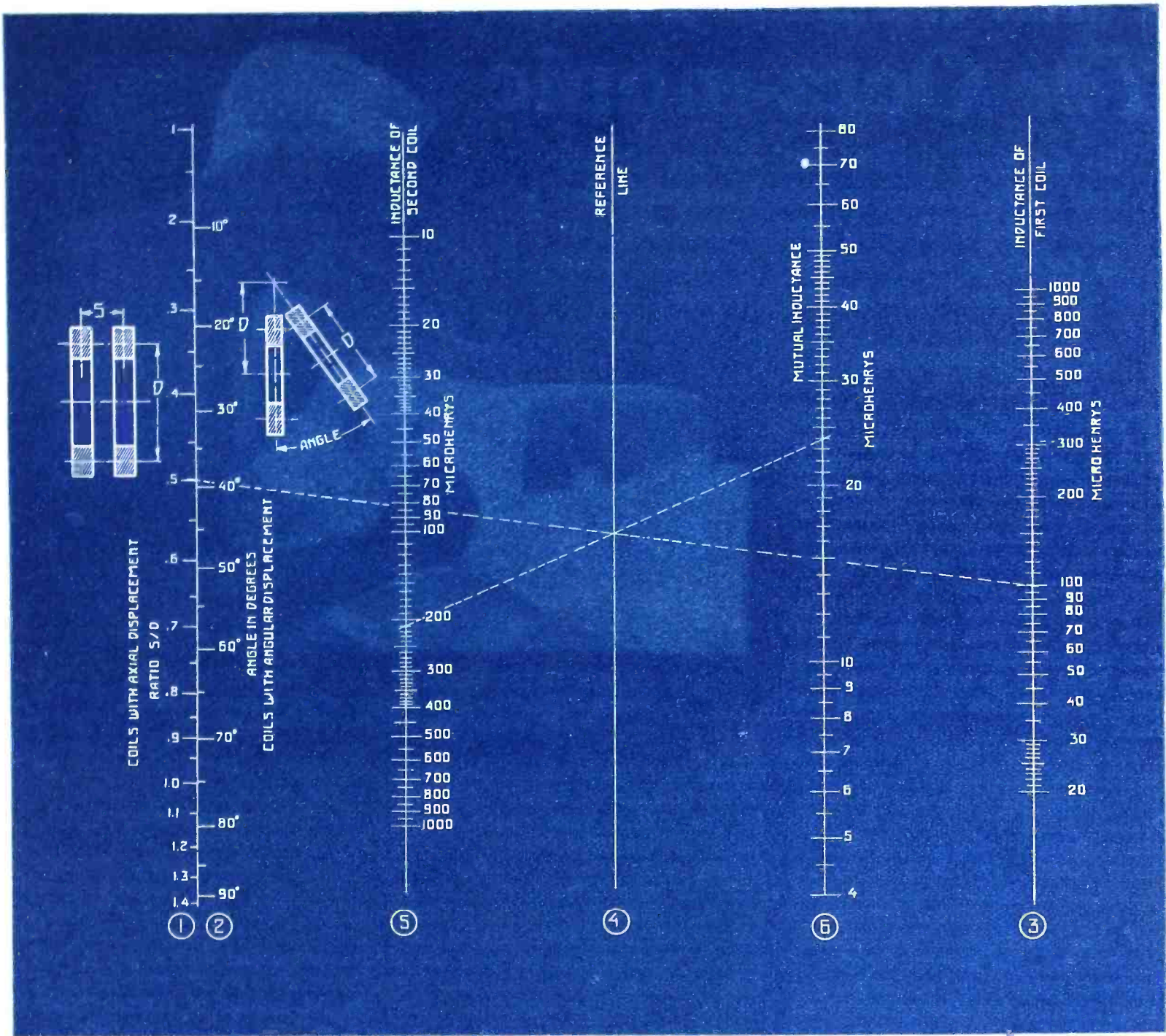

A MEASUREMENT CHART

For Use in Calculating the Mutual Inductance of Coils with Axial or Angular Displacement

By RAOUL J. HOFFMAN, A.M.E.

WHEN coupling two high-frequency circuits together, there is a choice of two general methods that may be employed:

1. Magnetic coupling;
2. Electrostatic coupling.

In some cases, a combination of these two methods is used; in most cases, however, either an inductive or direct magnetic coupling is employed.

When varying the coupling in two circuits, the mutual inductance also changes, and this value is often somewhat difficult for the radio experimenter to determine with accuracy.

In preparing this chart, the coupling of two coils of rectangular cross-section has been considered. The two circuits, acting upon each other, have a mutual inductance which follows the equation

$$M = K \sqrt{L_1 \times L_2}$$

wherein

- M = the mutual inductance;
- L₁ = the inductance of one coil;
- L₂ = the inductance of the other coil;

and

K = the coupling factor of the coils with a given displacement.

If the two circuits are in resonance the original inductance values, L₁ and

L₂, will be increased by the amount of the mutual inductance, M.

In the accompanying chart the coupling factor of the two coils has been plotted with axial displacement on scale No. 1 and with angular displacement on scale No. 2. The two drawings of the coils indicate just what is meant by "axial" and "angular" displacement.

The chart has been made up for coils that have the same diameter.

For example:

Let us calculate the mutual inductance for two coils with an average diameter
(Continued on page 355)

A Circuit That Is New in Principle and Performance — The Octa-monic

To the four fundamental circuits already used in radio reception the Octa-monic Receiver adds a fifth—a circuit absolutely new in principle that employs “harmonic detection” with amazing results

By JOHN BRENNAN

DURING the past few years the “circuit mills” have been turning out their grist of new hook-ups without interruption. So intensive has been this production that it would be difficult for any fan or radio engineer to enumerate even those receivers which have become nationally prominent.

While the number of these circuits have been countless, the fundamental circuits upon which most of them have been based are so few that they can easily be counted on the fingers of one hand.

The first really new and fundamental circuit to bring greater power and sensitivity to radio reception was the regenerative circuit. If one cares to investigate the regenerative circuit’s claim to fame, he need only look up the records in distance reception that were hung up by simple one-valve regenerative sets with two stages of low-frequency amplification. In spite of the greater power of present-day broadcasting stations, there are few receivers to-day, no

matter how many valves they may utilize, that can consistently reach out for the coast-to-coast reception obtained with the regenerative circuit during past years.

The old regenerative circuit, however, had one major and several minor faults which would render it obsolete for present-day requirements: Its poor selectivity would be an insurmountable objection to its use nowadays. The

regenerative receiver did a good job in its day, under the then existing conditions, but progress has moved on apace and left it behind.

The next worth-while development in circuits was the tuned-high-frequency circuit. This circuit grew out of the untuned-high-frequency circuit which became popular when only a handful of broadcasting stations were in operation. As the number of stations increased,



DAVID GRIMES CHECKS OVER THE OCTA-MONIC
Here is David Grimes, the designer of the Octa-monic circuit, making a final survey of the completed receiver.

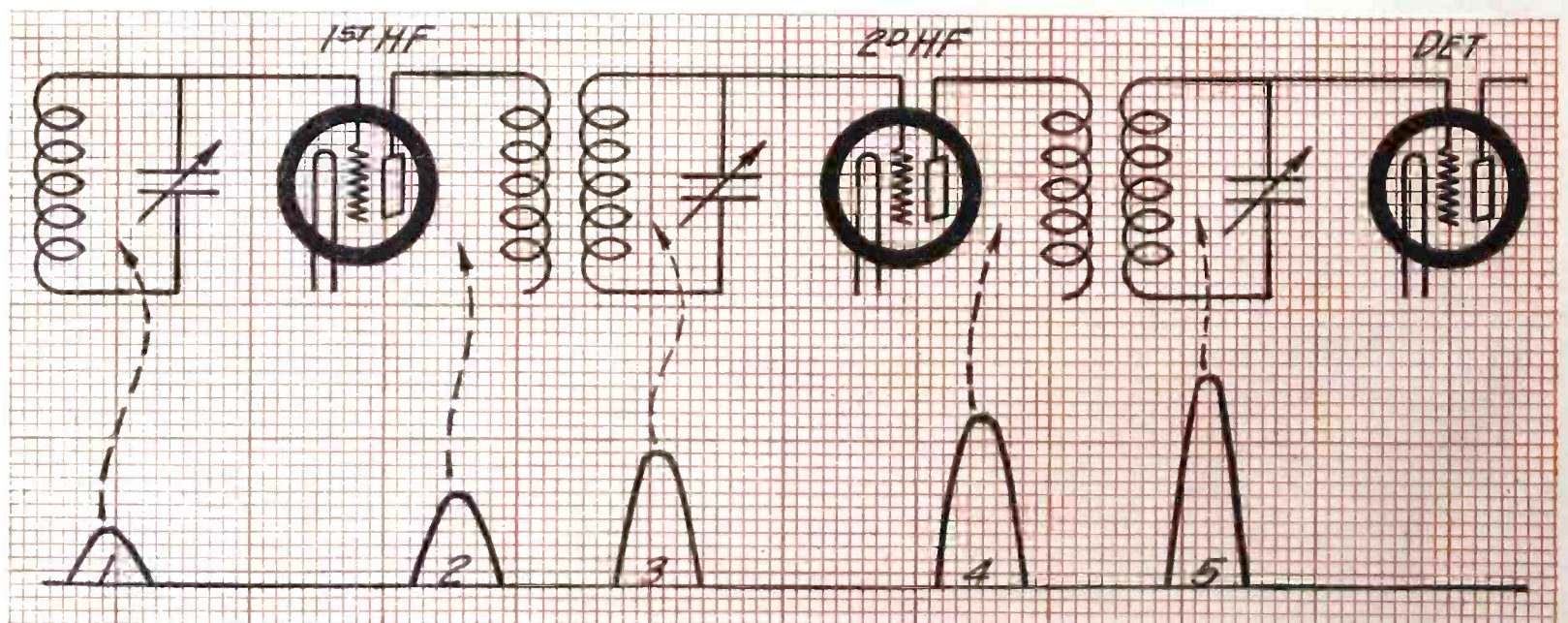

HOW SELECTIVITY DEVELOPS IN THE ORDINARY RECEIVER

FIGURE 1: The circuit is that of an ordinary three-valve, high-frequency amplifier, with the resonance curve of each circuit shown below. Note that while the amplitude increases steadily, the selectivity, as indicated by the width of the curve, is increased only by the two tuned transformers, at 3 and 5.

untuned-high-frequency amplification passed out of general use, as its selectivity depended on a single tuned stage and was not adequate for modern conditions.

With various refinements, tuned-high-frequency has enjoyed a well-earned popularity. Tuned-high-frequency amplification has done much to permit radio fans to navigate the maze of radio broadcasting stations whose programs interfered with each other when the ordinary receiving circuits were employed.

As far as selectivity is concerned, it has always been acknowledged that the superheterodyne circuit, the third of the fundamental circuits, stands supreme. But the unusual selectivity of the superheterodyne may become one of its most flagrant faults, simply because this selectivity is often obtained at the expense of tone quality. This sacrifice of tone quality cannot always be entirely eliminated in the superheterodyne, because its great sensitivity and selectivity depend upon the principle of converting the incoming wave into another wave of a longer wavelength (lower frequency), which often limits the tone-quality-giving side-bands that can be amplified by this system.

Some of the other disadvantages of the superheterodyne are its high cost, the difficulty of obtaining suitably matched units, and its characteristic of bringing in a station on more than one point on the dials, making operation and logging of stations sometimes quite bothersome.

The reflex and inverse duplex systems, while based on tuned and untuned-high-frequency amplification, utilized the same valves twice for both high-frequency and low-frequency amplification.

The inverse duplex system, with the additional selectivity and sensitivity im-

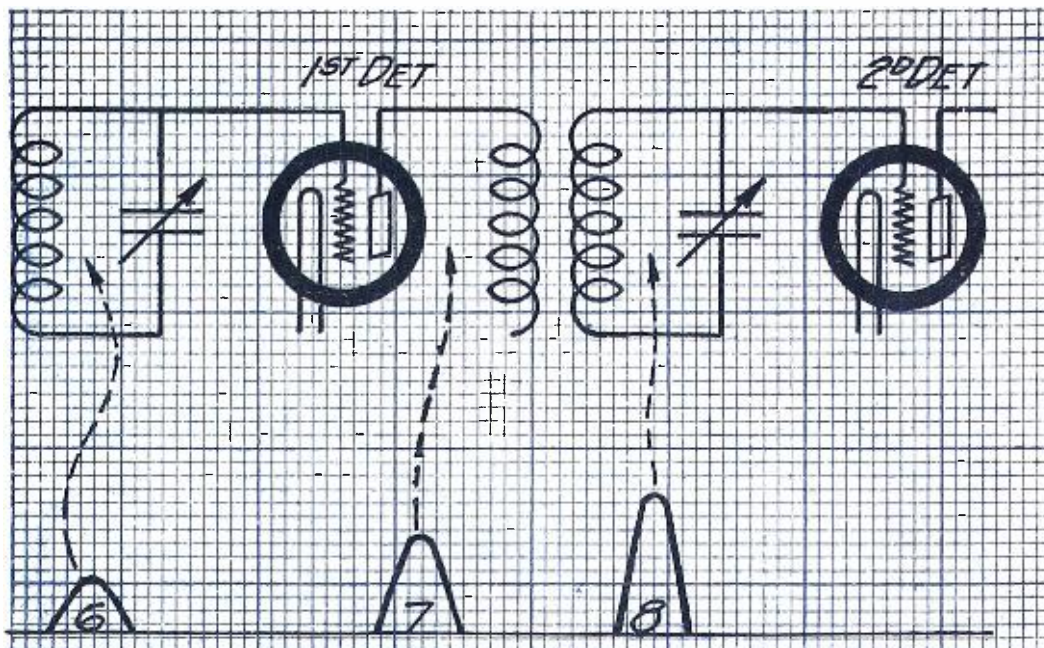

HOW THE OCTA-MONIC CIRCUIT DEVELOPS SELECTIVITY
 FIGURE 2: The two-valve Octa-monic circuit obtains the same increase in selectivity as that in Figure 1, with one less stage; one increase is introduced at 7 by the new principle of "harmonic detection" and another at 8 by the tuned transformer.

parted by the famous Grimes development of automatic regeneration, was probably the outstanding development of the reflex circuit.

Up to the present time, therefore, there have been four fundamental circuits. These four circuits are:

- The regenerative circuit;
- The tuned-high-frequency circuit;
- The superheterodyne circuit;
- The reflex circuit.

Now there has come upon the stage a circuit which uses a new idea in obtaining still greater selectivity without the usual line-up of intricate controls, variable couplings, delicately adjusted circuits and the various other devices that have usually been added to tuned-high-frequency circuits to increase selectivity.

It was while working on the refinements of various types of tuned-high-

frequency and reflex circuits in developing the inverse duplex system of amplification that David Grimes discovered the alluring possibilities of selectivity which were inherent in the standard type of vacuum valve. Grimes noticed that when rectification took place in the high-frequency valve harmonics were generated, which caused the broadcast stations to appear not only at their proper dialing, but on their half wavelength (double the frequency) as well.

It was found that the signals were not as strong at the harmonic generated at double the frequency by the detector valve, but that the signals generated at these double frequencies were much sharper, by far, than the signals obtained at the fundamental carrier frequency.

By careful tests and measurements, Grimes soon obtained sufficient data to prove mathematically that the generation of second harmonics increased the selectivity in proportion to the square of the incoming signal.

With the discovery of this remarkable action of the vacuum valve which results in a geometric increase in selectivity in the valve itself, a fifth fundamental circuit has been added to the list already enumerated.

The Octa-monic circuit, as this new circuit has been named, is distinctly different in its manner of performance from that of the other four fundamental circuits. It operates on the principle of wave-changing, but this wave-changing is accomplished automatically.

Every broadcast signal is brought into the receiver by means of the ordinary tuned circuit, but only the double-

(Continued on page 354)

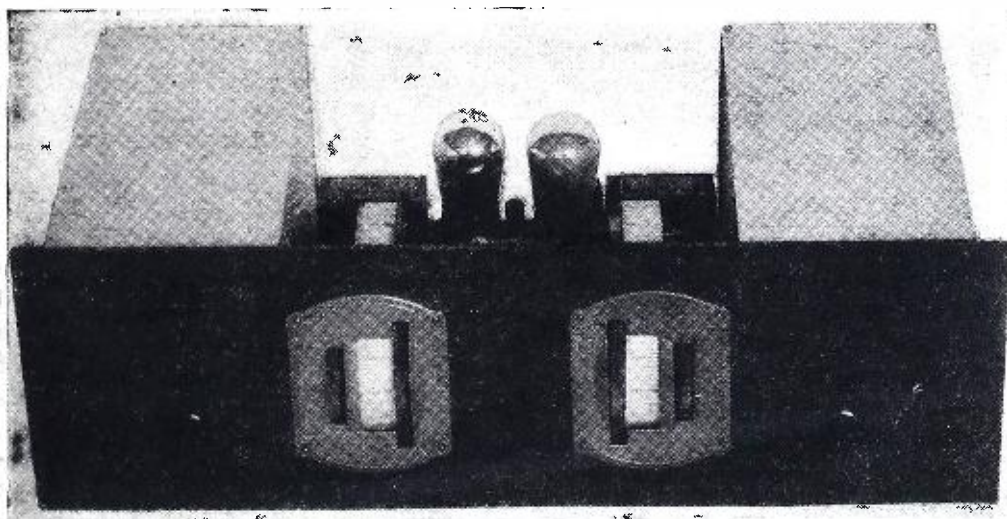

A VIEW OF THE COMPLETE RECEIVER

There is an appearance of balance about the Octa-monic receiver, due to the placing of the drum dials and other panel controls, and the arrangement of the two shields behind the panel.



"Loop and Socket" Reception

With the MagnaRay Power-pack supplying "B" voltages for the Magnaformer from the lighting lines, loop reception should be as clear and powerful as any fan could wish, without the worry and bother that come from run-down batteries and replacements.

SNAPPY "B" POWER FOR THE MAGNAFORMER WITH *The MagnaRay Power-Pack*

Superheterodyne reception may be brought to a new plane of quality and efficiency with this "B" power-pack, designed especially for the Magnaformer 9-8 Receiver. Here are the complete constructional details for this unit, that will develop, at 200 volts, 85 milliamperes of steady "B" current.

By LAURENCE M. COCKADAY

COST OF PARTS—Not over \$45.00

HERE IS A LIST OF PARTS NECESSARY FOR BUILDING THIS UNIT—

- | | | |
|---|---|--|
| A—National power transformer; | F—Lynch wire-wound resistor, type P, 4,000 ohms; | I—Binding post strip, 1½ by 9¼ by 3/16 inch; |
| B—National filter-choke coils, type 80; | G—Tobe buffer condenser (.1 and .1 mfd., with a common terminal); | J1, J2, J3, J4 and J5—XL aluminum binding posts; |
| C—Tobe Special "B" block, type 760-G (2, 2, 6, 1, 1 and 1 mfds.); | H—Lynch tapped output potentiometer resistor, type PRE; | K—Wooden baseboard, 9¼ by 10 by 3/8 inches. |
| D and E—Benjamin Cle-ra-tone vibrationless sockets; | | |

IN VIEW of the popularity and the increasing number of requests from POPULAR RADIO readers for information concerning the proper power apparatus to be used with the Magnaformer loop receiver, a new power-pack has been developed especially for use with this instrument. It is the work of a number of engineers of various companies specializing in this work.

The new unit that has been officially adopted as the standard for this receiver is called the MagnaRay Power-

Pack. It incorporates a number of interesting features that make it especially suitable for this work.

It is built of sectionalized units comprising a power transformer, a filter-choke unit and a condenser bank, which are enclosed in cans to cut stray fields to a minimum. It uses a filamentless rectifier valve of the Raytheon BH type, capable of delivering 85 milliamperes at 200 volts.

Another feature is the utilization of the new Raytheon voltage regulator

"R" type valve that keeps all voltages applied to the set constant at all times in spite of voltage fluctuations in the house-lighting power. The use of this valve also precludes any possibility of "motor boating."

The cost of this unit is not more than that of the usual high-grade "B" power-pack *without* a voltage regulator.

The unit may be used with any other receiver needing a constant source of "B" voltages from 22½ volts to 200 volts, using the lighting lines.

How to Construct the Unit

The new unit, as may be seen from Figure 1, is mounted on a wooden baseboard, K. A suitable piece of well-dried wood should be used for this purpose, with two one-inch strips fastened across the ends to raise it from the surface on which it is to stand. This will allow running the wires underneath. This wooden baseboard should be cut to a size of 9¼ by 10 by ¾ inch.

After this has been prepared, the next job is to mount the binding posts, J1, J2, J3, J4 and J5, on the binding-post strip, I. The strip may then be mounted on the edge of the baseboard with flat-head wood screws.

Next, mount the transformer, A, by means of four wood screws in the position shown in Figure 1. The filter-choke unit, B, may be mounted on the opposite corner of the baseboard, as shown in the same illustration.

Next, mount the condenser block, C, by means of two round-head wood screws as shown in the same illustration. The resistance unit, F, is supported by the connecting wires and need not be mounted until later. Fasten down the buffer condenser, G, with two screws as indicated.

Now fasten down the two sockets, D and E, with two screws to each socket. The last mounting job will be to fasten down the resistance unit, H, by means of two screws, one at each end of the resistor.

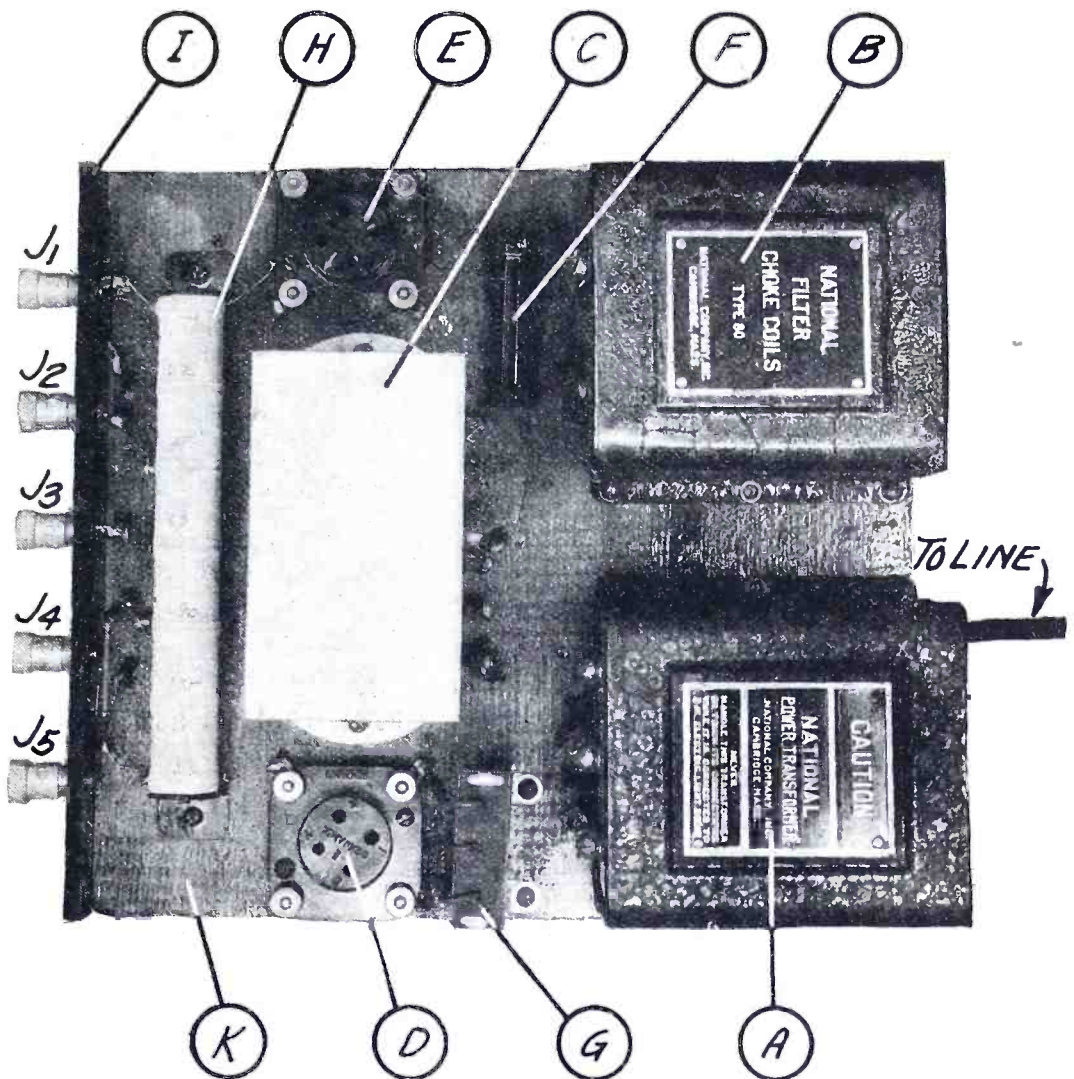

THE PANEL LAYOUT OF THE MAGNARAY

FIGURE 1: The mounting of the instruments on the wooden baseboard is a simple matter, as this picture shows. Most of the wiring is done under the baseboard.

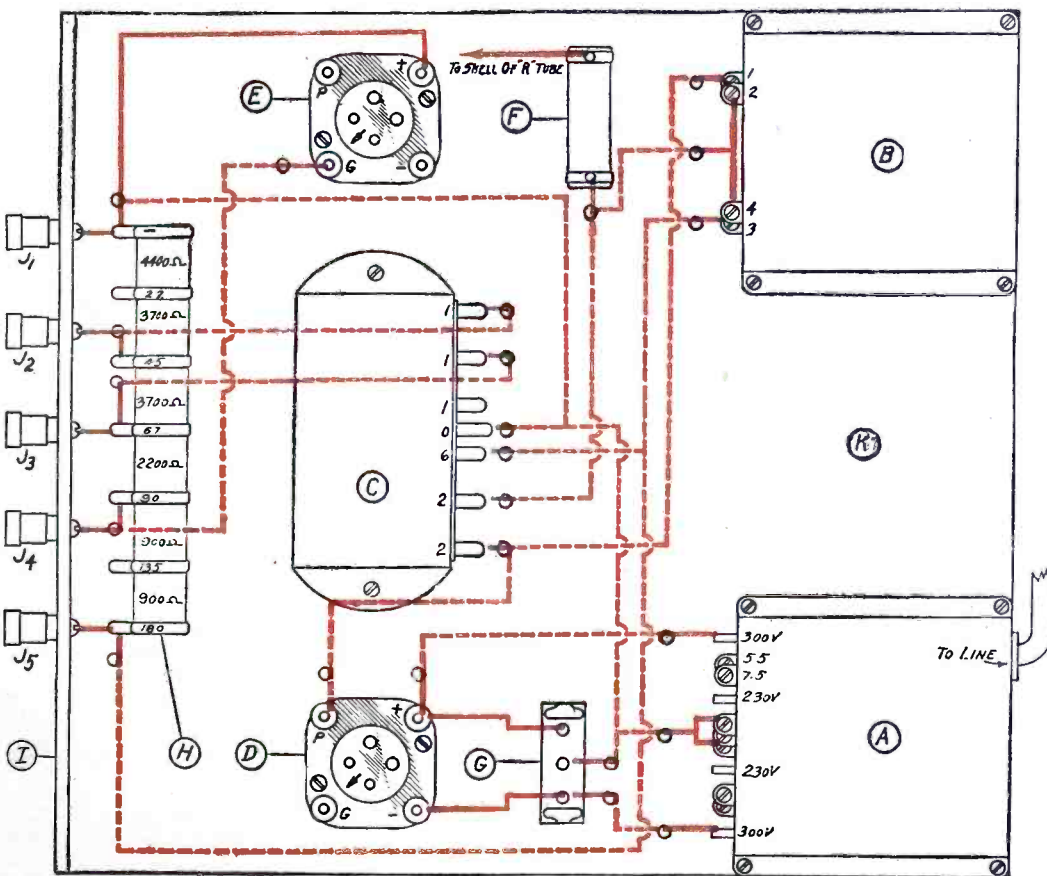

THE PICTURE WIRING DIAGRAM

FIGURE 2: The dotted RED lines show the wires to be run under the baseboard, and the solid RED lines the wires above the baseboard. The instruments are outlined in BLACK.

Be sure all of the units are fastened in the positions indicated in Figure 1.

This completes the construction work on the power-pack and it is ready to be wired. Refer constantly to the picture wiring diagram in Figure 2 in making connections. This diagram shows the instruments laid out in approximate positions, and the wiring is shown in heavy colored lines. Those wires that run above the wooden baseboard, K, are shown in solid lines, while the wiring running beneath the baseboard is shown in dotted lines. The wiring should be done with rubber-covered hook-up wire.

The diagrams are so complete and so easy to follow that no specific written instruction for wiring is necessary.

One wire that holds the resistor, F, runs through the baseboard, and one wire should be soldered and fastened by a clip to the metal shell of the regulator valve in socket E.

When the wiring has been completed the unit is ready for installation.

How to Hook Up the MagnaRay With the Magnaformer Receiver

The unit may be placed in the bottom portion of the console or radio cabinet upon which the Magnaformer receiver

(Continued on page 360)

Eliminate "Squeals" With the New High-Mu 2-Grid Valve

By L. JAMES

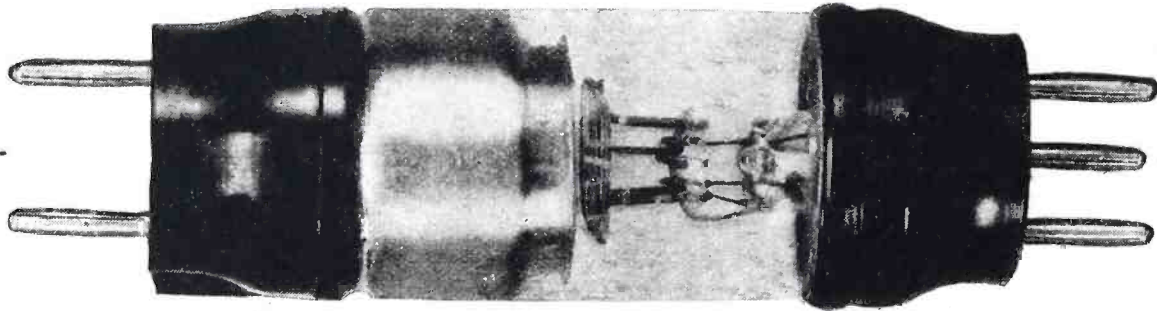

With this remarkable new "screened grid" valve a single high-frequency stage can be made to give amplification as high and as stable as an ordinary three-stage amplifier—and this can be done without any of the intricate methods formerly used to prevent feedback and "howling."

A NEW valve recently perfected by the British Marconi Company possesses many new and startling features that should be of absorbing interest to radio enthusiasts.

This valve is almost certain to have the effect of modifying the design of the high-frequency part of receivers, and, in fact, receivers have been prepared which utilize this new instrument. The valve has four electrodes—a filament, control grid, screen grid and plate. It should not be confused with the ordinary four-electrode valve. The new valve has distinctive features, being so designed that the capacity between the control grid and the plate is negligible when the screen is connected to a point at earth potential, such as one side of the filament battery, or to the plate battery. Also, the plate impedance and voltage factor of the new valve are of quite a different order of magnitude from those usual in the ordinary types of receiving valves.

The construction of the new valve is clearly shown in Figures 1 and 4. It will be seen to comprise a normal filament and grid; the filament is of the thoriated type, rated at 5 volts, .25 ampere, while the grid has the shape shown in the illustration. These elements are mounted at one end of the valve, a cap with three pins being provided. At the opposite end is mounted the screen and plate. The screen is of wire gauze having a fairly fine mesh welded to the edge of a circular metal band. Quite close to the gauze is a circular metal plate with dished edges which is used as the plate. These ele-

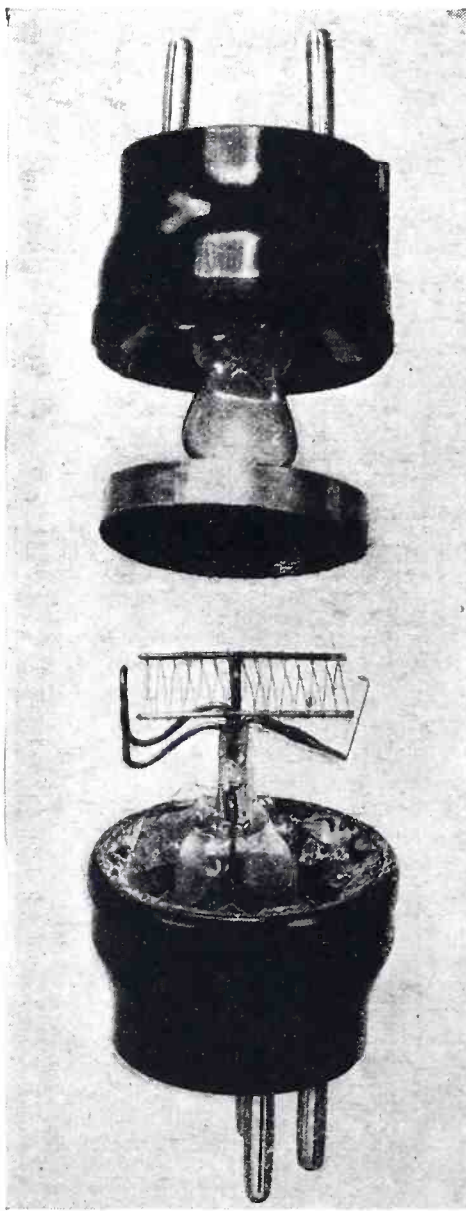

ELEMENTS OF THE NEW VALVE
FIGURE 1: The plate and "screen" grid are in the top section, and the filament and "control" grid in the lower.

ments are mounted at the opposite end of the valve from the grid and filament, and two pins are provided for connections.

Before one can fully appreciate the factors which led to the development of the new valve, one must consider in what way the original three electrode valve has proved to be defective.

An ordinary three electrode receiving valve has capacity between its grid and plate. This provides a coupling between the plate and grid circuit with the result that the amplified voltages in the plate circuit cause current to flow back to the grid circuit. It so happens that this current is usually of such magnitude and phase as to cause the stage to oscillate. Hence the most careful shielding of the components of these circuits is useless unless some means are provided for limiting the amount of current fed back through the valve's capacity, and various methods have been devised for neutralizing this capacity or for stabilizing the circuit.

Methods for neutralizing the valve's capacity are, on the whole, satisfactory, but owing to imperfect neutralization, caused, in some instances, by the difference between the phase angle of the neutralizing condenser and that of the valve's capacity, and in other instances by failure to provide a sufficiently tight magnetic coupling between the coils associated with the circuit, the balance obtained is not perfect. This results in a varying amount of feedback at the various wavelengths to which the circuit may be tuned, with the result that in practice, the precaution has often to

be taken of limiting the amount of amplification per stage.

Ordinary stabilizing devices usually act to limit the amount of amplification per stage, for this reduces the voltage difference of plate and grid, and therefore the amount of energy fed back from the plate to the grid circuit. Thus the tendency of the receiver to be unstable is reduced, but at the expense of amplification, and very often of selectivity as well.

As the main difficulty with high-frequency amplification is due to the valve's electrode capacity, it seems strange that only of late has a serious attempt been made to construct valves having a negligible plate to grid capacity, for with a valve of this type there would be no need to employ any of the special balancing or stabilizing devices so necessary with ordinary receiving valves. It would of course be necessary to remove completely all stray couplings between the individual stages of the receiver. This involves the removal of stray magnetic couplings due to the position of the various coils associated with the circuit, the removal of capacitive couplings due to the proximity of tuning coils, condensers, wires and other incidental apparatus, and of conductive couplings due to the impedance of connecting wires, batteries and so on.

Thus it is necessary to use metal screens or metal boxes, by-pass con-
(Continued on page 356)

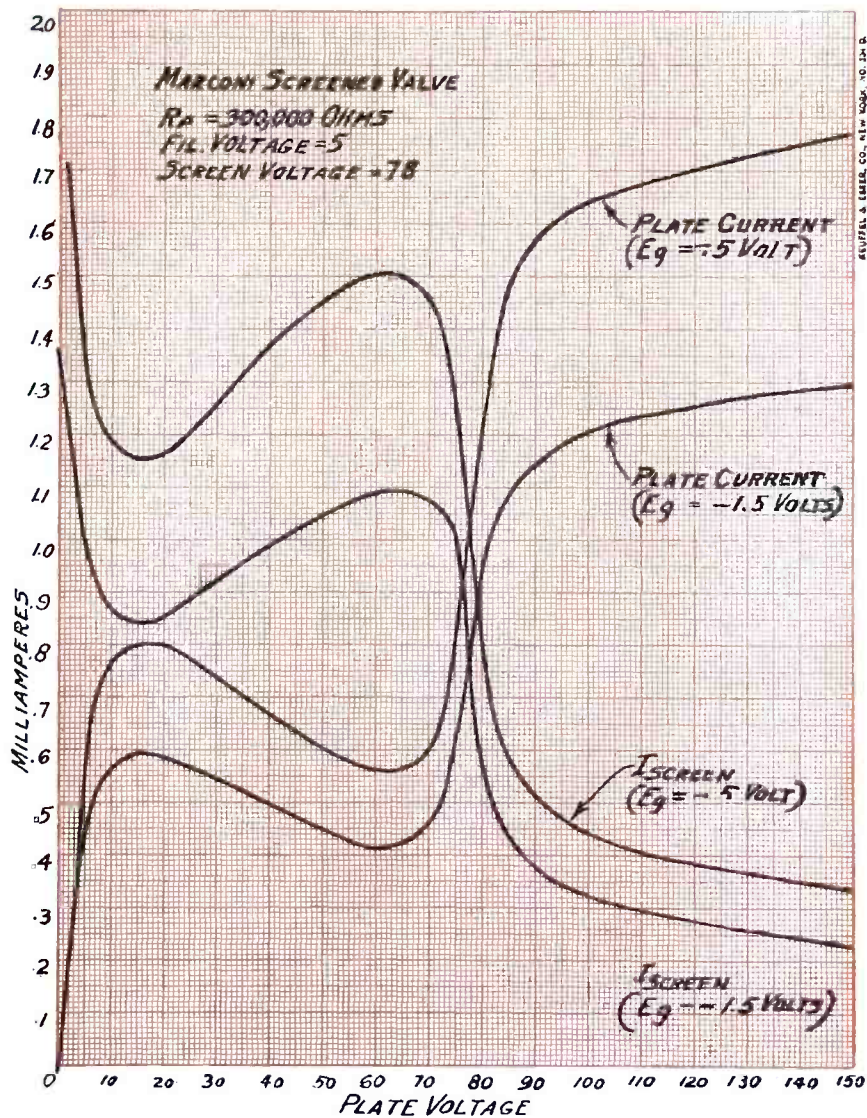

CHARACTERISTIC CURVES FOR THE SCREENED-GRID VALVE

FIGURE 2: In two of these curves the plate current is plotted against plate voltage. The other two curves show how the "screen grid" current varies under the same conditions.

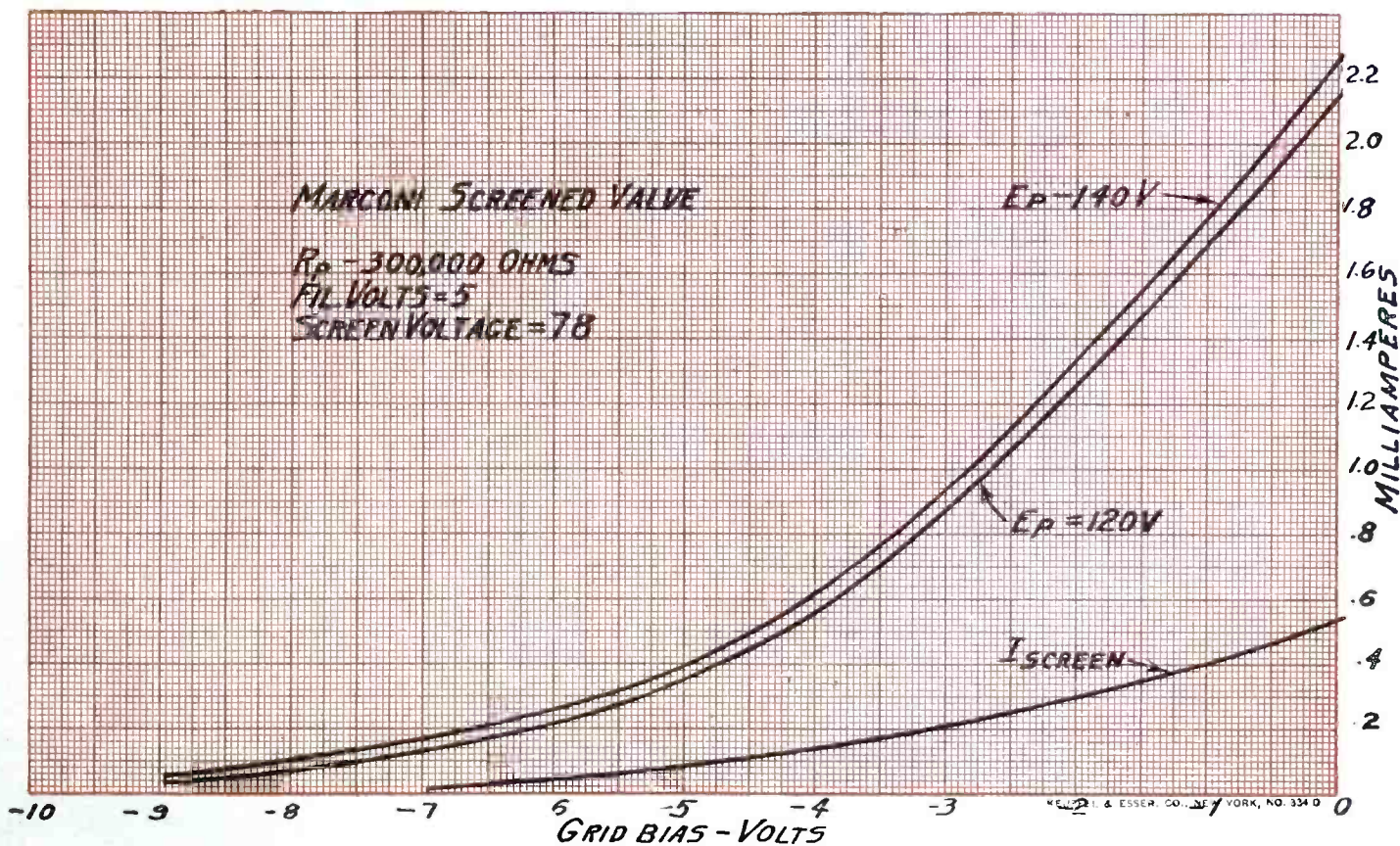

CURVES OF PLATE CURRENT AGAINST GRID VOLTAGE

FIGURE 3: The two top curves indicate the variations of plate current with grid bias at two different plate voltages in the operating range. The lower curve shows how the screen current increases under these conditions.

An Up-to-the-Minute High-Frequency Pack for Use With The Phono-Radio Reproducer



Here are the complete constructional details for an inexpensive yet highly efficient two-valve, high-frequency amplifier and detector, designed particularly for use in conjunction with the new electrical pick-up units and low-frequency amplifier packs that were described in POPULAR RADIO in the series of articles on combining the phonograph and the radio. The complete ensemble, such as is pictured above, should give broadcast and recorded reproduction of such variety and outstanding quality as to satisfy even the most exacting taste in aural home entertainment.

By JAMES MILLEN

COST OF PARTS—*Not over \$42.00*

HERE IS A LIST OF PARTS FOR BUILDING THIS UNIT—

- | | | |
|--|--|---------------------------------------|
| A and K—General Radio UX sockets; | C5—Sangamo mica condenser, .001 mfd.; | R4—Lynch 1,000-ohm suppressor and |
| B—9 by 13-inch bakelite sub-panel; | RFC—Samson RF choke, No. 85; | mounting; |
| C1—Sangamo mica condenser, .00025 mfd.; | R1—Carter 20-ohm switch-rheostat, type | T1 and T2—National Uni-Control B-D |
| C2—Tobe condenser, 1 mfd.; | M-20-S; | tuning unit complete with illuminated |
| C3—Precise midget condenser, 50-150 | R2—Lynch equalizer and mounting, No. 2; | dial; |
| mmfd., No. 940; | R3—Lynch metallized filament resistor, 2 | P—7 by 14-inch bakelite panel; |
| C4—General Radio neutralizing condenser; | meg., and mounting; | 7 Eby binding posts. |

A NEW trend in radio receiver design that is receiving considerable attention at present is the separation of the low-frequency amplifier from the receiver proper, as in the new LC-28.

As a result, the complete receiver may be considered as two separate components—the high-frequency amplifier and detector, and the combination low-frequency amplifier and power-pack. The phonograph pick-up, of course, may be substituted at will for the high-frequency amplifier and detector, so that either radio programs or phonograph records may be reproduced at the turn of a switch.

In the preceding issue of POPULAR RADIO, the writer described a combination low-frequency amplifier and power-pack designed for just such use.

This article gives the constructional details for a high-frequency broadcast pick-up for use with this amplifier.

In selecting the circuit for the receiver, simplicity of construction, general availability of the essential parts, stability of operation, ease of control, and high sensitivity (for the number of valves employed) were given careful consideration. It was finally decided to employ the new Uni-Control National B-D tuning unit, in a circuit of a revised type of design.

This new tuning unit consists of a standard B-D antenna inductance and high-frequency transformer mounted on a two-gang condenser of unique design. Instead of directly connecting the shafts of the two condensers together as a single unit, they are joined through a system of friction-driven

planetary gears of the type used in the well-known National vernier dials which were so popular a few years ago. The shaft of the first condenser is hollow and through its center passes another shaft which is connected to a small knob located at the center of the main tuning dial. When the main dial is turned, both condensers rotate. When the small knob is rotated, a vernier adjustment of the antenna tuning capacity may be made without changing the setting of the other condenser.

In the past it has always been necessary either to use a separate condenser for tuning the antenna circuit, or else, if the antenna condenser were ganged to another condenser, to employ a separate "trimming" condenser. With the new arrangement, however, these difficulties are overcome and at

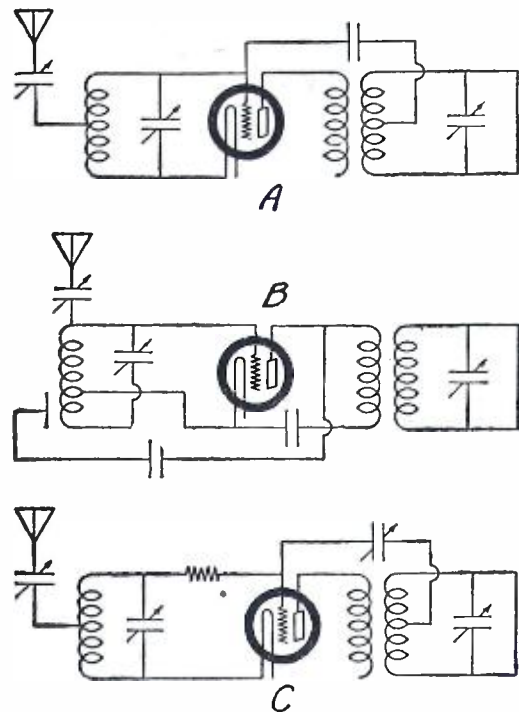

HOW THE B-D CIRCUIT DEVELOPED

FIGURE 1: At the top is the simplified schematic circuit of the original Browning-Drake circuit. At B is a modification of this circuit which has become known as the "Official" Browning-Drake circuit. At C is a further modification used in the unit described in this article.

the same time vernier reduction mechanisms are furnished to facilitate the adjustment of either the main or auxiliary knobs. As a rule, the small auxiliary knob need only be used when tuning for distant stations.

In many of the earlier receivers constructed and described in the various radio magazines, a circuit comprising one stage of high-frequency amplification of the type developed by Prof. Hazeltine was employed in connection with a regenerative detector. This circuit is shown at A in Figure 1.

With this circuit arrangement, however, it was usually necessary to employ one of the small UX-199 valves as a high-frequency amplifier rather than the more reliable UX-201-a. When the larger valve was used, it was found almost impossible to neutralize the receiver.

At B in Figure 1 is another circuit which was used by Browning and described by him in an article in the April, 1927, issue of POPULAR RADIO. This circuit, when used with the B-D tuning units, has become known as the "Official" Browning-Drake circuit. A small

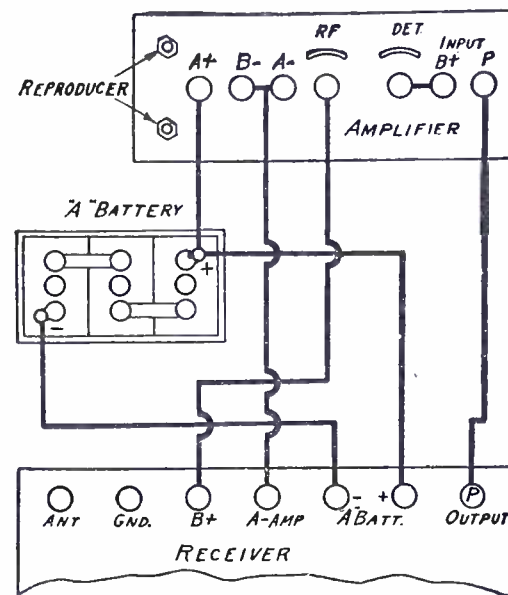

THE BATTERY HOOK-UP

FIGURE 2: This diagram shows the proper connections to be made for operating the high-frequency pack with the power-pack amplifier described in the October number of POPULAR RADIO.

valve was also found necessary for proper operation.

Recent experiment, however, has shown that if a suitable resistance be

The list of parts given in this article includes the exact instruments used in the apparatus from which these specifications were made up. The experienced amateur, however, will be able to pick out other reliable makes of instruments which have been approved by POPULAR RADIO and which may be used with good results. If instruments other than the ones listed are used, the only change that will be necessary will be the use of different spacings for the holes that are drilled in the sub-base for mounting the instruments. To any reader who has difficulty in obtaining any of the parts which are necessary in making up these model receivers and power units, POPULAR RADIO SERVICE BUREAU, 119 West 57th Street, New York City, will gladly assist in seeing that his requirements are promptly supplied.

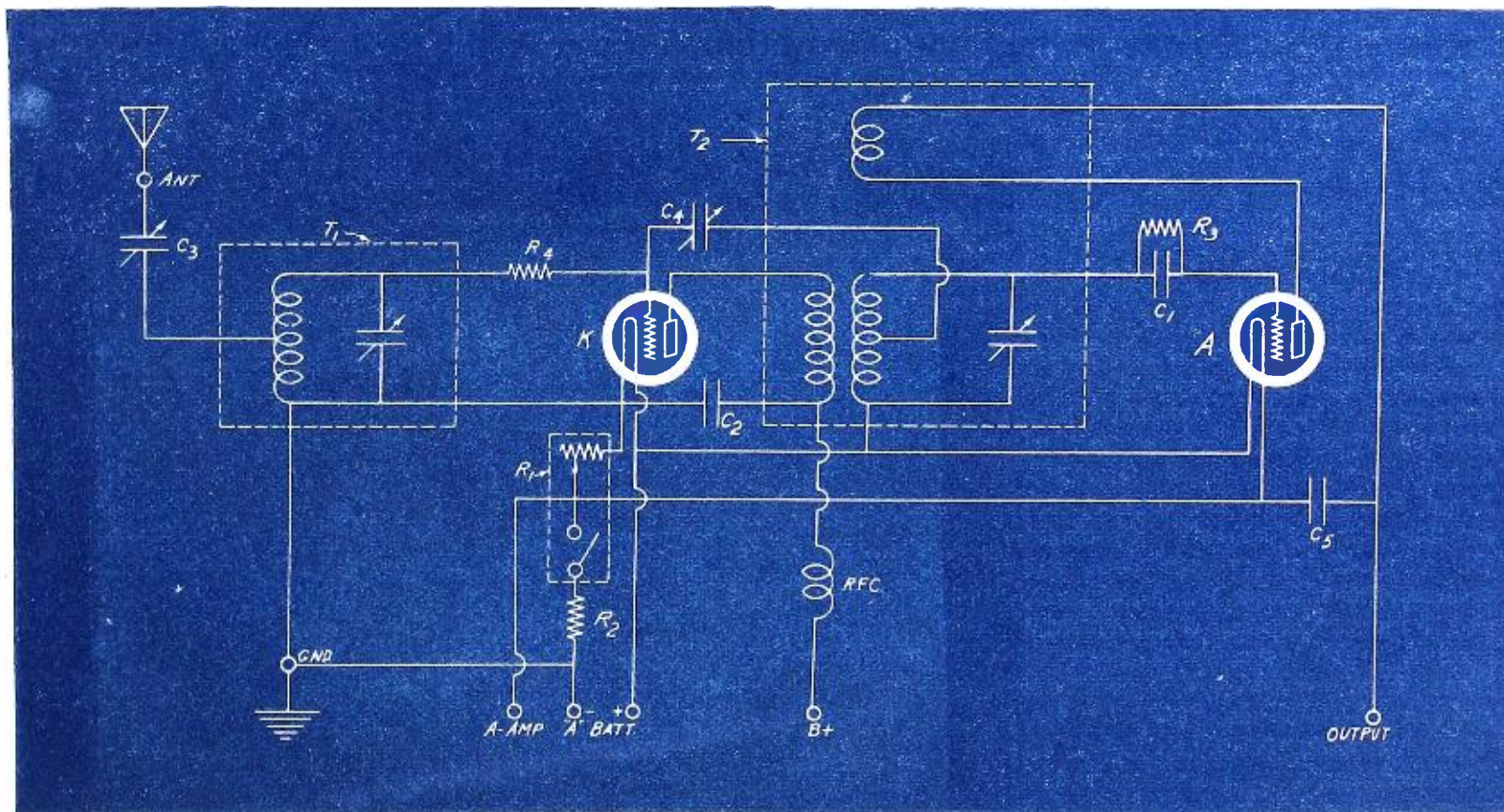

THE SCHEMATIC WIRING DIAGRAM OF THE UNIT

FIGURE 3: The lettering in this diagram corresponds to the list of parts and the constructional data in the text. As the wiring of the unit is quite simple, there should be no difficulty in doing it from this diagram.

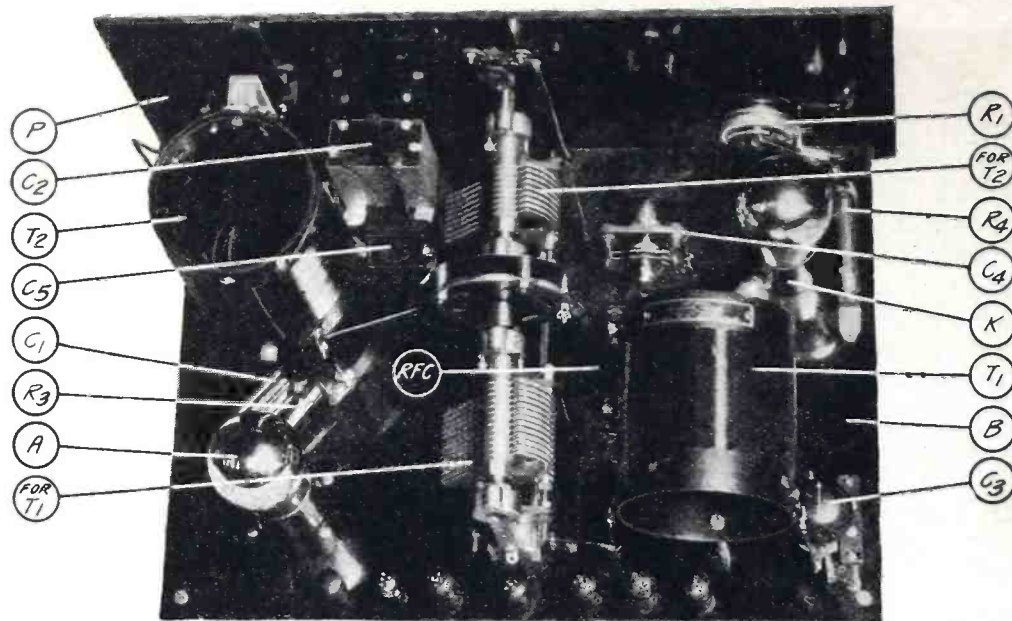

THE SUB-PANEL VIEWED FROM ABOVE

FIGURE 4: This view shows clearly the mounting positions of the B-D tuning unit with its gang condenser, the two valve sockets and the other instruments.

placed in the grid circuit of the first valve of the B-D circuit, as shown in Figure 1 at C, then no trouble will be had in neutralization when a UX-201-a type of valve is employed in place of the UX-199 type. As a result, the overall performance and reliability of the receiver is materially improved. In fact, it is possible, when employing such a grid resistor, to go even a step further and employ one of the new 5-volt, high- μ , high-frequency amplifier valves, such as the CeCo type K.

As the grid resistor is not located in the tuned circuit, it has no detrimental effects upon the selectivity of the receiver.

How to Construct the Receiver

As will be seen from Figures 4 and 5, the actual construction of the receiver is quite simple. Figures 7 and 6 give the layouts for the front panel and the sub-panel. Upon careful examination of Figures 4 and 5, it will be noticed that the resistor clips and socket contacts used by the writer in the construction of his receiver, were fastened directly onto the sub-panel. It is believed, however, that the average constructor will find it easier to obtain the standard resistor mountings and sockets, as specified in the list of parts, and to mount them in the conventional manner. The dimensions given in Figure 6 are for the Lynch mountings and General Radio sockets.

After preparing the panels, mount all the essential parts on the sub-panel and complete all wiring, as shown in Figure 3, except those connections to the dial light and switch-rheostat, R1, before mounting the front panel. If most of the wiring is run under the sub-panel

the appearance of the completed receiver will be considerably enhanced.

Upon referring to the circuit diagram, in Figure 3, it will be noticed that there are two "A" negative (—) terminals. The extra one is added so that the switch on the panel of the receiver may also be used to control the filaments of the valves in the externally connected low-frequency amplifier. The rheostat is so located in the circuit as to control only the high-frequency amplifier valve and thus serve as a volume control.

The equalizer, or automatic filament-control resistor, R2, takes care of the detector valve and also prevents more

than the rated 5 volts being applied to the high-frequency valve, even when the rheostat is set for minimum resistance.

When completed, the receiver may either be placed in a small 14-inch cabinet, and the low-frequency amplifier and power-pack located in some out of the way place, or else the entire outfit may be installed in a console type of cabinet.

How to Install the Receiver

It is most important that the antenna used with this receiver be not over about fifty feet in length. In fact, most excellent results are generally obtained with but a short length of wire run around the room in which the set is located. Should such an indoor antenna be employed, however, care must be used to see that it does not run close to any lamp cords or other AC lines not covered with a grounded shield such as the standard BX Cable. If such precaution is not taken a slight AC hum may be heard in the reproducer.

When everything has been connected up as shown in Figure 2, tune in a local station by means of the main tuning control. Then adjust the small compensator knob located in the center of the dial until the station is tuned in fully. The neutralizing condenser should then be adjusted. Generally the proper position will be with the plates interleaved about $\frac{1}{4}$ of the way. The antenna series condenser should be so adjusted (with plates about $\frac{3}{4}$

(Continued on page 360)

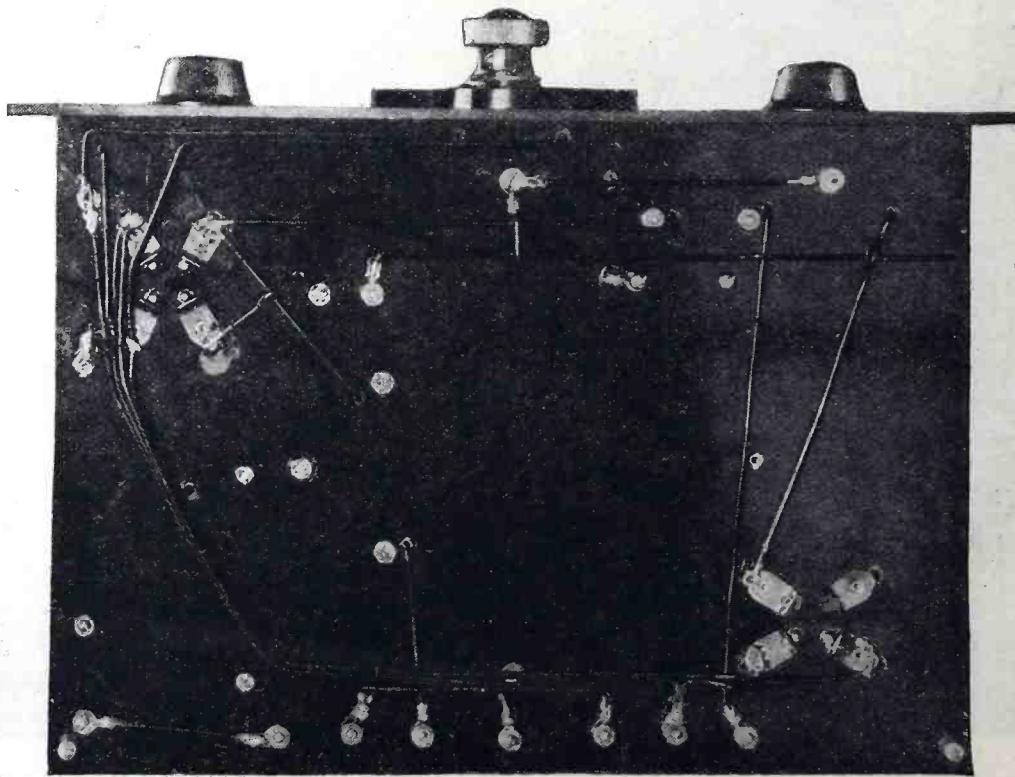

THE UNDER SIDE OF THE SUB-PANEL

FIGURE 5: The manner of wiring the unit may be seen in this view. Insulated bus wire, such as Celatsite, is convenient to use.

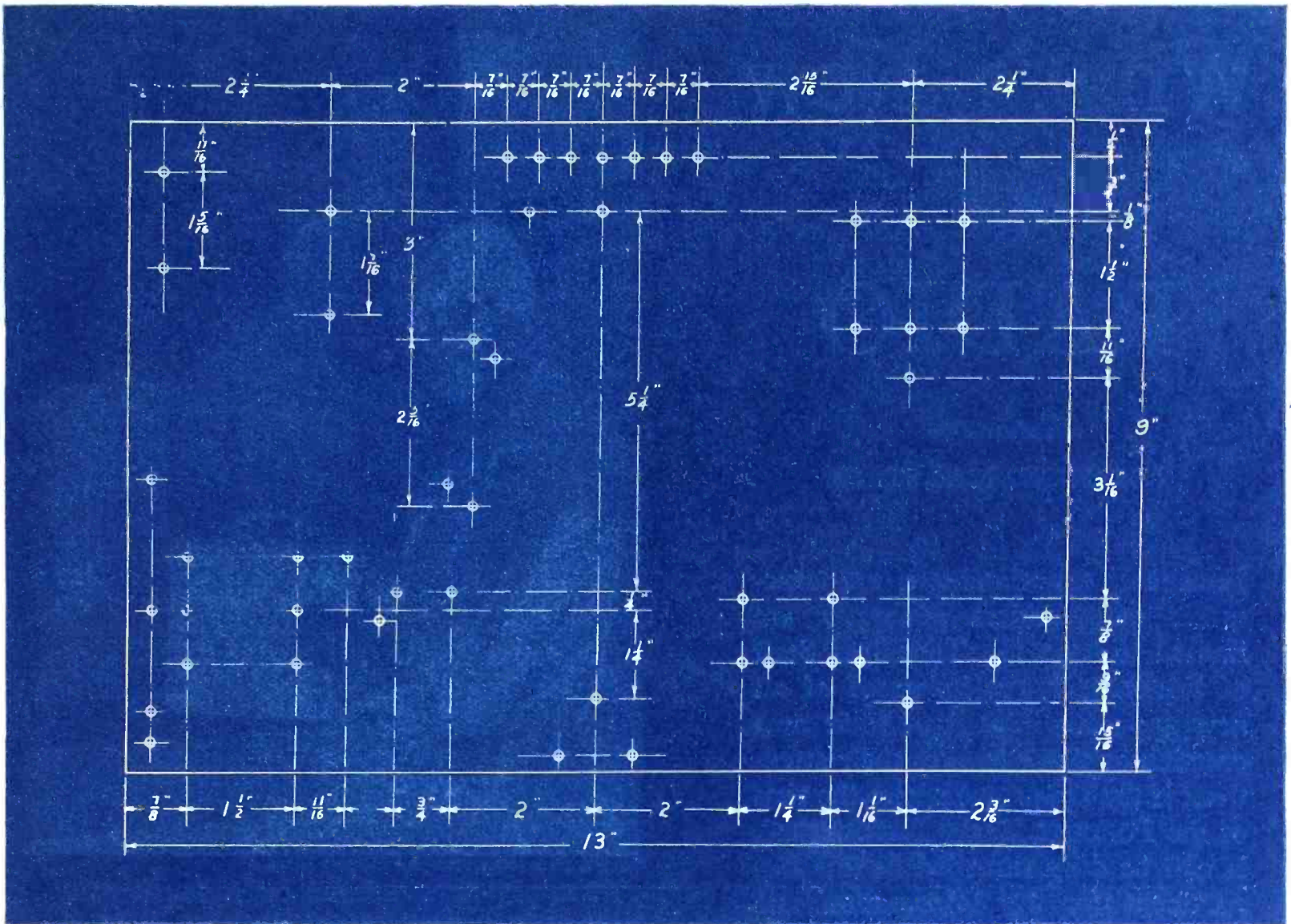

THE DRILLING PLAN FOR THE SUB-PANEL

FIGURE 6: This layout shows the exact positions for all of the holes that are to be drilled in the sub-panel for mounting the instruments, sockets and binding posts.

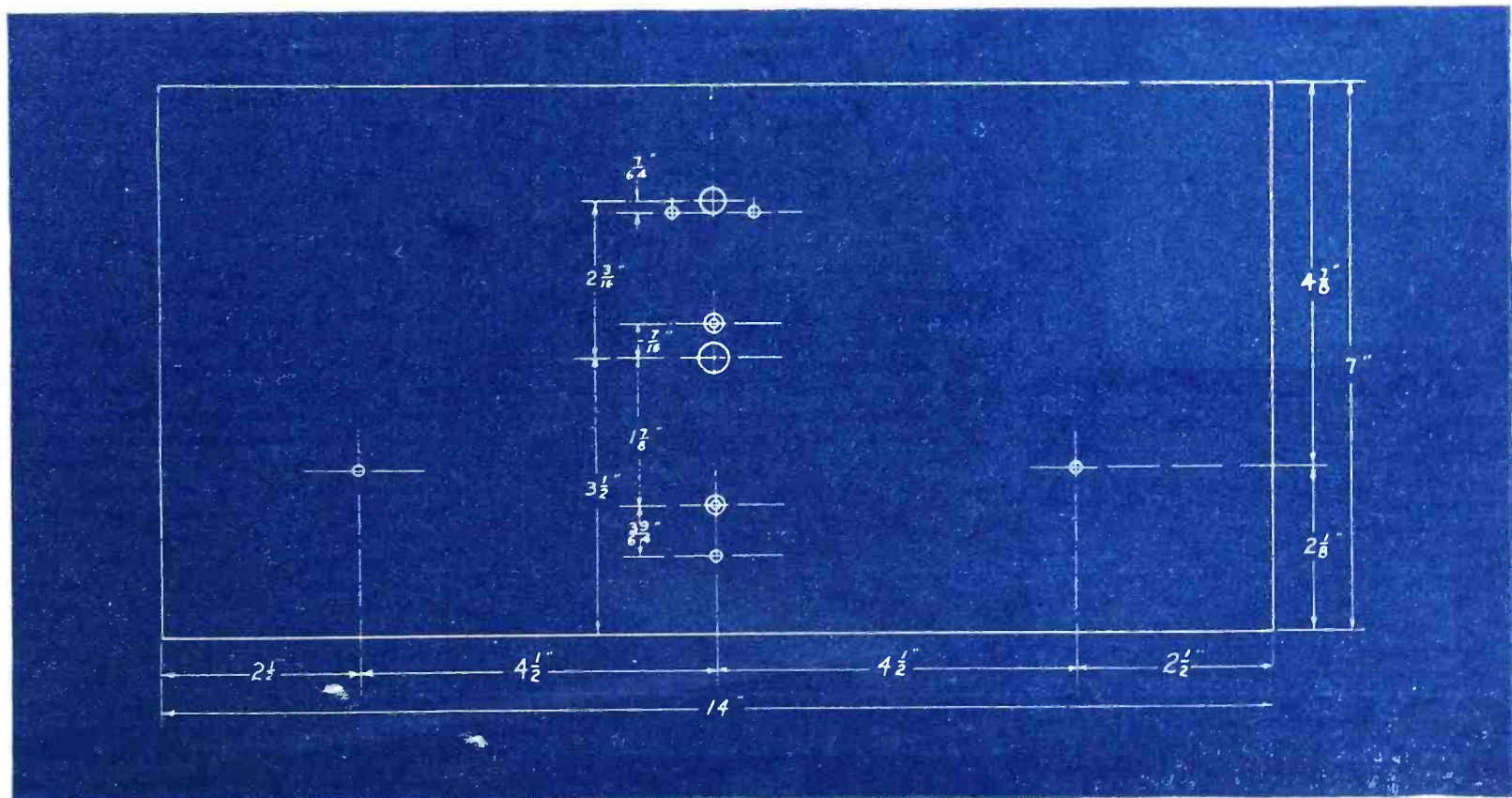

THE DRILLING PLAN FOR THE FRONT PANEL

FIGURE 7: This shows the holes that are to be drilled in the panel to mount the variable condensers, the rheostat and the knob for the tuning unit, T2.

What's New in RADIO

Conducted by
THE TECHNICAL STAFF

Inventors, experimenters, manufacturers and readers generally are invited to keep the Technical Staff of POPULAR RADIO informed of all new apparatus that is of their own creation or that comes to their attention; if the apparatus passes the tests of the POPULAR RADIO LABORATORY, it will be duly recorded in this Department for the information and benefit of all.

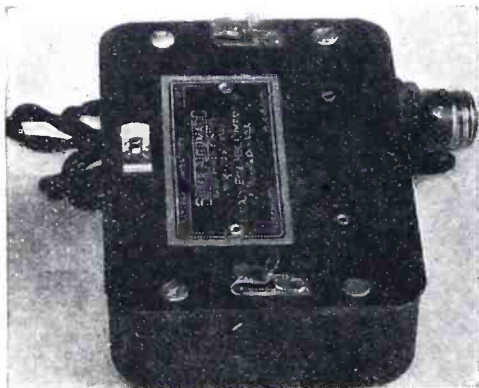

An Automatic Switch for the Battery Charger

Name of instrument: Automatic power control.

Description: This automatic switch permits a power-operated receiver to be controlled by the battery switch on the receiver. When the receiver is turned "off" by the operator, the unit automatically disconnects the "B" power-pack from the AC line and connects the battery charger to the line so as to replenish the current which has been drawn from the battery during the operation of the receiver. The charger will only be permitted to function until the battery has reached full charge, at which time the control unit automatically turns "off" the charger. The standard 2-ampere or 5-ampere chargers are par-

ticularly recommended for use with this unit. The control consists of two separate relays. These are enclosed in a metal case that measures $4\frac{1}{8}$ by $5\frac{3}{4}$ by 2 inches. The top of this case is of composition material and carries the necessary connection terminals and also the receptacles for the plugs from the "B" power-pack and the battery charger.

Usage: To control the power-pack of a receiver and to provide automatic control over battery charging.

Outstanding features: Compact in size. Always keeps battery fully charged. Controls the "B" power-pack and the "A" battery charge automatically. Prevents the storage battery from overcharging.

Maker: Liberty Bell Mfg. Co., Inc.

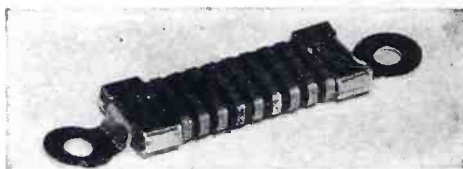

A Handy Form of Resistance Unit

Name of instrument: Fixed resistance unit.

Description: A composition strip $1\frac{3}{8}$ by $\frac{3}{32}$ by $\frac{1}{8}$ inch is used as the foun-

ation and upon this strip the resistance material, in the form of a flat metal ribbon, is wound. The terminals are in the form of round washers which are clamped directly onto the ends of the wound form. When used for filament control purposes one terminal of the unit may be attached directly to the valve socket and the other end to one side of the "A" battery circuit. Where the sockets are mounted directly on a metal sub-panel that is also connected to "A-" terminal it is only necessary to connect one end of the resistance unit to the "A-" terminal of the socket and the other end to the metal sub-panel. These units are obtainable in a wide variety of resistance values. The type H is supplied in resistances from $\frac{2}{5}$ ohm, for the control of 10 valves of the 201-a type, to 2 ohms, for the control of two of the 201-a type valves. The RU type is for use in series with a rheostat to permit the use of UX-100 valves with a 6-volt supply source. There is also a type T unit which has a resistance of 200 ohms and is center tapped. This is for use across the AC filament supply for power amplifier valves.

Usage: To provide fixed control of filament current, or for any other uses that call for a fixed resistance.

Outstanding features: Small in size. Easy to install.

Maker: Carter Radio Co.



From a photograph made for POPULAR RADIO

SLEUTHING INTERFERENCE ON THE ROOF TOPS

This device is a complete portable receiver for use in locating interference from power lines, electric signs, defective wiring, and other electrical disturbances that cause so much trouble in certain radio neighborhoods. It is made by the Davis Equipment Company.

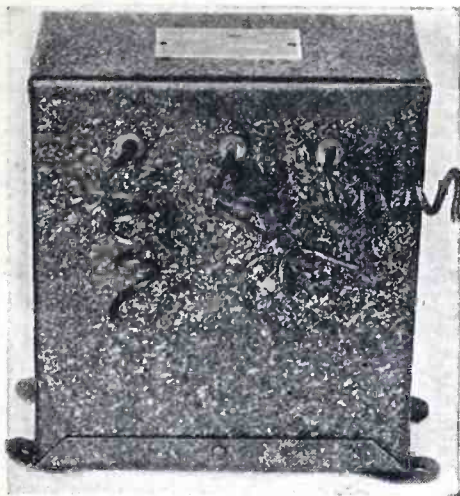

This Filter Choke Handles Unusually Heavy Currents

Name of instrument: Double choke No. 3584.

Description: Most of the chokes used in power-pack filters heretofore have been limited in their current-carrying capacity to 100 milliamperes or less. This new choke is capable of carrying up to 400 milliamperes safely. It consists of two chokes, inclosed in a single, crackle-finished iron case. The chokes are connected in series inside of the case and insulated leads are brought out from the common connection and the outer ends of the two windings.

Usage: In conjunction with suitable filter condensers to serve as the filter for an "ABC" power-pack that employs the Raytheon type BA, 350-milliampererectifier valve.

Outstanding features: Very compact in size for a double choke capable of carrying 400 milliamperes. The two chokes included in this one case provide all the inductance necessary for a filter for this type of power-pack.

Maker: Dongan Electric Mfg. Co.

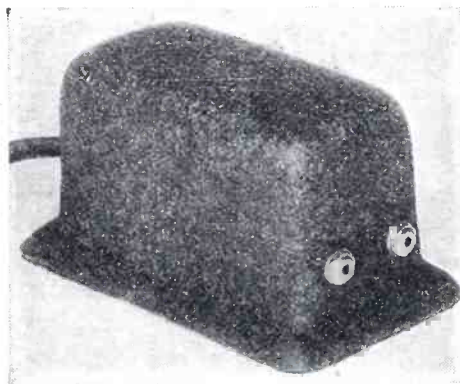

Protect Your Reproducer With This Unit

Name of instrument: "Orthophone" output filter.

Description: This filter unit consists of an iron-core choke coil and a condenser, both of which are inclosed in a one-piece stamped metal case. The overall size is $4\frac{5}{8}$ by $2\frac{1}{2}$ by $2\frac{3}{8}$ inches. The instrument is supplied with a brown crackle finish. The input terminals are in the form of a double-tipped cord similar to the cord on a reproducer. These are for connection to the receiver output where the reproducer is ordinarily connected. The output terminals of the Orthophone are small tip jacks mounted in one

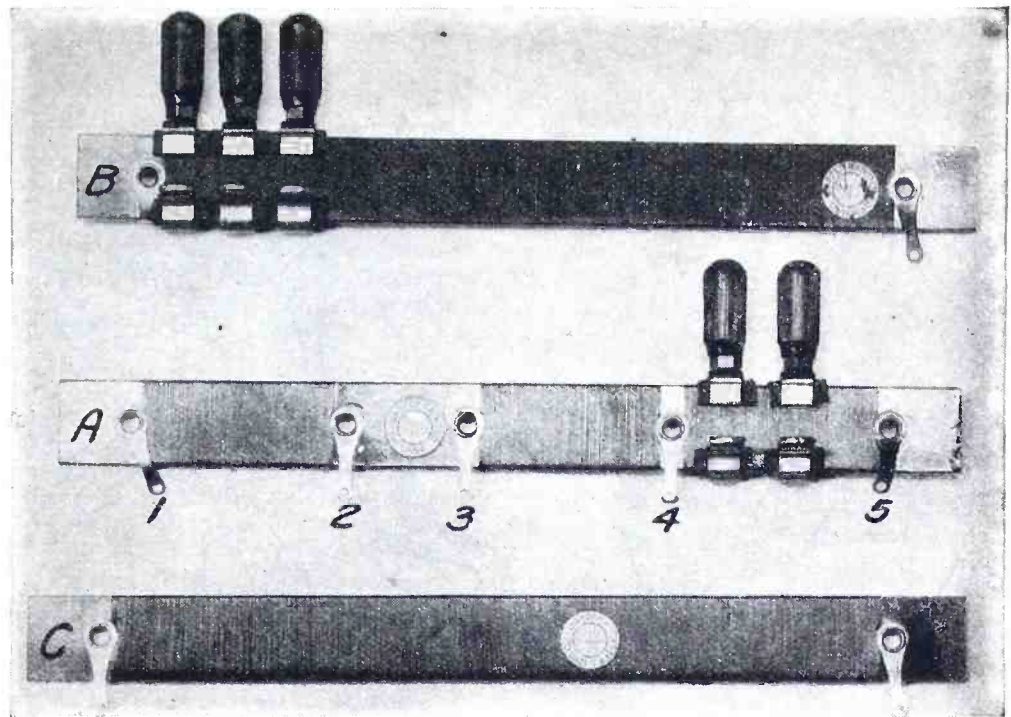

A Universal Output Resistor for Power-Packs

Name of instrument: Voltage control for "B" power-packs.

Description: This voltage-control unit consists of two insulating strips 8 inches long by $\frac{3}{4}$ inch wide by $\frac{1}{8}$ inch thick. These are wire wound and when connected into the circuit provide a total resistance of 10,000 ohms across the filter output. In connecting the units in a power-pack, the unit marked A is connected across the filter output with terminal 1 connected to the positive side. Unit B is then connected across from terminal 2 of strip A to terminal 3 to provide three variable "B" voltages which are tapped off at the three sliders. The two sliders between terminals 4 and 5 of strip A provide variable "C" voltages. Terminal 4 is the "B" connection and terminal 5 is the "C" maximum connection. The sliders are equipped with screw knobs which, when the proper adjustment of the slider has been made, are turned tight to make the adjustment permanent.

The strip C is provided for use in

series with strip A in cases where the output voltage is in excess of 200 volts. It is connected between the positive side of the filter output and terminal 1 of strip A. This unit C is obtainable in various resistance values to take care of output voltages up to 500 volts.

Usage: As the voltage divider across the output of a "B" power-pack to provide variable "B" and "C" voltages to fit the exact requirements of the receiver that is to be supplied by the power-pack.

Outstanding features: A flexible arrangement that can be used with any "B" power-pack with an output voltage of between 100 and 500 volts. The resistors are wire wound and have more than ample current carrying capacity to fit the needs of any power-pack or receiver. Provides variable "B" voltages for the detector, high-frequency and intermediate low-frequency stages of a receiver. Also makes provision for two variable "C" bias voltages.

Maker: Carter Radio Co.

end of the case. The reproducer tips are inserted in these jacks.

Usage: To be connected between the output of the receiver and the reproducer. It is for use with any receiver that employs 135 volts or more on the plate of the last low-frequency amplifier valve, and which does not include an output filter or output transformer.

Outstanding features: Small size. Neat appearance. Affords good protection for the reproducer windings.

Maker: Amsco Products Co.

A Fixed Condenser of Substantial Design

Name of instrument: Mica fixed condenser.

Description: Mica and tinfoil are used in the making of these condensers. After the condenser unit has been built up it is completely sealed in a bakelite case that is moulded under several



tons pressure. The terminals are in the form of wide brass strips that project from the ends of the condenser. These brass strips are punched so that the condenser may be fastened under binding posts, or may be attached directly to a valve socket terminal.

Usage: Wherever a fixed capacity of any definite value from .00005 mfd. to .025 mfd. is needed. May be obtained with grid-leak clips in capacities of .0001, .00025 and .0005 mfd.

Outstanding features: Extremely solid. Not affected by moisture or heat.

Maker: Micamold Radio Corp.

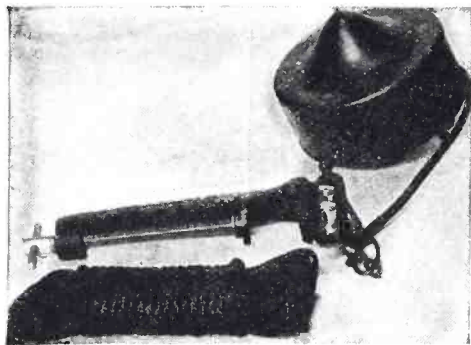

Make Your Piano a Radio Reproducer

Name of instrument: "Rotofor" radio "piano" reproducer.

Description: This powerful reproducer unit is equipped with a special mounting by means of which it may be securely clamped to the framework of any type of piano. The driving rod, which extends from the front of the unit, is allowed to rest snugly against the sounding board of the piano. It is this rod that carries the reproducing energy from the unit to the piano sound board, causing the latter to vibrate and thus reproduce the broadcast program.

Usage: For the reproduction of radio programs, making use of the piano sounding board as a reproducer.

Outstanding features: Easily installed. Good quality of reproduction.

Maker: International Radio Corp.

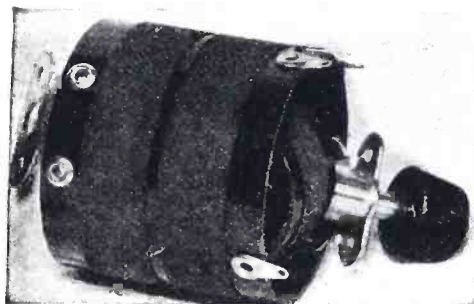

A Variable Coupling in Compact Form

Name of instrument: Coupling coil unit.

Description: This coupler consists of a primary winding and a split secondary winding. The secondary is wound on a bakelite form $2\frac{1}{4}$ inches in diameter by 2 inches in length. The primary or rotor coil is wound on a short length of $1\frac{1}{2}$ inch bakelite tubing, and is mounted on the stator form in such a position as to permit it to rotate through an arc of 180 degrees. The windings are of green, silk-covered, copper wire. The secondary winding is split into two equal halves, with two terminals brought out from each half. This arrangement makes this coupler adaptable to practically any circuit. Terminals are in the form of soldering lugs and are conveniently located on the rim of the stator form. Pigtail connectors are provided between the rotor coil and its terminals.

Usage: As an interstage coupling unit for use in high-frequency circuits or as an oscillator coupler in a superheterodyne receiver.

Outstanding features: Well made. Compact. Panel or base mounting. Readily adaptable to practically any type of high-frequency circuit.

Maker: Camfield Radio Co.

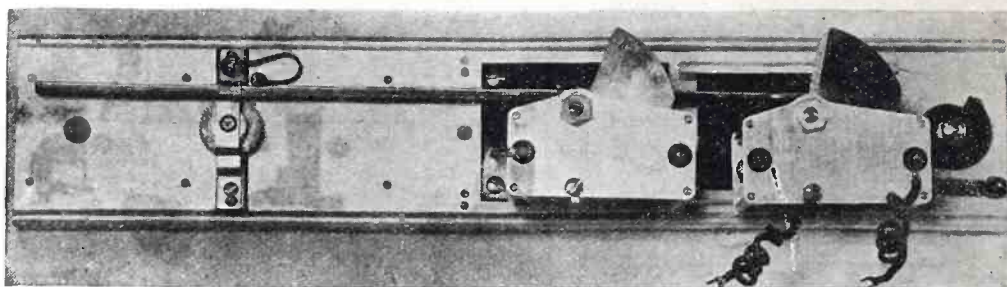

A Gang Condenser Unit That Simplifies Tuning

Name of instrument: Victoreen master control unit.

Description: This unit may be obtained in sizes comprising from two to four variable condensers that are mounted on a metal rack, equipped with a sliding gear arrangement that permits the tuning of the condensers by means of a single control shaft. To use this unit in a receiver it is mounted on the inside of the front panel of the receiver. The single-control shaft projects through the receiver panel and the tuning knob or dial is attached thereto. One of the condensers is equipped with an additional sliding-gear arrangement, which permits a compensating adjustment to be made on this one condenser to balance its capacity against that of the other tuned circuits in the receiver. This feature is especially useful when this condenser is connected in the input circuit of the first valve. By means

of this balancing adjustment it is possible to make up for the slight variation in circuit values which results from the antenna being coupled to this first circuit.

The condensers in this unit are thoroughly insulated from one another, and any possibility of body-capacity effect in tuning is largely eliminated. The hand, in tuning, does not come in close proximity with any part of the condensers.

Usage: As a complete single-control tuning unit for use with receivers that have from two to four tuned circuits of similar electrical values.

Outstanding features: Provides single-control tuning. The condensers are thoroughly insulated from one another. Permits separate adjustment to be made to compensate for slightly different electrical values in the antenna circuit. Easily installed.

Maker: George W. Walker Co.

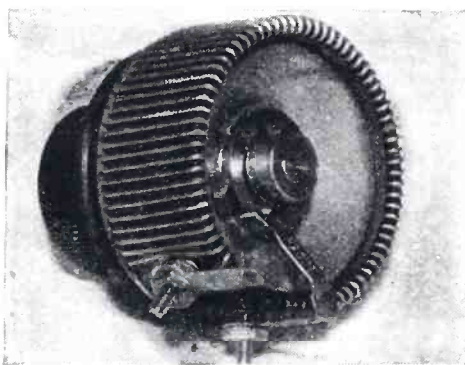

Positive Control for the Filament Circuits

Name of instrument: Filament rheostat.

Description: This rheostat consists of a metal frame that supports the resistance winding in a solid manner. The resistance winding consists of wire wound on a composition strip. This device is made in various resistance values, from the Model 775, which is a 75-ohm rheostat, down to the No. 702 $\frac{1}{2}$, which is a $2\frac{1}{2}$ -ohm rheostat capable of carrying 2 amperes continuously. 200 and 400-ohm potentiometers are also made in this style.

Usage: For controlling the filaments of one or more standard vacuum valves.

Outstanding features: Provides a light but firm contact on the sliding arm. Resistance winding uniform and firm. Single-hole mounting.

Maker: Herbert H. Frost, Inc.

A Reproducer with Good Volume and Tone

Name of instrument: Drum-type reproducer.

Description: The tone chamber of this

unit is made of heavy composition and resembles a 54-inch horn that has been curled up to fit into a small space. The actual length of the air column is $4\frac{1}{2}$ feet, in spite of the fact that the body of the reproducer is only about 15 inches in diameter. The reproducer unit used in this reproducer is one that is capable of handling tremendous volume. The tone chamber is enclosed in a metal case that is open at the front but protected by a silk screen. This whole unit is mounted on a heavy metal base and is equipped with a 5-foot extension cord for connection to the receiver output.

Usage: As a reproducer for use with any radio receiver, especially in cases where large volume is required.

Outstanding features: Great volume and fine tone quality. Capable of handling the output of even the most powerful receivers. Neat in appearance. Good workmanship and very substantial construction.

Maker: Temple, Inc.

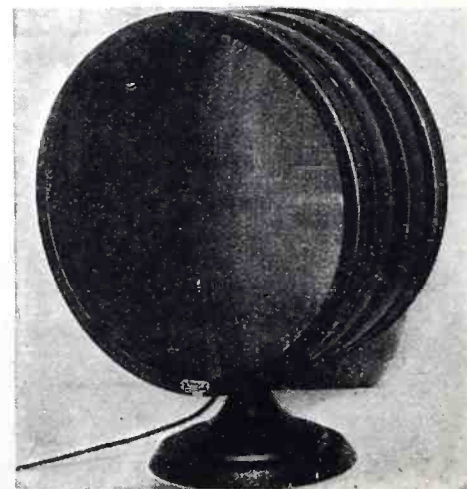



A Six-Valve AC Operated Receiver

Name of instrument: Simplex, model B, electric receiver.

Description: This 6-valve receiver comprises two stages of tuned-high-frequency amplification, a detector and three stages of low-frequency amplification. It includes a number of refinements which are of particular interest to the radio fan—such as, for instance, the elimination of all batteries, single-control tuning and the inclusion of the entire receiver and the power-pack in a single cabinet.

The McCullough type valves permit the use of low-voltage alternating current obtained from the house-lighting lines through a small step-down transformer which is included in the "B" and "C" power-pack. This eliminates the need for storage battery and its attendant charging device. It also simplifies the operation of the receiver.

The high-voltage direct current for the plate supply is obtained from the alternating-current lighting lines through a "B" and a "C" power-pack which is included in a compartment at one end of the receiver cabinet. This power-pack makes use of a Raytheon rectifier valve and provides the three "B" voltages and two "C" voltages required in the operation of the receiver.

The high-frequency amplifier consists of two tuned stages and a tuned detector input. The coupling transformers are small in size and are placed at an angle to one another to reduce undesirable interaction to a minimum. They are tuned by means of three variable condensers which operate together by a belt and pulley arrangement so that a single tuning control knob may be used. Superimposed on this knob is a smaller one which operates a compensating condenser to maintain an exact balance between the various circuits.

To permit just the proper degree of antenna coupling an arrangement consisting of four small tip jacks and a metal-tipped connection wire is provided. By plugging this tip into the different jacks varying degrees of coupling can be obtained and the best coupling for each installation is easily determined.

Sensitivity in the high-frequency amplifier is controlled by means of a variable resistance in the "B" voltage supply line to these two halves. This resistance is installed on the panel and is marked "volume" control. It serves also as an oscillation control and when adjusted so that the amplifier is just below the point of oscillation a high degree of sensitivity may be obtained for distance reception.

The low-frequency amplifier em-

plies three transformer-coupled stages. The transformer windings are of the low-ratio variety. This type is purposely used because of the better quality of reproduction obtainable with a low step-up ratio, and in order to make up for the somewhat smaller amount of amplification obtained with this method an extra stage is used. To provide a means for a certain amount of regulation of volume and tone in the low-frequency amplifier a variable resistance is included across the secondary of the second transformer. This resistance is also mounted on the front panel. It is a combination unit which includes not only the resistance but a switch which turns the receiver "on" and "off."

The cabinet is finished in dark mahogany. The metal front panel of the receiver proper is finished to match the cabinet and the front of the cabinet at either end of this panel is finished in a paneled effect with bronze drawer pulls for decorative effect. The tuning dial is calibrated directly in wavelength.

The receiver unit occupies only a part of the interior of the cabinet, and the power-pack is inclosed in a separate compartment at the left-hand end. An extension cord and plug, for connection to any AC light socket, is brought out through a hole in the rear of the cabinet. The antenna and ground connection wires are also brought out at the rear. Tip jacks for plugging in the metal tipped ends of the reproducer cord are included in the receiver unit and the cord is carried in to these jacks through a hole provided in the rear. These four connectors are the only external connections required. Under certain conditions an antenna is not required. Instead of the antenna connection, wire from the receiver may be connected directly to a special binding post provided on the power-pack. This permits the use of the electric light wires as an antenna.

The operation of the receiver is very simple. The power is switched "on" by means of the switch knob at the lower left-hand corner of the front panel. A brief period of time is allowed to elapse while the valve elements are warming up (about 30 seconds) and the receiver is then ready to tune in stations with the tuning knob in the center of the panel.

Usage: For the reception of radio broadcast programs.

Outstanding features: Requires no batteries. Receiver and power-pack included complete in the single cabinet. Single control tuning. Under certain conditions no antenna is required.

Maker: Simplex Radio Co.

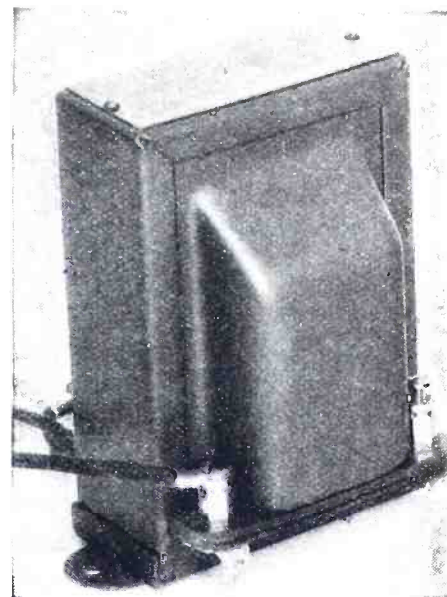

An Output Unit That Protects the Reproducer

Name of instrument: Output transformer, Superaudioformer type No. 27-B.

Description: In size and appearance this transformer is an exact duplicate of the Superaudioformer No. 27-A, and these two types are intended for use in the same amplifier. The primary winding of this output transformer is capable of carrying up to 40 milliamperes and it is therefore suitable for use in power amplifiers that employ UX-171 or UX-210 types of power valves in the last stage. The secondary impedance is correct to match the impedance of present-day reproducers.

Usage: As a coupling device to be connected between the plate circuit of the last low-frequency amplifier valve and the reproducer.

Outstanding features: Suitable for use with high voltages and high plate currents. Properly matched with reproducers in impedance. Good construction and design.

Maker: Pacent Electric Co., Inc.



Jacks for Use Where Space Is Limited

Name of instruments: Gem-Jacs.

Description: These jacks are extremely small in size. When mounted in a receiver they occupy panel space 1 inch high by 1 inch wide and extend back 1 inch from the panel. They are obtainable in single and double-circuit types, both open and closed. They are built up around a heavy "U" shaped metal frame, are well insulated and equipped with tinned extensions which serve as soldering lugs.

Usage: As an output terminal device where connections are to be made by means of a phone plug.

Outstanding features: Compact in size. Extremely rugged in construction. Easily mounted and easily wired.

Maker: Herbert H. Frost, Inc.
(Continued on page 390)



From a photograph made for POPULAR RADIO

HE RECORDS THE LIVES OF VACUUM VALVES

Here is the author of this article in a corner of the laboratory where he made the tests which are described below.

HOW RADIO FANS CAN LEARN TO READ

The Autobiographies of Valves

To many radio fans a vacuum valve is merely a complicated sort of electric bulb that "lights up" when used in a receiving set. But there are many electrical characteristics of valves that can neither be seen nor heard, but which are most important in determining how a valve will work. The methods of determining these qualities scientifically, and their effect on the operation and life of the valve, are described in this article by—

H. A. McILVAINE, E.E.

FEW developments of modern times have been more rapid and few successful productions have been fraught with more variables than those of the vacuum tube (more correctly known as the vacuum valve). Yet the electrical constants and characteristics of the valve have been understood little by the average experimenter.

We hear of "matched valves" and "high mu" valves for low-frequency amplification, and low-loss, hard and soft valves. One manufacturer says that one should buy "low impedance" (meaning plate to filament) valves, while another advertises, "I have the valves with the highest plate impedance."

As a matter of fact there are so many

electrical properties of vacuum valves which are not yet fully understood that it is difficult to obtain a numerical rating which will enable one to predict how a valve will act in any given position, in any given set and under any given set of conditions.

However, many vacuum valve characteristics are understood in a general way and this knowledge may be used to predict the action of a valve under certain conditions. By "certain conditions" are implied not only the set used, the position of the valve in the set, the wavelength that is being received, the antenna-ground system or loop and the weather conditions, but also the actual voltages applied.

For example, most of the electrical

characteristics of the valve have a meaning only when the plate, grid and filament voltages are specified.

One of the important factors in valve operation is cathode efficiency. The thoriated filament UX-199 type of valve, for example, is highly efficient at 3.0 volts and .06 amperes or .18 watts filament power-consumption, and several valves may be economically run from a dry "A" battery. Its electron emission efficiency is about 45 milliamperes per watt at its normal operating temperature of 2000° Kelvin during its normal life.

The old tungsten filament valves, like the UV-201 type, had only 1.6 milliamperes per watt electron emission—a much smaller operating efficiency.

The operating temperature of the thoriated filament valve is so low that the end of its life is not determined by a burned-out filament, as is the case with the high-temperature tungsten filament lamp, but rather by a loss of electron emission. This results from the evaporation of the film of thorium from the surface of the tungsten, which in turn is caused by a bombardment by gas particles or by an insufficient amount of the metallic thorium. Consequently, one of the simplest and most important tests on a thoriated filament valve that is suspected of being "dead" is to measure its electron emission.

If the electron emission is good, the gas pressure *cannot be very high*. The plate current, impedance, μ , and other factors which are limited by the geometry of the valve must be all right. In short, the valve must be good in all of its characteristics, if it was all right in the first place. The end of life is determined by the loss of the emitting surface.

It might be well to add that reliable vacuum valves stand up remarkably well and that they are blamed many times when the set or the batteries are at fault.

The valve may be checked very easily

with the set-up shown in Figure 1.

The grid and plate are first tied together so as to reduce the space charge. The grid-plate system will then collect most of the electrons in the UX-199 and 201-a types of valves when 50 volts is applied between the plate and grid system and the filament, the latter being at normal temperature. For the plate current is a function of grid and plate voltages such that

$$I_p = f(E_p + \mu E_g)$$

Putting the relatively high voltage of 50 volts on the grid is equivalent to putting $\mu \times 50$ on the plate. This emission value should be enough greater than the plate current which ordinarily flows under conditions of maximum plate, grid and filament voltage to insure that no distortion will occur on loud signals. If the total electron emission is less than this value, the valve may be considered useless, as the signals will be weak and their wave crests will be rounded off.

Let us assume that there is a sufficient emission of electrons and that the valve is limited only by space charge. This is the best condition for the type of valve that is ordinarily used for radio reception and transmission. The plate current flowing from the fila-

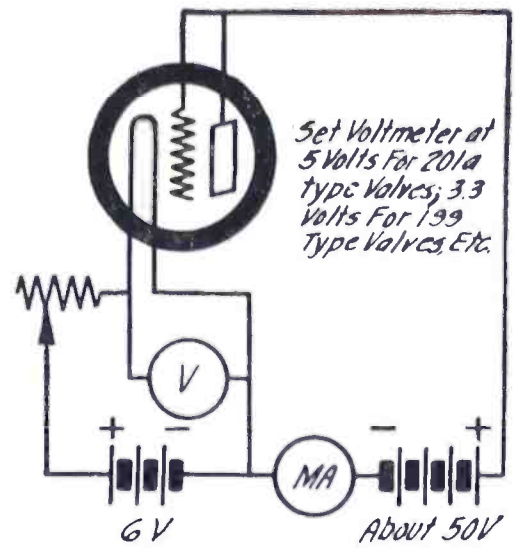

A TESTING HOOK-UP

FIGURE 1: This circuit is used in testing the emission characteristics of a vacuum valve. The emission is read in milliamperes on the meter MA.

ment to the plate quite naturally depends upon the filament-to-plate impedance, which is the resistance to the flow of plate current.

But in a valve the impedance itself changes with the conditions.

For example, if there were no electron emission the impedance would be great and would be equal to the impedance of an open circuit.

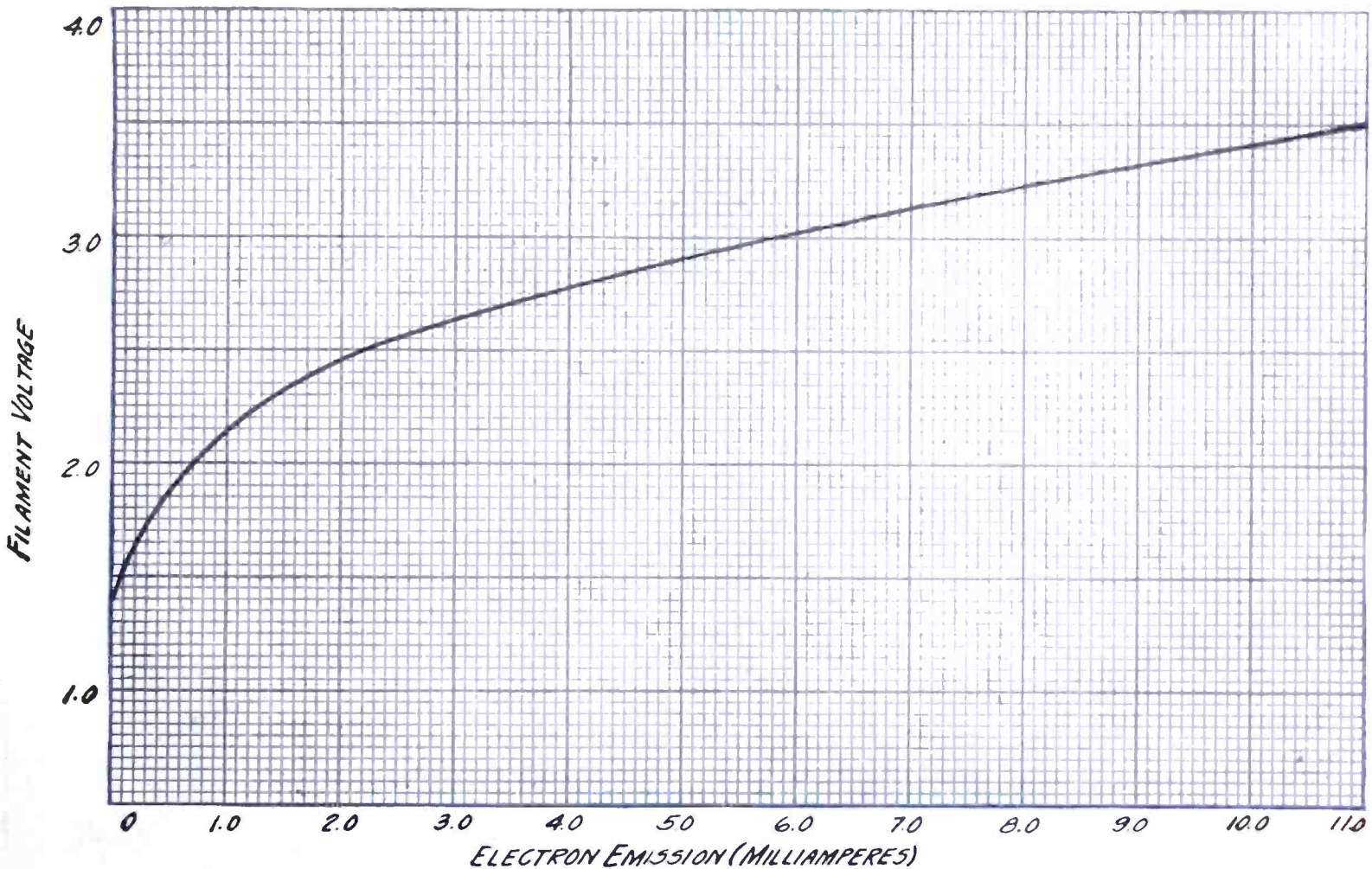

THE EMISSION CURVE ON A UX-199 TYPE VALVE

FIGURE 2: Here is shown the combined results of a series of tests on a number of UX-199 type valves, showing the electron emission with varying values of filament voltage. A test such as this can be made on the set-up illustrated diagrammatically in Figure 2.

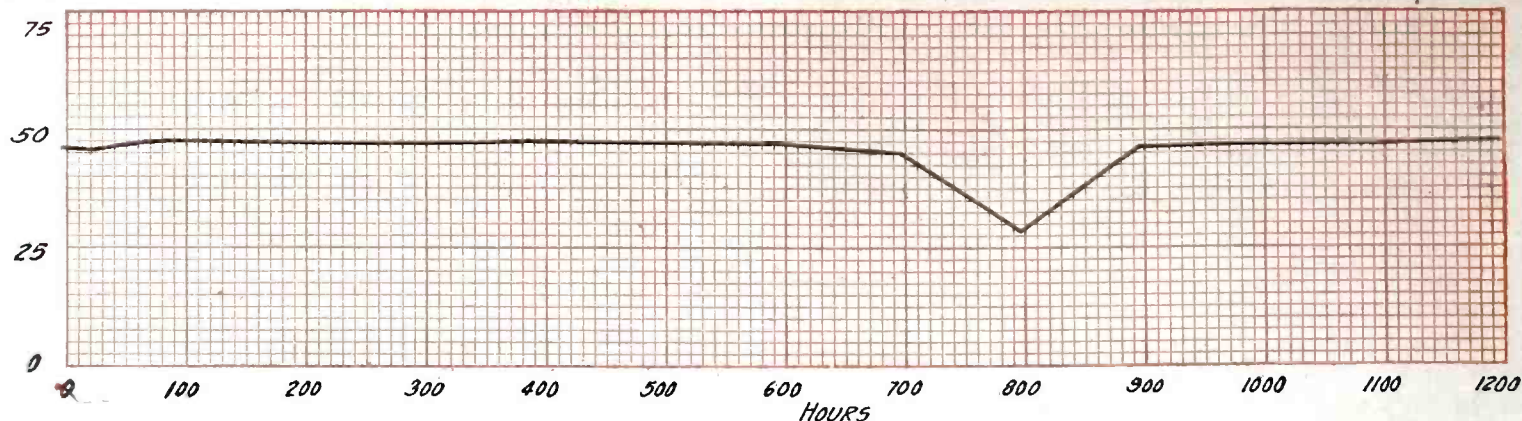

THE FILAMENT EMISSION LIFE CURVE OF A UX-201-a TYPE VALVE
 FIGURE 3: The plate current is recorded in milliamperes, with the grid and plate tied together for a period of fifty days.

But this factor is eliminated by keeping the electron emission higher than is necessary. The valve is then said to be limited only by space charge and the impedance is changed only by the charge in the space between the plate and the filament.

The geometry of the valve will affect the plate impedance and therefore the plate current.

For a given valve, the plate and grid voltages (assuming the filament voltage to be normal), will affect the impedance and plate current. That is, the impedance will decrease as the plate and grid system voltages rise. Thus, if valves are to be matched for plate impedance with their operating circuit, the voltage under which the impedance is taken must be specified. The voltage of the plate and grid system is

$$E_{pg} = E_p + \mu E_g$$

The amplification factor, μ , depends upon the geometry of the tube and is affected much less by the voltage of the plate and grid system.

The mutual conductance is usually taken as the ratio μ over R_i ; that is, the ratio of the voltage amplification constant over the output impedance. These are usually measured on the Miller bridge at light loads and low frequencies. Consequently, this is a measure of the light load amplification power of the valve and may or may

not represent what the valve will do under a heavy load.

There is another factor which better represents the stage voltage amplification of an amplifier stage. This factor is known as

$$A_v = \frac{\mu}{\left(\frac{R_i}{R_x} + 1\right)}$$

- Where A_v = voltage amplification
- μ = the voltage amplification factor of the valve
- R_i = the internal filament to plate resistance in ohms
- R_x = the external circuit impedance in ohms

An interesting conclusion which we may draw from this formula is the fact that if we make R_x a tuned impedance which is high, we may make R_i and therefore μ high. A_v therefore approaches the μ of the valve. In other words, we desire to have μ high. But to make μ high R_i also rises and offsets the high μ . But if we make R_x high also, then we may make R_i high without losing amplification.

We usually read A_v directly on the cathode ray oscillograph, which is an electron gun. The electrons come from a cathode, pass through the gun barrel which consists of a small metal tube, positively charged with respect to the cathode, and the stream is then converged to a small round pencil by passing through a negatively charged ring.

After passing between two sets of electrostatic plates, so placed that one pair switches the electron beam one way and another pair at ninety degrees with respect to the first pair, the beam lights up a small spot on a fluorescent screen. It will be seen readily that the spot will travel rapidly about the screen, causing a figure to be seen by the eye.

One of the big advantages of the cathode ray oscillograph is that its moving element has practically no inertia at ordinary or high frequencies. Thus, in order to measure the high-frequency amplification of a stage, we first put the input voltage and then the output voltage on a pair of plates and the difference in length of the two lines is the amplification A_v .

Another example of the many interesting uses of the cathode ray oscillograph was that used by Mr. E. W. Ritter to measure the grid and plate current distortion on the UX-240 valves, using valves having different contact potentials on the grid (different grid currents). A glow regulator valve and condenser were used to spread the wave periodically, while the other set of plates was connected to the output circuit of the valve, 60-cycle voltage being amplified. The ends of the wave were chopped off for grid current and plate current distortion.

(Continued on page 376)

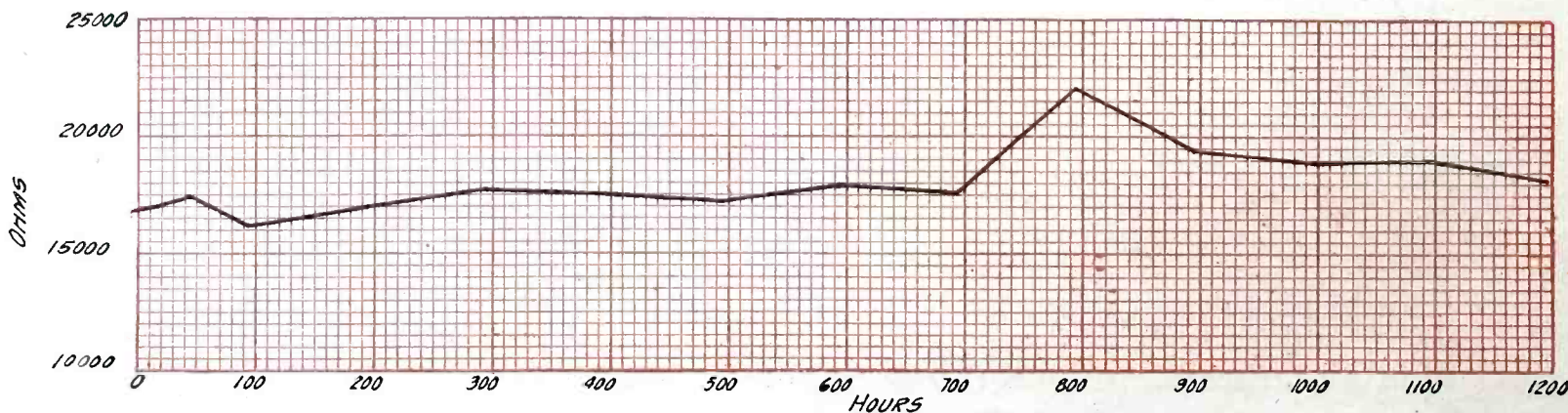

THE PLATE IMPEDANCE LIFE CURVE OF A UX-201-a TYPE OF VALVE
 FIGURE 4: This chart gives an indication of the variation of the plate impedance of a standard valve during 1,200 hours of its life.

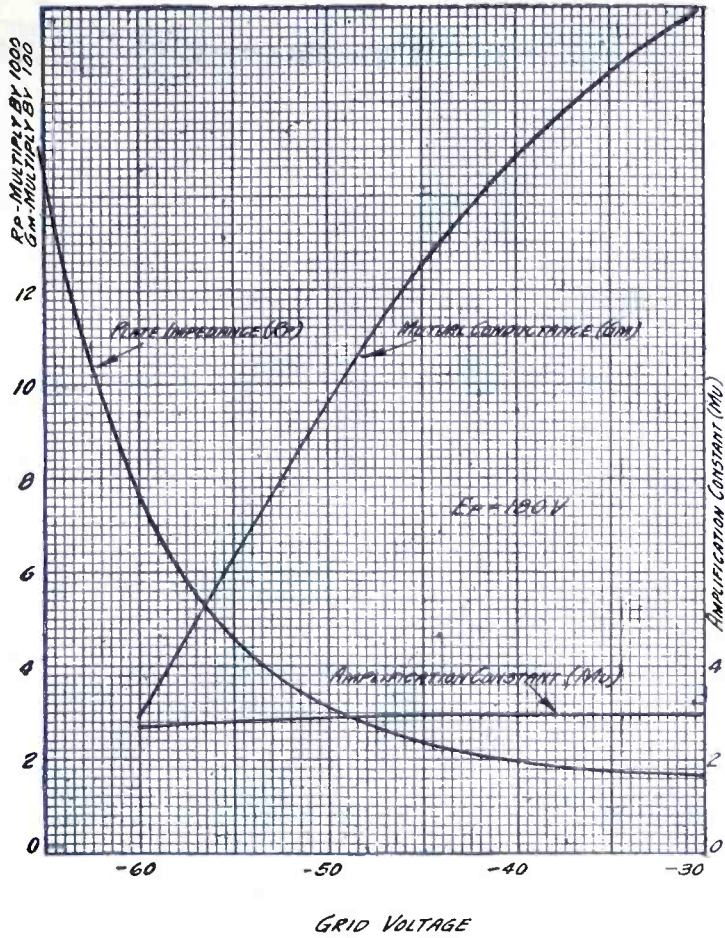

FIGURE 5: The curves above give the average characteristics for UX-171 type valves, including the plate impedance, the mutual conductance and the mu.

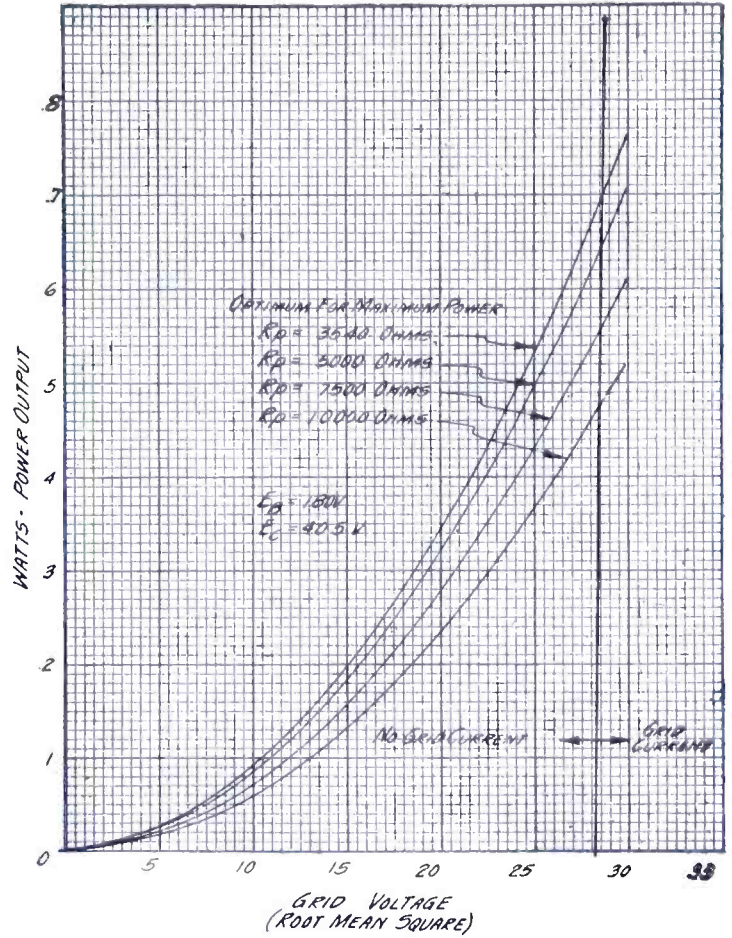

FIGURE 6: These curves give the average alternating-current characteristics for undistorted output of the UX-171 type valves.

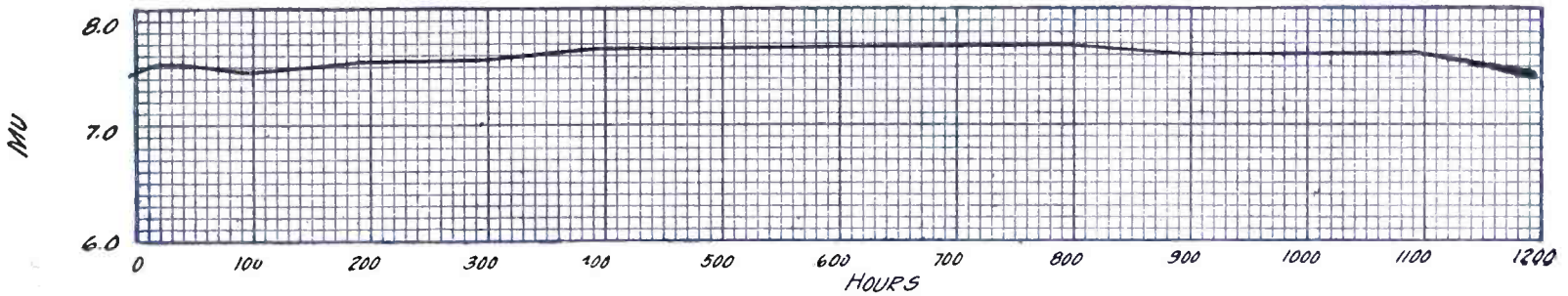

FIGURE 7: This curve, taken over a period of 1,200 hours, shows the uniform mu maintained throughout the range by a standard UX-201-a type valve.

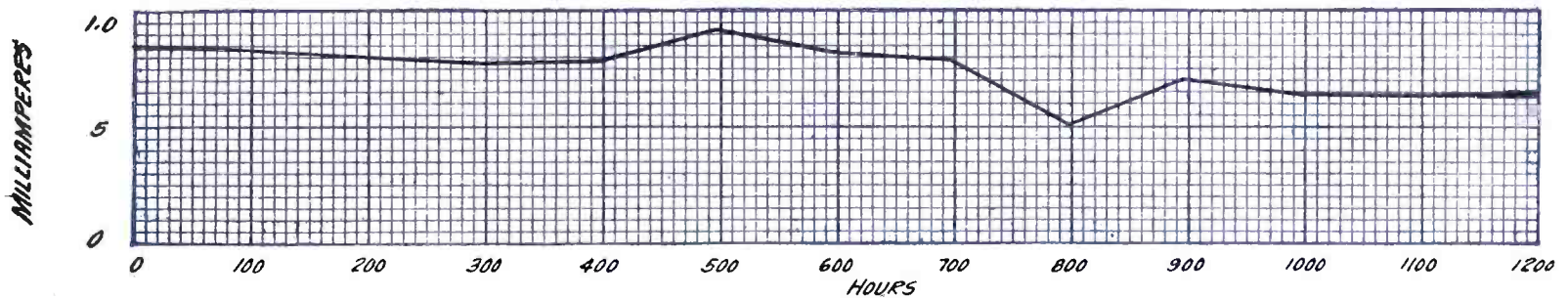

FIGURE 8: The plate current in milliamperes of a standard UX-201-a type valve is plotted against hours of life, showing the behavior of the valve from this point of view during a fifty day period.

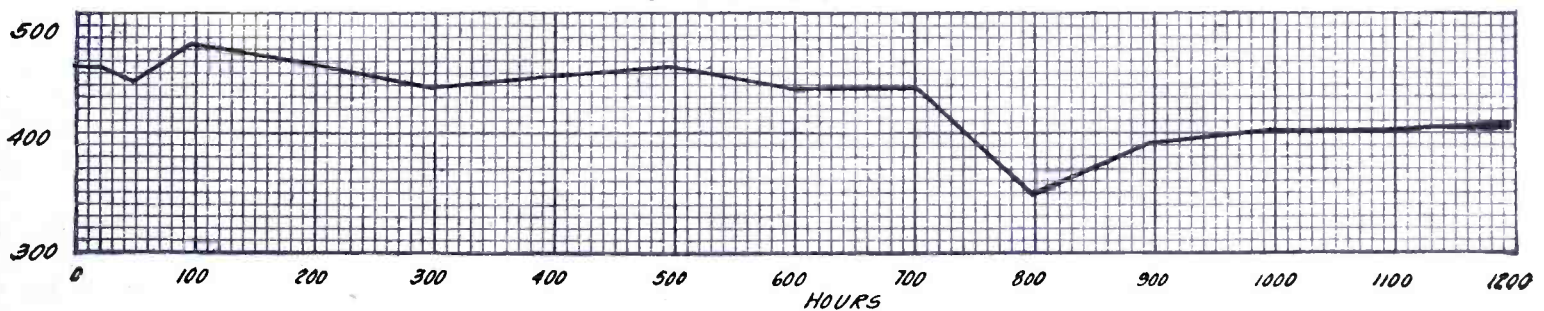

FIGURE 9: This curve was made on a standard UX-201-a type valve, and shows the variations of mutual conductance, in micromhos, during a period of fifty days.

HOW TO BUILD AND OPERATE THE Universal Tester

Here is a radio "Sherlock Holmes" that will ferret out your radio difficulties with ease and precision. It will not only test the emission of vacuum valves, but it also enables the user to discover the functional disorders of receivers and power-packs. And it is quite easy to construct and will not cause any great strain on the builder's pocketbook.

By MORRIS M. SILVER

COST OF PARTS: Not over \$34.00

HERE IS A LIST OF PARTS NECESSARY FOR BUILDING THIS TESTER—

- | | |
|---|---|
| M1—Sterling panel type milliammeter, 0-50 DC, type R-1626; | S2—Yaxley two-way, two-circuit switch, No. 60; |
| M2—Sterling panel type voltmeter, 0-300 DC, type R-415 equipped with 50,000 ohm resistor; | S3—Yaxley double-circuit switch, No. 40; |
| M3—Sterling panel type voltmeter, 0-120 DC, type R-642; | R—E-Z Stat rheostat, 20 ohms; |
| M4—Sterling panel type voltmeter, 0-8 DC, type R-641; | L—Power Clarostat, universal range, carrying capacity 40 watts; |
| S1, S4 and S5—Cutler-Hammer filament switches, type 8008; | T—Airgap socket, UX type; |
| | P—Composition panel, 8-7/8 inch by 3/16 inch by 11 inches; |
| | B1, B2, B3, B4, B5, B6, B7 and B8—X-L binding posts. |

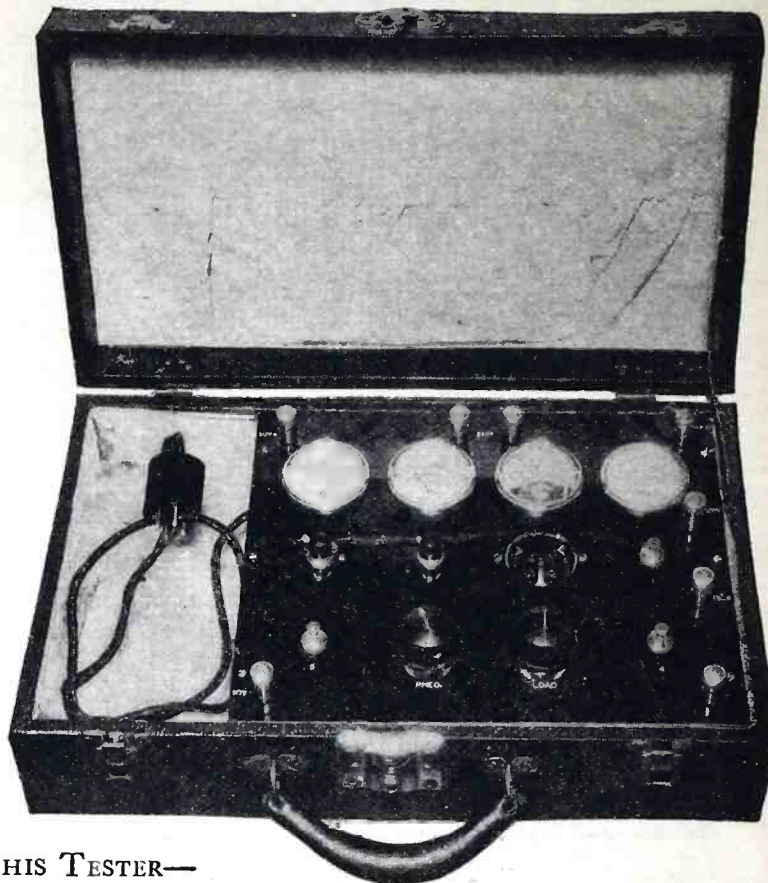

IT is the experience some time or other of nearly every set builder, radio owner, or repair man, to have a set become stubbornly inoperative for causes that are seemingly difficult to trace. And successive cut and try methods of detecting the trouble frequently lead to nothing but exasperation on the part of the trouble hunter.

In dealing with such conditions, the author has used a simple device of his own design that makes it possible to investigate intelligently many of the operating characteristics of receivers, vacuum valves or power-packs. The construction and operation of this universal tester and trouble shooter are so simple that any radio fan who has frequent occasion to test defective radio apparatus would do well to build one for himself.

In order to make clearer the possibilities of this instrument, seven uses to which the tester may be put are enumerated below:

1. Tests vacuum valve rating by reading filament emission.
2. Shows the condition of a radio circuit at any given valve by determining (a) filament voltage, (b) plate current.
3. Gives power-pack voltages and currents at any load or at the normal load of the receiver being tested.
4. Determines voltage of batteries.
5. Tests for open circuits.
6. Tests the condition of condensers.
7. Permits any meter to be used separately.

(Continued on page 362)

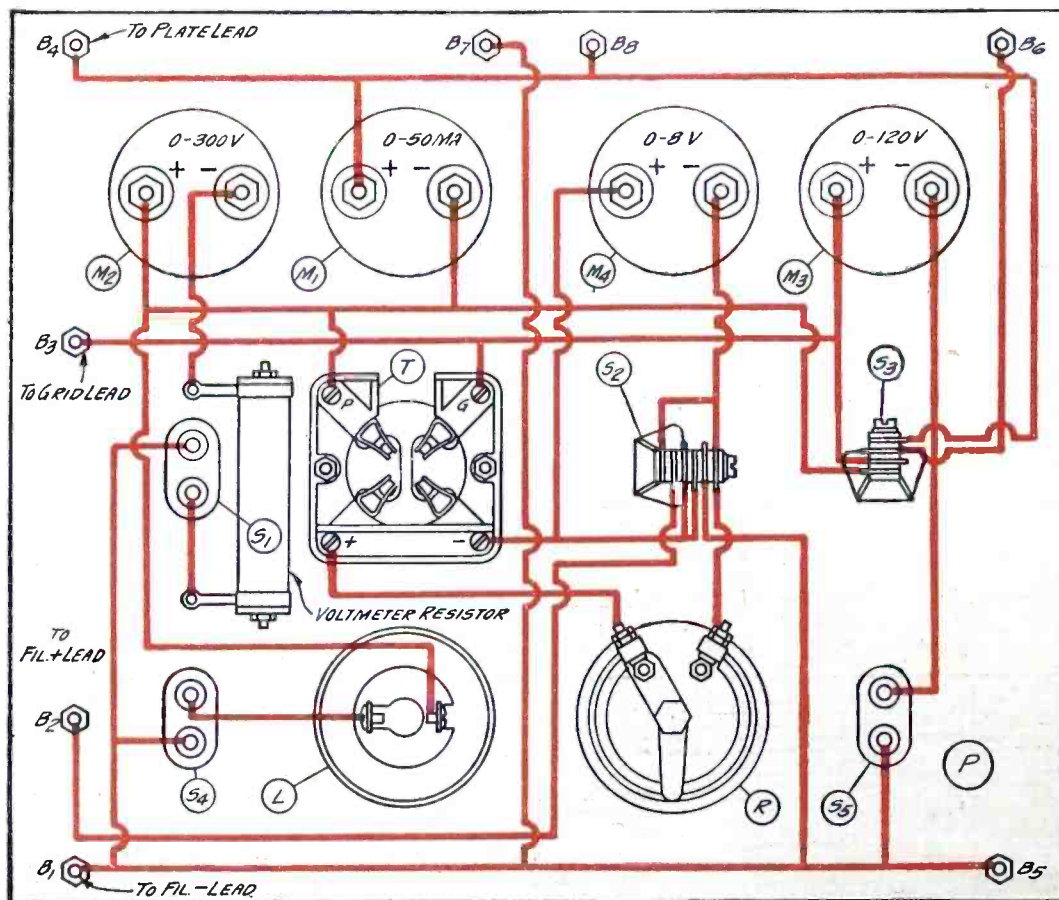

HOW TO WIRE THE TESTER

FIGURE 1: The instruments are outlined in BLACK lines, and the wiring is indicated in RED lines. All the wiring is done under the panel of the tester.

The New Belin Televisor

EDOUARD BELIN has been one of the most persistent experimenters in search of the ultimate solution of television, and his latest contribution involves many interesting new features. To provide for the more rapid transmission of photographs, Belin has applied several new principles to the problem. By projecting a beam of light from a powerful arc lamp and reflecting it through a small pair of oscillating mirrors, one of which sends the beam forth with a horizontal motion, and the other with a vertical motion, this ingenious experimenter has been able to speed up the process and greatly reduce the time element involved. Upon leaving the image to be transmitted, the agile beams strike a sensitive photo-electric cell mounted within the large cylinder shown in the photograph. Thus the light and dark spots on the image, whether moving or inanimate, cause changes in the electrical resistance of the cell, and this, in turn, is used to modulate the carrier wave of the special short-wave transmitter.

In this development Belin has found that the short waves make more effective transmitters of television impulses than do the longer ones, and the transmitter shown at the right has an adjustable wavelength ranging from 30 to 250 meters. Since Rangers' work most of the experimenters in television have favored the use of the shorter wavelengths, and even ultra-high frequencies have been used with success.

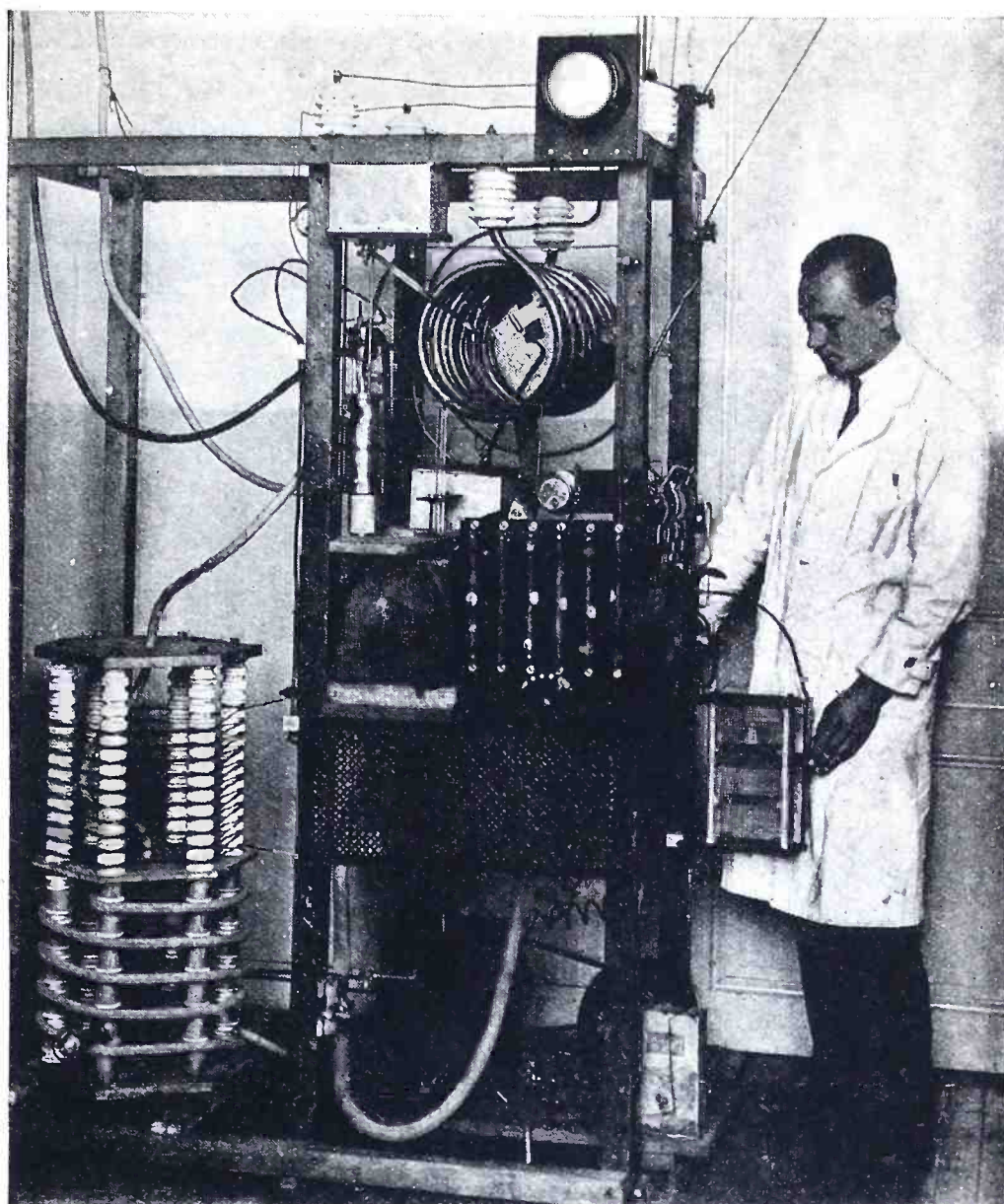

Delano

A SHORT-WAVE TRANSMITTER FOR TELEVISION

This 30-250 meter short-wave transmitter makes use of Holweck demountable valves (seen to the left of the aerial inductance); hence the water-cooling system shown in the picture here is necessary.

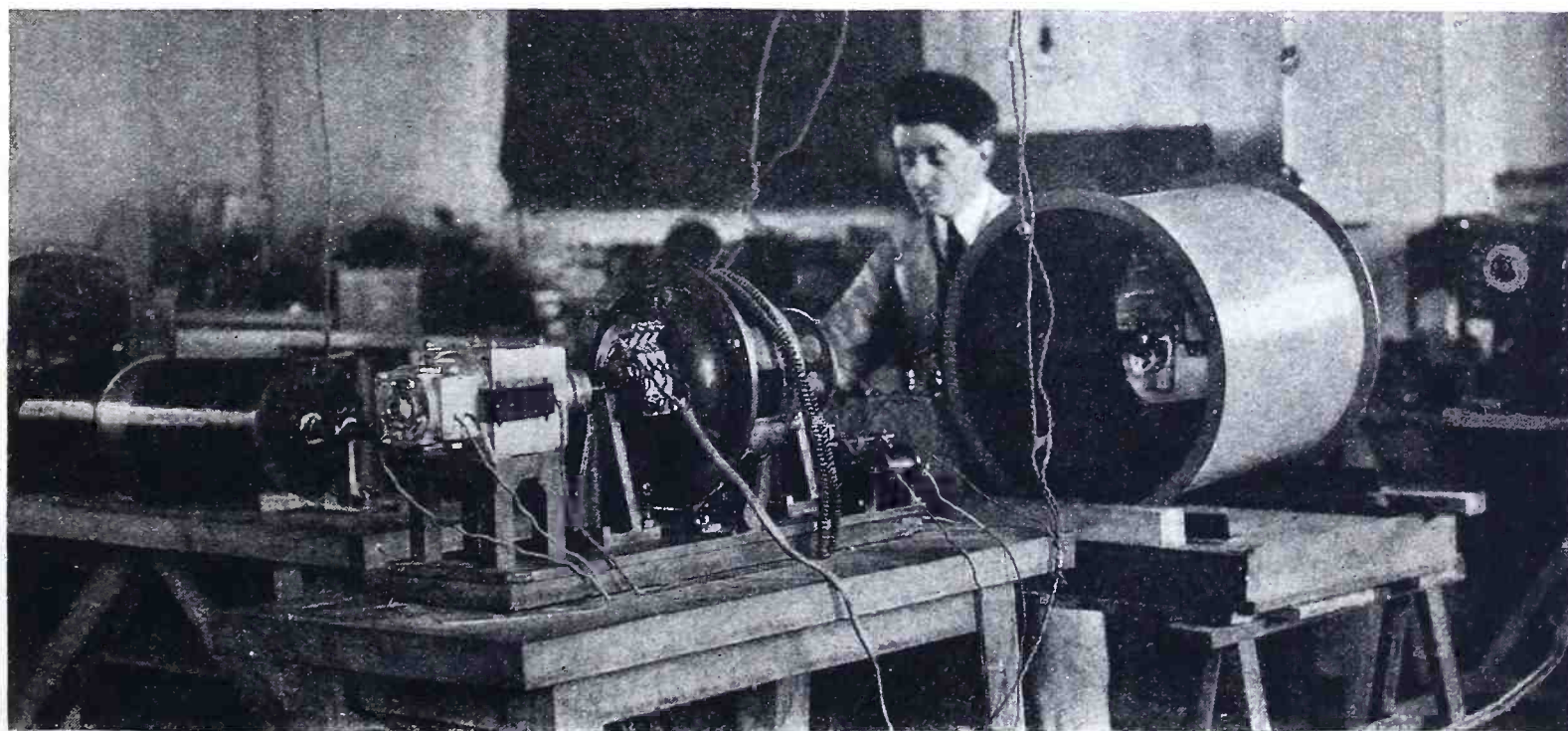

Delano

THE ELECTRICAL EYE OF THE BELIN TELEVISOR

By the use of rapidly moving beams of light and a photo-electric cell, Belin modulates the wave of his transmitter with reflected light from the images to be transmitted. The oscillating mirrors may be seen back of the dynamo and below the large cogwheel.

Ace High Quality at Deuce Low Cost With— The Lynch "Five" Receiver

By S. GORDON TAYLOR

COST OF PARTS—Not over \$37.00

Tone quality that will please the most discriminating ear—constructive simplicity within the abilities of the novice at set building—cost within the reach of the thinnest pocketbook—with these merits the Lynch "Five" should fill a need in the radio construction field that has long been desired and seldom before attained.

HERE IS A LIST OF PARTS FOR BUILDING THIS RECEIVER—

- | | |
|--|--|
| A—Precision antenna tuner, type 3-C; | P—Aerovox moulded mica condenser .0005 mfd.; |
| B—Precision junior tuning unit, type 3-B; | Q, R and S—Lynch special cartridge coupling condensers;* |
| C and D—WRC variable condensers, .0005 mfd.; | T1, T2, T3, T4, T5, T6, T7, T8, T9 and T10—Eby binding posts; |
| E—Carter midget rheostat, 3 ohms; | U—WRC Universal panel, 7 by 18 inches, equipped with Glodials; |
| F—Lynch suppressor, with mounting, type 500; | V1 and V2—Benjamin adjustable radio shelf brackets; |
| G1, G2, G3, G4 and G5—Eby DeLuxe sockets;* | W—Westinghouse Micarta sub-panel, 6 by 12 inches;* |
| H—Lynch metallized resistor, 2.5 megohms;* | Wire, screws, solder, etc. |
| I—Lynch special cartridge grid condenser;* | |
| J, K and L—Lynch metallized resistors, .1 megohm;* | |
| M, N and O—Lynch metallized resistors, .5 megohm;* | |

*NOTE: These instruments may be obtained completely mounted on the Lynch Five-valve DeLuxe deck.

IT was in an effort to strike a happy medium between performance and cost of construction that this new receiver was developed. Naturally enough, every one wants to own the best that radio has to afford, but, unfortunately, expense is very often an important consideration.

While the components of this particular receiver are inexpensive, the results obtained in selectivity, sensitivity, and volume are comparable with many of the more luxurious instruments. The tone is excellent, and it is made possible by the use of an inex-

pensive but scientifically accurate resistance-coupled amplifier. The construction of the set is also greatly simplified by the use of this resistance-coupled amplifier, which is available with all connections properly made. All in all, it is a set that can be conscientiously recommended to the experimenter who wants a better radio, but who does not have the wherewithal to purchase one of the more highly priced receivers.

The circuit is a simple one employing one stage of high-frequency amplification which, while it is unusually stable,

A Receiver That Will Fit in Any Corner

The Lynch "Five" Receiver, together with batteries and reproducer, occupies less space than many a five-valve receiving unit alone. This compactness is the result of a careful layout of instruments, and the use of a high-quality, resistance-coupled, low-frequency amplifier in place of the more bulky transformers.

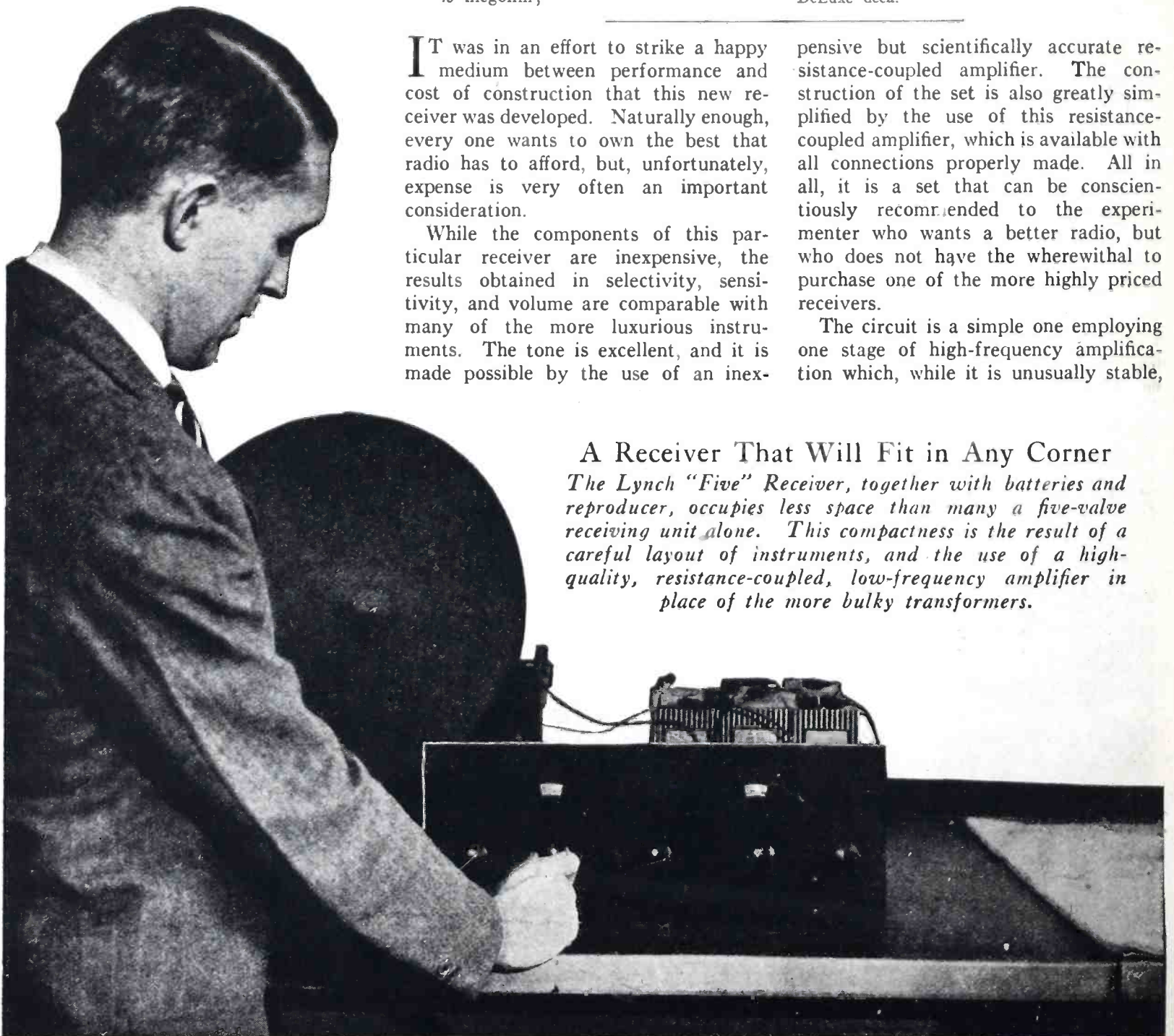

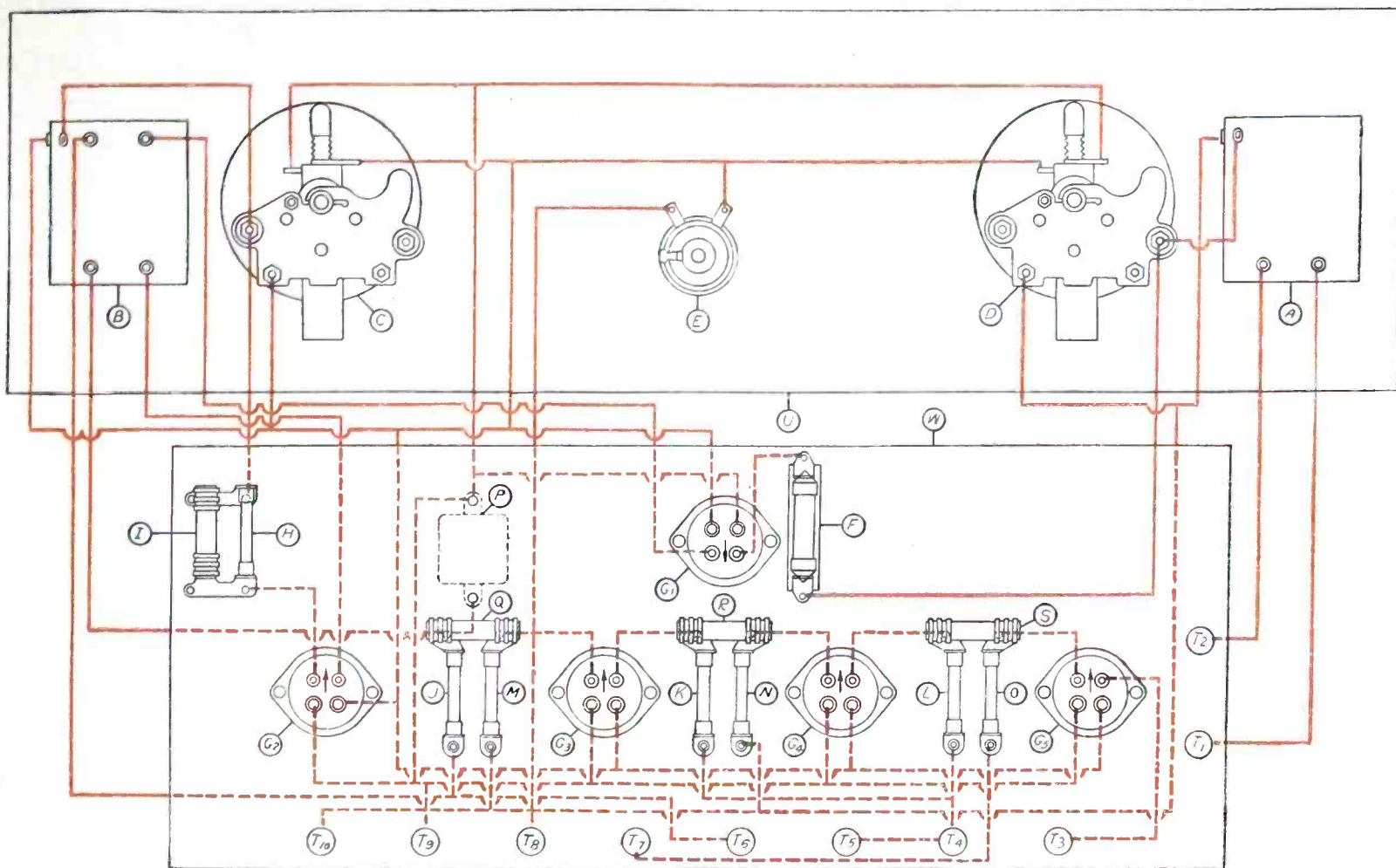

THE PICTURE WIRING DIAGRAM OF THE RECEIVER

FIGURE 1: The simplicity of the wiring of the receiver may be gathered from this diagram. The instruments are outlined in black; the wiring on the front panel and above the sub-panel is indicated in solid red lines, and that below the sub-panel in dotted red.

will give added sensitivity to the detector circuit. Two tuning controls with illuminated dials connected to two inexpensive variable condensers are used, together with a control for regulating the volume.

The receiver is to be used with an ordinary single-wire antenna, such as can be easily installed on any apartment or private residence. It may be built by even the most inexperienced in an evening, and set up and placed in operation in time to receive the programs from the broadcasting stations before they turn off for the night.

The only tools necessary for building this set are a drill, a pair of pliers, a screw-driver, a knife and a soldering iron.

The resistance-coupled amplifier has three stages of amplification, which provide excellent tone quality and which will operate the loudspeaker satisfactorily with ample volume for the ordinary home.

How to Construct the Receiver

The first job will be to mount the brackets, V1 and V2, as shown in Figure 2. Drill two mounting holes for the brackets at each end of the panel, U. The holes are on center-lines $2\frac{3}{4}$ inches in from the sides of the panel. The lower hole is $15/32$ inch above

the bottom of the panel and the upper hole is $1\frac{1}{4}$ inches above the lower. Mount the brackets on the panel with the long flange down and turned outward.

Next mount the condensers, C and D, on the vernier dials and secure with the set screw which is provided. Figure 2 shows the correct positions for these units.

With the single-hole mounting fas-

ten the antenna coupler, A, to the panel at the right end (looking from the rear of the set), with the main body of the coupler turned up above the rotor.

In the same manner fix the high-frequency transformer, B, in position at the left end of the panel. Then mount the rheostat, E, with the terminals up, in the center of the panel.

The remaining instruments are ready

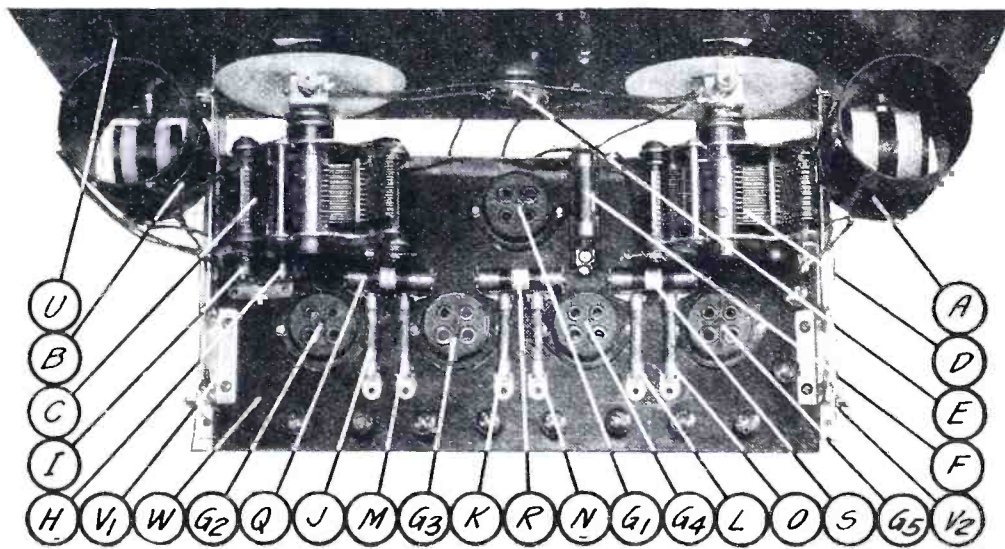

A VIEW OF THE RECEIVER FROM ABOVE

FIGURE 2: The valve sockets, together with the resistors and fixed condensers and their mountings, may be obtained already mounted in the Lynch five-valve Deluxe deck assembly; this makes the construction of the receiver a simple matter, even for the novice.

The list of parts given on page 348 includes the exact instruments used in the set from which these specifications were made up. The experienced amateur, however, will be able to pick out other reliable makes of instruments which have been approved by POPULAR RADIO and which may be used with good results. But we recommend that the novice follow the list, as the diagrams in this article will tell him exactly where to bore the holes and exactly where to place the connections. If instruments other than the ones listed are used, the only change that will be necessary will be the use of different spacings for the holes that are drilled in the sub-base for mounting the instruments. To any reader who has difficulty in obtaining any of the parts which are necessary in making up these model receivers and power units, POPULAR RADIO SERVICE BUREAU, 119 West 57th Street, New York City, will gladly assist in seeing that his requirements are promptly supplied.

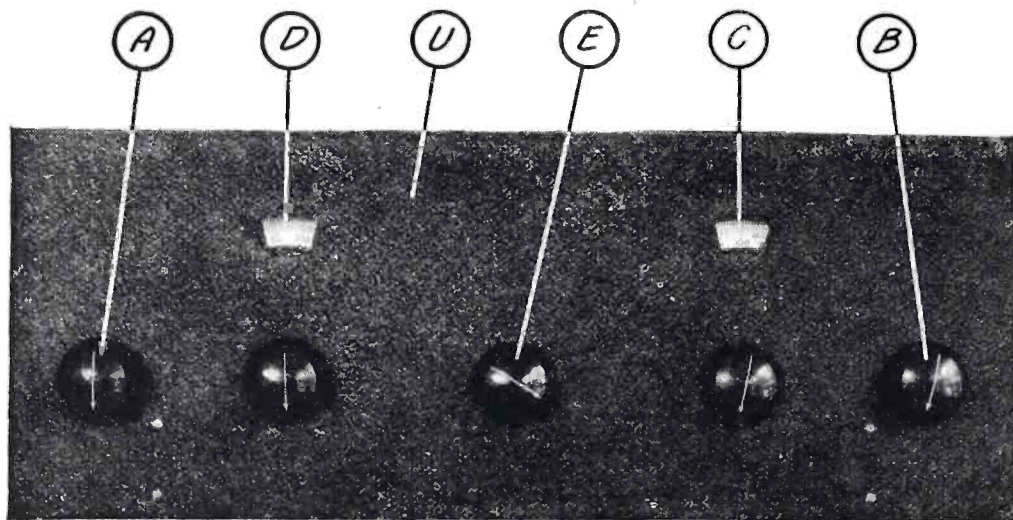

THE FRONT PANEL OF THE RECEIVER

FIGURE 3: The coupler, A, requires only one setting for all ordinary conditions of reception. Tuning is accomplished by means of the two knobs under the dial windows, C and D. At E is the filament switch, and at B is the control for regulating volume.

mounted on the bakelite deck assembly, with the exception of the fixed condenser, P, and the grid suppressor, F. Mount the latter on the center line of socket G4, as shown in Figure 2. Condenser P will be held in position by the wiring to its terminals.

Mount the bakelite deck assembly underneath the bracket shelves, with the front edge 1 inch from the panel. It will be found necessary to place the antenna binding post over slightly to clear the bracket shelf.

With the antenna coupler and high-frequency transformer which are specified in the list of parts it will be found necessary to cut off the shafts slightly to make the tuning knobs set near the panel.

Wire the receiver according to the picture wiring diagram in Figure 1. A flexible wire with a braided insulation, which can be pushed back for making connections, such as Corwico, will be found to facilitate wiring. Much of the wiring is done under the panel.

How to Operate the Receiver

Now connect the batteries, the antenna, the ground and the loudspeaker according to the connection diagram in Figure 4. Insert a Ceco type K high-frequency amplifier valve in socket G1, a Ceco type H special detector valve in socket G2, two Ceco type G high-mu valves in sockets G3 and G4, and a Ceco type F power valve in socket G6. The receiver is now ready for use. First turn the rheostat, E, clockwise to light the valves. The rotor of the coupler, A, should be set for maximum coupling (with its axis coincident with the axis of the stationary coil). Some local station should now be tuned in by adjusting the two variable condensers, C and D, simultaneously. Finally the signal may be strengthened and cleared up by adjusting the volume control (the rotor of transformer B).

It will be found that the stage of high-frequency amplification will give good selectivity and sensitivity and the resistance-coupled amplifier will give a surprising quality of reproduction when used with a good loudspeaker.

The owner of such a set need never be ashamed of it, as it will have a realistic tone quality such as is found in receivers of many times its cost, and when housed in an attractive cabinet will take its place with the best home furniture in decorative effect.

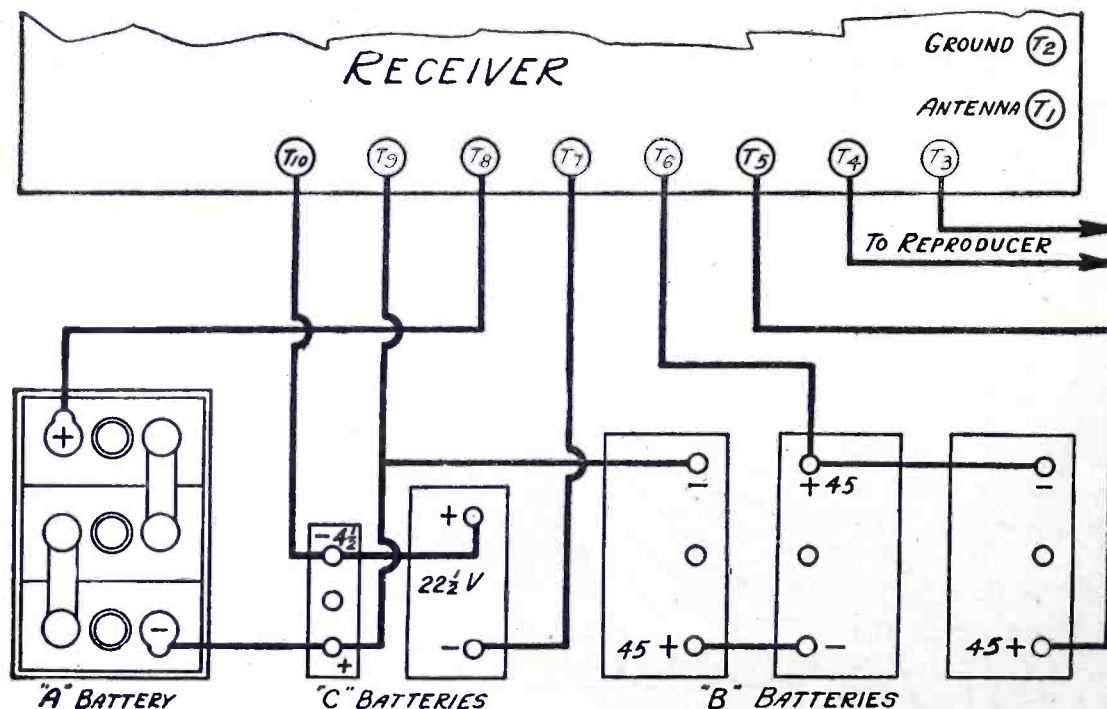

HOW TO HOOK UP THE RECEIVER

FIGURE 4: This diagram indicates the proper connections to be made between the row of binding posts on the receiver sub-panel and the batteries, reproducer, ground and antenna.



P-200
AMPLIFYING
TRANSFORMER
\$ 6.95

6:1 Ratio \$4.50
3 1/2:1 Ratio \$4.00
2:1 Ratio \$5.00
Super Amplifying Transformer

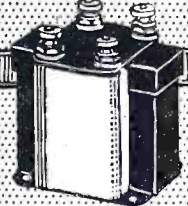

6:1 Ratio \$4.50
3:1 Ratio \$4.00
2:1 Ratio \$5.00
Sub-Panel Mounting Type

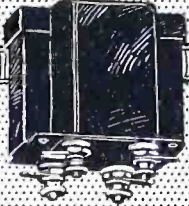



Autoformer
\$ 5.00



T-2445
Transformer for
RCA Tubes \$10.00

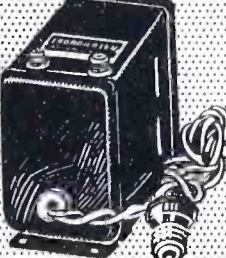

T-2098
Full Wave Rectifier
Transformer \$ 20.00



R-175
Battery Charger
\$ 12.50



T-2229 Raytheon
Heavy Duty
Rectifier Supply \$ 30.00



T-2291
Q.R.S. Heavy Duty
Rectifier Supply \$ 24.00

POWER PUSH-PULL
TRANSFORMER
AND
CHOKE

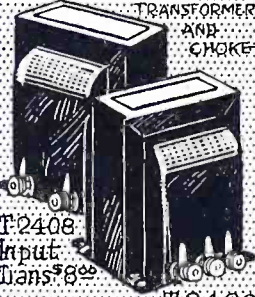

T-2408
Input
Trans \$ 8.00

T-2420
Output Choke
\$ 8.00



T-2099
Double Choke Unit
\$ 14.00

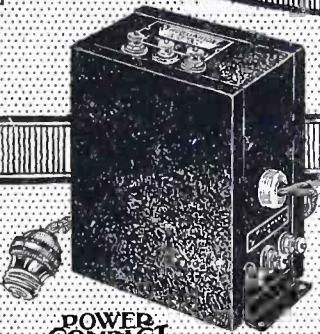

POWER
COMPACT
R-171 \$ 15.00

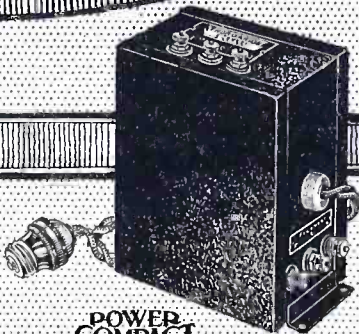

POWER
COMPACT
R-210 \$ 20.00

R-196
CHOKE COIL
\$ 5.00



R-76
Speaker Coupling
Transformer \$ 6.00

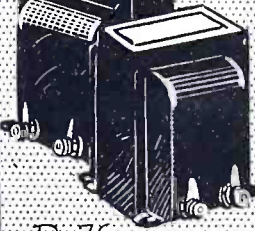

THORDARSON RADIO TRANSFORMERS

Supreme
in
Musical
Performance

FOR SALE AT
GOOD DEALERS
Everywhere

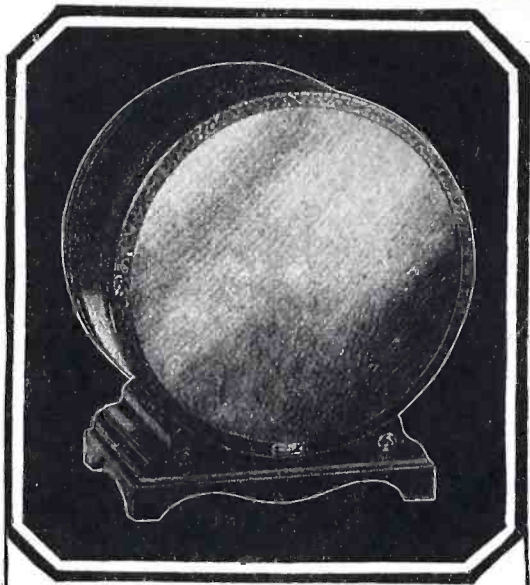

You Will Marvel at the
Tone Reproduction of the

TEMPLE AIR-COLUMN SPEAKER

People are positively astonished when they hear the TEMPLE AIR COLUMN SPEAKER for the first time. The marvelous clarity and purity of tone is amazing.

The TEMPLE AIR COLUMN SPEAKER brings new joy in radio. Thruout the entire musical scale this super-speaker is sensitive beyond comparison—unequaled for tone quality. Dance music—organ recitals—opera—hear them now in a way you never dreamed was possible!

Not a Cone

This new type speaker is selling like wildfire all over the country. New enthusiasts by the thousands are buying TEMPLE. Eddie and Fannie Cavanaugh, the Gaelic Twins of KYW, Chicago, say: "We have tried many speakers but none have the wonderful tone quality and volume of the TEMPLE."

Hear a TEMPLE AIR COLUMN SPEAKER demonstrated on the TEMPLE COMPARATOR at your nearest dealer. Make this test: Close your eyes as you hear different speakers. You'll pick the TEMPLE every time because of its unflinching purity and richness of tone reproduction.

CONSOLE CABINET MODEL No. 65—
priced at \$65.00; west of Rockies, \$75.00

DRUM TYPE MODEL No. 13—13 inch
—priced at \$29.00; west of Rockies, \$32.00

DRUM TYPE MODEL No. 18—18 inch
—priced at \$48.50; west of Rockies, \$55.00

If your dealer cannot supply you write for complete information and name of our nearest Temple dealer

TEMPLE, Inc.

213 S. Peoria St., Chicago, Ill.
LEADERS IN SPEAKER DESIGN

AC Rejuvenation for the Radiola 20

(Continued from page 318)

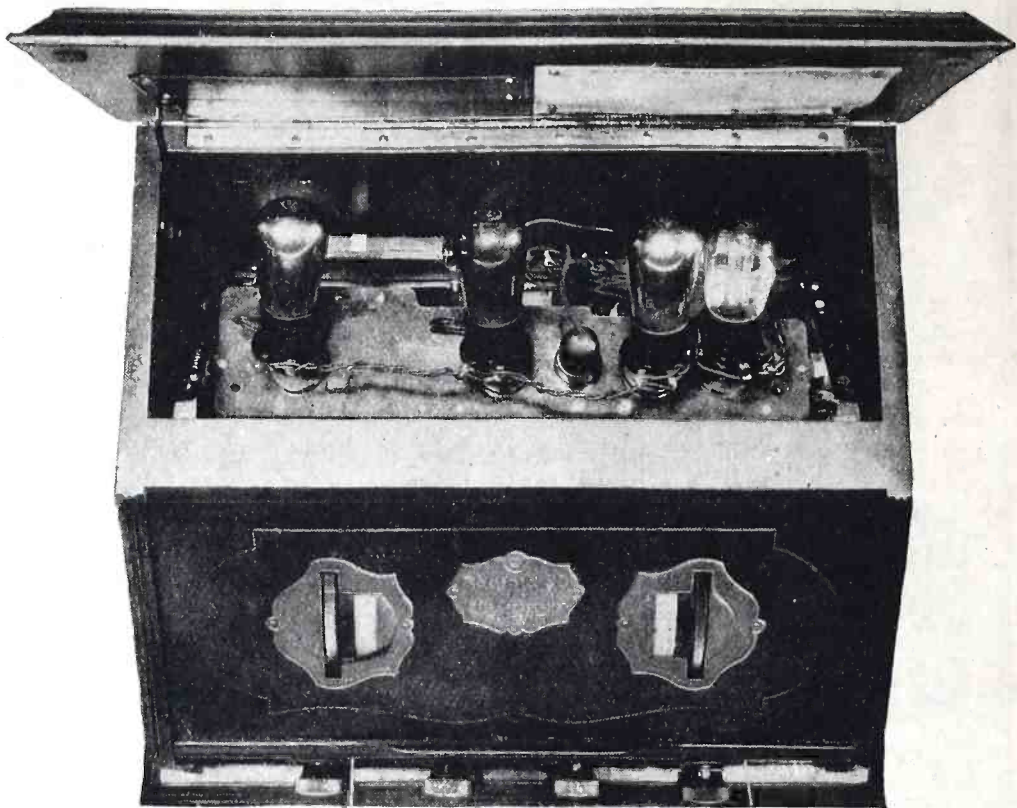

THE AC VALVES IN PLACE

FIGURE 3: This top view of the receiver shows the four new valves in the adapter sockets with the plug from the Powerizer inserted in its socket. The general appearance of the receiver and the operation remain practically the same.

may be placed in operation by throwing the switch of the power-pack. The AC valves will require about thirty seconds to heat up before they begin to operate, after which time the reception from the receiver should go on as smoothly as before the changes were made, but with added volume and improved tone quality.

The owner of a Radiola 20 desiring to make the changes outlined in this article should take care to see that his lighting current supplies AC current at a frequency of 60 cycles, since the Powerizer will not function on DC or on AC below the standard frequency.

The special sockets supplied as a part of the Powerizer equipment are provided with two exceptionally long prongs. These are the plate and grid prongs. The adapters are inserted in the sockets of the receiver in the usual way.

It will be noticed that there are no filament prongs in the adapters, since the filament current is supplied through a low voltage transformer contained within the Powerizer case. One transformer tap supplies 1½ volts for

the UX-226 valve, and the other tap supplies 2½ volts for the UY-227 valve.

The filament leads from the transformer taps are carried directly to the filament terminals of the adapters. A rather large flexible connecting wire should be used. As a matter of fact, ordinary flexible lamp cord is well suited for this use.

The UY-227 valve is of the heater type and is used as a detector. Figure 2 shows the heater cathode in blue. It should also be noted that the old volume control is changed so that it will conform to the new circuit.

The operation of the receiver will remain substantially the same as it was before the installation of the Powerizer. Naturally, the tuning will not be affected. If UX-199 type valves were employed in the Radiola 20 previous to the attachment of the Powerizer, a considerable increase in volume and sensitivity will be noted.

The radio experimenter, the professional set-builder, and the radio dealers themselves will find in this change a chance to improve this type of set in many ways.

TUNED LOW-FREQUENCY AMPLIFICATION FEATURES

The Counterfonic Six

Kenneth Harkness' latest circuit employs a low-frequency amplifier in which each stage is tuned to cover a specific band of audible frequencies, with a resulting output of undistorted quality. Don't miss the advance information and constructional articles for this unique receiver, starting in the December number of POPULAR RADIO.

Roxy's Absorbing Theory of "Radio Psychology"

(Continued from page 313)

icy of appealing to the sentimental side of human nature.

Probably one of the most interesting events for a man before the public is the advent of the daily mail. Here he finds the frank expressions of the opinions of the people, their likes and dislikes, their approval or disapproval, their response to him as an individual constantly in the public eye. Through the morning's mail which is deposited regularly on my desk I am often given a peep behind the scenes which proves invaluable in the daily task of pleasing the public. And the encouraging letters do a great deal to buck up my spirit on blue Mondays.

My motto is, "The public is always right" and to that end I read carefully the hundreds of letters from those who listen in and from the daily visitors who come to the Roxy Theatre, take their pens in hand to tell us how they feel about it all. When the criticism is constructive, I act upon it. If great admiration is expressed for an artist's talent, he is pushed forward. If a request is made, it is granted. After all, it's the public's broadcasting studio, built for their comfort and enjoyment. It's up to me to entertain them.

Forced and Free Vibrations

(Continued from page 321)

wholly to exclude them; but it is easy to exclude any ordinary station, even a nearby one, and listen to a distant station instead.

Regeneration thus judiciously applied to the N circuit may be small in amount, so that it may be left free and uncoupled to anything else. Melinsky's device of earthing the plate of the first tube gives the required stimulus in slight but sufficient amount, so that there is no loss of sensitiveness, in spite of the fact that re-radiation is avoided.

In most previous arrangements hitherto the antenna is usually attuned and coupled to a closed resonating circuit of the same frequency. In the new arrangement there is no tuned antenna and only slight coupling, in the ordinary sense; nor is there anything that can be called coupling for regeneration. The plan is to use a stiff circuit of high inertia, which can only respond to one particular frequency. It is left as free as possible to respond to that frequency, sufficient energy being introduced to overcome the damping, due to resistance, in a sufficient but slight manner and to avoid all feedback to the antenna, or any back communication to the ether, from the receiving station, so that it shall be a receiver and a receiver only—and not a spurious transmitter.

NOW! Make Things At Home

with The New

RED JACKET

HOME Work Shop

Only **\$10.00** DOWN

SENT ON TRIAL

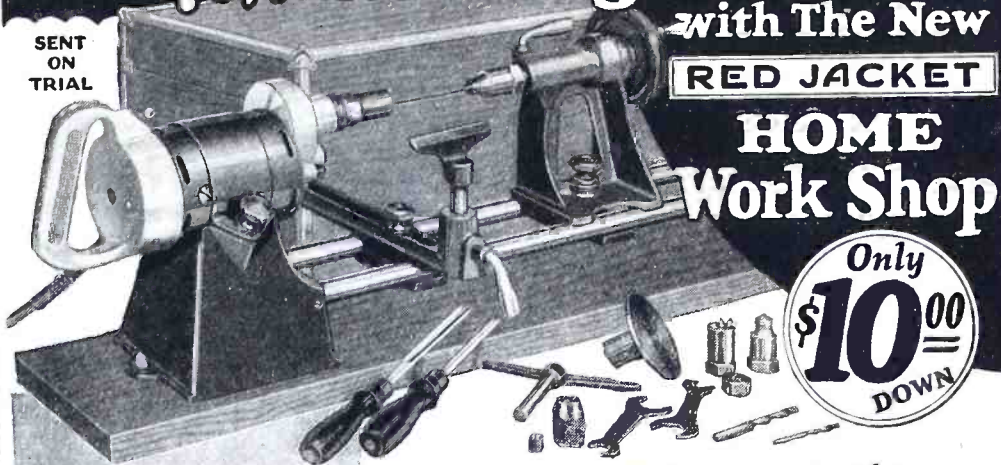

WACO CRAFTSMAN'S WONDER WORKING LATHE

CRAFTSMANSHIP is now accomplished without labor. Red Jacket electrically driven tools turn out work like magic. Here is a complete made to order workbench equipment of perfect, efficient and powerful craftsman's tools that are small and compact enough for portable use and so inexpensive that any man or boy may have one.



Red Jacket

A chest full of tools designed by a master for the private use of tool lovers and men who want to build, construct, invent and create at home. You will be able to make everything—attractive odd furniture, toys, home and garden improvements, all around manufacturing, repairing.

Turning
Sawing
Winding
Spinning
Grinding
Buffing
Polishing
Cabinet Making
Scroll Sawing
Drilling
Repairing
Dove tailing
Pointing
Jointing
Sharpening
Sanding
Scratching
Carving
Successful Masterpieces



The Complete Equipment

consists of the powerful Red Jacket Motor, with direct drive to the Waco precision wood turning lathe (capacity 9 in. x 34 in.); a bench saw, that has depth and side gauges; scroll and jig saw; and all accessories for both portable and stationary power drilling, buffing, grinding and cleaning. Attaches to any light socket and converts your work bench into a complete private tool and machine shop.



Special Crafts Course

And blueprint service is free to Red Jacket Shop owners—all that there is to know about handcraft methods, raw materials, woods, carving, sawing, turning, designing, carpentering, decorating, is taught by special correspondence.

10 DAYS' FREE TRIAL

Our literature tells you how to start a job of your own. If you are not pleased return the Shop.

2 OUNCES

of interesting reading will be sent you gratis. Send the coupon below. Sit back—see what we send you. It's free.

free CRAFTS COURSE

free BLUE PRINTS

MAIL THIS TO WACO

WACO TOOL WORKS,

542 N. Parkside Ave., Chicago, Illinois

Manager, Dept. 911. Please send me particulars about 10-day free trial, free blueprints, and \$10 down payment.

Name.....

Address.....

The Waco Guarantee

If it is not what you want when you get it—send it back

LOOK OUT FOR IMITATIONS: There is only one Red Jacket—one Waco—one Wm. L. Aylward, Mastercraftsman.

Buy On Your Own Terms

Only \$10.00 down. Liberal discounts for cash. Easy monthly payment plans. It is no hardship to own a Red Jacket.

Interesting Literature Free

Just send the coupon. You will be surprised with all it contains. Beautiful, Instructive, Fascinating, Interesting.

NEW AERO CIRCUITS WORTH INVESTIGATING

The Improved Aero-Dyne 6 and the Aero 7 and Aero 4 are destined to be immensely popular this season!



**AERO UNIVERSAL
TUNED RADIO FREQUENCY KIT**

Especially designed for the Improved Aero-Dyne 6. Kit consists of 4 twice-matched units. Adaptable to 201-A, 199, 112, and the new 240 and A. C. Tubes. Tuning range below 200 to above 550 meters. This kit will make any circuit better in selectivity, tone and range. Will eliminate losses and give the greatest receiving efficiency.

Code No. U-16 (for .0005 Cond.)..... \$15.00
Code No. U-163 (for .00035 Cond.)..... \$15.00



**AERO SEVEN
TUNED RADIO FREQUENCY KIT**

Especially designed for the Aero 7. Kit consists of 8 twice-matched units. Coils are wound on Bakelite skeleton forms, assuring a 95% air dielectric. Tuning range from below 200 to above 550 meters. Adaptable to 201-A, 199, 112, and the new 240 and A. C. Tubes.

Code No. U-12 (for .0005 Cond.)..... \$12.00
Code No. U-123 (for .00035 Cond.)..... \$12.00

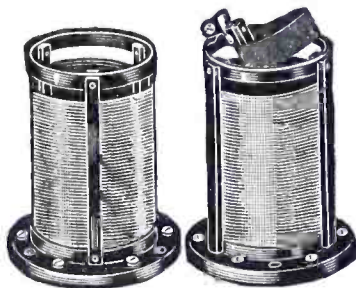

AERO FOUR KIT

An exceptionally efficient kit for use in the Aero 4 and other similar circuits. Consists of one Aero Universal Radio Frequency Transformer and one Aero Universal 3-Circuit Tuner. Uses 201-A, 112, 199 and new A. C. Tubes.

Code No. U-95 (for .0005 Cond.)..... \$8.00
Code No. U-953 (for .00035 Cond.)..... \$8.00

NOTE: All AERO Universal Kits for use in tuned radio frequency circuits have packed in each coil with a "fixed primary" a twice matched calibration slip showing reading of each fixed primary coil at 250 meters and at 500 meters; all having an accurate and similar calibration.

A NEW SERVICE

We have arranged to furnish the home set builder with complete Foundation Units for the above named Circuits and for the Chicago Daily News 4-Tube Receiver, drilled and engraved on Westinghouse Micarta. Detailed blueprints and wiring diagram for each circuit included in foundation units free. Write for information and prices.

You should be able to get any of the above Aero Coils and parts from your dealer. If he should be out of stock order direct from the factory.

AERO PRODUCTS, INC.

Dept. 104

1772 Wilson Ave., Chicago, Ill.

A Circuit New in Principle and Performance— The Octa-monic

(Continued from page 329)

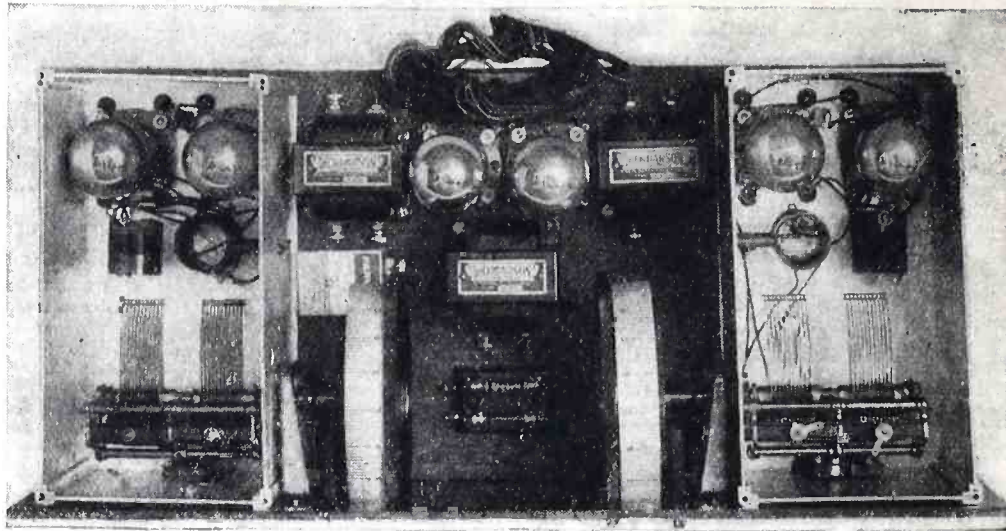

THE RECEIVER AS SEEN FROM ABOVE

The tops of the shield cans have been removed, showing the high-frequency amplifier, divided in two parts, at the ends of the base panel, and the low-frequency amplifier in the center.

frequency wave (harmonic) generated in the valve is picked up to be delivered to the detector for rectification and passed on to the low-frequency amplifier.

A comparison of the relative selectivity of the Octa-monic and tuned-high-frequency systems should prove of interest. In Figure 1 is shown the standard circuit arrangement of a tuned-high-frequency receiver with three tuning circuits or stages. Directly beneath each grid and plate circuit are shown the various tuning curves as obtained in each part of the circuit.

The curve at 1 shows the curve in the tuned input circuit and that at 2 shows the resonant curve in the plate circuit of the first valve.

It will be noted that there is no gain in selectivity in this tuned stage, when the signal passes from the grid to plate circuit of the tube. The gain in the curve is merely one of amplitude or amplification, having the same rounded or broad tuning characteristic as the original curve in the grid circuit.

Curve 3 is made sharper by the second resonant circuit which tunes the input to the second high-frequency valve, while curve 4 shows a still greater increase in amplitude, but no increase of selectivity over curve 3.

Resonant curve 5 in the tuned input circuit of the detector valve is sharper because of the additional tuning stage in the detector circuit.

To effect the transformation or increase in selectivity represented by curve 5 over that represented by curve 1, two stages of tuned-high-

frequency have been employed, using three tuned circuits and two amplifier valves.

In Figure 2 is shown the Octa-monic generator and detector circuits, with the resonance curves corresponding to each circuit. Resonance curve 6 in Figure 2 illustrates graphically the selectivity obtained in the tuned input of the harmonic generator. This, of course, is the same as that shown at 1 in Figure 1.

But when we look at the resonance curve for the plate circuit of this valve we find that curve 7, representing the curve form of the plate wave, is much sharper than the corresponding curve 2 of Figure 1. Careful measurement and plotting have shown that this curve 7 is equivalent in sharpness or selectivity to that shown as 3 in Figure 1.

Resonant curve 8 of Figure 2 is still sharper than curve 7, being made so by the tuned input to the detector, the detector input circuit being tuned to double the original signal frequency.

This resonance curve 8 is equivalent in selectivity to curve 5 of Figure 1, but this high degree of selectivity in the Octa-monic system shown in Figure 2 is accomplished with one less tuned circuit.

This remarkable increase in selectivity is but one of the features of this new circuit development. A further discussion of the principles which make this circuit an outstanding development in radio will appear in the next issue of POPULAR RADIO.

A Light Socket Superheterodyne

Here, at last, is what superheterodyne fans have been longing for for years—a super that gets its "A," "B" and "C" power from the lighting lines. Full constructional details in the December number of POPULAR RADIO.

The LC-28 Unipac Amplifier

(Continued from page 326)

battery cable that comes as part of the set. A 6-volt storage battery, preferably with a trickle charger, is used to light the valves of the LC-28 receiver. The Unipac requires no batteries.

Consult the hook-up diagram given in Figure 4 for the connections between the receiver and the Unipac. This shows a back view of the chassis of each of these units and indicates the cable connections and the proper colors of the wires to be connected. The plug of the Unipac should be inserted into a lighting socket with the switch turned "off." The antenna and ground are connected to the receiver in the usual way.

Place a UX-226 type AC valve or a CX-326 type AC valve in socket I. Place a UX-210 type AC or a CX-310 type AC power valve in socket H. Place a UX-874 or CX-374 type glow valve in socket G. Place two UX-216-b or CX-316-b type rectifier valves in sockets F1 and F2.

The unit is now ready for operation and the switch rheostat of the LC-28 receiver may be turned "on," as well as the switch of the socket of the house-lighting lines, and the set will be ready to operate, providing a reproducer has previously been connected to the two jacks O3 and O4. To handle the high-quality output of the LC-28 set satisfactorily, a reproducer of good quality should be employed.

There are no further adjustments to be made, either to the set or to the Unipac, and the complete receiver should be ready to give proper service for years to come without any trouble or tinkering.

A Measurement Chart

(Continued from page 327)

of 4 inches spaced 2 inches apart, considered from center to center of the coil windings. One coil has a self-inductance of 100 microhenrys and the other coil has an inductance of 210 microhenrys.

To use the chart first determine the ratio spacing divided by diameter

$$\frac{S}{D} \text{ — which is } 2 \div 4 = .5.$$

Connect this ratio of displacement .5 on scale No. 1 with 100 microhenrys on scale No. 3.

Then, connect the intersecting point on reference line No. 4 with 210 microhenrys on scale No. 5 and carry the line over to scale No. 6, where it will pass through 24 microhenrys, which is the mutual inductance of the two coils.

The effective inductances for the first circuit will then be 124 microhenrys and for the second circuit 234 microhenrys.

These values are within a fair degree of accuracy for engineering design work on radio circuits.



Transformers

Two Additions to Last Year's Radio Sensation. The Amazing Achievement in Audio Amplification

Designed for set builders who demand precision, sensitivity, high quality and efficiency

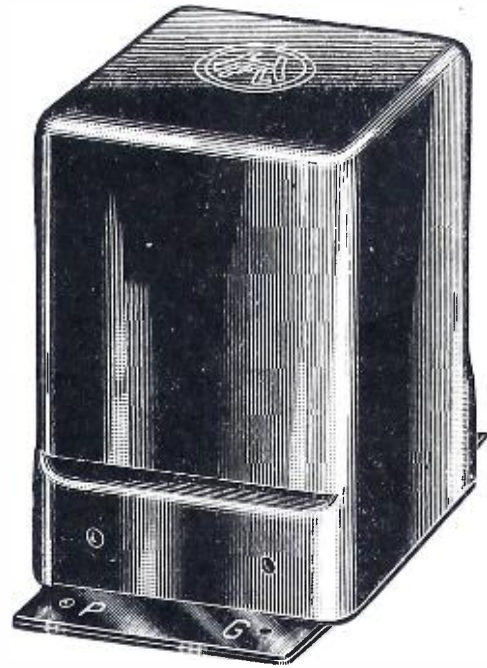
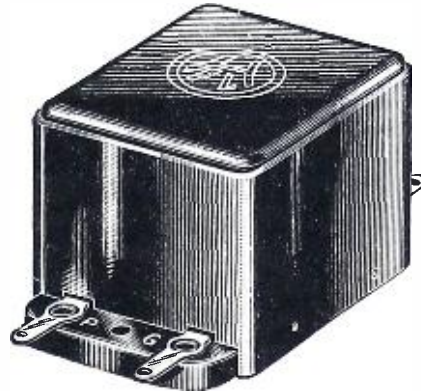

H. F. L. C-16 Audio Transformers and C-25 Output Transformer—New companions of a Great Unit, will work in any circuit and improve any radio set



H. F. L. Units Give Wonderful Clear Reception

Engineers acclaim H. F. L. C-16 a marvellously efficient Audio Transformer. It carries signals at highest volume and lowest amplitude without blasting or developing harmonics. Operates with all power tubes as well as standard tubes.

H. F. L. C-25 Output Transformer handles the voltage output of power amplifying tubes, at the same time matches the impedance of the average speaker to tubes. Protects loud speaker unit without reducing plate voltage.

Mechanical features of these two transformers are: A coil designed and treated to exclude moisture and withstand heavy electrical surges without breaking down—complete magnetic shielding to avoid inter-stage coupling—terminals brought out so as to insure short leads.

Set Builders—Dealers

If your jobber cannot supply you with H. F. L. Transformers, wire us for name of nearest jobber.

H. F. L. Facts

H. F. L. Units have been used, approved and most highly endorsed by *Radio News*, *Citizens' Call Book*, *Radio Review*, *Radio Age*, *Radio Engineering*, *Radio Mechanics*, *Chicago Evening Post*, the *Daily News* and others. Thousands of engineers and fans, who have turned to H. F. L. Units for better reception, hail them as the finest transformers known to Radio—unexcelled for Power, Selectivity and Purity of Tone.

Perfectly matched, skillfully designed, carefully made, rigidly tested—in a word, H. F. L. transformers are technically correct to the minutest detail.

All H. F. L. transformers are designed for baseboard mounting or invisible sub-panel wiring—each unit is enclosed and sealed in a genuine bakelite moulding.

H. F. L. Units are easily connected into the assembly, simplify set construction, and make a beautifully finished job.

Endorsed by America's Leading Engineers—Guaranteed by the Manufacturers

HIGH FREQUENCY LABORATORIES

133-F NORTH WELLS STREET,

CHICAGO, ILL.

RADIO PROBLEMS SOLVED

It is possible that your individual problem has been covered in an issue of POPULAR RADIO, and so as an aid to you we endeavor to keep a supply of back numbers in stock. The condensed index below gives a few of the subjects that have appeared recently; look this list over and if the information you want is covered, we will be pleased to supply back numbers at 35c a copy.

October, 1926

- How to Build the New LC-27 Receiver.
- The Radio Road Hog.
- POPULAR RADIO Circuits.
- Sets That Earn Incomes.
- Inside Information on New Radio Receivers.
- Why Signals Fade.

November, 1926

- How to Build the LC-Senior Power-Pack.
- Waves and Wavelengths.
- POPULAR RADIO Circuits.
- How to Select Your Radio Parts.
- How to Patent Your Radio Inventions.
- How to Solder.

December, 1926

- Uncle Sam's New Short-Wave Net.
- How Circuit Resistance Affects Selectivity.
- POPULAR RADIO Circuits
- How to Build the LC-Intermediate Power-Pack.
- Inside Information on New Radio Receivers.

January, 1927

- How to Build the New KH-27 Receiver.
- To Start and Stop Your Set Automatically.
- POPULAR RADIO Circuits.
- The Quack Doctors of Radio.
- How to Build the LC Junior Power-Pack.

POPULAR RADIO

119 West 57th Street

New York, N. Y.

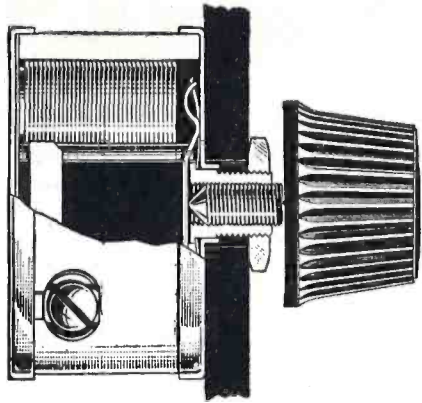

Bradleyohm-E
PERFECT VARIABLE RESISTOR

The graphite disc principle, utilized in the construction of Bradleyohm-E assures noiseless, stepless regulation of plate voltage when used in B-Eliminator hookups.

By turning the bakelite knob, the plate voltage output of the B-Eliminator can be adjusted, without steps or jumps, to the precise value for maximum volume. That is why prominent B-Eliminator manufacturers have adopted Bradleyohm-E.

Ask your dealer for Bradleyohm-E in the distinctive checkered carton.



Bradleyunit-A
PERFECT FIXED RESISTOR

This is a solid, molded fixed resistor that does not depend upon hermetic sealing for accuracy. It is not affected by temperature or moisture and can be soldered without disturbing its rating.

For resistance-coupling, grid leaks, and other applications, ask your dealer for Bradleyunit-A in any desired rating.

Allen-Bradley Co.
ELECTRIC CONTROLLING APPARATUS

276 Greenfield Ave. **AB** Milwaukee, Wis.

The New High-Mu 2 Grid Valve

(Continued from page 333)

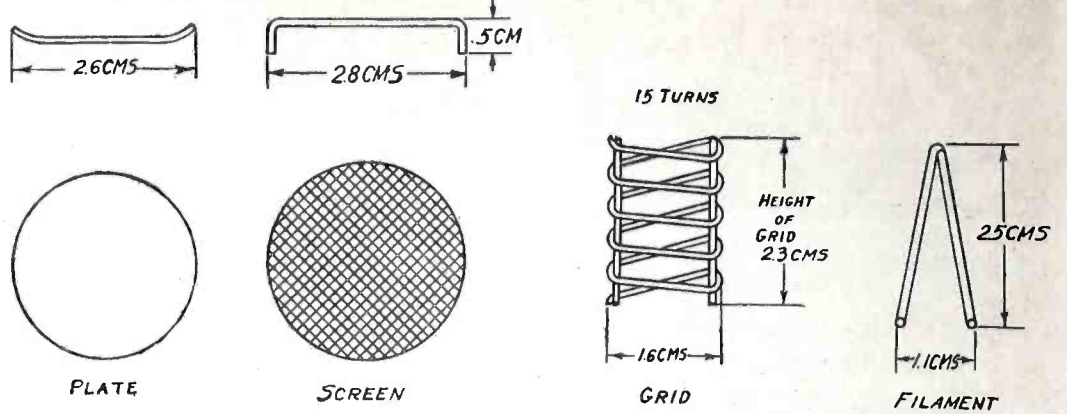

THE INNER ELEMENTS OF THE NEW VALVE

FIGURE 4: At the left is shown the circular plate with its dimensions. At the center left is the general arrangement of the screen. At the center right is shown the spiral grid, while at the extreme right is the filament. These are placed one above the other in reverse order.

densers and sometimes choking coils, according to the overall high-frequency amplification obtained.

The new valve is preferably mounted in a horizontal position, the grid and plate circuits being separated or isolated by metal screening boxes, so arranged that the partition dividing them is in the plane of the valve's screen grid, being cut away only just sufficiently to allow the glass bulb to pass through. The partition is earthed and the screen grid connected direct to the plate battery so that a practically complete electrostatic screen is formed.

Sample valves have been tested, and two sets of characteristic curves that were obtained are shown in Figures 2 and 3. Figure 3 shows the plate current for various grid bias values for plate voltages of 120 and 140 with the screen connected to positive 78 volts. An additional curve on this diagram shows the screen current. By the usual methods the amplification factor was found to be 135 for a plate impedance of 300,000 ohms. These figures vary a good deal with plate voltage and grid bias, but those given are values which would be obtained under normal operating conditions.

Figure 2 shows how the plate current and screen current vary with plate

voltage. The plate current rises rapidly with low plate voltages and then falls off, only to rise again and to remain practically steady for the higher plate voltages. The working part of the curve is the top portion, corresponding to plate voltages of 96 to 148. This top part is not quite flat and the two curves are roughly parallel. They show that the plate current can be changed by about 0.7 milliamperes by one volt grid bias.

From these curves it is clear that the voltage amplification obtainable, given an output circuit of suitable design, is very large indeed; in fact, we can get from the valve a voltage variation of from about 196 to 148 volts. If the impedance of the plate circuit is very high, we can get this voltage variation with a small input. Thus if the impedance of the plate circuit were made identical with that of the valve we should obtain a voltage amplification of 67. We would therefore obtain an output voltage of 27 volts peak value from an input of 0.4 volt peak value.

The valve is obviously one which will have to be used with circuits of high impedance, and ordinary high-frequency transformers will not be satisfactory.

A carefully constructed tuned plate circuit will provide the necessary im-

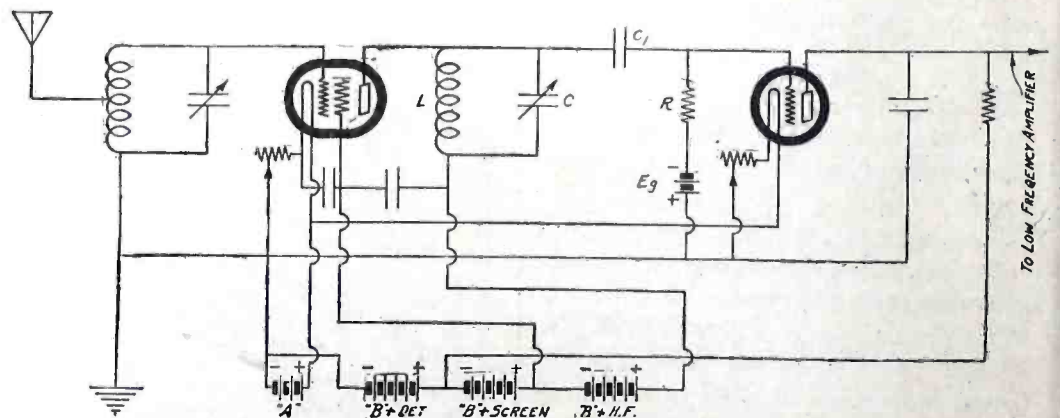

HOW THE SCREENED OR SHIELDED VALVE IS USED

FIGURE 5: This schematic diagram shows the hook-up for one of the new valves employed as a high-frequency amplifier and connected to a regular detector circuit. The text of the article describes the constants for a simple receiver of this type that will give an amplification of 60 or better for the single stage.

BIG RADIO CATALOG

From the
"Big, Friendly
Radio House"

NEW 1928 Book
Offers finest, new-
est well-known sets;
parts, eliminators,
accessories at lowest
prices.

Write for this
Catalog!

Western Radio Manufacturing Company

136 West Lake St. Dept. 58
CHICAGO, ILL.

6 TUBE RADIO ONE DIAL



Only \$32.50

Latest advanced circuit. All-steel chassis, totally shielded. Balanced parts of best quality. Marvelous power and selectivity. Gets the long-range stations as clear as a bell. One-dial single control. Encased in cabinet of fine finish and rare beauty. Here is a value unsurpassed in the realm of radio—just one of the mighty bargains listed in my new catalog. Get full details before you buy any radio. An unsurpassed value—just one of our many mighty bargains.

FREE Catalog, Log
and Call Book

It's just off the press! Chock-full of radio's latest and best 1928 developments. 132 pages of real radio information. Lists all the latest receivers, eliminators, chargers, speakers, kits, parts, etc. All the radio stations and newly assigned wave lengths. A regular encyclopedia of Radio information. And it's Free! Send for your copy today.



**A M E R I C A N
A U T O & R A D I O M F G . C O .**

Harry Schwartzberg, Pres.

Dept. 202 American Radio Bldg., Kansas City, Mo.

pedance, however, and is easily arranged. We have to remember, though, that a grid condenser and leak is necessary for coupling the stages. Thus a typical circuit will be as indicated in Figure 5. Here L is the tuning coil and C the tuning condenser of the first tuned plate circuit, C1 is the coupling condenser of .0003 mfd., while R is the grid-leak of 1 megohm. The return end of R is taken to the negative side of the filament battery so that the grid of the second valve has a negative bias equal to the fall in voltage over the filament rheostat. This is satisfactory, as the valve is a 5-volt one and would be heated from a 6-volt "A" battery.

For rectification, a valve set as a plate bend detector is used, the necessary grid bias being obtained through the grid battery, GB. To tune over the wavelength range of 200 to 600 meters, L may have an inductance of 290 microhenries and C a capacity of .0003 mfd. The impedance of this circuit at its resonant frequency is equal to

$$\frac{L}{CR}$$

ohms, ignoring the effect of the grid-leak. Thus the important factor is the resistance of the circuit, since for a given wavelength the inductance and capacity are fixed.

A circuit comprising a single layer coil, 3 inches in diameter, wound with No. 24 or 26 copper wire, will have an effective resistance of 80,000 to 100,000 ohms at 400 meters. Thus, with this coil we should obtain an amplification of about 34.

A better coil wound with 27 strands of No. 42 high-frequency cable will have a much lower resistance and the impedance of the circuit at 400 meters will be of the order of 250,000 ohms. The amplification with this circuit will therefore be 61 for the stage.

Measurements have been made for a single stage comprising a tuned plate circuit with a coil of high-frequency cable, and it was found that an amplification of well over 60 was obtained with perfect stability, with a simple screen placed between the grid and plate circuits. There was a certain amount of reaction which increased the signal a little, but did not cause instability at any wavelength. This was due to a slight coupling between plate and grid coils, but the tests serve to show that it is not necessary to employ complete screening when only one stage of high-frequency amplification is used.

It is quite a simple matter to build receivers with two or even three stages, but then the amplification is so great as not to make it worth while designing each stage for maximum amplification.

A single stage, designed as outlined in this article, should give enough amplification to meet the needs of any sort of reception.

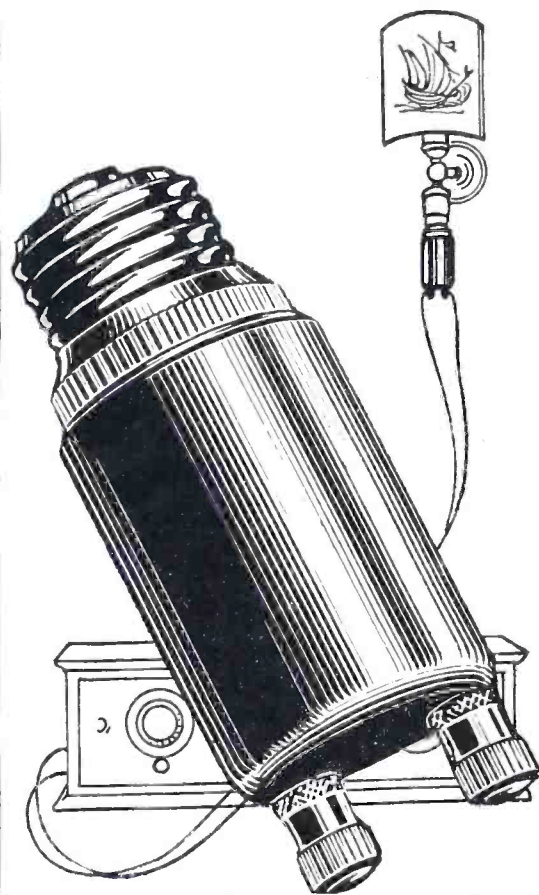

A Perfect Aerial in 5 Minutes

Just connect it to the set and plug in—that's all the work you need to do on an aerial that brings in programs with remarkable volume and clarity. It uses absolutely no current, reduces both static and interference, and completely eliminates the lightning hazard. Sold by all good dealers on a five-day, money-back basis for \$1.50.

Dubilier Light Socket Aerial



Building a Power-Unit?

Then select the condenser blocks built for long hours of heavy-duty service. Dubilier Blocks are the choice of leading manufacturers and of experimenters who build with care.

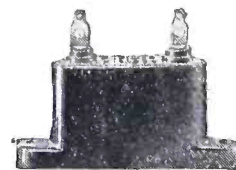

Micadon—the Standard of Radio

This famous fixed condenser is now incorporated in a moulded Bakelite case designed to meet modern receiver designs. Terminals adapted to soldered and screwed connections. All capacities. Price 45c to \$1.50.

DUBILIER CONDENSER CORP.
4377 Bronx Blvd., New York City

Dubilier CONDENSERS

Employing the New  "Octa-Monic" Principle

BUILT FOR MODERN BROADCAST CONDITIONS

Not Regenerative! Not Tuned Radio
But the Radically and

R. G. S.

A. C. Tube Models

R. G. S. "Octa-Monic" A-C Tube Kit

including instructions and blue-prints; all necessary apparatus, ready to build, \$119.60



R. G. S. "Octa-Monic" A-C Tube Chassis

Completely assembled according to latest laboratory methods, (carefully tested and selected heavy duty wire, lamp socket connections, cable, Power (A-C) Transformer, etc., etc.) with instructions and blue-prints for installation, ready to plug in your lamp socket and operate, \$129.60

R. G. S. "Octa-Monic" A-C Tube Receiver

housed in an attractive, partitioned, walnut table cabinet, \$149.60

NOTE: All models of the R. G. S. "Octa-Monic" have been adapted to the Cunningham A-C and Power Tubes, Four (4) CX 326, one (1) C 327, and one (1) CX 371. The "B" Battery Eliminator and the Cunningham Tubes are not included in the above prices. This eliminates an unnecessary expenditure on your part because the A-C Tube models of the R. G. S. "Octa-Monic" have been designed to operate satisfactorily with any good "B" Eliminator. It is recommended if your "B" Eliminator has no "C" battery tap, that you use the regular 40 volts of C battery.

Price Notice

Above prices do not include Cunningham A-C and Power Tubes nor the "B" Battery Eliminator. All A-C models will operate on any good eliminator. This, therefore, permits the use of your own "B" Battery Eliminator, thereby representing a very distinct saving to you.

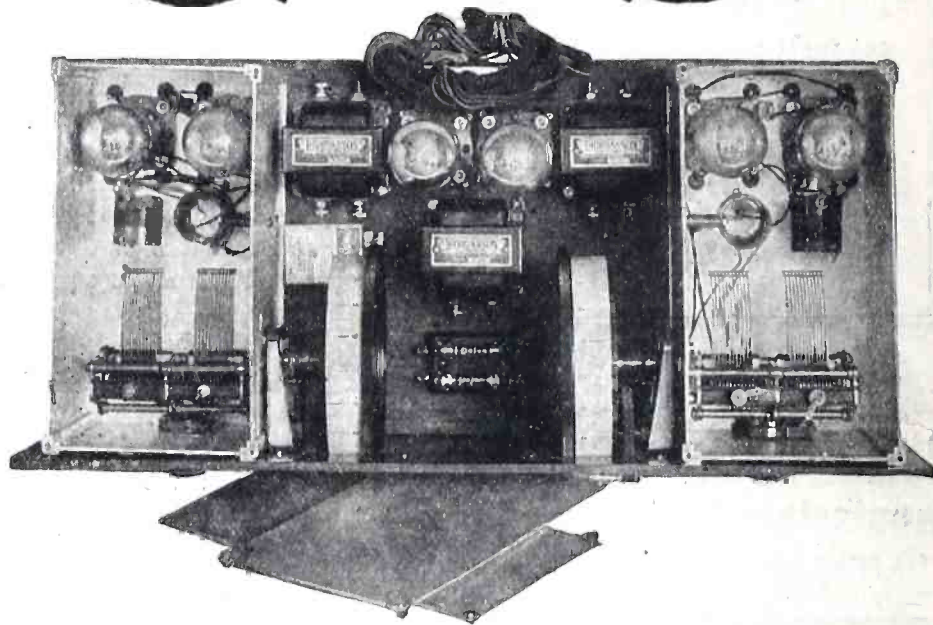

The fundamentally new R. G. S. "Octa-Monic" Receiver developed by David Grimes is one of the four great radio developments of the past 10 years. The R. G. S. "Octa-Monic" principles are fully as important and represent as basic a contribution to the Radio Art as did any of the discoveries of DeForest, Armstrong, Alexanderson, etc., etc.

These new and revolutionary principles of tuning, or the radio frequency end of the R. G. S. "Octa-Monic," produce results not only superior but these principles of tuning place this Receiver far in advance of any receiver developed to date. The R. G. S. "Octa-Monic" is fundamental and is as radically new as was the Super-Heterodyne.

These highly efficient principles employed in the new R. G. S. "Octa-Monic" cover not only the tuning or radio frequency end of this receiver but they cover the amplification end as well. The R. G. S. "Octa-Monic" amplifier (Power tube in the last stage) gives, unquestionably, as perfect reproduction as it is possible to buy, regardless of cost.

The R. G. S. "Octa-Monic" comes to you more heavily endorsed by able authorities than any other receiver ever presented to the Radio Public. The editor of one of the most important radio publications in America said that it was the only receiver he had ever seen in his career as an editor to which the terms "new and revolutionary" could be applied in good faith.

Selectivity superior to the super-heterodyne without cutting side bands, selectivity enough to eliminate the heterodyne squeals of local stations, operating on a higher octave; selectivity that is equal over the whole dial without being at all critical at any point; selectivity enough to separate with ease the local jumble of Metropolitan (New York City, Chicago, San Francisco, etc.) stations; selectivity enough to give five (5) degrees of silence between stations WEAJ and WNYC in a location 200 yards away from WNYC.

Selectivity positive enough to make use of vernier control unnecessary.

Sensitivity or Distance-Getting Ability. Can work right down to static level. This insures trans-continental or trans-oceanic reception on favorable occasions.

Volume sufficient to fill a hall that will seat 3500.

Tonal Quality that is as nearly perfect as development in the Radio Art will permit.

Straight Line Audio Amplification.

Stability Margin of 800 ohms. The average receiver has a stability margin of from 6 to 20 ohms. This high stability margin of the R. G. S. "Octa-Monic" eliminates any possibilities of howling from poor batteries or "motor-boating" from eliminators. Batteries registering as low as 10 volts will deliver a clear tone, free from howling, in this receiver.

Straight Line Radio Amplification insuring reception at all broadcast wavelengths.

Straight Line Volume Control that makes distorting of tone impossible.

DEALERS: Write for Complete Merchandizing Proposals

BUILT FOR MODERN



BROADCAST CONDITIONS

Employing the New  "Octa-Monic" Principle

Frequency! Not a Super-Heterodyne!
Fundamentally New

"OCTA-MONIC"

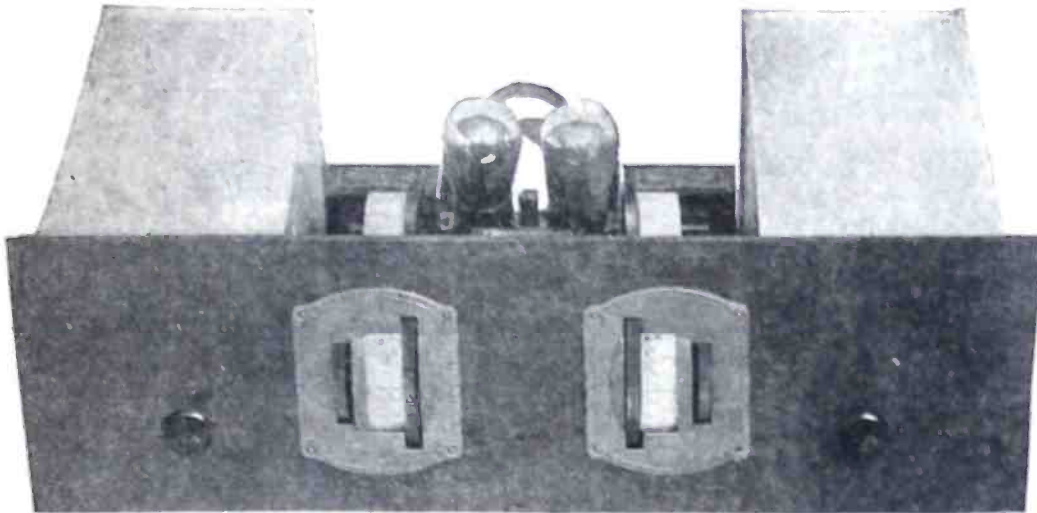

Automatic Wavetrap for prevention of heterodyning and whistling resulting from stations operating on one-half wave-length or on first octave beat.

Automatic Filament Control.

Employs 135 Volts or 180 Volts. Draws 22 mils.

Each R. G. S. "Octa-Monic" is carefully tested with scientific apparatus and under actual broadcasting conditions before it leaves the laboratories; while every piece of apparatus is just as thoroughly tested before it is built into this receiver.

The R. G. S. "Octa-Monic" is a closely co-ordinated Receiver built of quality apparatus. Careful tests are the basis for the choice of each piece of apparatus, tests that not only determine the merits of each individual part, but more importantly its relation to the whole receiver.

Standard Cunningham tubes (5, CX301-A's and 1, CX371, Power tube in last stage) and Western Electric Cone are recommended for best results.

The R. G. S. "Octa-Monic" is highly attractive in appearance. It is built on five-ply, specially shellacked sub-panel (20" x 9") to which is mounted a beautiful walnut finished, standard size panel (7" x 21") that will fit any good cabinet or fine console 7" x 21". The panel and drum escutcheons are trimmed in dull bronze.

You will find your R. G. S. "Octa-Monic" mighty easy to operate.

There are but two drums with vernier adjustments and two control knobs, one of which is an ordinary volume control and filament switch, the nearest approach to tuning efficiency, possible. Stations actually "click" or "tumble in" as you slowly revolve your drums.

The customary need of wooden screw-drivers or involved balancing devices is entirely removed in the R. G. S. "Octa-Monic." Major or minor adjustments are unnecessary. The R. G. S. "Octa-Monic" is free from ordinary service. Tuning condensers are the only moving parts, and as a consequence, there are no fussy mechanisms, either mechanical or electrical, to get out of order.

The R. G. S. "Octa-Monic" operates satisfactorily on either a good "B" battery eliminator or batteries without "motor-boating" or howling.

Orders cannot be accepted for individual pieces of apparatus or blueprints.

The R. G. S. "Four" employing the Inverse Duplex System (1) R. G. S. "Four Kit, all parts, complete instructions, \$74.40. (2) Chassis, assembled according to latest laboratory methods, \$84.40.

All prices slightly higher west of Denver. Canadian and Export prices on request.

Go to your dealer to-day and insist on a demonstration. If he hasn't stocked the R. G. S. "Octa-Monic" yet, tear off and mail to us the attached coupon with the required information. Every effort will be made to arrange a demonstration for you.

Arrange for that demonstration now because you have a real radio thrill waiting for you. In the R. G. S. "Octa-Monic" you will hear radio at its best. And when you hear the R. G. S. "Octa-Monic" you will know why it is: "The Synonym of Performance."

All models of the R. G. S. "Octa-Monic" and the R. G. S. "Four" are fully protected by Grimes Patents issued and pending.

*Trade Mark Registered.

DEALERS: Write for Complete Merchandizing Proposals

R-G-S Manfg. Co., Inc.

Staten Island

New York

Battery or "B" Eliminator Models

R. G. S. "Octa-Monic" Kit

of parts including all required apparatus, complete instructions and blue-prints, ready to build, \$84.60.



R. G. S. "Octa-Monic" Chassis

completely assembled according to latest laboratory methods, (closely co-ordinated and specially designed apparatus, eight foot Da Hery cable, etc., etc.) with complete operational instructions, ready to operate, \$89.60.

R. G. S. "Octa-Monic" Receiver

housed in an attractive, well-designed, walnut table cabinet, \$104.60.

R. G. S. "Octa-Monic" Tuning Kit

including all necessary apparatus and complete blue-prints and instructions, \$63.60

R. G. S. "Octa-Monic" Tuning Chassis

completely assembled according to latest laboratory methods with complete instructions and ready to wire to your favorite amplifier, \$66.60

Price Note

The apparatus required to build the radically new and fundamental R. G. S. Octa-Monic actually lists at over \$100.00.

R. G. S. MANFG. CO., Inc.
Staten Island, New York

Gentlemen:

Please arrange with my dealer, whose address I have printed below, for a demonstration of the new and revolutionary R. G. S. "Octa-Monic." I am much interested in this receiver but this request for a demonstration and literature, you understand, entails no obligation on my part.

My Name

Street

City or State

My Dealer's Name

His Address

BUILT FOR MODERN  BROADCAST CONDITIONS

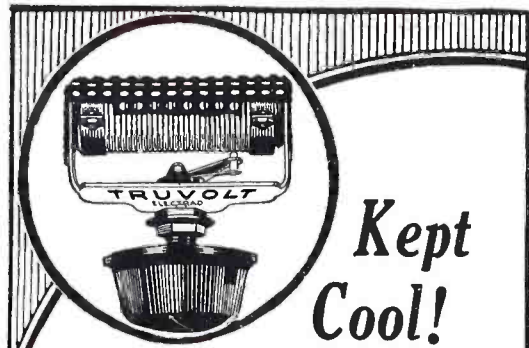

Kept Cool!

Like the best Airplane Motors

TRUVOLT

An All-Wire Variable Voltage Control

Here is the finest voltage control you can possibly buy for your power devices! Its special mechanical construction gives greater radiation area and keeps it cool like an air-cooled engine. This prevents deterioration and assures permanent accuracy with long life.

Resistance made entirely of nichrome wire with very low temperature coefficient and exposed directly to air—heat not held in by enamel coverings as in other resistances. Permits potentiometer control and gives positive metallic contact at all times with 30 exact readings of resistance.

| Type | Ohms Resistance | Milliamperes Current |
|-------|-----------------|----------------------|
| T-5 | 0 to 500 | 224 |
| T-10 | 0 to 1,000 | 158 |
| T-20 | 0 to 2,000 | 112 |
| T-50 | 0 to 5,000 | 71 |
| T-100 | 0 to 10,000 | 50 |
| T-200 | 0 to 20,000 | 35 |
| T-250 | 0 to 25,000 | 32 |
| T-500 | 0 to 50,000 | 22.5 |

Eight stock types with resistances up to 50,000 ohms. All rated at 25 watts.

Price, \$3.50 each.

Also full line of fixed wire resistances.

Write for free hook-up circular.

"This Is An Eliminator Year"

Dept. 18A, 175 Varick Street, New York, N. Y.

ELECTRAD

The MagnaRay Power-Pack

(Continued from page 331)

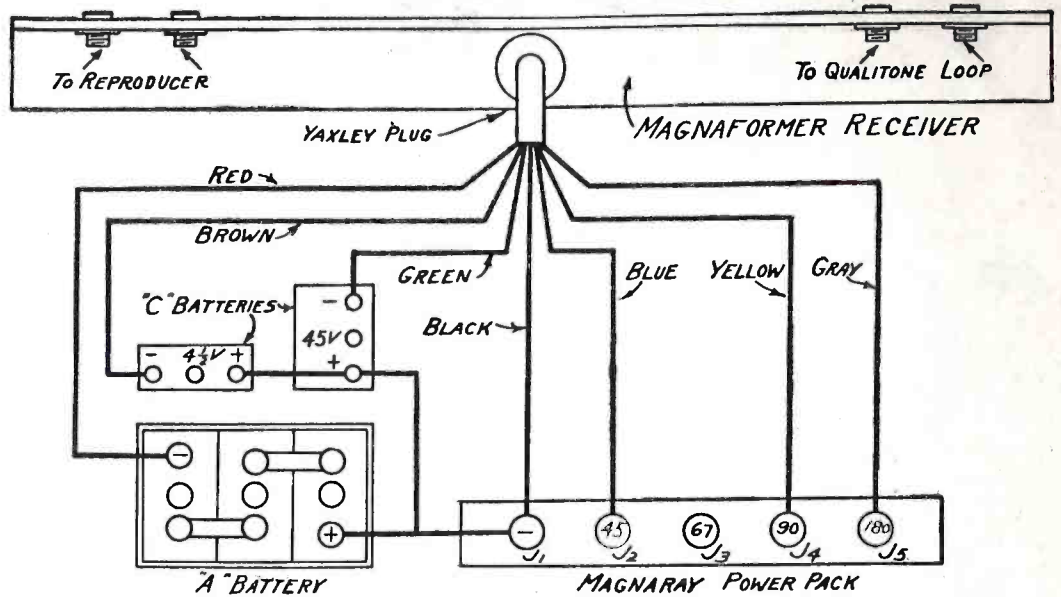

HOW TO HOOK UP THE MAGNARAY

FIGURE 3: The connections to be made between the Magnaformer, the MagnaRay and the "A" and "C" batteries are clearly shown in this diagram. The Yaxley plug and cable come with the Magnaformer receiver.

has been mounted. Wires should be connected up from binding posts J1, J2, J3, J4 and J5 to the cable furnished with the Magnaformer. The connections should be made as shown in Figure 3. A storage battery may be used as indicated in the diagram. Preferably a unit equipped with a trickle charger such as the Westinghouse, the World Storage Battery Co. unit, or the Fansteel "A" Power, may be used.

A Raytheon BH rectifier valve should be used in socket D and a Raytheon R regulator valve should be placed in socket E, with the proper connection made to its shell for the starting electrode.

When the complete unit has been hooked up with the Magnaformer receiver, and the loudspeaker and Qualitone loop have been connected, the switch on the receiver should be turned to the "on" position. The plug on the cable connected to the power transformer, A, of the MagnaRay power-pack should be inserted in the socket

and the house lighting current turned "on."

The receiver is now ready for operation and the voltages applied will remain perfectly constant irrespective of the lighting voltage variation in the house-lighting lines.

The regular operation of the Magnaformer 9-8 receiver may be carried out in exactly the same manner, from this point on, as described in the October issue of POPULAR RADIO, in the article on the construction and operation of the Magnaformer.

The complete unit will, from this time on, be automatic in operation and need no further adjustment or attention outside of filling the "A" battery with distilled water as it becomes necessary. This may be done at intervals of about four months.

The MagnaRay Power-Pack will maintain, at all times, efficient operation of the set, and enable the user to get the highest amount of satisfaction with the least worry and bother.

The Phono-Radio Reproducer

(Continued from page 336)

of the way "in") so that any of the local stations may be tuned in by the main control knob without resorting to the use of the correction adjustment each time.

On the panel of the power-pack amplifier will be found both a detector and a high-frequency amplifier "B" voltage adjustment device. Both of these levers should be moved until the best setting is found. With a receiver of the type described in this article, the optimum detector adjustment will most likely be at the center of the available voltage range, while the optimum high-frequency "B" voltage ad-

justment will most likely be the minimum voltage obtainable.

The "B" negative and "A" negative terminals on the amplifier should be connected together as shown in Figure 2.

In order to secure the full value of the excellent reproduction possible from a receiver employing a combination low-frequency amplifier and power-pack, such as the National, it is most essential that a high-grade reproducer be employed. The exponential horn type or the better grade of cone type, or a panel type such as the Lata balsa wood, are all satisfactory.

Want More Money?

You Can Increase Your Earning Power By Learning More About Radio

If you're making a penny less than \$50 a week, you're not getting what you ought to get out of Radio.

Thoroughly trained men—men whose knowledge of Radio is completely rounded out on every point—earn all the way up to \$250 a week.

Radio is a new industry with plenty of fine positions unfilled. There are countless opportunities in Radio for a man to earn a splendid salary. But these are not opportunities as far as you are concerned, unless you're fully qualified for them.

The only way to qualify is through knowledge—training—practical, complete training, that fits you to get and to hold a better position in the Radio field.

See If This Free Book Can Do You Any Good

I publish a 64-page book, printed in two colors and filled with facts and photos relative to Radio and its opportunities.

I don't say this book will help you, but it *does help* such a large percentage of those who read it that I can afford to send it to all who ask for it—free. You may get only a single idea out of this book that will be of any value to you. Or every line of it may give you a message.

At any rate, fill in the coupon below and look it over. It costs you nothing

A message to men now in the Radio business. And another to men who would like to be in.

I have helped all sorts of men to advance themselves in Radio. Lots of them, men who knew absolutely nothing about Radio when they first wrote me. Some who didn't know the difference between an ampere and a battle axe. Others, graduate electrical engineers who wanted special work in Radio. Licensed sea operators who were way behind on the "BCL stuff." "Hams" by the score. Last, but not least, the service and repairman or salesman who wanted to advance or go into the Radio business on his own. And the man already in on his own, who wanted to look forward to a more solid and permanent Radio future. My Free Book—see coupon below—tells about my helpful methods, and cites the experiences of a hundred men—giving photos and addresses.

but a two-cent stamp, and you place yourself under no obligation. I won't even send a salesman to call on you. And there's always a chance that that two-cent stamp may make quite a difference in your future.

What My Radio Training Is

Under my practical system, a man can study at home in his spare minutes and get a thorough, clear, practical and expert knowledge of Radio in from 4 to 12 months. The time required depends on his previous knowledge, his ability, and the time he can spare for study. He keeps right on with the job he has—no necessity for his leaving home or living on expense.

Then, as soon as he's ready for a better position, I'll help him to get it and to make a success of his work.

This proposition is open to anybody who is not satisfied with his job, his prospects, or his Radio knowledge. Regardless of how much you know already (or if you don't know the first thing about Radio technically), I'll fit my methods to suit your needs.

If you want to enter into any correspondence about your own situation, anything you write will come directly to me and will be held strictly confidential.

Tear the coupon off now before you turn the page and mail it to-day.

J. E. Smith, President

National Radio Institute

Washington, D. C.

*Oldest and Largest
Radio Home-Study
School in the World*

*Originators of
Radio Home-Study
Training*

J. E. Smith, President,
National Radio Institute,
Department 0-86, Washington, D. C.

Please send me your free book about the bigger opportunities awaiting the thoroughly trained Radio man. At present I (am) (am not) in the Radio business.

Name.....

Address.....

Town.....State.....



ACME

Celatsite Battery Cable

A rayon-covered cable of 5, 6, 7, 8 or 9 vari-colored Flexible Celatsite wires for connecting batteries or eliminator to set. Plainly tabbed; easy to connect. Gives set an orderly appearance.

Stranded Enameled Antenna
Best outdoor antenna you can buy. Seven strands of enameled copper wire. Presents maximum surface for reception, resists corrosion; this greatly improves the signal. Outside diameters equal to sizes 14 and 16. (We also offer solid and stranded bare, and stranded tinned antenna.)

Loop Antenna Wire
Sixty strands of No. 38 bare copper wire for flexibility, 5 strands of No. 36 phosphor bronze to prevent stretching. Green or brown silk covering; best loop wire possible to make.

Flexible Celatsite for sub-panel wiring
A cable of fine, tinned copper wires with non-inflammable Celatsite insulation. Ideal for sub-panel or point-to-point wiring. Strips easily, solders readily. Nine beautiful colors; sold only in 25 ft. coils, in cartons colored to match contents.

Acme Celatsite Wire
Tinned copper bus bar hook-up wire with non-inflammable Celatsite insulation, in 9 beautiful colors. Strips easily, solders readily, won't crack at bends. Sizes 14, 16, 18, 19; 30 inch lengths.

Spaghetti Tubing
Oil, moisture, acid proof; highly dielectric — used by leading engineers. Nine colors, for wire sizes 12 to 18; 30 inch lengths. (We also make tinned bus bar, round and square, in 2 and 2½ ft. lengths.)

Send for folder
THE ACME WIRE CO., Dept. P
New Haven, Conn.

ACME WIRE
MAKES BETTER RADIO

How to Build and Operate the Universal Tester

(Continued from page 346)

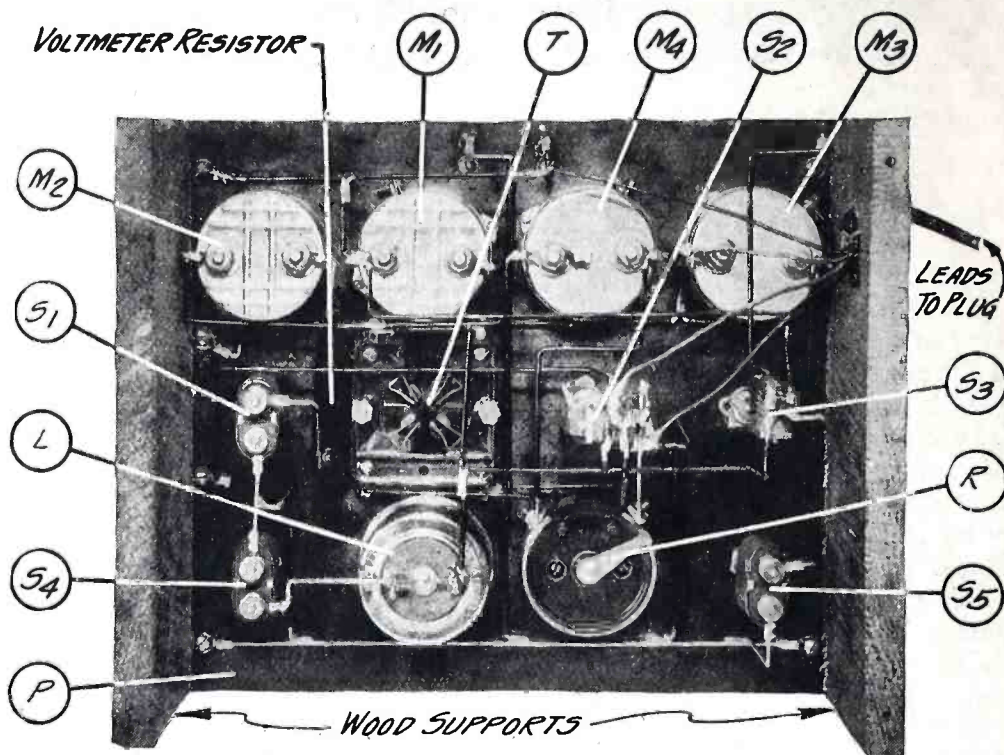

THE UNDER SIDE OF THE TESTER PANEL

FIGURE 2: The layout of the meters and other instruments is clearly shown in this view. The wood blocks to support the panel should be cut to fit the particular case that the constructor wishes to use.

On page 346 is shown the set built by the author and installed in a small leather carrying case. Figure 3 gives schematically the circuit employed.

All the instruments are mounted on a composition panel, drilled according to the specifications given in Figure 5. After the instruments are mounted, as shown in Figures 1 and 2, the wiring may proceed. This should be done as shown in the picture wiring diagram in Figure 1. The mounting and wiring of the instruments is so clearly shown in these illustrations that it is unnecessary to describe it step by step.

The testing plug may be made from the base of a burnt-out UX type of valve; the glass in the valve and other matter may be removed from the plug by carefully warming it until the cement matter is melted out. The ends of the cords to be terminated in the plug may now be inserted. It is very important that these cords should be spaced apart from each other as far as possible. The capacity effect between plate and grid leads may be sufficient to cause a variation in readings in plate current; therefore, wide separation of these leads is imperative. Of course, care

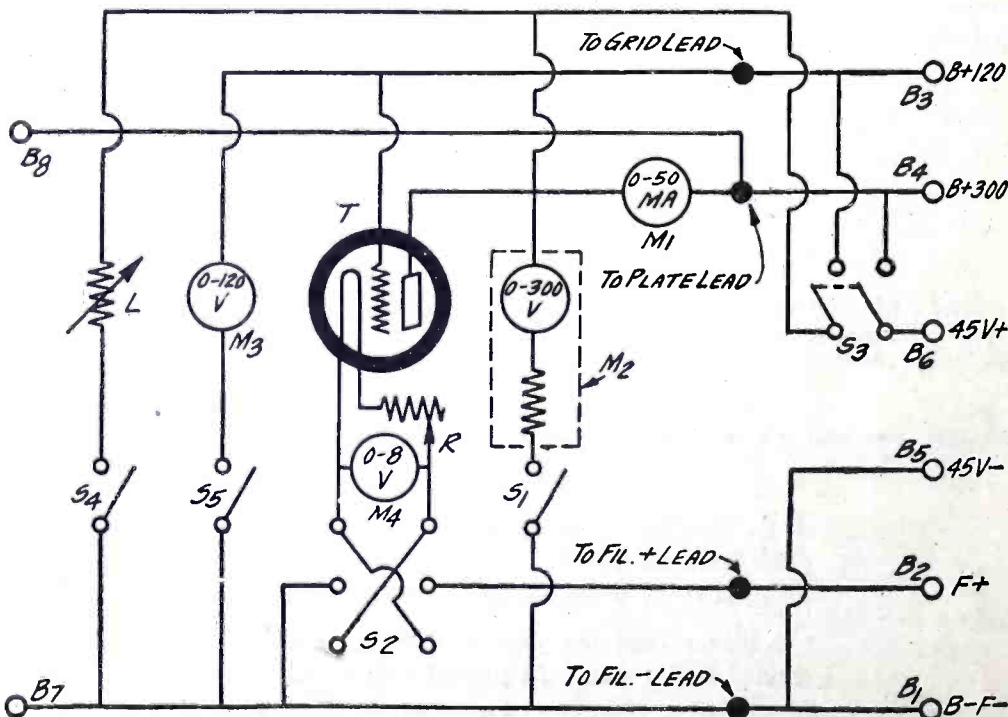

THE SCHEMATIC CIRCUIT OF THE TESTER

FIGURE 3: The heavy black dots indicate the point where the leads to the tester plug are connected. Switch S2 is used to correct the polarity of a receiver under test to coincide with the polarity of the voltmeter.

HOW TO OPERATE

The Universal Tester and Trouble Shooter

1. FOR VALVE RATING. Connect the "A" battery to the negative (—) and Fil. positive (+) posts. Insert the valve to be tested in the tester socket. Put switches 2, 3 and 5 to "on" position. Adjust the rheostat to proper voltage. Press button on milliammeter and read filament emission.*
2. FOR VALVE CIRCUIT TESTS. Remove the vacuum valve from its socket in the receiver under test and insert plug. Insert the valve in the tester socket. Read filament voltage with switch 2. The rheostat must be out. Press the button on the milliammeter to read plate current.
3. FOR POWER-PACK OUTPUT TESTS. Connect the output of the power-pack to the binding post marked "Elim." Turn "on" switches 1 and 4 and press button on the milliammeter. By adjusting the knob marked "Load," voltages at various current loads may be measured.
4. FOR BATTERY VOLTAGE TESTS. For voltages up to 300, connect the source of voltage to the binding posts marked negative (—) and "B" 300. Pull switch 1 and read the voltage. For voltages up to 120 volts, connect source of voltage to binding posts marked negative (—) and "B" 120. Pull switch 5 and read voltage. For voltages up to 8 volts, connect the source of voltage to binding posts marked negative (—) and Fil. positive (+). Turn switch 2 to the left and read the voltage.
5. FOR OPEN-CIRCUIT TESTS. Place the coil or transformer to be tested in series with one side of the 45-volt "B" battery. Turn switches 5 and 3 "on." A closed circuit shows a reading on the 120-volt meter; an open circuit does not. A good condenser shows a "kick" of the needle of the voltmeter; a shorted condenser shows a steady reading of the voltmeter.
6. FOR USING MILLIAMMETER SEPARATELY. Connect the positive terminal of the current source to the "B" 300-volt binding post, and the negative (—) terminal to the "B" 120-volt binding post. Turn switch 3 "on" and press the button on the milliammeter for the current reading.

NOTES

- A. Switch 2 is a double-pole, double-throw filament switch which is turned by the operator to correct the polarity of the receiver to coincide with the voltmeter.
- B. For test Nos. 1 and 5, the 45-volt battery must be in the circuit and connected to the binding posts marked "45 V" and "45 V—."
- C.* UX-201-a type valves, at 5 volts filament, should have over 25 milliamperes emission; UX-199 type valves, at 3.3 volts, over 6 milliamperes; UX-120 type valves, at 3.3 volts, over 15 milliamperes; UX-200-a type valves, at 5 volts, over 12 milliamperes; UX-171 type valves, at 5 volts, over 50 milliamperes.

PASTE THIS TABLE ON THE COVER OF YOUR TESTER

FIGURE 4: This table contains complete, condensed data for the operation of the Universal Tester, and should be kept handy for use. The ingenious experimenter will find many other uses about the laboratory or service shop to which the tester may be adapted.

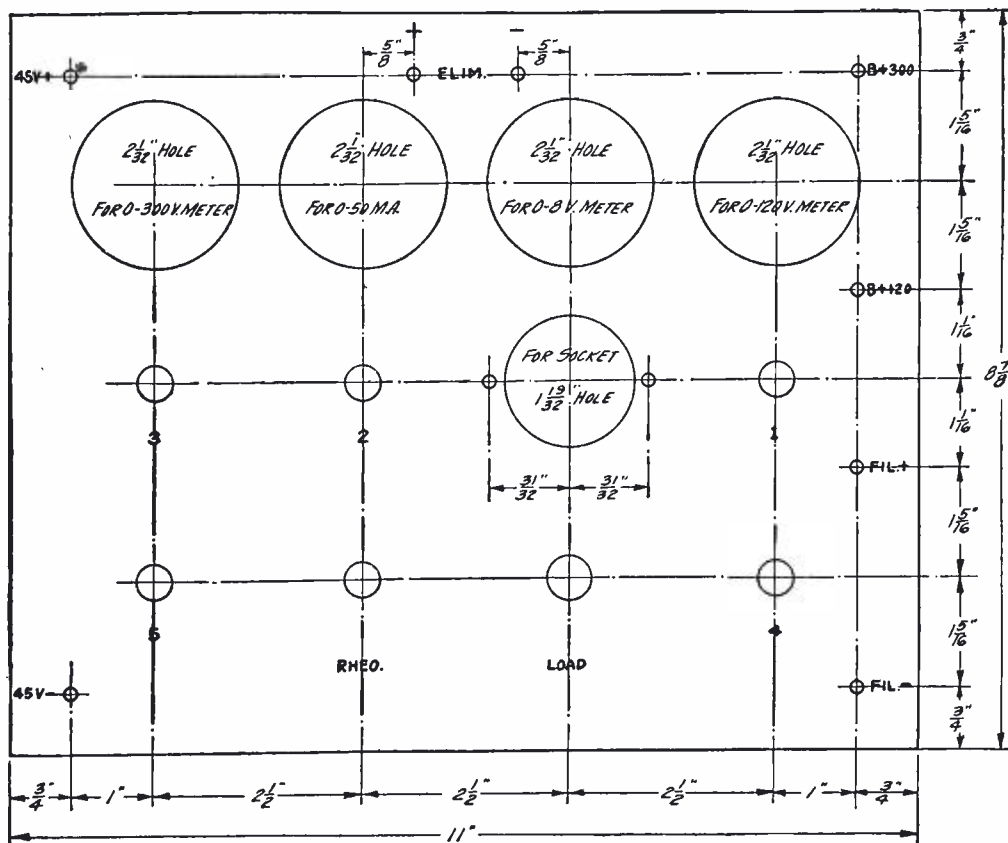

HOW TO DRILL THE PANEL OF THE TESTER

FIGURE 5: The exact positions of the instruments and the sizes of the holes are clearly indicated in this diagram. The meters are equipped with mounting rings that fasten them to the panel by means of small screws that come with the meters. No other fastening is required for them.

Finally—the Perfect "A" Eliminator

For Your Present Set or the Set you eventually buy

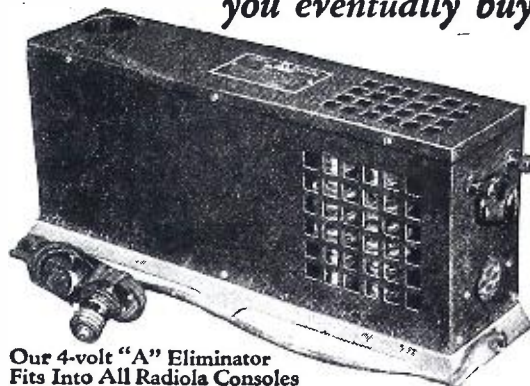

Our 4-volt "A" Eliminator Fits Into All Radiola Consoles

Silver Beauty POWER

Replaces "A" storage battery and charger; has full wave "dry" rectification; maintains required voltage in uniform, constant flow; operates automatically by moving a switch; economical—uses minimum amount of current (about 1-10 cost of using electric iron); has rheostat control for additional refinement in voltage and reception; gives maximum power to radio tubes and lengthens their life; no acids to test or spill. Satisfactory results guaranteed.

Its principle is simple and correct!

The 110 volts Alternating Current is scientifically reduced with the famous "Silver Beauty" transformer coil to deliver the proper voltage to an especially developed dry, noiseless rectifier, which transforms the electricity to direct current. This current of exact voltage, is then transmitted through a patented special filter which clarifies the current, eliminating all foreign noises caused by rectifier or generator.

The Silver Beauty "A" Eliminator is endorsed by prominent radio engineers—adopted by leading distributors and dealers—approved by thousands of users. These are sufficient reasons for making Silver Beauty your choice.

\$39⁵⁰ \$43⁵⁰ \$39⁵⁰

6-volt; 2 amp. 6-volt; 3 amp. 4-volt; 1/2 amp. \$2 Higher West of Rockies

Silver Beauty "B-C" UNIT

Does away with "B" and "C" batteries

Embodies every up-to-date refinement and principle, insuring smooth, unflinching reception. As beautiful as it is efficient.

No. 450 180 Volts—40 Milliamperes \$45

No. 460 135 Volts \$35

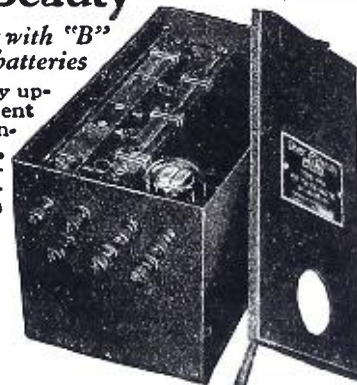

Individual adjustment adapted to all sets.

Silver Beauty CHARGERS

Employing an entirely new method of rectification. Two models—with or without bulbs.

See Your Dealer or Jobber

Triple-A-Specialty Company

Manufacturers of the famous Silver Beauty Chargers 312-316 South Hamilton Ave., Chicago, Ill.



Radio Parts and Accessories ~at Astonishing Prices!

Dealers, set-builders and fans by the hundreds are ordering this merchandise of the world's best-known manufacturers. Its quality is the best, and our prices will surprise you. In fact, you have a treat in store when you see this

New 1927-28 Hampton-Wright Free Catalog
of Radio Parts and Accessories

Mail This Coupon Today!

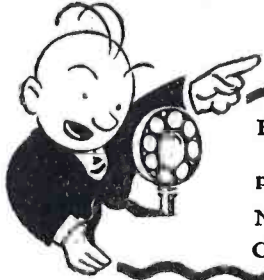

Hampton-Wright, 138 Darmody Bldg., Indianapolis, Ind.

Dear Sirs: I'm interested in this new catalog of Hampton-Wright radio parts and accessories at astonishingly low prices. Send one today to:

Name _____ Street _____
City _____ State _____

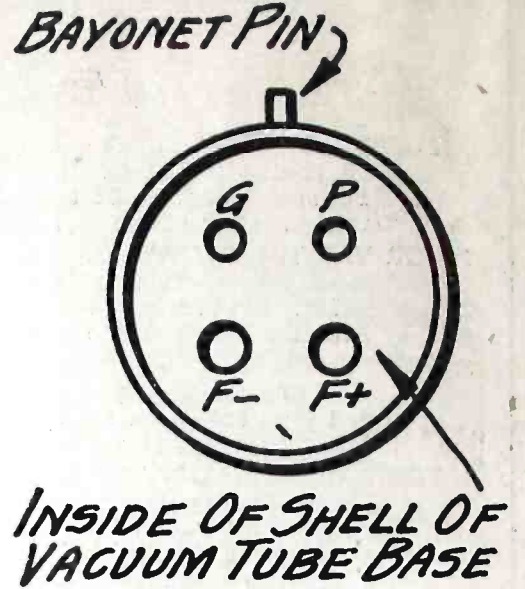

THE CONNECTIONS FOR THE VALVE TESTER PLUG

FIGURE 6: Insert the leads into their respective tongues and solder them into place. The leads may then be held firmly in place by pouring wax into the shell around the wires.

must be taken that the proper ends are soldered to their respective prongs. By referring to the diagram in Figure 6, mistakes in connecting the ends may be prevented.

It will be necessary to install a 45-volt "B" battery in the vacant space in the carrying case. The positive terminal of this battery should be connected to the binding post marked 45 positive (+), and the negative to the post marked 45 negative (-). The outfit is now complete and ready to operate. If the operation chart shown in Figure 4 calls for an "A" battery, it should be connected to the binding posts marked negative (-) and Fil. positive (+). The negative post is common to both "A" and "B" voltages.

The operation of the tester may be greatly simplified by cutting out the tabulated data of operation shown in Figure 4 and pasting it on a card or on the lid of the carrying case. In this table each switch is designated by a number instead of a name, and the various operations are described by switch numbers.

Many other uses for the tester will occur to the ingenious experimenter; these will help to make the completed unit a really helpful and worthwhile addition to the "service" equipment of the radio shop or laboratory.

FOR ANY OLD RECEIVER—

The Thordarson power-pack will give the convenience of "B" and "C" power from the lighting mains, and the pep and vigor that come from the UX-210 valve power stage that it employs. Full constructional details for this unit will appear in the December number of POPULAR RADIO.

HAMPTON-WRIGHT RADIO PARTS AND ACCESSORIES DARMODY BUILDING ✦ ✦ ✦ INDIANAPOLIS

Now!
**TELEVOCAL
TUBES**
for A. C. Sets

Electrify your set with the New Televocal A. C. 226 and A. C. 227 Tubes. Using these tubes, you can operate on A. C. current without "A" Batteries. Thoroughly tested; genuine Televocal quality; guaranteed.

Also use Televocal T. C. 112-A and T. C. 171-A Power Tubes. Now made with oxide-coated filament, current consumption is reduced 1/2—from 1/2 to 1/4 amperes.

Televocal Tubes are made in all standard types



TELEVOCAL CORP'N,
Televocal Building,
Dept. F-2, 588-12th St.
West New York, N. J.

**TELEVOCAL
QUALITY
TUBES**

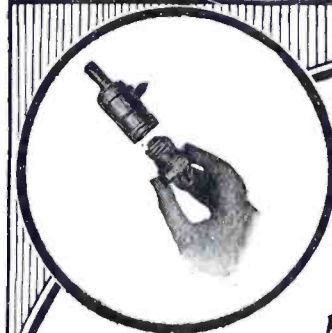

Listed by Underwriters' Laboratories

**Why
Erect
An Aerial?**

**ELECTRAD
Lamp Socket
Antenna**

\$1.00

Makes aerials unnecessary and in some instances gives better results. Consumes no current. Positively SAFE. Practical, simple and neat. Insert in any outlet. Tested at 2500 volts A.C.

At your dealer's or write
Dept. 60A, 175 Varick Street,
New York, N. Y.

ELECTRAD

RACON EXPONENTIAL SOUND CHAMBERS

Known the World Over for Their Superiority



Type OB No. 1315
Air Column 104 inches
Bell 18" x 24"; depth 13"

The RACON Process assures uniformity; strength; maximum quality; minimum weight.

Racon Horns insure quality of performance much more naturally than that obtained by any other mode of amplification because of the true scientific principles of design and the exclusive material employed. Every Racon horn conforms to the latest theory of exponential design.

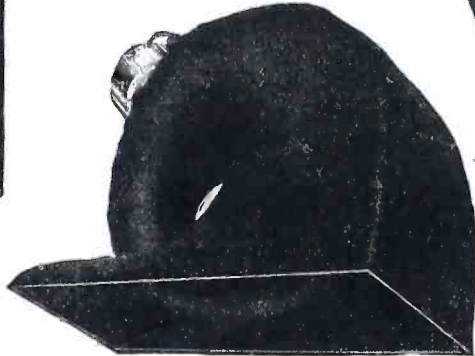

Type OB No. 320
Air Column 78 inches
Bell 10" x 20"; Depth 13½"

For further details address

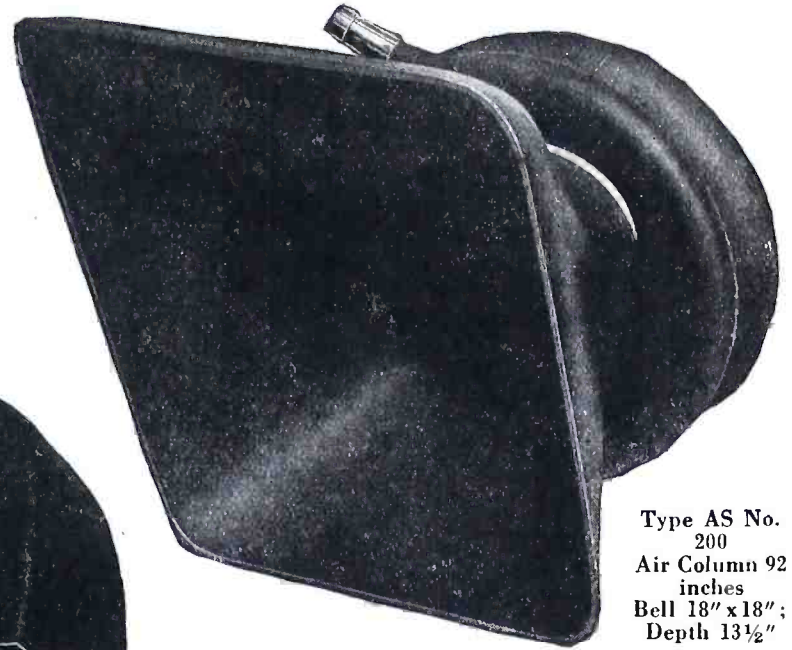

Type AS No. 200
Air Column 92 inches
Bell 18" x 18";
Depth 13½"

RACON Horns are made of impregnated cloth under our own patents No. 1,507,711 and No. 1,501,032.

RACON ELECTRIC COMPANY, Inc.

18-24 Washington Pl.

New York, N. Y.

LOOK!

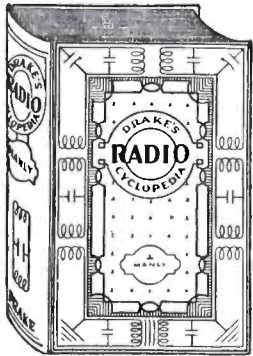

The Last Word in RADIO

Radio is an exact science, yet so new there is still much that is incorrect and unscientific in present equipment. The results are faulty reception and complaints.

To meet this need we have compiled the exact facts covering the entire scope of radio science and every type of receiver into one big, fine, new book. With it you can now *Be The Man Who Knows!*

DRAKE'S RADIO CYCLOPEDIA

Solves the Dealer's Service Problems

If you design, build, repair or service radio receivers you need this book. All subjects alphabetically arranged, with hundreds of cross references so you quickly find what you want. 1672 headings, 985 illustrations, 871 pages. Nothing else like it. It is the book of radio, just out. SEND TODAY. \$6.00 postpaid. Also for sale at all bookstores.

Big catalog of useful books sent free

FREDERICK J. DRAKE & CO.
Publishers

1011 S. Michigan Blvd., Chicago

THE "LYNCH 5" model

was built around SICKLES COILS

You can expect to duplicate the exceptional results only with the same SICKLES COILS

These are the same standard high quality accurately calibrated coils which have had no superior during the past five years. Specially designed for the

"LYNCH 5" DECK
Coil Set No. 28 \$4.50

There are Sickles Diamond-Weave Coils for all leading circuits.

THE F. W. SICKLES CO.
134 UNION STREET
SPRINGFIELD :: MASS.

| No. | Coil Prices |
|-----|----------------------------------|
| 30 | Shielded Transformer \$2.00 each |
| 24 | Browning-Drake 7.50 set |
| 18A | Roberts Circuit 8.00 set |
| 25 | Aristocrat Circuit 8.00 set |
| 28 | Lynch 5 4.50 set |



INSIST

AMPERITE is the only automatic filament control that keeps the temperature or voltage of the tube filament constant despite variations in the "A" battery voltage. It guarantees improved tube performance and increased tube life through always operating tubes at their proper filament temperature. Simplifies wiring, panel design, tube control, tuning. Eliminates hand rheostats. Do not confuse with fixed filament resistors which attempt to imitate AMPERITE but are entirely different in principle and operation. Insist upon *Amperite*. Price \$1.10 mounted (in U.S.A.) For sale by all dealers.

Write for FREE "Amperite Book" of season's best circuits and latest construction data.
Address Dept. PR11

Radiall Company
50 FRANKLIN ST., NEW YORK

AMPERITE
The "SELF-ADJUSTING" Rheostat



NOW DEMANDED BY EXPERTS

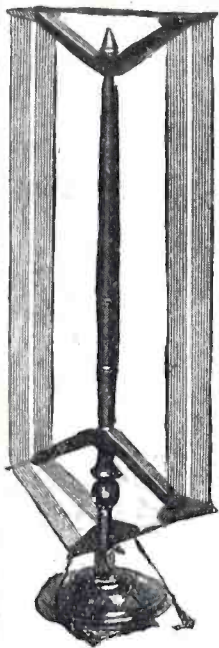

Radio Engineers and Technical Editors accept Quali-Tone Loops as the ultimate in effecting highest efficiency in radio reception.

Unexcelled for Distance - Selectivity - Tone

The electrical characteristics of Quali-Tone Loops meet the demand of present day successful loop antenna receivers—resulting in Quali-Tone Loops being highly endorsed and specified as standard equipment with the better circuits.

Holds Two World RECORDS For DX Reception

Convince yourself of Quali-Tone's superiority by comparing it with any other loop made.

Allow your set to do full justice to itself by using a Quali-Tone Loop.

The De luxe \$12.50
The Quali-tone 10.00

JOBBERs write for discounts. DEALERs Send for circulars

DURO METAL PRODUCTS CO.
2655 N. Kildare Avenue Chicago



Underwood & Underwood

THE "HIGH PRIEST" OF BROADCASTING

Roxy, shown seated in the center, is nationally known both as the builder of the Roxy Theatre, the "Cathedral of the Moving Pictures" and as one of the foremost of the broadcasting impresarios of the land. Behind Roxy is Frank A. D. Andrea.

BROADCAST LISTENER

Comments on radio programs, methods and technique —from the point of view of the average fan

By RAYMOND FRANCIS YATES

What Competitive Programs Are Doing to Radio

If there is one thing that has given to broadcasting a healthy blush during the past twelve months, it is competition between commercial enterprises bidding for air popularity.

Previous to the exploitation of radio, the art lacked that competitive feature which is so necessary as a stimulant to perfection. Sadie Jones, who used to soprano to heaven that her family and friends might listen at home, had no objective in denying other studios of their customers; and the parlor baritone, motivated by the laudable ambition of nailing a small-time vaudeville job, was far from being the kind of timber needed to help broadcasting rise above the levels of very ordinary entertainment. True, studio managers were dimly conscious of a competition with other broadcasters, but their ideas of supremacy involved nothing more inspiring than the slipshod presentation of talent which was no better than the average performance at church bazaars and Elks' Carnivals.

But commercial broadcasting has changed the complexion of the entire art.

Those who pay fancy prices for their time on the air, aim, it is evident, to make every moment worth the "B" battery current, and ham talent is again finding it necessary to take up fiddling,

yodelling, baritoning, piano practice and oratory within the privacy of its own chambers.

As an instance of the value of competitive broadcasting, we point to the programs of the Roxy and Capitol Theaters in New York. Here two factors, somewhat at loggerheads, are struggling for air supremacy as a pure matter of business. Barrels of glittering mazuma are being poured into chain hook-ups with ace-high talent, and broadcasting, as a whole, has benefited greatly from the struggle.

The opening of Roxy's "Cathedral of the Motion Picture" and the broadcasting of its 110-piece symphony was immediately answered at the Capitol by the addition of fourteen pieces to its already large symphony. The hotels of the country, aiming to attract diners by their music, are engaged in constant competition—a competition that, incidentally, is of more benefit to the radio fans than it is to the dining-room receipts.

There is nothing altruistic in the efforts of the commercial broadcasters in their attempt to engage the attention of the radio audience. They are interested in results rather than in philanthropy, and on a purely competitive basis they are making every effort to entertain as many listeners as possible.

It has been this increasing competition that has prevented broadcasting from

Aerovox Condensers are exclusively specified for the **Magnaformer** 9-8 Circuit



Eternal Life

We cannot guarantee eternal life, but we do guarantee the AEROVOX FILTER CONDENSER when properly used to outlast all the other equipment used in conjunction with it.

WHY???

Because—

each section of a block is individually sealed and impregnated against moisture absorption.

the safety factor used in manufacture, testing and rating will permit indefinite continuous operation at the rated working voltage without injury.

For all eliminators

AEROVOX
"Built Better"
70 Washington St., Brooklyn, N. Y.

HELLO JAPAN!

Magnaformer 9-8 Spans the Seas!



"It was not long before we located three very interesting carrier waves . . . 352, 375 and 395 meters, and from experience we knew they were long distance announcements were distinguishable, namely, Sydney, Tokio and Melbourne. . . . When 4 a. m. rolled around JOAK was way above the fading static level, and from 4 to 5 he steadily came through with volume to fill the house. In fact, it is probable that Mrs. Tischer has since heard some caustic remarks from her neighbors, as the singing of a loud-voiced Japanese soprano in songs which seemed to be dozens of verses in length is hardly compatible with restful slumber.
—K. G. Ormiston in "Radio Doings," Sept. 17, 1927

THE world's most powerful receiver has been developed in the Magnaformer 9-8. Imagine the thrill of receiving Tokio, Japan, Sydney and Melbourne, Australia, of spanning 6000 to 9000 miles of space! Such loud-speaker performance is truly exceptional. Only the most highly perfected receiver could accomplish it.

Add to this thrill of extremely long distance loud-speaker reception, the keen enjoyment you experience from listening to the Magnaformer's sonorous, true-to-life tone, and you have an entertainment combination that cannot be equalled.

See editorial article in this issue

ADVANCED ELECTRICAL DESIGN HERALDED BY EXPERTS

By its supreme performance in the five vital essentials—tone quality, distance, selectivity, ease of handling and volume—it has well earned and truly deserves its title—"Magnaformer—the Great Creator—Commander-in-Chief of the Air," the finest radio receiver ever designed.

When such radio experts as G. M. Best of "Radio,"

L. M. Cockaday of "Popular Radio," K. G. Ormiston of "Radio Doings," the technical editors of the *Citizens Radio Call Book* and other magazines, come out month after month with enthusiastic articles in praise of the exceptional performance of the Magnaformer 9-8, you can bank on it that this receiver is remarkable and unusual.

ABSOLUTE ELECTRICAL MECHANICAL PRECISION OF MAGNAFORMERS

The secret of the tremendous power and extraordinary performance of the Magnaformer 9-8 receiver lies in the Magnaformer Long Wave R. F. Transformers. These intermediates are strictly a laboratory product, each one being peaked in the laboratory to a wave length of EXACTLY 69.73 kilocycles (4300 meters), and permanently sealed. The full and complete wave-band, with 100% of its vital, quality-producing, harmonic-carrying side-bands, is positively and easily passed through all of the Radio Frequency amplifying stages, leaving no possibility for distortion. This accounts for the exclusive degree of True Tone Quality in the Magnaformer 9-8 and its wonderful non-critical selectivity.

Everybody Who Hears It Wants One

The Magnaformer 9-8 is THE receiver everyone would insist upon having if they only knew how remarkably it performs. It is easy to build. It will give you the greatest satisfaction you have ever experienced from any radio receiver. Everyone who tunes or hears a Magnaformer 9-8 wants one immediately. Its praises are being sung by set builders everywhere. Read the construction articles in *Radio*, *Popular Radio*, *Radio Doings* and *Call Book*; or build it from the full-size official construction sheet 26" x 34", printed both sides and full of illustrations.



Easy Tuning—Powerful Reception

Stations are easily tuned in or out at will without having to be located by a micrometer adjustment of the dials. The amplification per stage is nearly double. Changes from 9 to 8 or 8 to 9 tubes instantly by means of panel switch. The use of 9 tubes is necessary only on very distant stations.

Send Now for Free Illustrated Literature

Send at once for FREE illustrated story of the Magnaformer 9-8. We will also send you testimonials such as have never before been written about any receiver. We will include the full story of K. G. Ormiston's unique experience with the Magnaformer 9-8; W. D. Scott's challenge and defeat. All this will be mailed to you the same day we receive the coupon. Don't build another set till you hear from us. Send right NOW while you have it in mind.

Radiart Laboratories Co. 19 S. La Salle St., Dept. 48
CHICAGO, U. S. A.

COUPON

RADIART LABORATORIES
19 S. La Salle St., Dept. 48, Chicago

Dear Sirs: I am interested in the exceptional performance of the Magnaformer 9-8 Receiver, so please send me the Magnaformer Story, details of Ormiston's unique experience, and Scott's challenge and defeat.

Your Name.....

Address.....

City..... State.....

REMLER DRUM DIAL

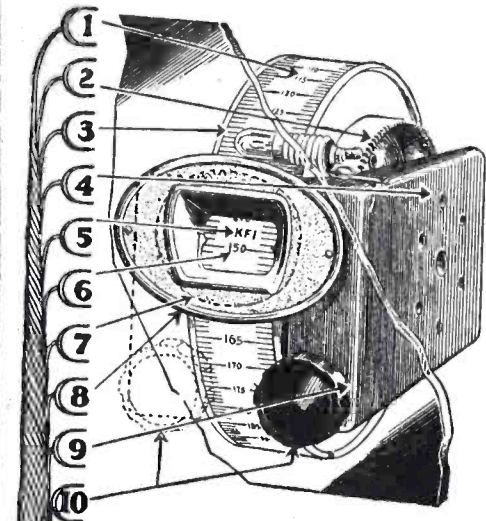

- 1 Readily changeable, white cardboard indicator strips. Supplied for clockwise or counter clockwise reading.
- 2 No back lash. Fine-tooth gear driven by spiral-cut pinion.
- 3 Station Settings spread over 15 inches of space.
- 4 Heavy brass bracket supports condenser; rigid construction.
- 5 Space provided for call letters.
- 6 Large, easily read figures.
- 7 Round hole for escutcheon plate; no special tools necessary.
- 8 Attractive bronze escutcheon plate.
- 9 Vernier control; Special shaft cannot bind in bushing.
- 10 Right or left hand control.

REMLER TWIN-ROTOR CONDENSER

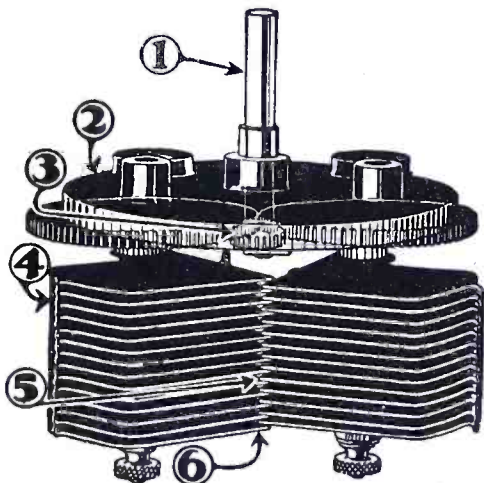

- 1 360° rotation of shaft and reduction drive give vernier control.
- 2 Proper placing of insulating material minimizes resistance to radio frequency currents.
- 3 Complete insulation of plates from dial and dial shaft and provision for grounding dial and shaft give absolute freedom from body capacity effects.
- 4 Plates carefully aligned by hand and soldered rigidly in position at three points.
- 5 Balanced Twin-Rotor construction gives utmost smoothness of operation.
- 6 Shape of plates permits attainment of very low minimum capacity and wide tuning range.

Write for free folder describing Remler parts
REMLER Division of
Gray & Danielson Manufacturing Co.
 260 First St., SAN FRANCISCO
 CHICAGO NEW YORK
 Eastern Warehouse, Elkhart, Indiana

going to the bow-wows. Fortunately, the warfare for air supremacy between the various high-class studios has but started and there is every reason to believe that it will become increasingly fierce. "Circulation" on the air is put as important as circulation in a publication, and as long as soap, silk, and hot-water heater manufacturers want to dole out the mazzuma, we know of one little radio listener who won't wait up to scare Santa Claus.

* *

The Joy of a Program Without an Announcer

SINCE 1923 we have—perhaps foolishly—persisted in the theory that the less heard from talky announcers the better.

Announcers have a habit of projecting themselves into the programs in a wholly unnecessary and, at times, annoying way. Quite forgetting that they are, after all, called upon to perform a function that is ordinarily performed by an inarticulate scrap of paper, they seem to be motivated by the notion that the event to follow is being presented merely as an excuse for the announcement and that they are, in the final analysis, the salt that leavens the whole broadcasting loaf.

It came somewhat as a pleasant shock to find that the Brunswick-Balke-Collender Company shared this theory with us, and that it was stubborn enough to try it out on WJZ, where announcers, although hand fed with the dainty, inane morsels prepared by special writers, are permitted to assume the acoustical proportions of a circus barker. For a solid hour of broadcasting the coterie of announcers, ordinarily very much in evidence, were absent. The wonder of it was that the program continued, smoothly and serenely, unpunctured with the verbal excursions of the studio *literati*. This particular program was deliciously unique, and besides giving Mr. Cross and his cohorts an opportunity for a cup of coffee at Childs, it proved beyond even a tiny whiff of doubt that too much windy announcing is very bad.

* *

Real Story Telling "On the Air"

We have always felt that some day somebody would find a way of telling stories on the air. *Collier's Weekly* was doing that very thing and doing it well on the Blue Chain every Sunday night. Between the reading of the story, the appearance of the characters who act portions of it, and the judicious use of music, *Collier's* originated, to our way of thinking, a sound device for the entertainment of the radio audience that has never been matched and probably never will be.

FROST-RADIO

EXCLUSIVELY SPECIFIED FOR THE

Magnaformer

9-8

The powerful Magnaformer, one of the season's most popular circuits, specifies Frost-Radio De Luxe Parts exclusively. Demand these quality parts from your dealer by name, ordering from the list below, so that you can build this great receiver right away.

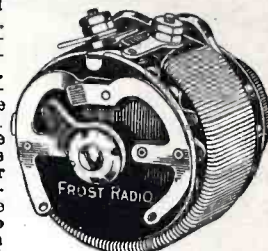

FROST-RADIO

FROST-RADIO PARTS FOR THE MAGNAFORMER

- 1 No. S-1810 De Luxe 10-ohm Bakelite Combination Rheostat and Battery Switch, gold arrow knob.
- 1 No. 1824 De Luxe 400-ohm Bakelite Potentiometer, gold arrow knob.
- 1 No. 1810 De Luxe 10-ohm Bakelite Rheostat, gold arrow knob.
- 1 No. 1830 De Luxe 30-ohm Bakelite Rheostat, gold arrow knob.
- 4 No. 253 Frost Cord Tip Jacks.

HERBERT H. FROST, Inc.
 Main Offices and Factory
 ELKHART, IND.

Chicago
 New York
 Boston
 Philadelphia
 Los Angeles

Washington, D. C.
 Pittsburgh
 New Orleans
 St. Paul
 Buenos Aires

The POPULAR RADIO Atlas and Log

will give you a list of all the NEW Broadcasting Stations with wavelengths and other necessary information

A Complete Atlas and Station Log

The "POPULAR RADIO International Radio Atlas and Log" will supply you with full information regarding broadcasting stations of the United States and Canada.

This most useful and practical Atlas consists of 16 pages, size 12" x 15", printed on good paper, from clear type in two colors and contains a complete series of double page maps, including—The World—The United States—Canada—North and South America, showing location of principal broadcasting, leading commercial and governmental radio stations.

SPECIAL FREE OFFER

You may have a copy of the "POPULAR RADIO International Radio Atlas and Log" free, with POPULAR RADIO for (8) eight months

For Only \$2.00

Pin \$2.00 in bills to the coupon below. If you are a subscriber to POPULAR RADIO your subscription will be extended eight months.

Date.....

POPULAR RADIO, Dept. 42A,
 119 West 57th St., New York City.

Enclosed is my remittance of \$2.00 for which you are to enter my subscription (extend my subscription) for (8) eight months for POPULAR RADIO and send FREE a copy of the "POPULAR RADIO International Radio Atlas and Log."

Name.....

Address.....

City.....State.....

FERRANTI

FERRANTI A. F. 4 TRANSFORMERS

*exclusively specified
for the Magnaformer
9-8 Circuit*



TRUE Musical Reception

... whether you build or buy your set!

That is your ideal, your goal in radio—true musical reception! Ferranti audio frequency transformers will give it to you, for they amplify every note faithfully, giving it the exact *tone* of the original. Even the elusive deep bass and quavering treble notes are caught and rendered exactly as they are—a transformer can do no more. Plenty of volume, too, and yet the amplified sound is always rich, mellow.

Whether you build your set from component parts or buy your set complete, make sure that Ferranti transformers are included in it. The part that they play in quality reception is so large, so important, that it is wise to use them if you want results.

Audio Frequency Transformer TYPE AF-3 \$12.00

A new and better standard for 1928 in audio frequency amplification. Confidently recommended to all who wish the best in rich tone quality over the entire broadcast range.

Ratio $3\frac{1}{2}$ to 1 Dimensions $2\frac{1}{4}$ " x 3" x $3\frac{3}{4}$ "
Weight . . . 1 lb 14 oz.

Audio Frequency Transformer TYPE AF-4 \$8.50

A Transformer giving exceptionally uniform amplification at a moderate price. All types tested to 1000 volts between windings and between windings and ground.

Ratio $3\frac{1}{2}$ to 1 Dimensions $2\frac{1}{4}$ " x 3" x $3\frac{1}{4}$ "
Weight . . . 1 lb. 8 oz.

Output Transformer TYPE OP-1, \$10.00

The finishing touch of the modern radio set. Will purify and improve the tone of your speaker. Prevents possible accidents from shock and burnouts by eliminating D. C. and high plate voltage at speaker.

Ratio 1 to 1 Dimensions $2\frac{3}{4}$ " x 3" x $3\frac{3}{4}$ "
Weight . . . 2 lbs. 10 oz.

FERRANTI Ltd.
Hollinwood, England

FERRANTI Incorporated
130 West 42nd Street, New York, N. Y.

FERRANTI ELECTRIC Ltd.
Toronto, Ontario, Canada

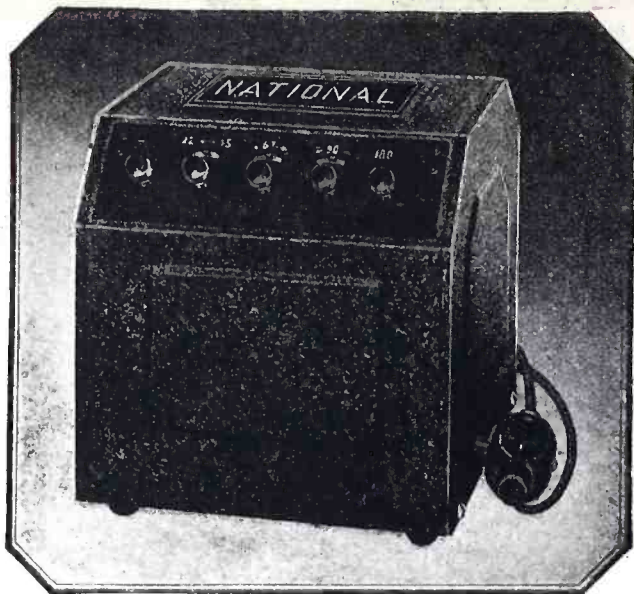

**AN ENTIRELY NEW AND UNIQUE
HEAVY-DUTY BETTER-B**

SUPPLIES

Detector voltages, 22 to 45, adjustable;
R. F. voltages from 50 to 75;
A. F. voltages from 90 to 135;
Power tube voltage 180 fixed.

AN EXCLUSIVE FEATURE

Tubes and by-pass condensers are protected against excessive and harmful voltages.

Designed for lasting service with liberal factors of safety.

**A STRICTLY HEAVY-DUTY
POWER UNIT**

Output rating is 70 mills at 180 volts. Uses R. C. A. UX-280 or Cunningham CX-380 Rectron.

Licensed under patents of Radio Corporation of America and Associated Companies.

For 110-120 Volts, 50-60 cycles A. C. List price with cord, switch and plug, \$40. Rectifier tube, \$5. Write National Co., Inc., W. A. Ready, Pres., Malden, Mass., for new Bulletin, L-124.

NATIONAL-B

Type 7180

A "B" That's Built for Service

**Musical Appreciation and
the Radio**

SINCE the inception of radio we have heard it said again and again by the heavy thinkers of the country that such widespread distribution of the musical classics over the air will eventually make of America a nation of music lovers hungry for the delicate morsels of the masters. To our way of thinking, it will do nothing of the kind. Appreciation of the classics does not, as many of our musical educators believe, come through mere exposure to them. As a matter of fact, too much exposure to them creates boredom even with those sensitive enough to catch the elusive meanings of the great composers and esthetic enough to enjoy fully the charm of music well written and played.

It is not always the intellectual person that best appreciates the work of the grandpas of music. There is the occasional moron, who, while his texture may not be so fine as that of the blue-bloods, gets just as much solid enjoyment out of "Coq d'Or" or the "Second Rhapsody" as a college professor with black ribbon on his specks, or a patron of the arts at a Mozart tea. The real appreciation of music comes from a source more fundamental than education; an individual either likes the classics or he does not, and the cultivated taste for them is apt to be both superficial and artificial. Beethoven's "Moonlight Sonata" might reach the soul of an Amazon head-hunter more easily than the intellectual who applauds with lifted hands at the best recitals. After all, the real test of music is in the effect it produces in its listeners and not in the mere appreciation of the technique or execution. And is it not true that a knowledge of technique often destroys the esthetic effect? Getting too close to a thing often robs one of the illusion necessary for fullest enjoyment.

While the gracious ministrations of the engineers of music, in their task of exposing over the radio the technique of Bach or the melancholia and morbidity of the Russian masters as expressed in their compositions, may appeal strongly to certain people, we are of the opinion that musical education on the air is being carried to a point where it has become something of a bore. It was to be expected that Walter Damrosch's splendid series of student excursions into the ante-chambers of the art would start an epidemic of musical education and that a considerable number of our musical apprentices would be suddenly seized with the impulse to put America wise to the ABC's of their trade.

One cannot tune the set in any more without hearing one of the musical papas chiseling away at the works of one of the masters, performing what is to them and to all of the fat lady presi-

REMOTE CONTROL

Mechanical Model \$18.00
Electrical Model \$60.00

(Add 10% west of Rocky Mountains)

Write for illustrated descriptive circular



Imagine the pleasure of tuning your radio without having to get up once all evening! Turn set "on" or "off," tune, regulate volume—from your easy chair! Easily attached to any single, removable dial receiver in a few minutes.

ALGONQUIN ELECTRIC CO., INC.
245 Fifth Avenue, New York City

Algonquin

TRADE MARK REG. U. S. PAT. OFF.
REMOTE CONTROL RADIO TUNING UNIT

**Set Builders!
Dealers!**

FREE

—big catalogue

Standard parts and equipment at money-saving prices, with discounts that show you a real profit. Electrical Phonograph—pick-ups—latest kits! New A C tubes and transformers—parts for any circuit—power audio equipment—short-wave supplies—they are all in our big new 1928 Catalogue. Write for it today, with discount sheet. 12-hour shipment guaranteed.

Van-Ashe Radio Co.

204 North 10th ST. ST. LOUIS, MO.

BUILD A SHIP MODEL LOUD SPEAKER

\$12.50

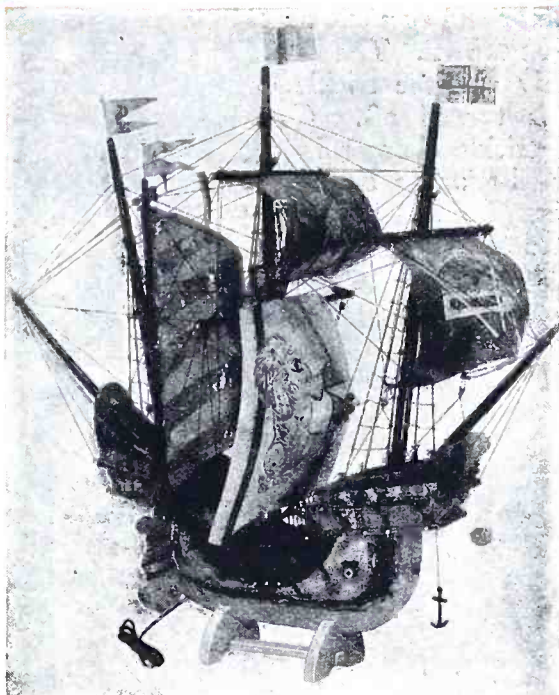

\$12.50

A combination of a beautiful ship model and a loud speaker that is easily worth \$100. You can build it yourself in a few spare hours with no other tool than a small tack hammer.

Size: 26 inches high; 12 inches wide; 27 inches long (overall). The La Pinta, a reproduction of one of the famous Fifteenth Century ships.

The famous Melody Ship which has met with instant approval everywhere it has been shown and played, can now be purchased in knock down form at the startlingly low price of \$12.50. This remarkable speaker combines

PERFECT TONE -- PLENTY OF VOLUME -- NO DISTORTION

No doubt you have often admired ship models and yearned to possess one but could not do so because the price was too high. Now it is possible to own a beautiful ship model and loudspeaker combined at a small cost. Let the **WORLD'S LARGEST BUILDERS OF SHIP MODELS AND SHIP MODEL LOUD SPEAKERS** supply you with all the necessary parts, cut to fit and ready to assemble from which you can build a beautiful model of the historic Mayflower, the Santa Maria or the La Pinta in a few hours. To all outward appearances the completed model is a beautiful ship model, but upon closer observation a loud speaker can be seen cleverly incorporated into the mainsail.

The loud speaker unit is of the Electro Magnet type. Power amplification is not needed to force the low tones through. They come through with perfect ease and do not interfere with the high notes, giving faithful reproduction at all frequencies. The mainmast, upon which the unit is securely fastened, is seated two inches deep in a three and a half pound solid wood hull, making it impossible for counter vibrations to affect the perfect reproduction of the Melody Sail. The driving pin is attached to our super-vibrating, especially prepared Melody Sail. The installation of the Melody Sail does not change the appearance of the model in any way. Melody ships come in three beautiful models, the Mayflower, the Santa Maria and the La Pinta, with parts cut to fit and ready to assemble. No tool needed but a small hammer.

You need not know anything about ship building or carpenter work in order to build one of these ships. No special knowledge of ship model building is necessary, either. We will supply all the parts from the hull down to the smallest piece of rigging, all cut to fit and ready to assemble. You cannot go wrong. Diagrams and plans

MINIATURE SHIP MODELS, Inc.

3818-20-22-24 Baring St., Philadelphia, Pa.

Canadian Branch: 1485 Bleury St., Montreal, Canada

Canadian Prices Slightly Higher. Send all Canadian Orders to Canadian Office.

of parts that are included with each kit tell exactly what to do with each part.

These plans show you step by step just how the model is constructed. Everything is made so simple that even a small child can build a beautiful model.

All you need is a small hammer to tap the parts into place. Here is a part of the instructions copied word for word from the diagram and instruction sheet that goes with the kits. "Take part No. 57, place it in front end of part No. 56 and tap lightly with a hammer. Next take part No. 58 and place it up against No. 57 and tap it with a hammer to bring it into place."

Easy! Nothing simpler. The instructions are like that from beginning to end. Do this and that and before you realize it a beautiful ship model has grown before your eyes.

Write for our free beautifully illustrated catalog, which contains photographs of all our models, together with complete details and price of each. We will send this catalog without obligation to you. Fill in the coupon below and we will act upon it immediately.

If, after assembling the model according to our instructions, you do not think it worth many times the purchase price, return it to us in good condition and we will gladly refund your money.

MINIATURE SHIP MODELS, INC., DEPT. W2
3818-20-22-24 Baring St., Phila., Pa.

Please send me complete parts, cut to fit and ready to assemble for the Melody Ship for which I agree to pay postman \$12.50, plus postage.

PLEASE PRINT NAME AND ADDRESS PLAINLY

Name.....

Street or R. F. D.....

City.....

State.....

YAXLEY For Radio Fans with Exacting Demands

Automatic Power Control

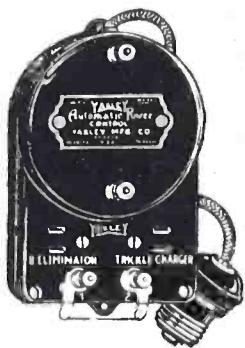

You can get greater pleasure through your radio set with this great convenience. It eliminates fussing with your radio when you turn it on or shut it off. The Automatic Power Control switches on the B eliminator and cuts out the trickle charger when you turn on the set. The B eliminator is cut out automatically and the trickle charger cut in when the set is turned off. Controls both B eliminator and trickle charger in combination or switches either eliminator or charger separately when either is installed alone. Makes your receiver a power operated set.

No. 444—Series Type. With the exclusively Yaxley feature that keeps the voltage drop less than two-tenths (2-10) volts when used with sets having a current draw equivalent to four 199 type tubes up to eleven 201 type tubes. \$5.00

Air-Cooled Switching Rheostat

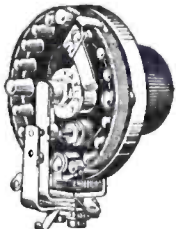

An ideal combination for modern radio receivers. Controls the switching of the set and at the same time permits building up of filament voltage slowly and holding it at exactly the right point for perfect reception. Furnished complete with Bakelite knob. 2 to 100 ohms. each, \$1.75

At your dealer's. If he cannot supply you, send his name with your order to

Yaxley Mfg. Co.
Dept. P, 9 So. Clinton St.
Chicago, Ill.

dents of Mozart societies throughout the country a perfectly laudable effort to penetrate the dark recesses of the boob American mind with the soft, mellow light of musical appreciation—a light that heretofore has found its way into the skulls of only the few. We have, though it at times caused us great pain, listened to many of these “educational” lectures on musical appreciation, and we must confess that this high-sounding talk has, for the most part, been practically valueless to us. As a matter of fact, we do not want to understand music too thoroughly from the technical point of view, and we resent the attempts of the connoisseurs to correct our delinquency. An understanding of music too often brings only disillusionment. A bootblack in the gallery is lifted almost out of his red flannel underwear by the “Miserere,” while the stiff-shirted critic sits in the orchestra listening for musical loose-screws and off-color technique. In the one case the appeal is to the emotions, in the other to the fugitive notion of technical perfection.

We ask of music only the power to inspire us and, incidentally, we ask of those who understand it only to keep right on with the work of interpretation, et cetera, and to realize that not everybody in America is even mildly desirous of sharing their knowledge. After all, there is little definite or tangible substance to music, aside from the concrete science associated with its purely physical side. When you leave beats, wavelengths, harmonics and the rest of sound phenomena out of it, you must, perforce, launch yourself into the more esthetic realm where one man's version is just as accurate as another's. Mendelssohn, you know, could have called his “Spring Song” “The Sleigh Ride” and it would have fitted the music just as well.

Perhaps we have said too much about this subject. If we have created the impression that all musical exposition is taboo with us, we wish to correct it. We enjoyed every one of Damrosch's lectures because they were not so technical that they robbed their listeners of emotional response to the subjects of his discourses. Then, too, his reflections on the Wagnerian operas were of such a nature that one could absorb them without fear of being disillusioned by their execution. We never fail to appreciate the sympathetic sketches of Milton Cross. What we object to is the persistent effort to make of radio one vast institution for musical discussion and analyzing. We want to enjoy music, we do not want to eat it. And we want to enjoy it in our own way, with pleasure and relaxation, and without the interference of a flock of long hairs who would have us listen with furrowed brows and eardrums straining for the slightest imperfection.

*The Coil's
the thing
that
makes
Radio*



NO RADIO UNIT IS ANY BETTER THAN ITS COIL

The performance of Battery Eliminators, Audio Transformers, Loud Speakers, and all other Radio Units is in exact ratio to the efficiency of their windings. It's the Coil that does the work!

Nearly all leaders in radio and radio parts use Dudlo Coils because they know their superiority.

DUDLO
Dudlo Manufacturing Corporation
FORT WAYNE, INDIANA

It has become
standard practice
to use

PARVOLT CONDENSERS

in circuits that break down ordinary by-pass condensers.

You will find that the same characteristics of accuracy, high direct-current resistance, and the ability to give continuous duty, at full rated voltage, make them desirable in circuits where even a poor condenser might “get by.”



The Acme Wire Co.
New Haven, Connecticut
6131-6

NEW!

the Official

BROWNING-DRAKE

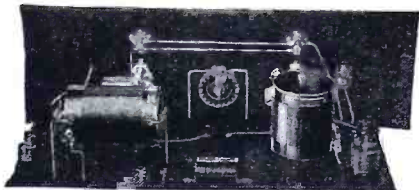

Two Tube Kit Set

This new assembly, the two tube Official Browning-Drake, has been designed to be used with any good audio transformer system now on the market, such as Amertran, Thordarson, etc. The combination gives a remarkable tone quality and great volume. This two tube assembly uses only the detector and R. F. tubes. Special type T foundation unit makes construction easy. The official Browning-Drake kit is used. Other Browning - Drake Corporation products incorporated in the assembly are the cartridge resistance and the neutralizer.

COMPARE!

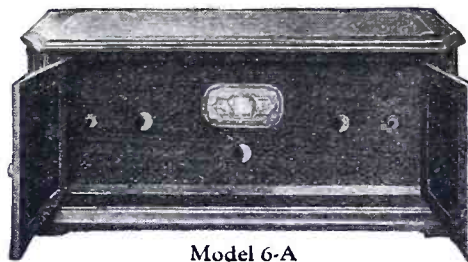

Model 6-A

COMPARE Browning-Drake tone quality with that of any other popular receiver now on the market. Your own ears will at once appreciate the superiority of Browning-Drake reproduction.

Model 6-A has six tubes. Single dial illuminated drum control simplifies tuning. Conventional Browning-Drake circuit is used incorporating famous Browning-Drake slot-wound R. F. transformer in latest and improved form.

Important parts are completely shielded. Cabinet is beautiful two-tone Duco walnut. Length, 27 inches; depth, 15 inches; height, 11 inches. Price without tubes and batteries, \$105.

BROWNING-DRAKE CORPORATION
CAMBRIDGE MASS.

DEALERS: Write or wire TODAY for further information on the Browning-Drake line of factory-built receivers and the Browning-Drake line of parts.

BROWNING DRAKE

TRADE MARK

Cabinets Receivers
Parts Kits

RADIO CATALOG free

2000 Exceptional Radio Values

1928 WHOLESALE CATALOG

RADIO of Sets, Kits and Everything in Radio

LOWEST PRICES to DEALERS

Every Set Builder Needs This Book

Every live dealer in radio sets, parts, accessories, supplies, etc., should have a copy of this bargain catalog. You will be amazed at the thousands of money-saving radio items illustrated and listed in this storehouse of everything you could possibly need in radio.

The GUIDE BOOK to Bigger RADIO PROFITS FOR YOU

The book contains all the latest and most popular kits—all the famous, nationally known radio parts, accessories and supplies—the very newest types and designs of table cabinets and consoles—everything at prices that mean bigger profits for you.

Short Wave Section Our catalog contains a section devoted to a showing of the highest grade short wave receiving and transmitting apparatus. Also the finest electrical appliances for use in the home.

Dealers Make More Money Tie up with a house that carries large, complete stocks, that gives you the highest quality radio parts, that insures speedy shipments and 100% satisfactory service.

Our wholesale vest pocket price list and discount sheet and catalog will be sent to you on request.

Make This a Big Radio Season!

BUT WRITE QUICKLY

SHURE RADIO COMPANY
339 U West Madison Street Chicago, Illinois

Radio's Finest 3-ft. Cone Speaker

No. 3 Kit complete
\$13.50
for 3-Foot DOUBLE Cone Speaker



G-R-P
3 FOOT CONE SPEAKER
Build It Yourself

IN one short hour or less you can assemble the finest speaker you ever heard. G. R. P. Simplified Assembly makes experts of novices; and the finest unit and other parts that can be designed and built assure you a speaker of unequalled tone quality. Reproduces all frequencies within range of human audibility—the low notes as well as the high. Operates perfectly at all voltages; will not lock or rattle.

No. 4 Kit complete
\$10.50
for 3-Foot Single Cone Speaker Wall Type

G. R. P. Unit is only Double Adjustable 4-pole, balanced armature unit. Same unit furnished with both kits.

Ask Your Dealer

for genuine G. R. P. Kit—either No. 3 or No. 4. Refuse substitutes; if your dealer will not get them for you, we will supply you direct f.o.b. N. Y. C., on receipt of price.

Write for "How to Build 7 Practical 3-Foot Speakers," by C. Denton; price 50c.; for a limited time sent for 10c.; coin or stamps. Write for your copy today.

Penn Radio Sales Co. Selling Agents
104-5th Avenue Suite 2757 New York City

MAGNAPHON

ELECTRICAL RECORD REPRODUCER



Price \$12.50

Will make the old type phonograph or any of the small portables perform like the new Electrical Reproducing Machines costing from \$350 to \$1,000.

The richness and tone range of the reproduction obtained by means of the MAGNAPHON will prove really amazing.

The deep bass notes, the drum beats, the very high notes, will all issue forth with a life-like mellowness and brilliance.

TWO PATENTED FEATURES

1. A peep-hole in the back of the instrument, making the position of the armature visible.
2. Adjustment screws with which the armature can be recentered if necessary.

EASILY INSTALLED

No adjustments—No removal of old sound box or fishing for correct angle is necessary. Just place the MAGNAPHON alongside the tone arm and insert the plug into the detector socket.

FROM YOUR DEALER OR US

If your dealer cannot supply you and will not get it for you, we will ship you direct on receipt of money order for \$12.50.

Tectron Radio Corporation
1270 Broadway New York

FOR RADIO DEALERS ONLY

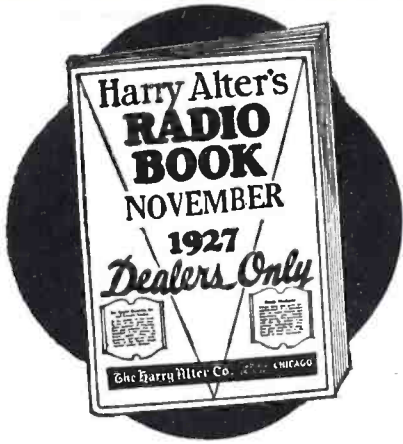

ROCK BOTTOM PRICES ON EVERYTHING IN RADIO

Only the newest and latest (1927-1928) radio goods; no obsolete products; no "seconds" or sub-standards. All goods of tested and proved quality and established reputation — absolutely guaranteed.

Get this Wonderful NEW PRICE GUIDE

Compare its money-saving values. Test our "Minute-Man" shipping service with a trial Rush order. Write now for your copy of Harry Alter's new "Radio Book."

The Harry Alter Co.
1749 Michigan Ave. CHICAGO

MAIL THIS COUPON

The Harry Alter Co.
1749 Michigan Ave., Chicago
Send at once a copy of your November price guide.

Name

Address

City State

The Hammarlund Hi-Q "Six"

(Continued from page 317)

shields in the grooves in the corner posts and in the partition posts.

The last job is to attach the two rocker arms to the cam operating assemblies, R7 and R8, so that they engage properly with the two cams on the drum dial, F.

This completes the construction and wiring work, and the receiver is ready for operation.

How to Install and Operate the Receiver

Place the receiver in the cabinet chosen for it and connect the Yaxley cable, Q, to the "A," "B" and "C" batteries as shown in Figure 4. Then connect the cable to the plug, Q, first being sure that the battery switch, K, is turned in the "off" position, and the rheostat, J, is rotated all the way in a counter-clockwise direction.

The antenna and the reproducer should now be connected to their proper binding posts.

Insert five UX-201-a type valves in sockets N1, N2, N3, N4 and N5, and insert a UX-112 type vacuum valve in socket N6. Next fasten the tops of the shields.

All tuning is accomplished by means of the double drum dial. Turn "on" the battery switch, K, and advance the rheostat, J, all the way. Then rotate the two knurled discs simultaneously at approximately equal settings until a station is tuned in, when the volume may be readjusted with the rheostat to a suitable value. A more careful setting of each of the drums may then be made.

During a series of tests in the heart of New York City all local stations were easily tuned in with realistic tone quality and without interference or background noises. In one evening, between the hours of 9:00 and 11:00 P. M., twenty-four stations were received through the locals. In broad daylight, signals from Schenectady and Philadelphia were tuned in on the loudspeaker at will.

The set will not squeal or howl and will not radiate or interfere with neighbors' reception. It may be mounted in a beautiful cabinet that will fit in with the best furniture in the home.

Once installed, the set will need no future tinkering or adjustment.

For experimenters who require additional details of theory, construction, and operation, as well as a full-size picture diagram, a 48-page manual may be secured from the manufacturers.

The set is recommended to the discriminating radio fan for all-round operation, and once installed should give full satisfaction indefinitely.

90 Volt Power Unit :: \$12.75

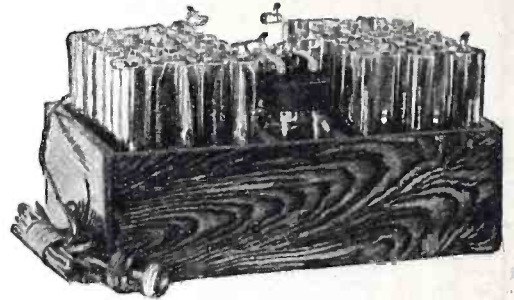

Hums, line noises, etc., positively impossible with this new advanced unit. Plug in and forget. Non-acid and noiseless. All detector and intermediate voltages plainly marked. Simpler to hook up than dry cells. Operates any type set 1 to 12 tubes. Greater volume and clearness guaranteed. If not thoroughly satisfied, return after using 30 days for complete refund. Guaranteed further 2 years. For 110-120 volts AC 25 to 60-cycle current. 90 volts, \$12.75; 112½, \$15.25; 135, \$17.50; 157½, \$19.50; 180, \$24.00; 202½, \$26.00.

Also built for DC current, 110 and 32 volts, at only \$3.00 additional, any size above. Ample stocks—same day shipments. Simply say—ship C.O.D. or write for my interesting literature, testimonials, etc.

B. HAWLEY SMITH

340 Washington Ave., Danbury, Conn., U. S. A.

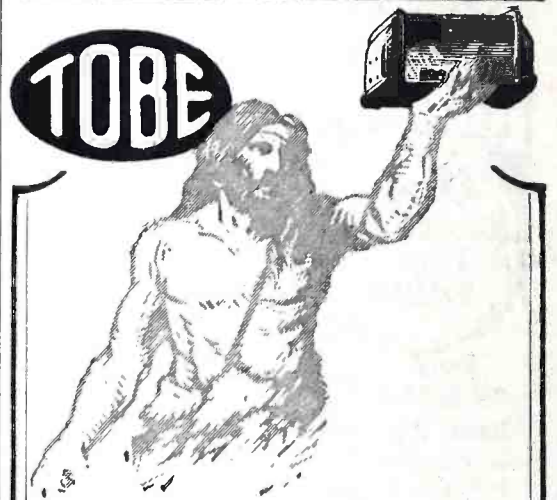

SAMSON

Chooses TOBE CONDENSERS
for the Samson Power Amplifiers

The unflinching, true and powerful quality of this fine Radio instrument matches the unflinching strength of TOBE Condensers and we have not been able to find any kind of a Delilah that will break down TOBE strength.

Just the same, when the orchestra plays Samson and Delilah, the haunting reality of it will ring truly and clearly on the Samson Power Amplifier, and the TOBE'S will insure its being just as good next year as now. Used also in the Samson Block for the official Hammarlund-Roberts Hi-Q.

- TOBE-SAMSON B BLOCK No. 713 using one 171 Power Tube
- TOBE-SAMSON B BLOCK No. 718 using two 171 Power Tubes in Push Pull
- TOBE-SAMSON B BLOCK No. 210 using two 210 Power Tubes in Push Pull
- TOBE-HAMMARLUND-ROBERTS OFFICIAL B-BLOCK for Hi-Q Set

Write for TOBE Power Pamphlet with descriptions of Power Circuits and prices of TOBE B BLOCKS

Tobe Deutschmann Co.
Cambridge Mass.

SM

The LC-28 Audio Amplifier

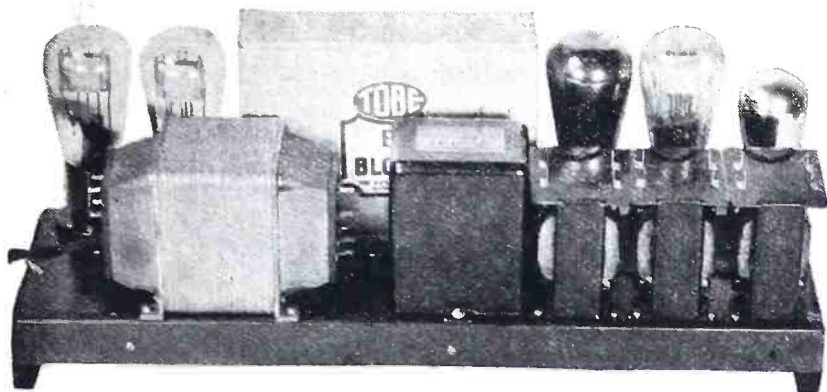

FOR the preferred audio frequency amplifier and power supply unit for the new LC-28 receiver, Laurence M. Cockaday called upon S-M engineers to have an amplifier designed to his exact specifications. The LC-28 Unipac is Mr. Cockaday's own selection—the ideal low frequency amplifier for the LC-28 receiver; and the two together provide a perfectly coordinated tone and power combination.

The LC-28 Unipac is a two-stage light socket operated power amplifier using one CX-326 A. C. tube in the first stage, and a CX-310 super power amplifier in the second stage. A combination of the new, specially developed, S-M 240 audio and 241 output transformers gives perfect tone and uniform amplification to all frequencies from below 100 to above 5000 cycles. The CX-310 tube, with a full 425 volts on its plate, results in beautiful rounded tone with ample volume, while the power supply, furnishing all ABC

power to the Unipac amplifier, also supplies B potential to the LC-28 receiver at 45 and 90 volts, with automatic glow tube voltage regulation.

Like all other S-M Unipacs (push-pull 171 or 210 types) the LC-28 is housed in a beautiful brown crystal-finished steel case which protects all parts and safely encloses all tubes and high voltages—for over 475 volts is delivered by the full wave rectifier using two CX-316B or CX-381 tubes.

Though especially designed for Mr. Cockaday's new set, the LC-28 Unipac will operate as an entire two-stage power audio amplifier and B power supply with any receiver at all. Used to replace the entire audio system of older receivers, it will also eliminate all B batteries and provide a quality of reproduction which is a positive revelation in tonal beauty.

The LC-28 Unipac may be procured from any good dealer as a kit ready to assemble, priced at \$81.25, or individual parts may be procured if desired.

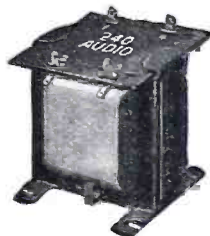

New S-M Transformers

Two new S-M audio transformers are now available, designed especially for Mr. Cockaday's LC-28 Unipac audio amplifier. Type 240, 3:1 ratio audio provides practically the same characteristics as the famous S-M 220, the largest selling high grade audio transformer, except for slightly less accentuation of notes below 80 to 100 cycles. Type 241 output protects speaker windings and boosts low note reproduction. Used together, a pair of 240's and a 241 provide an ideal audio amplifier in small space, at low cost, and with low power consumption—and they provide the 5000 cycle cut-off so necessary under present broadcast conditions to keep heterodyne squeals and noise at a minimum. Due to their small size, these transformers will fit in almost any of the older receivers, and once installed, will work wonders in tone quality improvement. Size 3 7/16 inches high, 2 1/4 inches wide, 2 5/8 inches deep, weight 2 lbs. 4 oz. each. Price, 240 audio, \$6.00; 241 output, \$5.00.

S-M audio transformers hold the record again this season—for largest sales in their class—and again for specification for more circuits than any other types!

| | | | |
|---------------------------------|---------|---------------------------------|---------|
| 1 S-M Super power transformer | \$18.00 | 4 Frost 253 tip jacks | .60 |
| 1 S-M 331 Unichoke | 8.00 | 1 Van Doorn chassis and cabinet | 8.00 |
| 2 S-M 240 audio transformers | 12.00 | 3 Eby binding posts | .45 |
| 1 S-M 241 output transformer | 5.00 | 20 Ft. Kellog hook-up wire | .20 |
| 1 Tobe 662 Condenser bank | 18.00 | 2 Frost FT-64 resistors | 1.00 |
| 5 S-M 511 tube sockets | 2.50 | 1 Frost F-1000 resistor | .50 |
| 1 Ward-Leonard 651 resistor kit | 7.00 | Total | \$81.25 |

SILVER-MARSHALL, Inc.

844 West Jackson Blvd. Chicago, U. S. A.

If you want all data on the LC-28 Unipac, the new transformers, and the Light Socket Improved Shielded Six, just drop the coupon below with 10c to cover mailing in an envelope, and we'll send it all to you.

SILVER-MARSHALL, INC.
844 West Jackson Blvd., Chicago.

Please send me all data on the Unipacs, Improved Shielded Six new transformers, ABC power units, etc. Enclosed is 10c to cover postage.

Name

Address

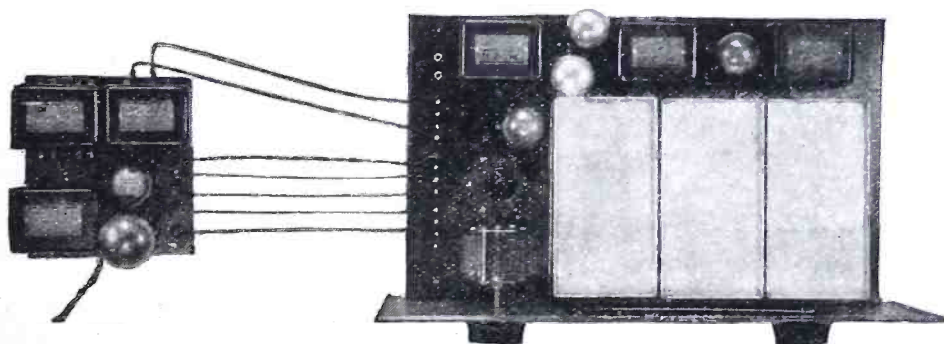

The A. C. Improved Shielded Six is ready—a completely light socket operated battery-less set using the new A. C. tubes. It's illustrated above, with its complete dry ABC power unit—less than 7 inches square.

Mr. John Harrison Hartley
Using Corwico Radio Wire
Again Wins the
World's International
Set-Building Championship



CORWICO

New!

BRAIDITE

HOOK-UP WIRE

"The Braid Slides Back"

Braidite is the neatest, fastest and easiest working hook-up wire made. In making a connection it is not necessary to strip back the insulation. Simply push it back, and after soldering the insulation slides right back into place, leaving no exposed sections of bare wire. Braidite holds its shape permanently after bending, and you cannot scorch or burn it with a soldering iron.

For Best Results Use Corwico Radio Wires
Sold by All Dealers

CORNISH WIRE COMPANY
30 Church St., New York

"CORWICO" RADIO WIRES
"Best from the Ground Up"

Antenna Wire (Solid Stranded and Braided)
Complete Aerial Kits
Magnet Wire
Battery Cable
Bus Bar Wire
Hook-up Wire
Lead-in Wire
Annunciator Wire
Loop Aerial Wire
Litz Wire
Flexible Wire

The Autobiographies of Valves

(Continued from page 344)

The amplifier valve is also tested under heavy loads with a large signal voltage, usually at 60 cycles frequency. This signal is applied to the grid of the tube and the change of plate current is obtained from the secondary of a transformer through the primary of which the valve's plate current is passed. This secondary current is passed through a thermocouple, the voltage of which is read on a hot-wire microammeter. The formula in terms of the valve factor will be as follows:

$$I_{ac} = \frac{\mu e_g}{\sqrt{(R_i + R_x)^2 \times X_x^2}}$$

Where I_{ac} = AC plate current in amperes
 R_i = internal resistance of the valve in ohms
 R_x = external circuit resistance in ohms
 X_x = external circuit reactance in ohms
 μ = voltage amplification factor
 e_g = alternating e.m.f. applied to the grid in volts

Other factors, such as a spilling of electrons around the end of the grid, may enter at heavy loads in poorly designed valves which have, perhaps, a high mutual conductance, to change the heavy-load amplification power of the valve. However, mutual conductance will usually give an indication of what may be expected of a vacuum valve as an amplifier under certain conditions, assuming other factors to be right. As μ stays about the same and as the impedance drops rapidly when the voltage of the plate and grid system is increased, it may readily be seen that this ratio and consequently the amplification of the valve increases rapidly with increased plate and grid voltages.

The fact that a valve has a high amplification factor does not necessarily mean that the tube will be a good amplifier. This may be seen if the impedance is increased as fast or faster than the amplification constant. In fact, the mutual conductance usually falls off at a given voltage in "high μ " valves. This occurs because a high amplification constant is usually obtained by increasing the grid wire size or turns per inch, in this way increasing the output impedance at a given plate-grid voltage as much as or more than μ was increased. Valves of this type are useful where voltage amplification is desirable, as in resistance-coupled amplifiers.

However, for general use, the tendency of modern power amplifier vacuum valve design is towards a lower amplification constant and output impedance and a consequent higher mutual conductance. The UX-120 valve has an amplification constant of 3.0 instead of 7.0, as is the case with the regular

IMMEDIATE DELIVERY ON
LC-28 UNIPAC
Laboratory Super
Silver Shielded Six

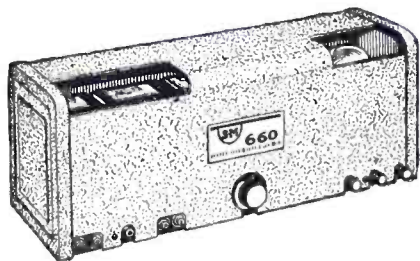

Send your order to us—immediate shipment—on all parts for the LC-28 Unipac—the amplifier and power supply described in this issue of Popular Radio. The Unipacs are recognized as the finest for pure undistorted power output—supplying all A, B and C power to the audio amplifier and 45 and 90 volt B voltages to the receiver as well. Complete parts for the LC-28 Unipac \$81.25. We can supply all other standard S-M Unipacs from stock, at regular prices.

Immediate delivery can be made on the famous Improved Laboratory Receiver—the eight tube receiver which is taking the country by storm—the most selective, sensitive and powerful set you can build. Complete parts—tested, matched and guaranteed—\$89.45. If two individual stage shields are desired add \$4.00 for both shields.

We can also supply immediately, complete kits on the famous Shielded Six—the receiver universally acknowledged for its purity of tone and distance getting ability. Can be built either for complete light socket operation or for battery or eliminator operation. The 630 Shielded Six kit for battery or eliminator operation is \$95.00—for complete AC operation \$99.00. Complete parts for the 652A, ABC power supply for the light socket operated Shielded Six \$36.50 or completely wired (less tubes) \$40.50.

Complete literature available—send for it and let us save you money on all standard apparatus.

SETBUILDERS SUPPLY COMPANY
514 South Peoria Street Chicago, U. S. A.



Your Neighbors Will Pay You
\$75⁰⁰ a week for Your Spare Time

You can easily sell them your spare hours for \$3 each by serving as "radio doctor," building them sets, selling them supplies at less than retail. A membership in the Association shows you how to cash in on Radio now and trains you for the \$3,000 to \$10,000 openings awaiting qualified men. The Association starts you in business if you wish. Investigate all it has done for others, all it can do for you. A MEMBERSHIP NEED NOT COST YOU A CENT.

Earn \$500 in Spare Hours

Our members are making big money with Radio. Werner Eichler, N. Y., earns \$50 a week—Lyle Follick, Mich., has earned \$500—F. J. Buckley, Mo.—makes as much as he receives from employer—all in spare time. Our members are starting radio stores, getting better positions, increasing their salaries, earning money spare time.

ACT NOW—for No-Cost Membership

Limited number of these memberships now available. They need not—should not—cost you a cent. To secure one, write today for details and our book, "Your Opportunity in the Radio Industry" that will open your eyes.

Radio Association of America
Dept. PR-11, 4513 Ravenswood Ave., Chicago

Send me your book and details of your Special Membership Plan.

Name

Address

City State

BENJAMIN

TRADE MARK

Cle-Ra-Tone Sockets

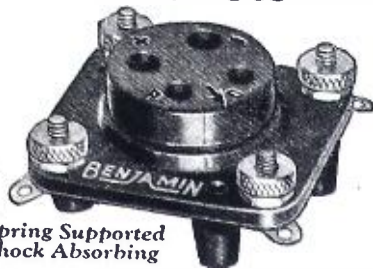

Spring Supported Shock Absorbing

USED the world over by set builders who know and want the best.

Stop tube noises. Anti-microphonic. The greatest contribution to the non-noisy operation of the set.

Tube "floats" on finely tempered springs. One-piece terminal to tube connection. Knurled nuts for binding post connections or handy lugs for soldering.

The choice for practically every prominent circuit for several years. Among the most recent hook-ups for which it has been specified are:

Magnaformer 9-8, L. C.-28, Camfield Super-Selective 9, Lynch Suppressor Circuit, H. F. L. Nine-in-Line, World's Record Super 10, Strobodone 8, Melo Heald Fourteen, St. James Super, Two-Dial Equamatic.

At all Radio Jobbers and Dealers

Made by

Benjamin Electric Mfg. Co.
120-128 S. Sangamon St., Chicago

247 W. 17th St.
New York

448 Bryant St.
San Francisco

Manufactured in Canada by the Benjamin Electric Mfg. Co. of Canada, Ltd., Toronto, Ontario

Corbett Cabinets

That Add to the Coziness of Any Home



Model "C" Walnut Only

The ultimate in elaborate and attractive radio furniture is offered in our model "C." It is an adaptation of the old Italian Chests, being designed and decorated in the spirit of the Renaissance period.

The back is grooved into place, and no nails or screws are used on any exposed surface. The front is grooved for 3/16" panel, the top rail being removable. Fancy folding top stay and piano hinge are applied.

PRICE LIST

MODEL "C" CABINETS

Walnut Only

| Panel Size | 10 in. deep | 12 in. deep | Weight | Mounting Boards |
|------------|-------------|-------------|--------|-----------------|
| 7x18 | 15.50 | 17.00 | 26 | .90 |
| 7x21 | 17.00 | 18.50 | 28 | 1.00 |
| 7x24 | 19.00 | 20.50 | 31 | 1.10 |
| 7x26 | 20.50 | 22.00 | 34 | 1.20 |
| 7x28 | | 23.00 | 37 | 1.30 |
| 7x30 | | 24.00 | 40 | 1.40 |

LC-28 CABINETS

Mahogany \$18.00 Walnut \$18.00

In stock ready for shipment
Write for illustrated folder

Corbett Cabinet Manufacturing Company
ST. MARYS, PENN.

POWERIZER

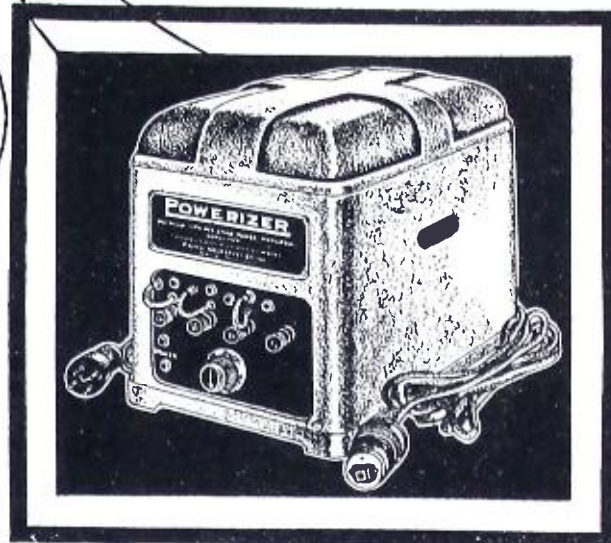
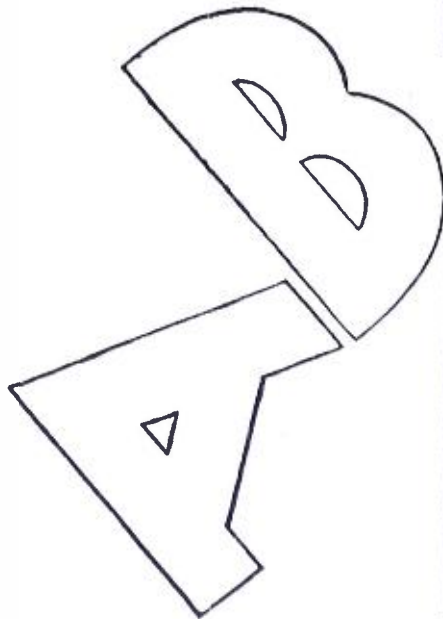

Model for Atwater Kent and other standard sets \$60
Radiola "20" model without tubes, \$59

MAKES YOUR SET AN A. C. ELECTRIC

with the newest
*A. C. Radiotrons which
require no batteries!*

Cymbals crash . . . the great bass booms . . . the baritone sax sighs and moans . . . dance music with jungle deep intonations . . . music such as you've never heard from your radio before . . . With the Powerizer, all those elusive low notes are captured—and reproduced with a rich mellowness.

Equip your set with a Powerizer and the finest tone quality in Radio is yours—for there is installed in your set the same system of A. C. Radiotron electrification that is used in the finest \$500 and \$800 A. C. Receivers.

Write for literature explaining details "How to make your set a modern A. C. Electric".

RADIO RECEPTOR CO., INC.
106 Seventh Avenue - New York

LICENSED BY RADIO CORPORATION OF AMERICA and Associated Companies

First in the Field
Specializing in
Cockaday Kits

S. HAMMER RADIO CO., 303 Atkins Ave. Brooklyn, New York

Cockaday Sets Now Made Easier to Build by Our New "Ready-to-Wire" Plan
50% of Your Time, Work and Worry SAVED!

All you need do is to connect bus-bar according to diagram, solder and your set is finished. These Kits are sent to you completely mounted, and assembled on a Veneered Mahogany baseboard and genuine bakelite panel, drilled and engraved. Genuine parts used as listed below; exactly as used in Mr. Cockaday's Laboratory Model. **COMPARE OUR OFFER!**

NEW! COCKADAY LC-28 RECEIVER

| | | | |
|---|---------|---|--------|
| 4 Hammarlund Mid-Line Variable Condensers, .000275 mfd. @ \$5.10..... | \$20.40 | 2 Carter Imp. Plugs and Tip Jacks, marked "antenna" and "ground," respectively, with insulating washers for antenna jack. Complete set..... | \$0.65 |
| 1 Hammarlund Double Drum Dial..... | 6.00 | 4 Benjamin Vibrationless Sockets @ 75c.. | 3.00 |
| 1 Set of Precision Radio Frequency Transformers, type 4-B..... | 12.50 | 1 Lynch Single Resistance Mountings..... | .35 |
| 3 Samson High Frequency Chokes, type No. 125, @ \$2.25..... | 6.75 | 1 Lynch Suppressor, 500 ohms..... | 1.50 |
| 1 Samson High Frequency Choke, type No. 85..... | 2.00 | 1 Lynch Suppressor, 600 ohms..... | 1.50 |
| 3 Aerovox Moulded Condensers, .02 mfd., @ \$1.50..... | 4.50 | 1 Lynch Suppressor, 700 ohms..... | 1.50 |
| 1 Aerovox Moulded Condenser, .00025 mfd..... | .35 | 1 Durham Metallized Resistor, 6 meg..... | .50 |
| 1 Aerovox Moulded Condenser, .00075 mfd..... | .40 | 2 Tait Brackets..... | 2.00 |
| 1 Yaxley Combination Switch and Rheostat, 6 ohms. No. 906-K..... | 1.75 | 1 Alcoa Aluminum Chassis..... | 7.50 |
| 1 Yaxley Cable Connector Plug with Cable, type 660..... | 3.00 | 4 Sets Spectral Aluminum Box Shields for LC-28 @ \$2.00..... | 8.00 |
| 4 Carter Fixed Resistance 4 ohms, type H-4, @ 25c..... | 1.00 | 1 Aluminum Panel, 6"x26"..... | 4.50 |
| | | 1 1/2" Extension Shaft..... | .50 |

READY-TO-WIRE KIT, PRICE \$90¹⁵

POWER PACK—AUDIO AMPLIFIER and LC-28 UNIPAC

to operate in conjunction with the LC-28 Receiver—in Stock!!

COMPLETE KITS **Magnaformer** 9-8 CIRCUIT IN STOCK

NEW! HAMMARLUND ROBERTS HI-Q SIX

Our New 1928 Catalog Is Now Ready. Send For It NOW!

THE PANEL FOR YOUR "LYNCH FIVE"



Here is an all-metal panel so carefully worked out that it will take almost any make of coil or condenser without the necessity of drilling additional holes. The panel itself is finished in a handsome brown crystalline lacquer and comes packed with Glodials, rheostat and brackets for mounting the sub-panel.

Known as the W. R. C. Universal Panel, it is truly universal in every sense. Actually nearly every make of instrument has been tried and found to fit properly in the insulated holes, and the experimenter will find an endless variety of combinations possible through its use. The W. R. C. Universal Panel is eminently adapted to the famous Lynch Five.

The WIRELESS RADIO Corp.
41 VARICK AVE.
BROOKLYN, N. Y. U. S. A.

CARTER

New "IMP" Power Switches
(for 110 Volt Circuit)

New "IMP" Automatic Power Switch
Replaces relay. Controls any type of "A" or "B" supply. Switches off filament circuit—3 operations in one.
\$1.50

New "IMP" Power Switch

New snap switch construction for 6 volt filament or 110 volt circuit. Complete with "ON" and "OFF" name plate.

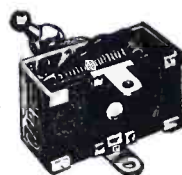

75c

Any dealer can supply

In Canada: Carter Radio Co., Ltd., Toronto

Offices in principal cities of the world



UX-199 valve. The impedance is also much lower.

Because of this fact and because of the greater electron emission from the larger filament to supply a greater plate current, and furthermore because this valve has a high negative grid bias, it gives great power amplification. It is superior to the UX-199 valve for operating a cone or horn reproducer, when used with 135 volts on the plate and 22.5 volts (negative "C" battery) on the grid. The lower impedance and high negative grid bias both make for distortionless amplification; the latter prevents the grid from drawing current and loading up the input circuit on loud signals with consequent high grid swings.

The UX-171 and the UX-112 valves are characterized by a still lower output impedance, a still higher positive plate voltage (180) and a still higher negative grid bias (-40½). Not only will a UX-171 type valve give a much greater improvement in quality, when amplifying strong signals, without overswinging the grid bias, but also a greater volume. Thus, contrary to popular opinion, there is a greater change in plate current for given change in grid voltage on a UX-171 type valve having a mu of 3 than on a valve such as the UX-240 having a mu of 30.

For example, an amplifier using two UX-171 type valves and proper low-frequency transformers together with an output condenser and choke across a cone reproducer, such as the Radiola Model 100, gives a volume and quality of reception that is a revelation to the listener. The filaments may be run directly from the AC mains (through a transformer with center tap) and the "B" and "C" voltages may be obtained from a power-pack, thus making the amplifier completely AC operated.

The UX-210 type valve has more power than the UX-120 and UX-171 type valves and its filament will stand a higher positive ion velocity bombardment without losing its film of thorium before the end of its normal life. This fact makes it possible to employ a higher plate voltage, such as 400 volts (without too great a plate current), with this valve, and to obtain a still better quality. The large amount of emission available in this tube permits distortionless amplification at extreme volumes.

For this reason such reproducers as the Rice-Kellogg, as exemplified in the Radiola 104, employ a valve of this type—which, by the way, may be lighted from the lighting circuit, thus conveniently supplying the greater filament energy needed. A "B" power-pack may be used to supply the plate current.

Plate current is dependent upon impedance and not, as is often thought,

Every



ALL-AMERICAN

TRADE MARK

Audio Unit Guarantees /
Natural Reproduction!

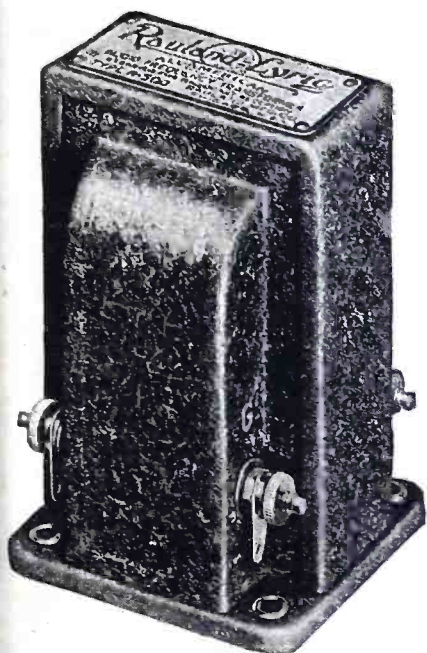

Rauland-Lyric Audio Transformer. Type R-500. Price...\$9.00

FINER radio reproduction than you have ever before experienced . . .

All those finer over-tones retained in their true and natural value, without muffle or distortion . . .

Smooth, flawless amplification . . . not a distorted note anywhere over the entire musical range . . . here is just what radio manufacturers and the public have been hoping to see developed!

All this is GUARANTEED by the makers of ALL-AMERICAN Audio Units.

These points of superiority have placed All-American in a position of leadership since 1919 . . . have made ALL-AMERICAN'S the largest selling transformers in the world.

ALL-AMERICAN Audio Units as shown here are the final refinement in radio manufacture. Any dealer, distributor or manufacturer will find it worthwhile to get the latest illustrated descriptive booklets—mailed free on request.

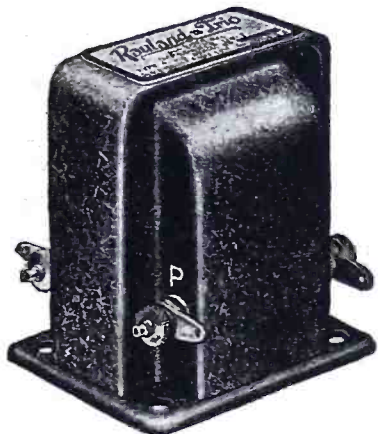

Rauland-Trio Impedance Unit. Type R-300. for Intermediate Stage. Price...\$6.00 Type R-310. for Final Stage. Price.....\$6.00

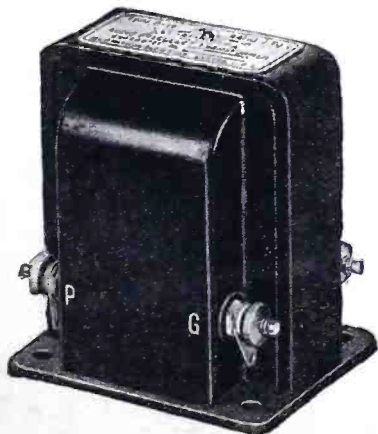

Audio Transformer
Type R-14, 3 to 1 Ratio, \$4.50
Type R-15, 5 to 1 Ratio, \$4.50
Type R-13, 10 to 1 Ratio, \$4.50

ALL-AMERICAN RADIO CORPORATION

4211 Belmont Avenue

Chicago, Ill.

The final improvement to be made in your set, install—



MODERN Type M Transformers

Regardless of how perfectly your set may be working, there is still finer reception in store for you. The performance of Modern Type M Transformers represents such an advance in audio amplification that they represent a new standard by which transformers may be judged. They combine high inductance, large core and wire sizes and perfectly proportioned windings. Impedances have been carefully matched to the units with which they must work.

The result is an almost flat performance curve with full response at 30 cycles and all over amplified high notes fully eliminated.

Satisfactory performance of Type M Transformers is guaranteed. Prices 1st and 2nd Stage, \$8.50 each; Output \$8.00; Push-Pull, \$10.00 each.

Mail coupon below for blueprint folder showing Type M audio amplifying circuits.

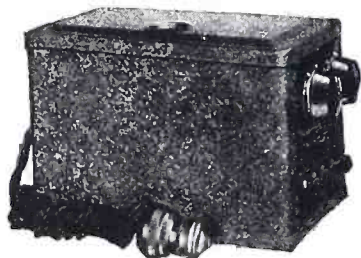

MODERN "B" Compact

A Raytheon "B" power unit that has been proven dependable and is guaranteed. Price \$26.50 without tube. Sent by mail, postpaid, if your dealer cannot supply you.

The Modern Electric Mfg. Co. Toledo, Ohio

Modern Elec. Mfg. Co., Toledo, Ohio Please send prints of Type M audio circuits. I enclose 2c stamp.

Name Address City

PR-11

upon electron emission. It is, therefore, affected by those factors which affect impedance. Of course, the end of the life of a valve is usually determined by the limitation of the plate current by emission.

Another constant that affects the operation of vacuum valves in high-frequency amplifiers is the inter-electrode electrostatic capacity—that property which causes the signal to be passed directly through the valve, in this way partially short-circuiting it and weakening the signal. This is done by induction of current directly from filament to plate without control by the grid. As is well known, such an undesired feed-back voltage may cause the valve to set up oscillations which destroy its ability as an amplifier.

Many other factors, such as inter-electrode leakage and detector action, are too numerous or too complicated to discuss at length in this article. However, when a valve is tested for detector action sensitivity, one valve may sound louder than another on a strong signal, while on a weak signal the condition may be reversed.

A valve such as the UX-200-a type containing caesium vapor that has atoms with electrons revolving much farther from the nucleus than is the case with the inert gas sometimes used in detector valves, is much more sensitive than one having inert gas.

The average grid-leak and condenser method of detection is obtained by adjusting the value of the leak resistance to give a proper range of grid potential. It has been shown by L. P. Smith, of the Research Laboratory, General Electric Company, that there are three main sources of distortion (1 and 2 result from the grid curvature characteristic): (1) frequency distortion due to harmonics; (2) amplitude distortion due to the fact that the rectified grid current varies as the square of the input voltage; (3) distortion due to the grid-leak and condenser.

There has also been developed the voltage regulator type of valve such as the UX-874, containing rare gases, carefully purified, and an alkali metal to furnish "starting" electrons. These valves will regulate and hold an almost constant voltage across their terminals over a wide range of current through them. Thus, the UX-874 will hold 90 volts at from 10 to 50 milliamperes load. They regulate by change in glow area.

There has not been space to mention all of the known and commonly used vacuum valve characteristics, or to discuss any one of them thoroughly. However, the data given above in brief form may serve to point out how many things must be taken into consideration, not only in the manufacture and testing of reliable vacuum valves, but also in their proper and most efficient use.

FREE Simplified BLUE PRINTS

You can have your choice of any one set of POPULAR RADIO Simplified Blueprints with your new or renewal subscription for POPULAR RADIO, accompanied by remittance of \$3.00. These Blueprints will make it possible for you to build a tested and approved set. You, as a reader of POPULAR RADIO, know the many entertaining, interesting and instructive articles that are published each month. We promise that throughout the coming months POPULAR RADIO will hold more and more of interest for Radio Fans.

Ease, Economy and Accuracy in Construction

Simplified Blueprints make it possible for anyone, without previous knowledge of radio, to construct a highly efficient radio receiver. These Blueprints consist of 3 diagrams as follows:

Panel Pattern

This Blueprint is the EXACT size of the actual set. So accurate that you need merely lay it on your panel and drill as indicated. No scaling or measuring to do, no danger of ruining the panel through faulty calculation.

Instrument Layout

Here again you have an actual size print of each instrument and binding post and its exact location both on the panel and within the cabinet.

Wiring Diagram

The unusual feature of this Blueprint is that it is an actual size picture diagram of the finished set. Each instrument and other parts appear in exact size and the wires are so clearly traced from one contact to another that you can connect all terminals accurately without even knowing how to read a hook-up diagram.

- Set No. 18—"The Improved Raytheon Power-Pack" (as described in the May, 1926, issue of POPULAR RADIO).
Set No. 22—"The LC-27 Broadcast Receiver" (as described in the October, 1926, issue of POPULAR RADIO).
Set No. 23—"The LC-Senior Power-Pack" (as described in the November, 1926, issue of POPULAR RADIO).
Set No. 24—"The LC-Intermediate Power-Pack" (as described in the December, 1926, issue of POPULAR RADIO).
Set No. 25—"The LC-Junior Power-Pack" (as described in the January, 1927, issue of POPULAR RADIO).

Use coupon below; indicate which set of Blueprints you want.

POPULAR RADIO

Dept. 49 119 West 57th Street New York City

POPULAR RADIO, Dept. 49 119 West 57th Street, New York City

Enclosed is my remittance of \$..... in full payment for subscription, with Blueprints as checked below, FREE.

- Set Number 18 Set Number 23
Set Number 22 Set Number 24
Set Number 25

Name..... Street..... City..... State.....

TRY IT 30 DAYS FREE
BEFORE YOU BUY

ALL METAL SHIELDED CHASSIS

Only 69.75
Retail List Completely Assembled

FACTORY PRICES - SAVE 50%
Choice of beautiful cabinets offered

3 Year Guarantee

8 tube - one dial

MIRACO
TRADE MARK REGISTERED

MAGNIFICENT TONE - SUPER SELECTIVE - POWERFUL DISTANCE GETTER

All Electric or Battery Set!

Big Discounts to User-Agents

MIRACO Users Say:

Reports from users everywhere leave little for us to add. These are only a few of the many in our files and which we receive daily. Send coupon for plenty of additional proof and testimony of nearby users.

CLEARER THAN A \$450.00 SET
Before I bought your set I tried out and heard quite a number of different makes sets and I believe I can truthfully say that I never yet have heard a set with such wonderful tone and clearness as the Miraco. I never thought that a set could be as clear and reproduce tones and voices as the Miraco. Saturday I listened to a \$450.00 set and it can't even come near your set for clearness and volume. I have logged some very distant stations on the Unitone and although people won't hardly believe me, the first week I had KFI Los Angeles on two nights in succession on a 30-ft. temporary inside aerial. —FRANK A. OLBENBURG, Milwaukee, Wis.

SHARPLY SEPARATE STATIONS
The Unitone brings in stations very clearly and with a selectivity that is amazing when you take in consideration the mass of stations on the air at the same time. I have heard three and four stations that were on almost same wavelengths at the same time and was able to tune out one after the other without the least interference. —W. L. BROBACK, San Francisco, Calif.

EXPERIENCED FAN PRAISES SET
Miraco is the most wonderful radio I have ever seen. I have had experience with many popular makes of radios, also have built a number of them myself but in tone quality it is far superior to all. For sensitiveness I can say it is more like a super-heterodyne. —R. D. WHITE, Proctor, W. Va.

HAS POWER TO SPARE
"Well Pleased" with Miraco would be putting it mildly. Haven't heard anything to equal it regardless of price. With temporary aerial tuned in WEAJ then WIOD Florida felt sure this must be WJZ the pet station of this locality. Stations all coming in clear with wonderful tone and tremendous volume. Seldom have more than half of volume turned on. A local agent insisted he could prove his set superior but to his surprise and astonishment my family and neighbors and the agent himself admitted his \$165 set had to step out of the way for Miraco. —H. W. HOEFL, Perkiomenville, Pa.

America's big, old, reliable Radio Corporation* (8th successful year) guarantees in its big, powerful, latest 6, 7 and 8 tube Miraco sets "the finest, most enjoyable performance obtainable in high grade radios." Unless 30 days' use in your home fully satisfies you a Miraco is unbeatable at any price for beautiful, clear cathedral tone, razor-edge selectivity, powerful distance reception, easy operation, etc.—**don't buy it! Your verdict final.** Save or make lots of money on sets and equipment—write for testimony of nearby users and **Amazing Special Factory Offer.**

Miraco's work equally fine on "AC" electric house current or with batteries. Take your choice. Many thousands of Miraco users—who bought after thorough comparisons—enjoy programs Coast

to Coast, Canada to Mexico, loud and clear—with the magnificent cathedral tone quality of costliest sets. Don't confuse Miraco's with cheap, "squawky" radios. Miraco's have finest parts, latest approved shielding, metal chassis, etc.—as used in many \$200 sets.

Deal Direct with Big Factory
Your Miraco reaches you completely assembled, rigidly tested, fully guaranteed. Easy to connect and operate. **30 days' trial free.** 3 year guarantee if you buy. You take no risk, you insure satisfaction, you enjoy **rock-bottom money-saving prices** by dealing direct with one of radio's oldest, most successful builders of fine sets. 8th successful year in the radio manufacturing business.

7 tube one dial
METAL SHIELDED CHASSIS
\$49.75
RETAIL LIST

MIRACO "Powerplus" sets—both in 8 and 7 tube models—have magnificently beautiful, clear cathedral tone quality. Turn one dial for stations everywhere. Ultra-selective. Miraco multi-stage distance amplification gives "power-plus" on far-off stations. Latest all-metal shielded chassis. Illuminated dial. Fully guaranteed. Try one free for 30 days! Choice of beautiful cabinets.

Dealers Write!

USER-AGENTS! Make big profits showing Miraco to friends. Get Our Special Wholesale Prices!

MIDWEST RADIO CORPORATION, Cincinnati, O.

BEAUTIFULLY ILLUSTRATED CATALOG AND AMAZING SPECIAL OFFER

Free!

SEND NO MONEY—30 DAYS' TRIAL, Special References, testimony of nearby Miraco users—all the proof you want—sent with catalog.

mail coupon right now!

Electrify Any Radio with MIDWEST NO-BATTERY "AC" Light Socket Power Units

BIG DISCOUNT TO User-Agent

"A", "B" and "C" power, direct from light socket, without batteries! Write for Midwest prices and discounts. Midwest Units are highest grade—lastingly dependable, quiet in operation, fully guaranteed.

6 tube Super 36.75
RETAIL LIST

Another Big Bargain! Famous powerful big Miraco Super 6, 1928 model—ultra selective! Thousands find it outperforms sets of much higher price. 30 Days' Trial Free. Fully Guaranteed.

MIDWEST RADIO CORPORATION
Pioneer Builders of Sets
479 E Miraco Building, Cincinnati, Ohio.

THIS COUPON IS NOT AN ORDER

Without obligation, send free catalog, **AMAZING SPECIAL OFFER**, testimony of nearby Miraco users. User Agent Dealer

NAME
ADDRESS

LYNCH

Improved Aristocrat
tube
de luxe Deck

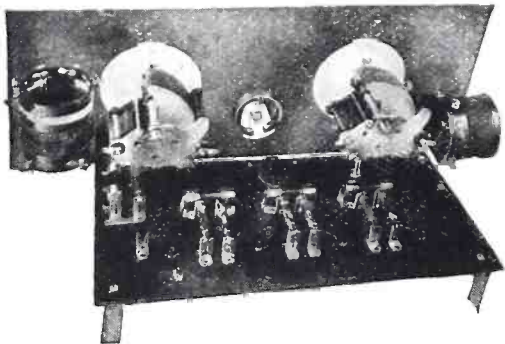

New and Different

Here is an example of a real receiver made with the Lynch 5 tube De Luxe Deck. This is one model of the Improved Aristocrat—The list price for all the parts necessary is less than \$30.00.

For Use in Building any 5-Tube Receiver

The Deck includes, all mounted ready for wiring

- | |
|---------------------------------------|
| 1 Westinghouse 6" x 12" Micarta Panel |
| 5 Eby De Luxe Sockets |
| 4 Lynch Cartridge Condensers |
| 7 Lynch Metalized Resistors |
| 4 Lynch Special Mounts |

The Deck is a Lynch innovation which greatly reduces the cost; improves the appearance and performance and simplifies home construction beyond belief.

The Lynch 5-Tube Deck

\$12.50

and Now

The LYNCH BOOK

Just off the Press

"Resistance the Control Valves of Radio"

A very thorough treatise on the proper use of resistors of every type for every radio purpose. Many pages—Many illustrations—Many dollars worth of sound information for a quarter.

Send your quarter and we'll send the book today

ARTHUR H. LYNCH, Inc.

General Motors Building

New York City

Sales Offices in Most Large Cities



WITH THE EXPERIMENTERS

CONDUCTED BY S. GORDON TAYLOR

Hints on the Pre-Selector

(This device improves the selectivity of any standard receiver. Complete constructional data were given in the May, 1927, issue of POPULAR RADIO.)

THE Pre-selector has been under test for a period of several months now with numerous types of commercial and home-made receivers, and so far not a single receiver has been found that was not made more selective through its use. There have been a few receivers which experienced a loss in efficiency when used with the Pre-selector, but these few exceptions were either super-heterodynes or old-fashioned regenerative receivers that employed no high-frequency amplification other than that obtained through the use of regeneration in the detector.

The letters received from readers so far indicate only one source of trouble in the Pre-selector—the failure of the oscillator to function. This may result from the use of a defective UX-199 valve in the left-hand socket, or to poor contacts between the left-hand coil and its socket.

It is a simple matter to test out the Pre-selector to determine whether or not its two circuits are functioning properly.

The frequency changer (detector) circuit is tested by connecting the Pre-selector to the "A" and "B" batteries, the antenna and the ground in the usual way, but with a pair of headphones connected between the 45-volt tap of the "B" battery and the "B+" terminal of the Pre-selector. The output binding post of the Pre-selector is left unconnected. Thus arranged, the frequency changer valve will function as a single-valve receiver and signals will be audible in the headphones. Tuning in this case is accomplished by means of the right-hand dial alone. During this test the left-hand valve (oscillator) may be either in or out of its socket, as it does not play any part in the test. Both coils must be in their sockets, however.

To test the oscillator circuit the Pre-selector should be placed 3 or 4 feet from the regular receiver and should be connected to the "A" and "B" bat-

teries, but not to the receiver or to the antenna. The receiver should be connected up in the regular manner, and some broadcasting station with a wavelength of 250 meters or lower should be tuned in. Then the left-hand dial of the Pre-selector should be slowly rotated. If the oscillator is functioning, a "birdie" whistle will be heard in the reproducer when the oscillator is tuned past the same frequency as the receiver.

If no heterodyne whistle is heard, try switching the valves in the Pre-selector. Perhaps the one in the left-hand socket is incapable of oscillating, but the one used in the frequency changer socket may be good for this purpose. If there is still no whistle in the reproducer, then it is likely that there is a poor connection somewhere in the oscillator circuit.

If these two tests are made and show the two circuits to be functioning, there should be no difficulty when the Pre-selector is connected between the antenna and the receiver.

Literature for the Experimenter

MANY experimenters may not be aware that there is a wealth of good radio literature available to anyone who asks for it. The costs are usually nominal.

Many of the larger radio manufacturers publish pamphlets that contain much helpful discussion of the various principles and practices involved in radio. Some of the low-frequency amplifier parts manufacturers, for instance, offer booklets which go into considerable detail regarding the theory of low-frequency amplification, and discuss the relative merits of various types of coupling for such amplifiers. Many of these booklets give hook-ups and design data, and suggest various uses for the instruments and parts involved.

It is well worth while for any experimenter to take advantage of the offers of these manufacturers, which may usually be found by consulting the advertising columns of POPULAR RADIO.

—DAVID LAY

All Electric Radio

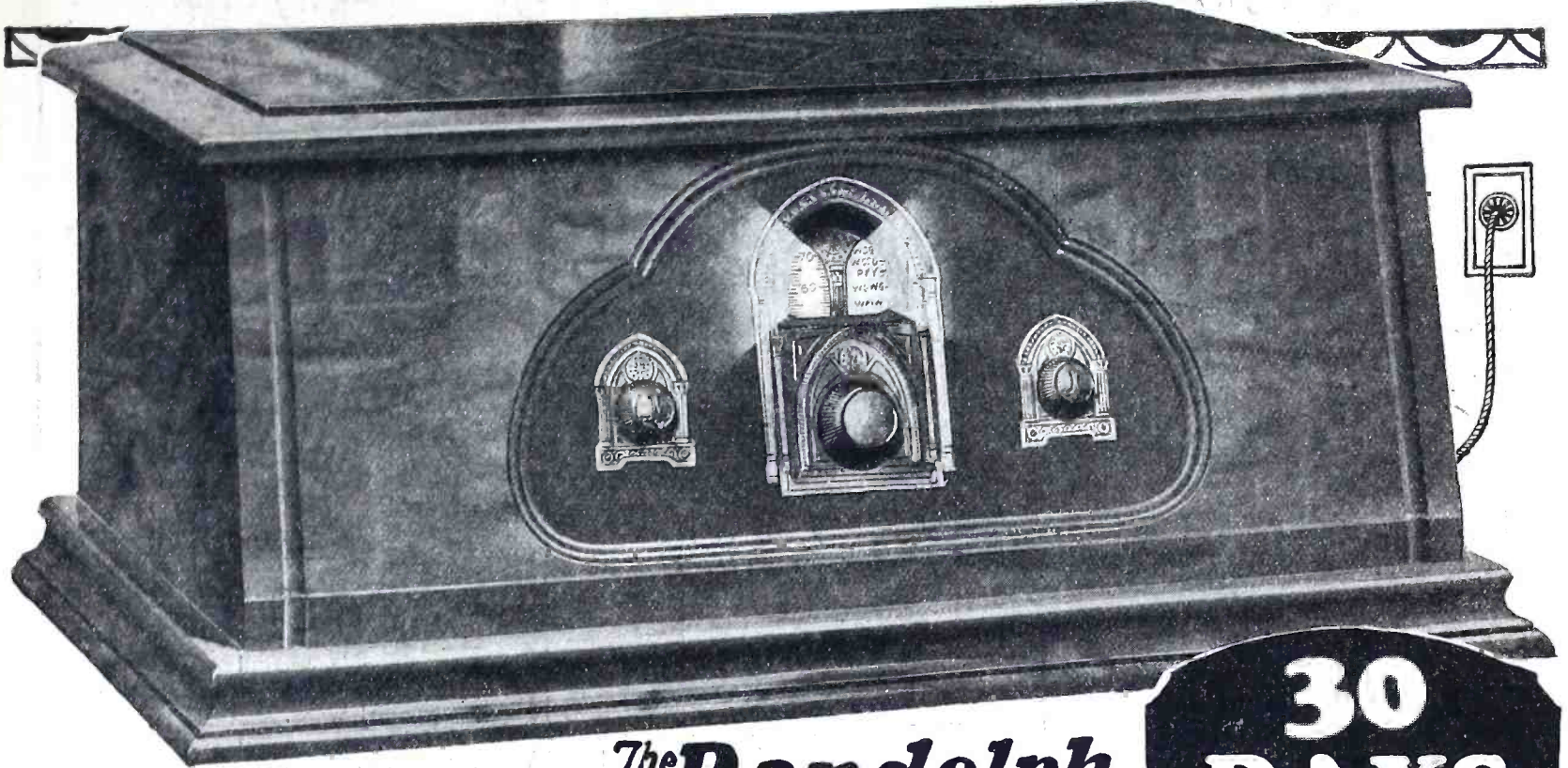

The **Randolph**

7 Tubes-Single Control

JUST plug this Randolph Radio into the electric light socket—and tune in. A powerful, selective radio that gives dependable coast to coast reception. **No batteries, chargers, eliminators, acids or liquids.** Here is complete radio satisfaction whenever you want it. The easy tuning with one control brings on all stations. Illuminated drum allows you to operate the radio in the dark and has space for logging stations. Every detail of the Randolph is modern and perfected—it is the utmost in radio—unsurpassed regardless of price. It is this wonderful radio that you test and try for 30 days FREE before you buy. Listen to it in your own home. When it convinces you by actual performance it is the ideal radio—the one you have always hoped for—you can buy it direct at factory prices. Be sure you write for free descriptive literature today.

**30
DAYS
FREE
TRIAL**

Beautiful Ampliphonic Console

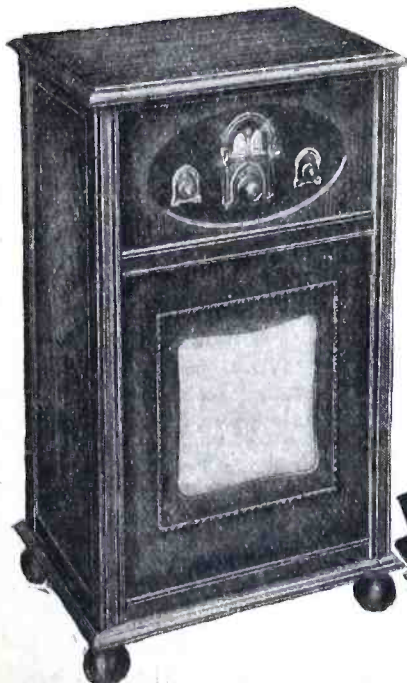

Illustrated here is one of the beautiful Randolph Seven Console Models—made of the finest carefully selected heavy solid walnut, hand-rubbed and with burl finish. Has built-in genuine large cone speaker that compares with any on the market. Assures unlimited reception of high notes and low notes clear as a bell. Completely electric—uses no batteries of any kind. Be sure you send for fully illustrated, full color folder giving complete details.

Genuine Walnut Cabinets

The finest of heavy, genuine, solid burl finish walnut is used in the making of all Randolph cabinets. No picture can do them justice. You must see them to appreciate them.

6-Tube Radio

New, modern, single-control, six-tube radio. Do not compare this set with old-style, 2-dial, 6-tube sets selling for about the same price. The Randolph 1928 Senior Six has also been tested and approved by the leading radio engineers. Comes in beautiful solid walnut cabinet of hand-rubbed finish. Single control. Illuminated drum with space for logging. Absolutely dependable and very selective. **Send for 30 days free trial. You test it before you buy.**

**6
Tube
\$55
Retail
Price**

**Biggest
Discounts
To
Agents**

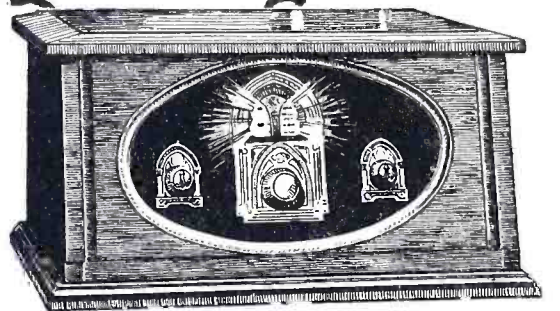

**All Sets
Guaranteed**

Biggest Discounts to Agents

Work either full or part time and make big money. Sensationally big discounts to agents. No experience required. Randolph All-Electric Sets sell on first demonstration. Tremendous advertising campaign helps you. Men and women both make big money this way. Demonstrating set sent on 30 Days TRIAL. **WRITE NOW** for proposition.

USE THIS COUPON TODAY!

**Randolph Radio Corporation
711 West Lake Street, Dept. 317
Chicago, Illinois**

Send me full particulars about the RANDOLPH Six and Seven-Tube Electric and Battery Table and Console Sets with details of your 30 Day FREE Trial Offer.

Name.....

Address.....

City.....State.....

Mark here if interested in Agent's proposition.

**RANDOLPH RADIO CORPORATION
711 West Lake Street Dept. 317 Chicago, Ill.**

Improved Positive for "B" Eliminators

VOLTAGE CONTROL

HEAVY DUTY Centralab Potentiometer



A new Centralab variable resistance that is all wire-wound and has exceptionally heavy current carrying capacity. Units are practically heat-proof and will dissipate up to 20 watts through entire resistance without danger of burning out. This new unit has great advantages for regulating the output of "B" eliminators. A single turn of the knob gives full resistance variation with the resistance remaining constant at any knob setting so that the knob or panel can be calibrated in volts.

Has sufficient current-carrying capacity to permit shunting a low resistance value directly across the "B" power output. This assures a constant current load sufficiently high to reduce the output voltage of the rectifier to workable pressure even though the set is not connected. By preventing the extremely high no load voltage, it serves to protect the filter condensers from break down—the most common source of trouble in "B" eliminators.

Centralab Potentiometer control also provides much better voltage regulation than can be obtained with series resistors. Any change in current at the set will produce a very small change in the voltage at the taps. This factor coupled with the non-inductive of Centralab Heavy Duty Potentiometers, insures best tone quality with a minimum of by pass condensers.

"B" Power Circuit for Best Possible Voltage Regulation

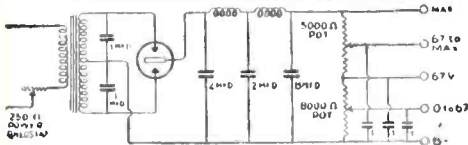

This circuit is suitable for any "B" power with an output of 200 volts or less. The resistances are Centralab Heavy Duty Potentiometers HP-005 and HP-008 and Power Rheostat PR-250.

Centralab Heavy Duty Potentiometer may be used as straight variable resistances by connecting the center terminal and one outside terminal. They may be used to replace resistances on old eliminators as well as in building new ones. The diameter is 1 1/2 inches.

Because of their heavy current carrying capacity, Centralab Heavy Duty Potentiometers are adaptable to transmitter work of Amateurs as Variable Grid Leak resistances, filament voltage dividers and various positions in receiver circuits.

Resistances—2,000, 3,000, 5,000, 8,000, 10,000, 15,000, 20,000, 50,000. Price, \$2.00.

At your dealer's, or C. O. D. Write for new folder "Resistances and Their Function in Radio Circuits."

CENTRAL RADIO LABORATORIES
17 Keefe Ave. Milwaukee, Wis.

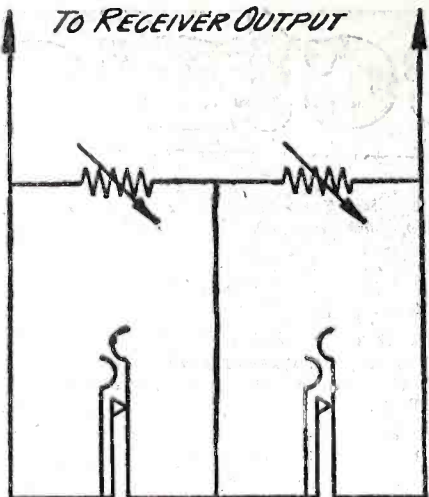

A HOOK-UP FOR BETTER REPRODUCTION

FIGURE 1: By hooking up in series two reproducers, one of which covers the lower audible frequencies well and the other the higher, a blended output of excellent quality may be obtained.

Better Reproduction Through the Use of Two Reproducers

MANY critical radio fans have found that by using a combination of two reproducers, connected in series, more realistic reproduction can be obtained. A combination of a horn reproducer with a cone reproducer will frequently give results far superior to those obtained with either reproducer alone. This improvement is particularly pronounced when one of the reproducers has a decided tendency to favor the medium and low notes and the other inclines toward the higher notes.

A further refinement can be obtained by using this arrangement, but with each of the reproducers shunted by a variable high resistance so that the volume of each of the reproducers can be individually adjusted to provide just the proper blend.

Figure 1 shows a schematic arrangement to facilitate these connections. With this arrangement the two reproducers may be used together by inserting their plugs into the two jacks, or either may be used alone by inserting its plug into one of the jacks. In the latter case the other jack maintains a closed circuit and at the same time short-circuits the unused resistance unit. The jacks should be of the single circuit, closed type, and the resistances should be variable from approximately zero to several megohms for best results.

Why Are Radio Receivers Shielded?

Few elements of radio construction are so commonly misunderstood as the shielding of a receiver. Shielding is the subject of widely varying views, ranging from the claim that it is absolutely essential, to a statement by some makers that shielding is only a clumsy com-

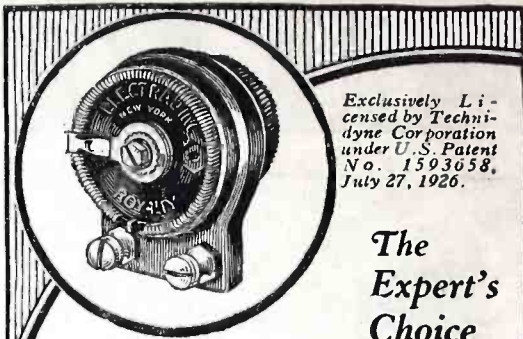

Exclusively Licensed by Technidyne Corporation under U.S. Patent No. 1,593,658, July 27, 1926.

The Expert's Choice

ROYALTY VARIABLE HIGH RESISTANCES

Reception from your radio depends upon the quality and efficiency of even its smallest parts. That's why fans everywhere insist on Electrad Royalty wherever variable high resistances are required.

Electrad Royalty Resistances are acknowledged superior because (1) Same resistance always secured at same point, (2) contact made positive by metallic arm on wire-wound strip, (3) resistance element not exposed to mechanical wear.

A range for every purpose—11 in all, designated A to L. Type E, \$2.00. All other types, \$1.50.

Write for hook-up circular
175 Varick Street Dept. 59B New York, N. Y.

ELECTRAD

Statement of the ownership, management, circulation, etc., required by the act of Congress of August 24, 1912, of POPULAR RADIO, published monthly at New York, N. Y., for October 1st, 1927, State of New York, County of New York.

Before me, a Notary Public in and for the State and county aforesaid, personally appeared Douglas H. Cooke, who, having been duly sworn according to law, deposes and says that he is the Publisher of the POPULAR RADIO and that the following is, to the best of his knowledge and belief, a true statement of the ownership, management, etc., of the aforesaid publication for the date shown in the above caption, required by the Act of August 24, 1912, embodied in section 411, Postal Laws and Regulations, printed on the reverse of this form, to wit: 1. That the names and addresses of the publisher, editor, managing editor, and business managers are: Publisher, Douglas H. Cooke, 119 West 57th Street, New York City, N. Y.; Editor, Raymond F. Yates, 119 West 57th Street, New York City, N. Y.; Managing Editor, Raymond F. Yates, 119 West 57th Street, New York City, N. Y.; Business Manager, E. A. Harm, 119 West 57th Street, New York City, N. Y. 2. That the owner is: POPULAR RADIO, Inc., whose stockholders are: Douglas H. Cooke, 119 West 57th Street, New York City, N. Y.; Laurence M. Cockaday, 119 West 57th Street, New York City, N. Y.; Theodora W. Cooke, 59 Beechmont Drive, New Rochelle, N. Y.; Charles C. Moore, 345 Madison Ave. New York City, N. Y. 3. That the known bondholders, mortgagees, and other security holders owning or holding 1 per cent or more of total amount of bonds, mortgages, or other securities are: NONE. 4. That the two paragraphs next above, giving the names of the owners, stockholders, and security holders, if any, contain not only the list of stockholders and security holders as they appear upon the books of the company but also, in cases where the stockholder or security holder appears upon the books of the company as trustee or in any other fiduciary relation, the name of the person or corporation for whom such trustee is acting, is given; also that the said two paragraphs contain statements embracing affiant's full knowledge and belief as to the circumstances and conditions under which stockholders and security holders who do not appear upon the books of the company as trustees, hold stock and securities in a capacity other than that of a bona fide owner; and this affiant has no reason to believe that any other person, association, or corporation has any interest direct or indirect in the said stock, bonds, or other securities than as so stated by him. Douglas H. Cooke, Publisher. Sworn to and subscribed before me this 20th day of September, 1927. Gerard J. Traub, Notary Public, Queens County. (My commission expires March 30, 1929.)

FREE!

Back Copies of Popular Radio

FOR the convenience of those readers of POPULAR RADIO who have been so unfortunate as to have missed the issues describing such remarkable receivers as the LC-28 and the Magnaformer Superheterodyne, the Subscription Department has made it possible to obtain these important numbers without cost. The articles describing the theory and construction of these receivers began in the September number. This, together with the October number, will be sent free to all those who subscribe during the coming month. This makes it possible to obtain fourteen issues of POPULAR RADIO for the price of twelve.

The subscription price of POPULAR RADIO is \$3.00 per year.

Subscription Department

POPULAR RADIO, Inc.
119 W. 57th St., New York City

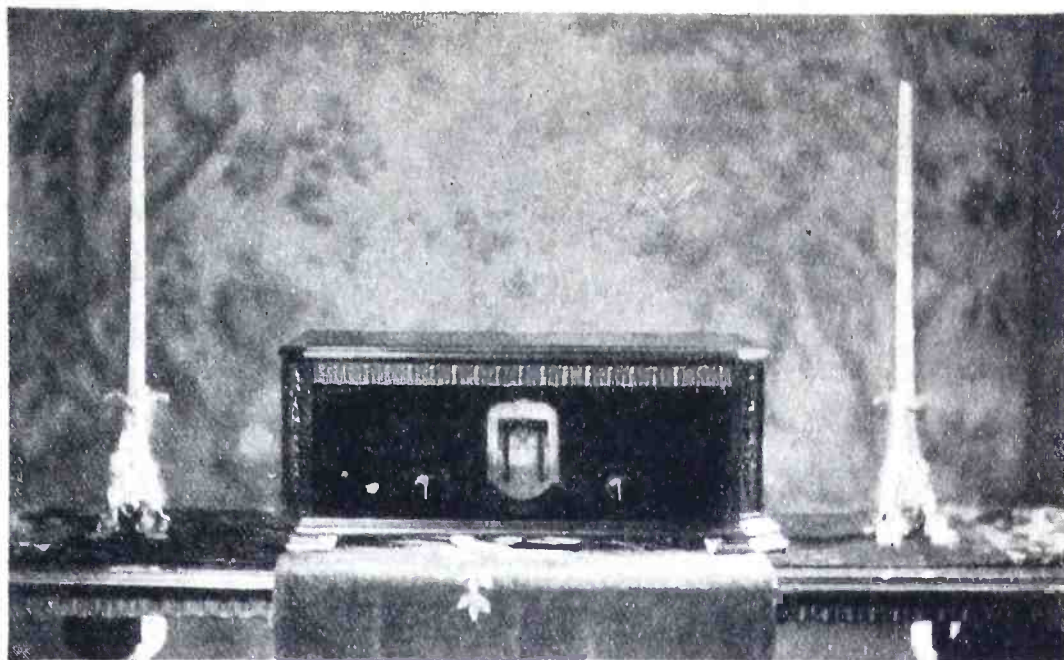

The New Improved Hi-Q Six—the creation of ten foremost American Radio Engineers—a receiver far in advance of its time

Exclusively CUSTOM-BUILT

From Our Simple Instructions
and at Great Savings!

NO ordinary standards can be applied to this latest improved Hammarlund-Roberts Receiver, for it is the result of a determination to produce America's very finest instrument—*absolutely regardless of cost!* Every modern constructional feature has been incorporated. Each part is the most efficient known to radio science, and the entire group has been purposely selected for perfect synchronization. Complete isolation of four tuned circuits plus Automatic Variable Coupling effects maximum and uniform amplification over the entire wave band. Distortion is totally eliminated. Oscillation is utterly absent. Symphonic transformers and a power tube

faithfully reproduce the full musical scale. Selectivity, even in crowded areas is something to marvel at. *And tonal quality simply MUST be heard to be appreciated!*

Such a set, factory made, and sold through usual channels, would cost \$250.00 to \$300.00, but through following our simple instructions you can purchase all parts for only \$95.80 (less cabinet) and build this supreme receiver yourself a CUSTOM-BUILT set which gives you CUSTOM-BUILT results at a saving of \$100 to \$150.

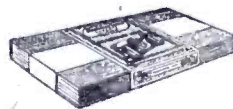

Completely drilled panel and sub-panel are foundation for easy building.

Get the complete Hi-Q Instruction Book from your dealer — or write us direct. Price 25 cents.



HAMMARLUND-ROBERTS, Inc. 1182-B Broadway, New York City
Associate Manufacturers



Radio Is MUSIC with

Build It Yourself in 30 Minutes

COMPLETE KIT, \$12.00

ENGINEERS have proved mathematically the superiority of the three-foot cone speaker. Radio fans all over America praise the FENCO, the double-cone speaker of superb quality.

The FENCO Kit contains everything you need to build a radio speaker that is equal to any \$60 speaker you ever heard.

Finest quality of materials. Easy to assemble. Satisfaction guaranteed or money refunded.

Send check or money order for \$12 today to

FENCO CONE COMPANY
57 Murray St., New York, N. Y.

The Three-Foot FENCO DOUBLE CONE

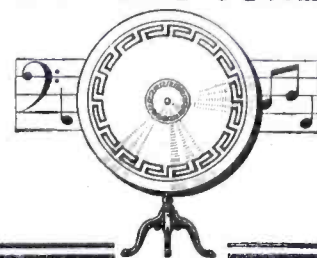

The GENERAL RADIO

TYPE 441

Push-Pull Amplifier

In a search for an amplifier combination which would give the maximum in quality and volume, the push-pull method has proved particularly satisfactory.

While push-pull transformer coupling does not increase the amplification per stage, the maximum undistorted power output is greatly increased. The reason for this is that distortion due to tube overloading cancels out, permitting a greater output from each tube than would be possible if the tubes were used as in other methods of coupling. A further advantage of push-pull amplification when using an A. C. filament supply is that hum voltages also cancel out, rendering the amplifier very quiet.

The type 441 unit with two type 171 power tubes having a plate voltage of 180 will give more volume and better quality than a single transformer coupled stage using the type 210 power tube with 400 volts on the plate.

The General Radio Type 441 unit is completely wired and mounted (as illustrated) on a brass base-board with conveniently located binding posts so that the unit may be built into a receiver or connected with an existing set as a separate unit.

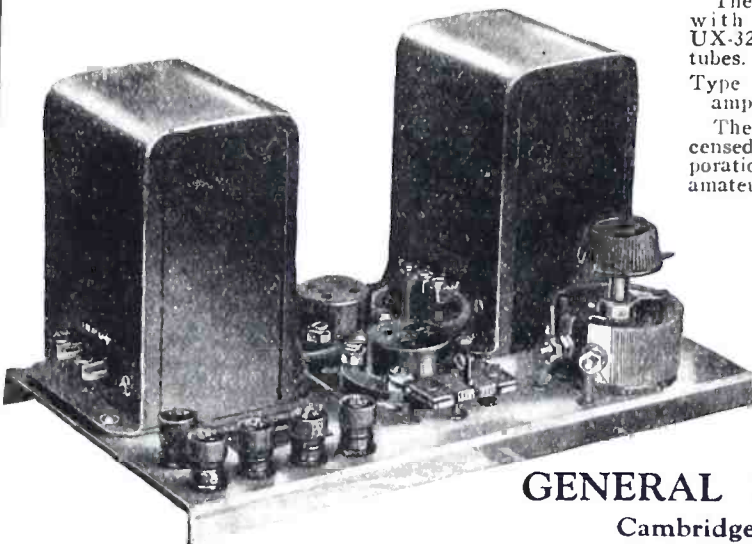

The type 441 may be used with either the UX-226, UX-326, or UX-171, CX-371 tubes.

Type 441 Push-pull amplifier\$20.00

The type 441 unit is licensed by the Radio Corporation of America for radio amateur, experimental, and broadcast reception only, and under the terms of the R. C. A. license the unit may be sold only with tubes.

Type UX-226 or CX-326 Amplifier Tube..\$3.00

Type UX-171 or CX-371 Amplifier Tube. 4.50

GENERAL RADIO CO.
Cambridge - - - Mass.

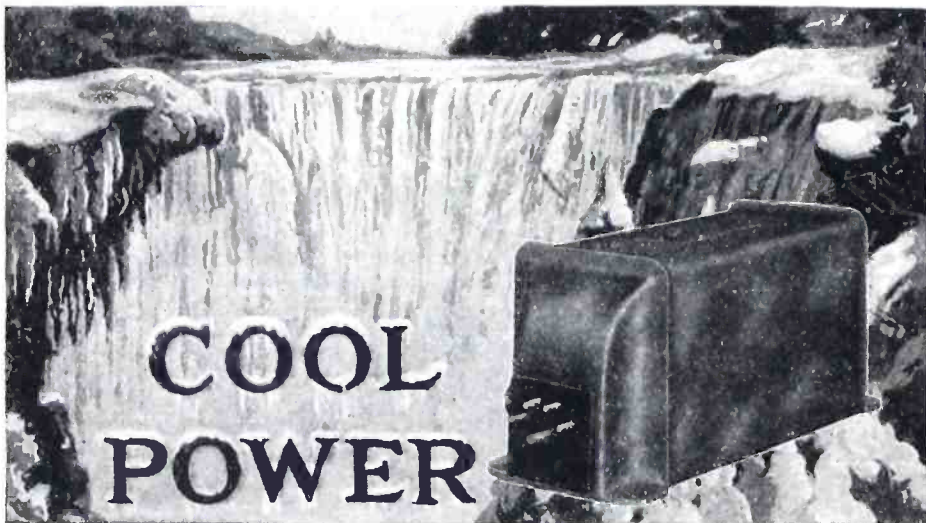

SAMSON POWER BLOCK NO. 210

The only block which will supply 500 volts at 80 mills to two 210 tubes

Powerize with Samson Units for Best Results

For new SAMSON Power Units insure the best there is in radio current supply by

1. Doing away with hum, motor boating and poor voltage regulation.
2. Remaining so cool after 24 hours continuous operation under full load that they will be well within the 20° rise of temperature specified by the A. I. E. E.
3. Being designed to more than meet the specifications adopted by the National Board of Fire Underwriters.
4. Insuring safety against shock because of protected input and output terminals.
5. Insuring for all tubes the correct filament voltages specified by their manufacturers.
6. Compensating for lighting circuit voltage variation by the use of a special input plug and terminal block to which is attached a 6 ft. flexible rubber-covered connecting cord and plug.

Our Power Units bulletin descriptive of these is free for the asking. In addition, our construction bulletin on many different "B" Eliminators and Power Amplifiers will be sent upon receipt of ten cents in stamps to cover the mailing cost.

SAMSON ELECTRIC COMPANY

Manufacturers
Since 1882

Principal Office:
Canton, Mass.

promise to offset faulty circuit design.

There are two important functions of metal shielding: First, to assist in cutting out undesired local stations and neighboring sources of interference; second, to isolate the high-frequency stages in order that electromagnetic coupling may be eliminated. The efficient performance of these duties usually requires that shield be free from openings of any magnitude.

In receivers of high amplification, the detector tube must be even more heavily guarded, since the detector is essentially an output device, which might otherwise send undesirable impulses along to the reproducer. This extra protection may be obtained through the use of an output filter in the detector circuit. Such a device permits only the useful portion of the detector output to reach the amplifier.

Thorough shielding affords a further advantage in that it permits insertion of tuning coils in closer proximity to each other and with parallel axes, thus conserving considerable space. Without shielding, the coils must be spaced further apart, and with their axes at difficult angles.

The other important function of shielding is to aid in the elimination of undesirable local signals. Receivers without scientific metal covering contain so many exposed wires and metal parts that direct pick-up of strong local signals is almost unavoidable. Shielding, however, confines all pick-up to the aerial, and places all responsibility for foreign signals upon the tuning devices. If the receiver tunes sharply enough to select the proper impulse from the aerial, local interference need never be feared.

—K. L. HENDERSON

A Handy Transformer Rule

NOWADAYS, when so many radio experimenters are constructing small power transformers to aid them in their work, they often find it necessary to figure the proper number of primary turns. Many of them are reduced, in order to find this number, to going through a very complicated formula. But, since such transformers are almost invariably designed for 110-volt, 60-cycle circuits, and for use with a core of silicon steel, it is possible to simplify the usual formula to the following:

Divide 835 by the cross-sectional area of the core in square inches, and you have the required number of primary turns. Simple, isn't it? The rule was obtained by substituting in the well-known formula:

$$N_p = \frac{E \times 10^8}{4.4fAB}$$

This assumes an economical flux density of 50,000 lines per square inch. This will be found correct for the average quality transformer iron.

—CHARLES D. SAVAGE

Your "B" Battery Eliminator
will give you better service with

Q · R · S

(Trade Mark Registered)

**Gaseous
Rectifier Tubes
ARE BETTER**

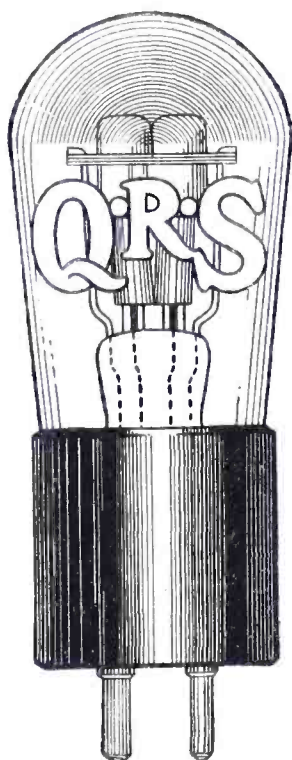

60 Milliamperes - \$4.50
85 Milliamperes - 4.50
400 Milliamperes - 7.00

Ask for Catalog of full line of Standard Tubes.

Guaranteed

The standing of the Q·R·S Company, manufacturers of quality merchandise for over a quarter of a century, establishes your safety.

Orders placed by the leading Eliminator Manufacturers for this season's delivery, approximating Four Million Dollars' worth of Q·R·S Rectifier Tubes, establishes the approval of Radio Engineers. Ask any good dealer.

THE Q·R·S COMPANY

MUSIC

Manufacturers

Executive Offices: 306 S. Wabash Ave., Chicago

Factories: Chicago—New York—San Francisco—Toronto, Canada—Sydney, Australia—Utrecht, Holland

Established 1900. References—Dun, Bradstreet, or any bank anywhere

CEC Tubes are Specified for the Lynch Five Receiver

DESCRIBED IN THIS ISSUE



Special Tubes for Particular Radio Functions

Besides General Purpose Tubes, CeCo produces Special Purpose Tubes, Power Tubes, Filament Type Rectifiers, Gas Filled Rectifiers and A. C. Tubes.

Each is Perfect for its purpose; tested to highest standards, critically inspected, evacuated by an exclusive process that assures longer life.

Ask your Radio Dealer for Complete Data Sheet of CeCo
C. E. MFG. CO., Inc., PROVIDENCE, R. I., U. S. A.

CEC RADIO TUBES

My Adventures With Radio Operators

HERE is a protest against capitalistic control that comes from an observant young lady in Vassar College who has apparently had experience in sending radiograms and telegrams. Perhaps some radio operator can answer her:

Just what explanation is there for the utterly blank expressions on the faces of radio and telegraph operators when they read your message?

By long and tedious calculations I reduced the explanation to three possibilities:

1. Operators are physically incapable of showing any expression;
2. The messages do not cause them to do so;
3. There is a professional ruling against it.

The first possibility was soon discarded, for by visiting one hundred and one representative radio and telegraph offices in seventeen different states I found eighty-nine operators who, when not actually reading messages, showed a natural facial appearance. These observations were made at different seasons of the year and at varying times of day to avoid error due to local circumstance.

Then came my more laborous task. I succeeded in classifying messages which might reasonably be expected to cause some play of the facial muscles into three groups; the tragic, the humorous and the startling. I composed several messages of each type and sent them, in progressive rotation, from each of the stations under observation to my friends here and abroad. I would submit first a tragic message, for instance:

"Grandfather broke five ribs falling from merry-go-round. Had five unused tickets."

Later I would send a message of the second class, such as a catchy riddle and answer, a humorous little verse or a sparkling quotation from the classics.

Finally, I would submit the third type, such as:

"Have planted the bomb. Tell Maisie to leave Woolworth Building by Friday noon."

In each case I carefully observed the face of the operator while he read. Of the three hundred and three experiments thus made, *not one* subject changed expression, nor so much as broke the rhythm of his gum-chewing.

I am, therefore, forced to accept the truth of my third possibility. There must be some secret regulation that forbids to all these splendid young men the right to a normal expression of emotion.

This is carrying capitalistic control too far. What are we, as one hundred per cent Americans, going to do about it?

—ALICE A. PECK

Snap Shots

PRY the poor radio announcer. While the rest of the crowd are climbing over the seats to join the snake dance he has to stay in his coop and tell the baseball world what is going on.

SOMEBODY is always taking the joy out of life. The short waves now used by amateurs carry as well in the daytime as at night and there is no longer any excuse for staying up till morning.

SEND FOR FREE CATALOG

from
Chicago's Oldest Radio Jobbers and See What You Save!

GREATER BETTER VALUES

New Kits Featured Include:
 Aero, Bodine, Camfield, Citizens, H-F-L Infradyne, Karas, Melo-Heald, Scott's, Silver-Marshall, St. James, Tyman, etc.

Everything new and desired—all under one roof. You don't need to look elsewhere. Complete stock carried.

Prompt Efficient Service
 Dependable Service

Telephone Maintenance Co.
 123-0 South Wells Street
 Chicago, Illinois
 Established in 1918

WHOLESALE ONLY

CHICAGO'S OLDEST RADIO HOUSE

**30 Days
FREE
TRIAL
5 year
Guarantee**

MARWOOD

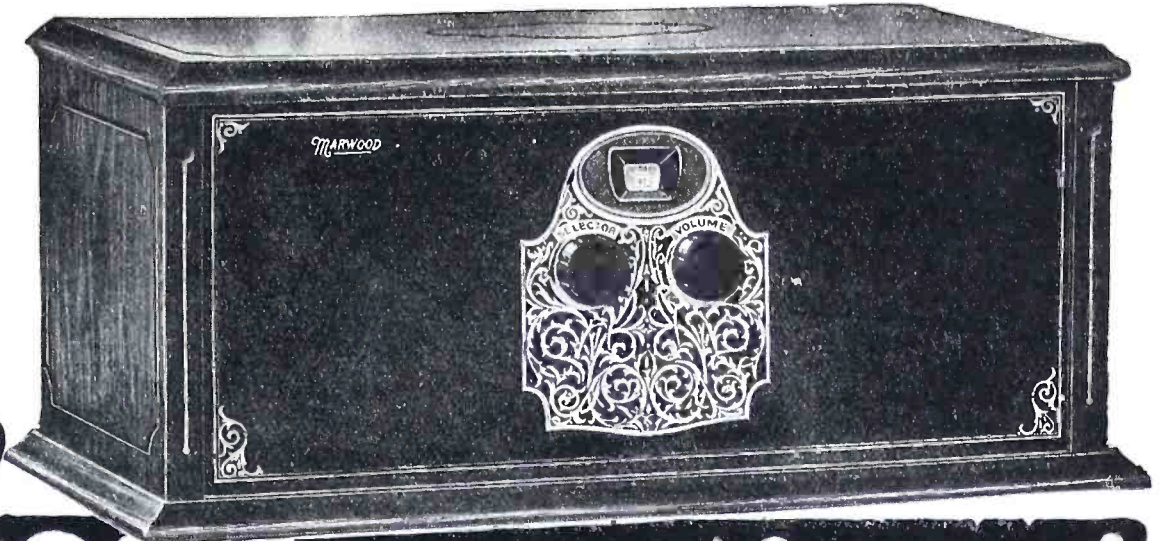

The 1928 Sensations! 8 Tube-1 Control



**ALL
ELECTRIC
8 Tube
1 Control
\$98 RETAIL
PRICE**

**Big Discount to Agents
From this Price**

**Has Complete
A-B Power Unit**

A REAL ALL ELECTRIC Radio with one of the best A-B power units on the market—no batteries needed—at the world's lowest price. This Marwood can't be excelled at ANY price. If you have electricity in your home, just plug into the light socket and forget batteries. No more battery trouble and expense. Costs less than 2c a day to operate. Always have 100% volume. ALL ELECTRIC Radios are high priced because they are new. We cut profit to the bone and offer a \$250.00 outfit for \$98.00 retail price. Big discount to Agents. Don't buy any Radio 'till you get details of this sensational new ALL ELECTRIC Marwood.

All Electric or Battery Operation

AGAIN Marwood is a year ahead—with the Radio sensation of 1928—at a low price that smashes Radio profiteering. Here's the sensation they're all talking about—the marvelous 8 Tube Single Control Marwood for BATTERY or ALL ELECTRIC operation. Direct from the factory for only \$69.00 retail price—a price far below that of smaller, less powerful Radios. Big discount to Agents from this price. You can't beat this wonderful new Marwood and you can't touch this low price. Why pay more for less quality? To prove that Marwood can't be beat we let you use it on 30 Days' Free Trial in your own home. Test it in every way. Compare it with any Radio for tone, quality, volume, distance, selectivity, beauty. If you don't say that it is a wonder, return it to us. We take the risk.

New Exclusive Features

Do you want coast to coast with volume enough to fill a theatre? Do you want amazing distance that only super-power Radios like the Marwood 8 can get? Do you want ultra-selectivity to cut out interference? Then you must test this Marwood on 30 Days' Free Trial. An amazing surprise awaits you. A flip of your finger makes it ultra-selective—or broad—just as you want it. Every Marwood is perfectly BALANCED—a real laboratory job. Its simple one dial control gets ALL the stations on the wave band with ease. A beautiful, guaranteed, super-efficient Radio in handsome walnut cabinets and consoles. A radio really worth double our low price.

Buy From Factory—Save Half

Why pay profits to several middlemen? A Marwood in any retail store would cost practically three times our low direct-from-the-factory price. Our policy is highest quality plus small profit and enormous sales. You get the benefit. Marwood is a pioneer, responsible Radio, with a good reputation to guard. We insist on the best—and we charge the least. If you want next year's improvements NOW—you must get a Marwood—the Radio that's a year ahead.

AGENTS

Make Big Spare Time Money

Get your own Radio at wholesale price. It's easy to get orders for the Marwood from your friends and neighbors. Folks buy quick when they compare Marwood quality and low prices. We want local agents and dealers in each territory to handle the enormous business created by our national advertising. Make \$100 a week or more in spare time demonstrating at home. No experience or capital needed. We show you how. This is the biggest season in Radio history. Everybody wants a Radio. Get in now. Rush coupon for 30 Days' Free Trial, beautiful catalog, Agents' Confidential Prices and Agents' New Plan.

**MARWOOD RADIO CORP.
5315 Ravenswood Avenue
Department B-2, Chicago, Illinois**

**Only
\$69 RETAIL
PRICE
Big Discount
to Agents
From This
Price**

Get Our Discounts Before You Buy a Radio

Don't buy any Radio 'till you get our big discounts and catalog. Save half and get a Radio that IS a Radio. Try any Marwood on 30 Days' Free Trial at our risk. Tune in coast to coast on loud speaker with enormous volume, clear as a bell. Let your wife and children operate it. Compare it with any Radio regardless of price. If you don't get the surprise of your life, return it. We take the risk. Don't let Marwood low prices lead you to believe Marwood is not the highest quality. We have smashed Radio prices. You save half.

6 Tube-1 Control

This is the Marwood 6 Tube, 1 Control for BATTERY or ALL ELECTRIC operation. Gets coast to coast on loud speaker with great volume. Only \$47.00 retail. Big discounts to Agents. Comes in handsome walnut cabinets and consoles. This low price cannot be equalled by any other high grade 6 tube Radio. Has the volume of any 7 tube set. If you want a 6 tube Radio you can't beat a Marwood and you can't touch our low price.

\$47

RETAIL
PRICE
Big Discount
to Agents from
This Price



Rush for Free Trial

MARWOOD RADIO CORPORATION,
5315 Ravenswood Ave., Dept. B-2, Chicago, Ill.
Send Agents' Confidential Prices, 30 Days' Free
Trial, New Catalog and Agents' New Money Mak-
ing Plan. No obligation on my part.

Name.....

St. or R.F.D.

City.....State.....

SEND TO

PRECISION FOR YOUR LC-28 KIT

Precision Coils are in the LC-28! Mr. Cockaday likes our Coils — you'll like our kits and service. Parts exactly as specified by Mr. Cockaday.

| | |
|---|----------------|
| 4 Hammarlund Mid-line Variable Condensers, .000275 mfd. @ \$5.10..... | \$20.40 |
| 1 Hammarlund double drum dial..... | 6.00 |
| 4 Precision type 4-B radio frequency transformers..... | 12.50 |
| 3 Samson high frequency chokes, type No. 125 @ \$2.25..... | 6.75 |
| 1 Samson high frequency choke, type No. 85..... | 2.00 |
| 3 Aerovox Moulded Condensers, .02 mfd. @ \$1.50..... | 4.50 |
| 1 Aerovox Moulded Condenser, .00025 mfd..... | .35 |
| 1 Aerovox Moulded Condenser, .00075 mfd..... | .40 |
| 1 Yaxley combination switch and rheostat, 6 ohms, No. 906-K..... | 1.75 |
| 1 Yaxley cable connector plug with cable, type 660..... | 3.00 |
| 4 Carter fixed resistances, 4 ohms, type H-4 @ .25..... | 1.00 |
| 2 Carter No. 10 tip jacks, @ 10c. each..... | .20 |
| 1 set insulating washers for tip jack..... | .05 |
| 2 "Imp" plugs cord tip type @ 15c. each..... | .30 |
| 1 Antenna name plate..... | .05 |
| 1 Ground name plate..... | .05 |
| 4 Benjamin vibrationless sockets @.75..... | 3.00 |
| 1 Lynch single resistance mounting..... | .35 |
| 1 Lynch Suppressor, 500 ohms..... | 1.50 |
| 1 Lynch Suppressor, 600 ohms..... | 1.50 |
| 1 Lynch Suppressor, 700 ohms..... | 1.50 |
| 1 Durham Metallized resistor, 6 megohms..... | .50 |
| 2 Tait brackets..... | 2.00 |
| 1 Alcoa aluminum chassis..... | 7.50 |
| 4 Sets special aluminum box shields for LC-28 @ \$2.00..... | 8.00 |
| 1 Aluminum panel, 6-in. by 26-in..... | 4.50 |
| 1 1/4-in. extension shaft..... | .50 |
| TOTAL..... | \$90.15 |

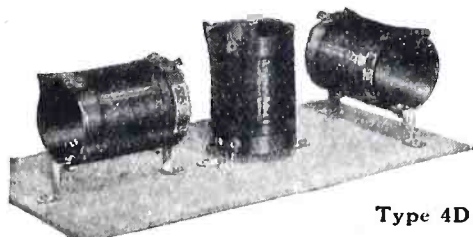

Type 4D

The New *Diamond Cut* PRECISION COILS

are now the
"Standard of Comparison"

They are accurate to within 1% of the rated inductance and most of them are better. Only with diamonds can this extreme accuracy be obtained. The *diamond cut* bakelite assures accurate spacing of the turns and uniform diameter of the tubing. Our new catalogue gives more details. Send for it.

Coils shown are our Type 4D and R. F. Choke No. 420
Type 4D—\$5 No. 420—\$1



No. 420

Send for our new
catalogue

Precision Coil Co., Inc.
209 Centre St., New York, N. Y.

What's New in Radio

(Continued from page 341)

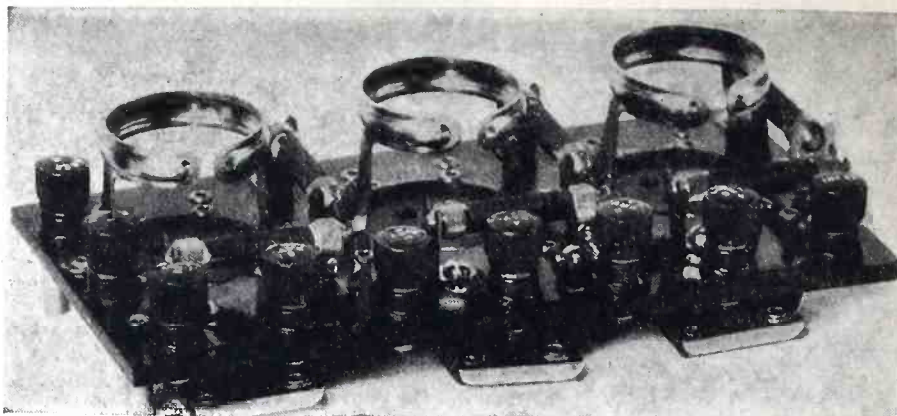

A Compact Amplifier Kit

Name of instrument: Resistance-coupled amplifier.

Description: This unit contains three stages of resistance-coupled amplification including the brackets for mounting the resistance, the resistances themselves and the necessary coupling condensers. The whole outfit is mounted on a bakelite strip that contains, as an integral part, the three vacuum-tube sockets. It is further equipped with the necessary binding-

posts for the "A," "B" and "C" batteries and the input and output terminals. The whole unit may be incorporated in a receiver that is being built by the experimenter.

Usage: In a radio receiving set as a complete amplifier.

Outstanding features: Compact amplifier arrangement. Neat workmanship, easy to install.

Maker: Heath Radio & Elec. Mfg. Co.



A Valve That Operates on Dry Cells

Name of valve: DV-3a.

Description: This valve has the same operating characteristics as the DL-3 valve. The only difference between the two lies in their physical shape and their bases. The DV-3a has an old-style UV-199 type base and is for use with the old-style 199 sockets.

This is also a dry-cell valve and has the same filament requirements as the DL-3 valve.

Valve rating:

- Filament voltage—3.
- Filament current—.065 ampere.
- Plate voltage—16.5 to 90.
- Negative grid bias—0 to 4.5 volts.

Valve characteristics (with a plate voltage of 90 and a negative grid bias of 4.5 volts), as determined in POPULAR RADIO TESTING LABORATORY:

- Plate resistance—16,900 ohms.
- Amplification factor—7.
- Mutual conductance—410 micromhos.
- Plate current—2.4 milliamperes.

Usage: As a detector, high-frequency amplifier or low-frequency amplifier in receivers equipped with old-style UX-199 type sockets.

Outstanding features: Less microphonic than the average dry-cell valve.

Maker: DeForest Radio Co.

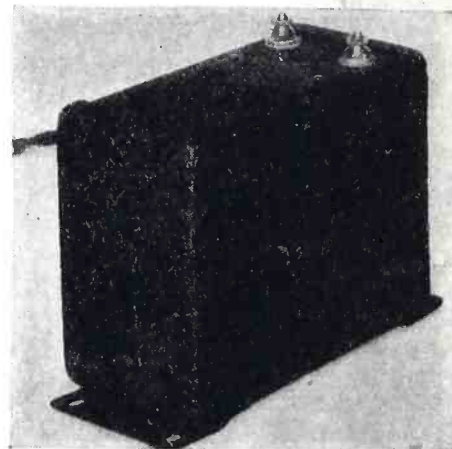

A Battery Charger That Requires No Attention

Name of instrument: Storage battery charger.

Description: This is a 2-ampere charger which consists of a step-down transformer and rectifier inclosed in a metal case. It is equipped with an extension cord and plug for connection to the AC lighting lines, and two output binding posts for connections to the battery. The rectifier used is the Raytheon cartridge type. A small fuse is included in the case to prevent damage to either the charger or the battery should the connections between the charger and the battery be reversed. The charger requires absolutely no attention except to turn it "on" and "off."

Usage: For charging 6-volt storage batteries from the alternating-current, house-lighting lines.

Outstanding features: Extremely small in size. Requires no attention.

Maker: Thordarson Electric Mfg. Co.
(Department continued on page 392)

Write today
for your copy of
**"Copper Shielding
for Radio"**

This new book shows how to improve the reception of your set. There is no charge.

Copper shielding means greater selectivity and sensitivity.

COPPER & BRASS
RESEARCH ASSOCIATION
25 Broadway, New York

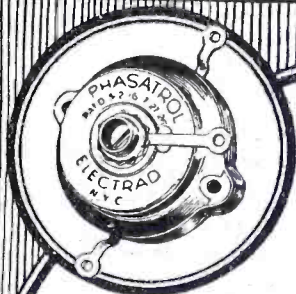

Licensed by Rider Radio Corporation. Pats. Pending. Patented 5-2-'16. Patented 7-27-'26.

**Don't
Endure
Oscillations!**

"Phasatrols"

Reg. U. S. Pat. Off.

A true balancing device for Radio frequency amplifiers

Price - - \$2.75

Either in the set you own or the one you intend building, solve the problem of proper control of oscillation by simply installing Phasatrol.

PHASATROLS make tuning easier. Endorsed and used by experts. Very easy to install in any tuned, untuned or reflex R. F. set.

Write for free hook-up circular for any set or circuit.

Dept. 58B, 175 Varick St., New York, N. Y.

ELECTRAD

Laurence Cockaday's

New
"LC - 28"
RECEIVER

Uses
**HAMMARLUND
CONDENSERS and
DRUM DIAL**

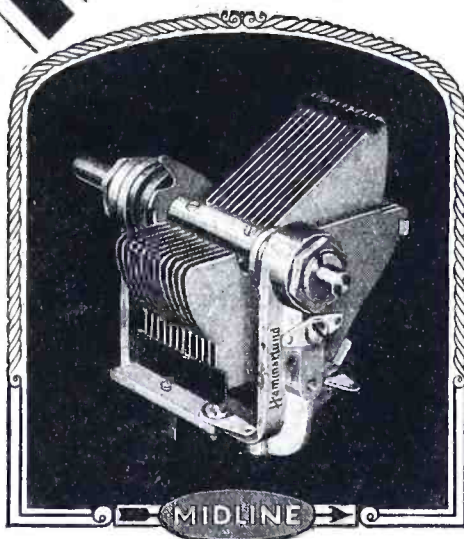

**Accurately
Matched**

A distinctive feature of the new "LC-28" Receiver is its inherently balanced R. F. amplifier—three stages, perfectly matched and stabilized without the addition of neutralizing devices of any kind. This means efficiency plus and it was attained in the simplest, most logical way—the designer selected Hammarlund "Midline" Condensers not only because past experience has proved their superior design and performance, but also because they are ACCURATELY MATCHED with laboratory precision.

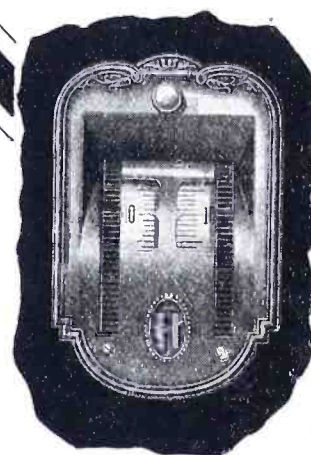

**Illuminated
DRUM DIAL**

Beautifully designed and substantially built. Gives distinction to any receiver and greatly simplifies tuning. Two-finger control. Illuminated from back of panel.

HAMMARLUND MANUFACTURING COMPANY
424-438 W. 33rd Street, New York

Many other leading radio designers have officially specified Hammarlund Precision Products for their latest receivers.

For Better Radio
Hammarlund
PRECISION
PRODUCTS

Dealer inquiries invited concerning several other new, interesting Hammarlund developments having a wide sales appeal.

A New A.C. Superheterodyne

Described in the December POPULAR RADIO

Here is an article, fresh from the Laboratory, describing in detail the construction of a 6-tube AC Superheterodyne Pack for use with the LC-28 Unipac. It is AC throughout and amazingly simple to build. No serious fan can afford to miss this issue of POPULAR RADIO.

\$3.00 sent to the Subscription Department guarantees the safe arrival of each new issue.

POPULAR RADIO, INC.

119 West 57th Street

New York, N. Y.



millions may now enjoy the thrill of improved reception with MUTER B POWER

When your favorite radio hour is at hand! That's the time to settle back at ease and appreciate the real joy of clear, true, uninterrupted reception with the new Muter B Power Unit. The Muter Policy of "Dependable quality at a popular price" has brought this enjoyment within the means of every set owner. Convince yourself of the pleasure that can now be yours by an early tryout on our liberal guarantee of satisfaction.

Outstanding Characteristics

FIXED CONTROLS used with separate fixed voltage taps, giving ample range and definite knowledge of voltage received.

CAPACITY ten tubes or seven with a power tube.

RATING 40 mls at 150 volts. Will deliver 180 volts for new type 171 power tube.

Condensers: Muter filter condensers of ample capacity and acknowledged quality ensure long life and uniform output.

Uses Standard Cunningham or Radio Corp. Full Wave Vacuum Rectifying Tube because of long life and stability. Used on 110 to 120 volt, 60 cycle A. C. Current Only.

No Noise—No Vibration

Model 3000 for 280 or 213 Tube\$24.50
Model 3050 for Raytheon B. H. Tube\$26.00

Ask Your Dealer—or Send Coupon

Prompt shipment, postpaid, will be made upon receipt of price—or C. O. D. plus postage, if you prefer. Make this moderate investment with perfect assurance that of all the enjoyment Radio offers you will find none greater than the difference in reception with Muter "B" Power.

LESLIE F. MUTER CO.

Dept. 806-PX
76th and Greenwood Ave., CHICAGO, ILL.

MUTER DEPENDABLE PRODUCTS

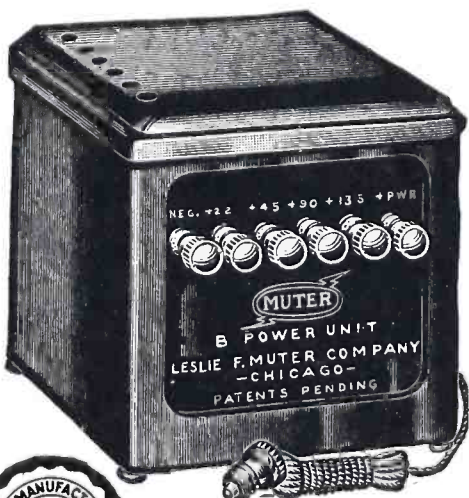

LESLIE F. MUTER CO.
76th and Greenwood Ave.,
Dept. 806-PX, Chicago, Ill.

- Send \$24.50 model for 280 or 213 Tube.
- Send \$26.00 model for Raytheon B. H. Tube.
- Payment is enclosed. You pay postage.
- Send C. O. D. plus postage.
- Send me complete Muter Catalog.

Name.....
Address.....
City..... State.....

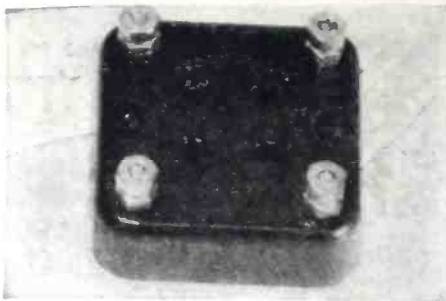

It Is Easy to Get the Valve Into This Socket

Name of instrument: Vacuum-valve socket.

Description: This rectangular base fits flat on the sub-panel or baseboard of the receiver. Within it are mounted the spring contact terminals. These contacts are in the form of double springs and are securely fastened in position to guarantee a firm sliding contact on the valve prongs. For added strength the base is reinforced at four points. Two screw holes are provided for the mounting screws. Both metal binding posts and soldering lugs are used on the four terminals. The four holes into which the valve prongs fit are tapered in such a way as to make it easy to fit the valve into the socket.

Usage: As the holder for the vacuum valves in a radio receiver.

Outstanding features: Positive contacts. Strong construction. Easy to insert valves.

Maker: Herbert H. Frost, Inc.

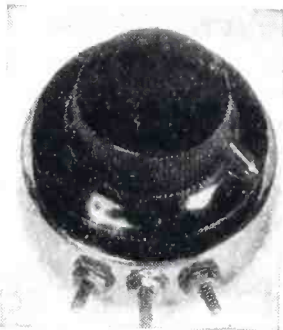

This Unit Provides a Smooth Voltage Control

Name of instrument: Variable resistor.

Description: This unit consists of a nickel-plated, cylindrical metal case with the wall lined with a special resistance composition. The contact member or arm is equipped with a pair of rollers so arranged that as the arm is turned these rollers press against the resistance, thus making the necessary contact. There is no sliding or scraping and for that reason there is no wear on the resistance material. The roller type of contact provides smooth variation of the resistance. The instrument is equipped with a composition knob and may be mounted on a receiver panel by means of a single hole in the panel. This unit is obtainable in various resistance values with maximums ranging from 400 to 500,000 ohms.

Usage: In the plate or grid circuits of receivers for the purpose of stabilizing the high-frequency circuits or controlling regeneration. In "B" power-packs for output voltage control. As plate or grid resistors in resistance-coupled amplifiers.

Outstanding features: Neat appearance. Smooth operation. Positive contact. May be obtained with two or three terminals for use as a series resistance or potentiometer.

Maker: Herbert H. Frost, Inc.

Knickerbocker 4

THE WONDER SET

2-Dial Karas Equamatic 5 Tube Receiver

THESE two famous receivers, as well as scores of other well-known sets, owe no small part of their marvelous performance to the use of Karas Parts. Karas Condensers, Transformers, Filters, Coils and Dials are the perfected products of a factory which has been building precision electrical apparatus for more than a third of a century. Write today for complete catalog of all Karas Parts, and details of the Knickerbocker 4 and the 2-Dial Karas Equamatic.

KARAS ELECTRIC CO.
4029-K North Rockwell Street
CHICAGO

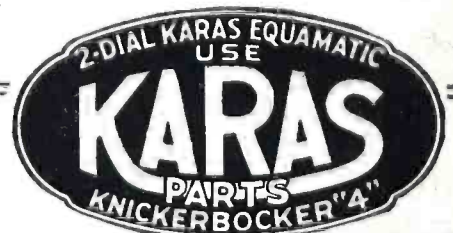

PRICES SLASHED On Standard Radio Products

Now ready! Harry Alter's price list for November. Saves you money on every requirement—not merely on a few "bait" bargains. Check and prove my unheard-of values. Test Alter's "Minute-Man" shipping service. Send for this big catalog—free.

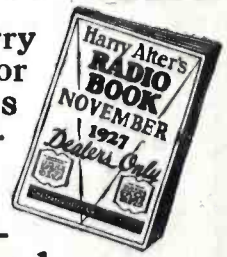

(NOTE: We Sell to Dealers Only)

The Harry Alter Co.

1749 Michigan Ave., Chicago, Ill.

MAIL THIS COUPON

The Harry Alter Co.
1749 Michigan Ave., Chicago
Send at once a copy of your November price guide.

Name.....
Address.....
City..... State.....

Townsend "B" Socket Power "Best in World!"

Says A. W. GALE
of Gloversville, N. Y.



Only
\$6.85
\$1.00 Down
Balance
C.O.D.

Below is a reproduction of Mr. Gale's letter of May 8th, 1927.

48 W. Fulton St.,
Gloversville, N. Y.

"Received the Townsend all O. K. It is the best in the World and that is saying some. I have a Radiola 4 tube. Get more stations than ever before. Some of them are CFCF, CKNC, WGY, KDKA, WGZ, WIP, WWJ, KTHS, KOP, KOA, WHAS, WTAM and KSD—besides 4 in Chicago, all in the East and then some."

A. W. Gale.

Replaces "B" Batteries

The letter above speaks for itself—proves beyond doubt that the Townsend "B" Socket Power is the most remarkable value in Radio today. Sam E. Fry of 1415 Holmes St., Kansas City, Mo., writes: "Eliminator works fine. Showed it to a friend and he wants one also. I will say it sure beats batteries. I get stations I never got before on a 6 tube set." Charles Ellis, 88 Jones Ave., Columbus, Ohio, says, "Your Eliminator is working fine. Have had station WJAX and others over 1,000 miles distant. Picked up 22 different stations one evening and around 30 another time. My neighbor has a \$27.50 Eliminator and I don't see that it works any better than yours."

Delivers up to 100 volts on any set, on D. C. or A. C.—any cycle. Full tone, clarity and volume.

Tested and approved by America's leading Radio authorities—Radio News and Popular Radio Laboratories

ORDER TODAY!

Simply fill out the coupon and slip it into an envelope with only \$1.00 and mail at once. Your Townsend "B" Socket Power Unit will be sent promptly. Deposit only \$5.85 plus postage with the postman. Try out for 10 days—then if not delighted with improvement in reception, return it to us and purchase price will be refunded.

TOWNSEND LABORATORIES
713 Townsend St., Dept. 19, Chicago, Ill.

Attach Only \$1.00
to this Coupon!
SEND TODAY

**10 Days
FREE
TRIAL**
You are the
Judge!

**TOWNSEND
LABORATORIES**
713 Townsend St.
Dept. 19, Chicago, Ill.

Gentlemen: Attached find \$1.00. Kindly send at once Townsend "B" Socket Power Unit, C. O. D., for \$5.85, plus postage, on guaranteed 10-day free trial.

Name.....
Address.....
City..... State.....

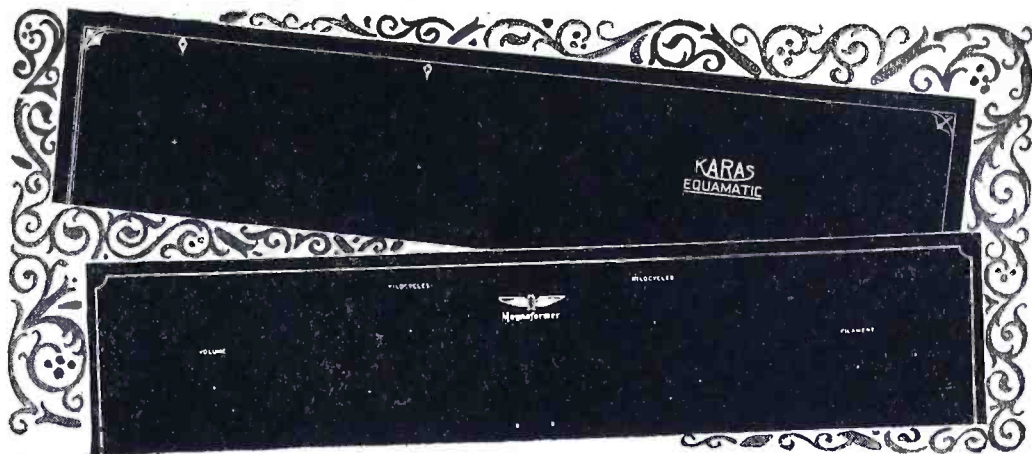

Panels for Magnaformer and Other Kits

FORMICA is supplying handsomely decorated and drilled front and sub panels for the Magnaformer Circuit; also Tyrman front and sub panels, H. F. L. new hook-up; Karas new hook-up; World's Record Ten; Camfield Nine and Camfield Seven.

Other kits for which Formica panels are available are Madison-Moore, Melo-Heald, Victoreen, St. James Infradyne and E. T. Flewelling's Super Eight.

These panels enable the home constructor to build a set equal in appearance and efficiency to the best manufactured receivers.

Sold by leading dealers and jobbers everywhere

The FORMICA INSULATION COMPANY
4641 Spring Grove Avenue Cincinnati, Ohio

Any parts—dealer
or jobber can get
Formica panels for you

FORMICA

Formica has a
Complete Service on
Insulating Parts for the
Radio Manufacturer

POPULAR RADIO DEALER AND JOBBER LISTS AVAILABLE TO MANUFACTURERS

The Service Bureau of POPULAR RADIO is able to place at the disposal of radio manufacturers a list of over 21,000 radio dealers, 3,926 radio manufacturers, 1,746 jobbers and 326 manufacturers' representatives. These addresses are immediately available for circularizing prospects for new Fall lines, and more detailed information and rates will be gladly supplied to those who wish to take advantage of what is without doubt one of the most carefully kept lists at present offered for use.

Address all inquiries to:

SERVICE BUREAU

POPULAR RADIO, Inc.
119 West 57th Street New York, N. Y.

ZRF

33% Greater
Amplification
from YOUR
RF Sockets



L. M. Cockaday—technical editor of POPULAR RADIO—made a careful study of radio-frequency amplification tube requirements. Co-operating with Mr. Cockaday, Zetka Laboratories have produced the ZRF—a ¼ amp. special duty Radio-Frequency amplifier—resulting in over 33% greater amplification per stage than is possible with standard tubes. He found in RF the main factors to be a low input capacity between the elements (which goes with a low mu) and a low plate impedance.

Try ZRF in the radio-frequency stages of YOUR SET. Only \$4.50 each. For complete characteristics of this remarkable new tube, write

ZETKA LABORATORIES, Inc., 73 Winthrop St., Newark, N. J.

ZETKA

The Clear-Glass Tube

RESISTANCE RANGE PLUS



FINE adjustment of resistance calls for limited range in most variable resistors.

But the Clarostat is different; it has not one turn, or part of a turn, of its knob to cover the resistance range, but *several turns*. Therefore, the resistance range of the Clarostat is that of the usual variable resistor, plus several more turns. Instead of practically zero to several hundred thousand ohms, the Universal Range Clarostat, for example, provides a range of practically zero to 5,000,000 ohms—and with that astounding range it has a more gradual adjustment than any other device with a tenth that range. One Clarostat, therefore, does the work of many variable resistors of other types. But the main thing about Clarostat is reliability. It combines the *reliability* of fixed resistance with the *convenience* of variable resistance.

CLAROSTAT

is the standard of variable resistance. And as with all standards, it is widely copied in appearance. Don't be fooled! Watch for the green box, and the name stamped on the Clarostat itself.

Your local dealer has the three types of Clarostat in stock. Watch the radio columns for how to better your present set, or how to build a better set, with Clarostats. Write us for descriptive literature.

AMERICAN MECHANICAL LABORATORIES, INC.
Specialists in Variable Resistors
285 N. Sixth Street, Brooklyn, N. Y.



Transoceanic Calls Heard

POPULAR RADIO'S "Calls Heard" Department is ready to serve all American amateurs by forwarding their calls heard (QSL) cards to their proper destination in foreign countries. These cards are delivered through agents in those countries who have or can obtain knowledge of the present address of foreign amateurs. POPULAR RADIO is also doing the foreign amateur the service of forwarding his QSL cards to the proper destination in this country. In addition, the magazine will publish a monthly list in the "Transoceanic Calls Heard" column. Address your cards to the foreign amateurs by call number and enclose them in envelopes to—

The Calls Heard Editor

POPULAR RADIO

119 West 57th Street, New York

THE following stations in the United States were received and logged at the amateur station of M. Meidieux (EF-8ARO), at Belfort, France, using a receiver with detector and one stage of low frequency:

1ADM, 1AQT, 1ARC, 1AVL, 1CNZ, 1VW, 2ADL, 2AYJ, 2AZK, 2CRB, 2CUQ, 2CYX, 2GX, 2HC, 2IZ, 2JN, 2PZ, 2TR, 3ACW, 3AEF, 3AFU, 3AKS, 3QE, 3SZ, 4DX, 4LK, 4RN, 4RR, 8ALY, 8BTH, 8DHX, 8JQ, 9ARA, 9DIJ.

THE following stations in the United States were received and logged at the amateur station of Roger Pieton (R390), at 92, Rue Riquet, Toulouse, France, using a Bourne circuit with one stage of low frequency:

1AAE, 1AD, 1ADM, 1ADK, 1ACD, 1AWE, 1BBM, 1BYV, 1BCV, 1BHS, 1BYF, 1BEB, 1BUX, 1CCZ, 1CM, 1CMX, 1CKP, 1CMF, 1CNZ, 1CPB, 1CRA, 1FN, 1GWE, 1IA, 1ISU, 1LRC, 1SAT, 1SMG, 1SW, 1VW, 1XV, 2AEB, 2AGN, 2AH, 2AHM, 2ALY, 2AMD, 2AML, 2AMJ, 2AWQ, 2AYJ, 2BLB, 2BSC, 2CH, 2EXE, 2GP, 2GX, 2JN, 2NM, 2MX, 2OX, 2TKX, 2TOG, 2TP, 2TTH, 2TXE, 2XAD, 3AH, 3BBG, 3BTQ, 3BWJ, 3CEC, 3CKJ, 3JM, 3QP, 3TN, 3XAE, 4AU, 4DV, 4FA, 4LP, 4OH, 4QY, 4RN, 4RP, 4XE, 5AGA, 5AXS, 5ACL, 5MX, 5JS, 5SH, 5UK, 6AGR, 6AZS, 6BAM, 6BDN, 8ACL, 8ACZ, 8ADE, 8ADG, 8AGA, 8AHE, 8ALY, 8ASB, 8AVL, 8AUL, 8AUT, 8BES, 8BOX, 8CCQ, 8CCS, 8CCA, 8CED, 8CEK, 8CLP, 8CSE, 8COA, 8DDN, 8DEM, 8DGB, 8DGH, 8DHX, 8DME, 8DOD, 8DON, 8DSF, 8LL, 9BAV, 9BBT, 9BDQ, 9BZI, 9CFN, 9CN, 9DB, 9DDP, 9DDZ, 9EFK, 9EFX, 9EIM.

THE following stations in the United States were received and logged at the amateur station of L. Berger (EF-8OEO), at Bayonne, France, using a three-circuit, low-loss receiver:

1ADM, 1BAT, 1CMX, 1SZ, 1VC, 2ASE, 2ATS, 2BOW, 2BIQ, 2BXU, 3BQZ, 3HS, 3MB, 3QW, 3QE, 3SZ, 3TF, 4RM, 5WZ, 6FU, 8AGK, 8AJN, 8BEN, 8BJB, 8BTH, 8CNH, 8DJG, 8JQ, 9ADK, 9AEB.

THE following stations in the United States were received and logged at the amateur station of J. Gimat (R221), at 14, Rue Riquet, Toulouse, France, using a Schnell circuit:

4DV, 4FA, 4IZ, 4KU, 4NH, 4OH, 4OY, 4TU, 4XE, 5ACL, 5AGA, 5AGQ, 5AX, 5XE, 6BZF, 7SF, 9ARA, 9ARK, 9BBH, 9BZI, 9CFN, 9CMV, 9CN.

Weak batteries? Never with Rectigon The Two-Rate Charger

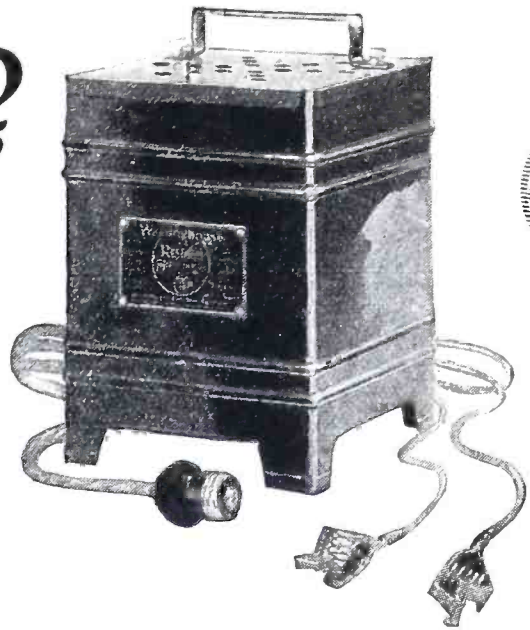

CONNECT your battery permanently to Rectigon—it will automatically “trickle in” new power to replace what you use; or if unusually long periods of set operation drain the battery faster than a “trickle will recharge, just swing the leads over to Rectigon’s high-rate terminals and bring the battery to full charge quickly and without bother. You need only the one charger to keep

3 Ampere Rectigon
~~\$18.00~~
now
\$14.00
5 Ampere Rectigon
~~\$28.00~~
now
\$24.00

your “A” at top notch for every program. Rectigon will recharge your wet “B” just as easily.

Rectigon is made by Westinghouse — broadcasters of first radio program from KDKA, back in 1920. Rectigon is safe, compact and simple. No moving parts to break or wear out, nothing to damage the set even if you tune in while charging. Get Rectigon at your dealer’s.

Westinghouse Rectigon Battery Charger

WESTINGHOUSE ELECTRIC & MANUFACTURING COMPANY, EAST PITTSBURGH, PA.
Offices in All Principal Cities — Representatives Everywhere
Tune in with KDKA—KYW—WBZ—WBZA

Rectox — for trickle charging only. Just attach the leads to your battery and connect Rectox to the light line. Left permanently on charge, at either 1/2 or 3/4-ampere charging rate, it keeps your “A” battery power peppy. No messy liquids, no moving parts, nothing to wear out.



Besides Rectigon and Rectox for better battery charging, Westinghouse also makes Micarta panels and tubing for better insulation, and radio testing instruments for better reception.





Crystal Clear Tones

Tone quality is what radio listeners want. Volume and distance mean nothing if the tones are blurred.

The Carborundum Stabilizing Detector Unit

REG. U. S. PAT. OFF.

brings you natural tones clear as crystal with assured volume and selectivity.

A tone perfecting unit that can be used on practically any set.

\$3.50 in U.S.A. Dealer or direct. Or the Carborundum Detector alone for \$1.50.

The Carborundum Company
Niagara Falls, N. Y.

Send for free Hook-up Book D.5

THE CARBORUNDUM COMPANY
NIAGARA FALLS, N. Y.
CANADIAN CARBORUNDUM CO., LTD.
NIAGARA FALLS, ONT.

SALES OFFICES AND WAREHOUSES IN New York, Chicago, Boston, Philadelphia, Cleveland, Detroit, Cincinnati, Pittsburgh, Milwaukee, Grand Rapids

The Carborundum Co., Ltd.
Manchester, England
Deutsche Carborundum Werke
Dusseldorf, Germany

Name _____

Street _____

City _____ State _____

Carborundum is the Registered Trade Name used by The Carborundum Company for Silicon Carbide. This Trade Mark is the exclusive property of The Carborundum Company.

LC-28—\$90.15

Kits ready for immediate shipment, no substitutions

| | |
|---|---------|
| 4—Hammerlund mid-line variable condensers .000275 mfd | \$20.40 |
| 1—Hammarlund double-drum dial | 6.00 |
| 4—Precision type 4B radio frequency transformers | 12.50 |
| 3—Samson high-frequency chokes, type 125 | 6.75 |
| 1—Samson high-frequency chokes, type No. 85 | 2.00 |
| 3—Aerovox Moulded Condensers, .02 mfd. | 4.50 |
| 1c—Aerovox Moulded Condensers, .00025 mfd. | .35 |
| 1—Aerovox Moulded Condensers, .00075 mfd. | .40 |
| 1—Yaxley combination switch and rheostat, 6 ohms, No. 906-K | 1.75 |
| 1—Yaxley cable connector plug with cable, type 660 | 3.00 |
| 4—Carter fixed resistances, 4 ohms, type 4H | 1.00 |
| 2—Carter No. 10 tipjacks .20 | |
| 1—Set insulating washers for tipjack .05 | |
| 2—"IMP" plugs cord tip type .30 | .65 |
| 1—Antenna name plate .05 | |
| 1—Ground name plate .05 | |
| 4—Benjamin vibrationless sockets | 3.00 |
| 1—Lynch single resistance mounting | .35 |
| 1—Lynch Suppressor, 500 ohms | 1.50 |
| 1—Lynch Suppressor, 600 ohms | 1.50 |
| 1—Lynch Suppressor, 700 ohms | 1.50 |
| 1—Durham metallized resistor, 6 megohms | .50 |
| 2—Tait brackets | 2.00 |
| 1—Alcoa aluminum Chassis | 7.50 |
| 4—Sets special aluminum box shields for LC-28 | 8.00 |
| 1—Aluminum panel, 6x26 inch | 4.50 |
| 1—1/4 inch extension shaft | .50 |

\$90.15

Magnaformer 9-8 Kits, \$128.99

LC-27 Kits, \$85.20

Dealers and Professional Set Builders write for Discounts

Wired sets in stock—write for prices

Transportation charges prepaid on retail sales when full remittance is received with order.

RADIO SERVICE CO.
P. O. Box 144 Knoxville, Iowa

POLYMET CONDENSERS

They Stand Abuse!



At All Dealers

Polymet Filter Condensers

They are selected by leading engineers and incorporated as standard equipment by nationally known manufacturers of receiving sets and power units. Follow the leaders.

Write for Polymet Catalog

POLYMET MFG. CORP.
599-601 Broadway, New York City

POLYMET

XL Products

Model "N" Vario-denser



Pep up Your Set!

Easier tuning—correct tube oscillation—more volume and clearness with an X-L VARIO DENSER in your circuit.

Specified and endorsed by foremost radio authorities in all leading circuits.

MODEL "N"—Micrometer adjustment easily made, assures exact oscillation control in all tuned radio frequency circuits, Neutrodyne, Roberts 2-tube, Browning-Drake, Silver's Knockout. Capacity range, 1.8 to 20 Mfd. Price, \$1.00.

MODEL "G"—Obtains the proper grid capacity on Cockaday circuits, filter and intermediate frequency tuning in superheterodyne and positive grid bias in all sets. Capacity range, Model G-1, .00002 to .0001 Mfd. Model G-5, .0001 to .0005 Mfd. Model G-10, .0003 to .001 Mfd. Price, each, with grid clips, \$1.50.

X-L PUSH POST—Push it down with your thumb, insert wire, remove pressure, wire is firmly held. Vibrations will not loosen, releases instantly. A push post that excels in appearance, action, service and convenience. Price, each, \$1.50.

PUSH POST PANEL—7 push posts mounted on black insulating panel with permanent white markings. Soldering lugs, raising bushings, screws for mounting, etc., in box complete. Price, \$1.50.



X-L Push Post



X-L Push Post Panel

FREE—New, up-to-date book of wiring diagrams showing use of X-L units in the new LOFTIN-WHITE constant coupled radio frequency circuit, and in other popular hook-ups. Send for yours today.

XL Radio Laboratories

2422 Lincoln Ave., Chicago, Ill.



THOUSANDS OF FANS HAVE WAITED FOR THESE AMERTRAN PUSH-PULL TRANSFORMERS!

THE intensive research work of AmerTran engineers has culminated in the new AmerTran push-pull units Nos. 151 and 152. With these new transformers one stage of AmerTran push-pull with power tubes following a first stage of AmerTran DeLuxe, provides for energy output to the speaker with less distortion than can be obtained with a single power tube.

With this system, tube distortion and harmonics are suppressed, and the slight hum caused by the raw AC on the filament of the power tube is entirely eliminated.

As in the case of the AmerTran DeLuxe transformers, the push-pull unit uses high permeability alloy cores. The multiple windings of the new unit are so arranged and balanced as to give high inductance coupling and minimum capacity coupling. The input transformer which works out of the plate of one amplifying tube to the grids of two power tubes has approximately the same primary impedance as the two-stage AmerTran DeLuxe.

Since various type of power tubes have different values of plate impedance, AmerTran

has provided output transformers to correspond with the power tubes of the speakers which are most generally used. Impedance ratios are calculated for a greater transfer of energy for frequencies from 50 to 100 cycles because it is in the case of these low frequencies where more energy is required to drive the loudspeaker mechanism.

You may purchase these units from your local authorized AmerTran dealer, and they are available in the following types and prices:

Push - Pull Input Transformers,
type 151..... \$15.00 each

Push - Pull Output Transformers,
type 152 (impedance ratio 4
to 1) for 2 UX-210 or similar
power tubes..... \$15.00 each

Push - Pull Output Transformers,
type 271 (impedance ratio 2
to 1) for 2 UX-171 tubes con-
nected push-pull..... \$15.00 each

AmerTran DeLuxe Transformers, available at your local dealers at a price of \$10.00 each, have been accepted as standard by radio engineers throughout the world. AmerTran Power Transformers, Chokes, and Resistors for high quality amplification have also enjoyed leadership as the products of a house that for over twenty-six years has specialized in the building of transformer units of every description.

AMERICAN TRANSFORMER CO.

178 EMMET STREET

Transformer Builders for
Over Twenty-Six Years

NEWARK, N. J.



You can always bank on Faradon

Whether you buy or build—the performance of your socket-power equipment can only be as reliable as the electrostatic condensers used.

Large manufacturers throughout the country have found Faradon Capacitors possess the qualities which are essential to reliability. Therefore they specify Faradon.

Take a leaf from their book and when you buy—either set, kit or for replacement—insist on the generally accepted standard or fixed condenser durability and specify Faradon Capacitors.

Your dealer can supply them in all desired capacitances. Ask for them by name—Faradon.

WIRELESS SPECIALTY APPARATUS COMPANY

Jamaica Plain, Boston, Mass., U. S. A.

Established 1907

Faradon

1232

Electrostatic condensers for all purposes

When the ball goes 'round the end for 40 yds.

"You're there with a Crosley!"

The Crosley Radio Corporation:
Can you explain "balancing," so folks can understand it? We technical people know that Hazeltine's neutrodyne principle is a wonderful thing. If you can make it understandable to laymen you're good.

Yours truly,
F. D. PITTS CO.
Boston, Mass.

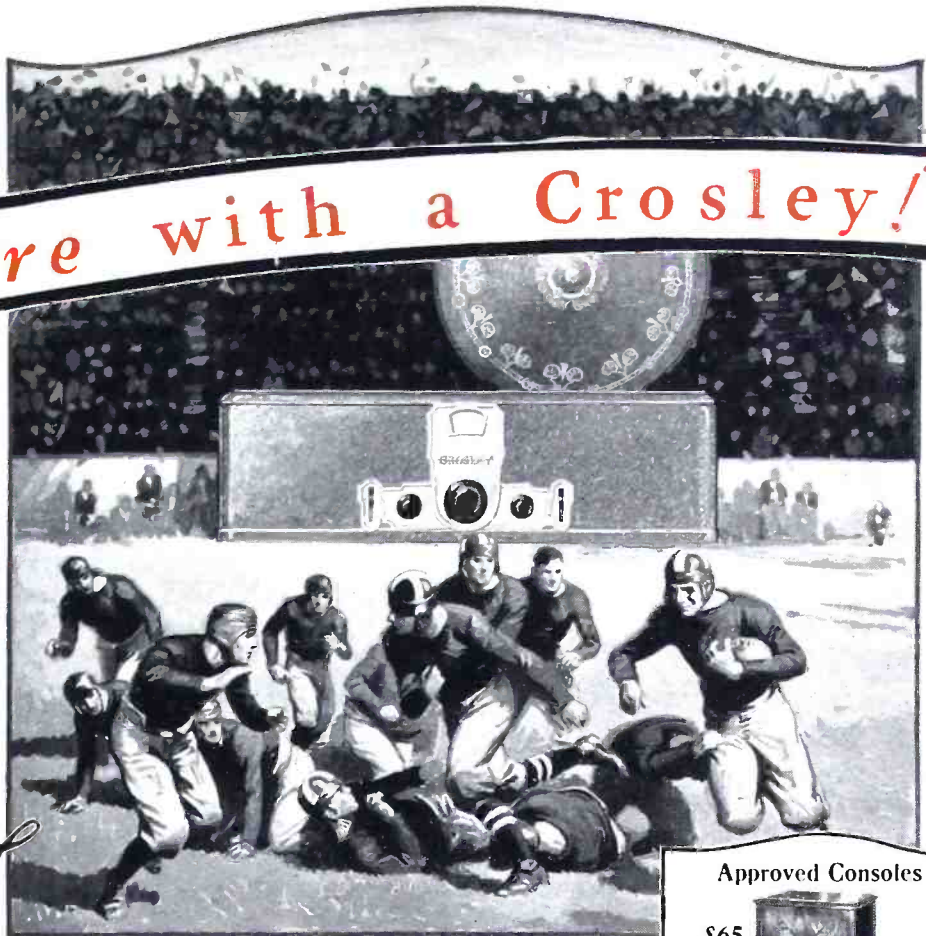

Nature always puts obstacles in our way. When men begin to study a new invention or discovery they find that there are many problems to solve before a successful device can be built. This was the case with the steam engine, the printing press, the automobile, the aeroplane, and every other major invention that you can think of.

The vacuum tube is, perhaps, one of the most remarkable inventions ever made. We found that we could use it to amplify the radio signals. But when we tried to tune these amplifiers, so that they would help us select the desired signal, we found that the vacuum had a tendency to misbehave.

When a tube is used to amplify, the output voltage is much stronger than the input voltage. This is the natural result of the amplification. But there is a path back through the tube through which some of the strong output voltage can get

back to the input side of the tube. The voltage is then again amplified and again returns, getting stronger each time, the result being that the tube goes wild. It becomes a miniature broadcasting station on its own hook.

If we can provide a second path from the output circuit to the input circuit, so arranged that the voltage which comes back through this second path is opposed to the

voltage that comes back through the tube itself we can prevent the trouble. This is called "balancing" because the second path is adjusted so that it exactly balances the path through the tube.

The Hazeltine method of balancing (or neutralizing) this path through the tube has several unique advantages over all the other methods that have been proposed. This is why Crosley radios use the Hazeltine "neutrodyne" method.

HAZELTINE DIVIDES BOLSHIEV VOLTAGES. BALANCING EACH OTHER BY OPPOSING EACH OTHER. THEY CAUSE NO RUMPS IN THE TUBE AND PROGRAM SIGNALS GO THROUGH AMPLIFIER WITHOUT INTERFERENCE.

THIS new Crosley Bandbox

6 TUBE RECEIVER *de luxe*
is the national radio hit at \$55.

The "All American" radio of 1928! With license to participate in the enormous radio resources of The Radio Corporation of America, The General Electric Co., The Westinghouse Co., The American Telephone and Telegraph Co., and The Hazeltine and The Latour Corporations, the Crosley Bandbox of 1928 is an "eleven" of super-efficient features and amazing co-ordinated performance. In it are incorporated:

- 1—The best idea of balancing.
- 2—The best ideas of shielding.
- 3—The best ideas of sharp tuning.
- 4—The best idea of controlling volume.
- 5—The best idea of station selection.
- 6—The best idea of finish and color.
- 7—The best idea of power tube use.
- 8—The best idea of console installation.
- 9—The best idea of power supply connections by enclosing all leads in a cable.
- 10—The best idea of AC tube operation.
- 11—The best idea of converting AC current to necessary radio DC.

Operation of the Bandbox receiver from house current is possible with the AC model at \$65, which uses the new amazing R.C.A. AC tubes. Power converter costs \$60 more.

These new Bandbox receivers are now on display at over 16,000 Authorized Crosley dealers. Their faultless reception of the many wonderful events constantly on the air is proving such a startling demonstration that a national enthusiasm sweeps the country in the natural exclamation—"You're there with a Crosley!" If you cannot locate the nearest dealer, write Dept. 16, for his name and literature.

Approved Consoles



Selected by Powel Crosley, Jr., as ideal, acoustically and mechanically for the installation of the Crosley "Bandbox." Genuine Musicone built in. Crosley dealers secure them from their jobbers through
H. T. ROBERTS CO.
1340 S. Michigan Ave.,
Chicago, Ill.
Sales Agents for Approved Console Factories
Showers Brothers Company
Bloomington, Ind.
The Wolf Mfg. Industries
Kokomo, Ind.

IMPROVED MUSICONES

Musicones improve the reception of any radio set. They are perfect affiliates in beauty and reproductive effectiveness for Crosley Radios. A tilt-table model with brown mahogany finish stands 36 inches high, \$27.50—16-inch Super-Musicone as pictured above with "Bandbox," \$12.75—12-inch Ultra-Musicone, \$9.75.



CROSLEY RADIO

THE CROSLEY RADIO CORPORATION
Powel Crosley, Jr., President, Cincinnati, Ohio
Prices slightly higher west of the Rocky Mts.



Crosley is licensed only for
Radio Amateur, Experimental and
Broadcast Reception

A L U M I N U M

IN RADIO—A SIGN OF QUALITY

IN the fine sets of many of the leading manufacturers you will find that Aluminum is the prevailing metal for shielding, variable condensers and chasses.

The reason for the widespread preference for Aluminum is expressed in three characteristics which are possessed in combination *only* by Aluminum:

High Electrical Conductivity, Workability, Lightness

Added to these characteristics, Aluminum is impervious to common corrosion.

The exhaustive experiments of leading manufacturers that have proved the superiority of Aluminum are a guide to the

layman in building or in buying.

Information on the subject of Aluminum in Radio will be sent on request. Write for the booklet, "Aluminum for Radio." It is sent without cost.

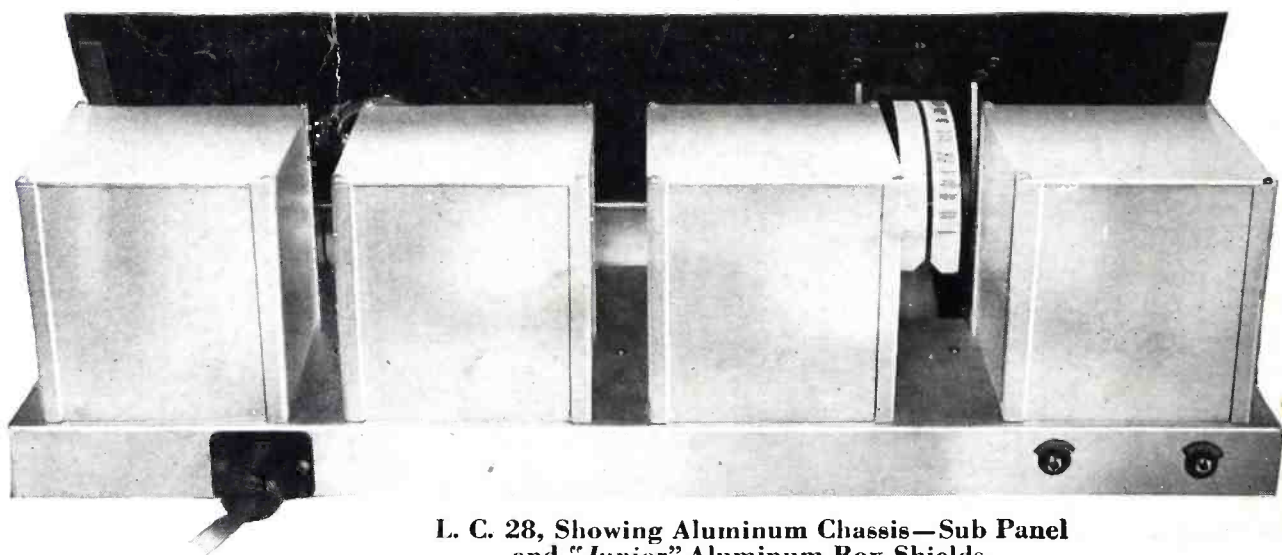

L. C. 28, Showing Aluminum Chassis—Sub Panel and "Junior" Aluminum Box Shields.

The Aluminum Company of America manufacture the L.C. 28 Chassis-Sub Panel and the "Junior" Aluminum Box Shields specified for Cockaday's L.C. 28



ALUMINUM COMPANY OF AMERICA

2461 Oliver Building, Pittsburgh, Pa.

Offices in 18 Principal American Cities



A L U M I N U M I N E V E R Y C O M M E R C I A L F O R M