

# Popular Radio

JANUARY • 1927

25¢

48  
9/20/9

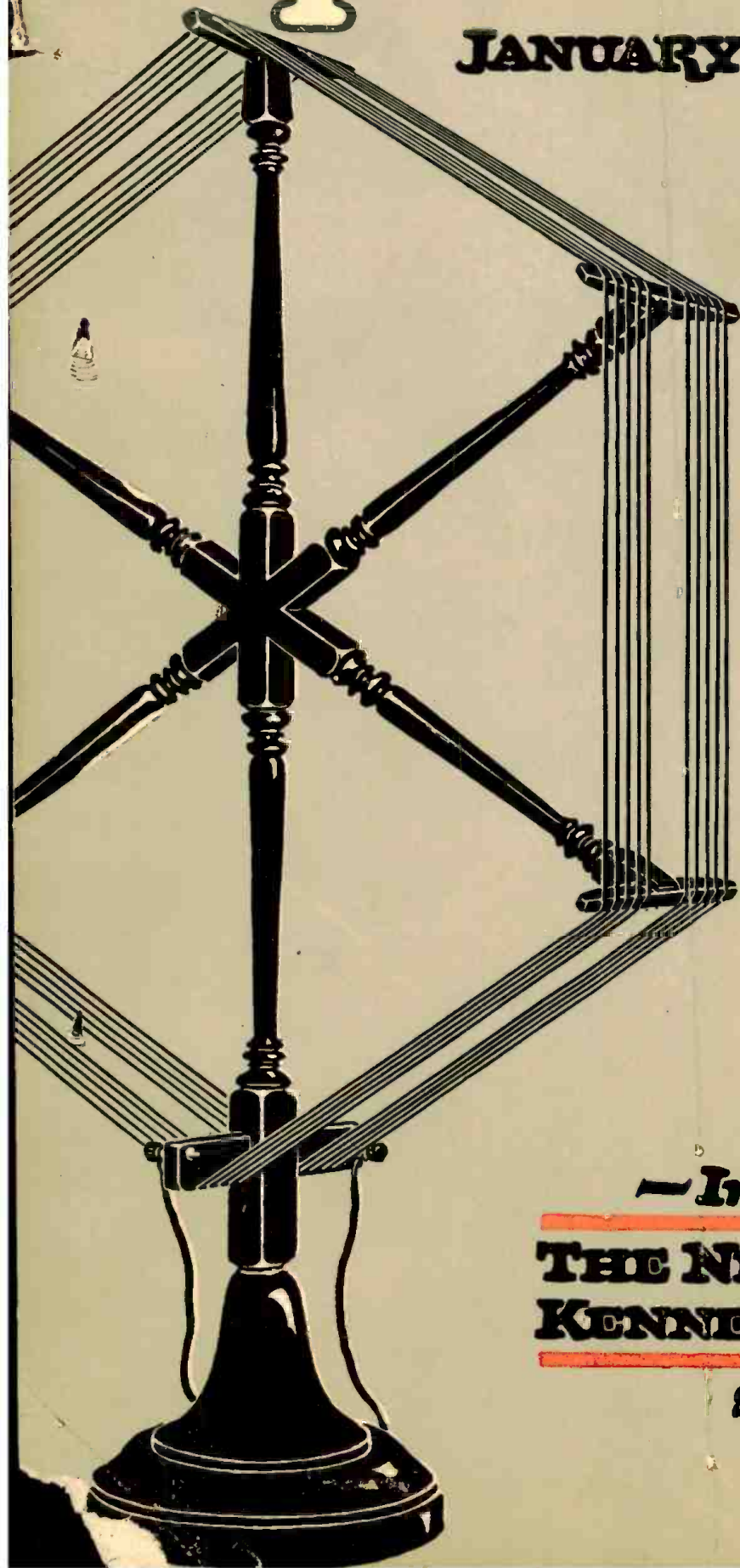

~ In this Issue ~

**THE NEW CIRCUIT BY  
KENNETH HARKNESS**

See page 14



## more distance on the same set

Want more stations on that storage battery set of yours? Want the far-away ones you get now to come in more easily and regularly? The Radiotron laboratories have developed a *super-detector* that slips right into the socket where you have a Radiotron UX-201-A now. Just change that one to a Radiotron UX-200-A.

It makes your set sensitive to fainter signals—reaches out to farther stations—picks up weaker ones you couldn't get before. It makes a big change for a very small cost!

Bring your storage battery set up-to-date with  
a power RADIOTRON UX-171 or UX-112  
a detector RADIOTRON UX-200-A  
and RADIOTRONS UX-201-A for all-round quality.

Bring your dry battery set up-to-date with  
a power RADIOTRON UX-120  
and RADIOTRONS UX-199 for all-round quality.

RADIO CORPORATION OF AMERICA  
New York Chicago San Francisco

H E A T I N G  
M E T A L  
I N S I D E · O F  
G L A S S

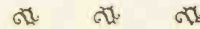

EVERYONE knows that glass melts easily, and metal requires a high temperature. Yet, at the Radiotron laboratories, the experimenters can put a Radiotron in the coil of a "high frequency furnace" and melt the metal *inside it* without melting the glass. This is done by an electric current that is induced inside the glass bulb, right through the glass.

This extraordinary furnace is not only used for experiment. In manufacture, every single Radiotron goes for a moment through such a furnace, just after the air has been exhausted out of it. The inside metal is heated red hot in the vacuum, and the tiny air bubbles boil right out of the metal and the glass, and are pumped away. Never before could such an exhaust be obtained.

This means *real performance* when the Radiotron gets into your set. And it adds another reason for insisting on a genuine RCA Radiotron with the RCA mark on the base and the glass. There are Radiotrons for every purpose.

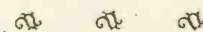

# RCA Radiotron

MADE BY THE MAKERS OF THE RADIOLA



APPROVED BY 18 MONTHS OF PUBLIC USE  
NO OTHER BATTERY IS LIKE IT

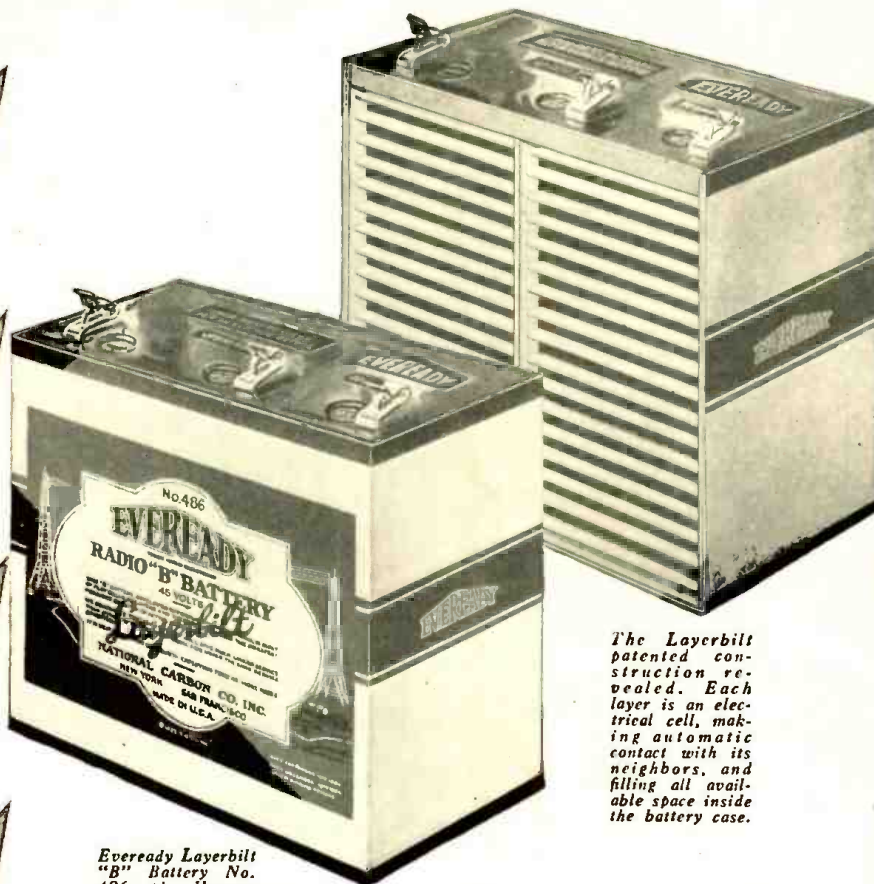

Eveready Layerbilt "B" Battery No. 486, the Heavy-Duty battery that should be specified for all loud-speaker sets.

The Layerbilt patented construction revealed. Each layer is an electrical cell, making automatic contact with its neighbors, and filling all available space inside the battery case.

## Practical tests have shown this to be the most economical of "B" Batteries

IN DAILY use in the home, Eveready Layerbilt "B" Battery No. 486 has fulfilled the promises made for it in laboratory tests. More than a year's study of the performance of this battery in the hands of the public has shown that it is the most satisfactory and most economical "B" battery ever developed. All loud-speaker sets require Heavy-Duty batteries—and the Layerbilt has proved itself absolutely the best of them all.

If you are now using the smaller, Light-Duty batteries, the Eveready Layerbilts will give you twice the service though they do not cost anything like twice as much. If you are already using Heavy-Duties, the Layerbilt, the longest lasting Heavy-Duty ever built, will run your set at least 25% longer, and again you will save money. Unless Eveready Layerbilts now are

connected to your set, you spend more on "B" batteries than you should, and you can have no idea how good a "B" battery can be. The Layerbilt holds a surprise in store for you.

Eveready Layerbilt's unequalled service is due to its unique construction. All other dry cell "B" batteries are made of cylindrical cells, with many soldered connections, and a great deal of space is wasted between the cells. The Layerbilt is built up of layers of flat current-producing elements, that make connection with each other automatically, and that fill all available space inside the battery case. It is every inch a battery. In it you get more active materials than in any other battery and the Layerbilt construction makes those materials much more efficient current producers.

Those are the convincing reasons why

the Eveready Layerbilt has proved itself the longest lasting, most economical and reliable "B" battery ever built.

Just remember this about "B" batteries—Heavy-Duty batteries are more economical than the smaller Light-Duty batteries on all loud-speaker sets, and the patented exclusive Eveready Layerbilt No. 486 is the most economical of all.

Manufactured and guaranteed by  
**NATIONAL CARBON CO., INC.**  
New York San Francisco  
Canadian National Carbon Co., Limited  
Toronto, Ontario

Tuesday night is Eveready Hour Night—9 P. M., Eastern Standard Time, through the following stations:

WEAF—New York	WTAM—Cleveland
WJAR—Providence	WWJ—Detroit
WEEF—Boston	WGN—Chicago
WTAG—Worcester	WOC—Davenport
WFI—Philadelphia	WCCO—Minneapolis
WGR—Buffalo	WCCO—St. Paul
WCAE—Pittsburgh	KSD—St. Louis
WSAI—Cincinnati	WRC—Washington

# Popular Radio

EDITED by KENDALL BANNING



FOUNDED 1911

VOLUME XI

January, 1927

NUMBER 1

## CONTENTS

(Cover design by Frank B. Masters)

### Who Will Pay the Man Who Pays the Broadcaster?

The practical part that the broadcast listener is playing—and must play—to maintain and develop radio programs

By *Orrin E. Dunlap, Jr.* . . . . . PAGE 11

### How to Build the New KH-27 Receiver

An entirely new type of audio-frequency amplification—the Hiler double-impedance system—is featured in this set

By *Kenneth Harkness.* . . . . . PAGE 16

### Radio's Contribution to Our Language—500 Words

By *Charles Magee Adams.* . . . . . PAGE 21

### To Start and Stop Your Set Automatically—

How to build an ingenious alarm-clock control that will turn your set on and off

By *O. D. Westcott.* . . . . . PAGE 22

### "KFP"—a Miniature Broadcasting Station that Directed a Battle

By *Lloyd Jacquet.* . . . . . PAGE 24

### Popular Radio Circuits

INSTALLMENT No. 6:

The "Henry-Lyford" Receiver  
The Hammarlund-Roberts "Hi-Q" Receiver

*The Technical Staff.* . . . . . PAGE 26

### The Quack Doctors of Radio

PART II: The Fake Fortune Tellers

By *E. E. Free, Ph.D.* . . . . . PAGE 28

### What Happens When You Tune Your Set

The second article in a new and significant series on the fundamentals of radio

By *Sir Oliver Lodge, F.R.S., D.Sc., LL.D.* PAGE 31

### How to Build the LC-Junior Power-pack

A highly efficient but low-cost power unit for any set that uses a power tube in the last stage

By *Laurence M. Cockaday.* . . . . . PAGE 33

### What's New in Radio

*The Technical Staff.* . . . . . PAGE 36

## DEPARTMENTS

The Yes and No Man . . . . .	44
What Readers Ask . . . . . <i>David Lay</i> . . . . .	56
With the Experimenters . . . . . <i>Richard Lord</i> . . . . .	62
Listening In . . . . .	74
With the Inventors . . . . . <i>William G. H. Finch</i> . . . . .	82
Broadcast Listener . . . . . <i>Raymond Francis Yates</i> . . . . .	96
The Beginner in Radio . . . . . <i>Armstrong Perry</i> . . . . .	102
Broadcasts . . . . . <i>Charles L. Reese, Jr</i> . . . . .	106

VOLUME XI

JANUARY, 1927

NUMBER 1

Published monthly by Popular Radio, Inc., 627 West 43rd St., New York, N. Y., telephone number, Chickering 1906; Douglas H. Cooke, President and Treasurer; Kendall Banning, Vice-President; Laurence M. Cockaday, Secretary; Joseph T. Cooney, Asst. Treasurer. Price 25 cents a copy; subscription \$3.00 a year in the U. S., Canada and all countries within the domestic postal zone; elsewhere \$3.50 a year, payable in advance. The International News Company, Ltd., No. 5 Bream's Bldg., London, E. C. 4, sole distributors in England. Entered as second class matter April 7, 1922, at the Post Office at New York, N. Y., under the act of March 3, 1879. Copyright 1926, and title registered as a trade-mark by Popular Radio, Inc. Copyright in Great Britain by Popular Radio, Inc., 6 Henrietta St., Covent Garden, W. C., London, England. For advertising rates address Popular Radio, Inc., 627 West 43rd St., New York, or 225 North Michigan Ave., Chicago. Printed in U. S. A.

LAURENCE M. COCKADAY, *Technical Editor*  
CHARLES L. REESE, Jr., *Managing Editor*

E. E. FREE, Ph.D., *Contributing Editor*  
JOHN V. L. HOGAN, *Contributing Editor*



# BROWNING-DRAKE RADIO



## TESTED... Then Highly ENDORSED

**S**INCE its introduction several years ago, Browning - Drake Radio has been **TESTED** by thousands of radio experts throughout the world . . . then wholeheartedly **ENDORSED** for dependable radio reception. This unusual endorsement has put Browning-Drake into a hundred thousand homes where Browning-Drake performance is giving permanent satisfaction to its owners.

During the summer of 1923, at Cruft Laboratory of Harvard University, Glenn H. Browning and Frederick H. Drake set a mathematical standard of design for radio frequency transformers. This scientific achievement resulted in the Browning-Drake slot wound radio

frequency transformer. By using one stage of scientifically designed radio frequency, incorporating the Browning-Drake transformer, together with the flexibility of dual-control tuning, a combination was found that has never been surpassed for all around radio reception.

Browning Drake produces only one model . . . the Browning-Drake Five which is completely assembled at its Brighton laboratories. Every set is unconditionally guaranteed. You will find the price of only \$95.00 as amazing as its performance. Ask the nearest Browning-Drake dealer to demonstrate it for you **TODAY**.

**DEALERS:** No reputable dealer can afford to overlook the Browning-Drake opportunity. Every Browning-Drake dealer has made money and every customer has been permanently pleased. Write or wire **TODAY** for proposition.

**BROWNING-DRAKE CORPORATION, Brighton, Mass.**

# A PAGE WITH THE EDITOR

WITH this issue of POPULAR RADIO the department "What's New in Radio," which was instituted about four years ago as a regular feature of the magazine, has been greatly expanded—in deference to the expressed wishes of our readers for more extensive information concerning the many new and useful inventions that are being placed at their disposal by the radio industry.

\* \* \*

INVENTORS, experimenters, manufacturers and readers generally are invited to keep the POPULAR RADIO LABORATORY informed of all new apparatus that is of their own creation or that comes to their attention; if the apparatus passes the tests of the laboratory, it will be duly recorded in that Department, for the information and benefit of all.

\* \* \*

IN view of the increased space given to "What's New In Radio" in this number, Dr. Free's Department "In the World's Laboratories" has been omitted this month. It will be resumed in the February issue and at greater length than usual.

\* \* \*

IN the interests of the two million or more broadcast listeners within a hundred-mile radius of New York, where radio reception is occasionally marred by code signals from the old-time spark transmitter that is still in service at the Brooklyn Navy Yard, the Editor took up with the naval authorities the question of doing away with this form of interference from this particular source.

\* \* \*

WITH characteristic promptness, Rear Admiral C. P. Plunkett sends the readers of POPULAR RADIO the following re-assuring message:

\* \* \*

"MY inquiry shows that we have been engaged for some time in converting our old-fashioned transmitter so as to avoid interference of every kind. We use a low-power tube set most of the time, but occasionally we get a message from far at sea, where we have to revert to the old transmitter. This, however, will be shortly remedied and I trust there will be no further complaint.

\* \* \*

"I THANK you very much for calling my attention to it, as I had only observed very occasional interference and hope to have it eliminated entirely."

\* \* \*

WHEN the Actors' Equity Association—which includes in its membership most of our important actors and actresses—recently forbade the broadcasting of a direct-from-the-stage performance of "The Miracle" from Station WIP of Philadelphia and WGBS of New York,

unless the members of the cast received a bonus of one-eighth of their weekly salaries, the Editor invited the amiable Mr. Frank Gillmore, their executive secretary, to explain the reason for Equity's action.

\* \* \*

To the observer on the side lines, there seems to be little if any reason for demanding extra pay for the cast, in view of the fact that the broadcasting of a play during an actual stage presentation entails no additional work to the performers, and indeed may be done without the knowledge of the cast.

\* \* \*

THE gist of Mr. Gillmore's explanation follows:

\* \* \*

"THE Actors' Equity Association is quite willing to allow its members to broadcast, and many of them do so regularly. It does insist that when any member, or members, broadcast the play in which they are currently appearing, or any part of that play, that they should be paid for it. And it has set the rate for that pay at one-eighth of their weekly salary, which is the rate charged for an extra performance whenever it is required.

\* \* \*

"Now then, why has Equity thought it necessary, or advisable to make, and to enforce such a ruling?"

\* \* \*

"WHEN radio was very much of a novelty, and some of the theatrical managers were quick to jump at this new way of presenting their attractions before potential audiences, individual actors and entire companies were sent to broadcasting stations to perform scenes, or whole plays in which they were appearing.

\* \* \*

"BUT the actors learned that any benefit which accrued from these performances was for the radio companies which sold sets or parts, and needed entertainment in order to interest prospective purchasers in their possession, and for the management of the plays in which they were appearing.

\* \* \*

"THE actors found that these performances for five hundred thousand or five million people did not bring them any more or better contracts, but it did bring them a good deal of extra work from which other people were profiting; either directly in money, or indirectly, in good will.

\* \* \*

"THAT is the basis of Equity's ruling; where there is extra work there should be extra pay. It is counted fair in all other lines of work, why should it not be fair for people of the theatre?"

"And although the ruling of extra pay for performances was at first applied only to special performances, because of its classification as an advertising stunt, the Council of this Association extended the ruling to cover all radio performances, whether picked up from the stage during a performance, or not."

\* \* \*

BUT does this answer the Editor's query?

\* \* \*

THE issue involved is of academic rather than of practical import, after all. Stage plays are written for presentation on the stage, where the appeal is to both the ear and the eye; the only theatrical performances that are successfully sent "on the air" are those which are broadcast from the studio, with the aid of explanatory remarks, a proper acoustical background and "off-stage" effects.

\* \* \*

To this observer on the side lines it still appears that the broadcasting of a play during an actual performance is of far greater publicity value to the production, and in this way reacts, to the advantage of both the producers and to the cast, than it is of benefit to the broadcast listener.

\* \* \*

"MAY I take this rather belated opportunity of very heartily congratulating you on the new POPULAR RADIO which is now, in my estimation, the finest radio magazine to be found in the world. It is my intention to keep all the copies of P.R. for binding."

—W. BRADLEY (G-2AUX), 10 Montecott Road, London, N. 8, England.

\* \* \*

IN POPULAR RADIO for next month—February—will appear two constructional articles.

\* \* \*

ONE will give instructions for building the Rauland-Lyric Amplifier, at a cost for parts not to exceed \$29.00.

\* \* \*

THE other article will tell how to assemble the All-Amaz Senior 3-tube Reflex receiver, at a cost for parts not to exceed \$44.00.

\* \* \*

AND in the March number will be published a constructional article of interest to all set owners—an article that will tell how to build your own cone loudspeaker at home.

*Kendall Tramming*  
Editor, POPULAR RADIO





# Can't tune 'em out?

**T**RY a Micadon 601 in series with the antenna of your set, if you find it hard to "tune out" nearby stations.

The Micadon will have the same effect as "loose coupling," and the selectivity of your set will be greatly improved. Capacities from .0001 to .0005 mfd. may be used—you will find a full explanation in our 32 page booklet, "Seventeen Ways to Improve Your Set."

Micadons, because of the patented principles of low-loss insulation and protection against variation in capacity which they embody, are a vital element in the improved reception of thousands of radio sets.

The tone, the efficiency, and the satisfactory operation of your set depend on the quality of the fixed condensers used.

If you want to be sure that your set will do all it was meant to do, be sure that the fixed condensers bear the name of Dubilier.

*Send 10c in stamps or coin for your copy of  
"Seventeen Ways to Improve Your Set."*

# Dubilier

**CONDENSER AND RADIO CORPORATION**

4377 Bronx Blvd., New York, N. Y.

# SM

## Speaking of Power Units—



330 and 329 Power Transformer  
331 Unichoke  
332 Condenser Bank

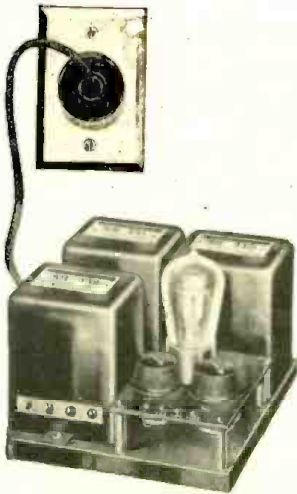

650 Plug-In "B"

Do you know that Silver-Marshall power units have been endorsed and chosen by the foremost engineers of this country for their most recent developments in batteryless receiver designs? Laurence Cockaday chose S-M parts to make up his LC-27 Junior Power Pack—Best used and specified them in his A.C. operated Browning-Drake—Radio News chose them for their Batteryless receiver which will be announced in the February issue. M. B. Sleeper built his new Radio Mechanics A.B.C. eliminator for 201-A and power tubes around them.

Why?—

Because S-M power units will furnish plenty of power—because the filtration is about one and one-half times as good as that of ordinary filter designs—because a selective filter is used as well as the usual "brute-force" method—because they're shielded electrostatically and magnetically against line noises. S-M power units will furnish far more power than the average receiver will ever require—they are good as a power source for amateur transmission work too.

TYPE 330 POWER TRANSFORMER is designed for Raytheon or Rectron tubes. It has two 300 volt secondaries, a 110 volt, 60 cycle primary and a 7.5 volt filament lighting winding. Rated at 85 milliamperes continuous duty without heating, it will furnish double this current for short periods. Price \$6.00.

TYPE 329 POWER TRANSFORMER is identical to type 330, except that it is provided with two 220 volt secondaries, a 5 volt filament winding with neutral tap, and a 110 volt A.C. primary with cord and plug. Price \$6.00.

TYPE 331 UNICHOKE is a two-winding high inductance filter choke licensed under the Clough Patent Application. Its current capacity is 85 milliamperes; or double this for short periods. Its filtration, when properly used, is guaranteed to be superior to that of all other standard power supply filters. Price \$6.00.

TYPE 332 CONDENSER BANK contains two 1/10th mf., two mf., two 1 mf., and one 4 mf. condensers, tested for an operating voltage of 250 volts D.C. It is intended for use in "A," "B" or "C" power supply filters. Price \$10.00.

### 650 Plug-In "B"

Built around the units described above, it will furnish from 10 milliamperes at 270 volts to 60 milliamperes at 180 volts.

650-C Plug-In "B" complete ready to operate, \$33.50, less CX-313 tube.

650-D Plug-In "B," same as 650-C except unwired, for CX-313 or Raytheon, \$29.00, less tube.

Do you know the secret of quality reproduction?

Have you your copy of "The Secret of Quality"? It tells you simply how to get the most out of your audio amplifier—how to get real quality. It contains laboratory data never before available even to many manufacturers. It is the only authoritative treatise on all types of audio amplification written in non-technical language ever published.

It's free! Ask your dealer for a copy.

Prices 10% higher west of the Rockies.

**Silver-Marshall, Inc.**  
844 W. Jackson Blvd., Chicago, U. S. A.

Do you know that an unofficial report of the largest telephone manufacturing company in the world set S-M 220 audio transformers as the very finest they had ever tested? Do you know that you can obtain these same transformers from your dealer at \$6.00 each—with an absolute guarantee of satisfaction or your money back?

Do you know that an S-M 221 output transformer will bring out the low notes in last year's set—for just six dollars?





From a photograph made for POPULAR RADIO

### POPULAR RADIO a Vital Factor in the Development of Radio

*"POPULAR RADIO has been a vital factor in the development of the radio industry, for not only has it encouraged independent experimentation on all types of radio receivers but it has given to the 'fan' the scientific facts upon which to base his work."*

*J. A. Browning*

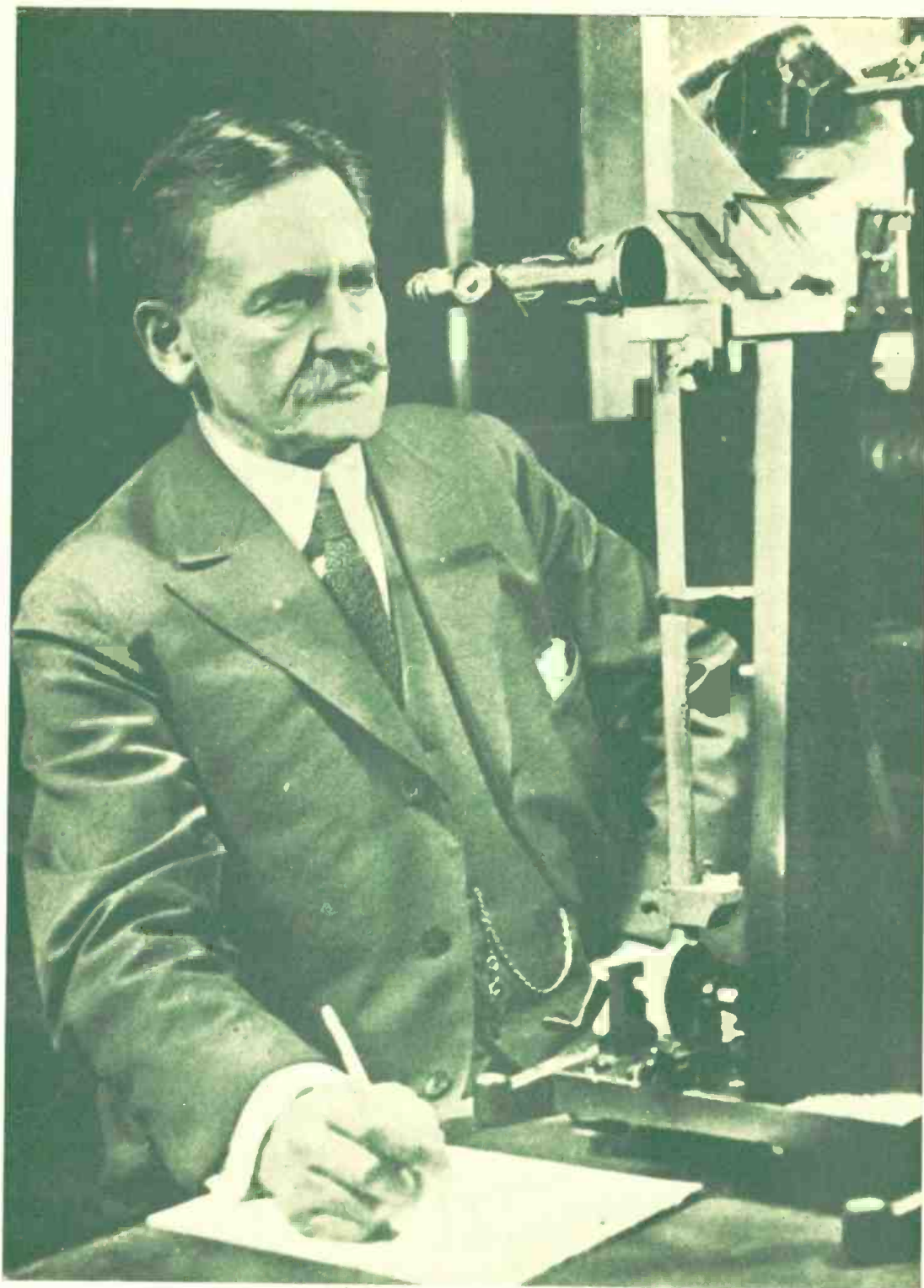

Underwood & Underwood

### He Corrects the Speed Measurements of Radio Waves

PROFESSOR ALBERT A. MICHELSON of the University of Chicago, dean of American physicists, at the recent meeting of the National Academy of Sciences, at Philadelphia, described the results of three years work on two mountain tops in California to determine the speed of light through space. His latest figure for this most fundamental of all the constants of Nature is 186,284 miles a second—replacing the formerly accepted figure of 186,326 miles a second. As radio waves are believed to have the same speed as light waves, Dr. Michelson's new figure applies also to them.



# Popular Radio



VOLUME XI

January, 1927

NUMBER 1

WHO WILL PAY THE MAN

## Who Pays the Broadcaster?

*The practical part that the broadcast listener is playing—  
and must play—to maintain and develop radio programs*

MILLIONS of dollars are invested today in broadcasting stations in the United States.

Millions more are being spent yearly on programs broadcast from these stations.

Most of this vast sum is paid for the maintenance of the 500 or more broadcast stations that are supported for the purpose of creating good will on the part of the radio audience toward the concerns that pay the bills.

These concerns are paying the bills because they believe that they are thus building up what the psychologists tell us is "a subconscious buying attitude" toward the products, or toward the merchandise, or toward the professional or other services, or whatever it is that these broadcasters have to sell.

Many of the broadcasting stations (the number of which at the present time is probably over 100) are becoming frankly "toll stations." They are renting out time on a rate-basis that each station determines separately on the basis of the area that it covers, and its influence as gauged by its estimated audience, and other factors.

The year 1927 is destined to see a rapid growth in the number of these "toll" stations.

At present most of the program features of outstanding merit and popularity are supported by business concerns that not only pay the toll station charges, but the fees of the artists as well—to say nothing of the innumerable incidental expenses incurred.

From these large expenditures the radio audience benefits. It will continue to benefit as long as these programs are continued.

But the programs will be continued only as long as those who pay the bills have reason to believe that the large amount thus invested brings back returns from the radio audience.

We, of the broadcast audience, the "broadcasters," will be able to listen-in on the great symphony concerts, upon the recitals of the world's greatest artists, upon athletic events of nation-wide interest, upon the voices of our statesmen, of our scientists, of our other leaders of eminence only so long as the broadcaster has reason to believe that the enormous expense that this service involves is justified on economic grounds.

POPULAR RADIO believes that the time has come when the radio audience not only can but should, in the interest of better broadcasting, convert this "subconscious" good will toward the patrons of radio broadcasting, to conscious and direct support of those who are maintaining the radio programs.

POPULAR RADIO believes that the most effective method of lending substantial aid and direct encouragement to those who are demonstrating their faith in this method of creating good will, and who are giving their effort and their substance to the development of a form of public service that has already become the established and important factor

in our American civilization may be expressed thus:

*To support those who are supporting radio broadcasting.*

The following article tells who some of

these outstanding patrons of broadcasting are and what they are paying to win the good will of the radio audience—your good will and mine.

—EDITOR

By ORRIN E. DUNLAP, JR.

**W**HEN it was announced that the broadcasting rights of the Jack Dempsey - Gene Tunney heavyweight championship fight had been purchased by George Ed Smith, President of the Royal Typewriter Company, there were a host of business men who asked: "What can a business concern profit from such a connection?"

Furthermore, their inquiry was given more significance when it was reported that the broadcasting costs ran upwards of \$25,000.

The network of WEAF costs \$4,080 for an hour hook-up. On the night of the fight the stations went on the air with the preliminary bouts and side-lights at 7:30 o'clock, making a total cost of at least \$12,000. In addition to WEAF's allied transmitters there were others linked into the circuit, including WJZ and affiliated stations. It was reported that the broadcasting rights cost \$15,000, of which 75 percent went to the Madison Square Garden Corpora-

tion and 25 percent to the Sesquicentennial Exposition.

Why was this expense warranted?

Why should a typewriter manufacturer send a word picture of a prize fight to radio fans who did not contribute a cent to the undertaking?

The answer was, "Advertising, goodwill, publicity."

Previous to the announcement that the fight would be put on the air it was rumored that Tex Rickard, the fight promoter would not permit a blow by blow description, or even a round by round telegraphic report to be released into space. Broadcast listeners throughout the nation were clamoring to hear the fight direct from the ringside. Whoever could persuade Tex Rickard to sanction microphones at the arena would be truly a friend of the millions sitting around the invisible ringside. When everything looked dark for the radio fans the announcement was made in the newspapers that the typewriter com-

pany had pulled the chestnuts out of the fire. The name of the company was on the lips of millions from coast to coast with extremely favorable comment for several days previous to the clang of the gong, which opened the battle in Philadelphia. Then, intermingled with the rounds and the lulls in the battle came the words, "Royal Typewriter," blazened through the ether lanes as a public benefactor, and carried into millions of homes on one of the largest varieties of wavelengths that ever wafted a single radio performance across America.

Some people may say, "Yes, suppose it cost \$30,000 or more, just think how much advertising space could be purchased in newspapers and magazines for that sum. Do you think that such an expenditure on the radio pays?"

Then the publicity expert may reply, "I agree that it seems like a lot of money to spend in one night, but it would not buy many pages in magazines that have a large national circulation. Further-



### He Pays Approximately \$9,000 a Week for Broadcasting

*At the present time the "Atwater Kent Hour," which is broadcast every Sunday evening over a chain of fifteen stations, is probably radio's most costly regular feature. The head of the company that pays this huge bill is Mr. A. Atwater Kent of Philadelphia—who believes that the good will of the radio audience is worth at least that much.*





Herbert

### A Contract that Cost \$35,000 to Entertain the Radio Audience for Three Hours

*When Mr. George E. Smith, the president of the Royal Typewriter Company, signed up the rights to broadcast the Dempsey-Tunney fight, he did so because he had faith that enough of the 15,000,000 broadcast listeners would be made favorably disposed to his product to convert this expenditure into an investment.*

more, one never knows who will read the printed advertisements. But when your name is broadcast with an event to which you know millions will tune in, you know that it is getting across, especially when it is mentioned time after time throughout the evening.

"You may see a crowd on Broadway watching an attractive electric sign, but that is only a small audience compared to the millions assembled around loudspeakers to hear your name mentioned with an event multitudes are most anxious to hear. They strain their ears to catch every word. The Dempsey-Tunney fight in reality sugar-coated the advertising in a delicious way as far as the effect was concerned; hundreds of thousands of people heard of this particular brand of typewriter in New England, Canada, the Mississippi Valley and on the other side of the Rockies, who may have never known of the machine previous to the fight. Now they are aware that there is one typewriter named "Royal,"—and they learned it through a pleasing circumstance. That creates good-will. It is advertising."

But the experienced ethereal advertiser warns that the bread cast upon the infinite expanse of radio space does not return, but is soon forgotten unless it is followed up by newspaper, magazine and billboard displays. Otherwise the radio auditor only knows the name of the product. Names are easily forgotten. It takes the periodical advertising to introduce the product more fully, explain its advantages and help to sell it.

Advertising through the ether lanes has been in vogue for about four years on a commercial scale, but the championship fight opened the eyes and minds of many business houses to inquire into the possibilities and results.

The backbone and background of broadcasting today is goodwill. There is method in the madness of the thousands of entertainers who actuate the microphone today. They are all advertisers or publicity seekers. They have something to sell to the radio audience. They want to attract listeners to their shops, or they are desirous of making their name, or the name of their product a household word. There are

few philanthropists behind the microphone. Few broadcast today for the novelty of having their friends hear their voices over the air; those days are past. Today broadcasting is a highly competitive business, with solicitors in the field searching for advertisers to sponsor programs. Remember when you are listening-in that no matter how sweet the music, or how famous the artist, the announcer is generally standing alongside distributing advertising figurative leaflets, which he spasmodically sprinkles through space on the wings of the song.

Last year several advertisers sponsored concerts by noted opera singers and symphony orchestras, as a means of acquainting the public with the name of their products. They are sponsoring more programs this season and have attached their name to concerts by Metropolitan Opera stars and even the Boston Symphony Orchestra. These broadcasts attract wide attention but apparently not on the vast scale that the fight did, because it appealed to a mass audience that included nearly everyone.

Radio is a medium which gets right into the home. However, the advertiser over the air must be careful and polite in making his entrance; he must make his bow courteously at the dials just as a salesman would at the door, and if his offering through the microphone is acceptable he will be welcomed into the household.

Today there are many advertisers in

the ether who never ask for applause in the form of mail. Any letters that they receive are not used for solicitation of business. Those days are over, according to the etherial impresarios. Today the main object is to create good-will, and constant pleading for applause does not build up good-will.

A tooth paste manufacturer recently offered a booklet over the air, and to all

who sent in a request he also mailed a sample of tooth paste to acquaint the public with his product. This procedure is sanctioned by the radio impresarios.

Another well-known tooth paste manufacturer, who does not broadcast, recently went through his test territory to determine whether or not his product was still the favorite. He found that a competitor, who sponsors a popular

PROGRAM FEATURE	SPONSOR	STATIONS
<i>Atwater Kent Hour</i>	Atwater Kent Mfg. Co.	WEAF, WEEI, WGR, WRC, WWJ, WSAI, WGN, WCCO, WJAR, KSD, WTAG, WCAE, WTAM, WOC, WFI
<i>Auction Bridge Hour</i>	U. S. Playing Card Company	WEAF, WEEI, WGR, WRC, WWJ, WSAI, WGN, WCCO, WJAR, KSD, WTAG, WCAE, WTAM, WOC, WFI, WCSH
<i>A &amp; P Gypsies</i>	The Great Atlantic & Pacific Tea Company	WEAF, WEEI, WJAR, WLIT, WRC, WDAF, WCSH, WCAE, WTAM, WWJ, WSAI
<i>Balkite Hour</i>	Fansteel Products, Inc.	WEAF, WEEI, WGR, WWJ, WTAM, WFI, WSAI, WGN, KSD, WOC, WDAF, WCAE, WCCO
<i>Champion Sparkers</i>	Champion Spark Plug Co.	WJZ, WBZ, KDKA, KYW
<i>Dairy Products Hour</i>	National Dairy Products Co.	WJZ, WBZ, KDKA, KYW
<i>Davis Saxophone Octette</i>	Davis Baking Powder Co.	WEAF, WEEI, WJAR, WLIT, WRC, WTAG, WCAE, WGR, WSAI, WCSH
<i>Dennisoncraft</i>	Dennison Mfg. Company	WEAF, WEEI, WLIT, WRC
<i>Clicquot Club Eskimos</i>	Clicquot Club Company	WEAF, WEEI, WCCO, WGN, WCAE, WJAR, WTAG, KSD, WOC, WGR, WFI, WTAM, WWJ, WSAI
<i>Eveready Hour</i>	National Carbon Company	WEAF, WEEI, WJAR, WTAG, WGR, WFI, WRC, WCAE, WTAM, WWJ, WGN, KSD, WSAI, WCCO, WOC
<i>Goodrich Zippers</i>	Goodrich Tire Company	WEAF, WEEI, WCCO, WGN, WCAE, WJAR, WTAG, KSD, WOC, WGR, WFI, WWJ, WSAI, WADC, WCAE
<i>Hohner Harmony Four</i>	M. Hohner, Inc.	WEAF, WEEI, WLIT, WGR, WRC, WCAE, WWJ, WLIB, WTAM
<i>Ipana Troubadours</i>	Bristol & Myers	WEAF, WEEI, WGR, WRC, WCAE, WWJ, WLIT, KSD, WCCO, WSAI
<i>Jolly Buckeye Bakers</i>	Burger Brothers	WEAF, WFI, KSD, WSAI, WCCO, WTAM, WWJ, WTAG, WLIB
<i>La France Orchestra</i>	La France Mfg. Co.	WEAF, WEEI, WGR, WLIT, WOC, WCAE, WTAM, WDAF, WWJ, KSD
<i>Maxwell Coffee Hour</i>	Cheek Neal Company	WJZ, KYW, WBZ, KDKA
<i>Royal Typewriter Hour</i>	Royal Typewriter Co.	WJZ, WBZ, KDKA, KYW
<i>Schickerling Crystal Gazers</i>	Schickerling Mfg. Co.	WEAF, WEEI, WGR, WFI, WCAE, WWJ
<i>Sixty White Minutes</i>	E. A. White Organization	WJZ, WBZ, KDKA, KYW
<i>Smith Brothers</i>	Smith Bros., Inc.	WEAF, WTAG, WGR, WRC, WCAE, WWJ, WSAI, KSD, WOC, WCCO, WDAF
<i>The Vikings</i>	Scott & Brown	WEAF, WEEI, WJAR, WTAG, WGR, WFI, WCSH, WCAE, WTAM, WWJ, KSD, WSAI, WCCO, WOC
<i>The Watchmakers</i>	Dueber Hampden Watch Co.	WJZ, WBZ, KDKA, KYW
<i>Tower Health Exercises</i>	Metropolitan Life Insurance Co.	WEAF, WEEI, WGR, WRC
<i>Whittall Anglo-Persians</i>	Whittall Associates	WEAF, WEEI, WGR, WTAG, WJAR, WCCO, WLIT, WRC, WOC, WCAE, WTAM, WDAF, WWJ, KSD, WGN
<i>Willys-Overland Hour</i>	Willys-Overland Co.	WJZ, WBZ, KDKA, KYW

Some of the outstanding program features that are broadcast from a chain of stations.

Nearly every owner of a receiving set has tuned in on at least some of the programs tabulated above. The sponsors of these program features and the toll stations to which they pay toll charges are listed above. What the toll charges amount to may be computed from the rate-card on page 94.



dance orchestra over a chain of stations, had forged ahead and captured the leadership in sales.

A razor manufacturer during his first year on the air is said to have received 75,000 letters; to many of those who commented upon the programs he mailed a small safety razor. This is reported to have greatly stimulated the sale of blades for that particular razor.

When asked what benefits an insurance company derived from radiating setting-up exercises a broadcast station official replied, "Health and longer life. Such broadcasting is very popular and thousands of dollars are spent yearly in sponsoring the early morning gym class. The physical director receives from 200 to 300 letters daily requesting the chart which illustrates the various exercises which he directs in front of the microphone. He has received more than 200,000 requests for charts. And not one name has been used for soliciting insurance."

An insurance company in the West built a broadcasting station and many wondered what motive prompted the undertaking and what benefit could be obtained from the expenditure. However, there was method in the "madness." Each insurance solicitor of this company has the call letters of the station on his business card. The solicitor travels in the farm sections and when he sees an antenna strung across the roof of the homestead or barn, he goes to the door and presents his card with the additional introduction, "I am from station ZYX." All the farmers are familiar with the station and are appreciative of the entertainment and market reports; in fact they consider the station their friend and the station's representative likewise. He is invited into the home and they talk about radio. Perhaps the station is on the air at the time the solicitor calls and the farmer says, "Come right in and hear your station. Just listen how loud we get it."

The farmer is glad to talk about radio and the benefits he derives from tuning-in. Then the conversation drifts to insurance. The farmer shows the salesman around his farm and the city man in return invites the rural resident to visit the broadcasting studio to see the "wheels go 'round." In this way contacts are made, and it is reported that a big increase in insurance business has resulted among the farmers out where the corn grows tallest.

How does the advertiser know that he is getting results on the radio?

He has several ways to check up on the results. First, by the amount of mail he receives. One broadcaster asked the radio fans to comment upon the programs, and the mail that resulted filled filing case after filing case with letters.

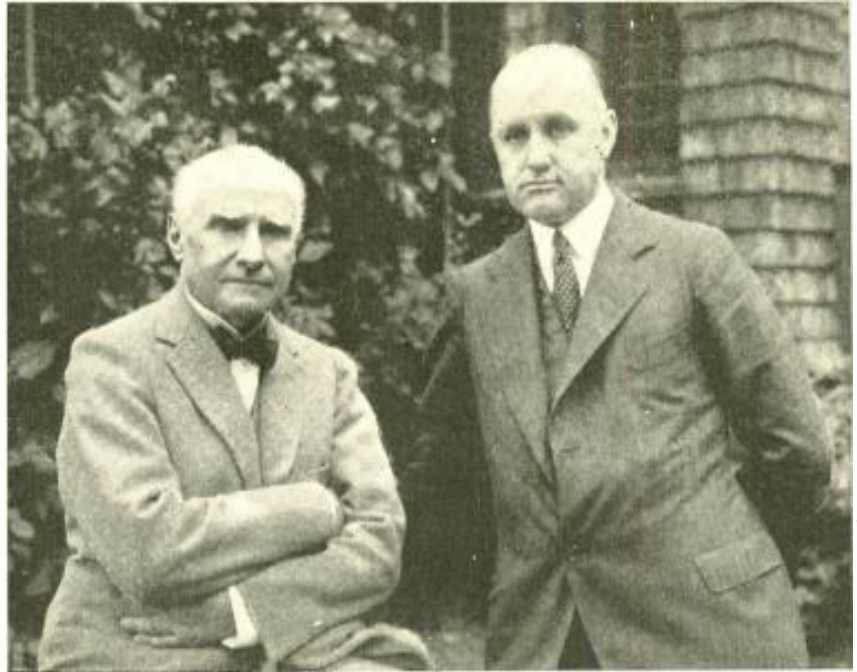

### The Donor of a Series of \$4,000 Concerts

*Every time the New York Symphony Orchestra under Walter Damrosch (at the left) gives a special recital before the microphone in the series of concerts arranged by the Fansteel Products, Inc., Mr. A. J. Troxel, the president of that concern (at the right) okeys a check for the music alone that amounts to 2.64 times the yearly income of the average family in the U. S.*

Another means of checking up on the radio is the reaction on the dealers. Salesmen find out if business has been stimulated because of broadcast programs. One advertiser who sold winter footwear sold his entire product by December, and broadcasting was given credit for helping to create the big demand; one dealer in Providence wired either to send ten cases of footwear immediately, or stop broadcasting, because he was swamped with orders.

Many manufacturers who sponsor radio programs find that their programs make it much easier to get high class dealers and distributors. This is said to be especially true in the automobile tire and accessory field. The dealers report that the good-will broadcasts attract customers to the stores. Some people come for applause cards or booklets that are offered over the air; others buy because they have enjoyed the concerts. Thus the broadcasts stimulate patronage and dealers are anxious to handle the wares of manufacturers who promote broadcasts.

A harmonica manufacturer engaged the microphone of a New York station with harmonica music and offered an instruction booklet on how to play the mouth-organ. Thousands wrote for the booklet and the New York harmonica market was sold out. No one could listen to the lessons on the radio and at the same time learn to play without a harmonica, and naturally they bought

the product of the firm that supported the program, because they wanted to have the proper instrument.

Auction bridge games that are broadcast with the object of teaching radio auditors to play the game, have attracted much attention among the invisible audience and resulted in the sale of thousands of packs of cards. This season the bridge games have been resumed on a weekly schedule instead of bi-weekly and a larger chain of stations is being used.

It has been found that different types of programs are more suited to be associated with certain products. The name "Happiness Boys" is synonymous to the name of the product they promote, as were Goldy and Dusty closely related to their cleanser. In the Eskimo Ensemble which entertains on Thursday nights with bright and sparkling music, the banjo is made to predominate because it creates a suggestion of the sparkling in the ginger ale which the particular troupe of Arctic residents represent.

What does a moving picture theatre gain from broadcasting? The Hertzian waves are employed to popularize the name of the show house and during the entertainment the theatrical program of the week is mentioned so that the public will be aware of the performance and who is acting on the screen.

(Continued on page 94)



From a photograph made for POPULAR RADIO

#### THE DESIGNER TUNES IN ON THE COMPLETED MODEL

FIGURE 1: After the final model had been built it was given a complete check-over both by Mr. Harkness and the technical staff in the POPULAR RADIO LABORATORY under all kinds of conditions, in order to determine its relative values of selectivity, tone quality and volume.

#### HOW TO BUILD THE NEW

# KH-27 RECEIVER

This new receiver features an entirely new type of audio-frequency amplification—the Hiler double-impedance system. It has been designed to attain the best possible tone quality as well as to meet high requirements for volume and selectivity.

By KENNETH HARKNESS

COST OF PARTS: *Not more than \$86.50*

#### HERE ARE THE PARTS THAT WERE USED IN THE LABORATORY MODEL—

- |  |   |  |
|--|---|--|
| <p>A1, A2 and A3—K-H radio-frequency transformers, comprising one antenna coupler, one second-stage coupler and one detector coupler;</p> <p>B1, B2 and B3—Hammarlund midline, 17-plate condensers, .00035 mfd.;</p> <p>C1 and C2—X-L vario-densers, type G, .0001 mfd. maximum;</p> <p>D1, D2 and D3—K-H Twin-Choke audio couplers;</p> <p>E—K-H choke coil, 30 henries;</p> <p>F—Any approved fixed condenser, .00025 mfd., with grid-leak mounting (Micamold condenser illustrated);</p> <p>G—Any approved fixed condenser, .001 mfd. (Micamold condenser illustrated);</p> <p>H and I—Any approved fixed condenser, .002 mfd. (Micamold condensers illustrated);</p> <p>J and K—Any approved bypass condenser, 1 mfd. (Dubilier condensers illustrated);</p> | <p>L—Any approved grid-leak, 3 megohms (Micamold grid-leak illustrated), with grid-leak mounting;</p> <p>M—Yaxley fixed resistance, 2 ohms;</p> <p>N—Any approved rheostat, 10 ohms (Yaxley rheostat illustrated);</p> <p>O1, O2 and O3—Any approved automatic filament control for ¼-ampere tubes (Amperite control illustrated);</p> <p>O4—Any approved filament control for ½-ampere tube (Amperite control illustrated);</p> <p>P—Any approved open-circuit jack, Junior type (Yaxley jack illustrated);</p> <p>Q—Yaxley pilot light bracket;</p> <p>R—Yaxley antenna switch, double-circuit Junior type;</p> <p>S—Any approved battery switch (Yaxley switch illustrated);</p> <p>T1, T2, T3, T4, T5 and T6—Any approved vacuum-tube socket (if prepared panel is obtained these are not needed)</p> | <p>U—Composition panel, drilled and engraved, 7 inches by 26 inches;</p> <p>V—Sub-panel, drilled and equipped with sockets, 7 inches by 25 inches;</p> <p>W1 and W2—K-H bakelite brackets;</p> <p>X—Any approved cabinet for 7 by 26-inch panel (Blandin R-20 cabinet illustrated);</p> <p>Y1, Y2, Y3, Y4, Y5, Y6, Y7, Y8, Y9, Y10 and Y11—Any approved binding post (Eby binding posts illustrated);</p> <p>Z1 and Z2—Any approved vernier dial (Aristocrat vernier port dials illustrated);</p> <p>One 6-volt lamp for pilot light;</p> <p>One set of POPULAR RADIO "KH-27" blueprints;</p> <p>24 6/32 round-head brass machine screws, ½-inch long, and nuts;</p> <p>12 6/32 round-head brass machine screws, ¼-inch long, and nuts;</p> <p>24 soldering lugs;</p> <p>Bus bar, etc.</p> |
|--|---|--|



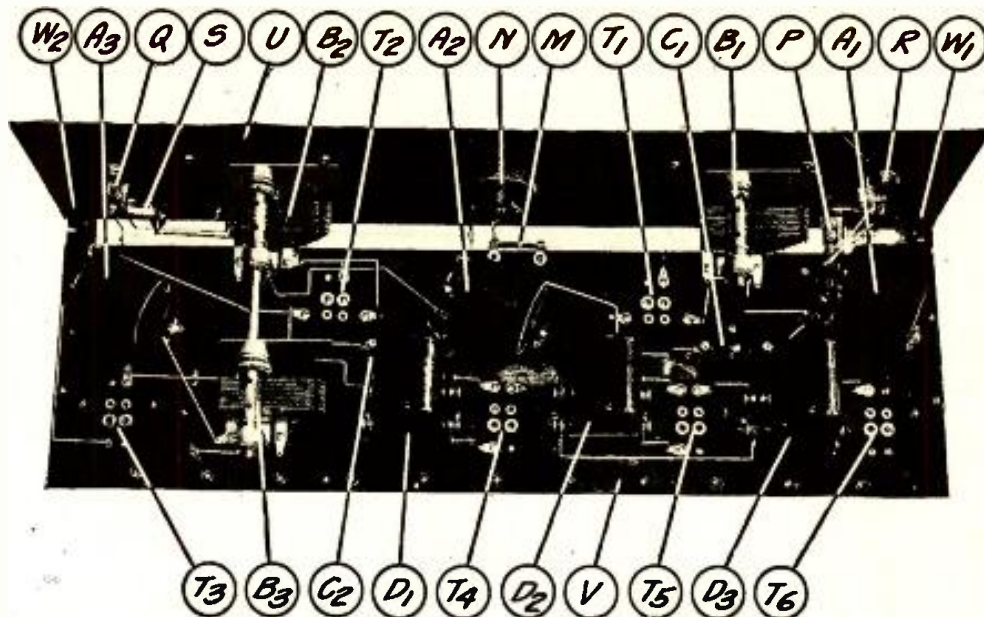

A VIEW OF THE SET FROM ABOVE

FIGURE 2: This view shows the general arrangement of all the instruments that are mounted on the panel or on the top side of the bakelite baseboard. Notice that the binding posts are mounted along the rear edge of the baseboard; the sockets in this case are rivetted directly to the baseboard itself.

THE KH-27 is the result of a long series of experiments conducted by the writer during the summer of 1926. The primary object of these experiments was the development of a receiver with perfect tone quality; all other characteristics were made subservient. However, in so doing, nothing was omitted of the essential characteristics of a good receiving set.

In addition, therefore, to its remarkable tone quality the KH-27 has the following desirable features:

1. It is an exceptionally good "distance-getter."

2. The selectivity is adequate for all purposes; even in districts surrounded by broadcasting stations the set will receive any desired station without interference from other stations.

3. The set is easy to operate; only two tuning dials are used.

4. It is entirely non-regenerative as it is neutralized to prevent oscillation. The set does not whistle or squeal and it cannot radiate.

5. Any type of outdoor or indoor antenna may be used with it; local stations can be received without any antenna if desired.

6. The set will operate with ordinary "A" and "B" batteries or on the house current by the use of power-packs.

7. Standard parts, easily obtainable, are used in the construction of the set.

The front and sub-panels are of standard size and any desired type of cabinet may be purchased to accommodate the set.

The set is easy to build and once it is installed will give consistently good performance without any special care or attention.

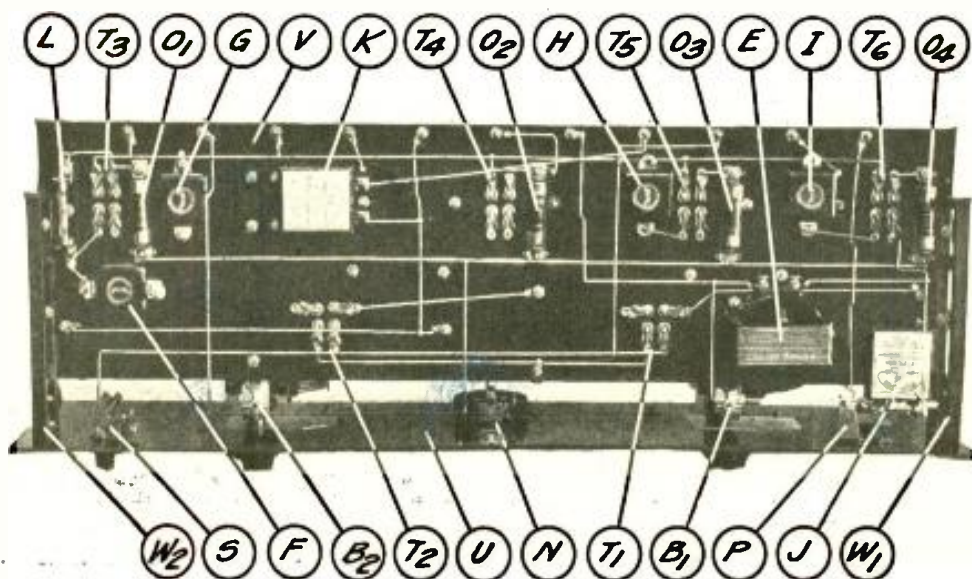

HOW THE RECEIVER APPEARS WHEN VIEWED FROM BELOW

FIGURE 3: The apparatus mounted underneath the bakelite baseboard is shown here as well as the general appearance of the wiring. The baseboard is fastened to the panel by means of bakelite brackets, shown at each end.

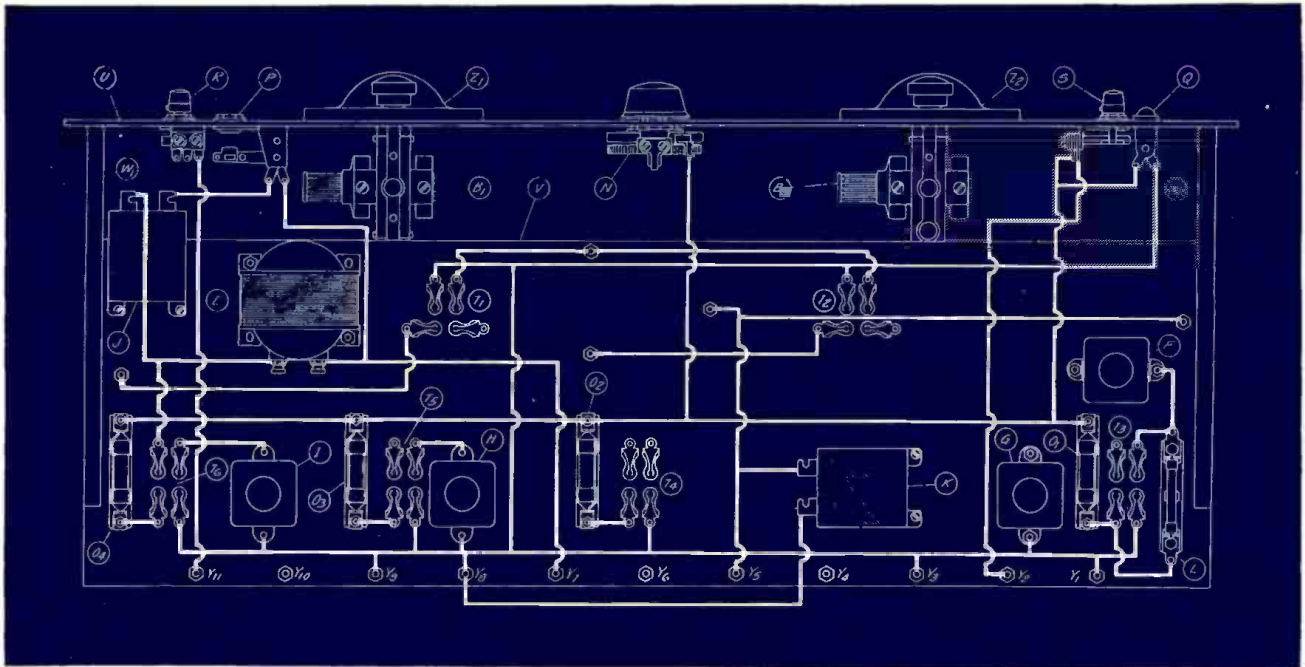

THE PICTURE WIRING DIAGRAM FOR THE BOTTOM SIDE OF THE BAKELITE BASEBOARD

FIGURE 4: The instruments are drawn in about their correct positions; the heavy white lines show exactly where to run the wires. All the parts are designated by the same letters that appear in the text and in the list of parts.

### Blue Prints for the KH-27 Receiver

**F**or the benefit of the experimental set builder who may prefer to assemble the KH-27 Receiver from larger diagrams than can be reproduced within the limited space of these magazine pages, a set of simplified blue prints in actual size has been prepared. This set includes (1) the two picture wiring diagrams, (2) the panel layout and the sub-panel layout, and (3) the schematic circuit diagram, as well as the complete list of parts used in the laboratory model. If this set of blue prints cannot be obtained from your dealer, it will be furnished upon receipt of a remittance of \$1.00 sent to the POPULAR RADIO SERVICE BUREAU, 627 West 43rd Street, New York City.

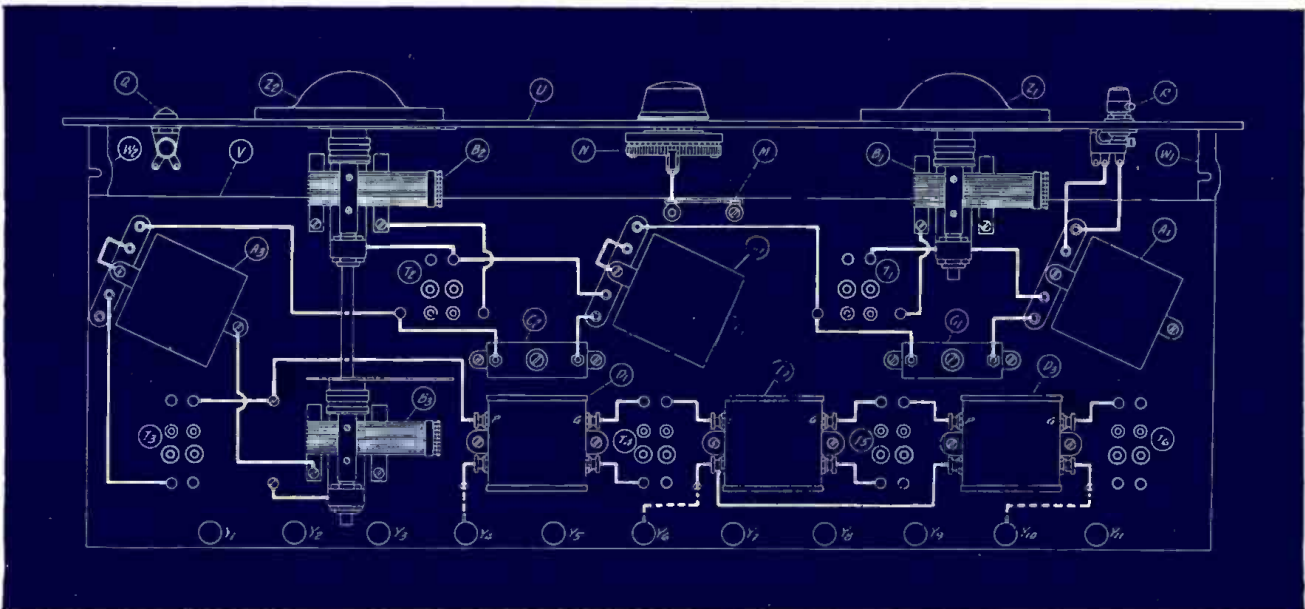

THE WIRING ON TOP OF THE BAKELITE BASEBOARD

FIGURE 5: This drawing shows the positions for the instruments on the top of the baseboard; the heavy white lines again show the wiring. The dotted portions of the wire shown here indicate that the wire runs through a hole in the bakelite baseboard and attaches to an instrument terminal on the lower side.





The list of parts given on page 16 includes the exact instruments used in the unit from which these specifications were made up. The experienced amateur, however, will be able to pick out other reliable makes of instruments which have been approved by POPULAR RADIO which may be used with good results. But we recommend that the novice follow the list, as the diagrams in this article will tell him exactly where to bore the holes and exactly where to place the connections. If instruments other than the ones listed are used, the only change that will be necessary will be the use of different spacings for the holes that are drilled in the sub-base for mounting the instruments. To any reader who has difficulty in obtaining any of the parts which are necessary in making up these model receivers and power units, POPULAR RADIO SERVICE BUREAU, 627 West 43rd Street, New York City, will gladly assist in seeing that his requirements are promptly supplied.

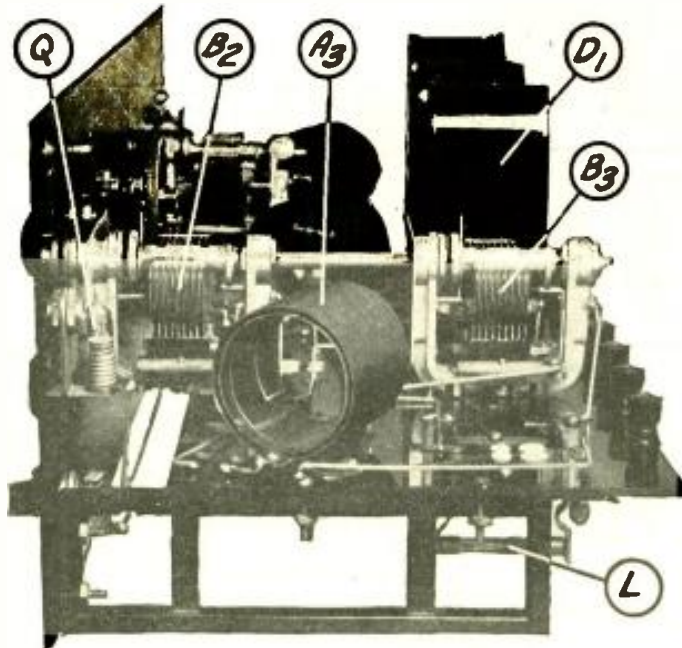

THE RECEIVER AS SEEN FROM THE RIGHT

FIGURE 9: This end view of the set gives a general idea of how the brackets and the bakelite baseboard are attached to one another and to the panel, and also how the coil and the gang condensers are mounted.

The KH-27 should satisfy all the cravings of the DX fans. The set has two stages of radio-frequency amplification and each stage gives a good solid boost to an incoming signal from the broadcasting station.

The radio-frequency transformers are unusually efficient. They are space-wound on an extremely thin film of dielectric material and losses are almost too low to be measured. The primary of each transformer is wound with fifteen turns of wire and is closely coupled to the secondary. Consequently, the amplification per stage is very high.

The primary of the first radio-frequency transformer, connected in series with the antenna, is tapped at the eighth turn to permit efficient reception of short waves with the average antenna. A switch on the front panel enables the operator to connect eight or fifteen turns in series with the antenna as desired.

The large primaries of the radio-frequency transformers insure high amplification and good distance reception, but they also have another important effect; they insure good tone quality by preventing side-band distortion in the radio-frequency amplifier. Transformers with small primaries of five or six

turns not only give meagre amplification but tune altogether too sharply and thus distort the incoming signals.

Each tuned circuit of the new receiver, considered by itself, tunes broadly enough to respond to frequencies about 12 kilocycles above and below the carrier frequency. To obtain good quality this is essential. But when the three circuits are tuned alike, interfering signals on frequencies outside the spectrum to which the set is adjusted are sifted out by the successive stages and do not reach the detector tube.

Consequently no interference from stations on adjoining wavelengths is

experienced. In New York, within half a mile of WEAJ and surrounded by about fifty other nearby stations, the set is capable of reproducing any of these stations without interference and can even bring in distant stations while the locals are on the air.

As mentioned above, the set is non-regenerative. Each stage of the radio-frequency amplifier is neutralized to prevent self-oscillation and to eliminate regeneration. The system of neutralization used in the set was developed by the writer and is an improved application of the Rice method. The scheme of connections is depicted in the wiring diagram, Figure 6.

Neutralization is effected by adjusting two, small, variable condensers. The large capacity of each of these condensers (.0001 mfd.) makes it easy to neutralize the set. The coils L1 and L2 are also part of the neutralizing system. These coils are placed inside of the radio-frequency transformers.

Before describing the construction of the set a brief explanation will be given of the special system of audio-frequency amplification used. The system is known as "double-impedance" audio amplification and is the invention of E. E. Hiler. The use of this system is largely responsible for the remarkable tone quality of the KH-27.

The principles underlying the operation of the double-impedance, audio amplifier are easily understood. The amplifier is similar to the standard "impedance-coupled" amplifier except that choke coils are used as grid-leaks instead of the usual high resistances. This difference is responsible for the many important advantages of the system. Practically uniform amplification of all

(Continued on page 68)

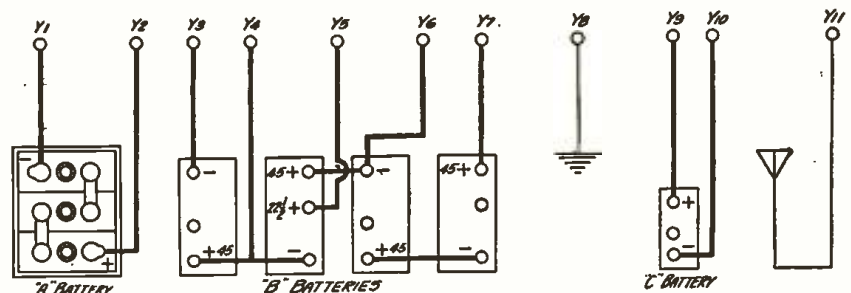

HOW TO CONNECT THE BATTERIES

FIGURE 10: The connections for the "A," "B" and "C" batteries and the antenna and ground to the binding posts of the receiver are clearly shown here. Note that these binding posts have been given numbers that correspond with those given in Figure 5.



## Radio's Contribution to Our Language—



# 500 Words

By CHARLES MAGEE ADAMS

IT has been estimated by philologists that the newest means of communication has added some 500 words to the language—only 100 fewer words than were added by the World War.

What is less generally known, however, is that most of these words—with the exception of the numerous “dynes,” “flexes,” “olas,” and “supers,” which have been deliberately coined—were in use by radio men before broadcasting came into existence. But it was not till some time after the advent of broadcasting that the evolution in radio language began.

The small group of early fans took over the vocabulary of the new art from the radio men and preserved its purity with zealous care. They were interested primarily in technicalities, and the sound of bristling technical terms was sweet music to their ears; the sweeter as they were used with absolute correctness.

Radio, however, soon lured to itself a large number of adherents who were not interested in the technicalities, and to whom the nice use of correct terms meant nothing. So, they proceeded to devise an array of short-cuts and terms based on the obvious, till today radio terminology is a jumbled polyglot of incongruities and mistakes which means something to the newcomer, but which tries the soul of the old-timer.

“Wet battery” is one of the most familiar examples.

This term is, of course, applied to the storage battery. It is derived from the

### Do You Know the Approved Terms for These Words?

1. Earphones
2. Wet battery
3. Lights
4. Aerial
5. Recharge
6. Handle
7. Box
8. Re-radiating receiver
9. Wheel
10. Wave
11. Acid
12. Horn
13. Controller
14. Station initials
15. Dying out
16. Hand squeal
17. Big tubes
18. Remote broadcasting
19. Sender

#### KEY

1. Head-phones; 2. Storage battery; 3. Tubes; 4. Antenna; 5. Charge; 6. Knob; 7. Cabinet; 8. Radiating receiver; 9. Dial; 10. Wavelength; 11. Battery solution or electrolyte; 12. Loudspeaker; 13. Rheostat; 14. Call letters; 15. Fading; 16. Body capacity; 17. Power tubes; 18. Remote-control broadcasting; 19. Transmitter.

fact that this type of battery contains a solution, which, to the newcomer, differentiates it from its brother, the dry cell. But the old-timer points out, with disgust and ample authority, that the term “wet” does not in reality differentiate it at all; that many types of primary batteries, of which the dry cell is one, also contain a solution, and that if a storage battery is meant the term “storage battery” ought to be used.

To the newcomer the expression “I just bought six new ‘A’ batteries” is perfectly correct. But the old-timer retorts that what he means is that he bought “Six new cells for an ‘A’ battery”; then goes on to explain that “cell” is an individual, and “battery” a collective term, citing the military use of battery as against gun.

Another expression that makes the old-timer gnash his teeth is “lights”—a usage again based on the obvious, this time the resemblance of many types of tubes to incandescent lamps. And “ear-phones”—

The old-timer will explain that the word “phones” necessarily implies ears, and that, accordingly, to say “ear-phones” is as senseless as “foot-shoe,” “neck-collar,” or “hand-glove.”

Who ever heard a listener who has joined the ranks of radio during the last two or three years say “antennae”? The old-timer will inform you with reams of authority, that this is the correct term, although it is popularly referred to as the “aerial.” Further, it

(Continued on page 61)

Nearly every fan has at times wished for a device to turn his set on for important programs—or off, after he has gone to bed. Well, here it is!



HOW THE CLOCK IS "SET" TO CONTROL THE RECEIVER  
It is connected up to the batteries that feed the receiver, and by a contact of one of the moving parts turns the receiver "on" and "off" at the time to which the clock is regulated.

## To Start and Stop Your Set Automatically

—Build the Ingenious Alarm-Clock Control Here Described

By O. D. WESTCOTT

HERE is an ingenious device that has been designed for the special benefit of the broadcast listener who wants to be reminded—automatically and infallibly—to tune in on a special program feature at the specified time.

This apparatus has the merit of being easy and inexpensive to construct at home; any experimenter who has ordinary proficiency with tools can build this "radio control clock." The service that this clock will render to the radio fan is unique and will add materially to the enjoyment that he gets from his receiver. For instance:

Does he want to be reminded to pick up the Arlington time signals at noon? If so, he merely tunes to the wavelength of that station, sets the time-switch to turn the receiver on a few moments before noon—and the signals will come in automatically.

Does he want to pick up a special program feature at 10:00 o'clock in the evening? If so, he just sets the control clock to turn off the receiver at 9:55; at that moment the set will become silent

—and he will thus be reminded to tune in on the station he wants to hear.

In like manner the control clock may be adjusted to turn off the set at a specified time after he has gone to bed—or to turn it on in the morning in time to participate in the radio gym class.

Figure 4 shows the schematic diagram of the electrical connections within the control unit; Figure 1, the front view of the "radio control clock"; Figure 3, the rear view, and Figure 2 the side view.

### How the Control Clock Works

This is what happens when the alarm goes off.

The wing nut on the end of the alarm wind-shaft turns in the opposite direction to the direction of rotation affected when the alarm is wound up. On this particular type of clock, the "alarm" wing nut is turned in a counter-clockwise direction to wind it up, so that when the alarm goes off this wing nut rotates in a clockwise direction. All that remains to be done, therefore, is to provide a means for translating the

motion of the "alarm" wing nut, to a contact so arranged that it will open or close a circuit as desired.

The motion of the wing nut in question is translated to the contact spring, B, shown in Figure 4, through the medium of a contact pin which moves inside of a casing. Whether the downward motion of the contact, B, which always takes place when the alarm goes off, opens or closes a circuit, depends upon the position of a jack switch, which has three contacts numbered 1, 2 and 3.

If it is desired to have the alarm close the circuit at a specified time, the jack switch control knob is pulled out. This closes the circuit between contacts 2 and 3 of the jack switch. Now, as the terminals  $T_1$  and  $T_2$  are connected in series with the filament lead to the receiving set, the receiver is turned off and the filaments of the tubes will not heat up as the circuit through the time switch is open.

A good idea of the state of the circuit at this time may be obtained by tracing



it through. The circuit runs from  $T_1$  to contact spring B and through the contact between B and A to terminal 1 of the jack-switch. Now, as the jack-switch control knob is pulled out, springs 1 and 2 are not in contact and the filament circuit is open at this point.

Tracing the circuit through from  $T_2$  it will be found that it is open at contact C, one of the terminals of the single-pole, double-throw switch which is formed by the contact spring B and the two contact terminals A and C. The contact spring B engages contact terminal A in its normal position (before the alarm goes off), and engages contact terminal C when the motion of the alarm wing nut is translated into a downward movement of the contact spring B.

Thus when the alarm goes off, contact spring B engages contact C and closes the filament circuit. The filaments of the tubes in the receiving set then heat up to normal temperature and the radio set functions. The circuit through the time switch is now traced, from  $T_1$  to contact spring B to contact C to jack-switch spring 3, to spring 2 and out to terminal  $T_2$ .

When the jack-switch is pushed in, the setting off of the alarm and the consequent turning of the wing nut opens the circuit through the time switch and the radio set is turned off. In this case, before the alarm goes off, the terminals  $T_1$  and  $T_2$  are connected in series with the filament lead to the receiving set and the radio set is in operation as the

circuit is closed, through the time switch. This circuit may be traced from  $T_1$  to contact spring B to contact A to jack-switch spring 1 and then to spring 2 (as the jack-switch control knob is pushed in causing spring 2 to engage spring 1), and out to terminal  $T_2$ .

When the alarm goes off, therefore, contact spring B is pushed downward; this opens the contact between A and B and turns off the radio set.

Now that you understand the theory of operation of this simple little device, you should be better able to go ahead with its construction.

*How to Build the Clock*

From the rear view of the unit, you can see that the box is divided into two compartments. The clock is in the upper compartment and the motion of the alarm wing nut is translated to the electrical elements which are located in the lower compartment. The electrical elements consist, simply, of two single - pole, double - throw switches (a-b-c) and (1-2-3); the former is operated automatically and the latter is operated by hand.

There are a number of ways of translating the movement of the alarm wing nut to the contact spring B; one is the contact pin arrangement used in the model described. The construction of this element is probably the only troublesome part of the entire job.

Drill a  $\frac{1}{8}$ -inch hole all the way through a  $\frac{1}{4}$ -inch brass rod, from end to end. Drill a  $\frac{3}{16}$ -inch hole, 1-inch

deep, in one end of this rod, and a  $\frac{3}{16}$ -inch hole,  $\frac{1}{2}$ -inch deep in the other end. This last operation leaves a  $\frac{1}{32}$ -inch wall, at each end. If this is too fine work for you use a  $\frac{3}{8}$ -inch rod instead of  $\frac{1}{4}$ -inch.

Then, slide a  $\frac{1}{8}$ -inch rod, through the hole in the  $\frac{1}{4}$ -inch rod. If this rod binds at all, it should be cut down  $\frac{1}{64}$ -inch or so with a file, or a piece of emery cloth, until it slips through the hole with a very small amount of friction.

Make a shoulder on the  $\frac{1}{8}$ -inch rod,  $\frac{3}{4}$ -inch from one end. This shoulder should have a diameter, a little less than  $\frac{3}{16}$ -inch, so that it will slide through the  $\frac{3}{16}$ -inch hole, in the  $\frac{1}{4}$ -inch rod. One way of making this shoulder is to solder a washer of the proper size at the point in question. This washer should be a little less than  $\frac{3}{16}$ -inch in diameter and should have a  $\frac{1}{8}$ -inch hole.

Now, slide the  $\frac{1}{8}$ -inch rod into the end of the  $\frac{1}{4}$ -inch rod that has the  $\frac{3}{16}$ -inch hole drilled to a depth of  $\frac{1}{2}$ -inch, inserting the end of the  $\frac{1}{8}$ -inch rod farthest from the shoulder, first. If you push the smaller rod through, as far as it will go, the shoulder will stop it at such a point that it will protrude about  $\frac{1}{2}$ -inch from the end of the  $\frac{1}{4}$ -inch rod, opposite to the end in which it was inserted.

Procure some fine spring wire and make a spring that will slide over the  $\frac{1}{8}$ -inch rod. Slide this spring over the end of the  $\frac{1}{8}$ -inch rod that has no shoulder, as yet, pushing it down be-

*(Continued on page 48)*



THE FRONT PANEL

FIGURE 1: This view shows how the clock and switch are mounted on the front panel of the unit.

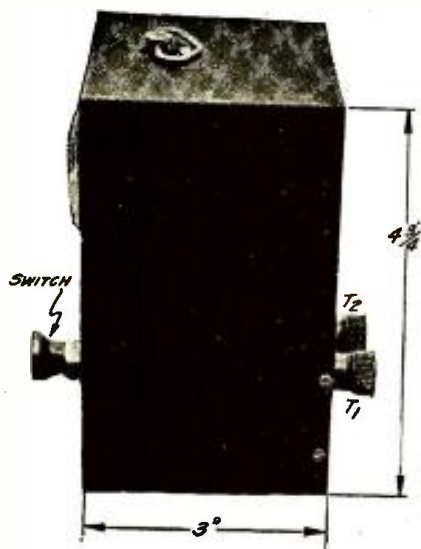

THE SIDE VIEW

FIGURE 2: A rectangular box of compact size houses all of the working parts; it may be made of wood or bakelite.

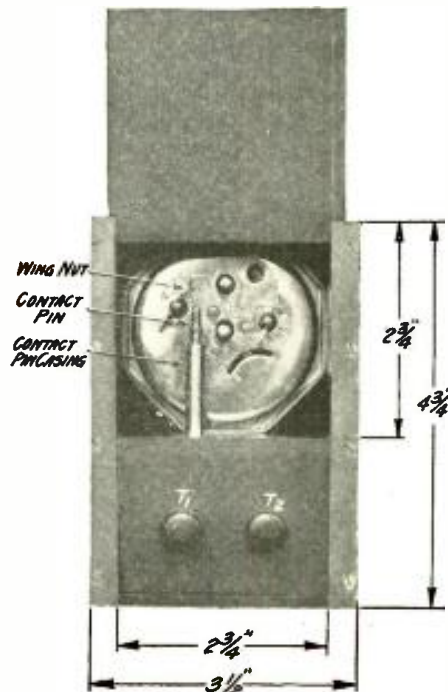

THE BACK OF THE UNIT

FIGURE 3: This picture shows most of the working parts and gives a good idea of how the box that holds them is made.

## A STATION THAT FOLLOWED ITS MASTER

When James Cruze, the director of this film, moved about the countryside, station KFP moved with him. The set was operated entirely by batteries.



# “KFP”

## *A Miniature Broadcasting Station That Directed a Battle*

What really happened on the memorable day when radio hams picked up the sounds of naval warfare between the reel hams

By

LLOYD JACQUET

AN Eastern radio amateur recently tore himself from his short-wave receiver and, reaching for the telephone, announced to the local newspaper editor that “pirates were waging a fierce battle off the coast of California.” There was no mistake about it, he said; he had heard cannon shots, the thunder of heavy boots on decks, wild oaths, the groans of dying men, and commands shouted through the din of clanging cutlasses. . . .

The ears of the amateur had not deceived him; he had indeed heard all these far-away manifestations of terrific pirate battling.

But what he did not know, was that movie cameras were reeling in the battle as fast as its echoes were wafted across the continent to the alert “hams.”

The amateur had been listening in unexpectedly on the first movie production ever directed through the use of radio.

If he had listened a little longer, he would have heard the voice of James Cruze, director, broadcasting his crisp orders of “Action” . . . “Camera!” and “Cut!” to the small army of actors before him.

If he could have viewed the battle he would have seen a dozen or more sailing ships of a type a century old, engaged in a vivid sea-fight on the waters of the Catalina Isthmus. And he would have observed Cruze, seated on the steep shore of California, directing by means of a microphone, one ship to fire, another to veer around into action, and still another to blow itself up and sink.

This spectacular and realistic sea-

fight is the climax of a moving picture romance built around the glorious Yankee victory over the Tripolitan pirates in 1804, in which the U.S.S. “Constitution” emerged with the first honors.

A large space was required for the setting, not the least important of which was the fighting scene off the Tripolitan Coast. Dozens of ships, pirate as well as American, dotted the body of water separating the Island of Catalina from the mainland, which figured as the Mediterranean Sea. These small ships had to be brought into action at the right moment, and put through a series of complicated manoeuvres at a time when the noise of the guns and the shouting of the crews would have drowned out the sound of a human voice, even if it had had the strength to carry over such a wide expanse of water.

As the battle-scene extended over a radius of twenty miles, the conventional megaphone direction was out of the question. Even with his powerful voice, Cruze could not hope to make himself heard at the nearest ship nearly a mile away from shore. So the long arm of radio was pressed into service for the first time, as an important auxiliary in photoplay making.

The electrical shops of the film studio turned out, under the direction of its chief engineer, as complete and comprehensive a miniature radio communication net as is owned by any commercial radio company. There was a main station, to be used at the base as the broadcaster; it was built to be entirely portable and self-contained.

This miniature station was operated entirely on batteries; the tube filaments were lit by means of a 12-volt storage battery and the plate voltage was supplied by a large group of heavy “B” batteries, sufficient to give 500 volts. For circuit, the miniature station was wired for the inductively coupled Hartley, and a stage of power amplification was added for the microphone circuit. It was normally rated at 15 watts, so that its range would be comparatively limited to the area of operation. Its wavelength was licensed at 110 meters, and the call letters given it by the Government, with its limited commercial license, were KFP.

Besides this small radio-telephone transmitting outfit, the electricians designed and built about two dozen short-wave receivers and installed them on the units of the wooden fleet, as well as in other strategic positions along the shore. The design was of the conventional short-wave style, familiar to amateurs. As a circuit, the flexible and easily tuned modified Reinartz was decided upon, so that the receiver consisted of a regenerative detector, followed by two stages of audio-frequency amplification. When used with headphones, the voice could be distinguished clearly, even over the maximum local noise.

It was a problem to mount these small receivers on the various vessels, as the rigging did not provide ideal aerial fastenings. Some antennas were but six to eight feet long, while others reached 30 feet. With an experienced operator assigned to each ship, the operation of



the small receiver and the prompt distribution of orders was assured.

Besides the ships of the movie fleet, tugs and motor boats, docks, headquarters on location, as well as the main office inland were provided with radio sets; thus the director was able to get in touch with every unit of his organization through this up-to-date communication system.

Because of its portability, the radio-telephone transmitter followed the direc-

tor wherever he went to direct the photoplay. At one time, it would be on a mountain side facing the Tripolitan fort, and then, on top of the barge-platform, a position which permitted the cameramen to get as close as possible to the action.

As the filming progressed, the orders were spoken into the microphone, and were picked up by the units to which they applied. With this novel "radio director," the handling of a small fleet

of wooden vessels scattered over an area of twenty square miles and filled with thousands of actors and extras became as easy as studio filming in spite of these seemingly unsurmountable obstacles for the director.

Radio, in the course of its comparatively young career has been called upon to perform many unusual duties, but in this latest application it showed its great adaptability in a dramatic manner.

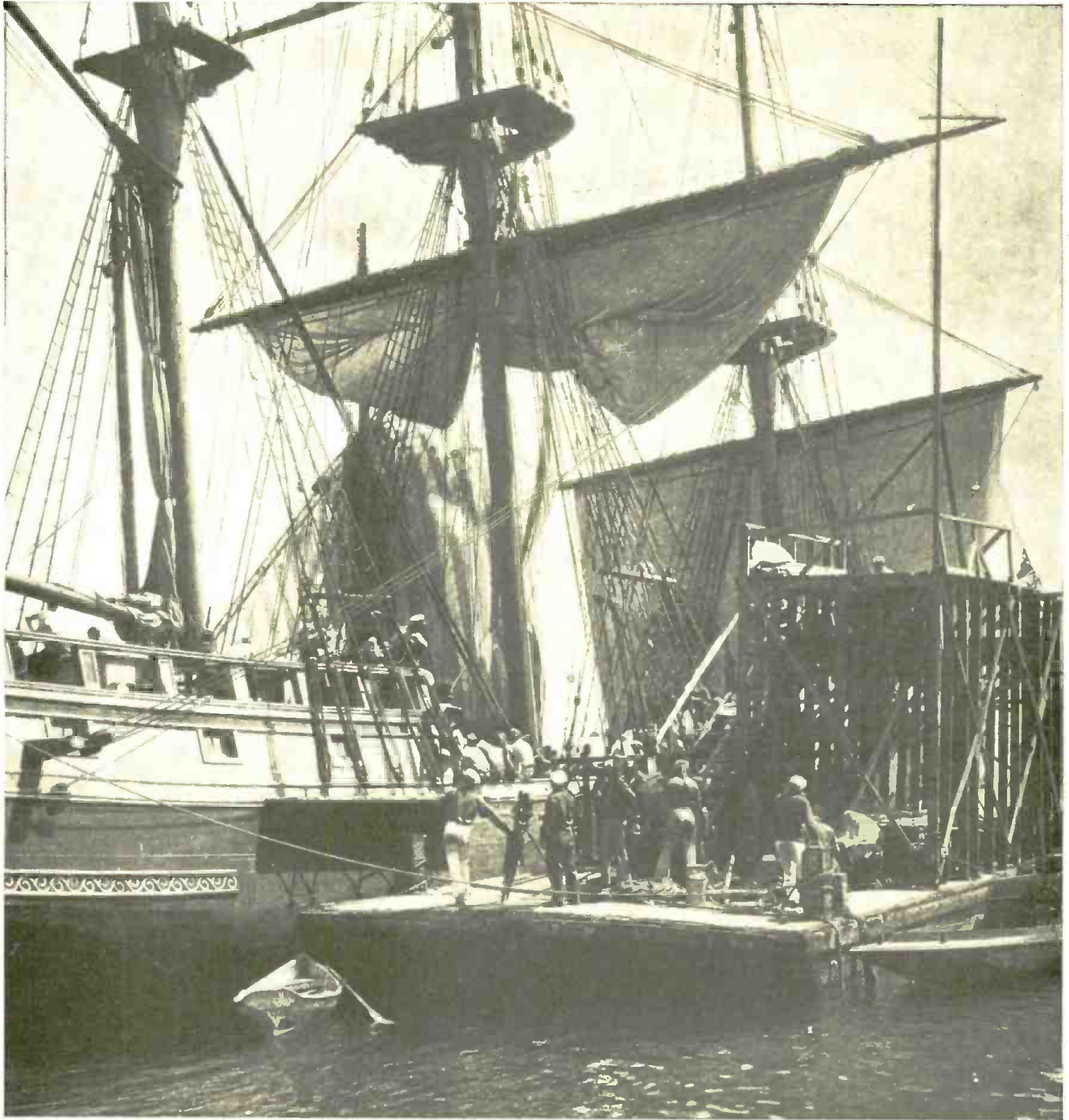

Paramount Pictures

#### ADMIRAL BROADCAST JOINS THE FLEET

*On the barge in the foreground is located the transmitting apparatus with which the movie director issued commands to the vessels engaged in the mimic battle; the antenna mast may be seen at the right. Receiving sets were installed on each ship, which enabled the different units to co-ordinate their actions with the scene as a whole.*

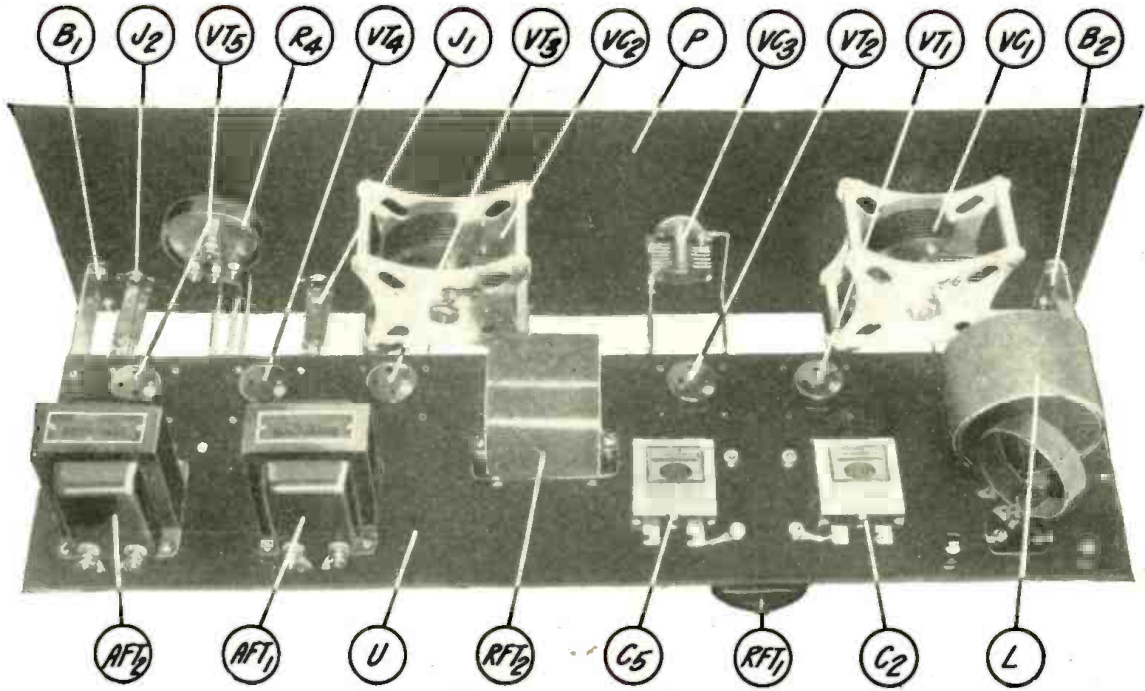

The "Henry-Lyford" Receiver

*This receiver combines excellent selectivity with fidelity of reproduction; a liberal supply of by-pass condensers affords quietness of operation. Tuning is simplified by utilizing a stage of untuned radio-frequency amplification which employs an iron core transformer. The usual filament-rheostat method of volume control is replaced by a variable, high resistance across the secondary of the first transformer.*

# Popular Radio Circuits

INSTALLMENT NO. 6

THE PARTS THAT ARE RECOMMENDED FOR USE IN THIS RECEIVER ARE—

- |  |   |   |
|--|---|---|
| <p>L—University antenna coupling transformer, type B-1;<br/>                 RFT1—University radio-frequency transformer, type B-2;<br/>                 RFT2—University tuned-radio-frequency transformer, type B-3;<br/>                 AFT1 and AFT2—Thordarson audio transformers, type R-200;<br/>                 VT1, VT2, VT3, VT4 and VT5—Benjamin sockets, sub-base mounting type;<br/>                 VC1 and VC2—Precise variable air con-</p> | <p>densers, .00035 mfd., type 845;<br/>                 VC3—Precise variable air condenser, .000055 mfd., type 940;<br/>                 C1—Micamold fixed condenser, .001 mfd.;<br/>                 C2, C4, C5, C6 and C7—Tole fixed condensers, 1 mfd.;<br/>                 C3—Micamold fixed condenser, .002 mfd.;<br/>                 R1, R2 and R3—Amperites, type 112;<br/>                 R4—Centralab modulator, type 500M<br/>                 S—Yaxley No. 10 filament switch;<br/>                 J1—Yaxley No. 2-a jack; ,</p> | <p>J2—Yaxley No. 3 jack;<br/>                 P—composition panel 7 by 24 inches;<br/>                 U—composition sub-panel;<br/>                 B1 and B2—Benjamin brackets;<br/>                 10 General Radio coil mounting jacks and plugs, type GR274 P-J;<br/>                 2 Eby binding posts;<br/>                 2 Kurz-Kash 4-inch dials, range 100 to zero;<br/>                 Belden 8-wire battery cable.<br/>                 COST OF PARTS: \$69.50.</p> |
|--|---|---|

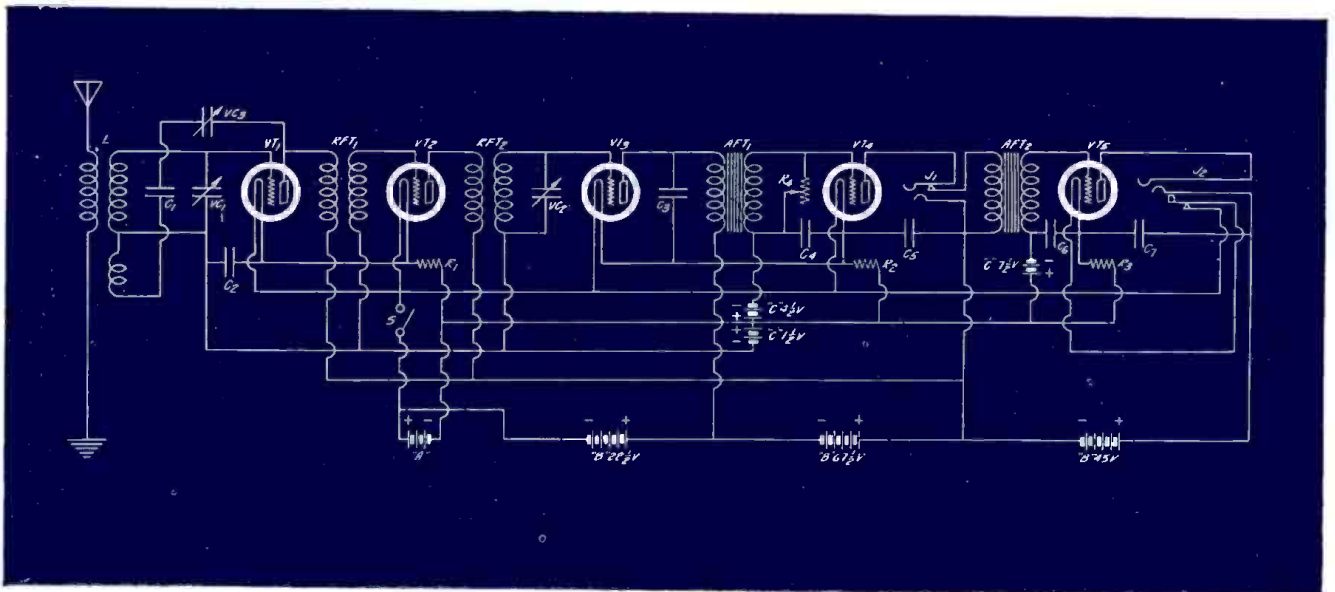



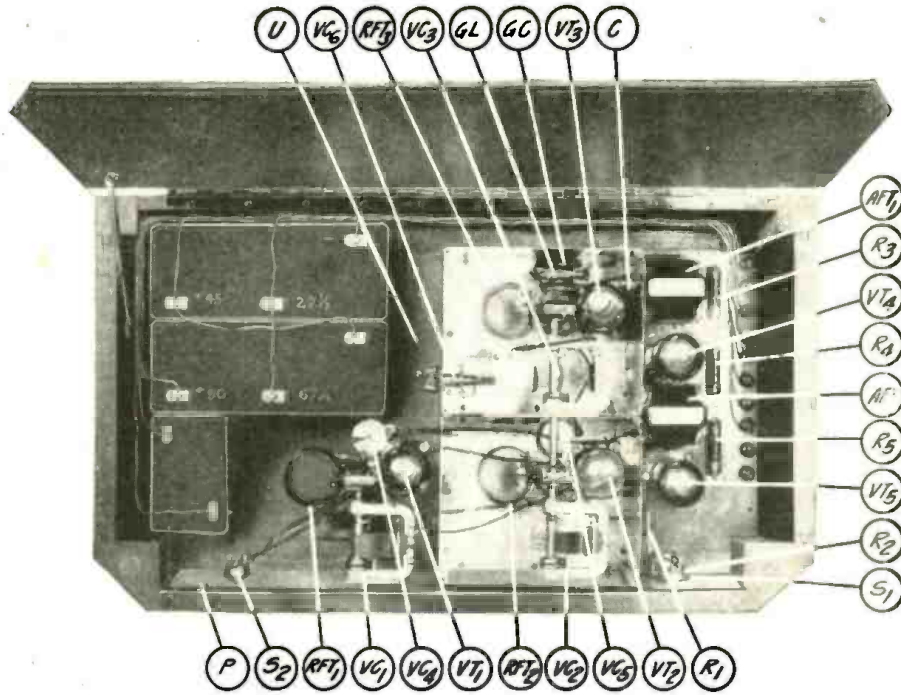

### The Hammarlund-Roberts "Hi-Q" Receiver

Here is a fine, shielded receiver that can be built at home, and that combines an excellent radio-frequency amplifier with a high-grade, transformer-coupled audio amplifier. Integral with the tuning condensers is a cam which operates the primary coils of the radio-frequency couplers. These are so regulated that the proper amount of coupling is obtained throughout all broadcast frequencies—a very desirable feature. The last stage of audio-frequency amplification permits the use of a UX-112 type or UX-171 type power tube. The "C" battery shown is for the UX-112 type tube; all other tubes are of the UX-201-a type.

#### THE PARTS THAT ARE RECOMMENDED FOR USE IN THIS RECEIVER ARE—

- |   |  |  |
|---|--|--|
| RFT1, RFT2 and RFT3—Hammarlund auto-couple coils;                 | .000032 mfd. capacity;   | S2—Carter "Imp" antenna switch No. 12;     |
| AFT1 and AFT2—Samson audio transformers, type HWA3, ratio 3 to 1; | C—Sangamo fixed condenser, .001 mfd.;                          | 10 Eby binding posts;                      |
| VT1, VT2 and VT3—Benjamin sockets, No. 9040;                      | GC—Sangamo fixed condenser, with grid-leak clips; .00025 mfd.; | 2 Mar-Co Vernier dials, No. 192;           |
| VT4 and VT5—Benjamin sockets, No. 9049;                           | GL—Durham metallized resistor, 2 meg.;                         | P—composition panel, drilled and engraved; |
| VC1, VC2 and VC3—Hammarlund mid-line condensers .00035 mfd.;      | R2—Carter combined midget rheostat and filament;               | U—composition sub-panel, drilled;          |
| VC6—Hammarlund Junior condenser,                                  | S1—Switch, No. 10 MS, 10 ohms;                                 | 2 Hammarlund shields;                      |
|   | R3 and R4—Amperites, No. 1A;                                   | VC4 and VC5—equalizing condensers;         |
|   | R5—Amperite, No. 112;  | R1—fixed resistance, 2 ohms;               |
|   | J—Carter short jack, No. 1;                                    | Extension shaft for condensers.            |
|   |  | <b>COST OF PARTS: \$63.05.</b>             |

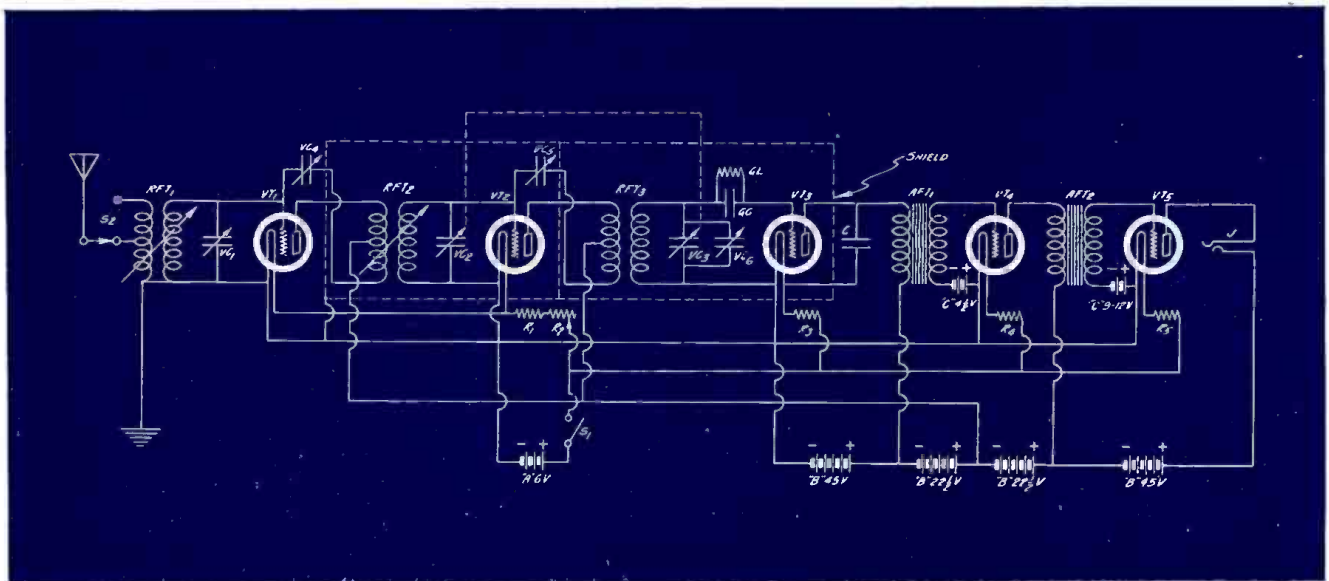

A favorite device of the fake fortune tellers is here used for a real scientific purpose. The familiar crystal ball is employed by Professor J. B. Morgan, of Northwestern University, in investigating the psychology of day-dreaming.



Underwood &amp; Underwood

# The QUACK DOCTORS of RADIO

## Part II. The Fake Fortune Tellers

In the first article of this series, which appeared in the August 1926 issue of POPULAR RADIO, Dr. Free exposed the efforts of quacks and charlatans to use radio terms and radio devices to impress victims seeking help for ill health. In this article he discusses the no less despicable misuses of radio by the harpies who prey on the credulity of men or women who ask to "know the future."

By E. E. FREE, PH.D.

**T**HERE are two subjects about which men and women will pay almost anything to be fooled; one is the future and the other is themselves.

Tell a man that by observing tea leaves in a cup or dealing cards out

on a table or conducting some other mysterious hocus-pocus you can glimpse the future of his business deals or the outcome of his love affairs, and he will turn his pocket book over to you and let you turn it inside out at your leisure.

Tell a woman that you can determine by some new and secret scientific device the percentage of "charm" that she possesses, or perhaps how to obtain more of this much-desired commodity, and she will lie in wait for every stray



nickel until she has amassed your fee.

These are human weaknesses. Great men have suffered from them. Fortune tellers have always thrived, never more so than today. And nowadays, like the quack doctors who prey upon the ill, these harpies of prediction have added radio and other marvels of modern science to their kit of tools.

*The Reproduction of "Supernatural" Voices by the Fakers of Spiritism*

The use of radio apparatus to produce mysterious voices or other sounds, supposed to be of supernatural origin and of weighty import, is the simplest of these devices; it was described months ago in POPULAR RADIO\* by Houdini. And of course the fakers who set out to use radio devices to assist their magic or to help create an impressive atmosphere of mystery in their seance rooms are careful to exclude, so far as possible, any clients who actually know anything about radio and who might see through and expose the fake.

There have been for many years a number of ways in which voices, apparently disembodied, may be created in seance rooms. Ventriloquism is possibly the earliest and most popular, although the ancient device of the concealed speaking tube still retains a well-deserved following among the profession. Radio is merely an improvement on this. It provides a speaking tube which needs no material connection. A confederate outside at a peep-hole, a small oscillator and a concealed receiver and telephone, and it is easy to astonish the prospective victim by remarks neither the source nor sense of which he can understand. It seems to make little difference how often the devices and methods of these fakers are exposed; their clients reappear to be duped in ever increasing numbers.

*The "Human Aura" Fake, and Its Relation to Ether Waves*

Closely related to radio and to its associated portions of general physical science also are the delusions which cluster around the idea of the "human aura."

This aura business possesses an ancestry almost as respectable as astrology. Many of the philosophers of antiquity held that there was given off from the human body a perceptible something, commonly thought of as having essentially the nature of an odor, although a much more delicate and subtle one than ordinary smells. This is probably quite true; we know that different races do differ slightly in body odor. Individuals probably do the same, as our dogs' noses well know. The savants of antiquity may be assumed to

have known this, and their references to the human aura probably mean nothing else.

But as the centuries passed and the ancient tongues were forgotten, these statements, like so many others among ancient dogmas, began to be interpreted mysteriously. And then, a few years ago, a German photographer made a discovery that gave the whole aura mystery new life; he actually photographed a human aura on a photographic plate. Around the edges of the portraits which he obtained appeared a fringe of what looked like light. The aura as a kind of radiation, mysterious, invisible and imperceptible to our senses, appeared among human delusions.

The method of the German photographer was soon exploded. Any expert in trick photography can make for you,

nowadays, as many aura photographs as you wish to pay for. The secret is the presence in the photographic plates of any one of several chemical substances which cause the image to spread on the plate, so that an apparent photograph of a fringe of light results. So firmly fixed, however, is the idea of an aura as some kind of radiation that it has even appeared under the definitions in the cross-word puzzles, and is doubtless in the dictionary itself.

When physical science discovered the extensions of the ether-wave series into the very short and very long ether waves, these facts were seized upon by the aura advocates. Human auras are now ascribed to various varieties of "rays," within and without the radio series. "When so marvelous a thing as radio is actually and provably real,"



From a photograph made for POPULAR RADIO

**Houdini Listens to the Mystic Voice**

*No one was more active than the late magician, Mr. Harry Houdini, in exposing the tricks and deceits of the fake spiritualist and fortune teller. Objects as simple and familiar as a tea kettle may serve to hold the radio apparatus which these harpies use to impress and mystify their victims.*

\*In the issue of October, 1922.

say the pro-aura arguers, "why may we not believe that some other variety of radio waves exist and create auras?" The answer is, of course, that you may if you want to. There is no law compelling people to disbelieve in foolishness.

An extension of the aura idea is the more recent one of some special human "ray," capable of accomplishing marvels, either toward other humans or on physical apparatus. The ancient superstition of the "evil eye" is a case in point, but it was matched last year, in England, when an alleged scientist announced that he had perfected an apparatus which could be moved by the glance of the human eye, apparently without any other agency whatsoever. Although I attempted to obtain a copy of this apparatus or directions by which it could be built, I was unsuccessful. The inventor has never submitted it to independent scientific test. We cannot imagine any way in which the eye could project energy of any kind, let alone enough of it to move any mechanical system, and it is probable that the apparatus is to be written down as pure fake.

#### *The "Character Meter" That Operates Through a "Mysterious Radiation"*

The idea has come over to the United States in the form of a device that is certainly pure fake. This is the so-called "character meter." Although constructed somewhat variously by different fakers who have used it, this apparatus usually consists of some device similar

to the little radiometers of opticians' windows, the tiny whirligigs which revolve rapidly inside their glass bulbs whenever the sunlight falls on them. The character meter, however, requires no sunlight. You merely put your face close to it and gaze intently at the internal mechanism. This mechanism moves. There is no revolution of the vanes, as in the radiometer, but a needle moves across a scale or a pointer turns or some other measurable thing happens. The claim is that some mysterious "radiation" from the human eye of the gazer has affected the apparatus and that the intensity of the movement inside the instrument indicates the strength of the "personality" or "will power" or what-not of the subject being tested.

This procedure is undeniably an impressive one, especially when it is displayed to a person who has merely heard some vague rumors of the "new radiations" discovered in recent years and who is prepared to believe that some one of these newly-discovered rays might really emanate from the human eye or from whatever part of the human body the factor of "personality" is supposed to inhabit.

The truth, however, is quite simple. The apparatus is actuated by the heat of the face. It will work equally well if a hand or any other part of a living body is held in front of it, or if the body is replaced by nothing more mysterious than an ordinary hot water bag well filled with the usual heated liquid. An equally instructive result would be

obtained by holding a thermometer against the skin. A certain amount of radiant heat is given off by the face, as well as by any other warm body. Delicate instruments will detect this heat without any difficulty whatsoever.

As to the records of strong or weak personality yielded by these devices, they are no more than records of the hotness and nearness of the face in front of the instrument. A man with a fever would register a personality transcending that of Napoleon Bonaparte himself.

There used to be sold in toy shops, by the way, a still simpler device for measuring "personality," although no one had the face to say that it operated by any mysterious radiation, radio-like or otherwise. This was a small strip of gelatin, a few inches long and about an inch wide. Placed on the open hand, held palm upward, this little gelatin strip promptly curled up, like a photographic print allowed to dry unpressed. The degree and promptness of the curl were supposed to indicate the "personality." What they did indicate, of course, was merely the moisture of the palm of the hand. The cook, with her hands fresh from the dishwater, invariably had the strongest personality of all present.

#### *"Character-Revealing" Devices That Are Explained by Words Borrowed from the Language of Radio*

Another and more modern variation of these character testers consists of a pendulum which is allowed to swing from the finger over a sheet of paper, frequently with letters or figures inscribed on the paper. If you try this experiment, using any small weight, like a penknife, tied to a string about twelve inches long and holding the upper end of this string in your fingers, you will discover that the weight at the bottom end of the string will begin to swing backward and forward in one direction or another. From moment to moment the direction of this swing will change. If the sheet of paper carries the letters of the alphabet, inscribed in a circle like the figures of a clock dial, the pendulum will swing successively to a series of these letters. Set down in order, these letters sometimes spell words. Thus the device operates exactly as does the famous and unlamented ouija board.

As a character measurer the device is not used to spell words, but the pendulum is arranged to trace a design on the paper, for example, by passing a fine-pointed and very soft pencil through a loose staple carried by the weight of the pendulum. The shape and size of the design drawn is supposed to have a most profound meaning concerning the person who made it. Again we run

*(Continued on page 49)*



Courtesy of the N. Y. World

### Will Your Character Make This Meter Shine?

One of the many forms of "meter" for testing character or personality consists of two metal plates connected by a wire and stood upright in a glass beaker which holds a "sympathetic" solution. The observers link hands around the table. If the personality concentrated in the circle is great enough, the top plate of the meter is supposed to glow with light; strong for vigorous personalities, weak for feeble ones.



**Q** A simple explanation of the functions of resonance and resistance in electrical circuits that will help the fan to understand how his radio set works.

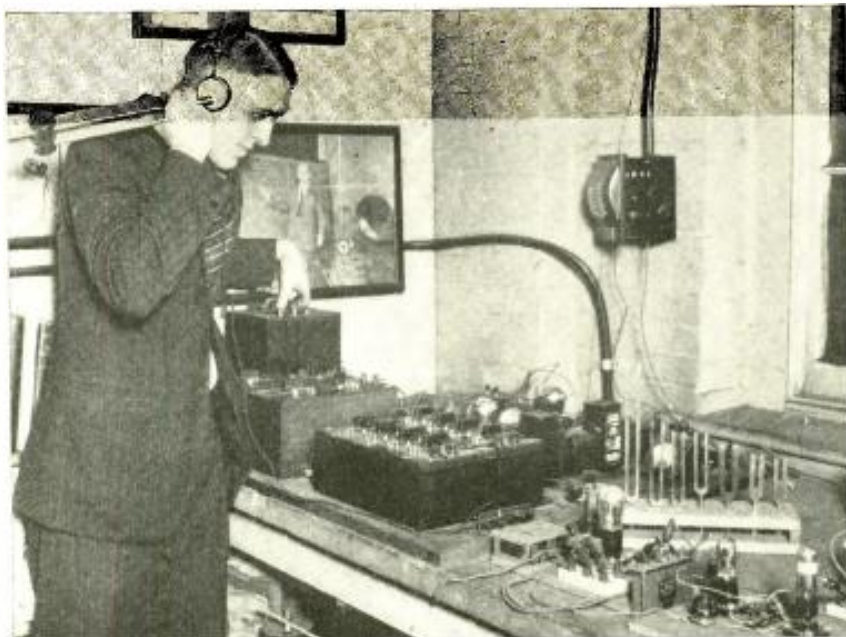

From a photograph made for POPULAR RADIO

#### HOW TUNING FORKS ARE USED TO TUNE AN ELECTRICAL OSCILLATOR

*The oscillator is set generating a frequency that may be judged by the ear to be about the order required; the standard tuning fork of a definitely known frequency is then struck and the sound applied to the headphone that is at the same time receiving the electrical oscillations from the oscillator and converting them into sounds. The frequency of the oscillator is then adjusted until it is exactly the same as that of the tuning fork by listening to the beats produced between the two frequencies. These beats cease when the two instruments are exactly in tune.*

#### WHAT HAPPENS

# When You Tune Your Set

#### ARTICLE No. 2

In the first installment of this new series of articles (in the November, 1926 issue) Sir Oliver began with a simple description of waves and wavelengths; in this and the following articles he treats of the conversion of radio waves into electrical impulses in tuning circuits, or electrical resonance and its analogy to mechanical or sound resonance. And finally he will describe the new method of tuning as embodied in the new "N" circuit, with which he has long been experimenting.

By SIR OLIVER LODGE, F.R.S., D.Sc., LL.D.

**T**HAT tuning is due to resonance, (that is, to the accumulation of small impulses which recur at the right frequency), is widely known. But few, perhaps, know the details that are associated with tuning and the extent to which the principle of resonance may be pushed.

This principle of resonance is most easily illustrated by sound.

If two similar tuning forks are mounted on resonating boxes or are fixed to the same sounding-board, and one of them is excited, the other responds and begins to vibrate in spite of the fact that it is a stiff mass of steel that has to be set in vibration. But the tuning must be accurate.

If one of the forks is slightly warmed

they will be thrown out of tune and there will be no appreciable response.

Another way of throwing them out of tune is to stick a bit of beeswax on one of the prongs of one of the forks. The wax acts as an extra load so that the impulses are not properly timed. The forks will then get out of phase, say in half a second, and, as they are then in opposition, they undo any impression which they may have made during the first quarter of a second.

Such forks, if sounded together, will beat together and produce another note which is an example of heterodyning.

Suppose one fork makes 256 vibrations a second, while the other makes 254.

If they are sounded together there

will be two beats a second, the combined sounds swelling out and dying away twice a second; this gives a beating sound which goes on as long as the simultaneously excited forks continue to vibrate at all. They give out just as much sound as before, as they are twice as strong as one fork alone.

If they were exactly in tune the sound would be a continuous wave of steady pitch, naturally twice as strong as one fork.

When they are out of tune the sound emitted is not a continuous wave but an intermittent one. It swells up to a maximum twice as strong as the continuous wave would have been, that is, four times as strong as one of the forks: then the maximum is followed by an

interval of silence, then another maximum, and so on. The increased maxima compensate for the minima, the rate of intermittence being the difference between the two rates of vibration.

If one fork is 256, while the other is 252 or 260, there will be four beats a second. If the difference in vibration is greater than that, so that the difference gives (say) 15 beats a second, the forks are decidedly out of tune; so that if they were to be sounded separately the ear would detect that one was a semi-tone higher than the other.

The beats would then be too rapid to be heard separately; they would merely give an unpleasant flickering or fluttering sensation which is called discord.

Two notes a semi-tone apart sounded together on any instrument are well known to be discordant. Helmholtz's Theory of Discord is that it is due to rapid indistinguishable beats.

This simple principle of beats is used in heterodyning, because electrical vibrations are so extremely rapid that no mechanical instrument can respond to them. No piece of matter can vibrate as fast as electrons can.

Electrical vibrations are reckoned in millions a second. But if we have two sources, one a million a second, the other 999,000, the difference in their rates of vibration is one thousand; so that the two vibrators will give a thousand beats a second.

An acoustic instrument like a telephone diaphragm can easily respond to a thousand a second; giving a note that may easily be audible to the ear. The middle C on the piano, which is the middle C between the treble and bass clefs, usually has 264 vibrations a second. The C in the treble clef is 528. The next octave above that is 1056, and that is perhaps the note or pitch to which the ear is most sensitive.

It is true that in order to convert the electrical vibrations into acoustic vibrations the alternating waves must be rectified; the negative pulses suppressed, and only the positive ones used.

This is the object of a crystal or a vacuum tube used as a detector. The crests of the waves, thus rectified or freed from their opposite components, then merge together to produce an electric current, all of one sign. They combine their effect on the telephone diaphragm, giving it a pull in one direction all through that part of the beat, which lasts only, say, one two-thousandth of a second.

Then comes the interval during which the diaphragm recovers, ready to be pulled again by the next beat; and so the diaphragm is repeatedly thrown into vibration by the intermittent current whose maxima and minima last each for the one two-thousandth part of a second. Thus though the full-wave disturbance would produce no mechan-

ical effect, because the vibrations are far too rapid to move the diaphragm but the intermittences or beats due to the superposition of the two rectified vibrations do cause an audible note of pitch a thousand a second.

So far we may consider the principle to be well-known and in common use. The interference of two audible sounds produce audible beats without any rectification, because the whole of the disturbance is within the range of audibility, and is not too rapid to affect matter.

Ether vibrations, however, are far too rapid to affect matter; they must be rectified, and then their beats may be heard, not as a beating note, but as an audible frequency. Nothing was heard until they were rectified; and then only the combined or resultant effect of the beats is heard,—heard as a clear note representing the difference in the original rates of vibration.

Something of the same sort happens in sound. Two tones strongly sounded together, even when they are far apart in pitch, give what is called a "difference" tone, which musical ears can appreciate.

For instance, suppose they differ by fifty vibrations a second. When sounded together there will be heard a low growl, deep down in the bass, of pitch fifty per second. Their beats have combined to produce such a tone.

That is not the orthodox explanation of "difference" tones, for a complete theory shows that there are not only "difference" tones, but also "summation" tones. For instance, suppose the two notes are two hundred and three hundred a second each. They will have a "difference" tone of one hundred, and a "summation" tone of five hundred.

The theory of these involves what is called the second order of small quantities, and is not as simple. They are called, in general, combination tones. Of these the "difference" tones are the loudest, the "summation" tones the next; and there are others, represented not only by  $p - q$ , and  $p + q$ , but  $2p - q$ ,  $2p + q$ ,  $pq$ , and others, which, however, are too feeble to be readily heard.

All these, no doubt, exist also in the electrical case, when two antennas nearly of the same pitch are excited together, or when one of them is excited by two powerful rates of vibration. The only thing used in practice, however, is the "difference" tone, which is most easily thought of as a tone resulting from the beats, and is employed in heterodyning. The heterodyning may be accomplished either at the sending or the receiving end, with many details which are known to practical radio telegraphers.

The only complication in the electrical  
(Continued on page 52)

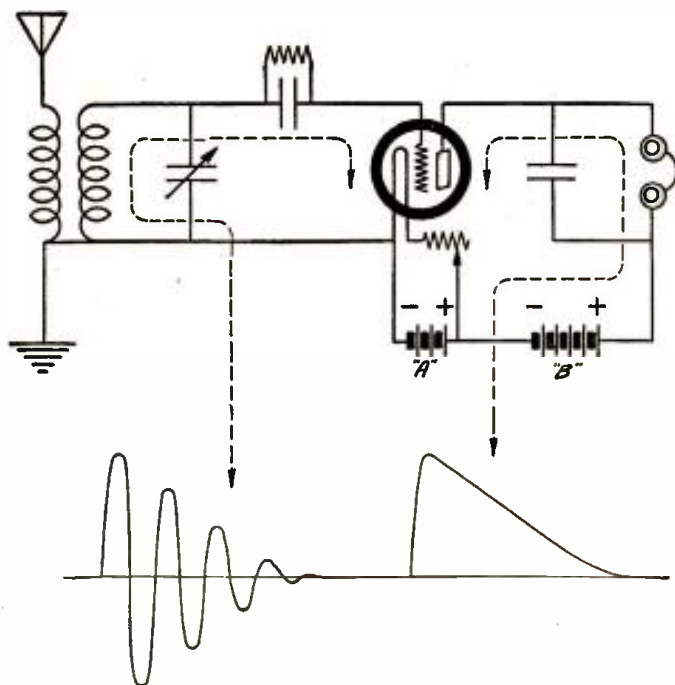

#### HOW A VACUUM-TUBE DETECTOR WORKS

Radio-frequency impulses, represented diagrammatically by the curved line in the lower left-hand portion of the diagram, actuate the grid of the vacuum tube by following through the tuned circuit connected with the grid. These separate impulses add up, through the actions of the tube, into one single audio-frequency pulse, represented diagrammatically in the lower right-hand corner. This is the impulse that flows through the plate circuit of the vacuum tube and produces the sounds that we hear in the loudspeaker.



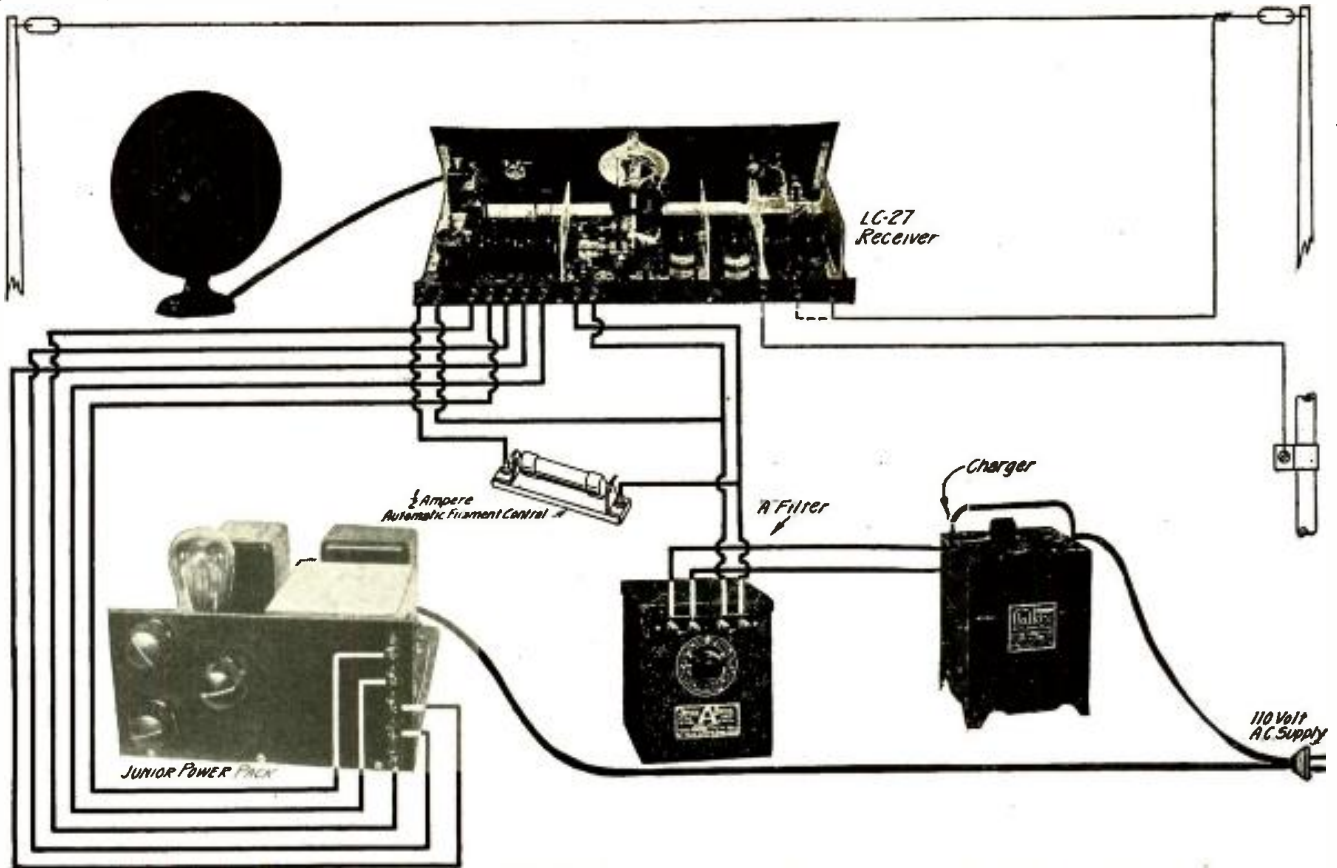

HOW THE POWER UNITS ARE CONNECTED

FIGURE 1: This picture-wiring diagram shows the LC-27 Receiver connected up with the "A" "B" and "C" power units and to the antenna, the ground and the loudspeaker; the 110-volt AC input to the charger and to the Junior Power-pack are connected in parallel to the lighting lines by means of a standard connection plug.

HOW TO BUILD THE

# LC-JUNIOR POWER-PACK

While this highly efficient but low-cost power unit has been designed especially for use with the LC-27 Receiver, it may be used with equal results with any receiver that uses a power tube in the last stage

By LAURENCE M. COCKADAY

COST OF PARTS: *Not more than \$39.50*

HERE ARE THE PARTS THAT WERE USED IN THE LABORATORY MODEL OF THIS UNIT—

- |  |  |   |
|--|--|---|
| <p>A—Silver-Marshall power transformer, type No. 329;<br/>         B—Silver-Marshall unichoke, type No. 331;<br/>         C—Any approved type UX socket (Klonsner socket illustrated);<br/>         D1 and D2—Sangamo filter condensers, series B, 2 mfd.;<br/>         D3—Sangamo filter condenser, series B, 4 mfd.;</p> | <p>D4 and D5—Sangamo filter condensers, series B, 1 mfd.;<br/>         D6 and D7—Sangamo filter condensers, series B, .1 mfd.;<br/>         E and F—Any approved variable resistance (Clarostat resistance illustrated);<br/>         G—Any approved high-current variable resistance to dissipate 5 watts, 2000 ohms (Centralab resistance illustrated);<br/>         H—Any approved fixed resistance, 10,000</p> | <p>ohms (Bradleyohm resistance illustrated);<br/>         I—Lynch resistor mounting;<br/>         J—Hardwood baseboard, 9 by 11 by ½-inch;<br/>         K—Bakelite panel, 4½ by 9 by ⅜-inch;<br/>         L1, L2, L3, L4 and L5—Any approved binding post (Eby posts illustrated);<br/>         One set of POPULAR RADIO blueprints for LC-Junior Power-pack.</p> |
|--|--|---|

HERE is a third power-pack for the LC-27 Receiver—and one that is particularly suited to the needs of the experimenter who wants a unit that is both economical to build and efficient in operation.

Although the cost of this unit has been reduced to the lowest possible

figure none of the necessary operating features have been sacrificed; the power-pack will be found altogether suitable for use with power tubes of the UX-171 or UX-112 type.

This unit has characteristics similar to those of the LC-Senior and the LC-Intermediate power-packs except for

two points: the filament current for the last tube in the set is furnished by the "A" power unit and no relay is used.

The quality of reception obtained from the receiver when this unit is used should be of the same high order as with its larger brothers. The power-pack will supply at least 180 volts for

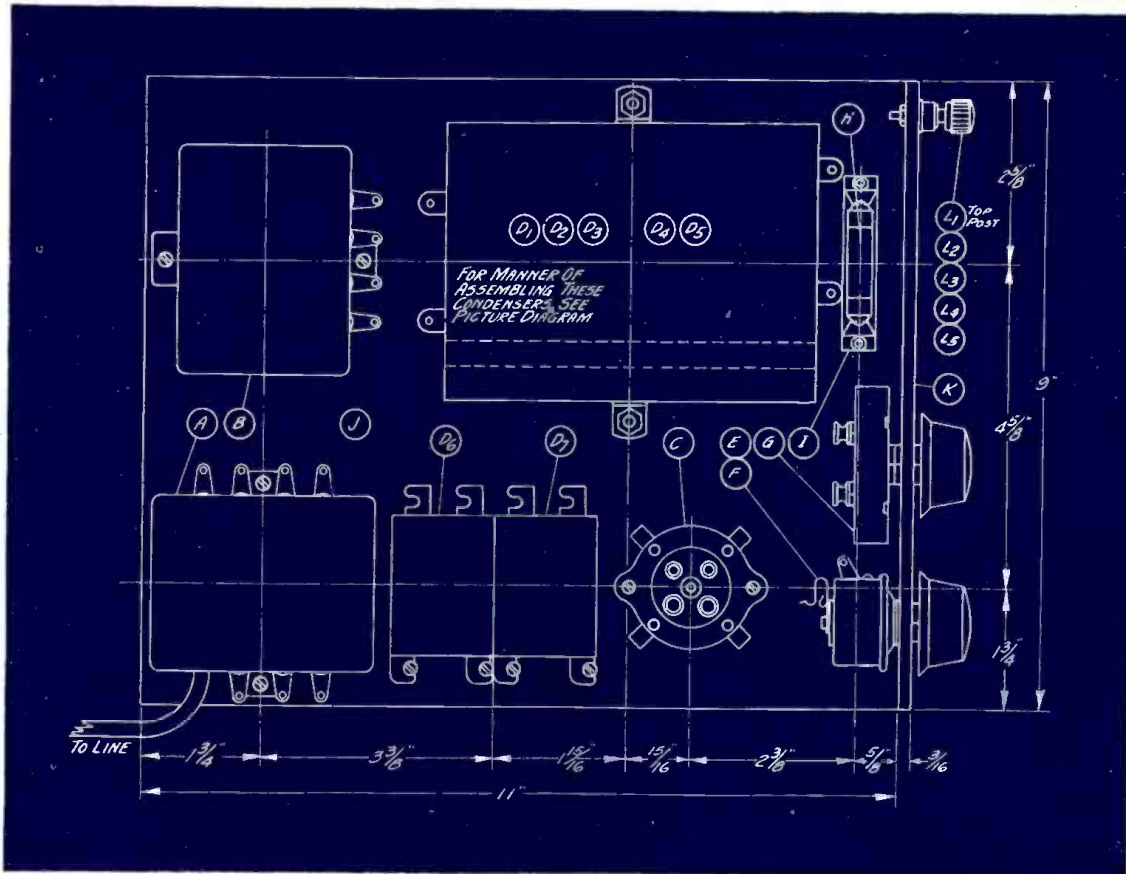

**THE WORKING DRAWING FOR CONSTRUCTION**

FIGURE 2: All of the parts are shown in their exact positions, given from centre to centre of each of the instruments.

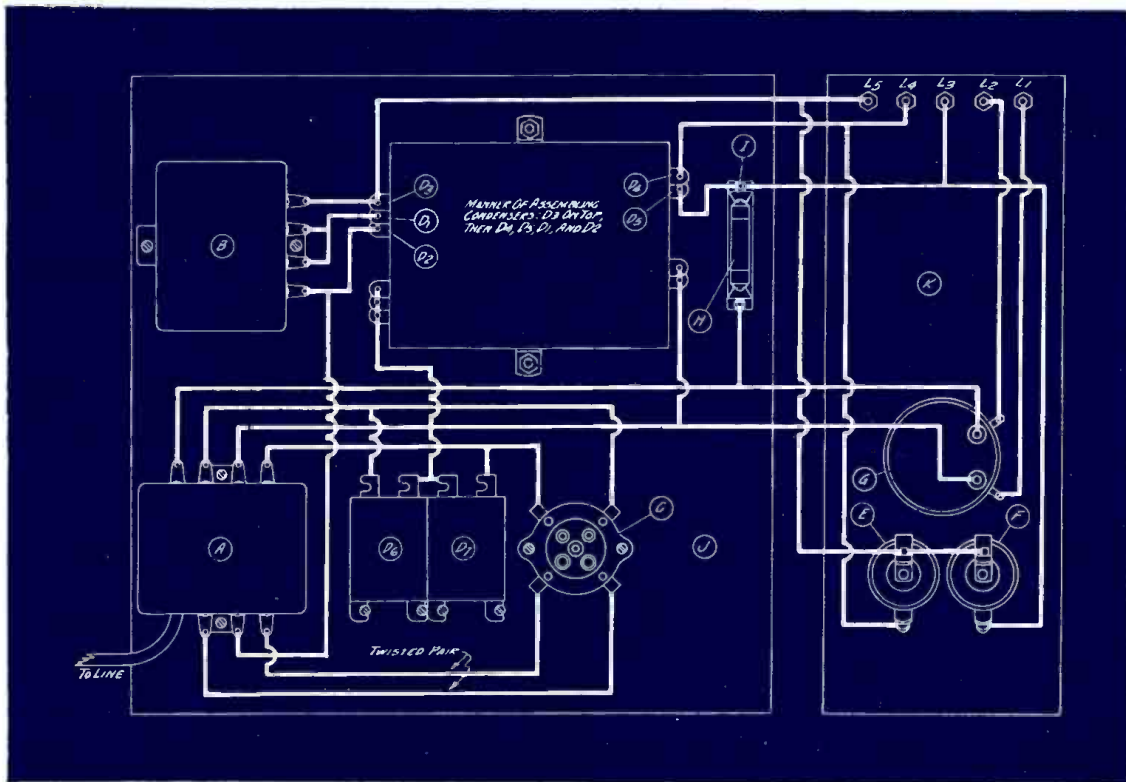

**THE PICTURE-WIRING DIAGRAM**

FIGURE 3: The instruments in this diagram are drawn in about their relative positions and the wiring is shown in heavy white lines.





THE "A" AND "B" POWER-PACKS INSTALLED

FIGURE 4: In the cabinet proper, on top of the table, is shown the receiver; the table compartment holds the charger, C, at the left, the filter unit, A, in the centre and the Junior Power-pack, B, at the right.

the power tube that is used in the last stage, and a variable voltage for the radio-frequency, the first audio-frequency stage, and the detector tube plate circuits. A variable "C" battery potential is also available from this unit for the power tube. The LC-27 receiver, when operated from this power-pack in conjunction with the 110-volt, 60 cycle, alternating current supply, will give lifelike reproduction and plenty of volume for ordinary home use.

*How to Construct the Unit*

After all the instruments and materials for building the power-pack have been procured, the baseboard, J, should be cut to the correct size, as shown in Figure 2. It should be smoothed with sandpaper and given a coat of stain and shellac.

Next, the small panel, K, upon which are to be mounted the binding posts and the voltage controls, E, F and G, should be prepared, as shown in Figure 5. When all the holes have been drilled, the seven binding posts should be mounted and the variable resistances, E, F and G, should be fastened to the panel, as shown in Figures 2, 3 and 7.

The panel, K, may then be fastened on one of the long sides of the baseboard, J, by means of three screws, as shown in Figure 1. These screws are inserted through the three holes in the panel into the edge of the baseboard, J. They should be strong wood screws.

Next, mount the transformer, A, by

means of two strong, short, wood screws to the baseboard, J, and mount the unichoke, B, in the same way. The positions for these instruments are given in Figure 2.

Next, mount the two small condensers, D6 and D7, as shown in Figure 2 and 6. This will require four, short, round-head, wood screws.

Then, mount the socket, C, with the large holes turned, as shown in Figure 6. This will require two flat-head wood screws.

The resistance mounting, I, should then be fastened down to the baseboard and the resistance, H, put in place in the clips.

The last construction job will be to mount the high-voltage condensers, D1, D2, D3, D4 and D5. These should be mounted in the following order:

D1 and D2 are placed first on the baseboard, J, with the terminals pointing toward the unichoke, B. Then, condensers, D4 and D5 are placed on top of these with the terminals pointing toward the panel, K. Lastly, the large condenser, D3, is placed on top with the terminals pointing toward the unichoke, B. All the lugs that are used for fastening the condensers down are lined up and a long machine bolt is put through them from the bottom of the baseboard and a nut screwed on to the end of this bolt, as shown in Figure 6. On the other side, the top condenser (D3) lug will extend out and away from all of the other lugs, and should be fastened in a similar manner, except that the bolt used for this purpose will not go through the bolts on the lower condensers but will be fastened tightly and hold the condensers in position by pressure. This side of the bank is shown in Figure 7.

This completes the construction work and the unit is ready to be wired.

*(Continued on page 78)*

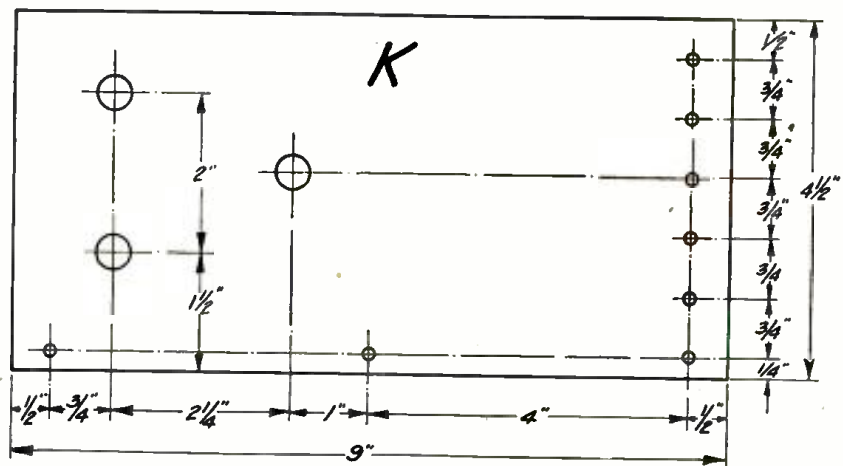

HOW THE BINDING POST PANEL SHOULD BE MADE

FIGURE 5: This drawing gives the exact size of the small panel, K, with the drilling hole locations for mounting the binding posts, the three mounting screws and the three variable resistances.

# What's in

Apparatus that is of  
broadcast listeners and  
genious and practical  
up-to-date fan

Conducted by  
**THE TECHNICAL STAFF**



### A RECEIVER BUILT ON A BABY-GRAND MODEL

*This unique console contains a home-made, six-tube, tuned-radio-frequency receiver; the top of the piano acts as a sound board for the loudspeaker mounted beneath. It belongs to Miss Violet Herbert.*

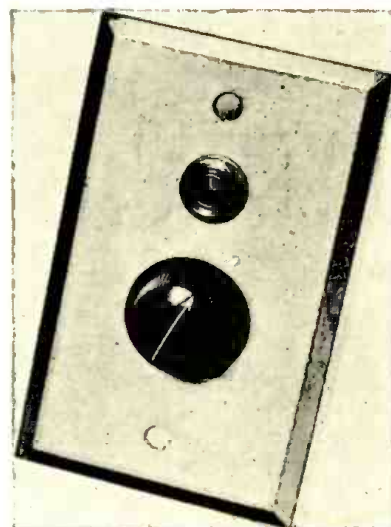

### A Plug for an Extension Loudspeaker

*Name of instrument:* Combination loudspeaker jack and volume control for wall mounting.

*Description:* This device may be connected to the wall and used in a distant part of the house for an extension loudspeaker connection. It consists of a jack with a series variable resistance, by means of which the loudspeaker may be plugged in and the volume tuned up or down to just the right degree without affecting the setting of the set. By this means the receiver on the other end of the line may be set for large volume and loudspeakers installed throughout the house with the volume controlled in the room to just the desired strength.

*Usage:* In connection with a receiving set and loudspeaker as an extension.

*Outstanding features:* Makes house wiring for radio easy. Neat in appearance. Easy volume adjustment.

*Maker:* Carter Radio Co.

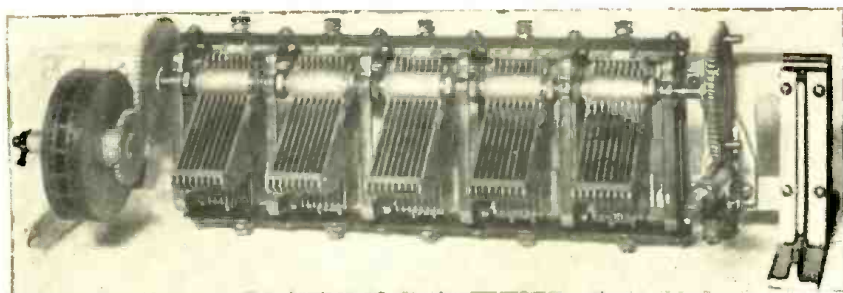

### A Gang Condenser that Makes a Set "Single Control"

*Name of instrument:* Five-gang condenser.

*Description:* This condenser combination contains five variable condensers mounted on a carefully designed and constructed chassis with a single shaft that is connected through a worm geared arrangement to an auxiliary shaft on which the dial to operate the set may be mounted. At the other end of the unit is a geared drum that carries the dial settings for

the receiver. A perfect balance may be obtained in all of the circuits by varying the position of any one or all of the rotor units in relation to any one unit.

*Usage:* In a receiver for producing true single-control operation.

*Outstanding features:* Elaborate and well carried out design. Easy to install. Easy to balance. Fine workmanship.

*Maker:* Perlesz Radio Corp.



# New Radio

interest and value to experimenters; inventions that the should know about

*Illustrated with photographs made for POPULAR RADIO*



## A Compact Automatic Charger that Employs a New Trickle Charger Tungar Tube

**Name of instrument:** Trickle charger.  
**Description:** A small, compact unit that is housed completely in a fireproof ventilated metal case. It is equipped with a switch for turning "on" and "off" and a meter for indicating the relative rate of charge. It is furnished complete with the proper extension leads for the alternating current lighting mains and also for connecting to the batteries to be charged.  
**Usage:** In combination with a storage "A" battery for keeping the battery at the best working condition.  
**Outstanding features:** Compact. Easy to install. Needs no attention. Keeps battery fully charged.  
**Maker:** Sterling Mfg. Co.



## A Loudspeaker Built Like a Tip-top Table

**Name of instrument:** Cone loudspeaker.  
**Description:** This reproducing unit, which is housed in a small table top and is mounted on a tripod similar in appearance to a tip-top table is unique in design and reproduces radio broadcast signals with a wealth of volume and with excellent tone quality, including all the high and low notes. It is finished in two-tone polished walnut and is equipped with an extension cord that enables the loudspeaker to be moved to various portions of the house.  
**Usage:** As a reproducer of broadcast programs in the home.  
**Outstanding features:** Neat appearance. Fine tone quality. High efficiency from a volume standpoint.  
**Maker:** Rola Co.



## A Connector Cable that Simplifies Set Installation

**Name of instrument:** Battery cable.  
**Description:** A unit that contains wires for connecting the storage battery and the "B" batteries to the set terminals. The wires are insulated and covered with a braided covering. Connectors

that are easy to attach are supplied for the battery terminals and for the binding posts.

**Usage:** For a receiving set installation between the batteries and the receiving set.

**Outstanding features:** Easy to install. Makes a neat installation. Good contact.

**Maker:** Birnbach Radio Co.



## A Resistor that Maintains a Constant Value

**Name of instrument:** Resistor unit.  
**Description:** This resistance utilizes a glass tube which is coated on the inner surface with a resistance film that is carefully baked to make it permanent. On each end of the resistor, a low-resistance film makes contact with the brass ferrules so that the contact resistance will not change. The resistance values are accurate and remain permanent.  
**Usage:** In any place in a radio receiving apparatus where accurate resistance values are necessary.  
**Outstanding features:** Permanent. Accurate. Easy to install. Neat in appearance.  
**Maker:** Daven Radio Corporation.



## A New Tube that Gives High Voltage and Consistent Operation in Power-packs

**Name of instrument:** Rectifier tube.  
**Description:** The new-type Raytheon rectifier, known as the BH type, has a greater output than the old type of tube and will satisfactorily furnish 85 milliamperes on continuous rating. When used in the old style Raytheon power-pack it will increase the voltage output by at least 25 to 30 percent. When used with the new type Raytheon units, it will supply even higher power and insure satisfactory service and maximum output from the UX-171 tube when used as an audio-frequency amplifier in the last stage in a receiver.  
**Usage:** As a rectifier tube in a "B" power-pack.  
**Outstanding features:** Higher power. Rugged construction. Will serve as a rectifier for furnishing "A," "B" and "C" voltages for the 199 type tubes. Will furnish "B" and "C" power for UX-171 and UX-112 type tubes. Uniform characteristics. More consistent operation.  
**Maker:** Raytheon Manufacturing Co.



Underwood & Underwood

**A RECEIVER THAT IS TUNED BY PUSH-BUTTONS**

All you have to do to tune in a station is to push one of the buttons on the switchboard; this actuates an electrical relay and tunes the set to exactly the right wavelength. There are eight relays in all, which may be adjusted to tune in your eight favorite stations.

a high grade unit for use in the popular impedance-coupled, audio-frequency amplifier. The two terminals are mounted on bakelite and extend through holes provided in the metal housing. An extension base provides lugs for attaching this instrument to the baseboard of a receiver. This unit is of the single impedance type of coil.

*Usage:* When used with a suitable condenser and resistance it will provide one stage of high grade audio-frequency amplification.

*Outstanding features:* Neat appearance. Rugged and compact. Terminals conveniently placed. Reliable design and workmanship.

*Maker:* General Radio Co.



**A New Unit that Will Carry Heavy Currents in Power-packs**

*Name of instrument:* Resistor.

*Description:* This resistance is a carefully made unit consisting of resistance wire wound on an insulating tube equipped with two soldering lug terminals, one at each end. The resistance wire is protected by a baked enamel covering to prevent oxidation. It is accurate in the values specified and will carry currents well in excess of the rated loads.

*Usage:* In a power-pack as a voltage divider or in any other place where resistors of high resistance values are necessary.

*Outstanding features:* Accurate rating. Permanent values. Neatly constructed. Easy to wire.

*Maker:* C. E. Mountford.



**A Voltmeter for Radiola Superheterodynes**

*Name of instrument:* Swivel jack voltmeter.

*Description:* This voltmeter is compact in size and is enclosed in a neat metal case finished in black. The voltage scale and hand are white while the dial is black; this makes for high visibility. The range is from zero to 6 volts and the dial scale is so calibrated. The instrument is equipped with a small switch by means of which the meter may be connected in the circuit at will. The terminals are in the form of two pins which are inserted in the small jacks provided for this purpose on the Radiola receivers. These pins are arranged on a swivel mounting to permit the meter to be turned at any desired angle.

*Usage:* To measure the voltage applied to the filaments of the tubes of any receiver equipped with the proper pin

jacks—notably the Radiola and the receivers incorporated in the Victor and Brunswick combination radio-phonograph units.

*Outstanding features:* Neat appearance. Compact. Highly visible scale and indicator. Easy to connect.

*Maker:* Beede Electric Instrument Co.



**A New Impedance for Audio-Frequency Amplification**

*Name of instrument:* Impedance coil.

*Description:* This instrument, which is encased in a japanned metal housing, is

**A Resistance that Will Help Reduce Noises in The Receiving Set**

*Name of instrument:* Fixed resistor.

*Description:* This unit, which is made by a new process, utilizes a metallized glass rod as the resistance element. It is of rugged construction and will stay permanently at the fixed value of resistance that is marked on the instrument. It will not produce frying sounds in receiving apparatus.

*Usage:* In a receiving set wherever a fixed resistance of various values may be necessary.

*Outstanding features:* Rugged construction. Permanence. Accurate calibration.

*Maker:* Arthur H. Lynch, Inc.







### A Compact Tube Charger That Reduces Battery Troubles

**Name of instrument:** Trickle charger.  
**Description:** This unit, which is entirely enclosed in a fireproof metal case, comprises a charger that uses a 2-ampere Tungar tube as the rectifier and contains the necessary transformer for supplying it with voltage. It is also equipped with a switch and an output regulator to suit varying needs of charge and an extension cord and plug for connecting to the 110-volt, 60-cycle lighting lines.  
**Usage:** In connection with a storage battery for automatic charging.  
**Outstanding features:** Compact size. Needs little care. Keeps storage battery always up to full charge. Variable adjustment feature. Fireproof.  
**Maker:** The Storad Manufacturing Co.

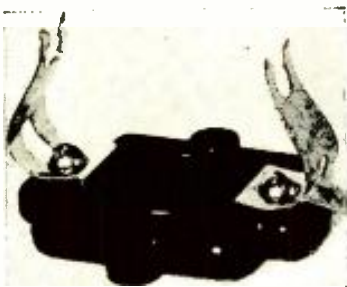

### A Fixed Condenser With a Grid-leak Mounting

**Name of instrument:** Molded mica fixed condenser with grid-leak attachment.  
**Description:** This is a carefully made fixed capacity unit; it is entirely surrounded by molded bakelite and provided with two holes for mounting with two screws to the baseboard. It also contains two clips for supporting a grid-leak and is equipped with soldering lugs.  
**Usage:** As a grid condenser in a receiving circuit.  
**Outstanding features:** Accurate values. Waterproof. Heatproof. Easy to install.  
**Maker:** Pilot Electric Mfg. Co., Inc.

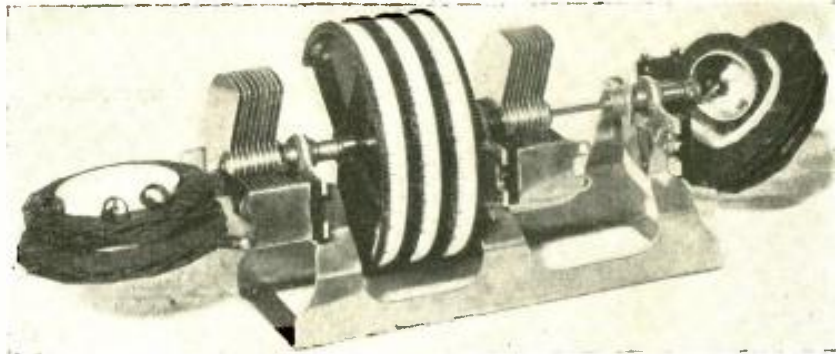

### A Tuning Unit to Bring the Roberts Receiver Up to date

**Name of instrument:** Complete Roberts tuning unit.  
**Description:** This new combination of variable condensers and coils is made especially for the Roberts circuit. It contains a variable condenser at the left which is controlled by the left-hand drum. This tunes the radio-frequency amplifier, the tap coil of which is located at the left. At the right is the variable condenser that tunes the regenerative detector and it is controlled by the right-hand

drum. The center drum controls regeneration by revolving the tickler coil, shown in the center of the detector coils at the right. This unit may be installed with a cut-away panel for the drum in your old Roberts receiver, or it may be used as the nucleus for a new set and will be found to give improved results in both tuning and operation.

**Usage:** It may be used with the Roberts circuit.  
**Outstanding features:** Simplified control. Easy assembly. Efficient operation. Brings an old set up to date.  
**Maker:** Alden Mfg. Co.



### A Power-pack that Replaces "B" and "C" Batteries

**Name of instrument:** "B" and "C" Power-pack.  
**Description:** This instrument, which is enclosed in a metal container, supplies the "B" and "C" voltages for the operation of any standard receiver which requires no more than 135 volts max-

imum. A Raytheon tube is employed as the rectifier in this device. Output terminals are provided to supply an adjustable detector plate voltage, three intermediate voltages, 45, 67 and 90, and the high voltage, which is 135. In addition, there are terminals for a 4 and 9-volt "C" supply and, for use with power tubes, a variable "C" voltage. The latter and the detector plate voltage are adjustable by means of two knobs mounted on the front of the instrument. The power-pack is also equipped with a switch for turning it "on" and "off" and an extension cable with plug for connecting to the alternating current lighting socket.

**Usage:** In connection with any receiver to supply all required "B" and "C" voltages.  
**Outstanding features:** Neat appearance. Compact. Rugged. Supplies ample variety of voltages to take care of the critical requirements of any circuit.  
**Maker:** DeWitt-La France Co.

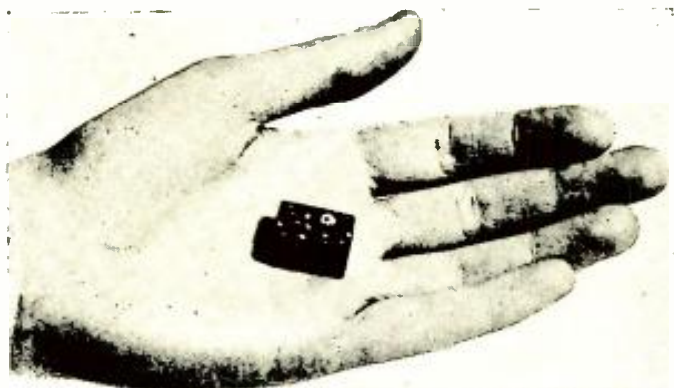

Pacific & Atlantic

### A NEW "SMALLEST SET"

This tiny radio receiver weighs no more than an ordinary finger ring but it will bring in local stations clearly. A crystal detector is used, of course, but it is so small that a pair of fine pinchers must be used to adjust it accurately. It was built by an English fan.

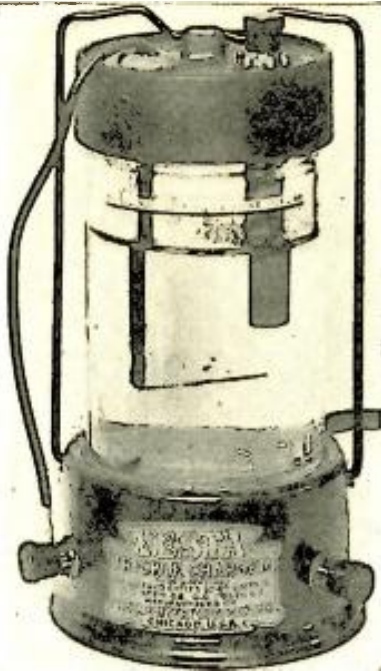

### A New Trickle Charger for "Pepping Up" Batteries

*Name of instrument:* Trickle charger.

*Description:* An improved electrolytic charger that may be left permanently connected to your battery and may be relied upon to slowly charge the storage battery of a radio set and keep it in fully charged condition at all times with no attention other than an occasional addition of distilled water. The unit is practically spill-proof and may be placed directly in the battery cabinet with the battery.

*Usage:* In connection with a storage battery as a permanent charging device.  
*Outstanding features:* Improved construction. Automatic operation.  
*Maker:* Vesta Battery Corporation.

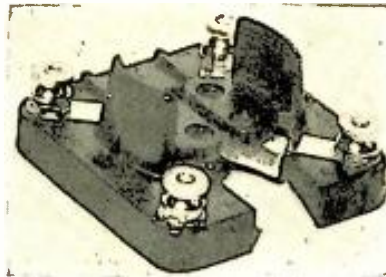

### A Socket to Increase the Efficiency of Your Amplifier

*Name of instrument:* Vacuum-tube socket.

*Description:* This unit, which is of high-grade molded bakelite, is formed in such a fashion that the insulating section between the grid and plate terminals is cut away; this reduces the capacity across the circuit to a minimum value. It is equipped with spring contacts that make firm and positive connection to the prongs of standard vacuum tubes. When used in radio-frequency circuits a decided improvement will be noted in the amplification obtained in each stage.

*Usage:* Can be used generally as a base for standard vacuum tubes and will be found of exceptional value in vacuum tubes that are functioning as radio-frequency amplifiers, or as a detector.

*Outstanding features:* Extremely low capacity from grid to plate. Neat workmanship. Rugged construction. Firm contact.

*Maker:* Airgap Products Co.

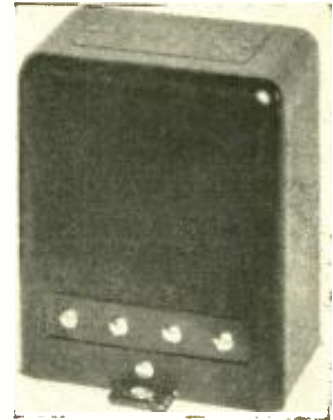

### A Transformer that Will Increase Volume and Tone Quality in Your Set

*Name of instrument:* Audio-frequency amplifying transformer.

*Description:* This is a high grade transformer for audio-frequency work that contains an exceptionally large core and windings that will increase the amplification at low frequencies to a great extent over that obtained with the older types. It is housed in a neat metal case with a strip holding the four terminals for the grid, filament and plate circuits.

*Usage:* In an audio-frequency amplifying circuit for producing better quality.

*Outstanding features:* High volume. More uniform amplification over the entire range of broadcast musical frequencies. Neat appearance.

*Maker:* Silver-Marshall, Inc.



Kadel & Herbert

### A SET THAT RECORDS WHAT IT RECEIVES

Broadcast programs may be "canned" for future use on this four-tube reflex set built by Norman Stuckey of New York. As the music is received the impulses are recorded on a moving, magnetized wire which runs between the two reels shown at the bottom of the cabinet. The program may be reproduced later by running the wire between two magnets attached to an amplifier, as long as the impression lasts, that is, for a period of from two to three months.

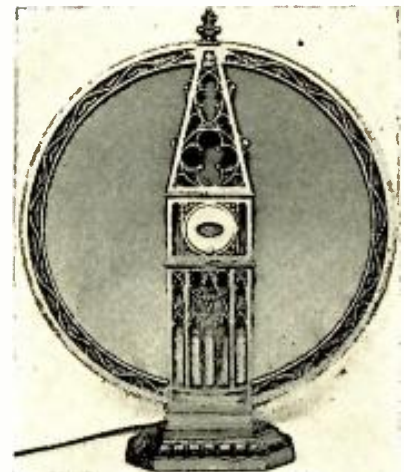

### An Efficient Loudspeaker of Novel Design

*Name of instrument:* Cone loudspeaker.

*Description:* This loudspeaker presents a happy combination of good reproducing qualities with fine appearance. The cone itself is 18 inches in diameter and is enclosed in an artistic metal frame, which affords protection to the delicate cone. The adjustable actuating mechanism is supported on a metal upright, artistically finished to match the frame.

*Usage:* To reproduce broadcast signals.

*Outstanding features:* Fine quality. Sturdy construction. Great volume.

*Maker:* Pathé Phonograph & Radio Corp.



## A New "Humless" Power-Operated Receiver

*Name of instrument:* The Garod "Model EA" Receiver.

*Usage:* For the reception of broadcast programs.

*Outstanding features:* Complete operation from the alternating current, house lighting lines. Nearly perfect tone quality with no hum. Good appearance. No adjustments to make. Entirely self-contained.

*Description:* Some of the most radical advances in radio equipment of this season are offered by this new power-operated Garod receiver as well as a reproduced tone of nearly perfect quality.

All of the operating current for the receiver is drawn from the AC lighting lines through an unusually compact power-pack that demands no attention on the part of the owner once it is installed. All the necessary adjustments in the power-pack are made in the factory and the whole receiver is tested by a service man when the set is installed to make sure that these adjustments are suitable for the special location of the individual set.

One of the most exceptional features of this receiver is its exquisite tone quality and quietness of operation. The objectionable "hum" that has been a cause for complaint in so many AC-operated sets has been eliminated in this receiver, for whatever "hum" may be found is never audible more than an inch or two from the loudspeaker. Tube noises have also been done away with by operating the filaments of the tubes at a point considerably below their normal voltage.\*

A UX-199 type tube is used as the detector; this helps to eliminate

\*The Garod Company is licensed under numerous patent applications of Benjamin F. Miessner covering the electrical power features of this receiver.



*This new self-contained receiver is operated by plugging in on the AC house lighting lines.*

noises in the receiver itself because, as a detector, the UX-199 type tube is extremely quiet.

A further reason for the fine tone quality is the careful design of the radio-frequency amplifier so that no side bands are cut and the full tonal values remain unimpaired.

Good appearance is also important in a receiver; and here again the Garod scores high. The cabinet is large enough to eliminate the necessity for overcrowding of the instruments and is of good substantial construction but, nevertheless, graceful in all its lines. The receiver and the table on which the receiver rests are a single unit. The table top is hinged and the receiver is attached directly to it. Just below this table top is a shallow compartment in which the power-

pack that operates the set is mounted.

The entire table, cabinet and front panel are of mahogany and all are finished, to match, in a dark brown. The tuning controls on the receiver panel are of composition material of this same color. All of the large surfaces of both table and cabinet are broken up with a paneled effect.

The receiver employs the neutrodyne principle and makes use of five tubes. There are two stages of neutralized-tuned-radio-frequency amplification, detector and two stages of transformer-coupled audio-frequency amplification. The same careful engineering design that was employed to produce the fine tone quality and efficient operation from the house lighting lines has been made use of to develop a five-tube receiver of the highest electrical efficiency. No single detail has been overlooked which might tend to increase efficiency, durability and dependability.

The receiver is tuned by means of the three large dials on the front panel which control the input to the first and second stages of radio-frequency amplification and to the detector. At the lower left-hand corner of the panel is a small selectivity control knob by means of which the over-all selectivity of the receiver may be adjusted to meet the needs of local conditions. This knob also serves as a volume control. In normal operation this knob may be set at the position which gives the best combination of volume and selectivity and left in that position. If extreme selectivity or extreme volume are required, this knob may be adjusted accordingly.

The corresponding knob at the lower right-hand corner of the panel provides a second volume control by means of which the strength of signals is increased or decreased as desired in the audio-frequency amplifier itself.

A novel feature of the receiver is the use of power tubes in all stages of amplification. This guards against the possibility of overloading the amplifier tubes, and contributes its share towards perfect tone quality. The power tubes used are of the UX-112 type in the two radio-frequency stages

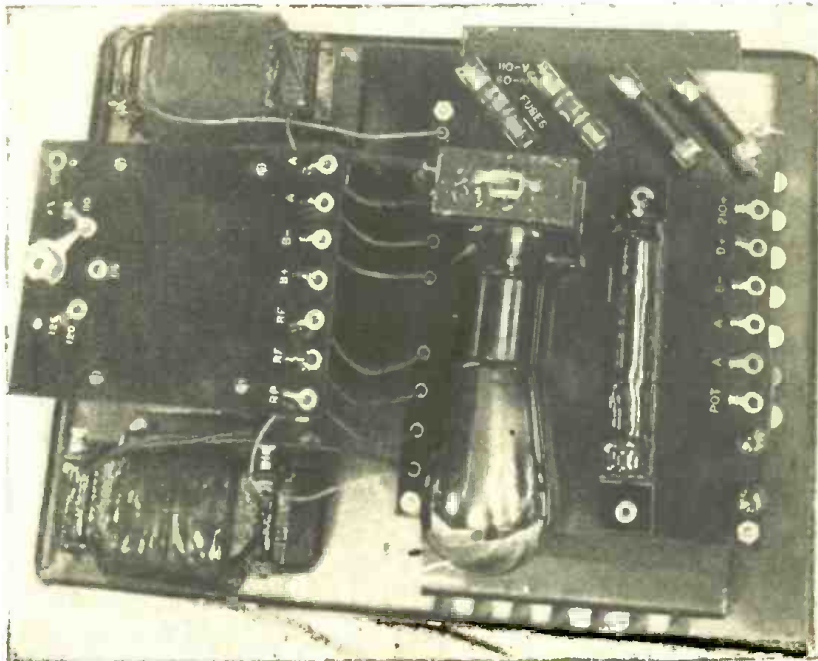

*This power unit supplies all of the operating current for the new Garod receiver. It prevents the hum from the AC lines entering into the receiver and marring the quality of the reproduction.*



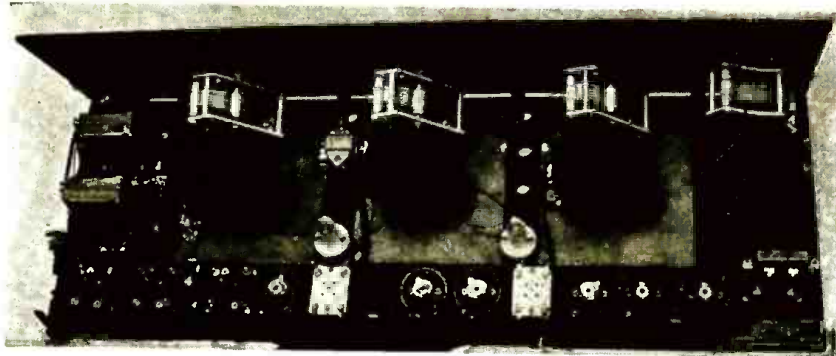

The new Garod receiver employs two stages of neutralized-tuned-radio-frequency amplification, a vacuum-tube detector and two stages of transformer-coupled audio-frequency amplification. Note the partial shielding of the three tuning condensers and the attached coils.

and in the first audio-frequency stage. In the last audio stage a UX-210 type power tube is used. As explained before the filaments of these four tubes are operated from the alternating current.

The detector tube is operated on direct current. The filament current consumption is sufficiently low to permit it to be drawn direct from the plate current supplied by the power-pack.

The Garod receiver will operate on any kind of an antenna. For maximum results a long outdoor antenna, about 100 feet long, is recommended. This is especially helpful in listening in on reception from great distances. For those who are not greatly interested in long-distance reception a

shorter outdoor antenna or an indoor antenna will give highly satisfactory results. Or one may go further and dispense with both of these types of antenna and use an ordinary loop antenna; this will give plenty of volume for ordinary use.

The only external equipment required for the operation of this receiver is a loudspeaker. It is recommended that the speaker be of the cone type; it should be the very best obtainable or it will not be capable of maintaining the fine quality of reproduction of which the receiver is capable.\*

Maker: Garod Corporation.

\*Any additional information regarding this receiver may be obtained by an inquiry addressed to the editor of this department.

## A Really Absolute Single-Control Receiver

*Name of instrument:* The Stewart-Warner Model 355 Receiver

*Usage:* For general broadcast reception.

*Outstanding features:* Absolute single-control operation. Fine tone quality with great volume. Good-looking cabinet.

*Description:* This receiver presents a striking feature in its simplicity of operation. It is an absolute single-control receiver; this means that all wavelength tuning is accomplished by means of a single knob. On the front panel there are two other control knobs but these have nothing to do with the tuning of the receiver. They simply regulate the volume of sound by varying the current supply from the batteries to the vacuum tubes.

The wavelength tuning knob is located in the center of the panel. Just above it are two small windows through which the wavelength to which the receiver is tuned may be observed. The tuning scale is calibrated both in degrees, as observed through the upper window; and in wavelength, as observed through the lower window.

The left-hand "tone control" knob is provided to vary the "B" battery current to the radio-frequency amplifier tubes; this allows the operator to adjust the volume of sound to any desired degree.

The right-hand knob regulates the filament current to all of the tubes. This knob requires no attention after it is once adjusted, unless the storage battery should become run down below normal.

This receiver is set in a console cabinet. This cabinet is of walnut and is

beautifully finished in a warm, shaded brown effect.



This new Stewart-Warner receiver, unlike most single-control sets, has no auxiliary or balancing controls; all the tuning is done with the knob in the center of the panel. The left-hand control is connected in the plate circuit of the radio-frequency tubes and may be used to adjust the volume; the right-hand control regulates the amount of filament current fed to all the tubes and requires no attention.

The receiving unit is located at the top of this console and is equipped with a metal front panel finished in antique, stippled bronze. The control knobs are set in bronze escutcheon plates which are mounted on the face of the panel.

Just below the receiver is an open grill-work behind which the cone-type loudspeaker is located. Special precautions have been taken, in installing the loudspeaker, to prevent any irregularities in reproduction which might result from enclosing a speaker in a rectangular compartment of a wood cabinet. The main feature in this accomplishment is a bell shaped baffle plate of non-resilient metal which tends to direct the sound out through the open grill.

Below the loudspeaker compartment is another compartment which provides space for all batteries used in conjunction with the receiver. This compartment is equipped with a drop front to permit ready access to the batteries.

In addition to the Model 355 the same receiving unit may be obtained in three other styles of cabinets ranging from a small table-mounting cabinet, just large enough to accommodate the receiver unit, up to a large art-console model.

The circuit employs six tubes. These provide three stages of radio-frequency amplification, a vacuum-tube detector and two stages of transformer-coupled, audio-frequency amplification. The first stage of radio-frequency amplification is untuned; but the input circuits to the second and third radio-frequency amplifier tubes and to the detector tube are tuned, making a total of three tuned circuits. The condensers, by means of which these circuits are tuned, are

(Continued on page 90)



# SO THAT YOUR ENJOYMENT MIGHT BE UNINTERRUPTED

Today you can be as sure of your B-power supply as you are of your electric lights. No longer need you worry whether your B batteries will run out at the most crucial moment of some national sporting event. No longer need you hesitate to invite the neighbors over to hear the opera for fear that your B-power unit will fail for lack of proper attention.

Raytheon has made possible absolutely reliable B-power that requires no attention. For years Raytheon Engineers studied the application of light socket power to the operation of radio in the home. Eventually the Raytheon rectifying tube was produced, giving an abundance of power, long life (no filament) and complete elimination of all service.

At this point the leading makers of radio equipment took up the task of incorporating the Raytheon rectifier in a complete B-power unit, ready for installation in the home. This has been accomplished with great success by the organizations represented on this page.

Their units, all tested and approved by the Raytheon Laboratories, represent a wide variety of styles and prices. Your dealer will be glad to recommend one best suited for your set. The fact that it is Raytheon-equipped means that unfailing B-power is yours at the touch of a switch.

Raytheon is the heart of reliable radio power.

Raytheon Manufacturing Company  
Cambridge, Mass.

## RAYTHEON rectifier

Organizations Manufacturing B-Power Units  
RAYTHEON-EQUIPPED



ELECTRICAL RESEARCH LABORATORIES, INC.  
Chicago, Ill.



GENERAL RADIO COMPANY  
Cambridge, Mass.



MAYOLIAN RADIO CORP.  
Bronx, N.Y.



AMERICAN ELECTRIC CO.  
Chicago, Ill.

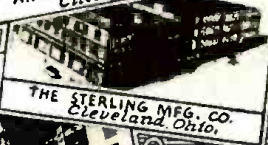

THE STERLING MFG. CO.  
Cleveland, Ohio.



PATHE PHONOGRAPH CO.  
Brooklyn, N.Y.



GRIGSBY-GRUNOW-HINOS CO.  
Chicago, Ill.

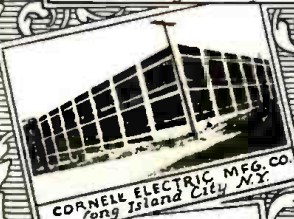

CORNELL ELECTRIC MFG. CO.  
Long Island City, N.Y.



THE WEBSTER COMPANY  
Chicago, Ill.

KING  
ELECTRIC  
MFG. CO.  
Buffalo, N.Y.



APCD MANUFACTURING CO.  
Providence, R.I.



SPARKS-WILMINGTON CO.  
Jackson, Michigan

J. S. TIMMONS  
INC.  
Germantown  
Phila., Pa.

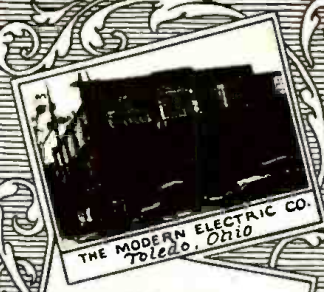

THE MODERN ELECTRIC CO.  
Toledo, Ohio

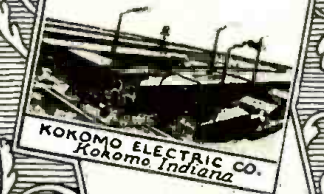

KOKOMO ELECTRIC CO.  
Kokomo, Indiana



ACME APPARATUS CO.  
Cambridge, Mass.

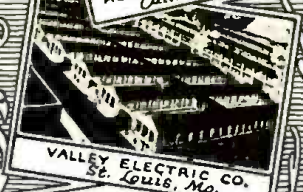

VALLEY ELECTRIC CO.  
St. Louis, Mo.

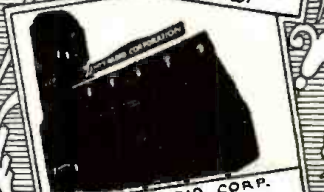

ZENITH RADIO CORP.  
Chicago, Ill.



BREMER-TULLY MFG. CO.  
Chicago, Ill.



STORAD MFG. CO.  
Cleveland, Ohio



ALL-AMERICAN RADIO CORP.  
Chicago, Ill.



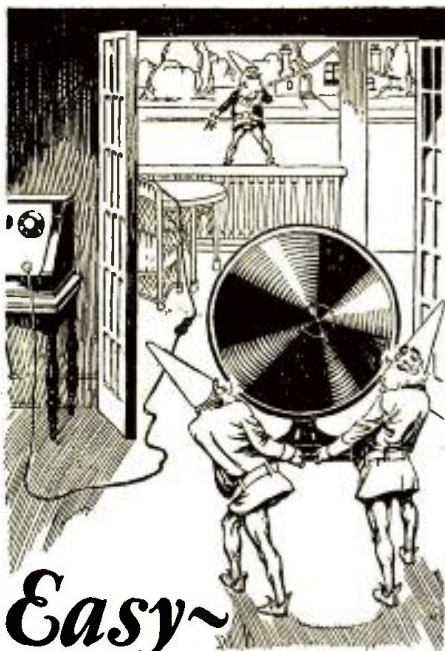

# Easy~ with the E-Z

Now you can have radio entertainment in any room, porch or lawn without disturbing your set! The E-Z Extension Connector hooks up to your set easily and quickly, enabling you to carry the loud speaker anywhere. Exclusive tension slot construction assures positive contact.



Connector only - 35c  
with 20 ft. cord - \$1.25 with 35 ft. cord - \$1.75  
" 25 ft. cord - 1.50 " 50 ft. cord - 2.00

## Raytheon Block Condensers

Guaranteed 1000 volt breakdown test. Finest materials and special impregnating compounds embodied in Polymet Block Condensers assure the lasting success of your construction job. Specify Polymet Condensers!



Type 1000-14 Mfd. tapped  
at 1, 1, 2, 2, 8 . . . \$9.50  
Type 1001-1-C-1 Mfd. . . 2.00

## Poly Claro-Plug

Every set deserves one—turns old set into new—improves tone—broadens the range—eliminates scrapes, rasps, hissing. Reduces static.

Over 125 manufacturers of receivers and power units use Polymet Products. THEY KNOW. Follow their lead—specify Polymet Products for best results. At all good dealers everywhere or send direct. Send for illustrated descriptions of all products. FREE on request.

Polymet Manufacturing Corporation  
599-C Broadway - New York City

"World's Largest Manufacturers of Radio Essentials"

# POLYMET PRODUCTS

# The YES and NO MAN



SCOTCHY.—Until you mentioned them, we had never heard of the *Happy-Go-Lucky Girls* at WSBF. \* \* \* Sure, here's their picture. \* \* \* By the way, the young lady on the left is *Alice McDonald* and the one on the right is *Venida Jones*.

JOCKEY KID.—We're an old scandal monger, eh? Well, can you beat that! Come around to this office and you'll get your finger nails pulled out one by one. \* \* \* *Rev. F. S. Lankenau* (KFUO) lectured on "One Hundred Thousand Divorces." \* \* \* KFUO is one of the many gospel voices on the air.

TOMMY LAD.—Did *Amie McPherson's* radio operator jump his wave? My, you're facetious. \* \* \* By the appearance of things, *Amie's* radio operator belied all of the *Red Hot Momma* songs. \* \* \* *Amie* needs a quartz crystal control.

SIR HOBGOBLIN, JR.—The "Chimes of Normandy" was broadcast by WMAQ and WLS on October 22nd. \* \* \* Who's going to be the big chain feature this year? Well, if *Damrosch* does not come within a micro-volt (is that the right term, Professor?) of it, we'll eat a 201-a tube.

JAMES COFFEY.—The *Belmont Orchestra* broadcasts from CNRV at Vancouver, B. C. \* \* \* *John Barnes* was the guest artist of the *A and P Gypsies*. \* \* \* If there was a fight in the studio of WHN on October 18th it was not reported to this office; perhaps it was between Mike and Milli Henry.

BILLY MONDAY.—The Actors Equity would not permit WGBX and WIP to broadcast "The Miracle."

DEARY ME.—These matrimonial queries keep us busy. \* \* \* No, the *Royal Herine* is not the wife of the "big 'ero." \* \* \* Is *Charlie Garland* (announcer at WBBM) as nutty as he sounds when he officiates at the "Nutty" Cluch Broadcast? Any announcer, my friend, is as nutty as he sounds.

AMBITIOUS.—What kind of experience counts most to become a studio manager? \* \* \* Well, floor walking, paper hanging, iron working—any one of these will afford the experience necessary to manage the average American studio. \* \* \* If you want to be real good and rise to the dizzy heights of your profession, get in a few months' experience as a subway guard; that's where you really learn to handle people.

J. H. M.—So you object to our anti-Brokenshireism! \* \* \* Well, perhaps we have been low and mean but we're not ready to apologize for it. \* \* \* If *Brokenshire* would try to be *Brokenshire*, he'd perform beautifully for, though it's hard to admit, his diction is good; it is only when he attempts to be the nonchalant and witty conversationalist that we lose our temper.

DIXIE.—Why should you inquire concerning the nationality of *Keith McLeod*? \* \* \* He's very much a Scot, although minus the whitewash brush and the kilts. \* \* \* He's five feet five and one-half inches in height and is *not* married. \* \* \* We are told he is thirty-two years old, and he is ambitious only to lead a happy, comfortable life; we don't know that he has a hobby. \* \* \* Your note is pleasant; write again.

HAYDEN B.—What if you do consider it bad taste that *Millon Cross* should have sung "Shake 'Em Up, Susie?" And what makes you think that he should confine himself to the classics or near classics? \* \* \* A singer is seldom known by what he sings; it's how he sings it.



GEORGE B. H.—The *Rev. Robert Hopkin* sermonizes from KOA. \* \* \* Yes, *Eddie Cantor* was on the air recently at WEAF. \* \* \* Little *John Little* is a regular feature at WSM, Nashville, Tenn. \* \* \* *Normal Clark* was the tenor of the South Sea Islanders; his photo is published herewith. \* \* \* *Robert Hauser* is the fresh smarty at WWRL; aside from his being a bumptious simp, it is said that the main part of the transmitter at WWRL is made up out of an old gas range.

ANNABEL.—*John Wells* was the tenor with the *A and P Gypsies*; he made his last appearance on the night of October 4th. \* \* \* You seem to be able to pick out the good ones. \* \* \* Unless we get a little more flattery the next time, you won't get answered!





# I Will Train You At Home To Fill a Big Pay Radio Job



"I give you all this apparatus so you can learn quickly at home the *Practical Way*"



J.E.S.  
FREE OF EXTRA COST

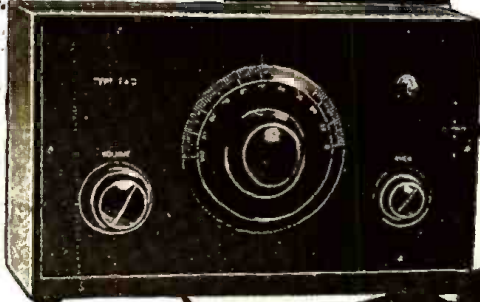

## You Get All of This

All instruments shown here and others sent to all my students free of extra cost under short time special offer. Clip coupon now—find out all about this big unequalled offer while you still have time to take advantage of it. This training is intensely practical—these instruments help you do the practical work. You learn workmanship and get added confidence in your ability.



### World Famous Training That "Pays for Itself"

My Radio course World-Famous as the training that "pays for itself." Make more money QUICK when you take up this practical course. Work on millions of antennae, receiving sets, offers you big chance to make spare time cash while you're learning. I'll show you how—teach you the latest "dope," furnish you with business cards, show you how to get the business and make it pay. My students don't wait a year to increase their income—they report QUICK INCREASES as a result of this course—often two or three weeks after starting. Howard Luce, Friedens, Pa., made \$320 in 7 weeks during spare time. D. H. Suite Newport, Ark., writes, "While taking the course I earned in spare time work about \$900." Earl Wright, Omaha, reports making \$400 in a short time while taking course—working at Radio in spare time! Sylvester Senso, Kaukauna, Wis., made \$500. These records not unusual—these men a few of hundreds.

### Your Satisfaction Guaranteed

We who know the results this practical tested training gets—the increased earnings it has brought to men everywhere—stand behind it all the way with a signed guarantee bond that we give you when you enroll. On completion if you're not entirely satisfied in every way, you get back every cent you've paid us. No strings to this offer—you yourself are the only judge. Get started today! It's your big chance for one of the bigger Radio jobs—mail coupon NOW for my Big FREE BOOK and proof! No obligation.

If you're earning a penny less than \$50 a week, clip coupon now. Send for AMAZING FREE BOOK, "Rich Rewards in Radio." Why go along at \$25 or \$35 or \$45 a week, when you could earn \$50 to \$250 in the same six days, as a Radio Expert? Hundreds of N. R. I. trained men are doing it—why can't you?

## Earn \$50 to \$250 a Week—

### RADIO EXPERTS IN BIG DEMAND

Radio needs trained men. Get into this new live-wire profession of quick success. It's the trained man, the Radio Expert, who gets the big jobs of this profession—paying \$75, \$100, \$200 a week and up. Every day N. R. I. trained men are taking good places in the Radio field—men just like you—their only advantage is TRAINING. You can prepare just as they did, by new practical methods. Our tested clear training makes it easy for you. Big Free Book contains all the proof.

## You Learn Quickly In Spare Time

So sure am I that I can train you successfully for a better future in this new Big-Pay profession, that I guarantee your training with a money-back bond. Lack of experience or education won't hold you back—common schooling all you need to start. You can stay home, hold your job, and learn quickly and pleasantly in your spare time. My practical, helpful methods enable you to start RIGHT AWAY toward one of the bigger Radio jobs paying \$50 to \$250 a week. No delay, no losing time from work—no scrimping or scraping to get your training.



**Operates WMAQ**  
"Accepted a position with the Chicago Daily News Station WMAQ. MY INCOME PRACTICALLY DOUBLED thanks to you. I handle all consultation, also do operating. Your course taught me not only the theoretical but also the practical knowledge that makes my work easy for me." Keith Kimball, Station WMAQ, Chicago, Ill.

## Get This FREE BOOK

Most amazing book on Radio ever written—full of facts and pictures—tells all about the great new Radio field, how we prepare you and help you start. You can do what others have done—GET THIS BOOK. Send coupon today—no obligation.

J. E. SMITH, President  
NATIONAL RADIO INSTITUTE  
Dept. A-86, Washington, D. C.



J. E. SMITH, President  
NATIONAL RADIO INSTITUTE  
Dept. A-86, Washington, D. C.  
Dear Mr. Smith—Without obligating me in any way, send me your free book, "Rich Rewards in Radio" and all information about your practical, home-study Radio Course.

Name..... Age.....  
Street Address.....  
Town..... State.....

EMPLOYMENT SERVICE TO ALL GRADUATES

Originators of Radio Home-Study Training



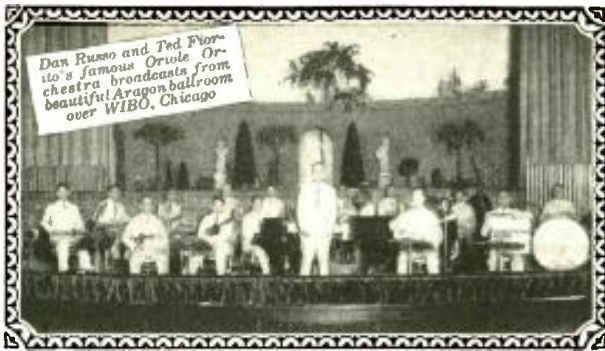

## Do you hear *All* of the Orchestra—or *only part*?



WHEN famous orchestras broadcast, do you clearly hear *all* the musicians? Or—through inability of your transformers to amplify low and high notes as evenly as middle tones—are you really only listening to a few of the instruments? Put Jefferson "Concertones" in your set and enjoy the whole orchestra!

Specified in latest circuits because they do not lose, distort or "blast" any audible notes from the lowest (30 cycles) to the highest (10,000 cycles). Ideal for safe, continuous use with power tubes. At your dealer's, \$6 each.

**JEFFERSON ELECTRIC MFG. CO.**  
Largest manufacturers of small transformers  
508 So. Green St., Chicago, Ill.

# Jefferson

## Concertone Transformers



No. 248  
E-5841  
Underwriter's  
App.

## "Little Joe" Lightning Arrester

Especially designed for Radio Work. Made of porcelain, small, neat, rugged and serviceable. Can be suspended on antenna or fastened to wall.

Ask Your Dealer

Mfd by **CIRCLE F MFG. CO.**  
Trenton, New Jersey

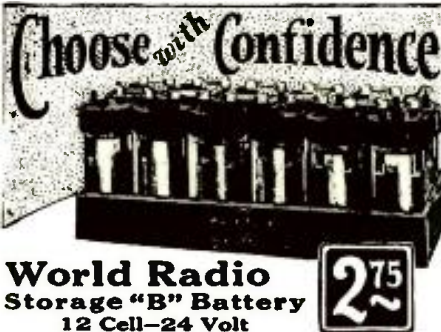

**World Radio Storage "B" Battery**  
12 Cell-24 Volt

Proved value. Thousands of users find reception almost magical. Clear, true power—instantly and unendingly. Wise economy. Sturdy construction—Solid Rubber Case protection. Recharged for almost nothing. Endorsed and listed as standard by famous Radio institutions including Pop. Radio Laboratories, Pop. Sci. Inst. Standards, Radio News Lab., Lefax, Inc., and other Radio authorities. What more need be said? *Extra Offer: 4 Batteries in series (96 volts) \$10.50.*

**Send No Money** Just state number wanted and we will ship same day order is received, by express C. O. D. Pay expressman after examining batteries. 5% discount for cash with order. Remember—you save 50% on World Batteries, so send order to-day.

**WORLD BATTERY COMPANY**  
1219 So. Wabash Ave. Dept. 77 Chicago, Ill.  
Makers of the Famous World Radio "A" Storage Battery  
Price: 6-volt, 100 Amp. \$10.00; 120 Amp. \$12.00; 140 Amp. \$13.00.  
All equipped with Solid Rubber Case.

Set your radio dial at 288.8 meters for the World Storage Battery Station W5BC. Variety—New Talent—Always Interesting.  
JESSE SULLIVAN—Director and Announcer—"On-CAW-go"

C. L. HOXIE.—Yes, *MacNamee* was sued for twenty-five thousand by a lady in Massachusetts; however, we did not know it was for battery. \* \* \* We have it from WEAF'S publicity department that there is no foundation for the charges. \* \* \* Whatever they are, the case has been put over for a year and the lady in question has had three different lawyers.

BERTIE.—Why does *Edward Hughesing* try to mimic *Norman Brokenshire*? \* \* \* Well, why does a nine year old play he's *Pawnee Bill* or *Jesse James*?

JIMMY WALKER.—The operating staffs of WJZ and WEAF will not be changed by the merger on November 15th \* \* \* Yes, the *Damrosch* programs are programs what are programs. \* \* \* *Whoops*, my dear!

JACK M.—Do we think that *Mr. Wentworth* (WEAF) is a better announcer than *Mr. MacNamee*? \* \* \* Well, that's a matter of personal opinion; given a chance on the big chain, *Wentworth* would, no doubt, become popular. \* \* \* Always remember, sir, that it is the big hook-up and not any special talent on the part of the announcer, that makes these laddies known to the multitudes. \* \* \* We dare say any tongue-tied man with a better knowledge of English than that possessed by the average announcer could not only do a more polished piece of work but he could become famous. \* \* \* The fame of an announcer is measured in watts.



BILL.—For the umpteenth time: *Frances Sebel* is the lyric soprano of the WEAF Opera Co.; here's her photo. \* \* \* Convince the citizens in Syracuse that you play the uke before you come to New York; you might be a wow in the home town but a 32nd degree flop here in New York.

Q AND Q.—What's the "inside" of the *Queen Marie* case at WJZ? \* \* \* One persistent rumor had it that the Queen, after being told that she was about to talk to 20,000,000, developed mental chills and made a capricious withdrawal. \* \* \* However, we are not inclined to give credence to this theory; we do admit though that the whole thing has the purple hue of mystery around it.

SUSAN.—Why did *Heywood Brown* write the introduction to *MacNamee's* book? \* \* \* He didn't; *Brown* wrote that stuff for his column and it flattered *MacNamee* so beautifully that he decided to use it as a preface for his book. \* \* \* We've never been flattered, so we don't know what we'd do under the same circumstances. \* \* \* "Black Bottom" a negro spiritual? My, no! It's just a roustabout song. \* \* \* We don't know what the Capitol Family does with all of *Major Bowes* "Thank you." \* \* \* Perhaps they can them.



**Windsor Wall or Table  
Type Cone Speaker  
Amazes Radio World**



Model 210  
(Pat. Applied For)

The latest model Windsor Cone Loudspeaker has astonished the world of radio. In convenience, quality of reception, and extremely low price, it far surpasses anything yet offered. The cone is 22 inches in diameter and is mounted on a sounding board which, in turn, is supported by an easel back. It can be hung up on the wall, as in the picture above, or stood upon any flat surface as shown in the picture below. It contains the famous Windsor loudspeaker unit noted for the extreme clarity and fidelity of reproduction.



Model 210  
22-inch Cone Loudspeaker with sounding board and easel back.

**\$15.00**

(West of Rockies \$18)  
(Pat. Applied For)

Model 302 (Shown below)  
With Moulded Composition Horn Loudspeaker and 18-inch Cone Loudspeaker.



(Pat. Applied For)

In this Windsor Console is combined both the Windsor Moulded Composition Horn Loudspeaker and the 18-in. Windsor Cone Loudspeaker. The top is 30 in. x 17 in. and stands 29 in. high. Plenty of battery and equipment space is provided by large shelf in rear. Price, finished in Mahogany or Walnut **\$48.00**  
(West of Rockies, \$55)

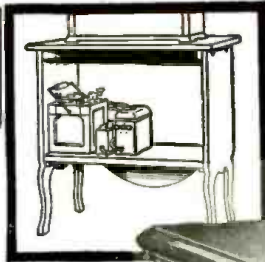

Rear view at left shows large compartment with ample space for batteries, battery charger, or battery eliminator, which are entirely concealed from view. Back is open for ventilation of batteries.

At right is shown the Cone Loudspeaker, with its sounding board, which is quickly and easily removable, allowing instant access to all batteries, battery charger, battery eliminator or other equipment and wiring.



(Pat. Applied For)

Model 200—with 22-inch Cone Loudspeaker

This Windsor Cone Loudspeaker Console is equipped with a 22-inch Windsor Cone Loudspeaker. Its top is 30" x 17" and is 29" high. The battery shelf provides ample space for batteries, charger, battery eliminator and other equipment. Beautifully finished in either Mahogany or Walnut.

Model 200

**\$29**

Console with Cone Loudspeaker Ready for Set and Batteries  
(West of Rockies, \$35)

**This is the Fastest Selling Line of Loudspeakers and Loudspeaker Consoles in the Radio World Today**



Model 100  
with Moulded Composition Horn Loudspeaker or 16-inch Cone Loudspeaker  
(Pat. Nov. 18, 1924)

Above is shown a beautiful Windsor Loudspeaker Console, finished in either Walnut or Mahogany, which provides ample space on top for any radio set. The battery shelf beneath will accommodate all necessary equipment. Equipped with either Moulded Composition Horn or 16-inch Cone Loudspeaker. Size: 38 in. x 18 in., and 29 in. high. Price **\$40.00**  
(West of Rockies, \$42.50)

To the right is shown the newest Windsor Loudspeaker Console. It is equipped with a 22-inch Cone Loudspeaker and cabinet suitable for 7-inch radio panels up to 26 inches in length. Battery shelf provides ample space for all equipment. Beautifully finished in either Walnut or Mahogany. Price (without receiving set) **\$44.00**  
(West of Rockies, \$52.00)



(Pat. Applied For)

Model 1000  
with 22-inch Cone Loudspeaker

*Note to Dealers.* Write or wire today for details of the highly profitable Windsor line.

Electrical Department

**WINDSOR FURNITURE COMPANY**

1414 Carroll Avenue • CHICAGO, ILLINOIS  
Los Angeles Branch—917 Maple Avenue



# Radio Ops See Foreign Lands



Radio operators on ships have marvelous opportunity for travel and adventure. They earn good pay—in addition to board and sleeping quarters.

Study at home now for a voyage next summer.

Radio Institute of America—world's oldest radio school—offers Home Study Courses that qualify you to pass the U. S. Government Commercial or Amateur License examinations.

Radio Institute conducts a special technicians' course for radio dealers, jobbers and service men. Write for booklet.

**RADIO INSTITUTE OF AMERICA**  
formerly Marconi Institute  
Established in 1909  
322A Broadway, New York City



Mail coupon for complete description of course.

CUT HERE

Radio Institute of America  
322A Broadway, New York City

Please send me your free booklet.

I am interested in the radio course which prepares for the Government Commercial, Broadcast or Amateur License.

I am interested in the technicians' course for jobbers, dealers and service men.

Name.....

Address.....

## To Start and Stop Your Set Automatically—

(Continued from page 23)

tween the 1/8-inch rod and the walls formed in the 1/4-inch rod, by the 3/16-inch hole which extends to a depth of 1 inch from the end. The spring will stop when it comes to the bottom of the 3/16-inch hole, and it should protrude about 3/8-inch from the end of the 1/4-inch rod, with the 1/8-inch rod pulled up as far as the lower shoulder will allow.

Now make a shoulder 5/16-inch from the end of the 1/8-inch rod that has the spring. You can make this shoulder in the same manner as you made the other one. This second shoulder is to keep the spring from sliding off the end of the rod.

This contact pin and its casing should be secured in the partition between the upper and lower compartments, in such a manner, that the wing nut on the end of the alarm wind-shaft will engage the upper end of the contact pin when the former rotates, and the lower end of the contact pin should be only 1/32-inch or so above the contact spring B.

### HERE IS A LIST OF THE PARTS THAT WERE USED IN THIS UNIT—

- 1 box 4 3/4 inches high, 3 1/2 inches wide and 3 inches deep;
- 1 Electrad, No. 20, single-pole, double-throw jack-switch;
- 1 New Haven "Tidy Tot," octagon-shaped, alarm clock;
- 1 piece of brass rod, 1 3/4 inches long, 1/4-inch in diameter;
- 1 piece of brass rod, 2 1/2 inches long, 1/8-inch in diameter;
- 2 Eby binding posts.

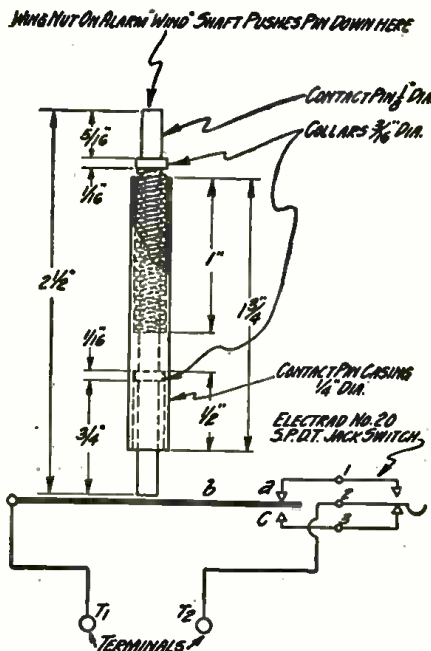

A WORKING DRAWING OF THE CONTACT PIN UNIT

FIGURE 4: A clear idea of how the action of the alarm clock makes or breaks the circuit may be obtained from this drawing; it also gives the necessary data for constructing the contact pin and its casing.



—a silk-covered cable of vari-colored Flexible Celatsite wires, for connecting batteries to set. Prevents "blowing" of tubes; gives your set an orderly appearance.



### Stranded Enameled Antenna

Best outdoor antenna you can buy. 7 strands of enameled copper wire; maximum surface for reception. Prevents corrosion and consequent weak signals.



### The Original Celatsite

—a tinned, copper bus bar wire with non-inflammable "spaghetti" covering, for hook-ups. 5 colors; 30-inch lengths.

We also offer the highest grade of "spaghetti" tubing for Nos. 10 to 18 wires. 5 colors; 30-inch lengths.

### Flexible Celatsite

Flexible, stranded wire for point-to-point and sub-panel wiring. Non-inflammable "spaghetti" covering. In black, yellow, green, red and brown; a color for each circuit. Put up in 25-foot coils.



Send for folder  
THE ACME WIRE CO., DEPT. P  
NEW HAVEN, CONN.



## Bradley Amplifier

Resistance-Coupled  
PERFECT AUDIO AMPLIFIER

Provides audio amplification with minimum distortion. Bradley's shielded resistors used in the Bradley Amplifier do not vary with age and are not affected by atmospheric conditions. Can be used to replace transformer amplifiers in standard radio sets with decided increase in tone quality.

**Allen-Bradley Co.**  
Electric Controlling Apparatus  
276 Greenfield Avenue Milwaukee, Wis.

## Bradley Leak

THE PERFECT GRID LEAK

Provides a noiseless range of grid leak resistance from 1/4 to 10 megohms. Assures most effective grid leak resistance value for all tubes. Small grid condenser (0.00025) is separate. Metal parts nickel plated. One hole mounting.

**Allen-Bradley Co.**  
Electric Controlling Apparatus  
276 Greenfield Avenue Milwaukee, Wis.



## The Quack Doctors of Radio

(Continued from page 30)

across our ubiquitous and mysterious "radiation"—truly a word to conjure with in these radio days—the movements of the pendulum being supposed to be directed by these "rays" escaping from the body of the experimenter and flowing down the string to the sensitive weight.

The secret, of course, is the fact that no one, unless by long and arduous training, can hold his hand and fingers absolutely still. There is always a tiny tremble, something that is exaggerated and easily visible in old people, but present and measurable by scientific instruments even in the young and vigorous. This tremble of the supporting fingers sets the weight to swinging; it will set any weight to swinging. The direction to which the weight swings is determined by accident. If messages are spelled out by the letters it is accident also, or else, as with the ouija board, it is a conscious or unconscious direction of the swing by the mind of the operator.

So long as these devices are used by the credulous merely for their own edification and amusement, it is no great business of the radio scientists or of anyone else. The Constitution of the United States guarantees to every man the right to make a fool of himself in his own way; or, if it doesn't, it ought to. But it is some of radio's business when these devices and their like are used to dupe the public and to extract money from them, as such devices are being

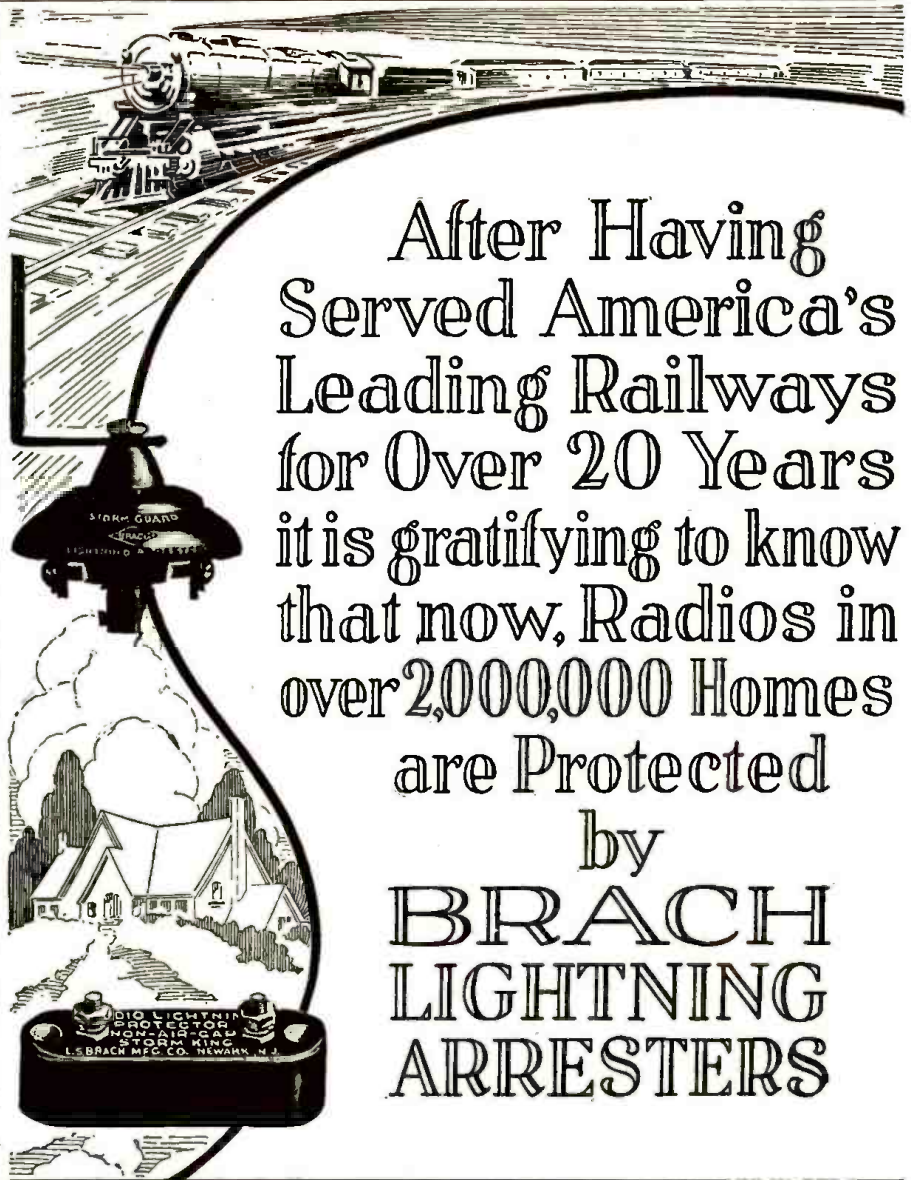

After Having Served America's Leading Railways for Over 20 Years it is gratifying to know that now, Radios in over 2,000,000 Homes are Protected by **BRACH LIGHTNING ARRESTERS**



Gilliams

### A MAGIC PROSPECTOR

Complicated electric devices, supposed to operate by radio, are appearing in place of the old-fashioned forked stick used as a "divining rod."

## BRACH CONTROLIT



Gives the SET SWITCH Control of Trickle Charger and "B" Substitute — AUTOMATICALLY.

No need, now, to operate three switches every time you turn on or off your set. The Brach CONTROLIT makes this unnecessary by eliminating all extra switches and placing complete control of your power plant and set in the set switch. At the same time it makes any Radio a light socket power-operated set.

Anyone can install a CONTROLIT — no extra wiring or altering is necessary.

See It At Your Dealer's

PRICE \$6 in U. S. A.

# Brach Radio Products

20 years in the lead

L. S. BRACH MFG. CO.

Newark, N. J., U. S. A.

Toronto, Canada



AC 12 - \$30

## From the highest musical note in nature, to the deepest—

*Amplion reproduces the whole range—perfectly*

**T**O the world-famous Amplion line of radio reproducers is added the Amplion Cone—time-perfected—clear and mel-

low in tone—strikingly distinct in the enunciation of the spoken word. In a graceful, two-tone mahogany cabinet, 14" x 14" x 9".

**AMPLION Reproducers, \$12 to \$45**

*Ask your dealer for a demonstration or write to us for interesting Amplion Booklet*



# AMPLION

**THE AMPLION CORPORATION OF AMERICA**  
Suite X, 280 Madison Ave., New York City

used, it is probable, in every fair sized city in the United States today.

It is probably too much to hope that the public can ever be persuaded to cease resorting to practitioners of occult foolery for answers to their questions as to the future or as to their own characters and capabilities. But we can hope that the public will learn what radio can do and what it cannot and that everyone can be taught that mysterious forms of radiation do not exist in nature and cannot be detected as effluvia of the human body or of the human soul.

*No Place for "Human Radiation" in the Spectrum of Ether Waves*

The long spectrum of the ether waves is now complete, from the radio waves at one end to the new cosmic rays of Dr. Millikin at the other. It is possible that there are longer radio waves than any which we now use, but they will be of similar character and not in the least mysterious. It is possible, too, that there are still shorter waves than those recently found by Dr. Millikin, but these will be merely another variety of gamma rays, as are Dr. Millikin's rays themselves. There are now no gaps in the series and no place for any mysterious "human" radiation, such as the fakers find it so convenient to assume. "Auras" and "eye rays" and "personal emanations" and all the rest of them must go into the dust heap, together with the chromotherapies and the famous electronic reactions.

I am not intending to asperse, however, the recent experiments of Dr. Ferdinando Cazzamali and others in attempting to detect an electromagnetic radiation from the human brain. This work is on a quite different basis. Nerve action is undoubtedly electrical, although the exact mechanism is not yet known. It is probable that nerves and brain cells send out electromagnetic waves when they operate, just as an electric motor does or an electric bell. These waves, however, are merely radio waves like any others. They will have the greatest scientific interest, if we can separate and study them. They may give us important clues about the physiology of nerve action. But no one has suggested that they would have the slightest relation to "personality" or that they would carry any "messages," still less that they would tell us, or anybody, anything about the future or about himself.

*Superstitions About Lodestones and Other Magnetic "Charms"*

Superstitions die hard. Last year a man was drowned in a small lake in New York State. The body was not found immediately. And so, with the reputed approval of the authorities, some quicksilver was placed in loaves of bread and these were thrown into the lake. It was supposed that an "attrac-

## KH-27 KITS

**SEND YOUR ORDER IN TODAY!**  
*Paris exactly as used by author in the Harkness KH-27 Receiver*

- 1 KH-27 Foundation Unit (including drilled and engraved bakelite front panel, 7" x 26", drilled bakelite sub-panel 7" x 26", with six tube sockets attached; one pair of bakelite mounting brackets and one 9" condenser shaft.)
- 1 Set of K.H. 27 R. F. Transformers (T1, T2, and T3)
- 3 K.H. Double Impedance Couplers
- 1 K.H. 30 Henry Choke Coil \$49.50
- 3 Hammarlund 17-plate condensers (Mid-line or S.L.F.) 14.25
- 1 Yaxley Rheostat, 10 ohms 1.35
- 1 Yaxley Fixed Resistance, 2 ohms .15
- 1 Yaxley Battery Switch, Midget Type .50
- 1 Yaxley Pilot Light Bracket .50
- 1 Yaxley Open Circuit Jack, Junior Type .45
- 1 Yaxley Antenna Switch, Double Circuit, Junior Type .85
- 1 Micamold Grid condenser, .00025 M.F. with G.L. mounting .45
- 1 Micamold fixed condenser, .001 M.F. .40
- 2 Micamold fixed condensers, .002 M.F. .80
- 1 Micamold grid leak mounting .30
- 1 Micamold grid leak, 2 or 3 megohms .45
- 2 Dubilier 1 MFD Condensers 2.50
- 2 N-L Variocouplers, (Type G1) .0001 Max. 3.00
- 4 Amperites (3 Type 1A and 1 Type 112) 4.40
- 2 Aristocrat Vernier Port Dials 4.00
- 11 Eby Binding Posts, engraved as follows: ANT; GND; A BAT; A BAT; B BAT; B DET; 67 V; 90 VOLTS; B BAT; C BAT; CBAT 1.65
- 1 6 Volt Lamp for Pilot Light .50

**Complete \$86.00**

**COMPLETE PARTS FOR \$38.90**  
**LC JUNIOR POWER PACK 38**  
*Send Money Order for Immediate Delivery*

# City

## Radio Stores

110 West 42nd Street, New York  
Downtown Store :: 79 Cortlandt Street



### MODEL "C" CHEST

Cabinets in stock—have piano hinge and are 10" deep—grooved front top rail being removable. Illustration shows gold line wood panel to match.

Sizes	Walnut Only	Panel to Match
7x18-10	\$15.00	\$1.26
7x21-10	17.00	1.47
7x24-10	19.00	1.68
*7x26-10	21.00	1.82
7x30-10	23.00	2.10
*7x28-11	23.00	1.96

\*For Madison-Moore Receiver.  
\*For Victoreen Receiver.

## Walnut Infradyne Cabinet

### \$30.00

## LC-27 Cabinets

Mahogany or Walnut with Baseboard

### \$18.00

The LC-27 cabinets have 25° slope and take 8" x 26" panel. They are full 10" deep back of the panel.

WRITE FOR folder showing complete LC-27 line and other Radio Furniture.

## CORBETT CABINET MFG. COMPANY

St. Marys - - Pennsylvania



tion" between the submerged body and the quicksilver would bring the loaves to rest over the spot. This superstition is at least three hundred years old. It did not work last year; so far as anyone knows it never has worked. Yet it is doubtful if it will die, even now.

The chief sale of magnetic iron ore, even today, is for what are called "lucky lodestones" for people to carry in their pockets and to wear on watch chains. When a Chicago publisher died suddenly this spring after having visited some graves of the ancient Mayas in Yucatan even the metropolitan newspapers carried the story that he had succumbed to an "ancient curse."

When these things can happen we dare not call ourselves a scientific nation. It is no wonder that radio is pre-empted by fortune tellers, and worse. But radio is accomplishing, on the other hand, a great work of popular education. It is teaching more and more people in each community the essential methods and viewpoints of science.

Possibly it is radio that is destined to drive superstition from the world.

### How Radio Landed Two Girls On Broadway

ONE of the most romantic episodes of the broadcasting studios deals with the landing of coveted contracts by two obscure choir girls in a suburb of Chicago.

A few months ago these two girls were singing a sacred duet in the story-book-like church. Seated in a rear pew that morning was John Clark, assistant program director of station WHT. So struck was he with the quality of the girls' voices that after the services he sought an introduction to them.

The outcome of the incident was that the two girls, Thora Martens and Dorothy Wilkins, entered the radio service and broadcast songs regularly for WHT.

A little while after this J. J. Shubert was making another production cast for the operetta hit, "The Student Prince." The cast was practically recruited; only two name parts were still open. An appeal was sent out to the Shubert agencies to fill these places.

As Mr. Shubert was writing telegrams in his room at a Chicago hotel, he tuned in station WHT on a receiver that a friend had loaned him. It happened that the two choir girls were on the air, singing one of their best numbers.

Mr. Shubert sent word to his Chicago director to make arrangements for an immediate audition. The hearing was satisfactory.

And that is how Miss Wilkins and Miss Martens were tendered a forty weeks' contract—which solved the problem of the producer and also gave two of radio's favored artists a foothold on the ladder to stardom.

—BERTHA STREETER



### SEND FOR THIS RADIO FOLDER

Contains seven hookups for B-Eliminators published in a prominent radio magazine.

Well-known B-Eliminator Manufacturers who use Bradleyohms

Acme, All-American, American Bosch, Brown & Green, DeWitt-LaFrance, Farrand, Forest Unitron, Grigsby-Grunow-Hinds (Majestic), Kellogg, Philadelphia Storage Battery (Philco), Precision, Radio Receptor, R. A. Rothermel, London; Spartana, Valley, Willard, Wilson.

## When You Build a B-Eliminator

Use Bradleyohm-E for the Variable Resistors and Bradleyunit-A for the Fixed Resistors



### Bradleyohm-E

For B-eliminator service requiring wide voltage control, Bradleyohm-E is essential. It is an oversize Bradleyohm with sufficient capacity to handle all normal B-eliminator requirements. Be sure to ask for Bradleyohm-E in the checkered carton. Your dealer can get them for you.



### Bradleyunit-A

This solid, molded, fixed resistor has no glass or hermetic sealing in its construction. It is a solid unit with silver-plated end caps and is not affected by temperature, moisture and age. By all means, use Bradleyunit-A when you need a fixed resistor.



ALWAYS insist that Bradleyohm-E and Bradleyunit-A are included with your B-Eliminator kit, if you want to be assured of perfect voltage control. The leading manufacturers of B-Eliminators have long since adopted these Allen-Bradley variable and fixed resistors as standard equipment for their B-Eliminators. In fact, Bradleyohm-E is used almost as universally as the Raytheon tube, itself.

You cannot afford to risk the use of inferior substitutes for the scientifically treated discs used in Bradleyohm-E. This remarkable variable resistor handles the strenuous requirements of B-Eliminator service without the slightest strain. Ask your dealer for Allen-Bradley Perfect Radio Devices, today.

### MAIL THE HANDY COUPON

Allen-Bradley Company  
276 Greenfield Avenue  
Milwaukee, Wisconsin

Please send me, FREE, your radio folder with seven B-Eliminator hook-ups.

Name.....

Address.....

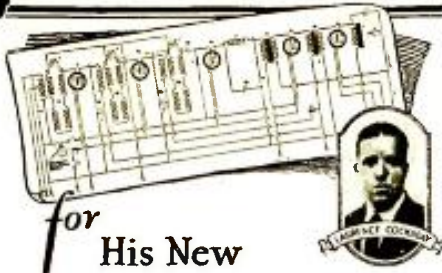

for  
His New

## “LC-27” Receiver

Laurence Cockaday uses

# The Hammarlund MIDLINE Condenser

Designers of construction kits know the danger to both their personal prestige and the successful operation of their product by including any parts of other than the highest standing.

Hammarlund has long preached and practiced the principle that *perfection* in each individual unit is essential to satisfactory performance of the completed receiver over a period of years.

The “Midline” Condenser is typical of Hammarlund quality. The full floating shaft may be adjusted to any position or replaced by a longer shaft for coupling to other condensers.

To assure permanent satisfaction with your “LC-27” Receiver, build it with the Hammarlund parts Mr. Cockaday uses.

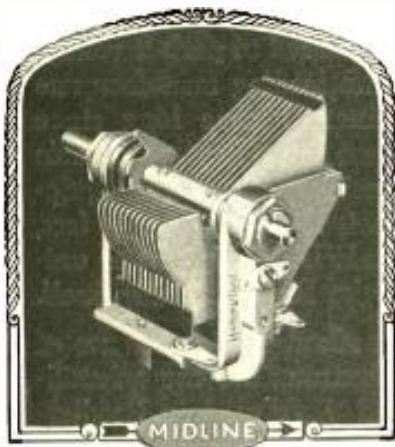

Among the other new circuits of the season for which Hammarlund products are specified are:

Locault “LR4”; St. James Super; Sargeant “Infradyne”; the New Harkness: “Henry - Lyford”; Morison “Varion”; Victoreen Super; Loflin & White; Pacent “Ultimax”; Browning-Drake; Popular Science Monthly “Powerful”; Carborundum; Hammarlund-Roberts “Hi-Q.”

We shall be pleased to refer to the proper authorities your inquiries regarding any of these receivers.

**HAMMARLUND MFG. CO.**  
424-438 W. 33rd Street, New York City

For Better Radio  
**Hammarlund**  
PRECISION  
PRODUCTS

## What Happens When You Tune Your Set

(Continued from page 32)

case is that we have no means of detecting, by ear or by instrument, the original ultra-rapid rates of vibration. They have to be rectified somehow before any acoustic instrument can respond, and then we can make use of their intermittences and differences and all of the superposed peculiarities and variations which are inflicted on them by microphonic speech or music, and which are duly reproduced with extraordinary and surprising perfection at the distant station.

This is due to the docility of electrons and the completeness with which they are able to follow in detail every peculiarity even of the most rapid vibrations. The vacuum-tube detector or the crystal can respond to these rates, however rapid; and when they are rectified by these devices, then our mechanical instruments and telephone diaphragms and ears can respond to the rectified peculiarities.

So much for the general principle on which etherial vibrations are brought down to an audible frequency. But now let us go into the matter of oscillations more in detail, and apart from any method of detection.

People have always known that a sounding instrument, when struck or bowed or plucked, was oscillatory. It had the two properties which were necessary for oscillation,—the power of elastic recovery and the power of overshooting the mark; the one being elasticity, the other being inertia.

It is by inertia that a base-ball rises into the air when struck by the bat against the force of gravity, expending its energy as it goes up, and then coming down again; reaching the hand of the fielder with much the same velocity as it started to ascend. Apart from the resistance of the air it descends with exactly the same velocity. This may be regarded as a case of recoil where the restoring force is due to gravity.

If a rubber ball thus thrown up

strikes a pavement on its return, it will rebound again, neglecting the effects of air resistance and friction, to the same height to which it originally went. Actually it will rebound up to a smaller height, due to this air friction and it can go on rebounding with many oscillations till friction wipes out its energy and turns it into an imperceptible amount of heat.

The same thing happens more easily in a pendulum. When you deflect the pendulum, the bob is raised against gravity. It falls back or recoils when you let it go, and returns to its original position with a definite velocity, and not only a definite velocity but a definite momentum; for the bob has inertia or mass.

Accordingly, it does not stay in its original position: it overshoots the mark, and rises on the other side to practically the same height as that to which it was raised when let go. It then returns again, once more overshoots its equilibrium position by reason of inertia, and so goes on oscillating for a long time.

A spring clamped in a vise will do the same thing. It is instructive to clamp a vertical wooden lath in a vise and fix a lump of lead on the top of it. If that load is now pulled aside, the lath will oscillate in a leisurely manner, much like an inverted pendulum.

The restoring force which causes the recoil is now not gravity but elasticity, and the inertia of the leaden ball is what prolongs the oscillations, and also regulates the frequency of vibration. The bigger the load the slower the vibration: the stiffer the spring the quicker the vibration. If the lath is shortened it vibrates more rapidly: if the load is diminished it vibrates more rapidly.

The two things, elasticity and inertia, are necessary for all vibration, and their ratio determines the rate of vibration. If you vary both in the proper proportions you can keep the rate of vibrations the same.

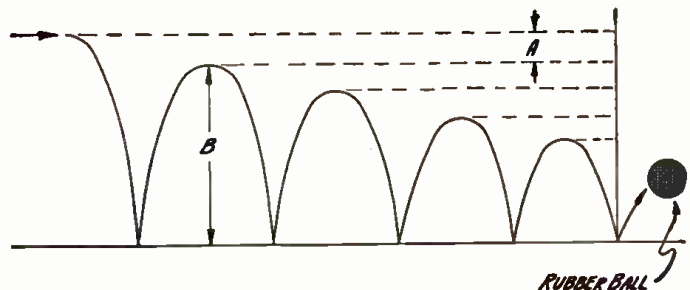

### HOW OSCILLATIONS DIE DOWN IN AN ELECTRICAL CIRCUIT

When a rubber ball falls and strikes the ground it only rises to the height “B” on the rebound. This height is less than the original height by the amount A; resistance in various forms kept the ball from rising as high as before. The third, fourth and fifth bounces are likewise reduced by resistance, so that each one is less than the former by approximately the same amount A, until the bounces die out entirely. This is a simple analogy to show the way in which resistance in a circuit causes oscillations to die out gradually until they cease entirely.



# The World's Knowledge of Radio

Contained  
IN FOUR VOLUMES

Of

## "EVERYMAN'S GUIDE TO RADIO"



**Beautiful!**  
Covers finished in richly embossed Art Fabrikoid, better than leather, making the four volumes fit for the finest bookshelf.



**1300 Illustrations!**  
"Everyman's Guide to Radio" contains 1300 beautifully engraved illustrations in 1200 pages of text.



**Flexible!**  
These four books represent the latest practice in the art of book manufacture. Perfectly flexible, without damage to pages or binding.



**Convenient!**  
A lot of information in a small space. Just the right size for the pocket and light in weight.

Contributed to by the world's leading radio scientists, without question, the most comprehensive, most interesting and absorbing, and the most complete set of radio books yet published in any country. It is impossible to give comparisons because comparisons do not exist. One must read Marconi on the subject of "beamed transmission"; the late Charles Steinmetz on "Waves"; Sir Oliver Lodge on Coils, or Ambrose Fleming on "Vacuum Tubes," before the significance of these writings of the masters of the art can be fully appreciated.

### 1200 PAGES OF INSTRUCTIVE READING

For the "Broadcatcher" as Well as the Experienced Radio Enthusiast

Four Books, 1200 pages, size 5 1/4" x 7 1/2" containing more than 1300 finely engraved illustrations and prepared by some of the greatest physicists and engineers of radio, "Everyman's Guide to Radio" stands as the first successful effort to meet the needs of all those who aspire to attainments in the science, whether they are "broadcatchers," skilled service men or students. This vast wealth of information represents studied compilation that has extended over two whole years and includes every phase of radio communication that can have any interest to those desiring meaty information.

### QUICK ANSWER TO EVERY RADIO PROBLEM

Intelligent use of "Everyman's Guide to Radio" gives quick, understandable answers to practically every radio problem regardless of the technical accomplishment of the reader. Special emphasis has been laid on the illustrations contained in the "Guide." Hundreds of specially prepared drawings and photographs answer most radio problems at a mere glance. No effort or expense has been spared to make the "Guide" of maximum value to radio listeners. It is the fascinating story of radio in pictures and it is the most complete collection of instructive radio photographs ever published.

### PHOTOGRAPHS AND SPECIFICATIONS OF ALL RADIO DEVICES INCLUDED

Over 200 pages of the "Guide" have been devoted to practical and exact descriptions, photographs and technical data of radio receivers, transformers, coils, B battery Eliminators, Power Packs, Loudspeakers, Condensers and General accessories; the amplification curves of all popular makes of audio transformers are included as well as the capacity curves of every standard make variable condenser so that the reader may directly compare the performance and design of one article with another. This information is invaluable to the radio constructor and set builder. It permits him to choose his parts intelligently and with a full knowledge of the particular use for which they are made. Never before has any organization taken upon itself the responsibility of bringing together within one set of volumes, the details of all standard radio apparatus.

### BOOKS YOU WILL BE PROUD TO OWN

It may be said without reserve, that "Everyman's Guide to Radio" is the most artistic and practical set of books ever published in the radio field. Each volume contains over 150 pages printed on heavy calendered paper in legible type, making for the comfort and convenience of the reader. The covers are beautifully embossed and bound in Art Fabrikoid, better than leather, flexible, making the books conveniently portable.

### CONDENSED TABLE OF CONTENTS

- Volume 1.
  - The First Principles of Radio
  - The Electricity of Radio
  - The Easy Principles of Diagram Reading
  - How Waves Are Generated
  - Mechanics Tuning
  - Detection and the Secret of Vacuum Tubes
- Volume 2.
  - Audio Frequency Amplification
  - Radio Frequency Amplification
  - Variable Condensers
- Volume 3.
  - Coils—How to Use Them
  - Improvement of Broadcast Reception
  - How to Make Radio Improvements
  - Learning the Length of Dots and Dashes
  - Batteries and Battery Chargers
  - Different Types of Radio Receivers
- Volume 4.
  - Accessories and Radio
  - Wonders of Radio Transmission

POPULAR RADIO, 627 West 43rd Street, NEW YORK

**EXAMINE THESE VOLUMES WITHOUT OBLIGATION TO BUY**

So sure are the publishers of "Everyman's Guide to Radio" that these four volumes are just what everyone needs to complete his reference library and so sure are they that they are the most practical, complete and beautiful set of radio books yet published that they are willing to mail them to those interested for examination without obligation to buy. Just fill out the attached coupon and mail. The books will be mailed immediately. Upon arrival, you pay the postman \$12.50 plus postage. Examine the books for 5 days. If, after that time, you are not convinced of their value to you, return them in good condition and your money will be refunded, at once and in full, without question.

**\$ 12<sup>50</sup>**

POPULAR RADIO, Inc.,  
627 West 43rd Street,  
New York, N. Y.

Gentlemen:

Send me a set of "Everyman's Guide to Radio" in four volumes. I agree to pay the postman \$12.50, plus postage. If, after carefully examining the books for a period of five days, I do not like them, I will have the privilege of returning them to you and my money, in full, will be immediately returned.

Name.....

Address.....

City..... State.....

# The Passing of "By-Pass" Condensers

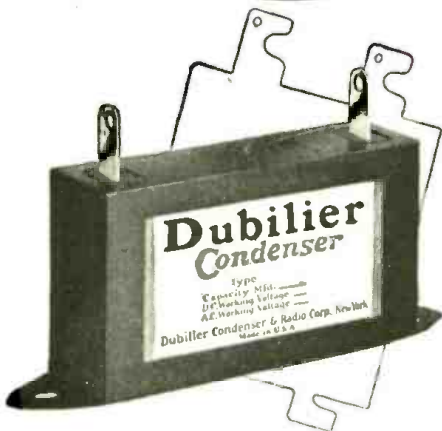

Dubilier Condenser Type 907  
Capacities 0.1 to 2.0 mfd.

Price \$.60 to \$1.75

"By-Pass" was the name originally given to small paper condensers by Dubilier. This name described their functions—such as shunting radio frequency currents around high resistances, and their use in amplifier circuits.

Now the clumsy old "By-Pass" condenser is out of date. The high voltages used in radio today along with sub-panel construction, demand a condenser of higher electrical efficiency and more compact size.

In the new Type 907, Dubilier has made a compact all-purpose condenser with a *working voltage\** of 160 volts D.C. With improved soldering lug terminals and mounting feet, Type 907 will give more efficient service in smaller space for every purpose for which the old "By-Pass" type of condenser has been used.

For long life at high voltages insist on Dubilier Paper Condensers.

Send 10c in stamps or coin for your copy of "Seventeen Ways to Improve Your Set."

## Dubilier

CONDENSER AND RADIO CORPORATION

4377 Bronx Blvd., New York, N. Y.

\*Working voltage means more than "test voltage." It is the voltage at which a condenser may be safely used in continuous operation.

A short spring with a big load can vibrate at the same rate as a long spring with a small load. If the load is too small, the vibrations die rapidly away; they have not enough energy. A pendulum with a heavy bob continues to swing longer than one with a light bob, for the resistance of the air has less effect upon it, or rather it has so much energy to begin with that it can overcome the resistance of the air longer.

The spring experiment is more instructive than the pendulum experiment from our present point of view; because increasing the load of an ordinary pendulum does not affect its time of swing. The restoring force, which is the weight in the case of a pendulum, is increased in exactly the same proportion as the inertia or mass is increased. Accordingly, all pendulums of the same length vibrate at the same pace, though the massive ones continue longer in vibration.

This is why a pendulum is so useful as a timekeeper, and the isochronism of a pendulum was used by Newton to prove that weight and mass were proportional,—a remarkable though as yet unexplained fact.

This singular simplification does not occur when we use elasticity as the restoring force. In the spring the two properties are separated; the extra load is independent of the stiffness of the spring; accordingly we can vary both separately, and show that the time of vibration varies directly, as the square root of the stiffness and inversely as the square root of the load. Quadrupling the load, keeping everything else the same, will double the time-period of swing, or cut the frequency of vibration in half.

Every musical instrument depends on the combination of these two properties: elasticity and inertia; and in the case of a reed instrument, like a harmonium or a concertina, the principles are applied very much as already described. The shorter and stiffer the reed, the higher the note or, in other words, the more rapid the vibration.

The reed need not be actually loaded because it has some inertia of its own. If it is loaded, the pitch is lowered.

If, on the other hand, the tip of the reed is filed away, it vibrates a little quicker. If the reed were filed lower down, at the part which bends and which therefore regulates the elasticity, it will vibrate slower. Thus by a file it is possible to tune a reed to any desired note.

In a stringed instrument, like a harp, a piano, or a violin, the recoil is due, not to the elasticity of the material, but to the stretching force or tension which brings the string back when struck or plucked or bowed; its own inertia being depended on for carrying it past the equilibrium position and maintaining the oscillation for a certain time.

## Write For Hampton-Wright's Radio Economy Catalog

Set Builders Attention!

Enjoy Real Radio  
Reception on These  
Cold Wintry Nights

Hampton-Wright's Radio Catalog lists only QUALITY Merchandise—the kind that makes for greater pleasures "on the air". All over the country hundreds of radio fans and set builders are acclaiming Hampton-Wright equipment. Don't delay—send for your free copy NOW!

SPECIFY CATALOG No. A8

Hampton-Wright  
P. O. Box 181  
Indianapolis, Ind.



—used in the LC-27

# AEROVOX

"Built Better"

## FIXED CONDENSERS

are Specified in

LC-27	by L. M. Cockaday
Diamond of the Air	" Herman Bernard
To be announced soon(?)	" John Rider
Raytheon "B" Eliminator	" Raytheon Mfg. Co.
UltraLyne	" R. E. Lacault
To be announced soon(?)	" R. E. Lacault

AEROVOX fixed condensers have been approved by M. I. T. and Yale Universities.

**AEROVOX WIRELESS CORP.**  
489-491-493 Broome Street  
New York



The rate of vibration then depends directly on the stretching force and inversely on the inertia of the string. It also depends on the length of the string. Accordingly, a string may be tuned either by altering the stretching force by twisting a peg to which it is fixed, or by shortening it, as in a violin, by the pressure of the fingers.

Every kind of matter, even air, has some inertia. The elastic recoil of air depends on its pressure, and its inertia depends on its density.

The ratio of the pressure to the density determines the rate of vibration of the air in an organ pipe of given length. The ratio of pressure to density varies with temperature, provided we reckon the temperature from absolute zero.

Accordingly, as a room gets warmer, the pitch of the pipes is raised, and an organ may go slightly out of tune with respect to the other instruments, the strings of an orchestra, for example, so that they may have to adapt themselves to the organ's new pitch. The air in an organ pipe has the two properties elasticity and density essential to vibration; though, as the inertia is small, the vibrations rapidly die away, and have to be maintained by blowing. Indeed the vibrations of all musical instruments except tuning forks die away rapidly, and if they do not die away rapidly enough for musical purposes, i.e. for the desired succession of notes in melody, they are purposely damped. In this case the friction has to be increased.

Vibrations die away for two reasons, first because of friction, second because of the energy emitted as sound. When a vibrating body emits sound, it does so at the expense of its own energy. A silent tuning fork continues to vibrate longer than one which is mounted on a sounding-board.

In electrical oscillations all this is true and has practical applications. Inductance takes the place of inertia; capacity, or rather its reciprocal, which has been called "stiffness," takes the place of elasticity. The dying away of oscillations is determined partly by the emission of waves, partly by electrical resistance. Sometimes one of these causes is the more prominent, sometimes the other; the first cause is useful, the second is waste. Resonance can be excited by the first, and can occur in spite of the second.

Where you get great distance on small power, you usually get great interference.

\* \*

Trans-oceanic radio stations use antennas three miles long.

\* \*

ONE in every seven families in the state of Victoria, Australia, has a receiving set.



Even if you can't drive a nail in straight, you can build this set.

## Build your 1928 model radio set NOW!

25c at Daven Dealers' 30c by mail

**T**HE Daven Bass Note Set—the "hook-up" that all radio fandom is talking about—and building! The pure-tone circuit that will be the feature of next year's leading factory-built sets. The set that will open your eyes—and ears!—to the new possibilities in radio! The set that will be the talk—the envy—the *model*—of your neighborhood!

You—no matter if you never tried set-building before—can build this set—easily, quickly—and equal the job of an expert. This new Book does the trick! Simple as A B C. Shows everything life-size. Numbers every wiring connection. Mistakes are practically *impossible* with such charts as these!

Get this Book. Build the first 1928 *model* set in your neighborhood. And learn the great big difference the Daven Bass Note Circuit makes in radio. Get this book at your Daven Dealer's, or write us—but *don't* put it off!

# DAVEN

## BASS NOTE CIRCUIT

### for COMPLETE Radio Reception

#### Factory Built Daven Bass Note Sets

If you are not interested in set building, but want the new completeness of reception, the easy 2-dial tuning, the sharp selectiveness that the Bass Note Circuit brings, you will be interested to know that we have bought a controlling interest in the Port Manufacturing Company of Newark. Write for Free Folder showing and describing complete Daven Bass Note Sets. Address,

Port Manufacturing Co., Radio Set Division of Daven Radio Corp., 151 Summit Street, Newark, N. J.



New 8th Edition Daven Manual  
This valuable book, newly revised, explains Daven Amplification in full detail, and shows how to apply Daven Amplification to any set. Get the Manual at your dealers' 25c—30c by mail. Complete Daven Catalog Free on Request.

"The Sine of Merit"  
DAVEN RADIO CORPORATION  
TRADE MARK "Resistor Specialists" REGISTERED  
151 SUMMIT ST., NEWARK, N. J.

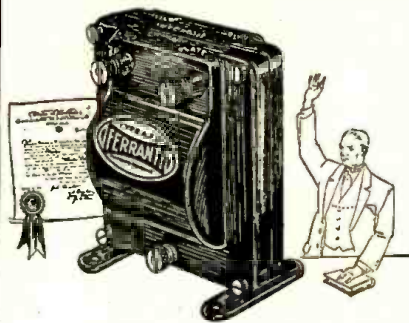

## All the Truth and nothing but the Truth!

If your set gives you poor quality, it is telling lies about the sending station. If it fails to transmit those low bass notes, it is concealing part of the truth.

You want true reception. You are entitled to it. So is your family. There is a way to get the truth in radio:—



Ferranti Transformers can probably modernize that old set of yours or improve the reception of even a new one. Your dealer can help you install one or two.

If you want to make the best of the power tube feeding the loud speaker, use Ferranti. If your dealer does not carry Ferranti, write us and we shall tell you where you can get one.

### HIGHSPOTS

High amplification ratio with flat curve.

Ferranti brings out the fundamental frequency of low tones—none are heard merely by inference from higher harmonics.

Every transformer tested ten times—all short-circuit turns eliminated. Windings have high impedance.

Built by an established manufacturing company with forty years' experience in the winding of coils of fine wire for electrical instruments and meters. Primary shunted with built-in condensers of correct capacity.

Tested to 1000 volts between primary and secondary and between primary and secondary and ground.

For the best available transformer results—Ferranti Audio Frequency Transformer A.F. 3—ratio 3½ to 1—\$12.

For a transformer far superior to the average, use Ferranti A.F. 4—ratio 3½ to 1—\$8.50.

**FERRANTI, Inc.**  
130 W. 42nd Street  
New York, N. Y.

No Better Transformer Is Available At Any Price



## WHAT READERS ASK

CONDUCTED BY DAVID LAY

In justice to our regular subscribers a nominal fee of \$1.00 per question is charged to non-subscribers to cover the cost of this service, and this sum must be inclosed with the letter of inquiry. Subscribers' inquiries should be limited to one question or one subject.

### A Volume Control for a Resistance-Coupled Amplifier

**QUESTION:** What is the best method of varying the volume in a three-stage resistance-coupled amplifier? I also want a wiring diagram that shows the proper connections for such an amplifier with an output filter and a volume control device.

—J. J. HOWARD

**ANSWER:** Figure 1 shows the circuit diagram for the amplifier with the features that you require incorporated in it. The filter unit consists of a high-inductance choke of 30-100 henrys and a high-voltage condenser of about 4 mfd. This is shown connected to the last stage of resistance-coupled amplification; a "C" battery is also included on this same stage. The dotted lines outline a high-resistance Electro-d potentiometer that has been made especially for this purpose.

is set up. There seems to be some kind of interference between the loudspeaker and the tubes of the set.

If I hold the tubes with my hands, the squawk stops but as soon as I let go, it starts up again. Can you suggest a remedy for this?

—GEORGE A. BORSET

**ANSWER:** The phenomena that you have noticed is caused by a mechanical vibration of the tubes from the audio-frequency sound wave that emanates from the loudspeaker.

A remedy for this would be to use a vibrationless type of socket for the detector tube. If this does not eliminate all of your trouble, replace all the tube sockets with vibrationless sockets and you will be sure to get rid of this troublesome noise.

### What Batteries Shall I Use In My Set?

**QUESTION:** What type of "B" batteries would you recommend for use in a six-tube set that employs a 171-type tube in the last stage with five, regular 201-a tubes in the radio-frequency amplifier, detector and first audio-frequency stage?

—RICHARD BARTON

**ANSWER:** You should use a heavy duty type of 45-volt "B" battery of any one of the approved standard makes as advertised in POPULAR RADIO. A smaller type of battery would not be satisfactory as the current consumption would be too high and the cells would run down in too short a time.

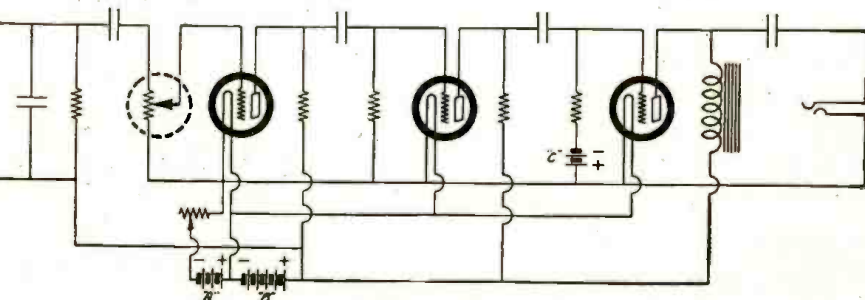

A SIMPLE VOLUME CONTROL

FIGURE 1: This diagram shows the proper connections for a resistance-coupled amplifier with an output filter and an efficient volume control. The control is outlined by the dotted line.



# The new Balkite Combination- with your "A" battery



U. S. PATENT. OCT. 12. 1929

## it supplies all radio power automatically from the light socket



### 3 New Balkite "B"s

Eliminate "B" batteries and supply "B" current from the light socket. Three models. Balkite "B"-W at \$27.50 for sets of 5 tubes or less requiring 67 to 90 volts. Balkite "B"-X for sets of 8 tubes or less; capacity 30 milliamperes at 135 volts—\$42. Balkite "B"-Y for any radio set; capacity 40 milliamperes at 150 volts—\$69. (In Canada: "B"-W \$39; "B"-X \$59.50; "B"-Y \$96.)



### The New Balkite Charger

Has two rates. A low trickle charge rate and a high rate for rapid charging. Can thus be used either as a trickle or as a high rate charger. Noiseless. Rates: with 6-volt battery, 2.5 and .5 amperes; with 4-volt battery, .8 and .2 ampere. Special model for 25-40 cycles. Price \$19.50. West of Rockies \$20. (In Canada \$27.50.)



### Balkite Trickle Charger \$10

MODEL K. With 6-volt "A" batteries can be left on continuous charge thus automatically keeping the battery at full power. With 4-volt batteries can be used as an intermittent charger. Or as a trickle charger if a resistance is added. Rate .5 ampere. Price \$10. West of Rockies \$10.50. (In Canada \$15.)

All Balkite Units operate from 110-130 volt, 50-60 cycle AC. The Balkite Charger is also made in 25-40 cycle model.

Now you can operate your radio set from the light socket. Merely by adding the new Balkite Combination Radio Power Unit. Once connected to your "A" battery and set and plugged into the light socket, it supplies automatic power to both circuits. You need not even turn it off and on, for it is controlled by the filament switch already on your set and is entirely automatic in operation. It will give you a constant quality of reception that cannot be secured in any other way.

Balkite Combination can be installed in a few minutes, either near the set or in a remote location. Like all Balkite Radio Power Units it has

no tubes, nothing to replace or renew, is a permanent piece of equipment, and is built to conform with the standards of the Underwriters' Laboratories. It is noiseless in operation. It will serve any set now using either 4 or 6-volt "A" batteries and requiring up to 30 milliamperes at 135 volts of "B" current—any set of 8 tubes or less, including power tubes.

Add Balkite Combination to your radio set and know the pleasure and convenience of owning a receiver always ready to operate at full power. Price \$59.50. [\$83 in Canada.] Ask your dealer. *Fansteel Products Company, Inc., North Chicago, Illinois.*

Listen to the Balkite Radio Symphony Concerts with Walter Damrosch and the New York Symphony Balkite Hour Saturday Nights 9 P. M. Eastern (8 P. M. Central) Standard Time, over WEA, WEEL, WGR, WFI, WCAE, WSAI, WTAM, WWJ, WGN, WCCO, KSD, WDAF, WOC.

FANSTEEL  
**Balkite**  
Radio Power Units



# Glowing spots of light in place of dials

MAR-CO controls, specified in the construction of the L. C. 27, add searching action — free from backlash — as well as the distinguished appearance that characterizes a 1927 model set.

## MAR·CO Illuminated Controls



### A Simple One-tube Set That Will Not Howl

**QUESTION:** Can you give me a simple circuit diagram that shows a hook-up for a variocoupler and a variable condenser to be used with one tube in a non-regenerative circuit for local reception on the headphones?

I want a circuit that will not squeal under any circumstances. At present I have a crystal set that gives very satisfactory service on the two stations that I listen to, but I would like to get a little more volume.

—E. B. T.

**ANSWER:** The hook-up that you require is shown in Figure 2.

You will need beside your variocoupler and your variable condenser, the following instruments—

- 1 grid-leak and condenser combination;
- 1 tube socket;
- 1 rheostat, 20 ohms;
- 1 single-circuit jack;
- 1 UX-199 tube;
- 3 dry-cell "A" batteries, 1½ volts each;
- 1 "B" battery, 45 volts;
- Connection wire and 6 binding posts.

You may be confident that this simple circuit will not radiate nor cause interference to your neighbors no matter how close they are located. This small set, when finished, should give you exceptionally clear and pure reproduction from all the local stations, if a good pair of high-resistance telephones are used with it.

### What Is an "Output Filter"?

**QUESTION:** I have often read in your magazine about output filters for loudspeakers but I do not quite understand what they are for or what they do. Will you give me a brief description of this piece of apparatus?

—JOHN BALL

**ANSWER:** The output filter, or speaker filter as it is sometimes called, consists of a high-inductance choke coil for feeding the high-voltage, direct current to the plate of the last tube in a receiver, usually a power tube. Combined with this is a large condenser, placed in parallel with the plate circuit and in series with the loudspeaker itself. This condenser allows the audio-frequency currents to flow through the loudspeaker to prevent a flow of direct current through the same instrument, thus protecting the windings of the speaker from the high voltage.

A still further use of the filter is to place a high impedance in the plate circuit of the tube so that the tube will operate on a more favorable characteristic than if the low-impedance winding of the loudspeaker were directly in the plate circuit of the tube.

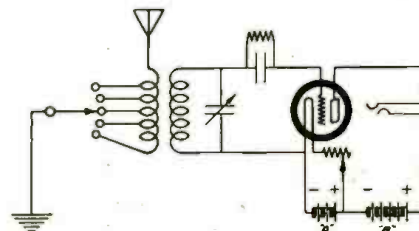

AN EFFICIENT ONE-TUBE SET

FIGURE 2: The wiring diagram for a one-tube non-regenerative receiver that will not radiate and that will give good clear reception from nearby stations.

## BROADCAST LISTENERS

The POPULAR RADIO ATLAS and LOG will give you a list of all the NEW Broadcasting Stations with wavelengths and other necessary information

### A Complete Atlas and Station Log

The "POPULAR RADIO International Radio Atlas and Log" will supply you with full information regarding broadcasting stations of the United States and Canada.

This most useful and practical Atlas consists of 16 pages, size 12" x 15". Printed on good paper, from clear type in two colors and contains a complete series of double page maps, including—The World—The United States—Canada—North and South America, showing location of principal broadcasting, leading commercial and governmental radio stations.

### SPECIAL FREE OFFER

You may have a copy of the "POPULAR RADIO International Radio Atlas and Log" free, with POPULAR RADIO for (8) eight months.

**For Only \$2.00**

Pin \$2.00 in bills to the coupon below.

If you are a subscriber to POPULAR RADIO your subscription will be extended eight months.

Date.....

POPULAR RADIO, Dept. 12A  
627 West 43rd St., New York City.

Enclosed is my remittance of \$2.00 for which you are to enter my subscription (extend my subscription) for (8) eight months for POPULAR RADIO and send FREE a copy of the "POPULAR RADIO International Radio Atlas and Log."

Name.....

Address.....

City..... State.....

## FIXED RESISTORS Micamold FIXED CONDENSERS

Kenneth Harkness uses MICAMOLD PRODUCTS exclusively in his new circuit, the KH 27.

All Micamold products are moulded in genuine Bakelite. Values and capacities guaranteed permanent.

Manufacturers use Micamold Resistors and Condensers to the exclusion of all others, for once inserted in the set, resistor and condenser trouble is forever eliminated.

Micamold Products are indestructible. They are not harmed by heat or cold and may if the builder desire, be soldered right into the set.

At all good radio stores or direct to Dept. P.

Micamold Radio Corp.  
Flushing & Porter Ave., Brooklyn, N. Y.

ACCURACY GUARANTEED  
—VALUES REMAIN CONSTANT

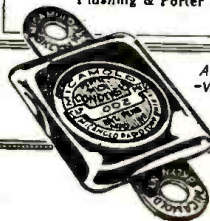



# YAXLEY

APPROVED RADIO PRODUCTS



## Automatic Power Control

No more inserting and removing plugs from your light socket—no more turning several switches every time you use your radio set when you have a Yaxley Automatic Power Control.

The Power Control automatically takes care of your B-eliminator, trickle charger and A battery when you turn your set on or off. It does this without fail. No danger of forgetting to turn one switch and find your battery run down or your tubes needlessly burning.

The Power Control cuts in the B-eliminator and A battery, cutting out the trickle charger when the set is turned on. The B-eliminator and A battery are cut out and the trickle charger cut in when your set is turned off.

No. 444 Automatic Power Control, Series Type—for use with sets with tubes having a current draw equal to or greater than 6 U.V.-199 tubes. . . . Each, \$5.00

No. 445 Automatic Power Control, Multiple Type—for use with sets having tubes with a current draw lower than that equal to 6 U.V.-199 tubes. Each, \$6.00

Order a Power Control from your dealer today. If he cannot supply you, send his name with your order

Yaxley parts have been approved for the K-H 27

**Yaxley Mfg. Co.**  
Dept. P 9 So. Clinton St.  
Chicago, Ill.

## Wonderful Volume with Clearness AMPL-TONE



**\$3.00**

Phonograph makers have spent years perfecting the acoustic properties of their phonographs. Use an AMPL-TONE Unit and make a real Loud Speaker in an instant or use it in your horn and get better results.

After all, speakers are as good as their unit. We make a real unit at a real price. Money gladly returned if you are not entirely satisfied.

We make units for other manufacturers.

The UNION FABRIC CO.  
DERBY, CONN.

Makers of the Excellent French AMPL-TONE Headset

Please send me an AMPL-TONE Unit for which I enclose \$3.00.

Name.....  
Address.....  
State.....

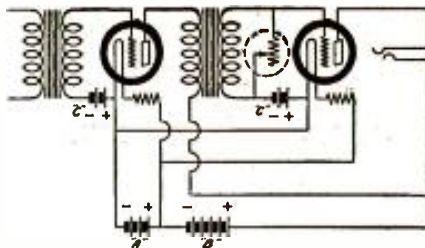

## AN AUDIO VOLUME CONTROL

FIGURE 3: A 50,000-ohm variable resistance connected across the secondary of the second transformer will provide an adequate volume control for a two-stage audio-amplifier.

## A Volume Control For a Two-Stage Amplifier

QUESTION: Please show me how to cut down the volume on a two-stage, audio-frequency amplifier? I have a set that employs good quality transformers and it gives exceptionally loud volume, too much for ordinary home use. I want a method of cutting down the volume that will not interfere with the quality of reproduction that I now get.

—GEORGE BERNEY

ANSWER: In Figure 3 you will find a hook-up that shows the amplifier equipped with the proper "C" batteries and a 50,000-ohm variable resistance that is used as a volume control. This resistance is shown in the diagram in a dotted circle connected directly across the secondary of the second transformer.

## How Many Amplifier Tubes Should I Use?

QUESTION: How many stages of resistance-coupled amplification should I use to get full loudspeaker volume? How many stages of impedance-coupled amplification would give me the same results and how many stages of transformer coupling would be approximately the same?

—RANDOLPH CHICKERING

ANSWER: You can use three stages of resistance coupling or three stages of impedance coupling with about the same volume as you will get from two stages of transformer-coupled amplification.

## How to Make an "A" Battery Voltage Reading

QUESTION: How may I use a battery voltmeter in the Browning-Drake set for reading the voltage of the "A" battery?

—LINTON OWENS

ANSWER: We suggest that you install two pin jacks on the panel in a suitable position and connect them directly across the "A" battery binding post of the receiver. Then you can use one of the new type of voltmeters that is equipped to fit the pin-type jacks. To make a reading, the voltmeter pins are inserted on these jacks and a reading taken; after this the voltmeter may be taken off the panel again and put away in the drawer for safekeeping until another check is desired on the "A" battery voltage.

A number of manufacturers of electrical instruments are now making this type of voltmeter.



## Samson Dual Impedance

*gives fine tone quality at low cost*

Majestic Music, real and rich in deep bass and high treble notes, will instantly flow from your radio receiver if you simply replace average audio transformers by inexpensive Samson Dual Impedances.

This latest development for fine tone quality, designed by Harold Donle, may be used where double impedance systems of amplification are recommended. These units are self contained. No extra parts to buy. Price \$5.00 each.

## SAMSON ELECTRIC COMPANY

Manufacturers since 1882



Main Office, Canton, Mass.  
Sales Offices in all large cities



# Send for Latest RADIO CATALOG and GUIDE

## Get Your Complete Parts for All the Newest Circuits Here

In every issue of Popular Radio and other radio magazines you will find the newest circuits of the world's greatest radio engineers. You will want to build these sets from the parts listed. BARAWIK service keeps up to date on all the new wrinkles. We have the parts used for all these new circuits, complete, ready to ship you the instant your order arrives. Take advantage of this unequalled service. Get what you want—quick—at a big saving. No order too large or too small for us. 300,000 fans swear by BARAWIK service. We can please you, too.

## Short Wave Equipment—Special Amateur Section

The Barawik line features this season a special Amateur Department in charge of F. J. Marco, owner of station 9ZA, a nationally famous radio engineer and an authority on amateur work. It presents the latest in short wave equipment, transmitting and receiving supplies and everything necessary for the amateur and experimenter. Special attention has been given to short-wave kits including the B-T, Aero Coil, Silver Marshall R.E.L., etc. It will pay you to get our new Guide at once.

## Radio's Newest at Rock-Bottom Prices

The new 1927 edition of the Barawik Catalog and Guide gives a comprehensive listing of the radio sets, parts, kits, supplies and accessories necessary in radio. This new Guide contains over 6,000 items of radio's newest developments, everything that a real fan will need from the complete factory-built set to the smallest screw, including labor-saving devices, tools, power supply units, amplifier equipment, etc. Standard equipment of the best known manufacturers at tremendous savings.

Besides the complete radio and amateur line there is shown a selection of electrical goods, household appliances, auto accessories and articles necessary in the home—all at a big saving in price.

Write today for your free copy of the 164-page guide. Also please include name of other fans. Mail the handy coupon NOW.



**BARAWIK CO.**

540-545 Monroe St. Chicago, U. S. A.

Mail This Coupon Now! For Free Copy

Name.....  
 Address.....  
 Fan.....  
 Address.....

## How to Get Rid of Separate Tube Rheostats

QUESTION: Is it possible to do away with the use of separate rheostats for each tube in my five-tube neutrodyne receiver? Can I use a resistance device that will take care of all the tubes, so that I will always get maximum results if my storage battery is kept up to proper charge?

—JAMES R. MILL

ANSWER: You may incorporate either one of two schemes in your set. The first is the use of separate filament controls, such as the Brachstat, the Elkay resistance or the Amperite. If you are using five ¼-ampere tubes you will need five ¼-ampere adjustors. The second scheme is the use of one adjustor for all of the five tubes; in this case, it would be necessary to employ a control adjustor that would pass 1¼ amperes.

\* \*

## Power Tubes for the Browning-Drake Receiver

QUESTION: Can I use a UX-112 tube in the Browning-Drake receiver (described in the August, 1926, issue of POPULAR RADIO) in place of the UX-171 tube? Why was the 171 tube used by the designer instead of the UX-112?

—GEORGE RUSSELL

ANSWER: You can use a UX-112 tube in this circuit with very good results. The UX-171 tube was recommended because it gives greater volume without distortion than is obtainable with the UX-112. The latter tube, however, will give plenty of volume for ordinary home use.

\* \*

## What "C" Batteries Shall I Use?

QUESTION: How many volts of "C" battery should I use on a 112-type power tube with 135-volts on the plate?

—G. PERKINS

ANSWER: Use a "C" battery of approximately 9 volts for this type of tube, if it is placed in the last stage of an audio-frequency amplifier. This is the voltage that will give you the least variation of reflection in a milliammeter connected in the plate circuit of this tube when it is in operation as an audio-frequency amplifier.

\* \*

## How to Cut Out Radiation

QUESTION: I have a three-circuit tuner and I understand that this type of set is liable to radiate and cause interference to my neighbors. In fact, one of my friends who lives in the next house demonstrated this clearly to me. I want to know what kind of unit I can use ahead of my present set to eliminate this trouble?

—V. REUSCHER

ANSWER: We suggest that you use one stage of neutralized radio-frequency amplification ahead of your present receiver. This will employ one more vacuum tube than you now use and it will add considerably to the range and selectivity of the set as well as cut out any objectionable radiation. A complete unit, such as the Pentrola, is recommended.



## Double Enjoyment Volume with Perfect Tone

Why sacrifice the excellent reproducing qualities of a set by the use of an inferior speaker. Proper design and construction has produced in the BURNS Speaker a most satisfying instrument. It is possible to reproduce with amazing exactness every note of music and inflection of the voice that the set is capable of picking up. A trial will convince.

At Your Dealer's or Write Direct

**American Electric**  
COMPANY

STATE AND 64TH STREETS  
CHICAGO, U. S. A.

Ask about BURNS B-Eliminator



# FREE

## NEW 1927 Radio Catalog

BEFORE you build or buy a radio be sure to consult our new 100 page catalog—sent to you free. All the latest kits, accessories, and parts—a million dollar radio stock to choose from.

## We Save You Money

We handle only brand new apparatus—standard makes that are fully guaranteed. QUANTITY sale of QUALITY parts explains our low prices. Compare with others and see why thousands of fans look to us as radio headquarters. Write for your copy of this new catalog today.

**Chicago Salvage Stock Store**  
Dept. PR, 509 S. State Street, Chicago, U. S. A.



### 500 Words

(Continued from page 21)

is usually pronounced "airial," when the dictionaries plainly give "a-ear-i-al."

The loudspeaker was on the brink of becoming "horn" when the advent of the "cone" intervened.

A few mistakes in terms have been accepted and given the status of good form simply through continued usage—another interesting case for the philologist. "Broadcast," in the past tense, is an outstanding example.

During the early days, every self-respecting announcer said "broadcasted." But the type of announcer who said "sang" for "sung," persisted in taking the short-cut "broadcast," till today, through usage, "This evening's program has been broadcast" is universally accepted as good form.

Most of these terms devised by the newcomer, though patent incongruities, are harmless. People know what they mean at least, and correctness is relative, most of all in speech. But there are some which cannot escape the classification of outright mistakes, of which a common use of wavelength is the most conspicuous.

Too often this is confused with power, as in the case of "Yes, WJZ comes in strong. They've got 455 meters." The old-timer, in fact anyone familiar with radio, will explain that wavelength is not a measure of power; that is simply represents the frequency of the broadcast wave. So here is an error in fact as well as terminology.

There is a commercial aspect to popular usage as it affects the radio vocabulary too. The word superheterodyne has, for example, been contracted to "super" in everyday speech, to such an extent that manufacturers are confronted with a real problem in keeping it from being confused with other receivers, not in fact superheterodynes, which employ the term "super" in their names. If the practice continues there is even reason to believe that these manufacturers will be forced to adopt a new name that they can protect legally.

So the junking of the radio vocabulary so sacred to the old-timer, and its replacement with a substitute jargon devised by the lay newcomer, goes on. Just now it seems pertinent to wonder what will ultimately become of such terms as "electrolyte," "rectifier," and "oscillator," when they have been put through the mill.

The lack of a common language is retarding the growth of radio in the Mukden region of China.

A hotel in Shaftesbury, England has been named "Listen Inn."

Australia averages about two radio sets to every 100 of population.



A complete metallic shield forms the back of the Eby Dial and minimizes the effect of body capacity. Removing hand does not detune receiver.

## EBY SHIELDED DIAL

Even the best instruments are inefficient unless properly controlled and accurately set. This sensitive, finely constructed indicating device is scientifically designed for exact micrometer tuning.

Hairline accuracy is obtained by smooth positive friction drive, eliminating all back lash. No gears or washers.

The Eby Shielded Dial operates any type condenser, clockwise and counterclockwise. Graduated from 0 to 100 and 100 to 0. Easy to mount by drilling one additional hole.

List Price \$2.50

**RMA** THE H. H. EBY MFG. CO., Philadelphia **RMA**  
Makers of Eby Binding Posts and Sockets.

### Bradleystat

**PERFECT FILAMENT CONTROL**

Provides complete noiseless filament control for all radio tubes without change of connections. Metal parts are nickel plated. One hole mounting. Self contained switch opens battery circuit when desired.

**Allen-Bradley Co.**  
Electric Controlling Apparatus  
276 Greenfield Avenue Milwaukee, Wis.

### Bradleyometer

**THE PERFECT POTENTIOMETER**

Uses graphite disc resistors which are noiseless and not affected by atmospheric conditions. Metal parts are nickel plated. One hole mounting. Finish and knob match Bradleystat. Made in 200 and 400 ohm ratings.

**Allen-Bradley Co.**  
Electric Controlling Apparatus  
276 Greenfield Avenue Milwaukee, Wis.

Used in the Kenneth Harkness-27 6-Tube Hook-up

**See that screw**

A SCREW DRIVER ADJUSTS AN X-L IN CROWDED PLACES

**X-L VARIO CONDENSER**

Used in POPULAR RADIO IMPROVED

### Browning-Drake Hookup

Indorsed by leading radio authorities

**Model "N"** A slight turn obtains correct tube oscillation on all tuned radio frequency circuits. Neutrodyne, Roberts two tube Browning-Drake, McMurdo Silver's Knockout, etc., capacity range 1/4 to 20-micro-micro farads. Price \$1.00.

**Model "G"** with grid clips obtains the proper grid capacity on Cockaday circuits, filter and intermediate frequency tuning in heterodyne and positive grid bias in all sets. Capacity range:  
Model G-1—.00002 to .0001 MFD  
Model G-5—.0001 to .0005 MFD  
Model G-10—.0003 to .001 MFD  
Price \$1.50

### X-L PUSH POST

Push it down with your thumb, insert wire, remove pressure and wire is firmly held. Releases instantly. Price 15c.

**Push Post Panel** permanently marked in white on black insulating panel. In box including soldering lugs, raising bushings and screws for mounting, etc. Price \$1.50

**X-L Radio Laboratories** 2422 Lincoln Ave. CHICAGO, ILL.





**B**ECAUSE the Sangamo condenser is solidly molded in bakelite, mechanical movement of dielectric or plates is impossible. This is one important factor in the permanent accuracy of the Sangamo.

No one has greater need for condenser accuracy than a great broadcasting station like WGN. Read Mr. Leverett's comment:

"Last June I used Sangamo Mica Condensers in a multiple band pass filter. This has been in use for some time, and has given the best of results, showing no shifting of the frequency band. This permanency I believe is due entirely to the consistency of these condensers, there being no apparent change in capacity nor leakage across them. I cheerfully recommend them wherever a constant capacity is required.

(Signed) Geo. H. Leverett,  
Asst. Engineer"  
Station WGN Chicago

**Sangamo Condenser Blocks**

American-made condensers, wound under uniform tension to eliminate air or ozone bubbles that cause breakdowns.



Handy sizes:

- 12 mfd. tapped 8, 2, 2 mfd.
- 14 mfd. tapped 8, 2, 2, 1, 1 mfd.
- 14 mfd. tapped 4 (high voltage), 4, 2, 1, 1, 1, 1 mfd.

Also separate condensers; special capacity blocks to order.

**Sangamo Electric Company**

6332-11 Springfield, Illinois

RADIO DIVISION, 50 Church Street, New York

SALES OFFICES—PRINCIPAL CITIES



**WITH THE EXPERIMENTERS**

CONDUCTED BY RICHARD LORD

**What Is the Ideal Type of Variable Condenser?**

To obtain a uniform distribution of station tuning over the entire dial range of variable condensers has been the ambition of alert engineers since the inception of the "straight-line" mania. It was thought at first that the "Philosopher's Stone" of tuning was represented by the straight-line-capacity condenser but experience finally dampened the ardor of its advocates. The straight-line-capacity condenser was indicted on one count only; it caused "traffic jams" on the lower wavelengths although it operated ideally on the higher wavelengths.

After straight-line-capacity, came the straight-line-wavelength idea, and here again the engineering wiseacres believed that they had completely and finally solved the problem of straight-line condensers. Again actual experience upset their calculations for the straight-line-wavelength condenser had what might be called a "peak of perfection" in the neighborhood of the medium wavelengths. That is, in the neighborhood of

50 degrees on a 100-degree dial the separation of stations was perfect and ideal conditions were effected in this small range. However, on both sides of this "peak of perfection" considerable bunching occurred and uniform distribution disappeared.

It was again believed, at first, that the straight-line-frequency condenser was the happy medium, designed, as it was, to obviate the undesirable features of its defeated predecessors. Once more experience proved that engineers were attempting to rob Peter to pay Paul and that the straight-line-frequency condenser, although it operated famously on the medium and lower ranges, fell down at the higher part of the dial.

If the straight-line-capacity, straight-line-wavelength and straight-line-frequency condensers failed to bring the results anticipated, what could be done? There was nothing else to "straight line," but it was obvious that it was possible to bring about a combination of these three effects and to produce a condenser with plates so curved that the device would effect a respectable separation of the miscellaneous wavelengths

STATIONS			DIFFERENCES BETWEEN STATIONS		SEPARATION IN DIAL DEGREES BETWEEN STATIONS USING VARIOUS TYPE CONDENSERS			
CALL LETTERS	WAVE LENGTH METERS	FREQUENCY Mc/cycles	IN METERS	IN Mc/cycles	STRAIGHT-LINE CAPACITY S.L.C.	STRAIGHT-LINE WAVELENGTH S.L.W.	STRAIGHT-LINE FREQUENCY S.L.F.	STRAIGHT-LINE TUNING S.L.T.
WNYC	526	570	34	40	11	5½	6	9½
WEAF	492	610	37	50	11½	6½	5	9½
WJZ	455	660	50	80	10½	6½	8	10½
WOR	405	740	45	93	8½	11	8	12
WHN	360	833	44	117	11	12	10	11½
WGDS	316	950	43	150	7	10	12	11
WFBH	273	1100	21	90	4	6	7½	7½
WGCP	252	1190	12	60	2	3½	4	3½
WHAP	240	1250	7	40	1½	2½	3½	3½
WNJ	233	1290	15	85	1½	2	4	3½
WIBI	218	1375						

**A SIGNIFICANT COMPARISON OF CONDENSER TUNING CURVES**

FIGURE 1: Every one of the types of condensers that are generally used—the straight-line-capacity, the straight-line-wavelength and the straight-line-frequency—give an ideal separation of stations for a certain part of their scale; this is blocked off in red on the chart shown above. But the straight-line-tuning condenser, which embodies the best parts of each of the other types, has ideal tuning characteristics over the entire scale of the condenser.



# Things you should know about Battery Chargers

General Electric presents a complete line of Tungar Battery Chargers having sufficient range to meet the charging requirements of all radio storage batteries—large or small. Tungar is easy to use. It assures fully charged batteries over a long period of years.

Economical and satisfactory operation of your set depends upon the correct selection of Charger as well as battery. Any good dealer will be glad to recommend the proper Tungar. But these few simple facts may be all the guide you need.

## The Two-ampere Tungar



This size Tungar charges all radio "A" and "B" storage batteries and auto batteries. It is particularly suited to sets having power tubes or using considerable current. It can be permanently connected to the battery and an overnight charge once or twice a week should be sufficient.

## The Five-ampere Tungar



The Five-ampere Tungar also charges all radio and auto batteries. But it has a high charging rate, charges faster and is best for very large batteries.

## The Tungar Trickle Charger



This youngest and already popular member of the family should be used with low capacity 4 or 6-volt radio "A" storage batteries. It is usually permanently connected and charges continuously at a low rate.



*Tungar—a registered trademark—is found only on the genuine. Look for it on the name plate.*

*Merchandise Department  
General Electric Company  
Bridgeport, Connecticut.*

# GENERAL ELECTRIC

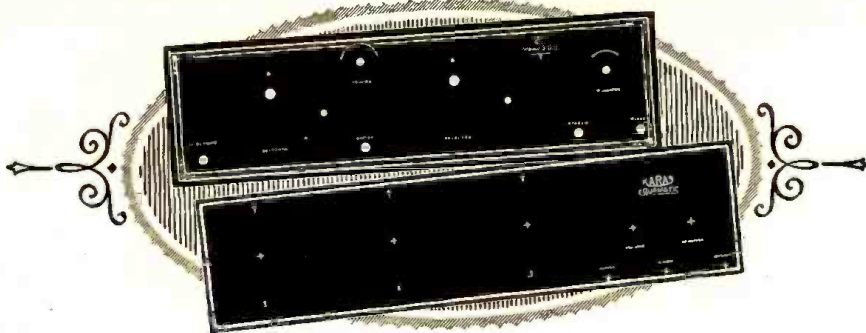

**POWER S.X, KARAS, H. F. L.**

**A**DDED to the list of handsomely Veri Chromed Formica kit panels are now the Bremer Tully Power Six, Karas Equamatic front and sub panels, H. F. L. Nine in Line Superheterodyne with sub panel, Victoreen Universal single dial control. There are also Infradyne 7 x 28, and 7 x 30, Aerodyne, St. James 8 Tube, Bremer Tully Counterphase, Browning Drake National, Madison Moore Superheterodyne, Camfield Duoformer. They are sold by leading jobbers and dealers.

Special panels cut to size and Formica tubing are also available for Amateurs

**The FORMICA INSULATION COMPANY**

4641 SPRING GROVE AVENUE

CINCINNATI, OHIO

Hear the FORMICA  
Orchestra Tuesday  
9 to 10  
over WLW



Formica has a  
Complete Service on  
Insulating Material  
for Radio Manu-  
facturers

over the complete range of the dial.

It is encouraging to note that the experimental laboratories of our condenser manufacturers have recently been dedicated to the perfection of condensers of this type. "Straight-line-tuning," is the term used in connection with this device and while the positive elimination of all condenser ills and problems has not been entirely accomplished, expert opinion expresses itself freely in favor of the straight-line-tuning condenser.

The radio experimenter does not need to be told that the embodiment of all of the features of the capacity, frequency and wavelength type of straight-line condensers into a straight-line-tuning device would naturally bring about greater selectivity. It is natural that the crowding of any group of stations into low, middle or upper ranges does not tend to facilitate tuning and trouble usually appears on the dial at the point where the condenser falls down. The straight-line-tuning condenser brings about this separation in an ideal way.

Actual tests using various types of condensers with appropriate size coils to cover the broadcast wavelength range are enlightening. In the table in Figure 1, the column headed "Wavelengths," lists the wavelengths of eleven stations in a typically radio-congested locality. The next two columns show differences in wavelength and frequency between these successive stations. How far apart or how close together will one log these stations on the dial is well shown in the next main column, labelled, "Separation in Dial Degrees."

Using an SLC (straight-line-capacity) condenser the stations below 275 meters are so badly bunched together that one has to split hairs in tuning them. Above 400 meters, however, this condenser affords pleasurable tuning.

Now considering the SLW (straight-line-wavelength) condenser column, we notice that low-wave stations are a bit further separated than with the SLC, but the tuning of the high-wave stations has changed to a crowded and bunched grouping. However, stations in the central broadcast range, i. e., between 300 to 400 meters approximately, are now ideally separated. The third sub-column in this group shows how the famous SLF (straight-line-frequency) condenser places these same stations on the dial. The low-wave stations are now placed quite a ways apart on the dial in an ideal manner, but the central band of stations are not quite as well separated as with the SLW type of condenser and the stations from 400 meters upward are now closely bunched together.

To sum up, the SLC condenser was excellent on the upper range, shown in red, the SLW was best on the middle range, shown in red, and the SLF was most satisfactory on the low range of stations, also shown in red.

**ELKAY**  
TRADE MARK REG.

**TUBE  
EQUALIZER  
SYSTEM**

**Eliminates  
Rheostats**

Elkay Equalizers replace variable rheostats, delivering correct voltage to any type of tube automatically. To use any combination of tubes in same set, merely insert correct value of Equalizer; there is one for every tube made. Before building your set, write for folder to The

Langbein-Kaufman  
Radio Co. (Dept. P)  
62 Franklin St.  
New Haven, Conn.

**50c**  
Each  
**75c**  
Mount-  
ed





CEC

A Type for  
Every Radio Need

**Write for data sheet of the  
Complete CeCo Line**

**C. E. MFG. CO., Inc.**  
Providence, R. I.

Largest Plant in the World Making  
Radio Tubes Exclusively



## LEWIS RADIO JOBBERS

Exclusive Distributors for

### KH-27

The Wonder Six-Tube  
Kenneth Harkness Circuit

KH-27—Essentials—\$49.50

KH-27—Complete—\$86.00

Dealers are getting remarkable business because of the repeat orders coming in on KH-27.

Our 24 Hour Service means  
Delivery at once—so order TODAY

We also distribute the following:

INFRADYNE	QUADRAFORMER
MADISON-MOORE	COCKADAY LC-27
SILVER MARSHALL	DAVEN BASS NOTE
KARAS EQUAMATIC	VICTOREN
NA-ALD TRUPHONIC	AERODYNE
HAMMARLUND-ROBERTS HI-Q	

We are the largest parts distributors in the East, carrying a most complete stock.

Write for our 1927 Catalog

**LEWIS RADIO JOBBERS**

The wholesaler for KH-27

2326 Columbia Ave. Phila., Pa.

## Sheet Copper for Shielding

### Shielding

**Prevents** aerial radiation and feedback.

**Insulates** against interference from adjoining circuits.

**Improves** efficiency, selectivity and tone quality.

**USE SHEET COPPER** because it combines low resistance with easy working qualities.

**COPPER & BRASS**  
RESEARCH ASSOCIATION  
25 Broadway — New York



From a photograph made for POPULAR RADIO

### MAKING ACCURATE ELECTRICAL MEASUREMENTS

FIGURE 2: A full understanding of electromotive force and current is necessary before the experimenter can hope to do any worthwhile experimental work.

It naturally follows that a condenser combining the separate good tuning qualities of the above three types would represent an ideal tuning device. The practical embodiment of these three qualifications is the SLT (straight-line-tuning) condenser. Just how it compares with the three other types is evident from the figures shown in the column. Notice that the SLT condenser listed in the last column covers the entire range with comfortable separation between stations.

—RAYMOND F. YATES

### What Electro-Motive Force and Current Are

To understand the workings of an electrical circuit it is necessary to obtain a clear idea of what is meant by current and what is meant by pressure or voltage. One cannot proceed very far in this direction without coming face to face with another factor called resistance. Electric current is expressed in amperes, electric pressure in volts and resistance in ohms. Taken separately, neither amperes, volts nor ohms can be defined or understood; but the law applying to one (called Ohm's law) deals with all three.

The first thing to remember is that volts and amperes have nothing to do with each other except as governed by ohms. You might have a pressure of a million volts and not have a single ampere flowing in a circuit if the resistance were great enough; on the other hand you might have a thousand amperes and a pressure of only a single volt, provided the resistance was small enough, your battery large enough and that you were able to maintain the one volt pressure.

Current is the quantity of electricity flowing per unit of time. It will help our understanding if we imagine electric current flowing in a wire to be the

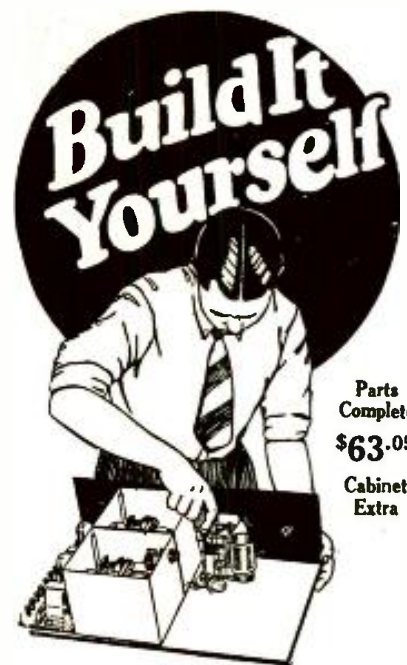

Parts Complete  
\$63.05  
Cabinet Extra

**Save \$50 to \$100!**

IMAGINE a radio without oscillation, without variation of volume on different wave lengths! Imagine a 5-tube receiver with the power of most expensive 8-tube sets! Imagine knife-like selectivity even in crowded areas! And tone quality as clear and pure as the natural unbroadcast signal!

That describes the 1927 Hi-Q Receiver designed by ten of America's leading Radio Engineers!

You can build this wonderful receiver yourself at home and save at least \$50 over a factory-made set of anything like the same efficiency. Get the "How to Build" book and approved parts from your dealer to-day and construct the receiver designed by Radio's Master Minds.

Send for the "How to Build It" Book—

The simplest and most complete instruction book ever printed. Covers every detail. 25c.



**Hammarlund**  
ROBERTS  
Hi-Q

\*High ratio of reactance to resistance.  
High ratio—Great selectivity—Loud Signals.

**HAMMARLUND-ROBERTS**  
INCORPORATED  
1182-B Broadway :: :: New York



**\$10**  
**Wheelan Super-Cone**

**NOW**—a full size 17" free edge quality cone-speaker—for only \$10.00—and sold on an iron-clad guarantee of perfect satisfaction or your money back after a 5-day trial.

Guaranteed to be as excellent in tone, volume and appearance as many speakers selling at \$25 or \$35. Insist on seeing guarantee tag which is attached to each Wheelan Super Cone.

Hear it in your own home, on your own set. Then if you are not convinced that it is the biggest value in cone loud speakers today, your dealer will cheerfully take it back and refund your money.

See the Wheelan Super-Cone today at your dealer's. If he cannot supply you, send us his name and address and we will see that your order is filled.

**WHEELAN MFG. CO.**  
254 West 34th Street :: New York

same as water flowing in a pipe; for direct currents, this will not be far from the truth. However, we must not carry the analogy too far, for water does not ordinarily flow around a circuit and back to its starting point as electricity does.

A circuit is the path that the electric current takes from the battery or dynamo where it originates, through whatever instruments or machines it is desired to operate, and back to its place of origin. If the instruments or machines are connected in a single path by a wire and the current passes through one after another, they are said to be connected in "series," but if the current divides and part of it passes through one device and another part through another device, they are said to be connected in "multiple." In a series circuit the same current passes through all of the units in the circuit but in a multiple circuit the current splits and the amount that passes through each branch is governed by the resistance met with in that branch.

Resistance is the sum total of the obstacles encountered by the current in its passage through the circuit. If the wire or other conductor which makes the circuit be short in length and reasonably large in diameter, a current may be forced through by a low voltage. But, if we use a smaller wire or a greater length the same voltage will not be able to force as much current through.

If a man, measuring eighteen inches across the shoulders, were to attempt to crawl through a hundred yards of pipe sixteen inches in diameter he would meet with considerable "resistance" and would not be able to travel as fast as if the pipe were larger. If we say this man's strength is represented by a certain number of "volts" at the beginning of his journey through the pipe, we can see that he would suffer a big "drop in voltage" by the time he reached the end. On the other hand, if the pipe were larger he would be stronger when he finished, and if we say his body represents one ampere of current, it could pass a given point quicker, which would be equivalent to a greater num-

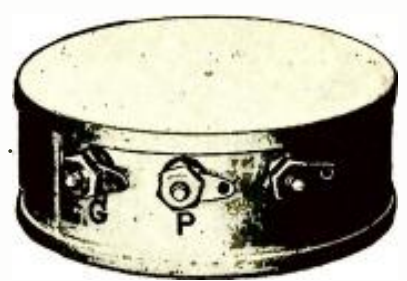

Shielded Tuned Radio Transformer, No. 30

## SICKLES Diamond-Weave Coils

The new Sickles Shielded Tuned Radio Transformer prevents both outside and local interference. It is remarkably compact, sharp-tuning, sturdy.

Sickles Diamond-Weave Coils have established an enviable reputation for low distributed capacity, low dielectric losses, and large range of frequency with small variable capacity.

The ideal coil for the Na-Ald Localized Control Tuning Unit and the Na-Ald Truphonic Assembly.

There are Sickles Diamond-Weave Coils for all leading circuits.

**THE F. W. SICKLES CO.**  
134 UNION STREET  
SPRINGFIELD :: MASS.

No.	Coil Prices	
30	Shielded Transformer	\$2.00 each
24	Browning Drake	7.50 set
18A	Roberts Circuit	8.00 set
25	Aristocrat Circuit	8.00 set

**DESIGNED to OUTLAST**  
**World Storage 'A' Battery**



**Two-Year Guarantee Bond in Writing** **NEW LOW PRICES**

Famous the world over for reliable, enduring performance. Solid Rubber Case lasting protection against acid or leakage.

Approved and Listed as Standard by Leading Authorities

including Radio News Laboratories, Popular Sci. Inst. Standards, Pop. Radio Laboratories, Radio Broadcast Laboratories, Radio in the Home and Lefax, Inc.

### Send No Money

Just state number wanted and we will ship same day order is received, by express C.O.D. Pay expressman after examining batteries. 5% discount for cash with order. Remember, you save 50% on World Batteries—so send your order today.

**WORLD BATTERY COMPANY**

1219 S. Wabash Ave.

Chicago, Ill.

**Solid Rubber Case Radio Batteries**

6-Volt, 100-Amperes	\$10.00
6-Volt, 120-Amperes	\$12.00
6-Volt, 140-Amperes	\$18.00

**Solid Rubber Case Auto Batteries**

6-Volt, 11-Plate	\$10.00
8-Volt, 18-Plate	\$12.00
12-Volt, 7-Plate	\$14.50

Set your radiolights at 288.5 volts for the World Storage Standard Station W-888. Variety—new talent—always interesting. Jerry Sullivan, Dir. and Promoter. "Chi-CAW-go"

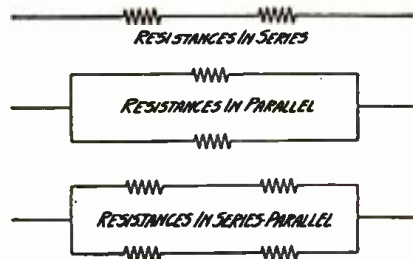

THREE WAYS TO CONNECT RESISTANCES

FIGURE 3: These simple diagrams show, at the top, two resistances in series, in the middle, two resistances in parallel and below four resistances that are connected in series-parallel.

## YOUR OWN BUSINESS Without Capital

Right now, there is an opportunity in your locality to profitably devote your spare time or all your time to a pleasant, easy and profitable business—one that does not require any training or capital.

The publishers of POPULAR RADIO offer you an opportunity to become their local representative to take care of expiring subscriptions and new subscriptions for POPULAR RADIO and two other popular magazines that they publish.

### SALARY AND COMMISSION

All material will be furnished you free of charge and you will be paid an attractive commission and salary.

Mail coupon for full particulars.

**POPULAR RADIO, Dept. 16,**  
627 W. 43rd St., New York City.

Send me full particulars regarding your salary and commission offer to local representatives.

Name.....  
Address.....



ber of amperes in unit time. Again, if he had only to crawl through twenty feet of the smaller pipe he could also come out with less loss of strength—that is "voltage."

It is the same with any number of volts from a battery or other source of electromotive force; the longer the wire or the smaller its size the greater will be the loss of voltage and the less the current that will flow. From this, it is easy to see that, other things being the same, the greater the resistance, the less will be the current and the less the resistance the greater the current. This is covered by Ohm's Law, which relates to direct currents, and is as follows: The strength of current is directly proportional to the electro-motive force and inversely proportional to the resistance; that is,

$$\text{Voltage} = \text{Current} \times \text{Resistance}$$

$$\text{Current} = \frac{\text{Electromotive Force}}{\text{Resistance}}$$

$$\text{Resistance} = \frac{\text{Electromotive Force}}{\text{Current}}$$

A direct current is one that flows continuously in the same direction. It is the kind that flows through the filament of your electron tube.

An alternating current is one that reverses its direction periodically. Two reversals (or a current impulse in each direction) constitute a cycle, and the number of cycles per second most generally used in electric power and lighting is 60 per second, and that used most in radio telephony and telegraphy ranges from 1,500,000, when the wavelength is 200 meters down to 100,000, when the wavelength is 3,000 meters.

The application of Ohm's Law to alternating currents involves factors not met with in continuous current circuits, and is beyond the scope of this article.

—GAY PRENTICE BLESSING

### Obscure Trouble-makers

HERE are trouble makers recently unearthed by a Federal radio supervisor in Oregon:

A sign on a street corner peanut roaster in an Oregon city, which caused trouble fifteen blocks away:

A small but active motor with a dirty commutator and improperly fitted brush:

Twelve defective flour bleachers equipped with electrical arcs in an Oregon flour mill:

Faulty insulators and other power line equipment on a high-voltage transmission line carrying 66,000 volts, which were found to be causing considerable interference to radio fans in western central Oregon.

In its desire to cooperate with the fans of that section the power company has appropriated money with which to purchase an auto equipped with a trouble-finding set, and has appointed a radio expert to patrol its lines.



TRADE MARK

for the  
LC-27

### The NEW TOBE 400-Volt Condenser

This is a new line of TOBE High-voltage Condensers, for 400 volts continuous operating voltage. The advent of the Raytheon BH Tube has made necessary condensers for higher working voltages than those formerly employed, in cases where the B-Eliminator Transformers deliver voltages in excess of 300 volts. The TOBE 400-volt Condenser is of the *short-path* type, is cased in a substantial metal container with heavy lugs, for attachment to baseboard or sub panel and is equipped with new and unique base terminals, for shortness of wiring and safety. These terminals are not found on any other make of condenser.



In the characteristic TOBE silvered finish, No. 401, 1 Mfd., \$2.00  
" 402, 2 " 2.75  
" 404, 4 " 4.50

### TOBE Output Filter Condenser

This 4 mfd. TOBE Condenser,—maximum working voltage 250 volts,—has been specially designed to save space in the construction of power tube output filters, now so generally required between the power tube plate of a Radio set and the speaker,—for protection of speaker windings and improvement of tone quality. An output device of this kind is recommended with the UX-171 and all other high-voltage power tubes.



Price, \$3.50



### The TOBE Veritas HI-Current Resistor

A special and unexcelled resistor, capable of radiating 4 to 5 watts continuously without change or deterioration. Unexcelled for use in B-Eliminators and for transmitting grid leaks. Made to be soldered directly into the circuits without the use of clips, although of standard length, so that standard mounts may be used if desired.

Prices—2,000, 2,500, 3,000, 5,000, 7,500 and 10,000 ohms.....\$1.10 each  
50,000 ohms......90 "  
.1 meg......80 "  
1/2, 1/4 and 1 meg......75 "

We have tried to make it possible for you to get TOBE apparatus at your dealer's. Ask him first—if it happens he is not yet stocked, we will be glad to forward your order on receipt of check or money order. Send for price-list P.R.

# Tobe Deutschmann Co.

Engineers, Manufacturers and Importers of Technical Apparatus

CAMBRIDGE,

MASS.

# Chosen by EXPERTS

GLENN H. BROWNING, Laurence M. Cockaday, Gerald M. Best and many other eminent radio designers use the Lynch Metallized Resistor in their experimental circuits and receivers. These men know radio; they have laboratory and testing equipment with which quickly to make accurate comparisons. There could be no better proof of the true merit of the Lynch Metallized Resistor than the endorsement of these experts.

Comprising a concentrated metallized deposit one-thousandth of an inch thick upon a rigid core, sealed forever within a glass tube, the Lynch Metallized Resistor gives conductive, non-arcing resistance that remains silent, accurate!

Dealers—Write us!

ARTHUR H. LYNCH, Inc.  
Fisk Bldg., Broadway & 57th Street  
New York, N.Y.

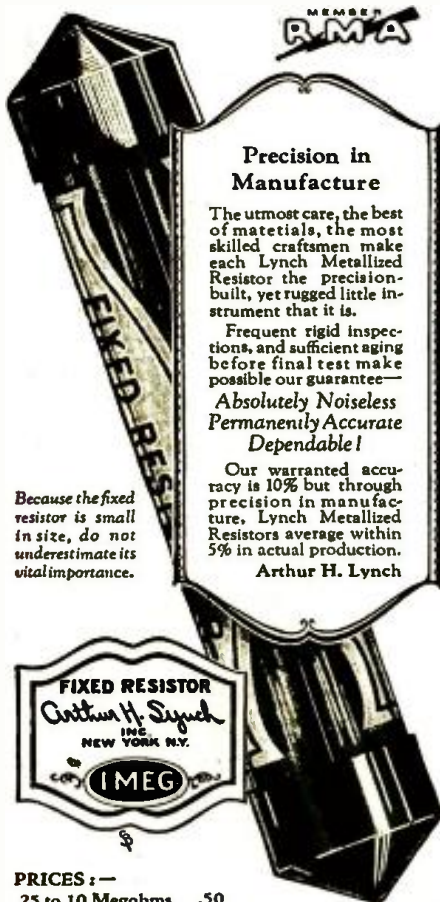

**Precision in Manufacture**

The utmost care, the best of materials, the most skilled craftsmen make each Lynch Metallized Resistor the precision-built, yet rugged little instrument that it is.

Frequent rigid inspections, and sufficient aging before final test make possible our guarantee—**Absolutely Noiseless Permanently Accurate Dependable!**

Our warranted accuracy is 10% but through precision in manufacture, Lynch Metallized Resistors average within 5% in actual production.

Arthur H. Lynch

*Because the fixed resistor is small in size, do not underestimate its vital importance.*

**FIXED RESISTOR**  
Arthur H. Lynch  
INC.  
NEW YORK N.Y.  
**IMEG**

PRICES:—

.25 to 10 Megohms	.50		
above .01 to .24 "	.75	Single Mounting	.35
.001 to .01 "	\$1.00	Double "	.50

Lynch Metallized Resistors cost no more than the ordinary kind. If your dealer cannot supply you it will be well worth your while to wait for the mail—we ship post-paid, at once.

# LYNCH METALLIZED FIXED RESISTORS

## How to Build the New KH-27 Receiver

(Continued from page 20)

audio frequencies can be obtained. In this respect resistance and impedance amplifiers are practically alike. Much higher amplification is obtainable, however, with impedance coupling using standard tubes and ordinary plate voltages.

The use of choke coils as grid-leaks *definitely and effectively remedies the inherent weakness of the earlier types of impedance amplifiers.* Each choke coil grid-leak offers an impedance of over one million ohms to the audio-frequency signal but the DC resistance of the choke is less than 2000 ohms and excess grid charges are immediately conveyed to the filament.

All possibility of distortion or blocking on this account is therefore eliminated. There is practically no limit to the volume that can be accommodated as far as this aspect of the system is concerned and full advantage can be taken of the amplifying characteristics of the tubes in the amplifier. The double-impedance amplifier is so perfect in this respect that almost any number of stages can be used. As many as seven stages have been employed without tube blocking taking place. It is unnecessary, however, to use more than three stages in the average receiving set.

The double-impedance, audio-frequency amplifier possesses many other unusual and important characteristics which are, however, beyond the scope of this article.

Another feature of the set is the output tone filter which passes the direct current to the plate of the last tube, through a choke coil, and permits only audio-frequency currents to pass through the blocking condenser and the loudspeaker windings.

### How to Construct the Set

The parts required to build this set are listed at the head of this article.

When all the instruments and materials for building the set have been procured, the front and sub-panels, U and V, shown in Figure 2 should be prepared.

First, cut the front panel, U, to the correct size, 7 by 26 inches, and the sub-panel, V, to 7 by 25 inches. Then square up the edges smoothly with a file. The centers for boring the holes by which the instruments are mounted should then be laid out on a panel as shown in Figures 7 and 8. A convenient method is to lay out all center holes on a piece of paper the same size as the panel; then the piece of paper may be fastened on the panel and the centers marked directly on the panel by punching through the paper with a sharp, pointed instrument.

If all the holes to be drilled are first

## Potter Condensers

Build the best—

Socket Power Devices  
—A and B Supply Devices  
Power Amplifiers  
Impedance Amplifiers

And are best—

For Filter Uses  
Rectifiers  
By Pass  
Blocking D.C.

American made of best of materials to full capacity. All sizes and types.

POTTER MFG. CO.  
North Chicago, Ill.

## Potter BY PASS AND FILTER Condensers



## Build It Yourself

IN one evening and for 1/5 the retail cost you can build a 3 foot cone speaker equal in every way to the finest factory-built cone speaker. Marvellous tone quality; reproduces perfectly every instrument in a complete symphony orchestra—the very lowest tones are clear, distinct and musical; the high notes are mellow and round. You'll really enjoy reception with this 3 foot cone equipped with

# 3 FOOT CONE SPEAKER

Parts Complete  
**\$14.15**  
Including Unit

## Penn Cone Speaker UNIT

designed especially for 3 foot cone; operates wonderfully with power tubes. Price \$9.50.

Complete set of parts—2 sheets genuine Alhambra Fonotex pair Back Rings, Unit Mountings, can Special Ambroid Cement and PENN Cone Speaker Unit—only \$14.15.

Ask your dealer. If he will not get it for you, we will ship you on receipt of price; or balance C.O.D. if you send deposit of \$5.

Pamphlet, "How to Build a Giant 3 Foot Cone Speaker for only \$14.15" sent for 10c., coin or stamps.

**PENN RADIO SALES CO.**  
104 Fifth Avenue Suite 2009 New York City  
Exclusive Selling Agents for G. R. Penn Mfg. Co., New York



started with a small drill, one-sixteenth of an inch in diameter or less, they can be more nearly centered.

The list of parts includes only the exact parts used in the set built by the author and shown in the illustrations. This set uses a completely drilled sub-panel in which the manufacturer has already rivetted six tube sockets, T1 to T6, inclusive. Those who wish to drill their own sub-panels will require six regular tube sockets of the sub-panel mounting type in addition to the parts listed. These six sockets should be mounted with nuts and bolts in the holes indicated in Figure 7.

After the panels are drilled, the builder may give them a dull finish by rubbing the face of the panels lengthwise with fine sandpaper until smooth. This process may be repeated, applying light machine oil during the second rubbing. Then rub the panel dry with a piece of cheesecloth.

A permanent dull finish will be the result. Or the panel may be left with its original shiny-black finish, if care has been exercised not to scratch it during the drilling.

If ready-made drilled and engraved front and sub-panels are bought, the work described above will be unnecessary as the drilling and finishing have already been done by the manufacturer of the panels. The panels, in this case, are beautifully made of black bakelite and, as mentioned above, the six tube sockets are securely rivetted to the sub-panel.

After the panels U and V have been prepared, or ready-made panels purchased, the builder is ready to mount the instruments on them.

First attach the sub-panel, V, to the front panel, U, by means of the two bakelite mounting brackets, W1 and W2. Then turn the set up on end so that you can reach both sides of the sub-panel, V. Figures 2, 3, 4 and 5 clearly show the positions occupied by the various parts.

On the lower side of the sub-panel, V, mount the four automatic filament controls, O1, O2, O3 and O4, the grid-leak mounting for the grid-leak, L, the fixed condenser, G, the two by-pass condensers, H and I, and the output filter choke coil, E. Note that the automatic filament control, O4, is mounted next the last tube, T6, at the extreme left of Figure 4 and the grid-leak mounting, for the grid-leak, L, is near the detector tube, T3, at the extreme right. The fixed condenser, G, is bolted to the sub-panel, V, near the detector tube, T3, on the right.

When screwing condenser G in position, attach soldering lugs on top of the sub-panel, V, and hold the condenser, G, off the lower side of the sub-panel with washers to insure firm contact to the terminals. The two fixed condensers, H and I, are not mounted on the

# A Striking Example of Radio's Real Prowess



Listen to

## MU-RAD

The SUPER-SIX-RECEIVER

Ask Your Dealer for Demonstration or Write to

**MU-RAD RADIO CORP.**

DEPT. P.

ASBURY PARK, N. J.

Licensed under Hiler Pat. No. 1589692

### FMC. DOUBLE IMPEDANCE AUDIO UNITS

Quadruple the output of power tubes and assure wonderful volume and perfect tone. Use them in place of transformers or resistance units.

Sold by All Dealers

**FREE:** "The Story of Amplification"

Write for a Copy

**Ford Radio & Mica Corp.**  
111 Bleecker Street, New York City

## CARTER

### "Midget" Rheostat with Filament Switch

Half Size **\$1**

All Resistances

2 ohm*	20 ohm*
3 ohm*	25 ohm*
6 ohm*	30 ohm*
10 ohm*	40 ohm*
15 ohm	50 ohm*
	75 ohm*

\*R.M.A. Standard

Eliminates separate filament switch, and simplifies operation, and controls. As soon as switch is moved from "off" position current is turned "on" for tubes and rheostat regulated as desired. Comes in all resistances including R.M.A. Standards. Specified in Hammarlund-Roberts Hi-Q and other circuits.

**Any dealer can supply**

In Canada—Carter Radio Co., Limited, Toronto

## POST RADIO COMPANY

605 Market St., Philadelphia, Pa.

We have the famous

### KH-27 KIT \$49.50

For Immediate Delivery

#### Comprising

- 1 KH-27 Foundation Unit (including drilled and engraved bakelite front panel, 7" x 26"; drilled bakelite sub-panel 7" x 25", with six tube sockets attached; one pair of bakelite mounting brackets and one 9" condenser shaft.)
- 1 Set of K.H. 27 R. F. Transformers (T1, T2, and T3)
- 3 K.H. Double Impedance Couplers
- 1 K.H. 30 Henry Choke Coil.....\$49.50

### KH-27 Complete \$86.00

Parts exactly as used by the author

Philadelphia's oldest radio company, with nine stores catering to the "fan" demand. Our reputation has been built on service to the customer and our ability to give you what you want.

#### Immediate Delivery on

LC-27, VICTOREEN, MADISON-MOORE, NEW SHIELDED QUADRIFORMER KIT, HAMMARLUND-ROBERTS HI-Q, REMLER INFRADYNE, MELO-HEALD KIT, KARAS EQUAMATIC, BROWNING-DRAKE, SILVER-MARSHALL SHIELDED SIX, AERODYNE—AND ALL THE 1927 KITS.

KH-27 Booklet - - 25 cents

Write for free descriptive literature

## POST RADIO COMPANY

Philadelphia, Pa.

# 22½ v. \$2.65

U  
N  
A  
C  
I  
D



E  
V  
E  
R  
L  
A  
S  
T  
I  
N  
G

## "HAWLEY" NEW TYPE

45 volts \$5.25, 90 volts \$10.00, 112½ volts \$12.50, 135 volts \$14.75, 157½ volts \$16.80, 180 volts \$19.20. Includes chemical. Nothing to purchase extra. Special sizes to order. Easily recharged upon any current including 32 volt systems. Any special detector voltage easily had. Operates any 1 to 10 tube set. Tested and approved by leading authorities, such as Popular Radio Laboratories, etc. Over 4 years sold on a non-red-tape 30 day trial offer with complete refund if not thoroughly satisfied. Further guaranteed 2 years. Knock-down kits at still greater savings. Complete "Hawley" "B" Battery charger \$2.75. Order direct—same day shipments, shipped C.O.D.—simply pay expressman cost on delivery or write for my free literature, testimonials, etc.

## B. HAWLEY SMITH

315 Washington Ave., Danbury, Conn.

sub-panel, V, but are held in position by the bus-bar wiring. Note that the figures show old type Dubilier by-pass condensers at J and K. The new type condensers may, of course, be used.

On the top of the sub-panel mount the coils, A1, A2 and A3, the two neutralizing condensers, C1 and C2, the fixed resistance, M, the eleven binding posts, Y1 and Y11, inclusive and the three double-impedance couplers, D1, D2 and D3. Looking down on the sub-panel, V, as shown in Figure 5, mount A1 on the right, A2 in the center and A3 on the left. Be sure to mount these coils in the proper holes; all three should be inclined at the same angle. Brass bolts must be used as the bolts are utilized to form electrical connections. When mounting these coils attach soldering lugs so that wires may be soldered to the bolts on both top and bottom of the sub-panel, V. Before mounting coil A3, screw one end of the grid condenser, F, in place; then bolt the grid end of coil A3 through the sub-panel, V, to the opposite terminal of the grid condenser, F. The mounting bolt is used to attach both parts to the sub-panel, V, and forms a direct electrical connection from A3, to the grid condenser, F.

When mounting the double-impedance couplers, D1, D2 and D3, to the sub-panel, V, make sure that the primary terminals (P and B) of each coupler point towards the left-hand side of the set when looking down on the sub-panel, V, as in Figure 5.

Now remove the shafts from two of the variable condensers, B2 and B3. Mount condenser B2 on the right-hand side of the front panel, U (looking from the front), and pass a screw through the aluminum casting of the condenser so that it passes through the hole drilled for that purpose in the sub-panel, V, and bolt condenser B2 securely to the sub-panel, V, directly behind the first condenser, B2. Then pass the nine-inch extension shaft through both condensers, B2 and B3, leaving enough of the shaft projecting through the front panel U, to mount the dial, Z2, thereon. Turn both rotors of the condensers, B2 and B3, to the same positions and tighten the shaft in place.

Note that the extension should pass through the two condensers easily. If you find it necessary to force the shaft or raise the sub-panel, V, to permit the shaft to pass through, loosen the nut holding the front condenser, B2, to the sub-panel, V, until the two condensers, B2 and B3, line up accurately.

Mount the remaining variable condenser, B1, on the left-hand side of the front panel, U (looking from the front). Also mount the antenna switch, R, and the phone jack, P, on the left, the battery switch, S, and the pilot light bracket, Q, on the right and the rheostat, N, in the center. Finally mount the two vernier dials, Z1 and Z2, in

## Yale GROUND HOG

Perfect Ground  
INCREASES POWER AND DISTANCE

### on your RADIO

Marvelous newly invented ground gives 100% improved reception. Increases power and distance, users say. Thousands getting results like D. S. Friedman, Radio Engineer of Burlington, Iowa, who writes, "Am very much pleased with way your Ground Hog operates. Am now able to tune in any good stations with little trouble from static." Everyone pleased and delighted. Users report, "Leaks stopped," "Static reduced," "end to jangling even in midsummer," "Results never dreamed of." Absolute satisfaction guaranteed or money back at once.

#### Efficiency Always Insured

Only ground on market that has power to draw and hold moisture thus assuring maximum efficiency at all times. Holds moisture indefinitely. Highly sensitive to radio energy. Proven valuable aid to clear, powerful distance reception.

#### SEND NO MONEY

Every radio owner needs a Yale Ground Hog. To introduce, we offer to those who act at once, regular \$5.00 size for only \$2.00. Send name today and pay postman \$2.00 plus 17c. postage on delivery, or send only \$2.00 with order and save postage.

#### Highest Approval

Tested and approved by Popular Radio Laboratory and other high scientific radio authorities. You can order direct today with absolute confidence of value and satisfaction.

FREE—Complete description of Ground Hog, proof of user satisfaction and full details of amazing special offer free on request—Send name today.

Yale Specialty Supply Co.

131 W. 5th St., Kansas City, Mo.



## F. D. Pitts Company

INCORPORATED

219A Columbus Ave.

Boston, Mass., U. S. A.

### Merchandising

Radio

Since 1919

DEALERS — send for large and profusely illustrated catalog on the products of scores of nationally advertised radio manufacturers.

Wholesale Exclusively

"Pioneers in the Distribution of Radio"



place. Full instructions are given by the manufacturers that explain the easiest way to mount these dials.

This completes the assembly and the set is now ready to be wired.

*How to Wire the Set*

The design of this set is such that the wiring of the grid circuit of each of the six tubes, and other wiring that carries high potential currents, are made extremely short and are isolated from other parts of the circuit. In fact, this idea has been employed throughout and the leads are so arranged that the shortest connections may be used. The set should therefore be wired with bus-bar.

Either a tinned-copper bus bar or an insulated bus wire such as "Celatsite" may be used for the connections. All connections should first be shaped so that they will fit. They should then be soldered in place.

Refer to the wiring diagram in Figure 6 and more specifically to the picture wiring diagrams in Figures 4 and 5 for the exact way in which to run the wires.

As the wiring instructions given in these diagrams are so explicit, it is not necessary to explain them in detail.

Start by wiring the lower side of the sub-panel, V. Note that the 67-volt binding post, Y5, is connected to the mounting bolts of coils A2 and A3. On the top of the sub-panel, V, these mounting bolts are connected to the primaries of coils A2 and A3. Note also that the radio-frequency, by-pass condenser, K, must be connected directly to the ground binding post, Y8, as shown in the picture wiring diagram.

When the wiring of the lower side of the sub-panel, V, pictured in Figure 4 is finished, turn the set over and complete the wiring as shown in Figure 5. No verbal comment is necessary. The diagrams clearly show all the wiring.

The set is now ready to be installed.

*How to Install the Set*

Insert the finished set in the cabinet which has been provided for it. Then with a seven-conductor cable, connect the set to a standard 6-volt storage "A" battery and four 45-volt standard, heavy-duty "B" batteries as shown in Figure 10. Also connect a "C" battery of from 16 to 40 volts, as shown, if a UX-171 type tube is used in the last stage. The best "C" battery voltage can be determined by test. If a UX-112 type or UX-201-a type tube is used in the last stage use no "C" battery at all. In this case short-circuit the "C" battery binding posts with a piece of wire. This is unusual but the double-impedance amplifier operates better without a "C" battery except when a UX-171 type or UX-210 type tube is used in the last stage. Furthermore, the full 180-volt "B" battery potential should be used although good results can be obtained with only 135 volts.

# Excels in Every Valuable Characteristic

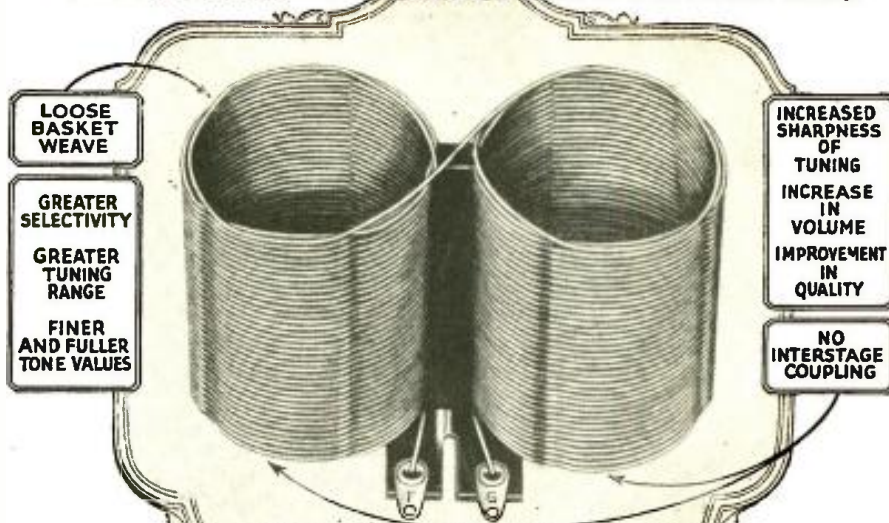

## The "Lekeless" Radio Frequency Transformer

170 TO 574 METERS - FOR .00035 MFD. CONDENSER

**Five Big Features**

- 1—Low apparent resistance at broadcasting frequencies.
- 2—Highest ratio of inductance over apparent resistance.
- 3—Lowest percentage of comparative increase of radio frequency resistance to direct current resistance.
- 4—Lowest apparent inductance at broadcasting frequencies compared to inductance at 1 Kc.

5—Lowest rate of decrease in ratio of inductance over apparent resistance at radio frequencies to the same values at audio frequencies.

**Superiority Shown in Every Test Applied**

These separate items of superiority are cumulative, and not only from the laboratory tests but from actual experience of amateurs and manufacturers this coil has proved to give the best results.

At your radio dealer's for \$2.50, or send his name with your remittance direct to us and we will see that you are supplied promptly.

Ask your dealer or send to us for free booklets of instruction, giving full information and working drawings for building:

- Improved Controllodyne 5-Tube Receiver
- General Utility Portable and
- Home 5-Tube Receiver
- De-Luxe Cle-Ra-Tone 3-Tube Receiver

## Benjamin Electric Mfg. Co.

120-128 S. Sangamon Street

New York: 247 W. 17th Street      Chicago: 448 Bryant Street      San Francisco: 448 Bryant Street

Manufactured in Canada by Benjamin Electric Mfg. Co. of Canada, Ltd., Toronto, Ontario

# BENJAMIN



Tuned Radio Frequency Transformers      Straight Line Frequency Condensers      All Benjamin Radio Products are of the same high standard as the far-famed Cle-Ra-Tone Sockets      Adjustable Brackets      Battery Switch

# Heavy-Duty RADIOHM



for  
**Simple Control  
of B-Battery  
Eliminator**  
and  
**C-Bias Regulation  
of Power Packs**

Tested and approved by the Raytheon Laboratories, and used in the L. C. Intermediate Power Pack, Centralab Heavy-Duty Radiohms provide full resistance variation with a single turn of the knob, allowing panel marking for proper setting to give various voltages.

Resistance remains permanent as adjusted (no carbon particles or discs), and remains same for any knob setting regardless of how often adjusted. Bushings and shafts insulated to withstand 1500 volts. Its smooth and noiseless operation will greatly improve your set. \$2 at dealers, or mailed C.O.D.



## Centralab Radiohm

Specified for the INFRADYNE, S-C, Samson T-C, Henry Lyford, Universal and many other circuits. Has no sliding contacts carrying current, and is both permanent and noiseless in adjustment. Furnished in 5 resistance valves, all smoothly variable to zero with a single turn. \$2 at dealers, or C.O.D.

### CENTRAL RADIO LABORATORIES

17 Keefe Ave., Milwaukee, Wis.

Makers of variable resistances for 69 makers of leading standard sets.

Canadian Rep.: Irvine W. Levine, Montreal.  
Great Britain Rep.: Rothmel, Ltd.  
London Australian Rep.: United Dist., Ltd.,  
Sydney.

# Centralab

Do not use less than 135 volts.

Connect the antenna and ground wires to the set, as shown in Figure 10. Make these two leads as short as possible and do not twist them together. Keep the antenna lead clear of both the ground and the battery leads.

Insert the tubes in the sockets. The tubes in sockets T1, T2, T4 and T5 should be of the UX-201-a type. The tube in socket T3 may be a UX-201-a or a UX-200-a type tube, preferably the latter if distance reception is desired. If a UX-200-a type tube is used insert the grid-leak in the clips of the grid condenser itself to provide a negative bias. If a UX-201-a type tube is used as detector, insert the grid-leak in the separate grid-leak mounting, to provide a positive bias.

If a UX-171 type tube is used in socket T6, it is much more economical to operate the set with a "B" power-pack instead of the four "B" batteries shown. Power-packs of this type may be purchased or constructed.

When an eliminator is used to supply the plate current a disagreeable noise known as "motor-boating" is sometimes heard. This can be removed by inserting three 10,000-ohm Lavite resistances between the power-pack and binding-post Y3, binding post Y4, and binding post Y5, respectively. If the power-pack is not supplied with a 67-volt tap, connect to the 90-volt tap and, if necessary, reduce the voltage supplied to the plates of the amplifying tubes by increasing the value of the Lavite resistance in series with this lead until the set can be easily neutralized.

#### How to Neutralize the Set

When the set has been installed, as described above, it must be neutralized before it is ready for continuous operation.

Turn on the battery switch, S, turn the rheostat volume control, N, to its maximum position and plug in your loudspeaker. Turn the antenna switch, R, so that only eight turns are included in series with the antenna.

Then take the second amplifier tube out of its socket, T2, wrap a little paper round one of the filament prongs and replace the tube in its socket so that it does not light. Then tune in some local station and adjust the capacity of the second neutralizing condenser C2 with an insulated screw driver. It will be noticed that at a certain value of capacity the signal is practically inaudible. If the capacity is either increased or decreased the signal again becomes audible. Set the neutralizing condenser C2 at the point at which the signal is inaudible. Then remove the paper from the filament prong and replace the tube in its socket.

Perform the same operation described above with the first tube in socket T1, adjusting the capacity of the first neu-

# Hoyt CELLCHEK



If you are trying to think of an acceptable, useful Christmas present for a friend with a Radio, give him one of these new and more accurate instruments, for testing his storage battery. The electrical meter indicates instantly whether the battery needs re-charging, is low or in good condition. And the CELLCHEK operates without the withdrawal of a drop of acid, keeps hands clean and protects rugs and furniture.

Price \$2.50

**BURTON-ROGERS COMPANY**  
Boston, Mass.

Sales Dept. for Hoyt Electrical Instrument Co.

## HAND BOOK FREE WITH Popular Radio

Kendall Banning, Editor, and Laurence M. Cockaday, Technical Editor of POPULAR RADIO, have compiled a book that will prove to anyone that he can build a set which will give distance, selectivity and tone volume, and at the same time a very definite basic knowledge of radio.

#### BUILD YOUR OWN SET AND SAVE MONEY

In "How to Build Your Radio Receiver," you will find complete specifications, constructional diagrams, photographs and instructions for building all of the following sets:

- A \$5 Crystal Set
- The Haynes Single-Tube Receiver
- A Two-Stage Audio-frequency Amplifier
- The Cockaday 4-Circuit Tuner
- A 5-Tube Tuned Radio-frequency Receiver
- The Improved Cockaday 4-Circuit Tuner
- The Regenerative Super-Heterodyne Receiver

#### ADVISORY SERVICE ALSO FREE

POPULAR RADIO maintains a big modern laboratory with a trained staff of investigators under the personal supervision of Mr. Cockaday. This Laboratory is always available through our Technical Service Bureau to answer, free to subscribers, by personal letter any problems you encounter which are not answered in either the "Handbook" or the magazine.

#### SPECIAL BOOK OFFER

You can secure a copy of "How to Build Your Radio Receiver" FREE, and have all the privileges of the Technical Service Bureau without additional expense, if you will send a remittance of \$3.00 in full payment of 12 months' subscription for POPULAR RADIO. (Or as an alternative, you may have the book and privileges of the Technical Service Bureau with POPULAR RADIO for 7 months only—for \$2.00. A two dollar bill will do.)

Remember you take no chance—we will refund your money in full if you are not more than satisfied.

### POPULAR RADIO

Department 15

627 West 43rd Street, New York



tralizing condenser C1, until the signal is also inaudible or at minimum audibility. Remove the paper from the filament prong and replace the first tube in its socket.

Now, revolve the two tuning dials, Z1 and Z2, in unison from 100 down to zero. The set should not oscillate. If it does, adjust the neutralizing condensers until the oscillations disappear.

**General Operating Instructions**

When the set has been accurately neutralized the set is ready for operation.

Stations are tuned in by turning the two vernier dials, Z1 and Z2. They should read approximately alike for any given station. Volume is controlled by the center knob turning the filament rheostat, N. This rheostat may be turned on full without harming the tubes. The resistance, M, is at all times in series with the filaments of the radio-frequency tubes.

The volume of the set should be carefully adjusted to give the best quality.

The antenna switch, R, should ordinarily be kept in the position in which only eight turns of the antenna coil, A1, are in series with the antenna. In this position low-wave stations are received best and the set is more selective for the reception of local stations. The switch, R, should only be turned to the opposite position when you wish to receive distant stations.

To maintain good operation watch your tubes and batteries. In common with every other set, good quality cannot be obtained with run-down batteries or inferior tubes.

If at all possible, use a large cone speaker with this set. If you use an inferior type of horn speaker or cone speaker you cannot possibly expect to obtain good tone quality. It is absolutely necessary to use a loudspeaker which will do justice to the set and which will accurately reproduce the undistorted electric energy supplied to it by the receiver.

**Radio Amateurs as World-Peace Makers**

WITH international communication a nightly occurrence, amateur radio stands to-day as one of the most powerful forces working for world peace. In this connection, there is no more significant statement than that made recently by one of our members, a retired army officer.

"Do you think," he said, "that any politician can stampede me into declaring war on my friends in other countries—friends with whom I hold nightly communications? Never!"

As the telephone, the railroad and the automobile have brought about a national understanding that to-day makes another civil war a virtual impossibility in these United States, so private two-way telegraphic communication is to-day quietly working toward world peace by bringing about international understanding and fellowship.

—HIRAM PERCY MAXIM

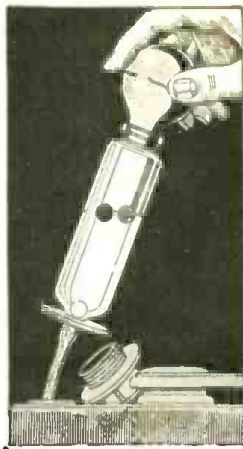

**Test Your Battery Easily Quickly Accurately**

**75c Complete**

**S O S Hydrometer**

Without withdrawing the Hydrometer. Balls make reading simple and easy.

Swim all three, charged fully  
Sinks the white, charge still right  
Sinks the green, charge is lean  
Sinks the red, charge is dead

Accurate—durable—no float to read or break. Over six million patented Chaslyn Balls used by leading Battery Manufacturers as standard equipment in Glass-cased Batteries and Power Units.

Ask your dealer. If he can't supply send seventy-five cents to:

**THE CHASLYN COMPANY**  
4609 Ravenswood Avenue Chicago

**\$10 Loud Speaker**

For \$10 you can get one of the finest loud speakers that money can buy—the new, perfected Dulce-Tone, the unit that utilizes all the scientifically developed, time-tested reproducing elements of your phonograph.

Dulce-Tone and your phonograph will improve the reception from any set. Greater volume, clearer tone, entire freedom from glare and distortion.

Nothing to install. Simple to use. Fully guaranteed. \$10 at your dealer's or with the coupon.

**THE GENERAL INDUSTRIES CO.**  
Formerly named The General Phonograph Mfg. Co.  
263 Taylor St., Elyria, Ohio

**Dulce-Tone**



Enclosed is \$10 for my Dulce-Tone. If I'm not satisfied after 10 days' trial, I'll return it and get my money back.

Name.....  
Street.....  
City..... State.....

**\$75 A WEEK BUILDING RADIO SETS — in your spare time**

**J**OIN the Radio Association of America. Learn how to build and repair radio sets. The Association will train you—start you out in business if you wish. Be the radio "doctor" of your community. \$3 an hour upwards easily made. Radio offers you a big money-making opportunity right now.

**Earns \$500 in Spare Hours**

"I have at last found myself," writes Lyle Follick, Lansing, Michigan, "I have already made over \$500 building radio sets after working hours." Werner Eichler, Rochester, N. Y., writes, "I have made over \$50 a week in my spare time."

Our members are starting radio stores, increasing their salaries, securing better positions, passing radio operator examinations, earning big money for the most enjoyable kind of spare-time work.

**What a Membership Means**

A membership in the Radio Association of America gives you the most up-to-date and thorough training in the Science of Radio.

You're taught how to build and repair all kinds of sets. You're given the train-

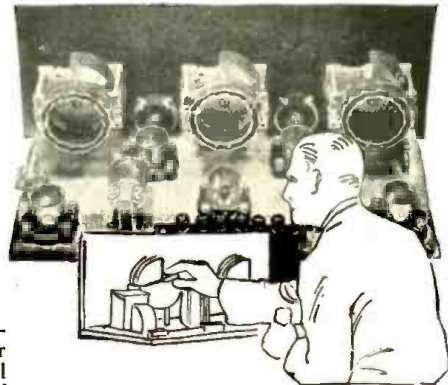

ing you need in preparing for a Licensed Radio Operator's examination. You receive the privilege of buying parts at wholesale prices.

You're helped to make money.

**Join the Association Now**

If you're interested in Radio for either pleasure or profit, join the Association without delay, because we have a plan whereby your membership may not—need not—cost you a cent. Only a limited number of these memberships are acceptable. Write now for details. Write before it's too late.

This Association has prepared a beautiful book that gives figure-facts regarding the profit possibilities of the Radio Industry, the purpose of the Association, and the details of the Special Membership Plan.

**Mail This Coupon**

**RADIO ASSOCIATION OF AMERICA**  
Dept. PR-1---4513 Ravenswood Ave., Chicago

Send me your book and details of your Special Membership Plan.

Name.....  
Address.....  
City..... State.....

## RADIO CABINETS

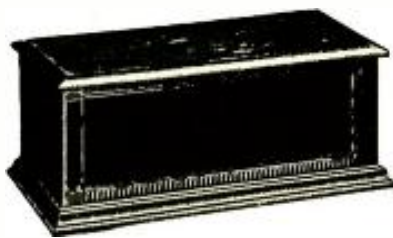

**Our Queen Cabinet**

Made in genuine black walnut only.

Our Queen cabinet is without a doubt the finest cabinet on the market. The tops of these cabinets have butt walnut veneer on solid black walnut core. The sides are solid walnut crossed grained and selected for beauty. The pillars on all corners are solid walnut; the front pillars have butt walnut overlays. The backs, bases and base mouldings are selected gumwood. These cabinets have a beautiful hand rubbed genuine lacquer finish. Piano hinges and lid holders. You positively will not be disappointed in the distinctive beautiful appearance of same.

No.	For panel	Depth back of panel	Genuine Walnut Our Price
718-10	Queen 7x18	10 in.	\$9.90
721-10	Queen 7x21	10 in.	10.15
724-10	Queen 7x24	10 in.	10.70
728-10	Queen 7x26	10 in.	11.25
730-10	Queen 7x30	10 in.	12.00
718-8	Queen 7x18	8 in.	8.70
721-8	Queen 7x21	8 in.	9.00
724-8	Queen 7x24	8 in.	9.55
726-8	Queen 7x26	8 in.	9.90

Transportation extra.  
The upper panel is removable to allow set to slide into place through groove. No screws necessary.

Panel or mounting board not included.

Send for Catalog showing  
Consoles, Desks, Radio Tables.

**UTILITY RADIO CABINET COMPANY**  
448-27th Street Milwaukee, Wisconsin

## Write

For Our Best

## Prices

on the following well-known circuits

## HENRY-LYFORD

## LC-27

The LC-27 Junior

## POWER-PACK

## HAMMARLUND

## Hi-Q

## INFRADYNE

## BROWNING-DRAKE

Also

Complete Parts for all other Circuits

Dealers: Write for Catalog

## HEINS & BOLET

Wholesale and Retail

44 Park Place New York



## LISTENING IN

PRACTICAL pointers from experimenters and broadcast listeners. What helpful hints can YOU offer to your fellow fan? Readers are invited to address their letters to the Editor of this Department.

### How I Made an Electric Soldering Iron Support

I HAVE built a number of radio receivers; in fact I believe that I have completed more than one hundred.

For soldering I use an electric soldering iron as it enables me to do a much neater job on the wiring.

When the iron gets hot it has to be placed on a piece of metal, glass or porcelain to keep it from burning the table top while it lies idle between the actual soldering operations.

I had an old desk extension for a telephone, as shown in Figure 1, and conceived the idea of using it for a soldering iron support.

Now, I never burn the table or anything lying on it, as I simply put the iron in the round part of the support, that ordinarily holds the telephone, and push it back out of the way.

I find this a very handy idea and believe that my fellow set-builders would do well to try it.

—ROBERT W. TAIT, *New York City*

### How I Improved Selectivity By the Use of Two Receivers

THREE months ago I built my first set, a simple crystal set with one dial control, as described in POPULAR RADIO.

A month later I built a larger five-tube receiver according to instructions in your magazine.

I live only a half a block away from station WFBH. When I had completed the set I found that I could not separate WFBH from stations on nearby wavelengths although I could get WJZ and WEAF without any interference.

One night when my smaller brother had been listening to the crystal set, I happened to turn on the large five-tube receiver, about three feet away from the other, with no aerial or ground. Immediately I began to pick up signals and I found that I could tune in all of the local stations without interference from WFBH.

Later I found that by turning the crystal set around so that it assumed

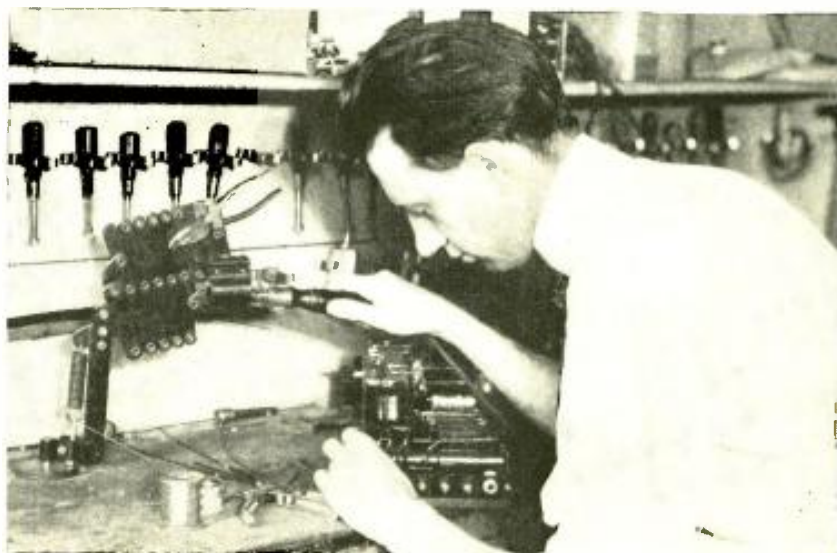

### HOW TO MAKE A SUPPORT FOR YOUR IRON

FIGURE 1: The soldering iron fits into the fixture on the extension that is ordinarily used for holding the telephone. The extension may be pulled out or turned in any position so that the iron will always be handy for soldering.



# Cooper **A** Eliminator

The "A" Battery is gone - - -  
- - - forever!

**N**OW you can enjoy radio without having to put up with the inconveniences caused by the storage "A" battery, for the "A" battery has been totally eliminated as a radio necessity.

The Cooper "A" Eliminator actually eliminates the "A" battery with all its messy watering and charging. Just plug the Cooper "A" Eliminator into the light socket and turn on the set . . . a simple throw of a switch and the current is on . . . tumble back the switch and the

current is off . . . supplies up to 2½ amperes of current, enough to operate any make of receiver using up to ten six-volt tubes.

The Cooper "A" Eliminator is not a power unit. It employs no trickle charger. It needs no attention of any kind . . . no batteries to water . . . no acids or liquids to replace . . . operates purely on a rectification and filtration principle . . . creates noiseless, distortionless filament current direct from the house lighting system.



Good radio dealers in most cities have the Cooper "A" Eliminator on display, \$87.50 (tubes extra); slightly higher West of the Rockies.

### This Free Booklet Tells the Story

We have prepared a very complete folder describing the Cooper "A" Eliminator and the principle upon which it is built. May we send it to you?

### DEALERS—JOBBER

The Cooper "A" Eliminator is entirely different from the many "A" power devices on the market. It offers tremendous sales possibilities. Limited distribution and full protection to trade outlets insure legitimate profit. Write for full particulars of our exclusive proposition.

**THE COOPER CORPORATION**

Radio Division—Dep't P

**CINCINNATI, OHIO**

Founded 1904—Factories, Cincinnati and Findlay, O.

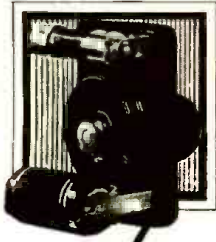

# Featuring

## CARBORUNDUM

REG. U. S. PAT. OFF.

### STABILIZING DETECTOR UNIT

They say that even hardened laboratory engineers are enthused over the new Carborundum Eight-Tube Super Set.

It is an absolute revelation and one of its great features is the Carborundum Stabilizing Detector Unit employed as a second detector.

With this marvelous set you will get crystal clear tones at super-hot volume to spare—greater distance—increased sensitivity

And one of the great reasons for its remarkable success is the

**\$3.50**

IN U. S. A.  
WITHOUT  
DRY CELL

### CARBORUNDUM STABILIZING DETECTOR UNIT

Improves Any Set

CARBORUNDUM GRID LEAKS  
CARBORUNDUM COUPLING RESISTORS

Send for new Hook-Up Book D-5

• THE CARBORUNDUM COMPANY, NIAGARA FALLS, N. Y.

SALES OFFICES AND WAREHOUSES IN

New York : Chicago : Philadelphia : Cincinnati : Cleveland : Boston : Detroit  
Pittsburgh : Milwaukee : Grand Rapids  
The Carborundum Co., Ltd., Manchester, Eng.

a certain position in relation to the big set, that I could get the stronger signals from the bigger set. In this way I cut out all my interference and am able to get out of town stations even while WFBH is going full blast.

—H. B. KRONTIN, Newark, N. J.

### How I Log Stations

I KEEP a small index file with a separate card for each station that I tune in on my set. I file the stations away alphabetically by call letters in one part of the file and alphabetically by cities in another section.

I include in this file all the data on wavelength, frequency, dial settings and strength of signals and I go over the file once every month or so with additional information on fading, quality of reception and signal strength. In this way, I am able to tell whether my set is working properly and keep a check on any new stations that may have started up as time goes by.

I also find this file a great help in logging and tuning in any out-of-town stations when I have visitors who want to hear how the set performs.

—HARRY SELTZ, Atlanta, Ga.

### A Handy Support for Drilling Panels

I HAVE found the following little "kink" useful in drilling large and unwieldy bakelite panels.

Cut a piece of wood, a half-inch or one-inch thick to a size about half again as big as the panel. Place the panel in the middle of this board and hold it in position by four blocks of wood, one at each edge, nailed to the wood underpiece.

Figure 2 shows a cross-section of one of these blocks of wood.

The heavy underpiece of wood serves a triple purpose; it keeps the drills from biting into and marring the table top after they have gone through the bakelite, it keeps the back of the bakelite from breaking out and the weight of it keeps the panel from sliding all over the work bench. The four blocks keep the panel held firmly down against this heavy piece of wood (as shown in Figure 2), and keep it from moving while the laying-out and drilling operations are going on.

—CHARLES F. FELSTEAD (6 CU), Los Angeles, Cal.

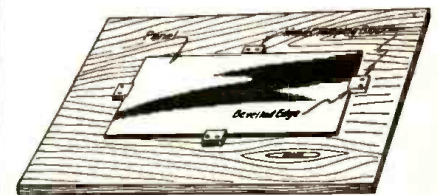

Harry Wood Underpiece

### A PANEL SUPPORT

FIGURE 2: How a panel may be fastened securely to the work-bench by means of wood clamping blocks for an accurate drilling job.

Why your set needs **AMPERITE**

Because clear reception and long tube life necessitate that delicate and self-adjustable control which only AMPERITE can give.

Eliminates hand rheostats. Simplifies set-wiring.

Accepted as the only perfect filament control in every popular construction set.

Price \$1.10 Complete

FREE—Write for "The Radiall Book," containing the latest popular hook-ups and construction data, to Dept. P. R.-1.

**Radiall Company**  
50 FRANKLIN ST., NEW YORK

**AMPERITE**  
REG. U. S. PAT. OFF.

The "SELF-ADJUSTING" Rheostat

### For the K.H.-27, also!

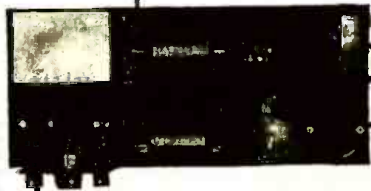

### The Intermediate Power Pack

DEVELOPED by Laurence M. Cockaday of POPULAR RADIO. Designed to operate the LC-27, K. H.-27 or any other power tube set. Gives a constant, uniform current of 180 volts at 60 mls. without distortion or hum. Voltage taps as on standard B batteries. No liquids or moving parts. After it is connected you can forget it.

You can build the Intermediate Power Pack in two hours, ready for operation, it is so simple and easy to construct.

A unique feature is a means provided for dispensing with the antenna on a Neutrodyne or any type of Tuned R.F. Receiver.

Complete list of parts as used in the laboratory model, including a 40 volt C bias for the UX-171 power tube, and Yaxley Automatic Relay \$47.50.

If your dealer cannot supply you, send check or money order direct.

### Filtrex B Power Supply

The Intermediate Power Pack is also built complete and encased in a beautiful metal case, finished in Duco midnight blue. Guaranteed against mechanical defects. Approved by POPULAR RADIO LABORATORY. Dealers write for information.

### CONNER CROUSE CORP.

52 Vanderbilt Avenue, New York



## A Simple Circuit Tester

In testing out receivers for faults in the coils or short circuits in the condensers, I find it is quite a help to install a series lamp testing outfit. This consists of a double length of lamp cord of about 6 feet in length with a lamp socket in series with one of the wires. In this lamp socket I place a 25-watt carbon lamp and I attach two wooden handle prick-punches to the ends of the wires.

To test out a coil I take the two wooden handles, one in each hand, and touch the bare metal ends of the punches to the two ends of the coils. If there is no open circuit the lamp will glow but if the wire is broken in the coil the lamp will not light.

In testing a condenser the metal ends of the two punches should be attached to the rotor and stator terminals respectively. If the lamp lights the condenser is shorted but if it is in good condition the lamp will not light.

Of course, the coils and condensers should be disconnected from the rest of the circuit while they are being tested.

—G. A. HOPKINS, *New York City*

\* \*

## How I Insure Good Contact to My Vacuum Tubes

PERIODICALLY I take out all the tubes used in my set and clean the bottoms of the prongs with a small piece of very fine emery paper. This brightens up the drop of lead on the bottom of the prongs and insures a better connection to the spring contacts in the sockets.

I have been able to clear up reception and improve the whole set in a few minutes by this simple process. The tubes often get dirty contacts and add resistance to the circuits and should be cleaned in this manner every month or so.

—EDWARD RAMMEON, *Lynchburg, Va.*

\* \*

## The Pin-jack Voltmeter

I HAVE found that I can economize on the instruments that are used in my experimental receivers by installing pin jacks on the panel, spaced properly to accommodate the standard makes of pin-jack voltmeters, so that I can use a single voltmeter and measure the "A" battery voltages on a number of sets with which I am experimenting.

It is a big job to prepare the large holes to fasten a regular voltmeter on the panel and a new voltmeter must be obtained for every set that is built. By the use of the above mentioned jacks and a pin-jack voltmeter, I can use the same instrument over and over again without rearranging the wiring of the set in the least.

—MAURICE SEIGRIST, *Los Angeles, Cal.*

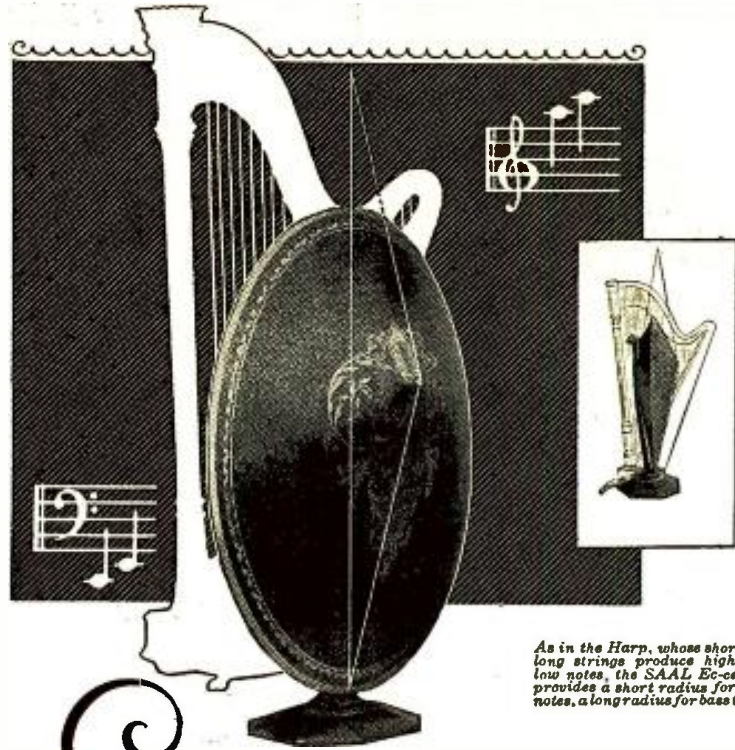

As in the Harp, whose short and long strings produce high and low notes, the SAAL Ec-centric provides a short radius for high notes, a long radius for bass tones.

# Ec-centric

—the new scientific SAAL EC-CENTRIC CONE  
whose balanced tone color is the sensation in radio today

Your receiving set may be getting all of the best that's on the air—but are you getting it? You cannot know the capabilities of your radio set, in volume, clarity, beauty of tone till you give it the advantage of the Saal Ec-centric.

On the principle of the harp, whose short strings produce the high treble notes, whose long strings give forth the deep base tones, the Saal Ec-centric, with its "center" actually off-center, provides a short vibrating radius for the high notes, a long radius for the rich low tones.

These exact relative proportions of vibrating area, definitely fixed by scientific principles, are provided for the first time in the Saal Ec-centric Cone. All rumble or "barrel tone" is eliminated. True balanced tone from soprano, flute and violin to pipe organ or 'cello. A demonstration will convince you.

Hear the Saal Ec-centric at your dealer's, or write us to direct you where it can be heard.

The Saal Ec-centric comes in two models: 20-inch, \$25;  
14-inch (Junior), \$15. Slightly more west of Rockies.



The SAAL Pedestal is an ornament to the most beautiful surroundings. Its pure wooden tone chamber, three feet in length, gives exceptionally clear mellow reception. Price, \$38



The famous SAAL Soft Speaker, the outstanding speaker of its type. Is giving satisfaction regardless of the set or equipment used. Standard with radio engineers. Price, \$22.50

# SAAL

H. G. SAAL COMPANY, 1800 Montrose Ave., Chicago, U. S. A.

# DEALERS AND PROFESSIONAL SET - BUILDERS

WRITE FOR  
LITERATURE  
AND OUR PRICES ON

The **LC-27** ALLEN-ROGERS  
GUARANTEED KIT

Hammarlund  
**Roberts**  
HI-Q

SILVER-MARSHALL  
CORBETT CABINETS  
BROWNING-DRAKE  
AMERTRAN  
SAMSON  
BRUNO  
KARAS

The **RADIO SHOP** of  
20 Worth St., Stamford, Conn.  
SERVICE FOR SET BUILDERS

QUALITY **DONGAN** PRODUCTS



# 1582

Specified for \$11 List

A Conspicuously  
Successful B-Eliminator  
incorporates

Dongan Radio-Power Unit

# 1582

for use with the Raytheon Tube

Thousands of these B-Eliminators have been built and are giving 100 per cent satisfaction. Dongan No. 1582 consists of 1 Transformer and 2 Chokes, designed in conjunction with Raytheon engineers. The Radio-Power supply is quiet, smooth and consistent all the time.

Built into handsome black metal case—very durable. Complete instructions for building. Send check or money order at once.

No. 147 transformer designed for use in connection with the output circuit, avoids the loss of B voltage due to the high resistance of the loud speaker and eliminates all risk of damage to the speaker. List . . . . . \$4.50

**DONGAN ELECTRIC  
MANUFACTURING COMPANY**  
2983-3001 Franklyn St. Detroit, Mich.  
Transformers of Merit for Fifteen Years

TRANSFORMERS OF MERIT FOR FIFTEEN YEARS

## How to Build the LC-Junior Power-Pack

(Continued from page 35)

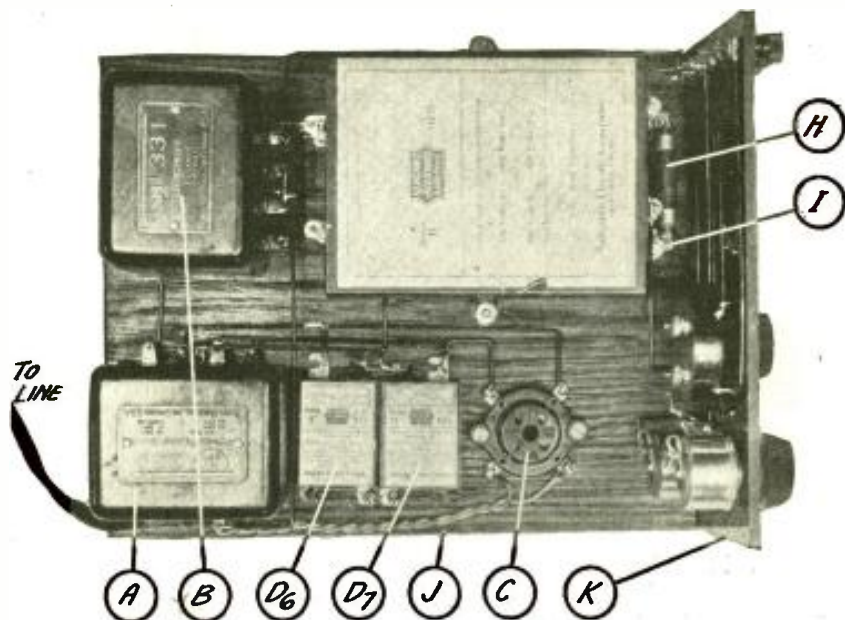

THE POWER-PACK AS SEEN FROM ABOVE

FIGURE 6: The relative positions of all the parts that are mounted on the baseboard are shown here; the parts are designated with letters which correspond with those given in the list of parts.

### How to Wire the Unit

The mechanical and electrical design of this device have been worked out with extreme care through months of experiment and test. The whole unit is self-shielding; and it is due to this as well as to the electrical design of the circuit that no hum is produced in the receiving set to which it is attached.

It is recommended that all wiring be done with an insulated, solid, round bus wire.\*

\*The type of bus wire used in all the experimental models of this unit was "Celatsite."

Start the wiring by connecting up the leads from the transformer terminals to the condenser and socket.

Then, run the wiring to the unichoke and the remaining terminals of the condenser bank, finally finishing up with the three variable resistances and the fixed resistance and binding posts. Be sure that none of the leads touch each other. They should be spaced about 1/4 of an inch wherever necessary. This completes the wiring and the power unit is ready to be installed in the cabinet.

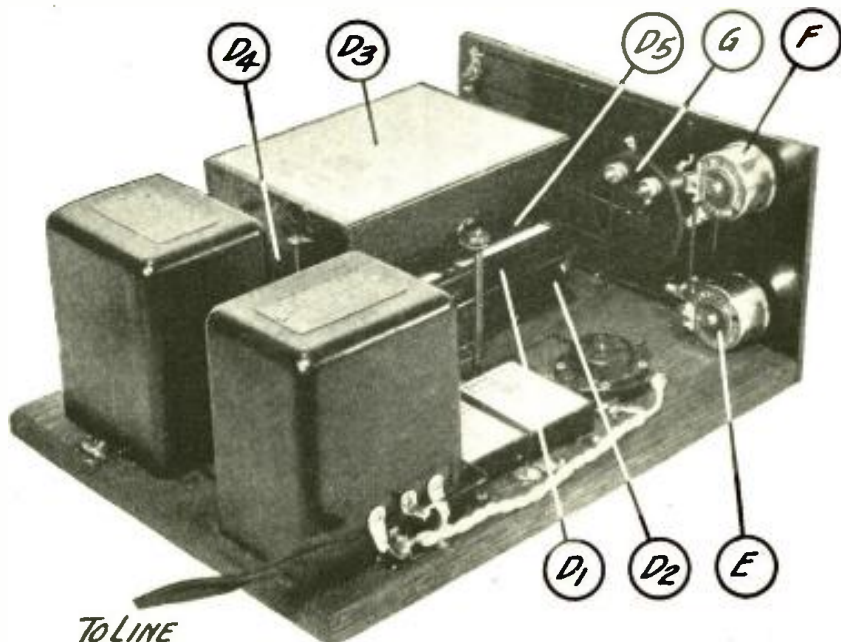

A REAR VIEW OF THE UNIT

FIGURE 7: This picture shows the back of the panel with the three resistances mounted upon it and gives a better idea of how the condenser bank is fastened to the baseboard.



# GENERAL RADIO

Parts and Accessories have a  
Laboratory Background of  
more than a decade

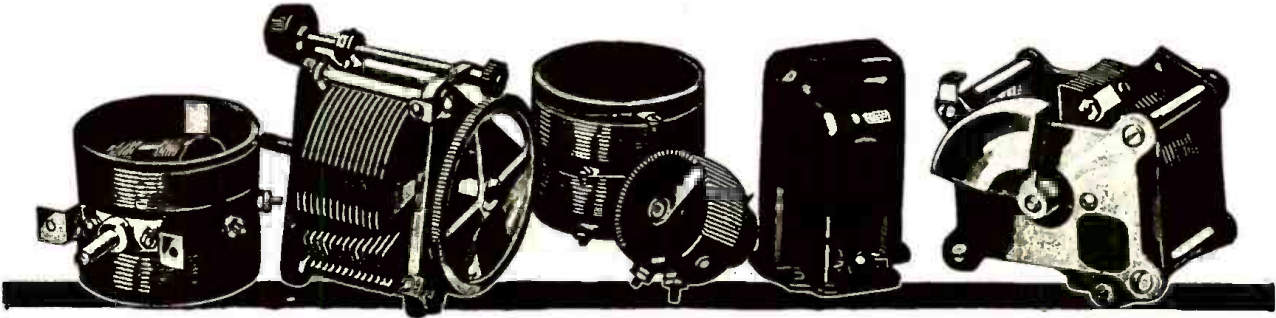

For more than a decade the General Radio Company has been manufacturing radio laboratory instruments and parts—the outstanding feature of which is **PRECISION**. These instruments have been supplied in ever increasing quantities to many well known radio laboratories of the country, including the General Electric Company, Westinghouse Electric Manufacturing Company, Bell Telephone Laboratories, Bureau of Standards, U. S. Navy, U. S. Signal Corps, as well as the leading engineering colleges.

Today, General Radio precision instruments are standard equipment in nearly all the radio laboratories throughout this and many foreign countries.

Through the merits of design, performance, and price, General Radio instruments for the scientist or set-builder are universally recognized as the Standards of Quality.

Since the early days of radio, amateur operators and setbuilders have looked upon the General Radio Company as a time-tried producer of dependable apparatus.

The conservative buyer of radio parts looks first to the reputation of the manufacturer. He knows from his own experience and those of others whether this reputation warrants his confidence. It is this self-same confidence upon which the popular preference for General Radio parts and accessories is based.

In building a radio receiver, remember that its performance depends primarily upon two things; an efficient circuit and the use of good parts.

Wherever you find a popular circuit you will invariably find General Radio parts.

Ask your dealer or write for our latest parts bulletin No. 926.

**GENERAL RADIO CO.**  
**CAMBRIDGE : : MASS.**

# GENERAL RADIO

*Behind the Panels of Better Built Sets*

# PARTS



Once this little jacket of live rubber slips over the bowling tube—you're through!

All over in less than one second! You can get it in sizes to fit every tube. Just ask for the

# Mc DONALD HOWL ARRESTER

"It Stops that Howl"

(TRADE MARK)

Sole Selling Agents for the U. S. A.  
SPARTAN ELECTRIC CORPORATION  
350 West 34th Street, New York City

Licensed and Manufactured by the  
Scientific Products Canada, Ltd.

MADE IN U. S. A.



PATENT PENDING

75¢ each

At all dealers



### How to Install the Power-pack

The articles in the November and December issues of POPULAR RADIO explained at some length the installation of the LC-Senior Power-pack and the LC-Intermediate Power-pack. The first unit is a high-powered, expensive installation that is necessary only where the greatest volume is an essential. The Intermediate Power-pack is a somewhat less expensive job and furnishes an intermediate power for operation of the LC-27 receiver, or any other receiver equipped with a power tube.

The Junior Power-pack will also operate with the LC-27 receiver and furnish plenty of volume and the same type of tone quality for ordinary home use. If the diagram in Figure 1 is followed on installation no mistakes can possibly occur.

Place the power-pack in the lower part of the cabinet with the "A" supply unit, which consists of a Balkite charger and a Joyce "A" power, in position, as shown. These positions are taken from the rear.

Wire up the units exactly as indicated in Figure 3; the leads are shown in this diagram by heavy lines. The input wire from the Balkite charger should be connected in parallel with the input wires to the Junior Power-pack and these should be equipped with a switch for turning them "on" and "off" and thus supplying the "A" and "B" current to the set. The battery switch at the set should also be turned "on" and "off" when the set is put into use or turned off, as the Joyce "A" power unit continues to furnish voltage even when the AC line is shut off. When the units have finally been connected, place a UX-213 full-wave type rectifier tube in the socket in the Junior Power-pack, making sure that the pin on the tube is turned to the correct position. Then, turn on the AC switch (and the battery switch at the set) and the receiver should begin to function.

After a station is tuned in, the "C" battery control, G, on the Junior Power-pack should be adjusted, so that the tube draws the correct amount of plate current. This may be determined by placing a 50-milliamper milliammeter in series with the plate circuit of the last tube and adjusting the control, G, for the correct plate current on the last tube. Either a UX-112 type tube or a UX-171 type tube is recommended. For the maximum output, the UX-171 tube will be found preferable. This is the only adjustment to make and the unit is ready for operation continuously and should give excellent service throughout the life of the tube, which should be for a year or more.

The power unit is free from hum and will supply enough volume, when used with a receiver, to bring out all the low tones without distortion and to give really lifelike reproduction.

## AUDIO FREE AMPLIFICATION

The four types thoroughly explained in a fully illustrated booklet 9"x12". This booklet will be sent to you absolutely FREE if you will send me six cents in stamps to cover cost of handling and postage.

W. McMANN  
DEPT. PR  
64 CHURCH STREET  
NEW YORK CITY

## FREE SIMPLIFIED BLUE PRINTS

You know how helpful, interesting and practical POPULAR RADIO is. You fully appreciate that at \$3.00 a year it is a real bargain. Consequently you should find it easy to convince one, two or more of your friends, who are not now subscribers, of the unusual value when any one of these thirteen sets of Simplified Blueprints (described on Page 104) is offered free with their twelve months' subscription for POPULAR RADIO at the regular price of \$3.00. In addition to the Blueprints given to your friends we will allow you one set free for each new subscription you send us with a \$3.00 remittance. Five new subscriptions and remittance of \$15.00 would entitle you to five sets free.

Only one set of Blueprints free with a renewal subscription whether your own or a friend's.

POPULAR RADIO, INC., Dept. 13  
627 West 43d Street, New York City

Enclosed is my remittance of \$..... covering ..... annual subscriptions for POPULAR RADIO (names on sheet attached). Send me set(s) checked below.

- |                          |            |                          |            |
|--------------------------|------------|--------------------------|------------|
| <input type="checkbox"/> | Set No. 4  | <input type="checkbox"/> | Set No. 18 |
| <input type="checkbox"/> | Set No. 6  | <input type="checkbox"/> | Set No. 19 |
| <input type="checkbox"/> | Set No. 12 | <input type="checkbox"/> | Set No. 21 |
| <input type="checkbox"/> | Set No. 14 | <input type="checkbox"/> | Set No. 22 |
| <input type="checkbox"/> | Set No. 15 | <input type="checkbox"/> | Set No. 23 |
| <input type="checkbox"/> | Set No. 16 | <input type="checkbox"/> | Set No. 24 |
| <input type="checkbox"/> | Set No. 17 | <input type="checkbox"/> | Set No. 25 |

(See page 104 for description of Sets)

Name.....

Address.....

Foreign postage 50c extra. No extra for Canada.





What Built the Reputation of

Mayolian B SUPPLY

The "B" Without a Buzz



Type 612 Delivers 40 Mils at 180 volts All voltages are adjustable Complete with Raytheon Tube \$42.50

PIONEERING in battery elimination, Mayolian was probably the first manufacturer to adopt the now far-famed Raytheon tube as the heart of its B Supply Units, and to earn the approval of Raytheon. From that day to this, each Mayolian has been rigidly held to the standards of the Raytheon and Mayolian laboratories. Years of exhaustive research, extreme precision in manufacture, skilled supervision—all these have contributed to the pre-eminent position of Mayolian.

Today, no matter what make or type of receiver you have, there is a Mayolian to give it a continuous, uniform, noiseless "B" Supply—direct from the nearest light socket, at half the cost of burning a 25-watt lamp.

The Heavy Duty Types of Mayolian employ the new Raytheon B H tube

The nearest dealer will gladly demonstrate in your own home. Write us.

MAYOLIAN RADIO CORPORATION 1668 Webster Ave., New York, N.Y.

Pioneers in Battery Elimination



The Power of Niagara— The Quiet of an Arctic Night

WITH THE INVENTORS



CONDUCTED BY WILLIAM G. H. FINCH

THIS department will keep you in touch with the latest inventions of interest on which patent rights have been granted, and which are significant contributions to radio art.

A Novel "A and B" Battery Charging Switch

PATENT No. 1,570,499, that is illustrated in Figure 1, was recently issued to John F. Keane, of Bridgeport, Conn. It describes a battery charger switch particularly designed for radio use.

The object of the invention is to provide a control switch that will permanently connect a radio set, storage "A" and "B" batteries and a charger, so that, through the manipulation of the switch, either of the batteries may be charged or the set may be connected for operation.

It has usually been the practice to connect the battery to the charger, and at the same time, to disconnect the set. This is inconvenient, time-consuming and open to the danger of making wrong connections which might result in damage to the set.

The present invention provides a central control switch, to which the batteries, set and charger are connected. By means of this switch the batteries may be individually connected to the

charger in the proper electrical relation while the set is at the same time automatically disconnected. On the other hand when the set is electrically connected to the batteries by means of the switch, the charger is automatically disconnected.

This switch also acts as a safeguard against improper connections of the set or the charger to the batteries which might cause the tubes to be blown out, or the set to be grounded during the charging.

A Correction

ON page 96 of the January, 1926, issue of POPULAR RADIO appeared a review of patent No. 1,545,697, issued to Oscar C. Roos, for a system of eliminating or reducing static in radio reception. This review stated that the patent was applicable to radio broadcast reception. The inventor advises that the invention is successful and practical when employed in radio telegraph reception, but not in radio telephone reception. The reviewer was misled by the language

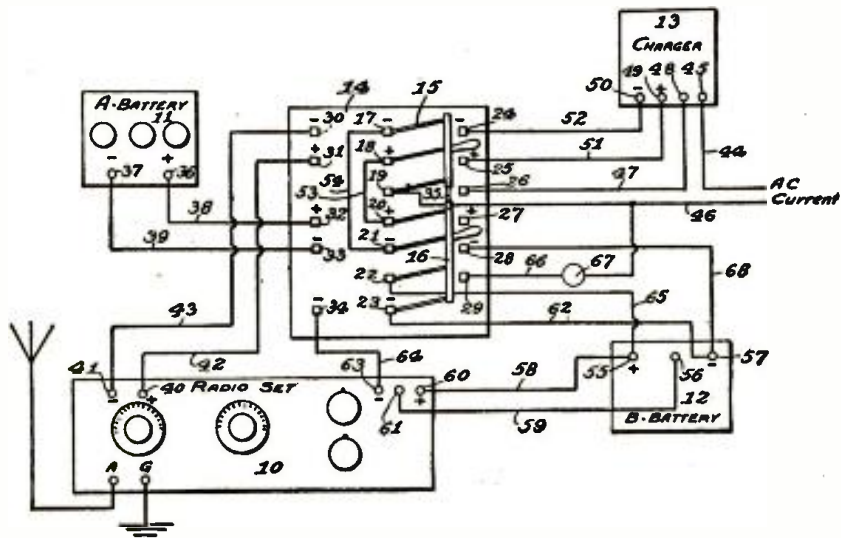

A NOVEL BATTERY CHARGING SWITCH

FIGURE 1: This seven-pole, double-throw switch will connect the charger to either the "A" or "B" battery or will cut off the charger and connect both batteries to the receiver as desired.





# Your program starts with a snap—

It does if your "snap" judgment is good! Because good reception demands lively batteries. And that's what you get when you snap on your Rectigon to do your charging. The time to start bringing in tomorrow's snappy program is tonight—after the last station signs off. You just plug into the light socket and attach the terminals. That keeps your batteries at their peppy best. That saves service station bother. And you'll never be caught with batteries run down, or absent for charging when the week's best program is on the air.

## when you charge 'em at home with

# The Westinghouse Rectigon Battery Charger

©, 1927, W. E. & M. Co.

No noise as it charges—not a bit of fuss. Not even a murmur that would disturb the mildest slumber.



No acids, no chemicals—no moving parts—nothing to spill or burn. No muss, no worry. You'll have no spoiled rugs, no ruined clothing.



Saves its cost in short order—Count the dollars spent in a few trips to the service station and you'll hotfoot it for a Rectigon, for the good it does your pocketbook as well as your batteries.



Charges both "A" and "B" batteries—Keeps both packed with power. Bulb is used for "B" battery charging and is enclosed, like all other parts, in metal, safe from accident. (Rectigon charges automobile batteries, too.)



Perfect safety for your set—If you tune in while you're charging there'll be no harm either to set or batteries. Nor will batteries be discharged if anything happens to the current while your Rectigon's attached.



THE RECTIGON is a superb Westinghouse product. Things you *can't* see, like extra heavy insulation, things you *can* see, like the durably enameled case—all are of highest quality. Westinghouse also manufactures a complete line of radio instruments, and Micarta panels and tubes.

WESTINGHOUSE ELECTRIC & MANUFACTURING CO.

Tune in on KDKA · KYW · WBZ · KFKX

No Storage Battery Radio is Complete Without a Rectigon

First in the Field  
Specializing in  
Cockaday Kits

# S. HAMMER RADIO CO., 303 Atkins Ave. Brooklyn, New York

Cockaday Sets Now Made Easier to Build by Our New "Ready-to-Wire" Plan  
**50% of Your Time, Work and Worry SAVED!**

All you need do is to connect bus-bar according to diagram, solder and your set is finished. These Kits are sent to you completely mounted, and assembled on a Veneered Mahogany baseboard and genuine bakelite panel, drilled and engraved. Genuine parts used as listed below, exactly as used in Mr. Cockaday's Laboratory Model. COMPARE OUR OFFER!

## LC-27 BROADCAST RECEIVER

### SENIOR AND INTERMEDIATE POWER PACKS

- 1 Hammarlund mid-line dual condenser, .000275 mfd. \$ 7.50
- 1 Hammarlund mid-line single condenser, .000275 mfd. 4.65
- 1 Precision Duo-Octoform coil set comprising one antenna coupler and two inter-stage couplers. 10.50
- 1 Amertran De Luxe first stage transformer. 10.00
- 1 Amertran De Luxe second-stage transformer. 10.00
- 1 Amerchoke # 854. 6.00
- 1 Dubiller or Tobe 4 mfd. Filter condenser. 5.50
- 1 Dubiller filter condenser. 1 mfd. .60
- 1 Mar-Co illuminated control, scale 0 to 100 3.50
- 2 Mar-Co small controls scale 0 to 50 and 50 to 0. 1.50
- 1 Carter Battery Switch. .65

- 1 Samson radio-frequency choke coil # 85. \$1.50
- 3 Aerovox, mica fixed condensers. .00025 mfd. 1.05
- 1 Durham or Daven Resistor 4 meg. .50
- 1 Lynch Grid Leak Mounting. .35
- 1 Carter Gem Jack. .25
- 1 Carter variable resistance, 0-10,000 ohms. 2.00
- 12 Eby binding posts. 1.50
- 5 Benjamin UX Sockets. 3.75
- 1 Ampette No. 1 Mechanical Kit (consisting of aluminum shields, binding post strip, decorated panel and Tait brackets. 12.50

READY-TO-WIRE KIT PRICE **\$85<sup>20</sup>**

LC-27 SENIOR POWER PACK KIT \$65<sup>20</sup>

LC-27 INTERMEDIATE POWER PACK KIT \$47<sup>50</sup>

SILVER SHIELDED SIX KITS *In Stock Now!*

HAMMARLUND-ROBERTS HI-Q KITS

## NEW! Authorized Headquarters for the KENNETH HARKNESS KH-27 Receiver

The Above Kits Can Also be Obtained  
Completely Wired to Specifications

Write for our interesting special circular which we have prepared  
on the LC-27 Receiver and above Kits.

Authorized service station for the LC-27.

DEALERS: WRITE FOR SPECIAL DISCOUNTS

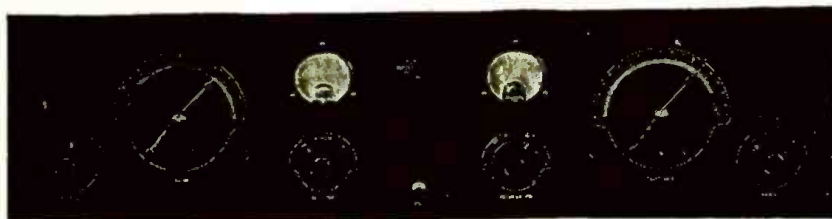

A New and Advanced Model

# Norden-Hauck Super-10

## Highest Class Receiver in the World

Panel Size: 36" x 9" x 1-4"

Weight: 55 lbs.

THE NORDEN-HAUCK SUPER-10 is an entirely new and advanced design of Receiver, representing what we believe to be the finest expression of Modern Radio Research Engineering. It is the product of years of experience devoted exclusively to the attainment of an ideal Broadcast Receiver—regardless of cost. Results obtained in every respect will upset all your previous ideas of good radio reception. Here are only a few of the host of features that place the NORDEN-HAUCK SUPER-10 far in advance of competition.

- 10 tubes employed to give perfect reproduction with unlimited range and volume power.
- Super selectivity on all wave lengths.
- Built to Navy Standards.
- Wide wave length range—with removable coils. Adaptable 35 meters to 3600 meters if desired.
- Use Loop or Antenna.

- Simple to operate, having only two major tuning controls.
- No Harmonics. Signals are received only at one point.
- Special Power Audio Amplifier, operating any loud-speaker and eliminates necessity of external amplifier.

The NORDEN-HAUCK SUPER-10 is available completely constructed and laboratory tested, or we shall be glad to supply the complete engineering data, construction blue prints, etc., for those desiring to build their own receiver.

**Upon Request** Complete literature, attractively illustrated, will be gladly mailed without charge, or full size constructional blue prints, showing all electrical and mechanical data, will be promptly mailed postpaid upon receipt of \$2.00.

Write, Telegraph or Cable Direct to

**NORDEN-HAUCK**  
Incorporated  
ENGINEERS—MARINE BUILDING  
Philadelphia, U. S. A.

TEAR OFF AND MAIL TODAY

NORDEN-HAUCK, Inc., Philadelphia, U. S. A.

Gentlemen:—

Please send me without cost or obligation on my part, attractive illustrated literature describing the new Norden-Hauck Super-10.

I enclose \$2.00 for which please send me, postpaid, complete full size constructional drawings and all data for building the Super-10.

Name \_\_\_\_\_

Address \_\_\_\_\_

employed in the second paragraph of the patent which stated:

"My invention relates to electromagnetic wave receiving systems."

Electromagnetic wave receiving systems defined would include both radio telephone and telegraph reception.

POPULAR RADIO is pleased with the true scientific attitude displayed by Mr. Roos in calling this correction to our attention; it is rarely that an inventor limits the scope of his own patent.

## A New AC Tube

ANOTHER patent on an invention on AC tubes (No. 1,568,172) was recently granted to Frederick S. McCullough, of Wilkesburg, Pa.

The invention aims to provide, in a cathode device of this kind, a cathode which may be heated by alternating or pulsating currents, so that ordinary house lighting current may be employed in the operation of the tubes. This cathode is so constructed that no perceptible hum or noise or current variation is produced in the circuit in which it is employed. This is due to the fluctuating field that is set up by the alternating current, provided, of course, that the voltage of the alternating or pulsating current is properly maintained with respect to the construction of the tube.

It will be seen from the illustrations, Figures 2 and 3, that the numeral 5 designates a suitable envelope containing a plate or anode 6. Inside of the anode, as usually arranged, is a grid or control electrode 7. Inside of the grid and out of contact with it is the cathode.

The cathode construction includes a body or rod, 8, which is made of porcelain or other suitable material and in which is enclosed a resistance heater, 9, that has several lead wires, 10, that extend out of the top of the tube. These wires are connected in an alternating current circuit, which may include a step-down transformer, 11, to maintain the voltage at a proper value for the construction of the tube.

Surrounding the rod and preferably tightly fitted to it, is an inner sleeve, 12, of a magnetic nature (such as nickel or copper). On the outside of this sleeve is a thin coating of heat resistant enamel or of insulation, 13. Fitted over this is an outer sleeve, 14, which is the actual cathode and which has preferably, a coating of a high emission character.

The heater wires should be co-extensive with the porcelain rod, while the inner sleeve, 12, should be slightly longer than the cathode, 14, and should extend above and below the cathode.

In operation, the tube may be connected in any standard or preferred circuit. The magnetic shield, 12, may be grounded through the lead wire, 12a. The heater is energized and this in turn heats the porcelain rod. The rod acts as a heat reservoir so that the tem-



# Which do you want Radio or Music?



WHEN you have read this advertisement you will realize that an important forward stride has been made in radio reproduction and you will be glad to have learned that, *no matter what kind, make or age of set you have*, you can now convert it in a few minutes time and at small expense into the *most perfect reproduction known to radio*.

In test after test under all conditions, before laboratory experts, set manufacturers, broadcasting artists of national fame, musical critics, and in tests by the radio public itself, the new Truphonic amplifying principle has definitely proved itself to be superior to all other methods of reproduction—barring none. And the Truphonic furthermore has the unique feature that it can be instantly attached to any set.

### What the Truphonic Is

The Truphonic is simply this: A compact instrument containing three stages of Truphonic coupling and an output unit to protect the loudspeaker from the powerful Truphonic output. A 6 foot battery cord contains all wires to the A and B batteries (including wires for C battery and additional B battery if power tube is used). A single wire with clip attached slips over the plate prong of the detector tube which is then reinserted in the socket of the set. It is as simple as ABC and can be attached by anyone in less than 5 minutes, without any knowledge of radio.

### Used in Commercial Sets

Although Truphonic amplification has been on the market only a short time it is now used in the sets of 22 radio manufacturers. Unfortunately it was not perfected in time for general use by manufacturers of large production this year. Next year the trend will be toward Truphonic amplification.

But if you want the most beautiful reproduction of music and speech in your home *right now*, get the Truphonic at your dealer's attach it, and *know* that you have the finest reproduction obtainable—no matter how much you can afford to pay.

If your dealer has not stocked the Truphonic we will send you one C.O.D. on 5 day money back trial. No Truphonic sent unless you give your dealer's name and address.

**Alden Manufacturing Company**  
Dept. 318C Springfield, Mass.



## TRUPHONIC Power Amplifier

Reg. U. S. Pat. Off.



Your Set



Truphonic

**\$20**  
Ready to  
attach



Your  
Loud  
Speaker

# RADIO PROBLEMS SOLVED

POPULAR RADIO maintains for the benefit of its readers a Technical Service Bureau and Laboratory, under the personal supervision of Laurence M. Cockaday which will, without charge, answer by personal letter any question, problem or request for information submitted by a subscriber. This service is, however, also available to readers, other than subscribers, at the very nominal rate of \$1.00 the inquiry in writing please confine your questions to one general subject, writing on one side of the paper only, and enclose a self-addressed and stamped envelope.

It is possible that your individual problem has been covered in an issue of POPULAR RADIO, and so as an aid to you we endeavor to keep a supply of back numbers in stock. The condensed index below gives a few of the subjects that have appeared recently, look this list over and if the information you want is covered, we will be pleased to supply back numbers at 35c. a copy.

**January, 1926**

- How to Get the Most Out of Your LC-26 Receiver.
- Some New and Useful Facts About Coils.
- When Your Set Won't Work.
- Straight-Line-Frequency Condensers.
- What's New in Radio Apparatus.

**February, 1926**

- How to Reduce Distortion in Amplification.
- Some Stunt Sets.
- Important Kinks in Wiring.
- How to Cut Down Your "B" Battery Bill.
- Hints for Amateurs.

**March, 1926**

- Why and How the Milliammeter Increases the Efficiency of Your Set.
- What "Inductance" Really Is.
- List of Broadcast Stations in the U. S.
- How to Build the S-C Receiver for Short and Long Waves.

**April, 1926**

- How to Get an Operator's "Ticket."
- What a Straight-Line Frequency Condenser Really Is.
- How to Build a Power-pack Amplifier.
- The New "Crystal Pilot"
- How to Build and Operate a Low-Power Transmitter.
- The Popular Radio Medal for Conspicuous Service.

**May, 1926**

- How to Draw Up Your Own "Tuning Graphs"
- How to Build the Improved Raytheon Power-pack.
- How to Build an Antenna Mast for \$15.00.
- Fifteen Ways to Reduce Static.
- Do Your Coils Broadcast?

**June, 1926**

- How to Build the New Home Receiver.
- How to Put Up a Good Outdoor Antenna.
- How to Get the Most Out of Your Ready-made Receiver.
- Audio-frequency Amplification. How to Get it Without Distortion.
- Four New Combinations of Units for Assembling the Raytheon Power-pack.

**July, 1926**

- How to Get the Best Reception in Summer.
- The Best Crystal Set for \$13.00.
- How to Build the Newest Portable "Town and Country" Receiver.
- Four New Combinations of Units for Assembling the Raytheon Power-pack.
- How to Get the Most Out of Your S-C Receiver.

**August, 1926**

- A New Method of Using Harmonics for Determining Frequencies.
- Popular Radio Circuits.
- How to Build the Improved Browning-Drake Receiver.
- How to Pick Out a Loudspeaker.
- How to Get the Most Out of Your "Town and Country" Receiver.
- Three Vacuum Tubes in One.

**September, 1926**

- Forecasting Radio Reception from the Weather Map.
- How to Build an Impedance-coupled Amplifier.
- A Radiant Crystal Pilot.
- Popular Radio Circuits.
- How to Simplify Your Set with Automatic Filament Controls.
- Inside Information on New Radio Receivers.
- How to Wire Your House for Radio.

**October, 1926**

- How to Build the New LC-27 Receiver
- The Radio Road Hog
- Popular Radio Circuits
- Sets That Earn Incomes.
- Inside Information on New Radio Receivers.
- Why Signals Fade.

**November, 1926**

- How to Build the LC-Senior Power-Pack.
- Waves and Wavelengths.
- Popular Radio Circuits.
- How to Select Your Radio Parts.
- How to Patent Your Radio Inventions.
- How to Solder.

**December, 1926**

- Uncle Sam's New Short-Wave Net.
- How Circuit Resistance Affects Selectivity.
- Popular Radio Circuits.
- How to Build the LC-Intermediate Power Pack.
- Inside Information on New Radio Receivers.

## POPULAR RADIO

Department 18  
627 W. 43d St., New York

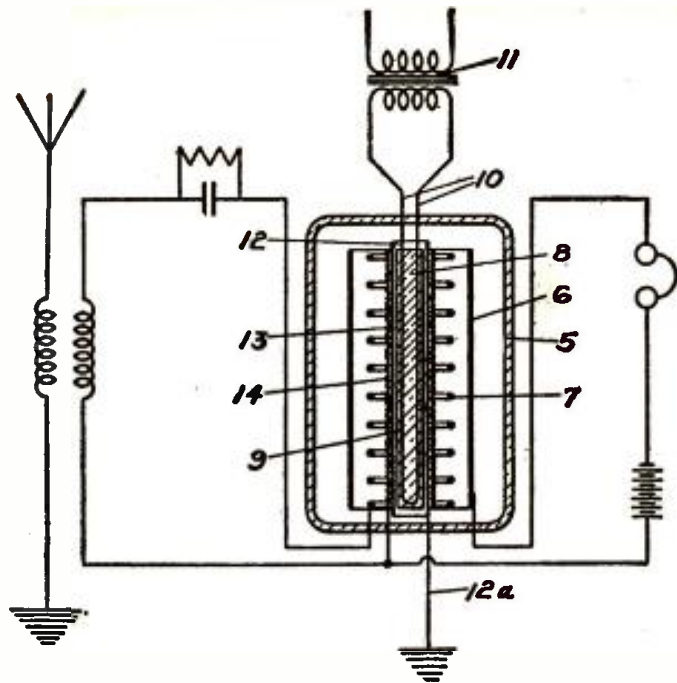

THE AC TUBE USED IN A SIMPLE CIRCUIT

FIGURE 2: The porcelain rod, 8, contains the AC heater wires, 10; the coated cathode, 14, however, is the actual electron emitter. The envelope, 5, contains a plate, 6, inside of which is a grid, 7. The voltage is maintained at a proper value by means of the transformer, 11.

perature of the cathode will not fluctuate with the maximum and minimum current values in the alternating heating circuit. The heat from the rod will be conducted through the inner sleeve, 12, to the outer sleeve or cathode, 14, raising it to an efficient emitting temperature.

If the voltage in the heater is properly proportioned to the construction of the tube, the magnetic shield, 12, will prevent the oscillating field that is produced by the alternating heater current

from affecting the operation of the tube in any manner. For this reason no hum or alternating current fluctuation is apparent in the tube circuit. The grounded shield eliminates any generation of eddy currents in the cathode and neutralizes the capacity between the heater wires and the cathode.

Instead of grounding the magnetic shield, it may be desirable to connect the cathode and the shield through a potentiometer, P, as shown in the illustration (Figure 3).

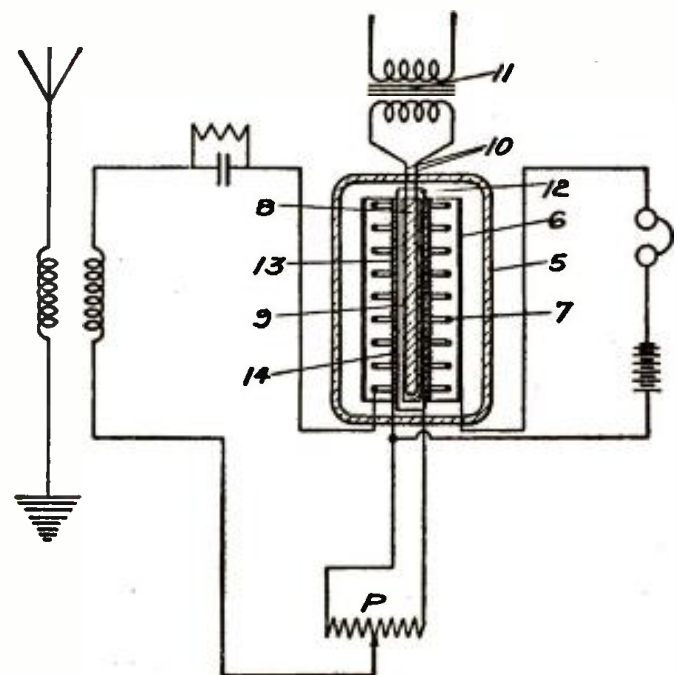

A MODIFIED CIRCUIT FOR THE AC TUBE

FIGURE 3: Here, the magnetic shield, 12, is connected through the potentiometer, P, to the cathode, 14, instead of being grounded as in Figure 2.



# Supreme in MUSICAL PERFORMANCE!

Tschaikowsky, Bee thoven, Brahms — would you listen with rapture to the rendition of their master pieces by the "hungry six" corner band? You would not!

Then why distort the masterful programs of the better broadcasting stations to the "hungry six" type of reception when Thordarson transformers are available at every dealer's?

Thordarson transformers are found in the majority of quality receivers, where musical performance is the first consideration — A conclusive proof of the musical supremacy of Thordarson amplification.

# THORDARSON RADIO TRANSFORMERS



**R-200**  
Amplifying Transformer

The transformer for the musical epicure. Has unusually faithful reproductive powers. Specified on such quality receivers as Zenith, Kennedy and Howard... **\$8.00**



**Standard**  
Amplifying Transformer

A good reproducing transformer suitable for the requirements of the average ear.  
2 to 1 ratio.....\$5.00  
3½ to 1 ratio.....4.00  
6 to 1 ratio.....4.50



**Autoformer**  
All Frequency  
Impedance Amplifier

Amplifies every note in the musical scale. An impedance with a step-up ratio, giving the even amplification of the impedance with the amplification, increase **\$5.00** of the transformer.....



**R-210**  
Power Compact

A complete foundation unit for power amplification and B-supply. Contains a power supply transformer and two chokes for power amplifier using UX-210 power tube..... **\$20.00**



**R-171**  
Power Compact

Similar to the R-210 type but designed for UX-171 power tube and Raytheon rectifier. Contains buffer condensers as well as power supply transformer and **\$15.00** chokes.....



**R-197**  
Power Supply  
Transformer

A Power Supply Transformer designed for B-supply using the R. C. A. UX-213 type full wave rectifying tube. Will supply up to 180 volts B. .... **\$7.00**



**R-196**  
30 Henry Choke

Designed either as a filter or an output choke. Completely shielded. Current carrying capacity 80 MA. Inductance 30 henries. D. C. resistance 280 ohms..... **\$5.00**



**R-76**  
Speaker Coupling  
Transformer

An output transformer designed as a protective device to keep the high direct current voltage of power amplification out of the speaker unit..... **\$6.00**

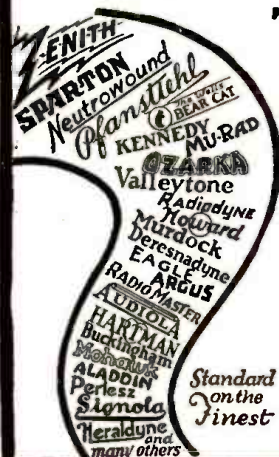

Standard on the Finest

**THORDARSON ELECTRIC MANUFACTURING CO.**  
*Transformer Specialists Since 1895*  
**WORLD'S OLDEST AND LARGEST EXCLUSIVE TRANSFORMER MAKERS**  
*Huron and Kingsbury Streets — Chicago, Ill. U.S.A.*

# 30 Days Free Trial

Just Out—  
1927  
Model

Yes Sir!

You can put a new 1927 Westingale Radio in your home and use it to your heart's content on 30 Days' Trial. Listen to music, concerts, news, sports, market reports from stations all over the country. Compare it with old style 3 or 4 dial sets costing more, then if not convinced that Westingale gives you the greatest Radio satisfaction and the best value for your money, you don't have to keep it.

New ONE  
Dial Radio

\$57<sup>00</sup>

Retail Price

Big Discounts  
to Agents

NOW! Westingale offers the last word in Radio. Either 1 or 2-Dial Control — easiest to tune and years ahead in powerful reception and tone. Newest period type cabinets, two-tone walnut finish. The front panel embossed in dull gold with artistic Spanish Galleon design. Unbeatable for performance, appearance or price.

2-Dial, 5 tubes \$47<sup>00</sup>

1-Dial, 5 tubes \$57<sup>00</sup>

Where else can you get so much for the money on 30 days trial? Why pay more? Why take chances? Why not have the NEWEST Radio when you can try them at our risk. Before you buy get our Free Catalog and 30 Day Trial Offer.

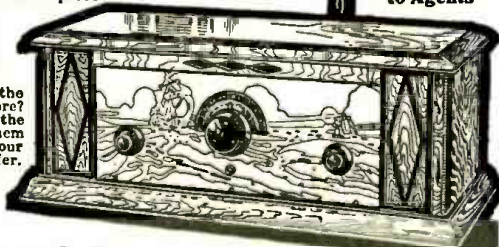

AGENTS

Make Big Profits — Buy at Cost

We want to appoint agent or dealer and place one Westingale Demonstrating set in each locality. Get demonstrator at big discount in price and on 30 days' trial, and make \$50 to \$100 a week as our representative. Our Free Book tells how.

**Your Own Radio--FREE**

Our FREE Catalog also explains a plan whereby you can put a Westingale Radio in your home on 30 Days' Trial—demonstrate it to your neighbors and friends and get your own set without cost. Write for catalog, discounts and complete details today.

Westingale Electric Co., Dept. 143, 1751 Belmont Ave., Chicago, Ill.



The obverse of the medal; this original is two-and-one-half inches in diameter.

## The Popular Radio Medal for Conspicuous Service

TO every radio amateur, to every amateur experimenter and broadcast listener, who is instrumental in alleviating human suffering or saving human life, directly through the medium of radio, recognition will hereafter be extended in the form of a medal that shall be known as "The Popular Radio Medal for Conspicuous Service." This medal is unique within the realms of radio in that it shall be awarded, not for scientific achievement or invention, but for service to humanity.

To insure a fair and unbiased consideration of all claims, a Committee of Awards has been appointed that includes five distinguished citizens of international fame. To assist this Committee of Awards, an Advisory Committee has been appointed that numbers among its members some of the most eminent citizens of the United States, including representatives of many of our most distinguished institutions.

The conditions under which the medal will be awarded are here specified:

1. The medal shall be known as the Popular Radio Medal for Conspicuous Service.
2. The medal shall be awarded, without discrimination as to sex, age, race, nationality, color or creed, to those radio amateurs, radio experimenters, broadcast listeners and other non-professionals through whose prompt and efficient action radio is utilized to perform an essential part in the alleviation of human suffering or in the saving of human life within the territorial confines of the United States and its possessions, or in the waters thereof.
3. The medal shall be awarded by a Committee of Awards that shall not exceed five in number. No member of this Committee shall be an employee, officer or stockholder of POPULAR RADIO, INC., nor shall any such employee, officer or stockholder have a vote in the deliberations of the Committee.
4. An advisory Committee, which shall cooperate with the Committee of Awards and which shall be particularly charged with the responsibility of making recommendations for awards of this medal, shall be made up of men and women who, because of their interest in the public welfare or because of their connection with institutions that are consecrated to public service, are in positions to bring to the attention of the Committee of Awards the exploits of candidates who are within their own special fields of activity.
5. The medal will be awarded for services rendered since Armistice Day, November 11, 1918.
6. Recommendations for awards may be submitted to the Committee of Awards at any time and by any person. Every recommendation must contain the full name and address of the candidate, together with a detailed account of the accomplishment on which the proposed award is based, and must be accompanied by corroboratory evidence from persons who have first-hand knowledge of the circumstances and whose statements may be verified to the satisfaction of the Committee of Awards.
7. The medal will be awarded to as many individuals as qualify for it and at such times as the Committee of Awards may authorize.



## New Vitalitone Ship Model Cone Speaker

Not a picture, but a real model of a ship sculptured by a foremost artist—and finished in antique polychrome—powered with the wonderful Vitalitone Unit and Cone—We are the pioneer manufacturers of cone speakers—and know what you want—Here it is.

"SUPREME QUALITY AND BEAUTY"

And only \$12.50 F.O.B. N. Y.

Your dealer or direct.

Vitalitone Radio Corporation

88 University Place, N. Y., U. S. A.





The reverse; the name of each recipient will be engraved in the space provided.

8. All considerations not specified herein shall be left to the discretion of the Committee of Awards.

All communications to the Committee of Awards may be addressed to—

The Secretary of the Committee of Awards, POPULAR RADIO Medal for Conspicuous Service, 627 West 43rd Street, New York.

### The Committee of Awards

- HIRAM PERCY MAXIM, *President of the American Radio Relay League.*
  - E. F. W. ALEXANDERSON, *Chief Consulting Engineer of the Radio Corporation of America.*
  - MAJOR GENERAL CHARLES MCK. SALTZMAN, *Chief Signal Officer of the Army.*
  - REAR ADMIRAL W. A. MOFFETT, *Chief of the Bureau of Aeronautics, U. S. Navy.*
  - DR. JOHN H. FINLEY, *publicist and journalist.*
- Secretary: Dr. E. E. Free, 627 West 43rd Street, New York.

### Advisory Committee

- SENATOR JAMES W. WADSWORTH, JR., *of New York.*
- HON. JOHN BARTON PAYNE, *Chairman, American Red Cross.*
- ADOLPH LEWISOHN, *Publicist.*
- JUDGE BEN S. LINDSAY, *of the Juvenile and Family Court, Denver, Col.*
- DR. J. MCKEEN CATELL, *Past President, American Association for the Advancement of Science.*
- DR. J. H. DELLINGER, *Past President, Institute of Radio Engineers.*
- FARLEY OSGOOD, *Past President, American Institute of Electrical Engineers.*
- C. E. GRUNSKY, *Past President, American Society of Civil Engineers.*
- DR. DAYTON C. MILLER, *President, The American Physical Society.*
- W. L. ABBOTT, *President, the American Society of Mechanical Engineers.*
- W. J. HOLLAND, *President, Carnegie Hero Fund Commission.*
- GEORGE K. BURGESS, *Director, Bureau of Standards.*
- COLIN H. LIVINGSTONE, *Past President, Boy Scouts of America.*
- DANIEL C. BEARD, *Chairman, National Court of Honor, Boy Scouts of America.*
- MISS SARAH LOUISE ARNOLD, *President, Girl Scouts.*
- DR. W. D. HAGGARD, *President, American Medical Association.*
- K. A. BICKEL, *President, United Press Association.*
- KENT COOPER, *General Manager, the Associated Press.*
- H. P. DAVIS, *Vice-President, Westinghouse Electric & Manufacturing Company.*
- DR. VERNON KELLOGG, *General Secretary, National Research Council.*
- JESSE LYNCH WILLIAMS, *Past President, Authors' League of America.*
- PROFESSOR GEORGE B. PEGRAM, *Dean of the Faculty of Applied Science, Columbia University.*
- PROFESSOR H. H. SHELDON, *Professor of Physics, New York University.*
- WM. HAWLEY ATWELL, *Grand Exalted Ruler, Order of Elks.*
- PROFESSOR EDWIN B. WILSON, *Harvard University, National Academy of Science.*
- W. E. HARKNESS, *Vice-President, American Telephone & Telegraph Company.*
- WILLIAM L. SAUNDERS, *President, United Engineering Societies.*
- COL. J. R. MCQUIGG, *Past Commander, the American Legion.*
- JOHN R. MOSS, *President, Kiwanis International.*
- W. D. TERRELL, *Chief Supervisor of Radio, Department of Commerce, Washington, D. C.*



# A Safety Valve for Your Radio

SUPPOSE the battery wires to your radio set became crossed, accidentally, what would happen? Almost anything from a serious fire, due to overheated wires, to a ruined B-Battery or a burned-out tube. The consequences are serious enough to warrant some careful thought right now!

The cheapest insurance against the dangers of crossed wires is to protect your radio set with a Belden Fused Radio Battery Cord. It provides

- 1—An A-battery fuse.
- 2—A B-battery fuse.
- 3—A polished bakelite cover for the battery fuses.
- 4—A compact connecting cable that dispenses with loose wires.
- 5—A color-code on each wire for identifying each circuit.
- 6—A time-saver, because the cord is quickly connected and easily concealed.

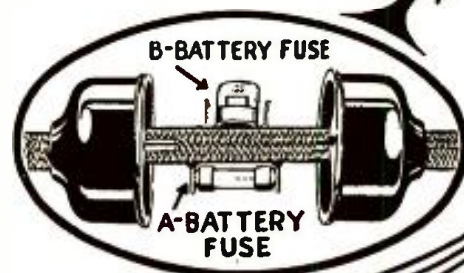

Eliminate fire hazard, ruined or discharged batteries, and burned-out tubes. Ask your nearest dealer for a Belden Fused Radio Battery Cord, today!

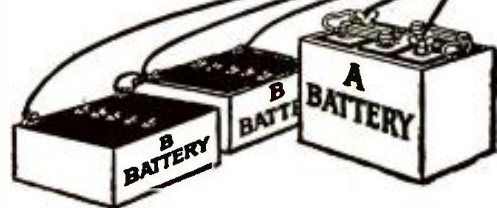

Belden Manufacturing Co.  
2316A South Western Avenue,  
Chicago, Illinois

use a

# Belden Fused Radio Battery Cord



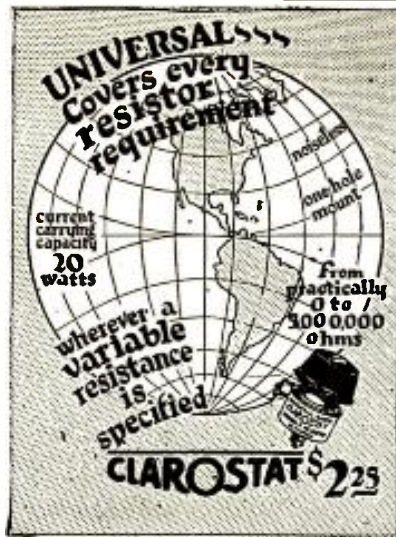

WHEREVER a  
resistance is specified  
pin your faith on

## CLAROSTAT

the greatest variable resistor!

That's what 59 leading B eliminator manufacturers are doing. After exhaustive tests, they are convinced that only CLAROSTAT acts as the perfect voltage control because . . .

it has a range of from practically zero to 5,000,000 ohms . . .

has a current carrying capacity of 20 watts—greater than that of any variable resistor—without the slightest danger of packing, arcing or crackling noises.



Have you sent for your copy of "The GATEWAY TO BETTER RADIO"? The edition is limited and you can't afford to be without it. 32 pages covering everything—reception, transmission, amplification and battery elimination. Send 25c in stamps or coin to Dept. PR.

American Mechanical Labs.  
285 N. 6th St., B'klyn, N. Y.

## What's New in Radio

(Continued from page 42)

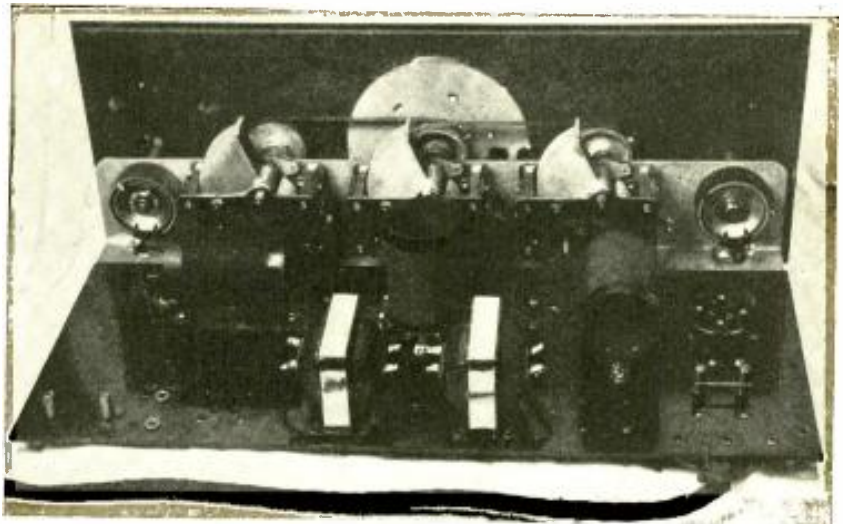

The three condensers of the new Stewart-Warner set tune the second and third radio-frequency stages and the detector circuit; note how they are connected together by a band to enable the three circuits to be tuned by a single control.

coupled together mechanically to operate from the single tuning knob on the front panel.

The size of the antenna used with the Stewart-Warner Receiver is not at all critical. If the receiver is used in congested districts where there are two or more local broadcasting stations, the antenna should not exceed eighty feet in length, because, under these conditions, maximum selectivity is essential. In suburban locations or in any place where there are no nearby broadcasting stations the antenna may be up to 150 feet long. A small, indoor antenna works well with this receiver and will provide ample volume on all local and semi-local broadcasting stations.

The manufacturers also offer their own make of vacuum tubes and strongly urge the use of these tubes in this receiver. The recommended tube equipment for the receiver is, therefore, six of the Stewart-Warner Model 501-AX tubes. Or, if the owner desires to use a power tube in the last stage of audio-frequency amplification, a standard UX-112 tube will be found suitable for this purpose.

The receiver may be operated from batteries or the operating current may be drawn from the alternating-current, light lines through a suitable power-pack. If batteries are used,

the equipment should consist of a 6-volt storage "A" battery and 90 or 135 volts of dry-cell "B" battery. A small dry-cell "C" battery of from 4½ to 9 volts is also required.

If power-packs are used to convert the house-lighting current to a form suitable for operating the receiver, it will be necessary to have an "A" power-pack capable of delivering at least 1½ amperes at 6 volts or, where a UX-112 type power tube is used in the last stage, the "A" supply unit must deliver 1¾ amperes at 6 volts. The "B" power-pack should deliver at least 90 volts and preferably 135 volts or higher; and taps should be provided to supply the lower voltages for the detector and radio-frequency amplifier tubes. Some "B" power-packs are also designed to supply the necessary "C" voltage. Where this is not done it is necessary to use a separate "C" battery.

The receiver has ample selectivity and sensitivity to meet all normal demands. In a test of this set, made in New York City, a number of Western and Southern stations were tuned in through the locals with really good reception and without interference. The set could not be made to squeal or oscillate.

Maker: Stewart - Warner Speedometer Company.

## A New Inductively Tuned Receiver

**Name of instrument:** The Kellogg "Model 507" receiver.

**Usage:** For general broadcast reception.

**Outstanding features:** Inductive tuning. Tremendous volume. Good tone quality. Artistic appearance. Easy to operate.

**Description:** The Kellogg "Model 507" receiver is a six-tube set consisting of three stages of tuned-radio-frequency amplification, a vacuum-tube detector and two stages of transformer-coupled, audio-frequency amplification. Tubes of the UX-201-a type are used throughout except in the second stage of audio amplification, which employs a UX-112 type power tube.

The panel is of wood, finished in dark walnut, and bears a modest

etched design which serves to break the monotony of the otherwise plain surface. The four operating control knobs are grouped on a decorative bronze plate which is located in the center of the panel.

The entire receiver is inclosed in an artistic walnut cabinet which matches the front panel of the receiver in coloring. The finish is soft and is enriched by shading which gives a pleasing high-light effect. The same receiver unit may be obtained in either a high-boy, console cabinet (as illustrated) or in a smaller table-mounting type of cabinet.

Power to operate the receiver may be supplied from "A," "B" and "C" batteries, or may be drawn from the



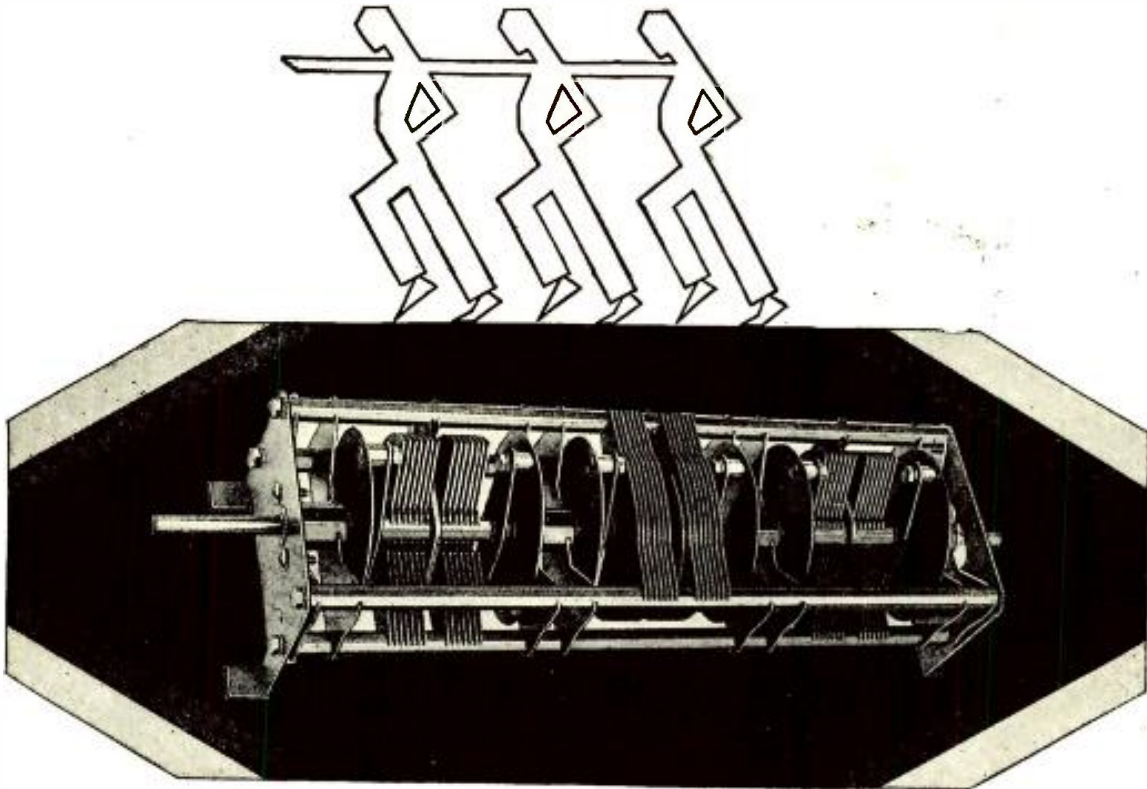

## THEY WORK AS ONE

It is a simple matter to mount three condensers on one shaft—but, sad to relate, they won't necessarily work as one.

Enter — Standardization, mechanical genius, electrical measurement—and the gang condenser problem is solved.

The new 3-gang AMSCO Allocator is an electrically accurate condenser for Simplified Control. It makes one-dial tuning really practical—not a theory.

Each of the matched units is a modified frequency condenser (straight tuning line) designed to allocate the stations in accordance with wave-length divisions.

*They work—as One!*

AMSCO Allocating Condensers are also furnished Single or Siamese—allocating by Frequencies (S. F. L.), by Wavelengths (S. T. L.), or by capacity variations (S. C. L.). Write for descriptive leaflets.

---

AMSCO PRODUCTS, INC.

Broome & Lafayette Streets

New York City

---



# AMSCO



## ALLOCATING CONDENSERS

# A tube may be bright but DUMB!

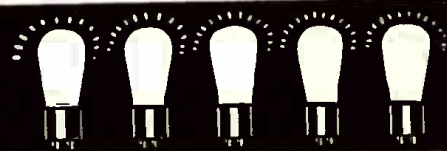

**TEST YOUR TUBES WITH THIS HANDY TESTER THAT TELLS WHETHER THEY'RE**

*"good", "fair" or "poor"*

A tube that lights may be low in efficiency and pulling the life out of your "A" battery. And, that single run-down tube is often the entire cause of weak reception. Get this reliable testing instrument, the Sterling Tube Tester, and be sure of the condition of your tubes. Don't guess! This tube tester tests the amplifying value of both large and small tubes, including power amplifiers and 300-A detectors. Simple to operate. No computations to make. See your dealer and also write for our interesting 32 page booklet—*G—on care and upkeep of radio.*

R-411 Home Tube Tester for 201-A and 301-A tubes, including power tubes, Price \$7.50.  
R-400 Home Tube Tester for 199 and 299 tubes, price \$8.50.

# Sterling

## Home Tube Tester

THE STERLING MFG. COMPANY :: :: :: :: Cleveland, Ohio

house-lighting lines through the use of special power-packs. If power-packs are used in place of batteries, they should be of recognized makes and should be capable of supplying 1 1/4 amperes at 6 volts for lighting the filaments, 135 to 165 volts for the plate supply, at a current drain of 25 milliamperes, and up to 12 volts for the necessary grid-bias ("C" voltage).

The UX-171 type power tube may be used in the second audio-frequency stage, in place of the UX-112 type. In this case the "B" power-pack should be capable of delivering somewhere between 150 to 180 volts, at approximately 35 milliamperes. At least 45 volts of "C" voltage should be available where this tube is used, and it must be variable so just the proper amount may be applied. The use of the UX-171 type power tube is practical only where the plate voltage is supplied by a power-pack because the current requirements of this tube make the use of dry-cell "B" batteries impractical.

The manufacturer of this receiver strongly recommends the use of an antenna not more than 80 feet in length and not less than 60 feet. The receiver is balanced for use with an antenna of this size. Directions are given in the instruction booklet by means of which the receiver may be adapted to an antenna of any length by the addition of a small fixed condenser in the antenna circuit.

The circuit used in the Kellogg receiver is an unusual one. Fundamentally, it employs the new "RFL" method of balancing out undesirable feedback. This represents only one feature of the circuit used, however. The Kellogg engineers have worked out many other features which are incorporated in the design.

Another feature is the fact that tuning is accomplished by varying the inductance of the four tuned circuits, rather than by varying the capacity. This is accomplished by winding each of the coils in two parts, and arranging them so that one part rotates inside of the other. As the inner part of the coil is rotated the inductance of the whole changes gradually, thus

## THE FAMOUS IVEYLINE CABINET

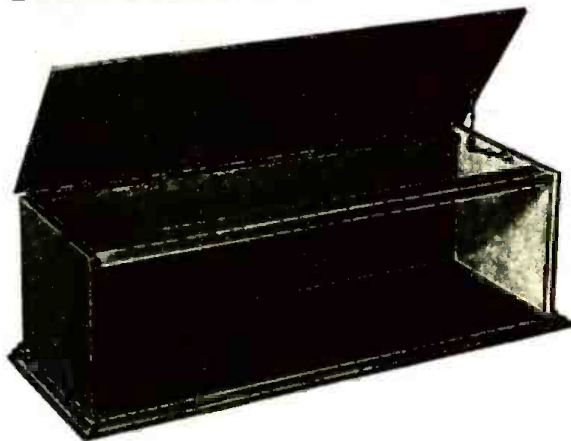

**Why Pay a Fancy Price for LC-27 Cabinets?**

Sloping front, piano hinge and lid support, rubber feet. Made to Author's design.

Mahogany finish... \$7.50  
Solid Walnut... 9.50  
f.o.b. Hickory. Cash with order.

	Mahog. Fin.	Solid Walnut
7" x 18" x 10"	\$3.50	\$5.00
7" x 21" x 10"	3.75	5.25
7" x 24" x 10"	4.00	5.50
7" x 26" x 10"	4.75	6.25
7" x 28" x 10"	5.50	7.00
7" x 30" x 10"	6.00	8.00

When we say Solid Walnut we do not mean a poplar or gum back and bottom.

Nickled full length piano hinge and lid support.  
Finish: Three coats of lacquer rubbed to a glossy polish.

**A Baseboard Free With Each Cabinet**

Prices f.o.b. Hickory—CASH WITH ORDER.  
We ship practically all orders on same day as received.  
Send for Free Catalogue Showing Our Piedmont Line also.

**THE SOUTHERN TOY COMPANY, INC.**  
Hickory, North Carolina



The rear view of the Kellogg receiver showing the set assembly with the tubes in place and the loudspeaker installed in the upper portion of the cabinet.



providing the necessary tuning effect.

Ordinarily, the technical features of the tuned circuits are of little interest to the owner of a manufactured receiver, but in this case this novel tuning feature presents especial interest to the lay owner of the receiver as a complete 180 degree turn of the main tuning control covers a waveband not exceeding 100 meters in width, instead of a band 350 meters wide. There is an auxiliary tuning knob which is a simple rotary switch with seven points. When this switch is set on the first point the receiver is capable of receiving over the waveband from 200 to 230 meters. That is, a 180 degree variation of the main control will tune the receiver through a very narrow band of approximately 30 meters.

When the auxiliary control is moved to the second point the receiver may be tuned through the band between 230 and 270 meters by a 180 degree rotation of the main tuning control.

The result of this arrangement is that the broadcasting stations are well spread out over the tuning dial. Instead of KDKA and WAHG coming in only one or two degrees apart on the tuning dial, as is the case with the average receiver, they are separated by about 12 degrees on the dial of the "507" receiver. And other stations which come in almost on top of one another on the dial of the average receiver are separated several degrees on the dial.

In addition to the single, wave-length-tuning control and the auxiliary waveband switch, already mentioned, there are two other minor controls provided on the panel of this receiver. One is a volume control which permits the adjustment of the volume of any incoming signal from maximum down to zero. This operates under the usual scheme of increasing or decreasing the filament current to the filaments of two of the radio-frequency amplifier tubes.

The other control is a rheostat in the filament circuit of the other four tubes.

The coils in each of the tuned circuits are individually inclosed in shields to limit undesirable interstage coupling and external pick-up. Openings are provided in the sides of the shield "cans" to accommodate the two shafts which simultaneously control the movable coils and the switches in the four circuits and which are operated by the main and auxiliary tuning controls on the panel of the receiver. Such an arrangement is of course necessary when four circuits are to be tuned by a single knob as in this set.

All of the instruments which make up this receiver are mounted on a substantial sub-base which in turn is supported on a wood foundation. The panel is attached to this sub-base by means of two metal brackets. The two filament control rheostats are mounted directly on the panel, but the two shafts which are geared to the two internal control shafts, project through the panel without being fastened to it. The tuning knobs are then attached to the outer ends of these shafts.

Maker: Kellogg Switchboard and Supply Co.

PURCHASER—What is the charge for this battery?

RADIO MAN—One and one-half volts.

PURCHASER—Well, how much is that in American money?

—American Boy

# KH-27 KIT

## Used by Kenneth Harkness



### AMAZING TONE QUALITY

The K. H. 27 gives marvelously clear and realistic reproduction at all frequencies. Mr. Harkness spent two years of research in audio frequency alone in order to achieve this perfect audio combination. The first and only set to use the new patented "Twinchoke" audio amplification. A real distance-getter too. Gets distance night after night. Perfect selectivity—no interference. Easy to operate—no whistles or squeals. The latest and greatest Harkness circuit.

#### Send for this booklet

Send 25 cents to address below for a copy of "How to build the KH-27" with complete description of circuit, photographs of set, list of parts, assembly directions and step-by-step wiring diagrams.

WITH the special parts in this official foundation kit and a few standard parts, easily obtainable in any radio store, you can build an exact duplicate of the KH-27 Receiver designed by Kenneth Harkness. Foundation kit contains:

- 1—Drilled and engraved front panel, 7 x 26 ins.
- 1—Drilled sub-panel, 7 x 25 ins., with six tube sockets attached.
- 2—KH bakelite mounting brackets.
- 1—Brass condenser shaft, 9 ins. long.
- 3—KH-27 Coils, including antenna, second stage and detector couplers.
- 3—KH Twin-choke Audio Couplers.
- 1—KH Output Filter Choke Coil.
- 1—Instruction folder, prepared by Kenneth Harkness, with directions for assembly and pictorial step-by-step wiring diagrams.

Bakelite front and sub-panels are completely drilled for mounting all parts. Pictorial instructions make wiring easy and success certain.

**KH-27 \$49<sup>50</sup>  
KIT**

If your dealer cannot supply you send check or money order to address below. Kit will be sent you immediately.

## TWINCHOKE Audio Coupler

### —used in the KH-27

The pure, realistic tone quality of the KH-27 is obtained by the use of three KH "Twin-choke" Audio Couplers. This new, patented coupling unit, quadruples power output of each tube enabling Twinchoke amplifier to handle *four times as much volume as any other amplifier without overloading*. This means perfect tone quality with ordinary tubes.

You can use Twinchoke couplers in *any* set—the set you now have or the set you are going to build. Connects just like a transformer. Either two or three stages can be used. Complete instructions and circuits with each coupler. Length—3". Width—2". Height—4 $\frac{3}{8}$ ". If dealer cannot supply you, order direct.

**\$7<sup>50</sup>**

Each



## Output Filter Choke Coil

### —used in the KH-27

Especially designed for output filter circuits to protect loudspeaker and insure perfect reproduction. Designed for 171 and 210 tubes. Improves tone quality with 201A or 112 tubes. Fits under sub-panel—less than 2 inches in height. Can be used with any amplifier or set. Instructions enclosed.

**\$5<sup>00</sup>**

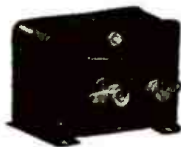

## TWINCHOKE Power Amplifier Kit

**JOBBERS  
and  
DEALERS**

Write For Discounts

This kit contains three KH Twinchoke Audio Couplers and one KH Output Filter Choke Coil—the essential parts for a three-stage Twin-choke amplifier. Kit includes complete instructions for building separate amplifier or incorporating amplifier in a complete set. Special price,

**\$25<sup>00</sup>**

**KH Radio Laboratories Inc.**  
124 Cypress Avenue, Bronx, N.Y.

**PATENTED SUBANTENNA!**

**Amazing New UNDERGROUND ANTENNA**

**Gets Distance Clearly**

Here you are, "Distance" fans! Install this new type underground "pick up system." Get distant stations loud and clear. SUB-ANTENNA so greatly reduces static and all other air noises that it lets the broadcast come thru clean and pure.

**Reduces Bothersome INTERFERENCE**

Power line leaks, arc light crackles, STATIC and other such nuisances as have made distance reception unpleasant, do not bother the "listener-in" with a SUBANTENNA. And you forever get rid of the unsightly mess of wire on your roof.

**Opens Up New, Greater Amplification Possibilities**

Instead of keeping your power turned way down to avoid amplifying foreign noises equally with the broadcast, you can now use the full power of your set to advantage. No matter how much amplification you choose to use, broadcast will so far dominate the air noises that the latter will be of no consequence.

**FREE TRIAL OFFER!**

Nothing else is like SUBANTENNA. It is not "just a wire." But you must try it to fully appreciate the wonderful new significance it gives to Radio. You can try it at our risk. Write at once for scientific explanation and for particulars of our FREE TRIAL OFFER. Write now. No obligation.

**CLOVERLEAF MFG. CO.**  
2716-F So. Canal St. Chicago

**Building Your Own 3 Foot Cone?**

*—choose cone material carefully*

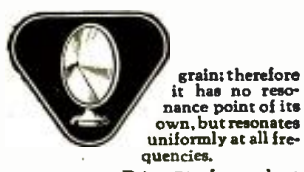

HERE is just one product made especially for the cones of cone type speakers—Alhambra FON-O-TEX. It is used by practically all the leading cone speaker manufacturers, because it produces tone quality far superior to papers or other substitutes for Alhambra FON-O-TEX.

This remarkable product has practically no

Price 75c for a sheet 38 x 38 inches—large enough for a 3 foot cone. Ask your dealer. If he hasn't Alhambra FON-O-TEX we will supply you. To the cost of the number of sheets you need add \$1.00 for packing, f. o. b., N. Y. C.

The SEYMOUR Co., Desk 101  
325 West 16th Street  
New York City

**ALHAMBRA FONOTEX**

PRODUCT AND PROCESS PATENTED

**FOR CONE TYPE LOUD SPEAKERS**

**To Dealers:**

Parts for 3 ft. Cone Speakers are the most demanded radio items of the day. If you are not carrying them do so at once. Write us for names of jobbers who stock Alhambra FONOTEX.

If we have no jobber near you we will supply you direct until we have.

**The SEYMOUR CO.**  
325 West 16th Street, New York City

**Who Pays the Broadcaster?**  
(Continued from page 15)

But what does all this cost? The cost of the programs—aside from the station toll charges—are matters of conjecture; information concerning the prices paid for broadcast artists varies greatly, and is generally regarded as confidential.

Perhaps the most costly programs are those of the Atwater Kent Hour, the A and P Gypsies, the Balkite Hour and the Eveready Hour which have been estimated as high as \$500,000 a year, including the toll charges.

The total cost of the Eskimos, engaged for the Clicquot Club Company's program, is \$202,800 a year; the performers probably cost about \$400 an hour. Orchestras such as the Silver-town, which is sponsored by The Goodrich Tire Company and the Ipana Troubadours, sponsored by Bristol-Myers Company, manufacturing chemists, probably cost from \$400 to \$500 an hour. The popular Goldy and Dusty during their period of contract, are said to have cost the Gold Dust Corporation about \$250 an hour. The Royal Orchestra, supported by the Royal Typewriter Company, must cost from \$500 to \$650 an hour. No figures have been given out about the costs of broadcasting the special concerts of New York Symphony Orchestra, but each appearance at the studio probably costs Fansteel Products, Inc., which maintains the Balkite Hour, from \$3,000 to \$4,000. The nine concerts of the Cleveland Symphony Orchestra, sponsored by the Sandusky Cement Co., cost that company about \$2,500 each. The Bristol-Myer program for some months cost at the rate of a total of \$107,000 a year. The Happiness Boys are said to cost the Happiness Candy Stores, Inc. about \$400 for each weekly appearance.

Artists such as McCormack and Gallucurci, who have appeared on programs sponsored by the Victor Talking Machine Company, would ordinarily charge about \$5,000 for an appearance, although, because of their connections with the Victor Company, it is probable that they charged little or nothing, taking their remuneration in the form of commissions on the stimulated sales of their gramophone records. On occasions, well known artists, such as appear on the Eveready and Atwater Kent Hours, for example, get fees ranging from \$1,000 to \$2,500 for an appearance before the microphone.

The Eveready Hour (which is said to be the oldest regular broadcast feature in the field, dating from December, 1923) costs the National Carbon Company an average of from \$5,000 to \$6,000 a week; this sum includes the toll charges as well as the costs of employing regularly a sixteen-piece orchestra, six singers and occasional great artists.

It may be parenthetically observed that the value to the artists of a broadcast appearance is becoming an important factor in the economic scheme of the radio industry. The Happiness Boys, for example, are receiving \$2,500 a week for their appearance in vaudeville—a value that has been created entirely by their popularity with the radio audience. And the Goodrich Silvertown orchestra unit, including the Silver Masked Tenor, is getting \$3,000 a week on the Keith-Albee vaudeville circuit. These artists established their professional value through their appearances before the microphone. It is this creation of values that must be taken into account by the artists when they contract for appearance in the broadcast studio.

**Charges for Network Stations for Hours After 6 P.M.**

Station	Location	Charge Per Hour	Charge Half Hour	Charge Quarter Hour
WEAF	New York	\$480.00	\$300.00	\$187.50
WEEI	Boston	350.00	218.75	136.72
WCSH	Portland	170.00	106.25	66.41
WTAG	Worcester	170.00	106.25	66.41
WJAR	Providence	170.00	106.25	66.41
WGR	Buffalo	230.00	143.75	89.84
WLIT	Philadelphia	210.00	131.25	82.03
WRC	Washington	210.00	131.25	82.03
WCAE	Pittsburgh	210.00	131.25	82.03
WTAM	Cleveland	180.00	112.50	70.31
WWJ	Detroit	230.00	143.75	89.84
WSAI	Cincinnati	240.00	150.00	93.75
WLIB	Chicago	350.00	218.75	136.72
WGN	Chicago	350.00	218.75	136.72
WOC	Davenport	170.00	106.25	66.41
WCCO	Minneapolis	250.00	156.25	97.66
KSD	St. Louis	250.00	156.25	97.66
WDAF	Kansas City	220.00	137.50	85.94
<b>TOTAL:</b>		<b>\$4,080.00</b>	<b>\$2,550.00</b>	<b>\$1,593.77</b>

NOTE: The day time charge (before 6 P.M.) for groups of stations is one-half of the evening charge for a like period of time.  
DISCOUNTS: A contract based on weekly usage is subject to 5 percent discount for six months, 10 percent for nine months and 15 percent for twelve months.

*The toll charges of your favorite program feature may be estimated from this rate card—provided you know the number of stations in the chain and the length of the program periods.*



# Faradon

## CAPACITORS

### “UNIVERSAL” FILTER CAPACITOR BLOCK



Model WS-3750  
\$10.50

This new FARADON “Universal” Filter Capacitor Block, of 14.2 Mfds. in one container, is for operation in connection with the most generally used Battery Eliminator circuits. It contains important features not heretofore found in grouped filter condensers.

The total capacitance is connected to fixed terminals in convenient units, permitting ready wiring as desired. Units to be connected in the circuit where possible high potential surges may occur are constructed to withstand a higher voltage than is usually required. Convenience, safety and continued satisfactory operation are combined in the FARADON Filter Block.

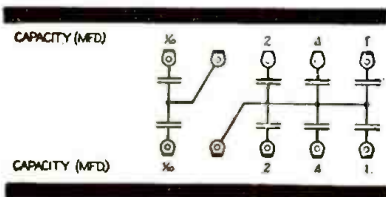

### BY-PASS CAPACITORS

Capacity MFD	Operating DC	Flash Test DC	Models Model No.	Price
1/2	150	500	WS3713	\$ .90
1	150	500	WS3714	1.20
2	150	500	WS3715	1.90



## RELIABILITY

Is essential to Satisfaction in By-Pass and Filter Capacitors.

Not until a product has successfully passed exacting final electrical and mechanical tests is it considered worthy of the “FARADON” trade mark and ready for commercial use. Dependable, efficient products are the result.

U. S. Army, U. S. Navy, Bureau of Standards, General Electric Co., Radio Corp. of America, Tropical Radio Telegraph Co., Westinghouse Electric & Mfg. Co., and Western Electric Co., are some of the large Faradon users.

Secure the reliable Faradon Capacitors from your Dealer.

## WIRELESS SPECIALTY APPARATUS COMPANY

Jamaica Plain

::

Est. 1907

::

Boston, Mass., U. S. A.

**FREE**



WITH  
**POPULAR RADIO**

Aside from the feature of economy, there is the thrill and satisfaction that comes from building your own receiving set.

Thousands of sets have never been constructed because of the atmosphere of mystery that has enveloped the whole subject of radio. Kendall Banning, Editor, and Laurence M. Cockaday, Technical Editor of POPULAR RADIO through their close contact with the great radio public sensed this and compiled a book that will convince the veriest beginner that technical training is not essential. If you have a little time to devote to a most fascinating pastime, send for a copy of "How to Build Your Radio Receiver."

**Free Advisory Service**

POPULAR RADIO is full of helpful suggestions as well as instructive and entertaining articles on radio and allied scientific phenomena. This information is supplemented by an advisory service that is free to all subscribers. Any problem you encounter that is not answered in the book or magazine will be answered by personal letter if you will submit it to the Technical Service Bureau.

**A Valuable Combination**

For the next thirty days we will give you a copy of "How to Build Your Radio Receiver," FREE and enroll you for all privileges of the Technical Service Bureau at no further expense, on receipt of your remittance of \$3.00 in payment for a 12 months' subscription for POPULAR RADIO. (As an alternative offer, if you wish the combination with POPULAR RADIO for 7 months only—send but \$2.00). In any event, you run absolutely no risk as we will refund in full if you are not more than satisfied with your purchase.

**CONTENTS**

In "How to Build Your Radio Receiver" you will find complete constructional diagrams, specifications, photographs and instructions for building the following sets. Each has been selected as representative of its circuit because in laboratory tests it proved the best for distance, selectivity, tone volume, simplicity of construction, ease in tuning, reliability and all-around satisfaction.

- A \$5 CRYSTAL SET
- THE HAYNES SINGLE TUBE RECEIVER
- A TWO-STAGE AUDIO-FREQUENCY AMPLIFIER
- THE COCKADAY 4-CIRCUIT TUNER
- A 5-TUBE TUNED RADIO-FREQUENCY RECEIVER
- THE "IMPROVED" COCKADAY 4-CIRCUIT TUNER
- THE REGENERATIVE SUPER-HETERO-DYNE RECEIVER

**POPULAR RADIO**

627 West 43d Street, N. Y. C.

*Offer expires Jan. 31st, 1927*

POPULAR RADIO, Dept. 15A,  
627 West 43d St., New York City

Enclosed remittance of \$3.00 is payment in full for a 12 months' subscription for POPULAR RADIO and copy of "How to Build Your Radio Receiver" FREE.

Name.....

Address.....

City.....State.....

Check here and remit \$2.00 if you prefer POPULAR RADIO for 7 months only in combination with "How to Build Your Radio Receiver."



Herbert

**A PORTABLE SET FOR USE IN WAR**

A new German invention is this portable radio receiving and transmitting apparatus, set into an armored side-car of a motorcycle. The radio apparatus is housed in a case which serves the dual capacity of protecting and shielding. The equipment for both transmitting and receiving is entirely self-contained and is ready for use by simply opening the door of its case.

**BROADCAST LISTENER**

*Comments on radio programs, methods and technique  
—from the point of view of the average fan*

By RAYMOND FRANCIS YATES

**Musicians Are Better Heard Than Seen**

At a time when television is imminent and the absence of vision over the radio is lamented, Leopold Stokowski, the able conductor of the Philadelphia Symphony Orchestra, agitates for the total concealment of the musicians during concerts.

Mr. Stokowski argues—and perhaps logically enough—that music to be properly appreciated, should be unattended with the sight of the source.

His psychology is no doubt sound, for what can the presence of the performers do but divide the impressions between two senses? As a matter of fact it is best appreciated with the eyes closed and the four other senses held in abeyance. Distractions must be excluded.

What, pray tell us, does the mere sight of a frantically animated conductor or a group of swaying violinists add to the music? Do we need to see the bird to be enraptured with his song? Or the frog to sense the lonesomeness of his croaking? Is not the radio, after all, a blessing in that it spares us sight of the source? What a sorrowing disillusion it would be to see the faces back of many of our best radio vocalists!

Say what you will, Mr. Stokowski has to our way of thinking voiced a sensible bit of psychology. Not that we are silly enough to lament the approach of television, but we do hold that television, insofar as it gives us sight of musical performers, is a totally unnecessary em-

bellishment. Time and time again, we have sat before our cone with eyes closed that we might exclude even this unoffensive piece of paper during a particularly delicious bit of music.

We crave realism to be sure but not at the price of distraction.

**An Important Trifle**

WE'RE just a little cross and you'll probably think we're a silly old crab when we tell you what it is about; time and trouble are laying a heavy hand on us these days, and the little things that tolerant youth used to laugh off, annoy and sting. There was a time back in the green days of the art when we were thrilled when WJZ whirled off a phonograph record—and here we are crabbing because the microphone switches of some of our studios click when they are manipulated!

Time was when these extraneous and unnecessary noises would have passed unnoticed, but broadcasting is getting to be a big boy now and it must watch more closely its P's and Q's.

Perhaps this little protest may serve as an index to the progress the art has made since KDKA'S raspy wave poured over an amazed land.

The next time you go to your radio listen for the little click that comes with the switching in and out of the microphone. You won't hear it listening to the better regulated studios (WJZ and WEAf for instance) but the haywire outfits still have it.





# New!

THE TRANSFORMER THAT INSURES RECEPTION AT ONE POINT ONLY ON THE DIAL. THIS HAS NEVER BEEN DONE BEFORE.

## THE MADISON-MOORE One-Spot TRANSFORMER JUST OUT!

In this new instrument, the intermediate frequency is of such high value that the reappearance of any station throughout the entire broadcast range is eliminated. Reception at more than one point on the dial, the feature that has annoyed every owner of a set, has been completely conquered by this latest radio engineering achievement.

This new MADISON-MOORE ONE-SPOT TRANSFORMER is even more wonderful than its predecessor, because it gives POSITIVE SELECTIVITY, HIGHER QUALITY, and GREATER DISTANCE. Yet, owing to increased production, the price for the new instrument is lower than for the former model.

Surpassing radio satisfaction is yours if you install MADISON-MOORE ONE-SPOT TRANSFORMERS. They are supreme in the realm of Radio.

*Ask your dealer. If he can't supply you, write us.*

MADISON-MOORE RADIO CORPORATION

2524 B Federal Boulevard

Denver, Colorado—U. S. A.

# MADISON~MOORE

*The Finest RADIO APPARATUS in the World!*

## The House of All Popular Kits

EVERY KIT INCLUDES FULL INSTRUCTION SHEETS FOR WIRING

**NEW IMPROVED  
DIAMOND OF THE AIR**  
5 Tube Kit, Complete Parts, **\$37.50**

Licensed Under  
Armstrong Patent 1,113,149  
Manufactured by Clapp Eastham Co.  
Exclusively for the Bruno Radio Corp.

**BERNARD SIX KIT**  
ONE FINGER COMPLETE CONTROL PARTS **\$40.00**

HAMMARLUND-ROBERTS Hi-Q Complete parts \$63.05

DAVEN BASS NOTE 5 tube \$65.00

New and Improved  
BROWNING-DRAKE 5 tube \$65.90

HENRY-LYFORD RECEIVER \$69.50

**LC-27 \$85.20**

KARAS EQUAMATIC \$88.70

S-M SHIELDED "6" \$95.00

AND OTHER POPULAR KITS, ELIMINATORS, SPEAKERS, ETC.

Always in Stock

Acme	Ceco	General Radio
Aero	Electrad	Silver-Marshall
Bruno	National	Samsom
Bodine	Dubilier	And others

Send for Catalogue

**B. C. L. RADIO SERVICE CO., Inc.**  
221 Fulton St. Dept. P N. Y. C.



## Announcing

the first of a series of new models of

**TIMBRETONE**  
REG. U.S. PAT. OFF.

Combined with the utility of a smoking stand is a loud speaker. Carry it about and have it where you want it—on the porch or along side of your easy chair.

Sales offices

**SANFORD BROS.**

CHICAGO	30 W. Walton Pl.
CHATTANOOGA	615 Broad Street
SEATTLE	Am. Bank Bldg.
SAN FRANCISCO	311 Minna St.

Factory: **TIMBRETONE MFG. CO.**  
Hoosick Falls, N. Y.

## The Good and Evil of Musical Scenarios

WHEN the Eveready Hour first made use of the musical scenario some two years ago, broadcasting was supplied with an inspiration which it has since feasted upon with the avidity of a long-starved dog.

Yet the employment of the scenario as an aid to better and more formal programs was a perfectly obvious thing to do—so obvious, indeed, that one is surprised that the service was not used long before. It was the only logical way in which a program could be formulated systematically and contemplated with the caution necessary to achieve something more than mediocre results.

That many other broadcasters were quick to see in the musical scenario an aid to more thorough work was natural and a bit encouraging, but that they should persist in applying the scenario to all sorts of advertising schemes is a trifle disconcerting. Even a most cursory survey of the present situation reveals many annoying irregularities in the musical scenario business. Those in charge of radio advertising seized upon the idea as a means of working into their programs supposedly subtle and adroit references to their wares.

That these references have been neither subtle or adroit, or even decently cognizant of the listeners' intelligence, does not need to be testified to by this Department. It was only a few nights back, that the Bryers Ice Cream Company attempted to seduce us with the enactment of an annoyingly obvious manuscript wherein we were constantly reminded of the convenience, nay, the utter necessity of this delectable delicacy. And Bryers is but a single offender; there are dozens of them.

To our way of thinking the practice is becoming obnoxious. Yet all of this was to be expected of the wise young copy artists who want to please their bosses.

While Mr. Stacey, the imaginative impressario of the Eveready Hour, supplied the original inspiration, he by no means supplied the bad example of making a thorough-going advertising prostitute of the radio scenario. Indeed, Stacey from the start put the thing on a lofty pedestal. Not once did he attempt to dramatize the life of a "B" battery or to induce his audience to buy the products of the National Carbon Company. In this his judgment was sound and there is the unquestioned success of the Eveready Hour to prove it. Not once did he cheapen his acts by even a flashing reference to the products of his company.

The continued indiscretion on the part of the over-zealous copy artists will, eventually, make of the radio scenario a thing to be avoided by all those who have a sincere desire to enter-

tain the air audiences. Not alone that, but it tends to frustrate even the best efforts of those who attempt to make honest use of it. Unless the radio audience can take more abuse than we think, it will sooner or later register its annoyance.

It was to be expected of the copy writers that they should ravish the scenario once its value was demonstrated. It is, as a matter of fact, the only other practical device that can be resorted to as a substitution for the straight, iron-bound, announce-it-play-it program that makes up the woof and warp of broadcasting.

Up until the time the hundred-dollar-a-week *literati* embraced it, the idea promised one day to emerge as a highly developed sub-art. Stacey showed the temper of the thing a dozen times. The "Assassination of Lincoln," "Evangeline," and "The Show Boat" was enough to establish for all time the legitimacy of the idea. True, Stacey's object was not wholly laudable for he, too, was seeking to establish good will, but he was sensible enough to know that he could create a lasting impression only by making his shows so delightfully entertaining that they would survive the general run of trash.

Given free reign, the new school of hack radio scenarioists will make of themselves an intolerable nuisance. As time goes on, they will become more daring and even less painstaking. We shall soon be listening to advertising dramas wherein animated boxes of breakfast food will launch themselves into plots designed to convince you that you really should have more mineral matter in your diet and that your general health and well being depends pretty much on the nature of your morning food.

It was but a short time back that the New York Edison Company staged an air play around a group of electrical conveniences, and "The Old Lady Who Lived In A Shoe" has long since been exploited by a kiddie shoe house over the radio.

We have had enough of it to know that these word merchants of the third-rate agencies will, unless checked, attempt to turn radio into a national medium.

We can expect little aid from the studio censors of the toll stations; they are the safety valves that pop only when the possibility of court action or ridicule looms up. To the public, they hotly claim that it is their earnest desire to keep the radio holy and pure, but to the advertisers they are willing to extend co-operation that stops just this side of insulting the audience of listeners in.

It is a question not how much can the public be entertained while it is being exploited, but rather how much can it be exploited while it is being entertained.



**THE Simplicity of tuning**  
**THE Efficiency of the Bakelite Shaft Condensers**  
**and the Beauty of the Bronze Front Plate**

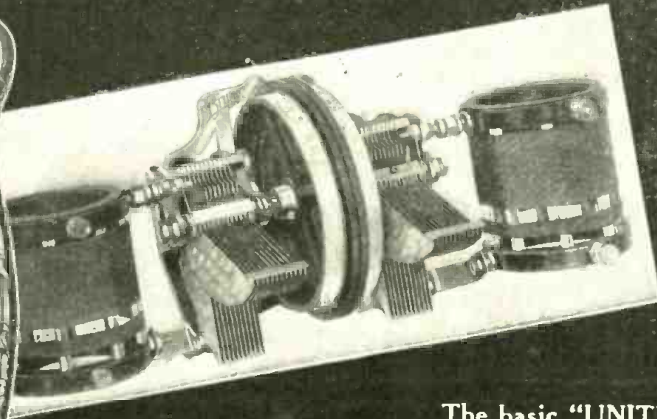
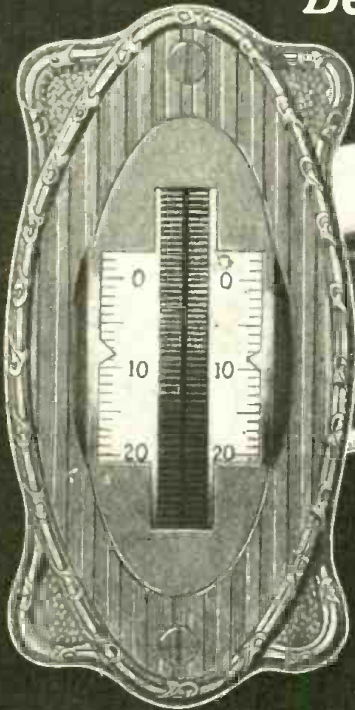

Makes the "UNITUNE" the most desirable tuning device ever designed.

ALL BRUNO "UNITUNES" may be mounted on a panel with only two screws.

The basic "UNITUNE" consists of a frame upon which are mounted two condensers operated independently by two bakelite drums projecting thru a beautiful bronze plate. It may be obtained in all standard capacities. Completely assembled it lists at \$11.00.

Other "UNITUNES" assembled with one or more Quartzite Coils for all popular circuits range from \$12.00 to \$21.00.

Booklet of Instruction and Blue Prints—25c

BRUNO RADIO CORP., LONG ISLAND CITY, N. Y.

**POPULAR RADIO**  
**5 MONTHS FOR \$1.00**

To double our list of subscribers, we will for a limited time accept \$1.00 as payment in full for a five months' subscription for POPULAR RADIO. This offer is open to new subscribers only. Tell your friends about it. They will appreciate this money saving opportunity to secure POPULAR RADIO promptly and regularly each month.

The convenient coupon gives other attractive offers good for either new or renewal subscriptions.

POPULAR RADIO  
 627 West 43rd Street  
 New York City

Date.....1927.

POPULAR RADIO, Dept. 17,  
 627 West 43rd Street,  
 New York City.

Enclosed is remittance of \$....., payment in full for subscription order for POPULAR RADIO as checked below.

- 5 months for \$1.00 (new subscribers only)
- 7 months and "How to Build Your Radio Receiver" for \$2.00.
- 12 months and "How to Build Your Radio Receiver" for \$3.00.
- 12 months and Set of "Simplified Blueprints" (see page 104) for \$3.00.
- 24 months for \$5.00.

Name.....  
 Address.....  
 City.....State.....

**Save Money on Your Panels**

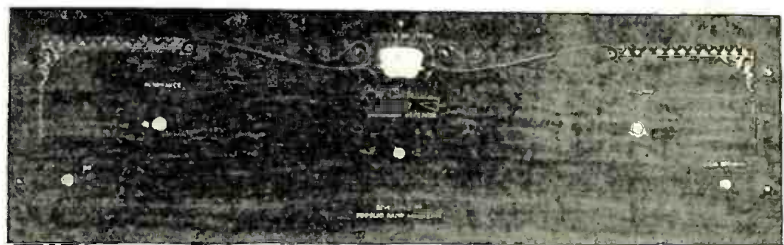

Illustrating the New Cockaday LC-27 **\$3.70**  
 Size 8 x 26. Drilled and Decorated **RETAIL**

**"VEE DEE"**

**Metal Art Panels for Successful Kits**  
 The Latest Improved and Technically Perfect

L. M. Cockaday—LC-27  
 Browning-Drake Improved  
 Hammarlund-Roberts Hi-Q  
 Silver-Cockaday

Karas Equamatic  
 Samson-DeLuxe  
 Infradyne-Remler Type  
 Bremer-Tully Power Six

Highest degree of special finishes—in wood grains, bronze duo-tones and high lighted novelty effects. Drilling work precise to the thousandth part of an inch. Steel of lowest carbon content.

Every special panel includes vulcanized fibre bushings for best insulation.

**Lowest Prices**

**Most Liberal Terms**

Selling Manufacturing and Jobbing Trade Only

**THE VAN DOORN CO.**

160 N. LaSalle St., Chicago, Ill.

Factories: Quincy, Ill.





# Power for the deep tones PLUS a "B" Eliminator

COMPLETE realism in radio reproduction requires that the deep bass tones as well as the high notes be prominently brought out. Only a UX-210 (or CX-310) tube, using up to 400 volts in your last audio stage, has sufficient power

to do this. To use this tube directly in your set, rewiring would be required to take care of the increased voltage. Now by merely attaching a POWERIZER and eliminating your present last tube, you can not only use this real power tube without rewiring, but eliminate "B" batteries as well.

POWERIZER operates from the lamp socket, using two power tubes—one the 210 or Super-Amplifier giving such marvelous tone that it has come to be known as the "Tonifier," the other a UX-216 (or CX-316) rectifying tube, making the POWERIZER a heavy duty super "B" eliminator.

You cannot KNOW what really perfect tone quality is until you hear FOWERIZER. POWERIZER can be attached to any set in a few minutes with no technical knowledge whatever. Ask the nearest POWERIZER dealer to demonstrate it to you today.

Our new descriptive leaflet, "New Tone for Old," will gladly be sent upon request. Write for it.

## POWERIZER

REG.

TESTED and APPROVED by ALL  
Leading Laboratories

Power Amplifier  
and "B" Eliminator  
combined — at cost  
of good "B" Elim-  
inator alone.

\$ 49<sup>50</sup>

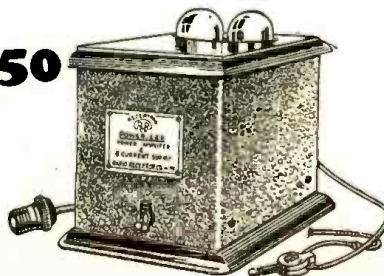

Radio Receptor Co.

106 Seventh Ave.

New York

## A Word About "Fresh" Announcers

THERE is no practice on the air more vicious than that of fresh announcing.

When it comes to announcing, we belong to the fundamentalist group and the old blackjack of this Department is always ready to sock a dissenter.

Just now our special murderer is hot on the trail of an exceedingly fresh young man who displays his wit (*sic*) before the microphone of WWRL. This chap is the leader of air rowdysim, for rowdysim it is—nothing more and certainly nothing less. His flow of tinsel vulgarity is sustained for fifteen minutes at a time and his stuff is perhaps the most banal and the most trashy of anything we have to listen to.

This freshy might be a wow at a smoker, but there is no place on the air for such tommyrot. Broadcasting has enough to overcome without living down such encumbrances.

## Will the "Canned Music" Return?

THAT there is a possibility of canned music returning to the air might upset those of our readers who recall the early use of gramophone records.

It has been months and months since a gramophone has been connected to the air, yet, if we read the stars rightly, this source of entertainment may be well on its way back. Many researches have passed under the bridge since last we heard the scratchy bellowing of the old type of reproducers; since that time the recording and reproduction of sound has been carried to a point where the most subtle effects and the most reluctant frequencies have been "canned," and not a mite of their pristine beauty is lost in the re-creating process. Electrical recording and reproduction based on the new physics of horn amplifiers has brought new hope for the talking machinery and radio.

Our smaller and less conspicuous broadcasters could well afford to use some of these new records. How much better they would be than even the best efforts of amateur talent used by many studios! Perhaps, after all, we are not too presumptuous in looking forward to the days when special records will be prepared and released for nominal sums to the smaller studios, much as movies are released today. With all of the good talent being attracted to the better stations, it will only be a matter of time before the little radiator will find itself without an audience. It is finding itself in competition not only with better talent but with stations that have sufficient power to carry the entertainment of this talent right into its home territory. The day will soon be here when the better radio features will be carried to every corner of the U. S.



## Are Announcers "Hampered" by Studio Rules?

In a recent statement to the press, a New York announcer whose cerebral measurement would be a hot subject for discussion at a congress of anthropologists, whined that he had been hampered in his efforts to improve broadcast presentations by studio rules.

A year ago this smarty was free to say what he would in introducing performers and, like others of his class, he became nothing short of obnoxious with his cheap humor and lengthy vocal excursions into subjects about which he knew nothing. Now that this particular studio to which he had been attached had muzzled him, he found his style cramped and he has intimated that the art was going to the bow-wows.

Imagine broadcasting going to the dogs because it is getting conscious enough to measure the damage that a lot of fresh young jackanapes have been doing to it by their nonsense!

That this young man should be forced to make such a statement is indeed encouraging and it seems to prove that sensible men have the upper hand.

## A New Ham Practice

It took a long time for the hack studio managers to find something to replace the reading of "coming over fine" telegrams, as a device to solicit the response of yokel listeners, but the great problem was finally solved.

Now, you just wire the studios that you wish to have such and such a song played and it will not only be played, but it will be dedicated to *you*.

According to late reports, this new puller of boob wires is working out beautifully in the West, where announcers are announcers and most of the radio is terrible. Is there any wonder that Western Union showed such a good report for the third quarter?



**A ONE-METER TRANSMITTER**

One of the features of the Radio World's Fair in New York was this unique exhibit that operates on AC current. Two square discs act as the fixed condenser; a small radio tube is enclosed in the metal shield.

# NATIONAL POWER AMPLIFIER

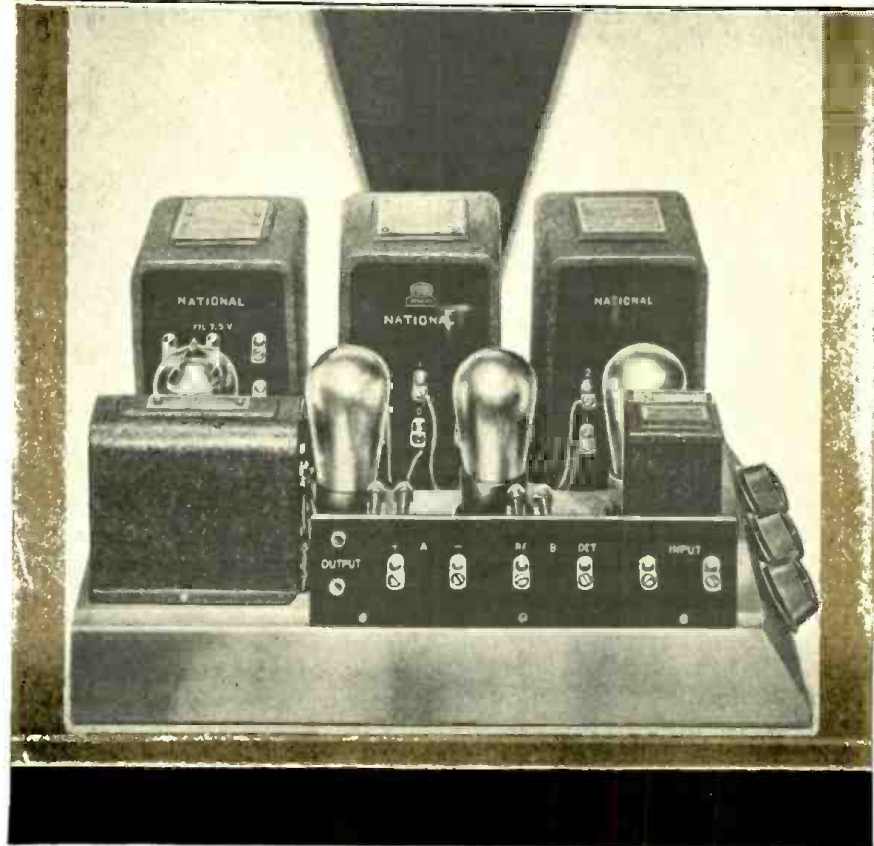

**M**AKES your present Radio Set the last word in Fidelity of Reproduction,—and supplies all B and C current from the lamp socket.

Designed on sound engineering principles in collaboration with Arthur H. Lynch and James Millen, it combines B-power-supply and complete audio-amplifier of the highest type. It is made to use either the Raytheon BH or Rectron Rectifying Tube. Each unit is newly designed for heavy and continuous duty, built to established NATIONAL standards.

The NATIONAL POWER AMPLIFIER is designed to plug directly into the detector output of any Radio set and has one stage of NATIONAL Impedaformer and two stages of resistance coupling with Lynch Resistors. Output from the UX-171 semi-power tube is through a NATIONAL Tone Filter, protecting the loud speaker and still further improving quality. All of the parts mount on a drilled and cored metal base.

Sold in complete kit form, including Raytheon BH Tube and every accessory and piece of wire required (except audio tubes). Easily assembled in an evening.

**PRICE \$85.00**

Price of kit as above but completely assembled ready to run \$95.00

The units are also sold separately

For home and professional set builders—for dealers' custom trade.

**The NATIONAL POWER AMPLIFIER**

NATIONAL products are built to engineering standards of excellence. Anyone who has ever built a set using NATIONAL BROWNING-DRAKE Coils and Transformers knows what that means. Send for Bulletin 116-PR.



National Co. Inc., Engineers and Manufacturers.—W. A. Ready, Pres., Cambridge, Mass.

Makers of NATIONAL BROWNING-DRAKE Coils and R. F. Transformers, Impedaformers, Condensers, Power Transformers, etc. for Radio.

## How to use Resistance in Radio!

**Send**  
for this new booklet!



**P**OWER amplifiers and current supply units, so popular today, have brought with them real problems on the use of resistance in radio. Many of these "eliminator" circuits employ high voltages and heavy currents which make low capacity resistances obsolete.

And new developments are coming every day! All of them depend upon resistance for the control of current—knowledge of the subject is important.

Ward Leonard Electric Company, for more than 35 years the manufacturer of Vitrohm Resistors, announces a helpful booklet which covers this problem of resistance and its use. It is of interest to experimenters, engineers, and merchants.

"How To Use Resistance in Radio" covers many of the latest developments in radio. A partial list of the subjects is given below.

*High-Voltage Current-Supply Unit*

*Variable Charging Rate Trickle Charger*

*110-Volt Direct Current, A & B Supply Unit*

*32-Volt Direct Current, A Supply Unit*

*Power Amplifier and Plate Supply Unit*

*How to obtain Grid Bias Voltages (C Battery) from your present eliminator)*

*Alternating Current Operated Receiver*

7235-4

Ward Leonard Electric Company  
37-41 South St., Mt. Vernon, N. Y.  
I am enclosing 15 cents for my copy of  
"How to Use Resistance in Radio"

Name.....  
Address.....  
City.....  
State.....

**Ward Leonard Electric Company**

A catalogue of Ward Leonard Vitrohm Resistors for radio will be sent free, upon request.



## The BEGINNER IN RADIO

CONDUCTED BY ARMSTRONG PERRY

### Anchoring the Antenna

ONE of the most important bridges in the country came near being erected without strength to sustain the snow load—all because an engineer forgot to include the snow load in his calculations.

Many an aerial fails just when it is needed most because of similar oversights. The snow load may be several times the weight of the wire when soft, clinging snow falls just before the thermometer goes to freezing.

Antenna masts often have an unsightly bend at the tip because flagstaves have been used instead of more rigid poles that can take the weight and strain without bending.

There is no need to erect a mast if there is a tree that can be used. An antenna that is anchored in a tree or that passes through one should be made of weather-proof wire, and that costs

more than bare wire and does not last as long, but the extra expense for wire is much less, usually, than the cost of erecting a mast as high as the tree.

Trees are valuable and their welfare should be considered as carefully as the success of the aerial. A band or wire around a limb will restrict its growth and may kill it. Tree surgeons recommend lag screws or eyebolts. Eyebolts are more secure because the washers and nuts prevent them from pulling out, but it may be more convenient to screw in a lag than to bore a hole for a bolt. A galvanized screw or bolt three-eighths or one-half inch in diameter and long enough to pass through the limb is strong enough for ordinary conditions. The limb used should be at least three times the diameter of the metal and be perfectly sound.

A pulley should be fastened to the eye before the screw or bolt is attached to the tree. This is done by spreading



### HOW TO ANCHOR THE ANTENNA TO THE ROOF

The wooden brackets and large glass insulators used on power lines make a good anchorage for the house end of the antenna for they are both strong and cheap and they are easy to attach.



**30  
DAYS  
FREE  
TRIAL**

# 7 Tube Set Single Dial Radio



## The Metrodyne

**ONLY ONE DIAL TO TUNE**

Retail Price

**\$75**

Completely Assembled

Big Discounts  
to Agents and Dealers

Wonderful offer direct from the factory! The world's greatest radio.

A perfect working, single dial control, 7 tube receiver. And just to prove our claims, we will ship it to your home for **30 days' free trial.** Test it under all conditions. Test it for distance, volume and tonal quality — and if you are not convinced that it is the best single dial set you ever heard, return it to the factory. We don't want your money unless you are completely satisfied.

**BIG PROFITS**

**TO AGENTS AND DEALERS**

Our Agents and Dealers make big money selling Metrodyne Sets. You can work all or part time. Demonstrate the superiority of Metrodynes right in your home. Metrodyne Radios have no competition. Lowest wholesale prices. Demonstrating set on 30 days' free trial. Greatest money-making opportunity. Send coupon below—or a letter—for our agent's proposition.

## Metrodyne Super-Seven Radio

A single dial control, 7 tube, tuned radio frequency set. Approved by America's leading radio engineers. Designed and built by radio experts. Only the highest quality low loss parts are used. Magnificent, two-tone walnut cabinet. Artistically gilded genuine Bakelite panel, nickeled piano hinge and cover support. All exposed metal parts are beautifully finished in 24-k gold.

Easiest set to operate. Only one small knob tunes in all stations. The dial is electrically lighted so that you can log stations in the dark. The volume control regulates the reception from a faint whisper to thunderous volume, 1,000 to 3,000 miles on loud speaker! The Metrodyne Super-Seven is a beautiful and efficient receiver, and we are so sure that you will be delighted with it, that we make this liberal **30 days' free trial offer.** You to be the judge.



**30  
Days' FREE Trial**

## Metrodyne Super-Six

Another triumph in radio. Here's the new 1927 model Metrodyne 6 tube long distance tuned radio frequency receiving set. Approved by leading radio engineers of America. Highest grade low loss parts, completely assembled in a beautiful walnut cabinet. Easy to operate. Dials easily logged. Tune in your favorite station instantly on same dial readings every time. No guessing.

Mr. Howard, of Chicago, said: "While five Chicago broadcasting stations were on the air I tuned in seventeen out-of-town stations, including New York and San Francisco, on my loud speaker horn, very loud and clear, as though they were all in Chicago."

We are one of the pioneers of radio. The success of Metrodyne sets is due to our liberal **30 days' free trial offer**, which gives you the opportunity of trying before buying.

**6  
Tube Set  
\$48.50**  
RETAIL PRICE  
Completely  
Assembled

**MAIL THIS COUPON**  
or send a postal or letter. Get our proposition before buying a radio. Deal direct with manufacturer — **Save Money.**

## Mail COUPON Below!

Let us send you proof of Metrodyne quality

F. L. Warnock, Greentown, Ind., writes: "I received the Metrodyne in good shape and am more than pleased with it. Got stations 2,000 miles away."

C. J. Walker, Mariposa, Calif., writes: "Received my Metrodyne Single Dial set O. K. I believe that these one-dial sets are going to be excellent sellers. I had no trouble in tuning in stations enough to satisfy anyone, so you will please send me another set."

Roy Bloch, San Francisco, Calif., writes: "Very often we travel from New York to the Hawaiian Islands quickly — from station to station — by means of the little tuning-knob which operates the electrically-lighted dial. The Metrodyne Single Dial Set is much easier to operate than any radio set I've ever seen."

We will send you hundreds of similar letters from owners who acclaim the Metrodyne as the greatest radio set in the world. A postal, letter or the coupon brings complete information, testimonials, wholesale prices, and our liberal **30 days' free trial offer.**

**METRO ELECTRIC COMPANY**  
2161-71 N. California Ave., Dept. 131  
Chicago, Illinois

Gentlemen:  
Send me full particulars about Metrodyne 6 tube and 7 tube sets and your **30 days' free trial offer**

Name.....

Address.....

If you are interested in AGENT'S proposition, place an "X" in the square

## METRO ELECTRIC COMPANY

2161-71 N. California Ave. • Dept. 131 • Chicago, Illinois



# FULL SIZE BLUE PRINTS

Price \$1.00 Per Set

LAURENCE M. COCKADAY has personally supervised the preparation of *Simplified Blueprints* of thirteen of POPULAR RADIO'S most popular circuits. Each set consists of one or more *Actual Size Blueprints*: first a Panel Pattern; second, an Instrument Layout; and third, a Picture Wiring Diagram all simplified in the fullest sense of the word because

The Panel Pattern can be laid on the panel and all holes drilled as indicated. No scaling to do and so accurate there is no danger of ruining the panel through faulty calculation.

The Instrument Layout placed on the sub-base permits you to indicate by pin-pricks the exact location of every screw.

The Picture Wiring Diagram gives every instrument in exact size, and position with every wire clearly indicated from one contact to the other. With no knowledge of radio symbols you can assemble every part and complete your wiring with no chance of error.

Set No. 4—"Cockaday 4-Circuit Tuner with Resistance-Coupled Amplifier" (five tubes, distortionless, two dials, automatic vacuum tube control, as described in the October 1924 issue of POPULAR RADIO).

Set No. 6—"The Cockaday 8-Tube Super-heterodyne Reflex Receiver" (eight tubes, two tuning dials, loop, non-radiating, distortionless, as described in January 1925 issue of POPULAR RADIO).

Set No. 12—"8-Tube Super-heterodyne with Single Control" (as described in October 1925 issue of POPULAR RADIO).

Set No. 14—"The LC-26 Broadcast Receiver" (as described in December 1925 issue of POPULAR RADIO).

Set No. 16—"The S-C All-Wave Receiver" (as described in the March 1926 issue of POPULAR RADIO).

Set No. 17—"The Power-pack Amplifier" (as described in the April 1926 issue of POPULAR RADIO).

Set No. 19—"The Improved Raytheon Power-Pack" (as described in the May, 1926, issue of POPULAR RADIO).

Set No. 19—"The New Home Receiver" (three tubes, two stages of radio-frequency amplification with crystal detector, as described in June, 1926 issue of POPULAR RADIO).

Set No. 21—"The Improved Browning-Drake Receiver" (as described in the August, 1926, issue of POPULAR RADIO).

Set No. 22—"The LC-27 Broadcast Receiver" (as described in the October, 1926, issue of POPULAR RADIO).

Set No. 23—"The LC-Senior Power-Pack" (as described in the November, 1926 issue of POPULAR RADIO).

Set No. 24—"The LC-Intermediate Power-Pack" (as described in the December, 1926 issue of POPULAR RADIO).

Set No. 25—"The LC-Junior Power Pack" (as described in the January 1927 issue of Popular Radio).

Full constructional and parts details for these Receiving Sets will be found in the issue of POPULAR RADIO indicated.

Back issues of POPULAR RADIO will be furnished at the rate of 35c a copy.

## POPULAR RADIO

Department 14

627 West 43d Street, New York

POPULAR RADIO, Inc., Dept. 14,  
627 West 43d St., New York City

Date.....

Enclosed is my remittance of \$..... for which kindly send me Blueprint Set (s) consisting of Panel Pattern, Instrument Layout and Wiring Diagram as checked below:

- |  |  |
|--|--|
| <input type="checkbox"/> Set Number 4  | <input type="checkbox"/> Set Number 18 |
| <input type="checkbox"/> Set Number 6  | <input type="checkbox"/> Set Number 19 |
| <input type="checkbox"/> Set Number 12 | <input type="checkbox"/> Set Number 20 |
| <input type="checkbox"/> Set Number 14 | <input type="checkbox"/> Set Number 22 |
| <input type="checkbox"/> Set Number 16 | <input type="checkbox"/> Set Number 23 |
| <input type="checkbox"/> Set Number 17 | <input type="checkbox"/> Set Number 24 |
| <input type="checkbox"/> Set Number 25 |  |

Name.....

Address.....

City..... State.....

the ring of the pulley, or the eye, and linking them together. After they are linked, they should be inspected carefully to discover if any cracks have started; some stock is so poor that it is weakened by spreading and breaks when the strain is placed upon it.

The pulley should be large enough to give the halyard plenty of room after exposure to the weather swells it. Sash cord is strong enough for any but very long aerials or those made of very heavy wire. It should be straightened and all tendency to kinking should be eliminated before it is rove through the pulley. An extra length of the cord should be kept on hand. As soon as the halyard shows the first sign of weakening, the end of the new cord should be sewn smoothly to the end of the old and pulled through the pulley; otherwise, someone may be tempted to climb the tree under dangerous conditions.

The two ends of the halyard should be tied together. When they are untied for any purpose, the cord first should be anchored so that it cannot escape. Even when the ends are joined they cannot be permitted to whip about without danger of the rope getting beyond reach. A bucket of sand or stones, with the weight adjusted to hold the aerial taut with the minimum strain on the limb and halyard, is the best anchor; it adjusts itself automatically to the movements of the tree and maintains an even strain. This arrangement makes it easy to lower the aerial for inspection and changes, and is ideal for experimenters. If children use the bucket for a swing, make it a hanging garden filled

with plenty of thistles and pincushion cacti!

The anchorage at the other end of the aerial also is important. The wooden brackets and glass insulators used on light and power lines are strong and cheap. To insure strength, the best method is to wrap two or three turns of the aerial wire around the insulator, but as such turns produce both inductance and capacity it may be better to tie the wire to the insulator with plenty of friction tape or other strong, non-conductive material. When very short waves are to be received there should be no turns in the aerial wire around the insulator.

With the aerial firmly anchored at both ends, the lead-in can be installed and changed at will without disturbing the higher wires that are so much harder to reach.



This radio fan, Carl Laemmle, Jr., sent a \$2,500 radiogram to get a scenario to a film company on time.

## \$2,500 to Send a Single Radiogram

CARL LAEMMLE, JR., age eighteen, is a radio fan. He turned to radio recently to help him to get out of a tight place.

He was writing a series of ten scenarios, entitled "The Collegians," for which he was to receive \$1,000 each. While touring Europe with his father, in search of material for the photoplay, his father became dangerously ill. Young Laemmle was too anxious about his father to think of his work for some time. When the crisis was passed and the patient well on the way to recovery, the boy realized suddenly that one of his scenarios would be due in Hollywood within a few days and that there was not time enough to send it by mail even if it were ready.

He finished the scenario as quickly as possible and sent it from London to Hollywood by radio. The bill was \$2,500—but the scenario reached the producing company on time.



### RAISING THE ANTENNA

When the antenna has been raised to the proper height by means of the halyard, a bucket of sand or stones should be attached to the end of this rope as an anchor.





**One Dial**  
LONG DISTANCE  
**5 TUBE RADIO**

**\$25.00**

**EVERYBODY**, including experienced radio engineers said — it cannot be done. But we did it—produced a high grade, long distance single dial control radio to operate a loud speaker to retail for \$25.00—and yet allow liberal discount to agents.

This marvelous instrument is the result of five years hard work by an organization of trained radio engineers. It is no experiment — thousands are in use—the results speak for themselves.

**There Will Be a Radio In Every Home**

Thousands have been waiting for just such a radio—a real long distance, powerful instrument but—at a price they can afford.

It is here, and live wide awake salesmen will recognize their opportunity immediately—they won't lose a single minute writing for full information.

Just as there are 100 Fords to one high priced car, just so will there be 100 Vikings to every \$75.00 and \$100.00 radio—think what this means to men who get in on the ground floor right now.

**A \$25 Radio That Gives You a \$75 Value**

Put a Model 599 Viking which retails for \$25.00 alongside any radio retailing for \$75.00 and even more. Compare them for ease of tuning—only one dial to tune on the Viking—distance received, volume and tone. The results will make any man say, "I'll save that \$50.00."

Radio is today the biggest and quickest selling line—thousands are being sold—salesmen have made unheard of profits. But here is a far greater, a far more interesting radio proposition than anyone ever dreamed of.

**You Should Make \$100.00 a Week Easily**

You can't help it—many will make more. Some will control a county—others will control many counties. We have the liveliest radio selling plan of today—instruments of all prices—a radio price to fit every pocketbook.

Any man who will follow our teaching cannot help but add big money to his present income and start to do it immediately. If you want more money here is your chance but you'll have to act quick—others will jump at this chance.

**Agents Wanted**  
**Make \$100.00 a Week**

**Sell Radio in Your Spare Time—Evenings**

You don't even have to give up your present position. The only time radio can be sold is in the evening—by demonstration. So here is a chance to add to your present income. During the past five years we have trained 4364 men in this very profitable business.

You'll be the first one with a real low priced long distance radio—your price will startle everybody—the results will be even far more startling. Once you demonstrate you're sure of a sale. No one can think of investing \$75.00 to \$100.00 in a radio when this instrument will get the same results and your retail price is only \$25.00. Just think of the advantage you have. Sell a radio for only \$25.00, and yet make a handsome commission.

**A Regular Radio at a Price Unheard Of**

Uses five No. 199 tubes, operates on three ordinary dry cells. Only one dial to tune—a feature generally only found in the highest priced instruments. Any child can tune the Model 599 VIKING—simply turn the dial. Cabinet is extremely attractive, 12 inches long, 8 inches high and 6 inches deep. The wood is covered with Keratol, embossed in a very attractive design. On the front are two very odd gold colored, colonial designs inserted in two panels. The base and ends are finished in a rough gold and black colored finish which together with the rich seal brown Keratol of the balance makes a cabinet that would be an ornament in any home.

The tuning is arranged so that it is accomplished by the use of one special low loss condenser and a basket weave coil. Sockets, rheostat, potentiometer and base board are all of bakelite. Three transformers give an abundance of volume for loud speaker. Parts will equal the average \$75.00 or \$100.00 radio instrument—only enormous production could possibly bring about this low price.

**Territory is Going Fast—**  
**Better Write Today**

Someone is going to get the big profit on the sales of these instruments in your community—is that someone going to be you? Write today for our 100 page book which fully describes not only this wonderful instrument but also a full line of radio at all prices. It's FREE for the asking.

**Use This Coupon**

H. D. Fischer,  
120 W. Austin Ave.; D  
Chicago, Illinois.

I am interested in selling your 5 tube set in this territory. Please send me your 100 page radio book, FREE.

Name.....

Address.....

City..... State.....

**SEND FOR 100 PAGE FREE BOOK** →



## Make Your Own CONE SPEAKER

### MONSTER SIZE

CIRCULAR CUT  
3 FOOT HIGH  
READY TO  
GLUE

Do you know that clarity of low tones and notes are obtainable only in speakers of at least this size? Build this FENCO CONE and note the difference.

Direct to Consumer

## FREE

Instructions and Blue Print

So easy to assemble that a child 12 years old can put it together in 30 minutes.

Send P. O. Money Order or Check

### Only \$12. Complete

Equal to \$60 manufactured speaker, 30 minutes easy work saves you \$48

HERE'S WHAT YOU GET

- 2 Sheets (circular cut) Alhambra Feno-text paper
- FENCO special adjustable balanced Unit
- 1 Baffle ring and set of Apex fittings
- 1 Mounting bracket and iron handle
- 1 Can Ambroid cement
- 3½ yds. Oriental gold lace

All for ONLY \$12 postpaid

FEN-CO CONE CO., 67 Murray St., New York



## BROADCASTS

CONDUCTED BY CHARLES L. REESE, JR.

### Radio Pays the Penalty of Congressional Indifference

RADIO conditions in the Middle West are reported as becoming more and more chaotic as a result of the "hands off" policy of the Federal Government. It is said that five stations in the district that have changed their wavelengths now interfere with reception from 23 other broadcasters and a petition has been sent from one of the principle cities of Tennessee signed by 70 listeners in asking the government for relief.

### The Coming of the "Radio Reporter"

RADIO announcers are achieving a new dignity now that the radio stories of big news events are being printed verbatim in the newspapers. The first event of this kind was the Dempsey-Tunney fight, when three expert stenographers, working in relays, were employed to take down the announcements of J. Andrew White and Graham McNamee as they came over the radio.

### China Opens Door to Radio

THE latest sign that the charms of radio are at last conquering the age-old prejudice of the Far East against anything new is the news that the bars against radio are down in Southern Manchuria. Up to now the use of radio receiving sets in this part of China has been prohibited to the ordinary person, but now a broadcasting station is to be built at Mukden and anyone who is willing to pay the tax of 25 cents on crystal sets and 50 cents on tube sets may own a receiver and listen to the programs broadcast.

### Australia Demands Broadcast Service

THE long-suffering American fan who spends half of his time at the radio in trying to find a point on the dial where no more than one station comes in at a time will find the demands that his Australian cousin makes of his broadcasting stations a little more than Utopian. The particular Australians demand that their stations broadcast on wavelengths at least 50 meters apart so that even the least selective set will have no trouble in separating them and in addition they ask that the broadcasters transmit on long waves at night and on short waves in the daytime hours in the hope that this will improve reception.

### Map-making by Radio

RADIO is proving to be of tremendous value to the map-maker, especially in the world-wide longitude determinations that are now under way, according to a statement recently made by Dr. William Bowie of the Coast and Geodetic Survey. When wired lines had to be used, survey stations could only be set up at a limited number of points but now, with the aid of radio, longitude stations may be set up in comparatively inaccessible locations to compile and to transmit data on the experiments.

### A "Secret" Radio for Mussolini

A RADIO transmitter which, it is claimed, will transmit messages that cannot be read except by those for whom they are intended and which is free from interference from other stations was recently presented to Mussolini by John Hays Hammond, Jr., the American inventor. The system employed by Mr. Hammond in what he calls his "narrowcasting" radio is the transmission of a low-frequency carrier wave modulated with super-audible waves. The inventor claims that no one who does not know the frequency of both the carrier wave and the modulating wave can listen in on the transmissions.

### Amateurs Keep in Touch with "River of Doubt" Expedition

THE Roosevelt "River of Doubt" Expedition, which has by now penetrated far into the wilds of Brazil, has been able to keep in constant touch with civilization through the efforts of amateurs in the United States. The radio apparatus used by the expedition was also built by New York amateurs.

## Simplified Blue Prints

of the

## "Town and Country"

Portable Receiver

The "Town and Country" Portable Receiver, developed by the POPULAR RADIO LABORATORY and described in July, 1926 issue, marks a decided advance in portable receiver design. While not a "vest pocket" receiver, the new "Town and Country" is small enough to be taken along on a motor boat or train trip. Efficiency has not been sacrificed for the sake of compactness.

The receiver uses six UX-199 tubes and one UX-120 power tube. Operating on a loop, tone quality is guaranteed by the use of a fundamentally correct circuit, high-class transformers and cone-type speaker.

The new "Town and Country" Portable Receiver is mounted in a special mahogany cabinet with a drop front and is equipped with a carrying handle. All equipment, including the folding loop, cone loud-speaker, batteries and connecting cable, is installed in a suitcase. Connections from the equipment to the set are made by means of jacks and plugs.

By using POPULAR RADIO Blue Prints in building your "Town and Country" receiver, you can save time, eliminate the possibility of error, and make your set exactly like the laboratory models (see page 104).

If your local dealer cannot supply you with Blue Prints of this set, they will be sent postpaid upon receipt of \$1.00 per set.

POPULAR RADIO

Service Bureau 14-B

627 W. 43rd St., New York City



# 30 DAYS FREE IN YOUR HOME

Tested and approved by all of Radio's Highest Authorities



Send Coupon for Amazing Special Offer!

Unless Trial Proves Your Miraco The Most Selective, Clearest Toned and Most Powerful Distance Getter Among Sets up to 8 Tubes, Don't Buy It!

BEAUTIFUL - BIG - POWERFUL Ultra Selective **MIRACO** Ultra 5

Retail \$ **49.75** LIST Price **49.75** *now only* **49.75** GET SPECIAL OFFER *one year* GUARANTEE

SPECIAL WHOLESALE PRICES

to User-Agents who will allow friends to listen to their Miracos.

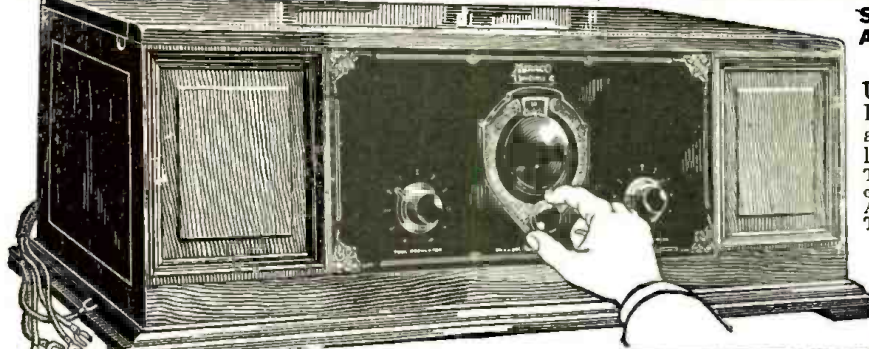

Built like—to look like—and perform like \$200 sets

## Real Single Dial Control! Magnificent Big Powerful Miraco "Unitune-5" Get Special Offer and Amazing Low Price!

The celebrated Miraco Ultra-5—U.S. Navy type circuit, has also been adapted to Single Dial Tuning—without sacrifice of selectivity, volume, clearness, power, tone, or distance getting qualities! In the magnificent big Miraco Unitune-5, above shown, you turn one vernier knob for stations everywhere. Beautiful hand-rubbed, piano hinged, solid walnut cabinet, 28 in. long, 16 in. deep, 10 in. high. Sloping Bakelite panel is walnut finished to match. Also offered on 30 days free trial!

## Coast to Coast and Foreign Reception Certified by Miraco users



Notice! Enormous sales of the celebrated Miraco Ultra-5 are resulting from delighted users so highly endorsing them to friends again enable us to add loads of costly new features, latest refinements and up-to-the-minute improvements such as you might expect to find only on much higher priced sets. Miraco this year is still better—more beautiful—more selective—more powerful for less money than ever before.

**USER-AGENTS WANTED - WRITE!** Reports from users everywhere leave little for us to add. There are only a few of the many in our files and which we receive daily. Send coupon for plenty of additional proof and testimony of nearby users.

**NO EQUAL FOR TONE, VOLUME, DISTANCE.** North, Wildwood, N.J. Miraco best packed set I ever saw shipped. Words cannot express the wonderful tone quality, volume, and distance. First night received 47 stations on loudspeaker. Up to last night, the 5th night, I have received exactly 103 stations; farthest is KGO, Oakland, Calif., on loudspeaker. Also Porto Rico, Cuba and Canada. Francis B. Lee.

**TONE QUALITY PLEASURES EVERYONE.** Philadelphia, Pa. Everyone that hears the Miraco is very pleased with its tone, distance, and distance. Also in during the International Test Week; KGO, Oakland, Calif.; Mex., Mexico City; Mex., GKW, Cuba; 2EH, Edinburg, Texas; also a station in Buenos Aires, Argentina. Geo. W. Hill, Jr.

**WISCONSIN HEARS COAST TO COAST.** Racine, Wis. I got within 210 London last Wednesday night on my Miraco. Heard a choir and an announcement. Heard also PWR, Havana, Cuba; CZZ, Mexico City and 104 American stations from coast to coast. Lawrence Ribars.

**SELECTIVITY—THROUGH STRONG LOCALS.** Detroit, Mich. I am more than satisfied with my Miraco. I can cut through WJZ, WJR, WGBH, very strong local stations, and this is done with quietness of a turn of the dial. It is simply perfect. Charles Paul.

**UTAH ENJOYS COAST TO COAST PROGRAMS.** Heber City, Utah. The Miraco sure can't be beat at any price. Coast to coast it does and more. I have had stations in New York and Cuba in the east, and scores of other stations on the west coast. I have logged up to date 150 stations and they all come in wonderfully. Monte Giles.

**MIRACOVINS AGAINST 3 OTHER MAKES.** Pearland, Texas. I tried these other makes and the Miraco is the best of them all. Received KFI, Los Angeles, Calif., on loudspeaker. O. H. Richards.

**Neuroches, Texas.** On my Miraco I have heard stations from Cuba to San Francisco and from Mexico City to Pittsburgh. Walter H. Frisbie.

**COAST TO COAST AND CLEAR.** Guthrie, Minn. We logged over 30 stations and got over 1500 miles on the loud speaker the first night—our first experience tuning a radio. The third night we got WJAX Jacksonville, Florida and KFI, Los Angeles, Calif., on the loudspeaker. Neighbors say Miraco is the best they have ever heard. O. R. Wolf.

**MIRACO BEATS A SUPER EIGHT.** Cobalt, Ontario, Canada. Miraco is one of the best radios in all the north country. There is a man here who has a Super Eight and our Miraco beats it. Sammie.

**OUTPERFORMS SOME \$300 SETS.** Blakey, Ga. I am well pleased with my Miraco. It does better than machines that cost \$300 or more. J. D. Tison.



Solid Walnut Cabinet

Solid Walnut Cabinet

# Big Powerful New Unitune 5 MIRACO ultra 5

28 in. long 27 in. long

TRADE MARK REGISTERED

ULTRA-SELECTIVE LONG DISTANCE 5 TUBE SETS EASY ON BATTERIES

Why run down your costly batteries burning 6, 7 or 8 tubes when users everywhere report that powerful big Miraco sets actually are *unsurpassed* (even at 2 to 4 times the price) for razor-edge selectivity, extreme long distance reception, clear natural tone, quiet easy tuning and powerful loud speaker volume—combined with great savings in use of battery current.

**Be Convinced—at Our Risk!** Enjoy a big powerful Miraco 30 days in your home. Compare it with highest priced sets. Then decide. Your verdict final. Remember, this offer is made direct to you by a famous big Radio Corporation—one of America's oldest, reliable makers of fine sets. Many thousands of satisfied customers. Postal or coupon brings testimony of nearby users and plenty of proof.

**Factory Prices Save You Up to 1/2!** Save or make a lot of money on sets.

Compare the construction with highest priced sets—study this picture

Note the neat sturdy high-class construction; wide spacings between parts eliminate losses and interference. All wiring concealed under genuine Bakelite base panel (M). Flexible wiring prevents broken or noisy connections. Flush-type sockets for the new tubes. (A) (B) (C)—"Duoformers"—famous exclusive Miraco Ultra low loss, self shielded and matched coils—one of the Miraco secrets of selectivity with powerful volume on long distance stations. (D) "Counter Balancer"—patented feature, NOT a rheostat or potentiometer. Controls oscillations on all wave lengths, reduces "B" battery consumption and further increases selectivity, distance range, clarity, power and volume. (E) (F) Shielded transformers of famous make effectively amplify all notes; beautiful tone quality. (G) Tone Modulator—regulates volume, switches current off or on. (H) (I) (J) Low Loss Straight Line Frequency Condensers—highest grade—equipped with ball bearings. Solid brass plates. Evenly separate all stations. (K) Connect E-Z Cable for attaching batteries. (L) Genuine Bakelite front panel. And many other latest features of costliest sets. Literature describes them fully, send for it!



RELIABILITY! The Mid-west organization was one of the very first to engage in the manufacture of radio sets. We consider them to be both morally and financially responsible. They have a reputation for fair and square dealing. THE PROVIDENT SAVINGS BANK & TRUST CO.



Rear View of Celebrated Ultra

**AGENTS! DEALERS!** Write for distribution. Nation-wide popularity, superior performance, amazingly low prices, make Miracos easy to sell.

**All the Proof you want is waiting for You!** Coupon or postal brings reports from hosts of users in your vicinity and elsewhere proving that Miraco sets at rock-bottom money-saving factory prices, outperform sets costing up to four times as much. You can also buy speakers, tubes, batteries, etc., at big savings from us! Get our proposition before spending money elsewhere.

**MIDWEST RADIO CORPORATION**  
Pioneer Builders of Sets Cincinnati, O.

479-S Miraco Building  
Without obligation, send free literature, testimony of users, AMAZING SPECIAL OFFER and full particulars of your big money-saving factory-price proposition on Guaranteed Miraco sets and all radio supplies. ( ) Agent ( ) Dealer

NAME \_\_\_\_\_  
ADDRESS \_\_\_\_\_

Send coupon for Amazing Special Offer!

This Coupon Is NOT An Order



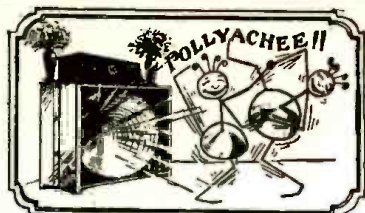

With the "EnSCO 3 ft. Cone Kit" you can make your own Cone Speaker in less than an hour—You can then enjoy all of the True Tones of Music without distortion.

Complete parts furnished in kit form. We guarantee this speaker the equal of any manufactured cone speaker at any price. With this THREE FOOT CONE SPEAKER you hear all the tones. It brings out the true depth and beauty of orchestral and instrumental music. Can be operated softly for living room music or full volume for dancing, and without trace of distortion. Kit includes famous "ENSCO" cone unit, the only direct drive, distortionless unit for large cones; Alhambra Fonotex for big cone, with brass apex, two Sepia Prints showing cabinet or simple stand construction. All necessary instructions.

Buy this wonderful speaker under our absolute guarantee. Your money back if you are not convinced that it is the finest reproducing medium obtainable at any price. It works on any set, with ordinary Tubes or with Power Output.

**ORDER COUPON—SEND NO MONEY**

Write your name plainly as indicated below, then mail and complete kit will be forwarded to you. Just pay postman \$10.00 upon delivery.

Name.....

Address.....

**ENGINEERS' SERVICE CO.**  
25 CHURCH ST. Desk Z NEW YORK CITY

**Outstanding Program Features of the Month**

DECEMBER 20th TO JANUARY 15th

**D**URING the coming month, December 20th to January 15th, the following regular and special program features are scheduled. This list, which will be augmented monthly as advance information is received, will be published in each issue of the magazine; all broadcast stations are invited to report coming program features of outstanding interest or importance. Reports should reach the Editor of POPULAR RADIO on or before the 23rd of the month preceding.

**DECEMBER**  
(Eastern Standard Time)

- 20th: *Willys-Overland Hour*, WJZ; 8:30 P.M.
- 20th: *A & P Gypsies*, WEA; 9:00 P.M. (Also broadcast from WEEL, WJAR, WDAF, WRC, WCSH, WCAE, WTAM, WLIT and WWJ).
- 20th: *Fireside Boys* (vocal), WJZ; 9:50 P.M.
- 20th: *B. A. Rolfe's Palais D'Or Orchestra*, WEA; 11:00 to 12:00 M.
- 21st: *Champion Spark Pluggers*, WJZ; 8:00 P.M. (Also broadcast from WGY and WRC).
- 21st: *Vikings*, WEA; 8:00 to 8:30 P.M. (Also broadcast from WEEL, WJAR, WTAM, WGR, WFI, WCSH, WCAE, WTAM, WWJ, KSD, WSAI, WCCO and WOC).
- 21st: *Jolly Buckeye Bakers*, WEA; 8:30 to 9:00 P.M. (Also broadcast from WFI, KSD, WSAI, WCCO, WTAM, WWJ, WTAG and WLIB).
- 21st: *Eveeady Hour*, WEA; 9:00 P.M. (Also broadcast from WEEL, WFI, WCAE, WGR, WWJ, WOC, KSD, WJAR, WCCO, WTAM, WGN, WSAI and WTAG).
- 21st: *Keystoners*, WJZ; 9:00 P.M. (Also broadcast from WRC and WGY).
- 21st: *Auction Bridge Instructions*, WEA; 10:00 P.M. (Also broadcast from WEEL, WCSH, WTAG, WJAR, WGR, WCAE, WTAM, WFI, WWJ, WSAI, WGN, WOC, WCCO, and KSD).
- 21st: *Cook's Tours*, WJZ; 10:00 P.M. (Also broadcast from WRC and WGY).
- 21st: *George Olsen's Orchestra*, WJZ; 10:45 P.M.
- 22nd: *Eastman Theatre Orchestra*, WJZ; 6:30 P.M. (Also from WHAM).
- 22nd: *Davis Saxophone Odette*, WEA; 8:30 P.M. (Also broadcast from WEEL, WJAR, WLIT, WRC, WTAG and WCAE).
- 22nd: *Ipana Troubadours*, WEA; 9:00 to 9:30 P.M. (Also broadcast from WEEL, WGR, WRC, WCAE, WWJ, WLIB, KSD and WCCO).
- 22nd: *Sixty White Minutes* (orchestra), WJZ; 9:00 P.M. (Also broadcast from WBZ, KDKA and KYW).
- 22nd: *Smith Brothers* (vocal and instrumental); WEA; 10:00 to 10:30 P.M. (Also broadcast from WTAG, WGR, WRC, WCAE, WWJ, WSAI, KSD, WOC, WCCO and WDAF).
- 23rd: *Royal Typewriter Orchestra*, WGY; 9:00 P.M. (Also broadcast from WRC, WBZ and WJZ).
- 23rd: *Goodrich Zippers* (orchestra and vocal), WEA; 10:00 P.M. (Also broadcast from WEEL, WCCO, WGN, WCAE, WJAR, WTAM, KSD, WOC, WGR, WSI, WWJ, WSAI and WADC).
- 23rd: *Clicquot Club Eskimos*, WEA; 9:00 P.M. (Also broadcast from WEEL, WCCO, WGN, WCAE, WJAR, WTAM, WGR, WFI and WWJ).
- 24th: *Happiness Boys*, WEA; 8:00 P.M.
- 24th: *Breyer Hour* (orchestra and vocal), WJZ and WRC; 9:00 P.M.
- 24th: *La France Orchestra*, WEA; 9:30 P.M. (Also broadcast from WEEL, WGR, WLIT, WOC, WCAE, WTAM, WDAF, WWJ and KSD).
- 25th: *New York Philharmonic Orchestra with Walter Damrosch*, WEA; 9:15 P.M. (Also broadcast from WEEL, WGR, WFI, WCAE, WWJ, WSAI, WTAM, WGN, KSD, WCCO and WDAF).
- 26th: *Capitol Theatre Grand Orchestra*, WEA; 7:20 P.M. (Also broadcast from KSD, WRC, WWJ, WSAI, WCAE, WTAG).
- 26th: *Atwater Kent Hour*, WEA; 9:15 P.M. (Also broadcast from WSAI, WEEL, WFI, WCCO, WTAM, WGN, WFI, WCAE, WGR, WOC, WTAG, WWJ and KSD).
- 26th: *Godfrey Ludlow* (violinist), WJZ; 9:30 P.M. (Also from WGY).
- 26th: *Maxwell House Coffee Hour* (orchestra), WJZ; 10:15 to 11:15 P.M. (Also broadcast from WBZ, WRC, WGY and KDKA).
- 27th: *Willys-Overland Hour*, WJZ; 8:30 P.M.
- 27th: *A & P Gypsies*, WEA; 9:00 P.M. (Also broadcast from WEEL, WJAR, WSAI, WDAF, WRC, WCSH, WCAE, WTAM, WLIT and WWJ).
- 27th: *Fireside Boys*, WJZ; 9:50 P.M.
- 27th: *B. A. Rolfe's Palais D'Or Orchestra*, WEA; 11:00 to 12:00 M.
- 28th: *Champion Spark Pluggers*, WJZ; 8:00 P.M. (Also broadcast from WGY and WRC).
- 28th: *Vikings*, WEA; 8:00 to 8:30 P.M. (Also broadcast from WEEL, WJAR, WTAM, WGR, WSI, WCSH, WCAE, WTAM, WWJ, KSD, WSAI, WCCO and WOC).
- 28th: *Buckeye Bakers*, WEA; 8:30 to 9:00 P.M. (Also broadcast from WFI, KSD, WSAI, WCCO, WTAM, WWJ, WTAG and WLIB).
- 28th: *Eveeady Hour*, WEA; 9:00 P.M. (Also broadcast from WEEL, WFI, WCAE, WGR,

- WWJ, WOC, KSD, WJAR, WCCO, WTAM, WGN, WSAI and WTAG).
- 28th: *Keystoners*, WJZ; 9:00 P.M. (Also broadcast from WRC and WGY).
- 28th: *Auction Bridge Instructions*, WEA; 10:00 P.M. (Also broadcast from WEEL, WCSH, WTAG, WJAR, WGR, WCAE, WTAM, WFI, WWJ, WSAI, WGN, WOC, WCCO and KSD).
- 28th: *Cook's Tours*, WJZ; 10:00 P.M. (Also broadcast from WRC and WGY).
- 28th: *George Olsen's Orchestra*, WJZ; 10:45 P.M.
- 29th: *Eastman Theatre Orchestra*, WGY; 6:30 P.M. (Also from WHAM).
- 29th: *Davis Saxophone Odette*, WEA; 8:30 P.M. (Also broadcast from WEEL, WJAR, WLIT, WRC, WTAG and WCAE).
- 29th: *Sixty White Minutes* (orchestra), WJZ; 9:00 P.M. (Also broadcast from WBZ, KDKA and KYW).
- 29th: *Ipana Troubadours*, WEA; 9:00 to 9:30 P.M. (Also broadcast from WEEL, WGR, WRC, WCAE, WWJ, WLIB, KSD and WCCO).
- 29th: *Smith Brothers* (vocal and instrumental); WEA; 10:00 to 10:30 P.M. (Also broadcast from WTAG, WGR, WRC, WCAE, WWJ, WSAI, KSD, WOC, WCCO and WDAF).
- 30th: *Royal Typewriter Orchestra*, WGY; 9:00 P.M. (Also broadcast from WEEL, WCCO, WGN, WCAE, WJAR, WTAM, KSD, WOC, WGR, WSI, WWJ and WSAI).
- 30th: *Clicquot Club Eskimos*, WEA; 9:00 P.M. (Also broadcast from WEEL, WCCO, WGN, WCAE, WJAR, WTAM, KSD, WOC, WGR, WFI and WWJ).
- 30th: *Goodrich Zippers* (orchestra and vocal); WEA; 10:00 P.M. (Also broadcast from WEEL, WCCO, WGN, WCAE, WJAR, WTAM, KSD, WOC, WGR, WFI and WWJ).
- 31st: *Happiness Boys*, WEA; 8:00 P.M.
- 31st: *Hohner Harmony Four*, WEA; 8:30 to 9:30 P.M. (Also broadcast from WEEL, WLIT, WGR, WRC, WCAE, WLIB, WTAM and WWJ).
- 31st: *Breyer Hour* (orchestra and vocal), WJZ and WRC; 9:00 P.M.
- 31st: *La France Orchestra*, WEA; 9:30 P.M. (Also broadcast from WEEL, WGR, WLIT, WOC, WCAE, WTAM, WDAF, WWJ and KSD).
- 1st: *New York Philharmonic Orchestra with Walter Damrosch*, WEA; 9:15 P.M. (Also broadcast from WEEL, WGR, WFI, WCAE, WWJ, WSAI, WTAM, WGN, KSD, WCCO and WDAF).
- 2nd: *Capitol Theatre Grand Orchestra*, WEA; 7:20 P.M. (Also broadcast from KSD, WRC, WWJ, WJAR, WCAE and WTAG).
- 2nd: *Atwater Kent Hour*, WEA; 9:15 P.M. (Also broadcast from WJAR, WEEL, WFI, WCCO, WTAM, WGN, WFI, WCAE, WGR, WOC, WTAG, WWJ and KSD).
- 2nd: *Godfrey Ludlow* (violinist), WJZ; 9:30 P.M. (Also from WGY).
- 2nd: *Maxwell House Coffee Hour* (orchestra), WJZ; 10:15 to 11:15 P.M. (Also broadcast from WBZ, WRC, WGY and KDKA).
- 3rd: *Willys-Overland Hour*, WJZ; 8:30 P.M.
- 3rd: *A & P Gypsies*, WEA; 9:00 P.M. (Also broadcast from WEEL, WJAR, WDAF, WRC, WCSH, WCAE, WTAM, WLIT and WWJ).
- 3rd: *Fireside Boys*, WJZ; 9:50 P.M.
- 3rd: *B. A. Rolfe's Palais D'Or Orchestra*, WEA; 11:00 to 12:00 M.
- 4th: *Champion Spark Pluggers*, WJZ; 8:00 P.M. (Also broadcast from WGY and WRC).
- 4th: *Vikings*, WEA; 8:00 to 8:30 P.M. (Also broadcast from WEEL, WJAR, WTAM, WGR, WFI, WCSH, WCAE, WTAM, WWJ, KSD, WSAI, WCCO and WOC).
- 4th: *Buckeye Bakers*, WEA; 8:30 to 9:30 P.M. (Also broadcast from WFI, KSD, WSAI, WCCO, WTAM, WWJ, WTAG and WLIB).
- 4th: *Eveeady Hour*, WEA; 9:00 P.M. (Also broadcast from WEEL, WFI, WCAE, WGR, WWJ, WOC, KSD, WJAR, WCCO, WTAM, WGN, WSAI and WTAG).
- 4th: *Keystoners*, WJZ; 9:00 P.M. (Also broadcast from WRC and WGY).
- 4th: *Auction Bridge Instructions*, WEA; 10:00 P.M. (Also broadcast from WEEL, WCSH, WTAG, WJAR, WGR, WCAE, WTAM, WFI, WWJ, WSAI, WGN, WOC, WCCO and KSD).
- 4th: *Cook's Tours*, WJZ; 10:00 P.M. (Also broadcast from WRC and WGY).
- 4th: *George Olsen's Orchestra*, WJZ; 10:45 P.M.
- 5th: *Eastman Theatre Orchestra*, WGY; 6:30 P.M. (Also from WHAM).
- 5th: *Davis Saxophone Odette*, WEA; 8:30 P.M. (Also broadcast from WEEL, WJAR, WLIT, WRC, WTAG and WCAE).
- 5th: *Sixty White Minutes* (orchestra), WJZ; 9:00 P.M. (Also broadcast from WBZ, KDKA and KYW).
- 5th: *Ipana Troubadours*, WEA; 9:00 to 9:30 P.M. (Also broadcast from WEEL, WGR, WRC, WCAE, WWJ, WLIB, KSD and WCCO).
- 5th: *Smith Brothers* (vocal and instrumental), WEA; 10:00 to 10:30 P.M. (Also broadcast from WTAG, WGR, WRC, WCAE, WWJ, WSAI, KSD, WOC, WCCO and WDAF).
- 6th: *Royal Typewriter* (orchestra and vocal), WGY; 9:00 P.M. (Also broadcast from WEEL, WCCO, WGN, WCAE, WJAR, WTAM, KSD, WOC, WGR, WFI, WWJ, WSAI and WADC).

**Build Your Improved Browning-Drake**  
by the aid of  
**Popular Radio SIMPLIFIED**  
**Blue Prints**

Easy, Quick and Accurate

The Improved Browning-Drake Broadcast Receiver, designed by Arthur H. Lynch, former Editor of Radio Broadcast and built and approved in the POPULAR RADIO LABORATORY.

Here is a receiver which combines all the advantages of a circuit that has long been recognized as standard with new ideas and improvements which have been made in receiver construction since the circuit was first designed.

High efficiency that emphasizes the tone quality is the outstanding characteristic of this new model.

By using POPULAR RADIO Blue Prints in building your Improved Browning-Drake Broadcast Receiver, you can save time, eliminate the possibility of error, and make your set exactly like the laboratory model (see page 104).

If your local dealer cannot supply you with Blue Prints of the Improved Browning-Drake, they will be sent postpaid upon receipt of \$1.00 per set.

A full description of this set, with detailed directions for building, was published in the August, 1928, issue of POPULAR RADIO. Send 35c for copy.

**POPULAR RADIO**

Service Bureau 14-A

627 W. 43rd St., New York City



- 6th: *Clicquot Club Eskimos*, WEAJ, 9:00 P.M. (Also broadcast from WEEL, WCCO, WGN, WCAE, WJAR, WTAG, KSD, WOC, WGR, WFI and WWJ).
- 6th: *Goodrich Zippers* (orchestra and vocal), WEAJ, 10:00 P.M. (Also broadcast from WEEL, WCCO, WGN, WCAE, WJAR, WTAG, KSD, WOC, WGR, WSI, WWJ, WSAI and WADC).
- 7th: *Happiness Boys*, WEAJ, 8:00 P.M.
- 7th: *Breyer Hour* (orchestra and vocal), WJZ and WRC, 9:00 P.M.
- 7th: *La France Orchestra*, WEAJ, 9:30 P.M. (Also broadcast from WEEL, WGR, WLIT, WOC, WCAE, WTAM, WDAF, WWJ and KSD).
- 8th: *New York Philharmonic Orchestra with Walter Damrosch*, WEAJ, 9:15 P.M. (Also broadcast from WEEL, WGR, WFI, WCAE, WWJ, WSAI, WTAM, WGN, KSD, WCCO and WDAF).
- 9th: *Capitol Theatre Grand Orchestra*, WEAJ, 7:20 P.M. (Also broadcast from KSD, WRC, WWJ, WJAR, WCAE and WTAG).
- 9th: *Atwater Kent Hour*, WEAJ, 9:15 P.M. (Also broadcast from WJAR, WEEL, WFI, WCCO, WTAM, WGN, WFI, WCAE, WGR, WOC, WTAG, WWJ and KSD).
- 9th: *Godfrey Ludlow* (violinist), WJZ, 9:30 P.M. (Also from WGY).
- 9th: *Maxwell House Coffee Hour* (orchestra), WJZ, 10:15 to 11:15 P.M. (Also broadcast from WBZ, WRC, WGY and KDKA).
- 10th: *Wilys-Overland Hour*, WJZ, 8:30 P.M.
- 10th: *A & P Gypsies*, WEAJ, 9:00 P.M. (Also broadcast from WEEL, WJAR, WDAF, WRC, WCAE, WCAE, WTAM, WLIT and WWJ).
- 10th: *Fireside Boys*, WJZ, 9:50 P.M.
- 10th: *B. A. Rolfe's Palace D'Or Orchestra*, WEAJ, 11:00 to 12:00 M.
- 11th: *Champion Spark Pluggers*, WJZ, 8-00 P.M. (Also broadcast from WGY and WRC).
- 11th: *Vikings*, WEAJ, 8:00 to 8:30 P.M. (Also broadcast from WEEL, WJAR, WCAE, WGR, WFI, WCAE, WTAM, WWJ, KSD, WSAI, WCCO and WOC).
- 11th: *Buckeye Bakers*, WEAJ, 8:30 to 9:30 P.M. (Also broadcast from WFI, KSD, WSAI, WCCO, WTAM, WWJ, WTAG and WLIB).
- 11th: *Eveready Hour*, WEAJ, 9:00 P.M. (Also broadcast from WEEL, WFI, WCAE, WGR, WWJ, WOC, KSD, WJAR, WCCO, WTAM, WGN, WSAI and WTAG).
- 11th: *Keystoners*, WJZ, 9:00 P.M. (Also broadcast from WRC and WGY).
- 11th: *Auction Bridge Instruction*, WEAJ, 10:00 P.M. (Also broadcast from WEEL, WCAE, WTAG, WJAR, WGR, WCAE, WTAM, WFI, WWJ, WSAI, WGN, WOC, WCCO and KSD).
- 11th: *Cook's Tows*, WJZ, 10:00 P.M. (Also broadcast from WRC and WGY).
- 11th: *George Olsen's Orchestra*, WJZ, 10:45 P.M.
- 12th: *Eastman Theatre Orchestra*, WGY, 8:30 P.M. (Also from WHAM).
- 12th: *Davis Saxophone Octette*, WEAJ, 8:30 P.M. (Also broadcast from WEEL, WJAR, WLIT, WRC, WTAG and WCAE).
- 12th: *Sixty White Minutes Orchestra*, WJZ, 9:00 P.M. (Also broadcast from WBZ, KDKA and KYW).
- 12th: *Ipana Troubadours*, WEAJ, 9:00 to 9:30 P.M. (Also broadcast from WEEL, WGR, WRC, WCAE, WWJ, WLIB, KSD and WCCO).
- 12th: *Smith Brothers* (vocal and instrumental), WEAJ, 10:00 to 10:30 P.M. (Also broadcast from WTAG, WGR, WRC, WCAE, WWJ, WSAI, KSD, WOC, WCCO and WDAF).
- 13th: *Royal Typewriter* (orchestra and vocal), WGY, 9:00 P.M. (Also broadcast from WEEL, WCCO, WGN, WCAE, WJAR, WTAG, KSD, WOC, WGR, WSI, WWJ, WSAI and WADC).
- 13th: *Clicquot Club Eskimos*, WEAJ, 9:00 P.M. (Also broadcast from WEEL, WCCO, WGN, WCAE, WJAR, WTAG, KSD, WOC, WGR, WFI and WWJ).
- 13th: *Goodrich Zippers* (orchestra and vocal), WEAJ, 10:00 P.M. (Also broadcast from WEEL, WCCO, WGN, WCAE, WJAR, WTAG, KSD, WOC, WGR, WFI, WWJ, and WSAI).
- 14th: *Happiness Boys*, WEAJ, 8:00 P.M.
- 14th: *Hohner Harmony Four*, WEAJ, 8:30 to 9:00 P.M. (Also broadcast WEEL, WLIT, WGR, WRC, WCAE, WLIB, WTAM and WWJ).
- 14th: *Breyer Hour* (orchestra and vocal), WJZ and WRC, 9:00 P.M.
- 14th: *La France Orchestra*, WEAJ, 9:30 P.M. (Also broadcast from WEEL, WGR, WLIT, WOC, WCAE, WTAM, WDAF, WWJ and KSD).
- 15th: *New York Philharmonic Orchestra with Walter Damrosch*, WEAJ, 9:15 P.M. (Also broadcast from WEEL, WGR, WFI, WCAE, WWJ, WSAI, WTAM, WGN, KSD, WCCO and WDAF).
- 16th: *Capitol Theatre Grand Orchestra*, WEAJ, 7:20 P.M. (Also broadcast from KSD, WRC, WWJ, WJAR, WCAE and WTAG).
- 16th: *Atwater Kent Hour*, WEAJ, 9:15 P.M. (Also broadcast from WJAR, WEEL, WFI, WCCO, WTAM, WGN, WFI, WCAE, WGR, WOC, WTAG, WWJ and KSD).
- 16th: *Godfrey Ludlow* (violinist), WJZ, 9:30 P.M. (Also from WGY).
- 16th: *Maxwell House Coffee Hour* (orchestra), WJZ, 10:15 to 11:15 P.M. (Also broadcast from WBZ, WRC, WGY and KDKA).

## Trans-Oceanic Calls Heard

POPULAR RADIO has now completed arrangements for forwarding to transmitting amateurs in England, France, Germany, Austria, Ireland and Italy all calls heard (QSL) cards that may be addressed to them by American amateurs care of this magazine. These cards will be delivered through local agents in those countries, who have or can obtain knowledge of the present address of the foreign amateurs. Plans have also been completed by this magazine for forwarding to transmitting amateurs in this country in turn all QSL cards that may be addressed to them by amateurs from those countries. American amateurs are invited to send their cards to foreign amateurs through this office, which will not only assure safe delivery through the special agencies which are thus provided, but which will publish a monthly list in a "Trans-oceanic Calls Heard" department.

Address your cards to the foreign amateurs by call numbers and enclose them in envelopes to—

The Calls Heard Editor,  
POPULAR RADIO  
627 West 43d Street, New York

The following stations were received and logged at the amateur station of D. O'Dwyer (GW-18B), 9 Upper Leeson St., Dublin, Irish Free State on an O-v-l low-loss tuner.

U-1CMX—July 25, 1926; signal strength, R6; rectified AC note on 37 meters; no fading.

U-1BXH—August 8, 1926; signal strength, R3; rectified AC note on 41 meters; very bad fading.

U-1AAO—July 11, 1926; signal strength, R7; rectified AC note on 37 meters; no fading.

The following stations were received and logged at the amateur station of A. Pelletier (FR-284), 23 Rue Bardinet, Paris-14e, France on a Bourne receiver with a detector and one stage of audio using a single-wire, inside antenna 12 meters long. The last seven stations were logged on a Vesla receiver.

U-4IZ—October 3, 1926; signal strength R7; calling CQDX; steady rectified AC note; very loud; no fading.

U-4WJ—October 3, 1926; signal strength R6; calling U-1AWE; rectified AC note, steady; no fading.

U-3AY—October 1, 1926; signal strength R6; calling CQ; steady AC note; no fading.

U-3DD—October 1, 1926; signal strength R6; calling U-9ARA; steady DC note; no fading.

U-4TK—October 3, 1926; signal strength R5; calling CQ France; rectified AC note, steady; no fading.

U-3CJ—October 4, 1926; signal strength R5; steady DC note; calling CQ; no fading.

U-8BR—October 5, 1926; signal strength R7; calling U-9AOI; very steady DC note; no fading.

U-8ATV—October 5, 1926; signal strength R6-R7; calling BZ-1AK; rectified, steady AC note; no fading.

U-8BEN—October 4, 1926; signal strength R6; calling M-1J; steady AC note, 50 cycles; no fading.

U-4SB—October 4, 1926; signal strength R6; calling M-9A; rectified AC note, steady; no fading.

U-4RN—October 5, 1926; signal strength R6; calling CQ; steady rectified AC note; no fading.

U-9BFB—October 4, 1926; signal strength R6; calling CQ; rectified AC note, steady; no fading.

# DOUBLE IMPEDANCE

## Audio Amplification

QUALITY and VOLUME:—Double impedance audio amplification quadruples the power output of audio tubes as no magnetic coupling is used. The grid can thus swing positive as well as negative, as positive grid currents do not substantially affect the wave shape. This effect is not possible without grid inductance as "tube blocking" develops before the overloading point is reached. The design of the units can be such as to give any frequency curve desired, making it possible to obtain perfect quality.

### KENNETH HARKNESS

Has selected this system for his KH-27 receiver for these reasons. His extensive research on audio amplifiers in order to obtain the best possible results convinced him that double impedance was the ultimate solution to the problem.

### COMPACT UNITS

Using figure "8" laminations can now be obtained through the following licensed manufacturers:

K. H. Radio Laboratories, Inc.  
124 Cypress Avenue, N. Y. C.

Ford Radio & Mica Corporation  
111 Bleeker St., N. Y. C.

Paragon Electric Corp.

14 Alvin Place, Upper Montclair, N. J.

American Specialty Company  
Bridgeport, Conn.

### YOUR PRESENT RECEIVING SET

Can be changed over very easily by the use of these units. Any of these manufacturers will gladly supply full data as to how to modernize and perfect your set. A complete factory built receiver is being made by the Paragon Electric Corp. which incorporates these units. These manufacturers are operating under

### BROAD BASIC PATENTS

Issued to and protected by the Hiler Audio Corp. Look for "Licensed under Hiler Patent 1589692."

### HILER AUDIO CORP.

10 Argyle Terrace Irvington, N. J.  
Terrace 4210

# UNIVERSAL

## Two New Companions TRANSOCEANIC "NEW PHANTOM"

SEVEN TUBES—100% SHIELDING—TUNES 35 METERS TO 3600 METERS

**\$220<sup>00</sup>** (No Accessories)

*"On The Air"*

### Compare These Features With Any Radio

\*Indicates Original Golden-Leutz Feature as Applied to Broadcast, Receivers, # Exclusive Feature

	Golden-Leutz Transoceanic	Any Other Radio
1. 100% shielding—Interstage shielding—Complete external shielding against extraneous disturbances* - - - - -	✓	
2. Totally shielded low loss variable condensers to prevent interaction between condenser and transformer fields* # - - - - -	✓	
3. Complete shielding between stators (grid circuit) of multiple condensers*, practically no shield losses - - - - -	✓	
4. Use of Indicating Meters and special switch to read "A," "B" and "C" battery voltages*, total of 8 readings - - - - -	✓	
5. Licensed under Hogan Patent 1,014,002 for single control (first licensee)* - - - - -	✓	
6. Optional individual control or simultaneous control of all tuning controls*, instantly changeable - - - - -	✓	
7. Use of interchangeable tuned radio frequency transformers to tune all broadcast wavelengths in the world, viz., 35 to 3600 meters* - - - - -	✓	
8. A special filter circuit in the output to exclude detrimental plate current from the Loud Speaker - - - - -	✓	
9. Use of Resistance Coupling in the Audio Amplifier, combined with impedance and transformer coupling for perfect reproduction* # - - - - -	✓	
10. Adjustable Antennae Coupling to adapt set to all various types and sizes of broadcast antennae* # - - - - -	✓	
11. Antennae Series Condenser for Extreme Selectivity in congested districts* # distant reception through locals possible - - - - -	✓	
12. Sealed Chassis to exclude moisture and dust* #, equally suited to any climate in the world - - - - -	✓	
13. Last stage, power audio, adaptable to 201A, 112,171 or 210 tubes, 550 volts maximum capacity for great volume* # - - - - -	✓	
14. Separate B Voltage Taps for Detector, Radio Amplifiers, Audio Amplifiers and Power Amplifiers* adaptable to all tubes - - - - -	✓	
15. Separate Bias Voltage Taps for Radio Amplifier, Audio Amplifiers and Power Amplifiers* adaptable to all tubes - - - - -	✓	
16. Power Audio Tube Filament arranged for heating by either battery or alternating current* - - - - -	✓	
17. No rivets to corrode, all connections soldered in accordance with Navy Specifications* - - - - -	✓	
18. Only piece of steel used is in condenser shafts, detrimental steel supports purposely omitted, all other material non-magnetic - - - - -	✓	
19. Metallized heavy current carrying, permanent value grid leaks and resistors - - - - -	✓	
20. Direct Disc Vernier Adjustments, etched black dials, silver graduations 0 to 100 - - - - -	✓	
21. Indicating rotors upon which calibrations can be recorded for reference, all calibrations permanent - - - - -	✓	
22. All insulating material Genuine Bakelite include sub-panels—coil bases—coil forms. Sockets new UX-type positive contact - - - - -	✓	
23. All Screws, Bolts and Nuts securely fastened by bronze lock washers* # - - - - -	✓	
24. Most Compact Multiple Tube Sets made, 9 tube less than 2 cubic feet; 7 tube less than 1 cubic foot. Dimensions 27 3/4 x 13 1/4 x 8" - - - - -	✓	
25. Scientifically determined distance between transformers and shield, not detrimentally close* # - - - - -	✓	
26. Volume Control device to regulate volume to any desired value without affecting quality - - - - -	✓	
27. Can be used with "B" and "C" Eliminators, special Golden-Leutz Eliminator made to match - - - - -	✓	
28. Practically all parts, except the meter and a few small parts, are manufactured in our factory - - - - -	✓	
29. Each receiver tested at night and calibrated to a station at least 2000 miles distant, insuring long range performance - - - - -	✓	
30. Design by Charles R. Leutz - - - - -	✓	

# GOLDEN-LEUTZ, INC.

*"Manufacturers of the Highest Class Radio Apparatus in the World"*

MAIN OFFICE AND WORKS:

SIXTH & WASHINGTON AVENUES, LONG ISLAND CITY, NEW YORK, U. S. A.

Cables: "Experinfo" New York—All Codes



# TRANSOCEANIC

## to the "SILVER GHOST" TRANSOCEANIC "PHANTOM"

NINE TUBES—100% SHIELDING—TUNES 35 METERS TO 3600 METERS

**\$250.00** (No Accessories)

*To Everywhere*

Phantom Models are now installed on the U. S. S. Vega and U. S. S. Utah.

**"MOST POWERFUL IN THE WORLD"**

We are now ready to demonstrate that the Phantom Model has a far greater range, greater degree of selectivity, easiest means of operation, finest electrical design and construction and the best quality of musical reproduction as compared with any radio broadcast receiver in the world.

### 9 TUBE TRANSOCEANIC "PHANTOM"

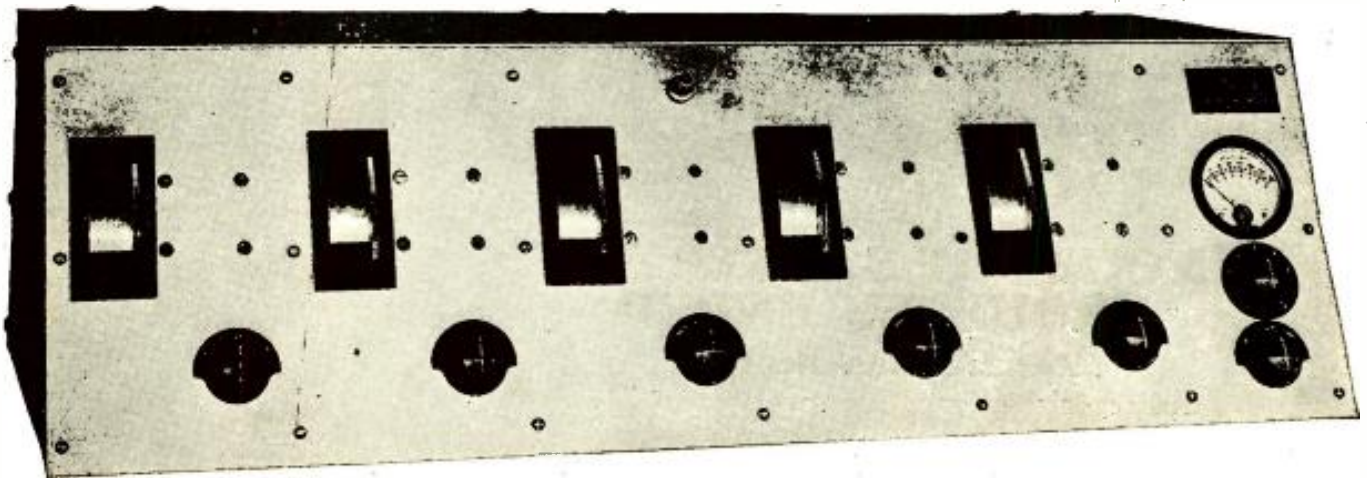

#### Universal Transoceanic "New Phantom"

Item	Quan.	DESCRIPTION	Price
1	1	Universal Transoceanic "New Phantom" Broadcast Receiver, 7 tubes, 2 tuned radio, detector, three audio and power audio amplifier. Including "A" Transformers for 200 to 560 meters tuning range. (No accessories included) -	\$220.00
<b>EXTRAS</b>			
2	1	Set selected tubes including detector and 210 power tube -	21.50
8	1	Set "B" Transformers for tuning 80 to 210 meters -	15.00
4	1	Set "C" Transformers for tuning 35 to 90 meters -	15.00
5	1	Set "AA" Transformers for tuning 500 to 1500 meters -	15.00
6	1	Set "BB" Transformers for tuning 1200 to 3600 meters -	15.00
7	1	6 volt 120 A.H. Storage Battery -	24.00
8	1	New Type Farrand Senior Loud Speaker, Cone Type -	32.50
9	1	Golden-Leutz Special Current Supply for 110 volts 50/60 cycle A.C. -	135.00
10	1	Antennae Equipment -	4.00
Total all accessories -			\$497.00
11	1	Complete Knocked Down Kit of all Transoceanic "New Phantom" Parts ready for assembly including constructional drawings (no accessories), "A" Type Transformers for 200 to 560 meters included -	\$190.00
12	1	Complete set of Constructional Drawings and Operating Data on Transoceanic "New Phantom" only -	2.00

Special quotation for dry "B" battery operation will be made on request

#### Universal Transoceanic "Phantom"

Item	Quan.	DESCRIPTION	Price
1	1	Universal Transoceanic "Phantom" Broadcast Receiver, 9 tubes, 4 tuned radio, detector, three audio and power audio amplifier. Including "A" Transformers for 200 to 560 meters tuning range. (No accessories included) -	\$250.00
<b>EXTRAS</b>			
1	1	Set selected tubes including detector and 210 power amplifier -	25.50
3	1	Set "B" Transformers for tuning 80 to 210 meters -	25.00
4	1	Set "C" Transformers for tuning 35 to 90 meters -	25.00
5	1	Set "AA" Transformers for tuning 500 to 1500 meters -	25.00
6	1	Set "BB" Transformers for tuning 1200 to 3600 meters -	25.00
7	1	6 volt 120 A.H. Storage Battery -	24.00
8	1	New Type Farrand Senior Loud Speaker, Cone Type -	32.50
9	1	Golden-Leutz Special Current Supply for 110 volts 50/60 cycle A.C. -	135.00
10	1	Antennae Equipment -	4.00
Total all accessories -			\$571.00
11	1	Complete Knocked Down Kit of all Transoceanic "Phantom" Parts, ready for assembly including constructional drawings (no accessories), "A" Transformers for 200 to 560 meters included -	\$220.00
12	1	Complete set of Constructional Drawings and Operating Data for Transoceanic "Phantom" only -	2.00

Special quotation for dry "B" battery operation will be made on request

# An Absolute Necessity!



**FRESHMAN  
AUTOMATIC  
CHARGER**

Complete  
with  
**TUNGAR**  
Tube Cord  
and Plug.

## YOUR "A" BATTERY TROUBLES ENDED

**Requires No Attention**

This remarkable device keeps quietly working for you all the time that your set is not in operation. It is controlled by the switch of your set which disconnects the charger automatically when you are using your radio. And, when you turn off your set it immediately resumes charging the "A" battery again.

**Foolproof and Dependable**

Whether it is a radio dance that you are giving or an excited assemblage listening to the results of a World's Championship sporting event you never need have fear of the broadcasting fading away through rundown "A" batteries; a condition which has happened so many times in the past to practically all owners of radio sets.

Our new 48 page book illustrating all Freshman Products is now ready. Write for it—free.

CHAS. FRESHMAN CO., INC.

Freshman Bldg., New York

## Changes in the List of Broadcasting Stations in the U. S.

These corrections and additions to the list which was published in the March, 1926, issue of POPULAR RADIO (together with the changes which have been published in succeeding months) make the list correct as of December 1, 1926. Further changes will be published each month in this magazine.

### STATIONS ADDED

KFKB	Millford, Kansas	431.4
KGDA	Dell Rapids, South Dakota	254.1
KGDI	Seattle, Washington	416.4
KGDJ	Cresco, Iowa	202.6
KGDM	Stockton, California	217.3
KRAC	Shreveport, Louisiana	220.0
KRLD	Dallas, Texas	357.1
KRSC	Seattle, Washington	499.7
KSOO	Sioux Falls, South Dakota	360.0
KWTC	Santa Ana, California	280.7
WAGS	Somerville, Massachusetts	250.0
WARS	Brooklyn, New York	285.0
WCGU	Lakewood, New Jersey	350.6
WEPS	Gloucester, Massachusetts	295.0
WFBE	Cincinnati, Ohio	232.4
WGWB	Milwaukee, Wisconsin	384.4
WHOG	Huntington, Indiana	241.8
WICC	Bridgeport, Connecticut	285.0
WKBW	Buffalo, New York	362.5
WKBY	Dahville, Pennsylvania	220.0
WKBZ	Ludington, Michigan	256.3
WLBC	Muncie, Indiana	223.7
WLBE	Brooklyn, New York	230.6
WLBK	Kansas City, Missouri	211.1
WOMT	Manitowoc, Wisconsin	254.1
WRES	Wollaston, Massachusetts	300.0

### STATIONS DELETED

WCAP	Washington, D. C.	488.5
WFBE	Seymour Indiana	225.4

### CHANGES IN CALL LETTERS

WBBS	New Orleans, La.	change to	WKBT
WFBH	New York City	change to	WPCH
WQAC	Amarillo, Tex.	change to	KGRS

### CHANGES IN WAVELENGTHS

KFEC	Portland, Ore., 247.8	change to	252.0
KFI	Los Angeles, Cal., 468.5	change to	467.0
KFPY	Spokane, Wash., 273	change to	272.6
KFQD	Anchorage, Alaska, 227.1	change to	300.0
KFUT	Salt Lake City, Utah, 260.7	change to	263.0
KFXF	Denver, Col., 249.9	change to	430.1
KGCG	Newark, Ark., 243.2	change to	239.9
KGCH	Wayne, Neb., 450	change to	434.5
KJBS	San Francisco, Cal., 220.4	change to	224.2
KNRC	Santa Monica, Cal., 208.2	change to	238.0
KSMR	Santa Maria, Cal., 209.7	change to	282.8
KSO	Clarinda, Ia., 241.8	change to	405.2
KWCR	Cedar Rapids, Ia., 277.6	change to	296.0
WCAM	Camden, N. J., 236.1	change to	336.9
WFRL	Brooklyn, N. Y., 205.4	change to	329.5
WGM	Jeanette, Pa., 372	change to	269.0
WJAF	Ferdale, Mich., 400	change to	407.0
WJBT	Chicago, Ill., 238	change to	468.5
WJBY	Gadsden, Ala., 270.1	change to	260.0
WMAL	Washington, D. C., 212.6	change to	293.9
WNJ	Newark, N. J., 252	change to	350.0

### CHANGES IN LOCATIONS

KFXF	Colorado Springs, Col., change to	Denver, Col.
KNRC	Los Angeles, Cal., change to	Santa Monica, Cal.
WOOD	Grand Rapids, Mich., change to	Furnwood, Mich.
WRNY	New York City, change to	Coytesville, N. J.
WSWS	Woodale, Ill., change to	Batavia, Ill.

## Is the Klu Klux Klan After Jewish Program Features?

WHAT is reported as "the first case of vandalism directed against a broadcasting station" occurred on the evening of November 12th, when the cable leading to the antenna of station WRNY was mysteriously cut during the broadcasting of a Jewish religious service from Temple Emanu-El in New York. WRNY is owned by Hugo Gernsback, and directed by C. D. Isaacson.

## A Call List for All the World

DX FANS should be interested in an "International List of Radio Stations of the World" that has just been made available in an English edition. This world-wide call list may be procured from the International Bureau of the Telegraphic Union, Berne, Switzerland.



# PRECISION COILS

## THE NEW DUO-OCTAFORM COIL FOR THE NEW LC-27



No. 320

This new coil was especially designed for maximum amplification at radio frequencies within the broadcast range.

It has a higher inductance than is used on any other type of tuning unit for the range to be covered. For this reason, the distributed capacity has been reduced to an extreme minimum by the "octaform" shape, so that a very small capacity is used for tuning. This value is 250 micro-microfarads.

List price \$3.50. Set of 3 for LC-27, \$10.50.

## THE PRECISION R. F. CHOKE COIL

Can be used wherever this type of coil is necessary. Very compact, being one inch in diameter and one and one-half inches long. Can be mounted on a sub-panel or a baseboard. Bracket for baseboard mounting provided with each coil. Has a very low distributed capacity, due to the slotted form of winding.

List price \$1.00.

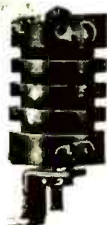

No. 340

## THE ORIGINAL COCKADAY COIL

The only coil ever specified by Laurence M. Cockaday, inventor of the famous Cockaday Four Circuit Tuner for use in his set. The best hard rubber tubing and double silk covered copper wire insures a coil of unusual quality, resulting in increased volume and greater selectivity. Dielectric and leakage losses are extremely low. Price, \$5.50.



No. 200

## PRECISION CONDENSERS AND POWER UNITS

Every Precision Product has been thoroughly tested and approved by POPULAR RADIO LABORATORY. They bear a full guarantee against defects in material and workmanship.

### THE NEW PRECISION HIGH VOLTAGE FILTER CONDENSERS

Made in the following capacities particularly for use where high voltage condensers are necessary:

- No. 46—4 mfd. DC working voltage 600. Price \$9.00.
- \*No. 26—2 mfd. DC working voltage 600. Price \$5.50.
- \*No. 44—4 mfd. DC working voltage 400. Price \$5.50.
- \*No. 24—2 mfd. DC working voltage 400. Price \$3.00.

\*Specified for the LC Senior Power-Pack.



### PRECISION B-SUPPLY No. 20 For Use With 110 Volts AC 50-60 Cycles

A very powerful and strongly constructed tube eliminator. Designed to withstand heavy loads and give up to 180 volts at 60 mls. Terminals are Neg. B, Pos. 22, 45, 90 and 180. Particularly designed to supply current for the new UX-216B tube, which gives a very constant current. Strong metal olive green case. Seven feet of wire and plug. Size of case 6" by 10 3/4" by 8". List price \$47.50.



No. 20

### EVERY DEALER SHOULD HAVE THESE

Write for a set of Precision Coil catalog sheets. They describe in detail all of the Precision Radio Parts used in POPULAR RADIO designed receivers for the past two years.



## COCKADAY'S LC-27 BUILT COMPLETE

NOW you can buy the new LC-27 Receiver built complete exactly as Mr. Cockaday's own laboratory model. All you have to do is connect the set with batteries, loud speaker, etc. and tune in. Five minutes from the time you get your LC-27 you can enjoy its matchless quality.

### EVERY SET CAREFULLY TESTED

Every LC-27 we build is carefully tested and fully guaranteed. Every LC-27 Receiver must function exactly like the original model or it cannot leave our factory.

### ONLY \$10 EXTRA

It costs only \$10 more to buy the LC-27 tested, built complete, and enclosed in the cabinet of your choice. There are three cabinet models from which you can choose. Prices, built complete, are as follows:

- With Corbett cabinet, S-20, pictured above, \$122.70.
- With open front Corbett Cabinet, S-15, \$113.20.
- With Blandin Cabinet, R-20, \$114.70.

### LC-27 Kit of parts \$85.20

Orders are being filled immediately, but we suggest you write us today, while we still have a plentiful stock on hand. Enclose check or money order or we will ship C. O. D. on deposit of \$10.

## THE NEW K. H. - 27

1 K.H.-27 Kit of Essential Parts	\$49.50	2 Micamold fixed condensers, .002 M.F.	\$ .80
3 Hammarlund 17-plate condensers (Mid-line or S.L.F.)	14.25	1 Micamold grid leak mounting	.30
1 Yaxley Rheostat, 10 ohms	1.35	1 Micamold grid leak, 2 or 3 megohms	.45
1 Yaxley Fixed Resistance, 2 ohms	.15	2 Duallier 1 MFD Condensers	2.50
1 Yaxley Battery Switch, Midget type	.50	2 X-L Varioldensers, Type G 1 (.0001 Max.)	3.00
1 Yaxley Pilot Light Bracket, Junior type	.50	4 Amperites (3 Type 1A and 1 Type 112)	4.40
1 Yaxley Antenna Switch, Double circuit, Junior type	.85	2 Aristocrat Vernier Port Dials	4.00
1 Micamold Grid condenser, .00025 M.F. with G.L. mounting	.45	11 Eby Binding Posts, engraved	1.65
1 Micamold fixed condenser, .001 M.F.	.40	1 6 Volt Lamp for Pilot Light	.50
		<b>Total Cost</b>	<b>\$86.00</b>

## COCKADAY KITS

### THE INTERMEDIATE POWER PACK Described in December, 1926, POPULAR RADIO

1 Yaxley Automatic Relay Switch No. 4444	\$5.00	1 Centralab Resistance, 2,000 ohms	\$2.00
1 Filtrix A-C Transformer, type K-180	5.25	1 Hardwood baseboard	.85
2 Filtrix Choke Coils, type K-@-\$6.75	13.50	1 Bakelite binding post panel, drilled	.50
1 Na-ald Socket	.35	1 Set POPULAR RADIO blueprints	1.00
6 Eby binding posts	.90	Connecting wire, screws, etc.	.50
1 Acracon condenser block, 14 mfd	11.00	1 8 ft. twisted silk lamp cord with attached plug	.40
1 Acracon filter condenser, 1 mfd, 400 volts D-C	1.00		
1 F & L Tapped Resistance—type 200, 20,000 ohms	5.25		
		<b>Total</b>	<b>\$47.50</b>

### THE LC SENIOR POWER PACK Described in November, 1926, POPULAR RADIO

1—Brach Controll	\$ 6.00	1—Precision paper filter condenser, No. 44, 4 mfd.	\$5.50
1—AmerTran transformer, PF-52	19.00	1—AmerTran resistor, No. 400	7.50
1—Benjamin UX-Socket	.75	1—Centralab resistance, 5 watts, 2,000 ohms	2.00
2—AmerChokes, No. 854	12.00	1—Bakelite binding post strip	1.50
7—Eby binding posts	1.05	1—Brass mounting strip	.80
1—Precision Paper filter condenser, No. 26, 2 mfd.	5.50	1—Hardwood baseboard	.60
1—Precision paper filter condenser, No. 24, 2 mfd.	3.00	1—Set POPULAR RADIO Blueprints	1.00
		<b>Total</b>	<b>\$65.20</b>

Wired complete, \$7.00 extra.

Other Popular Radio Kits Also in Stock

**PRECISION COIL CO., Inc.**

**209 Centre St., New York, N. Y.**



**COMPLETE**  
Nothing else to buy. Replaces "B" Batteries. Operates direct from Electric Light Socket on 110-120 volt A. C. Lighting Circuit. Delivers up to 100 volts.

**\$17.50**

New High Voltage Model  
Complete: Delivers up to 180 Volts

**Not only the most reasonable-**

but proved by 40,000 users to be also the most convenient, unfailing and satisfactory "B" Eliminator

**New High Voltage Model**

for extremely large sets, or sets using power tubes, now perfected. Delivers up to 180 volts. One control adjusts voltages on all taps.

*Equal to any "B" Eliminator regardless of price—not only in operation, but in workmanship, quality, durability and appearance*

**Money Back Guarantee**

Stop paying out money for costly, unreliable battery service and repairs. Permanent excellence can be built into economical "B" service. 40,000 users of the good Ferbend "B" Eliminator agree. That is why during the slack summer season we worked at full capacity to meet orders. That is why hundreds of unsolicited testimonials prove beyond the shadow of a doubt its splendid, enduring performance.

**Ask Your Dealer—or Send Direct**

Shipment made direct on receipt of price, or C. O. D. if preferred. Use for 10 days to convince yourself—if unsatisfactory write us within that time and purchase price will be refunded. Use Coupon NOW.

**They Want YOU to Know**

Montreal, Canada  
I am pleased to state that the Ferbend "B" Eliminator purchased from you is a wonder and is giving results far beyond my expectations. The tone and volume would satisfy the most critical. James Stroud, Electrical Engineer.

Yountstown, Ohio  
Your Eliminator is the best buy I have made in a long time. It has already more than paid for itself in saving on "B" batteries. R. L. Welsh.

Springville, N. Y.  
Having had perfect results with the newest Eliminators recently purchased you may send me six more by express at once. Leonard J. Cooper.

Burbank, Calif.  
I am more than pleased with your Eliminator. I am getting several Eastern stations through about 15 locals using the Eliminator. Jean Barnard.

St. Petersburg, Fla.  
I used your Eliminator all last winter, and it was as good, if not better than several I tried of much higher price. I am more than satisfied. Ben M. Pyatt.

Trenton, N. J.  
I have used your Eliminator for several months and unhesitatingly recommend it. It has added 25 per cent to the volume of my set and always has full voltage. J. M. Starger.

New Orleans, La.  
The "B" Eliminator which I purchased from you some three or four months ago has given entire satisfaction and I am well pleased with its performance. C. J. Murphy

Wilmington, N. C.  
I am well pleased with the Eliminator I purchased some time ago. It is all you claim and more. It brings in signals louder and clearer than any set of dry batteries I ever used. T. E. Lyon.

Amsterdam, N. Y.  
I have compared your Eliminator with other makes and it cannot be beat. My reception has easily increased 50 per cent. It gives me much better results than I was ever able to get with dry batteries. William Davis.

Wheeling, W. Va.  
The Eliminator purchased some time ago is giving remarkable results. William A. Raper, Jr.

Des Moines, Ia.  
Your Eliminator is fine. Rev. F. A. Case.

Louisville, Ky.  
Your Eliminator is all you claim it to be. Am very much pleased with it. Alonzo G. Smith.

Oil City, Pa.  
Your Eliminator has given me good service for over a year. George May.

St. Louis, Mo.  
After giving your "B" Eliminator a thorough trial wish to state that I am thoroughly satisfied. It's performance is perfect—absolutely no hum whatever. Frank Kolar.

Mattapan, Mass.  
I have used your Eliminator for six months and am satisfied with it in every way. It has increased the volume of my 6-tube Neutrodyne fully 50 per cent and there is absolutely no hum from the 60-cycle line. John W. Fursell, Jr.

**Second Successful Year**



**FERBEND ELECTRIC COMPANY**  
419 W. Superior St., Chicago, Ill.

**FERBEND "B" ELIMINATOR**

Approved and passed by the rigid Laboratory Tests of the two foremost Radio Laboratories in America  
—Radio News and Popular Radio

FERBEND ELECTRIC CO.  
419 W. Superior St., Chicago, Ill.

- Send \$12.50 model.  Send \$17.50 model.
- Send at once. Payment enclosed.
- Send C. O. D.  Send literature.

Name .....

Address .....

City.....State.....



# CROSLLEY

BETTER... COSTS LESS

# RADIO

**CROSLLEY RADIO INSTRUMENTS**  
Each item the utmost in radio at its price. All prices slightly higher west of the Rocky Mountains. Prices without accessories.



**THE "PUP" \$9.75**  
This little double-circuit one-tube set has brought happiness to thousands and made records for long distance receiving.



**THE "3-29" \$29**  
A 4-tube receiver of amazing efficiency. Creascendone and Crescendone. Everywhere considered marvelous at its price.



**THE "PORTABLE" \$35.00**  
The 4-25 in portable form, handy compact, efficient.



**THE "5-38" \$38**  
A five-tube tuned radio frequency set, with two stages of non-oscillating radio frequency amplification. Crescendone controlled. Two stages of audio frequency amplification.



**"REL-75" \$65**  
5-tubes. True cascade amplification, non-radiating even under any mis-handling. Its perfect balancing achieved by Wheatstone bridge in each stage of amplification. Exceptional selectivity and tone.



**THE "MUSICONSOLE" \$32.00**  
Embodies the Mustone in a beautiful console of two-tone mahogany finish and provides room for batteries and accessories. 24 1/2 inches long inside.



**6-TUNE "RFI-90" CONSOLE \$39**  
Introducing the double drum station selector! Includes Mustone in exquisite console. Room for batteries and all accessories. 40 inches high by 30 1/2 inches wide.

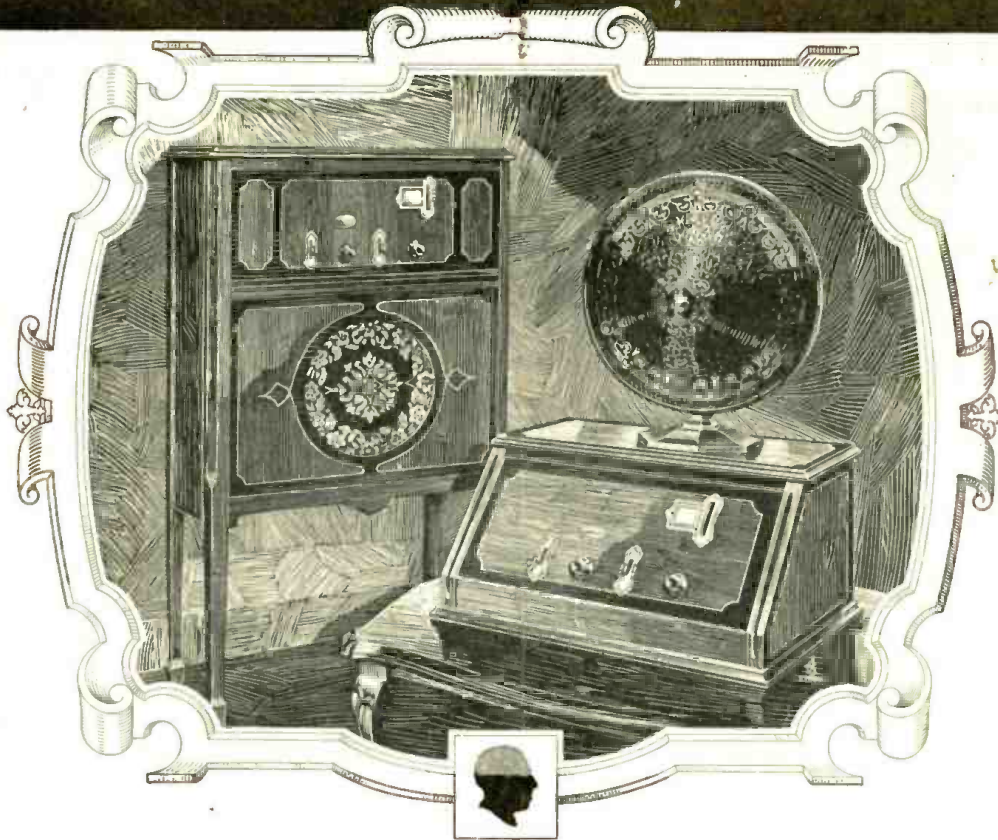

**CROSLLEY 1927 FEATURES**

Many exclusive—others found only in highest priced radios.

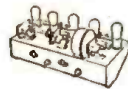

**ALL-METAL SHIELDED CHASSIS**

This truly great radio achievement, found in several Crosley sets, furnishes a substantial frame for mounting elements, produces excellent alignment of condensers, shields them from each other, prevents interstage, improves the stability of the circuit, increases selectivity and saves costs by standardizing this phase of manufacture.



**THE ACUMINATORS**

Crosley Acuminators permit tuning in—loud and clear—weak stations passed over and entirely missed by ordinary single dial radios. In tuning high powered and local stations they are not used. They are an exclusive Crosley feature.



**THE "CRESCENDON"**

When, on ordinary radios, ears must strain to catch a station miles away, a turn of the Crescendone on Crosley radios instantly awells reception to room-filling volume. An exclusive Crosley feature.



**THE SINGLE-DIAL STATION SELECTOR**

Nothing in radio equals the joy or the convenience of single dial control. Crosley's 1 in 10 drum control enables you to find the stations sought without log book or "tuning."



**POWER TUBES**

Power tube adaptability marks the Crosley "5-50" "5-75" and "RFI" sets. This feature enables Crosley provision for best radio reception at moderate cost.

## Amazing single dial control and reproduction

THE 5 tube 5-50

THE SUPER MUSICONE

THE 5-75 CONSOLE

Such a success! Enthusiastic owners report amazing performance—a drum dial delivering stations loud, clear, sharp; each an almost imperceptible turn of the drum apart. Write station letters on the drum; return to them at will. This marvelous receiver containing these advanced ideas in radio (some of them exclusive to Crosley), including metal shielding and power tube adaptability indicates Powel Crosley, Jr.'s genius in lowering prices by mass production methods.

Listen to this wonder reproducer of broadcasting! Then you'll understand why it is the biggest selling loud speaker on the market EVERYWHERE, and the most imitated. Its shape, however, is NOT the secret of its wonderful performance. Its delightful tone and the fidelity of its reproduction is achieved solely through the Crosley patented actuating unit. Avoid imitations. There is only one genuine MUSICONE. Smaller model, 12-inch cone, \$12.50.

This set includes ideas for radio reception perfection NOT found in any other radio. Marvelous exclusive Crosley "Crescendone" and "Acuminators" increase volume on distant stations and bring in programs entirely missed by and missed on ordinary one dial control radios. Console is 40 inches high with ample room for batteries and a genuine Crosley Musicone is built in. Radio chassis same as in the 5-50 receiver. Beautifully finished two-tone mahogany cabinet, rose gold fittings.

**\$50.**

**\$14.75**

**\$75.**

Prices slightly higher west of the Rocky Mountains

Write Department 16, for Illustrative Literature

Crosley manufactures radio receiving sets, which are licensed under Armstrong U S Patent No 1,113,149, or under patent applications of Radio Frequency Laboratories, Inc., and other patents issued and pending.

**THE CROSLLEY RADIO CORPORATION**

CINCINNATI, OHIO. POWEL CROSLLEY, Jr., President



# BREMER-TULLY COUNTERPHASE

**A set so, much better that  
it demands your attention**

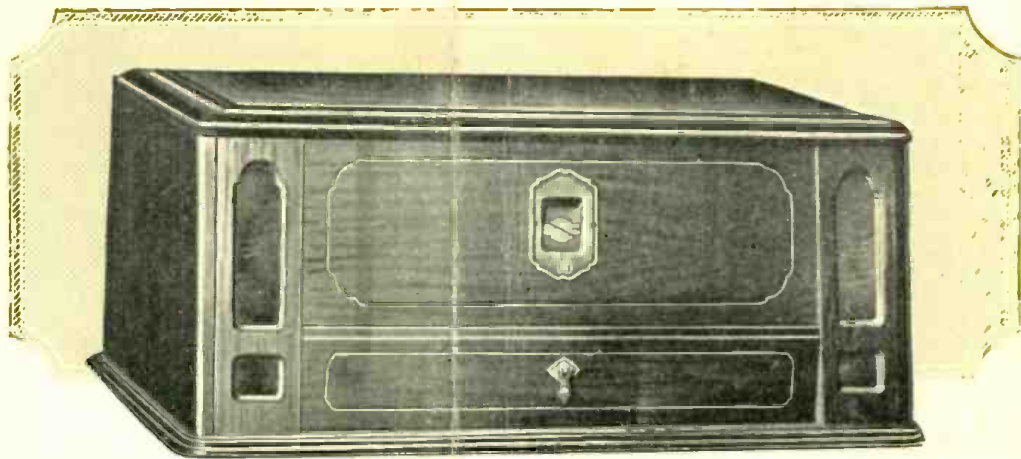

Here is a receiver that is "Single Control" and also sufficiently selective for your requirements, no matter where you live.

Of course that sounds impossible. It would be, except for the B-T "REJECTOR STAGE,"—an old principle now applied successfully for the first time in radio.

The *Rejector Stage* is an exclusive B-T feature. So also is the B-T patented Station Indicator, by which wave-lengths are read direct without dial numbers or log book.

On every set, on any part of the scale a glance at the tape tells you the mathematically exact wave-length at which your set is tuned.

It tells you with a hair-line accuracy where to turn for any wave-length you want. There are no allowances or variations—each set is individually calibrated in a way that's simplicity itself. One turn of the dial and you understand it.

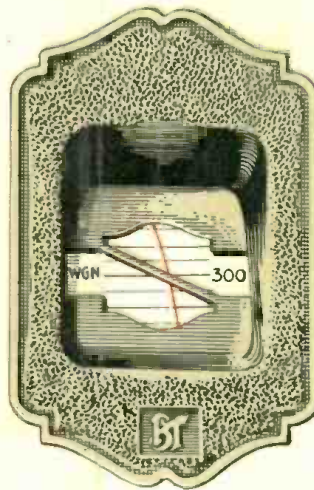

Expecting better things from B-T is only a natural result of continued successes, but the new Counterphase-Eight illustrated above exceeds all expectations.

It's full of surprises. It has set new records in day-time reception. With this model the "machinery" aspect disappears from the living room. A small door conceals the tuning controls. Both men and women approve it. There is no better furniture in radio than this model, and with any good speaker nothing now made will surpass its tone quality.

You must see and hear this set to appreciate its superiority.  
B-T Authorized Dealers in any City will gladly demonstrate.

## B-T B-POWER UNIT

Eventually you will buy this type of B-Power Unit—with no knobs to turn and "guess-work" Eliminated.

You will find it the most economical and the most satisfactory. It is worth more than the difference in price you can save on a cheaper unit.

Do you read "Better Tuning"? It's worth while whether you buy your set or build it.

Send 10c for latest edition.



The "SIX" similar to the "EIGHT" but with four "tuned stages" instead of five—and proportionately lower in price.



**B-T**  
**rem-**  
**Tully**

MANUFACTURING CO.  
520 So. Canal St., CHICAGO, ILL.

Capacity 150 volts at 60 milliamperes.  
East of Rockies \$49.50