

Popular Radio

DECEMBER
1926

25¢

WANTED - A Radio Humorist

How to Build the L.C.
Intermediate Power Pack

Popular Radio Circuits

the "B" eliminator for the big radio sets

AWAY with "B" batteries on those many-tube sets! Have you tried to work a "B" eliminator on a six, seven, eight tube set? Here's *one* that was designed specially to take care of the heavy current drain of these sets—the RCA Duo Rectron.

It delivers power aplenty for big or little sets. It delivers it smoothly, steadily, silently. And economically! It supplies up to 135 volts for the power tubes—taps for less if you want it—and a voltage regulator to keep the current exactly right for your radio set.

And also—it's a proved product of RCA!

For Christmas, what better idea than an RCA Duo-Rectron—to do away with "B" batteries forever, and give improved reception. It means top-notch performance all the time, with no care at all.



Buy with confidence



where you see this sign

RCA "B" BATTERY ELIMINATOR (DUO - RECTRON)

RADIO CORPORATION OF AMERICA NEW YORK CHICAGO SAN FRANCISCO



Eveready's exclusive Layerbilt
 construction *makes this*
the most economical of "B" batteries

IMPROVEMENT on top of improvement has been the history of Eveready Radio Batteries. Here, in the radically different Eveready Layerbilt, is the "B" battery which tops them all. The ability of this battery to give you unrivaled service and economy is due to its unique internal design. Instead of the usual assembly of round cells, it is built of flat layers of current-producing materials pressed firmly together. This construction makes use of the spaces now wasted between the round-type cells and avoids the usual soldered wire connections. Eveready Layerbilt is every inch a

battery. This exclusive Eveready Battery development packs more active chemicals in a given space and enables them to produce more current and give longer life.

This HEAVY-DUTY EVEREADY LAYERBILT BATTERY gives twice the service of the smaller Light-Duty batteries and greatly reduces your "B" battery operating cost.

Use Eveready Layerbilts on any set, and get not only this extra service, but also—the greatest "B" power operating economy—the most in "B" power dependent D. C. (direct current) purest form pure to Eveready

Tuesday night means Eveready Hour—9 P. M., Eastern Standard Time, through the following stations:

WEAF—New York	WTAM—Cleveland
WJAR—Providence	WWJ—Detroit
WEEI—Boston	WGN—Chicago
WTAO—Worcester	WOC—Davenport
WFI—Philadelphia	WOCO—Minneapolis
WGR—Buffalo	WOC—St. Paul
WCAR—Pittsburgh	KBD—St. Louis
WSAI—Cincinnati	WAC—Washington

EVEREADY
Radio Batteries
—they last longer

Manufactured by
 NATIONAL
 New York
 Canadian National
 Toronto

Published
 and
 subscription
 Internal
 at the
 Copyright
 LARRY
 CHAIR

Popular Radio

EDITED by KENDALL BANNING



FOUNDED 1911

VOLUME X

December, 1926

NUMBER 8

CONTENTS

(Cover design by Frank B. Masters)

- The Effect of Temperature on Signal Strength**
By *E. E. Free, Ph.D.* PAGE 763
- Wanted—A Radio Humorist**
By *Homer Croy* PAGE 766
- Uncle Sam's New Short Wave Net**
By *Captain J. L. Autrey* PAGE 769
- How Circuit Resistance Affects Selectivity**
Practical pointers about coil resistances in the radio-frequency circuit, for the experimenter who wants the greatest selectivity with the best tone quality that can be obtained
By *Glenn H. Browning* PAGE 770
- The Salt on the Tail of the Broadcast Frequency**
How the tiny piezo crystal serves the interests of the broadcaster by checking station wavelengths and preventing interference
By *Morris S. Strock* PAGE 773
- Popular Radio Circuits**
INSTALLMENT No. 5:
The Grimes "Inverse Duplex" Receiver
The "Infradyne" Receiver
By *The Technical Staff* PAGE 776
- If You Want to Read the Code—**
Practical advice, by a former Radio Inspector, for learning how to receive and transmit messages in code
By *Howard S. Pyle* PAGE 778
- How to Build the LC-Intermediate Power-pack**
The second of a series of articles to follow the "How to Build the LC-27 Receiver," published in October
By *Laurence M. Cockaday* PAGE 780
- "From Fire and Flood—"**
What five radio amateurs of Oklahoma did to win the POPULAR RADIO Medal for Conspicuous Service
By *Lloyd Jacquet* PAGE 783
- Simple "How to Build" Articles for Beginners**
NUMBER 17: How to Build an "A" and "B" Power-pack for Direct Current
By *Morris M. Silver* PAGE 785
- Inside Information on New Radio Receivers**
FOURTH INSTALLMENT
The Model 8C Kolster Receiver
The Ferguson Model 10 Receiver
The Cleartone Model 110 Receiver
By *S. Gordon Taylor* PAGE 786

DEPARTMENTS

- The Yes and No Man 798
The Beginner in Radio *Armstrong Perry* 818
What Readers Ask *David Lay* 840
In the World's Laboratories *E. E. Free* 848
Broadcast Listener *Raymond Francis Yates* 858
Broadcasts *Charles L. Reese, Jr.* 862

VOLUME X

DECEMBER, 1926

NUMBER 8

Published monthly by Popular Radio, Inc., 627 West 43rd St., New York, N. Y., telephone number, Chickering 1906; Douglas H. Cooke, President; Treasurer; Kendall Banning, Vice-President; Laurence M. Cockaday, Secretary; Joseph T. Cooney, Asst. Treasurer. Price 25 cents a copy; subscription \$3.00 a year in the U. S., Canada and all countries within the domestic postal zone; elsewhere \$3.50 a year, payable in advance. The National News Company, Ltd., No. 5 Bream's Bldg., London, E. C. 4, sole distributors in England. Entered as second class matter April 7, 1922, Post Office at New York, N. Y., under the act of March 3, 1879. Copyright, 1926, and title registered as a trade-mark by Popular Radio, Inc. in Great Britain by Popular Radio, Inc., 6 Henrietta St., Covent Garden, W. C., London, England. For advertising rates address E. R. Crowe & Company, Inc., 25 Vanderbilt Ave., N. Y. or 225 North Michigan Ave., Chicago. Printed in U. S. A.

LAURENCE M. COCKADAY, Technical Editor
CHARLES L. REESE, Jr., Managing Editor

E. E. FREE, Ph.D., Contributing Editor
JOHN V. L. HOGAN, Contributing Editor

Still the undisputed leader

Rauland-Lyric
AUDIO TRANSFORMER

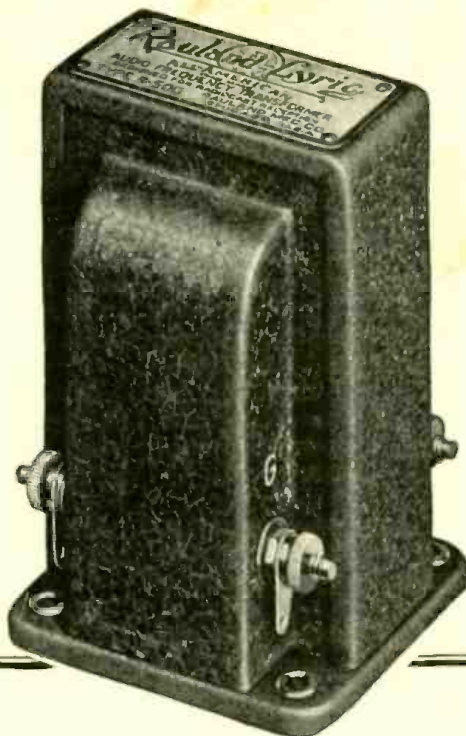

If you love music, and want your radio set to reproduce tones *faultlessly*, there is one audio transformer you can absolutely depend on—the famous Rauland-Lyric.

Voices and instruments alike are amplified with amazing realness by the Rauland-Lyric; with faithful amplification of those “overtones” essential to full, natural reproduction. The amplification curve of the Rauland-Lyric illustrates its outstanding superiority in tone purity.

The Rauland-Lyric is the undisputed leader in its field. It is invariably chosen by set builders who want the utmost in perfect tone quality.

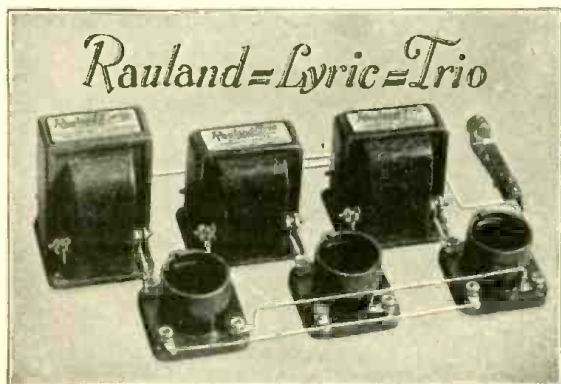

Write for “Modern Audio Amplification”, a free book, describing this fine unit.

A new high mark in three-stage audio amplifiers

Your receiver's tone quality depends in large measure on correct audio amplification. The famous Rauland-Lyric Transformer may now be combined with two Rauland-Trios (impedance units) to form the Rauland-Lyric-Trio—the highest known perfection in three-stage audio amplification. Rauland-Trio is a compact, well-made unit—containing in one shell—inductance, resistance, and capacity in correctly balanced relation.

New 1927 Radio Key Book

You'll enjoy reading it—48 pages of interesting, up-to-the-minute facts about radio, simply told. Also full construction details of all leading types of circuits. Send 10 cents (coin or stamps) to cover postage and mailing cost.

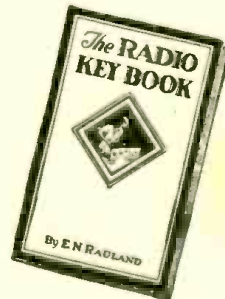

ALL-AMERICAN RADIO CORPORATION

4207 Belmont Avenue, Chicago, Illinois

OWNING AND OPERATING STATION WENR 266 METERS

A PAGE WITH THE EDITOR

RADIO experimenters and home set-builders need no introduction to Kenneth Harkness, whose place in the Radio Hall of Fame was assured when he developed the Harkness Reflex Receiver three years ago and the Counterflex Receiver last year—both substantial contributions to the radio art.

IT IS with particular gratification therefore that POPULAR RADIO now advises its readers that another—and the best—circuit developed by Mr. Harkness will be first and exclusively announced, with complete structural details, in the coming issue of this magazine—for January, 1927.

THE new Harkness Receiver (which is designated as the KH-27) is a 6-tube two-dial set that employs dual tuning.

AN outstanding feature of the receiver is the new form of amplification that it incorporates; it consists of double impedances that bring out both the high and low notes with remarkable clarity.

THE radio-frequency stages are neutralized so that the set cannot oscillate.

MR. HARKNESS, it may be observed in passing, has been working in radio for twelve years, during which time he has seen war service as a radio operator in the British Navy, did extensive work on the Armstrong super-regenerative circuit, wrote the book "Radio-frequency Amplification" and for two years served as the technical mainstay of the magazine "Radio in the Home." POPULAR RADIO welcomes him to its long and growing list of distinguished contributors.

WHEN Thomas A. Edison—who invented the incandescent light globe fifty years ago and who has expressed irritation at radio—possibly because he cannot also claim the parentage of the

light globe's offspring, the radio vacuum tube—recently burst forth into a broad critique of radio, he was obviously inspired in part by a desire to exploit his new type of phonograph record that was about to be placed on the market.

AND when the Grand Old Man of Menlo Park claims that the public interest in radio is waning, he merely utters an opinion based on a hope, and speaks without knowledge of the facts.

BELOW, for example, are a few facts and figures concerning the increase of public interest in radio; they carry the authority of an official report from the U. S. Department of Commerce, dated October 16, 1926—only a few days following Mr. Edison's statements.

THE indications are that the growth of interest in radio during the coming winter, and the increase in sales of radio receivers and apparatus, will break all records.

IT is unfortunate that these figures were not at Mr. Edison's disposal at the time he made his observations. Facts and figures are sometimes embarrassing details to reconcile with theories and opinions formulated without them.

ON October 15th the prize contest for answers to the question "How can radio broadcast programs be improved?" closed—according to schedule.

ALL answers that bear a post mark dated on or before October 15th are eligible for the cash prizes, as announced in the September number of this magazine.

THE wide interest in this live topic, as evidenced by the large number of entries, has evoked some novel and original ideas—which was, of course, exactly the purpose of this prize offer.

A PRELIMINARY study of the answers is now being made. When the best of the letters are selected, copies will be submitted to the judges for final decision. The prize-winning letter will be published, as soon as the winner is chosen, in POPULAR RADIO—probably in the February number.

THE judges of the contest are Prof. Alfred N. Goldsmith, Secretary of the Institute of Radio Engineers; Col. W. E. Harkness, Vice-president of the Broadcasting Company of America; Frank H. McDonald, President of the Broadcast Listeners Association; Frank W. Elliott, President of the National Association of Broadcasters; and the editors of POPULAR RADIO.

THE winners of the contest may thus be assured that their suggestions will be brought to the attention of the very men who are in the best position to make practical use of the ideas submitted.

HOMER CROY, whose article "Wanted—A Radio Humorist" appears on page 766 of this issue, is the novelist whose book and film "West of the Water Tower" made him famous practically overnight, and paved the way for the success of his latest novel "They Had to See Paris." This is his fifth contribution to POPULAR RADIO.

WITH the coming issue of POPULAR RADIO—for January—the department "What's New In Radio" will be considerably expanded.

THIS expansion has been made necessary not only by the rapid development of apparatus in the field of radio but also by the corresponding increase of interest on the part of experimenters and broadcast listeners alike in new types of receivers, loudspeakers, tubes, condensers, transformers, coils, antennas, rheostats, power-packs and other apparatus which constitute valuable contributions to the radio art and are increasing the efficiency of the receiving set.

READERS are invited to notify the Editor of the "What's New in Radio" department of any new inventions that are of particular interest; apparatus of outstanding merit, that is passed by the POPULAR RADIO LABORATORY, will be duly recorded and, whenever possible, pictured for the information and guidance of all.

Kendall Banning
Editor, POPULAR RADIO

	1925	1923	Per Cent Increase
TOTAL VALUE.....	\$170,390,572	\$54,000,470	215.5
LOUD SPEAKERS:			
Number.....	2,606,866	623,146	318.3
Value.....	19,162,591	5,608,330	241.7
RECEIVING SETS:			
Tube type—			
Number.....	2,180,622	190,374	1045.4
Value.....	88,800,538	13,326,116	566.4
TRANSFORMERS:			
Number.....	3,413,993	1,571,817	117.2
Value.....	7,457,805	3,929,581	89.8
RHEOSTATS:			
Number.....	3,531,871	1,085,171	225.5
Value.....	2,084,188	955,396	118.1
LIGHTNING ARRESTERS:			
Number.....	2,971,379	1,758,723	69.0
Value.....	506,034	422,036	19.9
RADIO TUBES:			
Number.....	23,934,658	4,687,400	410.6
Value.....	20,437,283	9,824,172	108.0
MISCELLANEOUS PARTS:			
Value.....	27,978,097	12,999,623	115.2

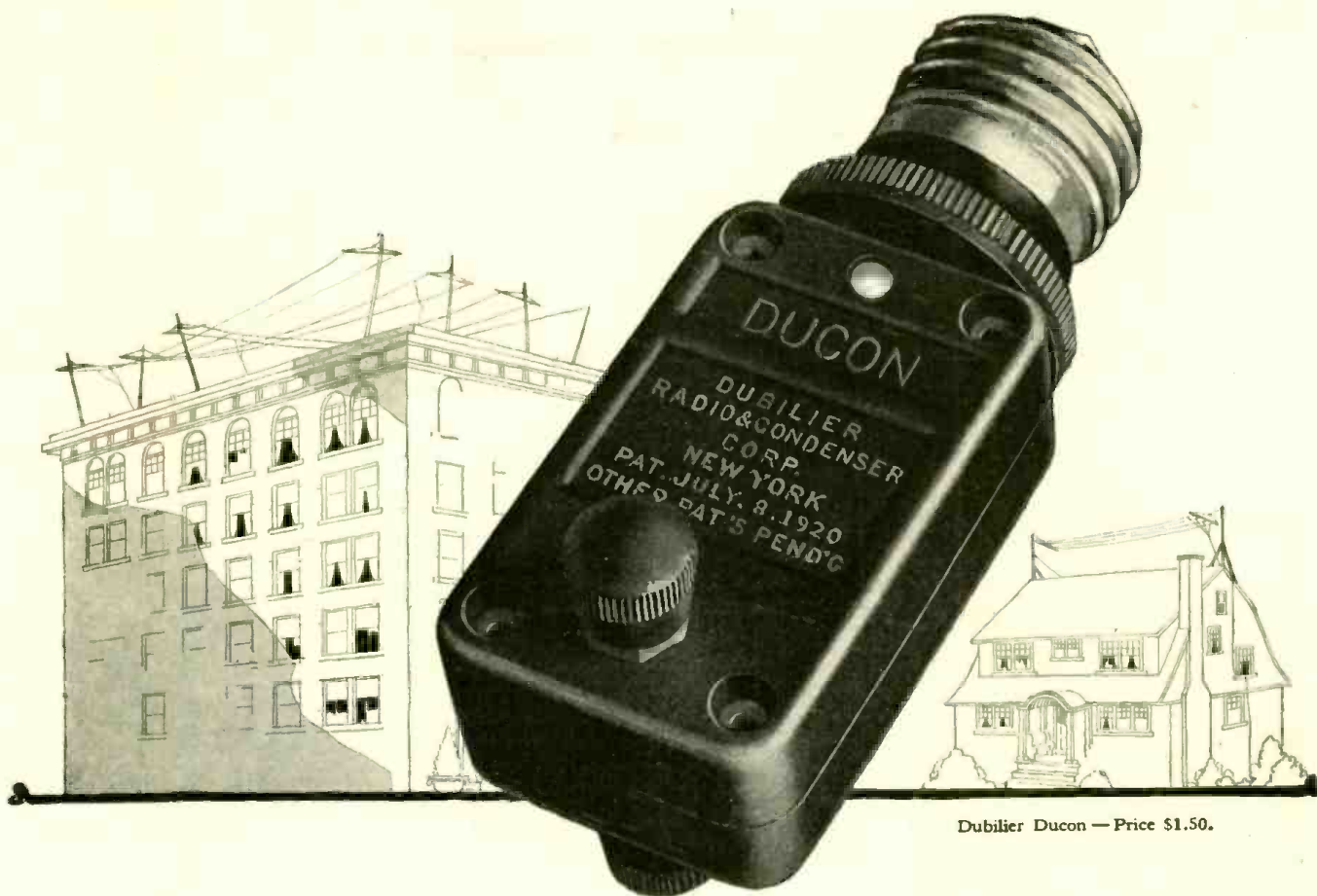

Dubilier Ducon — Price \$1.50.

Aerials have gone out of style

In the old days, when radio was new, the "fan" was known by crazy festoons of wire that decorated his housetop or yard.

These were the old-fashioned aerials, and no one has forgotten all the grief they caused.

Modern radio may use the hidden loop, or the short indoor aerial. But there is a better way. The Dubilier Ducon enables you to use the complete wiring system of your house without risk, and with better results than most out door aerials give.

You simply screw a Dubilier Ducon into any lamp socket, and connect it with the antenna binding post of your set. You will find that it increases selectivity—especially in crowded neighborhoods, and will reduce "static" in the summertime.

Try a Dubilier Ducon on your set tonight. They are sold by all good dealers on five days' trial for \$1.50

Dubilier
CONDENSER AND RADIO CORPORATION

SEEN BY THE CHRISTMAS SHOPPER

Some of the new and interesting radio apparatus that has just been put upon the market—and that offer suggestions for holiday gifts.

(Names and addresses of manufacturers of the apparatus mentioned will be furnished upon request by POPULAR RADIO SERVICE BUREAU)

A De Luxe Combination Receiver and Phonograph That Sells for \$1,000

This beautiful piece of inlaid furniture is a combination of the best there is in radio with the best there is in the phonograph art. These instruments list at \$1,000. They use no batteries or antenna; all you do is plug them in the light socket and they're ready to use. All necessary tubes come with the outfits; no extras to buy. To change from radio to phonograph, all you do is throw this switch. A gift you can be proud to give.

A Good-looking Set for \$260



HERE is the same receiver without the phonograph in connection with it, sold in this table form for \$260. It suggests an antique desk, doesn't it? No antenna is required. It's selective enough for the most crowded conditions. Used with this \$225 power loudspeaker, it gives as good reproduction and offers the same freedom from batteries as the \$1,000 combination phonograph-radio just shown you.

A Receiver Without Batteries That Costs \$400

THIS magnificent looking receiver sounds just as well as it looks. The parts inside are spaced far apart, reducing interaction to a minimum. Three large knobs serve as tuning dials. The dial settings for any station are nearly the same on all three dials. All you have to do is mark correct settings on a card and you can get the station back again any time it is on the air. This set gets its power direct from the current mains without storage or dry cells and it costs \$400.

A Good Two-dial Standard Receiver for \$225

THIS console is made by a manufacturer who has won an enviable reputation with this product; it's in its second year now, without radical change. Just two tuning controls. The console with loop and built-in loudspeaker is \$365; you must add about \$50 for charger, tubes and batteries although, of course, you can spend a little more on these items and make the set much easier to maintain. In the table model, without loudspeaker, the set costs

\$225. For about \$35, you can buy a good loudspeaker for it, but that brings the extras to about \$85.

Standard Storage Battery Tubes from \$2.00 Up



If your radio friends are still using the tubes they bought with the set a year ago, give them a new set of tubes. It's like having the valves ground and new piston rings put in your automobile; it peeps the set up wonderfully. Practically every storage battery set will work with UX-201-a type tubes throughout. They cost \$2.00 apiece. But most sets are equipped to use a power tube in the last stage, which makes them capable of handling a much louder signal without distortion. A power tube costs about \$4.50. So, with such sets, figure on one less UX-201-a type tube and get one power tube for the last stage.

A Fine New Detector Tube for \$5.00



THERE'S another substitution you can make that will tickle any fan who goes after distance; get him a UX-200-a type detector tube. It fits any set that uses a UX-201-a type detector tube. It's worth the \$5 for the extra volume and long distance it brings in. This is the line-up on storage battery tubes: first choice, three UX-201-a type tubes, one UX-200-a type detector tube and one UX-112 type or UX-171 type power tube, total cost \$15.50; second choice, four UX-201-a tubes and a power tube, \$12.50; and third, five UX-201-a type tubes, \$10.

Dry-Cell Tubes at \$2.25 to \$2.50

ABOUT dry-cell tube sets; here you require a different line. Corresponding to the UX-201-a type storage-battery tube is the UX-199 type dry-cell tube, selling for \$2.25; to the UX-112 type power tube, is the UX-120 type dry-cell, power tube, selling for \$2.50. Don't go wrong on tubes. Buy only standard makes that you know about and only dry-cell tubes for dry-cell sets and storage battery tubes for storage battery sets. The wrong kind of a tube is useless.

A Useful Power-tube Adapter for \$1.25



HERE'S an interesting combination that's a safe bet for anybody with a good five or six-tube set that isn't specially wired for a power tube; they'll call you quite an expert for picking out this combination! Buy this power tube adapter, making possible the use of a power tube with an ordinary set. It gives much clearer signals, especially on loud nearby stations. The adapter is \$1.25, the tube \$4.50, that's \$5.75. You add the necessary extra batteries for the power tube too, so they can hook the tube right up. It needs two 4½ volt "C" batteries, \$1.30 and one large 45 volt "B" battery, \$3.75. So with \$10.80, they have everything, even batteries for six or eight months, to run their power tube.

A Particularly Easy-to-Operate Set for \$231

THIS receiver is an interesting one because it uses alternating-current tubes. It's low in price for a receiver that eliminates all batteries. Laboratory tests on this receiver have shown up very well. Just two dials to tune. Loudspeaker and antenna are all you have to buy in addition to the set. That's \$231, plus \$35 or \$40 for those two items.



Loudspeakers Cost from \$10 to \$225

ABOUT loudspeakers, there is no end of choice. This \$225 power model plugs into any alternating-current lighting line and delivers volume nearly equalling that of the original music, or it can be softened down to a whisper without distortion. It is a wonderfully useful addition to a good set, now using a small, ordinary loudspeaker. It's a good addition to a good set, but it won't make a poor set into a good one.

Recommended for the LC SENIOR POWER PACK

THE NEW PRECISION
HIGH VOLTAGE
FILTER CONDENSERS



Made in the following capacities particularly for use where high voltage condensers are necessary:

- *No. 46—4 mfd. DC working voltage 600. Price \$9.00.
- *No. 26—2 mfd. DC working voltage 600. Price \$5.50.
- *No. 44—4 mfd. DC working voltage 400. Price \$5.50.
- *No. 24—2 mfd. DC working voltage 400. Price \$3.00.

*Specified for the Senior Power Pack.

THE PRECISION R. F. CHOKE COIL

Can be used wherever this type of coil is necessary. Very compact, being one inch in diameter and one and one-half inches long. Can be mounted on a sub-panel or a baseboard. Bracket for baseboard mounting provided with each coil. Has a very low distributed capacity, due to the slotted form of winding. List price \$1.00.



180 VOLT B-SUPPLY

for use with 110 v. AC 50-60C.

A very powerful, strongly constructed UX216B tube eliminator. Gives 180 volts at 60 mls. Particularly designed to supply current for the new UX171 tube. List price \$47.50.



No. 20

THE ORIGINAL COCKADAY COIL

The only coil ever specified by Laurence M. Cockaday, inventor of the famous Cockaday Four Circuit Tuner for use in his set. The best hard rubber tubing and double silk covered copper wire insures a coil of unusual quality, resulting in increased volume and greater selectivity. Dielectric and leakage losses are extremely low. Price, \$5.50.



No. 200

THE
LC-27

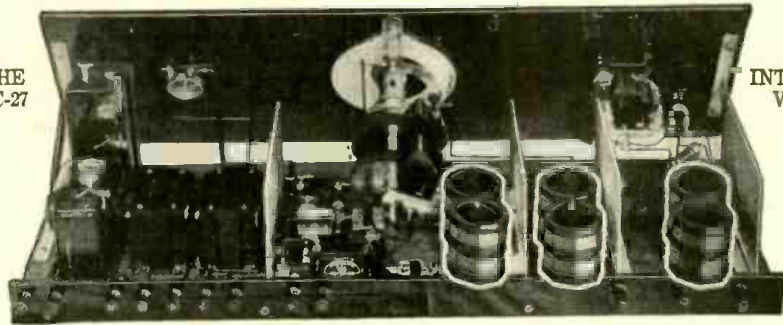

INTERIOR
VIEW

FOR THE LC-27 RECEIVER PRECISION DUO-OCTAFORM COILS

Used in Mr. Cockaday's newest contribution to radio.
Price each \$3.50.

BUILD THE LC-27 FOR CHRISTMAS

For the convenience of those consumers and dealers who wish to buy Cockaday's LC-27 in complete kit form, we offer the following parts exactly as used in Mr. Cockaday's laboratory model.

1—Hammarlund mid-line dual condenser, .000275 mfd.	\$7.50	1—Mar-Co. illuminated control scale 0 to 100	\$3.50
1—Hammarlund mid-line single condenser, .000275 mfd.	4.65	2—Mar-Co small controls for LC-27	1.50
1—Precision Duo-Octaform coil set, one antenna coupler and two interstage couplers	10.50	1—Carter battery switch65
1—Amertran De Luxe first-stage transformer	10.00	1—Samson radio-frequency choke coil No. 85	1.50
1—Amertran De Luxe second-stage transformer	10.00	3—Aerover mica fixed condensers, .00025 mfd.	1.05
1—Amerchoke No. 854	6.00	1—Durham resistor, 4 megohms50
1—Dubilier No. 902 filter condenser, 4 mfd.	5.50	1—Lynch grid leak mounting35
1—Dubilier No. 807 filter condenser, .1 mfd.60	1—Carter Gem Jack25
		1—Carter resistance, 0-10,000 ohms	2.00
		12—Eby binding posts	1.80
		5—Benjamin UX sockets	3.75
		1—Amperite	1.10
		Mechanical Kit consisting of aluminum shields, binding post strip, decorated panel and Talt Brackets	12.50
		Complete	\$85.20



Without Cabinet \$85.20

With Corbett Cabinet \$103.20

Built complete with cabinet \$10.00 extra

THE INTERMEDIATE POWER PACK

1 Yaxley Automatic Relay Switch No. 444	\$5.00	1 Centralao Resistance, 2,000 ohms	\$2.00
1 Filtrex A-C Transformer, type K-180	5.25	1 Hardwood baseboard, 7 3/4" x 18" x 3/8"85
2 Filtrex Choke Coils, type K. @ \$6.75	13.50	1 Bakelite binding post panel, 3 1/4" x 4 1/2" x 3/32" drilled50
1 Na-aid Socket35	1 Set POPULAR RADIO blueprints	1.00
6 Eby binding posts90	Connecting wire, screws, etc.50
1 Acracon condenser block, 14 mfd.	11.00	1 8 ft. twisted silk lamp cord with attached plug40
1 Acracon filter condenser, .1 mfd. 400 volts D-C	1.00		
1 F & L Tapped Resistance—type 200, 20,000 ohms	5.25		\$47.50

THE LC SENIOR POWER PACK

1—Brach Controlit	\$ 6.00	1—AmerTran resistor, No. 400	\$7.50
1—AmerTran transformer, PF-52	18.00	1—Centralao resistance, 5 watts, 2,000 ohms	2.00
1—Benjamin UX-Socket75	1—Bakelite binding post strip, 3 1/2" x 15" x 1/16"	1.50
2—AmerChokes, No. 854	12.00	1—Brass mounting strip, 17 1/2" x 1/2" x 1/16"80
7—Eby binding posts	1.05	1—Hardwood baseboard, 8 3/4" x 15" x 3/8"60
1—Precision paper filter condenser, No. 26, 2 mfd.	5.50	1—Set POPULAR RADIO Blueprints	1.00
1—Precision paper filter condenser, No. 24, 2 mfd.	3.00		
1—Precision paper filter condenser, No. 44, 4 mfd.	5.50		\$65.20

Exactly as used in the laboratory model. Every part fully guaranteed.

INFORMATION EVERY DEALER SHOULD HAVE

Write for a set of Precision Coil catalog sheets. They describe in detail all of the Precision Coils used in POPULAR RADIO designed receivers for the past two years.

A complete list of the new Precision Line of Radio Power Units are also given in easily filed catalog form.

PRECISION COIL CO., Inc.

209 Centre St. New York, N. Y.

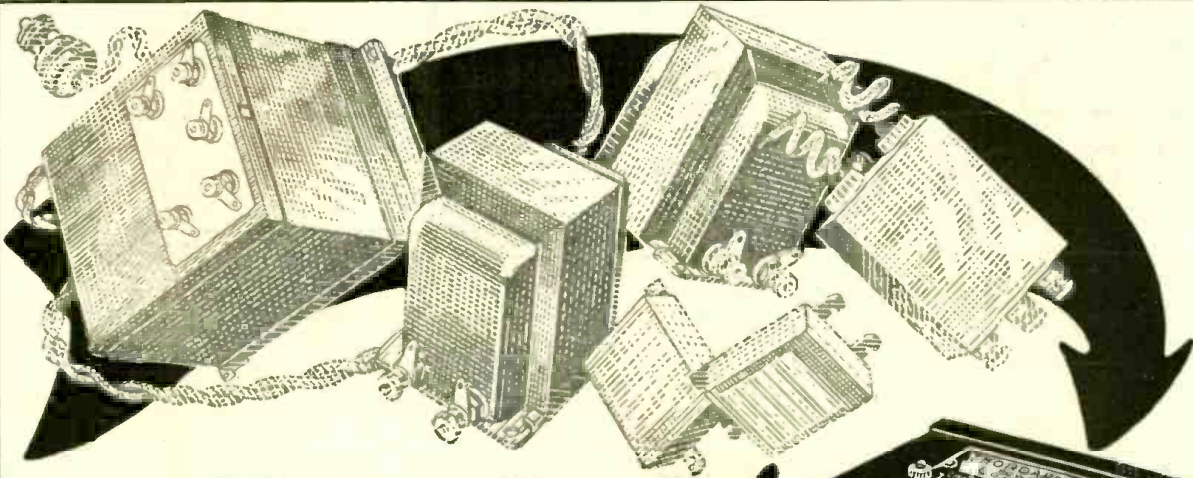

All in One!

THORDARSON POWER COMPACT

TYPE R-171

Contains a power supply transformer for Raytheon BH rectifier, 2 filter chokes, 2 buffer condensers, and a filament supply for UX 171 power amplifying tube.

\$15.00

TYPE R-210

Contains a power supply transformer for UX 216-B rectifier, 2 filter chokes, and a filament supply of 7½ volts for UX 210 power amplifying tube.

\$20.00

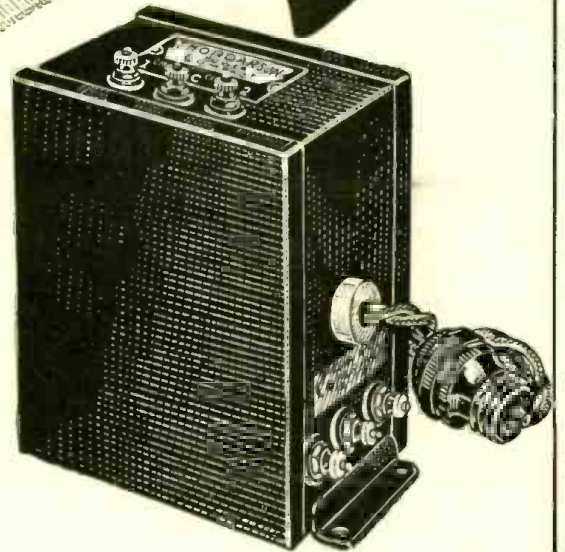

The Complete Foundation Unit for power amplification and B supply

Simplified Assembly. The Power Compact contains within itself the greater part of the complete B supply unit. With the Type R-171, only 14 leads complete the Raytheon assembly. All terminals are carefully located for the greatest ease of assembly.

Compactness. The only additional apparatus required to build the B supply are the condenser block (Raytheon type), a Raytheon tube BH, and the resistance units. The complete eliminator occupies a space of but 6 in. x 9 in. without crowding.

High Efficiency. The power supply of either Power Compact furnishes the proper current for maximum efficiency of the rectifiers used; the chokes are of sufficient capacity to carry the maximum output. Conservatively rated, will not heat up in continuous service.

High Voltage Output. The R-171 Power Compact assembly will deliver a maximum plate voltage output of 300 volts at 30 milliamperes, or 275 volts at 40 milliamperes.

The R-210 type assembly will deliver 400 volts to the plate of the power tube, and in addition, will supply a constant 90 volts to the receiver at any current drain up to 40 milliamperes.

Silent in Operation. There is no traceable hum, either mechanical in the compact itself, or electrical through the loudspeaker.

Complete Supply for Power Amplification. The Power Compact not only supplies B voltage, but also provides for the filament current and grid bias of the stage of power amplification. *Makes it possible to use power amplification even on sets designed for dry battery operation.*

Electrically Centered Filament Supply. The power tube filament supply is tapped at the exact electrical center for grid return. The center tap is taken from the common lead of two perfectly balanced windings—completely obliterating the A. C. hum. (An exclusive Thordarson feature.)

Write for instruction booklets SD-49 and SD-50.

If your dealer cannot supply, order direct from the factory.

THORDARSON ELECTRIC MANUFACTURING CO.
Transformer Specialists Since 1895
WORLD'S OLDEST AND LARGEST EXCLUSIVE TRANSFORMER MAKERS
Huron and Kingsbury Streets — Chicago, Ill. U.S.A.

AMSCO METALOID

GRID GATES & RESISTORS

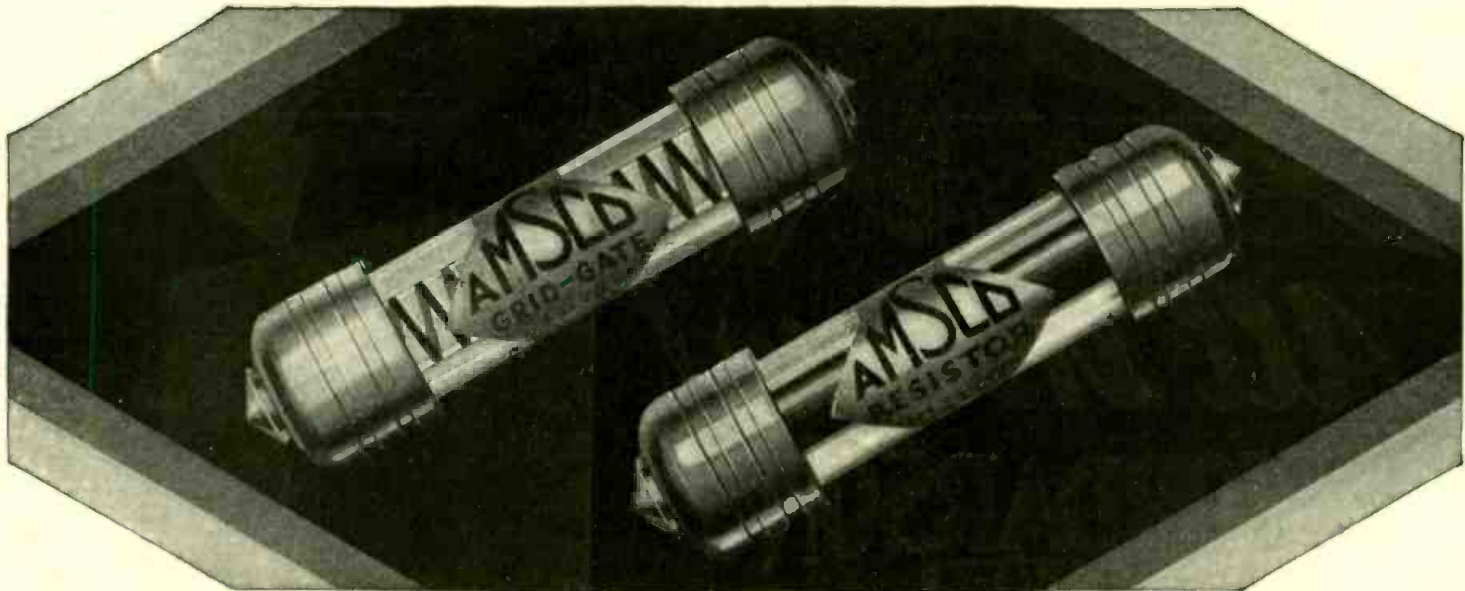

SILENT ACCURATE PERMANENT

THE secret of AMSCO excellence is in the changeless AMSCO METALOID resistance element. It is COLLOIDAL—smooth, stable, never varying with age, moisture or usage—superceding crystalline forms, with their jagged, noisy pathway to the current.

The element is fused into glass, and contact made by a welded joint, spun to the exterior cap. The large element, many times the size of inferior metallic resistors, will dissipate two watts of power with a 500 per cent margin of safe overload.

AMSCO Metaloid Grid Gates and Resistors are standard specification for fine Radio Receivers, and Battery Eliminators requiring high watt dissipation.

AMSCO Accuracy is guaranteed within five per cent of rated value—Silent operation guaranteed without qualification. Insist upon AMSCO.

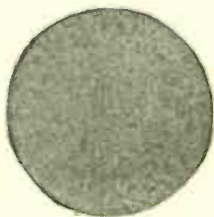

Microphotogram of Colloidal AMSCO metaloid element. "Smooth, unbroken and silent."

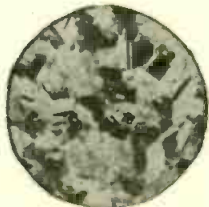

Microphotogram of typical crystalline metallic element. "Jagged and noisy."

Write for Zeh Bouck's monograph on R. C. Amplification. Also leaflets describing AMSCO Allocating Condensers, single, siamese, and three-gang—allocating by frequencies, wavelengths or capacity variations.



AMSCO PRODUCTS, INC.
Broome and Lafayette Streets New York City





The Unique Service Rendered by POPULAR RADIO

"POPULAR RADIO occupies the unique position of supplying its readers with 'popular radio news,' combining strict technical accuracy with ease of comprehension. Here the engineer and the layman find a common interest in its pages. The greatest commendation I could give POPULAR RADIO is the lively interest and pleasure with which I read each copy."

George Lewis,

GENERAL MANAGER, THE KEN-RAD CORPORATION

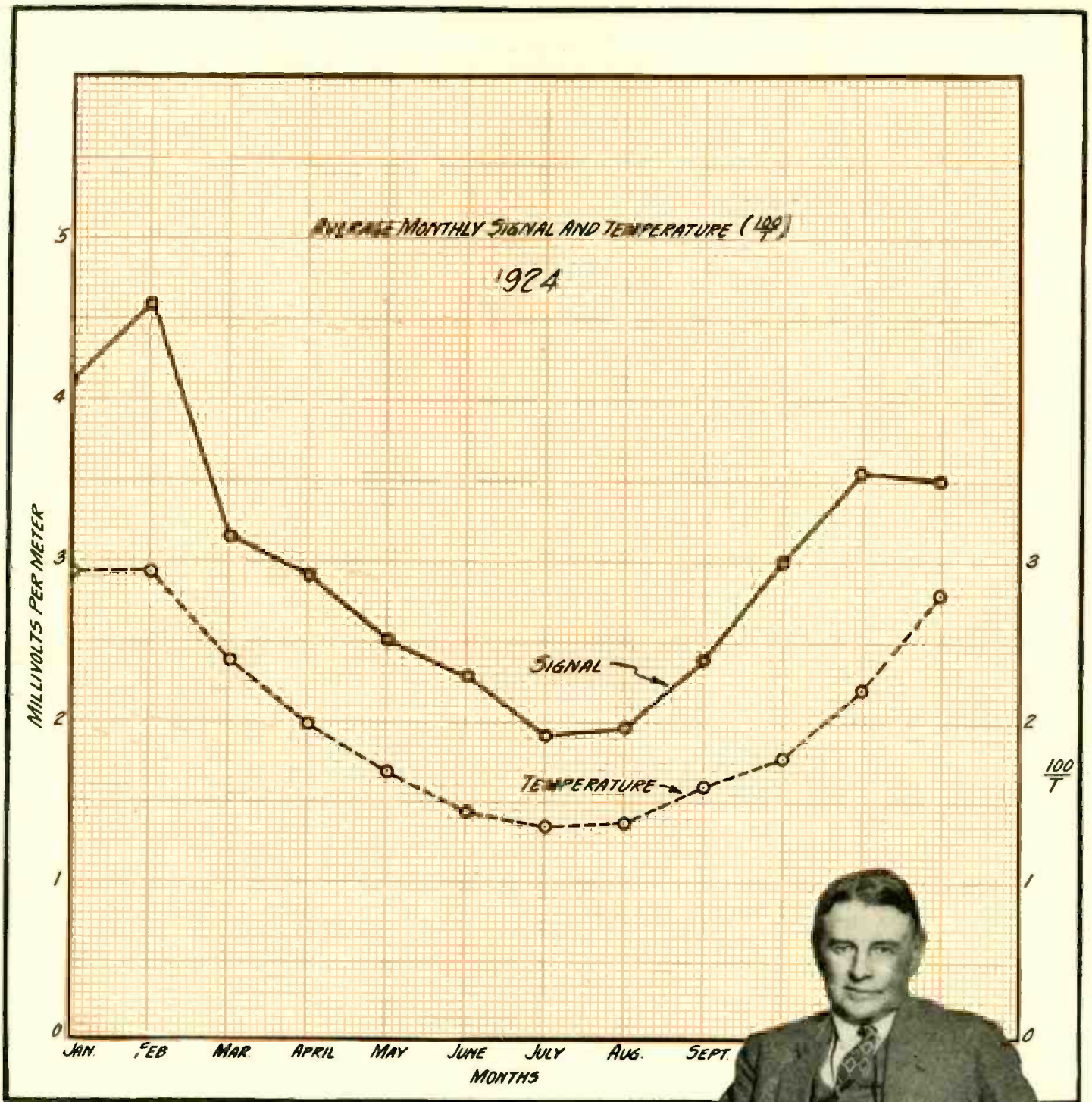

How Signal Strength Follows Changes in Temperature

Dr. L. W. Austin of the United States Bureau of Standards, seated at the right, finds that the air temperature has important influences on radio transmission. Two of Dr. Austin's graphs, reproduced above, show clearly that the strength of the radio signal corresponded with the average air temperature during 1924. The temperature curve is inverted, higher temperatures being toward the bottom of the chart.

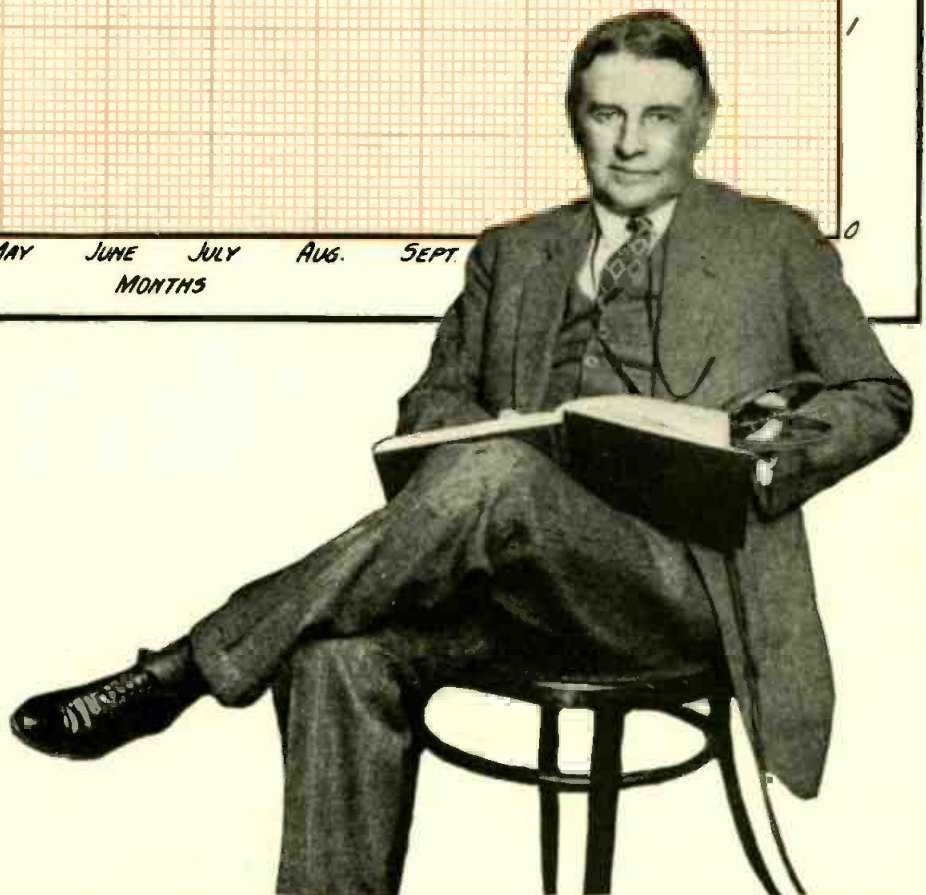

Underwood & Underwood

Popular Radio



VOLUME X

December, 1926

NUMBER 8

The Effect of Temperature on SIGNAL STRENGTH

Newly-collected data on the part that hot and cold waves play in radio reception holds out the prospect that "radio weather" will be forecast as accurately as the Weather Man now predicts rain and shine.

By E. E. FREE, Ph.D.

THE striking difference which exists between the good radio conditions of the winter months and the relatively poor transmission that is apt to be experienced in the summer is a good deal of a mystery.

In spite of many suggestions and some partial explanations, the difference in radio conditions between the colder months and the warmer ones remains inexplicably large. It is quite true that there are more atmospherics in the summer. These annoy the listeners and interfere with the clarity of reception. But that is not the point. Even when the actual strength of the received signal is measured electrically, so that the disturbing effects of lightning flashes and other sources of atmospherics are eliminated, the winter signal is found to be much stronger and more reliable than the summer one.

Undoubtedly meteorological factors are involved in this difference. Differences in air pressure have been invoked by some investigators. Others have blamed the greater moistness of the summer air. Still others lay the difference at the door of mere temperature, certainly the most obvious place to lay it, for the outstanding difference between the winter and the summer is that the latter is the warmer.

Over two years ago, in 1924, Dr. L. W. Austin, of the United States Bureau of Standards, noticed that the signals

received on the Bureau's antenna at Washington from the transatlantic radio stations at Tuckerton and New Brunswick, New Jersey, showed an apparent variation with the temperature of the air. In particular, the winter months of that year were characterized by several distinct cold waves. These periods of intense cold had noticeable effects on the received signal strength at Washington. Dr. Austin's curiosity was aroused. After announcing the effect apparently detected, he began records which would determine, over a period of many months, whether the temperature of the air really is to be considered one of the effective factors.

These observations* are now available over a period of more than two years. They show a clear relation between the two daily conditions, the temperature of the air and the strength of the received radio signal. The effect is an inverse one; when the temperature is high the radio transmission is low, and *vice versa*. Other factors are evidently at work also, for the effects of temperature are sometimes obscured. But that these effects exist, that temperature does alter the radio conditions in the

atmosphere, appears to be unmistakable.

A few moments study of Dr. Austin's comparative curves will convince anyone of the reality of the temperature effect. Even during relatively cold periods, a temporary increase of air temperature will be reflected at once in a diminution of radio transmission. Atmospheric heat is bad for radio; atmospheric cold is good for it. That is the clear meaning of the graphs.

The same conclusion is apparent from consideration of the monthly averages. The average signal strength during the month of February turns out to be more than twice what it is during the month of July. The February figure is even substantially larger than it should be according to the usual law of decrease of signal strength with distance.

The distance of transmission used in these tests is within the range of distance most likely to disclose, Dr. Austin points out, any atmospheric effects which may exist. It is neither too short nor too long. Over longer distances, like that across the Atlantic, the weather is not likely to be the same in all parts of the path followed by the waves. A cold wave at one point may be cancelled by a hot spell at another point. And for very short distances the effects due to the atmosphere do not have opportunity to show themselves.

The distance from New Brunswick to

*The results obtained by Dr. Austin will be published presently in a paper delivered by him before the Institute of Radio Engineers. By Dr. Austin's courtesy, POPULAR RADIO is permitted to announce in this article some features of the results and of their probable meaning, together with a graphic representation of the results themselves as reproduced on other pages.

Washington is 175 miles. From Tuckerton to Washington is 156 miles. Both of these distances lie, therefore, within the range between 100 miles and 200 miles, which is probably about that within which the effects of alterations of the atmosphere would be expected to play their maximum role. The wavelength of the New Brunswick signals during the tests was 13,600 meters. That of the Tuckerton signals was 15,900 meters. In the calculations, the

received strength of both stations was reduced to the basis of a 600-ampere antenna current for New Brunswick and of a 500-ampere antenna current for Tuckerton. Different days are, therefore, entirely comparable.

At first sight, it may seem that the differences discovered are perhaps explainable as due to changes in ground conductivity, rather than to effects of the air temperature. Like almost all radio waves over moderate distances,

these waves from Tuckerton or New Brunswick probably consisted of two parts; the part that came through the atmosphere and the part that travelled along the ground. Either or both might be affected by temperature.

That the real effects are largely in the upper levels of the air is indicated, however, by Dr. Austin's further observation that the signal strengths in question are not affected materially by long-continued rains or droughts or by the

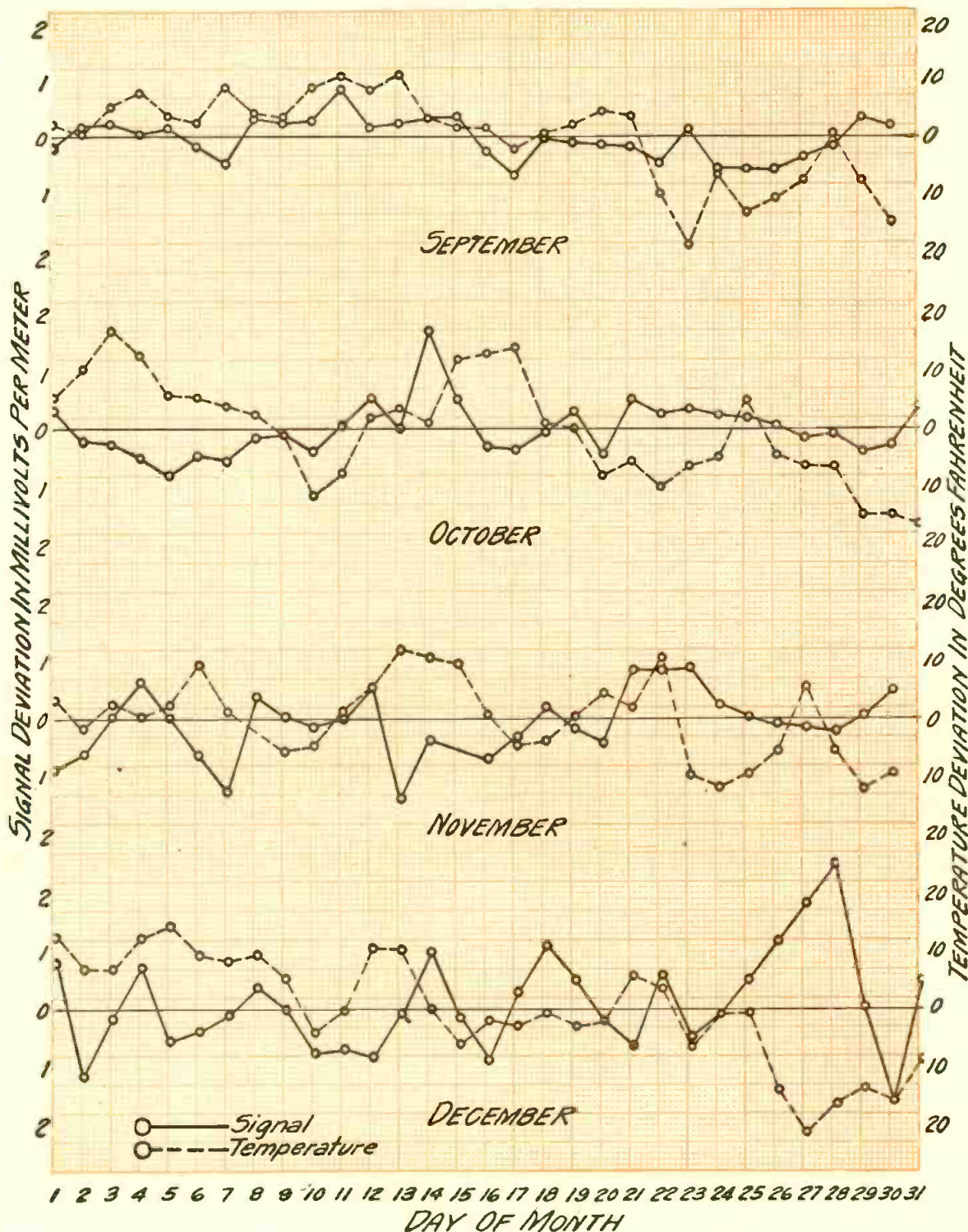

Note How Radio Follows Fluctuations in Air Temperatures

These curves show the daily deviations from the monthly averages for both temperature and the strength of the radio signal, as indicated, respectively, by the broken line and the solid one. When the temperature moves downward from the monthly average, the radio signal usually increases. The clearest instance on these graphs is during the week of December 25, shown at the right-hand end of the lowest curve.

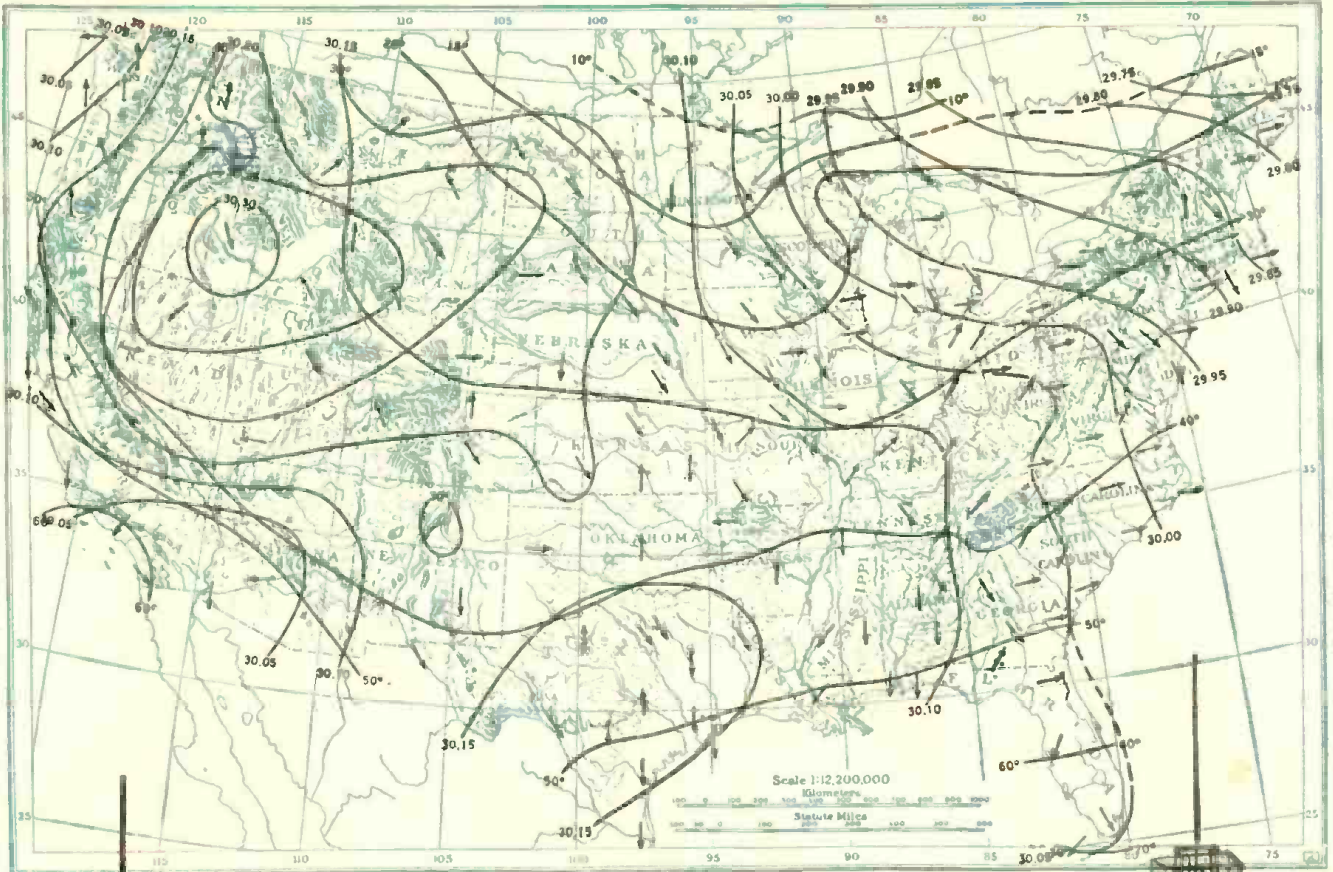

What the Weather Map Told the Radio Fan Last December

The map above shows average temperatures and air pressures (black lines) and average winds (arrows) for December, 1925. The United States Weather Bureau publishes these maps for every month. Below is the experimental radio receiving station of the Bureau of Standards at Kensington, Maryland.



Underwood & Underwood

presence of snow on the ground. All of these conditions, especially the soaking of the ground by rain, have marked effects on ground conductivity. The fact that they do not importantly affect the radio transmission tends strongly to prove that over the distance and with the wavelengths concerned the received transmission is largely through the air.

It was noted, also, that relatively rapid changes of radio transmission occurred at the times of the well-marked and wide-spread falls of temperature with which we are so familiar in the United States and which we call "cold waves." It was the effects of these waves, it will be remembered, which first drew Dr. Austin's attention to the problem nearly three years ago. The cold of such a wave affects the at-

mosphere at once; indeed, it is the arrival of colder atmosphere from farther north or from higher up above the earth which causes the cold wave. On the other hand, such cold waves do not immediately affect the conductivity or other characteristics of the ground.

It is safe to conclude, then, that the effects of cold or warmth on radio transmission are effects in the atmosphere.

The next question is that of what causes them.

Dr. Austin does not commit himself to any opinion about this, and, indeed, no final opinion is possible in the present state of our information. A change of temperature does many rather diverse things to the air. It alters, for example, the amount of water vapor which the air can hold without precip-

itating some of it as rain. Warm air holds much water; if the air is cooled a part of this moisture is instantly thrown out of the air, usually as fog, rain or snow.

Another difference between warm and cold air is in its density. Cold air is the heavier, quart for quart or cubic mile for cubic mile. It will sink beneath warm air, thus setting up more or less violent atmospheric circulations. It is also true, usually although perhaps not necessarily, that cold air tends to contain fewer dust particles than warm air.

In its electrical properties, which are, of course, the ones most likely to affect radio matters, the cold air is apt to contain fewer electrified air atoms or "ions" than does warm air. This gives it a

(Continued on page 856)

WANTED— A Radio Humorist

WE are greatly in need at once of a number of good radio humorists, male or female. Applicants must be able to make people laugh without hurting anybody's feelings. Steady employment, good salary and short hours. Don't wait to write—apply by wire.

—BROADCASTING DIVISION
ANY RADIO CORPORATION

By HOMER CROY

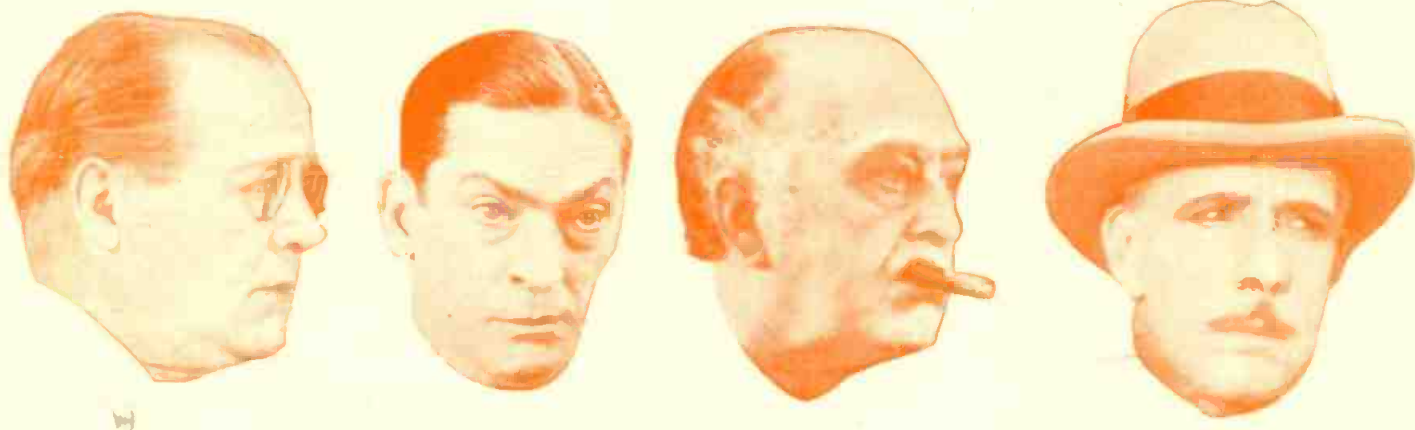

THIS is the story of a firm which had a Bright Idea.

It was a big firm with big money and, it liked to think, with big ideas. It had been watching other concerns going on the air and getting a lot of indirect advertising by putting over something in the radio line, and so it decided to do a little of the indirect stuff itself.

But instead of going in for music and a classical program, it decided to put on "something different."

"Why not give 'em something funny?" said the president. "People like to laugh."

It sounded good—just awfully good.

"We'll get the best comedian on Broadway, play him up and put over some thing that'll make 'em talk," said that up-and-coming man.

So they got a comedian who, in the pure English of Broadway, was a wow. So big was he that his name out in front could fill a house and when he went on tour they had to turn 'em away. And so popular was he that he was always being impersonated; and the newspapers constantly quoted his wisecracks.

The time came with the great comedian out in front of the microphone and the bright business men with ideas

settled back in their luxurious chairs at home, prepared for a good old-fashioned stomach laugh.

The comedian pulled his opener; it was pretty poor, but the business men smiled and waited for the fun to grow hot and heavy.

But it didn't. Instead, it seemed more like what the boys are finding at the North Pole.

The comedian pulled more of what he thought were sure-fires and went through his bag of tricks and a great sadness settled upon the faces of the waters. And also upon the faces of the bright business men, and now and then they had sharp shooting pains in the region of the pocket-book. They themselves had gone to the theatre and laughed and pounded their neighbors on the back and had pulled at their own suffocating collars, but now their collars were plenty loose.

Why was their comedian a riot in the theatre and a funeral on the air? They couldn't understand it.

At last, the comedian finished and was led away from the vibrating plate, and the agony was over and the bright business men had only to think of the fat check, outward bound.

The bright business men had made the discovery that what is funny on the stage is not necessarily funny on the air.

The reason that the great comedian so much resembled Sidney Carton on the scaffold was that he was the kind known on Broadway as a "prop" comedian. That is, his pockets were filled with strange devices and much of his humor consisted in pulling out these various articles and in talking about them, or trying them on, and also in wearing strange clothes. It wasn't legitimate humor; it was *eye* humor—and Mike has no eye. He is all ears and if the humor isn't *ear* humor, why then it is a total loss.

And that explains why radio humor is so hard to get.

In all other lines of entertainment we have great comedians and humorists, people who are known far and wide for their ability to create laughs—actors, humorous writers, comic artists, and so on—but as yet there is no great radio humorist. He will have to be developed—and it is a good field to get into by any one who has the ability to tease a laugh out of the immutable microphone.

Many a famous comedian from the stage has stepped in front of the microphone with the world ready to applaud—and then had to back away, a Hamlet in modern clothes. And because a person is funny in some other line doesn't mean that he will be a success over the radio. Charley Chaplin, the world's greatest comedian, is, when he goes on the air, pretty—but 'twere kinder not to dwell on it. And Harry Lauder, who has made the world laugh, is not a success when his wig and his crooked stick are taken away from him and he finds himself alone in the sound-proof room. One reason, is that his accent is so thick and his *rrr*'s so burry that they get all mixed up in the machinery and the people can't make head or tail of them.

Another reason, is that only a limited number of people in the United States know enough of the Scotch dialect to understand the stories. Radio has to pick something that everybody high and low, east and west, can understand, and what chance has a Swede in Minnesota to understand a Scotch story? "*Hoot, mon, ninna a nickel.*" Scotch goes fine on Broadway (I refer of course, to the dialect), and also it goes well and is understood in the larger cities, but at the cross roads it is a bunch of lilies.

Up to the present time the only general humor that has been successful, when given the freedom of the air, is singing humor. It is understood by all, it is in verse and it has the added pull of music. One does not have to catch all of it to understand it.

The opposite is true in a humorous story. One has to listen closely, to get every word, or the point will be lost—and there are fewer sadder things in the world, m'lord, than a joke without a point. People like to use the radio to help entertain their friends; they like to turn it on and to chat away while the music lends a pleasant, stimulating background. This they can't do when it is a humorous story. They have to take it as it comes, or not at all.

At first, it was thought that the failure in radio humor was due to the poor choice of comedians, and so the powers behind the broadcasting stations decided to get vaudeville comedians. They had, so the radio people thought, the ability to make people laugh; they had eliminated the poor lines until their pattern was almost sure fire, and so the vaudeville comedians were brought before the microphones and hope was in every heart. But when the comedians were heard without the glamour of the footlights and without the oddity of their clothes to add to their effect, they fell as flat as flypaper. Their chatter, divested of the surroundings and the

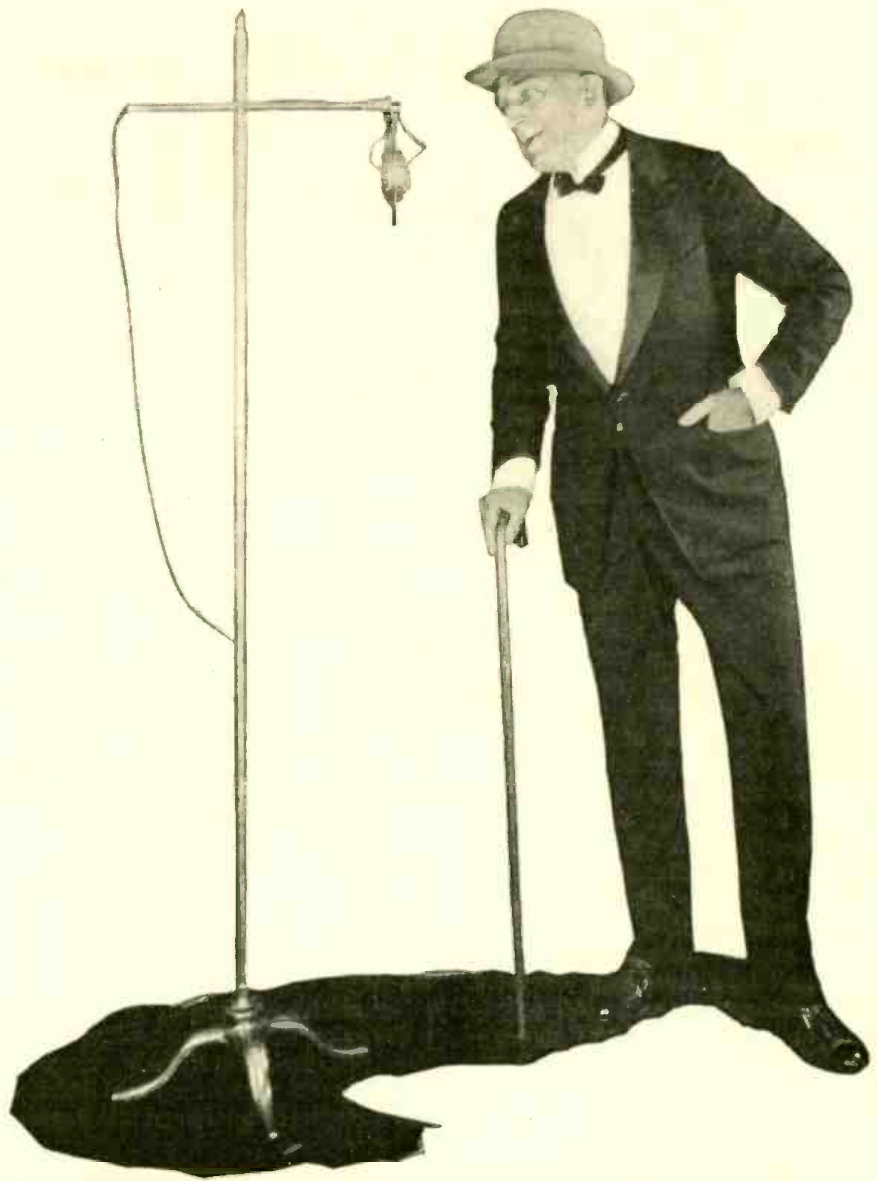

Posed by Raymond Hitchcock

funny make-up, was not wanted by the radio audiences.

And here, it is interesting to note that the English vaudeville comedians—"variety artists," they call themselves—are more successful when transferred to the radio than are ours. The reason is this. In England they have what is known as the "red nose" comedian; that is, when he comes on his only make-up is his red nose; he has to depend for his laughs on *lines*—not on his grotesqueries. He has worked over these lines, he has polished them and revised and tested them until they are all white meat, and so when he goes before the microphone he has more nearly what the radio audience wants than has the comedian who expects a funny hat and a mother-in-law joke to get him by.

One reason why humor over the radio is so flat is that it lacks spontaneity.

A vaudeville actor works with the

house lights on so that he can study the faces of the audience and tell exactly how the audience is responding to his jests, and he gets his inspiration in turn from the audience. But in the broadcasting studio, when the actor steps in front of the trembling tympanum, inspiration has flown out the window; his "audience reaction" is gone and he might just as well be holler-ing down a rain barrel.

Another reason for the poor quality of the humor which comes over the radio is the number of restrictions put upon it. Radio humor must not offend anybody—any race, any religion, any class of people—and it must be so simple that it can be understood by all. Great numbers of radio listeners are children, or people in their 'teens and the humor must be of such a nature as to appeal to them. Sophisticated or subtle humor would go over their heads. As a result a joke that will appeal to young and old, to the intelligent and

to the simple-minded and which has a point that will not be at the expense of any class or race of people is almost impossible to get. If the radio did not have such a wide audience it would be much easier to find humor for it.

Recently a patter comedian was put on at a studio not a hundred miles from New York and, after singing a comic song or two, began to tell funny stories about plumbers. The stories were fairly funny and the studio was well pleased, but the next day there was a vigorous protest from the secretary of a plumbers' union and also letters from a number of plumbers and their families protesting against the great injustice that had been done them.

Funny stories are not a success over the radio; that is, the average funny story is not. At first, the powers behind the radio thought that it would be a splendid idea to hook up the radio on some after-dinner speakers and let the people at home have a hearty laugh. And the microphone was trotted out and set up before the speakers' table, but if anybody at home laughed no record was ever found of it. After-dinner stories don't go over the radio. In fact, the ordinary, everyday funny story doesn't go at all. There are a number of reasons for it. In the first place, a good many after-dinner stories are off color, or their humorous kick depend on a double meaning. The radio can't take these into the home. A *risque* story may sound just awfully funny at a college fraternity dinner—especially if there has been a little wee doch and dorris—but when that story is turned loose in the privacy of a

home, before the wife and children and maybe grandma knitting in the corner (that is, if grandma knits any more) why, then it is a horse of a different color.

The joke that goes out over the radio must, above all other things, be clean and wholesome. The club smoker and after-dinner variety of a joke is a total loss.

The radio stations are not in favor of Jewish stories, funny as they may be, for the reason that many Jews are sensitive about them and write in complaining letters. The Scotch story goes much better than the Jew joke, but it is not a success away from the large cities where the Scotch dialect is better understood than in the small towns where they think all Scotchmen look like Harry Lauder, for it must be remembered that anything that goes out over the radio must have a universal appeal. It can't be aimed at just one class of people.

As a whole, a dialect story has hard sledding, but there is one dialect story that is almost sure fire—the negro story. None of the larger stations have a ban against it. One reason that the negro story goes over so well is that it doesn't hurt anybody's feelings. The negroes themselves are not sensitive about a negro story, as it usually deals with the race gently—it has no mean, biting spirit behind it. Another reason is that the negro dialect is a slow, musical, easily-understood dialect. It has what is known as "microphone quality," and also practically everybody in the United States knows the negro dialect. The same words transposed into Scotch

would not be understood so well, and as a result many in the radio audience would muffle the story.

One reason that radio humor usually is such a total loss is that it lacks spontaneity, and this is due to the fact that the actor has nothing to bring out his best. He recites his pattern without knowing whether it is going over or not and trusts to luck. If the element of spontaneity could be injected into it then the quality of the humor would be much higher. The funniest thing that has ever been sent over the radio was the result of this unexpected quality of spontaneity.

Graham McNamee and Major White had been sent out to report a football game in Philadelphia, and, as is known, these two are friendly rivals. The learned gentlemen took their places on the sidelines with their headpieces on, and all was set for the game. It had been raining and Major White was sitting under an awning, laughing and smiling and at peace with the world. McNamee, a few yards away, was waiting, ready to begin his announcing; in fact, he had started and was now filling in time until the game really began. And then unexpectedly something happened. Water had accumulated in the awning directly over White's head, and the canvas had sunk lower and lower under the great weight without that talented announcer noticing that anything was wrong with the world. Suddenly there was the cruel sound of ripping, a heavy gurgle of eager water and then a little Johnstown flood descended upon that famous hero. McNamee happened to be looking at him at the time and saw the great astonishment which came over Major White's face, and also what spread over his clothes, and Major White's frantic efforts to disentangle himself from the lines and the clinging canvas. McNamee began telling exactly what was happening—describing what he saw and he laughed so heartily at what he saw and at the strange contortions that the otherwise dignified Major White was going through that the people on the receiving line began to laugh too. The description and the merriment kept up for some five minutes, McNamee all the time laughing heartily. In all, it was the most spontaneous and humorous episode ever transmitted over the radio. And much of its effect was due to the hearty laughter on the part of the announcer.

What he saw and heard was funny to him and he succeeded in making it funny to his audience.

A professional humorist who has the ability to give a turn this feeling of freshness and spontaneity is Will Rogers.

(Continued on page 804)



Kadel & Herbert

"EYE HUMOR" MUST BE SUPPLEMENTED WITH "EAR HUMOR"

No matter how funny comedians whose fun depends upon make-up and props may be their humor is lost upon a radio audience unless the sounds that they make are in themselves funny. These "Radio Aces" (Macy and Scott) for example, must get over with their unseen audiences without the aid of the props that are drawn in this picture.

UNCLE SAM'S NEW SHORT-WAVE NET

The chance that the Army is giving to the radio amateur to render public service in peace or war

By CAPT. J. L. AUTREY
SIGNAL CORPS, U. S. A.

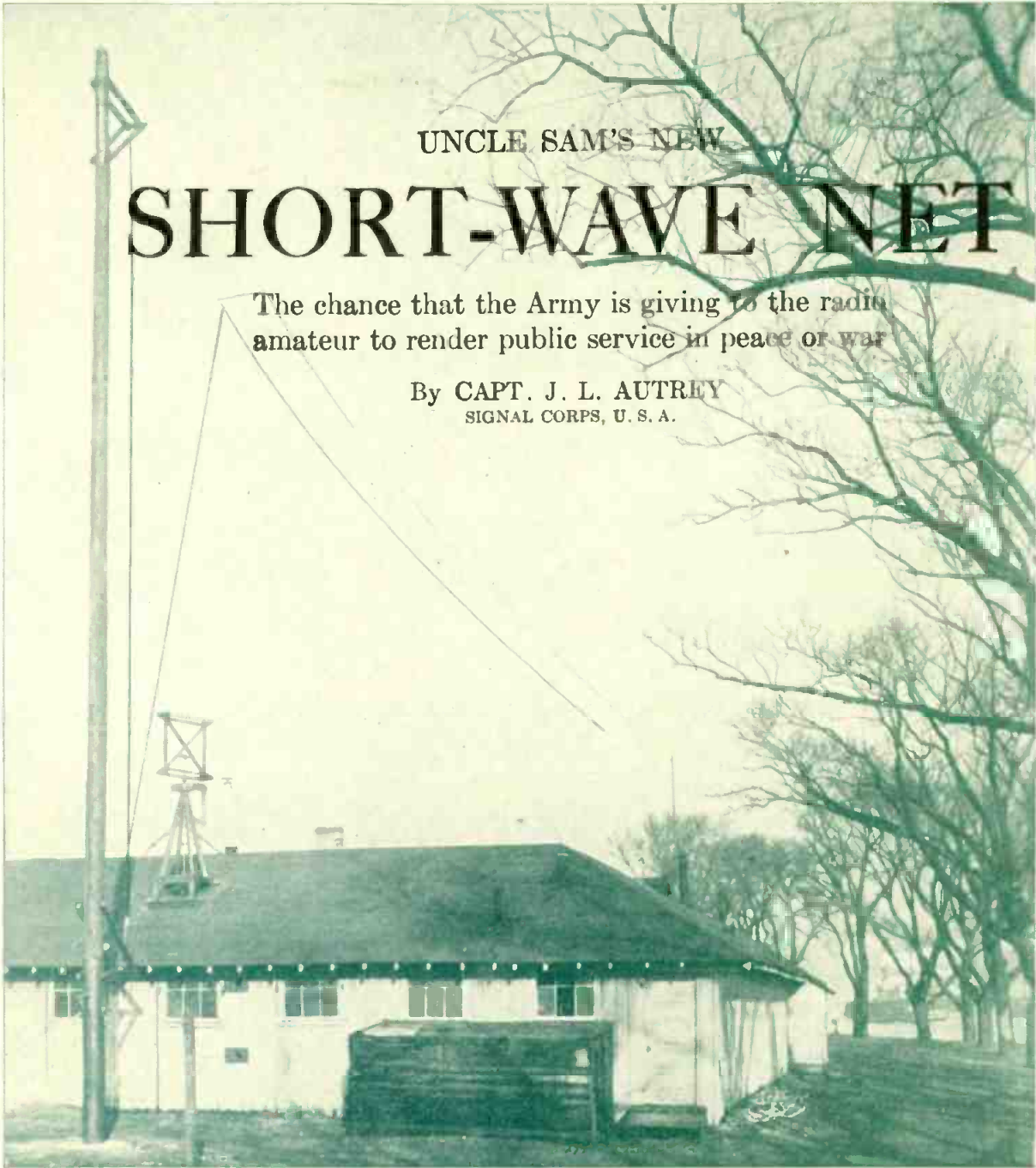

ONE OF THE CENTRAL STATIONS IN THE RADIO NET

The radio "shack" and antennas of amateur station 2SC, which is operated by the U. S. Signal Corps at the headquarters of the Second Corps Area, Governors Island, N. Y. Three antennas may be seen; the vertical transmitting aerial, the inverted "L", used for reception, and the outside loop.

THE transmitting amateurs' paradise, the short-wave territory of the ether, has not escaped the eagle eye of the military authorities. Indeed, the sympathetic support of the representatives of the army has always been a bulwark of defence when the amateurs' rights to the ether have been assailed.

The amateurs' part in the war is an old story, but the army's participation in amateur radio is comparatively new. Plans have been in the process of preparation for several years but now we have more than plans; we have army stations that have been specially designed and constructed for communication with amateur stations.

Three communication networks are provided for in the War Department's scheme of affiliation of the amateur with the Signal Corps. The first of these is known as the Corps Area Network.

A headquarters station is located in each Army Corps Area which acts as liaison agent for the army. This station supervises and maintains communication with the amateurs co-operating with the Signal Corps. A certificate of appointment is issued to all amateurs who volunteer and have been recommended for an assignment. A net control station, consisting of a principal and alternate is selected for each reserve division and each Governor's net to con-

trol and supervise all traffic to and from their respective subsidiary stations.

A second network, known as the Division Radio Net, links the Corps Headquarters Stations with brigade, regimental and reserve units within each Corps Area.

Finally there is the Governor's Radio Net which places him in touch with each unit of the National Guard in his State.

A unit in this system which is conspicuous for its efficiency and for the character of its equipment is that installed at the headquarters of the Second Corps Area, Governors Island, N. Y., and operated by the personnel of the Fourth

(Continued on page 832)

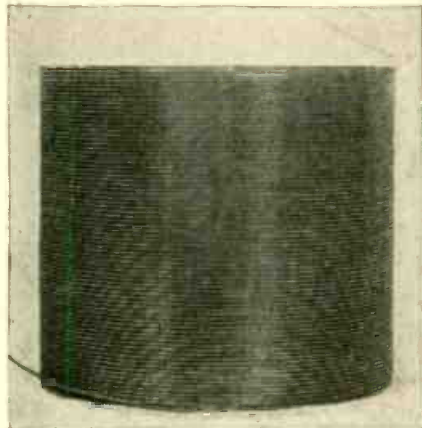

COIL 1

In this single-layer solenoid coil the turns are spaced and automatically wound on a cellulose cylinder.

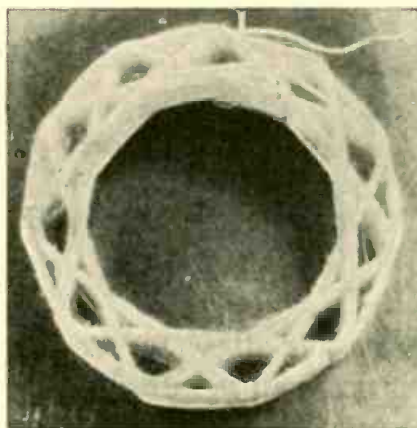

COIL 2

This coil is wound of insulated wire in a lattice-work form; it will be noted that it is entirely self-supporting.

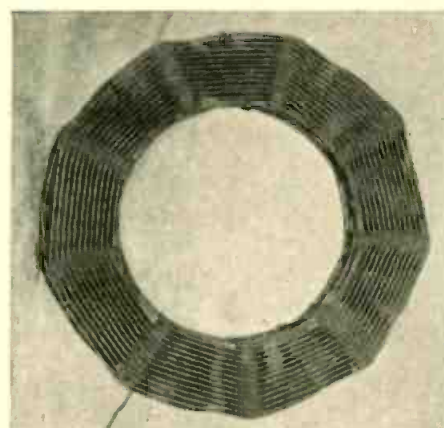

COIL 3

An entirely self-supporting lattice-work coil that has no dielectric except the silk insulation on the wire.

HOW CIRCUIT RESISTANCE AFFECTS

SELECTIVITY

Practical pointers about coil resistances in the radio-frequency circuit for the experimenter who is planning a receiver that will give the maximum of selectivity—and at the same time a good tone quality.

By GLENN H. BROWNING

WHENEVER radio experimenters get together it is a pretty sure bet that the talk will turn sooner or later to the subject of coils and radio-frequency resistance. And it is nearly as certain that the usual conclusion will be reached, that if we could make a perfect coil and condenser we could make receivers that would tune with perfect selectivity.

But the trouble with this whole conclusion is the fact no one has had much to say about quality of reception. For even if we could make a receiver that was perfectly selective in this way (and it must be remembered that selectivity is not wholly dependent upon coil and condenser resistance), we would be apt to spoil the quality of reception at the same time. For some of the better coils already have about as low a resistance as is consistent with good quality.

The lowest-loss coil, as nearly every one knows, is the single-layer solenoid in which the winding is spaced approximately one-half of the diameter of the wire.

The best way to find out how a radio receiver operates is to gain an exact understanding of the phenomena that take place in the fundamental circuits. In this case we shall take under consideration a circuit that is fundamental in all radio sets, a coil connected in parallel with a variable condenser.

This circuit is shown below in Figure 6.

Let us suppose that the coil, L , is a large coil or loop with the waves from a broadcasting station sweeping past it. These waves carry with them, or rather are made up of, what we call an electrostatic and an electro-magnetic field. The electro-magnetic field passing the loop sets up a small electro-motive force in every turn of wire. This creates a difference of electric pressure between the ends of the winding.

This electric pressure charges the parallel condenser which, when charged, tends to discharge and send a current back through the loop. If the broadcaster is transmitting at a wavelength of 300 meters (a frequency of one million cycles), the magnetic field passing by the loop reverses a million times a second; this means that the electric pressure or electro-motive force at the terminals of the loop also reverses at the same rate. Thus, the condenser is charged first in one direction and then in the other direction.

If this condenser is adjusted to resonance, a large current is built up in the coil and condenser circuit, and a difference of potential is established across the terminal of C which is 100 to 300 times the difference of potential that is impressed on the loop by the broadcasting station when the condenser

is not adjusted to its resonance value.

Thus, we may say that a coil and condenser have the same property in the electrical world that a spring with a weight attached has in the mechanical field. The weight is analogous to the coil while the spring represents the condenser. Now, suspend the weight on the end of the spring so that it will be free to bob up and down and tap the weight at regular intervals.

This tapping corresponds to the electrical impulse that is given the coil by the broadcasting station. Then, suppose, that you adjust the length or stiffness of the spring until the regular tapping occurs every time the weight starts its upward swing. This is mechanical resonance which comes at the point where a regular impulse of definite strength builds up the most motion in the weight and spring system. The motion built up, at resonance, corresponds to the current built up in the coil, and condenser system, at resonance.

It will be noticed in the above experiment that the regular tapping on the weight builds up very little motion, if the spring is not adjusted to the correct value.

In the same manner, a broadcasting station builds up little current in the electrical system unless the condenser

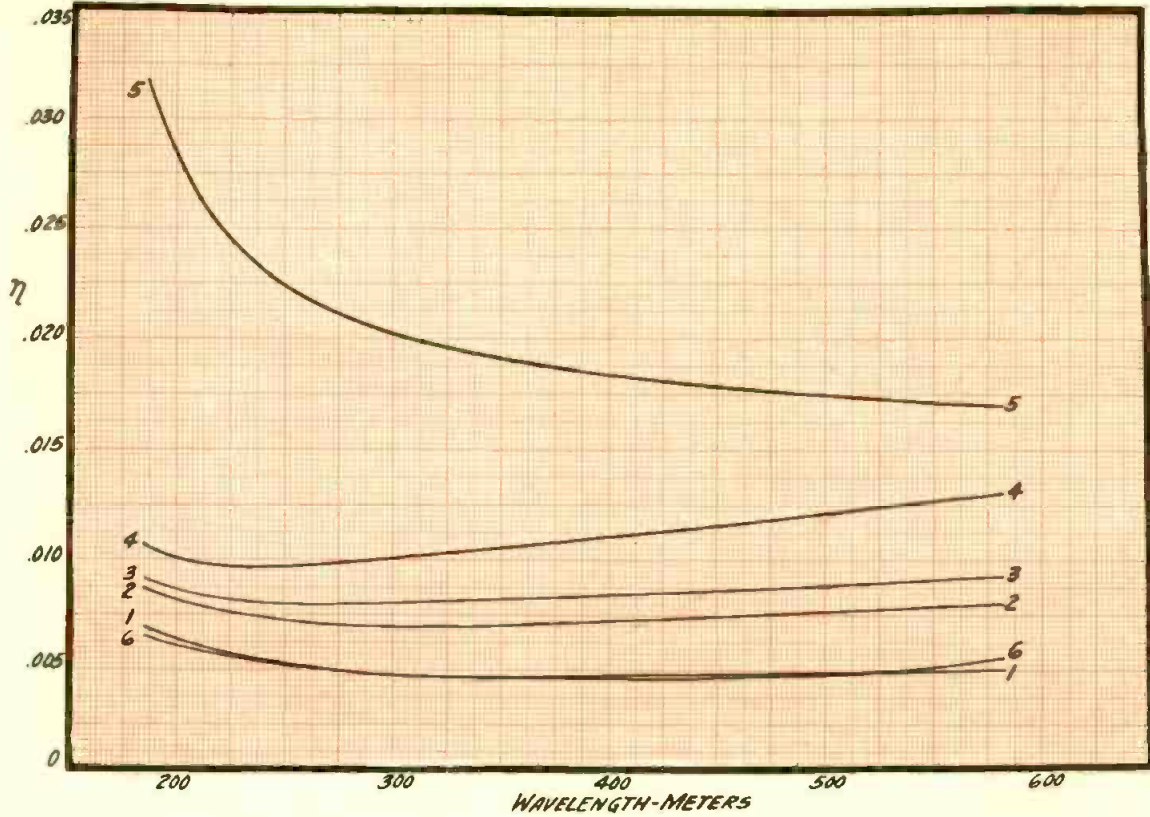

HOW N VARIES WITH THE WAVELENGTH

FIGURE 1: This curve-chart shows the variation of N (as explained by Mr. Browning) with the wavelength of six different kinds of coils that are illustrated through the article. Notice that N for Coil 5, which is a bunched wound coil, is higher than over any of the others; this indicates that this coil is not a good coil to use.

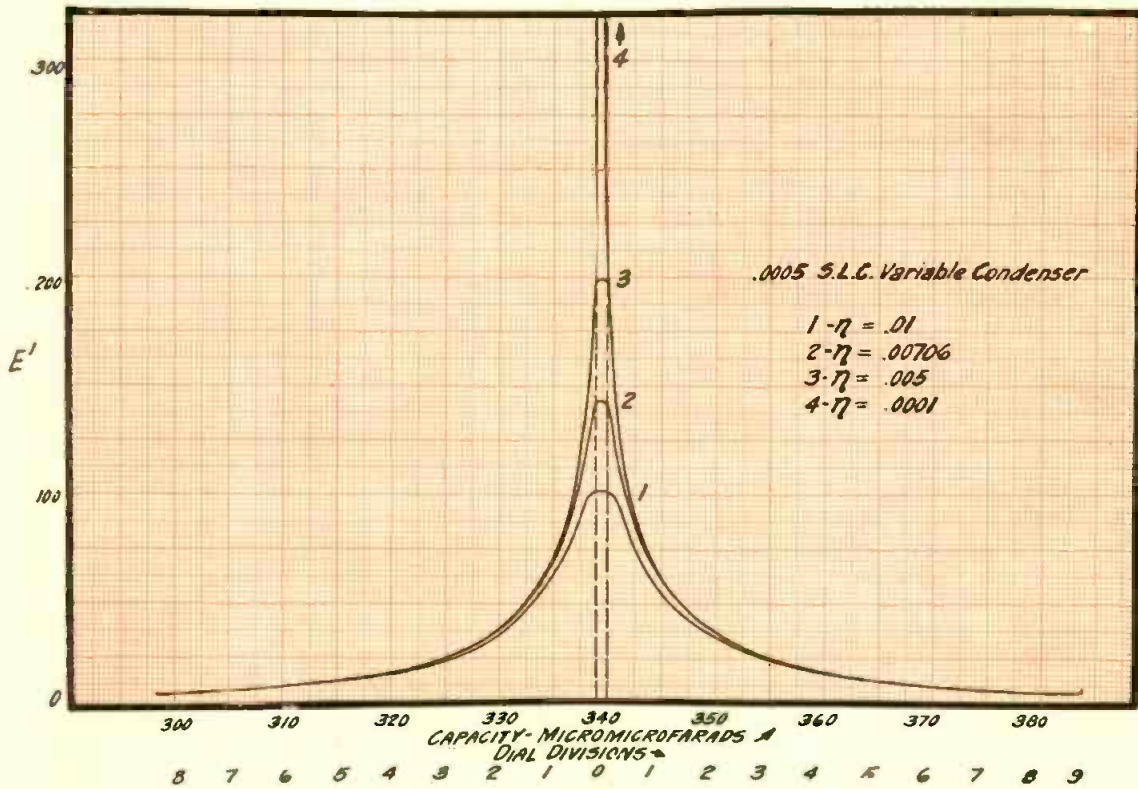

THE RESONANT VOLTAGES OVER A SHORT WAVELENGTH BAND

FIGURE 2: This chart indicates the increase in voltages at resonance over coils having varying values of N . Notice that Coil 4 with a value of N of .0001 has more than three times the voltage resistance of Coil 1 with an N of .01.

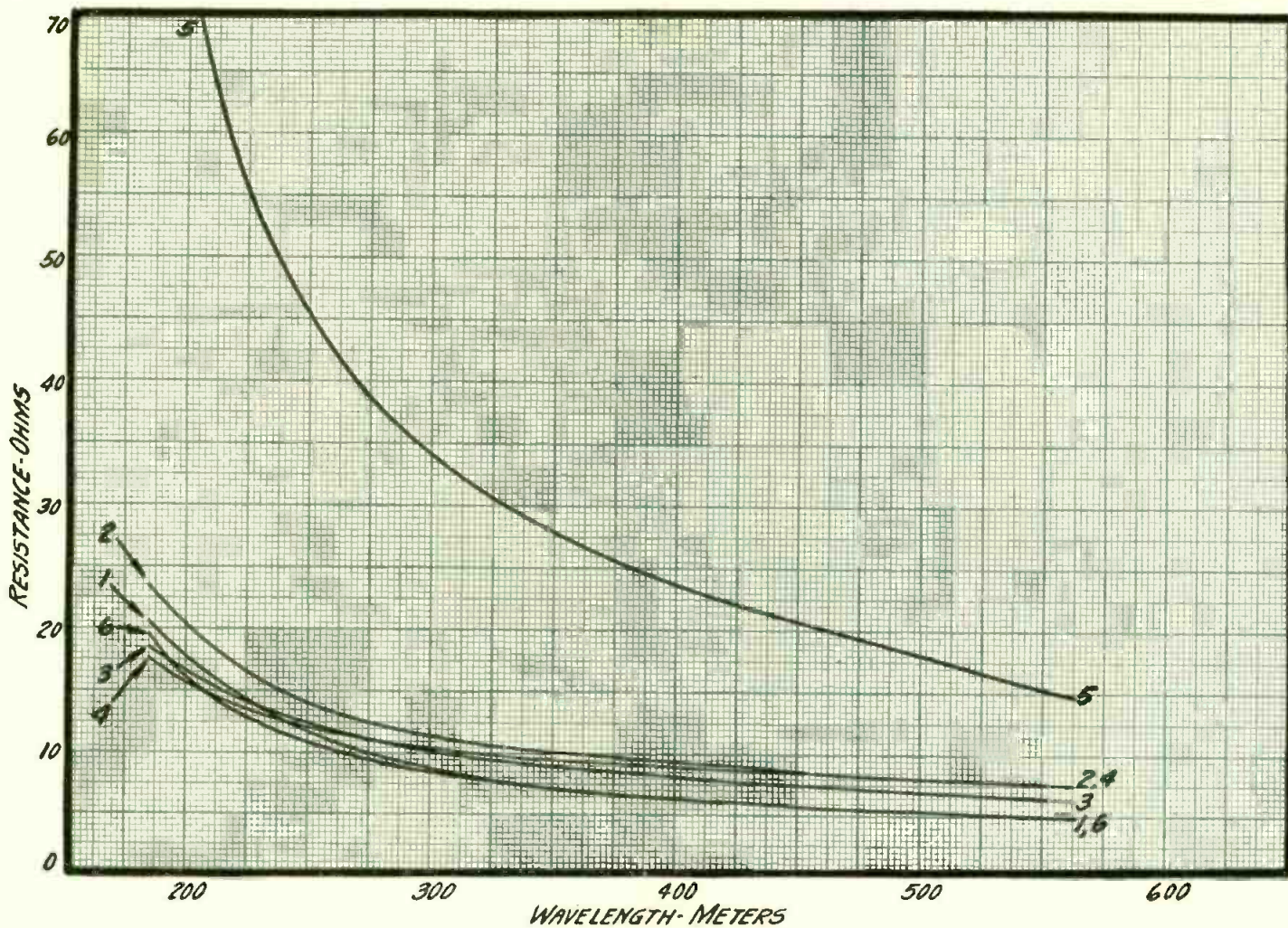

RESISTANCE PLOTTED AGAINST WAVELENGTH

FIGURE 3: This chart shows the resistance values of the coils under consideration at various radio frequencies; notice that Coils 1 and 6 have approximately the same resistance values.

is adjusted to resonance. Broadcasting stations on different wavelengths have different periods of electrical vibration which require, as we all know, different condenser settings to resonate the signal and make it audible. It is a fortunate thing for us that a coil and condenser have the property of selecting different stations at will for otherwise all stations within range would give a bedlam of sound in the loudspeaker.

The question naturally arises, why is one coil and condenser more selective than another?

The answer lies partly in the amount of resistance that is present in these two pieces of apparatus, for that is what damps the oscillations. Would our weight spring system build up a greater amount of motion if the weight were suspended in air or if it were immersed in alcohol? The answer is that the alcohol would naturally retard motion more than air.

The spring immersed in alcohol corresponds to a coil and condenser that have great amounts of resistance in them.

Let us consider the circuit, shown in Figure 6, a little more in detail.

Assume that a voltage is set up in the

coil, L , either from an oscillator or from a broadcast station. Call this voltage E . There is always a resistance in the coil and condenser which we will represent by R . Now let us calculate the

amount of voltage, E , that is set up across the condenser and let us see what can be done to make it as large as possible for the strength of the signals
(Continued on page 828)

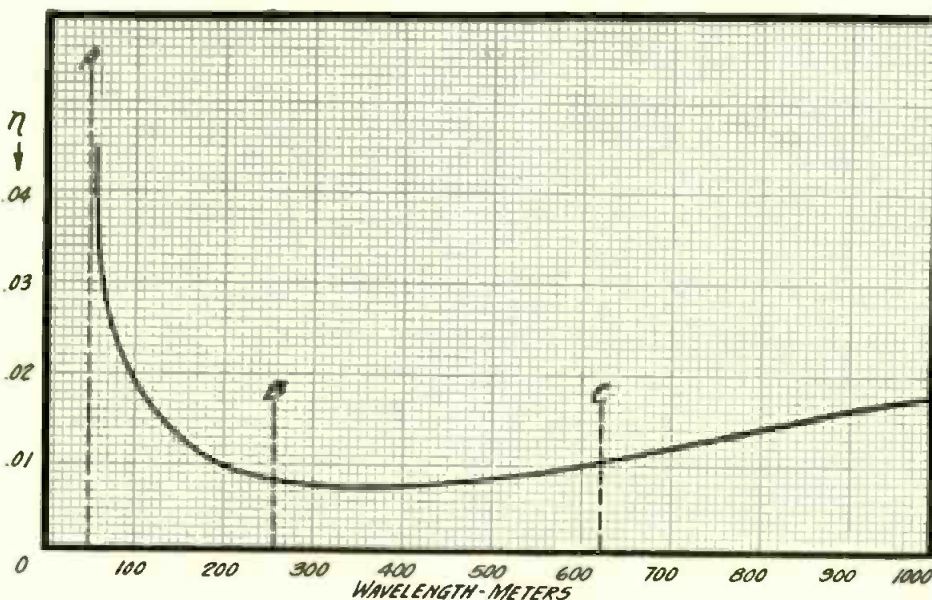

N PLOTTED AGAINST WAVELENGTH

FIGURE 4: This curve gives the general figures for the value N at various frequencies that include the wavelength band used for amateur broadcasting and commercial transmission and reception.

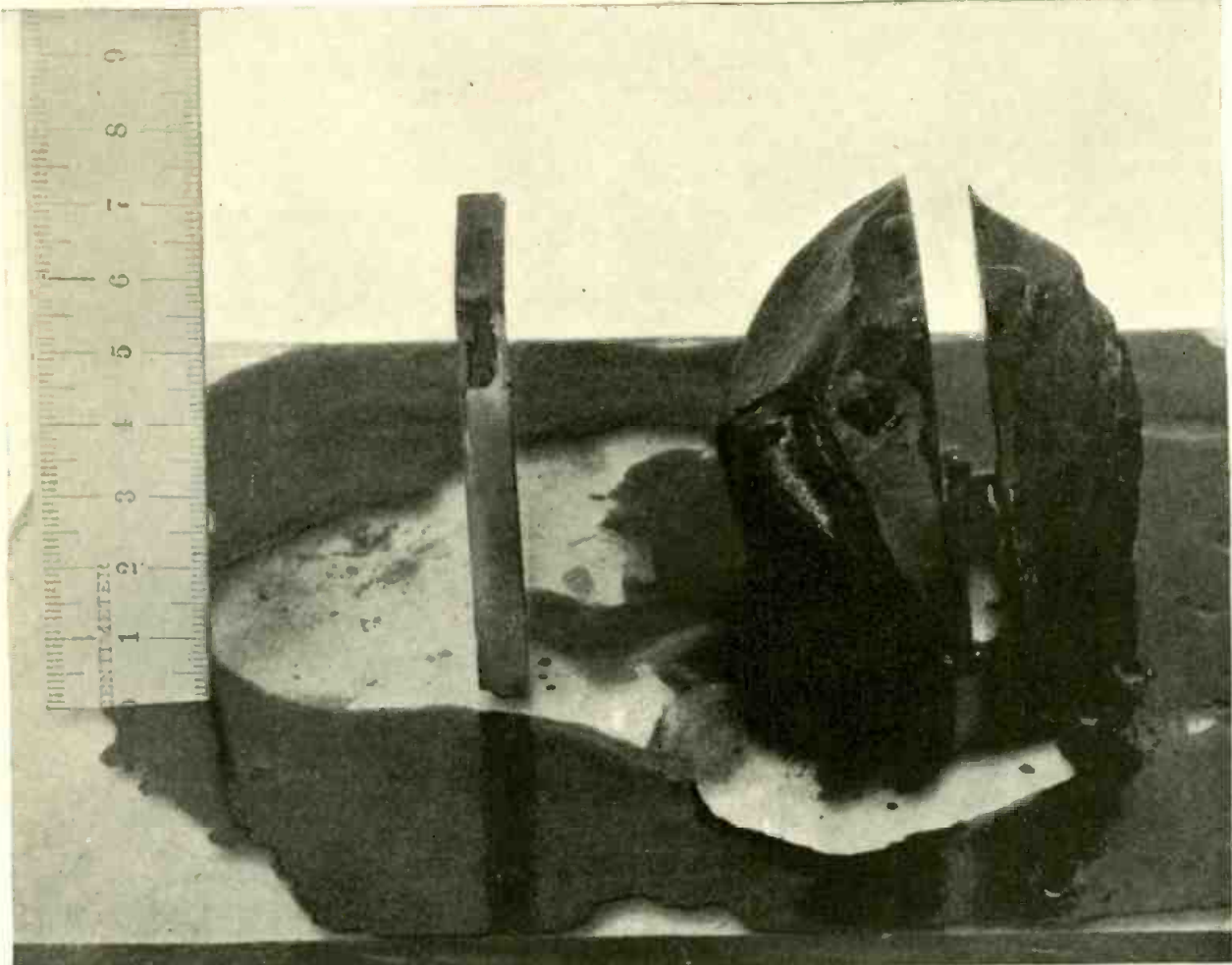

Bureau of Standards

HOW A PIEZO CRYSTAL IS CUT

FIGURE 1: The piezo plate is cut out of a section of quartz crystals; it will oscillate only if it is cut in the correct plane and contains no flaws. If the plate is cut roughly it is ground down smoothly to the correct thickness for the frequency to which it is to be used.

The Salt on the Tail of the Broadcast Frequency

How the tiny piezo crystal is serving the interests of the broadcast listener by checking the wavelengths of stations and preventing interference between transmitters.*

By MORRIS S. STROCK

MOST broadcast listeners are all too familiar with the shrill heterodyne whistle that often comes uninvited into their loudspeakers; and a good many of them know that this annoying whistle is due to interference between the carrier waves of broadcasting stations that have strayed too far off their assigned frequencies.

Few fans, however, realize that this source of interference, at least, could be eliminated forever if all broadcasting stations could be persuaded to add to their equipment a tiny piece of appar-

atus known as a "piezo crystal oscillator."

This interesting apparatus has the useful quality of maintaining certain predetermined frequencies for an almost unlimited time. If it is constructed so that one of its frequencies corresponds to the assigned frequency of a broadcasting station and is operated in conjunction with its transmitter, the station can never stray far off that frequency.

There are two ways in which the piezo oscillator may be used to keep the frequency of a broadcasting station at a constant value. It may be included in the transmitting circuit, or it may be

used as a separate piece of equipment.

For some time past the Bureau of Standards has experimented with the latter method of frequency control; and this article describes the apparatus and methods that were used to secure the desired result.

The term "piezo" is a Greek word meaning "press." "Piezo electricity" is produced by pressure upon certain crystals, notably Rochelle salts, sugar and quartz, a fact that was discovered about forty years ago by the Curie brothers.

Later it was found that a reversed effect could be secured. This was obtained through the action of an electric field upon a quartz plate cut from a

*Published by permission of the Director of the National Bureau of Standards of the U. S. Department of Commerce.

natural quartz crystal. The electric field was supplied by two metal plates connected in an electron tube radio-frequency generating apparatus.

When a quartz plate was placed between the two metal plates, it was found that it could be made to control or maintain a fixed value of frequency in the generating apparatus. Because of its physical characteristics, quartz was found to be more satisfactory for this purpose than other crystalline substances.

Thus the term "crystal," as applied to the piezo oscillator, is a rather incorrect expression for denoting this piece of apparatus. The quartz crystals, in their natural state, are very much larger than the plates which are cut from them. An idea of their size may be gained from Figure 1, by referring to the centimeter scale at the left.

The plates that are used in piezo oscillators are even smaller than this, as may be seen from Figure 2. "Piezo" is a much better term than "crystal," as the word itself suggests the action of the quartz plate and as the plate is only a part of the crystal. The terms "crystal controlled" and "crystal checked", as applied to transmitting stations equipped with one of the two forms of piezo apparatus previously mentioned, may therefore be somewhat misleading. It is better to say "piezo controlled" and "piezo checked."

When it has been properly cut from the crystal, the quartz plate generally gives three natural frequencies which are fixed by certain dimensions of the plate. Even a disc-shaped quartz plate gives these three frequencies.

As quartz is a durable and permanent material, the frequencies which it gives are equally permanent and constant. It is in this that the value of the quartz plate in maintaining a frequency standard arises.

Figure 4 shows a schematic wiring diagram of the piezo oscillator as used by the Bureau of Standards; Figure 2 shows a completed piezo oscillator that was built according to specifications prepared by the Bureau.*

In the illustration it is shown ready for operation except that the "A" and "B" batteries are not connected. The holder containing the quartz plate is shown attached to the right edge of the cabinet, and an interior view of a plate holder of exactly similar construction is shown at the lower left corner of the cabinet. The same oscillator, in operation, is shown in Figure 3.

The Technical Details of the Tests of the Piezo Oscillator

Arrangements were made with two of the Washington broadcasting stations, WRC and WCAP, whereby the piezo oscillator, shown in Figure 2, could be tested in the operating rooms of these stations in order to determine its possibilities.† For these tests, the quartz plate was first ground so that the sixth harmonic of one of its fundamental frequencies was 0.3 kilocycle‡ (300 cycles) higher than the assigned frequency of the broadcasting station; next, the plate was ground so that another of the fundamental frequencies was equal to the assigned frequency of the broadcasting station.

The method of performing the tests was to place the piezo oscillator near the transmitting set in the operating room of the station and listening for the beat note heard in the phones, which was produced by the interaction of the

*These specifications are known as Letter Circular 186, and may be obtained by request from the Bureau of Standards by anyone actually requiring them for constructing the device.

†Acknowledgment is due to the operating staff of stations WRC and WCAP for their cooperation in arranging these tests.

‡Hereafter written "kc."

utilized frequency of the piezo oscillator and the frequency of the transmitting set.

The reason that a harmonic from the quartz plate was used was to find out whether there would be less trouble from a possible blanketing effect from the transmitting set than when a fundamental frequency of the quartz plate were utilized. Of course there was no specific reason for grinding the plate so as to utilize the 6th harmonic rather than making (for example) the 4th or 5th harmonic equal 640.3 kc. This harmonic frequency was made slightly greater than 640 kc so that the transmitting circuit could be adjusted to exactly 640 kc by the pitch of the beat produced in the phones of the piezo oscillator instead of utilizing zero beat as in the second test. This principle could, of course, have been applied instead to a fundamental frequency of the quartz plate; it had nothing to do with the fact that a harmonic was utilized.

Figure 3, shows the piezo oscillator outfit during one of the tests in station WRC at Washington. The box at the right contains "A" and "B" batteries for the piezo oscillator.

Imagine that the transmitting set is to be adjusted by listening to the beat produced by the 6th harmonic of the quartz plate interacting with the frequency of the transmitting set. The observer wearing the head phones hears a beat note with a pitch equal to the difference between the frequency of the transmitting circuit and the oscillator. He now varies the frequency of the transmitting set by rotating a knob on the control board. This adjustment is continued until zero beat is obtained.

The transmitting set is thus adjusted to 640.3 kc (the 6th harmonic of the utilized frequency of the piezo oscillator). The knob is now rotated a little further in a direction such that the frequency of the transmitting set is slightly decreased, this adjustment being continued until the pitch of the beat note in the phones is estimated to be 0.3 kc (300 cycles). Thus the frequency of the transmitting set is brought close to the assigned frequency of 640 kc.

In this test the apparatus was placed about six feet from the control board; and the beat note heard in the phones, while not loud, was of sufficient intensity to be readily heard through the other noises in the operating room. This test proved very successful; the observer had no difficulty in noting slight changes in the frequency of the transmitting set. Without making a comparison with an audio-frequency note of 300 cycles, it was of course necessary to estimate when the resulting beat note was of that frequency. In this an error of even 0.2

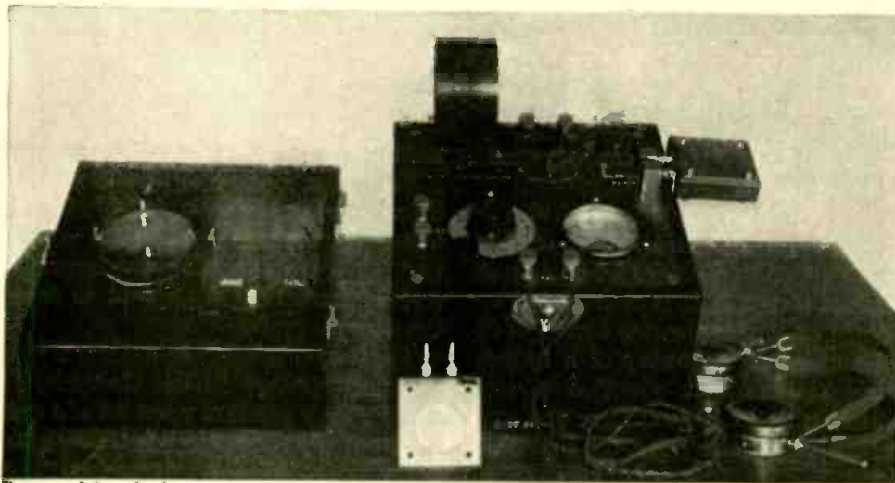

Bureau of Standards

A SET-UP FOR CALIBRATION

FIGURE 2: This standard wavemeter is crystal controlled; the crystals are mounted in the small rectangular blocks, one of which leans up against the end of the wavemeter and the other is connected to two binding posts in the wavemeter circuit.



Bureau of Standards

ADJUSTING A TRANSMITTER BY THE BEAT NOTE METHOD

FIGURE 3: *The station may be set at its correct frequency by adjusting the wavelength so that the beat note obtained between its frequency and the frequency of a crystal-controlled oscillator is of a certain fixed audio-frequency value. This is a simple way to check the frequency of any transmitter no matter how powerful it may be.*

kc (200 cycles) is unimportant as this is a difference of only 0.2 kc or 0.03 percent from the assigned frequency of the broadcasting station. Tests at WCAP met with similar results.

The quartz plate was reground so that it gave a fundamental frequency of exactly 640 kc, and tests similar to

those just described were repeated. Referring again to Figure 4, assume that the observer is once more adjusting the transmitting circuit to the piezo oscillator. In this case the proper adjustment is obtained at zero beat in the phones of the piezo oscillator. Barring interference from extraneous noise in the

operating room, the transmitting circuit can, by this method, be adjusted very easily to within 0.1 kc of the piezo oscillator frequency; in fact, if the headphones would respond to a sufficiently low frequency this adjustment could be made to an accuracy of about 16 cycles,

(Continued on page 807)

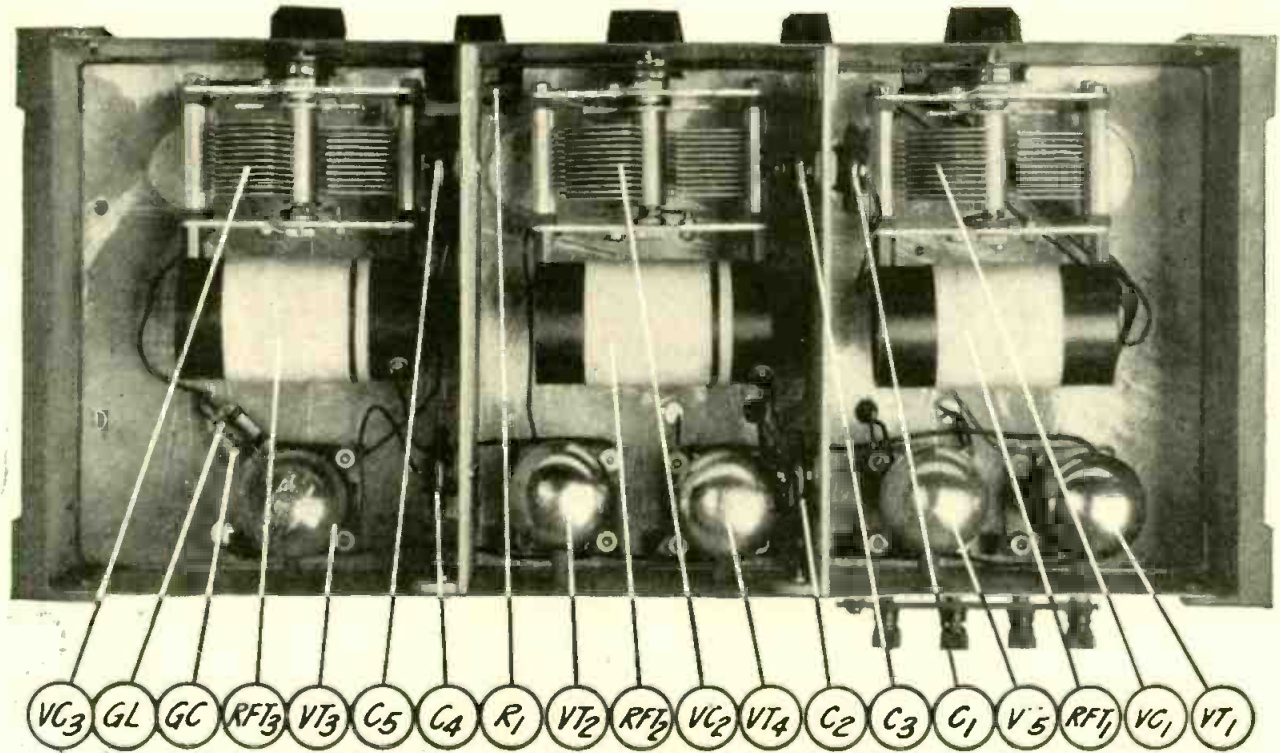

The Grimes "Inverse Duplex" Receiver

This receiver, has an efficient inversed reflex system, an output filter and a logical volume control. The circuit gives good volume with a fine quality of reproduction; selectivity is obtained by means of two extremely sharp stages of radio-frequency amplification.

Popular Radio Circuits

INSTALLMENT NO. 5

THE PARTS THAT ARE RECOMMENDED FOR USE IN THIS RECEIVER ARE—

- | | | |
|-----------------------------------------------------------|------------------------------------------------------------------------|---------------------------------------------------|
| RFT1, RFT2 and RFT3—Lind R F coils; | C1 and C3—Sangamo mica condenser, .00025 mfd.; | R2—Centralab potentiometer, zero to 250,000 ohms; |
| RFC—Grimes radio-frequency choke; | C2, C4 and C5—Sangamo mica condenser, .001 mfd.; | R3—DeJur resistor, 1 meg.; |
| AFT1—Samson audio-frequency transformer, ratio 2 to 1; | C6—Dubilier mica condenser, 1. mfd.; | R4—DeJur resistor, 24,000 ohms; |
| AFT2—Samson audio-frequency transformer, ratio 6 to 1; | C7—DeJur mica condenser .1 mfd.; | Grimes metal panel |
| AFC—Samson audio output choke; | GL—Lynch metallized resistor, 2 meg.; | Grimes metal instrument base; |
| VC1, VC2 and VC3—Lind variable air condenser, .0005 mfd.; | GC—Dubilier mica condenser, .00025 mfd. provided with grid-leak clips; | Grimes shields; |
| VT1, VT2, VT3, VT4 and VT5—Benjamin sockets; | J—binding posts for the loudspeaker tips; | Grimes cracked finish cabinet; |
| | R1—rheostat, 6 ohms; | 2 vernier dials; |
| | | Composition binding post strips; |
| | | 4 Eby binding posts. |

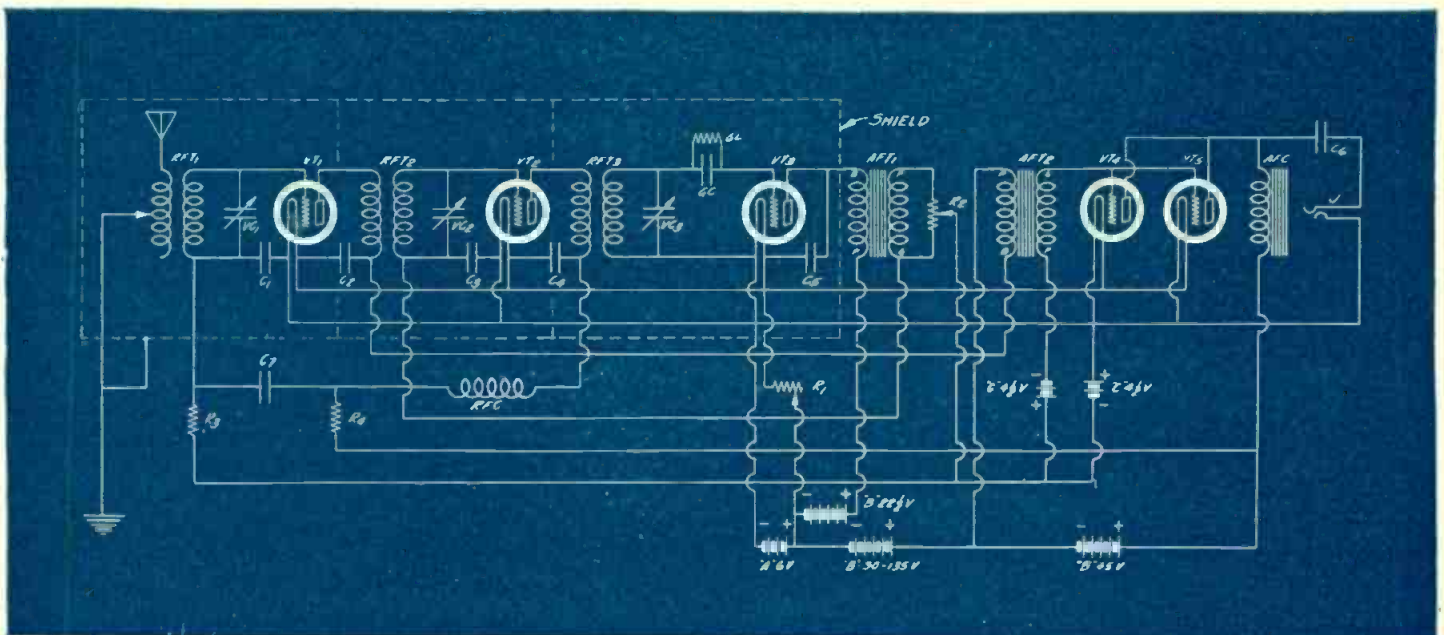

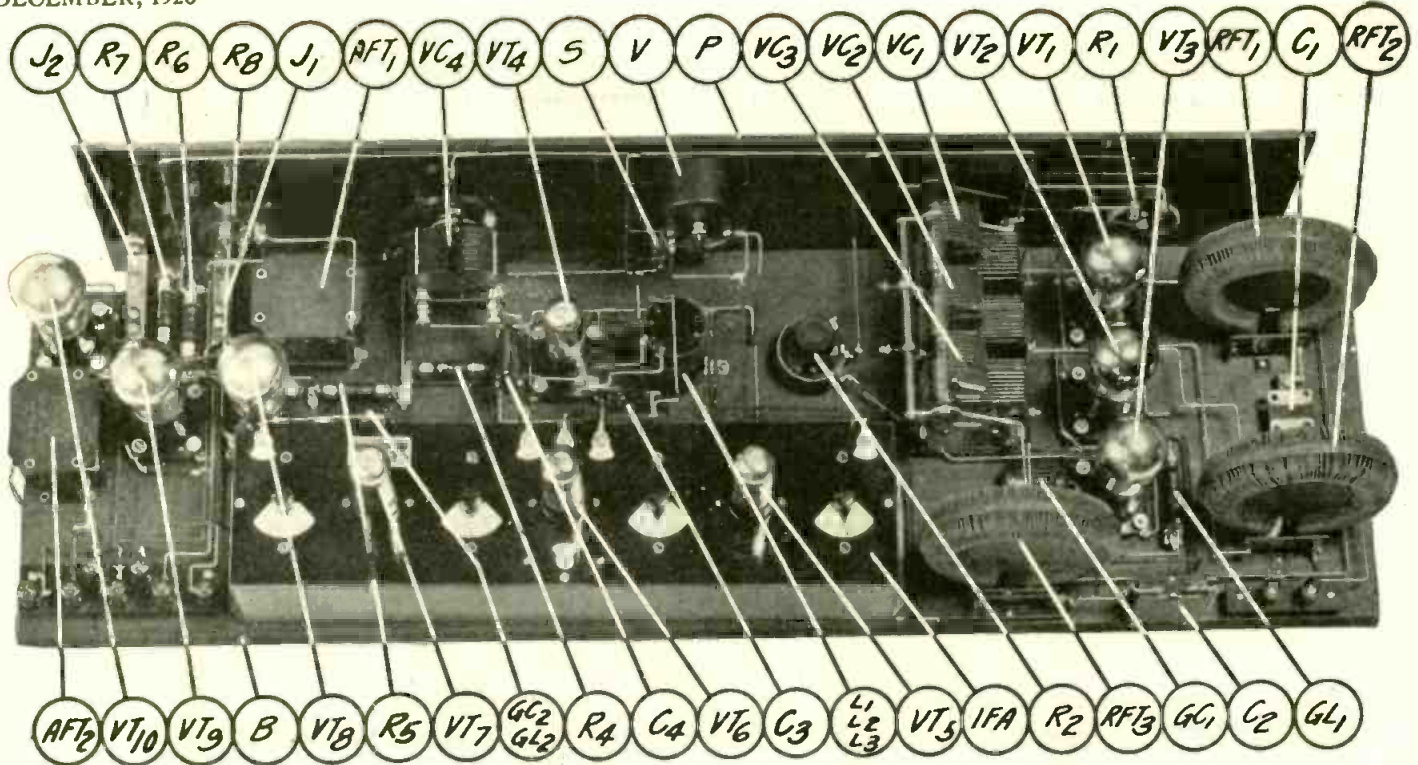

The "Infradyne" Receiver

This set has as a novel feature a new intermediate amplifier operating on short waves in conjunction with an oscillator intended to obtain a frequency of this order by heterodyning with the initial signals within the broadcast range. Distance reception with this circuit is readily attainable and when coupled with high-grade transformers, the quality of reproduction should be excellent. In the intermediate amplifier and the oscillator, UX-199 type tubes are used; the last tube is a UX-112, while the others are of the UX-201-a type. This receiver gives the best results with a fifty-foot antenna.

THE PARTS THAT ARE RECOMMENDED FOR USE IN THIS RECEIVER ARE—

- | | | |
|---------------------------------------------------------------------------------------------------------------------------------------------------------------------------------------------------------------------------------------------------------------------------------------------------------------------------------------------------------------------------------------------------------------------------------------------------------------------------------------------------------------------|--------------------------------------------------------------------------------------------------------------------------------------------------------------------------------------------------------------------------------------------------------------------------------------------------------------------------------------------------------------------------------------------------------------------------------------------------------------|----------------------------------------------------------------------------------------------------------------------------------------------------------------------------------------------------------------------------------------------------------------------------------------------------------------------------------------------------------------------------------------------------------------------------------------------------------------------------------------------------------------------------------------------------|
| <p>RFT1, RFT2 and RFT3—Thorola No. 33 doughnut radio-frequency coils;
 IFA—Remler Infradyne (intermediate) amplifier;
 L1, L2 and L3—Oscillator coils (each coil wound with No. 24 DSC wire, 8, 14 and 14 turns respectively);
 AFT1—AmerTran DeLux first stage transformer;
 AFT2—AmerTran DeLux second stage transformer;
 VT1, VT2, VT3, VT4, VT8, VT9 and VT10—Benjamin sockets;
 C1—Electrad mica condenser, .0001 or .00025 mfd.;</p> | <p>C2 and C3—Dubilier mica bypass condensers, 1 mfd.;
 C4—Sangamo mica condenser, .0005 mfd.;
 VC1, VC2 and VC3—Continental triple vernier air condenser;
 VC4—Remler air condenser, .00035 mfd.;
 GC1—Sangamo mica condenser, .00025 mfd.;
 GC2—Sangamo mica condenser, .0005 mfd., with grid-leak clips;
 GL1—Lynch resistor, 1 meg.;
 GL2—Lynch resistor, 2 meg.;</p> | <p>R3—General Radio rheostat, No. 301, 30 ohms;
 R4—Amperite, 6V-199 type;
 R5 and R6—Amperite, 1-A type;
 R7—Amperite, 112 type;
 S—Yaxley filament switch;
 V—Jewel No. 135 voltmeter, zero to 5 volts;
 J1—Electrad closed-circuit jack;
 J2—Electrad open-circuit jack;
 B—hardwood baseboard, 10 inches by 34 inches by 3/4-inch;
 P—composition panel, 7 inches by 30 inches by 3/16-inch;
 9 Eby binding posts.</p> |
|---------------------------------------------------------------------------------------------------------------------------------------------------------------------------------------------------------------------------------------------------------------------------------------------------------------------------------------------------------------------------------------------------------------------------------------------------------------------------------------------------------------------|--------------------------------------------------------------------------------------------------------------------------------------------------------------------------------------------------------------------------------------------------------------------------------------------------------------------------------------------------------------------------------------------------------------------------------------------------------------|----------------------------------------------------------------------------------------------------------------------------------------------------------------------------------------------------------------------------------------------------------------------------------------------------------------------------------------------------------------------------------------------------------------------------------------------------------------------------------------------------------------------------------------------------|

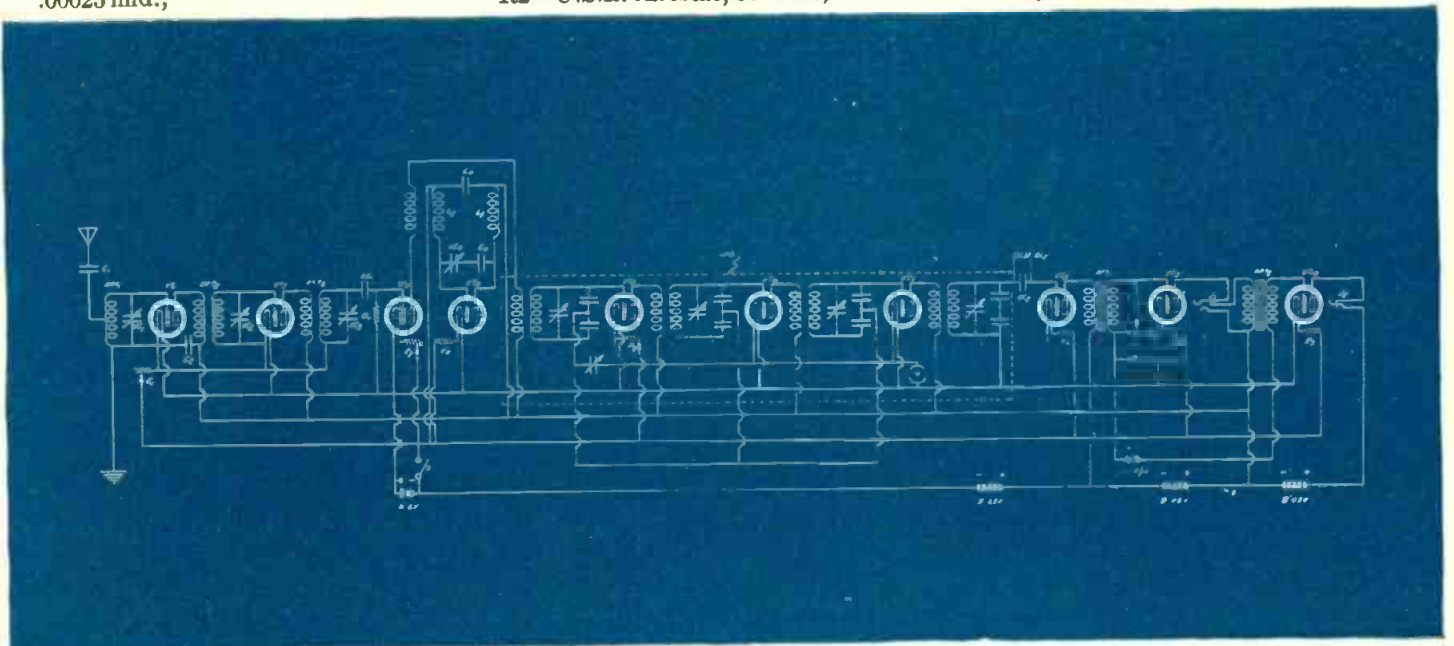

Q EVERY broadcast listener is familiar with the tiny "whistlings" that he picks up among the wavelengths below 200 meters; they are the code communications of the amateurs. To the fan who can read them a new and fascinating "world of ether" is revealed.



DO NOT STUDY THE CODE BY VISUALIZING DOTS AND DASHES—BUT
BY LISTENING TO "DITS" AND "DAHS"

If no neighborly operator is available, the beginner can get good practice in reading code by means of the ommigraph, which transmits interchangeable messages at adjustable speeds. Incidentally, this machine is employed by the Radio Inspectors for testing the abilities of applicants for licenses.

If You Want to Read the Code—

By HOWARD S. PYLE

RADIO broadcasting commanded the public attention to a far greater extent than had any previous scientific discovery, when the "radio craze" arrived in 1922.

The natural consequence followed; hundreds, then thousands and finally millions of enthusiasts took up the new offering and introduced it into their homes. Technical development naturally kept pace, and, with such an overwhelming interest, broadcasting developed at an astounding rate.

Two classes of radio broadcast enthusiasts developed; first the experimental class who derived their greatest enjoyment from trying every hook-up available and finally devising intricate

arrangements of their own; and second the class who were content to purchase a good set and exert their efforts to an endeavor to compile a long list of distant stations which they had heard.

Both classes of radio fans are now found to be searching for new fields to conquer. Witness any average man at the dial of his receiver of an evening, after an hour or so of logging distant stations and listening to a few numbers of their offerings; his hands are restless and as they wander over the dials; it is with rather an aimless purpose—just a hope that he may run across something a bit out of the ordinary.

Sometimes he will run into something that may stir his curiosity keenly.

Far down at the low end—two hundred meters and under, he will pick up a myriad of tiny whistlings exactly like those which he has come to know as the "carrier wave" of a broadcast station. This newer whistle, though, is broken up into alternate short and long sounds variously intermingled. The tones are varied—from almost one extreme of the musical scale to the other and he knows them from experience, as the dots and dashes of the Continental radio-telegraph code.

Similarly, at the upper extreme of his dial will he cross a similar series of dots and dashes, probably of greater strength and of more varied tone though more closely confined to an audible note of

about five hundred cycles. Broader tuning in a number of these waves will mark the wave as that emanating from a damped-wave transmitter, more familiarly known to him as a "spark set" and long the subject of much vehement protest from the great broadcast listening public, for the interference of which it has been guilty these five years gone. Fortunately, progress in receiver design and agitation leading to the almost forced abandonment of spark transmitters has lessened this evil, though numbers of them still exist.

The average fan, has as yet, but little interest in the transmitting equipment itself—but he is captivated by a curiosity as to just what those mysterious and elusive dots and dashes are saying. Here is a new field within the scope of his present equipment and it seems to open the gate to a freshened interest in the receiving set that has of late gathered a bit more dust than had been the case in the few years past.

Curiosity grows and a few casual inquiries among his friends brings out the fact that they too have been intrigued by the peepings and wailings of the various code signals. A few evenings later we find the average fan secretly poring over the conglomeration of long and short marks that form the code chart which he has purchased that day from a young amateur at the local radio shop—a knowing smile from the boy being the basis for that slight uneasy feeling.

Concentration for some two hours leaves him still in the dark as to just what the code is all about. Pride perhaps won't permit him to talk to the local amateur next door whom he once reported to the radio supervisor for "cluttering up the air"—though goodness knows the boy would be tickled pink to welcome him into the great ham fraternity. So the fan pores over his collection of dots and dashes and learns little, the total extent of his absorption being that "a dash is equal in length to three dots." Even if he does get a somewhat shaky picture planted in his mind so that by knitting his eyebrows and devoting all his faculties to the problem he can say with some little certainty that, "A is a dot and a dash," he cannot co-ordinate the sight of the dot and dash with its sound as carried on the ether lanes. Nor will he, for a long, long time, if he goes at it in that manner.

Mastery of an aural signal code, such as either the Morse telegraphic alphabet as used on the land-wires of the commercial wire telegraph companies throughout North America or of the so-called Continental or International code used on the land telegraph lines of

continental Europe and in radio communication the world over, is distinctly a process of sound and not sight; for this reason, it is wrong at the very start to memorize the alphabet by calling "A" a "dot and a dash" "B" a "dash and three dots." You do not read a message coming into your headphones by

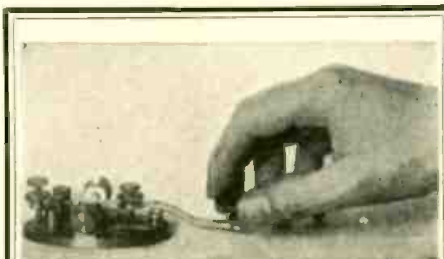

The Code Chart

"Dit Dah Method"

- A—Dit dah
- B—Dah dit dit dit
- C—Dah dit dah dit
- D—Dah dit dit
- E—Dit
- F—Dit dit dah dit
- G—Dah dah dit
- H—Dit dit dit dit
- I—Dit dit
- J—Dit dah dah dah
- K—Dah dit dah
- L—Dit dah dit dit
- M—Dah dah
- N—Dah dit
- O—Dah dah dah
- P—Dit dah dah dit
- Q—Dah dah dit dah
- R—Dit dah dit
- S—Dit dit dit
- T—Dah
- U—Dit dit dah
- V—Dit dit dit dah
- W—Dit dah dah
- X—Dah dit dit dah
- Y—dah dit dah dah
- Z—Dah dah dit dit

The Numeral Chart

"Dit Dah Method"

- 1—Dit dah dah dah dah
- 2—Dit dit dah dah dah
- 3—Dit dit dit dah dah
- 4—Dit dit dit dit dah
- 5—Dit dit dit dit dit
- 6—Dah dit dit dit dit
- 7—Dah dah dit dit dit
- 8—Dah dah dah dit dit
- 9—Dah dah dah dah dit
- 10—Da-a-ah (Long dash)

NOTE: O is sometimes used thus:

DAH DAH DAH DAH

Common Punctuations

- Period—Dit dit dit dit dit dit
- Comma—Dit dah dit dah dit dah
- Question Mark—Dit dit dah dah dit dit
- Attention Sign—Dah dit dah dit dah

seeing the dots and dashes but by hearing them. Therefore it should be the aim of every beginner to form a firm impression of the sound of the letter and not the sight picture of it.

There are several ways of doing this, the result of schemes formulated by individual interested parties. A great deal of research along the lines of code instruction was carried out by the U. S. Navy immediately after our entry into the European hostilities and with the establishment of the great Naval Radio Schools at Harvard, Great Lakes and elsewhere. The Navy was faced with the problem of turning out thousands of radio operators in the shortest possible time and that they did this successfully was the result of the most advanced methods of instruction. And in every instance, it was found that the sound teaching of the alphabet was far superior to sight, for one less mental process was required.

For example: a student hearing a short and a long buzz through his headphones would immediately see a dot and a dash when learning from the sight method and he would then have to exert his mental faculties again to associating a dot and a dash with its proper letter.

On the other hand, the sound student would hear the short and long buzz and immediately think the letter itself—not the dots and dashes associated with it and then the letter. The resultant instruction was greatly speeded up by using the sound method and the students speed increased at a far greater rate than when using other methods.

For the sound purpose, the printed code charts as commonly known in radio circles, do not answer at all, in fact it is strongly recommended that the student not even allow himself access to the familiar "dot and dash" code. Rather he should cut out the chart reproduced with this article, paste it on a piece of stiff cardboard and carry it with him, using it as his one and only alphabet card.

It will be noted that a dot is called a "dit" and a dash, "dah."

It may appear somewhat illogical at first thought and the student will perhaps feel a bit silly to refer to the letter "B" for example as "dah dit dit dit," but this will wear off and it will be found that he will in time become proficient in talking to friends who also have code knowledge by merely calling off the "dit dahs" corresponding to the letters making up the sentence he wishes to say. A refined "hog-latin" perhaps it may be termed.

For example, "How about it?" can be transmitted by word of mouth by saying instead, "dit dit dit dit—dah dah dah—dit dah dah—dit dah—dah dit dit dit—dah dah dah—dit dit dah—dah—dit dit—dah." Awkward and clumsy probably it sounds, but good practice for the code student and certainly a

(Continued on page 836)

The list of parts given below includes the exact instruments used in the set from which these specifications were made up. The experienced amateur, however, will be able to pick out other reliable makes of instruments which have been approved by POPULAR RADIO and which may be used with good results. But we recommend that the novice follow the list, as the diagrams in this article will tell him exactly where to bore the holes and exactly where to place the connections. If instruments other than the ones listed are used, the only change that will be necessary will be the use of different spacings for the holes that are drilled in the sub-base for mounting the instruments. To any reader who has difficulty in obtaining any of the parts which are necessary in making up these model receivers and power units, POPULAR RADIO SERVICE BUREAU, 627 West 43rd Street, New York City, will gladly assist in seeing that his requirements are promptly supplied.

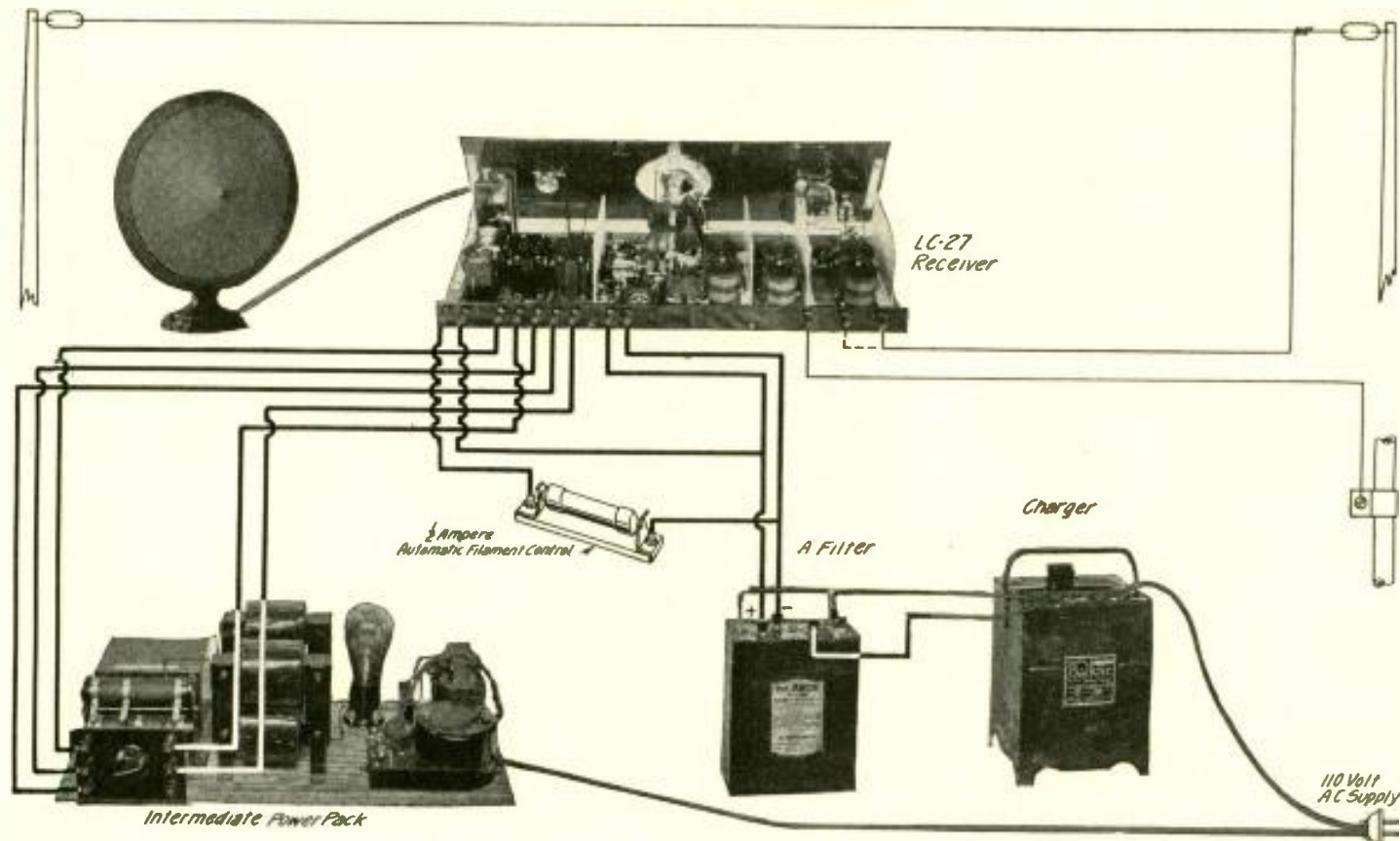

HOW THE UNITS ARE INSTALLED

FIGURE 1: This picture wiring diagram shows the LC-27 receiver connected up to the "A," "B" and "C" power and to the antenna, ground and loudspeaker. The input to the "A" supply units and the intermediate power-pack are connected in parallel to the 110-volt alternating current lines, so that no batteries are required.

HOW TO BUILD THE

LC Intermediate Power-pack

This unit, which has been developed in POPULAR RADIO LABORATORY, was designed especially for use with the LC-27 receiver, although it will be found extremely satisfactory when used with any type of receiving set—provided that a UX-171 type power tube is incorporated in the last stage of amplification.

By LAURENCE M. COCKADAY

COST OF PARTS: Not more than \$47.50

HERE IS A LIST OF PARTS USED IN THE LABORATORY MODEL—

A—Yaxley Automatic Relay Switch No. 444;
 B—Filtrex A-C Transformer, Type K-180;
 C—Any approved UX type socket; (Nald vibrationless socket illustrated);
 D-E—Filtrex Choke Coils, Type K;
 F—F1, F2, F3, F4, F5, F6; any approved binding posts; (Eby binding posts illustrated);

G—Acrakon condenser block; 14 mfd.;
 H—Acrakon Filter condenser, .1 mfd. for 400-volt operation;
 I—Hardwood baseboard; 7¾ inches by 18 inches by ½-inch;
 J—Resistance unit, type 200, 20,000 ohms total resistance; tapped to obtain correct voltages; (Mfd. by Harwick, Field & Leeb);

K—Any approved high-current variable resistance to dissipate 5 watts, 2,000 ohms; (Centralab Resistance illustrated);
 L—Bakelite binding post panel, 3¼ inches by 4¼ inches by 3 32/inch;
 1 set POPULAR RADIO blueprints;
 Connecting wire, twisted lamp cord, plug, screws, etc.

FOR those radio fans who have built the LC-27 Receiver (described in POPULAR RADIO for October, 1926) and who do not need the great volume of sound that can be obtained with the LC-Senior Power-pack (described in the November

issue) for supplying "A," "B" and "C" currents to the set, this Intermediate Power-pack has been specially designed.

This new unit, which is here described, has similar characteristics of the LC-Senior Power-pack except that the

power tube in the set is supplied with filament current from the "A" power unit. The voltage supplied is correct for the operation of the UX-171 type power tube in the receiver. This new unit gives the same type of quality re-

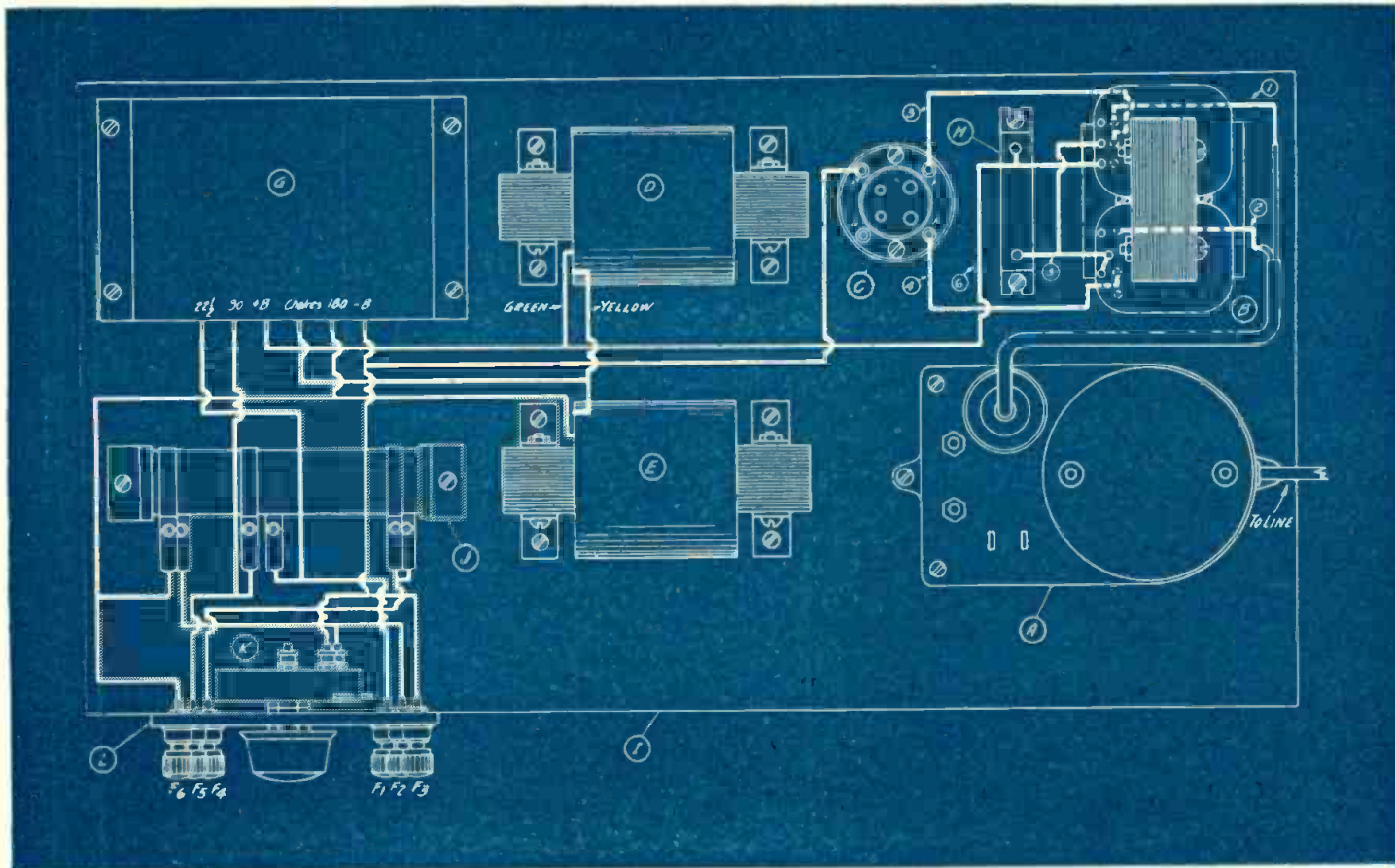

THE PICTURE WIRING DIAGRAM

FIGURE 2: The instruments in this diagram are drawn in about their relative positions, and the wiring is shown in heavy white lines. Notice that the input plug from the transformer, B, is inserted into the proper socket on the relay, A. The 110-volt lines should be connected to the power-pack by means of the input plug that is connected to the wires marked "to line" on this relay.

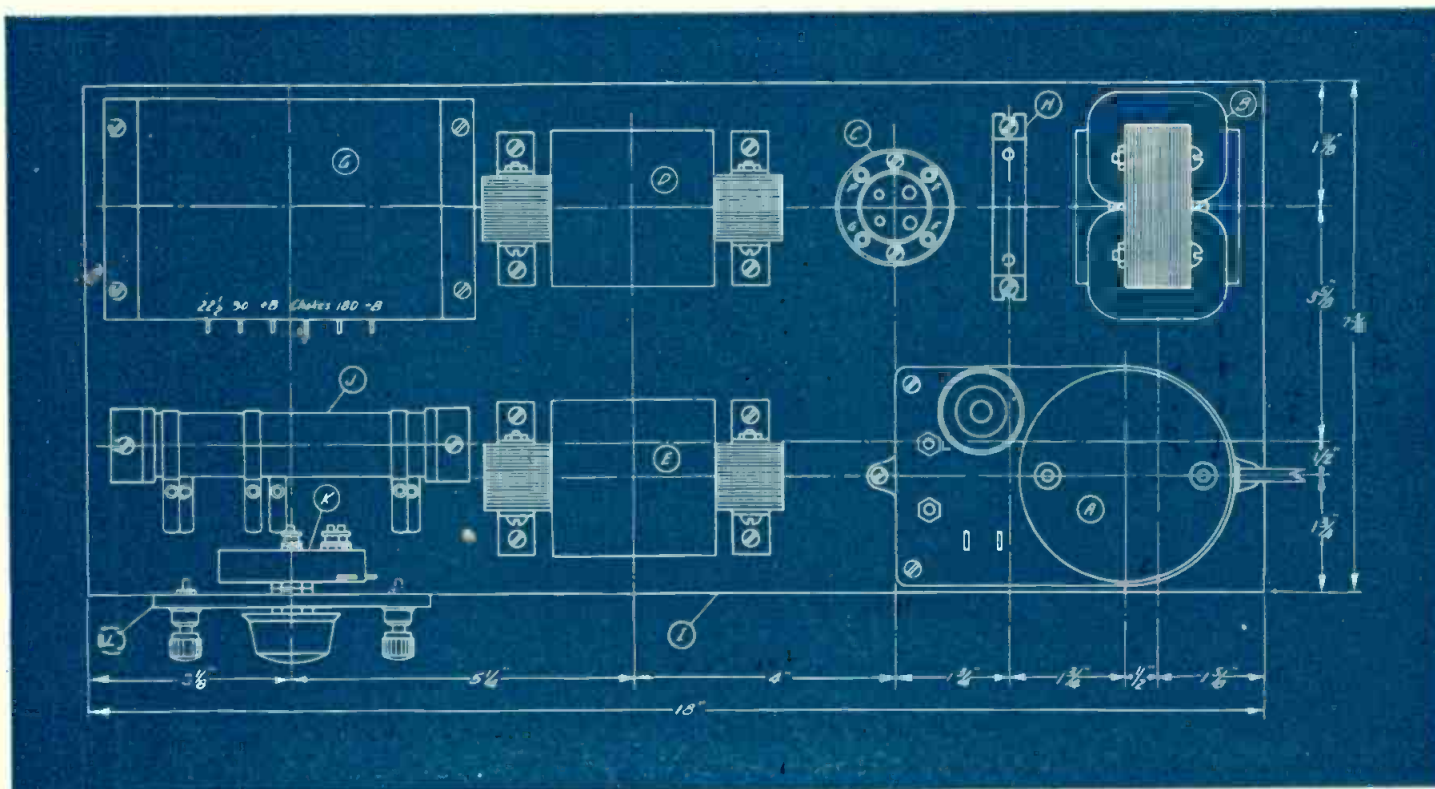

THE WORKING DRAWING FOR CONSTRUCTION

FIGURE 3: In this drawing all of the parts are shown in their exact positions; these are given from center to center for all of the instruments. If these dimensions are followed carefully the home-constructed unit should function exactly like the original model built in the laboratory.

production as its larger brother and will supply ample volume for ordinary home use. It furnishes over 200 volts for the UX-171 type tube that is used in the last stage of the LC-27 receiver when operated from this unit. It supplies approximately 90 volts for the first and second stages of radio-frequency amplification and for the first stage of audio-frequency amplification; it also supplies approximately 45 volts for the plate circuit of the detector tube. A "C" battery potential of 20 to 50 volts is also available from this unit for the power tube.

The LC-27 receiver when operated from this unit and in conjunction with the 110 volt 60 cycle alternating-current supply will surprise the uninitiated listener with the lifelike quality of the received broadcasting.

How to Construct the Power-pack

After all the instruments and materials for building the unit have been procured, the baseboard, I, should be cut to the correct size, as shown in Figure 3. It should be smoothed with sandpaper and given a coat of shellac.

Next, the small panel, L, upon which are to be mounted the binding posts F1 to F6 and the "C" battery control, K, should be prepared as shown in Figure 7. When all the holes are drilled the six binding posts should be mounted and the variable resistance, K, should be fastened to the panel L, as shown in Figures 2, 3 and 4. The panel, L, may then be fastened on one of the long

sides of the baseboard, I, by means of two screws as shown in Figure 4. These screws are inserted through the two holes in the panel, into the edge of the baseboard I. They should be strong, round-head wood screws, preferably brass.

Next, mount the control relay switch, A, by means of two wood screws. This should be mounted in the position indicated in Figure 3.

Then mount the transformer, B, by means of two strong wood screws fastened directly to the wooden baseboard, I, and mount the two choke coils D and E in the same manner. The positions for these instruments are also given in Figure 3.

Mount the socket, C, and the resistor, J, as shown in the same diagram.

Next, fasten down the condenser block, G, as shown. Be sure that it is mounted in the exact position shown in the drawing with the terminals turned and facing the resistor unit, J.

The last job is to mount the small condenser, H, in position between the transformer B and socket C. This should be fastened to the baseboard I with two small, brass wood screws.

This completes the construction work and the Power-pack is now ready to be wired.

How to Wire the Unit

The mechanical and electrical design of this device have been worked out with extreme care during months of experiment and test. The whole unit is self-

shielding; and it is due to this as well as to the electrical design of the circuit that no hum is produced in the receiving set to which it is attached.

It is recommended that all wiring be done with an insulated, solid, round bus-wire.*

When wiring up, the home-builder should refer constantly to the picture wiring diagram, Figure 2.

Start the wiring by preparing the transformer leads in the correct lengths. The color design of the transformer leads is clearly shown in Figure 6. By comparing this diagram with Figure 2 the proper wires to connect are easily determined.

A short piece of twisted lamp cord should be fastened to the two primary terminals of the transformer, B, and this should be attached at the other end through a plug to the relay switch, A. The plug should be inserted in the socket on the relay switch that is marked "B" Eliminator.

Then, wire up the leads to the socket and the resistance, the condenser bank, the chokes and the binding posts. Be sure that none of the leads touch each other when they are made with the "Celatsite" wiring. They should be spaced about 1/4 of an inch wherever necessary.

When the wiring is completed the Power-pack is ready to be installed.

*The type of bus wire used in all the experimental models of this unit was "Celatsite."

(Continued on page 810)

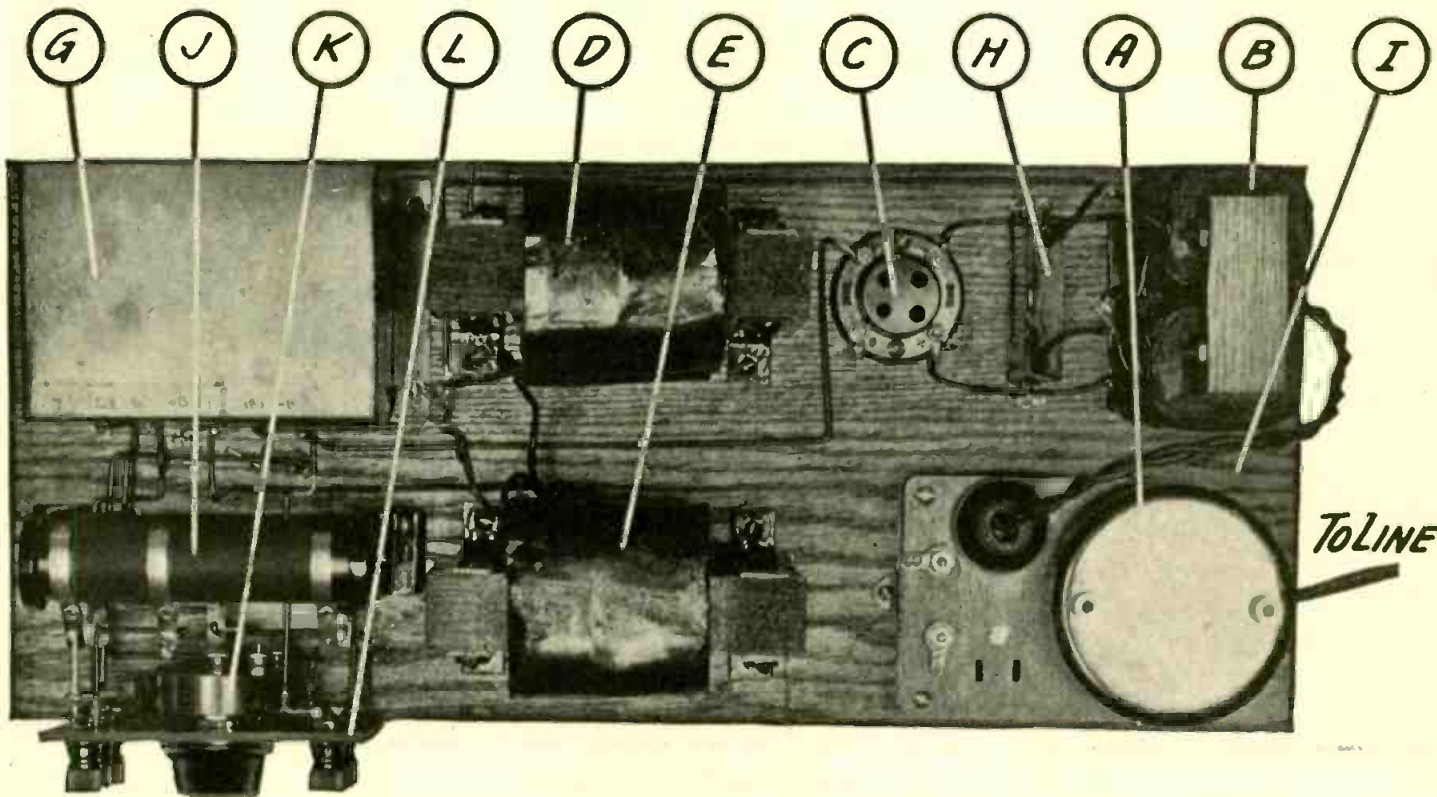

A VIEW OF THE POWER-PACK AS SEEN FROM ABOVE

FIGURE 4: The relative position of all the parts that are mounted on the baseboard and the connection panel; the parts are designated with letters that correspond with the list of parts and with those given in the text.

"FROM FIRE AND FLOOD—"

What five radio amateurs of Oklahoma did to win the
POPULAR RADIO MEDAL FOR CONSPICUOUS SERVICE



HALTON H. FRIEND, 5SR

Alvin C. Krupnick, Tulsa

THE SENDER AND THE RECEIVER OF THE CALL FOR HELP

The first call for help for the inundated area came from amateur station 5SR of Sand Springs; it was picked up by amateur station 5SG of Tulsa. From that moment amateur radio played an important part in the rescue of lives and property.



RAYMOND V. KINNEY, 5SG

By LLOYD JACQUET

ON the morning of June 9th, 1923, the inhabitants of Sand Springs, Oklahoma awoke to find their small city several feet under rushing water. The highways were impassable, the streets inundated; and the railroads useless. Rushing waters from the overflowing Arkansas River, augmented by a bad storm, had precipitated a flood. And the breakdown of all communication lines with the outside world made it impossible to tell the neighboring cities about the damage done or to summon aid; under the rush of water, poles supporting telephone and telegraph wires had fallen, and destroyed the precious remaining links with the country with one lone exception.

That one exception was a telegraph line.

All messages, consequently, were rushed to this single line. Messages of assurance, messages of query, messages of hope.

With this inrush of traffic, the line became quickly over oaded. And suddenly, in the middle of a message, the line gave out.

The last line of communication out

of Sand Springs had been silenced.

Thus, at midnight of the first night of the flood, Sand Springs was enveloped in a darkness more appalling than that of the leaden cloud-laden sky above. No news could be had from the outside. Worse yet, no news could be sent out from the stricken area.

Such were the desperate conditions in the middle of the first night.

And then the radio amateur came to the rescue.

As that last line of communication was breaking under the combined strain of traffic and storm, amateur radio fingers were weaving an invisible link which would withstand all assaults.

Shortly after midnight, Raymond V. McKinney, an amateur then located at 1342 North Elwood St., Tulsa, and owner and operator of station 5SG was sitting at his apparatus, just "tuning around." Suddenly, he stopped whirling the dials of his short wave receiver. Station 5SR, owned by Hatton H. Friend of Sand Springs, was calling him—and calling him desperately.

With a quick, business like click, he acknowledged the call. Back came the

hurried signals from the Sand Springs amateur:

"Will you take traffic for Tulsa? Urgent!"

Would he take traffic? Of course he would. Every amateur station does that, as a matter of service.

So 5SG nonchalantly switched over to his transmitter, and said:

"O. K., O. M. . . . GA!" which, in the snappy language of the amateur code means, "Certainly, Old Man, go ahead, I'm ready!"

But of course, McKinney did not expect the flow of traffic which followed.

For several hours young McKinney, who was only a fifteen-year old member of the amateur fraternity, labored hard, writing down the scores of messages, reports, news bulletins, notes, and traffic of all kinds for Tulsa and other points.

So the first contact from Sand Springs with the outside world, other than with wire and messenger had been successfully established.

The first news accounts which trickled into the newspapers of the country the
(Continued on page 814)

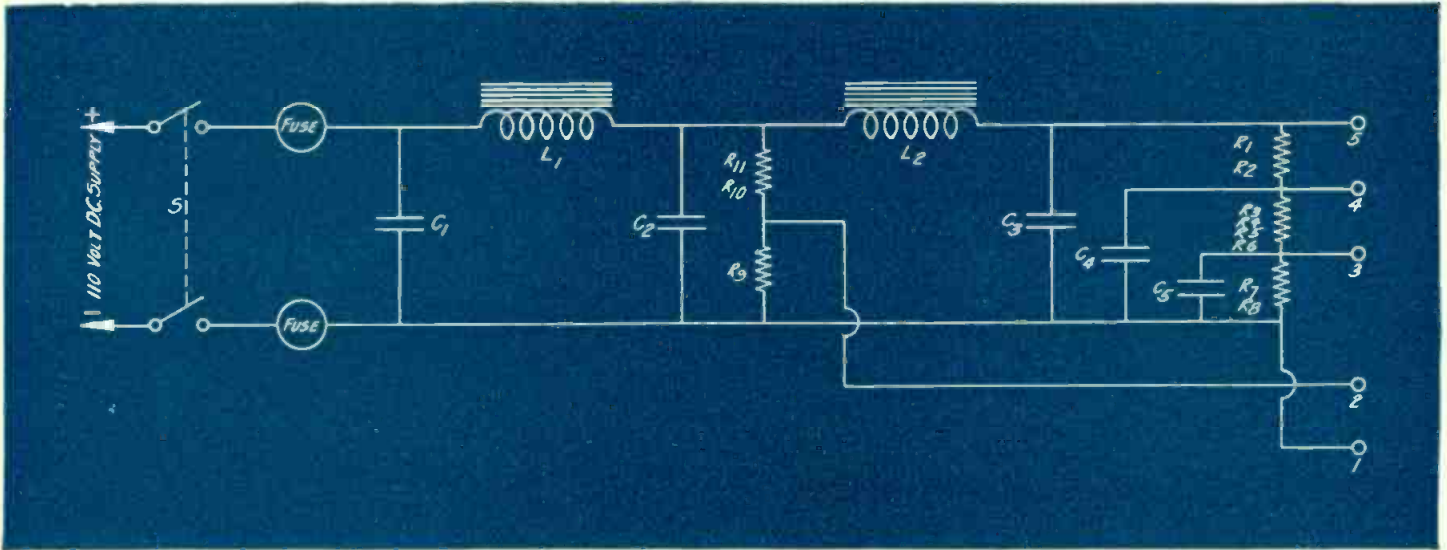

THE SCHEMATIC WIRING DIAGRAM

FIGURE 2: This diagram shows in schematic form just how the power-pack works. Separate circuits are used for the "A" and "B" current supplies; these circuits, of course, are connected in parallel.

The list of parts given on page 785 includes the exact instruments used in the unit from which these specifications were made up. The experienced amateur, however, will be able to pick out other approved makes of instruments which may be used with good results. But we recommend that the novice follow the list so as to be sure to obtain results similar to those obtained with the laboratory model. To any reader who has difficulty in obtaining any of the parts which are necessary in making up these model receivers and power units, POPULAR RADIO SERVICE BUREAU, 627 West 43rd Street, New York City, will gladly assist in seeing that his requirements are promptly supplied.

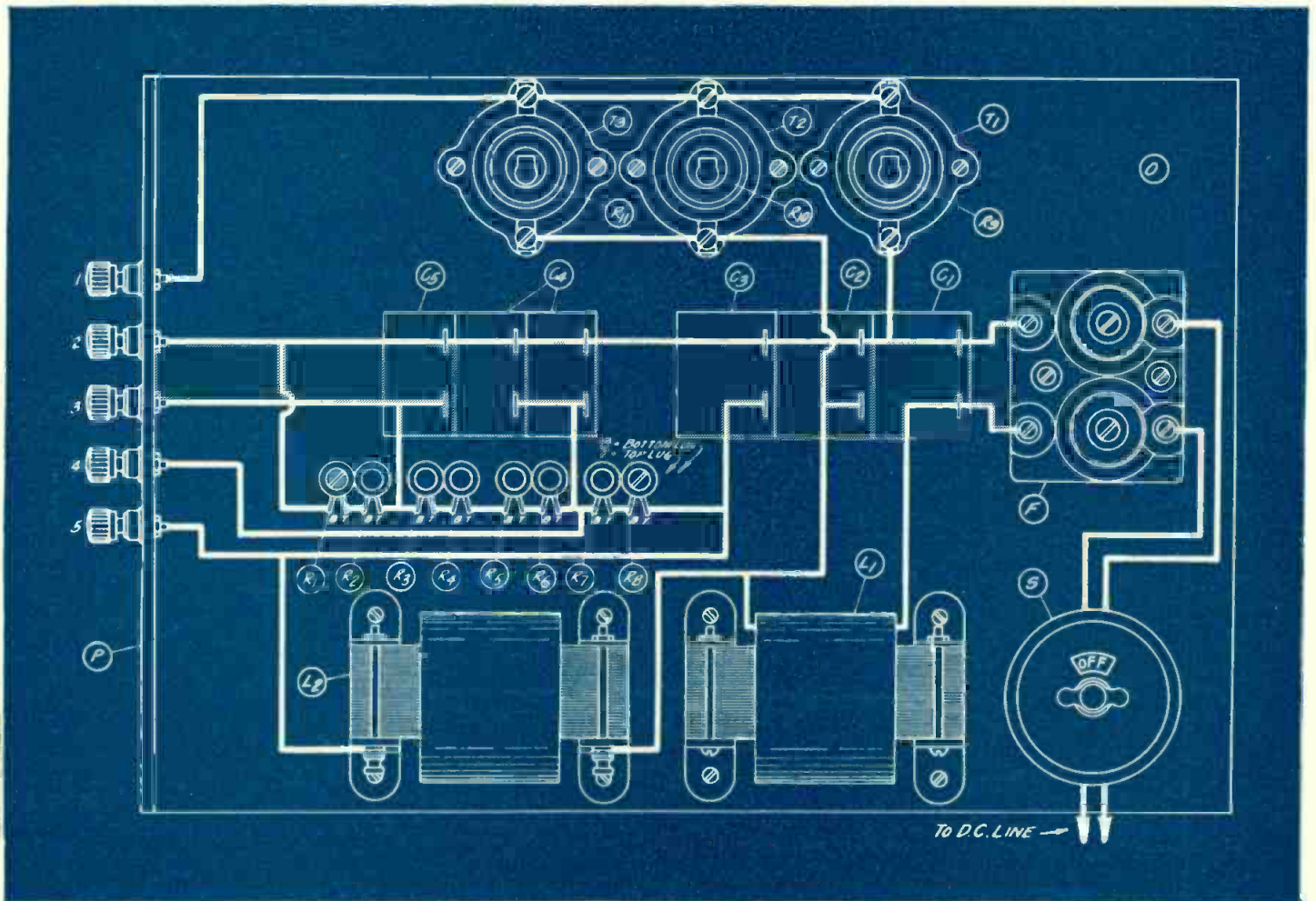

THE PICTURE WIRING DIAGRAM

FIGURE 3: This drawing, which shows the positions of the instruments on the baseboard as well as the wiring for the whole unit, should be referred to constantly—both in constructing and wiring the power-pack.

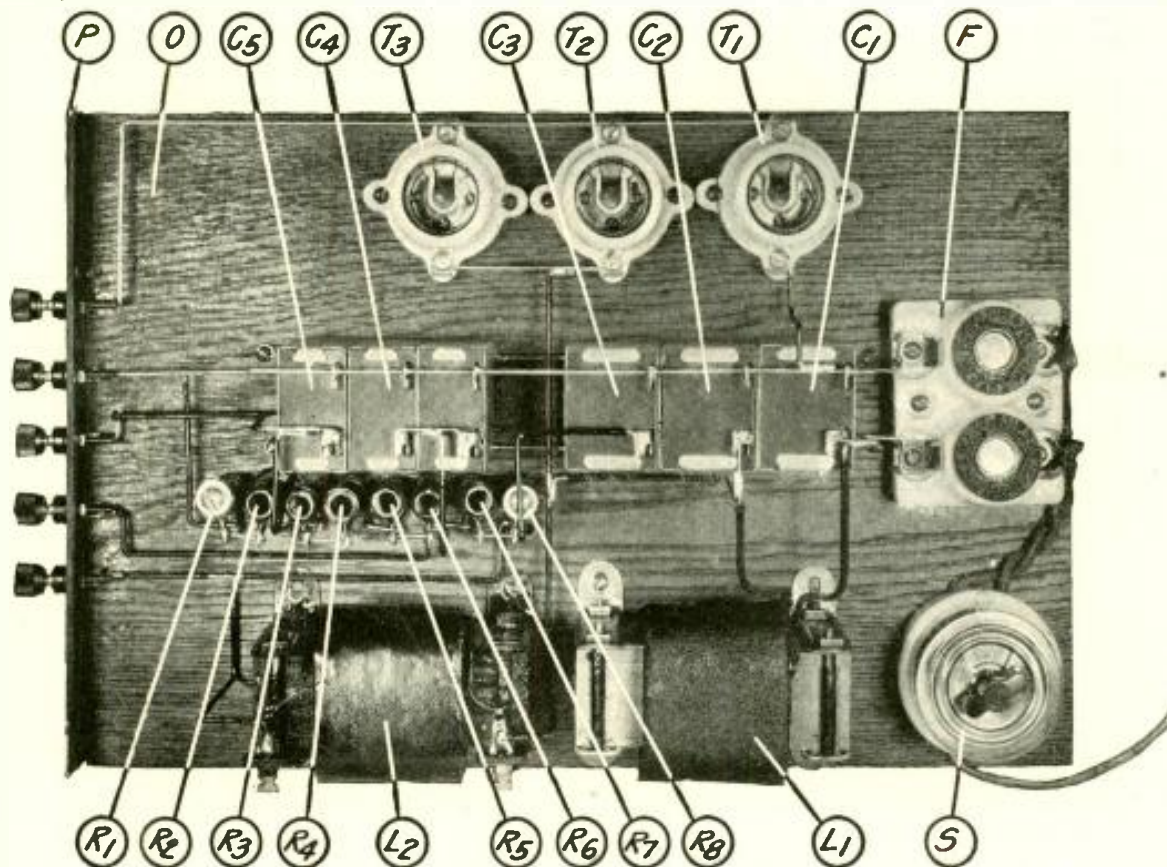

A TOP VIEW OF THE POWER-PACK

FIGURE 1: This view of the unit shows the simple arrangement of the various instruments upon the baseboard. All of the instruments are designated by means of letters which correspond with the designations used in the other illustrations, in the text and in the list of parts at the head of the article.

Simple "How to Build" Articles for Beginners

NUMBER 17

How to Build an "A" and "B" Power-pack for Direct Current

By MORRIS M. SILVER

COST OF PARTS: Not more than \$.40.00

HERE ARE THE PARTS THAT WERE USED IN THE LABORATORY MODEL OF THIS UNIT—

C1, C2 and C3—Tobe paper filter condensers, 2 mfd. each;
 C4 and C5—Tobe paper filter condensers, .5 mfd. each;
 F—Porcelain D.P. main-line fuse block;
 L1—Amerchoke, type 110;
 L2—Amerchoke, type 854;
 P—Bakelite binding-post strip, 1½ inches by 9½ inches by ½-inch;
 R1 and R2—5000 ohm resistors;*

R3—3500 ohm resistor;*
 R4—3000 ohm resistor;*
 R5, R6 and R7—1500 ohm resistors;*
 R8—750 ohm resistor;*
 S—Hart & Hegeman 250-volt, 10-amp., D.P. porcelain rotary snap switch;
 T1, T2 and T3—Hubbell base receptacles;
 R9—Ward-Leonard resistor, type EB7, to be inserted in base receptacle, T1;
 R10 and R11—Ward-Leonard resistors,

type DEB90, to be inserted in base receptacles T2 and T3;
 Extension cord and plug, 6 feet long;
 Baseboard, 9½ inches by 15 inches by ½-inch;
 5 Eby binding posts (marked as mentioned in text);
 2 Clearsite Fuses, 10-ampere;
 4 Wooden or rubber feet;
 *Contained in Ward-Leonard type C resistor kit.

POWER-PACKS that will supply both the "A" and "B" current to radio sets, from an alternating current supply, are common enough now; but the average listener-in whose house current is supplied in direct current still has to be satisfied to plug along with batteries.

To fill this very definite need the DC

power-pack that is described in this article was designed in the POPULAR RADIO LABORATORIES. It is both inexpensive and simple to build and it will supply both "A" and "B" current to the set straight from the DC lighting lines.

Even with the heavy plate-current drain of a superheterodyne, or of a set

that contains the new power tubes, the filament current supply is not affected. The "B" voltage remains practically constant with great changes in plate current and with these changes the filament current and voltage are not altered.

The schematic diagram, shown in (Continued on page 824)

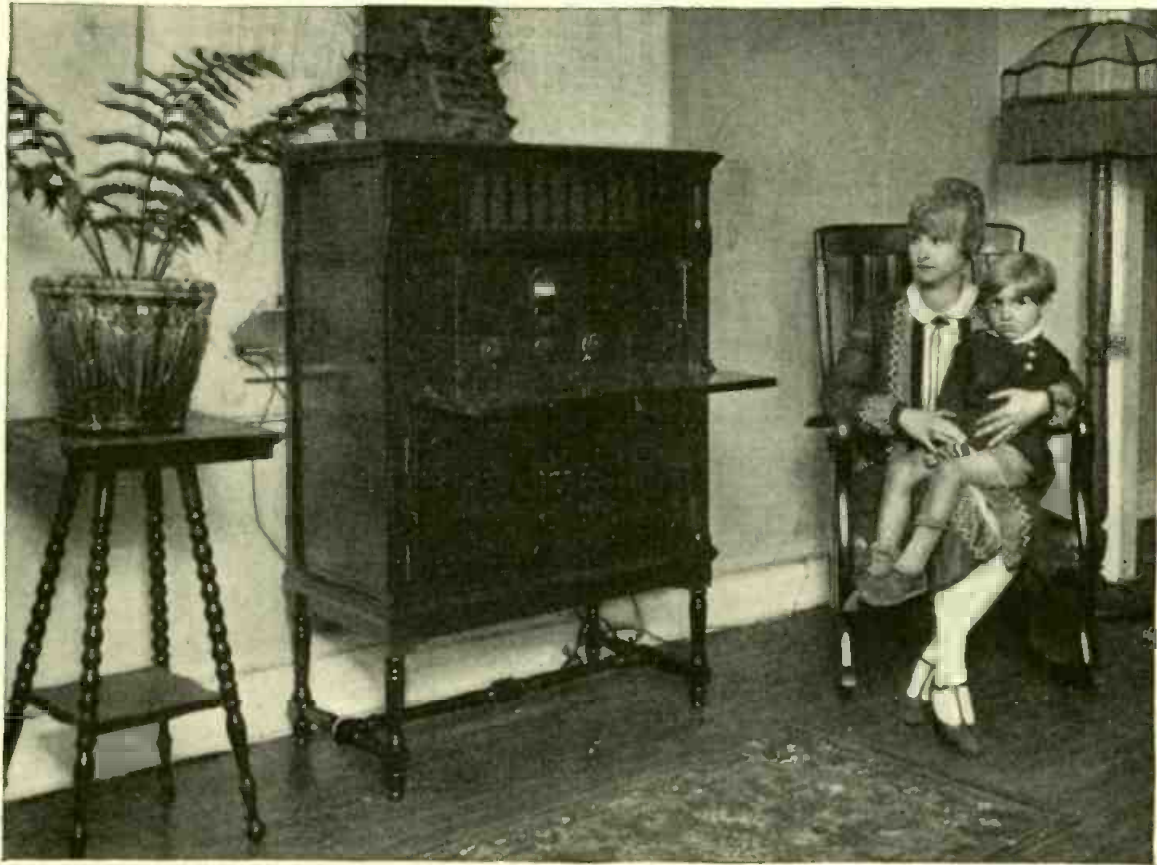

From a photograph made for POPULAR RADIO

A NEW RECEIVER THAT IS COMPLETELY SELF-CONTAINED

The compartment behind the closed doors at the bottom of the cabinet provides space for all of the batteries; the loudspeaker is concealed behind the grill at the top of the cabinet, and the loop is concealed in the door which occupies the entire left end of the cabinet.

INSIDE INFORMATION ON New Radio Receivers

By S. GORDON TAYLOR

Fourth Installment

THE MODEL 8C KOLSTER; THE FERGUSON MODEL 10; THE CLEARSTONE MODEL 110

The data incorporated in these critical surveys of sets that are only recently made available to broadcast listeners (or which will soon be available) is obtained at first hand by the technical staff of this magazine, largely from tests in the POPULAR RADIO Laboratory itself. The receivers already described in this series include the Radiola No. 28; the Fada "8;" the Stromberg-Carlson "Treasure Chest;" the Bosch "Amborada;" the Grebe "Synchrophase;" the Freed-Eisemann "800;" the Crosley "5-50;" the Murad "Super-Six" and the Freshman Console "6-F-11."

The Model 8C Kolster Receiver

ONE feature of the Model 8C "Kolster" receiver which commends itself to the average broadcast listener is that it is completely self contained. The cabinet is of the console type and is of brown mahogany; all of the large surfaces are a soft brown tone and are finished in a paneled effect with border inserts of black.

In front of the cabinet is a grill which extends across the front and just below the top of the cabinet; this grill conceals the cone-type loudspeaker from view but it does not interfere with the projection of sound.

Below the grill is a door which drops down to a position at right angles to the front of the cabinet; the operating controls and tuning scale are then exposed to view and the receiver is ready for operation. When the receiver is not in use, or after a station has been tuned in, this door may be closed or left open, as desired.

Immediately below this door are a pair of doors that open outward to provide access to the battery compartment. These doors remain closed at all times, of course, except at the rare intervals when it becomes necessary to

test or charge the storage battery or to replace the "B" batteries.

One end of the cabinet is in the form of a door and in this door the loop antenna is completely concealed. Instead of being hinged at one side the door is pivoted at top and bottom so that it may be revolved in a horizontal plane. The purpose of this arrangement is to permit the edge of the loop to be pointed in the direction of the station that is received to take advantage of the directional properties of the loop for the best reception. In the case

(Continued on page 794)

The New Ferguson Model 10 Receiver

A STUDY of the Ferguson Model Ten receiver gives evidence that careful consideration in the design of the receiver has been paid to all of the features which go to make up a first class receiver—attractive appearance, ease of control, reasonable price, sensitivity, selectivity, volume and tone quality. To the latter has perhaps been given the most attention.

In general appearance the receiver is attractive, due to the excellent quality of the cabinet work and to the soft brown tones in which the cabinet is finished. The cabinet is of walnut with a front panel of the same material; the coloring is uniform throughout, except for the edges of the cover, which are finished in a darker brown than the rest. No attempt has been made to break up the larger surfaces with borders or with contrasting colors and there is no necessity for such because the receiver is so small in size that the largest surfaces are not sufficiently large as to require such treatment.

The receiver will fit into any home surroundings inconspicuously; as it is small in size and is happily lacking in conspicuous adornment. It may be mounted on any small table, or a small battery cabinet stand will serve as a mounting for the receiver and at the same time conceal all of the batteries from view.

The front panel is plain except for the three control knobs which project through bronze escutcheon plates. The larger center plate also contains a window through which the calibrated tuning scale is visible. The knob on this plate is the wavelength tuning control with which practically all tuning is accomplished; the calibrated scale behind the window moves as this knob is rotated and shows the wavelength to which the receiver has been adjusted by means of this knob. For this purpose the scale is calibrated directly in wavelengths. Thus if it is desired to tune in a station of known wavelength it is necessary merely to turn this tuning knob until the desired wavelength is indicated on the scale.

The "sensitivity" control, at the lower right hand corner of the panel is an auxiliary tuning control provided for the purpose of adapting the values of the first tuned circuit to the characteristics of the antenna used. In many cases it will be found that once this knob has been adjusted for maximum sensitivity on one station it will provide maximum sensitivity throughout the entire broadcasting waveband without further adjustment. In other cases, if this knob is adjusted for maxi-



From a photograph made for POPULAR RADIO

A COMPACT TYPE OF RECEIVER TO SET ON A TABLE
This new Ferguson model strikes a keynote of simplicity—both in appearance and in operation. It takes up little space and may be mounted on any small table—or on a special battery cabinet as shown in this illustration.

imum response on a low wave broadcasting station and the receiver is then tuned to a high wave station, a slight readjustment of the sensitivity knob will be necessary. This applies only in the case of distant stations which call for extreme sensitivity if they are to be brought in at all.

On local stations there is no necessity for readjusting this sensitivity knob, once it has been adjusted for best response from any one station.

The volume control in the lower left hand corner of the panel permits the operator of the receiver to vary the volume to suit his particular taste. It provides absolute control of volume from maximum to zero.

These three knobs accomplish tuning and control of the receiver in a simple and natural way. Most people are interested only in reception from local and semi-distant stations; for these the receiver is a real single-control outfit, inasmuch as all tuning is accomplished by means of the main wavelength tuning knob. For the DX fan it will sometimes be necessary to resort to the use of the "sensitivity" knob as an auxiliary tun-

ing device to obtain the best volume.

The receiver is turned on and off in the usual manner by a small push-pull switch operated by a small knob just beneath the main tuning knob.

The sensitivity of the receiver is remarkable, considering the fact that only two stages of tuned radio-frequency amplification are used. Operating the receiver in New York City, from twenty to thirty stations may be heard by simply turning the main tuning control rapidly from one end of its range to the other. By turning this control slowly an even larger number of stations may be heard, without once varying the setting of the "selectivity" knob. During the early evening of September 28, with a heavy rain falling, a number of midwestern stations were brought in with ample loudspeaker volume and there was every indication that under favorable weather conditions the receiver would be capable of covering the entire United States without difficulty.

The selectivity of the receiver furnishes another surprise. For instance, a Chicago station was tuned in on 370
(Continued on page 790)



From a photograph made for POPULAR RADIO

THIS SET OPERATES WITHOUT BATTERIES

To put this receiver in operation an electric light socket, an antenna and a loudspeaker are the only external accessories required.

The Cleartone Model 110, AC Operated Receiver

BBROADCAST listeners have long been on the watch for a receiver which could be operated from the alternating current house lighting lines. This desire has been gratified in a number of receivers brought out within the past few months, but the majority of these made use of external power supply units. In other words a separate battery cabinet was still required to house the power supply units.

The new Cleartone Model 110 receiver does away with the necessity for all this by including the power supply equipment in the receiver cabinet. And this is accomplished without making the receiver any larger than many of the other table mounting type of receivers. The complete power supply equipment occupies a space only five inches wide at one end of the receiver cabinet.

The compact size of the power supply equipment is explained by the fact that this receiver uses vacuum tubes with filaments which are lighted by alternating current. Storage batteries, trickle chargers and chokes are therefore eliminated from the filament supply circuit.

All that is required is a small transformer to step the 110 volt house supply down to the proper operating voltage for these tubes. Even this transformer has been made a part of the larger transformer which provides the higher voltages for the plate supply of the Cleartone receiver so practically no space is required for the filament supply apparatus.

The power supply unit in this receiver consists of a rectifier tube, step-up transformer and filter. This supplies direct current at the high voltages required for the plate supply and alternating current at the low voltage required by the tube filaments.

In designing the receiver and the power supply equipment, special care was required in eliminating the possibility of a hum, due to the close proximity of the power supply equipment to the receiver circuit. The designers have been entirely successful in accomplishing this however, as there is no trace of hum or other noise from the supply source or supply equipment.

To put the Model 110 receiver into operation the five McCullough vacuum tubes are inserted in their sockets and

the UX-213 full wave rectifier tube is placed in the socket provided in the power supply unit; the antenna, ground and loudspeaker are then connected to the terminals provided inside of the cabinet and the cord provided with the receiver is plugged into a convenient lamp socket. After that it is only necessary to turn on the switch provided on the front panel and the receiver is "ready to go."

A single knob is provided at the left hand end of the panel to control the power supply unit; once this has been adjusted, it requires no further attention unless the voltage of the alternating current house lighting lines changes. By means of this knob the power supply unit may be adapted to the particular line voltage obtaining in any home. Unfortunately the so-called "110-volt" light supply may be anywhere from 110 to 120 volts actually, depending on the location of the installation in relation to the generating or transformer stations of the power company. The "off-on" switch provided just below this knob cuts the entire receiver off the light lines so there is no necessity for removing the plug from the line.

The receiver uses five tubes which provides two stages of tuned radio-frequency amplification, detector and two stages of transformer-coupled, audio-frequency amplification. The antenna circuit is tuned by a variable condenser, operated by one of the tuning controls on the front panel. The two radio-frequency stages are tuned by a tandem condenser which is operated by the second tuning control on the panel. Thus the three tuned stages are actually tuned by two controls. An incidental control is also provided to keep the two circuits, tuned by the tandem condenser, in balance. This control is useful when maximum sensitiveness is required, as when tuning in distant stations.

At the right hand end of the panel another knob is provided to regulate the volume.

Provision is also made to operate the receiver with batteries. This is a thoughtful provision, especially for those who may desire to take the receiver to camp or to the country where AC lighting current is not available. A battery rheostat and battery switch are provided on the panel for use at such times.

The cabinet is of neat appearance and is finished in a deep brown mahogany. The composition front panel and the control knobs which are mounted on it all match the cabinet in coloring, and the panel slopes back sufficiently to permit the tuning controls and calibrated tuning scales to be readily seen without crouching in front of the re-

(Continued on page 792)

Is actual reproduction possible?

ALTHOUGH it is common to hear such claims as "Perfect Reproduction," "Absolute Perfection," "The Living Artist Brought Right into your Home"—in spite of these claims scientists have never boasted absolute perfection in radio reproduction.

Let us look at the facts

At the broadcasting station the music of the violin, for instance, is changed into a radio wave, and is broadcast. It is then detected in your radio set and changed once more into an electric wave carrying the impulses of the music. This electric wave emerges from the detector tube not altogether perfect. However, it is so nearly perfect that radio science has turned its attention from the *broadcasting and detecting* phases of reproduction to the *audio amplifying* of the detector tube output.

Reproduction by good amplification has become the most important consideration in the art of radio. The amplifying transformers that were used in radio sets last year are definitely a thing of the past. Almost every set manufacturer has improved upon them. Some have adapted resistance coupling, others large size transformers, and some electric light socket power amplification.

Although these methods of amplification are an improvement, they do not and cannot give *perfect* reproduction, nor do they come as close to perfection as has now been made possible by the recently announced new principle of audio amplification.

The New Amplification

An entirely new system of amplification known as *Truphonic* has been developed. This system more nearly approaches actuality than any other yet devised. Scientific laboratory tests and tests before both the musically trained and the musically untrained ear establish this fact beyond question.

Unfortunately the Truphonic system was not developed in time to be generally used in this fall's production of radio sets

—with the exception of a number of the makers of the more expensive sets who have a smaller production, and who were able to incorporate Truphonic amplification into their instruments.

But for radio listeners and lovers of fine music who want this most nearly actual of all reproduction *now* and immediately, the Truphonic Power Amplifier is provided in the simple, compact form shown below—for instant attachment, without tools, and with no change whatever in your present radio set.

Whether you bought or made your set this year, last year or five years ago, the Truphonic will give you finer reproduction than you can get in any other way—regardless of how much you can afford to spend.

The Truphonic Power Amplifier operates directly from the detector output. No transformers now in the set are utilized. This pure detector music in every note, tone, and shade and in considerably greater volume, is so beautifully and faithfully reproduced that you will find it as difficult to describe as it is for us to attempt to describe it to you.

The Truphonic with Power Tubes

Besides the fundamentally great improvement in reproduction that the Truphonic brings to radio in such a conveniently applied form, there is the added advantage that for those who want extreme volume without overloading the last stage tube, the necessary extra B and C battery connections for the use of power tubes are provided for in the attachment cord.

We have tried in this space to give you some idea of what you may expect from this new principle of audio reproduction that has come to radio. We realize that we have made some strong claims for Truphonic amplification, but we have made no claim that you will not find more than backed up when you have tried the Truphonic yourself.

We urge you to get the Truphonic *now*,—so that you may begin immediately to have an altogether different kind of enjoyment of the splendid programmes that are coming to you over the air

Your dealer has the Truphonic, or will get it for you.



ALDEN MANUFACTURING CO.
Dept. 317 C—Springfield, Mass.

TRUPHONIC Power Amplifier

Not Resistance Coupled

\$20

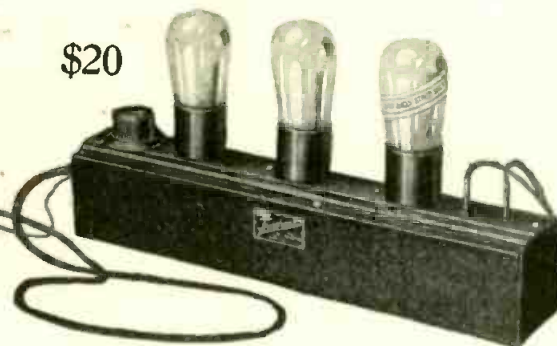
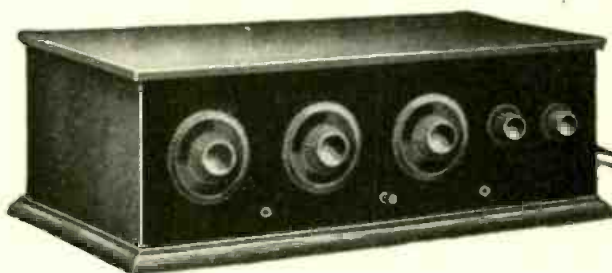

Why the



Silencer Socket is essential to clean-cut reception

In many cases good clean-cut radio reception is decidedly hampered by the disturbing microphonic noises within the radio tubes—particularly the detector tube. These disturbing noises are caused by shocks and jars—very often slight—which come from various vibrations such as the vibration of the loud speaker, tapping the radio set itself, walking in the room or even street traffic. These vibrations cause the grid and the plate of the tube to vibrate slightly in respect to one another.

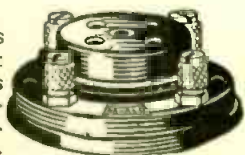

No. 481XS

"Float" your tubes!

In order to shield the tube against these shocks the Alden Silencer Socket has been designed. With this socket the tube is "cushioned" and "floated," absorbing all shocks in all directions—sidewise, up, down and pivotally. The marvellously balanced phosphor bronze springs which accomplish the "cushioning," form also the contacts for the tube and for the outside connections. This important point, among others, is fully covered by patents.

Contacts press firmly, strongly and flatly against the full length of the tube prongs. Special phosphor bronze, triple locked, contacts are held in constant tension insuring permanent quiet action. Solder lugs are provided for making connection either above or below the base panel. Or the lugs can be removed and the binding posts used. Round edge permits of mounting in any direction, and makes for a neat mounting on the base panel.

The Silencer Socket (for UV 201A and all UX tubes) is a markedly superior socket which large production enables us to sell for 50c. At all dealers.

Other Na-Ald Sockets



No. 481X

The Na-Ald No. 481X socket is the popular priced universal socket for all UV 201A and all UX tubes. This socket is in great demand for amplifying tubes. The price is 35c.

The Na-Ald De Luxe Socket is designed for heavy duty service with the big, high voltage, expensive tubes. Triple lamination, dual-wire contacts will carry the heavy current used. The tube prongs and socket contacts can be self cleaned simply by a half turn rotation of the tube in the socket. Alden processed moulding assures the necessary mechanical and electrical strength. The De Luxe Socket is 75c. at your dealer's.



No. 400

ALDEN MANUFACTURING CO.
Dept. 317C. Springfield, Mass.

The New Ferguson Model 10 Receiver

(Continued from page 787)

meters without interference from a local New York City station operating on 374 meters. Then just above this WGY was tuned in, again without interference from the station on 374 meters. There was no difficulty at all in tuning in Washington on 469 meters with the local stations WJZ and WEAJ going full blast; and in pulling in Philadelphia, on 509 meters and right between WEAJ and WNYC. This is excellent selectivity, as one will realize who is familiar with reception conditions in New York, which is a nest of high power stations.

It is well to mention here that this test was made with an antenna approximately 100 feet in length—long enough to make selectivity rather doubtful on many receivers. To make sure of ample selectivity, regardless of the length of the antenna used with the receiver, the manufacturers have included a switch inside of the receiver which provides four degrees of selectivity. Thus when the receiver is once installed in the home this switch can be set on the point which provides the desired selectivity and the owner may be assured of good reception without interference, regardless of the size of his antenna.

Plenty of volume of reproduction is provided through the use of three stages of audio-frequency amplification, using a power tube in the last stage. A new method of coupling is used which is claimed to combine the good qualities of impedance-coupled amplification with those of transformer-coupled amplification. The scheme as exemplified in

the Ferguson "Ten" certainly seems to bear out the claims.

A heavy wood chassis provides the foundation on which the receiver is assembled and wired. The cabinet and front panel simply serve as a housing for this assembly. Shielding is provided to reduce interstage coupling in the radio-frequency amplifier and also to provide protection for the instruments. This shielding takes a somewhat different form from the "cans" ordinarily used for this purpose but is apparently equally effective. Instead of completely enclosing the individual circuits in sealed metal boxes the manufacturer of this receiver has simply placed large copper partitions between the circuits.

The circuit makes use of two stages of radio-frequency amplification, detector and three stages of audio-frequency amplification. This requires the use of six vacuum tubes, five of which are of the 201-a type. The sixth is a 112 type power tube and is used in the last stage of audio-frequency amplification.

A three-section gang condenser is used to tune the antenna circuit and the circuits of the two radio-frequency stages simultaneously. The common shaft on which the rotors of these three condensers are mounted also serves as the mounting for a coupling coil in one of the radio-frequency circuits. By this means the coupling is automatically varied with the tuning condensers. This is one of the schemes used to obtain the increased efficiency of the radio-frequency amplification that is incorporated as the heart of this receiver.

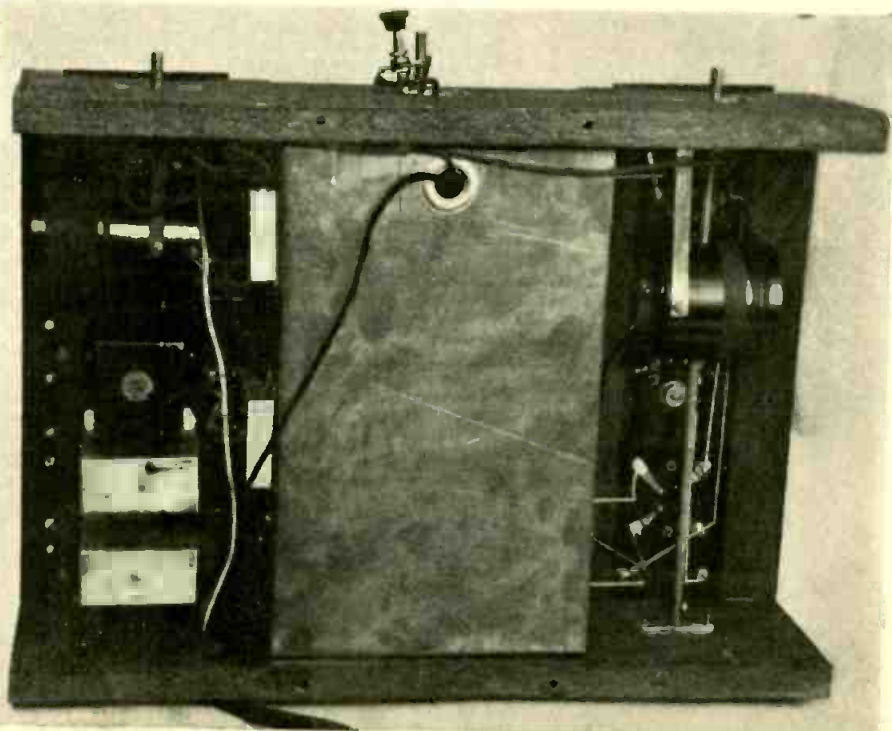

THE RECEIVER UNIT OF THE SET SHOWN ON PAGE 787
This shows a bottom view of the chassis. All of the instruments are mounted on a heavy wood foundation and partial shielding of the radio-frequency circuits is provided by the large metal box in the center.

FREE!



"MEN! Here's the 'dope' you've been looking for-

How TO GET INTO THE RADIO BUSINESS"

J.E.S.

\$50 to \$250 a Week
in Work That is Almost Romance

If you're earning a penny less than \$50 a week, clip coupon now for FREE BOOK! New book, profusely illustrated, tells all about the Radio Profession, thousands of openings—in work that is almost romance! YOU can learn quickly and easily at home, through our tested, improved methods, to take advantage of these great opportunities! Why go along at \$25 or \$35 or \$45 a week, when you can pleasantly and in a short time learn to be a Radio Expert, capable of holding the big jobs—paying \$50 to \$250 a week?

Clip Coupon for Free Book

Don't envy the other fellow who's pulling down the big cash. Our proven home-study training methods make it possible for you, too, to get ready for a better job, to earn enough money so you can enjoy all the good things of life. Most amazing book ever written on Radio tells how—thousands of interesting facts about this great field, and how we can prepare you, quickly and easily in your spare time at home to step into a big-pay Radio job. You can do what thousands of others have done through our training. GET THIS NEW FREE BOOK. SEND COUPON TODAY.

J. E. SMITH, President

NATIONAL RADIO INSTITUTE

WASHINGTON, D. C.
 Dept. PT-8

NOW!
Special Short Time Offer
6 BIG OUTFITS

Radio Needs Trained Men

National Radio Institute,
 Dept. PT-8
 Washington, D. C.

Dear Mr. Smith:

Without obligating me in any way, send me your FREE BOOK "Rich Rewards in Radio," and all information about your practical, home-study, Radio Course.

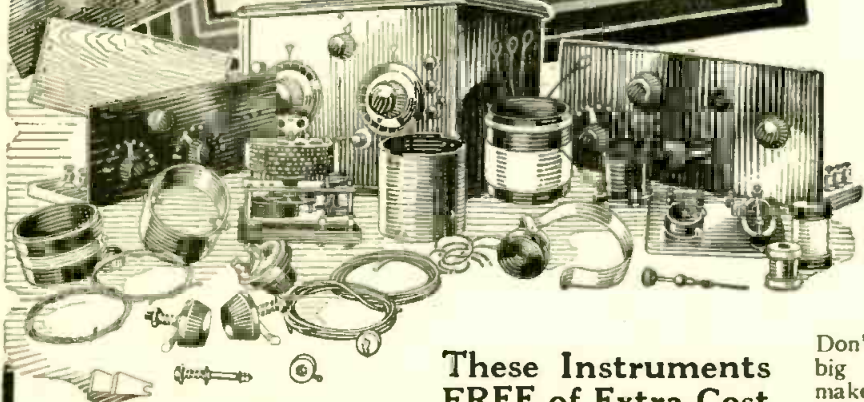

These Instruments FREE of Extra Cost

All instruments shown here and others—SIX BIG OUTFITS—sent to all our students free of extra cost under short time special offer.

Clip coupon now—find out all about this big unequalled offer while you still have time to take advantage of it. Our training is intensely practical—these instruments help you learn to do the practical work. Receiving sets, from simplest kind to thousand-mile receiver. Many other big features.



J. E. SMITH
 President

My Radio Training Is the Famous "Course That Pays for Itself"

Spare time earnings are easy in Radio when you know it the way we teach you. Increase your income almost from the start of your course through practical knowledge we give you. We show you how to hold the job, then our big Free Employment Department helps you get one. Free Book "Rich Rewards in Radio" tells how.

Howard B. Luce of Friedens, Pa., made \$320 in 7 weeks during his spare time. D. H. Suitt of Newport, Ark., writes, "While taking the course I earned in spare time work approximately \$900." Earl Wright of Omaha reports making \$400 in a short time while taking his course—working at Radio in his spare time only. Sylvester Senso, 207 Elm Street, Kaukauna, Wis., made \$500.

And when your training is completed you're ready to step into a real big Radio job like C. C. Gielow, Chief Operator of the Great Lakes Radio Telegraph Company; E. W. Novy, Chief Operator of Station WRNY; Edward Stanko Chief Operator of Station WGR; and hundreds of other N. R. I. Trained men. The National Radio Institute, originators of Radio Home-Study Training, established 1914, today offers you the same opportunity these men had, under a bond that guarantees you full satisfaction or money refunded. It's your big chance to get into Radio—mail coupon for FREE Book and profit.

SEND THIS COUPON TODAY

Name _____ Age _____
 Address _____
 Town _____ State _____

Now you can build a really professional radio set.

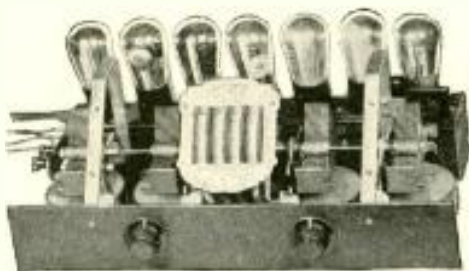

TO BUILD a really professional looking and efficiently operating radio set here are two new and important construction units.

The Truphonic Power Amplifier, more fully described on another page of this issue, provides by far the finest type of audio amplification so far developed. For the set builder the Truphonic may be had in a Caracomb Assembly which gives you a complete unit containing the following: Complete Truphonic audio amplifying system including an output unit to protect the speaker from burning out and demagnetization, sockets with attached leads for the tuning and detector end of the set.

The illustration shows how neatly this Catacomb Assembly houses all of these elements and how compactly it fits behind the tuning control. No holes to drill, no apparatus to mount. Short, direct leads with a minimum of soldered connections. This unit may be arranged in a hundred different ways to match all the requirements of every circuit and set design. A six foot battery cable is included, in which provision is made for the extra B batteries and C batteries for the use of power tubes.

The Truphonic Assembly is provided in two models, one for 6 tubes, \$20, and one for 7 tubes, \$22.



Localized Control Tuning Unit

The Na-Ald Localized Control (Trade Mark Reg. U. S. Pat. Off.) Tuning Unit (Quadruple model shown) is a boon to the set builder—a great advance in multiple condenser construction. It can be used with any form of radio frequency coils, and gives you simple control under the finger tips of one hand, enabling you to tune all the condensers at once, or to tune each one separately and distinctly.

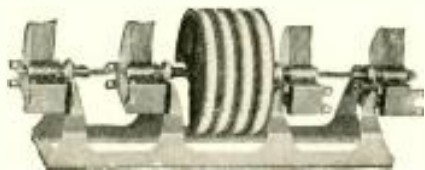

These advanced Na-Ald Localized Control Tuning Units are provided in several models (all are of .000375 capacity unless otherwise indicated). Double \$8, Double (.0005) \$10, Triple \$10, Quadruple, \$15, Double with tickler control \$10. With each unit is included the handsome panel plate shown above.

Your dealer has these Na-Ald advanced construction units, or can get them for you.

ALDEN MANUFACTURING CO.
Dept. 317C Springfield, Mass.

The model "Ten" receiver may be used with batteries, or may be operated from the house lighting lines through suitable power supply units. If the latter is used, any of the standard makes will be suitable. A six-volt supply is required for the filaments and must be capable of delivering 1 3/4 amperes. For the plate supply a voltage of 135 is required, at a drain of up to 30 milli-amperes. The current drain of the receiver is not actually as high as this but this requirement for the supply unit allows a margin of safety.

If batteries are used a six-volt storage battery is required and three "B" battery blocks of 45-volts each. The manufacturer also recommends an additional 45-volt block for the detector plate supply, using the other three blocks on the amplifier tubes only. This arrangement is desirable but not essential. Two small 4 1/2-volt blocks of "C" battery are also required for the grid

biasing voltages that are necessary.

Any sort of an antenna may be used with this receiver. For best all around results an outdoor antenna is to be recommended, and preferably one which is not more than 100 feet in length including the lead-in. Such an antenna provides plenty of "pick-up" whereas a longer antenna may tend to overload the detector tube. An indoor antenna will provide all the signal strength needed on stations up to 100 miles or more.

To simplify the operation of connecting the receiver to the batteries, a cable comes with the receiver and has the various wires plainly tagged; it is therefore necessary only to connect these wires to the battery terminals indicated by the metal tags. The other ends of the cabled connecting wires are permanently connected inside of the receiver.

There is little chance of even the rankest novice going wrong in connecting up this receiver.

The Cleartone Model 110, AC-operated Receiver

(Continued from page 788)

ceiver. The two major tuning controls are set at the lower edges of ornamental composition plates. At the upper edges of these plates, windows are provided behind which the calibrated tuning scales rotate.

This receiver may be used with either an indoor antenna, or with an outdoor installation. It is sufficiently sensitive to operate a loudspeaker on stations up to 20 miles distant when using a two foot wire for the antenna; it is therefore evident that an indoor antenna of 30 to 40 feet in length will provide plenty of volume for all normal reception purposes. For reception from great distances an outdoor antenna is to be preferred, of course. Such an antenna should not be more than about 75 feet in length, if the receiver is located in a city close to the broadcasting stations; for rural locations the antenna may be longer than this if desired.

Under reception conditions which can be considered only fair, this receiver brought in a number of stations up to

900 miles distant, on the loudspeaker; the closer stations came in with great volume—far too much for use in the home. But the volume control cut the volume down to suitable proportions.

The quality of reception was better than that usually obtained from receivers which do not make use of a power amplifier tube in the last audio stage. Evidently the McCulloch tubes are capable of handling considerable power without overloading; in any event the quality is good even when the volume control is turned up to provide great volume.

On the whole this Cleartone receiver is an excellent one for those who wish to enjoy radio without any effort other than that required to turn on the switch and tune in the stations. No thought or attention is required by the power supply equipment and there is nothing to wear out except the tubes—and their life is so long as to give little cause for worry so far as expense is concerned.

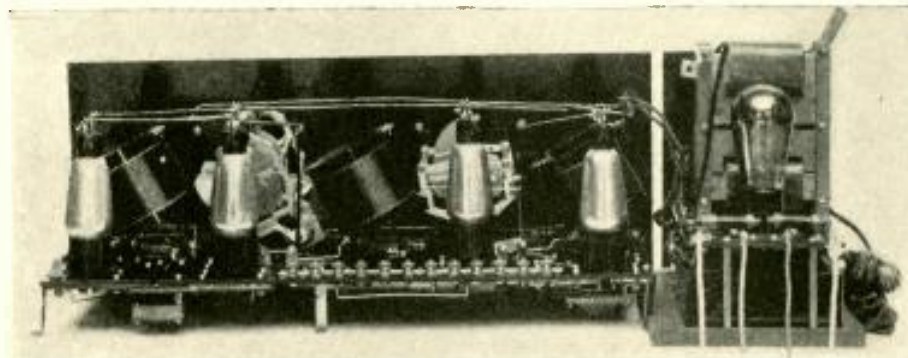

ALTERNATING CURRENT HEATS THE CATHODES

The power unit to supply the proper operating voltages from the house lighting lines is shown at the right. This unit supplies low-voltage AC for the heaters and high-voltage direct current for the plate supply thus eliminating all batteries.



A \$20,000,000 IDEA



"Approved by Raytheon"



Manufacturers of Complete B-Power Units, Raytheon-equipped:

Acme Apparatus Co., Cambridge, Mass.
 All-American Radio Corp., Chicago, Ill.
 Amer. Bosch Mag. Corp., Spring'd, Mass.
 American Electric Co., Chicago, Ill.
 Apco Mfg. Co., Providence, R. I.
 Cornell Elec. Mfg. Co., L. I. City, N. Y.
 Electrical Research Labs., Inc., Chicago
 General Radio Co., Cambridge, Mass.
 Grigsby-Grunow-Hinds Co., Chicago, Ill.
 King Elec. Mfg. Co., Buffalo, N. Y.
 Kokomo Electric Co., Kokomo, Indiana
 Mayolian Radio Corp., Bronx, N. Y.
 The Modern Elec. Mfg. Co., Toledo, O.
 Pathe Phonograph Co., Brooklyn, N. Y.
 Sparks-Withington Co., Jackson, Mich.
 The Sterling Mfg. Co., Cleveland, Ohio
 Storad Mfg. Co., Cleveland, Ohio
 J. S. Timmons, Inc., Germantown, Phila.
 Valley Electric Co., St. Louis, Mo.
 The Webster Co., Chicago, Ill.
 Zenith Radio Corp., Chicago, Ill.

TEN YEARS ago Charles Grover Smith began the intensive study of the possibilities of handling electrical power by gaseous conduction. With the resources of the Raytheon Research Organization behind him, he produced the Raytheon Rectifier, giving for the first time full wave rectification with simplicity, long life, and absolute reliability, and making possible in the one year since its introduction, a business in Raytheon-equipped B-Power units of approximately \$20,000,000.

Raytheon has many ideas. For their development Raytheon maintains a Research Organization housed in a separate building, and with a staff headed by such men as Mr. Smith, Dr. Vannevar Bush of M. I. T., Monsieur Andre of the La Radio Technique of Paris, Mr. J. A. Spencer, inventor of the Million Dollar Thermostat, and many others. The equipment at their disposal cannot be duplicated anywhere. It is little wonder that those close to radio power problems look to Raytheon for their most effective solution.

RAYTHEON MANUFACTURING COMPANY
 CAMBRIDGE, MASSACHUSETTS



The Romance of Raytheon

By DONALD WILHELM

BETWEEN the time Mr. Smith set to work on his research, and the time that the Raytheon Rectifier was produced there were many hours, days, and months of dreams, discouragement, thrilling discovery, and patience. It makes good reading. For example, we think of copper as being an excellent conductor, yet Mr. Smith found that he could pass seventy times as much current through a column of gas as through a copper wire of the same diameter.

If you are interested to know more about the years of research resulting in the development of the Raytheon Rectifier, we shall be glad to mail you a leaflet telling the story in the words of Mr. Donald Wilhelm, author of "The Story of Steel," "The Story of Wrought Iron," and many other publications. Drop us a line.

RAYTHEON rectifier

NA-ALD

Adapters for all tube and socket combinations

Na-Ald Adapters are indispensable to the set owner and set builder who wants a simple and instantaneous means of adapting any particular type of tube to the particular type of socket that is used in his set. For instance, if your set is now equipped with standard 201A sockets, and you want to use the small UV 199 type tube, simply insert the Na-Ald Adapter No. 429 into the 201A socket and insert the 199 tube into the adapter.

The various types of Na-Ald Adapters are given below. Specify them for best results:

For adapting small UX 199 and UX 120 tubes to UV 201A sockets, use Na-Ald Adapter No. 419X. Price 35c.



No. 419X



No. 421X



No. 429

To bring up to date and decidedly improve the Radiola III and IIIA and similar sets employing WD II Tubes, use Na-Ald Adapter No. 421X. Price 75c.

For adapting UV 199 tubes to standard 201A sockets use the Na-Ald No. 429 Adapter. Price 75c.

To adapt all UX tubes and UV 201A tubes to UV 199 sockets use Na-Ald Adapter No. 999. Price \$1.00.

Na-Ald Adapters are sold by all good radio stores and carry the Na-Ald unconditional guarantee.



No. 999

ALDEN MANUFACTURING CO.
Dept. 317C SPRINGFIELD, MASS.

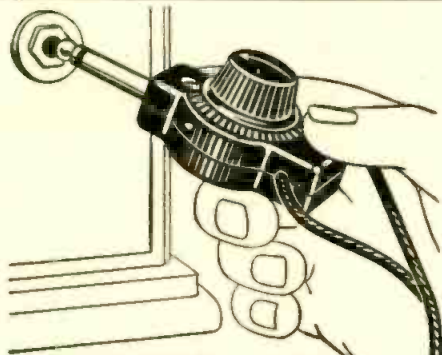

**NOTHING ELSE
LIKE IT!**

HERE is a simple radio control—the Centralab Modu-Plug—that is unique even in a field where phenomenal developments are common.

Provides smooth, noiseless control of tone and volume direct at the plug with the set operating at full efficiency. Without adjusting tuning dials or other controls, you can regulate volume from a whisper to maximum simply by turning the little knob on this plug. Reduces static interference—clarifies tone. Replaces the ordinary loud-speaker plug.

\$2.50 at your dealer's, or mailed direct on receipt of price.

CENTRAL RADIOLABORATORIES
17 Keefe Ave., Milwaukee, Wisconsin
Manufacturers of variable resistances for all radio circuits

Centralab

The Model 8C Kolster Receiver

(Continued from page 786)

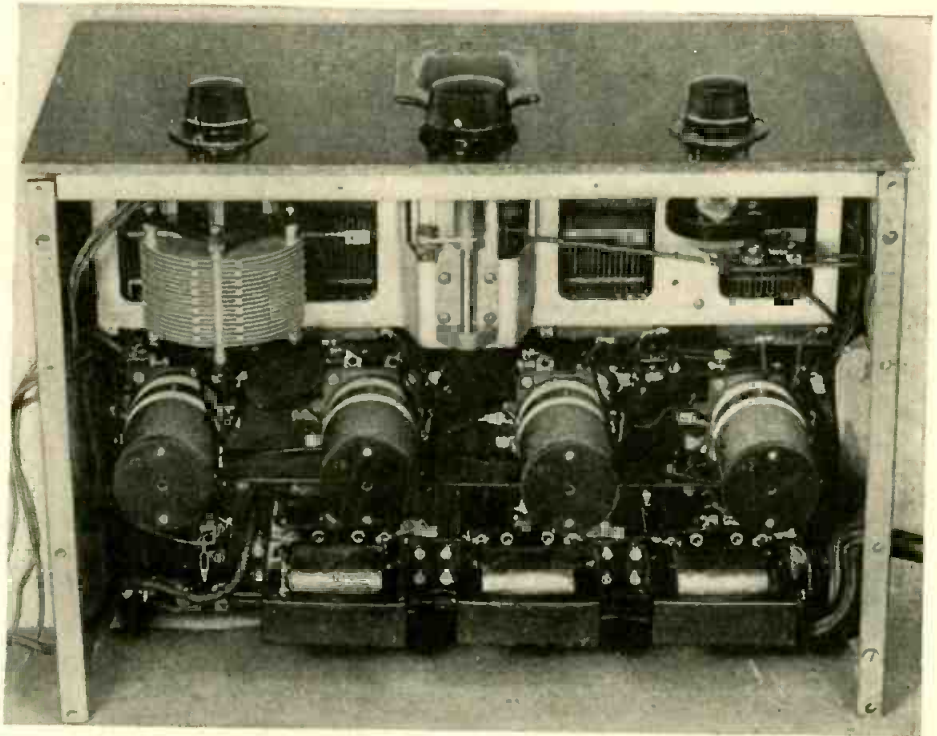

THIS RUGGED CONSTRUCTION ASSURES PERMANENCY OF ALIGNMENT

This receiver unit is a good example of the care exercised in making all parts rigid enough to withstand the hard knocks of shipping, without endangering the careful adjustments of circuit values made at the factory. Note the heavy cast frame in which the condensers are supported.

of reception from local stations this door need not be opened at all.

In addition to the 8C model four other models of the Kolster receiver are available. Two are for table mounting and there are two other smaller console models. Three of these five are eight tube receivers and in these three the receiver units are identical, the only difference lying in the style of the cabinet and in the equipment. The other two receivers use only six tubes and are intended for use with an outdoor or indoor antenna instead of with a loop.

The operation of the 8C Receiver is decidedly simple. There are three control knobs in all. The central knob, called the "station selector," tunes the four tuned circuits of the receiver simultaneously and is the main wavelength tuning control of the receiver. Just above this knob is a revolving scale which is calibrated directly in wavelengths and which shows the wavelength to which the receiver is tuned. This scale is lighted from within by a small lamp that also serves as a pilot light inasmuch as it is lighted only when the receiver is turned on. To the left of the main tuning knob is the antenna tuning control. This is called the "sensitivity" control because the receiver is always most sensitive when the antenna, as well as the other four tuned circuits are tuned to the exact wavelength of the transmitting station.

The third knob controls the volume. When a station has been tuned in with

the "station selector" this right hand knob is adjusted to provide just the desired degree of volume. A small lever just below the volume control knob serves as a battery cut-off switch to turn the receiver on or off.

If an outdoor or indoor antenna and ground connections are used in place of the loop antenna it is necessary to provide some means to adapt the receiver to the particular size of antenna in use. This adjustment is made by means of a small lever found just below the antenna tuning, or "sensitivity" knob. This lever may be adjusted to any one of three positions. Position No. 1 provides maximum selectivity while position No. 3 provides maximum sensitivity. Position No. 2 strikes a happy medium and will be the position at which this lever will usually be left when using an antenna of average size. When the loop antenna is used this lever is automatically cut out of the circuit.

The receiver unit is complete in itself and is shown on pages 794 and 796. It is entirely inclosed in an aluminum case, part of which has been removed in the views shown in the illustrations, to show the inner construction. This aluminum frame and case serves to shield the receiver from the loop antenna, thus preventing undesirable interaction; it also provides an absolutely rigid foundation for the inner assembly.

Care has been taken in every detail of the construction work to make everything secure so that the assembly, the

BOSCH RADIO

Armored



THE CRUISER—5 Tubes—\$100

The new Bosch Radio models are finer, more powerful, easier to operate, more beautifully incased. Built to please the radio wise purchaser, Bosch Radio upholds the judgment of those considered experts. Completely armored and shielded, the five tube Cruiser sets a new standard in performance and tuning simplicity for receivers up to double its price. It has unified control, a single station selector for most tuning and two dial advantages for "Cruising the Air."

The Amborada is an armored and shielded seven tube receiver, built on a steel chassis for rigidity and long life. Its great power and unusual ability will be a revelation to even seasoned radio veterans. Its single station selector is graduated in wave lengths, eliminating multiplicity of dials and troublesome tuning, and its clear, tonal range is from a whisper to orchestra volume. This receiver is incased in a low, handsome, early American period cabinet, with ample room for all batteries, charger and power units.

Bosch Radio offers a wide selection—five, six and seven tube receivers, two cone type reproducers, the famous NoBattery "B" Power Unit and other equipment. Hear Bosch Radio at your Bosch Radio Dealer. We will send you his name upon request.

AMERICAN BOSCH MAGNETO CORPORATION
SPRINGFIELD, MASS.

Branches: New York Chicago Detroit San Francisco

Manufactured under patent applications of the American Bosch Magneto Corporation and licensed also under applications of the Radio Frequency Laboratories, Inc.



THE AMBORADA—7 Tubes—\$310
All prices slightly higher Colorado, west and in Canada

For Power tubes

You don't have to change your set wiring



Na-Ald Connectoralds are particularly in demand for the new power tubes, UX 171, UX 112 and UX 120, which greatly increase the undistorted volume that a set will deliver. There is a Connectorald for every type of tube and set. Each type of Connectorald is equipped with cables to connect to the extra B and C batteries, necessary for power tubes. This makes it unnecessary to change the wiring of a set in any way. Except where noted, Connectoralds do not raise the tube in the socket.

Na-Ald Connectoralds

Trade Mark Reg. U. S. Pat. Office



No. 112

For UX 171 and UX 112 Tubes, Na-Ald 112 Connectoralds are recommended for maximum volume with storage battery sets. These tubes will deliver without distortion several times the volume of the regular 201A. Price \$1.50.



No. 120

For UX 120 Tubes in UV 201A sockets, the Na-Ald No. 120 Connectorald should be used. To convert a storage battery set to dry batteries with ample loud speaker volume, use a UX 120 tube in the last audio stage with the 120 Connectorald and UX 199 tubes with 419X Adapters in the other sockets. Price \$1.25.



No. 920

For the UX 120 Tube in UV 199 sockets, ample loud speaker volume without distortion is obtainable from any set equipped for UV 199 tubes by means of the UX 120 or equivalent tube, with the Na-Ald No. 920 Connectorald. The tube is raised slightly, but provides for its use in most sets with limited headroom. Price \$1.25.



No. 420

For UX 120 tubes in the UV 199 sockets of the Radiola Superheterodyne Semi-Portable and Radiola Super VIII. These excellent Superheterodynes will deliver ample volume for loud speaker operation when equipped with the UX 120 used with the Na-Ald No. 420 Connectorald. Price \$1.25.

ALDEN MFG. CO.
Dept. 317C
Springfield, Mass.



wiring and the delicate electrical balance of the receiver will remain unaffected by shipment. These precautions make it possible to balance the circuits exactly before the receiver leaves the factory, with assurance to both the manufacturer and the purchaser that no further attention will be needed in the way of adjustment.

The circuit that is employed was designed by Dr. Kolster who is well-known as the inventor of the radio compass, one of the most important aids to marine navigation ever developed.

The design of the circuit is such that it is absolutely free from oscillation because feedback has been overcome and interaction between circuits has been reduced to a minimum, without the necessity for elaborate interstage shielding.

For the most part the instruments used in the receiver unit are of special design and are manufactured in this company's own plant.

Undoubtedly most owners of one of these receivers will prefer to use the loop-antenna which is incorporated in the cabinet. This is more convenient than installing an outdoor antenna and will provide ample volume, quality, sensitivity and selectivity to meet the demands of almost any broadcast enthusiast. For the absolute maximum in sensitivity an outdoor antenna is to be preferred, of course. It need not be large, however; thirty or forty feet is sufficient. An indoor antenna of the same length may be used if preferred, and will provide greater sensitivity than the loop.

In the working test of this receiver, conducted by the author, extremely unfavorable conditions were selected in order to make the test a difficult one.

This might seem rather unfair to the manufacturer if it were not for the fact that the company's engineer who was cooperating in the tests suggested that sub-normal conditions be selected.

The receiver used in the tests was a standard, Model 8C Receiver which had previously been purchased from the regular stock of a local dealer. It was located in the basement of an apartment house in New York City and was entirely below the level of the surrounding ground. While using the loop stations were tuned in up to 800 miles distant and every one was received on the loudspeaker with ample volume to be comfortably audible anywhere in the room. Twenty-five stations were "pulled in" under these conditions in a little over an hour. This speaks most highly of the sensitivity and distance getting ability of the receiver.

Selectivity was excellent in spite of the fact that the receiver was located in close proximity to a number of powerful local stations. This was to be expected however, in view of the fact that there are five tuned circuits in the receiver.

Perhaps the outstanding features of the reception was the fine tone quality with great volume—outstanding because they are of more interest to the average receiver owner than is extreme sensitivity. The tonal reproduction was life-like and of a purity unmarred by distortion in any form. The volume was tremendous.

An idea of the volume of output of this receiver may perhaps best be conveyed by the statement that, even under the adverse conditions described above, it was necessary to cut down the volume on reception from stations as much as 500 miles away.

YOUR OWN BUSINESS Without Capital

Right now, there is an opportunity in your locality to profitably devote your spare time or all your time to a pleasant, easy and profitable business—one that does not require any training or capital.

The publishers of POPULAR RADIO offer you an opportunity to become their local representative to take care of expiring subscriptions and new subscriptions for POPULAR RADIO and three other popular magazines that they publish.

SALARY AND COMMISSION

All material will be furnished you free of charge and you will be paid an attractive commission and salary.

Mail coupon for full particulars.

POPULAR RADIO, Dept. 126,
627 W. 43rd St., New York City.

Send me full particulars regarding your salary and commission offer to local representatives.

Name.....

Address.....

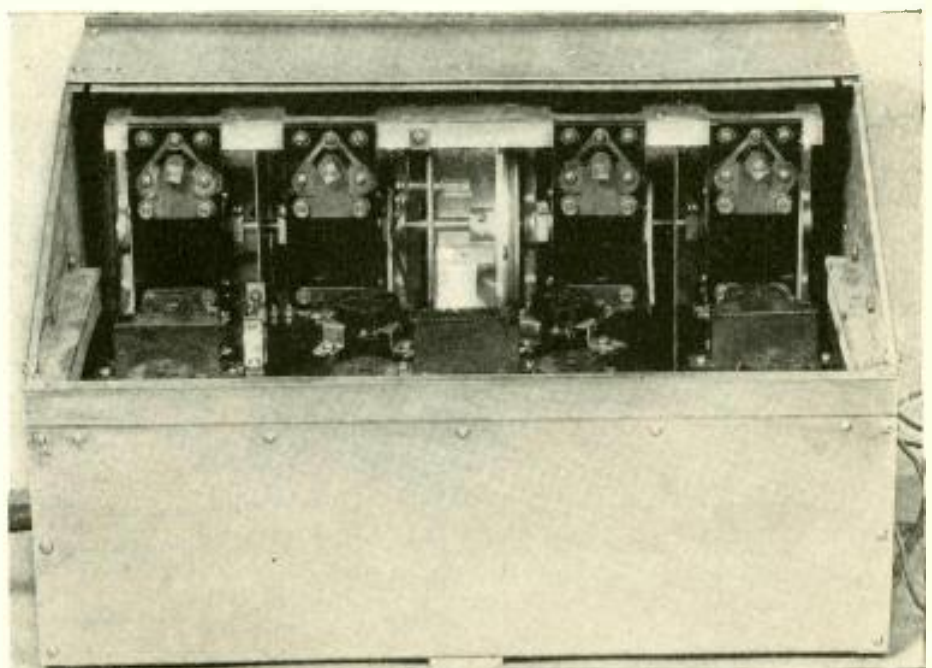

NOTE THE COMPLETE EXTERNAL SHIELDING

The strong metal box which completely encloses the receiver (one section has been removed) serves the double purpose of protecting the instruments and of shielding the receiver from interaction with the loop antenna.

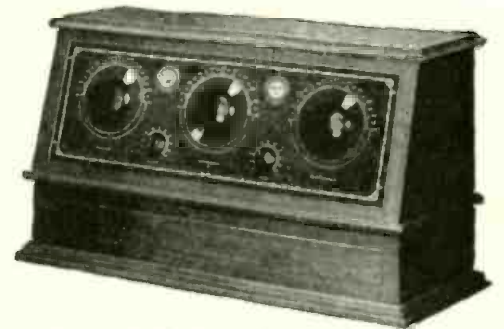
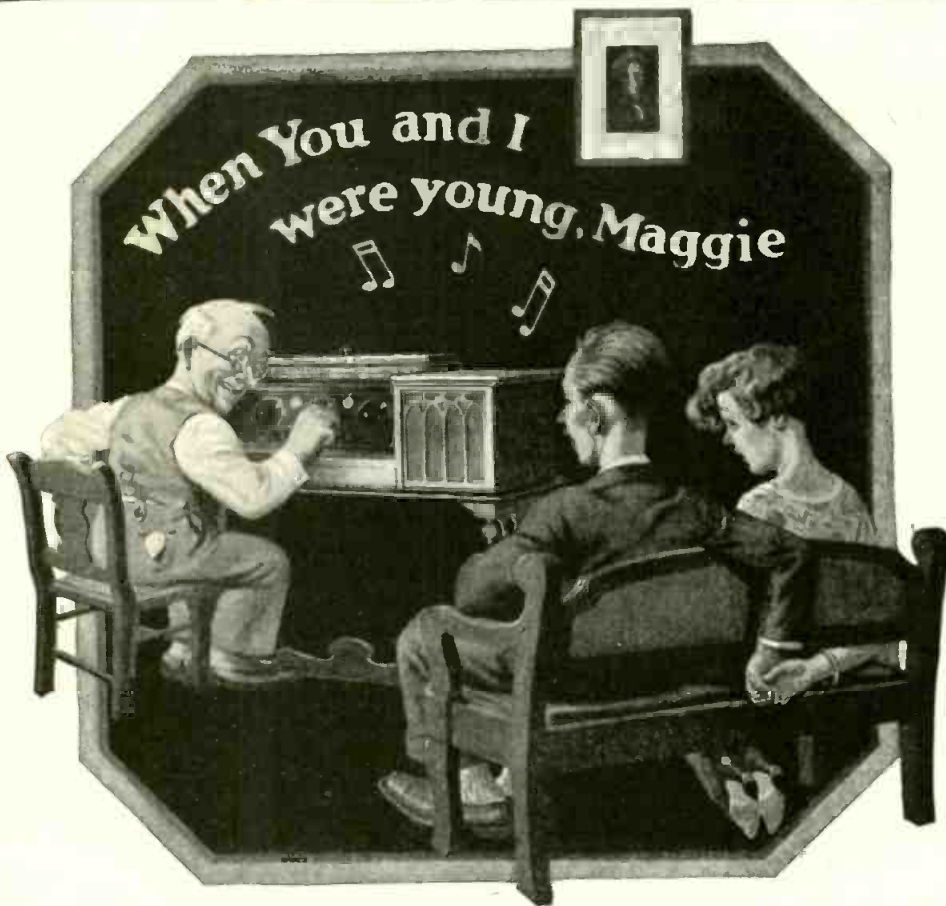

\$132.50 F. O. B. Chicago. Ozarka Senior 5 Tube Model complete with Loud Speaker and all accessories. Also built in a 7 Tube Model



\$100 F. O. B. Chicago. Ozarka Junior 5 Tube Model complete with built-in speaker and all accessories.



\$215 F. O. B. Chicago. Ozarka Console 5 Tube Model, solid walnut cabinet, complete with all accessories. Also built in a 7 Tube Model

Many Are Being Fooled in Radio By Believing Service Unnecessary

ANY radio, no matter what its price may be, nor who makes it, will only be as satisfactory as the trained service behind it.

In buying a radio there are a number of important things to consider—

APPEARANCE—

TONE—

VOLUME—

DISTANCE—

EASE OF TUNING—

and last but far the most important—SERVICE.

Tone and Volume can very easily be determined by listening. The only real way to prove distance and ease of tuning is by operating the instrument yourself, but the quality of service must be determined only by careful investigation.

Far too often it seems customary to claim that radio service is unnecessary. For four years this company has been building a factory trained service organization until today it consists of 4364 men who know Ozarka instruments in every detail. These men have been trained directly under Ozarka Engineers, the men who originated and developed Ozarka Instruments.

You'll find it well worth your time to investigate this organization before you decide on your radio. A trained Ozarka service man is near you—why not discuss this matter with him?

When anyone tells you that radio service is not necessary, think it over, your own good sense will tell you differently. You have a right to receive from your radio consistent operation, night after night and year after year—the right service by a service man who knows how, will guarantee you that lasting satisfaction you are entitled to.

The claim that service will not be necessary is the poorest type of salesmanship—it only leads to dissatisfaction later—far too often it is used to cover up the fact that the seller is not in a position to deliver service.

In the past, the selling of radio instruments has depended largely on having stock on hand to deliver—in the rush to buy very few paid any attention to what service could be delivered in case any little trouble came up.

Today, service in radio is not only being recognized and demanded but people who know, go even farther and demand—service by factory trained men.

You would never consider letting any all round mechanic repair your car—then treat your radio in exactly the same manner. Demand not only service but the service of men who know—the day of the radio wizard who knows all radio instruments is gone—the factory trained service man has taken his place.

We have a few Openings for the Right Men

WHILE there are today 4364 Ozarka representatives, some territory is still open. We want men who believe in the future of radio—men who are tired of working for some one else—men who would like to add to their present income by devoting their evenings to Ozarka.

At the start you can keep your present position. Later on, after you have proven what you can do, then you will give us all your time because it will pay far more than your present position.

The man we want may not have much money but he is not broke. He has lived in his community for some time—he has a reputation that his word is good. He may not have made any startling success but he has never "put over something" just to make money. He may know nothing about radio or salesmanship but he will be successful if he is willing to study what we are willing to teach him, without cost.

The field in radio is wide open for the trained man. The success of the 4364 Ozarka representatives proves what men can do. If you are interested, ask for a copy of the Ozarka Plan, a 100 page book which tells a true story of how big money and a permanent business can be built in radio. It is a story of life; of why some men fail while others succeed. This book has shown many men how to start making extra money immediately and within a very short time establish a business of their own.

OZARKA

INCORPORATED

120 W. Austin Avenue D

CHICAGO, ILL.

ASK... ANY... RADIO... ENGINEER



The Crowning Adventure of Burgess Radio Batteries

*They Flew Over the North
Pole with Byrd*

ON May 9, history was made
... American history ...
World history ... undying history.

Lieut. Commander Byrd, in his
fearless 1500-mile flight across the
top of the world, adds another
thrilling triumph to the long, proud
list of American achievements.

Radio went along, for radio has
become vital to the lives and
success of explorers and adven-
turers. Burgess Batteries went
along, sharing the fate—sharing
the hardships and the glory of
Commander Byrd, the Detroit
Artic Expedition, and Capt.
Donald MacMillan.

It is eminently significant that in these
glorious triumphs of American courage and
American equipment where the test of men
and their tools was the test of the survival of
the fittest, that the standard products of the
Burgess Battery Company were selected,
used and "carried on" under extreme and
unprecedented conditions.

BURGESS BATTERY COMPANY

GENERAL SALES OFFICES: CHICAGO

Canadian Factories and Offices:
Niagara Falls and Winnipeg

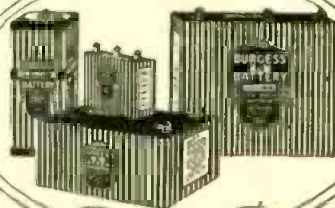

BURGESS RADIO BATTERIES

The YES and NO MAN

ALMA.—Yes, the *Atwater-Kent* programs will be continued this winter. * * * *Frances Alda, Lucrezia Bori, Madame Schumann-Heink, Frieda Hempel, Josef Hofmann, Albert Spalding, Maria Kurenko, Edward Johnson, Louise Homer, Reinold Werrenrath, Margaret Matzenauer, Mary Lewis, Rosa Ponselle and Charles Hackett* are signed for "appearance," and WEAF, WEEI, WSAI, WRC, WCCO, WTAG, KSD and WWJ are to be in each hook-up. * * * We're going to have some A1 programs according to the almanac.

JOSEPH B.—You evidently heard one of the General Electric short-wave experimental stations operating; the G. E. Co. have fifteen experimental licenses; 2XAW, 2XO, 2XAF, 2XAD, 2XAH, 2XI, 2XAK, 2XAZ, 2XAG, 2XAH, 2X1, 2XAM and 2XAE. * * * They are named in order of their wavelengths which run from 3 to 110 meters.

EDWARD M. B.—It was *Harold A. Loging* who broadcast the Indian folk songs from KOA. * * * So you want more baritone solos! My dear fellow, we'd give you *anything* but more baritone singing; baritones are nearly as plentiful as sopranos and sopranos, if anyone should ask you, are nearly as plentiful, and surely as pestiferous, as seven-year locusts. * * * We really ought to give you a good bawling out.

BAMBO.—You want to present a loving cup from the listeners of American to *Norman Brokenshire*. * * * Sure we're wild about the idea—crazy about it. We'll send you a couple of lead nickels. * * * (We wish we owned a hotel with a thousand rooms in it and could find you dead in each room.)

HARRY L.—*Fern Van Bramer* is the harpist who plays with *Lyon and Healy* at WGN. * * * We have heard nothing about *MacNamee* going to WSAI; its news to us. * * * Wouldn't it be terrible if WEAF lost him!

A.W.—*Kathleen Stewart* is now only a microphone name; *Miss Stewart* was married over six months back. * * * Yes, she did concert work before she joined WEAF'S staff. * * * She lives at Palisades, N. Y. and has the living room of her cottage papered with applause cards.

LITTLE BEN.—We don't know who is doing the announcing at WHN; they come and go at WHN. * * * *Edward S. Breck* is the piano accompanist at WOR.

* * * *Chest Beebe* plays the organ through WOR on Tuesday and Friday. * * * My, you listeners who don't watch for the announcement of names cause us a lot of trouble.

HALLY.—*Mary Lewis* has signed up with *Charles Dillingham* according to late reports. * * * *Graham MacNamee* used to be a music teacher before he crashed radio. * * * How do we get our information? Oh, we just gossip and write hundreds of letters to the publicity men at the studios.



PERY ADAMS, JR.—*Charlie Wellman* is an announcer at KFWB (Los Angeles); here's his photo. * * * Yes, *Mary Lewis* will broadcast again some time this winter; it will probably be through the WEAF-WJZ chain.

CHARLES I.—We don't usually give the verses of songs heard over the radio but you're so ingratiating that you almost disarmed us.

ALLEN D.—*August Werner* of the New York Edison Hours is a Norseman; he used to sing under *Riesensfeld* at the Rivoli, New York City. * * * How do we know all of this stuff? Oh, we're just an old gossip.

MABLE.—Why don't we have more jazz? *Why don't we have more jazz?* * * * Don't come to us with such a question; we'd give anyone ten years in Sing Sing for that request. * * * Jazz is an industry not an art.

MYRTLE AND MAZZIE.—So you sing just like the *Walton Sisters* do you? Well, that's no recommendation to us. * * * We hate baby talk in close-harmony. * * * If you *must* broadcast, try WBAL, in your own town—but don't ask us to listen.

JUST A LISTENER.—*Judge, Jr.* (WJZ) composes most of his own stuff. He wrote a play once called "The Brown Derby." * * * It was exposed to Broadway for one night only.

ELMER HAINES.—*Blande de Costa* is the soprano in the program of the Pro Musica Society (KOA). * * * Let's take the negro spirituals off the air? * * * All right, let's. But how are we going to do it?

Contrast the clumsy dials of only two years back . . . with the handsome illuminated controls MAR-CO makes today. Here is another good reason for building your set yourself!



Now dials give place ~ to glowing spots of light

- PICTURE a soft, subdued light in the room . . .
- ✓ ✓ your set in the corner ~ with glowing spots of light illuminating its swiftly readable *back panel* scales.
 - ✓ ✓ this is radio at its handsomest . . .
 - ✓ ✓ this is the panel arrangement ✓ the type of skillful tuning ✓ that distinguishes the 1927 trend in set construction.

Already, these new MAR-CO controls are specified or optional equipment in a score of this season's most advanced circuits. At once, they have become the standard in tuning control design. Use them, in whatever set you build, to give the final touch of style, and the utmost in precision control. MAR-CO controls are easy to install. The steel template pro-

vided reduces panel-drilling to the simple, fool-proof operation illustrated below. The original MAR-CO "friction-drive"—the action that makes backlash impossible—has been strengthened, to accommodate gang condensers. The MAZDA lamp supplied runs on your "A" battery, using only .1 ampere. The switch that controls this lamp may also be used as your filament switch, the lighted scales then serve as pilots. Scales read 0 to 100, or 100 to 0, as preferred. Price, including template, bulb, and bezel, \$3.50. Replacement bulbs, \$.20. Write today for the booklet that illustrates 15 standard makes of condensers mounted on MAR-CO back-panel controls. Martin-Copeland Company, Providence, R. I. Branch offices and representatives in principal cities.

—used in the LC-27

Prominent among the advanced circuit designs which call for MAR-CO controls, is the "LC-27"

MAR-CO *Illuminated* Controls

Here's how you drill the panel..



Screw Template to panel.



Drill holes through Template



Remove window opening



Bezel covers rough edge

that's ALL you CAN'T go wrong!

Chosen by EXPERTS

GLENN H. BROWNING, Laurence M. Cockaday, Gerald M. Best and many other eminent radio designers use the Lynch Metallized Resistor in their experimental circuits and receivers. These men know radio; they have laboratory and testing equipment with which quickly to make accurate comparisons. There could be no better proof of the true merit of the Lynch Metallized Resistor than the endorsement of these experts.

Comprising a concentrated metallized deposit one-thousandth of an inch thick upon a rigid core, sealed forever within a glass tube, the Lynch Metallized Resistor gives *conductive, non-arcing* resistance that remains silent, accurate!

Dealers—Write us!

ARTHUR H. LYNCH, Inc.
Fisk Bldg., Broadway & 57th Street
New York, N.Y.

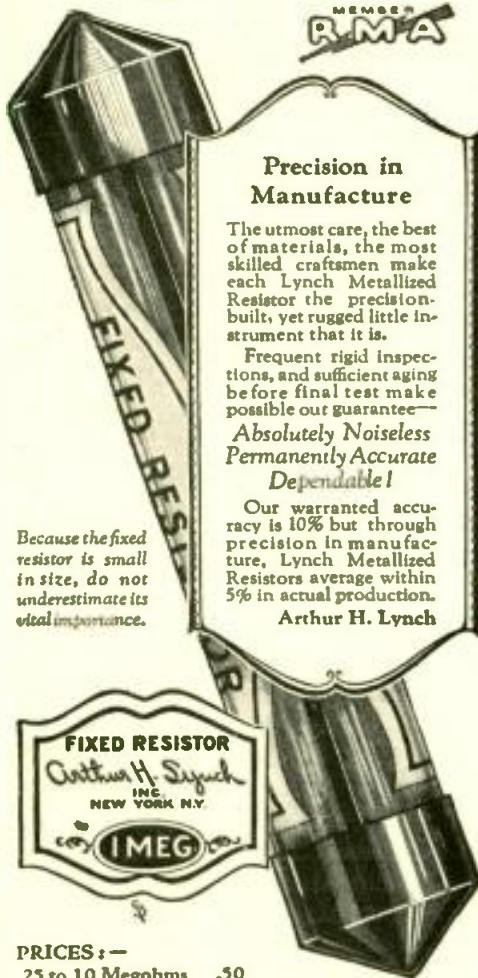

Precision in Manufacture

The utmost care, the best of materials, the most skilled craftsmen make each Lynch Metallized Resistor the precision-built, yet rugged little instrument that it is.

Frequent rigid inspections, and sufficient aging before final test make possible our guarantee—
Absolutely Noiseless Permanently Accurate Dependable!

Our warranted accuracy is 10% but through precision in manufacture, Lynch Metallized Resistors average within 5% in actual production.
Arthur H. Lynch

Because the fixed resistor is small in size, do not underestimate its vital importance.

FIXED RESISTOR
Arthur H. Lynch
INC.
NEW YORK, N.Y.
IMEG

PRICES:—

.25 to 10 Megohms	.50	Single Mounting	.35
above .01 to .24	.75	Double	.50
.001 to .01	\$1.00		

Lynch Metallized Resistors cost no more than the ordinary kind. If your dealer cannot supply you it will be well worth your while to wait for the mail—we ship post-paid, at once.

LYNCH METALLIZED FIXED RESISTORS

S. WENTWORTH.—Broadcasting stations do not pay for the use of new, unpublished songs.

BIG BOY.—No station that we know of specializes in poetry. * * * N.T.G. (WHN) used to throw a poetry fit occasionally; he shattered the diaphragms of at least four microphones with "Boots" and "Dangerous Dan McGrew."

HARRY M.C.—Franz Lehar wrote "The Merry Widow," not *Rudolf Friml*; excerpts from this have often been broadcast.

HINKY-DINK.—You're getting to be a regular customer. * * * How do you get a job in a studio? Well, that depends upon what you can do and how much you want for doing it. * * * If you can do a lot and want a little, you might get a job.

BELLE OF BELLPORT.—"Major" Andrew White is just as he sounds over the air, "regular." * * * He lives in New York City and is president of a radio concern. * * * We don't think that there is a more perfectly human announcer on the air—and, as you know, we're awfully fussy about announcers.

WRITER MAN.—Yours is an interesting letter. * * * WMCA gives a complete financial service, following the tape closely each day. * * * Yes, there is a great deal of room for improvement in program presentation.



G. H. WHITEHEAD.—K. K. at WGR (Buffalo) are the initials of Mr. Kenneth Kickett the announcer at that studio. He was formerly a research worker in the Eastman Kodak Laboratories at Rochester.

HARRY L.B.—One of the "Two Guitars" at WGBS is said to be a Russian prince traveling *incognito*; the other of the two is Serge Krotkoff, formerly a performer at Maxima's Cafe in Constantinople. * * * This sounds like publicity applesauce to these old ears. * * * Langston Hughes is the negro poet you are thinking of; he was "found" by Vachel Lindsay, while a bus-boy at a Washington hotel. * * * His work has been read over several stations.

ROBERT D.—Charles D. Isaacson is the impresario of WRNY; he was formerly musical critic of the *Evening Mail*. * * * So you are a Brokenshire fan. * * * Well, well! * * * Don't try to work up our enthusiasm; we eat men like Brokenshire.

SUPER-MAN.—Vee Lounhurst was not named after a real estate development; she is now playing at WMCA in the Hardman Hour. * * * So's your Aunt Jemima.



See that screw
A SCREW DRIVER ADJUSTS AN X-L IN CROWDED PLACES
X-L VARIO DENSER

Improved Browning-Drake Hookup

Indorsed by leading radio authorities

Model "N" A slight turn obtains correct tube oscillation on all tuned radio frequency circuits. Neutrodyne, Roberts two tube Browning-Drake, McMurdo Silver's Knockout, etc., capacity range 1/4 to 20-micro-micro farads. Price \$1.00.

Model "G" with grid clips obtains the proper grid capacity on Cockaday circuits, filter and intermediate frequency tuning in heterodyne and positive grid bias in all sets. Capacity range:

Model G-1—	.00002 to .0001 MFD
Model G-5—	.0001 to .0005 MFD
Model G-10—	.0003 to .001 MFD
	Price \$1.50

X-L PUSH POST

Push it down with your thumb, insert wire, remove pressure and wire is firmly held. Releases instantly. Price 15c.



Push Post Panel permanently marked in white on black insulating panel in box including soldering lugs, raising bushings and screws for mounting, etc. Price, \$1.50



X-L Radio Laboratories 2422 Lincoln Ave. CHICAGO, ILL.

AUDIO FREE AMPLIFICATION

The four types thoroughly explained in a fully illustrated booklet 9"x12". This booklet will be sent to you absolutely FREE if you will send me six cents in stamps to cover cost of handling and postage.

W. McMANN
DEPT. PR
64 CHURCH STREET
NEW YORK CITY

30 DAYS FREE IN YOUR HOME

Tested and approved by all of Radio's Highest Authorities



Send Coupon for Amazing Special Offer!

NOTE: This offer is made to prospective buyers by famous big Radio Corporation, one of America's oldest reliable manufacturers of fine sets—seventh successful year. Many satisfied users in every state. Postal or coupon brings testimony of nearby users and proof Miraco's outperform sets costing up to 4 times as much. Very easy to install and operate.

BEAUTIFUL-BIG-POWERFUL Ultra Selective **MIRACO** Ultra

Retail \$ **49.75** LIST Price now only **49.75** GET SPECIAL OFFER One year GUARANTEE

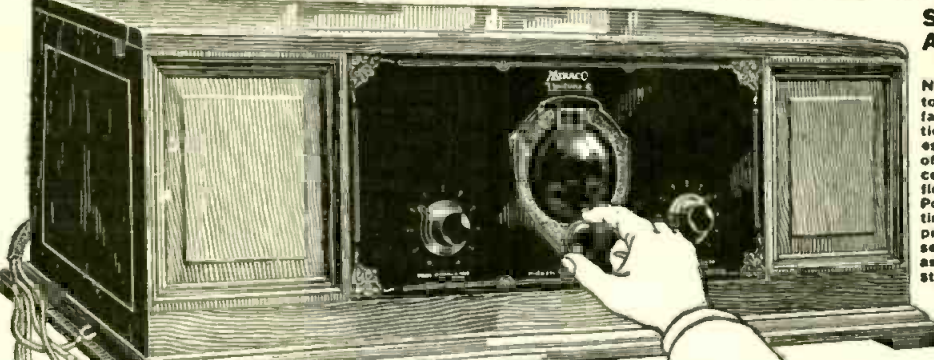

Built like—to look like—and perform like \$200 sets

Real Single Dial Control! Magnificent Big Powerful Miraco "Unitune-5" Get Special Offer and Amazing Low Price!

The celebrated Miraco Ultra-5—U.S. Navy type circuit, has also been adapted to Single Dial Tuning—without sacrifice of selectivity, volume, clearness, power, tone, or distance getting qualities! In the magnificent big Miraco Unitune-5, above shown, you turn one vernier knob for stations everywhere. Beautiful hand-rubbed, piano hinged, solid walnut cabinet, 28 in. long, 15 in. deep, 10 in. high. Sloping Bakelite panel is walnut finished to match. Also offered on 30 days free trial!

Coast to Coast and Foreign Reception Certified by Miraco users

MIRACO RADIO GETS EM COAST TO COAST

Notice! Enormous sales of the fine Receiver (resulting from delighted users so highly endorsing the set) again enable us to add hosts of costly new features, latest refinements and up-to-the-minute improvements such as you might expect to find only on much higher priced sets. Miraco this year are still better—more beautiful—more selective—more powerful for less money than ever before.

USER-AGENTS WANTED -- WRITE!

Reports from users everywhere leave little for us to add. These are only a few of the many in our files and which we receive daily. Send coupon for plenty of additional proof and testimony of nearby users.

HAS NO EQUAL FOR TONE, VOLUME, DISTANCE. North Wildwood, N.J. Miraco best packed set I ever saw shipped. Words cannot express the wonderful tone quality, volume and distance. First night received 47 stations on loudspeaker. Up to last night, the 5th day, I have received exactly 103 stations, farthest is KGO, Oakland, Calif., on loudspeaker. Also Porto Rico, Cuba and Canada. Francis H. Lee.

TONE QUALITY PLEASURES EVERYONE. Philadelphia, Pa. Everywhere that hears the Miraco is very pleased with tone, etc. Tuned in during international Test Week: KGO, Oakland, Calif.; WJ, Mexico City, Mex.; WJ, Mexico City, Mex.; WJ, Edinburgh, Scot.; also a station in Buenos Aires.

UTAH ENJOYS COAST TO COAST PROGRAMS. Heber City, Utah. The Miraco sure can't be beat at any price. Coast to coast it sure does and more. I have had stations in New York and Cuba in the east and scores of other stations on the west coast. I have logged up to date 150 stations and they all come in wonderfully. Monte Giles.

MIRACOWINS AGAINST 3 OTHER MAKES. Pearland, Texas. I tried three other makes and the Miraco is the best of them all. Received KFI, Los Angeles, Calif., on loudspeaker. O. H. Richards.

COAST TO COAST LOUD AND CLEAR. Guthrie, Minn. We logged over 30 stations and got over 1500 miles on the loud speaker the first night—our first experience tuning radio. The thing that night we got WJAX Jacksonville, Florida and KFI Los Angeles, Calif., on the loudspeaker. Neighbors say Miraco is the best they have ever heard. O. R. Wolf.

MIRACO BEATS A SUPER EIGHT. Cobalt, Ontario, Canada. Miraco is one of the best radios in all the north country. There is a man here who has a big Super eight and our Miraco best. I am proud of my \$300 SETS. Blakely, Ga. I am well pleased with my Miraco. It does better than machines that cost \$300 or more. J. D. Tison.

MOST SPECTACULAR SUPERIOR TO \$120.00 SET. Santa Cruz, California. I do not hesitate to show my friends the "Miraco Superior" over my (name) another set costing \$120.00. The Miraco is the most selective set I have seen yet and cuts out the jumble stations on the low wave lengths in 1 1/2 points. Wm. Schuetz.

MELLOW TONE -- LOUD AND CLEAR. Indian River City, Fla. A wonder set. Am having splendid results. I have had Miraco four nights and have stations on my list from Cuba to New York, Chicago, Denver, Texas, all complete in loud, mellow in tone and clear. I have one sold already and did not even try. Mr. H. G. Duff.

REFUSED TO TRADE IT FOR EXPENSIVE SET. Prosper, Ore. Over 31 stations brought in first night on loud speaker. I ordered the Miraco for a friend and he is more than pleased. I offered to trade it for a more expensive set but he refused and it has the name of the best set in the community. M. E. Milton.

PENNSYLVANIA BEGINNER GETS EM ALL OVER. Corry, Pa. Have had Miraco one month today and have received over 115 stations from all parts of the United States, Canada, Cuba, Mexico, etc. I think this is pretty good for a beginner. I had my experience before. Clarence Drugfelder.

LIKES IT BETTER THAN \$150 -- \$250 SETS. Westville, Ill. Miraco sure is a wonderful set. I get the stations easily without noise—that's one of the things I like about the Miraco. I've had three other sets that have ranged from \$150 to \$250 each but Miraco beats them all. My friends all like the Miraco. I have had stations all over the U.S.A. I tune in Mexico City and Havana, Cuba any time there are no air. Alex. Binder.

BEATS COSTLIER SETS WITH MORE TUBES. Lexington, O. I have given Miraco a thorough try out and find it to do all you claim. 85 stations logged so far, getting new ones every week. This list includes coast to coast, Canadian, Cuban and Mexican stations. The selectivity is remarkable. Others here in town have more expensive and elaborate sets with more tubes but do not ever do this. Fuller Temple.

MIRACO OUTPERFORMS THEM ALL. St. Francis, Kansas. I've heard a lot of radios but the Miraco is best all around. I am proud of my \$300 SETS. Comes in fine and clear. No noise. Get lots of distant stations. Sure am satisfied. Orvey Sharpe.

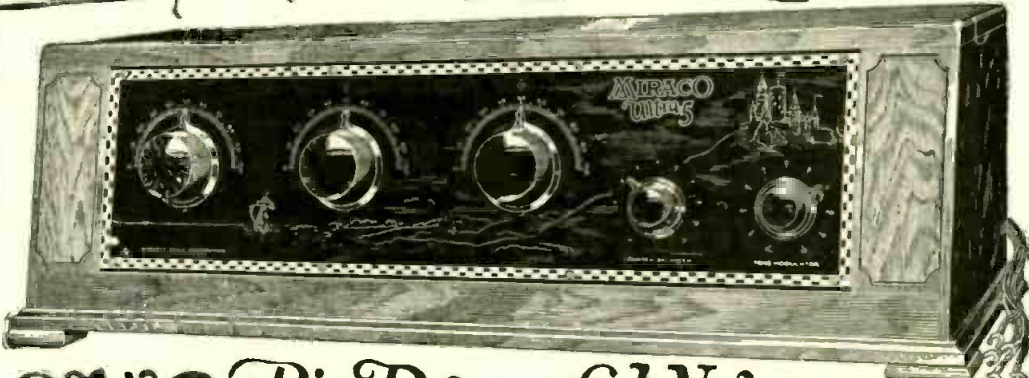

Big Powerful New Unitune 5 MIRACO ultra 5

Solid Walnut Cabinet 28 in. long 27 in. long
TRADE MARK REGISTERED
ULTRA-SELECTIVE LONG DISTANCE 5 TUBE SETS EASY ON BATTERIES

Unless Trial Proves Your Miraco the Most Selective, Clearest Toned, and Most Powerful Distance Getter—Don't Buy it!

No need to wear out expensive batteries burning 6, 7 or 8 tubes when users everywhere are reporting that the big latest Miraco 5-tube sets actually are unsurpassed (even at much higher prices) for razor-edge selectivity, extreme long distance reception, clear natural tone and powerful loud speaker volume combined with great economy in use of battery current! Enjoy a powerful Miraco 30 days in your home—at our risk—and be convinced! Your verdict final—absolutely no strings to this. Save or make a lot of money on sets and accessories this season by sending IMMEDIATELY for our Amazing Special Offer! Deal Direct with a Big Reliable Corporation Remember this offer is made direct to you by a big responsible manufacturing corporation—one of the oldest and most successful set-builders in the industry—a concern which has grown to immense size thru recommendations of its many thousands of satisfied customers who bought after trial.

Our Factory Prices Save You Up to One-Half We deal direct by mail with users, agents and dealers, thereby effecting great savings which are reflected in amazingly low prices. Everything we sell is high-grade. Don't confuse Miraco's with small, cheap sets. You'll be Proud of Your Miraco

In its big, handsome, expensive-looking solid walnut cabinet with sloping front, you'll be proud to have friends examine and hear your Miraco. In construction, appearance and performance, every inch a high-priced set. Handsomely gold illustrated genuine Bakelite front panel and genuine Bakelite knobs—finished in grained walnut. Finest parts obtainable—the kind used in \$200 sets. Bakelite sub-panel. Many exclusive features. Each Miraco reaches you completely assembled, rigidly tested, splendidly packed and factory guaranteed for one year. Easy to install and operate—full instructions supplied. Send NOW for testimony of nearby users and Amazing Offer!

What a \$3,000,000 Federal Reserve Bank Says:
"For years the Midwest Radio Corporation of this city have been very satisfactory customers of this Bank, one of the largest in Southern Ohio. The Midwest organization was one of the very first to engage in the manufacture of radio sets, and to us their success is evidenced by the sound and steady expansion of their business which we have observed year after year. We are personally acquainted with all officers of the Corporation and from experience know them to be men of honor, integrity and ability. We consider them to be both morally and financially responsible. They have a reputation for fair and square dealings." THE PROVIDENT SAVINGS BANK & TRUST CO. Member Federal Reserve System. Capital and Surplus over \$3,000,000.

Midwest Radio Corporation Pioneer Set Builders 7th Successful Year Cincinnati, O.
All the Proof you want is waiting for You!

Coupon or postal brings reports from hosts of users in your vicinity and elsewhere proving that Miraco sets at rock-bottom money-saving factory prices, outperform sets costing up to four times as much. You can also buy speakers, tubes, batteries, etc., at big savings from us! Get our proposition before spending money elsewhere.

Send coupon for Amazing Special Offer!

MIDWEST RADIO CORPORATION
Pioneer Builders of Sets
Cincinnati, O.
479-R Miraco Building
Without obligation, send free literature, testimony of users, AMAZING SPECIAL OFFER and full particulars of your big money-saving factory-price proposition on Guaranteed Miraco sets and all radio supplies. () Agent () User () Dealer

NAME _____
ADDRESS _____



The Brach- CONTROLIT

A WORTH-WHILE GIFT

RADIO devotees will be glad to get a Brach Controlit on Christmas morning. Controlit is new. It's novel. It's different. It is something that will add enormously to the enjoyment of radio.

Adding a Controlit to any set eliminates ALL switches from "B" Battery Substitute and Trickle Charger and places complete automatic control of set and power supply in one switch — the SET SWITCH itself.

It is the gift of gifts to owners of radio sets.

It should go with every new set at Christmas time.

Price \$6 — in U. S. A.

BRACH Lightning Arrester



No aerial should be without the protection to radio and home which a Brach Lightning Arrester affords. Good sense demands this protection. The authorities require it. Every Brach Arrester carries with it a \$100 insurance guarantee.

Prices as low as \$1

The New Brach TOTEM-POLE ANTENNA

Here is an aerial antenna that gives most complete reception and unusual clarity to radio. It is the size of a small flag pole, can be readily attached to roof or side or window ledge of house and does away with all unsightly makeshifts.

Totem-Pole Antenna with 100 feet wound wire and fasteners, complete for

Only \$10



Drip-Proof HYDROMETER

To the Hydrometer with the famous Chaslyn Balls is combined the Drip-proof feature which insures full protection against battery acid falling on and injuring parquet floors, rugs or clothing.

After testing battery, the Hydrometer can be washed without danger from dripping acid.

Something nice to present to a radio fan or to buy for your own use.

Price \$1



Brach Radio Products

L. S. BRACH MFG. CO., Newark, N. J.

L. S. BRACH OF CANADA, Ltd., Toronto, Can.

BUTTERFLY.—*Carolyn Andrews* is now back in the Capitol gang. * * * Yes, she is easily the most perfect soprano on the air; she is also the mother of a baby girl. * * * Do we expect to be in the Hall of Fame? Why certainly; why not?

JAMES BOWLES.—"Raindrop" was a fantasia presented by KNOX (St. Louis) on September 21, 1926. * * * *Mr. Gurewicz*, the saxophonist, "appeared" at WOR; *Sousa* once said that he was the greatest player of this instrument in America. * * * However, we're shouting for *Rudy Weedoff*.

HUCKLEBERRY.—We have tried to trace *Jack Donley* for you but our Intelligence Department has been unable to locate him; sorry. * * * Anything else we can do for you? * * * Yeah, we smoke cigars.

JOHNNY.—*Rudolph Puletz* played the French horn solo from WGBS on the night of September 21st; we did not hear him, but a French horn solo does not seem exciting to us. * * * It is said that this man comes from a family of French horn players. * * * We come from a family of poker players.

THOMAS BURNS.—We don't know who plays WGN's "phantom violin" and we care less; it's cheap publicity, to our way of thinking. * * * *Kelley Smith* is the studio director of WBBM. * * * Is *Mac-Namee* going to stay with the National Broadcasting Co.? * * * We presume so. Why should he leave?

CICERO.—The *Do-Re-Mi-Double Quartette* sings from KMOX. * * * If you think announcers are detrimental to programs, you're thinking straight. * * * That makes you a very dear friend of ours as N.T.G. might say if he had the chance.

JEROME J. J.—*Al Santoro* is the regular sports announcer of station KGO. Were we ever an announcer? My heavens, do we sound like one? * * * That's a very dangerous question to ask this department.

CRANKY.—KGO's play "The Trick" was written by *Mrs. Rudolph Coffee*, a Californian. * * * *Kay Renayne* sings "blue" songs from WBBM regularly. We are no great consumer of "blue" songs, we can tell you that. * * * Don't write nasty things about *Keith McLeod*! Some dark night you'll get tapped on the head with a piece of lead pipe; that's how much we think of *McLeod*.

JULES BERNIE.—*Estelle Wentworth* was the dramatic soprano singing from WPG Atlantic City. * * * She was the prima donna with San Carlos Opera Co.

N.Y.C. ANNOUNCER.—Do we ever tire of dishing out raspberries to the announcers? * * * We don't dish out raspberries to the announcers; we hide them and deal out gentle admonishments, but that is all. * * * Really, we're not nearly as vicious as we may sound.

CARL VAN BRUEN.—What made you think that *Carolyn Andrews* was *Mrs. Davia Mendoza*? * * * You're wrong. * * * *Lady Baltimore* (WBAL) is another "radio mystery."



Velvet Brings Joy Wherever You Are!...

Velvet Radio Speakers bring a definite contribution to Radio reproduction in more than mere beauty—for the rich vibrant tones are natural as life itself—It's "just as if you were there!"

MOST any Speaker brings something of Radio's joy—but until you have really heard a "Jewel Case" with its resonant tonal beauty, tonal completeness, naturalness, you have missed the fullest joy! There are so many claims in Radio we cannot ask you to believe our words—just believe your own ears when you listen to recreations of music, speaking, or singing so natural and satisfying you scarcely realize the living authors are miles away. That is Radio joy!



A rich musical background for the tinkling pleasantries of the card game—with the "Jewel Case". It's a musical instrument—supreme in tonal beauty and power—but it is, as well, a rarely beautiful piece of handicraft.

You'll find a delightful surprise in store—when first you hear the "Jewel Case"—or any Velvet Radio Speakers.

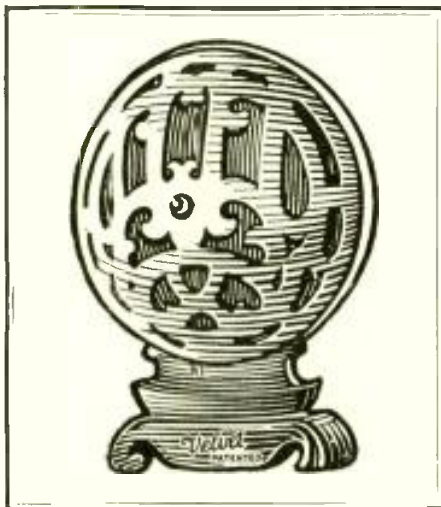

No. 18 \$27.50
"The Chinese Cone-Flex"

For Christmas

What more appropriate gift can you conceive—what more lasting pleasure can you give a loved one—than the joy to the eye and delight to the ear which the Velvet "Jewel Case", of all Radio Speakers, brings in superlative measure!

Ask your Dealer!

Sales Department
The Zinke Co.
1323 S. Michigan Ave.
Chicago, Ill.



No. 21
"The Jewel Case"

Words nor picture can fully reveal to you the soul of this instrument supreme—for it is as a living thing—so natural are its tone recreations.

Manufactured by
The Borkman Radio Corp.,
Salt Lake City, Utah
Kalamazoo, Mich.

Choose Velvet Radio Speakers



RMA



An
amazing
Special
Offer!

Free—A Log Book
with Every Set of
"Aristocrat"
Vernier Port Dials



THE Aristocrat Vernier Port Dial is the finest tuning, finest looking dial on the market—the finest dial that men and machinery can build. Yet, despite its incomparable quality and superior advantages, the Aristocrat costs no more than ordinary vernier dials.

Vernier ratio is 14 to 1—fine enough to bring in countless stations that you've never heard before. All mechanism and shaft ends are concealed. No gears, chains or cogs to backlash, wear out or get out of order. Easily installed—in but a few minutes. The famous Kurz-Kasch Split Bushing fits all condenser shafts—aligns rite, holds tite!

To acquaint you with this new superior dial we are making a special limited FREE Offer. With every set of

three Aristocrat Vernier Port Dials, your dealer will give you an up-to-date Log Book of 48 pages (worth \$1). It is bound in beautiful, two-toned MoCoTan Leather, embossed. Lists every station in the country using power of 250 watts or more. All the important foreign stations listed. Indexed by wave lengths, call letters and location. You must see this Log Book—only then can you appreciate how valuable it is.

Remember, the Aristocrat Vernier Port Dial is supplied in three finishes—black with white markings and mahogany or walnut with gold markings—at the same low price—\$2. It is sold at all the better dealers. If your's cannot supply you, tell us about it.

THE KURZ-KASCH COMPANY, DAYTON, OHIO

Moulders of Plastics

OFFICES: New York, Chicago, San Francisco, Los Angeles, Portland, Spokane, Denver, Toronto

KURZ  **KASCH**
Aristocrat Dials and Knobs

Wanted—A Radio Humorist

(Continued from page 768)

He is a good radio comedian; in fact, there is none better. And much of his success is due to this very element of spontaneity, and also to the fact that his jokes and comments are upon events and happenings fresh in the public mind. His comments are not the dead wood that so many entertainers pass out as humor. And also he has the ability to make his whimsical personality carry over the radio; he can transmit it and stands as alive before the people with the headphones as he does before a Follies audience, or before the diners at a banquet. Another factor in his favor is that he talks slowly and every word carries.

Many a comedian has failed in broadcasting for the reason that he has talked too fast. It would not be too fast before an audience which could see his facial expression and his illuminating gestures, but when these helps have to be imagined the talk is so fast that only a part of it is understood.

Irvin S. Cobb goes well over the radio, and one of the things which adds much to his particular brand of entertainment is the little chuckle he indulges in when telling a story. The story is funny to him and he so completely loses himself in it that he has to chuckle as he goes along, and this feeling of enjoyment is in turn imparted to his listeners. And again he tells mostly negro stories and he delivers the dialect so well that this, coupled with the fact, as explained above, that a negro story is the best kind of story to tell over the radio, makes him an outstanding radio success.

It is interesting to note in this particular that Judge, Junior, is growing in popularity as a radio humorist. He appears over WJZ and has a bright chatter concerning the latest on Broadway and its current attractions. At first, people thought that he was inspired by advertising, but now they are beginning to discover that he has nothing to sell and that he merely talks about what interests him. So he is coming to take his place among the popular entertainers. Judge, Junior, himself was a former vaudeville performer, but is no longer in vaudeville. He has a trained speaking voice and knows how to get his effects. He is one of the few variety artists who is a success over the radio.

It is particularly hard to get humor on the part of announcers at any of the larger radio stations, for the reason that the announcers are required to write out in advance what they are going to say and then must keep to the text. In this way they are not able to add anything personal or impromptu. In the smaller stations the announcers are allowed more freedom and can improvise and add to the entertainment by

Sign off to sweet dreams



You enjoy radio like a gentleman—if you can get the best out of your set and forget all worry and bother. That's your happy frame of mind when you keep your batteries full of pep with a Rectigon. The most absent-minded dial twister snaps on a Rectigon without a qualm. What if you do tune in while you're still charging your battery? There's no harm done, not the slightest. What if the current does go wrong in the dead of night? Your batteries will not be discharged with a Rectigon attached.

when you keep power in your set with

The Westinghouse Rectigon Battery Charger

©, 1926, W. E. & M. Co.

No noise as it charges—not a bit of fuss. Not even a murmur that would disturb the mildest slumber.



No acids, no chemicals—no moving parts—nothing to spill or burn. No muss, no worry. You'll have no spoiled rugs, no ruined clothing.



Saves its cost in short order—Count the dollars spent in a few trips to the service station and you'll hotfoot it for a Rectigon, for the good it does your pocketbook as well as your batteries.



Snaps on in an instant—Just plug into the light socket, snap on the terminals. Saves service station bother. Spares interruptions caused by absent batteries.



Charges both "A" and "B" batteries—Keeps both packed with power. Bulb is used for "B" battery charging and it is enclosed, like all other parts, in metal, safe from accident. (Rectigon charges automobile batteries, too.)



No Storage Battery Radio
is Complete
Without a Rectigon



THE RECTIGON is a superb Westinghouse product. Things you *can't* see, like extra heavy insulation, things you *can* see, like the durably enameled case—all are of highest quality. Westinghouse also manufactures a complete line of radio instruments, and Micarta panels and tubes.

WESTINGHOUSE ELECTRIC & MANUFACTURING CO.
Tune in on KDKA - KYW - WBZ - KFKX

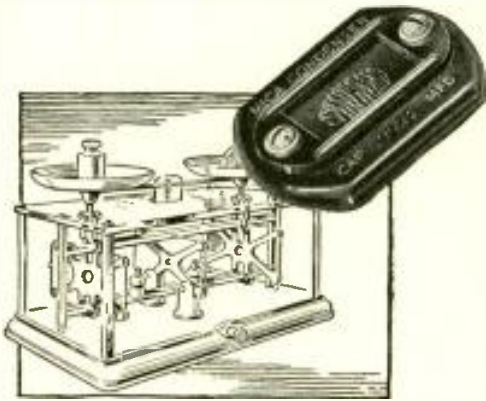

“Weighs out right capacity as accurately as the apothecary weighs out a precious drug.”

A. C. L.

TECHNICAL men were quick to appreciate Sangamo condensers in intermediate capacities. One engineer, well known to readers of radio publications—Austin C. Lescarbours—sends us the following characteristic comment, which is published with his consent:

“In my laboratory we develop new circuits and variations of old circuits, publishing the results in radio magazines. Needless to say, we are using and specifying Sangamo condensers throughout. In my opinion there is no other fixed condenser that can compare with the Sangamo in accuracy, permanent capacity value, neatness and handiness.

“The Sangamo condenser weighs out just the right capacity as the apothecary weighs out a precious drug.”

SANGAMO

Mica Condensers

are made in 34 sizes, ranging from 0.00004 mfd. to 0.012 mfd. Sangamo Wound Condensers are ready in capacities from 1/10 mfd. to 4 mfd.; Series A guaranteed for continuous operation at 250 volts AC, 400 volts DC; Series B guaranteed at 500 volts AC, 1000 volts DC; also 12 and 14 mfd. blocks.



Sangamo Electric Company

6332-10

Springfield, Illinois

RADIO DIVISION, 50 Church Street, New York

SALES OFFICES—PRINCIPAL CITIES

making wisecracks of their own. The larger stations are not in favor of it, as the stations wish to be bigger than any employee, and if the announcer has any element of popularity he is apt to become bigger in the eyes of the public than is the station itself—and then he wants more money and the corporation can't see anything funny about that.

A small station in New York has a rough and ready announcer who is steadily gaining fame and popularity. There is nothing subtle about him—merely rough, bubbling humor, but he is funny. Rarely does he ever introduce a speaker or an entertainer without getting a laugh out of his audience; and so popular is he that often he is bigger than the person he introduces. But a large station, with all the rules that a corporation hedges around its announcers, would not keep him. Just about the time he got to be popular, the corporation would send him on his way, but it is he who makes the small station very popular. He is one of the real radio humorists of the country.

And so we might close this article with an imaginary advertisement in the help wanted department of a newspaper:

WANTED—A RADIO HUMORIST

We are greatly in need at once of a number of good radio humorists, male or female. Applicants must be able to make people laugh without hurting anybody's feelings. Steady employment, good salary and short hours. Don't wait to write—apply by wire.

BROADCASTING DIVISION
ANY RADIO CORPORATION

Changes in the List of Broadcasting Stations in the U. S.

These corrections and additions to the list which was published in the March, 1926, issue of POPULAR RADIO (together with the changes which have been published in succeeding months) make the list correct as of November 1, 1926. Further changes will be published each month in this magazine.

STATIONS ADDED

KGCX	Vida, Montana	240.0
KGDE	Barrett, Minnesota	232.4
KSEI	Pocatello, Idaho	260.7
KXRO	Seattle, Washington	240.0
WBMS	North Bergen, New Jersey	223.7
WBRL	Tilton, New Hampshire	365.0
WDXL	Detroit, Michigan	296.9
WEDC	Chicago, Illinois	422.3
WJUG	New York, New York	516.9
WKBQ	New York, New York	285.0
WKBR	Auburn, New York	225.0
WKBV	Brookville, Indiana	238.1
WOBB	Chicago, Illinois	552.0
WOCB	Orlando, Florida	
WKBS	Galesburg, Illinois	361.2
WTRC	New York, New York	239.9

CHANGES IN CALL LETTERS

WBDC	Grand Rapids, Mich.	change to	WASH
------	---------------------	-----------	------

CHANGES IN WAVELENGTHS

KFOB	Fort Worth, Tex., 263	change to	508.2
KFWC	San Bernardino, Cal., 211.1	change to	291.1
KFWI	San Francisco, Cal., 226	change to	249.9
KFWM	Oakland, Cal., 206.8	change to	315.6
WCSH	Portland, Me., 256	change to	499.7
WEMC	Berrien Springs, Mich., 285.5	change to	315.6
WGES	Chicago, Ill., 249.9	change to	315.6
WJBV	Woodhaven, N. Y., 460.9	change to	288.3
WJBW	New Orleans, La., 340.7	change to	270.1
WLWL	New York, N. Y., 288.3	change to	384.4
WRNY	New York, N. Y., 374.8	change to	373.8

CHANGES IN LOCATIONS

KFOW	North Bend, Wash.	change to	Seattle Wash.
KFWI	South San Francisco, Cal.,	change to	San Francisco, Cal.

A Novel and Efficient Detector Receiver for Home .: Office .: Hotel

THE TALKING BOOK

Brings a new story every night



Complete Radio Receiver

Pair of standard Ear Phones, Aerial and Ground Leads, Indoor Antenna, Self-contained in attractive book. Connected in a second. It runs for a lifetime. No trouble—No overhead.

Equipped with New CELERUNDUM RECTIFIER

No battery required
Tone Quality unequalled

Price \$3.50

With Ear Phones \$6.00

Live Distributors Wanted

Manufactured & Guaranteed by

THE LISTEN-IN CO.

115 Federal St.

Boston, Mass.

Wonderful Volume with Clearness AMPL-TONE



\$3.00

Phonograph makers have spent years perfecting the acoustic properties of their phonographs. Use an AMPL-TONE Unit and make a real Loud Speaker in an instant or use it in your horn and get better results.

After all, speakers are as good as their unit. We make a real unit at a real price. Money gladly returned if you are not entirely satisfied.

We make units for other manufacturers.

The UNION FABRIC CO.
DERBY, CONN.

Makers of the Excellent French AMPL-TONE Headset

Please send me an AMPL-TONE Unit for which I enclose \$3.00.

Name.....

Address.....

State.....

The Salt on the Tail of the Broadcast Frequency

(Continued from page 775)

this being the lowest frequency recognizable as a musical note. As 16 cycles is only 0.016 kc, this error would be extremely small. Although this test utilized a fundamental frequency of the quartz plate, it was found that there was no blanketing effect from the transmitting set sufficient to affect the operation of the piezo oscillator except when the oscillator was placed close to the control board. Since in this test a fundamental frequency of the piezo oscillator was used instead of a harmonic, the beat note was much louder than that previously obtained.

From these tests of the piezo oscillator one may predict that if their use becomes general in broadcasting stations, all interference occasioned by beat notes between carrier waves of stations of different frequency assignments will be eliminated. This idea is based on the fact that no two stations could ever deviate in frequency to such an extent that their frequency difference would be appreciably less than 10 kilocycles, a frequency which is entirely too high to produce an objectionable beat note in the phones of receiving sets. Of course a broadcasting station equipped with piezo oscillator apparatus directly connected in its transmitting circuit so that the frequency is automatically controlled is even a step further toward the elimination of interference. However, this application of the piezo oscillator is expensive; it requires partially rewiring the transmitting circuit. On the other hand, the use of the piezo oscillator as a separate device costs no more than a well constructed frequency meter, and if the transmitting circuit is well designed, as indeed all transmitting circuits should be, so there are no sudden variations in frequency, it is merely necessary for the station operator to listen in the phones of the piezo oscillator at occasional intervals and make slight readjustments in the transmitting set demanded by the piezo oscillator.

The applications of the piezo oscillator described herein utilize the faculty of hearing. It should be quite possible to add other apparatus to the piezo oscillator so that a variation in frequency from the transmitting circuit will, instead of producing a change in beat note, cause a movement of a needle across a scale. Thus the individual

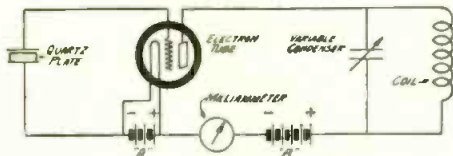

A PIEZO OSCILLATOR

FIGURE 4: This schematic diagram shows the quartz plate in the circuit of a vacuum-tube oscillator for generating alternating current oscillations on a standard frequency.



Make Your Set Safe With a Belden Fused Radio Battery Cord

FOR a perfect Radio Christmas, protect the new tubes and batteries, and also avoid fire hazard from crossed wires by hooking up your set with a Belden Fused Radio Battery Cord.

The tiny A and B battery fuses, concealed in the little two-piece bakelite shell, can be easily inspected.

This handy cord also improves the appearance of the set and eliminates all loose wires.

For maximum range and volume, ask your dealer for a Beldenamerial Aerial. It cannot corrode, even after years of service, and requires no cleaning.

Ask your dealer for a Belden Fused Radio Battery Cord.

Belden Manufacturing Co.
2316A S. Western Ave., Chicago, Illinois



This is a Radio Christmas

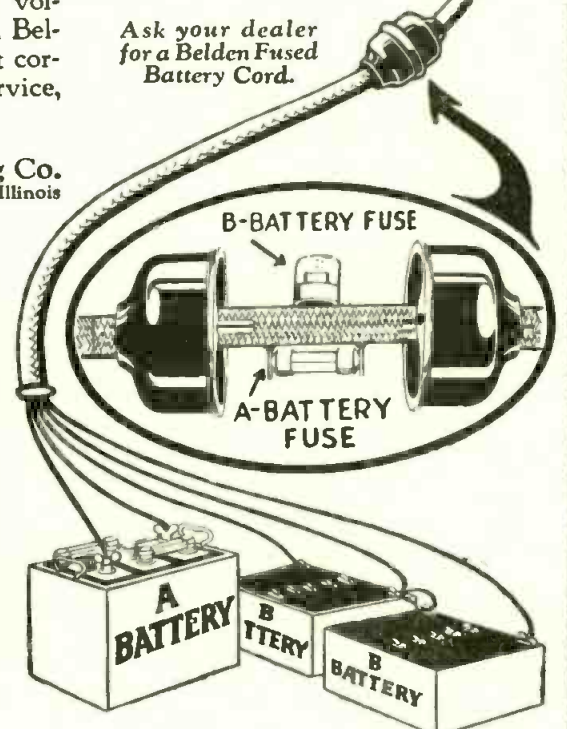

Q·R·S REDTOP Radio Tubes are Better



Super Detector
\$5.00

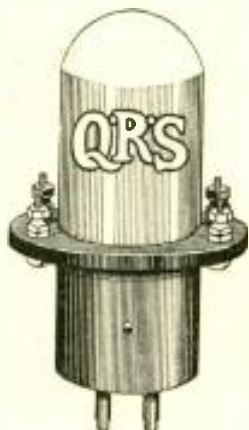

Power Tube
\$5.00



201A Type
\$2.00

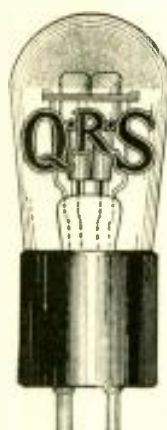

Full Wave
Rectifying Tube
\$6.00

EVERY TUBE ABSOLUTELY GUARANTEED

You Will Never Really Hear Your Radio Set Until You Use a Q·R·S Redtop Super Detector

The Q·R·S Redtop Super Detector Tube is without a doubt the most wonderful detector tube made—with a 25% greater volume and a tone quality in a class by itself.

American Radio Relay League operator Knaack of Station 9 U Y says of it "I hear stations I never heard before—it gives as much signal strength as a regular detector tube and one stage of amplification."

We have many such testimonials.

The Q·R·S Redtop Power Tube will supply a large volume of undistorted output to your loud speaker; combining the double grid—filament and plate features with our new Power Tube design.

Illustrated literature mailed without charge.

The Q·R·S Music Company
306 South Wabash Ave.
Chicago, Illinois

Factories at: CHICAGO NEW YORK SAN FRANCISCO
TORONTO, CANADA SYDNEY, AUSTRALIA

preference of the station operator could be satisfied. Also it may be mentioned that some operators prefer to have a beat note of a certain frequency produced in the phones of the oscillator when the transmitting circuit is properly adjusted, while others may prefer zero beat. As shown by the experiments, either of these requirements can be met readily and the accuracy of either is more than actually needed. In case the beat note method is used, then it may be desirable to match this beat note against that obtained from a tuning fork of known frequency.

The advantages of the piezo oscillator as a means of checking the frequency of a broadcasting station are peculiar to this piece of apparatus. Perhaps the most important advantage is that of constancy of calibration. The frequencies of the piezo oscillator as determined by the dimensions of the quartz plate are not affected by changes in inductance and capacity of the circuit; it is merely necessary that these quantities be of certain approximate values in order to secure a fixed frequency from the quartz plate. Depending upon the approximate values of inductance and capacity, the quartz plate will either give one of the fixed frequencies or it will refuse to function at all. The frequencies of the quartz plate will vary slightly with temperature, but for the use described in this article such changes are entirely too small to be considered.

Another advantage of the piezo oscillator is that, unlike a frequency meter or frequency indicator, it is unaffected by power variations in the transmitting set, which occur in both code transmitting stations and broadcasting stations. In broadcasting stations these power variations are caused by the voice or music modulations. The pitch of the beat note heard in the phones of the piezo oscillator is affected only by shifting frequency in the transmitting circuit, and although sounds due to modulation may be heard in the phones, such sounds are not loud and have no effect upon the frequency of the beat note. In conclusion, it may be said that nothing short of actual mechanical injury to the quartz plate will cause a change in its frequency sufficient to affect its usefulness in a transmitting station.

"Man, you ain' gettin' no distance a-tall, is you?"

"Say, brown gal, heah dat whistlin'?' 'Ems de Canary Islands!"

—Princeton Tiger.

* * *

Here lie the remains of a radio fan
Now mourned by his many relations,
He filled up his gas tank while smoking his pipe
And was picked up by twenty-one stations.

—Exchange

Note the Difference

Two tubes in one bulb—
Consumes no more current

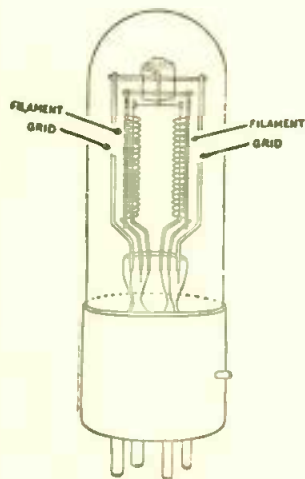
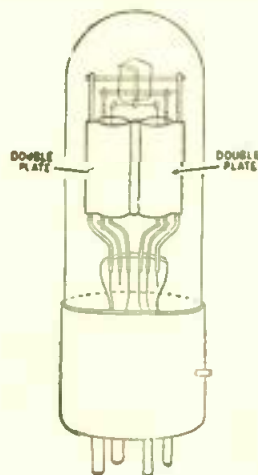

Clearer Reception—Better
Tone Quality

You will never know how
good your set is until you
use better tubes

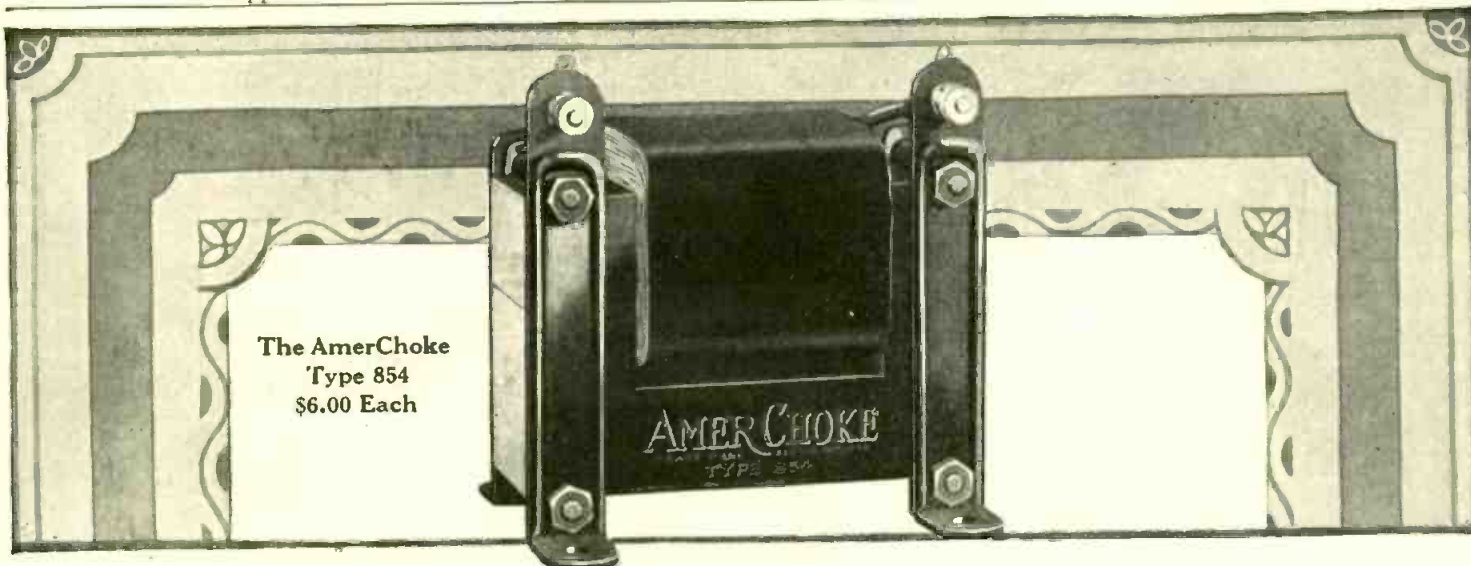

AMERTRAN RADIO PRODUCTS

A RELIABLE CHOKE for FILTER CIRCUITS

The AmerChoke Type 854 is a choke coil or impedance designed primarily for use in filter circuits. As an output impedance with a fixed condenser it forms an ideal filter for the loudspeaker, insuring tone quality equal to the average output transformer. And it will be *more* economical. For filter circuits in "B" Eliminators, the AmerChoke will give perfect results due to its scientific design and generous proportions.

To obtain even, quiet current supply use the AmerChoke and the AmerTran Power Transformer (described at the left) in the construction of your power amplifier.

The AmerChoke type 854 has a no-load inductance of approximately 100 henrys at 60 cycles with average close butt joints. Magnetic saturation from direct current is prevented by two butt joints in the iron core. The AmerChoke shipping weight is about 5 pounds and the price \$6.00 each FOB Newark, N. J., or at any Authorized AmerTran Dealer.

AMERICAN TRANSFORMER COMPANY

178 Emmet Street, Newark, N. J.

"Transformer builders for over twenty-five years"

AmerTran Power Transformer Type PF-52

Type PF-52 is intended for use in the power supply developments. It will convert the standard 110 volt, 60 cycle alternating house lighting current to a higher voltage for the plate and low voltages for filament supply. \$18.00 each.

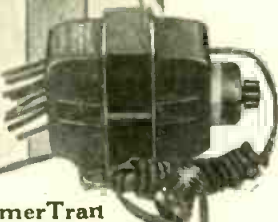

The AmerTran De Luxe Audio Transformer

This new transformer sets an entirely new standard of Audio Amplification. It makes possible a transformer coupled amplifier that excels all other forms of amplifiers. Made in two types for first and second stages. Price—\$10.00 each

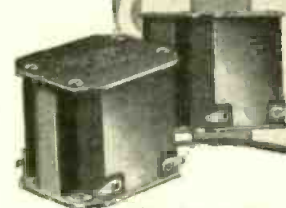

Other AmerTran Products:

AmerTran Resistor Type 400 — \$7.50.
AmerTran Heater Transformer Type H-28 (for A. C. Tubes)—\$10.00.

We shall be very glad to send you upon request a copy of our booklet "Improving the Audio Amplifier" together with other interesting and constructional data.

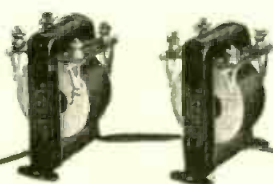

AmerTran Types AF-7 and AF-6

AmerTran Audio Transformers, types AF-7 and AF-6, have been considered for years among the leaders in audio amplification. These popular and efficient models are made in two types—AF-7 (ratio 3 1/2:1)—AF-6 (ratio 5:1) \$5.00 each.



Noiseless!

HAS your receiver become a miniature Babel of strange noises? Look to your grid-resistor. There lies the seat of distortion in most cases.

The Durham Metallized Resistor is scientifically built to function as noiselessly as the balloon gliding silently towards the sky. Fixed in resistance value, and temperature-proof.

500 ohms to 10,000 ohms.....	\$1.00
Above 10,000 ohms to .24 meg.....	.75
.25 meg. to 10 meg.....	.50

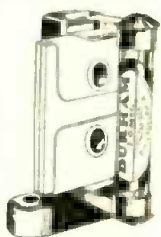

DURHAM RESISTOR MOUNTING

Made of moulded insulation of exceptionally high resistance. Has best quality, tension-spring, bronze contacts. The only upright mounting made. Occupies but little space in set.

Single mounting.....	50c
For condenser.....	65c

DURHAM METALLIZED RESISTORS

INTERNATIONAL RESISTANCE CO.

Dept. A. Perry Bldg., Philadelphia, Pa.

How to Build the LC Intermediate Power-pack

(Continued from page 782)

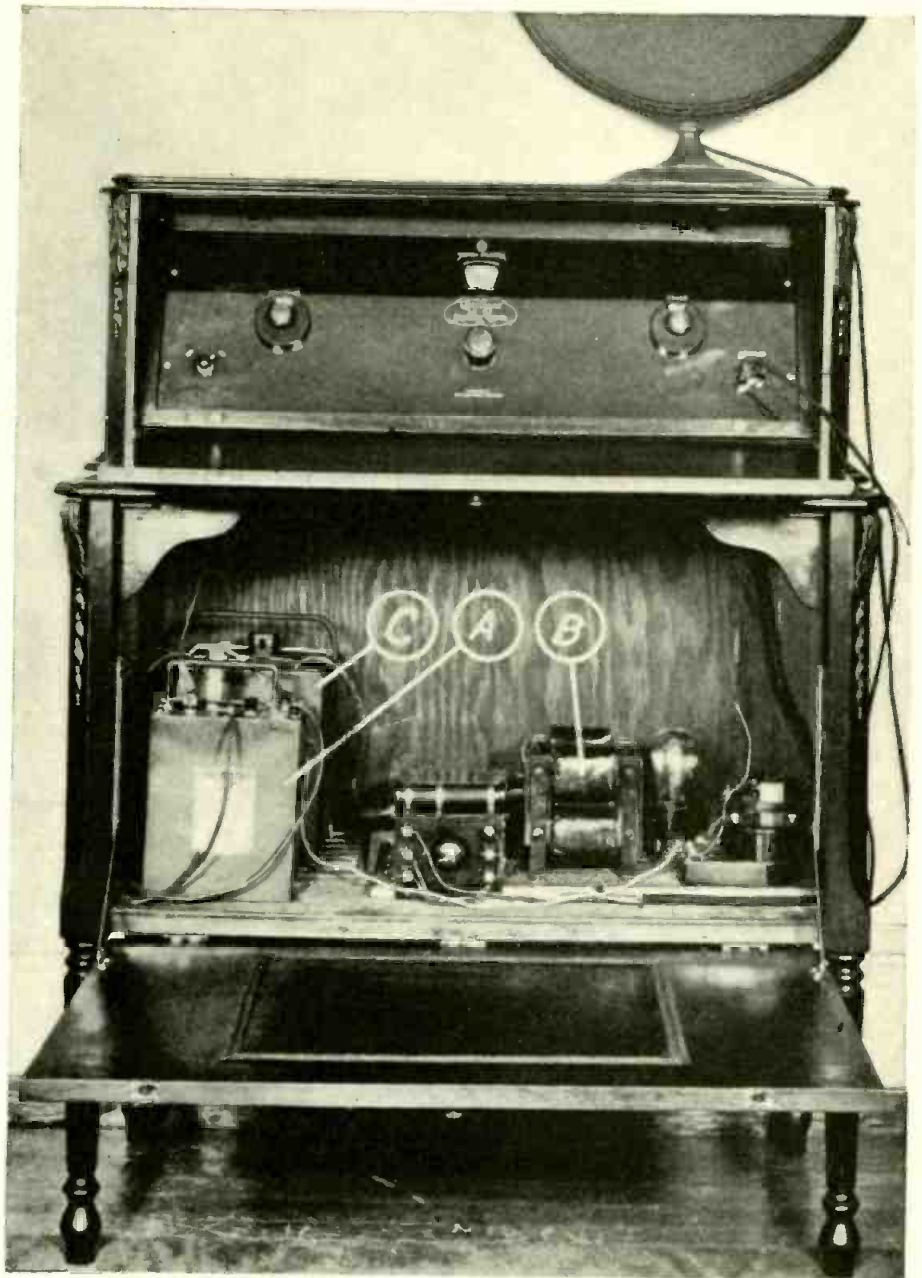

HOW THE "A" AND "B" POWER-PACKS ARE INSTALLED IN THE BLANDIN CONSOLE

FIGURE 5: In the top compartment is shown the set and in the lower compartment is shown the charger, C, and the filter unit, A, which supply the "A" power to the receiver. At the right, is shown the intermediate power-pack, B, which supplies the "B" and "C" voltages to the set.

How to Install the LC-Intermediate Power-pack with the LC-27 Broadcast Receiver

In the October issue the receiver was shown with complete installation data for use with a standard "A" battery and dry-cell "B" batteries; in the November issue the operating data was given for using the receiver totally on an alternating current supply, with a Davy "A" Power-pack and the LC-Senior Power-pack. In this present article, in Figure 1, is shown the electrical connection for the LC-27 Receiver when used with the LC-Intermediate Power-pack. For use in conjunction with these, the Balkite "A" battery charger, type H or type J, and the "A box" Filter Unit is shown as a combination "A" power unit for supplying current to the filaments of all the tubes. This will enable the operation of the set totally without batteries

as the "A," "B" and "C" voltages will be supplied from the power units.

In the illustration (Figure 5), are shown the various units installed in one of the standard Blandin Consoles with the set in the cabinet proper and the Power Units installed underneath in the battery compartment. The charger "A" is used to rectify the alternating current and to deliver it to the filter B, which extracts the hum and supplies the remaining pure direct-current to the filaments of the tubes in the set. The LC-Intermediate Power-pack is designated as (C) in this picture. It supplies the "B" and "C" power for the tubes in the set. The wiring between the power units and the set itself may be done with the special Belden power cable connector-assembly or it may be done with separate wires as illustrated in Figure

\$15⁰⁰

(West of Rockies,
\$18.00)

An astonishingly low price for this 22-inch Windsor Cone Loudspeaker mounted on sounding board and supplied with easel. Can be hung on wall or stood on table or floor.



This Amazing New Cone Speaker Hangs on Wall or Stands on Table!

NOW the radio world enjoys a new sensation—a 22-inch cone loudspeaker mounted on a sounding board and equipped with an easel back so that it can be hung on the wall, stood on a table, or placed on the floor.

And this is the famous Windsor Cone Loudspeaker that reproduces *all* the tones as they are broadcast. From the deepest throated pipes of the largest organ to the softest note of a crooning lullaby—from full volumed brass of a band playing “The Stars and Stripes Forever” to the last faint note of “Home Sweet Home” played by a master violinist—*every* tone, *every* sound is reproduced with perfect fidelity in all its beauty, just as it entered the microphone.

This wall and table model Windsor Cone Loudspeaker has no equal in value in the world of radio. When compared with the average cost of cone-type loudspeakers of even smaller size and without the sounding board and easel back, the cost of this Windsor model is amazingly low.

Dealers everywhere are showing this new radio wonder. Go to your dealer today—see and hear this marvelous loudspeaker—note its extreme utility—compare its low price with others—compare its tone—its volume—then you will have no other. If your dealer should not have one, send your name and address for complete information and prices on the entire Windsor line of Cone and Horn Loudspeakers and Loudspeaker Consoles.

Note to Dealers Write or wire today for details of the highly profitable Windsor selling franchise.

WINDSOR FURNITURE COMPANY
World's Largest Manufacturers and Originators of Loudspeaker Consoles
1414 CARROLL AVE. . . . CHICAGO, ILLINOIS
Los Angeles Branch, 917 Maple Ave.

This Windsor Cone Loudspeaker Console is equipped with a 22-inch Windsor Cone Loudspeaker. Its top is 30" x 17" and is 29" high. The battery shelf provides ample space for batteries, charger, battery eliminator and other equipment. Beautifully finished in either Mahogany or Walnut. Price only . \$29⁰⁰
(West of Rockies, \$35)

Model 200
With 22-inch Cone

In this Windsor Console is combined both the Windsor Moulded Composition Horn Loudspeaker and the 18-inch Windsor Cone Loudspeaker. The top is 30" x 17" and stands 29" high. Ample battery and equipment space is provided by large shelf in rear. Price finished in Walnut or Mahogany. \$48⁰⁰
(West of Rockies \$55)

Model 302
With Moulded Composition Horn Loudspeaker and 18-inch Cone Loudspeaker

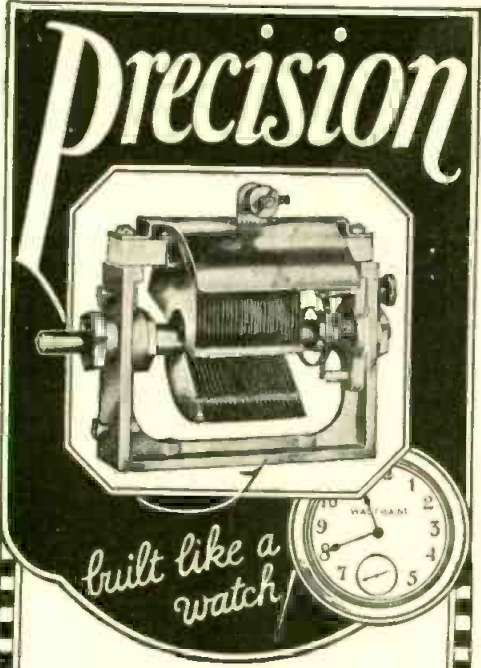

Precision

of detail, both electrically and mechanically, is what places so far ahead of the field the

Samson Uniform Frequency Condensers

Electrically this condenser has mathematically proportioned plates so that all stations are uniformly spaced. The dielectric is small and well removed from the field. The plates are small and close together avoiding losses due to fringing effects and large plate area and are plated for high surface conductivity.

Mechanically this condenser is the smallest made. It is built on a rugged frame capable of mounting in all positions with or without single-hole mounting. The rotor is of heavy construction having cone bearings on either end and should wear indefinitely without adjustment. A shield is incorporated with the condenser to protect against injury and dust.

The Samson Uniform Frequency Condenser is furnished in five sizes: Prices 500 mmf., \$7.50; 350 mmf., \$7.25; 250 mmf., \$7.00; 125 mmf., \$7.00; 75 mmf., \$7.00.

Our book "Audio Amplification"—already accepted as a manual of audio design by many radio engineers—contains much original information of greatest practical value to those interested in bettering the quality of their reproduction. Sent upon receipt of 25c.

Samson Electric Co.

Main Office
Canton, Mass.
Manufacturers
Since 1882

1. A hole should be bored through the back of the cabinet and the back of the battery compartment for running the leads between the set and the power-units; the exact connections for all of these wires is shown clearly in Figure 1.

The input wire to the relay switch should be connected in parallel with the input wire to the Balkite charger and these should be plugged directly into the 110-volt, 60-cycle power lines through a standard plug and socket arrangement.

If the set is to be used with an antenna, it should be connected as shown in heavy black lines in Figure 1. If added selectivity is required, this wire may be connected to the second post, as indicated by the dotted line. The ground connection is also shown in this same pictorial diagram. If, however, the set is to be used without an antenna, the ground should be connected to the end binding post that is ordinarily used for the antenna. Notice that the filament circuit is connected externally to the set with two wires run across to the two "A" binding posts. The wire running to the "A" (-) post includes a 1/2-ampere automatic filament control.

The loudspeaker should be inserted in the jack on the front of the panel of the set. The set is now ready for operation.

How to Operate the Set with the Intermediate Power-pack

First of all, place two UX-201-a type tubes in the first and second sockets in the receiver. Then place a UX-200-a type tube in the third socket with a UX-201-a type tube in the fourth tube socket.

Put a UX-171 type tube in the last or fifth socket. Then insert a UX-216-b type tube in the socket on the power-

LEGEND
COLORS OF TRANSFORMER LEADS
1-AND 2- YELLOW
3-AND 4- ENAMEL
5- RED
6- BLACK

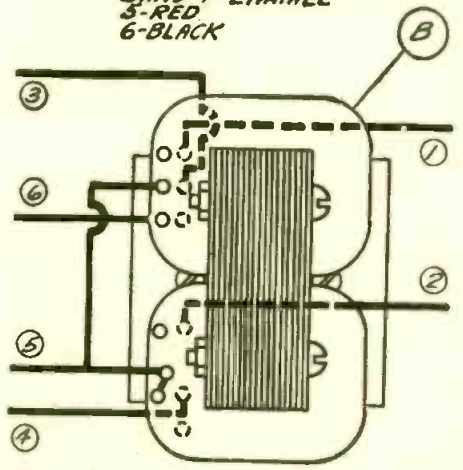

NOTE: LEADS TAKEN FROM UNDER SIDE OF TRANSFORMER ARE SHOWN DOTTED

HOW THE TRANSFORMER LEADS ARE DESIGNATED

FIGURE 6: This small drawing gives the correct information for wiring up the leads from the transformer, B, to the various other parts of the circuit. The leads are designated by color as well as by number.

pack. Be sure that the pins of the tubes are pointed in the direction of the arrows on the sockets otherwise the plate circuit may be short-circuited through the filaments.

After the "A" and "B" power-packs are connected and the plug is placed in the 110-volt light socket with the switch turned off, the set is ready to run. By merely turning the switch on the lamp socket the "A" power-pack will begin immediately to furnish current to the filaments of the tubes and this will cause the automatic relay switch A on the "B" power-pack to operate and turn on the "B" and "C" power.

Next, vary the "C" battery adjust-

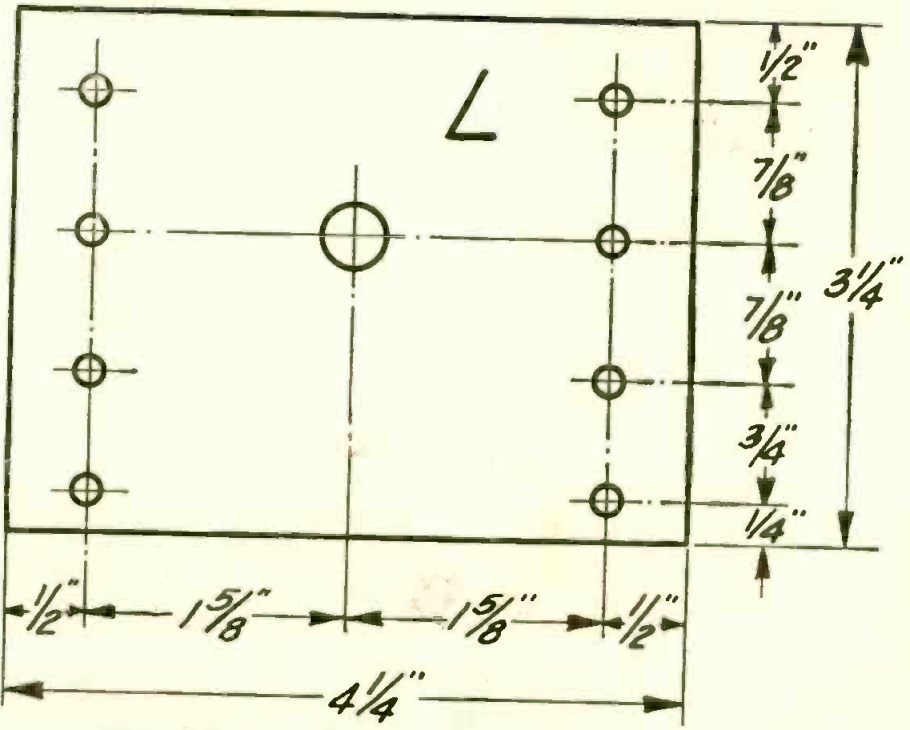

HOW THE BINDING-POST PANEL SHOULD BE MADE

FIGURE 7: This drawing gives the exact size of the small panel, L, as well as the dimensions for the drill holes for the binding posts and the "C" battery control resistance.

A Brief Study of Audio Amplification



Type 285

Audio Transformers

Under average conditions two stages of audio amplification are necessary to produce the desired loudspeaker volume.

Usually a combination of 1 to 2.7 and 1 to 6 ratio transformers proves most satisfactory, with the high ratio preferably in the last stage.

The new General Radio Type 285-D transformer has a ratio of 1 to 2.7 and has been designed specifically for use in the first stage of audio amplification following the new type 200A detector tube. Because of its high input impedance, it produces very noticeably better tone quality than is possible with other transformers having a lower input impedance.

This transformer is particularly adapted, therefore, to use in the first stage of audio amplification and gives excellent results in the second stage as well.

Type 285..... 1 to 6.... Price, \$6.00

Type 285-D... 1 to 2.7... " 6.00

Type 285-L... 1 to 2.... " 6.00

IN THE design of any amplifying device for use at audio frequencies, it should be kept in mind that the curve of voltage amplification against frequency should approximate as closely as possible a horizontal line, if true tone quality is to be preserved in the process of intensifying the audible notes.

Since the purpose of amplification is to effect a considerable increase in volume, the curve representing the character of amplification should be as high as possible as well as a straight line running in a horizontal direction.

While it is a comparatively simple task to design a transformer to have a high and even amplification curve over any narrow frequency band, it is considerably more difficult to maintain the same degree of amplification at very low and very high frequencies as in the middle of the range.

In order that a transformer may function efficiently at low frequencies, its input impedance must be high—several times the plate impedance of the tube at 100 cycles. This is accomplished in the General Radio Type 285 transformers by means of a core of large cross-section of high permeability steel and a primary coil of many turns. Proper coil design, avoiding excessive coil capacity and magnetic leakage prevents loss of notes above the middle register.

Careful laboratory measurements of all General Radio Type 285 Audio Transformers show a high and comparatively flat curve over practically the entire section of the audio range covered by the human voice and musical instruments.

It will be remembered by radio experimenters whose interest in the science dates back to the early days of broadcasting, that in 1917 the General Radio Company brought out the first closed core transformer to be sold commercially. This instrument was the type 166. It established a new and higher standard of audio frequency transformer design. Since that time the subject of amplification has been exhaustively studied in the laboratories of the General Radio Company with the result that transformer design has been constantly improved and today the General Radio Company is universally recognized as an outstanding manufacturer of quality transformers.

Ask your dealer or write for catalog 975 containing full descriptions and prices of all General Radio Parts

GENERAL RADIO CO.
Cambridge, Mass.



Type 369

Coupling Impedance

While the greater amplification that is obtained by a transformer coupled amplifier has much in its favor, slightly better quality can sometimes be obtained by the use of impedance coupling, if one is willing to dispense with the greater amplification per stage of transformer coupled amplification.

The impedance method of coupling is considerably more efficient than the use of resistances because it allows a much larger proportion of the plate voltage to be impressed on the plate of the amplifier tube.

By using a choke of sufficiently high inductance a quality of reproduction may be obtained which can not be distinguished from that obtained by the use of resistances and a larger amplification per stage produced.

Type 269 Coupling Impedance,
Price, \$5.00 ea.

GENERAL RADIO

PARTS AND ACCESSORIES

Behind the Panels of Better Built Sets

Better than ever!

The NEW

Mayolian
"B" SUPPLY

Type 612

The "B" Without a Buzz

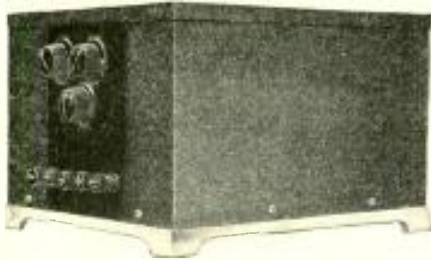

Delivers 180 Volts

**ALL VOLTAGES
ARE ADJUSTABLE**

**Complete with
Raytheon Tube**

\$42.50

A MAYOLIAN gives you, direct from your light socket, silent, dependable "B" current—at half the cost of burning a 25-watt lamp. This means greater efficiency, more volume, better tone from your receiver—and the permanent solution of all "B" battery problems.

More than four years of pioneering and intensive research have led us to the development of five types to meet the voltage and current requirements of any receiver.

Mayolian Units have earned the endorsement of the leading engineers, magazines and receiver manufacturers, because each laboratory-built Mayolian is unconditionally guaranteed for one year—provided seals remain unbroken, and installation instructions are carefully followed. Mayolian pays for itself over again every year.

*The nearest Mayolian Dealer
will demonstrate. Write us!*

**MAYOLIAN
RADIO CORPORATION**
1668 Webster Ave., New York, N. Y.

Pioneers in Battery Elimination



*The Power of Niagara—
The Quiet of an Arctic Night*

ment K, on the power-pack until the last tube in the set draws the proper plate current. This may be determined by means of a milliammeter connected in series with the plate circuit. Then, tune in a station exactly as outlined in the article in the October issue of POPULAR RADIO. When a signal is tuned in loud, make a further adjustment of the "C" battery resistance, K, until the tone quality sounds the best. When this is done the set is ready for constant use and will need no further care.

If an "A" battery is to be used with the set it may be connected in place of the "A" power-pack except that there will be no wires running from it to the 110-volt alternating-current supply.

If the constructional data in this article and in the article on the receiver in the October issue is followed closely, and if the connection diagram shown in Figure 1 at the head of this article is adhered to strictly, this intermediate power-pack will need no further attention and the set will give the right kind of service on broadcast reception with no more fuss or bother than the simple turning on and off of an electric-light socket switch.

"From Fire and Flood—"

(Continued from page 783)

following morning were sent by radio from these amateur stations. And thus the world knew of the plight of Sand Springs. The town was no longer isolated!

As it became known that a way had been opened through the flood to Sand Springs, and that young McKinney was handling messages free of charge into the stricken community, his little shack resembled a busy telegraph office. Anxious men and women wrote out messages of inquiry to parents and friends; these were dispatched quickly and directly to Halton Friend.

There wasn't much sleep for McKinney and Friend the first night. Thirty minute schedules were agreed on. First one station, then the other transmitted the accumulation of messages. Arms began to stiffen, and fingers grew numb as several thousand words passed over the keys of the operators.

After the first day, the traffic increased, and station 5GA, operated by Edward Austin, Tulsa, came to the rescue. Then another station in Sand Springs was brought into action, 5GJ, owned and operated by Howard Siegfried.

Besides messages for the local telephone company, press news for the *Tulsa Tribune* and the *Tulsa Daily World*, over 200 personal messages and 40 special reports were handled by the 5GJ and 5SR stations in Sand Springs and by 5GA in Tulsa. Instead of a half hour schedule, a ten-minute schedule was possible. Siegfried's first watch began at 7.30 P.M. the second day of

LC-27 KITS

**PARTS EXACTLY \$85.20
AS USED BY**
AUTHOR Parcel Post
Prepaid
COMPLETE WITH INSTRUCTIONS

**The SILVER
SHIELDED SIX**

COMPLETE \$95.00
SPECIFIED PARTS Parcel Post
Prepaid
WITH INSTRUCTIONS

THE NEW Hammarlund **Roberts HI-Q**

COMPLETE \$63.05
AUTHORIZED KITS Parcel Post
Prepaid
WITH INSTRUCTIONS

**SMALL DEPOSIT WITH ORDER
WILL INSURE SHIPMENT
ON DAY OF RECEIPT**

**DEALERS: Get our attractive
discounts before buying elsewhere**

RADIO MAIL ORDER HOUSE
296 BROADWAY NEW YORK CITY

Bradley-Amplifier

**Resistance-Coupled
PERFECT AUDIO AMPLIFIER**



Provides audio amplification with minimum distortion. Bradleyunit shielded resistors used in the Bradley-Amplifier do not vary with age and are not affected by atmospheric conditions. Can be used to replace transformer amplifiers in standard radio sets with decided increase in tone quality.

Allen-Bradley Co.

Electric Controlling Apparatus
276 Greenfield Avenue Milwaukee, Wis.

Bradley Leak

THE PERFECT GRID LEAK



Provides a noiseless range of grid leak resistance from 1/4 to 10 megohms. Assures most effective grid leak resistance value for all tubes. Small grid condenser (0.00025) is separate. Metal parts nickel plated. One hole mounting.

Allen-Bradley Co.

Electric Controlling Apparatus
276 Greenfield Avenue Milwaukee, Wis.

Cooper **A** Eliminator

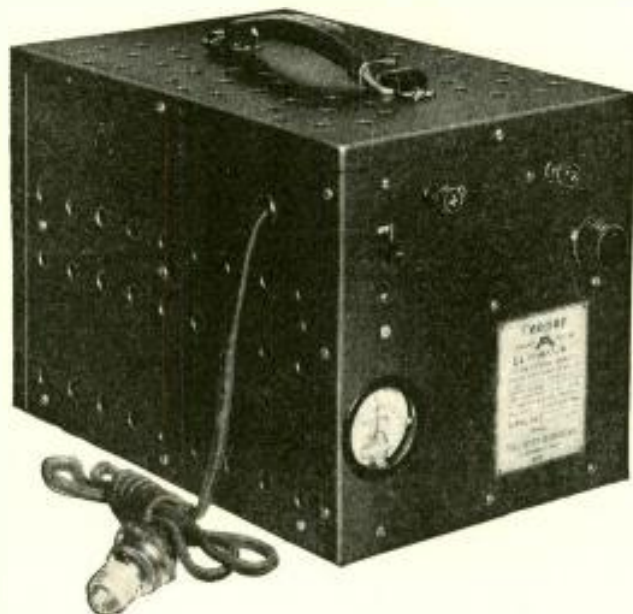

DEALERS — JOBBERS: The Cooper "A" Eliminator is entirely different from the many "A" power devices on the market. It offers tremendous sales possibilities. Limited distribution and full protection to trade outlets insure legitimate profit. Write for full particulars of our exclusive proposition.

Actually Eliminates the "A" Battery!

**Operates Any Receiver Direct from the house current!
No batteries to water—needs no attention of any kind!**

At last the storage "A" battery, with its messy watering and charging, has been totally eliminated as a radio necessity.

Now any set can be operated direct from the light socket. The Cooper "A" Eliminator actually eliminates the "A" battery—creates filament current direct from the house light-

ing system. The Cooper "A" Eliminator requires no attention of any kind—no batteries to water or bother with—no acids or liquids to replace—plug it into the light socket as you would an electric iron or toaster. A simple throw of a switch and your current is on—tumble back the switch and the current is off.

Not a Power Unit — Employs No Trickle Charger

The Cooper "A" Eliminator operates purely on a rectification and filtration principle. It delivers up to 2½ amperes of noiseless, distortionless filament current that works wonders with your receiver. The Cooper "A" Eliminator is designed to operate on any make or type of receiver using up to ten 6-volt tubes. It consumes current only while you use the set.

Send for This Free Booklet!

We have prepared a very complete folder describing the Cooper "A" Eliminator and the new principle upon which it is built. A letter or post card will bring it to you free.

Good radio dealers in most cities have the Cooper "A" Eliminator now on display. Price \$87.50 (tubes extra); slightly higher west of the Rockies.

THE COOPER CORPORATION, Radio Division, Dept. P, CINCINNATI, OHIO

Founded 1904 — Factories, Cincinnati and Findlay, Ohio

EBY SHIELDED DIAL

FOR ANY TYPE CONDENSER

Turns Clockwise and Counter-Clockwise

Completely shielded by its metallic back, this dial minimizes the effect of body capacity and improves the appearance and performance of any set. Sensitive and finely constructed, it makes accurate tuning possible and keeps the instruments set even after your hand is removed from the dial.

The Eby Shielded Dial operates any type condenser whether it turns clockwise or counter-clockwise. Graduated from 0 to 100 and from 100 to 0 with a hairline indicator and beautifully moulded black Bakelite housing.

No gears or washers to wear out. Smooth, noiseless, sensitive action obtained by an anti-backlash friction drive and non-microphonic construction. One hole mounting.

Eby Products are recommended and used in the Infradyne, Hammarlund-Roberts, Cockaday, LC 27, Browning-Drake, Victoreen, Madison-Moore, Lynch and Varion Power Units and other popular circuits.

Price, \$2.50

Made by
THE H. H. EBY MFG. CO.
4710 Stenton Ave. Philadelphia, Pa.
Manufacturers of Eby Binding Posts and Eby Sockets

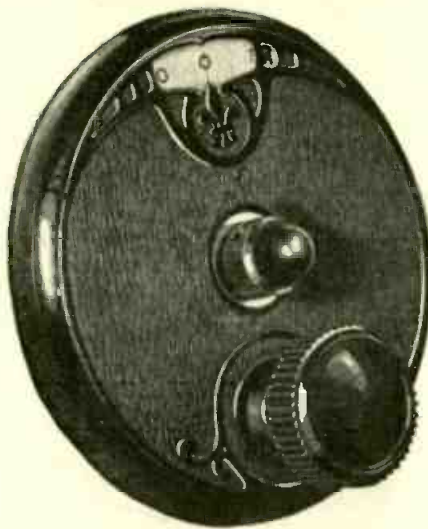

A complete metallic shield forms the back of this new dial and minimizes the effect of body capacity. When the hand is removed the set stays tuned to the station coming in when your hand was on the dial.

the flood, and he stayed at his post until 7:00 A.M. the next morning. After nearly twelve hours of continuous operating, he was relieved by Halton Friend, who continued until 6:00 P.M.: that night.

From then on, it became easier to handle the traffic that was piling up at both ends. Even then, operator Austin welcomed the assistance which J. B. Lewis (whose station 5WX was not then in operation), offered him in running his station.

Static was increasing. And added to the torment of sore muscles, was the increasing sleepiness that overcame the tired little group of doughty operators. Only now and then were they able to snatch a few hours of rest.

During the whole of the second day, messages kept on going between the two links. Static was playing havoc with the tympanums of the young operators. Apparatus was beginning to show wear under the unaccustomed pressure to which it had been subjected continuously for several days at a stretch.

First, McKinney's station began to sputter. The operator in Sand Springs grew anxious as his fellow-amateur's signals showed signs of unsteadiness; to him, it meant the loss of the threadlike connection which tied Sand Springs with Tulsa. At Tulsa, McKinney fixed up one bit of apparatus, then another, as he worked the key hour after hour.

First, the insulators sparked; then the rectifier brewed difficulties. This part of the transmitter absolutely had to be repaired and time was taken, between schedules and winks of sleep, to repair the cells individually so that they could go on with their important work of rectifying the current for the transmitter.

On the third day, the waters began to recede. One of the roads became passable, though it was in very bad condition. On the fourth day, gangmen from the Southwestern Bell Telephone Company, Western Union, and M. K. & T. were patching up wires, righting poles, and stringing lines to replace those that had carried away in the flood. Soon, line communication was re-established.

Until the 14th of June, the stations manned by the amateurs kept up their service as an auxiliary to the lines. Then, Sand Springs was back in the swing of things, drying itself out of one of the worst floods it has ever experienced. And the small group of radio amateur operators switched off their transmitters to catch up with lost sleep.

For this service in alleviating human suffering and saving human life, the Committee of Awards has conferred upon five radio amateurs—Raymond V. Kinney, Halton H. Friend, Edward Austin, Howard Siegfried and John Lewis—the POPULAR RADIO Medal for Conspicuous Service.

Attention Dealers

Send for our 200 page catalog



The finest and largest exclusive Radio Catalog in the United States

Schneitter Radio Company

Dept. C

St. Joseph :: Missouri

"used in the LC-27"

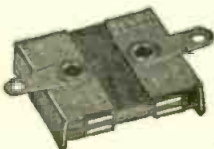

AEROVOX

"Built Better"

FIXED CONDENSERS
are Specified in

- | | |
|-------------------------|---------------------|
| LC-27 | by L. M. Cockaday |
| Diamond of the Air | " Herman Bernard |
| To be announced soon(?) | " John Rider |
| Raytheon "B" Eliminator | " Raytheon Mfg. Co. |
| Ultradyn | " R. E. Lacault |
| To be announced soon(?) | " R. E. Lacault |

AEROVOX fixed condensers have been approved by M. I. T. and Yale Universities.

AEROVOX WIRELESS CORP.
489-491-493 Broome Street
New York

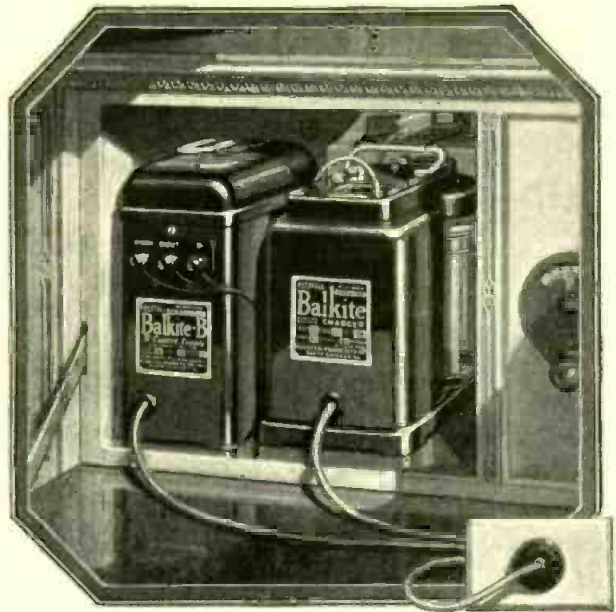

The new
Balkite "B" at \$27.50
 and the new
Balkite Charger convert your radio set
 into a light socket receiver



Balkite Trickle Charger

MODEL K. With 6-volt "A" batteries can be left on continuous or trickle charge thus automatically keeping the battery at full power. With 4-volt batteries can be used as an intermittent charger. Or as a trickle charger if a resistance is added. Charging rate about .5 ampere. Over 200,000 in use. Price \$10. West of Rockies \$10.50. (In Canada \$15.)

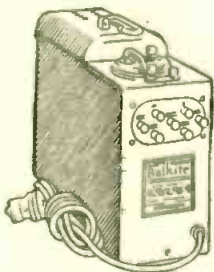

Balkite Combination

When connected to your "A" battery supplies automatic power to both "A" and "B" circuits. Controlled by the filament switch on your set. Entirely automatic in operation. Can be put either near the set or in a remote location. Will serve any set now using either 4 or 6-volt "A" batteries and requiring not more than 30 milliamperes at 135 volts of "B" current—practically all sets of up to 8 tubes. Price \$59.50. (In Canada \$83.)

All Balkite Radio Power Units operate from 110-120 volt AC current with models for both 60 and 50 cycles. The new Balkite Charger is also made in a special model for 25-40 cycles.

To enjoy the convenience of operating your radio set from the light socket add the new Balkite "B" and the new Balkite Charger.

Balkite "B"—the unique "B" power supply—eliminates "B" batteries entirely and supplies "B" current from the light socket. The new Balkite "B"-W at \$27.50 serves any set of 5 tubes or less where 67 to 90 volts are required. Balkite "B"-X at \$42 serves sets of up to 135 volts and 8 tubes. Balkite "B"-Y at \$69 serves any standard set.

The new Balkite Charger at \$19.50, with both high and low charging rates, is the most convenient of all methods of charging your "A" battery. At the low rate it can be left on continuous or trickle charge. Thus it automatically keeps your battery at full power. With heavy duty sets, large sets or sets in constant use where excessive "A" current is required, a few hours' operation at the high rate quickly brings the battery to full charge. This new

charger gives you the advantages of both trickle and high-rate charging.

Both Balkite "B" and the Balkite Charger are entirely noiseless in operation. Both are permanent pieces of equipment, with nothing to wear out or replace. Other than a slight consumption of household current, their first cost is the last. Both are built to conform with the standards of the Underwriters' Laboratories.

Over 650,000 radio sets—one of every ten—are already Balkite equipped. Add these two Balkite Units to your receiver now. Then you too will know the convenience of

Balkite Light Socket Operation. Then you too will know the convenience of owning a radio set always ready to operate at peak power.

West of Rockies: Balkite Charger \$20. In Canada: Charger \$27.50; "B"-W \$39; "B"-X \$59.50; "B"-Y \$96.

Fansteel Products Company, Inc., North Chicago, Illinois.

The Balkite Radio Symphony Concerts with WALTER DAMROSCH and the New York Symphony

These concerts are broadcast every other Saturday Evening. On intervening Saturdays Mr. Damrosch gives one of his popular piano recitals on Wagner's great music dramas. At 9 P. M. Eastern Standard Time, over a group of 13 stations: WEAf, WEEl, WGR, WFl, WCAE, WSAI, WTAM, WWJ, WGN, WCCO, KSD, WOC, WDAF.

FANSTEEL
Balkite
 Radio Power Units

Reliable—Noiseless Powerful

KEEPS your set full of live, marvelous energy — banishes its dull, listless moments due to run down batteries. Improves tone, and cuts operating cost to almost nothing. Rigidly tested and fully guaranteed. Double the pleasure to be derived from your receiving set with the

Cornell Voltage Supply

("B" Battery Eliminator)

Equipped with long life Raytheon Tube which has no filament to burn out

Type "B"—137 to 220 volts at 30 milliamps.; 150 volts at 60 milliamps.

\$39.50

Type "CB"—(illustrated below) 142 to 227 volts at 30 milliamps.; 155 volts at 60 milliamps.

\$49.00

(West of Rockies, add \$1.00 to above list prices)
Sold only through authorized CORNELL Dealers



Tested and approved by Raytheon Laboratories

Beautify your Set
With its deeply etched plate, in antique gold finish, this new attractive smooth friction, 9 to 1 vernier dial will beautify your set and make it a 1927 model
List Price \$1.50.

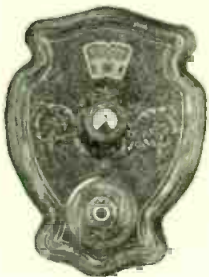

CORNELL ELECTRIC MFG. CORP.
Rawson & Annabelle Sts., Long Island City, N. Y.

Please send full information about your Cornell Voltage Supply; also name of nearest dealer.

Name _____

Address _____

If dealer, check here and receive special dealer proposition.



The BEGINNER IN RADIO

CONDUCTED BY ARMSTRONG PERRY

A Good Set to Begin With for \$16.85

THE picture at the bottom of this page shows the "makin's" of a beginner's one-tube receiver. In the back row are the "B" and "A" batteries, which cost a total of \$2.40; in front (left to right), are: a honey-comb coil, costing 50 cents, a .001 straight-line condenser, costing \$1.75; rheostat at \$1.00; a spool of No. 22 double cotton-covered wire, costing 75 cents, Baldwin phones, costing \$12.00; a WD-11 detector tube, costing \$2.50; and a grid-leak and condenser for 45 cents.

By using cheaper phones—and fairly good ones may be purchased as low as \$2.50—the cost of this entire outfit can be brought down to \$11.85. Adding \$5.00 for aerial wire, guy rope, insulators, lightning arrester and ground clamp, this still is about as cheap a plaything as a man can buy. The money it will save in gas, oil and tires will more than pay for it in a season.

A man who builds this set and listens to all it can bring in will acquire a fund of useful experience and the rudiments of a liberal education. Several hook-ups are possible. With a larger honey-comb coil, suitable for the longer waves, a set built of these parts has brought in European code stations. The higher-

powered broadcasting stations come in over distances up to a thousand miles with average atmospheric conditions.

Why Honeycomb Coils are Useful to Experimenters

In the early days of radio, most transmission was on wavelengths above 600 meters. Inductance coils for receivers were wound on cylindrical tubes either in single layers or with one layer over another. A single-layer coil used in reaching the longer wavelengths might be three or four feet long, and it took up so much space that it was inconvenient to use in a small room. Bank-wound, or multi-layer, inductances had disadvantages also, one of which was the amount of distributed capacity between the turns and layers.

It was discovered later that a coil one inch long could be made to provide as much inductance as a single-layer coil three feet long, if the wire were zigzagged around the tube or form instead of being wound straight around. Furthermore, the turns could be widely spaced by this method, and made to cross each other at angles that reduced capacity effects.

With the coming of the broadcasting era, and the crowding of the amateur



HERE ARE THE PARTS YOU NEED TO BUILD THIS SET

Any boy with ordinary proficiency with tools can assemble this single-tube receiver from the parts that he can buy at any radio shop.

FREE This 84 Page WONDER BOOK

Send For It TO-DAY

You must have this latest guide to Radio prices and Radio quality. All of our vast resources and radio experience have been utilized to assemble for you in one gigantic institution, the best and newest things in radio. The Randolph catalog is indeed the radio market place of the world—a masterpiece of merchandising that befits our house—THE LARGEST EXCLUSIVE RADIO MAIL ORDER HOUSE IN THE WORLD.



Radio Bargains

OVER 2000 ITEMS

From the most beautiful, fully equipped console radio set, down to the smallest part or tool for the set builder—kits, parts and supplies of every conceivable type and style. 5, 6, 7 and 8 tube sets, with three dial, two dial, and the newest and most popular single simplified control. All sets are assembled in beautiful, genuine mahogany and walnut cabinets in a choice of latest types and designs.

A complete line of "B" batteries, eliminators, including the famous Raytheon Eliminators, latest types loud speakers, cone speakers, "A" power units. Everything in radio at money saving prices.

RADIO KITS

Includes the following well known circuits, designed and approved by the world's foremost radio engineers: Madison Moore Super; Victoreen Super; Silver Marshal Six; Sargent's Infradyne; Remler Super; Short Wave Kits; 9-in-Line Super; New Acme Reflex; Cockaday; Neutrodyne; Browning-Drake; all classes of radio frequency. Super Heterodyne and every other approved popular circuit.



We Save You Money because we handle radio exclusively and sell a tremendous volume of everything in Radio.

Volume purchases regulate prices.

We command rock bottom prices from manufacturers, and in many cases we contract for entire factory output of exclusive products. You will benefit by our great volume of purchases and sales, by securing anything you may want in radio at a substantial saving.

The New Ampliphonic Six The Latest Two-Dial Receiver WITH THE Genuine Amplion Unit

Genuine dark tone and shaded walnut cabinet. Measures 27x16 in. Beautifully etched burl walnut panels. Built-in loud speaker with Amplion unit. Large doors open to smaller doors enclosing a large compartment for batteries, chargers, eliminators, etc., everything concealed in this exquisitely designed radio cabinet. Stands 39 in. high. Top

6 Tube Tuned Radio Frequency
6-tube tuned radio frequency two dial control receiver. 3 stages of direct and transformer amplification. Has provision for power tube and an additional tap for increased "B" battery voltage. Very latest construction including solenoid coils, bakelite sockets taking all the latest X-type tubes, modified straight line condensers. Wonderful volume, nothing like it on the market at more than twice the price. Without Accessories

\$79.50



Symphonic Five

Brown Spanish leatheroid finish cabinet with gold engraved walnut panel to match. Contrasted beautifully with the black fine tuning knobs. Two small knobs control volume and clarity. The volume control is of the finest smooth slow variation type. Roller bearing. Condensers are of the modified straight line frequency type, substantially constructed and of latest design. All is sub-panel mounted, using the new X-type socket. Latest development in solenoid coils. Two stages of low ratio audio amplification with high grade transformer offers the true amplification required for both low and high notes.

\$24.90

Without Accessories

The set complete with five type X201A tubes, two 45 volt "B" batteries, one 100 Amp. Hr. storage battery, complete aerial equipment, one battery cable attached, including cone speaker of the same type as \$54.75 pictured

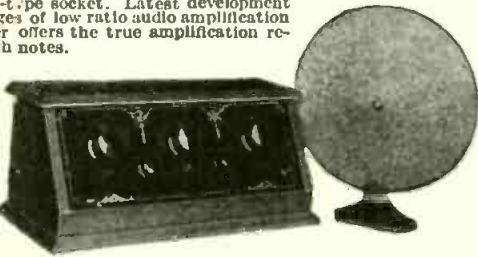

These sets are typical examples of the bargains in our catalog. You may order direct from this page, sending P. O. money order or draft for full amount. We ship freight or express, charges collect. We guarantee to back up every article with our own, as well as manufacturer's, assurance of quality.

Columbia Senior Six

Beautiful table set. New localized control. One hand to tune with, three rotating drums easily controlled and easily logged. Dark finish etched panel mahogany finished hand-rubbed cabinet. Size 7x22.

6-tube set, giving tremendous volume, wonderful tone quality, latest straight line condensers, solenoid coils; sub-base mounting and new amplification. Designed to sell for over 100.00. Price, **\$36.50** without accessories

Set complete with two 45 volt "B" batteries, 100 amp. hr. Storage "A" battery, one 4 1/2 volt "C" battery, six type X201A tubes, complete aerial kit, attached battery cable, quality cone speaker or Victor horn type loud speaker..... **\$65.45**



Columbia Grand 6-Tube Console Set

Here's a sensational bargain in a console radio with built-in loud speaker and adjustable unit. Spacious compartment for all batteries, etc. Very latest type 6 tube tuned radio frequency receiver. Low loss modified straight line frequency condensers. Has three stages of low ratio audio amplification. Designed to accommodate new power tube. Equipped with X-type sockets. Beautiful gold etched panel with handsomely engraved designs. Price of set with accessories, **\$42.65**
This set with all accessories which include 2 45 volt "B" batteries, 100 Amp. Hr. storage "A" battery, 6 201A tubes, aerial and ground equipment—everything complete, nothing else to buy..... **\$65.95**

You Must Have This Book

Space limitations here prevent our telling you more about the Randolph Catalog. Simply fill out and mail the coupon—or you may send a postal or letter—and this truly remarkable Radio book will come to you ABSOLUTELY FREE. MAIL THE COUPON NOW.



Beautiful hand rubbed, two-toned mahogany finished cabinet, size 18 x 19 x 36. Built-in loud speaker.

This Coupon Brings the Great RADIO Book FREE

RANDOLPH RADIO CORPORATION
180 N. Union Ave., Dept. 193 Chicago, Illinois
Send me—free—your 84-page, 1927 Radio Book.

Name _____
Street and No. _____
R.F.D. _____ Box _____
City _____ State _____

Randolph Radio Corporation
180 North Union Avenue • Dept. 193 • Chicago, Ill.

Leadership

with Benjamin Radio Products
in Securing the Best Radio Results



All Benjamin Radio Products are of the same high standard as the far-famed Cle-Ra-Tone Sockets—

You will find that almost every good radio set in the neighborhood has some or all Benjamin Radio Products in it. Radio experts and set makers have proved through long experience that only radio parts conscientiously and painfully made to improve delicate tonal quality, selectivity and volume can bring a leadership in securing the best radio results.

If you would have your set just as good or better than your neighbor's make sure that every component part is reliable and bears the trade mark of a manufacturer in whom you can place your full confidence. The world-wide recommendation of Benjamin Radio Products by radio authorities is the best testimonial for their scientific accuracy and uniformity in securing the best radio results.

Rewards for Radio Reasoners

Awards for novel and original hook-ups, modifications of existing circuits; trade names; slogans; write our nearest office for full details.

If your dealer cannot furnish you with Benjamin Radio Products send amount direct to our nearest sales office with his name and we will see that you are promptly supplied.

Benjamin Electric Mfg. Co.

120-128 S. Sangamon St.
Chicago

New York: 247 W. 17th St. San Francisco: 448 Bryant St.

Manufactured in Canada by the Benjamin Electric Mfg. Co. of Canada, Ltd., Toronto, Ontario

Improved Tuned Radio Frequency Transformers



Space wound; basket weave; cylindrical; highest practical air dielectric. Proved to give the best results in sharpness of tuning, increase in volume and improvement in quality. Authoritative laboratory tests and practical experience of manufacturers and amateurs shows that this type of coil excels in every important characteristic.

2 1/4-inch Diameter Transformer

Compact. Especially desirable for crowded assembly. Eliminates interfering "pick-ups."

Set of Three, \$5.75
Single Transformer, \$2.10

3-inch Diameter Transformer

Capacity coupling reduced to lowest degree. For use with .00035 Mfd. Condensers.

Set of Three, \$6.00
Single Transformer, \$2.25

"Lekeless" Transformers

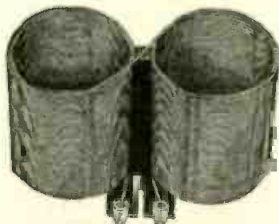

Uniform high inductance, low distributed capacity and low resistance. The external field is so slight that it permits placing coils close together without appreciable interaction.

Single Transformer, \$2.50

Cle-Ra-Tone Spring Supported—Shock-Absorbing Sockets

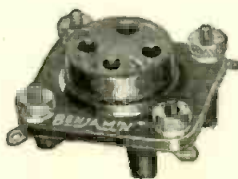

Spring Supported, Shock-Absorbing. Stop Tube Noises. The greatest aid to non-noisy operation. Contacts always clean.

75 cents each

Straight Line Frequency Condensers



Eliminates bunching of stations. Spreads the log evenly over the dial. Makes tuning easy. Adjustable turning tension. Compact. A beautiful instrument that not only improves reception, but adds to the good appearance of the set.

.00025 Mfd., \$5.00 .00035 Mfd., \$5.25
.0005 Mfd., \$5.50



Brackets
An aid to simplification in set construction. Supports the sub-panel, with room underneath for accessories and wiring.

Plain—70c pair. Adjustable—\$1.25 pair

Battery Switch

Quick, positive, clean-cut make and break. When it's "in" it's "off", eliminating danger of wasteful use of battery.



30 cents each

down to wavelengths around 200 meters, honey-comb coils lost some of the great popularity that they had formerly among amateur experimenters, because they are less efficient below 600 meters than they are above that wavelength. However, they still are used extensively because of their convenient size and form and because they are mounted in such a way that they are interchangeable. A coil designed to cover the broadcasting wavelengths can be removed from the mounting and a coil that will bring in the transoceanic commercial stations can be plugged in, all in a moment.

Another advantage that the honey-comb coil gives the experimenter is the ease with which circuits can be constructed and changed. A single honey-comb coil shunted by a .001 mfd. condenser, will cover a waveband from 130 to 12,000 meters wide, depending on the number of turns in the coil. The smallest coils in common use have 25 turns and tune down as low as 120 meters. The largest have 1,500 turns and tune up to 26,500 meters. Even with a single coil and condenser, several different circuits can be made. The De Forest ultraudion circuit is one of the most popular of these and, with proper coils, will cover almost the entire range of wavelengths used in radio transmission. There is another circuit in which a large coil, say one of 1500 turns, can be employed as a loop aerial to pick up long waves from high-power stations.

Two coils, in a two-coil mounting, form a variometer, which may be used in tuning the antenna or the plate circuit. They can be operated in a parallel position or can be made to form any angle up to 90 degrees, so the transfer of energy from coil to coil is under control. A slight change of wiring turns the variometer into a variocoupler, suitable for use in most of the three-circuit hook-ups. The amount of inductance in the primary or secondary circuit can be changed instantly by removing one coil and plugging in another.

With three coils and a three-coil mounting, regenerative circuits that require a tickler coil can be constructed; with a three-coil mounting and a complete set of coils, dozens of different



A THREE-CIRCUIT TUNER

By means of three honeycomb coils and a triple coil mounting, an efficient tuner may be built for single-tube operation.

Announcing

the new *Prest-O-Lite*

Trikl-Automatic Radio "A"

Power Unit

\$29⁵⁰



Look at these new features

The battery. Ample capacity. Extra thick, rugged plates, deep-grooved separators. Unusually large acid volume requires infrequent watering. One-piece, leak-proof rubber case, with acid-tight cover. Screw post seal and double baffle vent to prevent leakage and acid spray.

The charger. Built on an entirely new principle. Silent in operation. Adjustable to needs of individual user. Economical to operate. Nothing to get out of order. Nothing to replace. Built to last for years.

No moving parts. No bulbs. No electrolyte. No water or acid to be added. No electrodes to wear out. *Entirely automatic.* No switches to operate by hand. Built-in power relay automatically shuts off the charger when radio is in use and turns it on again when radio is idle. Will operate at any distance from set.

Fully enclosed. Entire unit enclosed in beautiful metal case, with hinged cover and handle.

AN "A" power unit combining Prest-O-Lite's fine storage battery with a trickle charger. A unit that can be plugged into an electric light socket, then hooked up to the radio set—and forgotten! It charges itself automatically.

It's new. Entirely automatic in action. No switches to operate by hand. Now you can have full storage-battery power for your radio *all the time*. Power that is noiseless and without the slightest pulsation, the kind of power that brings in the distant stations loud and clear.

Never again will you have to bother with a charger. Never again will a run-down "A" battery spoil your radio.

A thing of beauty.

The unit is beautifully finished in deep maroon. Small and compact. Even in full view under the library table it looks well.

You'll find further details in the column at the left. But the main thing is to see it. Go to the Prest-O-Lite dealer's store. There's one near you. Or write us and we will give you a lot of interesting facts about this wonderful new "A" power unit.

And remember, it is made by a company which has had more than twenty years of manufacturing experience.

THE PREST-O-LITE CO., INC.
INDIANAPOLIS, IND.

New York San Francisco
In Canada: Prest-O-Lite Company of Canada, Ltd., Toronto, Ontario

RADIO DEALERS SHOULD WRITE AT ONCE FOR FULL DETAILS



Prest-O-Lite



Write for **Free**
Hampton-Wright Radio Catalog

Enjoy the Pleasures of Radio This Christmas Through Hampton-Wright

THIS great catalog lists hundreds of efficient items that help you secure fine radio reception. All over the country radio enthusiasts are using Hampton-Wright products successfully. Don't delay — write for YOUR catalog in time for the holiday season.

HAMPTON-WRIGHT, Inc.
P. O. Box 181 INDIANAPOLIS, IND.
Specify Catalog No. A-8

Make this a Hampton-Wright Radio Xmas



circuits and variations of circuits can be constructed. A complete set of coils, with from 25 to 1,500 turns, may be purchased, unmounted, for about \$16.00. Mounted, they cost a little more.

Unmounted coils may be hung on a rod, connected with the circuits by clips and wires, and adjusted with the fingers. The wavebands covered by the coils overlap to some extent, so the experimenter can cover most of the wavebands in common use without purchasing a complete set.

One further advantage of the honeycomb coil is that it can be packed and carried with little danger of injury. The ordinary variometer, composed of a stator and rotor, easily may be broken or even mashed flat. The compact honeycomb coil, on the other hand, can be stowed away in a Scout's haversack or a travelling bag, with a handkerchief or a pair of socks occupying the hole in the center, and it usually reaches the end of the journey in good condition even though it may have been sat on en route.

To Get that Station Just Below Your Tuning Range

SOMETIMES, when your receiver is tuned down to its lower limit, you may hear a station whispering, too faintly to be heard, words that you are sure would be interesting if you could catch them. Or it may hum some bewitching tune, loudly enough to whet your musical appetite but too softly to give satisfaction.

When that happens, take one of those fixed condensers that may be purchased anywhere for a quarter and connect it in series with your aerial, as shown in the picture. A series condenser reduces the wavelength of the antenna circuit.



A SIMPLE TRICK TO AID IN TUNING

By connecting a fixed condenser in series with your aerial, as shown above, you may be able to tune in on a station that now escapes your set.

DEALERS AND PROFESSIONAL SET-BUILDERS

WRITE FOR LITERATURE AND OUR PRICES ON

The **LC-27** ALLEN-ROGERS GUARANTEED KIT

Hammarlund Roberts HI-Q

- SILVER-MARSHALL
- CORBETT CABINETS
- BROWNING-DRAKE
- AMERTRAN
- SAMSON
- BRUNO
- KARAS

The RADIO SHOP of STAMFORD
20 Worth St., Stamford, Conn.
SERVICE FOR SET BUILDERS

ACME CELATSITE BATTERY CABLE

—a silk-covered cable of vari-colored Flexible Celatsite wires, for connecting batteries to set. Prevents "blowing" of tubes; gives your set an orderly appearance.

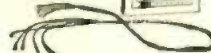

Stranded Enameled Antenna

Best outdoor antenna you can buy. 7 strands of enameled copper wire; maximum surface for reception. Prevents corrosion and consequent weak signals.



The Original Celatsite

—a tinned, copper bus bar wire with non-inflammable "spaghetti" covering, for hook-ups. 5 colors; 30-inch lengths. We also offer the highest grade of "spaghetti" tubing for Nos. 10 to 18 wires. 5 colors; 30-inch lengths.



Flexible Celatsite

Flexible, stranded wire for point-to-point and sub-panel wiring. Non-inflammable "spaghetti" covering. In black, yellow, green, red and brown; a color for each circuit. Put up in 25-foot coils.



Send for folder

THE ACME WIRE CO., DEPT. P
NEW HAVEN, CONN.

ACME WIRE
MAKES BETTER RADIO



Send your good wishes ...and a Tungar too

If he enjoys the radio—surprise him with a G-E Tungar. It will keep batteries fully charged; help him to obtain better reception. Through the years, its helpfulness will be a constant reminder of your greetings.

Two ampere, five ampere, or Trickle Charger—your dealer will show you the correct type for any service. They are all made by General Electric—they all can be permanently installed, and they all say “good-bye battery charging problem.”

P. S. Treat yourself to one, too.

Two ampere—charges all 2, 4 or 6 volt “A” and 24 to 96 volt “B” batteries in series—and auto batteries, too.	as two ampere but charges faster.
Five ampere—same range	Trickle—charges 4 or 6 volt radio “A” storage batteries: four charging rates up to one-half ampere.

East of the Rockies
2 ampere Tungar, \$18
5 ampere Tungar, \$28
Trickle Charger, \$12
(60 cycles—110 volts)

*Merchandise Department
General Electric Company
Bridgeport, Connecticut*

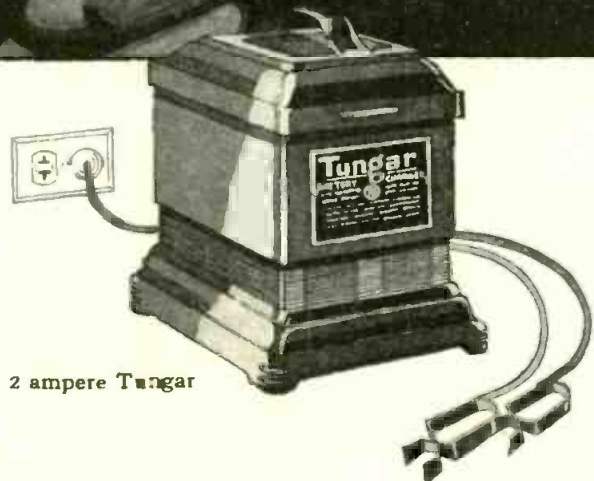

2 ampere Tungar

 **Tungar**
REG. U.S. PAT. OFF.
BATTERY CHARGER

Tungar—a registered trademark—is found only on the genuine. Look for it on the name plate.

GENERAL ELECTRIC

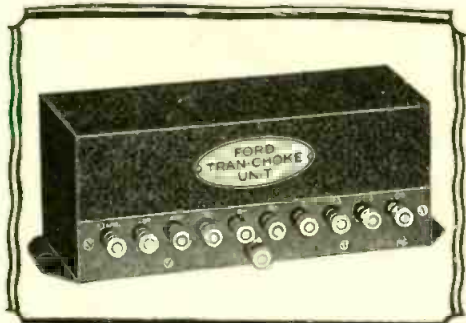

-FORD-

Tran-Choke Unit

A combination of transformer and chokes completely shielded in one unit

For Building the
**RAYTHEON
POWER SUPPLY**

Each unit is supplied with a Raytheon tube

Write for Complete Literature

Authorized Distributors

- E. P. Denham, Seattle, Wash.
- Gray Sales Co. Philadelphia, Pa.
- S. D. Darmstader, Chicago, Ill.
- James C. Pope, Jr., Minneapolis, Minn.
- Industrial Sales Co., San Francisco

FORD RADIO & MICA CORP.
111-113 Bleecker St. New York City

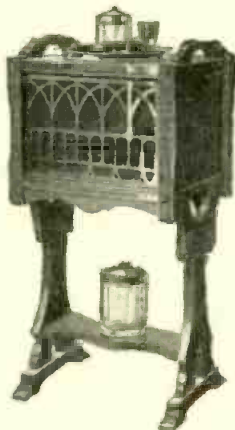

Announcing

the first of a series of new models of

TIMBRE TONE

REG. U.S. PAT. OFF.

Combined with the utility of a smoking stand is a loud speaker. Carry it about and have it where you want it—on the porch or along side of your easy chair.

Sales offices

SANFORD BROS.

- CHICAGO 30 W. Walton Pl.
- CHATTANOOGA 615 Broad Street
- SEATTLE Am. Bank Bldg.
- SAN FRANCISCO 311 Minna St.

Factory: **TIMBRE TONE MFG. CO.**
Hoosick Falls, N. Y.

How to Build an "A" and "B" Power-pack for Direct Current

(Continued from page 785)

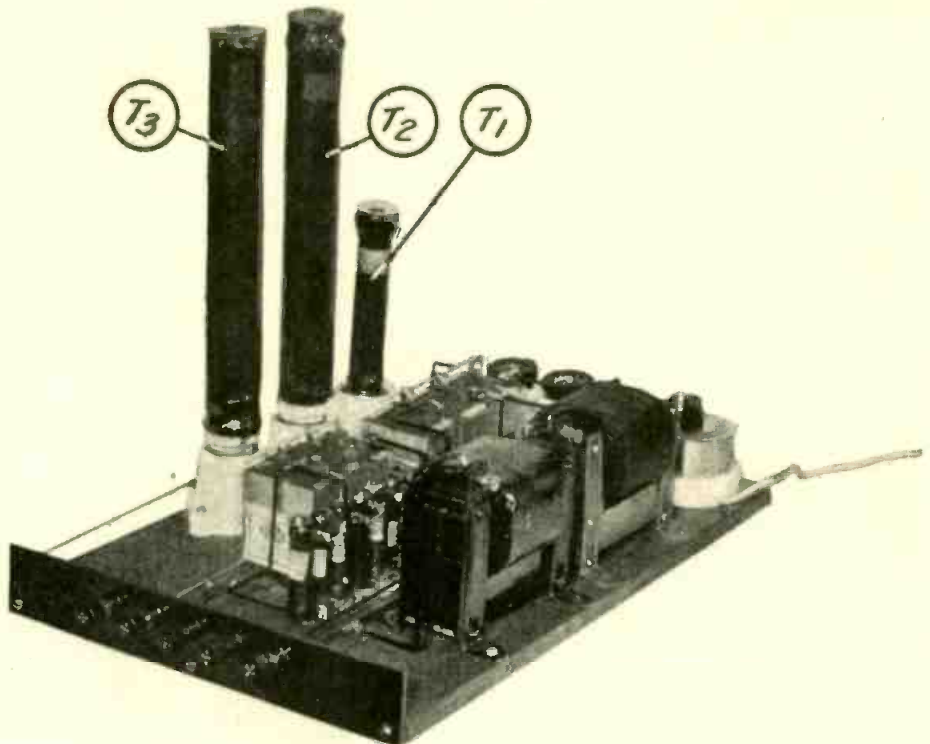

AN END VIEW OF THE UNIT

FIGURE 4: The three large resistors, that are used in the "A" circuit, are shown here in place. This view also shows how the binding-post strip is mounted.

Figure 3, illustrates how this is done. The DC supply passes through the switch S, and then, as a safety measure, through a 10-ampere fuse on both sides of the line. Whatever ripple or fluctuation in current there is present up to that point is smoothed out by the chokes L1 and L2. All condensers in the circuit act as a by-pass for any unevenness of voltage at those points so that the output finally comes out as a pure DC supply. The resistances, R7 and R8, provide for a 40-volt drop for the detector tube; R3, R4, R5 and R6 furnish 85 volts, for the radio-frequency tubes; while R1 and R2 furnish the balance of the voltage output, or a total of slightly less than 110 volts of "B" supply. A variety of combinations may be obtained, however, by carefully making connections to the proper resistors.

The connections shown in the picture wiring diagram, Figure 3, enable the constructor to obtain the voltages mentioned above. For the convenience of the experimenter who may desire other voltages than those mentioned, the following data has been compiled.

The voltages obtained at any one of the resistances in the order they are at present placed in the eliminator is given in Table 1.

Thus, if it is desired that the detector

voltage be 22, then the detector tap should be connected to the end of resistance R8. The balance of the voltage may then be divided in the same manner. For instance if it is desired to have 85 volts on the radio-frequency tubes, then the tap should be connected to the end of resistance R3. The other resistors, R2 and R1, will add 25 volts more for the audio-frequency tubes, making a total of 110 volts available. These voltages were obtained with a DC supply of 120 volts. For other line voltages, these values will be practically proportional.

How to Construct the Unit

Cut the baseboard to the size given in the list of parts and proceed to lay out the instruments. The constructor should be careful that the layout, after it is finally assembled, will be a convenient one for wiring. Figure 1 shows a good arrangement.

The bank of condensers before mounting on the board were first turned upside-down showing the bottoms of the cases with the mounting lugs nearest the experimenter. These lugs were all soldered together by means of two lengths of bus bar each connecting a row of mounting lugs. Loops were made at the ends of the bus bar. The loops thus provided a means for fastening

TABLE 1

Resistor	R8	R7	R6	R5	R4	R3	R2	R1
Voltage	22	40	50	70	75	85	100	110

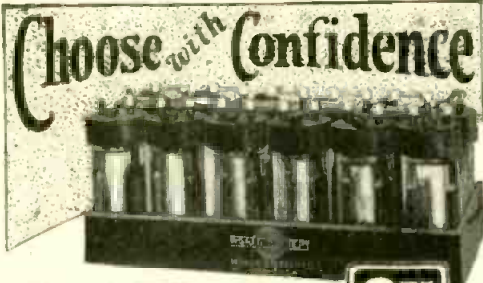

World Radio Storage "B" Battery
12 Cell—24 Volt



Proved value. Thousands of users find reception almost magical. Clear, true power—instantly and unendingly. Wise economy. Sturdy construction—Solid Rubber Case protection. Recharged for almost nothing. Endorsed and listed as standard by famous Radio institutions including Pop. Radio Laboratories, Pop. Sci. Inst. Standards, Radio News Lab., Lefax, Inc., and other Radio authorities. What more need be said? *Extra Offer: 4 Batteries in series (96 volts) \$10.50.*

Send No Money Just state number wanted and we will ship same day order is received, by express C. O. D. Pay expressman after examining batteries. 5% discount for cash with order. Remember—you save 50% on World Batteries, so send order to-day.

WORLD BATTERY COMPANY

1219 So. Wabash Ave. Dept. 77 Chicago, Ill.
Makers of the Famous World Radio "A" Storage Battery
Prices: 6-volt, 100 Amp. \$10.00; 120 Amp. \$12.00; 140 Amp. \$13.00.
All equipped with Solid Rubber Case.

Set your radio dials at 288.8 meters for the World Storage Battery Station W5BC. Variety—New Talent—Always Interesting. JERRY SULLIVAN—Director and Announcer—Chi-CA-W-go

Bradleystat

PERFECT FILAMENT CONTROL

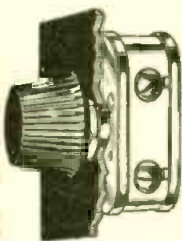

Provides complete noiseless filament control for all radio tubes without change of connections. Metal parts are nickel plated. One hole mounting. Self contained switch opens battery circuit when desired.

Allen-Bradley Co.

Electric Controlling Apparatus
276 Greenfield Avenue Milwaukee, Wis.

Bradleyometer

THE PERFECT POTENTIOMETER

Uses graphite disc resistors which are noiseless and not affected by atmospheric conditions. Metal parts are nickel plated. One hole mounting. Finish and knob match Bradleystat. Made in 200 and 400 ohm ratings.

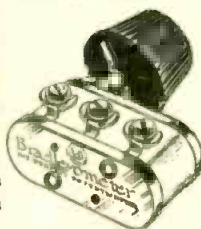

Allen-Bradley Co.

Electric Controlling Apparatus
276 Greenfield Avenue Milwaukee, Wis.

PROVED!

FORTY Thousand Tests on different sets have proved the satisfactory performance of the good Ferbend "B" Eliminator. 40,000 Ferbend "B" Eliminators are now in use. This wonderful instrument is in its second successful year of usefulness. Until you have used a Ferbend "B" Eliminator you have not known the ultimate in radio enjoyment. The satisfaction of Ferbend owners is proved again and again—every day of every month—by the steady flow of hundreds of unsolicited testimonial letters from users of this very fine instrument. The few reproduced here are merely examples of what every mail brings from all sections of America. This flow of testimonials proves beyond a doubt the splendid performance, reliability, convenience and long-lasting qualities of the Ferbend "B" Eliminator. "No Hum"—"More Volume"—"Less Static"—"More Clarity"—"Complete Satisfaction." These reports from users are repeated again and again all through the testimonials. They prove the Ferbend "B" Eliminator is "over the top" to stay.

USERS ARE ENTHUSIASTIC

Fort Riley, Kans. Am getting wonderful results with my Eliminator and good reports from those I have sold.
Floyd M. Farwell.
WIRE CHIEF, Sig. Det.

Ambridge, Pennsylvania We are more than delighted with your Eliminator. Have had it since February and have had splendid results.
F. L. McGRAW.

Petaluma, Calif. I am highly pleased with your Eliminator. It will out-perform any "B" Eliminator on the market today. I have demonstrated it to friends owning Eliminators costing \$50 to \$75 and they all agree with me.
Ralph J. Rorden.

Dryden, Ont. I am more than pleased with your "B" Eliminator and there is no doubt about it being better than any wet battery on the market.
D. M. Kentner.

Montreal, Quebec, Canada I have sold all six of your "B" Eliminators and every one is pleased with it. It is one of the best on the market regardless of price.
Alfred A. Michband.

Yankton, So. Dak. Our Eliminator has served its purpose wonderfully and we enjoy our radio very much since we received it.
Gust. Rundquist

Mt. Morris, N. Y. The "B" Eliminator purchased months ago has given more than best results. Would not part with it for anything.
Frank J. Huver.

Brooklyn, N. Y. I highly recommend your Eliminator to anyone regardless of the kind they expect to buy. Have had mine for over a year.
W. G. Stein.

New Orleans, La. The "B" Eliminator I purchased from you some time ago is very satisfactory and I am much pleased with it.
W. M. Kline.

Amsterdam, N. Y. The Eliminator is great. Have advised all my friends to get it for I know none could work any better or give more satisfaction.
Reg. Firth.



\$12.50

COMPLETE

Nothing else to buy. Replaces "B" Batteries. Operates direct from Electric Light Socket on 110-120 volt A.C. lighting circuit. Delivers up to 100 volts.

**~ FERBEND ~
"B" ELIMINATOR**

Within Reach of ALL

Second successful year—40,000 in use. Amazingly low in price—amazingly high in performance. An unequalled value in radio. Equal or superior to any "B" Eliminator regardless of price. We made this claim over a year ago. Today this statement still stands true—proved by overwhelming evidence.

NEW IMPROVEMENTS

developed and perfected by the Ferbend Electric Co., now give even greater lasting satisfaction to Ferbend users. New solution and new special alloy electrodes make possible a perfect electrolytic rectifier having longer life than any other type of rectifier.

FERBEND Wave Trap

This Company also manufactures the famous Ferbend WAVE TRAP—the instrument which has been widely imitated but never equalled. It is the only original and genuine. Priced at

\$8.50

**Ask Your Dealer—or
Send Direct**

If you prefer, we will make shipment direct to you upon receipt of price, or C. O. D., if desired. Use for 10 days to convince yourself—if unsatisfactory, write us within that time and purchase price will be refunded. Use coupon now.

THE FERBEND "B" ELIMINATOR is approved and passed by the rigid Laboratory Tests of Radio News, Popular Radio and Radio Broadcast.

FERBEND ELECTRIC CO., 419 W. Superior St., Chicago, Ill.

MAIL THIS COUPON TO-DAY!

FERBEND ELECTRIC CO., 419 W. Superior St., Chicago

Send at once. Payment enclosed. Send C. O. D. Send Literature

Name.....

Address.....

City..... State.....

LC-27

Guaranteed by Allen-Rogers

Means—

1. That every part is especially selected by the individual manufacturer for ALLEN-ROGERS.
2. That each part is thoroughly tested for ALLEN-ROGERS by the Radio Electrical Laboratories under the supervision of R. E. Lacault, E. E.
3. That official full size blue prints accompany your complete set of parts.
4. THAT YOUR LC-27, WHEN COMPLETED, WILL WORK AND SOUND LIKE COCKADAY'S OWN.

This is why the complete set of LC-27 parts you get from Allen-Rogers, the only direct representative of the Committee of 21 Manufacturers, carries the following:

GUARANTEE

WE unreservedly GUARANTEE that anyone can construct the LC-27 Receiver to function properly when built by using a complete set of parts distributed by us. This means that if the set built by you does not work as we claim it should we will make it do so without cost to you, even though we should have to rebuild the entire set.

COMPLETE SET OF SPECIALLY TESTED LC-27 PARTS
\$85.20

LC-27 Mechanical Kit
\$12.50

AmerTran Power-Pack Kit for LC-27
\$63.50

This kit carries the regular ALLEN-ROGERS guarantee

Names of responsible set builders in your locality will be furnished upon application.

Attractive discounts to Jobbers and Dealers. Send for free descriptive folder

Direct representative of the Committee of 21 Manufacturers

Allen-Rogers

Incorporated

"Kit Headquarters"

118 East 28th St., New York, N.Y.

TABLE 2

Filament Current in amperes	T3	T2	T1
.75	DEB 90	—	EB 12.5
1.00	DEB 90	DEB 90	EB 5
1.25	DEB 90	DEB 90	EB 6
1.50	DEB 90	DEB 90	EB 7
1.75	DEB 90	DEB 90	EB 10

the assembled block to the baseboard.

The resistors R1 to R8, inclusive, should also be assembled before mounting by laying them on the workbench and soldering their ends together in the proper order. The values of each resistor may be found by referring to the list of parts that is printed at the head of this article.

The resistor block may now be mounted by simply inserting bolts through each end resistor and fastening to the base. Before inserting the bolts, slip a washer under the head of each bolt. This will protect the brittle porcelain jackets of the resistors.

Next, mount chokes L1 and L2. The snap switch should then be placed in line with the chokes and the fuse block right back of the switch. The arrangement of the base receptacles provides a convenient means for placing additional receptacles.

The next step is to cut and drill the binding-post strip. This strip is fastened to the end of the baseboard with three screws after mounting the binding posts in the following order, starting from the end nearest the chokes: "B" Amp. (+), "B" RF (+), "B" Det. (+), "A" Bat. (—), "A" Bat. (+). The power-pack is now ready for wiring.

How to Wire the Power-pack

The best form of attack is to wire the out of the way places first, and then to follow with the easier connections.

Refer constantly to the picture wiring diagram. Use insulated bus bar, such as celatsite, to lessen the possibility of short circuits.

How to Operate the Unit

The large resistors, R9, R10 and R11, are regulators for the supply to the filament of the tubes. Their values, as mentioned in the list of parts, are for a five-tube set having a power tube of the UX-112 type in the last stage and the

other tubes of the UX-201 type. Since each UX-201-type tube consumes ¼-ampere and the UX-112 type consumes ½-ampere of current, the total current consumption will be 1½ amperes. In this manner the amount of current consumed by all the filaments may be easily determined. The filament current consumption of each tube is clearly noted on the carton containing the tube. In the case where the total current consumption varies from those stated, the resistors to be used in the receptacles will have to be inserted as shown in Table 2.

For currents over 2 amperes another receptacle must be placed alongside T3 and wired in parallel with it. Calling this added receptacle T4, the resistors are given in Table 3.

The power-pack is now ready to connect to the receiver. Connect the binding posts of the receiver to the pack in their proper order. It will be noticed that the no binding post is provided for the "B" (—) minus connection. This is due to the fact that "B" minus (—) and "A" (+) are automatically made in the apparatus and at the same time grounded. As a precaution the present ground lead of the set should be broken and a .002 mfd. to .5 mfd. condenser inserted between the ground and the ground lead.

With the recent popularity of the new power tubes where large "B" voltages are required it may be necessary to add "B" battery blocks sufficient to cover the voltage required. This is only true where the utmost volume is required. For instance, if a total of approximately 180 volts is necessary add one 45-volt block and one 22½ volt block. Of course, these should be placed in series with the negative terminal connected with the B amp (+) binding post of the power-pack and with the positive terminal connected to the B Amp. (+) of the receiver.

TABLE 3

Filament current in amperes	T4	T3	T2	T1
2.00 amperes	DEB 90	DEB 90	DEB 90	EB 3.5
2.25 "	DEB 90	DEB 90	DEB 90	EB 4.25
2.50 "	DEB 90	DEB 90	DEB 90	EB 5.

How to Increase the Range of Your Ammeter and Voltmeter

In a coming issue of POPULAR RADIO Mr. K. B. Humphrey will tell how to get full value out of these two instruments—without buying new apparatus.

An Amazing New World

OF RADIO Is Now Yours!

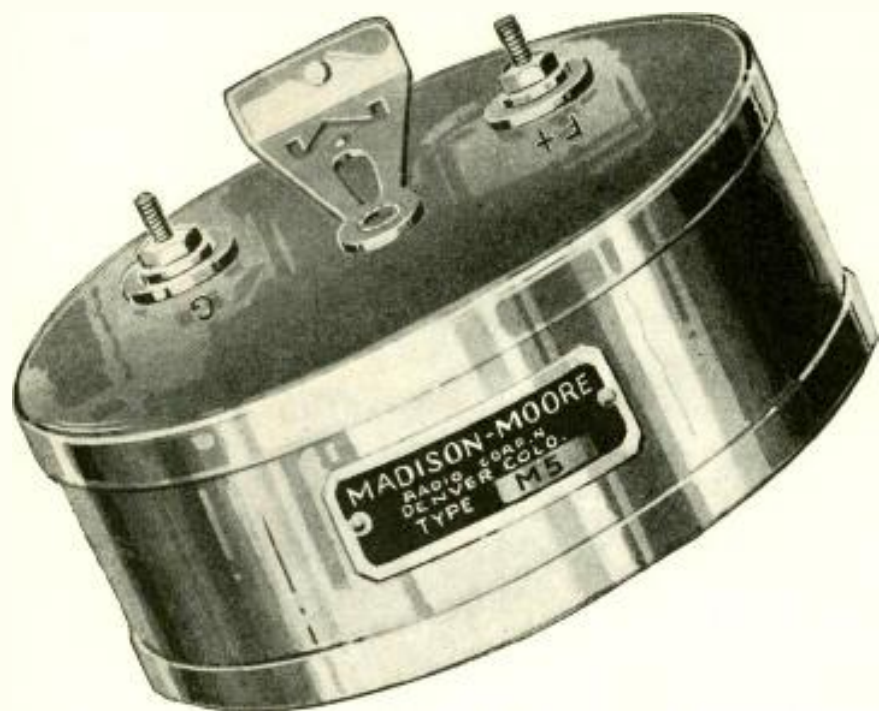

Distance, Quality, Volume, Selectivity --- a new conception of these essentials awaits you with the use of

MADISON - MOORE TRANSFORMERS

Stations from afar, which some of the finest receiving sets have failed to record, come in easily with this instrument. Your dials become the magic key to a new and untouched realm of sound and melody.

Tone is vastly improved and beautified, the most delicate shadings being faithfully reproduced.

Selectivity, always a problem, is no longer difficult. MADISON-MOORE Transformers make every night a radio certainty, for they bring in DX like locals.

Stations which the listener never before brought in, frequently come with loud speaker volume with the use of only a two-foot loop. Quality is immensely improved on all reception.

Every MADISON-MOORE Unit is subjected to most exhaustive laboratory tests before it is approved for use. Every instrument is precision made and is as nearly perfect, electrically and mechanically, as skill and fine apparatus can make it. Radio Engineers and authorities accord it highest praise.

WHEN YOU HAVE INSTALLED MADISON-MOORE TRANSFORMERS YOU WILL ENJOY THE UTMOST FROM YOUR SET.

{ If your dealer cannot supply you, write us }

MADISON-MOORE RADIO CORPORATION
2524 Federal Boulevard
Denver, Colorado - U. S. A.



READ THE GUARANTEE

MADISON~MOORE

The Finest RADIO APPARATUS in the World!

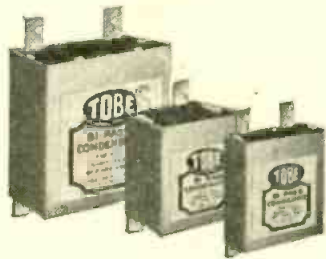

The TOBE Filter Condensers are specified in the new and deservedly popular Henry Lyford Receiver. This is another tribute to the carefully maintained quality of TOBE products.



The TOBE High-Voltage Power-Pack Type Condensers are especially designed for use with the AmerTran Power-Pack, and are specified for it. They will not break down in use. Send for special literature.

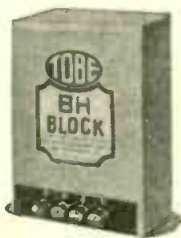

The TOBE BH BLOCK, made to be used with the new Raytheon BH Tube. The first B BLOCK of its kind. Contains one 6 and two 4 Mfd. TOBE Filter Condensers.

Price - \$11.00

Tobe Deutschmann Co.
Cambridge :: :: Mass.

How Circuit Resistance Affects Selectivity

(Continued from page 772)

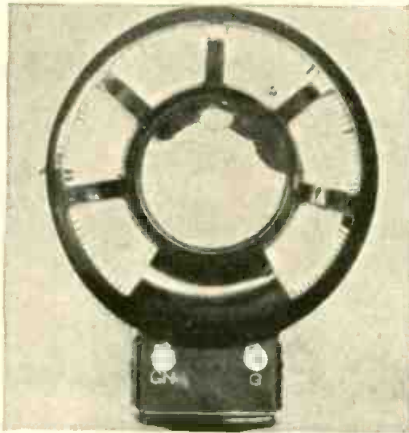

COIL 4

This toroid coil consists of a primary and a secondary that have been wound in spiral shape on a torus form.

from any station depends directly upon E' .

$$E' = 2 \pi f L i \dots\dots\dots 1$$

Now where L is the inductance of the coil in henrys; f , the frequency of the incoming signal; i , the current flowing through the coil, and π , the ratio of the circumference to the diameter of a circle. The magnitude of i will depend upon a number of things. It will be larger, the greater E , is made and when R is made smaller. The expression for i is

$$i = \frac{E}{\sqrt{R^2 + X^2}} \dots\dots\dots 2$$

Where E is the voltage set by the incoming signal, R , the resistance of the circuit, and X , a tuning factor varying as C changes.

$$X = 2\pi f L - \frac{1}{C 2\pi f}$$

Combining equations 1 and 2:

$$E' = \frac{2 \pi f L E}{\sqrt{R^2 + X^2}} \dots\dots\dots 3$$

It is apparent that E' can be made a maximum if the capacity, C , is so chosen as to make $X = 0$. Then

$$E'_{max} = \frac{E 2\pi f L}{R} \dots\dots\dots 4$$

This equation brings out the significance of an abbreviation usually called where

$$\eta = \frac{R}{2\pi f L}$$

Equation 4 then reads

$$E'_{max} = \frac{E}{\eta} \dots\dots\dots 5$$

As may be seen, η is the governing factor of a circuit because if η is small, E'_{max} , the voltage across the condenser when turned to resonance, is large.

It so happens for a narrow band of wavelengths, such as from 200 to 550 meters, η , for a well designed circuit, is almost constant and is a convenient way of rating the value of a coil and con-

No. 248
E-5841
Underwriter's
App.

"Little Joe" Lightning Arrester

Especially designed for Radio Work. Made of porcelain, small, neat, rugged and serviceable. Can be suspended on antenna or fastened to wall.

Ask Your Dealer

Mfd by **CIRCLE F MFG. CO.**
Trenton, New Jersey

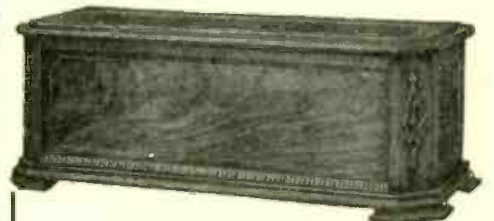

MODEL "C" CHEST!

Cabinets in stock—have piano hinge and are 10" deep—grooved front top rail being removable. Illustration shows gold line wood panel to match.

Sizes	Walnut Only	Panel to Match
7x18-10	\$15.00	\$1.26
7x21-10	17.00	1.47
7x24-10	19.00	1.68
*7x26-10	21.00	1.82
7x30-10	23.00	2.10
*7x28-11	23.00	1.96

*For Madison Moore Receiver.
*For Victoreen Receiver.

Walnut Infradyne Cabinet \$30⁰⁰

LC-27 Cabinets

Mahogany or Walnut with Baseboard \$18⁰⁰

The LC-27 cabinets have 25° slope and take 8 x 26 panel. They are full 10" deep back of the panel.

WRITE FOR folder showing complete LC-27 Line and other Radio Furniture.

CORBETT CABINET MFG. COMPANY
St. Marys - - Pennsylvania

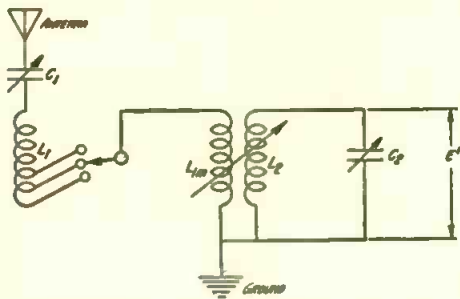

A TYPICAL RF TUNING CIRCUIT
 FIGURE 5: This indicates where the values of E' were taken in order to make the curves shown in Figure 2.

denser when used in receiving broadcast signals. However, if the values of η were taken for a wide band of wavelengths, the resulting curve would be something like that shown in Figure 4. The dotted line, A, indicates the natural period of the coil or the wavelength where the coil is tuned by the capacity in the winding itself.

The region B-C is where the coil should be used, for η is the smallest average value through that range.

The importance of η will be further brought out by plotting a number of resonance curves. In plotting a resonance curve, a signal of definite and constant frequency is assumed and the value for E' across the condenser, is calculated for different settings of the condenser C. This curve then gives an idea of the selectivity of the circuit when used in a radio receiver, and is therefore of the greatest importance.

Figure 2 shows such a curve where E' is charted against the capacity of a 500 micromicrofarad (.0005 mfd.) condenser. Below the capacity markings are given dial readings, zero reading being considered resonance. Four curves are shown with $\eta = .01$ (this would be a poor coil), $\eta = .00706$, $\eta = .005$ (represents a good coil) and $\eta = .0001$ (this value could only be obtained with the aid of regeneration).

Several interesting points are here brought out. First, the smaller the value of η the greater the signal strength of the received signals ($\eta = 0.01$ gives a signal represented by 100 while $\eta = .0001$ gives a signal 100 times as great).

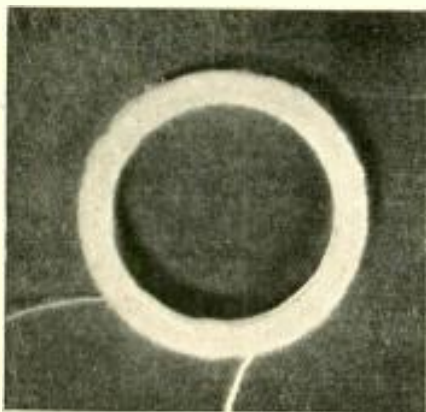

COIL 5

A compact, multiple-layered coil that is wound in bunched formation.

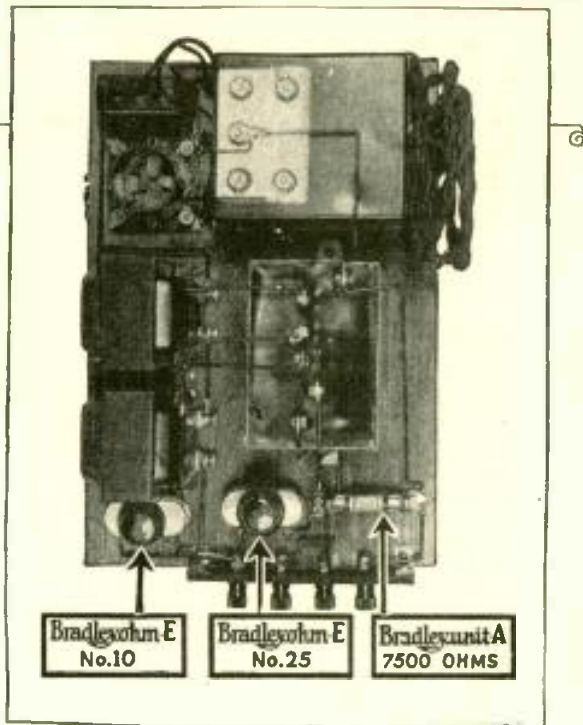

What a whale of a difference a few Bradleyohms make —in a B-Eliminator!



Bradleyohm-E

For B-eliminator service requiring wide voltage control, Bradleyohm E is essential. It is an oversize Bradleyohm with sufficient capacity to handle all normal B-eliminator requirements. Be sure to ask for Bradleyohm-E in the checkered carton. Your dealer can get them for you.



Bradleyunit-A

This solid, molded, fixed resistor has no glass or hermetic sealing in its construction. It is a solid unit with silver-plated end caps that are not affected by temperature, moisture and age. By all means, use Bradleyunit-A when you need a fixed resistor.

MAGAZINES and newspapers have been publishing circuits and instructions for assembling B-eliminators. Many types of kits have been used, but the outstanding feature has been the almost unanimous recommendation to use Bradleyohm-E for plate voltage control and Bradleyunit-A for the fixed resistor.

The leading manufacturers of B-eliminators have long since adopted Allen-Bradley variable and fixed resistors as standard equipment for their B-eliminators. In fact, the Bradleyohm-E has become almost as universally used in Raytheon tube B-eliminators as the Raytheon tube itself. The scientifically-treated graphite discs in these remarkable units have never been equaled for silent, stepless plate voltage control so essential for the satisfactory operation of a radio set with a B-eliminator.

When you build your B-eliminator, always insist that Bradleyohm-E and Bradleyunit-A are included with kit. You then will be assured of perfect voltage control. Send for folder "How to Build a B-eliminator" describing seven popular hookups.

ALLEN-BRADLEY CO.

276 Greenfield Ave. :: Milwaukee, Wis.

Use
Allen-Bradley
 Perfect Radio Devices

The NEW LC-27

is the result of experiments by one of radio's most eminent engineers. We carry all the genuine parts as used by Mr. Cockaday in his laboratory model. The LC-27 is one of the best sets you have ever heard.

- 1-Hammarlund Mid-Line Dual Condenser .000275 mfd. \$ 7.50
- 1-Hammarlund Mid-Line Single Condenser .000275 mfd. 4.65
- 1-Precision Duo-Octaform Coil Set. 10.50
- 1-Amertran DeLuxe 1st stage. 10.00
- 1-Amertran DeLuxe 2nd stage. 10.00
- 1-Amerchoke. 6.00
- 1-Dubilier #902 Filter Condenser, 4 mfd. 5.50
- 1-Dubilier #907 Filter Condenser, 1 mfd.60
- 1-Mar-Co Illuminated Dial 0-100. 3.50
- 2-Mar-Co Small Controls especially for LC-27, 0- to 50, 50 to 0. 1.50
- 1-Carter Battery Switch.65
- 1-Samson Radio Freq. Choke Coil #85. 1.50
- 3-Dubilier .00025 Condensers. 1.05
- 1-Lynch 4 meg. resistor.50
- 1-Lynch single mounting.35
- 1-Carter Single Circuit small jack.25
- 1-Carter resistance 0 to 10,000 ohms. 2.00
- 12-Eby Binding Posts. 1.80
- 5-Benjamin U.X. Sockets. 3.75
- 1-Amperite 1 ampere. 1.10
- Mechanical Kit, consisting of aluminum shields, binding post strip, decorated panel and Tait brackets. 12.50

Complete Parts Ready to Wire \$85.20

Corbett Cabinet for the LC-27 only \$18.00

Mail Orders Promptly Filled

SUN RADIO CO.

64 VESEY ST. NEW YORK



It Delivers Full "B" Voltage

Burns
B-BATTERY ELIMINATOR

Operates from lighting current like other household appliances. Uses Raytheon rectifying tube. Furnishes smooth unflinching plate current without hum or vibration.

Write the Manufacturer

American Electric
COMPANY

State and 64th Streets

CHICAGO, U. S. A.

Makers of BURNS Speakers

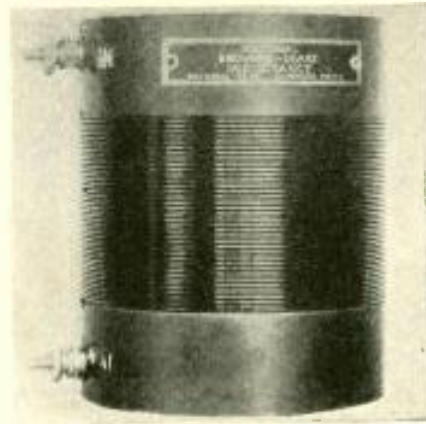

COIL 6

A solenoid coil wound with enamel wire in spiral slots on an insulating cylinder.

Second, the resistance does not determine the absolute selectivity of the circuit, for if the condenser is two divisions off resonance, the amount of signal received is the same no matter what the value of η . This means that absolute selectivity cannot be obtained with this circuit, no matter how low the resistance may be.

Consider a local station broadcasting on a wavelength such that it would be resonant on the condenser at .00032 mfd. Let another station, whose signal strength at the receiver is only one-tenth as strong, be on such a wavelength as to be resonant on the condenser at .00034 mfd. If we want to hear the weaker station, we naturally set the condenser at .00034 mfd., but we also hear our local station, for the signals from the two are in the ratio 200 to 150.

These figures assume that the coil and condenser have such a resistance that they are represented by curve No. 3.

There is one solution of the problem which lies in coupled circuits, shown in Figure 5, but the adjustments require considerable skill on the part of the operator, as he has three controls to operate instead of one, and the setting of one may change the settings of the other two. In actual operation, C_1 and C_2 would be first resonated, and then the coupling between L_{1m} and L_2 adjusted. This would require resetting C_1 and C_2 and this series of operations continued until the best selectivity with greatest signal strength is obtained. The system is clumsy and has an added disadvantage that only half as much voltage E^1 is obtained as with the former tuning arrangement.

Let us now consider the effect of η , or the circuit resistance factor, on the quality of the received signals.

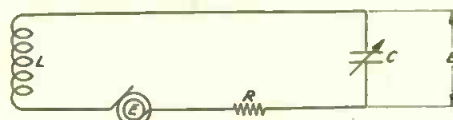

A TUNING CIRCUIT

FIGURE 6: This diagram shows the theoretical circuit for the closed oscillating circuit that is generally used in tuning

F. D. Pitts Company

INCORPORATED

219A Columbus Ave.

Boston, Mass., U. S. A.

**Merchandising
Radio
Since 1919**

DEALERS — send for large and profusely illustrated catalog on the products of scores of nationally advertised radio manufacturers.

Wholesale Exclusively

**"Pioneers in the
Distribution of Radio"**

BROADCAST LISTENERS

The POPULAR RADIO ATLAS and LOG will give you a list of all the NEW Broadcasting Stations with wavelengths and other necessary information

A Complete Atlas and Station Log

The "POPULAR RADIO International Radio Atlas and Log" will supply you with full information regarding broadcasting stations of the United States and Canada.

This most useful and practical Atlas consists of 16 pages, size 12" x 15", printed on good paper, from clear type in two colors and contains a complete series of double page maps, including—The World—The United States—Canada—North and South America, showing location of principal broadcasting, leading commercial and governmental radio stations.

SPECIAL FREE OFFER

You may have a copy of the "POPULAR RADIO International Radio Atlas and Log" free, with POPULAR RADIO for (8) eight months.

For Only \$2.00

Pin \$2.00 in bills to the coupon below. If you are a subscriber to POPULAR RADIO your subscription will be extended eight months.

Date.....

POPULAR RADIO, Dept. 122A
627 West 43d St., New York City.

Enclosed is my remittance of \$2.00 for which you are to enter my subscription (extend my subscription) for (8) eight months for POPULAR RADIO and send FREE a copy of the "POPULAR RADIO International Radio Atlas and Log."

Name.....

Address.....

City..... State.....

To transmit speech and music so that it preserves its natural quality not only the carrier frequency of (say) a million cycles a second must be received, but a band of frequencies from 5,000 to 10,000 cycles plus or minus the carrier. This band is necessary to carry the high overtones which are so essential to lifelike reproduction.

The 10,000 cycles band is marked on Figure 3 by the two dotted lines.

Consider curve No. 4. The peak of this curve gives $E' = 1000$. Notice that the dotted line crosses the resonance curve where E' is approximately 185, so that a note of 10,000 cycles would only experience an amplification of 185 while the low tones would be amplified 1000. This is what is known as the cutting off of side bands which tends to destroy good quality. This tendency is sometimes apparent with a regenerative receiver, when the effective value of resistance may be lowered to an extremely small value.

Coil 3, as obtainable in practice, would not have this tendency to clip side bands, but if used in a multiple stage receiver, would probably be as low a resistance coil as should be used.

To determine the best shape and type of winding for coils, six standard types were measured. The result of this work is shown in Figure 3 where resistance is charted against wavelength and in Figure 4 where η is plotted against wavelength.

Coil 5 is a compact, multiple-layered coil, but it has a high resistance. Some of this resistance is due to the fact that the distributed capacity is large, and the coil is being worked too close to its natural period, as may be seen by comparison with the general η curve Figure 1.

Coil 4 is a toroid. The coil proper is long, with a small diameter.

Coils 1 and 6 show up easily as the best of the six. They have spaced windings one on a bakelite form, the other almost self supporting. It is interesting that at broadcast wavelengths it makes little measurable difference whether a coil has a bakelite form or whether it has the form slipped out so as to be self-supporting.

The measurements on circuit resistance were taken by the quarter deflection method, and a number of them checked by means of a vacuum-tube voltmeter; hence it is believed the values given are nearly correct.

It may be hoped that the theoretical resonance curve given in Figure 2 will be carefully studied by those who are experimentally inclined. For, from this, it is easy to see how difficult it is to get absolute selectivity on powerful local stations.

Of course, those who have operated receivers know that such is the case, but they have been prone to lay the blame on improper design or poor construction.

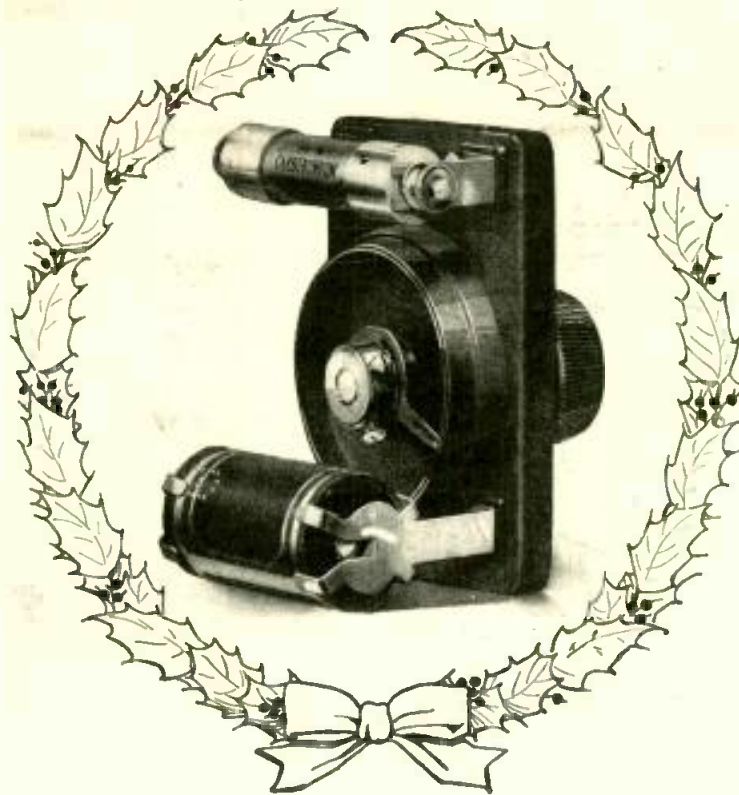

*Increased Selectivity
Greater Distance
More Volume*

BUT ABOVE ALL.—

Quality of Tone

On any set from the modest little Crystal Hook-up to the Super Outfit—you simply install

THE CARBORUNDUM
Reg. U. S. Pat. Off.
STABILIZING DETECTOR UNIT

\$3.50 (in U. S. A.) Dealer or Direct

Our Hook-up Book tells you how—send for it

THE CARBORUNDUM COMPANY
NIAGARA FALLS, N. Y.

SALES OFFICES AND WAREHOUSES IN
New York, Chicago, Boston, Philadelphia, Cleveland,
Detroit, Cincinnati, Pittsburgh,
Milwaukee, Grand Rapids

The Carborundum Co., Ltd., Manchester, Eng.

The Carborundum Company
Niagara Falls, N. Y.

Please send free Hook-Up Book D-5.

Carborundum is the Registered Trade Name used by The Carborundum Company for Silicon Carbide. This Trade Mark is the exclusive property of The Carborundum Company.

Name _____

Street _____

City _____ State _____

MODERN "B" Compact

Buy Him One for Christmas

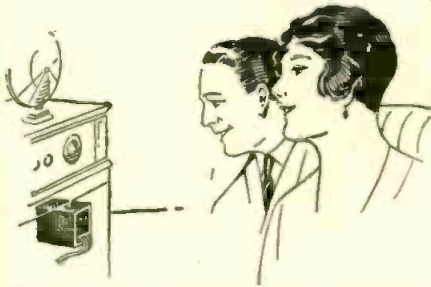

IF YOU want to tune in on C S (Complete Satisfaction) at Christmas get your radio enthusiast a Modern "B" Compact. Improves reception, does away with "B" Batteries—connects to a light socket.

The Modern "B" Compact has ample power for sets up to six tubes. There are three B+ taps and two variable voltage controls.

If your dealer can't supply you, don't accept any substitute but order direct by mail.

Price, Complete with
Raytheon Tube

\$30.00

(EAST OF THE ROCKIES)

The Modern Electric Mfg. Co.
Toledo, Ohio

MODERN "B" POWER UNIT
FOR SETS LARGER THAN SIX TUBES
\$50.00 East of the Rockies

*Constant as Niagara
Silent as the Sphinx*

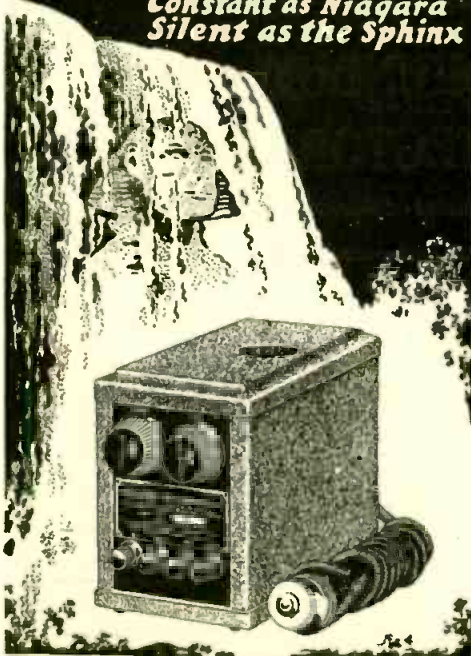

Uncle Sam's New Short-Wave Net

(Continued from page 769)



WHERE THE ARMY SENDS OUT ITS CALLS TO THE AMATEURS

The interior of station 2SC; this is one of the headquarters stations which act as liaison agents for the army. Station 2SC is on the air every night between 7 P. M. and midnight transmitting on a wavelength of 77 meters.

Signal Service Company under the direction of Capt. J. L. Autrey. This is station 2SC, designed and built by the Signal Corps Repair Shop in Brooklyn for transmission on a wavelength of 77 meters. It is a duly licensed amateur radio station, as are all the stations participating in the Government's amateur network. The transmitter is housed in a glass case, facilitating easy inspection and demonstration. Most modern amateur stations are powered by "B" batteries; this gives an unfluctuating plate voltage and, consequently, a steady note. With transmitters as powerful as 2SC, however, it is not economical to use "B" batteries for plate potential. On the other hand, fading and fluctuating wavelength is usually encountered when plate potential is secured from the power mains. Station 2SC is unusual, however, in that it has a crystal controlled transmitter; thus it is able to

obtain its power from the regular mains without the usual fluctuating note.

When a voltage is applied to the surfaces of a crystal, oscillations of a frequency that depend upon the thickness of the crystal are set up. This phenomenon is known as the piezo-electro action.*

With most crystal-controlled transmitters, the grid to filament potential is used to actuate the crystal; but this is not sufficiently steady for harmonic operation. Consequently, a 40-volt plate battery is used, which greatly improves the functioning of the device. The crystal is one millimeter thick, giving oscillations of 1934 kilocycles, corresponding to a wavelength of 155 meters. The oscillations so generated are used to actuate two 5-watt VT-2 tubes with the associated tuning circuits constituting the crystal oscillator. The output of the

*Described in POPULAR RADIO, November, 1925

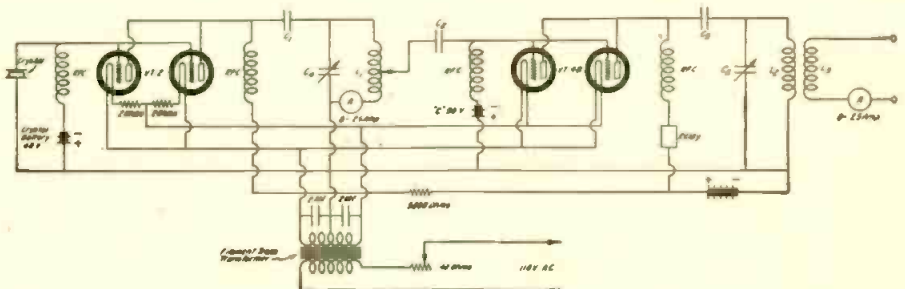

THE CIRCUIT DIAGRAM OF THE ARMY TRANSMITTER

This drawing shows the electrical connections of the various instruments that go to make up the crystal-controlled vacuum-tube oscillator that is used for short-wave communication between the army and the amateur at station 2SC.

ACTUAL SIZE BLUE PRINTS

Price \$1.00 Per Set

LAURENCE M. COCKADAY has personally supervised the preparation of *Simplified Blueprints* of thirteen of POPULAR RADIO's most popular circuits. Each set consists of one or more *Actual Size Blueprints*: first a Panel Pattern; second, an Instrument Layout; and third, a Picture Wiring Diagram all simplified in the fullest sense of the word because:

The **Panel Pattern** can be laid on the panel and all holes drilled as indicated. No scaling to do and so accurate there is no danger of ruining the panel through faulty calculation.

The **Instrument Layout** placed on the sub-base permits you to indicate by pin-pricks the exact location of every screw.

The **Picture Wiring Diagram** gives every instrument in exact size, and position with every wire clearly indicated from one contact to the other. With no knowledge of radio symbols you can assemble every part and complete your wiring with no chance of error.

Set No. 4—"Cockaday 4-Circuit Tuner with Resistance-Coupled Amplifier" (five tubes, distortionless, two dials, automatic vacuum tube control, as described in the October 1924 issue of POPULAR RADIO).

Set No. 6—"The Cockaday 8-Tube Super-heterodyne Reflex Receiver" (eight tubes, two tuning dials, loop, non-radiating, distortionless, as described in January 1925 issue of POPULAR RADIO).

Set No. 12—"8-Tube Super-heterodyne with Single Control" (as described in October 1925 issue of POPULAR RADIO).

Set No. 14—"The LC-26 Broadcast Receiver" (as described in December 1925 issue of POPULAR RADIO).

Set No. 15—"The Orthophase Receiver" (as described in the February 1926 issue of POPULAR RADIO).

Set No. 16—"The S-C All-Wave Receiver" (as described in the March 1926 issue of POPULAR RADIO).

Set No. 17—"The Power-pack Amplifier" (as described in the April 1926 issue of POPULAR RADIO).

Set No. 18—"The Improved Raytheon Power-Pack" (as described in the May, 1926, issue of POPULAR RADIO).

Set No. 19—"The New Home Receiver" (three tubes, two stages of radio-frequency-amplification with crystal detector, as described in June, 1926 issue of POPULAR RADIO).

Set No. 21—"The Improved Browning-Drake Receiver" (as described in the August, 1926, issue of POPULAR RADIO).

Set No. 22—"The LC-27 Broadcast Receiver" (as described in the October, 1926, issue of POPULAR RADIO).

Set No. 23—"The LC-Sentor Power-Pack" (as described in the November, 1926 issue of POPULAR RADIO).

Set No. 24—"The LC-Intermediate Power-Pack" (as described in the December, 1926 issue of POPULAR RADIO).

Full constructional and parts details for these Receiving Sets will be found in the issue of POPULAR RADIO indicated. Back issues of POPULAR RADIO will be furnished at the rate of 35c a copy.

POPULAR RADIO

Department 124

627 West 43d Street, New York

POPULAR RADIO, Inc., Dept. 124,
627 West 43d St., New York City

Date.....

Enclosed is my remittance of \$..... for which kindly send me Blueprint Set (s) consisting of Panel Pattern, Instrument Layout and Wiring Diagram as checked below:

- | | |
|----------------------------------------|----------------------------------------|
| <input type="checkbox"/> Set Number 4 | <input type="checkbox"/> Set Number 17 |
| <input type="checkbox"/> Set Number 6 | <input type="checkbox"/> Set Number 18 |
| <input type="checkbox"/> Set Number 12 | <input type="checkbox"/> Set Number 19 |
| <input type="checkbox"/> Set Number 14 | <input type="checkbox"/> Set Number 20 |
| <input type="checkbox"/> Set Number 15 | <input type="checkbox"/> Set Number 22 |
| <input type="checkbox"/> Set Number 16 | <input type="checkbox"/> Set Number 23 |
| <input type="checkbox"/> Set Number 24 | |

Name.....

Address.....

City..... State.....

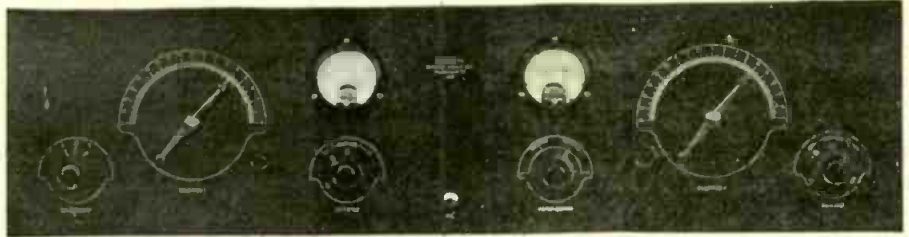

STANDARD ADMIRALTY MODEL

Norden-Hauck Super-10

Highest Class Receiver in the World

"The Norden-Hauck Super-10 is an entirely new and advanced design of Receiver, representing what we believe to be the finest expression of Modern Radio Research Engineering. In point of extreme range with tremendous audibility and quality of reproduction the Super-10 is the best Broadcast Receiver that can be built today. Wave length range adaptable 35 meters to 3600 meters with removable coils."

Mail the attached coupon today and we will tell you of a host of features that place the Norden-Hauck Super-10 far in advance of competition.

Write, Telegraph or Cable Direct to

NORDEN-HAUCK, Inc. Engineers

Marine Building, Philadelphia, Pa., U. S. A.
Cable Address NORHAUCK

NORDEN-HAUCK, Inc.
Philadelphia, U. S. A.

Gentlemen:—

Please send me without cost or obligation on my part, attractive illustrated literature describing the new Norden-Hauck Super-10.

I enclose \$2.00 for which please send me, postpaid, complete full size constructional drawings and all data for building the Super-10.

Name.....

Address.....

RADIO DEALERS

Get the new 1926-27 VAN-ASHE Catalogue

Shows all the newest parts, circuits and kits—all the hard-to-get items that set-builders demand. 12-hour shipments—extra-good discounts. Mail the coupon.



204 North 10th St. ST. LOUIS, MO.

Send Catalogue.

Name.....

Address.....



Approved Parts
for

Eliminators Power Amplifiers

Dongan has perfected transformers and chokes of several types which are used widely with UX, RCA and Raytheon Tubes for both Eliminator and Power Amplifiers.



2568
ABC Power Unit

Designed for use with Raytheon BH tube. Eliminates all batteries. Built into sturdy good-looking black metal case.

List \$17.50

Power Amplifier for Home Use

Use Dongan No. 2567 transformer half wave with UX 216 B-tube used in conjunction with UX Power Amplifier tube No. 210.

List \$10.00

Dongan transformers available for all standard types of power Amplifier tubes.

Type H-Audio Transformer

A Super-Transformer for present wave length conditions. Unusual power and smoothness.

List \$4.50

FANS

Order these and other Dongan parts from your dealer or send to the factory for complete information on constructing eliminator and power amplifier units.

MANUFACTURERS

For a reliable source of supply on the latest designs Dongan offers quantity production on all approved types. For special requirements our engineering department is at your service.

DONGAN ELECTRIC
MANUFACTURING COMPANY
2983-3001 Franklyn St. Detroit, Mich.



*Accurate Primary
Coupling at Every
Condenser Setting
with the New*
**HAMMARLUND
"AUTO-COUPLE"**

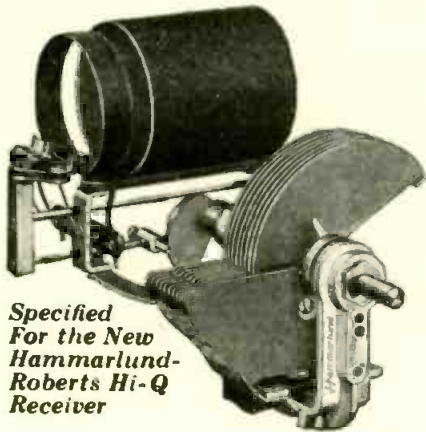

*Specified
For the New
Hammarlund-
Roberts Hi-Q
Receiver*

THE "Auto-Couple"—Hammarlund's latest contribution to radio—is a scientifically correct arrangement of Space-Wound Coil, "Midline" Condenser and Aluminum Shield, which encloses the complete assembly with accompanying tube and its socket.

It gives automatic, graduated primary coupling, assuring maximum transfer of energy at every broadcast wave-length and controlling undesirable oscillations on the low waves.

The "Auto-Couple" may be used in any tuned radio frequency circuit.

For the convenience of set-builders coils, condensers and shields are sold separately.

The Condenser used with the "Auto-Couple" Coil is the new Hammarlund "Midline" or "S-F-L" .00035 (17 plates), or any other make of condenser of the same capacity rating having a back extension shaft.

*Ask Your Dealer About It.
Write for Folder*

HAMMARLUND MFG. CO.
424-438 W. 33rd Street, New York City

For Better Radio
Hammarlund
PRECISION
PRODUCTS



From a photograph made for POPULAR RADIO

**ONE OF THE AMATEUR STATIONS IN THE
ARMY RADIO NET**

Radio station SXAN, operated by E. G. Raser at Trenton, N. J., is one of the many amateur stations that help the army to maintain communication under all conditions. Three transmitters are shown in this layout; 38-meter and 76-meter transmitters and a 250-watt emergency broadcasting set is shown in the background.

oscillator is supplied to a tuned circuit consisting of inductance L-1 with variable condenser C-4, of .0006 microfarads capacity in parallel with it. Tuning is accomplished by adjusting the variable condenser until the maximum output is secured in the radio-frequency ammeter in the plate circuit.

The power amplifier consists of two VT-4B tubes in parallel. These are of 50 watts capacity each, and secure their plate potential from a 750-volt direct current generator. The relay in the plate circuit is controlled by the operator's transmitting key. The tuned plate circuit is adjusted to 77 meters, half that of the crystal oscillator, with the aid of variable condenser C-5. Resonance is indicated by maximum deflection on the antenna ammeter.

On page 832 are shown the details of the transmitter. At the far left is the crystal with its adjustable contact. The ammeter indicates the point of resonance when condenser C-4 in the crystal oscillator plate circuit is correctly adjusted. The inductance in its plate circuit consists of seven turns of edge-wise mounted conductor seven inches in diameter. The tap P controls the power input to the power amplifier.

At the center is a filament voltmeter; the variable condenser at the right is in the plate circuit of the power amplifier

and in parallel with inductance L-2 that consists of 7 turns of edge-wise copper strip. The meter at the far right measures the antenna current and indicates the correct adjustment of variable condenser C-5.

Because of the size of the tubes used, the filament current is supplied from the power mains through a filament transformer equipped with suitable smoothing condensers.

The antenna system, shown on page 769, is a single vertical wire reaching up 40 feet directly from the transmitter. The counterpoise consists of two 60-foot wires, 8 feet from the ground, forming a V of 45 degrees.

Station NKF once held undisputed claim to the possession of the clearest and steadiest note known to short-wave radio. But with the advent of 2SC and its crystal-controlled transmitter and many amateur "B" battery-powered transmitters which are independent of power line voltage fluctuation, the short wave territory, is now vibrant with steady, clear signals.

It is anticipated that the various networks will play their part in the summer manoeuvres of the various National Guard and Reserve organizations. Those interested may communicate with the Signal Officer at the Army Corps Area headquarters in which they are located.

A New Circuit by Kenneth Harkness

In the next issue of POPULAR RADIO—for January—will be published for the first time the complete constructional details of a new receiver (to be known as the KH-27) that has just been developed by an engineer who is known to experimenters throughout the country.

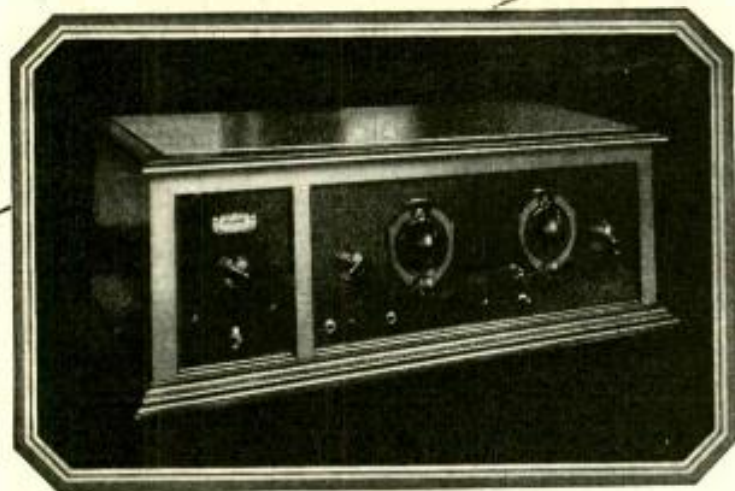

\$ 231

with 5 McCullough AC
Tubes and Rectron 213
without Loud Speaker

Clearartone LEADS THE WAY

Here is the first successful
low-priced set to elim-
inate "A" and "B" batteries

EVERYBODY was waiting for a set that would eliminate "A" and "B" Batteries without being high-priced. Here it is at last. The Clearartone Radio Electric Model 110, operating from the house current and using no fluids or acids. And the price including 5 McCullough AC Tubes and Rectron 213 (without loud speaker) is only \$231.00. What other set has such advantages at this figure?

The Clearartone Electric Model 110 abolishes the battery problem by using McCullough AC Tubes. They are undoubtedly the greatest achievement in radio today. The

set has won the approval of such eminent authorities as Professor Wilcox of the Armour Institute of Technology, of Chicago.

This set is the result of five years of exclusive radio receiving set manufacturing. You will marvel at its tone quality and volume. And the selectivity, which is attained by two vernier dial controls is exceptionally acute. The high quality of workmanship insures a set which will give years of satisfactory service fully guaranteed by a manufacturer of the highest standing in the radio industry.

THE CLEARARTONE RADIO COMPANY
2427 Gilbert Avenue :: :: :: :: Cincinnati, Ohio

— DEALERS —

Let us tell you how this set will help you do away with losses due to heavy service costs. We have some interesting facts and figures for YOU.

CLEARARTONE *Complete* RADIO SETS

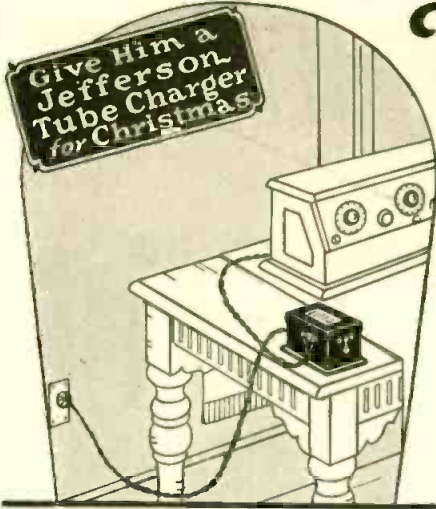

Tubes weaken as do batteries

DOES your set bring in the distant stations you got when it was new? Is your volume as great as then? If not, look to your tubes.

To keep large or small type tubes at highest efficiency, attach a Jefferson No. 275 Tube Charger to the light socket and connect it for 10 minutes, once a month.

Improved reception—plus longer life of tubes and batteries—will be worth many times the price to you. Guaranteed and made only by Jefferson. Get one today. Ideal Christmas Gift!

KEEP TUBES LIKE NEW—CHARGE THEM MONTHLY and ALL AT ONCE

JEFFERSON ELECTRIC MFG. CO.
Largest manufacturers of small transformers
508 So. Green St. :: :: Chicago

\$3.50
at
your dealers



Jefferson No. 275 Tube Charger

Send for Latest RADIO CATALOG and GUIDE

Get Your Complete Parts for All the Newest Circuits Here
In every issue of POPULAR RADIO and other radio magazines you will find the newest circuits of the world's greatest radio engineers. You will want to build these sets from the parts mentioned. BARAWIK service keeps up to date on all the new wrinkles. We have the complete parts for all these new circuits, complete, ready to ship you the instant your order arrives. Take advantage of this unequalled service. Get what you want—quick—at a big saving. No order too large or too small for us. 300,000 fans swear by BARAWIK service. We can please you, too.

Short Wave Equipment—Special Amateur Section
The Barawik line features this season a special Amateur Department in charge of F. J. Maroo, owner of station 9ZA, a nationally famous radio engineer and an authority on amateur work. It presents the latest in short wave equipment, transmitting and receiving supplies and everything necessary for the amateur and experimenter. Special attention has been given to short-wave kits including the B-T, Aero Coll. Silver Marshall R.E.L., etc. It will pay you to get our new Guide at once.

Radio's Newest at Rock-Bottom Prices
The new 1927 edition of the Barawik Catalog and Guide gives a comprehensive listing of the radio sets, parts, kits, supplies and accessories necessary in radio. This new Guide contains over 6,000 items of radio's newest developments, everything that a real fan will need from the complete factory-built set to the smallest screw, including labor-saving devices, tools, power supply units, amplifier equipment, etc. Standard equipment of the best known manufacturers at tremendous savings.

Besides the complete radio and amateur line there is shown a selection of electrical goods, household appliances, and accessories and articles necessary in the home—all at a big saving in price. Write today for your free copy of the 164-page guide. Also please include name of other fans. Mail the handy coupon NOW.



BARAWIK CO.
540-545 Monroe St.
Chicago, U. S. A.

Mail This Coupon Now! For Free Copy

Name.....
Address.....
Fan Address.....

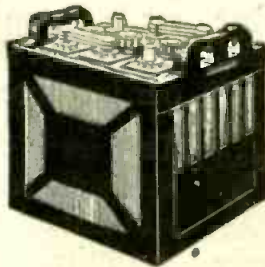

CHICAGO Radio Batteries

SOLID ONE PIECE RUBBER CONTAINERS

Guaranteed for 2 Years

FAMOUS for unexcelled quality, guaranteed long-lived service and unvarying dependability, Chicago Batteries offer the Radio fan an "A" Power that is backed by years of experience and master workmanship with the finest materials available. Endorsed and approved by leading Radio and Automotive authorities. Chicago Batteries in their new non-leak, solid rubber cases represent an amazing value at lowest cost.

PRICES RADIO BATTERIES Solid Rubber Cases

- 6 volts, 100 ampere hours..... \$ 8.79
- 6 volts, 120 ampere hours..... 10.79
- 6 volts, 140 ampere hours..... 13.50

SEND NO MONEY

Buy Chicago Batteries direct from the manufacturer. Batteries shipped same day order is received. Express C. O. D. or 5% discount cash with order.

MOGUL ELECTRIC LABS.
1216 So. Peoria St. Chicago, Ill.

If You Want to Read the Code—

(Continued from page 779)

secretive enough way of conversing.

The foregoing applies mainly to reception—to learning to receive in the code. Transmission on the other hand, is naturally but the reverse of reception in that rather than saying to yourself "dah dit dit dit—that's B" when you hear those characters, you say "B—that's dah dit dit dit," and then proceed to make the equivalent on the telegraph key.

Transmission is erroneously thought by a large number to be simple and easy to acquire, and that it naturally follows with proficiency in reception. Not so. Acquiring a good "fist" as formation of code characters on the key is known among the profession, is a considerable art in itself and one acquired only by constant and conscientious practice. In making the characters, we are often told by instructors and text books to place fingers in a certain way in grasping the key knob. Don't do it—hold the key in the most natural manner, so that an even down pressure may be maintained and so that the muscles automatically relax on the up stroke of the key. This will come natural as it will be the easiest "feel" to your hand. You will learn with experience, which grip answers you best and enables you to send for hours if need be with little arm and hand fatigue.

Some who are in favor of the "dit dah" method for instruction in receiving, do not favor it for transmission but suggest rather that the conventional "dot and dash" alphabet be used from which to practice transmission. The writer does not hold in this. As it is almost essential that reception and transmission be learned together and not individually, the student should not be confused by two code charts. While it is true that he sees the message he is transmitting, he does not see the dots and dashes that form the words of the message and accordingly must think in terms of "dit dah" when transmitting as well as receiving. Why then should he not use the "dit dah" method for both purposes?

A great deal of assistance in learning to receive is not to be had from sending to one's self. It is difficult, and in fact almost impossible to increase one's speed ability by listening to one's own transmitting; a student following this procedure will be greatly benefited at the outset of his studies however, because constant repetition of the letters as he transmits them will enable him form a memory chart of the associated sounds quicker than by reading from the code chart and endeavoring to memorize that "A is dit dah."

For actual receiving practice, nothing is better than a good receiving set for the student gets practice on exactly

what he will expect to copy over the air. The great drawback here though is that few code transmittals nowadays take place at a speed of less than eighteen or twenty words a minute and the sounds will be but a meaningless jumble of dits and dahs to the student who has not yet acquired a reasonable proficiency. Occasionally, if the student is fortunate enough to own a receiver capable of tuning to 15,000 or 20,000 meters (a honey-comb set with proper coils is admirable) he will find a few stations which, probably from necessity caused by static or other interference, are sending very slowly, often repeating each word twice. Such transmission will give the student much good practice, and he need not feel discouraged if he is not successful in copying "solid," or without error. Such practice as this applies of course, to the more advanced student after he has become thoroughly familiar with the sound of each letter, and desires to improve his speed. For the actual beginner, we must use different methods.

By far the best practice for a beginner is to have some good sender transmit to him by the hour with a buzzer or other practice outfit capable of imitating the sound of wireless telegraph signals. Unfortunately, it is difficult to find among one's casual friends a radio telegrapher or even a good sender in the neighborhood. It is possible that we may find a Morse telegrapher in the vicinity who would be willing to do some sending, but this also is problematical. It is poor practice to have another student, green as himself, attempt the transmission, for until he has developed the firm, precise fist of the professional telegrapher, he will not be able to send characters which will have the proper sound.

For example: while the letter "C" is represented on the code chart as "dah dit dah dit" and we know that a "dah" is a character three times the length of the "dit," yet in actual communication over the air professional operators place a slight slur on the first "dah" making it more like "da-ah" and which has a tendency to make the letter more distinguishable and less jerky than were the strict interpretation of the code adhered to. Thus were the letter "C" sent exactly as called for, "dah dit dah dit" it would be the equivalent of two letter N's run together, and might lead to confusion with a double N. Hence the slight drag on the first "dah" by the professional man. This holds likewise with the letter Y—actually "dah dit dah dah" but used commercially thus: "da-ah dit dah dah."

The student need not concern himself with these professional formations however, but learn the code exactly as called for and it will be found that the slight swing that eliminates the jerkiness will come with experience and each student will develop an unconscious

\$75 A WEEK BUILDING RADIO SETS

—in your spare time

JOIN the Radio Association of America. Learn how to build and repair radio sets. The Association will train you—start you out in business if you wish. Be the radio "doctor" of your community. \$3 an hour upwards easily made. Radio offers you a big money-making opportunity right now.

Earns \$500 in Spare Hours

"I have at last found myself," writes Lyle Follick, Lansing, Michigan, "I have already made over \$500 building radio sets after working hours." Werner Eichler, Rochester, N. Y., writes, "I have made over \$50 a week in my spare time."

Our members are starting radio stores, increasing their salaries, securing better positions, passing radio operator examinations, earning big money for the most enjoyable kind of spare-time work.

What a Membership Means

A membership in the Radio Association of America gives you the most up-to-date and thorough training in the Science of Radio.

You're taught how to build and repair all kinds of sets. You're given the train-

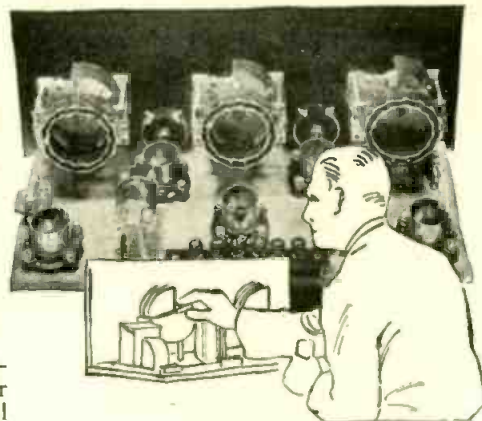

ing you need in preparing for a Licensed Radio Operator's examination. You receive the privilege of buying parts at wholesale prices.

You're helped to make money.

Join the Association Now

If you're interested in Radio for either pleasure or profit, join the Association without delay, because we have a plan whereby your membership may not—need not—cost you a cent. Only a limited number of these memberships are acceptable. Write now for details. Write before it's too late.

This Association has prepared a beautiful book that gives figure-facts regarding the profit possibilities of the Radio Industry, the purpose of the Association, and the details of the Special Membership Plan.

Mail This Coupon

RADIO ASSOCIATION OF AMERICA
Dept. C-12—4513 Ravenswood Ave., Chicago
Send me your book and details of your Special Membership Plan.

Name.....
Address.....
City.....State.....

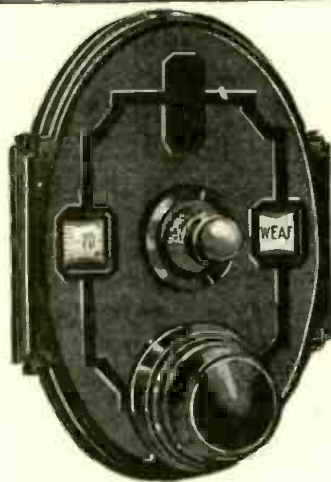

Accurate Recording Dial

Its simplicity and efficiency has overwhelmed the real radio fans.

Its positive friction grip insures absolute smooth action.

Graduated from 0 to 100 or reverse

Sold in three ways.
Recording Dial \$2.00
(Ratio 10 to 1)

With Micrometer Control . . . 2.75
(Coarse ratio—and 200 to 1)

Illuminated extra50

Send direct if your Dealer cannot supply you

Mydar Radio Company
5 Campbell St. Newark, N. J.
"Pioneer Mfrs. of Micrometer Dials"

Potter Condensers

Build the best—

- Socket Power Devices
- A and B Supply Devices
- Power Amplifiers
- Impedance Amplifiers

And are best—

- For Filter Uses
- Rectifiers
- By Pass
- Blocking D.C.

American made of best of materials to full capacity. All sizes and types.

POTTER MFG. CO.
North Chicago, Ill.

Potter
BY PASS AND FILTER
Condensers



YAXLEY
APPROVED RADIO PRODUCTS

Automatic Power Control

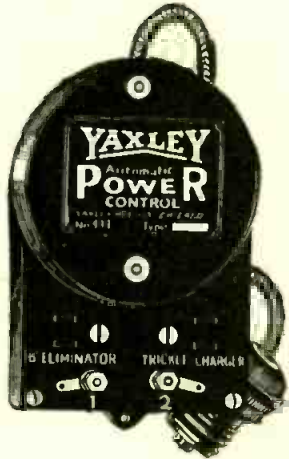

Here is a gift of gifts for your radio friends—the latest radio convenience that every set owner will want. The Yaxley Automatic Power Control does all the extra switching for you. It takes care of your B eliminator or trickle charger or both. When you turn your set on, the trickle charger is off, the B eliminator is on. When you turn the set off, the Power Control is standing guard for you. It works automatically and without fail to turn off the B eliminator and turn on the trickle charger.

No. 444, Series Type—for use with sets with tubes having a current draw equal to or greater than 6 U. V. 199 type tubes Each, \$5.00

No. 445, Multiple Type—for use with any set and especially for sets having tubes with a current draw lower than that of 6 U. V. 199 type tubes. Each, \$6.00

At your dealer's. If he cannot supply you send his name with your order to

Yaxley Mfg. Co.
Dept. P, 9 So. Clinton Street
Chicago, Ill.



individuality to his style of sending peculiar only to himself. Many an old timer in the professional operating field can tell from the type of sending to which he is listening just which identical operator is doing the transmission. Individual style is bound to develop in any sender—it is as natural as the various peculiarities of feature which make no two human beings exact counterparts of one another.

A warning is in order here however; by all means, let the style develop naturally and without conscious effort on your part. One of the greatest pests in the radio operating field is the operator who has, by much painstaking effort acquired what he is pleased to term an "exclusive" fist and which is variously referred to as the "gulf swing," "Great Lakes swing" or some similar moniker, depending upon which particular section the operator hails from.

If the beginner is handicapped by the lack of a good hand sender to transmit to him, he has recourse to a few other methods. Phonograph records are available which contain excellent code matter transmitted by an excellent hand-sender; these appear on the records at various speeds from but a few words per minute up to the highest commercial speeds. Artificial static and interference is produced and the records are made to sound for all the world like actual radio signals through the headphones. Such practice is excellent and a set of records should be part of the student's equipment.

Another practice machine is available to him, and forms good practice for the reason that it is the identical automatic transmitter by which the U. S. Radio Inspectors determine the code ability of an applicant for a radio operator's license. Such a machine is known under the trade name of the "omnigraph," and has the advantage of offering a constant change of subject matter inasmuch as the dits and dahs are cut into the periphery of aluminum dials which are easily interchangeable. The omnigraph also has adjustments to permit of any speed of transmission.

In spite of years of research and various devised methods, it is agreed almost universally that the only way in which to obtain a mastery of the code characters is by constant practice. Teaching the sub-conscious mind while asleep is but one of the many ways evolved to attempt to speed up such instruction, but when all is said and done, constant plugging, for an hour or so daily for from five to eight months is required to make a good twenty-word operator. The man who is really intent on learning the code, will accept the inevitable, buckle down to steady practice and not waste his time on any of the somewhat dubious methods that may be suggested to him. Such a man will make the grade and graduate a good operator.

CARTER "HI-OHM" Universal Volume Control for All Circuits

—used in the LC-27



Produces a uniform percent change in resistance. The resistance characteristic curve is mathematically correct for all circuits. Resistance element moisture proof and protected, insuring long life and unvarying electrical characteristics.

Half Size Complete with knob \$2

500,000 ohm	"
300,000 "	"
200,000 "	"
100,000 "	"
50,000 "	"
10,000 "	"

New "Midget" Rheostat ALL METAL

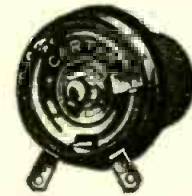

Smallest made. Self-cooling all metal frame absorbs and radiates heat. No moulded parts to crack or break. Smooth, silent positive contact. Made in all resistances, including New R.M.A. Standards.

Half Size 50¢

Both items used in all the popular circuits

Any dealer can supply

In Canada—Carter Radio Co., Limited, Toronto



FREE SIMPLIFIED BLUE PRINTS

You know how helpful, interesting and practical POPULAR RADIO is. You fully appreciate that at \$3.00 a year it is a real bargain. Consequently you should find it easy to convince one, two or more of your friends, who are not now subscribers, of the unusual value when any one of these thirteen sets of Simplified Blueprints (described on Page 833) is offered free with their twelve months' subscription for POPULAR RADIO at the regular price of \$3.00. In addition to the Blueprints given to your friends we will allow you one set free for each new subscription you send us with a \$3.00 remittance. Five new subscriptions and remittance of \$15.00 would entitle you to five sets free.

Only one set of Blueprints free with a renewal subscription whether your own or a friend's.

POPULAR RADIO, INC., Dept. 123
627 West 43d Street, New York City

Enclosed is my remittance of \$_____ covering _____ annual subscriptions for POPULAR RADIO (names on sheet attached). Send me set(s) checked below.

- | | |
|-------------------------------------|-------------------------------------|
| <input type="checkbox"/> Set No. 4 | <input type="checkbox"/> Set No. 17 |
| <input type="checkbox"/> Set No. 6 | <input type="checkbox"/> Set No. 18 |
| <input type="checkbox"/> Set No. 12 | <input type="checkbox"/> Set No. 19 |
| <input type="checkbox"/> Set No. 14 | <input type="checkbox"/> Set No. 21 |
| <input type="checkbox"/> Set No. 15 | <input type="checkbox"/> Set No. 22 |
| <input type="checkbox"/> Set No. 16 | <input type="checkbox"/> Set No. 23 |
| | <input type="checkbox"/> Set No. 24 |

(See Page 833 for description of Sets)

Name _____

Address _____

Foreign postage 50c extra. No extra for Canada.

Marvelous New STORAD

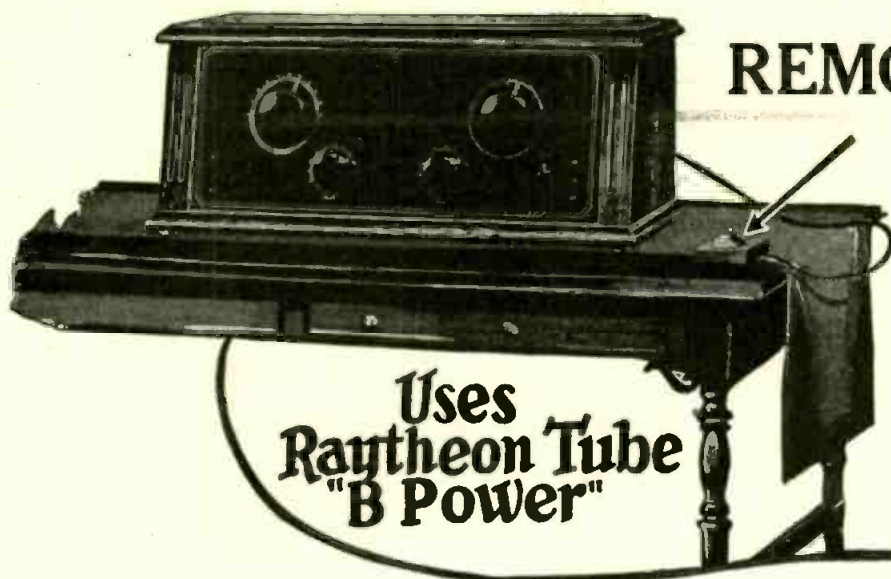

REMOTE CONTROL
POWER
SUPPLY

with
Set Control
Button

Uses
Raytheon Tube
"B Power"

Type 101X—"B Power" Supply, Raytheon Tube Type Unit operating on house lighting circuit. Three variable controls from 180 volts down. Has REMOTE CONTROL feature.

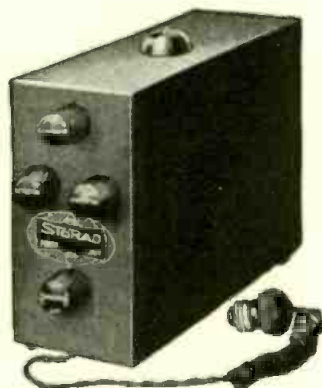

Type 201AX—"B Power" Supply and Trickle Charger

Combination unit illustrated here, combines Raytheon type "B" Eliminator with Storad Trickle Charger. Operates with REMOTE CONTROL.

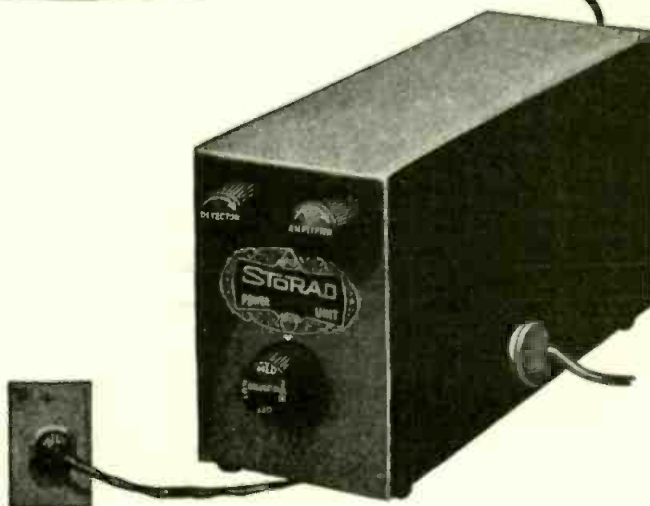

Plug in Trickle Charger here

Unique, Practical and an Exclusive Storad Feature!

Here is the kind of Power Supply you have been waiting for—REMOTE CONTROL—the kind that is controlled with one button placed where you want it. Place your eliminator, charger and batteries where you wish—cellar, clothes press, or cabinet—you do not have to touch them to turn them on or off. The control button turns off the set and eliminator and turns on the Trickle Charger at the same time.

Interchangeable With Other Units

You do not have to use all Storad Units to enjoy this REMOTE CONTROL feature. A Storad Trickle Charger will work with any make of eliminator and operate it by REMOTE CONTROL, or you can use a Storad 101X "B Power" with another make Trickle Charger and enjoy the same advantages.

Raytheon "B Power"

Storad "B Power" Units having the REMOTE CONTROL feature are Raytheon Tube Type. Storad Exclusive Circuit (Patent Pending). Tobe Deutschmann Heavy Duty Condensers are used throughout.

100% Over Capacity

That's why Storad Power Supply will work on any set without hum. Storad Heavy Duty Units have ample power for UX171 Power Tubes even when used on the largest sets.

No More Power Worries

Put a Storad on your circuit and your power worries are over. You will have current—lots of it when you want it. Storad Power Supply is the result of three years of research work and one year of actual test.

Insist on Storads from your dealer or write us direct.



Type 701X Trickle Charger. Sufficient capacity for "A" Batteries used with larger sets. Variable Control regulates charging current from 1/2 to 1 amp. Has REMOTE CONTROL feature.

The Storad Manufacturing Company

2417 Detroit Avenue, Cleveland, Ohio

SM

630

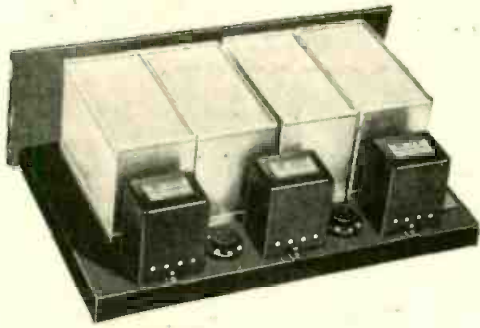

SHIELDED SIX

Endorsed and approved by Radio Broadcast, Citizens Radio Call Book and many other prominent publications and newspapers.

The Shielded Six is one of the highest types of broadcast receivers. It embodies complete shielding of all radio frequency and detector circuits. The quality of reproduction is real—true to the ear.

Behind the Shielded Six is competent engineering. It is sensitive. Day in and day out it will get distance—on the speaker. It is selective. Local stations in the most crowded areas separate completely—yet there are but two dials to tune.

These features—its all-metal chassis and panel, its ease of assembly, and many others—put it in the small class of ultra fine factory built sets, priced at several times the Six's cost.

The SM-630 Shielded Six Kit—including all specified matched and measured parts to build this remarkable receiver—price \$95.00.

The 633 Essential Kit—contains 4 condensers, 4 R.F. transformers, 4 coil sockets, 4 stage shields and the link motion—all laboratory matched—price \$45.00.

Clear and complete instructions, prepared by S-M engineers, go with each kit—or will be mailed separately for 50c.

220 & 221 Transformers

S-M 220—the big, husky audio transformer you hear in the finest sets—the only transformer with the rising low note characteristic that means real quality—not only on paper—but when you hear it—\$6.00.



S-M 221 is an output transformer that will bring out the low notes on your present set. It eliminates blasting for practically all good speakers—\$6.00.

All prices 10% higher west of the Rockies.

SILVER-MARSHALL, Inc.

841 W. Jackson Blvd.

Chicago, U. S. A.



WHAT READERS ASK

CONDUCTED BY DAVID LAY

In justice to our regular subscribers a nominal fee of \$1.00 per question is charged to non-subscribers to cover the cost of this service, and this sum must be inclosed with the letter of inquiry. Subscribers' inquiries should be limited to one question or one subject.

A Power Tube Without A Storage Battery

QUESTION: I have a five-tube, tuned-radio-frequency receiver in which I use UX-199 tubes. This receiver gives good results so far as distance is concerned but the volume is insufficient and the tone quality is poor when the set is adjusted for maximum volume. I have constructed one of the Raytheon Power-packs described in POPULAR RADIO and as this unit is capable of supplying operating voltage for a UX-112 or UX-171 power tube, I would like to use one of these tubes in the last audio stage to improve volume and tone, if it is possible to do this without resorting to the use of a storage battery for the filament supply.

—FRED STROCH

ANSWER: It would scarcely be practical to obtain the filament voltage for either of these power tubes from dry cells. The simplest plan to follow would be to use a dry-cell power tube (UV-120) in the last stage. This little power tube gives very good results—far better results than a UX-199 in the last audio stage. If a plate voltage of 135 volts is supplied to this tube the only circuit change necessary will be to bring out separate "B" (+) plus and "C" (-) minus leads for this last tube. This is done as shown in Figure 1.

If you wish to go further than this, how-

ever, and use a five-volt power tube such as either of those you mention, you can draw the filament lighting current from the alternating current house lighting lines through the medium of a small step-down transformer such as is used to operate doorbells. The transformer should be one which supplies five volts across the secondary terminals, or a six-volt transformer may be used, with a series rheostat at the point marked X in Figure 1.

To use this scheme with your receiver the wiring of the circuit should be changed as shown in Figure 1. The dotted lines show the old connections which are removed. The filament terminals of the last socket are disconnected from the receiver filament circuit and reconnected directly to the secondary terminals of the bell-ringing transformer. The arm of the potentiometer, R, which may be a standard 400-ohm instrument, is then connected to the grounded side of the receiver "A" battery circuit. Separate "B" (+) plus and "C" (-) minus leads will have to be provided for the power tube, as mentioned above, to allow the higher plate voltage to be supplied to the power amplifier tube and the proper grid-bias ("C" voltage) to the grid of this tube. If your power-pack is capable of supplying 180 volts, the biasing voltage should be about 40 volts if a UX-171 tube is used and 12 volts with the UX-112. Best results will be obtained with the UX-171.

In putting the power-amplifier tube into operation for the first time in this circuit, turn on the receiver filament and switch on the power to the Raytheon and filament supply transformers. Then adjust the potentiometer R until no hum is heard.

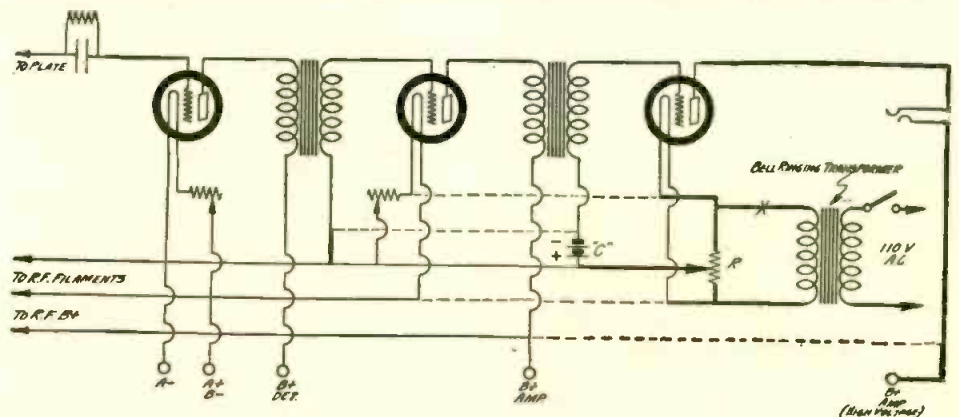

HOW AC IS USED ON THE POWER TUBE FILAMENT

FIGURE 1: This diagram shows the changes necessary in a two-stage amplifier to use straight alternating current on the last tube filament. The dotted lines show the disconnected wires and the heavy black lines show the new connections.

**Greater Distance
Finer Selectivity
Greater Power**

with

AERO COIL
SUPER-SENSITIVE

INDUCTANCE UNITS



TUNED RADIO FREQUENCY KIT

\$12.00

The Aero Coil Tuned Radio Frequency Kit illustrated above will positively improve the performance of any receiver. Patented Aero Coil construction eliminates radio frequency losses and brings tremendous improvement in volume, tone and selectivity.

Kit consists of three matched units. The antenna coupler has variable primary. Uses .00035 condenser. 8 page color circuit, layout and instruction sheet for building the supersensitive 5 tube Aero-Dyne receiver packed FREE with each kit. Extra copies, 75c. each.

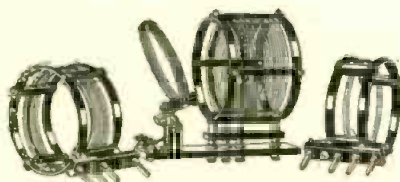

LOW WAVE TUNER KIT

\$12.50

Completely interchangeable. Adapted by experts and amateurs. Range 15 to 130 meters. Includes three coils and base mounting, covering U. S. bands, 20, 40 and 80 meters. You can increase the range of this short wave tuner by securing coils No. 4 and 5. Combined range of 15 to 550 meters. Both interchangeable coils fit same base supplied with short wave kit and use the same condensers. Coil No. 4 price \$4.00; Coil No. 5, price \$4.00.

These Aero Coils are available at your dealers. Get yours today!

Aero Products, Inc.

Dept. 104
1772 Wilson Ave.
Chicago, Ill.



IT HOWLS

Now it doesn't!

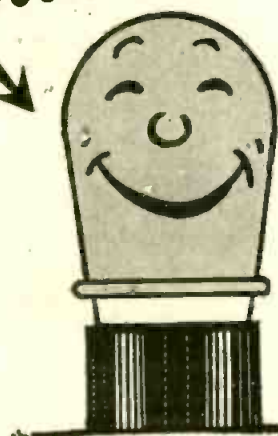

**Mc DONALD
HOWL
ARRESTER**

"It Stops that Howl!"

Slip one of these live rubber jackets over each trouble-making tube . . . and the Howl stops.

Remember the name! You can get it for every size tube. It sells for 75c each. Just ask your dealer, or write.

Sole Selling Agents for the U. S. A.

SPARTAN ELECTRIC CORPORATION
350 West 34th Street, New York City

Manufactured in the U. S. A., by the
SCIENTIFIC PRODUCTS CANADA, LTD.

"It Stops that Howl!"

**WARD LEONARD
VITROHM**

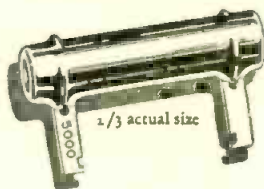

The resistor units you need for

VARION, Raytheon

and AmerTran
Battery Eliminators



NOT affected by moisture, continuous service or overload. Wire wound, vitreous enamelled (glass-like); the permanently reliable resistor. Non-inductive; zero temperature co-efficient. Compact; easy to use; hard to break.

All sizes you need; separate units; or handy kits of units, totalling 21,750 ohms in various resistances. Recommended for all approved A. C. and D. C. eliminators. 34 years manufacturing of resistance as specialists.

Ward Leonard Electric Company



7235-2

LC-27

ALL PARTS IN STOCK

1—Hammarlund mid-line dual condenser, .000275 mfd.	\$7.50
1—Hammarlund mid-line single condenser, .000275 mfd.	4.65
1—Precision Duo-Octaform coil set, one antenna coupler and two interstage couplers.	10.50
1—Amertran De Luxe first-stage transformer.	10.00
1—Amertran De Luxe second-stage transformer.	10.00
1—Amerchoke No. 854.	6.00
1—Dubilier No. 902 filter condenser, .4 mfd.	5.50
1—Dubilier No. 907 filter condenser, .1 mfd.	.60
1—Mar. Co. illuminated control, scale 0 to 100.	3.50
2—Mar. Co small controls for LC-27.	1.50
1—Carter battery switch.	.65
1—Samson radio-frequency choke coil No. 85.	1.50
3—Aerovox mica fixed condensers, .00025 mfd.	1.05
1—Durham resistor, 4 megohms.	.50
1—Lynch grid leak mounting.	.35
1—Carter Gem Jack.	.25
1—Carter resistance, 0-10,000 ohms.	2.00
12—Eby binding posts.	1.80
5—Benjamin UX sockets.	3.75
1—Amperite.	1.10
Mechanical Kit consisting of aluminum shields, binding post strip, decorated panel and Tait brackets.	12.50

LIST PRICE \$85.20

We can also supply the Corbett Cabinet for this receiver at \$18.00

DEALERS

Write for wholesale prices. We are headquarters for all Silver-Marshall Apparatus as well as 79 other lines.

Send for 52 page "Shure Shots" catalog.

SHURE RADIO CO.
1-19 S. Wells St. Chicago

Making Radio Better by SHIELDING

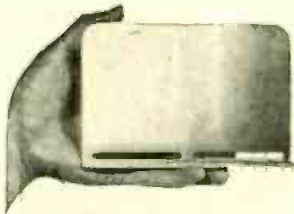

The Alcoa Radio Shields are especially designed for insertion between stages or instruments.

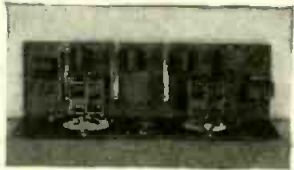

Alcoa Radio Shields in the new A. C. Varion Receiver, marketed in kit form by the Morison Electric Supply Co., Inc., 15 East 40th St., New York City.

Aluminum Shields of the can-type give total shielding to this new Silver-Marshall Receiver.

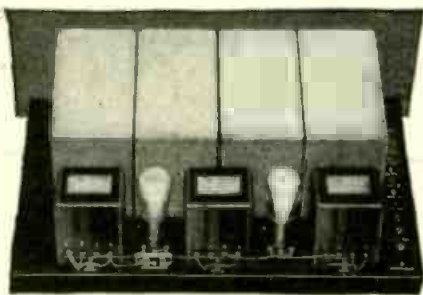

SHIELDING is a most important necessity to get real radio results today. Partial shielding prevents undesired coupling, disturbing pick-up of local signals, increases distance, enhances tone quality.

Aluminum excels all other metals in shielding value. The conductivity of virgin aluminum (highest mass conductivity known), its easy fabrication, make aluminum the cheapest, as well as the best metal to use.

Any radio receiver can be shielded with aluminum with more electro magnetic efficiency, with less weight and more cheaply than with any other metal.

Interest at the radio shows was so great that we invite experts, manufacturers, constructors and amateurs to send for the new and unusual treatise on this subject by L. M. Cockaday, E. E. Free and the Research Engineers of the Aluminum Company of America. Use the coupon below.

ALCOA



TRADE-MARK

Only the Genuine Bears this Mark

ALUMINUM COMPANY OF AMERICA
Pittsburgh, Pa.

Aluminum Company of America,
Room 2321, Oliver Building, Pittsburgh, Pa.

Gentlemen:

Please send me a complimentary copy of the booklet "Aluminum Radio Shields."

Name

Street City

What Circuit do you now use?

What one will you build next?

Sparkling in Electrolytic Rectifiers

QUESTION: I am using a four-jar electrolytic rectifier to charge my storage "B" batteries but it does not seem to function quite satisfactorily. When it is in operation there is a great deal of sparking around the aluminum electrode in one of the jars, while the aluminum rods in the other jars sparkle very little but glow with a greenish phosphorescent light of equal intensity all over the immersed part of the rods. Perhaps this description will provide some inkling as to the cause of the trouble I am having. Can you help me out?

—STANLEY FANCHER

ANSWER: The brilliant sparkling of one electrode in a jar indicates that the jar is a "dud." If the electrodes in all of the jars sparkled more or less violently it would be an indication that the electrodes were too small or the load was too heavy for the number of jars used. In your case the other three jars are working properly as indicated by the greenish glow but they are probably somewhat overloaded due to the failure of the first jar. It is most likely that your trouble will be eliminated by replacing both the lead and aluminum electrodes in the "dud" jar. Before putting in the new electrodes pour the solution out of the jar, wash the jar thoroughly, and refill with new solution.

A "dud" jar is a mysterious thing. A multi-jar rectifier may be made up from aluminum electrodes and lead electrodes all cut from the same pieces, and with solution all mixed at one time. Still, when the rectifier is put into operation it may be found that some of the jars work perfectly while others are useless. The trouble is usually due to impurities in or on the electrodes and the only sure cure for the bad jars is to make them up all over again, using new electrodes and a fresh solution.

When one jar sparkles excessively it is not only working poorly but it puts an added strain on the other jars, which have to carry the burden of the poor jar as well as their own.

* * *

The "Telephone Antenna"

QUESTION: On page 191 of the June, 1926 issue of POPULAR RADIO mention is made of an invention that covers the use of a device to be used with an ordinary telephone to take the place of an ordinary antenna. Some time ago, I read an article mentioning the use of a metal plate under the telephone and insulated from it by the felt. Is this the same idea?

—G. B. SHAWN

ANSWER: The only difference is one of technical construction. The principle of operation of both is the same. The small capacity of the plate to the line corresponds to the small condenser in series with the lighting wires used in "wired wireless." The wires act as guides for the high-frequency wave.

The signal received in this way is usually not very strong except on local stations and any disturbance on the line may cause a noise in the receiver comparable to that of the station. The receiver should not be used on automatic telephones and where there is a local switchboard.

Just Out! **30 Days FREE TRIAL** *1927 Models*

on any

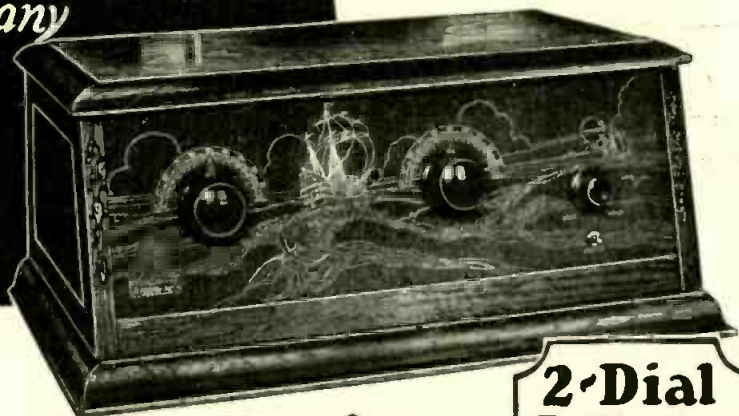
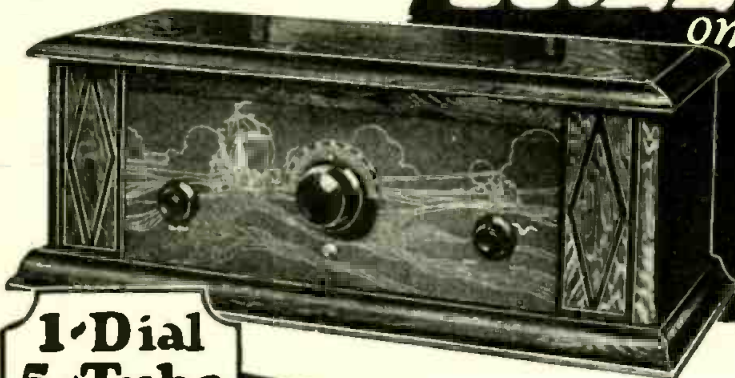

**1-Dial
5-Tube
\$57⁰⁰
Retail Price**

**2-Dial
5-Tube
\$47⁰⁰
Retail Price**

Westingale RADIO

*The Last Word in
Guaranteed
Radio
Sets*

*and
the
Biggest
Values
Ever
Offered*

Yes, Sir!—you can put a NEW 1927 Model Westingale 5-tube Radio in your own home and use it to your heart's content on 30 DAYS' TRIAL. Entertain your family and friends. Listen to the music, concerts, sports, news, market reports from stations all over the country. Compare it with other sets for beautiful appearance—wonderful performance and low price—and if you are not convinced that Westingale gives you the greatest measure of Radio satisfaction and the best value for the money—YOU DON'T HAVE TO KEEP IT.

Big—Powerful—Dependable 5-Tube—Coast to Coast Set

Don't buy any Radio until you send the coupon below for our FREE Catalog, which pictures and describes both the new 1-Dial and 2-Dial Models. Why pay more? Why not get the NEWEST Radio? Why take chances when all we ask is a 30-Day Trial at our risk to convince you that these NEW 1927 Westingale Models are years ahead in powerful reception—wonderful loud, clear tone—handsome appearance—and EASY, simple control?

Look at these two distinctive Westingale Models—they're the last word in every way. Every late feature—every new worth-while idea is embodied in their makeup. Newest style period type cabinets. Two-tone, hand-rubbed Walnut finish. The front panels enhanced with an artistic Spanish Galleon design embossed in dull gold. These new Westingale Models are unsurpassed in appearance—unbeatable in performance—and unbeatable in price. Don't wait. Mail this coupon now for full particulars. Get posted before you buy.

AGENTS Wanted—Buy at Cost

Right now we want to appoint an agent or dealer and place one demonstrating set in each locality, because we know that each demonstration will sell more sets. This is your chance to get a Westingale Radio at a big discount and make it pay you big money.

For a limited time we offer a big reduction way below retail prices on the FIRST Westingale outfit placed in each locality. Anyone can make quick sales and big profits in taking orders for Westingale sets. No radio experience necessary. We show you how. \$50 to \$100 a week—full or spare time. Our FREE book tells all about it.

Your Own Radio--FREE

Our FREE Catalog also explains a plan whereby you can put a Westingale Radio in your home on 30 Days' Trial—demonstrate it to your neighbors and friends in your spare time, and get your own set without cost before the trial period is up.

Mail the coupon or a post card for our FREE Radio Catalog today. Be first in your locality to get special discount prices and our FREE Radio offer.

Westingale Electric Co.

Dept. 122 1751 Belmont Avenue, CHICAGO

Mail Today—Don't Delay

Westingale Electric Co.,
Dept. 122—1751 Belmont Ave.,
Chicago, Ill., U. S. A.

Please send your FREE Catalog on the New 1927 Westingale Radios. Also full particulars of your Special Discount on the first outfit placed in each locality and your FREE Radio Offer.

Name
Address

Build The Outstanding Circuit of the Year **HENRY- LYFORD**

Receiver

With the Deliberately Unbalanced Circuit

This new unbalanced feature gives a tremendous increase in sensitivity without losing selectivity. Its high and low wave length range permits you to hear the North Pole expeditions, government stations and amateurs, a tuning feature not obtainable with the average circuit.

Complete parts carefully packed and fully guaranteed **\$69.50**

Complete as Used Parts in the LC-27 Intermediate **POWER-PACK**

	Total
1—Yaxley Automatic Relay Switch No. 444	5.00
1—Filtrex A-C Transformer, type K-180	5.25
2—Filtrex Choke Coils, type K, @ \$6.75	13.50
1—Any approved UK type socket	.35
6—Any approved binding posts	.90
1—Acracoon condenser block, 14 mfd.	11.00
1—Acracoon filter condenser, .1 mfd., 400 volts D-C	1.00
1—Resistance Unit—type 200—20,000 ohms total resistance. Tapped to obtain correct voltages	5.25
1—Any approved high-current variable resistance to dissipate 5 watts—2,000 ohms	2.00
1—Hardwood baseboard, 7 1/4" x 18" x 3/8"	.85
1—Bakelite binding post panel, 3 1/4" x 4 1/2" x 3/32" drilled	.50
1—Set Popular Radio blue prints	1.00
1—Connecting wire, screws, etc.	.50
1—8 ft. twisted silk lamp cord with attached plug	.40

Complete Parts \$47.50
Complete Parts as used for LC-27 Receiver \$85.20

Dealers: Write for catalog

HEINS & BOLET

Wholesale and Retail

44 Park Place New York

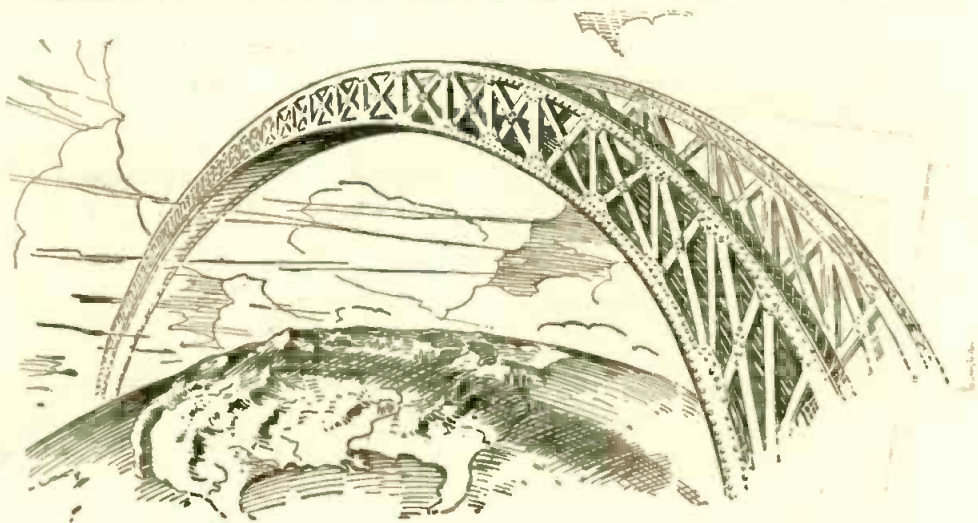

Bridge great distances

The new PRIESS "9" NINE brings in remote stations with astounding quality—even when the locals are at the height of their broadcasting

Deep, sonorous bass notes as well as the faintest sounds of a violin—there are no "squeaks" or "howls"—no background noises. Instead a tone quality to marvel at.

Because of its matchless selectivity the Priess Nine is ideally suited for use in cities and other congested broadcasting districts—it goes through the locals as though they were not there.

Fourteen years of RADIO experience are back of every Priess set. A home demonstration involves no obligation and is a guarantee of your satisfaction. Write for names of dealers.



Console \$335

The one set
for city use

Enclosed panel operated loop and built-in loud speaker. A splendid piece of furniture in addition to its radio perfection. NINE TUBES give tremendous power. Single dial control and direct reading wave length. No outside aerial. No lightning hazard. Priess known quality and value.

Priess

TRADE MARK

STRAIGHT 9 NINE

"Outstanding radio performance and value on the market today—without exception"

PRIESS RADIO CORPORATION
688 Broadway, New York

Authorized Priess Dealers
show this sign in their windows

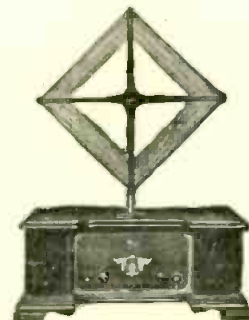

Table model \$195

Why
your set
needs

AMPERITE



Because clear reception and long tube life necessitate that delicate and self-adjustable control which only AMPERITE can give.

Eliminates hand rheostats.
Simplifies set-wiring.

Accepted as the only perfect filament control in every popular construction set.

Price \$1.10 Complete

FREE—Write for "The Radiall Book," containing the latest popular hook-ups and construction data, to Dept. P. R.-12.

Radiall Company

50 FRANKLIN ST., NEW YORK

AMPERITE

REG. U.S. PAT. OFF.

The "SELF-ADJUSTING" Rheostat

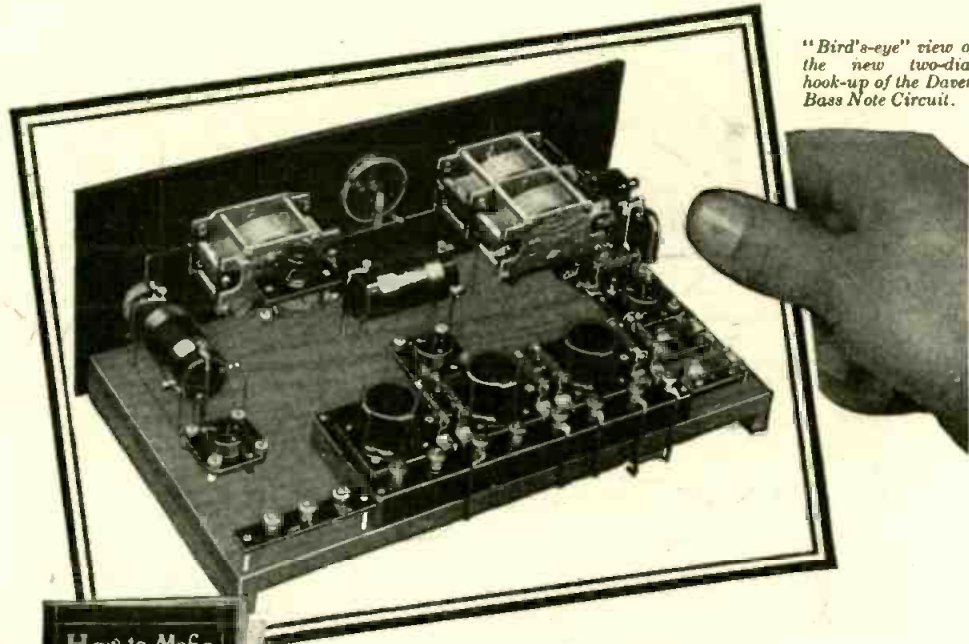

"Bird's-eye" view of the new two-dial hook-up of the Daven Bass Note Circuit.

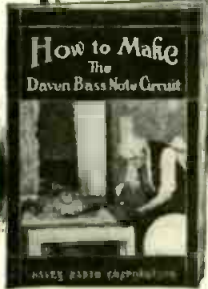

And Now— The Bass Note Circuit in a 2-Dial Hook-up

CLEARER than ever—even more selective—and always that crystal purity of tone—from highest soprano down to deepest, richest bass. The same astonishing Daven Bass-Note Circuit—with new refinement added.

For instance, *two tuning dials only*—instead of the usually accepted three. A Radio Frequency choke coil that prevents the radio waves from entering the audio amplifier. A special compensating condenser that increases selectivity, especially in long-distance tuning. And a brand new layout, requiring less base space and a smaller, neater panel.

READ "HOW TO BUILD THE BASS-NOTE CIRCUIT"

A new book that tells you in the simplest, clearest manner how to make yourself a Daven Bass Note Receiver. A wiring diagram of an altogether *new type* shows you quickly how to assemble the parts. Even a boy can follow it clearly.

25c per copy at any Daven Dealer's—or 30c by mail. And it's worth ten times that in the new kind of radio reception it will help you obtain. Get your copy *now*—while the edition is plentiful—later on you might have to wait for another printing.

DAVEN

BASS NOTE CIRCUIT

for COMPLETE Radio Reception

Daven Catalog Free on Request



DAVEN GLASTOR
the new Transparent Resistor.
Enduring, noiseless, changeless.
Complete range of resistances.



DAVEN HI-DUTY GLASTOR
Specially designed for B-Eliminators. Will carry the highest currents known to radio.



The obverse of the medal; this original is two-and-one-half inches in diameter.

The Popular Radio Medal for Conspicuous Service

TO every radio amateur, to every amateur experimenter and broadcast listener, who is instrumental in alleviating human suffering or saving human life, directly through the medium of radio, recognition will hereafter be extended in the form of a medal that shall be known as "The Popular Radio Medal for Conspicuous Service." This medal is unique within the realms of radio in that it shall be awarded, not for scientific achievement or invention, but for service to humanity.

To insure a fair and unbiased consideration of all claims, a Committee of Awards has been appointed that includes five distinguished citizens of international fame. To assist this Committee of Awards, an Advisory Committee has been appointed that numbers among its members some of the most eminent citizens of the United States, including representatives of many of our most distinguished institutions.

The conditions under which the medal will be awarded are here specified:

1. The medal shall be known as the Popular Radio Medal for Conspicuous Service.
2. The medal shall be awarded, without discrimination as to sex, age, race, nationality, color or creed, to those radio amateurs, radio experimenters, broadcast listeners and other non-professionals through whose prompt and efficient action radio is utilized to perform an essential part in the alleviation of human suffering or in the saving of human life within the territorial confines of the United States and its possessions, or in the waters thereof.
3. The medal shall be awarded by a Committee of Awards that shall not exceed five in number. No member of this Committee shall be an employee, officer or stockholder of POPULAR RADIO, INC., nor shall any such employee, officer or stockholder have a vote in the deliberations of the Committee.
4. An advisory Committee, which shall cooperate with the Committee of Awards and which shall be particularly charged with the responsibility of making recommendations for awards of this medal, shall be made up of men and women who, because of their interest in the public welfare or because of their connection with institutions that are consecrated to public service, are in positions to bring to the attention of the Committee of Awards the exploits of candidates who are within their own special fields of activity.
5. The medal will be awarded for services rendered since Armistice Day, November 11, 1918.
6. Recommendations for awards may be submitted to the Committee of Awards at any time and by any person. Every recommendation must contain the full name and address of the candidate, together with a detailed account of the accomplishment on which the proposed award is based, and must be accompanied by corroboratory evidence from persons who have first-hand knowledge of the circumstances and whose statements may be verified to the satisfaction of the Committee of Awards.
7. The medal will be awarded to as many individuals as qualify for it and at such times as the Committee of Awards may authorize.



NEW 8th EDITION DAVEN MANUAL

This valuable Book explains Daven Amplification in full detail, and shows how to apply it to your set. 25c at dealers. 30c by mail.

"The Sine of Merit"
DAVEN RADIO CORPORATION
TRADE MARK "Resistor Specialists" REGISTERED
152 SUMMIT ST., NEWARK, N. J.



The reverse; the name of each recipient will be engraved in the space provided.

8. All considerations not specified herein shall be left to the discretion of the Committee of Awards.
All communications to the Committee of Awards may be addressed to—

The Secretary of the Committee of Awards, POPULAR RADIO Medal for Conspicuous Service, 627 West 43rd Street, New York.

The Committee of Awards

- HIRAM PERCY MAXIM, *President of the American Radio Relay League.*
 - E. F. J. W. ALEXANDERSON, *Chief Consulting Engineer of the Radio Corporation of America.*
 - MAJOR GENERAL CHARLES MCK. SALTEMAN, *Chief Signal Officer of the Army.*
 - REAR ADMIRAL W. A. MOFFETT, *Chief of the Bureau of Aeronautics, U. S. Navy.*
 - DR. JOHN H. FINLEY, *publicist and journalist.*
- Secretary: Dr. E. E. Free, 627 West 43rd Street, New York.

Advisory Committee

- SENATOR JAMES W. WADSWORTH, JR., *of New York.*
- HON. JOHN BARTON PAYNE, *Chairman, American Red Cross.*
- ADOLPH LEWISOHN, *Publicist.*
- JUDGE BEN S. LINDSAY, *of the Juvenile and Family Court, Denver, Col.*
- DR. J. MCKEEN CATTALL, *Past President, American Association for the Advancement of Science.*
- DR. J. H. DELLINGER, *Past President, Institute of Radio Engineers.*
- FARLEY OSGOOD, *Past President, American Institute of Electrical Engineers.*
- C. E. GRUNSKY, *Past President, American Society of Civil Engineers.*
- DR. DAYTON C. MILLER, *President, The American Physical Society.*
- W. L. ABBOTT, *President, the American Society of Mechanical Engineers.*
- W. J. HOLLAND, *President, Carnegie Hero Fund Commission.*
- GEORGE K. BURGESS, *Director, Bureau of Standards.*
- COLIN H. LIVINGSTONE, *Past President, Boy Scouts of America.*
- DANIEL C. BEARD, *Chairman, National Court of Honor, Boy Scouts of America.*
- MISS SARAH LOUISE ARNOLD, *President, Girl Scouts.*
- DR. W. D. HAGGARD, *President, American Medical Association.*
- K. A. BICKEL, *President, United Press Association.*
- KENT COOPER, *General Manager, the Associated Press.*
- H. P. DAVIS, *Vice-President, Westinghouse Electric & Manufacturing Company.*
- DR. VERNON KELLOGG, *General Secretary, National Research Council.*
- JESSE LYNCH WILLIAMS, *Past President, Authors' League of America.*
- PROFESSOR GEORGE B. PEGRAM, *Dean of the Faculty of Applied Science, Columbia University.*
- PROFESSOR H. H. SHELDON, *Professor of Physics, New York University.*
- WM. HAWLEY ATWELL, *Grand Exalted Ruler, Order of Elks.*
- PROFESSOR EDWIN B. WILSON, *Harvard University, National Academy of Science.*
- W. E. HARKNESS, *Vice-President, American Telephone & Telegraph Company.*
- WILLIAM L. SAUNDERS, *President, United Engineering Societies.*
- COL. J. R. MCQUIGG, *Commander, the American Legion.*
- JOHN R. MOSS, *President, Kiwanis International.*
- W. D. TERRELL, *Chief Supervisor of Radio, Department of Commerce, Washington, D. C.*

THE NEARLY PERFECT TRANSFORMER

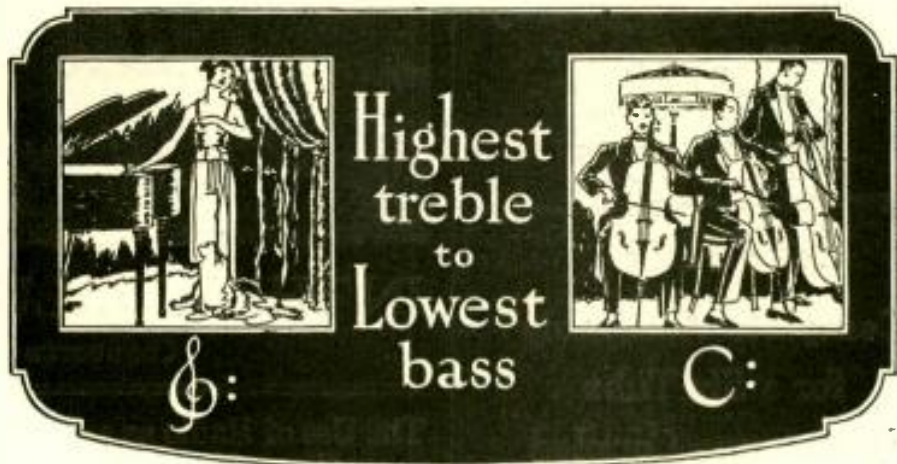

Every note .. naturally .. which the ear can hear!

Are you permitting your transformers to censor your reception? Are they cutting out those low base notes of the base viol or the kettledrum? Are they giving proper amplification to the high notes of the piccolo and the human voice?

Here is an opportunity for you to get every note to which you are naturally entitled. Whether you are using a cone or a diaphragm type speaker, Ferranti Transformers are suitable. Ask your dealer about Ferranti. If he does not handle it, write us and we will let you know who does.

FERRANTI, INCORPORATED, 130 W. 42nd St., New York, N. Y

FERRANTI TRANSFORMER

HIGHSPTS

High amplification ratio with flat curve.
Ferranti brings out the fundamental frequency of low tones—none are heard merely by inference from higher harmonics.
Every transformer tested ten times—all short-circuit turns eliminated.
Built by an established manufacturing company with forty years' experience in the winding of coils of fine wire for electrical instruments and meters.
Windings have high impedance.
Primary shunted with built-in condenser of correct capacity.
Tested to 1000 volts between primary and secondary and between primary and ground.



For the best available transformer results — Ferranti Audio Frequency Transformer A.F. 3 — ratio 3½ to 1 — \$12.

For a transformer far superior to the average, use Ferranti A.F. 4—ratio 3½ to 1 — \$8.50.

THE NEARLY PERFECT TRANSFORMER

Scientifically Built **PIERCE** **AIRO**

Complete Assembly
for a Six Tube
Resistance-Coupled

SINGLE
DIAL **Receiver**

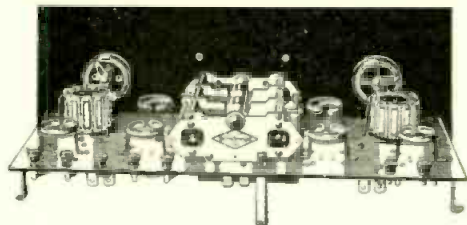

Front and Interior Panel View

Build your own set with Pierce-Airo Complete Assembly. Save time and money. You will possess one of the best receivers possible to obtain. Audio stage is resistance-coupled giving finer tone. Pierce-Airo is a mechanically and electrically perfect product, perfected by United Scientific engineers and assures distortionless amplification combined with single dial control—the two big features in radio this season. Ask the nearest radio dealer to show you Pierce-Airo TO-DAY.

Pierce-Airo Complete Assembly with a 7 x 18 Processed Bakelite Panel. Ready for Wiring.

Price Only

\$42⁵⁰

United
Scientific Laboratories, Inc.
80 Fourth Ave., New York



IN THE WORLD'S LABORATORIES

CONDUCTED BY DR. E. E. FREE

The Use of Radio as an Aid to Vegetable Growth

MR. WILLIAM BOOT, of Nottingham, England, erected miniature radio antennas over his tomato plants and produced, so the story runs, the most enormous yields of tomatoes ever obtained in his neighborhood. Thus begins a story which has gone the rounds of British and American newspapers during the past few weeks and which has been interpreted as indicating that mysterious electric energies pulled down out of the ether by a radio antenna have some remarkably stimulating effect on the growth of plants.

It is too bad that this is not true. The radio fan who decorates his back yard with assorted antennas might better withstand the objections of his anti-radio relatives if he could maintain that the presence of all those wires was good for the family garden. Although electric currents, such as would be supplied by a generator or a battery, have been found, in a few experiments stimulating to plant growth, there is no

evidence to prove that radio has any effect at all.

The most careful investigation ever made of these matters was conducted, over a period of eight years, by scientists attached to the United States Department of Agriculture. The results have been published recently.* Plants of various kinds were grown under a wire network kept charged to a high potential. "These experiments do not show," the authors report, "any well-defined increase in yield due to electrical treatment."

It remains barely conceivable that electric effects of some kind do exist but are too obscure to be readily perceived; certainly there can be no such clear effect as Mr. Boot's experiences would indicate. Probably what happened in his case was that some other factor became effective at the same time that the radio wires were installed over his garden.

*"Electroculture," by Lyman J. Briggs, A. B. Campbell, R. H. Heald and L. H. Flint. Bulletin No. 1379, U. S. Department of Agriculture, 34 pages, 1926. For sale by Superintendent of Documents, Washington, D. C., price 10 cents.



Underwood & Underwood

A DELUSION OF RADIO'S RELATION TO PLANTS

Mrs. Lulu F. McManis, an "electronic" practitioner of Kirksville, Missouri, is reported to believe that radio waves related to the famous "electronic reactions" will measure the growing power of bean seeds. Scientists generally regard this as a mistaken idea.

YOU CAN BUILD THE NEW SHIELDED HI-Q*



The Hammarlund-Roberts Board of Engineers

The Hammarlund-Roberts Hi-Q Receiver is the joint creation of ten leading engineers. A wealth of experience plus highest reputation for quality parts guarantee unexcelled performance.

- Benjamin Electric Mfg. Co.
- Carter Radio Company
- Durham Resistors
- Eby Manufacturing Co.
- Hammarlund Mfg. Company
- Martin-Copeland Co.
- Radiall-Company (Amperite)
- Samson Electric Co.
- Sangamo Electric Co.
- Westinghouse Micarta.

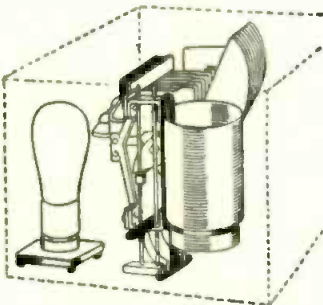

Automatic Variable Coupling

A wonderful new feature. Same control operates both tuning condenser and primary coil coupling. This gives maximum and equal amplification and selectivity over entire tuning range.

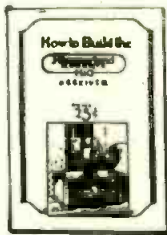

"How to Build It" Book

Written by the Hammarlund-Roberts Board of Engineers in very simple A B C language. Every detail described, numbered and diagrammed so that you can easily understand it. Send 25c for your copy.



The Hi-Q Foundation Set

The Key to this wonderful receiver. Includes drilled and engraved panel, and sub-panel and all the essentials required to start building. Price \$10.50.



\$6⁹⁵

Over 57,000 Built at Home You Can Do It Too

LAST year 57,453 radio lovers had the fun of building the Hammarlund-Roberts Receiver at home—a wonderful tribute to the genius of America's ten leading engineers who designed this remarkable instrument.

The new Hi-Q Receiver is even more wonderful than our set of last year. A study of its modern features will disclose simple dual tuning, Complete Shielding, Automatic Variable Coupling, high detection efficiency, high power output and utter absence of oscillation.

An inspection of any home-built Hi-Q Receiver will prove that here for the first time 5 tubes equal 8. Actual test will prove a sensitivity equal to that of expensive "Supers." Reception is startling both in distance and power; volume is full and all signals have those rich, undistorted tone qualities which fall like a caress on the most sensitive ear.

Save \$50 to \$100—Build It Yourself

When over 57,000 novices have built successful Roberts Receivers, you can build one, too. Send 25c for the "How to Build It" Book or get a copy from your dealer. Follow the simple directions, solder a few connections and in a few hours you, too, will have the satisfaction of having built one of the world's finest receivers at less than half the price of factory-made sets not nearly so good.

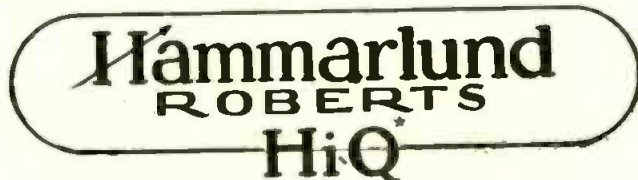

*High ratio of reactance to resistance.
High ratio—Great selectivity—Loud signals.

HAMMARLUND-ROBERTS, 1182-B Broadway, New York

Sterling RADIO INSPECTORS



Pocket Meter



Panel Meter



No. R-25-28 Filament Meter



No. R-32 Charge Indicator



No. R-411 Tube Tester



No. R-406 Universal Tube Tester

Be Protected Against the Common Ailments of Radio Reception!

NO set is so good that it can continue to entertain satisfactorily night after night without some servicing and inspection on your part.

To make it easy for every set owner to give the receiver the care it deserves, Sterling has produced complete Care-Taking and Inspection Equipment.

These devices for keeping your batteries and tubes in healthy condition, for locating troubles, and for promoting better reception, should be a part of your radio equipment.

Write for our helpful literature or see your nearest dealer.

The Sterling Mfg. Company
Cleveland, Ohio



Sterling RADIO CARE-TAKERS



No. R-111 Bulb Type A & B Battery Charger



No. R-900 Vibrating Type A & Auto Battery Charger



No. R-101 Bulb Type Trickle Charger



No. R-403 Tube Reactivator



No. R-225 Midget Tube Reactivator

The Alleged Effect of Radio Waves on Pigeons

THE power of homing pigeons to find their way back to the proper dove cote in spite of distance and all other obstacles is one of the most mysterious phenomena of Nature. Equally remarkable is the ability of the migratory birds to make long journeys twice a year and yet to return year after year to the same locality at either end. Many zoologists have puzzled over these facts and no one has been able to formulate a satisfactory theory to account for them.

The latest attempts to do so have been made in France and involve an essentially mystical effort to relate these abilities of the birds to radio waves.* The pigeon is supposed to possess some direction-finding apparatus with which such waves are perceived or with which it is possible to follow the magnetic field of the earth. Advocates of these ideas go so far, even, as to imagine the pigeon's human owner sending out from his body radio waves which the pigeon can perceive and follow at distances of a thousand miles. One of the advocates of this viewpoint² cites the famous—and thoroughly exploded—"electronic reactions" of Abrams in support of his contention.

It ought to be needless to point out that there is not the slightest real evidence for these ideas, nor are they even plausible. Dr. Lakhowsky asserts that homing pigeons cannot fly successfully in the neighborhood of large radio transmitting stations but no convincing evidence is cited that this is true. The way in which the pigeon finds his direction is a very real problem which greatly deserves intensive scientific work. But it will do no good to indulge in fancies about the supposed relations of radio waves, "human" or otherwise, to the matter.

*"The Origin of Life, of Radiation and of Living Beings" (in French), by Georges Lakhowsky, Paris, 1926. Some suggestions are reviewed (without approval) by the distinguished scientist Dr. Ch. Maurain in *La Nature* (Paris), number 2728, pages 44-45 (July 17, 1926).

²"Radiations and Life" (in French), by Jules Regnault. *Radio-Electricité* (Paris), Volume 7, pages 273-274 (July 25, 1926).

A New Material for Making Condensers

THE usual method of constructing fixed condensers of metal sheets separated by paper or some other insulator is abandoned in a new condenser described recently to the French Academy of Sciences by M. Albert Nodon.* The material used is a colloidal solution of oxide of iron in glycerine. This is absorbed in the pores of canvas or other heavy cloth and is placed between metal plates, preferably of aluminum, which form the terminals.

*Reported to the Academy at the session of May 25, 1926. Described in *L'Industrie Electrique* (Paris), Volume 35, pages 332-333 (July 25, 1925); also in *La Nature* (Paris), number 2729, page 60 (July 24, 1926).

Have You Tubes You Can't Rejuvenate?

The AETNA TUBE RE-ACTIVATOR often makes efficient tubes of old worn-out ones which ordinary "tube rejuvenators" have been unable to revive. This is possible because the AETNA employs an entirely different method of re-thoriation, as explained below.

The AETNA RE-ACTIVATOR soon pays for itself by bringing worn-out tubes back to life and eliminating the necessity of buying new ones



All the so-called "rejuvenators" on the market today heat the filament by passing a small amount of current through it. The AETNA TUBE RE-ACTIVATOR heats the filament at a slow, even temperature, and in addition bakes the tube externally, which redeposits on the filament some of the thorium that has been driven onto the side of the glass by use.

The shell surrounding the tube is essentially a miniature oven, containing a patented element that furnishes the heat for this purpose.

Works on either D-C or A-C Current.

Ask your dealer or send us \$5.00 for prompt shipment. If not fully satisfied after week's trial return to us for refund.

Aetna Machine Mfg. Co.
426 S. Clinton St.
Chicago

Hoyt

PHONE PLUG MILLIAMMETER

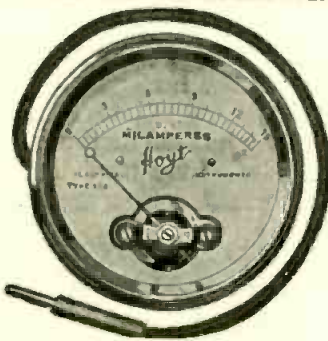

This precision, moving coil instrument is made to plug into the loud speaker lead on your set and enables you to adjust your C-battery bias on the power tube, for perfect reproduction. Instantly attached. A necessary accessory if you desire the utmost in quality.

Price—\$8.50

Send for Catalog "Hoyt Meters for Radio"

BURTON-ROGERS CO.
BOSTON, MASS.
Sales Dept. for Hoyt Electrical Instrument Co.

Colloidal solutions consist of very tiny particles of one substance, in this instance the oxide of iron, suspended in another substance. What apparently happens in Nodon's condenser is that each one of the billions of tiny iron particles acts as an individual condenser plate, the dielectric being supplied by the glycerine in which these particles are suspended. The capacities obtained are very high. Quite modest dimensions for the parts give capacities measured in thousands of microfarads. However, the charge leaks away in a small fraction of a second, so the condensers are useful only for high-frequency work. They are suggested for telephone condensers. Whether they have been tried importantly in radio work does not appear.

New Measurements of Radio Intensities

THE measurements of long-wave radio intensities and of the intensities of atmospheric which are made regularly by the United States Bureau of Standards, in Washington, have recently been reported, for 1925, by Dr. Austin.* The results show no very startling departures from those of previous years. The methods used have been compared during the year with those used for similar purposes by the Radio Corporation of America and by the Bell Telephone Laboratories. The agreement between the different methods proved satisfactory.

The familiar Austin-Cohen formula for calculating the intensity of the field received at a given distance and for a given frequency has been modified slightly to bring it more exactly in accord with the whole mass of data now accumulated. The modification affects the exponential term e^{-u} . The value of u is now taken as $4.57 \times 10^{-5} d \times f^{0.6}$. d is the distance in kilometers and f is the frequency in kilocycles.

Contrary to the usual impression of observers on broadcast wavelengths, the intensity of the atmospheric disturbances in 1925 was somewhat less than in 1924. This applies, of course, only to the long wavelength tested; namely, 12,500 meters. As before, the prevailing direction for atmospheric in summer, at Washington, is from the southeast, which Dr. Austin suggests may mean origin in eastern South America or in Africa. In winter the prevailing direction is from the south west, probably the highlands of Mexico.

"This is in accord," says Dr. Austin, "with the idea that disturbances generally originate over land and are most intense in the afternoon and evening in the regions where the sun passes very nearly overhead."

*"Long Distance Radio Receiving Measurements and Atmospheric Disturbances at the Bureau of Standards in 1925," by L. W. Austin, *Journal of the Washington Academy of Sciences* (Baltimore, Md.), Volume 16, pages 398-408 (August 19, 1926).



Don't Neglect
this Vital
Point
of
Contact!

A FEW spare moments, a screw driver, and you have sure, perfect connection between your aerial and lead-in wire. No noise, no soldering, no loss of "distance" due to swinging aerial or corrosion. Tip-Top cannot work loose.

Jobbers and Dealers, write us!

JAMES F. DOOLAN
MANUFACTURING CORPORATION
36-42 West 47th St., New York

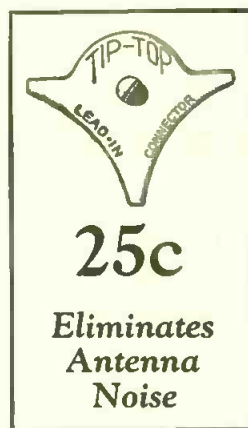

The 2 Biggest Bargains Famous HARKNESS Kits Better than Ever

HARKNESS 3-tube Kit. Most extraordinary outfit of its size made. Equals any ordinary 5-tube set. A wizard for distance. Unexcelled in tone quality. *Complete parts.
ONLY \$36.00

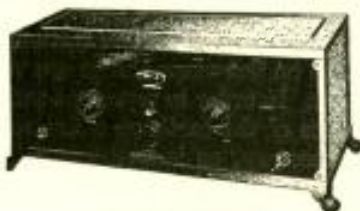

Another Winner The Improved 5-Tube Single Dial Tuning

A truly remarkable set, which will do everything the most critical fan could demand. Simplicity itself in operation, the last word in tone quality, volume and selectivity.

Kit Complete parts and simplified instructions for use in special cabinet **\$47.50**
Chassis in 7 x 18 cabinet, as shown **\$55.00**
Set in 7 x 18 cabinet, as shown **\$62.50**

These prices are list.
Jobbers and Dealers—write for attractive discounts.

FREE—A special 16-page Harkness Book with complete illustrations, diagrams, etc., will be mailed on request.

THE RADIO GUILD Inc.

241 Market St., Newark, N. J.

DESIGNED to OUTLAST World Storage A Battery



Two-Year
Guarantee
Bond
in Writing

**NEW
LOW
PRICES**

Famous the world over for reliable, enduring performance. Solid Rubber Case lasting protection against acid or leakage.

Approved and Listed as Standard by Leading Authorities

including Radio News Laboratories, Popular Sci. Inst. Standards, Pop. Radio Laboratories, Radio Broadcast Laboratories, Radio in the Home and Lefax, Inc.

Send No Money

Just state number wanted and we will ship same day order is received, by express C.O.D. Pay expressman after examining batteries. 5% discount for cash with order. Remember, you save 50% on World Batteries—so send your order today.

WORLD BATTERY COMPANY

Dept. 3

1219 S. Wabash Ave.

Chicago, Ill.

KDKA W5BC WEAF KYW

The Intermediate Power Pack

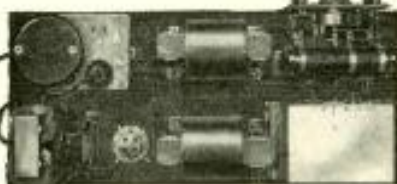

Designed to operate the LC-27 Receiver and other power tube sets

In developing the Intermediate Power Pack, Mr. Cockaday feels that he has at last produced a B Power Supply that is past the experimental stage.

Giving a constant, uniform current of 180 volts at 60 mils. without distortion or hum, the Intermediate Power Pack will operate any power set. The special 40 volt C bias is ample for the UX171 tube. Voltage taps are the same as those on standard B batteries.

There are no liquids or moving parts. After being connected to your set, no further attention is necessary. Operation cost is less than one-third of a cent per hour.

You can build the Intermediate Power Pack in two hours, ready for operation, it has been made so simple and easy to assemble.

No Antenna Necessary

A unique feature of the Intermediate Power Pack is a means provided in the unit for dispensing with the antenna on a Neutrodyne or any type of Tuned R. F. Receiver.

List of Parts

As Used in the Laboratory model

1	Filtrex AC Transformer, type K-180	\$5 25
2	Filtrex Choke Cols., type K, at \$6.75	13 50
1	Na-Ald Socket, type 481X	.35
6	Eby binding posts	.90
1	Acracoon condenser block, 14 mfd.	11 00
1	Acracoon filter condenser, .1 mfd., 400 volts DC	1 00
1	H. F. & L. tapped resistance	5.25
1	Centralab Resistance, type 200, 20,000 ohms	2.00
1	Hardwood baseboard, walnut finish	.85
1	Bakelite binding post panel, drilled	.50
1	Set Popular Radio blueprints and construction booklet	1 00
	Catalytic connection wire, screws, etc.	.50
1	8 ft. twisted silk lamp cord with plug	.40
		\$42.50
1	Yaxley Automatic Relay Switch No. 444	\$5.00

If your dealer cannot supply you, send check or money order direct to

Filtrex B Power Supply

The Intermediate Power Pack is also built complete and encased in a beautiful metal case, finished in Duco midnight blue. Guaranteed against mechanical defects. Approved by Popular Radio Laboratory. Dealers write for information.

CONNER CROUSE CORP.

52 Vanderbilt Avenue, New York

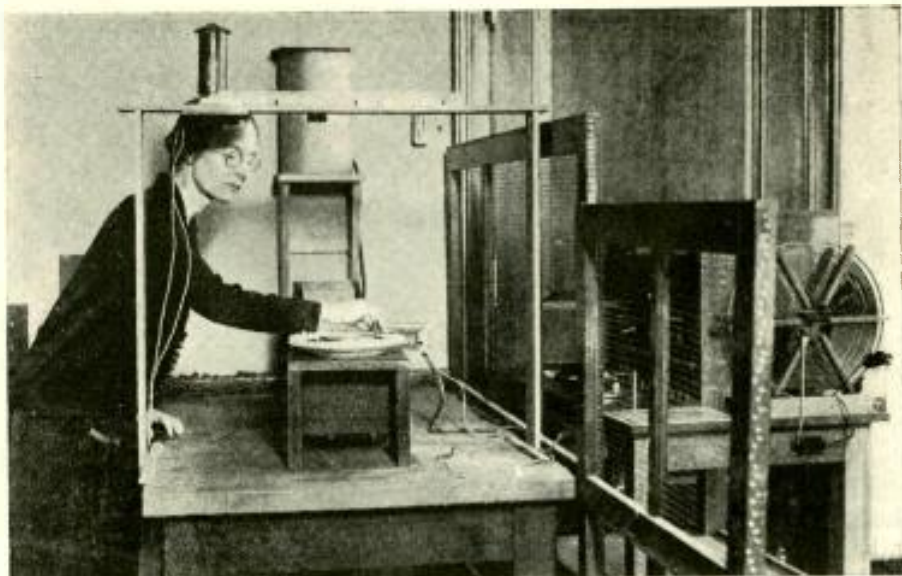

Underwood & Underwood

TESTING GLASS FOR RADIO-FREQUENCY CONDUCTIVITY

Professor Louise S. McDowell, of Wellesley College, recently carried out, at the Bureau of Standards, tests of the conductivity of different kinds of glass for radio-frequency currents. A glass plate is floated on liquid quicksilver. On top of the glass is more quicksilver, held in place by a copper ring. The glass thus forms the insulator of a condenser, to which different voltages were applied at frequencies between 1000 and 1,000,000 cycles. The power loss in the glass was found to increase markedly at high temperatures, even at the temperature of boiling water.

Special Maps for Radio Use

THE fact, too commonly forgotten, that the true paths of radio waves between one station and another are not indicated correctly by laying a ruler on a map, is emphasized by Mr. R. Keen, a British electrical engineer, in a recent article.* Radio waves follow the rounded surface of the earth. In the absence of disturbances they presumably follow what mariners call a "great circle" course, the great circle being the shortest line which can be drawn on the surface of the earth's sphere connecting two points thereon. On a globe this is perfectly clear. A circle so drawn gives the direct path of the waves correctly and shows the correct direction of the wave for each of the two stations.

But on flat maps things are very different. In order to represent the curved surface of the earth on a flat surface it is necessary, as is well-known, to distort the shapes and positions of the continents, making some variety of "projection" of the real land surface onto the flat sheet of paper. Mercator's projection, probably the commonest one used on ordinary maps, distorts the polar regions greatly and is exactly accurate only at the line of the equator.

For small areas, like a city or a county, the distortion of real shapes and directions thus produced is not important. The departure of the real land surface from flatness is not great enough to do harm. But when long distances must be laid off on maps, as they must in considering radio transmission, the direction obtained by drawing straight

lines in the usual way may be seriously wrong. It is necessary to take this into account, Mr. Keen urges, in studying directional radio effects, the direction of static and similar problems.

There are two cures. One is to use a globe rather than a flat map. This is undoubtedly the best procedure if a good globe is available. The idea of the facts thus obtained is far more vivid than the idea that one gets from a map. The other cure is to plot out on a map the directions which great-circle paths would really take between the stations in which you are interested. These will seldom be straight lines.

A Carbon-Dust Microphone

THE Reisz microphone, much mentioned recently in radio news from Germany, is described in a recent British patent issued on the device.* The active material is a layer of fine dust of carbon (coal is mentioned) held between a rubber membrane and a block of marble. Electrical contact is made with the layer of coal dust by means of two metal electrodes at its sides. The sound waves are allowed to beat against the thin rubber diaphragm, through which they act on the layer of coal dust, causing this to be alternately compressed and released. The microphonic action is evidently the same as in the old carbon microphone, one of the familiar instruments of the early days of telephony. Although much has been claimed for the distortionless qualities of this microphone, the principle now disclosed does not seem very promising.

*"Maps and Wireless Waves," by R. Keen. *The Wireless World* (London), Volume 10, pages 73-76 (July 21, 1926).

*British Patent No. 250,430, filed June 25, 1925. Noted in *The Wireless World* (London), vol. 18, page 888 (June 30, 1926).

TONES

QUALITY
BEYOND BELIEF
WITH
POWERIZER

Combined "B" Eliminator and Power Amplifier

POWERIZED radio reception is so true—so faithful, that the radio entertainers are literally transported into your own home. Such remarkable reception up to this time has been offered only in the most expensive new Super-Power sets. Now YOU can have it by merely attaching a Powerizer to your present set, at the cost of a "B" eliminator alone. Ask the nearest Powerizer dealer to demonstrate it TODAY.

RADIO RECEPTOR CO.
106 Seventh Ave. New York

Price
\$49.50



Modernize your set with a scientific

SAAL Soft SPEAKER



SAAL Ec-centric Cone

Showing the new SAAL Ec-centric construction in cones. Stylus is scientifically placed at the umbo of eccentricity to give proportional vibrating areas for both high and low tones. Cone measures 20 inches in diameter and reproduces all tones whether the set is equipped with or without power amplifier. Price, \$25. Junior Model, \$15. All prices slightly higher west of the Rockies.



SAAL Horn No. 5

The broad polished bell is of non-warping Bakelite, the goose neck of cast aluminum in crackle gold finish. The horn has no metallic resonance and is guaranteed not to blast or chatter. Standard equipment for radio engineers in laboratory work. Price \$22.50.



SAAL Pedestal

Tones rise through the 3-foot wooden tone chamber and emerge from both front and back of the top, hence non-directional. The top is level with your ear when you are seated tuning in. American walnut finish with inlaid design. Price \$38.

The greatest improvement in radio this year is the improvement in speakers. In SAAL, speakers have been developed to do justice to the finest radio receivers.

Furthermore, the tone chamber and vibrating area of SAAL speakers—horn, cone, and pedestal—are scientifically shaped for sound reproduction.

The new Ec-centric Cone is different. Its stylus is "off center." Just as the harp and piano have short and long strings for high and low notes respectively, the Ec-centric cone provides a short and long radius to give proper vibrating area for both extremes of sound. This cone reproduces all tones equally well, without loss of low notes, or over-accentuation of high notes. And completely prevents drum or barrel tone.

In Horns, SAAL has always been standard. SAAL Soft Speaker No. 5 is the latest and most popular SAAL Horn ever offered. It requires no adjustments and no additional power for quality reception. It will give 100% satisfaction regardless of the set or equipment with which it is used.

The SAAL Pedestal is an ornament to the most beautiful surroundings. Its pure wooden tone chamber, three feet in length, gives exceptionally clear mellow reception. The Pedestal is designed for those who prefer the tone quality of horn reproduction in a drawing room piece. Keeps the speaker away from the set and eliminates harmonics.

Modernize your set with one of these scientific SAAL Soft Speakers and get the fullest return from radio now.

H. G. SAAL COMPANY
1800 Montrose Ave., Chicago, U. S. A.

Oh boy
KESTER
Rosin Core
Radio SOLDER
Sure is Safe and Simple

Approved by
Radio Engineers
A Genuine Solder
CHICAGO SOLDER COMPANY
1221 W. 14th St., Chicago, U. S. A.

Distributors and
World's Largest Manufacturers of
Soft Fluxing Solder
SOLDER DEALERS
CAN SUPPLY YOU

WORLD FAMOUS MAKERS OF HORNS · CONES · PEDESTALS



CONTINENTAL
LO LOSS

SINGLE CONDENSER

A combination straight line wave length and frequency condenser of improved design specially built for those who appreciate fine reception.

Capacity .00035
List Price, \$3.00

CONTINENTAL
LO LOSS

DOUBLE CONDENSER

A combination straight line wave length and frequency condenser. Each section capacity .00035. List Price \$6.50.

RECOMMENDED BY POPULAR RADIO AND LAWRENCE M. COCKADAY FOR THE LC-27 CIRCUIT.

“used in the LC-27”

CONTINENTAL
LO LOSS

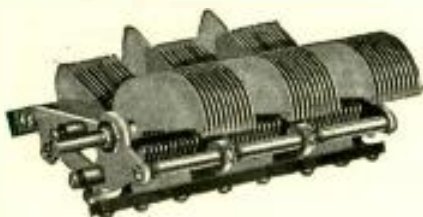

TRIPLE CONDENSER

The one condenser exclusively recommended by Mr. E. M. Sargent for the INFRA-DYNE Circuit. The low dielectric losses, exact capacities and mechanical perfection of this condenser makes it the logical choice for one dial receivers of the better class. Straight line wave length and frequency—Each section capacity .00035—List price \$9.50.

IF YOUR DEALER CAN'T SUPPLY YOU, WRITE DIRECT

Gardner & Hepburn, Inc.
611 Widener Bldg., Philadelphia, Pa.

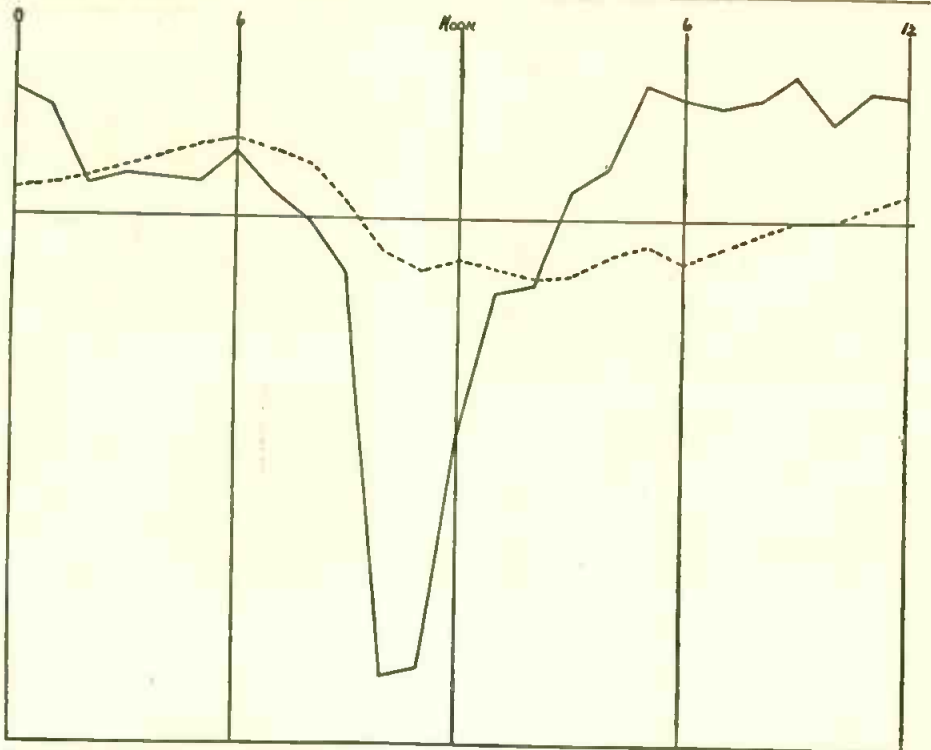

From Professor Sanford's "Bulletin."

RECORDS OF SUDDEN EARTH ELECTRIFICATION

The solid line shows the average charge, from the records of Professor Fernando Sanford, at Palo Alto, California, for nine disturbed days in 1925. The dotted line is the normal course of the earth charge, on undisturbed days. The sudden drop of the solid line in the forenoon indicates the enormous increase of negative charge which the earth receives on the disturbed days and which must have significant effects on radio. The cause of this curious phenomenon is unknown.

Disturbances of Earth Electricity

THAT the earth usually possesses a negative electric charge which commonly varies during the twenty-four hours in a more or less regular manner has already been described in POPULAR RADIO, together with some of the possible effects which these terrestrial electric disturbances have on radio transmission and reception.* At several observing stations in different parts of the earth the hour-by-hour variations of the earth's electric potential are measured and recorded throughout the year.

One of these stations is at Stanford University, California, where Professor Fernando Sanford, heads a terrestrial electric observatory in which such records are kept continuously, day and night, by means of recording apparatus. In the most recent report of this observatory Professor Sanford records a series of curious disturbances of the earth's electric charge which occurred on nine days included among the days in 1925 for which satisfactory records of the earth charge are available.†

The characteristic thing about these nine disturbed days is that the earth's potential suddenly showed a marked change toward the negative, as though the surface of the soil at Palo Alto had

suddenly received an enormous addition of free electrons. This was not accompanied, in general, by any marked or sudden change in the electric potential of the air. Most curiously of all, these sudden disturbances almost always began in the forenoon, usually between eight and ten A. M.

It is difficult to imagine a cause for these events and Professor Sanford refrains from suggesting any. The changes are not due to the so-called magnetic storms which occasionally sweep across the earth, causing unusual variations in the direction of the compass needle or in the intensity of the earth's magnetic field. It is a characteristic of these magnetic storms that they begin all over the earth at the same time. They are believed, therefore, to be caused by something outside the earth, presumably by magnetic disturbances in the sun. Since Professor Sanford's disturbances of earth charge begin at almost the same hour of the clock at Palo Alto they must have either some local cause or some relation to the elevation of the sun above the horizon at that time.

It is impossible to imagine that the sudden increase of the negative charge on the earth in this fashion would be without its effects on radio transmission or reception. Comparative records of radio conditions have not been kept and probably are not available from amateur logs or other sources, since the onset of the electric disturbances is at an hour when little radio broadcasting would be in progress on the Pacific Coast

*"Earth Electricity; Does it Affect Radio Reception?" POPULAR RADIO for June, 1926; pages 111-113 and 180-181.

†"Summary of Observations of Earth Potential, Air-Potential Gradients, and Earth Currents for the Year, 1925." Bulletin of the Terrestrial Electric Observatory of Fernando Sanford, Volume 3, 24 pages. Palo Alto, California, July, 1926.

First in the Field
Specializing in
Cockaday Kits

S. HAMMER RADIO CO., 303 Atkins Ave., Brooklyn, New York

Cockaday Sets Now Made Easier to Build by Our New "Ready-to-Wire" Plan
50% of Your Time, Work and Worry SAVED!

All you need do is to connect bus-bar according to diagram, solder and your set is finished. These Kits are sent to you completely mounted, and assembled on a Veneered Mahogany baseboard and genuine bakelite panel, drilled and engraved. Genuine parts used as listed below; exactly as used in Mr. Cockaday's Laboratory Model. **COMPARE OUR OFFER!**

LC-27 BROADCAST RECEIVER SENIOR AND INTERMEDIATE POWER PACKS

- 1 Hammarlund mid-line dual condenser, 000275 mfd. \$ 7.50
- 1 Hammarlund mid-line single condenser, 000275 mfd. 4.65
- 1 Precision Duo-Octoform coil set comprising one antenna coupler and two inter-stage couplers 10.50
- 1 Amertran De Luxe first stage transformer. 10.00
- 1 Amertran De Luxe second-stage transformer. 10.00
- 1 Amerchoke # 854 6.00
- 1 Dubiller or Tobe 4 mfd. Filter condenser. 5.50
- 1 Dubiller filter condenser. 1 mfd. .60
- 1 Mar-Co illuminated control, scale 0 to 100 3.50
- 2 Mar-Co small controls scale 0 to 50 and 50 to 0. 1.50
- 1 Carter Battery Switch. .65

- 1 Samson radio-frequency choke coil # 85. \$1.50
- 3 Aerovox, mica fixed condensers, 00025 mfd. 1.05
- 1 Durham or Daven Resistor 4 meg. .50
- 1 Lynch Grid Leak Mounting. .35
- 1 Carter Gem Jack. .25
- 1 Carter variable resistance, 0-10,000 ohms. 2.00
- 12 Eby binding posts. 1.80
- 5 Benjamin UX Sockets. 3.75
- 1 Amperte No. 1 Mechanical Kit consisting of aluminum shields, binding post strip, decorated panel and Tait brackets. 12.50

READY-TO-WIRE KIT PRICE \$85.20

LC-27 INTERMEDIATE POWER PACK

- 1 Yaxley Automatic Relay Switch No. 444 \$5.00
- 1 Filtrex A-C Transformer, type K-180. 5.25
- 2 Filtrex Choke Coils, type K, at \$6.75. 13.50
- 1 Na-Aid UX type socket. .35
- 6 Eby binding posts. .90
- 1 Aeracon condenser block, 14 mfd. 11.00
- 1 Aeracon filter condenser, 1 mfd. 1.00
- 1 Resistance Unit—type 200. 5.25
- 1 Centralao high current variable resistance 2.00

- 1 Hardwood baseboard, 7 3/4" x 18" x 3/4". \$.85
- 1 Bakelite panel, 3 3/4" x 4 3/4" x 3/32", drilled. .50
- 1 Set POPULAR RADIO blueprints. 1.00
- 1 Connecting wire, screws, etc. .50
- 1 8 ft. twisted silk cord with attached plug. .40

COMPLETE KIT PRICE \$47.50

COMPLETE KIT OF PARTS FOR LC-27 SENIOR POWER PACK \$65.20

**Completely Wired Sets!
In Stock Now!**

**Silver Shielded Six!
Kits In Stock Now!**

WE GIVE SERVICE AND GUARANTEE THE OPERATION OF ANY LC-27 KIT OR SET PURCHASED FROM US

Write for our interesting special circular which we have prepared on the LC-27 Receiver and also catalogue. Do it now.
Authorized service station for the LC-27.

DEALERS: WRITE FOR SPECIAL DISCOUNTS

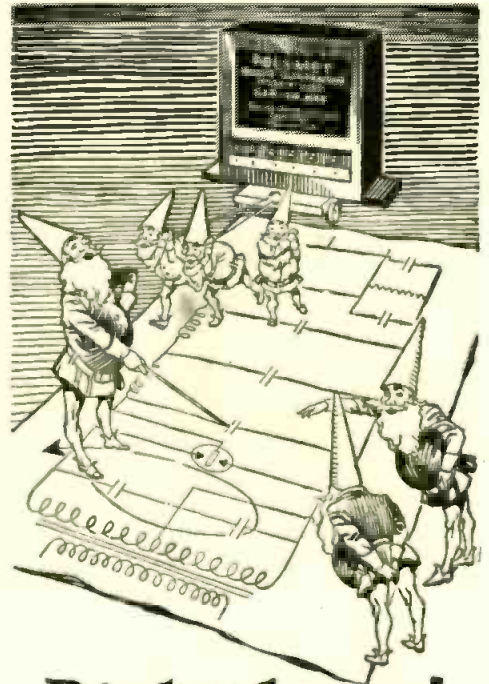

Right here!

You can't go wrong when you use Polymet High Voltage Condensers in sets or power units. Built to withstand 1,000 volts permanently, and individually tested for this rating, their obvious superiority, both in workmanship and performance, definitely establishes Polymet's leadership as condenser manufacturers.

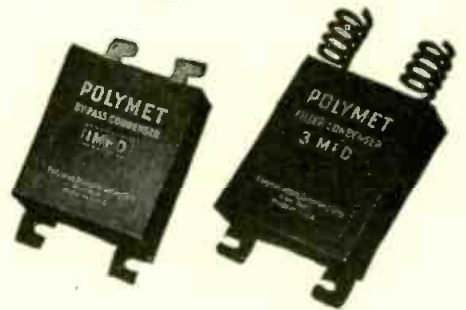

Polymet condensers incorporate finest insulating paper, best foil and specially prepared impregnating compounds. An exclusive, new and improved process renders them non-inductive, with high dielectric resistance for long life. Obtainable as individual units or in blocks; in cans or unmounted; with fixed or flexible leads.

Capacities .1 to 5. Mfd. . 60c to \$4.50

**Raytheon
Circuit
Blocks**

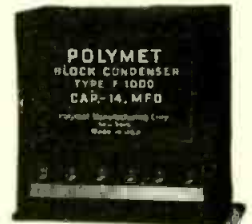

Tested by the Raytheon Laboratories, they have passed with highest honors and been given an enviable rating.

F1001 .1-C-1 Mfd. . . . \$2.00
F1000 14 Mfd. 9.50

Polymet Products are used by over 125 high grade receiver and power unit manufacturers. There's a reason—Polymet Products have passed their exhaustive tests! Follow the manufacturers—specify Polymet Products—at all good dealers everywhere.

Illustrated descriptions sent FREE on request.

Polymet Manufacturing Corporation
599-C Broadway • New York City

"World's Largest Manufacturers of Radio Essentials"

POLYMET

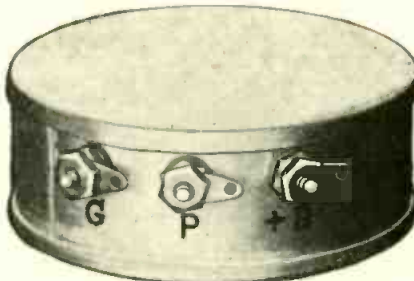
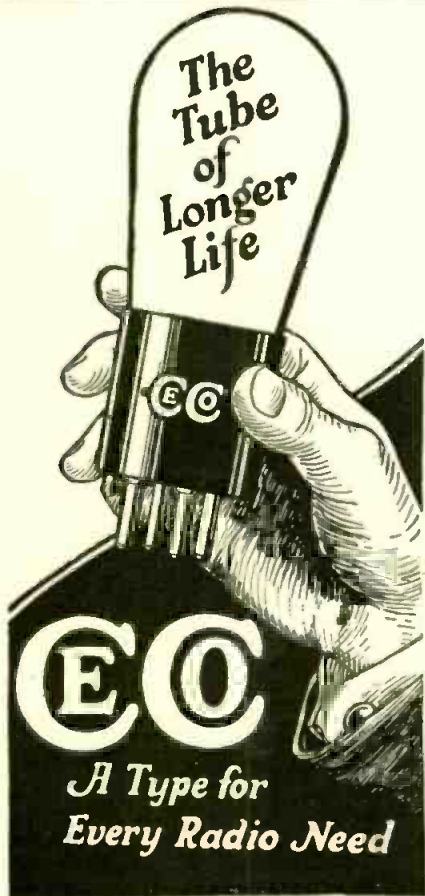

Shielded Tuned Radio Transformer, No. 30

SICKLES Diamond-Weave Coils

The new Sickles Shielded Tuned Radio Transformer prevents both outside and local interference. It is remarkably compact, sharp-tuning, sturdy.

Sickles Diamond-Weave Coils have established an enviable reputation for low distributed capacity, low dielectric losses, and large range of frequency with small variable capacity.

The ideal coil for the Na-Ald Localized Control Tuning Unit and the Na-Ald Truphonic Assembly.

There are Sickles Diamond-Weave Coils for all leading circuits.

THE F. W. SICKLES CO.
134 UNION STREET
SPRINGFIELD :: MASS.

No.	Coil Prices
30	Shielded Transformer \$2.00 each
24	Browning Drake 7.50 set
18A	Roberts Circuit 8.00 set
25	Aristocrat Circuit 8.00 set

Write for data sheet of the Complete CeCo Line

C. E. MFG. CO., Inc.
Providence, R. I.

COCKADAY LC-27 PANELS

As used by Mr. Cockaday
in his original Laboratory Model



Mounting Is All YOU Need to Do

We cut, drill and engrave the LC-27 Panel, especially for use in the Cockaday Receiver. This genuine bakelite panel and its exquisite decorations are guaranteed to be impervious to moisture. The LC-27 Panel will not warp or otherwise lose its shape, no matter how long it remains in service, while the lustre of its finish lasts indefinitely. **\$9⁰⁰**

Also the Improved BROWNING-DRAKE Panels **\$7⁵⁰** in stock, ready for Use.

CORTLANDT PANEL ENGRAVING CO.
79 Cortlandt Street New York City

The Effect of Temperature on Signal Strength

(Continued from page 765)

greater insulating power than warm air, a difference which is reinforced by the greater dryness of the cold air. It is possible, also, that the ions of the cold air are enough sparser than in the warm air to produce a difference in the loss suffered by radio waves in traversing it.

These ions in the air are believed to be swung back and forth, you remember, by every radio wave which passes through the atmosphere. High up in the air, in the region of the famous Heaviside Layer, the ions are so far apart that most radio waves cannot swing them widely enough for neighboring ions to collide with each other. Near the surface of the ground, where the air atoms are very close together, the few of them that are ionized are much more likely to knock against each other, when the waves swing them. A considerable loss of energy from radio waves is believed to be due to this collision of the swinging ions. This is why so much energy is lost by a departing radio wave just after it leaves the antenna, before it can traverse the lower part of the air and reach the Heaviside region along which it usually travels with very little loss.

It is conceivable that the tendency of dry, cold air to contain fewer ions than moist warm air may make it a better transmitting medium for radio, so that less loss is experienced on dry, cold days. But this is not certain, for the ionization of the air is not dependent on temperature alone nor can we be absolutely sure that the loss of energy due to ionic collisions in the lower air is the chief loss which radio waves suffer, even over the comparatively short distances which Dr. Austin's tests refer to.

Another group of possible causes concerns the upper levels of the air. Ordinarily, the circulation of the atmosphere, with all of its winds and storms and cold waves and other changes of temperature, is confined to the lower fifteen or twenty miles. Above this turbulent zone, sounding balloons have shown the existence of a relatively quiet layer of air which meteorologists call the "stratosphere." The air in this stratosphere is very thin and light, being so high above the earth. It has a temperature nearly constant at about seventy degrees below zero, Fahrenheit. It lies, however, well below, in level, those uppermost levels of all, which are supposed to be highly electrified, to carry the radio waves and to constitute the Heaviside Layer.

We do not know exactly how far such disturbances as cold waves extend upward into these strata of the atmosphere. One theory of the winter storms so common in North America and in Europe considers them due to masses of

-RADIO FANS-

If you are interested in securing the very best prices on all the new, improved KNOCK-DOWN KITS for the following receivers—

LC-27

- New and improved BROWNING-DRAKE 5 Tube
- DAVEN BASS NOTE 5 Tube
- S-M SHIELDED "6"
- LC SENIOR POWER PACK
- KARAS EQUIMATIC

- New Improved HAMMARLUND-ROBERTS Hi-Q
- SAMSON T-C 5 Tube

- REMLER INFRADYNE 10 Tube
- RAYTHEON B SUPPLY; AMER-TRAN POWER PACK

and all the latest types of A and B eliminators and loud speakers—

Write to us before you buy!

Remember: All our knockdown kits are guaranteed to consist of all parts used by original designers.

J and M Radio Co.
88 Walker St.
New York City

Console Cabinets without sets



Only \$31.⁵⁰

These beautiful Console Cabinets have Genuine Walnut 5 ply selected stock for tops, sides as well as upper and lower front doors. The legs and minor parts are selected gum. All finished with genuine lacquer, hand rubbed, furniture finish.

These cabinets are designed to accommodate a radio set, charger, batteries and accessories.

Cabinet can be had with or without grill or horn. No. 120 cabinets without grill or horn compartment will take a set with panel up to 7x28"-10" deep. Our price \$31.50. No. 125 cabinet with grill improved natural tone horn of very good quality will take receiving set with panel up to 7x21". Our price.....\$34.50

Transportation charges extra. Specify size panel of your set.

We can furnish Utah or Burns Units at additional cost.

Send for catalog showing regular cabinets, Hi-Boy Consoles, Radio Tables and Radio Benches.

UTILITY RADIO CABINET COMPANY
448-27th Street :: :: Milwaukee, Wis.

cold air which slide down from the polar regions and mix slowly but violently with the warmer air of the temperate regions and of the semi-tropics. If this is a true picture of a cold wave, that wave probably extends well up toward the lower surface of the supposedly undisturbed stratosphere. It may even force this lower surface into an upward bulge or draw it down into a valley. Whether such storms in the lower air can ever reach high enough to affect the Heavyside region, even ever so slightly, we do not know. It would be rash to state that this effect is by any means an impossibility.

The truth is, it will be apparent, that we know too little, as yet, about the real nature of the upper levels of our atmosphere to be able to say much about what does happen in them or about the effects which such things as cold waves and hot spells have on these upper levels. Exploration of the upper air, above ten miles or so from the earth, is difficult and slow. If the temperature effects which Dr. Austin finds, originate, as is quite possible, within these higher stories of our earth's attic, it may be some time before we are able to interpret them fully or with assurance.

Indeed, it is more than possible that we shall learn new facts about the upper air from our radio studies, rather than interpreting radio studies by aid of our knowledge of the upper air. Sounding balloons will rise only some twenty or twenty-five miles. Radio waves go much higher; at least as high as the Heavyside region, a level hopelessly inaccessible to man or to balloons, although possibly reachable by Professor Goddard's suggested explosive rocket. Radio investigations like that of Dr. Austin on temperature effects, are likely to tell us more of the nature of the upper air and of the effects of surface weather on it than any other scientific procedure that has been advanced and carried out.

Meanwhile, the practical conclusion is that the air temperature has a distinct relation to the signal strength with which radio is transmitted over distances in the neighborhood of 150 miles. Much has been done already in correlating radio reception with the weather, as several recent articles in POPULAR RADIO have described. The temperature relation discovered by Dr. Austin is another fact useful in the same connection.

It will not be long, one may imagine, until the prediction of radio conditions for a few hours or days in advance will be just as possible as it is now to predict rain or hurricanes or other outstanding features of the weather. The possibility of such forecasts of radio conditions throughout the world would be a great boon to the listening radio public as well as to the commercial companies that handle traffic.

Stop It!



\$15
Complete
with tube

Last quarter—eight minutes to play—score tied—your favorite has the ball on opponent's twenty yard line—first down—ten yards to go—looks like a touchdown—

Broadcasting coming in fine—play by play—and then,—it fades away. Tubes are not lit—"A" Battery is out—run down.

This cannot happen to those who use the

FRESHMAN AUTOMATIC CHARGER

This device keeps the "A" Battery fully charged at all times

An absolute necessity—fool proof and dependable in every respect. Equipped with a Tungar Rectifying Tube which supplies a steady charging current to the "A" Battery when the set is not in use. When the radio is in operation the charger is disconnected by means of an automatic relay.

No LIQUIDS USED—"B" ELIMINATOR CONNECTION
Sold by Authorized Freshman Dealers Only

Write for our new 48-page book illustrating and describing the entire line of Freshman Masterpiece Receivers and other apparatus

CHAS. FRESHMAN CO., Inc.
Freshman Bldg., NEW YORK—2626 W. Washington Bldg., CHICAGO

STOP!

Don't Work Without Pay

SAVE 100% OF YOUR TIME AND WORRY

Buy any of the RECEIVERS listed below 100% READY-TO-WIRE at the VERY BEST MARKET PRICES.

**PAY NO MORE
OUR SERVICE IS FREE**

You pay no more to us for our 100% READY-TO-WIRE RECEIVER than you would pay to others for the KNOCKDOWN kit of PARTS.

! FREE !

Our PROPOSITION to the Consumers, known as the GUARANTEED - MONEY - SAVER will be mailed FREE upon request.

—IF—

YOU are interested to SAVE TIME and WORRY on any of the latest advertised POPULAR RADIO or other well known RECEIVERS, and POWER-PACKS as listed below,

WRITE for our PROPOSITION which GUARANTEES you the UTMOST SAVINGS

An entirely new idea makes it possible for anyone to build the most complicated receiver with factory precision in less than half the time. Standard Receivers, Cone type Loudspeakers, A and B-Battery Eliminators, also Knockdown Receivers and Power-Packs at lowest in the country prices.

Our 100% Ready-to-Wire Receivers and Power Packs

L-C-27-Cockaday

Samson T-C- De-Lux

Improved Browning-Drake

Karas Equomatic

New Henry Lyford

Hammarlund-Roberts Hi-Q

DAVEN BASS NOTE

Remler Infradyne

Silver Marshall Shielded Six

Diamond of the Air

L-C-Senior Power Pack

L-C-Intermediate Power Pack

General-Radio Power Pack

Raytheon B-Supply Power Pack

! REMEMBER !

That all Standard Receivers we sell are GUARANTEED to be GENUINE and as REPRESENTED, we also guarantee OUR 100% READY-TO-WIRE RECEIVERS to be composed of the exact same parts as used in the laboratory model used by Mr. Cockaday and other designers.

—WRITE TODAY—

You will only have yourself to blame, If you don't write us at once your name.

Consumers Service Co.
CO-OPERATIVE ASS'N

Direct Buyers for the Consumer

263-67 East 24th Street

Paterson, N. J.



Henry Miller

RADIO PROGRAMS PRINTED FOR THE BLIND

The Braille system of printing in raised letters that may be read by touch is employed by the State Institution for the Blind in Berlin, for enabling the sightless to follow the broadcast features. This blind girl is mailing the programs to those similarly afflicted.

BROADCAST LISTENER

*Comments on the radio programs, methods and technique
—from the point of view of the average fan*

By RAYMOND FRANCIS YATES

When the Broadcast Studio Is Not Needed

EVERY careful listener can distinguish the difference between music broadcast from a studio and music broadcast from a place outside the studio.

There is to the latter an unmistakable "hollowness" and reverberation.

To overcome this, acoustic engineers have gone to great effort in building studios with cork-covered walls, heavy carpeted floors and sumptuous draperies. These devices are used to kill the reflection of sound which, the wiseacres claim, is a destructive factor in reproduction; it is claimed further that perfection of tone and "naturalness" is possible only from a studio built on the principle of a padded cell.

That an engineer should claim that perfect pick-up comes only from a place of this sort is strictly an engineer's business and that we should differ with him, even though it may betray gross ignorance on our part, is strictly our own business. Be that as it may, that's exactly what we are going to do. This hollowness and reverberation, this diabolical "sound reflection" if you will, adds a touch of realism which to us is necessary to create a perfect illusion. It may be bad engineering; it may be bad acoustics. But we like it. It's natural. It's real.

In listening to the Capitol Grand Symphony Orchestra, there is conveyed to us with the music a sense of immen-

sity, and grandeur; we can all but feel our presence in a great theatre. There is an unescapable realism to it. It sounds as though the music were being played in a big, spacious auditorium. Surely, we would not care to experience the illusion that this grand orchestra was playing right in our own 12 by 24 living room; that would be a destructive sensation. We want to be transmitted to the scene and not to have the scene brought to us. And that is just what a prepared studio does not do with the larger orchestras. The music sounds "cramped;" there is a "deadness" to it that creates an impression of detachment; it may be too perfect to sound true.

In the case of trios and instrumental solos, perhaps this "studio effect" is desirable, but we are doubtful. We would much rather listen to the dinner music of WEAJ transmitted from the dining room of the Waldorf-Astoria than to an *ensemble* from a padded cell. In the latter case, the illusion of "space," of being present in a huge dining room, is evidence and that to us is realism.

Even in this prejudiced frame of mind, we can more than dimly appreciate the technical difficulties involved in transmitting from small studios. To turn an orchestra loose in a small, unprepared room would be nothing short of a musical tragedy. That is patent.

The solution to the whole problem seems to lie in using enormous studios with carefully regulated acoustical properties. In such a place, a good

LC-27 KITS

SEND YOUR ORDER IN TODAY!

Parts exactly as used by author in the LC-27
Broadcast Receiver

1—Hammarlund mid-line dual condenser, .000275 mfd.	\$7.50
1—Hammarlund mid-line single condenser, .000275 mfd.	4.65
1—Frascon Duo-Octaforn coil set, one antenna coupler and two interstage couplers.	10.50
1—Amertran De Luxe first-stage transformer.	10.00
1—Amertran De Luxe second-stage transformer.	10.00
1—Amercok No. 854.	6.00
1—Dubiller No. 902 filter condenser, 4 mfd.	5.50
1—Dubiller No. 907 filter condenser, 1 mfd.	.60
1—Mar-Co illuminated control, scale 0 to 100.	3.50
2—Mar-Co small controls for LC-27.	1.50
1—Carter battery switch.	1.65
1—Samson radio-frequency choke coil No. 85.	1.50
3—Aerovox mica fixed condensers, .00025 mfd.	1.05
1—Durham resistor, 4 megohms.	.50
1—Lynch grid leak mounting.	.35
1—Carter Gem Jack.	.25
1—Carter resistance, 0-10,000 ohms.	2.00
12—Rby binding posts.	1.80
5—Benjamin UX sockets.	3.75
1—Amperite.	1.10
Mechanical Kit consisting of aluminum chassis, binding post strip, decorated panel and Tait brackets.	12.50
Complete.	\$85.20

COMPLETE PARTS FOR \$47⁵⁰
LC INTERMEDIATE POWER PACK

Send Money order for immediate delivery

City

Radio Stores

110 West 42nd Street, New York
Downtown Store :: 79 Cortlandt Street

22½ v. \$2.65

U
N
A
C
I
D



E
V
E
R
L
A
S
T
I
N
G

“HAWLEY” NEW TYPE

45 volts \$5.25. 90 volts \$10.00, 112½ volts \$12.50. 135 volts \$14.75, 157½ volts \$16.80. 180 volts \$19.20. Includes chemical. Nothing to purchase extra. Special sizes to order. Easily recharged upon any current including 32 volt systems. Any special detector voltage easily had. Operates any 1 to 10 tube set. Tested and approved by leading authorities, such as Popular Radio Laboratories, etc. Over 4 years sold on a non-refund 30 day trial offer with complete refund if not thoroughly satisfied. Further guaranteed 2 years. Knock-down kits at still greater savings. Complete “Hawley” “B” Battery charger \$2.75. Order direct—same day shipments, shipped C.O.D.—simply pay expressman cost on delivery or write for my free literature, testimonials, etc.

B. HAWLEY SMITH
315 Washington Ave., Danbury, Conn.

The most comprehensive line of radio reproducers in the world

AMPLION CONE
AC12.....\$30

AMPLION DRAGON
AR19.....\$42.50

AMPLION PATRICIAN
AA18.....\$45

Amplion reproduces the entire musical scale with absolute fidelity

—no matter what set you have, you need an Amplion to bring out its best

THE Amplion Patrician assembles a 48" air-column with the matchless Amplion reproducing unit in a richly carved mahogany cabinet, 18" x 12" x 9". The Patrician is non-directional and is notable for the pleasant, soft mellowness of its tone.

The Amplion Cone is totally different in principle from any cone type of reproducer. Its especial superiority lies in its clear, clean-cut reproduction of speech.

The Amplion Dragon is used as a standard of comparison in radio experimental laboratories all over the world.

To any radio enthusiast no gift could be more acceptable than an Amplion. Prices range from \$12 to \$45.

Ask your dealer for a demonstration or write to us for interesting Amplion Booklet.

THE AMPLION CORPORATION OF AMERICA
Suite X, 280 Madison Avenue, New York City
From 1887..... A path of brilliant achievement to 1927



More
power!



Type
200A

POWER DETECTOR

POWER—and more of it—that's the biggest thing in the tube field today! Sonatron's famous power tubes are giving new life to thousands of sets—and new enjoyment to thousands of set owners. The very next thing you should do is to buy this remarkable power detector—and hear the amazing improvement in reception which it brings! It's one of a family of 25 distinct types—the world's largest tube line!

SONATRON-ize your set!



The
Sonatron Amplifier
with 3 Red, White and Blue
Matched Power Tubes

Adds three stages of amplification to any set, even a crystal. One connection, made in a moment, and you have this source of amazing power and tone. Adds beauty to your set, and makes your batteries last longer. For dry-cell or storage battery sets, \$20 complete. At your dealer's.

SONATRON TUBE CO., Chicago, New York, Newark, N. J., Detroit, Windsor, Ont., Canada

SONATRON

Nationally
Advertised

Standard
Quality

Manufacturers of the WORLD'S LARGEST-TUBE LINE

soprano could sing with an acoustical background that would give her voice every opportunity to reach its fullest beauty. It is true that the better artists feel annoyingly strange when singing in studios for the first time. They miss that sensation experienced in large auditoriums.

Some day, perhaps our larger broadcasters will be able to afford great auditoriums from which to broadcast. To our way of thinking, it will be a great day for radio when they are.

What "Chain Broadcasting" Promises to the Fan

THE haywire broadcasters, it seems, are rapidly coming to the ends of their ropes, which means that within the next year broadcasting will shake off a number of its grotesque performers and settle down into a respectable source of entertainment.

The work of consolidating some of the better studios has begun; perhaps before this comment has appeared in print, the WJZ-WEAF chains will have been brought together into one great system. And this is but one of the changes that will occur. WPG, WIP and WGBS are to be incorporated into a chain, and plans, to say nothing of wires, are being laid to bring together other good microphones.

The passing of the smaller transmitting stations will be accomplished painlessly and quietly, for the public will naturally forsake them for the cooperative programs offered by the chain stations. It will not only be a matter of the survival of the fittest but the passing of a strictly detrimental factor. The smaller studios cannot, or at least they have not, been able to attract the better performers nor can they afford real artists the type of transmission that they are justified in demanding. Their presence on the air has done nothing but increase interference and lower the general standard of broadcasting.

Chains of capable stations, on the other hand, hold out great promise for higher quality in programs. It is reasonable to assume that three to twenty stations in a chain can afford, by pooling their resources, both technical and financial, to hire better artists and by so doing to avoid much of the banal stuff that now finds its way to the air. It seems that the day of the ham radio performer is coming to an end.

Have You a Pet Radio "Uncle?"

If you are much of a listener you've probably heard one of the many "Uncles" on the air.

If you haven't, we don't know how you have managed to escape them. There's "Uncle Robert," "Uncle Henry," "Uncle Gee-Bee," (a dear old

NEW U. X. UNIVERSAL FITS ALL TUBES

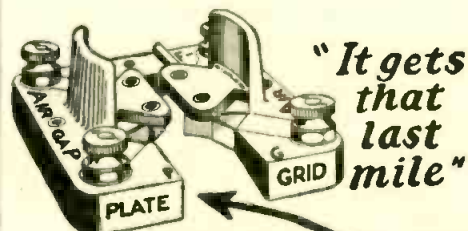

The **AIRGAP**
SOCKET

Because

They introduce a minimum of grid-plate capacity and aid in preventing objectionable feedback is the reason Mr. John B. Brennan, Tech. Ed. Radio Broadcast gives (in November issue) for selecting Airgaps for the new four tube R. B. Lab. Circuit which contains many refinements brought forward by the manufacturers of the 1927 season and years of development work by Mr. Keith Henney director of Broadcast Laboratory.

At all dealers or direct 60c.

AIRGAP PRODUCTS CO., Mfr.
11 Campbell St., Newark, N. J.

SEE THAT GAP?

Electrically and
Mechanically Perfect

Sheet Copper for Shielding

Shielding

Prevents aerial radiation and feedback.

Insulates against interference from adjoining circuits.

Improves efficiency, selectivity and tone quality.

USE SHEET COPPER
because it combines low
resistance with easy work-
ing qualities.

COPPER & BRASS
RESEARCH ASSOCIATION
25 Broadway — New York

soul) "Uncle Walt" and many, many Uncle Whosits. These men are much given to the use of the word "kiddie" and when the announcers say that the next fifteen minutes are to be devoted to the kiddies with dear old Uncle Jack at the microphone, you are supposed to capitulate to the spirit of the occasion and adjust yourself to Mother Goose and the "Story of the Grey Horse." That puts you down as a big-hearted Gus making sacrifices in the interests of the kiddies. (Note the human appeal in that word?)

Just the other day, at the POPULAR RADIO Laboratory, we tuned in on Uncle Robert (WHN). Uncle Bob, "as his little wards fondly call him," is one of the greatest kiddie-kar papas in radiodom. Uncle Robert always comes to the studio with a corps of his "little charges" who sing and recite for you—providing you are willing. Personally we were not willing. Far from it. No sooner had Uncle Robert's "little charges" broken into (and "broken into" are the right words) one of their songs than we were a little speck disappearing in the direction of the 42nd Street Ferry.

Really, there is only one intelligently managed kiddie broadcast that we know of and that is the Sunday morning period put on by WJZ. That station, contrary to the accepted laws of broadcasting, does not employ an Uncle. Its announcers simply read from the funny papers and broadcast music that might appeal to the juvenile imagination. WJZ has exploded the Uncle theory and still it manages to attract the attention of thousands of youngsters.

A Rare Treat of Old-time Minstrelsy

If you want to spend a pleasant Sunday evening some time, get the old jimmy pipe out and tune in to one of the minstrels broadcast by WGBS. After listening to several of them, this department is willing to testify before a Congressional Committee to the effect that WGBS is putting on a series of minstrel shows worth anybody's cigar store coupons.

If you have been in the habit of listening to some of the minstrels broadcast from here and there and from time to time, you will probably accuse us of being goofy after making such a statement. Be that as it may, WGBS is releasing every other Sunday a line of "nigger talk" that is about as funny as anything that we have ever heard broadcast—with the possible exception of Mr. MacNamee's rollicking reflections on the Dempsey-Tunney fight.

But how do the scientists hope to conquer static when after all these years they can't make a fussy steam radiator shut up?

—Macon Telegraph

Build This Set— the Standard of Merit!

For more than a year and a half the Diamond of the Air has been a favorite with fans. It works on loop or indoor or outdoor aerial.

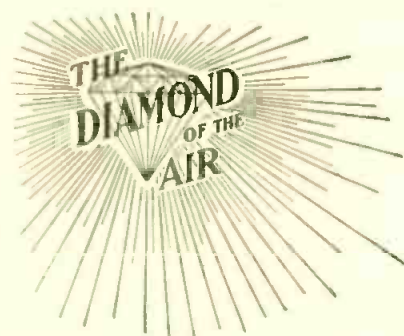

Licensed under Armstrong Patent 1,113,149.
Manufactured by Clapp-Eastham Co.
exclusively for the Bruno Radio Corp'n

Complete Kit of Parts, with
Blue Print, Ready to Wire, as
Specified by Herman Bernard

\$37.50

Simplicity, Efficiency and Beauty The Bruno Unitune

The name Unitune stands for something new and beautiful in radio—two drums that actuate two Bruno bakelite shaft straight line frequency condensers, the circuit being completely assembled and mounted on a frame. A bronze panel plate goes with the unit, used for all the popular circuits.

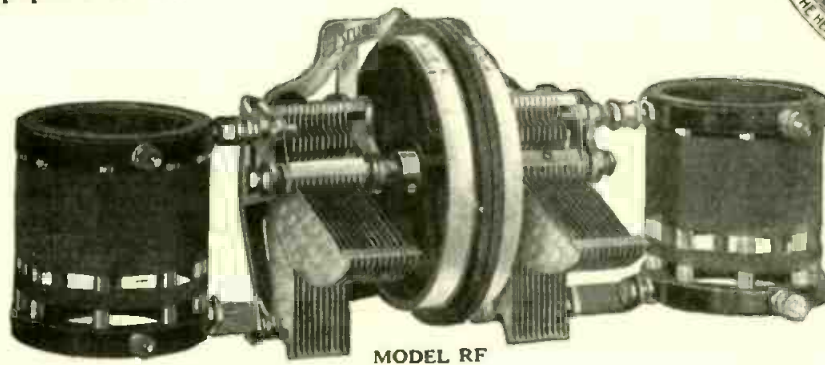

Price
\$17.00

UNITUNE Model 2C

This basic instrument consists of two bakelite shaft Bruno straight line frequency condensers (.0005 mfd. unless otherwise specified), mounted on an aluminum frame; a bronze panel plate and two drums, with scale. The condensers are insulated from each other. \$11.00

UNITUNE Model CC

Consists of one .0005 mfd. bakelite shaft, straight line frequency condenser and a three circuit tuner on one frame, with regular Bruno drum control. Price.....\$12.00

UNITUNE Model RF

Consists of the basic condenser frame, Model 2C, and two Bruno LOW LOSS RF transformers. This combination provides two radio frequency stages and covers a wavelength of 200 to 550 meters. Price, completely assembled.....\$17.00

UNITUNE Model CF

Consists of 2C unit with one fixed RF coupler and special three winding coil, with fixed primary and tickler, for use in capacity feedback regenerative circuits. Price.....\$19.00

UNITUNE Model TK

This model is similar to Model RF except that the right hand condenser holds a standard BRUNO THREE-CIRCUIT TUNER. It is adaptable to a variety of circuits. Price, completely assembled.....\$20.00

UNITUNE Model BD

Consists of two condensers and two specially wound coils designed for use only in the BROWNING-DRAKE circuit. Price.....\$21.00



"BRUNO 99"—3-circuit Tuner, wound on Quartzite glass and specified in the Diamond of the Air. Covers Broadcast band and brings efficiency to any circuit. It mounts with single hole.....\$5.50

"BRUNO 99"—Matched R. F. Coil for the 99 Tuner. Used in the Diamond of the Air and will improve any good circuit. All bolts and screws furnished.....\$3.00

BRACKETS—Well made of die-cast aluminum. Substantial supports. Simplify wiring. Used in the DIAMOND OF THE AIR and the BERNARD.

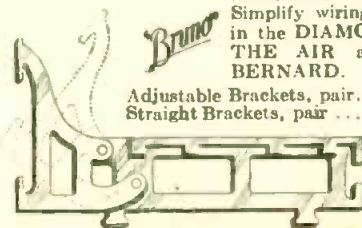

Adjustable Brackets, pair.....\$1.25
Straight Brackets, pair.....1.00

SEND IN FOR BOOKLET

B. C. L. RADIO SERVICE CO., Inc.
Dept. P :: 221 Fulton Street :: New York City

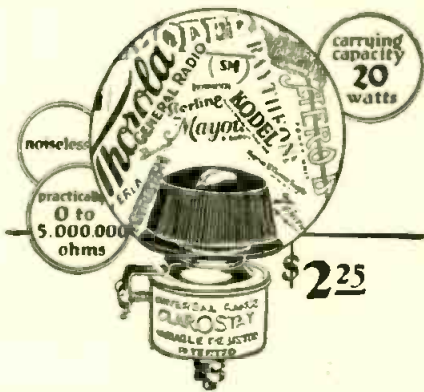

59* of the leading
"B" Eliminator
manufacturers
(RAYTHEON, of course, included)

**and the roll is growing!*

USE OR RECOMMEND
the greatest variable resistor!

CLAROSTAT

CLAROSTAT covers every resistor need. It is designed for the precision control of modulation, regeneration, oscillation, grid action, plate voltage and general laboratory practice.

"THE GATEWAY TO BETTER RADIO"

a 32-page book which gives accurate instructions for the use of CLAROSTAT in every conceivable type of circuit is now available. It covers all the popular types of receivers, B eliminators and power amplifiers. May we send you a copy? Price 25c.

AMERICAN MECHANICAL
LABORATORIES, INC.

Dept. P.R.

285-287 North 6th St.
Brooklyn, N. Y.

one
hole
mount

CLAROSTAT



BROADCASTS

CONDUCTED BY CHARLES L. REESE, JR.

Will Radio Compete with the Newspapers?

WHETHER the citizen of the future is to have his news served to him *via* radio or must seek it out in the papers is one of the problems that is beginning to loom as broadcasting threatens to become a serious rival of the daily press. Even now almost all important sporting events are reported for the radio audience. The solution will probably be a compromise, in which radio will handle the "spot" news, the reports of sport events and all news in which speed of communication is an essential, leaving to the papers the more detailed and leisurely report of events and editorial comment.

Radio Beacons for Airplanes

THE first radio beacon of the new type which will guide commercial airplanes in their cross-country flights has just been completed at College Park, Md. A tower, seventy feet high, rises from a frame building in which is housed the radio apparatus; this tower supports a triangular loop antenna which will emit double-beam waves. Plans call for a chain of these beacon stations, across the continent, spaced 200 miles apart.

To Protect Airplane Passengers by Radio

PASSENGERS on French commercial planes will be given all the protection that radio affords. According to a recent decree of the French Government, every commercial plane that carries ten passengers and that makes non-stop flights of more than 160 kilometers must carry radio equipment and a skilled operator.

Local Taxes on Radio Sets

BROADCASTERS may soon be in for a shearing if politicians through the country follow the example set by a little town in Kentucky, which has recently passed an ordinance whereby any commercial or amateur broadcaster residing there must pay an annual license fee of \$100. The tremendous development of

broadcasting in this country has been largely due to the absence of tax restrictions of this kind upon either transmitting or receiving sets; and although it is too much to hope that other state and city governments will entirely ignore this golden opportunity for taxation in an entirely new field they should be made to realize the hampering influence of such restrictions.

New Laws to Restrict Radio Advertising

WHEN the radio bills that Congress is expected to act upon this fall eventually become law it is almost certain that they will contain two provisions that have been fairly well agreed upon; that all advertising matter that is paid for directly or indirectly, must be announced frankly as furnished by these advertisers; and that there shall be no discrimination as to charges, terms or service to advertisers.

The First Golf Championship to be Broadcast

WHAT is said to be the first broadcast "side-line" report of golf championship play was the transmission of matches in this year's national amateur golf championship at Baltrusol by WOR. Ten miles of telephone wire formed a network over the entire course so that the announcer was able to broadcast each play as it was made by plugging in at points along the fairway.

A Portable Receiver as an Ear-Trumpet

A RADIO receiver is a useful accessory at a heavyweight championship fight, according to Jack Poppele, a radio engineer, who arrived at the Sesquicentennial stadium for the Dempsey-Tunney fight to find, like many others, that his seat was nearly three-quarters of a mile from the ring. Poppele, however, was foresighted enough to bring a portable radio with him, so, with a wire over his shoulder for an antenna, he listened to the ringside broadcasting of the fight while he tried to see what he could in the ring with a pair of binoculars.

YOUR INDIVIDUAL RADIO PROBLEMS SOLVED

POPULAR RADIO maintains for the benefit of its readers a Technical Service Bureau and Laboratory, under the personal supervision of Laurence M. Cockaday which will, without charge, answer by personal letter any question, problem or request for information submitted by a subscriber. This service is, however, also available to readers, other than subscribers, at the very nominal rate of \$1.00 the inquiry.

In writing please confine your questions to one general subject, writing on one side of the paper only, and enclose a self-addressed and stamped envelope.

It is possible that your individual problem has been covered in an issue of POPULAR RADIO, and so as an aid to you we endeavor to keep a supply of back numbers in stock. The condensed index below gives a few of the subjects that have appeared recently, look this list over and if the information you want is covered, we will be pleased to supply back numbers at 35c. a copy.

January, 1926
—How to Get the Most Out of Your LC-26 Receiver.

—Some New and Useful Facts About Coils.
—When Your Set Won't Work.
—Straight-Line-Frequency Condensers.
—What's New in Radio Apparatus.

February, 1926
—How to Reduce Distortion in Amplification.
—Some Stunt Sets.
—Important Kinks in Wiring.
—How to Cut Down Your "B" Battery Bill.
—Hints for Amateurs.

March, 1926
—Why and How the Milliammeter Increases the Efficiency of Your Set.
—What "Inductances" Really Is.
—List of Broadcast Stations in the U. S.
—How to Build the S-C Receiver for Short and Long Waves.

April, 1926
—How to Get an Operator's "Ticket."
—What a Straight-line Frequency Condenser Really Is.
—How to Build a Power-pack Amplifier.
—The New "Crystal Pilot."
—How to Build and Operate a Low-Power Transmitter.
—The Popular Radio Medal for Conspicuous Service.

May, 1926
—How to Draw Up Your Own "Tuning Graphs."
—How to Build the Improved Raytheon Power-pack.
—How to Build an Antenna Mast for \$15.00.
—Fifteen Ways to Reduce Static.
—Do Your Coils Broadcast?

June, 1926
—How to Build the New Home Receiver.
—How to Put Up a Good Outdoor Antenna.
—How to Get the Most Out of Your Ready-made Receiver.
—Audio-frequency Amplification. How to Get It Without Distortion.
—Four New Combinations of Units for Assembling the Raytheon Power-pack.

July, 1926
—How to Get the Best Reception in Summer.
—The Best Crystal Set for \$13.00.
—How to Build the Newest Portable "Town and Country" Receiver.
—Four New Combinations of Units for Assembling the Raytheon Power-Pack.
—How to Get the Most Out of Your S-C Receiver.

August, 1926
—A New Method of Using Harmonics for Determining Frequencies.
—Popular Radio Circuits.
—How to Build the Improved Browning-Drake Receiver.
—How to Pick Out a Loudspeaker.
—How to Get the Most Out of Your "Town and Country" Receiver.
—Three Vacuum Tubes in One.

September, 1926
—Foretelling Radio Reception from the Weather Map.
—How to Build an Impedance-coupled Amplifier.
—A Radiant Crystal Pilot.
—Popular Radio Circuits.
—How to Simplify Your Set with Automatic Filament Controls.
—Inside Information on New Radio Receivers.
—How to Wire Your House for Radio.

October, 1926
—How to Build the New LC-27 Receiver
—The Radio Road Hog
—Popular Radio Circuits
—Sets That Earn Incomes.
—Inside Information on New Radio Receivers.
—Why Signals Fade.

November, 1926
—How to Build the LC-Senior Power-Pack.
—Waves and Wavelengths.
—Popular Radio Circuits.
—How to Select Your Radio Parts.
—How to Patent Your Radio Inventions.
—How to Solder.

POPULAR RADIO
Department 128
627 W. 43d St., New York

The Abox Filter

Real "A" elimination at last. Filters current direct from charger to set—employs an entirely new type condenser. The first device of its kind ever offered to the public.



Contains No Batteries

Cannot run down or wear out

Price
\$19.50

East of Rockies

THE Abox Filter is in no sense a Battery. It is a filter circuit consisting of a choke coil and two of the new Andrews electrolytic condensers which operate on a new principle and permit enormous capacity with small space, cost and weight.

The Abox Filter handles as much as five amperes and renders the current absolutely smooth and suitable

for proper operation of the tubes. It is always ready for immediate use, even after long idleness.

There is nothing to wear out.

It does not deteriorate either in use or disuse, and will last for many years.

For an explanation of this remarkable development write for description of its construction and use.

THE ABOX COMPANY • 215 N. Michigan Ave. • CHICAGO

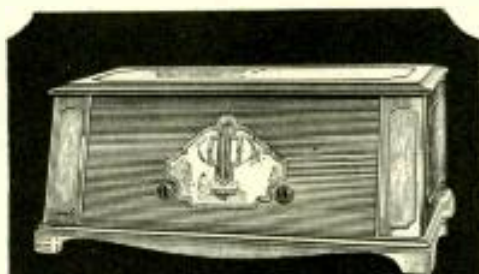

The New 6-Tube



With Donle Truphonic Audio Amplification

which delivers pure tone in any volume over the entire tonal scale, and the patented Elkay Synauto R. F., which smooths out the tuning over the whole dial from 200 to 580 meters . . . is a receiver that will be modern for years to come.

Completely shielded. Neat Uni-Control—the flexibility of 3 dials at your finger tips. In brown antique, Duco-finished mahogany, \$125. (Exclusive franchise to the Trade.)

The Langbein-Kaufman Radio Co.
Dept. P.
62 Franklin Street New Haven, Conn.

Yale GROUND HOG INCREASES POWER AND DISTANCE on your RADIO

Marvelous newly invented ground gives 100% improved reception. Increases power and distance, users say. Thousands getting results like D. S. Friedman, Radio Engineer of Burlington, Iowa, who writes, "Am very much pleased with way your Ground Hog operates. Am now able to tune in any good stations with little trouble from static." Everyone pleased and delighted. Users report, "Leaks stopped," "Static reduced," "end to jangling even in midsummer," "Results never dreamed of." Absolute satisfaction guaranteed or money back at once.

Efficiency Always Insured

Only ground on market that has power to draw and hold moisture thus assuring maximum efficiency at all times. Holds moisture indefinitely. Highly sensitive to radio energy. Proven valuable aid to clear, powerful distance reception.

SEND NO MONEY

Every radio owner needs a Yale Ground Hog. To introduce, we offer to those who act at once, regular \$5.00 size for only \$2.00. Send name today and pay postman \$2.00 plus 17c. postage on delivery, or send only \$2.00 with order and save postage.

Highest Approval



Tested and approved by Popular Radio Laboratory and other high scientific radio authorities. You can order direct today with absolute confidence of value and satisfaction.

FREE—Complete description of Ground Hog, proof of user satisfaction and full details of amazing special offer free on request—Send name today.

Yale Specialty Supply Co.

131 W. 5th St., Kansas City, Mo.



Made in the World's Largest Radio Parts Plant

- Variable condensers
- Fixed condensers
- Midget condensers
- Rheostats
- Potentiometers
- Universal sockets
- Vernier dials
- One-piece dials
- Filament switches
- Binding posts
- Sub-panel brackets
- Coil Mounting brackets
- Snap terminals and strips
- Pilot lights
- Adjustographs
- Short wave plug-in coils
- Audio transformers
- Radio transformers
- Small knobs
- Lug Jacks
- Plugs

THOUSANDS DO WHY NOT YOU?



At dealers everywhere

If the Set Builder Needs It PILOT Makes It

Millions of Pilot parts Now in use In America In Europe Even in Far away Australia

Under all kinds Of conditions In every type Of receiver. Pilot assures Set builders Products of Perfect quality That cost Less because Pilot Makes and sells More parts Than any other Manufacturer.

PILOT ELECTRIC MFG. CO., 100 So. 3rd St., Brooklyn, N. Y.

BRITISH ISLES, R. A. Rothermel, Ltd., London AUSTRALIA and NEW ZEALAND United Distributors, Ltd., Sidney BRAZIL and ARGENTINE, Samuel Meyer, Rio Janeiro and Buenos Aires

Radio Saves \$22,000 on Lecturers' Salaries

EDUCATIONAL lectures by radio are apparently more attractive to the average man than free lectures given in school buildings and halls, according to statistics recently compiled in New York. The Board of Education there has announced that the attendance at free lectures has been reduced so much because of the information now available over the radio and other sources that the number of lectures for the coming year will be drastically curtailed and the appropriation for the Board of Lectures will be reduced from \$38,000 to \$16,000.

Britain's Broadcast Empire

Two powerful new broadcasting stations that are now planned for the two leading cities of India, Calcutta and Bombay, will help to make England's rapidly growing radio empire nearly as vast as her territorial possessions. Australia and South Africa have for some time had stations that rivaled England's own in power and range and these two new broadcasters in India will complete the chain. The original plans for the stations were laid immediately after the successful use of broadcasting during the general strike in England showed the tremendous value of radio as a means of retailing information to the great mass of the people when all other means of communication fail.

A Real Radio Eden

THE radio paradise of the world, according to reports from abroad, is Bude-in-Cornwall, a small town in western England where listeners-in are able to tune in American stations at almost any time and where Continental broadcasters are received even in the hot summer months with clear quality and loud volume. Visitors to the village report that, for some unexplained reason, signals come in better there than in any place they have ever been, although in Bodmin, only a few miles away, there is an absolute dead spot, and the nearest broadcaster can hardly be heard even on a five-tube set.

Sixty-five New Broadcasters by January

AMERICAN fans will have sixty-five new stations to listen to before the year is up as a result of the ruling of the Department of Justice that makes it nearly impossible for Secretary Hoover to refuse to grant a license to any and all applicants. At least that is the estimate of the Department of Commerce which still has 650 applications on its files. The deluge of new stations will not be heavier because few of the applicants will be able to get their apparatus ready to go on the air before that time.

Morison's Has All Parts!

LC INTERMEDIATE POWER PACK

- 1 FILTREX A-C Transformer, Type K 180..... \$5.25
- 1 Na-ald Socket, Type 481 X..... .35
- 2 FILTREX Choke Coils, Type K @ \$6.75..... 13.50
- 6 Eby Binding Posts..... .90
- 1 Aeracon Condenser Block, 14 mfd..... 11.00
- 1 Aeracon Filter Condenser, .1 mfd. 440 volts, D.C..... 1.00
- 1 Hardwood Baseboard, walnut finish, 7 3/4" x 18" x 1/2"..... .85
- 1 Hardwick, Field & Leeb Resistance Unit, Type 200..... 5.25
- 1 Centralab High-current variable resistance, 2,000 ohms total..... 2.00
- 1 Bakelite Binding Post Panel, 3 1/4" x 4 1/4" x 1/2" drilled..... .50
- 1 Set "Popular Radio" blueprints, and construction booklet..... 1.00
- Celastite Connecting wire, screws, etc..... .50
- 1 8 ft. twisted silk lamp cord with attached plug..... 40

\$42.50

Yaxley Automatic Relay Switch, No. 444, \$5.00 extra

Morison's Gives You SERVICE! WHOLESALE :: RETAIL

MORISON
Electrical Supply Co. Inc.
15 EAST 40TH STREET
NEW YORK CITY

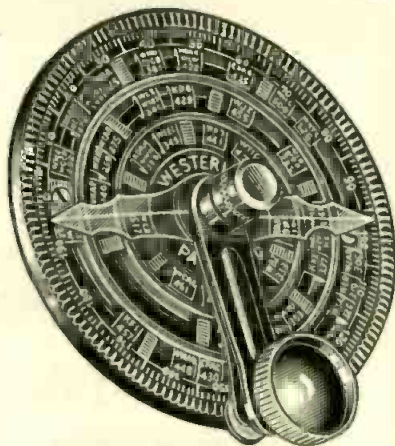

The NEW

WESTERLAND SUPER-VERNIER TUNING DIAL

Gets More Out of Your Set

BECAUSE:

1. Sharper Tuning (150-to-1 gear ratio)
2. Quicker Tuning (instant jump from station to station)
3. Easier Tuning (stations logged on face of dial — no charts or log-books needed)
4. Simple operation (one-knob control)
5. Absolute elimination of backlash (worm-gear movement guarantees this)
6. Easy to attach (no holes to drill in panel)

With the Westerland Super-Vernier Dial you can hit the peak of the wave every time. This means better reception, longer distance, freedom from interference—in short, maximum results from your set.

Ask your dealer or order direct

WESTERLAND CORP.
Dobbs Ferry, N. Y.

Price \$2.50

Faradon

CAPACITORS

“UNIVERSAL” FILTER CAPACITOR BLOCK



Model WS-3750

This new FARADON “Universal” Filter Capacitor Block, of 14.2 Mfds. in one container, is for operation in connection with the most generally used Battery Eliminator circuits. It contains important features not heretofore found in grouped filter condensers.

The total capacitance is connected to fixed terminals in convenient units, permitting ready wiring as desired. Units to be connected in the circuit where possible high potential surges may occur are constructed to withstand a higher voltage than is usually required. Convenience, safety and continued satisfactory operation are combined in the FARADON Filter Block.

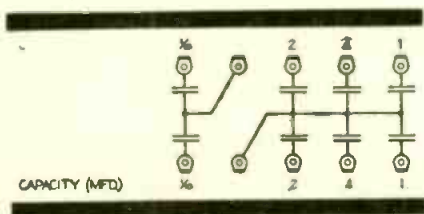

BY-PASS CAPACITORS

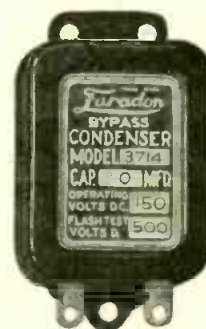

Capacity MFD	Models		Model No.
	Operating DC	Flash Test DC	
1/2	150	500	WS3713
1	150	500	WS3714
2	150	500	WS3715

RELIABILITY

Is essential to Satisfaction in By-Pass and Filter Capacitors.

Not until a product has successfully passed exacting final electrical and mechanical tests is it considered worthy of the “FARADON” trade mark and ready for commercial use. Dependable, efficient products are the result.

U. S. Army, U. S. Navy, Bureau of Standards, General Electric Co., Radio Corp. of America, Tropical Radio Telegraph Co., Westinghouse Electric & Mfg. Co., and Western Electric Co., are some of the large Faradon users.

Secure the reliable Faradon Capacitors at your Dealer's.

WIRELESS SPECIALTY APPARATUS COMPANY

Jamaica Plain

::

Est. 1907

::

Boston, Mass., U. S. A.

Build A Giant

3 FOOT CONE SPEAKER

Save Four-fifths of Retail Cost; Equals Finest Speaker Made



You can build this SENSATION of the Radio Shows in one evening at home yourself. make it equal to a factory-built speaker; and save!

Only with a 3 ft. speaker can you get real tone quality—every note of the brass horns in an orchestra, the beats of the bass drum, the low notes of a pipe organ and ALL the in-between tones to the highest note of the violin and the shrill treble of the piccolo.

But you must choose your unit with care. It is most important. Insist on a

Penn Cone Speaker Unit

Designed especially to operate a 3 ft. cone and to work perfectly even with power tube. Adjustable to the audio output of any set. Recommended by leading radio engineers. Finest seasoned steel magnet; double pole vibrator; shortest, most substantial driving rod on any cone speaker unit. A marvel of design and construction.

Your dealer has or can get the PENN Unit for you. Insist on examining it before you accept any other. Price, \$9.50. If he hasn't the PENN or will not get it for you, we will ship you direct, prepaid, on receipt of price. Parts complete—including 2 sheets of Alhambra FONOTEX, PENN Back Rings, Unit Mountings, Special Ambroid Cement and PENN Cone Speaker Unit, only \$14.15. Construction article. "How to Build a 3 Ft. Cone Speaker for only \$14.15" sent for 10c. coin or stamps.

PENN RADIO SALES CO.

104 Fifth Ave. Suite 2077 New York City

Exclusive Distributors for
G. R. PENN MAN'G. CO.
New York City

Choose Your Cone Materials Carefully

In Building Your Own

3 Foot Cone



MADE especially for cone type speakers. ALHAMBRA FON-O-TEX is used by practically all leading cone type speakers manufacturers. This remarkable material has no grain; hence no resonance point of its own; but resonates uniformly at all frequencies.

Price 75c for a sheet 38 x 38 inches, large enough for a 3 foot cone. Ask your dealer. If he hasn't Alhambra FON-O-TEX we will supply you. To the cost of the number of sheets you need, add \$1 for packing and delivery charges.

The SEYMOUR Co., Desk 101
325 West 16th St. New York City

ALHAMBRA
FONOTEX
PRODUCT AND PROCESS PATENTED
FOR CONE TYPE LOUD SPEAKERS

Outstanding Program Features of the Month

NOVEMBER 20th to DECEMBER 15th

DURING the coming month, November 20th to December 15th, the following regular and special program features are scheduled. This list, which will be augmented monthly as advance information is received, will be published in each issue of this magazine; all broadcast stations are invited to report coming program features of outstanding interest or importance. Reports should reach the Editor of POPULAR RADIO on or before the 23rd of the month preceding.

NOVEMBER

(Eastern Standard Time)

- 20; *Walter Damrosh*, WEA, 9:15 P.M. *Piano Lectures and New York Philharmonic Orchestra.* (Also broadcast from WEEL, WGR, WFI, WCAE, WWJ, WSAI, WTAM, WGN, KSD, WCCO and WDAF).
- 22; *A & P Gypsies*, WEA, 9:00. (Also broadcast from WEEL, WJAR, WDAF, WRC, WCSH, WCAE, WTAM, WLIT and WWJ).
- 23; *Auction Bridge Instruction*, WEA, 10:00—10:30 P.M. (Also broadcast from WEEL, WCSH, WTAG, WJAR, WGR, WCAE, WTAM, WFI, WWJ, WSAI, WGN, WOC, WCCO and KSD).
- 26; *Happiness Boys*, WEA, 8:00 P.M.
- 27; *Walter Damrosh*, WEA, 9:15 P.M. *Piano Lectures and New York Philharmonic Orchestra.* (Also broadcast from WEEL, WGR, WFI, WCAE, WWJ, WSAI, WTAM, WGN, KSD, WCCO and WDAF).
- 28; *Atwater Kent Hour*, WEA, 9:15 P.M. (Also broadcast from WJAR, WEEL, WFI, WCCO, WTAM, WGN, WCAE, WGR, WOC, WTAG, WWJ and KSD).
- 29; *Rolf's Palais D'Or Orchestra*, WEA, 11:00 P.M.
- 29; *A & P Gypsies*, WEA, 9:00 (Also broadcast from WEEL, WJAR, WDAF, WRC, WCSH, WCAE, WTAM, WLIT and WWJ).
- 30; *Auction Bridge Instruction*, WEA, 10:00-10:30 P.M. (Also broadcast from WEEL, WCSH, WTAG, WJAR, WGR, WCAE, WTAM, WFI, WWJ, WSAI, WGN, WOC, WCCO and KSD).
- 30; *Keystoners*, WJZ, 9:00 P.M. (Also broadcast from WRC and WGY).
- 30; *Eveready Hour*, WEA, 9:00 P.M. (Also broadcast from WEEL, WFI, WCAE, WGN, WWJ, WOC, KSD, WJAR, WCCO, WTAM, WGN, WSAI and WTAG).
- 30; *George Olsen's Orchestra*, WJZ, 10:45 P.M.

DECEMBER

- 1; *Eastman Theatre Orchestra*, WHAM, 6:30 P.M. (Also from WGY).
- 1; *Radio Nature League*, WBZ, 8:30 P.M.
- 2; *Eskimos*, WEA, 9:00 P.M. (Also broadcast from WEEL, WJAR, WTAG, WFI, WCAE, WSAI, WTAM, WGR, WWJ, WOC, WCCO, KSD and WGN).
- 2; *The Zippers*, WEA, 10:00 P.M. (Also broadcast from WFI, WCAE, WWJ, WGR, WOC, WCCO, WTAG, KSD, WSAI, WJAR, WGN, WDAF and WCSH).
- 2; *Royal Typewriter Hour*, WJZ, 9:30 P.M. (Also broadcast from WGY, WRC and WCAD).
- 3; *Happiness Boys*, WEA, 8:00 P.M.
- 4; *Walter Damrosh*, WEA, 9:15 P.M. *Piano Lectures and New York Philharmonic Orchestra.* (Also broadcast from WEEL, WGR, WFI, WCAE, WWJ, WSAI, WTAM, WGN, KSD, WCCO and WDAF).
- 5; *Atwater Kent Hour*, WEA, 9:15 P.M. (Also broadcast from WJAR, WEEL, WFI, WCCO, WTAM, WGN, WCAE, WGR, WOC, WTAG, WWJ and KSD).
- 6; *A & P Gypsies*, WEA, 9:00. (Also broadcast from WEEL, WJAR, WDAF, WRC, WCSH, WCAE, WTAM, WLIT and WWJ).
- 6; *Rolf's Palais D'Or Orchestra*, WEA, 11:00 P.M.
- 7; *Keystoners*, WJZ, 9:00 P.M. (Also broadcast from WRC and WGY).
- 7; *Eveready Hour*, WEA, 9:00 P.M. (Also broadcast from WEEL, WFI, WCAE, WGR, WWJ, WOC, KSD, WJAR, WCCO, WTAM, WGN, WSAI and WTAG).
- 7; *Auction Bridge Instruction*, WEA, 10:00-10:30 P.M. (Also broadcast from WEEL, WCSH, WTAG, WJAR, WGR, WCAE, WTAM, WFI, WWJ, WSAI, WGN, WOC, WCCO and KSD).
- 7; *George Olsen's Orchestra*, WJZ, 10:45 P.M.
- 8; *Eastman Theatre Orchestra*, WHAM, 6:30 P.M. (Also broadcast from WGY).
- 8; *Radio Nature League*, WBZ, 8:30 P.M.
- 9; *Eskimos*, WEA, 9:00 P.M. (Also broadcast from WEEL, WJAR, WTAG, WFI, WCAE, WSAI, WTAM, WGR, WWJ, WOC, WCCO, KSD and WGN).
- 9; *The Zippers*, WEA, 10:00 P.M. (Also broadcast from WEEL, WFI, WCAE, WWJ, WGR, WOC, WCCO, WTAG, KSD, WSAI, WJAR, WGN, WCAE and WCSH).
- 9; *Royal Typewriter Hour*, WJZ, 9:30 P.M. (Also broadcast from WGY, WRC and WCAD).
- 10; *Happiness Boys*, WEA, 8:00 P.M.
- 11; *Walter Damrosh*, WEA, 9:15 P.M. *Piano Lectures and New York Philharmonic Orchestra.* (Also broadcast from WEEL, WGR, WFI, WCAE, WWJ, WSAI, WTAM, WGN, KSD, WCCO and WDAF).
- 12; *Atwater Kent Hour*, WEA, 9:15 P.M. (Also broadcast from WSAI, WEEL, WFI, WCCO,

Build Your Own

Big 3 Foot Cone Speaker

Unit developed and speaker designed by Clyde J. Fitch, noted radio engineer. Results guaranteed equal to the finest factory-built speaker or your money back if you wish it. Easily assembled; operates from any receiver that will work a speaker; wonderful tone quality at any volume even with power tubes.

Radio Show Sensation

FREE Blue Print

Famous Tun-Bar Unit sent prepaid on receipt of \$7.50, or C. O. D. charges collect, if you prefer. Free blue print with each order for unit; blue print alone, \$1.

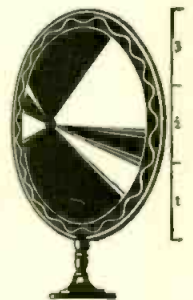

Tun-Bar
Cone Speaker UNIT

\$7.50 Direct from maker

TUNBAR RADIO CO.

26 Cortlandt St. Desk "R" New York City

M & H

The House of 30 Years' Reputation

Where there is only one quality—the best—where prompt attention, courteous service and practical knowledge hold old customers and make new ones.

Complete Parts COCKADAY'S NEW RECEIVER

THE LC-27

Parts exactly as used by the author and as described in October Popular Radio, \$85.20

All Charges Fully Prepaid
CORBETT CABINET \$18.00 EXTRA

Complete Parts

THE LC-27
Intermediate Power Pack \$47.50

WRITE US for the BEST Proposition on These Popular Kits:

Sargent's Infradyne, Victoreen Super-Het, Improved Browning-Drake, Hammarlund-Roberts Hi-Q, Power Pack Amplifier and other standard kits

M.&H. SPORTING GOODS CO.
512 Market St., Phila.

You may have wondered why a Radio Set using the NATIONAL BROWNING-DRAKE TRANSFORMERS perform so exceptionally well

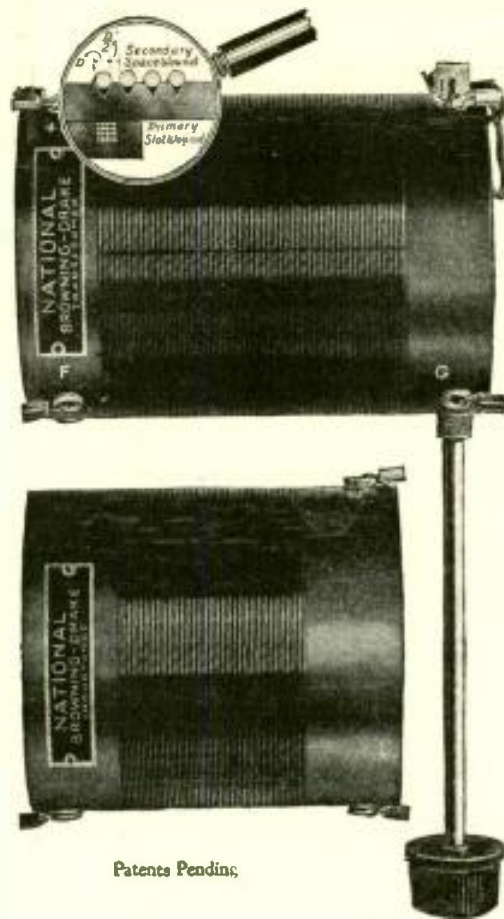

Patents Pending

There are
2
reasons
for this

1. SLOT-wound Primary
2. SPACE-wound Secondary

These are the 2 reasons why the NATIONAL BROWNING-DRAKE TRANSFORMERS are so sensitive and selective. They were developed mathematically by Glenn H. Browning and F. H. Drake after a year of research at Harvard University and are made under Glenn H. Brownings supervision.

The NATIONAL TUNING-UNITS comprise these fine coils and the NATIONAL "Equicycle" condensers (plates developed by Prof. R. F. Field of Harvard University, and Carl A. Hellman of Washington, D.C.) —and the unexcelled NATIONAL VELVET VERNIER DIALS, Type A, Type B, or Type C, the ILLUMINATED DIAL.

Price B D - 1 B, \$10.25 B D - 2 B, \$14.75
Inductance Coil and Transformer—Separate \$8.50

NATIONAL Radio set essentials may be easily assembled into a modern receiving set—sensitive, selective, easy to operate and easy to listen to.
Send for Bulletin 116 P.R.



BD - 1 B

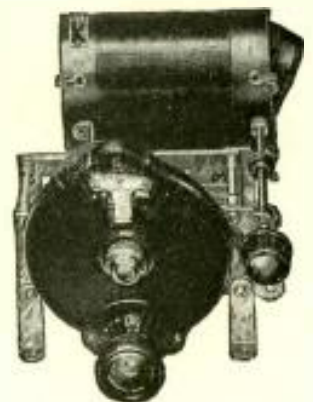

BD - 2 B

BE SURE YOU GET THE GENUINE

NATIONAL

RADIO PRODUCTS

NATIONAL CO., INC., Engineers & Manufacturers; W. A. READY, Pres., 110 Brookline Street, Cambridge, Mass.
Makers of Browning-Drake Coils and Transformers, Equicycle and Equimeter Condensers, Impedaformers and other Radio Products



**Shining Eyes—
Happy Hearts—
A Resonant Xmas With
The New MU-RAD
SUPER - SIX - RECEIVER**

ONE DIAL CONTROL

MU-RAD
RADIO CORPORATION
Asbury Park, N. J.

When the gifts are untied, the candles extinguished and the kiddies gather 'round at the close of a happy Christmas Day, the soft sweet tones of MU-RAD will waft their way into your heart. Faithful reproduction, exquisite tonal qualities, simplicity of operation—all this is yours with the new MU-RAD receiver. Ask your nearest dealer for a demonstration. You may exchange your old MU-RAD set for new yearly models.

- WTAM, WGN, WFI, WCAE, WGR, WQC, WTAG, WWJ and KSD).
- 12; *Rolle's Palais D'Or Orchestra*, WEAJ; 11:00 P.M.
- 13; *A & P Gypsies*, WEAJ; 9:00. (Also broadcast from WEEL, WJAR, WDAF, WRC, WCSH, WCAE, WTAM, WLIT and WWJ).
- 14; *Keystoners*, WJZ; 9:00 P.M. (Also broadcast from WRC and WGY)
- 14; *Eveready Hour*, WEAJ; 9:00 P.M. (Also broadcast from WEEL, WFI, WCAE, WGR, WWJ, WOC, KSD, WJAR, WCCO, WTAM, WGN, WSAI and WTAG).
- 14; *George Olsen's Orchestra*, WJZ; 10:45 P.M.
- 14; *Auction Bridge Instruction*, WEAJ; 10:00-10:30 P.M. (Also broadcast from WEEL, WCSH, WTAG, WSAR, WGR, WCAE, WTAM, WFI, WWJ, WSAI, WGN, WOC, WCCO and KSD)
- 15; *Eastman Theatre Orchestra*, WHAM; 6:30 P.M. (Also broadcast from WGY).
- 15; *Radio Nature League*, WBZ; 8:30 P.M.
- 15; *A & P Gypsies*, WEAJ; 9:00. (Also broadcast from WEEL, WJAR, WDAF, WRC, WCSH, WCAE, WTAM, WLIT and WWJ).

Trans-Oceanic Calls Heard

POPULAR RADIO has now completed arrangements for forwarding to transmitting amateurs in England, France, Germany, Austria, Ireland and Italy all calls heard (QSL) cards that may be addressed to them by American amateurs care of this magazine. These cards will be delivered through local agents in those countries, who have or can obtain knowledge of the present address of the foreign amateurs. Plans have also been completed by this magazine for forwarding to transmitting amateurs in this country in turn all QSL cards that may be addressed to them by amateurs from those countries. American amateurs are invited to send their cards to foreign amateurs through this office, which will not only assure safe delivery through the special agencies which are thus provided, but which will publish a monthly list in a "Trans-oceanic Calls Heard" department.

Address your cards to the foreign amateurs by call numbers and enclose them in envelopes to—

The Calls Heard Editor,
POPULAR RADIO
627 West 43d Street, New York

THE following stations were received and logged at the amateur station of Horace L. Pither, 133 Melfort Road, Thornton Heath, Surrey, England, on an 0-v-1 receiver using no ground with a single-wire antenna fifty feet long with a twenty-five foot feeder.

U-2CV—September 4, 1926; signal strength, R6; steady AC note.

U-1BIT—September 4, 1926; signal strength, R5; using AC.

U-1AXA—September 4, 1926; signal strength, R6-7; good steady DC note, calling BZ-1BI.

U-1CKP—September 5, 1926; signal strength, R8; good note, very loud; calling B-08.

U-1BJK—September 5, 1926; signal strength, R6; steady note, slight interference.

U-1DI—September 5, 1926; signal strength, R7-8; note steady, very loud.

The following station was received and logged at the amateur station of A. Jamison, 60 Clifton Road, Bangor, County Down, Ulster, Ireland, on a modified Hartley 0-v-2 receiver. A fifty eight-foot horizontal Hertz antenna was used with twenty two-foot leads spaced three inches.

U-1AW—August 22, 1926; signal strength R7; on 30 meters; no fading.



**Reception
Not Deception**

Volume, not noise.
Tone, not blare.
Clear, mellow, perfect reception of every sound from a whisper to a full orchestra.
That's what radio enthusiasts everywhere are enjoying with the new Dulce-Tone, the perfected radiotalking-machine-speaker.
Dulce-Tone, for \$10, and your phonograph make the finest loud speaker money can buy. Try it and see. Your money back if you're not completely satisfied. At your dealers, or send the coupon.

THE GENERAL INDUSTRIES CO.

Formerly named The General Phonograph Mfg. Co.
261 Taylor St., Elyria, Ohio

Enclosed is \$10 for my Dulce-Tone. If I'm not satisfied after 10 days' trial, I'll return it and get my money back.

Name.....
Street.....
City..... State.....

Battery Testing Simplified

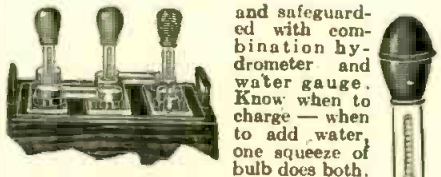

and safeguarded with combination hydrometer and water gauge. Know when to charge — when to add water, one squeeze of bulb does both.

This is an exclusive IN-A-CAP feature. It extends about 3" above battery, is properly vented so battery can be used and charged with hydrometer in place. It is not necessary to handle the instrument therefore it cannot drip, be misplaced or broken. Don't ruin your battery when it is so simple to care for. It insures longer battery life, protects rugs, floors, clothes, and makes certain good reception at all times. Tested and approved by leading radio publications. Sold on money back guarantee. 75c each. Set of three \$2.00. Where space is limited we recommend our special In-A-Cap with patented balls instead of float. 2 1/2" above battery. Also where volt meter is used our In-A-Cap Water Gauge set of 3 for \$1.00 no float or balls included.

The latest convenience on the market our Curved Battery Filler. Replenish your A Battery, B Battery, Trickle Chargers, Power Units and Eliminators without moving them from the

cabinet, the curve does the trick, fits into the tightest places, also good for your automobiles. No radio should be without one. 6 oz. bulb 75c. 4 oz. bulb, 65c. 100 amp. hard rubber case battery with carrying handle, \$12.00; one In-A-Cap hydrometer and one curved battery filler, free.

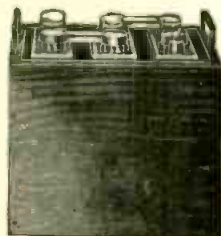

IN-A-CAP HYDROMETER CO.
1347 W. 14th Pl., Chicago

Heavy-Duty RADIOHM



for Simple Control of B-Battery Eliminator

GET full efficiency from your "B" Battery Eliminator by installing a Centralab Heavy-Duty Radiohm. Full resistance variation with a single turn of knob, allowing panel marking for proper setting to provide various voltages. Tested and approved by the Raytheon Laboratories.

Resistance remains permanent as adjusted (no carbon particles or discs), and remains same for any knob setting regardless of how often adjusted. Bushing and shaft insulated to withstand 1500 volts. Its smooth and noiseless operation will greatly improve your set.

\$2 at your dealer's or mailed direct on receipt of price.

CENTRAL RADIO LABORATORIES

17 Keefe Ave., Milwaukee, Wis.

Makers of a full line of variable resistances for 69 manufacturers of leading standard sets.

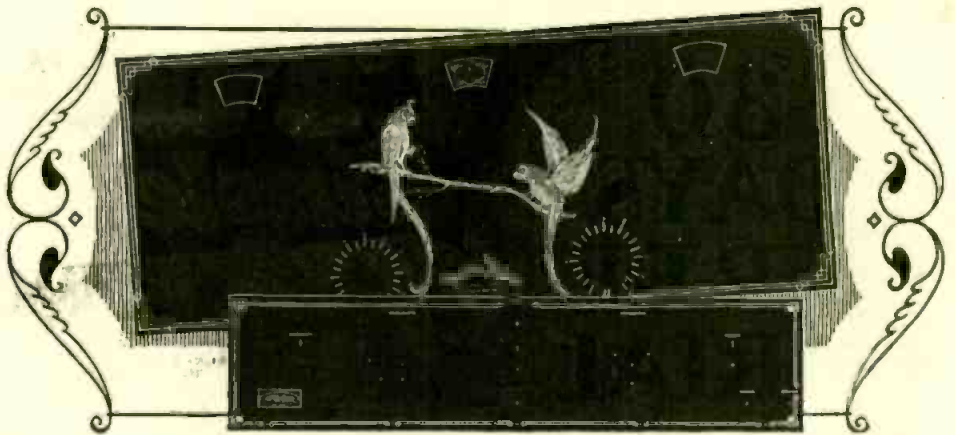

Kit Panels With Gold Decoration

FORMICA is this year providing amateurs through the leading jobbers and dealers with handsomely decorated gloss black panels with gold decoration for the leading kits; Infradyne, Aerodyne, Bremer Tully Counterphase and Power Six; Browning Drake National; General Radio Universal; Victoreen Superheterodyne; Madison Moore Superheterodyne; Camfield Duoformer; St. James 8 tube; Karas Equamatic front and sub panels; and H. F. L. Superheterodyne.

Manufacturers are using handsomely decorated Formica panels in dull finish some of them in two colors.

The FORMICA INSULATION COMPANY

4641 SPRING GROVE AVENUE

CINCINNATI, OHIO

Hear the FORMICA Orchestra Tuesday 9 to 10 over WLW



Formica has a Complete Service on Insulating Material for Radio Manufacturers

HAND BOOK FREE WITH Popular Radio

Kendall Banning, Editor, and Laurence M. Cockaday, Technical Editor of POPULAR RADIO, have compiled a book that will prove to anyone that he can build a set which will give distance, selectivity and tone volume, and at the same time a very definite basic knowledge of radio.

BUILD YOUR OWN SET AND SAVE MONEY

In "How to Build Your Radio Receiver," you will find complete specifications, constructional diagrams, photographs and instructions for building all of the following sets:

- A \$5 Crystal Set
- The Haynes Single-Tube Receiver
- A Two-Stage Audio-frequency Amplifier
- The Cockaday 4-Circuit Tuner
- A 5-Tube Tuned Radio-frequency Receiver
- The "Improved" Cockaday 4-Circuit Tuner
- The Regenerative Super-Heterodyne Receiver

ADVISORY SERVICE ALSO FREE

POPULAR RADIO maintains a big modern laboratory with a trained staff of investigators under the personal supervision of Mr. Cockaday. This laboratory is always available through our Technical Service Bureau to answer, free to subscribers, by personal letter any problems you encounter which are not answered in either the "Handbook" or the magazine.

SPECIAL BOOK OFFER

You can secure a copy of "How to Build Your Radio Receiver" FREE, and have all the privileges of the Technical Service Bureau without additional expense. If you will send a remittance of \$3.00 in full payment of 12 months' subscription for POPULAR RADIO. (Or as an alternative, you may have the book and privileges of the Technical Service Bureau with POPULAR RADIO for 7 months only—for \$2.00. A two dollar bill will do.)

Remember you take no chance—we will refund your money in full if you are not more than satisfied.

POPULAR RADIO

Department 125

627 West 43rd Street, New York



FREE

NEW 1927 Radio Catalog

BEFORE you build or buy a radio be sure to consult our new 100 page catalog—sent to you free. All the latest kits, accessories, and parts—a million dollar radio stock to choose from.

We Save You Money

We handle only brand new apparatus—standard makes that are fully guaranteed. QUANTITY sale of QUALITY parts explains our low prices. Compare with others and see why thousands of fans look to us as radio headquarters. Write for your copy of this new catalog today.

Chicago Salvage Stock Store Dept. PR, 509 S. State Street, Chicago, U. S. A.

30 DAYS FREE TRIAL

7 Tube Set Single Dial Radio



The Metrodyne

ONLY ONE DIAL TO TUNE

Retail Price
\$75
Completely Assembled
Big Discounts to Agents and Dealers

Wonderful offer direct from the factory!

A perfect working, single dial control, 7 tube receiver. And just to prove our claims, we will ship it to your home for **30 days' free trial**. Test it under all conditions. Test it for distance, volume and tonal quality — and if you are not convinced that it is the best single dial set you ever heard, return it to the factory. We don't want your money unless you are completely satisfied.

BIG PROFITS TO AGENTS AND DEALERS
Our Agents and Dealers make big money selling Metrodyne Sets. You can work all or part time. Demonstrate the superiority of Metrodynes right in your home. Metrodyne Radios have no competition. Lowest wholesale prices. Demonstrating set on 30 days' free trial. Greatest money-making opportunity. Send coupon below — or a letter — for our agent's proposition.

Metrodyne Super-Seven Radio

A single dial control, 7 tube, tuned radio frequency set. Approved by America's leading radio engineers. Designed and built by radio experts. Only the highest quality low loss parts are used. Magnificent, two-tone walnut cabinet. Artistically gilded genuine Bakelite panel, nicked piano hinge and cover support. All exposed metal parts are beautifully finished in 24-k gold.

Easiest set to operate. Only one small knob tunes in all stations. The dial is electrically lighted so that you can log stations in the dark. The volume control regulates the reception from a faint whisper to thunderous volume, 1,000 to 3,000 miles on loud speaker! The Metrodyne Super-Seven is a beautiful and efficient receiver, and we are so sure that you will be delighted with it, that we make this liberal **30 days' free trial offer**. You to be the judge.

Mail COUPON Below!

Let us send you proof of Metrodyne quality

F. L. Warnock, Greentown, Ind., writes: "I received the Metrodyne in good shape and am more than pleased with it. Got stations 2,000 miles away."

C. J. Walker, Mariposa, Calif., writes: "Received my Metrodyne Single Dial set O. K. I believe that these one-dial sets are going to be excellent sellers. I had no trouble in tuning in stations enough to satisfy anyone, so you will please send me another set."

Roy Bloch, San Francisco, Calif., writes: "Very often we travel from New York to the Hawaiian Islands quickly — from station to station — by means of the little tuning-knob which operates the electrically-lighted dial. The Metrodyne Single Dial Set is much easier to operate than any radio set I've ever seen."

We will send you hundreds of similar letters from owners who acclaim the Metrodyne as the greatest radio set in the world. A postal, letter or the coupon brings complete information, testimonials, wholesale prices, and our liberal **30 days' free trial offer**.

METRO ELECTRIC COMPANY
2161-71 N. California Ave., Dept. 139
Chicago, Illinois

Gentlemen:

Send me full particulars about Metrodyne 6 tube and 7 tube sets and your **30 days' free trial offer**

Name _____

Address _____

If you are interested in AGENT'S proposition, place an "X" in the square

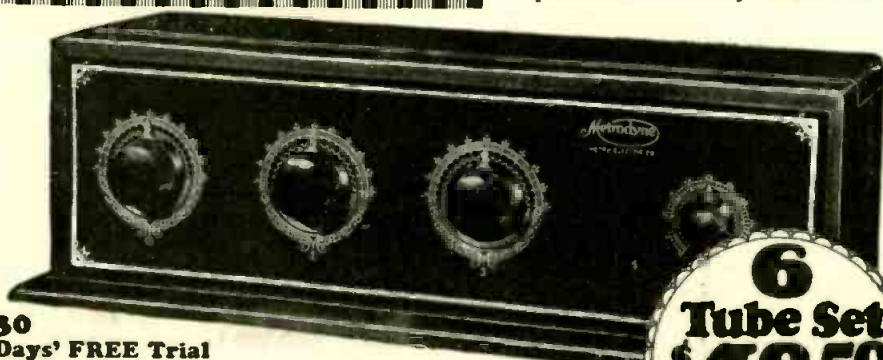

30 Days' FREE Trial

Metrodyne Super-Six

Another triumph in radio. Here's the new 1927 model Metrodyne 6 tube long distance tuned radio frequency receiving set. Approved by leading radio engineers of America. Highest grade low loss parts, completely assembled in a beautiful walnut cabinet. Easy to operate. Dials easily logged. Tune in your favorite station instantly on same dial readings every time. No guessing.

Mr. Howard, of Chicago, said: "While five Chicago broadcasting stations were on the air I tuned in seventeen out-of-town stations, including New York and San Francisco, on my loud speaker horn, very loud and clear, as though they were all in Chicago."

We are one of the pioneers of radio. The success of Metrodyne sets is due to our liberal **30 days' free trial offer**, which gives you the opportunity of trying before buying.

METRO ELECTRIC COMPANY
2161-71 N. California Ave. • Dept. 139 • Chicago, Illinois

6 Tube Set
\$48.50
RETAIL PRICE
Completely Assembled

MAIL THIS COUPON 
or send a postal or letter. Get our proposition before buying a radio. Deal direct with manufacturer — **Save Money.**

CROSLLEY RADIO
All prices slightly higher west of Rocky Mts.



This little double-circuit 1-tube set has made long distance records.



4 tubes. Amazing efficiency. Crescendon equipped!



The 4-29 in portable form.



Five tubes, tuned radio frequency. Two stages non-oscillating radio frequency amplification, Crescendon, two stages audio frequency amplification.



6 tubes, 1-dial control acuminators, Crescendon, power tube adaptability.



6 tubes. True-cascade amplification, non-oscillating and non-radiating.



In a mahogany console, 5-tube 5-50 receiver, Crosley Musicone speaker, ample compartment for batteries.



Double drum station selector! Musicone and room for batteries and accessories.



12-inch size, \$12.50. Super Musicone, \$14.75. Musicone Deluxe, \$23.50. Also beautiful Musi-console with room for batteries and accessories, as below.



Crosley Features

"CRESCENDON"

When, on ordinary radios, ears must strain to catch a station miles away, a turn of the Crescendon on Crosley radios instantly swells reception to room-filling volume. An exclusive Crosley feature.

ALL-METAL SHIELDED CHASSIS



This truly great radio achievement, found in several Crosley sets,

furnishes a substantial frame for mounting elements, produces excellent alignment of condensers, shields the units from each other, prevents interstage, improves the stability of the circuit, increases selectivity and saves costs by standardizing this phase of manufacture.

THE SINGLE-DIAL STATION SELECTOR

Nothing in radio equals the joy or the convenience of single dial control. Crosley's single drum control enables you to find the stations sought without log book or "tuning"

"THE ACUMINATORS"

Crosley Acuminators permit tuning in—loud and clear—weak stations passed over and entirely missed by ordinary single dial radios. In tuning high powered and local stations they are not used.

USE OF POWER TUBE

Power tube adaptability marks the Crosley "5-50", "5-75" and "RFL-51" sets. This feature typifies Crosley provision for best radio reception at moderate cost. This feature is in keeping with all that is most progressive.

HEAD PHONES

\$3.00

QUALITY AND BEAUTY IN CABINETS AND CONSOLES

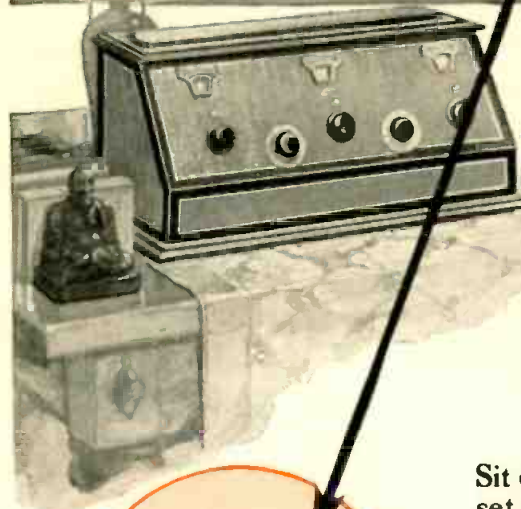

5-tube 5-38

with the

CRESCENDON

which builds great volume on distant stations

\$38

Sit down before any ordinary 5-tube tuned radio frequency set and turn the dials. Some stations will come in clear and loud. Others you will hear but faintly and the manner in which they slip away is exasperating.

Then try a Crosley 5-38. From a far-away station come the faint strains of an almost forgotten melody. How keenly you want to hear it! You turn the Crescendon and, with a rush of swelling tone, the music suddenly reaches a volume and clarity as though it were broadcast from a station but a few miles away!

Such is the function of the Crescendon—an exclusive Crosley device—a feature of this 5-tube tuned radio frequency set, known as the Crosley 5-38.

In external appearance, too, the set will delight you. The beauty of its two-tone mahogany cabinet is enhanced by art metal trimmings which harmonize in color and design. The dials are recessed behind windows and vernier-controlled condensers make tuning easy and accurate.

Like all Crosley radio sets, the famous 5-38 is available at extremely low cost—the result of Crosley mass production which has established the world's greatest radio values.

THE CROSLLEY RADIO CORPORATION, CINCINNATI—POWEL CROSLLEY, Jr.,

Crosley manufactures radio receiving sets, which are licensed under Armstrong U. S. Patent No. 1,113,149 or under patent applications of Radio Frequency Laboratories, Inc., and other patents issued and pending. Owning and operating station WLW, first remote control super-power station in America. All prices without accessories.



President

For Catalogue write Dept. 16



look
inside
that Christmas Radio Set

THE equipment is as important as the set. The distance reach of a set depends a great deal on the tube in the detector socket. The over-all performance of a set depends very much on the tubes in every socket. The volume and tone quality you will get are dependent upon the tube in the last audio stage. In every point, the tubes are as important as the set. And everyone who realizes this insists on genuine RCA Radiotrons.

The research laboratories of RCA, General Electric and Westinghouse have developed Radiotrons to new accomplishment, year by year. And the manufacturing skill of these same companies keeps RCA Radiotrons far in the lead in accurate making.

Be sure, when you buy a Christmas radio set, that you are getting genuine RCA Radiotrons with it. You can tell by the RCA mark inside the glass at the top. Or take out the tube, and look at its base.



Extra! Extra!
Gift Ideas
for Radio fans

A "spare" Radiotron—genuine RCA Radiotron, of course—of the type he uses.

A *power* Radiotron UX-112, UX-174 or UX-210 for bigger volume and finer tone.

A special *detector* Radiotron UX-200-A for storage battery sets—for longer distance reach.

Ask any dealer all about these Radiotrons—he'll tell you which to get. But be sure it's a genuine RCA Radiotron, if it's to be worthy of gift giving.

RADIO CORPORATION
OF AMERICA
New York Chicago
San Francisco

RCA Radiotron

MADE BY THE MAKERS OF THE RADIOLA