

# Popular Radio

*with which is combined The Wireless Age*

**25¢**

★ **FEBRUARY**  
**1926**



**How to Build  
the New Orthophase  
Radio Receiver**

# silent power

...from your lighting socket

THE most rigid specification set for the Duo-Rectron, the new RCA "B" battery eliminator, was that it be silent—hum-free.

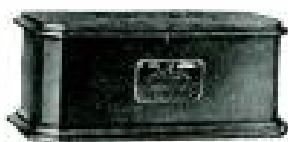

The hum of the 110 volt, 50 or 60 cycle line current has been filtered out by a special filter system. And the perfection of this system is guarded by minutest care in manufacture.

In many important points the Duo-Rectron meets demands never met before.

One new feature is a *voltage regulator*—a new tube that keeps plate voltages constant. The Duo-Rectron has taps for 22½, 45, 90 and even 135 volts. Hook up where you will, you get the voltage marked—no more—

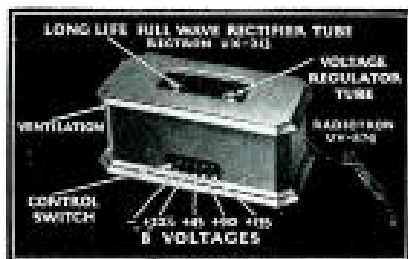

RCA Duo-Rectron, complete \$65

no less. This means that whether you have a one tube set or a ten, you can depend on the Duo-Rectron for the correct volt-

age, under any current drain, all the way up to 50 milliamperes.

The new rectifying tube, Radiotron UX-213, is built for long service—designed especially for this power unit.

Everything has been considered in the RCA Duo-Rectron—silent power, reserve power, economical power, constant power!

\* \* \*

The RCA Uni-Rectron is a power amplifier for loudspeakers. Connect it with the first audio stage of any set and get super-power amplification from an A.C. socket. Price complete, \$105

## RCA Duo-Rectron



RADIO CORPORATION OF AMERICA • NEW YORK • CHICAGO • SAN FRANCISCO



Acoustics  
by Brandes  
has made  
possible a  
perfect  
Cone Speaker!



The Type H—a simple horn of graceful lines and antique green and black finish. Great in volume—true in tone. Adjustable.



The Brandes Cabinet of mahogany, finished in walnut brown. The same unit, quality of tone, and even greater volume than the Type H Speaker.



The Phonograph Attachment. Same unit as Type H. Adjustable, furnished with a connection to fit all phonographs.

WHAT avail the expression of a master pianist, the throbbing symphonies of a great orchestra, if the radio speaker cannot give them minutely true reproduction?

Through a Brandes Cone you can actually recognize the singer's voice, the player's touch. Great artists play for you just as they did when you heard them before, at Carnegie Hall.

It is a fact that improved radio acoustics, such as the new Brandes speakers (cone, cabinet and horn types) has done much to encourage better broadcasting.

And those who hear great artists through a Brandes, *really* hear them!

© Copyrighted by Brandes Products Corp. 1926

# Brandes

—experts in radio acoustics since 1908

All apparatus advertised in this magazine has been tested and approved by POPULAR RADIO LABORATORY

# POPULAR RADIO

WITH WHICH IS COMBINED "THE WIRELESS AGE"

EDITED by KENDALL BANNING



FOUNDED 1911

## CONTENTS for FEBRUARY, 1926

VOLUME IX	(Cover design by Frank B. Masters)	NUMBER 2
A Patrol on the Frontiers of World Peace.....	FRONTISPIECE	
Battling Bandits by Broadcasting.....	<i>Richard E. Enright</i> ....	Page 105
How to Reduce Distortion in Amplification.....	<i>Hugh S. Knowles</i> .....	112
Some Stunt Sets.....		124
Important Kinks in Wiring.....	<i>Louis W. Hatry</i> .....	126
Chalk Talks in Radio.....	<i>J. W. Goosetree</i> .....	131
No 4: How a Crystal Receiver Works		
Helping the Deaf to Hear Through Their Hands.....		133
How to Cut Down Your "B" Battery Bill.....	<i>Edgar H. Felix</i> .....	134
How to Build the New Orthophase Receiver.....	<i>Richard J. Griffith</i> .....	142
Country-wide Tests of the New LC-26 Receiver...	<i>Walter L. Raymond</i> ....	156
"What Set Shall I Buy?".....	<i>The Technical Staff</i> ....	159
DEPARTMENTS		
In the World's Laboratories.....	<i>E. E. Free</i> .....	162
What Readers Ask.....	<i>Hugh S. Knowles</i> .....	170
The Broadcast Listener.....	<i>Raymond Francis Yates</i>	174
In the Experimenter's Laboratory.....	<i>Laurence M. Cockaday</i> .	180
Calibrating an Oscillating Receiver.....		
An Efficient Coil Winder Eliminating that Continuous Whistle.....		
Antenna Coupling for Short-wave Receivers.....		
What's New in Radio Apparatus.....	<i>The Technical Staff</i> ....	186
With the Inventors.....	<i>William G. H. Finch</i> ..	190
Hints for Amateurs.....	<i>Albert G. Craig</i> .....	195
Listening In.....	<i>Lloyd Jacquet</i> .....	197
Broadcasts.....	<i>J. Andrew White</i> .....	200

VOLUME IX

FEBRUARY, 1926

NUMBER 2

Published monthly by Popular Radio, Inc., 627 West 43rd St., New York, N. Y., telephone number, Chickering 1906; Douglas H. Cooke, President and Treasurer; Kendall Banning, Vice-President; Laurence M. Cockaday, Secretary; Joseph T. Cooney, Asst. Treasurer. Price 25 cents a copy; subscription \$3.00 a year in the U. S., Canada and all countries within the domestic postal zone; elsewhere \$3.50 a year, payable in advance. The International News Company, Ltd., No. 5 Bream's Bldg., London, E. C. 4, sole distributors in England. Entered as second class matter April 7, 1922, at the Post Office at New York, N. Y., under the act of March 3, 1879. Copyright, 1926, and title registered as a trade-mark by Popular Radio, Inc. Copyright in Great Britain by Popular Radio, Inc., 6 Henrietta St., Covent Garden, W. C., London, England.

Printed in U. S. A.

LAURENCE M. COCKADAY, *Technical Editor*

E. E. FREE, Ph.D., *Contributing Editor*

JOHN V. L. HOGAN, *Contributing Editor*

For advertising rates address

E. R. CROWE & COMPANY, INC.

New York: 25 Vanderbilt Avenue

Chicago: 225 North Michigan Avenue

Grebe  
Binocular Coils  
Reg. U.S. Pat. Off.  
and  
Low-wave  
Extension  
Circuits

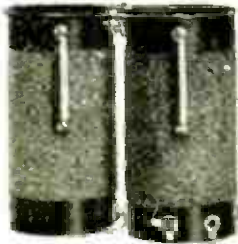

A B

The high-wave reception range of the Grebe dial (B)—from 550 down to 240 meters—equals the practical tuning range of the usual receiver. The low-wave range of the Grebe dial (A) provides additional reception down to 150 meters.

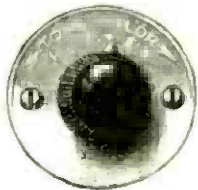

Grebe "Colortone"

Usual  
Dial

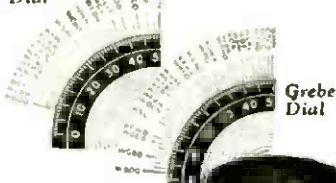

Grebe  
S-L-F  
Condenser



Flexible Unit Control



"Take the lead and set an example of diligent toil."  
—Confucius

Much toil and great diligence have made the Synchronphase worthy of first rank in radio receivers.

Doctor Hu

# Imitation

## —the Sincerest Flattery

LAST year Grebe developed the fieldless Binocular Coils and S-L-F (straight line frequency) Condensers.

These Grebe developments have now been adopted on a number of other receivers.

This year Grebe has devised the Low-Wave Extension Circuits, "Colortone," and Flexible Unit Control. It will be interesting to see how soon these, too, are added to other sets.

In buying a Grebe Synchronphase now, you will have advances in radio construction, such as other receivers will probably show next season.

Ask your dealer to demonstrate all these Grebe developments.

A. H. Grebe & Co., Inc., 109 W. 57th St., New York  
Factory: Richmond Hill, N. Y.  
Western Branch: 443 So. San Pedro St., Los Angeles, Cal.

This company owns and operates stations WAIG and WBOQ; also low-wave rebroadcasting stations, mobile WGMU and marine WRMU.

# The GREBE

# SYNCHROPHASE

TRADE MARK REG. U.S. PAT. OFF.

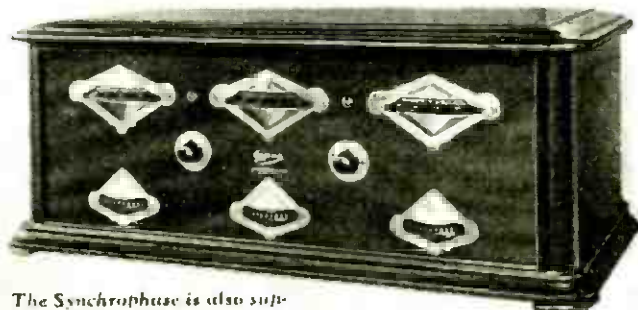

The Synchronphase is also supplied with battery base



All Grebe apparatus is covered by patents granted and pending.

# PAGES WITH THE EDITOR

DURING this month of February the Editor not only invites but urges every reader of POPULAR RADIO to become a temporary member of the Editorial Staff and to express his ideas and opinions about the magazine—*particularly* his constructive criticism.

JUST as a starter—to help our readers to express their opinions—a ballot-like form is printed on the following page.

TAKE out your pencil—now—and check off, in the small squares, the types of articles that you believe should be retained—the types of articles that, in your judgment—are of greatest value or interest to the largest number of readers.

Do *not* check the type of articles that you believe are of lesser value or interest.

AND *double check* the one particular type of article that is of greatest interest to you.

THEN tear out the page and enclose it in an envelope addressed to the Editor of POPULAR RADIO, 627 West 43d St., New York City.

As this is an attempt to get an expression of opinion from our readers as a whole, the Editor requests that only one ballot be sent in by each person.

THE "How-to-build" type of article for the experimenter and experienced set builder, treating of a radio receiving set that embodies newly developed circuit systems from a constructional viewpoint. (*Example*: "How to Build the New LC-26 Receiver," in the December, 1925, issue, and "How to Build the New Orthophase Receiver" in this February, 1926 issue.)

THE "Simple How-to-build" articles for beginners type of article, embodying simple circuits of known worth for the inexperienced set builder. (*Example*: "How to Build a One-tube

(Continued on page 6)

## DEPARTMENT OF COMMERCE

OFFICE OF THE SECRETARY

WASHINGTON

November 17, 1925.

Mr. Laurence Cockaday,  
Popular Radio,  
627 West 43d Street,  
New York, N. Y.

My dear Mr. Cockaday:

I want to express my appreciation of your attendance and service at the Fourth Radio Conference, which has just adjourned. The conference recommendations, if legislation is enacted to make them effective, must mean a great step in radio progress. Your work on the committee on operating regulations contributed to the conference success and I greatly appreciate your willing service.

Very truly yours,

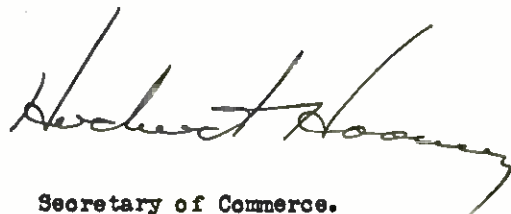

Secretary of Commerce.

*A letter from the Secretary of Commerce that speaks for itself.*

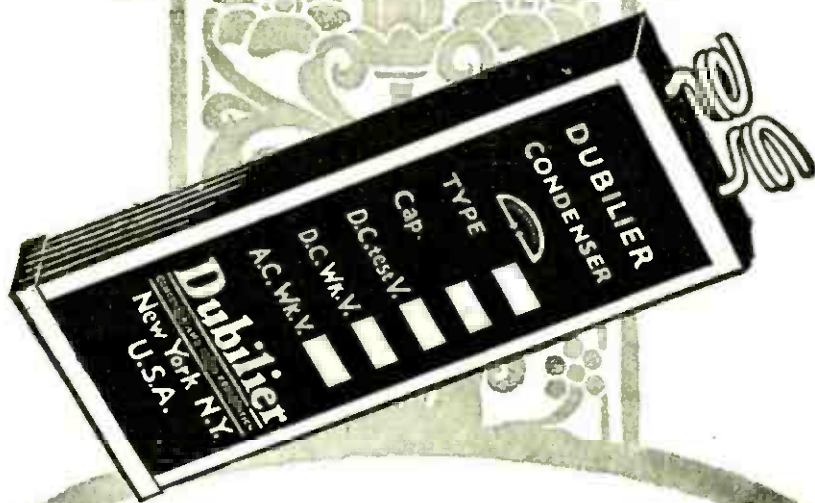

## Be Sure to Use the Right Condenser for the Job

If you are building a "B" battery eliminator, be sure to use the right type of condenser in the filter circuits. The usual type of "By-Pass" condenser is not designed for the high voltages required.

Dubilier Filter Condensers are especially designed for use in the filter circuits of "B" battery eliminators. Their working voltage is very conservatively specified. That is why they give a permanent life of efficient service at voltages up to their maximum working ratings.

Remember that, *with no load*, the D.C. voltage impressed on the condenser in your filter circuit is 1.4 times the secondary terminal voltage of the A.C. transformer.

Use the right condenser for the job—made by the pioneer manufacturer of radio condensers.

# Dubilier

CONDENSER AND RADIO CORPORATION

## PAGES WITH THE EDITOR

(Continued from page 4)

Regenerative Receiver for Use with the New UX-199 Tube" in the January, 1926 issue.)

□ THE "How to Get the Most Out of Your Ready-made Receiver" type of article, giving complete data on operation of well-known and widely-used sets. (Example: "The Garod Neutrodyne Type V Receiver" in the November, 1925 issue, or "The Freed-Eisemann Neutrodyne" in the September, 1925 issue.)

□ THE non-technical article for the average broadcast listener on the operation of a receiving set or on the care of batteries or tubes or on reception troubles and how to remedy them. (Example: "When Your Set Won't Work," in the January, 1926 issue, or "How to Cut Down Your 'B' Battery Bill," in this February, 1926 issue.)

□ THE article on the technical operation of receiving apparatus for the more experienced radio experimenter and engineer, treating of new facts, theory and practice. (Example: "How to Reduce Distortion in Amplification" in this February, 1926 issue, or "The Part That Your Condenser Plays in Tuning," or "Some New and Useful Facts About Coils," in the January, 1926 issue.)

□ THE article descriptive of new applications of radio that tells how the various new developments are being used in everyday life. (Example: "Pictures by Telephone—or Radio," in the December, 1925 issue, or "Battling Bandits by Broadcasting," in this February, 1926 issue.)

□ THE article that describes new inventions or the latest systems of radio transmission and reception in the field of radio. (Example: "Motion Pictures by Ether Waves," in the August, 1925 issue.)

□ THE pure science article that treats of the theory of radio phenomena or of scientific hypotheses from a popular viewpoint. (Examples: "How Earth Magnetism Affects Radio Waves," in the October, 1925 issue, or the series of articles by Sir William Bragg on "The Atom," such as in the January, 1926 issue.)

□ THE article that treats of the application of the apparatus or principles developed by radio to other forms of scientific work. (Example: "Radio's Newest Instrument—the Photo-electric Cell," in the November, 1925, or "The New Wave-transmission Phonograph," in the January, 1926 issue, or "How a Loudspeaker Device Brings Hearing to the Deaf," in the April, 1925 issue.)

□ THE article that deals with the broad, economic, political, educational and international significance of radio. (Example: "Radio and the War Menace," in the October, 1925 issue, or "Will Radio Kill the Small Newspapers?" in the January, 1926 issue.)

□ THE article that treats in popular vein of the technique and methods of the broadcasting studio. (Example: "The Oboe in 4-D," in the December, 1925 issue, or "Secrets of the Studio," in the October, 1925 issue.)

□ *In the World's Laboratories*: a monthly review of the progress made in the field of electrical science and invention that is of importance to and that is interpreted in terms of radio.

□ *What Readers Ask*: solutions to the common problems that confront the owners of radio receiving sets, including data on all popular circuits.

□ *In the Experimenter's Laboratory*: practical notes and commentaries of a technical nature for the guidance and instruction of the radio experimenter, based upon laboratory tests and research work.

□ *The Broadcast Listener*: monthly commentary and criticism of broadcasting programs, policies and methods.

□ *What's New in Radio Apparatus*: a classified monthly list of new radio parts of special interest, containing new features that have been recently placed on the market and that have been tested and approved by the POPULAR RADIO LABORATORY.

□ *Broadcasts*: a brief survey, told in tabloid form, of the news events that are of special interest to radio fans generally.

□ *With the Inventors*: a summary of the more important radio inventions on which patents have recently been granted, but which are not on the market.

□ *Listening In*: short items of practical helpfulness to owners of radio sets—contributed by the readers themselves for the guidance of their fellow-fans. This department tells how to solve kinks in construction, how to eliminate troubles common to radio receivers in general, reports of results obtained on home-built sets and improvements made by the experimenters on factory-built receivers.

□ *"What Set Shall I Buy?"*: a tabulated list of information concerning the range, prices and outstanding features of ready-made receiving sets approved by the POPULAR RADIO LABORATORY—published as a guide to the prospective set buyer.



Editor, POPULAR RADIO



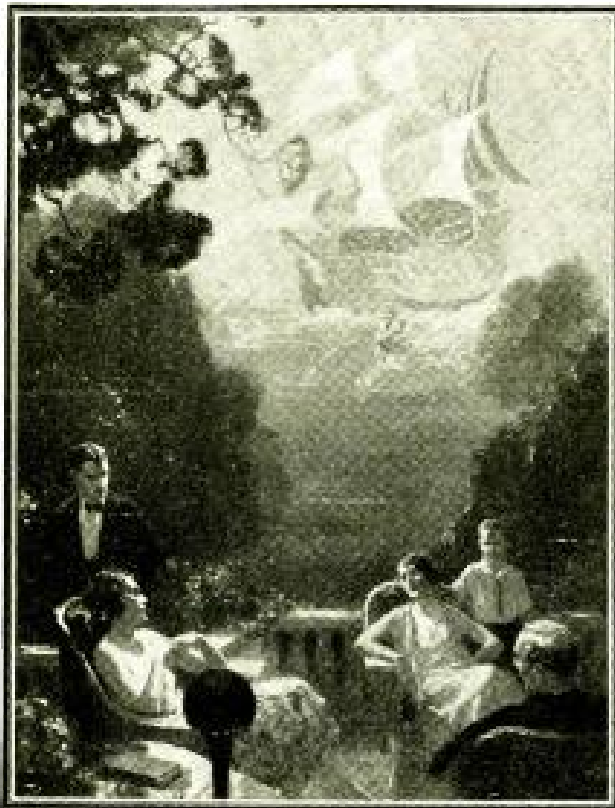

## The Eveready Hour

LIKE the fabled ship in which Jason brought home the enchanted fleece of gold, the Eveready Hour brings a rich treasure of entertainment to charm the harbor-homes of its hearers.

Inaugurated two years ago, the Eveready Hour was an adventure in broadcasting—an hour of connected entertainment, uninterrupted by the frequent injection of the name of the broadcaster.

Many of these programs have become famous. Thousands of letters voice the appreciation of our audience and ask for repetition of favorites. We make no requests for these letters, but they mean much to our artists and to us, and are of great value in helping us in our efforts to arrange programs of a distinctive nature and pleasing to the vast audience.

Radio has already become a highly specialized art worthy of the most scrupulous code of ethics, and the Eveready Hour represents a sincere effort to pioneer in providing the most acceptable form of radio entertainment.

Eveready programs cover a wide range of entertainment and human interest, transporting us to periods of wholesome simplicity; to barren islands where marooned sailors meet adventure, starvation and death; to battle-

scarred France with singing doughboys; to emotional heights by telling with music the stories of the seasons; and to memories of yesteryear aroused by old ballad and musical comedy favorites.

Eveready Hour begins at 9 p. m. each Tuesday night, Eastern Standard Time.

NATIONAL CARBON COMPANY, INC.  
New York San Francisco

Canadian National Carbon Co., Limited, Toronto, Ontario

Tuesday night means Eveready Hour—  
9 p. m., Eastern Standard Time, through  
the following stations:

WEAF—New York	WSAI—Cincinnati
WJAR—Providence	WWJ—Detroit
WEET—Boston	WOC—Davenport
WTAC—Worcester	WEAR—Cleveland
WFI—Philadelphia	WCCO { Minneapolis
WGR—Buffalo	{ St. Paul
WCAE—Pittsburgh	WGN—Chicago
	KSD—St. Louis

**EVEREADY**  
**Radio Batteries**  
—they last longer

# AMERTRAN

TRADE MARK REG. U.S. PAT. OFF.

## DE LUXE

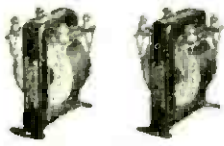
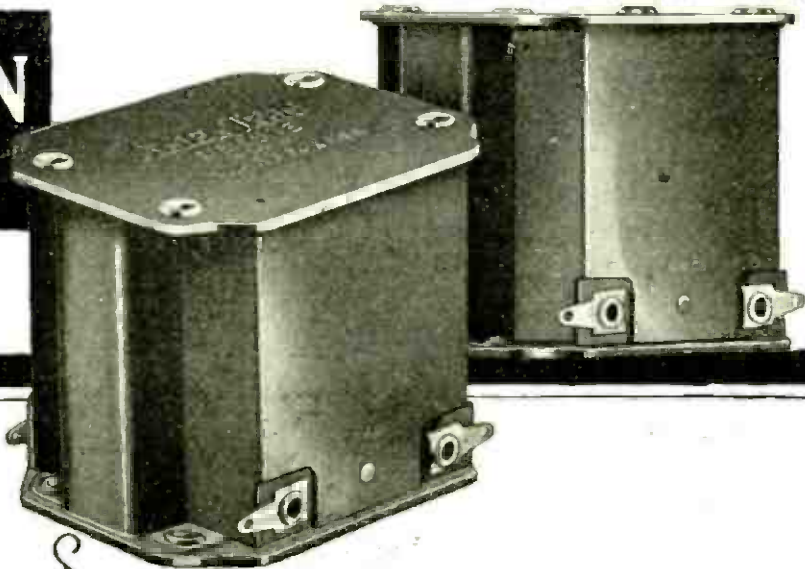

AMERTRAN  
Types AF-7 and AF-6

AmerTran audio transformers Types AF-7 and AF-6 have been considered for years among the leaders in audio amplification. These popular and efficient models may now be purchased at a considerable saving in cost. Types AF-7 (ratio 3:1)—AF-6 (ratio 5:1) \$5.00 each

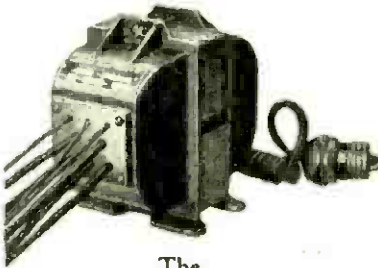

The  
AMERTRAN Power Transformer

Type PF-45, 65 V<sub>0</sub>-60 cycles 110 volts  
primary, 450-8-4-8, 3 secondary

Type PF-45 is intended for use on the standard 110 volt, 60 cycle house lighting circuit. It has three separate well-insulated secondary windings. These are enclosed in a strong metal case provided with mounting feet. The secondary leads are standard code flexible wires left long enough to reach the terminals in the average set without splicing. This transformer is well suited for supplying AC power for filter circuits, and is designed with the usual margin of safety \$15.00 each



The New AMERCHOKE  
Type 854

Type 854 is a scientifically designed impedance or choke coil of general utility, designed primarily for use in filter circuits. As an output impedance for by-passing direct current from the loudspeaker it is just as efficient and more economical than an output transformer. When used with a 1 mfd. (or greater) fixed condenser, the tone quality equals that of the best output transformer. DC saturation is prevented by two adjustable butt joints in the core, \$6.00 each

## A New Standard of Excellence in Audio Amplification

THIS new audio transformer has been developed for those who are satisfied only with the utmost in quality. It possesses an unusually straight line frequency characteristic extending the range below the lowest note now being broadcast, and actually shows a gain of about three octaves below that previously obtained.

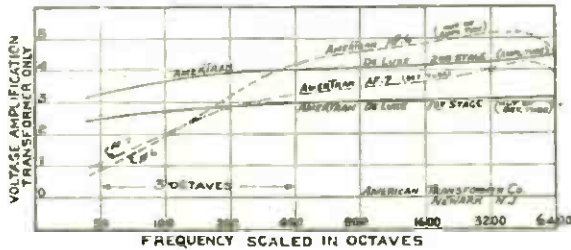

The AmerTran De Luxe is a transformer of moderate size and weight, enclosed in a strong metal case with mounting holes at both top and bottom so that it may be inverted, affording simplified connections. While the AmerTran De Luxe will improve any set, appreciation of its uniform amplifying qualities can best be realized when operated in conjunction with straight line frequency loudspeakers, such as the best cone and disc types, and with a tube in the last stage capable of handling the output.

The AmerTran De Luxe is made in two types, one for the first stage and one for the second stage, and plainly marked as such. The chief difference between these two types is that the first stage transformer has approximately 50% greater primary inductance than the second stage transformer, thus more nearly corresponding to the operating impedances of the tubes out of which they work. For this reason it is advisable to purchase and operate these transformers by the pair!

PRICE, EITHER TYPE, \$10.00

Write for descriptive booklet on AMERTRAN Radio Products

### American Transformer Company

178 Emmet Street, Newark, N. J.

"Transformer builders for over twenty-four years"

## SOLD ONLY AT AUTHORIZED AMERTRAN DEALERS



There Will Always Be a Need for  
POPULAR RADIO

*"I HAVE regularly received and read POPULAR RADIO since the first issue of its publication; in order to keep abreast with the times in this rapidly growing scientific industry, I could not afford to miss a copy. There has been and always will be the need for your publication."*

A handwritten signature in cursive script, appearing to read "W. A. Dubilier". The signature is written in dark ink on a light background.

PRESIDENT, RADIO PATENTS CORPORATION AND OF  
THE D'UBILIER CONDENSER & RADIO CORPORATION

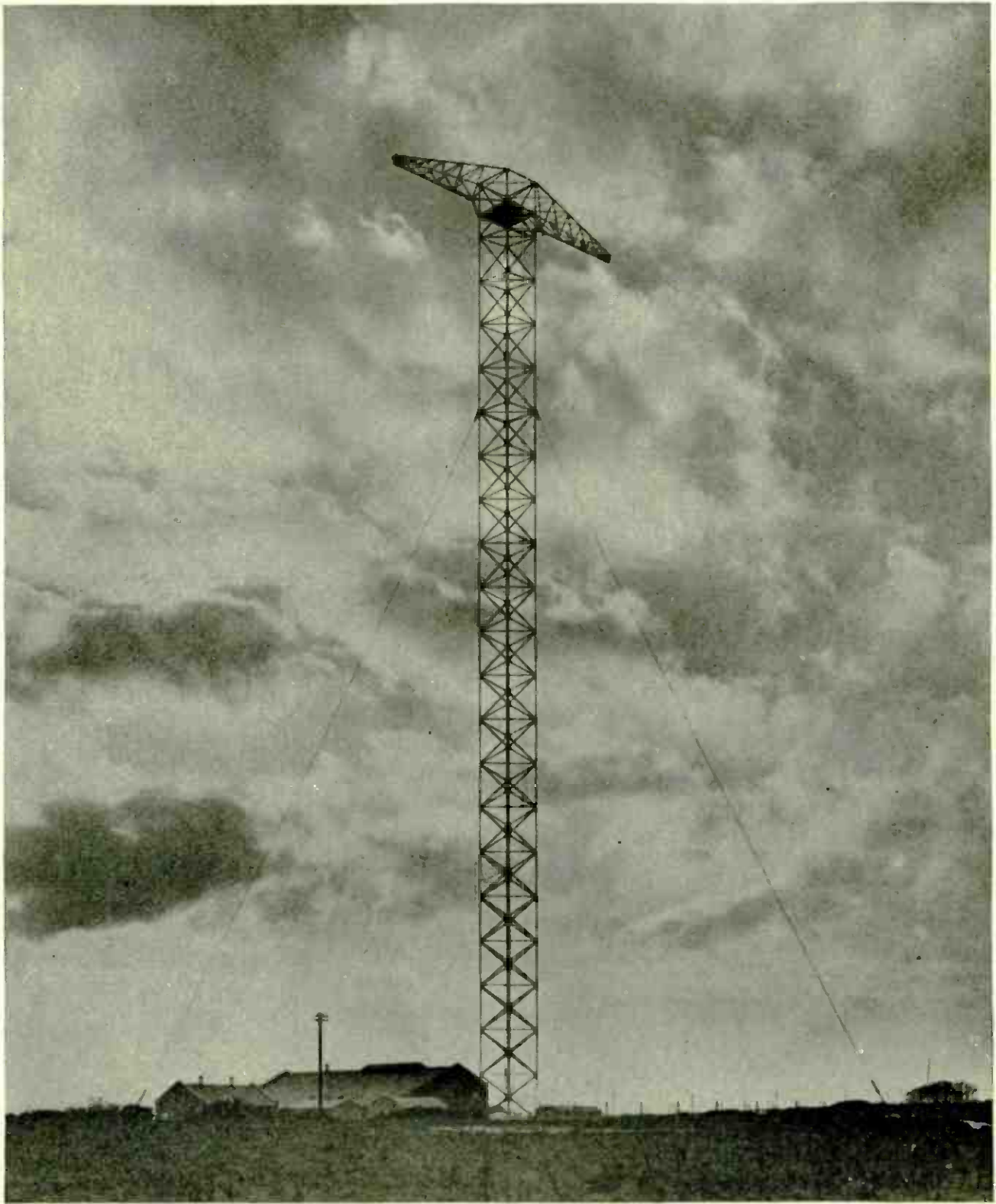

Kadel & Herbert

## A Patrol On the Frontiers of World Peace

*"I will make them one nation in the land."*

—EZEKIEL 37:22

One by one a regiment of broadcasting stations is encircling the world; it now numbers about 800. The great part that these stations are destined to play in bringing the peoples of the earth into understanding is incalculable. This shows the powerful new station at Dorchester, England, which is figuring prominently in the present international broadcast tests.

# Popular Radio

WITH WHICH IS COMBINED "THE WIRELESS AGE"

VOLUME IX

FEBRUARY, 1926

NUMBER 2



## Battling Bandits by Broadcasting

How the newly-developed radio apparatus with which the police are experimenting will add to the peril of fugitives—and the unique system of communication of which it is a part

By COL. RICHARD E. ENRIGHT

POLICE COMMISSIONER OF NEW YORK

A BANDIT raid had taken place in New York. A jewelry store had been broken into and the daring raiders had leaped into an automobile and had made an apparently successful dash from the scene of the crime.

But the bandits had reckoned without radio—the newest and most subtle agency in the hands of the law—when they had headed for the suburbs and supposed liberty.

Hardly had the bandit car disappeared when red lights flashed in police booths at every bridge and ferry in the city. Similar lights flashed and gongs rang in police booths in outlying parts of the city.

Through the municipal broadcasting station of the City of New York—Station WNYC—came the voice of a headquarters official, in even, unruffled tones, giving a description of the men and their car. At approximately two hundred places of

strategic importance the word was received, for the alarm had been made general. Patrolmen were on the lookout everywhere. The capture of the bandits was effected at a bridge before the raiders had gone a mile from the scene of the robbery. In a few minutes the news of the capture was "on the air" and patrolmen went back to their beats.

For the purpose of meeting just such an emergency, which has been described in hypothetical form, the City of New York has taken a long step forward in the use of radio—a step which is almost revolutionary and which will be watched with interest by police officials in every other city in this country and abroad.

The International Police Conference held in New York, in May, 1925, got a demonstration of the possibilities of the city-wide system of radio alarm on which New York was then working and which,

it is believed, will make an almost complete change in the method of communication between headquarters and outlying stations.

The visiting police chiefs saw a patrol box, in which was a new type of radio receiver with a green light burning, this light indicating that the power was on. Then a red light flashed and a gong rang, as summons to the patrolman. Through the receiver came a voice from police headquarters giving directions regarding a crime which was supposed to have been committed within the patrolman's precinct. The new device was given every possible test, and it met these tests satisfactorily. In fact, before the conference it had been tried out under adverse conditions, the most disadvantageous locations having been chosen, such as Far Rockaway, Long Island, Tottenville, S. I., and Northern Manhattan. Some difficulty was experienced in Northern Manhattan, owing to the effect of surrounding steel buildings, but all the tests were satisfac-

tory, and New York's advanced step in criminal-catching by radio was pronounced the outstanding sensation of the police conference.

The hard-headed police chiefs who examined this new radio device and had it demonstrated in actual use, were not more impressed with its possibilities in the way of leading to the capture of criminals than by its promise as a factor in deterring crime. Anything that will make potential criminals think twice before committing a crime is indeed welcome. The automobile would be a wonderful deterrent of crime if the motors were in the hands of the police alone. But all the new devices which have meant speed in transportation have been effectively used by criminals as well as by officers of the law, and the gift of the gasoline motor must be regarded no better than a fifty-fifty proposition when it comes to crime prevention. Radio, however, is something that lends itself absolutely to police control. With radio police booths scattered



International

#### CAUGHT IN THE RADIO NET

*With the aid of the new type of radio receiver developed for the special use of the police, the efficiency of the system of alarm employed by the New York forces of law enforcement are expected to be largely increased—particularly in the arrest of law-breakers who seek escape via the public highways.*

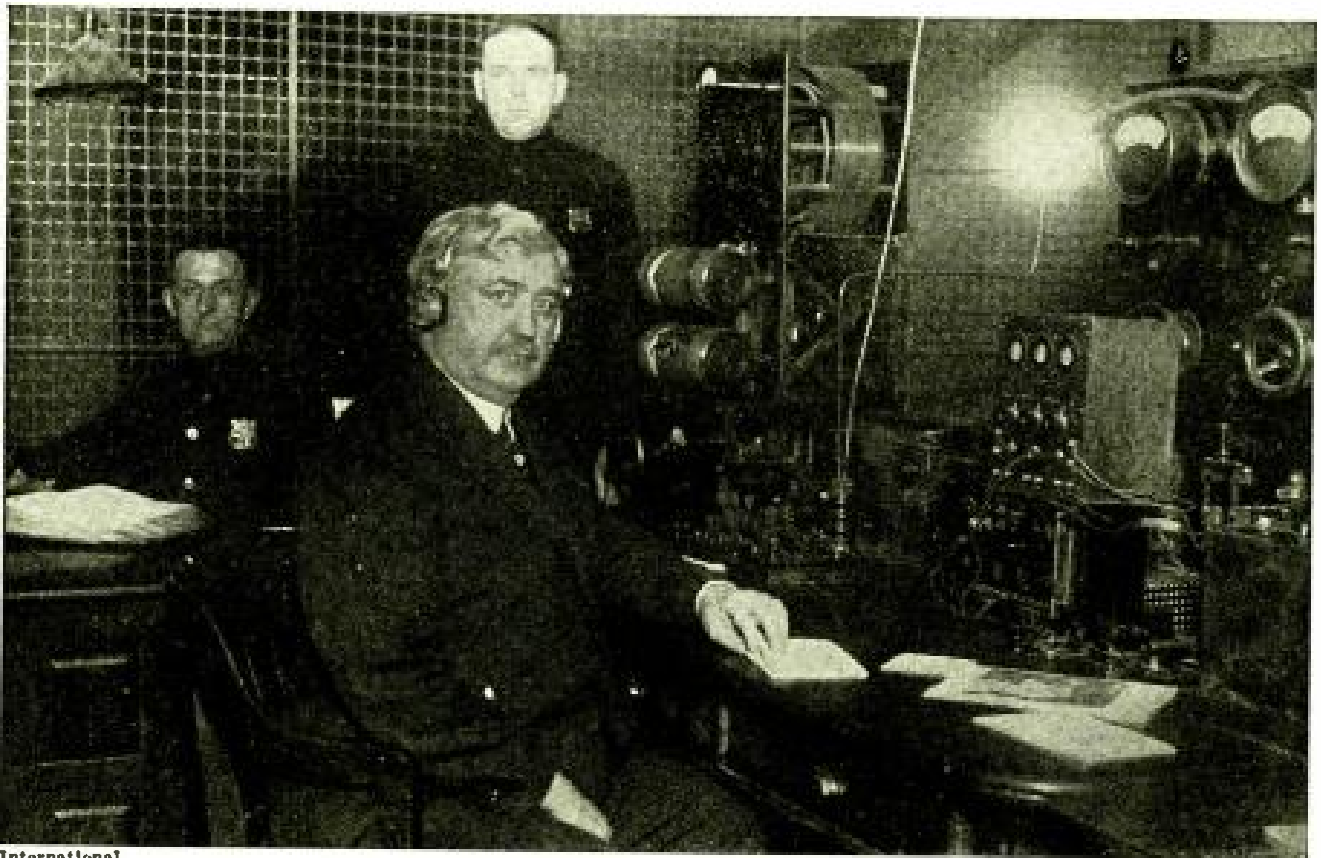

International

#### THE POLICE COMMISSIONER AT HEADQUARTERS

*The installation of this broadcasting apparatus by the Police Department of New York has led to many applications of radio for the apprehension of law-breakers; this article tells of the latest.*

about a city's outlying sections, what criminal is not going to take them into account before committing a crime?

For covering strategic points, radio is looked upon as ideal. The criminal, after the commission of his crime, seeks the ordinary avenues of escape,—generally the railroads. If he knows there is a radio police booth at every station, he will be a poor general if he does not take them into account. If he plans to avoid the railroads and escape to the country through the suburbs, there are the suburban radio receiving stations to be taken into account. Then there are the radio stations at bridges and ferries—in fact a complete net thrown about the city, with hundreds of ears listening simultaneously to the instructions from headquarters: "Here is a description of your man—now get him."

Furthermore there is the fact that, in case of a general alarm, every individual who owns a radio set may listen in and be on the lookout for the criminal.

These are the things which, it is predicted, will make radio a real crime deterrent. Criminals, when once they understand the working of this new agency that has been brought into effect against them, will give a wide berth to any city that is protected by a system of radio alarm.

How does this new form of police protection work, and how was it developed?

For many months the City of New York has been sending police alarms over its new broadcasting station, WNYC, located in the Municipal Building. These so-called alarms have generally taken the form of descriptions of missing persons and stolen automobiles. The success of this experiment led me to the belief that the use of radio in the department might be extended. Plans were worked out by S. E. Anderson and his associates in the Bell Telephone Laboratories, according to which the Western Electric constructed 186 receiving sets, which will be placed at various vantage points in Greater New



Kadel &amp; Herbert

WATCHING FOR THE RED LAMP TO LIGHT ON THE RECEIVER AS THE—  
*When the red light flashes the police station's "number" is being called by the central transmitter, so that a message may be delivered. Each receiver is sharply tuned to a 3000 cycle tone, but it is so adjusted that its light flashes only when its own signal is called. This receiving apparatus was installed at a Brooklyn station house as a part of the new selective radio signal system of the New York Police Department.*

York before the publication of this article.

The receivers are of fine quality and so designed that one booth may be signaled singly. If so desired, a group of booths may be signaled, or a general alarm will reach all simultaneously. At headquarters there is a simple box, which, with a turn of the signaling key, is set for the desired stations. The operator at headquarters sends a signal to WNYC, and the police call goes out on the regular wavelength of that station. This call can be heard by all who are "listening in" on WNYC. If it is desired to keep the police information secret, the call may be sent out in code. Thus the radio listener, who finds his program shut off, may catch such unintelligible words as "Brazil sugar preferred whales ships broadaxes," and will know that a police message of the utmost importance is being sent out. As

a rule, however, the instructions will be broadcast without regard to code.

Suppose it is desired to get word to a patrolman at Bayside. His booth is signaled and the impulse turns on a red light and rings a gong. The red light will continue to burn and the gong to ring until the patrolman answers.

The basis of the system is the Western Electric railroad selective telephone train dispatching system now in general use on railroads in this country and in Europe. For every division these systems consist ordinarily of a single line to which are connected a number of stations capable of being called by the dispatcher individually or in groups. It was felt that such a system was adapted to radio transmission and would permit broadcasting from a central radio transmitting station without requiring the constant attention of opera-





Kadel &amp; Herbert

#### —OPERATOR SENDS A WARNING ON THE TRANSMITTING APPARATUS

*A set of six small levers which move up and down in their respective slots operate the transmitter. Each slot is provided with a number of stops which are designated with a letter or number; when the levers are set at the combination of letters and numbers which forms the "call" of an individual police station the signal is sent out automatically from the broadcaster WNYC. Any station may be called separately or all the stations may be called at once.*

tors at the receiving stations.

The transmitter attachment consists of a vacuum tube oscillator tuned to approximately 3,000 cycles, and a number of calling keys. These keys control a relay whose contacts short circuit the plate windings of the oscillator coil when in the normal or unoperated position.

Operating any of the calling keys opens and closes its contacts in a regular sequence determined by the code for which the key is set. Each of the individual keys is set to a certain code call, which it will continue to make until reset. One of the individual call keys is used as a master call for the entire system, so that by the operation of this key every receiver is called simultaneously. The other four keys are for the main group calls. The master key is similar in appearance to a

miniature cash register, and, by setting its levers to the proper code combinations, any desired station may be called individually on this key, which may be used also for some of the group and sub-group combinations.

The output terminals of the oscillator of the transmitter attachment may be connected directly to the speech input equipment of a standard radio telephone transmitter in place of a microphone. The sensitiveness of the radio receiver is adjusted for the reliable operation of the signaling system, which is sharply tuned to a 3,000-cycle tone. Even should the signaling system relays be operated occasionally by excessive volume of speech or music, the receiver signal lamp will not light unless the proper code call is sent.

The receiver apparatus is designed in

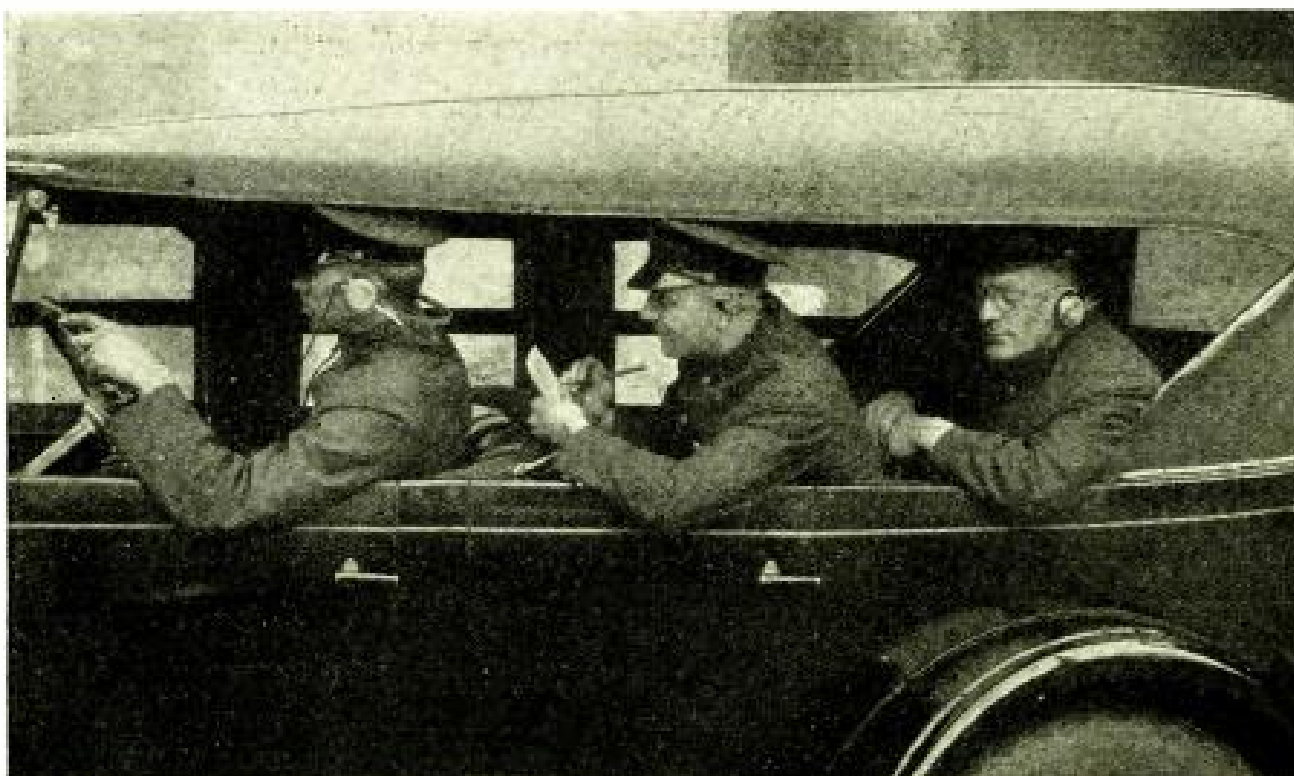

#### TAKING TEST ORDERS FROM HEADQUARTERS IN A RADIO-EQUIPPED CAR

*To enable the police to keep in touch with headquarters even while on the trail of their man, this automobile has been equipped with a radio set by the Cleveland Department of Public Safety. Later it expects to equip all ten of the Police Reserve Squads with radio receivers and to install a broadcasting station at headquarters.*

two types, one for each kind of power supply. A green signal lamp will light only when the power is turned on. Both the DC and AC types of radio receivers are designed for operation from an open antenna. All the controls are on a panel inside the receiver and are inaccessible when the receiver cabinet is locked.

The selector is the heart of the signaling system. It consists of a mechanism unit mounted on a magnet unit, the whole enclosed in a glass case for protection. All the transmitting keys are so arranged that one second after the completion of their calling signal, they send out a signal which restores all selectors under their control to normal. An audible signal may be connected, using an additional relay necessary to handle the heavy current required by a large gong.

A key is used by the policeman to extinguish the red signal lamp when he takes up the head telephones. To the right of the key is the green signal lamp,

indicating that the power is on the receiver, and on the extreme right is a switch for turning power on and off.

The apparatus is readily portable. It will be impossible for anyone to tamper with the set when it is locked in the patrol booth. With no wires to cut, it will be impossible for lawbreakers to keep the patrolman from connection with headquarters. Not alone is the radio system of police communication regarded as a certain deterrent of crime, but its possibilities in the way of life-saving are not to be overlooked. In case of an accident, where quick communication with a patrolman from headquarters is necessary, the radio system is looked upon as ideal. Also it is felt that it will add to the security of residents in outlying districts of the city.

The radio telephone will be an important adjunct to the radio telegraph, which has been in effective use by the police department of the City of New York since 1918. At headquarters a radio telegraph

operator is on duty day and night. He is prepared for any call that may indicate an emergency.

If an injured person is being brought in on a ship, a call can be sent when the vessel is within 250 to 300 miles of the port of New York, and an ambulance will be in waiting at the dock. Or, if officials are bringing in a prisoner of importance and it is desired to have an extra guard when landing, a call is sent to police headquarters before the ship reaches port, and as many detectives as are necessary are at hand when the gang-plank is lowered. In case of any disaster to a ship within reasonable radio distance of the port, police headquarters is ready to send assistance. Much of the work is keeping in touch with police and fire boats. The following record, which is published for the first time, is interesting, showing as it does the large part radio plays in the activities in and around New York Harbor:

The total number of calls sent and received from June 3, 1924, to June 3, 1925, 12,767, classified as follows:

Mayor's Committee, steamer <i>Macon</i> ....	800
Steamer <i>Manhattan</i> , Police Department.	10,500
From other stations, shore to ship.....	60
Ship to shore.....	50
Suspicious boats.....	1,000
Ambulance cases.....	5
Transmitted and received for city officials .....	150
Derelicts .....	10
For Federal Government.....	5
Distress .....	25
Shooting on steamers.....	3
Calls for assistance.....	25
Boats on fire.....	11
Fallen airplanes.....	4
Bodies recovered.....	100
Assaults on steamers.....	12
Automobiles overboard.....	5
Lost boys.....	2

It is estimated that it will cost about

\$50,000 to equip the City of New York with the radio telephone system which is being installed in the outlying districts and points of strategic vantage. The successful working of this system, which has responded favorably to every preliminary test, will mean that other large cities throughout the world will follow New York's lead and that lawbreakers everywhere will find in radio a new and baffling agency, making crime just so much more difficult to "get away with."

Any agency or device that makes crime more difficult has a distinct value in police work. The radio telephone should not only make crime more difficult but, through the publicity it must inevitably give the subject of police surveillance and activity and the punishment of crime and criminals, it can become a moral force and a promoter of law and order without a peer. The Police Department has made a systematic effort, throughout my administration, to secure vigorous and sincere co-operation from every decent, law-abiding citizen and everybody or organization in the suppression of crime, and there is every reason to believe that the radio telephone will render exceptional service in the accomplishment of this purpose. Those in charge of broadcasting equipment should bear this in mind and also, that a heavy responsibility rests on them in regard to the promotion of it. The potentialities of the radio telephone are almost limitless and the next few years will no doubt see some very startling developments in it. One of its principal fields of usefulness must always be in the dissemination of police intelligence, and it is to be sincerely hoped that this marvelous device will always be in the hands of those devoted to public service and the common good.

### How to Build a Receiver for Both Short and Long Waves

ANOTHER constructional article—prepared by the POPULAR RADIO Laboratory—of particular value and interest to the radio experimenter, will appear in this magazine next month.

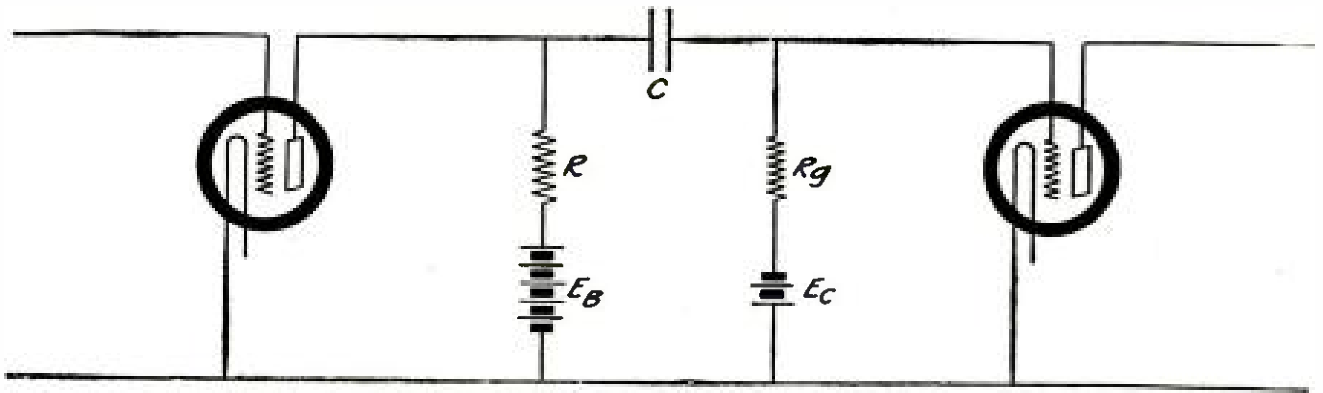

THE FUNDAMENTAL DIAGRAM OF RESISTANCE COUPLED AMPLIFIERS

*This shows a skeleton circuit of the type of amplifier discussed throughout this article. The coupling resistance is shown at  $R$ ;  $E_B$  is the "B" battery,  $C$  the coupling condenser,  $R_g$  the grid-leak and  $E_C$  the grid biasing battery. The "A" battery circuit has been omitted since if all connections are made to the negative "A" battery this circuit does not affect the external circuits and serves only to heat the filament.*

## HOW TO REDUCE DISTORTION IN AMPLIFICATION

PART I

THIS series of articles has been prepared for the special benefit of the average fan who likes to build his own receiver but who is discouraged by the usual distortion in reception. As most of this distortion occurs in the audio-frequency amplifier, these articles will concentrate on this phase of the problem. This first article in the series is a study of tube problems and of resistance coupling methods of amplification.

By HUGH S. KNOWLES

WITH the passing of the novelty of radio reception an insistent demand for good reproduction has come from all classes of listeners-in.

Engineers are carrying on intensive research work in an attempt to satisfy this requirement. Those who design our transmitting stations have done so well that any good broadcasting station today transmits signals which are almost perfectly modulated.

The perfection of the receiving and reproducing apparatus has lagged far behind that of the transmitter. This is

especially true of the receivers built by the average fan who has only a meager knowledge of receiver design to call upon.

Most of the distortion in receivers occurs in the audio-frequency amplifier which amplifies the weak, rectified, audible signals delivered by the detector. Further distortion occurs in the loudspeaker but this is minimized in the best ones now on the market. It is possible that a more complete understanding of the problems of amplification will enable the experimenter to

minimize the distortion occurring in his present receiver and aid him in the design of new ones.

By dividing the problems encountered in the different types of amplification and presenting each more completely the author hopes to present some problems which have previously been under-emphasized, primarily because of lack of space and the attempt by authors to cover too much in one article.

The problems will be taken up progressively from the point where an undistorted signal current is applied to the input of a vacuum tube, through the tube, the interstage coupling device and to the input of the next tube in a cascade amplifier.

For the sake of brevity and clarity the more common abbreviations have been used in discussing the vacuum tube and its associated circuits.\*

Figure 1 shows a vacuum tube. In addition to the usual elements three capacities and two resistances are shown. The capacities exist because of the adjacent tube elements. The various elements are comparable to small plates of a condenser. Generally these capacities are very small and may be neglected but under certain conditions which will be investigated later they are important.

There is normally a flow of electrons from the filament to the plate and under certain conditions to be mentioned the grid intercepts some of them. Work is done in moving them, therefore some electrical resistance exists between the electrodes. The resistance between the electrodes of the tube and between the binding posts in the socket will be high enough to be negligible if the tube and socket are properly designed so they are neglected for our purpose.

When the grid of a vacuum tube is negatively charged it repels the electrons, as they are small quantities of negative electricity and like charges repel. The flow of electrons from the filament to the grid is therefore negli-

gible, or what is the same thing the resistance between the two is very high—approaching infinity.

Potentials or voltages are said to be higher as they become more positive. In a tube the point of lowest potential in the filament, which is emitting electrons, is used as a convenient reference point and all potentials are referred to it. The grid, for example, is said to be at 0 potential when it is connected to the negative filament terminal.

As the potential of the grid is increased it begins to attract electrons. This attraction increases rapidly with an increase in the grid voltage. Put differently, the resistance from the filament to the grid decreases rapidly with slight increases in grid potential after a certain point.

This effect is shown graphically in Figure 2. Curve B is for a low mu tube of the 201-a type. After the grid becomes more than about 3 volts posi-

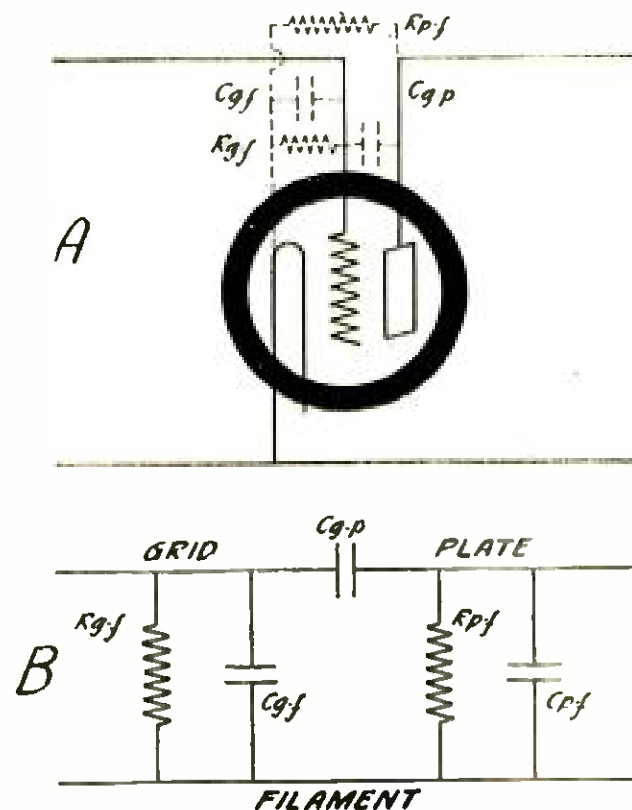

TWO DIAGRAMS OF A VACUUM TUBE  
 FIGURE 1: The upper diagram shows a tube as it is usually drawn, together with the inter-electrode capacities and resistances (except the grid to plate resistance). The lower is the theoretical equivalent of the upper.

\*See Appendix (a)

tive the grid current rises rapidly. The resistance from grid to filament can be easily calculated by Ohm's law.

$$R = \frac{E}{I} \quad (1)$$

where  $R$  is the resistance called  $R_{g-f}$  in Figure 1,  $E$  is the actual grid voltage  $E_g$ , and  $I$  is  $I_g$  or the grid current.  $I_g$  in Figure 2 is given in microamperes or millionths of an ampere.

Curve A is the same type of curve for a mu 20 tube. The mu of a tube is roughly a measure of its ability to control the electron stream from the filament to the plate.\* In a high mu tube this greater control is obtained by making the grid mesh finer, the grid wire larger and by placing it where it most effectively controls the flow of electrons. We would then expect it to intercept more electrons at a given potential than the grid of a low mu tube.

This is clearly shown in the curve. The values of  $I_g$  at the left *must be multiplied by ten* to get the proper value for curve A. For convenience they were plotted on the same sheet. When  $E_g$  equals 2 volts positive, for example,  $I_g$  is about 136 microamperes. Multiplying by ten this gives 1,360 microamperes which if plotted on the same scale as curve B would be off the top of the sheet. This gives a value of  $R_{g-f}$  of only 1,470 ohms which is in shunt to the input.

In one corner of the chart the circuit employed in obtaining the curve is shown. This will be given for all curves. Note that there is no resistance in the grid circuit except that of the microammeter which is negligible compared to the grid-filament resistance.

If there were a resistance  $R_{in}$  in this circuit and a current  $I_g$  flowed through it by Ohm's law there would be a voltage drop in it given by

$$E = R_{in} I_g \quad (1a)$$

where  $E$  is the voltage drop,  $R_{in}$  the

input circuit resistance and  $I_g$  the grid current. The voltage  $E_g$  actually applied to the grid would then be less than  $E_c$  by an amount  $R_{in} I_g$  as obtained from (1a). In the setup used for Figure 2 as shown on the graph this resistance was negligible hence although  $I_g$  reached quite high values  $R_{in}$  being negligible made the product of the two negligible. In this case  $E_g$  equalled  $E_c$ .

Normally there is a high resistance in the grid circuit. When this is true any grid current causes a drop in the potential applied to the grid and decreases in turn the amplification. Especially in the last stage of amplification variations in grid potential of eight or ten volts are not uncommon and they average several volts.

The type of distortion secured is shown in Figure 3 where A is the input signal applied to a grid having no bias. This is generally the case in resistance, coupled amplifiers since the negative bias obtained by the use of a coupling condenser and leak is very small. On the negative half of the cycle there is no distortion, as the grid current is negligible. On the positive half, however, the peaks are cut off, due to the drop through the input circuit resistance  $R_{in}$  with consequent distortion and introduction of harmonics.

An inspection of curves A and B in Figure 2 shows that it is *especially* imperative that the grid of a high mu tube never go positive.

We have then the first requirement for distortionless amplification: that the grid of the tube *should never go positive*. This is then the upper limit of the potential which should be applied to the grid. Later we will find the lower limit, the difference giving us the variation in grid voltage which can be used without distortion of the output.

Figure 4 gives a series of curves of the relation of the plate current to the grid voltage in a vacuum tube of the 201-a type with different values of resistance  $R$  in the output or plate cir-

\*See Appendix (b)

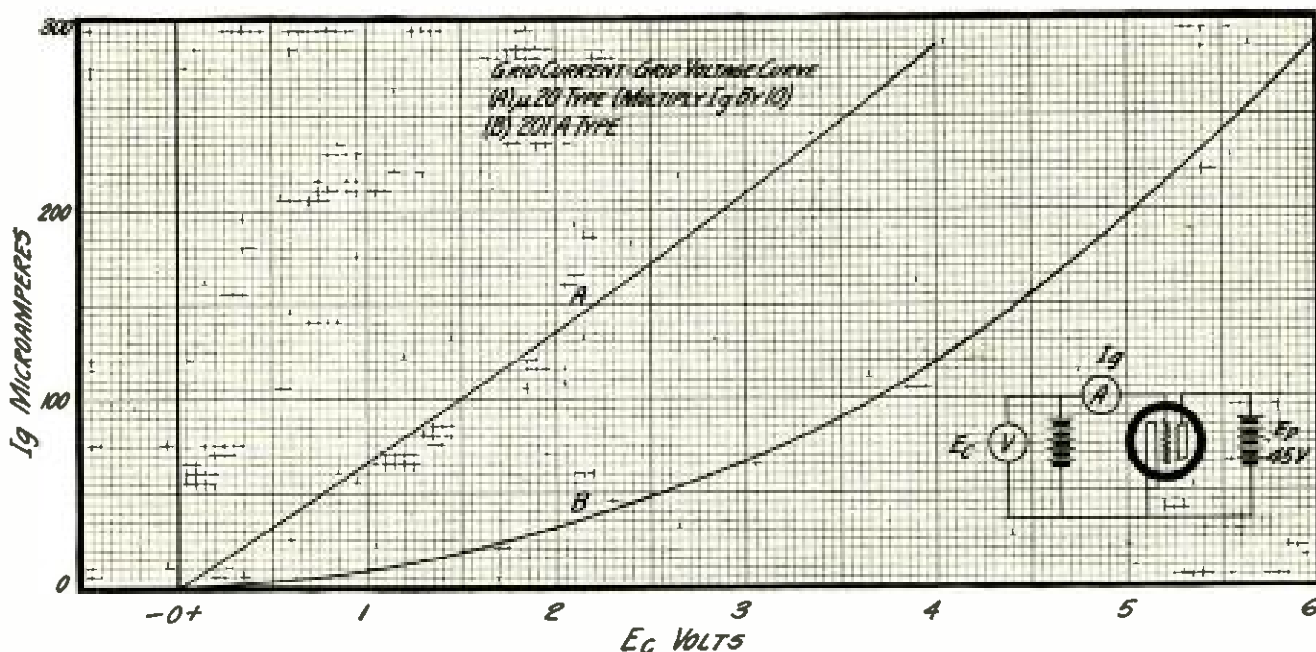

CURVES THAT SHOW THE RELATION BETWEEN THE GRID VOLTAGE AND GRID CURRENT

FIGURE 2: This relationship as it occurs in an amplifying tube. Curve A is for a typical  $\mu$  20 tube and B for a  $\mu$  7.8 tube. The values of  $I_g$  for curve A should be multiplied by 10. If curve A had been plotted with the same co-ordinates as B it would have gone off the top of the graph at only .45 volts positive on the grid.

cuit. Curve A is made with negligible resistance in the output circuit and is the static curve usually given in discussing the amplifying properties of a tube. The formula for the relation between the two clearly shows that although there is a portion which appears to be linear, actually only a *very small* part may be considered linear.\* Only the portion of the following curves below 0 grid bias should be considered in view of what we have found above.

It is important that the portion of these curves below  $E_g = 0$  be a straight line for distortionless amplification. This follows from the fact that currents of varying amplitudes must be amplified proportionally. If the curve were a parabola for example and a signal of 2 volts were applied to the grid the amplified signal would have an amplitude of 4 units and if one of 3 volts were applied the amplified signal would be 9 units. The ratio of 2 to 3 is higher than the ratio of 4 to 9 and loud signals would be overamplified. The curve A is more nearly a parabola than a straight

line and it is evident that the tube itself is a distorting device. Fortunately by adjusting the associated circuits it can be made to amplify almost without distortion.

Curves B to G in Figure 4 are dynamic curves which show the relation of the plate current to grid voltage of a tube with some resistance in the output circuit which is normally the case. As the resistance  $R$  approaches 12,000 — 15,000 ohms, which is the approximate plate resistance  $R_p$  of the tube, a portion of the curve becomes linear. When  $R$  is 40,000 ohms the curve is substantially straight down to  $E_g = -12$  volts. The fact that the slope or steepness of these curves decreases as  $R$  is increased does not indicate that the tube becomes a less efficient amplifier. Actually it will be found that curve G gives the highest voltage amplification. The graphical method of representing amplification has not been used because in such a case the slope of the curve has to be increased to give the desired impression.

The fact that the greater portion of the curves in Figure 4 become linear as  $R$  is increased is very significant since

\*See Appendix (c)

it is this fact that permits distortionless amplification. We will investigate it more fully later.

In Figure 1 there is a resistance  $R_{p,p}$  which has been so named to indicate it is the resistance in the tube from the filament to the plate. We will call this  $R_p$  when referring to its resistance to direct currents and  $r_p$  when referring to alternating currents. If this resistance were of the ordinary type the current through it would be proportional to the voltage across it and it would follow Ohm's law previously given. If, say, ten volts were applied and a current of one ampere flowed then two amperes would flow if twenty volts were applied. If we keep all of the variables in a vacuum tube constant and vary the voltage  $E_p$  actually applied to the plate (not necessarily the "B" voltage) and measure the corresponding changes in plate current we find a curve of the result closely resembles curve A in Figure 4. Using equation (1) we can calculate  $R_p$  from such a curve. The relation between the plate resistance and plate voltage is shown in Figure 5. These curves show that as the plate voltage is decreased the plate resistance rises rapidly.

If a resistance  $R$  is introduced in the plate circuit the voltage  $E_p$  on the plate will be less than the "B" voltage by an amount equal to the drop through  $R$  computed by equation (1a). This is analagous to what occurs in the grid circuit under similar conditions and  $I_p$  is used instead of  $I_g$  and  $R$  instead of  $R_g$ . The whole expression for the

voltage on the plate under static conditions then is

$$E_p = E_B - RI_p \quad (2)^*$$

Returning to the effect of the introduction of  $R$  in the plate circuit, we find it convenient to study its effect when  $R_p$  is constant. As Figure 5 shows this is done by keeping  $E_p$  constant. In Figure 6 therefore  $E_B$  has been increased after every increase in  $R$  until  $E_p$  was 90. These measurements were made with a 201-a type tube and curve A Figure 5 shows that for  $E_p = 90$ ,  $R_p$  is approximately 13,500 ohms.

It is here very evident that as the resistance is increased the curve becomes linear over a very considerable portion. When  $R$  was 39,000 ohms the curve was linear to —28 volts on the grid which means that distortionless amplification could be obtained on this portion. By operating with a negative bias of 14 volts a signal having a peak voltage of 14 could be amplified without distortion. In practice 410 for  $E_B$  is prohibitive and subsequent considerations will show that higher values of  $R$  should be used and that  $E_B$  can be less.

From our dynamic curves it is possible to find the amplification that can be obtained and its character. From Figures 4, 6, 7 and 8 we can find the change in plate current which takes place with a given change in  $E_g$  and for the approximate value of  $R$  we are using. If we obtain the variation in drop across  $R$  with

\*See Appendix (d)

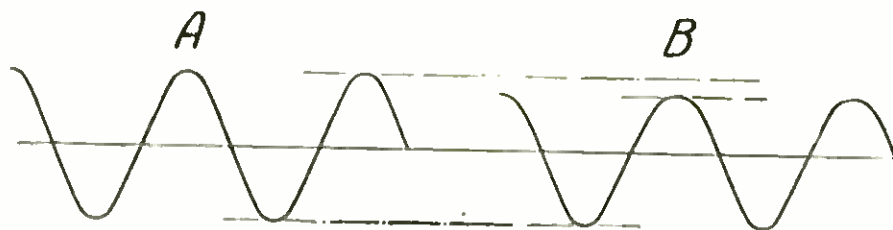

#### HOW DISTORTION IS CAUSED IN A GRID WITHOUT A NEGATIVE BIAS

FIGURE 3: Curve A shows the incoming undistorted signal which is applied to a grid with no bias. On the positive half of the cycle the grid becomes positive and attracts electrons thus lowering the grid to filament resistance. The effect of this on the wave form is shown in curve B, where the positive half has been distorted with consequent introduction of harmonics.



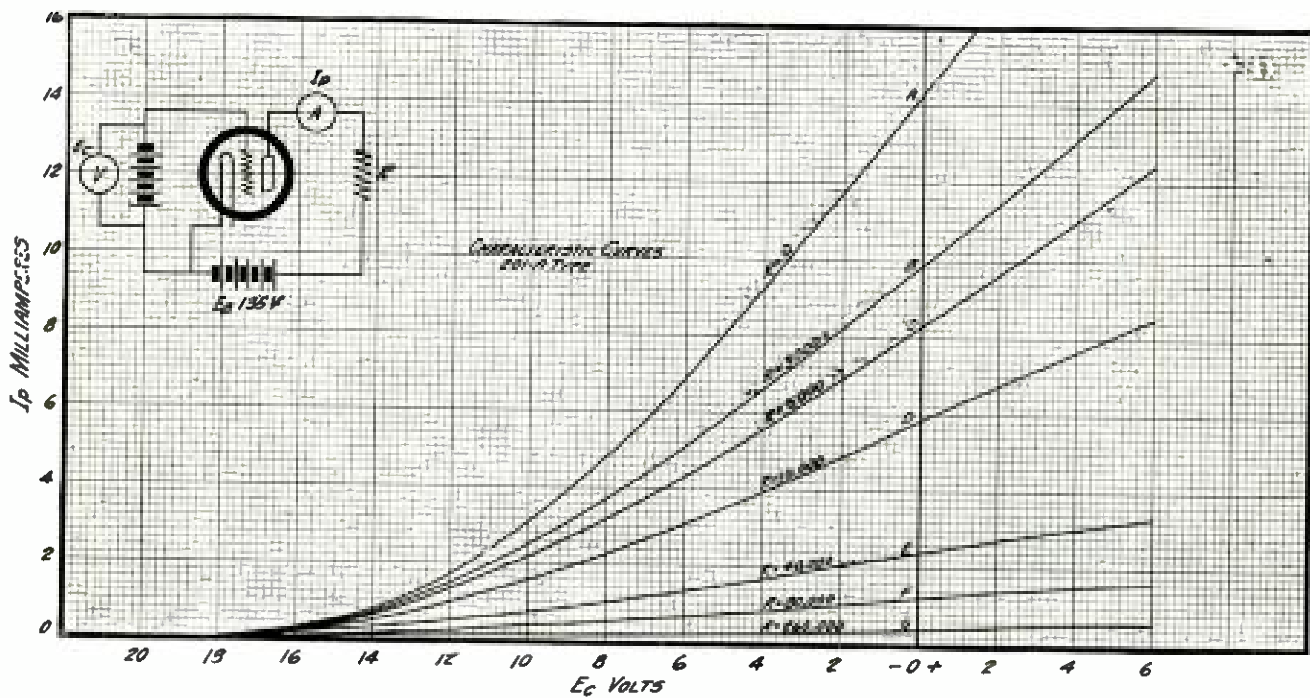

THE EFFECT OF VARYING RESISTANCES IN THE PLATE CIRCUIT

FIGURE 4: This family of curves shows the relation between the plate current and grid voltage in an amplifying tube that has varying amounts of resistance in the plate circuit. A skeleton circuit on each graph in this article shows the method employed in obtaining it.

variations in  $E_r$  we can determine the amplification, since this drop is what is applied to the grid of the next tube and the ratio of the two is the amplification per stage, assuming all of it is applied to the next grid. See the amplifier diagram for a characteristic circuit of this type.

Let  $E_r'$  be the voltage applied to the input of the second tube.

If an alternating current voltage  $e_r$  is applied to the grid of the first tube there will be a variation in the plate current  $i_p$ . The product of this times  $R$  (commonly called the coupling resistance) gives the alternating current voltage drop across  $R$  (if the resistance is non-inductive).

It is now evident that the amplification is distortionless when the tube is operated on a linear portion of the  $I_p$ - $E_r$  curve because the variations in  $I_p$  are proportional to  $E_r$ . And since  $R$  is constant  $I_p R$  is proportional to  $E_r$ . Also it indicates that the amplification of curve G Figure 4 may be greater than that of curve F. The variations of  $I_p$  with  $E_r$  are greater in F than in G but in the latter case these variations

have to be multiplied by 260,000 and in the former by 80,000 to secure  $E_r'$ . We will temporarily disregard C and  $R_r$  in the amplifier diagram and assume all of this drop is applied to the grid of the second tube.

The amplification per stage is given by

$$A = \frac{\mu R}{r_p + R} \quad (3)^*$$

where  $A$  is the amplification,  $\mu$  the mu of the tube,  $R$  the resistance of the coupling resistance and  $r_p$  the alternating current plate resistance which may be considered to be half the direct current resistance in a high mu stage. In the average low mu stage  $r_p$  is approximately  $.8 R_p$ .\* This formula assumes that all of the drop in  $R$  is applied to the grid of the following tube which, as will be shown later, is not always the case.

To familiarize the reader with the use of this formula it may be well to solve a typical problem. Assume that we are using a 201-a type tube with a mu of 10. This value is taken primarily for simplicity although some of the independent tubes have approximately

\* See Appendix (e).

this value. The coupling resistance has a value of .12 megohm or 120,000 ohms (this one was supposed to be .1 megohm). A milliammeter was put in the plate circuit of the tube and the current was found to be .86 milliampere. This value could be predicted by examining curve C in Figure 7, which shows that for zero grid bias .86 milliampere flows in the plate circuit when a 135 volt "B" battery is used. The grid will be at approximately this voltage since curve B, Figure 3 shows that negligible current flows in the grid circuit. There will, therefore, be a negligible drop in the grid-leak, and the grid will be at approximately zero potential. From equation (2) we find that  $E_p = 135 - 120,000 \times .00086$  or 32 volts. From Figure 5 curve A, which is for this type tube, we find that  $R_p$  is approximately 34,500 ohms when  $E_p$  is 32 volts. We have said that  $r_p$  is approximately  $\frac{R_p}{2}$  so it will be about 17,250 ohms in this case. Substituting these values in (3)

$$A = \frac{10 \times 120,000}{17,250 + 120,000} = 8.74 \text{ or } 87.4 \text{ percent of the } \mu \text{ of the tube.}$$

It is evident that as  $R$  gets very large  $A$  approaches  $\mu$ . The *maximum* amplification that can be obtained per stage then is  $\mu$ . The rate at which  $A$  rises with increases in  $R$  is less than would at first be expected due to the fact that  $E_p$  is continually decreasing and hence  $R_p$  and  $r_p$  rising.

In Figure 10 a curve is given showing the percentage of  $\mu$  obtained with varying ratios of  $R$  to  $r_p$ . Since the rate at which  $r_p$  will increase with increases in  $R$  varies this is the only satisfactory way to plot a general curve. The amplification in our problem could more easily have been obtained by using

this curve.  $\frac{R}{r_p}$  in the above case was  $\frac{120,000}{17,250}$  or approximately 6.95. For this value of the ratio we find the percentage of  $\mu$  obtained to be approximately 87.5 which agrees with our previous answer since 87.5 percent of 10 is 8.75.

To get a good percentage of  $\mu$  per stage it is well to make  $R$  fairly high and keep  $r_p$  as low as possible by making  $E_p$  high. This can only be done by increasing  $E_b$  since there will be a greater

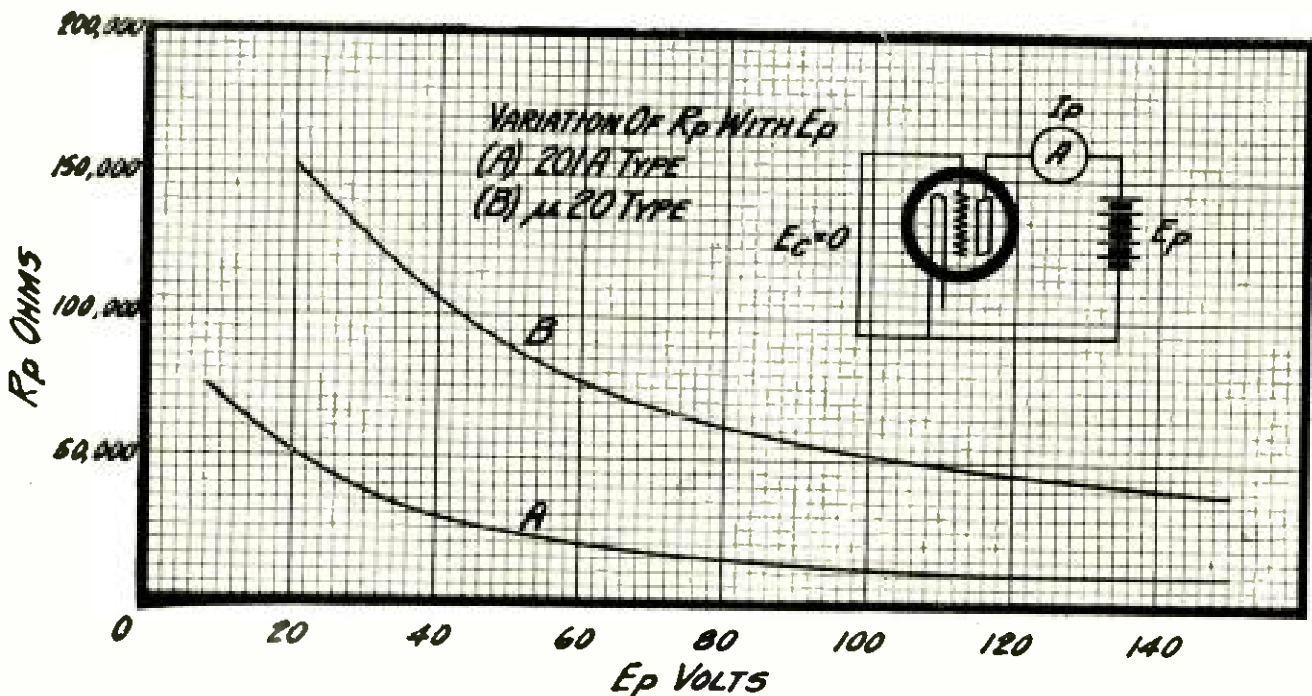

THE VARIATIONS IN THE FILAMENT-TO-PLATE RESISTANCE  
 FIGURE 5: These curves show the way in which the filament to plate resistance varies with plate voltage. Note that although the curves do not appear to rise rapidly as the plate voltage is decreased the resistance is actually increasing rapidly since the plate resistance values on the left are high.

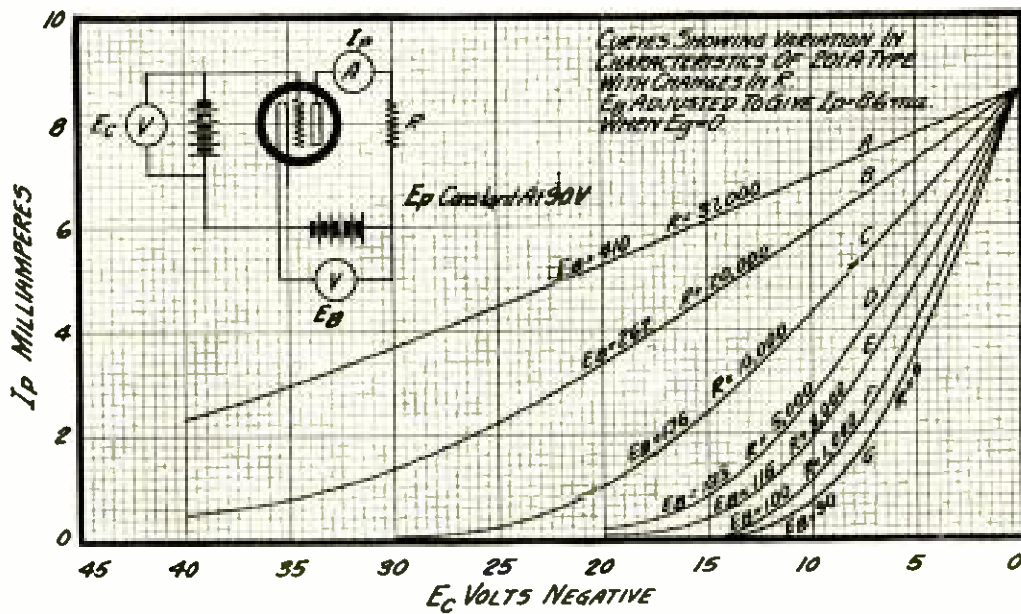

THE PLATE CURRENT PLOTTED AGAINST GRID VOLTAGE

FIGURE 6: These dynamic curves, in which plate current is plotted against grid voltage, show how a greater portion of the curve becomes linear as the plate resistance R is increased. The portion of these curves used in amplification should be linear.

drop in R as it is increased and less of the "B" voltage will be applied to the plate. If a tube having a mu of ten is used and one combination gives a voltage amplification of 6 and another 8 the difference does not seem very great. If say three stages are used in cascade then the overall amplification of the combination becomes 216 and 512 respectively, which shows it is worth while to secure the additional amplification.

A high "B" battery voltage is necessary to secure good results with this type of amplification. In the first place where 135 volts is used in the plate circuit, calculations from the curves given will show that only 18 to 40 volts are actually applied to the plate the average being about 30 for the low mu tubes. This will be somewhat higher for the high mu tubes due to their higher plate resistance and averages about 50 volts.

This low voltage means a high value for  $R_p$ . It also means a lower mu. Although mu is fairly constant over the normal plate voltage range specified for amplification it decreases rapidly when voltages of the order of 20-25 and 30-35 for the low and high mu tubes respectively are used as plate potentials.

Figures 6, 7 and 8 clearly show the advantage of using high plate voltages. This increases the linear portion of the curve over which distortionless amplification can be secured. Increasing the plate voltage from 135 to 180 when using a 201-a type tube and a .12 megohm coupling resistance increases the total grid swing permissible from 10 to 16 volts. Where a stage is to handle maximum grid voltage variations the grid biasing battery should be adjusted so the normal bias operates the tube in the middle of the linear portion of the curve.

In the above case, for example, a bias of 5 and 8 volts respectively would be used permitting a peak voltage of 5 and 8 to be applied to the grid and amplified without distortion. It should be remembered that as the signal is amplified and increases in amplitude provision must be made for the greater variation in grid voltage.

An inspection of the curves in Figure 8 shows that to get much variation in  $E_g$  without producing distortion, i.e., operating where the curves begin to bend, a high plate voltage has to be used. With only 135 volts "B" battery the high mu tubes should therefore only

be used on the first stage or possibly first two stages if the signal is weak.

Unless the voltage is raised a 201-a type tube which will permit higher variations in  $E_g$  should be used next. Either a tube of this type or a power tube of the new type should be used in the last stage both because of the larger variation in  $E_g$  which can be used and because to get maximum power from a tube the impedance of the output circuit should be equal to that of the tube. Since the impedance of the new speakers is rather low a low value of  $r_p$  is necessary to get maximum power.

Only enough negative bias should be used to prevent the grid going positive because increasing this bias increases the plate resistance of the tube which for the reasons previously noted is objectionable.\*

So far only the problems of getting a variation in drop across  $R$  which was proportional to  $e_g$  have been discussed.

They have been concerned with amplification of signals of varying amplitude. This variation in potential has to be applied to the grid of the following tube. This is ordinarily done by using a "coupling" condenser which offers very little reactance to the flow of alternating currents but practically infinite reactance to the high direct current voltage from the "B" battery. This is shown at  $C_c$  in the amplifier diagram.

If the coupling resistance is non-inductive the drop across  $R$  will be almost independent of frequency. When the frequency rises to the point where the reactance of the interelectrode capacities becomes appreciable there will be a decrease in amplification with increase in frequency.

In tubes of the 199 type this capacity is low enough so no trouble from this source occurs for frequencies up to about 300 kilocycles. The effective capacity between the electrodes increases with  $R$  and may become ten or more times the geometric capacity (that due to the

\*See appendix (d).

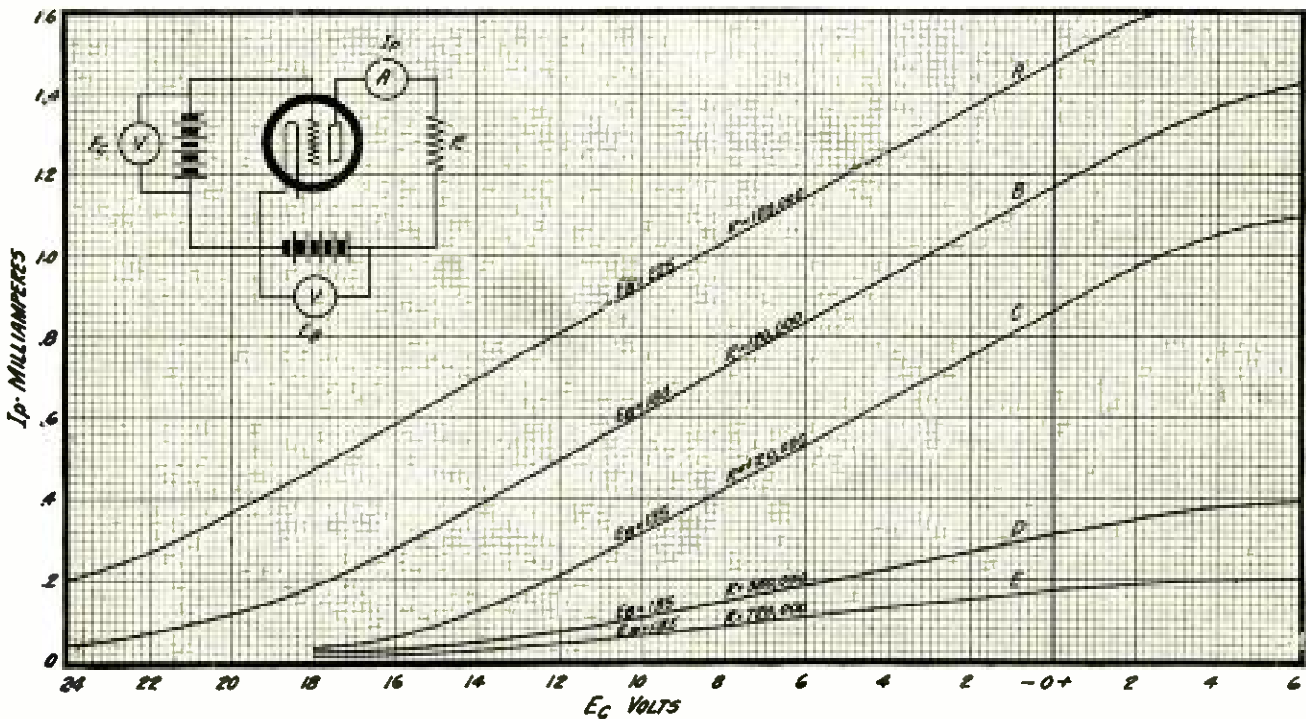

THE PLATE CURRENT AND GRID VOLTAGE IN A 201-A TYPE TUBE

FIGURE 7: These curves show the relation between plate current and grid voltage for a 201-a type tube with different "B" battery voltages ( $E_B$ ) and plate resistances ( $R$ ). Note that as the "B" battery voltage is increased the portion of the curves below 0 grid voltage which is linear is increased; this permits a signal of higher amplitude to be amplified without distortion.

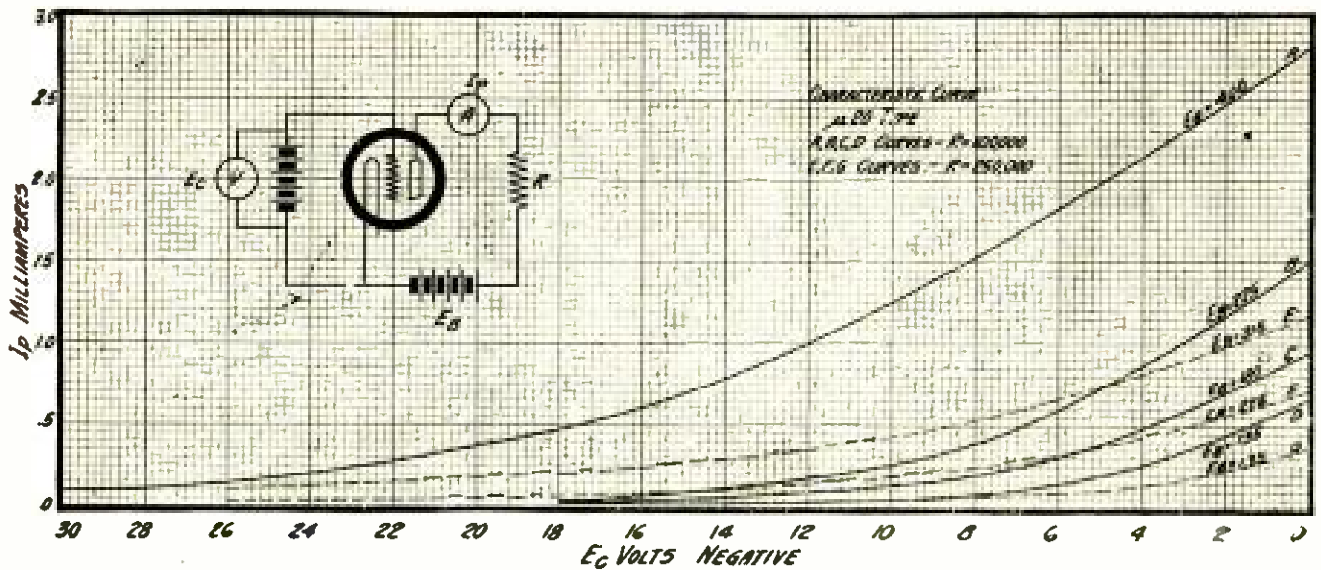

THE RELATION BETWEEN PLATE CURRENT AND GRID VOLTAGE FOR A MU-20 TUBE

FIGURE 8: These curves correspond to those in Figure 7 except that they are for a mu-20 tube. These show that only a very small grid variation can be permitted if distortionless amplification is to be secured. If grid variations of the order of those permissible on a 201-a type tube are to be used the "B" battery voltage will have to be about -100 as shown in curve A.

dimensions of the elements, spacing, etc.) and therefore more serious.\* In high mu tubes this capacity is large and may become objectionable at the higher audio frequencies. Considerable trouble from this source can occur in very high mu tubes having a low mutual conductance or high plate resistance.

Where a coupling condenser is used, as is generally the case, there may be marked frequency discrimination. This is frequently disregarded and the plot of amplification of such an amplifier against frequency is represented as a straight line. The reactance of this condenser is inversely proportional to the frequency.† This capacity in series with the tube input capacity, the resistance  $R_{g-i}$  and grid-leak (these three being in parallel), is in shunt to the resistance R. It is quite evident that if the leak has a low resistance, and the input circuit low resistance, such as is obtained with a positive grid, the impedance of the output circuit of the first tube will vary considerably with frequency. If the grid is kept negative

$R_{g-i}$  can be neglected. If then the leak can be kept high the capacity of the coupling condenser can be fairly low without the variation in its reactance over the range of say 60 to 3,000 cycles causing much frequency discrimination. The voltage across R, divides itself between C and  $R_{g-i}$ . The drop in C is proportional to its reactance.\*

If, as is generally the case, the grid is operated with no bias there is a resultant accumulation of electrons on the grid, due to the occurrence of a rectifying action (see Figure 2) which is similar to that in a detector tube having a grid condenser. This must be removed to minimize distortion. A time constant of discharge enters here.† This is one of the reasons a lower resistance leak is commonly used in the last stages of an amplifier of this type. The grid becomes more positive and more charge accumulates which has to be removed to minimize distortion. This lower resistance leak, however, introduces the distortion previously mentioned.

If only a .006 coupling condenser is used and a .1 meg leak, the variation in amplification over the audio range may

\*See figure 16 in R. B. King's "Thermionic Vacuum Tubes and Their Applications."—Bell Tech. Journal, Oct., 1923.

†See appendix (f).

\*See appendix (f).

†See appendix (g).

be as high as 75 percent depending on  $r_p$ . To minimize this a coupling condenser of at least .1 microfarad should be used. A .5 microfarad condenser is somewhat better although increases in capacity after this do not give a corresponding lessening of frequency discrimination.\*

Where the input to the first stage is connected to the output of a regenerative detector a .001 or .002 mfd. condenser is frequently connected across R to offer a low impedance path to the radio frequencies. An inspection of the circuit used will show that this is across  $r_p$ . The variation of reactance of this condenser to audio-frequencies may be enough to cause very marked frequency discrimination with consequent distortion. This condenser should be as *small* as possible to secure oscillations. If this has to be fairly high it is better to use a transformer in the first stage. The circuit comprising the primary of the transformer and this condenser can still offer inductive reactance to the low frequencies.

Reviewing briefly then what has been found note that the grid should never go positive in a high mu tube and only very slightly so, if at all, in low mu tubes. The value of R, the coupling resistance should be several times that of  $r_p$ , the alternating current plate resistance, to secure a reasonable proportion of the voltage amplification of the tube and to increase the linear portion of the dynamic curve. This in turn means a high value of  $E_B$  to keep  $E_p$  fairly high and  $r_p$  low. Since, except in the last tube, we are interested in voltage amplification high mu tubes should be used if possible. It must be remembered that the linear portion of a high mu tube is proportionally less than that for a low mu tube and if it is to be used after the first stage a high plate voltage must be used to increase this linear portion. If this cannot be done a lower mu tube should be used.

The coupling condenser should be large and the leak have a high resistance so the variation in the reactance of the coupling condenser at audio frequencies is only a small proportion of the resistance of the leak. To keep  $r_p$  as low as possible (i.e., the effective plate voltage as high as possible) the negative bias should not be higher than necessary to prevent the grid going positive in successive stages. It should, therefore, be increased in the last stages.

An inspection of the curves given will show that there is considerable latitude in the choice of constants for an amplifier depending on the tubes, "B" battery voltage, etc.

The foregoing material has been presented in the hope that enough of the fundamental principles involved have been given to permit the designing of an amplifier for a specific need.

---

## Appendix

(a) The capital letters E, I and R are used to denote respectively direct-current voltage, current and resistance. For convenience the small letters e, i and r are used to denote respectively the alternating current voltage, current and resistance. The subscripts g, f and p denote respectively grid, filament and plate.  $R_p$  for example denotes the direct current plate resistance and  $e_g$  the alternating voltage on the grid. X is used to denote reactance with the subscripts c and L to indicate capacitive and inductive reactance. The subscripts B and C indicate the usual "B" and "C" battery circuits and are used for example to distinguish between the voltage of the "B" battery and that actually applied to the plate.  $E_B$  indicates the "B" battery voltage and  $E_p$  the voltage actually applied to the plate, the two being equal only when there is no resistance in the output circuit.

In Figure 1  $C_{g-p}$  indicates the capacity from grid to plate, and so on.

(b) Mu is the ratio of the plate to grid voltage variations which produce the same changes in plate current.

(c) Van Der Bijl's formula in his "Thermionic Vacuum Tubes" which holds to a first approximation is  $I_p = \left( \frac{E_p}{\mu} + E_g + e \right)^2$

(d) The effective voltage on the plate is of course a function of the grid voltage. For grid biases below 0 the effective voltage is  $E_p - \mu E_g$ . To compute the plate resistance from Figure 5 for values of  $E_g$  other than 0 use this relationship to secure the effective value of  $E_p$ . If the

\*See appendix (h).

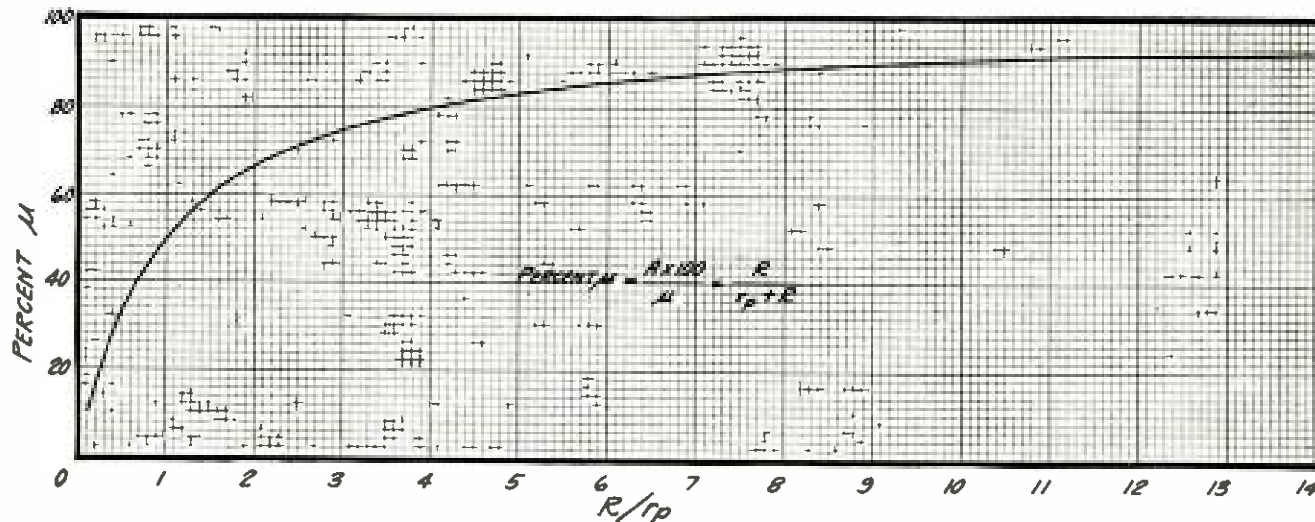

A CURVE THAT SHOWS THE PERCENT MU AMPLIFICATION PER STAGE  
 FIGURE 10: This curve shows the percent mu (of the tube) amplification which can be obtained per stage as the ratio of the coupling resistance to the plate resistance is varied. This shows both that mu is the maximum amplification which can be obtained per stage and that the amplification obtained approaches this value as the ratio of the coupling to plate resistance becomes very high. It also shows that the plate resistance should be kept low by keeping the plate voltage high.

bias is -2 for example and  $E_p$  is found to be 30, the mu of the tube 10, then the effective value of  $E_p$  is  $30 - 10 \times 2$  or 10 volts. Reference to Figure 5, then, will give  $R_p$ .

(c) The amplification per stage is the ratio of the output voltage to input voltage considering all of the output voltage to be impressed on the second grid. By definition (see (b) above)  $\mu E_g = E_p$ . That is a variation in the grid voltage of  $E_g$  will produce mu times this variation in  $E_p$ . Therefore  $i_p$  the alternating current component of the plate circuit in which we are interested is expressed by

$$i_p = \frac{\mu E_g}{r_p + R} \tag{4}$$

For simplicity this can be understood best by referring to (1). Equation (4) is comparable to (1) except that alternating voltages and resistances are taken into consideration. In our case we have used non-inductive resistances so that their alternating current resistance is substantially the same as the direct current resistance and this value of  $R$  can be substituted directly. However,  $r_p$  is not equal to  $R_p$  as was pointed out above but is approximately half  $R_p$ . To get  $r_p$  divide  $R_p$  derived from Figure 5 by 2.  $E_g'$  is then the product of  $i_p$  and  $R$  or

$$E_g' = i_p R = \frac{\mu E_g R}{r_p + R} \tag{5}$$

the total amplification is the ratio of (5) and ( $E_g$ ) or

$$A = \frac{E_g'}{E_g} = \frac{\mu R}{r_p + R} \tag{6}$$

This shows that  $r_p$  must remain constant over the portion of the curve the tube is operated on. For the portion of this curve that is linear  $r_p$  is constant as computations will show. The alternating current plate resistance  $r_p$  is the slope of the effective plate voltage-plate current

curve. This slope is 2 in the average tube and approaches the theoretical value 1.5 when the effective voltage is large in comparison with the potential drop in the filament. An inspection of Figure 8 will show that the slope is roughly 2. The curves in Figure 7 give a value of approximately 1.1. The average low mu stage gives a value of about 1.25.

(f) The reactance of a condenser  $X_c$  is expressed by

$$X_c = \frac{1}{2\pi fC}$$

where  $f$  is the frequency,  $C$  the capacity in farads,  $\pi = 3.1416$  and  $X_c$  is measured in ohms. The drop in voltage across this condenser is proportional to its reactance. This portion of the voltage across  $R$  is lost, only the drop across the leak being available for the second grid. If the leak is made large, say, .5 to 1 megohm, then the difference in reactance of a .1 microfarad condenser to frequencies of from 60 to 3,000 cycles will only be a relatively small proportion of the whole. A .5 microfarad coupling condenser is satisfactory for the average amplifier.

(g) See chapter on detection in "Principles of Radio Communication" by J. H. Morecroft.

(h) If a more perfect amplifier is wanted, one that will give amplification below 60 cycles, or one which will amplify direct current variations, a more nearly aperiodic amplifier can be made by eliminating the coupling resistance. In this case a "C" battery having a voltage equal to  $E_p$  plus  $E_c'$  should be connected where the coupling condenser normally goes ( $E_c'$  being the bias wanted on the second grid). This then "counteracts" the plate potential of the previous tube and gives a resultant negative value in addition. This will be aperiodic up to frequencies for which the reactance of the interelectrode capacities is appreciable.

"A woman is only a woman" the poet Kipling may write, "but a good pipe is a crystal receiver," John Kott of Chicago paraphrases. He built the set for \$1.50.

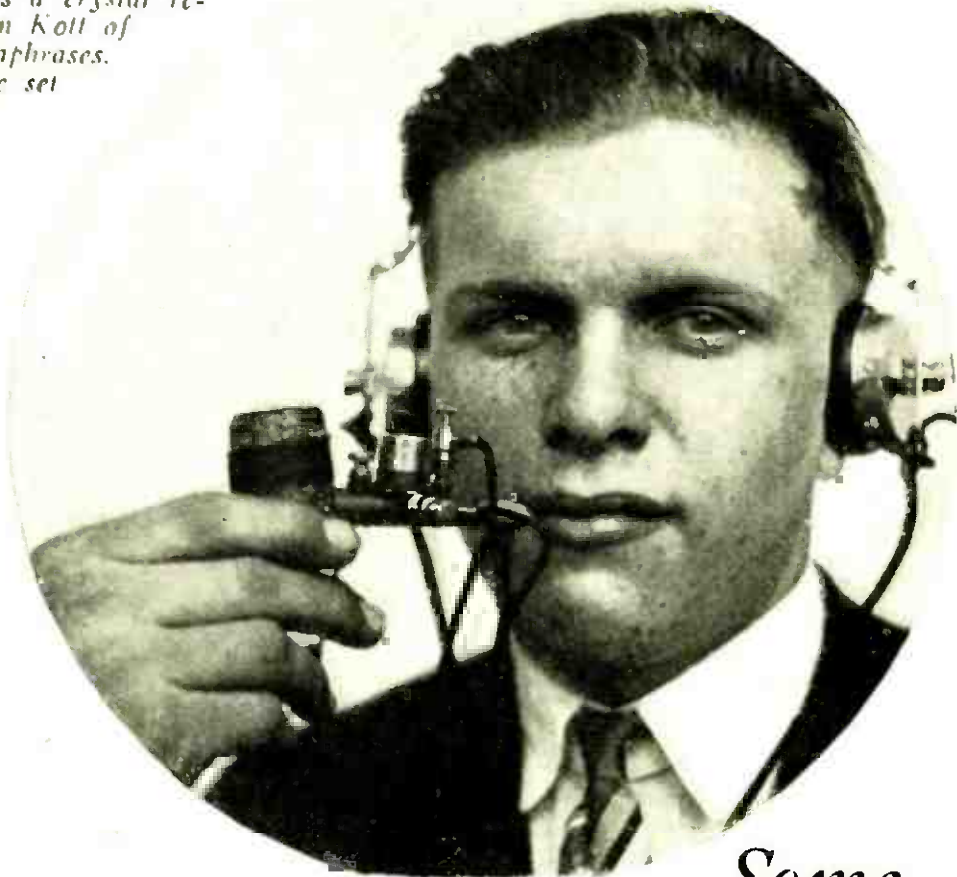

Underwood & Underwood

*Some*

## STUNT SETS

Peculiar but Practical Receivers  
Built by Radio Fans



Kadel & Herbert

R. G. Fehrenz of Brooklyn can listen in on a prohibition lecture that issues from a set built in a beer-mug—if he wants to.



Kadel & Herbert

This miniature set, built in a toy piano by C. W. G. Brown, may play the famous "Prelude" of Rachmaninoff—if the famous "Prelude" of Rachmaninoff is being broadcast from a studio.



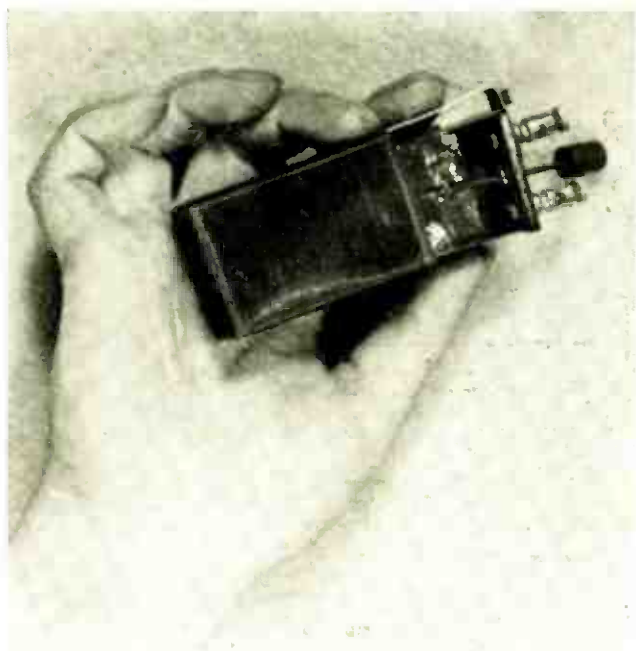

Kadel & Herbert

*This miniature radio set was built in and about an ordinary matchbox by Edward Bessinger of Elmhurst, N. Y. The crystal detector has been placed inside while the set is tuned by sliding the cover on and off.*

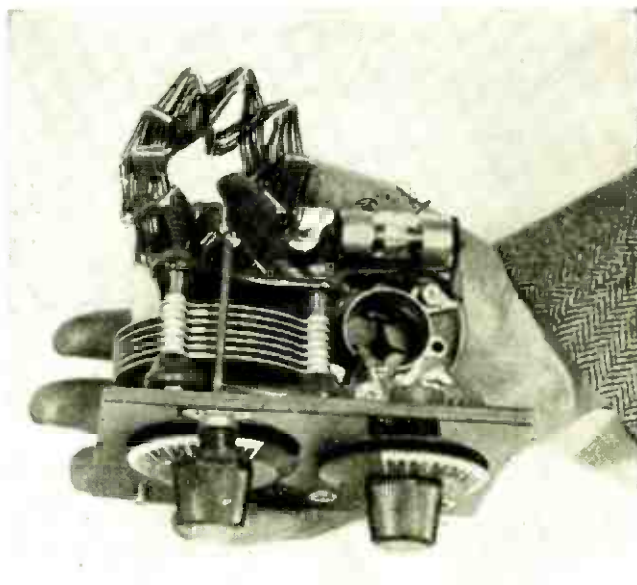

Kadel & Herbert

*This one-tube set built by F. G. Mathews of North Bergen, N. J., in which a simple regenerative circuit is used, scarcely covers the whole of a man's hand. Although the set has been compactly built there is little crowding of the instruments.*



Pacific & Atlantic

*To while away her spare moments while waiting to keep appointments, Miss Addie Rolf of New York need merely to open her leather card case and listen in on what the wild ether waves are saying. But who would keep Miss Rolf waiting?*

14

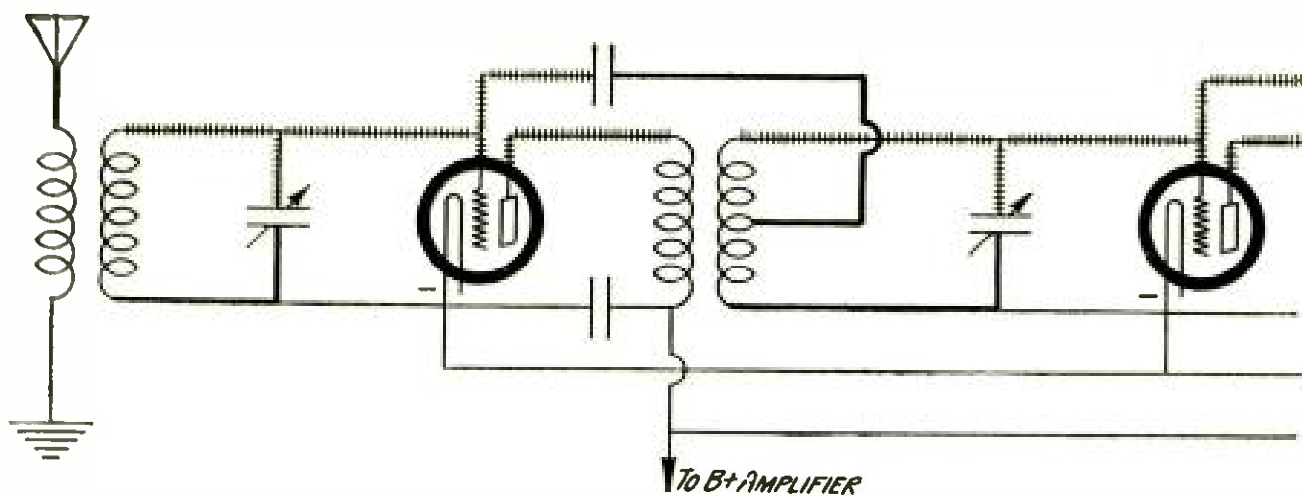

CRITICAL WIRES IN A RECEIVING SET

FIGURE 1: When you connect up your receiver, it is essential that some parts of the wiring be as short as possible and that they be kept separated from other wires. In the neutrodyne circuit (as shown above) the most critical wires are those shown in the wiring with small rungs crossing them. The wires shown in heavy black lines are less critical but should be spaced for the best results. All the other wires shown in the diagram may be bunched together and run in a cable.

## Important Kinks in Wiring

What wires to "bunch," what wires to isolate and when to use spaghetti covering.

By LOUIS W. HATRY

IN general "wiring" can be done in two ways and with two kinds of materials. First, there is bus-bar wiring which is square-rigged, a thing of geometrical beauty and nicety. And there is the popular "straight-line wiring." The point of the latter is that it does not choose square corners or parallels; it eliminates care and accuracy.

Both kinds of wiring can be done with stiff or flexible wire.

The bus-wiring looks best if square or round bus-wire is used, covered (or not) with spaghetti.

The straight-line wiring, which is the simplest, may be done either with stiff or flexible wire, but the flexible wire is easiest to handle so it therefore fits in with the nature of the straight-line job.

It is but natural that the bus-wiring is generally preferred. It is a beautiful way to connect up, if it is done properly. Done improperly it will make a maze that is fairly dizzying. To avoid the maze

requires a little thought in looking for short-cuts that require a minimum of bends.

Don't let the difference between square and round bus-wire bother you insofar as losses are concerned. Choose one or the other only by your preference in appearance. The writer, for instance, likes best and almost consistently uses square bus-wire. But he has met many people who like round bus-wire for no other reason than its appearance.

For the same reason, use—or don't use—spaghetti. In the audio-frequency circuits spaghetti cannot matter. In the radio-frequency circuits it will not make much difference if you take the necessary precautions of spacing the wires properly. Its loss can only be a dielectric one.

The size of the bus-wire should not bother you. In self-supporting wiring, the wire must be of sufficient size and of the proper material to have the required stiffness, rigidity, for self-support.

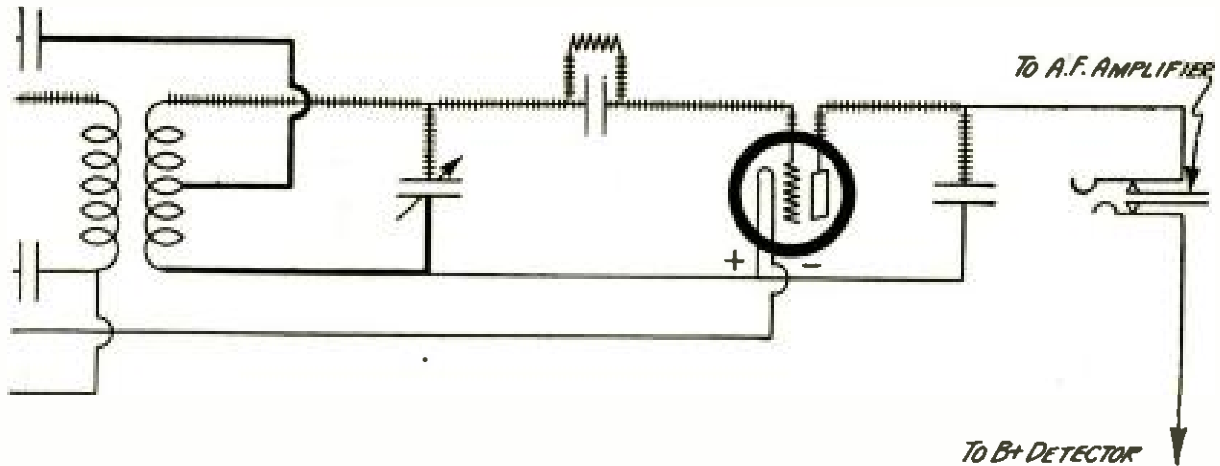

In straight-line wiring the wire may be relatively small.

There are rather radical differences in the necessary methods of wiring of the radio-frequency circuits of a receiving set and the audio-frequency and direct current circuits. The two divisions of radio-frequency and audio-frequency are sufficient for discussion here.

A five-tube circuit, with two stages of tuned and neutralized radio-frequency amplification, with a vacuum tube detector and two stages of audio-frequency amplification will be taken as an example.

In Figure 1 are shown the radio-frequency circuits of the set mentioned. Some of the connections are crossed with little rungs, some are left plain and still others heavily lined. Differentiation was necessary, the reason for which will later become apparent.

The coils, it must be mentioned, should be mounted in a clear space with no wires run through them or near them if such can be avoided. If a wire must come near, do not let it come nearer than one-half inch.

As most of us choose bus-wiring because of appearance and in spite of added capacity, respect for the capacity it does add should make us take the necessary precautions to see that the capacity is kept low.

The condenser, in turn, must be mounted away from the coil for two reasons; first, to keep the capacity relation low and, second, to keep eddy-current losses down.

Both effects are important.

Those leads that are at highest radio-frequency potential difference to the grounded parts of the circuit are marked by the tiny rungs. These leads should

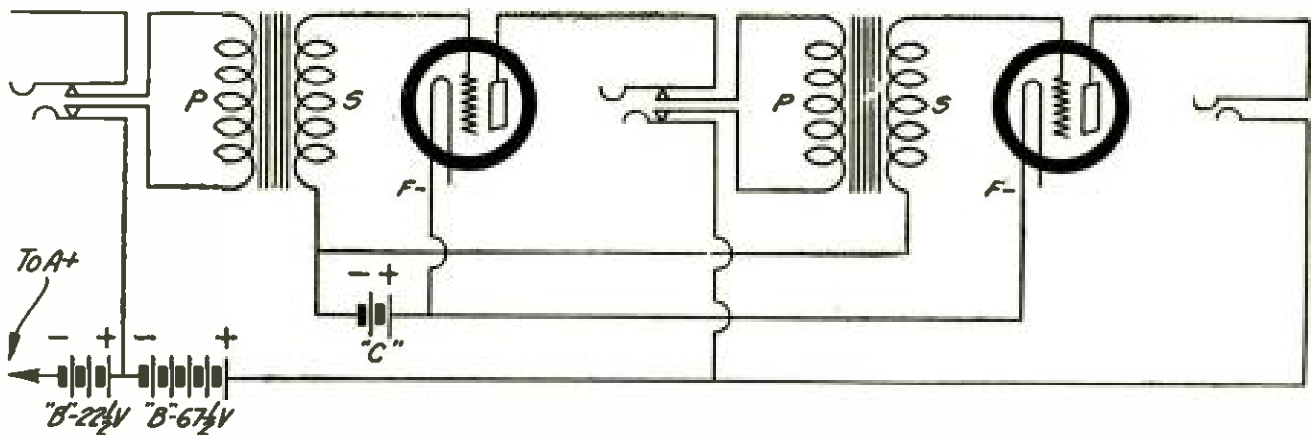

HOW TO WIRE A TWO-STAGE AUDIO-FREQUENCY AMPLIFIER

FIGURE 2: The author tells in this article some of the precautions that should be taken in wiring up an amplifier such as this. One of the important points is to bunch the filament circuits and "B" battery wires.

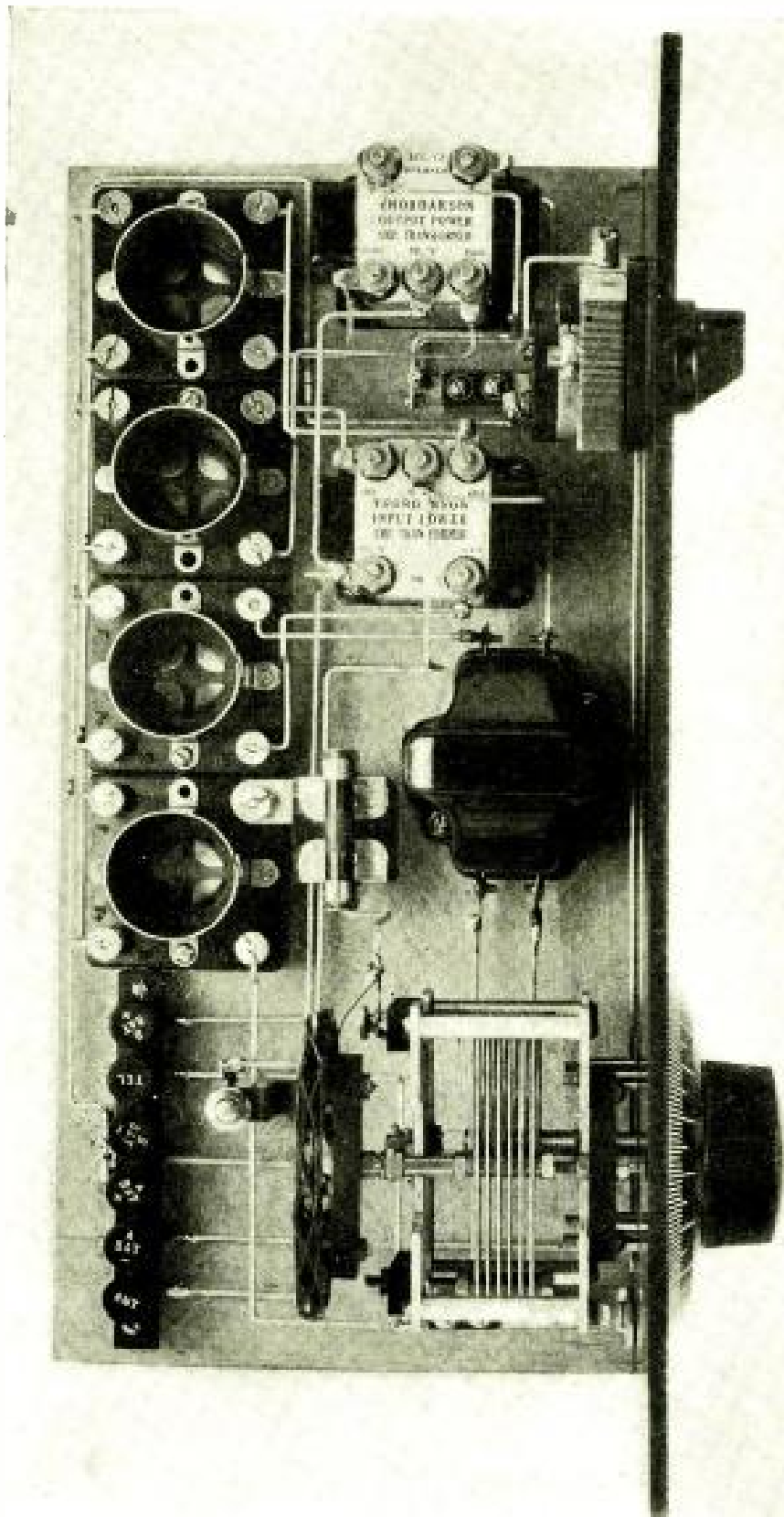

#### A NEATLY WIRED RECEIVER

FIGURE 3: Notice that the regular square bus-bar type of wiring is used and notice how neat are the right angle turns.

be short. They should cross others at as nearly right-angles as possible. These leads should be well separated from any leads that they parallel.

The leads of next importance are the heavy lines of Figure 1. In general these leads carry radio-frequency current or are at some radio-frequency potential

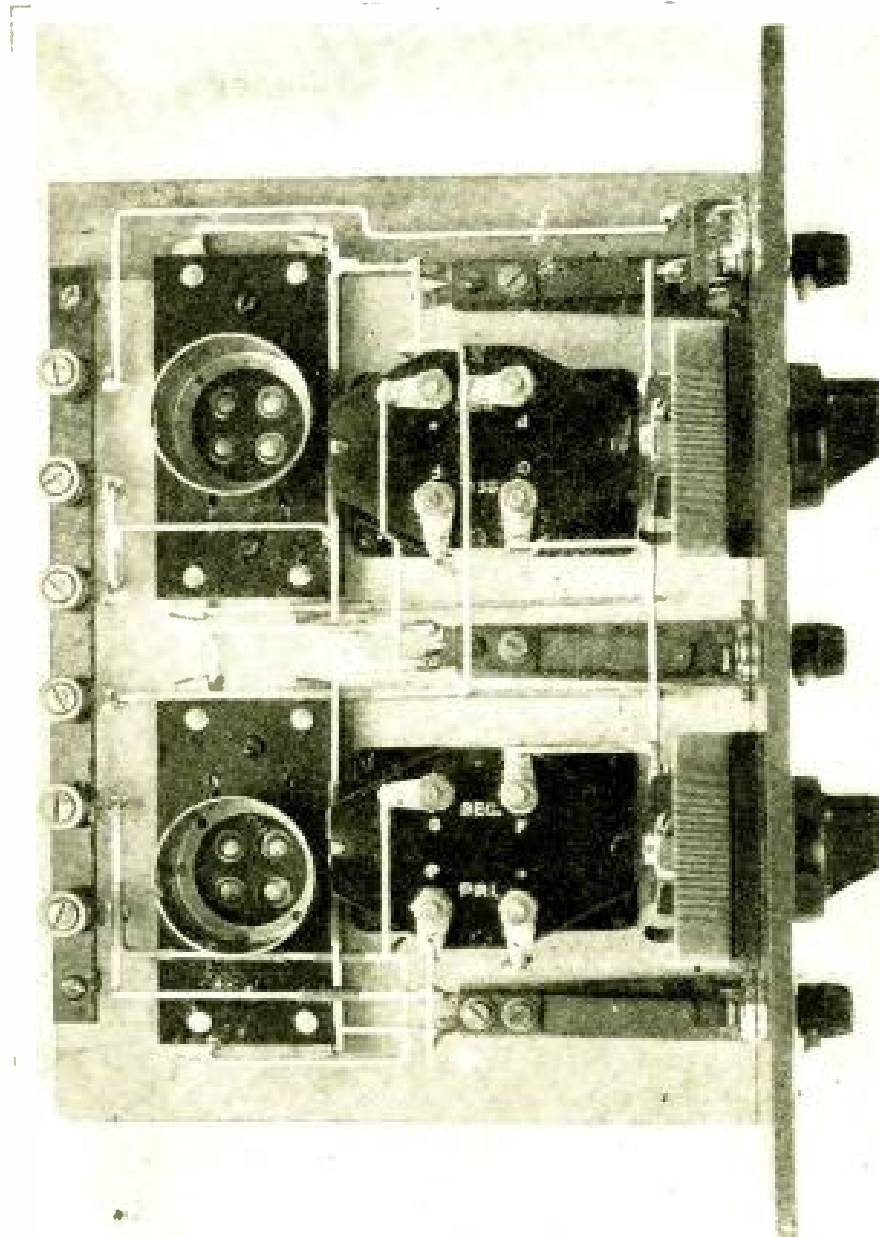

A TWO STAGE AMPLIFIER

FIGURE 4: *This picture shows how the diagram in Figure 2 was used for wiring up the two stages of transformer-coupled amplification.*

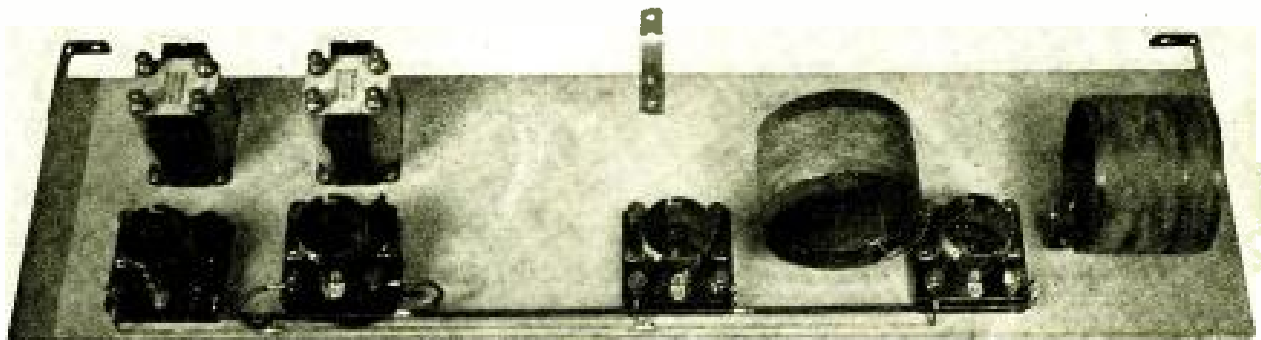

A SKELETON OF A TUNED-RADIO-FREQUENCY SET

FIGURE 5: *Notice that the wiring of the filament circuits of all the tubes is run together in a bunch. This is what the author refers to when he speaks of "bunch-wiring."*

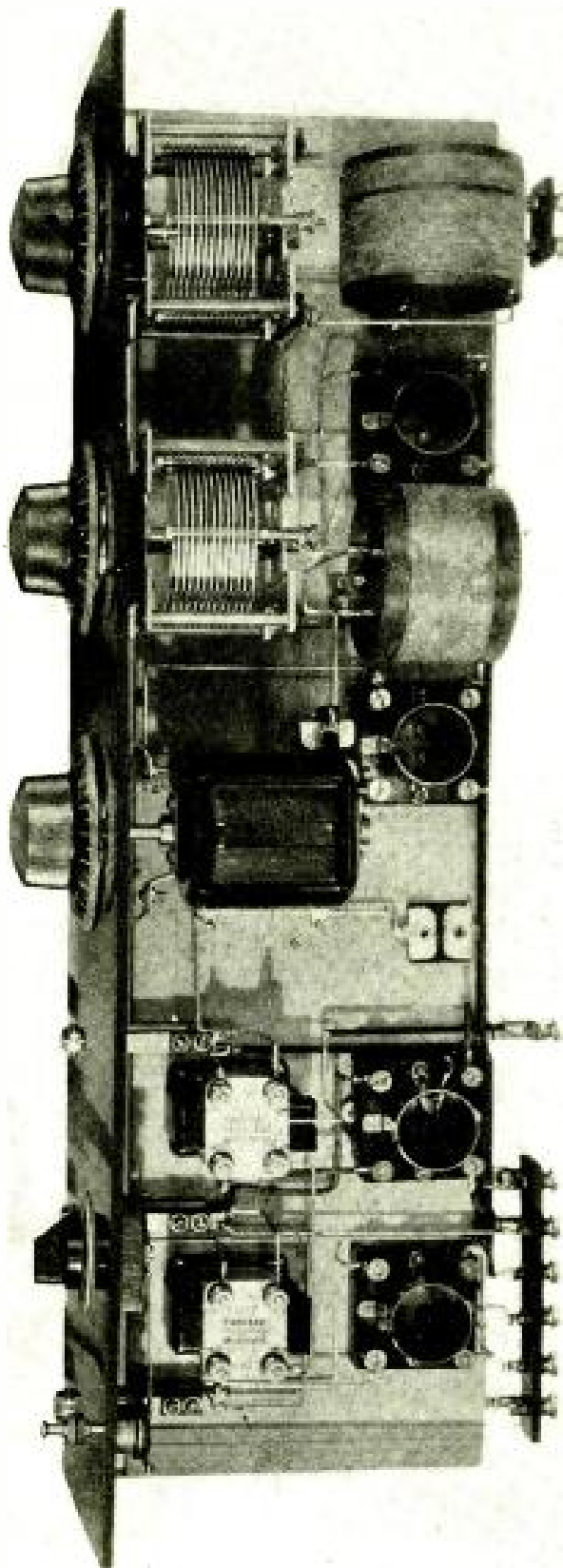

#### AN EXAMPLE OF GOOD WIRING

FIGURE 6: *This picture illustrates the layout and wiring for one stage of tuned-radio-frequency amplification with regenerative detector and two stages of transformer-coupled audio amplification. The wiring is done with square bus wire, and spaghetti is used only where absolutely necessary to prevent short circuits.*

### Another Hoffman Chart

IN POPULAR RADIO for next month—March—will appear No. 14 of the series of computation charts designed for the practical guidance of the experimenter who designs and builds his own sets. This chart will give a simple and accurate method of calculating the inductance of toroid coils.

above the grounded parts of the circuit. They should also be as short as possible, and they should be well separated. Such leads should be separated by a distance of about an inch when run parallel.

The leads of which the length is least important and of which the relation to each other is entirely unimportant, are marked in light black. This is because they are at ground radio-frequency potential—zero. They are of a definite potential, however, in relation to the “runged” connections. It is sometimes convenient to run these “ground wires” all together. In the analysis of the circuit from a radio-frequency standpoint the “B” battery leads to the coils are considered to be at zero potential although they do have a definite DC potential.

Next look at the circuits in Figure 2. These are the audio-frequency circuits of a five-tube set. Every lead shown carries current vibrating at audible frequencies or rather some audio-frequency potential with respect to other parts of the circuit.

As installed in the average radio receiving set the leads to the audio-frequency circuits are usually kept short.

Very short leads in an audio-frequency amplifier are not nearly as important as in the radio-frequency currents.

Spaghetti on the wiring adds no losses in an audio-amplifier. The filament or DC wiring should generally be run along the sockets close to the baseboard. This will leave more room for the remainder of the wiring. Leads can be taken off to the rheostats and filament terminals.

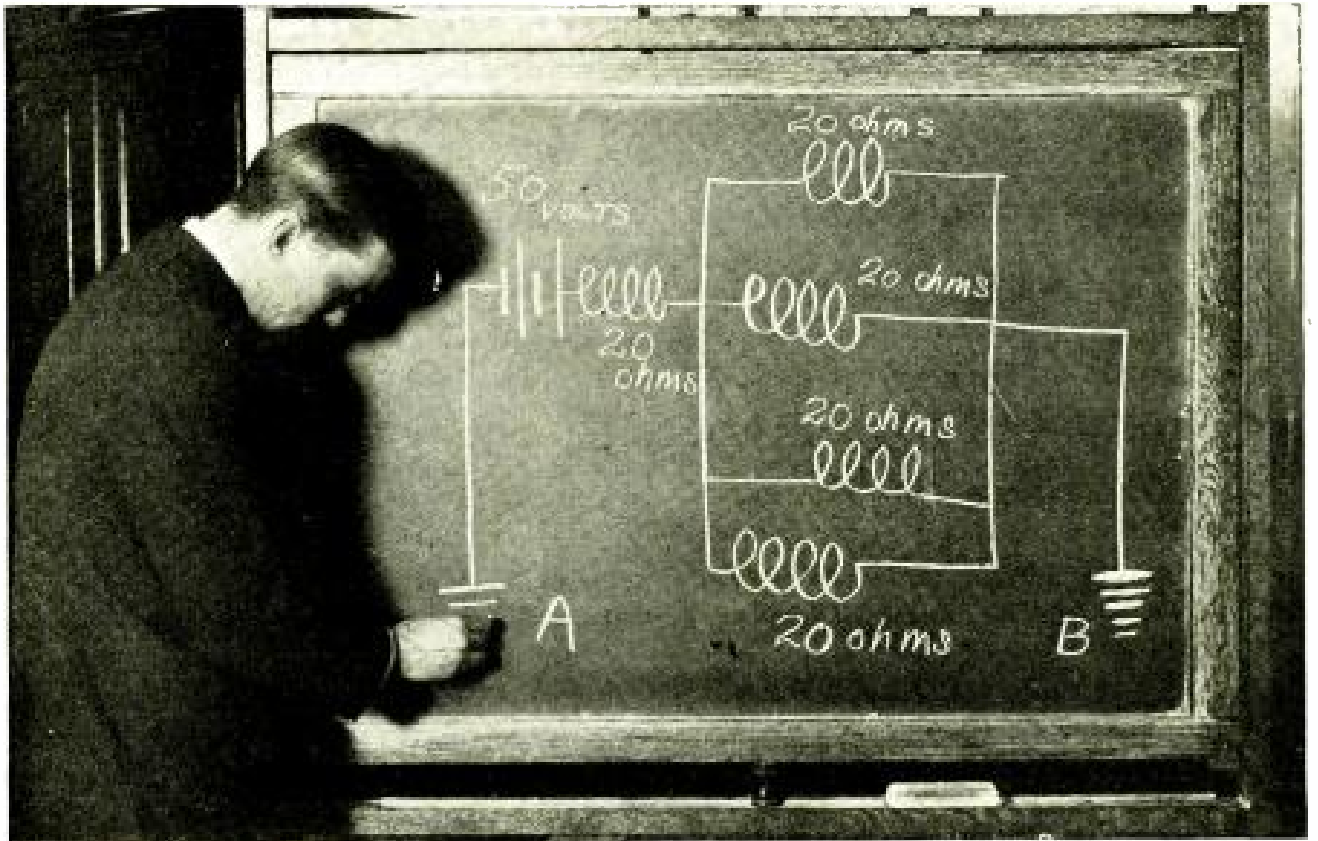

From a photograph made for POPULAR RADIO

### HOW WATTAGE IS FIGURED WHEN RESISTANCE AND VOLTAGE ARE KNOWN

*The effective resistance of the four resistances that are connected in parallel is 5 ohms which is obtained by adding their reciprocals or  $1/20$  which will equal  $4/20$  and then dividing this answer into one. The quotient is 5 ohms. This 5 ohms is added to the 20 ohms at the left with which the four parallel resistances are in series. The total effective resistance of this circuit is then 25 ohms. The text explains the rest of the problem.*

## HOW A CRYSTAL RADIO RECEIVER WORKS

### *Chalk Talks in Radio—No. 4*

This is the fourth article of the series. The preceding articles were "Ohm's Law in a Nutshell," "Watt's Law in a Nutshell" and "What Current Means in Radio." Keep these articles for reference

By J. W. GOOSTREE

**T**HE answer to the problem in the last chalk talk is as follows:

50 volts divided by 25 ohms equals 2 amperes.

2 amperes times 50 volts equals 100 watts.

100 watts then is the power that was represented in the electrical circuit that contained a number of resistances.

In this talk we will confine our conversations to radio proper.

We will put a simple radio receiving set on the table, and pull it apart.

First, we'll lop off the antenna and put it in the upper left-hand corner of Figure 1. This symbol looks like the letters "T" and "V" placed upon one another.

The antenna is that part of a receiving

set that reaches out into the ether, gathers in the high-frequency current and leads it down through the entrance switch, through the primary of the loose coupler, and into the ground.

The symbol for electrical "ground" or "earth" is a vertical line with a few short horizontal lines underneath it. This is shown to the left at the bottom of Figure 1.

We spoke of loose couplers and high-frequency current, a moment ago. In the coupler the current leaves the primary which is at P in Figure 1, and passes into the secondary winding at S. How does this happen?

It is like this:

When some broadcasting station is sending those high-frequency waves that fly around everywhere at the speed of light until some of them run into one of the thousands of antennas that are almost as conspicuous today as telephone lines, they induce in the antenna the electric impulses that flow down the lead-in wire. They come to the primary of the loose coupler, and rush through its windings. This causes a sympathetic electric wave motion through the secondary circuit, but in this case the impulses are caught like rats in a trap. Then, here they go along the winding, and over the other wires toward the detector.

When they start through the crystal

detector, it becomes "peeved," and throws a "caloric fit." The detector in its refusal to allow these impulses to flow through in one direction, totally forgets about the impulses from the opposite direction, and they slip past the unsuspecting crystal. One-half of these impulses then dashes into the condenser, like fiddler crabs into the sand.

And blam! before they discover they can't get through the dielectric, the microfarads kick them out, heels over head.

So, into the windings of the receiver they go, pellmell, and mad as hornets because the microfarads kicked them out of the condenser. They hit the ohms in the receiver coils like Yale's eleven hitting Harvard's defense line in a football championship game.

The ohms do their best to stop the milliamperes' mad onslaught, but they find it impossible. The milliamperes overcome the ohms' resistance and on they go through the very heart of the telephone coils. This turmoil going on all around the cores of the coils makes them nervous and shaky. This attracts the attention of the telephone receiver's diaphragm and it vibrates in sympathy with the cores, but in so doing never shirks its own duty, which is the changing of the electric impulses into sound waves. That is the drama that goes on inside a simple radio circuit.

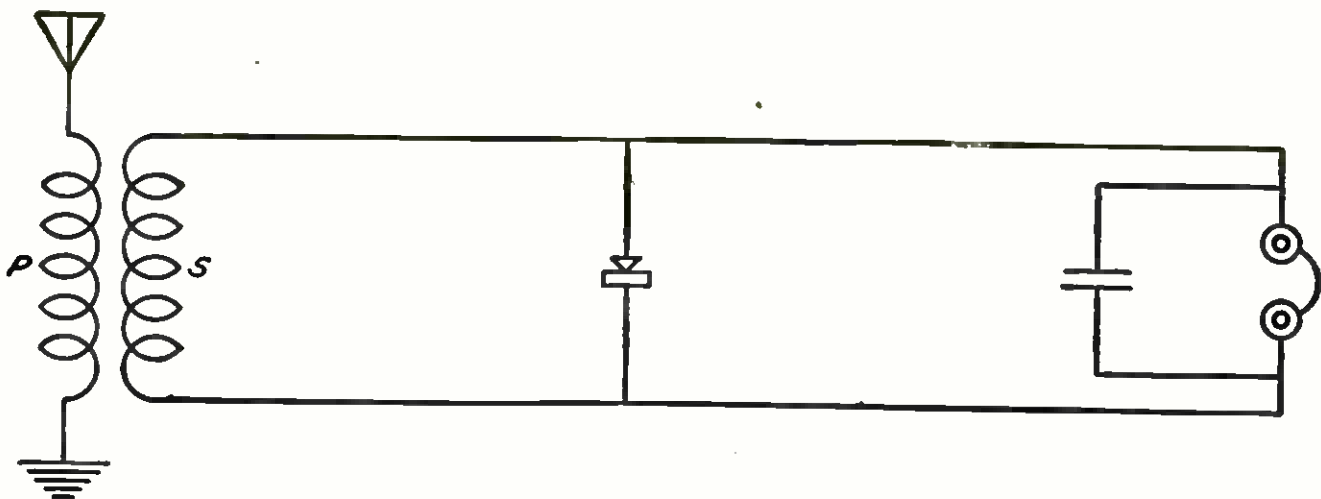

A SIMPLE RADIO RECEIVING CIRCUIT

FIGURE 1: P represents the primary of the loose coupler and S the secondary. The symbol in the center is used to represent a crystal detector; the short parallel lines at the right designate a fixed condenser; and the two coils at the extreme right are symbols for headphones.





United

#### HOW THE APPARATUS LOOKS IN USE

*The rectangular leather-covered box shown on the desk above contains the microphone that picks up the sound vibrations of the voice and converts them into electrical energy. Current is drawn from the four dry cell batteries. The picture on the right shows how the receiver is held close to the sensitive skin of the palm of the hand so that the vibrations may be easily heard. Professor Robert H. Gault, the inventor, is shown experimenting with the apparatus.*

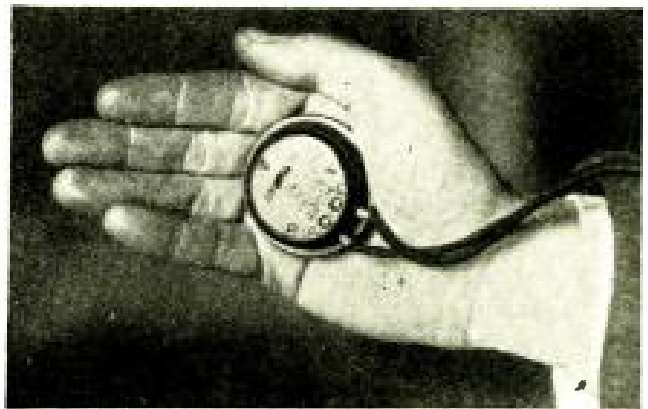

## Helping the Deaf to Hear Through Their Hands

**T**O restore the ability to "hear" to those who are deaf, a specially constructed telephone that purposes to provide new ears for them in the palms of their hands has been developed by Professor Robert H. Gault of Northwestern University.

The basis of his device is to convey vibrations of sound by mechanical means to a sensitive skin area, where they may be felt and translated back into words.

The apparatus, (as is shown by the illustration reproduced on this page), is simple. A microphone operated by dry

cell batteries picks up the sound of the voice and transmits it to a telephone receiver which is placed in the palm of the hand. The vibrations are then carried to the sensitive surface of the skin through the diaphragm of the receiver.

Previous experiments along this line have shown that persons who are totally deaf may "hear" and enjoy musical vibrations such as those obtained by placing the fingertips upon the sounding-board of a piano; but this is thought to be the first time that the sense of touch has been used to interpret the vibrations of speech.

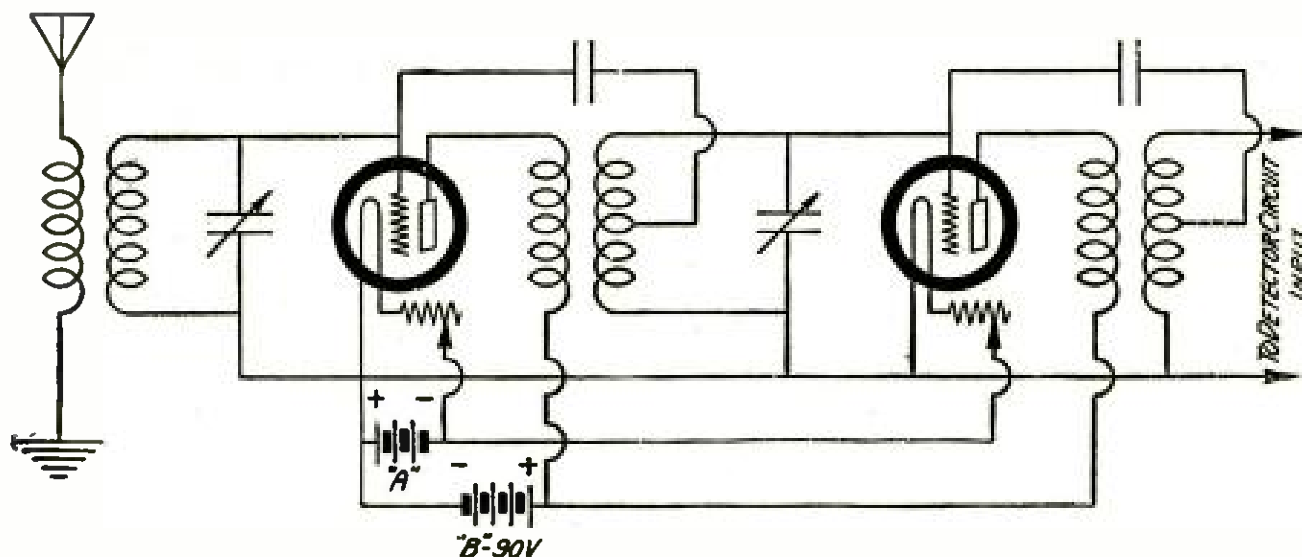

#### A WASTEFUL METHOD FOR CONNECTING GRID RETURNS

FIGURE 1: This diagram shows a poor method, from an efficiency standpoint, of connecting the grid returns of a radio-frequency amplifier. Notice that they are connected to the positive filament terminal which produces a large drain on the "B" batteries.

## How to Cut Down Your "B" Battery Bill

Do your "B" batteries run down quickly? If they do—read this article. It tells how to reduce the drain on your "B" batteries and at the same time get better reception.

By EDGAR H. FELIX

**E**CONOMY of operation is rarely viewed with the same importance as selectivity, sensitiveness and volume when a new radio receiving circuit is decided upon. Yet, by the observance of a few simple precautions, it is possible to cut the "B" battery bill almost in half, without sacrifice of any of the other desirable qualities of the ideal receiving set.

Before analyzing several of the most widely used circuits, it is desirable to understand why "B" battery current in a receiving circuit may be reduced, without loss of volume or sensitiveness. Then the reason for the slight circuit changes suggested will be at once clearly apparent.

The useful output of any vacuum-tube circuit are radio-frequency or audio-frequency variations in the "B" battery cur-

rent. A vacuum-tube amplifier should increase the relative intensity or amplitude of these variations, whether of audio or radio frequencies, without affecting their frequency.

The output of the "B" battery is, in effect, a direct-current carrier, passing through the plate circuit of a vacuum tube. As small voltage variations are impressed upon the grid, the plate current, drawn from the "B" battery through the meshes of the grid, is caused to vary but to a much greater degree than the impulse supplied to the grid. Hence we have an amplified reproduction of the current in the grid circuit impressed upon the direct current passing from the "B" battery through the tube.

The amount of "B" battery current therefore, need not be larger than is

necessary to accommodate these variations.

An analogy may make this clear:

Suppose you were attempting to communicate signals by means of waves in a trough. By splashing the surface of the water with a paddle at one end of the trough, it would convey, by means of the ripple making its way to the other end, a visual signal. The amplitude or height of the ripple might be but half an inch. As long as the water were at least half an inch deep, you could communicate half-inch ripples to the other end. There would be no improvement in this primitive communication system if the depth of the water were increased to two or six feet.

The water, in this analogy, represents the plate current; the paddle, the grid; and the ripples, the fluctuations or useful output of the tube.

Wastefulness of "B" battery current is the result of passing six milliamperes through a vacuum tube for the purpose of accommodating fluctuations corresponding only to a half a milliampere.

There are three simple methods of reducing plate current:

*First*, by maintaining the correct potential relationship between grid and filament through the use of a "C" battery

or by utilization of the negative drop across the rheostat in the negative filament lead;

*Second*, by employing the lowest-plate voltage which gives good results;

*Third*, by regulation of the filament current to the minimum which maintains good quality of reproduction.

The elements of any multi-tube radio receiver may be generally classified into three general parts:

(1) Those handling radio-frequency currents;

(2) Those concerned with rectification;

(3) Those devoted to amplification of audio-frequency currents.

Economy measures of a different nature are applicable to each of these general elements of radio receivers.

In reflex circuits these functions are combined in whole or in part and consequently the same economy measures, which can be applied to receivers having these circuit elements separated, cannot be incorporated in most reflex circuits. Reflex circuits depend for their economy on the fact that fewer tubes are required to do the same work rather than on individual economy per tube.

Negative biasing cannot always be applied successfully to the radio-frequency

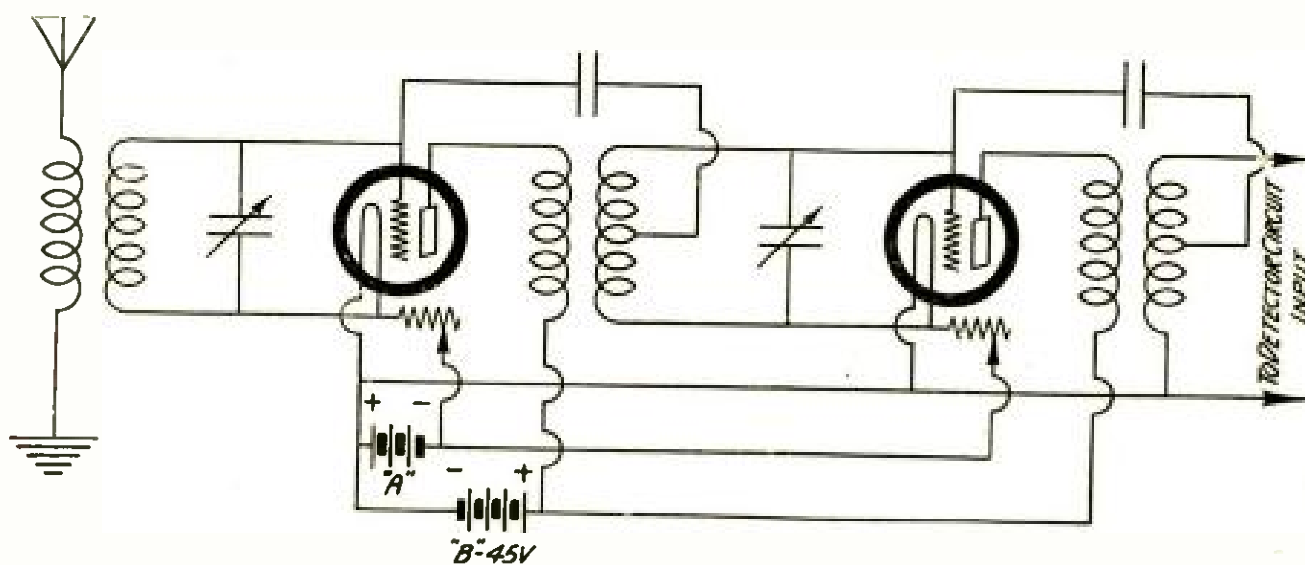

THE CORRECT GRID RETURN SCHEME

FIGURE 2: This diagram shows you how to change the grid connections from a positive return to a negative return. Notice that in both cases the grid return wires are connected to a point between the rheostats and the filament terminal, thus reducing the drain on the "B" battery considerably by making the grids more negative.

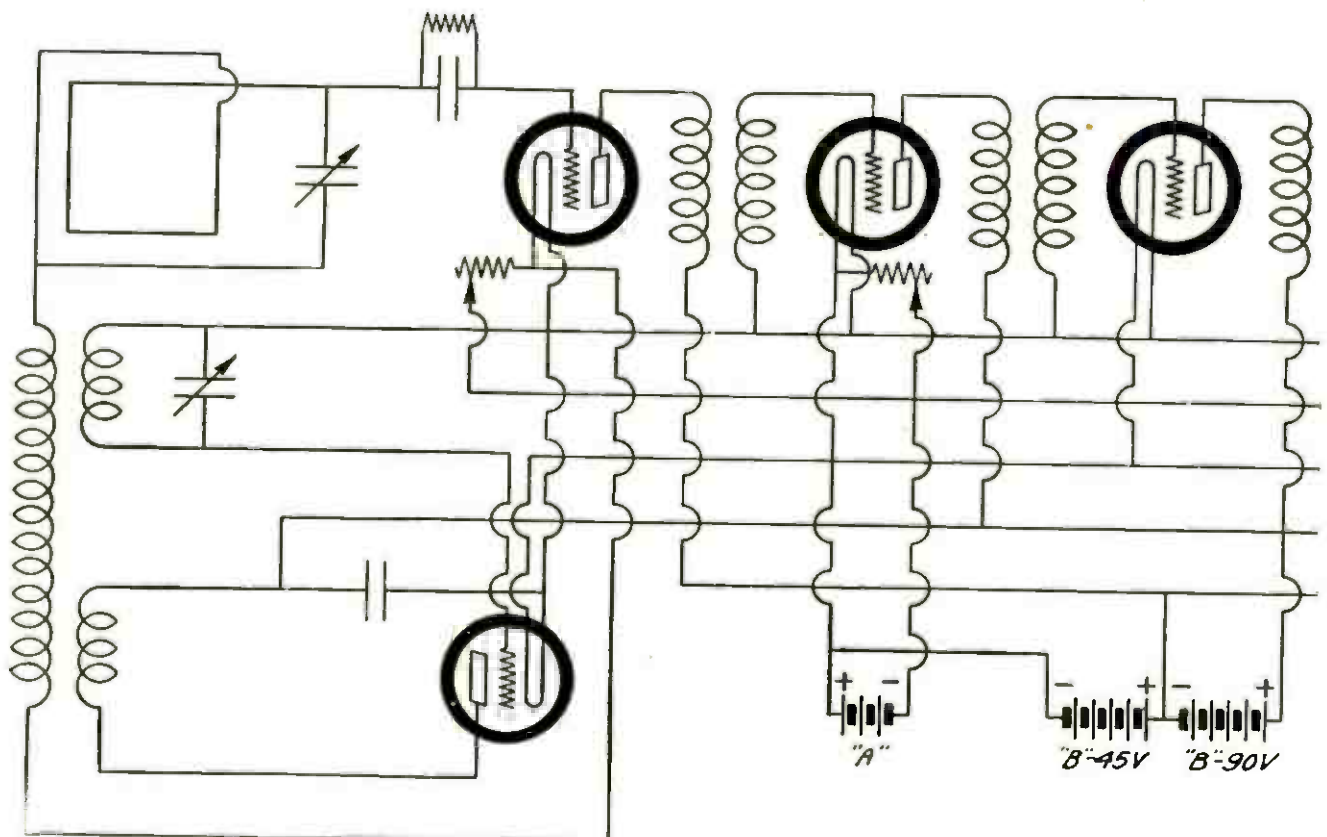

A SUPERHETERODYNE THAT CONSISTS OF TWO DETECTORS, THREE INTERMEDIATE-FREQUENCY RADIO AMPLIFIERS, AN OSCILLATOR AND ONE STAGE OF AUDIO AMPLIFICATION

FIGURE 3 (ABOVE): This circuit is exceedingly wasteful of "B" batteries and would cause them to run down in a month or so. See Figure 4 for the information that would cut down the drain on the batteries.

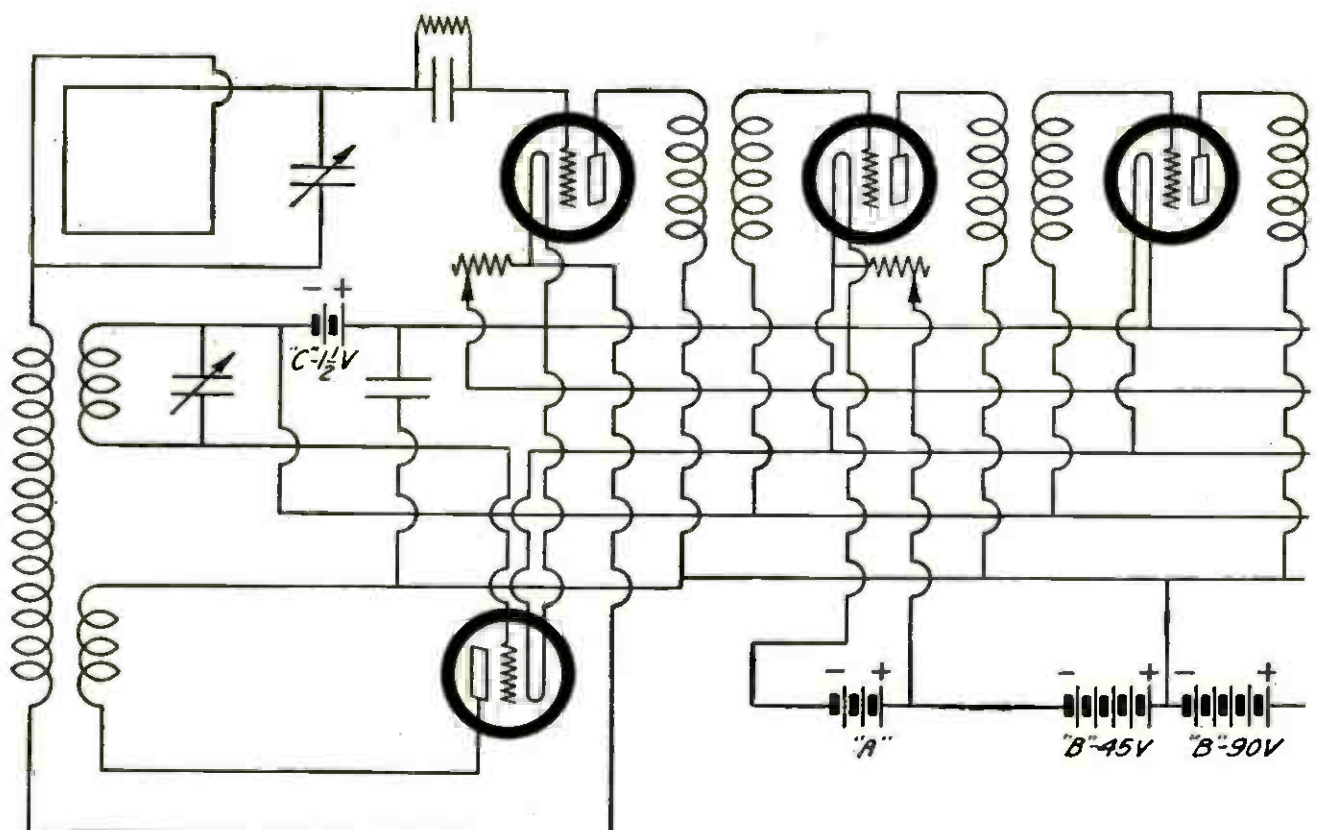

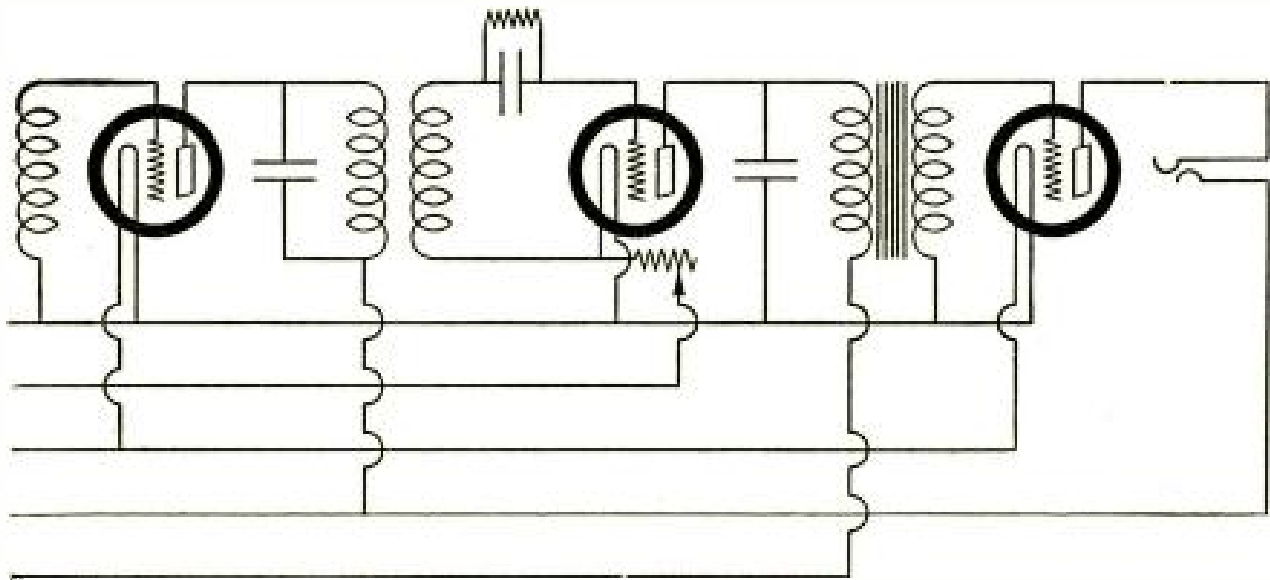

THE CORRECT HOOK-UP

FIGURE 4 (BELOW): This diagram is a revised edition of that shown in Figure 3. Notice that two "C" batteries are incorporated—one in the grid circuit of the oscillator and one in the grid circuit of the audio amplifier. Notice that the three radio-frequency amplifiers also have their grid returns connected to the 1½-volt "C" battery. This cuts the drain on the total circuit approximately in half when considered from a "B" battery standpoint.

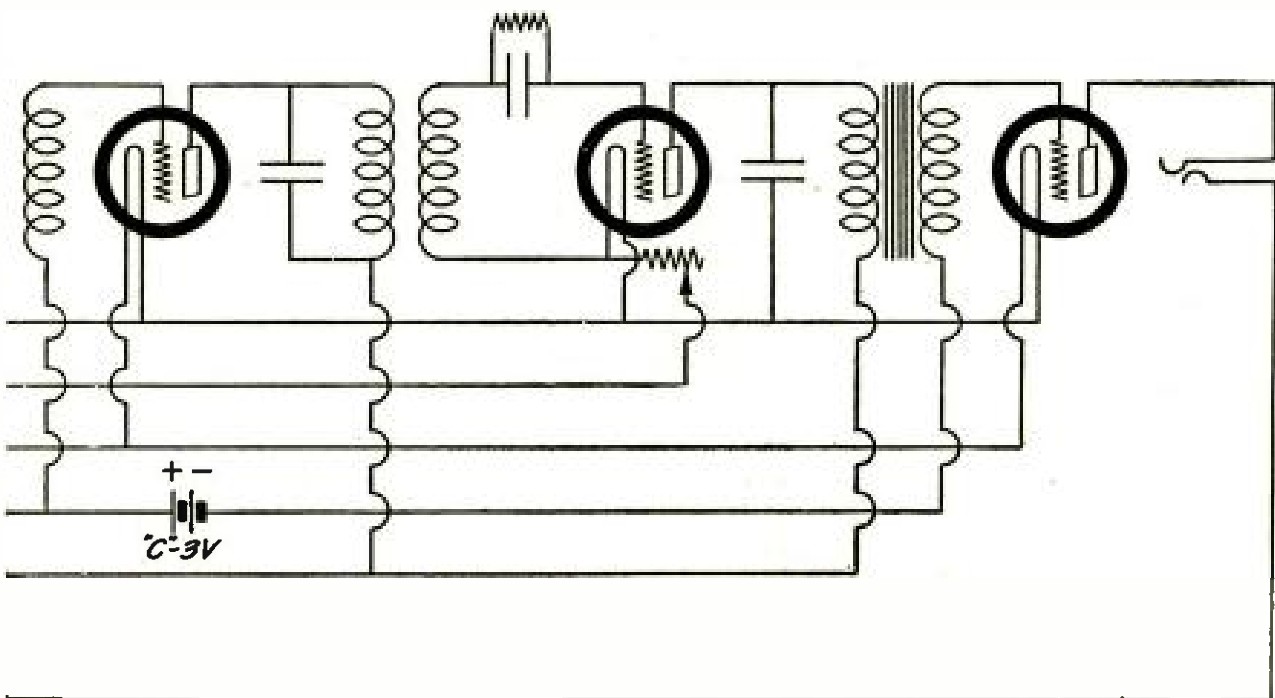

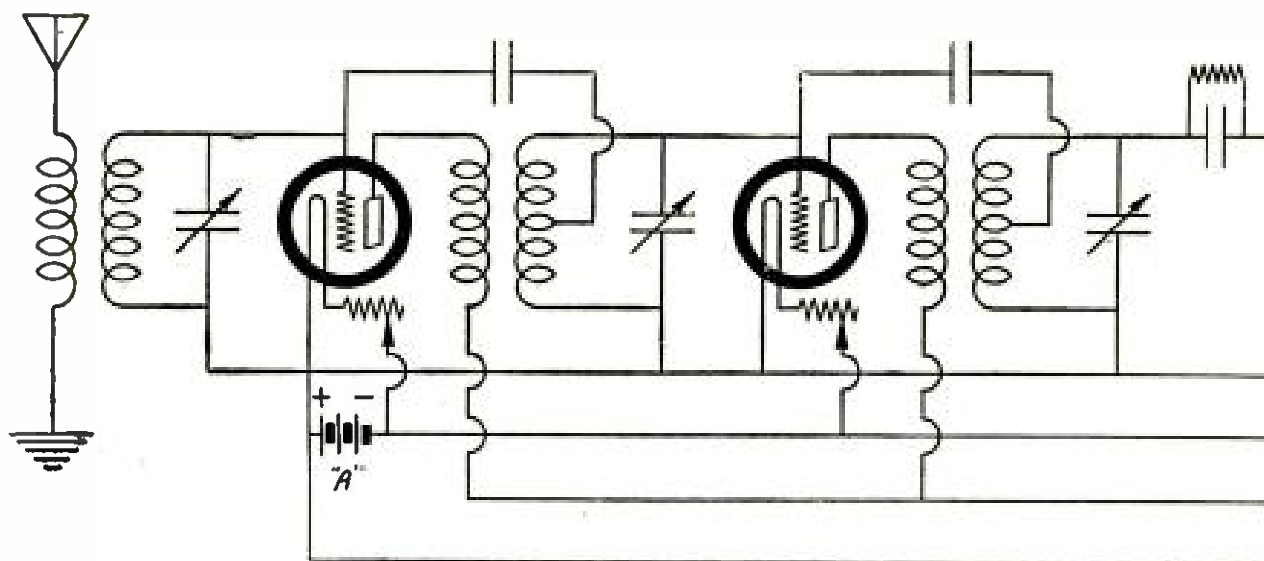

THE CONNECTIONS FOR THE NEUTRODYNE WITHOUT "C" BATTERIES AND WITH POSITIVE GRID RETURNS

FIGURE 5: *This is a wasteful procedure and causes the "B" batteries to run down too quickly. The proper "over-all" connections are shown in Figure 6.*

amplifier operating on broadcast frequencies because, in unstable circuits, it will make the amplifier oscillate. The principal economy measure which can be taken advantage of in the radio-frequency amplifier is the use of comparatively low plate voltage.

Many receiving sets are equipped with a single, high-voltage binding post supplying the plate circuits of both radio and audio-frequency amplifier tubes. While high voltage is desirable to secure the utmost audio-frequency amplification of good quality, it is not essential to effective radio-frequency amplification. Consequently, separate plate-potential binding posts for radio and audio-frequency amplifier tubes permit the use of 45 volts on the radio-frequency tubes and 90 volts on the audio-frequency amplifier tubes, securing the greatest possible economy without sacrifice of signal volume.

In the case of neutrodyne circuits, however, because of the increased plate-circuit impedance resulting from reduced plate voltage, there is loss of signal strength during long distance reception when 45-volts plate potential is used instead of 90. For local reception this is not a disadvantage. As most listening is done with local stations it is desirable

to have easy means at hand for changing plate voltage as required by receiving conditions. A good test clip on the radio-frequency "B" battery lead makes it a matter of a moment to change the plate voltage from 45 to 90, when long distance work is attempted. This slight effort amply justifies itself in the longer life secured from "B" batteries, if only 45 volts is used during local reception.

One measure can be applied to any neutralized radio-frequency circuit, without likelihood of causing self-oscillation. The grid return, leading from the secondary inductance to the filament, should be connected with the negative filament lead, between the rheostat and the negative side of the "A" battery. In this way the small potential drop across the filament rheostat is utilized in reducing the plate current. In a normally stable circuit this amount of negative drop is not sufficient to cause self-oscillation, yet it is sufficient to reduce the plate current to a measurable extent.

Figure 1 shows two stages of neutralized tuned-radio-frequency connected so that it draws 12 milliamperes, and Figure 2 shows the same amplifier rewired with the result that plate-current drain is reduced to about 9 milliamperes.

Radio-frequency circuits depending

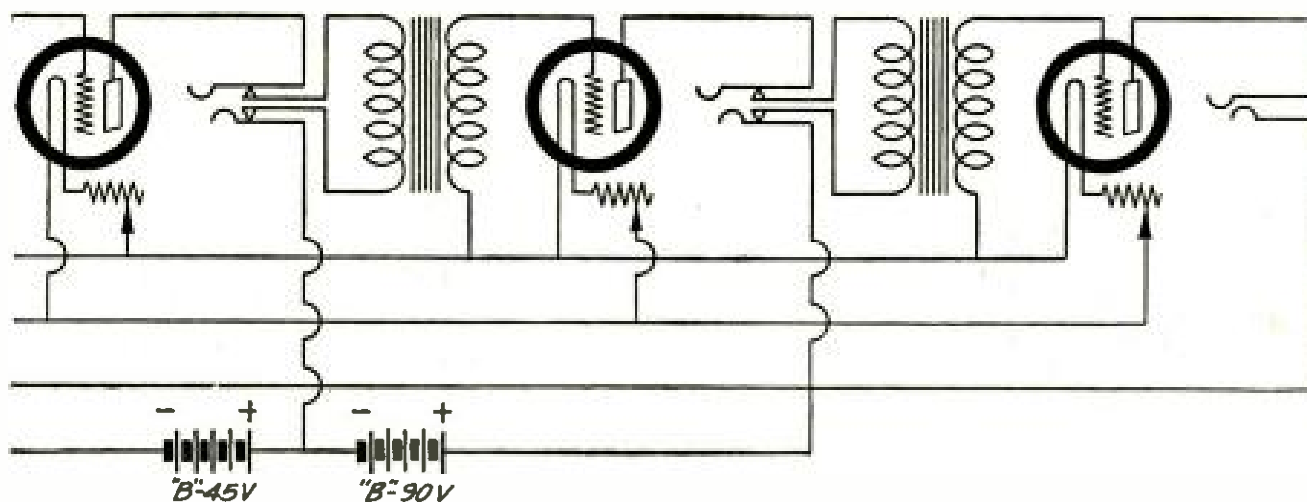

upon a potentiometer to prevent self-oscillation are inherently wasteful because the function of the potentiometer is to place a positive bias upon the grids, which greatly increases the plate current. There is no remedy for this, inasmuch as even a small negative bias causes this kind of amplifier to oscillate continuously.

The use of moderate filament brilliancy, by cutting down filament current with the rheostat, not only reduces plate current to a marked degree but prolongs tube life and conserves filament current. The radio-frequency amplifier, handling as it does minute currents, is not improved in its effectiveness by heavy filament emission. Many receivers are therefore equipped with two filament rheostats—one for the radio-frequency tubes and the other for detector and audio-frequency amplifier tubes—so that great economy is attainable in the radio-frequency amplifier, while maximum volume output is at the same time secured from the audio-frequency end of the receiver through the use of greater filament current.

With receivers equipped with a single rheostat for all tubes it is necessary to increase the filament current for all tubes to the maximum required by the last stage of audio-frequency amplification. Since successive stages of amplifi-

cation have made the variations in the last amplifier circuit large as compared with those in the first tube of the receiver, there is obviously, as the analogy in the earlier part of this article pointed out, a considerable waste of plate-battery current to use as much filament current in the radio-frequency end of the set as in the audio. On the other hand, reduction of plate current to an amount less than that required by the variations in the audio-frequency amplifier results in distortion. Two filament rheostats overcome this wasteful practice.

One habit of inexperienced listeners when receiving an excessively loud signal from a nearby broadcasting station is to reduce volume by detuning. Volume can be reduced just as effectively by reducing filament brilliancy with the filament rheostat, resulting in saving of "B" battery, "A" battery and tubes. Detuning, on the other hand, is equivalent to the practice of a motorist who attempts to reduce the speed of his car by stepping on the brakes, with the throttle still open!

The most economical method of connecting an intermediate-frequency amplifier in the superheterodyne is discussed when that circuit is taken up in detail.

To secure the greatest sensitiveness in the detector, it is necessary to place the

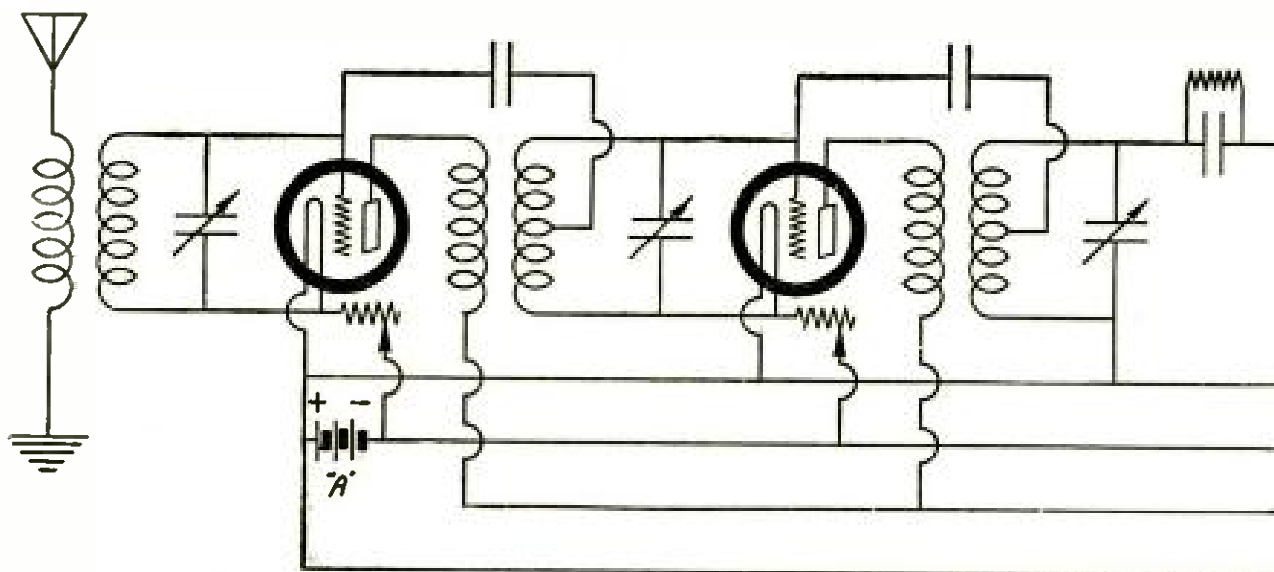

AN EFFICIENT NEUTRODYNE CIRCUIT

FIGURE 6: In this diagram the grid returns are connected to the negative sides of the filaments in the radio-frequency amplifier and the two audio-frequency amplifiers are provided with a negative "C" battery of  $4\frac{1}{2}$  volts. Notice, however, that on the detector a positive grid return is correct.

filament rheostat in the negative lead and to connect the grid return from the secondary inductance directly with the positive filament lead. Low plate voltage, however, is not only possible but desirable. Although the UV-201-a tube will operate satisfactorily as a detector with 90 volts on the plate, the most effective voltage is either  $22\frac{1}{2}$  or 45 volts, according to the characteristics of the particular tube.

The "C" battery should be installed in every audio-frequency amplifier. It not only substantially reduces operating costs but improves quality of reproduction as well. The negative terminal of the "C" battery goes to the grid return and the positive to the negative filament lead.

As an indication of the saving which this useful battery can achieve, its installation in a Crosley Trirdyn, for instance, reduced the plate current from 13 to 5 milliamperes; a Teledyne set has its total plate current dropped from 11 to 5 milliamperes.

In view of the long shelf-life attainable with modern "B" batteries, particularly in the larger sizes, reduction of plate current results in proportionate saving of "B" battery operating cost. Therefore any measure of economy, even with

a set drawing but little plate current, is highly desirable. Now let us consider the principal kinds of receiving sets to which the economies outlined may be applied.

The simple regenerative receiver with two stages of audio-frequency amplification is most economical when:

1. The lowest effective voltage is used on the detector tube, through a separate "B" battery binding post for the purpose.
2. The lowest effective plate voltage is applied to the amplifier tubes to secure satisfactory volume and quality, through a separate binding post for the amplifier tube "B" battery supply.
3.  $4\frac{1}{2}$  volts negative bias is applied to the grids of the audio-frequency amplifier tubes.

Tuned-radio-frequency circuits, whether neutralized according to the Hazeltine method or otherwise, are most economical when hooked up as shown in the illustration, which embodies the following features:

1. Separate binding posts for detector, radio-frequency and audio-frequency amplifier plate voltage, permitting the use of the lowest effective voltage in each circuit.
2. Grid return of radio-frequency tubes connected to negative "A" battery. With the filament rheostat in the negative filament leg.
3.  $4\frac{1}{2}$  volts "C" battery for audio-frequency amplifier tubes.

All plate voltages should be adjusted to the lowest effective operating point. Sometimes only 45 volts is required for all tubes when listening to local stations



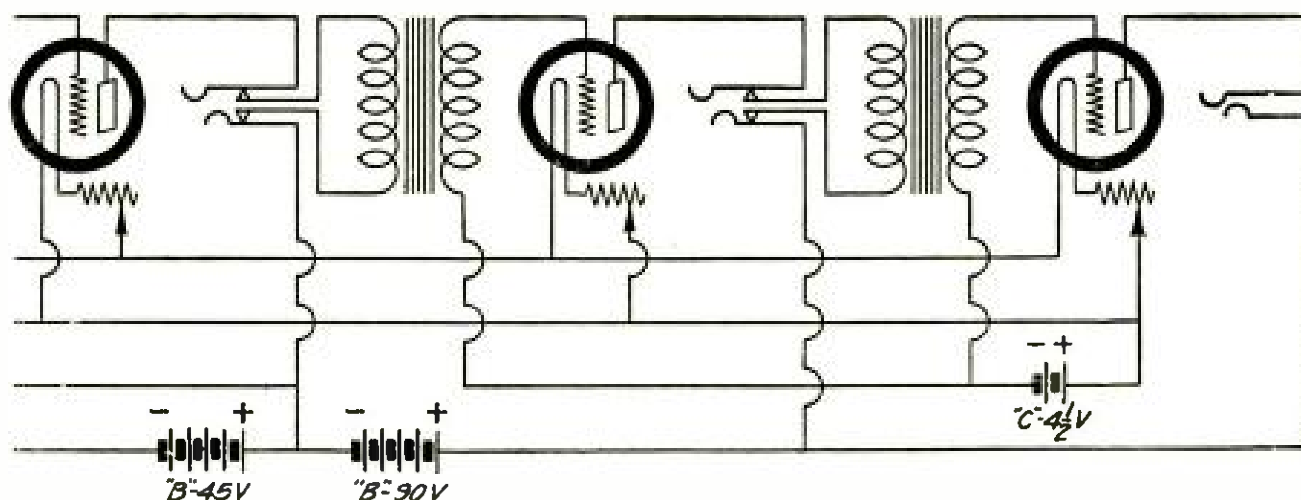

while best long-distance work is done with 90 volts. In that case the "B" battery lead should be equipped with a test clip so that these changes may be made conveniently and quickly.

The superheterodyne circuit is more widely abused than any other. Some home-made superheterodynes have been found which draw as high as 100 milliamperes! Yet the fullest capabilities of this circuit may be taken advantage of with a receiver drawing but 20 milliamperes or even less from the "B" battery. There is no good reason why a superheterodyne should draw substantially more current than this, and if you have one which does so it is well worth while to consider the following economy measures:

1. *In the oscillator:* (a) Do not use more than 45 volts plate potential; more than this is wasteful and unnecessary; (b) Use  $1\frac{1}{2}$  volts negative bias on the grid return; this substantially reduces the current drain of that part of the receiver.

2. *In the detector circuits:* (a) Do not use excessive plate voltages;  $22\frac{1}{2}$  is often sufficient; more than 45 is wasteful.

3. *In the intermediate-frequency amplifier:* (a) Do not use more than 45 volts plate potential; many superheterodynes use 90. (b) Use  $1\frac{1}{2}$  volts negative bias on the grids; this results in substantial savings.

4. *In the audio-frequency amplifier:* (a) Use  $4\frac{1}{2}$  volts negative bias on the grid; (b) Use only as much plate potential as is necessary to secure satisfactory operation.

The circuits for two superheterodynes are shown, one as it is often built by the home constructor, and the other taking advantage of every possible economy. The first superheterodyne drew nearly 40 milliamperes; the second only 18. That ratio is somewhat better than cutting the "B" battery bill in half.

Although it would be possible to show specifically the changes necessary in a great variety of circuits to secure the utmost economy, the same principles which have been illustrated in the examples so far given can be applied to almost any circuit.

### What a Straight-line Frequency Condenser Really Is

*If you want to know all that goes into the production of a condenser with true straight-line frequency characteristics, what is the true worth of a low minimum capacity—and what "straight-line frequency" really means, read the article on this subject in a near issue of POPULAR RADIO.*



## THE HOOK-UP FOR THE ORTHOPHASE RECEIVER

FIGURE 1: Notice that all of the symbols for the instruments bear designating letters which reappear in the list of parts and throughout the text and the following illustrations; this eliminates the possibility of mistakes in construction and wiring up.

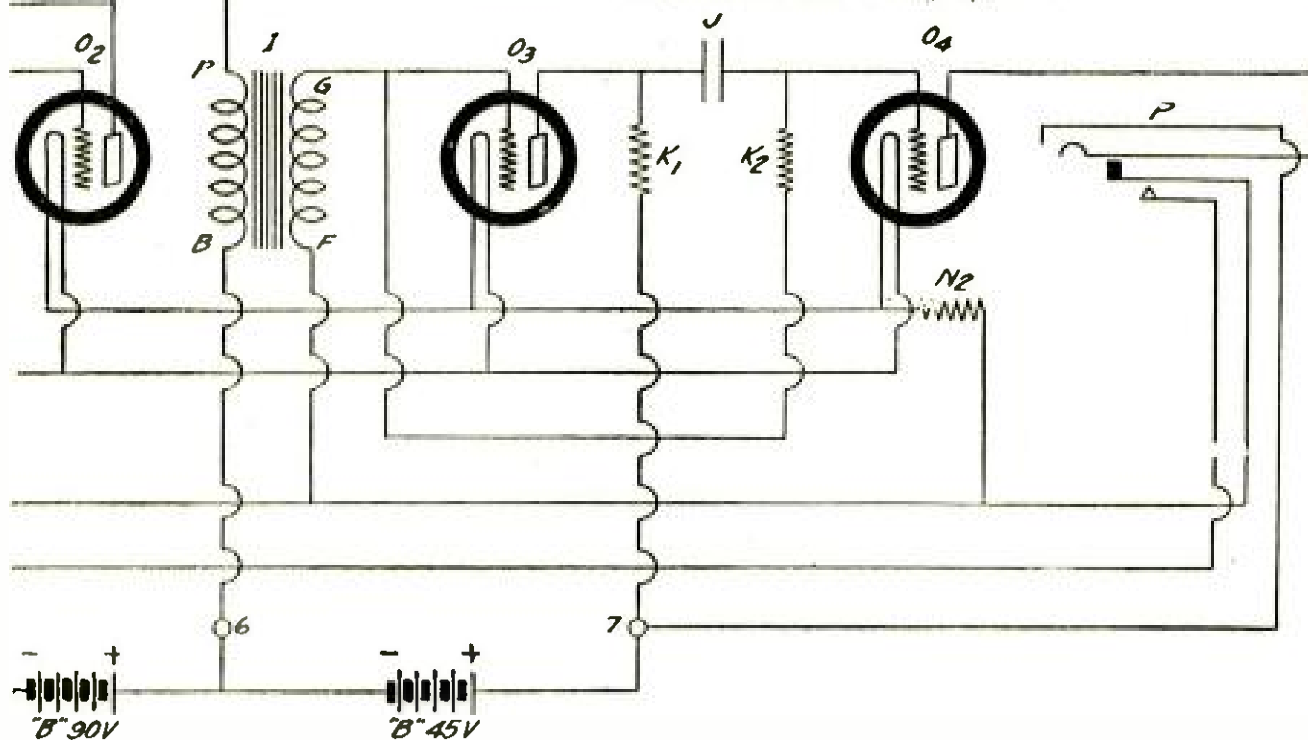

The list of parts here given includes the exact instruments used in the laboratory set, from which these specifications were made up. The experienced amateur, however, will be able to pick out other reliable makes of instruments of similar characteristics and equal efficiency. But we recommend that the novice follow the list, as the diagrams in this article will tell him exactly where to bore the holes and exactly where to place the connections. If instruments other than the ones used in the original model are used, the only change that will be necessary will be the use of different spacings for the holes that are to be drilled in the panel for mounting the instruments.

THE radio fraternity in general, including engineers, experimenters and those to whom radio is a source of amusement and education, are almost unanimous in placing quality of reproduction at the top of the list of the most essential factors in deciding whether a receiver is good, fair or bad.

While truthful reproduction is essential, there is another property which might be considered equal to it in importance, and without which a receiver is valueless, no matter how beautifully it may reproduce the transmitted music or voice; the ability to select one station and to reproduce the broadcasting from that station, without the "background" of sounds

emanating from some other unwanted station. For no matter how clear the tone quality of a receiver may be, it will be wasted if the music from two or more stations is jumbled together into a mass of dissonant noise.

In addition to tone quality and selectivity, there are, of course, other things to be considered in building or purchasing a receiver. These include sensitivity, or the ability to pick up weak signals, ease of operation and, in the case of a home-built outfit, it is desirable that a receiver be as simple and as easily built as possible.

The Orthophase receiver was designed with the purpose of securing tone quality and selectivity, for these two are

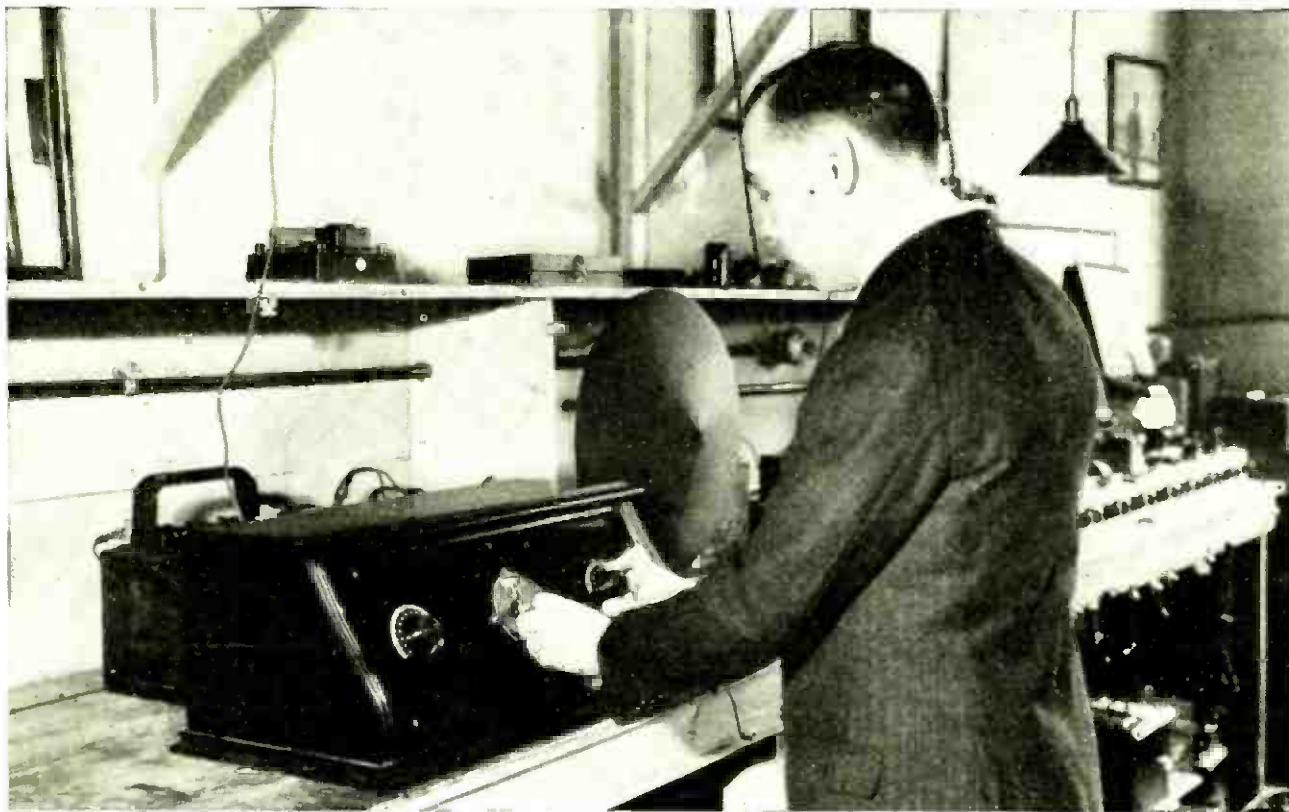

#### THE AUTHOR TESTS OUT THE FINAL MODEL

*FIGURE 2: One of the completed receivers set up in the laboratory for final test and calibration. Other receivers built in a similar manner by experimenters should tune at approximately the same dial settings.*

the most important of all the properties of a receiver.

Several factors help to guarantee faithful reproduction in this receiver. In the first place, the signal is detected or rectified by a crystal detector, which, as is well known, gives a true tone-portrait of the original broadcast sound. This is due, of course to the linear characteristic of the crystal rectifier. After rectification the signal must be amplified and of course the true characteristic of the rectified signal must be preserved during amplification if we are to have life-like tone-quality delivered by the loudspeaker. The amplifying system of the Orthophase has been designed to fulfill these conditions as nearly as possible. The audio-amplifying system comprises two transformer stages and one resistance-coupled stage. While an old-type transformer has been used in the first stage, no detrimental effects are observed by its use, as it follows the crystal detector and so is not subject to overloading, or saturation of its core, as there is no

direct current flowing through its primary, which would be the case were it connected in the plate circuit of a tube.

In the second stage, one of the new-type large-sized transformers is used, to enable the handling of the higher power present in this stage. This transformer is designed to amplify all frequencies equally, having an especially large core to withstand saturation, and a high primary impedance so as to amplify the low tones as well as the higher ones. These two points, in connection with correctly designed secondary distributed capacity and so forth, give a high-voltage amplification, while preserving all the characteristics of the original sound.

The last audio stage is resistance-coupled, and of course, is also a quality amplifier. To enable the handling of the great power and volume at this stage a power tube is used. This avoids overloading of the last tube, which is the cause of much distortion in many amplifying systems.

The selectivity of the Orthophase Receiver is due in a large measure to the extremely loose coupling of the receiver to the antenna system and to the use of low-loss, low-resistance coils in the radio-frequency amplifying system.

The receiver also is extremely sensitive.

Another important item is ease of operation, especially to those who consider a radio receiver primarily as a musical instrument.

The wavelength is controlled by the middle dial, which may be calibrated and logged. The right-hand dial may be used to control the volume, or its position can also be logged, as this dial may always be set at approximately the same point as the middle or wavelength dial. The left-hand dial is used to tune the antenna circuit and is not critical in its adjustment.

Inasmuch as several principles not commonly used in radio receiving enter into the operation of the Orthophase receiver, it may be well to consider briefly the theory of its action.

### Features of the Receiver

In Figure 1 it will be noted that the variometer A is in the antenna circuit and is coupled loosely to the grid-coil B. When a radio wave from a broadcasting station strikes the antenna it sets up a high-frequency oscillating current in the antenna circuit consisting of the variometer A, condenser G, antenna and ground. As the grid-coil B is coupled inductively to the variometer A, a high-frequency current will be set up in the oscillatory circuit that consists of the grid-coil B and the variable condenser E, providing this latter oscillatory circuit is tuned to resonance with the antenna circuit and the signal being received. This operation, of course, is identical with that of practically all modern receivers.

It will be noted that the grid of tube O1 is connected to the upper end\* of grid-coil B, while the grid of tube O2 is connected to the lower end of the same coil. As, at any one instant, the two ends of a coil in which an alternating (or oscillating) current is flowing are at opposite potentials, it will be apparent that at the instant when the grid of tube O1 is positive the grid of tube O2 will be negative, and *vice versa*. This means that when the plate-current flow of tube O1 is *increased* due to its grid becoming positive, the plate-current flow of tube O2 is *decreased* due to its grid becoming negative. It is, of course, apparent that when the grid of tube O1 becomes *negative* and the grid of tube O2 becomes *positive*, the plate-current flow of tube O1 is decreased and

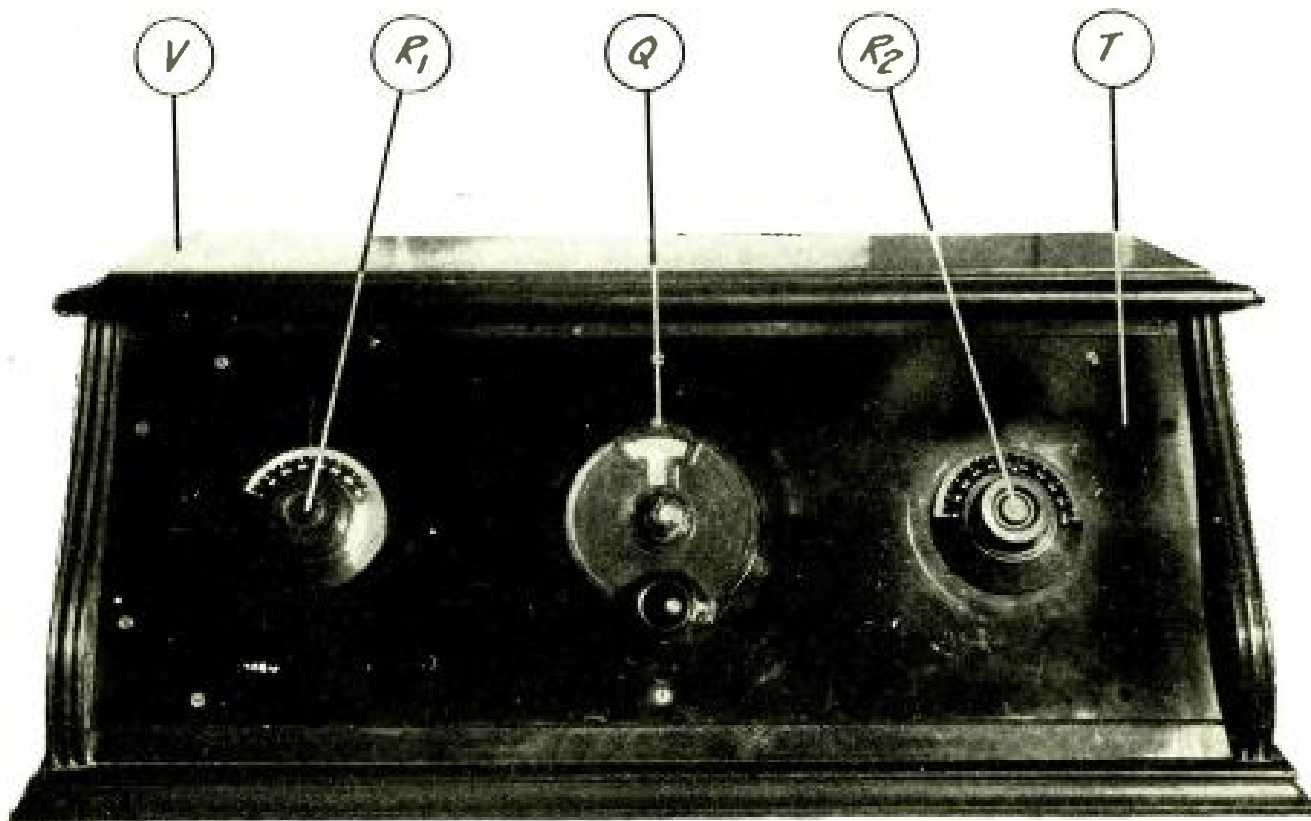

THE FRONT VIEW OF THE NEW RECEIVER

FIGURE 3: How the set looks from the front. As the dials and knobs are marked with letters which correspond to the instruments to which they are attached, the prospective operator will have no trouble in locating the various tuning controls, as they are explained in the instructions for tuning.

the plate-current flow of tube O2 is increased. In other words, the reception of a signal from a broadcasting station will simultaneously *increase* the plate-current flow of one tube and *decrease* that of the other, at one instant, and at the next instant will reverse the process. The frequency of these reversals will, of course, depend on the frequency of the signal being received.

Considering the plate-coil D, it will be noted that the left\* half of it is included in the plate-circuit of tube O1 and the right half is included in the plate-circuit of tube O2. This being the case, any variation of current in the plate-circuit of tube O1 will be effective upon the left half of the plate-coil D. This variation of current flowing through the left half of the plate-coil D will set up, by induction, a current of magnified voltage in the entire winding of the plate-coil D. Similarly, any variation of current in the plate circuit of tube O2 will affect the right half of the plate coil D, and will also set up a current of magnified voltage in the entire winding. From the foregoing it will be seen that the plate-coil D is the equivalent of a transformer with a secondary and two primary windings.

It is to be noted that the plate current of tube O1 flows through the plate coil D in the reverse direction to that of tube O2. This being the case, an *increase* of current in the plate circuit of tube O1 will induce in the plate coil D a current in phase with that induced by

a decrease in the current of tube O2, and vice versa. It is therefore evident that as the plate current of one tube is always increased when that of the other is decreased, the induced currents in the entire winding of the plate coil D will always be in phase and additive. These combined currents are passed through the detector L and being rectified make themselves effective upon the primary of audio transformer H as a pulsating current. This induces a voltage of audio frequency in the secondary of audio transformer H, which is applied to the grids of tubes O1 and O2. It is to be noted that as grid coil B and auxiliary coil C have a relatively small amount of inductance and practically zero impedance to audio-frequency currents, the grids may be considered as being connected in parallel to transformer H when considering audio-frequency currents.

The tubes O1 and O2 will therefore act as audio amplifiers in *parallel*, for as the plate currents of tubes O1 and O2 flow through the primary of transformer I in the same direction, the plates may also be considered as being in parallel when considering audio-frequency currents.

The secondary of audio transformer I is in the input circuit of tube O3, and since tubes O3 and O4 act as straight audio amplifiers, no explanation of their operation is necessary.

\*It is to be noted that "upper," "lower," "right" and "left" refer in this case to the position on the Figure 1 and not on the receiver itself.

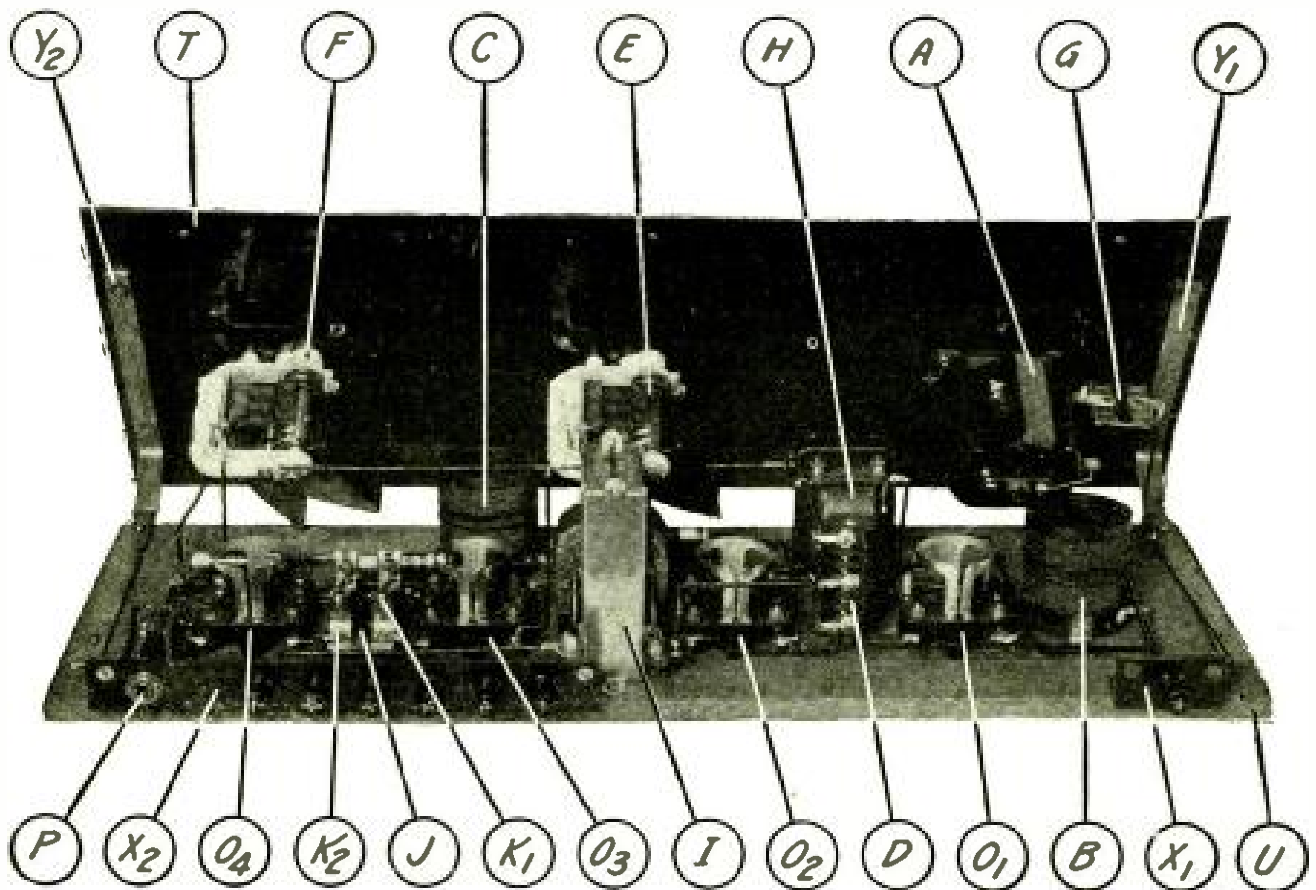

VIEW OF THE SET FROM THE REAR

FIGURE 4: This picture shows the general arrangement of all the instruments fastened to the panel or base. The exact locations for the instruments are shown in Figure 5.

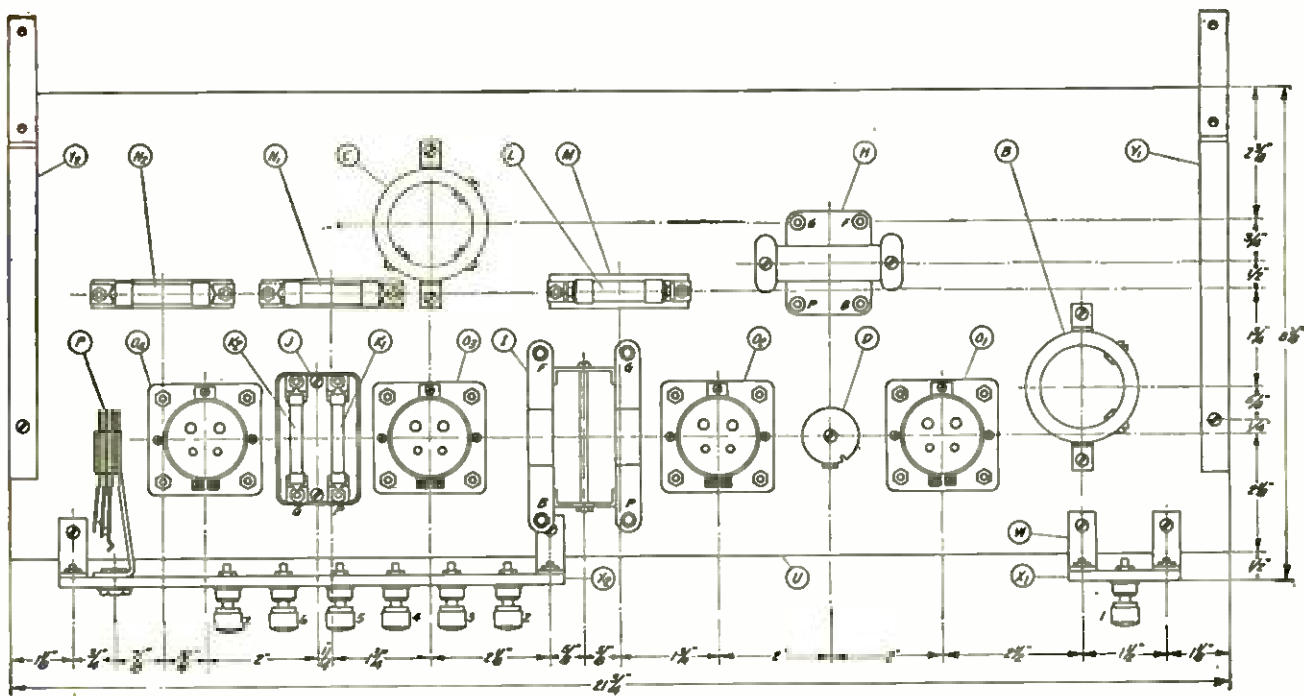

THE WORKING DRAWING FOR CONSTRUCTION

FIGURE 5: Here are shown the correct positions for the instruments which are mounted on the baseboard. The positions are given center to center, for all instruments.

So far we have not considered the action of auxiliary coil C, as it has been assumed that it was removed or short-circuited. We have noted above that the variations of plate current through the tubes O1 and O2, due to the incoming signals, induced combined and magnified currents in the plate coil D, these currents being of the same frequency as the oscillations derived from the antenna circuit. It will be found that, due to the distributed capacity of the windings of audio transformer H, and due to the capacity between the windings, a great amount of this radio-frequency current from the plate coil D leaks into the secondary of audio-frequency transformer H, without being rectified.

It will be found that, at any one instant, if the grid of tube O1 assumes a positive charge (and consequently the grid of tube O2 assumes a negative charge) a potential of positive sign appears at the left-hand end of the secondary of audio transformer H. During the other half of the cycle it will assume a negative potential, it being noted that at any instant the radio-frequency potential of terminal F- of transformer H is the same as that of grid O1 and opposite to that of grid O2.

To simplify matters we will consider the action of auxiliary coil C when the grid of tube O1 becomes positive and the grid of tube O2 becomes negative. As the potential at the F- terminal of audio transformer H is the same as grid O1, it will also be positive at this instant. Now, in the absence of auxiliary coil C, this reflexed positive charge would be applied directly to the grid of tube O2, whose potential at this instant is negative, due to the oscillations from the antenna. It will be seen that these potentials would tend to nullify or neutralize one another.

Similarly, in the absence of the auxiliary coil C, the reflexed positive potential being applied to the grid of tube O1 through the resonant circuit comprising the grid coil B and the condenser E, would have its sign reversed and would be applied to grid O1 as a negative charge. The grid O1 at this instant being positive, these potentials would nullify one another as in tube O2.

We will now consider the action of the reflexed potential when the auxiliary coil C is included in the circuit. The reflexed radio-frequency potential at F- of transformer H, which we assumed to be positive at this instant, is applied to the grid of tube O2 through the resonant circuit comprising auxiliary coil C and condenser F. This circuit, being resonant to the frequency of the reflexed radio-frequency current, will cause a considerable voltage to be built up, the phase of the reflexed radio-frequency current will be reversed, and instead of a positive potential, a higher negative potential will be applied to grid O2, and as the grid of tube O2 is already negative (at this instant), due to the incoming signal, this reflexed potential will reinforce the potential derived from the antenna.

Similarly, the original reflexed positive potential will have its sign reversed to negative by auxiliary coil C and reversed back to positive by the grid coil B and will be applied as a magnified positive potential to grid O1, reinforcing the positive potential already on grid O1 due to the incoming signal.

With the theory of the action of the Orthophase circuit in mind, it is felt that it will be much easier to build and operate the receiver described in this article, and we may now proceed with the actual construction.

The schematic diagram is shown in Figure 1.

### Parts Used in Building the Set

In all the diagrams in this article each part bears a designating letter; in this way, the prospective builder of a set may easily determine how to mount the instruments in the correct places and connect them properly in the electric circuit.

The same designating letters are used in the text and in the list of parts at the beginning of the article. (See page 142.)

### How to Construct the Set

After procuring all the instruments and materials for building the set, the amateur should prepare the panel T. (Shown in Figures 4, 5, 6 and 7.)

First of all, cut the panel to the correct size, 8 by 22 inches. Then square up the edges

smoothly with a file. The centers for boring the holes (which are necessary for mounting the instruments) should be laid out on the panel as shown in Figure 9. A convenient method for doing this is to lay out all center holes on a piece of paper the same size as the panel; then the piece of paper may be fastened on the panel and the centers marked directly on the panel by punching through the paper with a sharp, pointed instrument.

If all the holes to be drilled are first started with a small drill, one sixteenth inch in diameter or less, they can be more nearly centered.

The holes outlined with a double circle should be countersunk, so that the flat-head machine screws used for fastening the instruments are flush with the panel. All the rest of the holes are straight drill holes. Sizes for

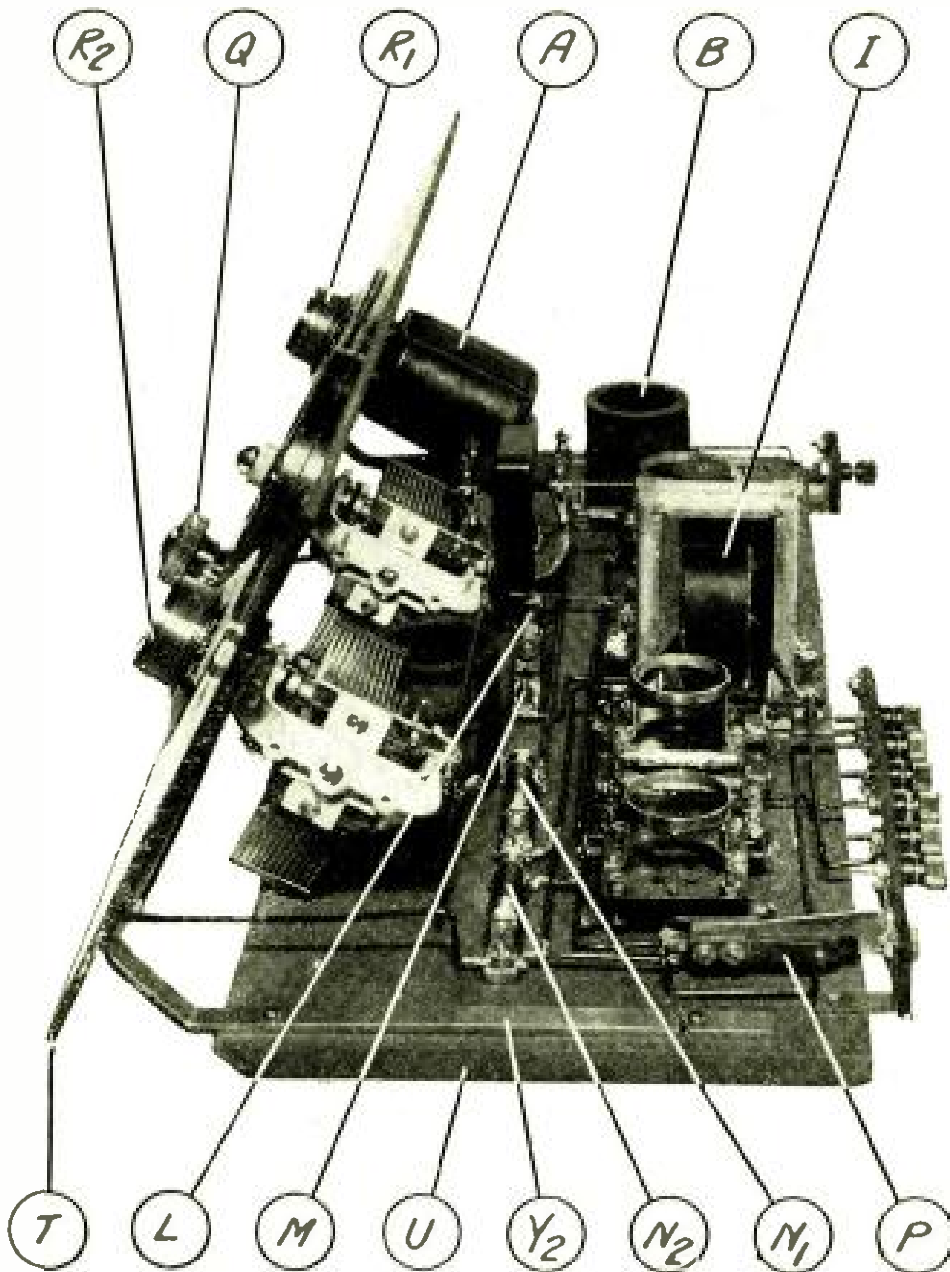

VIEW OF THE RECEIVER AS SEEN FROM THE RIGHT

FIGURE 6: This end view shows the manner in which the panel is held in position by the large brass brackets, and a general scheme of mounting the condensers, the sockets, the transformers and the battery connection block.



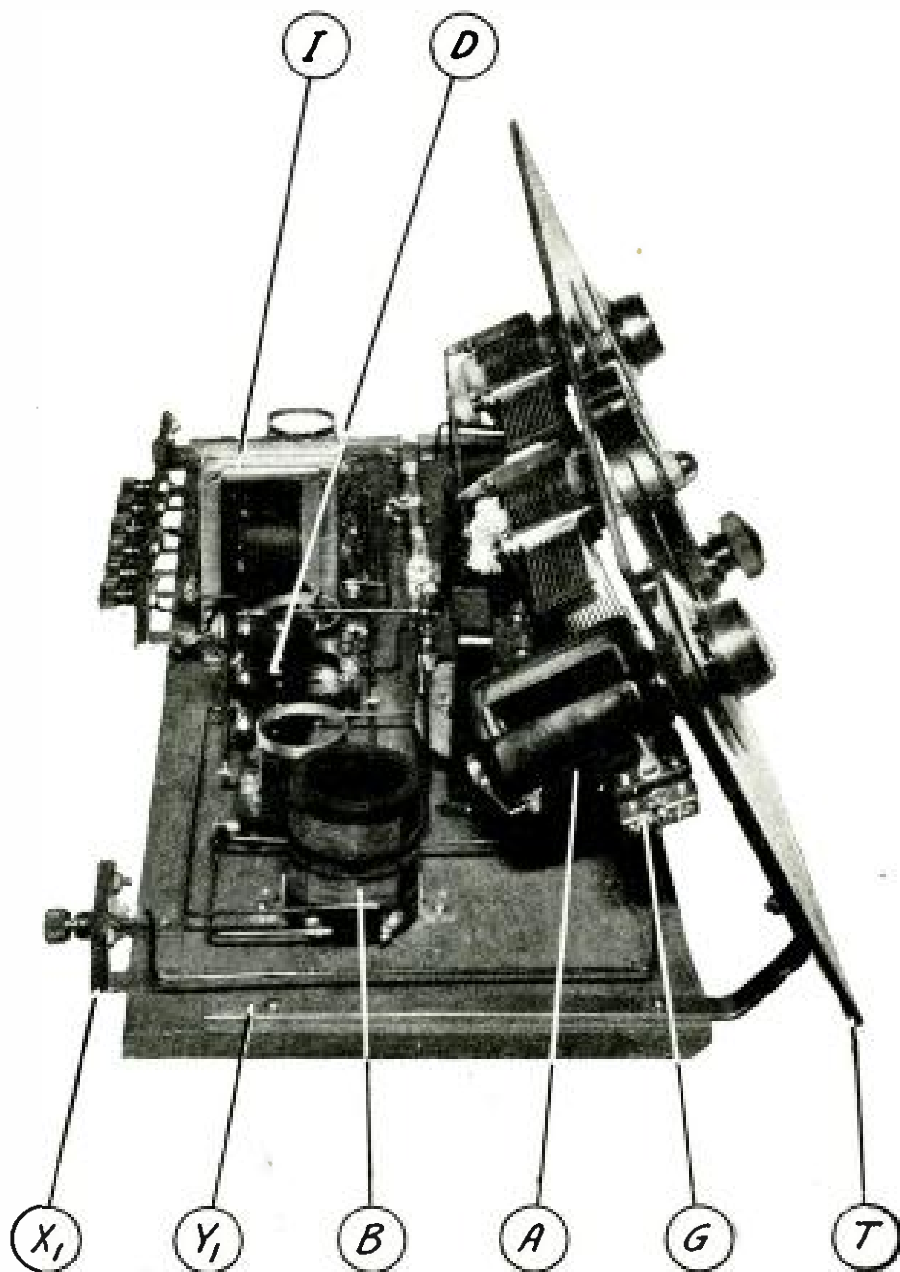

VIEW OF THE RECEIVER AS SEEN FROM THE LEFT

FIGURE 7: This illustration shows the general manner of mounting the radio-frequency transformer, the variometer and the antenna connection block.

the diameters of these holes have not been given, but the builder will readily decide what size hole is necessary by measuring the diameter of the screws and shafts of the instruments that must go through the holes.

When the panel is drilled, the builder may give it a dull finish by rubbing the face of the panel lengthwise with fine sandpaper until it is smooth. This process should be repeated, except that light machine oil should be applied during the second rubbing. Then rub the panel dry with a piece of cheesecloth. A permanent dull finish will be the result. Or, the panel may be left with its original shiny-black finish, if care has been exercised, so that it has not been scratched during the drilling.

After the panel has been prepared the experimenter is ready to mount the instruments on it.

First, attach the fixed condenser G to the variometer A by inserting the screw through the condenser lug and into the threaded terminal lug nearest the front or panel end of the variometer. (See Figures 4 and 8.)

Now, mount the variometer A on the panel T by means of two screws and nuts inserted through the panel. (See Figure 4). Make sure the two terminal lugs on the stator point *away* from the center of the panel (See Figure 8).

Then attach the dial R1 as follows: First turn the rotor of the variometer so that the front rotor lead points upward, then slip the dial onto the shaft, with the 100 mark opposite the indicating mark on the panel and tighten up the set screw in the dial. Next mount the variable condensers E and F on the panel, so that the rotor plates will swing upward when they are not meshed. (Shown in Figures 4, 6,

7 and 8). Now attach the dial R2 to condenser F by tightening the set screw in the dial, making sure that the 100 mark on the dial is opposite the indicating mark on the panel when the plates of the condenser are meshed.

After this attach the vernier dial Q to condenser E as follows: Fasten the stop pin, which is supplied with the dial, to the panel and then place the dial on the condenser shaft, making sure that the stop-pin engages the hole at the top of the dial on the reverse side. Then, with the condenser plates meshed and the dial set to the 100 degree mark, tighten up the set screw in the dial, making sure the dial is flush against the panel.

This completes the construction work on the panel and the experimenter is ready to mount the instruments on the baseboard. The baseboard is supplied with the cabinet, and it should be taken out and the instruments mounted on it as shown in Figure 5 which is the working drawing for construction.

First mount the four sockets 01, 02, 03 and 04 in their respective places as shown in Figures 4, 5, 6 and 7 with the P terminals at the front.

Next attach the amperites N1 and N2 in their

respective places as shown clearly in Figure 5. All these instruments are to be screwed directly to the baseboard. Next fasten down the resisto-coupler J as shown in Figure 5. Be sure the terminal marked P is next the similarly marked terminal on socket 03.

Next mount the grid coil B in the position shown in Figures 4, 5, 6 and 7, fastening it down with two small screws inserted through the holes in the brackets at the bottom of the coil. Be sure that the two terminals of the coil point away from the socket 01. Now, mount the auxiliary coil C in the same manner, in its correct position as shown by Figures 4, 5, 6 and 7, making sure that two terminals point to the right and the single terminal points to the left when looking at the rear of the set. (See Figure 8). Next mount the plate coil D, by noting its position in Figures 4, 5, 6 and 7, with the terminals at the rear of the set, and pointing to the left, when looking at the rear of the set.

Now mount the grid leak holder M in its correct position as shown in Figures 4, 5, 6 and 7, by screwing it down to the baseboard. Then mount the audio-frequency transformer H in

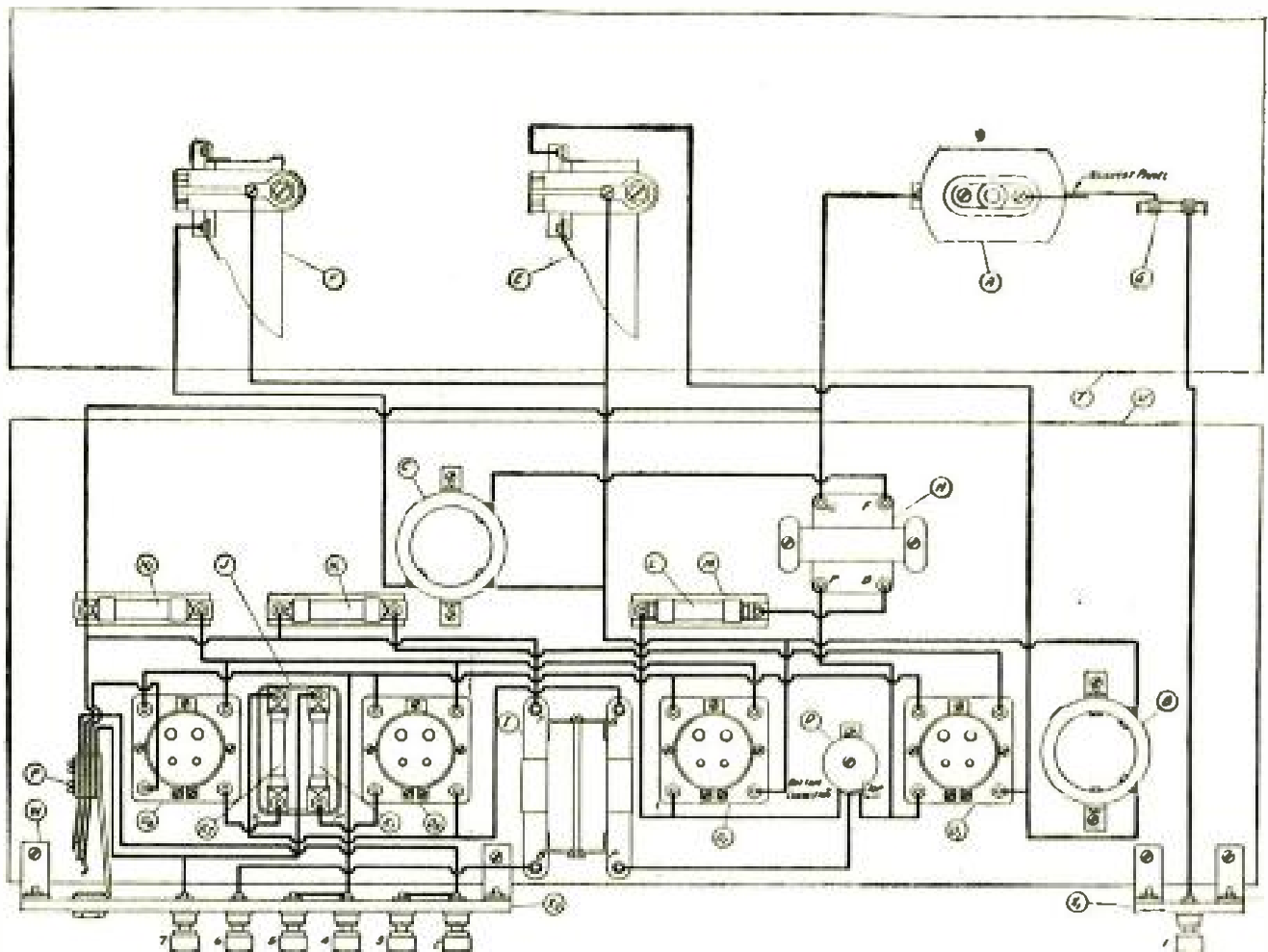

THE PICTURE DIAGRAM FOR CONNECTING UP THE VARIOUS INSTRUMENTS

FIGURE 8: The upper rectangle represents the panel and on it the instruments are drawn just as they appear. The lower rectangle represents the baseboard and the instruments are drawn in about their relative positions. The wires drawn in heavy black lines show the exact way to run the wires to connect the instruments and parts after you have mounted them according to the instructions given.

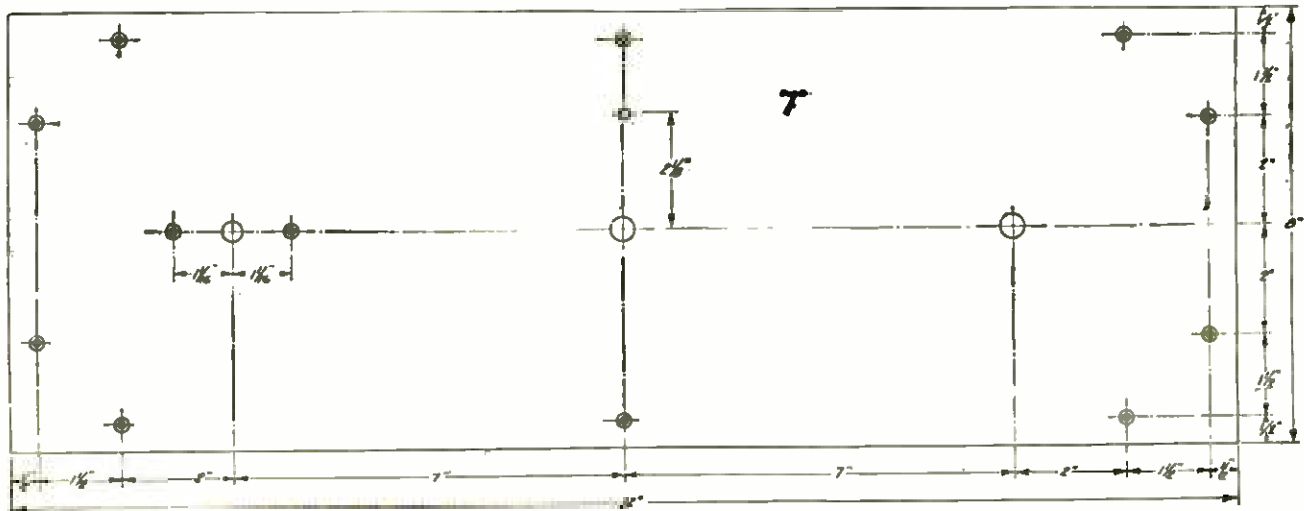

THE DRILLING PLAN FOR THE PANEL

FIGURE 9: This drawing shows where to drill the holes for mounting the instruments. The correct spacings are given for the holes. The holes outlined with a double circle should be countersunk. Always start drilling holes in the panel with a small drill—*one-sixteenth is a desirable size.*

place as shown in Figures 4, 5, 6 and 7, being sure the terminals are pointing in the direction indicated in Figure 5. The Superaudioformer I is mounted in the same manner, with like attention being paid to its terminals.

When this is done, the work on the baseboard may be left for a while and the two connection blocks X1 and X2 (the dimensions of which are shown in Figure 12), should be prepared and the binding posts attached. The small brass brackets may then also be screwed tight to the blocks and the jack P mounted on the larger block X2.

Now fasten down the two blocks X1 and X2, on the sub-base U by means of four screws inserted through the brass brackets into the baseboard. Their position may be found on Figure 5.

Then prepare the two large brass brackets Y1 and Y2, which are to be used for attaching the main panel T to the base U at the proper angle; the dimensions for these angles including the drilling and bending are also shown in Figure 13. Be sure that you have the angles made with the correct drilling holes and bends so that the panel will fit evenly. Then mount the panel in position on the brackets. This had best be done by slipping the baseboard U in position in the cabinet with the brackets Y1 and Y2 attached and then fastening the panel in position with four screws.

You are now ready to start on the wiring as the construction work is completed.

#### *How to Wire the Set*

The design of this receiver is such that the wiring of the grid circuit of each of the four tubes is as short as possible and is isolated from the other parts of the circuit. In fact, this idea has been employed throughout and the leads are so arranged that the shortest connections may be used. As this is the case, the set should be wired with bus bar.

Either a tinned-copper, round bus-bar or an insulated round bus-bar such as "Celatsite" may

be used for the connection. All connections should first be shaped so that they will fit. They should then be soldered in place. Refer to the wiring diagram in Figure 1 and more specifically to the picture diagram in Figure 8 for the exact way in which to run the wires.

Start the wiring by running a wire from binding post No. 1 to the end of condenser G not attached to the variometer A.

Next run a wire from binding post No. 2 to binding post No. 3 and continue it over to the extreme left-hand\* spring of the jack P. Now run a wire from the second spring from the left of the jack P to the left end of Amperite N2. Then run an extension of this wire to the left end of the Amperite N1 and continue it over to the F-terminal of transformer I.

Now going back to the left end of Amperite N2; run a wire from this point over to the panel and parallel to same, connecting it to the left-hand screw of the bracket that holds the variometer A to the panel. Now extend this wire over to the G terminal of the transformer H.

Next run a wire connecting the left front terminals of all the sockets O1, O2, O3 and O4 together. (These are the F+ terminals of the sockets.) Now run a wire from the left front terminal of socket O3 to binding post No. 4 and also extend it to binding post No. 5. This last wire should be run between socket O3 and the resisto-coupler J.

Now run a wire from the right-hand end of Amperite N2 to the front right-hand terminal of the socket O4 and run an extension of this wire to the front right-hand terminals of the sockets O3 and O2.

Next, run a lead from the right-hand end of Amperite N1 to the front right-hand F terminal of the socket O1. Then, run a wire from binding post No. 6 to the B terminal of transformer I.

\*The front connection on any instrument refers to the side of the instrument nearest the panel and right and left refer to the constructor's right and left as he sits facing the back of the set in wiring up.

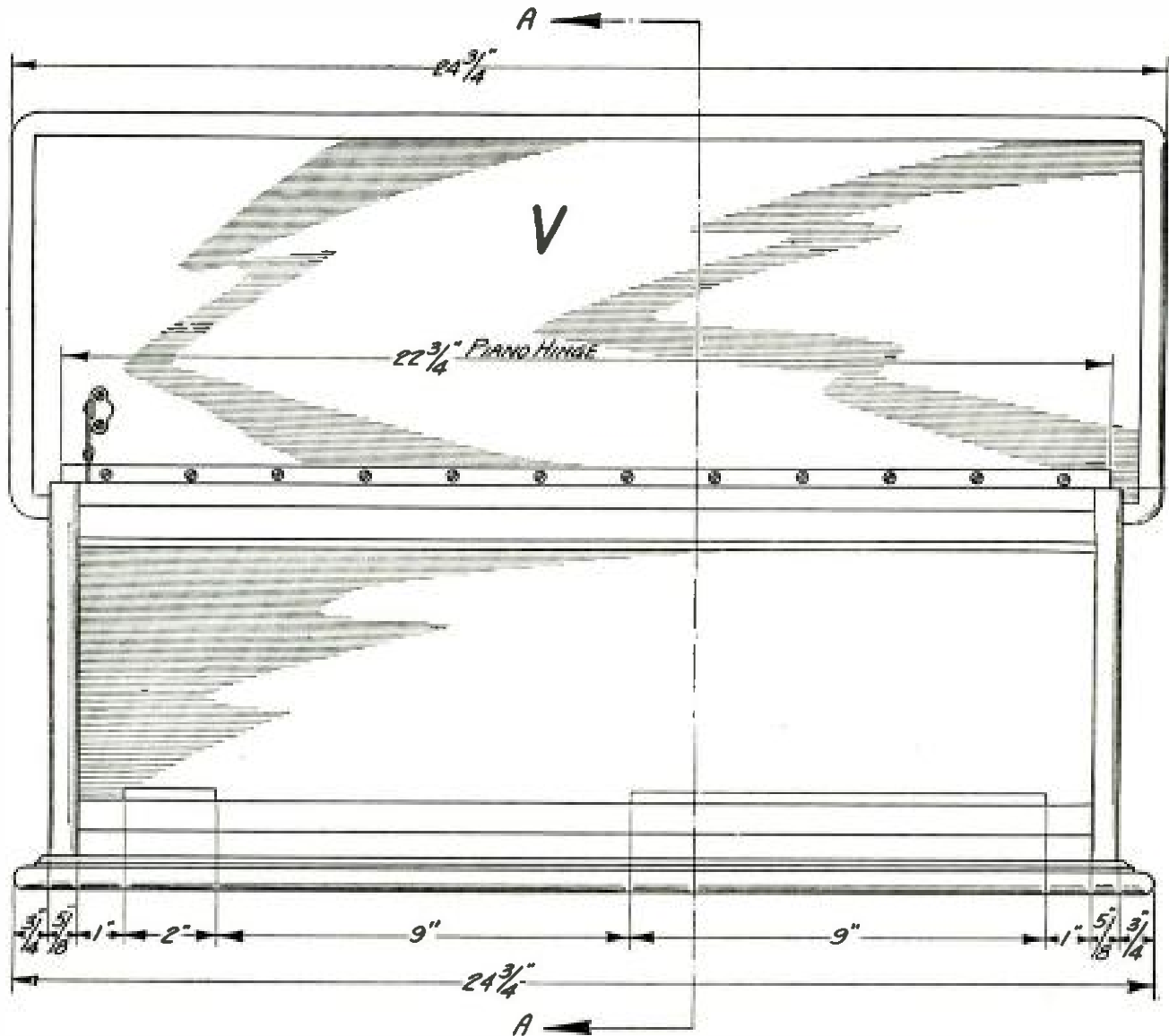

After this, run a wire from binding post No. 7 to the right-hand connection or frame of the jack P. Also run an extension of this wire to the B terminal of the resisto-coupler J.

Now connect the middle or remaining spring of the jack P to the P terminal of the socket O4.

Next connect the G terminal of the socket O4 to the G terminal of the resisto-coupler J, and connect the P terminal of the resisto-coupler J to the P terminal of the socket O3. These last three connections are very short.

Now, run a lead from the G terminal of the socket O3, between the socket O3 and the transformer I, and around to the G terminal of transformer I. Next run an extension from this point over to the F terminal of the resisto-coupler J.

Next, connect the terminal marked P on the transformer I to the center terminal of the plate coil D.

Now connect the bottom terminal of the plate coil D to the terminal marked P on the socket O2. Then run an extension of this wire to the left end of the grid leak holder M, taking care to keep this last lead at least a quarter of an inch from the core of transformer I. The lead should run between socket O2 and transformer I. After this, run a wire from the

right-hand end of grid-leak holder M to the terminal of transformer H, which is marked B.

Then run a lead from the terminal marked P on the transformer H to the top connection of plate coil D. Next, run an extension of this lead from here to the terminal marked P on the socket O1. Now, run a wire from the rear connection of the grid coil B to the G terminal on the socket O1. Then run an extension of this wire, between the grid coil B and the socket O1, connecting it to the lower stator terminal of the variable condenser E. Make sure this lead is kept one-half inch from the transformer H.

Next connect the front terminal of the grid coil B to the grid terminal (marked G) on the socket O2. Then extend this lead, between the socket O2 and the plate coil D, between the grid-leak holder M and the transformer H, and connect it to the rotor terminal of the condenser E. Then run a further extension over to the rotor of the condenser F. After this run a wire from the rear right-hand terminal of the auxiliary coil C, directly up and solder it on the lead running from the rotor of condenser E to the rotor of condenser F.

Next connect the rear left-hand terminal of auxiliary coil C to the upper stator connection of the condenser F.



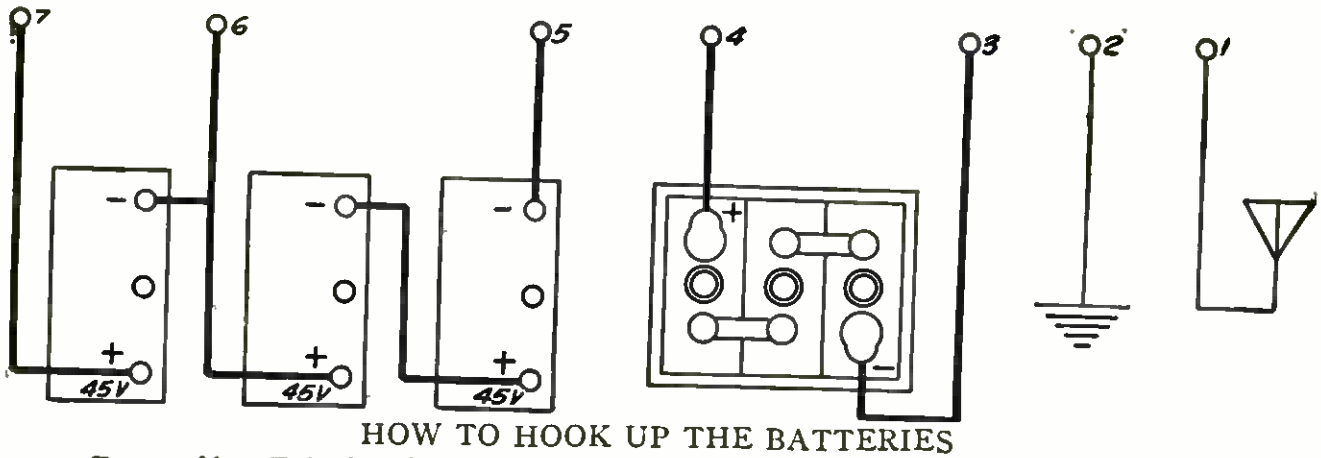

HOW TO HOOK UP THE BATTERIES

FIGURE 11: This drawing prevents the builder from making mistakes in connecting the batteries to the terminals of the receiver. Follow these instructions and the set will be hooked up correctly, because the terminals shown in the wiring diagrams are marked with designations that correspond with the numbers given here.

In searching for distant stations, dial Q may be revolved slowly from zero to the maximum, at the same time turning dial R2 at the same rate of speed, keeping the latter dial at a setting just below that which produces the humming. If desired, stations may be located by means of the "carrier-wave-beat note" method, which is commonly used in tuning ordinary regenerative receivers.

Once the station is located, its volume may be improved as outlined above for local stations and if desired the settings of the dials logged for future reference, although it is not necessary to log any except dial Q.

In turning off the set it is necessary only to withdraw the loudspeaker plug from the jack P and the current supply to the filaments is automatically cut off.

An Orthophase receiver similar to the one herein described has consistently received Pacific Coast stations in New York City on a short indoor antenna of fifteen feet, in all but the poorest radio weather, when the static level

was too high to permit tuning the receiver to its most sensitive condition.

Of course, it is understood that wherever possible an antenna of 60 feet to 120 feet should be used, as less critical tuning is required to secure equal results.

In periods of heavy static the antenna may be disconnected entirely, and by shifting the ground wire from binding post No. 2 to binding post No. 1, satisfactory results may be had, on local reception and also on distant reception in most localities. The condenser G must be short-circuited in this case.

Regarding selectivity, it might be well to mention that KFI in Los Angeles has been tuned in in New York City, while WJZ in New York and WCAP in Washington, D. C., were in operation. By referring to the wavelengths of these three stations, the remarkable selectivity of the Orthophase will be apparent, the above being only one example of this quality.

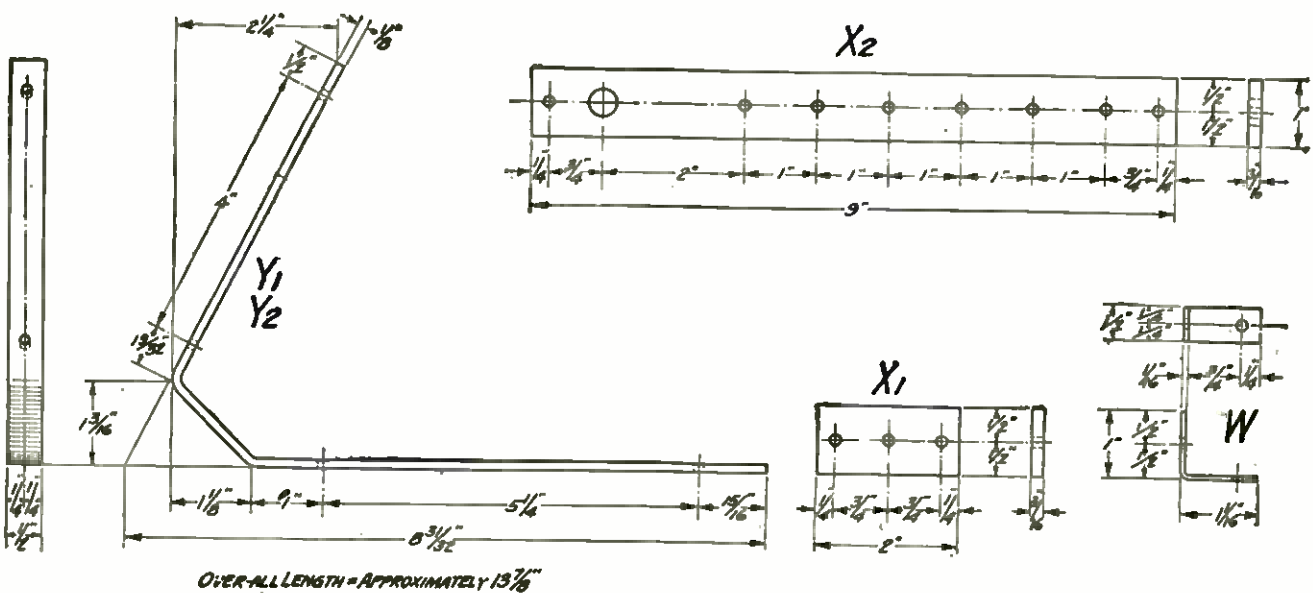

OVER-ALL LENGTH - APPROXIMATELY 13 7/8"

DETAILS OF THE BRASS BRACKETS AND THE CONNECTION BLOCKS

FIGURE 12: This drawing gives the necessary data for making the insulated blocks on which the binding posts are to be mounted; it also gives the dimensions for the large and small brass brackets that are used to fasten the large and small panels to the baseboard.

A Tuning Chart to Adjust to Your Own Set

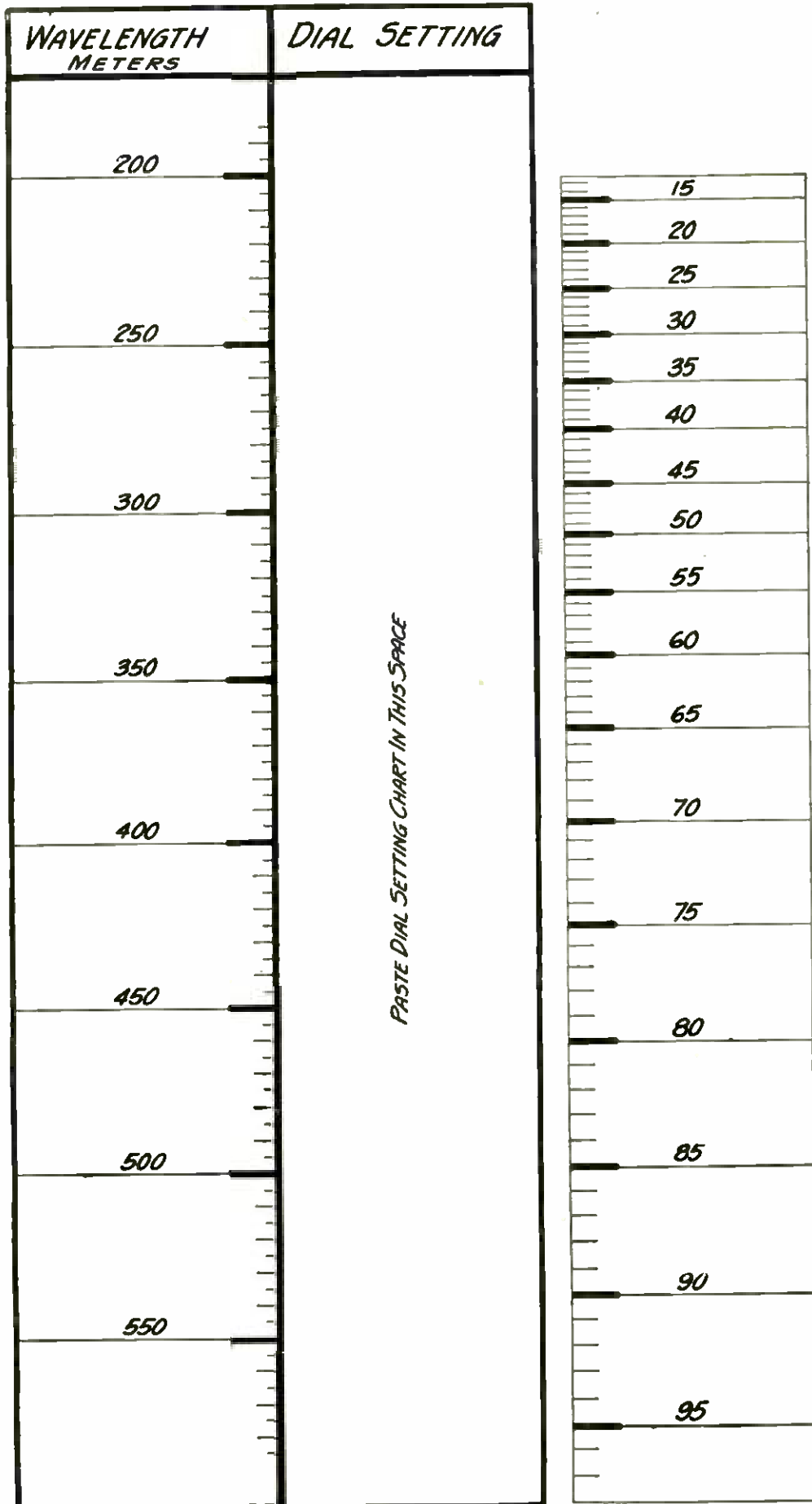

FIGURE 13: Cut out the chart at the left and paste it on a piece of thin, stiff, white, bristol paper. Then cut out the small chart at the right. It should be pasted in position on the blank space on the right-hand side of the main chart underneath the heading "Dial Setting." To get it in exactly the right position tune in a station of around 350 to 450 meters and find out what setting it comes in on on your dial. For instance, a station on 405 meters would come in somewhere near 72, 73 or 74 on your dial according to the variation of the condenser in the set. If it comes in at 73 (say), paste the dial setting part of the chart in place so that 405 meters on the wavelength scale is exactly opposite 73 on the dial setting scale. Then all the other stations will tune in exactly as indicated by the completed chart.



From a photograph made for POPULAR RADIO

#### AN OPERATING TEST ON THE NEW RECEIVER

*In this photograph is pictured the installation of the LC-26 receiver in the Washington Hotel at Washington, D. C., during the reception of distant stations. A cone-type loudspeaker was used. The designer of the circuit is shown tuning in the various broadcasters while the author writes down the call letters as verified by the listeners.*

## Country-wide Tests of the New LC-26 Receiver

Here are given the results of the reception on the receiver first described in the December issue of POPULAR RADIO as installed in various sections of the country and operated before authoritative witnesses. Can you match these records with your own receiver?

Anyone with a LC-26 set should be able to do it.

By WALTER L. RAYMOND

THE description of the construction of the LC-26 Broadcast Receiver in the December issue of POPULAR RADIO created such widespread interest among experimenters and set builders that it was followed by another article in the January issue with complete details of operation of this set.

Since then, however, so many letters have been received asking about the results that could be obtained in different sections of the country that the staff of POPULAR RADIO has taken one of its receivers to various cities and operated it in the presence of witnesses to determine

just what the receiver would do under varying local conditions.

The first test was conducted at New Haven, Conn., at the home of Mr. William Austin, Jr. The receiver was set up and attached to a 100-foot single-wire antenna that was already installed in connection with a Four-circuit Tuner. The new LC-26 receiver was installed in its place and a record made on the receiver starting at 11 o'clock in the morning.

Not only was this well known "dead spot," (so far as New York stations are concerned), overcome, but the following New York stations



were brought in with approximately the same volume as when received in New York City:

- |      |      |
|------|------|
| WFBH | WMCA |
| WRNY | WEAF |
| WJZ  | WNYC |
| WOR  |      |

The receiver also brought in on the loudspeaker, stations:

- |                           |                         |
|---------------------------|-------------------------|
| WOO, Philadelphia, Pa.    | WEEL, Boston, Mass.     |
| WPG, Atlantic City, N. J. | KDKA, Pittsburgh, Pa.   |
| WBZ, Springfield, Mass.   | WGY, Schenectady, N. Y. |

An almost unbelievable distance record for the daytime was also made in bringing in station WMBF in Florida before 4 o'clock in the afternoon.

The list of stations received during the evening comprised stations in the Middle West and Canada and as far south as Miami.

The New York stations were received clearly on the loudspeaker by using just the ground alone.

The next test was made in New York City before a group of well known engineers. In one complete revolution of the tuning dial from zero to 100, the following stations were picked up in succession:

- |                           |                              |
|---------------------------|------------------------------|
| WSBC (at 209.7 meters)    | WEBH, Chicago, Ill.          |
| WOK, Chicago, Ill.        | WGY, Schenectady, N. Y.      |
| WBBR, New York, N. Y.     | WMBF, Miami, Fla.            |
| WGCP, New York, N. Y.     | WEAR, Cleveland, O.          |
| WRNY, New York, N. Y.     | WTAM, Cleveland, O.          |
| WAAM, New York, N. Y.     | WFI, Philadelphia, Pa.       |
| WEBJ, New York, N. Y.     | WJY, New York, N. Y.         |
| WEBH, New York, N. Y.     | WLW, Cincinnati, O.          |
| WEEL, Boston, Mass.       | WSB, Atlanta, Ga.            |
| WOAN, Lawrenceburg, Tenn. | WMAF, South Dartmouth, Mass. |
| WPG, Atlantic City, N. J. | WJZ, New York, N. Y.         |
| WLIB, Chicago, Ill.       | WCAE, Pittsburgh, Pa.        |
| KDKA, Pittsburgh, Pa.     | WRC, Washington, D. C.       |
| WJAR, Providence, R. I.   | WBAP, Ft. Worth, Tex.        |
| WAHG, New York, N. Y.     | WOC, Davenport, Ia.          |
| KOA, Denver, Colo.        | WEAF, New York, N. Y.        |
| WSAI, Cincinnati, O.      | WOO, Philadelphia, Pa.       |
| WBZ, Springfield, Mass.   | WNYC, New York, N. Y.        |
| WMCA, New York, N. Y.     | KYW, Chicago, Ill.           |
| WJIN, New York, N. Y.     | KSD (at 546 meters)          |

This makes a total of 40 stations in twenty-five different cities, located throughout the United States. These stations were all received when using an outside antenna of about 110 feet in length. The reception was accomplished entirely on a loudspeaker.

A more thorough test at New York City lasting for two days between the hours of 11:30 P. M. and 1:30 A. M. Eastern Standard Time was made and the following stations were logged:

- |                         |                           |
|-------------------------|---------------------------|
| WCBD, Zion City, Ill.   | CHYC, Montreal, P. Q.     |
| WIP, Philadelphia, Pa.  | WNAC, Boston, Mass.       |
| WGR, Buffalo, N. Y.     | WEAN, Providence, R. I.   |
| KPRC, Houston, Tex.     | WKRC, Cincinnati, O.      |
| WCAD, Canton, N. Y.     | WFI, Philadelphia, Pa.    |
| WOC, Davenport, Ia.     | WSB, Atlanta, Ga.         |
| WBAP, Ft. Worth, Tex.   | WJAR, Providence, R. I.   |
| KFKX, Hastings, Nebr.   | PWX, Cuba                 |
| KLX, Oakland, Cal.      | WPG, Atlantic City, N. J. |
| WEAR, Cleveland, O.     | WEBH, Chicago, Ill.       |
| WHT, Chicago, Ill.      | WREO, Lansing, Mich.      |
| KFI, Los Angeles, Cal.  | WHT, Chicago, Ill.        |
| WRC, Washington, D. C.  | WHIO, Des Moines, Ia.     |
| WBZ, Springfield, Mass. | WOI, Chicago, Ill.        |
| KDKA, Pittsburgh, Pa.   | WSM, Nashville, Tenn.     |
| WJR, Pontiac, Mich.     | WENR, Chicago, Ill.       |
| WLW, Cincinnati, O.     | WMAQ, Chicago, Ill.       |
| KOA, Denver, Colo.      | WHAZ, Troy, N. Y.         |
| KGO, Oakland, Cal.      | CFCF, Montreal, P. Q.     |
| WOJ, Chicago, Ill.      | WDZ, Tuscola, Ill.        |
| KYW, Chicago, Ill.      | WOAN, Lawrenceburg, Tenn. |
| KSD, St. Louis, Mo.     |                           |
| WCAU, Philadelphia, Pa. | WGY, Schenectady, N. Y.   |
| WCAE, Pittsburgh, Pa.   | WHAM, Rochester, N. Y.    |

- |                                   |                                |
|-----------------------------------|--------------------------------|
| WGN, Chicago, Ill.                | CKAC, Montreal, P. Q.          |
| WEEL, Boston, Mass.               | WCAP, Washington, D. C.        |
| WSMB, New Orleans, La.            | BM, Chicago, Ill.              |
| WOK, Chicago, Ill.                | WMAF, South Dartmouth, Mass.   |
| WLIT, Philadelphia, Pa.           |                                |
| WCCO, St. Paul-Minneapolis, Minn. | WSAI, Cincinnati, O.           |
| WFAA, Dallas, Tex.                | WMC, Memphis, Tenn.            |
| WLS, Chicago, Ill.                | WMBF, Miami, Fla.              |
| WCX, Pontiac, Mich.               | WOO, Philadelphia, Pa.         |
| WWJ, Detroit, Mich.               | WTIC, Hartford, Conn.          |
| WLIB, Chicago, Ill.               | WGBU, Fulford-by-the-Sea, Fla. |
| CNRO, Ottawa, P. Q.               | WGN, Chicago, Ill.             |
| WHB, Kansas City, Mo.             | WOS, Jefferson City, Mo.       |
| WOAW, Omaha, Nebr.                | WWAE, Plainville, Ill.         |

In a test in the same city for operation through interference the following stations



Brown Bros.

THE ANTENNA INSTALLATION

In this picture of the Blackstone Hotel in Chicago is shown the exact location of the single-wire antenna that was swung from one window to another during the tests. The antenna is shown by the white line and the lead-in was located by the point indicated by the black arrow.

were logged without interruption from nearby stations: WGN, of Chicago, was received through WHN; WHT was received through WJY; WIP of Philadelphia and WOC of Davenport were received through stations WEA and WNYC, New York. KYW was also received through WNYC. Station WQJ in Chicago was received through WJZ, New York. Stations WPG, WJAR, WLIB and KDKA could also be received without interference while all of them were on the air.

The next test was made in Washington at the Washington Hotel. Mr. Cockaday, who was a member of the Hoover Radio Conference and the author took one of the sets to Washington and set it up in a suite on the eighth floor and had a single-wire antenna rigged up on the roof about 120 feet including the lead-in. In daylight at Washington, WJZ and WEA were brought in clearly on the loudspeaker and also the new experimental super-power station 2XAR of the Radio Corporation of America. These were received during their noon-hour broadcasting.

The Washington Hotel itself is only about three blocks from WCAP in Washington. The following stations were logged during three evenings:

WEBH, Chicago, Ill.	WILAZ, Troy, N. Y.
WBBM, Chicago, Ill.	WSB, Atlanta, Ga.
WOK, Chicago, Ill.	WCAE, Pittsburgh, Pa.
WHT, Chicago, Ill.	WCX, Pontiac, Mich.
WLIB, Chicago, Ill.	WJR, Pontiac, Mich.
NAA, Washington, D. C.	WHO, Des Moines, Ia.
WLW, Cincinnati, O.	WFBH, New York, N. Y.
KOA, Denver, Colo.	KOIL, Council Bluffs, Ia.
WEAF, New York, N. Y.	WLIT, Philadelphia, Pa.
WIP, Philadelphia, Pa.	WAHG, New York, N. Y.
WBZ, Springfield, Mass.	WFI, Philadelphia, Pa.
WFI, Philadelphia, Pa.	KYW, Chicago, Ill.
WCAP, Washington, D. C.	WSAI, Cincinnati, O.
WRC, Washington, D. C.	WOR, Newark, N. J.
KDKA, Pittsburgh, Pa.	WOAN, Lawrenceburg, Tenn.
WRCA, Richmond, Va.	WBAP, Fort Worth, Tex.
WJZ, New York, N. Y.	WOAW, Omaha, Nebr.
WMCA, New York, N. Y.	WTAM, Cleveland, O.
WMBF, Miami Beach, Fla.	WOO, Philadelphia, Pa.
2XAR, Bound Brook, N. J.	WGY, Schenectady, N. Y.
WEEL, Boston, Mass.	WDAF, Kansas City, Mo.
WJBL, Decatur, Ill.	KGW, Portland, Ore.
WSM, Nashville, Tenn.	
WSMB, New Orleans, La.	

It will be noticed that the country was pretty well covered from Washington.

The last test was made in Chicago at the Blackstone Hotel, which is located only two blocks from the powerful Westinghouse station KYW. A 100-foot wire was installed along the ledge of the windows on the tenth floor of this building, which has twenty-two floors in

all. A wire was brought into the living room and attached to the LC-26 with the steam radiator pipe used as a ground.

The following list of out-of-town stations was received during the week of tests between the hours of 11:30 P. M. and 2 A. M. Central Standard Time:

KDKA, Pittsburgh, Pa.	KPRC, Houston, Tex.
WPG, Atlantic City, N. J.	KFI, Los Angeles, Calif.
WSMB, New Orleans, La.	WEAH, Wichita, Kan.
WGR, Buffalo, N. Y.	WJJD, Mooseheart, Ill.
WSAI, Cincinnati, O.	WKAR, Lansing, Mich.
WGAZ, South Bend, Ind.	WBAP, Ft. Worth, Tex.
KTHS, Hot Springs, Ark.	WRC, Washington, D. C.
WIAZ, Troy, N. Y.	WOC, Davenport, Ia.
WTAM, Cleveland, O.	WJR, Detroit, Mich.
WOR, Newark, N. J.	WOAW, Omaha, Nebr.
WSB, Atlanta, Ga.	WLW, Cincinnati, O.
WOS, Jefferson City, Mo.	KFI, Los Angeles, Calif.
WCAE, Pittsburgh, Pa.	WKRC, Cincinnati, O.
WBAP, Fort Worth, Tex.	WHB, Kansas City, Mo.
WEAF, New York, N. Y.	WBAP, Ft. Worth, Tex.
WJR, Detroit, Mich.	WFBC, Knoxville, Tenn.
WHO, Des Moines, Ia.	WCAU, Philadelphia, Pa.
WSUI, Iowa City, Ia.	WSBT, South Bend, Ind.
WAHG, Richmond Hill, N. Y.	WDAF, Kansas City, Mo.
WSM, Nashville, Tenn.	KYW, Chicago, Ill.
WLIB, Elgin, Ill.	KFKX, Hastings, Nebr.
WCX, Detroit, Mich.	KPNF, Shenandoah, Ia.
WFAA, Dallas, Tex.	WAFB, Port Huron, Mich.
	KNX, Hollywood, Calif.

The following Chicago stations were received without interference from KYW:

WSBC	WBCN
WENR	WMAQ
WQJ	WHT
WBBM	WLS
WOK	WMBB
WIBO	WGN
WCES	WEBH

Stations KDKA in Pittsburgh; WBAP Fort Worth; WPG Atlantic City; WAHG Richmond Hill, New York, were received while KYW was broadcasting.

Stations WOC Davenport; WEA New York; KDKA Pittsburgh; WLW Cincinnati and WHB Kansas City were received in the middle of the day.

One station whose call letters were not obtained was heard through great static, talking in Spanish. This station finally signed off by announcing in English that the time was 11:35. The time in Chicago (C. S. T.) was 12:35 A. M. This station signed off with chimes.

This series of tests conducted by engineers of POPULAR RADIO's technical staff and witnessed by other reliable authorities on radio reception should be of interest to radio fans and experimenters all over the country who wish to satisfy themselves of the selectivity and sensitiveness of the new receiver.

## Use Popular Radio Blue Prints in Building the Orthophase Receiver

WHILE experienced set-builders will be able to construct the Orthophase Receiver (described in this issue) from the description and design shown in the article, it will be found much easier if POPULAR RADIO blue prints are used. These prints save time because the panel and instrument layout prints (which are exact size) may be used as templates, thus eliminating the necessity of making careful measurements for drilling holes and locating instruments. The wiring diagram is approximately exact size; it shows the location of all wires and connections desirable for greatest efficiency. A set of blue prints of the Orthophase Receiver will be sent postpaid on receipt of \$1.00 per set sent to POPULAR RADIO SERVICE BUREAU, 627 West 132d Street, New York City.

# "What Set Shall I Buy?"

*A guide to the prospective buyer of a ready-made receiver*

LESS than a year ago there were only a very few ready-made sets on the market; today there are about 140, ranging from small and inexpensive crystal receivers, which sell for as low as four or five dollars, to elaborate superheterodynes that run into the hundreds. Those that have been approved by the POPULAR RADIO LABORATORY will be pictured each month until the series is completed. They will be accompanied by brief but specific data concerning them—as a helpful guide to the broadcast listener and to the prospective listener who is thinking of selecting the receiver that will best meet his special needs as well as the limitations imposed by his purse. The data following each of the sets pictured in this series are the manufacturers own specifications and claims; they were obtained through a form of questionnaire sent to all manufacturers of receiving sets approved by POPULAR RADIO.



The Type 100 Receiver

MANUFACTURER'S NAME; Music Master Corporation	DETECTOR TUBE; Music Master A Type or UV-201-a
MODEL NUMBER; Type 100	AUDIO TUBES; Music Master A Type or UV-201-a
NUMBER OF TUBES; five	TYPE OF "A" BATTERY; Music Master storage 6 volts 90-amp. hour
TYPE OF TUNING; tuned-radio-frequency	TYPE OF "B" BATTERY; Music Master, two blocks of 45 volts each
TYPE OF DETECTOR; vacuum tube	DETECTOR "B" VOLTAGE; 45 volts
RANGE ON PHONES; (none specified)	WAVELENGTH RANGE; 195 to 560 meters
RANGE ON LOUDSPEAKER; (none specified)	NUMBER OF TUNING CONTROLS; three
COST; \$100.00 (without accessories)	"A" BATTERY CURRENT USED; 1¼ amperes
ANTENNA RECOMMENDED; outside, 65 to 100 feet	"B" BATTERY CURRENT USED; 8 to 10 milliamperes
KIND OF TUBES FOR R. F.; Music Master A Type or UV-201-a	



### The WorkRite Winner

MANUFACTURER'S NAME; WorkRite Mfg. Co.	DETECTOR TUBE; 201-a
MODEL NAME; WorkRite Winner	AUDIO TUBES; 201-a
NUMBER OF TUBES; five	TYPE OF "A" BATTERY; 6-volt storage
TYPE OF TUNING; tuned-radio-frequency (neutrodyne)	TYPE OF "B" BATTERY; 90 volts
TYPE OF DETECTOR; vacuum tube	DETECTOR "B" VOLTAGE; 45 volts
RANGE ON PHONES; coast to coast	WAVELENGTH RANGE; 200 to 550 meters
RANGE ON LOUDSPEAKER; coast to coast	NUMBER OF TUNING CONTROLS; three
COST COMPLETE; \$100.00 to \$125.00	"A" BATTERY CURRENT USED; 1.25 amperes
ANTENNA RECOMMENDED; 50 feet, outside	"B" BATTERY CURRENT USED; about 15 milli-amperes
KIND OF TUBES FOR R. F.; 201-a	

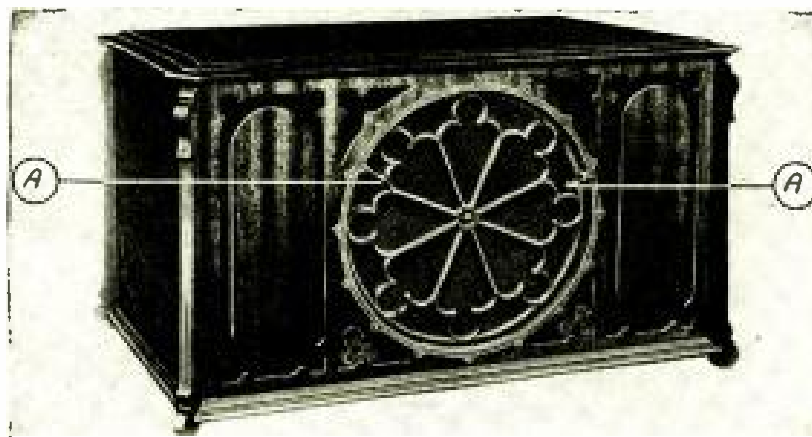

### The Model L-3 Ultradyne

MANUFACTURER'S NAME; Phenix Radio Corporation	KIND OF TUBES FOR R. F.; UV-201-a
MODEL NAME; Model L-3 Ultradyne	DETECTOR TUBE; UV-201-a
NUMBER OF TUBES; six	AUDIO TUBES; UV-201-a
TYPE OF TUNING; tuned-radio-frequency	TYPE OF "A" BATTERY; storage (6 volts)
TYPE OF DETECTOR; vacuum tube	TYPE OF "B" BATTERY; dry cell
RANGE ON PHONES; 1,000 to 2,000 miles	DETECTOR "B" VOLTAGE; 90 volts
RANGE ON LOUDSPEAKER; 500 to 1,000 miles	WAVELENGTH RANGE; 180 to 560 meters
COST COMPLETE; \$185.00	NUMBER OF TUNING CONTROLS; two
ANTENNA RECOMMENDED; indoor or outdoor (single wire)	"A" BATTERY CURRENT USED; 1½ amperes
	"B" BATTERY CURRENT USED; 20 milliamperes

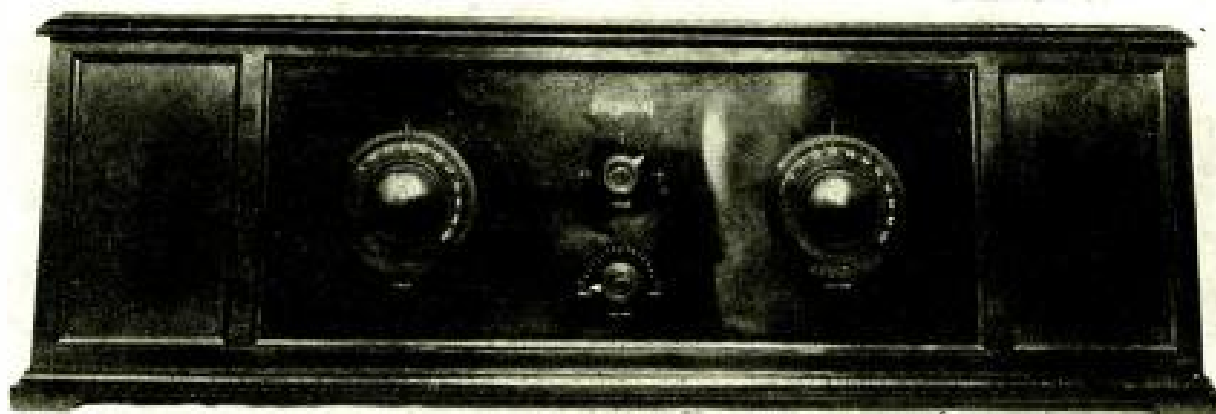

### The Ferguson Six

MANUFACTURER'S NAME; J. B. Ferguson, Incorporated

MODEL NAME; Ferguson Six

NUMBER OF TUBES; six

TYPE OF TUNING; tuned-radio-frequency

TYPE OF DETECTOR; vacuum tube

RANGE ON PHONES; (none specified)

RANGE ON LOUDSPEAKER; (none specified)

COST COMPLETE; \$180.00

ANTENNA RECOMMENDED; outdoor

KIND OF TUBES FOR R. F.; UV-201-a or C-301-a

DETECTOR TUBE; UV-201-a or C-301-a

AUDIO TUBES; UV-201-a or C-301-a

TYPE OF "A" BATTERY; 6 volt storage

TYPE OF "B" BATTERY; 90 volts dry cell

DETECTOR "B" VOLTAGE; 22½ to 45 volts

WAVELENGTH RANGE; 200 to 550 meters

NUMBER OF TUNING CONTROLS; two

"A" BATTERY CURRENT USED; 1.5 amperes

"B" BATTERY CURRENT USED; 25 milliamperes

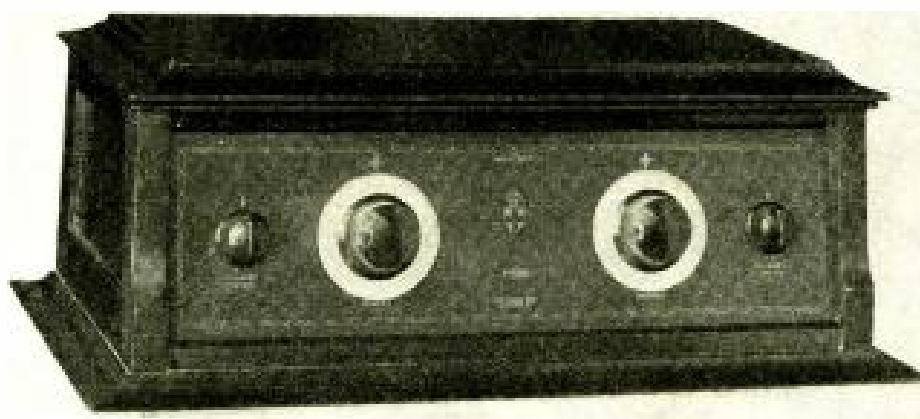

### The Goldfinch

MANUFACTURER'S NAME; Guthrie Company

MODEL; Goldfinch

NUMBER OF TUBES; five

TYPE OF TUNING; tuned-radio-frequency

TYPE OF DETECTOR; vacuum tube

RANGE ON PHONES; transcontinental

RANGE ON LOUDSPEAKER; transcontinental

COST; \$75.00 (without accessories)

ANTENNA RECOMMENDED; 80 feet

KIND OF TUBES FOR R. F.; hard

DETECTOR TUBE; hard or soft

AUDIO TUBES; hard

TYPE OF "A" BATTERY; 6-volt

TYPE OF "B" BATTERY; any type

DETECTOR "B" VOLTAGE; 20 to 60 volts

WAVELENGTH RANGE; 200 to 700 meters

NUMBER OF TUNING CONTROLS; two

"A" BATTERY CURRENT USED; 1.25 amperes

"B" BATTERY CURRENT USED; 13 milliamperes



## IN THE WORLD'S LABORATORIES

CONDUCTED BY DR. E. E. FREE

### Millikan's Ultra-short Rays from Space

IN the last issue of this Department we wrote of Professor Skobeltzyn's measurements of the "shortest" ether waves ever measured, those coming from the exploding atoms of radioactive materials. Before the item was off the press Dr. R. A. Millikan, the distinguished physicist who now heads the California Institute of Technology, at Pasadena, announced to the National Academy of Sciences, meeting at Madison, Wisconsin, his discovery of a kind of ether waves far shorter than those measured by Professor Skobeltzyn or by anyone else; about one fiftieth as long, in fact, as any ether waves previously known.\* Thus does the progress of investigation dispose of the most careful generalizations. Nothing remains for long the "shortest" or the "longest" or the "fastest" of science.

Professor Millikan's new rays were detected, not in or from any material on earth, but coming from the depths of space. Back of their final detection there is a long story of patient investigation. Nearly a quarter of a century ago investigators noticed that some variety of very short ether waves were present in the atmosphere. For example, these waves would penetrate the metal cases of instruments and cause the discharge of electric charges inside them. They came to be called, on this account, the "penetrating radiation" of the atmosphere. It was known that a small amount of radioactive material is present in the soil and in the air. Most scientists believed, therefore, that the penetrating radiation was composed of gamma rays from these radio-active materials; that it consisted, merely, of very short radium rays such as those measured by Professor Skobeltzyn and others.

\*"High Frequency Rays of Cosmic Origin," by R. A. Millikan. *Science* (Lancaster Penna), vol. 62, pages 445-448 (November 20, 1925). The address to the National Academy of Sciences was delivered on November 9, 1925.

About ten years ago, however, two German physicists, Kohlhorster and Hess made observations from balloons and reached the conclusion that there was more of this penetrating radiation in the air at high altitudes than at the surface of the earth. They suspected, therefore, the continual arrival from space of some extremely short variety of ether waves. Several scientists repeated this work under other conditions and failed to confirm it. The war intervened and all such work was interrupted.

After the war, Dr. Millikan, among others, took up once more the investigation of this mysterious penetrating radiation. He sent recording instruments up in airplanes and in sounding balloons. With an assistant, he went himself to the top of Pike's Peak, in Colorado, taking with him the apparatus for investigation of the penetrating rays. All this work was either negative or inconclusive. The reality of the penetrating ray remained unproved. Finally, in the summer of last year, Dr. Millikan and one of his assistants, Mr. Harvey Cameron, carried out an ingenious series of experiments in which radiation-detecting apparatus was sunk at different depths in two snow-fed lakes high in the mountains of California.

The height of these lakes above the sea decreased the layer of air above them, so that the penetrating rays would not be absorbed; for, penetrating as they are, these rays will not traverse any large amount of matter, even of matter as thin as air is. At the same time, the water of the lakes absorbed any stray gamma rays which might be coming from the surrounding soil. The lakes being snow-fed, their water was not itself radioactive, as many spring and river waters are.

The experiment was a success. The penetrating rays were detected. Their difference in penetrating power in the two lakes corresponded exactly with the difference in elevation of the lakes and thus with the different absorbing power of the layers of air above them. The penetration of the rays enabled, also, an estimate of their wavelength. Dr. Millikan's figure for the shortest waves is .0004

Angstrom unit, this unit being, you remember, the one commonly used to measure the wavelength of light. It is one ten-billionth of a meter, which means that the wavelength of the newly discovered ray—which will be named, doubtless, the Millikan ray—is only one twenty-five-trillionth of a meter. The discovery of these rays lengthens the known spectrum of ether waves by nearly six octaves.

The source of the rays remains a mystery. The fact that they are the same by night as by day rules out the sun as a source. The relation to depth in the two lakes appears to be a conclusive proof that they come from space. Calculation indicates that the wavelength of the shortest of the new rays is about that which ought to be possessed by radiation produced when four atoms of hydrogen combine to form one atom of helium, an atomic combination which physicists suppose, on quite other grounds, to be possible in the stars and perhaps elsewhere in space. Another atomic change which might produce these very short waves is that which would occur when a free electron and a free proton (the positive nucleus) combine to form an atom of hydrogen. Whatever be the exact source of the rays, it is reasonably certain, Dr. Millikan believes, that they originate

in some transformation of atomic nuclei which is occurring all through space.

Readers of POPULAR RADIO will remember that the idea of a very short variety of ether waves, far shorter than any then known, was postulated, some years ago, by Dr. Felix Michaud, of Paris, to explain the facts of gravitation.\* Gravitational forces are due, Dr. Michaud believed, to the absorption of these pervasive, space-rays by matter. Two bodies in space partially shield each other from the rays and are therefore forced toward each other. Although the new Millikan rays lie in the region of the ether-wave spectrum in which Dr. Michaud expected to find his gravitational rays, it is not apparent, as yet, that they furnish much support to the theories of the distinguished Parisian physicist. The Millikan ray is apparently too feeble, as well as too easily absorbed by matter, to satisfy the conditions which a gravitational ray must meet. It remains possible, however, that still other and shorter rays exist. The ether-wave theory of gravitation is by no means disproved.

\* For an account of these theories see: "Do Ether Waves Cause Gravitation?" POPULAR RADIO for December, 1923, vol. 4, pages 468-477.

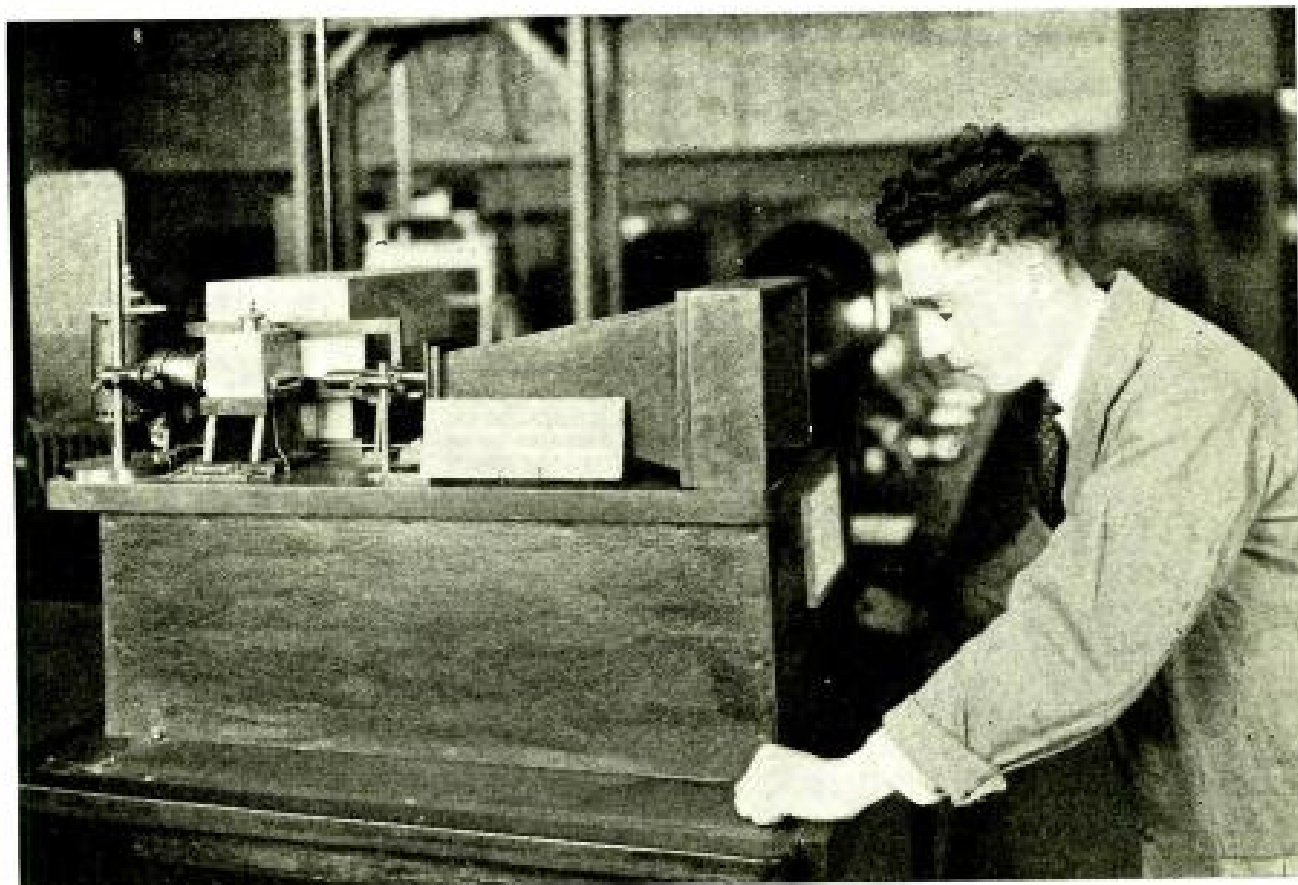

From a photograph made especially for POPULAR RADIO by Campbell-Gray, London

#### TESTING THE PENETRATING POWER OF GAMMA RAYS

*Before the discovery of Dr. Millikan's new rays, the gamma rays from radium were the shortest and most penetrating ether waves known. At the Science Exhibition at Wembley, near London, last summer, the National Physical Laboratory contributed this apparatus demonstrating the gamma rays given off by radio-active material inside the lead box behind the electroscopie at the left. This photograph and the one on page 169 of this issue are published by special permission of the British Empire Exhibition Committee of the Royal Society.*

### Filaments That Emit Ions

A RECENT scientific discovery, made by Dr. C. H. Kunsman and his colleagues at the Fixed-Nitrogen Research Laboratory, at Washington, may prove, it is by no means impossible, one of the really important steps forward in radio technique.\* It is too soon to be sure of this. Dr. Kunsman does not even describe his discovery as a radio one at all. Nevertheless, it is not too much to say that it has a chance of proving to be quite as important to radio as was the invention of the audion tube.

The discovery is of a convenient and apparently reasonably permanent source of positive ions, just as the hot filament of an ordinary radio tube constitutes a source of negative electrons.

A positive ion consists, you remember, of an atom which has lost, temporarily, one of its electron planets. The atom then has a positive charge. In the familiar sodion detector tube, for example, the operation of the tube depends upon the presence in it of a cloud of ions of sodium. Each of these ions is really an atom of sodium gas which has had its outermost electron knocked off. The atom is then short one electron, which means one unit of negative electricity. It carries, therefore, one unit of positive charge. Normally, of course, the atom is neutral, the positive electricity of the nucleus of the atom being just neutralized by the negative electrons present in the atomic structure.†



From a photograph made especially for POPULAR RADIO

#### THE NEW IONIC TUBE

Dr. Kunsman is holding a special vacuum tube (not for radio use) containing the new filament material which emits ions instead of electrons and which is described on this page.

In the sodion tube, the ions are produced by the impacts of fast-moving electrons on sodium atoms or by the collisions of sodium atoms with each other. Ions can be produced, also, in other ways. There has not been available, however, any source of these ions which was either so convenient or so dependable as the hot filament is as a source of electrons.

Dr. Kunsman has provided this. He finds that a hot mixture of iron and an alkali metal oxide, such as potassium oxide, will give off a continual stream of alkali ions. For example, one may use a fused mixture of iron oxide with about one percent of the oxide of potassium. This mixture itself will give off some ions, but more are emitted if the material is reduced, by hydrogen, so that a part or all of the iron oxide is converted into metallic iron and possibly a part of the potassium oxide into metallic potassium. In a similar way, a mixture of iron with the comparatively rare element, caesium, will give a stream of caesium ions.

To see the possible importance of this in radio we need only to remember that the operation of the ordinary amplifier and detector tubes depends on a stream of electrons given off by the filament. Suppose we make a radio tube which contains, instead of the ordinary tungsten or thoriated-tungsten filament, a strip or wire of the new material discovered by Dr. Kunsman. This new tube will operate with *ions*, just as our present tubes do with *electrons*.

The most obvious new feature thus introduced is that the tube will be electrically reversed. The plate will be negative; the filament will be positive. If a C battery is used, its polarity must be the reverse of present practice. The particles of electricity inside the tube will still move from filament to plate, as now. But these particles will be positive, not negative. The passage of current through the tube will be reversed.

This reversal is not likely to be, in itself, of any great importance. What is likely to be important is that the ions, which now replace electrons as the tube-current carriers, are vastly heavier than electrons. A potassium ion, for example, weighs over 60,000 times as much as does a single electron. This means that the stream of ions from filament to plate will have a considerable inertia. It will not be deflected so easily or so quickly as is the stream of electrons in an ordinary tube. Also, space charge relations will be quite different; the internal impedance characteristics of the tube will be altered; there will be entirely different responses of the tube to the frequency of the voltage impressed on the grid.

For some purposes, of course, these changes will mean no improvement. There are times when we wish the current-carrying particles in a tube to have as little mass and as low an inertia as possible. Then what we need is an

\*"A New Source of Positive Ions," by C. H. Kunsman. *Science* (Lancaster, Penna.), vol. 62, pages 269-270 (September 18, 1925).

† The modern theories of the structure of the atom have been described in numerous papers in POPULAR RADIO during 1924 and 1925.



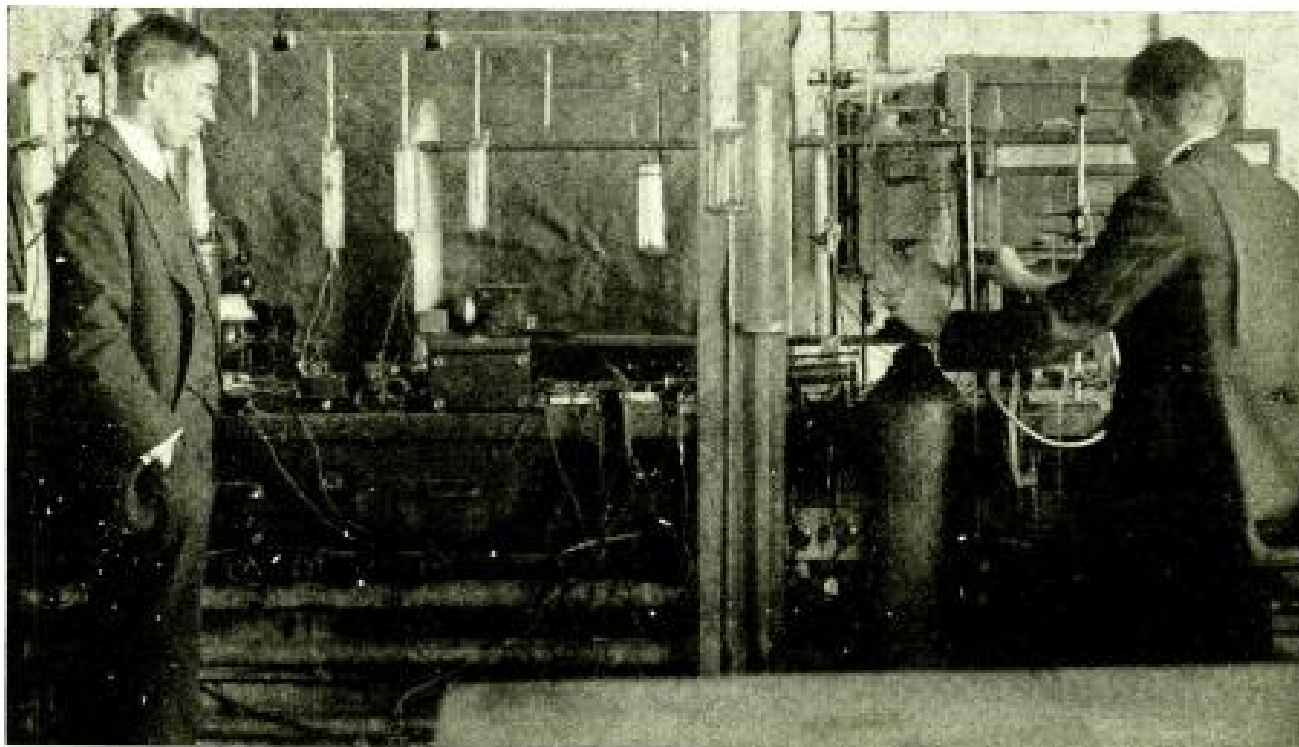

From a photograph made especially for POPULAR RADIO

#### TESTING THE NEW ION-EMITTING MATERIAL

*This apparatus, set up in the Fixed-Nitrogen Research Laboratory, at Washington, is used by Dr. Kunsman (at the left) and his assistant, Mr. R. A. Nelson, to determine the ionic emission and other properties of the new material. Several special vacuum tubes are connected to the glass manifold in the center. The vacuum pumps are behind Dr. Kunsman and the electric meters are in front of Mr. Nelson. POPULAR RADIO is indebted to Dr. F. G. Cottrell, Director of the Laboratory, for permission to publish this photograph and those on pages 166 and 168.*

electron tube, like those now in use. But there are other purposes for which some electric inertia in the tube is advantageous. When all of the characteristics of an ionic tube have been worked out we shall discover, probably, that there are numerous radio uses to which the new ion-emitting material of Dr. Kunsman may be put. It will be very interesting, for example, to try this material, and the reversed tubes made with it, for audio-frequency amplification under the large loads which some of the modern loudspeakers and public address systems are coming to require.

### Rolling Hoops Through the Ether

JUST two years ago POPULAR RADIO predicted that the newer quantum theories of the nature of light would be applied some day to radio waves as well and would profoundly modify our ideas of the nature of radio transmission.\* The first part of this prediction has been fulfilled. A possible application of the quantum theory to radio waves has been suggested by no less an authority than Sir Oliver Lodge; the same scientist, as it happens, whose work we were reviewing back in 1924 when we made the prediction just mentioned.

In a recent address, delivered as President of the Radio Society of Great Britain, Sir Oliver suggests a new structure for the ether waves of radio, a structure which brings them in line with modern ideas of the nature of light. This

structure may be visualized, essentially, as a vast series of rounded rings of force, flying outward from an energized antenna as though a boy were throwing millions of hoops from the top of a tower.† Sir Oliver, as is his admirable custom, makes this suggestion tentatively and with modest disclaimers of originality. Nevertheless, a substantial element of originality is there and the suggestion is likely to play a significant part in the development of the newer theories of light and other radiations, as well as in the theories of radio.

Modern theories of ether waves are characterized, readers of this Department will remember, by great uncertainty and confusion. On one side, there are many facts about light and X rays and radio waves which indicate that all such radiations consist of waves in the ether, not unlike the waves on the sea. This is the "undulatory" or spreading-wave theory. On the other side, there are many facts, notably the facts of photo-electricity, which refuse to fit into the wave theory at all. They indicate, on the contrary, that light is composed of innumerable minute particles or "bundles" of energy, each flying through space as though it were a bullet shot out from the luminous source like

\*"Are Ether Waves Composed of Minute Particles?," POPULAR RADIO for February, 1924, page 209.

†"The Mechanism of Radiation," by Sir Oliver Lodge. Presidential Address before the Radio Society of Great Britain, delivered September 23, 1925. Printed in *Experimental Wireless and the Wireless Engineer* (London), vol. 2, pages 884-888 (November, 1925).

lead slugs from a machine gun. This is the quantum theory. The light bullets are called quanta.\*

The conflict between these two theories has developed mainly in the field of light waves, the wavelengths of which are to be measured in billionths of a meter instead of the meters which we use for radio waves. Radio waves have been left out of account, doubtless because the simple wave theory fits well enough the phenomena ordinarily encountered in radio. No puzzling quantum phenomena, like those of photo-electricity, have been met with, as yet, in the radio field.

However, there can be small question that all ether waves are essentially alike. If there

\* For an account of the differences between the wave theory and the quantum theory, with references to some of the literature, see: "New Theories of Ether Waves," in this Department of POPULAR RADIO for August, 1925, pages 168-171. On photo-electricity see: "Radio's Newest Instrument—The Photo-electric Cell," POPULAR RADIO for November, 1925, pages 397-404.

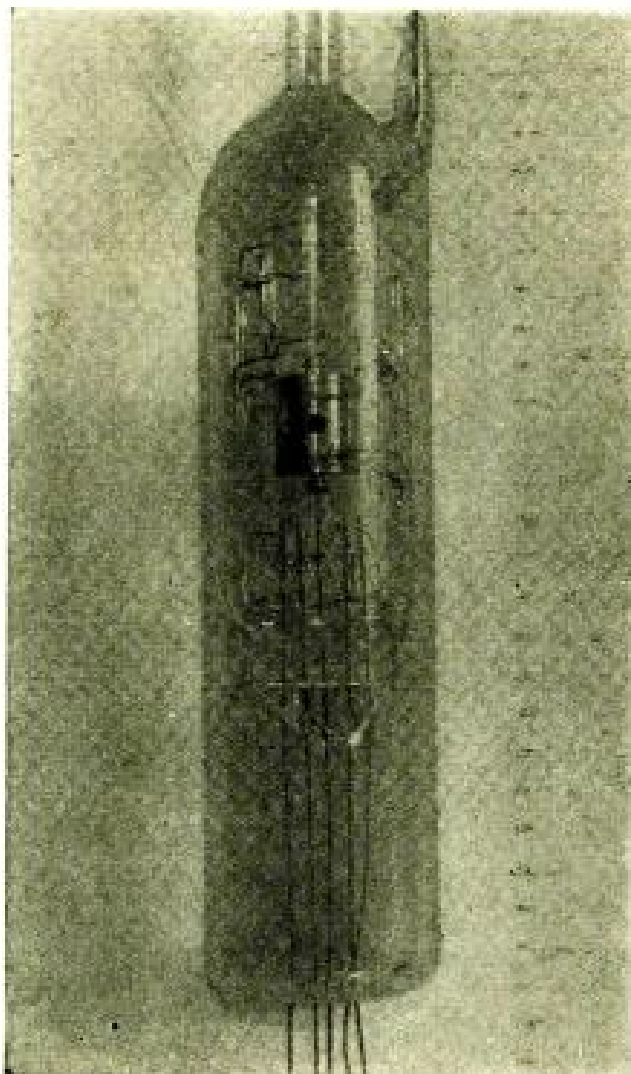

From a photograph made especially for POPULAR RADIO

#### HOW AN IONIC TUBE IS BUILT

These tubes are not constructed for radio use, but merely to test the properties of the ion-emitting material and the effects of the emitted ions on gas mixtures inside the tube. The ion-emitting source is inside the metal cylinder at the center.

are small quanta in light rays and if the quantum theory applies to them (instead of the wave theory) we must expect to find quanta in radio waves also. We must prepare to abandon our simple, present-day theory of a spreading ripple in the ether, moving out uniformly from the transmitting antenna. In his Radio Society address Sir Oliver sets out to visualize, so far as may be possible, something of what this radio-wave quantum may be like.

It is reasonably certain, of course, that neither the quantum theory nor the wave theory is completely wrong nor completely right. The true theory of ether waves must embody and explain both of them. It must be consistent with the facts that indicate the presence of waves as well as with the facts that indicate the bullet-like quanta. Last year, Sir J. J. Thompson, familiar to readers of POPULAR RADIO through his researches on electrons and atoms,\* made such a harmonizing suggestion. He suggested that *both* waves and quanta were sent out simultaneously from a radiating body. Or, to phrase the matter differently, he suggested that the radiation which went out had both the properties of a wave and the properties of a flying particle.†

Sir Oliver Lodge takes this as his starting point. He points out, also, that it is impossible to imagine that the ultimate "particle" of radiation can be anything of the nature of a solid particle, even an atom or an electron. The thing that flies is no particle in that sense, but is, he believes, some disturbance in the ether. The problem which confronts us is the decision between a single, discrete disturbance in the ether—as, for example, a vortex ring like a smoke ring in air—and a continuing, alternating disturbance such as would constitute a true wave.

The solution suggested is based on the idea of loops or rings of force. Everyone is familiar with the lines of force looped up and down the diagram of a radiating antenna. These lines are supposed to represent the electromagnetic forces existing when the antenna is energized. "The question arises," says Sir Oliver, "whether these lines of force are physical realities or only geometrical abstractions. Most of us thought they were abstractions. Faraday seems sometimes to have had an instinct that they might be real."

"If the lines of force are realities," Sir Oliver continues, "the loops which are thrown off by a transmitting aerial are not mere pictorial representations or diagrammatical illustrations but are a bundle of physical realities, each loop with an independent existence, *each loop constituting a quantum.*" \* \* \* "What I suggest is that *the quantum arises from the reality of the lines of force.*"

\* See, for example, "New Theories of How the Atom is Put Together," by Sir Joseph John Thompson, POPULAR RADIO for September, 1923, vol. 4, pages 179-186.

† The suggestion, made originally in an address at Cambridge, England, was printed in *The Philosophical Magazine* (London), vol. 48, pages 737-746 (October, 1924). It was amplified, in more popular form, in a lecture at Guy's Hospital, London, on May 7, 1925, and has been published in a pamphlet, "The Structure of Light," issued by the Cambridge University Press, Cambridge, England, 1925.

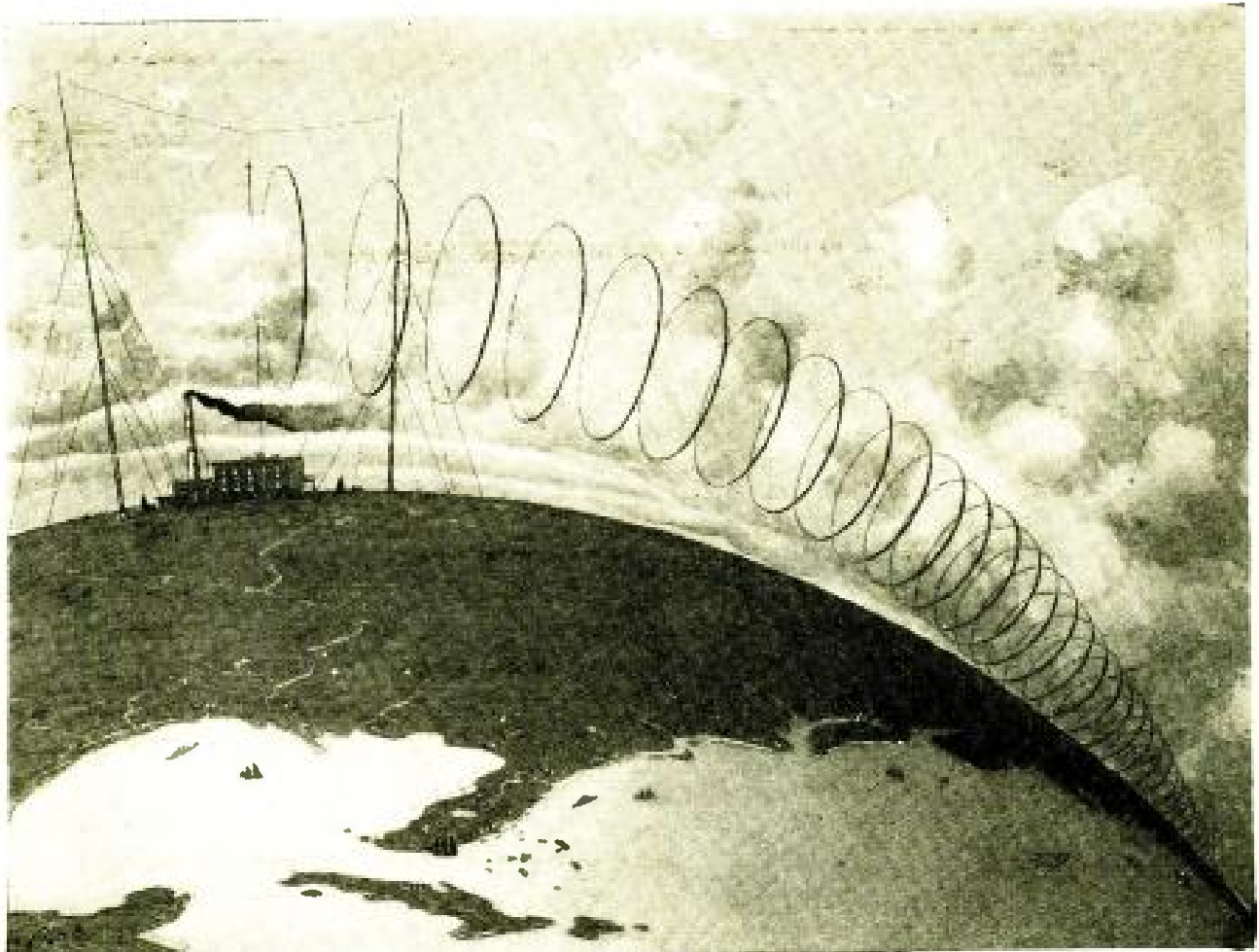

From a photograph made for POPULAR RADIO by Arthur T. Merriek

### SIR OLIVER LODGE'S SUGGESTION OF ETHERIC HOOPS

*This diagram, greatly simplified, gives an idea of the suggestion that ether waves consist of loops of force, flying off through space from an energized antenna. In reality, the loops of force are thought of as being numbered by billions each second, and as flying off in all directions and with all possible inclinations of the plane of the loop. The loops move with the speed of light. Light rays are supposed to consist of similar loops much smaller in their diameter.*

For a radio antenna, the quantum-loop thus emitted is conceived as large but feeble; something, Sir Oliver said, "of the nature of waves in some respects, though apparently vortex rings, but vortex rings with a wavelength equal to their own circumference." For an ordinary broadcasting wave, then, the circumference of the quantum-loop would be of the order of three hundred meters and its diameter a little less than one third as much. A vast number of these separate rings or loops of energy is sent out from each antenna; one ring, as Sir Oliver appears to assume, for each electron which travels up and down the antenna wire. Since the rings are of relatively large diameter, a large absorber (the receiving antenna) is needed to pick up their energy and to make them physically perceptible.

In the case of light, the rings of energy are assumed to be produced by the fall of an electron from one position inside an atom to another position. The displacement is minute and the diameter of the quantum-ring sent out is equally so. Accordingly the absorbing unit may be small. A single atom may pick up a quantum of light; it will not absorb the much larger quantum-rings of radio.

Sir Oliver does not pretend to have completed the mathematical application of this hoop-of-energy idea to all the facts of physics or to have solved all of the difficulties in making such applications. He offers it merely as a suggestion. As such, it is probably the most reasonable and comprehensible yet made toward the solving of the great riddle of radiation. And not the least interesting thing about it, to the radio engineer, is that it has been attained and developed by a study of our own pet radio waves instead of by the study of the physicist's usual material among the "shorter" waves—Sir Oliver would say the smaller hoops—which constitute X rays and light.

### Static from Drifting Snow

It has long been known to the physicists that fine dust or fog, suspended in air, is likely to become electrified. That steam clouds from locomotives or from factory chimneys can also acquire an electrification and may become the source of local interference is a suggestion already noted in this Department.

Now comes a German scientist, Dr. A. Stäger, with careful experiments indicating that

loose snow may be electrified with ease; experiments, which point to drifting snow in cold weather as a very probable site of electrical discharges which may be quite perceptible in nearby radio receivers.\*

Dr. Stäger finds that when fine powders are blown about by air currents they invariably become electrified. Snow swept along by a gale in the Swiss mountains was found to be strongly charged. It is concluded that the electrification thus developed in snow clouds or in clouds of ice crystals makes an important contribution to the electricity of certain varieties of thunderstorms. One may draw, quite obviously, the further conclusion that when snow is blown along by the wind during the wintry nights of this time of the year, the electrification developed may become a veritable static broadcaster, although presumably with no great intensity. †

That actual falls of snow are frequently accompanied by troublesome static is an observation made by many radio listeners. Two winters ago, in response to a note to this effect in POPULAR RADIO, many readers wrote us confirming it from their own experience. And, if Dr. Stäger's results are accepted, we must ascribe similar static-creating properties to loose snow blown along the ground by wind.

Listeners who live in localities where loose snow is frequently blown about can perhaps obtain data confirming or refuting Dr. Stäger's ideas by noticing whether or not the amount of static is greater when much loose snow is adrift. It will be interesting, too, to note whether this static is of the "whispering" variety or of some other kind.

\*"Experimental Investigations into Contact Electrification by Dust and Cloud-Forming Powdered Substances, and Especially of Snow as a Factor Producing Storms" (in German), by A. Stäger. *Annalen der Physik* (Leipzig), vol. 76, pages 49-70 (January, 1925). A later account appears in the same magazine for August, 1925.

†"Radio Interference From Clouds of Steam," POPULAR RADIO for July, 1925, page 87. Additional observations, confirming those recounted in this note, have been published by P. L. Mercanton, in a letter printed in *Nature* (London), vol. 115, pages 874-875 (June 6, 1925).

## Radio to Test Theory of Drifting Continents

THAT the continents of the earth, Africa, Eurasia and the two Americas, are not fixed in their positions, but drift slowly across the earth's surface, is the revolutionary theory proposed fourteen years ago by the distinguished German geologist, Professor Alfred Wegener. Since then, and especially since the end of the war made international scientific cooperation again possible, the world's geological experts have been devoting an increasing amount of attention to the idea. It was under active discussion at the meeting of the British Association for the Advancement of Science, at Southampton, last summer, upon which occasion Professor J. W. Gregory, head of the Department of Geology at the University of Glasgow, made the suggestion that the matter be put to the test by means of radio.\*

Professor Wegener's idea is that the rocks of the earth are not uniformly rigid, but that there exists a layer of semi-viscous rock, many miles down below the surface, on which layer the continents float, much as icebergs float in the sea. The land mass of the two Americas was once in contact, he thinks, with the western edge of Europe and Africa. Anyone can note on the map that the two continental margins seem to fit into each other, like the parts of a picture-puzzle. During the millions of years of past geologic time America has drifted, Professor Wegener believes, to the west. It is drifting still. Evidence is produced to indicate that early determinations of the longitude of Greenland show a more easterly position than the present one. According to Professor Wegener, this westward motion of Greenland may have been as much as thirty meters a year.

\* Professor Gregory's suggestion was published in a newspaper notice released by Science Service, Washington, D. C., on September 2, 1925, and printed in *Science* (Lancaster, Penna.), vol. 62, number 1602, page x of advertising section (September 11, 1925). We are indebted to Professor Gregory for kindly supplying some additional details.

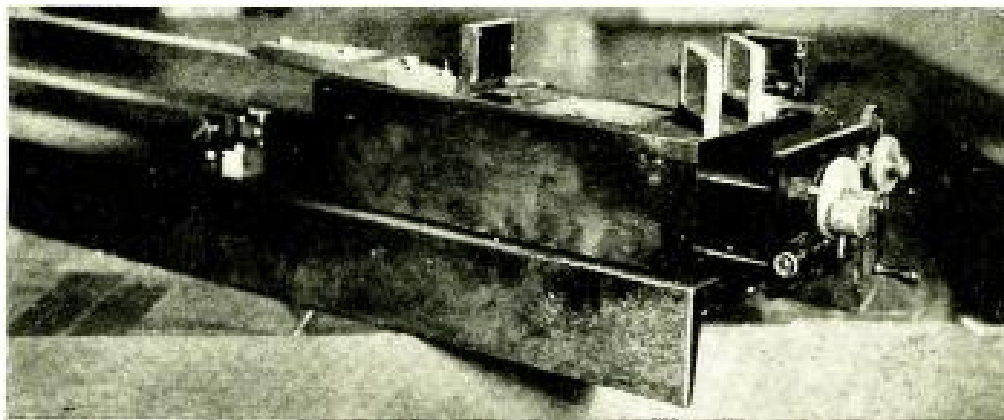

Robert H. Moulton, Chicago

### PROFESSOR MICHELSON'S FAMOUS INTERFEROMETER

*With this instrument, devised by himself, Professor A. A. Michelson, the distinguished physicist of the University of Chicago, has investigated a series of light-wave phenomena which indicate the wave theory of ether waves, instead of the quantum theory. Sir Oliver Lodge's new "flying loop" theory is an attempt to reconcile these two opposing theories of radiation.*

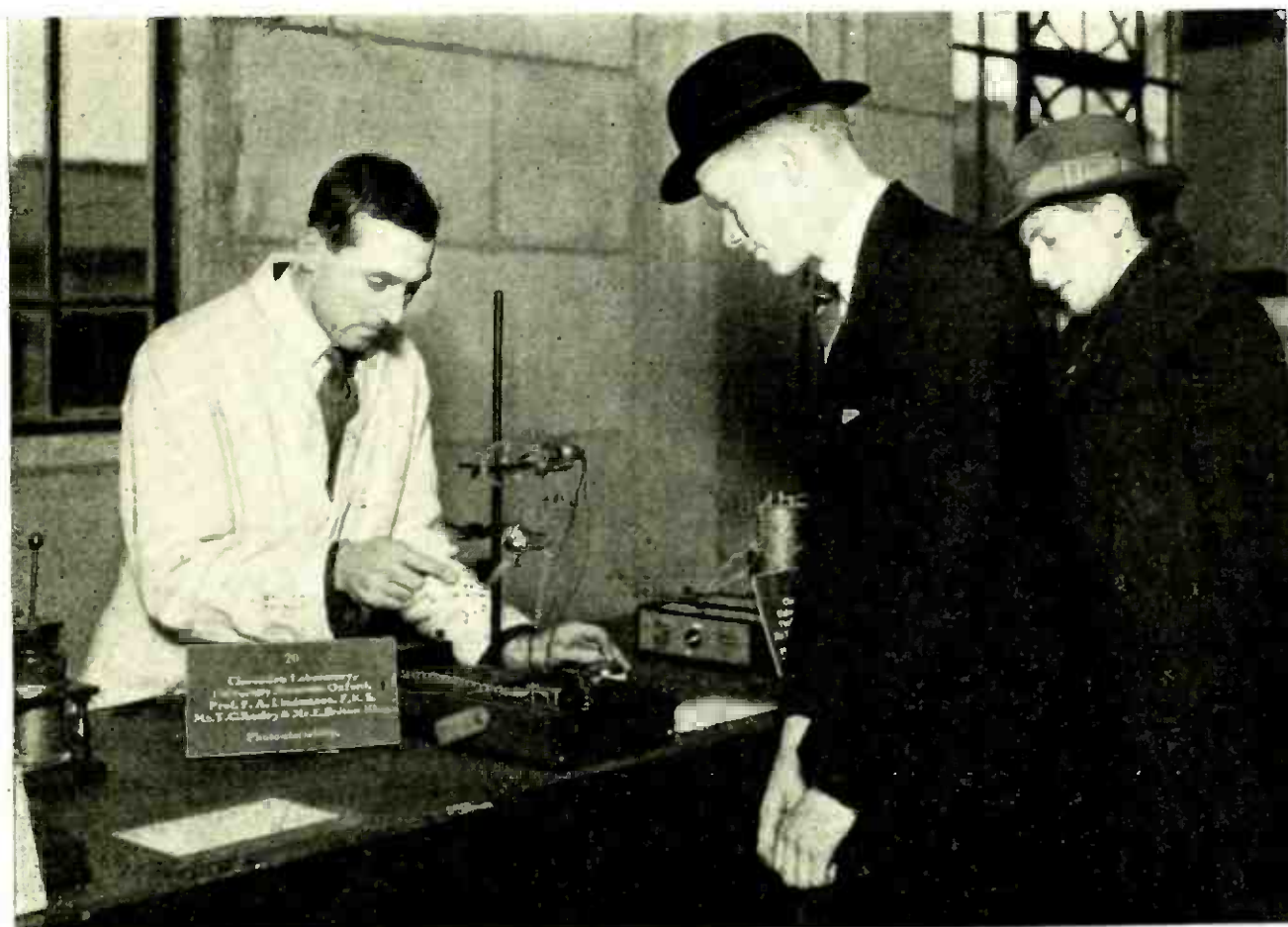

From a photograph made especially for POPULAR RADIO by Campbell-Gray, London

### PHENOMENA WHICH THE WAVE THEORY WILL NOT EXPLAIN

*As pointed out on a previous page, the phenomena of photo-electricity have never been explained satisfactorily by the wave theory of light. The quantum theory does explain them. This exhibit, set up by the physicists of Oxford University at the Wembley Exhibition, demonstrates the emission of electrons from metallic caesium, contained in the lower bulb, under the influence of light rays from the upper, electric-light bulb.*

This amount is ample, Professor Gregory pointed out at Southampton, to be detected within a very few years by means of radio determinations of longitude. The radio time signals sent out from the greater radio telegraph stations constitute, as every radio fan knows, the most precise method of determining longitude yet devised. This radio time is compared with local time, as read from the stars. If the point of observation drifts, by even so little as thirty meters a year, this drift is soon evident as an increased difference in time. It is proposed to apply this suggestion to the determination of the motion, if any, of Greenland by making radio longitude determinations there for a series of years until the truth or falsity of the Wegener theory becomes apparent.\*

\* The Wegener theory is outlined in detail and the evidence for it is collected in "The Origin of Continents and Oceans," by Alfred Wegener, translated by J. G. A. Skerl, 205 pages. E. P. Dutton and Company, New York, 1924.

### The Tilting of Radio Waves

In this department for September, 1925, were described the important experiments of Dr.

Smith-Rose and Mr. Barfield on the inclination of the electrostatic and electromagnetic fields at the front of a radio wave arriving from a distant station. It was expected that the wave-fronts might be found to be tilted downward somewhat when they were arriving after a passage through the upper atmosphere—through the so-called Heaviside Layer. No determinable effect of this kind was discovered, at least one of the obstacles being the fact that the conductivity of the soil in England was high enough to affect the inclinations of the electric and magnetic fields of the wave.

Dr. Smith-Rose and Mr. Barfield have now published an account of this work especially from the viewpoint of the radio engineer.\* The conclusions are unchanged, but radio experts especially interested in the subject or intending to repeat the experiments will do well to consult the experimental details and the mathematical theory outlined in the newer and more complete publication.

\*"Some Measurements on Wireless Wave Fronts," by R. L. Smith-Rose and R. H. Barfield. *Experimental Wireless* (London), vol. 2, pages 737-749 (September, 1925).

## WHAT READERS ASK

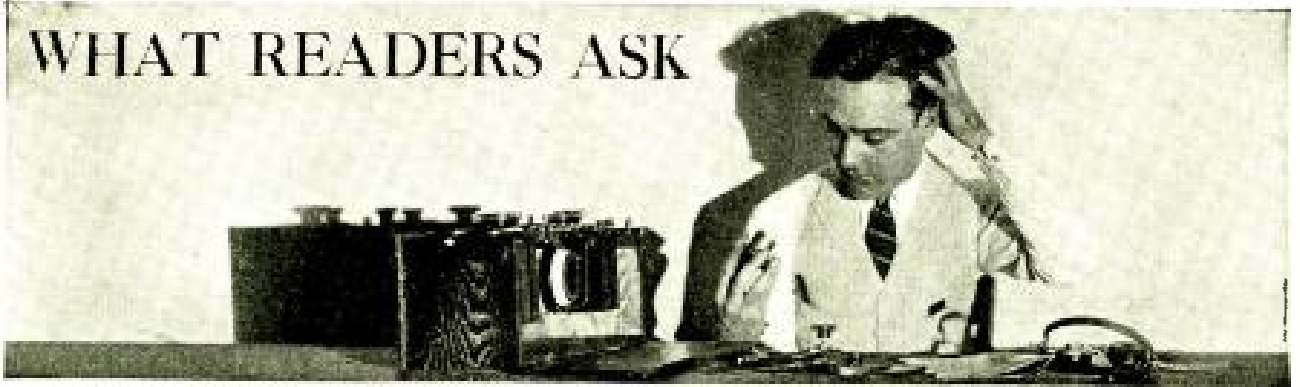

CONDUCTED BY HUGH S. KNOWLES

*In justice to our regular subscribers a nominal fee of fifty cents per question is charged to non-subscribers to cover the cost of this service, and this sum must be inclosed with the letter of inquiry. Subscribers' inquiries should be limited to one question or one subject.*

### A Simple Way to Control Regeneration

**QUESTION:** I have an eight-tube superheterodyne of standard construction using a separate oscillator. I want to experiment with the use of regeneration in the loop circuit. Is there any simple method of controlling the amount of regeneration secured without having to use a separate coil, tickler or anything of that type?

N. FRAZER

**ANSWER:** A simple way of controlling regeneration is shown in Figure 1. A loop with a mid-tap should be used. The outside turn, if the loop is of the pancake type, should be connected to the grid and the mid-tap to the negative filament lead. The loop tuning condenser which is incorporated in the set (not shown in the diagram) is connected from the grid to the filament. A small variable con-

denser of from .00005 to .0001 should be connected as shown at VC. The coil L is the output coil or primary of the first intermediate-frequency transformer. If VC is one of the "midget" condensers now available it can be mounted on the front of the panel. If tuning is too difficult when using it tune the set to a low wavelength and adjust VC just below the oscillating point and leave it fixed.

This arrangement should be used only when a separate oscillator is used and the amount of energy from the oscillator can be controlled. In circuits of the autodyne type tuning is considerably more complicated and this arrangement is not recommended.

### How to Use a Grid Bias

**QUESTION:** I want to build a five-tube receiver of the neutralized radio-frequency type; it will employ two stages of radio-frequency amplification and two of transformer-coupled audio-frequency amplification. Is there any way of get-

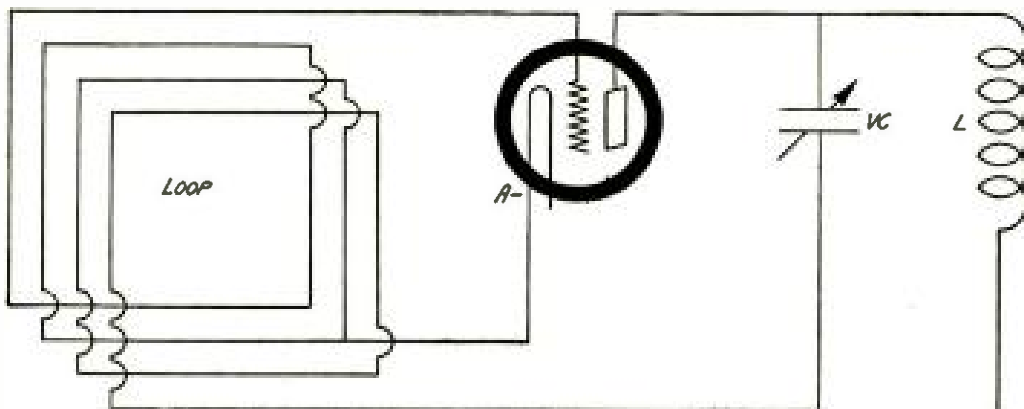

THE CONTROL OF REGENERATION IN THE LOOP CIRCUIT

**FIGURE 1:** This is a skeleton diagram showing the connection of the small variable condenser which controls the oscillations. The loop tuning condenser which is mentioned in the text, is not shown here.

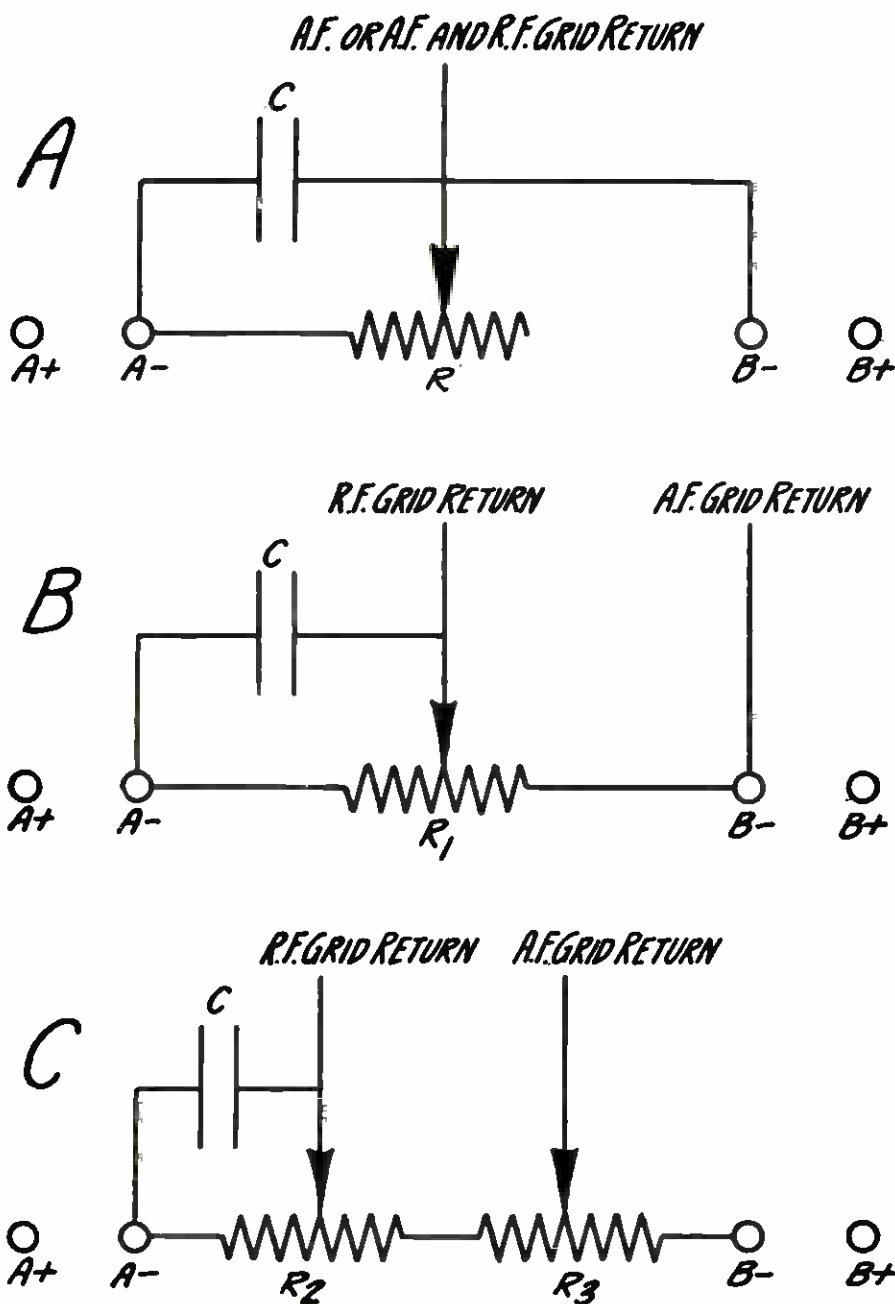

**THREE WAYS TO SECURE A GRID BIAS WITHOUT A "C" BATTERY**  
 FIGURE 2: These three diagrams, A, B, and C, illustrate the methods of obtaining a grid bias which have been described. Other methods which make use of the same principle will readily suggest themselves to the experimenter.

ting the proper grid bias without using a "C" battery? Should I use a bias on both the radio and audio stages?

HARVEY SMITH

ANSWER: The bias normally necessary on a receiver of this type may easily be obtained by any of the three methods shown in Figure 2. If the radio-frequency stages are "neutralized" or "balanced" to prevent oscillation, it is advisable to use a negative bias on the first two tubes. The ampere-hour delivery of a "B" battery rises rapidly with decrease in current drain and a negative bias on these tubes will considerably increase the "B" battery life.

If the set is carefully designed and the coils set so there is negligible inductive feed back

it will be fairly easy to neutralize the amplifier even with a negative grid bias. In this case the method shown in Figure 2 A may be used. This gives the same bias to both the radio and audio-frequency tubes. R should be a 400 ohm potentiometer used as a variable resistance; C should be a .002 to .006 mfd. condenser to bypass the radio-frequency currents. It should be connected from the end of the secondary of the radio-frequency transformers to the negative filament lead. Make the connections as short as possible.

The bias which is secured can be readily determined from Ohm's law

$$E = RI$$

where E is the bias, R the amount of resistance used in the potentiometer (i.e. the fraction actually used, not 400 ohms) and I, the

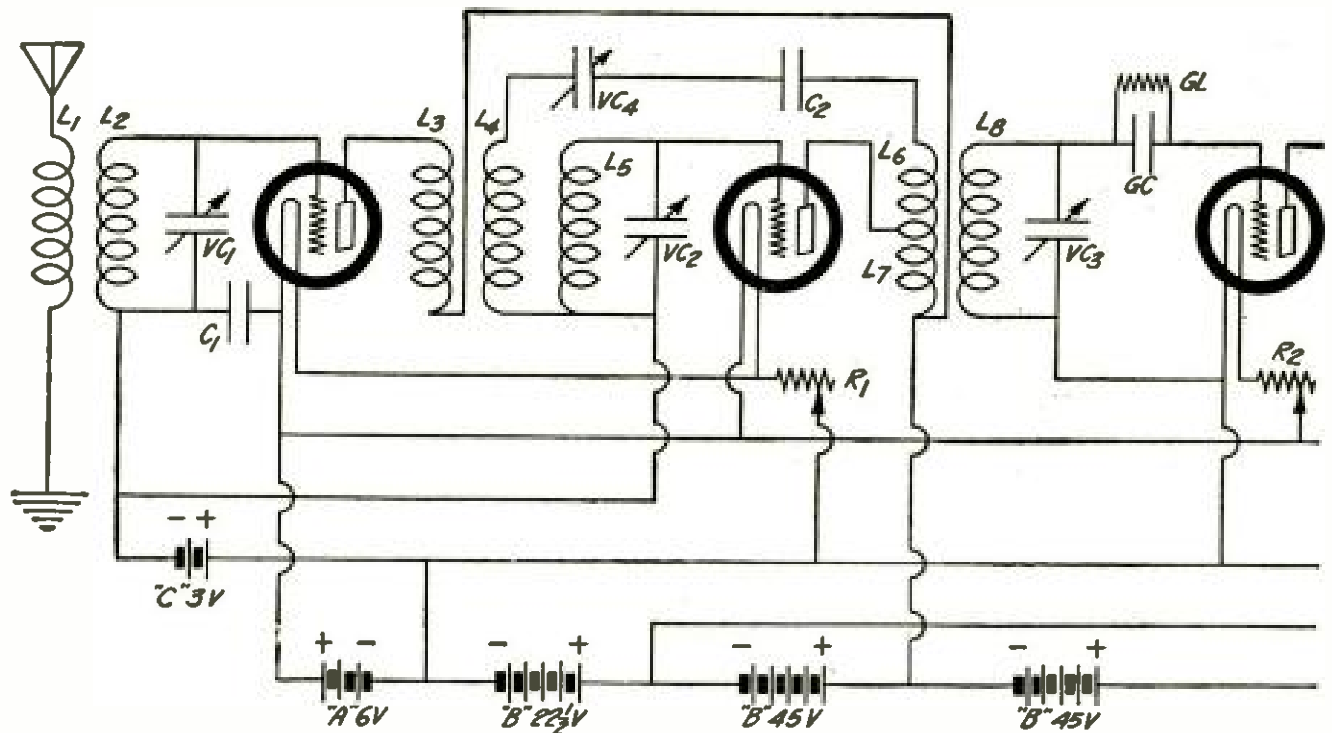

plate current or "B" battery drain of the whole set.

Three or more volts bias should be used on the audio-frequency amplifier. If the radio-frequency stages can not be stabilized with this much bias either the method shown in Figure 2, B or C may be used. The method shown in B will give a fixed bias for the audio stages with a fixed plate current and a variable bias on the radio-frequency stages. The latter variable is an advantage, as it permits adjustment just below the oscillating point for maximum sensitivity.

The bias on the audio stages will depend on the "B" battery current which in turn will vary with the grid bias used on all of the tubes. With this bias properly adjusted the normal current for a set of this type will be about 10 to 15 milliamperes. The equation previously given shows that if a 200 ohm potentiometer is used at R, the bias will vary between 2 and 3 volts, which is slightly low. A 300 ohm potentiometer will give a bias of from 3 to 4.5 volts and a 400 ohm potentiometer from 4 to 6 volts on the audio stages. In each case the grid voltage can, of course, be reduced to 0 by decreasing the amount of resistance between the slider arm and the negative A to O.

The arrangement shown in Figure 2 C permits variation of the bias applied to both the radio and audio-frequency amplifying tubes. The radio-frequency bias may be adjusted from 0 to 2 or 3 volts with a 200 ohm potentiometer at R<sub>1</sub> depending on the plate current, and the audio bias regulated from 2 or 3 volts to 4 or 6 with the same size potentiometer at R<sub>2</sub>. Radio-frequency by-passing condensers should be used as shown. The impedance across the biasing resistance is very small compared to that of the whole output circuit and there will be negligible grid voltage variation due to the alternating plate current variations.

### The Parts You Need for a "Nameless" Receiver

QUESTION: I have a set of coils for a "Nameless" set and would like to build one. I find that the circuits available vary somewhat, and I should like to have the proper circuit and a list of the other parts necessary with their values.

C. HOOPES

ANSWER: The circuit you request is given in Figure 3. You will need the following parts in assembling it:

L1, L2, L3, L4, L5, L6, L7 and L8 are a set of Bremer-Tully "Nameless" circuit coils; VC1, VC2 and VC3—Variable condensers, .00025 mfd.;

C1 and C2—Fixed condensers, .001 mfd.;

R1 and R3—Rheostats, 20 ohm;

R2—Rheostat, 6 ohm;

GC—Grid condenser, .00025 mfd.;

GL—Grid-leak, 2 megohm;

J1 and J2—Jacks, double circuit;

J3—Jack, single circuit, filament control type;

AFT1—Audio-frequency transformer, first stage type;

AFT2—Audio-frequency transformer, second stage type.

The "A" and "B" batteries should have the values noted.

R1 controls the filament current of the two radio-frequency tubes, R2 the current of the detector tube and R3 that of the two audio-frequency amplifier tubes. The filament of the last tube is controlled automatically by the jack, but if the telephone plug is inserted in the first jack the rheostat has to be readjusted. This trouble can be eliminated by using an automatic filament control cartridge in series with the fila-



## THE HOOK-UP OF THE "NAMELESS" RECEIVER

FIGURE 3: The proper wiring diagram of the "Nameless" Receiver using "C" batteries in both the radio and audio-frequency stages is shown here.

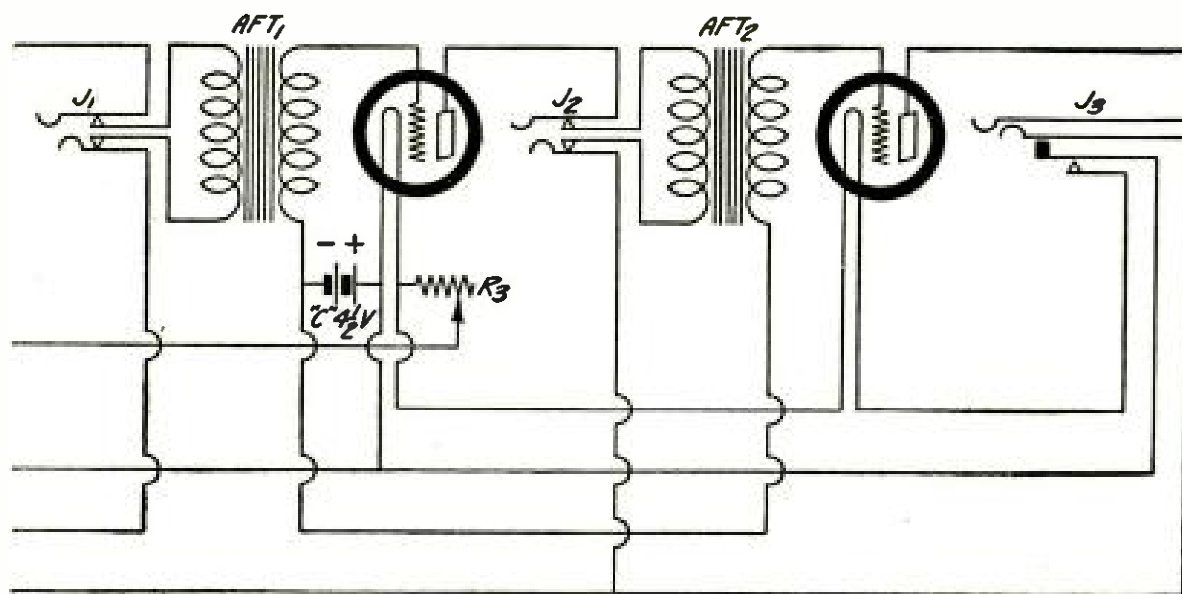

ment of the last tube after disconnecting it from the rheostat R3.

The condenser VC4 should be adjusted just below the oscillating point when the set is tuned to a low wavelength. The condenser C2 prevents the "B" battery being short-circuited through VC4.

The value of GL will vary slightly with different tubes and several values should be tried.

If a hard tube of the 201-a type instead of a UV-200 is used for a detector the grid return from the detector tube should be connected to the A plus. The rheostat R2 should then be a 30 ohm one.

### "C" Battery with Resistance Amplifier

**QUESTION:** I have a set using two stages of radio-frequency amplification, detector, one transformer and two resistance stages of audio-frequency amplification. The transformer stage has a "C" battery giving it 3 volts (negative), but the resistance stages have none. I would like to know whether or not the resistance stages should be connected to use this negative bias?

FRANK MCGEAR

**ANSWER:** Less "C" negative bias can be used in a resistance-coupled amplifier than in a transformer-coupled amplifier. This is due to the fact that the combination of the

blocking or grid condenser and leak gives a very small negative bias. Where only a small bias is wanted this system of obtaining it is satisfactory. This is sufficient for the first stage if a 201-a type tube is used, both because the bias needed is slight and the plate voltage is fairly low. Although 135 volts is generally used on the plate circuit the drop through the coupling resistance generally brings this down to from 25 to 50 volts. In the last stage practically the full 135 volts is applied to the plate due to the low resistance of the loudspeaker. Unless special provision has been made for either using a lower plate voltage or introducing a resistance in this circuit it will be advisable to use about 4.5 to 7.5 volts negative bias on the last tube. This would require a high resistance leak which would permit the accumulation of a high charge on the condenser. The grid cannot become more negative than necessary to reduce the grid current to zero by this method. This has the disadvantage of giving a high grid swing when a loud signal comes in and if the coupling condenser is large there is some time lag before the condenser can fully discharge and reach the point of no signal operation. By connecting the leak to the C (-) lead that you now have you can secure the proper bias with a lower resistance leak. (A separate "C" battery can be used by connecting the plus C to the A minus and the C minus to the leak.) The leak should have a value of approximately .1 megohm (100,000 ohms) as a lower value materially reduces the amplification. The reason for this is apparent when it is remembered that this leak is in shunt to the input circuit of the tube and will therefore lower the voltage applied to the grid of the tube. A more complete discussion of this subject appears on page 112 of this issue.

¶ The article, "How to Build and Operate a Low-power Transmitter," originally scheduled for this issue, will appear in POPULAR RADIO for April.



Kadel & Herbert

### BROADCAST LISTENERS ATTEND A CEREMONY BY RADIO

*When Bishop Manning laid the cornerstone of the nave of the Cathedral of St. John the Divine in New York, the occasion was attended—aurally—by those within reception range of station WÉAF. The broadcasting of historic events is vastly extending public interest in the news of the world.*

# The BROADCAST LISTENER

*Comments on radio programs, methods and technique.  
—from the point of view of the average fan*

By RAYMOND FRANCIS YATES

## Eight Ideas for Solving the Copyright Problem

A FEW months back we had a little sympathy with the demands of the American Society of Composers and Authors and their efforts to make the broadcasters pay a reasonable fee for the right to use copyrighted work. Subsequent action on the part of the composers, however, has caused us to pitch our tent in the camp of the National Association of Broadcasters and the appalling political power of this department is now squarely behind the movement to free broadcasting from a threat aimed at its very existence. This sudden change in attitude was brought about by the unreasonable fees asked by the composers, fees that show no tolerance, no mercy and anything but a desire to contribute to the most civilizing art that has appeared in the whole range of human history.

Broadcasting paralyzes one's mental faculties with its possibilities and yet a peanut-minded coterie of composers would aim an arrow at its very solar plexis or what it thinks to be its solar plexis. It was the spirit of this threat rather than its possible consequences that caused us to dispatch the following wire to the chairman of the Broadcasters committee during its November meeting in Washington:

"It is evident that the Society of Authors, Composers and Publishers is made up of unreasonable and highly overrated writers of the Irving Berlin school of hunk music. They write ditties on their cuffs in Keen's Chop House and expect the American public to pay millions for them. Fortunately broadcasters have been victimized only to the extent that they highly overestimate the importance of the Society of Compromisers, Augers and Penalizers.

"Why does not the National Association of Broadcasters take advantage of its own tremendous power for publicity and banish once and for all time this blustering menace to the radio art? Here is a suggested plan:

"1. Let the National Association of Broadcasters appoint Music Finding and Publishing Committee with the slogan 'More Music From America.'

"2. This committee, through the voice of nearly three hundred broadcasting stations, to ask every American musician to submit his themes for music and words to a central office. The Society of Authors controls only 400 composers. We have 15,000 in America to say nothing of undiscovered talent.

"3. Guarantee the writer of every new song suitable for broadcasting \$1,500, which means that every broadcaster in the United States would pay \$5.00 for the right to perpetually broadcast a new number.

"4. Broadcasters to organize friendly groups of publishers not members of the Society of Composers. These publishers to receive sole right to publish songs found and popularized by the broadcasters. Publishers would pay authors of song standard royalty. This in addition to the original payment by the broadcasters of \$1,500.

"5. On a 500-song-a-year basis, this plan would cost each broadcaster only \$2,500 yearly for the use of the latest songs.

"6. Permit broadcasters to sell songs by mail and to announce this on the air.

"7. Broadcasting is the most powerful pub-

licity agency in the world today. It can popularize a song over night. Every song hit is  $\frac{1}{4}$  song and  $\frac{3}{4}$  plugging. Radio can make more song hits in one month than the Society of Composers has made in its entire career.

"8. Broadcasters should completely and severally boycott all producers of music that are hostile to radio. The offensive and the initiative should be taken by the National Association of Broadcasters and not by the Society of Composers, Authors and Publishers."

\* \* \*

### Another Good Word for a Broadcast Act

THE young man who builds up and measures out the Eveready programs may be a novice in the entertainment business, but he has turned out to be an imaginative broadcasting experimenter of no mean ability. For over a year now, he has been providing this department, week in and week out, with a program that is always refreshingly new in thought and in execution. Often these new radio acts are so new that they squeak a little if you put your ear right up close to the horn but they never squeak to the point of hurting. That is something that you cannot say about the new thrusts that have been made by some of our more widely recognized impresarios. The Eveready Hour is rarely dull and is often magnificent.

Back in November, Edgar White Burrill read the sombre lines of "Evangeline" with a warm and sympathetic musical accompaniment



S. R. Winters

### A RADIO DETECTIVE ON WHEELS

*By means of this automobile, which is fitted out with wavermeters and directional devices, radio supervisors of the Department of Commerce track down disturbers of the listener-in's peace. Violet-ray and X-ray machines (such as are used in doctors' and dentists' offices), leaking power lines, electrically-operated oil-bearing furnaces and sources of interference are located and remedied. Broadcasting stations that venture off their assigned wavelengths are warned to return to their own part of the wavelength band. The area covered by New York, Pennsylvania, Ohio, West Virginia and Michigan is policed in this way.*

in the background. It was, according to our fourth-rate judgment, a splendid piece of work but it began to move ponderously after the first half hour had passed. Unless your heart is especially susceptible to the stabs of sentimental poems, a full hour's recitation of "Evangeline" is a pretty heavy dose. It seems to us, and here again we may show ourselves up as being a *naïveté*, that the dramatic features of the poem could have been read in a bare half hour, leaving out the more irrelevant passages. The presentation of this feature left us with the notion that poetry accompanied with music is good if you know where to stop.

\* \* \*

### The WEAF Boys Take to Football

WHEN we reach the ninth page of this review we are usually as limp as a rag. This time we have just enough strength left to register a weak protest against the very un-football-like announcing of the two honor graduates of the A. T. and T. Diplomatic School, the Messrs. Carlin and McNamee. This pair might make excellent observers in a clash between the eleven of the Erasmus and Washington High Schools but they flopped badly while working as a unit



Pacific & Atlantic

#### BRINGING IN A PROGRAM WITH A PUSH BUTTON

*A row of push buttons supplants the usual condenser dials on the panels of this novel receiver. These buttons are wired to cut in on portions of an inductance coil, so that all that is necessary to tune in on a certain station is to push the button marked with its call letters.*

on the Cornell-Pennsylvania game. Their deportment was just plain terrible. Mr. Carlin sounded like a man who had just completed a digest of the Spaulding Year Book, after years and years of ignorance of the game.

First off, Mr. Carlin tried to be flippant and witty and Mr. Carlin is the easiest person in the world to detect in a flippant and witty mood. Mr. Carlin also muffed the significance of many plays, and, to top it all, he found it necessary constantly to correct himself. He did this as many as three times.

When it was all over, the ingratiating Mr. McNamee bobbed up to the microphone and told the audience that he was glad that he personally would announce the Army-Navy game.

This, of course, put an end to all doubt as to the perfect manner in which the Army-Navy game would be handled.

\* \* \*

### Nicknames for Announcers

If there is anything contributing to the barber-shop atmosphere of our more loosely managed radio studios it is the nicknames that many of our publicity-hunting announcers take for themselves. To hear the roll call of America's announcers, you might think it was the scrape football team of the gashouse gang. There is the "Merry Old Chief," the "Solemn Old Judge," "The Hired Hand" and dozens of other cheap pseudonyms. All of this, of course, is a neat part of the plan for bigger and better popularity for the announcers. Somebody it seems (perhaps it was Charlie Chaplin) once told the announcers that when they spoke they were speaking to the "masses" of America and it would be necessary for them to gab in a tongue and in a style that the American masses would understand. With few exceptions, this advice has been carried out to the letter and now there is nothing left for our announcers to do but to talk out of the corner of their mouths and to say "Hully gee" on the least provocation.

\* \* \*

### An Apology

SEVERAL issues back we waltzed out with a suggestion which has since proven tardy—to be exact we were just about one week late with it. We suggested that broadcasters use the time between studio features to give the late news items of the day. That we figured would be much better than the practice of permitting announcers to fill the interim with impromptu this and that. The records now show that WJZ had begun this sometime before the thought had occurred to us. That, of course, made our big idea a *faux pas* and we hereby bow low and magnificently to the real originator of the innovation.

\* \* \*

### Bad Manners That Need Correction

HERE is 1926 and we still have broadcasters who eat from their knives and who do all sorts of impolite things. It was only a few Sundays

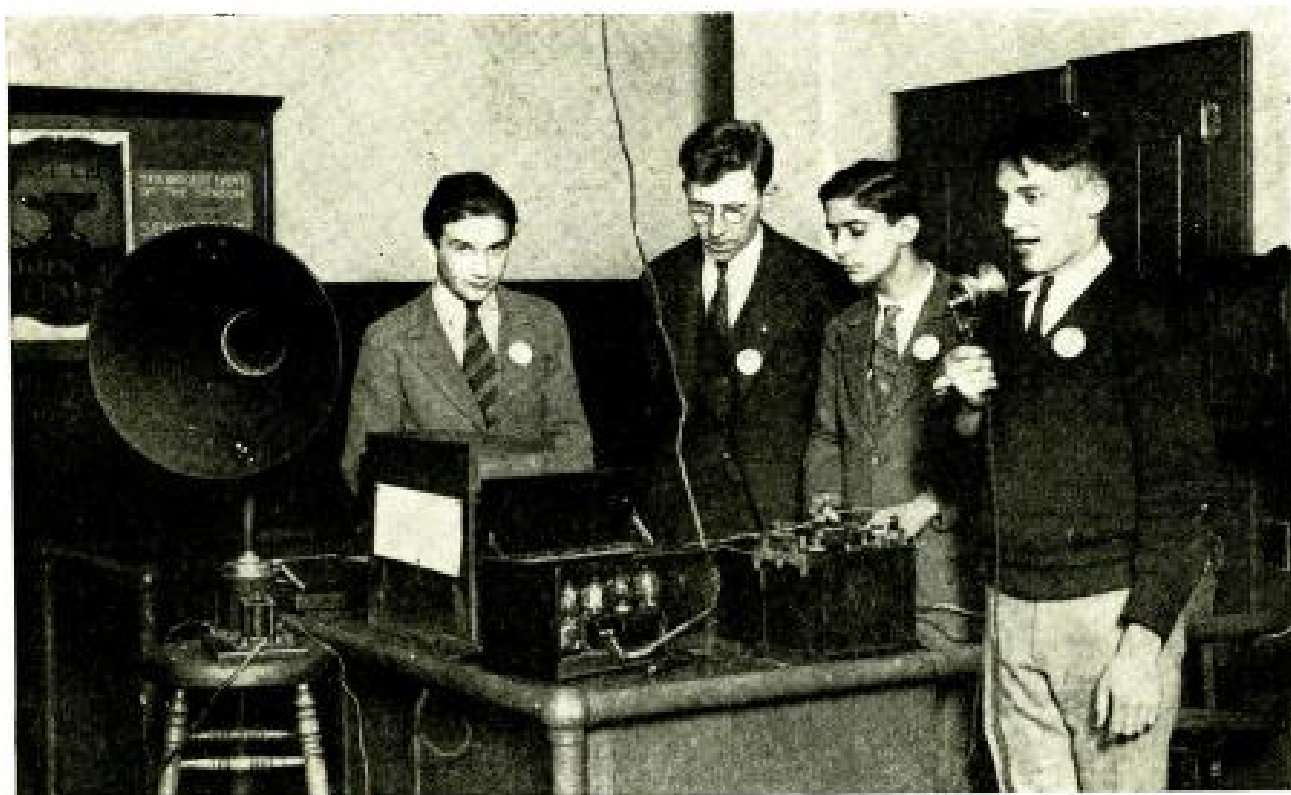

Kadel &amp; Herbert

### THIS AMPLIFIER LEADS THE CHEERING FOR DEAR OLD ALMA MATER

*Why strain the vocal chords of the cheering section of the grandstand at an athletic contest when radio apparatus can do the work better? To the Brooklyn Technical High School, New York, belongs the credit of reducing to a science the energies expended in noise-making; a single cheerer, by means of this apparatus, can give a yell that can be heard a mile away.*

back that WMCA became impolite to an extent that, to our knowledge, has been unmatched in the annals of the art. WMCA was guilty of more than a tactless error; it was just a plain offense.

This station was scheduled to broadcast its dinner music at seven o'clock; something that had been in the past a staple and satisfying feature coming as it did at the end of a rather uneventful afternoon. You can well imagine that this department developed a somewhat high temperature in the region of the collar bones when, instead of hearing the overture of the orchestra, it was introduced to a gentleman who was selling—guess what? Automobile paint! We were tremendously stirred by this crass breach of form and while at our hottest we had even thought of writing to Mr. Hoover to see if his next conference could not put down a law to thwart the trick of obtaining listeners under false pretenses. On second thought, we decided that mother has only one pair of hands and that she has plenty of naughty broadcasters to take care of without our becoming a tattle-tale.

\* \* \*

### A Crestfallen Critic

FULLY understanding the staggering difficulty of finding a radio program scheme that would meet with universal approval and being fully cognizant of our own limitations in the matter,

we asked our readers (in the November issue) to help us solve this enigma of the radio business. Up until this time, we had thought that radio listeners had some pretty definite notions about what they wanted and they did not want and that they would, upon the least provocation, show our studio managers how far they were from hitting the popular idea.

Our plan, we regret to announce, has fallen flatter than Aunt Clara's pancakes, and we are quite broken up about it. We did receive a deluge of letters but, instead of proving our point, they showed unmistakably that our studio managers are not so dumb as we had thought they were and that, further, they are giving the great American public a pottage of entertainment with just about the right flavor. Here we have been basing our calculations on a *pate de foi gras* basis when we should have started off with noodle soup. And so we turn away crushed and defeated but way down in this old hulk a tiny voice is saying: "You've got the right idea but the world is cockeyed."

The first prize for the best program received goes to Mrs. Bessie Jones of Glen White, W. Va. We might add that it was Mrs. Jones' letter more than her program that caused us to favor her solution to the problem.

Mr. J. B. Davis, Keyport, N. J., came within a bed-time story of beating out Mrs. Jones. Mr. Davis was doing fine until he put "Children Stories" in between 7:30 and 7:35 o'clock.

## The Applause Card Nuisance

WE have just about lost our patience with the studios that insist upon asking for mail after each feature, and we are posting a fair warning now. If it continues for another thirty days—let's see, that puts the time limit at February 20—we shall set out on a special murder campaign, and no power in this wide, wide world will stop the carnage. Dark-skinned men in slouch hats with bandanna handkerchiefs about their necks will be stationed outside studio entrances to strike low those who dare to invite listeners-in to write to this or that artist. This is final.

If there is one thing that sends this reviewer into something more than a mild frenzy, it is the invitation to applaud this or that artist (and often much less) by mail. Nor does that mean that we are a savage old ingrate. While we do not raise our hands very high or shout "bravo" while applauding at the theater, we applaud as often and as boisterously as any theatergoer west of Eighth avenue between Fifty-ninth and Thirty-fourth streets. What we object to, and the one and only cause of our special thirty-day murder campaign, is being asked to applaud. In asking you to applaud, an announcer arbitrarily assumes that you have just graduated from 6th Grade Class B and that, further, you are mentally nothing short of a classical specimen of dumb-bell.

Imagine, if you will, the spectacle of Mr. Ziegfeld stepping out on the stage at the New

Amsterdam Theater to ask his audience to applaud! Now just a moment there. We knew that you would say that Mr. Ziegfeld pays good big money to his actors and that we have no right to make such a comparison. Well, Smarty, we insist that this has absolutely nothing to do with the case. Nobody insisted that Annabell Tish come to KFI or that Hortense Simpson should bring to a close her three years of vocal lessons with a *début* from WJZ.

All of this is by way of combating a growing American tradition that all broadcast performers are, in a measure, a sort of entertainment section of the Salvation Army and that you, ourselves, and your good neighbor Jones, owe each and every artist a nice helpful word of encouragement. You are supposed to carry around with you a line of thought something like this: "Well, the poor devils are doing their best to entertain the great American public, and I guess I at least owe them an applause card." If you don't believe that that is the thought you are supposed to put under your old derby, just listen to the pathos in the voice of the next announcer that asks you to endorse the activities of any performer.

There is just one more angle to this subject, Dear Reader, that we wish to discuss with you before you indulge in the big, airy paragraphs beyond. You have probably heard the nice little boys down at WEAJ come to the microphone and tell you in a sort of well-you-know-it-doesn't-make-any-difference-to-us way that the members of the Little Wonder Gas Lighter orchestra would appreciate knowing whether or not their program was good. The Little Wonder boys, no doubt, have an autographed post card (Mr. Antonio Bambirinio, the conductor conspicuously seated in the exact center of the first row) which they will be glad to send to their admirers. It may be that you will be lucky enough to horn in on some of the free samples of baking powder that the big-hearted president of the Hoosick Falls Chemical Company has decided to distribute, or perhaps you can get that cookbook that tells you about muffins without butter and shortening.

The WEAJ announcing sorority exhibit some of the most beautiful, hand-carved announcements that have ever been turned loose upon the air of these United States. Nobody but a full-fledged graduate of the A. T. and T. Diplomatic School could issue such carefully tooled invitations. Time and time again we have sat before our loudspeaker and defiantly answered them back with: "Well, you're pretty slick, but you can't fool this sly old weasel."

Now here is some inside dirt. Don't you believe what we said about WEAJ not being interested in receiving applause cards. It is rumored that the first thing the big director of broadcasting does when he arrives at the office in the morning is to ask for the number of applause cards received. If the number is not great enough to satisfy the advertiser, the professors of the WEAJ Diplomatic and Rhetoric School are given implicit instructions to remain closeted with "the boys" until they can exude an announcement that will make John D. Rockefeller, Sr., write for the catalog of the Pine Valley Oil and Refining Co.



Pacific & Atlantic

### THE HEAD RADIO ANNOUNCER

Mr. Arthur F. Edes (known to radio fans as E-F-A, is president of the Radio Announcers of America. He is the program director of station WEEI in Boston.

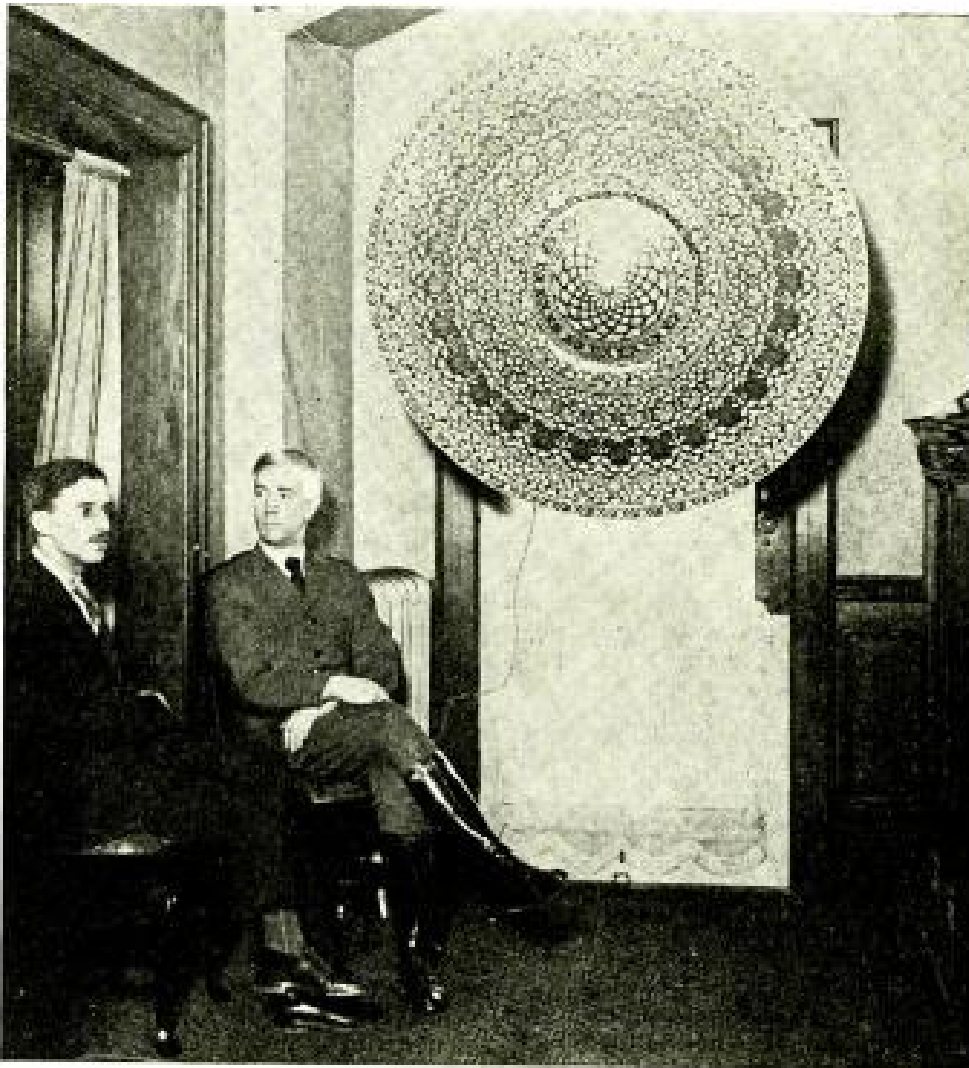

Armstrong Perry

### A LOUDSPEAKER THAT MAY SUPPLANT THE DANCE ORCHESTRA

*This plaque-like device, which the inventor, Mr. M. C. Hopkins (seated at the left), has appropriately named the "Titanafram," has been developed for use in halls or auditoriums where reception in loud volume is required. It is said that under favorable conditions the volume of sound from it can extend over five miles. This picture shows one of the two experimental instruments now in use.*

### Re. the Battle for Better Announcing

WHATEVER our luck may have been in the matter of finding a masterpiece in programs, we have found plenty of public sympathy in our battle for better announcing. The many announcers who have "bawled us out" over various *nom de plumes* will do well to read a few of the legitimate letters that we have received. We are presenting two for examination:

"Dear Sir:—

"Upon several occasions you have distinctly voiced our sentiments about announcers, but what can we do about it? We of the radio audience are placed somewhat, not by choice, but by circumstance, in the beggar class. Since we can not be choosers we patiently listen to the announcer entertain himself, knowing that our time will eventually come to be entertained; therefore I say that we require only the briefest introduction and comment from the announcer. Let the talent entertain, for that's

what they're there for. If the announcer must fill in a number, and he should always be suitably prepared against such an emergency, let him do it as an entertainer—without apology and with little comment. Then let the radio audience judge of the merit of his effort.

"With the arrangement of program such as I have outlined above, it seems to me that everybody might be suited in part of the program, and almost everybody in all of the program.

J. B. D."

"Dear Sir:—

"Your attention is respectfully invited to the attached article with reference to Announcers. This article 'hits the nail on the head' and is the first truthful criticism regarding announcers that I have seen, all critics appear to be fearful of saying a word to them. Personally I see no use of announcers whatever. When we first had phonographs each record had an announcer, but they died away. A society for the elimination of announcers would have many charter members.

"W. A. S."

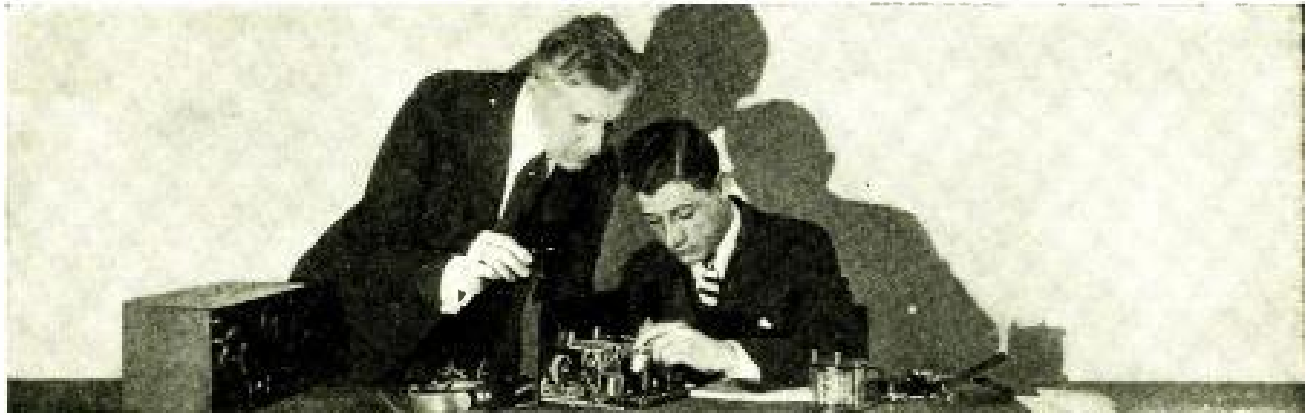

## IN THE EXPERIMENTER'S LABORATORY

CONDUCTED BY LAURENCE M. COCKADAY

### Calibrating an Oscillating Wavemeter

STATION WWV of the Bureau of Standards, in Washington, D. C., has been making a practice of transmitting standard-frequency signals twice each month for the benefit of those who want to calibrate wavemeters or have use for the standard-frequency signals. These transmissions serve as a reliable means for calibration work because of the unquestioned accuracy of the frequencies transmitted.

The transmissions occur on the 5th and 20th of each month, starting at 10 P.M. and lasting until 11.32 P.M., Eastern Standard time. They are arranged on a definite schedule; a certain band of frequencies is transmitted on each of these nights. On October 20, for instance, the band of frequencies from 1,500 to 3,000 kilocycles was covered (200 to 100 meters) as follows:

10.00 to 10.08 P.M.	trans. freq.	1,500 kc	or	200 m.
10.12 to 10.20 P.M.	trans. freq.	1,650 kc	or	182 m.
10.24 to 10.32 P.M.	trans. freq.	1,800 kc	or	167 m.
10.36 to 10.44 P.M.	trans. freq.	2,000 kc	or	150 m.
10.48 to 10.56 P.M.	trans. freq.	2,200 kc	or	136 m.
11.00 to 11.08 P.M.	trans. freq.	2,450 kc	or	122 m.
11.12 to 11.20 P.M.	trans. freq.	2,700 kc	or	111 m.
11.24 to 11.32 P.M.	trans. freq.	3,000 kc	or	100 m.

The transmission is by means of continuous wave telegraphy and it is therefore necessary to use an oscillating receiver in receiving the signals. The procedure of the transmission is to tune the transmitter to 1,500 kc and at 10.00 P.M. the transmission is started on this frequency. Transmission consists of miscellaneous signals, the call of WWV and announcement of the frequency, all in continental code, and a series of dashes. This continues for eight minutes. Four minutes are then allowed to tune the transmitter to the next frequency and from 10.12 to 10.20 the process is repeated at a frequency of 1,650 kc. and so on.

The signals are also transmitted from station 6XBM, Stanford University, California, from 10.00 to 11.32 Pacific Standard time, for the use of those located in the west. Thus the signals are available to anyone in the United States who has a fairly sensitive receiver.

A complete schedule of the transmissions covering a period of four months is given in the monthly *Radio Service Bulletin* which may be obtained from the Superintendent of Documents, Government Printing Office, Washington, D. C., at a cost of five cents.

As to actual process of calibrating the wavemeter, a description of the calibration of one of the type described on pages 267-271 of the September, 1925, issue will be useful.

The calibration was made during the transmission on the night of October 20. Unfortunately the experimenter was forced to miss the first three frequencies. Using the other five frequencies, however, four coils for this wavemeter were calibrated, covering from 50 meters up to 555 meters. This, of course, called for the use of the harmonics of the regenerative receiver used for the reception, and of the harmonics of the oscillator wavemeter.

The first frequency tuned in was 2,000 kc or 150 meters (from now on we will refer to wavelengths rather than frequencies). Leaving the receiver tuned to this wavelength, coil X2 (see page 267 of September issue) was inserted in the wavemeter and the wavemeter placed about four feet from the receiver. The wavemeter dial was then slowly rotated until a loud heterodyne whistle was heard in the headphones connected to the receiver, indicating that the wavemeter was tuned to resonance with the receiver, and was therefore tuned to 150 meters. The reading of the wavemeter dial, 88, was then noted and the first point for our calibration curve thus obtained. Moving the wavemeter closer to the receiver the dial was again moved and another heterodyne whistle was heard at 11. This whistle was fainter than the first and the experimenter therefore knew that the wavemeter was tuned to the second harmonic of the received signal, or 75 meters. Thus the second point of calibration was obtained.

Coil X3 was then inserted in the wavemeter and the dial slowly rotated throughout its entire range. Two heterodyne whistles were heard,



one quite strong at 12.5 on the dial and a weaker one at 94. Knowing the range of coil X3 to be somewhere in the neighborhood of 120 to 400 meters it was evident that the low setting was the wavelength to which the receiver was tuned, 150 meters, giving the third point. Turning the dial of the wavemeter to 94 meant that the wavelength to which the wavemeter was tuned was higher; therefore the second harmonic of the wavemeter must be heterodyning with the oscillations of the receiver at 150 meters. This meant that the wavemeter was tuned to twice the wavelength of the receiver, or 300 meters. This was point No. 4 for our curve. When coil X4 was inserted two more heterodyne whistles were heard at 35.5 and 98.5 on the wavemeter dial. The range of coil X4 was known to be about 190 to 600 meters. The dial setting 98.5 was approximately in the middle of the dial range (180 degree dial) therefore the whistle heard there meant that the wavemeter was tuned to 450 meters and the receiver oscillating at 150 meters was heterodyning with the third harmonic. With the wavemeter tuned to the other whistle at 35.5, it was tuned to 300 meters, the second harmonic of which was heterodyning with the received wavelength, 150.

Finally coil X1 was placed in the wavemeter and the wavemeter moved close to the receiver. The range of this coil was known to be about 30 to 100 meters. One heterodyne whistle was heard at 92 on the dial. It was therefore evidently tuned to the second harmonic of the receiver, or 75 meters.

Thus from the one standard signal received on 150 meters two calibration points were found for all the wavemeter coils but the smallest and one point was found for the latter. All of this was accomplished during the 12-minute period of the 150 meter transmission from WWV.

When the transmission was started on 136 meters the same process was repeated. In this case one calibration point was obtained on each of the smaller coils X1 and X2. On X3 two points were obtained and on X4, three points.

From the five frequencies transmitted from WWV the experimenter was able to obtain six points for coil X1, seven for coil X2, nine for coil X3 and fifteen for coil X4. This was enough to make up calibration curves for each of the four coils. The form used in making up the curves were the same as the illustration on page 271 of the September, 1925, issue of POPULAR RADIO.

—S. GORDON TAYLOR

## An Efficient Coil Winder

WITH the aid of two wooden discs, a carriage bolt and a sewing machine, the radio experimenter who winds his own coils can do an infinitely quicker and better job than he can do by the usual method of winding his coils by hand.

Figure 2 shows how the device is attached to a portable electric sewing machine. The ap-

paratus itself, as shown in Figure 3, consists primarily of two wooden discs between which is centered the tube or form upon which the wire is to be wound. These discs are connected together by a carriage bolt, which when tightened holds the tube securely in place.

The thicker of these two discs rests against the flywheel of the machine. It is held in

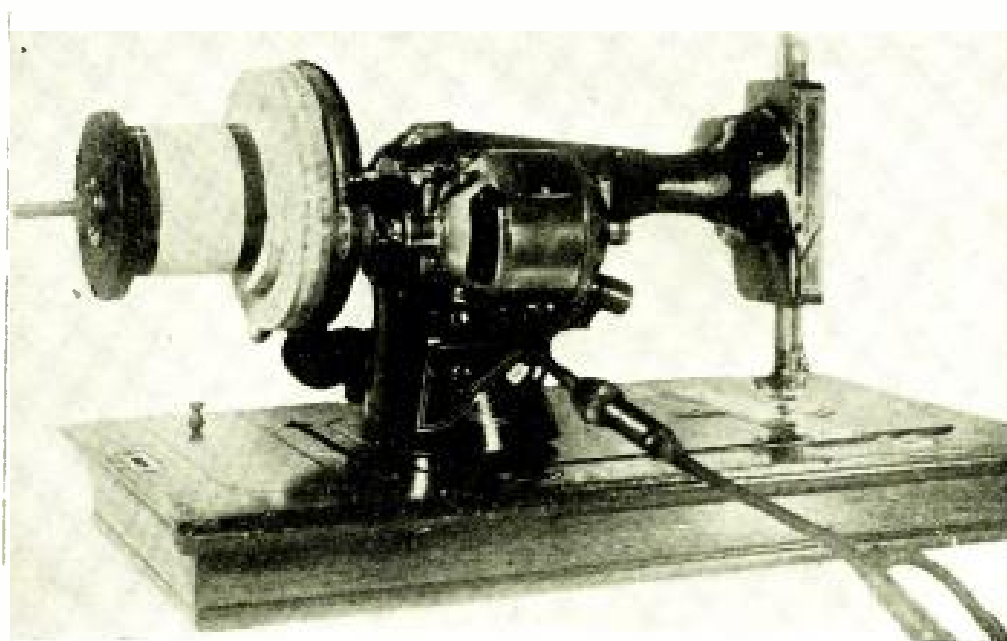

A COIL WINDING MACHINE

FIGURE 2: *This picture shows how the ordinary electric sewing machine may be used for winding coils with the aid of a simple attachment.*

place by two or three screw-eyes that pass between the spokes of the flywheel. These screw-eyes hold the disc securely in position. They may be easily unscrewed when the housewife wants to sew.

The winding form, usually a Bakelite tube, is placed between the discs and the bolt is tightened slightly. The machine is then spun slowly and the tube shifted to a central position so that it runs true. The bolt is then fully tightened and the winding started. In this way a coil may be wound in a few minutes that would ordinarily require an hour if done by hand. And when finished, the machine wound coil will not only look better but it may actually be a more efficient coil than one wound by hand.

The so-called "binocular" coils used in both

the Grebe and Grimes radio sets may be easily and quickly wound on this machine. This type of coil has somewhat the same electrical characteristics as the toroidal or "doughnut" coils. Incidentally, the binocular coils are wound in pairs but the windings are in opposite directions. (Simply turning a coil, end for end will not reverse the direction of the winding.)

But with the help of this machine, the problem is easily solved.

First, one set of coils is wound, with the motor rotating in one direction. The brushes on the motor are then shifted so as to reverse it. Finally another set of coils may be wound corresponding to the first set but with the windings in the opposite direction so that the fields will be reversed.

—H. G. BERSIE.

### Eliminating that Continuous Whistle

LETTERS are sometimes received from owners of receivers, in which they state that a receiver which functioned well for some time suddenly developed a tendency to whistle continuously. Sometimes the whistle is high pitched and other times it is in the form of a coarse roar. In some cases, too, the whistle may be noticeable from the first day the receiver is hooked up.

There are various causes of this trouble. Perhaps the most common is defective or worn out "B" batteries.

In certain types of receivers one or more worn out "B" batteries will start trouble by first causing a slight but continuous whistle which grows in volume as the batteries run down further. On the other hand it is also possible for a new battery to cause this trouble due to one defective cell. Such a case was experienced recently. A new 22½ volt battery

was installed with others in a receiver and immediately a pronounced shrill whistle was noticed. All of the batteries tested over 20 volts, which is high enough for satisfactory operation. Nevertheless the receiver would not whistle with a different set of "B" batteries. Finally a small voltmeter was used to test the individual cells of the batteries and disclosed the fact that one of the cells in the new battery was defective. Its voltage was less than ½ volt. This cell was short circuited with a piece of wire to cut it out of the circuit altogether and the bothersome whistle immediately disappeared.

Often the use of three stages of transformer coupled audio frequency amplification will cause a whistle, and it is for that reason that more than two stages are seldom used in modern receiving set design.

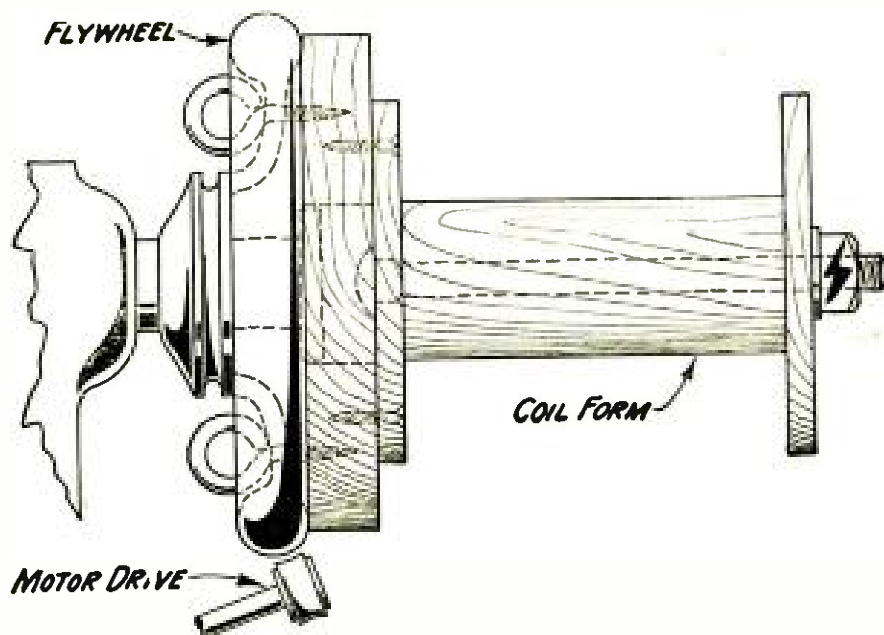

THE WINDING FORM

FIGURE 3: This drawing indicates the mechanical construction of the coil winding device and the method of attaching it to the flywheel of the sewing machine.

## THE HARTLEY CIRCUIT

FIGURE 4: This circuit, or some of its modifications, is probably the most commonly used today for reception on wavelengths under 100 meters. The accompanying article discusses the necessity of suitable coupling between the antenna and closed circuits if maximum efficiency is to be obtained in short-wave reception. The use of the variable condenser in the antenna circuit is optional, as explained in the text.

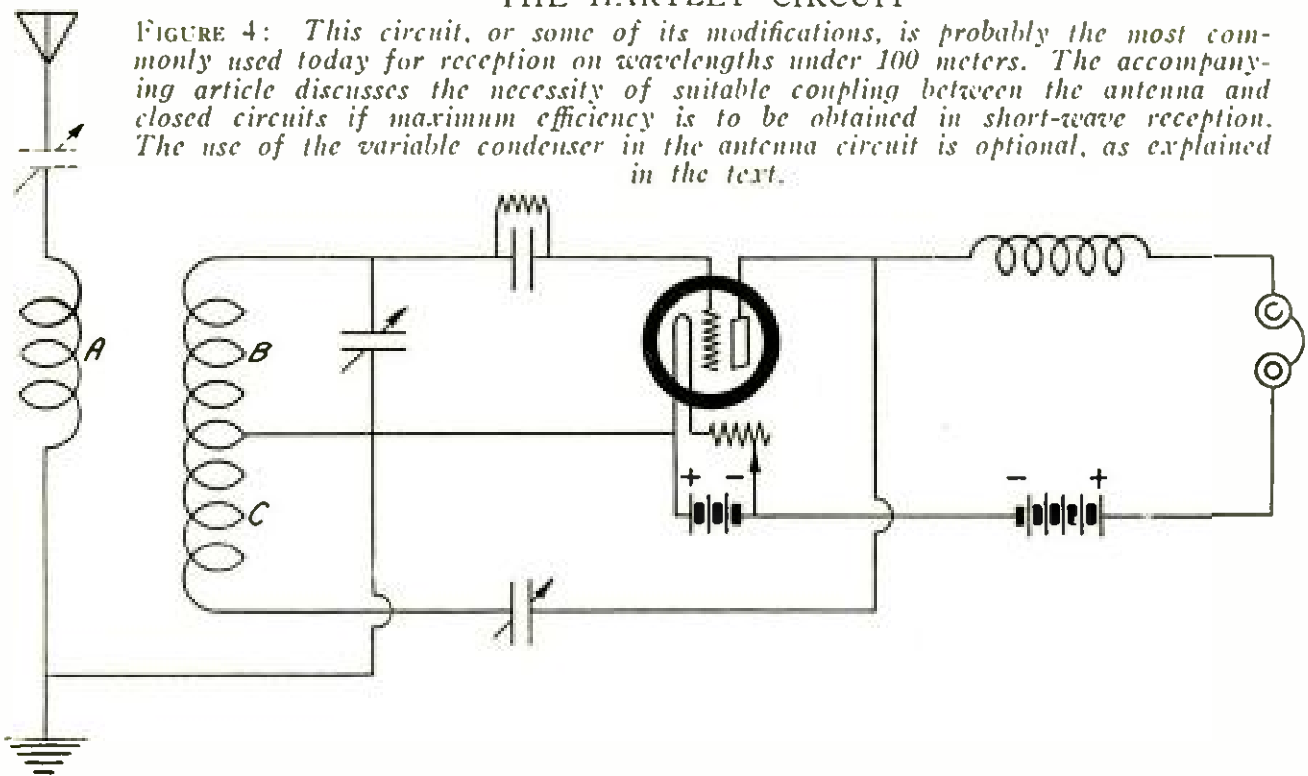

If three stages are to be used (with transformers) it is usually quite essential that they be doctored up with fixed condensers and resistances across the transformer windings. Frequently a fixed condenser of about .0005 mfd. capacity across the secondary of the first transformer with a similar condenser and a variable resistance such as the Bradleyohm No. 25 (25,000 to 250,000 ohms) across the secondary of the second transformer will help to eliminate the trouble. Similar doctoring may be necessary in the case of the third transformer too, however.

Where only two stages of transformer coupled audio amplification are used the whistle may also be present, usually due to the use of transformers of poor quality or too high ratio. About 5 to 1 ratio is as high as can safely be used, and even this ratio is advisable only in the case of the first stage of a two stage amplifier. The second stage ratio should be not higher than about 3 or 4 to 1.

Another common cause of a continuous whistle or howl, especially in the present day multi-tube receivers, is the so-called "microphonic howl."

In this case the vibration of the diaphragm of the loudspeaker causes the tubes to vibrate. Usually this sort of a howl builds up until it assumes tremendous proportions. When the receiver is turned on the howl may not be in evidence at all, or else only slightly. Within a very short time, however, it becomes very noticeable, gathering volume as it goes along. In some cases a sudden jar of the receiver will be needed to start it, but once it gets started it can only be stopped by turning off the receiver for an instant.

The first remedy for this type of trouble is to move the loudspeaker as far from the receiver as possible. If this does no good, about the only alternative is to mount the tube

sockets on sponge rubber or replace the sockets with the vibrationless type. Often it will be sufficient to do this with the detector tube only. It is also well to try shifting tubes around as some tubes are more "microphonic" than others. Especially in super-heterodyne and other receivers using five or more tubes, a single tube may cause all the trouble. When it is located and replaced the trouble disappears.

A less frequent cause of the continuous whistle results from running the antenna lead close to, and parallel with, the receiver. It is always advisable to bring the antenna to the receiver from the rear and at a right angle to the back of the receiver. Also run the lead to the loudspeaker directly away from the receiver, and from the body of the operator. In some cases a pronounced whistle is obtained when the operator touches the loudspeaker cord or places his hand near it, especially while his other hand is on the dials in the act of tuning the receiver.

In addition to the type of whistle mentioned here, there are, of course, the whistles frequently encountered in regenerative receivers and in radio frequency amplifiers. These are of a different sort entirely and can be distinguished by the fact that they vary with variations of the tuning controls of the receiver.

### Antenna Coupling for Short-wave Receivers

One of the problems in short-wave reception is to obtain proper coupling between the antenna and tube circuits.

To obtain the maximum results and to avoid so-called "dead spots," which are caused by the antenna circuit or one of its harmonics being

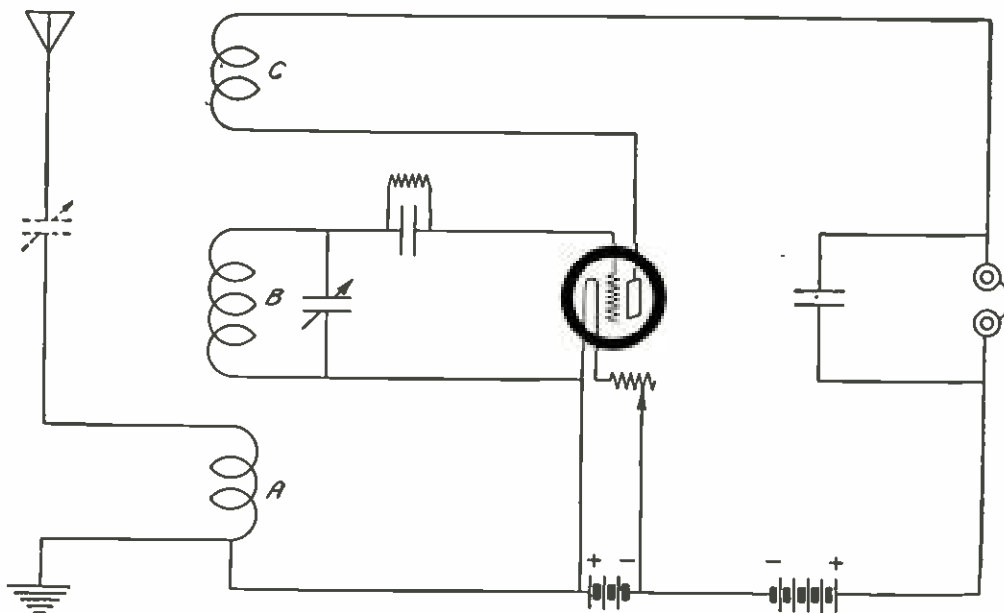

### THE STANDARD THREE-CIRCUIT TUNER

FIGURE 5: This is another circuit which is used extensively in short-wave reception. Frequently the type of tuning unit used in this circuit does not permit variation of the number of turns in the antenna coil and in that case a series antenna condenser may be used to decided advantage in the reduction of "dead spots."

in resonance with the tuned, tube circuit, it is necessary to provide:

- (1) Variable coupling between the antenna coil and the grid coil;
- (2) Variable control of regeneration, and,
- (3) Some means of partially tuning the antenna circuit.

Practically all short-wave receivers today make use of either the Hartley circuit (Figure 4), the modified Reinartz (which is practically the same as the Hartley), or the standard three-circuit hook-up using primary, secondary and tickler (Figure 5). This article, therefore, refers particularly to these circuits.

If an untuned antenna circuit is used with a receiver designed to cover the short-wave bands from 30 to 120 meters and providing controls

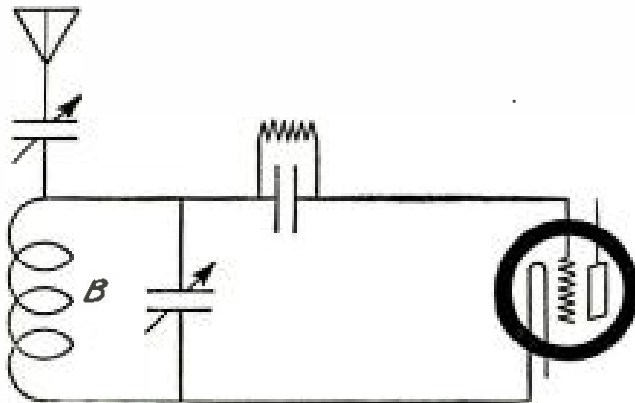

### DIRECT ANTENNA COUPLING

FIGURE 6: Some degree of success has been met with in coupling the antenna directly to the closed circuit through a series antenna condenser as shown here. This method may be used with either of the hook-ups shown in Figures 4 and 5, thus eliminating the necessity for antenna coils. Coupling is varied by means of the antenna series condenser.

for (1) and (2) above, it will be found that at certain wavelengths it is impossible to make the receiver oscillate unless the coupling between the antenna and closed circuit coils is loosened to such an extent as to make signals extremely weak. This condition results from the condition of broad resonance of the antenna circuit with the closed circuit and absorbs enough energy from the closed circuit to stop oscillation. If the coupling between antenna and closed-circuit coils is loosened sufficiently, the antenna circuit absorbs less energy and therefore does not so readily stop oscillation. This loose coupling decreases the signal strength, however, due to the smaller energy transfer from the antenna circuit to the closed circuit.

Now, with the coupling fairly close, oscillation would not stop if the antenna circuit could be tuned sufficiently to shift its wavelength either up or down so that it, or its harmonics, would no longer be in resonance with the closed circuit.

This broad tuning of the antenna circuit may be accomplished in a variety of ways. The most satisfactory plan, in the case of the Hartley type of circuit, is to provide two or more different coils for the antenna circuit.

If it is desired to tune the circuit to a certain wavelength but it is found that even with fairly loose coupling the receiver will not oscillate satisfactorily at that wavelength, an antenna coil with a different number of turns is substituted, thus shifting the wavelength of the antenna circuit to a point where it no longer interferes with the functioning of the tube circuit.

In the Hartley type of receiver, a single closed-circuit coil will not, of course, cover the entire 30 to 120 meter band. Because of the extremely sharp tuning at low wavelengths it is advisable to use a low capacity tuning condenser and this naturally limits the range of

each closed-circuit coil so that three or perhaps four coils are needed to cover this entire band. Using a three plate condenser (maximum capacity .000045) across the grid portion of the closed-circuit coil, four coils are needed. The range of the smallest coil may be approximately from 30 to 45 meters, the next one from 45 to 65, the next 60 to 90 and the largest 80 to 120. Three antenna coils of 5, 13 and 21 turns respectively, will probably serve to tune the antenna. This, however, will depend a good deal upon the proportions of the antenna that is used. Antennas of all lengths seem to work out about equally well for short-wave reception—a single wire anywhere from 25 to 150 feet will be satisfactory.

Another method of tuning the antenna is by means of a very small variable condenser in series with the antenna as shown by the broken lines in Figures 4 and 5.

Usually, by this means, it is possible to reduce the number of antenna coils needed to two or even one. In the case of three-circuit tuners, in which no provision is made for changing antenna coils, the use of an antenna series condenser will be found especially useful.

A third method which has met with some success is that illustrated in Figure 6.

By the use of this method, the antenna coil is eliminated entirely and the antenna is connected directly to the grid end of the closed-circuit coil, through the antenna series condenser. This method controls the amount of coupling between antenna and closed circuit by means of a variable condenser.

The maximum capacity of series antenna condensers used for this short-wave work will depend to some extent on the size of the antenna used. The best plan in any particular installation is to try out different condensers until the best one is found. A three or five-plate variable condenser will in some cases work out quite satisfactorily, while in other cases a simple homemade device as illustrated in Figure 7 will serve the purpose, especially if the receiving antenna is large.

Every owner of a short-wave receiver should experiment a little with various antennas, antenna coils, series antenna condensers, and various degrees of coupling. Many of these receivers in operation at the present time are not giving anywhere near the results of which they are capable, simply because the coupling arrangement used is not suitable. A receiving range of 10,000 miles is not too much to expect

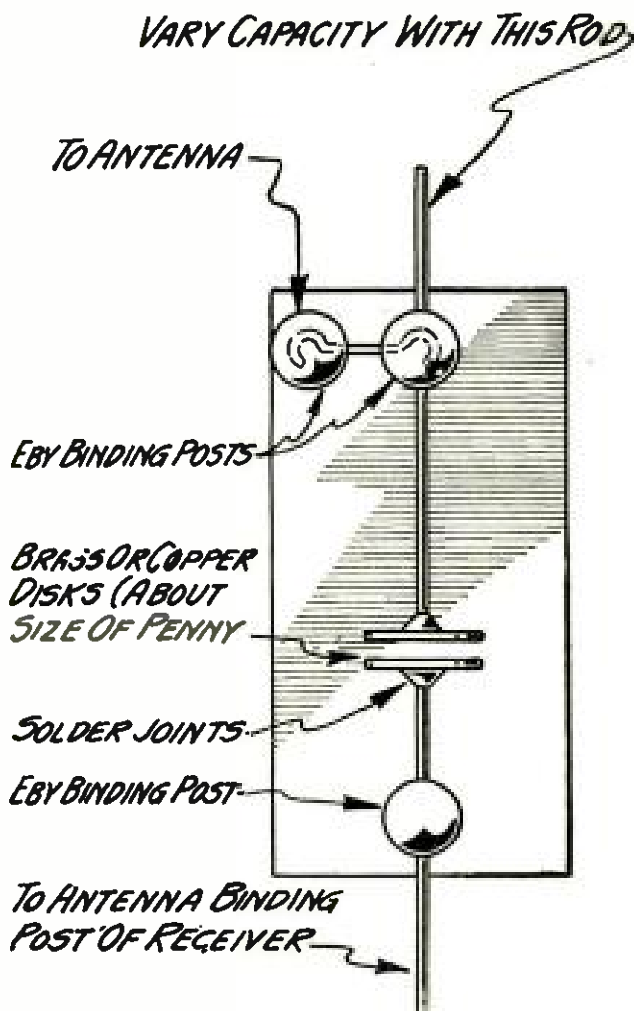

A SIMPLE HOME-MADE ANTENNA SERIES CONDENSER

FIGURE 7: In some cases a regular .0001 or .00025 mfd. variable condenser will serve as the series antenna condenser for use in short wave reception. As a rule, however, it is necessary to use extremely low values of capacity for this purpose. The simple condenser shown here serves the purpose well.

of any efficient short-wave receiver in reception of amateur code signals. In short-wave broadcast reception the range is bound to be somewhat less. However many South American listeners are enjoying the programs broadcast nightly from KDKA at Pittsburgh, on a wavelength around 60 meters, at distances of 3000 miles and more.

—S. GORDON TAYLOR

## A Receiver That Will Operate on 50 to 550 Meters

In the March issue of POPULAR RADIO will appear an article containing complete information on the constructional details for building a new receiver that will operate over a band of wavelength from 50 to 550 meters. This description will be of interest alike to the seasoned amateur and experimenter as well as the inexperienced novice. It is probably the first tuned-radio-frequency receiver that has as yet been described for operating over such a wide wavelength band. One exclusive feature of the new receiver is that the wiring is prepared in advance for the experimenter so that all he has to do is to hitch it on to the set. It is the result of collaboration on the part of two engineers—McMurdo Silver and Laurence M. Cockaday and it will be known as the S-C Receiver.



THIS department is conducted by POPULAR RADIO LABORATORY for the purpose of keeping the radio experimenter and the broadcast listener informed concerning the newest inventions and the approved developments in radio equipment. Only such apparatus as has been tested and endorsed by the Laboratory is noted in these columns.

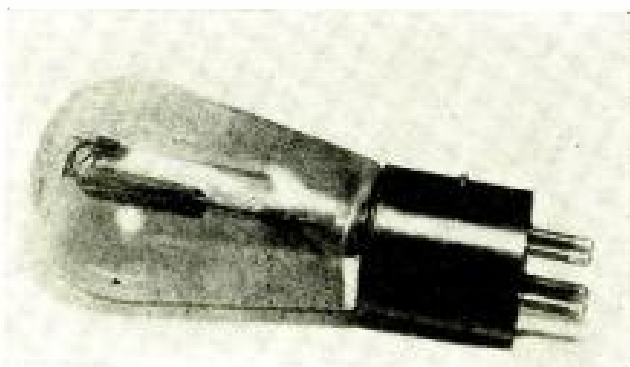

*A Tube for Greater Volume*

**A NEW POWER TUBE**

*Name of instrument:* UX-210 vacuum tube.

*Description:* This new tube which contains a husky thoriated filament is especially manufactured for use in the last stage of audio-frequency amplification where great volume is desired. It is also a reliable oscillator for laboratory work. It may be operated directly from a 6-volt storage battery on the filament without rheostat with 157 volts on the plate. With  $7\frac{1}{2}$ -volts filament potential across the terminals of the tube, it may be used with plate batteries as high as 425 volts with a 35-volt "C" battery. At this voltage it has an output resistance of 5000 ohms, conductance of 1550 micromhos and a voltage amplification factor of 7.75. It is equipped with the large standard UX base.

*Usage:* In connection with radio receiving apparatus for use as a power tube.

*Outstanding features:* Rugged construction. Reliable operation. Powerful.

*(Further details furnished on request)*

**A TWIN ELEMENT VARIABLE CONDENSER**

*Name of instrument:* Dual variable condenser.

*Description:* A really well made tuning unit

comprising two sets of stator and rotor plates with two variable vernier units for adjusting them to the same capacity. One of the vernier controls is adjusted from the front panel of the set on which the set is mounted. The end plates are constructed of die cast aluminum cut away as shown in the photograph. The insulation is accomplished by means of two clear bakelite strips upon which the stator elements are mounted. The bearing, which is large, is fitted with a novel tension adjustment, which, although it varies the tension on the shaft, does not vary the spacing between the plates and between the rotor and stator sections.

*Usage:* In any radio-frequency circuit for tuning.

*Outstanding features:* Dual operation with single shaft. Rugged construction. Easy to balance. Neat appearance. Equipped with a shield between the stator elements.

*(Further details furnished on request)*

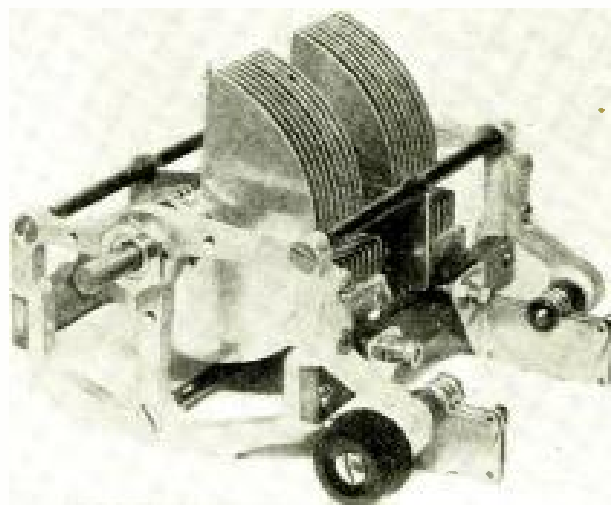

*A Dual Unit With Verniers*

## Apparatus Approved by Popular Radio

This list of apparatus approved by the POPULAR RADIO LABORATORY will be continued as a part of the WHAT'S NEW IN RADIO APPARATUS department until all instruments, parts and complete sets have been included. The listing is alphabetical by manufacturer's name and the installment in this issue includes only the letters A and B.

## AERIALS

*Stranded enameled antenna*; Acme Wire Co.  
*"Ribbon" copper aerial*; Acorn Radio Mfg. Co.  
*Enameled ribbon aerial*; Acorn Radio Mfg. Co.  
*Hollow radio aerial*; American Display Co.  
*Antennaphone*; Antennaphone Co.  
*Flat copper antenna ribbon*; Baltimore Brass Co.  
*Beldenamel aerial wire*; Belden Mfg. Co.  
*"Storm King" complete aerial outfit*; L. S. Brach Mfg. Co.

## AUDIO-FREQUENCY TRANSFORMERS

*"Acme" audio-frequency transformer*; Acme Apparatus Co.  
*Algo audio-frequency amplifying transformer*; Algonquin Electric Mfg. Co.  
*Rauland-Lyric audio-frequency transformer*; All-American Radio Corp.  
*All-American audio-frequency amplifying transformer*; All-American Radio Corp.  
*Audio-frequency transformers*; American Specialty Co.  
*Amertran DeLuxe transformer*; American Transformer Co.  
*"Fada" audio-frequency transformer*; F. A. D. Andrea, Inc.  
*"King Cole" audio-frequency transformer*; Anylite Electric Co.  
*Brandes audio-frequency transformer*; Brandes Products Corp.  
*Branston audio-frequency transformer*; Chas. A. Branston, Inc.

## BATTERIES

*"Arrow" storage batteries*; Arrow Battery Co.  
*Radio "B" Batteries at "factory prices"*; Ayres Battery Corp.  
*Burgess "A," "B" and "C" batteries*; Burgess Battery Co.

## BATTERY CHARGERS AND RECTIFIERS

*"Acme" battery charger*; Acme Electric & Mfg. Co.  
*Silent battery charger*; Acme Engineering Co.  
*"Apco" "A" and "B" battery chargers*; Apco Mfg. Co.

## BATTERY ELIMINATORS

*"Acme" "B" eliminator*; Acme Apparatus Co.  
*"Apco" rectodyne*; Apco Mfg. Co.

## BINDING POSTS

*Ajax binding posts*; Ajax Electric Specialty Co.  
*Bel-Tone mounted binding posts*; Bel-Tone Radio Co.

## CRYSTAL DETECTORS

*Syn-tec radio crystal*; Appliance Radio Co.  
*"Airader" detector*; Bernard's Radio Co.  
*"B Metal" crystal*; B-Metal Refining Co.

## DIALS

*Na-ald dials*; Alden Mfg. Co.  
*Bradleynier*; Allen-Brauley Co.  
*Radion knobs and dials*; American Hard Rubber Co.  
*Split-Em vernier instrument control*; American Instrument Works.  
*Regal knobs and dials*; American Specialty Co.  
*Amsco dials*; Amsco Products, Inc.  
*Apex vernier dial*; Apex Electric Mfg. Co.  
*Bell dial*; Bell Mfg. Co.

## FIXED CONDENSERS

*Mica fixed condenser*; Aerovox Wireless Corp.  
*Aerovox bypass condenser*; Aerovox Wireless Corp.

## GRID-LEAKS AND RESISTANCES

*Tubular grid-leak*; Aerovox Wireless Corp.  
*Bradleyleak*; Allen-Bradley Co.  
*Bradleyohm*; Allen-Bradley Co.  
*Bradleyunit*; Allen-Bradley Co.  
*Clarostat*; American Mechanical Labs.  
*Amplex Lavite resistance*; Amplex Instrument Labs.  
*Amplex grid-leak*; Amplex Instrument Labs.  
*Arbee grid-leaks and resistances*; Arbee Mfg. Co.  
*Grid-leak*; A. C. Brady Co.  
*Volt-X variable grid-leak*; Burton & Rogers Mfg. Co.  
*Volt-X grid-leak mounting*; Burton & Rogers Mfg. Co.

## HEADPHONES

*Bel-Canto headset*; Bel-Canto Radio & Tel. Equipment Co., Inc.  
*Berstan headset*; Berstan Radio Products.  
*Navy type headset*; Brandes Products Corp.  
*Superior headset*; Brandes Products Corp.

## JACKS

*Radio jack*; Adams Radio Mfg. Co.  
*Amplex jack*; Amplex Instrument Labs.  
*Tri-jack*; Brooklyn Metal Stamping Co.  
*"B. M. S." jack*; Brooklyn Metal Stamping Co.

## KITS

*A-C Dayton XL-5 Knocked Down Set*; A-C Electrical Mfg. Co.  
*Acmeflex kit*; Acme Apparatus Co.  
*All-Amax Senior kit*; All-American Radio Corp.  
*"Cockaday" and "Tobias" kits*; Amplex Instrument Labs.  
*Neutrodyne, Superheterodyne and Tobias kits*; Amplex Instrument Labs.  
*Melco Supreme kits*; Amsco Products, Inc.  
*"Fada" neutrodyne kit*; F. A. D. Andrea, Inc.  
*Superheterodyne kit*; Apex Electric Mfg. Co.  
*"Pacific Rainbow" Super-Het kit*; Baldwin Pacific & Co.  
*Bel-Tone Superdyne kit*; Bel-Tone Radio Co.  
*Dyne-O-Might kit*; Birch-Field Radio Corp.  
*Superheterodyne kit*; J. T. Boone Radio Corp.  
*Superheterodyne kit*; Charles A. Branston, Inc.  
*B-T R.F. Circuit*; Bremer-Tully Mfg. Co.

## LOOPS

*Aalco folding loop*; Aalco Radio Laboratories, Inc.  
*Amplifex loop*; Amplifex Radio Corp.  
*Berling loop*; Berling Magneto Co.  
*Basket-weave folding loop aerial*; Bodine Electric Co.  
*Super-folding loop aeriels*; J. T. Boone Radio Corp.

## LOUDSPEAKERS

*Royal radio speaker*; Adler Mfg. Co.  
*Junior Ambotone*; American Bosch Magneto Corp.  
*Ambotone reproducer*; American Bosch Magneto Corp.  
*Burns loudspeaker*; American Electric Co.  
*Amplion loudspeaker*; Amplion Corp. of America  
*Bell-type speaker*; Apex Electric Mfg. Co.  
*Armstrong speaker*; Armstrong Speaker Co.  
*Atwater Kent loudspeaker*; Atwater Kent Mfg. Co.  
*Bel-Canto loudspeaker*; Bel-Canto Radio & Tel. Equip. Co.

## A VARIABLE RATIO VERNIER DIAL

*Name of instrument:* SLF converter tuning dial.

*Description:* This dial is designed to operate with an ordinary straight-line-capacity condenser for obtaining straight-line-frequency tuning. It accomplishes the same results as using a straight-line-frequency condenser with an ordinary dial. The condenser shaft itself is fastened to a lever which operates in a spiral cam slot which is mounted on the dial bearing. Throughout the first lower settings of the dial, the condenser revolves much slower than the dial itself, but this ratio of movement of the condenser and the dial increases until at the upper settings of the dial, the condenser is moving at an increased rate. The rate of change of capacity with dial setting is of course correct for producing straight-line-frequency tuning when used in connection with the proper coil and condenser that will cover the wavelength band that it is desired to operate over.

*Usage:* In any radio-frequency circuit for controlling the tuning apparatus.

*Outstanding features:* Efficiency. Straight-line-frequency tuning. Smooth operation.

Converts old sets to the new style of tuning. 360 degree operation.  
(Further details furnished on request)

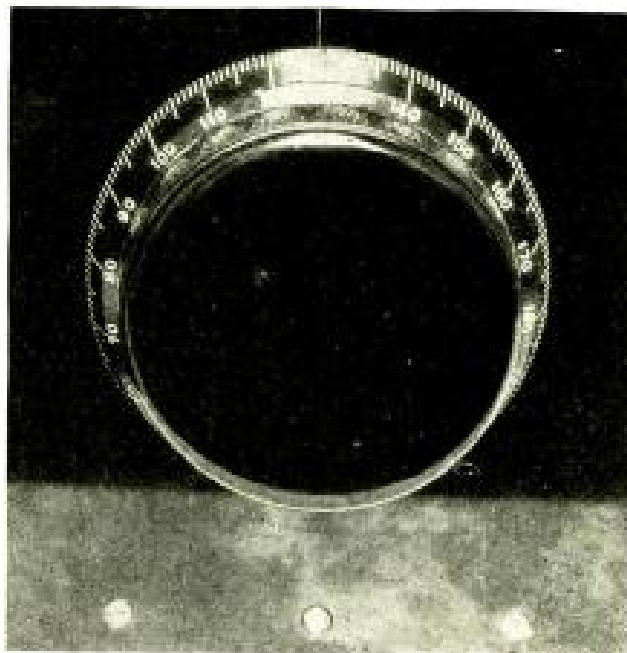

*A New Converter for SLF Tuning*

*Bel-Canto cabinet speaker;* Bel-Canto Radio & Tel. Equip. Co.  
*Semi-console cabinet (combination horn and cabinet);* Blandin Phonograph Co., Inc.  
*"Sonochord" loudspeaker;* Bondette Mfg. Co.  
*Brandes speaker, type H;* Brandes Products Corp.  
*Brandes cone-type loudspeaker;* Brandes Products Corp.  
*Brandes cabinet speaker;* Brandes Products Corp.  
*Orchestrion De Luxe;* F. Bremerman & Sons  
*Bristol Audiophone loudspeaker;* Bristol Co.

## MISCELLANEOUS ACCESSORIES

*"Spaghetti";* Acme Wire Co.  
*Window lead-in;* Acorn Radio Mfg. Co.  
*"Little Giant" circuit breaker;* Bruno H. Ahlers  
*Na-ald sponge rubber cushion;* Alden Mfg. Co.  
*Standard tube base;* Alden Mfg. Co.  
*Allen special radio soldering paste;* L. B. Allen Co., Inc.  
*Alpha "Special" spaghetti;* Alpha Radio Supply Co., Inc.  
*Insulated, square and round bus bar wire;* Alpha Radio Supply Co., Inc.  
*Bosch Nobattery;* American Bosch Magneto Corp.  
*Radion loudspeaker horn;* American Hard Rubber Co.  
*Radion loudspeakerphone cap;* American Hard Rubber Co.  
*Coil mount;* American Radio & Supply Co.  
*Spaghetti tubing;* American Radio & Supply Co.  
*"Nifty" lead-in;* Amoroso Mfg. Co.  
*"Nifty" ground clamp;* Amoroso Mfg. Co.  
*Apollo nickel zinc;* Apollo Metal Works  
*Adaunit;* Auto Indicator Co.  
*Porcelain pedestal;* Barkelew Electric Mfg. Co.  
*Ear cushion for phones;* Bates & Co.  
*Belden battery cords, headset cords, tips and terminals;* Belden Mfg. Co.  
*B-11 radio tubing;* Bentley-Harris Mfg. Co.  
*Blackburn ground clamp;* Blackburn Specialty Co.  
*Bearings for radio tuning coils;* Edward Board

## PANELS

*Radion panels;* American Hard Rubber Co.  
*Condensite products;* Bakelite Corp.  
*Bakelite products;* Bakelite Corp.  
*Redmanol products;* Bakelite Corp.

## PHONE PLUGS

*Ajax multi-phone plug and connector;* Ajax Electric Specialty Co.  
*Multiple phone plug;* Barkelew Electric Mfg. Co.  
*Series phone plug and post;* Barkelew Electric Mfg. Co.  
*Series phone plug for binding post mounting;* Barkelew Electric Mfg. Co.

## PHONOGRAPH ATTACHMENTS

*Burns Concert loudspeaker unit;* American Electric Co.  
*Amplion phonograph unit;* Amplion Corp. of America

## POTENTIOMETERS

*Bradleyometer;* Allen-Bradley Co.  
*Regal potentiometer;* American Specialty Co.  
*Amsco potentiometer;* Amsco Products, Inc.  
*Amsco "Dubtwindr" potentiometer-rheostat;* Amsco Products, Inc.  
*"Eada" potentiometer;* F. A. D. Andrea, Inc.

## POWER AMPLIFIERS

*One stage power amplifier;* Bristol Co.

## RADIO CABINETS

*Radio cabinet;* A. Hall Berry  
*Blandin radio cabinet;* Blandin Phonograph Co., Inc.

## RADIO-FREQUENCY TRANSFORMERS

*"Acme" radio-frequency transformer;* Acme Apparatus Co.  
*"Acme" "D" unit (tuned radio-frequency transformer with condenser);* Acme Apparatus Co.  
*Radio-frequency transformer;* Aero Products, Inc.  
*All-American radio-frequency transformer;* All-American Radio Corp.  
*Amsco radio-frequency transformer;* Amsco Products, Inc.  
*Radio-frequency tuned transformer;* Benjamin Electric Mfg. Co.  
*Branston radio-frequency transformer;* Chas. A. Branston, Inc.



"Tri-Coil" radio-frequency transformer; Brooklyn Metal Stamping Co.

## RECEIVING SETS

A-C Dayton XL-10 receiver; A-C Electrical Mfg. Co.  
 A-C Dayton receiver; A-C Electrical Mfg. Co.  
 "Paragon" receivers; Adams-Morgan Co.  
 Adler-Koyal neodyne; Adler Mfg. Co.  
 Torodyne receiver; Ainsworth Radio Co.  
 Air-Way receivers; Air-Way Electric Appliance Corp.  
 Ajax crystal receiving set; Ajax Electric Specialty Co.  
 All-American receiver; All-American Radio Corp.  
 Amber Marx-O-Dyne 5-tube set; Amber Sales Corp.  
 Bosch receiver; American Bosch Magneto Corp.  
 Electrola receiver; American Specialty Co.  
 Amplex DX5 receiver; Amplex Instrument Labs.  
 Melco Supreme receiver; Amsco Products, Inc.  
 Deresnadyne broadcast receiver; Andrews Radio Corp.  
 King Cole receiver; Anylite Electric Co.  
 Apex Super 5 receiver; Apex Electric Mfg. Co.  
 Microdyne receiver; Apex Electric Mfg. Co.  
 Atwater Kent radio-frequency receiver; Atwater Kent Mfg. Co.  
 Standard "B" pocket radio; Auto Indicator Co.  
 Aragain radio receiver; Autometal Corp.  
 Baby Grand crystal receiver; Beaver Machine & Tool Co., Inc.  
 Biltmore Master Reflex receiver; Biltmore Radio Co.  
 Dyne-O-Might receiver; Birch-Field Radio Corp.  
 Blair No. 11 receiver; Blair Radio Laboratories  
 Brandola receiver; J. F. Brandeis Corp.

## RHEOSTATS

"Acme" rheostat and potentiometer; Acme Apparatus Co.  
 Bradleystat; Allen-Bradley Co.  
 Regal rheostat; American Specialty Co.  
 Amplex rheostat; Amplex Instrument Labs.  
 Amsco rheostat; Amsco Products, Inc.  
 Amsco double rheostat; Amsco Products, Inc.  
 Amsco "Dublwundr" rheostat-potentiometer; Amsco Products, Inc.  
 "Fada" rheostat; F. A. D. Andrea, Inc.  
 Brach-stat; L. S. Brach Mfg. Co.

## SOCKETS AND ADAPTERS

Na-ald sockets and adapters; Alden Mfg. Co.  
 All-American radio tube socket; All-American Radio Corp.  
 Radion socket; American Hard Rubber Co.  
 Amplex socket; Amplex Instrument Labs.  
 Amsco socket; Amsco Products, Inc.  
 Baldwin-Pacific Super Lo Wave adapter; Baldwin-Pacific & Co.  
 Belden socket; Belden Mfg. Co.  
 Bell socket; Bell Mfg. Co.  
 Cle-ra-tone socket; Benjamin Electric Mfg. Co.  
 Seven and eight socket shelves; Benjamin Electric Mfg. Co.  
 V. T. Sockets; Bennington Radio & Electric Mfg. Co., Inc.  
 Flewelling socket; Buell Mfg. Co.

## SWITCHES

Fil-fone control switch; A-C Electrical Mfg. Co.  
 Bradleyswitch; Allen-Bradley Co.  
 Regal switches; American Specialty Co.  
 Amsco switches; Amsco Products, Inc.  
 "Kant-Blo" signals; Apex Radio Co.  
 Combined switch and arrester; Barkeley Electric Mfg. Co.  
 Antenna selector switch; Barkeley Electric Mfg. Co.  
 Battery switch; Benjamin Electric Mfg. Co.  
 Single and double inductance switches; Bruno Radio Corp.

## TESTING INSTRUMENTS

Perfection hydrometer; Bemco Mfg. Co.  
 Hoyt tube tester; Burton & Rogers Mfg. Co.  
 Voltmeters; Burton & Rogers Mfg. Co.

## TUBES

"Sea Gull" amplifier and detector tube "E"; Aberdeen Specialty Co., Inc.  
 "Sea Gull" rectifier tubes; Aberdeen Specialty Co., Inc.  
 Raytheon tube; American Appliance Co.  
 Bluebird tube; Bluebird Tube Co.  
 Vacuum tube; Brendoune Corp.  
 "True Blue" vacuum tube; Brighton Laboratories, Inc.

## TUNING INDUCTANCE UNITS

"Copp" vario elector; A-C Electrical Mfg. Co.  
 A-C Dayton complete units; A-C Electrical Mfg. Co.  
 A-P coils; Acme Products Co.  
 Aero coil tuning inductances; Aero Products, Inc.  
 All-American toroid coils; All-American Radio Corp.  
 All-American radio-frequency coupler; All-American Radio Corp.  
 Amsco honeycomb coils; Amsco Products, Inc.  
 Amsco variometer; Amsco Products, Inc.  
 Honeycomb coils; Atwood Electric Co.  
 Bel-Tone variocoupler; Bel-Tone Radio Co.  
 B & P micrometer-type low-loss tuner; Barrett & Paden  
 Bel-Tone variometer; Bel-Tone Radio Co.  
 Bel-Tone filter tuner; Bel-Tone Radio Co.  
 Bel-Tone Major tuner; Bel-Tone Radio Co.  
 Branston oscillator coupler; Chas. A. Branston Inc.  
 Branston honeycomb coil; Chas. A. Branston, Inc.  
 Branston three-coil mounting; Chas. A. Branston, Inc.  
 Heterus coil; Chas. A. Branston, Inc.  
 Bruno "77" low-loss tuning coil; Bruno Radio Corp.  
 Bruno low-loss tuned radio-frequency coil; Bruno Radio Corp.  
 Bruno short-wave tuning coil; Bruno Radio Corp.  
 Flewelling tuner; Buell Mfg. Co.

## TOOLS AND EQUIPMENT

Jack wrench; Adams Radio Mfg. Co.  
 Condenser plate cleaner; Atwood Electric Co.  
 "Solderette" electric soldering iron; Bechler Steel Products Co.  
 Junior bench saw; W. B. & J. C. Boice.  
 B-T low-loss tuner; Bremer-Tully Mfg. Co.  
 Bruno engraving set; Bruno Radio Corp.

## VARIABLE CONDENSERS

"Acme" variable condenser; Acme Apparatus Co.  
 Bradleystat; Allen-Bradley Co.  
 Worm-drive vernier condenser; American Brand Corp.  
 Kelford variable condenser; American Specialty Co.  
 Amplex grid-condenser; Amplex Instrument Labs.  
 Amsco low-loss variable condenser; Amsco Products, Inc.  
 Amsco straight-line-frequency condenser; Amsco Products, Inc.  
 "Fada" variable condenser; F. A. D. Andrea, Inc.  
 Variable condenser; Barrett & Paden.  
 Variable air condenser; Beacon Radio Mfg. Co.  
 Low-loss condenser; Benjamin Electric Mfg. Co.  
 Turn-it adjustable condenser; Chas. E. Bonine  
 Super variable condenser; J. T. Boone Radio Corp.  
 B-T Lifetime condenser; Bremer-Tully Mfg. Co.  
 B-T tandem condenser; Bremer-Tully Mfg. Co.  
 3 in 1 variable condenser; Bruno Radio Corp.  
 Flewelling condenser; Buell Mfg. Co.

## WIRE

"Celatsite"; Acme Wire Co.  
 Battery cable; Acme Wire Co.  
 Alpha square, round and insulated bus bar wire; Alpha Radio Supply Co., Inc.  
 Gosilco; American Luminous Products Co.  
 Belden loop wire; Belden Mfg. Co.  
 Belden Litz wire; Belden Mfg. Co.  
 Belden hook-up and magnet wire; Belden Mfg. Co.



## WITH THE INVENTORS

CONDUCTED BY WILLIAM G. H. FINCH

*THIS department will keep you in touch with the latest inventions of interest on which patent rights have been granted, and which are significant contributions to radio art.*

### Tuning in the Stations by Name

THERE is an idea for a station indicator that greatly simplifies tuning in patent No. 1,555,743, which was issued to E. G. Ballenger of Atlanta, Ga.

An object of the invention is to provide a simple attachment which can be easily applied to any panel-board and connected to the shaft of a tuning element. Then as a portion of the indicator is moved, space for the names of the broadcasting stations will successively appear through a slot in the panel.

The invention comprises a casing which is somewhat like a radio tuning dial in appearance.

Within this casing is placed a movable strip on which may be listed the names of the various broadcasting stations.

This strip is connected by suitable gearing to the shaft of a tuning element forming part of the radio set so that as the dial is moved, and the set is tuned to various stations the strip moves, bringing into view in the slot the names of these stations. Therefore, if a person wants station WEAF of New York he does not have to remember the wavelength; he need but turn dial or dials until the name or call letters of this particular station appear through the slot.

One form of the station indicator is shown in Figure 1.

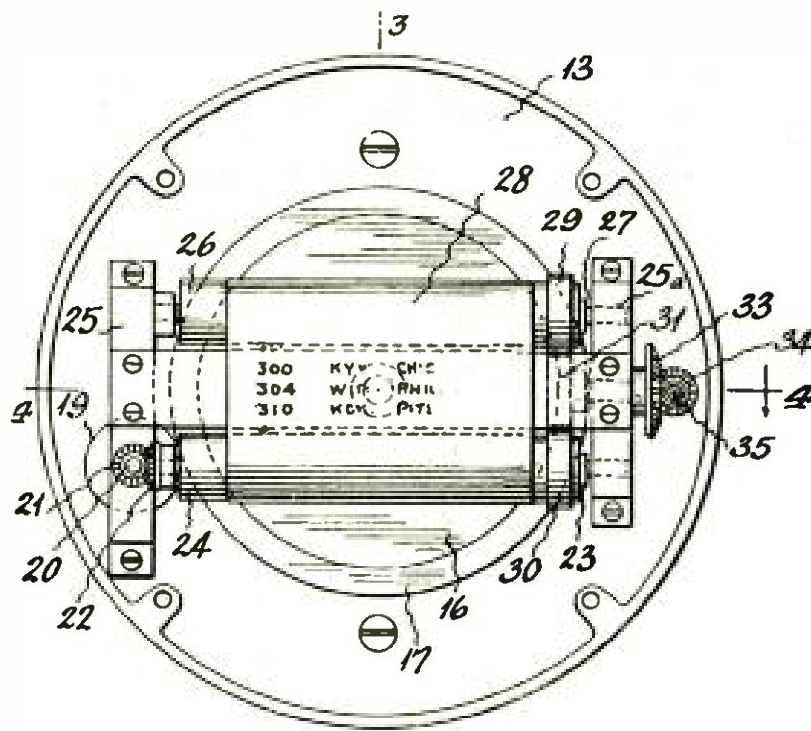

THE BALLENGER STATION INDICATOR

FIGURE 1: *This drawing shows the details of the invention; on the moving strip is shown how the stations are listed, and also the simple system of gears.*

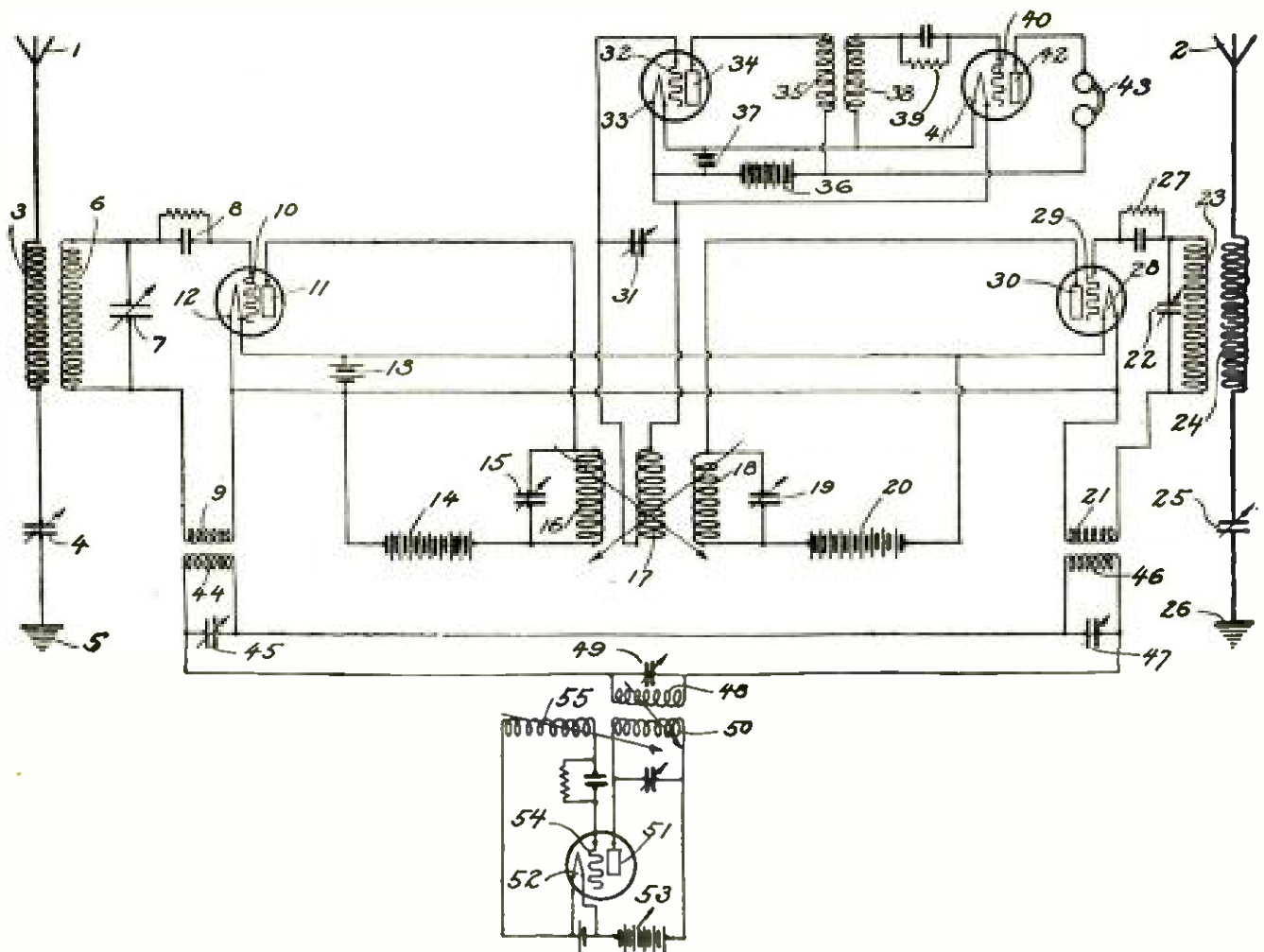

A SYSTEM OF CONTINUOUS WAVE RECEPTION

FIGURE 2: This diagram illustrates a receiving system in which two differently tuned receiving circuits are balanced against each other. A beat note, which is substantially the same in both circuits, is produced by means of a local oscillator and undesired frequencies are balanced out while retaining the desired signals.

### A Novel Scheme for "Eliminating Static"

LE ROY E. HUMPHRIES, of Atlanta, Ga., was recently granted Letters Patent No. 1,549,310, "on a radio receiver and static elimination system."

This invention relates broadly to radio communication, but more particularly to a radio receiving system used for the reception of high frequency current signals wherever they are subject to interference from "static" or strays of an untuned or aperiodic character. These strays excite the receiving system by shock excitation or by induction, leaving it free to oscillate at its own natural period or to the interference that is offered by local transmitters in proximity to the receiving station.

A system is provided for the reception of signals so that the detrimental or interfering effect of the static or stray currents is minimized or eliminated, thus providing a more reliable and efficient system for reception.

Another object of the invention is to provide a circuit arrangement for a receiving station so as to make possible the simultaneous transmission and reception of signals. To this end

the transmitter is located in close proximity to the receiving station, but produces no interference with the functioning of the receiving apparatus.

There is also a receiving circuit arrangement that has a pair of differently tuned energy collecting circuits that are connected to differentially coupled circuits which are tuned to substantially the same frequency. A separate circuit is cumulatively coupled with the resultant field of the differentially coupled circuits and connected to an independent radio receiving apparatus which, by virtue of the differential operation of the associated circuits, will respond to a selected incoming frequency to the exclusion of strays or undesired frequencies.

Another object of the invention is to provide a receiving system that is particularly adapted to continuous wave reception. A pair of differently tuned receiving circuits are balanced against each other and a local source of oscillations is supplied to each circuit through a link circuit that has branches coupled one to each of the receiving circuits and each tuned to a frequency equal to the frequency of the opposite receiving circuit. In this way a resultant beat note of substantially the same frequency in

each receiving circuit is produced and undesired frequencies and strays are balanced out while retaining the desired signal. (See Figures 2 and 3.)

### A Telephone Receiver as a Loudspeaker

HENRY G. SALL, of Chicago has been granted patent No. 1,552,959 covering a telephone receiver in which the armatures of the polarized electromagnets are connected with the receiver diaphragm by means of a link which serves to transmit the vibrations. This instrument, which may be used as a loudspeaker, is shown in cross section in Figure 4.

The diaphragm of this receiver may be made of any suitable resilient sheet material such as mica, bakelite or a suitable metal, and is tensioned to resist deflection from its normal plane in either direction. A link connects the diaphragm with the receiver armature in such a way as to maintain a fixed distance between them. In this way the diaphragm may position the armature centrally between the magnet poles and resist the movement of the armature from its central position.

The employment of a resilient coupling between the link and diaphragm prevents grating noises and preserves, unimpaired, the mechanical union between these parts.

### A Simple Crystal Detector Mount

PATENT No. 1,554,640, covering a simple method for mounting crystals for radio detection purposes was issued recently to Volney T. Miller of Kansas City, Mo.

This is a combination of a crystal detector element with a mutual mounting. The mounting has a series of parallel grooves or corrugations across its face, while the apex of a part of these grooves has ends overlapping the edge of the crystal.

Figure 5 shows the device in perspective; the grooving may be plainly seen.

### A Variable Mercury Condenser

A RECENT patent, No. 1,553,766, issued to Charles A. Friedrich of Brooklyn, New York, covers a variable mercury condenser, illustrated in Figure 6.

Mercury-controlled devices have nearly always been found unsatisfactory for radio work in the past, because they have not given accurate enough adjustments; therefore most of them were abandoned in the laboratory.

One fault in mercury-controlled devices has been the imperfections in construction and in the material used for the mercury containers. It has been found that the container, in order to permit the use of mercury as a controlling ele-

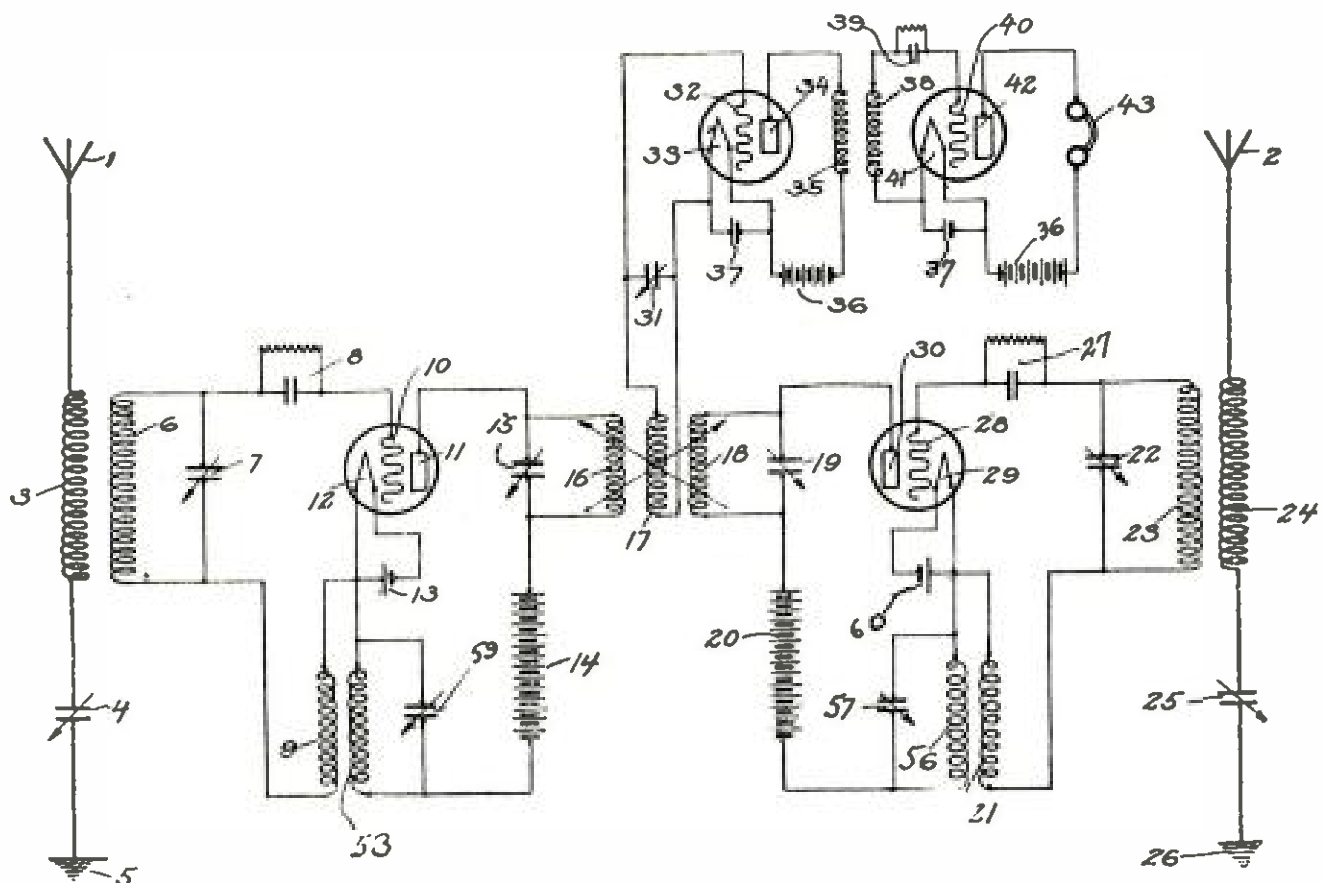

A VARIATION OF THE HUMPHRIES SYSTEM

FIGURE 3: Another form of the system for continuous wave reception in which each of the receivers operates with self-excited oscillations for beat reception.

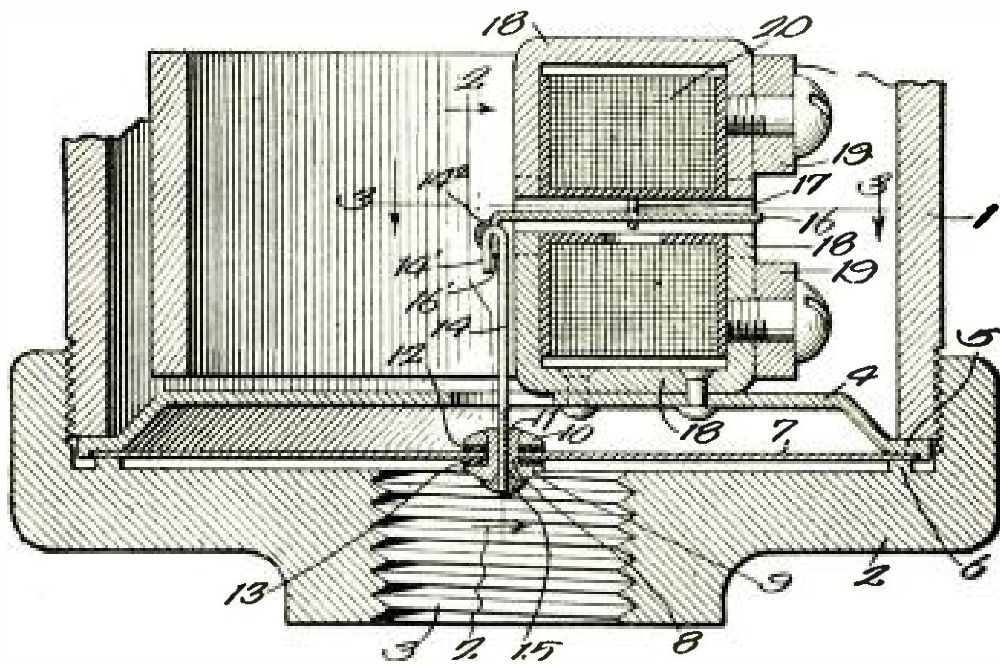

THE SMALL TELEPHONE RECEIVER

FIGURE 4: This shows a cross section of the construction of this new receiver in which the armatures of the polarized electromagnets are connected with the diaphragm indirectly by means of a link. A resilient coupling is employed between the link and the diaphragm to prevent grating noises and insure good mechanical connection.

ment, must be so constructed that the surface tension will always cause the mercury to move as a continuous mass. In other words, the cohesion of the molecules of mercury must be increased to resist the attraction or adhesion of the walls of the container, which tends to break up the mercury mass.

This end is accomplished in Mr. Friedrich's invention by using a circular container of which one or both face walls are spherically curved or convex; in this way the mercury mass that fills only a part of the container diminishes in thickness from the center toward the periphery of the container. By reason of the greater weight at its wider or thicker part, the surface tension of the mercury is considerably increased and the molecules at the narrower parts resist

the force of adhesion exerted by the walls of the chamber.

Having overcome the difficulties in the use of mercury as a controlling element, use may be readily made of it in the construction of grid-leaks, rheostats and variable condensers, greatly

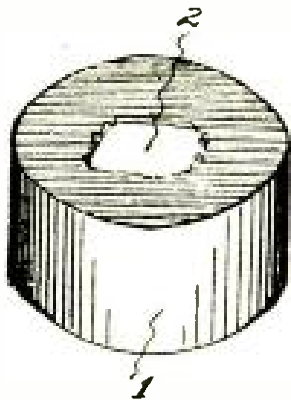

A SIMPLE MOUNTING FOR CRYSTALS

FIGURE 5: A series of parallel grooves or corrugations run across the face of this mounting for detector crystals. The center grooves overlap the face of the crystal.

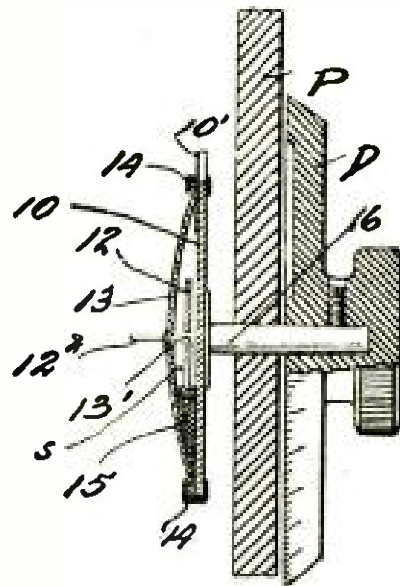

A NEW VARIABLE MERCURY CONDENSER

FIGURE 6: A cross-sectional view of the Friedrich condenser. The problem of increasing molecular cohesion by means of a strong surface tension so that the mercury will always move as a continuous mass and not adhere to the walls of the container has been solved by using a circular container of which one face wall is spherically curved.

simplifying the construction of others, while at the same time increasing the efficiency.

Other liquids than mercury may be adopted to act as the controlling element without departing from the principle of this invention.

### A New Anti-static Method

A METHOD for reducing static interference in radio receiving by balancing signals received on a loop and a capacitive antenna has been patented (No. 1,556,137), by Roy A. Weagant of New York.

Mr. Weagant has discovered that the most objectionable forms of static impulses seem to behave as though they are due to vertically propagated waves heterogeneously polarized. Knowing that signal waves are horizontally propagated and vertically polarized, he has devised a new method for minimizing static interference.

The present invention is based on discoveries made by Mr. Weagant before and also on certain additional facts he has discovered in regard to the properties of different types of aerials, when they are associated in a certain way.

Antennas of different forms draw energy from the static and signal waves in different ways. The phase and direction of currents produced in them are differently affected by the polarization and direction of transmission of these waves. These differences, he finds, can be utilized to at

least partially cancel static and retain signals from one-half of the horizon.

It is well known that a vertical open antenna receives horizontally propagated vertically polarized signal waves equally well and with like effects, no matter from what direction they may arrive; it is also known that such an antenna, whether grounded directly or through a counterpoise, will also receive static waves.

On the other hand, a loop antenna or a system of loops is differently affected by the direction of arrival of signal waves, and on purely theoretical grounds Mr. Weagant believes it probable that it is also differently affected by static waves when their direction of polarization changes.

In applying these principles, the inventor also finds that if currents are set up in associated antenna which are largely indifferent to the polarization of vertically propagated waves, so far as reception of energy is concerned, and which are differently affected by the azimuthal direction of horizontally propagated waves, he is enabled to geometrically combine the effects of the antenna currents on a common detector circuit. The result is that at least part of the static currents, and the signals from one-half of the horizon are approximately neutralized, while currents due to signals from the other half of the horizon are retained and more or less effectively added. Thus a most useful method and apparatus is produced for reducing both static and interference effects. A schematic diagram of this method is shown in Figure 7.

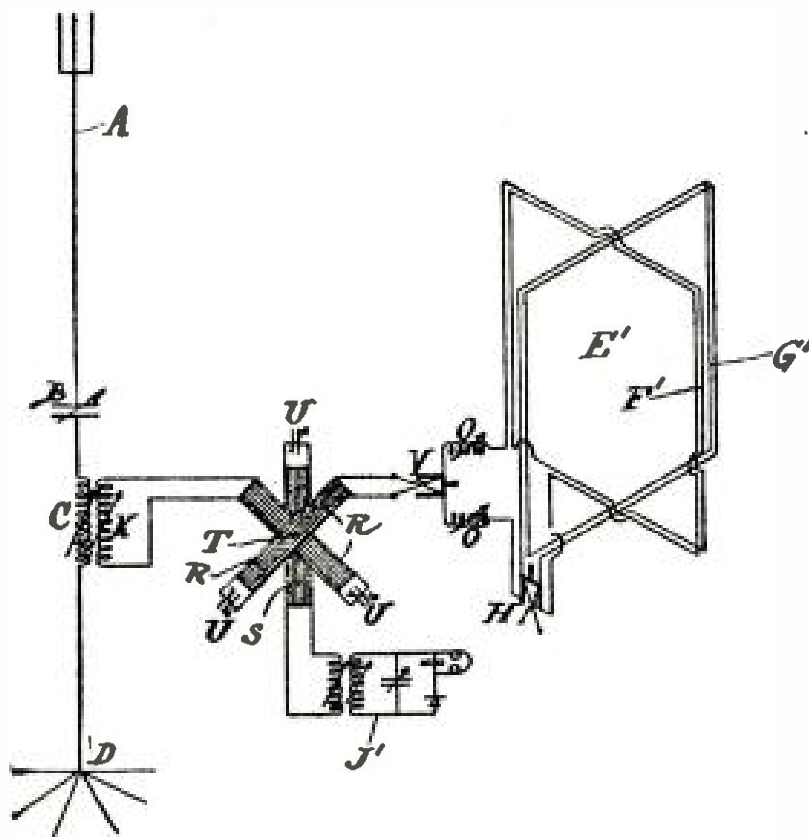

WEAGANT'S ANTI-STATIC METHOD

FIGURE 7: A wiring diagram of a new method of reducing static disturbances by balancing signals received on a loop and a capacitive antenna.

# HINTS FOR

# AMATEURS

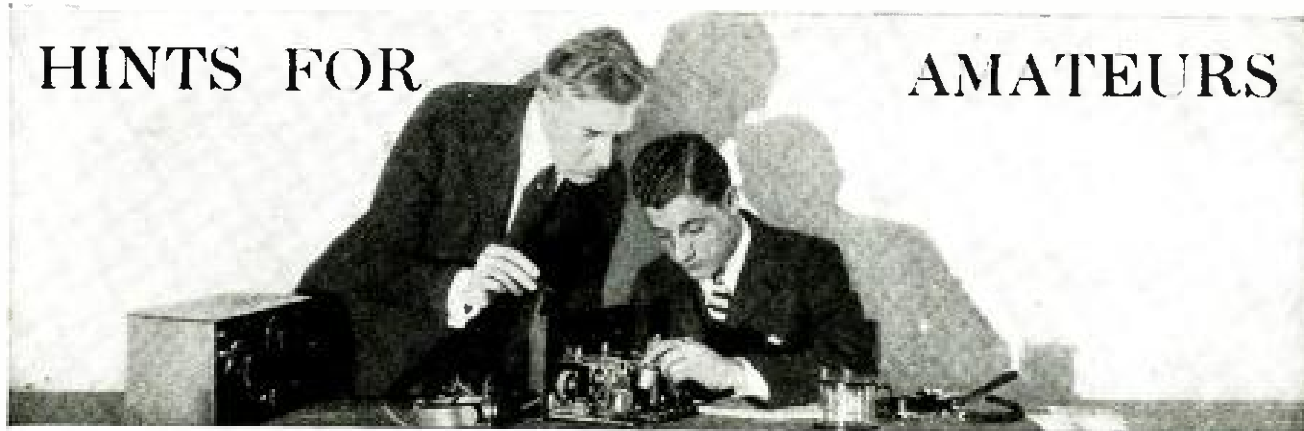

CONDUCTED BY ALBERT G. CRAIG

## The Variable Grid-leak

THE use of a variable grid-leak in a regenerative receiver will be found to be a decided improvement in regenerative control over the ordinary fixed type of leak. It will allow the tuning in of more distant stations as well as increased selectivity of the receiver. Try one in your set, if you haven't one now, and notice the difference in results.

## Clips for the New AC Tube

THE two heater terminals on the AC tube, which are placed at the top and protruding from a small bakelite connection block, do not offer a ready connection to the wires that furnish them with AC current. The manufacturers, however, have now placed on the market a small clip that fits on the tube connections and is equipped with binding post terminals for holding the wire.

## Replacing Crystals

MANY owners of home-made crystal sets complain that their crystal receiver works very well for a period of three or four weeks and then the volume steadily decreases until the signals are almost inaudible. They ask what the trouble is. The crystals deteriorate with use and should be replaced by new ones whenever the signal strength dies down to a value below which the signal is too weak to be understood. This is the only upkeep necessary with a crystal receiver and it

is low, for the crystals cost but a fraction of a dollar.

## The Plate Resistance Value for a Resistance-coupled Amplifier

A RESISTANCE of 250,000 ohms in the plate circuit of the resistance-coupled amplifier tubes will be found to be the best value to use for maximum amplification. Values higher than this will reduce the plate current to too low value, and values lower than this will cut down the amplification per stage with the standard tubes now in use.

## The Tube Rejuvenator

SOMETIMES the owner of a receiving set finds that the filaments of his tubes seem to give out. This does not mean that they burn out. They light up, but the volume obtained with them in this condition is very small. A thoriated filament tube may become damaged by excessive plate current application or by some other mishap. The original condition may be restored by using one of the tube rejuvenators that has recently been placed on the market. These rejuvenators consist of a transformer with taps for applying an alternating current voltage to the filament. The voltages that should be applied vary in intensity and the application of each voltage should be made for only a certain length of time. These tube rejuvenators have been found to restore at least fifty percent of the tubes that have heretofore been considered worthless.

### How to Test Your Batteries

If you find that the quality of reproduction in your receiver is deteriorated, that is, if the reproduction begins to get ragged, look at your batteries to see that they are not exhausted. Measure the voltage of the "B" batteries first. They should register more than  $16\frac{1}{2}$  volts for every  $22\frac{1}{2}$  volt section. If they do not give a reading above this value, replace them with new batteries. Also, test your "A" battery with a hydrometer and be sure that the reading is above 1.150. If it is lower than this, charge it at once.

After this is done, you will notice that the quality will be improved greatly unless you have some other trouble in the audio-frequency amplifier.

---

### The Most Economical Receiver

For local reception up to ten miles on the headphones, a good selective double-circuit crystal receiver will give really fine results. This type of receiver has practically no operating expense. The only expense incurred would be in replacing the crystals every two or three months. The cost of these crystals is so low as to make this expense negligible.

---

### A Hint for Cleaning the Panel

NEVER use water for washing the panel or any part of a radio receiver. If the panel gets dirty or greasy, dampen a soft cloth in alcohol and rub it lightly over the surface to be cleaned. This will remove the dirt and grease, and upon drying it off with another clean cloth it will leave a beautiful smooth polish without in any way damaging the apparatus. The alcohol evaporates rapidly.

---

### When You Tighten the Panel

WHEN screwing the panel to a radio set, first be sure that the holes drilled in the bakelite are spaced correctly, so

that they will gauge with the center portion of the wood—top, sides and bottom. Do not try to screw the wood screws directly into the wood without first drilling a small hole to give the screw a chance to start properly. Use a small drill of about one-half the diameter of the screw and drill the hole about two-thirds the depth that the screw should go into the wood. This will give you a good, secure fit and will prevent splitting the wood.

---

### How to Test Loose Connections

If you have a loose connection in your set that makes a jarring or rattling sound in the headphones or loudspeaker, it would be well to lift up the lid and investigate each wire to find out which one may be loose. Use a small wooden rod for moving the wires while you have a station tuned in. By pushing the wires with the rod slowly back and forth, you will hear a loud sound when you move the one that is loose. Then you can tighten it at the binding post or solder it fast where it is loose.

Never use a metal screw-driver for this purpose, as you may shortcircuit the "A" and "B" battery connections and blow out all your tubes.

Never fuss around the insides of any radio receiver with a screw-driver when the batteries are connected.

---

### Keep Away from Power Lines

WHEN you install your antenna wires be careful that they do not run over or under any electric wires or cables that may be in the vicinity. Do not place them near any such wires because the wires themselves may carry high-voltage currents, and if they fell on your antenna they might conduct the high voltage currents down to your receiver while you were tuning in. This might subject you to a severe shock. Keep your antenna away from such lines and prevent accidents.





## LISTENING IN

PRACTICAL pointers from experimenters and broadcast listeners. What helpful hints can YOU offer to your fellow fan? Readers are invited to address their letters to the editor of this Department.

CONDUCTED BY LLOYD JACQUEE

### How I Avoided Accidental Grounds

I WAS surprised some time ago to see the rheostats in the filament circuits of my five-tube neutrodyne get heated up red hot. After investigation the trouble was traced to an "accidental ground."

What had happened was that the entire output of the "A" battery had short-circuited through the portion of the rheostats in use, and as this device is made to carry only a small amount of current it was badly burnt.

The ground connection of the receiver is usually placed in the negative filament lead of the vacuum tube. The rheostat then is in the

negative lead and in series with the "A" battery. Then the negative side of the "B" battery is connected to the positive terminal of the "A" battery.

Now, if some misconnection is made, say in the "B" battery circuit, the "A" battery discharges through the rheostat.

The only way to prevent this trouble is to obviate any possibility of an accidental ground. This can be done cheaply and conveniently by placing a large capacity fixed condenser in series with the ground lead. It will not interfere with ordinary reception, and will prevent any trouble of this sort.

—FRANCIS PARKER

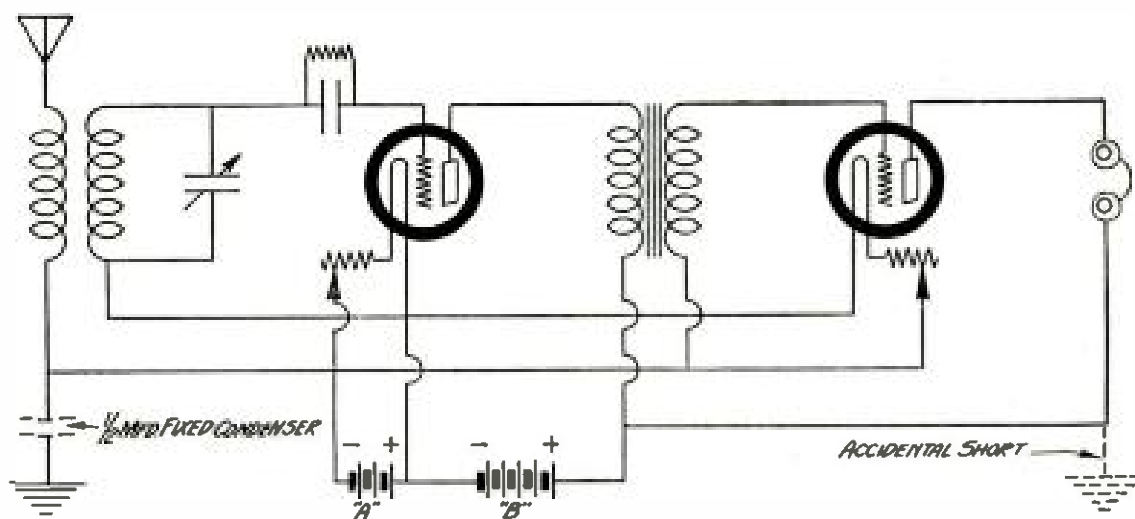

A LARGE FIXED CONDENSER INSERTED IN THE GROUND LEAD  
 This diagram shows how a condenser may be used to insulate the set from ground, thus preventing short-circuits in case the "B" batteries happen to become grounded or if the "A" battery is being charged.



#### HOW TO MOUNT THE VARIABLE RESISTANCE

*This picture shows how the variable resistor may be mounted directly on the terminals of the transformer.*

#### How I Reduced Interference With a Variable Resistance

**S**INCE I am located where there is a great deal of interference from electrical devices such as motors, starters, household appliances and other "noise makers," my reception has been marred considerably. I was told that there

was no remedy for this except to remove the source of the noise, which is impossible in this case.

In an effort to reduce the trouble so that I might enjoy the programs I hit upon the idea of shunting out the noise.

Following out this idea I shunted a variable high resistance unit across the primary of the last radio-frequency amplifying transformer of my five-tube, tuned-radio-frequency receiver. I found that a resistance of from 5000 to 3000 ohms could be used.

The lower the resistance used, the less noise there will be, but the volume of reception will also be cut down to a considerable extent. However I found that with a variable Bradley-stat the right resistance value to give pleasant reception with a suitable volume can be readily obtained.

It is easy to fasten this resistance to the transformer, and practically no alteration need be made to the set itself. The resistance is merely connected to the two terminals of the primary of the transformer.

My theory is that the resistance passes the noises, (as well as a certain amount of energy), and prevents them from going through the transformer winding and into the loudspeaker circuit.

—PAUL E. LAMAR

#### Is Your Antenna Short Circuited?

**A**NTENNAS that are partially grounded are often an unsuspected cause of trouble to radio fans.

I was bothered for an entire month with a peculiar condition of reception in which signals went on or off without the least warning. At first, thinking it was a case of poor batteries, or defective tubes, or possibly a loose connection in the set, I checked up on all those details but there was no improvement.

Finally during a wind storm, I discovered that the trouble was due to the branch of a tree, against which my single wire antenna was rubbing, thus grounding itself.

However I wanted to make sure that I had a defective circuit in the antenna.

By means of a pair of telephone receivers, and a battery, I was quickly able to determine

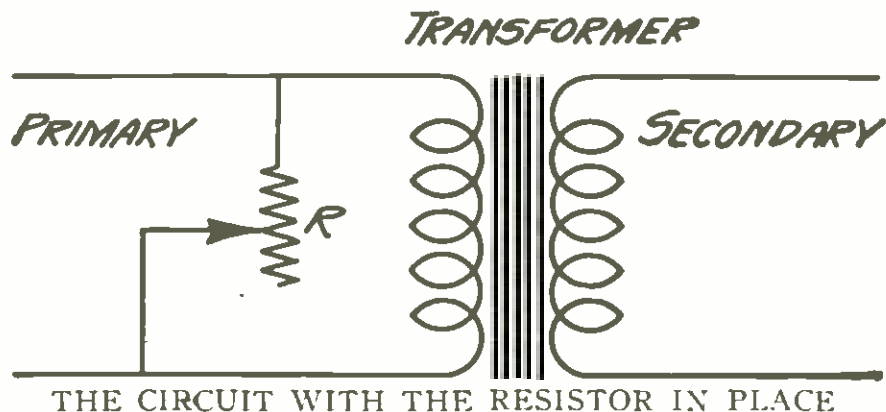

*This diagrammatic sketch shows the connections for hooking the variable resistance in shunt to the primary of the audio-frequency transformer for cutting down extraneous noises.*



#### HOW TO ATTACH THE BLUEPRINT TO THE PANEL

*A convenient method for drilling the holes in the correct places in the panel is to paste a blueprint in correct position on the panel and spot the holes directly from the markings on the blueprint. When the drilling is done, the paper may be loosened and taken off the panel.*

that it was grounded. The phones were connected in series with the antenna and the battery and ground. Each time the tip of the phones was touched on the battery, a loud click was heard. When the branch was blown away from the antenna wire, the click was very faint.

By removing the aerial at a greater angle I was able to make it clear the tree, and do away with my shortcircuited aerial and poor reception.

—MILTON BRANDT

#### How I Avoided Mistakes by Drilling Panels

IT has been my experience to spoil many good panels by carelessly laying out the drilling, or by making mistakes in measurement that disfigured the whole set.

In order to guard against these costly errors I have developed an idea which seems so elementary and yet is so effective that I am passing it along to other radio builders for their benefit.

Most construction articles in good magazines include a detailed drawing of the panel layout. Because of the small amount of space available this cannot be given in full size. Get a sheet of drawing paper, or even thin drawing "skin,"

and lay out the panel as shown in the magazine illustration, but in full size.\* Check over everything carefully and then secure the piece of insulating material that is to make up the panel proper.

This material should be secured cut exactly to size. Its best surface is selected, and a light coat of shellac is quickly applied. On top of this lay the full size drawing or a blue print, dimensions upwards, and press down firmly with a board padded with a cloth or newspapers. Guard against the drawing sheet from slipping. By comparing the edges of the paper with those of the panel, this can be carefully watched.

The shellac acts as an excellent glue and will hold the drawing on the surface tightly for the drilling. This should not be attempted, of course, before every hole is properly center-punched. By marking on the drawing the size of drills needed for the various holes, the work can be quickly and efficiently done.

To remove the drawing, just moisten it and peel it off. The extra shellac on the panel surface can be quickly removed by means of a rag dipped in alcohol.

In this way, you will never make a mistake in panel drilling.

—HENRY D. WALLER

\* POPULAR RADIO blue prints may be used in place of the drawings as they are exactly full size.

**Q** What little kinks have YOU discovered that are of interest and value to your fellow fans? Write and tell the editor of this department about them—and enclose illustrations if they are needed.

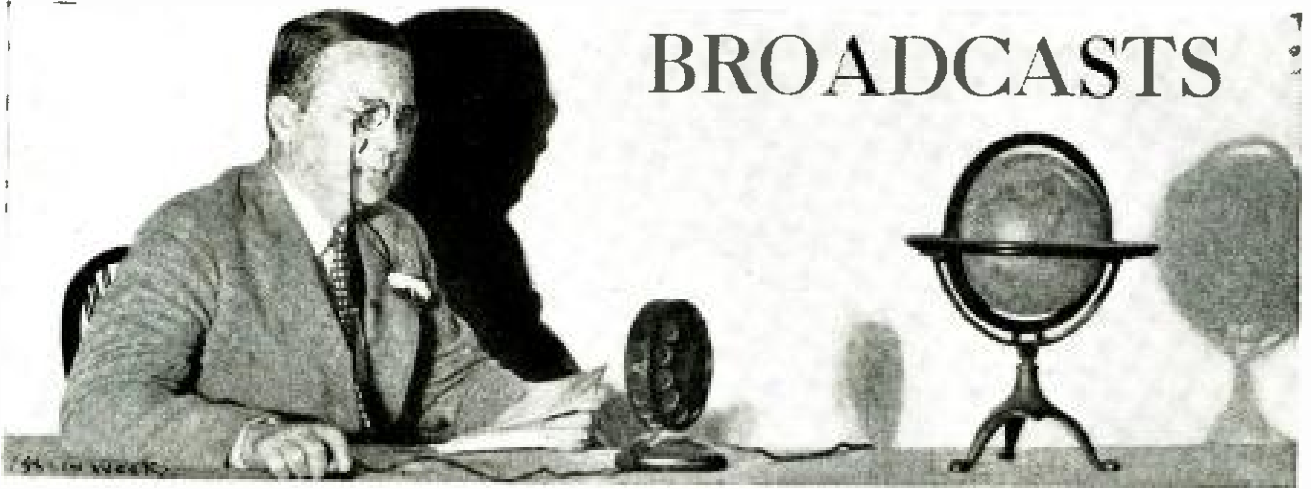

# BROADCASTS

CONDUCTED BY J. ANDREW WHITE

*In this department the Dean of Broadcasters—whose voice is known to millions of broadcast listeners—records items of interest and value to all radio fans everywhere.*

## The Warfare Between Churchmen and Scientists

THE Very Reverend William Ralph Inge, dean of St. Paul's, London, exploded a theological bombshell it appears by the statement made in a recent sensational article in which he declared that Christianity and science are still at war. His declaration that the church must face the facts of science is echoed in a renewed discussion of the subject prominently before all Christian churches now. Dean Inge declares there is very serious conflict between Christianity and science and that churchmen who declare otherwise either are thoughtless or are wilfully shutting their eyes.

## Help Summoned by "Live Radio"

THROUGH carrier current, a development of radio, communication was maintained with the outside world when a cloudburst and flood destroyed railroad, telegraph and telephone lines at Wenatchee, Wash. For several days the only messages reaching or leaving Wenatchee were transmitted over the high-power electric lines of the Puget Sound Power and Light Company which were recently installed over the mountains to Seattle. The apparatus used is similar to a radio outfit but instead of radiating waves through space in all directions the voice currents are kept concentrated about the power lines, thus insuring privacy and direction for the communications.

## Is Radio Changing Our Taste in Music?

THAT Beethoven was born only four years ago for many of us, with our first acquisition of radio sets, is the interesting angle from which the uplift in musical taste and appreciation is viewed by Percy A. Scholes, widely known musical critic of the British Broadcasting Company, who recently left London for a tour of America. He looks upon the intro-

duction of broadcasting as the greatest event in the history of the art of music and is unrestrained in his congratulations to America for developing this activity. Less than eighteen months ago, he says, English radio enthusiasts were protesting that Beethoven, Bach and Wagner were acceptable only to "highbrows who like to swank about their superior tastes," but these attacks have given way to admiration for the works of classical composers, music that has artistic impulse. This further prediction is added: "Give listeners plenty of fine music and they will learn to like it; our British experience is sure to be the American experience."

## What the "Whistling" Form of Interference Really Is

THAT fairly constant and annoying whistle which receivers pick up when the dials are set at a certain point seems to be a source of some misunderstanding among many novices. It is a form of interference set up when two high-powered broadcasting stations are too close together geographically, although they may be wide apart in wavelength or frequency. Radio Supervisor E. A. Beane, of the Chicago District, reports tests wherein he discovered that two stations, one operating on 560 kilocycles and the other on 1,200 kilocycles, produced a beat note frequency of 640 kilocycles, or the difference between the frequencies at which the two oscillators were functioning. Another frequency equal to their sum is also created, under the well known principle of heterodyning. It appears, however, that the third wave, or frequency, has a field strength considerably lower than the originals, and is reported to be objectionable for a distance of only five miles when the two stations are using 500 watts of power, and twenty miles when 5,000 watts power is used. Some time ago the Navy took this phenomena into consideration and decided to use frequencies ending in 5; any new frequency created by beat notes is therefore not an as-

signed frequency, or wavelength, and cannot interfere with regular channels, since their sum or difference would necessarily be a frequency ending in O. A reassignment by the Department of Commerce to prevent this form of "beat" interference may be undertaken on this basis—that is, increasing all assignments by 5 kilocycles, or reducing them that much.

### \$800 in Prizes for Short Radio Dramas

To stimulate the writing of plays especially designed for broadcasting, station WLS of Chicago is sponsoring a "national radio play contest" in cooperation with the Drama League of America. To be eligible for this contest plays must be written "as though they were to be produced for the blind" with every exit and entrance indicated and with as many explanatory sounds (such as rain, automobiles and telephone bells) as possible, to take the place of a background. And they must be one-act plays that take from eighteen to twenty-five minutes to produce and with no more than five characters. Prizes of \$500, \$200 and \$100 are offered for the three best plays submitted.

### A New List of Foreign Stations

AVAILABLE to those who would like to have it is a supplementary list of foreign broadcasting stations recently issued by the Department of Commerce; included are six stations in Den-

mark, eighteen in France, fourteen in Sweden, eight in Switzerland, two in Yugoslavia, six in Argentina, four in Chile, one each in Poland, Peru, Hongkong, Ceylon and Morocco; sixteen in Japan, nineteen in Australia, two in Canary Islands, and two in Tunis, Tunisia.

### Small Receivers for Japanese Fans

MANUFACTURE of small radio sets was recently undertaken in Japan but none have yet been placed on the market. It is expected that this field will be entered actively before long, following the announcement of the merger of the Nipponphone Phonograph Company, Tokyo, and the Tokyo Phonograph Company.

### More Radio, More Milk

FROM Strasbourg comes word that Rhineland dairymen have discovered that music not only soothes the cow, but induces her to increase her milk supply. It is asserted that in recent tests when a phonograph was placed within hearing of the placid German cow, appreciation of the musical accompaniment to the absorption of bran mash resulted in increases of 6½ percent in the quantity of milk given by bossie. It has not yet been determined, however, whether repetition of a limited repertoire of numbers would result in the contempt for the musical aid induced by familiarity, but so as to take no chances it is now proposed to install radio loudspeakers in the barns that the cows may have a bit more of variety in their programs.

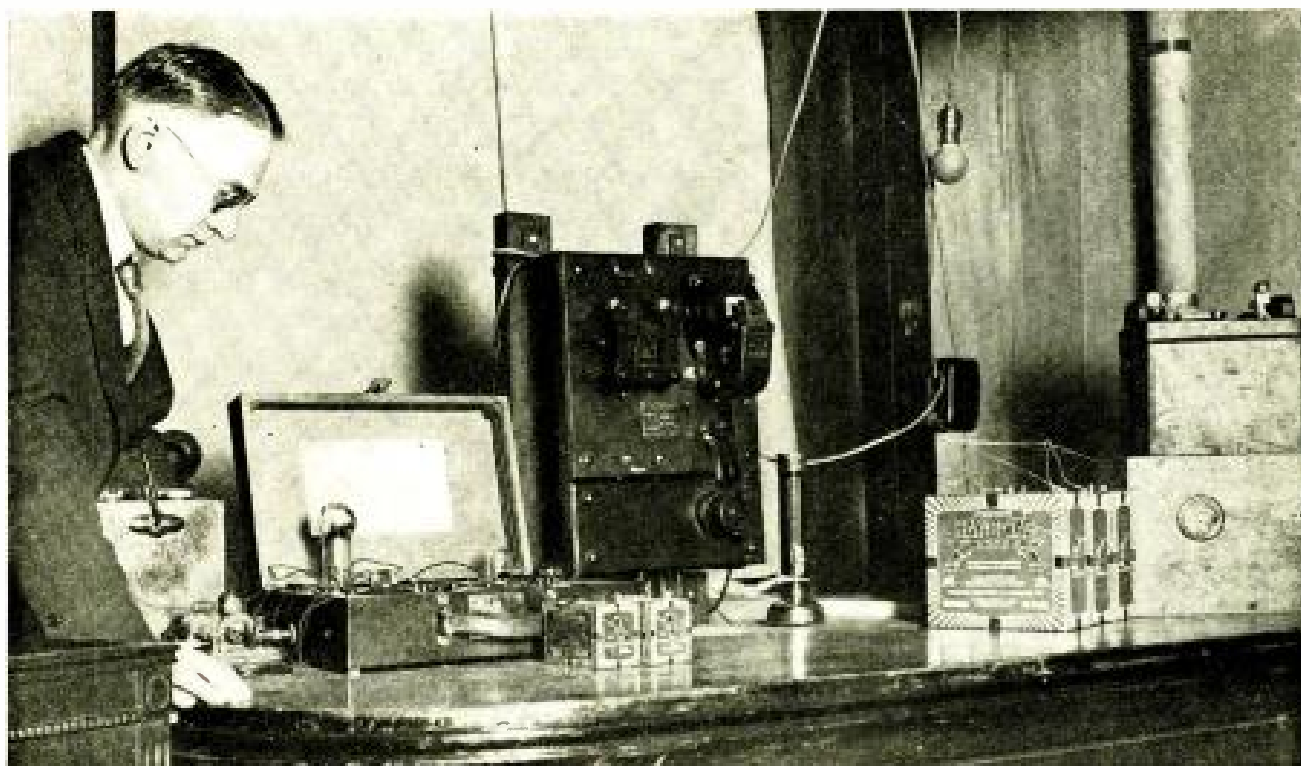

Kadel & Herbert

### A TUBE THAT GOES TO WORK AT THE WAVE OF YOUR HAND

The large tube in the portable radio set at the left is a new development of the radio vacuum tube that is energized into activity by the slightest shadow that falls upon it. In a recent demonstration by its inventor, Mr. V. K. Zworykin, a washing machine was started by waving a hand in front of the tube.

### Transatlantic Movies by Radio

A NEW machine for the almost instantaneous transmission of photographs or motion pictures by radio, known as the "radioscope," is shortly to be subjected to transatlantic tests, according to an announcement from the Telefunken Company of Berlin. A paper surface ten centimeters square bearing either writing or a photograph can be transmitted in a few seconds, it is claimed, and ultimately transmission will become instantaneous. Lessened cost of operation due to speed is the inherent difference between the German device and previous instruments of similar type, according to the announcements which credit the invention to Dr. Carolus of the University of Leipzig. Confirmation of the report that the tests would be held with the co-operation of the Radio Corporation of America could not be obtained through the New York officials of that company, who also denied knowledge of the invention which, it was said, had no connection with the several successful tests of radio picture transmission between New York and London.

\* \* \*

### The New "Panatropé" Instrument

BEFORE a distinguished audience in which New York society was represented by such



Kadel & Herbert

#### A CLOSE-UP OF THE NEW "SHADOW" TUBE

*The new photo-electric cell is compared by its inventor, Mr. V. K. Zworykin, with one of the standard 199 type. By placing an obstruction in the way of the light rays falling upon the uncoated portion of the bulb at the top, it is possible to operate relays which will control power.*

names as Mrs. Vincent Astor, Clarence H. Mackay and Otto H. Kahn and with the field of music represented by Leopold Auer, Frank Damrosch and Henry Hadley, among others, a new musical instrument which utilizes the electrical principle for the reproduction of sound was presented recently at Aeolian Hall, New York. Westinghouse, General Electric, Brunswick and Radio Corporation collaborated in the development of the instrument of which it was said that it was not a new or improved phonograph, but a milestone achievement in the union of electricity with music, based upon recording and reproduction by electricity. Dr. Alfred N. Goldsmith, speaking through the instrument from Washington, described the operation as one which superseded the mechanical method of phonograph recording. He explained that the singer stands in front of a device which is analogous to the finest broadcasting microphones and the electrical currents therein set up are amplified by vacuum tubes like those in a receiving set, and that the final output of these tubes operates a most precise cutting tool which makes the master record. The horn is absent, he said, and the energy for cutting the record no longer comes from the voice of the singer, but from electric generators or batteries feeding the vacuum tubes. On the reproduction end, no sound box is used and no horn. Instead of the needle resting in the conventional phonograph groove vibrating a sound box diaphragm it actuates a tiny strip of metal in what is known as the electrical pick-up, a small device enclosing the needle holder. Through these vibrations electrical currents are produced which pass through a powerful vacuum tube amplifier, operated from alternating current from an ordinary electric light socket, and the amplified output is fed into a loudspeaker of the free-edge cone type.

\* \* \*

### The Don Dons the Headphones

SPAIN continues to show additional progress in radio with another broadcasting station to be erected at Malaga, the first in that section of the country. Static interference has made the reception poor from foreign stations, and the Malaga fans are celebrating the advent of the new local station to a point where it is reported that radio receiver sales are reaching boom proportions.

\* \* \*

### The First Receiver to Be Bequeathed

FOR the first time on record, in New York at least, a radio set has been bequeathed by its owner by will and testament. The official files contain mention of practically everything imaginable, from fountain pens to millions of dollars in legacies, but it was a new one on the Surrogate's Court when the will of Edward F. Gordon was filed and it was shown that a beneficiary was to receive the radio set prized by the late departed. Gustave W. Fuerth, of Newark, was the friend named to enjoy that distinction.

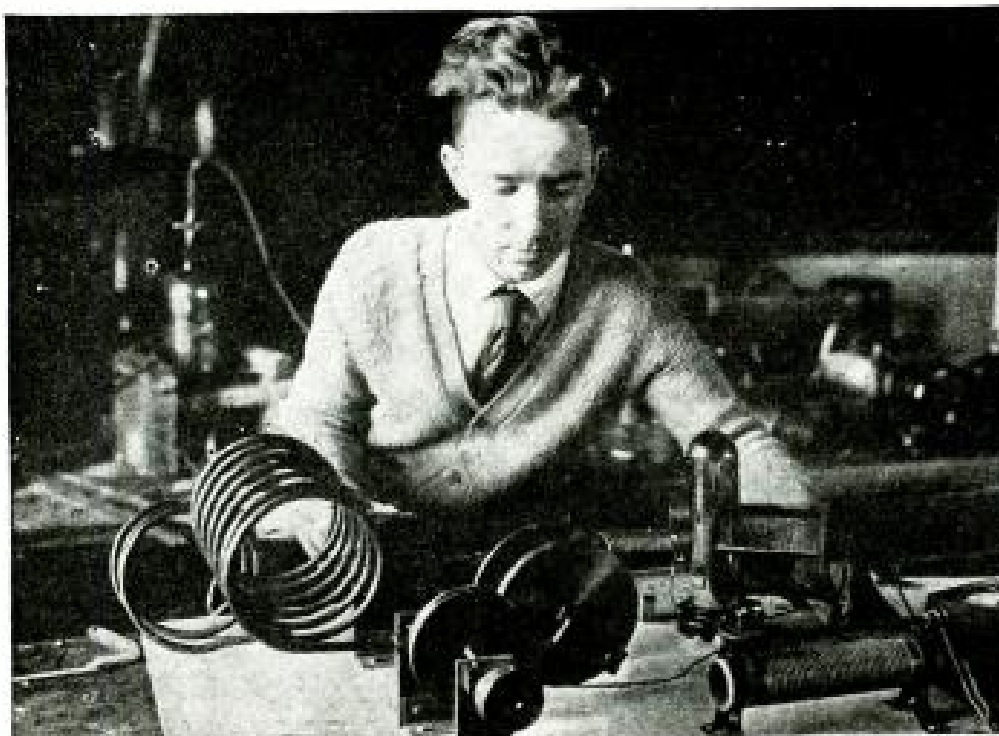

Underwood &amp; Underwood

### A "CONFIDENTIAL TRANSMITTER"

*By means of this short-wave transmitter which he has invented W. W. Salisbury hopes to carry on conversations by radio as privately as by telephone. By calculating the length of the transmitted waves and concentrating them in a narrow shaft with a reflector, he expects to direct them accurately.*

### How Radio Helps the Small College

JUST as the new and open style of football created by the rules committee brought colleges and universities into national prominence in sections of the country which had not previously known of their existence, so may radio publicize institutions of learning into country-wide fame such as their founders never hoped for. This possibility is indicated in the recent formation of an association of professors representing the educators who are broadcasting, headed by a president who hails from Carleton College, wherever that may be. Other member institutions are Beloit, Nebraska Wesleyan, Wisconsin, Kansas, Michigan, Ohio State and Iowa State.

### The "Song of the Atom"

EVER since radio research brought about the division of the atom, increasing wonders have pyramided so rapidly that it will hardly occasion any surprise to learn that now the radio audience has been introduced to the song of the electron. The demonstration occurred during a broadcast talk by Dr. Peter I. Wold, professor of physics at Union College. A photo-electric cell was connected to the broadcast circuit of WGY and a disc with many rows of perforations was placed between the cell and a light source. The photo-electric cell is coated on its inside surface with metal potassium which is very sensitive to light. At the center of the cell is a plate of tungsten. When light falls on the potassium coating

electrons are given off and travel to the tungsten plate, thus constituting a current. By means of a motor the disc with circular rows of holes was rotated between the light and the cell. When the disc was revolved slowly a low pitched note was given off, rising gradually as the speed of the disc increased. For the construction of an organ, the ingenious experimenter would need only to have rotating discs with rows of holes of the right numbers, which could be uncovered by small slides operated from a keyboard, and the loudness of the notes could be controlled by regulating the brightness of the lamp.

\* \* \*

### A High Power Station for Bavaria

FURTHER word has been received that finally a real high-power broadcasting station will soon start operating in Bavaria. It is located in Herzogstrand, to be exact, and providing it is found feasible to satisfactorily modulate speech and music as much as fifty kilowatts of power will be employed for broadcasting purposes. The construction of the station has been in progress for some time, and it is now said to be nearing completion, with an antenna stretched between two mountain peaks.

\* \* \*

### How Many Broadcast Listeners Are There?

ACCORDING to the figures recently compiled by the British Broadcasting Company there are 10,000,000 listeners on the British Isles alone; of this number 8,500,000 own the "very simplest receiving apparatus."

## "Radio Scouts"

AN interesting experiment has been conducted by the Boy Scouts of America in co-operation with station KDKA, at Pittsburgh, Pa., for the benefit of boys who live on farms so far out in the country that they cannot attend troop meetings. Once a week a snappy troop meeting program has been broadcast, including songs, bugle calls, the Scout Oath and Law, addresses, cheers and games. Boys who listen in are invited to enroll. They are known as "Radio Scouts."

\* \* \*

## What Was Accomplished at the Radio Conference

REGARDLESS of the informal nature of the Fourth Annual Radio Conference, held in Washington recently upon the call of Secretary of Commerce Herbert Hoover, it cannot be denied that it faced every one of the issues confronting the broadcasting situation squarely and decisively.

One need only tune to the higher frequencies with a sensitive receiver in any part of the country to realize that there is something wrong which must be remedied if broadcasting is to prosper. The ether today is an overcrowded bedlam with interfering carrier waves and radiating receivers. Fortunately, the upper part of the broadcast band has been reserved for high grade stations, each operating upon its exclusive channel, reducing heterodyning of car-



Fotograms

### A NOVEL TYPE OF MICROPHONE

*These new double-button microphones have been installed as part of the equipment of New York's newest station, WIIAP. Each microphone is mounted upon a pivot so that it may be turned towards or away from the performer to vary the volume of sound transmitted.*

rier waves on wavelengths above 280 meters to a minimum.

But even this reserved domain has been threatened by the clamor of scores and hundreds of applicants for wavelengths who would encroach themselves upon the long suffering listener. Up to this time, licenses have been granted to broadcasting stations on the theory that the ether is free to all those who would use it. As a consequence, we are now faced with a superabundance of stations and only by the adoption of a new basis for the issuance of licenses can we avert a chaotic condition of the ether.

In dealing with this problem, the conference went on record as opposing the granting of a single additional license until there shall be a substantial reduction in the number of broadcasting stations now operating. It further recommended that hereafter the basis for issuing a license shall be service to the listener. The license shall be regarded as permission to trespass upon the sacred domain of public property, extended only to those who render a public service by using one of the few available paths in the ether. It shall not be used for selfish purposes, such as direct advertising and the hawking of wares. Only the good-will type of educational or entertainment program may be sponsored by commercial organizations. After a definite date the manufacture of radiating receivers, the all too-prevalent disturbers on the highway of the ether, shall be discontinued.

It is true that these and other recommendations of the Conference are simply the expressions of opinion of a body of qualified experts, representing the broadcast listeners, newspapers conducting radio sections, radio magazines, broadcasting stations, receiving set manufacturers and operating radio telegraph companies. Many of their recommendations the Secretary of Commerce is not empowered to carry out. Certainly an informal conference is not endowed with authority to delegate him powers which amount literally to those of a dictator of the ether. Nevertheless, the advice of the conference, as embodied in its reports, will undoubtedly be a potent influence in shaping legislation which will make possible the legal enforcement of most of its recommendations.

—EDGAR H. FELIX

\* \* \*

## A Radio Set for Every Boy Scout Troop

A RECENT questionnaire sent to the 800,000 Boy Scouts throughout the country revealed that 95 percent of them either own radios—or want to. In Boy Scout camps the use of the radio is practically universal; a Boy Scout troop without a radio outfit is a rare exception. Furthermore, this may be applicable even to winter camps, as indicated by 600 Boy Scouts who last winter spent their holidays camping in the Interstate Park of New York and New Jersey. Radio sets were almost as thick as snowshoes and skis.



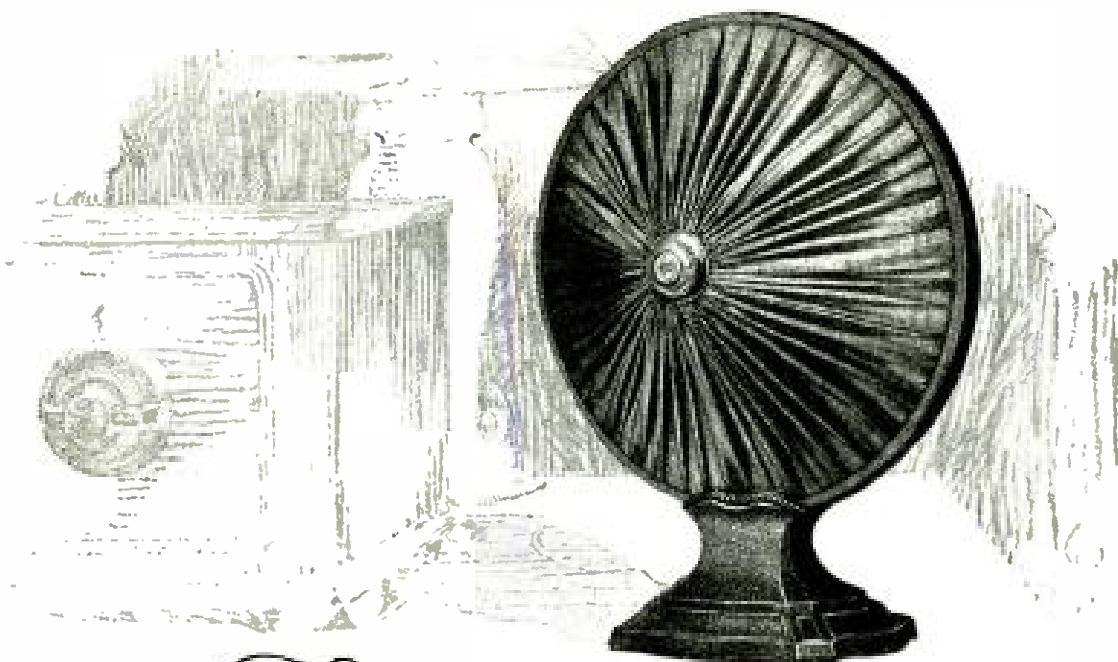

# The Jewett Cone

## The Season's Sensation

Before Radio was born, inventors were experimenting with drum-head, cone-shaped reproducers.

They are experimenting yet.

But there is nothing experimental about the Jewett Cone.

For E. H. Jewett put the problem up to Youth. And the fearless, original, young Radio wizards who do Jewett designing produced a cone *on proved acoustical principles*.

A cone containing a reproducing unit and a horn. But no drum-head.

A cone, therefore immune to heat, dampness, puncture or tear.

A cone, furthermore, that is good looking both front and back, and blends harmoniously into any setting.

Abundant Volume, excellent Distance, and brilliant Quality will combine to make your Jewett Cone a joy and a delight.

Yet the Jewett Cone costs only a little more than the cheap speakers which it so notably out-performs.

We commend this new reproducer to you as a product of true Jewett Quality, and a characteristic achievement of an organization world famous for ability and originality.

**JEWETT RADIO & PHONOGRAPH COMPANY**

5668 TELEGRAPH ROAD

Factories: Allegan, Michigan — Pontiac, Michigan

PONTIAC, MICHIGAN

*"Quality Broadcasting to Match  
Quality Products—Station WJR"*

In Canada: Jewett Radio-  
Phonograph, Ltd.,  
Walkerville, Ontario

Export Sales Office:  
116 Broad Street, New  
York City.



# Chosen from circuits as BEST PRACTICE IN



General Radio  
Type 277-D  
Coupling Coil  
Price \$1.50

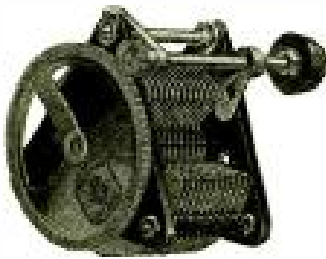

General Radio  
Type 247-H  
Geared Variable Condenser  
Price \$5.00



General Radio  
Type 368  
Micro-Condenser  
Price \$1.25

## The RADIO BROADCAST **UNIVERSAL** FOUR TUBE RECEIVER

In selecting the Radio Broadcast "UNIVERSAL" our aim has been to single out one particular circuit which from a standpoint of performance, simplicity and economy of construction and operation would meet the most rigid requirements of amateur set-builders under all reasonable receiving conditions.

Every conceivable type of circuit worthy of consideration has been investigated. Comparisons were made under a wide variety of receiving conditions by competitive tryouts with other receivers of creditable performance.

We found that the Radio Broadcast UNIVERSAL out-rivaled the other circuits in all-round achievement.

# GENERAL

## INSTRUMENTS

*Behind the Panels*

# more than 200 representing the RECEIVER DESIGN

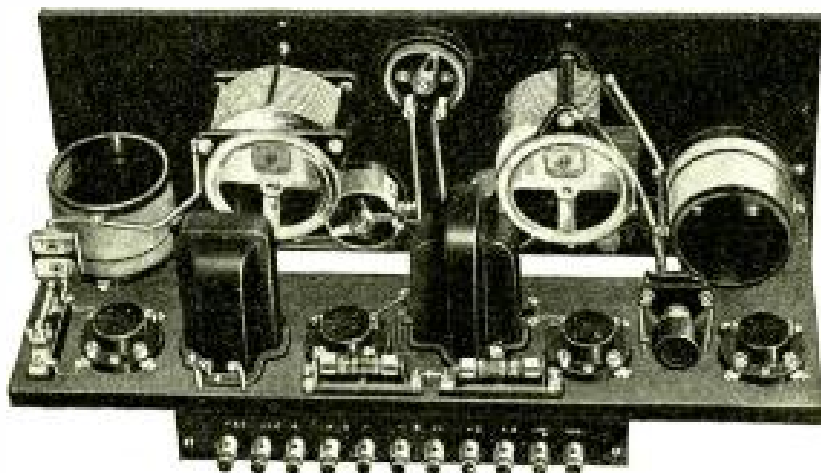

While the circuit itself is not new in principle its efficiency can not be doubted—the best proof of this being its performance.

To the set builder who expects real results from his set and wants advance assurance that he will get them we recommend the "UNIVERSAL" as the circuit to build.

We have prepared a booklet which contains all information necessary to the home construction of the UNIVERSAL. These booklets are available FREE to all set-builders who are looking for a reliable circuit built of reliable parts.

Ask your dealer or write for our booklet containing complete construction details for the Radio Broadcast "UNIVERSAL."

GENERAL RADIO CO.  
Cambridge 39 Mass.

# RADIO MENTS of Better Built Sets



General Radio  
Type 285  
Audio Transformer  
Price \$6.00

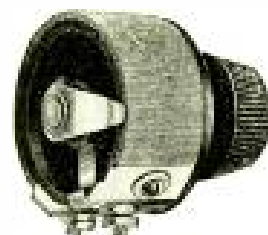

General Radio  
Type 301  
Rheostat  
Price \$1.25

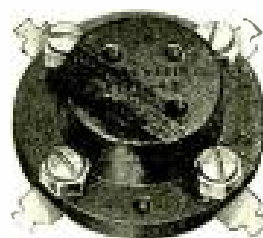

General Radio,  
Type 349  
UX Tube Socket  
Price 50c.

# MICARTA & KDKA

REG. U. S. PAT. OFF.

## Big Names in Radio

Building your own set? Take a tip from KDKA and use Micarta panels. Build right.

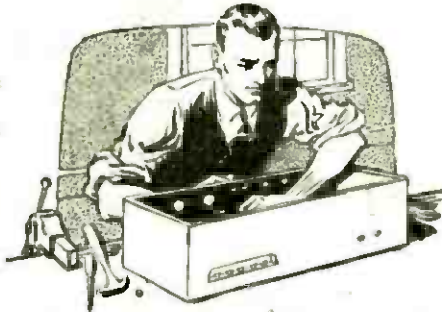

faces. Won't dull, fade, or wear off.

Very strong and rigid. Easily and neatly drilled, too, with no worries about

Match your set with mahogany, black, walnut grain or burl, all the popular effects with beautiful gloss sur-

chipping, cracking or breaking out. Be particular; Micarta is worth asking for by name.

WESTINGHOUSE ELECTRIC & MANUFACTURING COMPANY

Offices in Principal Cities—Representatives Everywhere  
Tune in sometime with KDKA—KYW—WBZ—KFKX

Westinghouse manufactures, also, a complete line of Micarta tubing, instruments, and Rectigon Battery Chargers.



Fabricators of Micarta for the Radio Trade

PAUL GOLDSTEIN & CO., Inc.  
54-56 Franklin Street  
New York, N. Y.

CALVERT SPECIALTY CO.  
141 North 11th Street  
Philadelphia, Pa.

# Westinghouse

© 1926, W. E. & M. Co.

# RADIO 'RITHMETIC



© 1926.  
W. E. & M. Co.

## How to Prove this Result

Complete your set with a Rectigon! Keep your batteries so full of life that every turn is a tune, every adjustment of the delicate knobs a means of furthering your radio joys.

It's a simple thing with a Rectigon. Just snap the leads into place and your "A" and "B" batteries—your automobile bat-

tery, too—will surprise you with their old-time pep.

There's no muss or fuss with a Rectigon. No acids or chemicals. No moving parts and no noise. It's a handsome, bright, maroon-enameled helper that will get the best out of your radio—and continue to do so.

*No storage-battery radio is complete without a Rectigon.*

WESTINGHOUSE ELECTRIC & MANUFACTURING COMPANY

SOUTH BEND, INDIANA

Westinghouse manufactures, also, a complete line of Micarta radio panels, Micarta tubes and instruments.

# The Westinghouse Rectigon Battery Charger

*All apparatus advertised in this magazine has been tested and approved by POPULAR RADIO LABORATORY*

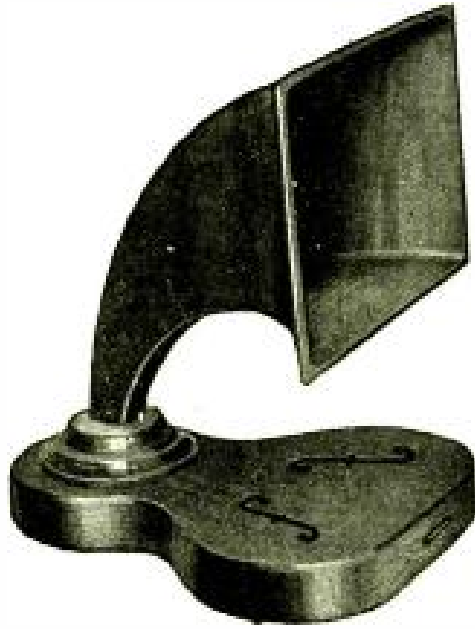

# TIMBRETONE

REG. U.S. PAT. OFF.

Mindful of the part the Radio Public has played in the past four years and of the confidence placed in TimbreTone, we take this opportunity of thanking our many friends.

We have earnestly tried to please. In our small way we have striven to produce a speaker that would give "Quality"—We feel that we have done so—AND SHALL STRIVE TO IMPROVE EVEN THAT QUALITY DURING THE COMING YEAR.

We have associated with us the firm of Sanford Bros. who have been in business over 25 years and we are proud of the fact that they selected *TimbreTone* as the speaker they wanted to represent in the selling field. The combination means for you—QUALITY—DEPENDABILITY—and SERVICE.

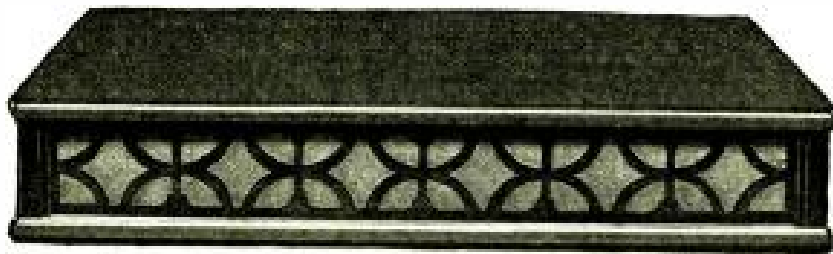

**ADDRESS THE NEAREST OFFICE**

## SANFORD BROS.

CHICAGO  
30 W. Walton Pl.

CHATTANOOGA, TENN.  
615 Broad St.

SEATTLE, WASH.  
Am. Bank Bldg.

SAN FRANCISCO, CAL.  
311 Minna St.



FACTORY

TIMBRETONE MFG. CO.  
HOOSIC FALLS, N. Y.



Retail Price  
 In U. S. A. \$15.00  
 In Canada \$21.00

### Why You Should Use A Resistance-Coupled Audio Amplifier

THE tone quality of a radio receiver is vitally affected by the construction of its audio amplifier. Poor, overloaded audio transformers are the most frequent cause of distortion, because they are unable to amplify equally all the tone frequencies of a musical program. Some tones are over-amplified, while others are subdued, or entirely eliminated. Harsh, unnatural tones are therefore produced by the loud speaker, and the quality of rendition is extremely unsatisfactory.

The better type of audio amplifier uses no transformer whatever. It is called the Resistance-Coupled Amplifier, because small fixed resistance units take the place of the bulky transformer of earlier models and they produce amplification without distortion. For clarity and purity of tone, nothing has excelled the resistance-coupled amplifier.

### Why You Should Choose Bradley-Amplifier Resistance-Coupled PERFECT AUDIO AMPLIFIER

THIS compact resistance amplifier is easily installed by any one in any type of radio receiver. Convenient terminals make the Bradley-Amplifier as easy to connect as a B-Battery. The sockets will hold old or new tubes without adapters, and a C-Battery connection is provided for the new tubes.



The distinguishing feature of the Bradley-Amplifier is the use of Bradleyunit Resistors. These small, solid, molded units cannot break, deteriorate or change with age. They are soldered into place and require no attention. For amplification without distortion be sure to ask your dealer for a Bradley-Amplifier. Try one tonight!



**Allen-Bradley Co.**

276 Greenfield Ave.,  
 Milwaukee, Wisconsin

Please send me your latest booklet on the Bradley-Amplifier.

Name.....

Address.....



# ACCEPTED and PROVEN!

The Cockaday LC-26 Receiver is the outstanding success of the radio year. For weeks we have been working to catch up with the demand. Today we can make shipment on the complete parts at once.

## COMPLETE PARTS FOR THE LC-26

1 General Radio Type 269 Variometer with knob	\$5.30	1 Bradley leak $\frac{1}{4}$ to 10 Megs.....	\$1.85	1 Cabinet, Mahogany or Walnut Finish.....	\$14.50
1 General Radio Rheostat Type 214A, 7 Ohms.....	2.25	3 Bradley units $\frac{1}{4}$ meg.....	2.25	1 Hardwood Baseboard.....	.50
1 Precision Octoform Coil Set.....	5.50	1 Bradley unit $\frac{1}{2}$ meg.....	.75	4 Small Brass Brackets.....	.20
1 Amsco Double Condenser No. 1814	6.25	3 Amperites 1A.....	3.30	2 Large Brass Brackets.....	.15
1 Micamold Condenser .00015 mfd..	.35	1 Amperite No. 112.....	1.10	1 Antenna Connection Block 1 x 2 Inches.....	.15
1 Micamold Condenser .00025 mfd..	.35	3 Benjamin Standard Sockets.....	5.00	1 Battery Connection Block 1 x 9 Inches.....	.25
2 Daven Resisto-Couplers with 1 mfd. condensers.....	3.00	1 Carter Single Circuit Jack.....	.70		
1 Amertran DeLuxe 1st Stage Transformer.....	10.00	2 Carter No. 2 Jack Switches.....	2.00		
		3 Eby Binding Posts.....	1.20		
		1 Fynur Vernier Dial.....	3.50		
		1 Drilled and Engraved Panel.....	7.50		
				Blueprints for LC-26.....	\$1.00
					\$77.90

**McLAUGHLIN SINGLE CONTROL DELUXE 8-TUBE RECEIVER**  
Complete parts—\$113.40

**HAMMARLUND-ROBERTS BROADCAST RECEIVER**  
Specified parts—\$60.80

All parts for the Raytheon plate supply unit—\$41.10

WHOLESALE RETAIL



15 East 40th Street, New York City

A postcard will bring the list of parts and full information on these or any other circuits in which you are interested.

It is our aim to have new material first, to ship you promptly and, most of all, to send you the exact parts called for by you.

# CARTER

New "IMP" Loop



Again Carter leads with a loop that is compact, sturdy, yet highly efficient. No possibility of loose wires breaking. Weighs one pound, diameter 16 inches. Taps are provided for all loop circuits.

See one at your dealers. Write for illustrated folder.

In Canada—Carter Radio Co., Limited, Toronto

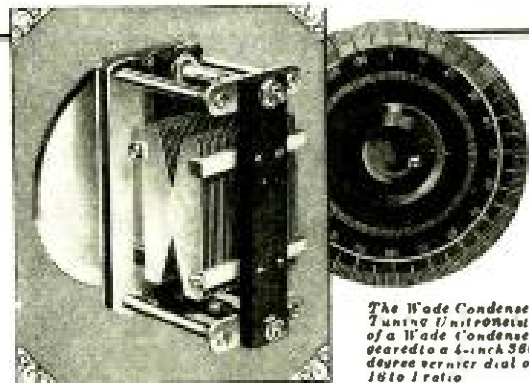

The Wade Condenser Tuning Unit consists of a Wade Condenser geared to a 4-inch 360 degree vernier dial of 18 to 1 ratio

## "Spreads" Stations All Over the Dial

THE Wade Condenser Tuning Unit is geared to a dial that is graduated all the way around—from zero to 360 degrees. This means twice as much space between stations for close tuning adjustment; even wider separation of stations than the rotor plate types of straightline frequency condensers using standard 180 degree dials. Covers the whole broadcast range and down below 200 meters. A separately grounded frame, insulated from both sets of plates, shields the condenser from all body capacity effects.

### PRICES

Prices are for the complete unit.  
Capacity .000125 mfd. .... \$6.00  
Capacity .00025 mfd. .... 6.25  
Capacity .00035 mfd. .... 6.35  
Capacity .0005 mfd. .... 6.50  
The 4-inch dial, calibrated on entire circumference, is built in as part of the condenser.

The VIKING TOOL AND MACHINE CO., Inc.  
745-B 65th Street, Brooklyn, N. Y.







## Now FORMICA Offers Complete Panel Service!

**F**ORMICA has improved its service to the American Radio manufacturer by offering completely decorated and finished front panels. The decorations are done in gold, silver and other colors by the Veri-Chrome process. They are by far the most handsome panels used in radio today—and the panels with the most permanent finish.

This service is now extended to amateur set builders who wish to assemble certain well known kits. In numerous in-

stances the Veri Chromed Formica panel is a part of the kit.

Dealers can supply you with the following Veri Chromed Formica panels: Bremer Tully Counterphase, Nameless and No. 1, Best's Superheterodyne in two sizes, 7x20 and 7x26; and Browning Drake four tube for National Kit.

Formica panels in all the usual standard sizes are sold by most dealers.

Write for booklet "What Formica Is."

THE FORMICA INSULATION CO.  
4641 Springrove Avenue, Cincinnati, O.

# FORMICA

Made from Anhydrous Bakelite Resins  
**SHEETS TUBES RODS**

*All apparatus advertised in this magazine has been tested and approved by POPULAR RADIO LABORATORY*

*Accuracy*  
Accurate  
and stay accurate  
*helps your DX record*

LUCKY nights happen when a set built out of fence wire by rule of thumb can get DX. But the surest way to get the utmost in radio performance is to have all parts in correct electrical balance. Especially the fixed condensers, for they must release the incoming impulses at exactly the right time, or there is discord. This is where accuracy counts most.

The accuracy of Sangamo Mica Condensers is doubly assured. They are tested individually for accuracy, and guaranteed to be within 10 per cent of marked capacity. They are solidly molded in bakelite, absolutely impervious to any outside influence. There are no exposed edges. You can boil them, freeze them, expose them to acid fumes or heat the terminals with a soldering iron, but their capacity remains unchanged.

Sangamo Mica Condensers are made in all standard capacities, with or without resistor clips. They can be easily installed in any set, old or new.

Also available: Sangamo By-Pass Condenser 1 MFD. \$1.25. 1/2 MFD. .90



All progressive dealers have Sangamo Condensers in stock, or will quickly secure them if you insist.

**Sangamo Electric Company**  
1421-7 Springfield, Illinois

RADIO DIVISION, 50 Church Street, New York

SALES OFFICES—PRINCIPAL CITIES

For Canada—Sangamo Electric Co. of Canada, Ltd., Toronto.  
For Europe—British Sangamo Co., Ponders End, Middlesex, Eng.  
For Far East—Ashida Engineering Co., Osaka, Japan

**KORACH**  
Tuned Loop  
Multiple Switch Board Tuner  
Directional  
Base Compass for Logging  
Collapsible

For those who demand  
**Superior Results**

Leads the march toward perfect radio reception under all conditions. Not merely a "loop" but an ingenious arrangement of mechanical skill designed for superior results. L. M. Cockaday, using this loop, reached out across the Atlantic to audibly hear many trans-continental Stations.

**Selectivity Plus Distance**

unheard of with common loop aerials. The Korach excels on all sets designed for loop reception. Priced at \$12.50 and for sale by all good dealers. Full particulars sent for 2c stamp and name of local dealer.

**KORACH RADIO CO.**  
20 E. JACKSON BLVD. Dept. 10 CHICAGO, ILL.  
Dealers and Jobbers: Write today for attractive proposition

**THE KORACH JUNIOR**

A modification of the "Senior" but possessing all its important features - - - \$10.00

**Oh boy**  
**KESTER**  
ROSTIN CORE  
**Radio SOLDER**  
Sure is Safe and Simple  
APPROVED BY RADIO ENGINEERS  
A GENUINE SOLDER  
CHICAGO SOLDER COMPANY  
4221 Wrightwood Av., Chicago, U.S.A.  
Originators and World's Largest Manufacturers of Soft Plug-in Solder  
YOUR DEALER CAN SUPPLY YOU

All apparatus advertised in this magazine has been tested and approved by POPULAR RADIO LABORATORY



**Crosley Super-Trirdyn Special  
And Crosley Musicone Illustrated**

In the Crosley Super-Trirdyn Special, 3 tubes do the work of 5. Solid mahogany cabinet with popular sloping panel. **\$60.00**

The Crosley Musicone reproduces full tonal qualities of music and voice without distortion. New low price. **Now \$14.75**

# Every home should have an *Entertainment Corner*

Be it a cottage in the valley or a mansion on the hill, no home can be complete without its entertainment corner. What magic in that phrase—the *entertainment corner!* What magic in the thought of choosing from countless forms of diversions the one that suits your mood!

In hundreds of thousands of homes throughout the world, the center of the *entertainment corner* is a Crosley radio. It may be the sturdy Crosley "Pup"—the famous long-range one-tube set that costs but \$9.75; or the magnificent \$60 Super-Trirdyn Special—the finest radio that Crosley builds; or one of the many Crosleys ranging between them in price.

Whatever the model or its price, Crosley is giving the flawless service which has made "Crosley" a hallmark of radio throughout the radio world. The present tremendous Crosley volume has been achieved by developing radio sets of simpler design, easier operation and unfailing dependability. And with each increase in production came greater *value*. When buying for your *entertainment corner* you can buy with confidence—if you buy a Crosley.

See the complete Crosley line at the nearest Crosley dealer's. Address Department 16 for his name and our illustrated catalogue.

## THE CROSLEY RADIO CORPORATION CINCINNATI OHIO

Powel Crosley, Jr., President  
Cable Address: Listenin-Cincinnati

Owning and operating W'LL, first remote control super-power broadcasting station.

Crosley manufactures receiving sets which are licensed under Armstrong U. S. patent No. 1,113,149 and priced from \$9.75 to \$60.00 without accessories. None of the prices quoted include batteries, tubes, headphones, etc. Add 10% to all prices west of the Rocky Mountains.



**Crosley Pup**

A genuine long range Crosley receiving set. Easy to tune through local stations.

**\$9.75**

**Crosley 3 Tube  
52 S. D.**

Mahogany finished cabinet, sloping panel. Holds all batteries.

**Now \$32.50**



**Crosley Super-Trirdyn Regular**

More compact than the Special Model—but exactly the same superb performance. New price

**Now \$45.00**



# CROSLEY RADIO

BETTER · COSTS LESS

All apparatus advertised in this magazine has been tested and approved by POPULAR RADIO LABORATORY

*It Stabilizes Any Reflex—*

## THE CARBORUNDUM STABILIZING DETECTOR UNIT

To make the Carborundum Fixed Detector even more efficient for Reflex Sets this Stabilizing Detector Unit has been evolved.

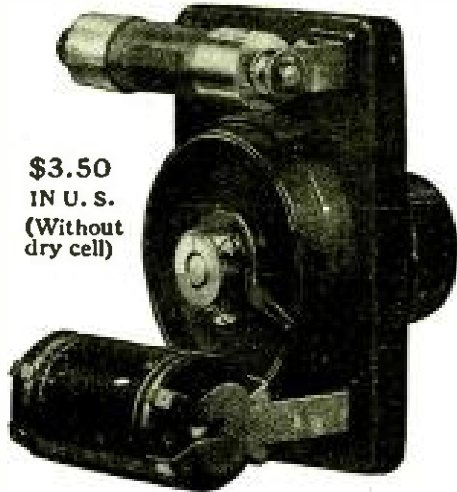

\$3.50  
IN U. S.  
(Without  
dry cell)

With this Stabilizer you can absolutely perfect your Reflex Set because it adjusts the detector resistance to match the circuit.

It stabilizes the circuit, controls self oscillation, eliminates howls, increases sensitivity. Gives you greater range and increased volume.

By a turn of the knob you supply a potentiometer controlled booster voltage to the Carborundum Fixed Detector, adapting the detector instantly to the receiving conditions. A tiny flash-light battery is all you need to complete the device. The unit comes to you equipped with a genuine Carborundum Fixed Detector.

*From Your Dealer or Direct  
Send for Illustrated Booklet showing Hook-Ups*

THE CARBORUNDUM COMPANY, NIAGARA FALLS, N. Y.  
New York, Chicago, Boston, Philadelphia, Cleveland, Detroit  
Cincinnati, Pittsburgh, Milwaukee, Grand Rapids

### TONE

Full, sweet, mellow and natural, without the slightest indication of distortion, is another achievement that is making the APEX SUPER FIVE the most popular of all receiving sets.

### VOLUME

That supplies dance music or entertainment without any loss, is a feature for which the APEX SUPER FIVE is world famed.

### DISTANCE

Lends added enjoyment to radio with an indescribable fascination of tuning-in far away stations, which is always possible with the APEX SUPER FIVE.



Ask your dealer for a demonstration. Your eyes and your ears will tell you that APEX stands at the high point of perfection in both performance and appearance.

\$80 without accessories.

### SUPER 5

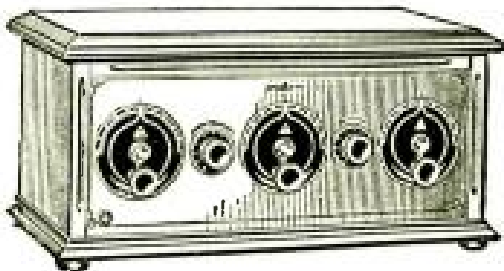

APEX ELECTRIC MANUFACTURING CO.  
1410 W. 59th St. Dept. 202 CHICAGO

## best for condensers —brass

As plates and columns BRASS has the right temper to preserve alignment with small clearances. BRASS is readily soldered in making proper electrical contact and its easy machining qualities give economy in production.

COPPER & BRASS  
RESEARCH ASSOCIATION  
25 Broadway, New York

# Straight-Line-Frequency Tuning Without the Brakes!

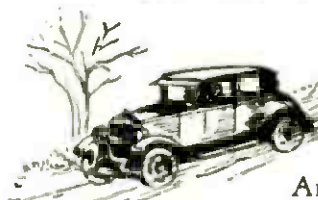

ALL-AMERICAN Condensers, with their smooth-sliding plates (see sketch at left), require no tensioning. There is no sensation of raising a weight or letting it fall.

Compactness, also, far exceeds that of rotor types. (See dimensions on sketch.)

Efficient shielding prevents the touch of the fingers from affecting the tuning, and protects the plates permanently from dust or damage.

Taking full advantage of the 360° rotation, there is an ALL-AMERICAN Dial with two scales, both on the upper half, where they are always visible. Used with the ALL-AMERICAN Toroid Coils, these Condensers space out equidistant on the dial all wave-frequency channels from 550 meters down even to 175 meters. Power and selectivity are greatly improved through the absence of stray magnetism.

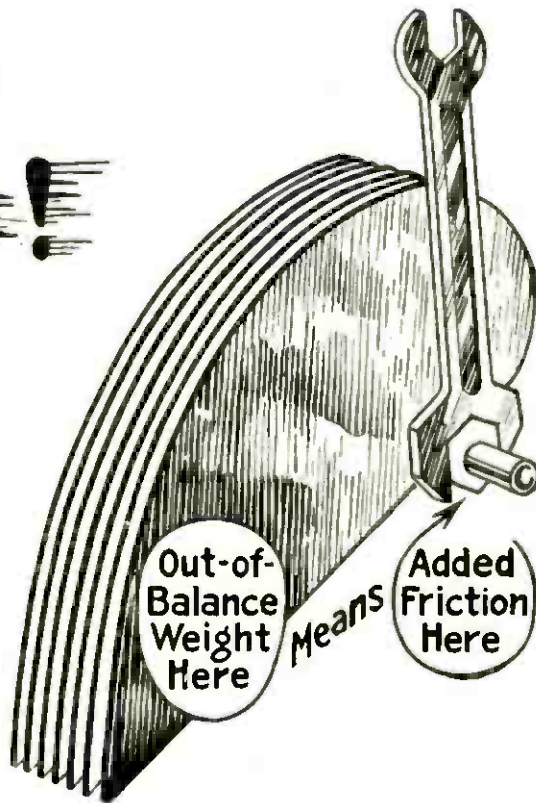
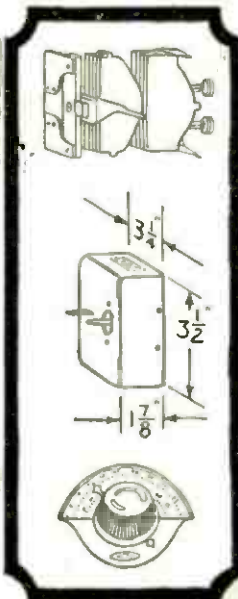

**ALL-AMERICAN  
STRAIGHT-LINE-FREQUENCY  
TUNING**

<p style="text-align: center;"><b>ALL-AMERICAN Straight-Line-Frequency CONDENSERS</b></p> <p>Type C-35 Max. 350 micro-microfarads (Min. 10.5 mmf. at 400 meters) . . . \$4.50</p> <p>Type C-50 Max. 500 micro-microfarads (Min. 11.8 mmf. at 400 meters) . . . \$5.00</p> <p>Type C-40, 360° Dial . . . 1.00</p>	<p style="text-align: center;"><b>ALL-AMERICAN TOROID COILS</b></p> <p>Type T-1 Antenna Coupler . \$3.50</p> <p>Type T-2 R.F. Transformer . 3.50</p> <p>Set of 3 coils complete . . . 10.50</p> <p>The R. F. Transformer has a small primary, closely coupled to the secondary, entirely air-insulated. The coupler has taps for long and short antenna. All bases are of bakelite.</p>
--	---

ALL-AMERICAN RADIO CORPORATION, E. N. Rauland, Pres., 4211 Belmont Ave., Chicago, U.S.A.

OWNING AND OPERATING STATION WENR—266 METERS

# ALL-AMERICAN

*Pioneers in the Radio Industry*

All apparatus advertised in this magazine has been tested and approved by POPULAR RADIO LABORATORY

# STUDY RADIO!

Radio, the field of unlimited opportunity, calls for more trained men.

Prepare yourself for a high salaried position by using your spare time to study radio at home.

Radio Institute of America, the world's oldest radio school, has graduated more than 7,000 students. The value of RIA training is universally recognized—and graduates readily secure positions.

*This coupon will bring you a wealth of important and interesting information.*

## RADIO INSTITUTE OF AMERICA

Formerly Marconi Institute    Established in 1909  
322-A Broadway                      New York City

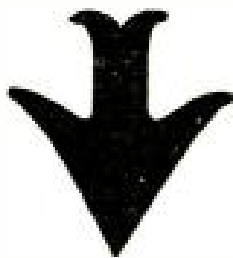

Radio Institute of America  
322-A Broadway, New York City  
Please send me full information about your Home Study Course of radio instruction.  
I am interested in the complete course, including code instruction, which qualifies for the U. S. Government Commercial or Amateur Radio License.

Name.....

Address .....

.....

No. 248  
E-5841  
Underwriters App.

### "Little Joe" Lightning Arrester

Especially designed for Radio Work. Made of Porcelain, small, neat, rugged and serviceable. Can be suspended on antenna or fastened to wall.

Ask Your Dealer  
Mfg'd by CIRCLE F MFG. CO.  
Trenton, New Jersey

22½ Volt  
un-acid  
everlasting  
rechargeable  
"B"  
Storage  
Battery  
**\$2.95**  
includes  
chemical



45 volts \$5.25, 90 volts \$10.00, 112½ volts \$12.50, 135 volts \$14.75, 157½ volts \$16.80. Truly the biggest buy today. Easily charged on any current including 32 volt systems. Any special detector plate voltage had. Tested and approved by leading authorities such as POPULAR RADIO laboratories. Over 3 years sold on a non-red tape 30 day trial offer with complete refund if not thoroughly satisfied. Further guaranteed 2 years. Knock-down kits at greater savings. Complete "Hawley" "B" Battery charger \$2.75. Sample cell 35c. Order direct—send no money—simply pay the express-man cost on delivery. Or write for my free literature, testimonials and guarantee. Same day shipments.

**B. HAWLEY SMITH, 315 Washington Ave., Danbury, Conn.**



**C-H Radioloc**

The radio switch that locks with a key. Protects tubes and batteries against children and meddling adults. One hole mounting—quiet operation. Dust-proof case. Two keys with every switch.

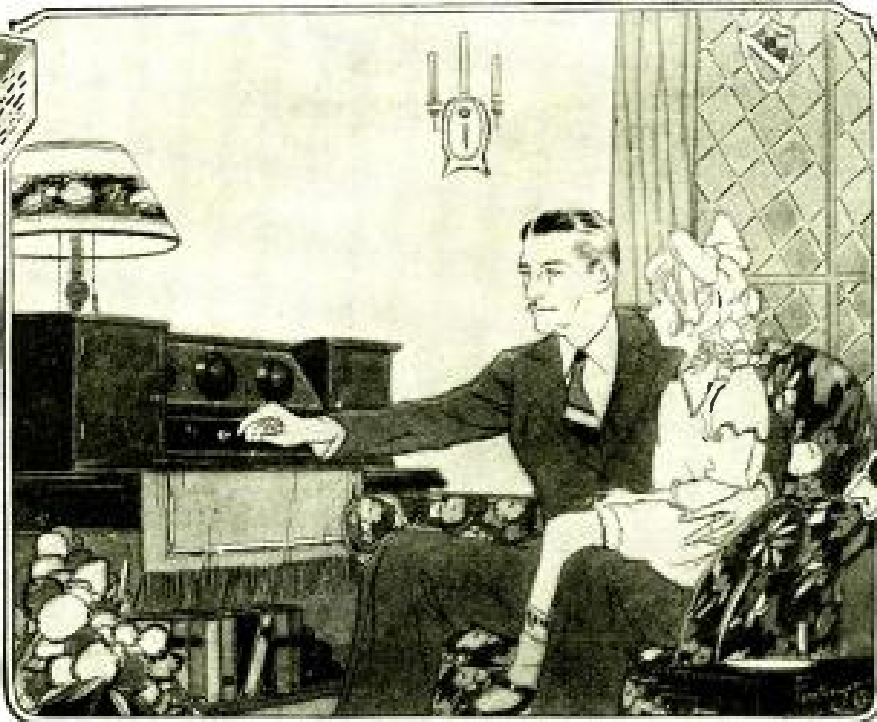

**C-H Heavy Duty Radio Switch**

More than a million in use. Preferred by both home set-builders and manufacturers. Many have imitated the knob, but no one can duplicate the patented "floating contactor" construction—the secret of its long life.

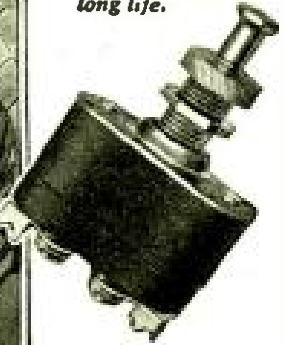

## Thus More Than a Million Concerts Start Every Night

THE first panel mounting switch built exclusively for radio service? It carried the Cutler-Hammer trade mark.

The first radio switch that locked with a key to protect tubes and batteries from meddling fingers? It was designed by C-H engineers.

The first handy toggle type radio switch? Yes—it, too, was built by Cutler-Hammer.

Little wonder that they are found in more than a million sets today. For they were designed to render the trouble proof service for which they are now famous and their patented mechanism cannot be duplicated. Because they sell in such tremendous quantities their cost of production is remarkably low.

That explains why most radio fans build them into their sets, and why you find them on so many manufactured sets today.

Your new set will, most likely, have a C-H Switch, whether it is the product of your own hands or a huge factory.

*A list of some of the prominent radio manufacturers using C-H Radio Switches*

- Acme Apparatus Co.
- American Bosch Magneto Co.
- Argus Radio Corporation
- Astral Radio Corp.
- Chas. A. Branston Co.
- Chelsea Radio Co.
- Dayton Fan & Motor Co.
- Freed - Eisemann Radio Corp.
- Gilfillan Bros., Inc.
- Howard Radio Co.
- Malone - Lemmon Laboratories
- Wm. J. Murdock
- Robbins Radio Co.
- Silver-Marshall Co.
- R. E. Thompson Co., Inc.
- Victoreen Radio Co.
- Workrite Mfg. Co.



**C-H Radio Toggle Switch**

The very popular toggle switch idea applied for the first time to radio. Beautiful appearance. "On" or "off" with a flip of the finger. Neatly etched plate to indicate position. Requires very little space back of panel. Contacts are broad and self cleaning. Quiet operation. One hole mounting. Nickel finish.

**THE CUTLER-HAMMER MFG. CO.**

Member Radio Section, Associated Manufacturers of Electrical Supplies  
MILWAUKEE, WISCONSIN

# CUTLER-HAMMER

## Radio Parts for Performance

All apparatus advertised in this magazine has been tested and approved by POPULAR RADIO LABORATORY



# Why WESTON Popularity?

**Results!** Continuous and long-life dependability! Assurance in use! Beauty of design!

These are the reasons for the great popularity of these two of the famous Weston Radio Line.

The Weston Instant-Change Radio Plug, the pioneer automatic device of its kind, gives fast, positive and most satisfactory contact between headset and loudspeaker.

The Weston Model 489 Radio Table Voltmeter supplies a portable instrument of great value in checking all voltage conditions of radio sets and has given thousands of radio enthusiasts more economical reception, longer tube life, better battery service, more resonance in tone, greater volume and distance.

To get the best from your receiving set use a reliable and dependable voltmeter. Write for the complete information contained in our new free edition of "Weston Radio Instruments."



WESTON ELECTRICAL INSTRUMENT CORPORATION  
115 Weston Avenue Newark, N. J.



## STANDARD THE WORLD OVER WESTON

Pioneers since 1888

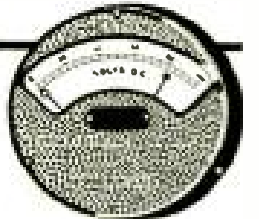

### Wonderful Volume with Clearness AMPL-TONE



**\$3.00**

Phonograph makers have spent years perfecting the acoustic properties of their phonographs. Use an AMPL-TONE Unit and make a real Loud Speaker in an instant or use it in your horn and get better results.

After all, speakers are as good as their unit. We make a real unit at a real price. Money gladly returned if you are not entirely satisfied.

The UNION FABRIC CO.  
DERBY, CONN.

Makers of the Excellent French AMPL-TONE Headset

Please send me an AMPL-TONE Unit for which I enclose \$3.00.

Name .....

Address .....

State .....

### Premier B Battery Cabinet

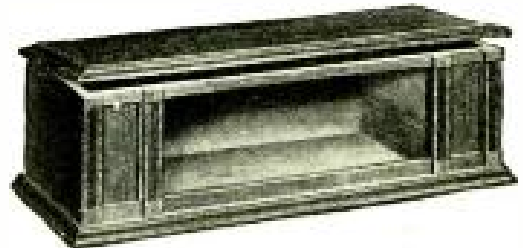

Our Premier B Battery Cabinet is a beautiful piece of furniture. The B battery compartment will take any type B battery. The space of each B battery compartment is 4 1/2" wide, 8 1/2" high and 10" deep.

No.	For Panel	Deep	Genuine Walnut
718-10	7 x 18	10"	\$18.50
721-10	7 x 21	10"	19.00
724-10	7 x 24	10"	19.50
726-10	7 x 26	10"	20.00
728-10	7 x 28	10"	21.00
730-10	7 x 30	10"	22.00

F.O.B. Waukesha, Wis.

The tops of these cabinets are figured walnut, the ends and B battery panels are select walnut, all 5 ply veneer. The bases are built up of massive molding. Nickel plated piano hinges and lid holders. The material and finish in these cabinets will equal the best furniture obtainable.

WE MAKE 9 STYLES OF CABINETS FOR 11 SIZES OF PANELS. Send for our 1925-26 line of cabinets at "Factory to User" prices.

### Utility Cabinet Company

Phone 721

Waukesha, Wisconsin



# Balkite

## Radio Power Units

*the ideal power supply for any radio set*

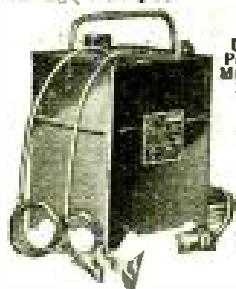

U. S. Patent May 27, 1924

### Balkite Battery Charger

Entirely noiseless. Can be used while the set is in operation. Charging rate 2.5 amperes. Operates from 110-120 AC 60 cycle current. Special model for 50 cycles. Also for 25-40 cycles with 1.5 ampere charging rate.

Price \$19.50  
West of Rockies, \$20  
In Canada, \$27.50



U. S. Patent May 27, 1924

### Balkite Trickle Charger

Can be connected to the usual 6-volt battery and left on permanent (or trickle) charge. Automatically charges the "A" battery and supplies "A" current from the light socket.

With smaller batteries can be used as an intermittent charger, or trickle charger if a resistance is used.

Charging rate .4 to .5 amperes. Size 5 1/2 x 2 1/2 x 5 inches. Operates from 110-120 AC 60 cycle current. Special model for 50 cycles. Price \$10

West of Rockies, \$10.50  
In Canada, \$15

Balkite Radio Power Units are the ideal power supply for any radio set. They simplify and improve radio reception. They reduce the amount of attention you must give your set. With their use your current supply is always exactly what is required for each circuit.

The popular Balkite Battery Charger is entirely noiseless and can be used while the set is in operation.

The Balkite Trickle Charger converts your "A" battery into a permanent "A" power unit that supplies full "A" current at all times from the light socket.

Balkite "B" eliminates "B" batteries entirely and supplies plate current from the light socket. Balkite "B" for sets of 6 tubes or less. Balkite "B" II for sets of 6 tubes or more.

An ideal installation is a Trickle Charger and "A" battery, and Balkite "B." This enables you to operate your set entirely from the light socket.

### Noiseless—No bulbs—Permanent

All Balkite Radio Power Units are entirely noiseless in operation. They have no moving parts, no bulbs, and nothing to adjust, break or get out of order. Each is a permanent piece of equipment with nothing to wear out or replace. They require no other attention than the infrequent addition of water. They require no changes or additions to your set.

Manufactured by  
FANSTEEL PRODUCTS COMPANY, Inc.  
North Chicago, Illinois

FANSTEEL  
**Balkite**  
*Radio Power Units*

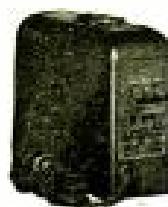

U. S. Patent May 27, 1924

### Balkite "B"

Eliminates "B" batteries. Supplies plate current from the light socket. Operates with either storage battery or dry cell tubes. Keeps "B" circuit always operating at maximum efficiency. Requires no attention other than adding water twice a year.

Designed for sets of 6 tubes or less. Occupies about same space as 45 volt dry "B" battery. Operates from 110-120 AC 60 cycle current. Special model for 50 cycles.

Price \$35  
In Canada, \$49.50



U. S. Patent May 27, 1924

### Balkite "B" II

Same as the new Balkite "B" but will fit any set including those of 8 tubes or more. Operates from 110-120 AC 60 cycle current. Special model for 50 cycles.

Price \$55  
In Canada, \$75

The Gould Unipower is equipped with a special Balkite Radio Power Unit

BALKITE BATTERY CHARGER · BALKITE TRICKLE CHARGER · BALKITE "B" · BALKITE "B" II

ALL BALKITE RADIO POWER UNITS ARE TESTED AND LISTED AS STANDARD BY THE UNDERWRITERS' LABORATORIES

# Biggest dollar's worth in RADIO

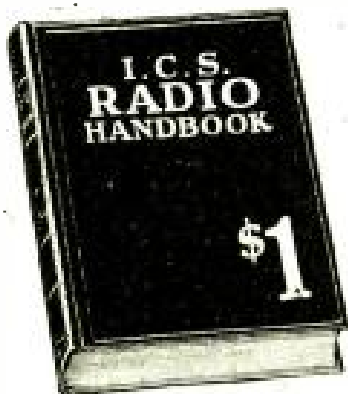

100,000 SOLD

Compiled by  
**HARRY F. DART, E.E.**  
Formerly with the Western Electric Co., and U. S. Army Instructor of Radio.  
Technically edited by  
**F. H. DOANE**

THE greatest book on Radio ever written. Price only \$1. Filled with sound, practical, tested information for every radio fan, from beginner to hard-boiled owl. Written, compiled and edited by radio experts

of national reputation.

You may dip into this I. C. S. Radio Handbook at random, or hunt up special information you want, or read it right through. Starts with simple explanations of Radio phenomena and leads you along gently until you can understand the most technical diagram. Hundreds of suggestions for getting more pleasure out of Radio. Will save you from wasting money on things that won't work.

New—Authoritative—Complete

**514 PAGES**  
**150 ILLUSTRATIONS**

Every page tells you something useful. And there are 514 pages! More than 150 illustrations and diagrams! Note this partial list of contents:

Electrical terms and circuits, antennas, batteries, generators and motors, electron (vacuum) tubes, many receiving hook-ups, radio and audio frequency amplification, broadcast and commercial transmitters and receivers, wave meters, super-regeneration, codes, license rules. Many other features.

## Money back if not satisfied

Send \$1 today and get this 514-page I. C. S. Radio Handbook before you spend another cent on parts. Money back if not satisfied.

MAIL THE COUPON TODAY!

International Correspondence Schools  
Box 8251-G, Scranton, Penna.

I enclose One Dollar. Please send me—post-paid—the 514-page I. C. S. Radio Handbook. It is understood that if I am not entirely satisfied I may return this book within five days and you will refund my money.

Name.....

Address.....

Check here  and enclose \$1.50 if you wish the deluxe edition, bound in Leatheroid.

## Steinite <sup>LOW</sup> <sub>LOSS</sub> Interference Eliminator

No Radio Set Complete Without It

Now you can select stations at will, cut out interference and undesired stations—tune in loud and clear. Wonderful results with any tube or crystal set using any kind of aerial except loop antenna. Partially absorbs static.



**\$1** Amazing Results, Better Reception Guaranteed or We Refund Your Dollar. Send Order Today.

### Select Stations At Will

Try this Interference Eliminator on your set—no tools—nothing to add—attached in 2 minutes to aerial. Doesn't disturb present log. Directions easy to follow. Two big banks testify to our reliability. Order today—dollar bill will do—we take the risk—money back if you say so.

**STEINITE LABORATORIES**

301 Radio Building, ATCHISON, KANSAS  
Five Tube Set - \$29.75

Write for complete Steinite Radio literature—it's FREE. Most beautiful and least expensive radio sets in America.

## DURHAM

### Variable Leaks And Tube Maker's Data



Standard Type

Instruction sheets say that you should try different values. With a DURHAM this is done with a smooth-running plunger. Fits your present clips.

New Panel Mount

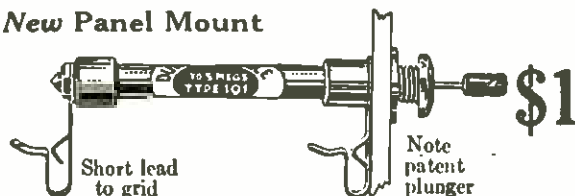

Durham convenience and accuracy brought to your fingertips. This type makes shortest path from socket to condenser or coil. Fits in 1/4" hole.

There's a DURHAM for every need

No. 100—1,000 to 100,000 ohms (audio)  
No. 101—0.1 to 5 megohms (for UV-200 and WD-12)  
No. 201A 2 to 10 megohms (for UV-199 or 201A)

**DURHAM & CO., Inc.**  
1936 Market St., Philadelphia

# A Foe to Old Man Static

This demon tormentor with his rattles and hammers—this tiresome soloist with his monotonous concerts—this outlaw of the ether, will be a stranger in your home when you use the "Electrad" Lamp Socket Antenna.

Just plug-in on any electric light line, no need of outdoor or indoor aerials. Reduces "canary bird" reradiations from nearby oscillating sets. A distance getter. The complete, efficient and economical aerial.

**Price 75c.**

At most good dealers together with other handy "Electrad" Guaranteed Radio Essentials.

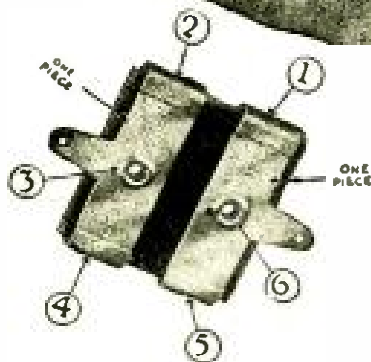

## "The Six Point Pressure Condenser"

The "Electrad" Certified Fixed Mica Condenser is a revelation in accuracy and design. Value guaranteed to remain within 10% of calibration. Standard capacities, 3 types, licensed under Pat. No. 1,181,623, May 2, 1916 and applications pending. In sealed dust and moisture proof packages. List 30c to 75c.

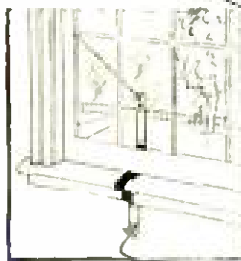

"ELECTRAD" LEAD-IN—Price 40c.—Fits under locked windows. No holes to bore. Extra waterproofing. Made to meet "Electrad's" high standard—there is a difference.



# ELECTRAD INC.

428 BROADWAY

NEW YORK CITY

All good dealers sell other "Electrad" Radio Devices—Audiohms, Variohms, Certified Grid Leaks, Electrad Royalty Variable High Resistances, Etc.

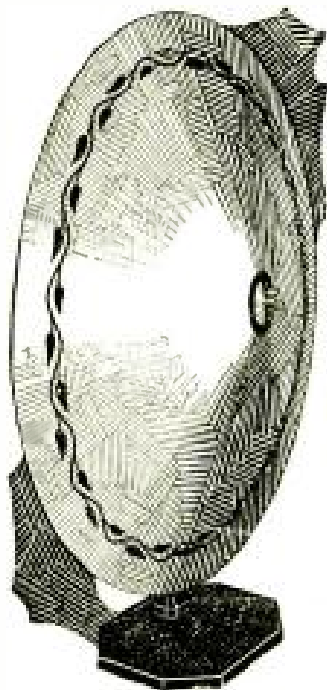

# Make Your Own Cone Loud Speaker —and Save \$25<sup>00</sup>

(All Parts Supplied)

Why pay \$35 or more for a cone loud speaker when you can easily assemble a splendid super-sensitive one at home with the complete parts we send you—and save \$25?

With the parts we send you is a special complete cone unit, blue print and

simplified directions for assembling. Even if you don't know the first thing about radio, the directions are so clear that you can easily set up this wonderful speaker in a few interesting hours. Don't confuse this cone with the small-size ones being sold by other manufacturers. Stands eighteen inches high, complete in every detail. Not only unmatched for beauty, but reproduces both music and voice with faultless accuracy. Yet the cost is amazingly low—

you pay only \$10 for this remarkable instrument—the most approved form of loud speaker known. We can offer you this big saving because the cost of labor in assembling and packing of the cone is a big item, and our method of selling also eliminates all jobbers' and dealers' profits.

## SEND NO MONEY

Simply send name and address and the complete outfit will be sent you by return mail. When postman brings package, deposit with him only \$10.00 in full payment. If you aren't more than delighted—if you're not absolutely convinced that you have a cone speaker equally as fine as any \$35 cone sold—simply return the parts within ten days and your money will be instantly refunded. Never before has a better radio bargain been offered. You would pay at least \$35 for a cone speaker of equal quality anywhere. Act at once. Write NOW!

**Scientific Radio Laboratories**  
254 West 34th St. Dept. 32 New York City

Ask about our SPECIAL CLASS NOW FORMING

## Be a RADIO EXPERT

### STUDY at HOME

Radio, the wonder of all ages, has grown with gigantic strides. Radio experts are needed to keep pace with the growth. Thousands of good-paying positions are open to trained men. Be a radio expert—earn big money—travel—get into the limelight. There's romance, power and fortune ahead for men with vision now just as there was when Henry Ford got started on his auto. The ground-floor opportunity is here.

### YOU EARN WHILE YOU LEARN



I. J. MENDELS

- In my 16 yrs. experience, I have met and coped with every electrical and radio problem.
- I have educated thousands for the better paying positions in radio manufacturing and have taught in one of the world's largest technical schools.

No matter what your present occupation is I can help you to qualify in a short time to write your own ticket in the fascinating, fast-growing, big-pay, long-profit field of Radio! And not only am I able to give you a better, more complete knowledge of Radio itself, but I will show you how to apply your knowledge to turn it into big money quickly.

### \$2,000 to \$10,000 a Year!

Millions of dollars a year are now being divided among radio men not so well trained as I propose to train you. You will command \$2,000 to \$10,000 a year salary or you can take it in profits from a real business all your own. I will show you.

### Fascinating New Profession

I am not going to make you a mere radio mechanic. I will train you to handle the big problems of Radio as well, because that's where the big money lies. You will be qualified in every branch of radio.

### Learn Quickly—At Home

Under my personal direction you will learn quickly at home—in spare time. Don't wait to think this over. Mail in the coupon at once—and when you have all the facts before you, then give serious thought to my offer and your future.

### The Wonderful SUPERDYN

A high powered advanced design broadcast receiver. Gets all stations within 3000 mile circle. Mail the coupon Now for full details of this wonderful instrument and how to get it FREE. Mail the coupon Now! Today!

IRWIN J. MENDELS Director, AMERICAN Radio Engineers Dept. 112, Hearst Square, Chicago

### MAIL THIS COUPON

IRWIN J. MENDELS, AMERICAN Radio Engineers Dept. 112, Hearst Square, Chicago, U. S. A.

Send me your big catalog and full particulars of your complete course of training. Also tell me more about the A.R.E. Twin Superdion Long Distance Receiver and how I can get it free.

Name.....  
Address.....  
City..... State.....



## ARBORPHONE

### What You Expect of Your Set

With the Arborphone anyone can tune in enough stations to satisfy the most ambitious air-adventurer. From stations near or far there is a delightful ease of tuning and purity of tone quality unsurpassed in radio.

Housed in a really beautiful cabinet Arborphone lends a new charm to your prettiest room.

You cannot buy better radio—at any price. Ask any Arborphone owner or dealer.

Most interesting radio facts—written for everyone to understand—are described and illustrated in Arborphone Catalog. A copy sent free at your request.

\$55<sup>00</sup>  
\$60.00  
In Rocky Mt. and Pacific Coast States.

**MACHINE SPECIALTY COMPANY**  
Ann Arbor, Michigan



## Separate All Stations Evenly

**I**T is not necessary to tear down and rebuild your present set in order to separate the stations evenly on the dials. By merely substituting *Rathbun Straight Line Frequency Converters* for your present dials—you will be able to secure real S. L. F. tuning.

Here is a variable vernier control that provides a ratio of 50 to 1 down where the stations are crowded—gradually and smoothly decreasing in uniform ratio over the full 360° of the dial. The stations are evenly separated around the entire circle. There are only two moving parts—a cam and a lever. The action is dependable and accurate—without a particle of backlash. Easier tuning and immeasurably better logging are obtainable from straight line capacity condensers with these new converters.

Remember that we build the *Rathbun Single Hole Mounting Condenser* with genuine Bakelite ends. This year's models are enclosed with transparent pyralin dustbands which preserve their high efficiency for life. They are small, light and rugged—always reasonably priced.

Ask your dealer for *Rathbun Straight Line Frequency Converters*  
He has them in stock or will get them for you promptly

PRICE \$3.50

**RATHBUN MANUFACTURING CO., INC.**

JAMESTOWN, N. Y.

R.M.P.A.

## CABINET For LC-26 Receiver

Built exactly to specifications with piano hinge, lid stay, and splined mounting board.



List prices:  
GENUINE AMERICAN WALNUT... \$17.00  
GENUINE MAHOGANY..... 17.00  
MAHOGANY OR WALNUT FINISH. 14.50

## McLaughlin Super-Heterodyne

To specifications in October, 1925, issue with piano hinge and lid stay.

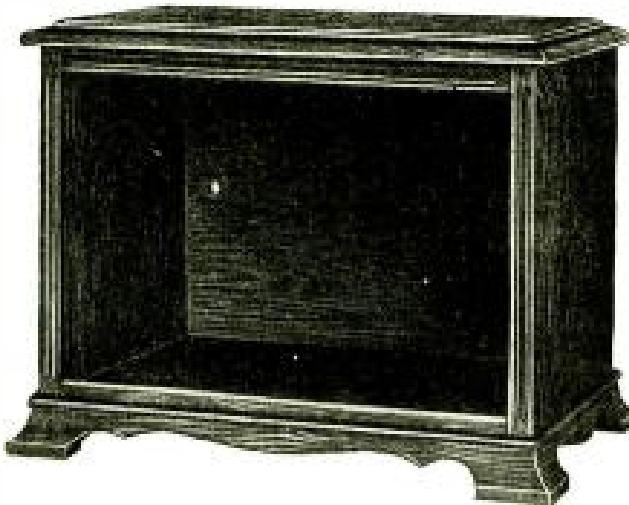

List prices:  
GENUINE AMERICAN WALNUT. \$12.00  
GENUINE MAHOGANY..... 12.00  
MAHOGANY FINISH..... 9.60

### Hammarlund-Roberts Cabinet

Built to take 9x15" sloping panel foundation unit with fancy panel effect line grooves and piano hinge.

List prices:  
AMERICAN WALNUT OR MAHOGANY \$14.00  
MAHOGANY FINISH..... 11.50

Standard Cabinets in Stock (Specify model "T.")  
Of the same design as the McLaughlin cabinet above except having rabbetted instead of grooved front. Piano hinge and lid stay.

Size	Mahog. Walnut any finish or Ma- hogany	Size	Mahog. Walnut any finish or Ma- hogany	Size	Mahog. Walnut any finish or Ma- hogany
7x18-8	\$8.65	7x28-8	\$11.90	7x21-10	\$10.90
7x21-8	9.30	7x30-8	12.75	7x24-10	11.70
7x24-8	10.10	8x30-8	13.70	7x26-10	12.65
7x26-8	10.70	7x18-10	10.20	7x30-10	13.30

SPECIAL CABINETS TO ORDER  
SHIPPING CHARGES PREPAID

CORBETT'S CABINETS have been preferred for several years by quality set builders and are unquestionably superior in design and finish. They are backed by our guarantee to please you. Carefully hand rubbed piano finish. Well packed for shipment.

WRITE FOR CATALOG showing attractive models for all sizes of radio cabinets, consoles and tables. Jobbers and Dealers write for discounts.

CORBETT CABINET MFG. COMPANY  
St. Marys, Penna.

# Burns



Clarity  
Volume  
Beauty

PRICES  
Three Finishes  
\$22.50 \$25.00  
\$30.00

### FOR REAL ENJOYMENT

Use the BURNS Loud Speaker on your receiving set. Produces utmost in volume and clarity of tone. Reaches full range of musical scale—equal to hearing the original production.

At your dealers or direct

*American Electric Company*  
State and 64th Streets, Chicago

## HEADQUARTERS For LC-26 Parts

General Radio Parts  
E.I.S. Apparatus  
Dubilier Condensers  
Weston Meters  
Formica Panels  
Premier Jacks  
Cunningham Tubes  
General Electric Tungars  
Mahogany Cabinets  
Special Engraving  
Special Condensers, Coils,  
Shielding, Etc.

No General Catalog Issued

Write for Quotation on any Radio  
Apparatus or Material Required.

**NORDEN-HAUCK, Inc.**  
ENGINEERS

1617 Chestnut Street, Philadelphia, Pa.

# Let the Pure Tones Through

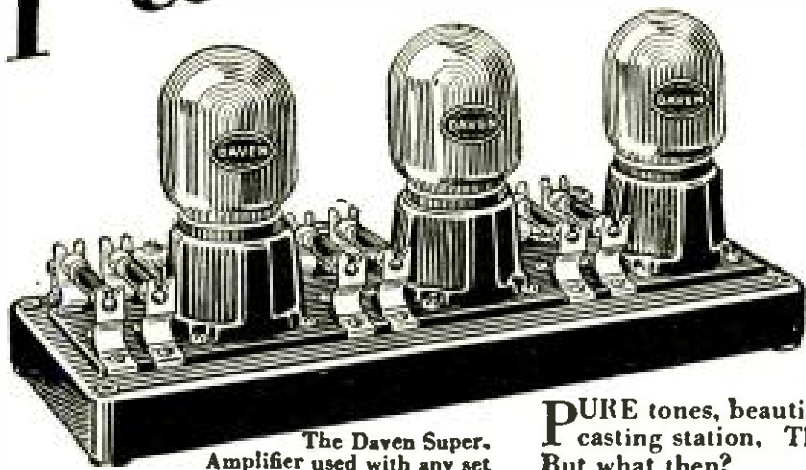

## Make Your Old Set A 1926 Model!

The Daven Super-Amplifier used with any set or circuit carries through the full, clear tones of the broadcasting station programs. If you prefer to assemble the Amplifier, obtain the Daven 3-stage Kit, which includes all parts except sockets.

**P**URE tones, beautifully clear and full, go out from the broadcasting station. They reach your detector still pure and clear. But what then?

From the detector your amplifying apparatus operates. Distortion arises unless you take advantage of a method of amplifying that far-sighted manufacturers and thousands of set builders are now adopting—Resistance Coupled Amplification. Resistance Coupling is not new, but *Resistance Coupling with real volume amplification is new.* It is the most approved method of letting pure tones through.

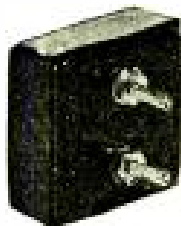

The new Daven Special Coupling Condenser Type "A", for Resistance Coupled Amplification, sold separately and also included in all Daven Amplifiers, Kits and Resisto-Couplers. For greater volume and better quality.

The Daven Super-Amplifier costs little. It is easily and conveniently installed in any set made. Buy it complete to save hook-up labor. For those preferring to assemble, the Daven 3-stage Kit gives all the necessary parts except sockets. You will join hundreds of others who have written to thank us for the improvement Daven has given.

Write us today for The Resistor Manual, an authoritative book on Resistance Coupled Amplification, 25c at good dealers, 30c by mail.

DAVEN PRODUCTS ARE SOLD ONLY BY GOOD DEALERS



The new Daven High MU Tube Type MU-20, used with the Daven Super-Amplifier, gives 50% more volume—6 volt, ¼ ampere. A Daven Power Tube Type MU-6 in the last or output stage helps any set regardless of the method of amplification—6 volt, ½ ampere.



THE RESISTOR MANUAL is the handbook of Resistance Coupled Amplification. At your dealer's 25c. By mail postpaid 30c.

*"The Sine of Merit"*

DAVEN RADIO CORPORATION  
Resistor Specialists

Newark

Reg. U. S. Pat. Off.

New Jersey

CLIP THIS COUPON

DAVEN RADIO CORPORATION  
153 Summit Street, Newark, New Jersey  
Please send me the following on Resistance Coupled Amplification:

- Check One  
 Resistor Manual. 30c is enclosed.  
 Complete Catalog (free).

Name.....

Address.....

For Dealers: Send your letterhead and we will have our nearest distributor communicate with you.

## THE BIG LITTLE THINGS OF RADIO

All apparatus advertised in this magazine has been tested and approved by POPULAR RADIO LABORATORY

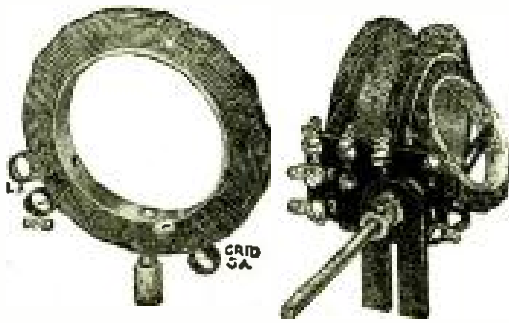

Sickles Coil Set No. 24 for Browning-Drake Circuit. Price \$7.50.

# SICKLES

## DIAMOND-WEAVE COILS

(Trade Mark registered Aug. 4, 1925)

*For Browning-Drake, Roberts, Craig,  
and Hoyt Circuits*

(Patented Aug. 21, 1923)

Compactness of form, rigidity of construction, and the supremely efficient Diamond-Weave method of winding are well-known characteristics of Sickles Coils.

These refinements of design and construction result in low distributed capacity, low dielectric losses and large range of frequency with small variable capacity.

There are Sickles Diamond-Weave Coils for all leading circuits.

*Send for descriptive catalog*

## The F. W. Sickles Co.

134 Union Street  
SPRINGFIELD, MASS.

### COIL PRICES

No. 18A Roberts Circuit	\$ 8.00 set
No. 24 Browning-Drake	7.50 set
No. 20 Craig Circuit	4.50 set
No. 19 Acme Reflex	4.50 set
No. 8 Knockout Reflex	4.00 set
No. 21 Hoyt Circuit	10.00 set

## Connections Rot

when prepared for soldering with  
ordinary flux

### "PERFECTO" SOLDERING FLUID

is the choice of 50 leading radio manufacturers because it is *free from acid*. No set can be better than its connections. Easy to use, "Perfecto" never creeps, cannot corrode.

#### DEALERS

*The sale of this 25c bottle to each of your customers insures your parts from blame—establishes hearty good will toward you. Write for display box and our offer.*

Fans, if your dealer cannot supply, send 25c and his name for this necessary bottle.

**FIRTH RADIO CORP.**  
25 Beaver St. N. Y. C.

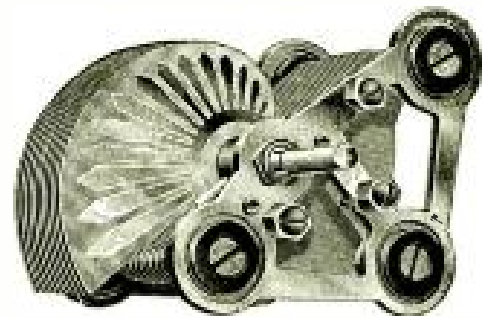

## Heath Straight Line Wavelength Condensers

*Give better radio reception  
all around the  
Dial*

*Write for Booklet*

**Heath Radio and Elec. Mfg. Co.**  
206-210 First Street, Newark, N. J.





# At the CLICK of a switch

Unipower gives you continuous, un failing "A" power of the highest quality / / /

**Y**OU click a switch. Your set begins to operate—feeding on a new kind of "A" power, rich and quiet and always at full voltage.

Again you click the switch. Your set is off. Your "A" power supply *automatically* begins to replenish itself direct from your house current. That is Unipower!

### *A new thrill in radio*

Unipower is now in use in thousands of sets and has the enthusiastic endorsement of set manufacturers. It does away with "A" current failure—the most frequent cause of poor radio reception.

Unipower is a single compact unit, quickly and easily installed. Just connect two wires to your set, plug in on your light current, and the job's done! Unipower is equipped with an exclusive Balkite charger of special design. It will last you for years, and contains no tubes, bulbs, lamps or parts that require frequent replacement.

A unique feature of Unipower is the master-control switch that governs the operation of your entire set. When this switch is ON, your set operates quietly and perfectly, drawing its "A" power from Unipower's rich, full reserve. When the switch is OFF, your set is off—and Unipower automatically recharges from the house current.

The nearest radio dealer can supply you with Unipower. Ask him for a demonstration today.

The Gould Storage Battery Co., Inc.  
250 Park Avenue • • New York



*This shows how snugly the 6-volt Unipower fits into limited space*



**FREE!** Write for interesting booklet, "Unipower—a Triumph in Radio Power", describing Unipower's many advantages and economies.

*The standard Unipower operates from 110-125 Volt A.C.—60 cycle. It is supplied in two types. The 4-volt type for sets using UV 199 tubes or equivalent—\$35.00. The 6-volt type for sets using UV 201-A tubes or equivalent—\$40.00. West of the Rockies, prices are slightly higher. (Special models, 25-50 cycle, are available.)*

# Unipower

TRADE MARK

*Off when it's on  
On when it's off*



# ACME WIRE RADIO PRODUCTS

---

## Celatsite Battery Cable

For connecting A and B Batteries (or current supply) to radio set. Silk braid covering 5 flexible Celatsite wires—5 feet long—a different color for each terminal. Prevents messy wiring and "blown" tubes. Adds greatly to the appearance of your set.



---

## Enameled Antenna Stranded

The best outdoor antenna you can put up. 7 strands of enameled copper wire; maximum surface for reception. Enameling prevents corrosion and consequent weak signals. 100, 150 or 200 foot coils, boxed.



---

## Loop Antenna Wire

You can make a good loop with Acme wire made of 65 strands of fine copper wire, green silk covered. Flexible; non-stretching, neat.

---

## Flexible Celatsite Wire

Flexible stranded wire for "point to point" and sub-panel wiring—latest method of wiring sets. 5 colors, black, yellow, green, red and brown, one for each circuit. 25 ft. coils.



---

## The Original Celatsite Wire

Celatsite is a tinned copper bus bar wire with a non-inflammable "spaghetti" insulation in five colors. Supplied in 30 inch lengths.

---

## Flexible Varnished "Spaghetti"

A perfect insulation tube for all danger points in set wiring. Costs little more and is worth a lot more than the cheaper substitutes offered. Black, yellow, red, green, brown, for wires No. 10 to No. 18. 30 inch lengths.



---

Send for Folder

**THE ACME WIRE COMPANY, Dept. P**  
New Haven, Conn.

# DON'T WAIT!



PEP UP THAT SET NOW WITH  
**X-L RADIO PRODUCTS**

Just install them in your receiver and hear them speak for themselves

*Endorsed by* **POPULAR RADIO LABORATORY** and other leading radio authorities in all the latest circuits

**Model "N" Vario Denser**  
Capacity range 1.8 to 20 micro-micro-farads, for balance in Roberts two tube, Browning-Drake, McMurdo Silver's Knockout, Neutrodyne and tuned radio frequency circuits. Price \$1.00

**Model "G" Vario Denser**  
For the Cockaday circuits, filter and intermediate frequency tuning in super-heterodyne and positive grid bias in all sets.

G-1-	.00002 to .0001 MF.
G-5-	.0001 to .0005 MF.
G-10-	.0003 to .001 MF.

Price Each With Grid Leak Clips, \$1.50

## X-L Push Post

A binding post that really does excel in looks, action, service and convenience. Just push it down—insert wire—cannot jar loose from vibration. No screwing or danger of shearing off wires. Furnished attractively plated with soldering lug and necessary markings.

Price Each 15 Cents

**X-L RADIO LABORATORIES**  
2422 Lincoln Ave. CHICAGO

# Get This Big Western Radio Catalog

NEW  
1925-1926  
EDITION

DEALERS, send for our big live catalog. Contains nationally advertised high quality sets, kits and parts. Use your letterhead.



**Western Radio co.** MFG  
134 W. Lake St. Chicago, Ill



A Type for every Tube Application

# I got 'em!

REGARDLESS of the set—in the final analysis it's the tubes that tell the story of whether "you get 'em" or not—that makes possible clear, joyous, reception. That's why Sylvania Tubes are preferred and insisted upon by every radio user that has ever tried them.

Sylvania Tubes have clearly demonstrated time and time again their absolute superiority over the average product—yet they cost no more and you can buy them from any wide awake dealer. If the dealer in your town does not have them—write us direct.

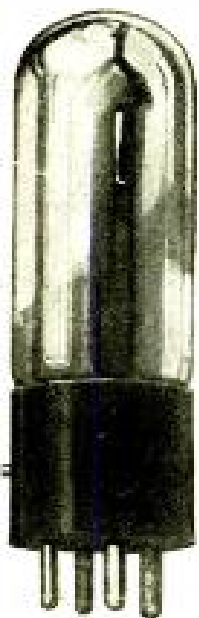

**To Wide Awake Dealers and Jobbers**

We are interested in making a connection with wide awake dealers and jobbers covering the exclusive selling rights of Sylvania Tubes in the territory covered—For details write or wire today.



# Sylvania

Radio Tubes

**SYLVANIA PRODUCTS COMPANY**  
Emporium, Pennsylvania



# Compare

the **FULL WAVE**  
BATTERY CHARGER

before you buy  
**ANY** charger

**H**ERE is the smallest, the most compact, the most efficient charger made. It charges in almost half the time, because it uses the FULL electric wave. Costs less to operate, just a few cents for a full charge. Needs no expensive bulbs, no water, no acids, nothing to spill or get out of order. Needs no adjustments. Just hook on the clips, attach the plug to the electric socket and charge your BATTERY OVERNIGHT.

Passed by the National Board of Fire Underwriters  
Liberty Electric Corp. of New York, 342 Madison Ave.

Model "A" for A Batteries **\$18**  
East of the Rockies  
Model "A-B" will charge **\$22**  
A & B batteries simultaneously.  
East of the Rockies

## Radio Dealers WANTED!

If you are the type of dealer who hustles after business, who isn't content to wait for trade to come in but who takes sets out to demonstrate, can talk and sell quality merchandise, and knows Radio values, we have a big proposition for you. Are you that dealer?

### 50% DISCOUNT TO DEALERS

We manufacture a complete line of high grade receivers and sell to dealers at 50% discount. We are authorized distributors for more than 225 Nationally advertised lines.



Write today for amazing offers new 112-page catalog and regular monthly catalogs quoting below-the-market prices on latest merchandise—all free. Everything in Radio for less. Just fill in coupon, pin to your letter head and mail today, NOW.

AMERICAN RADIO MFG. CO.  
1416-18 McGee Street, Dept. P., Kansas City, Mo.

AMERICAN RADIO MFG. CO., 1416-18 McGee St., Dept. P, Kansas City, Mo.

Gentlemen: Mail me your new 112-page catalog. Also put me on list for regular monthly mailings.

Name.....  
Address.....  
City.....State.....

**To-day-in every good set**

**Less wiring—  
Fewer losses**

Full, clear, rich tone depends on more than on just good apparatus. It depends, first of all, upon careful, compact wiring. AMPERITE eliminates complicated wiring, avoiding leaks and losses. Requires no attention. Controls the filament perfectly, bringing the utmost out of each individual tube. Permits use of any tubes or combination of tubes. Used in all popular construction sets. Price, \$1.10.

*There is an AMPERITE for every tube*  
Write for free hook-ups  
**Radiall Company**  
Dept. P.R.-2, 50 Franklin St., N. Y. City

# AMPERITE

REG. U.S. PAT. OFF.

**The "SELF-ADJUSTING" Rheostat**

→ **AROUND THE WORLD** →

2LO London  
365 m., 2FC Sydney  
1100 m., RH  
Vienna 600 m.,  
BAV Haeren 1100  
m., DKP Kbely  
1150 m., KOM-  
AROV 1800 m.,  
OXE Lyngby,  
2400 m., BER-  
LIN 430 m., PAS  
Amsterdam 1050  
m., EBX Carta-  
gena 1200 m.,  
ROME 470 m.,  
LP, Konigswu-  
sterhausen 680 m.,  
WGY Schenectady  
109 m., 3LO  
Melbourne 1720  
m., KOA Denver  
322.4 m., BUDA-  
PEST 2000 m.,  
SBR Brussels 270  
m., WEA New  
York, 491.5 m.,  
HAMBURG 392  
m., WMBF Mi-  
ami Beach 384.4  
m., CFAC Cal-  
gary 430 m.,  
WGY Schenectady

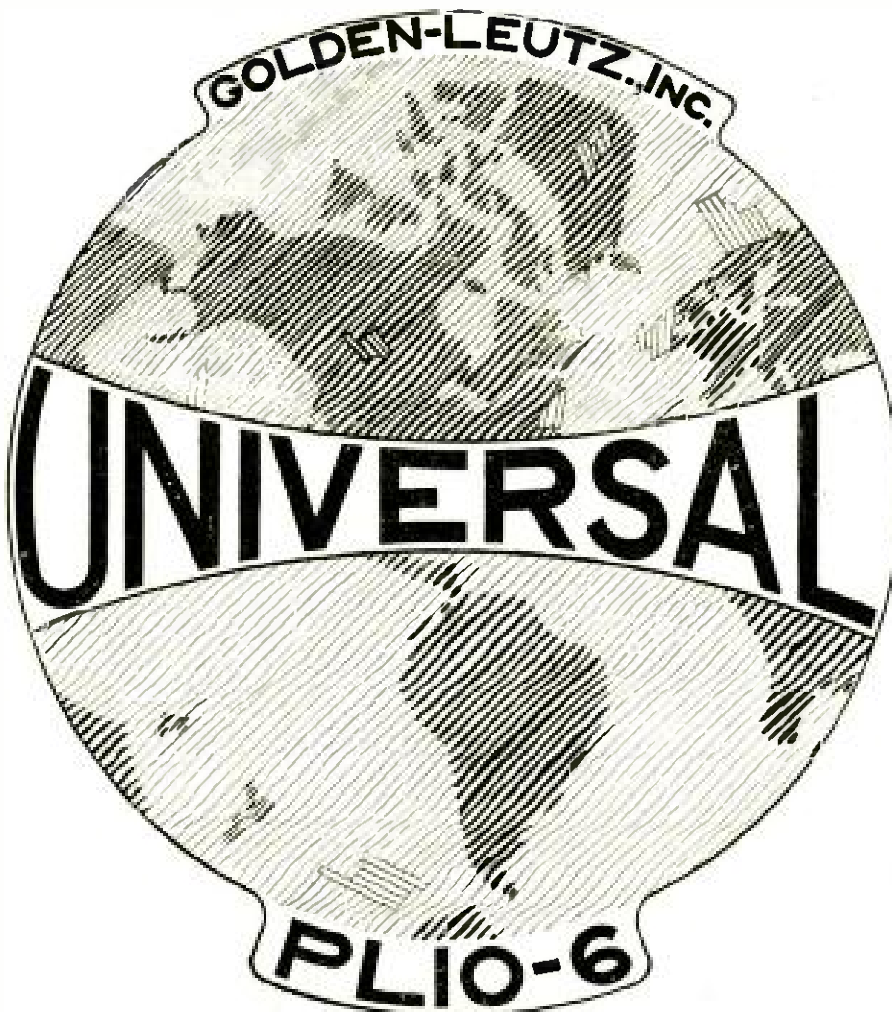

40 m., SMA Ade-  
laide 850 m.,  
CYX Mexico City  
350 b., FL Eifel  
Tower 2600 m.,  
2BD Aberdeen 495  
m., PRG Prague  
1000 m., PCGG  
The Hague 1070  
m., 2FL Sydney  
770 m., STOCK-  
HOLM 440 m.,  
HBI Geneva 1100  
m., WGY Sche-  
nectady 1660 m.,  
BRESLAU 413  
m., KGO Oak-  
land 361.2 m.,  
CKAC Montreal  
425 m., CHAC  
Halifax 400 m.,  
PWX Havana 400  
m., KDKA Pitts-  
burgh 64 m.,  
FRANKFORT  
467 m., WOAZ  
San Antonio 394.5  
m., NAA Arling-  
ton 2500 m.,  
CHXC Ottawa 435  
m., WOC Daven-  
port 483.6.

**Traveling Around the World**

A yacht equipped with a Universal Plio-6, traveling around the world, would hear broadcasting programs every night regardless of its location, because the Universal Plio-6 tunes all wave-lengths from 35 meters to 3600 meters. An American owner of this Golden-Leutz Receiver can listen for all European stations as it tunes to the different wave-lengths used by foreign broadcasters. In addition, for reception of American broadcasting stations from foreign countries this wonderful receiver, designed by Chas. R. Leutz, is already breaking distance records.

*Cable, wire, write or phone for literature today*

*Manufactured by*

**GOLDEN-LEUTZ, INC.**

(With which has been incorporated Experimenters Information Service and E. I. S., Inc.)

**476 Broadway - - New York City**

CABLES "EXPERINFO," NEW YORK

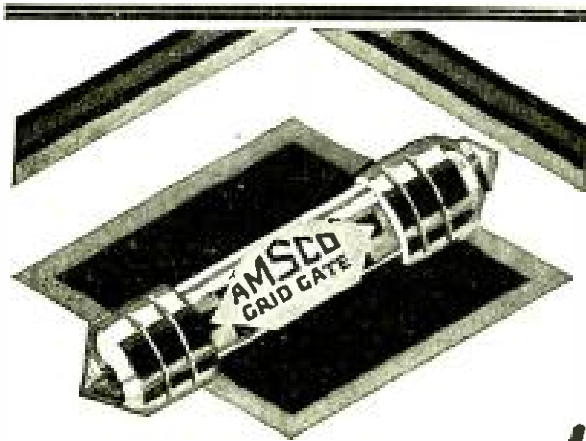

*Amsco's Newest!*

**Grid Gates, Resistors  
and Resistance Couplers**

Grid Gates are the Amsco improvement on "leaks." They provide measured and exact control of the current flow. Extra large for noiseless service. Fit all mountings. Insist upon Amsco Grid Gates, Amsco Resistors, Amsco Resistance Couplers. The latter are made with .006 condenser in genuine Bakelite base with mountings for two Resistors.



**The New Amsco  
Universal Sockets**

Especially designed to fit all the new types and sizes of U. X. and C. X. radio tubes. Clicks into contact—making positive wipe connection. Most compact and fool-proof socket made. One hole mounting. The Ultimate Socket—will be 1926 standard. Ask your Dealer.

AMSCO PRODUCTS, Inc.  
Broome and Lafayette Sts., N. Y. C.



# AEROVOX

**FIXED  
CONDENSERS**

have won an enviable  
**Reputation**

among the foremost radio experts\*  
~ there's a reason

\*Tested and approved by M. I. T., Yale, Radio News, Popular Radio and Popular Science. Used by over 200 of America's leading set manufacturers.

Made in all capacities. Also manufacturers of Grid Leaks, Resistors, Resistofomers and Rheostats.

**AEROVOX WIRELESS CORPORATION**  
491 Broome Street New York City  
Chicago Office: 53 W. Jackson Boulevard  
Cincinnati: 304 Palace Theatre Building

**FOR CLEAR, QUIET "B" POWER**



**RADIO  
Storage "B" Battery**

**12 Cells  
24 Volts** Lasts Indefinitely—Pays for Itself  
Economy and performance unheard of before. Recharged at a negligible cost. Delivers unfading power that is clear, pure and quiet. Approved and listed as Standard by leading Radio Authorities, including Pop. Radio Laboratories, Pop. Sci. Inst. Standards, Radio News Lab., Lefax, Inc., and other important institutions. Equipped with Solid Rubber Case, an insurance against spill and leakage. Extra heavy glass jars. Heavy rugged plates. Order yours today!  
**SEND NO MONEY** Just state number of batteries wanted and we will ship day order is received. Extra offer: 4 batteries in series (96 volts), \$10.50. Pay exp. man after examining batteries. 5 per cent discount for cash with order. Mail your order now!

**WORLD BATTERY COMPANY**  
1219 So. Wabash Ave., Dept. 77 Chicago, Ill.  
Makers of the Famous World Radio "A" Storage Battery  
Prices: 6-volt, 100 Amp. \$11.25; 100 Amp. \$13.25; 140 Amp. \$14.00.  
All equipped with Solid Rubber Case.

**World  
STORAGE BATTERIES**

Set your Radio Dials at 210 meters for the new 1000 watt World Storage Battery Station, WSHC, Chicago. Watch for announcements.

HDRA - WEAJ - WSN - WJS - KHJ - RSO - KEAF - WJY - WOP

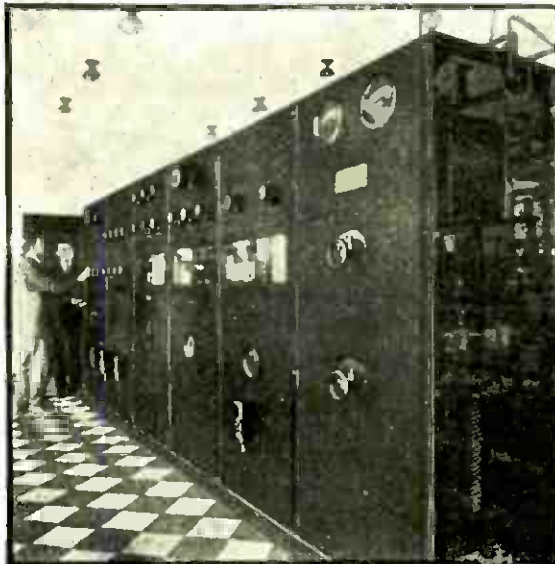

**\$50. to \$250 a week  
IN WORK THAT IS  
ALMOST ROMANCE**

**Be a Radio Expert**

Get into the great new Big-Pay Industry—Radio. If you're earning a penny less than \$50 a week, clip coupon now. Send for AMAZING FREE BOOK. Be a Radio Expert, and draw down big money for the easiest and most fascinating work in the world. Positions everywhere. Thoroughly-trained men are in big demand. Need for Radio Experts in every community. Short hours. BIG PAY. Free book gives all the facts. Astonishing opportunities—thousands of them! Every day N. R. I. trained men are taking good places in the Radio field. Free book tells all about their success. Send for it now!



**Learn Quickly and Easily  
AT HOME**

Master Radio Engineers will show you how to qualify quickly and easily at home, for Radio's fine jobs. We guarantee to train you successfully. Lack of experience no drawback—common schooling all you need. Our tested, clear methods make it easy for you. Send coupon now for free proof.

**Instruments Given  
with Course**

All instruments shown here and many others given to students for practice work while learning. Receiving sets, from simplest kind to thousand mile receiver. An UN-EQUALLED OFFER. Many other big features for limited time only.

**Famous Training  
That "Pays for  
Itself"**

Spare time earnings are easy in Radio. Increase your income almost from the start through practical knowledge we give you. This is the famous practical training that pays its own way.

Get  
this  
Amazing  
Book

Most amazing book on Radio ever written—full, interesting facts about this great field and how we prepare you and help you start. You can do what others have done. GET THIS BOOK.

**Send Coupon**

Send coupon today for special limited offer, including all instruments—you'll get full particulars by return mail.

**National Radio  
Institute**

Dept. BT8, Washington, D. C.

You get  
all of  
these



**MAIL THIS NOW**

**NATIONAL RADIO INSTITUTE  
Dept. BT8, Washington, D. C.**

Without obligating me in any way, send me your free book, "Rich Rewards in Radio," and all information about your practical, home-study Radio course.

Name..... Age.....

Address .....

Town..... State.....

**PROOF**



**Operates WMAQ**  
"Accepted a position with Chicago Daily News—Station WMAQ. My income practically doubled, thanks to your fine course."  
KEITH KIMBALL, Chicago.



**Gets Big Job**  
"Just been made Sales Manager of this Radio concern—a big raise in pay. Regret I did not take course sooner."  
R. E. JONES, Bay City.



**LARGEST RADIO SCHOOL IN THE WORLD**

ORIGINATORS OF RADIO HOME-STUDY TRAINING

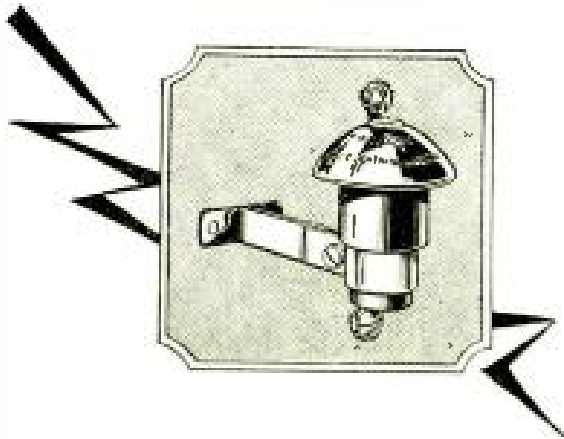

It says  
**“Stop”**  
 and lightning won't harm  
 your set

The National Board of Fire Underwriters specify that an approved Radio Lightning Arrester *must* be used with all out-door aerial installations.

Protection is easy. Insure your insurance and save your set with a **WIRT LIGHTNING ARRESTER** (listed as standard by the Underwriters Laboratories). The cost is a trifle.

**THE WIRT LIGHTNING ARRESTER** is an approved air gap type, made of bakelite giving ample insulation, with brass terminals moulded in bakelite, far enough apart so that there is no leakage. A "petticoat" of bakelite shields the arrester from water and dust. Handsome and rigid. Lasts a lifetime. Easy to install. Full directions on box.

When you install your **WIRT LIGHTNING ARRESTER**, get a **WIRT INSULATOR** and prevent leakage along your lead-in wires. It keeps the wire at the proper distance, provides perfect insulation, and prevents wear and tear on the wire by preventing sagging and swaying.

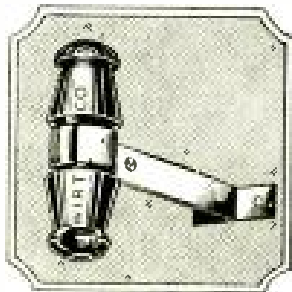

**THE WIRT LIGHTNING ARRESTER IS LISTED AS STANDARD BY THE UNDERWRITERS LABORATORIES.**

WIRT LIGHTNING ARRESTER.....\$1.00  
 WIRT INSULATOR ..... .35

Sold by leading Radio dealers

**WIRT COMPANY**  
 PHILADELPHIA PENNSYLVANIA  
 Makers of Dim-A-Lite

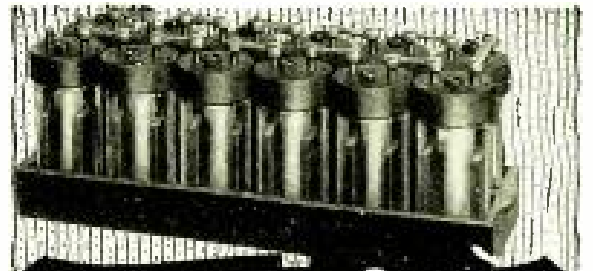

**FREE!**

To Each Purchaser of a **WORLD 6V. Auto or Radio BATTERY**



**12-Cell—24 Volt Storage 'B' Battery**  
 Positively given free with each purchase of a **WORLD 'A'** Storage Battery. You must send this ad. with your order. **WORLD Batteries** are famous for their guaranteed quality and service. Backed by years of successful manufacture and thousands of satisfied users. Equipped with *Solid Rubber Case*, an insurance against acid and leakage. You save 50 per cent and get a

**2-Year Guarantee Bond in Writing** **WORLD Battery owners "tell their friends." That's our best proof of performance. Send your order in today.**  
**Solid Rubber Case Radio Batteries**  
 6-Volt, 100-Amperes ..... \$11.25  
 6-Volt, 120-Amperes ..... 13.25  
 6-Volt, 140-Amperes ..... 14.00

**Solid Rubber Case Auto Batteries**  
 6-Volt, 11-Plate ..... \$11.25  
 6-Volt, 13-Plate ..... 13.25  
 12-Volt, 7-Plate ..... 16.00

Approved and Listed as Standard by Leading Authorities including Radio News Laboratories; Popular Science Institute of Standards; Popular Radio Laboratories; Radio Broadcast Laboratories; Radio in the Home; and Lefax, Inc.

**SEND NO MONEY** Just state battery wanted and we will ship any order is received by Express C. O. D. subject to your examination on arrival. **FREE 'B'** Battery included. **Extra Offer:** 5 per cent discount for cash in full with order. Buy now and get a guaranteed battery at 50 per cent saving to you.

**WORLD BATTERY COMPANY**  
 1219 So. Wabash Ave., Dept. 3 CHICAGO, ILL.

**World STORAGE BATTERIES**

For **AUTO and RADIO**



WORLD - WILCO - WEN - WWS - WOL - WGO - WRAF - WJY - WOP

Make your own coils with the **Franklin Coil Winder** **Low loss self support - ing**

Same device winds both spider web or solenoid coils in different sizes. Coils easily removed in perfect shape. All metal brass and aluminum. Approved by Popular Radio.

For sale only by **FRANKLIN COIL WINDER**  
 81 Irving Place New York City

**You can wind Coils for all Circuits**

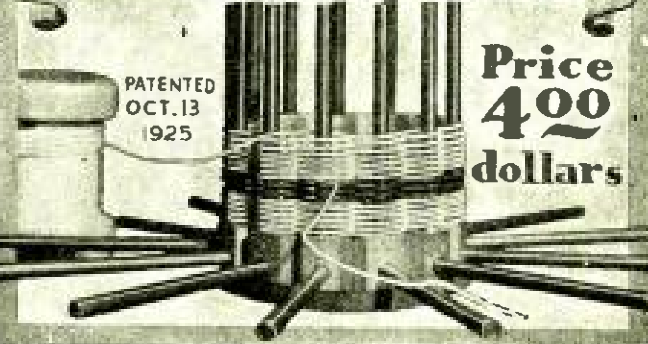

PATENTED OCT. 13 1925

Price **4.00** dollars



# NEW WOODCRAFT LINE

of ENCLOSURES AND CONSOLES WITH  
ADJUSTABLE PANEL OPENING

It is now possible to buy Enclosures, Consoles and Tables for Radio Sets, regardless of the size of panels used. The Panel opening in all Woodcraft Models are adjustable up to a maximum of 30" x 10". It is also possible to mount panel to tilted or perpendicular position in each Model.

Because of exclusive Woodcraft design (broad patents pending) it is possible to effect this quick change in panel size and position instantly without screw holes, cutting, etc., beautifying the panel.

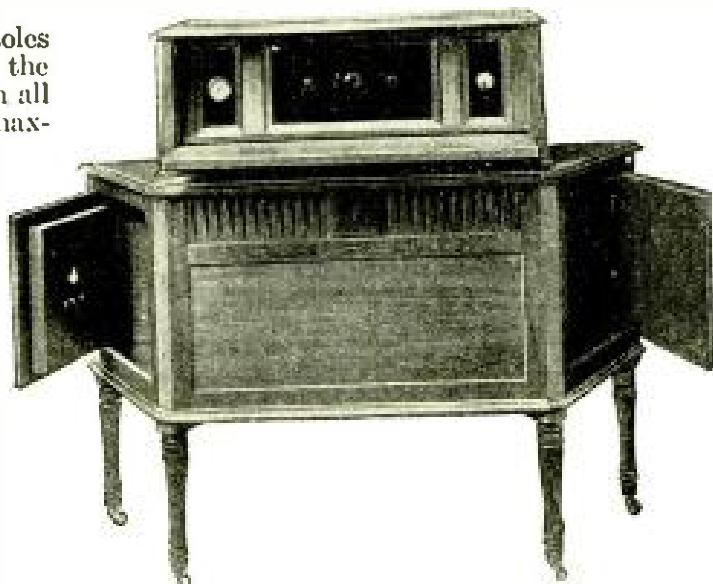

The Woodcraft is by no means a make-shift. Built of genuine dark Walnut with five coats of lacquer, rubbed to a piano-satin finish. Many two-tone, carved and inlaid effects, make Woodcraft Models as beautiful as may be imagined. All panels are completely surrounded by  $\frac{1}{8}$ " two-tone bevel.

Woodcraft Tables, Consoles and Cabinets will prove an attractive addition in the most carefully appointed Drawing Room.

If you hesitate to purchase an attractive cabinet because you contemplate buying a better set in the future, you need no longer delay, as your new set, when purchased or built, may be instantly installed in this cabinet. In the meantime, your present set may be made more wonderfully attractive and eliminate all unsightly wiring, batteries, speakers, etc.

The Woodcraft line is very complete and the three models illustrated are merely representative models. Write us direct for a complete catalog of Consoles, Speakers and other models.

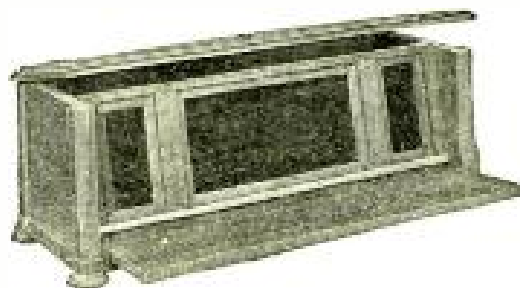

## THE DETROIT WOODCRAFT CORP.

Sales Depts.

4611 Woodward Ave., Detroit, Mich.

MAKE YOUR SET UP TO DATE

# AMPLION

*Product of Nearly 40  
Years' Experience*

**Bring in those distant  
programs clear and loud!**



**T**HE actual originators and world's oldest makers of loud speaking devices have created in The Amplion a long distance radio reproducer so clear and powerful that many users say it can be used instead of another tube in a set. Hear The Amplion — in comparison! — and you will understand the reason it leads in sales throughout the world — is the choice of the Royalty and Nobility abroad, and of the musically critical everywhere. Write for the "Amplion Pedigree."

**THE AMPLION CORPORATION of AMERICA**  
*Executive Offices: Suite X, 280 Madison Ave., New York City*  
*Canadian Distributors: Burndept of Canada, Ltd., Toronto*

Supreme clarity of tone caused Amplions to be chosen for use in St. Peter's, Rome, to reproduce important papal ceremonies.

All Amplions are completely equipped with cords and panel plugs.

Speakers and console units  
**\$12 to \$4250**



*"It gets  
that  
last  
mile"*

**SEE THAT GAP?**

## The AIRGAP SOCKET

### THE BEST TEST

Listen in on your detector, replace old socket with an Airgap Socket, note the wonderful improvement. You will then use no other.

**Sent direct if your dealer cannot supply you. 75 cents each**

**AIRGAP PRODUCTS CO., Mfr.**  
 188 N. J. R. R. Ave. Newark, N. J.

## Binghamton. N. Y. to the Pacific on this indoor aerial!

# Effarsee

ANTENNAE  
REG. U. S. TRADE MARK  
 PATENT PENDING



Fans everywhere report better reception with this new scientifically designed antenna than with outdoor wires. Increased range, knife-like selectivity, greater volume.

*Sweetens Reception!  
 Increases Selectivity!  
 Cuts Down Static!*

Type IXL EFFARSEE contains a thousand feet of copper aerial wire, covered with parchment. Equipped with special fixed condensers. Can be used inside or out—can be hung on walls, used under rugs, anywhere. Write for distance reports of enthusiastic users.

Type IXL (Large) . . . \$4.00  
 Type BXL (Small) . . . \$2.50  
 At any radio dealer or write direct.

**THE FISHWICK RADIO CO.**  
 137 Central Parkway Cincinnati, O.



New 5 Ampere Size

# Say Tungar

## when you want the best battery charger



The Tungar is a G-E product, developed in the Research Laboratories of General Electric.

The new Tungar charges any make and size of storage battery: radio "A" and auto batteries, and "B" batteries as high as 96 volts in series.

East of Rockies

Two ampere size \$18.00  
Five ampere size \$28.00

60 cycles . . . 110 volts

Merchandise Department  
General Electric Company  
Bridgeport, Connecticut

"Tungar" is fast becoming the word for battery charger. And no wonder!

Tungar is the trouble-proof, easy-to-use charger for *all* batteries. It's the original bulb charger. It's manufactured by General Electric. It makes no disturbing noise. It can't blow out Radiotrons and it cannot create radio interference.

# Tungar

REG. U.S. PAT. OFF.

**BATTERY CHARGER**

*Tungar—a registered trademark—is found only on the genuine. Look for it on the name plate.*

# GENERAL ELECTRIC

You must  
protect the  
circuit against  
leaks and losses

**RADION**

*The Supreme Insulation*

*does it!*

**R**ADION offers the *utmost possible protection* against leaks and losses. Designed by engineers exclusively for radio purposes, it is the most efficient insulation as indicated by authoritative, impartial tests.

Radion Panels reduce surface leakage and dielectric absorption to a minimum. Their beautiful surface finish adds to the attractiveness of any set. Radion Dials match their beauty of finish and help to get close tuning. Radion Sockets eliminate capacity effects; they are made both for new UX tubes exclusively and with collar adapters for old-type tubes.

Radio dealers have the complete line of Radion low-loss parts. Manufacturers will find it to their interest to write us for prices on moulded parts. Send for catalog.

*FREE Booklet. "Building Your Own Set" mailed on request.*

**AMERICAN HARD RUBBER COMPANY**

Dept. B14, 11 Mercer St., New York City

Chicago office: Conway Building

Pacific Coast Agent: Goodyear Rubber Co., San Francisco—  
Portland

*Hoyt*

"Super"-Control Meter

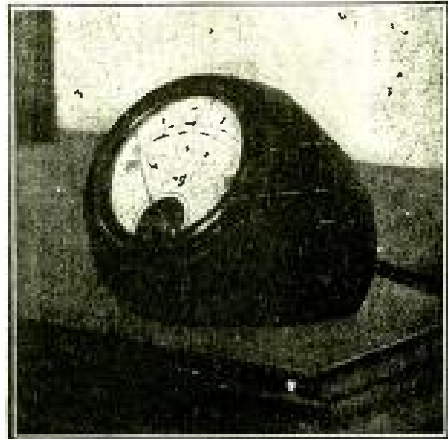

**FOR PRECISION CONTROL**

of Radiola Superheterodynes Nos. 20, 25 and 28

Instantly attached without any change in wiring to jacks already installed for this purpose. Permits setting rheostat for exact filament voltage for best reception and longest tube life.

A HOYT moving-coil voltmeter, type 17, with bronze rim, wood case to match set, non-scratch base and cord.

**Price \$8.50**

**BURTON-ROGERS CO.**

26 Brighton Ave.

Boston, Mass.

National Distributors

*Two Wonders of the Night!*

AND THE  
**ARAGAIN RADIO RECEIVER**

**AUTOMETAL CORPORATION**

**NIAGARA FALLS**

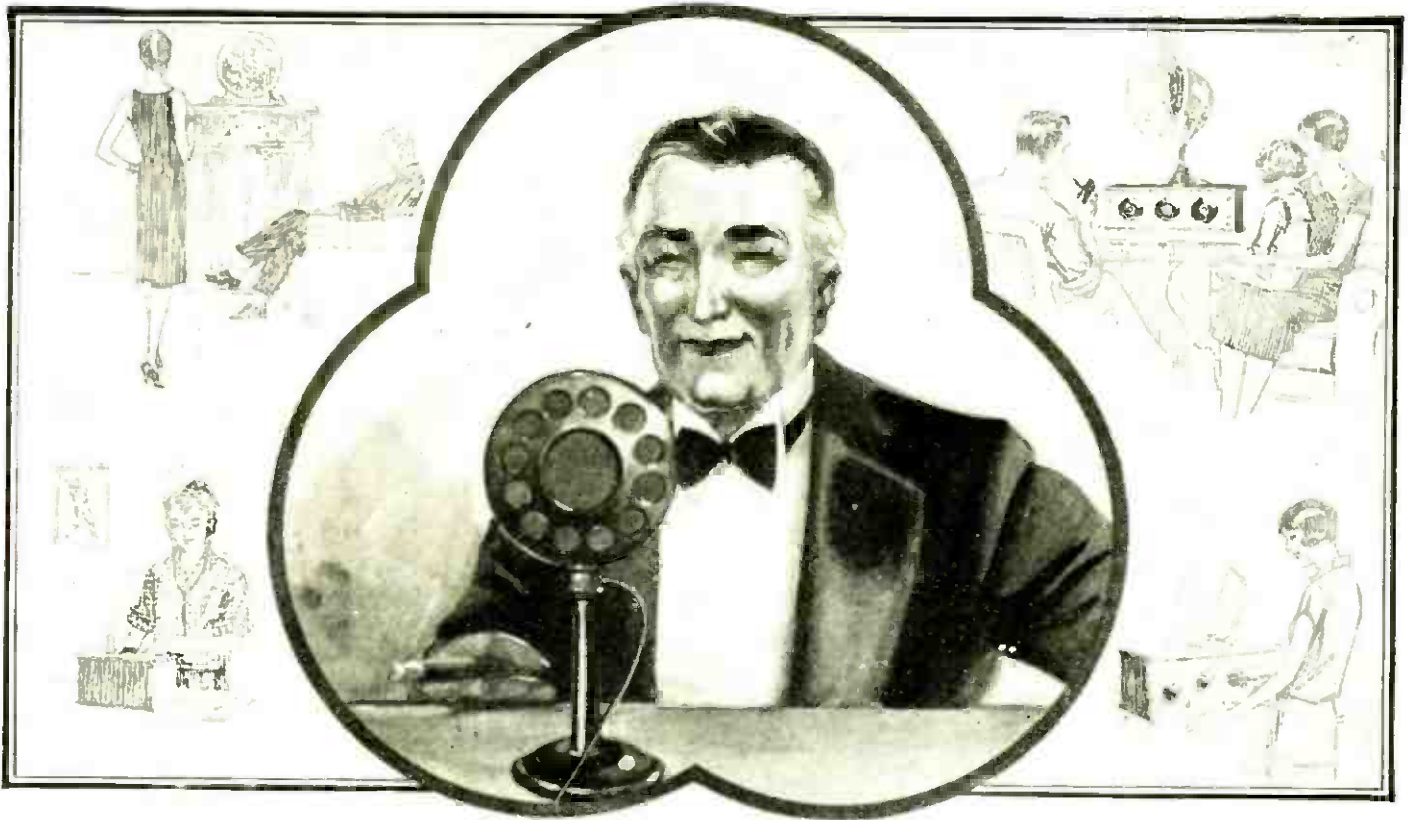

## Great names become real folks

The President, the Secretary of Commerce, and scores of leaders in politics, science and industry are no longer mere "names." Through radio they speak direct to you. The very tones of their voices are known to millions.

In bringing Radio broadcast reception within the reach of everyone, Bakelite has had a major part. You will find it in receiving sets, speakers and accessories, for it improves both appearance and performance.

Bakelite is the most widely used material for panels, dials, knobs, tube bases and sockets, rheostats,

variable and fixed condensers and other parts requiring lasting insulation.

In speakers Bakelite is used for magnet spools, housings and diaphragms, as it is unaffected by temperature and atmospheric changes. Because of its resonance it is also used for speaker "bells" and "cones."

It is a fact that over 95% of radio set and parts manufacturers use Bakelite, for they know that its electrical properties, as well as its beauty of color and finish are permanent, unimpaired by time or service.

Write for Booklet 28, a helpful guide when buying a radio set or parts.



Shaw Insulator Co.  
Tube Socket



Shaw Radio Corp.  
Resisto Coupler



Micanold Radio Corp.  
Grid Condenser and Leak



Carter Radio Co. Flat Plug



Shaw Insulator Co.  
Binding Posts and  
mounting, and Con-  
necting Elec. Labora-  
ries Bakelite Tube  
Base

### BAKELITE CORPORATION

247 Park Avenue, New York, N. Y.  
Chicago Office: 636 West 22d Street

# BAKELITE

REGISTERED

U. S. PAT. OFF.



THE MATERIAL OF A THOUSAND USES

The registered Trade Mark and Symbol shown above may be used only on products made from materials manufactured by Bakelite Corporation. Under the capital "B" is the numerical sign for infinity, or unlimited quantity. It symbolizes the infinite number of present and future uses of Bakelite Corporation's products.

All apparatus advertised in this magazine has been tested and approved by POPULAR RADIO LABORATORY

## A RADIO CABINET OF BEAUTY AND ELEGANCE DIRECT TO YOU AT LOWEST COST

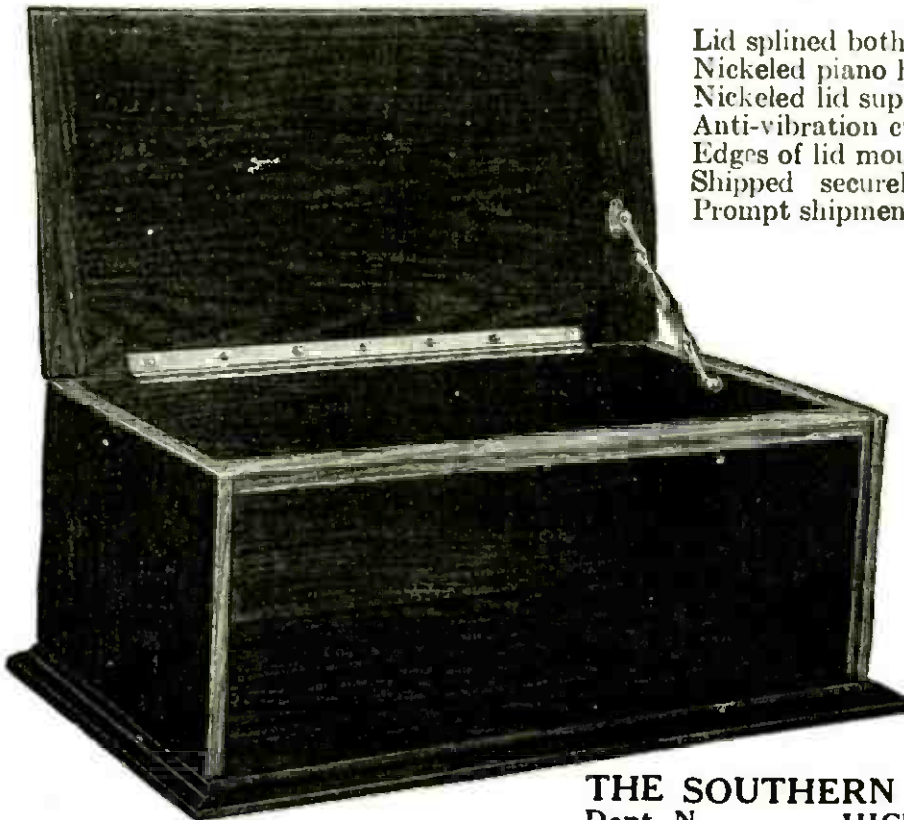

Lid splined both ends to prevent warping.  
Nicked piano hinge—Full length.  
Nicked lid support of artistic design.  
Anti-vibration cushion feet (not visible in cut).  
Edges of lid moulded to match bottom.  
Shipped securely packed in strong carton.  
Prompt shipment. Big stock for holidays.

	Hardwood, Rubbed Mahogany Finish	Solid Black American Walnut
7 x 18 x 7 1/2 or 10 in. deep	\$3.50	\$5.00
7 x 21 x 7 1/2 or 10 in. deep	3.75	5.25
7 x 24 x 7 1/2 or 10 in. deep	4.00	5.50
7 x 26 x 7 1/2 or 10 in. deep	4.75	6.25
7 x 28 x 7 1/2 or 10 in. deep	5.50	7.00
7 x 30 x 7 1/2 or 10 in. deep	6.00	8.00

Add 25c. for "E-Z" Fone plug.  
CASH WITH ORDER or C. O. D.  
if 1/4 of price is sent with order.  
Prices F. O. B. Hickory, N. C.  
Order express shipment, often  
cheaper than mail and much safer  
from damage.

FREE WITH EACH CABINET  
a glued-up stock non-warping 1/2-  
inch BASEBOARD.

Free Catalogue.

THE SOUTHERN TOY COMPANY, INC.  
Dept. N. HICKORY, NORTH CAROLINA

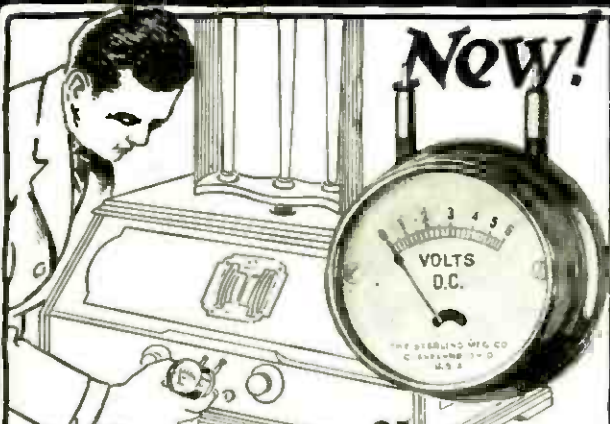

**Every Radiola 25-28 Owner  
Should Have This  
Tube Saver and  
Aid to Better Reception**

If your set is a Radiola 25 or 28 you can obtain the best results only by correct adjustment—measuring your tube filament voltage to exactly 3.0 volts.

Get the new Sterling Voltmeter especially designed for Radiolas 25 and 28. Handy—no leads to fuss with—plugs right into the set. Save tubes, better reception.

Ask your R. C. A. dealer or write our factory for details

PRICE \$7.50

**Sterling**  
R25-28 Filament Voltmeter

THE STERLING MANUFACTURING CO.  
Dept. G Cleveland, Ohio

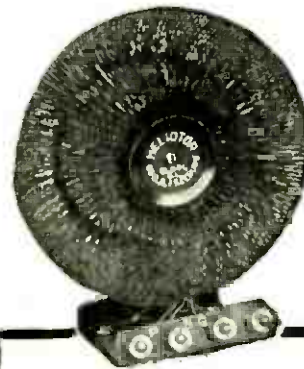

HELIO-TOR

THE  
TRUE  
TOROID

PRE-EMINENT because of

GREAT POWER AND RANGE due to reduced radial spread of secondary turns. Concentric internal toroidal primary.

KNIFE-LIKE SELECTIVITY due to extremely low capacity effects.

PURE TONE QUALITY due to isolated nature of winding.

ABILITY TO SHUT OUT ELECTRICAL INTERFERENCE.

UNIFORM INDUCTANCE VALUE for use with gang condenser or multiple control.

SMALL SIZE (3 1/2" to 4" dia.). Sizes for all condensers. Tuning range 200 to 570 meters.

STRONG AND RIGID AIR CORE CONSTRUCTION. Low resistance losses. Mounts on base board or condenser.

"Better Amplification" tells how and why. May we send you a copy?

GEO. A. FREEBURG CO.  
165 Lovell St. Elgin, Illinois

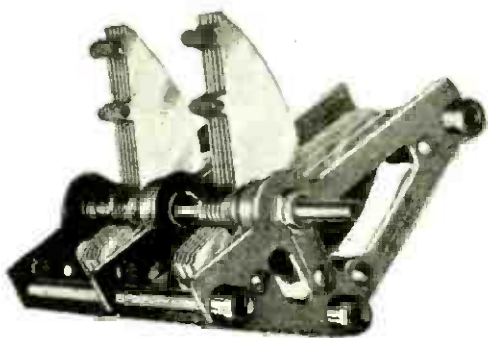

Made under Hogan Patent No. 1,014,002  
Jan. 9, 1912

# Simplified Tuning!

Dial crowding has been responsible for blurring radio reception. You can now get new pleasures from your radio. Just as each note on the piano has its tone, so each degree on the dial will have its station. U. S. Tool Straight Line Frequency Condensers make this possible. These condensers spread the stations uniformly round the dial, each degree has its station and *one station only*.

## The U. S. Tool New Straight Line Frequency Condensers

are the latest product of skilled engineers, designed and manufactured in a factory that for years has specialized in the making of precision instruments.

When you use the U. S. Tool S. L. F. Condenser you will know the real joys of radio performance.

*Write for booklet*

**U. S. TOOL COMPANY, Inc.**

**Ampere**

**New Jersey**

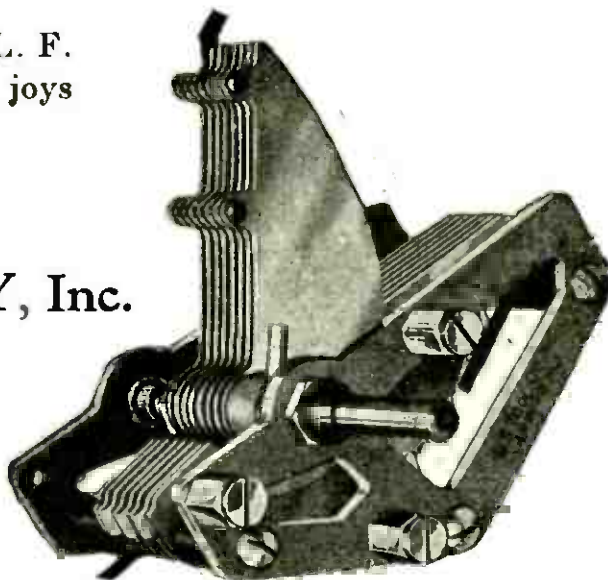



**Better Quality — Greater Volume**

More Economical  
to operate your set with

## Raytheon Tube B-Eliminator

Using



**Transformers**

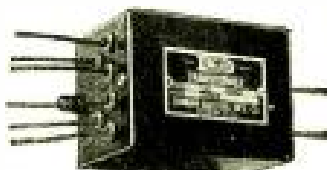

509 Full Wave  
\$7.00 List

**Chokes**

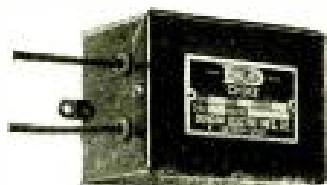

514 20 henry  
\$5.00 List

**Raytheon Tubes**  
\$6.00 List

Also Transformers and  
Chokes for R. C. A.  
and Cunningham Tubes

Built complete, including winding of coils, in  
Dongan Plants.

**Manufacturers**

Leading B-Eliminators today use Dongan Transformers and Chokes. One division of our big plant is equipped for large production for manufacturers. Special prices on request.

**Jobbers**

"Finest all-year radio merchandise on the market," said one of the country's leading jobbers. Dongan wishes new connections in certain territories.

**Other Dongan Products**

**Audio Transformers**

**Voltmeters**

**DONGAN ELECTRIC MANUFACTURING CO.**  
2983-3001 Franklin St. Detroit, Mich.

TRANSFORMERS OF MERIT for FIFTEEN YEARS

Practical in every respect the new Raytheon Tube B-Eliminators add more to the pleasure of radio than any achievement in two years. Performance is consistent and your B-Eliminator costs less to operate.

It is very easy to build your own B-Eliminator — and inexpensive compared with the cost of B-Batteries.

Order from your dealer or send check or money order direct to factory. C. O. D. Deliveries made on request.

## More Profits for the PROFESSIONAL Set Builder

WE have an unusually interesting proposition to make to the man who is now building (or has the ability to build) radio receiving sets for resale.

This is a real opportunity. Write to-day for full information.

**Gearhart-Schlueter Radio Corp.**

714 Voorman Ave.  
Fresno, California



## PRECISION BI-PASS and FILTER CONDENSERS

Every good radio-set needs by-pass condensers. Use a TOBE .002 Mfd. around the primary of the first audio transformer, thus by-passing the radio frequency currents out of the audio end and improving the tone. You can put this in your set yourself.

On resistance or impedance-coupled amplifiers, the coupling condensers should be TOBE, not less than 0.1 Mfd., to pass all the low notes and secure really truthful reproduction.

TOBE Condensers are standard for smoothing and filter work in the Raytheon Plate Supply Unit.

TOBE Condensers are ACCURATE, durable, SILENT, dependable, and REASONABLE in price.

**"A BETTER CONDENSER"**  
In the silver case and the silver carton  
**AT YOUR DEALERS**

**TOBE DEUTSCHMANN CO.**  
CORNHILL BOSTON, MASS.



# Send for this RADIO RADIO BOOK FREE

# 1926 Catalog of RADIO BARGAINS

## Save 1/3 to 1/2

The World's Largest Exclusive Radio Mail Order House Will Send You This Wonderful Book FREE



## AMERICAN RADYNOLA 5 TUBE SET

64 illustrated pages containing thousands of bargains in radio sets, semi-finished sets and radio kits of all styles, sizes and approved circuits. 5-tube sets as low as \$29.50. Beautiful models of the very latest designs and types. Elaborate console models with loud speakers built right in cabinets of genuine mahogany and walnut. All sets guaranteed. Coast to coast receiving range. Also contains everything in radio supplies, including batteries, chargers, loud speakers, transformers, condensers, rheostats and any other parts you may want for improving your set or building a new one. Guaranteed saving to you of 1/3 to 1/2.

\$29<sup>50</sup>

### The Biggest 5-Tube Value on the Market

Positively the world's greatest 5-tube radio bargains. Regular \$75.00 value. Our large quantity production enables us to sell this set for only \$29.50, fully built and wired in beautiful mahogany cabinet of latest design with sloping Bakelite panel of Satin finish, handsomely etched and engraved as illustrated. Constructed of the finest low-loss condensers, coils and sockets. Bakelite baseboard panel and dials. Price for set only. **\$29<sup>50</sup>** Transportation charges extra, shipping weight 25 lbs.



This set with all accessories, including the famous American Bell loud speaker with adjustable unit, 2-45 volt "B" batteries, one guaranteed 100 Ampere Hour, storage "A" battery, cable for battery connection, 5-201A tubes, Aerial and ground equipment, and everything complete ready to set up and operate. Nothing else to buy. Price. **\$59<sup>75</sup>** Transportation charges extra. Shipping weight 100 lbs.

### Order Direct from This Page! Save About One-Half!

Order direct from this page. Save 1/3 to 1/2. Our guarantee protects you. Money cheerfully refunded if you are not satisfied. Write your order and prices plainly. Send post office money order, or bank draft for full amount to insure safety. Refer to any bank or commercial agency regarding our reliability.

#### SEMI-FINISHED 5-TUBE RADIO FREQUENCY SET

\$18<sup>75</sup>

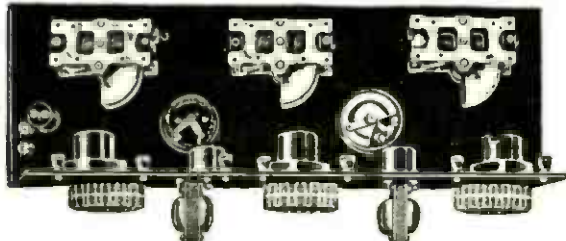

This special offer is astounding the radio world. Coast to coast reception on loud speaker. Low loss condensers and sockets. Highest quality transformers. Bakelite rheostats. All wiring concealed under Bakelite baseboard. 7x18 panel—fits into any standard 7x18 cabinet. Complete instructions for operating. Guaranteed saving to you of \$50.00. Price of set all mounted, \$18.75. Cabinet of same model as American Radynola pictured above \$5.65 extra.

#### SEMI-FINISHED 8-TUBE SUPER-HETERODYNE

\$43<sup>75</sup>

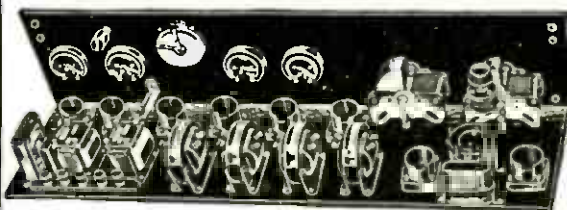

World's Famous 8-tube super heterodyne. Fully mounted on panel and baseboard. Comes completely assembled ready to wire and operate. We have testimonials from thousands of builders of this set. Some have received foreign stations on loop aerial. Unsurpassed in volume and tone quality. Low-loss straight line frequency condensers, vernier dials, finest quality rheostats. Matched Columbia long waved transformers. Requires only three screws for attaching panel and baseboard and set is ready to operate. 7 x 30 panel. Price of set only \$43.75.

Complete Parts for Best 45 Kilocycle Super-Heterodyne Genuine Remler Parts

\$49<sup>50</sup>

Requires following accessories to complete this set: 7x30 cabinet, 8-201A tubes for storage battery operation or No. 199 tubes for dry cell operation. 100 Ampere hour storage battery, 2-45V "B" batteries, loud speaker, center tapped loop aerial. All these items are listed in our catalog at a tremendous saving.

You must have our catalog no matter what set or kit you want. Our line is complete and includes all popular sets, such as Superheterodyne, Neutrodyne, Ultradyn, Reinartz, Regenerative, Radio Frequency, Browning-Drake, Super-Heterodyne Reflex and all other latest circuits. Kits, sets and parts manufactured by all well known manufacturers such as Frost, Howard, Baldwin, Brandes, Western Electric, Columbia and others.

Our semi-finished sets come with all parts mounted on panel and baseboard ready for wiring. Do not fail to send for our catalog. Remember—we are the largest exclusive radio mail order dealers in the world and carry the best of everything in radio. We save you 1/3 to 1/2 on the following kits. Detailed descriptions appear in our catalog.

Catalog includes list of broadcasting stations, general radio information and facts about our free service division. Write for it today.

**NEUTRODYNE**  
Genuine licensed Neutrodyne kit of parts, come fully assembled on the panel and baseboard with complete instructions. **\$29.75** ready to wire. Price.

**COCKADAY**  
3-tube Cockaday kit of parts, fully assembled on panel and baseboard, ready to wire **\$15.85** Price.

**FOUR TUBE BROWNING-DRAKE AND COCKADAY'S NEW LC 25 CIRCUIT PARTS ARE IN OUR CATALOG.**

Complete Parts for Cockaday Resistance Coupled and 5-tube set at prices that will astound you. Also complete parts for AC Kit.

## RANDOLPH RADIO CORPORATION

159 N. Union Ave. Dept. 249 Chicago, Illinois

All apparatus advertised in this magazine has been tested and approved by POPULAR RADIO LABORATORY

# NEW 96 PAGE RADIO GUIDE

The Book To Go By

# SEND FOR YOUR COPY NOW FREE

When You Go To Buy



96 pages—compiled by experts—and crammed full of standard values in radio parts, equipment and apparatus. You will find the newest and finest in radio in its pages.

One tube sets to the new big multi-tube outfits. Authorized parts for every new popular circuit, cabinets and latest devices. Write for your free copy now. A postal brings you your copy. Send for it today.

### COMPLETE PARTS FOR HAMMARLUND-ROBERTS

A full page devoted exclusively to this new, flash circuit. All standard, specified parts in stock. Complete information in catalog.

### RAYTHEON PLATE SUPPLY UNIT

All Parts

List of parts with complete detailed information in yours free. Write for our newly issued catalog.



- 1 General Radio Variometer, type 269, equipped with rheostat knob
- 1 General Radio Rheostat, type 214-a, 7 ohms, equipped with rheostat knob
- 1 Precision Octaform coil set
- 1 Ameco special double unit condenser No. 1814, each section .0003 mfd.
- 1 Micanoid fixed condenser, .00015 mfd.
- 1 Micanoid fixed condenser, .00025 mfd.
- 2 Daven resisto-couplers (new type which incorporated 1 mfd. condenser concealed in base)
- 1 Amertran DeLuxe transformer, first stage
- 1 Bradleysak 4 to 10 m<sup>2</sup>.
- 3 Bradleysak 1/2 megohm
- 1 Bradleysak 1/2 megohm
- 2 Amperites No. 1a

### KIT or FACTORY BUILT COCKADAY'S LC-26 BROADCAST RECEIVER

Factory Built Set, built of same parts (listed below) used in original laboratory model. Fitted with walnut or mahogany sloping cabinet. Tested and guaranteed. **\$77.50**

- 1 Amperite No. 112
- 5 Benjamin standard "Clear-tone" sockets
- 1 Carter single-circuit jack, No. 101
- 2 Carter Jack switches, No. 2
- 8 Eby binding posts
- 1 Fynour vernier control knob and gail
- 1 Universal decorated panel, 8 x 22 inches
- 1 Baseboard
- 4 Small brass tracklets
- 1 Antenna connection block, 1 x 2 inches
- 1 Battery connection block, 1 x 9 inches
- 2 Large brass brackets
- 1 Box of assorted screws, consisting of screws, nuts, washers, etc.
- 30 Feet brass wire
- 4 Feet of tubing
- 1 Set of PORTER RADIO templates

### COCKADAY'S TONE CLARIFIER

Improves the tone of your receiver.

All Parts in Stock  
Write for descriptive literature, parts, and information now. Yours FREE!

### McLAUGHLIN'S SINGLE CONTROL SUPER

SILVER MARSHALL  
Complete Parts

DEALERS—WRITE FOR INFORMATION AND DISCOUNTS

WHOLESALE RADIO SERVICE CO., Dept. 1026, 6 Church St., N. Y. C.

## FREE BLUEPRINTS



# A Wild Radio Fan!

is one who finds he cannot get selectivity and distance because he has used cheap transformers. Let us prove these selective and sensitive combinations obtainable with—

## WERNER

### Radio Frequency TRANSFORMERS

They cover the entire broadcasting wave range and have been used by the best radio Engineers for the past 2 years.

Get a full size Blue Print of a selective 6 tube loop receiver FREE by ordering from us direct.

Werner transformers are fully guaranteed and tested on actual broadcast reproduction; also guaranteed damp and moisture proof and will give perfect reception in any climate.

### WERNER LOOP ANTENNA

Used with any type of loop receiver. Adjustable to a fine degree of clearness; can be folded or extended without tools.

Price Postpaid \$14.00.

Send for free circuit diagram and descriptive literature. Book containing 9 up to date practical R. F. circuit diagrams and treatise on R. F. Amplification, postpaid, 25c.

Werner Products Approved by "Popular Radio."

Audio Freq. \$6.

R. F. \$4.

Ask Your Dealer.

WERNER RADIO MFG. CO.  
204-206 NINTH STREET BROOKLYN, N. Y.

## Do You Know

What voltage a new battery should show?

How long it can be used with satisfactory results—in the detector circuit? In the amplifying circuit?

When should storage "B" batteries be recharged?

Find out and check your radio battery testing requirements with a

# Sterling

## POCKET METER

There is a type for every battery testing need and combination types for "A" and "B" battery testing.

THE STERLING MFG. CO.  
Dept. G CLEVELAND, OHIO

No. 45 Voltmeter  
For testing the amperage of dry cell A batteries and for voltage measurement of B batteries, dry cell and storage.



0-35 amp. scale, 1 amp. divisions  
0-50 volt scale, 1 volt divisions  
List Price \$3.50

# They All Tried It—but it took a Ferguson to bring the Chicago-Dartmouth game to Concord, N.H.

**Y**OU can always count upon a Ferguson to *win*, especially when the phenomenal is to be accomplished.

This letter, like many others that have come to us unsolicited, shows that in radio, as in everything else, "the proof of the pudding is in the eating."

J. B. FERGUSON, INC.  
41 East 42nd St., New York

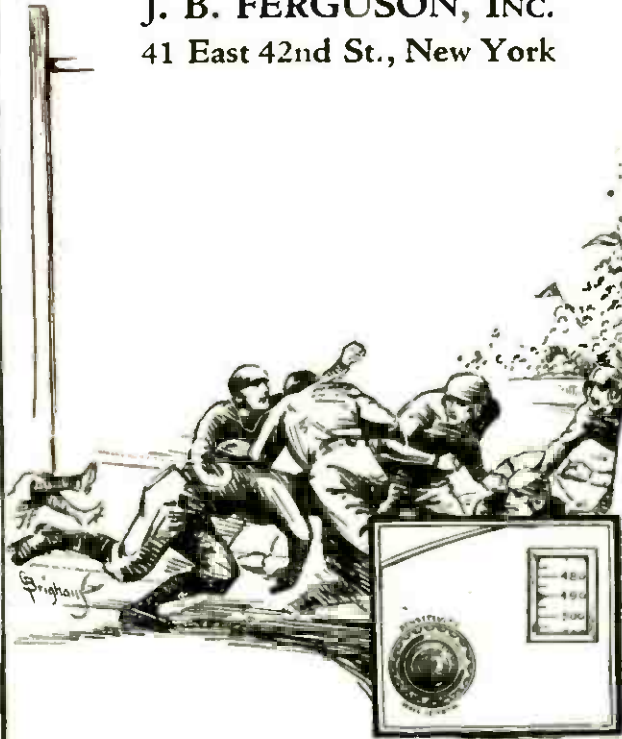

ROBERT A. GEORGE  
AUTHORIZED DISTRIBUTOR OF  
BOSCH AND FERGUSON RADIO  
SIXTEEN RIDGE ROAD  
CONCORD, N. H.

November 17, 1925.

J. B. Ferguson, Inc.,  
41 East 42nd Street,  
New York City.

Gentlemen:

You might be interested to learn that I was successful in bringing in the Dartmouth-Chicago football game broadcast last Saturday afternoon by KYW and as far as I can learn the Ferguson was the only set in the city that got it although I think everybody who owned a powerful set tried very hard to get it. Had it not been for considerable interference I would have had the whole game but as it was I missed the first and third quarters. There were about thirty-five on hand to hear it and although they were disappointed not to get it better when they found that no one else even found KYW they were very enthusiastic about the set.

Thanking you for past favors and wishing you every success, I remain,

*Robert A. George*

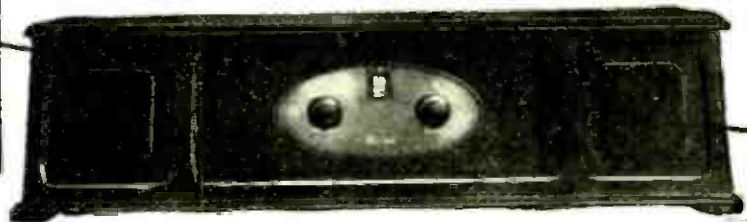

One Tuning Control—  
Calibrated in Meters!

Choose your program, turn to its wavelength and in comes your station.

# Ferguson

J.B. INCORPORATED

The Gold Standard of Radio Receivers

Witness a comparative demonstration at your Authorized Ferguson Dealer's and learn why Ferguson is recognized as "The Gold Standard of Radio Receivers."

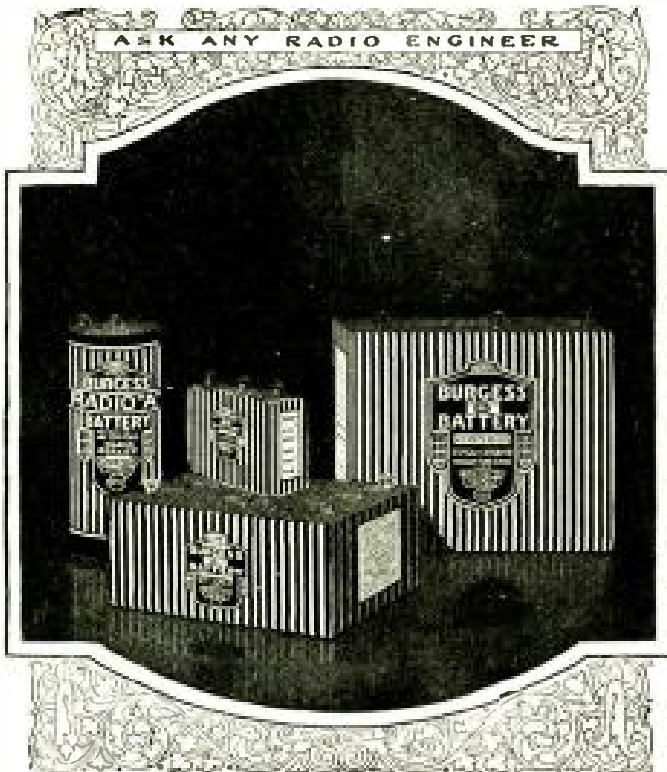

## Contributors to your radio entertainment

**V**ERY probably hidden away in the cabinet of your receiving set, the batteries you use are nevertheless surrendering their power unseen and unheard.

And to be able to contribute their energy and to add to the complete efficiency of your receiving equipment, those batteries must combine every desirable factor and formula known in the electro-chemical field.

Such Batteries are Burgess—products of the Burgess Laboratories—products which have been used by practically every famous explorer, the majority of amateurs and the leading radio engineers.

That's why when you use Burgess Radio 'A', 'B' and 'C' Batteries you are using batteries which assure the utmost dependability, longer life and complete satisfaction.

**BURGESS BATTERY COMPANY**  
GENERAL SALES OFFICE: CHICAGO

Canadian Factories and Offices:  
Niagara Falls and Winnipeg

**BURGESS RADIO BATTERIES**

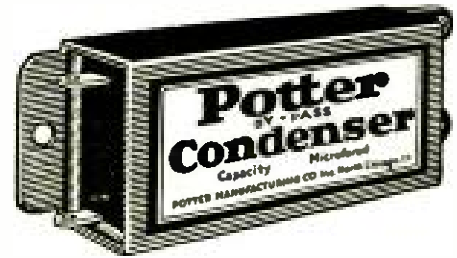

## In your "B" Supply Unit use **Potter** FILTER **Condensers**

(An American-Made Product)

All sizes—All specifications—Meet all requirements—Made in 3 voltage ranges.

Full specifications and details  
at your dealer's or direct

**POTTER MANUFACTURING COMPANY**  
North Chicago, Illinois

### TONE

Full, sweet, mellow and natural, without the slightest indication of distortion, is another achievement that is making the APEX SUPER FIVE the most popular of all receiving sets.

### VOLUME

That supplies dance music or entertainment without any loss, is a feature for which the APEX SUPER FIVE is world famed.

### DISTANCE

Lends added enjoyment to radio with an indescribable fascination of tuning-in faraway stations, which is always possible with the APEX SUPER FIVE.



Greater Radio Apparatus

Ask your dealer for a demonstration. Your eyes and your ears will tell you that APEX stands at the high point of perfection in both performance and appearance.

\$80 without accessories.

**SUPER 5**

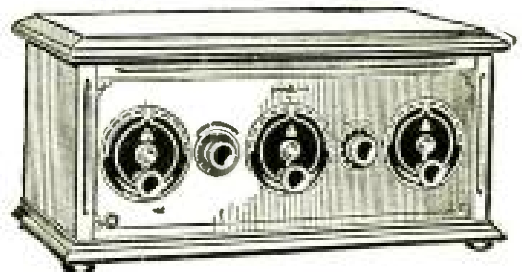

**APEX ELECTRIC MANUFACTURING CO.**  
1410 W. 59th St. Dept. 202 CHICAGO

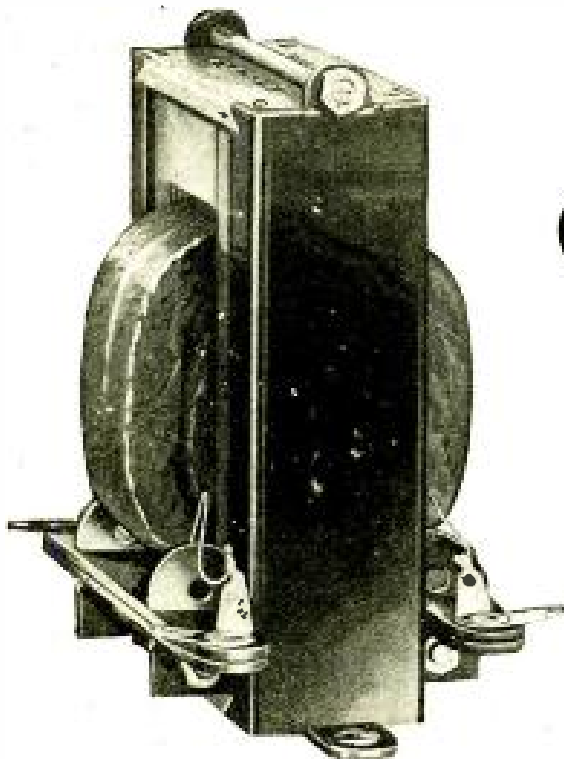

# QUANTITY!

is essential

to

# TONAL QUALITY

## PACENT SUPERAUDIOFORMER

REG. U. S. PAT. OFF.

**Q**UANTITY, proportioning and correct disposition of materials will not, in themselves, give true reproduction. If you want pure tonal quality, get a new Pacent Superaudioformer. It gives undistorted tone because the original extra large coil construction and adequate iron and copper permits better reproduction. It is built large to do a man's size job.

Get a Superaudioformer TODAY. You will find that music comes in naturally, unmarred, undistorted no matter how high or low the range.

THE SUPERAUDIOFORMER HAS BEEN SELECTED AS THE MOST PERFECT TRANSFORMER BY THE ENGINEERS OF THE OLDEST AND LARGEST ENGINEERING LABORATORIES IN THE WORLD.



### Engineering Achievements

- Straight Line Frequen
- Condenser
- Microvern
- Universal Isolantite
- Socket
- New U. X. Isolantite
- Adapter
- Radiodyle
- Radiofile
- Autoplug
- Rheostata and Jacks

Write for Our  
Illustrated Booklet

### HERE ARE EIGHT BIG REASONS:

1. Specially selected iron
2. Original coil design
3. Plenty of iron
4. Plenty of copper
5. Extra heavy insulation
6. Correct ratio, 3 to 1
7. Undistorted Tone
8. Covers the entire musical range.

Accept no substitute for the Superaudioformer. If your dealer cannot supply you, write us direct.

## PACENT ELECTRIC COMPANY, INC.

91 Seventh Avenue, New York City

Washington    Minneapolis    Boston    San Francisco    Chicago    Birmingham  
Philadelphia    St. Louis    Buffalo    Jacksonville    Detroit    Pittsburgh

Canadian Licensed Manufacturer: White Radio Limited, Hamilton, Ont.

**"DON'T IMPROVISE - PACENTIZE"**

First in the Field  
Specializing in  
Cockaday Kits

# S. HAMMER RADIO CO., 303 Atkins Ave. Brooklyn, New York

Cockaday Sets Now Made Easier to Build by Our New "Ready-to-Wire" Plan  
**50% of Your Time, Work and Worry SAVED!**

All you need do is to connect bus-bar according to diagram, solder and your set is finished. These Kits are sent to you completely mounted, and assembled on a Veneered Mahogany baseboard and genuine bakelite panel, drilled and engraved; in a solid Mahogany Cabinet. Genuine parts used as listed below; exactly as used in Mr. Cockaday's Laboratory Model. COMPARE OUR OFFER!

## 8 TUBE NEW SINGLE DIAL CONTROL SUPERHETERODYNE

- |   |  |
|---|--|
| 2 Precise No. 750 Syncrodensers .0005.....\$9.00              | 1 N. Y. Coil fixed condenser .006..... \$ .75                              |
| 1 Precise No. 744 Coupler..... .60                            | 1 N. Y. Coil fixed condenser .00025..... .35                               |
| 2 Precise Aluminum Brackets pr.2.00                           | 2 Dubilier 1. Mfd. By-Pass condensers..... 2.50                            |
| 1 Precise No. 1900 Filterformer. 4.50                         | 1 Dubilier No. 640 fixed condenser .00025 clips..... .45                   |
| 1 Precise No. 1700 Super Multi-former.....20.00               | 1 Daven Grid leak 2 meg..... .50   |
| 2 Precise Audio Transformers No. 480—5 to 1 and 2½ to 1.15.00 | 1 Precision Inducto coupler No. 260..... 1.85                              |
| 1 Marco 4 inch Vernier Dial... 2.50                           | 1 Gen. Radio 2 Ohm Rheostat No. 214-A..... 2.25                            |
| 1 Hammarlund, Jr. Midget... 1.80                              | 1 Gen. Radio 400 Ohm Pot. No. 214-A..... 3.00                              |
| 2 Carter Imp. Jacks..... 1.00                                 | 1 Genuine Bakelite Panel Drilled and Engraved 10" x 14½" x 3-16"..... 4.35 |
| 1 Carter Holdtite Do. Jack... 1.00                            | Wire, screws, etc..... .20   |
| 1 Carter Holdtite Single Jack... .70                          |  |
| 1 Benjamin No. 9050 8-gang socket shelf.....11.00             |  |
| 1 Benjamin Battery Switch... .35                              |  |
| 1 Weston No. 301 Volt Meter... 8.00                           |  |
| 1 Weston No. 301 Milliammeter 8.00                            |  |

**READY-TO-WIRE KIT, PRICE, . \$101.65**  
**WIRED COMPLETE In Genuine Mahogany Cabinet . \$115.00**  
**UNASSEMBLED KITS IN STOCK**  
D. T. W. LOOP IN STOCK

## Cockaday's New LC-26 Receiver

- |   |  |
|---|--|
| 1 General Radio Variometer type 269 with rheostat knob..... \$5.30        | 3 Bradleyunits. ¼ megohm... \$2.25                     |
| 1 General Radio Rheostat type 214-a, 7 ohms, with rheostat knob..... 2.25 | 1 Bradleyunit ¼ megohm.... .75                         |
| 1 Precision Octaform coil set 5.50  | 3 Amperites No. 1a..... 3.30                           |
| 1 Amsco Double Unit Condenser No. 1814..... 6.25                          | 1 Amperite No. 112..... 1.10                           |
| 1 Micamold fixed Condenser .00015 mfd..... .35                            | 5 Benjamin standard "Clear-tone" sockets..... 5.00     |
| 1 Micamold fixed Condenser .00025 mfd..... .35                            | 1 Carter single-circuit jack No. 101..... .70          |
| 2 Daven resisto-couplers (new type)..... 3.00                             | 2 Carter Jack switches No. 2..... 2.00                 |
| 1 Amertran DeLuxe transformer, first stage..... 10.00                     | 8 Eby binding posts..... 1.20                          |
| Bradleyleak ¼ to 10 meg. .... 1.85  | 1 Fynur vernier control knob and dial..... 3.50        |
|   | 1 Universal decorated panel, 8 x 22 inches..... 7.50   |
|   | 4 Small brass brackets.....                            |
|   | 2 Bakelite Connection Blocks 1 x 2 plus 1 x 9..... .35 |
|   | 2 Large Brass Brackets....                             |

**READY-TO-WIRE KIT, PRICE, . \$62.50**  
**WIRED COMPLETE In Genuine Mahogany Specified Cabinet \$77.00**  
**UNASSEMBLED KITS IN STOCK**

**HAMMARLUND ROBERTS!**  
**KITS IN STOCK**

**WRITE FOR BOOKLET about these Parts and Kits. Also for Free Radio Catalog**

Transportation Prepaid. One-third must accompany all C. O. D. orders. Not insured unless insurance charges included

## You Can See at a Glance with an S. O. S. Hydrometer

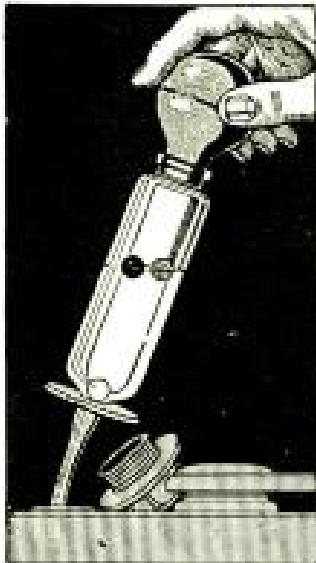

75c.

Swim all three, charge fully.  
Sinks the white, charge still right.  
Sinks the green, charge is lean.  
Sinks the red, charge is dead.

### the state of your "A" Battery

No figures to read, no float to stick or break. The CHAS-LYN balls tell the story. Quickly — easily — you don't even have to remove the hydrometer from the battery. No need to spill acid or get it on your fingers. Small and compact, fits easily into battery compartment. You do not have to move battery.

Ask your dealer, if he can't supply, write us enclosing price.  
Sold the world over.

**THE CHASLYN COMPANY**  
4611 Ravenswood Ave., Chicago

## PROVED BY PERFORMANCE!



TRF Kit  
\$12.00

## AERO COILS

This season—thousands more fans found the answer to complete radio satisfaction thru Aero Coils. Selectivity! Distance! Power! All these—to a degree not yet even approached by any other inductances. And simply because the Aero Coil is patented—both in principle and in construction. Any set—any circuit is greatly improved by substituting these wonder inductances for those you are now using. At your dealers.

Write for free Aero Booklet!

- |         |                                       |        |
|---------|---------------------------------------|--------|
| CT-80   | Three Circuit Tuner.....              | \$8.00 |
|         | (Variable Primary)                    |        |
| TRF-110 | Radio Frequency Regenerative Kit..... | 11.00  |
| WT-40   | Wave Trap Coil.....                   | 4.00   |
| OS-55   | Oscillator.....                       | 5.50   |
| AX-45   | Antenna Coupler.....                  | 4.50   |
|         | (Variable Primary)                    |        |

**AERO PRODUCTS, INC.**  
217 N. Desplaines St. Chicago

*“Even the organ  
crescendo was perfect”*

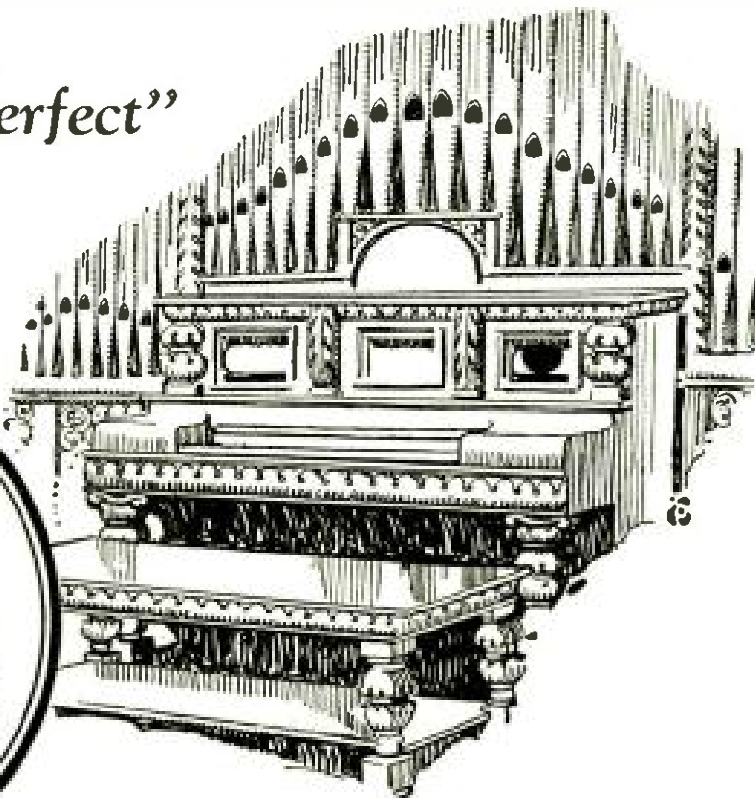
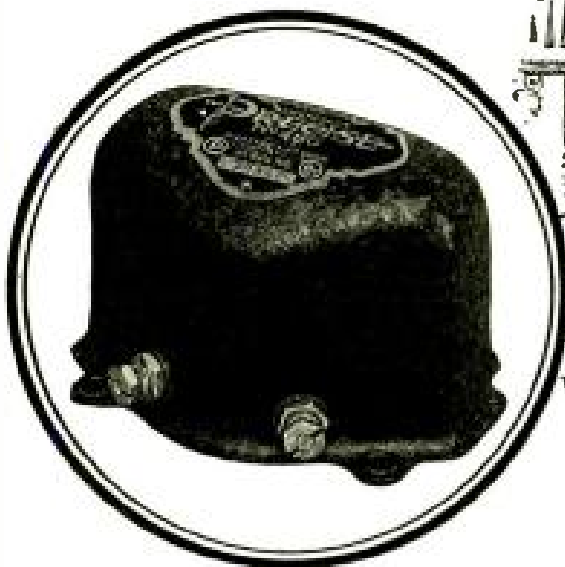

A VETERAN set-builder recently remarked about the purity of tone at tremendous volumes that he got through the Super-size Precise No. 480 Audio Transformer. In particular was he impressed with a recent organ recital which he had received. “Why,” he said, “even the organ crescendo was perfect.”

The big Precise No. 480 is truly a master transformer, designed for radio reception in a concert hall if necessary. It brings forth the deep rich tones or the high clear tones with magnificent volume. The ratio of voltage amplification to frequency is practically a straight line, assuring uniform amplification over the entire range of useful audio frequencies.

Made in two ratios,  $2\frac{1}{2}$  to 1 and 5 to 1.  
Price, \$7.50 either ratio.  
Ask your nearest radio dealer to show  
you the complete Precise Line.

## PRECISE MFG. CORP.

### ROCHESTER, NEW YORK

126 Liberty St.,  
New York City.  
205 W. Harrison St.,  
Chicago, Illinois.  
821 Market St.,  
San Francisco, Cal.

BRANCH OFFICES:  
454 Builder's Exchange,  
Minneapolis, Minn.  
1127 Pine St.,  
St. Louis, Mo.  
701 A.O.U.W. Bldg.,  
Little Rock, Ark.

Canadian Distributors:  
Perkins Electric, Ltd.,  
Toronto, Winnipeg, Mon-  
treal.

*Faradon*



NOW *Faradon* FOR SET BUILDERS

FARADON MICA CONDENSERS, since the advent of radio broadcasting, have been used extensively by the great broadcasting stations throughout the country, and are now available for receiving sets, in the Model T.

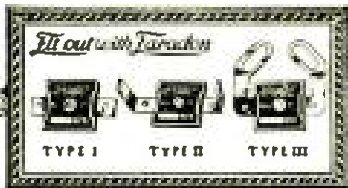

*Faradon*  
MODEL T RECEIVING SET  
CONDENSERS  
FOR  
Permanent accuracy  
~improved reception  
and increased set value

QUALITY AT ——— PRICE — TYPE I ——— LOW PRICE

Dealers displaying this distinctive four color sign have on hand Faradon Model T Condensers to fill your requirements.

Faradon Wholesalers will furnish display cards to Dealers. Should your Wholesaler not have a supply write us direct.

**Wireless Specialty Apparatus Co.**  
JAMAICA PLAIN, BOSTON, MASS., U. S. A.  
ELECTROSTATIC CONDENSERS for all PURPOSES

Faradon



**-it's in the Tube**

Your receiving set can be no better than its tubes. CECO Tubes give maximum results in clarity of tone, rich volume and long life. Our charted tests (results confirmed by laboratories of national reputation) PROVE CECO TUBES SUPERIORITY —as detectors, as amplifiers. Buy CeCo Tubes whether your set takes one tube or eight. Now ready! CeCo Tubes with new type Long PRONG BASES. Also, power amplifier tubes, E (Dry Cell Type), F (Storage Battery), for last stage of Audio Frequency. Ask your radio dealer.

C. E. Mfg. Co., Inc.  
702 Eddy St., Providence, R. I.



**ARE YOU THE MAN**

to be first in your town to sell and demonstrate POWEROLA, the famous 5-tube, no-battery ELECTRIC LIGHT SOCKET RADIO RECEIVER (not an attachment), universal for D.C. or A.C. (100-115 v. 40-60 cycle), now sold and demonstrated by the NEW YORK EDISON CO., public utility companies and radio, electric and music dealers everywhere. Absolutely dependable, fully guaranteed, powerful, practical, perfect in performance. Tested and endorsed by Popular Radio, Radio Broadcast, Radio News, all leading authorities and engineers of your local electric light company.



**Are You the Man Who Sees! Opportunities Ahead for Real Money Making?**

**You, too, can make Powerola**

Send \$1.00 for wiring diagrams showing parts used and how to make any set or circuit (1 to 8 tubes) operate satisfactorily without A, B or C batteries, from A. C. or D. C. This is the newest and greatest proposition in radio. Write for literature, terms and prices at once.

**POWEROLA RADIO CORP.**  
1845 BROADWAY NEW YORK CITY



# KARAS Parts Are Intended Only for the Few Who Demand Finest Quality and Workmanship

IT takes many manufacturers to supply the tremendous demand for condensers and transformers in this vast radio market of ours. If all home set builders were ready to pay the price which *real* quality commands, a big proportion of them would necessarily be disappointed — the Karas factory could not begin to take care of all. Karas parts are designed and built for the select few—you builders who want the utmost in quality, in quiet operation, in appearance. You who take pride in your workmanship—whose sets have that “professional” appearance which is the envy of all your radio friends.

Just as water quickly finds its level, so did Karas Harmonik Transformers and Orthometric Condensers quickly find the exclusive market for which they were intended.

The most skillful home radio set builders the country over, discovered Karas Harmonik Trans-

In many places, good dealers who wanted a stock of Karas products could not be supplied. If *you* are still unable to find them in your local stores, tell your dealer that we are now able to take care of his requirements. Or, if you wish to get Karas parts in the quickest possible time, we will be glad to send them to you direct.

However you buy Karas Harmonik Transformers or Orthometric Condensers, you do not run the least risk of their not performing up to your highest expectations. If there is the slightest cause for disappointment during a thirty days' test, you are invited to return the parts to the dealer from whom you bought them, or to us if you buy direct. Your money will be promptly refunded without question or quibble.

Karas radio parts are the pride of an organization that has been making precision electrical apparatus for more than thirty years. We believe we are making the finest transformers and condensers possible to produce and we are glad to back them up

with this, the strongest guarantee we know how to write.

**I**N all hook-ups designed by Mr. Cockaday, Karas Harmonik Transformers and Karas Orthometric Condensers may be used with the utmost satisfaction. They have received the approval of the Popular Radio Laboratory and have been used in many of the circuits designed by Mr. Cockaday and his associates.



THE KARAS HARMONIK "ALL-STAGE" RATIO AUDIO FREQUENCY TRANSFORMER

Price \$7 each. Shipped direct where dealers cannot supply, cost plus a few cents postage paid to postman on receipt. Parcel post is prepaid where payment accompanies order. Our 30-day Money Back Guarantee applies, wherever and however purchased.

formers soon after they were placed on the market in 1924. When Karas Orthometric Condensers appeared a year later they were snapped up far too quickly for our own comfort. Perhaps it was because they were the first to meet the demand for a Straight Frequency Line tuning instrument. More likely it was because of the enviable reputation created the year before by Karas Harmonik Transformers. At any rate, it was months before we could fully supply the insistent, clamorous demand that came to us from all sides.

We begin to think now that the number of set builders who want the very "Best that Money Can Buy" is far greater than we first imagined. Our production has been greatly increased to provide for the growing numbers who demand Karas parts and will accept nothing else.

23 plate, .0005	Mfd., \$7.00
17 plate, .00037	Mfd., 6.75
11 plate, .00025	Mfd., 6.50
5 plate, .0000972	Mfd., 6.50

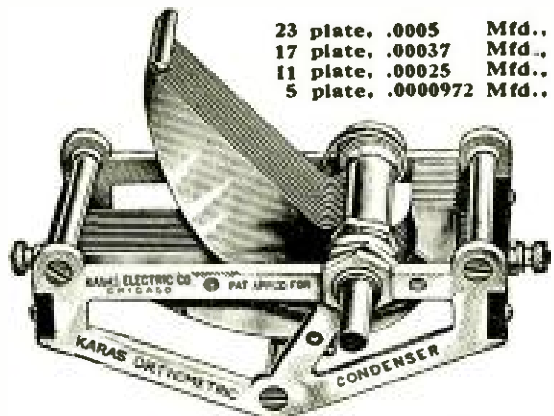

THE KARAS ORTHOMETRIC (STRAIGHT FREQUENCY LINE) CONDENSER

Prices and sizes above. Shipped direct where dealers cannot supply. No money in advance. Pay the postman price plus a few cents postage. Or send cash with order and we prepay parcel post. 30-day Money Back Guarantee.

**KARAS ELECTRIC COMPANY**  
4036 NORTH ROCKWELL ST. CHICAGO

# COMO

## VARIABLE RATIO AUDIO TRANSFORMER

4 to 1      6 to 1      8 to 1

all in one transformer

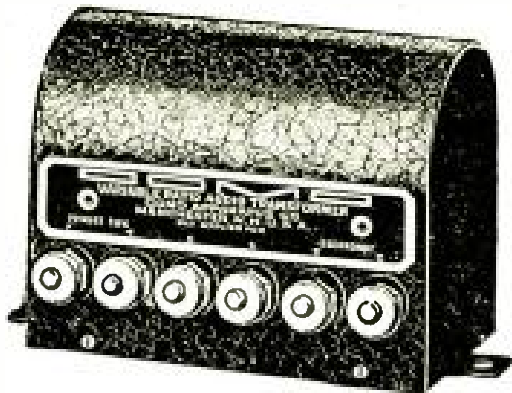

With this new Como Variable Ratio Transformer the set builder may secure for each stage of audio amplification the exact ratio best suited to the purpose. He may match more closely the primary impedance of the transformer with the plate impedance of his tubes, with a choice of 6 different values.

Built by a pioneer in radio manufacturing, this new Como product will reproduce music and speech with lifelike faithfulness.

In the familiar Como round-top, shielded metal case, at your dealer's.

**Price \$6.00**

Send for descriptive pamphlet V

**COMO APPARATUS CO., INC.**

Kelley Street  
Manchester, N. H.

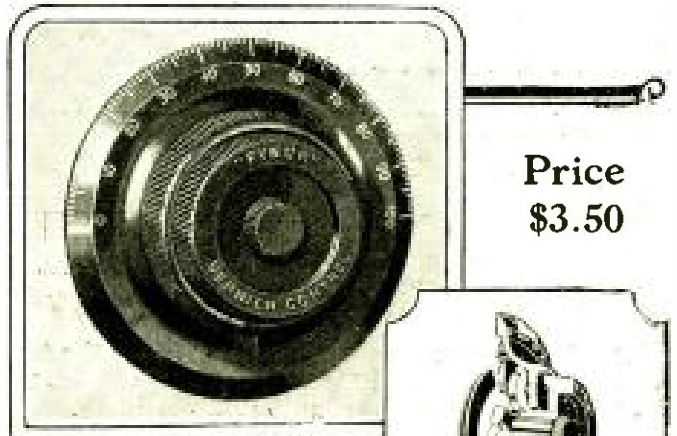

Price  
\$3.50

### The Best Dial for the Finest Tuning

There's no backlash nor lost motion in the Fynur Dial. It's absolutely accurate—durable—and very simply constructed. It's the finest dial you can buy for distance tuning or for separating low wavelength stations. Dual control. No gears. Operates by traction. Will fit any standard  $\frac{1}{4}$ " shaft.

If your dealer cannot supply you, write to us

AUGUST GOERTZ & CO., INC.  
270-286 Morris Ave. Newark, N. J.

## FYNUR VERNIER CONTROL

—a distinct innovation in the capacity unit field

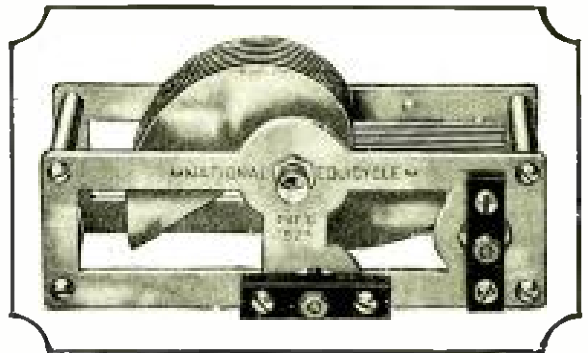

### The New NATIONAL EQUICYCLE Condenser

(Patented Feb. 10, 1925)

The latest development in straight line frequency control as applied to NATIONAL CONDENSER design.

Increases range of rotation from  $180^\circ$  to  $270^\circ$ , permitting more precise adjustment and sharper separation of stations. And accomplishes this without gears, cams or levers.

It has the same electrical efficiency and mechanical ruggedness that have always characterized NATIONAL DX Condensers. Prices:

Made in Two Sizes	With Dials	Without Dials
.0005	\$7.00	\$5.00
.00025	7.50	5.50

Get the genuine. Insist upon NATIONALS. Your dealer appreciates your patronage and will gladly get them for you. Write for Bulletin 111 Pt.

**NATIONAL COMPANY, INC.**

W. A. READY, President

110 Brookline Street

Cambridge, Mass.

# AN OPEN LETTER

## To Big and Little Radio Set MANUFACTURERS:

Sets to operate by simply plugging in on the house electric current, eliminating the "A" battery, are the Dominating Demand successful radio manufacturers will promptly meet.

If you want to increase your sales, equip your set with the McCULLOUGH AC TUBE to play off the house electric current.

To be prepared for this important development, *send us your set and we will wire it for you* to operate using the McCullough AC Tube, free of charge. Send sets to our Laboratory at 20 Grand Avenue, Brooklyn, N. Y.



### ALSO TO "B" ELIMINATOR MANUFACTURERS:

We will be glad to work with you to equip sets to use McCULLOUGH AC TUBES to eliminate the "A" battery in happy combination with your "B" Eliminator to eliminate the "B" battery. This will give dealers and the public the "batteryless" set everybody wants.

### McCULLOUGH SALES CO.

DISTRIBUTORS

### McCULLOUGH A C TUBES

25 W. BROADWAY, N. Y.

533 Wabash Ave., Chicago  
963 Liberty Ave., Pittsburgh, Pa.

**Standard Parts**  
**Mr. Laurence Cockaday's**  
**L. C. 26**  
**Broadcast Receiver**

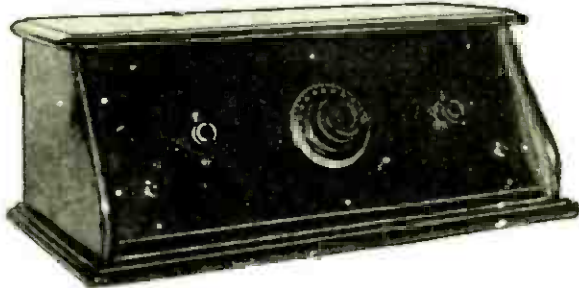

**BLUE PRINTS FURNISHED**  
 Parts sold in kit form or separately

Parts Used by Mr. Cockaday in Building his Laboratory Set

	List Price
1 General Radio variometer, type 269, equipped with rheostat knob.	\$5.30
1 General Radio rheostat, type 214-a, 7 ohms, equipped with rheostat knob.	2.25
1 Precision Octaform coil set.	5.50
1 Amsco special double unit condenser No. 1814, each section .0003 mfd.	6.25
1 Micamold fixed condenser, .00015 mfd.	.35
1 Micamold fixed condenser, .00025 mfd.	.35
2 Daven resisto-couplers (new type which incorporates .1 mfd. condenser in base)	3.00
1 Amertran Deluxe transformer, first stage	10.00
Bradley leak 1/4 to 10 meg.	1.85
3 Bradley units, 1/4 megohm	2.25
1 Bradley unit, 1/4 megohm	.75
3 Amperites No. 1a	3.30
1 Amperite No. 112	1.10
5 Benjamin standard "Cle-ra-tone" sockets	5.00
1 Carter single circuit jack, No. 101	.70
2 Carter Jack switches, No. 2	2.00
8 Eby binding posts	1.20
1 Fynur vernier control knob and dial	3.50
4 Small brass brackets	
1 Antenna connection block 1 x 2 inches	.80
1 Battery connection block, 1 x 9 inches	
2 large brass brackets	

Complete Parts (including 1 Bakelite drilled and engraved Panel 8 x 22") **\$59.75**

**EXTRA SPECIAL**

For the convenience of those who want

**Mr. Laurence Cockaday's**  
**L. C. 26 RECEIVER**

we have in stock completely wired L. C. 26 receivers made up by our radio engineers. }

**IN A GENUINE**  
**MAHOGANY CABINET**  
 Ready For Use  
**SPECIALY PRICED**

**\$97.50**

Wired without cabinet only \$83.50

All parts carried for every  
**SILVER-MARSHALL CIRCUIT**  
 Immediate shipment on all mail orders.

**HEINS & BOLET**  
 44 PARK PLACE, NEW YORK

**TEN DAYS**  
**FREE**  
**TRIAL!**



Note: No strings to above offer—made by a famous big Radio Corporation, one of America's oldest and most reliable makers of quality sets—sixth successful year.

**POPULAR NEW LONG DISTANCE**  
**MULTI-TUBE MIRACO SET**

An Illinois user says: "I have Los Angeles, Calif., and N. Y. on my list." An Okla. user reports: "Have heard from N. Y. City to San Francisco over loud speaker." A Minn. user writes: "Have received, clear and loud on speaker, N. Y., Dallas, Los Angeles and Canada." An Ala. user gets "all the stations in U. S., some in Canada." Reports from users everywhere prove Miraco sets out-perform sets 2 or 3 times as costly. Satisfaction fully guaranteed. Send for Amazing Special Offer today—a postal brings it.

**Satisfaction or Your Money Back**



Factory Prices Save You 1/3 to 1/2

Send no money—but save or make a lot of money on sets and supplies by writing today for latest free literature. amazing special offer and plenty of additional testimony from users. Radio's most amazing values in multi-tube sets.

**MIDWEST RADIO CORPORATION**  
*Pioneer Builders of Sets*  
 479-X E. 8th Street Cincinnati, Ohio

**LOMBARDI**  
 Straight Line Frequency Condensers

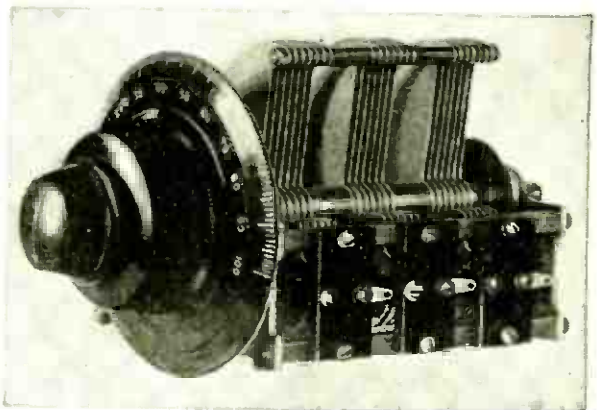

Are real precision instruments, fit for the highest grade of Radio Sets. Their substantial and careful design is immediately apparent to anyone who knows Radio. Patented ball and taper-bearing shaft and watch spring pig tail insure permanent accuracy. Made in both single and multiple units. Multiple units licensed under Hogan patents.

Manufacturers and home set builders write for full descriptive matter.

**LOMBARDI RADIO MFG. CO.**  
 67 Minerva St. Derby, Conn.

# IT IS TRUE!

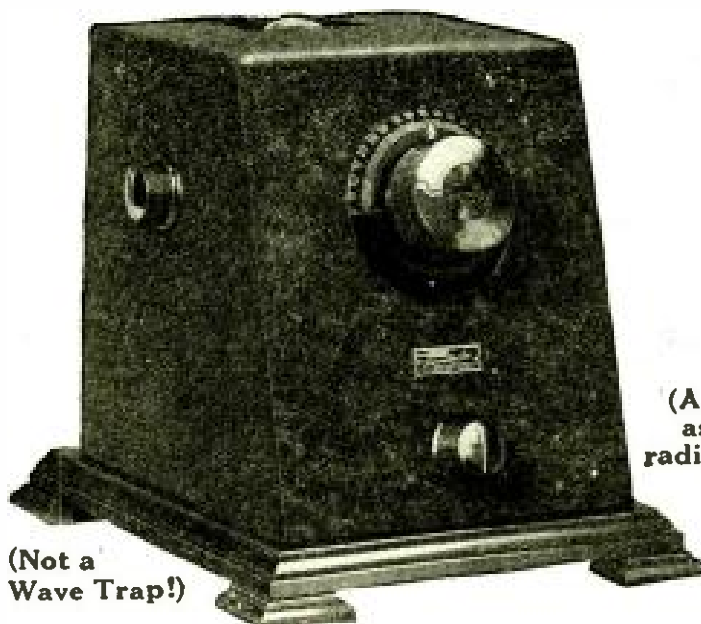

(A permanent asset to your radio equipment)

(Not a Wave Trap!)

## 188 times the energy!

WOAI signal intensity of 11, on the audibility meter, jumped above 2000 with Penetrola—188 times as strong! WCAL signal intensity of 35 was scrambled with WCBD at 29. But with Penetrola WCAL went to 2000 plus, and WCBD to zero—*selectivity with a vengeance!*

Any Penetrola demonstration will show you things like that on any set with any number or arrangement of stages. The wanted station is immensely intensified; interference is overwhelmed. So much volume is available for distance that a shorter aerial may be used. Your set is stopped from radiating and is stabilized. It is needless to approach oscillation. And dial readings stay substantially the same.

Principles known to be of immense promise, but hitherto elusive, are now successfully applied

by Walbert Penetrola. The widely heralded Isofarad Circuit, latest Walbert development, is the foundation of Penetrola—unduplicated in any way by anybody, because there is no other Isofarad\* circuit. Nor is there any substitute for Penetrola action, which amplifies *ahead* of the detector, strengthening signals which would otherwise never be detected! Remember, signals too weak to detect cannot be amplified *beyond* the detector.

In a few moments any receiver, however costly, can be transformed with Penetrola. Or anyone can quickly assemble the Penetrola kit and obtain amazing Penetrola results most economically. The Penetrola price buys performance which cannot be obtained with any amount of investment in a receiver alone.

WALBERT MANUFACTURING COMPANY, 949 WRIGHTWOOD AVE., CHICAGO

\*Booklet with complete theoretical data and construction details for 5 or 6 tube receivers—\$.25.

Penetrola in Black Crystallite, for instant Attachment . . . . . \$35

Penetrola Kit with Complete, Simple Instructions . . . . . \$15

If your dealer is not stocked, remit purchase price direct to factory and you will be promptly supplied. State whether you wish Penetrola for outdoor aerial or for loop receiver

# PENETROLA

All apparatus advertised in this magazine has been tested and approved by POPULAR RADIO LABORATORY

# ANYONE CAN BUILD A SET WITH SIMPLIFIED BLUEPRINTS

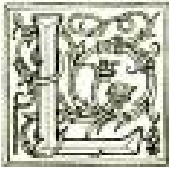

AURENCE M. COCKADAY has personally supervised the preparation of *Simplified Blueprints* of eight of POPULAR RADIO's most popular circuits. Each set consists of at least three separate *Actual Size* Blueprints; first a Panel Pattern; second, an Instrument Layout; and third, a Picture Wiring Diagram all simplified in the fullest sense of the word **because**

**The Panel Pattern** can be laid on the panel and all holes drilled as indicated. No scaling to do and so accurate there is no danger of ruining the panel through faulty calculation.

**The Instrument Layout** placed on the sub-base permits you to indicate by pinpricks the exact location of every screw.

**The Picture Wiring Diagram** gives every instrument in exact size and position with every wire clearly indicated from one contact to the other. With no knowledge of radio symbols you can assemble every part and complete your wiring with no chance of error.

## Priced at \$1.00 per Set of Three Prints

Set No. 4—"Cockaday Four-Circuit Tuner with Resistance-Coupled Amplifier" (five tubes, distortionless, two dials, automatic vacuum tube control, as described in the October, 1924, issue of POPULAR RADIO).

Set No. 6—"The Cockaday 8-tube Super-heterodyne Reflex Receiver" (eight tubes, two tuning dials, loop, non-radiating, distortionless, as described in January, 1925, issue of POPULAR RADIO).

Set No. 9—"Portable Town and Country Receiver" (six tubes, three stages of transformer coupled, radio-frequency amplification, loop antenna, tuned by variable condenser as described in May, 1925, issue of POPULAR RADIO.)

Set No. 11—"5-Tube Tuned Radio-Frequency Receiver with Simplified Control" (as described in August, 1925, issue of POPULAR RADIO).

Set No. 12—"8-Tube Superheterodyne with Single Control" (eight tubes, two straightline variable condensers, as described in October, 1925, issue of POPULAR RADIO).

Set No. 13—"Ratheon Plate Supply Unit" (a really dependable method for obtaining a "B" source of supply as described in November, 1925, issue of POPULAR RADIO).

Set No. 14—"The LC-26 Broadcast Receiver" (as described in December, 1925, issue of POPULAR RADIO).

Set No. 15—"The Orthophase Receiver" (a circuit development using a new principle in radio-frequency amplification, making a receiver with great sensitivity, combined with sharp tuning and ease of operation, as described in February, 1926, issue of POPULAR RADIO).

Full constructional and parts details for these Receiving Sets will be found in the issue of POPULAR RADIO indicated. Back issues of POPULAR RADIO will be furnished at the rate of 35c a copy

**Popular Radio**

627 West 43d Street

Dept. 24

New York City

POPULAR RADIO, Inc., Dept. 24  
627 West 43d St., New York City Date.....

Enclosed is my remittance of \$..... for which kindly send me Blueprint Set (s) consisting of Panel Pattern, Instrument Layout and Wiring Diagram as checked below:

Set Number 4     Set Number 9     Set Number 12     Set Number 14  
 Set Number 6     Set Number 11     Set Number 13     Set Number 15

Name.....  
Address.....  
City..... State.....

## DEALERS

Write for terms on these fast selling Blueprints. An attractive Display Chart free with orders.

All apparatus advertised in this magazine has been tested and approved by POPULAR RADIO LABORATORY

The  
New  
**C  
O  
C  
K  
A  
D  
A  
Y  
L.  
C.  
26**

# Bigger Radio Bargains Than Ever Before

## BARAWIK'S 1926 RADIO GUIDE

ANY real radio bug will find Barawik's Radio Guide a gold-mine of information, for it presents, in concise form, the famous radio circuits you have read about. Besides, it illustrates and describes sets, kits, accessories and parts that are needed by every set builder, fan, novice or beginner. As a catalog and guide, it is invaluable; and it shows you how you can save big sums in the very things you need, or it helps you to decide what set will best meet your needs and your pocketbook.

It shows the newest straightline condensers, low-loss coils, vernier dials, tubes, cone speakers, A and B current supply, batteries and everything from a crystal to the expensive complete DeLuxe console receiver—and one, two, three, five and eight-tube Superhet sets—at startlingly low prices. Whether you just want supplies for your present set or desire a new one, here you can secure them at a guaranteed saving.

Fill in the coupon now for your free copy or drop us a postal or letter. Do this before you spend another cent for anything in radio—now, while this announcement is before you. You'll be well repaid. Also please include name of radio fan or fans who would be interested.

As an example of Barawik values, we offer you here the famous Cockaday L. C. 26 Receiver and other famous circuits. Order direct from this ad. Satisfaction guaranteed. For other kits and circuits, consult the Barawik Guide (Free copy on request).

### COCKADAY'S L. C. 26 RECEIVER

The latest Cockaday triumph, said by many to be the best receiver ever devised. An improved 4-circuit tuner, single dial control, one stage of radio frequency amplification. Cannot oscillate in the antenna or radiate. The talk of the radio world and offered to you at the usual Barawik saving.

- |   |   |
|---|---|
| 1 General Radio Variometer, type 269, equipped with rheostat knob                         | 1 Amer Tran DeLuxe transformer, first stage |
| 1 General Radio Rheostat, type 214-a, 7 ohms, equipped with rheostat knob                 | 1 Bradley leak 1/4 to 10 meg.               |
| 1 Precision Octaforn coil set   | 3 Bradley units 1/4 megohm                  |
| 1 Amsco special double unit condenser No. 1814, each section .0003 mfd.                   | 1 Bradley unit 1/2 megohm                   |
| 1 Micamold fixed condenser, .00015 mfd.   | 3 Amperites No. 1a                          |
| 1 Micamold fixed condenser, .00025 mfd.   | 1 Amperite No. 112                          |
| 2 Daven resisto-couplers (new type which incorporated 1 mfd. condenser concealed in base) | 5 Benjamin standard "Cle-ra-tone" sockets   |
|   | 1 Carter single-circuit jack, No. 101       |
|   | 2 Carter Jack switches, No. 2               |
|   | 8 Eby binding posts                         |
|   | 1 vernier control knob and dial             |
|   | 1 panel, 8 x 22 inches                      |
|   | Complete parts, <b>\$54.50</b>              |

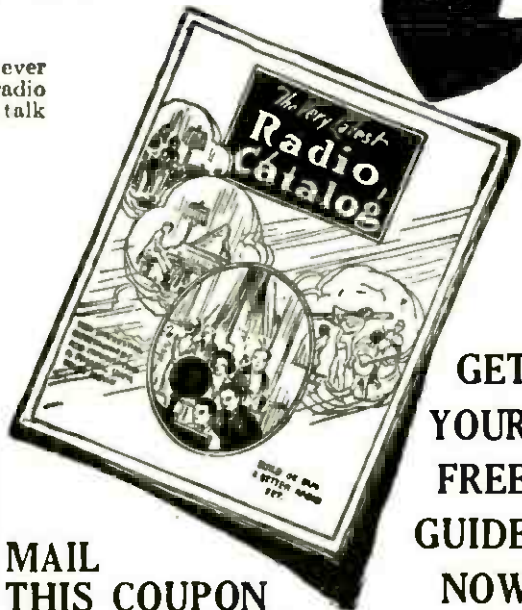

GET  
YOUR  
FREE  
GUIDE  
NOW

<b>RAYTHEON TUBE B-ELIMINATOR</b>	Complete Kit	<b>\$39.50</b>
<b>HAMMARLUND-ROBERTS</b>	Complete Parts	<b>\$57.50</b>
<b>McLaughlin</b>	Complete Parts	<b>\$82.50</b>
8-tube Super		

#### Other Famous Circuits

Here are a few sample bargains from the Barawik Catalog:

- Complete parts for Remler-Best 8-tube Super... \$18.45
- Complete parts for B-T Counterphase 6... 63.50
- Complete parts for Silver-Super Autodyne... 62.50
- Complete parts for Hazeltine Neutrodyne... 29.25
- Complete parts for Browning-Drake circuit... 32.25
- Guaranteed 201A type Tubes... 1.15
- Guaranteed 45-v. large B batteries... 2.55

Order direct from this ad or get a free copy of our complete catalog of everything in radio.

MAIL THIS COUPON

BARAWIK CO., 102-104 So. Canal St., Chicago  
Send me my copy of your new Radio Catalog and Builder's Guide.

Name.....  
Address.....  
Friend.....  
Address.....

*The Barawik Co.*

102-104 So. Canal St., Chicago, Ill.

# As Amazing As— A Stroke of Magic!

Variable condensers that are not straight line frequency, tune as if they were, if you install

**BRUNO**

## Magic Dials

As if at the touch of a wondrous wand, stations otherwise crowded together — are evenly separated. Uncrowd the air with the Magic Dial! Genuine moulded Bakelite with fluted columns of Arabian inlay. . . . \$2.50

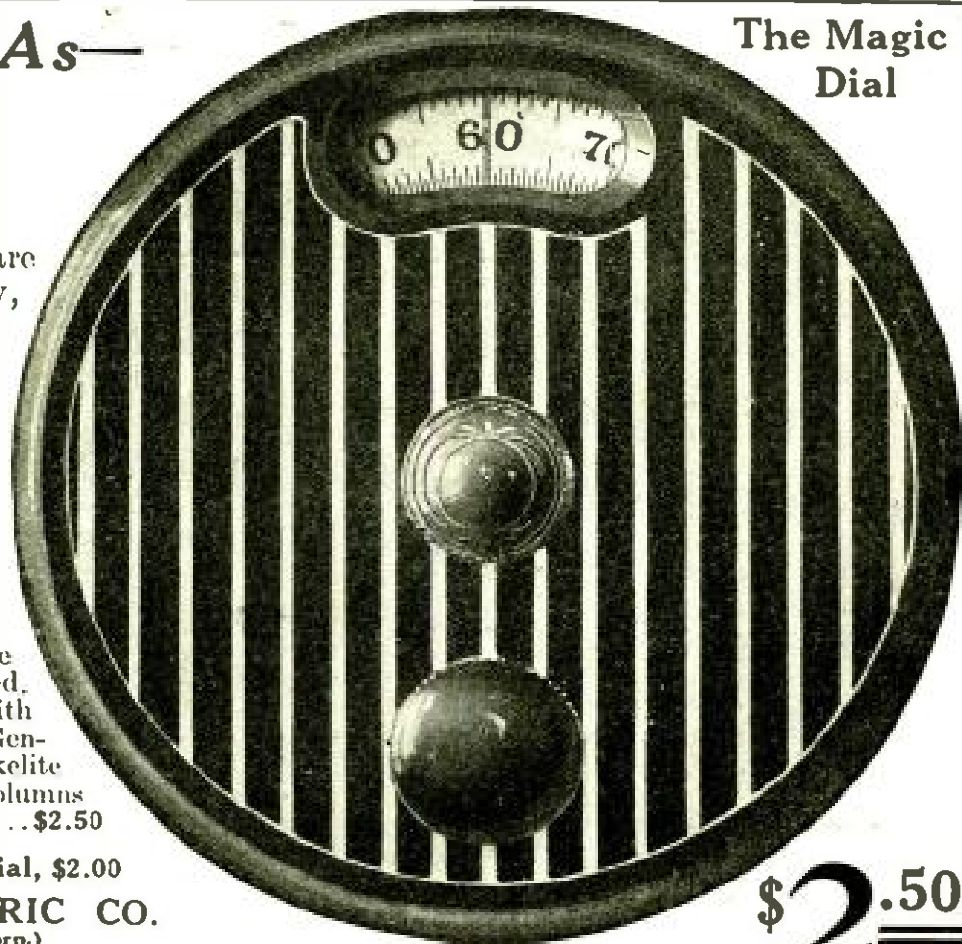

The Magic  
Dial

"SLO-MOSHEN" Vernier Dial, \$2.00

**POWERTONE ELECTRIC CO.**  
(Subsidiary of Bruno Radio Corp.)

Dept. P

223 Fulton St.

N. Y. City

If your dealer can't supply you, order direct.

**\$2.50**

# FREE SIMPLIFIED BLUEPRINTS FREE

YOU CAN HAVE YOUR CHOICE OF ANY ONE OF EIGHT SETS

You can have your choice of any one of eight POPULAR RADIO Simplified Blueprints with your new or renewal subscription for POPULAR RADIO, with which is combined *The Wireless Age*, accompanied by remittance of \$3.00. These Blueprints will make it possible for you to build a tested and approved set, while POPULAR RADIO for 12 months will keep you in touch with the progress being made in radio.

You, as a reader of POPULAR RADIO, know the many entertaining interesting and instructive articles that are published each month. Every issue some new item is sure to attract your attention. We promise that throughout the coming months POPULAR RADIO will hold more and more of interest for Radio Fans.

### Ease, Economy and Accuracy in Construction

Simplified Blueprints were prepared under the personal supervision of Laurence M. Cockaday. They make it possible for anyone, without previous knowledge of radio, to construct a highly efficient radio receiver. Each set of Blueprints consists of 3 prints as follows:

#### Panel Pattern

This blueprint is the EXACT size of the actual set. So accurate that you need merely lay it on your panel and drill as indicated. You can readily appreciate the convenience of this blueprint. No scaling or measuring to do, no danger of ruining the panel through faulty calculation.

#### Instrument Layout

Here again you have an actual size print of each instrument and binding post and its exact location both on the panel and within the cabinet. Even the cabinet structure is clearly shown.

#### Wiring Diagram

The unusual feature of this blueprint is that it is an actual size picture diagram of the finished set. Each instrument and other parts appear in exact size and the wires are so clearly traced from one contact to another that you can connect all terminals accurately without even knowing how to read a hook-up diagram.

Set No. 4—"Cockaday Four-circuit Tuner with Resistance-coupled Amplifier" (five tubes, distortionless, two dials, automatic vacuum tube control) as described in October, 1924, POPULAR RADIO.

Set No. 6—"Cockaday 8-Tube Super-heterodyne Reflex Receiver" as described in January, 1925, POPULAR RADIO.

Set No. 9—"The Portable Town and Country Receiver" (six tubes, three stages of transformer-coupled, radio-frequency amplification, loop antenna) as described in May, 1925, POPULAR RADIO.

Set No. 11—"5-Tube Tuned Radio-Frequency Receiver with Simplified Control," as described in August, 1925, POPULAR RADIO.

Set No. 12—"8-Tube Super-heterodyne with a Single Control," as described in October, 1925, POPULAR RADIO.

Set No. 13—"Raytheon Plate Supply Unit" (a really dependable method for obtaining a "B" source of supply as described in November, 1925, issue of POPULAR RADIO).

Set No. 14—"The LC-26 Broadcast Receiver" (as described in December, 1925, issue of POPULAR RADIO).

Set No. 15—"The Orthophase Receiver" (A circuit development using a new principle in radio-frequency amplification, making a receiver with great sensitivity, combined with sharp tuning and ease of operation, as described in February, 1926, issue of POPULAR RADIO).

### POPULAR RADIO

Dept. 29

627 West 43rd Street New York City

Use coupon below; indicate which set of Blueprints you want.

POPULAR RADIO, Dept. 29

627 West 43rd Street, New York City

Enclosed is my remittance of \$ . . . in full payment for subscription, with Blueprints as checked below. FREE.

- |  |  |
|--|--|
| <input type="checkbox"/> Set Number 4  | <input type="checkbox"/> Set Number 12 |
| <input type="checkbox"/> Set Number 6  | <input type="checkbox"/> Set Number 13 |
| <input type="checkbox"/> Set Number 9  | <input type="checkbox"/> Set Number 14 |
| <input type="checkbox"/> Set Number 11 | <input type="checkbox"/> Set Number 15 |

Name.....

Street.....

City..... State.....

All apparatus advertised in this magazine has been tested and approved by POPULAR RADIO LABORATORY





**INDUCTO COUPLER**

Price \$1.85

James L. McLaughlin, the authority on superheterodyne design recognized the superiority of Precision Coils when he recommended the Inducto Coupler for use in his One Control Superheterodyne. The Inducto Coupler is for use where a split winding coil is desired.

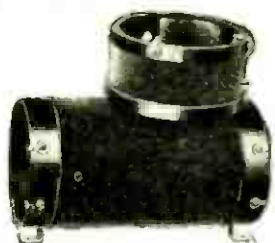

**COCKADAY COIL**

Price \$5.50

(New Octaform Base)

Because the success of his 4-circuit tuner so largely depended on the efficiency of the coil, Cockaday in using the Precision Cockaday Coil in his Laboratory model, paid a great compliment to the marked accuracy and efficiency of Precision Coils.



**AUTODYNE COUPLER**

Price \$3.50

Used in the Superheterodyne Reflex Receiver described in the January 1925 issue of Popular Radio.

**PRECISION ANTENNA COUPLER**

for the McLaughlin DeLuxe One-Control Super. May be used when an outdoor aerial is desired with a superheterodyne. Price \$3.50.

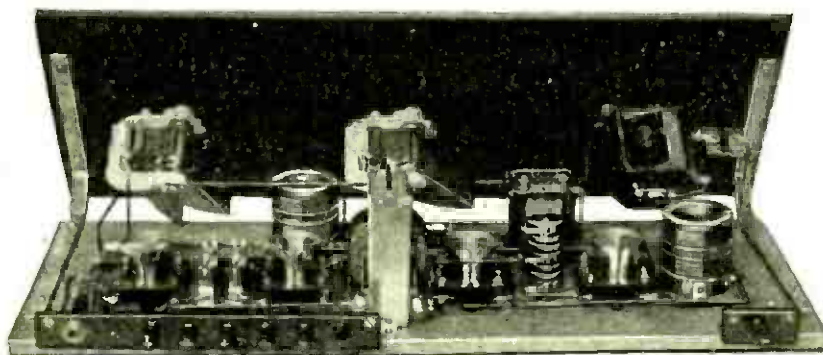

*In the*  
**ORTHOPHASE RECEIVER**

the only coils that can be used are the Precision Orthophase coils. List price \$7.50.

**The PRECISION OCTAFORM COIL**

shown at the right, is a new type of inductance used in the Cockaday LC-26 Receiver and is the only coil that can be used in this set. List price \$5.50.



**KITS IN STOCK**

Cockaday LC-26 and Cockaday "B" Battery Eliminator Kits are in stock. Let us ship you one or both made of exactly the same parts as used by Mr. Cockaday in his laboratory models. Build a set that's a year ahead of the present models. LC-26 Kit, \$81.90. Cockaday "B" Eliminator Kit \$42.05. Write today.

Precision Kits are absolutely guaranteed. Complete Popular Radio constructional blueprint is included in each kit.

Send money order today or we will ship a kit C.O.D. upon receipt of your order. Postpaid anywhere in the U. S. A.

Dealers write for information about the complete Precision Line.

**PRECISION COIL Co., INC.**

209 Centre Street, New York, N. Y.

## The Big Obstacle to SENDING Removed—



Price \$17

More than  
simply  
a key

MARTIN VIBROPLEX SENDING MACHINE WORKS THE EASY WAY—JUST PRESS THE LEVER—the machine does the rest.

Over 100,000 Radio and Telegraph Operators consider VIBROPLEX a first necessity, and use it daily. An expert's speed, clarity and precision result to beginner and master operator alike from the use of VIBROPLEX—signals that are *easy to read*.

The illustrated model (\$17) can be used directly in the majority of DX circuits; furnished with extra heavy contact points (\$25) for direct use in any circuit (without relay).

Send check, or money order for either model, or pay postman.

**VIBROPLEX CO. of AMERICA**  
825 Broadway NEW YORK

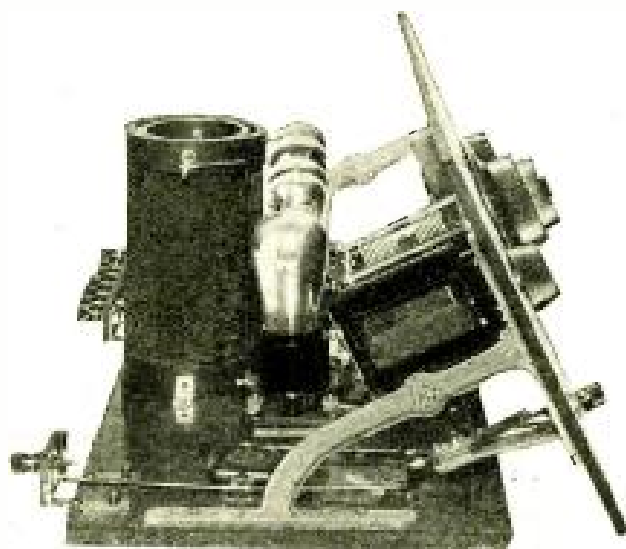

**YOUR** L. C. 26 Receiver will be easier to build and look better if you use the TAIT Special Alloy Bracket. Approved by Popular Radio Laboratory. Made especially for the New Popular Radio Standard Cabinet described in the December issue of Popular Radio. Sent postpaid anywhere in the world upon receipt of price \$2.00 per pair. Order from

**MORISON ELECTRICAL CO.**

15 East 40th St., New York

Or direct from

**TAIT, 161st Street and Washington Avenue**  
New York City

L. C. 26 laboratory-built sets to order \$100.00  
postpaid and guaranteed.

## FREE — Our Latest 100 Page RADIO CATALOG

Just off the press—waiting for you. All the latest sets with special kits to build them. Parts and accessories by well-known manufacturers. Every fan needs this latest guide-book to the best in radio. Write for your FREE copy.

**Chicago Salvage Stock Store**  
509 S. State Street, Chicago, U. S. A.  
Dept. PR6



## Build Your LC-26 With the Aid of Popular Radio Blue Prints

*It is Easy, Quick and Accurate*

The LC-26 is the ideal all-around receiver, combining unusually fine tone quality, selectivity and distance-getting ability, with simplicity of construction and operation. It operates on any antenna from 10 feet to 200 feet long, indoors or out.

In tests at Washington, D. C. the LC-26 brought in over 40 stations in one night, the farthest away being KGW, Portland, Oregon.

At Chicago, Ill., the LC-26 brought in KFI, Los Angeles, every night for a week, and over 60 other stations. WEA, New York, was heard clearly at eleven o'clock in the morning.

At New Haven, Conn., it brought in WMBF, at Miami Beach, Florida, at 4:00 p.m., as well as New York stations for which New Haven is a dead spot.

All reception on the LC-26 is on the loudspeaker, as it has no phone connection.

By using POPULAR RADIO Blue Prints in building your LC-26, you can save time, eliminate the possibility of error, and make your set exactly like the laboratory models (see page 62).

If your local dealer cannot supply you with Blue Prints of the LC-26, they will be sent postpaid on receipt of \$1.00 per set.

A full description of the LC-26, with detailed directions as to how to build it, was published in December POPULAR RADIO.

**POPULAR RADIO**

Service Bureau 24-A

627 West 43d Street, New York

# N E W

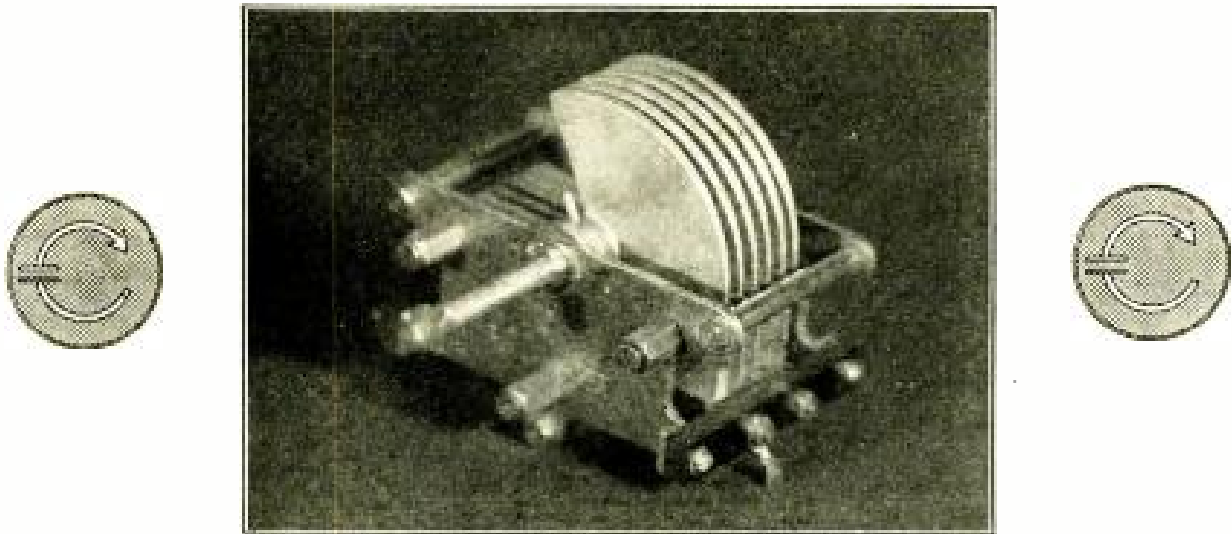

**A Radically New Type of Lower-Loss Design Which Gives a Straight Frequency Tuning Curve with a Semi-Circular Rotor Plate of Rugged Compact Construction**

**F**OUR years ago, Cardwell revolutionized the radio world by the introduction of the low-loss condenser. Accepted practice was flung to the winds—instead of large, leaky, dielectric end plates, the dielectric was limited to the smallest practical quantity of hard rubber, placed perpendicularly to the plates; and the rotary plates were grounded to metal ends, eliminating body capacity. Mechanically, the condenser was built to last beyond the life of the set.

*It is significant of the perfection of Cardwell design and construction that today after four years of imitation the original Cardwell Low-Loss Condenser still has lower losses than its nearest competitor.*

When the crowding of broadcasting stations made it evident that a straight frequency tuning curve would be popular, many condensers were rushed on the market with flimsy plates, and weak over balanced construction. Electrical efficiency and mechanical strength were sacrificed in order to approach straight frequency by the shaped plate method. Large panel space was required, and accurate logging was impossible.

Meanwhile Cardwell engineers were per-

fecting a new condenser in which straight frequency tuning curve is secured by a regular variation of the thickness of the air-dielectric, with a pronounced gain in compactness, efficiency, and mechanical strength. The new condenser is exactly the same size as the original Cardwell. The whole condenser with plates wide open will mount behind a 4 inch dial, and extends less than 3 inches back from the panel. It can be substituted for Cardwell Type "B" or "C" Condensers without disturbing panel holes, other instruments, or connections. Plates are semi-circular, and so thick that it is almost impossible to bend them out of alignment, and change the logging of the set.

Electrical losses are so low that the user is assured absolutely maximum selectivity.

Following the well-known Cardwell policy of never allowing any instrument to reach the public until it is perfected, this condenser has passed through months of rigid laboratory tests, and we now announce that we are producing **THE FINEST CONDENSER EVER MADE.**

**PRICE, .00035 Mfd . . . \$4.75**  
ALL SIZES MANUFACTURED

Send Post Card for Full Information on Type E

# C A R D W E L L

81 PROSPECT STREET

BROOKLYN, N. Y.

"THE STANDARD OF COMPARISON"



**THE PARTS**

the dealer sold you—

You can blame them, your circuit or static. But most frequently

**RECEPTION TROUBLES**

are caused simply by a bad connection. A dirty untinned soldering iron *cannot fail* to make a bad joint.

The iron can be properly cleaned only by the chemicals in

**SOLDERCAKE**

grooved, always ready to use.

*Dealers*—You can insure your reputation by selling this necessary Soldercake to every customer. Write now for our helpful proposition.

*Fans*—25c and your dealer's name will bring this cake postpaid to you.

**C. de P. FIELD CO.** 110 East 42nd Street  
NEW YORK CITY  
(Estab. 1860)



**ELKAY 5-TUBE  
SUPER-SELECTOR**

Compares favorably in appearance, selectivity, volume, distance and tone quality with sets at twice its price. Has one stage R. F., detector, one stage of transformer coupled amplification and two resistance coupled amplifiers. Only two dials. A radio frequency choke permits same smooth operation on low or high wave lengths. Control over selectivity a distinct departure—an ELKAY invention.

**\$80**

Also made with 4 tubes at \$70. Blue prints, \$1.00. See the ELKAY at your dealer's. (Dealers, write for exclusive agency.)

**THE LANGBEIN-KAUFMAN RADIO CO.**  
511 Chapel St., Dept. P., New Haven, Conn.

An LK Product



**ACME COILS**

**SATISFACTION**

The National Company, Cambridge, Mass.  
Browning-Drake, Inc., Brighton, Mass.  
G. Boissonault & Company, New York  
Clapp Eastham Company, Cambridge, Mass.  
Waterbury Button Company, Hartford, Conn.

Including many other manufacturers find it to their advantage to use our Coil Service. Regardless of your own facilities you will undoubtedly find our service profitable to you. Ask us for estimates and samples.

**ACME PRODUCTS CO.**

107 W. Canton St. Boston, Mass.

**FIXED RESISTORS**

*Micamold*

**FIXED CONDENSERS**

*“Made of Mica and Moulded in genuine Bakelite”*

With Micamold Resistors and Condensers you need no clips or mounts—just solder direct to the terminals, thus eliminating point or loose contact and accidental dislodgment of the units.

Micamold Products are moulded in genuine Bakelite and guaranteed within 5% of calibrations and constant in value. They are noiseless, moistureproof and indestructible.

At all good Radio Stores

**MICAMOLD RADIO CORP.**  
Flushing and Porter Aves., Brooklyn, N.Y.

ACCURACY GUARANTEED  
—VALUES REMAIN CONSTANT

MOULDED UNDER PRESSURE OF 50 TONS



# The "ORTHOPHASE"

## R. J. Griffith's Push-Pull Radio Frequency Circuit

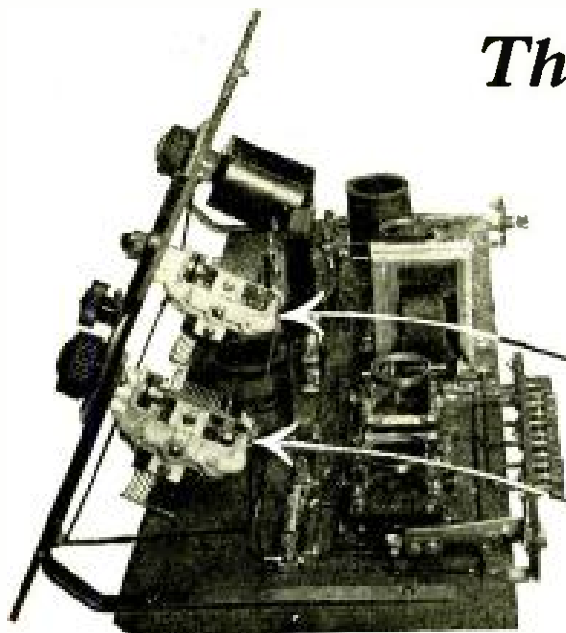

Uses

# HAMMARLUND

*Straight-Line Frequency*  
**CONDENSERS**

Made in  
All Standard  
Capacities

**D**ESIGNERS of new circuit adaptations are extremely careful of the materials they use.

They can ill afford to sponsor any but the best and dare not take chances when presenting a new idea to the radio public for the first time.

During the past year, there have appeared many new circuit arrangements for which Hammarlund Precision Products were specified.

Not because some other good make might not have worked satisfactorily, but because *Hammarlund quality insured success.*

R. J. Griffith's remarkable push-pull radio-frequency receiver is one of the first of the 1926 developments to employ Hammarlund Precision Products.

*Write for Hammarlund Descriptive Literature*

*Distributes  
Stations Equally  
Over the Dials*

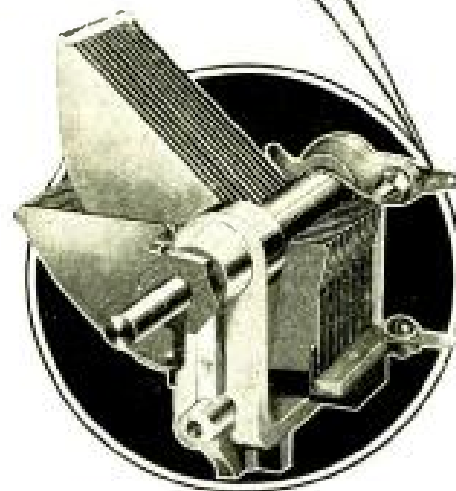

HAMMARLUND MANUFACTURING CO.  
424-438 W. 33rd Street, New York City

For Better Radio  
**Hammarlund**  
PRECISION  
PRODUCTS



# WHAT DO YOU WANT TO KNOW ABOUT RADIO?

POPULAR RADIO, with which is combined *The Wireless Age*, maintains for the benefit of its readers a Technical Service Bureau and Laboratory, under the personal supervision of Laurence M. Cockaday which will, without charge, answer by personal letter any question, problem or request for information submitted by a subscriber. This service is, however, also available to readers, other than subscribers, at the very nominal rate of 50 cents the inquiry.

In writing please confine your questions to one general

## October, 1923

- Practical hints for Coil Calculations.
- How to make a Two-stage Audio-frequency Amplifier.
- Ten good rules for Broadcast Listeners.
- How to make a simple Honeycomb Receiver.

## November, 1923

- The 100 Best Hook-ups (Part 1).
- Receiving without Antennas.
- How to build the New Regenerative Super-heterodyne Receiver (Part 1).
- How to build a combination Short and Long-wave Receiver.

## December, 1923

- How to select your Radio Parts.
- The 100 Best Hook-ups (Part 2).
- How to Read a Diagram (Part 1).
- How to build an efficient Crystal Receiver.
- How to build the Super-heterodyne Receiver (Part 2).

## January, 1924 (Out of Stock)

(A Reprint of Mr. Cockaday's article describing the DX Regenerative Receiver may be had for 25 cents.)

## February, 1924

- How to add "Push and Pull" amplification to the 3 tube Cockaday 4-Circuit tuner.
- The original 4-Circuit Tuner as a Portable Set with Loop.
- The 100 Best Hook-ups (Part 4).
- How to build a 3-tube Reflex Receiver.

## March, 1924

- Hoffman Transformer Measurement Chart
- The 100 Best Hook-ups (Part 5).
- How to build an Amateur Transmitter.
- A 3-tube Reflex Receiver (Part 2).

## April, 1924

- How to build a Simplified Neutrodyne Receiver.
- The 100 Best Hook-ups (Part 6a).
- How NOT to Tune the Single Circuit Receiver.
- A Novel Substitute for "B" Batteries.

## May, 1924

- A Compact Radio Kit for a Spring Hike.
- How to Get the Maximum Radio-frequency Amplification.
- 100 Best Hook-ups (Part 6b).
- Where Interference Comes In.
- How to Make an Audio-frequency Amplifier that Does Not Distort.

## June, 1924

- How to Install a Receiver on your Boat.
- The 100 Best Hook-ups (Part 7).
- How to Build a Regenerative Receiver for Use with an Indoor Antenna.
- How to Make a Two-Slide Tuner.

## July, 1924

- How to Avoid Local Interference.
- How "Resistance" Affects Radio Circuits.
- An Ideal Set for Summer-time Reception.
- 100 Best Hook-ups (Part 8).
- How to Do Your Soldering Correctly.
- How to Build the POPULAR RADIO Portable.

## August, 1924

- How to build a single dry-cell tube, four-circuit tuner.
- How to build a two tube reflex receiver.
- Helpful hints for the broadcast listener.

## September, 1924

- How to build a single dry-cell tube reflex receiver.
- How to build a multi-wave tuner.
- How to improve broadcast reception.

## October, 1924

- How to build the (Cockaday) Four Circuit Tuner with a Resistance-coupled Amplifier.
- How to Select a Ready-made Receiver.
- How to Build a Detector-amplifier.
- A Radio Set to Pack in Your Suitcase.
- Harnessing the Radio and the Movie.

## November, 1924

- How to Locate Interference from Power Lines.
- Cockaday Article for Beginners.
- How to Build a Low-loss Tuner for Short-wave Reception.
- The New Type of Superheterodyne.

## December, 1924

- How to Build a Non-radiating 7-tube Superheterodyne Receiver.
- Cockaday Article for Beginners.
- How to Get the Most Out of Your Ready-made Receiver.

## January, 1925

- How to Build the Cockaday 8-tube Super-heterodyne Reflex Receiver.
- How to Improve Broadcast Reception.
- Cockaday Article for Beginners.

## February, 1925

- How to Get on a Radio Program.
- A Loudspeaker for a Crystal Set.
- How to Build a 4-tube Reflex Receiver with the New Sodion Detector.
- Cockaday Article for Beginners.

## March, 1925

- How to Build the Improved DX Regenerative Receiver.
- Factors that Govern the Capacity of Condensers.
- What "Induction" Means to Your Set.
- A Five Meter Vacuum-tube Transmitter and Receiver.

## April, 1925

- Single Control Receivers.
- How to Improve Broadcast Reception, VI: Increasing the Selecting Power of Your Receiver.
- How to get the Most out of Your Ready-made Receiver.
- Quartz Crystal as a New Wavelength Standard.

subject, writing on one side of the paper only, and enclose a self-addressed and stamped envelope.

It is possible that your individual problem has been covered in an issue of POPULAR RADIO, and so as an aid to you we endeavor to keep a supply of back numbers in stock. The condensed index below gives a few of the subjects that have appeared recently, look this list over and if the information you want is covered, we will be pleased to supply back numbers at 35c. a copy.

## May, 1925

- Factors That Affect Antenna Capacity.
- How to Wire Your Home to Have Radio in Every Room.
- Handy Tools for Radio Fans, The Hydrometer.
- How to Build the "Portable Town and Country Receiver."

## June, 1925

- New Development in Vacuum Tubes.
- How to Build a Five-tube A-C Receiver.
- How to Draw Up Your Own Tuning Chart.
- Watt's Law in a Nutshell.
- "What Set Shall I Buy?" First Installment.

## July, 1925

- The Best 101 Hook-ups.
- "What Set Shall I Buy?" Second Installment.
- Broadcast Stations in the United States.
- What's New in Radio Apparatus.

## August, 1925

- "Motion Pictures" by Ether Waves.
- A New Type of Hornless Loudspeaker.
- How to Build a 5-Tube Radio-Frequency Set with Simplified Control.
- Trouble Shooting.
- Hints for Amateurs.

## September, 1925

- How the Air Affects Radio.
- When You Turn Your Dials.
- Useful Charts for Amateurs.
- Call Letters That Have a Past.
- Broadcasts.

## October, 1925

- How Earth Magnetism Affects Radio Waves.
- How to Improve Broadcast Reception.
- What Makes a Low-loss Coil?
- How to Build the New 8-Tube Super-heterodyne with a Single Control.

## November, 1925

- Radio's Newest Instrument—the Photoelectric Cell.
- How to Build the Raytheon Plate Supply Unit.
- New Methods of Calibrating Your Receiver.
- Practical Pointers About Transformers.
- Multi-layer Coils.

## December, 1925

- How to Build The New LC-26 Receiver.
- How to Improve Broadcast Reception.
- What Every Radio Experimenter Should Know About Condensers.
- "Truthful Reproduction." How to Get It from Your Set.
- Radio that Runs on a Beam.

## January, 1926

- How to Get the Most Out of Your LC-26 Receiver.
- Some New and Useful Facts About Coils.
- When Your Set Won't Work.
- Straight-Line-Frequency Condensers.
- What's New in Radio Apparatus.

# Popular Radio

627 West 43d Street

Dept. 28

New York City

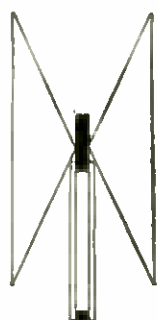

Section of the New Acme FREE-EDGE CONE Loud Speaker, showing the two free-edge cones.

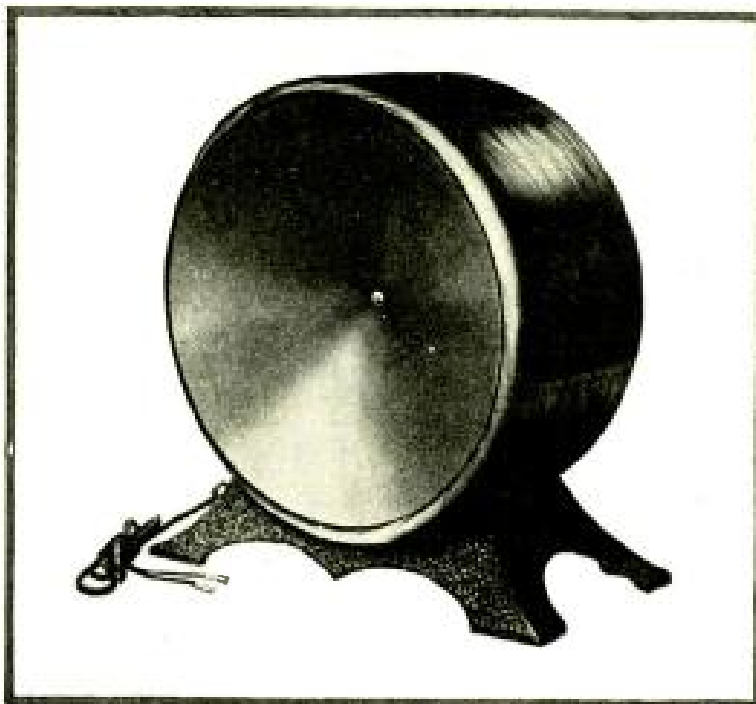

## After 5 years and 256 experimental models—Acme is proud to put its name on this Loud Speaker

**H**ERE in our laboratories at Cambridge, our radio engineers and sound experts have been at work, ever since broadcasting started, striving to perfect an ideal type loud speaker.

Two years ago, after having made, studied and tested 203 models, we obtained a very good horn type loud speaker. But our radio and sound engineers determined to go even

further. After 23 months more of experimenting; making and testing 53 additional loud speaker models they at last developed the ACME Free-Edge Cone Loud Speaker.

As far as it is humanly possible to judge we feel certain that we have the finest loud speaker ever produced. This new type loud speaker does away with inherent resonance common in other types. Because of this improvement the new Acme now brings out the low notes and soft over-tones never before obtainable in any loud speaker.

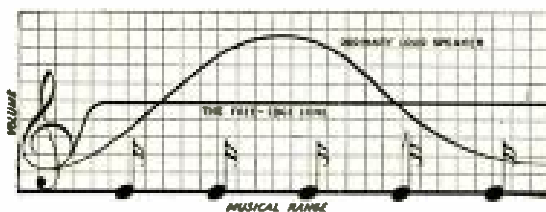

**NOTE** the equal volume over the musical range with the free-edge cone in contrast to the ordinary loud speaker.

The latest development in radio reproduction is the cone type loud speaker but the double Free-edge Cone is a further advancement because resonance is eliminated and faithful reproduction obtained over the whole musical range.

*Claude Haines*

President Acme Apparatus Company

Send for the new edition of our famous book "Amplification without Distortion" telling the why and the how of perfect radio reception.

**ACME APPARATUS COMPANY,**  
Dept. C8, Cambridge, Mass.

Gentlemen:

I am enclosing 10 cents (U. S. Coin or stamps) for your booklet "Amplification without Distortion."

Name.....

Street.....

City.....State.....

# ACME

*~for amplification*

# This RADIO MANUAL FREE

with  
**Popular Radio**

with which is combined *The Wireless Age*

## When You Build Your Own Set

Aside from the feature of economy, there is the thrill and satisfaction that comes from building your own receiving set. Instead of being a mere "dial-twister" you will necessarily have a very definite basic knowledge of what radio is all about after constructing a set.

Thousands of sets have never been constructed because of the atmosphere of mystery that has enveloped the whole subject of radio. Kendall Banning, Editor, and Laurence M. Cockaday, Technical Editor of POPULAR RADIO, through their close contact with the great radio public sensed this and compiled a book that will convince the veriest beginner that technical training is not essential. If you have a little time to devote to a most fascinating pastime, send for a copy of "How to Build Your Radio Receiver" and discover how simple and easy set building really is. This famous book has made it so.

## Free Advisory Service

POPULAR RADIO is full of helpful suggestions as well as instructive and entertaining articles on radio and allied scientific phenomena. This information is supplemented by an advisory service that is free to all subscribers. Any problem you encounter that is not answered in the book or magazine will be answered by personal letter if you will submit it to the Technical Service Bureau. For this purpose a big modern laboratory with a trained staff of investigators under Mr. Cockaday's personal direction is always at your service.

## A Valuable Combination

For the next thirty days we will give you a copy of "How to Build Your Radio Receiver," FREE and enroll you for all privileges of the Technical Service Bureau at no further expense, on receipt of your remittance of \$3.00 in payment for a 12 months' subscription for POPULAR RADIO. (As an alternative offer, if you wish the combination with POPULAR RADIO for 7 months only—send but \$2.00). In any event, you run absolutely no risk as we will refund in full if you are not more than satisfied with your purchase.

POPULAR RADIO Dept. 25,  
627 West 43d Street,  
New York City.

Offer expires  
Feb. 27, 1926

Enclosed remittance of \$3.00 is payment in full for a 12 months' subscription for POPULAR RADIO and copy of "How to Build Your Radio Receiver" FREE.

Name.....

Address.....

City..... State.....

Check here and remit \$2.00 if you prefer POPULAR RADIO for 7 months only in combination with "How to Build Your Radio Receiver."

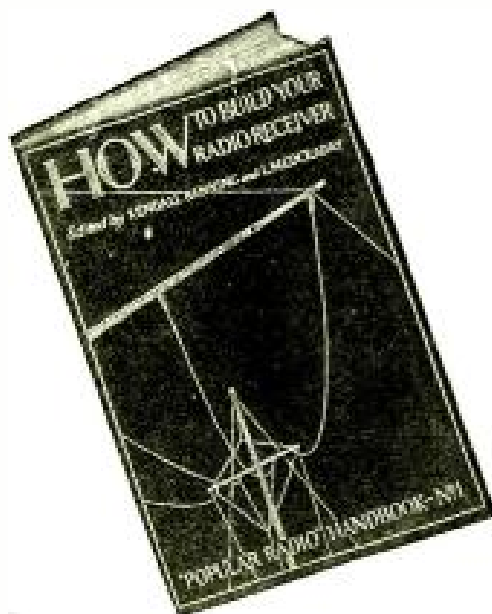

In "How to Build Your Radio Receiver" you will find complete constructional diagrams, specifications, photographs and instructions for building the following sets. Each has been selected as representative of its circuit because in laboratory tests it proved the best for distance, selectivity, tone volume, simplicity of construction, ease in tuning, reliability and all-around satisfaction.

### A \$5 CRYSTAL SET

The simplest up-to-date set for local broadcast reception. Approximate range, 15 miles, though distances up to 400 miles are not extraordinary. Gives clear signals on headset without distortion. No operating cost whatever.

### THE HAYNES SINGLE TUBE RECEIVER

An efficient set that may be made by a novice at an approximate cost of only \$15 for parts. Simple to tune, selective, good audibility. Long distance range up to 1,000 miles on earphones. Six-volt storage battery and 22½-volt "B" battery required, or may be adapted for dry cells and dry cell tubes.

### A TWO-STAGE AUDIO-FREQUENCY AMPLIFIER

This instrument may be added to any set, crystal or tube, to strengthen the received signals, so that they will operate a loud-speaker. It is easy to construct, efficient and inexpensive, costing only \$15 for parts. Operates on the same "A" battery that is used on the vacuum-tube detector unit.

### THE COCKADAY 4-CIRCUIT TUNER

A 3-tube set, famous for its high selectivity and beautiful tone. So neat and compact that it may be kept in a bureau drawer. Cost of parts about \$40. Receiving range approximately 1,500 miles on a loud-speaker. Operates on a 6-volt storage battery and two 45-volt "B" batteries, or may be adapted to dry cells and dry cell tubes.

### A 5-TUBE TUNED RADIO-FREQUENCY RECEIVER

Two stages of tuned radio-frequency amplification, detector, and two stages of audio-frequency amplification are here employed so that the possibility of "oscillation and re-radiation" is eliminated. The set can be operated on a loop antenna and may be built at a cost of only \$90 for parts. Six-volt storage battery and two 45-volt "B" batteries required. Range about 1,000 miles on loop or indoor antenna and 2,500 to 3,000 miles on an outdoor antenna.

### THE "IMPROVED" COCKADAY 4-CIRCUIT TUNER

Probably the most important contribution yet made to the equipment of the radio fan. A compact 5-tube set with a receiving range of over 3,000 miles. Cost of parts about \$95. Wave length range from 150 to 675 meters. Automatic tuning and power amplification. Maximum volume of sound, excellent reproduction and no interference. Requires a 6-volt "A" battery, three 45-volt "B" batteries, one 22½-volt "B" battery and a 9-volt "C" battery.

### THE REGENERATIVE SUPER-HETERODYNE RECEIVER

More sensitive, more selective and more simple to tune than any other 6-tube receiver yet developed. A three-section 6-tube set employing the Haynes Single Tube Receiver as tuner. May be further extended to a four-section, 8-tube set by the addition of the two-stage audio-frequency amplifier. The cost of parts approximates \$100. Range of 3,000 to 4,000 miles on a loud-speaker. Has been called the "Rolls-Royce" of radio receivers.

**POPULAR RADIO**  
627 West 43d Street, New York City



# Years of experience are behind this radio battery



TWENTY years ago, when the automotive industry was in its infancy, Prest-O-Lite gave the motor-car its first dependable eyes. Today Prest-O-Lite Batteries, for radio and motor-cars, are sold by millions in all parts of the world, and there is always a Prest-O-Lite or radio dealer service station within a few steps of your home.

Prest-O-Lite Radio Batteries were especially designed for radio in the world's largest electro-chemical laboratories. In engineering, materials and workmanship nobody offers more than Prest-O-Lite. Prest-O-Lite Storage Batteries deliver their rated ampere-hour capacity at full power, thus lengthening the time between recharging and assuring you good, clear reception.

The name Prest-O-Lite has always represented a product of highest grade, and a manufacturer with twenty years' successful manufacturing experience has a dollars-and-cents value to you. It is a guarantee that your money will be wisely expended.

Prest-O-Lite Batteries are attractively priced from \$4.75 up. It is no longer necessary to take a chance on batteries of unknown make.

THE PREST-O-LITE CO., Inc.  
INDIANAPOLIS, IND.  
New York San Francisco  
In Canada: Prest-O-Lite Company of  
Canada, Ltd., Toronto, Ontario

### Send for Free Booklet

"What every owner of a radio should know about storage batteries" is a little booklet which every radio fan will find interesting and helpful. It is crammed full of hints that will bring surprising radio results—and save you money. It's yours for the asking—without obligation.



Designed especially for radios

## Prest-O-Lite

STORAGE BATTERIES FOR  
MOTOR-CARS AND RADIO

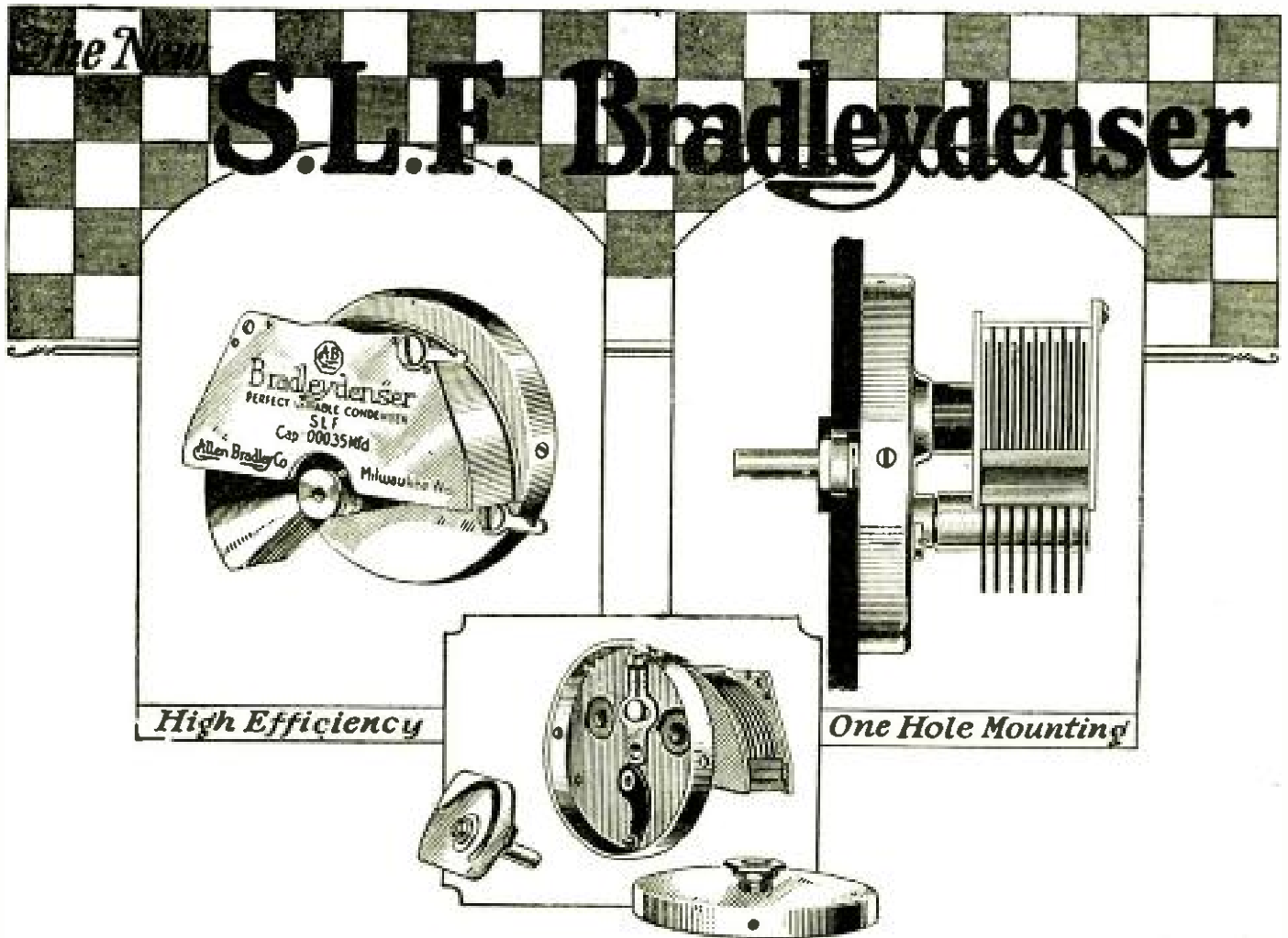

## A Compact Straight-Line-Frequency Condenser

**T**HE new S. L. F. Bradleydenser is the outcome of long, careful research in condenser design. It provides straight-line-frequency tuning over the entire circumference of a 360-degree dial. Stations are widely and evenly spaced over twice the dial-spacing of ordinary condensers. This unique control is obtained by using a special cam on the condenser shaft which provides the straight-line-frequency tuning now demanded by all set builders. The efficiency of the condenser is extremely high, due to the unique construction that practically eliminates insulating material in the condenser.

**A**NOTHER outstanding feature of the new S. L. F. Bradleydenser is the compact design which eliminates entirely the long eccentric rotor plates, ordinarily used with straight-line-frequency condensers. The Bradleydenser can be substituted for any condenser in a set without interfering with other parts on the panel. The one-hole mounting also simplifies installation. The S. L. F. Bradleydenser is the latest Allen-Bradley contribution to better radio. Be sure to bring your set up-to-date by getting a set of S. L. F. Bradleydensers from your nearest dealer.

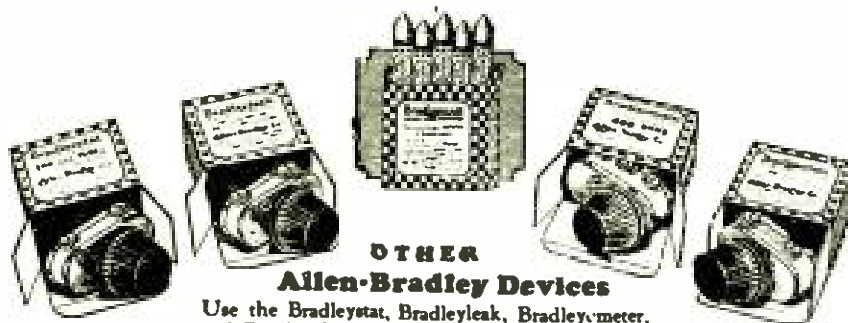

### OTHER

### Allen-Bradley Devices

Use the Bradleystat, Bradleyleak, Bradleymeter, and Bradleyohm in your next set. For resistance amplification, use the Bradleyunit Resistor.

### Mail the Coupon

Allen-Bradley Company,  
276 Greenfield Avenue,  
Milwaukee, Wisconsin.

Please send us your latest literature  
on the new S. L. F. Bradleydenser  
and other items of the Allen-Bradley  
line.

Name.....

Address.....

# Beauty-Quality-Performance



The World at your  
finger tips with  
**ACCURATUNES**



**\$175**

## The new **RECORDING DIAL**

**I**T is but natural that the Recording Dial, the finest dial of its kind, should be the product of the pioneer manufacturers of Vernier controls.

Every step forward in radio has seen a new dial, by MYDAR, designed along new lines. And so with the Recording Dial you have, we believe, a tuning masterpiece delicately responsive and deadly accurate.

On this new dial ample space has been provided to jot down call letters. Requires *no drilling* of the panel to mount. Rotates a full 360 degrees either clockwise, or counter-clockwise. The dial itself is beautifully proportioned and made of genuine Bakelite. Ratio 12 to 1.

**MYDAR RADIO COMPANY**  
5 Campbell St., - NEWARK, N. J.



**A. J. VERNIER**

Used on Super-Hets and regenerative sets, the A. J. offers a degree of tuning efficiency that will be a revelation. Made of Bakelite. Geared 150 to 1.

**\$225**

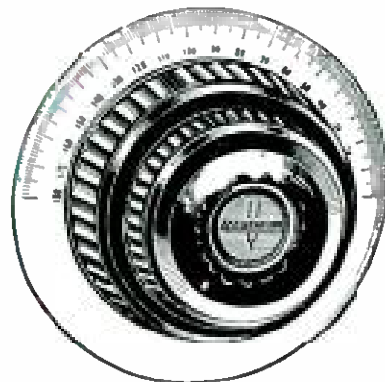

**ACCURATUNE**

These dials insure clear and precise reception of programs, and with even those stations so crowded on the lowered wave lengths easily segregated. Geared 80 to 1.

**\$350**

# The **World's Greatest** **Radio Receiving Set!**

New and Improved  
**FRESHMAN**  
**MASTERPIECE**



## The Franklin Model

**T**HE Freshman Masterpiece five tube radio receiver is known all over the world as the "WONDER SET." Its ease of operation, its distance getting ability and mellow tone have spread happiness and education in hundreds of thousands of homes in every part of the globe.

The Franklin Receiver, illustrated above, with built-in loud speaker of great volume and superb tone, is encased in a heavy five-ply genuine mahogany cabinet. The front cover opens in desk-like fashion; a most convenient and attractive arrangement. A console cabinet to match, can be had if you desire. This cabinet, with spacious compartments for all accessories, is priced at only Forty Dollars.

Sold on Convenient Terms by authorized Freshman Dealers, who also install and service them.

**CHAS. FRESHMAN CO., Inc.** Freshman Building, New York  
2626 W. Washington Blvd., Chicago