

HOLD
FILE

Popular Radio

Edited by **KENDALL BANNING**

**SEPTEMBER
1924**

25¢

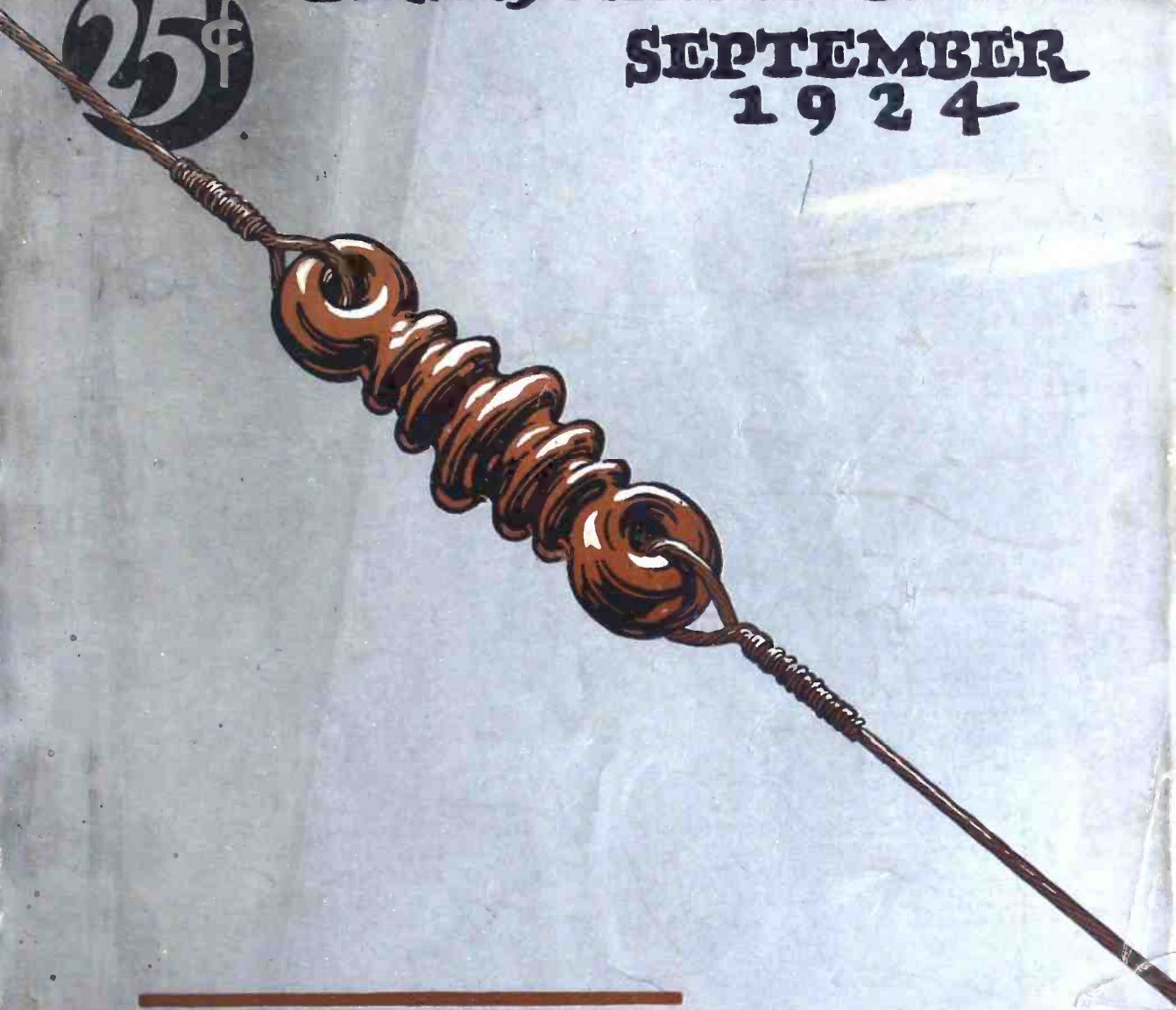

**Helpful Hints on
TUNING**





Radiotrons WD-11 *and* WD-12 *Made History!*

It isn't a genuine WD-11 unless it's a Radiotron.
It isn't a genuine WD-12 unless it's a Radiotron.
It isn't a genuine UV-199 unless it's a Radiotron.
It isn't a genuine UV-200 unless it's a Radiotron.
It isn't a genuine UV-201-a unless it's a Radiotron.

You Can Change Your Set to Dry Battery Operation.

If your radio set is equipped with navy type tube sockets, you can change to dry battery operation by inserting WD-12 Radiotrons. Ask your dealer for information as to how this can be done.

These are dry cell tubes—the tubes that made possible the swift progress of radio in the home everywhere. They meant clear tone—undistorted detection—radio and audio amplification—and volume reproduction—all with dry batteries. They meant radio in the city—on the farm—off in camp—everywhere!

And to-day, there are millions of these popular Radiotrons in use. Everybody

knows them familiarly as “WD-11’s” and “WD-12’s.” But they are not genuine unless they are **RADIO-TRONS.**

Always be sure to look for that mark on the base, and for the RCA mark on the glass. It's important, whether you are buying a new set with the Radiotrons in it, or buying new Radiotrons to replace old ones. Then you have the genuine—sure to live longest—serve best.

Radio Corporation of America

Sales Offices:

233 Broadway
New York

10 So. LaSalle Street
Chicago, Ill.

433 California Street
San Francisco, Cal.



This symbol of quality is your protection

Radiotron

REG. U. S. PAT. OFF.

Guarantee

Every Brandes Product is sold subject to the approval of the purchaser. If for any reason you are not fully satisfied, if you think it does not fully come up to our guarantee that it is better than any other at the price, return it to your dealer within ten days, and he will immediately refund the full purchase price.

He will not ask any questions. He will take your word, if the product does not meet with your approval. You don't have to prove anything to him.

This guarantee really amounts to a free trial.

Frederic S. Sutherland
President

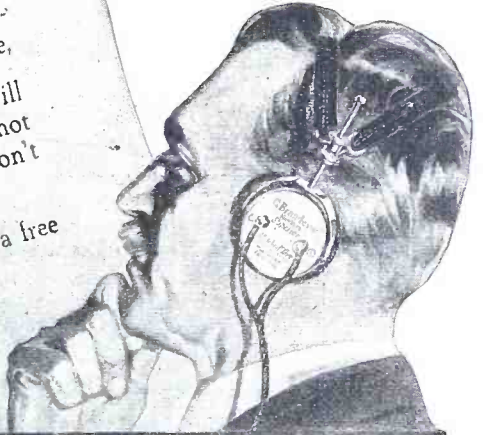

A 16-year-old pledge

More than a million and a half Brandes Headsets and *Table Talkers* are today doing valiant service! With each sale this time-tried guarantee assumes new strength and meaning. It is an old pledge that bespeaks the unlimited confidence of the manufacturer in his products—a confidence based on the continued acceptance of Brandes products by an alert public.

Brandes

The name
to know in Radio



Superior Matched Tone Headset \$6
\$7 in Canada



Table-Talker \$10.
50¢ extra west of the Rockies
In Canada \$14



Navy Type Matched Tone Headset \$8
\$11 in Canada

© C. Brandes, Inc. 1924

Please refer to POPULAR RADIO when answering advertisements.

POPULAR RADIO

EDITED by KENDALL BANNING



CONTENTS for SEPTEMBER, 1924

(Cover design by Frank B. Masters)

VOLUME VI

NUMBER 3

"An Army Moves on Its Ears".....	FRONTISPIECE
How Radio Will Fight the Next War.....	Charles McK. Saltzman Page 219
How to Improve Broadcast Reception.....	John V. L. Hogan..... 230
Helpful Hints on Tuning	
Tips on Tuning.....	Alfred P. Lane..... 237
Finding Mines by Radio.....	E. E. Free..... 238
Simple "How-to-build" articles for Beginners.....	Laurence M. Cockaday..... 246
No. 2: How to Build a Single, Dry-cell Tube, Reflex Receiver	
100 Best Hook-ups.....	Technical Editor..... 249
Installation No. 10	
How to Use a Simple Formula for Determining	
Maximum Inductance.....	Oliver Lodge..... 254
A New and Remarkable Long-distance Typing	
Machine.....	William G. H. Finch..... 257
Practical Pointers for the Listener.....	Y. Z. Muts..... 267
A Measurement Chart.....	Raoul J. Hoffman..... 268
For a Quick Calculation of Ohm's Law: Article No. 10	
How to Work Hard Rubber.....	D. H. Killeffer..... 271
How Radio Brings the College Home to Dad.....	Alfred M. Caddell..... 277
How to Build a Multi-wave Tuner.....	B. S. Bickelhaupf..... 281
(Part I)	
Learning a Modern Art in a Modernized	
"Bohemia".....	288
Where to Look for Lost Energy in Coils.....	Morris S. Strock..... 290
A Radio Set in a Telephone Receiver.....	Harold F. Lane..... 297

DEPARTMENTS

What Readers Ask.....	Laurence M. Cockaday..... 298
In the World's Laboratories.....	E. E. Free..... 304
Hints for Amateurs.....	Albert G. Craig..... 312
"Trouble Shooting".....	S. Gordon Taylor..... 314
Facts You Hunt for.....	Richard Lord..... 317
Broadcasts.....	David Lay..... 319

VOLUME VI

SEPTEMBER, 1924

NUMBER 3

Published monthly by Popular Radio, Inc., 627 West 43rd St., New York, N. Y., telephone number Chickering 1906; Douglas H. Cooke, President; Kendall Banning, Vice-President; H. C. Bodman, Secretary; T. M. Hobby, Asst. Treasurer. Price 25 cents a copy; subscription \$3.00 a year in the U. S., Canada and all countries within the domestic postal zone; elsewhere \$3.50 a year, payable in advance. The International News Company, Ltd., No. 5 Bream's Bldg., London, E. C. 4, sole distributors in England. Entered as second class matter April 7, 1922, at the Post Office at New York, N. Y., under the act of March 3, 1879. Copyright, 1924, and title registered as a trade-mark by Popular Radio, Inc. Copyright in Great Britain by Popular Radio, Inc., 6 Henrietta St., Covent Garden, W. C., London, England. Printed in U. S. A.

E. E. FREE, Ph.D., Contributing Editor LAURENCE M. COCKADAY, R.E., Technical Editor

For advertising rates address

E. R. CROWE & COMPANY, INC.

New York: 25 Vanderbilt Avenue

Chicago: 225 North Michigan Ave.

The GREBE CLARIFIER



Increases Selectivity
Increases Signal Intensity
Improves Quality
Prevents Radiation

And—
Is Easily Connected



\$30



TRADE MARK
REG. U. S. PAT. OFF.

“Do justice to thy neighbor”
—Confucius

Safeguard him against objectionable sounds by the use of the Grebe Clarifier.

Doctor Wu

THE first practical, workable solution of the problem of radiation from regenerative receivers. Unlike the “wave-trap” it increases signal intensity.

Ask your dealer or
write for literature

A. H. GREBE & CO., INC.
Van Wyck Blvd. - Richmond Hill, N. Y.
Western Branch: 451 E. 3rd St., Los Angeles, Cal.

Please refer to POPULAR RADIO when answering advertisements.

PAGES WITH THE EDITOR

THE leading article in this number is destined to attract widespread attention both in military as well as in scientific circles, not only because it contains information that has not heretofore been revealed to the public, but also because the writer, Major General Charles McK. Saltzman, the Chief Signal Officer of the Army, gives it such unquestioned authority.

ONE of the main points of General Saltzman's article is this: that radio is destined to play an enormously important rôle in the next war. And a point of no less importance is this; that the success or failure of this radio work must lie in the hands of the radio experts—those who are today the radio amateurs and the radio experimenters.

EVERY radio fan owes it not only to his country but to himself to learn what the radio experts will be called upon to do in the warfare of the future—and what he personally may be called upon to do. The article on page 219 will set him to profitable thinking.

"You should have a short article on the advantage of an American Radio Time," writes Frederic Shunaman of Crane Valley, Sask., "and send a marked copy to every broadcasting station, urging that the announcer give out all announcements as to future programs in radio time as well as in local time. When that day comes, I will quit doing mental arithmetic."

"I WISH to commend your editorial department upon its freedom from influence by the advertising department."—C. E. Haywood.

AN amusing story comes from the Playhouse Theater in New York of how POPULAR RADIO was the indirect means of breaking up a performance of "The Show Off"—almost!

WHEN this comedy started its career, the actor who impersonates the radio fan who saves the family from ruin (Mr. W. Lee Tracy) was presented with a copy of POPULAR RADIO, which has since appeared in one of the scenes. This copy aroused Mr. Tracy's interest in radio—and he became not merely a stage fan but a real fan. And he furnished his stage aunt, Miss Helen Lowell, with a real receiver to take the place of the stage receiver, too!

DURING the performance one evening he tuned in and accidentally picked up a station from which a critic was reviewing the very play that was then being enacted. The audience could not listen in, but Miss Lowell, who took the earphones, turned red with excitement when she heard the critic laud her acting and nearly missed her lines, which might have meant breaking up the scene.

"INCIDENTALLY," concludes Mr. Tracy, "I now have a set in my dressing room and between the acts I am becoming quite a DX fan."



From Little Meadows, Pa., "sixteen miles from a railroad, mosquitoes and bobbed hair," comes this gay picture from W. R. Bradford, the popular cartoonist of the Philadelphia NORTH AMERICAN. "Wonderful reception in this heretofore dead spot with the Cockaday-acmedyne circuit," he reports. "The greatest distance recorded on a loop has been Mobile, Ala., 1,100 miles from here." . . . But we can't help wondering how the cat stood the journey.



"Experience is the Vital Factor in Excellence"

The first "talking machine" became a finished reproducer of speech and music only by years of experience devoted to gradual development.

THOMPSON SPEAKER

Fourteen years devoted to making radio products furnished the background from which the Thompson organization has perfected the Thompson Speaker.

Each part of the Thompson is the result of the best known engineering experience and these parts are assembled in a manner that is possible only to experienced radio engineers.

The 7 superior and distinctively Thompson features are seven reasons why you should not "Just get along" with an ordinary speaker when you can get a Thompson. \$35.

Few users ever need all the range and power that the Thompson Neutrodyne will deliver. Made by the same organization. \$150 without tubes or batteries.

R. E. THOMPSON MANUFACTURING CO.

Manufacturers of Radio Apparatus for the U. S. Army and Navy and numerous foreign governments

150 NASSAU STREET • NEW YORK, N. Y.
FACTORY: JERSEY CITY, N. J.

Licensed under Hazeltine Patent
Nos. 1,450,080, 1,489,228 and
other patents pending



Please refer to POPULAR RADIO when answering advertisements.

PAGES WITH THE EDITOR

(Continued from page 4)

EVERY week brings increasing evidence that radio is bursting through international barriers and bringing the various peoples of the world into a friendly contact that is leading to an amity and understanding that has never before been possible. Geographical boundaries are meaning less every month to the broadcast listeners. It is only a matter of a short time now when the whole world will be able to listen in on a single broadcast program.

THE real significance is this; with this increase of range is coming an increasing interest in an "international language"—not merely the international code that enables transmitting amateurs of different tongues to exchange messages in a fashion, but a language that all of us can comprehend. Such a tongue has long been the dream of the idealists.

ESPERANTO is one of the oldest of these international languages. But it is now being challenged by *llo*—whose champion is Oscar C. Roos of Boston. "As a sample of *llo*," he writes, "as applied to technical writing, I am sending you a translation of an excerpt from your *With the Inventors* department."

HERE are the two items printed together, for comparison:

ENGLISH ORIGINAL
PATENT NO. 1,468,116

Method of Amplifying Potential Variations.
Invented by Irving Langmuir of Schenectady, New York.

This patent describes certain applications of the fact that the vacuum tube may be employed as a device to limit the amperage of an electric current. The emission of electrons from the filament forms an upper limit to the current that can pass through a tube, no matter what the potential of the grid. In the figure is shown Langmuir's application of this fact to the amplification of the voltage of radio signals, instead of the more usual method of amplifying their current strength. The second tube from the left (which has no grid) acts as the current-limiting device. The plate current of the first tube being thus limited, the difference of potential between the filament and the plate of this tube is variable and reflects, with considerable amplification, the potential variations on the grid of this tube. In this way the changes of voltage in the antenna circuit are greatly amplified before being impressed on the grid of the third tube. The same principles can be applied to the elimination of high antenna voltages due to static.

ILO TRANSLATION
PATENTO NO. 1.468.116

Metodo por ampligo di Potencial—variadi.
Inventita da Irving Langmuir de Schenectady, New York.

Ca patento deskriptas partikulara aplikesi dil fakto ke la vakuo-tubo povas utilisar kom instrumento por limitizar la quanto di kurento elektra. L'emiso di elektroni de la filamento provizas supra limito di la kurento, qua povas trapasar tubo independante de la potencialo dil greto. En la figuro l'aplikeso di ca fakto da Langmuir a l'amplifikado dil volto-quanteso di radio—signali montresas, vice la plu uzuala metodo por multipligar lia kurento—fortesco. La duesma tubo de la sinestro (qua ne havas greto) agas kom kurento-limitizera devizuro. La plako-kurento di la unesma tubo esante tale limitizita, la diferenco di potencialo entre la filemento e la plako di ca tubo varieblas a relektrigas, kun konsiderabla ampligo,

la variesi di potencialo an la greto di ca tubo. Camaniere la volte-kanji en l-anteno-cirkuito ampligas multe ante imprimegar an la greto dil triesma tubo. La sama principi povas aplikesar a l'elimineso di alta volto-quantu di la anteno debita ad atmosferala charji.

* * *

FROM Sacramento comes a letter from a sharp-eyed reader, Dale Hunter, who points out an error on page 26 of the July number, which gave the formula

$$\text{amperes} = \frac{\text{ohms}}{\text{volts}}$$

The formula should have read

$$\text{amperes} = \frac{\text{volts}}{\text{ohms}}$$

As this slip was typographical and as the same formula was given correctly in somewhat different form on page 25, the Editor hopes—and believes—that our readers have not been led astray.

* * *

THE first newspaperman in the world to perceive the value to journalism of the new and remarkable Finch radio transmitter and receiver (described for the first time by the inventor himself on page 257 of this issue) was Marlen Pew, who was the general manager of the International News Service at the time that the apparatus was first called to his attention. Mr. Pew's foresight obtained for his organization the first and exclusive (and for over a year the secret) use of this labor-saving invention; in Mr. Pew's opinion it has greatly increased the speed and efficiency of the machinery for news-gathering.

* * *

ONE of the most flattering tributes to our book, "*How to Build Your Radio Receiver*" (which is given free to POPULAR RADIO subscribers for a limited period), comes from such an authoritative source as to constitute an official appraisal. "I couldn't get the customs officer to appraise its value for less than \$3.00," reports Erskine A. Mowatt of Westmount, P. Q., Canada. "However, I found it well worth the five percent duty!"

* * *

IN the coming number of POPULAR RADIO—for October—will be published the complete working plans of the newest and best of all the receiving apparatus developed in the POPULAR RADIO Laboratory by Laurence M. Cockaday: "How to Build the 4-Circuit Tuner with a Resistance-coupled Amplifier." If this article creates anything like the demand that was created by Mr. Cockaday's five preceding "how-to-build" articles on his own developments, the October edition will sell out in two weeks.

Kendall Trauning
Editor, POPULAR RADIO

“the superior tone quality of Erla Duo-Reflex circuits, as well as their unmatched range and volume, stamp them as the most advanced types yet developed”



Erla Selectoformer imparts to novices expert skill in tuning, easily bringing in long range signals through local interference. List \$5



FACTORY sealed cartons of complete parts now make child's play of assembling time-tested Erla Duo-Reflex circuits, tube for tube, the most powerful ever built.

Synchronizing reflex and audio transformers, tested capacity condensers, balanced crystals, these and other factory-packaged units assure proper materials, while correct construction is made equally certain through a stenciled base-board, drilled and lettered panel, and full-size blueprints showing exact location of every wire. Even soldering is eliminated, through Erla solderless connectors.

Examine a completed Erla demonstrating receiver at your nearest dealer's. See how easy it is to build. Your dealer will gladly co-operate. Or get in touch with us direct, giving your dealer's name.



Erla reflex transformers alone amplify at maximum both received and reflexed radio frequency currents, without distortion. List \$5



Gold, nickel or black Erla bezels enhance any receiving set 100%. Telescoping patented rim fits 1/8" to 1/4" thick panels. List, 20c-30c



Unique ability to amplify three stages without trace of distortion proves conclusively the superiority of Erla audios. List price, \$5



Wiping contact of diagonal, tilted springs exclusive to Erla sockets assures clean, positive engagement, eliminating current loss. 65c-75c

Electrical Research Laboratories
Dept.R 2500 Cottage Grove Ave., Chicago

ERLA



The words "tested capacity" found exclusively on Erla fixed condensers, guarantee accuracy unapproached. Made in 11 sizes, 30ct to 75c ea.

Please refer to POPULAR RADIO when answering advertisements.

The Practical Way to Buy Radio



That button identifies the Ozarka Factory Representative in your city. It is your assurance of complete radio satisfaction.



THE automobile is a success today because of the service station. Little things sometimes go wrong with the best of cars—exasperating to the owner but very easily corrected by the trained mechanic.

The same condition is true of radio instruments. No matter what anyone tells you, the most perfectly constructed radio instrument sometimes requires service.

The pleasure you derive from radio depends not only on the quality of your instrument, but on the quality of the service you can secure on that particular make of instrument.

Ozarka Radio instruments are sold only by direct factory representatives—men who have been thoroughly trained on our instrument *and no other*.

The Ozarka Representative knows every part, every wire of the Ozarka. In fact he completely assembles his own instruments. His training on installations, aeriels, ground connections, operation and service comes directly under our own engineers who designed and perfected the Ozarka circuit.

This method of training men for radio sales and service is not an untried idea. It was originated by Ozarka, Incorporated, two years ago. Today nearly 1900 men are delivering this service. More are right now going thru their training. The sign of the long distance goose is your protection. The Ozarka representative will gladly set up an instrument in your home without any obligation on your part. He will set it side by side with all others for beauty, distance, volume, tone and ease of operation.

He won't tell you he has the best—he'll let you prove it by your own operating, and his complete installed price will be much lower than other instruments of similar high quality. The Ozarka four-tube model for loud speaker operation sells for only \$40.00. Our illustrated book No. 200 describes the Ozarka instrument fully. A copy is yours for the asking. Please mention the name of your county.

He won't tell you he has the best—he'll let you prove it by your own operating, and his complete installed price will be much lower than other instruments of similar high quality. The Ozarka four-tube model for loud speaker operation sells for only \$40.00. Our illustrated book No. 200 describes the Ozarka instrument fully. A copy is yours for the asking. Please mention the name of your county.



More Ozarka Representatives Wanted

RADIO under the Ozarka Plan offers an exceptional opportunity to the right kind of men. 1900 Ozarka Factory Representatives have been trained under our plan to sell, install and service the Ozarka Radio Instrument.

The man we want is now employed—he has held his present position for some time—he is not a "floater" jumping from job to job. He feels certain that there must be some way whereby he can better his condition—he is not afraid to try.

He may not be a salesman, but he can talk convincingly on something that he knows perfectly, and firmly believes in. He may not have much money, but he is not "broke." He is mechanically inclined—he is willing to give Ozarka his spare time in study in his own home under our engineering department.

The Ozarka Plan will give such a man more money, more independence, and possibly his first *real* opportunity to build up a permanent, profitable business of his own which will quickly justify giving it all of his time.

The Ozarka Plan is fully described in a large illustrated book. A copy will be sent to men who are willing to tell us fully about themselves. Unlike any book you have ever read, the Ozarka book is a true story of life, of men, of why they fail, and how they succeed. It is founded on the principle that nothing is impossible to the man who is determined and willing to try.

In territory not now covered, the right man is wanted. The investment in money is small, but the investment in time and study is considerable. If you are determined and willing to put forth the necessary effort to obtain a splendid profitable business of your own, write and say "Send me your Ozarka Plan Book No. 100." It may be the turning point in your life. Don't fail to mention the name of your county.

OZARKA, INC., 806 Washington Blvd., Chicago, Ill.

Please refer to POPULAR RADIO when answering advertisements.

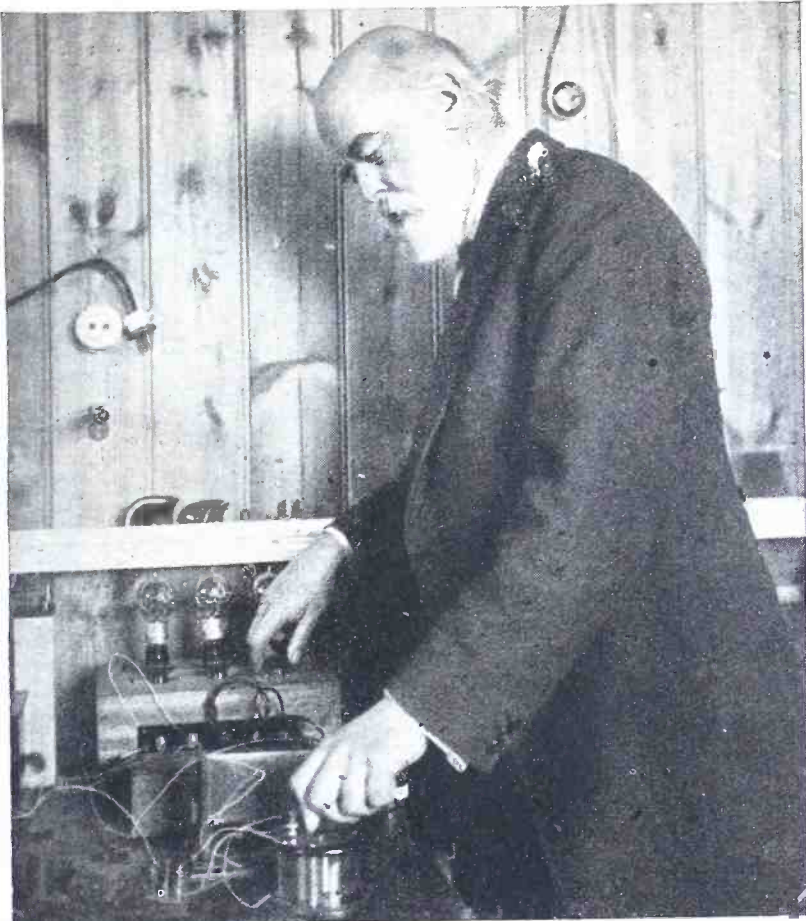

From a photograph of Sir Oliver Lodge made for POPULAR RADIO by Hoppe London

How POPULAR RADIO Is Serving Science

"CONGRATULATIONS to POPULAR RADIO and its successful endeavor to interest readers in scientific principles! . . . I consider that the vogue of wireless is a means of educating the public in some of the principles of science which have a bearing on their favorite pursuit, and that thus a few of them may be diverted into the paths of science. That is one reason why I make use of the opportunity which POPULAR RADIO seems to offer."

Oliver Lodge

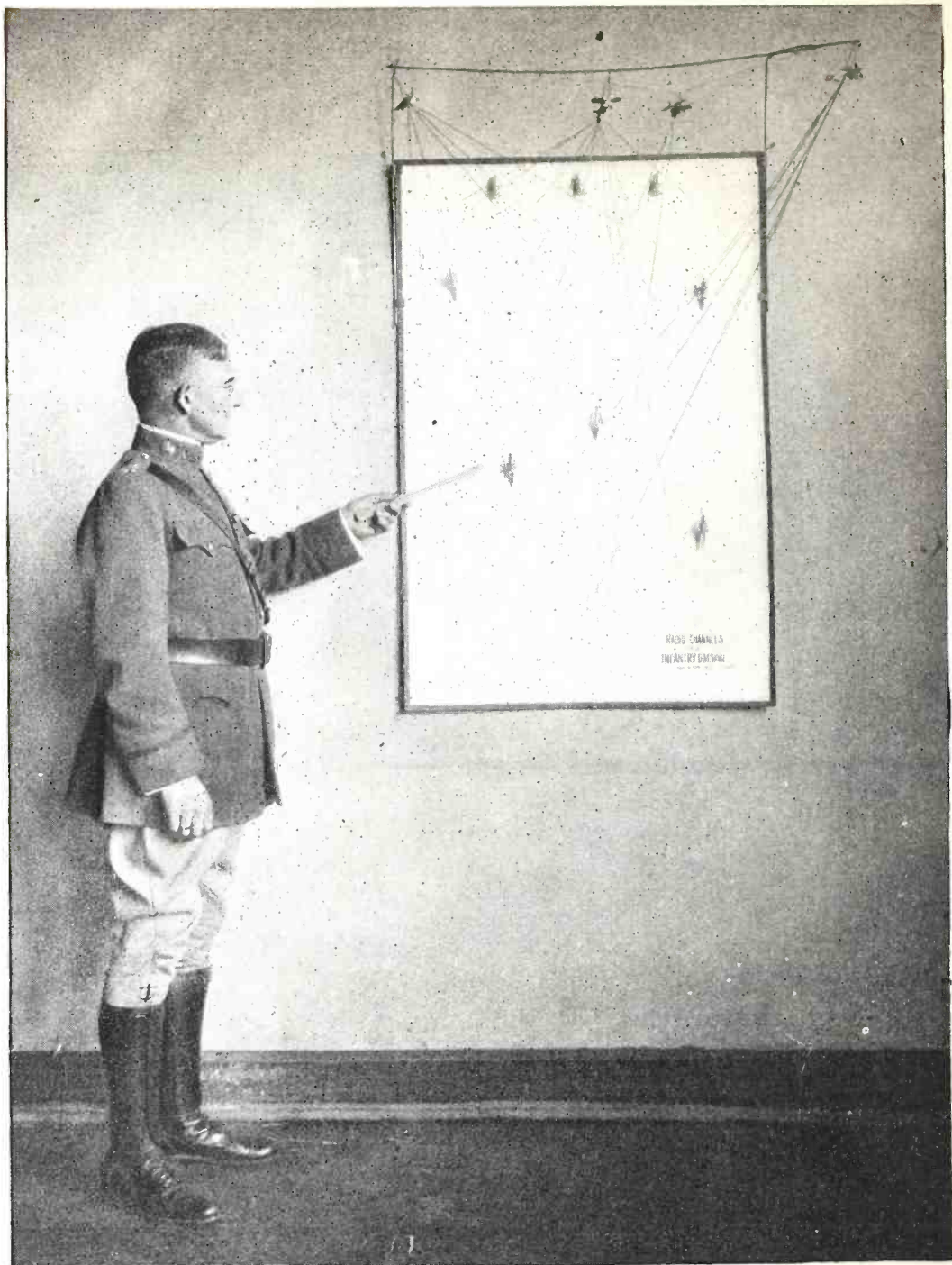

From a photograph made for POPULAR RADIO

"An Army Moves on Its Ears"

GENERAL SALTZMAN explains, by the aid of this map-diagram, how radio provides the necessary means of instant communication between the units attached to an infantry division at the front. At the end of his pointer are the model guns representing the supporting artillery; on the front line are the tanks, and still farther in advance are the airplane scouts. All are linked by radio to General Headquarters and to the commanders of the infantry units.

Popular Radio

VOLUME VI

SEPTEMBER, 1924

NUMBER



How Radio Will Fight the Next War

The tremendous influence that the new science is destined to have upon military and naval operations of the future, as viewed by one of the country's military leaders—

MAJOR GENERAL CHARLES McK. SALTZMAN
Chief Signal Officer of the Army

IT has been said many times in the past two years that radio will be the most essential scientific weapon of the next great war. The sudden and remarkable development of broadcasting, with its attendant rapidity of technical progress and its unexampled arousal of public interest in the possibilities of radio forces, has directed the attention of all imaginative scientists to the warlike possibilities of these marvelous new energies and implements.

There are predictions of manless airplanes directed by radio and arriving suddenly from some distant base to shower explosives on forts or fleets or to spray great cities with a fatal rain of chemicals. We hear of destructive rays capable of blowing up instantaneously the entire ammunition supply of a citadel or of converting

shrivelled corpses in the twinkling of an eye. Terrible mechanical men, of dimensions and possessed of superhuman power are predicted as one device of radio control. These monsters will plow through an army, it is claimed, as an elephant through a flock of sheep.

It is a bold man who will set his face nowadays to the accomplishment of preventive science. It is possible that terrible devices will be invented which they will work as much destruction as claimed for them by the madmen. But they have not been invented. The military experience of past centuries indicates that if they are

Nevertheless, there is an important sense in which the next great war will be, inevitably, a radio war.

Radio is essentially a means of communication. That is its use at present. So far as we can see, that will be its chief use in the future, whether that future be one of war or of peace. And it is as a means of communication that radio finds—and probably will continue to find—its especial importance in the military arts.

It used to be said that an army moves on its belly. In a sense that is still true. The services of supply which provide to the mobile forces a sufficiently constant stream of things to eat and drink are among the indispensable essentials of a successful campaign.

But in another sense, an army moves on its ears. Communication between the different units engaged in a joint military operation is quite as essential as is the continual supply of food, replacements and ammunition. Indeed, over short periods it is more essential. A military unit can exist for some hours without either food or water. It may hold out for days without further supplies of ammunition and without reinforcements.

But, a fifteen-minute lapse of communications at a critical moment in any modern operation may bring a whole campaign to naught and cause the useless sacrifice of thousands of lives.

If communications were perfect all along a battle front and were never interrupted, there would be no more Lost Battalions. What is still more important, there would be many fewer lost battles.

The chief business of radio in warfare is to see to it that this perfection and constancy of communications is maintained so far as may be humanly possible.

The backbone of radio communication in a battle unit is what is called the "radio net." This consists of a considerable number of what are called "channels" of communication between the different units. These channels

should be separate and non-interfering.

At the very front of a battle line there are the infantry battalions and the posts of observers, machine-gun squads and the like. Whether they occupy fixed positions, as in trench warfare, or whether they are moving more or less rapidly, as in a mobile campaign, it is these front-line troops and units that are in continual contact with the enemy. Communications between them and the headquarters farther to the rear are a vital necessity, not only to provide exact and up-to-the-minute information of the movements and actions of the enemy, but also to control the movements of the front-line troops themselves in proper accordance with the general plan of battle, which plan itself is changing continually as the field situation develops.

Each front-line post must be provided, therefore, with a dependable channel of communication leading to the immediate headquarters of that post; usually to the headquarters of the regiment to which that post belongs.

These regimental headquarters must then be tied by a dependable communication channel to the headquarters of the brigade. Brigade headquarters must be tied to the headquarters of the division; these must connect with the headquarters of the army corps; corps headquarters must have connection with the general headquarters of the army, and so on.

In addition, there are necessary a number of collateral communication channels. Airplane squadrons attached to the divisions or brigades must be connected with the proper headquarters. Observation balloons must have their provision for sending in the needed information of visible enemy movement. Supporting artillery must be in continual touch with the forces with which they are working as well as with their own observers in airplanes or in especially placed observation posts.

The communications organization of an army in the field requires in the neighborhood of 240 separate communi-

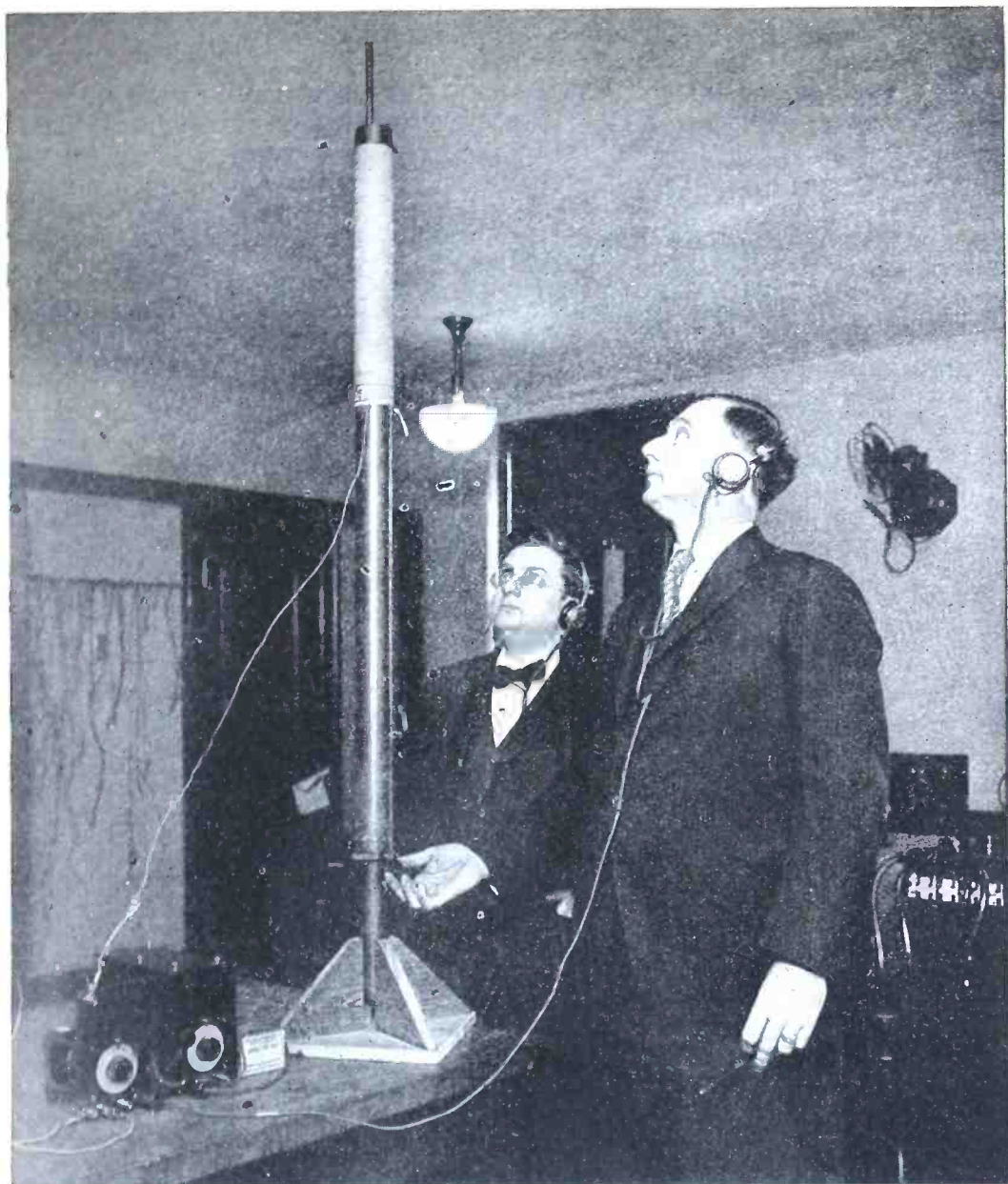

From a photograph made for POPULAR RADIO by Harris and Ewing

THE NEW FIFTY-METER RECEIVING COIL OF THE ARMY

Lieutenant Colonel J. O. Manborgue, on the right, is explaining to Dr. E. E. Free the characteristics of the resonance coil receiver developed recently for the army's work with short wavelengths. This coil is adjustable for precise tuning and has been used successfully with waves as short as fifty meters. Such sets will be extremely useful, it is expected, for communication to and from the front-line units of an army.

cation channels. It is not always necessary that radio should provide all of these, but it is important that radio should be able to provide them all in

case of need.

This brings us to the first great problem which the Signal Corps of the United States Army has been compelled

to work out in devising a radio combat plan for our troops. It is the problem of keeping all these channels separate.

By increasing the selectivity of the radio sets in use and by making use of shorter and shorter wavelengths, especially for the front-line posts and for the smaller and more mobile units, this problem is being solved. It is possible, now, to equip a combat organization in the field with the necessary communication network in such fashion that inter-

ference between adjacent units is not a serious handicap.

We have about reached, however, the possible limit to the number of separate, non-interfering channels that can be provided in this way. If the combat forces of the army demand additional communication channels, as it is probable that they will, the radio engineers must look in new directions for their provision.

One of these directions is the use of



International

RADIO ORDERS TO THE TANKS

Radio apparatus which will work inside a tank in action, in spite of the tremendous noise of gun-fire and machinery, has been perfected by the Signal Corps. By this means the tanks that constitute the first line of an attacking force can be kept in continual touch with the infantry that follows them and with the artillery that covers their advance.

the extremely short wavelengths. The radio authorities of the French army have already made use of waves as short as 1.5 meters. Still shorter waves than this are well known in laboratory work. The shortest radio waves of all, those of infra-red rays—the so-called “black light”—have already been put to use for communication purposes by the Signal Corps of our army.

It is distinctly possible that radio sets working on waves between twenty meters and a few centimeters can be perfected to a point where they will provide some hundreds of additional non-interfering channels for communication between the front line units. Between these units it is not necessary that long distances be covered and accordingly the high absorption of the very short waves by the atmosphere and other obstacles is no particular objection.

Indeed, in some ways this high absorption and short range is a positive advantage. It helps to prevent inter-

ference between neighboring units on the front line. The commander of a battalion in the trenches or of a forward placed machine-gun post must not only be able to communicate with his own headquarters in the rear but he must be able to do so without interference from the similar communications of his neighboring commanders to the right and left of him.

Another possibility of further multiplication of communication channels lies in the use of directive radio beams. Experimentation on this has already gone far enough to assure us that it is possible to restrict the transmitted waves of a properly constructed station to a comparatively narrow wave front. Progress in this direction is sure to be rapid and will provide, obviously, a great increase in the number of possible non-interfering channels.

A third possibility of acquiring additional separate channels lies in what might seem at first sight to be a backward

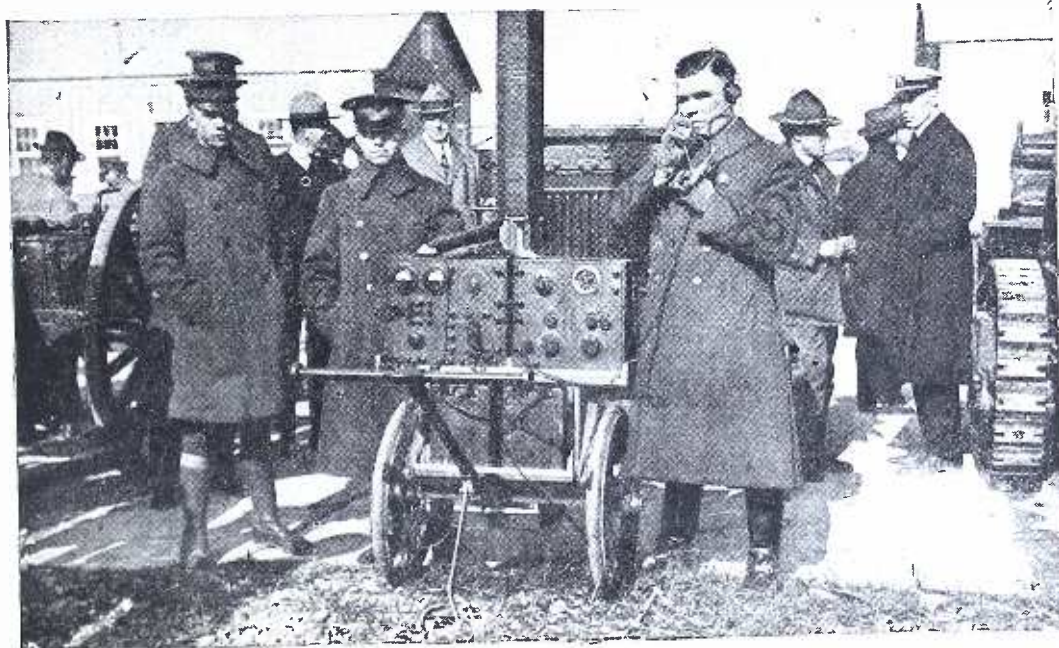

Underwood & Underwood

THE PORTABLE TRANSMITTER FOR TANK CONTROL

This transmitting station, mounted on a truck, is used by the officer commanding a tank advance. Over his radio telephone this officer keeps in continual touch with the men inside each of the moving tanks. On top of the transmitter truck is seen the resonance wave coil antenna. Similar antennas serve for reception on the tanks.

step. This is the use of wires.

Wire telephones have been the main reliance of armies in all recent wars. They were a great advance over the former wig-wag and courier systems but they were far from perfect. Wire breakage is too frequent, especially in an area that is subject to bombardment by artillery or by airplanes.

The recent development of line-radio methods may go a long way toward meeting this difficulty. If radio waves are used on the wires instead of the older direct-current telegraph or ordinary telephony, breaks in the wires do little harm. The radio waves leap the gap and go on. It is probable, therefore, that line radio over wires will be an important feature of army communications in the next war.

Still other increases in the number of channels are possible by such devices as the Hammond double-modulation system, the use of multiple codes and the like. There is small doubt that the next few years will demonstrate that radio will be able to provide as many non-interfering channels as the army may demand, even

if this number should run into thousands.

In this question of non-interfering channels, there is another matter to be reckoned with. This is our intentional interference with the radio communications of the enemy and the prevention of his intentional interference with ours.

During the last war the experts of the German navy worked out an ingenious interference producer consisting essentially of a sending set with two rotating variometers. This set transmitted a continual "mush" covering all the ordinary wavelengths; leaving clear, however, one single channel through which their own radio communication was to be conducted.

It is understood, however, that the operation of this device in practice was not an entire success. In spite of the intention to keep open one single channel for uninterrupted use, it was found that the interference with German communications was even more serious than the interference inflicted on the enemy.

This is the probable result of any such device. It is unlikely, in actual warfare, that any enemy would attempt to fill the

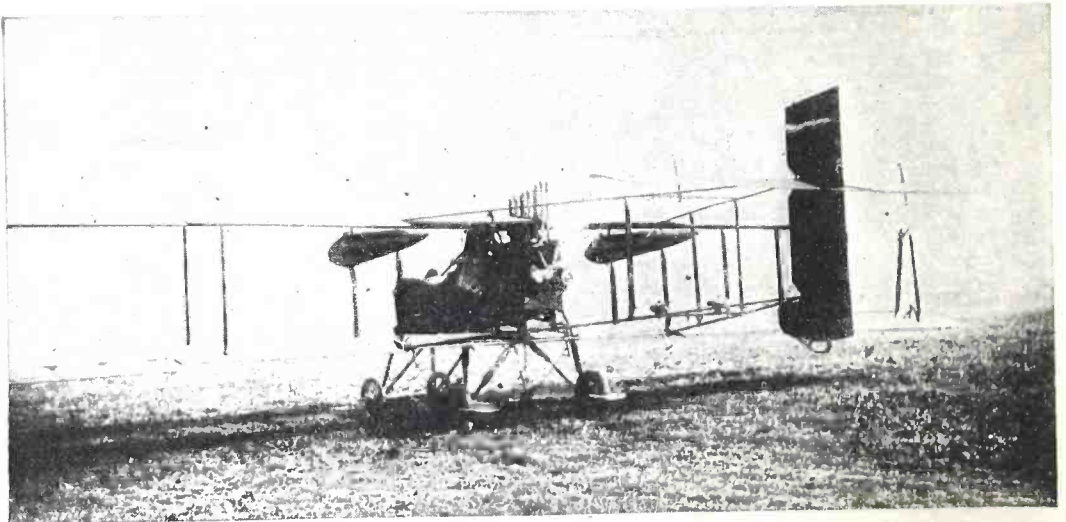

International

THIS RADIO-CONTROLLED AIRCRAFT IS LIABLE TO CAPTURE

The radio experts of a defending force may be able to interfere with radio-controlled devices sent against them. In aircraft warfare radio will be more useful, General Saltzman believes, for ship-to-ground communication than for automatic control. On the lower right wing of this airplane may be seen the two wind-driven generators that supply the power for the radio transmitter.

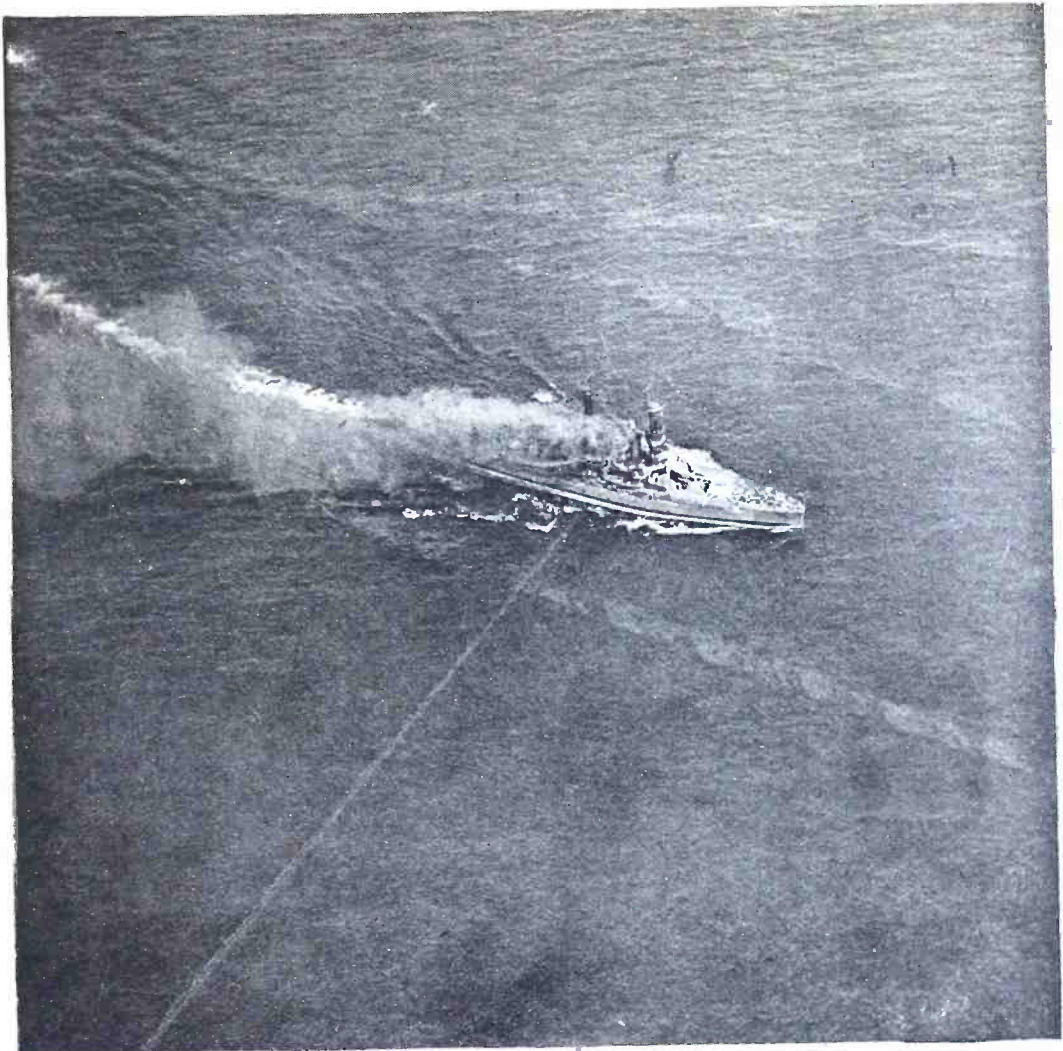

Official photograph, U. S. Navy

TORPEDOES MAY YIELD TO RADIO CONTROL

Torpedoes directed by radio signals have been perfected and tested. But these tests have not allowed for intentional interference. The radio experts of the threatened ship may be able to send out radio waves of their own that will deflect the approaching engine of death or cause its mechanism to jam. "It is one thing to hit a target," says General Saltzman, "and quite another thing to hit a man who is trying to shoot you."

ether with an interfering mush. There would be too much danger of spoiling his own communications. The kick of the gun would be worse than its bullet.

There is a real problem, however, in the maintenance of secrecy. What you send out by radio the enemy can pick up as easily as you can. Ordinary telegraph codes are a very insufficient protection, for what one man can devise in

the way of a secret code another man can read if he has time enough.

That last is the crux of the matter. You must see to it that the enemy lacks time to read your code. Hence the desirability of the mechanical code writers which automatically scramble a radio message at the sending station and unscramble it at the receiving one. The codes of these instruments can be altered

at intervals according to a pre-arranged scheme. By the time the enemy has secured the clue to one code, that code has been abandoned and another one is in use.

Still further possibilities lie in the use of the new radio-vision devices. Machines like this could send written messages, coded or uncoded, from the front to headquarters or *vice versa*. Maps or photographs could be sent also and would be of tremendous assistance in planning or carrying out all kinds of military operations.

All such visible materials could be automatically scrambled and unscrambled by the sending and receiving machinery. A double code would be possible; one for the radio transmission, another for the printed message or other material that was sent. That the enemy could read such a double code in time to do him any good is extremely doubtful.

Another problem that the Signal Corps has had to meet in designing a communication network for the army is the problem of mobility. It is impossible to lug around a complete broadcasting station with each infantry battalion. Neverthe-

less, it is essential that the front-line posts shall be able to transmit as well as to receive.

The solution of this problem is the portable set now in use in the army and known as SCR-77-A. This set weighs but seventy-five pounds and is operated by two men. The antenna is a loop. Power is supplied by batteries. The wavelength range is from seventy-four to seventy-six meters, providing nine non-interfering channels for communication. A break-in device provides for two-way communication.

This set can be picked up at a moment's notice and carried along behind advancing troops. On arrival at a new position the set is merely placed on the ground, a few adjustments are made, and in a minute or less the set is ready either for transmission or for reception.

This SCR-77-A set has weaknesses and shortcomings, but so had Dr. Alexander Graham Bell's first telephone transmitter. This set was the first short-wave set ever designed for a military purpose, and the Signal Corps deserves great credit for its initiative in entering a comparatively unknown field of re-



THIS MAP WAS SENT AND RECEIVED BY RADIO

To demonstrate the possibility of sending military maps from one part of the army to another very rapidly, POPULAR RADIO requested Mr. C. Francis Jenkins of Washington, D. C., to send and receive this map over his apparatus for transmitting photographs and drawings by radio.



Kadel & Heroert

NO MORE LOST BATTALIONS

These Signal Corps men attached to the training station at Camp Vail, New Jersey, are demonstrating how easy it is for troops accidentally isolated in the field to rig a temporary antenna and get in touch with their comrades back at headquarters.

search and development to bring forth a new type of radio apparatus. Notwithstanding any defects in this first short-wave set, the results have been far reaching and will be reflected in other short-wave equipment of the Signal Corps.

The chief problem in providing still greater mobility than this—if, indeed any greater mobility be necessary—is the problem of high-tension current for the plate supply. Dependable batteries competent to supply this are both bulky and heavy. Possibly some inventor will produce some day a method of sending out radio power from the rear so that this power can be used to supply mobile sets on the front.

If this could be done, every front-line commander could carry his own individual radio telephone in his pocket and be thus in continual mouth-to-mouth communication with his commander back at headquarters. This has already been provided for airplanes in flight, where

the motion of the plane supplies the necessary power for the transmitter.

As another future solution of this problem, some radio engineers dream of a way of adding a local modulation of a wide-spreading system of standing carrier waves created by a powerful central station well behind the lines. This is merely a variant, of course, of the idea of sending radio power to the mobile stations. Which of these ideas, if either of them, will prove to be the final solution of this problem it is not now possible to foresee.

The final problem of army radio communications is that of speed. This is related to the problem of providing more channels. The more words that can be handled by one channel the fewer channels, in general, will be necessary. Speed is also important for its own sake. Quick communication between headquarters and the front may be quite as important as sure communication.

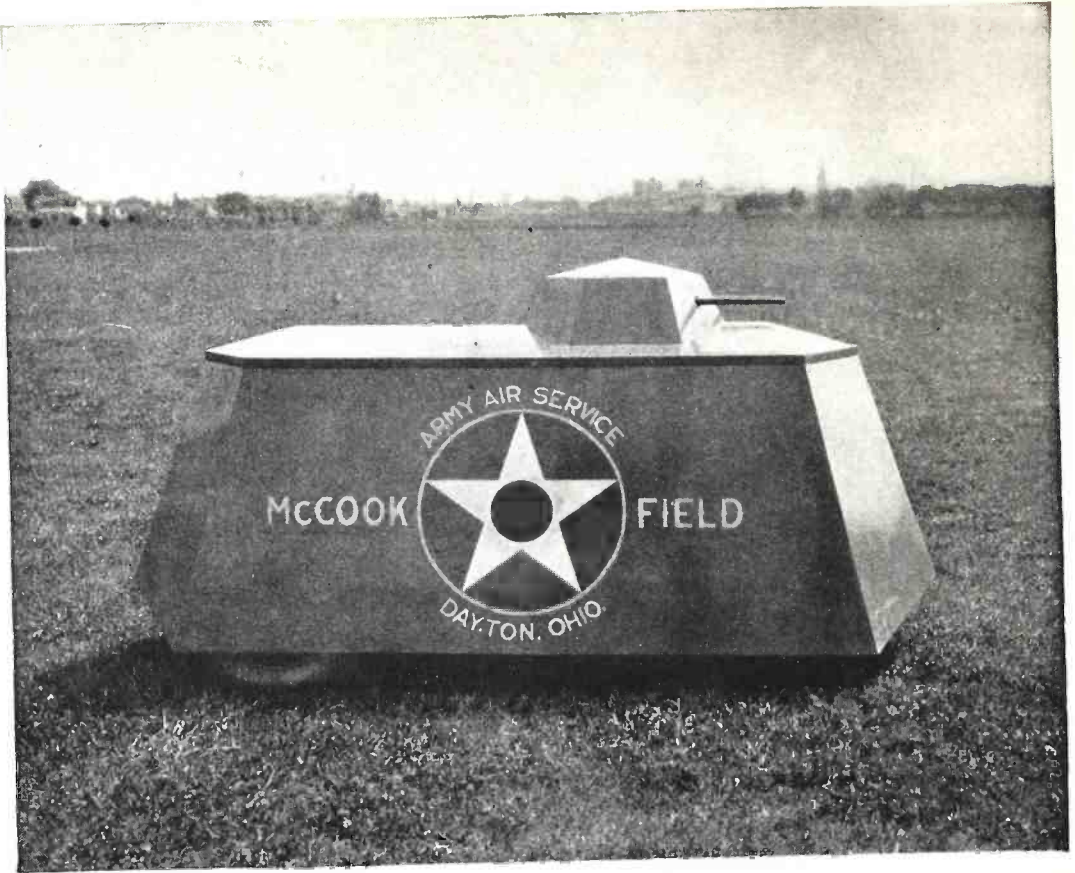

Official photograph, Army Air Service

THE ARMY'S RADIO-CONTROLLED TANK

This model armored car, now at McCook Field, Ohio, has been operated successfully by radio signals sent out from an airplane flying overhead. This same tank, entirely unoccupied, ran through the streets of Washington under the direction of a radio operator riding in an automobile many yards behind.

One suggestion is the use of double modulation for telegraphy; dots being sent at one frequency, dashes at another frequency and spaces at a third. By using the codes and devices already available it has been possible to send as many as 1,000 words a minute. It is probable that this speed can be greatly increased even with usual radio apparatus. The radio-vision apparatus provides for still more considerable increases, since a page of printed matter containing several thousand words can be sent by this apparatus in a few seconds.

Radio is already well equipped, as you can see, to provide future armies with the communications that they need; the "ears" without which no army can move

or fight. Now how about the predicted applications of radio-controlled machinery?

There is no denying that these applications are possible. Ships have been directed by radio; automobiles have steered themselves through the streets of Washington, the operator seated at his radio transmitter in another car following along behind; manless airplanes have been flown successfully by radio signals from the ground.

Still more spectacular predictions such, for example, as the flight of destructive aerial torpedoes controlled from airplanes flying in safety far behind and above their convoy; these are also possible so long as nobody interferes.

It is the same old problem of it being easy to shoot a man with a rifle. Anybody can do this when the "man" is a pasteboard dummy set up a few yards away. But when the man is as active as you are; when he too has a rifle and when he is trying his best to shoot *you*, markmanship becomes a different matter.

Just so with these radio-controlled torpedoes and poison-charged airplanes. The calamity howlers who fear them so much forget the possibilities of defense. It is usually not so very difficult to discover the code that underlies the radio signals by which such radio-controlled devices are operated. Transmitting stations of the defending army might be able actually to capture such engines of destruction and return them to their senders. A lesser degree of interference, sufficient in most cases to destroy the effectiveness of the radio control, would be still easier to accomplish.

When the old battleship, the *Tozca*, was fired on and sunk under radio control off the Carolina capes, nobody was trying to interfere. The radio control officers had the ether to themselves. It would not be so in war. Maybe under the conditions of real warfare, the battleship would have responded to enemy signals, turned around and proceeded to ram her supposed controllers.

The history of warfare has been a well balanced struggle between inventions for offense and inventions for defense. The invention of ship armor was met by the invention of the armor-piercing projectile. The use of poison gas was met by the perfection of the

gas mask. Neither the destroyer nor the protector is ever very far in advance of the other.

And so, we may be sure, it will be with whatever real "death rays" have been invented or will be invented. If radio turns itself to destruction, some other branch of radio will be turned simultaneously to the duty of protection.

Meanwhile, the real business of radio in warfare will be that service that it alone can render efficiently, the service of communication.

This brings us, finally, to what remains one of the most pressing problems of the Signal Corps. This is the provision of adequately trained men for quick service in case of war. A competent radio man cannot be created by signing a paper or by pinning a chevron on somebody's sleeve. It takes months of hard study. The best men need not only months but years of experience.

How are we to get these men in time of war?

The only visible source is the great and growing body of American radio amateurs. It is to be hoped that every patriotic amateur will take the trouble to acquaint himself with the needs of the Signal Corps and with the things that he, the amateur, must know in order to serve his country in time of war.

Only thus will radio be ready to do its bit. The best plans in the world, the last word in technical knowledge and equipment, will not avail one iota if we cannot obtain, should we need them quickly, the men to operate this equipment and to make these plans effective.

Is Radio Guarding the Morals of Our Boys?

"THE percentage of juvenile cases among boys in the courts in this country has been reduced in the past two years about 41 percent, which is due very largely to the interest in radio."

—MANSEL M. KEITH



A SWINGING ANTENNA LIKE THIS CHANGES THE TUNING
Antennas rock when the bough bends or the tree sways in the wind. If the wind blows the tree toward the house, the antenna sags down to the position shown in the dotted line. This changes the capacity of the antenna and is often the cause of fading signals.

HOW TO IMPROVE BROADCAST RECEPTION

Helpful Hints on Tuning

An article of practical value to every user of a radio receiving set, written by one of the world's foremost radio authorities—

JOHN V. L. HOGAN

AN odd thing about the transmitter defects (described in the article of last month) is that their effects upon the receiver are in a number of respects like those of certain defects which may exist in the receiving set itself.

Where the difficulty in reception is caused by something that has gone wrong at the transmitting station, you have, of course, no direct cure available to you. You may write to the broadcasting station explaining the trouble and your observations upon it; and you should do that in every instance, for you will thus be helping not only yourself but thousands of other listeners.

On the other hand, if the defective operation is to be blamed upon your own receiving apparatus, you have the opportunity of remedying it right before you. All you need is a little information as to what produces these possible troubles in radio receivers, and a few suggestions as to how they may be eliminated.

It is probably worth while, therefore, to interrupt our discussion of transmitter troubles at this point so that we may consider for a moment some of the things that can happen at a receiving station and which will produce similar effects.

Unless you are able to determine definitely whether some particular phenomenon is due to a cause existing at the radio sending station, you will naturally hesitate to write to the broadcaster about it. There would be the distinct possibility that the trouble really lay in your own receiver and that the broadcast station management could do nothing whatever to help you!

Frequency Changes in Your Receiver

Let us first take up the effects produced by variations in the frequency of the carrier wave received from a radio-telephone transmitter, so that we may find out what things can happen within your receiving set and there produce similar effects.

As I pointed out last month, fluctuations in the frequency of a carrier wave may occur slowly, or with moderate rapidity, or even at a high rate. The resulting effect will, of course, be different in each of these cases.

A slow change of carrier frequency will cause the signals heard in a sharply tuned receiver to vary slowly in strength, as the wave swings in and out of

resonance with the receiver. It is almost obvious that an identical effect would be produced if something caused the resonant frequency of the receiver to vary slowly, for then, assuming the carrier wave to remain fixed in frequency, the receiver itself would slowly swing in and out of tune. As the receiver's tuned frequency departed from the frequency of the carrier wave, the signals would necessarily weaken, only to become stronger again as the receiver returned to resonance with the wave frequency.

Possibly you are one of those listeners who has always thought that the frequency to which his receiver responded best was determined by the settings of the dials and by nothing else. An impression of that kind is certainly warranted by some of the discussions of tuning that have been written, but it is really far from the fact. Where we are considering only the closed tuned circuits of a receiver, that is to say, the circuits in which a coil is shunted directly by a condenser for tuning, it is safe to consider that the tuning depends mainly (if not entirely) upon the

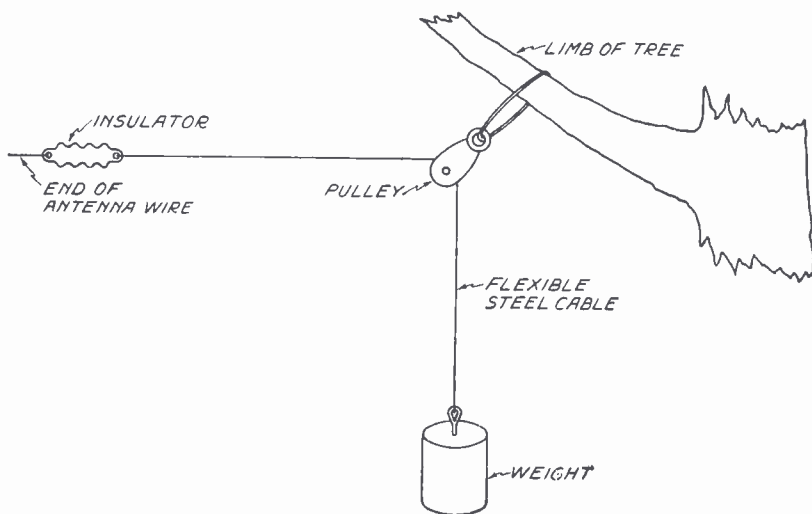

THE RIGHT WAY TO FASTEN AN ANTENNA TO A TALL TREE

By using a pulley and weight fastened to the end of the antenna (as shown above) you can get rid of the trouble caused by the swaying of the tree in the wind. The weight takes up any slack in the wire and keeps the antenna always at the same tension and consequently always at the same distance from the ground.

values of the coil and the condenser, and that some particular setting of the tuning condenser is invariably best for the reception of some single wave frequency (or wavelength). On the other hand, where the antenna circuit is to be taken into account the situation is very different.

How to Tune the Antenna Circuit

It is probable that most of the receiving sets in use require reasonably accurate adjustment of the antenna circuit in order to give good signal strength from moderately distant stations. Such adjustment means that the natural electrostatic capacity of the antenna, in conjunction with its inductance, must be balanced against the inductance of the coils and the capacity of the condensers that are connected in the antenna-to-ground circuit within the receiving set. The resonant wavelength of such an antenna circuit, or (which is another way of saying the same thing) the wave frequency that will best be received at any time, is controlled by the values of *all* these inductances and capacities. Thus, even though you may leave the adjustable coils and condensers within the receiving set at any fixed value, the

slightest change in the inductance or capacity of your receiving antenna will change the "tune" of your receiver. If the change in the antenna circuit is slight, the effect may not be serious; also, if your receiver uses a broadly tuned (or so-called "aperiodic") antenna circuit you may not notice the variations. On the other hand, (and this is the situation with most of the receivers in use), if your antenna circuit is sharply tuned you will find that fluctuations in your antenna constants will make themselves felt to a serious degree.

It is a fortunate thing there are only two general causes for such changes in antenna capacity and inductance. One of these is the actual movement of the receiving antenna with respect to other conducting bodies in its neighborhood, and the other is the variation of capacity of other wires or conductors located near the antenna under consideration.

Variations of Antenna Capacity

Taking up the first of these, it is not hard to see that if your antenna is a long wire, hung loosely so that it may swing in the wind, it will have a larger capacity when it dips down toward the earth than when it is drawn high above the ground.

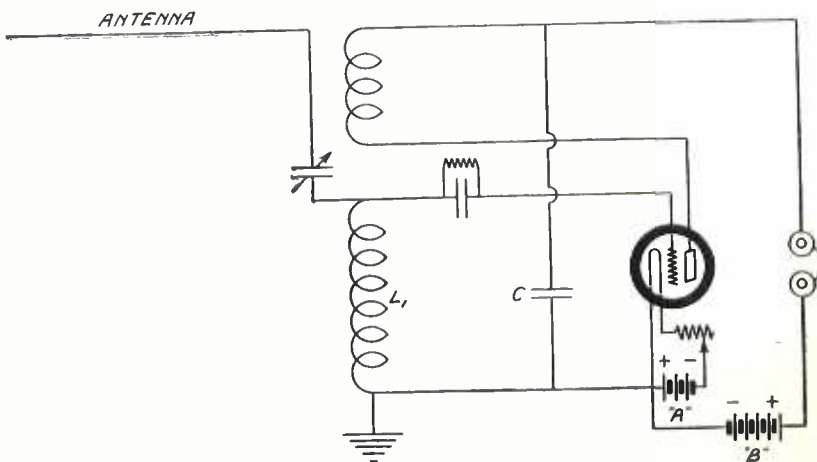

THE SINGLE CIRCUIT IS SENSITIVE TO ANTENNA CHANGES

The secondary circuit is the most sensitive part of any receiver and in the single circuit the antenna is directly connected to this part of the receiver. Three-circuit sets, especially those in which the antenna is left untuned, are affected very little by changes in the capacity of the antenna.

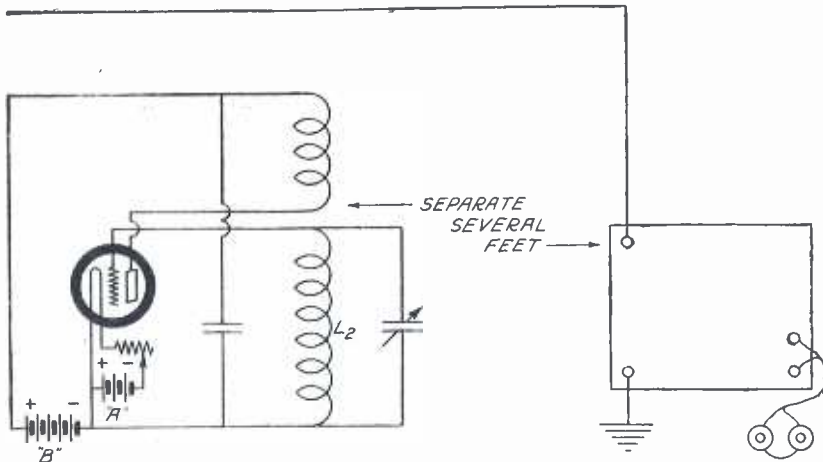

HOW TO TEST FOR VARIATIONS IN THE RECEIVING SYSTEM

On the right is the receiving set (such as is shown on the preceding page) or any other set which is to be tested. On the left is shown a circuit for an oscillator capable of producing continuous and steady radio-frequency oscillations. By tuning the two sets to the same or "beat" note, variations in the receiver will produce periodic howling noises.

This is simply because the antenna wire acts like one plate of a condenser, the other plate being the conducting surface of the ground; we all know that the nearer the two plates of a condenser are placed together, the higher will be the capacity of that condenser. The changes of capacity produced by a slight swinging of an antenna wire may be so small as not to affect tuning appreciably, but as a practical matter it is not uncommon for received signals to fade out and swing in again as the antenna drifts back and forth in the breezes.

In most instances such variations in signal strength, caused by changes in the receiving antenna, sound very much like the signal intensity variations that are caused by frequency fluctuations at the transmitter. Indeed, they also sound a good deal like the common "fading" effects that are due to the little-known changes in space between the transmitter and the receiver. Usually, however, when the soaring of signal strength is caused by movement of the receiving antenna wires it is of more or less regular or periodic occurrence; that is, the signals swing in and out a more or less definite number of times per minute,

corresponding to the mechanical swings of the antenna wires.

The obvious cure for this particular defect is to string your receiving antenna fairly taut, and if it is suspended from a tree or other support that can sway in the wind, to rig it with a weight and pulley so that it will not dip toward the ground. This alone may not be enough, however, for if there are telephone lines, power wires or in fact any conducting bodies near the antenna, and if they can swing or move toward and away from the antenna wire, its effective tuning will be changed by their motions. For best results, then, you must not only prevent your own antenna from swinging but you must locate it out of the vicinity of all other conducting bodies that *can* move.

A Test for Frequency Variations

There is one infallible test by which you can determine whether variations in signal strength are caused by fluctuations at the transmitter, by changes in your receiving antenna constants, or by a "fading" effect in space between the sending and receiving stations. By connecting a simple tuned-antenna (single-

circuit) regenerator to your antenna and tuning it to a moderately distant broadcasting station *while allowing the receiving set to oscillate*, you can find out whether the fluctuations are of frequency or of intensity. To do this, you should adjust the receiver to oscillate at a frequency just the veriest trifle different from the frequency of the carrier wave. This can be done by setting the tuning condenser or inductance as closely as possible "between the two whistles" that are characteristic of oscillating-receiver or heterodyne reception, and carefully tuning to one side or the other so that a slow beat-flutter in the signal is heard. Such exact adjustments are difficult unless you use a vernier or geared condenser, but in that case are not hard to obtain.

With the regenerator so adjusted, listen carefully to this fluttering sound produced by the slow beats between the carrier wave and the oscillations of your own receiver. If the flutter swings in and out, or if it turns into a musical tone of varying pitch, you may be certain that frequency changes are taking place somewhere in the system. If the flutter or the low musical beat note remains practically constant, but the sounds increase and decrease in intensity, you may be sure that the carrier wave is constant in frequency, that your antenna does not swing enough to worry about, and that the fading is caused either by power variations at the transmitter or by fluctuations of the "carrying power" of the space between your receiver and the transmitting station.

How to Find Out Where the Change Occurs

Let us assume that this test shows, by the changes in pitch of the beat-note heard when you allow your regenerator to oscillate at a frequency very near to that of the carrier wave, that somewhere in the system there is a change of radio frequency going on. The next thing to find out is whether the frequency

variation is at the transmitter or in your own receiver. This is easy. All you have to do is to set up a radio-frequency oscillating circuit (which may be another regenerative receiver) near, but not too near, to your own receiving set, and pick up the oscillations which it produces. Such an oscillator will generate radio-frequency currents of practically constant frequency for reasonably long periods of time and you should have no difficulty in producing a beat-note signal between its oscillations and those of your own receiver.

If this beat-tone is constant in pitch, even when the sound frequency is reduced to a very low note or flutter, you can assure yourself that your receiver's oscillation frequency is uniform and, therefore, that your antenna does not change appreciably in its constants under the conditions of your tests. It is a fair conclusion, having procured these results, that the frequency variation is occurring at the radio transmitting station upon which the observations were taken. This can be checked by stopping your receiver from oscillating, tuning it to the transmitter in question and then adjusting the second oscillator (which uses no antenna, of course) to make beats with the wave currents from the broadcasting station. If these beats are of variable pitch, that is, if the beat or note frequency changes while you are listening and without your touching the receiving set or oscillator, it is proof that the carrier wave is varying in frequency and you are entirely justified in writing to the broadcasting station to ask them to steady things up so as to permit improved reception.

Changes in Nearby Conductors

The second general cause of changes in the inductance and capacity of receiving antennas is even more serious than the mechanical swinging discussed above, but fortunately it does not happen so frequently.

Where a large number of receiving sets are installed close together, however,

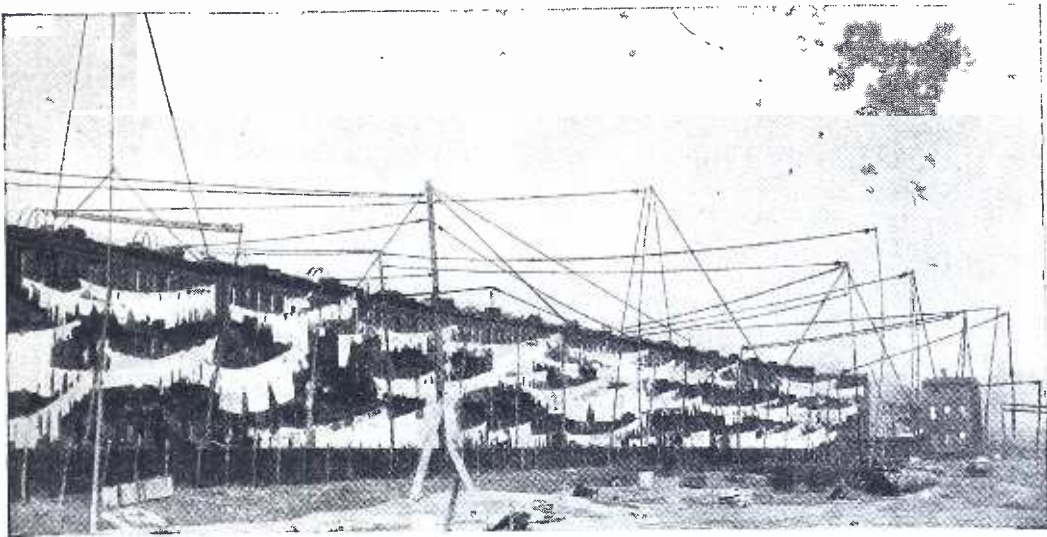

CARELESS TUNING CREATES RADIO CHAOS WHERE ANTENNAS ARE PLENTIFUL

In neighborhoods where antennas are strung close together, great care must be used in tuning; otherwise the set will break into oscillation and spoil the reception of every other nearby receiver.

as in the same apartment house, it often creates a great deal of annoyance. This second cause is the variation of capacity of conductors in the vicinity of the receiving antenna. For instance, if another receiving antenna is hung within fifteen or twenty feet of yours and is connected to ground through a receiving set, the operation of tuning that other instrument is likely to throw your receiver out of adjustment.

To illustrate this, let us assume that you have "tuned in" the signals that you desire to hear from some particular broadcasting station. This has been done, we will say, while your neighbor's antenna tuning condenser is set at 20° on the scale. If, now, he moves his condenser to 80° (for example) he may increase the effective capacity of his antenna, and, also, because your two antennas are close together, increase the capacity of yours. That would be likely to throw your receiver so far out of tune that the signals to which you were listening would vanish quite without warning, and you would have to retune your set to bring them in again. Should it happen that the act of retuning your

receiver similarly disturbed your neighbor's reception, he would be likely to adjust his once more and thus again disturb your balance. Thus an exceedingly aggravating condition may arise, and you may neither be able to enjoy the operation of your outfits!

If you notice tuning effects of this kind, which are evidenced by the sudden dropping out of signals, or by their irregular weakening, or by their appearance at various different settings on your antenna tuning scale, first see how far your receiving antenna is from other wires. If there is another antenna near it, get together with your radio neighbor and find out by experiment whether the adjustment of his set affects the tuning of yours and *vice versa*. If you interfere with each other in this way, try to work out a plan whereby your two antennas may be kept as far apart as possible, and after moving them to the new locations, try the test again.

Sometimes it happens that the two antennas cannot physically be separated far enough to prevent them from affecting each other; in such instances some improvement may be had by installing

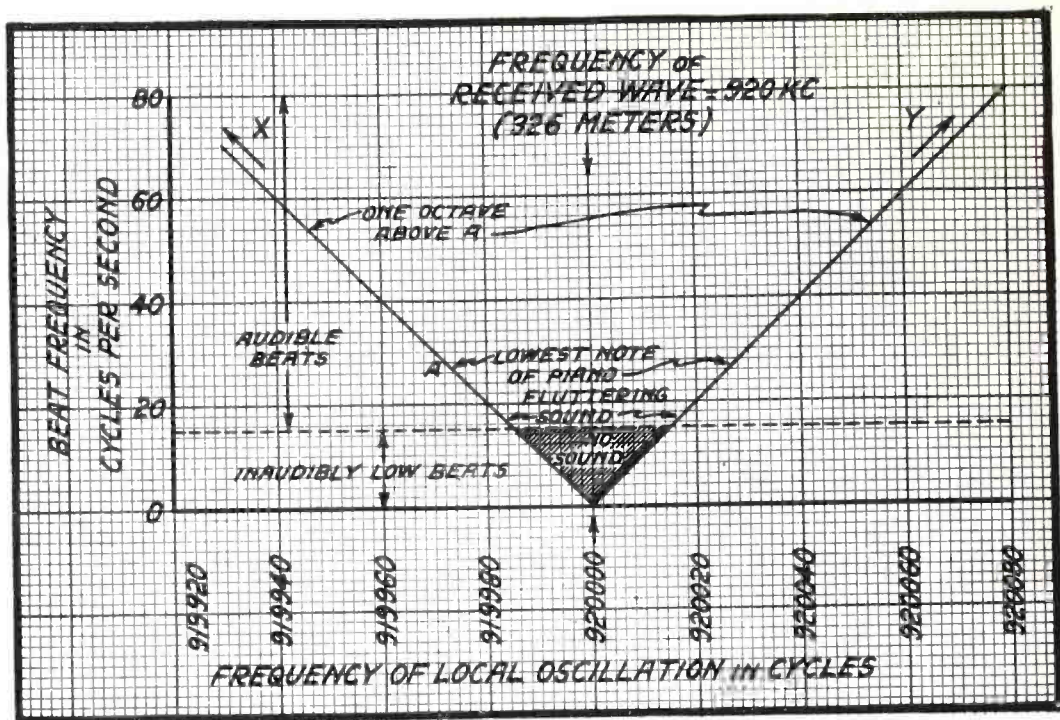

HOW A SILENT OR BEAT NOTE IS PRODUCED

When two high-frequency waves are near the same rate of oscillation, they reinforce each other and neutralize each other in regular sequence. If this sequence occurs at a rate above sixteen times a second, an audible note is produced in the telephones. The two sides of the V in the diagram show the plotting of this note as one of the radio frequencies changes wavelength. The darkly shaded section marked "no sound" is the "beat" note.

broad-tuned antenna circuits in both receivers, for the reactions caused by tuning coupled circuits will generally be less. Some loss in signal strength may be experienced, but as a rule it will be more than compensated for by increased convenience in tuning.

Neighboring antennas are not the only conductors that change in capacity and thus affect tuning conditions. If your antenna runs close to a power wire or a telephone circuit, you may find that certain broadcasting stations tune in best

at one setting sometimes and at other settings at other times. Where a certain wavelength is best heard on your tuner may then depend upon whether somebody's telephone is idle or is in use, or whether a certain elevator is running, or whether the lights in some particular house are turned on or off. The remedy for troubles of this kind is to follow the good old rule of keeping your receiving antenna as far as you possibly can from all other conductors, including wire lines and your neighbors' antennas.

In next month's article I will try to explain some other odd effects in tuning and receiving. All of these troubles are of quite frequent occurrence, and very few of them are well understood by the majority of radio listeners. Even though you may not now be bothered by any of them, they may be worrying your friends and by learning about them you can perhaps be extremely helpful.

Tips on Tuning

GENERALLY speaking, a selective receiver (one that tunes sharply) is a good one, because this is evidence that there are few losses in the set itself.

* * *

DON'T be discouraged if the primary circuit *does not* tune sharply. It is due to the high resistance of the antenna circuit, and beyond making sure that you have a good ground connection, there is little that can be done about it.

* * *

IF you have no vernier condenser, the sharpest kind of tuning can be done by resting the rubber end of a long pencil between the edge of the dial and the panel and turning slowly so as to get a micrometer effect.

* * *

VARIATIONS in the internal capacity of different tubes will often change the tuning slightly. When you put in a new tube be sure to test for this variation—or else you may find that the tuning chart varies.

* * *

IF you cannot make the tickler work, it may be due to a partially exhausted "B" battery. One bad cell in the whole block will sometimes cause a loud squeal that is hard to find.

* * *

BROAD tuning and weak signals are often the result of moisture collecting in the insulation of the tuning coils. They may not feel moist to the hands, but the dampness is there just the same. You will be surprised at the improvement that follows a good drying out in the sunlight or by placing the apparatus near the stove.

* * *

FOR summer work a short antenna cuts down the static. The signal may also be somewhat weaker, but it does not fall off as much as the static and the result over-all will be more pleasing reception.

* * *

LOOSE or worn variable condenser shafts make it appear that the broadcasting from one particular station is never on the same wavelength. Keep the thrust bearings tight enough to prevent variation in the spacing of the plates and the stations will always come in on the same dial settings.

* * *

A GRADUAL change in the location of the best point on the dial for a station that you hear often is sometimes due to a change in capacity of the set caused by the drying out of the wood of the cabinet. This is particularly true if the cabinet fits closely against the tuning coils or condensers and if the wood is new and green.

* * *

SOME home-built sets tune to one division on the dial when the hand is resting on it and to another place when the tuning is done with a pencil rubber. In most cases this is due to the fact that the rotary plates of the condenser are connected to the grid circuit, and the capacity of the hand near the shaft, changes the tuning. The remedy is to reverse the connections to the condenser so that the rotary plates are *grounded!*

* * *

YOU can learn to tune a set by "rule of thumb" without knowing what the different controls actually do, but you will be able to tune quicker and more accurately if you have, at least, a working idea of what happens electrically when you make a change in adjustment.

* * *

IF a local station is too loud on two steps and not loud enough on one step, leave the jack in the second step and control the volume by slightly tuning out the signal. This gives better reproduction than turning down the rheostats.

—ALFRED P. LANE

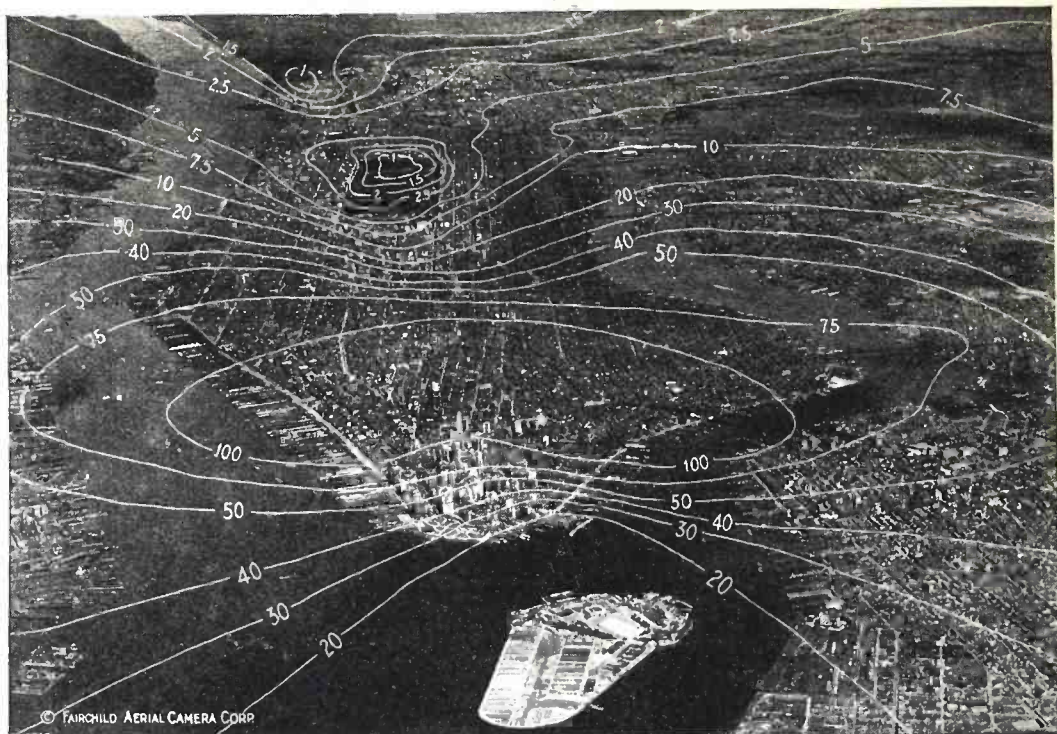

American Telephone and Telegraph Co.

HOW OBSTACLES DEFLECT RADIO WAVES

This airplane map of New York City shows how the signal strength of the radio waves from a broadcasting station is affected by the mass of steel buildings in the city, just as underground masses of metallic ores may deflect and modify them.

Finding Mines by Radio

There may be a mine underneath your house. There is now no way of finding new mines, except to stumble over them by chance. Radio ought to be of great use in exploring underground conditions and discovering unknown bodies of ore. Radio amateurs have a chance to work this out—and maybe to make their fortunes!

By E. E. FREE, Ph.D.

IN the days when King Solomon sent his engineers and his soldiers off into the land of Saba—which we know as Sheba—to bring back gold and copper for his temples, there was only one way of finding mines. You walked around until you chanced to see some gold or some copper ore sticking out of the ground. Then you had found a mine.

A lot of things have changed since the days of King Solomon and the Queen of Sheba but this is one thing that has not changed. We still find mines, in this century of steam engines and airplanes and radio, in the self-same way that Solomon's engineers found them. We walk around until we stumble over them.

Every one of the great mining camps was found in this way. Tonopah, the famous silver camp in Nevada, was discovered because a prospector's mule got away and kicked a chunk off a rock. The chunk proved to be silver ore. Cobalt, one of the richest of the Canadian camps, had a railway built right over the ore without anybody recognizing it. The blacksmith of the construction gang used a lump of the silver ore for a spare anvil, thinking that it was ordinary rock. It was months afterward before anyone recognized that the railway builders had accidentally found a mine. I camped once for a week on the identical spot in California where some men came along a few years later and discovered—by absolute accident—a silver mine from which they have taken, I understand, over ten million

dollars worth of the precious metal. That is the way it is always. The business of mine finding is utterly capricious. You just go out somewhere in a country that looks generally promising and wander around waiting for Lady Luck to touch you on the shoulder. You need not know anything about geology. You need never have seen a mine. No man who ever lived in Nevada knew less about mining than did Jim Butler, the man whose mule discovered Tonopah.

After a mine is found the geologists can help. When the mule has kicked off the telltale corner of the rock and you see there before your eyes the thin thread of gold or silver that may lead on to your fortune, then it is time to go into town, file the notice of your claim and hire a geologist. The geologist can tell you much about how to



U. S. Bureau of Mines

RADIO WAVES PASS THROUGH SOLID ROCK

This photograph was taken during the investigations of the United States Bureau of Mines on the use of radio in the rescue of men imprisoned by mine disasters. The radio is coming in by carrier-current methods, but broadcasting can also be received by the passage of the radio waves directly through the rocks.

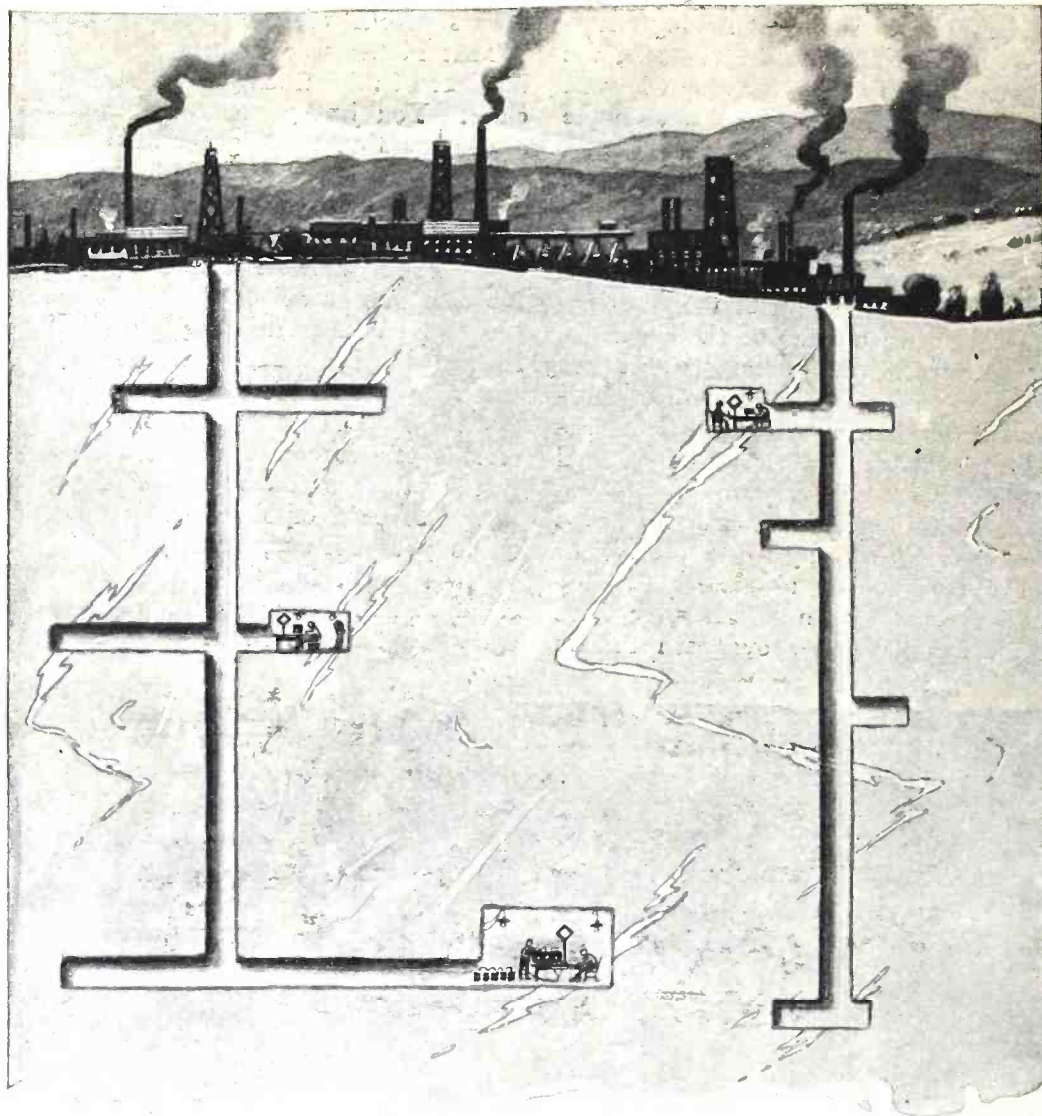

follow up your good fortune, about where to look for extensions of the mineral vein that you have found, about how best to discover just how valuable it is, about whether there is any probability of other veins in the immediate neighborhood.

But, for telling you where and how to find the mine in the beginning, neither the geologist nor any other kind of scientist is of the slightest use. That matter lies entirely on the lap of Lady Luck. If it were not so the geologists would have found all the mines already

and all the rest of us would be working for them.

It begins to look, however, as though Lady Luck was going to have a rival. Science is developing some new methods of investigating rock structures and other underground conditions that promise much help in this adventure of mine finding. The most promising ones are radio methods. It is distinctly probable that the prospector, wandering around with his burro and his pick-pointed hammer, will give place in a year or two to a radio engineer riding on a wagon-

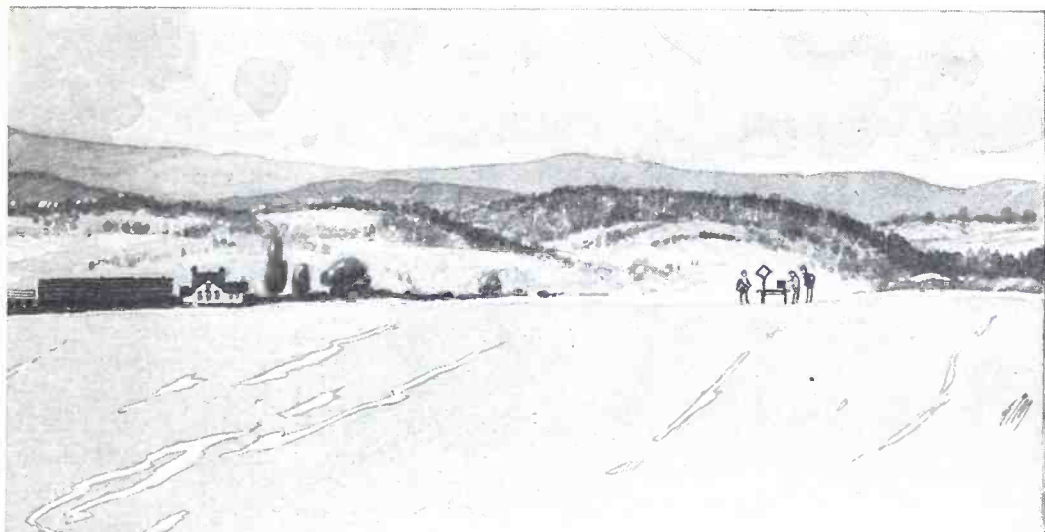

From a drawing made for POPULAR RADIO by Arthur Merrick

HOW RADIO CAN HELP US TO SEE UNDERGROUND

Radio waves sent out from a transmitter in one part of an existing mine can be received in other parts of the mine or by parties on the surface of the ground, and will furnish much information about intervening ore bodies, the existence of which is unknown.

load of coils and batteries and condensers. If anything is ever to improve the stumble-over-it method of King Solomon it is probable that radio will be that thing.

This would be an extraordinarily important benefit to civilization. There is complaint of the shortage, present or prospective, of many minerals. The United States Bureau of Mines fears a shortage of lead. The Department of Agriculture seeks earnestly for greater American sources of potash, a mineral essential in the making of fertilizers. Coal and oil are the very life blood of our industries yet the visible supplies of both are definitely exhaustible.

Gold and silver are probably less necessary, yet the west complains that there have been no great new finds of bonanza ore for years; not since the discovery of Goldfield. The mining men have paraphrased the immortal pronouncement of the governor of Carolina. "It is a long time," they say, "between bonanzas."

Why is this? Have all the great mines been discovered?

No one believes it. There are probably a hundred bonanza ore bodies waiting to be discovered for every one that has been found. But they are not, perhaps, quite so evident on the surface of the ground. These unfound bonanzas are buried under barren rocks or perhaps the dirt and gravel from the hills has washed down over them. The mule-kick method of Jim Butler at Tonopah, the stumble-over-it plan of King Solomon's emissaries will no longer suffice. Science must take a hand in the game and in Science's hand there will be at least one trump—radio.

The radio devices that will help in this job of finding new mines are already accomplished facts so far as the radio aspects of them are concerned. They have been developed for purposes of communication, by broadcasting or otherwise, or they have been worked out in the laboratory for this or that purpose of scientific work. With the single exception of a direct-beam transmitter that will produce much power on an

intermediate wavelength, we already possess ample radio equipment and knowledge to accomplish a great deal in all kinds of underground exploration including the finding of new mines.

What we do not possess and what we need very badly indeed is more information about how radio waves behave when they pass through rocks, through underground waters and through or near the ore bodies that constitute useful mineral deposits. The desirable thing, just now, is to focus attention on this side of the problem; to persuade as many radio engineers and amateurs as possible to devote some of their time and skill to its investigation.

Let us see, first of all, just what we do know about the structure of the earth and about the usual ways that mineral deposits occur in it.

In very general terms there are two kinds of such deposits; flat, layer-like deposits called "strata" and narrow, pipe-like deposits called "veins." Coal is a good example of the first kind. A coal bed is just a flat layer of coal in between a lot of layers of rock, like one black blanket piled up between a lot of gray or brown ones.

The vein deposits are different. They are cracks or holes in the rock, like cracks in a cement pavement or like worm-holes in a garden soil. Into these fissures in the rocks there have come up from deep down in the earth some hot waters carrying in solution a little gold or silver or other metal. These waters have deposited the metals that they carried in the cracks and holes of the rock. This makes the veins. We find these veins (where they reach the surface of the ground) and follow them down into the earth, mining out the metal that they contain as we go down.

A good illustration of all this is an old-fashioned layer cake with a lot of icing in between the layers and none at all on top. We can think of the icing as representing the minerals in the ground; the cake part represents the other rocks.

A full layer of icing, spread out evenly between two layers of cake, will represent, for example, a bed of coal. That is just the way the coal occurs, spread in between two layers of ordinary rock.

But suppose that here and there in the cake there have been little cracks and holes. The icing will penetrate into these. If the cook has pressed down the layers of the cake as she put them together the icing may have been squeezed *upward* into such cracks or holes in the top part of the cake. This is a good illustration of a mineral vein. It is a thin sheet or pipe of metal-bearing "icing" running up into the unmineralized rock.

Now imagine that on the top of such a cake there is a very tiny bug who likes icing and who has a geological habit of mind. There is no icing, remember, on the top of the cake. What little was there in the beginning the bug has already eaten off. His problem is to find out where the icing is underneath so that he can bore himself a hole down to it. What will he do?

He will do just what human mining engineers do. He will find some place where some icing-filled "vein" has gotten clear out to the top of the cake. He will follow this down, making a "mine" as he goes.

This is simple enough so long as the cake is of the ordinary shape and undamaged. You know—and probably our bug geologist would know—that somewhere underneath his feet the cook has put a broad, thick layer of icing, or possibly many layers of it. All the bug has to do, really, is to dig a shaft *anywhere* and he will strike "mineral."

But suppose that the cake, after it was made, has been in a railway accident. Suppose it was jarred and cracked in a dozen places and suppose a trunk fell on it so that it was squeezed all out of shape. Then the problem of a geological bug who came along later to mine into it would be a problem of considerable complexity.

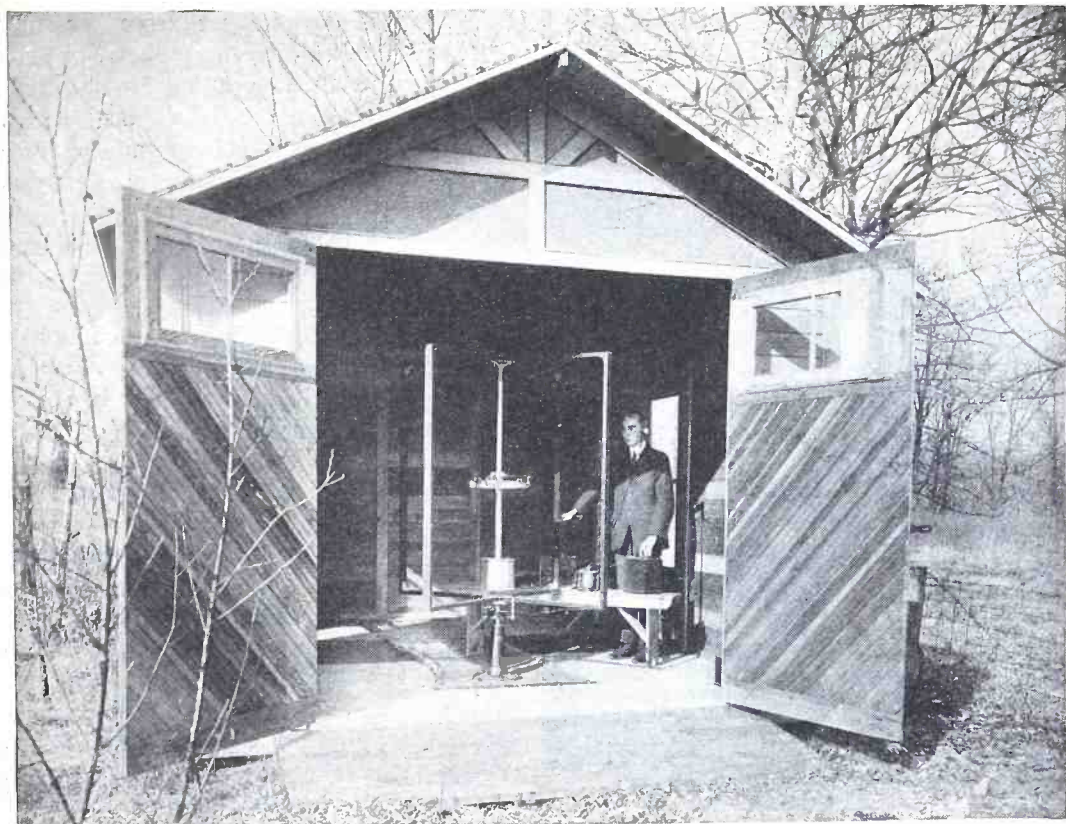

Bureau of Standards

THE TYPE OF RADIO APPARATUS THAT WILL BE USEFUL IN MINING WORK

This receiver, developed by the U. S. Bureau of Standards for tests with direction finders and with directive radio, permits the determination of the direction from which a given radio wave is arriving as well as of the strength of the signal.

That is exactly what has happened to the rocks of the earth. Not that anything has fallen on the earth and smashed it, but the slow contraction of the globe as a whole has crushed and tilted and fractured the surface rocks until layers that were once horizontal have been stood up on end, until great breaks that the geologists call "faults" have cut across the whole earth structure; until, in a word, the original character of the rocks and mineral deposits has been thoroughly obscured, even more thoroughly than the character of the cake-and-icing layers in a cake that has been smashed by a whole baggage car full of trunks.

So, the problem that confronts the

geologist who tries to do for the earth what our imaginary bug was trying to do on his cake is a very difficult problem indeed. The rocks under his feet are so bent and twisted and broken that it is usually impossible to figure out in any detail what they were like in the beginning. The geologist knows, perhaps, that there is mineral in these rocks *somewhere*. The question is where? If he bores a hole down at random he is as likely to miss his mineral deposit as he is to hit it; even more likely, in fact, for the mineral deposits occupy only a small fraction of the total volume of the rock.

You see how valuable it would be if geologists had some way of exploring

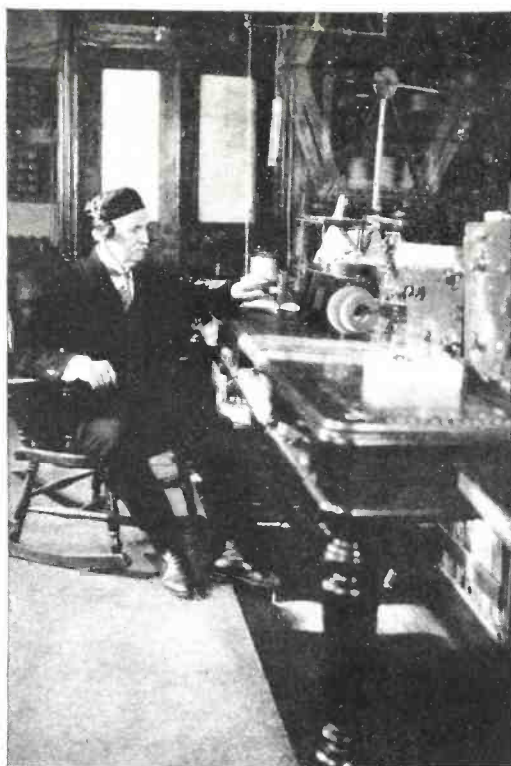

Courtesy of Dr. J. Harris Rogers

A PIONEER IN UNDERGROUND RADIO

Dr. J. Harris Rogers of Hyattsville, Maryland, has long been an experimenter on the possibility of receiving radio waves underground. During the World War, Dr. Rogers installed at his laboratory a receiving loop at the bottom of a fifteen-foot well, by which he was able to receive transmissions from European stations.

the conditions underground without going to the expense of digging shafts or boring drill holes, both of which are extremely expensive operations. What we want is some way of *seeing* into the earth, as though the rocks were made of glass.

This, we believe, is just what radio may provide. The radio waves go through the earth just as they go through air and water. To them the rocks *are* like glass; they have, that is, the most useful property of glass, transparency. Can we devise, then, some way to use radio waves in locating mineral deposits without actually digging for them?

Scientists believe that we can.

The possibilities start from the fact that the mineral deposits possess, in general, electric properties that are different from the properties of ordinary rocks. This fact has already been put to practical use in locating mineral deposits. For example, the Swedish and Norwegian government geologists have devised a method of tracing the locations of the great buried beds of sulphurous iron ore that exist in those countries.

This ore conducts electricity about 2,000,000 times better than ordinary rock does. The geologists introduce an alternating electric current into the ground at some point where they suspect an ore deposit underneath. The other terminal of the electric circuit is placed in contact with the ground some distance away. Then the observers go along with telephones in the space between the two ground contacts, touching the terminals of the telephone circuits to the ground from place to place. The sounds in the telephones enable them to map the path of the current through the ground (and the underlying rocks) between the two ground contacts. It is found that the current follows the places where there is ore. Thus the ore bodies can be mapped and vast deposits of iron and copper ore have been traced out in this way.

Strictly speaking this is not a radio method. It depends merely on the conducting power of the ore for electric currents. But if ores are more highly conducting for electric currents than barren rock is they will behave differently toward radio waves also. A layer of ore underground will reflect a radio wave that goes downward into the ground and strikes it. Radio waves will follow along a conducting ore body much as the waves of line-radio follow along the conducting wire of the line. Furthermore, the occurrence of conducting ore bodies in the direct path of a wave will bend the wave or absorb it altogether, just as masses of steel buildings deflect or absorb the radio waves of broadcasting stations.

It is easy to see how these facts can be put to use in mines. Suppose, for example, that there exist in a certain mining district two mine shafts a mile or two apart, with unexplored ground in between them. The problem for the geologists is to determine whether the mile or two of untested ground between the shafts contains ore or does not contain ore. How shall he do it?

One way is this. Put a radio transmitter in one of the shafts. Send out a known wave. Go to the other shaft with a sensitive loop receiver. Determine the strength and the direction of the wave from the transmitting station in the first shaft. If the mines possess, as most mines do, a lot of wide-spreading passages at the bottoms of the shafts or at different intermediate depths, test the effect of moving the transmitter and the receiver, alternately, to several positions in these passages. Then reverse the set-up; put the transmitter in the second mine and the receiver in the first, thus testing the behavior of the waves when their direction underground is reversed.

An investigation like this—the whole thing could be carried out in a couple of days—will furnish a great deal of information about the nature of the rock between the two mines. If a conducting ore body is there its presence will be pretty sure to be evident from the behavior of the waves.

This study can be supplemented, also, by investigations above ground. With the transmitter in one or the other of the shafts the audibility of the waves on the ground surface can be mapped in the same way as underground. If an ore body exists and comes near the surface anywhere, that fact is reasonably sure to be indicated by an increase of audibility at that point, as well as by a tendency for the wave-directions to focus toward that neighborhood.

What we need now is some actual test of these methods in real work in and about mines. There are many min-

ing towns where the nature of the underlying ore bodies has been worked out in much detail by actual shaft-sinking and hole-drilling. The things that exist underground are known. Such a town would be a good place to start.

Let the radio amateurs in such towns organize an investigation of the underpinning of their neighborhood. Let them set up transmitters above ground and below. Let them take portable receivers equipped with directive loops and map carefully the course of the waves through, around and above the known bodies of ore. The results of such a comprehensive investigation in an area where the geology is already known might start a new profession; the profession of radio geologist.

Nor do such investigations need to be confined to towns where the mines are metal mines. Coal, too, has electric properties that differ from the properties of plain rock. Even oil deposits can be detected magnetically and probably their behavior toward radio waves will be found to differ from the behavior of ground that contains no oil.

It is quite likely that every kind of mineral deposit, even every variety of rock, has its own special behavior toward radio waves. If we understood these behaviors more fully; if we but knew as much about the geological side of the problem as we know already about the radio side of it, we would probably be able to go around over the surface of country where no mines have been discovered and tell, by radio, whether any mines were there.

Clarence King, probably the greatest of American geologists, always insisted that geology was necessarily an imaginative business. "One geologist," he used to say, "can actually *see* into the earth just as far as another; that is, not at all." For geologists, I suppose, this is true. But I am not so sure that it will remain true when the radio engineers get on the job.

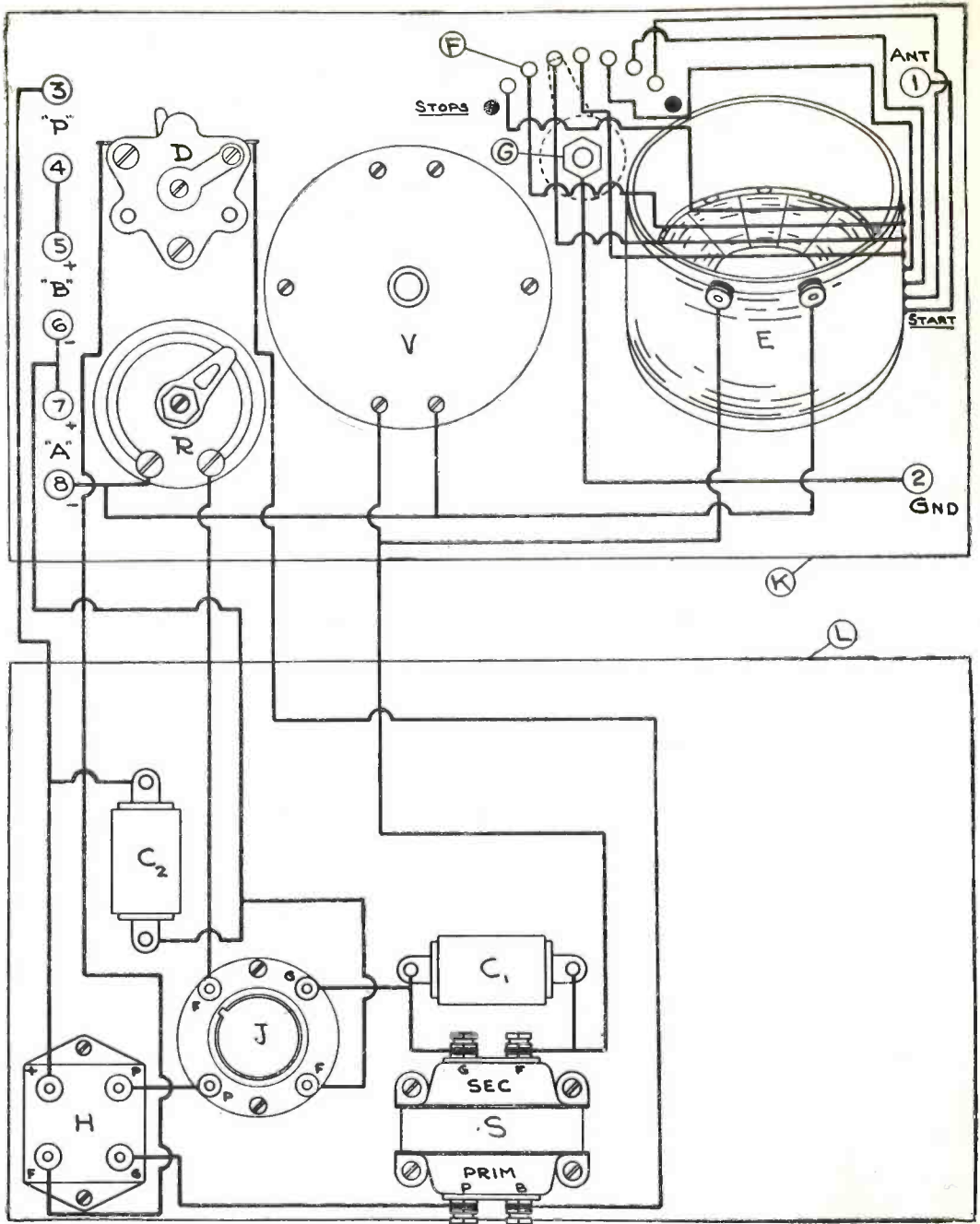

A "Picture Diagram" of the Hook-up

A glance at the above illustration will convince even the novice that a radio set is really easy to wire up. In this form of diagram the instruments are shown in picture form and the connecting wires are drawn in, IN THE EXACT MANNER THAT THEY SHOULD GO IN THE SET. The terminals on the various instruments are plainly shown and the instruments are marked with designating letters that reappear in the text and the list of parts.

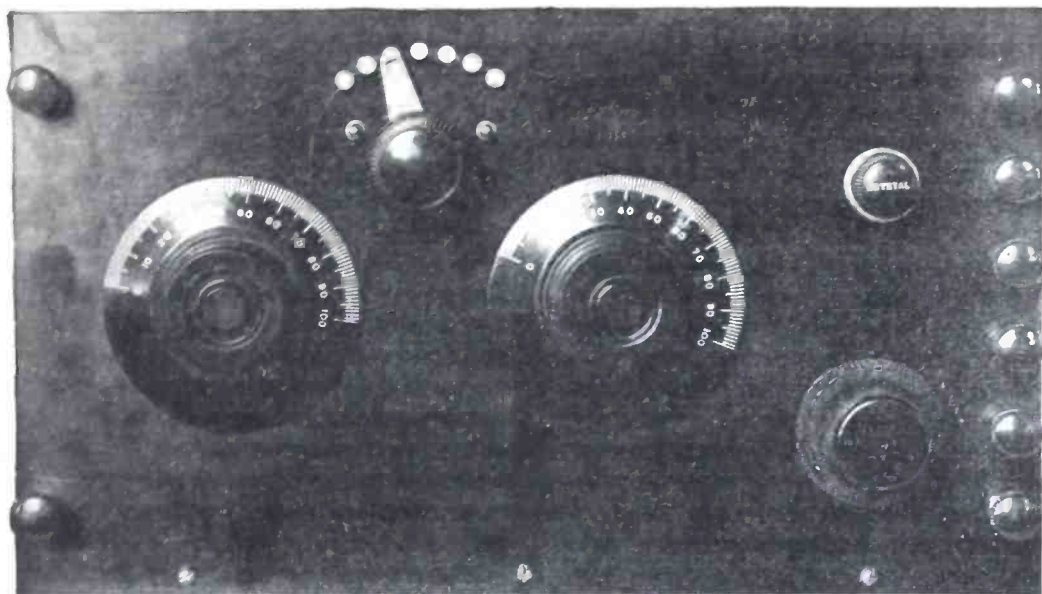

THE PANEL ARRANGEMENT OF THE SINGLE-TUBE REFLEX

The antenna and ground binding posts are on the left, with the battery and phone binding posts on the right. The antenna is tuned by the switch lever and taps. The left and right dials control the coupling and secondary tuning, respectively. The knob to adjust the crystal is marked, and the one below it operates the rheostat.

Simple "How-to-build" Articles for Beginners No. 2

How to build a single, dry-cell tube, reflex receiver

By LAURENCE M. COCKADAY, R.E.

COST OF PARTS: *Not more than \$25.00*

APPROXIMATE RANGE: *500 miles*

HERE ARE THE ITEMS YOU WILL NEED—

- | | |
|-----------------------------------------------------|---------------------------------------------------------|
| C1 and C2—Freshman mica fixed condenser, .001 mfd.; | K—composition panel, 7 by 12 inches; |
| D—Freshman crystal detector; | L—baseboard, 7 by 12 inches; |
| E—Simplex variocoupler with spiderweb rotor coil; | R—Amsco rheostat, 30 ohms; |
| F—switch points; | S—Jefferson "Star" audio-frequency transformer; |
| G—switch lever; | V—Mignon "Equal Element" variable condenser, .001 mfd.; |
| H—Cardwell radio-frequency transformer; | eight binding posts. |
| J—Na-ald socket for UV-199 or C-299 vacuum tube; | |

THE second receiving set of this series is a reflex set employing a single, dry-cell tube and a crystal detector.

This set was built in the POPULAR

RADIO laboratory with the express purpose of giving to the beginner a set that employs radio-frequency amplification and audio-frequency amplification with minimum expense and extreme simplicity

of construction as well as operation.

Anyone can make it. It will give surprising results.

All you have to do is to take this magazine to a dealer and ask him to give you the parts specified at the top of this page.

When you have purchased all of the parts (which are standard parts and should be carried by all dealers) take them home and lay out the instruments on the panel as shown in the picture-diagram on page 246 and the front and rear photographs on pages 247 and 248.

As all the parts are lettered with the same letter as given in the list of parts, you can make no mistake. The wiring is shown exactly as you should hook it up.

When you have the set all wired you can set it going by connecting on the batteries, phones and the antenna and ground terminals.

Binding post No. 1 is for the antenna. No. 2 is for the ground. No. 3 and No. 4 are for the phones. No. 5 is for the positive "B" battery, 45 volts. No.

6 is for the negative terminal of the same "B" battery. No. 7 is for the positive "A" battery, 4½ volts, and No. 8 is for the negative terminal of the same "A" battery.

A 100 to 150-foot single-wire antenna is recommended.

Tuning this set is simple. The switch and taps control the primary or antenna circuit and the proper setting will depend largely on the electrical characteristics of the antenna itself. On loud signals from nearby powerful stations the adjustment of the crystal is not sensitive, but on weak stations a careful adjustment of the crystal will improve the signal strength.

The tuning of the secondary circuit is done mainly with the variable condenser, although the coupling must also be changed somewhat with the other dial.

In order to economize on "A" battery current and prolong the life of the tube it is, of course, desirable to keep the rheostat turned down as much as possible without detracting from the signal strength.

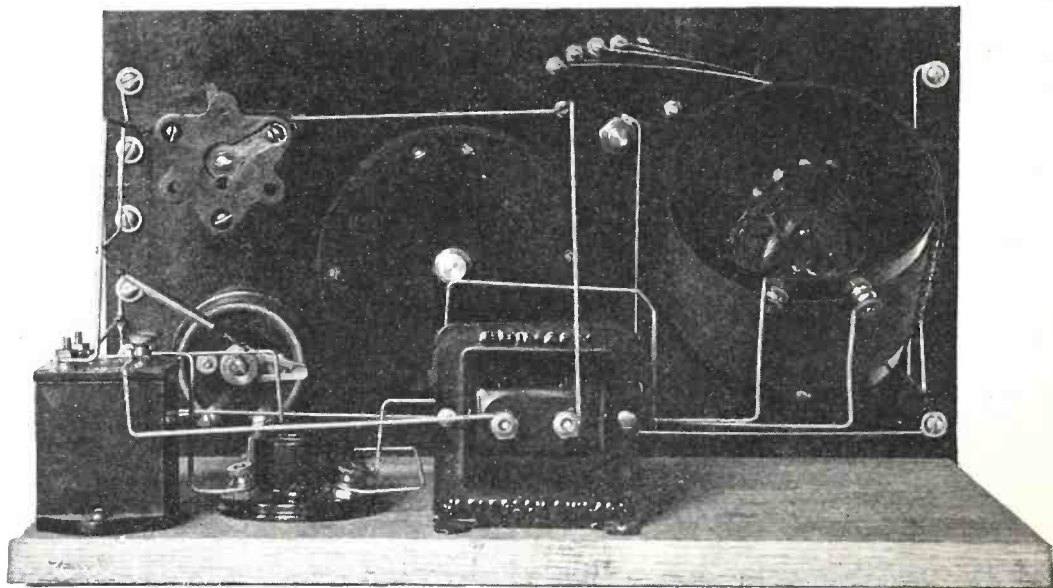

THE REAR VIEW OF THE SET

Study this view in connection with the picture diagram of the hook-up on page 246. The location and connecting points of each wire appear clearly and you can determine just how to bend the wires to get the shortest connection with the proper clearance.

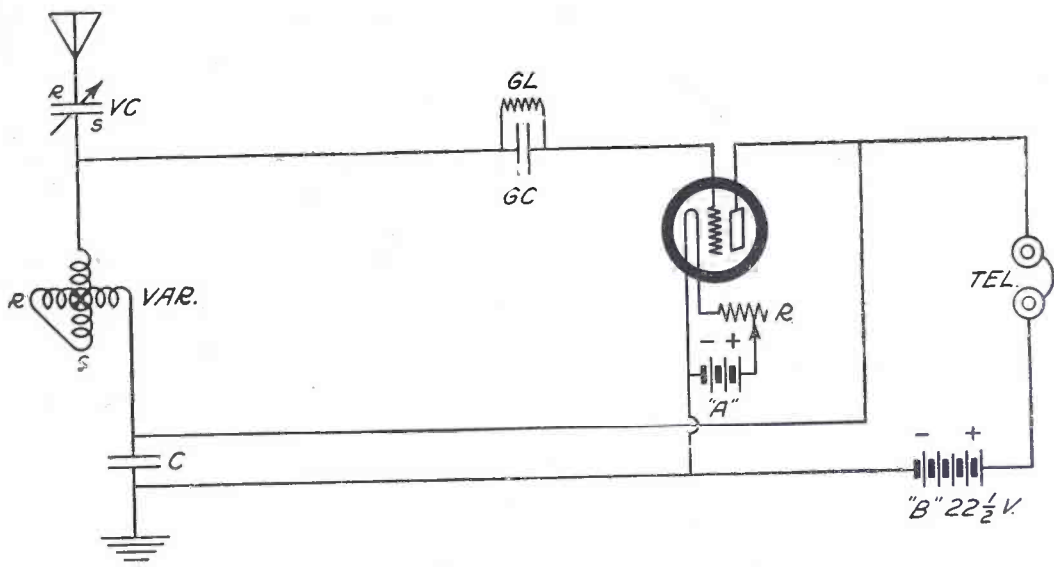

SIMPLE ONE-TUBE REGENERATIVE RECEIVER

Cost of parts: Not more than \$19.00.

Selectivity: Fair.

Operation: Simple to tune. Wavelength is controlled by the variable condenser and the variometer. Regeneration is controlled by the filament rheostat.

Construction: Extremely simple.*

Approximate range: 500 miles.

Outstanding features: This is a simple set to build and operate. It will give good results in the hands of beginners. But the filament rheostat should not be turned up too high or the set will radiate badly.

**(See POPULAR RADIO, February, 1924, page 197. for constructional details.)*

100 BEST HOOK-UPS

INSTALLMENT NO. 10

EVERY one of the hook-ups that are published in this series has been thoroughly tested. By going over these diagrams, the radio novice may decide just what circuit meets his needs. Through the footnote, he may locate the previous issues of POPULAR RADIO that carries full constructional details. Remember that the receiving range given for each set is the average of a number of reports sent in from many different sections of the country; in locations that are particularly favorable to radio reception, the rated receiving range may be greatly exceeded, just as in so-called "dead spots" the reverse may be the case. In the summer-time, reception in all localities is much poorer than in winter.

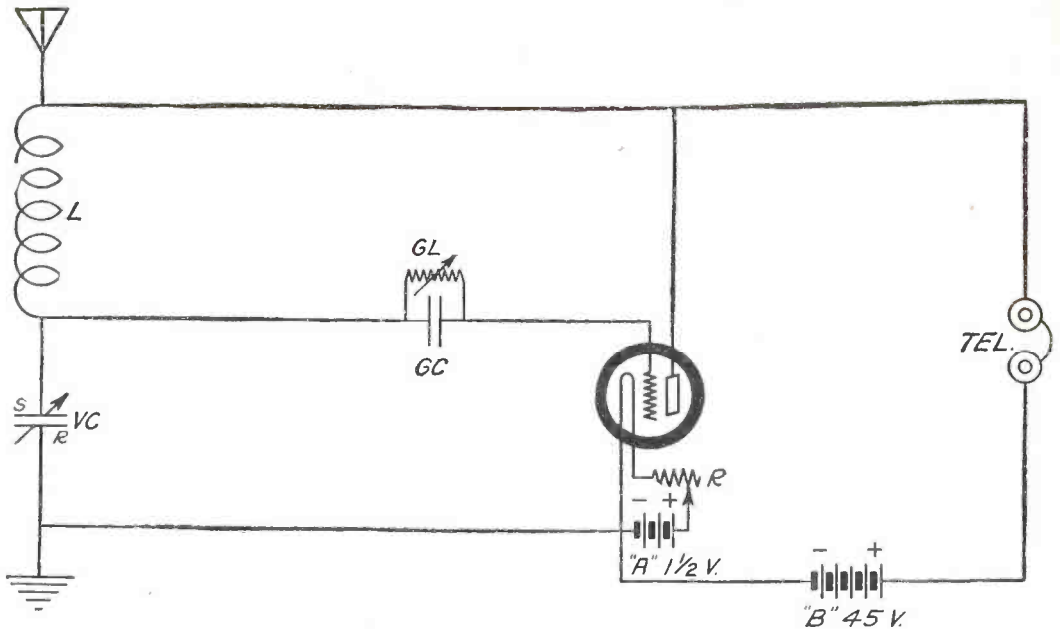

MODIFIED COLPITS CIRCUIT FOR RECEIVING

Cost of parts: Not more than \$14.00.

Selectivity: Fair.

Operation: Simple. The variable condenser changes the wavelength and the filament rheostat controls regeneration.

Construction: Easy to make.*

Approximate range: 500 miles.

Outstanding features: Only a single, simple control for tuning. The filament rheostat should not be turned up too high or the set will radiate badly.

*(See POPULAR RADIO, May, 1924, page 439, for constructional details.)

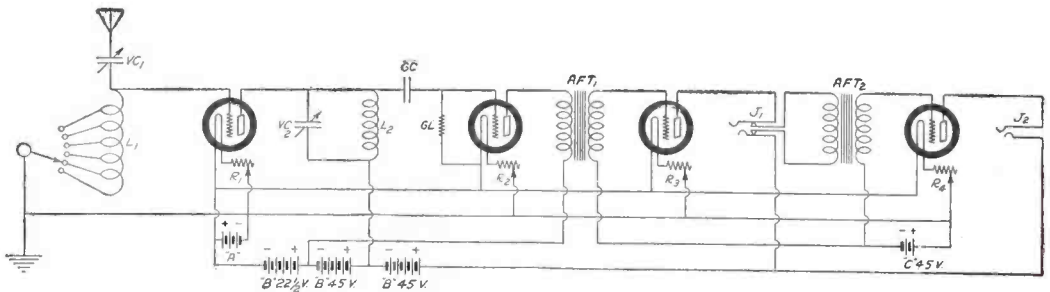

ONE STAGE OF TUNED-RADIO-FREQUENCY, DETECTOR AND TWO STAGES OF AUDIO-FREQUENCY AMPLIFICATION

Cost of parts: Not more than \$30.00.

Selectivity: Good.

Operation: Not difficult to tune.

Construction: Not any more complicated than the ordinary 3-tube regenerative receiver.*

Approximate range: 2,000 miles.

Outstanding features: Good on DX reception. No potentiometer used. Truthful reproduction.

*(See POPULAR RADIO, May, 1924, pages 446-7, for constructional details.)

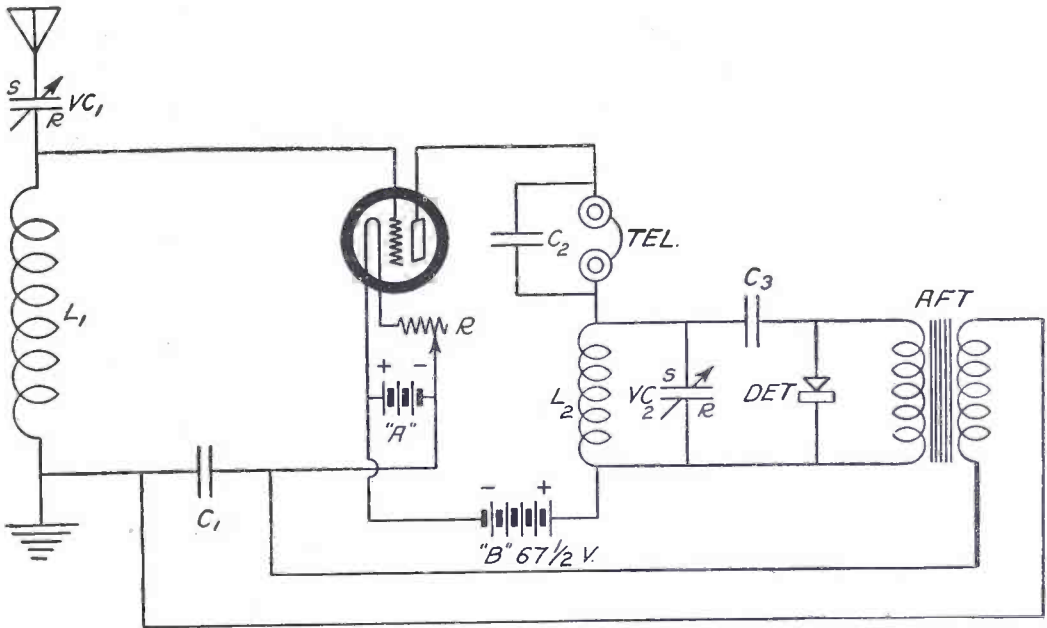

SINGLE-TUBE REFLEX WITH TUNED-PLATE CIRCUIT AND A CRYSTAL DETECTOR

Cost of parts: Not more than \$30.00.

Selectivity: Good.

Operation: Easy to tune. The variable condenser in the antenna circuit tunes the input circuit to the tube and the variable condenser in the plate circuit tunes that circuit.

Construction: Just an ordinary acquaintance with tools and some ability in wiring up the circuit is necessary.*

Approximate range: 500 miles.

Outstanding features: A good set for the experimenter who wishes to learn the principles of radio-frequency amplification and of the reflex.

*(See POPULAR RADIO, May, 1924, page 498, for constructional details.)

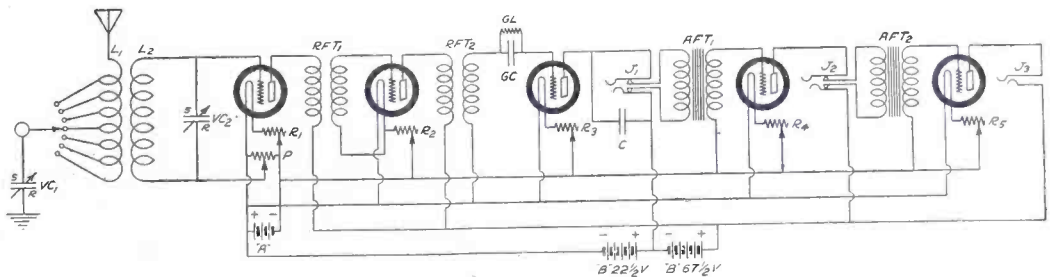

TWO STAGES OF TRANSFORMER-COUPLED RADIO-FREQUENCY AMPLIFICATION WITH VACUUM-TUBE DETECTOR AND TWO STAGES OF AUDIO-FREQUENCY AMPLIFICATION

Cost of parts: Not more than \$54.00.

Selectivity: Good.

Operation: Easy to tune. The two variable condensers control tuning. Coupling is varied by means of the variocoupler, and regeneration in the first stage is controlled with the potentiometer.

Construction: More or less complicated. There are a number of precautions that should

be taken to get the circuit to function properly.*

Approximate range: 1,500 miles.

Outstanding features: Only two dials for changes of wavelength. The coupling can be set for the desired degree of selectivity and then all other tuning can be accomplished with the two condensers.

*(See POPULAR RADIO, June, 1924, pages 610-1, for constructional details.)

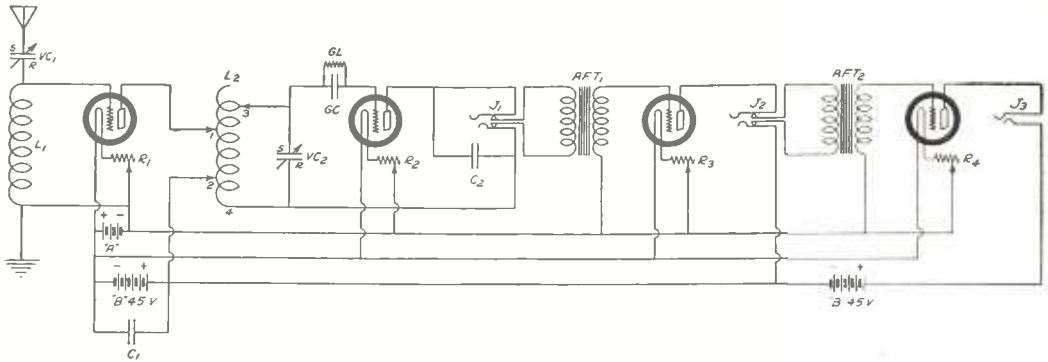

REGENERATIVE CIRCUIT COMPRISING ONE STAGE OF TUNED-RADIO-FREQUENCY AMPLIFICATION, VACUUM-TUBE DETECTOR AND TWO STAGES OF AUDIO-FREQUENCY AMPLIFICATION

Cost of parts: Not more than \$35.00.

Selectivity: Very good.

Operation: Fairly complicated.

Construction: Rather difficult to make.*

Approximate range: 2,000 miles.

Outstanding features: Tuned-radio-frequency amplification is employed with a novel means for coupling the plate circuits of the radio-frequency amplifier tube and the detector tube together, to obtain regeneration.

*(See POPULAR RADIO, May, 1924, pages 502-3, for constructional details.)

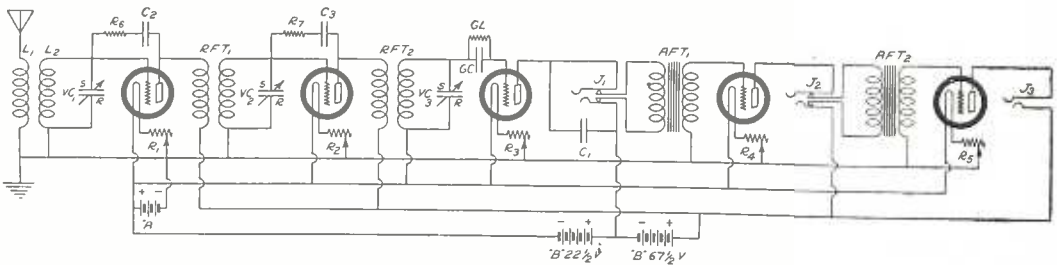

THE PHLODYNE PRINCIPLE INCORPORATED INTO A RADIO-FREQUENCY CIRCUIT WITH VACUUM-TUBE DETECTOR AND TWO-STAGE AUDIO-FREQUENCY AMPLIFIER

Cost of parts: Not more than \$60.00.

Selectivity: Very good.

Operation: Not very difficult to tune. Three variable condensers, which are set at practically the same settings, control the tuning.

Construction: Complicated.*

Approximate range: 2,400 miles.

Outstanding features: Oscillation and regeneration are prevented by means of "phasing out." The set will not radiate.

*(See POPULAR RADIO, May, 1924, pages 500-1, for constructional details.)

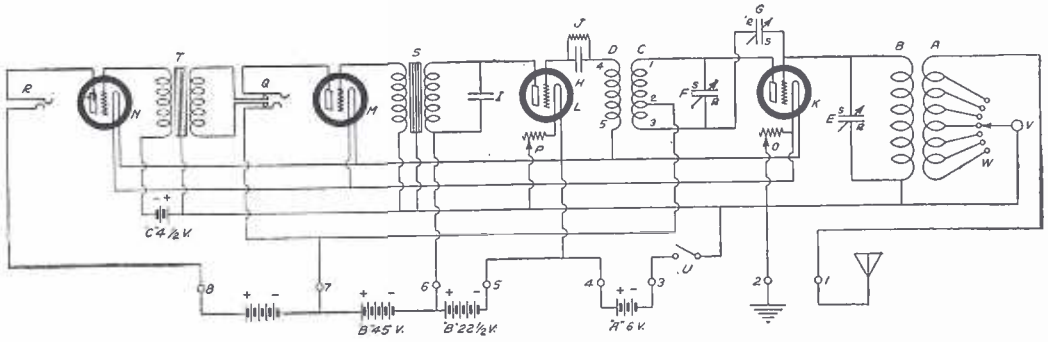

THE CRAIG CIRCUIT, EMPLOYING THE PRINCIPLE OF TUBE-CAPACITY NEUTRALIZATION

Cost of parts: Not more than \$70.00.

Selectivity: Excellent.

Operation: Easy to tune. Two dials on the variable condensers tune the input and the output circuits of the radio-frequency tube.

Construction: Not hard to build.*

Approximate range: Up to 3,000 miles.

Outstanding features: Exceptional volume. DX reception and clarity of reception. Does not radiate.

*(See POPULAR RADIO, April, 1924, page 378, for constructional details.)

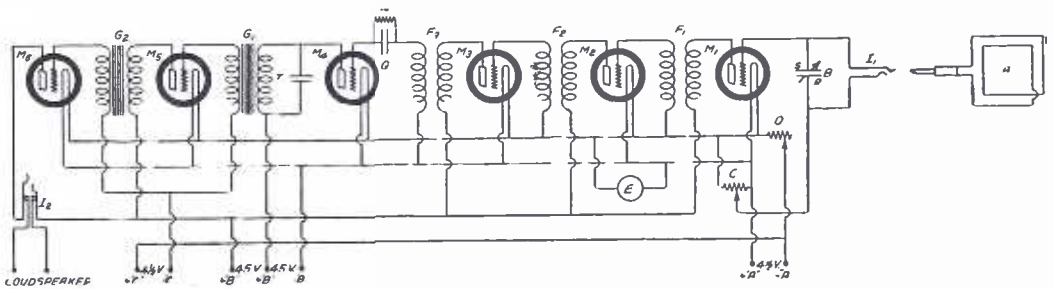

THE POPULAR RADIO PORTABLE

Cost of parts: Not more than \$100.00 (complete with tubes, batteries and loud-speaker).

Selectivity: Good.

Operation: Extremely simple. All tuning is done with the variable condenser, and regeneration in the first tube circuit is controlled by the potentiometer.

Construction: Not difficult, but there is a lot of work necessary.*

Approximate range: Up to 1,500 miles.

Outstanding features: Portability. All batteries and tubes and loudspeaker contained in carrying case. Simplicity of operation.

*(See POPULAR RADIO, July, 1924, page 60, for constructional details.)

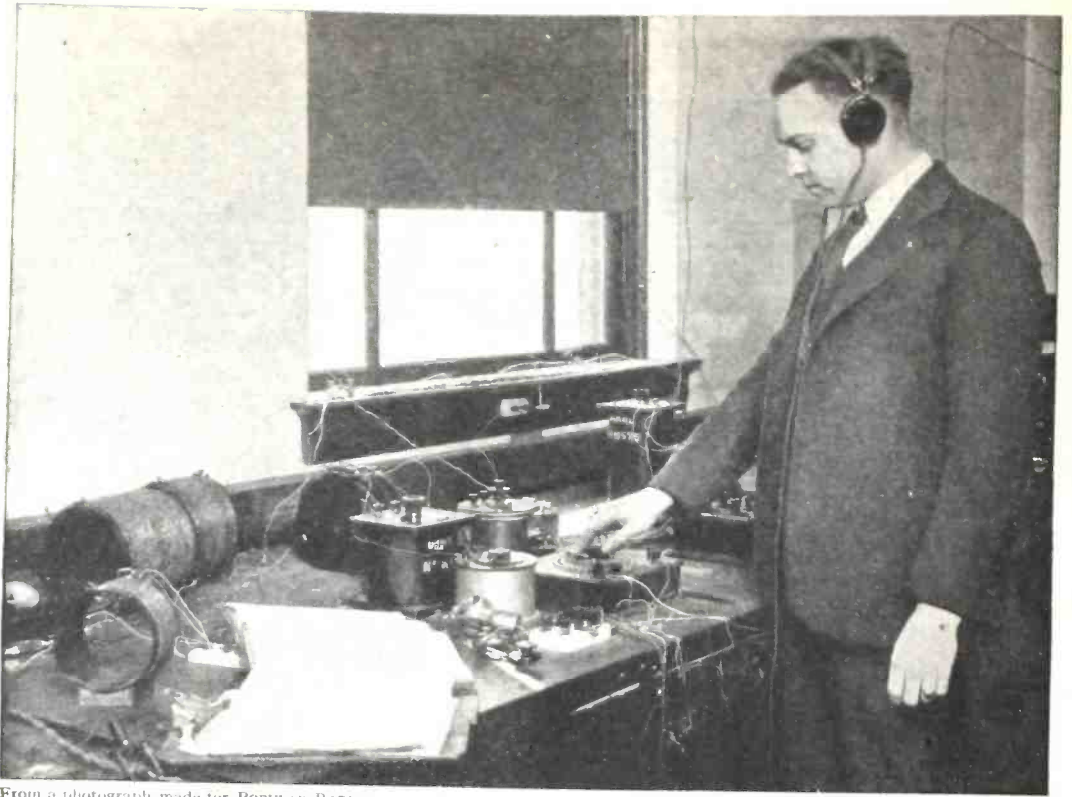

From a photograph made for POPULAR RADIO

ONLY LABORATORY TESTS SHOW REAL COIL VALUES

The value of any inductance can be determined beforehand by formula within close limits. But a laboratory test under actual working conditions will often reveal discrepancies due to variations in some factor. The insulation, for instance, may be thicker or thinner than standard.

HOW TO USE 'A SIMPLE FORMULA FOR Determining Maximum Inductance

Article No. 9

Inductance plays an important part in the operation of every receiving set. Indeed, the difference between a good set and a poor one is often merely a matter of wrong inductance values. This article shows how to figure the maximum inductance by a simple formula.

By SIR OLIVER LODGE, F.R.S., D.S.C., LL.D.

A NEW and remarkably simple expression for the inductance of a coil, wound so as to give a maximum value for a given length of wire, has been given in a previous article. By this formula the inductance equals the length of wire employed multiplied by three

times the number of turns. Or in symbols,

$$L = 3 n l$$

This is such a simple expression that it ought to be useful; but its applicability depends entirely on the proper conditions being satisfied. The coil must

be of the right shape and size to accommodate the wire in the form of a ring of proper dimensions. Suppose we have a number of bobbins (winding forms or tubes), all of the right shape but of different sizes, and also suppose that we have to choose the right size, in order to give a required amount of self-induction with a covered wire of given thickness, that is to say, so many turns to the inch. Or, we may consider that we have to decide on the wire suitable for winding a given size winding form in order to give the required inductance.

When I say that the forms or bobbins are to be of the right shape I mean that they must all have the same proportion between their dimensions and the size of the channel in which the wire is going to be wound. If the channel is 3 of any unit (say $\frac{3}{8}$ -inch square), the mean diameter of the coil will be $1\frac{3}{8}$ -inch; or, more completely, the external diameter will be $1\frac{6}{8}$ inch, and the internal diameter 1 inch; that is to say, the diameter of the bobbin, measured with a pair of callipers to the bottom of the channel, will be just one inch.

In passing from one bobbin to another this proportion is to be maintained.

Each bobbin will be just like another except that all dimensions will be increased proportionately. They will then be all of the right shape for maximum self-induction. And by suitably choosing the wire you can get any inductance you like.

The number of turns that can be wound on a given bobbin will depend on the size of the channel, which, as we know, is to be of a square cross-section. For a given size of channel the number of turns is known. Thus, suppose the wire is of such a thickness that 20 turns take up an inch of space, and suppose the channel is $\frac{1}{2}$ -inch wide and deep. It is obvious that we shall get 100 turns on it, ten layers of ten turns each.

The bobbin being of the right shape, if the channel is $\frac{1}{2}$ -inch wide, the mean diameter of the bobbin will be $\frac{11}{3}$ of $\frac{1}{2}$ inch, that is, $1\frac{5}{6}$ inches. And the average length of each turn will be roughly 6 inches, more accurately $5\frac{3}{4}$ inches. So the total length of wire will be 100 times that, and the inductance 300 times that again. In other words, the product $3nl$ will be 172,800 inches, or 14,400 feet.

If this is somewhere near the value required, well and good. But if it is

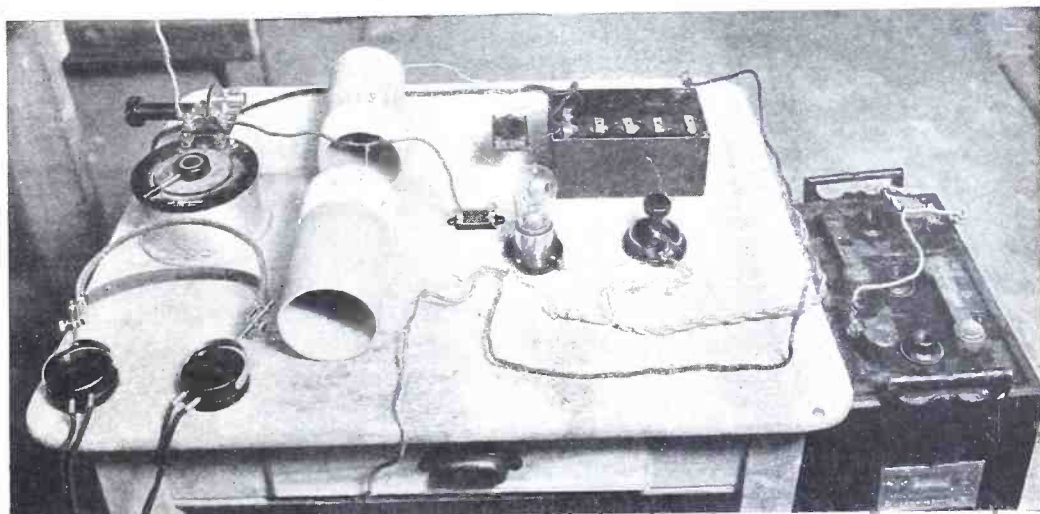

From a photograph made for POPULAR RADIO

AN EXPERIMENTAL SET-UP FOR TESTING COILS

The comparative value of any two home-made coils may be determined with simple apparatus, but precision instruments are necessary for absolute measurements.

much too small, we can either choose a thinner wire for the same bobbin, or select a bobbin of larger size. A small change in the thickness of the wire will make a considerable difference in the inductance.

For instance, reducing the thickness of the wire to one-half will increase the inductance 16-fold. A small increase in the linear dimensions of the bobbin, retaining the proportionality (as we must), will likewise make a great difference in the inductance. For, doubling all the linear dimensions, without making any other change, increases the inductance 32 times. But that is hardly surprising, since one bobbin will be 8 times the weight or bulk of the other, and will be manifestly much bigger.

By the use of thin wire the bobbin can be kept quite small, even for large sized inductances. Suppose each layer of wire in a certain channel consists of 30 turns; the total number of turns will be 900, and the length of wire that is to be used will be the required inductance length divided by 2,700, since that is three times the number of turns.

That sort of arithmetic enables us to select a suitable wire for a given bobbin.

Another mode of writing the expression $3 n l$ is $6 \pi n^2 r$ where r is the mean radius of the bobbin; which is very nearly

$$19 n^2 r$$

So if the external diameter of a bobbin were 7 centimeters, and its internal diameter 4 centimeters, so that the mean radius is $\frac{11}{4}$ centimeters; and if 225 turns of wire are wound in its channel, being 15 to each layer of covered wire 1 millimeter thick; then (since $19 \times \frac{11}{4} = 52$) the inductance will

be $52 \times (225)^2 = 2.6325$ million centimeters or 26.3 kilometers.

The simple formula $3 n l$, or its equivalent $19 n^2 r$, will apply to any ring or disc coil of fair sized aperture for which

$\log_e \frac{8r}{R}$ is not far from 3.5.

For a thin disc or cylinder coil of breadth b the geometric mean distance of its wires from each other is

$$R = \frac{1}{4} b$$

and for a disc coil $b = \frac{1}{2} (D-d)$

$$\text{while } r = \frac{1}{4} (D+d)$$

$$\text{so } R = \frac{1}{8} (D-d)$$

Thus the term of which the logarithm has to be taken in the expression for L is $\frac{8r}{R} = 16 \times \frac{D+d}{D-d}$; and the natural log of

that will be $2.77 + \log \frac{D+d}{D-d}$

So if $\frac{D+d}{D-d} = 2.1$ it would be just right; that is to say, $\log \frac{8r}{R}$ is just about

$3\frac{1}{2}$. This would mean that the outside diameter of the disc coil would be about three times the internal or aperture diameter, and that is a likely sort of value, moderate departure from which would not affect the result greatly.

We have now incidentally justified the reckoning of the inductance of any disc coil as $\pi n^2 (D+d) (\log \frac{D+d}{D-d} + .77)$; where the .77 represents our 2.77 with 2 subtracted from it.

If the breadth of the winding is equal to the breadth of the internal aperture, this result is $3 n l$. But it must not be thought that this gives the maximum inductance for the given wire: it would be possible to get many more turns by greater concentration.

"What Receiver Shall I Buy?"

To answer this question, POPULAR RADIO has compiled data concerning all of the radio sets now on the market—data ranging from costs to reception range; from the number of tuning controls to the kinds of batteries required; from the types of detectors used to the range of wavelengths covered. This helpful information will shortly appear in POPULAR RADIO—as a practical guide to every buyer and prospective buyer of a receiver.

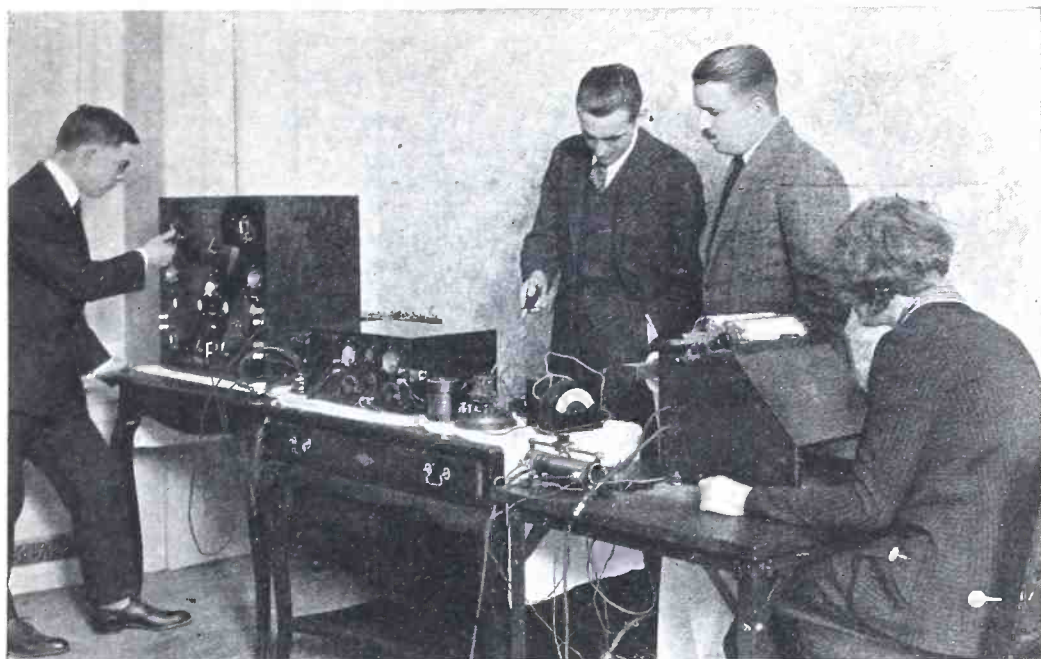

From a photograph made for POPULAR RADIO

THE INVENTOR POINTS OUT THE HEART OF HIS RECEIVER

The little gray instrument on a round base is the "Finch Relay"; the perfection of this small instrument makes the whole apparatus successful.

A NEW AND REMARKABLE

Long-distance Typing Machine

The first detailed and authoritative description of the radio transmitting and receiving apparatus that has aroused such extraordinary interest in the newspaper world by sending messages at the rate of 100 words a minute and turning them out in finished, typed form without the aid of human hands and in entire secrecy, by its inventor—

WILLIAM G. H. FINCH

THE larger newspapers of today print the story of happenings on the other side of the globe on the same day that they occur. To do so the newspapers must use the cable, radio and the land telegraph.

This service entails great expense. Only the large papers in great centers can afford to operate on such a scale. The smaller papers must rely on getting their news from some disseminating agency, by telegraph or mail. This service may be slow or it may be interrupted, as in cases when the telegraph

lines might be down. At any rate it is still expensive.

Most of us have heard of the telegraph printer. This is a machine that prints out messages that have been sent over wires by specially-spaced electrical impulses. Both the transmitter and the receiver are somewhat similar to a typewriter; the main difference is that the transmitter operates a selective device that sends out the electrical impulses, and the printer at the other end of the line receives these impulses and converts them back into letters and spaces them

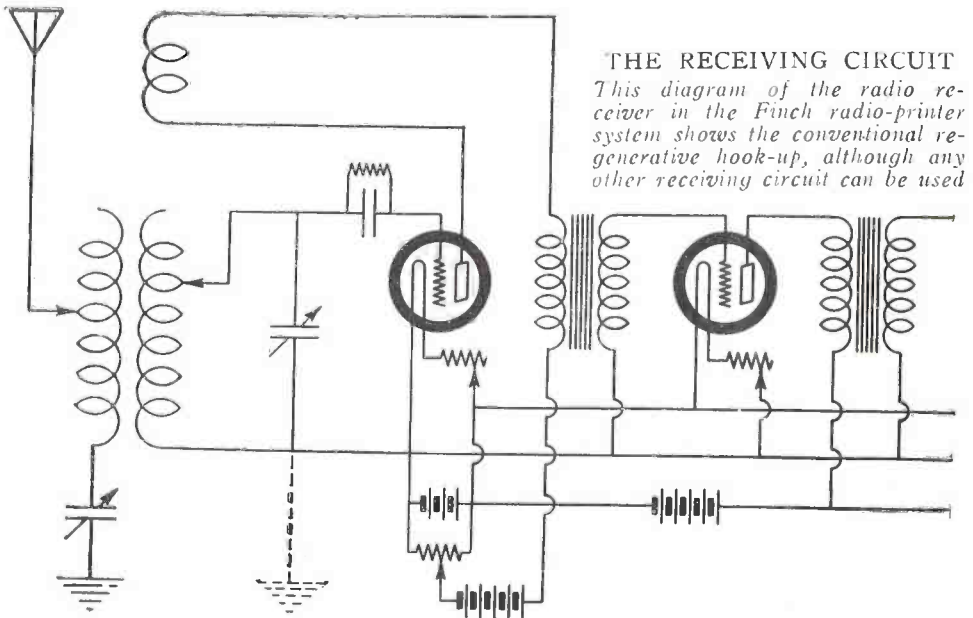

into words in the same formation as they were recorded by the transmitter.

Until lately, the part played by radio in news dissemination has been confined almost solely to transoceanic work. But due to the new developments, that are described for the first time in this article, radio must become the prime factor.

Such a radio system as here described is able to speed up transmission, eliminate interference and make the transmission available only to those for whom it is intended!

For example: a large news company sends out a very important and exclusive story in full detail to a group of distant newspapers which subscribe to the service, with the assurance that the story can be received, word for word, at a high rate of speed and only by those equipped with the necessary special receiving apparatus.

With this system, the whole front page of a newspaper can be transmitted at a speed of hundreds of words a minute. A distant subscriber can take the printed word stories and set them up in type immediately.

The automatic high-speed radio printer is a combination of the present telegraph-

printer equipment (such as is employed on land lines) with that of a suitable radio installation. In order to describe the system in a simple manner, no mention will be here made of complex radio circuits, which are already well known to the art, and which obviously may be employed. Let us simply assume that we have an ordinary complete radio circuit (consisting of a transmitting and a receiving unit) to work with. At the transmitting end, the manually operated key is replaced with a machine transmitter, while at the receiving end the output of a suitable amplifier is fed into a sensitive relay*—which in turn controls the circuit of the receiving printer†, as shown in Fig. 1. This is fundamentally what is done.

The system comprises a transmitter that has a source of continuous oscillations, which may be a vacuum-tube alternator or an arc. The oscillations are interrupted or modulated by a system of impulse transmission such as that employed in the operation of a telegraph typewriter, which employs the Baudot code.

* Finch Patent, Feb. 17, 1920.

† Finch Patent, Jan. 29, 1924.

FROM THE AERIAL TO THE AUTOMATIC PRINTER

for the detector with two stages of audio-frequency amplification, the output of which is connected to the Finch radio relay A, which in turn controls a local circuit B, actuating the telegraph printer C.

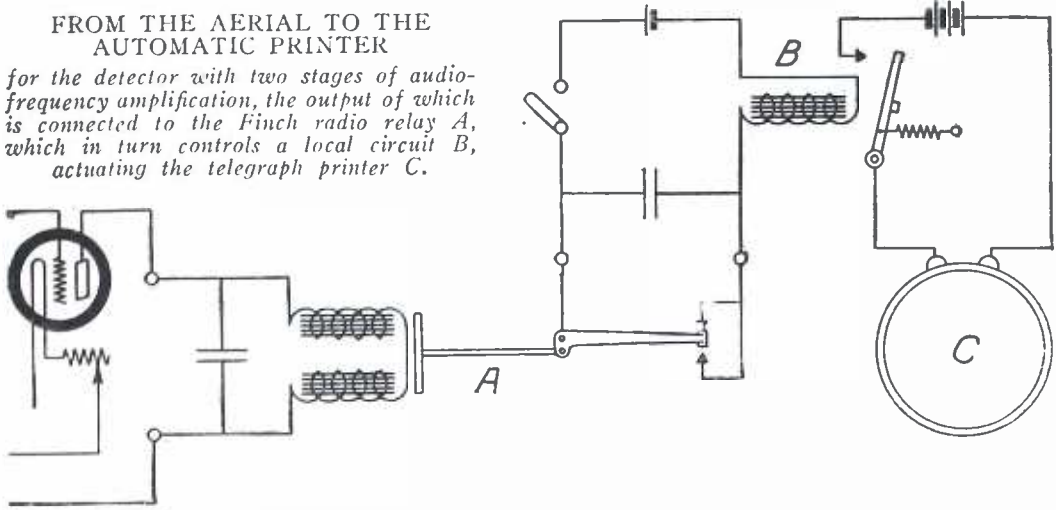

Numerous receiving systems may be employed in addition to various amplifiers, such as transformer-coupled radio-frequency, tuned-radio-frequency, audio-frequency, or tuned-audio-frequency (the last two tubes generally being in parallel). Or a 5-watt tube may be employed, with various schemes for keeping these circuits stable and the tubes from oscillating.

The state of the radio art today permits one to employ almost any type of relay if sufficient amplification is employed. Therefore, one has a choice of employing a multi-stage amplifier on the end of which is tied a power amplifier, or of using a sensitive radio relay with comparatively little amplification.

It is well known that the more complicated the circuits are (that is, the more tubes that are employed), the more the difficulties increase in proportion. Therefore, the sensitive radio relay has its advantages, inasmuch as it permits operation on much weaker signals, thereby cutting down the number of tubes that would be necessary in operating the usual relay. This reduces the cost of operation all around.

During the early part of 1920 numerous stations were copied at high speeds both at Buffalo and Detroit by the system here described; the average distance was about 1,500 miles.

In the early part of 1921, the management of the International News Service saw the possibilities of employing the system for the dissemination of news. Accordingly, a test was arranged by them between the Navy Department at Washington and Buffalo, and between the Inter-City radio station at Detroit and New York. The results were successful and proved beyond doubt that the telegraph printers that were then available could be operated by radio. From that time on the International News Service has been experimenting and investigating the possibilities of establishing a supplementary radio news service.

Since that time numerous tests have been made, principally between Tarrytown (the receiving station) and New York (the transmitting station), a distance of twenty-five miles. A little over two years ago the work had progressed to such a point that tests were conducted for long continuous periods of operation in which the Kleinschmidt printer was operated at a speed of ninety words a minute, with very few errors.

Tests were then renewed in the heart of New York's skyscraper district, between Fifty-ninth Street and Broadway, which is at the entrance to Central Park, and 21 Spruce Street, two blocks south of Brooklyn Bridge. While these tests

	1	2	3	4	5
A	●	●			
B	●			●	●
C		●	●	●	
D	●			●	
E	●				
F	●		●	●	
G		●		●	●
H			●		●
I		●	●		
J	●	●		●	
K	●	●	●	●	
L		●			●
M			●	●	●
N			●	●	
O				●	●
P		●	●		●

	1	2	3	4	5
Q	●	●	●		●
R		●		●	
S	●		●		
T					●
U	●	●	●		
V		●	●	●	●
W	●	●			●
X	●		●	●	●
Y	●		●		●
Z	●				●
SPACE			●		
CAR. RET.				●	
LINE FEED		●			
FIGURES	●	●		●	●
LETTERS	●	●	●	●	●

FIVE-UNIT CODE

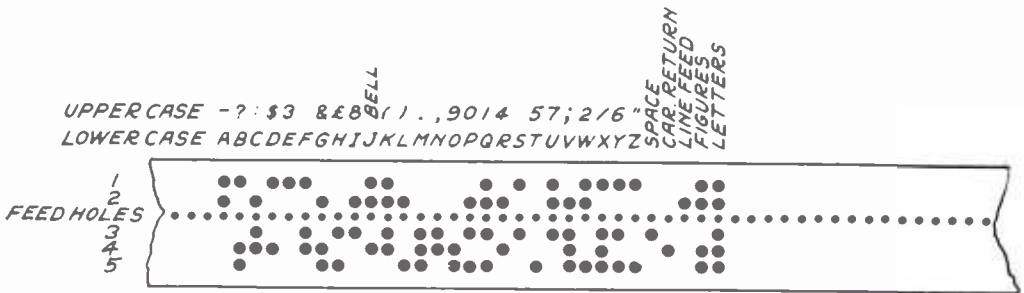

THE BAUDOT CODE FOR TAPE TRANSMISSION

FIGURE 2: The upper chart shows the code with the position of the impulses for each letter. The lower figure shows how these impulses are represented by perforations cut in the tape by a machine operated like a typewriter; as the tape rolls through the transmitting machine an electric contact is made through each hole which causes an impulse to be sent out over the radio transmitter.

were going on, numerous ships in both the Hudson and East Rivers were sending out test signals that would have rendered useless any ordinary system. The Brooklyn Navy Yard's high-power transmitter was also within sight, to say nothing of the various broadcasting stations (of which there are eleven in that district). The adverse conditions that were then overcome as far as working through interference is concerned can be easily appreciated.

A. M. Stevens became associated with

this work in the early part of 1922, and has materially contributed to the system as it now exists, and during the past six months has conducted other tests successfully at the average speed of 65 words a minute over long periods, with very few errors, on the Federal Telegraph System, between Los Angeles and San Francisco.

In order to still further prove the dependability of the system, the writer suggested that the receiving station be located in the very midst of the coun-

try's most powerful broadcasting stations at the Waldorf-Astoria Hotel, which is located only a few blocks away from WEAf, WHN, WJZ and WJY.

This demonstration was most successful; the printer was operated during the afternoon and evenings with remarkable accuracy, and the newspaper men present were extremely enthusiastic over the new project.

It might be well to state that this test was conducted on an extremely short wave, ranging from 60 to 125 meters in length. This was the first time that such a demonstration was made on such high frequencies.

For the information of those who are interested in the construction and operation of this high-speed transmitter system the following data is offered.

How the Transmitter Works

The three well-known American systems that employ the Baudot code are the Kleinschmidt system, the Western Electric, and the Morkrum. In each system the message to be transmitted is first prepared by a perforator on a paper tape from a standard typewriter keyboard.

The tape (Figure 2) is then fed through a transmitter which translates the tape perfora-

tions into electric signals, which are reproduced on the receiving end and printed in page or tape form. Although the type of perforator and transmitter used in each of the systems is mechanically different, the result in operation is the same.

A glance at Figure 3 will show that for each character a definite time duration, depending upon the speed with which the equipment is operated, is maintained. This is indicated by the distance between the heavy bars. Each character is itself composed of one "start" and five "selecting units."

Illustrating the letter "Y," which requires the selection of the first, third and fifth time units, we see that the sequence of operation will be: the start impulse, and immediately following that, the impulses for the five units. The second and fourth units are not required and no impulse is sent for these periods. The first, third and fifth *do* require impulses and consequently we get a graphic representation of letter "Y" as indicated in Figure 3.

The letter "P" is also shown. The impulses required for this character are the second, third and fifth. That gives us a graph for letter "P" as represented. Comparison with Figure 2 will show the similarity between this and the letter "P" as received on the undulator.

Figure 4 shows on a strip of tape, the signal shapes as recorded by an undulator for the words "Popular Radio."

Figure 5 shows the synchronizing impulses which are sent out to keep both the transmitter and receiver in step. The Kleinschmidt tape-feeding and transmitting mechanism is shown in Figure 6. The tape is prepared by the perforator and is fed through the transmitting distributor and is stepped forward by

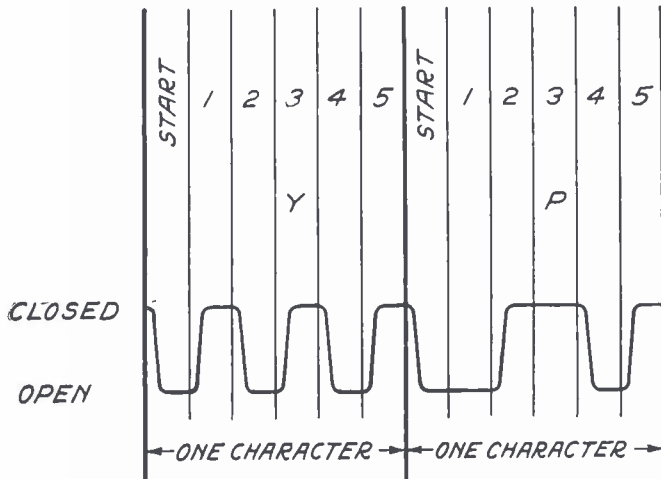

HOW THE IMPULSES FOLLOW EACH OTHER TO FORM THE CHARACTERS

FIGURE 3: Every letter takes the same amount of time to transmit; it consists of five short periods which synchronize with the five periods of the receiving apparatus, so that an impulse sent during any one of the five sending periods will register in the corresponding receiving period. The curve shows how the impulse-space-impulse forms a wave train and the second part of curve shows the effect of letter P.

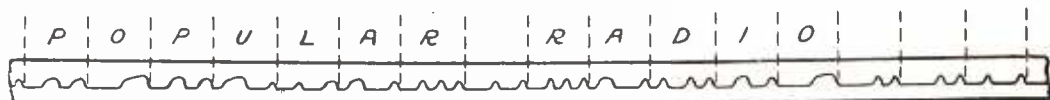

A GRAPHIC IMPRESSION OF THE TRANSMITTED SIGNALS

FIGURE 4: The words "Popular Radio" as they would appear after being transmitted by the Finch Radio Transmitter and received on an undulator.



THE TRANSMITTER AND RECEIVER MUST KEEP TIME

FIGURE 5: The synchronizing impulses which are sent out regularly to keep the transmitter and receiver in step.

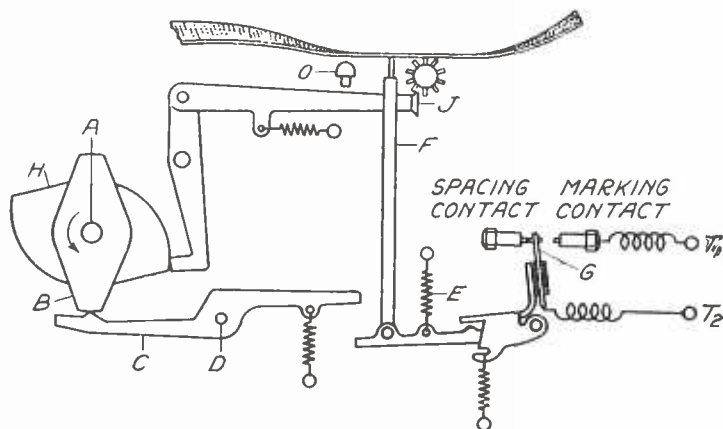

THE KLEINSCHMIDT TAPE-FEEDING AND TRANSMITTING MECHANISM

FIGURE 6: The tape is fed forward by means of the cam H and the pawl J. Five pins, F, located one behind the other, operate in succession and make contact through each row of holes in the paper.

means of the cam H and the pawl J, once for every half revolution of the transmitting shaft A (Figure 6). For every revolution of the transmitting shaft two impulses are transmitted.

The transmitting cam shaft A is motor-driven through a friction clutch at any desired speed from 40 to 100 words a minute. As the shaft A revolves, the cam B moves lever C about a pivot D allowing the spring E to draw the pin F upward. If a hole in the perforated tape presents itself above the pin F, the latter pin will pass through the tape and the contact tongue G will move over against its negative or marking contact as shown. If, however, the pin F is blocked by the tape, the contact tongue G will remain against its spacing contact. Six cams B, six levers C and five pins F are located one behind the other and operate in succession.

The contact tongue is connected in place of the usual manually operated telegraph key in the radio transmitter, and impulses are therefore sent out as the 5 pins F move upward, one after the other, and are blocked or not blocked according to the perforations in the tape.

At the beginning of every character, one of the cams on the transmitting shaft A actuates a train of mechanism similar in every respect to that described above, except that no vertical pin F is included. At the beginning of each character the transmitting tongue moves to the right and sends out an impulse. This impulse is followed by the five selecting impulses.

The speed of transmission is from 65 to 100 words a minute.

The transmitting cam shaft A is not stopped after each character, but revolves constantly, sending out one character after another until the sending station wishes to stop transmission; this may be done at any time by moving a lever in the path of a stop arm attached to the transmitting cam shaft A. When the cam shaft A is stopped, transmission ceases, although the motor continues to drive the friction clutch through which the cam shaft is driven.

If, for any reason, it is desired to repeat a character a number of times, the button O (Figure 6) may be depressed so as to hold the pawl J out of engagement with the tape-feed wheel ratchet. In this way the tape will re-

main stationary and the same character will be sent over and over again as long as the transmitting cam shaft A continues to revolve and the button is depressed.

In order to signal quickly to the distant station, a bell-signal mechanism is provided as illustrated in Figure 7. Shaft K is clutch-driven and revolves only when the bell handle L is moved to the right. When the handle L is moved to the right, and then released the shaft K is released and the transmitting cam shaft A is stopped during one revolution of the shaft K. During this revolution the cam M moves the contact tongue G back and forth by means of the levers shown, sending the characters "figure shift," "J" and "letter shift" over the line. Whenever the letter "J" is selected in the printer, while the carriage is in the upper case, a bell is rung and no printing takes place.

If the bell handle L is held over to the right when the shaft K completes one revolution the latter will continue to revolve sending out a bell signal to the distant station once every revolution as long as the bell handle is held over; when the bell handle is released, however, the shaft K will be stopped and the transmitting cam shaft A will continue its motion.

At the beginning of each revolution of the shaft K, a small mechanical bell is operated so that the operator at the sending station may know how long to hold the bell handle L to the right in order to send out any desired number of bell signals.

Another glance at Figure 1 reveals a conventional regenerative radio receiver that employs two stages of audio-frequency amplification, the output of which is connected to the Finch radio relay which in turn controls a local circuit for the telegraph printer. The description of the operation of this printer is shown in Figure 8 in which the light brush arm N is clutch-driven at a speed slightly faster than the speed of the transmitting cam shaft at the transmitting station. This increased speed at the receiving station is compensated for by delaying the brush arm, after each character is received, sufficiently to keep the sending and receiving stations in step.

Normally the brush arm is held stationary by the "start" magnet armature with the brush resting on the start segment and the relay tongue held against its spacing contact. When a character is received a marking impulse precedes the first five selecting impulses and a cir-

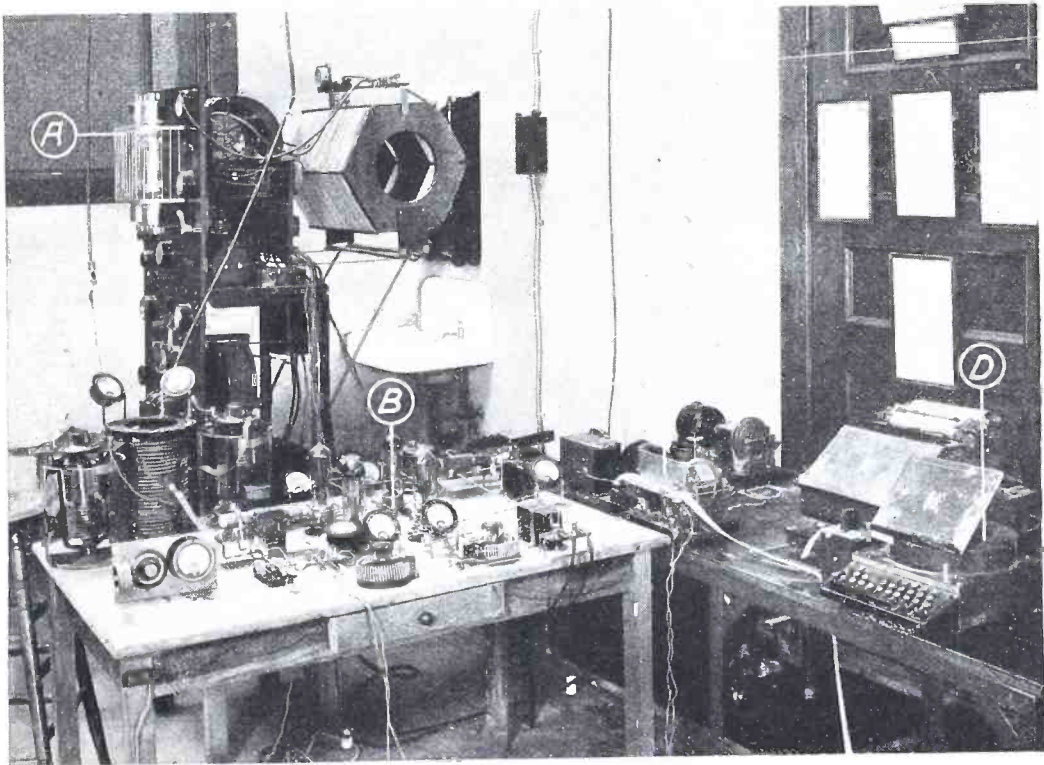

From a photograph made for POPULAR RADIO

THE PARTS OF THE HIGH-SPEED RADIO TRANSMITTING APPARATUS

A is a standard type of vacuum-tube transmitter for 600-meter wave transmitter. B is the short-wave outfit. Either can be actuated by the electrical impulses produced by the tape passing through C. D is the automatic tape perforating machine which cuts the proper perforations in the tape according to the letter struck by the key.

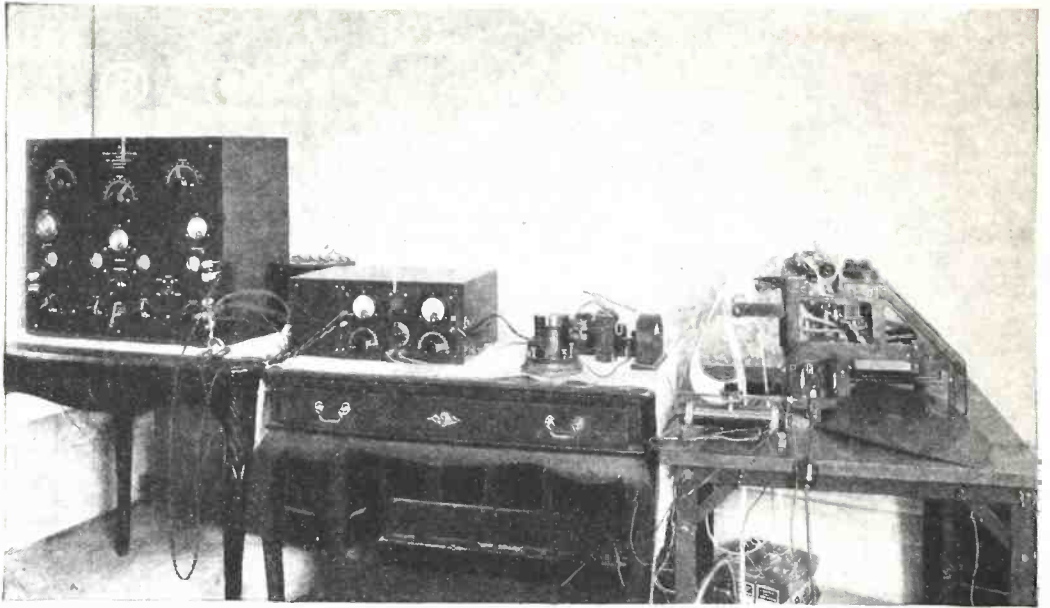

From a photograph made for POPULAR RADIO

WHERE THE RADIO IMPULSES ARE TURNED INTO TYPEWRITTEN PAGES AUTOMATICALLY

The radio impulses coming in over the air are received and amplified by radio receiver *A*, passed through selector and filter *B* and the impulses then operate Finch relay *C* and the control apparatus which actuates the automatic printer *D*.

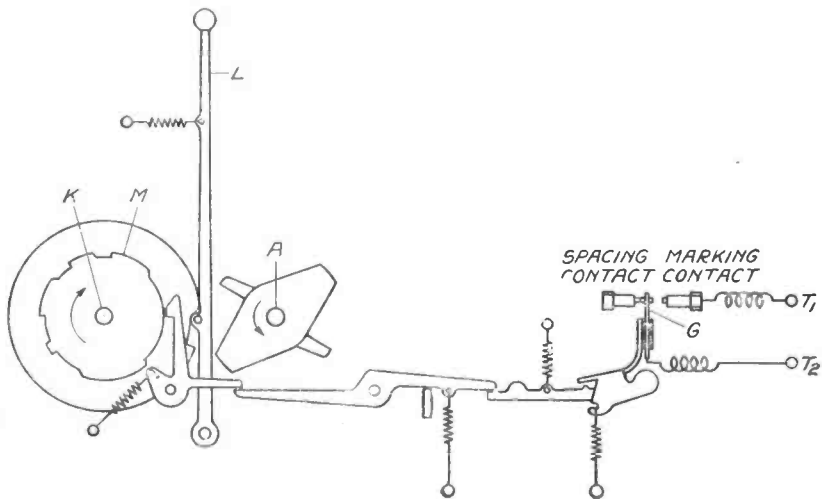

THE BELL SIGNALLING MECHANISM TO CALL THE DISTANT STATION

FIGURE 7: Moving the handle *L* to the right, the shaft *K* is released and the transmitting camshaft *A* is stopped during one revolution of the shaft *K*, while cam *M* sends "figure shift," "J" and "letter shift" over the line. This combination results in a bell being rung at the receiving station.

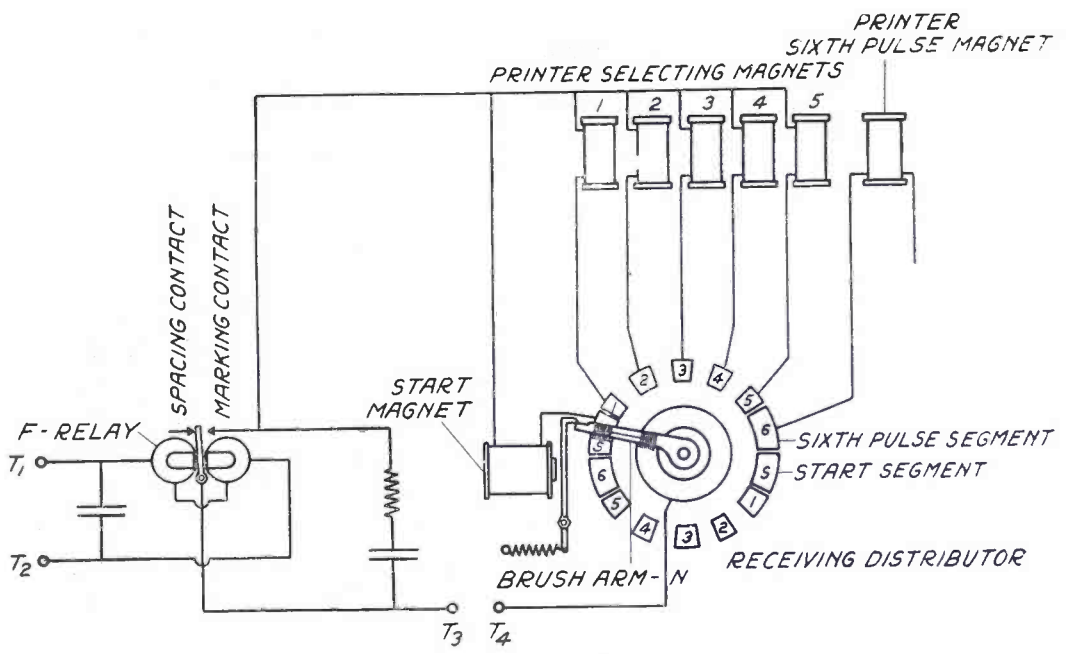

THIS BRUSH SYSTEM CONTROLS THE MAGNETS

FIGURE 8: The distributing brush of the receiver mechanism operates in synchronizism with the transmitter and as each impulse is received it operates the magnet which happens to be electrically connected by means of the brush at that particular instant.

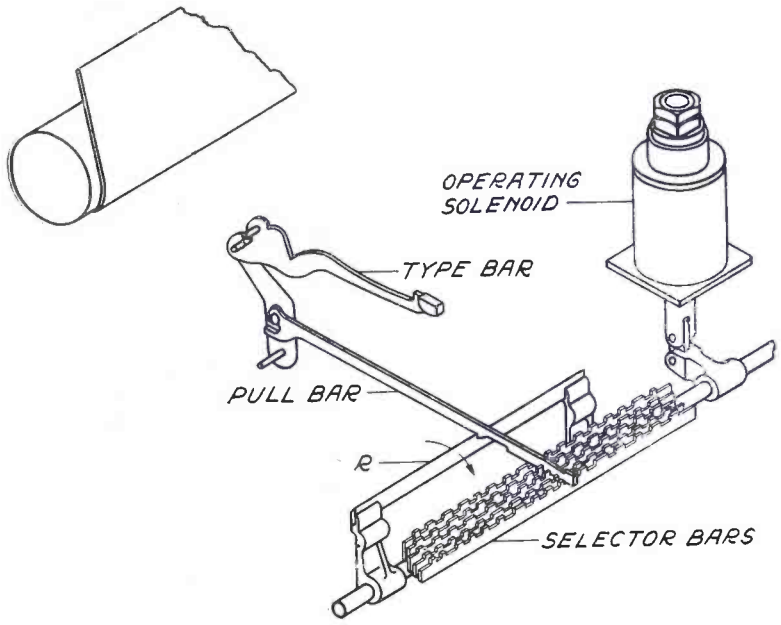

THE SELECTOR BARS LINE UP BY THE PULLS OF THE FIVE MAGNETS

FIGURE 9: Like a combination in a tumbler lock, the pull bars drop into the selector bars when the right combination is formed by the pulls of the magnets. Bail R then being actuated by the operating solenoid, causes the type bar to hit the paper and print the proper letter.

cuit is completed through the marking contact of the radio relay, the start magnet then is operated and the brush arm is released.

A local battery is connected to the solid ring of the receiving distributor and the marking contact of the radio relay is in series with the common return wire for the selecting magnets and the start magnet. Each one of the selecting magnets in the printer is connected to a corresponding receiving segment. If, therefore, the brush passes over receiving segment No. 1 while the line relay tongue is against its marking contact, the first selecting magnet will be energized and similarly the second, third, fourth and fifth selecting magnets. As the brushes pass over each segment in turn they will or will not carry current to each successive selecting magnet according to whether or not the radio relay is in a make or break position.

After the brushes pass over the five selecting segments they pass over a sixth-pulse segment, completing a circuit through the sixth-pulse magnet in the printer and then again come to rest on a start segment.

When a selecting magnet is energized its armature lifts a pawl in the path of a selector bar and a latch locks it in this position. Five pawls are located on a bar that is moved by the sixth-pulse magnet. When the selection is stored up in the pawls on this bar, the sixth-pulse magnet is operated and the pawls that were lifted move the corresponding selector bars to the right.

Each type-bar (Figure 9) is connected to a pull-bar mounted directly above and at right angles to the selector bars. When one or more of the selector bars is moved to the right, a slot is presented under one of these pull-bars and the selected pull-bar drops so that a hook on the under side of the pull-bar is in the path of an operating bail R. This bail is moved by an operating solenoid whenever a pull-bar drops into a slot in the selector bars. In this way the selected type-bar is thrown upward and the proper character is printed.

Spacing after every letter is provided for by means of a spacing solenoid which is energized whenever a type-bar moves upward. Spacing between words is accomplished in a similar manner except that the type-bar selected does not carry any type and therefore does not print.*

The largest users of the now available communication systems (wire and radio) are the newspapers and the news services, and to them follows the opportunity of utilizing this or other systems that may be developed in the future.

Among the advantages of using the automatic high-speed radio printer may be included the following features:

1: It insures secrecy of its messages,

thereby preventing use by unauthorized persons.

2: It makes possible high-speed operation, from 65 to 100 words a minute, thus insuring low costs.

3: It supplies all services to remote locations at a nominal figure.

4: It furnishes a local news service to the newspapers in the larger cities where it is difficult to obtain wire facilities.

5: Its quadruple operation makes available four different channels of operation which may be employed for four different kinds of services.

Other kinds of business enterprises that depend upon communication systems are: shipping companies, brokerage houses, banks and railroads, all of whom may eventually make use of such a system.

It is obvious that any zone or number of zones may be accurately and completely covered by such a system. A zone area may cover 100, 1,000 or 3,000 miles or more, and any number of receiving printers may be set up in these zones that would be operated automatically from the zone station. If there are numbers of zones to be covered with different natures of service, the assignment of different frequencies for each zone station would eliminate the possibilities of overlapping or interfering with other zones. In other words, radio printers may be located in each zone and could be supplied with an entirely different service to those of the other zones without one zone interfering with another.

In some cases it might be desirable to have a transmitter powerful enough to cover the whole country. If, for instance, the President delivers a message, or if news matter of national importance is to be transmitted, such a station could be operated on a predetermined frequency and all zone stations could then be instructed as to the necessary adjustment to be made on their local receivers, and could receive and print the news simultaneously.

* Mr. Finch's associates in this work have been A. M. Stevens, Wm. A. Bruno, and J. Geo. Uzman, all of whom have contributed to the success of the system as it stands today.



Photo News

The efficiency of your set depends largely upon proper adjustments. Here is a set on which William Delaney of New York brought in 49 stations in a single night.

Practical Pointers for the Listener

By Y. Z. MUTS

Don't Burn Your Tubes Too Brightly: One of the most expensive stunts of the radio fan is burning the filament of the tubes at the maximum brilliancy. This may give more volume for a short time, but it cuts down the life of the tube. If you are after louder signals, use more "B" battery on the plate—but do not overload that either! Ascertain the maximum plate voltage the tube will stand; this information is usually printed on a slip of paper in the package containing the tube.

Attach Your Receiver to Your Windshield: You may combine the joys of motoring and listening in by attaching a shelf for the portable set to the windshield of the automobile. Tuning operations can be conveniently carried out by the individual sitting on the front seat with the driver.

How to Use Old Mirrors: Old and broken mirrors lying around the house can be put to good use by the experimenter while he is repairing broken connections in receivers. Merely direct rays of light on the place where you are working on the receiver. By such a method you will not need a flashlight for dark corners and you will thus save the battery. With the aid of the mirror a light may be directed in almost any position, which would enable the experimenter to get light in almost any corner of the set during an emergency.

How Radio Waves Leak Off Trees: Never let an aerial or lead-in run through branches of trees; that is one way of reducing the efficiency of your receiver. The tree with its running sap and moist bark is an excellent conductor of radio-frequency currents and the tendency is for radio waves to leak off to the ground through this connection. Remember this when camping.

Pointers About Your Lead-in: The lead-in should be well insulated and kept distant from the sides of the houses along which it is brought down from the receiver. It should not run adjacent or parallel to the other current-carrying conductors of any kind. At the point of entry into the home great care must be exercised; if the wire is bare (without any covering) it should be passed through a long porcelain tube or brought into the house by some other insulating medium. Under no condition should the bare wire touch any part of the building. After the wire is brought into the room, it should run to the antenna binding post in the most direct path with the minimum amount of twists or turns.

A One-night Test Is Useless: Remember that a test of a radio set that extends over one night only is poor policy. At least a week of listening, covering varying varieties of weather, temperatures and static conditions, is advisable before either accepting or condemning a set. It may bring in plenty of "DX" one night and get only locals the next, due to the difference in the weather and other atmospheric factors.

How to Avoid Body Capacity: A long ground lead or a poor one often causes body capacity in the receiver. Connecting the ground to a steam radiator is poor policy, because the pipes take many turns before they get to the ground and actually act as a counterpoise. The best ground is the water pipe.

How to Prevent Splitting Your Baseboard: A bit of soap rubbed on the screws used to fasten instruments to the mounting board, will prevent the wood from splitting—which often occurs when the screw is fastened too tight! to the wood.

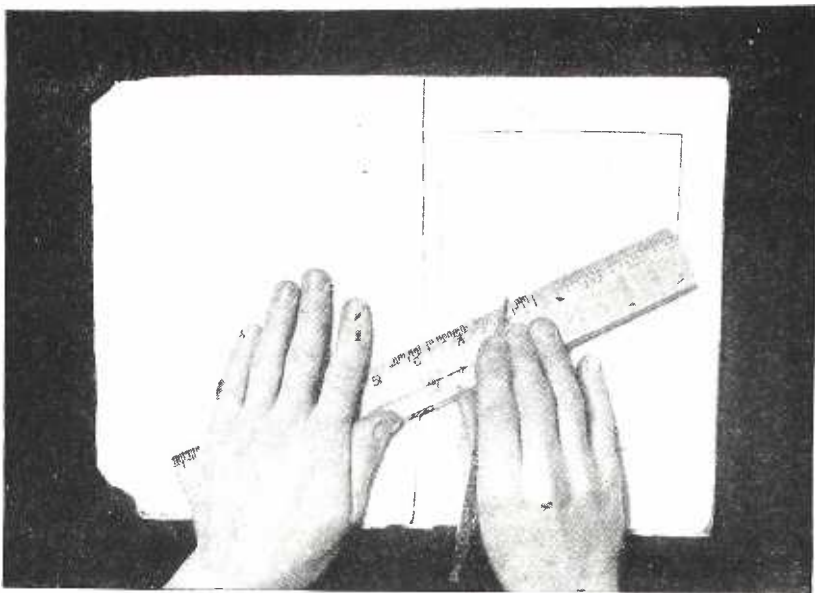

ALL YOU NEED IS A RULER, A PENCIL AND A PAIR OF HANDS
By means of the table on the facing page, the amateur who builds his own apparatus may calculate in an instant the values of resistance, current, and voltage in any DC electric circuit.

A MEASUREMENT CHART

FOR A QUICK CALCULATION OF OHM'S LAW

ARTICLE NO. 10

By RAOUL J. HOFFMAN, A.M.E.

THE amount of current that flows in a circuit depends upon the voltage of the battery and upon the value of the resistance in the circuit. The equation—called Ohm's Law—applied to above conditions, states that the current is equal to the voltage divided by the resistance or

$$I = E/R$$

wherein I denotes the current measured in amperes, E is the electric pressure (voltage) measured in volts, and R is the resistance, measured in ohms.

Ohm's law is equally applicable to direct current (DC) and alternating current (AC) circuits, but in the latter case the above simple relations must (in general) be modified. Ohm's law is correct only

for solid conductors at ordinary temperatures; in radio work it is used to calculate the resistance required, in a rheostat, for the proper operation of a filament for various tubes and the various voltages supplied.

For example:

Using a WD-12 tube, which requires a current of .25 amperes at a filament voltage of 1.1, we can find the necessary resistance by transposing the above formula, so that the resistance is equal to the voltage divided by the current. Substituting the above values, we have:

$$R = \frac{E}{I} = \frac{1.1}{.25} = 44 \text{ ohms}$$

which is the resistance of the filament.

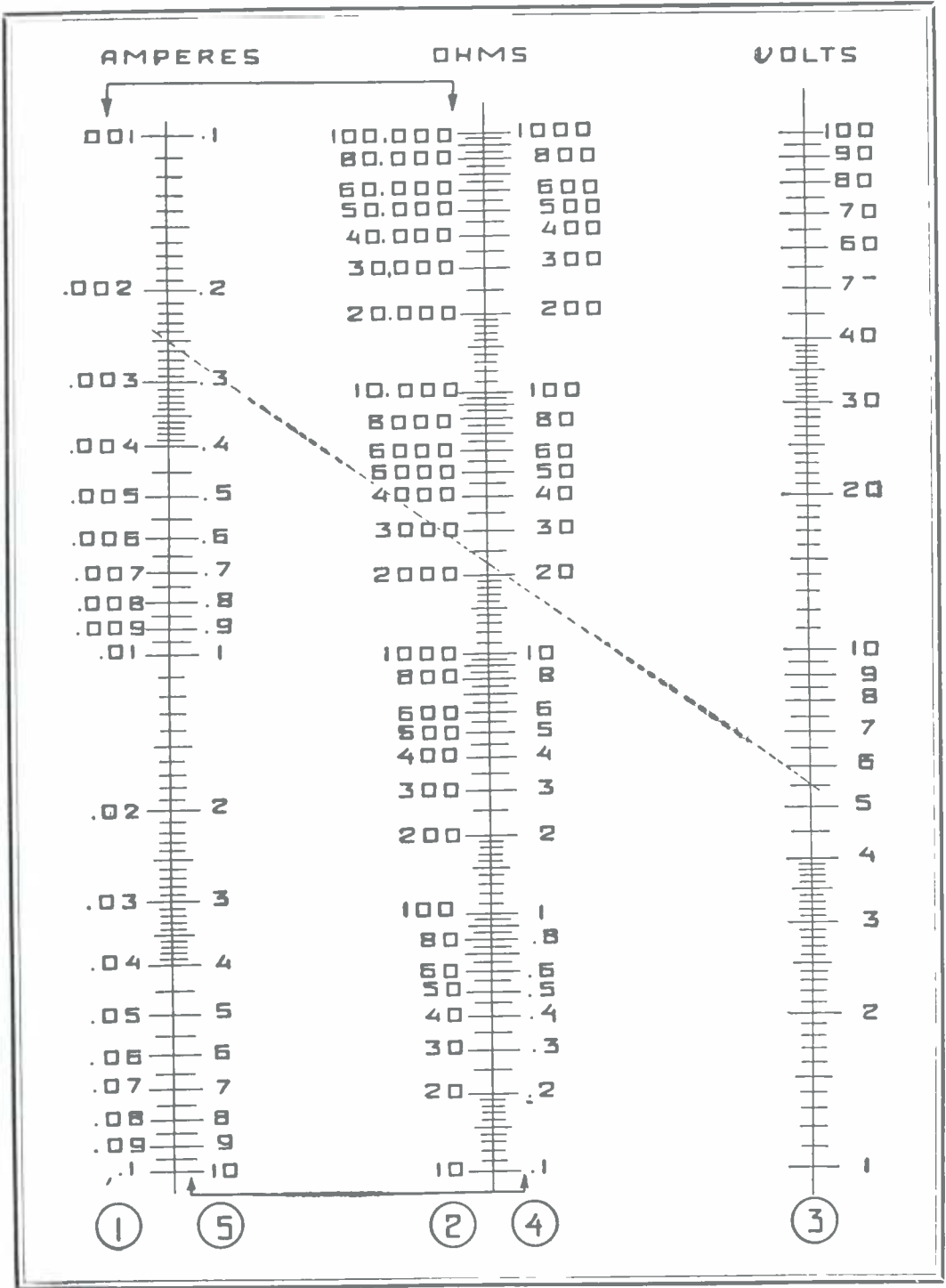

MAKE YOUR CALCULATIONS ON THIS TABLE

The text of this article tells you just how to determine the proper resistance to use with a certain type of vacuum tube and a certain voltage "A" battery. There are a great many other uses that you will find for this handy chart in connection with the calculation of Ohm's Law.

Using a 6-volt storage battery (6.6) we will have an additional voltage of 5.5 volts, which should pass through a resistance current of .25 amperes.

We therefore, divide 5.5 by .25 and find the necessary resistance to be 22.0 ohms, which is the additional resistance required for the circuit. Adding a certain amount of resistance, allowing for filament control, we find we will

have to use a 30-ohm rheostat for this purpose.

For handy calculation, a chart is attached which can be used in the same manner as any one of the charts previously published.

For the above example, connect 5.5 on scale No. 3 with .25 on scale No. 5 and read (on scale No. 4) the resulting resistance of 22.0 ohms.

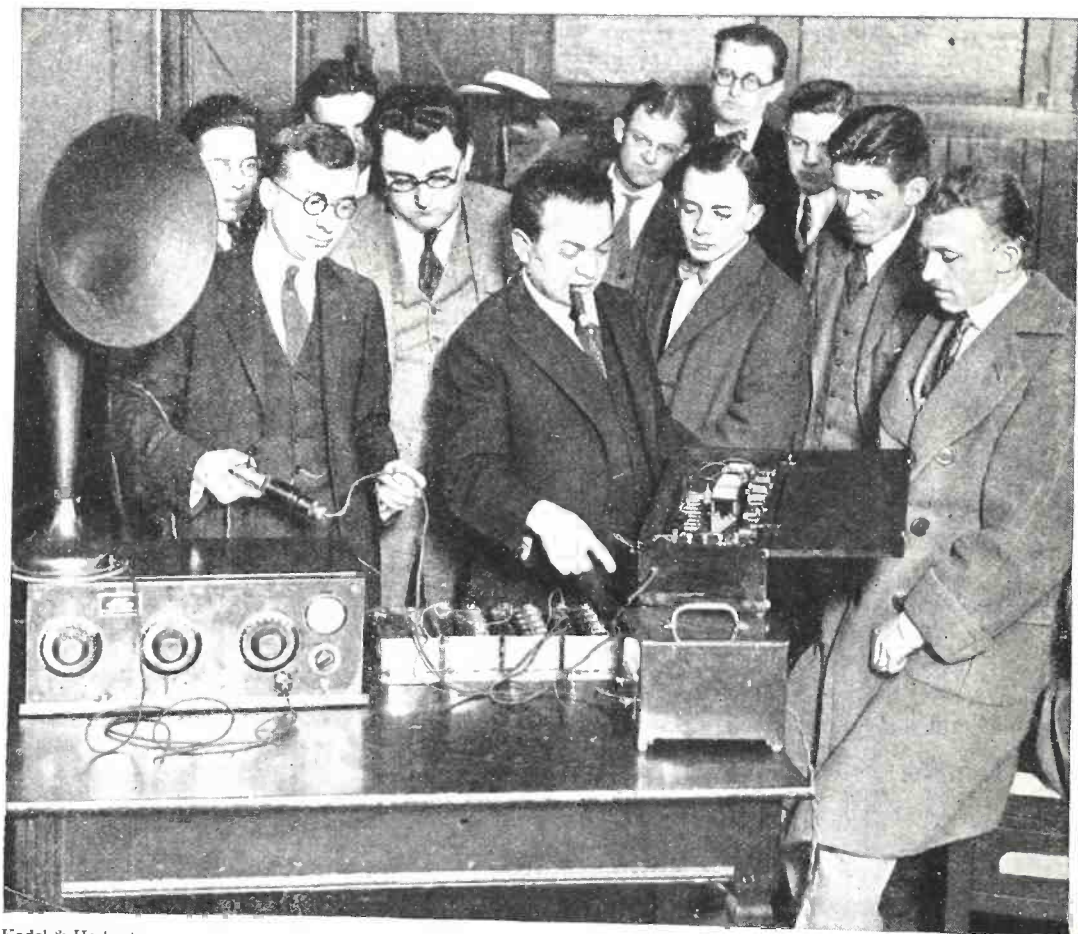

Kadel & Herbert

A NOVEL DEVICE ELIMINATES THE "A" BATTERY

The latest development by Harry W. Houck, a well-known radio engineer, is the instrument pictured above, which is being demonstrated before a group of radio experts. The inventor is shown connecting the wires running to the device to the electric light socket. William Dubilier is pointing at the instrument, which is contained in a metal cabinet similar to that of a battery charger. This new apparatus makes it possible for the operator to light the filaments of the tubes in the radio receiver from either AC or DC current without the usual humming sound being produced in the receiver.



THE AUTHOR MAKES A HARD-RUBBER BRACKET

The little piece of hard rubber, cut from an old panel and bent as described in this article, may be fastened to the main panel by a screw or bolt and makes a convenient support for many radio devices.

How to Work Hard Rubber

In this practical article the author, who is a distinguished chemist, tells how the radio experimenter can make useful devices out of discarded hard-rubber panels. That Mr. Killeffer is himself a radio fan and uses these rubber brackets and sub-panels on his own sets, adds to the interest of the article for amateur experimenters.

Illustrated by a series of special photographs posed by the author—

D. H. KILLEFFER

HAVE you ever needed a small piece of hard rubber of just the right size to mount the binding posts on the back of your set, and after you have tried all the radio stores in the neighborhood have you thrown up your hands in disgust because the prices for what you want were too high to consider? Then you think, of course, about the old panel from your last

year's set and you spend a few hours trying to saw out the piece of rubber that you want, only to have the thing crack in all kinds of fiendish ways. The edges are not smooth, the corners are not square and you are no better off than before.

If you have been through all this sort of thing, here is where you get help.



SOFTENING THE PANEL

The end of the panel is dipped into a pan full of hot water until the rubber becomes soft. Note that the shears which are to be used in cutting the panel are also dipped into the water, so that they, too, will be warmed.

We are going to think for a moment about hard rubber generally and just how the "nature of the brute" makes it about the easiest thing to handle that you could wish. Have you ever happened to hold a hard-rubber comb under the hot water faucet for too long? Even if you did this you probably never thought of it in connection with your radio set, so I will remind you of what happened.

The comb got soft, and bent. Hard rubber, no matter how hard it seems, becomes positively cheesy when you dip it for a few minutes into boiling water. Your comb looked as though it had been through the war when you tried to use it while it was too hot. Now, not only does the piece of hard rubber

from your panel cease to be hard and brittle when it is properly heated, but you can save yourself all the agony of trying to saw it. A knife that will not even "cut hot butter" will do a beautiful job cutting hot hard rubber!

Now to settle that problem about a small rubber panel for your binding posts, or for something else around your set.

Take that old panel—of course, these remarks apply only to hard rubber and not to bakelite or any of the similar panel compositions—and mark out on the panel just the small piece that you want to cut out of it. A scratch awl or a sharp darning needle is best for the marking, although you can use a pin if you have to. It is not good practice to use a lead pencil because you may forget to clean off the marks completely and they are likely to cause leaks in current later on.

After you have your piece marked out, dip that part of the panel into boiling water and leave it there for four or five minutes. Get a pair of shears or a knife as hot as the rubber by dipping them into the boiling water too. Then pull out the rubber and the shears and while both are still hot cut the rubber along one of the lines that you have made. If you do not get the line entirely cut before the rubber cools, simply dip it back in the boiling water and try again. Don't worry if you bend the rubber out of shape a bit for that is easy to fix.

For a long cut use a pair of scissors. They will give you, usually, a straighter line than a knife will. Be sure they are hot. If you try to cut hot hard rubber with a *cold* pair of scissors or with a *cold* knife, or if you lay your hot panel down on a *cold* table to cut it, you are sure to have trouble. As soon as the rubber is cooled it gets hard again.

Be sure that the rubber is hot enough to be soft before you try to cut it. Five minutes in boiling water—not just

lukewarm, but actually boiling hard—is generally enough, but if it is not, don't hesitate to try again. When you make the cut hold the rubber in your hand with a piece of cloth to protect you, or else carefully warm a piece of smooth metal and lay the rubber on that to cut it.

Now, having cut out the small piece that you want, you will probably find that it is all out of shape. I told you not to let that worry you. Now I am going to tell you how to get it smoothed out again:

Dip the small piece in boiling water again and then put it on something smooth and not too cold. Press it out flat with your hand and leave it to cool. Be sure that the surface you put it on is perfectly smooth and clean, because the rubber will harden in just the shape of the thing it is lying on. If the rubber piece that you have cut out is small enough the bottom of a flat-iron that is just warm enough to hold your hand against comfortably is about the best thing to use.

Don't try to press out the rubber with the iron; invert the iron and lay the hot piece of rubber on it to cool. When it is cool, you will have a first-class job.

The precaution of not having the iron too hot is very necessary. If you get it too hot you are likely to burn the rubber, and "your nose knows" what that means—not only yours, but all the other noses in the neighborhood.

Here is another good use for that discarded rubber panel. Many of the recent directions for building sets call for little brass angles, and they surely are handy things to have around. However, there are many places in a set where such angles could be used if they were *insulators* instead of conductors.

Well, why not make some angles out of rubber? You can use that same old panel we have been talking about. Cut out a piece of hard rubber and,



HOW TO MAKE THE CUT

The warmed rubber and the warmed shears are lifted out of the hot water and a piece of the panel is cut off along a line previously marked out with a scratch-awl or similar instrument.

while it is still hot, bend the piece into the shape you want. But be sure that you provide a way for it to cool in just the desired shape because if you do not, you will get all kinds of irregular shapes.

For instance, suppose you want a right-angle piece an inch wide with its two legs each an inch long. First cut out a strip of rubber an inch wide and a little more than two inches long, say two and three-sixteenths, to allow for the bend. Now heat this in your boiling water, bend it over the edge of something square and let it cool there. When you cut the piece be sure to make it wide enough, because hard rubber is not so strong as brass.

After you have cut and bent your



NOW TO TRIM THE ROUGH EDGE OF THE CUT-OFF PIECE

While the small piece of rubber is still warm enough to be somewhat soft, the rough edge (where it was cut off from the old panel) may be trimmed down with a warmed knife until it is absolutely straight and true.

little angle, the necessary holes for mounting can be drilled in it and you have a bracket that your wires may touch without danger of short circuiting anything. Be very sure that the rubber is quite hot and soft before you try to bend it. Otherwise it is sure to crack.

This softening of rubber that is so useful now to radio fans was just the thing that Charles Goodyear, a Connecticut inventor, set out to correct some seventy years ago. Before his time *all* rubber was soft and sticky and not nearly so elastic and stretchy as the rubber we know. If you have ever handled a piece of crude rubber you will know what I mean. It is almost the stickiest stuff you can think of, but still it will stretch a little bit and it has some other properties that are quite remarkable.

Rubber begins its existence as a milky sap from a tree, very much like

the sap of the common milkweed. It consists of millions of tiny droplets of rubber suspended in the watery sap. If this sap is allowed to sour or if it has the water boiled out of it, these little droplets separate out like the curd in ordinary milk. This curd is what we know as crude rubber and it has to be worked between rolls in order to get the water out of it before it is even fit for shipment to the rubber factories. Often it is held over a smoky fire to "cure" it and make it easier to handle.

That was the only kind of rubber there was before Goodyear conceived the notion of adding sulphur to it. It is said that he had the lucky accident to drop a piece of crude rubber mixed with sulphur on a hot stove.

The crude rubber, Goodyear knew, would stick to almost anything. Especially would it stick to other pieces of rubber. Most disagreeable of all it would soften and run like molasses if



A FLAT-IRON AS AN ANVIL TO MAKE THE BEND

The small piece of rubber, warmed again, if necessary, by dipping it once more in the hot water, is bent roughly at a right angle by bending it over the edge of a flat-iron or any similar object that has a right-angle edge. Do not make the bend too quickly or the rubber may crack.

it happened to be laid in the sun or to be warmed in some other way. Even with sulphur in it, the rubber was still pretty bad until Goodyear dropped it on the stove. That changed everything. That made the first hard rubber; the first radio panel.

That is all there is to hard rubber today. It is crude rubber and sulphur, heated together; "vulcanized," as they call it. If you put only a little sulphur into the crude rubber and do not heat it too hot or too long it will come out elastic like a rubber band. If you put in more sulphur and heat it a long time it becomes hard rubber. Of course, there are many other things that can be put into the mixture to make the hard rubber better for particular purposes, but always there must be these two; rubber and sulphur.

In the factory where your radio panel was made, sulphur and crude

rubber are mixed in immense machines like a bread mixer and whatever else the maker may think necessary is added. Then the whole thing is worked between large, warm, iron rollers until it is properly mixed. The mixture is pressed into molds and heated until it is finished.

The molds for radio panels usually have linings of smooth tin foil so that the surface of the panel will be smooth when the job is done. After it has cooled the hard rubber must be polished and then it is cut in just about the same way as I have described above, except that immense cutters are used, much like the paper cutters in a printing shop, instead of a pocketknife or a pair of shears.

One possible trouble with hard rubber is that if you keep it in hot water too long (say, for hours), or if it is left in the sunlight or if it becomes too old, some of the sulphur that has been

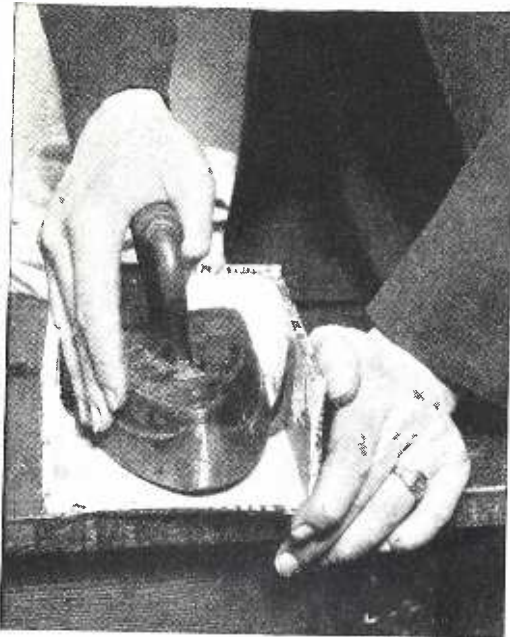

THE FINAL STEP

After the piece of rubber has been bent roughly into shape over the edge of the iron it may be trued up by pressing it into the corner of a cigar box, holding the side of the box at an exact right angle with its bottom. The rubber should be held in this position until it is entirely cool.

put into it so carefully will work its way to the surface. The panel ceases to be a good insulator.

If your panel loses its surface brilliance or becomes light colored through age or otherwise, do not use it. It is sure to cause trouble when it looks that way. If you want it to work well again

take off the instruments and scour the surface of the panel with steel wool moistened with a little lubricating oil until the surface is jet black again, or mahogany if it was that color to start. Of course, this "rusting" of the surface of rubber does not happen easily and generally takes some years under ordinary circumstances. And if your panel does "rust" scour off the surface of it and it will work like new again.

One more thing: Don't try to drill a panel when it is too cold. It is very likely to crack. It ought to be about ordinary room temperature, for if it is warm it becomes cheesy and if it is cold it becomes brittle. Use a drill just like you use for drilling metals. Mark the centers with a punch or with a small drill before you start the main drilling and put your panel on a firm piece of soft wood bearing against the other side of the hole you are drilling.

After you have drilled the hole use a countersink on both sides of it to clean off the little ridge of rubber around it. You do not need to make this countersink deep at all; about one thirty-second of an inch all around the hole is ample. This makes the switch taps, or whatever you are screwing onto the panel, fit better and hold tighter by giving them a bearing on the panel itself instead of on the little ridge around the hole.



Keystone

A royal radio fan, King Ferdinand of Roumania, snapped while sending a message to his son, Prince Carol, in Bucharest, from the St. Assise radio station in Paris.

A PLAY-BY-PLAY DESCRIPTION OF THE GAME

Side-line reports of the intercollegiate athletic contests are broadcast from the university's own station, so that the folks back home can listen in on son John's enthusiasms and share his interests.



How Radio Brings the College Home to Dad

The unique uses of the broadcasting station operated by the University of Illinois for letting the folks back home listen in on the student activities.

By ALFRED M. CADDELL

THE colleges throughout the land are breaking down their academic bounds and going more and more into the lives of the people.

Out in the middle west the University of Illinois is doing big things in radio—you have probably heard its station WRM on the air!

For a score of years, or since electricity began to assert itself in the practical affairs of men, a course in electrical engineering has been one of

the principal educational features that this university has had to offer. And like other progressive institutions throughout the land, when radio stepped forth in its swaddling clothes, it took the infant art into camp and is now doing its share to develop it into a colossal giant.

Let's drop off a few hours at Urbana, Illinois, situated in the land of alfalfa and corn, a little more than a hundred miles south of Lake Michigan. The

time was—not so long ago—when Student John left the country fireside and journeyed to Urbana to get an education. For the next several months, home made its appeal to him principally through memory, while Mother and Dad, back in the country perhaps, had a more or less imaginative perspective of the "U" that John talked so much about. But now if John sings or plays in the university band or gives a scientific address he can go home to them every night. Radio has stimulated in the minds of the people—the tax-payers who support the university—more than usual interest in education. It has humanized the university to them, and they tune in and claim it as their own.

But the University of Illinois does not at present go in for university extension courses *via* radio. Rather, it confines its activities to broadcasting programs that have their origin in the

university itself, to student and U. S. Officer Training Corps instruction, and to research and experimental work.

At regular times each week during the school year, for instance, it broadcasts programs of music, student plays, lectures of a non-technical nature by members of the faculty, running stories of football, basketball and other games that are of enough importance to make the people of Illinois want to listen. A short time ago it broadcast the running story of the Wisconsin-Illinois basketball game; on the following Saturday night it broadcast the story of the seventh annual indoor relay carnival which was held in the university armory and in which forty-five colleges and universities participated.

Occasionally some man of prominence speaks at some university function—and his talk can be tuned in by the folks back home.

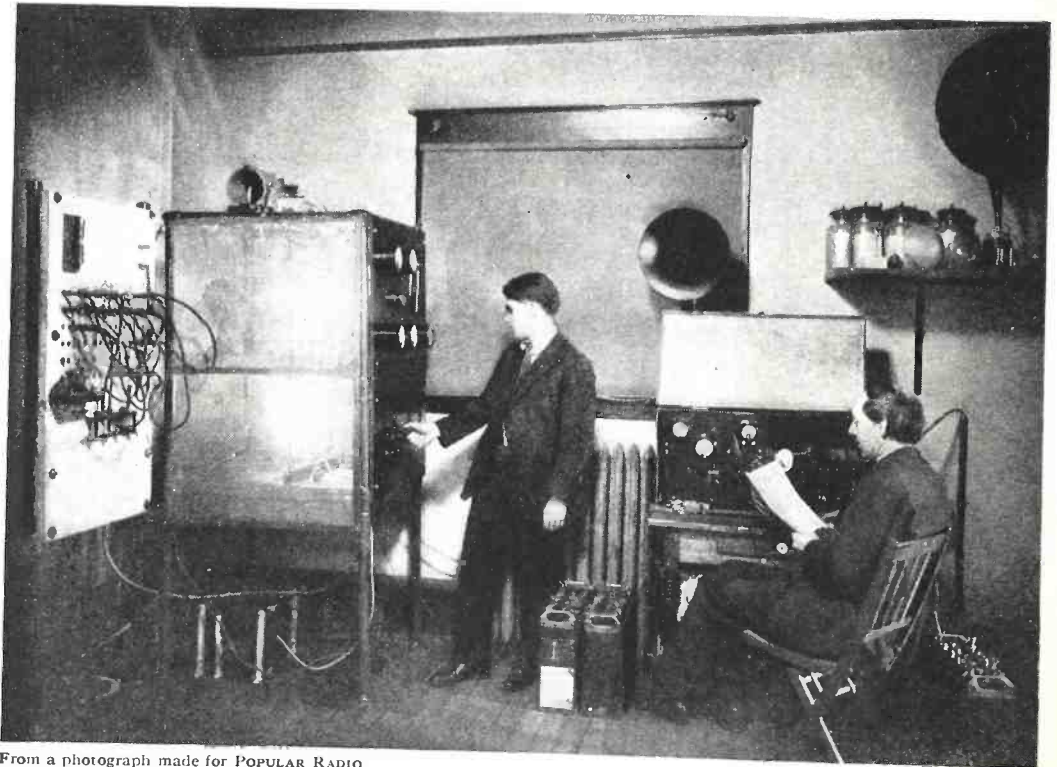

From a photograph made for POPULAR RADIO

A PEEP INTO STATION WRM

Here are seen the control boards, tubes and other sending apparatus of the University of Illinois station.



From a photograph made for POPULAR RADIO

WHERE COLLEGE STUDENTS STUDY RADIO

In this laboratory expert instruction is given in the technique of radio, and research work is encouraged.

Usually the musical programs come from two sources; either they are given by members of the faculty of the School of Music or else they are rendered by students in that school whose work is among the best. Concerts by the university band and the glee club are also broadcast frequently.

However, station WRM does not broadcast anything that is not of or by the university. That is, it does not permit people outside of the institution to use the station. This policy, on the face of it, might be construed as being selfish or unthoughtful, but after all this is a state university, supported and maintained by the tax-payers of the state, and the university authorities cannot use money for any purpose other than that for which it has been appropriated. The tax-payers would resent

the spending of money if WRM allowed outsiders to use the station.

Still another purpose for which the university uses the radio laboratory is for student instruction.

A course in radio is given in the electrical department of the College of Engineering. This course is open to seniors and those who take it are so credited in their electrical engineering work. Furthermore, because of the presence at the university of a Reserve Officers' Training Corps, the authorities are under contract with the government to give such a course, and the men in the signal detachments are required to make a study of radio communication.

The equipment of the radio laboratory of the university includes standards of the well-known constants of radio-frequency circuits and radio-frequency

measuring instruments, such as thermogalvanometers, precision wavemeters, precision variable condensers, calibrated variable condensers and voltmeters, vacuum-tube oscillators, power-absorbing high-frequency resistances, phantom antennas and other apparatus.

The laboratory work includes the more important radio measurements such as are necessary in radio engineering work; among these are the measurements of high-frequency resistances of coils and antennas, high-frequency measurements of condenser capacity and phase differences, inductance and logarithmic decrement. Among the important vacuum-tube measurement experiments are measurements of amplifier constants, mutual conductance, plate resistance, vacuum-tube characteristics, detection coefficients, and power-tube efficiencies. Also a few experiments on reception and radiation faults.

A few practice experiments are given in the technique of connecting up and operating power-tube oscillators, radio-telephone modulators and vacuum-tube amplifiers. The experiments, as well as the classroom work, are designed to follow the class of work done in the standard courses in direct and alternating-current theory and dynamo laboratory courses that are usually given in first-class engineering colleges.

A look-in at the transmitting apparatus in the laboratory—broadcasting station WRM—discloses an up-to-the-minute point of view. The transmitter is of the permanent type; the apparatus is mounted in a heavy iron-pipe framework, and the controls and meters are mounted on a large micarta panel. The oscillator consists of two 250-watt tubes in parallel, closed oscillator circuit of the Hartley type, with the inductively coupled antenna. The resistance of the antenna is 35 ohms at the frequency and wavelength used for broadcasting—namely 360 meters. With four amperes radiating, the power input into the antenna is 520 watts, as this is the usual

amount of radiation during broadcasting. The transmitter framework also contains three 250-watt modulator tubes in parallel in a separate sheltered compartment, the modulator tubes drawing 400 milliamperes during modulation with the vowel "a," and 75 milliamperes when no sound occurs, constant current modulation being used, and provided with the aid of a 20-henry choke.

The speech amplifier furnishes amplified voice-frequency power to broadcast this change in modulator plate current and oscillator output, the power speech amplifier containing three vacuum tubes, the last stage of which is a 50-watt power tube, and two 5-watt power tubes, furnishing agitation for the 50-watt tube. Control equipment for the entire transmitter is placed on the special amplifier panel. When broadcasting from the university auditorium, or the recital hall half a mile from the laboratory, a two-stage low-power voltage amplifier is used at the microphone end.

The antenna is of the L type, supported between iron-pipe masts 90 feet high, and is 15 feet wide with seven accurately spaced stranded wires. The counterpoise is placed on supports six feet above the ground and has about the same area as the antenna. The antenna lead-in is of the cage type. The natural wavelength of the antenna is 340 meters, and its resistance at this wavelength and frequency 18 ohms. The university's programs are broadcast from studios in the Smith Memorial music building. All the studios in this building are padded and insulated, making them free from echo, and results which compare favorably with those of any of the commercial sending stations are secured.

A third use to which the radio laboratory is put is that of research and experimentation. All of the experimental work is not directly connected with broadcasting, of course, but most of it is connected indirectly to radio, and the presence of the broadcasting station helps in many ways.



From a photograph made for POPULAR RADIO

THE COMPLETED TUNER HAS A SYMMETRICAL APPEARANCE

The secondary condenser dial and the knob that controls the coupling of the tickler are conveniently close together, so that tuning is quick and easy. This tuner can be used with any of the standard detector units on the market or with the detector, two-stage unit to be described in October POPULAR RADIO.

HOW TO BUILD A MULTI-WAVE TUNER

PART I

Here is a set that has been built by an amateur for use on all wavelengths. It will bring in everything within range that is coming in over the ether

By B. S. BICKELHAUPT, M.D.; (2CBA)

COST OF PARTS: *About \$30.00 **

RECEIVING RANGE: *Up to 1,500 miles*

HERE ARE THE ITEMS YOU WILL NEED—

- A, B and C—De Forest honeycomb coil mounting (Type LC-100);
- D—U. S. Tool .001 (43-plate) variable condenser;
- E—U. S. Tool .0005 (24-plate) vernier variable condenser;
- F—U. S. Tool .0005 (23-plate) variable condenser;

- G—series-parallel switch;
- H—composition panel, 7 by 15 inches;
- I—hardwood sub-base, 7 by 14¼ inches;
- J—cabinet;
- 6 Eby binding posts;
- wood screws, bus-wire, etc.

* This does not include the costs of the tubes, coils or batteries.

DURING a period of about two years I have made, through actual construction, a fairly exhaustive study of reception apparatus. And I have found that, for a receiver which will work well on all wavelengths and that will be selective in its tuning and clear in reproduction, a honeycomb set offers real satisfaction.

The set described in this article employs the regenerative circuit, using a tickler coil for feed-back and single-layer coils for the short broadcasting wavelengths. It is an old and well-tried outfit, and those who know agree that it is a good all-around receiving set. By using a variable bridging condenser across the tickler coil, regeneration may be secured by either magnetic coupling or by having a tuned-plate circuit. In other words, you can control the regeneration by changing the coupling of the tickler coil to the secondary coil, or you may get regeneration by moving the tickler coil as far away from the secondary as possible and then tune the plate circuit with the bridging

condenser. Another advantage of this arrangement is that you can secure regeneration over a wider range of wavelengths for any given size of tickler coil than when a fixed bridging condenser is used.

As the tuning coils are detachable, any size coils may be used, from the large duo-lateral or honeycomb coils used for receiving the long-wave transatlantic stations, down to small single-layer coils suitable for receiving the broadcasting which is being done in an experimental way by stations WGY and KDKA on waves from 97 to 107 meters.

It is interesting to note that a large number of the regenerative circuits which have been widely advertised can be duplicated by the triple-coil receiver of the type here described.

Close-coupled, untuned primary circuits are easy to construct. It is only necessary to remove the primary coil and substitute one that has only three or four turns, and then turn the mounting so that the coil is brought as close as possible to the secondary.

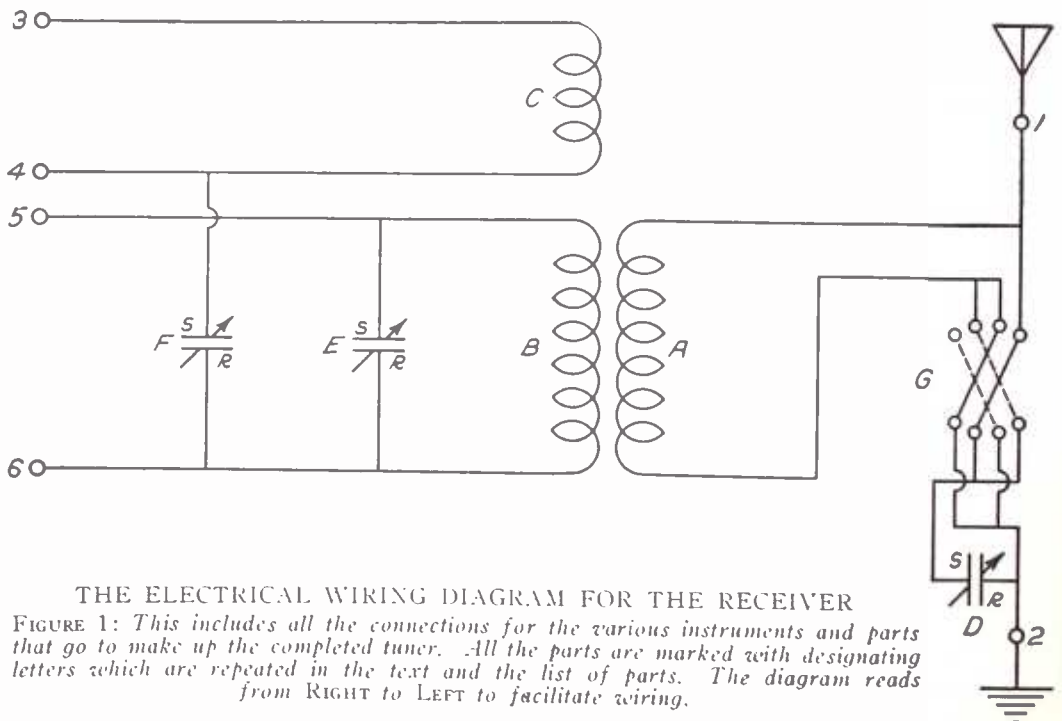

THE ELECTRICAL WIRING DIAGRAM FOR THE RECEIVER

FIGURE 1: This includes all the connections for the various instruments and parts that go to make up the completed tuner. All the parts are marked with designating letters which are repeated in the text and the list of parts. The diagram reads from RIGHT to LEFT to facilitate wiring.

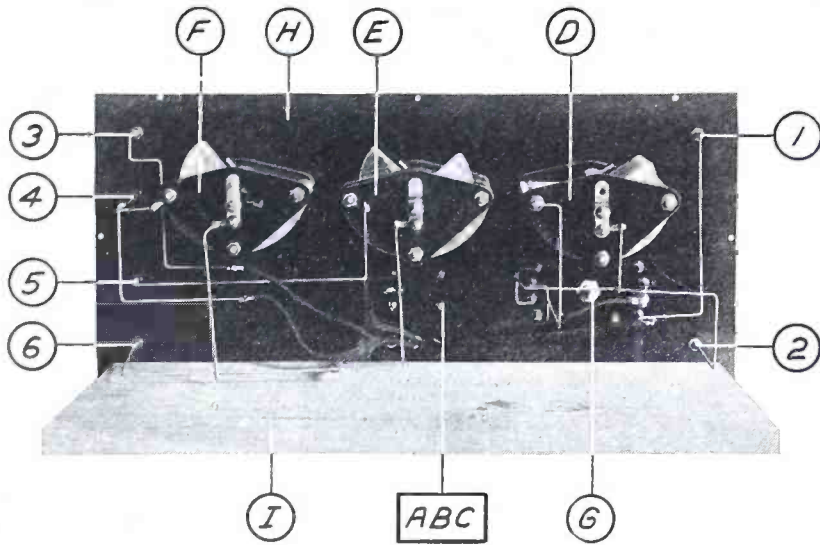

THE REAR VIEW OF THE SET

FIGURE 2: This picture shows the general arrangement of all the instruments fastened to the panel. The exact locations for the instruments are given in Figure 3.

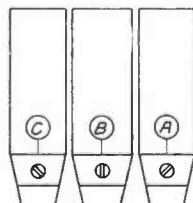

THE WORKING DRAWING FOR CONSTRUCTION

FIGURE 3: Here are shown the correct positions for the various instruments. As all of them are fastened to the panel, the location of them is governed by the holes in the panel as laid out in Figure 6.

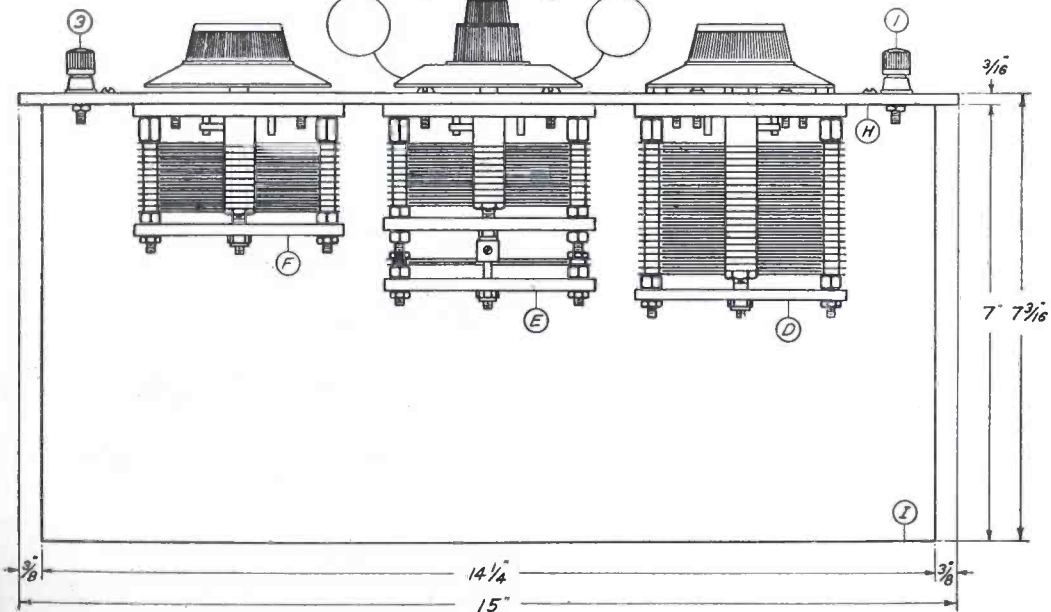

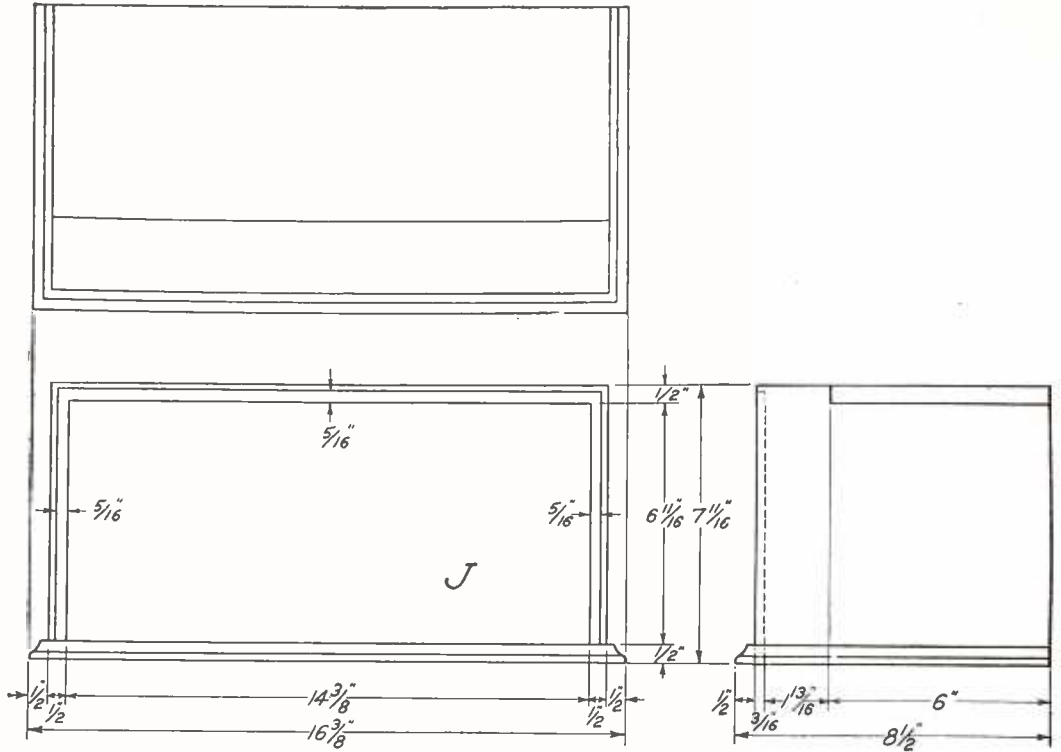

THE DIMENSIONS FOR THE CABINET

FIGURE 7: This drawing (which contains the top, front, and side measurements for the hardwood cabinet) may be turned over to a competent cabinet worker who can build it from these instructions alone.

in the following order, beginning at the top: plate, positive "B" battery, grid and positive filament. See Figures 2, 3, 4 and 5.

Next, fasten the honeycomb coil-mounting A, B and C on the front of the panel in the lower center, as shown in Figures 3, 4 and 5.

Now, mount the three variable condensers D, E and F on the panel. The correct position for each is shown in Figures 2, 3, 4 and 5. This completes the construction work on the set. It is now ready for wiring.

How to Wire the Set

Connect the antenna binding post (No. 1) to the top of the primary coil A and also to the lower right-hand switch point, looking at the rear of the set. Connect the two middle right-hand switch points together and also connect them to the bottom of the primary coil A. The top right-hand switch point is left unconnected. Connect the top left-hand and the third-left-hand switch point together, and also join them to the rotary plates of condenser D and to the ground binding post (No. 2). Connect the second left-hand switch point and the fourth left-hand switch point together, and join them to the stationary plates of condenser D.

Connect the top of secondary coil B to the

rotary plates of condenser E, to the rotary plates of condenser F, and also to the filament binding post (No. 6). Connect the bottom of the secondary coil B to the stationary plates of condenser E, and also to the grid binding post (No. 5).

Connect the top of the tickler coil C to the plate binding post (No. 3).

Connect the bottom of the tickler coil C to the stationary plates of condenser F, and also to the positive "B" battery binding post (No. 4). This completes the wiring.

How to Construct the Special Coils

Honeycomb coils may be used with this set, but for short-wave work, single-layer coils are possibly better to tune with, although there is little difference if you can get duo-lateral or honeycomb coils that are free from insulating varnish, and the paper binding strips are replaced by celluloid. The single-layer coils must be made in the manner about to be given, because otherwise, they will not function properly.

Cardboard or bakelite tubing 4 inches in diameter and 1 inch wide is used, and the wire is wound in a single layer to the desired number of turns. Regular mounting plugs may be employed, and, if the coils are made as directed,

they will be found to be sturdy and capable of withstanding rough usage without damage.

For one of the primary coils, wind on 15 turns of No. 18 DCC copper wire. For another primary coil, use 20 turns of No. 24 DCC copper wire.

The secondary coils should be 25 and 30 turns of No. 24 DCC copper wire. Tickler coils of two sizes can be made of 35 and 45 turns of No. 28 DCC wire, respectively.

In winding the coils place the coil to be wound in front of you and begin winding from the left side, winding toward you and finishing at the right-hand edge. The left-hand edge may be termed the "beginning" and the right-hand edge the "end" of each coil.

The beginning of each coil (left-hand edge), should be soldered to the lower terminal of each plug and the end (right-hand edge) of each coil, to the upper terminal of each plug. After this is done, care should be taken that the plug is set as near flush with the coil as possible, for here is where a short-circuit may occur, due to the fact that the wire may be bent in such a way as to cause a "short." A small piece of blotting paper, or a piece of ordinary tire tape, or even fibre, may be used in much the same way as DeForest uses fibre in his coils, and if you do that, you will avoid the possibility of "shorting." Instead of using fibre, ordinary white celluloid, or transparent

celluloid, such as is used in automobiles for side curtains, may be used as coil straps. This material may be obtained from any automobile supply shop, in various lengths, and can be cut into strips 1 inch in width.

Care should be taken when mounting, to see that the primary or tickler coils, when in the set, will be flush with the secondary and not at an angle to it. This may be accomplished by placing a piece of paper between the coil and the right side of the plug. This will serve to tilt the coil so that it may be brought flush with the secondary.

The single-layer inductances are admirably suited to short-wave work, and that is why we have the single-layer tuning coil, the variocoupler, loose coupler and variometer. Is it not therefore safe to claim that single-layer coils employed in a honeycomb set should give excellent results?

There is no doubt in my mind about this set being the best set for receiving on all wavelengths. Changes in wavelengths may come and go, but this set will operate on every wavelength up to 600 meters on single coils, and above 600 meters up to 25,000 meters on the regular duo-lateral or honeycomb coils.

The second part of this article will give the constructional data on a detector and two stage audio-frequency amplifier for use with this tuner.



From a photograph made for POPULAR RADIO.

THE NEW "POPULAR RADIO PORTABLE" RECEIVER IN ACTION

Reports of the success of the latest development of the POPULAR RADIO LABORATORY continue to come in from all over the country. Full instructions for building this remarkably efficient set were given by Laurence M. Cockaday in the July issue of this magazine.

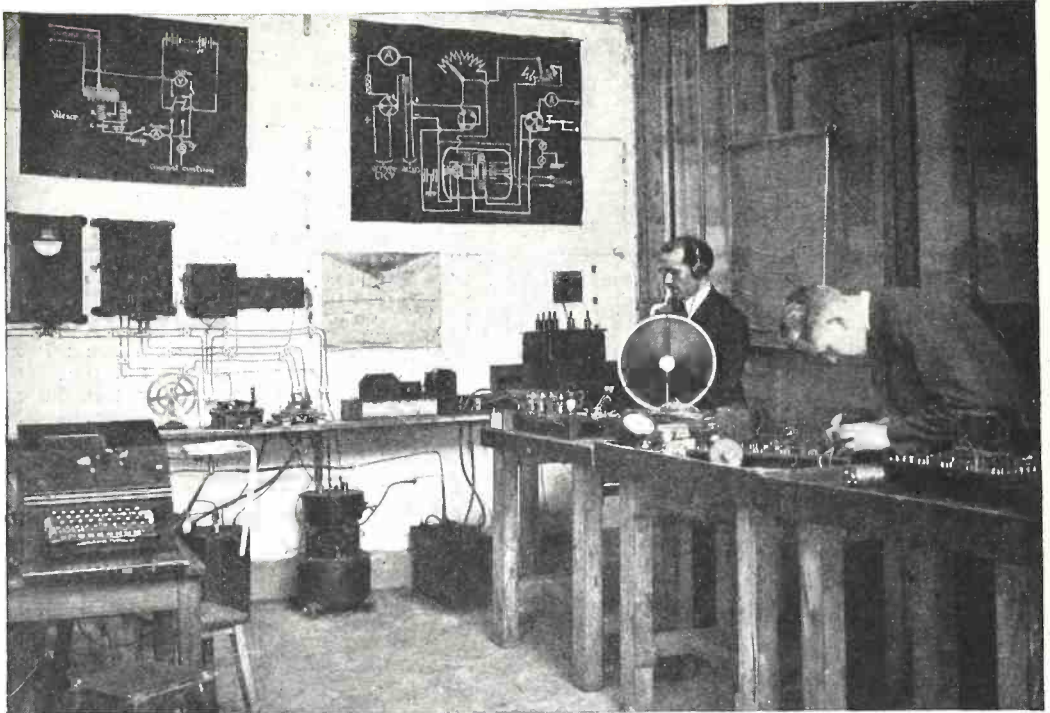

From a photograph made especially for POPULAR RADIO by Louis Raffalovich, Paris

WHERE THE FRENCHMEN LEARN HOW TO HOOK UP SETS

In this corner of the school the advanced students receive practical training in constructing the various circuits used in radio telephony and telegraphy. The experimenter bending over the table is Mr. Frederick M. Delano, Jr., special correspondent of POPULAR RADIO in Paris.

Learning a Modern Art in a Modernized "Bohemia"

Science invades the famous Latin Quarter of Paris

ON the famous "left bank" of the Seine, in Paris, the home of the artists and students who created the "Bohemia" of romance, stands the great French radio school, the *École Pratique de Radioélectricité*. Here are trained the radio operators who are needed for the French navy and for the merchant marine as well as for other radio services in France and her colonies. Here come, too, the young Frenchmen who desire training in radio in order to secure licenses as transmitting amateurs or for the purpose of undertaking radio experimentation and invention as a lifework. Courses are given in every radio subject, from brief courses for radio mechanics or for learning code, up to the full training of a radio engineer.

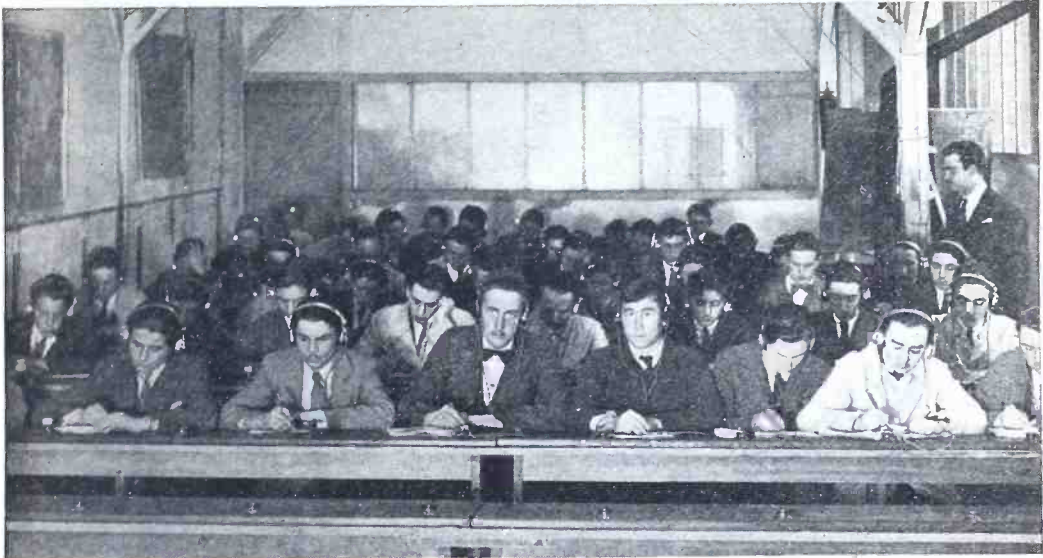

F. M. Delano, Jr.

A CLASS IN SIGNAL RECEPTION

Every desk in the school's lecture rooms is equipped with a small socket like a telephone jack. Into this socket the student slips the connection of his head set, so that he can listen to code practice or any other material that the instructor may cause to be supplied over the wires.

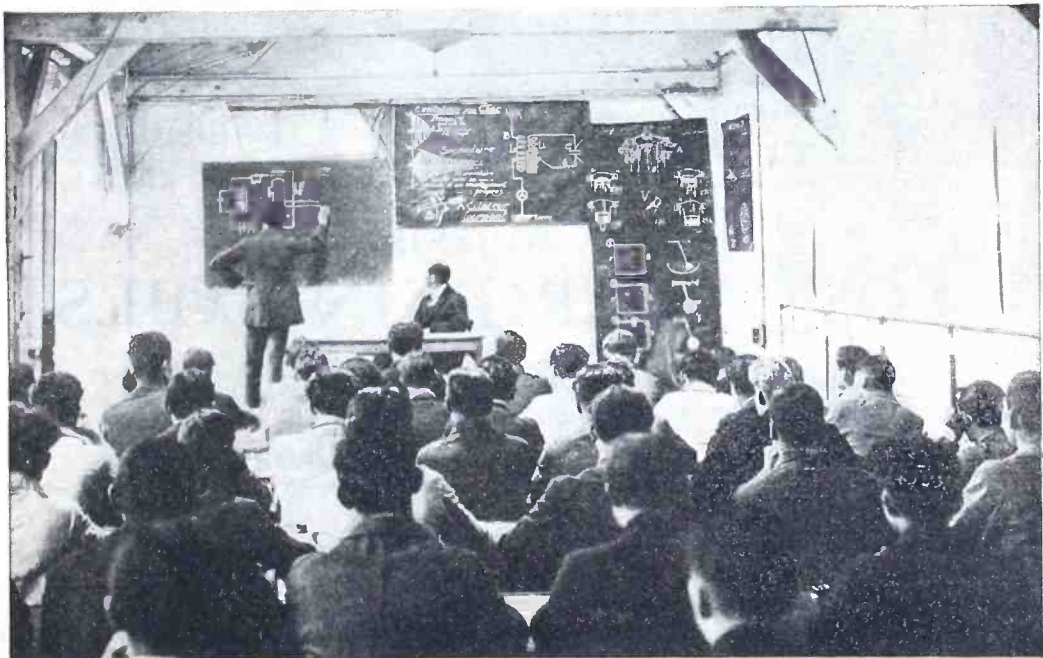

F. M. Delano, Jr.

A LECTURE ON RADIO THEORY

The diagrams on the blackboard will be familiar to many a graduate of American radio schools. Note especially the drawings of the swinging pendulum used to illustrate the effect of resistance and inductance on the oscillations in an electric circuit.



From a photograph made for POPULAR RADIO

KEEP THE AUDIO TRANSFORMER AWAY FROM THE TUNING COIL
In arranging the instruments, remember that audio transformers necessarily contain a lot of iron which has a particularly strong choking effect at radio frequencies.

WHERE TO LOOK FOR LOST ENERGY IN COILS

Practical pointers for increasing the efficiency of your receiving set—written exclusively for POPULAR RADIO by an expert of the Bureau of Standards with the special permission of the Director

By MORRIS S. STROCK*

IN the tuned circuit of every radio receiving set there are one or more coils of wire which carry the feeble alternating currents induced in the an-

*Published by permission of the Director of the Bureau of Standards of the U. S. Department of Commerce.

tenna by the incoming radio waves.

Such currents go to make up a minute amount of electrical power. If the coils in which these currents flow are improperly made, they will waste a larger portion of this power than is necessary.

This condition limits the flow of useful current with the result that the current value may not be quite high enough to produce an audible signal in the telephone receivers. In this case the substitution of more efficient coils would give understandable reception from a distant station when otherwise it could not be heard.

A receiving set that employs regeneration or radio-frequency amplification will detect exceedingly minute currents, yet, there is always a threshold current value below which even these sensitive circuits will fail.

There are two other reasons for using efficient coils, and these reasons involve the signals obtained from *any* transmitting station. The first of these additional reasons tells us that efficient coils increase the selectivity of the circuit.

Selectivity is something every receiving circuit needs, and means of improving it are *well worth while*.

Coils of low power loss will permit of good amplification without excessive filament currents or high plate voltages.

This means that the signals will be less noisy and less distorted—and, to all those who are interested in broadcast programs, what single consideration is more important than that of securing reproduction which is natural and life-like?

Let us take an inventory of the factors that cause these power losses, in order to learn how to avoid them.

First, it should be stated that power losses in a coil increase as the resistance of the coil is increased.

Resistance—more properly called high-frequency resistance—may be measured. Radio-frequency resistance changes somewhat with the frequency, but at all radio frequencies the same features of coil construction always cause an *increase* in apparent resistance. Therefore, change of apparent resistance with frequency need not be considered in detail. A factor that influences the radio-frequency resistance of coils is the size of the

conductor.

Alternating currents of radio frequency are unevenly distributed through the conductor, their effect being most pronounced on the surface, and the higher the frequency the greater this skin effect will be. Therefore, if the surface area of the conductor is increased, its resistance will usually be decreased. For braided or stranded conductor this statement may not be literally true. For instance, at frequencies below 1,000 kc* (wavelengths over 300 meters) a solid conductor sometimes has a lower radio-frequency resistance than stranded Lit-zendraht cable of greater surface area.

Second, the insulating material between the turns of the coil increases its apparent resistance.

This is due to a phenomenon called dielectric absorption. The insulation acts much the same as the insulation (dielectric) of a condenser, and if the insulating material is a poor dielectric the losses are relatively high.

Third, the insulating material of the form upon which the coil is wound and other insulating material in the field of the coil, will also increase its resistance and for the same reasons just given.

Fourth, any metal in the field of the coil will increase its radio-frequency resistance because the metal object has eddy currents induced in it and these currents absorb useful power from the circuit. At the back of the panel in many radio receiving sets is placed a metal shield which serves a certain useful purpose; it will, however, considerably *increase* the resistance of coils mounted too close to it.

Fifth, leakage of current between the turns of the coil will increase its radio-frequency resistance. This most usually occurs when the conductor insulation collects moisture.

Sixth, unused turns (dead ends) often increase the resistance of a coil. The dielectric effect previously mentioned.

* Kc is an abbreviation for kilocycles-per-second. One kc = 1,000 cycles; therefore, 1,000 kc = 1,000,000 cycles.

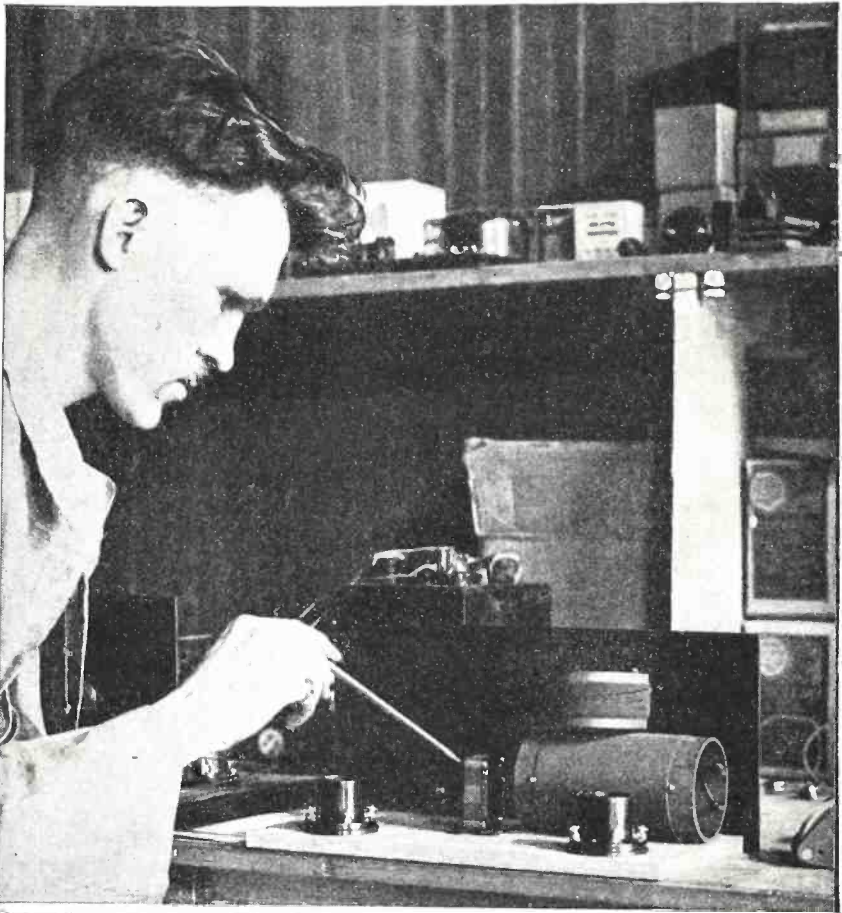

From a photograph made for POPULAR RADIO

THE WRONG WAY TO ARRANGE THE INSTRUMENTS

If you place the audio transformer up against the tuning coil as shown, it may cut down the efficiency of the set as much as fifty percent. It will make the signals weaker and will cause the tuning to be very broad.

increases the distributed capacity of the windings and in the case of dead ends, a resonance effect may be obtained which causes the radio-frequency resistance to rise to a high value.

Seventh, taps taken from the coil and connected to switch points, increase its resistance. The switch points being imbedded in insulating material, the phenomenon of dielectric absorption comes into play.

Results of actual tests showing how the radio-frequency resistance of coils is increased will emphasize the remarks just given and point the way to practical hints forming the second part of this article.

A first example involves a typical coil (shown at the left in Figure 1) such as might be used in the antenna circuit of a receiving set. (For the present, the hand of the observer holding the metal rectangle is to be ignored; this will be considered shortly.)

This coil was made by winding sixty turns of No. 20 DCC wire around a four-inch cylinder of phenolic insulating material (bakelite, so called, but actually it may be something else). At 750 kc (400 meters) the radio-frequency resistance of this coil was 3.2 ohms—and now comes the significant part of the experiment. An identical coil was wound on a dry cardboard cylinder and its

resistance at the same frequency was only 1.1 ohms. Thus the humble cardboard, used in a dry place, was superior electrically (although not mechanically) to the more aristocratic insulating material. This is not true, however, when the cardboard absorbs moisture.

Now, consider the one-sixteenth inch brass rectangle shown at the left of this coil. Metal parts of greater weight or size than this are frequently used in mounting coils. For mechanical reasons this may be necessary, yet the amount of metal should be reduced as much as possible. The metal piece shown in the photograph was placed inside the coil and the apparent resistance was thereby increased 0.5 ohm.

A final test of this coil shows the effect of leakage. A few drops of clean water were allowed to soak through the insulation over the area shown by the dotted lines, and the resistance of the coil was increased 0.6 ohm. This hints at the importance of protecting the coil winding from moisture, especially in the case of cotton insulation which readily absorbs moisture from damp air. These measurements were made in a dry atmosphere so that the cotton insulation was extremely effective.

At the right of Figure 1 is shown a so-called spider-web coil which was wound from No. 24 DCC wire on dry cardboard. This type of winding supposedly gives lower radio-frequency resistance than a winding in cylindrical form because of a slight spacing of the turns. This factor is, in itself, an advantage, yet due to the peculiar form of winding the losses may be unnecessarily high. At 713 kc (420 meters) the resistance of this coil was 3.9 ohms. Another coil was made by winding the same kind of wire on a cylinder of dry cardboard so that the same inductance was secured—that is, either coil could be substituted in the measuring circuit without changing its frequency. The radio-frequency resistance of the second coil was only 2.9 ohms.

We now come to an excellent example of how a coil should *not* be made. This is shown in Figure 2,—the primary portion of a two-circuit tuner (loose coupler) made in the days when little was known of coil losses. If the designer had *tried* to secure a high radio-frequency resistance he could scarcely have done better! Note the large brass rod for the sliding secondary, the insulating material completely covering the

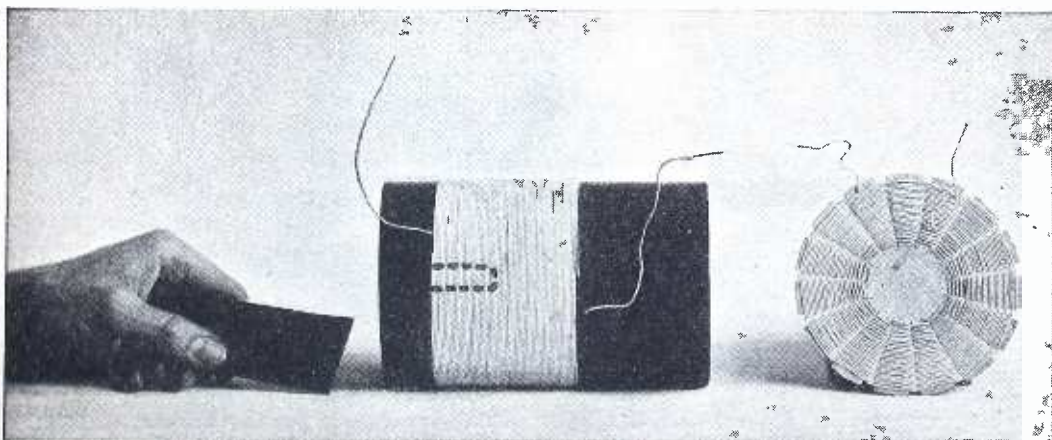

From a photograph made for POPULAR RADIO

EXPERIMENTAL COILS THAT GAVE SURPRISING RESULTS

FIGURE 1: The dotted lines on the center coil indicate the area that was wet with a few drops of clean water. Wetting just this small portion of the coil greatly increased the resistance. The spiderweb coil was not as efficient as a straight cylindrical coil of the same inductance value.

winding (70 turns of No. 22 SSC wire), the large switch points embedded in the insulating material, and finally, the large metal support for the coil form. This construction incorporates excellent *mechanical* features and one good electrical feature—firm contact on the switch points. In securing these results, however, the radio-frequency power losses were greatly magnified. A measurement of resistance including all the turns of this coil, gave a value of 25 ohms at 483 kc (620 meters),—*at least five times the necessary value.*

Thus far we have taken an inventory of the causes of power losses in coils and have given practical examples of these losses. Working from this foundation, we will now give practical hints for reducing or eliminating power losses. It must be borne in mind that merely substituting an efficient coil for one of poor design in a receiving circuit will not give any startling improvement in results, if the rest of the circuit and the antenna and ground system have an unnecessarily high radio-frequency resistance. Reasonable precautions in wiring and careful selection of parts should, however, take care of these difficulties. In the case of coils, the ex-

perimenter has quite a field, for he frequently makes them himself, or, if the purchased article is used, it can usually be rewound if necessary.

An ideal coil, as far as power losses are concerned, would be one made by winding a conductor of zero resistance into a coil having no material support and using the whole thing in an isolated position. This fantastic illustration emphasizes the importance of taking precautions which will approach this condition. These precautions will apply to all coils used in: wavetraps; single-circuit tuners; two-circuit tuners; regenerative tuners; tuned-radio-frequency transformers in reflex or neutrodyne circuits. Single-layer coils only, are assumed—multi-layer coils, except those having spaced turns, should *never* be used for broadcast or amateur frequencies.

First considerations involve the conductor.

Unless space is rather restricted it is a good rule to use nothing smaller than No. 20 copper wire. An instance was once noted, where, in the wiring of a receiving set, an inexperienced person had used steel wires! This introduced an unnecessary resistance of several

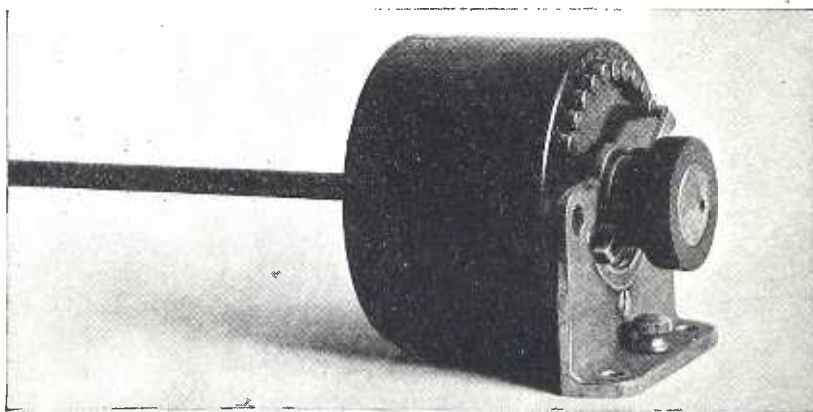

From a photograph made for POPULAR RADIO

AN EXAMPLE OF ELECTRICAL INEFFICIENCY

FIGURE 2: *This primary portion of a two-circuit tuner (loose coupler) was made in the old days when little was known of coil design. It has almost every fault mentioned in this article, including large masses of metal in the field and too much insulation material surrounding the coil. It has five times the resistance at radio frequencies that such a size coil should have!*

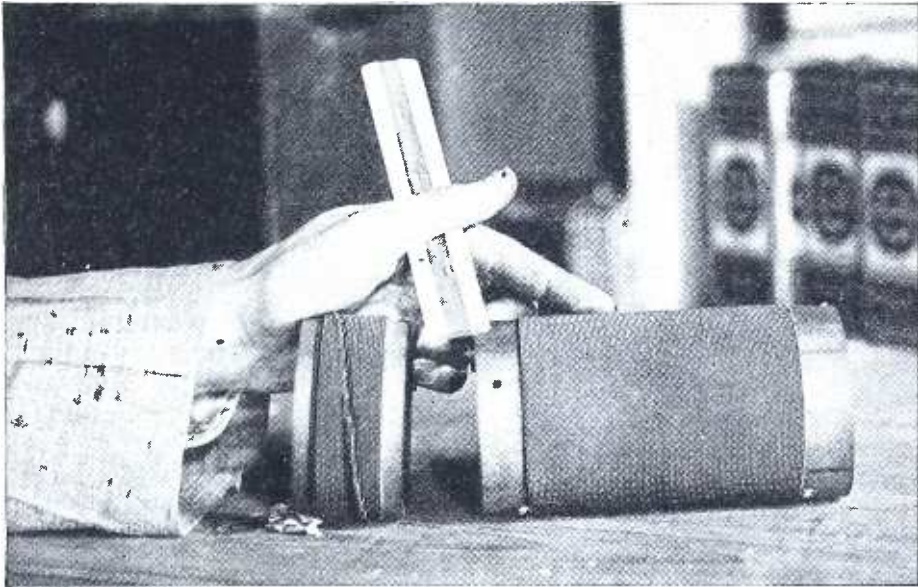

From a photograph made for POPULAR RADIO

THE RELATION OF COIL DIAMETER TO LENGTH IS IMPORTANT

These coils represent about the limits of diameter and length for the highest efficiency. Avoid long, small coils and very large, short coils; both extremes are bad because they require more wire to get the same inductance—and this increases the loss.

ohms and the set would not operate satisfactorily. When some of the longer steel wires were replaced with copper wires, the circuit gave good results.

Stranded (Litzendraht) cable, consisting of enameled strands of fine wire braided in a special manner, often gives a lowered resistance at frequencies above 1,000 kc (wavelengths below 300 meters) provided the following precautions are observed:

- (1) Testing each strand for continuity;
- (2) Testing each strand, for possible shorting through insulation, with every other strand;
- (3) Observing great care in winding so that no strands will be broken;
- (4) Equal care in soldering terminals so that no strands will be missed.

A violation of any of these conditions may cause an excessively high radio-frequency resistance. Precautions (1), (3) and (4) are necessary because the fine strands break easily and are difficult to solder; precaution (2) is necessary because "pin holes" are common in the

enamel insulation. The best way to remove enamel from these fine strands is by heating cautiously to a dull red and plunging into alcohol.

The insulation and spacing of the conductor is also important. Enamel insulation, alone, is not desirable because it gives a noticeably higher radio-frequency resistance than silk or cotton-covered wire of the same size. The enamel is a poor dielectric and because of its thinness, gives the coil a high distributed capacity—hence the resistance is increased. Double-cotton-covered wire is good, because the cotton insulation gives good spacing between turns, and the cotton itself, when dry, is an efficient dielectric. Enameled wire which has a double-cotton-covering has a peculiar advantage in that the enamel excludes moisture and prevents leakage losses while the cotton takes care of the spacing. Here the dielectric effect of the enamel is not serious because of greater spacing of the turns. Wire that has single cotton or single silk insulation is not desirable; double silk insulation is

very good and does not absorb moisture as readily as cotton.

Having decided upon the conductor and its insulation, it is logical to consider the winding form.

Phenolic insulating materials, commonly used for this purpose, are usually not as good from the dielectric viewpoint as dry cardboard or wood, although their non-hygroscopic properties are excellent, as well as their ability to withstand high voltages. In the receiving circuit, however, no such voltages exist, so this latter advantage is *nil*. These materials are mechanically stronger than any other kind and this advantage is worth considering if the equipment is for rough portable use.

Other winding forms are hard rubber, cardboard and wood. Hard rubber has excellent non-hygroscopic properties and most hard rubber has lower dielectric losses than cardboard or wood; it is also better from the mechanical viewpoint.

Wood forms are not common except for use in rotors but for this purpose they may be made almost as efficient as cardboard. The wood should be treated the same as the cardboard but the drying process should be longer. One difficulty in the use of wood is that it may have been rather green when turned out at the factory. If a close examination reveals no sign of cracking and if the wood itself appears dry it is most probably well seasoned.

Wood or cardboard forms as purchased should not have been varnished or treated with any compound, particularly black varnish, which may increase the power losses.

In mounting the completed coil, precautions must still be observed but mechanical requirements of metal mean the sacrifice of some electrical efficiency. However, as little metal as possible should be used, especially inside of the coil. Also, the coil should be mounted at least two or three inches from any shields at the back of the panel. Taps should be connected by short wires to

switch points which should be small in order to reduce the dielectric effect of the insulating material in which they are imbedded.

Two general factors can be taken advantage of to reduce coil losses. *First*, use no more turns or taps than are necessary; if a variable condenser is used, it will take care of the fine tuning adjustment. *Second*, do not use a long coil of small diameter, nor a very short coil of large diameter; to do so means that more wire will be needed to secure a given amount of inductance,—with the result that the radio-frequency resistance will be somewhat greater. It can be shown experimentally that the maximum inductance with a *given length* of wire is attained when it is wound in a coil with a diameter equal to about 2.3 times its length. This is a good standard to go by, but the limits are rather wide and coils somewhat longer or shorter, relative to their diameters, may be used, the approximate extremes in either direction being shown in Figure 3.

Coils of various fancy forms of winding may be purchased or the experimenter may be capable of winding them himself. Some of these coils actually have low losses while others may not be as efficient as simple single-layer coils wound with precaution. When coils are purchased, select those having lowest losses by avoiding:

- (1) Small conductors;
- (2) conductors having fine individual strands,—broken strands cause high resistance;
- (3) closely spaced enameled wire;
- (4) bulky coil forms;
- (5) coil terminals mounted in large blocks of insulating material;
- (6) large pieces of metal used in mounting;
- (7) heavily varnished windings;
- (8) more taps or turns than are necessary.

One brief concluding sentence suggests the marrow of this article:

As proved by laboratory tests, radio-frequency coils in a receiving set waste power, and definite precautions in coil construction reduce these power losses, enabling the set to give clearer signals.

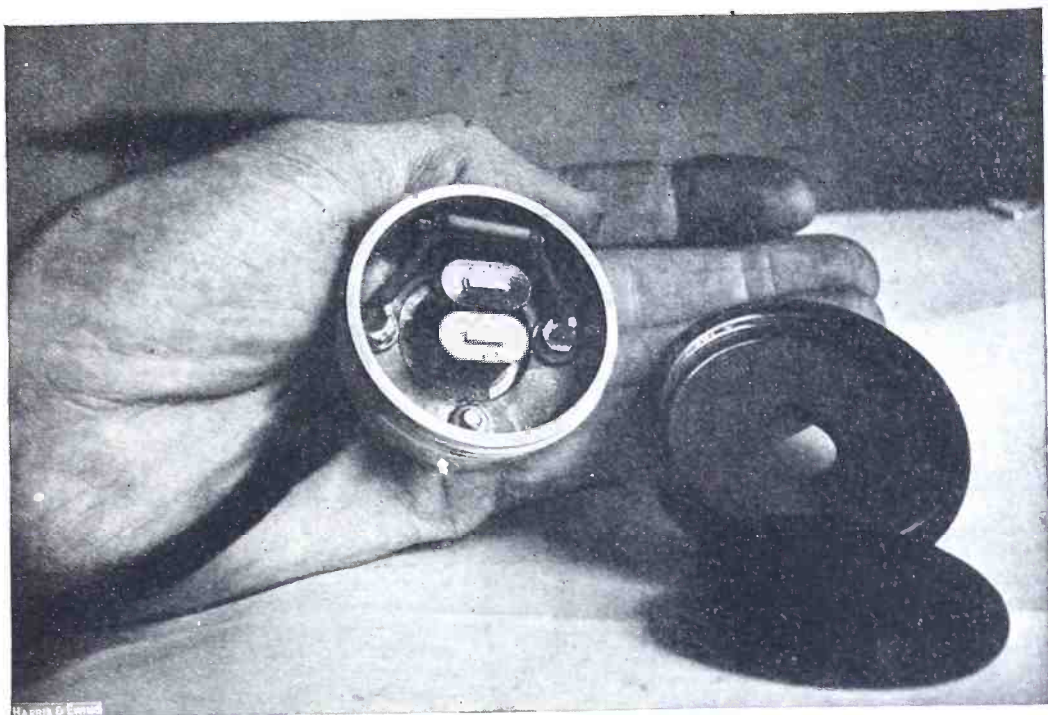

A Radio Set in a Telephone Receiver

By HAROLD F. LANE

WASHINGTON, D. C., is unfortunate in having only one powerful broadcasting station on the air at a time. Accordingly the local fans who do not care to reach outside the city can make use, with advantage, of crystal sets that do not require tuning and that are capable, therefore, of being built in a small space and made from the simplest of materials.

The "super-fliver" is one of these.

All of the "works" are contained in the case of an ordinary telephone receiver. With any old thing for an antenna and with a radiator for ground, the set will bring in all the volume one could desire—short of a loudspeaker.

It will work well on the pie-pan hook-up described recently in *POPULAR RADIO*, and occasionally it will work well enough on a bed spring. Under especially favorable conditions it will bring in the programs on either the antenna or the ground alone, without the other one. Under some conditions one wire can

be used for antenna (or for ground) and the missing connection supplied through the body, by leaning one's hand, for example, against a lamp post.

The parts necessary are merely a telephone receiver that has room enough inside the case for the fixed crystal detector, and the detector itself. The telephone used in the set here described is taken from a loudspeaker unit. It is about the smallest that I have seen.

The crystal used must be a fixed one and, as with the telephone, the main consideration is size. The one shown in the photograph is of the kind called "sensitite." It is of the cartridge type and is about one half-inch long by one quarter-inch in diameter.

All that is necessary in constructing the set is to fasten the crystal inside the telephone case and solder in the two leads, placing the crystal in parallel with the magnets of the telephone. The two telephone leads serve to connect to antenna and ground.

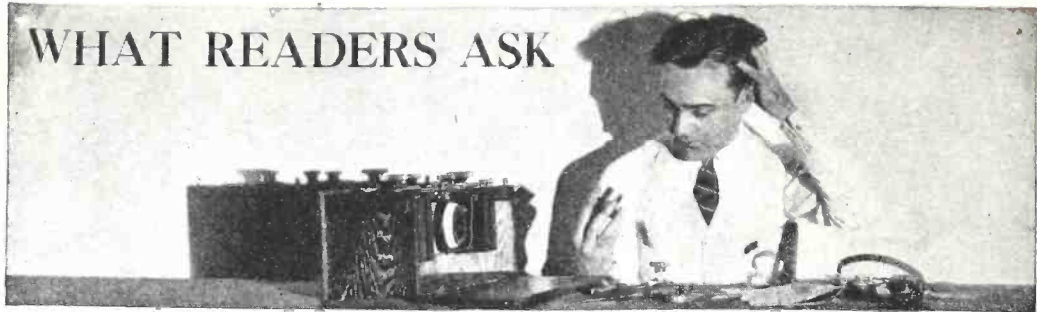

WHAT READERS ASK

CONDUCTED BY LAURENCE M. COCKADAY

In justice to our regular subscribers a nominal fee of fifty cents per question is charged to non-subscribers to cover the cost of this service, and this sum must be included with the letter of inquiry. Subscribers' inquiries should be limited to one question or one subject.

Simple Variometer Regenerator

QUESTION: I have two variometers of reliable makes and a good variable condenser of .0005 mfd. capacity. Will you please send me a circuit that will be regenerative but that will enable me to build a set without much more expense? Please include a by-pass condenser across the telephones, if this can be done in such a circuit.

EARL WHITE

ANSWER: See Figure 1 in which appears the circuit you have asked for. The necessary

parts for this set are given below, together with their proper constants:

- VAR1—variometer;
- VAR2—variometer;
- VC1—variable condenser, .0005 mfd.;
- C—mica fixed condenser, .0005 mfd.;
- GC—mica fixed condenser, .00025 mfd.;
- GL—variable grid-leak;
- R—filament rheostat, 6 ohms;
- TEL—telephones.

Use a soft tube, such as the UV-200 or the C-300. Tuning is accomplished by the grid variometer VAR1 and the variable condenser VC1. Regeneration is controlled by means of the plate variometer VAR2. Do not turn the plate variometer to too high a value or you will cause the set to squeal and radiate and this will interfere with your neighbors' reception.

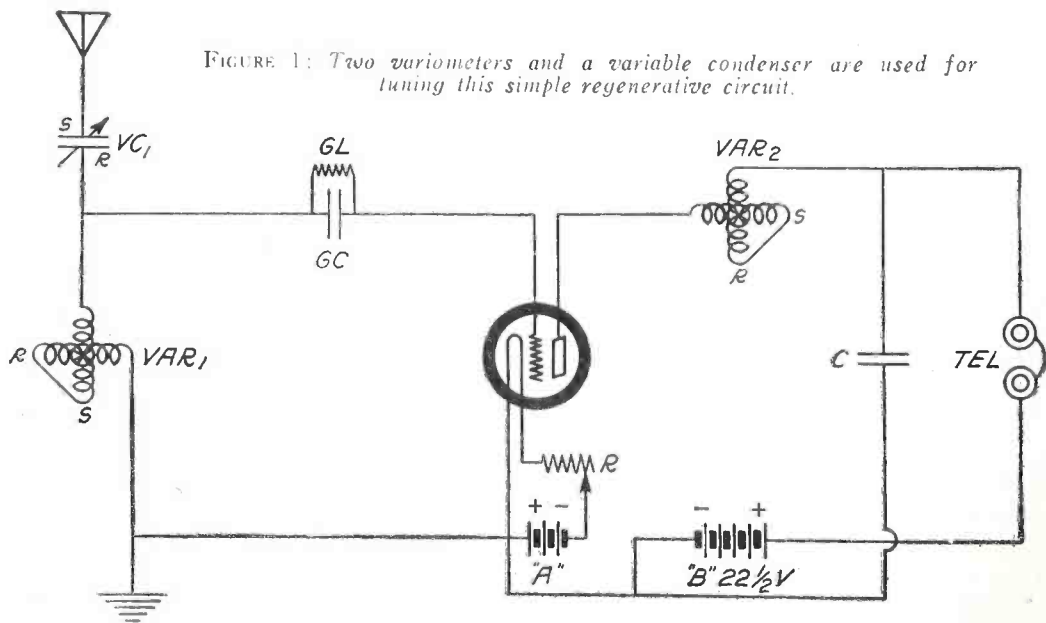

FIGURE 1: Two variometers and a variable condenser are used for tuning this simple regenerative circuit.

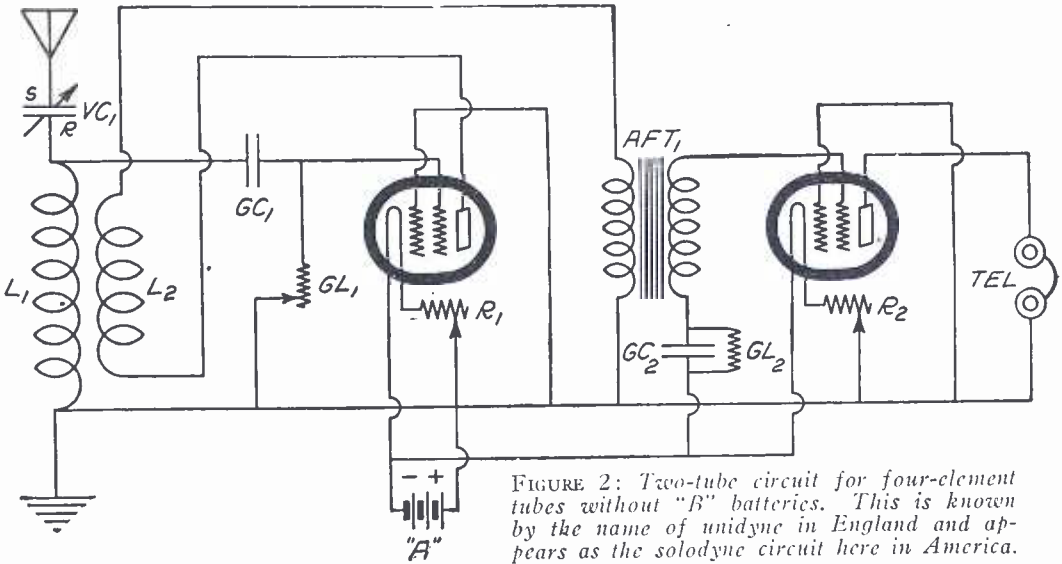

FIGURE 2: Two-tube circuit for four-element tubes without "B" batteries. This is known by the name of unidyne in England and appears as the solodyne circuit here in America.

Circuit for Four-element Tube That Dispenses with a Separate "B" Battery

QUESTION: I have been experimenting for some time with vacuum tubes for reception, and I have had some success in eliminating the "B" battery. I use Myers tubes and I use the potential drop across the filament rheostat for the plate energy. As you probably know, the grid of the Myers tube is placed very close to the filament; this makes such a tube extremely sensitive when only a small voltage is put upon the plate. The voltage drop I use is between 2 and 3 volts.

I hear that two Englishmen have been experimenting with a circuit for accomplishing the same result and thought I would write to you and ask if you could get the circuit and the necessary data to duplicate their results. Can you enlighten me?

ARTHUR J. COMPTON

ANSWER: The circuit shown in Figure 2 has been creating considerable interest in England during the last month or so. It operates on two 4-element vacuum tubes, without any separate plate battery. That is, it uses the same principle of utilizing the potential drop across the filament rheostat that you have used yourself. However, it also uses a second grid connected to the positive side of the fila-

ment battery to act as a further aid in assisting electrons across from the filament to the plate.

The parts you will need for trying out this scheme are as follows:

- L1—honeycomb or duolateral coil, size L-50;
- L2—honeycomb or duolateral coil, size L-75;
- VC1—variable condenser, .0005 mfd.;
- GC1—mica fixed condenser, .0005 mfd.;
- GC2—mica fixed condenser, .002 mfd.;
- GL1—variable grid-leak;
- GL2—fixed grid-leak, 1/2 megohm;
- R1 and R2—filament rheostats;
- AFT1—audio-frequency amplifying transformer;

two British "Thorpe" 4-element vacuum tubes and sockets.

Although this circuit will function as well as, or possibly better than, the circuit you have been using, it cannot give as great volume as a set designed to operate on separate plate batteries. This does not mean that the idea is not a good one for portable use.

Microphonic Noises in a Five-tube Set

QUESTION: How may I eliminate the noise, which sounds like the ringing of a bell, every time a truck passes my house or every time the table shakes or the dials are turned? It is terribly annoying, especially when I am trying to get distance.

U. G. HUDSON

ANSWER: Use vibrationless sockets such as the Workrite sockets or the Benjamin sockets, or mount your regular sockets upon a strip of sponge rubber.

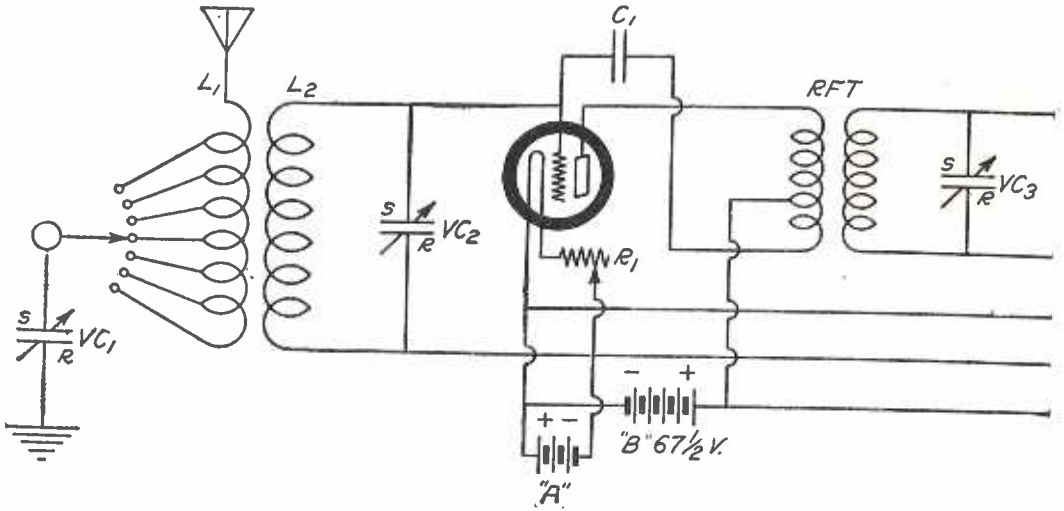

Single-stage Neutrodyne with a Crystal Detector and Two Stages of Audio-frequency Amplification

QUESTION: Can you give me a hook-up for one neutroformer, a variocoupler, a crystal detector and two stages of amplification including a "C" battery on the last stage? I have enough parts for this I think.

JOHN DRENNAN

ANSWER: The circuit you require is drawn for you in Figure 3. The parts you will need are given below:

- L1 and L2—primary and secondary coils of an ordinary variocoupler;
- VC1—variable condenser, .001 mfd.;
- VC2—variable condenser, .0005 mfd.;
- VC3—variable condenser, .00035 mfd.;
- C1—neutrodon condenser;
- RFT—neutroformer;
- AFT1 and AFT2—audio-frequency amplifying transformers;
- R1, R2 and R3—filament rheostats, 20 ohms;
- J1 and J2—double-circuit and single-circuit jacks, respectively;
- DET—crystal detector.

The tubes may be any hard tubes of standard make.

Baseboards for Home-built Receivers

QUESTION: What kind of wood is the best for use as the baseboard for home-made sets? I noticed quite a difference when I changed my set, which had a baseboard of white pine, to a baseboard made out of hard walnut. I am wonder-

ing if there might be some kind of wood that would be even better.

A. D. ROUGH

ANSWER: A hard wood is usually better because it has a closer grain than the softer varieties. Hard oak, walnut, or maple will serve the purpose equally well. If the wood is boiled in paraffin it will be better, for it will have all the pores filled up with paraffin and leave no space for the absorption of moisture.

Wavelength Range of Triple-honeycomb Regenerative Receiver

QUESTION: Will the triple-coil honeycomb receiver tune above 600 meters? I have a friend who has one of these sets, and he told me, casually, that it would tune to any wavelength at all. I tried out the set for a few minutes, but I thought it only went up to about 600 meters.

I like the set, and, if it can pick up high-powered arcs on high wavelengths, I will build one. I have been studying the code and want to practice by listening in to press messages and the like.

JOHN S. WINTERS

ANSWER: This receiver will tune up to 25,000 meters without difficulty. You will have to use various sizes of coils in each of the three positions for specified wavelength bands to be covered. We recommend that you get in touch with the manufacturers of this type of coil and request that they send you the wavelength ranges of the coils they make, so that you can pick the proper sizes for the wavelength ranges you wish to cover.

FIGURE 3: A circuit that contains one stage of neutralized radio-frequency amplification with a crystal detector and two stages of audio-frequency amplification.

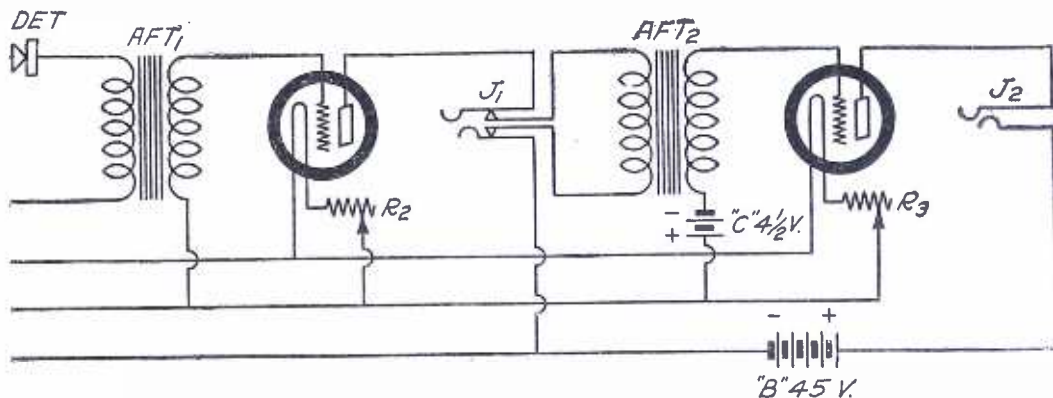

Fixed or Adjustable Crystal Detectors for Reflex Work?

QUESTION: Which will be the best for me to use with a reflex, a fixed crystal or one that is adjustable? I have three stages of radio-frequency amplification that I have been using right along with a vacuum-tube detector and I want to reflex two of these stages and use the extra tube as a third-stage audio-frequency amplifier. Which should I get, the fixed or the adjustable?

RAYMOND D. THOMPSON

ANSWER: With the three stages of audio-frequency the fixed crystal will have sufficient sensitivity for consistent work and will save you making an extra adjustment. If you were using only one or two stages of radio frequency, however, the adjustable crystal would be advisable on account of the extra sensitivity it would afford.

The Distortionless Amplifier Added to the Four-circuit

QUESTION: Will you please give me a diagram and constructional data on the distortionless amplifier recently described in POPULAR RADIO, and containing a variable resistance-coupled amplifier connected to the four-circuit tuner? I think this should make an admirable combination.

HOWARD KITCHENER

ANSWER: There have been so many requests for just this thing that we will not only publish what you have asked but it will also contain a big improvement in the amplifier circuit. This will come out in the October issue of this magazine.

Correct Capacity for Coupling Condensers in a Resistance-coupled Amplifier for Audio-frequency work

QUESTION: What do you recommend for the correct capacity for the condensers in the grid circuits of resistance-coupled audio-frequency amplifiers? I notice that some people recommend values as low as .001 while others recommend values as high as 1 to 2 microfarads. What do you recommend?

A. SIMPSON TAYLOR

ANSWER: We advise the use of a condenser of .015 mfd. for use with C-301-a or UV-201-a tubes. This size is large enough to insure passing the lower frequencies down to about 25 cycles and will not be as bulky in a set as the paper variety. Three of the small mica fixed condensers of .005 mfd. connected in parallel will give the correct capacity, or one of the correct capacity can be used, as there is at least one concern making this size for this specific use.

The Antenna for the Tobias Regenerator

QUESTION: Could I use a bell-wire antenna strung around three sides of a room 14 feet by 16 feet? I would put it in back of the picture moulding. Please let me know if this will be all right. If so, I will build the set.

F. D. E.

ANSWER: The method for putting up your antenna which you describe will be entirely suitable for the type of receiver you mention. It will not work well with ordinary types of receivers, however.

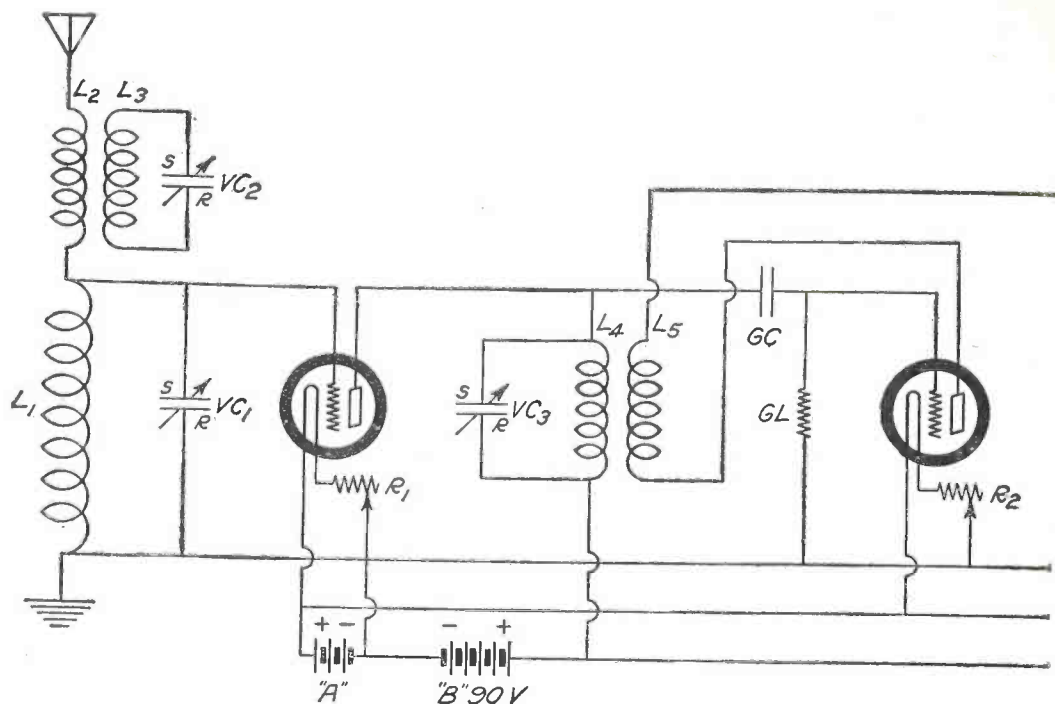

Radio-frequency Receiver with a Wavetraps

QUESTION: I would like to get a circuit for one stage of tuned-plate radio-frequency amplification, with a vacuum-tube detector and two stages of audio. Please also include an inductively coupled wavetraps in the antenna circuit. I have a trap like this now, and it helps me to tune out the local stations. I think it might be a help on the larger set I intend to build if you can supply me with a suitable hook-up. I would also like to use regeneration on the detector tube.

SAMUEL BRAKOFF

ANSWER: You will find in Figure 4 a circuit that will meet your requirements.

The parts necessary to get to build this set are the following:

- L1—honeycomb or duolateral coil, size L-35;
- L2—honeycomb or duolateral coil, size L-25;
- L3, L4 and L5—honeycomb or duolateral coils, size L-50;
- VC1, VC2 and VC3—variable condensers, .0005 mfd.;
- C—mica fixed condenser, .0005 mfd.;
- GC—mica fixed condenser, .00025 mfd.;
- GL—variable grid-leak;
- R1, R3 and R4—filament rheostats, 20 ohms;
- R2—filament rheostat, 6 ohms;
- J1 and J2—double-circuit and single-circuit jacks, respectively;

AFT1 and AFT2—audio-frequency amplifying transformers.

The tubes recommended for the first, third and fourth sockets are De Forest DV-3, UV-201-a or C-301-a tubes. The tube for the second socket may be a soft tube, such as a C-300 or a UV-200 tube.

Tuning is accomplished by the two condensers, VC1 and VC3.

The coils L2 and L3 should be mounted in double-coil mountings; likewise coils L4 and L5.

Regeneration is controlled by moving coil L5 closer to or farther away from coil L4.

The wavetraps, consisting of coils L2 and L3, should be adjusted for the proper coupling and the tuning controlled by the variable condenser VC2.

Soft Tubes as Amplifiers

QUESTION: Can a soft tube be used as an amplifier for radio or audio-frequency amplification? I have several of them and thought I might be able to use them in a two-stage amplifier that I am building to take to the country. Let me know whether or not they will be suitable.

U. J. WATSON

ANSWER: A soft tube can be used as an amplifier, but the voltage applied to the plate must be lower than 22½ volts. It cannot compare to the regular hard amplifier tube with a higher plate voltage, however.

FIGURE 4. One stage of tuned-radio-frequency amplification, regenerative detector, and two stages of audio-frequency amplification. The antenna circuit includes an inductively coupled wavetrap for eliminating local high-powered signals.

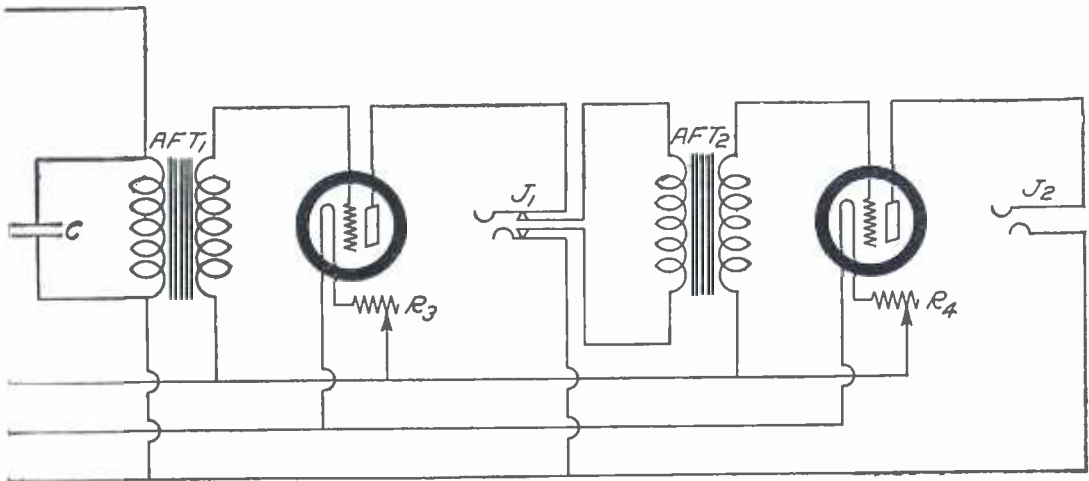

Defective Vacuum Tubes

QUESTION: One of my tubes has slowly become worn out or something. The volume of the set during the last week has steadily declined on the last stage. I took the last tube out and exchanged it for the tube in the first stage and it was weak. I then placed the first-stage tube back in its proper socket and it was O. K. This led me to think that something was happening to the last-stage tube. I asked a friend to bring over one of his tubes and when we tried it in my set it worked fine. This proved it was not my set but the tube.

The filament lights all right; probably a little better than any of the other tubes, but the music and speech comes in very faintly and muffled up. What could be the trouble?

ALFRED SCHOENER

ANSWER: The tube you are using is probably of the thoriated filament type. You have been using it with the filament turned up too high or else it is defective. The thoriated filament contains a minutely thin coating of thorium, about one atom deep, all over its surface. When the tube filament is forced (turned up too high) this coating is evaporated off too fast, in the form of liberated electrons, and

the wandering thorium in the interior of the filament does not have a chance to replace it. The electron stream given off by the filament then falls off rapidly and the signal strength also decreases greatly. Take the tube back to the dealer and he will probably replace it if you have not used it too long, and if the filament is not burned out.

What Type of Receiver to Use

QUESTION: What kind of a receiver should I get for local reception with the headphones? I care nothing for distance and nothing for reception on a loudspeaker. Please tell me what type of set to buy.

A. J. FERNALD

ANSWER: In our next issue we will publish an article on "How to Select a Ready-made Receiver," in which you will find data on various receiving sets, together with information as to the facts that you should consider before making your choice.

What Is a By-pass?

QUESTION: Just what is the function of a by-pass condenser?

ROBERT GOODMAN

ANSWER: A by-pass condenser is used in the plate circuit of vacuum-tube detectors to pass the radio-frequency currents around the headphones or the primary of an amplifying transformer.

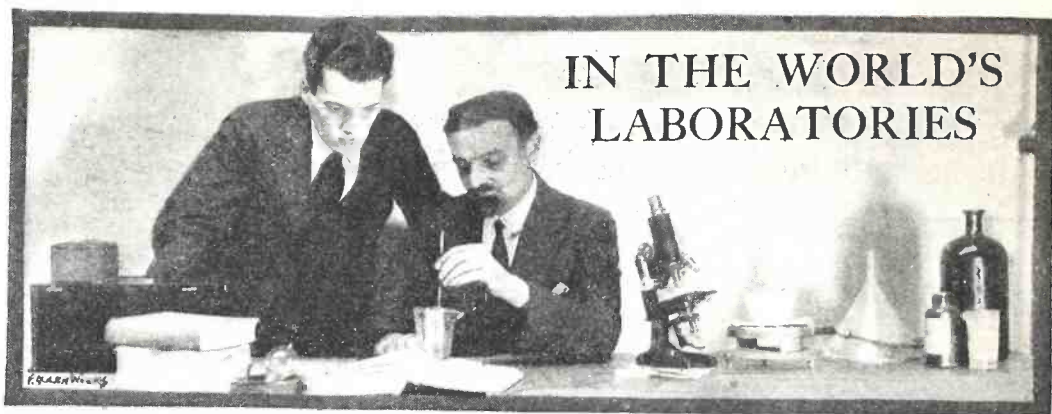

IN THE WORLD'S LABORATORIES

CONDUCTED BY DR. E. E. FREE

Doctors Approve the Radio Stethoscope

At the recent meeting of the American Medical Association at Chicago one of the most interesting events was the demonstration of the new radio stethoscope staged for the benefit of the attending physicians in a hall on the Municipal Pier.

The possibility of such an instrument has been evident for some time and several such devices have been built, the first of them, we believe, by Professor R. B. Abbott of Purdue University.* The present instrument is a development in the laboratories of the Western Electric Company, assisted by Dr. Richard Cabot, one of the distinguished physicians of Boston.

At the Chicago demonstration the apparatus was connected to a large number of earphone receivers, so that all of the physicians in the hall could listen to the same heart at the same time. The advantage of this in instruction in the medical college is obvious even to the laity. Another advantage is that patients ill in bed in hospital can have their heartbeats taken, listened to and recorded without being disturbed by the presence of a class, or even of a consulting physician, in the sickroom.

The apparatus is not strictly a radio one; a better description of it is the "electrical" stethoscope. It does involve, however, the use of audio-frequency amplification and of other principles developed primarily for radio use. It is one of the contributions of radio to other sciences and possibly one of the most useful of them all.

British Controversies Over the New "Unidyne" or "Solodyne"

SOME weeks ago Mr. G. V. Dowding, Technical Editor of the admirable British weekly, *Popular Wireless*, and Mr. K. D. Rogers, Assistant Technical Editor of the same publication, announced a method of reception that

has aroused the most active controversy in radio circles in England. While this controversy has been occasioned more by the manner of the announcement than by any technical feature of the circuit, it has involved none the less an acrimonious discussion of the merits of the method itself.

The method is essentially a way of avoiding the use of the "B" battery. All the power is supplied from a single filament battery of the usual low-tension character. The secret is the use of a supplementary grid placed close to the filament of the vacuum tube.

This device is described by its advocates as one of the most revolutionary inventions ever made in the radio field. On the other hand, its opponents claim that the principle involves nothing new and that the admitted advantage of getting rid of the "B" battery is more than compensated by losses of sensitivity and amplifying power.

A number of circuits for use with the supposed new principle have been published by *Popular Wireless*.* All of them make use of the four-electrode tube containing the supplementary grid. Some of the circuits involve, also, an audio-frequency transformer having the unusually high ratio of 1 to 10. This is so arranged that its secondary feeds back to

* The first announcement, incomplete in details, was published in volume 5, pages 337-338 (May 3, 1924). A more complete description was issued the following week; vol. 5, pages 373-374 (May 10, 1924). Further articles, describing circuits and giving constructional data for sets, will be found in the following issues of the same publication: May 17, pages 407-411; May 24, pages 455-456; May 31, 491-495; June 7, pages 531-532; June 14, pages 563-567. The essentials of the circuit have been published in the United States by the *Christian Science Monitor* (Boston), for May 22, 1924, page 11. A more complete American publication of the material published in *Popular Wireless* is begun in the August, 1924, issue of *Radio News* (New York), and will be continued in later issues. The name "solodyne" has been substituted for "unidyne" in referring to this circuit in America, the British name having been pre-empted here by another and quite different hook-up. For certain adverse opinions concerning the principle used by Mr. Dowding and Mr. Rogers (who, however, are not named nor referred to specifically) see *Wireless World* (London), vol. 14, pages 267-270 (June 4, 1924).

* See POPULAR RADIO for February, 1924, page 204.

the plate an increased voltage developed from the supplementary grid, which is claimed to have the effect of building up a higher operating voltage across the tube than could be obtained from the unaided filament battery.

As this transformer, however, is omitted from several of the published circuits and as its satisfactory operation is a matter of considerable doubt, it seems fair to conclude that the most essential element of the new method is the use of the supplementary grid.

The operation of this grid depends on the small distance intervening between the supplementary grid and the filament.

In any variety of thermionic tube the escape of the electrons from the filament occurs almost independently of the other electrodes in the tube. It is a function, merely, of the temperature and character of the filament. The purpose of the plate potential is to take these loose electrons discharged from the filament and pull them over toward the plate so that a substantial filament-to-plate current may be maintained in the tube.

Now this function of the plate depends upon two factors: (1) the difference of potential between the plate and the filament and (2) the distance that the plate and the fila-

ment are apart. A decrease of the distance between the electrodes will have the same effect in increasing the plate current as will an increase of the plate voltage. It is apparent, therefore, that a low-potential plate, placed very near the filament, will attract practically as many electrons as will a high-potential plate placed farther away.

This is the essential theory of the extra grid in the solodyne tube. Instead of a plate very near the filament, a grid is used in this same position. This grid attracts the electrons set free from the filament. Since the grid is so close to the filament this attraction is considerable, even though the potential drop between the filament and this grid is only (on the average) half of the potential drop across the filament itself.

The extra electrode being a grid and not a plate, many of the electrons attracted to it pass through it and go on to the plate placed beyond. To quote the publication in the *Christian Science Monitor*, the electrons are "shot at the plate" instead of being pulled toward it.

There is small doubt that this principle will work. Indeed, it involves no new theory at all and has been employed many times in various experiments with four-electrode tubes.

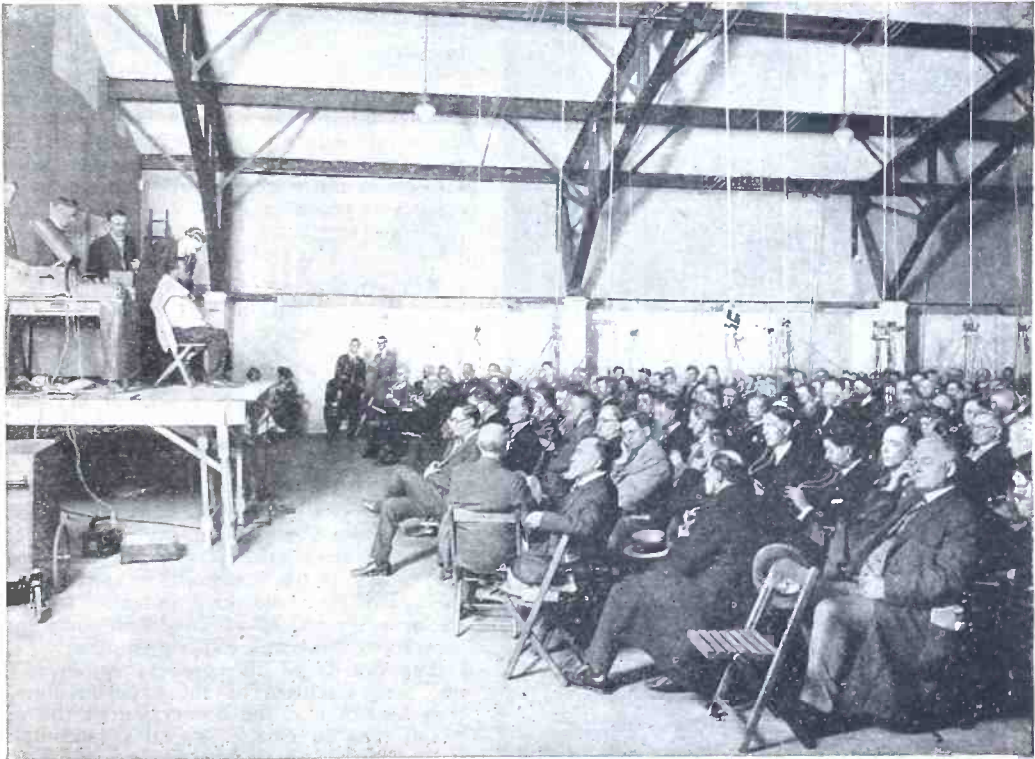

Western Electric

HOW THE ELECTRICAL STETHOSCOPE WAS DEMONSTRATED

This photograph, taken at the Chicago meeting of the American Medical Association, shows how all the assembled physicians listened to the hearbeats of the same patient. The individual earphones were connected to the multiple distributors hung down from the roof, and thence to the stethoscope itself.

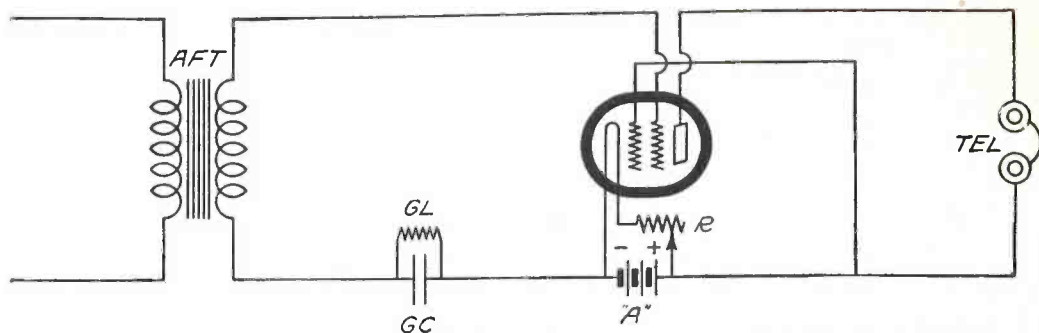

A GENERALIZED HOOK-UP FOR THE BRITISH UNIDYNE TUBE

The supplementary grid is really much closer to the filament than is the other grid. It operates, therefore, to shoot the electrons through the ordinary grid toward the plate. The inventors claim that this action enables the "A" battery to produce an electron current sufficient to operate the tube, no high-tension "B" battery being necessary.

The only question is whether the amplification obtained in tubes built on this principle will prove to be sufficient in practical work. Only a considerable experience with the tube and the circuits will determine this. In the hands of the American amateurs this experi-

ence should be forthcoming very soon.

The editor of this Department feels impelled to add a word of friendly criticism of the superabundant enthusiasm which led the editors of *Popular Wireless* to make such unusually sweeping claims for the novelty and importance of these circuits when they were first announced. Had they been launched on the radio world a little more gently they would have had, we suspect, far less bitter criticism to face.

It is to the credit of American radio journalism that this mistake was not repeated by *Radio News*. The editorial announcement of the solodyne in the August issue of that magazine is characterized by admirable scientific caution in the statement of what the new circuits will probably do.

Pictures by Wire

THE sending of photographs either by wire or by radio is nothing new. At least a dozen different methods for doing this have been devised. Two, the best of them, the process of M. Edouard Belin and that of Mr. C. Francis Jenkins, have been described in detail in POPULAR RADIO.

In spite of this familiarity of the subject the recent experiments of the American Telephone and Telegraph Company and the Western Electric Company in transmitting photographs from Cleveland to New York over the telephone lines has interest, not only because the details of the transmitting apparatus seem to involve some novelties, but also, because of the previous record of these two companies in successful electrical experimentation.

The details of the process employed have not been disclosed by the experimenters, but it is known that the conversion of the photograph into an electric signal is accomplished in much the usual way by means of a fine pencil of light falling on a sensitive photoelectric cell. Photographs used for transmission are in film form and the light pencil shines through the film, thus varying in intensity with the transparency or opacity of each small unit of the film in turn.

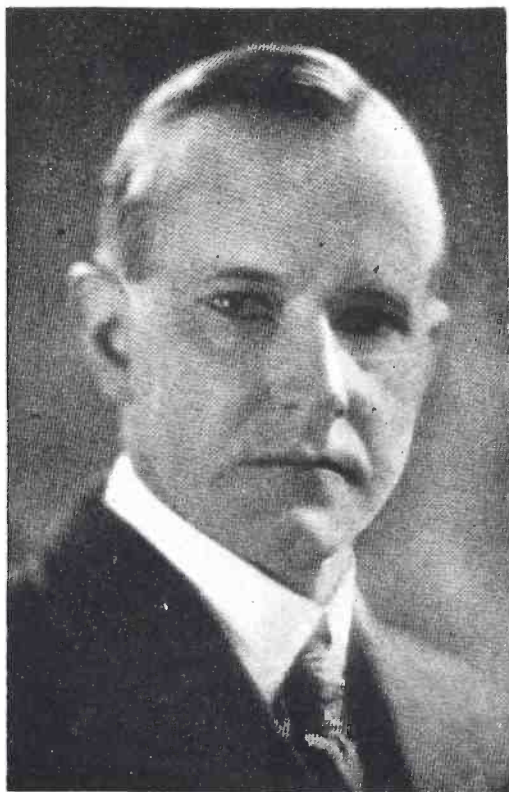

Kadel & Herbert

A PHOTOGRAPH BY TELEPHONE

This photograph of President Coolidge was sent from Cleveland to New York over the telephone lines while the process was in operation between these two cities.

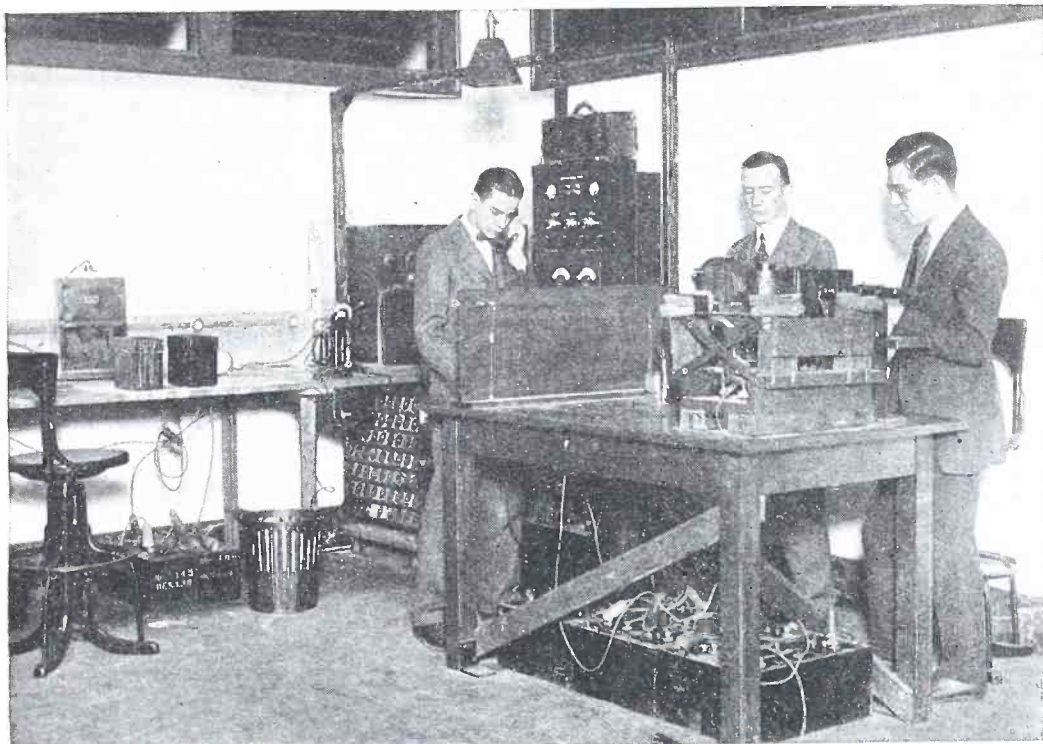

Kadel & Herbert

THIS MACHINE RECEIVED THE TELEPHONED PHOTOGRAPHS

This apparatus, installed in the offices of the American Telephone and Telegraph Company at 195 Broadway, New York City, was the receiving end of the Cleveland-New York line. The machine itself is at the right. Back of the board at the left of the table are the terminals of the telephone line used for controlling the apparatus. Note the rubber sponges on which the photograph receiver is supported to minimize vibration.

The chief novelty of the process is believed to be the apparatus used to recover the signal from the electric current in the telephone wire and to re-convert this signal into a photograph. The device used is a special light valve developed in the telephone laboratories and which has not yet been described officially. Vacuum-tube amplifiers are used at the transmitting end to amplify the signal from the photoelectric cell before putting it on the wire.

During the Republican Convention at Cleveland the process was in regular use between that city and New York. A five by seven inch photograph can be sent, it is announced, in less than five minutes. As a test of speed a photograph was taken in Cleveland, developed, sent to New York and re-developed there in a total time of thirty-three minutes.

The telephone company is prepared, its officers announce, to install this process commercially on its better trunk lines whenever there is sufficient public demand for a commercial service.

There is no present promise, it may be well to point out, of a method of television by this process. A moving picture by wire (or by radio) would require at least ten or twelve complete pictures a second. The ordinary mo-

tion picture uses sixteen. The process of the telephone company requires five minutes for one picture, and must be considered as a means of sending photographs or similar unchanging views by wire rather than a means of seeing at a distance. For this latter problem the method of Mr. Jenkins continues to be, in our opinion, the most promising one in the field.

The new telephone company process can be applied to the transmission of photographs by radio as well as by wire but not so surely or successfully. In all methods of radio transmission there is an outstanding difficulty due to fading and static. Fading produces undesired differences in intensity of the lines or dots that make up the received image. Static may produce extra dots or blotches that are not in the original photograph at all. As yet, no successful method has been devised to overcome this.

A New Theory of Static and the Weather

GENERAL GUSTAVE FERRIÉ, the chief of the radio service of the French army and always one of the most active European investigators in radio science, has announced a new and in-

interesting idea of the cause of static. Conjointly with M. Reginald Bureau of the French Meteorological Service, General Ferrié has been studying the occurrence of static in France and especially its relation to the prevalence of storms of wind, rain or snow. A preliminary report was presented to the Academy of Sciences in April. A further paper is available in the reports of this institution.*

In brief, the theory of General Ferrié and M. Bureau is that any atmospheric disturbance, especially the "front" of contact between a cold-air current from the north and a warm-air current from the south, may be the seat of atmospheric movements that produce, also, electric disturbances and consequent static. In France, as in the United States, such "fronts" are characteristic of the storms that sweep across each country in a general easterly direction.

*The first paper is "The Meteorologic Origin of Certain Disturbances in Wireless Telegraph Reception," by R. Bureau; *Comptes Rendus de la Academie des Sciences* (Paris), vol. 178, pages 556-558 (April 5, 1924). The recent paper will be found in the same publication, vol. 178, pages 1623-1625 (May 12, 1924), under the title, "The Influence of Meteorologic Discontinuities on Certain Atmospheric Disturbances of Wireless Telegraphy," also by M. Bureau.

In France these storms come from the North Atlantic and end against the great mountain wall of the Alps. In the United States the majority of the storms come from the North Pacific, sweep across the country in a great arc concave toward the north and leave our shores into the North Atlantic. The thesis of M. Bureau's recent paper is that the front across which such storms advance is practically always a point of origin for much static.

The novelty and importance of this idea lies in the conclusion that any kind of storm, or even a mere stirring of the atmosphere by powerful currents, may cause static. It is not necessary to have a true thunderstorm, with visible lightning. It is obvious that this idea fits into much other data; for example, into the fact of unusual prevalence of static in mountainous regions, as described several times in POPULAR RADIO.

Mountainous countries are usually regions of considerable air movement. So are the tropics; and the tropics, as every sea-going operator knows, are the great home of severe static.

The work of General Ferrié and M. Bureau

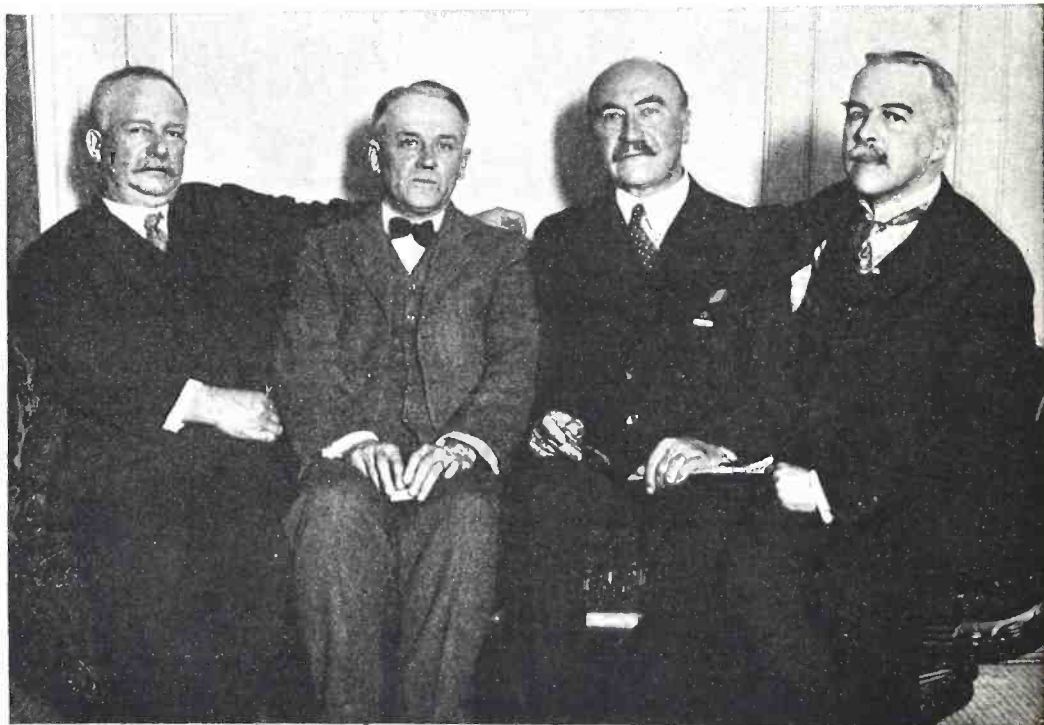

Henry Miller

FOUR DISTINGUISHED CHEMISTS DISCUSS ATOMS

This photograph was taken during the meeting of the American Chemical Society at which Dr. Millikan presented the views of atomic structure described in his article in POPULAR RADIO for August, 1924. At the left of the photograph is Dr. Charles L. Parsons, Secretary of the American Chemical Society; next to him is Dr. Millikan; next is Dr. L. H. Baekeland, inventor of Bakelite and president of the society; at the right is Dr. Gilbert N. Lewis, a distinguished exponent of the chemical theories of atomic structure.

is admittedly no more than a beginning on this subject. It does constitute, however, an important step in the understanding of static and toward the possibility, often forecast in these columns, that the static impulses, now no more than a nuisance, will be used when we understand them better as a valuable means of learning what is going on in the earth's atmosphere and perhaps of forecasting the weather.

How Electric Waves Move Through Liquids

THE conduction of electricity through liquids, as, for example, through the sulphuric acid in a storage battery, is a very different matter from the conduction of electricity in a metallic wire.

In the wire there are a number of loose electrons. When a potential is applied to this wire some of the electrons drift along through it, passing between the places occupied by the more or less fixed atoms of the metal itself. In a solution like the sulphuric acid there are no fixed atoms; all of them are movable. That is why the liquid will flow. Also, it is believed that there are not any great number of loose electrons.

The liquid does contain, however, a large number of ions; that is, of atoms or groups of atoms which have lost or gained an electron or two and have acquired, thereby, an electric charge. In sulphuric acid, for example, there are believed to be many millions of ions of two kinds. One kind is the hydrogen ion. It consists of a hydrogen atom that has gained an electron and has become negatively charged. The other kind of ion is what is called the "sulphate ion." It is group of four atoms, one of sulphur and three of oxygen. It has *lost* one electron and has, therefore, a positive charge of one unit.

The current is carried through the acid solution by these ions. For example, an electron enters the solution at one of the terminals. Nearby it finds a single hydrogen atom, possessing, as usual, a single electron. The new electron attaches itself to this hydrogen atom. The atom then has two electrons; it has become a hydrogen ion. Immediately, by virtue of its negative charge, it is attracted to the other plate (the positive one) of the battery. It moves over. Having reached the plate it gives up its excess electron and becomes an ordinary atom again.

This is what is called "electrolytic" conduction. It is what is happening when a storage battery is being charged, except that there are occurring then some more or less complex chemical changes on the surface of the lead plates. This kind of conduction is contrasted by the scientists with the other kind of conduction that occurs in wires, the kind called "metallic" conduction.

In the case of the passage of electric waves or of rapidly alternating electric currents through a solution there has been considerable uncertainty. Was it necessary for the ions to

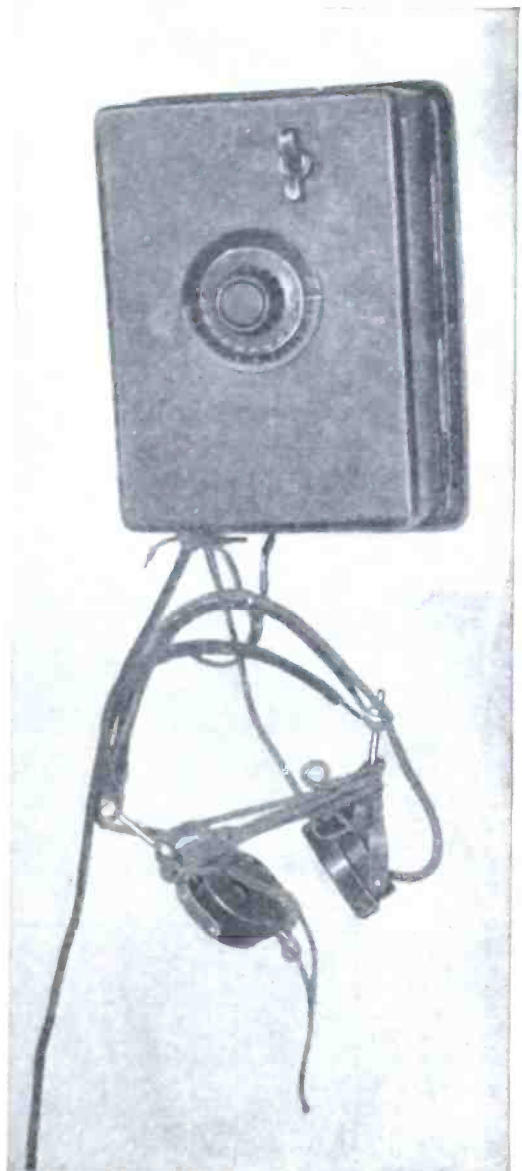

Wired Radio, Inc.

WIRED RADIO ON PAY-AS-YOU-ENTER BASIS

Drop a nickel in this receiver, installed on Staten Island, New York City, and you can hear the programs sent out over the power lines of the local electric company according to the line-radio system of General Squier.

move clear across the solution, carrying the same electron to the other plate; or could the electrons be exchanged in passage? Or, to mention a third possibility, could all the ions simply swing back and forth under the impulse of an oscillating current, not moving very far from their medial positions?

These problems reduced themselves to the

question of the path of an ion in the solution when an alternating current was passing through it. Did the ion move far or move little as the waves of current went through?

Most of the experimentation until recently indicated that the ions moved a relatively long distance. It was found, for example, that the resistance of a given solution for high-frequency current was apparently much higher than the resistance of the same solution for direct current or for alternating currents of very low frequencies, like the 60-cycle current of ordinary lighting circuits. This indicated a relatively long path for the ions. When the frequency was too high, it became impossible, the scientists thought, for the ions to complete their necessary swing back and forth across the solution in the short time of one cycle of the wave.

Recent experimentation in France has cast much doubt on this conclusion. Monsieur J. Granier has restudied the question and has made an especial effort to remove some sources of accidental error, especially the errors due to the capacity of the wires, electrodes, etc., when very high-frequency currents are used.*

The result is to show that the previous conclusion of a lower conductivity for very high-frequency currents is wrong. It was due to the disturbing effect of internal capacities in the apparatus. When these disturbing effects are removed or compensated, the conductivity of a certain solution for high-frequency current is substantially the same as for low-frequency current or (chemical effects aside) for direct current.

* "The Conductivity of Electrolytes for Very High Frequencies," by J. Granier. *Comptes Rendus de la Academie des Sciences* (Paris), vol. 178, pages 1520-1522 (May 5, 1924).

We must conclude, therefore, that the conduction of electric waves in liquids is carried out by substantially the same process as in metallic conducting media, by the back-and-forth swing of charged particles. Each ion (or each electron, if the solution contains free electrons) swings through only a small distance, the exact distance of the swing depending on the frequency of the current or wave that is passing.

In the case, therefore, of the passage of radio waves through or over the surface of the sea no special electrolytic effects are to be anticipated. The sea will behave exactly as does a metallic conductor having the same relatively low conductivity as sea water.

A Hot-wire Ammeter that You Can Make at Home

A SIMPLE hot-wire ammeter that is accurate enough for many purposes in an experimental radio laboratory is illustrated by the accompanying drawing.* The wire to be heated is of German silver, and is very thin. It is connected as a part of the circuit carrying the current to be measured.

As this wire is heated by the passing current it lengthens a little, owing to the thermal expansion of the German silver alloy. When this happens the wire B, attached to the spring, pulls the heated wire A over toward the right. This motion causes the pointer C to move across the scale and gives the reading of the ammeter.

* This device is described by Dr. J. H. T. Roberts in his article on "Constructional Notes" in *Popular Wireless* (London), vol. 5, page 55 (March 8, 1924).

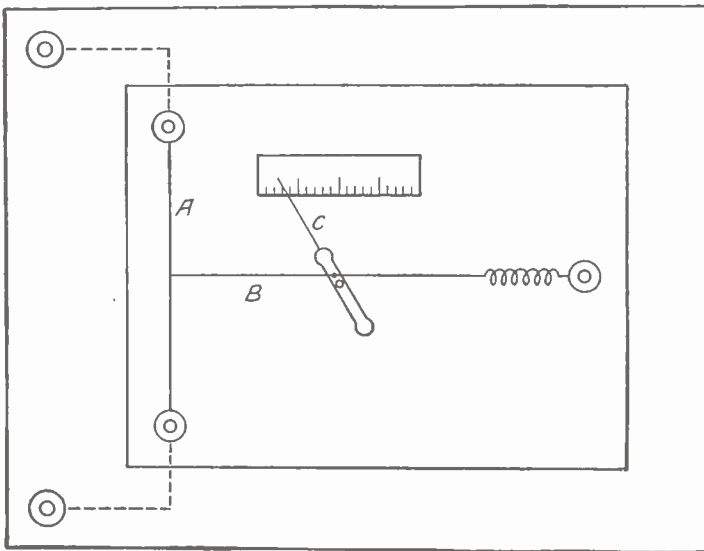

THE CONSTRUCTION OF A HOME-MADE HOT-WIRE AMMETER

A is the tungsten wire through which the current passes and which expands and gets longer as it grows hot. The wire B, with its attached spring, pulls the wire A over to one side and the amount of the deflection is measured by the pointer C.

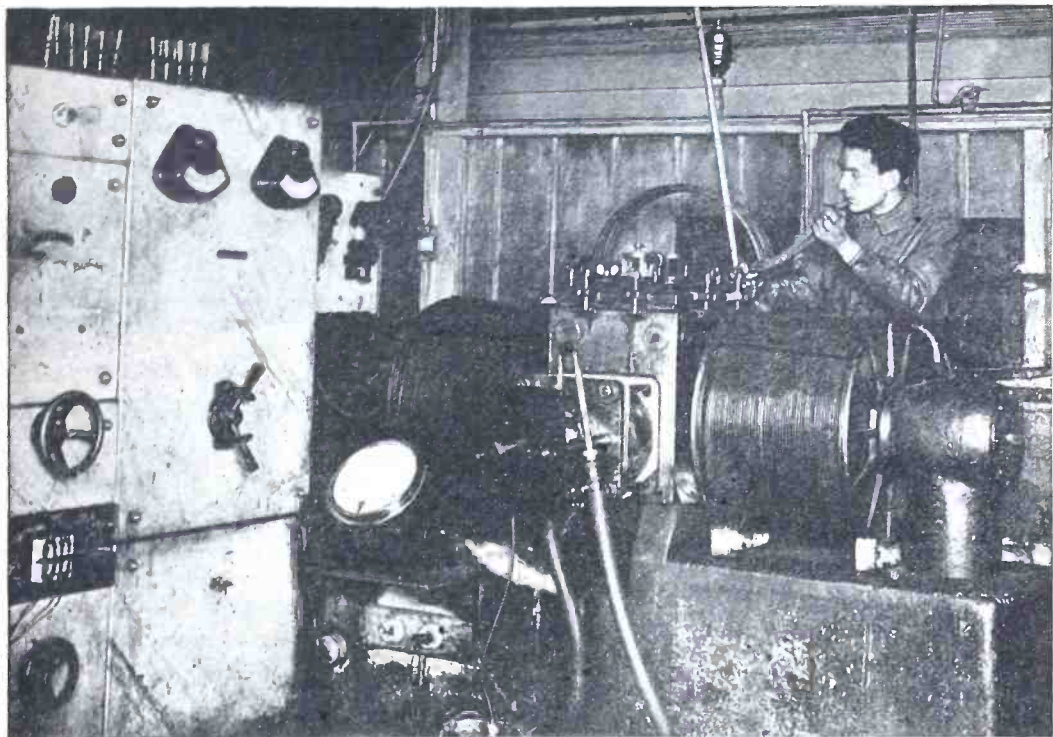

Kadel & Heroert

INSIDE THE TRANSMITTING STATION AT THE EIFFEL TOWER

The largest and most powerful radio station in France is that of the Eiffel Tower in Paris. It is from this station that General Ferrié and his associates have conducted the tests of short-wave transmission and other radio phenomena, which have rendered the radio service of the French Army famous among radio engineers both here and in Europe.

The instrument may be calibrated by using known currents measured with a standard ammeter or in any convenient way. Different sizes of German silver wire, or wires of other alloys, may be used for the measurement of larger or smaller currents.

The wire chosen should be such that its thermal expansion will give the proper amount of movement for the range of current strengths to be measured.

Other Things Beside Electrons Escape from Hot Filaments

It is customary to discuss the theory of the vacuum tube as though the electrons escaped from the hot filament all by themselves, without the companionship of any other varieties of particles. We have known that this was not strictly true. For example, the blackening of the inside of the glass of an electric lamp bulb is known to be due to atoms of tungsten (or of any other filament material) shot out somehow or other from the filament. But the purity of the electron stream in a radio vacuum tube has been a convenient mental fiction.

Professor A. M. Tyndall and Mr. G. C. Grindley have now investigated this matter

quite completely, using a filament of fine platinum wire.* It is found that the emissions from the heated wire include not only the electrons but a considerable number of positively charged ions and a copious supply of tiny invisible particles that carry no electric charge at all.

The positive particles are believed to be aggregates of several platinum atoms one or more of which has lost an electron. That is, they are complex platinum ions. The uncharged particles are merely little bits of platinum, ranging from one atom upward. Some of them contain thousands or even millions of atoms and may even be of microscopic size.

These experiments were done in the air. They are especially applicable, therefore, to the conditions in "soft" or gas-filled vacuum tubes. It is probable, however, that the same results would be secured, in essentials at least, with a filament in an almost perfect vacuum like that of the "hard" tubes. It is apparent that a complete theory of tube operation will have to take account of some rather complex emission phenomena.

* "The Emission from an Incandescent Platinum Wire in Air," by A. M. Tyndall and G. C. Grindley. *The Philosophical Magazine* (London), vol. 47, pages 689-702 (April, 1924).

HINTS FOR

AMATEURS

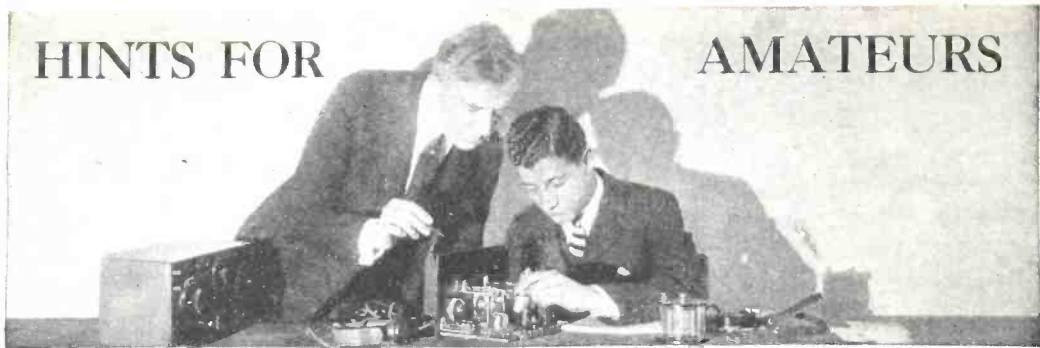

CONDUCTED BY ALBERT G. CRAIG

The Proper Way to Wire up an Insulator

ON the cover of this month's issue will be found a drawing of an insulator. This drawing shows in detail just how to connect up the wire that holds up the far end of the single-wire antenna. Wrap the wires around the eyelets in the insulator in the fashion shown and the result will be a neat and strong connection that will not come undone.

So many antennas are fastened up in makeshift and cumbersome wrappings and twists of wire, just because the erector did not know how to finish off a joint.

Make your antenna neat and ship-shape by following out this month's cover suggestion.

Leakage Through Paste

NEVER use soldering paste freely enough to leave traces of it when the joint is completed. If you should see any trace of paste scattered around a joint, on a jack, or on the panel, use alcohol to wash it off, otherwise, you will experience weakness of signal, due to leakage through the paste.

Avoid Electric Wiring of Unknown Voltage

NEVER touch, or go near, any wires that you do not know about. They may be harmless but still they may carry dangerous voltages.

Never take chances with electricity.

How to Get Good Results on a Loop Antenna

SETS designed for use on an outdoor antenna do not ordinarily work on a loop antenna. To get good results out of a loop antenna, a set should be used that is designed especially for this purpose. Such a receiver contains from one to three or more stages of radio-frequency amplification. For loudspeaker operation, then, at least four or five tubes should be used, unless the receiver is of the reflex variety in which the tubes do double duty.

"Trouble Shooting"

READ the trouble-shooting department of this magazine. You will find that it follows up every receiver that will be described in the constructional articles. Read this section, even if you do not happen to build all of the sets. You will find that it contains hints and suggestions that will be invaluable to all set owners and set builders.

Standard Tubes Give Best Results

WHEN you buy vacuum tubes for receiving sets be sure that you get one of the standard, licensed makes. They run more uniform and give consistent results. Besides this, they can be replaced if they develop defects that are not the result of misuse.

Do not use "bootleg" tubes, as you will almost always experience trouble with them.

Five Hints for Erecting a Receiver

THESE hints were contained in a bulletin of the Chamber of Commerce, of Washington, D. C. They are of interest to radio fans.

1. Keep all radio antennas and wiring away from electric light and power wires.
2. Do not attach antennas to old brick chimneys.
3. Ground metal masts used for supporting antennas.
4. Take sufficient precautions to prevent crossing (short-circuiting) of storage battery terminals and "B" battery terminals.
5. Provide approved protective devices in the lead-in.

The Right Size for the Grid Condenser

FOR use with a vacuum tube, a .00025 mfd. mica fixed condenser will be found to be correct. With a larger condenser connected in the grid circuit, the circuits will be found to be unstable, especially with the ordinary form of regenerative sets. Too small a condenser will give weak signals.

How to Disconnect Batteries from a Receiver

IF the two wires that connect any battery to a set touch each other, the battery becomes short-circuited. For this reason it is always better to disconnect the wires at the batteries first. Then disconnect the wires at the set end.

This prevents short-circuits and the batteries will not suffer.

Distance Range on Crystal Sets

DON'T expect to get a reliable range of more than fifteen miles out of a crystal receiver. Under extremely favorable conditions you *may* get much greater distances, but this is not usual and the consistent range that you will get well is not more than the distance mentioned.

Use a Ground Clamp for a Good Ground Connection

JUST walk into a radio store and ask for a ground clamp. This is a small strip of metal that is stamped with the necessary holes for the tightening bolt. Scrape the water pipe that runs nearest to the set you are installing. Wrap the metal strip around the cleaned portion of the pipe and fasten with the bolt. Then solder the end of the ground wire on to the end of the strip and you have a good ground for receiving.

It is almost impossible to solder a wire directly to a pipe that contains running cold water.

The Best Way to Learn Radio

THERE is no way that will teach you more quickly how radio really works than to build a set yourself, no matter how simple the set you build may be. Start out with a simple, one or two-tube receiver and when you have gotten it together and learned how to tune it, you will know just what the various instruments do when you turn the knobs.

Then when you have mastered the first one, see how much easier the second one is, even if it is much more complicated. If you really want to know the how and why of radio this will put you on the right track.

Keep Transformers and Tuning Coils Apart

DO not place the audio-frequency transformers too near the tuning coils when you lay out that new set. Keep them spaced at least two inches away and the set will function better, with a larger amount of volume and greater sensitivity.

The iron core of the transformer will interfere with the proper operation of the tuning coil. Its effect, if it is placed too close, is to introduce losses into the tuning circuit, or to add to the resistance of the tuning circuit.

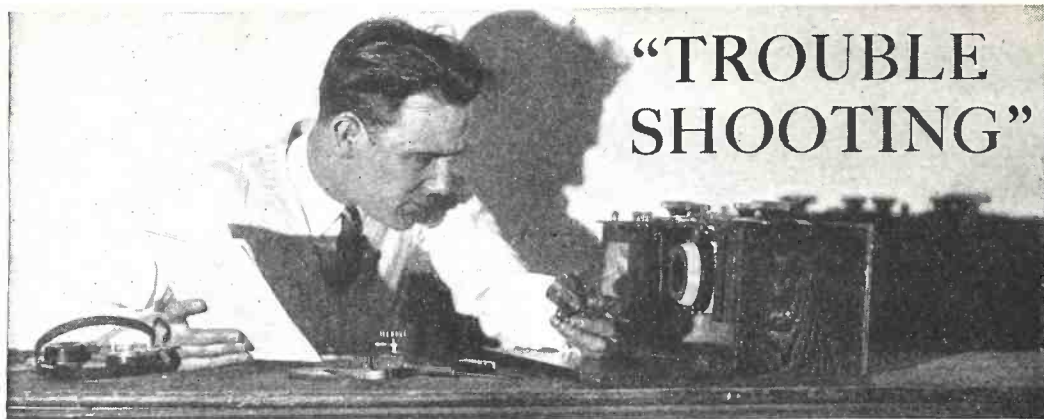

“TROUBLE SHOOTING”

CONDUCTED BY S. GORDON TAYLOR

EVERY radio receiver requires a careful balancing of all of its parts if the best results are to be obtained. Two receivers made from exactly the same design may give widely different results, owing to variations in the parts used, the skill of the experimenters and the locations of the receiver. This department is conducted for the special benefit of readers who have built the radio receivers described in POPULAR RADIO and who want to profit from the experience of others in operating them—to learn the little kinks that get the maximum results.

Hints on Neutralizing the Craig Non-regenerative Tuned-radio-frequency Receiver

(This set was described in POPULAR RADIO for April, 1924)

IN the description of the operation of this simplified neutrodyne receiver (in POPULAR RADIO for April, 1924) complete instructions were given for an easy method to follow in setting the neutralizing condenser. This method made use of the signals of a nearby, powerful broadcasting station, and could only be followed when the filament of the radio-frequency amplifier tube was disconnected. For this latter reason powerful signals were essential to force their way through the radio-frequency tube when it was not functioning.

How to Neutralize for Storage-battery Tubes

SOME readers have had difficulty in neutralizing their sets because there were no powerful broadcasting stations sufficiently close to their receivers to make practical the plan outlined above. It is for such conditions as this that the following suggestion is made.

Assuming that a UV-201-a or C-301-a tube is used for the radio-frequency amplifier it will usually be found that the set will be neutralized with the neutralizing condenser G not quite half meshed; in other words, with the dial set at approximately 40. With all tubes in operation and the neutralizing condenser set at this figure the tuning dials of the other two condensers are rotated over the entire scales. If the receiver does not break into os-

cillation during this process, it will be an indication that the condenser G is properly adjusted. However, if the set does begin to oscillate (as evidenced by a clicking sound as a certain point on either of the dials is passed), the proper setting of the neutralizing condenser has not been found. In that case the adjustment of the condenser should be varied slightly by setting it at 37½. If it still oscillates, try 35. If the oscillation is still noticeable as the other dials are rotated, try again; this time try increasing the capacity of the neutralizing condenser. In almost every case when these tubes are used the setting of the neutralizing condenser will be found to lie somewhere between 35 and 45 on its dial. In any case, however, the proper setting can be found by following the above procedure until the neutral point is found.

Dry-cell Tubes Lower the Settings

WHEN UV-199 or C-299 tubes are used the setting of the neutralizing condenser will be much lower. The same suggestions may be used as for the larger tubes but the neutralization tests should start at 10 on the dial of condenser G, instead of at 40, as is the case where the larger tubes are used. Incidentally, it is not always possible to neutralize the circuit completely when the smaller tubes are used. Sometimes, even when the receiver is neutralized as closely as possible, there will still be a certain amount of oscillation at the extreme lower settings of the other two dials.

This is not important, however, as this will cause no trouble on the broadcasting wavelengths.

Dry-cell Tubes Can Be Used Throughout the Circuit

SOME readers prefer to use UV-199 or C-299 tubes throughout, in place of the UV-200 and UV-201-a tubes (or C-300 and C-301-a) specified in the original description. This change is entirely practical and requires no alteration of the circuit. Best results with the small tubes will be obtained, however, if the voltage on the plates of the radio-frequency and first audio-frequency amplifier tubes is reduced to 45 volts with 45 volts also on the detector plate (the same voltage on the first three tubes, using the same "B" battery). A total of 90 volts should be used on the last amplifier tube. Referring to the diagram on pages 378 and 379 of the April issue, the battery connections would then be as follows:

Binding posts 1 and 2 should be connected to antenna and ground respectively. Number 3 connects to the negative side of the 4½-volt "A" battery which may be made up of 3 dry cells connected in series. Number 4 connects to the positive side of this battery. Number

5 is connected to the negative side of two 45-volt "B" batteries which have been connected in series, or four 22½-volt "B" batteries, in series. Numbers 6 and 7 are both connected to the positive 45-volt connection of the series of "B" batteries. Number 8 then connects to the last positive tap on the "B" battery for 90 volts.

How to Make the Set More Selective

IN locations where the simplified neodyne receiver is located close to broadcasting stations, greater selectivity may be desirable. There are several ways in which this may be accomplished, all of which require some change in the coupler. The most practical method is to move the primary winding further down on the stator tube of the coupler. A suitable distance has been found to be ½ inch. This will bring the top of the primary winding 1 inch below the top of the stator tube. This change requires taking the coupler out of the receiver and is not necessary under normal conditions, but where greater selectivity is needed this plan will prove reliable and will not reduce the efficiency of the receiver.

Tips on the Tobias Regenerative Receiver for Use with an Indoor Antenna

(This set was described in POPULAR RADIO for June, 1924)

THE tubing and rotor, specified in making the special coupler described for use in connection with this receiver, were such a snug fit that difficulty has been found in some cases in rotating the rotor coil when the coupler was assembled, due to the fact that the inner ends of the stator windings were brought through to the inside of the tube. The rotor, in turning, sometimes strikes this wire and stops. If pushed past, the insulation is scraped off the wire, with the possibility of short-circuiting the rotor and stator windings.

What to Do When the Rotor Sticks

WHERE this difficulty is encountered, the best remedy is to replace the stator tube with another having a slightly larger inside diameter. Radion tubing cannot be obtained in a suitable size, so it is recommended that bakelite tubing, 1/16 inch thick and with an outside diameter of 4⅞ inches be used. This should be drilled and wound in exactly the same manner as was the radion tube used in the original receiver described in the June issue. With this new tube installed it will be found that there is plenty of clearance between the two sets of windings.

A Spring Washer Keeps the Rotor from Turning too Easily

WHERE it is found that there is not sufficient tension on the rotor to keep it from being jarred out of adjustment a spring washer

of suitable size may be installed between the dial and the panel. This will maintain a steady pressure and will take up any irregularities there may be in the bearing of the dial against the panel, or in the rotor bearing against the inside front of the stator tube. If the bakelite stator tubing suggested above is used, it will be necessary to provide another tension bearing to hold the rotor in the center of the larger tube. The plan worked out consists of soldering a bearing on the shaft just inside of the front panel, with springs pressing forward against the panel. This forward pressure, together with the back pressure provided by a spring washer under the dial, provides a secure tension at all times and at all settings.

Tips on Tuning the Tobias Receiver

THE best way to master the tuning of the Tobias receiver is to go about it in a systematic manner. It really is simple, and the settings of the first two dials (the main tuning controls) may be logged, when the best setting for any particular station has been found, and the same station will always be found at this setting.

In many present-day receivers the first two dials tune in a station at approximately the same setting of both the dials. In this respect the Tobias receiver is different in that the setting for the condenser is much lower than that for the coupler rotor dial. A tuning chart cannot be presented here because the chart of one of these receivers varies with the different type and size of antenna it is used

on. However, any reader can easily make up his own chart. With the condenser dial set at 10, rotate the coupler dial until a station is tuned in. Bring this station up to maximum volume with the variometer dial. Then change the condenser setting to 20 and turn the coupler dial backward until the same station is again tuned in. Continue this, on several different settings of the condenser until the best combination is found for the particular station being received. Then make a note of the best combination for each of the stations commonly received and this record of settings will constitute a reliable and useful "log."

Lower "B" Battery Voltage Sometimes Helps

In testing out this receiver it is advisable to try different "B" battery voltages on the plate of the detector tube. In most cases best results are obtained with 45 volts, but this is not *always* the case. Sometimes 22½ volts will give greater volume as well as more stable control of regeneration. This last is an important consideration because when a distant station is tuned in it is decidedly unsatisfactory to have the receiver suddenly "flop" into an oscillating condition from no apparent cause.

Keep the Antenna Short and Out of the Way

It is well to have the antenna lead running as directly away from the receiver as possible, and never have it run in front of the receiver or close to the operator's hand. There is a strong body-capacity effect around the antenna lead and, if it is too close to the operator, he will find it unstable in tuning.

An odd characteristic of this Tobias receiver is, that it gives much better results when used with a 30-foot indoor antenna than it does with a highly efficient 100-foot antenna outdoors. Some readers have tried the receiver out on their outdoor antenna with results that did not come up to their expectations, due to their belief that a receiver which will give such good results on an indoor antenna should give proportionately better results on the larger outdoor type. An all-important factor is, that with this receiver on an indoor antenna results are equal to those obtained with the average three-circuit receiver, with two stages of audio-frequency amplification, using an outdoor antenna. On the ground floor of an apartment house in New York City, with 30 feet of No. 22 DSC wire tacked to the picture moulding, sufficient volume was obtained on a station 25 miles away to be heard 150 feet from the loudspeaker.

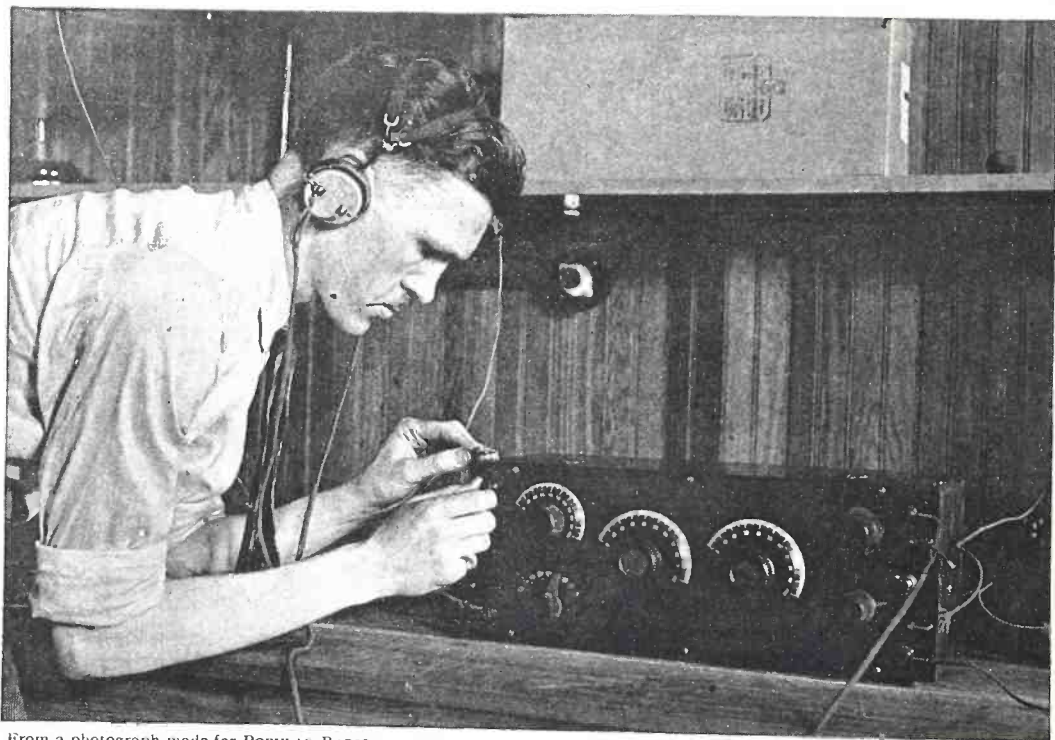

From a photograph made for POPULAR RADIO

TESTING OUT A TWO-TUBE CRAIG SET

This receiver is just like the one referred to on pages 318 and 319 except that it contains only the radio-frequency stage and the detector. It is excellent for local and long distance reception on the headphones.

FACTS YOU HUNT FOR



CONDUCTED BY RICHARD LORD

A limited number of questions of general scientific interest will be answered each month in this department. Readers are invited to send in questions that have puzzled them—but the selection of questions for answer cannot be guaranteed nor can questions outside the radio field be answered by mail.

Why is it that the wavelength of a broadcasting station sometimes varies suddenly by 10 or 15 meters while transmission is going on?

It is a poorly designed station that will vary as much as this (within the usual broadcasting range) unless someone does it purposely. Perhaps the trouble is with the receiving wave-meter, not with the broadcaster. However, small variations in the frequency of a station are common and almost inevitable. Anything that changes slightly the capacity of a condenser or the inductance of a coil may alter the transmitted frequency. For example, a change in the temperature of the apparatus room may do this.

What is the idea of the extra piece of string that hangs out of the end of a telephone cord?

TIE a knot in this inside the hole in the receiver case (or wherever else the cord is fastened). Then, if there comes a sudden jerk on the cord this knot will take the strain, keeping it off the wires and the electrical connections.

What is the greatest speed ever observed for electrons?

IN free space, as, for example, in the cathode ray inside a highly exhausted vacuum tube, some electrons have been known to reach a speed within ten percent of the speed of light; that is, a speed of over 160,000 miles per second. According to the Einstein Theory, if an electron actually did attain the speed of

light it would lose its mass, which means that practically it would cease to exist.

How can a man be knocked down by an electric shock, when the same shock applied to a balanced metal rod will not even knock over the rod?

AT first sight this does seem very strange. The secret is that the man is not really knocked over; he knocks himself over. What the electricity does is to cause a sudden contraction of the man's muscles. That makes him jump. He may jump straight up in the air, or sideways, or in any direction. He seems to have been hit and knocked, but really he has jumped. The actual blow of the electricity is negligible.

What is meant by "miles of standard cable" as a unit of amplification, audibility and similar characteristics?

THIS is an expression borrowed from telephone engineering. Before there was any radio the telephone engineers used to describe line losses and the like in terms of what would occur in one mile of standard 19-gauge telephone cable using a current of 796 cycles. Modern practice among radio engineers is tending to drop this unit and to substitute the specification of power, current or voltage amplification, or (for audio frequency) of the change in audibility as measured by an audibility meter.

What is the phosphor-bronze metal used for antenna wire?

It is really only bronze, containing no phos-

phorus. The "phosphor" part of the name comes from the fact that phosphorus is used in the process of manufacture in order to de-oxidize the tin used in the alloy. The usual composition of phosphor-bronze is about 4 or 5 percent tin and the balance copper.

Is it true that an American discovered the principles of radio telegraphy even before the German, Hertz, discovered electric waves?

Yes. Professor Dolbear patented in 1882 a method of transmitting signals up to distances of one-half mile. It is probable that he had hold of what proved later on to be the old spark system of radio telegraphy, but the theory of his experiments was not understood at the time.

Will slate make a good material for radio panels?

No. Most slate contains a good deal of iron and other minerals that are more or less conducting for electricity. While slate panels can be used, and are used, in direct-current work, the loss of radio-frequency currents through them is so high that their use in radio cannot be recommended.

What is meant by the space charge in a vacuum tube?

WHEN the tube is operating, that is, when the filament is hot, electrons are continually flying off from this filament into the space around it. Some of these electrons move across to the grid or the plate, the latter making the plate current of the tube. Other electrons return into the filament and still others hover around the filament. There is always a cloud of these loose electrons in the space near the filament. They form what is called the space charge. Since they tend to repel new electrons just escaped from the filament, this space charge must be taken into account in all exact calculations of tube and filament behavior.

Do radio waves cause mirages?

No. Mirages are due to the bending of light rays in different layers of the air. For example, when the soil of the desert gets hot the air next the ground gets hot, too. It then bends light rays upward, so that the sky beyond is reflected as though in a mirror. This makes an appearance of water. Many inexperienced travelers have been fooled by it.

How can one compute the distance between two radio stations from a map? I am told that the mere measurement with a ruler will not give the correct result.

FOR short distances ruler measurement, using the scale printed on the map, is accurate enough for most purposes. But for long dis-

tances it may be considerably wrong. This is because the earth is really spherical and any representation of it on a flat surface is necessarily distorted. The best way to take long, straight-line distances is to measure them on a globe, using the scale printed on the globe and a piece of string to measure with. The computation of such distances from any flat map requires considerable knowledge of how maps are made.

What is distributed capacity in coils?

IT is the capacity between two adjacent turns or layers of the coil. These two conductors, being side by side with a layer of air between them, may behave like a small condenser. And, since radio-frequency currents do not require a full metallic circuit, but can pass through a condenser or a chain of condensers, such currents may pass along a coil by the condenser action of the adjacent windings, without taking the trouble to follow all the way along the wire. Under some conditions in radio this may cause serious losses of energy.

How much does the resistance of a hot copper wire differ from the resistance of the same wire when it is cold?

AT the temperature of boiling water a copper wire will have an electric resistance about 30 percent greater than at ordinary temperatures. A very hot day may make a difference of about 10 percent above the resistance on a cold day. The exact differences vary with the kind of copper wire, its hardness, its chemical composition and the like.

What is the velocity of sound in a vacuum?

THERE is no velocity of sound in a vacuum, for sound will not move at all under such circumstances. Sound waves are waves in matter; for example, in water or in air. In a vacuum there is no matter and, therefore, no sound. In air, sound has a velocity of about 1,000 feet a second, this being variable with the density and temperature of the air. This is about the lowest velocity of sound for any substance. In dense substances, like metals, the velocity of sound is much greater.

What is the meaning of the distress signal "S. O. S."?

IT has no meaning except the one assigned to it in the radio code, that is, the signification of distress. The letters are purely arbitrary and were selected for this signal by the International Radio Telegraphic Conference held at Berlin in 1908. The signal was adopted by the United States in 1912. The origin of the letters is said to have been in a general call previously used by German ships, "S. O. E.," the final S having been substituted for greater clarity in sending.



ITEMS of general interest that you ought to know; bits of useful information that every radio fan ought to know.

CONDUCTED BY DAVID LAY

Sir Oliver Lodge Thinks Ether May Have Psychic Functions

SIR OLIVER LODGE, whom readers will remember as writing for POPULAR RADIO an opinion opposing the famous article, "There Are No Ether Waves," published in POPULAR RADIO by the late Dr. Steinmetz, is still firmly of the conviction that the ether exists. At the recent Jubilee Meeting of the London Physical Society, Sir Oliver reaffirmed his belief in the reality of this space-filling medium and in the conclusion that the Einstein theory of relativity did not necessarily controvert the reality of the ether. Sir Oliver is well known, also, as a convinced spiritualist, and he implied in his remarks that the causes of the psychic phenomena in which he believes so firmly may lie in some properties or functions, as yet unknown, of this mysterious medium that carries the radio waves.

Regular Broadcasting Begins in Switzerland

SWITZERLAND has been among the slowest of the European countries to take up radio, the only broadcasts having been ones sent out more or less incidentally from the radio telegraph stations. It is now announced, however, that four fully equipped broadcasting studios are to be installed at Basle, Geneva, Lausanne and Zurich.

Atoms That Last Only One Millionth of a Second

READERS of the articles on atomic structure that have been published in recent issues of POPULAR RADIO will recall that the atoms of radium break up, yielding a long series of other explosive atoms, the final result of the process being an atom of lead. One of the intermediate atoms between radium and lead is so extremely explosive that its average life is only in the neighborhood of a millionth of a second. Short as this time is, Dr. J. C. Jacobsen of the University of Copenhagen, has de-

vised a way to measure it and to prepare a "mortality table" for these very short-lived atoms, just as the life insurance experts have prepared similar tables for men.

Sounds Move Faster in Summer Than in Winter

RECENT calculations of the speed of sound waves in air made by Dr. W. J. Humphreys and published in the *Journal of the Franklin Institute* emphasize a curious consequence of the fact that the movement of sound waves is affected by the pressure and density of the air. The speed of sound is, on the average, about 30 feet a second faster in summer than in winter. The speed of sound in air decreases, also, with elevation above the earth. At a height of about seven miles sound is over ten percent slower than it is near the ground.

Many Short-wave Tests Scheduled for Fall

AS POPULAR RADIO has been predicting for nearly two years, the short waves in the neighborhood of 100 meters are proving more and more useful. Test with such waves from European and South American stations are now being arranged. The American Radio Relay League, Hartford, Connecticut, will be glad to keep qualified amateurs informed by mail concerning the dates of tests and similar information.

"Sealed" Radio Sets Fail in Australia

THE Australian experiment of paying for broadcasting by selling sets sealed to receive only at a certain wavelength seems to have proved a failure. The government has rescinded it and sets are now sold "open," which means that they may be tuned to any wavelength. Each set owner will have to pay an annual fee of about ten dollars, the proceeds of which will be distributed by the government among the licensed broadcasting stations.

Headphones Blamed for Skin Trouble

It is reported in Germany that several cases of a severe rash on the sides of the face have been traced to poisoning by some constituent of the composition used in making the cases for headphones. Some persons seem to be especially sensitive to this curious kind of poisoning, just as some persons are extremely sensitive to poisons like that of poison ivy. If such a super-sensitive person wears the headphones for a long period the rash results. No cases have been reported, so far, from America, possibly because the American makers of headphones use hard rubber more than they do the various chemical compositions employed for insulating purposes.

* * *

Automatic Regulation of Clocks by Radio

ADDRESSING the last meeting of the clock experts, organized as the Horological Institute of America, Mr. F. D. Urie, astronomer of the special time observatory at Elgin, Illinois, pre-

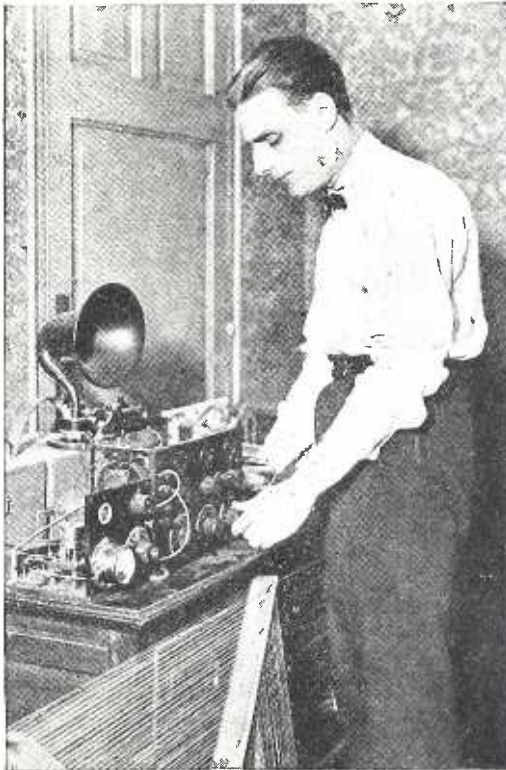

Wide World

THE AMATEUR WHO FOOLED THE FRENCH RADIO SLEUTHS

Reginald Gowraud is the young French radio expert who set up a concealed broadcasting station and sent out voice messages for days before the French authorities were able to learn the location of his transmitter.

dicted that all clocks on streets, in railway waiting rooms and similar places will be regulated automatically by radio signals sent out at intervals from a central station. It will be impossible for such clocks to be wrong unless they stop entirely.

* * *

Radio Apparatus Used to Sort Cigars

ACCORDING to Mr. John Liston of the General Electric Company, that company has perfected a device that will sort cigars automatically according to their color. The cigars roll down a little chute and pass under a beam of light. Light reflected by the cigar enters a sensitive photoelectric cell, like those used recently by General-Ferrié to amplify starlight. If the cigar is a *colorado claro*, the light reflected into the cell has one intensity, the signal from the cell, properly amplified, opens a little gate and the cigar rolls into that box. If, on the other hand, the passing cigar happens to be of another color, say a *colorado maduro*, the cell signal is different, another gate is opened and the cigar goes into a different box.

* * *

Court Decides Against Restriction of Broadcasting by Copyright

THE United States District Court at Cincinnati, Ohio, in a case brought by a music publisher against a broadcaster, has decided that the performance of a copyrighted song or musical selection over the radio is not a "public performance for profit" in the meaning of the law. Accordingly, says the court, the owner of a copyright cannot prevent the broadcasting of his production, nor can he demand royalty therefore. The decision will be appealed, and it is not binding, in any case, upon courts in other jurisdictions. Nevertheless, the decision is an important step toward the much-to-be-desired clarification of the laws of copyright as they apply to the totally new means of distribution and publication which radio has provided.

* * *

Will a Ship's Speed be Measured by Radio?

THE possibility of a totally new instrument for the use of navigators was suggested not long ago by Captain R. H. Ranger of the Radio Corporation of America. A ship is moving, let us imagine, at a certain definite speed. The radio waves move past this ship at another definite speed, approximately the speed of light. May it not be possible, the captain suggested, to devise an instrument that will measure the difference in speed between the ship and the waves that pass it? If this can be done, an instrument could be arranged on the bridge of a steamer to show the captain each moment the exact speed of his vessel relative to the shore. It would be entirely unaffected by currents, winds and other errors of the present automatic logs.



Keystone

"HIS YOUNGSTER'S VOICE"

The venerable John Coolidge, of Plymouth, Vermont, the father of President Coolidge, by means of this super-heterodyne receiver, is enabled to listen in upon his distinguished son's campaign speeches.

Radio Lecture Combined with Motion Picture in Germany

ACCORDING to the *Illustrierte Radio Zeitung* of Munich, a German technical lecture bureau arranged recently for a radio lecture broadcast from the station at Königswusterhausen to be picked up and rendered by loudspeakers at five widely separated cities: Berlin; Vienna; Copenhagen, Denmark; Christiania, Norway, and Gothenburg, Sweden. The lecture was arranged to describe a motion picture and this picture was run off simultaneously in the five cities, the loudspeaker accompanying it with the necessary running comment. The means used for maintaining exact synchronization between the film and the lecture are not stated.

New Measurements of Earth Currents

IT is well known to radio engineers that small currents of electricity are flowing continually from place to place through the rocks and soils of the earth. These currents are supposed to bear some relation to the earth's magnetism and possibly to some of the many mysteries of radio transmission. Mr. O. H. Gish of the Carnegie Institution has just announced some new measurements of these earth currents made in the magnetic observatory at Watheroo, Australia. Lines of wire several miles long are laid in north-south and east-west directions and the currents flowing in these lines are measured. Both currents

vary more or less regularly each day. The south-north current is greatest at about 7 A.M. and 5 P.M. and is least at noon and midnight. The east-west current is greatest at about 9 or 10 P.M. and least at about 11 A.M. It is reasonably certain that these daily variations of earth electricity as well as the similar variations of earth magnetism are related in some manner to electric or luminous energy received from the sun, energy that is believed, also, to have profound effects on radio.

Eight Broadcasting Stations in Germany

AMONG many evidences of the growing interest in radio in the German Republic is the fact that eight fully equipped broadcasting stations are now on the air with regular programs. The locations are Berlin ("Voxhaus"), Königsberg, Hamburg, Frankfurt am Main, Breslau, Stuttgart, Leipzig and Munich. A second station will soon be opened in Berlin and a new one at Münster, in Westphalia. The wavelengths used are in about the American range, varying between 392 and 486 meters. Some of the programs from Voxhaus, in Berlin, are broadcast simultaneously on 680 meters from the great radio telegraph station at Königswusterhausen. A glance at the published programs indicates a surprising preponderance of music, especially of dance music. The reputation of the Germans for preferring somewhat ponderous lectures does not seem to include the radio audience.

No Very Short Ether Waves from Space

IN POPULAR RADIO for December, 1923, were presented the interesting ideas of Dr. Felix Michaud of Paris concerning the possible arrival from space of very short ether waves, much shorter even than the X rays. These new "ultra-X rays" were supposed by Dr. Michaud to be the cause of gravitation. Dr. R. A. Millikan, whose views about atoms POPULAR RADIO published last month, and Mr. Russell M. Otis, have made a careful effort to detect the existence of this very short radiation. They used the predicted effect of the rays in producing ions in open air and inside a sealed vessel of metallic lead exposed on Pike's Peak, Colorado. The attempt was a failure. No such rays were detected and Dr. Millikan and Mr. Otis are inclined to believe that they do not exist. It was discovered, however, that the air on Pike's Peak contains a substantial amount of radioactive matter, the source of which is unknown.

* * *

Radio Phonofilm of Democratic Convention

DURING the Democratic Convention in Madison Square Garden in New York City, Dr. Lee de Forest took a motion picture of the delegates in the Garden and made, at the same time, a record of the noise and shouting by means of his "talking movie" apparatus called the phonofilm. The noise of the Garden was picked up on an ordinary microphone, sent by

radio to the De Forest laboratories elsewhere in New York and there photographed on a moving motion picture film. The picture record was made simultaneously in the Garden itself. The two films thus produced have been combined to give the finished sound-and-sight production.

* * *

Short-wave Tests from the Arctic Regions

THE Canadian government steamer *Arctic*, now on her annual cruise in the region of Baffin's Bay, is carrying this year a short-wave, ICW transmitter. The call is VDM and the wavelength will be 120 meters. According to *QST*, the schedule of transmissions will be from 11.00 P.M. to midnight each night except Wednesday, with an extension on Saturday nights until 3.00 A.M., all Eastern Standard time. Canadian amateurs have agreed to keep watch for the transmissions with the idea that the data obtained may help elucidate some of the many remaining mysteries of radio transmission in the polar regions.

* * *

Radio Prize Established in Paris

THE Parisian magazine, *Je Sais Tout* (which means "I Know Everything"), has presented the sum of 20,000 francs, normally about \$4,000, to the Paris Academy of Sciences to be awarded to the person who makes what is judged to be the most important contribution during the year to the art or science of radio.

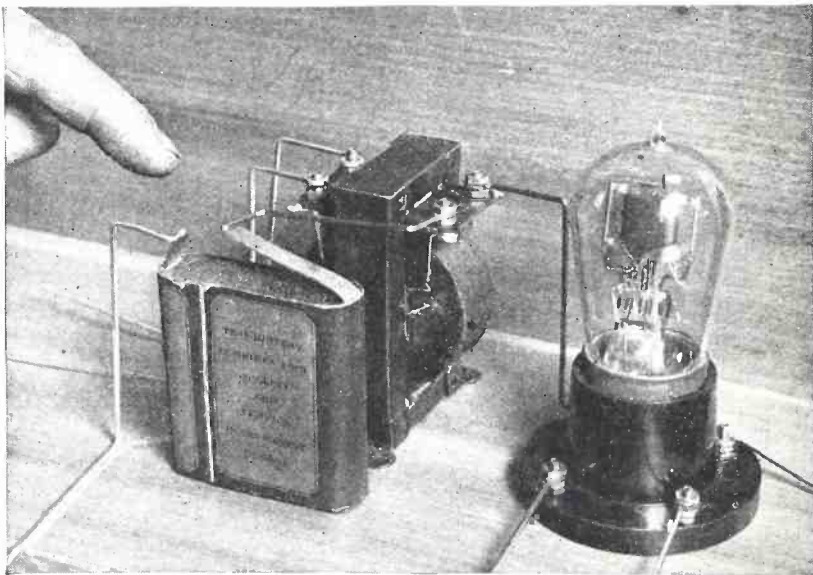

Kadel & Herbert

A NEAT WAY TO FIT THE "C" BATTERY

In order to avoid fitting extra binding posts with the necessary extra wire in the set, it is entirely feasible to cut the filament lead of the transformer, and solder a small flashlight battery into the circuit as shown. The negative side of the battery is connected to the transformer.



When you stop for the night

*Throw up an aerial and tune in just as if
you were at home*

THERE is no reason why you should deprive yourself of radio entertainment when you are away on a vacation. If your home set is too large and bulky, you can easily build a small vacation set you can carry anywhere.

The cost of your vacation set will be comparatively small. The battery of your car will furnish the necessary electrical current and if you have a home set, you can take a tube and the "B" batteries from that.

You should use the same care in selecting parts for your vacation set as you used when you built your home set. Buy dependable instruments and then mount them on a first class panel.

Use a Celoron panel and you help your instruments do their best work.

Celoron, a bakelite material, is one of the finest insulating materials known. It has high dielectric strength and great

resistance to atmospheric attacks. You can drill it, saw it, tap it and bore it, and it never buckles, warps, or cracks. It is practically indestructible.

Celoron panels have been approved by the U. S. Navy and the U. S. Signal Corps. They are used by the best radio manufacturers and by thousands of radio fans.

You can buy Celoron Radio Panels in three finishes—black, oak, and mahogany. These never lose their lustre or become discolored.

Practically all good dealers handle Celoron Radio Panels.

Send for free booklet

If you will clip out the coupon below and mail it to us, we will send you an interesting booklet entitled, "Getting the Right Hook-up with Celoron." This little book is full of helpful suggestions for building and operating a radioset. Send for your copy now. It is free.

CELORON A BAKELITE PANEL

Diamond State Fibre Company

Branches in Principal Cities

Bridgeport, Pa.

Toronto, Canada—London, England

If you want to build a beautiful cabinet use Vulewood—the new cabinet material. If your dealer has not stocked Vulewood, write us. We will send you a pamphlet telling you how to make a Vulewood cabinet and will give you the address of the nearest dealer, who sells Vulewood.

Diamond State Fibre Co., Dept. R., Bridgeport, Pa.

Please send me without charge a copy of the booklet, "Getting the Right Hook-up with Celoron." My radio

dealer's name is

Name

Address

Please refer to POPULAR RADIO when answering advertisements.

Turn On Your Radio—

The Modern Radio
Gets All Its Power
from the Light Socket.
The Day of the Radio
Battery is Past.



RUN-A

All A·B & C Radio Power

<i>Run-a-Radio for</i>	
AC	\$75
DC	\$65
"B" Battery only	\$37.50

Please refer to POPULAR RADIO when answering advertisements.

As You Turn On Your Lights!



The Whole Story of Run-a-Radio In Ten Questions

1. Q. Does Run-a-Radio take the place of all batteries?
A. Yes. With Run-a-Radio you need no A B or C batteries whatever, to operate your radio set.
2. Q. Will it work with either dry cell or storage battery tubes?
A. Yes. More volume is obtained, of course, with storage battery tubes.
3. Q. How does it work?
A. You simply connect Run-a-Radio to your set, and plug it into the light socket. Turn on your radio as you turn on your light. There are models for both A C and D C current.
4. Q. How much does Run-a-Radio cost to run?
A. About as much as one electric light.
5. Q. Is it cheaper than batteries?
A. Its cost is only a little more than regular battery equipment at the start, and it saves you about fifty dollars a year thereafter.
6. Q. Suppose I only want to take the place of B batteries?
A. Use Run-a-Radio B, (a separate B battery substitute.)
7. Q. Will my radio work just the same?
A. Probably better. Run-a-Radio makes it sound always just as it did when your batteries were new and in first-class condition. There is no hum or crackle as from depleted batteries. Distance as great or greater.
8. Q. Will it work on any radio set?
A. Yes. Regenerative, neutrodyne, reflex, superhet.—Run-a-Radio runs them all. Guaranteed for one year.
9. Q. Can I carry it from room to room?
A. Easily. It is about the size of a starch box and weighs only 40 pounds. Finished in rich mahogany or Brewster Green, crackle finish.
10. Q. Doesn't Run-a-Radio mean the end of all batteries in radio?
A. Of course. It is the obvious last step in radio convenience. Soon no radio set will be considered modern without Run-a-Radio.

YES, here it is at last. You have seen it coming. You knew it was the next big step in Radio—the step that would say good-bye to all the expense and inconvenience of radio batteries, and let you turn on your radio as you do your light. Others have approached the goal, making B battery substitutes only. Run-a-Radio has reached it. Run-a-Radio gives you all A B and C power direct from light socket—or B current only if that's all you want. No "ifs," "buts" or "ands"—there's the whole story.

Needless to tell you any more. Needless to talk about the inconvenience of batteries—the disappointment of a "dead" receiver just when you wanted some special program—the big expense of recharging B batteries six or eight times a year at eight dollars a crack for some of the big multiple tube sets—needless to remind you of spoiled rugs, of dragging storage batteries around to be charged, of the hum and crackle when the B's run low. You know all about it—and you have said a hundred times—hurry up that final invention that says 'Good-Bye Batteries!'—when it's ready, I want it!"

RADIO

Direct From Light Socket!

Here it is!

The day of the dead radio is past.

Hereafter, your radio is as ready as your electric light—and always in shape for 100% performance.

Send in the coupon so we can give you folder with all details and tell you where you can hear Run-a-Radio working, and where you can get yours!

RADER APPLIANCE CO., Inc.

DEPT. PR-1

4912 Hudson Blvd., Corner 13th Street
WEST NEW YORK, NEW JERSEY

**DEALERS: Territories are now
being assigned**

RADER APPLIANCE CO., Inc. Dept. PR-1
4912 Hudson Blvd., Corner 13th Street,
West New York, New Jersey
Send me without obligation information regarding
Run-a-Radio and name of nearest dealer.

Name _____
Street _____
City _____

Ask your neighbor
— he knows

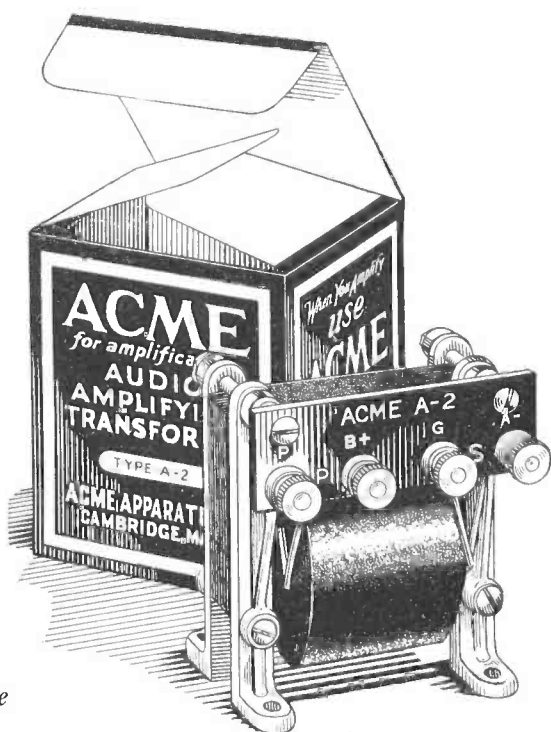

ACME A-2
— for volume

ACME Transformers are used by thousands of radio owners to get increased range and louder, clearer radio. Acme Transformers give maximum amplification without distortion. Each transformer

is tested and carries a guarantee tag. The name "Acme" is a guarantee of best results. Use Acme Transformers in the set you build. Look for them in the set you buy.

ACME APPARATUS COMPANY
Transformer and Radio Engineers and Manufacturers
Cambridge, Mass.

ACME
~ for amplification

Please refer to POPULAR RADIO when answering advertisements.

Improve your set with ACME "lowest loss" condenser

Because of low losses and sharp tuning practically all the currents on the antenna can now be used

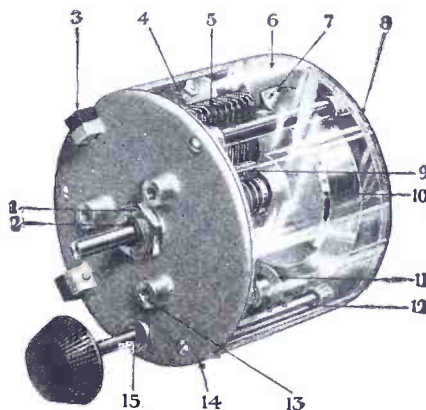
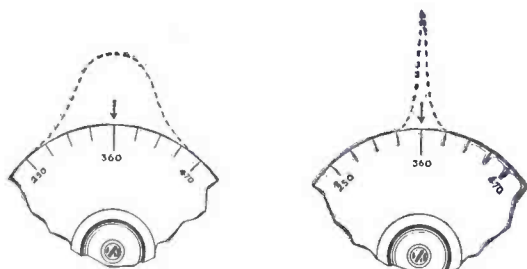

Which one is your tuning circuit

—the hump or the peak?

HERE are the curves of two tuning circuits. The hump has a high loss condenser and the peak a low loss condenser. Both receive broadcasting, but the peak receives local and distant stations without interference, while the hump receives only the nearby stations with interference. The new Acme Condenser will change your tuning circuit from a hump to a peak.

The Acme engineers have been working for two years to bring out a condenser which would give to Radio experimenters sharp tuning and minimum losses. The new Acme Condenser has these fundamental advantages and also has many new improvements in structure and equipment. See the illustration with explanation, and, for more information, write to us for booklet, "Amplification without Distortion," which contains many diagrams and helpful hints on how to build and get the most out of a set.

ACME APPARATUS COMPANY
Dept. 92 Cambridge, Mass.

- 1—Steel brass cone bearings adjustable.
- 2—Lock nut for bearing.
- 3—Highest grade hard rubber Dielectric in that part of the field to prevent losses.
- 4—Brass separator to which both rotary and stationary plates are soldered, making continuous circuit for each.
- 5—Brass silver plated plates; rotary plates logarithmic.
- 6—Dust proof covering.
- 7—Stops at extreme end of movements.
- 8—Coiled connection between shaft and heads allowing lubrication of bearings.
- 9—Brass separator to which both rotary and stationary plates are soldered, making continuous circuit for each.
- 10—Counterweight which balances rotary plates.
- 11—Noiseless friction Vernier control seven to one ratio.
- 12—Brass separators to prevent twisting and to take strain off Dielectric.
- 13—Panel mounting holds for 120 degree spacing.
- 14—Metal heads.
- 15—Steel bushing to prevent wear on Vernier shaft. ALL parts are of non-rusting metal, except steel bearing which is covered with nickel-plated protective surface. End plate capacity is .000016 m.f., full capacity is .0005 m.f.
Price \$6.50

Cut out and send this coupon

Acme Apparatus Company
Dept. 92, Cambridge, Mass., U. S. A.
Gentlemen: I am enclosing 10 cents (U. S. stamps or coin) for a copy of your book, "Amplification without Distortion."

Name

Street

City State

ACME ~for amplification

Please refer to POPULAR RADIO when answering advertisements.

Stop Tube Noises

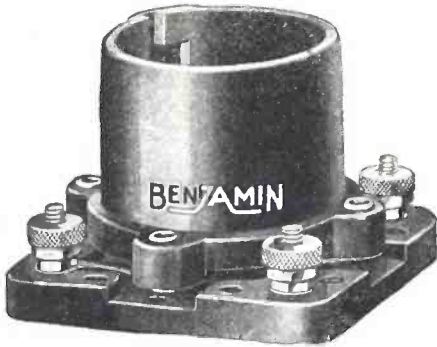

BENJAMIN CLE-RA-TONE SOCKET CLEARER RADIO TONE

Shock absorbing. Tube holding element "floats" on perfectly balanced springs. Takes up all jar and mechanical vibrations which interfere with clear reproduction. A vital necessity for and used by leading makers of portable sets. Made of molded Bakelite. Underside of base provided with smooth bosses for accurate mounting. Contact springs keep tube prongs clean. In two sizes, for standard and UV-199, etc., tubes.



Benjamin RADIO-BATTERY SWITCH

Lightest and neatest switch made. Requires only 1/4-inch hole in panel. Requires no washers. Only one adjustment necessary. The push-pull single contact features give positive contact. When it's in it's off, avoiding accidental cutting in of battery.

Ask your dealer, or send us his name and address and we will supply you through him

BENJAMIN ELECTRIC MFG. CO.
547 W. Jackson Blvd., Chicago.
247 W. 17th St. New York 580 Howard St. San Francisco

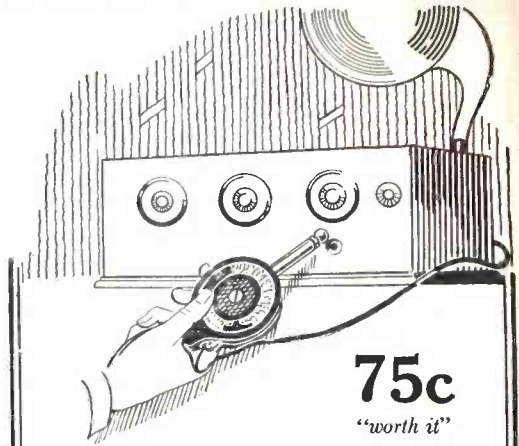

Poly Plug

Eliminates every inconvenience so annoying in the operation of the unsatisfactory screw type plug.

There is no necessity to take Poly Plug apart, no screws to tighten, and what's even more important, positive contact is always maintained.



A wonderful feature of the Poly Plug is the tension slot, allowing the phone cords to be pulled and jarred without disturbing the contact.

At your dealers or sent postpaid on receipt of purchase price.

POLYMET MFG. CORP.
70-74 Lafayette Street
New York City

Madera Die-Cast Wood

"Clearspeakers"

Are all WOOD all-the-way-down

The wonderful performance of "Madera" die-cast wood sending metal radio horns into the discard.

Madera Clearspeakers are not made the usual way, with metal throat and wood bell—but are all die-cast wood, much denser than natural wood.

Our new models are finished in rich mahogany and walnut effect, as well as in black or brown crystal finish.

No. 804, here illustrated, 12 inches high, in crystal, only \$15

Send for Circulars

American Art Maché Company
351 West Austin Avenue Chicago, Illinois

FAHNESTOCK CLIPS

"Popular Wherever Radio Is Used"

14 Sizes in Beautiful Display Case.

Dealers write for big money-making proposition.

FAHNESTOCK ELECTRIC CO.
Long Island City, L. I.

Save on your Radio Table by buying direct—from the factory



\$22

Direct from Factory

\$22

From the Factory

RADIO Table No. 81 shows the utmost refinement of line, design and workmanship. It will blend with the most exacting home environment. Cabinet contains space for "A" and "B" storage batteries, hook for headphones and magazine rack. Four insulated holes are provided at the rear for lead-in wires. Top measures 36 x 20 inches. Supports weight of over 200 pounds. Offers choice of Hardwood (birch) in Mahogany or Walnut Finish.



OAK

\$7

From the Factory

\$10.50

Direct to You

COMBINES exceptional strength, durability and handsome appearance. Table No. 82 may be had in Solid Oak or Imitation Mahogany. There is one roomy drawer, and a strong shelf for batteries. Top 20 x 30 inches.



\$10.50

Direct to you

SALISBURY BROS. FURNITURE CO.
Randolph, Vermont

\$7

From the Factory

A REMARKABLY substantial, handsomely finished piece of furniture, (Radio Table No. 29.) Can be furnished in Golden or Fumed Oak or Imitation Mahogany. Complete with one long drawer and handy shelf for batteries. Durably made to stand great strain.

Salisbury Radio Tables

Seize this opportunity to buy a high grade radio table at a big saving. Strongly made of the best materials, and beautifully finished. They'll set off your receiver, and provide an enduring piece of furniture for your home. Just check the table and finish you want in the coupon opposite—and we'll do the rest.

SALISBURY BROS. FURNITURE CO.
Dept. B-2, Randolph, Vermont

Send the Salisbury Radio Table which I have checked and indicated finish wanted.

- No. 81 (\$22) finished in
- No. 82 (\$10.50) finished in
- No. 29 (\$7) finished in

I will pay the expressman \$..... plus expressage on delivery.

Name.....

City..... Street..... State.....

Please refer to POPULAR RADIO when answering advertisements.

100 Ampere Hour "A" Batteries for WD12 or UV201-A Tubes

JUMBO

Instantly Recharged

without electrical equipment at home, or at Jumbo Service Dealers

While You Wait

NEVER NEED REPAIRS

Every Recharging Completely Renews the Battery

30 Day Trial

Ask Your Dealer—or Write Directly to Us for
OUR 30 DAY TRIAL PLAN

We offer an Attractive Proposition to Dealers—
and a few Exclusive Territories to Distributors

PRIMARY MANUFACTURING CORPORATION

85 to 87 Mercer Street, New York

'Phone: Canal 8852-8853

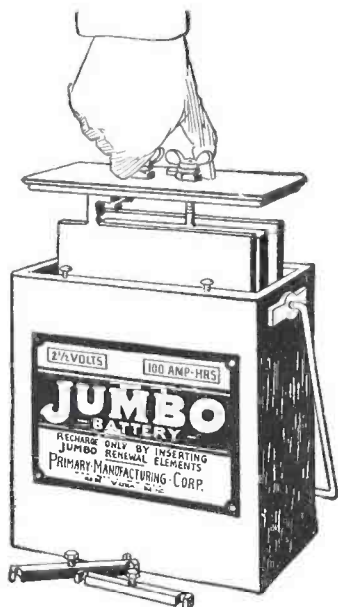

YAXLEY

Approved Radio Products
The Mark of High Quality

Announcement

The name may be new to you but the product is an old and true friend to the radio public. Hundreds of thousands of Yaxley made parts are giving satisfaction in sets all over the country. Now, you may secure Yaxley Approved Radio Parts under the name of the maker. Insist on Yaxley. It is your guarantee.

Radio Jacks



You will recognize this Inter- **\$1.00**
stage Jack. Code No. 4.

Yaxley Radio Jacks are single nut mounting; fit any standard thickness panel without use of spacer washers. Have genuine phosphor bronze springs; pure silver self-cleaning contact rivets and other exclusive features. Fit all plugs. Fully guaranteed.

Jacks - Rheostats - Potentiometers - Switches - Plugs - Etc.
Ask your dealer, or write for full information.

YAXLEY MFG. CO.
213 N. Desplaines St., Chicago, Ill.

LEGO WONDER
FIXED DETECTOR
for
REFLEX & CRYSTAL SETS
Something entirely new.
100% SENSITIVE.
No parts to wear out; practically everlasting.
Unconditionally Guaranteed.
Designed to withstand high Plate Voltage.
For Sale by All Dealers or Sent Postpaid. Insured \$1.00
Lego Corp., 225 W. 77th St., N.Y.C.

SIMPLEX

Lightning Arrester
Ask Your Dealer
SIMPLEX RADIO CO.
Mfrs. Philadelphia

Use — Price 75¢

DURHAM
Variable Grid Leak
At dealers, or postpaid
Durham & Co., 1936 Market St., Phila.

Please refer to POPULAR RADIO when answering advertisements.

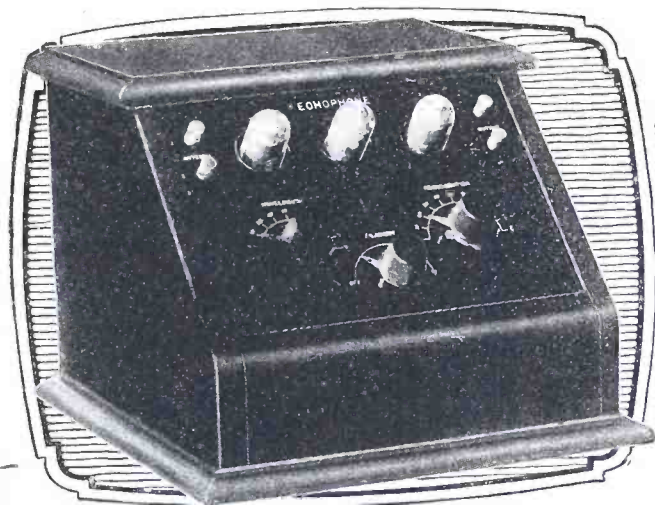

At Last!

5-Tube Efficiency from a 3-Tube Set

HERE'S a new marvel in Radio—a three tube Regenerative Receiver, licensed under Armstrong Patent No. 1113149, that gives you all the Volume, all the Tone Quality, Selectivity, and Distance of the average five tube set, but with expensive batteries and equipment eliminated.

It's the Echophone "3." A beginner can install and operate it. But the more you know about Radio, the greater will be your amazement that so much can be accomplished by such a simple 3-Tube Set!

The Echophone "3" gives ideal Headphone or Loudspeaker Service on dry cells. It has a perfectly balanced tuning unit with two simple controls.

Covers entire broadcasting range of 200 to 600 meters, and brings in far-distant stations with remarkable trueness of tone.

Beautifully assembled—only highest grade tested units used with Flexible Wiring throughout. All parts mounted on a heavy Formica panel which slips into an exquisitely finished Adam brown Mahogany Cabinet with space in rear for all batteries. Highly ornamental.

Fewer tubes, reduced up-keep cost, dry cell adaptability, superiority of reproducing qualities—yet priced at only \$50.00. And possible only through the Armstrong patent.

What are you going to do? Spend \$75.00 to \$100.00 more than necessary for a new set? Or instead ask your dealer to demonstrate the Echophone "3"? Anyway write at once for descriptive circular. Address The Armac Radio Company, Agents, 1120 N. Ashland Ave., Chicago, Ill.

Manufactured by THE RADIO SHOP

1120 N. Ashland Avenue,
Chicago, Ill.

Long Beach
California

Sunnyvale,
Calif.

Price
ECHOPHONE "3"
Without Tubes and
Dry Cells

\$50⁰⁰

*Get New Thrills.
Listen in on the*

ECHOPHONE

Storage Battery Results at Dry Cell Cost



Dealers: Get in touch
with your Jobbers

Please refer to POPULAR RADIO when answering advertisements.



CANNON-BALL HEADSET \$3.50

Regardless what price you pay for a receiving set, its efficiency and sensitiveness means nothing if your headset or loud speaker fails to do its duty.

The Camco Cannon-Ball Headset is rapidly increasing its circle of enthusiastic friends. It is a quality headset at a fair price. And you can count on it to give you a reproduction of the program with a clearness and richness of tone that will please your ears.

Ask your dealer to let you examine the interior of the phones. Slip them over your head and on your ears and note how comfortable they are.

Camco craftsmen specialize on radio headsets and loud speakers. This develops perfection to the highest degree.

Invest your money wisely—Camco Cannon-Ball, \$3.50; Camco Grand, \$4.75, and the



CAMCO Loud Speaker \$9.50

The brown fibre, Camco Loud Speaker pictured here is a very pleasant family friend. Twenty-two inches tall. Ten inch bell. Artistic, black enamel metal base and six foot, durable black cord. Complete with a clear, mellow tone Camco Loud Speaker Unit making a quality speaker at a fair price. At your dealers.

DEALERS: Ask your jobber about Camco products or write for complete details.

CANNON & MILLER CO., Inc.
SPRINGWATER, N. Y.

BEWARE of Imitations!

The **UNCLE SAM MASTER TUNING COIL** is the original 3-circuit tuner. Demand only the genuine if you want **DISTANCE, SELECTIVITY, VOLUME.**

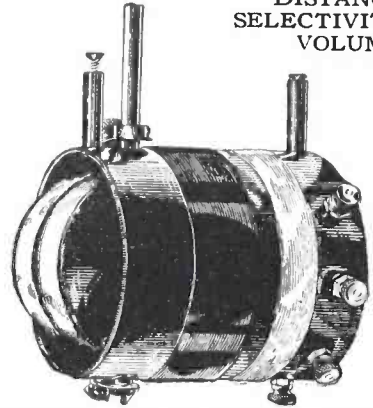

UNCLE SAM MASTER TUNING COIL

Verifications from satisfied users prove conclusively such DX Reception as Philadelphia to KFAE (Pullman, Wash.), Ardmore, Pa. to WKAQ (Porto Rico), Trenton, N. J. to KHJ (Los Angeles). And as to selectivity, a committee of engineers in Philadelphia clearly heard 49 different stations sign off in 8½ hours on the air.

The only licensed all Litz Tuner

Only \$5.50

At all good dealers

Ask your dealer or send self-addressed, stamped envelope for FREE wiring diagrams of circuits using this coil.

UNCLE SAM ELECTRIC CO.
215 E. 6th St. Plainfield, N. J.



There is only one

GENUINE

EBY Binding Post

"With Tops which Don't Come Off"

Eby Posts are scientifically designed, beautifully finished and their price is right.

EBYS are Binding Posts PLUS

H. H. EBY MFG. CO. : Philadelphia

Please refer to POPULAR RADIO when answering advertisements.

Dear Jim:

You know how I've been spending my money for parts. Well, last night our home-made "superhet" was making a lot of noise but little music, when I happened to remark to Nell that a couple of new vernier condensers at \$7 each might improve it.

And she snapped right back at me, that one new hat at \$14 would improve *her* con-sid-er-ably, and what was more she intended to be improved. Women are so inconsiderate.

I was ready to kick the set to pieces and give up Radio forever, when Eddie who works at Whump's Radio Store called to ask about a little bill which had escaped my mind.

I asked him to look over the set and see if he could tell what was causing the trouble. "What's the use?" he said. "The set is probably O. K. Why don't you get some batteries you can recharge when they run down? That's what's making it noisy."

Well, to make the story short, I got him to trust me for a set of Willard A's and B's, and you should hear that "super" perform now.

Wife Nell hasn't said any more about the hat either.

Yours for better reception,

Sam.



WILLARD RADIO BATTERIES WTAM

(The Voice of the Storage Battery)

WTAM is the Radio Research Laboratory and Broadcasting Station of the Willard Storage Battery Company, Cleveland, Ohio.

Its function consists of research which is being done to improve the quality of radio reception and the broadcasting of radio programs for your entertainment.

Write for WTAM's own booklet, "Better Results from Radio." Most interesting booklet ever published on this subject. Mailed to you with our compliments.



Tear me off the page and mail me to WTAM. I'll bring you "Better Results."

.....
Name

.....
City and State

.....
Street Address

Please refer to POPULAR RADIO when answering advertisements.



The New SATURN Improved Automatic Radio Plug



SATURN Perfect Jacks

Easy soldering terminals with crowfoot offset, tinned with non-corrosive solder flux compound.

Rounded corner brass brackets, nickel plated. German silver blades with sterling silver contact points.

A still better SATURN Plug—handier, more durable and greater value than ever at the reduced price. Genuine Bakelite, no metal parts projecting to produce capacity effects or short circuits. Connected without a screwdriver or any other tool—just by inserting cord terminals. Strong automatic grip—instantly released by pressure on small release lug. Absolutely fool-proof. Efficiency unconditionally guaranteed.

Reduced price 75c

The SATURN Battery Switch

A new SATURN Product, built of the same high grade material and on the same standards of perfection as the SATURN Plug and Jacks. Perfectly balanced because of exclusive blade construction. Switch pulled out makes connection, pushed in, breaks connection. Fits any thickness of panel.

List price 75c.

How to Buy SATURN Products

SATURN Products are sold by the great majority of radio dealers. If your dealer has none, send us your order, mentioning his name. Your satisfaction with every order absolutely guaranteed.

Write for Our New Circular

The SATURN Mfg. & Sales Co., Inc.

Dept. P.

48 Beekman St.
New York, N. Y.



Slight Touch Releases the Lips



FREE

To Each Purchaser of a **World Battery**

A 24-Volt "B" Storage Battery positively given FREE with each purchase of a WORLD "A" Storage Battery. The WORLD Battery is famous for its guaranteed quality and service. Backed by years of Successful Manufacture and Thousands of Satisfied Users. You save 60%.

Prices That Save and Satisfy

Auto Batteries	Radio Batteries
6-Volt, 11 Plate \$12.25	6-Volt, 100 Amps. 12.50
6-Volt, 13 Plate 14.25	6-Volt, 120 Amps. 14.50
12-Volt, 7 Plate 17.00	6-Volt, 140 Amps. 16.00

Shipment Express C. O. D. subject to examination. 6 per cent discount for cash in full with order.

2-Yr. Guarantee Bond in Writing With Each World Storage Battery

proves satisfactory World performance. Mail this ad with your name and address—we will ship battery day order is received, and give you your choice of "B" Storage Battery or a handsome nickel finish Auto Spotlite, FREE. Write TODAY.

WORLD BATTERY COMPANY

1219 So. Wabash Ave. Dept. 3 CHICAGO, ILL.

This FREE "B" Storage Battery takes the place of dry cell "B" batteries. Can be recharged and will last indefinitely. To be sold retail for \$6.00. It is the only battery of its kind equipped with solid rubber case—and insurance against acid and leakage. Take advantage of this remarkable introductory offer NOW. (To those who prefer it, we will send FREE a handsome nickel finish Auto Spotlite, instead of the "B" Battery. Be sure to specify which is wanted.)

GIVEN FREE

To introduce this new and superior World "B" Storage Battery to the Public



Radio Dealers HEADQUARTERS

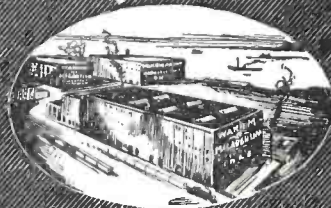

EIGHT BIG WAREHOUSES TO SERVE YOU

BIG CATALOG FOR DEALERS ONLY

DEALERS ONLY

Big, new Catalog out Sept. 1 Write on your letterhead, asking for C1002.

WAKEM & McLAUGHLIN
225 E. ILLINOIS ST. - CHICAGO

Please refer to POPULAR RADIO when answering advertisements.

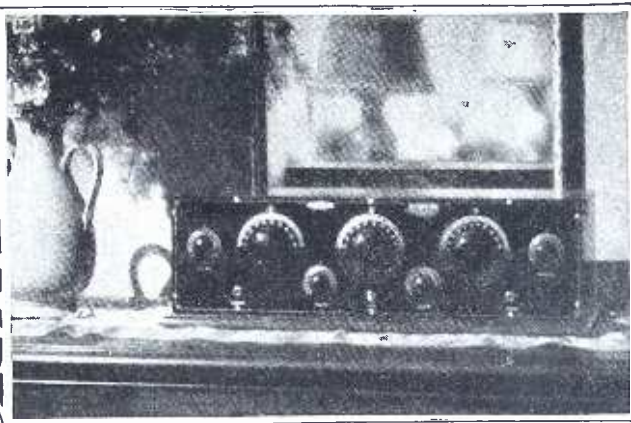

Plus Clearness



Priced at \$115.00, less tubes and accessories, the XL-5 represents a wonderful value in a fine receiving set. (West of the Rockies--\$120.00)

Reputable radio jobbers and dealers will be interested in a detailed description of the A-C Dayton XL-5. Our sales plan is an attractive one. Write for complete information.

**GUARANTEED
WITHOUT
RESERVATION**

HERE is a new receiving set--- designed as all fine sets, to give volume, selectivity, distance and simplicity of operation ... But **PLUS** one feature that marks its superiority ---**CLEARNESS OF RECEPTION.**

The A-C Dayton POLYDNE XL-5 is a super, five tube receiver that will enable you to honestly enjoy your favorite programs, without the annoyance of interference and distortion. The XL-5 receives the finest orchestral and vocal music exactly as played, with perfect clarity of modulation.

True radio enjoyment will be yours with this new receiver. Its mechanical refinements have resulted in a beautiful set, one that will fit the arrangement and decorative scheme of any room in the home.

Your radio or music dealer will gladly demonstrate the A-C Dayton XL-5 for you. Ask to see it---to hear its remarkable clearness of reception. Write for the name of the nearest dealer.

**THE A-C ELECTRICAL MFG. COMPANY
DAYTON, OHIO**

Makers of Electrical Devices for over Twenty-Years.

A-C DAYTON

XL-5

Please refer to POPULAR RADIO when answering advertisements.

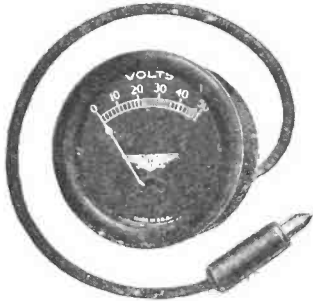

Jewell No. 84 "B" Battery Voltmeter
\$2.75

Test Batteries Often

If you are having trouble with your radio set check your batteries the first thing.

If you do not wish to invest \$10.00 in a Jewell No. 57 "A" and "B" battery voltmeter, our No. 84 "B" battery voltmeter will prove a valuable substitute.

Send for our 15-A radio catalog just off the press.

Order from Dealer

Jewell Electrical Instrument Co.

1650 Walnut St. Chicago

G. W. Radio 5 Circuit Plug

Patented April 8, 1924

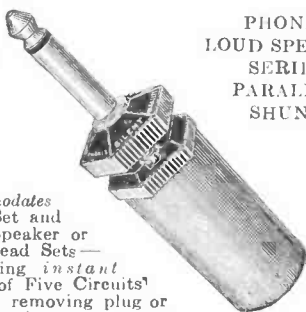

PHONES
LOUD SPEAKER
SERIES
PARALLEL
SHUNT

Accommodates Head Set and Loud Speaker or Two Head Sets—permitting instant choice of Five Circuits' without removing plug or changing tips.

Price \$1.00

At Your Dealer or Direct from Us
MADE OF GENUINE BAKELITE
Jobbers Write for Quantity Discounts

Manufactured by

G. E. WALKER CO., Inc.
1926 CHESTNUT ST. ST. LOUIS, MO.

BRAIDED COPPER RIBBON



CLEARER SIGNALS
INCREASED RANGE
TAKES LESS BATTERY CURRENT

Our newest and best radio antenna wire Braided Flat Ribbon

Contains over one-half mile of wire strands. For out door or indoor use. In Copper—Tinned Copper—Enameled Copper. We also make round antenna wires in all types and metals. Loop wires, Litz wires, Cotton covered wires.

Ross Antenna Co.
9 Charles St., Providence, R. I.

GLASS CABINETS

Built to Order

Get greater distance, decrease body capacity howls, stop leakage, make your set more nearly electrically perfect, more attractive, and something different. How? Write for free booklet, "GLASS CABINETS", giving full information, description and instruction, how to order and use.

IF YOU HAVE NO GLASS CABINET YOU'RE NOT A BUG

7" x 7" x 26" inside 1/4" plate glass \$8.75
Holes drilled to order, any size 12 1/2c each

STEFFEN GLASS CABINET CO. Chicago, Ill.
6028 Ingleside Avenue

AMPLION

The World's Standard Loud Speaker



GILFILLAN NEUTRODYNE

A new powerful set of greater Clarity Distance, Simplicity and Beauty

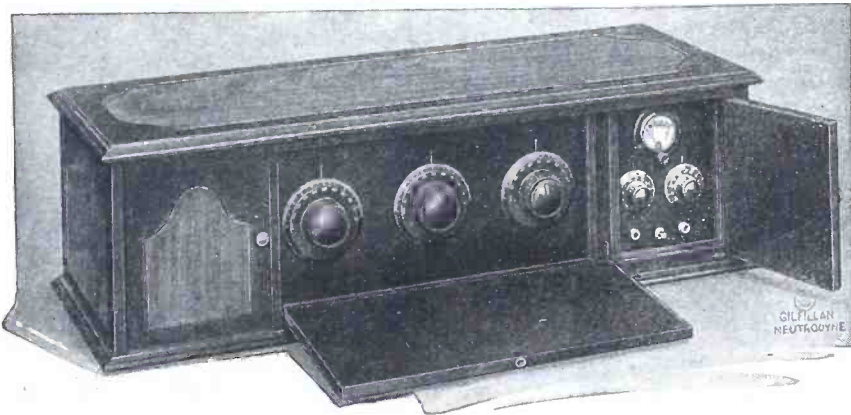

A handsome two-tone American Walnut Cabinet, 33 ins. long, 12 ins. wide and 10 inches high

Complete, without Loud Speaker, phones, tubes or batteries **\$175.00**

The introduction of the GILFILLAN NEUTRODYNE set is the longest forward step in Advanced Radio Engineering

The engineers who designed and built this Set are leaders in Radio Invention and Construction. They reviewed and analyzed every American receiver and have given their best in producing this highly sensitive, accurate, selective NEUTRODYNE set. Extremely simple to operate, convenient to install and of an artistic design that will be a handsome addition to any room.

In the GILFILLAN NEUTRODYNE every detail has been reviewed and corrected to assure highest amplification, finest selective re-

ception and positive neutralization. Its well-balanced, neutralized circuit gives distortionless reproduction of speech and music of ample volume and great clarity.

It is truly a marvel in the radio world and the first "straight line" set with a properly proportioned and beautifully designed and finished cabinet which can be completely closed whether in use or not.

Manufactured at 3 convenient shipping points, addresses below, assures prompt delivery and national distribution.

Robbers and Dealers — looking for a high grade set of assured merit, ample power and real beauty, will write at once for our sales proposition and place their orders early to prepare for sales of unheard of volume!

GILFILLAN BROS. INC.

Los Angeles, Calif., 1815 W. 16th St.

New York City, 225 W. 57th St.
Kansas City, Mo.,
2525 W. Penn Way

Send for Descriptive Literature showing Special Features and Details.



LICENSED MANUFACTURER



UNDER NEUTRODYNE PATS.



Please refer to POPULAR RADIO when answering advertisements.

RATHBUN

SINGLE-HOLE MOUNTING

SUPERIOR CONDENSERS

NEW Combination Types

NEW points of strength added to a still greater development of the exclusive Rathbun features that have won such wide recognition for these condensers. The vernier attachment is so utterly independent of the variable elements as to be practically a "condenser within a condenser." Neither shaft can move the other. Vernier contact fully insulated from rotor contact. Vernier capacity of only .00002 mfd. affords the most critical tuning. Other points of these new condensers are, the smallest amount of Bakelite for dielectric consistent with strength, positive contacts (no current through bearing), all metal parts of brass, bronze and aluminum assures minimum resistance, contacts from rotor and stator plates widely separated for highest efficiency, and of course, SINGLE HOLE MOUNTING. You'll never know just how good a RATHBUN Condenser is until you've tried one.

PRICES

Plain Types		Combination Vernier Types	
3 Plate Vernier, .00002	\$1.00	3-11 Vernier Variable	\$4.50
11 Plate Variable, .0002	3.00	3-23 Vernier Variable	5.00
13 Plate Variable, .00025	3.00	3-43 Vernier Variable	6.00
15 Plate Variable, .0003	3.25		
23 Plate Variable, .0005	3.50	Combination Types	
43 Plate Variable, .001	4.50	Include Knob and Dial.	

Write for Literature TODAY

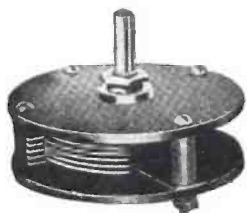

RATHBUN
Manufacturing
Company, Inc.
JAMESTOWN
NEW YORK



Radio Apparatus

"Does more than you expect it to do"

Broadcast Tested, High Quality Audio Transformer

For clearness of tone, amplification of voice and music from nearby and distant broadcasting stations, is unequalled by any Transformer on the market.
3 1/2 to 1 Ratio... \$4.25
5 to 1 Ratio... 4.50



Perfect Contact Vernier Rheostat

For fine filament control of tubes and superfine tuning, the Regal Vernier stands alone. Nothing just like it on the market.



Complete with Knob
6-Ohms... \$1.25
30-Ohms... 1.25

At all good dealers—otherwise write direct for complete descriptive folder No. 24, sending dealer's name.

AMERICAN SPECIALTY CO.

Bridgeport,

Connecticut



DUTCH RADIO VALVE

D-201-A

.25 Amp. 5-6 Volts

Detector - Amplifier
Guaranteed

Rigidity tested by expert engineers

LIST PRICE \$4.00

Special discounts to dealers.
A few more distributors wanted.

Sole distributors for U. S.
D. R. V. IMPORTING CO.
515 Orange St., Newark, N. J.

Dealers, write to Distributors in your territory

Distributors

CALIF.—Marshank Sales Co.
1240 South Main St., Los Angeles, Cal.,
MISSOURI—St. Louis Radio Tube Laboratory,
3572 Olive Street, St. Louis, Mo.
CANADA—Consolidated Electric Lamp Co.
43 Queen St., E. Toronto, Ontario

Radio EQUIPMENT

Write for your
free copy
of

Ward's Radio Catalogue

MONTGOMERY WARD
Chicago Kansas City St. Paul Portland, Ore. Oakland, Cal. Ft. Worth

A Valuable 68-Page Reference Book on Radio—a Market Place for the Best in Sets and Parts

We want you to have a copy of Ward's new Radio Catalogue. You will find it to be an encyclopedia of information on Radio, the liveliest topic of the day. It contains a new Radio map—diagrams of the best hook-ups—descriptions of complete sets, and standard parts for building sets.

Headquarters for Radio

Montgomery Ward offers you all types

of Radio Equipment at a saving. We sell direct to you only merchandise of highest quality. Everything you buy from us, carries our 52-year-old guarantee—"Your money back if you are not satisfied."

Enjoy the Long Winter Evenings

Every form of entertainment can be brought into your home by Radio. Keep in touch with the world—Sports—Election Returns—Dance Music—Speeches—Sermons—Current Events—you can enjoy them all by Radio.

Write today for your copy of this complete Radio Catalogue. Address our house nearest you: Dept. 38-R.

ESTABLISHED 1872
Montgomery Ward & Co.

The Oldest Mail Order House is Today the Most Progressive

Chicago Kansas City St. Paul Portland, Ore. Oakland, Cal. Ft. Worth

Please refer to POPULAR RADIO when answering advertisements.

You Can Pay More But You Can't Buy More

"Shepcu" "All Wave" Jr.

Trade-Mark Patents Granted and Pending

Non-Radiating DX Coupler

"The finest tuning unit in existence." Guaranteed to bring in stations 1500 miles away on one tube with two and three tube volume. "Shepcu" bank wound and tapped primary and tapped secondary give selectivity unattainable any other way. Eliminates all variometers, variocouplers, and loading coils. May be used in single, double or triple circuit.

Six efficient Hook-ups in every box or sent for 10 cents in stamps to cover mailing.

At radio dealers or sent prepaid on receipt of price.

\$6

They're All Local Stations

with a

"Shepcu" "All Purpose"

Trade-Mark Patents Granted and Pending

Receiver

A one tube set with all the selectivity, distance and volume of expensive many-tubed outfits. Contains "All Wave" Jr. Coupler and other highest quality parts. Operates loud speaker on nearby stations. Terminal arrangement permits quick, easy change of hook-ups without tools. Supremely simple to operate.

Hook-up chart with every set or sent for 10 cents in stamps to cover mailing.

At radio dealers or sent prepaid on receipt of price.

\$21

without accessories

Made and Backed by An Absolute Money Back Guarantee by

SHEPARD-POTTER CO., Inc.

33 South River Street

Plattsburgh, New York

TEST YOUR BATTERIES

with a

FREAS HYDROMETER

They are reliable

FREAS No. 1 HYDROMETER SET

Scientifically designed to work freely.

FREAS CLEARVIEW HYDROMETER SET

A straight barrel type instrument.

Price \$1.00 Each

FREAS RADIO "B" HYDROMETER SET

Especially designed for use with the "B" Battery.

Price 75 Cents

If your dealer cannot supply you write to the factory direct and your dealer will be supplied.

Manufactured by

FRANCIS L. FREAS GLASS WORKS
Conshohocken, Pa.

To Jobbers:—You will be interested in our Proposition. Write Dept. P.



Manufacturers of Radio Parts

As large wholesalers only and carrying stock in eight largest cities in Australasia, we can give standard lines exclusive representation. Send us your catalogue and samples by Parcel Post, which we will pay for or return. Not interested in sets.

UNITED DISTRIBUTORS, LTD.

SYDNEY, AUSTRALIA

CABLE ADDRESS "SUPERIOR"

Reference:

United Manufacturing & Distributing Co.
9705 Cottage Grove Avenue
CHICAGO, ILL.

The Traffic Cop of the Air



Add a Ferbend Wave Trap to your set and "Police" your reception. Regulate the Traffic! Guaranteed to tune out any interfering station. Sent postpaid on receipt of \$3.50, or C. O. D. plus postage. Send for free booklet Ferbend Electric Co., 21 E. South Water St., Chicago



Charge Your Battery For A Nickel

The Gold Seal Homcharger charges Radio and Auto Batteries at home overnight for a nickel. Your dealer has it. Write for FREE booklet and list of broadcasting stations.

The Automatic Electrical Devices Co.
132 West Third St., Cincinnati, Ohio



Please refer to POPULAR RADIO when answering advertisements.

DAY-FAN



Model OEM-7 Four Tubes - \$98
 Model OEM-11 Three Tubes - \$90

Here it is! *The set you've been waiting for*

The DAY-FAN receiving set, Model OEM, is here. It is the result of many months of patient and painstaking experimenting.

The Duo-plex circuit, developed in our own laboratories, gives it a volume, range and clearness of tone equal to any set on the market at any price.

It is simplicity itself. In a few minutes a beginner can learn to "Tune

in" on the station he wants with no interference from other stations.

So extremely well balanced is this set that the dial settings are always the same, EVERYWHERE, EVERYTIME.

Dependable, pleasing in appearance, a thoroughly quality product, this set is worthy of your immediate investigation. You can get complete details by filling out and sending in the coupon below.

The Dayton Fan and Motor Company
Manufacturers of High Grade Electrical Equipment for over 35 Years
 DAYTON · OHIO

The Dayton Fan & Motor Co.
 Dayton, Ohio

Without obligating me in any way, please send me complete information concerning your OEM receiving set.

Name

Street

City State

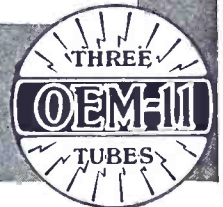
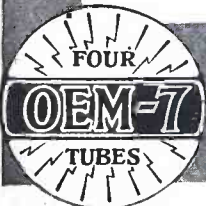

Please refer to POPULAR RADIO when answering advertisements.



PRODUCTS

Full Line of Parts

- VARIOMETERS
- VARIOCOUPERS
- TRANSFORMERS
- CRYSTAL DETECTORS
- INSULATORS
- DIALS
- HEAD PHONES
- SWITCH LEVERS
- V. T. SOCKETS
- VARIABLE CONDENSERS
- TELEPHONE PLUGS
- TELEPHONE JACKS
- RHEOSTATS
- POTENTIOMETERS
- CRYSTALS, ETC.

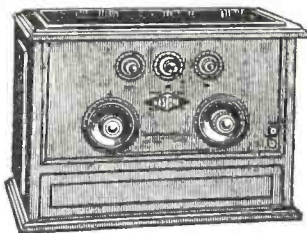

Bestone V-60
"The Aristocrat of Radio"

- PERFECT TONE
- VOLUME—DISTANCE
- SIMPLICITY OF OPERATION
- NO WHISTLES OR FOREIGN NOISES
- 4-TUBES—NON REGENERATIVE

Write for Particulars

Manufactured and Guaranteed by
Henry Hyman & Co., Inc. 476 Broadway, New York
 212 W. Austin Ave. Chicago
Manufacturers of the Complete Quality Bestone Line

FORE'S MASTER FORE BATTERY CHARGER



Charges
Radio A6
Volt and
22 1/2
Volt B
Batteries

Charges
6 Volt
Auto-
mobile
Batteries

The Fore Battery Charger will make anyone proud of his radio set.

Call at your jobber or dealer for them or write either address below for advice as to where they can be obtained.

Manufactured by
Fore Electrical Mfg. Co.
 5255 N. Market Street
 St. Louis, Missouri

Sales Department
The Zinke Company
 1323 S. Michigan Blvd.
 Chicago, Illinois

Get Better Amplification



AUDIO FREQUENCY TRANSFORMERS give you extra volume and preserve the original tone quality as well. The correct design with the needed extra weight in the core makes the difference. Shell type laminated core. Accurately wound coils.

Fully Guaranteed

3 1/2 to 1 Ratio \$4 : 6 to 1 Ratio \$4.50
 Ask your dealer. If he cannot supply you, send his name with your order to

National Transformer Mfg. Co.

Manufacturers of Transformers of All Types

Dept. A, 154 Whiting St., Chicago, Ill.

O'NEIL AUDIPHONE

All music and speech re-vivified by "laminated voice-core." **\$30**
 Complete with connecting cord

O'NEIL MFG. CO.

714 Palisade Avenue West New York, N. J.

Please refer to POPULAR RADIO when answering advertisements.

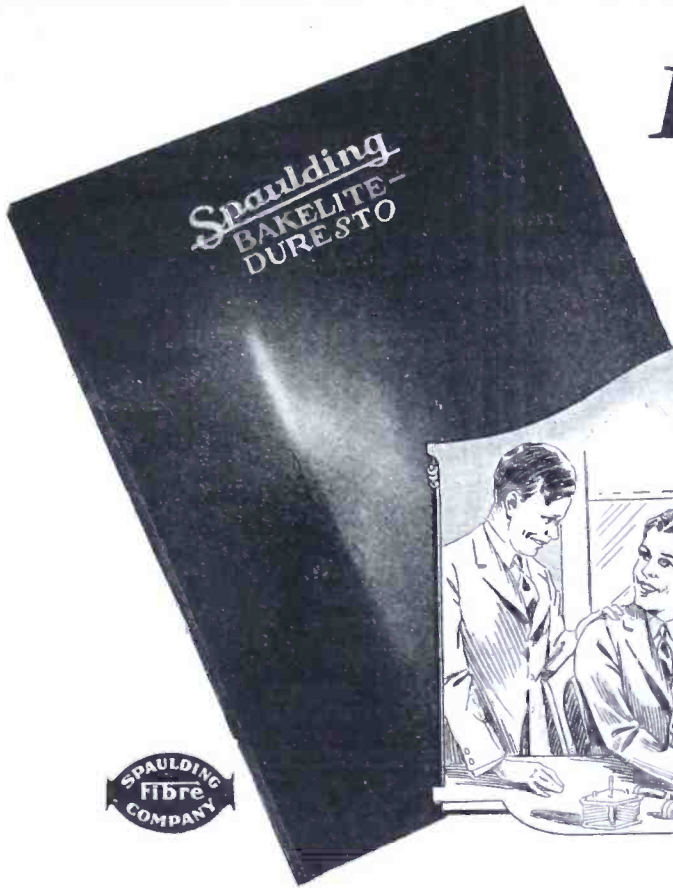

**Look at
that
Finish!**

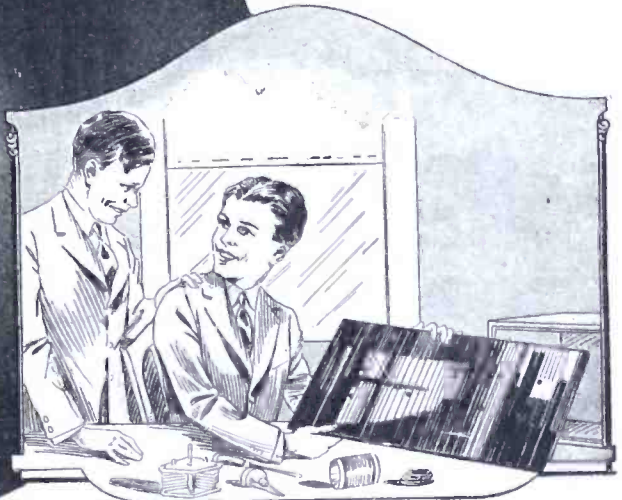

—And the High Gloss is Everlasting

Manufacturers

Manufacturers who desire to build quality into their products and who insist on speed and economy in their plants should write our nearest office for complete information on Spaulding Bakelite-Duresto.

Sales Offices—Warehouses

- New York City
- Chicago
- Philadelphia
- Boston
- Los Angeles
- San Francisco

A beautiful black, high gloss finish is but one of the superior features Spaulding Bakelite-Duresto panels can offer you.

Bakelite-Duresto panels drill and engrave easily without chipping. Will not warp, shrink or split. Highest in dielectric strength. The best that money can buy.

Insist on Bakelite-Duresto. Your dealer will cut and drill it for you.

Write for descriptive circular

SPAULDING FIBRE COMPANY, INC.
Tonawanda New York

Spaulding

BAKELITE-DURESTO

Panels - Sheets - Tubes & Rods

Please refer to POPULAR RADIO when answering advertisements.

A Whirlwind Success!

AMERICAN BRAND CONDENSERS

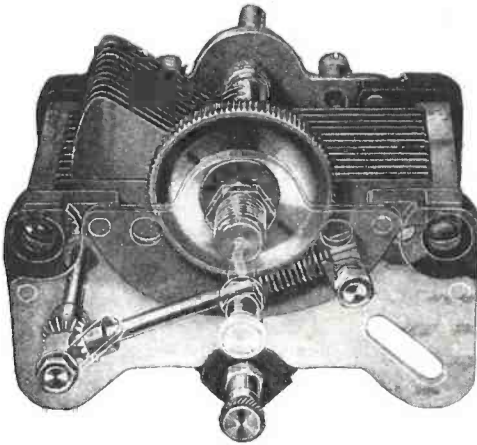

with
the **100 to 1**
Worm Drive
23 Plate, only \$5.00

These Condensers are now ready for you. Jobbers and dealers everywhere should have them to fill the public demand.

American Brand Condensers are made with the highest ratio geared adjustment ever developed on variable condensers. They are without question the Lowest Loss condensers available today. Their price is no higher than the price of ordinary condensers.

Please ask your dealer to show you this condenser—if he can't do so, write us for a descriptive folder and send us your dealer's name.

NOTE TO DEALER: If your jobber can't supply you, write us—

American Brand Corporation
8 West Park St. Newark, N. J.
Factory Philadelphia

A SENSITIVE, SELECTIVE COIL

KELCOIL

SMALL IN SIZE
GREAT IN RESULTS
SPLENDID DX RECEPTION]



\$6

Dealers
Distributers
Write us for
Attractive
Proposition



If Your Dealer
Cannot Sup-
ply You Send
Us His Name
and Address

SYCO RADIO PRODUCTS CORPN.
438 DREXEL BLDG. PHILADELPHIA



KEY TO THE AIR CAGE ANTENNA

A highly efficient Antenna System sold on a guarantee of
Reliable Reception.



Patented. The genuine bears the trade mark Key to the Air.

Price \$2 At your dealers—or direct
by mail on receipt of price.

STAFFORD RADIO CO.

Medford Hillside, Mass.

Send for circuit diagrams

RED-HEAD PHONES

Used and Praised the World Over

3000 Ohm \$6.50. 2000 Ohm \$5.00.

Complete with Cord and Headband

At your dealer's, or sent direct

The Newman-Stern Co., Newman-Stern Bldg., CLEVELAND

Ask Your Dealer to
show you the Remarkable
HOWARD NEUTRODYNE RECEIVER
Licensed under Hazeltine Patents
Send for Illustrated Folder
HOWARD RADIO CO.
4248 N. Western Ave. Chicago, Ill.

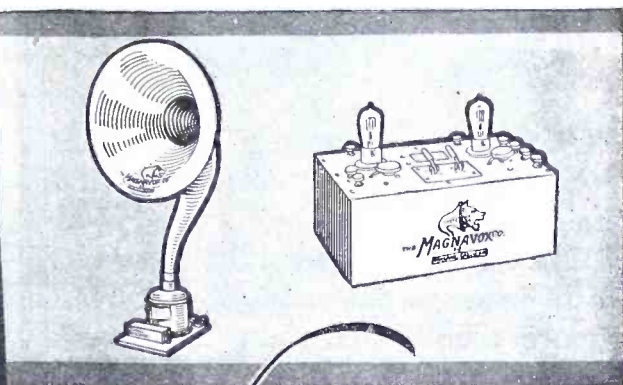

Now a MAGNAVOX Radio Tube

INTO the design of this new Tube have gone over two years' research and experiment along original lines, culminating in discoveries which made possible an entirely new principle of tube construction.

One trial convinces the most exacting user that the Magnavox will replace ordinary tubes to great advantage in any receiving set.

Magnavox Radio Tubes and other Magnavox Products are sold by reliable dealers everywhere

THE MAGNAVOX COMPANY

New York Oakland, Calif. San Francisco

Canadian Distributors:

Perkins Electric Limited, Toronto, Montreal, Winnipeg

Magnavox Radio Vacuum Tube Type A is a storage battery tube for use as audio frequency and radio frequency amplifier in all standard circuits. Highly recommended also for detector use.

This tube is not critical of adjustment either as to plate or filament. Filament consumption one quarter of an ampere. **\$5.00**

9R

Please refer to POPULAR RADIO when answering advertisements.

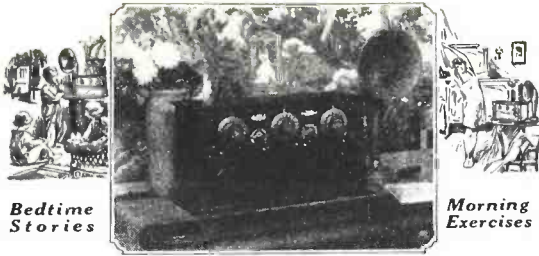

WHEN you own a Radiodyne the world's foremost entertainers and educators serve you. With this efficient receiving set you can bring operas, sermons, lectures, dance music, etc., right into your home clear and distinct on loud speaker no matter where broadcasted or where you live.

WALNART Radiodyne CL

Uses Light Socket for Antenna

"I have no outside antenna. I just plug into the light socket. Picked up Omaha last Sunday morning at ten o'clock when the temperature was 95 and the sun shining." Frank Williams, Winona, Minn.

Outside or Inside Aerial for Daytime

"Received Cuba, Canada, New York and California on loud speaker with 70 foot ribbon antenna in attic. Also have a single 75 foot wire outside for daytime, volume and distance."

L. G. George, Fairmount, Ill.

Write for illustrated folder which describes the Radiodyne in detail. Every radio fan will be interested in this new type receiver.

Western Coil & Electrical Co.
308 Fifth St., Racine, Wis.



This Trade Mark is Your GUARANTEE

Of Reliable Dependable Radio Products
Walnart "Trouble-Proof" Radio Products include: Unbreakable unconditionally guaranteed tube sockets, "B" Battery and inductance switches, Variable Condensers (plain and vernier), Vernier Adjusters, Dials, Variable Grid Resistances, Lettered Binding Posts, etc.

Write for literature

"Makers of good goods only"

WALNART ELECTRIC MFG. CO.
Dept. 1003 Chicago

Latest Development In

RADIO

The New Pfanstiehl
Non-Oscillating
Principle
Complete Outfits

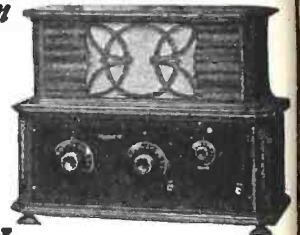

\$5 DOWN
Easy Monthly Payments

The season's biggest sensation. Carl Pfanstiehl's improvement over Neutrodyne, Super, Reflex, etc. Positively non-regenerative. Brings a new degree of musical quality, selectivity, and simple operation. Solid Mahogany cabinets. Accessories included. Dry cell or storage battery operation. Write today for **FREE Trial Offer!** Write quick and get our special price offer with 2 week's **FREE Trial**, and easy payments, 3, 4, or 5 tube sets. Write today. **Marshall Radio Products, Inc., Marshall Blvd. & 19th St., Dept. 58-36, Chicago, Ill.**

LOUD SPEAKING CRYSTAL SET

Stations brought in from over 1000 miles and music heard all over the room right from crystal set with the **STEINMETZ AMPLIFIER**. Get our complete catalog.

STEINMETZ WIRELESS MFG. CO.
5969 Baum Blvd., Pittsburg, Pa.

CRESCENT LAVITE RESISTANCES

12,000 }
48,000 } Ohms.
50,000 }
100,000 }



LIST
\$1.50

Special Sizes to Order

Used in all Circuits. Dealers write for discount.
CRESCENT RADIO SUPPLY CO. 1-3-5 Liberty St., Jamaica, N. Y.

new-

in Appearance
in Principle
in Results

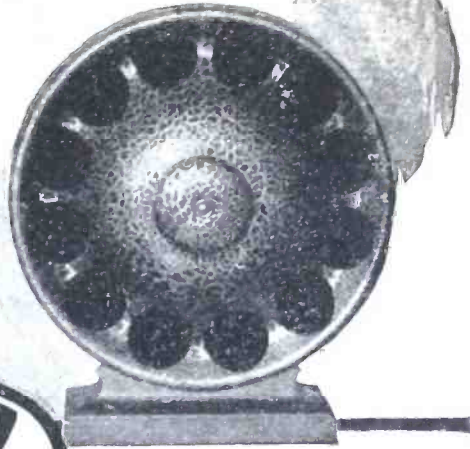

Imported

LOUDSPEAKER

TYPE W

THE new N & K Loudspeaker, Type W, has broken away from all tradition. It is specially designed to overcome the faults common to the hastily produced speakers of the early days of radio.

It projects sound by *reflection*. In this process the sound is *diffused*, so that it issues from the speaker *in all directions*, not merely in one direct line. And it projects the sound waves in their *full roundness* thus avoiding distortion.

Type W is new and pleasing in shape, which, together with its handsome finishes, will harmonize with the most artistic surroundings.

Instead of wood or metal, a new light-weight material, *burtex*, is employed. This material has a quality of eliminating chatter and false vibrations, which so often ruin the effect of a speaker. The base is of wood, felt protected to prevent the marring of polished surfaces.

The speaker unit has been designed by the same engineers and developed in the same factory as the famous N & K Phones. As a result, Type W is characterized by extreme clearness, mellowness and the accurate reproduction of high tones as well as low ones.

Operates without auxiliary batteries, and on any plate voltage from 45 to 150 volts. Requires no adjustment, thus eliminating the uncertainty and annoyance of adjustable units.

The N & K Imported Loudspeaker is now having an advance showing at a number of the leading stores in each city. Write us at once for names of dealers in your vicinity.

The speaker is sold under a definite guarantee of satisfaction or your money back. Dealers are authorized to send it on *five days' approval* to responsible customers.

Try the N & K Loudspeaker in your own home, on your own radio set, at your convenience and convince *yourself* that it is *the Loudspeaker* for you. Price, complete with 6-foot cord, \$27.50. *Free descriptive folder on request.*



TH. GOLDSCHMIDT CORPORATION, DEPT. P9, 15 WILLIAM ST., NEW YORK

This Loudspeaker is made by the makers of famous N & K Imported Phones, Model D, 4000 Ohms, price \$8.50, and the N & K Phonograph Unit, price \$7.50

Please refer to POPULAR RADIO when answering advertisements.

AT LAST!

A Handy, Portable Helpmate for Filling Batteries With Distilled Water

No lost time—No Stopping—No Overflow

Use this handy battery filler, holding a half gallon of distilled water for filling your batteries. It can be carried anywhere. It will eliminate that tedious work especially noticeable in filling the small openings in "B" batteries. It prevents overflow of electrolyte with attendant destruction of table tops and rugs.

It has countless other uses making it a very handy laboratory accessory, around the garage and in the home. It practically costs you nothing because it saves in labor and insures the life of your battery.

Write for folder explaining care of batteries.

OTHER RELIABLE RADIO DEVICES

Reliable Neutralizing Condenser Reliable Syringe Type Filler
 Reliable Audio Frequency Transformers Reliable Battery Carrier
 Reliable Radio Frequency Transformers

THE RELIABLE PARTS MFG. CO.
 2819 Prospect Avenue Cleveland, Ohio



for "A" & "B"
RADIO BATTERIES
 and
 Automobile Batteries
\$1.50

RELIABLE RADIO BATTERY FILLER

RADIO'S LATEST DEVELOPMENT

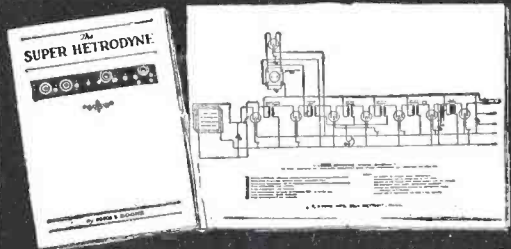

Super-Hetrodynes

\$50 worth of wiring charts and hook-ups for only \$1

This valuable book gives you a series of over thirty super-hetrodyne wiring diagrams and hook-ups which would easily cost more than \$50 if purchased separately. Not a catalog—but a thoroughly scientific text-book with a wealth of data on every phase of super-hetrodyne equipment. Sixty-four pages of worth-while information, with more than fifty illustrations. Only \$1.00 postpaid. Get it to-day—at your dealers or use the coupon below.

J. T. BOONE RADIO CORPORATION

BOONE SUPER-HETRODYNE TRANSFORMER KITS
 BOONE SUPER FOLDING LOOP AERIALS
 BOONE SUPER VARIABLE CONDENSERS

From your dealer or direct from our factory.

J. T. BOONE RADIO CORP., 3469 E. Jefferson, Detroit, Mich.

- Enclosed is \$1.00 for your text-book "The Super-Hetrodyne."
- Please also send me information on your Super-Hetrodyne Transformer Kits—Folding Loop Aerials—Low Loss Variable Condensers.

Name.....
 Address.....A2

When guests arrive, you *know* your Diamond batteries will "stand by you" for an evening of uninterrupted and perfect performance.

Radio Plate "B" BATTERIES DIAMOND ELECTRIC SPECIALTIES CORP.

102 SO. ORANGE AVE., NEWARK, N. J.
 Dealers—Jobbers, Write for Proposition



WE REPAIR The Following RADIO TUBES

WD-11.....	\$2.50	DV-6A.....	\$2.50
WD-12.....	2.50	UV-199.....	2.50
UV-200.....	2.50	C-299.....	2.50
UV-201.....	2.50	UV-201A.....	2.50
C-300.....	2.50	C-301A.....	2.50
C-301.....	2.50	Marconi.....	2.50
DV-6.....	2.50	Moorhead.....	2.50
DV-1.....	2.50	UV-202.....	3.50
DV-2.....	2.50	C-302.....	3.50

Mail orders solicited and promptly attended to.
 Dealers and Agents Write for Special Discount.

H. & H. RADIO COMPANY
 Clinton Hill Sta. P. O. Box 22-E. Newark, N. J.

Please refer to POPULAR RADIO when answering advertisements.

Think what an audio transformer must do!



Why accept the handicap of anything less than the best?

Made in two types:

AmerTran AF-6 (Turn ratio 5) for use in the first stage.

AmerTran AF-7 (Turn ratio $3\frac{1}{2}$) for use in further stage when AF-6 is used in the first stage.

Price, either type,

\$7

At Your Dealer's

*"Improve your set
with an
AmerTran"*

WE need a new conception of power measure to fit radio thought. Start with a horse power (33,000 lbs. lifted one foot in one minute)—something we can grasp. Now drop to "fly-power"—the work expended by a fly in crawling one inch up a window pane in one second. It isn't much power, yet one "fly-power" is sufficient to furnish the initial electric force entering your receiving set in a message broadcasted from across the continent *over a period of 35 years!*

Is it any wonder then, that the instruments that must convert this infinitesimal force back into the original broadcasted message *must* be of the very highest type? Would you expect a cheap alarm clock to have the accuracy of a chronometer? Insist upon an AmerTran transformer.

American Transformer Company

175 Emmet Street, Newark, N. J.

Designers and builders of radio transformers for over 23 years

Please refer to POPULAR RADIO when answering advertisements.

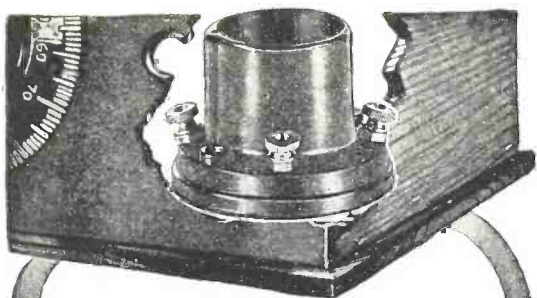

Get Directly at Them

Are the contacts in the sockets of your radio set easily accessible for ordinary and necessary cleaning?

With Na-ald De Luxe Sockets in use you need neither sandpaper or an extra reach to keep contact strips and tube terminals bright and clean.

Just rotate the tube three or four times. Instantly the dual-wipe laminated contacts remove corrosion, making a bright perfect connection. This action is on the side of the tube terminals away from the soldered ends. "It's the contact that counts."

Make your Superheterodyne set free from socket trouble by using Na-ald De Luxe Sockets.

Sockets and panel mounts for all tubes. Prices 35c to 75c.

Send for Catalogue

ALDEN MANUFACTURING CO.

Dept. C.

Springfield, Mass.



Keep
Contacts
Clean

NA-ALD

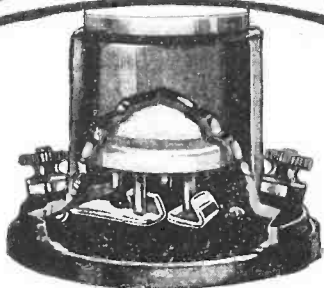

DUPLEX

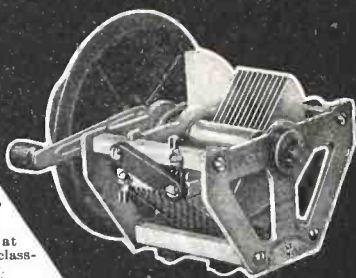

SERIES "FR"

Tests of May, 1924, at Yale University are classics in Radio History. They are standards for your guidance.

The "DR" Compact Precision condenser has forged ahead rapidly due to its performance and price.

Write for "Cons" and "Facts." Some valuable distributors' territory still open.

PATS. APPLD FOR

TRADE MARK
NONE OTHER

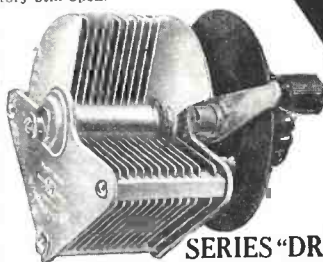

SERIES "DR"

The **DUPLEX ENGINE GOVERNOR CO., Inc.**
50 Flatbush Ave. Extension, Brooklyn, N. Y.

VACUUM TUBES REPAIRED

WD-11, WD12, \$2.50
UV-201A, UV-199,
And others for **2**

Quick service. All tubes repaired by us guaranteed to work as good as new. Send your dead tubes. All you pay is \$2.50 plus Postage to Postman.

THOMAS BROWN CO.

511-519 Orange St. Newark, N. J.

METALECTRIC SOLDERING IRON

"Accepted as the logical solution to radio problems by leading amateurs, manufacturers, and Governmental departments."

Write for descriptive literature.

Post Electric Co. (Inst. Division) 30 E. 42d St., New York



SOLDER WITH INSULATION

At Least 1,000 Miles More Distance

is the usual reward if you can solder without impairing the insulation of your set.

If you are building a radio-frequency amplifier you should read our free booklet:

"HOW TO SOLDER RADIO SETS"

Write for it

THE VALLEY FORGE CHEMICAL CO., Valley Forge, Pa.

Please refer to POPULAR RADIO when answering advertisements.



Atlas

TRADE MARK

RADIO REPRODUCTION speaker

ATLAS floods the room with the best that's in your set. Write for the interesting booklet you ought to read before buying any speaker.

Multiple Electric Products Co., Inc., 36 Spring Street, Newark, N. J., Dept. B. New York, Boston, Philadelphia, Baltimore, Pittsburgh, Detroit, Chicago, St. Louis, Denver, 550 Howard Street, San Francisco.

Marconi Wireless Telegraph Co. of Canada, Ltd. Sole Canadian Distributors

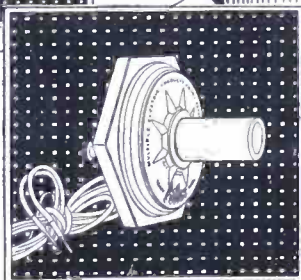
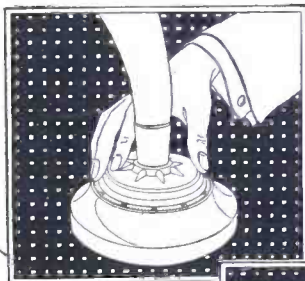
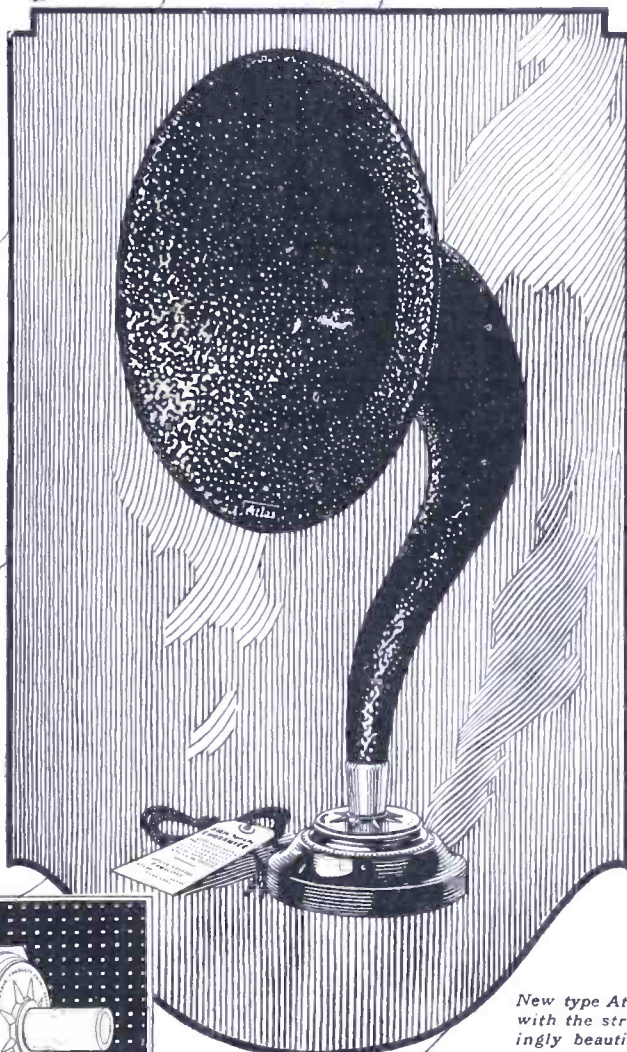

A slight turn of the exclusive Atlas harmonizer (Pat. applied for) — and your speaker is harmonized with the broadcast you are hearing and the set you are using. It gives you radio — as you ought to hear it.

Atlas unit, with attachment couplings to fit all standard phonographs.

New type Atlas with the strikingly beautiful bronze-brown ripple-finish gooseneck horn.

Please refer to POPULAR RADIO when answering advertisements.

EARN

\$3,000 to \$10,000 a Year as Radio Expert

Enter fast growing radio field, thousands of big pay jobs waiting for you. U. S. Gov't., Steamships, R. R's., Corporations eagerly seek Radio trained men. Advancement rapid, earn from \$3,000 to \$9,000 yearly.

Pleasant Home Study In

RADIO



A. G. MOHAUPT

Prepare for Big Pay in Spare Time

My reputation as Radio Engineer and instructor insures you complete, speedy success, at home in spare time; earn while you learn. I make you expert in radio designing, building, repairing and operating and teach you only practical "inside" dope. You quickly complete my course and a few pleasant hours prepare you to step into Big Pay. No experience required.

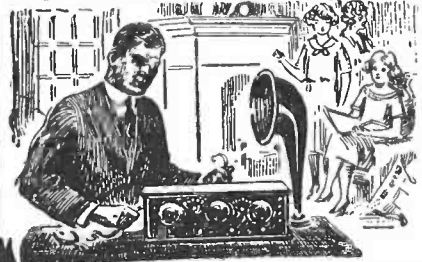

FREE 1000 Mile Radio Outfit

This set, when completed, has a range of over 1000 miles. I give it free with my course. I give you practical training by having you work on this set. The knowledge you gain is not mere book knowledge but is usable, practical experience.

When you have finished my course, you can sell this set at a price that will pay the cost of the course. For a short time only, by my special plan, I will give a tube radio set in handsome cabinet to men, absolutely **FREE**. Send at once for my **FREE** wonder-book of inside Radio "dope." Act quickly.



MAIL COUPON

A. G. MOHAUPT, Radio Engineer,
Radio Association of America,
4513 Ravenswood Ave., Dept. 59, Chicago
Please send me details of your Home Study Course—also your Free "Radio Facts" and information on how I can get a FREE 1000-mile Radio Set.

Name.....
Address.....
City.....State.....

PYREX INSULATORS



Perfect Reception demands perfect Antenna Insulation. To obtain maximum efficiency from your receiving set use PYREX Insulators. PYREX is employed by the U. S. Navy Coast Guard and Air Mail Services and by well known Amateurs. PYREX does not absorb or retain surface moisture. It has exceptionally low phase angle and is a true "low loss" Insulating material. PYREX Broadcast Reception Insulators retail at \$.45 each.

Inquiries from responsible Jobbers invited.

CORNING GLASS WORKS
Industrial Division Corning, N. Y.

Spintite



For Round or Hex Nuts

It's great fun to build a radio set with Stevens Spintite Wrenches. They spin up the tough little nuts in a jiffy—tight as if soldered.

Set of 3 Round Spintites \$1
Set of 3 Hex Spintites \$1
Write for Radio Tools Booklet No. 21

STEVENS & CO.
Toolsmiths since 1899
375 Broadway New York

Big Money Building Cabinets with a JUNIOR BENCH SAW



People will pay you liberally for handsome cabinets to cover their Radio and you can build them easily and quickly with a Junior Bench Saw. Does your ripping, mitering, rabbeting, tenoning, sanding, grinding and many other operations with ease and accuracy. Special blades cut bakelite. Saws 1 1/2" stock—driven by 1/4 H. P. motor attached to any light socket.

Sold on Absolute Money Back Guarantee
Write for descriptive folder
W. & J. BOICE, 1730 Norwood Ave., Dept. 909, Toledo, O.

Please refer to POPULAR RADIO when answering advertisements.

Comparing — The MOZART Baby GRAND

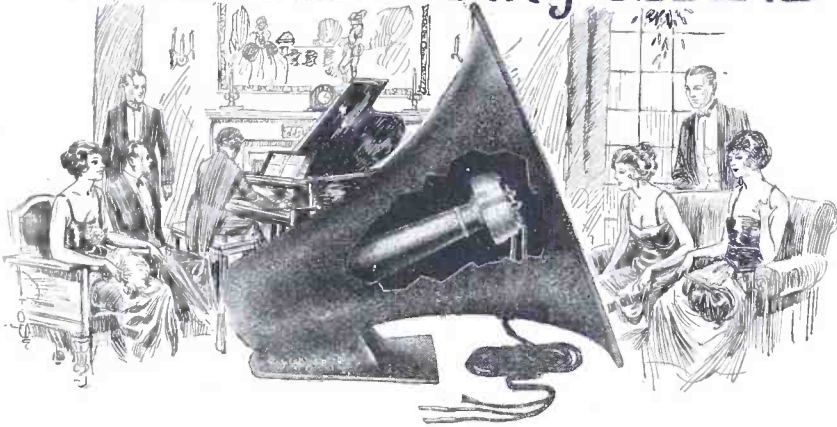

IT IS when compared with others under exactly similar conditions that the Mozart-Grand shows up to such material advantage and below is only another of the "appreciations" we have continued to receive right through these summer months without a break.

"Please ship me by express, C. O. D. six (more)— I have a unit with six plugs for which there are six different makes of speakers, ranging from \$10 to \$55. These speakers can be used one at a time on the same concert. This way I tell the quality of speakers. There is no doubt in my mind your speaker is the best— (even) if the price were three times the amount it is."

(Signed) P. C. Bartlett, Anamosa, Iowa.

PRICES F. O. B. Factory.

Reproducer complete with (gold plated) unit and polarity-indicating cord.....	\$12.00
Unit only with polarity-indicating cord, gold plated.....	5.00
Unit only with polarity-indicating cord, nickel plated.....	4.00

Shipping weight of reproducer, 8 lbs. (approx.)
 Dimensions—Diameter of bell 12". Length and height over all, 12½".
 No extra Batteries required.
 Orders shipped direct from the factory or through your dealer.

(RADIO DIVISION)

The MOZART GRAND CO.

Manufacturers of Fine Instruments

Newark, N. J.

U. S. A.

Please refer to POPULAR RADIO when answering advertisements.



This Radio Battery Has "Over Twice The Life"

THE Burgess Radio "A" is exclusively a radio battery, designed especially for service on the "A" or filament circuit of dry cell vacuum tubes.

In Radio service it has over twice the life of the ordinary No. 6 ignition battery . . . costs approximately the same . . . has a rapid recovery to high voltage after short periods of rest . . . practically no voltage is lost when not in use.

Replace your worn out "A" battery with a Burgess. Compare the service in your own set under any and all conditions. Then let your experience guide you in your future purchase of Radio 'A,' 'B' and 'C,' batteries; there's a Burgess Battery for every radio purpose.

"ASK ANY RADIO ENGINEER"

BURGESS RADIO BATTERIES

BURGESS BATTERY COMPANY

Engineers - DRY BATTERIES - Manufacturers
FLASHLIGHT - RADIO - IGNITION - TELEPHONE
General Sales Office: Harris Trust Bldg., Chicago
Laboratories and Works: Madison, Wisconsin

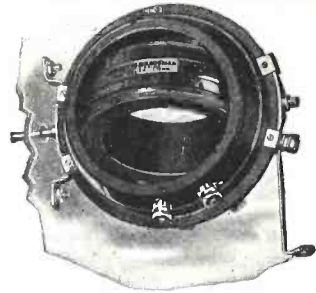

PATENTS APPLIED FOR

Select with a

LANGBEIN & KAUFMAN VARIABLE CLARIFYING SELECTOR

LIST \$7.00

A new aerial tuning device, eliminating the use of taps. Control of coupling and selectivity actually possible. Send for our Diagram-Booklet showing its use with our VT25 Variotransformer. Employed in the Lloyd C. GREENE CONCERT SELECTOR.

JOBBER, DEALERS: Send for our latest trade sheet

THE HOME OF MOULDED TUNER SPECIALTIES

LANGBEIN & KAUFMAN

654 Grand Avenue New Haven, Conn.

S. Hammer Radio Co. 305 Atkins Ave. Brooklyn, New York

COCKADAY 4-CIRCUIT TUNER

These are GENUINE Complete Parts

	List Price		List Price
1 Drilled Panel 7x24	\$3.90	1 Patent Single Jack	\$.60
1 Precision Coil	5.50	2 Amertran Transformers	14.00
2 Amisco 26 Pl. Cond. 4" Dial	11.00	2 Amisco Switch Levers	.60
5 Melco Tube Sockets	5.00	3 48,000 Ohms Lavite Resistances	3.75
1 Amisco 6 Ohm Rheostat	1.00	1 .00025 Dub. & .0005	.90
3 Amisco 20 Ohm Rheo.	3.75	1 Fr. Como Dup. P. P. Transformers	12.50
2 Amplex Grid Densers	2.50	1 Panel 1x12	.40
1 Durham Var. Grid Leak	.50	1 Sub Panel 3x2 1/4	.40
1 Amisco 400 Ohm Pot.	1.50	11 Switch Points, 4 Switch Stops, Wire, etc.	.20
1 Bradley Leak	1.85		
2 Patent Doub. Jacks	1.60		

Never Before at This Price **\$51.00**
List Price \$72.45
Wired Complete in genuine Mahogany Cabinet \$85.00

ONE TUBE COCKADAY FOUR CIRCUIT RECEIVER

1 Precision Coil	\$5.50	1 Amisco 30 Ohm Rheo	\$1.30
2 U. S. Tool Ver. Cond.	9.00	1 Switch Lever	.20
1 .00025 Dubilier	.45	9 Switch Points	.10
1 Amplex Grid Denser	1.25	1 7x12 Panel	1.25
1 Bradley Leak	1.85	1 8x12 Baseboard	.60
1 Na-aid Socket	.75	6 Binding Posts	.40
			List Price \$22.55

Special Kit Price **\$17.50**

The Above Parts May Be Bought Separately—Write for Catalog

Orders over \$5.00 Shipped Prepaid, Money Orders or C. O. D. One-third must accompany all C. O. D. orders. Not insured unless insurance charges included.

"Built First- **Coto** -to Last"

INSIST ON THE SILVER
PLATED AIR CONDENSER
FOR YOUR RADIO SET.

Please refer to POPULAR RADIO when answering advertisements.

ATWATER KENT

R A D I O

BACK of ATWATER KENT Radio there is a tremendous factory with laboratory and manufacturing facilities that are not surpassed in the whole world—

—there is the spirit and guiding impulse of master workmanship—

—there is a nation-wide reputation for precision—and a recognition of the name "ATWATER KENT" as a standard of excellence—

—there is the accumulated experience of more than a quarter of a century in the manufacture of precision electrical instruments—

It is these qualities and high standards that have produced leadership for ATWATER KENT Radio;—and have made it what many consider perfection in radio construction.

ATWATER KENT MANUFACTURING COMPANY
4933 STENTON AVENUE, PHILADELPHIA, PA.

THINK OF WHAT IS BACK OF IT

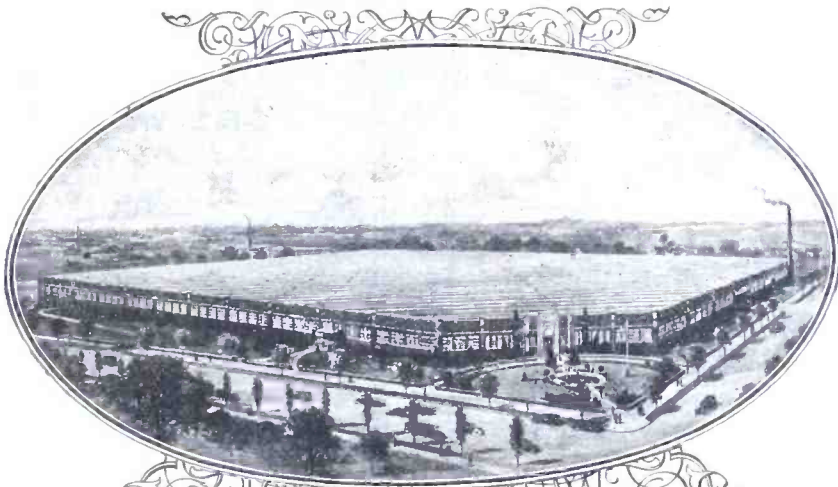

Please refer to POPULAR RADIO when answering advertisements.

New!

Scientifically correct and guaranteed!



—its calibrated

Resistances can be read in terms of the megohm through panel peep-hole. (Also equipped for table mounting.) Set it for specified resistance—adjust it for best results. Accuracy assured. Each Fil-ko-leak hand calibrated (1/4 to 5 meg.—the operating range for all tubes) and doubly checked.

You cannot get all that your set can give unless your grid leak resistance is precisely correct.



2.00

Terminal posts spaced to fit the standard grid condensers

FIL-KO-LEAK
SCIENTIFICALLY CORRECT
VARIABLE GRID LEAK



—with battery switch

And at no extra cost! Fil-ko-stat gives perfect control of any type tube in any hook-up—maximum signal strength—longer tube and battery life. Stops tube noise. Brings in DX stations you never heard before. Switch attaches to regular "Stat" mounting screws.

2.00

FIL-KO-STAT
SCIENTIFICALLY CORRECT
RADIO RHEOSTAT



—with \$100 guarantee

Protects your set from lightning or we pay you \$100 or repair the set. That's our guarantee. "Umbrella" shield keeps dust, moisture, etc., from the hermetically sealed Bakelite insulation. Maximum reception assured, because all radio impulses reaching antenna reach your set. No leakage losses.

1.50

FIL-KO-ARRESTER
SCIENTIFICALLY CORRECT
RADIO LIGHTNING ARRESTER



If dealer has none send his name and your remittance to Dept. PR224



HARRISBURG, PA.
New York Office, 220 W. 34th Street
FOREIGN REPRESENTATIVES
Radio Stores Corp., New York

Getting volume with RUBICONS

Radio pleasures—like all other pleasures—are greatly enhanced by sharing with others. Users of RUBICON transformers know this to the fullest degree, perhaps. For, they have a full and well-balanced line of audios, \$6, radio, \$5, power—and the widely-specified RUBICON DUPLEX (\$12 the pair) Push-Pull System.

Free folder of details

"The Inside Story" guides your selection with data on ratios, winding, characteristics, etc. Your copy sent upon receipt of postcard.

RUBICON COMPANY
918 Victory Bldg.
Philadelphia

EASTERN COUPLER and Inductance

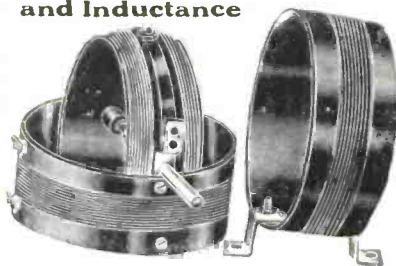

Price \$6.00

An Unrivaled Value

100% EFFICIENT for the SUPERDYNE CIRCUIT

This circuit, which uses only four tubes, is the ONLY RIVAL of the SUPER-HETERODYNE and surpasses all other circuits for all around efficiency.

Radio engineers all endorse the EASTERN COUPLER for maximum results with the Superdyne Circuit.

Wound with double silk wire on genuine bakelite tubing, with moulded rotor

This circuit is less expensive to construct than most 3 tube sets.

Picture hook-ups and material list FREE with each coupler.

Mail Orders Filled. Dealers Communicate

EASTERN COIL CORPORATION
22 Warren St., Dept. PR. New York, N. Y.

\$25 FOR \$10

THE FAMOUS BEL-CANTO LOUD SPEAKER

Price \$10
Direct from Factory to you
Delivered Free C. O. D. to your door.
Coming, "The Bel-Canto Headset," something entirely new.

BEL-CANTO MFG. CO.
General Office and Factory
417-419-421 E. 34th St. Dept. P. R. New York City

Please refer to POPULAR RADIO when answering advertisements.

GAROD

ANNOUNCES THEIR NEW POWERFUL NEUTRODYNE MODELS THE GEORGIAN AND THE V

The public wants
Power



The Garod Georgian

Rich brown hued walnut, with door-panel borders of inlaid ebony and holly—5 tube model—built-in loud speaker—battery compartments and accessory drawer. Will grace the finest drawing room—provide the best in radio reception. Size 35½" long—16½" deep—42½" high.

\$400⁰⁰

The Garod V

Genuine mahogany highly finished cabinet—graceful 15° sloped genuine mahogany panel—carved feet—five inch dials—double reading Weston volt-meter—5 tube model. Size 34½" long—13¼" deep—11½" high.

\$195⁰⁰



The Garod RAF

The receiver that made GAROD famous. Added mechanical improvements—4 tube model—with which you are familiar. Size 19½" long—7½" deep—10" high.

\$135⁰⁰



- Power—to produce great volume.
- Power—to bring in distant stations.
- Power—to work through local stations:
- Power—to moderate or intensify volume.
- Power—to render the original quality of tone transmitted.
- Power—to select programs.
- Power—to get the best out of the program.



These models have power plus—and then more power. They are full voiced—with tonal quality of exquisite timbre. They can be controlled to meet the capacity of the small living room, or manipulated to take full advantage of the acoustic possibilities of the large hall.

In every respect, they are worthy of bearing the name GAROD.

We are now ready to enter orders, and grant jobbers of standing, exclusive non-conflicting territories, where open.



SEE OUR EXHIBITS AT

First Radio World's Fair
Madison Square Garden, New York
September 22 to 28, 1924

Third Annual Chicago Radio Show
Coliseum, Chicago, Ill.
November 18 to 23, 1924

The **GAROD** Corp.
120 Pacific Street, Newark, N. J.

Please refer to POPULAR RADIO when answering advertisements.

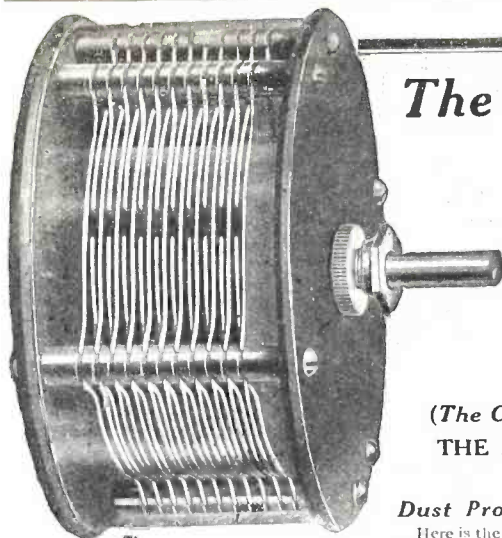

The King of Condensers

A Laboratory Instrument
at a Commercial Price

NIAGARA MIGNON

(The Condenser with the red and blue edged plates)
THE PERFECTLY BALANCED EQUAL ELEMENT
VERNIER VARIABLE CONDENSER

Dust Proof

Here is the most beautiful and efficient radio condenser ever designed. It will improve the efficiency of any set and will last a life time.

Only one-half the depth of the ordinary condenser. A great space saver. Minimum losses, sharpest tuning, maximum efficiency on all ultra sensitive circuits.

The entire condenser is encased in a transparent enclosure which protects it from dust and assures constant uniform

Anti-Body Capacity

capacity. This dust-proof enclosure also eliminates any possibility of short circuiting.

The new Niagara-Mignon equal element type of condenser is a perfectly balanced instrument. The area of the rotor plates is exactly equal to the area of the stator plates.

Has tapered watch pivot bearings. All plates are locked under pressure in milled posts of micrometer accuracy which avoids any variation in capacity.

Can be bought wherever good radio equipment is sold, or will be sent prepaid upon receipt of price.

Complete with separate vernier attachment which may or may not be used, as desired.

LIST PRICES

- 18 Plate .0003 . . . \$4.50
- 22 Plate .0005 . . . 5.50
- 44 Plate .001 . . . 6.50

LIBERAL DISCOUNTS
TO
JOBBER AND DEALERS

NIAGARA SALES CORP., 3 Waverly Place, New York, N. Y.

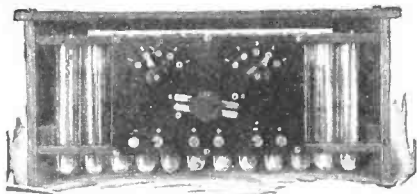

100 VOLT TYPE

Your money back if
you're not satisfied
with KIC-O

We have thousands of unsolicited letters of recommendation. KIC-O "B" batteries will make good for you, too. Life unlimited. Not harmed by short circuiting, overcharging, idleness. Panel switches give single cell variations. Recharge from any 110-volt A. C. line with small home-rectifier. Charge lasts 3 to 6 months in detector plate circuit.

GUARANTEE

Your money back on any KIC-O Battery if not satisfied within 30 days.

Write for full information Mounted Rectifier. . . . \$2.50
on "A" and "B" Batteries Unmounted Rectifier. . . \$1.00

Volts	Price, Plain	With Panels
22	\$5.50	
32	7.25	\$11.75
48	9.50	14.00
68	12.50	17.00
100	17.50	22.50
145	23.50	28.50

Kimley Electric Company, Inc.
2667 Main St. Buffalo, N. Y.



KIC-O Storage "B" Batteries — long service, low cost.

"Take No Chances—Use Como"
COMO DUPLEX
The World's Standard Push Pull
Transformer

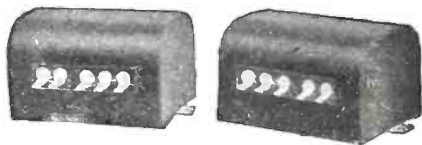

PRICE \$12.50 per pair

For maximum volume without distortion

What Prominent Writers on Radio Subjects say About Como.

Lewis B. Hagerman, Technical Editor, *Chicago Post*: "Actual Tests show this transformer to be far superior to any others of similar makes."

R. J. Robbins, *New York Sun*: "After consideration of several well-known makes of push pull transformers which are available "COMO DUPLEX" was selected as most satisfactory."

C. White, *Radio World*: "COMO DUPLEX" is infinitely superior—most other push pull transformers seem to be ordinary transformers with a center tap brought out as a makeshift."

E. P. Gordon, *Open Road*: "A system of audio-amplification which is becoming increasingly popular. Its use . . . will give surprising results in both quality and volume, and is thoroughly recommended by this department."

NEED WE SAY MORE?

COMO APPARATUS COMPANY
446 Tremont St. Boston, Mass.

For Sale at Leading Dealers

Please refer to POPULAR RADIO when answering advertisements.



FADA

Improves the 5-tube Neutrodyne

YES, sir! We've made it better in every way. Improved its looks, improved the circuit, eliminated unnecessary detail in making, and incorporated the latest and best ideas in Neutrodyne efficiency. Letters from ten thousand FADA boosters have helped us work out the new and improved FADA 5-tube Neutrodyne. We've put all binding posts in the rear, simplified the wiring and beautified the panel arrangement. Two stages of radio frequency, detector and two stages of audio frequency amplification (using the new FADA Audio Transformers) make this new FADA Neutrodyne about the best

looking and most dependable radio receiver anyone can make. Your dealer sells the new FADA knock-down set of Neutrodyne Receiver Parts No. 169-A for \$72. Look for it in his window. With every one goes the new and enlarged edition of

"How to Build FADA Neutrodyne Radio Receivers"

This is the latest and most up-to-date 76-page text-book on Neutrodyne. 38 pages of pictorial description, 44 illustrations, 30 pages of receiver trouble shooting in general and a fine, big, full-size picture wiring diagram. This picture wiring diagram alone is worth the price of the book. Book sold separately on receipt of price—use coupon below.

F. A. D. ANDREA, INC., 1581 Jerome Ave., New York



F. A. D. ANDREA, INC.
1581 Jerome Ave., N. Y.

Gentlemen: Enclosed find 75 cents for which send me the new FADA book, "How to build FADA Neutrodyne Radio Receivers." D

Name.....
Street or R. F. D.....
City.....
State.....

Please refer to POPULAR RADIO when answering advertisements.



A new RHEOSTAT

with immovable coils

The coils of the new Centralab Rheostat are made of bright, non-corroding wire, and are firmly clamped between and imbedded in insulating discs so they cannot move. This eliminates the noise in the set caused by lateral movement of coils away from and towards each other as the contact arm passes over them. It also maintains a uniform spacing between windings, giving smooth, even regulation and eliminating dead spots.

The contact arm is made of sturdy, spring tempered phosphor bronze, and is positively locked to the shaft. The contact shoe slides over the resistor at a tangent and cannot catch. The rheostat is attractive in appearance and substantial in construction. All metal parts except wires are of brass, heavily nickel plated. The knob may be adjusted flush with the panel or replaced by any standard dial. Single hole mounting. Firm, positive contacts.

- No. 206—6 ohms maximum resistance . . . \$1.25
 - No. 230—30 ohms resistance . . . \$1.25
- F. O. B. Milwaukee.

Centralab ADJUSTABLE GRID LEAK

- No. 106—(without condenser) . . . \$1.25
- No. 107—(with .00025 condenser) . . . \$1.60

Centralab NON-INDUCTIVE POTENTIOMETER

- No. 110—400 ohms . . . \$1.50
- No. 111—2000 ohms . . . \$1.75

To JOBBERS and DEALERS: The trade mark of products of the Central Radio Laboratories has been changed from **CRL** to **Centralab**

Centralab

CENTRAL RADIO LABORATORIES
305 Sixteenth Street MILWAUKEE, WIS.

GREWOL

The

PERMANENT DETECTOR

\$1.50

Sold by
Good Dealers Every-
where or Direct Upon Receipt of Dealer's
Name and \$1.50

Patented May 15, 1923
Serial No. 1454997
Infringement subject to prosecution

GREWOL 2 in 1 Crystal

Two surfaces instead of only
one. Double life, double
value. 50c each.

GUARANTEED BY

GREWOL MFG. CO.

NEWARK, N. J.

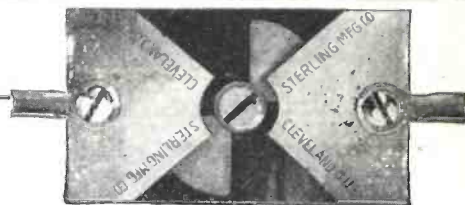

ACTUAL SIZE

Sterling

R311 MICROCONDENSER

Make it
a Part
of Your
Radio
Frequency
Circuit
Because—

Unusually Wide Range of Capacity—
Perfect Equalization Where Others
Fail—Cures Many Hopeless Sets,
Rexlex and Others.
Convenience and Simplicity of
Installation.
Extraordinary Ease of Adjustment—
A Turn Sets it and it Stays Put.
A Turn of the Screw Slot in the
Visible Plate Sets it in the Equalized
Position.

The Equalized Position Then Remains Fixed With-
out Any Further Manipulation.
The Use of a Long, Dry Stick, Sharpened at the End,
Makes Perfect Equalization Possible Without Any
Error Due to Hand or Other Capacity.
Price, Including Connecting Lugs and Screws . . . \$1.00

THE STERLING MFG. CO. 2843 Prospect Ave. Cleveland, O.
See our exhibit at the first RADIO WORLD'S FAIR, Madison
Square Garden, September 22nd to 28th, 1924.

"THE AIR IS FULL OF THINGS YOU SHOULDN'T MISS"

Prices reduced!

EVEREADY Radio B Batteries

they last longer

No. 766
Horizontal
22½-volt
large size
"B" Battery
Formerly
\$2.50
Now \$2.00



No. 764
Vertical
22½-volt
medium size
"B" Battery
Formerly
\$1.90
Now \$1.75



— Growing popularity of radio
— Greater demand for "B" Batteries
— Installation of improved
 manufacturing equipment
— Increased and more
 economical production

Enabled us to greatly reduce Eveready
"B" Battery prices as of August 1st

Here's where you profit

— Better quality, longer-lasting
Eveready "B" Batteries — Much lower
operating cost than ever before
Now — repower your radio set with
fresh Eveready "B" Batteries
They last longer

Manufactured and guaranteed by
NATIONAL CARBON COMPANY, INC.
Headquarters for
Radio Battery Information
New York San Francisco

No. 772
Vertical
45-volt
large size
"B" Battery
Formerly
\$5.00
Now \$3.75



No. 767
Horizontal
45-volt
large size
"B" Battery
Formerly
\$5.00
Now \$3.75



NEW!
No. 770
Vertical
45-volt
extra large size
"B" Battery
for heavy duty
on multi-tube
sets and
power amplifiers
New low price
\$4.75



Please refer to POPULAR RADIO when answering advertisements.

A VERY POPULAR STYLE OF RADIO TABLE

Specifications—Hardwood, rubbed mahogany or golden oak finish; height over all, 31 inches; size top 24 x 34 inches; drawer, with lock, size 4 x 10 x 13 3/4 inches; battery cabinet, size 17 x 14 1/4 x 16 inches.

Prices—No. 30-R—Freight paid East of the Mississippi River, Cash With Order, \$18.00.

RADIO CABINETS

Hardwood, mahogany finish. Hinged lid. Front rabbeted for panel. By selling these direct to the customer, we are able to offer them at exceedingly low prices.

Prices postpaid East of the Mississippi River. Cash with order.

7 x 14	10 in.	\$3.00	7 x 21	10 in.	\$3.50	7 x 26	10 in.	\$4.50
7 x 18	10 in.	3.25	7 x 24	10 in.	3.75	7 x 27	9 in.	5.00 Neutrodyne
						7 x 28	10 in.	6.00

Watch this space next month for New Style Radio Desk. Send for free catalogue of Radio Furniture.



No. 30-R
Plenty of leg room
Weight crated 85 pounds

NOTE: Cut shows battery cabinet on left, but these are all made with cabinet on right.

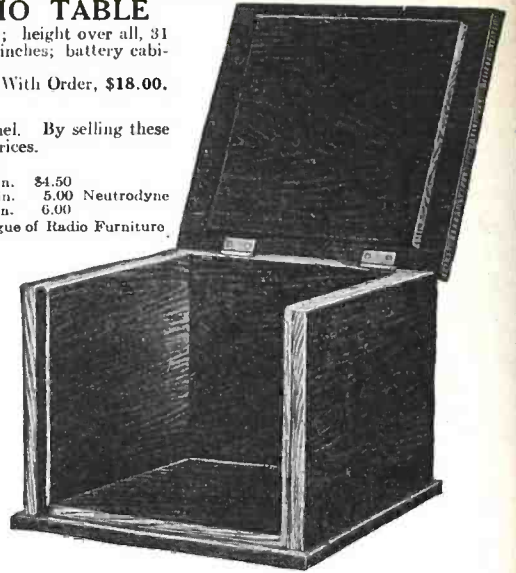

CABINETS IN ODD SIZES AT RIDICULOUS PRICES!

We have discontinued making these sizes, and while they last you may have them at these prices. Brand-new, rubbed mahogany finish, ready for use.

- 6' x 7' x 7' deep
 - 6' x 10' x 7' deep
 - 6' x 14' x 7' deep
 - 6' x 21' x 10' deep
 - 9' x 14' x 10' deep
 - 12' x 14' x 10' deep
- Just \$1.50 each.
F. O. B. Hickory, N. C.
Cash with order—no C. O. D.

THE SOUTHERN TOY CO., Hickory, North Carolina



*Write for
a copy
today*

A new twenty-four page booklet will be sent, gratis, to those interested in building their own receiving sets.

A simplified method of construction is described. Illustrations and diagrams

On Request

EISEMANN MAGNETO CORPN.

WILLIAM N. SHAW, *President*
165 BROADWAY, NEW YORK
Dept. E



**Required for
the Best
Sets**

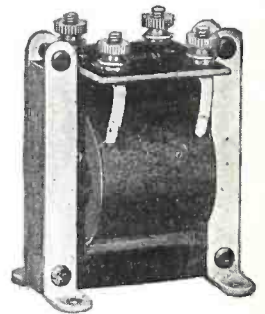

Include Dongan Type C Transformer in your plans for your set. Then you will be certain of that clear smooth reproducing quality. No better Audio Frequency Transformer is manufactured.

Dongan has built Transformers for 15 years and Type C represents radio's greatest achievement in Audio Frequency Transformers.

Ratio 3 1/2 to 1 for all types of hook-ups.

Bakelite Panel, Nickel Plated Trimmings.

Free 2-color catalog on request

Dongan Electric Manufacturing Co.
2983 Franklin St. Detroit, Mich.

Transformers of Merit for 15 years.

Type C \$3.50
Transformer List
(Audio Frequency)

Get our literature on Dongan Voltmeter for panel or portable requirements.

Territories Open

We want the best jobbers and dealers in those territories still available. Our discounts will interest you.

Please refer to POPULAR RADIO when answering advertisements.

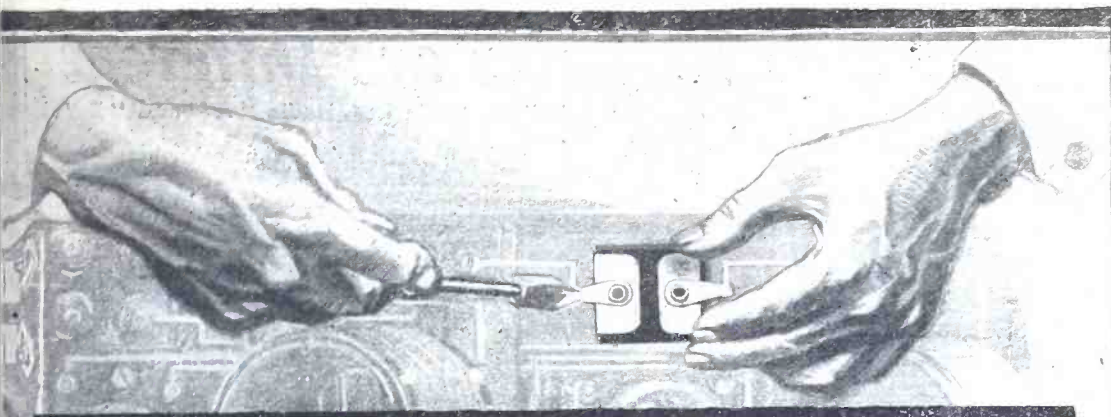

Nine out of ten sets use **MICADONS**

Nine out of every ten sets made use Micadons—the standard fixed radio condenser. Set builders choose them for many reasons.

They know that the Micadon is a Dubilier product: hence supreme in quality and efficiency.

They know that Micadons can be obtained in accurately matched capacities and the capacity is permanent.

They know that Micadons are easily installed, equipped as they are with extension tabs for soldering and eyelets for set screw assembly.

They know that Micadons are made with type variations to meet every possible requirement.

For best results use Micadons

Dubilier

CONDENSER AND RADIO CORPORATION

Please refer to POPULAR RADIO when answering advertisements.

USL Radio Batteries are Different

The many exclusive features of construction incorporated in USL Radio "A" and "B" Batteries differentiate them entirely from just ordinary batteries.

Two exclusive patented features can be had in no other batteries, namely, **Machine Pasted Plates and Fumed Oxides.** Machine pasting makes USL plates uniform and fumed oxides of 100% purity give them the highest possible capacity.

USL Radio "A" Batteries are made with thick plates, very resistant to wear and neglect. The separators are double usual thickness, long lived and free from operating trouble.

USL Radio "B" Batteries also have thick plates. Perfect insulation is insured by glass jars and special sealing, which unlike hard rubber is totally unaffected by electrolyte. The plates are flexibly suspended from their covers, avoiding accumulation of sediment on plate supports, which would cause partial "shorts" and noisy operation.

USL Radio "A" and "B" Batteries are built for radio and are fully guaranteed. They are sold and serviced from Coast to Coast by 7,300 authorized USL Battery Stations.



USL Radio "A" Battery made in 2, 4 and 6 volt sizes 30-140 ampere hour capacities.

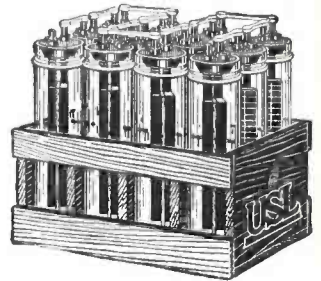

USL Radio "B" Battery made in 24, 48 and 96 volt sizes 4,500 milliampere hour capacity.

For Every

USL

TRADE MARK

STORAGE BATTERIES

Radio Need

U. S. LIGHT & HEAT CORP., Niagara Falls, N. Y.

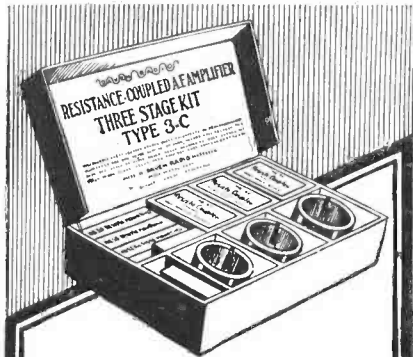

The Aristocrat of Amplifiers

Quality in Radio is No Less Marked Than Quality in People. The *Resistance Coupled Amplifier* is a quality product.

Type 3-C Kit as illustrated contains all the parts necessary to build a three stage Resistance Coupled Amplifier, \$13.50.

Read "Resistors, Their Practical Application to Radio Reception" By Zeh Bouck. Price 15c.

Also read "The How and Why of Resistance Coupled Amplification", 10c.

Both booklets obtainable from your Dealer.

DAVEN RADIO CORP.

"Resistor Specialists"

9-11 Campbell St., Newark, N.J.

"Use GEN-WIN wire wound radio products for genuine satisfaction."



Set builders everywhere acclaim the superiority of Gen-Win windings. Perfect performance assured by unconditional guarantee.

"None Better Made"

"GEN-WIN" Master Tuning Coils
Price \$5.50

Tuned Air Core Transformers
[Set of 3 \$6.00

Reflex Coils
Set of 2 \$3.00

Variometers (Pig Tail) \$3.50

Variocouplers (180°) \$3.50

COCKADAY UNIT

Full Set A, B, C and D Coils
Made strictly in accordance with Mr. Cockaday's specifications. Tested and Approved by him in POPULAR RADIO Laboratories. Three Large Blue Prints, Illustrated Instructions and Material Lists free with each unit. Separate 50c.

For 1, 3 and 5 tube set

\$5.50



At Dealers or Sent Postpaid

General Radio Winding Co.

Dept. PR 9

214 Fulton St., New York

Please refer to POPULAR RADIO when answering advertisements.

Haynes-Griffin

RADIO SERVICE, Inc. 41 West 43rd St., N. Y. City



A. J. Haynes, Assoc. Inst. Radio Engineers, author of "Super Success" and designer of special parts for the Super Heterodyne.

"Super Success"

by A. J. Haynes

No matter whether you have built a "Super" or not, whether you are thinking of building one or not, you should have a copy of Mr. Haynes' new booklet "Super Success".

Here, in one booklet, Mr. Haynes presents the information which he has gathered in over a year's experimentation with Super Heterodyne receivers. Some of this material has already appeared over Mr. Haynes' signature in the radio magazines, but much of it has never before been available to radio fans. Many valuable hints, such as using the "Super" to receive the new low-wave-length broadcasts of WGY and KDKA, how to spread the oscillator dial readings to cover just the desired band of wave lengths, and numerous other "kinks" Mr. Haynes has discovered, are published for the first time in this booklet.

Included also is a price list of the very parts used by Mr. Haynes in constructing his personal Super Heterodyne. Copies of the first edition of this most complete and most authoritative book on the "Super" may be had at 25c each.

Complete parts for the Haynes Simplified Super Heterodyne, including a drilled, engraved panel, may be purchased for \$72.13. Send for detailed price list.

Advantages of the HAYNES Simplified Super Heterodyne

No. 1—Matched Transformers

Mr. Haynes says: "My experience in studying the problems of hundreds of experimenters who have brought their Super Heterodynes to me has convinced me that their chief source of difficulty lies in the improper matching of the radio frequency transformers."

These transformers are the heart of the super heterodyne. Unless they are perfectly matched, radio frequency amplification will be choked, and your "Super" will not deliver as it should.

Following out our policy of always keeping a step ahead in offering improved apparatus, Haynes-Griffin Intermediate Wave Transformers are submitted, after manufacture, to the Haynes Laboratory Test.

Every Transformer Is Individually Tested

Under the supervision of Mr. Haynes, every Transformer is tested, and its peak of resonant frequency exactly ascertained. Then the transformers are matched in sets of four which display identical characteristics.

Every radio fan who constructs his "Super" with Haynes-Griffin Transformers can be sure that he will obtain the best possible results from his set. Laboratory testing and matching insures the highest degree of selectivity, sensitivity and tone quality.

Sold only in Matched Sets of Four

Every set of Haynes-Griffin Intermediate Wave Transformers after being tested, is packed in a sealed carton containing the Haynes-Griffin guarantee that each transformer has been tested, found electrically and mechanically perfect, and carefully matched with the other three. Set consists of one Input and three Inter-Stage Transformers. Price, set of four, \$20.00.

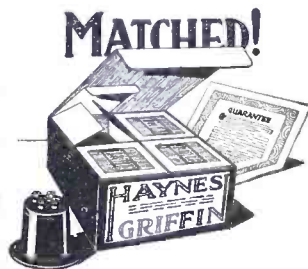

HAYNES-GRIFFIN RADIO SERVICE Inc.,

41 W. 43rd St., New York City

111 S. Clark St., Chicago, Ill.

Increase Your Sales—Add to Your Profits
Supply the Great Demand for

RADIO

The Sutcliffe Company, representing more than twenty-five prominent manufacturers and carrying a complete stock of Radio supplies, can, by quick service and practical assistance, help you build a profitable Radio business.

Complete Lines—Prompt Shipments—Expert Service

Our new fall and winter catalogue, now ready for distribution, gives a complete index to our Radio stocks. One item, or a thousand, can be safely ordered. We fill and ship 90% of all orders on the day received. Practically all replacements can be made from stock. Complete testing apparatus for tubes and batteries. When a set leaves us it is in perfect condition. Our service department

is in charge of a licensed operator and Radio engineer.

If you are a dealer, send at once for our Radio catalogue which illustrates and describes each article and gives wholesale price. Everything in Radio is here, and everything is of the best. Write for Catalogue to-day. Prominent manufacturers whose products we distribute:

Cunningham Tubes
Magnavox
Federal
Frost
Atwater Kent
Western Electric
Fada
Allen Bradley
All American

Dubilier
Workrite
U. S. Tool
Music Master
Crosley
Burgess Batteries
Grebe
Remler
Brandes

Cardwell Condensers
Jefferson Transformers
Cutler Hammer
Willard Batteries
Acme
Eby Binding Posts
Roller Smith
Carter
and other reliable manufacturers

Address Department "A"

The Sutcliffe Co.

LOUISVILLE, KENTUCKY

Send For Our New Catalogue To-day



Putting QUALITY into RADIO



JEFFERSON Super-Sensitive Amplifying TRANSFORMERS

Mail this coupon and get your copy of our latest bulletin, "Putting Quality into Radio."

JEFFERSON ELECTRIC MFG. CO.
427 So. Green St., Chicago, Ill.

Send me Bulletin No. 570, "Putting Quality into Radio."

Name.....

Address.....

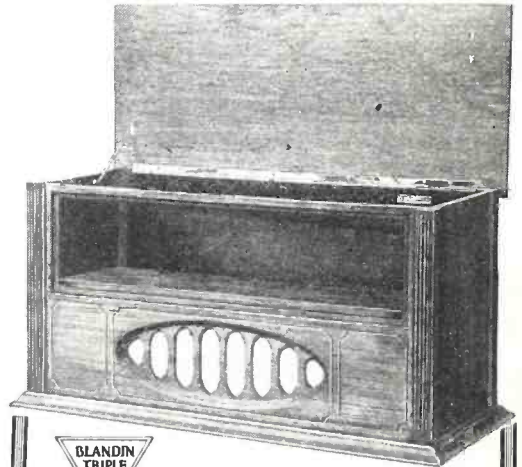

The New "35-D" Super Radio Cabinet

Panel at top 7 x 26-10 1/4". Deep enough for 8 tubes. Built-in spruce horn. Two dry cell compartments. Door in back. Built of mahogany—piano finish. Same quality and equipment as

Blandin Triple "A" De Luxe Series
Also new De Luxe sizes, 7 x 18-7"; 7 x 24-7"; 7 x 26-7 1/4"; 7 x 30-8" and 8 x 36-8". Write for illustrated price list.

Jobbers and dealers, write for discounts
BLANDIN PHONOGRAPH COMPANY, INC.
1500 16th St. :: :: RACINE, WIS.

Please refer to POPULAR RADIO when answering advertisements.

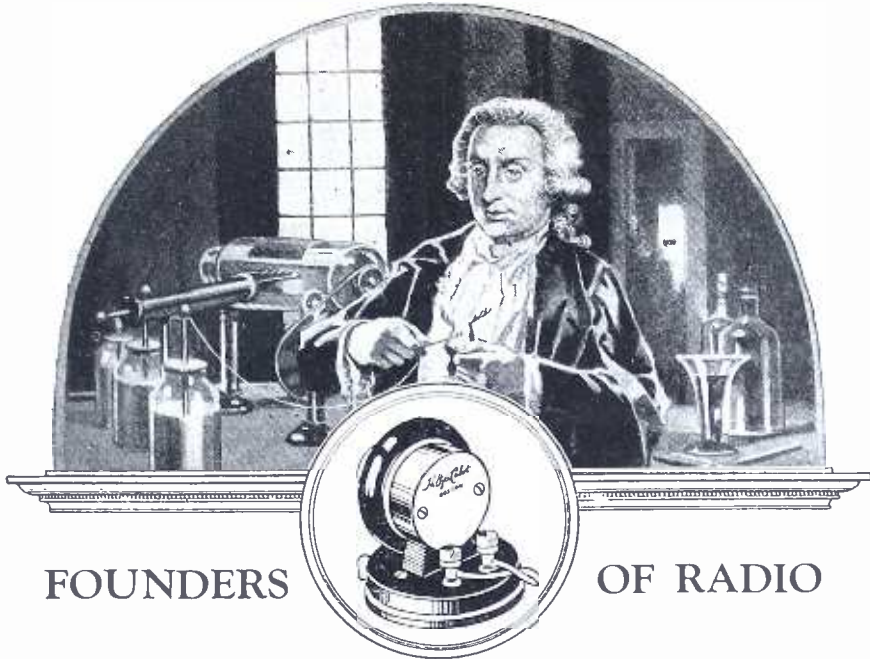

FOUNDERS

OF RADIO

LUIGI GALVANI

BORN AT BOLOGNA, ITALY, 1737

GALVANI contributed much to knowledge of electricity. Educated in medicine, he obtained great renown as an anatomist, and was appointed lecturer at the University of Bologna.

Like many other great scientific discoverers, Galvani's valuable researches resulted from an accident. History records that in preparing some frogs' legs as a special dish for his wife, he noticed that when the nerve muscle was touched by a scalpel, twitching of the frogs' legs occurred. He became inter-

ested, and so contributed his genius to the advancement of electricity.

Galvani's primitive experiments were an important link in that long chain which has finally led to radio. Perfection is always the result of years of effort and experimentation. Holtzer-Cabot's thirty-five years' experience in the manufacture of delicate electrical apparatus has produced for you three perfected Radio receiving units.

Ask your dealer to let you try a Holtzer-Cabot Loud Speaker, Phonograph Attachment or Headset. The results will speak for themselves.

- Holtzer-Cabot Loud Speaker
- Loud Speaker Phonograph Attachment
- No. 2 Universal Head Phones
- No. 4 National Head Phones

WRITE FOR BOOKLET Department P.R.

THE HOLTZER-CABOT ELECTRIC CO.

125 Amory Street
BOSTON

6161-65 South State St.
CHICAGO



Please refer to POPULAR RADIO when answering advertisements.

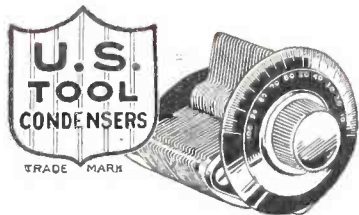

Innovations that Set NEW Standards of Condenser Efficiency

Types #3, #4, #5, #6

The efforts constantly directed to keep U. S. Tool Condensers the leader, have resulted in these remarkable new features:

Types 3, 4, 5 and 6 guaranteed 3%, plus or minus, from indicated capacity.

TYPES 5 and 6: LOW LOSS; METAL END PLATES.

ALL VERNIER TYPES: equipped with "patent applied for" friction vernier mechanism.

ONE PIECE STATOR: biggest advance in condenser construction. Eliminates broken contacts and soldered joints. Positive results. No leakage.

HEXAGON SHAFT: eliminates fanning of rotor blades.

PIGTAIL CONNECTION: soldered to rotor shaft; best positive type of connection.

MOUNTING LUGS: three lugs creating 3 point suspension, mechanically correct—condenser alignment without undue strains on front end plate or panel.

For 100% condenser satisfaction, use U. S. Tool Condensers when building your set.

ASK YOUR DEALER to show you types 3 and 4, with celeron end plates; types 5 and 6 with low loss, metal end plates.

100% GUARANTEED

Write for Literature

U. S. TOOL COMPANY, INC.

116 Mechanic St., Newark, N. J.

Mfrs. of special tools, dies, jigs, automatic machinery and sub presses

COAST TO COAST on the R.C.S. Circuit, using RayCoils



RayCoils "A" for Reinartz, RayCoils "B" for RCS and Ultra Audion Circuits, RayCoils "C" for RCS, Ultra Audion and Tuned Radio Frequency Circuits, RayCoils "D" for Tuned Radio Frequency and Neutralizing Circuits of 4, 5 and 6 Tubes, RayCoils "E" for Reflex Circuits.

- A = \$2.50
- B = 2.00
- C = 2.00
- D = 2.00
- E = 2.00

Use the RCS Circuit with or without Radio Frequency for Simplicity in operation and results. Not equalled by any set for volume and distance.

Coils in Separate Box With Wiring Diagram

Working Blue Prints of four sheets 12 x 18 of all standard circuits, as Variometer Hookup, Reinartz one and three tube, R.C.S. three and four tube and R.C.S. five tube Tuned Radio Frequency, 50 cents a set.

We also carry a complete line of Carter, Howard, Kellogg, Modern, All-American and Trimm parts.

If your dealer cannot supply you, we will mail direct.

R. C. SCHOONHOVEN

Major Q. M. R. C.

310 SENECA ST.

ELGIN, ILL.

MIRACO GETS EM FROM COAST TO COAST

PRICE ONLY \$29.50

At rock bottom prices you get the efficiency of sets costing three times as much. Users tell us that Miraco Radio frequency receivers pick up stations from coast to coast. Operate either on dry cells or storage battery. Solid mahogany cabinets—finest workmanship throughout. Order direct or send for bulletin.

Two tube outfit \$29.50
Four tube outfit \$54.50

DEALERS AGENTS—write for proposition quickly—it's a winner.
THE MIDWEST RADIO COMPANY
812 Main Street Cincinnati, Ohio.

RADIO TUBE EXCHANGE

We Repair All Standard Makes of Tubes, Including

W. D. 11 or 12
U. V. 199 or C. 299 \$2.50
C. 11 or 12
U. V. 201A or C. 301A
D. V. 1 or D. V. 2
U. V. 200 or 201
C. 300 or 301

U. V. 202 Repaired, \$3.50
All tubes guaranteed to do the work.

RADIO TUBE EXCHANGE

200 BROADWAY, NEW YORK

All Mail Orders Given Prompt Attention. Orders Sent Parcel Post C. O. D.

Please refer to POPULAR RADIO when answering advertisements.

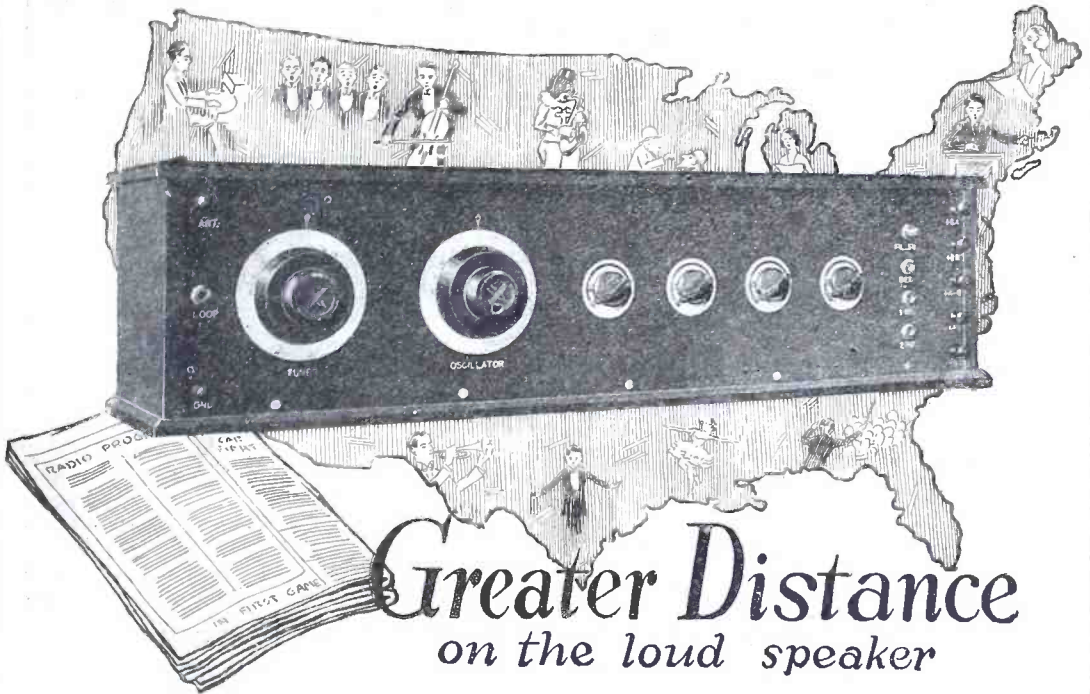

Greater Distance on the loud speaker

Send for 32 page illustrated book giving latest authentic information on drilling, wiring, assembling, and tuning 6 and 8 tube Ultradyne Receivers.

50c

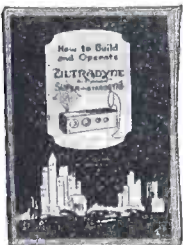

Ultradyne Kit

Consists of 1 type "A" Ultraformer, 3 type "B" Ultraformers, 1 Tuning Coil, 1 Oscillator Coil, 4 matched fixed Condensers.
The Ultraformers are new improved long wave radio frequency transformers, specially designed by R. E. Lacault, Consulting Engineer of this company and inventor of the Ultradyne.
To protect the public, Mr. Lacault's personal monogram seal (R. E. L.) is placed on all genuine Ultraformers. Ultraformers are guaranteed so long as this seal remains unbroken.



\$62



NO ordinary standards of distance can be applied to the Ultradyne Receiver. The "Modulation System" of radio reception, used exclusively in the Ultradyne, completely revolutionizes all previous conceptions of range.

The "Modulation System" is the latest development of R. E. Lacault, A.M.I.R.E., Consulting Engineer of this company and formerly Radio Research Engineer with the French Radio Research Laboratories.

This "Modulation System" is a decided departure from the detector arrangement used in all other Super-Heterodynes. It causes the incoming signal to modulate the oscillations produced locally just as the voice modulates the carrier wave of a broadcasting station. Provides greater rectification and produces greater signal strength which is far more noticeable on weak signals.

In addition the Ultradyne incorporates every good feature of all types of Super-Heterodyne receivers.

PHENIX RADIO CORPORATION
7-9 Beekman St. New York City

ULTRADYNE

The Improved
SUPER-HETERODYNE

Please refer to POPULAR RADIO when answering advertisements.

Tune in
with ease

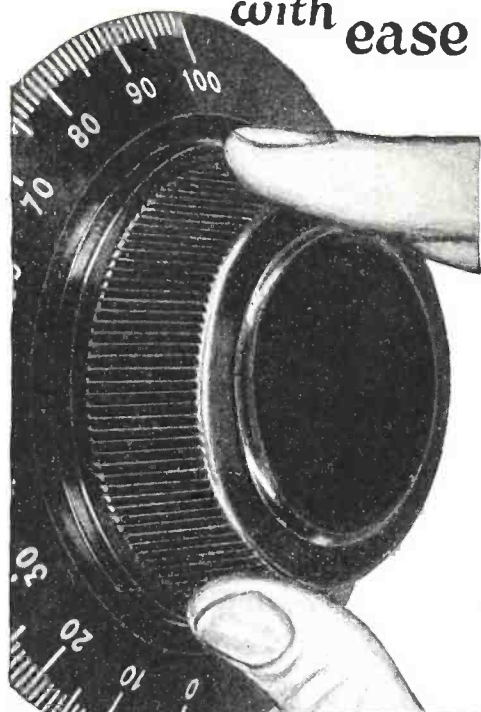

NA-ALD

Super DeLuxe Dials

*Where eye and hand are
in scientific balance*

Test these dials with any other and see how much more quickly you can turn to any degree or fraction of a degree.

Shorter intermediate lines; numerals on the bevel and a generous knob are the reasons.

These are truly beautiful creations which gave that final touch of dignity and attractiveness to the quality set. On the set you buy look for the minute Na-ald trademark as you would for "Sterling" on silver.

75c. Other prices of Na-ald Dials are: 3 1/8" 50c, 3" 35c and 2" (rheostat) 35c.

ALDEN MFG. CO.
Dept. C. Springfield, Mass.

NA-ALD

TWO CONDENSERS IN ONE

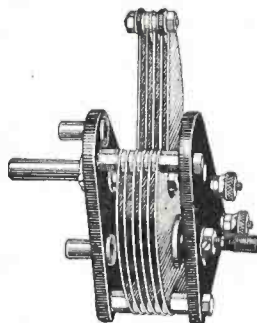

No. 610

The Kellogg Switchboard & Supply Company have just placed on the market a standard 11 plate variable condenser of minimum .000074 and maximum .00035 microfarads, and has as part of its construction a micrometer vernier condenser with a capacity minimum of one micro-microfarad and a maximum of ten micro-microfarads.

It is designed to provide a vernier of minute capacity that can be used as a bias, eliminates unnecessary wiring and its attendant difficulties and complications; limits the number of parts necessary in the set and provides the greatest degree of efficiency in circuits requiring grid, micrometer or biasing condenser.

USE—IS THE TEST

**KELLOGG SWITCHBOARD
& SUPPLY COMPANY**

1066 W. ADAMS STREET
CHICAGO, ILL.



all free! RADIO LIBRARY

JUST SEND A POST CARD YOU GET absolutely free—the A-K "Library of Latest Radio Literature," written by foremost radio authorities. Contains HUNDREDS of valuable wiring diagrams, HOOK-UPS, illustrations, articles, data, etc.

EXPLAINS in clear, understandable language the popular new circuits: reflex, neutrodyne, phuliform, "nameless," super-heterodyne, etc., and how to build sets. Covers long and short wave amplification, push-pull and audio amplifiers. Latest information on multitudes of other radio subjects. **LOG BOOK INCLUDED FREE.** Also our latest Radio Catalog featuring **NATIONALLY ADVERTISED** lines at attractive savings. Write today—offer limited. Address

ATWOOD-KING, INC.
Dept. M-9 163 W. Washington St., Chicago

ATWOOD KING
INC.

Your Condenser Makes a Difference



**Elgin Elraco
Precision Condensers**

are made by precision tool makers. You will notice the difference the **precision** makes in your receiving when you use the Elraco. All sizes.

Ask your dealer or write for full information

ELGIN RADIO CORPORATION
Radio Division of the Elgin Tool Works, Inc.
69 N. State St. Elgin, Ill.

Please refer to POPULAR RADIO when answering advertisements.

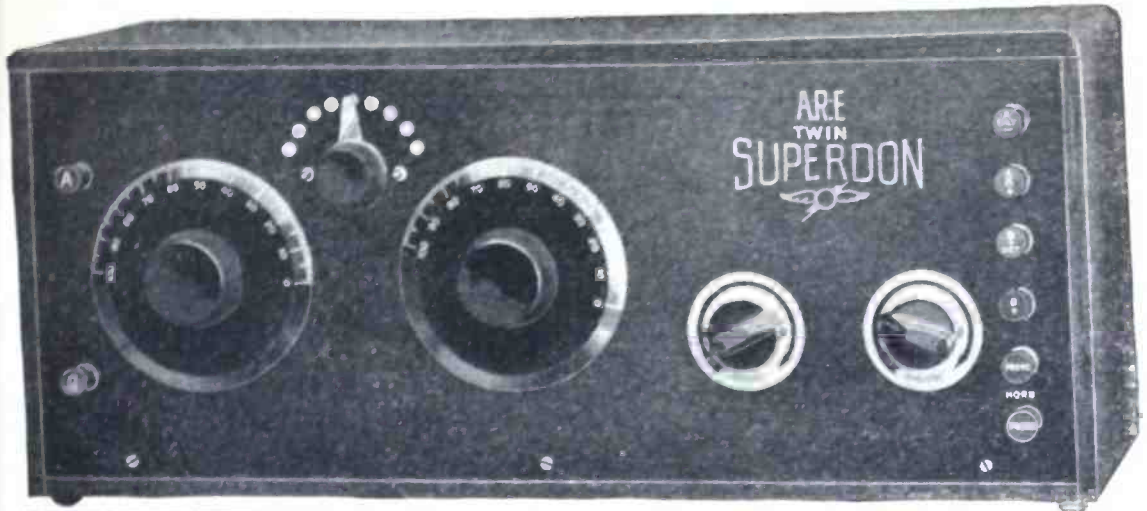

FREE THIS GENUINE A.R.E. TWIN SUPERDON LONG DISTANCE RADIO RECEIVER

No matter what your present occupation is, I can qualify you in a few weeks' time to write your own income ticket in the fascinating, fast-growing, big-pay, long profit field of Radio! And, not only am I able to give you a better, more complete knowledge of Radio itself, but I will go still farther with you. I will show you how to apply your knowledge to turn it into big money quickly!

\$2,000 to \$10,000 a Year
BE YOUR OWN BOSS

Hundreds of radio manufacturers, thousands of transmitting stations, big research laboratories and more than 15,000 ships are dividing millions of dollars a year among radio men. They are paying \$2,000 to \$10,000 a year to men not so well trained as I propose to train you and they are constantly bidding for the men with the better, broader training. Do you want your share of this big money in salary, or do you want to take it in profits from a business all your own? Either way, I'll show you.

YOU WILL KNOW THESE THINGS

I do not propose to make you a mere radio mechanic, or just a repair man. Out of my training you will learn not only "How to do it," but "Why it's done that way." I am going to train you to handle the big problems of Radio because that's where the big money lies. And I am going to give you this broad training in such simple language that you can't help but grasp it. You will learn how to construct, install and operate all kinds of radio transmitting and receiving equipment — on land or sea; you will learn the functions and requirements of all parts and apparatus used in all types of radio transmitting and receiving equipment. In short, you will be qualified in every branch of Radio — theoretically and practically. And, as I stated above, I am going to show you how to turn your knowledge into quick cash!

LEARN QUICKLY—AT HOME!

No need for you to leave your home or your present employment to take this complete course of training. You need only to apply yourself diligently in easy, spare time study, under my personal direction. Don't wait to think this over. Mail in the coupon now—and when I have laid all details and particulars before you, then will be the time to give my offer and your future—some real serious thought.

Instant CASH FOR YOU A Big Advantage

When I answer your coupon, I'll tell you about a big special advantage you will gain from your association with me, which will enable you to make some real money as soon as you start the course. So mail in the coupon now—today. ©1924 A. R. E.



IRWIN J. MENDELS, Radio Engineer

You need serve no apprenticeship. I have done that for you. In my 15 years' experience, I have met and coped with every electrical and radio problem. In fact, so broad has been my experience that I doubt if there is a single principle of radio that I have not had to apply in some manner or means in the conduct of the various manufacturing and research enterprises with which I am associated. It is this great, broad practical experience which I have gained from contact with all phases of the radio industry that you are going to benefit by. And I will impart my knowledge to you with the skill of an instructor who has not only trained thousands for the bigger positions in radio manufacturing, but with the experience of one whose privilege it has been to teach in one of the world's largest technical schools. Experience is the greatest of teachers. I offer you 16 years of experience.

The Wonderful A. R. E. Twin Superdon

All broadcast stations within a 3000 mile circle are within the easy reach of the A. R. E. SUPERDON. Voice and music come in strong and with unmistakable, natural tone. This is not a one tube, cheaply made experimental set, but a high grade, twin super-powered professional type instrument, made up of only high quality parts. The A. R. E. Twin Superdon is built to last all time. Its artistically marked panel and large dials with their deeply cut white engravings present a very pleasing appearance. Cabinet in which the efficient A. R. E. Twin Superdon is contained matches the best of furniture. MAIL THE COUPON at once so that I can tell you more about the A. R. E. Twin Superdon and how you can get it FREE. Don't wait! MAIL THE COUPON NOW—Today!

Irwin J. Mendels, Director
AMERICAN RADIO ENGINEERS
646 N. Michigan Blvd., Dept. 82, Chicago

MAIL THIS COUPON TO AMERICAN RADIO ENGINEERS
646 N. Michigan Blvd., Dept. 82, Chicago

Send me your book, radio and full particulars of your course of training which will enable me to earn \$2,000 to \$10,000 a year. Also tell me how to turn my knowledge of radio into big money. I can get it.

Name _____ Address _____
City _____ State _____

Please refer to POPULAR RADIO when answering advertisements.



The RāBAT Junior \$3.96

A Rechargeable Wet 'B' Battery. Capacity 800 Mil-Amps.
12 CELLS 24 VOLTS

Rabat users have found it much easier to get clearer and more distinct tones because with good batteries, distortion and weak signals have been practically eliminated.

In making your battery replacement, the installation of RABATS will not only give you longer battery life, higher and more continuous voltage but will also bring you much clearer tones—and you can tune in on many more stations.

Rabat
Chemical
Chargers
for "B"
batteries
Junior
\$1.40
Senior
\$4.80

The Radio Rabat Company
714 Bangor Building, Cleveland, Ohio



The RāBAT Senior

A Rechargeable Wet 'B' Battery. Capacity 2800 Mil-Amps.

24 \$9.60
12 CELLS VOLTS

48 VOLTS \$17.88

The Radio Sensation!

MODERN "PUSH-PULL" Transformers are the recognized last word in Radio Amplification.

Here's why—

1. Perfectly balanced.
2. Capable of the greatest possible amplification.
3. Distortion reduced to a minimum.
4. Adds clarity and volume to any set.
5. Can be used in any "PUSH-PULL" circuit now available with any of the standard tubes now on the market.
6. Made with the greatest care, thoroughly tested and fully GUARANTEED.
7. Coils are wound on our own specially designed winding machines in our own factory.

Price per matched pair. Sold by all good dealers. Bulletin FREE ON REQUEST. **\$12.50**

The Modern Electric Mfg. Co.
Toledo, Ohio

MODERN Long-Wave 30 K.C. Transformers, each **\$5.00**

MODERN Standard Audio Transformers, each **\$5.00**

MODERN famous one-tube Reflex Audio Transformers, each **\$5.50**



20^{FT} MAST

\$ PREPAID 10.



Install this steel aerial mast for greater range and better results. Neat, substantial construction. 20 Ft. Mast, \$10. 40 Ft. Mast, \$25. 60 Ft. Mast, \$45. Freight prepaid if remittance is sent with order—otherwise C. O. D. Write for circular.

S. W. HULL & CO., 2048 East 79th Street, CLEVELAND, O.

REDUCE THE NOISES IN YOUR SET
USE A

TURN-IT

ADJUSTABLE GRID LEAK

TURN-IT RADIO SALES, Inc. See Page 62
30 Church St., N. Y.

Distance! The Only AUTHORIZED COCKADAY COIL

Gets distant stations easily and clearly. Made in strict accordance with specifications by L. M. Cockaday, inventor of the famous Cockaday Four Circuit Tuner. Greater volume, sharper tuning, maximum selectivity. Guaranteed. At your dealers—otherwise write us direct.

Price \$5.50
PRECISION COIL COMPANY
209-C Centre Street New York

Please refer to POPULAR RADIO when answering advertisements.

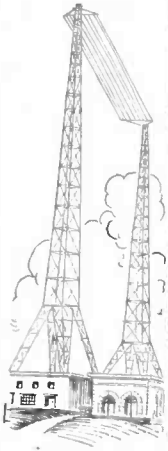

This Certificate Opens the Way to the Best Radio Positions Get It - And Earn Up To \$10,000 a Year

No previous experience in electricity or Radio is necessary. In a few months of pleasant study, right at home in spare time, you can easily win the certificate and qualify for one of the splendid, big money making positions in Radio.

John P. Zinno, who was a buck private when he enrolled, now, with his certificate, is earning over \$3500 a year in his own Radio shop. L. A. Godby has increased his pay \$1800 a year since he received his certificate. L. G. Biles holds a splendid position as Asst. Radio Editor of the Philadelphia Public Ledger. Emmett Welch is making over \$400 a month in his own Radio business.

PAY INCREASES OVER \$100 A MONTH



I am averaging anywhere from \$75 to \$150 a month more than I was making before enrolling with you. I would not consider \$10,000 too much for the

course. (Signed) A. N. LONG, 121 No. Main St., Greensburg, Pa.

DOUBLES SALARY



I can very easily make double the amount of money now than before I enrolled with you. Your course has benefited me approximately \$3000 over and above what I would have earned had I not taken it.

T. WINDER, 731 Belford Ave., Grand Junction, Colo.

Hundreds of other men are occupying equally attractive positions after winning our Certified Radio-technician certificate.

Read in the panel the stories of just a few of our graduates. Our course can mean as much to you

Easy Now to Become a Certified Radio-technician

No other work in the world today offers such opportunities, such big money, such rapid advancement, such a promising future as does Radio. And the Expert Radio-technician is the man who is in a position to choose the best of these opportunities — to jump farthest ahead in this newest and fastest growing industry.

Become an Expert Radio-technician. You can easily and quickly. The National Radio Institute, America's first and largest Radio School, has devised a remarkable method that makes it easy for anyone to qualify right at home during spare time. Prominent radio experts give you

personal advice and instruction through the mail. They grade your papers, answer your questions, and in every possible way help you in your work. And you learn the practical, wonderful side of radio by actual practice on patented instruments we send you free. The Certified Radio-technician Certificate awarded you on the completion of your course is government recognized, counting for 5 to 10 points on all government license examinations.

Instruments Free to Students

An extraordinary feature of this course is the use of four patented instruments, owned exclusively by us, which give practical training in radio operation, installation, maintenance and repair—all of which you must have to become an Expert Radio-technician. Among these instruments is the wonderful Natrometer, said by experts to be the perfect device for teaching the Radio Code. All of these instruments are given free to students.

Send for Radio BOOK

Thousands of positions are open to Certified Radio-technicians. Find out what your opportunities are in this fascinating profession. Send for interesting book which gives complete details on plan by which the National Radio Institute quickly qualifies you at home in spare time as a Certified Radio-technician. Send the coupon or a postcard for free book NOW. NATIONAL RADIO INSTITUTE, Dept. 32JA, Washington, D. C.



NATIONAL RADIO INSTITUTE, Dept. 32JA, Washington, D. C.

Send me your book, "Rich Rewards in Radio," with full particulars about the opportunities in radio, and how you will quickly train me in my spare time at home to win a Certified Radio-technician Certificate. Also about your employment service and special tuition offer.

Name..... Age.....

Street..... Occupation.....

City..... State.....

Please refer to POPULAR RADIO when answering advertisements.

ULTRA HANDY CHARGER

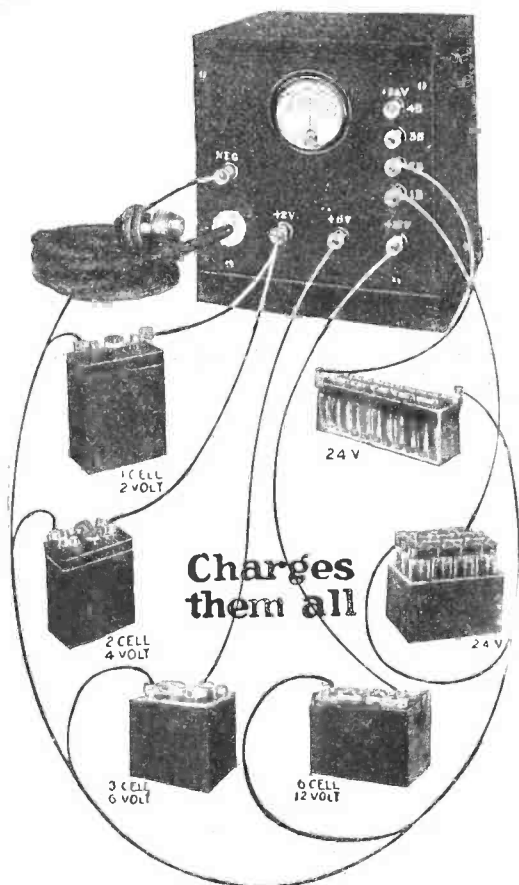

ULTRA MODEL **\$18.00**
f. o. b. ST. LOUIS

Note

"Handy Charger" Features

No bulbs to break. No auxiliaries necessary.
No acids to spill. No sticking contacts.
No fast-wearing parts. No wood used—Fireproof.

The most complete, most flexible and quickest battery charger on the market at any price. Will charge every radio and automobile battery in the one machine. Furnished complete with a precision *Weston Ammeter*. Beautifully finished Case—automatic in operation. Costs less than 1 cent per hour to run. Ask your dealer. Illustrated descriptive folder on request. Write us.

INTERSTATE ELECTRIC CO.
of St. Louis, Mo. 4339 Duncan Ave.

KING QUALITY ALL THE NAME IMPLIES RADIO APPARATUS

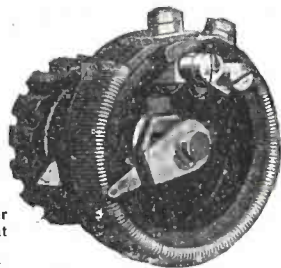

Amplifier
Rheostat
With
Pointer

THE KING QUALITY LINE:

Adapters	Dials	Rheostats
Bakelite Knobs	Inductance-	Switch Levers
Binding Posts	Switches	Vacuum Tube-
Contact Points	Panel Mountings	Sockets

KING MANUFACTURING CORP.
BUFFALO NEW YORK



CARDWELL Rotor Grounded CONDENSER

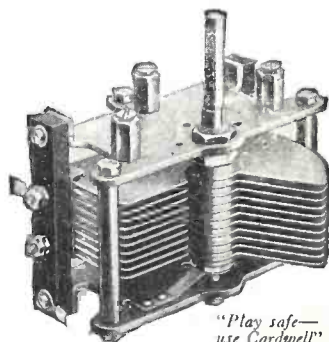

"Play safe—
use Cardwell"

It is a significant fact that of all the various kinds of radio apparatus on the market to-day the **CARDWELL CONDENSER** is the **ONLY** unit which is recognized by engineers and technical Editors of National prominence as the **ONE** best.

Write for instructive literature and prices

Allen D. Cardwell Mfg. Corp.
81 Prospect St. Brooklyn, N. Y.

Why be satisfied with a jumble of interfering stations?

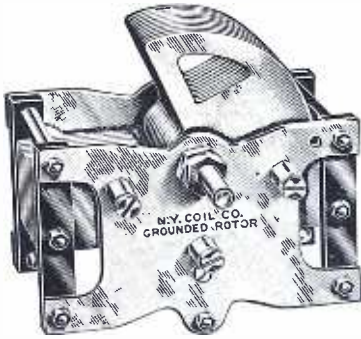

Without Vernier

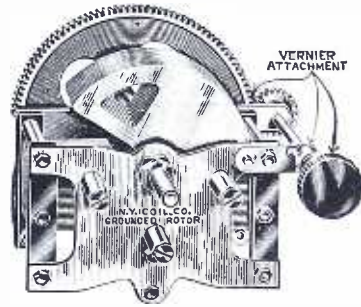

With Vernier Attachment

Install a New York Low Loss Grounded Rotor Variable Condenser in your present set and receive the *full pleasure* of broadcasting. Our new Low Loss Condenser is in a class by itself—superlatively better—no other condenser manufactured incorporates so many vital improvements.

ADJUSTABLE CONE TYPE BEARINGS, PIG TAIL CONNECTIONS AND STOP, STRAIGHT LINE CAPACITY, GEARED VERNIER ACTION (which may be purchased separately if desired);—only geared vernier that swings a 4" dial,—DIELECTRIC OF GENUINE HARD RUBBER WITH WIDE SPACING OF PLATES. In a word, a precision instrument possessing the absolute minimum losses, the maximum obtainable efficiency, insuring GREATEST DISTANCE, SHARPEST POSSIBLE TUNING AND WONDERFULLY CLEAR RECEPTION.

.0005 (23 plate) without Vernier, \$4.50. Geared Vernier attachment complete \$1.50.

Unequaled for Super Heterodyne, Neutrodyne and all exacting circuits. September deliveries.

OUR SUPER HETERODYNE KIT AT \$20.00, consisting of oscillator coupler, Input, and three *matched* intermediate *air-core* transformers, makes up the best set known to date.

Other items of proven superiority,—Distortionless Audio Transformers, Tuned Radio Frequency Transformers, By-Pass Condensers, and Precision New York Mica Fixed Condensers.



Type B

Adapted by leading heterodyne builders and set manufacturers, the most uniform capacity of any condenser manufactured. Price, .00025, 35c., .00025 with grid leak clips 45c. Type C furnished in all capacities to .006.



Type A

NEW YORK COIL CO., 338 Pearl Street, New York

Pacific Coast—MARS HANK SALES CO., 1240 S. Main St., Los Angeles, Cal.

Please refer to POPULAR RADIO when answering advertisements.

Automatic Plug

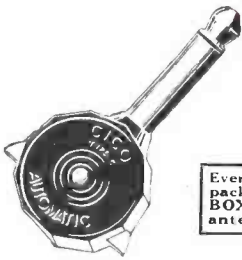

STANDARD RADIO PARTS

Bakelite Jack

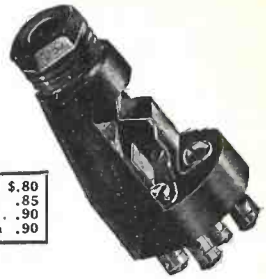

Every CICO PRODUCT is packed in a distinctive GREEN BOX and unqualifiedly guaranteed against all defects.

No. 30-Single circuit open .80
 No. 31-Single circuit closed .85
 No. 32-Double circuit .90
 No. 33-"A" Battery Switch .90

CICO AUTOMATIC PLUG—

Gives instantaneous connection. A slight pressure on the wings with thumb and index finger releases tips for change. Bakelite body. Metal parts nickel-plated. Takes all tips. Price 80c.

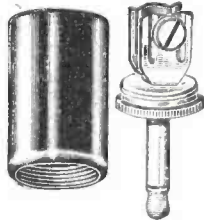

2-Way Plug

CICO 2-WAY PLUG—
 Two sets of headphones or loudspeaker and one set of phones may be connected simultaneously. Fits all standard jacks. Takes all types of tips. Price 60c.



Bakelite Rheostat

One point mounting. Binding post connections. Vernier or plain types, 6-10-20-30 ohms. Absolutely uniform resistance. Plain, \$1.35. Vernier, \$1.50

CICO BAKELITE JACK —

Moulded completely from bakelite. No metal in frame construction. Short springs of special phosphor bronze. Sterling silver contact points. Scientifically perfect in every detail. Exceptional value.

Consolidated Instrument Co. of America, Inc., 41 East 42nd St., New York



RADIO CABINETS

"From the Lumber to You"

Special sizes to order



Mounting Boards 50c Each

WILL NOT WARP OR CRACK

Made of No. 1 wood finished in either Mahogany or Walnut, bright or rubbed finish to match the finest of furniture.

PRICES

Cash with order, prepaid east of Missouri River; west, add 15 cents to quoted price. Send Post Office or Express Money Order.

Panel Sizes	Imitation Walnut or Mahogany	Genuine Walnut or Mahogany
7 x 10 x 7	\$3.00	\$4.75
7 x 14 x 7	3.30	5.50
7 x 18 x 7	3.82	6.75
7 x 24 x 7	5.25	9.00
7 x 26 x 7	6.05	10.00
7 x 28 x 8	7.25	11.50
7 x 27 x 9	7.25	12.50
7 x 40 x 10	11.25	18.00

Manufacturers' and Dealers' Inquiries Solicited

THE PERKINS-CAMPBELL CO. (Established 1879)

410-440 New St., Cincinnati, O. (References: Dun or Bradstreet's)



Patented Aug. 21, 1923

Sickles Knockout Coil

Built for famous Radio Broadcast Knockout reflex receiver. Used by set builders who appreciate quality. Price \$4.00 a pair.

The F. W. Sickles Co.
 Springfield, Mass.

Dept. B

337 Worthington St.

DX ANTENNA WIRE

Hard drawn copper — with CORRUGATED surface — gives increased range and clearer signal. Sold in coils of 100, 200, and 500 ft. \$2.00 per 100 ft.

XARDELL CORPORATION
 Dept. R. Utica, New York

For Satisfactory Reception USE

TURN-IT ADJUSTABLE GRID LEAK

List Price \$1.00
TURN-IT RADIO SALES, Inc. Panel Control 50c
 30 Church Street, N. Y.

See Page 64

Please refer to POPULAR RADIO when answering advertisements.

A Challenge to Sending Stations

Thorola notes are as pure as the singer's—exactly. Thorola's speech is as sharp as the voice of the speaker—exactly. Thorola tones are as clear as the tones of any musical instrument.

Thorola IS a great musical instrument.

Distance is the only difference between Thorola Loud Speaker and the sending station! In radio laboratories Thorola reproduction is now considered a *test* and a challenge of sending quality, so faithful is Thorola. Gone is distortion, rattle, blare, screech.

Most remarkable, it is now possible to attain BOTH volume AND absolute clarity even on weak signals.

This is what now gives thousands of fans a new notion of radio pleasure. Thousands already know these new possibilities opened by Thorola Loud Speaker. Thousands heeded the first

Thorola announcements. Thousands convinced themselves that Thorola was another great triumph for America's oldest makers of loud speaking apparatus.

Thorola success is certain. Or else the daring Thorola guarantee is impossible. Thorola MUST be far better, or we lose. You can't.

So send the money-back coupon quickly for your Thorola, if your dealer cannot supply you. (Thorola is ordinarily sold only through regular channels, protecting dealers.)

But this coupon offer, good until dealers are supplied, will give you the thrill of Thorola now. The coupon brings you Thorola direct.

Horn of Thorite

The famous synthetic material with controlled acoustic properties impossible in wood or metal.

Permanent Adjustment

A new principle which permanently adjusts Thorola to each individual set, assuring highest efficiency always.

THOROLA 4

\$25 14½" Bell Horn. Complete with Cord and Plug. Beautiful Black Florentine Finish.

THOROLA 3

12" Bell Horn and Cord. Finest Black Florentine Finish. **\$20**



No external battery required
Plug in same as headphones

THOROLA

Made by the Makers of Famous THOROPHONE High Power Model—\$45

It is the greatest improvement you can make in your set. It stamps you as the cleverest fan in your crowd. This coupon gets astounding **RADIO RESULTS**. Sign and mail.

REICHMANN CO., 1729-35 West Seventy-fourth St., Chicago

GUARANTEE

Thorola is guaranteed approximately twice the volume of any loud speaker (except Thorophone itself) in your own opinion, or money refunded at any time within 30 days from purchase. Thorola will give from 2 to 3 times the volume of most well-known makes of loud speakers. Thorola improvement in tone quality is even more remarkable.

30-DAY TRIAL COUPON—Good This Month Only

REICHMANN CO., 1729-35 West Seventy-fourth Street, Chicago
I am unable to obtain Thorola from my Thorodealer. Therefore please supply me promptly, shipment prepaid. I enclose in the amount of \$..... for one Model..... Thorola Loud Speaker. I understand that this full amount will be promptly refunded if I return the instrument, at your expense, for any reason within 30 days from date.

Name..... Date.....
Street Address.....
Town and State.....

Please refer to POPULAR RADIO when answering advertisements.

**NOTED EXPERIMENTERS
Make This Their Headquarters
For Hard-to-Get Parts**

CRAIG TWO TUBE REFLEX RECEIVER

Parts for Fixed Coupler and Radio Frequency Transformers \$3.00

1 Hammerlund .0006 condenser	5.00
1 Hammerlund .001 condenser	6.00
1 U. S. Tool—3 plate condenser	1.50
2 Federal Sockets for 193 Tubes \$1.00 each	2.00
1 R. U. F. Semitized Crystal Detector	1.25
1 Amco 30 Ohm Rheostat	1.25
1 Carter Single Circuit Jack	.80
1 Carter Double Circuit Jack	.60
1 Federal No. 65 Audio Frequency Transformer	7.00
1 Amertran A. F. Transformer	5.00
2 .001 Mfd. N. Y. Coll Mica Fixed Condenser .30 each	.80
1 Amco Switch Lever with Switch Points and Stops	.45
Kit Consisting of Above Parts.	\$ 30.00

IMPROVED FOUR CIRCUIT TUNER

3 48000 Ohm Lavite Resistances \$1.50 each	4.50
2 Amco 25 plate Varner Condensers with Dials \$4.50 each	9.00
2 Ampex Griddens \$1.25 each	2.50
Kit Consisting of Above Parts.	\$13.50

CRAIG SIMPLIFIED NEUTRODYNE

Parts for Craig Coupler and R. F. Transformer	3.25
41 Plate Cardwell Condenser	6.00
21 " " "	6.00
11 " " "	4.25
Kit Consisting of Above Parts.	\$ 15.00

COCKADAY DISTORTIONLESS AMPLIFIER

1 Fr. Como Push and Pull Transformers	Pr. 12.50
Amertran Transformer	7.00
No. 25 Bradleyohm	2.00
5 30 in. Lenxth Celatrite Wire \$.25 each	1.25
2 Quinby Radio Frames 7x8 in. \$1.00 each	2.00
Kit Consisting of Above Parts.	\$ 21.00

Try us on any radio parts you have been unable to secure.

MORISON
Electrical Supply Co. Inc.

C.O.D. Mail orders will be shipped promptly

Wholesale

Retail

15 East 40th Street New York City

Radio **HARTMAN** Products

HARTMAN ELECTRIC CO.
MANSFIELD, OHIO.

PROGRESSIVE DEALERS everywhere buy RADIO SUPPLIES from

CLARK & TILSON, Inc.
552A Seventh Ave., N. Y. C.

Send for price list and discount sheet

Wholesale Radio Supplies of national reputation since 1921

POPULAR RADIO

will pay a substantial commission and monthly salary to a few more representatives

YOU are well acquainted with POPULAR RADIO and its real appeal to radio fans. You have doubtless frequently referred friends to special features it contained, without any thought of reward. Many of our friends who started in this way are now earning substantial sums by acting as our authorized subscription representatives in their localities.

It costs nothing to start. Just fill out the coupon below and also give us two persons of your acquaintance to whom we may refer. We will send you sample copies and full supplies and credentials that will enable you to represent not only POPULAR RADIO but four other fast selling magazines as well.

You assume no obligations, financial or otherwise. You are at liberty to devote all or part of your time as you prefer. But if you are the right kind of person you will find that our commission terms are so liberal that you will be particularly well paid for whatever time you do devote to our interests. And there's a monthly salary in addition. Mail the coupon today.

POPULAR RADIO, 627 West 43d St., New York City

Popular Radio, Inc., Dept. 96,
627 West 43rd St., New York City.

Please send me full particulars of your commission and salary offer to accepted representatives of POPULAR RADIO and four other magazines.

Name.....

Address.....

City.....State.....

Names, addresses and occupations of two references are on sheet attached.

Learn Electricity and Radio

Learn in 12 Weeks



Great School of Coyne

Be An Electrical Expert

Come to Chicago—the Electrical Center of the World. Come to Coyne—learn electricity in 12 weeks. \$200,000 worth of electrical apparatus. Complete training on everything from door bells to power plants. Radio course Free. Fit yourself to earn \$250 to \$600 a month. Get started now.

Write for Free Book and details of special offer and Life Scholarship.

MR. H. C. LEWIS, PRES.

COYNE ELECTRICAL SCHOOL
1300-1310 W. Harrison St., Dept. 6-612 Chicago, Ill.

FOR DISTANCE

TURN-IT
ADJUSTABLE
GRID LEAK

Try it

TURN-IT,RADIO SALES, Inc.
30 Church St., N. Y.

See Page 68

Please refer to POPULAR RADIO when answering advertisements.

TOWER'S

a Mile High

TOWER'S Scientific

Perfect Tone mates

\$ NOW 2.95

Plus a few Cents Postage

WORLD'S GREATEST HEADSET VALUE

Production Now Over 1,000,000 A Year

Every set tested and approved by licensed radio operators.
Every set covered with money-back guarantee.

OUR \$200,000.00 COMPANY STANDS SQUARELY BACK OF EVERY HEADSET

Order at once by post card and we will ship immediately by Parcel Post C. O. D.

THE TOWER MFG. CO.

98 Dept. Brookline Ave., Boston, Mass.

Scientific

Placed

IN CARTONS, ONE ON TOP OF THE OTHER, 14 DAYS' PRODUCTION WOULD REACH A MILE INTO THE SKY.

TOWER'S SCIENTIFIC HEADSET

Lightest of all in weight, higher resistance, with elimination of distortion. Longer cord (full 5 ft.)

Companies of more limited production could not afford to sell such quality phones at anywhere near this price.

As the **LARGEST EXCLUSIVE MFGRS.** of headsets in **THE COUNTRY**, we are able to produce the **TOWER'S SCIENTIFIC Headset** at the low price of **\$2.95.**

14 Days Production - 1 Mile High



Please refer to POPULAR RADIO when answering advertisements.

30 leading set makers acknowledge the Leadership of PACENT



Adapters
Audioformers
Coil Plug
Coil Plug Receptacle
Condensers, Variable
Detector Stand
Duojack
Duoplug
Duo Lateral Coils
Headsets, Everyone
Jacks
Jack Set
Loop Plug
Loop Jack
Multijack
Plugs
Potentiometers
Rheostats
Resistances, Cartridge
Sockets
Super Audioformers
Twin Adapter, etc., etc.

PACENT
Radio Essentials

Write for Complete
Catalog P-9

The foremost radio set manufacturers in the United States and Canada are using Pacent Radio Essentials as Standard Equipment. Only a high standard of quality, which is dependable at all times, could justify this choice.

Let the judgment of these manufacturers guide you in the selection of your radio equipment. You can build a better set than your neighbor if you use better parts. "Don't improvise—Pacentize" is the slogan for radio results.

Your dealer will be glad to show you the Pacent Radio Essentials that you need for the next set you build.

PACENT ELECTRIC COMPANY, Inc.
22 Park Place, New York

WASHINGTON
JACKSONVILLE

MINNEAPOLIS
SAN FRANCISCO

BOSTON

CHICAGO
BIRMINGHAM

PHILADELPHIA
ST. LOUIS

DUPLEX

TRADE MARK
NONE OTHER



The "RK-1" Supplementary Kit fills a gap in Circuit Construction

In the Superheterodyne or Ultradyné, after you have bought the coils, transformers, etc., you need this kit to complete your set.

It contains the famous Series "FR" condensers with the other necessities.

This presents a good opportunity for jobbers.

The **DUPLUX ENGINE GOVERNOR CO., Inc.**
50 Flatbush Ave. Extension, Brooklyn, N. Y.

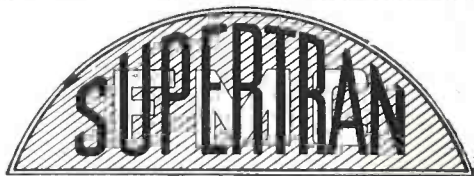

Registered U. S. Patent Office

AN IMPROVED AUDIO

In the Supertran the core laminations are mica insulated with a special compound eliminating howling and squealing so prevalent in ordinary transformers.

Write for free literature

FORD MICA COMPANY, Inc.
33 East 8th Street New York

2650 MILES

with ONE TUBE. Broadcasting from Atlantic Coast and Cuba heard in California by users of the **CROSS COUNTRY CIRCUIT**. This range is due to simplicity of set and operation as only one control is used for tuning. Easily and cheaply built. Dry cell tubes may be used. Complete instructions, with panel layout, assembly views, etc., postpaid for 25c. Or further information for red stamp.
VESCO RADIO CO. Bx. PR-117, Oakland, Calif.

68 STATIONS ON CRYSTAL without tubes or batteries.

You fellows who haven't tried my hook-up don't know what you are missing. Write.

LEON LAMBERT
540 Volutsia Wichita, Kansas

Please refer to **POPULAR RADIO** when answering advertisements.

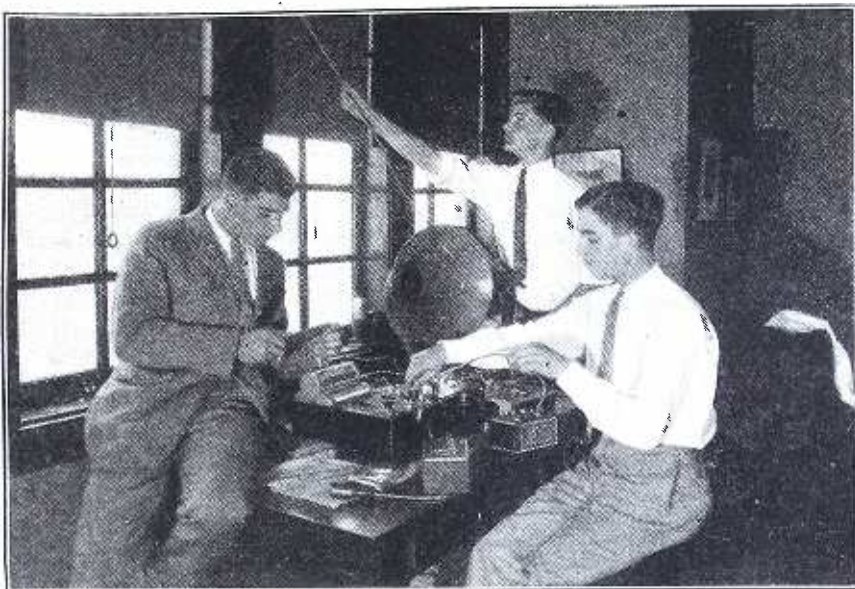

“This set’s going to be busy from now on”

THIS fall will be radio’s greatest season. The big football games are approaching. The world’s series will soon monopolize the air. And news-hungry crowds will cluster around loud speakers, eagerly following the course of the national elections.

More than ever before, boys will be kings of radio. Their skill in radio construction will be called on in every neighborhood. New parts will be bought at their recommendation. Their advice will be sought on the purchase of sets. Everywhere radio buyers will be directed by them. And the manufacturer who swings the boy vote to his product will benefit enormously.

The direct way to reach

boys with your product is by advertising in **THE AMERICAN BOY**. 500,000 boys, averaging 15½ to 16 years old, read it regularly—follow its stories, articles and advertisements closely. So aggressive are **AMERICAN BOY** readers in their radio practice that highly technical articles are welcomed by them. They are quick to try new methods, test new parts—and their own purchases form a large proportion of radio sales.

Through advertising in **THE AMERICAN BOY** you can win boys to your products. And thereby give your business the firmest kind of footing in the radio world. Copy reaching us by Sept. 10th will appear in November.

The **American Boy**
The Biggest, Brightest, Best Magazine for Boys in All the World
Detroit Michigan

Please refer to POPULAR RADIO when answering advertisements.



Performance plus Beauty

Choose your panel for its insulating value as well as for its appearance.

MAHOGANITE Radion Panels

give you both the supreme insulation and the beauty of polished mahogany. For Mahoganite is not a surface finish but an insulating material which extends from one side of the RADION Panel to the other.

21 Stock Sizes Mahoganite and Black

6 x 7	7 x 14	8 x 26
6 x 10½	7 x 18	9 x 14
6 x 14	7 x 21	10 x 12
6 x 21	7 x 24	12 x 14
7 x 9	7 x 26	12 x 21
7 x 10	7 x 30	14 x 18
7 x 12	7 x 48	20 x 24

RADION

The Supreme Insulation

PANELS



Look for this stamp on every genuine RADION Panel. Beware of substitutes and imitations.

At the best Radio Shops or write to

American Hard Rubber Co.
11 Mercer St. New York

See our exhibit at the FIRST RADIO WORLD'S FAIR, Madison Square Garden, SEPTEMBER 22d-28th, 1924.

A Loudspeaker That Costs a Million Dollars



Never heard of one? You've got it now, except for one thing—the Rhamstine* Needlephone. That's a conservative estimate of what the phonograph makers spent in perfecting sound reproduction without distortion; and the Needlephone gives you all this advantage without removing the needle from the reproducer.

The phonograph makers years ago abandoned the metal diaphragm and perfected the mica reproducer, to improve tones, not distort them.

Since it alone uses the phonograph reproducer only the **RHAMSTINE* NEEDLEPHONE**

\$10 COMPLETE WITH CORD
For use with any phonograph except Edison's without Victor adapter.

can give you all the advantages of the phonograph. It is as big a step ahead of the phonograph loudspeaker which replaces the phonograph reproducer as that unit was over the old loudspeaker with a tin horn. It alone takes full advantage of phonograph perfection.

Take No Risk—Send No Money

Rhamstine* backs up these claims and wants you to prove them at his risk. Send the coupon, pay on delivery, and try it with your own set and your own phonograph. Try it with a soft needle on local broadcasting and see what real mellowness is. Try it with a loud needle and get a new standard of perfect amplification with volume and without metallic noises. Then if it is not better than your former best, we'll gladly refund your money.

Send today—you need the best for summer reception.

J. Thos. Rhamstine*

Woodbridge at Beaubien, Detroit, Michigan
Send me the Needlephone. I'll pay the postman \$20. upon its arrival. It is distinctly understood I may return it if I desire, within 5 days and receive a refund in full.

Name

Address

*Radio and Electrical Products

Build your set the AMPLEX "KIT" way!



Save Money, Time, Trouble.
No technical skill required.

Cockaday Imp. (5 Tube) \$56.50
Cockaday Imp. (1 Tube) 19.50
Superdyne (4 Tube) 33.75
Neutrodyne (with Pada Kit) 46.25
Tobias (3 Tube) 33.50

FREE: KIT Katalog P-9A.

AMPLEX INST. LAB.
88 W. Broadway N.Y.C.



THE EXCLUSIVE CHOICE OF DR. MAC MILLAN for his ARCTIC EXPEDITION

Zenith Radio Corporation
328 South Michigan Avenue, Chicago, Ill.

What Size Grid Leak Shall I Use?

Don't Worry, Just Use a

TURN-IT ADJUSTABLE GRID LEAK

List Price \$1.00 Panel Control 50c
TURN-IT RADIO SALES, Inc.
30 Church Street, N. Y. See Page 58

Perfect Mastery of Radio



MU-RAD MA-15 RECEIVER

"'This rug, my master,' whispered the merchant to the third prince, 'will carry you wherever you will—instantly. Simply express the wish and you are immediately transported.'" —Arabian Nights Entertainment.

SIMPLE as wishing. "Magic" made Real in the new MU-RAD MA-15 RECEIVER. Programs from extreme distances easily selected with just ONE DIAL. The second dial controls volume. Louder distance reception. Everything you expect of radio and more.

Three stages of transformer coupled radio frequency amplification, detector and two stages of audio frequency amplification. Will not radiate. Panel-mounted voltmeter with button switch. Solid mahogany cabinet, with engraved Formica panel, hand polished, Adam Brown finish.

Write for Literature

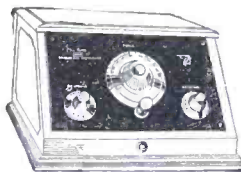

MU-RAD MA-18 RECEIVER

Two stages each of audio and radio frequency amplification. Wave length range 230 to 500 meters
PRICE \$110
 (without accessories)

MU-RAD LABORATORIES, INC.

809 FIFTH AVE. ASBURY PARK, NEW JERSEY

Please refer to POPULAR RADIO when answering advertisements.

Standard Insulation—Wherever Dials Turn

With every facility for testing materials used in radio work, the United States Signal Corps chose Bakelite for the potentiometer base here shown. We also illustrate a Rogers Radiometer, Kellogg Condenser and Fil-Ko-Stat, all of which are Bakelite insulated.

These critical radio experts, as well as the most inexperienced amateur, have come to

recognize the phrase "Made of Bakelite" as a guaranty of excellence in radio insulation.

Bakelite enhances the value of any radio set. Its high electrical resistance, stability and beauty of finish have led to its adoption as standard insulation by the large majority of radio manufacturers.

Send for a copy of our Radio Booklet K

Send for Our Radio Map

The Bakelite Radio Map lists the call letters, wavelength and location of every broadcasting station in the world. Enclose 20c to cover the cost, and we will send you this map. Address Map Department.

BAKELITE CORPORATION

247 1/2 Park Avenue, New York, N. Y.

Chicago Office: 636 West 22d Street

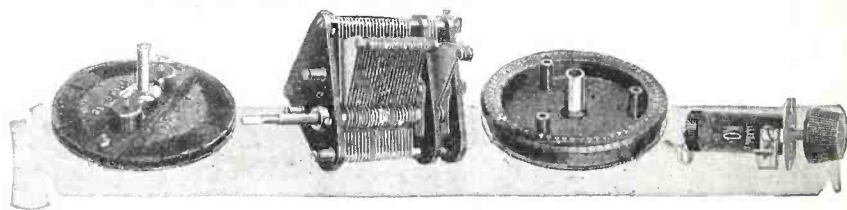

BAKELITE Condensite REDMANOL

are the registered Trade Marks for the Phenol Resin Products manufactured under patents owned by **BAKELITE CORPORATION**

THE MATERIAL OF A THOUSAND USES

\$27.50



STARTLING

Exceptional are results with a superheterodyne built around a Liberty R-40 Kit.

Range greatly increased. Easy to tune. Separate stations 3-5 meters apart. Tones pure and clear. Your expectations fulfilled.

Simple but complete data enable you to build an exact copy of a laboratory model. All details worked out.

Ask your dealer. If he can't supply you order direct. Liberty Kit carries a broad guarantee.

FREE Give your dealer's name and we will send complete plans, blue prints, etc., free.

Liberty Electric Corporation
Department 109

STAMFORD

CONNECTICUT



Then Get Our **FREE Bulletin No. 94**

It shows recent developments and improvements in parts, and the kind you must use if you want the best in Radio. Send for this book today.



SENT FREE

PREMIER PARTS

Quality Unsurpassed—For Every Known "Hook-up"
All Good Dealers Sell Them

Premier Electric Company

3807 RAVENSWOOD AVE., CHICAGO

Please refer to POPULAR RADIO when answering advertisements.

The NEW Heath NON-DIELECTRIC CONDENSERS

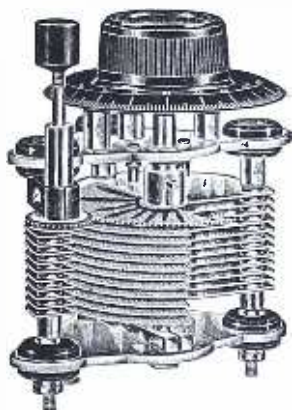

OLD fashioned dielectric end plates (insulating material) which waste condenser efficiency just as leaky piston rings waste gasoline, completely discarded in the new HEATH CONDENSERS. Grounded end-plates of aluminum entirely do away with the old difficulties of dielectric loss and warping of plates. No shielding necessary. Minimum Loss, all metal, except for the small pieces of hard rubber in the end plates which separate the rotor from the stator plates. Therefore extraordinarily rigid.

Permanently FLAT Plates

The well-known Heath process of stamping and tempering rotor plates—makes the new HEATH an instrument of lasting accuracy.

Micrometer Geared Vernier

Ordinary adjustments reduced by separate geared adjustment to hair breadth distinction. The most highly perfected vernier so far developed.

HEATH SOCKETS

With Shock Absorber Feature

Cushioning device entirely eliminates vibration. Bakelite base into which reinforced phosphor bronze, self-cleaning contacts are securely embedded. Binding posts are slotted hexagon nuts. HEATH standards of material and workmanship.

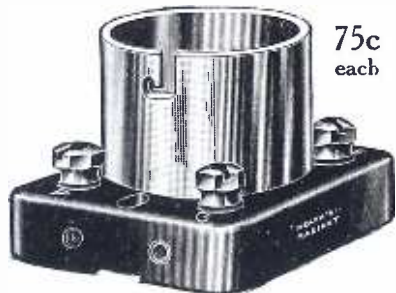

HEATH Bakelite Dial

Specially designed easy grip knob, beautifully proportioned, highly polished and clearly incised. Brass bushing centered by precision machinery to positive accuracy for perfect balance. Made in 2 inch, 3 inch and 4 inch diameters. A typical HEATH product.

Write Today for Literature

HEATH RADIO & ELEC. MFG. CO.
204 First Street
Newark, N. J.

*Simple Tuning
Three Controls*

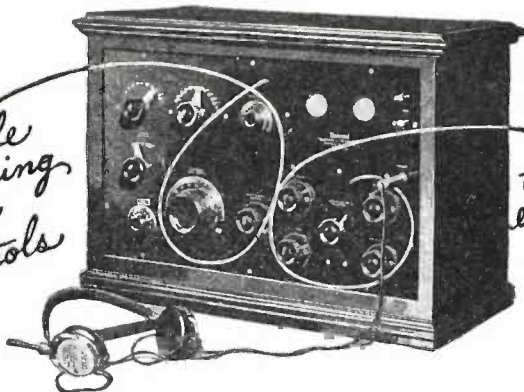

These to produce exceptional tone refinements

USERS enthusiastically proclaim the Federal 'Fifty-Nine' as 'Federal's Finest'—The 'Fifty-Nine' represents the accomplishment of an ideal after over a quarter century's

patient striving. It gives all the beauty of Federal Tone, Selectivity and Distant Range, plus a simplicity of operation that opens the real thrills of radio to novice and professional alike.

FEDERAL TELEPHONE AND TELEGRAPH COMPANY
Buffalo, N. Y.

Priced at

\$177

With headphones

For loop reception (No. 61)

\$46 Extra



Boston New York Philadelphia Pittsburgh
Chicago San Francisco Bridgeburg, Canada

Federal
Standard RADIO Products

Look for this sign



Simplify your Tuning

with

E-Z-TOON
(EASY TUNE)

RADIO DIALS

Stations that are hard to get are brought in quickly with E-Z-TOON dials. They give that vernier control so essential to easy tuning, selectivity, and long distance. They have a smooth, easy movement, no cogs, gears, back lash or lost motion.



There are two dials in one, the smaller one having a ratio of 50 to 1. This gives you closer tuning than you ever dreamed of before. Easily installed. Just take off old dials, slip on E-Z-TOON and tighten the screw.

3" dials \$2.00
4" dials \$2.25

Write for illustrated folder.

E-Z-TOON Radio Co.
3236 W. Washington St., Indianapolis, Ind.

AMPLEX

GRID-DENSER

GETS 'EM

ANY Set—Cockaday, Super Heterodyne, Superdyne, or Neurodyne—works better when equipped with GRID-DENSERS, the semi-variable-fixed condenser, for

Just by turning its knob you get the exact necessary capacity for maximum efficiency. So say Cockaday, Haynes, Greiff, Crosby and others.

Replace your fixed condensers with GRID-DENSERS and hear those DX stations come tumbling in.

Sizes .0005 Plain or with **1.25**

.001 Gridleak Clips

Write for Booklet P 9 Hook Ups FREE

AMPLEX INSTRUMENT LABS.

88W Broadway, New York, N.Y.

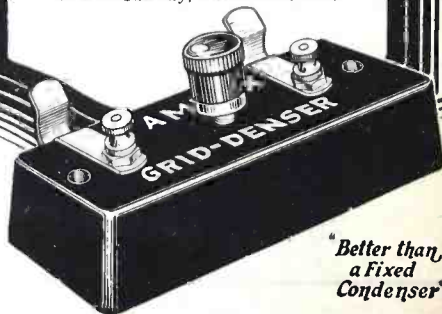

"Better than a Fixed Condenser"

Please refer to POPULAR RADIO when answering advertisements.

Balanced Transformers for Balanced Circuits



PRECISE
Transformers
for Best Results

Correctly designed, scientifically constructed; "laboratory instruments at commercial prices."

No. 800 In Put } Price
No. 801 Out Put } per Pair **\$11**

*Precise Power Amplifying
Transformers for "Push-
Pull" Audio Circuits*

The perfect amplification and volume of broadcast entertainment reproduced by these instruments attest to the extreme care used in the construction and balancing of coils.

Write direct or to the nearest branch or sales office. Our proposition is of unusual interest to Dealers and Jobbers.

Precise Manufacturing Corporation

Mfgs. of Complete Line of Radio Transformers

Rochester, N. Y.

Branches: 53 W. Jackson Blvd., Chicago, Ill. 821 Market St., San Francisco, Cal.

**Eastern Sales Office: Niagara Sales Corp., 3-5 Waverly Place,
New York City**

**Southern Representative: Saal Products Sales, Inc., 35 Warren
St., New York City**

**Canadian Distributors: Perkins Electric, Ltd., Toronto, Montreal and
Winnipeg**

30 Days' Trial—Precise Transformers are sold on 30 days' trial. If not satisfactory return and get your money back. Every transformer fully guaranteed for one year against mechanical defects.

Please refer to POPULAR RADIO when answering advertisements.

Takes the MYSTERY out of RADIO!

Just one book answers every question about this modern miracle



50,000 SOLD
514 PAGES

Compiled by
HARRY F. DART, E.E.

Formerly with the
Western Electric
Co., and U. S.
Army Instructor of
Radio.

Technically Edited by F. H. Doane

BE A RADIO expert—it's easy for the 50,000 who own this compact, complete Radio Handbook. Written in good, plain, understandable language. Crammed full of facts, every one useful and important. Explains how receivers and transmitters work, how to build and operate them. Whatever you or your friends want to know, it's here. Will save you many times its small cost.

TELLS ALL ABOUT: Electrical terms and circuits, antennas, batteries, generators and motors, electron (vacuum) tubes, every receiving hook-up, radio and audio frequency amplification, broadcast and commercial transmitters and receivers, super-regeneration, codes, license rules. Many other features.

Nothing else like it. Make this extraordinary book your radio library—just this one little giant is all you need. Everything in one index, under one cover, in one book, for one dollar. The biggest dollar's worth in radio to-day. Combines the knowledge of many expensive works. Buy this and save the difference. Stop experimenting in the dark. Before you spend another cent on parts or even touch a dial, sign and mail the coupon below and get this unique guide to successful radio.

Send \$1 to-day and get this 514-page I. C. S. Radio Handbook—the biggest value in radio to-day. Money back if not satisfied.

TEAR OUT HERE

INTERNATIONAL CORRESPONDENCE SCHOOLS
Box 8250-D, Scranton, Penna.

I enclose One Dollar. Please send me—post-paid—the 514-page I. C. S. Radio Handbook. It is understood that if I am not entirely satisfied I may return this book within five days and you will refund my money.

Name.....

Address.....



LOW LOSS CONDENSER

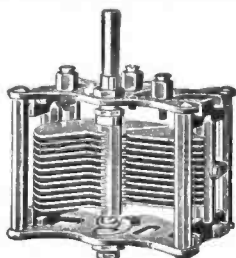

With losses far too low to measure—the new AMSCO rotor grounded condenser combines every point that the foremost radio engineers demand as being essential to a PERFECT condenser product.

Write for instructive booklet J

AMSCO PRODUCTS, Inc.

Broome and Lafayette Sts. New York

Buy

FIBROC PANELS

Because—

- They insure the lowest dielectric losses, and freedom from distortion.
- They are easy to work, will not warp, split or crack.
- They will make your set equal in appearance to the finest manufactured sets.

Fibroc Qualities



FIBROC IN BAKELITE

Ask your dealer for
FIBROC Panels

Write for special radio folder—
it contains helpful suggestions.

Fibroc Insulation Co.
257 Lincoln Ave.
Valparaiso, Ind.

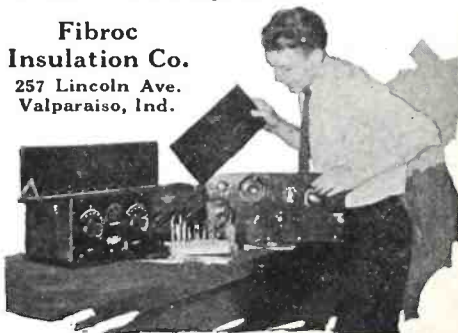

Please refer to POPULAR RADIO when answering advertisements.

They said it couldn't be done!

HERE

it is at

\$60

Clarity
Beauty
Volume
Distance
Selectivity

**A 5-TUBE SET,
TUNED RADIO FREQUENCY**

built of the finest low loss material and in a beautiful genuine solid mahogany cabinet at only *sixty dollars*.

*Ask your dealer for a free demonstration
Complete catalogue gladly sent on request*

**FRESHMAN
MASTERPIECE**



Chas. Freshman Co., Inc., 106 Seventh Ave., New York

Please refer to POPULAR RADIO when answering advertisements.

The Best Modern Performance At a Lower Price

Four Tube
Set
\$75.00



Five Tube
Set
\$120.00

The New Cleartone Goldcrest is a tuned and balanced radio frequency set whose performance has all the characteristics of the neutrodyne, which won such country wide popularity last year.

It is made in a plant where woodworking is an art and products of the highest beauty have been made for generations. So you can expect the most from its appearance and you will not be disappointed.

At the price it is the most outstanding value on the radio market today.

JOBBERs and DEALERs: Cleartone Goldcrest speaks for itself better than we can speak for it. Send for a sample. Examine and test it. Ask your customers what they think of it.

Model 60	\$60.00	Clear-O-Dyne Model 71	\$90.00
Model 61	75.00	Clear-O-Dyne Model 72	135.00
Model 62	120.00	Clear-O-Dyne Model 80	120.00
Clear-O-Dyne Model 70	75.00	Clear-O-Dyne Model 81	190.00

The Cleartone Radio Company, :: :: Cincinnati, Ohio.



**Use HOMMEL
SERVICE
to build your radio
business**

Hommel Service may be likened to a business "contractor". Brick by brick it erects a sturdy structure of radio business—a business that will very soon march shoulder to shoulder with the selling of phonographs.

Every music dealer is the logical outlet for radio supplies. This organization is your logical radio distributor. Our wide experience in this field and an almost inexhaustible stock of nationally known radio supplies, together with our liberal discounts and policy of wholesaling only is proof of that statement.

Our Dealer's Service Department too is always at the command of all Hommel Dealers.

Write for Hommel's Encyclopedia of Radio Apparatus No. 256-P

WHOLESALE **LUDWIG HOMMEL & CO** EXCLUSIVELY
929 PENN AVENUE  PITTSBURGH, PA.

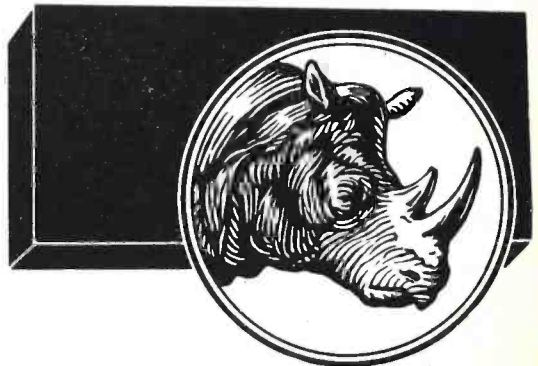

tough!

Bakelite-Dilecto has astounding mechanical strength; yet it is easily cut into perfect radio panels. Used by foremost radio set manufacturers.

bakelite-dilecto

Tell it by its Red Stripe

Resists heat, cold, water, oil, steam, solvents and all weather elements. Highest in dielectric strength. Always satisfies. Don't spoil your set's chances by using inferior material.

THE CONTINENTAL FIBRE CO.
Factory: Newark, Delaware

Service from:

New York, Woolworth Bldg. San Francisco, 75 Fremont St.
Chicago, Wrigley Bldg. Los Angeles, 307 S. Hill St.
Pittsburgh, 301 Fifth Ave. Seattle, 1041 Sixth Ave. So.

Please refer to POPULAR RADIO when answering advertisements.

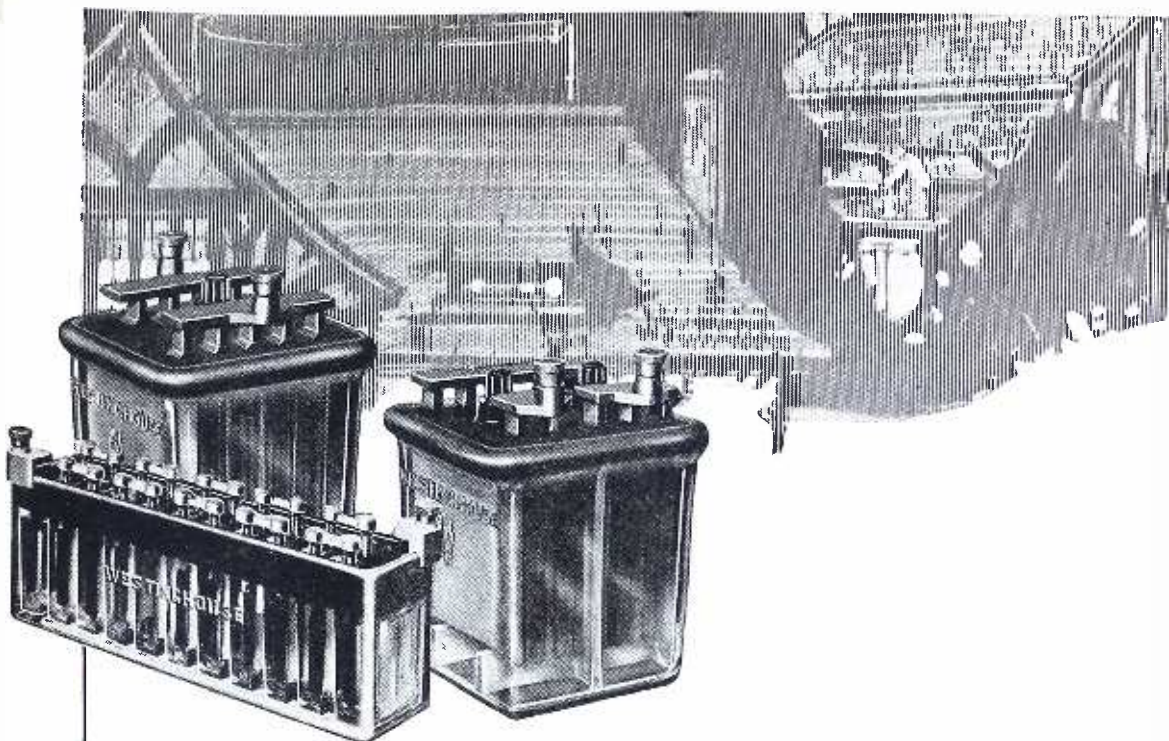

FULL voltage battery current all the time! That's what you want. Westinghouse Radio Storage Batteries will give it to you. No more operating with run-down batteries! No more sudden drops in battery voltage! No more throwing away worn-out batteries! Westinghouse Batteries last. They hold their charge. They can be easily recharged. There's a size and type for every radio need. Built by Westinghouse, you *know* it's **RIGHT!**

Westinghouse **CRYSTAL CASE** Batteries have one-piece clear glass cases, with solid glass cell partitions and high plate rests (deep sediment spaces). Perfectly insulated against current leakage. "A" Batteries. 2 volts, for low-voltage tubes, such as WD-11 and WD-12. 4 volts, for tubes like UV-199. 6 volts, for tubes UV-201A or C-301A. Also rubber-case types. "B" Batteries. 22 volts. Regular and quadruple-capacity types. "C" Batteries in 6-volt units.

WESTINGHOUSE UNION BATTERY CO., Swissvale, Pa.

WESTINGHOUSE

RADIO

"A," "B" and "C"

BATTERIES

Please refer to **POPULAR RADIO** when answering advertisements.

Achievement!

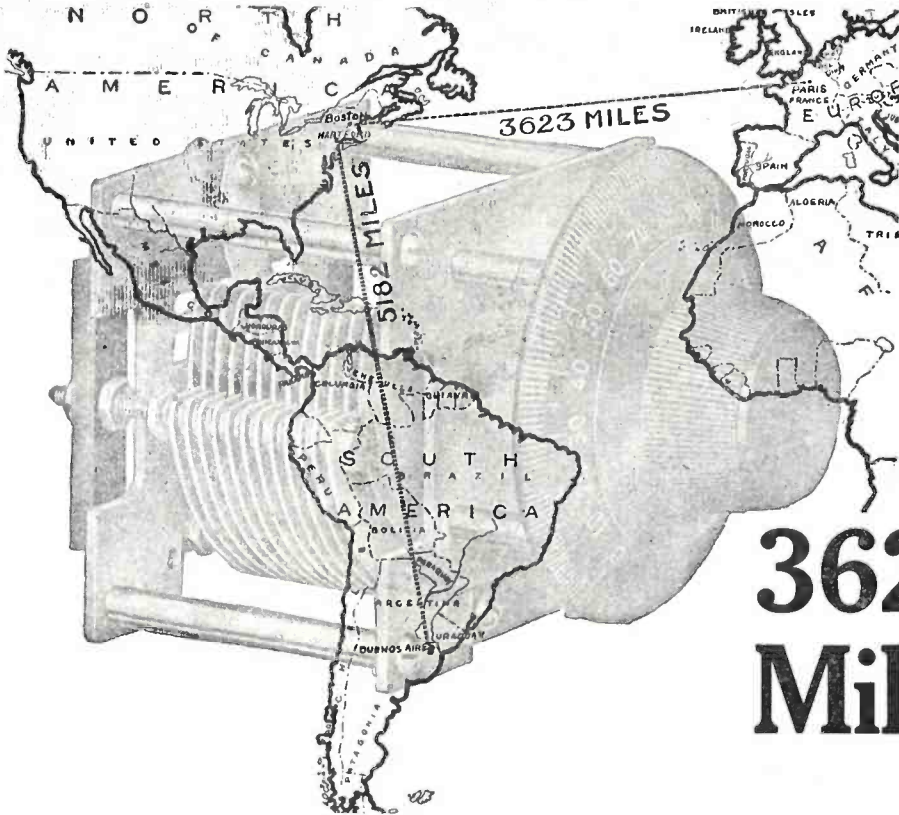

3623 Miles

This record was made by two amateur-built receiving sets (builders' names on application) in which NATIONAL CONDENSERS AND VELVET VERNIER DIALS were a part.

It is only by careful selection of parts that such an achievement is possible.

Size--	.001	.0005	.00035	.00025
Prices--	\$7.00	\$6.00	\$5.75	\$5.50

Complete with Velvet Vernier Dial. Write for Bulletin No. 104 E.

Made by
NATIONAL COMPANY, Inc.
 Established 1914

Engineers and Manufacturers
 Cambridge 39, Mass.

CARTER "HOLD-TITE" JACK

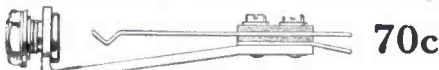

70c

Guarantees you full strength of signal on account of its perfect insulation. There are no losses when Carter Jacks are used.

Insist on the original.
 Any dealer can supply
 In Canada--Carter Radio Co. Ltd.--Toronto

Carter Radio Co.
 1807 REPUBLIC BUILDING
 CHICAGO

UNITY VERNIER RHEOSTAT



The Highest Type
 Instrument Made

Any Resistance \$2.00

"Hear a Set
 That Uses One"

ELIMINATE THE NOISES IN YOUR SET

The book "TUBE CONTROL," written for the amateur, and for the benefit of Radio Reception, by J. Elliott Jenkins, Engineer of Broadcasting Station W. D. A. P. will tell you how to clear up your signals.

Every set owner should have this book.

10c at your dealers, or 14c postage to
 UNITY MFG. CO., 224 N. Halsted St., Chicago
 NEW YORK OFFICE: 50 Church Street

Please refer to POPULAR RADIO when answering advertisements.



*The Most Beautiful
Set in America*

\$150

MICHIGAN FOUR

“The most beautiful set in America” is the unanimous opinion of everybody who has seen this powerful four tube set.

And added to its beauty—Radio reception of unusual quality.

The Michigan controls give the closest vernier adjustment obtainable; greater selectivity; longer distance; and unusual simplicity of operation.

The same stations can always be brought in at the same positions of the dials. Logging is simple and sure.

The beautiful mahogany case has an inlaid crotch mahogany drop panel, a built-in loud speaker, and ample room for batteries. The set and accessories are self-contained. The loud speaking unit is adjustable to meet all strength of signals, and has an unsurpassed and pleasing tone-quality.

The set is non-radiating, and operates equally as well with standard 6 volt or dry cell tubes.

Different styles and types from \$27.00 up.



**Michigan “Midget”
M. R. C. 10**

1 tube Regenerative long distance wonder \$27.00.



Michigan M. R. C. 12

3 tube Regenerative Detector and 2 stages of amplification. \$57.00.

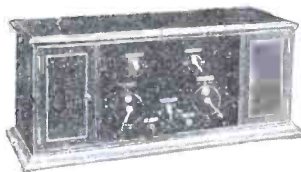

Michigan M. R. C. 3

3 tube receiver in handsome case with inlaid panel door, and compartments for batteries, headphones, etc. \$87.50.

Licensed under Armstrong U. S. patent 1,113,149 and pending letters of patent 807,388.

MICHIGAN RADIO CORPORATION

33 Pearl Street,

Grand Rapids, Mich.

Please refer to POPULAR RADIO when answering advertisements.

SAVE MONEY

Because of advances in price already announced these special offers are limited to 30 days' acceptance.

NOW is the time to subscribe for your favorite magazines or to renew your current subscriptions regardless of when they expire. No matter what you read, you will find practically every magazine has made a drastic cut in price for this short period preceding the annual rush season.

POPULAR RADIO can be had at a genuine saving with every magazine listed on this page. Or if you wish to include other magazines not named, submit your complete list for our lowest price on them all—*our price is the lowest obtainable anywhere.*

All combinations not starred (*) may go to separate addresses, which enables you to utilize these money saving offers for gift purposes or for making up a neighborhood order.

Just check the combination of magazines you want, sign the slip below and mail promptly with your remittance.

POPULAR RADIO

627 West 43rd Street, New York City, N. Y.

POPULAR RADIO, Dept. 92,
627 West 43rd Street, New York City.

Enclosed is \$..... Please see that yearly subscriptions are at once entered in my name for each of the magazines I have checked in the special bargain club list at the right.

Name.....

Street and Number.....

City..... State.....

(If not a NEW subscription, please mark R after the name of the magazine, to indicate RENEWAL.)

Prices for Canada and foreign countries will be quoted on request.

McCall's Popular Radio \$4.00 Reg. For..... \$3.25	Modern Priscilla Popular Radio \$5.00 Reg. For..... \$3.95
Youth's Companion (52 issues) Popular Radio \$5.50 Reg. For..... \$4.50	Judge Popular Radio \$8.00 Reg. For..... \$5.50
*American Magazine *Woman's Home Companion Popular Radio \$7.00 Reg. For..... \$5.60	Pictorial Review Modern Priscilla Popular Radio \$6.50 Reg. For..... \$4.95

Or You Can Make Up Your Own Club of POPULAR RADIO With:

American Boy.....	5.00 reg., for...	\$4.35
American Magazine.....	5.50 reg., for...	4.85
Boy's Life.....	5.00 reg., for...	4.10
Christian Herald (52 issues).....	5.00 reg., for...	3.85
Collier's (52 issues).....	5.00 reg., for...	4.10
Cosmopolitan.....	6.00 reg., for...	5.35
Delineator.....	5.00 reg., for...	3.85
Designer.....	4.50 reg., for...	3.45
Film Fun	5.00 reg., for...	4.10
Good Housekeeping.....	6.00 reg., for...	5.35
Hearst's International.....	6.00 reg., for...	5.35
House & Garden.....	6.50 reg., for...	5.60
*Judge	8.00 reg., for...	5.50
Live Stories	5.00 reg., for...	4.10
McClure's.....	6.00 reg., for...	4.85
National Geographic.....	6.50 reg., for...	5.85
People's Home Journal.....	4.00 reg., for...	3.15
Physical Culture.....	5.50 reg., for...	4.60
Popular Science Monthly.....	5.50 reg., for...	4.85
QST.....	5.00 reg., for...	4.20
Radio.....	5.50 reg., for...	4.60
Radio Broadcast.....	6.00 reg., for...	4.85
Radio Digest (52 issues).....	8.00 reg., for...	6.85
Radio News.....	5.50 reg., for...	4.60
Radio World (52 issues).....	9.00 reg., for...	7.35
Scientific American.....	7.00 reg., for...	5.60
Snappy Stories	7.00 reg., for...	5.60
Today's Housewife.....	4.00 reg., for...	3.10
Vogue (26 issues).....	8.00 reg., for...	6.85
Wireless Age.....	5.50 reg., for...	4.60

*Must go to one address:

Note: If you wish any TWO or more of these magazines with POPULAR RADIO, simply deduct \$2.35 from the bargain club price quoted, then add POPULAR RADIO at \$2.35. For example:

Christian Herald.....	\$3.85 less \$2.35=	\$1.50
Radio.....	4.60 less 2.35=	2.25
POPULAR RADIO, added at only.....		2.35

Remit this amount **\$6.10**

Please refer to POPULAR RADIO when answering advertisements.

The amazing Telomonic principle

*now made surprisingly simple
for you to construct!*

FANS who build them all—pick Telos as the “most sensitive and most perfectly stabilized set.”

G. Dwight Cabot, of the Revere Trust Co., says it is “the best thing I ever operated, as to selectivity, quality of tone, or volume.”

An electrical engineer, S. S. Hertz, reports “the clearness of reproduction, of both voice and music, was remarkable—better than I have ever obtained”

Even under adverse conditions—the results are astonishing. The performance of a Telos set on the Cornell Special of the D. L. and W. prompts the operator in charge to write: “Previous results, **with greater tube equipment**, never brought in greater than 400 mile distances, whereas Friday night we found it necessary to drop to the



detector for Chicago, Montreal and Cincinnati.”

Such are the results that trained engineers, who are thoroughly competent to judge, get with Telos.

But now anyone with the slightest mechanical bent can easily duplicate these performances. An “Easy-built” Telos Kit will be ready about September 10th. It will contain all the essential parts for 3 stages of Telos tuned R. F., 2 stages of resistance coupled A. F., with either crystal or vacuum tube detector. Either UV 199, or DV 3 tubes may be used throughout. The actual construction is so simplified, and so plainly marked out for you, that building a record-breaking outfit is merely an afternoon’s fun—and you will be surprised to find how inexpensively you can build it complete this way.

A folder is now ready that pictures the Telos Kit, and tells all the facts you want to know. It’s free, but the edition is limited to those who are genuinely interested in building a better set. The coupon below is for your convenience. Use it—or write —to-day.

Telos Radio

Danziger-Jones, Inc.,
Dept. A, 25 Waverly Place,
New York, N. Y.

Send me a copy at once of your new booklet describing the Telos Kit.

Name

Address

Please refer to POPULAR RADIO when answering advertisements.

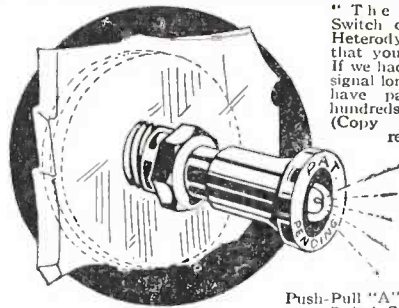

"The Kant-Blo Switch on our Super-Heterodyne does all that you claim for it. If we had installed this signal long ago it would have paid for itself hundreds of times." (Copy of letter on request.)

Push-Pull "A" Battery Switch Style

YOUR MONEY BACK IF YOU BLOW A TUBE

When your radio set is equipped with a Kant-Blo

Kant-Blo

Only one Kant-Blo needed to protect any number of any kind of radio tubes

SWITCH SIGNAL BINDING POST
"Lights on any Short Circuit"

The Kant-Blo Signal is easily installed. Simply takes the place of either the ordinary push-pull "A" Battery Switch or one "B" Battery Binding Post now on set. Kant-Blo Signals—both Binding Post Style and Switch Style—are at all the best radio stores. If your dealer is out of stock send us \$2 for a Kant-Blo Binding Post Style, or \$3 for the Switch Style, and we will ship any number of KANT-BLOS direct to you, charges prepaid.

Sole Distributors
APEX RADIO COMPANY

Suite 208, 503 Fifth Ave., New York, N. Y.
Manufactured by Gano, Kramer Co., Inc., New York

HAMMARLUND VERNIER VARIABLE CONDENSER

Will Increase Your Range and Volume
ELIMINATES INTERFERENCE

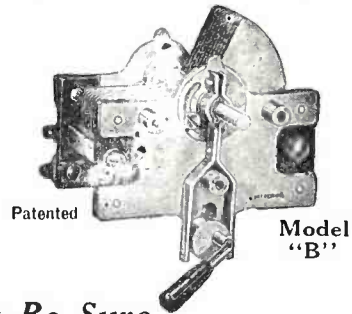

"Just Be Sure
It's a Hammarlund"

- | | |
|------------------------------------------|------------------------------|
| (1) Lowest losses (too small to measure) | (4) Rotor grounded to frame |
| (2) Micrometer Vernier | (5) Adjustable cone bearings |
| (3) Soldered brass plates | (6) Double wiping contacts |
| | (7) Takes any size dial |

Write for New and Interesting Folder

HAMMARLUND MFG. CO.
144-146 W. 18th Street, New York

Canadian Representatives
RADIO LIMITED, Montreal, Que.

If It Isn't Here—Ask Cockaday

WE make every effort to keep a supply of back numbers of POPULAR RADIO in stock as they contain a wealth of current information that is frequently sought, but which, having been printed once, cannot be published again. A condensed index appears below, and if the information you want is listed we'll gladly supply any issue on receipt of your remittance of 35c. a copy.

On the other hand, many problems arise that are peculiar to the individual case. As such they would not prove of sufficient general interest to warrant pub-

A full reprint of Mr. Cockaday's original 4-Circuit Tuner and the Tuned Radio Frequency Receiver will be found in "How to Build Your Radio Receiver" advertised on page 86.

January, 1923 (Out of stock.)

(A Reprint of Mr. Cockaday's article describing the DX Regenerative Receiver may be had for 25 cents.)

September, 1923

- How to get a radio license.
- How weak signals are regenerated.
- How to make a battery charging rectifier.
- How to build the Haynes DX receiver.

October, 1923

- Practical hints for Coil Calculations.
- How to make a Two-stage Audio-frequency Amplifier.
- Ten good rules for Broadcast Listeners.
- How to make a simple Honeycomb Receiver.

November, 1923

- The 100 Best Hook-ups (Part 1).
- Receiving without Antennas.
- How to build the New Regenerative Super-heterodyne Receiver (Part 1).
- How to build a combination Short and Long-wave Receiver.

December, 1923

- How to Select your Radio Parts.
- The 100 Best Hook-Ups (Part 2).
- How to Read a Diagram (Part 1).
- How to build an efficient Crystal Receiver.
- How to Build the Super-heterodyne Receiver (Part 2).

January, 1924

- How to Build the Improved Four-circuit Tuner.
- How to Read a Diagram (Part 2).

February, 1924

- How to add "Push and Pull" amplification to the 3 tube Cockaday 4-Circuit tuner.
- The original 4-Circuit Tuner as a Portable Set with Loop.
- How to build a 3-tube Reflex Receiver.

April, 1924

- How to Build a Simplified Neutrodyne.
- A Novel Substitute for "B" Batteries.

May, 1924

- A Compact Radio Kit for a Spring Hike.
- How to Get the Maximum Radio-frequency Amplification.
- Where Interference Comes In.
- How to Make an Audio-frequency Amplifier that Does Not Distort.

June, 1924

- How to Install a Receiver on your Boat.
- How to Make Your Own Grid Condensers.
- How to Build a Regenerative Receiver for Use with an Indoor Antenna.
- How to Make a Two-Slide Tuner.
- How to Calculate the Wiring of Coils

July, 1924

- How to Avoid Local Interference.
- How "Resistance" Affects Radio Circuits.
- An Ideal Set for Summer-time Reception.
- How to Build the POPULAR RADIO Portable.

lication. But if you will submit any such problems to the Technical Service Bureau, which is under Mr. Cockaday's personal supervision, you will receive a prompt answer by return mail. Please confine your questions to one general subject, write on one side of the sheet and enclose a stamped, addressed return envelope.

This personal Service is free to all subscribers and you may write as often as you wish. To readers, other than subscribers, the same Service is available upon payment of a nominal charge of 50c. per inquiry.

POPULAR RADIO, Inc.

627 West 43d Street

Dept. 98

New York City

Please refer to POPULAR RADIO when answering advertisements.

Choose the safe— and leak-proof way

THE amount of radio energy you actually conserve by using MAR-CO parts may be small. The difference between MAR-CO precision and parts of unknown quality can scarcely be recognized when you buy them.

Using MAR-CO parts may mean that you get just one or two more stations out of a hundred. But those one or two are almost sure to be DX stations or special programs you particularly want to get.

It costs virtually no more to choose the safe and leak-proof way—specify MAR-CO whenever you buy plugs, jacks, switches, condensers, and other small parts. Martin-Copeland Company, Providence, R. I.

Phones and Speaker

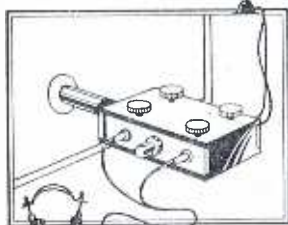

on the same
plug

One plug now serves for both phones and speaker. Both are permanently connected—and the handy switch shifts reception from one to the other instantly! A big step forward in plug design! You'll wonder why you ever put up with inconvenience of two separate plugs!

MAR-CO
SWITCH PLUG \$1.00



When the Phone rings

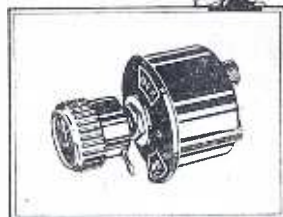

No modern set lacks the convenience of a MAR-CO filament battery throw switch. Its definite on and off positions make it far superior to any pull switch. Saves tubes and batteries—you don't forget to turn them off! Saves annoying interruptions when you only want to stop reception for a minute!

\$1.00

SHUR-GRIP JACKS

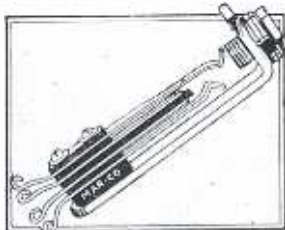

with hooked terminals—make set construction easier—short circuits impossible—and leak-proof connections permanent!

Formica insulation thruout—heavily nicked finish—sterling silver contacts—five types—60 cents to \$1.00—and mighty well worth the difference!

Please refer to POPULAR RADIO when answering advertisements.



CELESTO PANEL

Shadow Black
comes in these
sizes:

7x9	7x30	6x24
7x10	7x40	6x26
7x12	6x9	6x28
7x14	6x10	6x30
7x18	6x12	6x40
7x21	6x14	8x12
7x24	6x18	8x40
7x26	6x21	9x28
7x28		

CELESTO "SHADOW BLACK"

THIS is the most beautiful radio panel ever developed! All the unsurpassed insulating qualities of genuine Hard Rubber..... and striking beauty besides.

SHADOW BLACK Celesto Panels *cannot* scratch; they *cannot* show finger marks.

No illustration can convey to you the actual beauty of SHADOW BLACK Celesto Panels. Go to your dealer today and inspect them!

TRIANGLE RUBBER & SUPPLY CO.
68-74 South St., Boston, Mass.

Myers Get Every Station

Amateurs can get practically every station on this continent with a one Myers Tube Set. We have verified records on file to prove it.

No bunched leads—hence no noise, tube hiss or interference—make Myers Tubes supreme for clarity of reception of long-distance stations.

Practically Unbreakable

Two types: for dry and storage batteries. Complete, ready to mount and absolutely guaranteed.

Demand Myers Tubes at reliable dealers. Otherwise send price and be supplied post-paid.

See "Made in Canada" on every genuine Myers Tube.

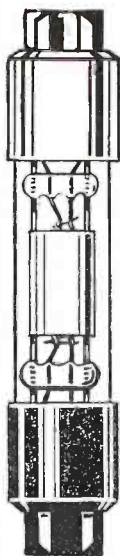

E. B. Myers Co. Ltd.
Radio Vacuum Tubes
Montreal, Canada

A C H LONG DISTANCE ONE TUBE SET

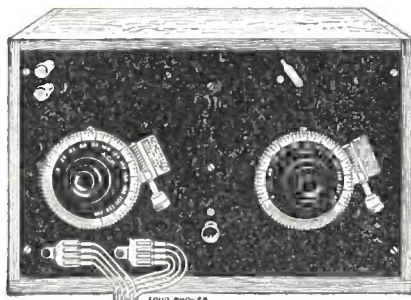

\$17.50 Mail Orders Only

Price includes Case and Parts, all mounted, ready to wire. No Solder. For Dry Cell Tube.

Including

- 2 A. C. H. Sharp Tuners.....\$5.00
- 2 A. C. H. 4-Phone Connectors.....25

NOTE—\$2.00 must be sent with
C. O. D. Orders

YES—Use the Wonderful A C H
Sharp Tuners

A. C. Hayden Radio & Research Co.
25 E. Battle St., Brockton, Mass., U. S. A.

Please refer to POPULAR RADIO when answering advertisements.

HOW TO BUILD THE POPULAR RADIO PORTABLE

Here is a practical portable receiver—developed by the technical staff of Popular Radio—that is not merely a summer set, for use indoors and out-of-doors, but which will be found to be a highly efficient loop receiver that can be used all the year round, for both local and DX reception. The set can be used at home or put into its carrying case and used on the automobile, the boat or anywhere where a suitcase can be carried.

By LAURENCE M. COCKADAY, R.E.

COSTS OF PARTS: About \$100.00
APPROXIMATE RANGE: Daytime 150 miles, night, 1,500 miles
HERE ARE THE ITEMS YOU WILL NEED—

- A—Marion loop antenna, with plug attachment.
- B—National variable condenser, .00035 mfd.
- C—Aurora potentiometer, 400 ohms.
- D—Unity volume rheostat, with "off and on" switch.
- E—Hoyt voltmeter, 0 to 6 volts scale.
- F1, F2 and F3—Dahmer Duratran radio-frequency transformers.
- G1—Jefferson No. 45 audio-frequency transformer.
- G2—New York Coil audio-frequency transformer.
- H1, H2, H3, H4, H5 and H6—Benjamin vibrationless sockets for 199 tubes.
- I1—Patent jack, single-circuit.
- I2—Patent jack, double-circuit.
- J—Panel, 10½ inches by 15½ inches.
- K—Cabinet, dimensions as given in Figure 8.
- L—Carrying case, dimensions as given in Figure 8.
- M1, M2, M3, M4, M5 and M6—C-299 or UV-199 dry-cell tubes.
- N—Holt Seal dry batteries, No. 6 each, 16 volts (six required).
- O—2½ volt (100-ohm) No. 263, call.
- P—Timbretone loudspeaker.
- Q—New York Coil mic. plug for grid-leak.
- R—Daven grid-leak, 5 megohms.
- S—Eveready "C" battery, No. 271, 45 volts (one required).
- T—New York Coil mica fixed condenser, .001 mfd., with lugs.

HOW TO BUILD THE POPULAR RADIO PORTABLE

THE ELECTRICAL WIRING SCHEME

FIGURE 174. The electrical wiring scheme for the Popular Radio Portable. Notice the various instruments which are used in the complete circuit. Notice the diagram is drawn to show exactly as it goes into the set when assembled.

THE summer is the time when all the radio equipment we own is used. It is the time when we are out of doors more than in. It is the time when we are at some time of the year, in the city house, with the radio set, for the night, for the day, for the week, for the month, for the year, for the life-time. Some of us, who throw ourselves into winter and another set, and some of us prefer to mount a camp, for some prefer to go to the seashore, some go to the shore who merely want to be there in the summer heat, to be able to listen to a radio set! For this reason, many have considered it as a winter sport, an indoor sport. This is only a mistake. For radio broadcasting that fills an important place in our lives. If we could have a radio set that we could use at the seashore, we could have a lot of pleasure and health to us. It is not a toy and it is not an expensive thing. It is practical, it is efficient, and it is the best thing you can make it and anyone can make it work. It is by using one tuning control.

BEING an instrument, built according to acoustic requirements, it is meeting the higher standards demanded by the Radio Public, for a reproducer of Radio programs. Made entirely of wood and finished in Mahogany.



Made in Hoosick Falls, N. Y., by the Timbretone Mfg. Co.

Please refer to POPULAR RADIO when answering advertisements.

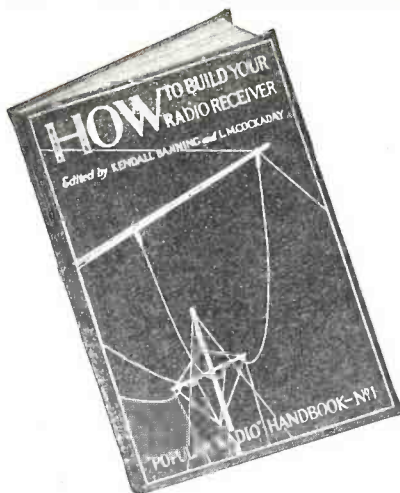

Offer Extended 15 Days
POPULAR RADIO
 7 Months for \$2.00

Including copy of this big 100-page Handbook in full cloth binding.
"How to Build Your Radio Receiver"
 Compiled by Kendall Banning and L. M. Cockaday

It Is Cheaper to Build Than to Buy

HALF the fun of radio lies in building your own receiving set. There is a fascination not easily described in listening to broadcast programs through a set that you have constructed yourself. And aside from this you will find that by utilizing your spare time in a very interesting way you have effected a real economy.

POPULAR RADIO is all that the name implies. Its articles cover technical subjects in language that the uninitiated can understand and enjoy. The charts, photographs, diagrams and detailed descriptions take all the mystery out of radio and enable the veriest beginner to experiment with new hook-ups and get the same results as our own laboratory.

"How to Build Your Radio Receiver," is compiled in the same style. A half hour spent in absorbing the first half dozen pages will make it possible for you to start right in and build any of the seven types of receivers presented. There is no guess work involved. A list of the few simple tools required, and every part specified by brand name makes mistake impossible. It is a real instruction book and as such is invaluable as a reference volume.

An Attractive Combination Offer

For a limited time this big book will be included with a seven months' subscription for POPULAR RADIO, which will give you all the privileges of the Technical Service Bureau explained on page 80. All for \$2.00. POPULAR RADIO carries only satisfied readers, so bear in mind that you run no risk and mail your remittance today without fail.

Dept. 95
 Popular Radio
 627 West 43d St.
 New York City

Enclosed remittance of \$2.00 is payment in full for a 7 months' subscription for POPULAR RADIO. Also send me all charges paid, a copy of your 100-page, cloth-bound book, "How to Build Your Radio Receiver," by Kendall Banning and L. M. Cockaday.

Our unconditional guarantee protects you entirely. If you are not more than satisfied, notify us within ten days and your remittance will be returned in full.

Name.....
 Address.....
 City.....State.....
 Offer expires September 10, 1924.

In "How to Build Your Radio Receiver" you will find complete constructional diagrams, specifications, photographs and instructions for building the following sets. Each has been selected as representative of its circuit because in laboratory tests it proved the best for distance, selectivity, tone volume, simplicity of construction, ease in tuning, reliability and all-around satisfaction.

A \$5 CRYSTAL SET

The simplest up-to-date set for local broadcast reception. Approximate range, 15 miles, though distances up to 400 miles are not extraordinary. Gives clear signals on headset without distortion. No operating cost whatever.

THE HAYNES SINGLE TUBE RECEIVER

An efficient set that may be made by a novice at an approximate cost of only \$15 for parts. Simple to tune, selective, good audibility. Long distance range up to 1,000 miles on earphones. Six-volt storage battery and 22½-volt "B" battery required, or may be adapted for dry cells and dry cell tubes.

A TWO-STAGE AUDIO-FREQUENCY AMPLIFIER

This instrument may be added to any set, crystal or tube, to strengthen the received signals, so that they will operate a loud-speaker. It is easy to construct, efficient and inexpensive, costing only \$15 for parts. Operates on the same "A" battery that is used on the vacuum-tube detector unit.

THE COCKADAY 4-CIRCUIT TUNER

A 3-tube set, famous for its high selectivity and beautiful tone. So neat and compact that it may be kept in a bureau drawer. Cost of parts about \$30. Receiving range approximately 1,500 miles on a loud-speaker. Operates on a 6-volt storage battery and two 45-volt "B" batteries, or may be adapted to dry cells and dry cell tubes.

A 5-TUBE TUNED RADIO-FREQUENCY RECEIVER

Two stages of tuned radio-frequency amplification, detector, and two stages of audio-frequency amplification are here employed so that the possibility of "oscillation and re-radiation" is eliminated. The set can be operated on a loop antenna and may be built at a cost of only \$90 for parts. Six-volt storage battery and two 45-volt "B" batteries required. Range about 1,000 miles on loop or indoor antenna, and 2,500 to 3,000 miles on an outdoor antenna.

THE "IMPROVED" COCKADAY 4-CIRCUIT TUNER

Probably the most important contribution yet made to the equipment of the radio fan. A compact 5-tube set with a receiving range of over 3,000 miles. Cost of parts about \$95. Wavelengths range from 150 to 675 meters. Automatic tuning and power amplification. Maximum volume of sound, excellent reproduction and no interference. Requires a 6-volt "A" battery, three 45-volt "B" batteries, one 22½-volt "B" battery and a 9-volt "C" battery.

THE REGENERATIVE SUPER-HETERODYNE RECEIVER

More sensitive, more selective and more simple to tune than any other 6-tube receiver yet developed. A three-section, 6-tube set employing the Haynes Single Tube Receiver as tuner. May be further extended to a four-section, 8-tube set by the addition of the two-stage audio-frequency amplifier. The cost of parts approximately \$100. Range of 3,000 to 4,000 miles on a loud-speaker. Has been called the "Rolls-Royce" of radio receivers.

POPULAR RADIO

627 West 43d Street :: New York City

Please refer to POPULAR RADIO when answering advertisements.

Do You Want Improved Reception?

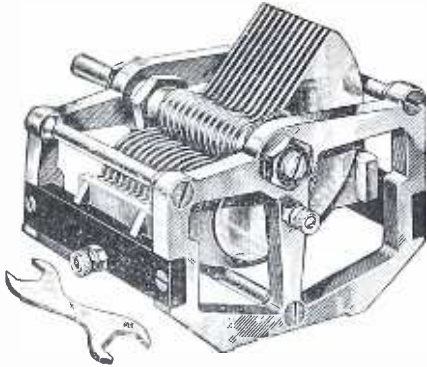

13 plate \$4.50
 23 plate 5.00
 35 plate 6.50

We guarantee you'll find in the Bremer-Tully "Lifetime" Condenser, more advanced features, more vital improvements more essential advantages than any other.

No matter what circuit you're using this condenser will improve it. This product is electrically perfect and mechanically beyond comparison. The only low-loss condenser that gives real straight line wave length. Better and simpler tuning.

Examine it at your dealers. Write for "20-point" folder; it gives the details.

Bremer-Tully Leads Again With a Real Low-Loss Tuner

This is the original Bremer-Tully product, already known as the first "tuner", but *improved* with the new B-T method of inductance winding and the new adjustable untuned primary which gives results heretofore impossible.

Low dielectric losses, windings supported with least possible insulation.

Adjustable untuned primary successfully meets the great problem of the past—that of adapting a tuner to the various types of antennae, circuit requirements and local receiving conditions.

Adjustments permit greater selectivity or increased signal strength as desired.

A new support providing either panel or base mounting. Single hole mounting can be used if desired.

A new adjusted lubricated cone bearing. Binding Post connections—with tinned soldering lugs.

Adjustable to any circuit requiring a tuner. Two Types *Broadcasting* 200-565 meters. For short wave work 50-160 meters.

Price \$5.00

Bremer-Tully Mfg. Co., 534 S. Canal St., Chicago

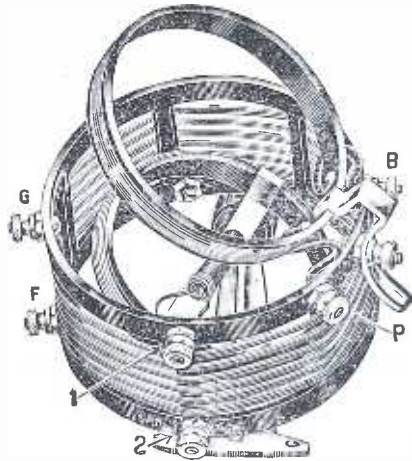

"Better Tuning" (now in sixth edition) packed with each tuner or sent on receipt of ten cents. Tells you why and shows you how.

Complete instructions and diagrams for progressive construction from Crystal to Reflex and Radio Frequency circuits.



12 Cells
24 Volts
Solid
Rubber
Case

\$4.00⁰⁰ COD SPECIAL

INTRODUCTORY PRICE
For a limited time *only*, and to introduce this new and superior Storage "B" Radio Battery to the Public, we are selling it for \$4.00. Regular Retail Price is \$5.00. You save \$2.00 by ordering NOW. A finer battery cannot be built than the

World Storage "B" Battery
(12 CELLS—24 VOLTS)

To ten million homes with Radio Sets—and to countless millions of prospective buyers—this WORLD Storage "B" Battery brings a new conception of battery economy and performance. Here is a battery that pays for itself in a few weeks—will last for years and can be recharged at a negligible cost. *And you save \$2.00 by ordering now.*

A Superior Battery Equipped With Heavy Duty C-1-8 in. x 1 in. x 1/4 in. plates and plenty of acid circulation. Extra heavy glass jars allow ready observation of charge and prevent leakage and seepage of current. It holds its charge, while idle, at constant voltage. You will find this battery a boon to long distance reception. It does away with a great many noises so often blamed on "static." Mail your order today.

SEND NO MONEY

Just state number of batteries wanted and we will ship day order in received. EXTRA ORDER: 4 batteries in series (36 volts), \$16.00. Pay Expressman after examining batteries. 5 per cent discount for cash in full with order. Send your order NOW and save \$2.00.

WORLD BATTERY COMPANY

Makers of the famous World Radio "A" Storage Battery
1219 S. Wabash Ave., Dept. 77, Chicago, Ill.

SAVE \$2.00 BY ORDERING NOW!

**Buy with Care
and You
Can Build with
Satisfaction**



- C-H 4 Ohm Rheostat
- C-H Potentiometer
- C-H Vernier Rheostat
- C-H Radio Switch
- C-H 30 Ohm Rheostat
- C-H Grid Leak

"Built by The Master Builder"

CUTLER-HAMMER

NEW SIMPLIFIED BLUEPRINTS

Insure ease, accuracy and economy in construction

Each set consists of three prints: (A) Panel Pattern; (B) Instrument Layout; (C) Wiring Diagram.

Panel Pattern.

This blueprint is the exact size of the actual set. So accurate that you need merely lay it on your panel and drill as indicated. You can readily appreciate the convenience of this Blueprint. No scaling to do, no danger of ruining the panel through faulty calculation.

Instrument Layout.

Again you have an actual size print of each instrument and binding post and its exact location both on the panel and within the cabinet. Even the cabinet structure is clearly shown.

Wiring Diagram.

The unusual feature of this blueprint is that it is a full size picture diagram of the finished set. Each instrument or other part appears exact size and the wires are so clearly traced from one contact to another that you can connect all terminals accurately without even knowing how to read a hook-up diagram.

Blueprints Ready.

At the present time three sets of Blueprints are available and have been priced at the very low figure of \$1.10 per set, post-paid. Each set consists of three Blueprints and we cannot break a set to supply single prints.

"Improved" Cockaday 4-Circuit Tuner was described in the January, 1924, issue of POPULAR RADIO. It is a simplified regenerative set that can be built with about \$95.00 worth of parts. It provides for automatic tuning, practically unlimited distance range, maximum volume, excellent reproduction and no interference.

Set of three constructional Blueprints, \$1.10.

The Non-Regenerative (Simplified Neutrodyne) Tuned-Radio-Frequency Receiver, described in the April, 1924, issue of POPULAR RADIO, can be built with parts costing about \$70.00. This circuit has remarkable sensitivity and is notable for its ease of control, distance range and clarity of reception.

Set of three constructional Blueprints, \$1.10.

In the May, 1924, issue of POPULAR RADIO, is a complete description of an Audio-Frequency Amplifier. This is a newly developed type of amplifier that is entirely unmarred by distortion. The parts will cost about \$45.00. Blueprints further simplified by showing circuit diagrams in right-to-left sequence—the way you build.

Set of three constructional Blueprints, \$1.10.

For convenience use the coupon below in ordering sets of Blueprints. If you desire any of the descriptive articles mentioned above, enclose 35c additional for each article wanted. Complete list on page 80.

POPULAR RADIO, Inc., Dept. 94
627 West 43rd St., New York City Date.....

Enclosed is my remittance of \$....., for which kindly send me Blueprint Set (s) consisting of Panel Pattern, Instrument Layout and Wiring Diagram as checked below:

"Improved" Cockaday 4-Circuit Tuner.
 Non-Regenerative Tuned-Radio-Frequency Receiver.
 Audio-Frequency Amplifier.

Name.....
 Address.....
 City..... State.....

Any new subscriber sending us \$3.00 in payment for an annual subscription for POPULAR RADIO is entitled to any set of *New Simplified Blueprints* FREE.

Anyone sending us \$3.00 in payment for a new subscription with set of Blueprints free, is also entitled to any one of these three sets of Blueprints free. Send two new subscriptions with \$6.00 and choose two sets of Blueprints for yourself; send three new subscriptions with remittance of \$9.00 and we will mail you all three sets of Blueprints.

You enjoy and appreciate the value of POPULAR RADIO and should have no difficulty in convincing at least one friend that at \$3.00 a year with a set of Blueprints, free, it is a bargain. Do it today and mail your order promptly to POPULAR RADIO, Dept. 94, 627 West 43rd St., New York City.

Please refer to POPULAR RADIO when answering advertisements.

Radio Without the Horn!



Goodbye to the Old-Fashioned Horn Speaker!

A Vastly Better Reproduction With this New Radio Console!

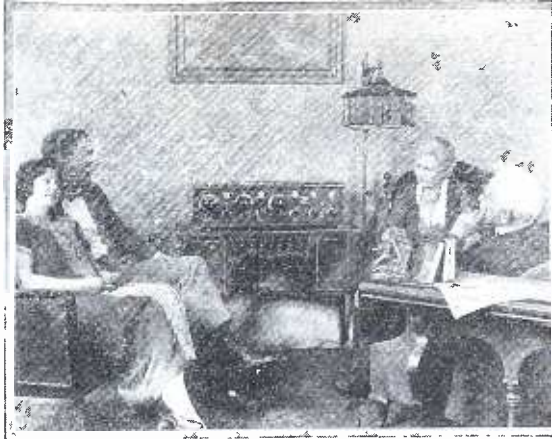

"Our old horn speaker never gave tones like this! An artistic addition to the living room—everything in its place—it's a joy!"

New Console Has Its Own Perfect Loudspeaker!

Ample Space for All the Rest of Your Outfit!



HERE is something that enables you to enjoy radio in the home without the clutter of unsightly apparatus that plays havoc in the decorative scheme of your living room! The horn speaker is out of date and out of place in radio for the home. This console with its in-built loudspeaker is scientific and sightly.

A Truly Wonderful Tone

It does a better job of reproducing, for it has the best unit of all that have been tried and its sound-box is of resonant wood instead of metal, fibre, or composition.

The appearance of a Windsor loudspeaker console is a delight. Its convenience is a joy. A piece of real living room furniture of pleasing lines and finish—and it accommodates all the miscellany of equipment which hitherto had no place except on table tops, shelves or floor. Ample space on top for any set, with plenty of elbow room in front. Nothing in sight but the dials. Everything else goes inside—from behind—in spaces cleverly designed to hold the largest batteries and outfit—besides the self-contained loudspeaker—all unseen and protected from dust or disturbance.

You Need This Console Whatever Your Present Outfit Is

It makes no difference what kind of radio outfit you have—this console was designed for your use. The graceful exterior of this console gives no hint of its inner utility, for it is a simple and effective piece of furniture in every line. But a glance at the interior reveals a most ingenious arrangement of the in-built loudspeaker with space either side and in front. These spaces are ample for the largest A battery, and the largest

wet B batteries and the largest charging outfit. It is 38 in. long, 18 in. deep, and 29 in. high. Notice the artistic grill that conceals soundbox, and the provision of "knee room" beneath. Made in mahogany or walnut finish, and the price is only \$40!

Dealers!

The sale of these consoles has already reached extraordinary figures. They are selling in surprising quantities in even smallest stores where there is one in the window or on the floor. It is a convenience and a value not to be duplicated. Write us for discounts and particulars of big newspaper advertising campaign.

FREE!

Dealers are now showing Windsor loudspeaker consoles and have them for immediate delivery to your home. Write us for name of nearest dealer who has the Windsor franchise. Special: We will mail

you free on receipt of coupon printed below the Windsor Amusement Bulletin for radio fans. It not only lists the name, location, wave-length and time of broadcasting but describes the character and kind of amusement. With this bulletin in hand you know when and where to get what you want on your radio. This bulletin is Radio's amusement guide. Clip coupon!

WINDSOR FURNITURE COMPANY
1422 Carroll Ave., Chicago:

(3)

Please furnish name of dealer showing the new Windsor loudspeaker console, and also forward me without any cost or obligation your complete Radio Amusement Bulletin that gives the kind of entertainment provided by the different broadcasting stations throughout the country.

Name.....

Address.....



\$40

Loudspeaker Included

Windsor Loudspeaker Console

Please refer to POPULAR RADIO when answering advertisements.

FREE PARTS!

Introduce **POPULAR RADIO** to a few of your friends and take your pick of radio parts

HERE is an opportunity for you to secure all or any of the parts needed to build complete either of two very popular receivers or an amplifier—and at no expense. You, surely, are well acquainted with the features of **POPULAR RADIO** that have given it more subscribers than any other radio publication. Won't it be easy to use your enthusiasm in inducing your friends and their friends to subscribe too?

To make it possible for you to secure an order from everyone we will permit you to make the following offers:

POPULAR RADIO			
24 Months for \$5.00	counts	75 credits	
12	"	"	3.00
8	"	"	2.00
6	"	"	1.50
4	"	"	1.00

You remit the full amount collected with names and

addresses of subscribers and ask for the parts that your total CREDITS entitle you to: or, if you prefer, let us credit them to you and when you have a substantial total, order the parts you want and we will charge against your CREDIT account.

As a further concession, suppose you have sent us 5 annual subscriptions for **POPULAR RADIO**, and in addition to a set of Approved Cockaday Coils want a 6-ohm Amseco Rheostat. The Coils are 220 CREDITS and the Rheostat, 50 CREDITS. The subscriptions total only 250 CREDITS and you need 20 CREDITS more. We will permit you to buy the additional CREDITS at 3c apiece—so for 5 annual subscriptions and 60c in cash we will ship the two parts you want.

Subscriptions sent us on this offer do not include premiums to the subscriber too, as we want you to have the full CREDIT value.

CREDITS Needed for Parts Required for the "Improved" Cockaday 4-Circuit Tuner

(Described and illustrated in **POPULAR RADIO** for January, 1924)

Quantity	Item	Credits
1	set Approved Cockaday Coils	220
2	26-plate Amseco Vernier Variable Condensers (3180)	360
2	Amplex Grid-lensers @ 50	100
1	Bradleyleak	74
5	Melco Vacuum tube sockets @ 40	200
1	6-ohm Amseco Rheostat	50
2	Pacent double circuit jacks @ 40	80
1	Pacent single circuit jack	28
2	American Transformers @ 280	560
1	Pair Como push-pull transformers	500
2	Switch levers and knobs @ 12	24
1	Switch points @ 3.5	7
4	Switch stops @ 3.5	2
1	.0005 mica condenser-transformer mounting	18
1	.00025 mica condenser with clips for grid leak	18
3	48,000-ohm Lavite resistances @ 60	180
1	400-ohm Amseco potentiometer	70
12	Hard rubber binding posts @ 4	48
1	7 x 24" panel—hard rubber	120
1	3 x 24" panel—hard rubber	16
1	12 x 1" panel—hard rubber	16
3	20-ohm Amseco rheostats @ 60	180
1	Durham variable grid leak	30
		2901

CREDITS Needed for Parts Required for the Tuned Radio-Frequency Reflex Receiver

(Described and illustrated in **POPULAR RADIO** for August, 1924)

Quantity	Item	Credits
1	Hammarlund .0005 mfd. (21-plate) condenser	240
1	Hammarlund 001 mfd. (41-plate) condenser	280
1	U. S. Tool 3-plate condenser	60
1	R. U. F. semi-fixed crystal detector	50
1	Amseco 30-ohm rheostat	50
1	Carter double-circuit jack	40
1	Carter single-circuit jack	36
1	Federal No. 65 audio-frequency transformer	280
1	Amertran Type AF-7 (ratio 3 1/2 to 1) audio-frequency transformer	280
2	N. Y. Coll mica fixed condensers, .001 mfd. (with soldering lugs) @ 16	32
	Amseco switch lever with switch points and stops	19
	Materials for the construction of the special fixed coupler and the radio-frequency transformer	85
2	Federal sockets for 199 tubes @ 40	80
1	Composition panel (radion 7" x 18")	90
1	Cabinet (Shepeco 18")	190
8	Eby Binding Posts @ 8	64
2	UV-199 or C-299 vacuum tubes @ 200	400
		2276

CREDITS Needed for Parts Required for the Non-Distorting Audio-Frequency Amplifier

(Described and illustrated in **POPULAR RADIO** for May, 1924)

Quantity	Item	Credits
1	No. 25 Bradleyohm (25,000 to 250,000 ohms)	80
1	Bradleyleak 1/4 to 10 megohms	74
2	Amseco Rheostats (20 ohms) at 50	100
4	Naald Standard Vacuum Tube Sockets No. 400 at 30	120
1	Amertran Transformer (5 to 1 ratio)	280
1	Como Input Transformer	250
1	Como Output Transformer	250
1	Martin-Copeland Jack double circuit	32
1	Martin-Copeland Jack single circuit	24
1	Dubilier Mica Fixed Condenser, .00025 mfd. with clips for transformer	18
6	Dubilier Mica Fixed Condensers, .005 mfd. plain, at 24	144
1	7" x 12" Radion Panel	60
2	Quimby Radio Frames, 7" x 8" at 34	68
10	Eby Binding Posts at 8	80
1	Connection Block	14
5	Celatsite Wire at 10	50
		1644

The specifications in all three sets name the parts used in building the original laboratory sets. We know that these parts if used will insure satisfactory results. But it does not prevent you from using other brands which will prove equally satisfactory. In fact, if you prefer some other brand or any parts not listed on this page, tell us what you want and we will tell you the number of credits required. We are prepared to supply any radio material you may require.

We also want to call your attention to the famous **POPULAR RADIO** Simplified Blueprints described on page 88. Any of these three sets will be supplied for only 44 Credits.

Or for 60 Credits you may have a copy of "How to Build Your Radio Receiver" described on page 86.

POPULAR RADIO

Department 91

627 West 43d Street, New York City

Please refer to **POPULAR RADIO** when answering advertisements.

New Models
BRISTOL
RADIO RECEIVERS

**Incorporating the Patented Grimes
 Inverse Duplex System**

Watch for further announcements in all leading radio publications.

Grimes System Insures Natural Tone Quality

Improved Bristol Audiophone Loud Speakers—gives greater volume, is more sensitive and still maintains its round, full tone and its distinctive freedom from distortion.

Ask for Bulletin No. 3017-L.



SENIOR AUDIOPHONE
 15-inch Bell
 Price.....\$30.00



JUNIOR AUDIOPHONE
 11-inch Bell
 Price.....\$22.50



BABY AUDIOPHONE
 With Fibre Horn
 Price.....\$12.50

Manufactured by

THE BRISTOL COMPANY
 Waterbury, Connecticut

Please refer to POPULAR RADIO when answering advertisements.

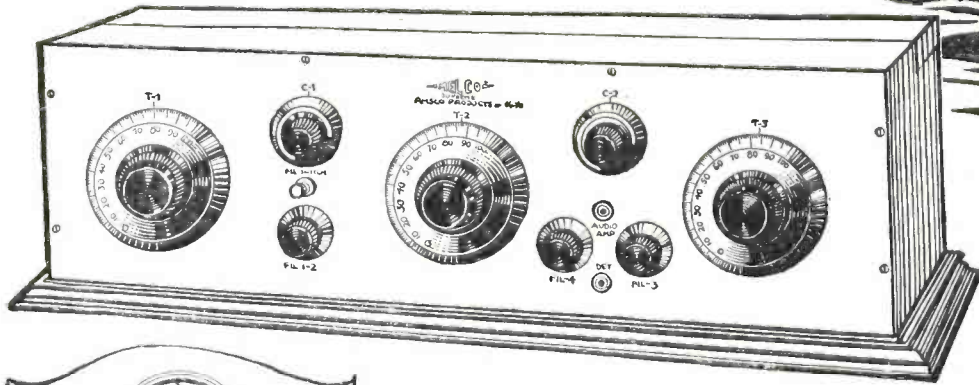
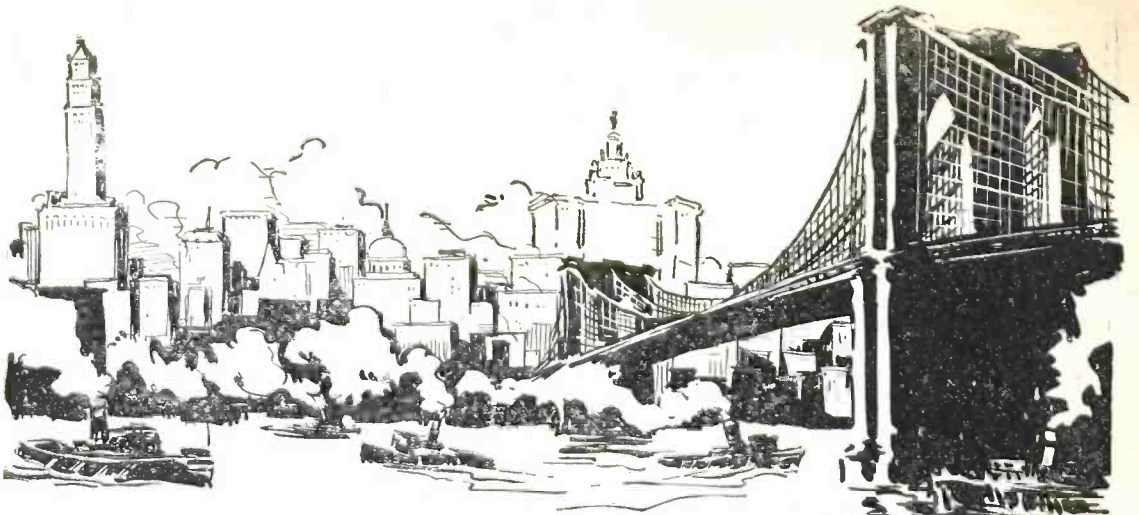

*"Satisfies Every
Radio Wish"*

Pre-Tuned
Pre-Logged



MELCO-SUPREME Tuned Radio-Frequency

Just as bridges link neighboring cities--so does the Melco Supreme link the happenings of even the most distant towns with your own fireside.

Complete descriptive literature on request

AMSCO PRODUCTS INC

Broome & Lafayette Strs. New York

Please refer to POPULAR RADIO when answering advertisements.

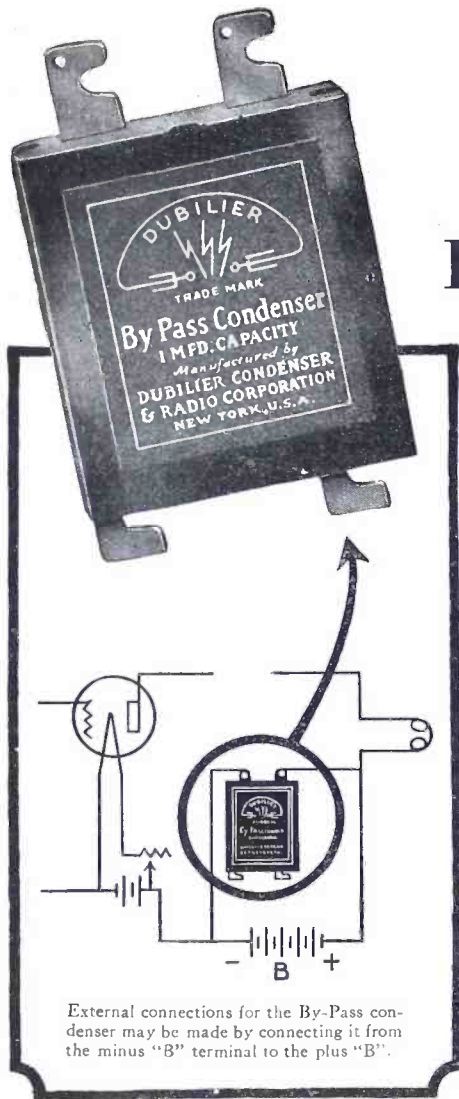

External connections for the By-Pass condenser may be made by connecting it from the minus "B" terminal to the plus "B".

THE BY-PASS CONDENSER

Improves Reception

You will get the program clearer if you install a Dubilier large capacity By-Pass Condenser in your radio set. Just locate it as the diagram indicates. The result is that the minute fluctuations of the "B" battery are smoothed out into a steady, even flow of current, devoid of all noises.

The result is astonishing! Signal strength is increased—tones purer—volume smoother. The whole program comes in far truer and pleasanter than ever before.

This By-Pass Condenser in quality of material and workmanship measures up to that high standard for which all Dubilier radio devices are famous.

Dubilier

CONDENSER AND RADIO CORPORATION

Please refer to POPULAR RADIO when answering advertisements.

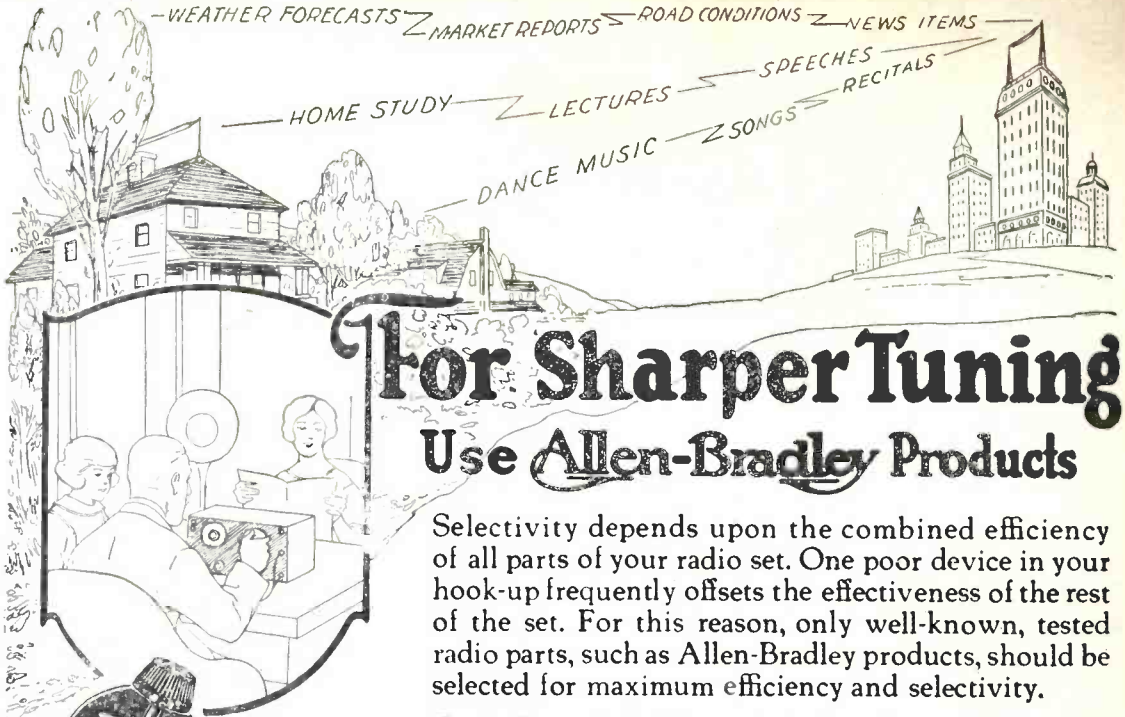

For Sharper Tuning Use Allen-Bradley Products

Selectivity depends upon the combined efficiency of all parts of your radio set. One poor device in your hook-up frequently offsets the effectiveness of the rest of the set. For this reason, only well-known, tested radio parts, such as Allen-Bradley products, should be selected for maximum efficiency and selectivity.



\$1.85
For All Tubes

Bradleystat
PERFECT FILAMENT CONTROL
It is standard equipment on many fine sets.

This remarkable radio filament rheostat, utilizing graphite discs, instead of coiled wire, stands supreme for noiseless, stepless control.



\$1.85
1/4 to 10 Megohms

Bradleyleak
THE PERFECT GRID LEAK
1/4 to 10 megohms assures maximum efficiency for all tubes.

Proclaimed by Crosley, Kennedy, Amrad, Cockaday, Flewelling, and other leading radio experts, as the perfect grid leak. A range of 1/4 to 10 megohms assures maximum efficiency for all tubes.



\$2.00
No. 10
10,000 to 100,000
No. 25
25,000 to 250,000
No. 50
50,000 to 500,000 ohms

Bradleyohm
THE PERFECT RESISTOR
A highly-praised adjustable resistor for radio circuits. It is made in three sizes, and provides a marvelously smooth and noiseless variation that assures rapid adjustment to the point of highest efficiency.

A highly-praised adjustable resistor for radio circuits. It is made in three sizes, and provides a marvelously smooth and noiseless variation that assures rapid adjustment to the point of highest efficiency.

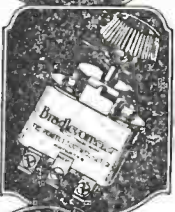

\$2.00
for 200 ohm
\$3.00
for 400 ohm

Bradleyometer
THE PERFECT POTENTIOMETER
Another Allen-Bradley contribution to radio. Made in two sizes for all types of radio frequency circuits. No coiled wire to slip or break in operation.

Another Allen-Bradley contribution to radio. Made in two sizes for all types of radio frequency circuits. No coiled wire to slip or break in operation.



60c
for A or B batteries

Bradleyswitch
PERFECT BATTERY SWITCH
A totally-enclosed convenient battery switch for A or B-battery circuits. Requires only one hole in panel for mounting, and is completely protected against accidental injury. Saves batteries and tubes.

A totally-enclosed convenient battery switch for A or B-battery circuits. Requires only one hole in panel for mounting, and is completely protected against accidental injury. Saves batteries and tubes.

Allen-Bradley Co.
Electric Controlling Apparatus

276
Greenfield
Ave.



Mil-
waukee,
Wis.

Manufacturers of graphite disc rheostats for over twenty years.

Allen-Bradley Co.
276 Greenfield Ave., Milwaukee, Wis.
Please send me a complete set of your bulletins of Allen-Bradley radio products.

Name

Address

Please refer to POPULAR RADIO when answering advertisements.

Quality ~

"The Choice
of Radio
Experts"



Sold by
Good Radio
Dealers
Everywhere

Easily Recognized

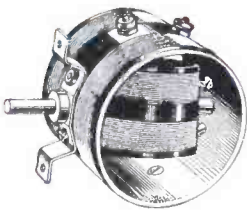

Vario Couplers

Panel Switches

Tube Sockets

Wavemeters

Ammeters

Knobs and Dials

Condensers

When you buy General Radio apparatus you are buying certainties. You can definitely depend upon its *superior performance* in broadcast reception.

By insisting upon General Radio apparatus at the start you avoid the disappointments which so often follow the purchase of inferior parts.

Look for the red cartons with the General Radio label.

Ask your dealer or write us for our Descriptive Bulletin 917-U.



Transformers

Laboratory
Instruments

Insulators

Binding Posts

Potentiometers

Rheostats

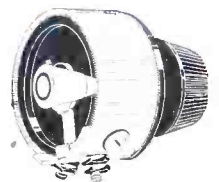
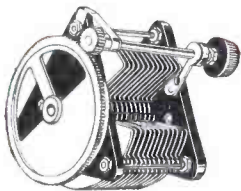

GENERAL RADIO Co

Cambridge, Mass.

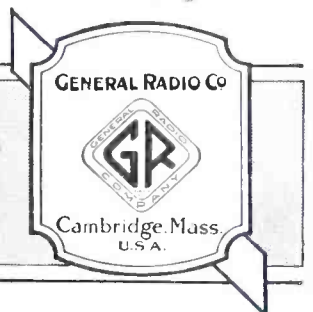



Of Course It's
a **CROSLEY**
Better - Cost Less