

Popular Radio

Edited by **KENDALL BANNING**

JULY 1924

25¢



**In this Number—
How to Build a
PORTABLE RECEIVER**



Radiola Regenoflex, with Radiola Loudspeaker, and 4 Radiotrons WD-11; with space for batteries inside; complete except batteries and antenna)

\$206



With a Radiola on the Front Porch

All the jazz of the big orchestras in faraway big towns comes through clearly for dancing. The fine music is true, sweet toned, undistorted. The sports news rings out with all the thrill of bleachers or ringside. The Regenoflex is a leader among the new Radiolas that are making this a great radio summer!

A Radiola Regenoflex on the front porch —and that porch can be way up in the mountains, or off at the seashore—but it's not too far away to be in on the fun.

The improvements in its mechanism offer greater sensitivity and greater selectivity; clearer tone; and complete simplicity. Where *quality* of reception counts as much as distance, the Regenoflex is the receiver for this summer's fun!

This symbol of quality



is your protection

"There's a Radiola for every purse"

Send for the free booklet that describes every Radiola.

RADIO CORPORATION OF AMERICA
Dept. 47. (Address office nearest you.)
Please send me your free Radio Booklet.

Name _____

Street Address _____

City _____ R. F. D. _____

State _____

Radio Corporation of America

Sales Offices

233 Broadway
New York

10 So. LaSalle Street
Chicago, Ill.

433 California Street
San Francisco, Cal.

Radiola

REG. U.S. PAT. OFF.

Improved Radio Programs ~this summer!

*Millions of homes will be enlivened
by stirring sports, important news
and gay music—via Radio*

Plug in your headset or your *Table-Talker*. You're in the midst of a season of keenest enjoyment. More interesting programs than ever before—crammed with a diversity of vital events and artistic treats. And stronger sending and clearer reception to help you get the very *best* out of your set.



Table-Talker - \$10.00
50c additional west of the
Rockies
In Canada - \$14.00



Navy Type Headset \$8.00
In Canada - 11.00



Superior Headset - \$6.00
In Canada - 7.00

The Presidential Campaign

is being waged right in your home. You can follow the important messages of all parties. You can be *part* of the stirring battle—not just an outsider wondering what is going on. You'll *know* the candidates—and their platforms. You will vote with keener interest—this year.

The Churches, Too,

are promising to be generous in the broadcasting of their services. Off in the woods—down at the shore—or right in the city when you cannot attend you may have the word and the inspiration of your particular faith.

Tremendous Improvements

in broadcasting and receiving assure you a full quota of pleasure. Stronger sending stations—the telephonic connection of distant stations—broadcasting over a waveband rather than a single wave length. Sets of greater selectivity, improved tubes and circuits and loud-speakers. Lowered prices. All these will contribute to making this a real radio season!

For sixteen years the Brandes name has consistently stood for service—for skill—and dependability.

Brandes

The name to know in Radio

All Brandes Products are sold under a money back guarantee by reliable dealers everywhere.

POPULAR RADIO

EDITED by KENDALL BANNING



CONTENTS for JULY, 1924

(Cover design by Frank B. Masters)

VOLUME VI

NUMBER 1

Radio in the German Diet.....	FRONTISPIECE
How Radio Is Helping the Deaf to Hear.....	<i>Henry Smith Williams</i> Page 3
Where the Costs of Broadcasting Should Lie.....	<i>Lee de Forest</i> 11
How to Avoid Local Interference.....	<i>Lloyd S. Graham</i> 12
What the Manager of a Broadcasting Station Hears.....	<i>Homer Croy</i> 17
How "Resistance" Affects Radio Circuits.....	<i>Julian K. Henney</i> 24
An Ideal Set for Summer-time Reception.....	<i>J. R. Marsh</i> 30
100 Best Hook-ups.....	<i>Technical Editor</i> 39
Installment No. 8	
The Circus That Came to Willie.....	<i>W. T. Meenam</i> 44
Will the Broadcast Listeners Listen in on Advertising?.....	<i>Herbert Hoover</i> 49
The Lingo of the Ham.....	<i>E. O. Knoch</i> 50
How to Do Your Soldering Correctly.....	<i>Technical Editor</i> 53
A Classroom 2,000 Miles in Diameter.....	<i>Kenneth M. Swezey</i> 56
How to Build the POPULAR RADIO Portable.....	<i>Laurence M. Cockaday</i> 60
Important Trifles.....	<i>Edward T. Jones</i> 72

DEPARTMENTS

What Readers Ask.....	<i>Laurence M. Cockaday</i> 76
In the World's Laboratories.....	<i>E. E. Free</i> 82
Hints for Amateurs.....	<i>Albert G. Craig</i> 90
"Trouble Shooting".....	<i>S. Gordon Taylor</i> 92
Broadcasts.....	<i>David Lay</i> 95
Listening In.....	<i>Kendall Banning</i> 101

VOLUME VI

JULY, 1924

NUMBER 1

Published monthly by Popular Radio, Inc., 627 West 43rd St., New York, N. Y., telephone number Chickering 1906; Douglas H. Cooke, President; Kendall Banning, Treasurer. Price, 25 cents a copy; subscription \$3.00 a year in the U. S., Canada and all countries within the domestic postal zone; elsewhere \$3.50 a year, payable in advance. The International News Company, Ltd., No. 5 Bream's Bldg., London, E. C. 4, sole distributors in England. Entered as second class matter April 7, 1922, at the Post Office at New York, N. Y., under the act of March 3, 1879. Copyright, 1924, and title registered as a trade-mark by Popular Radio, Inc. Copyright in Great Britain by Popular Radio, Inc., 6 Henrietta St., Covent Garden, W. C., London, England. Printed in U. S. A.

E. E. FREE, Ph.D., *Contributing Editor* LAURENCE M. COCKADAY, R.E., *Technical Editor*

For advertising rates address

E. R. CROWE & COMPANY, INC.

New York: 25 Vanderbilt Avenue

Chicago: 225 North Michigan Ave.



GREBE

INDIVIDUAL SHIELDS

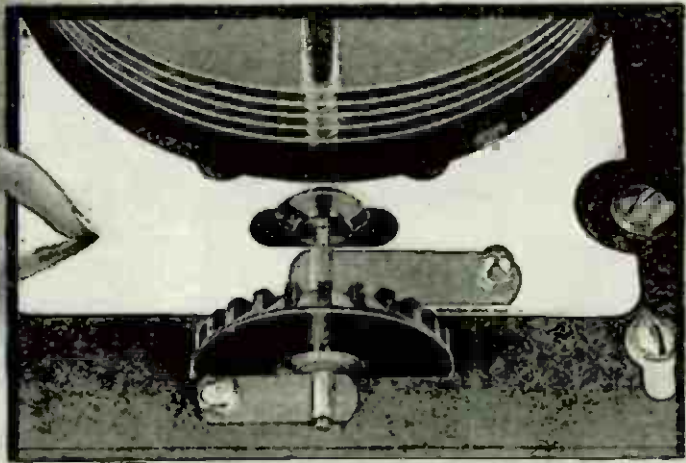

"The Sage attends to the inner and not to the outer."
— Lao Tzu

The wise buyer of a radio receiver is not misled, he looks inside the cabinet.

Doctor Mu



Grebe Regenerative Receivers are licensed under Armstrong U.S. Pat. No. 1,113,149.

CLOSE inspection of many receivers reveals but one large shield to prevent body-capacity effects. As a result of research, each tuning control on a GREBE Receiver has its own aluminum shield of special size and shape.

This is just one of many details of craftsmanship which make for the high efficiency of GREBE Receivers.

Ask your Dealer or write us.

A. H. GREBE & CO., Inc.
Van Wyck Blvd. Richmond Hill, N. Y.
Western Branch: 451 East 3rd Street, Los Angeles, Cal.

PAGES WITH THE EDITOR

THE Editor hereby invites the readers of POPULAR RADIO to join his editorial advisory staff—and to give their advice in writing concerning an editorial problem that is confronting him. The problem is this:

THE first edition of 5,000 copies of "How to Build Your Radio Receiver" (Popular Radio Handbook No. 1) was gobbled up so eagerly that a second edition of 10,000 copies was hurried to press within a few days after the first edition was published. And plans are now being made for a third edition—in anticipation of what appears to be a steadily growing demand for the practical, specific "how-to-build" data that this volume contains.

(Note to subscribers: For a limited period only this book will be given away free of charge with each \$3.00 subscription to POPULAR RADIO. In case you are already a subscriber, the book will be given to you with a \$3.00 renewal.)

HERE is where the problem comes in: Within the next few weeks the editorial task of compiling Popular Radio Handbook No. 2 will be started. And in order that it may contain information that will be of the greatest possible value to the greatest possible number of radio fans, the Editor not merely invites but urges the readers of POPULAR RADIO to offer

their suggestions. Their co-operation and advice will be of inestimable value in determining the contents of this new volume.

POPULAR RADIO Handbook No. 1 tells how to build receiving sets—ranging from the most efficient little crystal set up to the Improved Four-circuit Tuner and the Super-heterodyne. Succeeding editions of Handbook No. 1 will contain descriptions of the latest and most approved receivers; each new edition will be brought up to date. But Handbook No. 1 will always be restricted to one subject—how to build radio receiving sets.

POPULAR RADIO Handbook No. 2 will contain quite a different kind of information than its predecessor—but information of no less value.

HERE, for example, are some of the general classes of subjects that are of special interest to different classes of readers. Which are of special interest to you?

How to Build Your Own Radio Parts— such as variometers, coils, crystal-detector stands and other items that some fans like to make for themselves.

How to Select Your Radio Parts— useful hints for the radio experimenter who assembles his own apparatus with parts that he can buy.

(Continued on page 6)

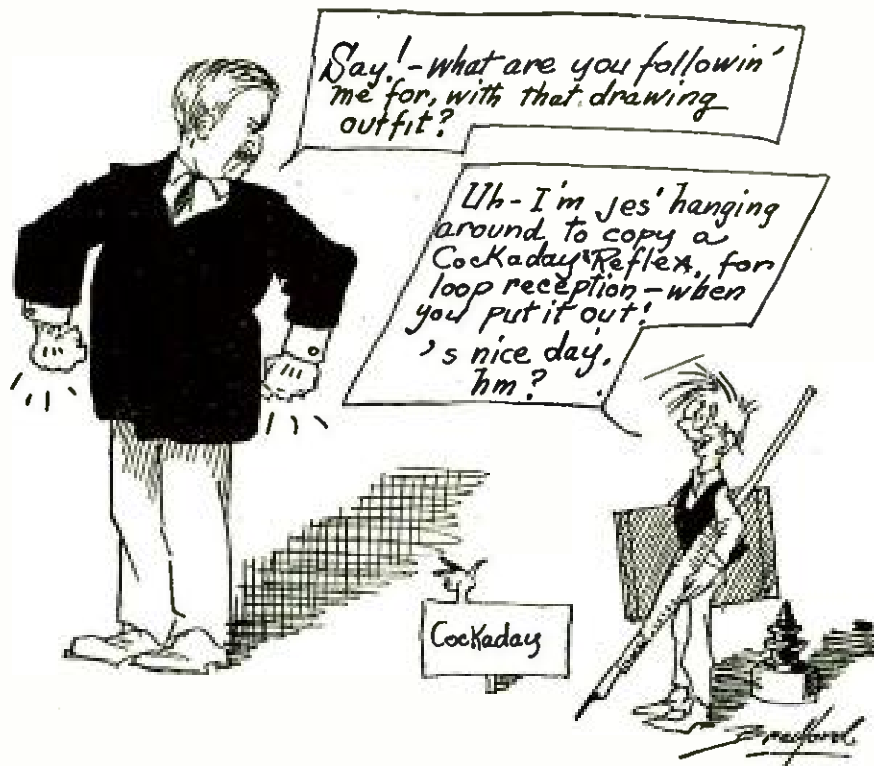

"I'll bet Cockaday could give us a dandy reflex for loop reception, what?" suggests cartoonist W. R. Bradford of THE NORTH AMERICAN of Philadelphia, in a letter that details his success with the four-circuit tuner and which includes the little sketch reproduced above. "Tell Mr. Bradford that we'll have such a receiver ready this fall," replies Mr. Cockaday—"and that the picture doesn't look a bit like me!"

Be sure it's a THOMPSON. Then you will be sure of getting features that are possible only to an organization which has been making wireless and radio apparatus exclusively for 14 years.

THOMPSON SPEAKER (MAGNAPHONE)

Unusual tonal qualities and a practically unbreakable horn are just two of the features that have made the Thompson Speaker such a phenomenal success. Compare the tone at good radio dealers—\$35.

THOMPSON NEUTRODYNE

Hear and compare the Thompson with any radio set. Even in Neutrodynes there is a big difference. Thompson sales prove this. \$150 without tubes and batteries.

R. E. THOMPSON MANUFACTURING CO.
*Manufacturers of Wireless Apparatus for the U. S.
Army and Navy and numerous foreign governments*
150 NASSAU STREET · · NEW YORK, N. Y.
FACTORY: JERSEY CITY, N. J.

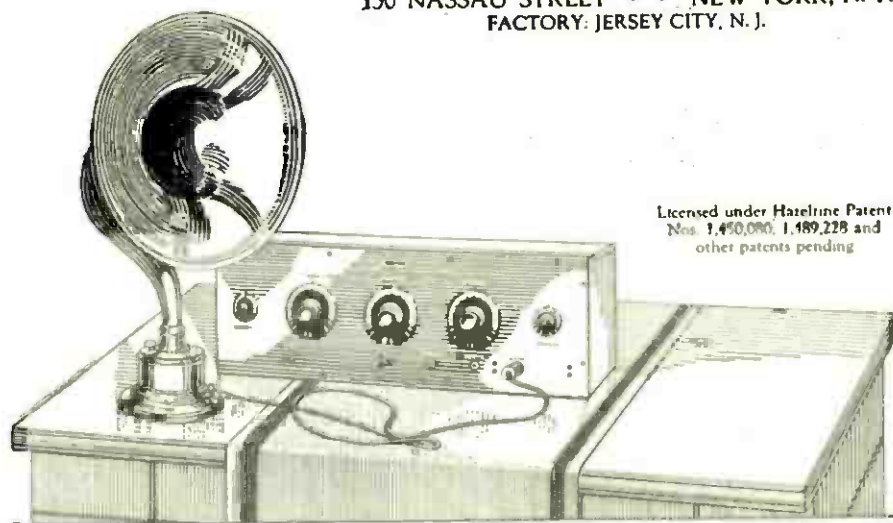

Licensed under Hazeltine Patent
Nos. 1,450,090, 1,489,228 and
other patents pending



J. C.

PAGES WITH THE EDITOR

(Continued from page 4)

How to Tune Your Receiver—

practical pointers for the broadcast listener who wants to get the greatest possible efficiency from his set.

How to Calculate Capacities, Inductances, Resistances, Wavelength and Other Statistical Data—

for the amateur who designs his own set.

How to Construct Your Antenna—

what kind you need and how to get it.

How Radio Works—

how radio waves are transmitted and received, how the vacuum tube works, how the antenna is energized, how the microphone operates and the theories of radio phenomena generally.

How to Get the Maximum Efficiency from Your Radio Apparatus—

how to increase selectivity, how to calibrate your wavemeter, how to get amplification without distortion, how to reduce interference—how to get the best results generally from your set.

How to Build Your Own Apparatus—

such as wavemeters, loudspeakers, battery charging rectifiers and other equipment.

How to Learn the Code—

How to Select the Receiver Best Fitted for Your Needs—

a summary of the different circuits with reference to their capacities, costs, range, selectivity, operation and other practical points that are of value to the fan.

How to Use Your Receiver in the Summer—

how to install it on your motor car, on your canoe, motor boat and on your yacht; how to set it up in camp and use it on vacation journeys; how to overcome the summer-time problems in reception.

How Radio Is Being Applied—

how science is making practical use of radio apparatus in medicine; how radio is used in educational work, in business, in politics, in communication in mining, in exploration work and in the field of science generally.

OR do you prefer the general science articles that have only an indirect bearing on radio phenomena? Such articles, for example, as those that treat of the various theories about atoms, the ether hypothesis, the Heavyside Layer and other problems?

WHAT do you advise? Every suggestion will be considered carefully, and every letter will be acknowledged. And *Handbook No. 2* will contain the kind of information that the majority of our readers select.

"I BUILT one of the Cockaday four-circuit tuners exactly as described in your magazine and have been operating it for about a month. In my estimation it cannot be beaten. One very fine feature of it is, that I can eliminate all code. On DX I have made no effort to find from what distance it is possible for me to receive, but stations within a 2,000-mile radius I find very simple to tune in. Most of the time I have to run on the second jack, for when I plug in on the last jack the volume of sound almost drives me out of the house.

"Your magazine cannot be surpassed for news or for the accuracy of its wiring diagrams."

—J. LEO PHELAN, Waterbury, Conn.

AWAY back in 1909 a tall, lanky, good-natured youth from Missouri ambled into the Editor's sanctum in New York and shyly submitted a manuscript. It showed the spark of talent and the Editor bought it. (The Editor later learned that this was the first article that the tall, lanky youth had ever sold to a magazine.)

* * *

THEN the youth's contributions gradually began to find their way into other magazines. Slowly his little spark of talent grew into a flame—and in due time the youth's name began to appear on books. And last year one of his books, "West of the Water Tower," suddenly soared into the Best Seller class and the author's name was emblazoned from one end of the country to the other. The author was Homer Croy.

* * *

SOME of that "human interest" quality that distinguishes Homer Croy's work will be found in his article on page 17 of this number of POPULAR RADIO; it gives that same little tug to the heartstrings that Homer Croy puts into almost everything he writes.

* * *

"I HAVE read POPULAR RADIO since the first issue which I found on a newsstand in Vernon, Texas, about two years ago, and I have learned that what POPULAR RADIO says is," writes H. J. Reeder of Belzoni, Miss. "I have also learned that when Mr. Cockaday puts his name to an article or hook-up it is the last word. I built his four-circuit tuner and grounded it to the railroad track, using an antenna 130 feet long, and get all the stations from Detroit to Mexico City—WEAF and WOR to PWX, KFI and KHJ and all intermediate ones."

* * *

"It is a good deal of fun for us braver spirits to listen to the President over the radio. It appeals to the sense of impudence and bravado," writes F. P. A. in *The World*, New York. "When he says something we don't quite agree with, we intrepid ones holler 'Is that so?' It is almost as much fun as ringing the doorbell on Hallowe'en, and running away."

* * *

OR, one might add, of writing anonymous letters to editors!

* * *

THE decision made by the readers of POPULAR RADIO as to whether they prefer the left-to-right or the right-to-left circuit diagrams will be announced next month.

Kendall Banning

Editor, POPULAR RADIO

EVEREADY
Radio Batteries
- they last longer

FREE!

The Story of
EVEREADY
DRY CELL
RADIO
"A" BATTERIES
for
DRY CELL
VACUUM TUBES

How to
get the most
out of your
"B"
BATTERY

No. 771
EVEREADY
TELEPHONE
RADIO BATTERY
THREE
CELLS

EVEREADY
BROADCASTING
HOUR GLASS
*An Aid in Determining
By Hours
THE LOCATIONS
CALL LETTERS
& WAVE LENGTHS
of Principal Stations*
NATIONAL CARBON CO., INC.
MAKERS OF EVEREADY BATTERIES
SAN FRANCISCO

Informative and money-saving booklets on radio batteries sent free on request. If you have any questions regarding radio batteries, write to G. C. Furness, Manager, Radio Division, National Carbon Company, Inc., 128 Thompson Avenue, Long Island City, N. Y.

Every radio user should have these books

THEY contain battery facts that it is important for you to know. They are not catalogs, not advertising pamphlets, but each one tells the story of one kind of battery, what it is, what it does, how to connect it, how you can get the utmost in satisfaction and service out of it.

Do you know why a "B" Battery is necessary? Do you know how much "B" Battery current your tubes use? Do you know what a "C" Battery can do for you? All these things and many more are told in these informative booklets. Many of these facts you

**EVEREADY
HOUR GLASS**

When you wonder what that station is, turn to this list of Class B broadcasters and their schedules of transmission without waiting to hear the call letters. You can pick the station from its wave-length and the time at which you hear it. Sent FREE.

can secure elsewhere only by digging through several different works on radio engineering. These booklets present battery facts, in plain language, with a few simple diagrams.

These pocket-size pamphlets cost you nothing. They are sent free on request, part of our service to the radio user. Whether you use Eveready Radio Batteries or not, these booklets will interest you, and answer your questions. To take the mystery out of radio batteries, read these four booklets. Write for them to-day. Remember, they are FREE.

Eveready Radio Batteries are manufactured and guaranteed by
NATIONAL CARBON COMPANY, INC., New York—San Francisco
Headquarters for Radio Battery Information
Canadian National Carbon Co., Limited, Toronto, Ontario

Please refer to POPULAR RADIO when answering advertisements.

Improve your set with ACME "lowest loss" condenser

Because of low losses and sharp tuning practically all the currents on the antenna can now be used

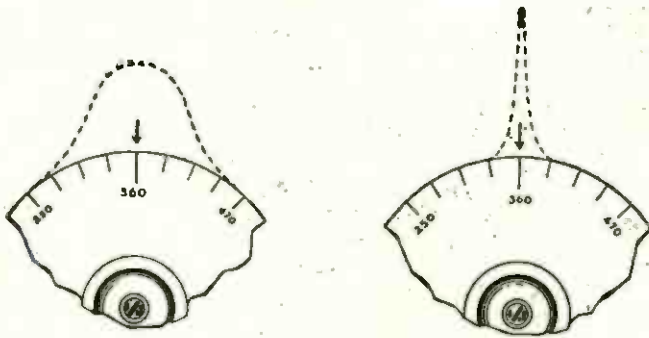

Which one is your tuning circuit

—the hump or the peak?

HERE are the curves of two tuning circuits. The hump has a high loss condenser and the peak a low loss condenser. Both receive broadcasting, but the peak receives local and distant stations without interference, while the hump receives only the nearby stations with interference. The new Acme Condenser will change your tuning circuit from a hump to a peak.

The Acme engineers have been working for two years to bring out a condenser which would give to Radio experimenters sharp tuning and minimum losses. The new Acme Condenser has these fundamental advantages and also has many new improvements in structure and equipment. See the illustration with explanation, and, for more information, write to us for booklet, "Amplification without Distortion," which contains many diagrams and helpful hints on how to build and get the most out of a set.

ACME APPARATUS COMPANY
Dept. 90 Cambridge, Mass.

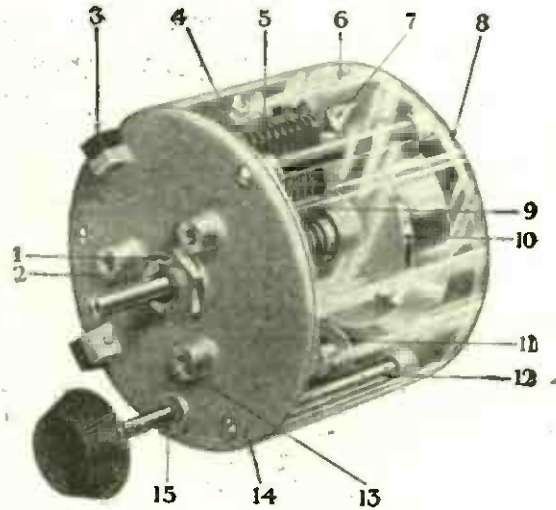

- 1—Steel brass cone bearings adjustable.
- 2—Lock nut for bearing.
- 3—Highest grade hand rubber Dielectric in that part of the field to prevent losses.
- 4—Brass separator to which both rotary and stationary plates are soldered, making continuous circuit for each.
- 5—Brass silver plated plates; rotary plates logarithmic.
- 6—Dust proof covering.
- 7—Stops at extreme end of movements.
- 8—Coiled connection between shaft and heads allowing lubrication of bearings.
- 9—Brass separator to which both rotary and stationary plates are soldered, making continuous circuit for each.
- 10—Counterweight which balances rotary plates.
- 11—Noiseless friction Vernier control seven to one ratio.
- 12—Brass separators to prevent twisting and to take strain off Dielectric.
- 13—Panel mounting holds for 120 degrees spacing.
- 14—Metal heads.
- 15—Steel bushing to prevent wear on Vernier shaft. ALL parts are of non-rusting metal, except steel bearing which is covered with nickel-plated protective surface. End plate capacity is .000016 m.f., full capacity is .0005 m.f. Price \$6.50

Cut out and send this coupon.

Acme Apparatus Company
Dept. 90, Cambridge, Mass., U. S. A.
Gentlemen: I am enclosing 10 cents (U. S. stamps or coin) for a copy of your book, "Amplification without Distortion."

Name

Street

City State

ACME ~for amplification

Please refer to POPULAR RADIO when answering advertisements.

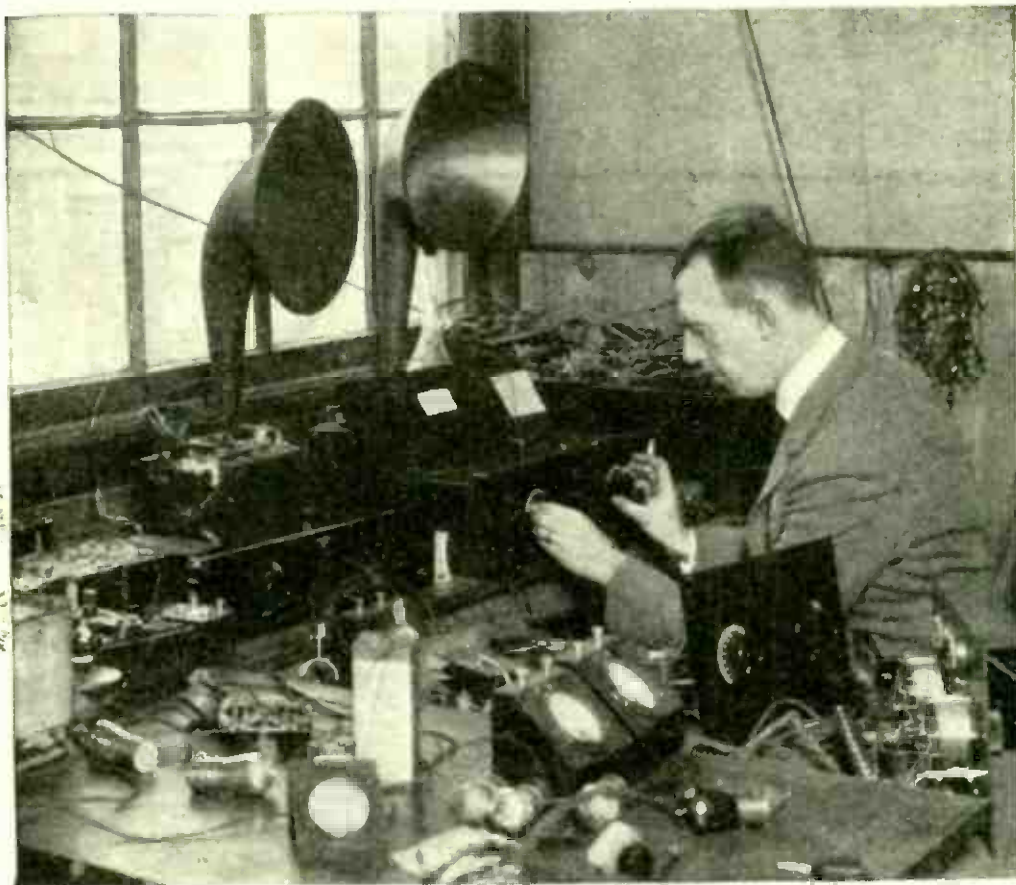

The Unique Position Occupied by POPULAR RADIO

POPULAR RADIO should be complimented in presenting to the radio public such comprehensive technical articles from the hands of scientists occupying unquestioned positions in the radio world, and I hope that it will continue to maintain the high and dignified standard that is so evident to your readers.

—POWELL CROSLY, JR.



Continental

Radio in the German Diet

Politics of the world are being revolutionized by broadcasting; lawmakers whose speeches are heard by hundreds of thousands cannot speak with quite the abandon of those who address small groups only. Here Chancellor Marx is seen addressing the German Diet—and Germany's broadcast listeners.

Popular Radio

VOLUME VI

JULY, 1924

NUMBER 1



How Radio is Helping the Deaf to Hear

Many people who cannot hear ordinary conversation at all are able to hear perfectly through radio headphones. Just why this is so, and how the devices perfected by the radio engineers are opening up a world of normal hearing to those unfortunates who have been shut in by deafness is told in this timely article.

By HENRY SMITH WILLIAMS. M.D., LL.D.

I HAVE a patient about sixty years old who is in superb physical condition and mentally as active as a youth, whose every sense seems keenly alert—except that he is slightly “hard of hearing.” In ordinary conversation with him, you do not notice this defect. He hears everything that you say, provided you talk in an average conversational tone, and in a room where there is not too great intrusion of noises from the city street. But if you are a good observer, you will note that he turns his head a little to the right as he listens to what you are saying. This tells you that he is straining a little, perhaps unconsciously, to catch the softer tones of your voice, and that his right

ear serves him better than the other in the reception of sounds that are near the limits of audibility.

A specific test reveals that there is, in fact, a very marked difference in the hearing power of this man's ears. The tick of a watch in a still room is heard about a foot away from the right ear; but the left ear cannot detect the slightest sound of ticking even when the watch is pressed firmly against it. So far as sounds of that order are concerned, if the right ear were no better than the left, the man would be “stone deaf.” And even the right ear detects the watch tick at only a third or a fourth the normal distance.

Ability to hear the ticking of a

watch, near or far, is of no practical consequence to most of us, of course. And fortunately we are not called on in every-day life to interpret many sounds of similar intrinsic quality. None the less is it desirable that we should be able to hear such sounds, because we recurrently find ourselves listening to sounds at such a distance from their source that the air waves conveying them are thinned out to a degree that reduces their power to the watch-tick level. This is the case, for example, with the softer tones of the actors' voices at the play, if you chance to be seated toward the rear of the auditorium.

I am not surprised, then, on further



HEARING THROUGH THE BONES .

If the vibrating diaphragm of a telephone be touched to a knuckle, where the bone is close to the surface, the sound will be conducted through the skeleton of the body until it reaches the ear and is heard. This little instrument is the "ossophone," invented by S. Brown of England.

questioning the patient who hears the watch inadequately, to learn that he finds himself in difficulty at the theatre unless he can get a seat near the front row. If he is back of the middle of the auditorium, the play becomes for him in effect a pantomime. Only the louder tones of the more penetrating voices are audible as speech; at most, he hears a sequence of inarticulate murmurs. It seems to him almost incredible that the younger folk at his elbow really hear what the performers are saying.

Under such circumstances, the "talking drama" scarcely takes precedence over the movie; and of course, lectures are utterly taboo, and concerts give but qualified pleasure. The superlative "unheard melodies" immortalized by Keats are not those that you strain the ear to hear, and miss only because they are just beyond your restricted range of audibility. And as to pulpit deliveries—even a good sermon is scarcely inspiring if reduced to a combination of pantomime and missing-word contest.

But note, now, this curious circumstance: The man who finds himself thus handicapped in listening to performances adapted to normal ears—and who, furthermore, loses much of an ordinary conversation when speakers are at a little distance, as about a dinner table, or where there is unwonted noise—may nevertheless be able to use a telephone without difficulty. In particular, he may hear every syllable of a "long-distance" communication, though the person at the other end of the wire may be talking in tones that would be inaudible to the listener if spoken directly from the farther corner of the room in which he sits.

How is this anomaly to be explained?

An answer that may or may not be completely adequate at once suggests itself, if we consider the elementary fact that the telephone diaphragm is held close to the ear, so that practically all the sound waves that issue from the orifice of the receiver rush directly into



Pacific & Atlantic

RADIO APPARATUS HELPS THE DEAF CHILD TO LEARN

The radio amplifier so strengthens the tones of the teacher's voice that children who are partially deaf can hear perfectly. School instruction that was formerly impossible for such children has now become as easy as for children with normal ears. This picture shows experiments with deaf pupils in the schools of Cincinnati.

the orifice of the external ear. The cup of the receiver combines forces with the cup of the ear to condense the sound waves, in a sort of vortex, into the channel leading to the ear drum. The sound waves here may be likened to water poured into a funnel and of necessity issuing in a vortex stream from the spout.

Even if we disregard this vortex, or focalizing, effect of the apparatus, and consider only the effect of the nearness of the telephone diaphragm to the ear drum, the results of a simple calculation are rather startling. Unobstructed sound waves, of course, tend to spread in every direction; and as they thus travel in spherical space, they diminish in intensity at any given point in direct ratio, not to the distance merely, but

according to the square of the distance.

Let us see what this implies in the case under consideration. As the telephone receiver is held against the head, the diaphragm from which the sounds emanate is not much more than an inch away from the ear drum—let us say, one tenth of a foot. So the sound-producing vibrations that impinge on the ear drum, even if not concentrated, would be one hundred times as intense as they would be if the receiver were held a foot away from the head. And if you were to step ten feet away from the receiver, the sounds would be ten thousand times enfeebled.

In other words, the voice issuing from the telephone diaphragm, when the receiver is held in the usual position against the head, is ten thousand times

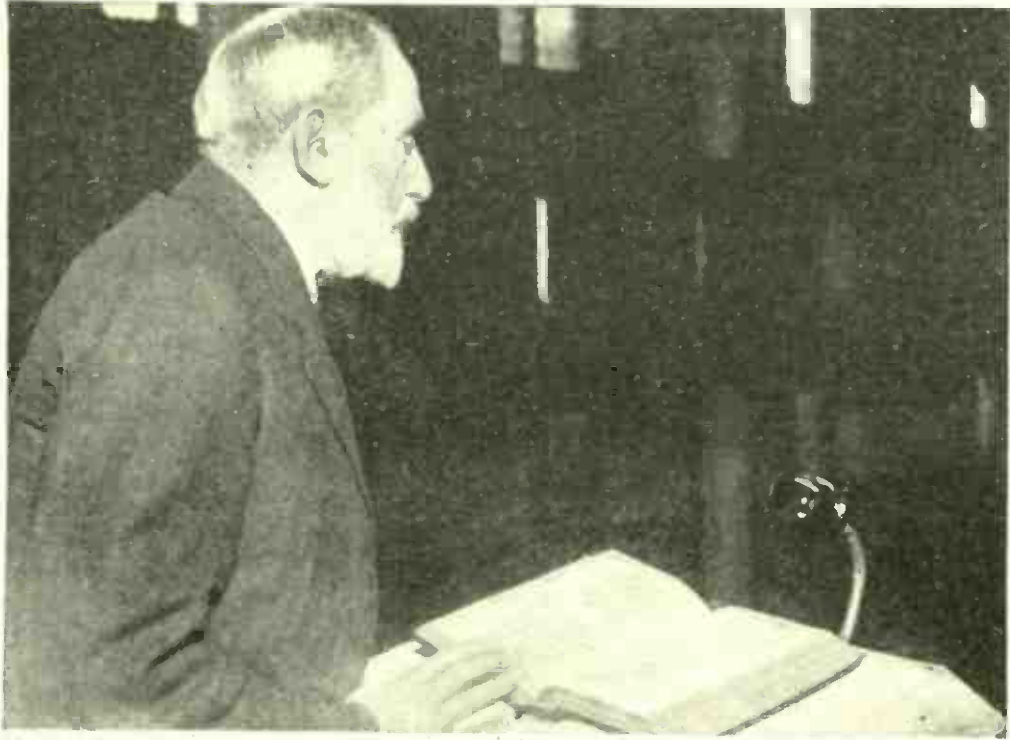

Kadel & Herbert

THE MINISTER TALKS INTO THE MICROPHONE—

Note the installation directly on the pulpit, which permits the voice to be amplified and distributed to the pews as well as to be broadcast by radio. This installation was made in the Wood Green Wesleyan Church in England.

louder than the same voice would be if issuing directly from the vocal apparatus of a person ten feet away from you. Of course, the sounds of the telephone message are not, as a rule, comparable in volume to the conversational tone of an ordinary voice; but with such advantage in placement, it seems natural enough that even a feeble telephone message should often make itself audible to an ear that cannot record ordinary conversation.

It is equally natural to expect that in proportion as the telephone sounds are amplified, the probability that they will be heard by a partially deaf person will be enhanced. And this, of course, is what the makers of the various familiar instruments with telephone-like ear-pieces to be used by the deaf are aiming at. They merely endeavor to supply a more convenient substitute for the old-fashioned speaking tubes and ear trumpets; the purpose in each case being to concentrate sound waves so that they impinge *en masse* on a particular ear drum instead of being scattered in all

directions. The modern instrument, however, may amplify the sound waves that it handles, instead of being content merely to concentrate them.

Of the instruments designed to accomplish this purpose, the most successful that I have personally tested is the so-called vactuphone devised by Mr. Earl C. Hanson. This instrument might be likened to a miniature radio transmitting station minus the broadcasting antenna. Its microphone catches attenuated sound waves, as from a relatively distant voice in conversation, and transmutes them into electric waves that are amplified in a small audion tube (precisely as in audio-frequency amplification in the ordinary radio receiver), and ultimately re-transmuted into sound waves by a headphone held at the ear.

The entire apparatus, including the batteries, is compacted into a small hand box that is readily portable. I have tested the vactuphone in my office, by setting the instrument on the floor beside my desk; and have been able to hear distinctly words spoken in a tone

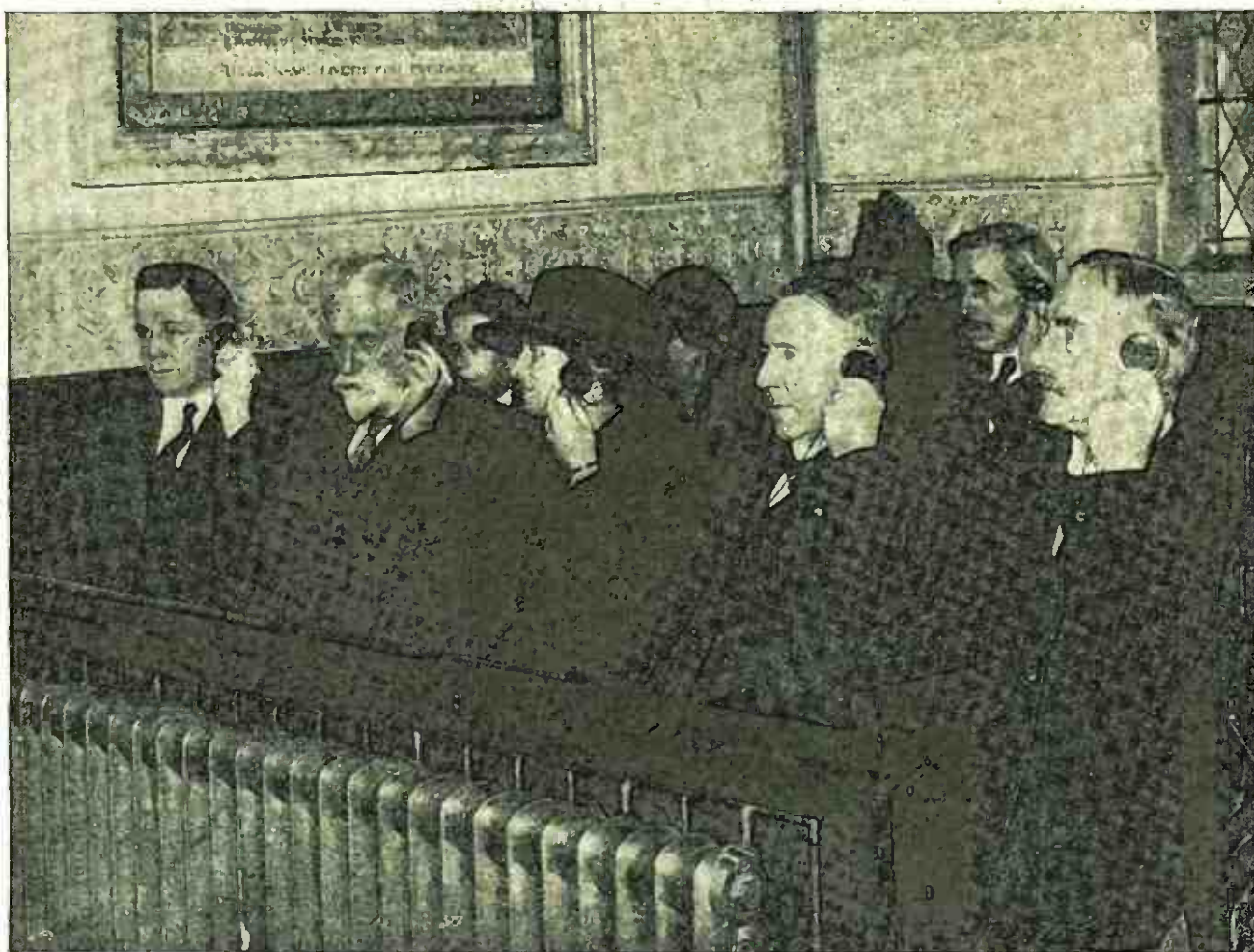

Kadel & Herbert

—AND THE DEAF PARISHIONERS LISTEN ON THE EARPHONES

This particular section of the church was reserved for the deaf parishioners. This installation enabled some of them to hear the sermons in their entirety for the first time in ten years.

otherwise inaudible by a person standing in a distant corner of the room with his back toward me. I am told that the apparatus has been used successfully in the theatre, the box being placed on the floor or held in the lap.

The micro-telephone idea thus utilized has been variously applied. For example, at the Wood Green Wesleyan Church, in England, and at Grace Lutheran Church of Norfolk, Nebraska—to cite two instances from widely separated regions—the needs of partially deaf parishioners have been met by the installation of a microphone at the pulpit and a series of headphones in certain pews; and it is recorded that church attendants who had not heard a sermon for many years are now able to listen on an equality with their normal-eared confrères.

But this, after all, only illustrates in a small way what has happened on a large scale wherever radio broadcasting has been established—and that is pretty nearly everywhere in the civilized world. There are today unnumbered thousands of individuals who regularly “listen in” with full appreciation on radio programs that include lectures, debates, sermons and musical performances that would be largely or altogether unheard by the same listeners were they actually present in the auditoriums whence the programs come. Thanks to the amplifying power of the radio receiver, a listener hundreds of miles away may have his ear drum set aquiver by sound waves vastly more powerful than those that would reach him were he seated in the front row, within a dozen feet of the speaker. Indeed, we are all aware that

the radio voice, emphasized by a loudspeaker, may be far louder than the voice it reproduces. An original murmur may be transformed into a roar.

Let it be recalled that the vast majority of persons who become partially deaf in middle life have no defect or malformation of the auditory apparatus that even an expert can detect. Their auditory sensibilities are simply dulled. Loudish sounds they can hear apparently as well as ever; softer sounds that once were audible are now indistinct or quite unheard. For such individuals—constituting doubtless the vast majority of “deaf” persons the world over—radio today offers substantial benefits and consolation. Probably the time will come when entire courses of radio lectures and entertainments will be pro-

vided with this vast audience of the “hard of hearing” chiefly in mind.

But has radio anything to offer for the alleviation of the infirmity of that smaller but still numerically important class of persons whose “deafness” is not due to mere dulling of the sensibilities but to actual malformation or perhaps congenital defect of the hearing apparatus?

Even a tentative answer to that question involves at least a cursory view of the anatomical structure and relations of the auditory apparatus itself. This, as familiarly known, has three divisions, conveniently spoken of as the external ear, the middle ear, and the internal ear. The external ear is a mere collector of sound waves. The middle ear consists essentially of a drum-head, or

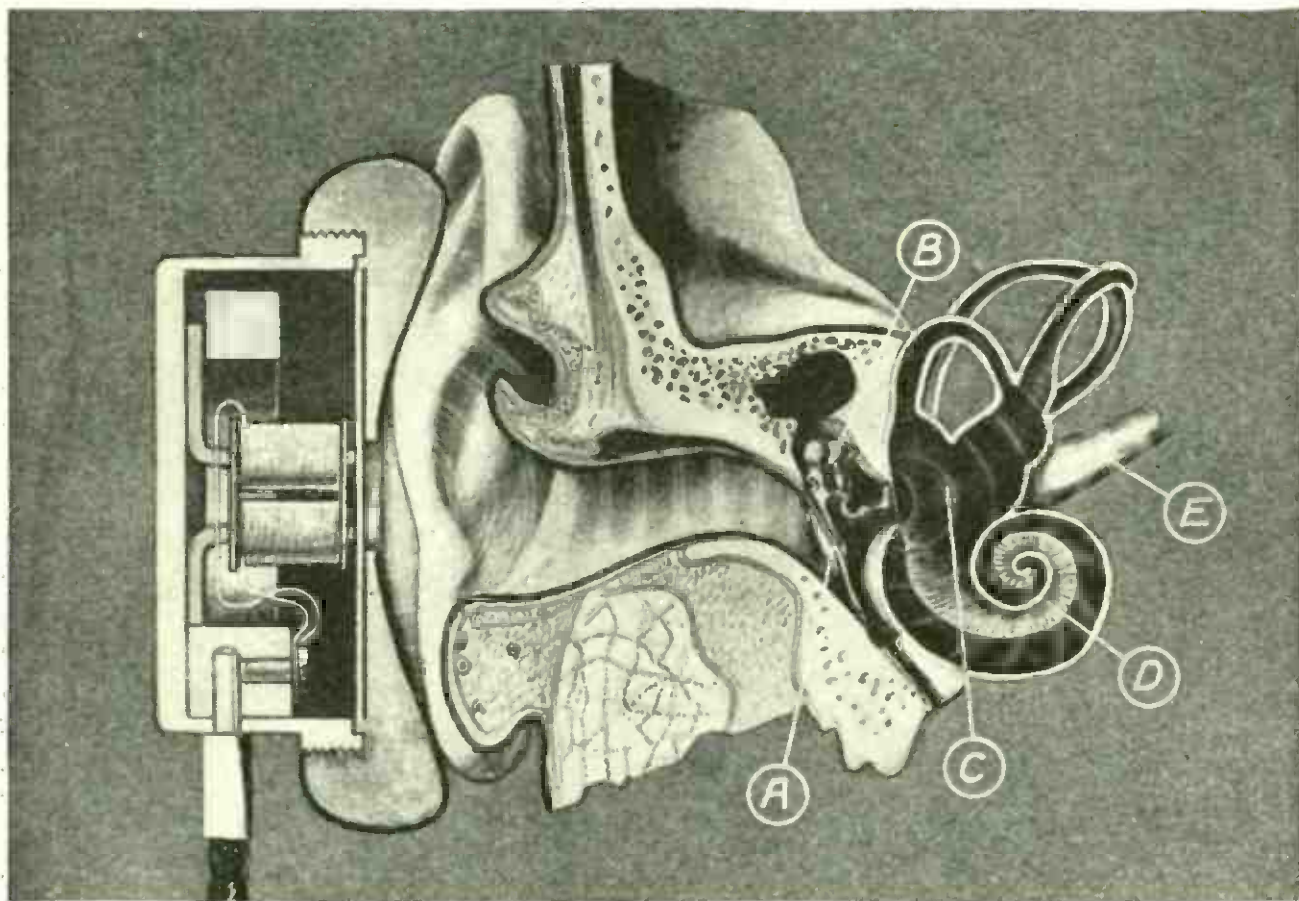

Western Electric Co.

THE LIVING MACHINE WITH WHICH YOU HEAR

In this drawing of the human ear you see how the sound waves from the telephone receiver enter the ear passage and impinge against the ear drum, A. The waves then traverse three small bones, B, reaching the liquid-filled sack of the inner ear, C. The real organ of hearing is the coiled-up membrane marked D. E is the auditory nerve that carries the sound message to the inner ear. (The newest theory of hearing is described in "In the World's Laboratories" in this issue of POPULAR RADIO.)



International

HOW SOUND WAVES ENTER THROUGH THE SKULL

The telephone receiver connected to an amplifying apparatus does not need to be held to the ear; if it is pressed against the forehead the sound waves enter the bones of the skull and thus reach the inner ear directly, without passing through the ear drum and the middle ear. Persons whose ear drum and middle ear have been destroyed may be able to hear thus by bone conduction. This picture shows the "atophone" bone vibrator, recently invented by Marconi.

tympanum, shielding a cavity that contains three curious little bones that by their joint leverage amplify the vibrations of the tympanum to something like thirty times their initial intensity. The amplified vibrations are passed on to the serum-filled cavity of the internal ear, an amazing labyrinth of membrane and bone intricately associated with the fimbriated ends of the nerve tract leading to the auditory centers in the brain.

Any part of this intricate apparatus—a mechanism as a whole so delicate as to respond to sound waves of less than the ten-millionth of a centimeter in amplitude—may suffer injury from traumatism or disease. Obviously, it makes a vast difference whether the injury, in any given case, affects, say, the sound-collecting "pinna" (visible ear), the bones of the middle ear, or the nervous and cerebral tissues on which final interpretation depends. The ques-

tion "Can radio help the deaf?" scarcely has definite meaning unless we have a clear understanding as to the nature of the physical defect or malformation on which deafness depends.

If, for example, the defect is due to an involvement of the middle ear in an inflammatory process that originated in the pharynx and extended to the ear through the eustachian tube (which normally connects throat and ear), the case is probably far more hopeful than if there is involvement of the "cochlea" (shell-like labyrinth) of the internal ear. The injury to the middle ear may prevent the proper transmission of vibrations from the ear drum to the essential mechanism within; so that deafness may seem to be complete. And yet it may be possible to convey equivalent vibrations to the internal ear through another channel, and thus to restore hearing, at least in a measure.

Such is the purpose of instruments like the so-called "ossiphone," designed to transmit sound vibrations through the bony structure of the body to the internal ear, which itself is imbedded in the bony structure of the skull. The ossiphone is essentially an electromagnetic substitute for the ordinary telephone ear piece, in which the vibrating diaphragm is replaced by an oscillating iron bar against which the would-be listener places his knuckles or his fingertips. A modified form of ossiphone has "resonators" to be held between the teeth. Persons whose internal auditory mechanism is unimpaired have been able to hear radio messages in this way, though unable to hear the slightest sound through the headphone.

The ordinary headphone may serve the same purpose in such cases, however, if the cap is unscrewed, so that the fingertips of the listener may be placed on the diaphragm. It is reported that Mr. Harry Dufony, of Jersey City, though deaf, is able to hear radio programs in this way; and Miss Helen Keller has recently given a really thrilling description of the sensations that came to her when she made a similar test.

Miss Keller, as everyone knows, is deaf and blind, but has an almost unbelievably trained sense of touch to do service for eyes and ears. According to her own account, she "spent a glorious hour listening over the radio to Beethoven's 'Ninth Symphony,' experienced—though not, she thinks, as other people "hear" it—through contact of her fingertips with the telephone diaphragm. She writes:

"What was my amazement to discover that I could feel, not only the vibrations, but also the impassioned rhythm, the throb and the urge

of the music! The intertwined and intermingled vibrations from different instruments enchanted me. I could actually distinguish the cornets, the roll of the drums, deep-toned violas and violins singing in exquisite unison. How the lovely speech of the violins flowed and flowed over the deepest tones of the other instruments! When the human voices leaped up, trilling from the surge of harmony, I recognized them instantly as voices.

"I felt the chorus grow more exultant, more ecstatic, upcurving swift and flame-like, until my heart almost stood still. The women's voices seemed an embodiment of all the angelic voices rushing in a harmonious flood of beautiful and inspiring sound. The great chorus throbbed against my fingers with poignant pause and flow. Then all the instruments and voices together burst forth—an ocean of heavenly vibration—and died away like winds when the storm is spent, ending in a delicate shower of sweet notes.

"Of course, this was not 'hearing,' but I do know that the tones and harmonies conveyed to me moods of great beauty and majesty. I also sensed, or thought I did, the tender sounds of nature that sing into my hand, swaying reeds and winds and the murmur of streams. I have never been so enraptured before by a multitude of tone vibrations.

"As I listened, with darkness and melody, shadow and sound filling all the room, I could not help remembering that the great composer who poured forth such a flood of sweetness into the world was deaf like myself. I marveled at the power of his quenchless spirit by which out of his pain he wrought such joy for others—and there I sat, feeling with my hand the magnificent symphony which broke like a sea upon the silent shores of his soul and mine."

If radio can open such a wonderland as that to a listener who is "stone deaf," who shall dare to place a limit on the possible benefactions of the new art? It constitutes a potent medium for the intellectual and aesthetic education, not merely of persons of normal hearing (to whom, one might have supposed, its benefits would be confined), but to the great multitude of the partially deaf, and even, it appears, to at least a certain proportion of the unfortunates who, under ordinary conditions, cannot hear at all.

How to Get the Maximum Efficiency from Your Receiver

To meet the demands of broadcast listeners who want specific, detailed and essentially helpful information about the care and operation of their radio apparatus, a series of articles on this subject by the distinguished radio expert, John V. L. Hogan, will start in POPULAR RADIO—for August.

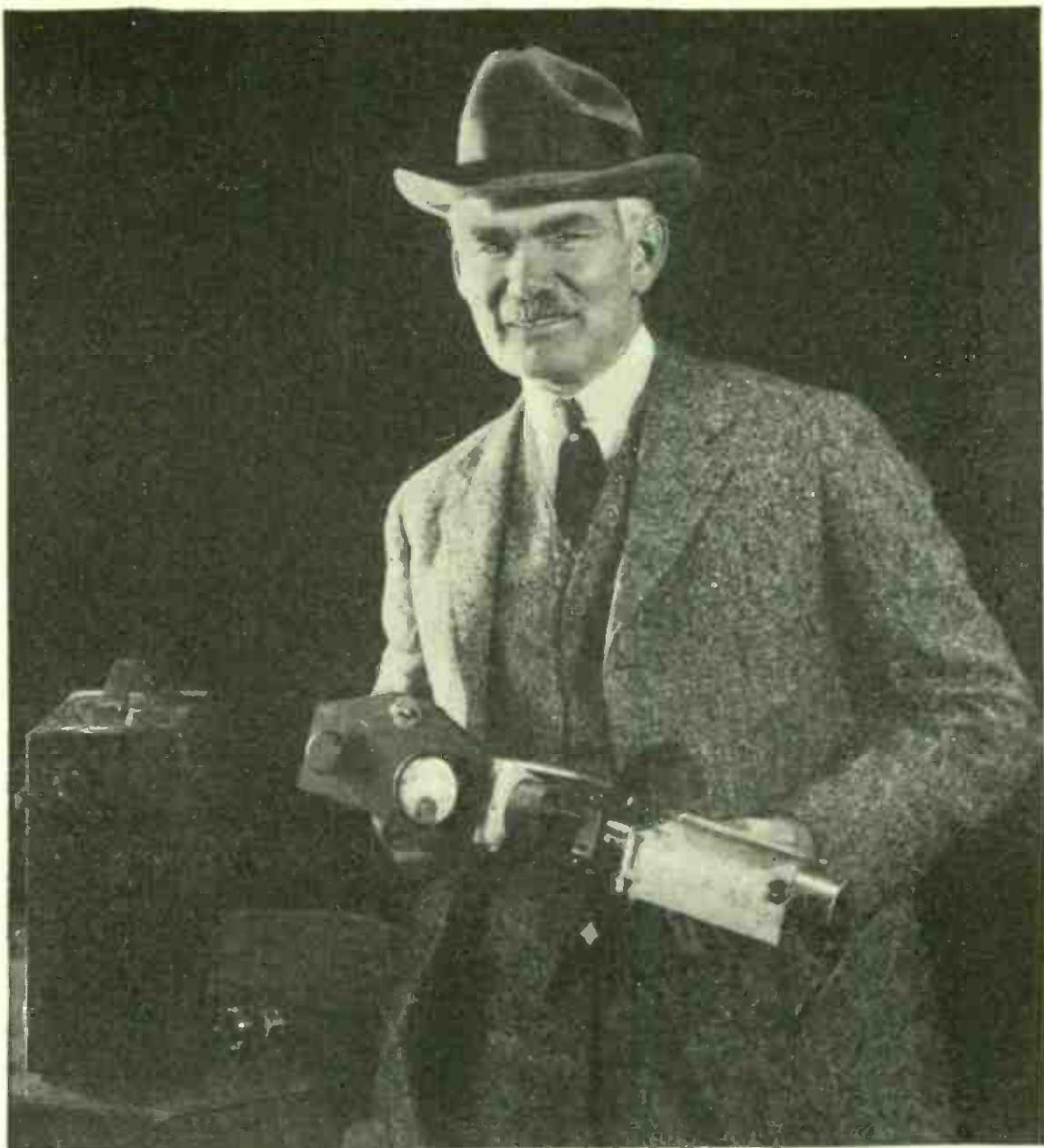

Where the Costs of Broadcasting Should Lie

Q My opinion is that the most practical and efficient procedure for solving the question as to who will pay for broadcasting would be for the Government to levy a slight tax on every audion bulb which is manufactured and to distribute (under proper supervision) the large sum that would thus be collected among the leading broadcasting stations for the purpose of paying for high-class entertainment and educational features.

Q I recognize that it might be difficult to find a precedent for this type of governmental activity in the United States. But then, radio broadcasting itself has no precedent and one of its main missions is, I hope, to knock off the barnacles that so thickly cluster over the hull of the Ship of State.

Q But if the Government undertakes this sort of work, may it be constrained not to lease broadcasting privileges, paid for by public taxation, to any individual or to any single incorporate body.

Lee de Forest

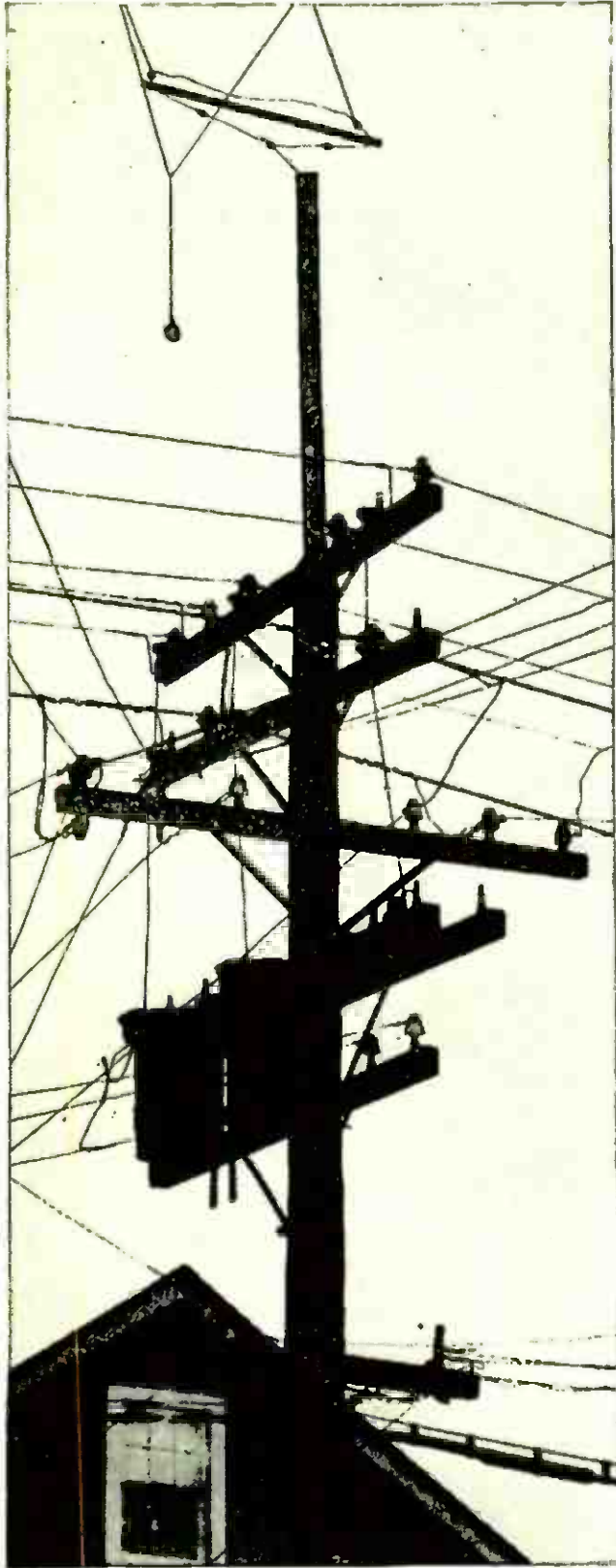

From a photograph made for POPULAR RADIO

HOW NOT TO PUT UP YOUR AERIAL

How one fan erected his antenna on top of this pole that carries a maze of both telephone and electric light wires is an unexplained wonder. "Don't attach your aerial to a pole that carries power lines," is a fundamental rule. An accidental contact may occur and ruin your set or even kill someone by electric shock. And if the pole bears transformers, the interference caused by leakage is still another cause of grief.

HOW TO AVOID Local Interference

Some of the queer noises attributed to "static" are caused by local interference *that can be eliminated*. Some of the more common sources of such interference are pointed out in this article—which also tells how the nuisance may be lessened if not stopped altogether.

By LLOYD S. GRAHAM

ONE of the most perplexing problems that face the radio enthusiasts at the present time is "local interference." It is a most irritating factor and one which produces many misunderstandings concerning the efficiency and even the possibilities of radio.

For instance, how many listeners really know the difference between local interference and static? The engineering departments of radio equipment manufacturers find that half of the fans do not know. Some of the experts have difficulty in telling the difference between the two.

Local interference began to be a problem in the radio world when receiving equipment reached the highly sensitive point which is fairly common today. High amplification brought out a lot of factors that the average radio enthusiast never supposed existed in the air—queer noises, and mysterious telephone buzzes. Sounds of running trolley cars, tantalizing whistles and shrieks were heard, intangible, irritating, unidentified.

The same conditions that brought music perfectly from the western coast

(to the man with the four-tube set in the central west) usually brought in also many other sounds which could never have been described adequately on an applause card—unless the card was made of asbestos.

Because of the lack of information on this subject some of the facts recently discovered by research workers of the radio equipment manufacturers are of particular interest and value to the enthusiast who may be somewhat dazed by some of his experiences with this type of interference.

It has been found, for example, that much of the local interference comes from power lines. These lines may be within a few feet of the antenna of the individual receiving set or they may be miles away. The impulses are sometimes carried to the proximity of the receiving set by telephone or other lines.

On this point Mr. L. C. F. Horle, a prominent radio engineer, says:

"When one uses receiving apparatus of ordinary sensitivity, one may have an antenna fairly closely located to a power line, but when the apparatus is so designed as to allow of reception over tremendous distances (and that is the common kind of broadcast apparatus today) the presence of power lines invariably hampers or completely spoils the reception of radio signals by reason of the voltages induced from the power wires, and that influence is slowly but surely forcing the broadcast antenna away from the power line."

This interference from power lines is difficult to control. Take, for instance, the case of the broadcast listeners in Batavia (N. Y.); in common with hundreds of other communities in this country, they are having trouble continually in obtaining clear reception. Several listeners have appealed to the radio manufacturers and to the press for help in solving the problem; they have even gone to the extent of offering a reward of fifty dollars for information which will place the cause of inter-

ference and lead to its elimination. Yet few engineers are eager to tackle so extensive a problem. It is one, they realize, which may take time and much money, and which might be unsolved despite their efforts. However, it is the theory of one research department that the interference in Batavia comes from power transmission lines, either directly or indirectly. One reason for this opinion is, that this community is in the direct line of heavy power transmission across New York State. If the weakness in the power lines could actually be located, much could be done to eliminate it. There may be places



From a photograph made for POPULAR RADIO

A COMMON CAUSE OF INTERFERENCE

The common vacuum cleaner—or sewing machine or dishwasher or cream-whipper—that operates by motor is more than likely to disturb broadcast listeners in the immediate neighborhood in case the motor is old or defective. If such a small motor causes interference, have it repaired.

or worn entirely off; there may be places in the lines where the insulation is thin where telephone lines run for long distances parallel to the power transmission lines; there may be other underlying causes of the disturbance in this connection.

The trouble *may* be eliminated by the repair of all lines. It may be eliminated by the use of condensers. The power transmission disturbances may even come in through a telephone line to the home of the broadcast listener.

An important point to bear in mind is that the underlying cause of the disturbance *may be many miles distant from the point* where the annoying

disturbance actually manifests itself.

To illustrate:

An engineer at one of the naval radio receiving stations on the New Jersey coast, during the war, found, that although it was an out of the way place, comparatively free from power lines, yet interference was a real problem until all of the lines, power as well as telephone, were buried below the frost line for a distance of 500 feet. Later the lines were buried for a distance of 1,500 feet from the station, and this eliminated most of the interference, but not all.

Part of the interference was never identified as to location. There was no

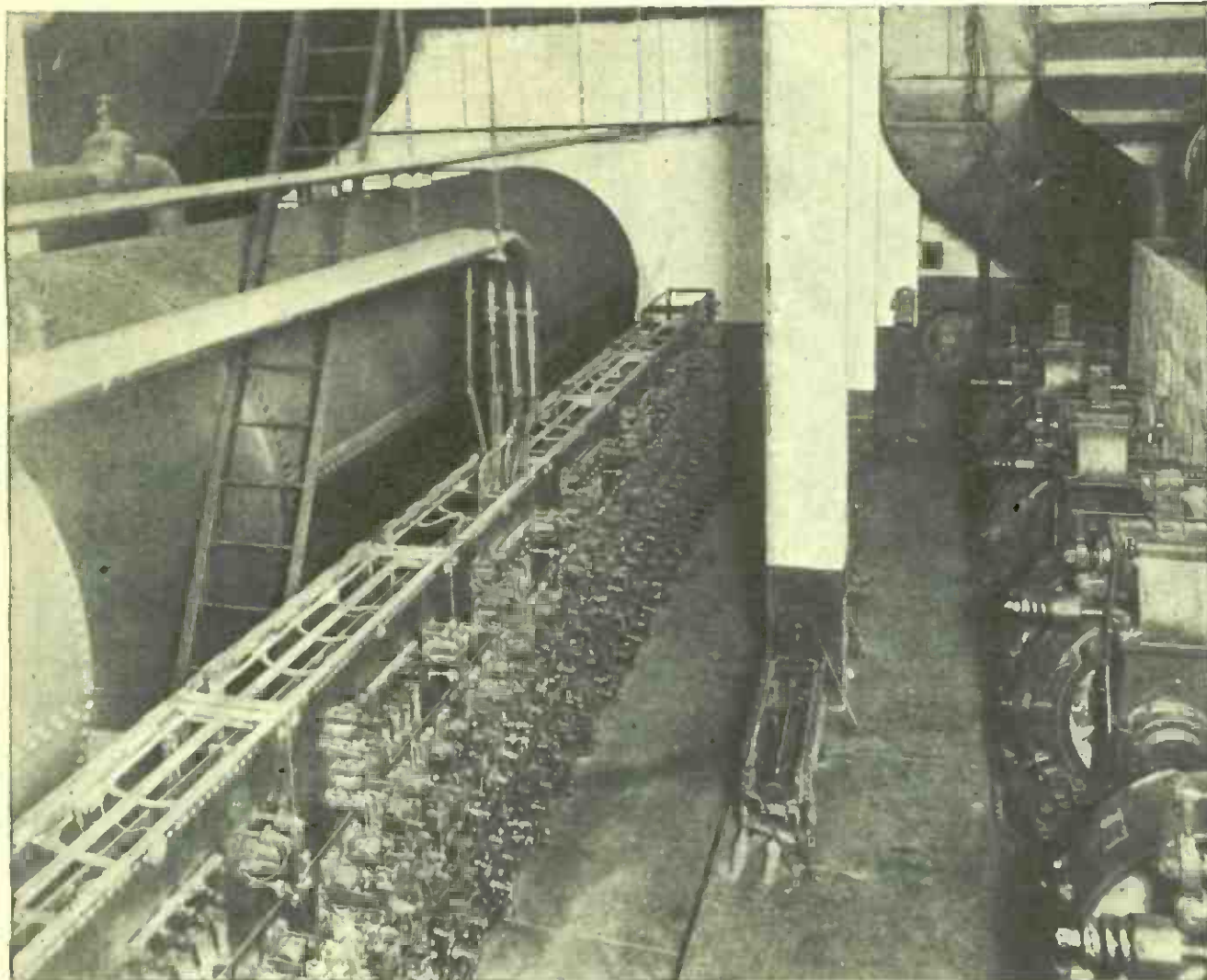

From a photograph made for POPULAR RADIO

SUCH MACHINES CAUSE ANNOYANCE TO THE BROADCAST LISTENER

This battery of motors and automatic controls that operate elevators in hotels and office buildings, constantly flash forth high-frequency impulses that the broadcast listener thinks is static. Electric welding machines and other electrically-operated apparatus are also prolific sources of annoyance.

trolley line for many miles around, yet in reception at this station, the technical navy men on duty could frequently hear the operation of a trolley car; they could hear the motorman operate the controls, the clicks of the lever as it went from contact to contact. But the motorman, the car, and the line were never identified.

One other important cause of interference is defective power equipment or electrical machinery that is out of order. This, also, is extremely difficult to locate.

There is the case of a receiving set in a Boston restaurant. Like most other restaurants, this one had a big electric suction fan in the kitchen for ventilation. The receiving set made itself unpopular by a hideous roaring sound. It was afterwards discovered that the motor which operated the suction fan was defective; it needed new contact brushes. The motor was put in first-class condition and the arcing of the commutator ceased—and most of the interference was eliminated. Still more of it was eliminated when a condenser of three microfarads was placed as close to the motor as possible, and connected with the power-supply lines.

Generator and motor troubles cause a large amount of interference, not only in the immediate vicinity, but by causing radiation of high-frequency energy over the lines to which they are connected.

There was much interference encountered in reception at the Technical High School of Buffalo. The trouble was eliminated almost entirely when two copper-mesh screens were placed around the magneto that was used in ringing telephone-exchange calls, as the copper mesh acted as a shield against the high-frequency energy which the machines radiated.

The story is told of a naval radio receiving station in a certain eastern city, during the war, where messages were received by radio and relayed on to their destinations by ordinary telegraph.



From a photograph made for POPULAR RADIO

VIOLET RAY AND X-RAY MACHINES CAUSE LOCAL INTERFERENCE

When father gets a headache and retires to the privacy of the bathroom to obtain the soothing effects of the household violet-ray machine, it is likely that he will give anyone within a radius of half a mile, who happens to be listening in on a receiving set, a headache all his own. This is one of the most frequent causes of interference in cities. Violet and X-Ray machines commonly used in hospitals as well as in doctors' and dentists' offices are practically sure to cause interference.

The interference from the telegraph lines caused so much trouble that the efficiency of the station was seriously hampered. The trouble was eliminated by lining the radio receiving room with ordinary wire mesh. This absorbed the radio energy that was thrown off by the telegraph apparatus.

There was a certain belt in northern Pennsylvania from which came persistent reports of local interference.

Radio research workers finally located the trouble in an oil-pipe line! The pipe-line company used an electrical buzzer device for detecting pipe breaks. When the buzzing stopped, watchers were warned that there was a break or some trouble in the pipe line. This buzzing device radiated "interference" in large quantities. Receiving sets between parallel lines one mile each side of the pipe line had great trouble on account of interference; this trouble was stopped by placing fixed condensers across the vibrators, which in no wise affected the efficiency of the buzzing device for the purpose for which it was designed.

Then there was the case of a man in New Hampshire who had both a nickel-in-the-slot player piano and a radio receiving set. The radio set would not work while the piano was in operation. In this case a condenser was placed across the motor-supply line of the piano and the efficiency of the radio set was restored.

Another frequent cause of local interference to broadcast listeners is the use of violet-ray and X-ray machines as well as other medical high-frequency machines which are commonly used in medical schools, hospitals, doctors' and dentists' offices and even in homes. Unless this apparatus is properly shielded so as to absorb the high-frequency waves that are radiated, it will cause highly irritating

interference within a radius of at least half a mile. The ordinary vibrator used in the home will create this interference for every one in an apartment house while in use.

High-tension coils of any type, used in connection with gasoline engines are often serious causes of local interference. This can be eliminated by the use of a screen of copper mesh about them or by the judicious use of condensers.

It has been discovered that changing the ground of a receiving set often eliminates some local interference. If the ground is to a water pipe, change over to a radiator pipe, or some other pipe, and *vice versa*.

Do not erect an antenna in close proximity to a power line, or use a power transmission line pole for one end of the antenna (as one Buffalo man did), and expect to obtain perfect reception. It can't be done.

The causes of and remedies for interference that are touched upon in this article probably cover ninety percent of the cases. Yet there are probably hundreds of causes of local interference which are not now identified and as many remedies which are not now known but which are on the verge of discovery. It is the universal prediction of radio research workers that great progress will be made during the next few months in determining, locating and eliminating causes of local interference.

Are We Receiving Radio Signals from Mars?

ARE the strange and unexplained noises that we sometimes hear in radio receivers in reality some form of radio impulses sent out from some other planet? Next month—August—Mars will approach nearer to the earth than ever before since radio was discovered. What this approach of our celestial neighbor may mean to science and to the radio fan will be told by Lieutenant Commander Fitzhugh Green, U. S. N., in POPULAR RADIO—next month.



THE MORNING MAIL AT A BROADCASTING STATION

At station WJZ a clerical staff is kept busy reading letters from fans and classifying them according to their contents—which include suggestions about programs, inquiries about artists, technical comment and reports on long distance reception.

What the Manager of a Broadcasting Station Hears

Don't think that radio broadcasting is a one-way line of communication. Thousands of fans write, telephone and telegraph to the station managers. Here are some of the things they say!

By HOMER CROY

I AM the manager of a broadcasting station. I am the person who opens the letters and receives the telegrams. And oh, such letters!—Such surprising telegrams! Sometimes they are amusing and then again. . . .

But I will tell you about them.

When I go to my desk of a morning, my mail is in two piles. One is the ordi-

nary business correspondence, letters to do with the engagement of performers, routine matters and so on; the other is the "fan" letters, as they are called.

I attend to the business correspondence first and then some time during the day go through the "fan" letters.

One morning my eye happened to catch a letter in the fan mail with two

special delivery stamps on it. It was a small square envelope, almost covered by the address and the stamps. What could it be? Why should a person put on *two* special delivery stamps? I slit the envelope, drew the letter out. . . . It was from a little girl. Her cat, Abbie, had disappeared and she wanted us to send out an "allarm," as she spelled it. Enclosed was a drawing showing the white spots on Abbie so that we could describe her. "Please be quick," she said, "because Father saw some gypsies in the neighborhood and they may have got her. She knows her name when you speak to her."

It was a simple, touching little incident, but I have always remembered it—and wondered what became of Abbie. I never heard.

Much of the mail is routine—how much the person enjoyed the concert,

or the reverse—and when a person doesn't like a selection on the program he is frank about it, *he* doesn't mince words. Many of the letters have to do with reports on "distance records," requests for "repeats," and so on. Then all of a sudden, something real and human will leap out, a letter that goes clear to the bottom of the human heart.

This was one: on the outside there was nothing to distinguish it from hundreds of other fan letters, but when I opened it I noticed something peculiar about it. On closer inspection I saw that it had been folded many times in straight, parallel lines. I began to read it. It was from a woman. She lived in a small town and was ambitious to get ahead. She had gone to a "normal" to prepare herself for teaching. She had little money—her father was poor; she studied very hard late at night in



Underwood & Underwood

RADIO FANS RANGE FROM POOR FOLK IN THE ALMSHOUSE—

The station manager, in arranging his programs, must constantly bear in mind the widely divergent classes of fans who listen in, ranging from young to old, white to black, rich to poor. This picture was made in an almshouse near Washington, D. C.

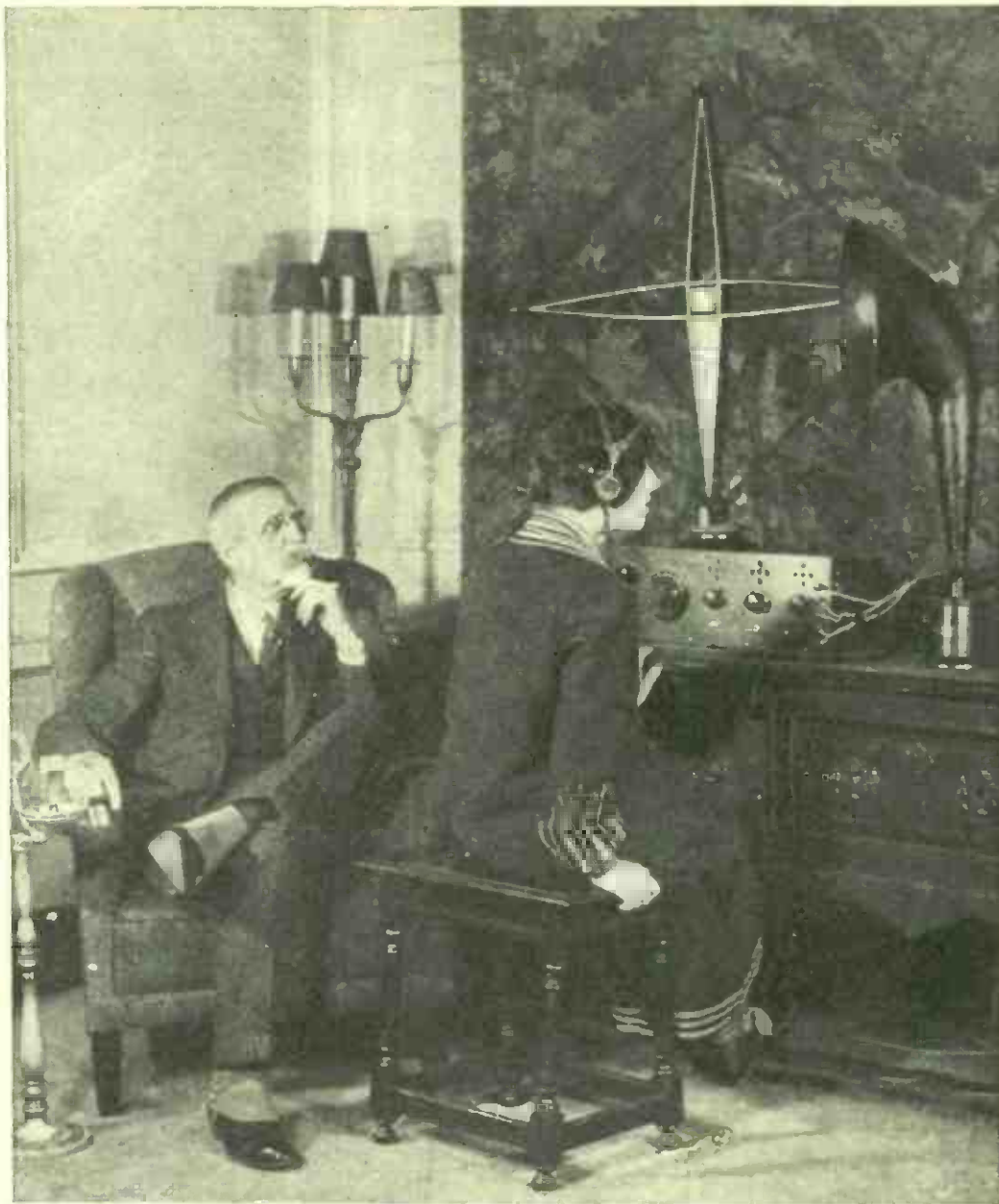

International

—TO THE WELL-TO-DO WHO LIVE IN LUXURY

Just what proportion of his audience prefers jazz and ringside reports of prize fights and what proportion prefers lectures and symphony music is part of a station manager's problem.

order to complete the course while her money lasted, but the strain was too much. Illness fell upon her—when she came out of it she was blind. Now she could no longer teach; she looked about for something to do—she became a masseuse. This is her letter:

"I want you to know how much your entertainments mean to me. My massage work is very exhausting; when evening comes I am so tired that I cannot go out. The constant association with sick people, the worry about expense, the strain of trying to go without sight, the care of my father who is feeble and hard of hearing, the anxiety for my mother, who is seventy-four years old and who has

to work so hard to serve a deaf husband and a blind daughter, all these things brought me to a dreadful state of mind. Life was hard—and then you came with your wonderful evenings! I can lie on my couch and rest, I do not have to take my cane and go out; and father is able to hear over the radio. The talk which we heard last night about Christ and Christianity stirred all three of us. I do wish some philanthropist, who would like to do something for the blind, would furnish radio sets to those less fortunate than I."

"Less fortunate than I!" The phrase rang in my ears. It haunted me for days; and then the next letter I pick up may have laughter in it.

One letter, I recall, was from a mother

who had a son named Oscar. She said she hated to admit it but Oscar was a "holy terror." She had tried everything with him, had spanked him, locked him up in closets and sent him to bed supperless—but Oscar seemed to thrive on it. Now an idea had come to her: would we on Friday night, after his bedtime story, call Oscar's name and give him a talking to? She thought it would do wonders for Oscar!

Another letter was from an excited father—an eight-pound boy had just arrived and he wanted the world to know about it. He wanted us to send it out broadcast—he said that he had "lots of friends" and they would all be pleased to know the big news. But that was not all—his wife's father and mother lived in an adjoining state and he most particularly wanted them to know.

"Will you kindly broadcast it three nights in succession, as they have a new Ford and

may be out riding and I wouldn't want them to miss it?"

And then at the bottom he added a very human touch—one that any father who has had a nurse come to the house and who has been through the big event will recognize:

"Please excuse pencil as I cannot find anything."

Such requests as these we usually answer by form letter, explaining that under the license issued by the United States Government a sending station is prohibited from putting into the air anything of a purely personal nature.

The enthusiasm people have for their favorite sending station is surprising. Constantly we receive presents in the form of picture postals, candy; one girl learning my name sent me a crocheted necktie; a boy in Florida sent us a live baby alligator. He had heard our station and wanted to make us a present.



Pacific & Atlantic

A TYPICAL FAMILY OF RADIO FANS IN GERMANY

It is only a matter of time when entertainment broadcast from American stations will be picked up regularly in Europe. The popularity of radio is growing rapidly abroad, as this after-dinner family party, equipped with seven headphones, attests.



Kadel & Herbert

5,600 LETTERS FROM FANS—THE RESULT OF A TEN-MINUTE TALK

When Bernays Johnson broadcast an informal lecture from station WOO in Philadelphia on the subject of radio minerals and crystal sets, he was rewarded with what is said to be a world's record in fan correspondence.

We put the pet in a goldfish bowl and kept it at the office, but one morning when we came to work it was floating on top. It had been frozen to death.

But I think the most unusual demonstration of affection for a sending station was one that happened to WGY. They received a letter from an enthusiast—Yadon, by name—in Delevan, Wisconsin, saying that a son had just arrived in the family and that he had decided to name it after WGY, so the boy went into the world christened Wallace Gordon Yadon. He is now a husky youngster with a set of earphones of his own.

Sometimes, as we sit at a sending station, seeing no one, hearing no one, we seem so aloof and remote from the world, without a place in it, and then a letter warm with the breath of life comes to us. One ambitious to write

short stories should be connected with a sending station—so often people will write more than they will tell in person. One can plow right down into the depths of the human heart. One letter was from the younger of two elderly sisters; they lived alone—two old maids, with gray hair and shrunken, withered hands. The one passion of their lives had been church; it was the big event of the week for them; Sunday morning they put on their old-fashioned clothes, locked the door behind them, dropped the key into their bag and went to church. There had been a rough winter; they had grown more feeble—they were no longer able to go to church. A radio set was put in. Now each Sunday these two old women dress up in their old-fashioned clothes, put on their hats and their worn silk gloves and devoutly listen to a



From a photograph made at WJZ for POPULAR RADIO

THE TELEPHONES ARE KEPT BUSY DURING A BROADCAST CONCERT

The larger stations keep a staff of attendants on hand to answer calls from listeners; sometimes the calls come from distant states! The messages range from comments on reception and transmission to praise and criticism of the program.

church service. During the Scripture reading, they follow the pastor in their Bibles, and at the offertory they solemnly place money on a plate. At the end of the service they gather up the money and send it to the church where they once worshiped; then they take off their faded, old-fashioned clothes—and another week has gone out of their lives.

In the minds of the simple, radio and religion are often connected; I suppose, to the untutored, they both represent the supernatural, for so often we receive letters connecting the two. One was from a lumberjack in the big forests of Canada. His letter was on wrapping paper; in my fancy I could see him with a candle before him gripping the stub of a lead pencil, his tongue out, his heavy, unaccustomed fingers—more used to a cant hook—struggling with a new and difficult task.

"You sure got me tonight with your church servis and singing. I ain't been to church for

eleven years and I want some more. A man was killed by a tree which he didn't see. I wish he could of had it then. Where would be the closest place to get a loud speaker?"

That simple, short, misspelled letter told so much. I could see the camp transformed, could see the lumberjacks with their French Cannuck cook sitting around their cabin, staring at the floor, the room filled with smoke, the odor of unwashed bodies, shaggy whiskers, could hear the deep, heavy breathing—all listening to a church service a thousand miles away.

While we are on the subject of Canada I will tell of another letter that came in to our office. It was from an American wife of a French-Canadian living in Shawinigan Falls, Quebec. This is the letter:

"I want to tell you about our little daughter, Maria, aged four. In our family we speak only French. Last evening we were much astonished to hear Maria say, suddenly, in English, 'This is station blank; one minute please.' We expect to teach her English by radio."

I will give one more letter, just as it came to us. I have not investigated it personally and give it only for what it is worth, as it is of such a remarkable nature that one may well hesitate about accepting it. William T. Walters, living in Cohoes, New York, was stricken with brain fever at the age of sixteen months. When he recovered he was deaf. He is now thirty-one years old; as a result, he has gone through thirty years of his life in silence. A friend of his, Myron J. Jackson of that city, wishing to entertain him put up a receiving outfit and by signs asked the deaf man to put on the earphones. Here is Mr. Jackson's letter:

"I adjusted the machine to a good clear tone, and after listening for a few minutes the deaf man, to our surprise and amazement, pointed to an imaginary mustache on his face, which meant, 'Man.' At this his mother exclaimed, 'Will can hear!' Expression and animation came into his face, while we waited motionless. At the end of the discourse his mother asked him in sign language if he had heard. With that the man nodded and drew his right hand across his breast. In his language this meant 'Honest.' I asked him what the man had been talking about. Pointing to a cigar he blew imaginary smoke from his mouth. The address had been on 'Tobacco.'"

But all our letters are not from people telling us how much we have given them. No indeed. Stacks of them are from people who want to give *us* something. People write to us, or come to see us personally, with all kinds of queer ideas. They think the public is just suffering to be helped by them. One man had just invented a new kind of rheumatism cure; he wanted to tell about his wonderful discovery. "Then," he said, "I'll do something that has never been done before—to every person who writes in I'll give a free sample of the medicine." He was perfectly serious about it—in fact, he looked upon himself as a benefactor of mankind.

Propaganda is what we have to fight.

hardest of all. People come to us with everything—they want to tell how to take care of your teeth and then end up with an advertisement for their particular brush or paste; how to vote, how to play some new Chinese game—their idea is to popularize it, get in some advertising without paying for it. Mothers come with talented daughters and want them to sing; child-wonder violinists, baby elocutionists, animal and bird imitators and so on. One day a man with an old cut across his face came to our office; he said that he was an Englishman from South Africa—he wanted to deliver a talk on "How to Train Lions." When I began to probe into it I found that he thought maybe some circus man would be listening and give him a job. He was the first person who ever came to us wanting to use our sending station as a means of getting himself a job. The cut on his face, he explained, was from one of his training experiences.

Thus they come to our station, young and old, wanting to "put something over;" wanting to tell about some wonderful real estate development, wanting to tell the world about some "new thought" idea that is going to make the human race over—oh, they are quite convinced that they can do a great and wonderful thing for the public by talking an hour on "The Syncopes of the Soul—How to Make the Most of Them." A strange, strange lot they are, all dreadfully in earnest. One was a bootlegger who wanted to warn people against methyl alcohol in cheap whisky!

Our duty is to sort the wheat from the chaff. And our only way of knowing what our success is, is by the "fan" letters that come in—those humorous, pathetic, astonishing, inspiring, necessary "fan" letters. We want them.

Finding Mines by Radio

How radio waves are being used in new and significant ways for adding to the world's wealth will be told by Dr. E. E. Free in POPULAR RADIO for August.

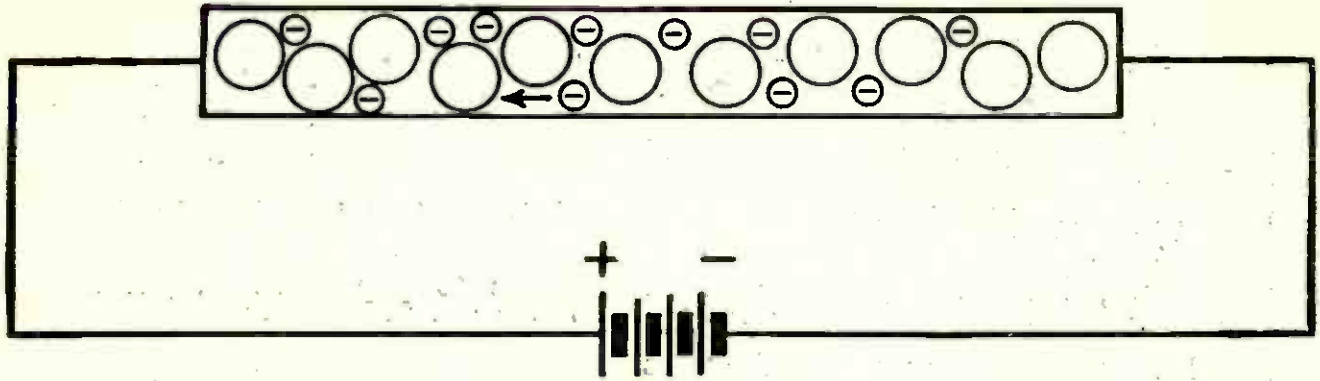

HOW ELECTRONS DRIFT THROUGH A CONDUCTING WIRE

The small spheres represent the electrons; the large spheres represent the atoms of copper. The arrow shows the direction of drift of the electrons under the electromotive force applied by the battery. The electrons are really much smaller, in proportion to the atoms, than they are shown here. Collision of the electrons with the atoms is one cause of resistance.

How "Resistance" Affects Radio Circuits

All ordinary radio circuits have three electrical properties; *resistance*, *inductance* and *capacity*. This article is a simple explanation of what resistance is and of how it affects the constants of a radio circuit. The following articles of this series will tell about inductance and capacity.

By JULIAN K. HENNEY

"WHAT do you mean, resistance?"

He was a budding enthusiast. He had followed directions to the extent of winding "sixty turns of DCC wire on a four-inch tube," had hitched it to a "twenty-three-plate variable," and with the aid of other unintelligible apparatus had heard music from both coasts.

And yet he wasn't satisfied. As he said he was "from Missouri," he wanted to know *why*. And when he heard about resistance and inductance and capacity and kindred radio terms his curiosity was whetted. He didn't know that "DCC" meant "double cotton-covered wire" until the dealer had explained, and the dealer himself was not sure about inductance.

"The only thing I know anything

about is resistance," said the enthusiast, "and the books don't say much about that. It's all inductance and capacity. Who put the inductance in my coil? Where is it now? What good is it? And how much have I? What do you mean, inductance?"

All three of these things, resistance, inductance and capacity, are essentials of radio circuits. Resistance is always present, and always something of a nuisance; inductance and capacity may be present or not, but in a complete radio circuit, all three are invariably present.

Resistance is perhaps the easiest to understand of the three properties of electric circuits. It is not difficult to imagine electricity as flowing through a wire, like water through a pipe. Al-

though the actual mechanism is not the same, the laws governing the two phenomena are somewhat similar. The quantity of water that will flow through a given pipe in a given time is expressed by

$$\text{Water per second} = \frac{\text{pressure}}{\text{friction}}$$

Thus, a pipe of small cross section will have a large friction opposing the flow of water, and the quantity actually flowing will be relatively small.

The analogous law for a steady direct electric current is

$$\text{electricity per second} = \frac{\text{pressure}}{\text{resistance}}$$

Now the question naturally arises, what is there in a wire that corresponds to the friction in a water pipe and thus hinders the flow of the electricity?

To answer this question it will be necessary to delve somewhat into modern electron theory.

According to modern theories, insulators and conductors are composed of molecules and electrons. The electrons of insulators are bound together in a certain definite fashion, kept in their positions by a kind of electronic "Mason

and Dixon line." Conductors, on the other hand, possess certain free electrons which are able to move about under an electric force. These free electrons moving at velocities which may even exceed the stupendous figure of 6,000,000 centimeters—about thirty-five miles—a second are being bumped and hindered in their progress by the massive molecules which are also in vibration. Although the individual electrons move with this speed, it must not be thought that they go from one end of a wire to another at this rate. Their actual motion is in all directions, and under the action of a driving force (such as a battery) they tend to drift in the direction of the electromotive force. The rate of this "drift," which constitutes an electric current is seldom greater than one centimeter a second.

On their way toward the end of the wire, the electrons bump into the molecules that stand in the way, huge mountains of metal that impede the progress of the infinitesimally small, quickly darting carriers of electricity. This electrical "bumping" gives you an idea of one way in which "resistance" may arise.

If *one* unit of electrical pressure, known as the volt, is applied to the ends of the

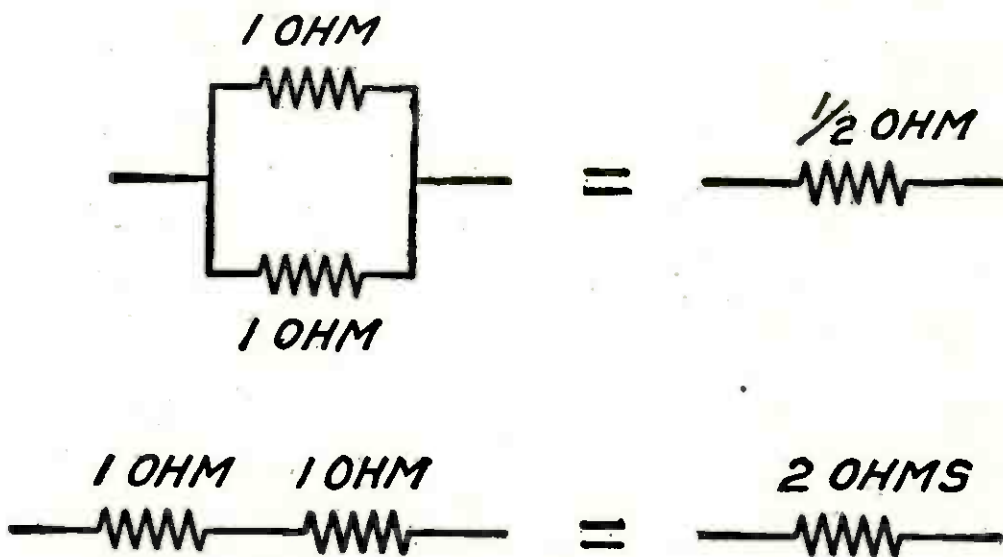

HOW RESISTANCES MAY BE ADDED OR DIVIDED

The upper figure shows two resistances in parallel; the joint resistance is half that of either one. In the lower figure the same two resistances are connected in series; the joint resistance is then twice that of a single one.

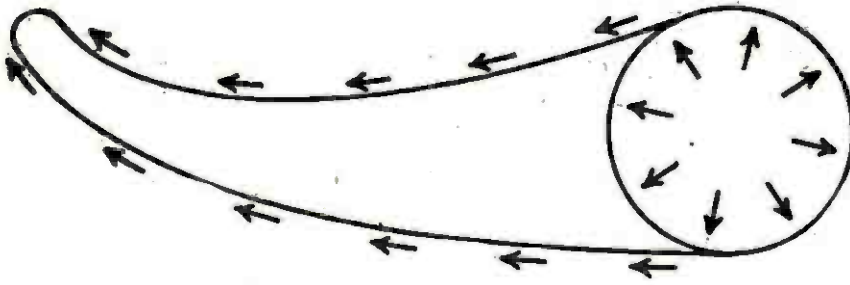

WHAT THE "SKIN EFFECT" DOES TO CURRENT IN A WIRE

When an electric current flows in a wire, in the direction of the outer arrows, the electrons tend to crowd toward the surface, as indicated by the radial arrows shown on the cut-off end of the wire. This is what is called the "skin effect."

wire so that the uncountable number of 6.28×10^{18} or 6.28 million million million electrons flow through the ammeter per second, the resistance is said to be *one* ohm. The actual flow of current in this case is said to be *one* ampere. Our law then becomes

$$\text{amperes} = \frac{\text{ohms}}{\text{volts}}$$

The ohm is the unit of resistance and is defined as the resistance of a column of mercury 106.3 centimeters high, having a weight of 14.45 grams, the temperature being 0° Centigrade.

In our water analogy, the longer the pipe and the smaller the diameter, the greater the friction. The electrical analogue is similar. The resistance of a conductor is determined by its length, its diameter, and the kind of material of which it is composed. In general, pure metals have a lower resistance than alloys, and the higher the temperature the greater the resistance. This latter fact is obvious, for the molecular agitation becomes greater as the temperature rises, and this means that the electrons will meet with more collisions on their journey along the wire.

The table shows the relative resistance of several metals and alloys.

Material	Specific Resistance
Silver	1.468
Copper	1.562
Aluminum	2.665
Zinc	5.751
Iron	9.065
Platinum	10.917
German silver	20.243
Mercury	94.070

German silver is an alloy composed of copper, nickel, and zinc.

At low temperatures, the molecules composing a metal are sluggish in their movement. Near the absolute zero point, Professor Kammerlingh-Onnes has found that the resistance drops very suddenly. For instance the resistance of mercury at 3° Absolute, or 270° below zero Centigrade, dropped to less than one ten-millionth of its value at the freezing point of water. A current once started in a ring of metal at these low temperatures continues for hours after the electromotive force is removed, showing that the losses due to resistance are extremely small.

At high temperatures, most metals experience a rise in resistance. Carbon is an exception to this rule. Not only does the resistance of carbon not increase with rise in temperature, but it actually decreases. Selenium has its resistance affected by light, so that schemes have been utilized whereby the sunrise turns off the light in a channel buoy. Bismuth, when placed in a magnetic field, undergoes a change in resistance, so that the strength of the field may be measured by noting the change of resistance.

In our water analogy we saw that the only force opposing the flow of water—hence something to be made as low as possible—is the friction in the pipe. In electric circuits, resistance plays the same role—it uses up the energy in the production of heat which in most radio instruments is to be avoided.

Forcing current through the heater coil of an electric iron produces heat energy from electric energy. The filament of an ordinary incandescent lamp becomes hot and glows for the same reason.

The phenomena considered up to this point have been true of "direct current" resistance, that is, the resistance offered to a steady flow of electricity. In radio, however, we are not dealing with steady currents, but with currents that reverse their direction of flow many, many times a second. Other forces come into play as soon as we leave the realm of steady currents, and jump into "radio-frequency" circuits.

At 300 meters the current reverses its direction twice each cycle or two million times a second. Instead of sticking to the "straight and narrow" the current seems to try to get away from the wire. Like water on a rapidly rotating grindstone, it moves toward the outside of the wire. At very high frequencies, that is, at low wavelengths, the current is actually carried in a thin layer on the out-

side of the wire or other conductor.

This phenomenon is known as the "skin effect." The crowding of the current to the outside cuts down the effective cross section of the wire which increases the effective resistance.

Litzendraht wire, commonly known as "litz," was originated to overcome this increase of resistance with frequency. This wire is composed of many strands of fine wire, each insulated from the other. Litz is not effective unless great care is taken to see that each strand is cleaned and soldered when making connections. Broken wires within the cable destroy its effectiveness at once. With currents corresponding to a 1,000-meter wave this stranded wire is particularly useful, while at extreme low wavelengths the current reverses so frequently that the advantages of stranding the wire are not so apparent.

At 200 meters, 99 percent of the current is carried in a thin shell on the outside of the conductor. The thickness of this surface layer is about .009 inch. For this reason copper tubing is often

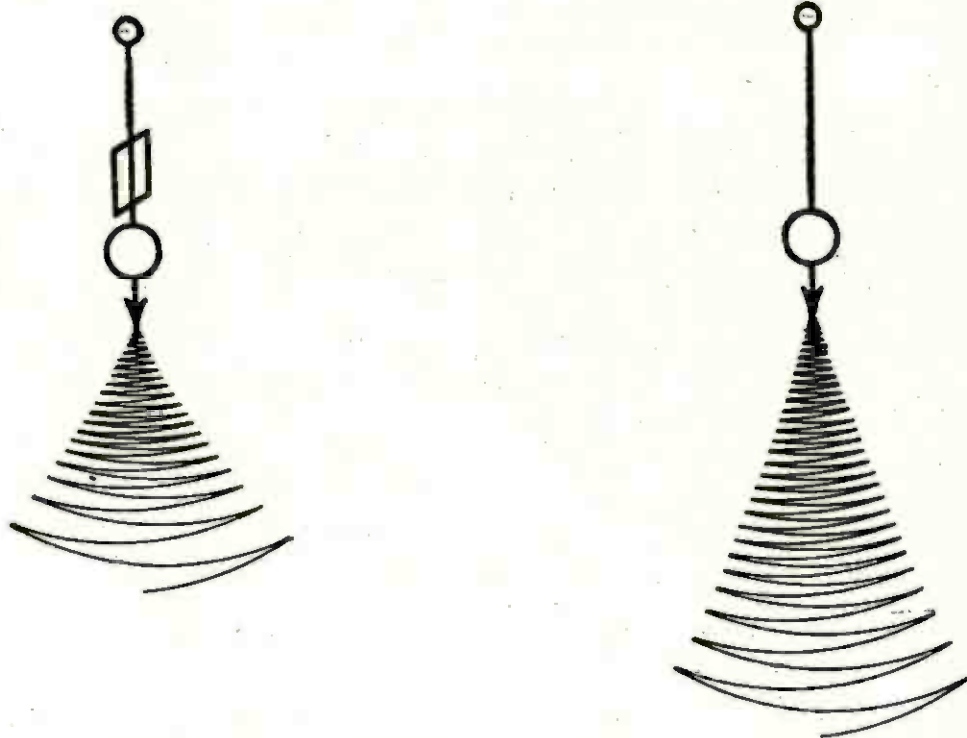

HOW THE OSCILLATIONS OF A PENDULUM ARE DAMPED

The wind-vane attached to the pendulum at the left increases the air resistance and damps the oscillations of the pendulum. In an analogous way, electric resistance in a circuit damps out the electric oscillations of an alternating current.

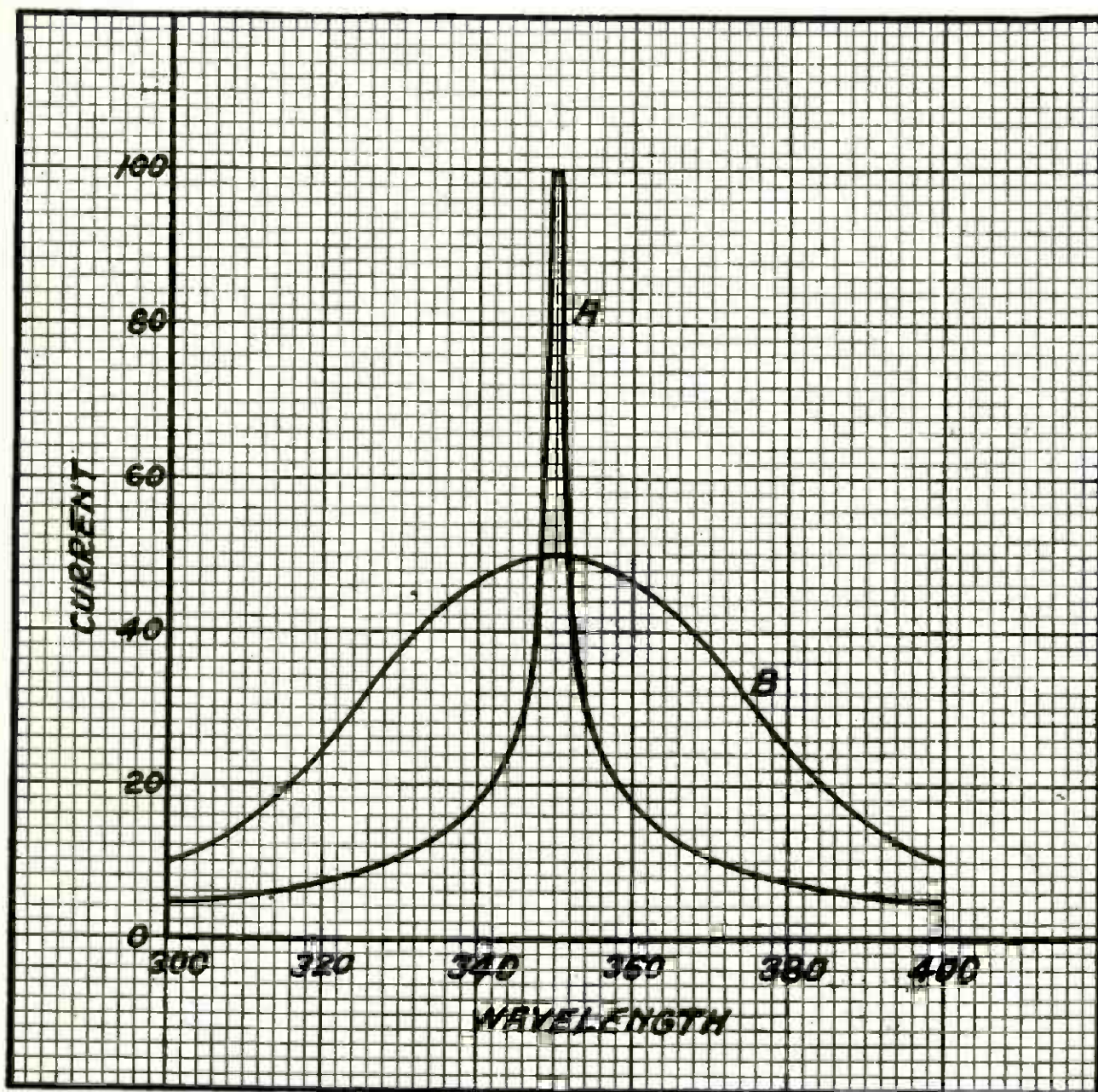

HOW RESISTANCE IN A CIRCUIT AFFECTS TUNING

Resonance curve A corresponds to a circuit that has little resistance. The tuning is sharp on a wavelength of 350 meters. Curve B represents a circuit containing more resistance. The resonance is less sharp and the tuning is broadened.

used for heavy high-frequency currents; the hollow conductor has approximately the same high-frequency resistance as a solid wire.

Just as mechanical friction is the bane of all engineers, electrical resistance, except where heat is required, is a thing to be avoided by electrical engineers. It is not sufficient in designing a coil to go to a wire table, pick out a size of wire that has a low direct-current resistance, and wind up a coil. The problem is one of winding a coil that will

have a low resistance to *high-frequency currents*—and that is a task that has bothered even the best of engineers.

The effect of resistance in high-frequency circuits is to damp out the oscillations that exist in the circuit, and such damping out is not advisable. An analogous effect may be seen by counting the number of oscillations a pendulum makes before and after hanging a vane on the bob, so that the air resistance is increased.

The immediate result of adding re-

sistance to a radio circuit is to broaden its tuning. For instance, the two curves shown on the preceding page are "resonance curves" of a small receiving set. It will be seen that for a given wavelength (360 meters) the amount of current is large. On either side of this peak the current falls off rapidly, so that wavelengths lower and higher than 360 will cause little interference.

The other curve shows at once what happens when resistance is added to a high-resistance circuit. Signals of lower and higher wavelengths are much more noticeable than in the first case.

How are we to avoid resistance in a circuit, say in a receiving set?

A complete answer involves the mutual effects of circuits on each other, which is a matter that we will discuss in the next article, under inductance.

There are, however, a few practical rules to bear in mind, though, like many rules, they frequently fail:

1. Make only single-layer coils—or if more than one layer is necessary, use a bank winding.
2. Space solid wires about the distance of the diameter of the wire. Do not space Litz wire—wind turns closely together.
4. Avoid taps.
5. Avoid larger coils than necessary. Do not expect a coil large enough to tune to waves of 3,000 meters to do good work on 300 meters.
6. Use small tubes and many turns rather than large tubes and few turns.
7. Make leads short and of the same size of wire as the coil.
8. Choose the size of wire carefully.

It is a safe rule to use wire between the sizes of No. 18 to No. 30, although it must be admitted that tuners made of smaller or larger wire than these limits sometimes work and work well.



From a picture made for POPULAR RADIO

HOW TO CLEAN YOUR CRYSTAL

When crystals collect a certain amount of grease and dirt they do not function properly. When they refuse to rectify, they are usually discarded. They may be cleaned, however, by washing and scrubbing with a clean toothbrush dipped in alcohol. When cleaned in this manner and allowed to dry they will be almost as good as new.

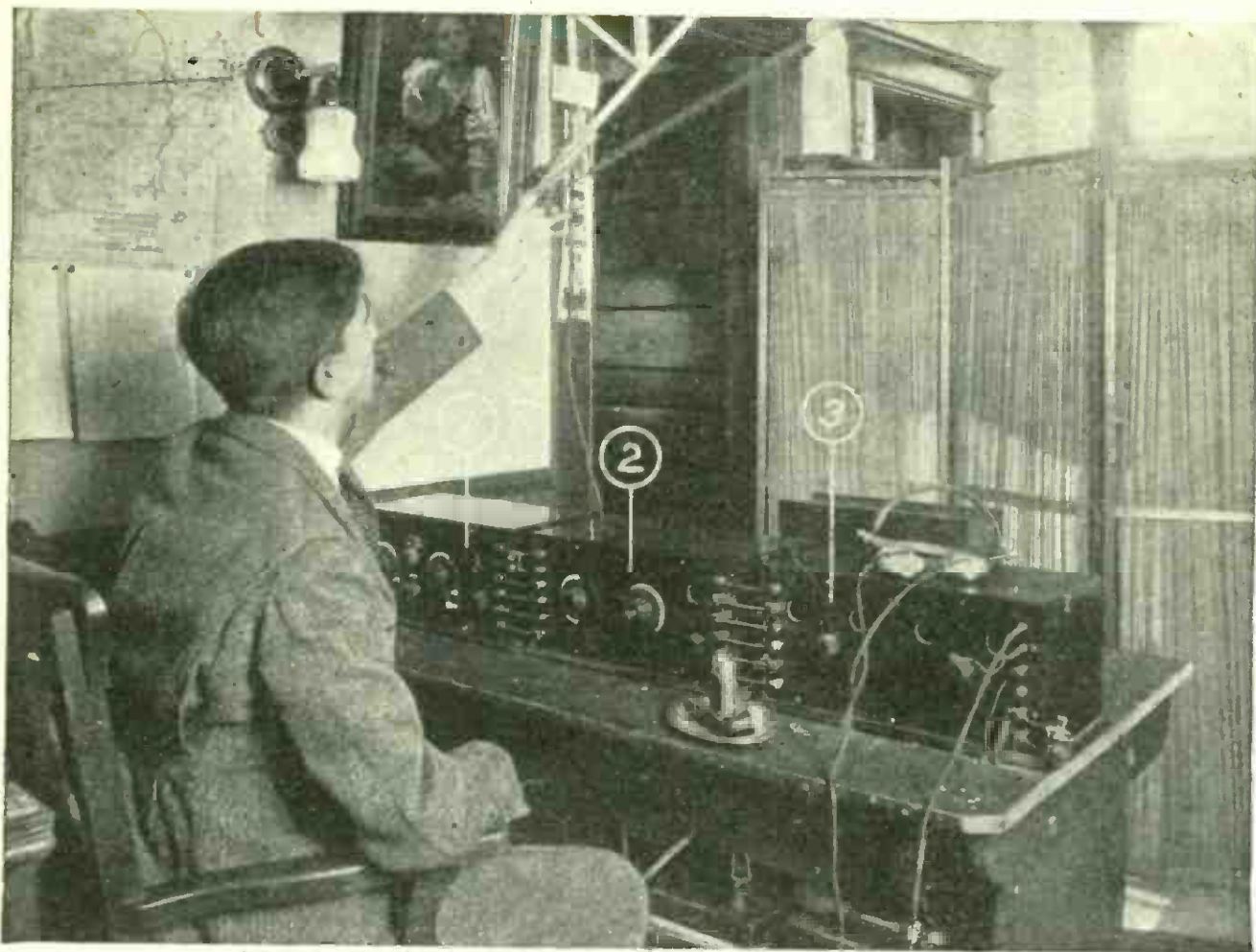

From a photograph made for POPULAR RADIO

The author finds that with the loop attached to his super-heterodyne receiver he can overcome most of the obstacles to hot-weather reception, and at the same time he gets the much-sought distance. Cabinet No. 1 contains the tuner, cabinet No. 2 the oscillator and cabinet No. 3 is the radio-frequency amplifier.

An Ideal Set for Summer-time Reception

This novel set (which is a development of the super-heterodyne receiver described in POPULAR RADIO) utilizes a loop aerial—thereby reducing static to a minimum and practically eliminating interference from stations operating on the same wavelengths.

By J. R. MARSH

THERE are few experienced radio fans who will question the advantage of a directional loop over any other antenna system for use with a super-heterodyne. On the other hand, the experience needed to properly operate a super-heterodyne can no doubt be

acquired more easily with the usual antenna and ground than with the loop. A properly designed loop and a slight addition to cabinet No. 1 of the simplified super-heterodyne described in POPULAR RADIO for September, November and December of 1923, will give such

manifest advantages, in operation and results, as to many times justify the trouble and slight expense involved.

Before describing the loop and its results, let us first consider its advantages. They are:

1: Reduction in amount of interference both from code and from heterodyning between transmitted carrier waves. This is accomplished by means of directional tuning.

2: Less annoyance from static.

3: Greater selectivity, because the resistance present in the ordinary antenna system is almost totally absent in the loop.

4: Much better quality. Accomplished by (1), (2) and (3) plus the elimination of regeneration in the "first" detector circuit (cabinet No. 1).

5: Greater distance.

Now there may be some skepticism about No. 5. But it's true. Successful DX reception requires the elimination of noise, code signals, static and other distracting factors as far as possible. Regeneration in the "first" detector circuit (cabinet No. 1) is, in the writer's

opinion, more harmful than helpful to distant reception. And the directional loop cuts down other interference to a minimum.

Receiving conditions, under which the set described in this article has been used, have been particularly annoying. A location, between the N. Y., N. H. & H. Railroad and Long Island Sound, midway between Bridgeport and New Haven in Connecticut and adjoining a trolley line, is a combination trying to the patience of anyone striving for perfect reception with a super-sensitive receiver.

One point should be emphasized; audio-frequency amplification must be employed. One stage of audio with a by-pass condenser connected across the primary of the transformer and followed by a push-pull stage of amplification with "C" battery bias, such as described by Mr. Laurence M. Cockaday in recent issues of POPULAR RADIO, is an ideal combination, or a Western Electric 10-A or 14-A outfit can be used with great satisfaction. Failing in these, a Bristol single-stage power amplifier, using a

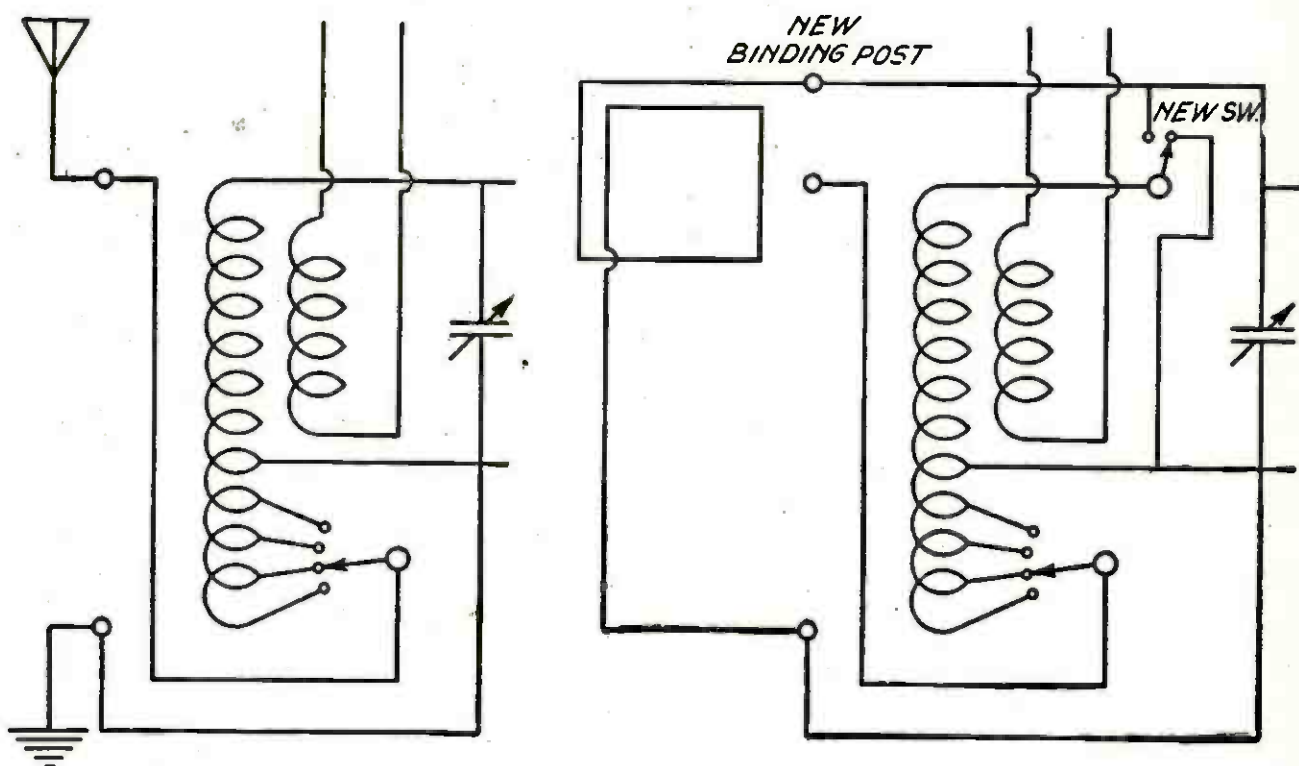

THE CHANGES TO MAKE TO ADAPT THE SET TO A LOOP

FIGURE 1: At the left is shown the part of the circuit in cabinet 1 (the detector unit) as it was originally. At the right is shown the changes the author makes.

VT-2 or UV-216-a tube will be found satisfactory. Whatever type of amplification is used, be sure it is properly designed and built *to avoid distortion*, and use a proper amount of "C" battery to aid in this and also to cut down the drain on the "B" batteries. It is perfectly satisfactory to operate the set itself on a 45-volt "B" battery, with 90 volts to 125 volts on the audio-frequency. This, also, is an important economy on "B" batteries as it is impractical to bias the intermediate-frequency tubes without first neutralizing the grid-plate capacity. This latter practice would eliminate regeneration in these stages and weaken the signals. Incidentally, the regeneration in these stages is so easily controlled by the potentiometer that no noise or distortion need result from it, and it is a help in bringing up the efficiency of the amplifier.

Perhaps, before proceeding to describe the loop, it would be well to give a log of the stations picked up in three weeks' time, using a Western Electric 10-A amplifier and loudspeaker with the horn in the adjoining room. With two or three exceptions these stations were all tuned in directly on the horn, without the use of headphones.

Some slight unevenness will be noticed in the relative settings of the oscillation condenser (second column under "Settings") and the corresponding wavelengths. This is due to the fact that broadcasting stations do not, as a rule, continually check their wavelength, and variations *do* occur. The oscillation condenser should have a critical maximum point for each wavelength, provided the oscillation coupling is unchanged. All the above readings were made with the coupler fully at maximum. This coupling need only be touched occasionally, when needed, as a vernier adjustment. Rather than trying to do all the adjusting with the oscillation condenser, use the coupler at 95 on the dial which will leave five points margin.

You may note that the oscillation-

condenser dial readings only go up to 57 for the maximum wavelength now in use. The condenser used is a Fett and Kimmel split-frame vernier with 27 plates. A condenser of 17 plates of the same size and *without* vernier would be much better, any vernier action needed being obtained by the use of the oscillation coupler, as described in the preceding paragraph.

The 7-plate condenser in cabinet No. 1 is used twice, as will be noticed. The loop is covered with 10 turns of silk-covered multi-strand loop-antenna wire (not Litz, which is braided). The turns are spaced $\frac{3}{8}$ inch on centers, and each side of the loop is $35\frac{1}{2}$ inches. The lead-in from the loop to the set is approximately 6 feet, 6 inches long and, to reduce capacity effect in handling the loop, "electric iron" flexible cable was used, the two insulated wires thus being always side by side. The condenser effect in this lead-in stabilizes the loop against body capacity to a marked degree. The inductance of this loop, combined with the capacity of the lead-in wire plus the shunt 7-plate variable condenser, has a wavelength range of from 360 meters to 590, so a tap is taken at the end of the seventh turn on the loop, and a switch is provided to "dead end" the last three turns when lower wavelengths are desired. Using seven turns only gives a range of from 235 meters to 360 or 365 meters, thus avoiding overlap, and giving a total range fully adequate for all but five or six small-powered stations.

Constructional Details

For changing the "first" detector circuit, obtain one switch and two switch points similar to those controlling the primary tuning, and mount the switch on the panel vertically on a center with the existing switch and $2\frac{1}{2}$ inches below it, center to center. Mount the two switch points directly above the new switch and about $\frac{1}{2}$ inch on centers. Add an additional binding post on the left end of cabinet No. 1 and $1\frac{1}{2}$ inches vertically above the existing ground binding post. Having completed the mounting, change the wiring thus:

(a); by removing the line connecting the outside of the primary winding on the



From a photograph made for POPULAR RADIO

THE LAYOUT OF THE APPARATUS

Here is shown the method of setting up the three cabinets of the set, with the power amplifier placed in back of cabinet No. 3. The loop is suspended from an arm attached to the door frame and guyed to the picture molding.

LOOP LOG

No.	Call Letters	Wavelength	Settings		Full or Tapped Loop		Location	Distance, Miles
1	WABT	252	20	13½	T.L.		Washington, Pa.	280
2	WAAM	263	26	14	T.L.		Newark, N. J.	70
3	WIAD	254	33	15	T.L.		Philadelphia, Pa.	135
4	WNAC	278	40	17	T.L.		Boston, Mass.	150
5	WTAS	275	43	17½	T.L.		Elgin, Ill.	760
6	KFKX	286	45	18	T.L.		Hastings, Neb.	1,200
7	WCAU	286	47	18½	T.L.		Philadelphia, Pa.	135
8	WPAJ	283	51	19	T.L.		State College, Pa.	300
9	WSAI	309	58	20½	T.L.		Cincinnati, O.	600
10	WLW	309	59	20½	T.L.		Cincinnati, O.	600
11	KDKA	326	72	24	T.L.		E. Pittsburgh, Pa.	335
12	WBZ	337	85	26	T.L.		Springfield, Mass.	50
13	WCAL	360	89	27	T.L.		Northfield, Minn.	1,100
14	WDAP	360	94	28	T.L.		Chicago, Ill.	750
15	WHN	360	0	29½	F.L.		New York City, N. Y.	60
16	WHAZ	380	10	30	F.L.		Troy, N. Y.	140
17	WGY	380	9	31½	F.L.		Schenectady, N. Y.	150
18	WTAM	390	12	31½	F.L.		Cleveland, O.	440
19	WFI	395	15	34	F.L.		Philadelphia, Pa.	135
20	WOAI	385	13	32½	F.L.		San Antonio, Tex.	1,660
21	WDAR	395	10	33	F.L.		Philadelphia, Pa.	135
22	WBAV	390	10	33½	F.L.		Columbus, O.	525
23	WDAF	411	27	34½	F.L.		Kansas City, Mo.	1,130
24	WOR	405	20	35	F.L.		Newark, N. J.	70
25	WJY	405	20	35	F.L.		New York City, N. Y.	60
26	WHAS	400	20	35	F.L.		Louisville, Ky.	680
27	PWX	400	25	35¼	F.L.		Havana, Cuba	1,350
28	WLAG	417	28	37½	F.L.		Minneapolis, Minn.	1,050
29	WSB	429	35	39	F.L.		Atlanta, Ga.	800
30	CFCF	440	36	40	F.L.		Montreal, Canada	330
31	WOS	441	38	39	F.L.		Jefferson City, Mo.	1,000
32	WJAZ	448	39	40½	F.L.		Chicago, Ill.	750
33	WJZ	455	45	42½	F.L.		New York City, N. Y.	60
34	WCAE	462	46	45½	F.L.		Pittsburgh, Pa.	340
35	WCAP	469	50	46	F.L.		Washington, D. C.	250
36	WRC	469	50	46	F.L.		Washington, D. C.	250
37	KFI	469	47	45	F.L.		Los Angeles, Cal.	2,500
38	WBAP	476	53	47½	F.L.		Fort Worth, Tex.	1,460
39	WFAA	476	54	45	F.L.		Dallas, Tex.	1,430
40	WOC	484	55½	45½	F.L.		Davenport, Iowa	900
41	WEAF	492	60	48	F.L.		New York City, N. Y.	60
42	WMC	500	64	51½	F.L.		Memphis, Tenn.	1,000
43	WIP	509	66	52	F.L.		Philadelphia, Pa.	135
44	WOO	509	66	52	F.L.		Philadelphia, Pa.	135
45	WWJ	517	70	54	F.L.		Detroit, Mich.	500
46	WOAW	526	73	52½	F.L.		Omaha, Neb.	1,180
47	KYW	536	79	57	F.L.		Chicago, Ill.	750
48	KSD	546	83	56	F.L.		St. Louis, Mo.	920
								28,800
								Average, 600

variocoupler with the condenser. This is the line that continues from the condenser to the grid of the tube,

(b); by connecting the new binding post with the left of the two new switch points and thence to the variable condenser,

(c); by connecting the outside of the primary winding on the coupler with the new switch arm,

(d); by connecting the right-hand switch point with the ground lead from the ground post to the other side of the variable condenser.

Diagrammatically the wiring before and

after will be as shown in Figure 1.

Note what occurs when the new switch arm is thrown to the right; the one terminal from the loop goes to the grid, the other goes to the grid return with the condenser in shunt. The variocoupler primary is grounded at both ends, and no feed-back takes place.

This is the normal way to use the loop. But suppose you think you have a very distant station and you cannot seem to find the absolutely correct hair line for the oscillation-condenser setting. Then, throw the switch to the left, which places the loop inductance and the variocoupler primary winding in parallel. Now,

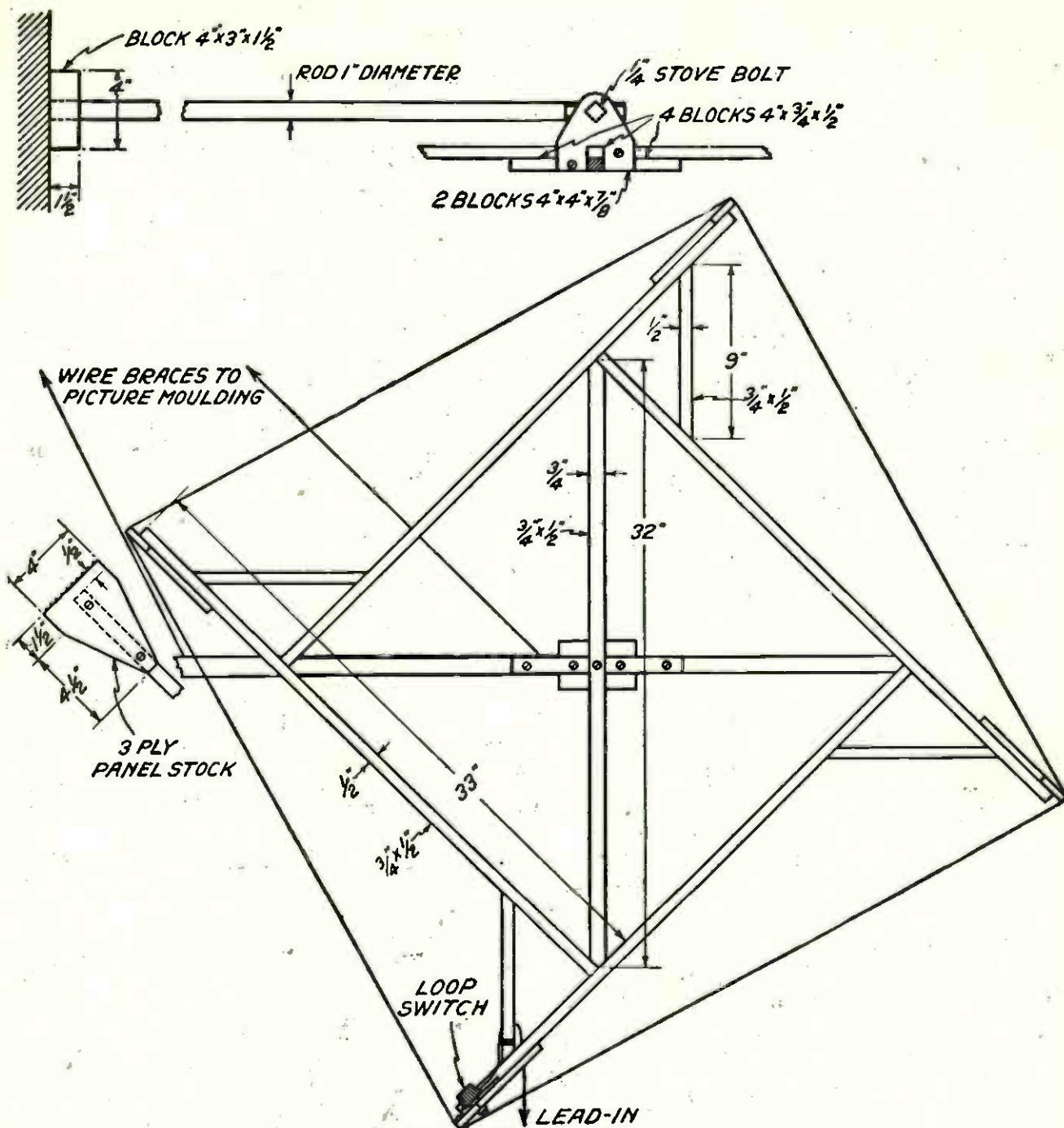

THE MECHANICAL DETAILS OF THE LOOP

FIGURE 2: This drawing gives the dimensions for the wooden pieces, the arrangement of the tap switch and the method of support.

advance the condenser in cabinet No. 1 (since two inductances in parallel require more capacity for a given frequency than either one alone) to the point where the characteristic crackle of the station static noise is noticeable. If your coupling dial is set at 50 on the variocoupler you will find a considerable regeneration taking place, and the exactly correct setting on the oscillation condenser will be comparatively easy to find.

Now, throw the switch back to the right, reset the primary condenser, and you have the maximum tuning and signal which the correct condenser setting will give. Of course, on very weak signals care in bringing the potentiometer and rheostat on cabinet No. 3 to the point nearest oscillation without distortion will

strengthen signals, as will adjustment of the other two rheostats.

Construction of the Loop

The diagrams in Figures 2 and 3 show clearly the construction of the loop and its support in such manner as will permit easy revolution. Provision is made for practically full 360°, thus permitting the lead-in corner of the loop to be beyond the center of the loop in respect to the broadcasting station, although it will work almost as well when reversed. The maximum signal strength position of the loop is not very definitely marked, but the minimum or right-angle position can be easily found by the almost complete cessation of signal, so the best maximum should be taken at right angles to

the minimum. Sometimes, when two carrier waves from stations in different directions are heterodyning, as is often the case close to the 360 and 400-meter wavelengths, a compromise position can be found giving an almost complete minimum on the undesired station. For instance, at Milford, Connecticut, it has been found possible to separate PWX from WHAS and from WOR by using this simple expedient.

As will be seen from the diagram (Figure 2), this loop is so supported that its vertical over-all dimension is nearly 4 feet. A loop of this size should preferably be mounted over the table containing the set. Assuming an average ceiling height of 9 feet to 9 feet 6 inches clear, the lowest corner of the loop can be from 4 feet 6 inches to 5 feet off the floor, the former being well within reach of an operator sitting at the table. The loop should be so placed laterally, with respect to the chair used by the operator, as to avoid the possibility of striking the head on sudden arising.

The loop, after construction and before wiring, should be stained with the desired color and then waxed. Be sure to rub the wax down very thoroughly. In applying the wire, start with a switch point fastened through the corner of the lowest 3-ply block, connecting thereto with a split brass clip soldered to loop wire. The final turn should be secured in a similar manner to another switch point on the opposite side of the same block. The lead-in wires at the end of the flexible lead-in cable should be separated slightly and the two wires secured to the reverse ends of the switch points, using similar clips. Tape the insulation of the cable where the wires

are separated. Secure the cable to the frame of the loop with a binding of tape. The connections of the other end of the lead-in wires to the binding posts on cabinet No. 1 should be made in a similar manner, and with similar clips. These clips should be of heavy construction, and the jaws may have to be spread slightly to fit over the binding posts. Allow length enough in the lead-in cable to make the turning of the loop possible without any strain on the cable. A total length of 6 feet, 6 inches will be found to be about right.

In winding the loop make slight grooves in the ends of the plates, evenly spaced, but only about one half the diameter of the wire in depth. Do not force the wire down into the slots, as this may injure the insulation or the wire. Do not pull the first few windings too tightly, as this may distort the frame of the loop. Adjust the tension of the wires after all turns are on, before soldering on the final clip. After the winding is completed and the switch is mounted, this switch being also on the lowest plate, carefully bare the beginning of the eighth turn at a point about opposite the switch nut, and solder on a wire from this to a lug secured under the switch nut. Similarly, connect the terminal switch point (end of the tenth turn counting in the same direction) to the switch point provided for the switch on the plate. When this switch is closed the last three turns of the loop will be dead-ended, as shown in Figure 3.

Brace the supporting rod with two wires connected to the picture moulding. Lateral bracing will hardly be necessary if the wall end of the rod is fitted firmly into a collar

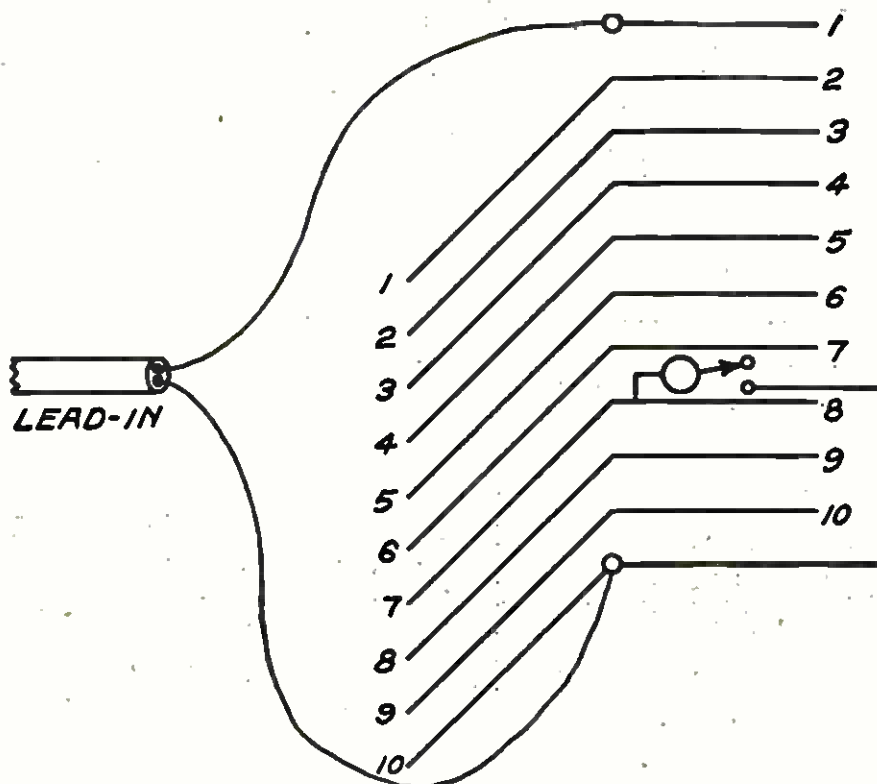

HOW THE LOOP IS WIRED AND TAPPED

FIGURE 3: The figures denote the turns of the loop so that you will know just where to place the short-circuiting switch and where to take off the lead-in wires.

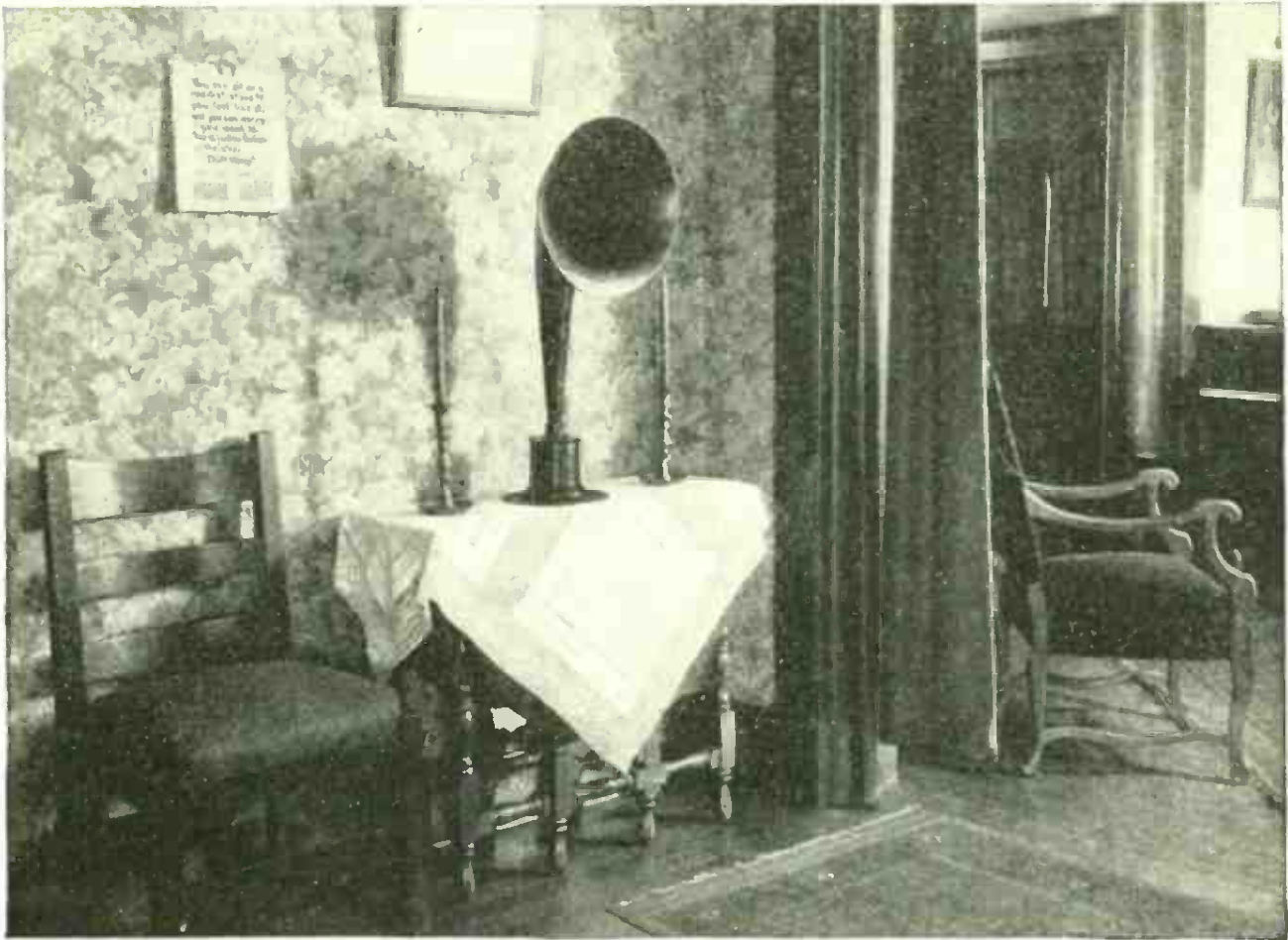

From a photograph made for POPULAR RADIO

A TIDY INSTALLATION FOR THE LIVING ROOM

The author places his loudspeaker in the adjoining living room. He tunes in with the headphones and then switches on the loudspeaker and then goes into the room where the loudspeaker is located and enjoys the program.

well secured in place. If lateral bracing wires are used, they must be placed so as not to interfere with the turning of the loop.

You have been told how to use the coupler in parallel with the loop, but another practical experiment may be made by connecting one end of a moderate length indoor antenna to the loop. This is best done by slipping the end of the antenna wire into a Fahnestock clip, and slipping the flat end in between the switch arm on the loop and the switch point. If the switch is a heavy-duty one, with a multiple-strip blade, it will hold this clip firmly. You will still find some directional effect in the loop, but a limited wavelength range. The results are interesting. There are other combinations which you may try with this outfit.

How to Operate the Set

It may be well to point out three simple changes to be made in the set which will improve its operation and particularly so when using a loop.

1: Remove the two top binding posts from the right-hand end of cabinet No. 3, drill out the holes slightly and insert a pair of phone-tip jacks, permitting the use of headphones, whenever desired, by merely pushing the tips into the jacks. Remount the binding posts (removed) on the rear of the cabinet directly in

line with the jacks. Connect the rear of the jacks to the binding posts by bus-wire and in order to make it still possible readily to remove the front panel use two sections for each connection, joining each pair by a Fahnestock clip mounted on the end of the cabinet. It is a great convenience to be able to hook in a pair of phones instantly, at any time, without disturbance, to the audio stages, which will be connected, of course, to the binding posts reset on the rear of the cabinet.

2: Connect a mica fixed condenser across the new wires from phone jacks to reset binding posts of, say, .005 mfd. capacity. This will mellow reception, and, if the capacity is too large, will reduce the volume somewhat. Even mica condensers vary from their rated capacities at times, so it will be best to try several sizes, .001, .0025 and .005 mfd., until the correct one is found for best all around results.

3: Connect a mica fixed condenser across the binding posts leading to +A and -A to keep any stray intermediate frequencies out of the "A" battery. This addition will materially ease operation and increase sensitivity.

4: Add a small-size mica condenser across the leads connecting the two top binding posts on the right-hand end of cabinet No. 1 with the two top binding posts on the left-hand end of cabinet No. 1. Try out varying capacities.

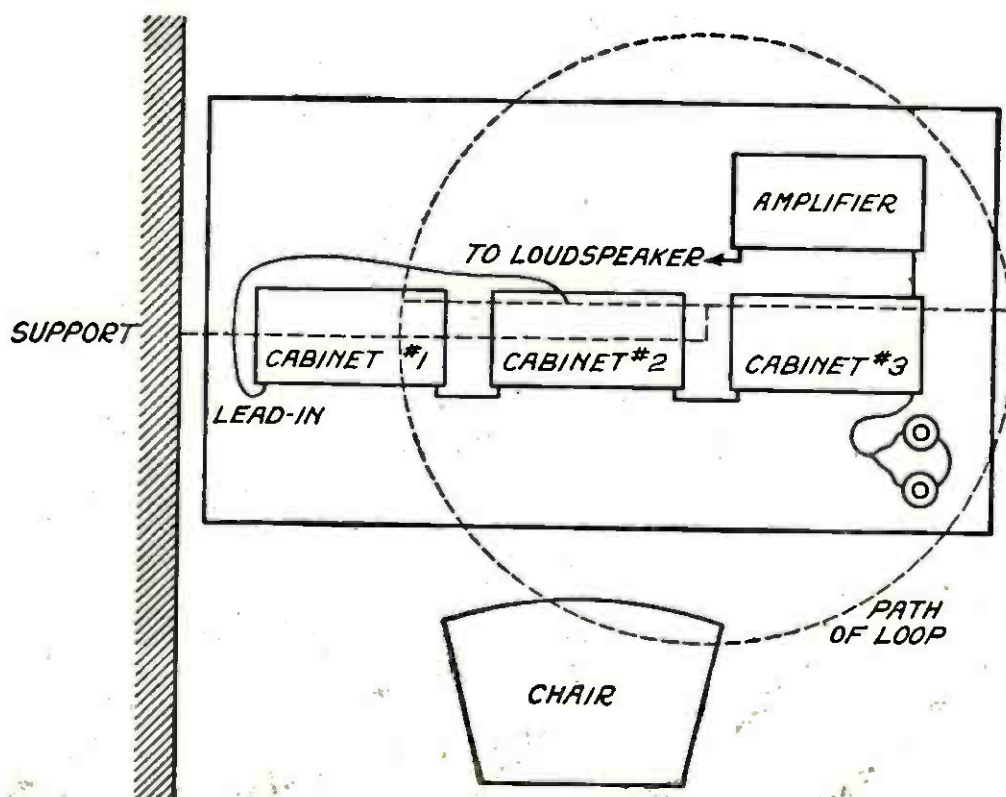

FIGURE 4: A schematic view of the table layout showing the path of the loop as it revolves in position above cabinets 2 and 3.

say, .00025, .0005, and .001 mfd. Select the one that does not lower the settings of the oscillation-condenser dial too greatly, not over 4 to 5 divisions. For instance, if the condenser dial settings for Station WJY are 20-35 before adding this condenser, they should be 20-30 or 20-31 after adding.

The addition of this condenser is of real value, increasing the range of the potentiometer and consequently giving greater amplification because the oscillation point is not so quickly reached on the intermediate amplifier

tubes, and generally sharpening the tuning, and consequently the selectivity.

After adding the above condenser it was found possible to tune out WSAI on 309 meters wavelength and 600 miles away, a station whose received signal at Milford, Connecticut, is always strong, and tune in KGO at Oakland, California, on 312 meters wavelength and 2,500 miles away, the latter being weakly audible on the loudspeaker and without interference. The direction of loop for these two stations is practically the same.

The New and Terrible "Death Rays"

THE dream of inventors and scientists has at last come true; energy may now be transmitted through space without the use of wires, cables, pipes or other carrier mediums. Not only that, but this current is powerful enough to halt motor cars, cripple airplanes in flight and to destroy life! How this amazing invention operates and what it can do will be told by its inventor, Mr. H. Grindell Mathews of England, in POPULAR RADIO for August—next month.

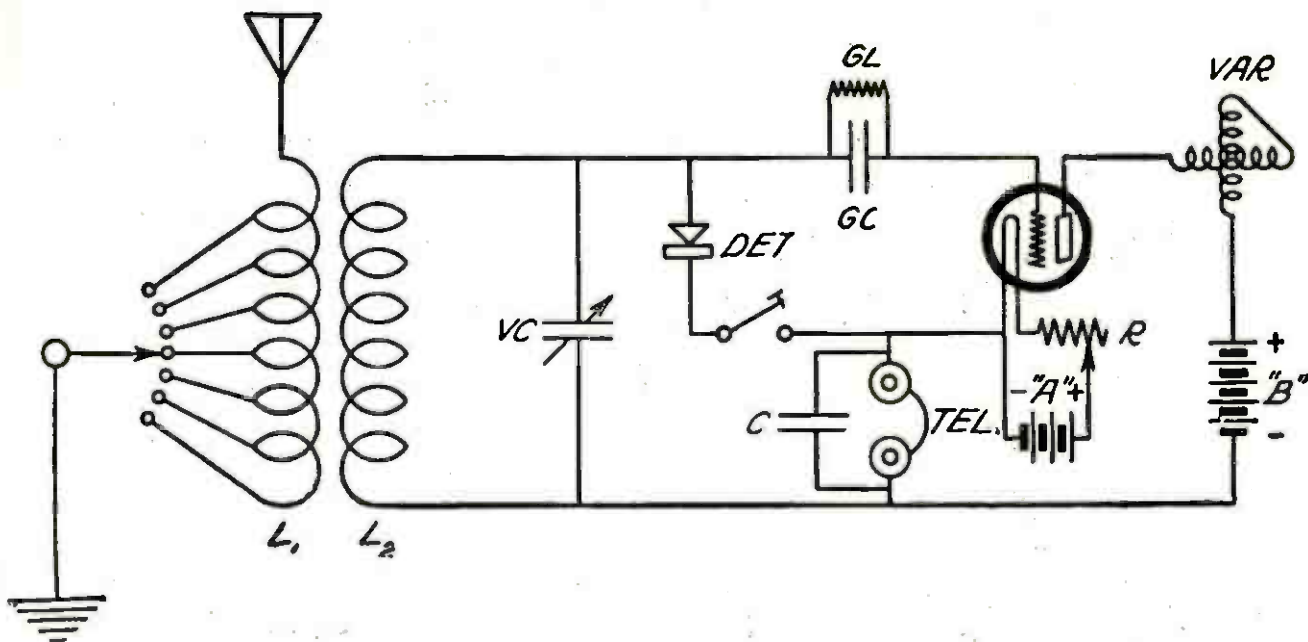

COMBINATION CRYSTAL AND REGENERATIVE VACUUM-TUBE RECEIVER

Cost of parts: Not more than \$27.00.

Selectivity: Good (with crystal). Excellent (with vacuum tube).

Operation: Simple.

Construction: Not complicated.*

Approximate range: 15 miles (with crystal);

500 miles (with vacuum tube).

Outstanding feature: By simply throwing a switch, the operator can listen in with a crystal detector for local reception, or can use the vacuum tube for distant stations.

**(See POPULAR RADIO, May, 1923, page 397, for constructional details.)*

100 BEST HOOK-UPS

INSTALLMENT NO. 8

IN this series of hook-ups is being published—for the special benefit of the radio novice who is undecided as to just what circuit he wants—100 of the best radio receiving and amateur transmitting circuits, each thoroughly tested. The approximate ranges given here are averages based on actual records made with sets throughout the country. During the summer the actual ranges may fall to 50 percent of the value given, while in the winter, in the best of conditions, the actual ranges may exceed the values given by as much as 500 percent. All of these circuits have been described in detail in previous issues of POPULAR RADIO.

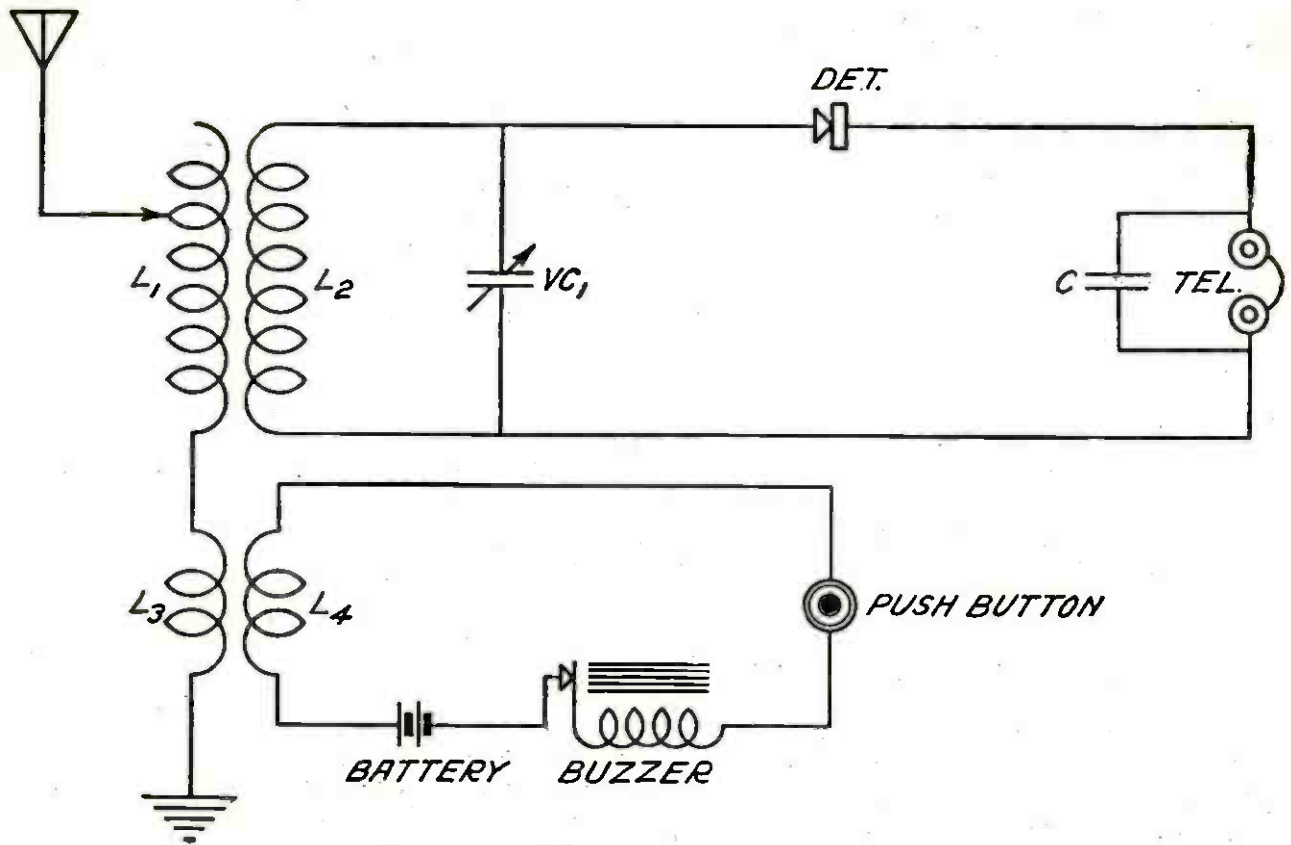

CRYSTAL RECEIVER WITH INDUCTIVELY COUPLED BUZZER TEST

Cost of parts: Not more than \$20.00.
 Selectivity: Good.
 Operation: Easy.
 Construction: Very easy to make.*

Approximate range: 15 miles.
 Outstanding feature: A really good buzzer test for setting the crystal for maximum sensitivity.

*(See POPULAR RADIO, February, 1924, page 188, for constructional details.)

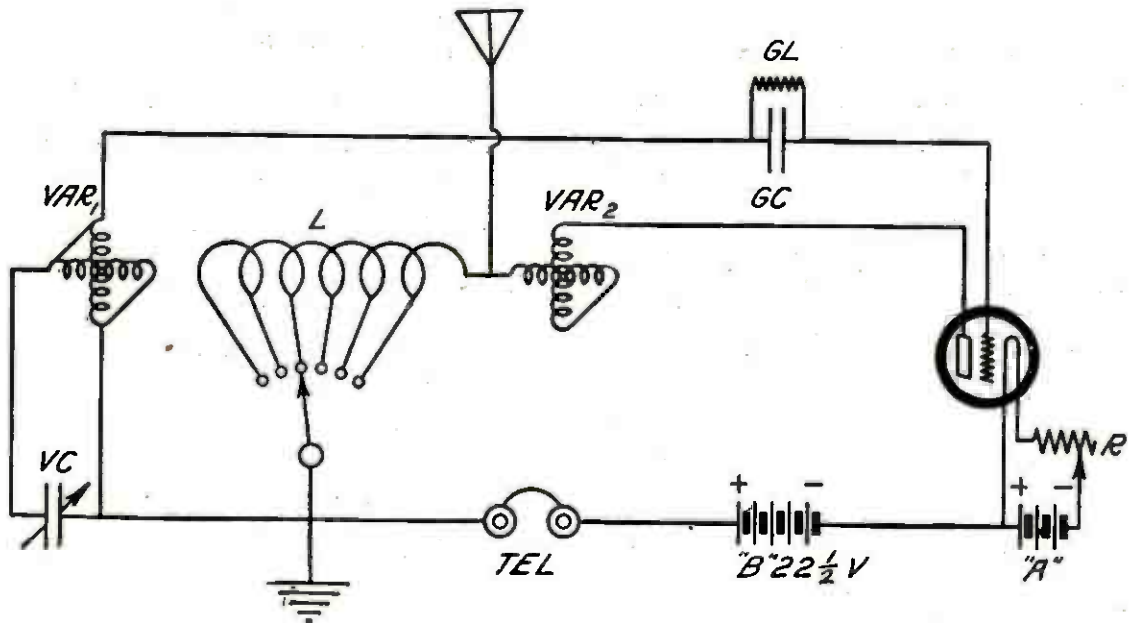

NOVEL VARIOMETER HOOK-UP

Cost of parts: Not more than \$24.00.
 Selectivity: Fair.
 Operation: Rather complicated.
 Construction: Just an ordinary acquaintance with tools and some experience in wiring up the circuit is necessary.*

Approximate range: 800 miles.
 Outstanding features: Strong signals from one tube. The set will readily radiate, unless carefully handled. For this reason is a menace to a neighbor's reception, in the hands of a novice.

*(See POPULAR RADIO, August, 1923, page 176, for constructional details.)

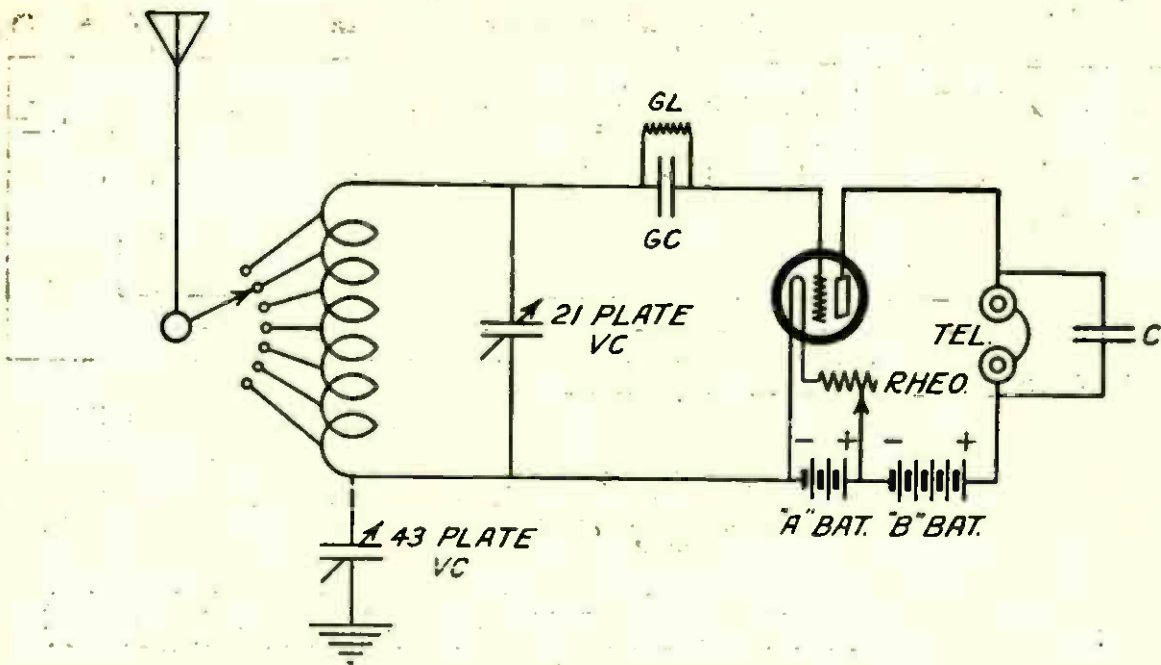

CONDUCTIVELY COUPLED, CONDENSER-TUNED, VACUUM-TUBE CIRCUIT

Cost of parts: Not more than \$20.00. *Note:* The cost of tubes and batteries are not included in the costs given in these descriptions.

Selectivity: Fair.
Operation: Simple.

Construction: Easy to build, and a good circuit for the beginner to try.*

Approximate range: 100 miles.

Outstanding feature: The best set for the beginner to learn the operating characteristics of the vacuum tube with.

**(See POPULAR RADIO, January, 1923, page 61, for constructional details.)*

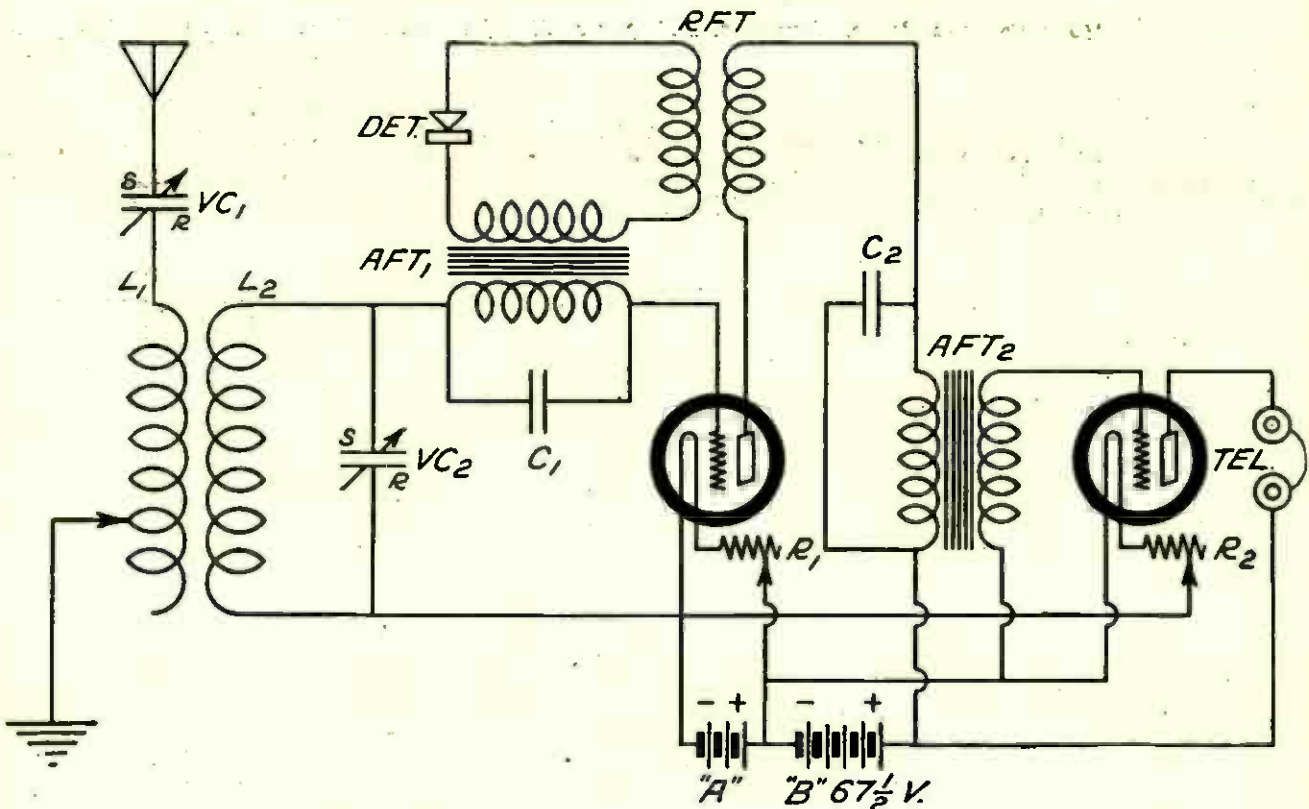

TWO-TUBE CRYSTAL-DETECTOR REFLEX

Cost of parts: Not more than \$45.00.

Selectivity: Very good.

Operation: Fairly simple.

Construction: Not easy to make. Care must be used in mounting the transformers in the proper position with respect to each

other.*

Approximate range: 1,000 miles.

Outstanding features: Loudspeaker operation is possible with only two tubes. The circuit has the advantage, also, of being workable with a short antenna.

**(See POPULAR RADIO, March, 1924, page 293, for constructional details.)*

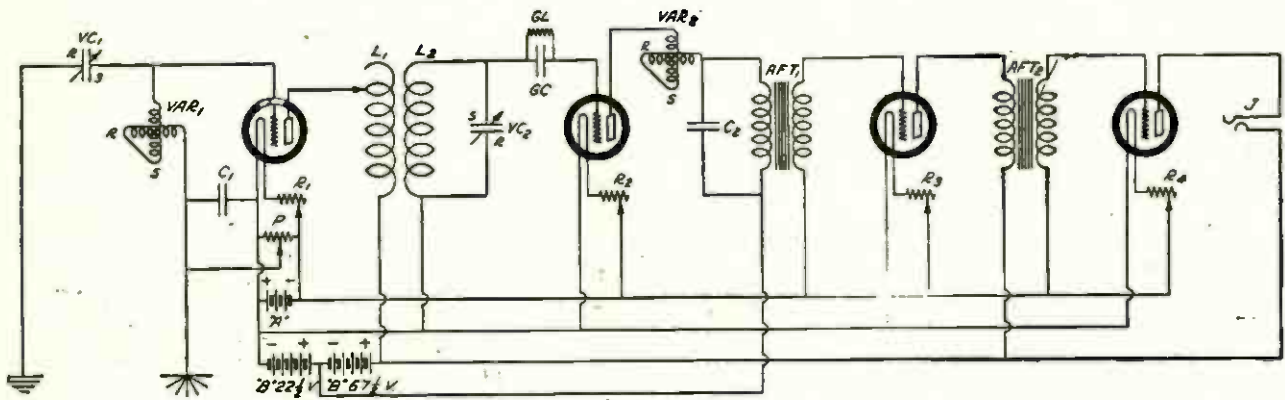

ONE STAGE OF TUNED-RADIO-FREQUENCY AMPLIFICATION, WITH A VACUUM-TUBE DETECTOR AND TWO STAGES OF AUDIO-FREQUENCY AMPLIFICATION

Cost of parts: Not more than \$50.00.

Selectivity: Excellent.

Operation: Not hard to tune. Some experience will have to be gotten, however, before the operator will be able to get the most out of the set.

Construction: Rather complicated. The layout of the set should be carefully studied

before it is finally decided upon.*

Approximate range: 500 miles.

Outstanding features: The set will operate without an antenna and employs two grounds or a ground and a short piece of wire acting as a counterpoise. It tunes extremely sharp, and will operate a loud-speaker.

*(See POPULAR RADIO, November, 1923, pages 374-5, for constructional details.)

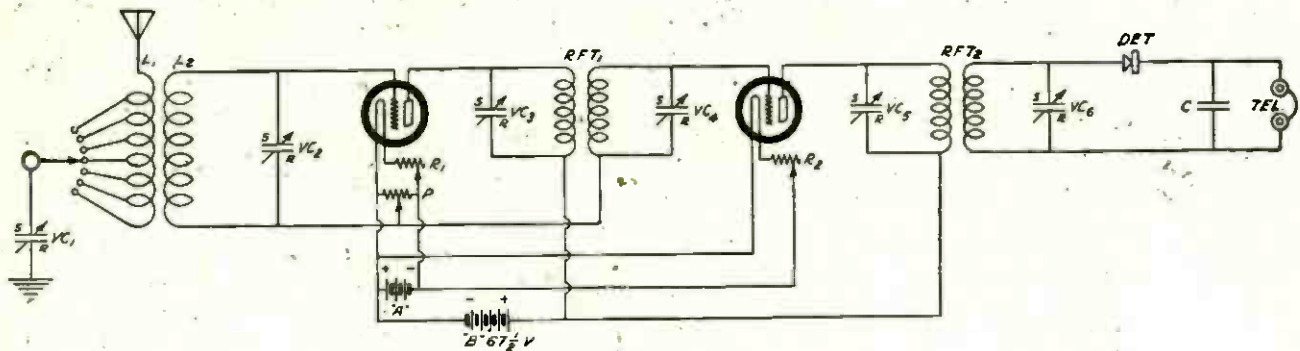

CIRCUIT EMPLOYING TWO STAGES OF TUNED-RADIO-FREQUENCY AMPLIFICATION, WITH A CRYSTAL DETECTOR

Cost of parts: Not more than \$56.00.

Selectivity: Excellent.

Operation: Rather critical in operation.

Construction: Not very hard to make. Be sure that the best parts are obtained and the results will exceed expectations. Poor

parts will render the circuit useless.*

Approximate range: 1,500 miles.

Outstanding features: A set for the man who wants distance, but who is willing to depend on the headphones instead of trying to use a loudspeaker.

*(See POPULAR RADIO, April, 1924, pages 400-1, for constructional details.)

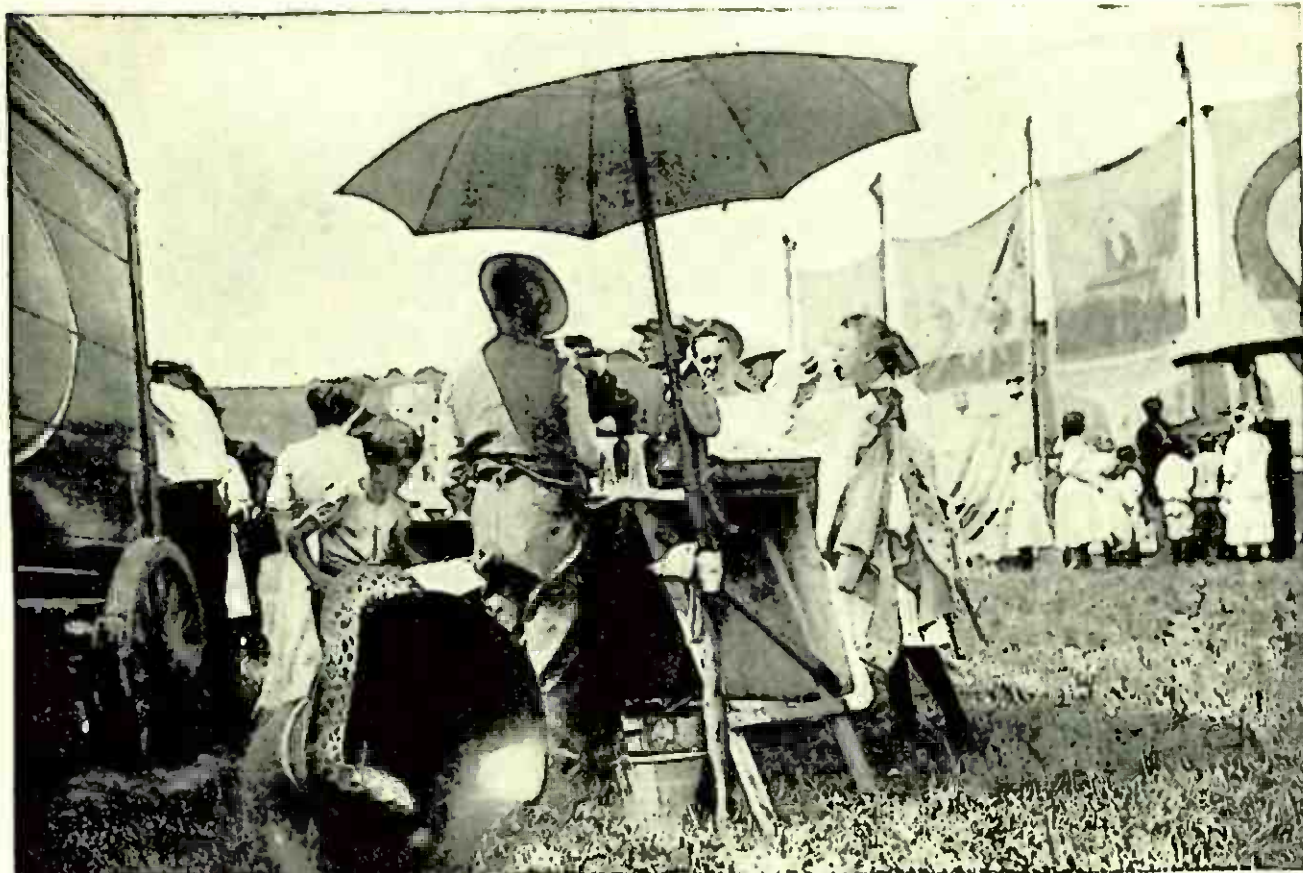

Brown Bros.

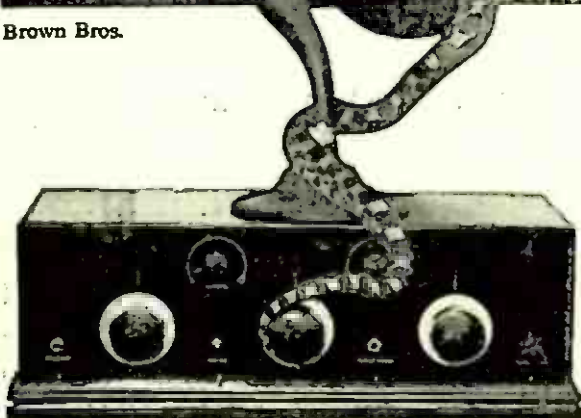

International

"Last night I lissened in on my radio set and heard the wild animals and G it was great. Please do it again."

—WILLIAM NOYES, aged 10.

The CIRCUS

that Came to Willie

By W. T. MEENAM

FOR the first time in history a real circus has been broadcast.

For the first time in history a microphone has been brought "under the big top" (as the circus tent is called) directly in front of the elephants and tigers and the steam calliope and circus freaks and the circus announcer, and the strange noises have been sent out into the ether so that children, big and little, who had never been to a circus or heard a lion's roar could experience a new thrill.

And they did not sound a bit like the

noises made by Brer Rabbitt or Sam Chipmunk or any of the other bedtime story characters, either. No siree! No bedtime story ever had a character like Leo, the real African lion, whose chesty bass roar in New York was heard not only over a greater part of the United States and Canada, but in far-off London!

This unique experiment was conducted in the "greatest show on earth"—that of the famous Barnum and Bailey-Ringling Brothers' Circus, in collaboration with station WGY in Schenectady and

station WJZ in New York City.

Station WGY was connected to the circus scene by land circuits. The signals were carried by wire from New York to the control room of the station in Schenectady, and from that point they were sent to two distinct transmitting units. From the first, transmitter signals were sent out on 380 meters wavelength, and from the second, the signals were broadcast on 107 meters. It was on the latter wavelength, with its freedom from interference, that the voices of the circus captives were carried across the Atlantic.

"All I needed to complete the illusion of being at the circus," wrote in one fan, "was a bag of peanuts."

On the night that the circus took the ether it was playing in New York City.

But the audience was asked to think of the concert of animals as coming from the jungle. It is probable that the audience could imagine such a picture—but to those who were trailing the microphone the scene was quite different.

Caged and tethered animals flanked both sides of the circus corridors. On the left, one glanced into the haughty, supercilious countenance of a camel and on the other side into the cold, wicked eye of a Bengal tiger.

Back of the cage of tigers and almost within reach of their swishing tails, the radio operators set up their amplifying unit, through which the microphone with a 500-foot lead was connected by wire to the control room of WJZ. As the radio operators were getting into communication with stations WJZ and WGY,



"LADI-E-S AND GENTLEMEN —"

Here is the circus announcer standing before the radio apparatus through which he introduced the side show to the boys and girls within a radius of 2,000 miles. Just after this picture was snapped little Cliquot, the African bushman, poured an impassioned "speech" into the microphone.

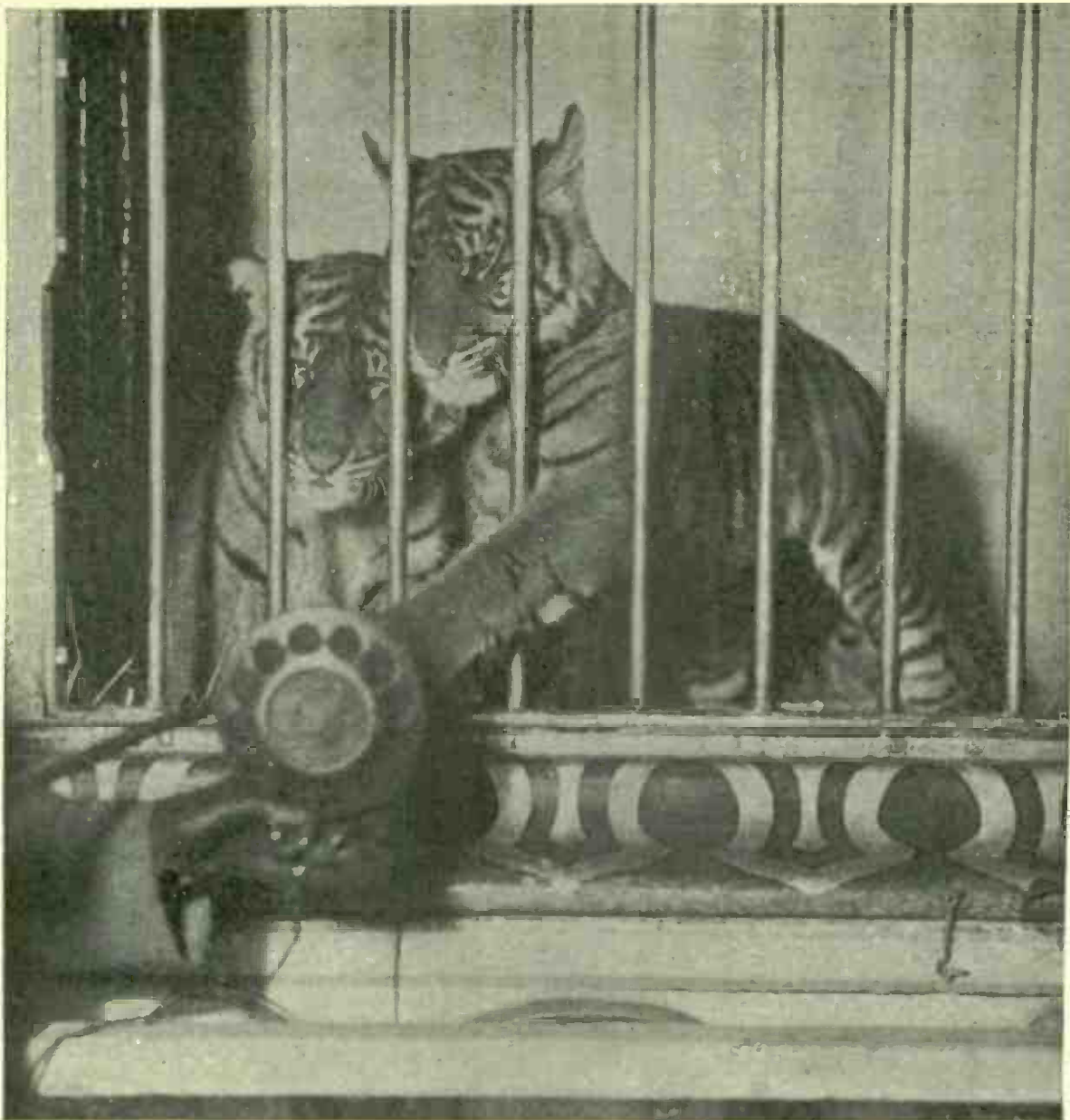

Kadel & Herbert

THE TIGERS GROW KITTENISH WITH THE MICROPHONE

But when they were aroused to vocal utterance, they roared out of turn, and the listening fans were treated to a real jungle bedlam.

preparatory to opening the circuit, Lew Graham, the circus announcer, dapper in conventional garb, explained to the roustabouts and others within hearing that the microphone is a delicate instrument made to catch the slightest sounds. He warned them not to scuffle feet, clear throats, scratch matches or make other sounds.

Then the menagerie went on the air.

After the preliminary words in which Lew established relations with all the little boys and girls, the microphone was taken within a few feet of the steam calliope. After this distinctive instru-

ment had given the proper circus flavor, the journey through jungleland began.

The "mike" was taken direct to the cage of "Queenie," a Bengal tiger that is perpetually peevish. Her trainer spoke a few words to introduce her pets, but "Queenie" spoke out of turn and drowned out her words at the sight of a keeper whom she particularly disliked.

While the tigers were still giving vent to their feelings, the microphone was taken to a neighboring cage that was filled with lions. Their trainer introduced each of his friends and each acknowledged the introduction in turn.



HATTIE, THE ELEPHANT, MAKES HER DÉBUT TO THE FANS

Strangely enough, the voice of the mighty elephant is a tiny squeal. But when the elephant "trumpets" through its trunk the noise may be heard for miles. Hattie obliged with both noises.

No prodding was necessary; they became vocal at the sight of the iron, and they fairly made the well-known welkin ring.

But time was passing and the menagerie had but a half hour to do its radio turn. Cutting back through the growing crowd and dragging the wire with them, the radio men carried the "mike" to the long row of elephants, big and little. In the center of the group, with toes whitewashed for the evening show, stood the husky Hattie, biggest of lady elephants. Hattie wasn't shy; every time

her name was called she responded in emphatic elephant language. Then along came Will. This magnificent elephant came down elephant lane unescorted, stopped at the microphone and when his name was called he just threw back his palm-leaf ears and trumpeted. It was an elephant-sized blast, and no amplification was necessary to get it through to Schenectady!

Next on the program was Cliquot, the African bushman. Cliquot delivered a speech in bushman patois. He was glib—even eloquent—and toward the end

grew plaintive and tearful. Lew had told him that his little brothers and sisters in Africa might hear him.

With the long wire trailing out behind and the crowd following close, the microphone was then taken to the noisiest animals in the menagerie, the seals, where there were solos and choruses. The sleek animals squirmed around flapping their tails, and while they barked they kept their eyes glued to the point from which live fish are generally tossed.

The final performers were the laughing hyenas. It was feared that they might be too sleepy after supper to find anything to laugh at, but they were finally aroused. But it wasn't a healthy,

hearty laugh. You shivered at the thought of hearing a laugh like that on a dark night!

By this time crowds for the evening show had begun to assemble, and already white-coated salesmen with lemonade, popcorn and peanuts were announcing their wares.

It was time for jungleland to say good night to its out-of-town customers. Cliquot must join the freaks in the side shows; camels and elephants must don their gorgeous panoplies for the grand parade.

So Lew Graham "signed off," concluding the first air performance of any circus menagerie.

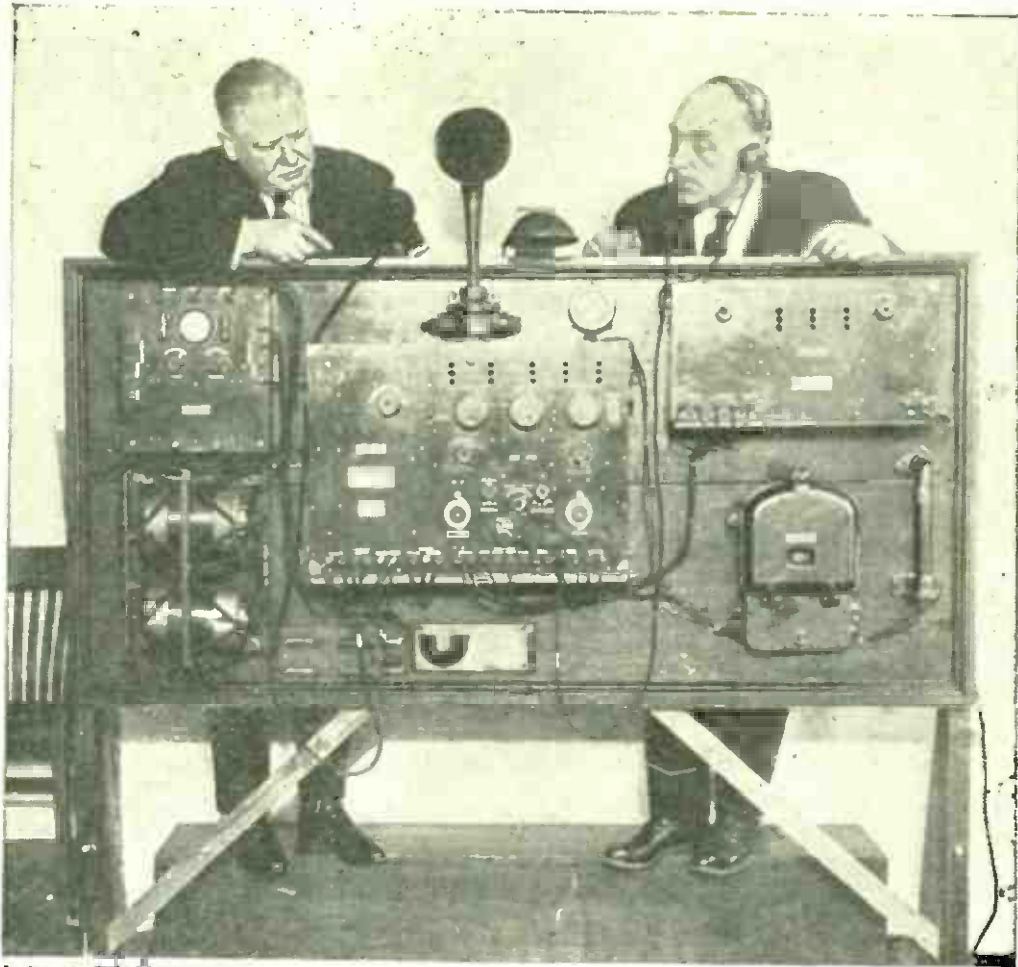

Underwood & Underwood

A BROADCASTING STATION FOR TRAPPING CROOKS

In order to increase the efficiency of the police department of Larchmont, New York, a prominent business man, Mr. Frank E. Campbell (at the left) has presented the town with this radio station that has a transmitting range of 600 miles. Chief of Police Wm. M. Hinds (at the right) reports that the apparatus will be used for broadcasting descriptions of stolen automobiles, descriptions of "persons wanted" and other police news, as well as entertainment that will add to the life of the community.



Underwood & Underwood

Will the Broadcast Listeners Listen In on Advertising?

IN a sense, the desire to advertise something is the principal motive for the carrying on of broadcasting today. Most of it, of course, is very indirect and must be, for the matter sent out must first of all be acceptable to listeners. The Secretary of Commerce has no control of it under existing law. The public itself is the final arbiter, and an effective one, as to what it desires to hear and, consequently, as to what shall be broadcast. Doubtless, radio will continue to be used for advertising, but no one can say today what form it will take or to what extent or in what manner it will be carried on. Like so many other problems of this new art, only time and experience will give the answer.

Herbert Hoover

SECRETARY OF COMMERCE

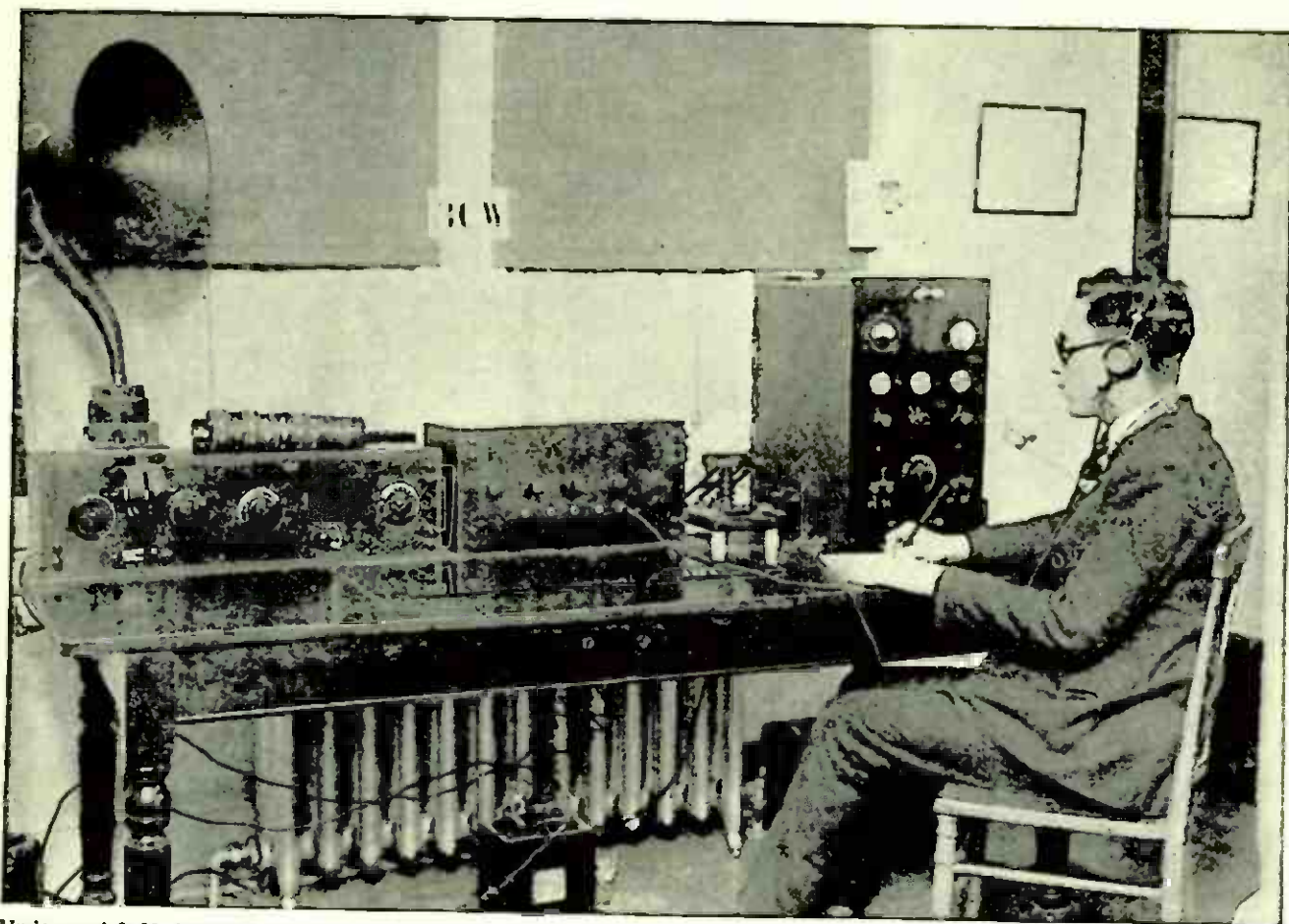

Underwood & Underwood

A TYPICAL AMATEUR TRANSMITTING AND RECEIVING STATION
It belongs to Bernard Elfman of Philadelphia, who is known to his amateur friends of the ether by the call letters 3CW. His station's code signals have been picked up as far away as Alaska.

The Lingo of the Ham

Every broadcast listener is familiar with the busy buzz of code messages that amateurs exchange with each other below 200 meters. If you want to know what they are saying—read this article and find out!

By E. O. KNOCH

HOW many broadcast listeners really know what the amateurs are doing in radio? How many can read the code or have any knowledge of what is going on below two hundred meters? It is safe to say that only a small percentage are even aware of the existence of the transmitting amateur—except to blame him for the code interference which spoils their concerts!

With a really selective receiver, (such as has often been described in POPULAR RADIO) the chance for inter-

ference of this kind is practicably negligible. This does not mean, however, that there will be no code interference. Government and commercial stations often use spark transmitters, which are incapable of being tuned in such a way as to emit a really sharp wave. But this obsolete type of transmitter is fast disappearing among the amateurs; they now use continuous-wave transmitters almost entirely. Such a transmitter emits an exceedingly sharp wave signal and is much more

efficient than any other type; it is significant that CW (continuous-wave) transmitters, as they are called, should have been adopted by the amateurs, who are always experimenting with anything novel.

The amateurs were assigned wavelengths below two hundred meters because when the assignments were made, these low wavelengths were considered worthless. Yet the amateurs have developed them to such an extent that amateur transatlantic communication is now a nightly occurrence, and low-power transmitters have been heard distances up to ten thousand miles, a feat of which any broadcasting station might well be proud.

Communication by means of code or telegraphy is naturally more or less cumbersome. For this reason the amateurs have developed a sort of shorthand which bids fair to become almost a new language.

Below is a typical conversation between two amateurs, together with its interpretation. As will be seen from this, they make use of the abbreviations of the International Radio-telegraphic Convention, and also other abbreviations of their own.

The most common phrase of this amateur lingo is "old man" (abbreviated as "om.") Other abbreviations of a similar nature will be seen from the translation given below.

This latter is not intended to be a literal translation, but merely as a general explanation of what is meant by the conversation given in the column opposite. This is how the conversation might be recorded:

AMATEUR LINGO
(6EOK) r ok—qra?
q s b ?—w h a t i s u r
power?—10 watts hr
om—k

TRANSLATION
Received OK. Where
are you located? How
is my tone? What is
your power? I am
using ten watts here,
old man. Transmit.

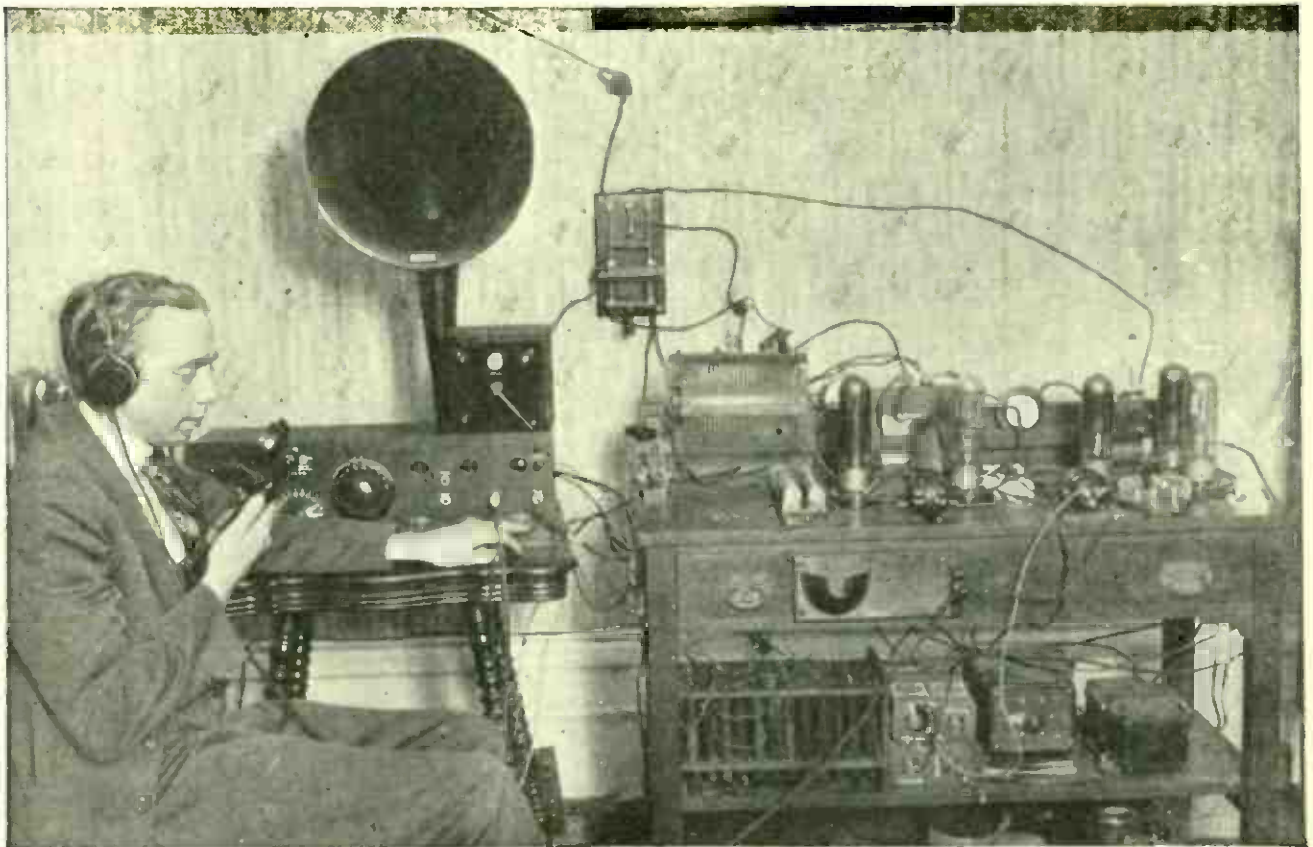

Kadel & Herbert

ONE OF THE STATIONS THAT MAKE UP THE NIGHTLY CHORUS.
Kenneth Decker's station call letters are 2CMK. Its signals have been picked up all through the United States and also in Honolulu and Cuba. He uses five 50-watt tubes for transmitting both his voice and CW telegraphy.

AMATEUR LINGO
(6CIA) r ok om—My qra is 2823 east sixth street, los angeles, cal.—qra?—am using 5 watts hr nw om—get nearly 1 amp rad—ur qsb is vy gud—u r qsa vy hr om—qrk? ga

TRANSLATION
Received OK, old man. I am located at 2823 East Sixth Street, Los Angeles, Cal. Where are you located? Am using five watts here now, old man, and I get nearly one ampere radiation. Your tone is very good, and your signals come in very strong here, old man. How do mine come in there? Go ahead.

(6EOK) ok—fb tnx —qss bd om—u r qrz hr.—mi qra is san jacinto, cal.—qtc?—qtc nil hr om—k

OK. Fine business. Thanks. Your signals are fading (or swinging) badly here, old man. They are also very weak. My location is San Jacinto, Cal. Have you any messages for me? I have none for you, old man. Transmit.

(6CIA) r om— —tnx qtc 1 hr om qrv?—k

Received OK. Thanks. Yes, I have one message for you, old man. Are you ready? Transmit.

(6EOK) nd om—sorri—qrm fm spk and qrn—pse qta ga

Nothing doing, old man. Sorry. Interference from spark station and static. Please repeat the last radiogram. Go ahead.

(6CIA) r ok—qtc 1 hr om—qrv?—k

Received OK. I have one message for you, old man. Are you ready for it? Transmit.

(6EOK) ok om—qrv ga

OK old man. Yes, I am ready. Go ahead.

AMATEUR LINGO
(6CIA) r ok om—nr 1 fm 9wo to 6bkx Greetings from 9wo sig 9wo—k

TRANSLATION
Received OK, old man. Number 1 from 9WO to 6BKX. Greetings from 9WO. Signed 9WO. Transmit.

(6EOK) r r—nr 1 ok —qrh? pse qsl crd om —sa om what r u using fer plate supply?—s o u n d s like pure dc—

Received Number 1 OK. What is my wavelength? Please acknowledge (having worked me at this time) by sending me a card, old man. Say, old man, what are you using for plate supply? It sounds like pure direct current.

(6CIA) r ok om—am using S tubes om—they all tuk its pure dc hi hi—nil hr nw om cul 73s to 6eok

Received OK, old man. I am using "S" tubes, old man. They all think it is pure direct current. hi hi (this is the amateur's method of laughing with his key). Nothing more here now, old man. See you later and best wishes to 6EOK.

(6EOK) r ok—fb om hi—dont ferget to qsl —wel nil hr nw om so cu agn and best 73s

Received OK. Fine business, old man, hi. Don't forget to write me that card. Well, nothing more here either, old man, so see you again and best wishes.

(6CIA) r ok om will qsl crd om—cul 73s to 6eok sk ga

Received OK, old man. Will write you a card, old man. See you later and best wishes to 6EOK. End of transmission. Go ahead.

(6EOK) r ok—73s cu agn sk

Received OK. Best wishes. See you again. End of transmission.

(6CIA) sk

End of transmission.

How to Work Hard Rubber

HAVE you ever needed a small piece of hard rubber of just the right size to mount the binding posts on the back of your set? Or as a support for some piece of apparatus? In POPULAR RADIO for August, Mr. D. H. Killefer, a distinguished chemist, tells how to cut it, bend it and otherwise handle it as easily as one handles soft rubber.

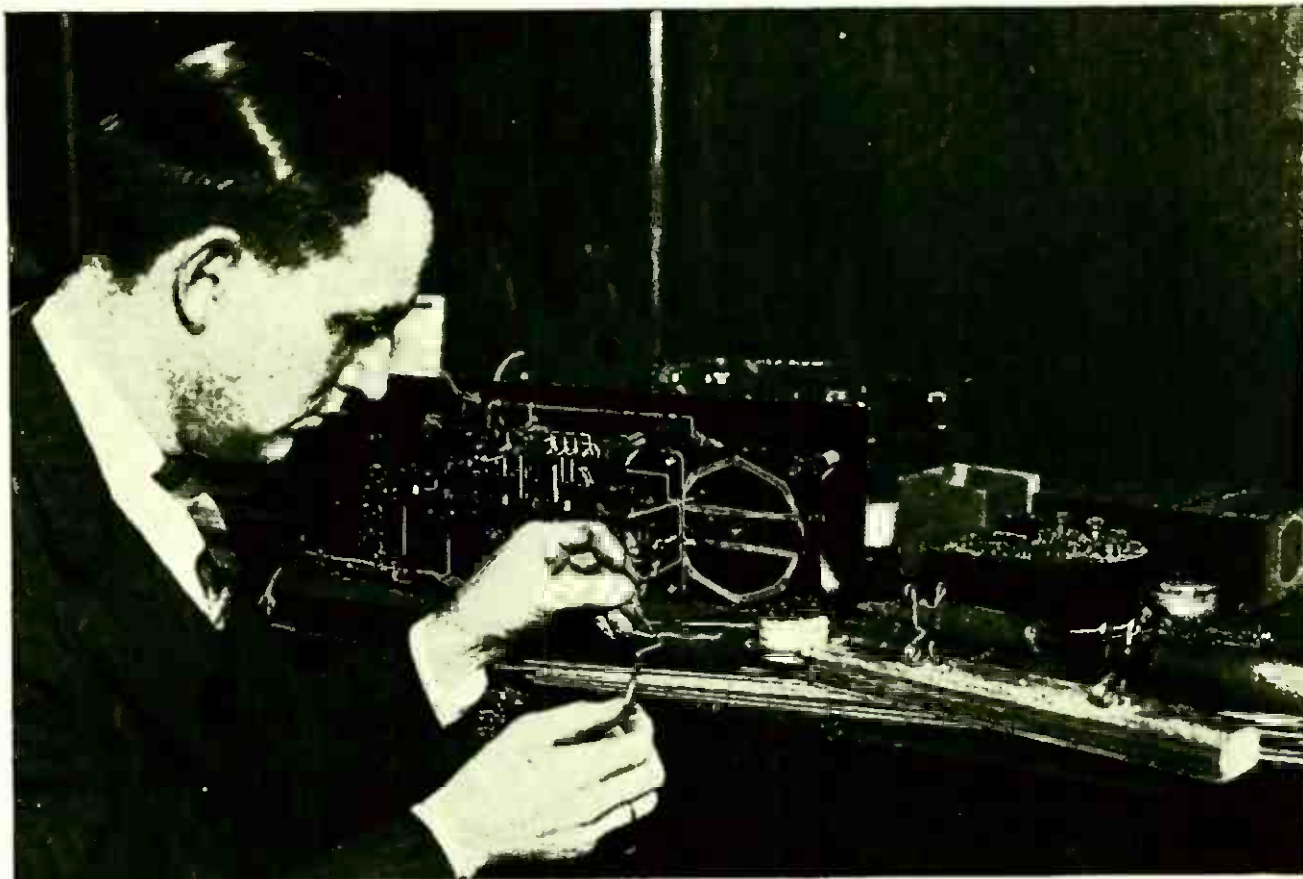

- 1: *In applying soldering paste to any piece of metal or wire, do so sparingly with a matchstick. A thin film of the paste is all that is necessary.*

How to Do Your Soldering Correctly

Use only enough soldering flux to make a thin smear on the parts that you are soldering. Never use so much that it runs down on the insulation of any part. Never use so much that it drips off onto some vital part of the windings of any of the instruments. If you do, you may permit acid corrosion to take place, with detrimental effects on the operation of the set you are wiring up.

And then, use only enough solder to properly stick the two parts together. It is a good precaution, in soldering, to tin both pieces before soldering them together. This should be done in the following manner:

In soldering a wire in position first place a small quantity of soldering flux on the end of the wire. (This can be done with a matchstick.) See Figure 1. Then prepare the iron by removing any oxidization from the tip with a file. Next, heat the iron and coat it with a

little flux and "tin" it properly with solder so that the tip is covered with a bright film of solder. See Figure 2.

Next, use the iron to tin the two contacts, one on each end of the wires. To do this touch the end of the soldering iron to a piece of solder so that a small bead of solder adheres to the iron. See Figure 3. Then place the iron on either of the wire ends until the flux sizzles up and the solder runs over the surface. See Figure 4. This is called "tinning."

When both parts are tinned, place them together, in the proper position, and touch the end of the soldering iron to them again. See Figure 5. When they heat up sufficiently, the two coverings of soldering will melt together, merge into one, and if the iron is withdrawn and the parts held fixed, for a minute, they will "freeze" together, and the result will be a strong, neat joint.

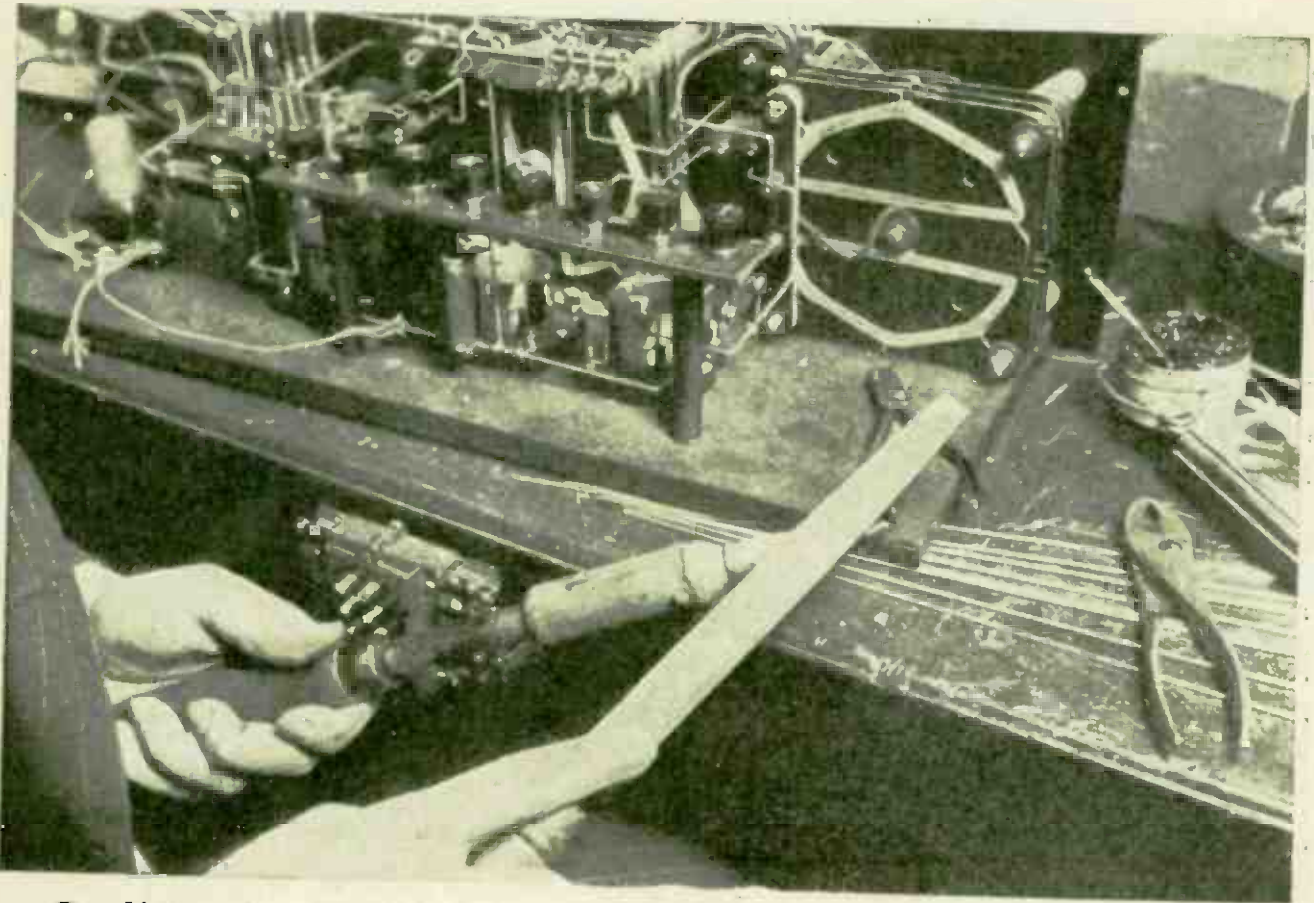

2: *If the point of the iron becomes oxidized (blackened) brighten it up with a smooth file. Then "tin" the end with solder and wipe it on a cloth, while hot.*

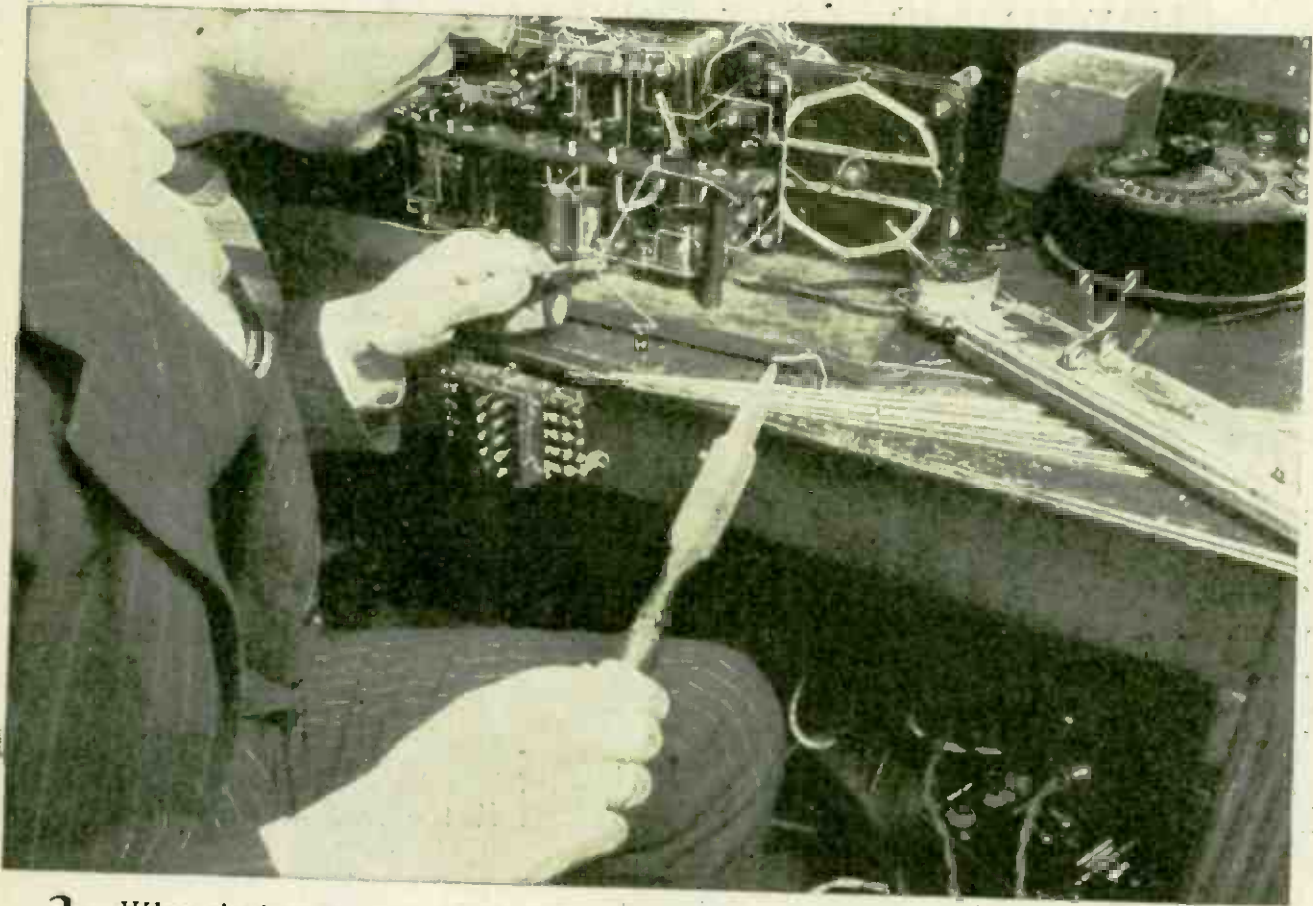

3: *When tinning the ends of wires to be soldered, hold the wire in one hand with a pair of pliers and touch the end of the iron to a strip of solder. This will form a small bead of molten solder on the end of the iron.*

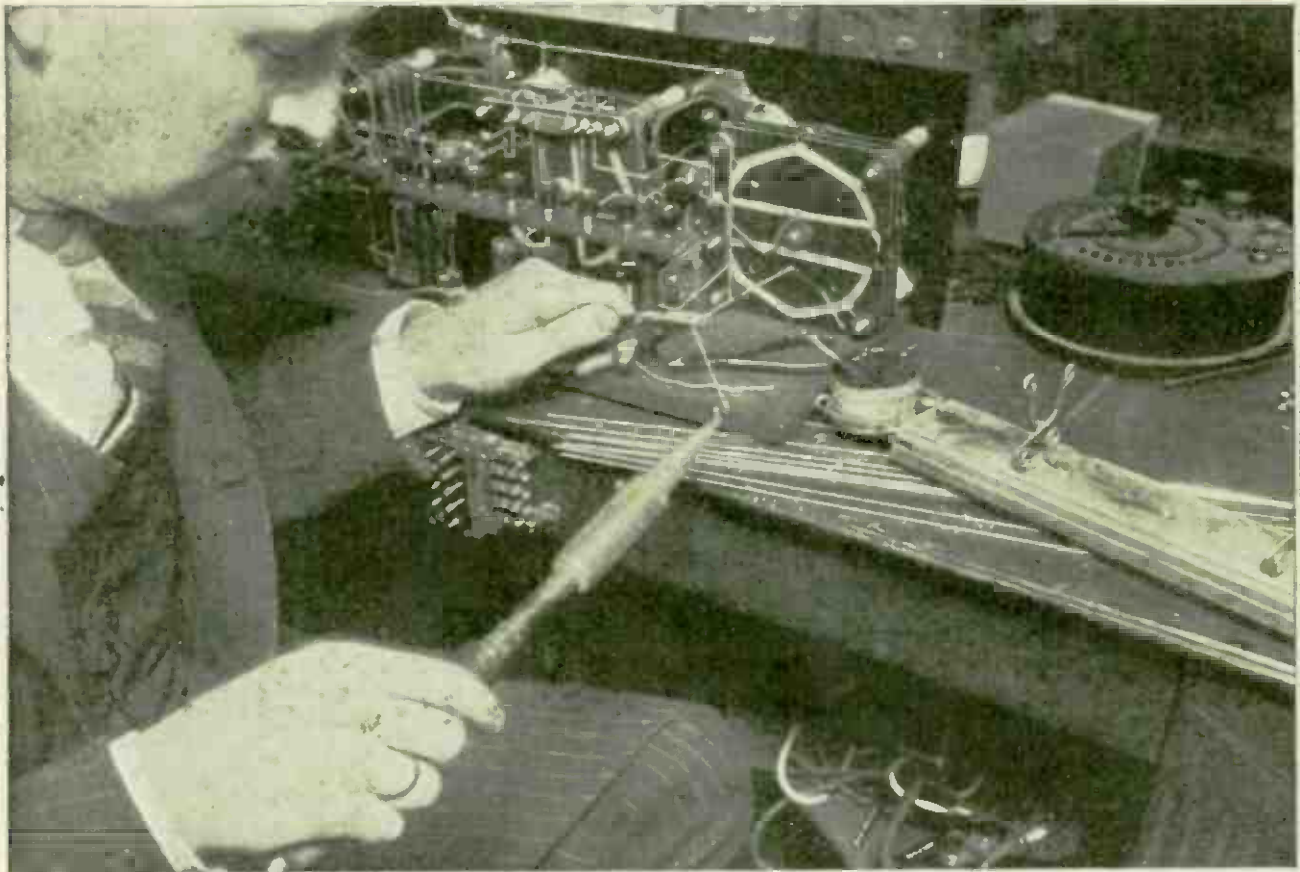

- 4:** Then carry the iron over to the piece of wire and apply the solder to all sides. The soldering paste will bubble slightly for an instant and then the solder will "run" all around the wire.

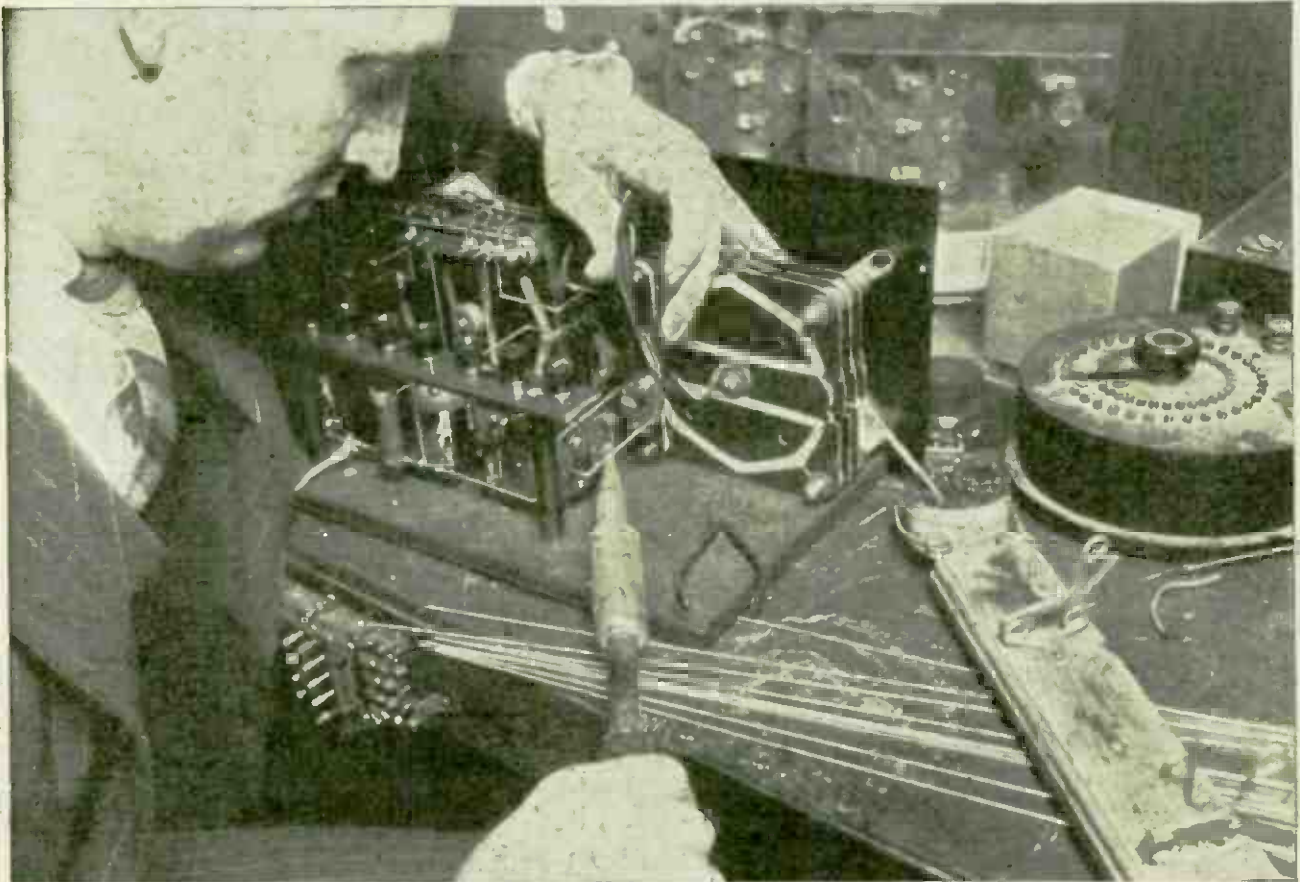

- 5:** While the wire is being held in the correct place with the pliers, place the tip of the iron with a small drop of solder on it against the place to be joined, and hold it there until the two tinned pieces fuse together. When withdrawing the iron blow on the parts until they freeze.



From a photograph made for POPULAR RADIO

POSSIBLY 200,000 PEOPLE LISTENED IN ON THIS LECTURE
When Prof. Herman H. Horne addressed his class of university students of philosophy on February 13th, his talk was broadcast over the eastern section of the continent.

A Classroom 2,000 Miles in Diameter

How the introduction of the microphone into the classroom foretells a change not only in what the teachers have to say but also how they say it.

By KENNETH M. SWEZEY

DOWN on famous old Washington Square on the outskirts of Greenwich Village—the so-called “bohemian center” of New York—there is a university lecture room that covers an ef-

fective area almost half as big as the United States!

In other words, the lectures given there by its professors are broadcast over a territory as large as the range of sta-

tion WJZ, which is one of the most powerful stations in the world.

This particular lecture room which has thus burst through its walls is of peculiar interest, not only because radio is making it possible for it to extend its influence in a way that makes a Jules Verne dream seem tame in comparison, but also—and more particularly—because its experiments in disseminating education are prophetic of a development that may revolutionize our whole attitude toward education.

Some day, the lectures of our foremost professors, scientists and other leaders in the educational field may be brought, by radio, into the homes of all who care to tune in. The new University of the Ether is growing.

The lecture room on Washington Square belongs to New York University, which is one of the sixty-odd colleges and universities that now maintain licensed broadcasting stations.

To this institution the call of radio seems to have been too pressing to have remained unanswered.

It all started with a lecture or two that was given through WJZ by one of the members of the faculty. The response, in the form of letters of inquiry and appreciation, was so overwhelming that the only thing the university could conscientiously do was to expand and develop the program as best it could under the limited amount of data that had accumulated from experimentation.

Dr. James E. Lough, dean of the Extramural Division, and head of the Department of Psychology, is now the supervisor of all the university's broad-

casting work. In his opinion the broadcasting of university lectures is to be compared with the discovery of printing as a means of educating the masses.

"We are still in the experimental stage," Dean Lough states, "but no one can be blind to the possibilities that this innovation offers. In arranging this first complete series of university lectures we have had no mile-posts to guide us; we are exploring an entirely new field of education. We have arranged a series of popular lectures, dealing with such matters as public affairs, literature, elemental philosophy, modern public problems and the less intricate features of psychology. We have pitched them on a reasonably high plane, assuming that there are enough interested listeners who are not college bred who are appreciative of such a course. The flood of letters we are receiving from our radio audience afford us an excellent guide for future radio programs."

Judging from the letters, the lectures have been exceptionally well received by the radio audience. The number of letters from professional men, written on business stationery, is astonishing. Doctors, lawyers, merchants, engineers have all sent in critical and appreciative remarks, and expressions of hope for the continuance of this type of work. Indeed, letters that are scribbled and scrawled on odd bits of paper, such as are encountered in sheaves in response to the average broadcast feature, are particularly prominent by their absence. The culture and intelligence of a discriminating middle class predominates.

One lecture is arranged for each

An Historic Occasion on an Historic Site

SO FAR as known, the first regular university lecture to be broadcast direct from the classroom through a powerful station was broadcast by WJZ from a classroom of the New York University Building on Washington Square, New York, on February 13, 1924, when Prof. H. Horne lectured to his class in philosophy—and to a radio audience variously estimated at from 100,000 to 200,000 persons. It was on the same site that John W. Draper took the first photograph of the human face and Samuel F. B. Morse sent the first telegraphic communication—and both of these men were New York University professors.



Radio Corporation of America

WHERE THE LECTURER'S VOICE IS "CONTROLLED AND TRANSMITTED"

Here is pictured the actual control and transmitting apparatus that is used in broadcasting the course of lectures through the ether. The transmitters are of the most modern vacuum-tube type and are located in the transmitter room of station WJZ in New York.

school day, giving a total of five lectures during the usual week. A typical schedule runs something like this:

Monday; "Public Affairs in the City of New York," by Prof. Rufus D. Smith of the Department of Public and Social Economy. This is a study of the city of New York, its conditions of business, culture, population and government. Special attention is given in the lectures to such questions as transportation, port development, housing, financing, etc. These lectures are designed especially for students interested in practical civic and social problems.

Tuesday; "Right Habits of Reading," by Prof. Howard R. Driggs of the Department of English. Proper reading habits and literary appreciation are the central aims of these lectures. They include discussions of the basic problems of getting and measuring results in composition, vitalizing grammar, building the vocabulary and cultivating the spirit of authorship.

Wednesday; "Philosophy of Life," by Dr. Herman H. Horne of the Department of Philosophy. This is a series of talks on philosophical thinking and living.

Thursday; "Modern Public Problems," by Dr. Henry P. Fairchild, professor of social economy. These lectures deal in a scientific manner with some of the leading problems in life in organized society. Such problems are being discussed as crime, unemployment, economic stratification, eugenics and feminism.

Friday; "Systematic Psychology," by Dean James E. Lough, professor of psychology. These lectures undertake a scientific study of the functions and phenomena of consciousness. It is their purpose to give the student a working conception of the mind.

Unlike the broadcasting from other schools, what goes out over the air, through WJZ, is an actual classroom lecture that is being given to the regular students by their customary professor.

Wires are led directly from the broad-

casting station to the microphone located in the classroom of the Washington Square building of the university.

One of the officials commented that this system had more than the advantages that were at once apparent, for, besides giving the extra benefit to the listener, it held up a warning hand that put a new responsibility in the conscience of the professor who was giving the lecture. For, whereas the professor might "get away with murder" in the privacy of his classroom, there was no telling what superior intelligences might be listening in among his new radio audience of one or two thousand people of all ranks and classes. The result is that the professors are more inclined to put more sincere thought into the preparation of their lectures than was before considered necessary. Here is a use for the radio microphone which might be vastly extended, to our politicians especially, with no little benefit!

The university has planned to take advantage of the summer months by broadcasting some of the summer-course features, including musical programs. The psychology of warm weather dictates that material of a lighter and more

entertaining nature be supplied than in the cooler months when the mind works under less inertia.

A radio club formed of undergraduates has been active some time. A short while ago the rumor leaked out in several magazines that these fellows were going to set up their own station and take over the broadcasting of the university. This rumor is, however, "student stuff," according to the faculty, and as far ahead as the faculty can see, the radio committee intends to carry on its work just as it is done at present.

In the fall the university expects to be able to secure clear land wires to connect the uptown division of the New York University with the station; it also expects to broadcast unusual features simultaneously through WGY and through the Washington station of the Radio Corporation, besides WJZ. This would increase its audience manifold.

So far, lectures have been given singly, though with more or less connection. Just what the future will be is not definitely known. But it is probable that a few regular extension courses will be evolved, with text-books and pamphlets as a basis for study.

The Very Latest Example of "Television"

THIS action picture of a jumping horse is NOT made from a motion-picture film; it shows an actual scene from life as transmitted by radio direct from the spot to a screen in the laboratory by means of the apparatus invented by Mr. C. Francis Jenkins of Washington. By means of this invention it is now possible to SEE moving scenes as they take place at distant points.



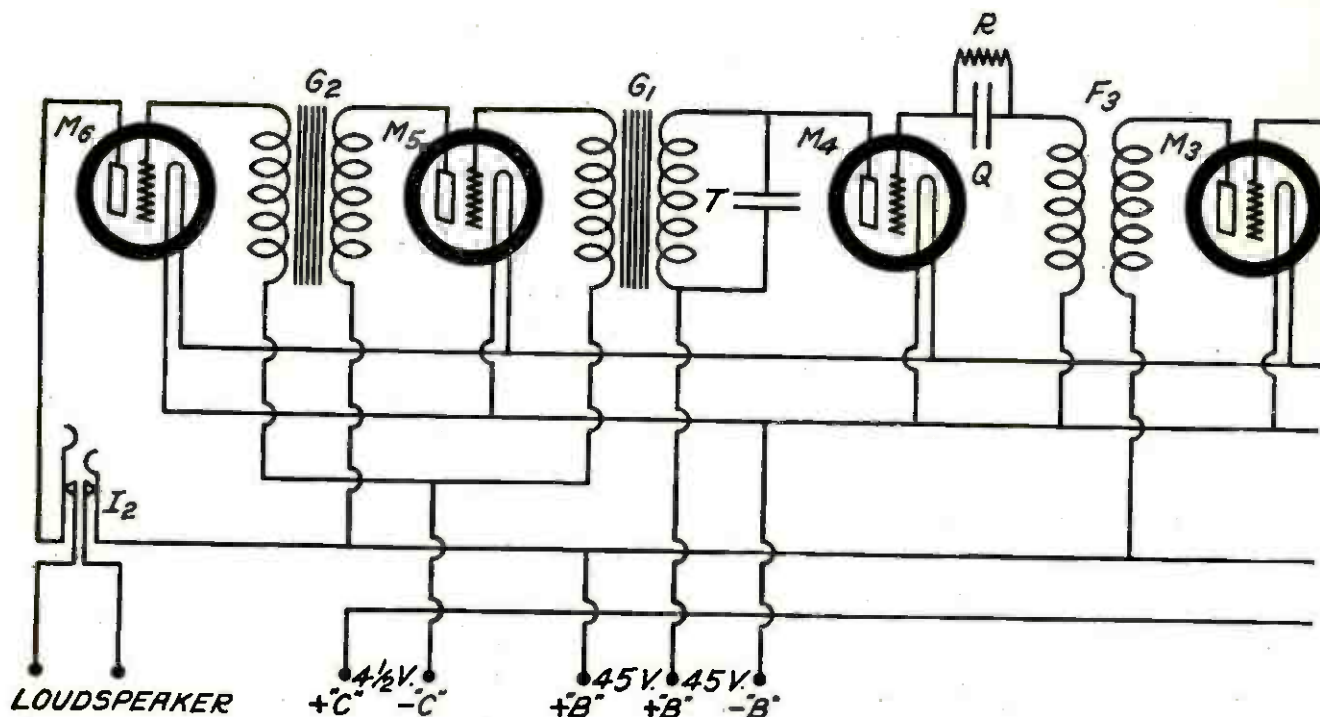

HOW TO BUILD THE POPULAR RADIO PORTABLE

Here is a practical portable receiver—developed by the technical staff of POPULAR RADIO—that is not merely a summer set, for use indoors and out-of-doors, but which will be found to be a highly efficient loop receiver that can be used all the year round, for both local and DX reception. The set can be used at home or put into its carrying case and used on the automobile, the boat or any where a suitcase can be carried.

By LAURENCE M. COCKADAY, R.E.

COSTS OF PARTS: *About \$100.00*

APPROXIMATE RANGE: *Daytime 150 miles; night, 1,500 miles*

HERE ARE THE ITEMS YOU WILL NEED—

- | | |
|--|---|
| <p>A—Marion loop antenna, with plug attachment;</p> <p>B—National variable condenser, .00035 mfd. (17 plates) with vernier dial;</p> <p>C—Amsco potentiometer, 400 ohms;</p> <p>D—Unity vernier rheostat, with "off and on" switch;</p> <p>E—Hoyt voltmeter, 0 to 6 volts scale;</p> <p>F1, F2 and F3—Dubilier Duratran radio-frequency transformers;</p> <p>G1—Jefferson No. 45 audio-frequency transformer;</p> <p>G2—New York Coil audio-frequency transformer;</p> <p>H1, H2, H3, H4, H5 and H6—Benjamin vibrationless sockets for 199 tubes;</p> <p>I1—Federal jack, single-circuit;</p> <p>I2—Pacent jack, double-circuit;</p> | <p>J—panel, 10½ inches by 15¼ inches;</p> <p>K—cabinet, dimensions as given in Figure 9;</p> <p>L—carrying case, dimensions as given in Figure 8;</p> <p>M1, M2, M3, M4, M5 and M6—C-299 or UV-199 dry-cell tubes;</p> <p>N—Red Seal dry batteries No. 6, each 1½ volts (six required);</p> <p>O—Everready "B" batteries No. 763, each 22½ volts (four required);</p> <p>P—Timbretone loudspeaker;</p> <p>Q—New York Coil mica fixed condenser, .00025 mfd., with clips for grid-leak;</p> <p>R—Daven grid-leak, 5 megohms;</p> <p>S—Everready "C" battery, No. 771, 4.5 volts (one required);</p> <p>T—New York Coil mica fixed condenser, .001 mfd., with lugs.</p> |
|--|---|

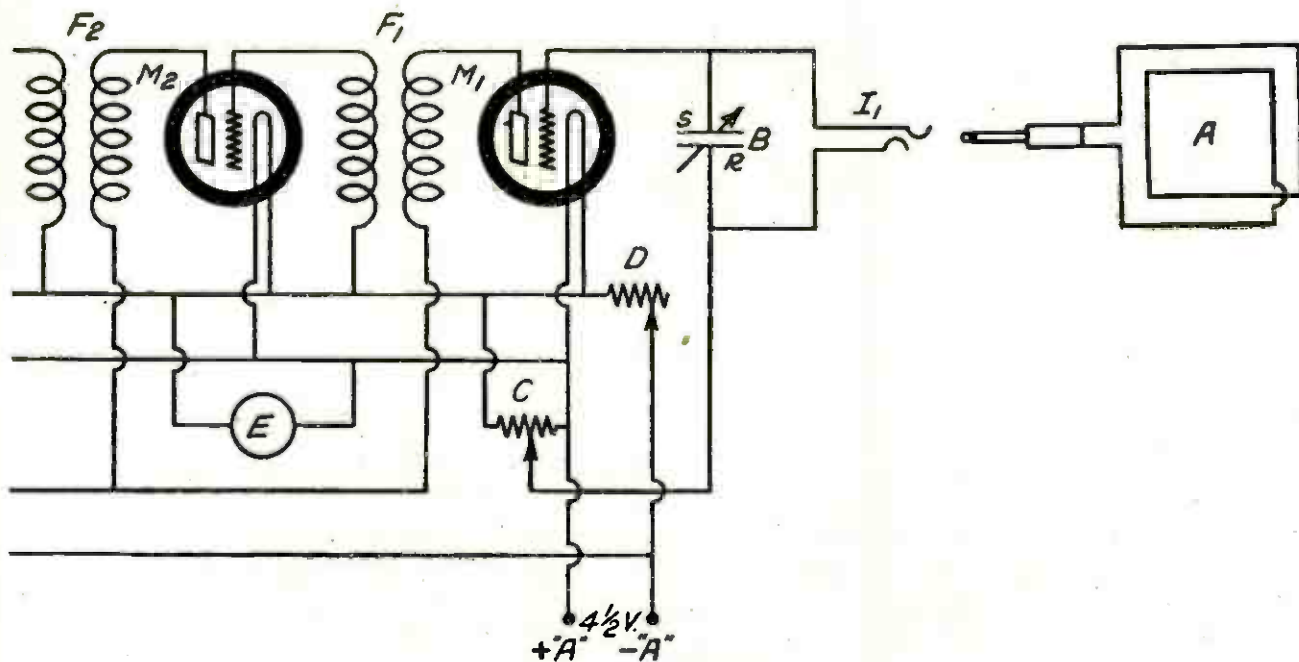

THE ELECTRICAL WIRING SCHEME

FIGURE 1: This drawing gives the correct connections for the various instruments which are used to make up the complete circuit. Notice that the diagram is drawn from RIGHT to LEFT, so that the wiring is shown exactly as it goes into the set when you are wiring up.

THE summer season is, naturally, an out-of-doors season. All of us, at some time during the summer, feel the urge to "get back to nature," and some of us, who are lucky enough, do throw ourselves off the track of the winter grind and take a vacation. Some of us prefer to trot ourselves off to a mountain camp. Some go on motor tours; some prefer the cooling breezes of the seashore; some go yachting. Few there are who merely want to sit in the house, in the summer heat, to sit and listen to a radio set!

For this reason, many have considered radio as a winter sport, an *indoor* sport. But this is only as true as people make it, for radio broadcasting is something that fills an important summer need.

If we could only take a portable radio set with us to that camp up in the Adirondacks, or on that motoring trip through Yellowstone Park, or to the seashore, we certainly would get a lot of pleasure and help to while away the time and fill the pleasant hours of rest and recuperation.

The trouble has been that we simply cannot take all the radio equipment we have at our city house with us. It would be too bulky. How would we take down the antenna from the roof and roll it up? How would we set it up every time we wanted to listen? Who would lug the heavy storage battery? Who would carry the loudspeaker?

But what would you say if you didn't have to bother with an antenna? What would you say if the set could be carried as easily as a suitcase? If you had only to pull a plug and turn a dial to listen? If there were not any storage batteries to bother about and if the set would run 150 hours without any care or further attention?

This article tells you how to make just such a set—the POPULAR RADIO Portable Receiver, for all around use during the whole year.

The set is not a toy and it is not an experiment. It is practical, it is efficient. Anyone can make it and anyone can make it work. It has only *one* tuning control.

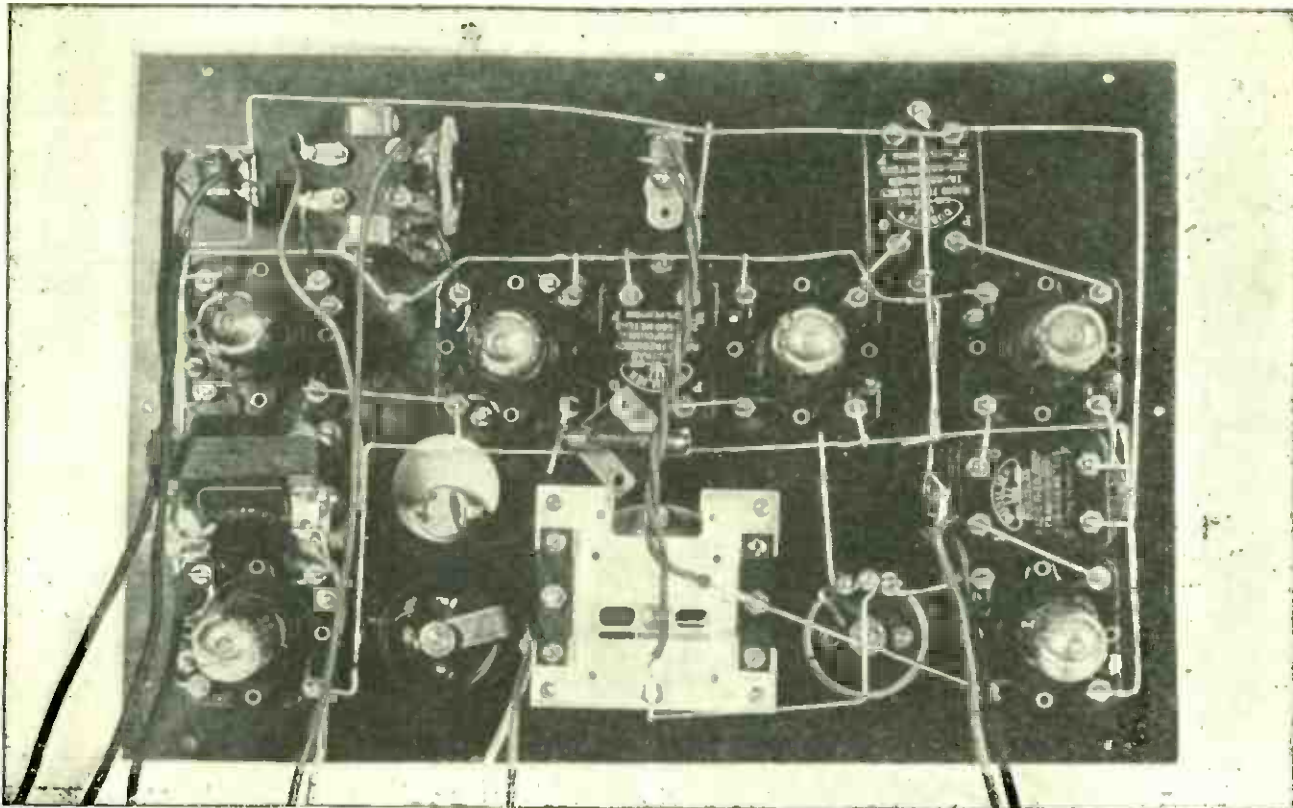

VIEW FROM THE REAR OF THE PANEL

FIGURE 2: This picture shows clearly the arrangement of the parts as they are mounted directly upon the back of the panel.

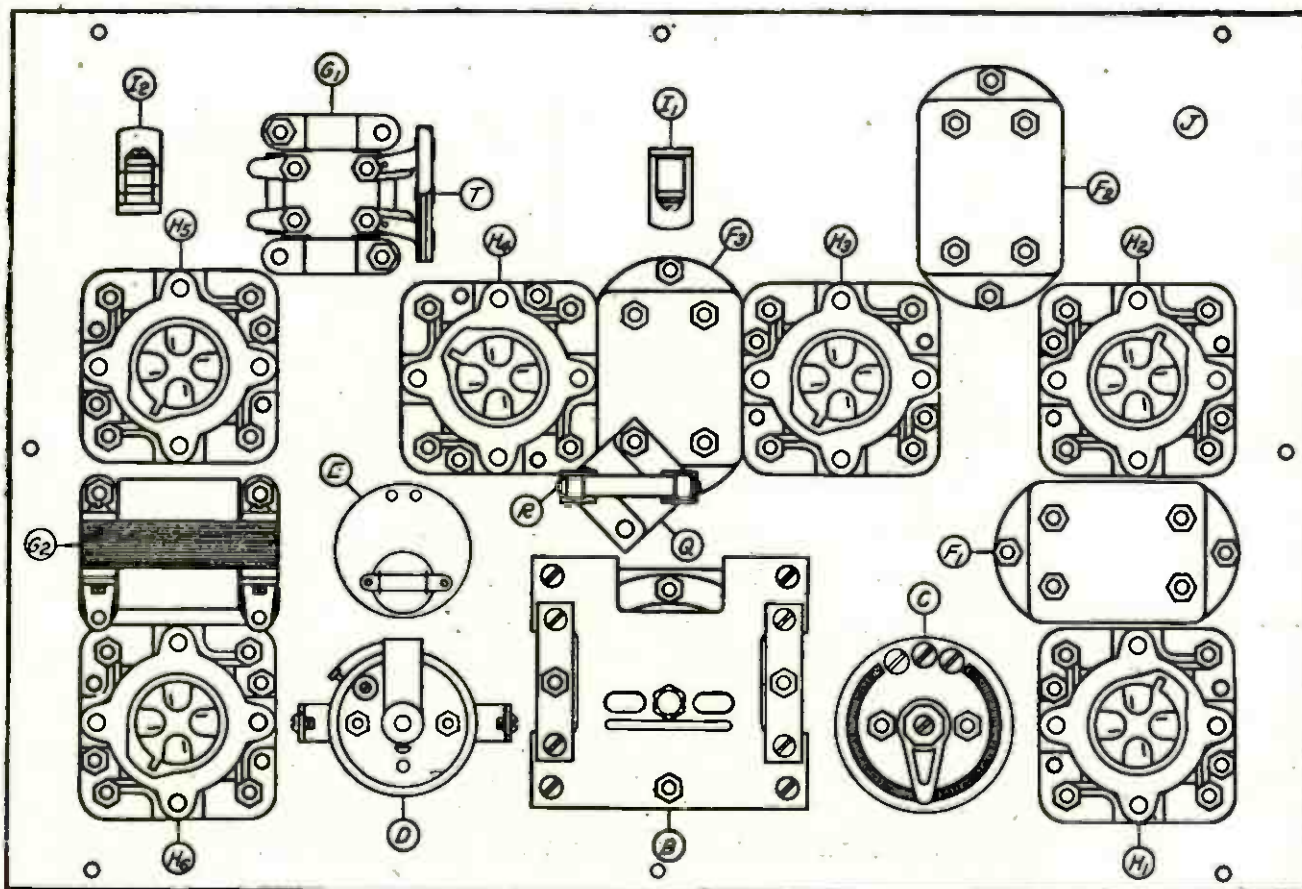

THE WORKING DRAWING FOR CONSTRUCTION

FIGURE 3: This diagram is made from the same view as Figure 2, but it contains the designations for the various parts. The same letters are used in the text and in the list of parts.

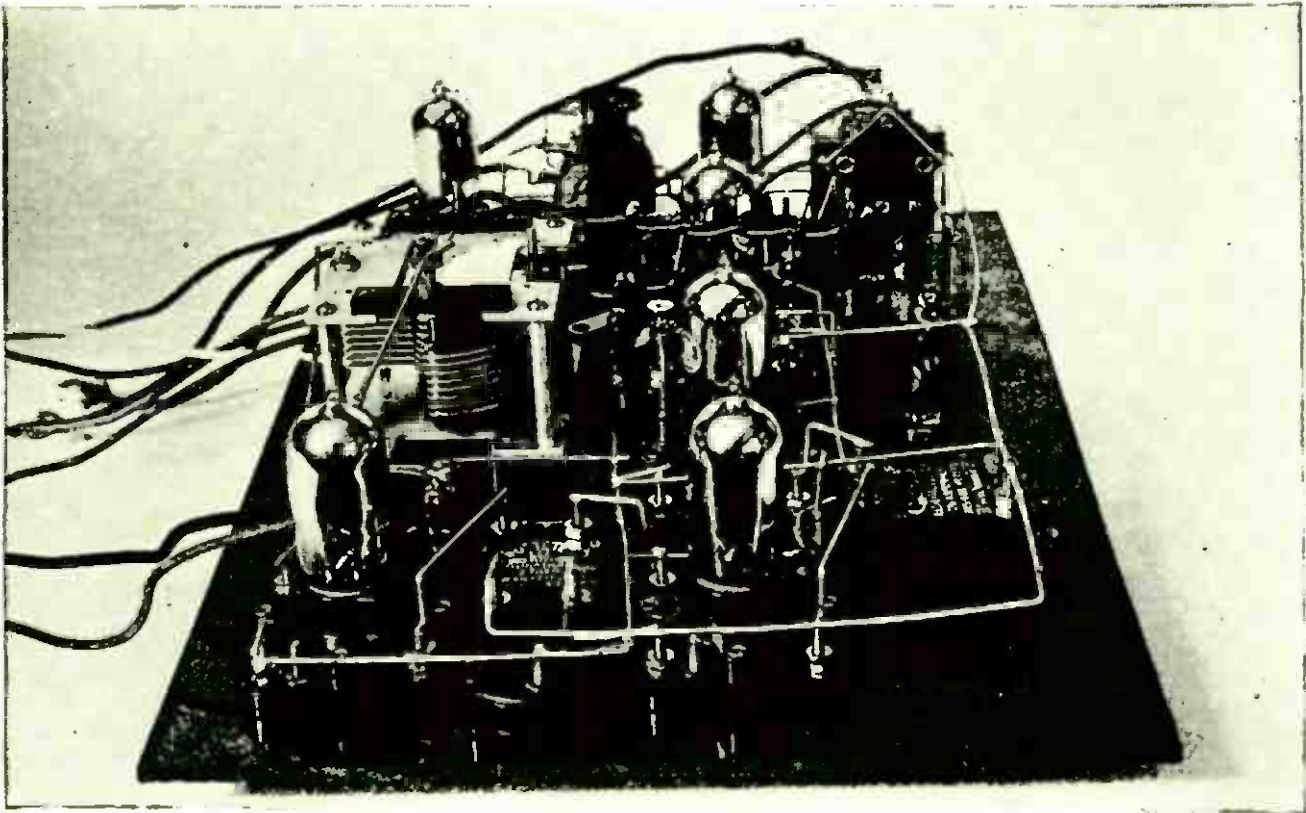

REAR-OF-PANEL VIEW, FROM THE RIGHT SIDE

FIGURE 4: This picture shows clearly the arrangement of the tube sockets and the radio-frequency transformers; study this picture before you do the wiring.

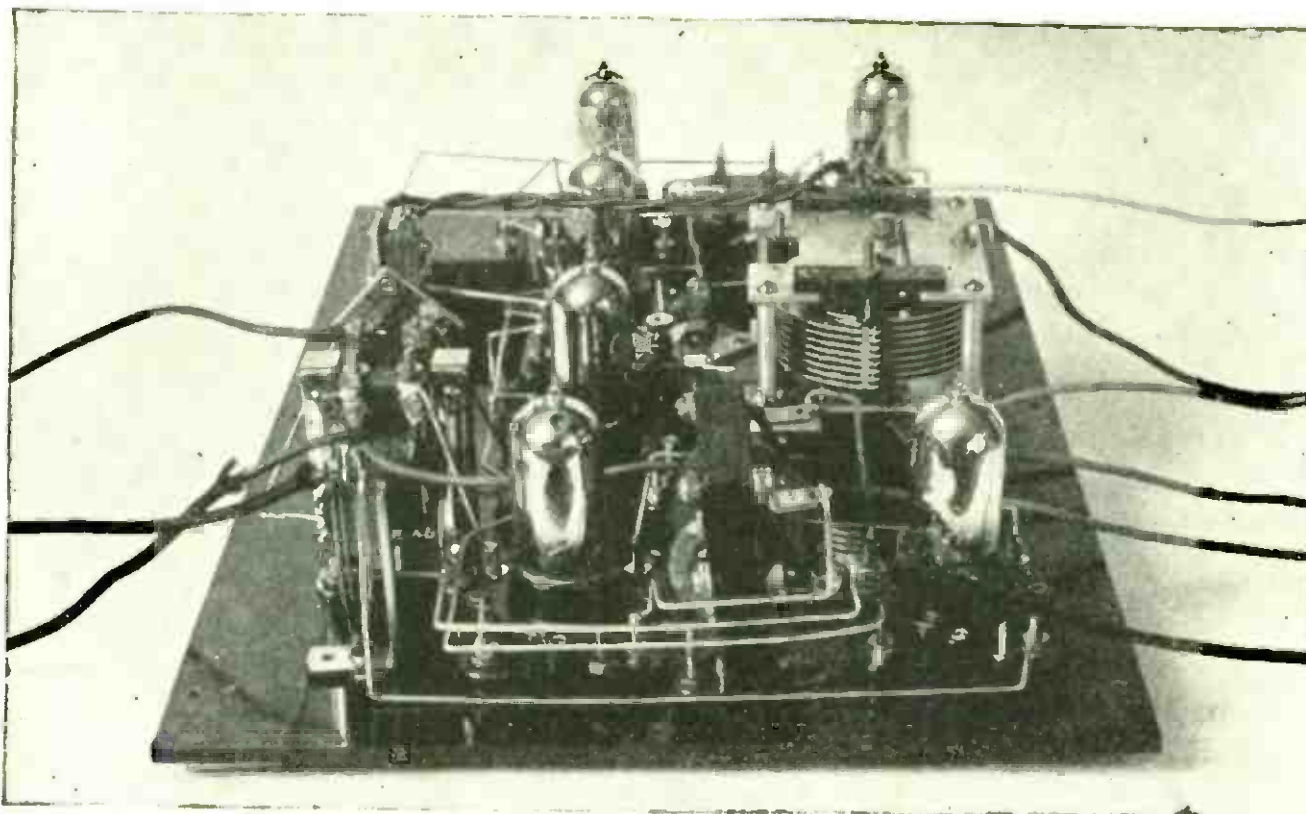

REAR-OF-PANEL VIEW, FROM THE LEFT SIDE

FIGURE 5: This shows the arrangement of the audio-frequency end of the works. Notice that the output circuits of the audio-frequency amplifier are kept widely separated from the input circuit to the radio-frequency amplifier.

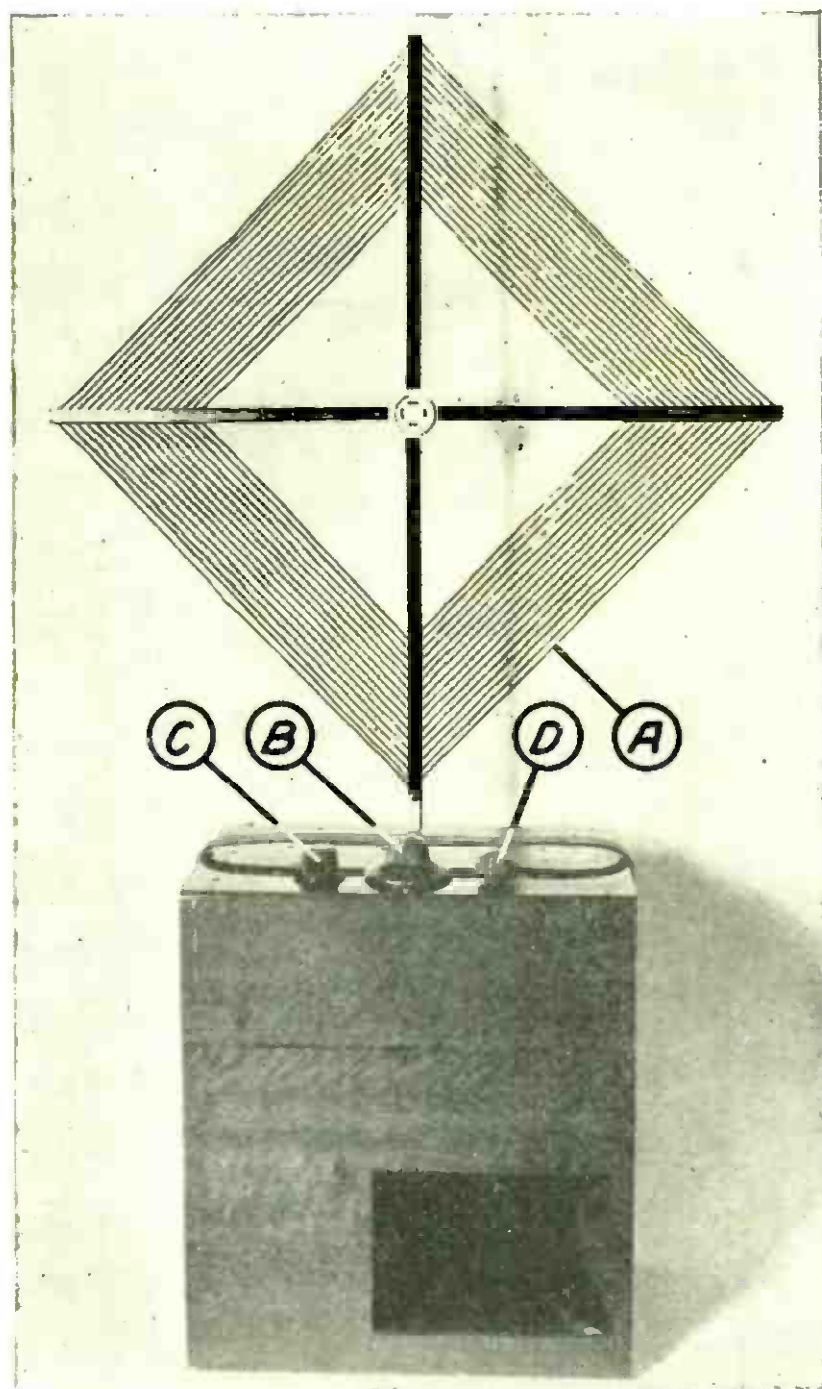

FRONT VIEW OF THE COMPLETED PORTABLE

FIGURE 7: This illustration shows the set ready to operate. It has been taken out of its carrying case and the folding loop A set in place. The tuning is accomplished by turning the knob B. The set is put into and out of operation by lifting or pushing down knob D, which also controls the filaments. The volume is controlled by turning knob C. The aperture at the lower right portion of the cabinet is the loudspeaker horn.

with a piece of cheese-cloth, and a dull permanent finish will be the result. Or the panel may be left with its original shiny-black finish, if care is exercised so that it is not scratched during drilling.

Next, mount the variable condenser B, by removing the dial mechanism and inserting the four screws and the shaft through the panel as indicated in Figures 2, 3, 4, 5, 6 and 7, and as told in the instructions for mounting, which come with the condenser.

Next, mount the six tube sockets H1, H2,

H3, H4, H5 and H6, as shown in the same Figures mentioned above. Be sure that you have the sockets pointing in the same direction as indicated in the drawing of Figure 3. Use only two screws to each socket at diagonal corners, although there are four holes in the socket. These screws should be inserted through the panel.

Next, mount the three radio-frequency transformers F1, F2 and F3 by means of two screws each, in the holes drilled for them in the panel, and secure them with nuts. Use three-quarter-

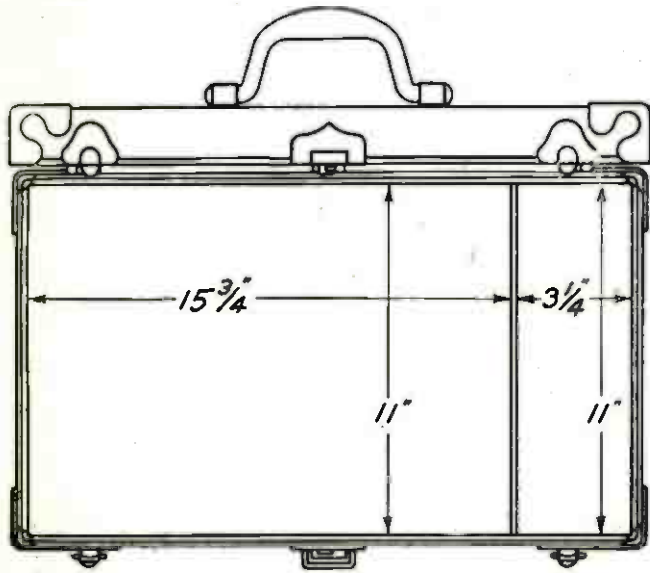

THE DESIGN AND DIMENSIONS FOR THE CARRYING CASE

FIGURE 8: This sketch can be turned over to a sample-case manufacturer who can make it for you out of fibre (or leather, if you prefer).

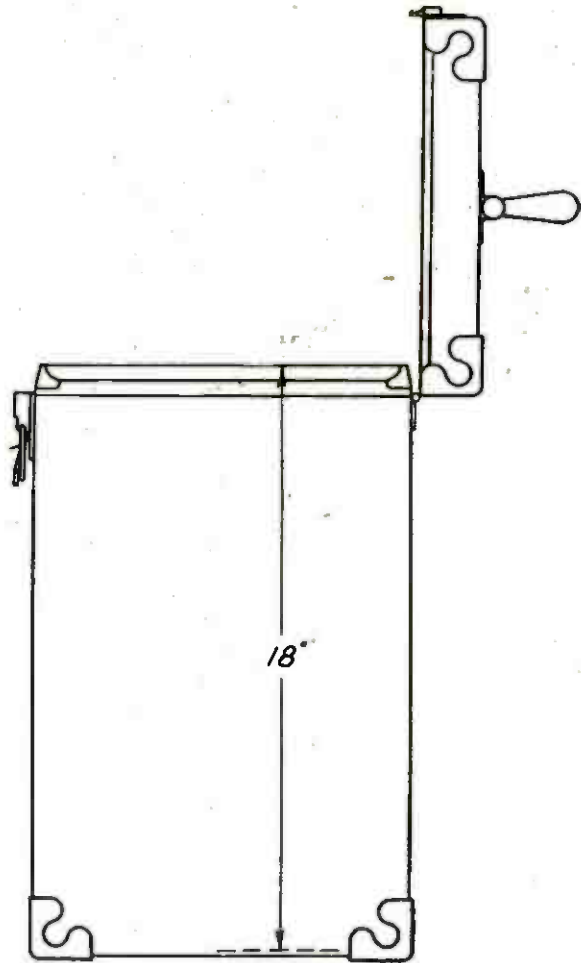
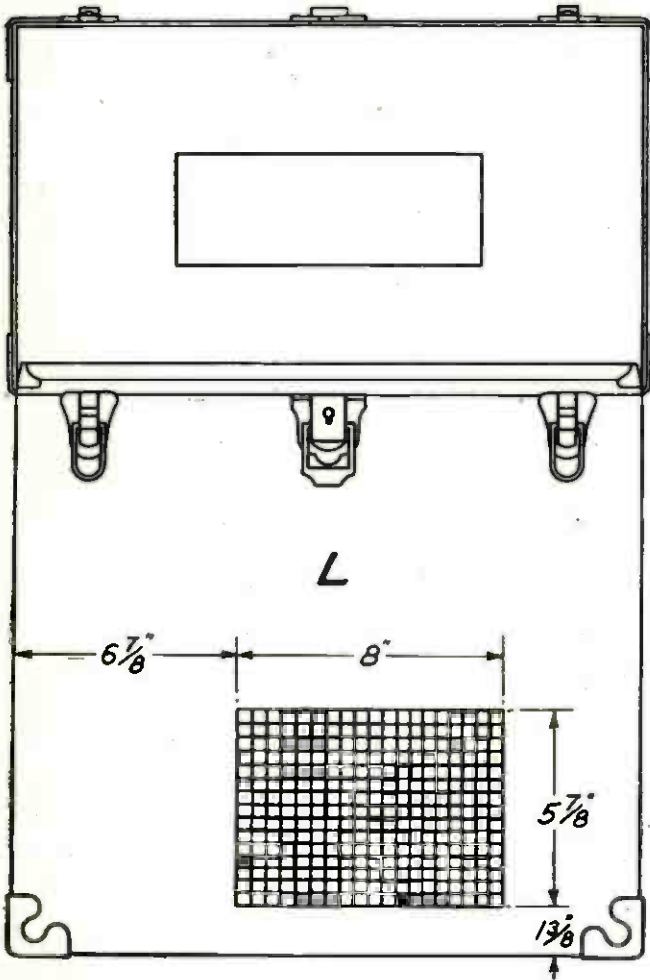

inch screws so that the screws may be used for shielding when the wiring is being done.

When this is finished fasten down the two audio-frequency transformers G1 and G2 in a similar manner, as shown in Figures 3 and 4.

Then attach the voltmeter E, by loosening the long screws and inserting the meter through the large hole drilled for it in the panel, after which the round disc is put in place in the rear of the panel and the screws tightened up to hold it fast. (See Figure 3.)

Place the two jacks I1 and I2 in their re-

spective positions, and fasten securely by tightening up the two large nuts on the front of the panel. One of these jacks is for connecting an outside loudspeaker or in case headphones are to be used.

Now, mount the rheostat D, by removing the knob and sticking the rheostat up against the panel with the shaft protruding through the hole in the panel and fasten with two screws. Then screw the knob back on again. (See Figures 3 and 4.)

Then attach the potentiometer C with two

screws. The whole shaft of the instrument comes off with the knob in this case, by loosening a small expansion screw located in the end of the split shaft. Fasten on the shaft and knob when the instrument has been mounted and adjust the pointer so that it reads correctly.

This completes the construction work on the panel itself, and it is now ready for wiring.

How to Wire the Panel

First of all it will be noticed that the layout of the instruments is such that the natural sequence of wiring follows along so that there are no long leads which have to carry high-frequency currents. The first radio-frequency tube is arranged so that the connections from it to the tuning condenser and the transformer are very short. Likewise the connections from the first transformer to the second tube are as short as possible and so on.

Another important feature is the fact that the circuits are so arranged that the back coupling between stages is kept as small as possible. There are no wires or circuits of the second stage that come close to, or parallel with, the wiring of the first stage, and so on.

And finally, the output circuit of the audio-frequency amplifier has been carefully arranged so that there is little capacity from it to the input of the radio-frequency amplifier. Otherwise the set would have an objectionable whistle. This is the same trouble that affects so many home-made radio-frequency sets of

three stages or over. As stated before, if the set is constructed and wired *exactly* as shown in Figures 1 and 2, this trouble will not be experienced.

Start wiring the filament circuits first. Lay the panel upon its face in the position shown in Figure 2. Then start at the left-hand terminal of the rheostat D, and run a piece of bus-wire over to the near terminal of the last tube, the one immediately at its left, H6. Continue on with this wire to the fifth tube, H5, then the fourth, H4, the third, H3, the second, H2, and on to the first tube-filament connection at H1. This wire should be in one length and should run alongside the sockets on the side nearest the variable condenser until it reaches the second tube socket H2, when it should continue on between the first transformer, F1, and the second tube socket, H2, turning at the right edge of the set and continuing to the first tube socket terminal on H1. This wire forms the negative filament bus, from which all the tubes are fed with current.

Then run a wire from the left-hand post of the potentiometer C, to the negative filament bus that has just been completed. Do the same thing from the F terminals of the first and second radio-frequency transformers F1 and F2. These form the grid returns.

Next, start the positive filament bus at the right-hand post of the potentiometer C and running to the positive filament connection of the first tube socket H1, then on to the remaining filament connections of the second tube socket H2 and the third socket H3, and to the F terminal on the third radio-frequency transformer F3. From here the same wire should be carried on to the remaining filament terminal of the fourth socket H4, and then lead it between the first audio-frequency transformer G1, and the fifth socket H5, and attach to the remaining filament terminal of this socket. Then carry the same wire along down the left edge of the set to the last tube socket

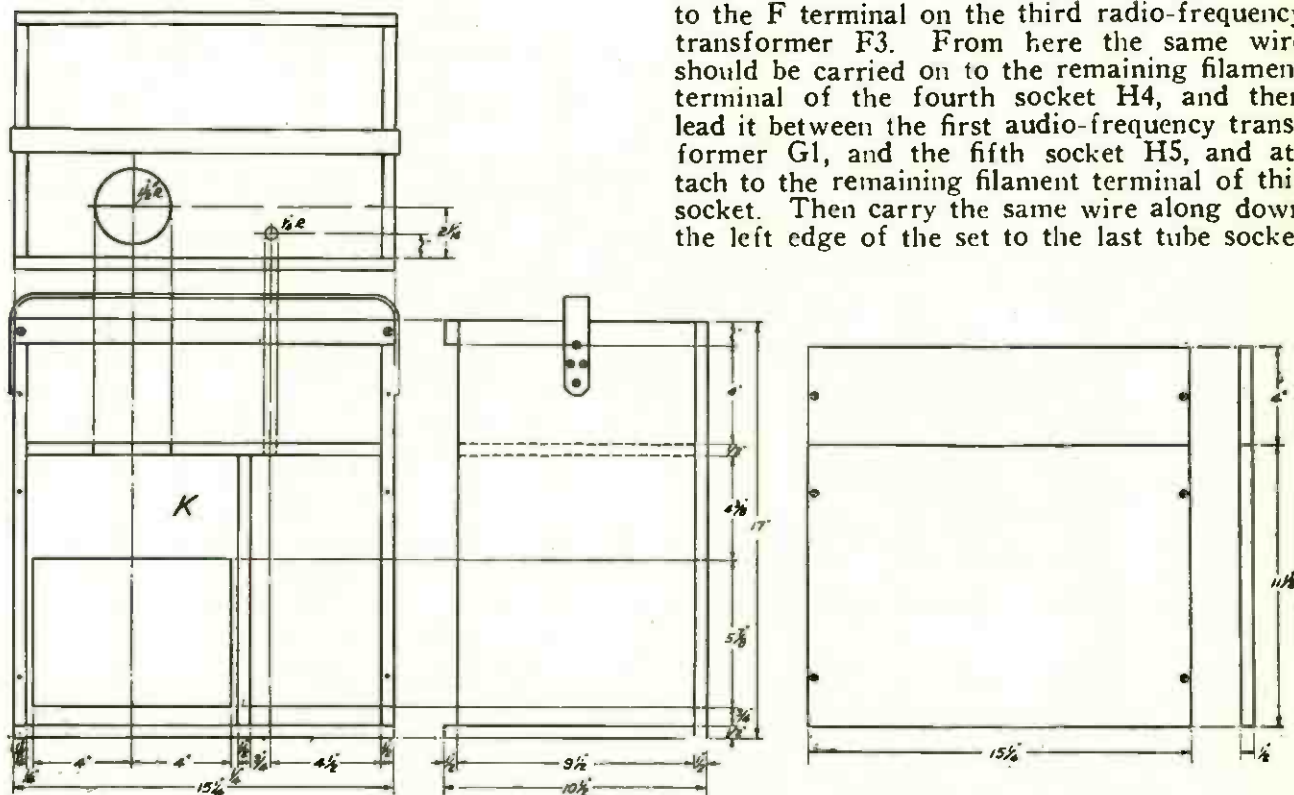

THE DESIGN AND DIMENSIONS FOR THE CABINET

FIGURE 9: At the left is shown the rear view of the cabinet with the dimensions for the compartments. Directly over this is the top view, giving the spacings and dimensions for the hole for the loudspeaker unit and the hole for the battery connections. In the center is shown the side view and at the right are the dimensions for the two pieces that form the back cover.

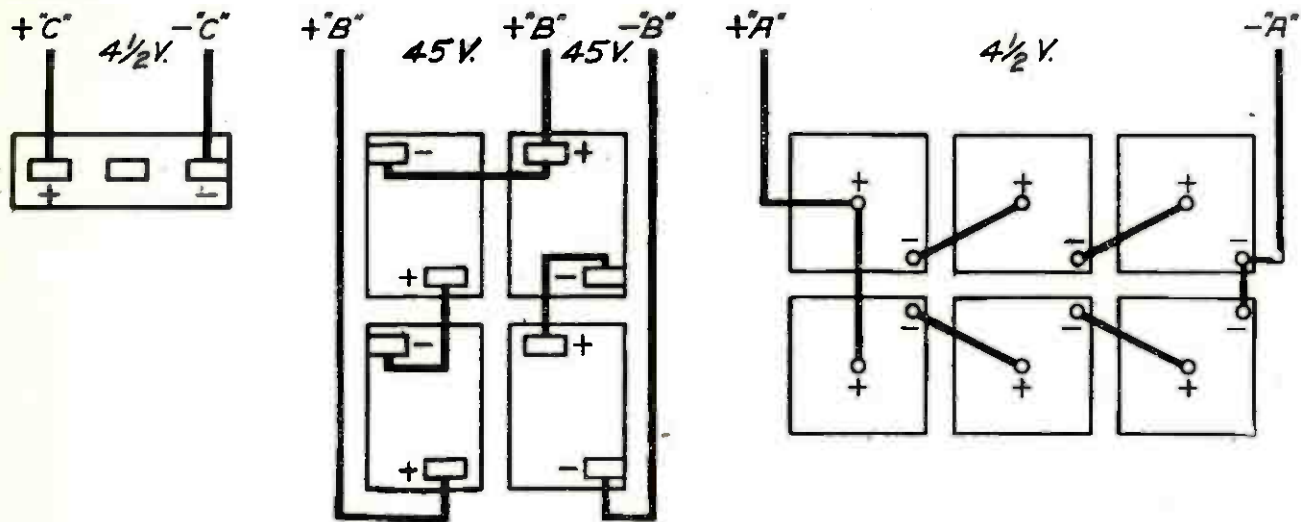

HOW TO HOOK UP THE BATTERIES

FIGURE 10: This drawing, if it is compared with the wiring diagram in Figure 1, will show you exactly how to connect up the batteries so that you can make no mistakes.

H6, and attach to the remaining filament terminal.

Next, connect up the variable condenser B to the grid terminal of the first tube socket H1 and the center post of the potentiometer C. Then connect the variable condenser C to the jack I1 by means of two pieces of flexible wire twisted together, as shown in Figure 2.

The next job will be to finish up the plate and grid connections from all the transformers to the tube sockets, including the fixed condenser Q and the grid-leak R, as indicated in the wiring diagram in Figure 1.

Next, wire the two voltmeter connections across the two filament busses, one side to the positive and one side to the negative.

Now wire up the by-pass condenser T across the primary of the transformer G1.

Then wire up the last jack I2 and the connection work is finished, except for placing the flexible leads that run down to the "A" and "B" batteries and to the "C" battery, and the flexible leads to the loudspeaker.

Make all these wires about three feet long and later they can be cut off to the right length when the batteries are being connected.

The lead for the positive "A" battery should be soldered on to the wire running to the right-hand post of the potentiometer C. The lead for the negative "A" battery should be fastened to the right-hand terminal of the rheostat D, the terminal that has been as yet unconnected.

The lead for the negative "B" battery should be fastened to the same point as the positive "A" battery lead.

The lead for the 45-volt detector positive "B" battery tap should be soldered to the terminal marked "B" Bat. on the first audio-frequency transformer G1.

The lead for the 90-volt amplifier positive "B" battery tap should be soldered to the terminal marked B on the second audio-frequency transformer G2.

The lead for the positive "C" battery should

be soldered to the same point as the negative "A" battery lead.

The lead for the negative "C" battery should be fastened to the terminals marked F on both audio-frequency transformers G1 and G2.

The two leads running to the loudspeaker P should be soldered to the two inside terminals of the jack I2.

Refer carefully to the wiring diagram in Figure 1 and the illustration shown in Figure 2 for the correct way to hook up the set and the proper way to run the wires. If this is done no trouble should be experienced.

Shielding the set is accomplished by soldering the two filament busses to the heads of the screws that pass through the panel J and the hard-rubber cases of the three radio-frequency transformers, F1, F2 and F3. These screw heads are closer to the hand, while tuning, than the transformer windings, and, if they are kept at filament potential, they form an effective shield against body capacity and eliminate the losses from eddy currents that occur when large plate-metal shields are used for this purpose. Be sure that you leave no excess soldering flux to run down into the jacks or onto the insulating parts of any of the transformers or the windings.

The wiring is then complete and the cabinet can be worked up for mounting the set, the batteries and loudspeaker.

The Cabinet and Loudspeaker

The dimensions and general arrangement of the cabinet are shown in Figure 9. This should be constructed of some kind of hard wood, preferably mahogany or walnut. It should be made from 1/2-inch stock.

The builder, if he is handy with carpenter's tools, can make it himself. Otherwise the drawing given in Figure 9 may be turned over to a cabinet maker who will understand just how to make it. It will be noticed that the cabinet is divided, by means of two partitions, into three compartments. Looking from the

back of the cabinet (with the two back pieces removed) these compartments are: Upper compartment, for the set itself; lower-left compartment, for the loudspeaker P; lower-right compartment, for the "A," the "B" and the "C" batteries.

The loudspeaker P is screwed to the shelf of the cabinet and its actuating receiver sticks up through the round hole cut for it in the shelf. The speaker is held by four wood screws. See Figures 9 and 11. The violin shaped part of the loudspeaker should be removed, as it is not used.

There is also a rectangular hole cut into the front of the cabinet through which the signals can be heard when the set is put into operation. The dimensions for both of these holes are clearly shown in Figure 9.

The cabinet should also be equipped with a leather strap fastened onto each side of the cabinet (see Figure 9) to facilitate lifting the cabinet and set out of the carrying case, when it is desired to install it permanently in the home, or for changing the batteries. Otherwise the set can be left in the carrying case, for it will operate as well in or out.

When the cabinet is ready, the set can be attached to it as shown in Figures 6 and 7,

by means of wood screws fastened through the panel J into the edges of the cabinet. Use long narrow brass screws for this purpose, as well as for fastening the sides of the cabinet together. Do *not* use iron screws.

Connecting Up the Receiver

First, connect up the two flexible leads from the jack I2, to the loudspeaker unit P. It will probably be necessary to loosen the screws in the panel J and set the panel up on edge to do this. Then insert all the other flexible leads, for the battery connections, through the hole drilled for them into the battery compartment.

These leads should all be tagged and stuck through one by one so that no mistake is made in connecting to the batteries.

Place the six dry cells N in two rows of three each, with the terminals facing as shown in Figure 10. Then place the six battery jumpers in position as shown in the same Figure.

Tie the batteries in the correct position with a strong piece of cord and set them in front of the opening to the battery compartment with the positive terminal toward the back, or nearest the compartment. Now select the positive "A" battery lead running to

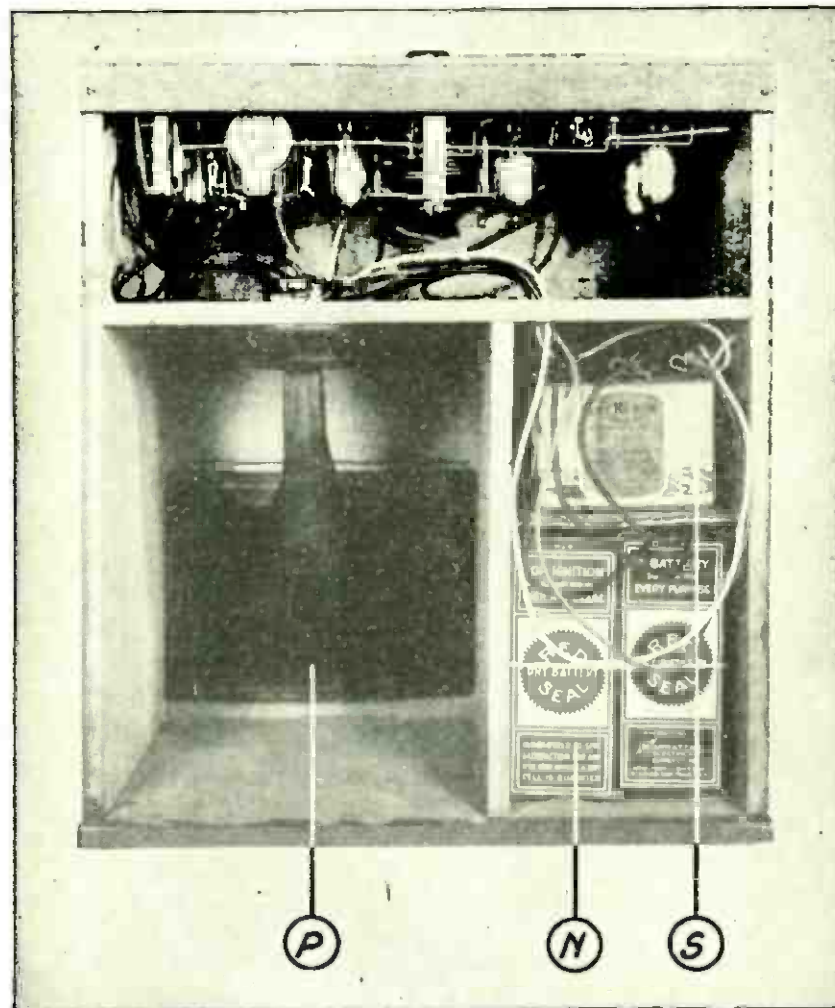

REAR VIEW OF THE COMPLETED SET

FIGURE 11: This picture shows the set with the batteries connected and put in place. It shows the panel set on top and screwed down and the loudspeaker installed and connected up. All that remains to be done is to screw on the two back pieces and the set will be fully enclosed.

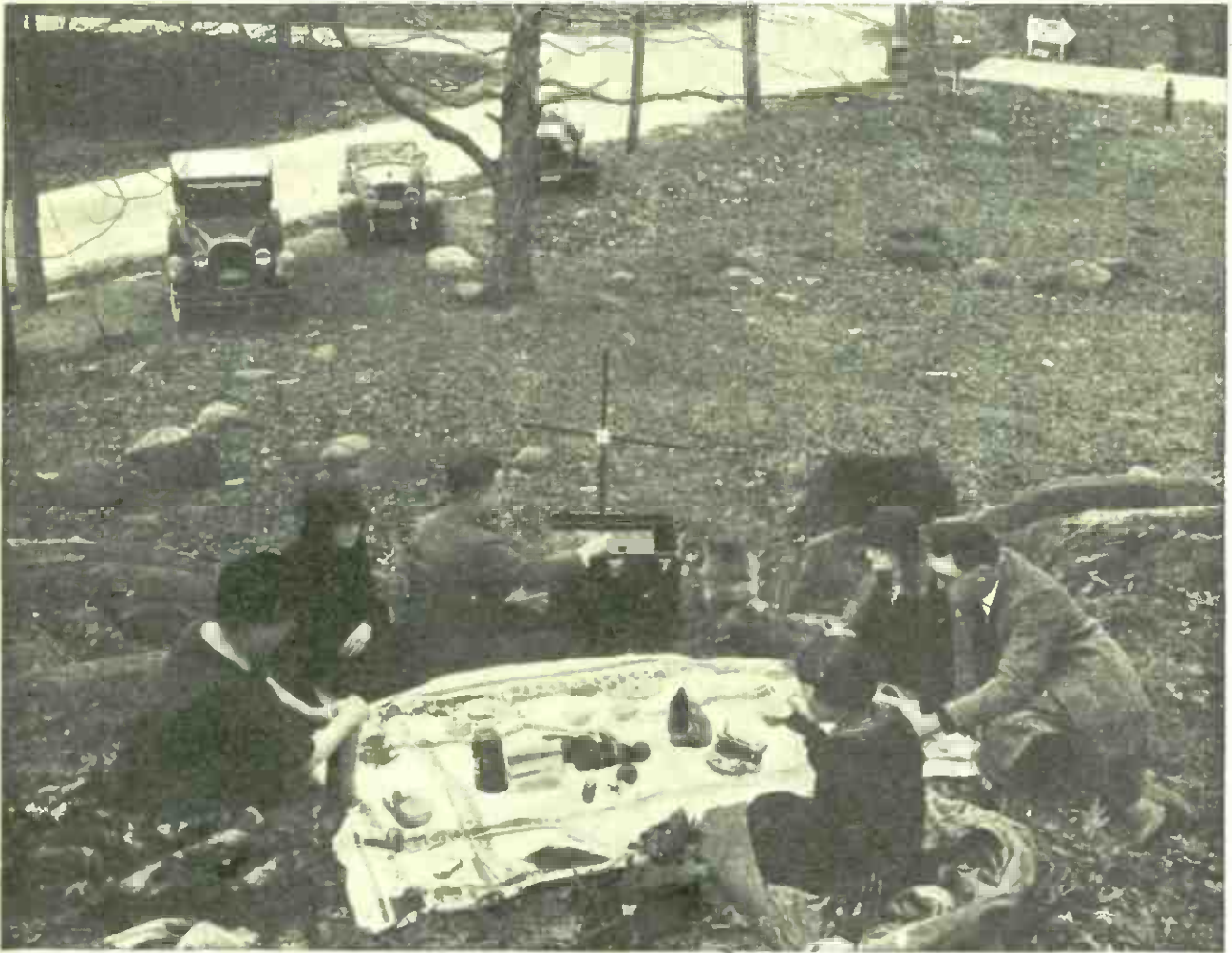

From a photograph made for POPULAR RADIO

THE "POPULAR RADIO PORTABLE" RECEIVER IN USE

One of the prime advantages of this set lies in the fact that it is at all times ready for service and may be as easily transported as a suitcase. It is an ideal receiver for summer-time radio.

the set and fasten it firmly underneath the binding post of the positive end of the "A" battery.

Then push the batteries back into the compartment. Then take the negative "A" battery lead running to the set and attach it to the negative binding post of the negative end of the "A" battery.* (See Figures 1 and 10.)

Now obtain a piece of heavy corrugated cardboard, such as is used for packing cases, and cut a piece that will fit the compartment and lay it so that it covers the "A" batteries N, completely. The "B" batteries, O, can then be hooked up and set on top of the "A" batteries without fear of a short circuit.

To hook up the "B" batteries connect them in series and set them in two rows of two batteries each, edgewise, and then attach the positive "B" battery lead, running to the amplifiers in the set, to the positive 90-volt terminal, which should be placed so that it goes first into the compartment. Then connect the positive "B" battery lead running to the detector in the set, to the tap on the "B" battery that will give 45 volts, or between the second and third batteries, O. Now finish up by connecting the

negative "B" battery lead running to the set, to the negative terminal of the "B" battery, O. Then push the "B" batteries into the compartment on top of the "A" batteries as far as they will go.

This will leave just enough room for the "C" batteries. This should be connected to the two remaining leads running to the set. Be sure that the "C" battery is connected with the negative terminal toward the grids of the two audio-frequency amplifiers and the positive terminal connected toward the filament. (See Figure 1.)

When this is done, screw on the lower portion of the back of the cabinet and the battery connections are completed and will not have to be bothered until you have worked the set for 150 operating hours or more. Be sure to follow out the connections of the batteries as explained in the text and according to the diagram in Figure 1.

The set is now ready to put into operation.

Operating data

Place the six tubes (UV-199's or C-299's) in their respective sockets. This can be done by inserting the hand with the tube in the opening left in the rear of the set for this purpose.

* The middle terminals of the dry cells are positive terminals and the outside terminals of the dry cells are negative terminals.

Or, if the tubes stick, and are not easy to get in, loosen the screws in the panel J and tilt the panel up. However, first be sure that the rheostat D is turned fully off by revolving in a counter-clockwise direction until it "stops." The rheostat, D, also has a filament switch incorporated in it and all that is necessary to start the set into operation is to pull the knob *up*. Pushing it *down* cuts off the "A" battery current and shuts the set off.

Next, insert the loop A in the middle jack I as shown in Figure 7.

Set the potentiometer C at about half way and rotate the variable condenser B until a signal is picked up. Then rotate the potentiometer C in either direction until the signal is amplified or cut down to the desired strength.

This is really all there is to tuning in. It is very simple.

The whole set may be placed anywhere, on a table, on the floor, on the ground, in a car, on a boat, or in any other place. A fibre case such as shown in Figure 8, which gives the dimensions for the set compartment and the loop and phone compartment should be obtained for carrying the set around

when it is used out-of-doors.*

The set can be slipped easily into the case and taken out on a picnic or anywhere.

In testing out the set in an automobile, the author traveled over 100 miles in the daytime, and had no difficulty in picking up the broadcasting stations signals at this distance with enough intensity to operate the loudspeaker satisfactorily.

In the evening, on one motor trip through the city of New York, running down Riverside Drive, enjoyable reception was obtained from two Chicago stations, from Pittsburgh, Springfield, Washington, Boston, and Cleveland, as well, of course, as from all the local stations.

The set should prove ideal for summer use.

* For the convenience of our readers POPULAR RADIO will furnish, upon request, the names and addresses of firms that will make up the sample case to order.

Why This Is a Radio Summer—

¶ There are now 591 broadcasting stations in the United States; no town or hamlet need be without a broadcast program.

¶ The power of the broadcasting stations has been increased and their radiation efficiency increased by improvements in antenna systems.

¶ The efficiency of receiving sets generally has been vastly increased.

¶ The loop type of receiver has come into vogue—particularly the portable set with self-contained aerials, which is easily carried on vacation and business trips.

¶ Inter-connecting systems of broadcasting have been developed so that important stations are now simultaneously broadcasting important features.

¶ Re-broadcasting from high-power stations is being done through relay stations scattered throughout the country.

¶ More important sporting events, musical programs, political gatherings and church services are being broadcast than ever before—and are covering the entire country on a scale that has never before been possible.



From a photograph made for POPULAR RADIO

The successful operation of your set may depend upon such a tiny part as a grid-leak (shown in the author's hand).

Important Trifles

—THAT MAKE OR MAR YOUR RECEIVING SET

What is a grid-leak? What does it do? What is a grid condenser for? What is the purpose of the "C" battery? Why do most new circuits incorporate them in their make-up? These are some of the questions that the author answers in this simple explanatory article.

By EDWARD THOMAS JONES, A.I.R.E.

IT was Dr. Lee De Forest who, while conducting further research work on vacuum tubes in 1908, discovered that by inserting a small condenser in the "grid" circuit the sensitiveness of the tube as a detector of feeble electric waves was materially increased.

Dr. De Forest points out in his patent "that in order to prevent the grid and plate members of the vacuum tube from receiving an electrical charge from the

'B' battery supply, I insert the condenser (grid condenser) in the otherwise mechanically closed circuit (See Figure 1) and find that the presence of this condenser produces a great increase in the sensitiveness of the oscillation detector as determined by the very marked increase in the sound produced in the telephone receivers."

The small (.00025 mfd.) condenser inserted in the grid circuit permits the

high-frequency oscillations to pass to the grid while the "B" battery voltage is stopped. The grid condenser is often referred to as a "stopping" condenser.

The grid condenser, therefore, should be of efficient design, so that there will not be any appreciable loss of radio-frequency energy and at the same time the condenser must be capable of stopping the "B" battery supply shown in the drawings (between the grid and plate of the tube).

There are a considerable number of grid condensers on the market. Some

of them are really poor, but there are a few reliable makes which are highly efficient.

Late in the year 1913, Langmuir made application for a patent on the grid-leak. His patent was finally allowed five years later.

The grid resistance (See Figure 2) acts to assist the grid of the vacuum tube in resuming a potential equilibrium before the next wave-train is impressed on it.

The grid of a vacuum tube, even though not maintained at a pre-deter-

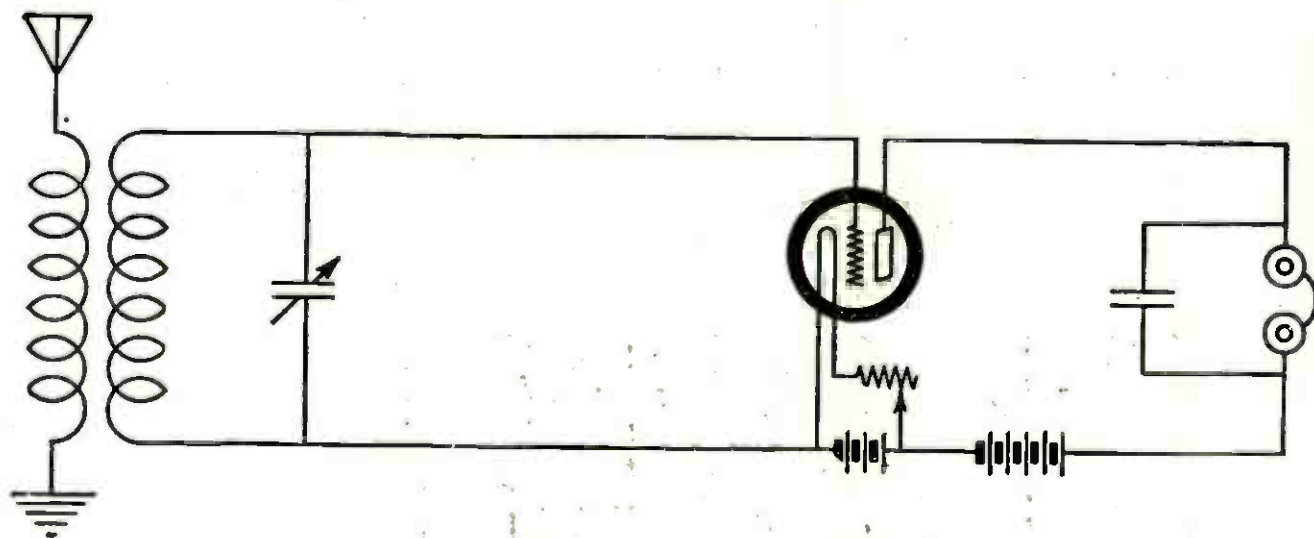

AN OLD FORM OF DETECTOR CIRCUIT—

FIGURE 1A: An early form of detector circuit, in which the grid condenser was not used.

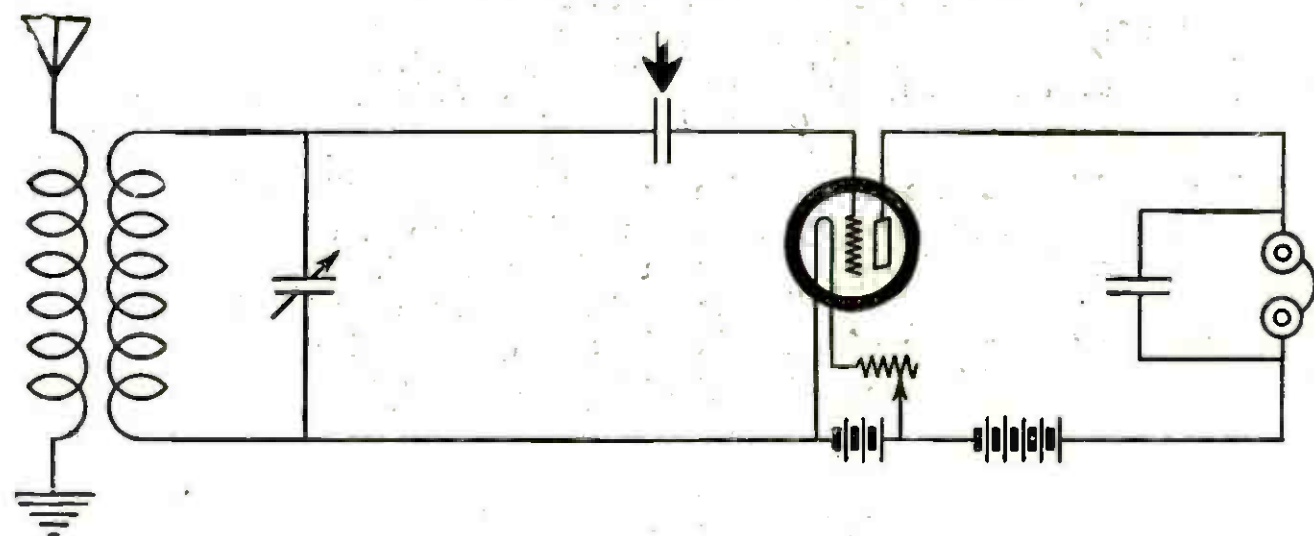

—AND THE IMPROVED CIRCUIT

FIGURE 1B: The same circuit as shown in Figure 1A, except that the grid condenser (as indicated diagrammatically by the heavy arrow) has been added and the sensitivity of the circuit greatly increased.

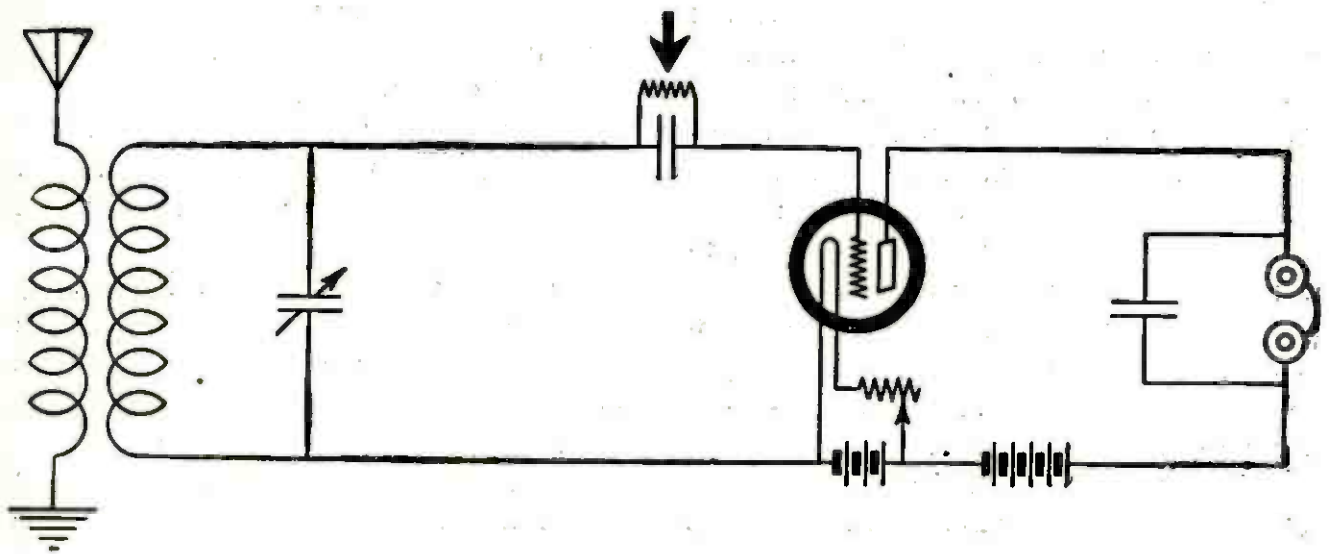

THE SAME CIRCUIT—WITH A GRID-LEAK ADDED

FIGURE 2: The grid-leak is shown at the heavy arrow. This small device tends to keep the grid of the tube at a proper voltage for most efficient operation.

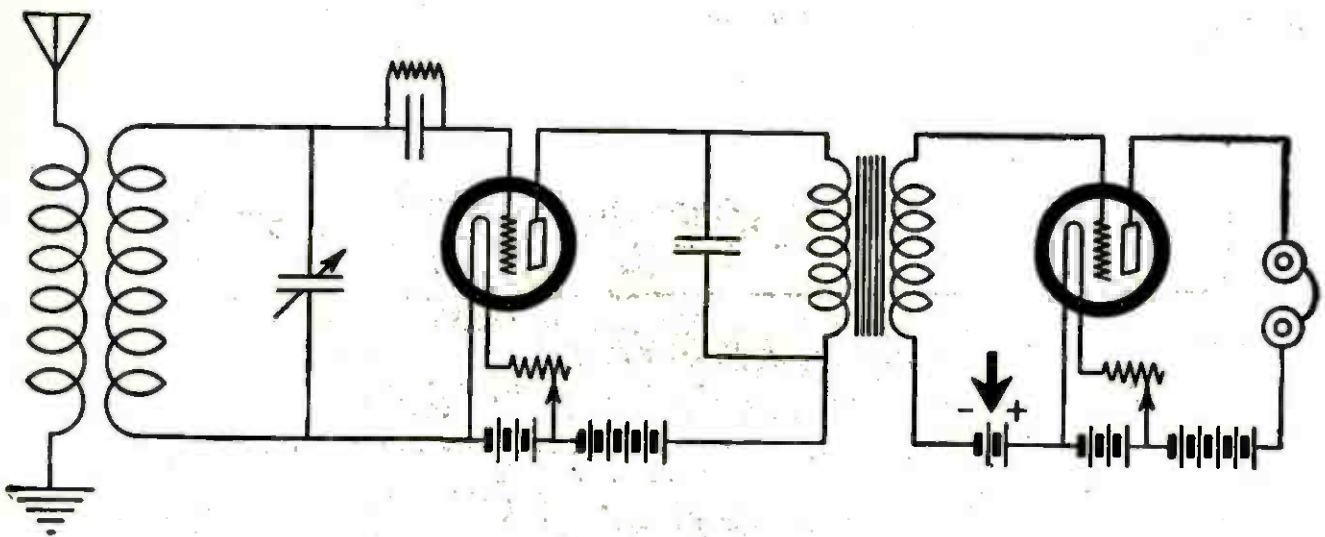

WHAT THE "C" BATTERY DOES TO THE CIRCUIT

FIGURE 3: The "C" battery, when added to the grid circuit of an audio-frequency amplifier (as indicated by the arrow), helps to keep the grid at a proper negative potential and eliminates a large amount of distortion as well as prolonging the life of the "B" batteries.

mined potential, assumes a negative charge as it receives electrons from the filament. Dr. Langmuir points out that this charge (the grid potential) is determined by the surface of the grid and by the rate at which the charge may leak off to the filament.

When the grid is positively charged it attracts electrons from the filament at a rate varying with the degree of positive charge. When the grid is negatively charged its electron attracting power decreases with the amount of

negative charge until a value is reached at which no more electrons are passed through the grid.

Therefore, we see that both the grid-leak and the grid condenser are important though small, items of the radio receiver.

The capacity of the grid condenser as well as the value of the grid resistance should be so chosen that the grid will be supplied with the greatest possible voltage charge from incoming signals and still will have resumed its equilibrium

before the next wave-train has arrived.

In the early part of 1912 Lowenstein made a patent application on the "C" battery. In his specification Mr. Lowenstein said: "the theoretical considerations involved are somewhat abstruse and are not fully understood; but the advantages of the ultranegative connection is fully established by repeated tests which I have carried out in actual practice. I therefore note the fact without attempting to explain it."

We also know that the volume and clearness of speech and music heard in the headphones or loudspeaker is materially improved when a "C" battery of correct potential is inserted in the grid circuit. This is because the grid of the tube can be operated at the portion of the characteristic curve where either de-

tection or amplification takes place at best efficiency.

The "C" battery, therefore, not only improves the quality of reception and increases the volume, but it cuts down the plate current and lengthens the life of "B" batteries.

For instance, two UV 201-A tubes operated at 90 volts plate potential in an amplifier circuit without "C" battery were found to draw 11 milli-amperes. When a 3-volt "C" battery was inserted, the drain was decreased to 6 milli-amperes. When the "C" battery was increased to $7\frac{1}{2}$ volts the drain dropped to 2 milli-amperes.

It is clear, therefore, that the life of the "B" battery can be increased by the application of a "C" battery of correct potential, as is shown in Figure 3.

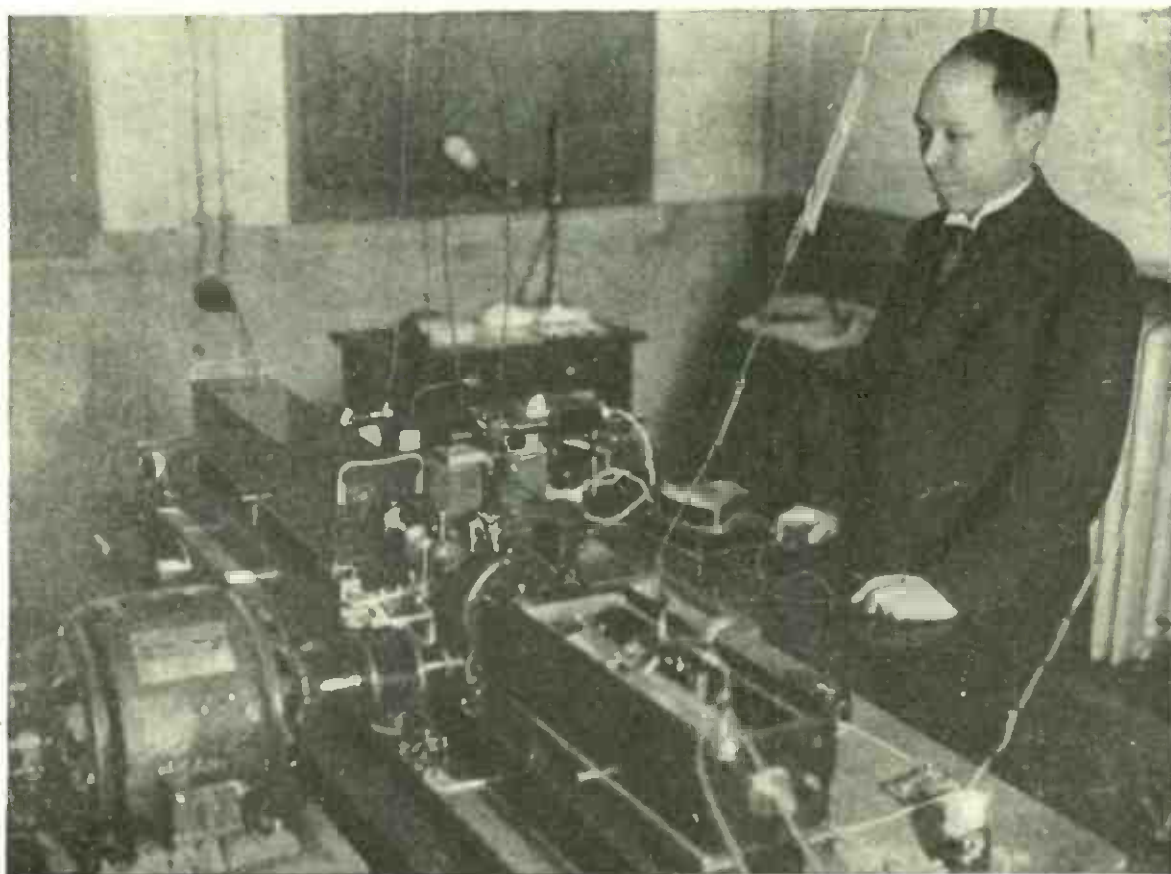

International

A JAPANESE SCIENTIST WHO SENDS PHOTOGRAPHS BY RADIO

What are reported to be "the first photographs ever sent by radio" in the realms of the Mikado were transmitted by Mr. Takeuchi, an engineer connected with the laboratory of the Mitsubishi Trading Company. The apparatus is shown above.

WHAT READERS ASK



CONDUCTED BY LAURENCE M. COCKADAY

Selective Crystal Circuit

QUESTION: I have a variometer, a variocoupler, and a .001 mfd. variable condenser, and I would like to make these up into a simple crystal set for my uncle to listen in on. He lives within a mile of a big broadcasting station and I think the crystal set would give him satisfaction at this distance. He likes the headphones best, anyway. Will you recommend a hook-up for me to use?

ALFRED J. WHITE

ANSWER: We have drawn a circuit for you which you will find in Figure 1.

You will notice that the variable condenser is connected in the antenna circuit, which it controls. The variometer is used for tuning the secondary circuit, and the variocoupler varies the coupling.

The Polarity of the Electron

QUESTION: What is the general understanding about the charge on the elec-

tron? Is it generally conceded that it is positive or is it negative? I am sort of rusty on this subject, and have gotten into an argument about it.

H. M. B.

ANSWER: The electron is considered to be a negative charge.

Radio Frequencies

QUESTION: What is the lowest frequency of an alternating current that is spoken of in radio literature as "radio frequency"?

FRANK G. STEPHENS

ANSWER: About 10,000 cycles-per-second. Audio-frequency currents begin at higher frequencies than this, it is true, but they run down to about 16 cycles-per-second, while the radio frequencies run upwards. The highest radio frequencies in everyday use are the lowest wavelengths used in experimental amateur transmitters and they run up as far as 3,000,000 cycles or more.

There is a portion of the audio-frequency range which overlaps with a portion of the radio-frequency range.

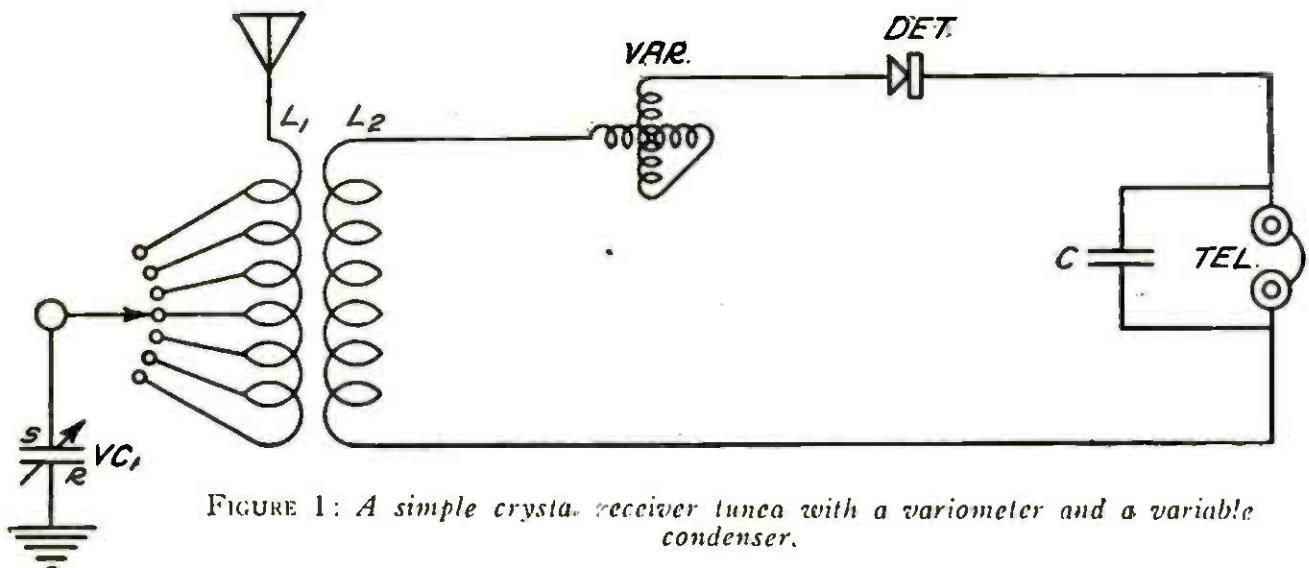

FIGURE 1: A simple crystal receiver tuned with a variometer and a variable condenser.

A Heterodyne Receiver for Amateur CW Telegraphy

QUESTION: Please give me a hook-up with one stage of tuned-radio-frequency amplification, and a vacuum-tube detector, with a separate oscillator, for heterodyning CW signals. Also give the constants that should be incorporated for work on or about 200 meters. I don't want any audio-frequency amplification as I want to work with the headphones. I want to put the whole outfit in one cabinet that can be placed on my operating table in my transmitting station.

H. B. C.

ANSWER: The circuit you need is given in Figure 2. The constants for this circuit are given below, together with the list of parts:

- L1 and L2—primary and secondary coils of a low-wave variocoupler;
- RFT—radio-frequency transformer composed of two honeycomb coils, size L-35,

- mounted in a double-coil mounting;
- L3—honeycomb coil, size L-25 or L-35;
- L4—oscillator coil, consisting of 30 turns of No. 18 DSC wire wound on a 3-inch composition tube. This coil should be tapped at the center;
- L5—exploring coil, consisting of 15 turns of No. 18 DSC wire wound on a 3-inch composition tube;
- VC1, VC2, VC3 and VC4—variable condensers, .0005 mfd., with low minimum capacity;
- GC1 and GC2—mica fixed condensers, .00025 mfd.;
- C—mica fixed condenser, .0005 mfd.;
- P—potentiometer, 400 ohms;
- GL1 and GL2—variable grid-leaks;
- R1 and R3—filament rheostats, 30 ohms;
- R2—filament rheostat, 6 ohms;
- TEL—telephones.

The first and third tubes are hard tubes and the second tube is a soft detector tube. The third tube is the oscillator which is used to heterodyne the CW signals and make them audible.

This system can be used instead of the usual regenerative circuit arrangements so commonly used by the amateur for the reception of CW signals.

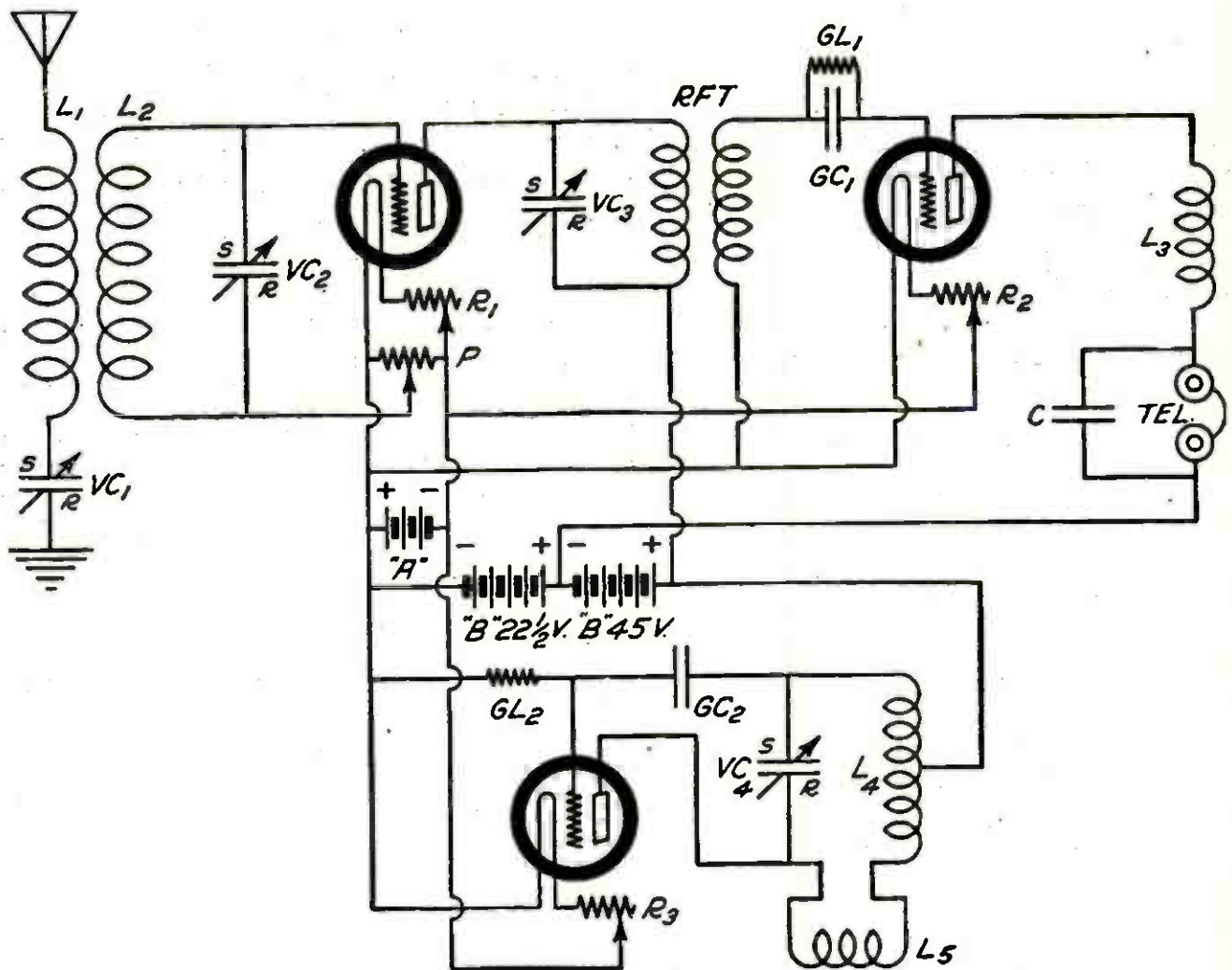
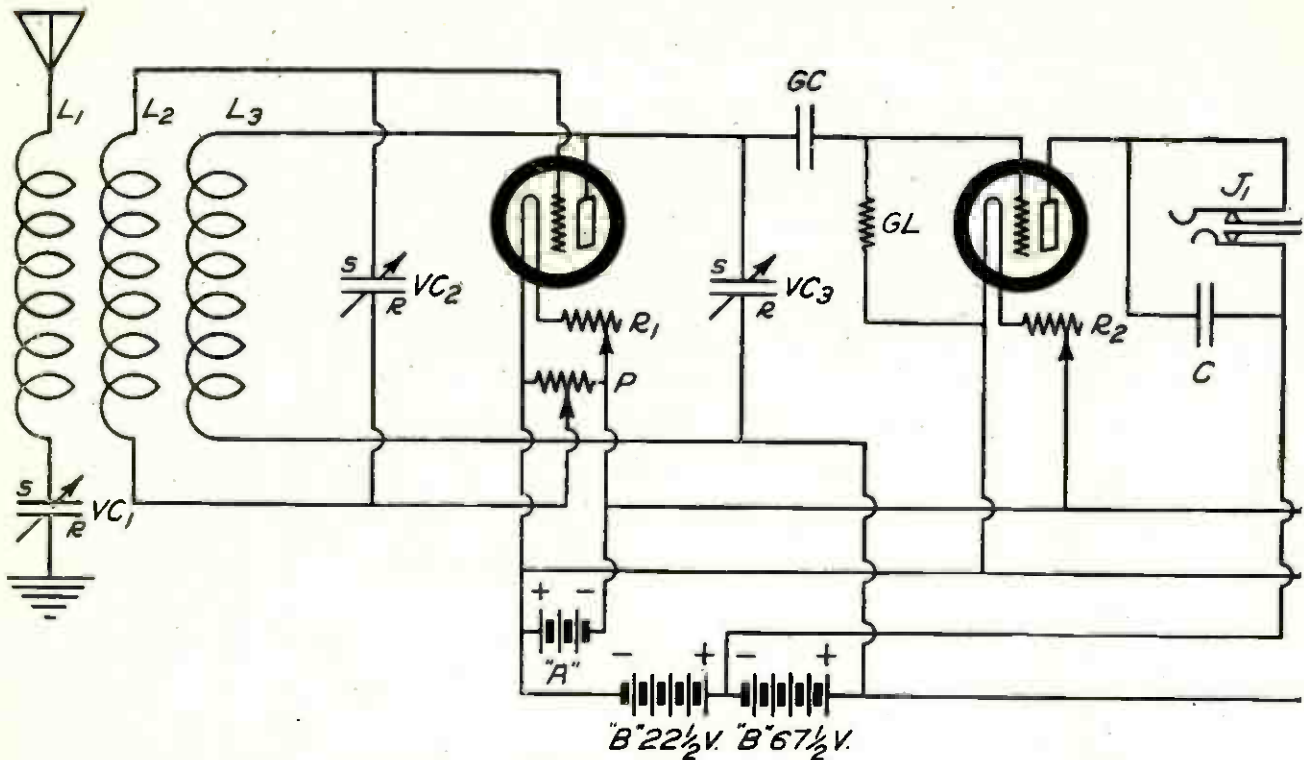

FIGURE 2: A heterodyne receptor for CW work on low wavelengths which is exceptionally satisfactory for amateur code work.



Tuned-radio-frequency Amplification with Honeycomb Coils

QUESTION: Will you please give me a circuit that can be used with honeycomb coils, and which will employ one stage of radio-frequency amplification in combination with two stages of audio-frequency amplification? I want to use a vacuum-tube detector of the soft variety with this outfit if it is possible.

MARIUS DUVAL

ANSWER: You will find a circuit that should be what you require in the diagram in Figure 3. The parts you will need are the following:

- L1—honeycomb or duolateral coil, size L-75;
- L2—honeycomb or duolateral coil, size L-50;
- L3—honeycomb or duolateral coil, size L-75;
- VC1—variable condenser, .001 mfd.;
- VC2—variable condenser, .0005 mfd.;
- VC3—variable condenser, .00025 mfd.;
- GC—mica fixed condenser, .00025 mfd.;
- C—mica fixed condenser, .0005 mfd.;
- GL—variable grid-leak;
- P—potentiometer, 400 ohms;
- R1, R3 and R4—filament rheostats, 30 ohms;
- R2—filament rheostats, 6 ohms;
- J1 and J2—telephone jacks, double-circuit;
- J3—telephone jack, single-circuit;
- AFT1 and AFT2—audio-frequency amplifying transformers.

The tubes recommended in this circuit are three DV2 tubes, or three UV-201-a tubes or three C-301-a tubes for the amplifiers, and one C-200 or one UV-200 for the detector.

The "B" battery should be tapped at 22½ volts for the detector, with the full 90 volt on the plates of all the amplifiers.

Sets That Work Without Outdoor Antenna Attachment

QUESTION: Is there any receiving set on the market that works without having to put up extensive antenna equipment on the roof and without having to string a lot of wires around the room? If so, where can I get information regarding such equipment?

ALAN F. JEROME

ANSWER: Yes. The super-heterodyne is one; the reflex set is another; and some straight radio-frequency sets will serve for this purpose. We recommend that you write for descriptive bulletins to the following concerns: Radio Corporation of America, Operadio Corporation, Deforest Radio Tel. and Tel. Co., Murad, Acme, and others that you can find in the advertising pages of this magazine, that advertise sets of this description.

Moisture on Coils

QUESTION: Will moisture damage the efficiency of radio coils?

J. F.

ANSWER: Yes. This will cause leakage between turns and will detract greatly from the signal strength that you should get if the coils were thoroughly dried out. If you have a set in this condition it would be a good thing to put it on a shelf over a stove and let it heat up over night. Do not allow it to get too hot, or the insulating material in the transformer windings may melt and run out.

FIGURE 3: Circuit employing one stage of impedance-coupled radio-frequency amplification with vacuum-tube detector and two stages of audio-frequency amplification.

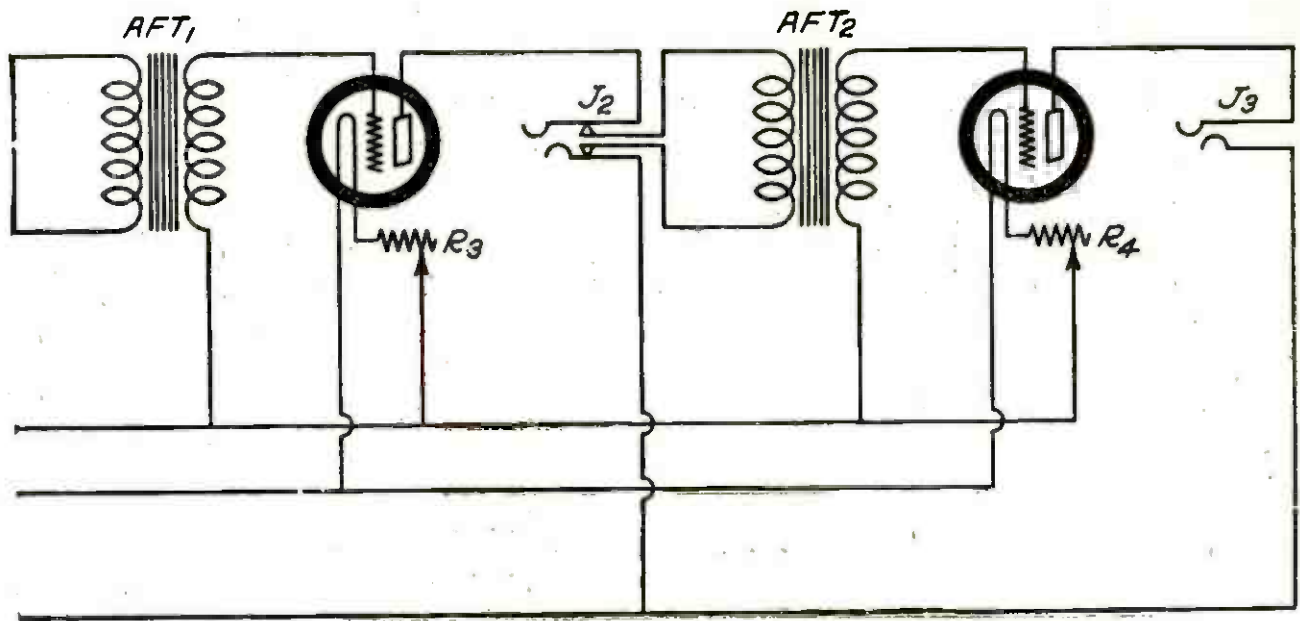

Is There Danger from Lightning?

QUESTION: Is there any danger from lightning hitting an antenna over the house? Does the antenna attract lightning?

D. F.

ANSWER: There is no more chance for lightning to strike a radio antenna than for it to strike a steel building, a fire escape, a smoke stack, or any other elevated structure.

The ground attracts lightning, or, in other words, lightning usually discharges from the clouds to the earth, and some lightning discharges are miles in length. It is, therefore, improbable that such a small thing, relatively, as a receiving antenna would cause a deviation for such a gigantic electrical discharge.

In the last ten years we have heard of only two or three instances where lightning has struck near an antenna, and this percentage would indicate that the discharge would have hit the same spot whether the antenna were there or not.

Gold-plated Bus-wire

QUESTION: Is gold-plated bus-wire any better to use to wire a set than the ordinary tinned bus-wire?

WALTER G. FERN

ANSWER: The gold-plated wire cannot oxidize, and this is claimed to be one of its advantages. However, the oxidation that forms on tinned-copper bus-wire affects its radio-frequency resistance to such a small extent that we do not think this advantage means very much. The gold-plated wire does make a nice looking job, though.

What Is the Best Wood to Use for Cabinets for Radio Sets?

QUESTION: I have built a four-circuit tuner with five tubes and want to make a fine cabinet to use with it. I am rather handy with tools, and think I can make a good job of it. What wood would you advise?

K. N. M.

ANSWER: Either mahogany or walnut makes a good-looking job. Be sure that you get real kiln-dried stock or it will warp out of shape after you have worked it.

Correct Voltage for Dry-cell Detector Tubes

QUESTION: How many volts should ordinarily be used on dry-cell tubes when they are used as detectors?

R. B. ANTON

ANSWER: 45 volts is usually more efficient.

The Craig Neutrodyne

QUESTION: Does the Craig neutrodyne described in the April issue give really good loud reception and is it sensitive to distant signals?

A. D. TORCHIO

ANSWER: This set produces an exceptionally good quality and strong signal from both local and distant stations. It is a really efficient and easily controlled receiver.

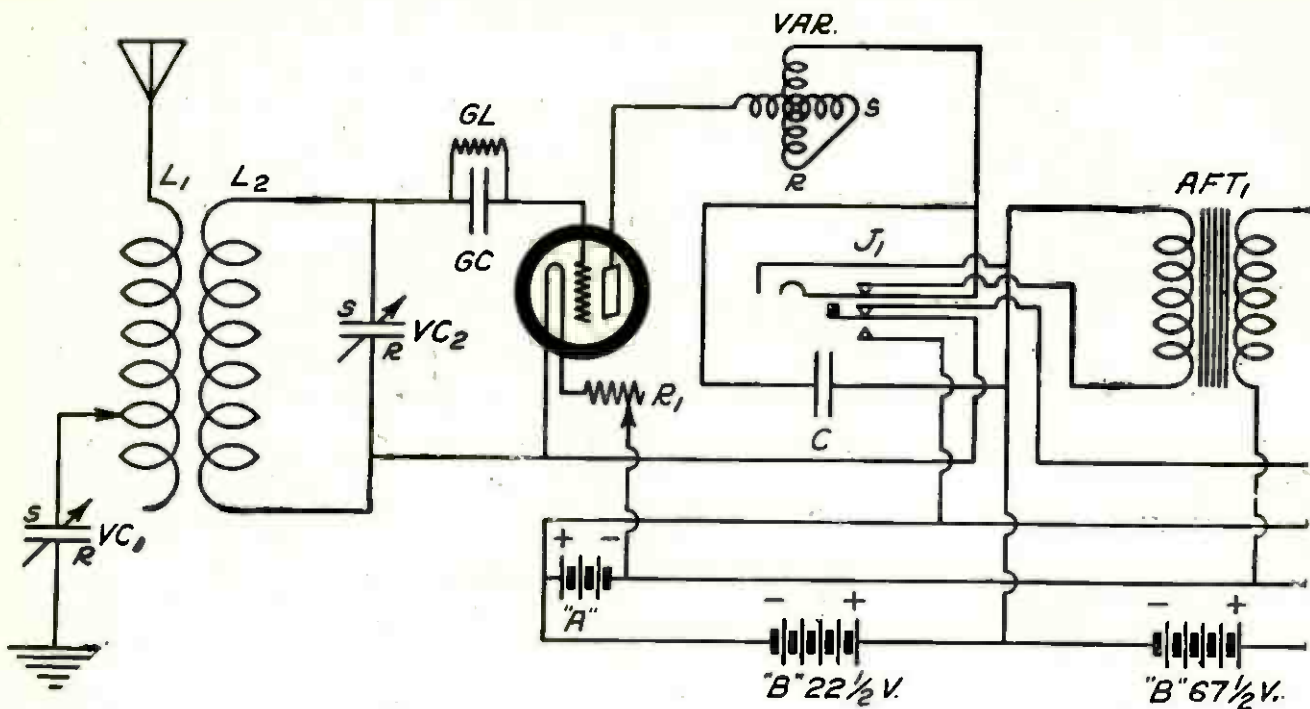

Circuit for Filament-lighting Jacks

QUESTION: I am sending you a hook-up of my three-circuit tuner, with two stages of audio-frequency amplification added to it. What I would like to get would be the additions necessary to add filament-lighting jacks (automatic jacks) to it. Would I have to change the circuit around much? Would the constants for the circuits have to be changed any?

If you can, will you please give me the corrected circuit with the filament-control jacks and also a list of correct constants to use with the circuit?

J. F. RUSSELL

ANSWER: The diagram in Figure 4 gives the circuit you require. For best operation you should use parts having the following constants:

L1 and L2—primary and secondary coils of a variocoupler, 180 to 600 meters;

VAR—variometer;

VC1—variable condenser, .001 mfd.

VC2—variable condenser, .0005 mfd.;

GC—mica fixed condenser, .00025 mfd.;

C—mica fixed condenser, .0005 mfd.;

GL—variable grid-leak;

R1—filament rheostat, 6 ohms;

R2 and R3—filament rheostats, 30 ohms;

J1 and J2—automatic-lighting jack, double-circuit;

J3—automatic-lighting jack, single-circuit;

AFT1 and AFT2—audio-frequency amplifying transformers.

The first tube should be a "soft" detector tube and the other two tubes should be hard

tubes of the thoriated-filament variety.

Use a variocoupler and a variometer that has little or no dope on the windings.

Squeaks from a Power Amplifier

QUESTION: I have a Western Electric 10-a power amplifier, and lately it has developed a steady squeak or whistle. How can I stop this? I don't know the slightest thing about electricity and the whole set was given me for a birthday present by a nephew. It worked very well for three months until this whistling sickness struck it.

G. G. B.

ANSWER: Get a new set of "B" batteries. You had better ask the dealer to send a man around to put them in for you.

A Resistance-coupled Amplifier for the Super-heterodyne

QUESTION: How would a resistance-coupled amplifier work with the super-heterodyne? Would it require more stages than the transformer-coupled amplifier recently described for this use in your magazine?

THOS. F. FLYNN

ANSWER: A resistance-coupled amplifier should work well in this connection. You will have to use two or three more stages, however, than if you use the amplifier described. The control should be quite simple and stable.

FIGURE 4: This diagram shows how to add automatic lighting jacks to a popular regenerative hook-up.

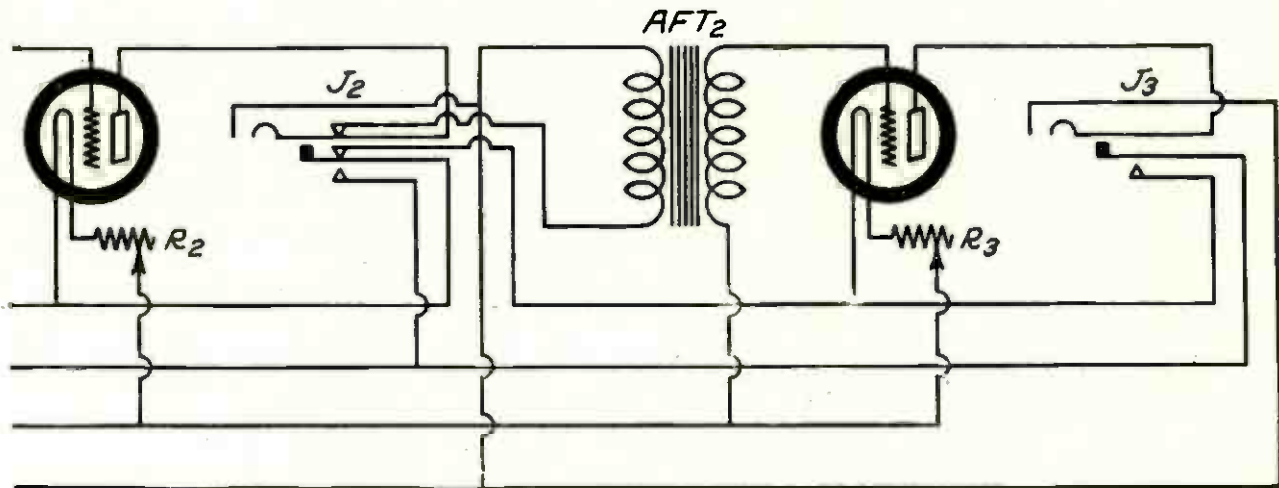

What Tools to Use

QUESTION: What tools are necessary for a man to have to make a set properly? I am absolutely sold on the idea of building a set since looking at the instructions given in your magazine. They are so complete that I believe anyone could follow them. Now I want to know what tools I need.

DONALD ROBERTSON

ANSWER: The following tools are essential: One electric soldering iron with a small tip; set of screw-drivers up to $\frac{1}{4}$ inch; complete set of drills, including countersink; one breast drill; one brace; set of wood drills; strip solder; one can of soldering paste; two pairs of pliers, with cutters; one hacksaw; hacksaw blades; one handy jackknife; set of small socket wrenches for hexagon nuts; set of small files, including triangular and rat-tail; bus-wire; one match stick. The match stick is used in applying the soldering paste.

Single-cotton-covered Wire

QUESTION: Do you advise the use of SCC copper wire for the windings of coils? I am going to make one of your sets and have read two articles on the set I want. The first article published about a year ago called for single-

cotton-covered wire but the more recent article calls for double-silk-covered wire. Is this an improvement?

L. S. WHITE

ANSWER: The DSC wire is best. There is less chance of a short circuit between turns and it collects less moisture.

Can the Automobile Battery be Used to Light Tubes?

QUESTION: Would it be possible for me to run two wires down to my garage to the car battery to light the filaments of the tubes used in the radio receiver?

JOHN PRENTICE

ANSWER: The battery, if it is a 6-volt one, will be suitable. However, if it is to be used for the radio set, it should not be placed more than 25 feet away from the set. This is because the voltage drop in the wires leading from the car to the set may be too great and the voltage that finally is applied to the tubes will be too low if the distance between the two is too great.

Capacity of the "Secondary" Condenser

QUESTION: What is the proper size of condenser to use across the secondary coil of an ordinary variocoupler for covering the American broadcasting wavelengths?

FRANK BENSON

ANSWER: The capacity to use is .0005 mfd. This is usually known as a 23-plate condenser.



IN THE WORLD'S LABORATORIES

CONDUCTED BY DR. E. E. FREE

Is There a New Universe Still Smaller Than the Electrons?

ONE of the most startling discoveries of modern science is the complexity of things that are almost infinitely tiny. Atoms are small enough; so small that the tiniest dust mote contains billions of them. And inside these tiny atoms we have discovered the well-ordered universes of electrons. It reminds one of the old jingle about the small bugs and the still smaller bugs "and so *ad infinitum*." We find small particles and then still smaller particles and so on, perhaps not to infinity, but to far tinier dimensions than anyone would have dared to predict a generation ago.

And now we must consider, it seems, the possibility that there exist in the universe some particles as much tinier than electrons as electrons are tinier than paving stones or billiard balls. These new small particles—the latest approach to the "*infinitum*" of littleness—are not particles of matter as we know it; they are particles of *light*.

It has commonly been considered that Sir Isaac Newton, great scientist that he was, made one mistake; he believed that light consisted of particles. These particles were shot out, he thought, from any glowing material like the flame of a candle, much as bullets are shot out of guns. Newton still believed this when he died.

Afterward other scientists came along with experiments that seemed not to be explainable on the basis of this particulate or "corpuscular" theory of light and there grew up gradually in men's minds the wave theory of light; the theory that most scientists now hold. Now this theory is suffering, in its turn, the fate of its predecessor. There are facts that will not fit well into the wave theory. How this is resulting in the development of the so-called quantum theory of light has been told already in this department.*

And now the quantum theory is leading scientists back to the old light-particle or cor-

puscular theory of Sir Isaac Newton. Perhaps that long-dead genius was as right in this as he was in so many other guesses that he made about the nature of the universe. Perhaps it has been the rest of us, not he, who have been wrong.

The latest attempt to develop a theory of light particles is that of the French nobleman and distinguished scientist, Louis, Duc de Broglie. Starting from known and accepted facts, including those troublesome facts that do not fit well into the wave theory of light, Doctor de Broglie has deduced mathematically what some of the properties of the light particles must be like.*

They will not be, of course, much like particles of matter. Yet they will have the property of mass, the property that manifests itself under ordinary circumstances as what we call weight. The mass of one light particle has been calculated and comes out as about ten septillionths of the mass of an electron.

Remember that hydrogen is the lightest substance in the world and think of as much hydrogen gas as would occupy the space of a pin head. In this tiny space there will be some 1,000,000,000,000,000 atoms. From this you can get a feeble idea of how little one hydrogen atom weighs. Now an electron weighs only about 1/1800 as much as this. A pretty small "bug," you would say; pretty well down toward the limit of the infinitely little.

But the particle of light, the new "quantum" that the Duc de Broglie has worked out, has a mass only 1/100,000,000,000,000,000,000,000 as great as the mass of one electron. If the size of these tiny light particles bears any ordinary relation to their mass (as it probably does) and if you were the size of one of them, you might wander around for centuries inside one single electron and never even find out that you were inside of anything. The electron would be as much larger than you as the blue vault of heaven is larger than a man.

This idea leaves the imagination aghast.

* "A Tentative Theory of Light Quanta," by Louis de Broglie. *The Philosophical Magazine* (London), vol. 47, page 446 (February, 1924).

* POPULAR RADIO for February, 1924, page 207.

The universe of atoms was wonderful when we first found it. Then came the universe of electrons inside the atoms; whole solar systems far more complicated than the system of the sun and planets on which we ride. And now we are to have, the scientists suspect, still another universe inside the electron. And outside it too, for if the Duc de Broglie is right, all light is composed of these tiny particles. Some of them are locked up, perhaps, inside the electrons of matter. Others get out from time to time and light our lamps or help make plants grow or bring us news of distant stars.

Doubtless radio, too, is made up in some way of these inconceivably tiny particles. Radio waves and light are apparently different varieties of the same thing. If light is really made up of particles and not of waves, the thing that carries radio is doubtless of similar constitution. It may be convenient to speak of radio "waves" just as it is convenient to speak of "wavelengths," though strict accuracy would force us to use "frequency" instead. But what seems to be a "wave" in radio may be an appearance only. The real thing, the quantum theory suggests, may be something very different. Perhaps a small, rapidly-moving particle; perhaps something else.

Whatever these details, it begins to be apparent that just as all material things are merely manifestations of a world of atoms and electrons which is invisible, so the electrons themselves are merely manifestations of something smaller. Professor J. H. Jeans, one of the most distinguished of British scientists, puts it this way: "It seems difficult," he said, "to interpret this conception * * * except by supposing that the electric forces with which we are familiar are to be regarded as manifestations of a sub-universe more fine grained than anything we have so far imagined.*"

In the last years of the nineteenth century the discovery of radioactivity opened up a new and revolutionary chapter of science; that of electron physics. There is every probability that we stand today at the beginning of another chapter that is to be still more revolutionary; the chapter that will deal with the quantum particles of light.

Is the Brain a Broadcasting Station?

It has been suggested several times in the past ten years that radio waves of some kind are sent out involuntarily by the brain and that these waves explain the puzzling phenomena of telepathy. The so-called "N rays" were much discussed some years ago. More recently a French student, the Abbé Rochu, has published a book on what he calls "Human Waves."† The usual suggestion is that some

* "The Present Position of the Radiation Problem," by J. H. Jeans. The Eighth Guthrie Lecture, summarized in *The Proceedings of the Physical Society* (London), vol. 35, pages 222-224 (August 15, 1923).

† The book of Abbé Rochu is referred to by Mr. Joseph Roussel in *Radio-Électricité* (Paris), vol. 5, page 117 (March 19, 1924). In the same publication for October 15, 1923, there were some other suggestions along the same line.

undiscovered and mysterious variety of radiation is produced by the thinking human brain and can be perceived, on occasion, by other brains.

To most scientists these speculations do not seem particularly attractive. It is true that nerve action and brain action are undoubtedly electrical in their nature. It is reasonably

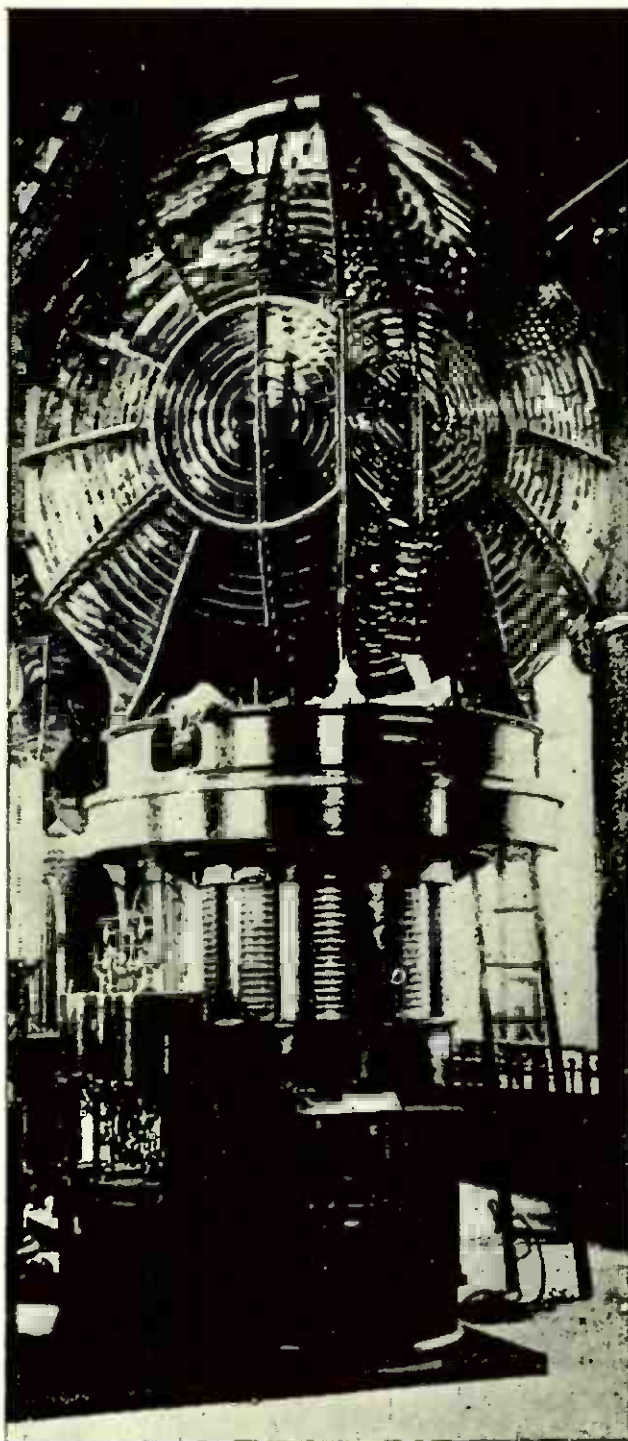

Kadel & Herbert

IS THIS A GUN FOR BULLETS OF LIGHT?

A distinguished French scientist believes that light is composed of very tiny particles shot out from luminous materials like bullets from a gun. This great lighthouse lamp would emit each second more than a billion billion billions of these light particles or "quanta."

certain, therefore, that any nervous process, including thought, will produce some kind of electromagnetic disturbance in the ether. All electrical changes produce such disturbances. The "static" that a radio set picks up from street-cars or X-ray machines or even from electric door-bells is a case in point.

But this sort of thing is a long way from a definite "ray" or "wave" that can be related to thought or to living matter. Such rays or waves are not impossible. All scientists would agree that they *might* exist. But science considers, with excellent reason, that there is

small profit in the investigation of remote possibilities. Science takes one step at a time. Before we begin speculating about transmissible "human waves" let us first determine, if we can, whether such a thing as mental telepathy really exists at all.

There was a time not so long ago when no respectable scientist dared speak of telepathy as even thinkable. He would have been laughed out of his profession. But that has changed. The possibility that thoughts may be transferred from mind to mind otherwise than by the usual senses is now admitted to be a proper subject for investigation in even the most conservative scientific circles. Professor Gardner Murphy of Columbia University is conducting extensive experiments in this field. Dr. R. H. Gault of Northwestern University is engaged in another series of tests, in some of which he has used the Chicago broadcasting station at the Edgewater Beach Hotel.

A third test of telepathy was carried out recently from Station WOR under the auspices of the editors of the *Scientific American*. And in a recent issue of this same publication there are reported some remarkable German experiments carried out recently by Dr. Carl Bruck, an official adviser of the Sanitary Department of the German Government and a well-known physician of Berlin.*

In all of these tests the procedure is substantially the same. One person thinks of a word, an idea, a drawing or something else. The other person tries to discover, without being told, what it is that the first person is thinking of. In the experiments from broadcasting stations listeners are asked to try to receive some idea which is not named but upon which the speaker or other persons at the broadcasting station are concentrating their minds at that moment.

The experiments of Dr. Bruck seem to have been the most careful and complete that have been carried out so far. If we assume the doctor's good faith and competence—neither of which there seems reason to doubt—we must admit that he has secured favorable evidence of considerable strength. A few of the drawings obtained in his experiments are reproduced on this page.

With a little more evidence of this sort we shall be compelled to admit that something of the nature of mental telepathy does actually occur; perhaps not always but at least on some occasions. Then will come the real problem for the physicist and physiologist; the problem of finding out how it happens.

It may be radio waves of some kind. The thinking mind may be a broadcasting station. But we must not try to predict our result. Science moves one step at a time. The problem now is whether or not telepathy is real. Do Dr. Bruck's results represent some real natural force not yet fully understood or are they merely curious accidents?

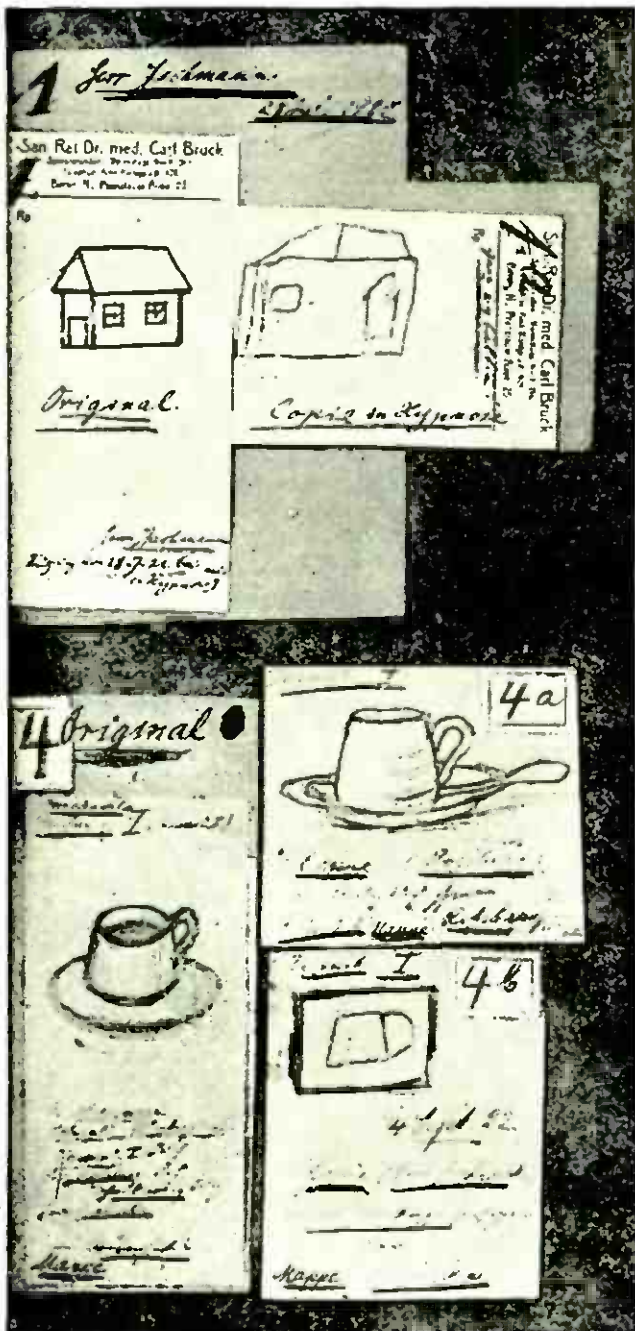

Courtesy of *The Scientific American*

DRAWINGS BY TELEPATHY

At the left are the original drawings of a house and a cup; at the right are the attempts made by the subject to reproduce by mental telepathy the original drawings, which the subject had not seen.

* "Experimental Telepathy; Tests by Dr. Carl Bruck, M.D., Berlin, on the Transmission of Drawings," adapted by Dr. Alfred Gradenwitz from the investigator's report." *The Scientific American* (New York), vol. 130, pages 304-305 (May, 1924).



Courtesy of The Scientific American

HOW ONE MAN DREW WHAT ANOTHER MAN THOUGHT ABOUT

These photographs, also from the experiments of Dr. Bruck, show how a hypnotized subject tried to reproduce drawings of which another person was thinking. The middle drawing of the lower row represents an attempt to reproduce the bottle on its left. The attempt succeeded, actually, in copying the drawing of a lamp which was still in the portfolio waiting for the next test.

The Little Ladders With Which We Hear

ONE of the most important pieces of apparatus with which the radio engineer must concern himself is one that was constructed by nature, not by man. It is the marvelous assemblage of devices that we call the inner ear; the machine by which we hear sounds and distinguish what they are.

This ear-machine of ours is the necessary channel of radio, as of other sounds, to the human brain. A good loudspeaker, for example, is a loudspeaker which fits its sound output to the peculiarities of the ear. A bad loudspeaker is one that fails in some way to

suit the requirements of this perceiving mechanism. Hence the importance of the ear, studied as a physical machine, to the entire art of communication, an importance which was recognized long ago by the telephone engineers and which has prompted the brilliant series of researches on the mechanism of hearing and of speech carried out during the past five years in the telephone research laboratories of the Western Electric Company.*

* For a recent summary of some results of these investigations see "Physical Measurements of Audition and Their Bearing on the Theory of Hearing," by Harvey Fletcher; *Journal of the Franklin Institute* (Philadelphia), vol. 196, pages 290-326 (September, 1923). See also the note of Dr. Fletcher's "papa machine" in this Department of POPULAR RADIO for May, 1924, page 510.

One of the most recent papers from this laboratory has to do with the fundamental theory of how we hear different tones and with the function of that curious little ladder of living fibers which anatomists find hidden away in the inmost recess of our ear.*

The real apparatus of hearing is not the outer ear that we see but is the so-called inner ear; a set of levers, membranes, chambers and nerve fibers deeply buried in the massive bone just behind the visible or outer ear.† The nerve over which messages of sounds reach the brain runs to this inner ear and terminates in a liquid-filled sack containing a long, thin membrane that is curled up like the spiral of a sea-shell. If you take hold of this membrane and stretch it out flat you will see that it is a little over an inch long and if you examine it carefully under a microscope you will detect a great many distinct fibers running crosswise of the membrane, like the rungs of a ladder.

This ladder-like membrane with its thou-

* "The Auditory Masking of One Tone by Another and Its Probable Relation to the Dynamics of the Inner Ear," by R. L. Wegel and C. E. Lane. *The Physical Review* (Corning, N. Y.), vol. 23, pages 266-285 (February, 1924).

† In the article of Dr. Williams on page 8 of this issue of POPULAR RADIO there is a figure showing the parts of the inner ear.

sands of rungs is the real organ of hearing. Each one of the separate rungs of the ladder is connected with a tiny fiber of the nerve of hearing. Sounds that reach the ear cause vibrations in the rungs of this tiny living ladder and these vibrations are carried by the nerve fibers to the brain where they produce the sensation of sound.

The first physical theory of the perception of sounds was proposed many years ago by the great German scientist Helmholtz. It was his idea that the ladder-membrane of the inner ear behaved as an organ of resonance. He noted, as many anatomists had noted before him, that the rungs of this little ladder were of different lengths. At one end of the ladder they were very short; at the other end they were much longer.

It seemed, therefore, as though the individual rungs might be tuned just as are the strings of a piano or a harp. The shorter rungs would be tuned to the high notes, the longer rungs to the low notes. The perception of tones of different pitch would be accomplished, then, by the vibration of those particular rungs of the ladder that happened to be tuned to whatever tone was entering the ear.

Each rung was supposed to have its individual nerve connection with the brain. By sensing which rung was vibrating, the brain



C. Brandes, Inc.

MATCHING THE TONES OF TELEPHONES FOR HEAD-SETS

The mechanism of the human ear is such that for precise hearing of faint signals over the telephone the tones fed into the two ears should be exactly alike. Accordingly some manufacturers of high-grade telephone head-sets test each instrument and match the two receivers exactly to each other. The matching is done instrumentally, so that the human equation is altogether eliminated.

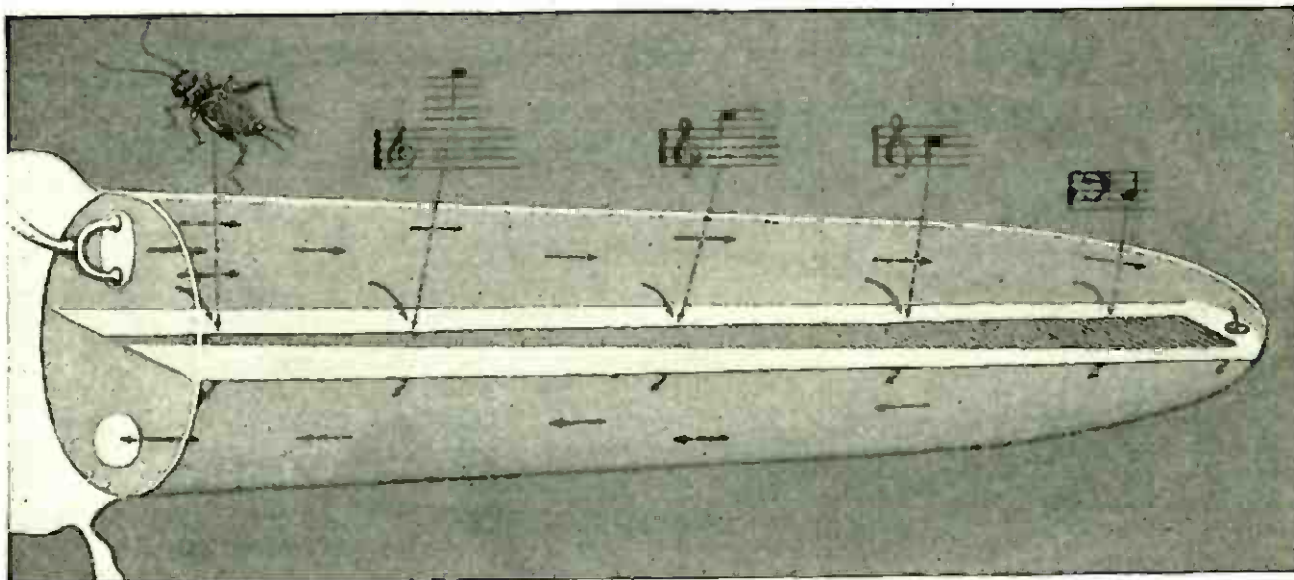

From a drawing made for POPULAR RADIO by Arthur Merrick

THE LADDER OF FIBERS WITH WHICH WE HEAR

The conical chamber represents the innermost cavity of the ear (as described in the text). Sound enters this cavity through the window and the small, stirrup-shaped bone shown at the upper left-hand corner. Very low-pitched sounds proceed entirely to the right-hand end of the cone and back again as indicated by the black arrows. Notes of higher pitch are short-circuited through the ladder of fibers, as shown for the different notes. The shrill note of the cricket goes through the ladder very close to the near end, where the fibers are shortest.

perceived what tone was coming in. Just so, a deaf musician might touch his sensitive fingers to the strings of a tuned harp and know, by feeling which of the strings were vibrating, just what tones were being sounded in the air of the room.

This theory of Helmholtz was ingenious and plausible. For years it commanded the adherence of most scientists. But gradually facts began to accumulate that could not be reconciled with this theory. The ways that tones blend in music, the effect of one tone in suppressing or "masking" the perception of another tone, the exact amounts of energy necessary in order to affect the ear perceptibly at different pitches, some of the phenomena of partial deafness; from all these sources came indications that the simple theory of resonating rungs in the little ladder could not be quite all that there is to the hearing of sounds.

Now the scientists of the Western Electric Laboratories have proposed a new theory of hearing quite different from this older theory of Helmholtz. To see what this new theory is it is necessary to examine a little more closely just how the ladder of sensitive rungs is inserted in the inner ear.

It is contained inside a long, liquid-filled tube and the ladder itself (together with the skin-like membrane that supports it) forms a partition along the whole length of this tube, so that the tube is divided into two tubes side by side. The construction is shown in the diagram printed herewith, but this diagram has been stretched out straight for the sake of greater clearness. In the ear itself, the whole mechanism is rolled up into a spiral coil.

Let us follow the course of a little jar or shock of some kind communicated to this dou-

ble tube with the ladder-membrane as its central partition. This little shock first enters the liquid of the tube at one end of one of its compartments, as indicated in the diagram. Then the shock passes through this compartment, along one side of the ladder-membrane until it reaches the other end of the double tube. Here there is a little hole in the partition and through this hole the shock passes to the liquid in the other compartment; to the other side, that is, of the ladder-membrane.

Then the wave of disturbance in the liquid that corresponds to our little shock starts back again along the tube, but now it is in the other compartment. Finally, the disturbance ends at the initial end of the tube, where it began, but on the other side of the dividing membrane.

This is the course of any sound wave inside the double tube of the inner ear. During this passage the wave must set up in some fashion the nervous disturbance that we recognize as sound. How does it do it?

The wave accomplishes this, say Mr. Wegel and Mr. Lane, by not going all the way to the end of the double tube. If the wave is of very low pitch it *may* go clear to the end and back again. But with a wave of higher pitch the construction of the two parallel tubes and their separating membrane is such that the wave is, so to speak, "short-circuited." It passes *through* the membrane (and the ladder) at some intermediate position and sets up, directly at the point of passage, the vibration in the liquid on the other side of the tube.

The exact point at which the wave vibration passes thus through the separating membrane depends on the frequency (that is, the pitch) of the wave. The nerve fibers in the mem-

brane carry to the brain a message identifying this exact point of passage. This is how we hear differences in pitch.

The importance of all this to radio is that it helps to explain many puzzling things in the apparent behavior of radio apparatus. For example, many loudspeakers do not deliver the very low tones at all. A note having a frequency of 100 vibrations a second will be absorbed entirely by the apparatus, only the upper harmonics of this tone (200 vibrations, 300 vibrations, 400 vibrations, and so on) being delivered by the horn. Nevertheless, when this mixture of the harmonics is heard, what one seems to hear is the fundamental tone of 100 vibrations. The ear perceives (or seems to perceive) a tone that is not there at all; leaving unperceived the higher-pitched, harmonic tones that really are there.*

For this curious fact, as well as for many other remarkable features of the reaction of the ear to mixed tones and to mixtures of tones and noise, explanation can be found on the basis of the new theory of the working of this little many-runged ladder that we hear with. There is every reason to believe that further study of this ladder and of its pecu-

* This fact has been observed experimentally; see: "The Physical Criterion for Determining the Pitch of a Musical Tone," by Harvey Fletcher. *The Physical Review* (Corning, N. Y.), vol. 23, pages 427-437 (March, 1924).

liarities will be of the greatest importance in improving radio apparatus.

The motion picture is possible only because of a defect of the human eye. The eye cannot see very rapidly. Because of what is called the persistence of vision, the separate pictures of the motion picture, sixteen of which are flashed on the screen each second, seem to blend into a continuously moving scene. The motion is really by sharp jerks; our eye fools us into thinking that it is smooth and lifelike.

Just so, if we learn to understand better the peculiarities of our little ear-ladder we may be able to fool it pleasantly and comfortably into thinking that radio music is better than it is.

The New Cathodophone

The new microphone named the "cathodophone," which has made some stir in Germany, operates on the principle of a current of electricity through ionized air; thus avoiding the use of diaphragms or other mechanical devices.*

Many years ago Professor Walther Nernst, the famous German chemist, invented a special kind of incandescent electric lamp that is still known as the Nernst lamp. The glowing element of this lamp is not a filament but is a

* "The Cathodophone as a Pick-up Microphone," by F. Gerth. *Der deutsche Rundfunk* (Berlin), vol. 2, pages 401-403 (March 16, 1924).

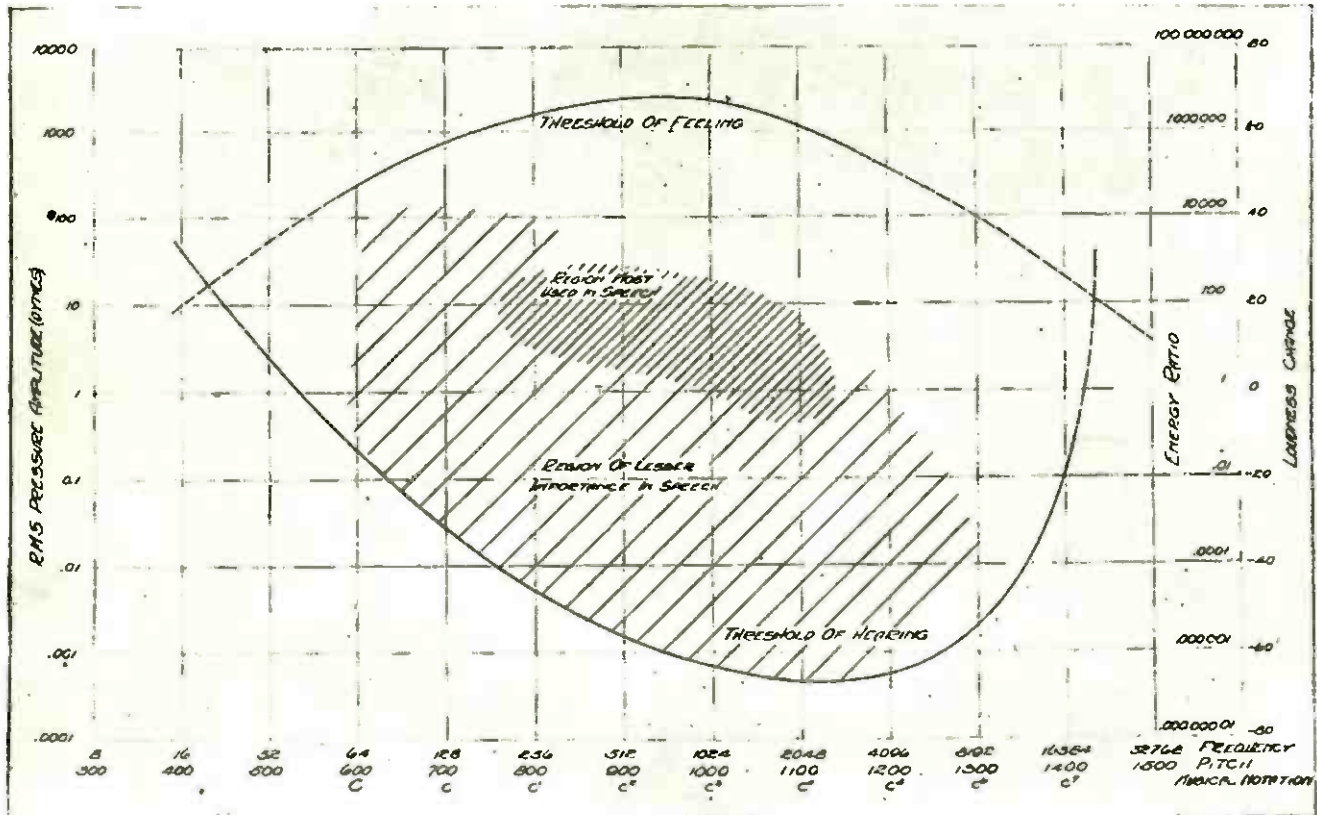

Western Electric Co.

THE LIMITS OF SOUNDS AUDIBLE TO THE NORMAL EAR

The area inclosed between the two lines indicates the sounds that one can hear. Above the top curved line sounds are too intense and are felt rather than heard. Below the bottom line the sounds are too weak to hear. At the right and left of the inclosed area lie the sounds that are too shrill and too low, respectively, to affect the ladder of fibers in the ear.

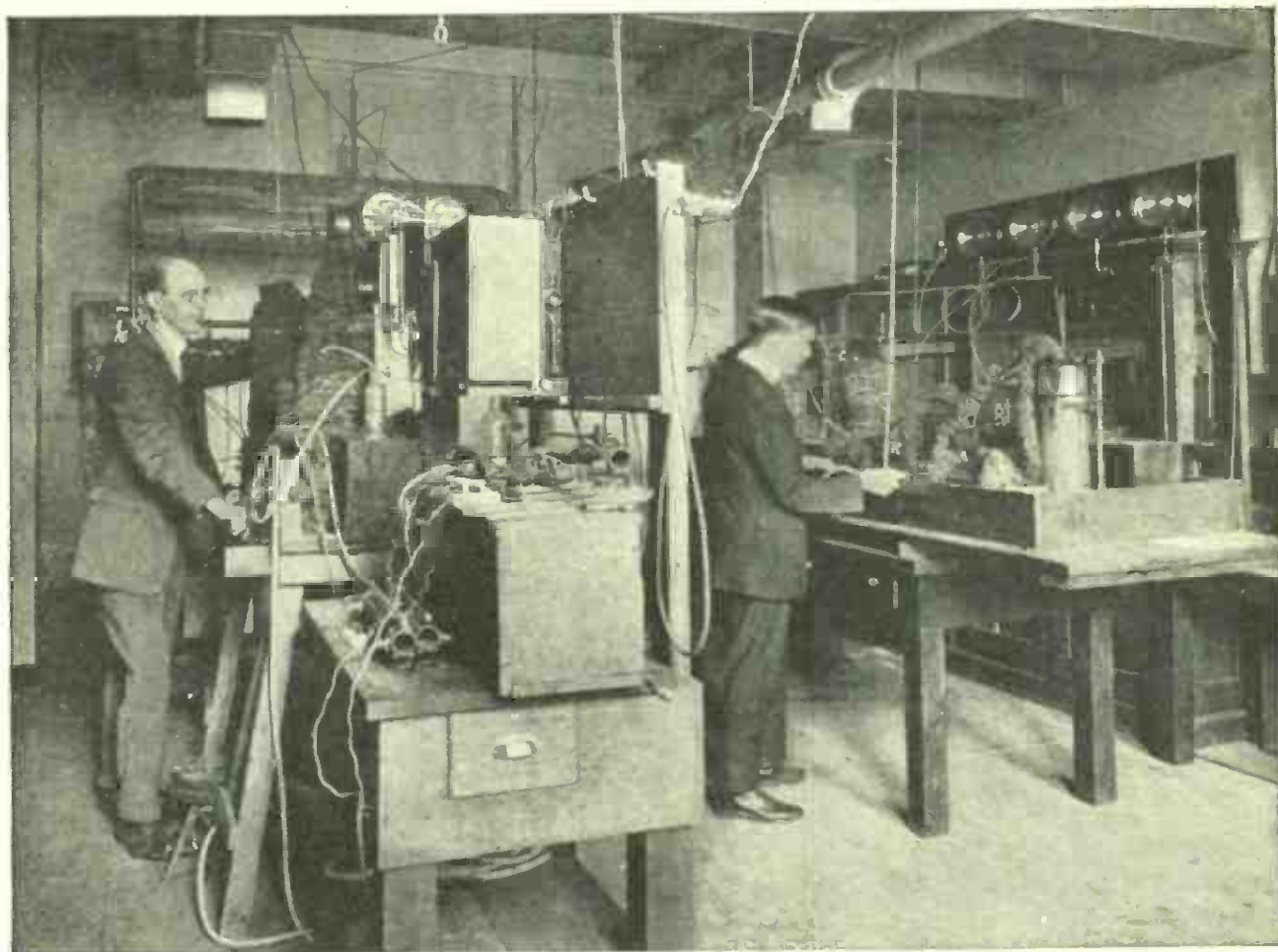

U. S. Bureau of Mines

FOUR HUNDRED DEGREES BELOW ZERO

In the Cryogenic Laboratory of the U. S. Bureau of Mines, at Washington, the Government scientists have assembled apparatus capable of working with liquid helium, with solid and liquid hydrogen, and with other substances which exist only at temperatures between 400 and 450 degrees below zero, Fahrenheit.

short cylinder made of certain infusible materials. The electric current passes through this cylinder and heats it white hot, so that it glows. It has long been known, furthermore, that this glowing cylinder produces ions in the air around it.

These ions, you remember, are merely molecules or atoms of the air gases which have lost one electron each and have come to possess, in this way, a positive charge. If a collecting cylinder is placed around the glowing filament of a Nernst lamp, current will pass between the filament and the collector by virtue of the ions, just as current passes in the Sodian tube by virtue of the sodium ions in it.* It is this ionization current that is utilized in the cathodophone.

If sound waves in the air enter the space between the glowing filament and the ion-collector that surrounds it they agitate the ionized gas in this space and produce variations in the ionization current, just as they do in that somewhat similar device, the glow transmitter of Dr. Phillips Thomas.†

* The Sodian Tube was described in POPULAR RADIO for March, 1924, page 302.

† The glow transmitter was described in POPULAR RADIO for April, 1923, page 290.

Frozen Gas in Upper Air

IN this Department in the issue of POPULAR RADIO for March, 1924 (page 299), there were reported the striking ideas of Professor Lars Vegard of the University of Christiania, Norway, with regard to the constitution of those upper levels of the earth's atmosphere that comprise the much-discussed Heaviside Layer.

By a study of the light from these levels, as manifested in the aurora and as analyzed by a spectroscope, Professor Vegard had reached the tentative conclusion that at these great elevations, 100 or 200 miles above the ground, the part of the air remaining was mainly frozen dust of nitrogen.

Professor Vegard has now offered additional evidence favoring this idea by producing in the laboratory a light-spectrum similar to the spectrum observed in the aurora. Working with Professor Kamerlingh-Onnes, Professor Vegard was able to make a thin layer of frozen nitrogen crystals much like the crystals that he supposes to exist in the upper air.

When the nitrogen crystals thus formed were subjected to powerful electric discharges in a vacuum they shone with a light similar to the light of the aurora.



CONDUCTED BY ALBERT G. CRAIG

Tips on Tuning

WHEN you get a new set, don't expect to be able to get the most out of it in the first evening you try it. Even the most experienced operator has to "get the hang" of a new receiver before he makes it do just what he wants it to do.

So, be patient with that new set and endeavor to find out just what happens when you turn the knobs. This may take you a week or it may take you a month, according to your proficiency and the application you put into the task.

You will soon note, if you pay attention to it, that for each change of wavelength on the dials you may have to change the other controls accordingly.

For the lower wavelengths you will have to decrease regeneration, and for the higher ones you will have to increase it. This holds true, generally, whether the set contains a potentiometer control, a variometer in the plate circuit, or some form of tickler control such as used in the honeycomb circuits, or in a kind of circuit that is controlled by the filament rheostat.

Neutrodyne sets do not have this control, but they usually contain three dials that have to be set approximately at the same settings.

A good plan, with any type of set, is to keep a plan of all the settings for all the various wavelengths. For instance, you may have a set with two large dials and for a given station on

a given wavelength, you will have the first dial set at 10, the second dial set at 20. Then you may notice that the filament knob should be turned up about three-quarters of the way. For another station on a higher wavelength, you may have the first dial at 20 and the second one at 30, and the filament knob turned up still higher, and so on for still higher wavelength stations.

If you make a chart with a number of columns, you can log the station, and the dial settings for the various wavelengths and you can always tune in the wavelength and the station you want by simply referring to it.

How to Drill Glass

WHEN drilling a hole in glass, make a roll of putty and place this in a small circle around the spot where you wish to drill the hole. This forms a basin, into which pour a small quantity of turpentine. Then take a three-cornered file and sharpen the end of it into a sharp pyramid. Fit this into a brace and go ahead and drill the hole.

How to Save Your Tubes

DON'T turn up the filaments of your tubes above the amount necessary to obtain the required loudness. If you do, you will soon ruin the tubes. The filaments of the tubes will light up properly, it is true, but the signals will be weak and distorted, after such abuse.

Where Power Lines Carry Danger

DON'T run the antenna wires near, over, or under power wires. The winds may blow, and the storms may storm, and the antenna may fall across the power lines or the power lines may fall across the antenna. In any case this might be dangerous to property on account of fire, or to life on account of serious shock.

Keep the antenna away from *any* wires that you don't know about and prevent accident.

Good Parts for a Good Set

WHEN you buy the parts for your home-made set don't neglect one single part. Get good ones all the way through if you want complete satisfaction. A set composed of 99 good parts would be rendered more than useless by the introduction of one single cheap and poorly constructed instrument into its makeup. So look after the smaller things with as much or greater vigilance as the (seemingly) more important ones.

How to Keep Your Battery Fit

KEEP the plates of your storage battery covered with solution. If you allow the electrolyte to fall below the top of the plates, the battery will eventually be damaged and rendered useless.

You do not have to put in more *acid*; all you have to replace is *distilled* water. The water evaporates but the acid in the solution *does not*.

Never allow the storage battery to run down too far. This may damage the battery and it surely will impair reception. You may get all sorts of squeals, howls and whistles with a run-down battery.

How to Clean Variable Condensers

IF your variable condensers are allowed to stand out in the open, they will collect a quantity of lint and dirt

between the plates. This may cause leakage between the rotor plates and the stator plates.

An ordinary pipe cleaner passed between the plates is a simple method for cleaning out this dirt.

How to Tune in Distant Stations

ON a regenerative receiver, the nearer to the oscillating point the receiver is operated, the sharper the tuning will become. So that when you wish to tune in a distant station through a strong local station you should increase the regenerative control until the local signals are eliminated and the distant ones come through. Do not allow the set to *go beyond* the oscillating point, however, or you will interfere with your neighbors' reception.

Folding Loops for Portable Receivers

THERE are now a number of folding loop antennas on the market that make ideal equipment for a set that can be taken on a trip to the country or on any set where portability is a necessity. The loop can be folded up into a small space and tucked away in a small compartment in the cabinet.

How to Use a Crystal Detector in Radio-frequency Receivers

THE crystal can be used successfully in any radio-frequency receiver as a detector. It finds the greatest popularity, however, in the reflex receiver, where tube economy is an essential. For instance, in a two-tube reflex receiver, it is possible to employ two stages of radio-frequency amplification, a crystal detector and two stages of audio-frequency amplification.

This is a great economy over the standard circuit for two stages of radio-frequency, vacuum-tube detector, and two stages of audio-frequency amplification, that employs five tubes.



“TROUBLE SHOOTING”

CONDUCTED BY S. GORDON TAYLOR

EVERY radio receiver requires a careful balancing of all of its parts if the best results are to be obtained. Two receivers made from exactly the same design may give widely different results, owing to variations in the parts used, the skill of the experimenters and the locations of the receiver. This department is conducted for the special benefit of readers who have built the radio receivers described in POPULAR RADIO and who want to profit from the experience of others in operating them—to learn the little kinks that get the maximum results.

Helpful Hints for Operating the Four-circuit Tuner

BE absolutely sure that all connections are correct and properly made. Unless the experimenter is absolutely certain that he has followed the instructions in detail, it will be well to start off by checking over all wiring and connections. The wiring blueprint for the five-tube “Improved Four-circuit Tuner,” prepared by POPULAR RADIO’s Technical Service Bureau will be of assistance here.*

By far the most prevalent source of trouble has been found to lie in poor coils. The majority of builders of the four-circuit tuner purchase their coils ready made, and there are many makes of coils on the market that are practically useless in this circuit. Cases have been known where several makers of the four-circuit receiver living in the same town or neighborhood, have been uniformly unsuccessful in obtaining proper results, due to the fact that only coils of a poor grade were obtainable in the local radio stores. The price is not necessarily an indication of quality, although it provides a fair basis for judgment.

To produce the proper results, it has been found by experiment and experience that coils for this circuit should be wound on high-grade composition, or preferably hard-rubber tubing. Cardboard tubing impregnated with asphaltum

* A set of three full-size blueprints showing panel layout, instrument layout, and wiring, may be obtained for \$1.10 from the Technical Service Bureau of POPULAR RADIO.

or other composition does not serve the purpose at all well and should be avoided. Next, double-silk-covered wire, No. 18 gauge, has been found preferable to single-cotton-covered wire of the same size. Double-cotton-covered wire should in no case be used, because its use results in greater spacing between turns, due to the greater thickness of the double insulation, and this in turn results in an entirely different electrical value for the coils. Certain manufacturers are putting coils on the market with green double-cotton-covered windings, presumably as an imitation of silk insulation. This is a point which should be watched carefully.

BE absolutely sure that *no shellac, collodion, or other binder of any kind is used on the tubing or on the windings* of the coils. An example of the bad effect of even a small amount of shellac is shown in the experience of one reader who reported that he had constructed this receiver, using the best of parts, including a set of coils put out by a manufacturer whose product was known to be first-class. The results obtained had not been satisfactory, however, and an investigation disclosed the fact that in some way some of the turns of the stabilizer winding had become loosened and in order to keep them in place, the builder had placed a little shellac on the windings in several places. He was advised to replace the coils with a new set of coils and upon doing so found his trouble eliminated entirely.

IN some home-made and also some manufactured coils, shellac is used on the tubing as waterproofing, or to make the wire stick while winding. Even this use of shellac has a bad effect, in spite of the fact that very little of the shellac is on the wire itself.

It is not always possible to determine from the action of the receiver whether the fault is in the coils. Among the effects that improper coils may have, however, are the following: Lack of selectivity; failure to bring in DX stations, although tone and volume may be good on the local stations; distorted music and speech; poor control of oscillation, evidenced by excessive howling; body capacity resulting in howling when the hand is placed near the tuning dials. The coils can make all the difference between a very good and a comparatively poor receiver.

THE variable condensers should be as good as the coils. Condensers used for tuning the secondary and stabilizer circuits must be electrically efficient. Any radio-frequency losses due to poor construction or poor materials in the condensers will have their proportionate effect on the efficiency of the entire receiver. It is not absolutely necessary that the make of condensers specified in the descriptive article be used, although these were the condensers that were satisfactorily used in Mr. Cockaday's experimental receiver. If other condensers of good quality are used the results should be excellent. It is usually found that their use will give somewhat different settings for a given wavelength than those given in the tuning chart which appeared in the January issue. However, this is not important as it is an easy matter to make up one's own tuning chart.

BEWARE of poor condensers; they may play all sorts of tricks. They may make it possible, for instance, to pick up the same station on several different settings of the secondary condenser dial. They may make it impossi-

ble to receive stations that operate at certain wavelengths, although other stations on higher or lower wavelengths come in well. They may make it possible to jump fifty or a hundred meters by moving the dial only two or three degrees. Such eccentricities as these are usually the result of poor internal contact between vernier plate, main shaft and bearings, due to faulty construction. Usually where this condition obtains, it will be found that a grating sound results when the condenser dials are rotated.

SOMETIMES it will be found that a poor condenser does not result in any outstanding peculiarity but, instead, simply reduces the efficiency of the receiver all around. A similar condition may be due to other causes, too, but when it does exist it is well to pay particular attention to the condensers.

THE grid condenser is not particularly critical. As a matter of fact, a fixed condenser of .00025 microfarad capacity will serve for this purpose in place of the type that was specified in the description in the January issue. About the only faults that can exist here are either a short circuit or a complete break inside of the condenser. In either case, the receiver will practically refuse to function, and if it works at all it will be with only a fraction of its normal volume.

ON the other hand, the small by-pass condenser is extremely important and is usually quite critical in adjustment. A condenser was not included at this point in the original four-circuit receiver described in the May (1923) issue of POPULAR RADIO, but in many cases it was found that this addition helped wonderfully. A small, variable, mica condenser was specified for this use in the improved receiver described in January because it was found that some receivers of this type functioned better with a capacity of about .00025 microfarad at this point, while others required higher ca-

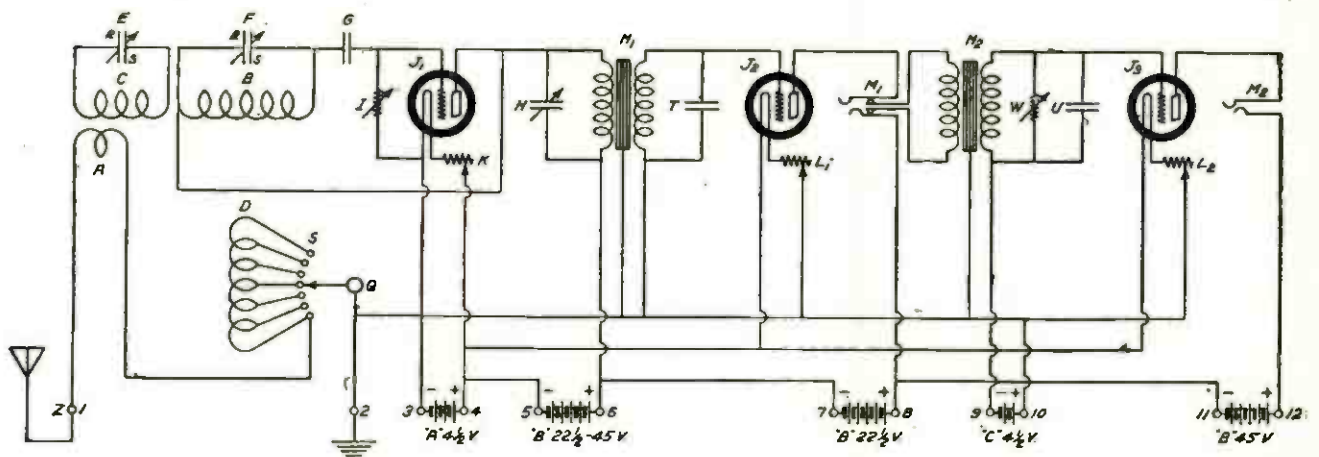

THE ELECTRICAL WIRING DIAGRAM FOR THE THREE-TUBE SET EMPLOYING DRY-CELL TUBES

FIGURE 1: This diagram shows exactly how to wire up the instruments in their respective places in the circuit. This hook-up includes a "C" battery for the last stage of amplification.

capacity for best results, up to .0005 microfarad. Provision for variation between these values is, therefore, well worth while.

THE value of this variable condenser lies in its influence in controlling the oscillation of the receiver. If the oscillation is so great that it is difficult to tune in stations without distortion, the trouble can often be remedied by increasing the capacity of this condenser. In the condenser used for this purpose in the receiver described in the January issue, this is done by turning the small knob in a clockwise direction. If the capacity is increased too much it will tend to broaden tuning. A point will be found, however, where oscillation will be properly controlled without affecting sharpness of tuning and it is at this point that the condenser should be permanently set.

THE grid-leak will behave differently in different receivers, depending on the characteristics of the detector tube used. In some cases its adjustment will be found very critical; in others it will have comparatively little effect, regardless of how it is adjusted, provided it is a variable grid-leak, and it should be variable to provide proper flexibility of adjustment of the circuit. Generally speaking, it should be much the same in its adjustment as is the variable by-pass condenser mentioned above. That is, sharpest tuning and maximum oscillation will be obtained with the knob nearly all the way out, and it is at this setting that it usually gives best results. In cases where a hard tube is used as a detector (such, for instance, as the UV-201-a or any of the dry-cell tubes). The adjustment of the grid-leak will usually be found very critical.

THERE has been an increasing demand for a hook-up for the Improved Four-circuit Tuner that will require only three tubes, especially for use with dry-cell tubes. Such a hook-up is therefore shown in Figure 1. The parts used are identical with those specified for use in the Improved Four-circuit Tuner described in the January issue, with the exception of the rheostats, sockets, and Bradley Ohm. Also, the potentiometer has been eliminated, as it is not necessary where dry-cell tubes are used, inasmuch as they are not critical as to plate potential. For the sake of convenience the list of parts is given here, as adapted to this hook-up. These parts are not necessarily the only ones that will give good results, however. Many other makes will serve as well, but the instruments should, in any case, be of good standard make and should have the electrical values given here.

WHEN dry-cell tubes are used, the use of UV-199 (or C-299) tubes is recommended, as they are better amplifiers than the WD-11 or WD-12 tubes. They require an "A" battery, voltage of 4½ volts as compared with 1½ for the other tubes, but on the other hand, their current consumption is so small that a set of three ordinary dry cells, connected in

series to supply the proper voltage, will have longer life than three similar cells connected in parallel and used with the WD-11 or 12 tubes. Moreover, if desired, a 4½-volt flashlight battery may be used to supply current for the UV-199's. This latter fact will prove to be a decided advantage if the receiver is to be used as a portable outfit. The use of flashlight cells is not recommended for general use because their life is comparatively short.

FOR those who wish to use standard six-volt tubes this same hook-up can be used except that the "A" battery should be a 6-volt storage battery, the rheostats of proper resistance to correspond with the tubes used, the "B" battery voltage reduced to 18 volts if a UV-200 (or a C-300) tube is used as detector, and a 400-ohm potentiometer connected directly across the "A" battery leads, with the detector "B" battery negative lead connected to the arm of the potentiometer instead of direct to the positive side of the "A" battery circuit as shown above. It will be well, too, to use a separate set of "B" batteries for the amplifier with the negative lead connected direct to the "A" plus side of the circuit.

LIST OF PARTS

- Precision four-circuit coil set, units A, B, C, D;
- A—primary winding, consisting of a single turn of tinned-copper bus-wire 1/16 inch square;
- B—secondary winding, consisting of 65 turns of No. 18 DSC copper wire;
- C—stabilizer winding, consisting of 34 turns of No. 18 DSC copper wire (coils A, B and C are wound on a hard-rubber tube, 3¼ inches in diameter and 5 9/16 inches long);
- D—antenna tuning coil, consisting of 43 turns of No. 18 DSC copper wire, double-bank-wound on hard-rubber tube 3¼ inches in diameter and 15⅞ inches long. Taps are taken off at beginning, 3d, 7th, 13th, 21st, 31st and 43d (last) turns;
- E and F—Amsco vernier variable condensers, 26-plate, .0005 mfd.;
- G—Dubilier, .00025 mfd. mica fixed condenser;
- H—Amplex grid-denser (small variable, mica condensers);
- I—Bradley-leak, variable, ¼ to 10 megohms;
- *J1, J2, J3—Alden-Napier UV-199 sockets;
- *K—Amsco filament rheostats, 30 ohms;
- L1 and L2—same as K;
- M1 and M2—Pacent jacks, one double-circuit and one single-circuit;
- N1 and N2—Amertran audio-frequency amplifying transformers, 5 to 1 ratio;
- Q—Amsco switch lever;
- S—switch points;
- T—Dubilier .0005 mfd. fixed mica condenser (with lugs for transformer mounting);
- U—Dubilier .00025 mfd. mica fixed condenser;
- W—Bradley Ohm—25,000-200,000 ohms.

* If tubes other than UV-199 (C-299) are used, sockets and rheostats must fit the requirements of the tubes.



ITEMS of general interest that you ought to know; bits of useful information that every radio fan ought to know.

CONDUCTED BY DAVID LAY

Can Radio Legally "Interfere with Religious Worship?"

DOES interference with the radio reception of a church service constitute a violation of the Kansas law that prohibits "interference with religious worship"? This is the question that is agitating the folks in Norway, Kansas, who maintain a church that is equipped with a radio receiver and who get their entire service, from sermon to music, from Omaha. They claim that a small broadcasting station near Norway is interfering. "If the interference is done purposely," states Attorney General Charles B. Griffith, "it is purely a case of interference with religious worship and subject to the same penalties as if it were actual interference with the services if conducted within the church at Norway."

King Makes His Radio Debut

FOR the first time in history, the subjects of the British crown were enabled to hear their sovereign's voice by radio on April 22, when King George opened the British Empire Exhibition at Wembley.

Radio Concerts in the Parks

OPEN-AIR radio concerts in the municipal parks of Dallas are taking the place, in part, of sing-songs and movies. Huge loudspeakers are erected in the play parks of the city and concerts in distant cities are broadcast for the benefit of children and grown-ups who do not have the advantage of radio in their homes. There are about fifteen municipal parks in Dallas and vicinity that will be provided with radio loudspeakers. It is estimated that more than 100,000 persons will be entertained in this manner during the summer months.

Radio Guides Ferry-boats

Fogs are so thick on the Bay of San Francisco that ferry service between that city and the cities of Oakland and Alameda on the opposite side of the bay is often delayed and

occasionally becomes virtually impossible. The distance is nearly four miles and the currents and tides are strong. Accordingly it is proposed to install radio beacons built on the crossed-coil system devised by the Bureau of Standards. With the beacons in operation the ferry-boat captain will be able to steer a straight course across the bay, no matter how thick the fog.

Re-broadcasting Experiments

THE re-broadcasting of American programs in England having ceased temporarily because of the difficulties of transatlantic transmission during the summer, the British engineers have turned their attention to France. Concerts from the Eiffel Tower have been picked up in England, sent some two miles over a land wire to the Sheffield station of the British Broadcasting Company and there re-broadcast to the surrounding country. Why does not some enterprising American station prepare to do this same thing for both the British and the French concerts as soon as the good transmitting weather returns in the fall?

Receiving Broadcast Programs on Metal Disks

SOME weeks ago a program broadcast from WGN in Chicago was received in New York by Mr. Frank Hoyt and recorded on aluminum disks somewhat similar to phonograph records. These disks were then taken to Chicago and played into the microphone one morning a few days later. The second broadcasting was sufficiently strong and clear to enable a second recording of the same program in New York.

Standardizing Dry Batteries

A COMMITTEE representing the scientific bureaus of the United States Government as well as important sections of the electrical industries is at work on a set of standard specifications for dry-battery cells intended for different uses, including those used in radio.

The "Vox Haus"

THE new German broadcasting station recently opened in Berlin has a good name. It is called "Vox Haus," which is mixed German-Latin for "The House of the Voice." The wavelength is 400 meters, with a daily program of music and talks.

Every Man His Own Aerial

So advises Professor A. M. Low, as quoted in the *New York Herald*. "The human body," says the professor, "makes a first-class aerial. All you have to do is to stand on a couple of tumblers and grasp the air terminal of the set with a wet finger and thumb." There is less trouble with atmospheric, the professor adds, with this kind of human antenna.

New Way to Announce Call Letters

ANOTHER possible device for curing the present trouble of call letters that are inaudible when the announcer pronounces them is suggested by a reader, Mr. E. W. Moreau. It is that the announcer should follow each letter by the number of that letter in th. alpha-

bet. For example: "W-23, H-8, N-14." A list of the alphabet, with the number of each letter, can be tacked up near the receiving set to permit ready recognition of the combined letter and number.

Radio Keeps Swedes at Home

THE often mentioned advantage of radio in keeping the younger members of the family at home nights instead of on the streets has received official recognition in Sweden. In a decree announcing some additional encouragements to radio development the Swedish Government speaks of the assistance of radio to "the renaissance of family life."

Radio Crosses Highest Mountains in the World

THE new French radio station in Indo-China is able to communicate directly with the station at Bordeaux, in France. The line connecting these stations on the map passes over the great mountain mass of the Himalayas, the mountains which contain Mount Everest, the highest mountain peak in the world. The mountains do not seem to interfere at all with radio communication across them.



Pacific and Atlantic

THE NEWEST RADIO BOB

This Washington barber shop is provided with a nickel-in-the-slot radio receiver. By dropping a five-cent piece in the box one can listen to the local programs while the barber is at work.



Keystone View Co.

THE "GERMAN BAND" OF TODAY

No longer do the small groups of itinerate musicians solicit pennies from the public—not even in Germany! The really up-to-date vender of harmonies now uses a portable radio set and merely tunes in the best music that the broadcasting stations can produce.

Radio Mysteries that Need Explaining

AMATEURS who have agreed to co-operate with the American Radio Relay League in its program of experimental work have been asked to collect observations and ideas not only concerning a number of instrumental and laboratory questions, but also about the effect of the weather on radio transmission, the effect of the phase of the moon (if there is any such effect) and similar little-understood aspects of radio transmission. The very puzzling phenomena of "dead spots" will come in, also, for a share of the attention.

* * *

Broadcasting for Pay

THE license granted by the American Telephone and Telegraph Company to Station WHN as the outcome of the litigation threatened by the company against that station is said to be the most liberal broadcasting license ever granted by the telephone interests for the use of the patents that they control. WHN is not only permitted the use of present inventions and granted the right to apply later for

an increase of power, but is permitted to broadcast material for pay, a right enjoyed hitherto only by WEAJ.

* * *

Radio to be Taught in Paris Schools

THE interest in radio is rising so high in France that a sum of 20,000 francs has been appropriated to commence the establishment of courses in radio construction and theory in the public schools of Paris. A group of Parisian professors is supporting a movement to have radio taught in the schools everywhere in France, especially in the rural districts, where the availability of radio receivers and of people who could operate them would be especially valuable to the inhabitants.

* * *

A Unique Incident in Reception

THERE is an ironic touch about an incident recently reported by *Popular Wireless* (London). A program was being broadcast from New York and a group of English fans were trying hard to hear it. Only one song got through. It was "Drink to Me Only With Thine Eyes."



General Electric

WINNER OF THE RADIO DRAMA PRIZE

A few months ago station WGY offered \$500 for the best play written for the purpose of being broadcast by that station's players. It was won by Miss Agnes Miller of New York City, with "A Million Casks of Pronto."

Is Color Due to Electrons?

THE tiny electrons that play so prominent a rôle in the vacuum tube and in other necessities of radio are now credited with causing the difference between substances that are colorless like sugar and those that have brilliant colors like the aniline dyes. Dr. Julius Stieglitz, one of the most distinguished American chemists, has formulated a theory that ascribes colors and color differences to varied manners of vibration of the electrons inside the molecules of the substances concerned.

A New Principle for Telephones

A RECENT British patent discloses what seems to be a novel way of converting an audio-frequency electric oscillation into an audible sound wave. The electric oscillations are communicated to a condenser consisting of a number of conducting plates separated by plates of a flexible dielectric. The changes of charge make the condenser alternately shorter (with the plates pressed together) or longer, in synchronism with the electric oscillations. This mechanical oscillation of the condenser is communicated by a lever to a piston that alternately lets through and shuts off a blast of

air, thus producing an audible note of the same frequency as the original audio-frequency electric oscillations.

* * *

Money for Broadcasting Opera

THE Radio Music Fund, organized not long ago in New York City to raise by public subscription enough money to provide first-class musical attractions for broadcasting, announces that sufficient funds to provide for the broadcasting of grand opera have been received and that broadcasts of this quality of program will be begun in the fall of this year.

* * *

A Remarkable Experiment in Line Relay for Broadcasting

A SHORT time ago a program of the United States Chamber of Commerce was picked up by line telephone at Carnegie Hall, New York City, and was broadcast simultaneously from WEA, WGY, KDKA, and KYW. A roll-call of the engineers employed to condition and control the land lines used in this one relay indicates, says Mr. Edgar H. Felix of the American Telephone and Telegraph Company, that sixty-five persons were needed.

* * *

The New Game of "Miles per Dollar"

THE newest form of radio golf, says QST, is one in which you divide the maximum miles of distance that you have obtained by the number of dollars that you paid for the set that brought in this distance. If you get a station 1,000 miles away on a \$20 set, that counts you a record of 50 miles per dollar.



Kadel & Herbert

A NOVEL "SPIDER-WEB AERIAL"

A circular loop, such as the one built into an efficient spider-web design by Harold Herbert of New York, should prove to contain a large inductance value while still preserving low distributed capacity. For broadcast reception the loop should have about half the number of turns shown.



International

THE RADIO "STUMP" FOR POLITICIANS

One candidate in the recent French elections has built what is probably the most comfortable election "stump" yet devised. On top of his automobile he has mounted a loudspeaker; inside the car is the microphone and the necessary amplifiers. The car can be stopped anywhere and a crowd collected by a few words spoken into the microphone. Then the owner, seated comfortably inside his car, could address the neighborhood through the loudspeaker.

Nine-meter Waves in Use in France

THE radio authorities of the French Army continue to be at the forefront of experimentation with unusually short waves. Transmissions on 45 and 25 meters have been carried out at the Eiffel Tower, with the co-operation of the French amateurs all over the country as to reception. Now experiments are under way with transmitting and receiving sets using a nine-meter wave. The results are described as very good, both for transmission and reception.

* * *

A New Freak of Broadcast Transmission

THE broadcasting station recently put in service at Brussels, Belgium, has displayed a surprising "zone of silence" extending directly south-southeast from the location of the antenna. Within this zone the signals are very faint; outside the zone, even at greater distances from the station, the transmissions have normal audibility. The phenomena seems somewhat similar to the well-known behavior

of WEAJ in New York City, but it is impossible to ascribe the Brussels case to the effect of steel buildings, for such buildings are not numerous in that city.

* * *

Radio Grows in England

THE latest report of the British Postmaster General reports 720,000 licenses granted for receiving sets in Great Britain. There being no license system in the United States the exact number of sets in use is not determinable, but we are probably still ahead of England in proportion to the population.

* * *

How an Earthquake Demonstrated the Use of Radio

VISITORS to Japan report a greatly increased interest in radio and especially in the organization of a corps of transmitting amateurs similar to those who are at work in the United States. The several days of serious disorganization that followed the recent earthquake at Tokyo have brought home to the entire population the importance of the service which a numerous group of radio amateurs can render.

To Call New Radio Conference

SECRETARY HOOVER has announced his intention of calling a third radio conference similar to those held in 1922 and 1923. The conference will convene some time after the adjournment of Congress and will include representatives of the many interests concerned in the radio industry. It is expected that the most important work before the conference will be the devising of a plan to minimize interference between broadcasting stations, there being no indication of an immediate decrease in the number of stations licensed, although the available wavelengths are already overcrowded.



Kadel & Herbert

HIGH-POWER RADIO APPARATUS ON A MODERN LINER

The multiple lead-in of the S.S. DEUTSCHLAND, some wires of which carry high-voltage currents dangerous to human life, are protected by a metal grating that prevents careless or inquisitive passengers from touching the live parts and receiving a serious shock.

Radio Used to Find a Sick Cow

A RECENT statement of the United States Department of Agriculture describes how a cow much "wanted" by the Department was located by radio. The cow had tuberculosis. The Department knew this and wanted to kill the cow. But the directions were imperfect and agents sent out to compensate the farmer and to dispose of the dangerous animal were unable to find the farm. So the farmer was "paged" from KDKA. Two days later he came in to the office and guided the agricultural agents to his farm.

"Five Thousand New Words Added by Radio"

So says Dr. Frank H. Vizetelly, famous expert on English words and editor of the well-known column, "The Lexicographer's Easy Chair" in the *Literary Digest*. So many inquiries about new radio terms came pouring in to his office, says Dr. Vizetelly in an interview in the *New York Herald-Tribune*, that he was compelled to study up on radio himself. Now he estimates that English is richer by perhaps five thousand radio terms, hundreds of which, like the word "radio" itself, have become familiar to everyone, though they were totally unknown except to experts until the last year or two.

A Radio Station that Saves \$150,000 a Year

THE radio station on Iceland cost some \$5,000 to install. Now it is estimated that the effect of this station in preventing shipwreck and in assisting the fishing fleet with weather bulletins has had a money value already of more than \$150,000; thirty times the cost of the installation.

The Pope and Westminster Abbey to be on Same Program

BRITISH radio authorities are planning, it is announced, to arrange on next Easter Day, a special broadcast program which will include a choir service broadcast direct from Westminster Abbey by the choir of that famous English church. It is planned to have a special message from the Pope broadcast at the same time. His Holiness is already a broadcast listener, a receiving set having been installed not long ago in the Vatican at Rome.

Pink Pills for Pale Detectors

A NEW variety of crystal detector invented in Europe uses a little pellet of galena or other material made by crushing the original mineral to powder and then compressing it into a tablet in exactly the same way that is used in making compressed tablets of drugs. The pellet thus formed is said to have a greater number of sensitive points than has the natural crystal.



LISTENING IN

CONDUCTED BY KENDALL BANNING

HELP your neighbor. If you have discovered any little Kink that helps to eliminate trouble in your radio apparatus, or if while experimenting with the connections of your set you should run across some interesting phenomenon, or if you should discover some new hook-up that gives better results—send it to the "Listening In" page.

Unexplained "Bogies of the Ether"

AMONG the strange host of wonders that radio has brought in its train must now be included the "radio haunts" with which an occasional fan believes he is pursued. Radio supervisors and inspectors are hearing many queer tales about strange messages emanating from somewhere within the boundless realms of radio land. Some complaints are weird, a few pathetic and still others almost convince one that there are "ethereal bogies." Radio is of itself more or less of a marvel and a mystery, with the rapid advancement of its range, manipulation and scope, and it is small wonder that certain susceptible fans and even operators long in the game, hear or imagine they hear curious and unaccountable messages verging on the supernatural. Some of these complaints perhaps improperly classified as "bugs and nuts" of the ether, insist that they are haunted by "Hertzian spooks," which in certain cases seem to approach from the spiritual angle and assume "radio control" of their victims. They not only exercise an undue influence, but create actual fear in the hearts and minds of those persecuted. Certain students of the problem refuse to believe that it is all imagination, attributing the influence to something supernatural or at least a

power not yet understood. Of many cases reported to the Department of Commerce, there is none so striking as the "Strange Case of Operator Blank," on which there is a thick file of papers. Here is his story:

Nearly four years ago, a sea-going radio operator of twenty years' experience reported to the supervisor of a coastal district that he was the object of radio persecutions in the form of radio telephonic messages which were transmitted to him continually, by virtue of wired wireless, when he was ashore. Three unprincipled young operators, he asserted, kept a surveillance over his every move, reading his thoughts, and at times "neutralizing" his brain action. These three persecutors relieved each other but kept up their vocal messages day and night, no matter where he was. Their sinister influence, he felt sure, was affecting his young daughter when she was near him, and practically broke up his home. He appealed to scientists, doctors, radio experts, the government and police without benefit, as the source of the radio emanations could not be traced. They seemed to come from a coastal point. Even while on an automobile trip across the continent and into Canada, the "phantom" radiophone or photophone messages pursued him. The messages were transmitted on various frequencies and were impossible to ignore. Operator Blank believed the young men had invented an ultra-modern transmitting set of which no one knew the circuit. He said the boys told him it was a "wired-wireless psychometer" effecting the transmission of speech by a "therapeutic oscillator," and received by "triplex phantoming attunement." He couldn't get away from the messages, and he was certain that the boys kept a log of his thoughts.

Later on, when he was again at sea, the messages pursued him, evidently through the medium of radio. In the Atlantic or Pacific the

effect was the same and the operator came to believe that the "primary phonetic" effect kept his head aching continually; sometimes he was driven from his radio shack. He was certain his death could be caused by these boys if they desired. He again took up the matter of locating the station with authorities in New York, San Francisco and Washington, but no one was able to aid him nor locate the unknown station. Unofficial and unsigned messages continued to follow him causing interference with his regular traffic, his sleep and his mental stability. Investigations showed him to be in good physical and mental state, but although pronounced sound in his mind and body and only about forty-two years old, he was literally driven from the sea and his profession.

Following up some of his suggestions, radio officials report that spiritualists have been affected in a similar way, and from New York came information that complaints of this character were increasing—in fact, were becoming common. Department of Commerce radio officials say that during the full of the moon complaints of weird and unnatural radio messages in the ether come in with a strange regularity.

Then there is the story of one oldtimer who declared that he no longer needed headphones, his ears having become so tuned to the notes

of code stations that he could pick up messages from almost anywhere!

Other curious cases reported to the Department include the western farmer, who, whenever plowing in a field near an insane asylum, declared that he was influenced and persecuted by voices which seemed to come from a queer box on the sill of a window in the institution. He came to Washington in an effort to rid himself of this "radio control." When he returned the box was no longer visible and it is understood he was bothered no further, though it was never wholly explained.

From Philadelphia came a story of a woman who was constantly hearing radio voices, especially when riding on a train, although it was long before trains were equipped with receiving sets. Another woman out west recently wrote that waves from a certain radio station pass through her house and her person, causing a most unpleasant effect; she said she could never sleep until the station closed for the night.

During the World War, complaints of this type, and others attributed to German spies and codes, came to the Department's supervisors in great numbers, some of them obviously from people with unsound minds who sought to become radio sleuths and desired special transmitting licenses and stations.

—CARL H. BUTMAN

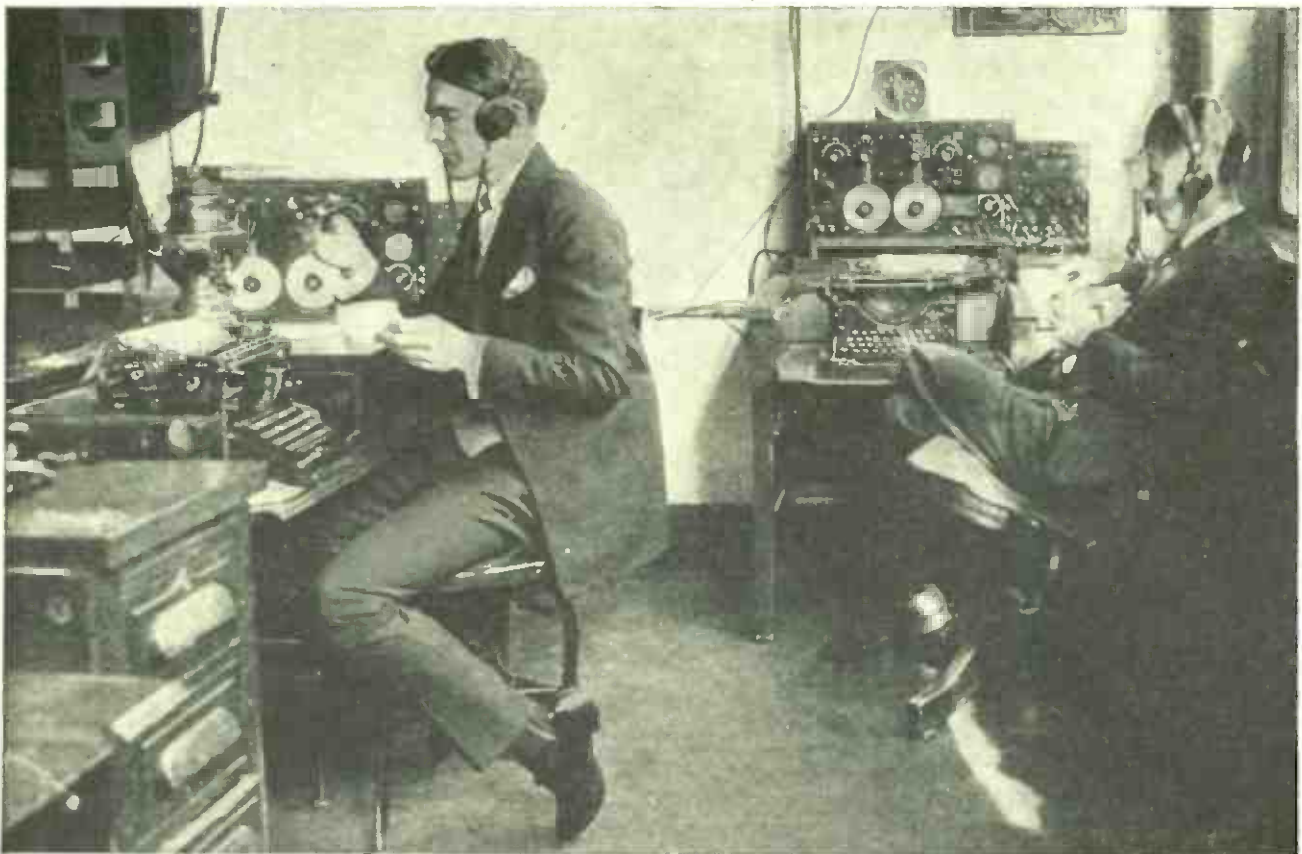

Pacific & Atlantic

THEIR JOB IS TO PICK UP DISTRESS SIGNALS

Always listening in for calls for help are S. T. Simpson (left) and B. E. Stahl (right), members of a shift on the Naval Radio S O S and Receiving Service. These two sets receive from all the Atlantic Coast stations. These are the two operators who were in close touch with the dirigible SHENANDOAH during its famous wild flight in a storm.

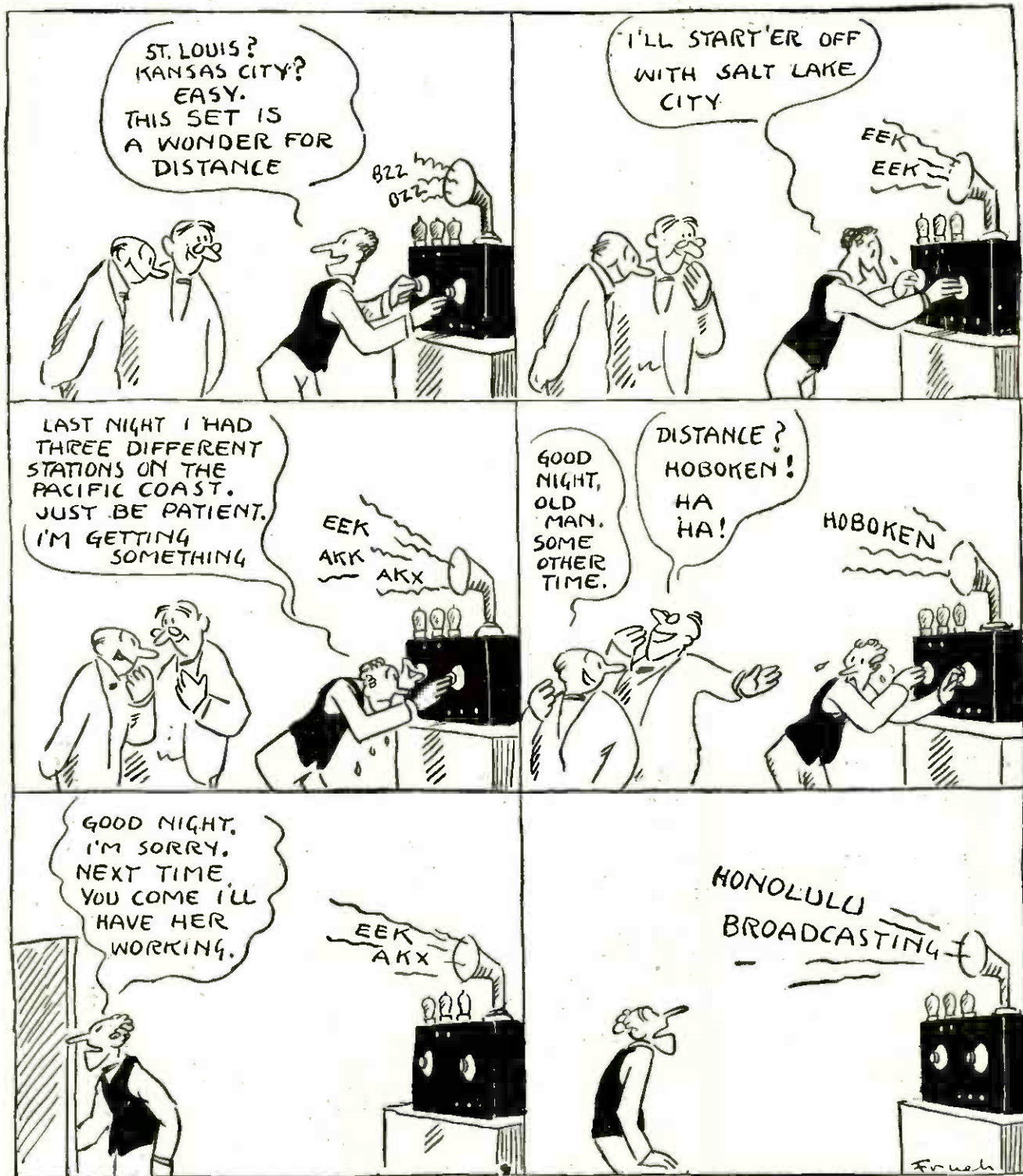

Courtesy of The World, New York

"NINE TIMES OUT OF TEN"

What an African Fan Picks Up

THE sun never sets on the British Empire—nor does it, apparently on the circuits that have been published and advocated by POPULAR RADIO. The Cockaday four-circuit tuner has been built and used all over the earth. Here is what a fan in Somerset West, C. P., South Africa, writes about another of our circuits:

I find the Haynes DX Circuit, published in your September issue, excellent. It seems to me that the signal strength is slightly greater than with the usual single-circuit hook-up. Of course I haven't Haynes parts, merely adapted my single-circuit tuner to the circuit and reduced my variable condenser to nine plates.

We have no broadcasting here as yet, but some amateur telephony from Capetown.

I have built four sets from time to time but for 200 meters I have yet to find an arrangement that beats the Haynes with a 2-step audio-frequency amplifier.

—R. McLEAN

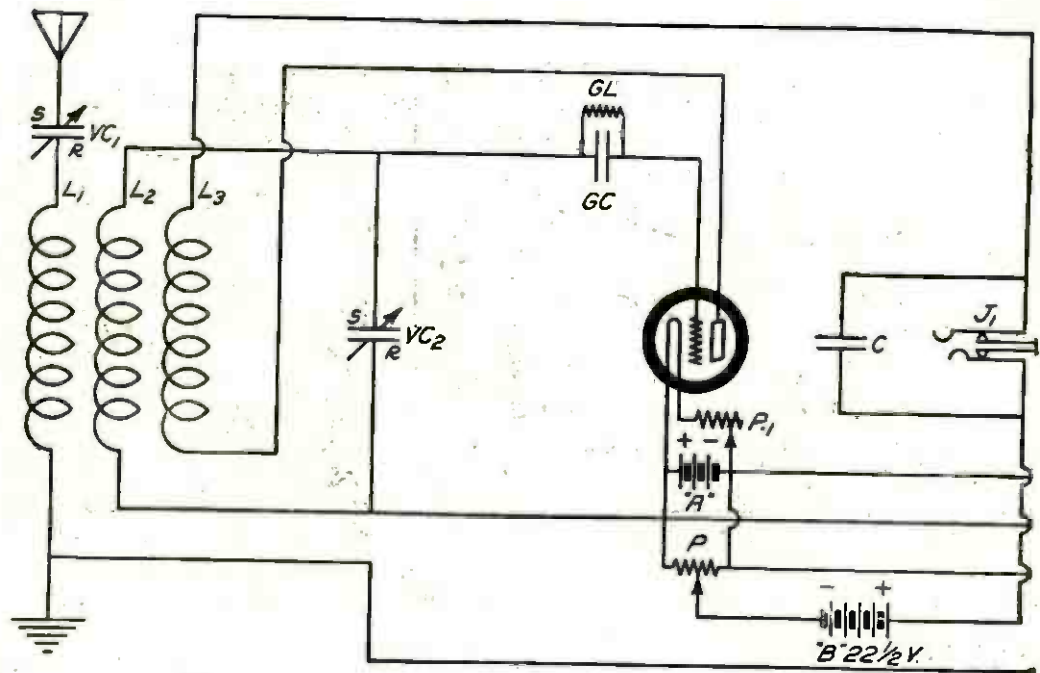

Practical Pointers for Novices

MANY people ask POPULAR RADIO what radio set to build. "What good circuits in the one-tube and three-tube classes can I assemble for myself?" they inquire. "What kind of antenna shall I use?" "Must I use a storage battery or will a dry battery serve as well?"

Here are some answers to these questions from a radio engineer:

The ideal antenna for reception of broadcasting, regardless of the trade-mark of your set, is a single copper wire of the stranded variety, about 150 feet long. The higher the wire is stretched above buildings, trees and other objects the louder will be the reception and the greater will be the distance covered. The outdoor wire is far superior to any form of indoor antenna.

The antenna has a marked influence on the selectivity of the set, that is, on its ability to tune stations in or out as the operator desires, without interference.

The direction in which the antenna points should be considered. If preference is to be given to western stations the antenna should point east and west with the lead-in wire taken off the western end. The antenna must be well insulated from supporting objects such as masts, housetops and chimneys. It should not run over metal roofs or electric-light wires. If there are any power lines, telephone wires or electric lines of any kind in the vicinity, the antenna should run at right angles to them. There is no necessity for a joint in a single-wire antenna; the wire purchased should be long enough to serve also as the lead-in, connecting to the set at the binding post marked for the antenna.

On most sets, just below the antenna binding post, there is another binding post provided for a ground connection. A No. 14 copper wire with insulated covering can be used to connect this binding post with a radiator or a cold-water pipe, thus making the ground contact. The surface of the pipe or radiator should be filed clean and a firm connection made by means of a ground clamp which can be obtained from most stores handling radio supplies.

Other connections that must be made before the installation is complete are the battery connections. There are two different types of batteries necessary. One known as the "A" battery, may be a storage battery or an ordinary dry cell. The other, or "B" battery, is a high-voltage battery, usually ranging from 22½ volts to 90 volts. Such batteries can be obtained in 22½-volt sections and connected in series to supply the necessary voltage.

There are two types of tubes, those which require a storage battery and those which operate on one or more dry cells. The chief advantage of the dry-cell tube is that it eliminates the expense of a storage battery and the trouble of having it recharged. If the dry-cell tubes are employed, the sockets should be mounted on sponge rubber or on springs to prevent disturbing noise caused by jars which shake the elements of the tube. In purchasing a complete set which is equipped with dry-cell tubes, it is well to make sure that the sockets are mounted on such cushion supports.

High grade apparatus does not deteriorate in value as quickly as cheap instruments. The general public is fast becoming educated in the theory and practical side of radio, and many of them are now quick to recognize that cheaply built sets soon become obsolete.

A good receiving set will be a good investment for a period of several years before newer devices and improvements warrant the expense of new equipment. The majority of improvements made, such as new tubes, can

FIGURE 1: *The triple-coil regenerative receiver with two stages of audio-frequency amplification.*

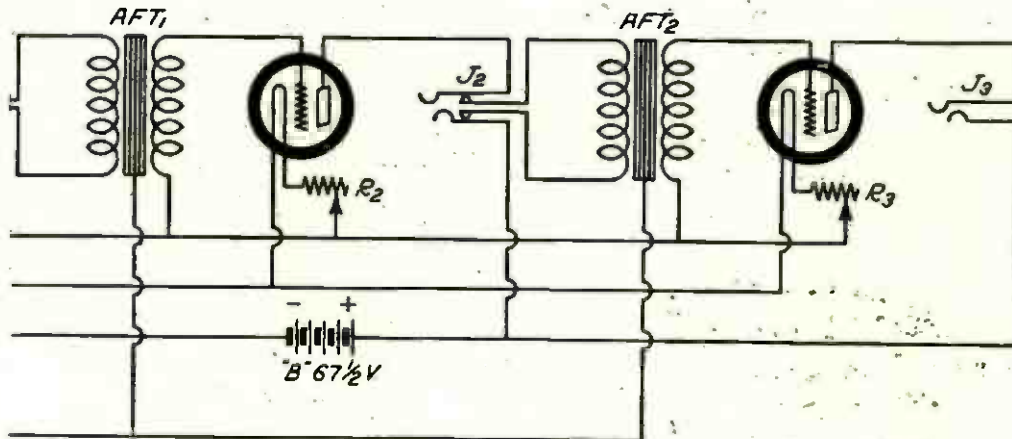

easily be adapted to work in all sets. A standard regenerative receiver, built in 1913, before music was in the air, can, even today, be brought up to date at only a small expense.

The standard triple-coil regenerative set shown in Figure 1 consists of a vacuum-tube detector and two stages of audio-frequency amplification. It is a reliable circuit for those who wish to assemble a set for dependable service. If properly installed, it will pick up the majority of high-power broadcasting stations in half of the United States. A loudspeaker can be used on near-by stations. It is always well to remember that the simpler the

circuit, the easier it is to control, and the less opportunity there is for something to go wrong.

Among single-tube sets, one of the most satisfactory that I know of can be made by following the reflex circuit shown in Figure 2. It is simple to build and easy to operate. It is selective and when used in New York City it has picked up practically all of the important stations as far away as the middle west. WGY, at Schenectady, has actuated a loudspeaker with sufficient volume to be heard throughout a six-room apartment.

—ORRIN E. DUNLAP, JR.

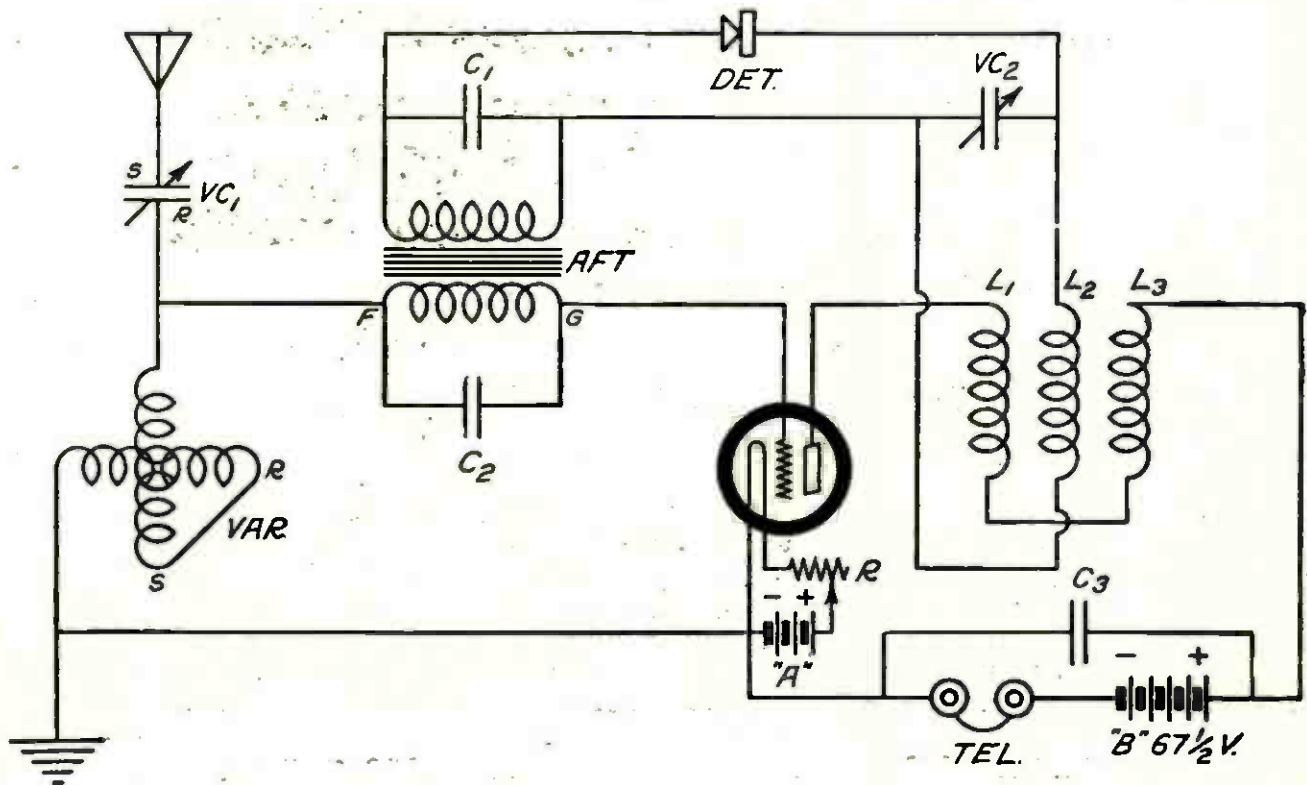

FIGURE 2: *A novel single-tube reflex with a crystal detector, which should be of interest to experimenters.*

A New Use for Radio Towers

THE growing applications of radio to forms of public service are giving new demonstrations almost daily. The Bureau of Aeronautics of the United States Navy Department has found a novel use for the gigantic 600-foot towers of the Arlington radio station; it is described as follows:

This new use involves the placing of a weather-recording device that has a double function; it records the direction of the wind, and at the same time its velocity.

The old method for making this determination was by means of hydrogen-filled balloons which, when released from the surface of the earth, were followed in their courses by means of a theodolite—a sort of telescope that records horizontal and vertical angles. These records, when plotted, indicated the velocity and direction of the wind which caused the drift of the balloons. This method, however ingenious it may have been, had one great drawback; it would not function in dull or foggy weather.

The new device installed on the towers is automatic and operates by means of wind pressure and thus will function in either clear or thick weather, the records being continuously and permanently registered by the other apparatus in a building near the base of the tower. This apparatus records the wind

conditions on a paper chart, in ink. The recording apparatus and portions of the charts are shown in the photograph.

—S. R. WINTERS

A Tip for Saving Your Vacuum Tubes

HAVE you ever burned out your tubes during the course of your experiments? Here is a practical hint from a reader in Boyden, Iowa, who has hit upon a scheme for avoiding this particular kind of loss.

During several years of experimenting with vacuum tubes I think I have learned one trick of value to your readers. When you try out a newly constructed set for the first time and don't want to risk from \$5.00 to \$25.00 worth of tubes, try the following:

Set your rheostat so that all resistance is in the circuit. Then connect your "A" battery and adjust the filament temperature to a dull red. Now reconnect the "A" battery across the "B" battery binding posts, and rearrange it so as to test both the detector and amplifier circuits. If the filaments fail to light, your set is O. K.; if they do light, check your connections and change the offending one. No "B" battery is used at all during the tests. Time required about 30 seconds, and no extra material.

—MARVIN STUTZMAN

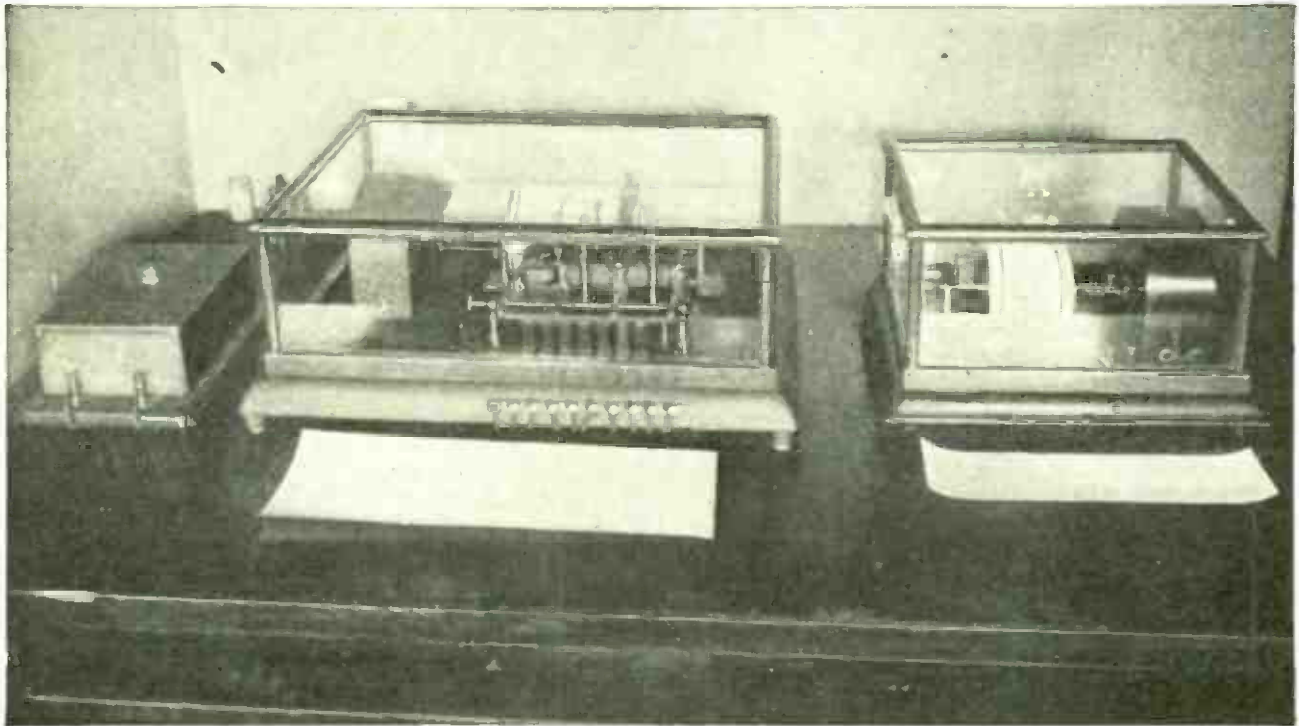

S. R. Winters

AEROLOGICAL INSTRUMENTS IN A RADIO TOWER

These recording instruments are located in the aerological office at the base of the Arlington tower; they keep a continuous record of the wind direction and velocity and the percentage of sunshine as given by the apparatus on the top of the tower.

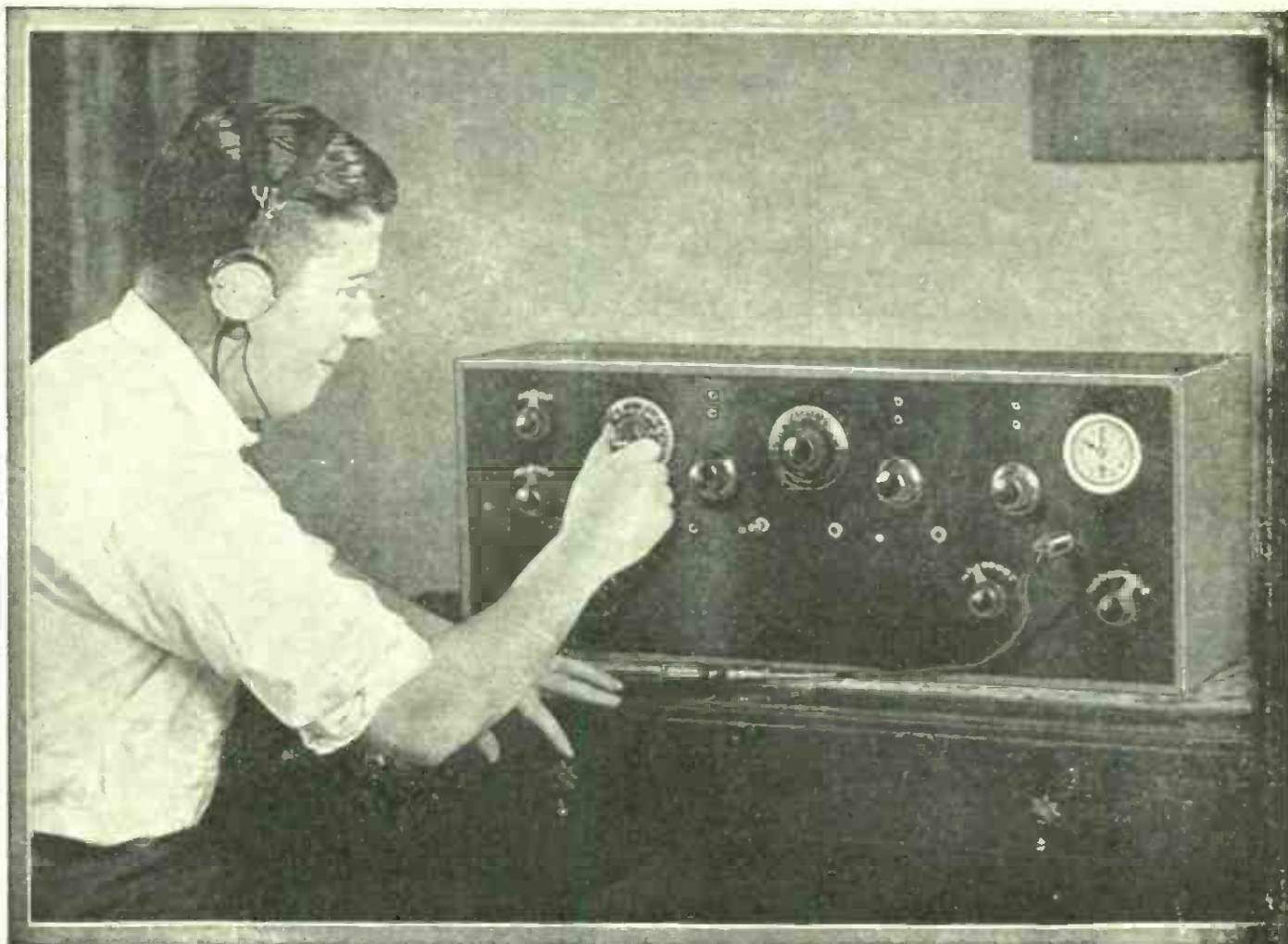

With the clock in his panel Mr. Kent checks time with the Government signals from Arlington and keeps track of broadcasting schedules. Note the beautiful finish of the Celoron panel.

What Kent says about panels

Albert Kent builds his own sets. He uses instruments of the highest quality. He has found that it does not pay to mount his parts on just any old radio panel. He writes:

"Having completed over thirty radio receivers of various styles, I thought you would like to know of the truly wonderful results obtained with the use of Celoron panels.

"After a great deal of experimentation, I developed a simple three circuit regenerative receiver; and in order to obtain a constant normal range of approximately 2,000 miles with three tubes, apparatus of the highest quality had to be used.

"By the process of elimination, I found that Celoron was the only satisfactory

panel, mainly because of its extremely low loss of high frequency currents. This characteristic brings in distant stations clearly with a simple hook-up. I find working with Celoron a pleasant task and every completed receiver makes a strikingly beautiful appearance. The first one, after three years' hard use, still looks like new.

"I wish I could tell every experimenter to begin building his set in the right way by using the best obtainable panel—and that is Celoron."

CELORON

A Bakelite Material

For set builders we have a special free booklet, "Getting the Right Hook-Up with Celoron." It contains valuable hints for set builders. Write to Department 4 A for your copy.

Diamond State Fibre Company

Branches in Principal Cities

Bridgeport, Pennsylvania

Toronto, Canada London, England

Please refer to POPULAR RADIO when answering advertisements.

CROSLEY

Announcing — The New Models — each a leader in its line



Crosley Trirdyn 3R3, \$65.00



Crosley Trirdyn 3R3 Special, \$75.00



Crosley 51, \$18.50



Crosley 51-P Portable, \$25.00



Crosley 52, \$30.00



Crosley 51-A, \$14.00



Crosley 50, \$14.50



Crosley 50-A, \$18.00

**One of these Crosley Models
will satisfy every pocketbook,
every purpose and every taste**

Read the next page carefully, you will find the Radio Receiver to please you. Your satisfaction is guaranteed by the fact that Crosley manufactured and sold more Radio Receiving Sets, in the past year, than any other manufacturer in the world.

For Sale by Good Dealers Everywhere

Write for descriptive circular

The CROSLEY RADIO CORPORATION

POWEL CROSLEY, Jr., President

716 Alfred Street, Cincinnati, Ohio

Licensed under Armstrong
U. S. Patent No. 1,113,149

Crosley Owns and Operates
Broadcasting Station W L W

CROSLEY
Better - Cost Less
Radio Products

CROSLEY

Announcing — The New Models — each a leader in its line

Guaranteed Satisfaction at a Reasonable Price

CROSLEY 50 A new one tube Armstrong Regenerative Receiver. We believe this to be the most efficient one tube receiver ever put on the market. Like our present Model V, which it supersedes, it will bring in, under average conditions, on headphones, broadcasting stations at a distance of one thousand miles or more. Uses any standard storage battery or dry cell vacuum tube. **Price \$14.50.**

CROSLEY 50-A A new two stage Audio Frequency Amplifier to match the new Model 50 receiver. This unit is equipped with a filament switch for shutting off the current from the "A" and "B" Batteries. When used in connection with the Crosley Model 50 Receiver, it gives the equivalent of a three tube regenerative receiver. **Price \$18.00.**

CROSLEY 51 In twenty-four days this receiver became the biggest selling radio receiving set in the world and it holds that position to-day. It uses two standard storage battery or dry cell tubes, regenerative detector and one stage of audio frequency amplification. Will bring in local stations on the loud speaker at all times, and under average conditions will also bring in distant stations on the loud speaker. **Price \$18.50.**

CROSLEY 51-A A new one stage Audio Frequency Amplifier to match the Model 51 receiver. When used in connection with the Crosley Model 51 Receiver it gives the equivalent of a three tube regenerative receiver. **Price \$14.00.**

CROSLEY 52 A new three tube Armstrong Regenerative Receiver, has phone jack to plug in on two tubes and filament switch to turn off the "A" and "B" Batteries. It is unusually efficient, will provide loud speaker volume on distant stations under practically all conditions, and is in every way an ideal receiver for the home. **Price \$30.00.**

CROSLEY 51-P This is our new portable set. It is the Crosley Model 51 two tube receiver mounted in a leatherette covered carrying case, has a compartment for a pair of headphones and one to hold an ample power plant for the popular dry cell vacuum tubes. This receiver can be used as a stationary set in the home or as a portable. **Price \$25.00.**

CROSLEY TRIRDYN 3R3 This three tube receiver gives the efficiency and volume of a five tube receiver. Incorporating Radio Frequency Amplification, Regenerative Detector with one stage of Reflexed and one stage of straight Audio Frequency Amplification. Can be calibrated accurately—stations logged and returned to at will. Used on outdoor or short indoor antenna and is, we believe, the most efficient and sharpest tuning receiver on the market at any price for bringing in long distance stations. **Price \$65.00.**

CROSLEY TRIRDYN 3R3 Special This receiver is exactly the same as the Trirdyn 3R3 except the solid mahogany cabinet is larger, and more handsomely designed to harmonize with the most beautiful furniture settings. There is sufficient space inside for all the "A" and "B" Batteries required when standard dry cell tubes are used. **Price \$75.00.**

For Sale by Good Dealers Everywhere

Write for descriptive circular

The CROSLEY RADIO CORPORATION

POWEL CROSLEY, Jr., President

716 Alfred Street, Cincinnati, Ohio

Licensed under Armstrong
U. S. Patent No. 1,113,149

Crosley Owns and Operates
Broadcasting Station W L W

CROSLEY
Better - Cost Less
Radio Products



The dignified simplicity, sturdy lines, fine workmanship and beautiful finish of Table No. 81—appeal to every one who loves fine furniture. Cabinet contains space for two "A" batteries and one "B" battery—hook for headphones and magazine rack. Four insulated holes are provided at the rear for lead-in wires. Top measures 36x20 inches. Guaranteed to support weight of over 200 pounds. Choice of plain solid oak—or hardwood (birch) in mahogany or walnut finish.

Send no money

JUST mail the coupon below—and pay the expressman, \$22, on delivery, plus the small express charge. Save by buying direct from the manufacturers. Absolute satisfaction guaranteed.

SALISBURY BROS. FURNITURE CO.
Randolph, Vt.

Salisbury Radio Table

Mail this coupon today

SALISBURY BROS. FURNITURE CO.
Dept. B-1, Randolph, Vermont.

Send the Salisbury Radio Table, No.81, finished in (check).....solid oak, (check)..... mahogany finish, (check)..... walnut finish. I will pay the expressman \$22 and expressage on delivery.

Name.....

Address.....

City.....

LIBERTY Super-Heterodyne Kit #R-40

\$27.50

Containing
1 Special Input Transformer
3 Intermediate Wave Transformers
1 Oscillator Pick-up Coil
1 By-Pass Condenser. Complete plans, drawings and specifications

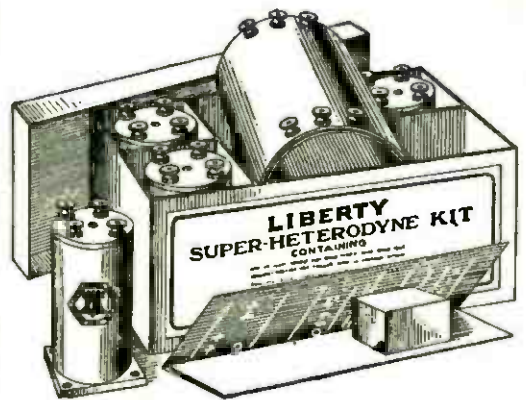

The home builder who uses the Liberty Kit in his super-heterodyne is assured of exceptional, satisfactory results.

The Liberty Kit contains complete plans, drawings and specifications to easily build this masterpiece receiver—the receiver that is unsurpassed for selectivity, distance records, and simplicity in tuning.

The heart of the super-heterodyne is the transformers. Use parts contained in the Liberty Kit and be sure of results. Fully guaranteed.

Ask your dealer, or order direct, sending us your dealer's name—send no money—pay postman.

Descriptive circular on request

LIBERTY ELECTRIC CORPORATION
Department 101

Stamford

Connecticut



Write for
a copy
today

A new twenty-four page booklet will be sent, gratis, to those interested in building their own receiving sets.

A simplified method of construction is described. Illustrations and diagrams.

On Request

EISEMANN MAGNETO CORPN.

WILLIAM N. SHAW, President

165 BROADWAY, NEW YORK

Stop Amplifying Static!

GET good radio results all summer! Take advantage of the better receiving sets—of the better broadcasting.

And use N & K Imported Phones.

Because N & K Phones, used with detector unit alone, bring in the entire range of broadcasting—both high and low tones—with utmost clearness, without exaggeration of interfering noises.

Recent laboratory tests made with N & K Phones showed a *maximum audibility over the wide range of 300 to 6000 cycles*. We believe this to be the widest range of any phone made.

Most radio users this summer will *stop amplifying static* by giving their loud speakers a rest. If they use N & K Phones, the amazing clearness of N & K reception will permit them to suppress static and get the full effect of the broadcasting.

Take home a pair of N & K Phones today and be your own judge. Any authorized N & K dealer will sell you a pair on our money-back guarantee basis. If your dealer is not yet supplied, order from us direct.

N & K Head Set—Model D

4000 ohms, has extra large diaphragms, which give greater clearness and greater comfort. Neat, leather-covered head bands. Six foot cord. Sold under Guarantee: "Your money back if N & K Phones do not give clearer, mellower, more natural tone and fit more comfortably." Price \$8.50. Send for free folder—"The Phones the Fans Are All Talking About."

DEALERS:

Put an N & K Head Set into the customer's hands and tell him to try it. N & K will do the rest! N & K is backed by widespread advertising which goes direct to radio fans all over America. Display N & K Phones and you cannot fail to cash in on this advertising. Packed in cartons of ten. Ask your jobber.

TH. GOLDSCHMIDT CORP.

Dept. P7

15 William Street

New York



Please refer to POPULAR RADIO when answering advertisements.

THE NATIONAL PERFECT VERNIER CONDENSER

Minimum
Loss
Maximum
Signal
Strength

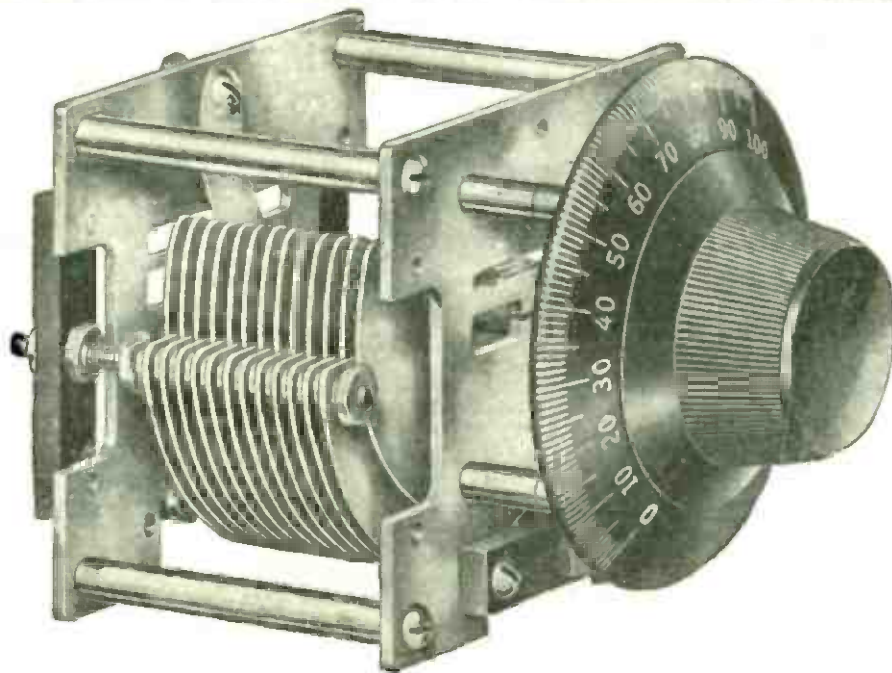

Sizes and Prices	
.001	\$7.00
.0005	6.00
.00035	5.75
.00025	5.50

TYPE DX

A low loss Condenser with a "VELVET VERNIER"

Tested and approved by a number of the country's leading Radio Engineers, and used successfully in Reflex, Radio Frequency, Neutrodyne and Super-Heterodyne Circuits. Write for bulletin 104A

MANUFACTURED BY

NATIONAL COMPANY, Inc., Engineers and Manufacturers
 106 Brookline Street Established 1914 Cambridge, Mass.

from the RB laboratory

This 52 page Book describes how to make
9 KNOCKOUT Radio Receivers

50c

B. R. Linton, Hapeville, Ga., using the 1-tube Knockout set described in this book, hears KFI, Los Angeles and many other distant stations regularly on his loud speaker.

YOU, too, can build a Knock-out distance-getter. This book tells you how! No "trick" circuits; each of the sets has been built and tested in the Radio Broadcast laboratory -- where all new circuits are tried out--under the personal direction of Arthur H. Lynch. The 9 Knock-out sets described in this book were chosen because of the exceptional results obtained with them by hundreds of Radio Broadcast readers. You can buy all of the parts from your nearest dealer.

The first edition of Radio Broadcast's Knock-out series was sold in less than 10 days. The second edition--more data, more photographs--is going fast. If your dealer cannot supply you, use the coupon today. If dissatisfied we will refund your money.

RADIO BROADCAST, Doubleday, Page & Co.,
 Garden City, N.Y.

I enclose 50 cents in payment for a copy of Radio Broadcast's Knock-Out Series to be sent to

P. R.

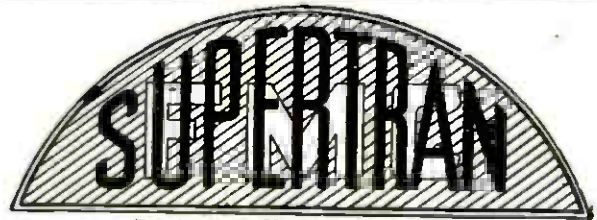

Registered U. S. Patent Office

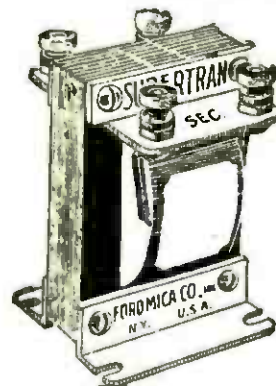

VOLUME

The Supertran TALKS while other transformers whisper! The reason for its enormous sound magnification lies in the skillful engineering design -- the result of years of intensive research and study.

Price \$6.00

Clarity
 Distance

These transformers are specially designed for the Neutrodyne and Reflex circuit.

Can be used with any amplifying tube on the market with excellent results.

Eastern Distributor
 Wetmore-Savage Company, Boston
 West and Southwestern Distributor
 Beckly-Ralston Co., Chicago

Manufactured by
FORD MICA COMPANY, Inc.
 33 East 8th Street New York

“THE CHOICE OF RADIO EXPERTS”

Specially Designed

For the
Superheterodyne
and Long Wave
Reception

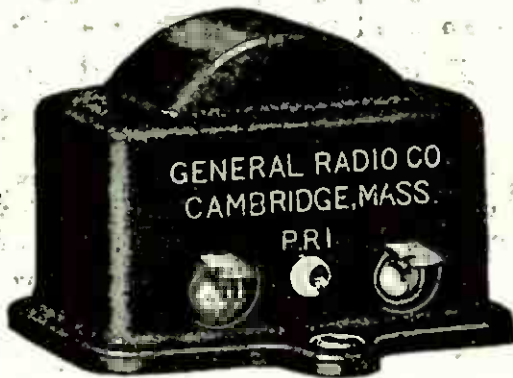

Shielded
Electrostatically
and
Electromagnetically

Type 271 Medium Frequency Transformer

Amplification of wavelengths around 10,000 meters falls between the ranges of radio and audio frequencies. It, therefore, requires a transformer materially different in design from radio or audio frequency transformers. The type 271 M. F. Transformer is specially designed to meet the specific requirements of medium frequency amplification. For use in the Superheterodyne and in long wave reception it is unequalled.

It is shielded electrostatically and electromagnetically. Very compact and rugged. An instrument of high electrical efficiency.

Price, \$5.00

GENERAL RADIO COMPANY
Manufacturers of
Electrical and Radio Laboratory Apparatus
CAMBRIDGE, MASS.

Write *TODAY* for descriptive bulletin 918U

GENERAL RADIO Co

Cambridge, Mass.



Please refer to POPULAR RADIO when answering advertisements.



Every Radio Fan Should Have This Book

LIKE a little radio encyclopedia, this I. C. S. Radio Handbook is packed with concise, sound information useful to everybody from beginner to veteran hard-boiled owl. It starts with simple explanations of radio phenomena and leads you along gently until you can understand the most technical diagram.

You may dip into it at random, or hunt up special information you want, or read it right through. Different types of receiving and sending hook-ups are explained; electrical terms and circuits; antennas; batteries; generators and motors; electron (vacuum) tubes; interesting experiments; definitions, and thousands of suggestions for getting more pleasure out of radio.

A pocket course in radio!

Every page tells you something useful, and there are 514 pages; hundreds of illustrations and diagrams. It is the biggest dollar's worth in radio, and will save you from wasting money on things that don't work.

Send \$1 to-day and get this 514-page I. C. S. Radio Handbook before you spend another cent on parts. Money back if not satisfied.

Price Only



514 pages
Pocket Size

Compiled by
HARRY F. DART
E.E.

Formerly with
the Western
Electric Co.,
and U.S. Army
Instructor of
Radio.

Technically
edited by
F. H. DOANE

-----TEAR OUT HERE-----

INTERNATIONAL CORRESPONDENCE SCHOOLS
Box 8253-C, Scranton, Penna.

I enclose One Dollar. Please send me—post-paid—the 514-page I. C. S. Radio Handbook. It is understood that if I am not entirely satisfied I may return this book within five days and you will refund my money.

Name.....

Address.....

Benson Portable Superflex

Most Efficient Two-tube Set in the World

\$49.50
without
accessories.

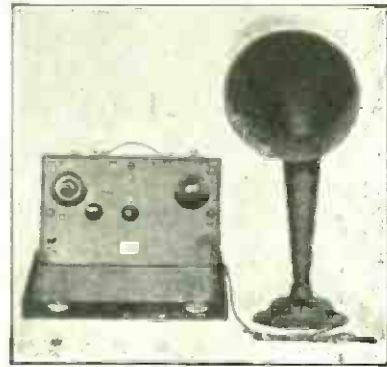

\$74.50
including
2-301A
tubes, 90v.
"B" batteries,
1 pair
head-
phones, 4
Dry cells,
Aerial
equipment

Patent Applied For

This set employs the famous Benson Reflex Transformer which provides uniform amplification on all frequencies corresponding to wave-lengths from 200 to 650 meters.

Very light weight. In leatherette case. Requires no permanent aerial, ground or loop for local stations—long range on loudspeaker.

Take it with you on all trips, use it in your hotel room, on vacation, any time, anywhere.

During a recent test by radio engineers, 43 out of town stations were brought in loud and clear.

Order at once, insuring prompt delivery

BENSON ENG. CO.
2125 HALSTED ST. CHICAGO, ILL.

KING QUALITY

ALL THE NAME IMPLIES

RADIO APPARATUS



Inductance
Switch

Black or
Mahogany
Bakelite

THE KING QUALITY LINE:

Adapters	Dials	Rheostats
Bakelite Knobs	Inductance-Switches	Switch Levers
Binding Posts		Vacuum Tube-Sockets
Contact Points	Panel Mountings	

RADIO DIVISION
KING SEWING MACHINE CO.
BUFFALO NEW YORK



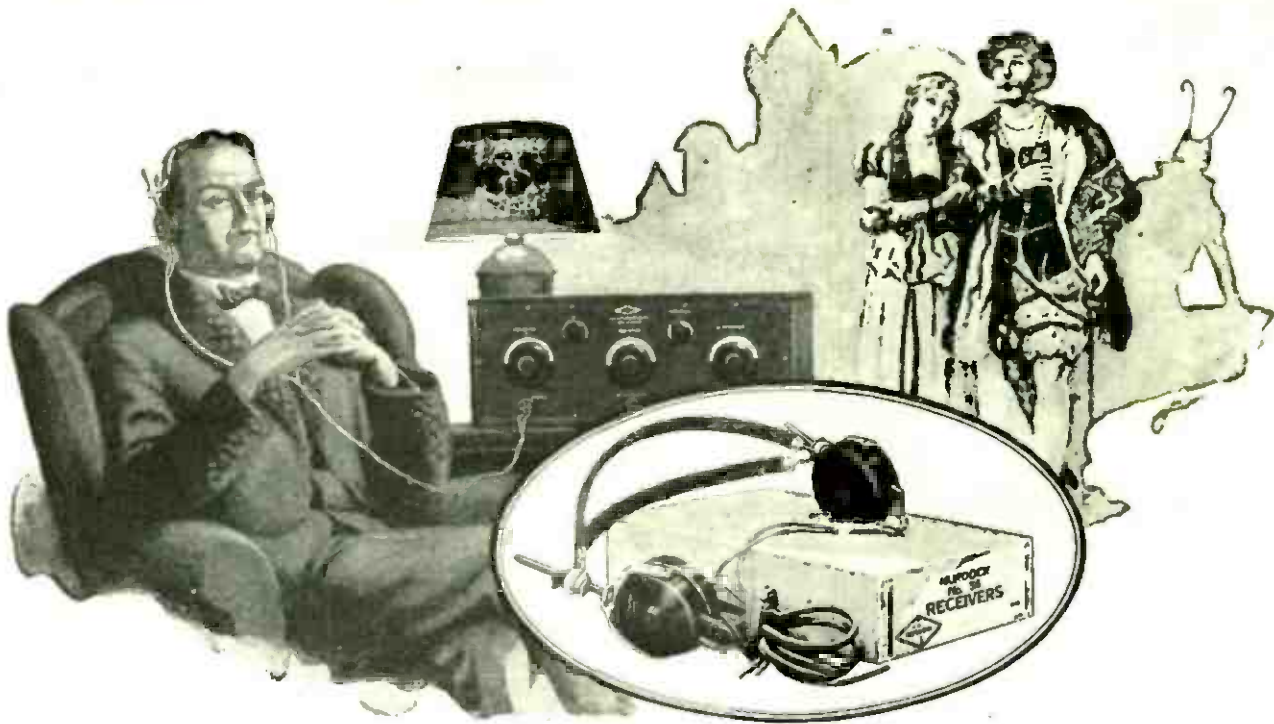

Get a "close up" of the radio stage with Murdock Radio Phones

H EADPHONES are your ticket to the Theatre of the Air. If you make a poor selection, you'll find yourself in the rear row of the balcony, straining to catch the fun on the radio stage. Voices and music sound "over the hill and far away."

Plug in a pair of Murdock Radio Phones—and note the difference. It's just like being in fifth row center. High and low notes, loud and soft tones—come in round, mellow and true.

High efficiency

THE fine acoustical qualities embodied in Murdock's permit the user to receive distant signals with great volume and clearness. Powerful magnets and sensitive diaphragms—correctly seated and clamped—are important features in the success of Murdock Radio Phones.

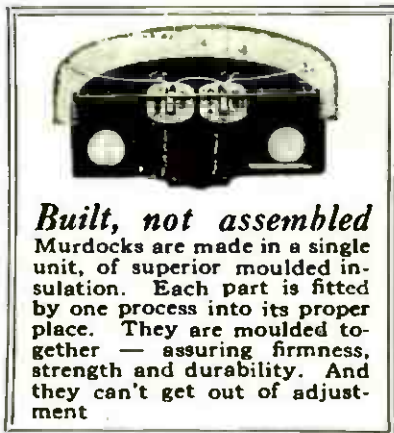

Built, not assembled
Murdocks are made in a single unit, of superior moulded insulation. Each part is fitted by one process into its proper place. They are moulded together—assuring firmness, strength and durability. And they can't get out of adjustment.

Light and comfortable

MURDOCKS are noted for their comfort. They are very light in weight. The new improved flat headband does not bind the head. Ear caps cover the ears and exclude outside noises. As a result of these features, you can wear Murdock's for hours without discomfort or fatigue.

When you compare the high efficiency of Murdock's, with their very moderate price—you'll be convinced that they

are the best 'phone value on the market. Get a pair of Murdock's to-day and test them out. They are fully guaranteed.

Murdock Neutrodyne

ASSURES the utmost in selectivity, distance, volume and clarity. See this beautiful set at your dealer's. (Illustrated above.)

WM. J. MURDOCK COMPANY, 375 Washington Avenue, Chelsea, Mass.
Branch Offices: Chicago and San Francisco

MURDOCK RADIO PHONES

Standard since 1904

—MAIL COUPON FOR FREE BOOKLET—

Wm. J. Murdock Co.
375 Washington Ave., Chelsea, Mass.
Gentlemen: Please send me, without obligation, your free booklet, "The Ears of Radio," which explains the importance of radio 'phones to efficient radio reception.

Name

Street

City State

Please refer to POPULAR RADIO when answering advertisements.

ULTRA HANDY CHARGER

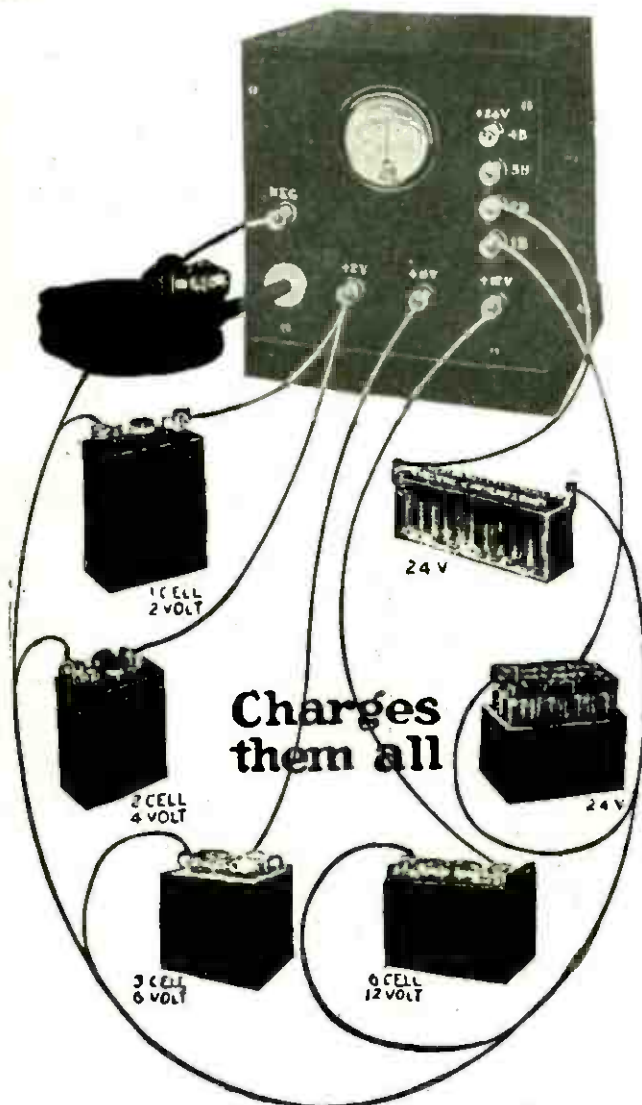

ULTRA MODEL **\$18.00**
f. o. b. ST. LOUIS

Note

"Handy Charger" Features

- No bulbs to break.
- No acids to spill.
- No fast-wearing parts.
- No auxiliaries necessary.
- No sticking contacts.
- No wood used—Fireproof.

The most complete, most flexible and quickest battery charger on the market at any price. Will charge every radio and automobile battery in the one machine. Furnished complete with a precision *Weston* Ammeter. Beautifully finished Case—automatic in operation. Costs less than 1 cent per hour to run. Ask your dealer. Illustrated descriptive folder on request. Write us.

INTERSTATE ELECTRIC CO.
of St. Louis, Mo. 4339 Duncan Ave.

TRI-JACK

BUILD your set with TRI-JACK and you will eliminate jack troubles. TRI-JACK is the most notable improvement in jacks so far.

TRI-JACK is super-compact (Bakelite 1" x 1"), dustproof, solderless, and it combines both the single and double circuit jack in one. Ask your dealer to show you one!

\$1.25

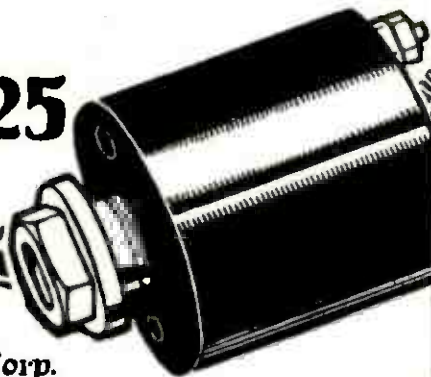

BROOKLYN METAL STAMPING Corp.
718 Atlantic Avenue, Brooklyn N.Y.

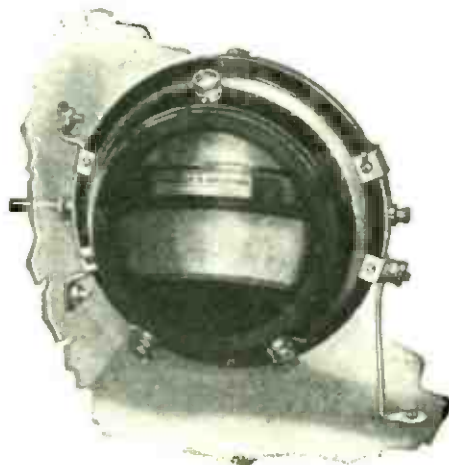

Amplify with

LANGBEIN & KAUFMAN TUNED RADIO FREQUENCY VARIOTRANSFORMERS

TYPE VT25 LIST \$8.50

Connected same as a fixed radio-frequency transformer, but continuously adjustable to the peak of the wave.

MAXIMUM AMPLIFICATION AT ALL WAVE LENGTHS

SEND FOR DIAGRAM #101

THE HOME OF MOULDED TUNER SPECIALTIES

LANGBEIN & KAUFMAN

654 Grand Avenue

NEW HAVEN

CONN.

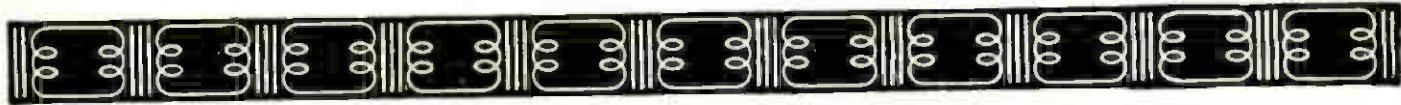

Voices across the sea

Special service transformer at Radio Central, Rocky Point, L. I.—300 k.v.a., 60-cycle, 3-phase, 22,000 volt, oil-cooled: made by American Transformer Company.

By courtesy of Western Electric Co.

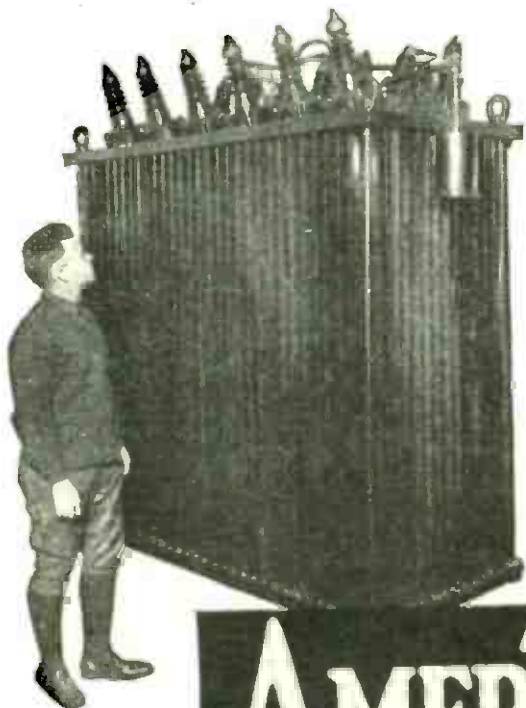

Used in the recent successful demonstration of

Talking to Europe



An important element in the receiving sets which were successful in

Receiving from Europe

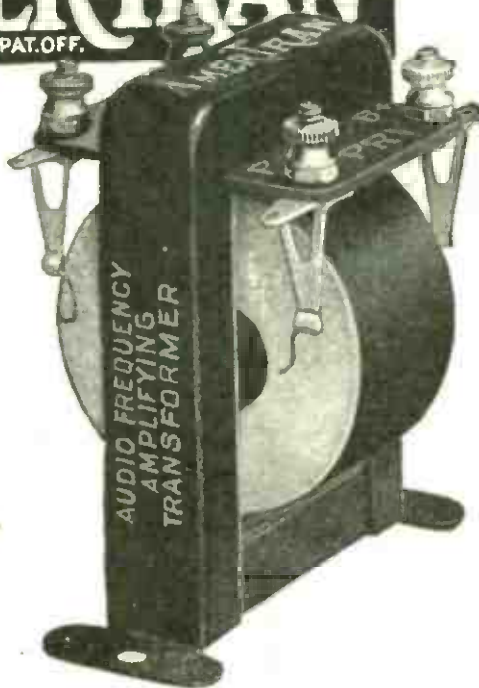

Now made in two types: AmerTran AF-6 (Turnratio 5)—for first stage; AmerTran AF-7 (Turnratio 3½)—a companion transformer for use in further stages when AF-6 is used in the 1st stage.

Price, either type \$7.00 at your Dealer's

American Transformer Company

Designers and builders of radio transformers for over 23 years

175 EMMET STREET

NEWARK, N. J.



CICO

STANDARD RADIO PARTS

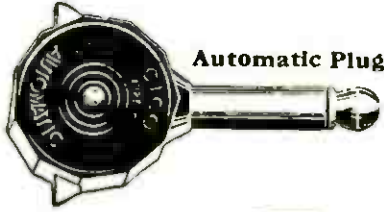

Automatic Plug

CICO AUTOMATIC PLUG—Gives instantaneous connection. A slight pressure on the wings with thumb and index finger releases tips for change. Nothing to take apart—no tools—no set screws. Bakelite body. Metal parts nickel-plated. Takes all tips. Price 80c.



Bakelite Jack

CICO BAKELITE JACK—No soldering necessary. Connections made to neat binding posts. Moulded completely from bakelite. No metal in frame construction. Short springs of special phosphor bronze. Sterling silver contact points. Scientifically perfect in every detail. Exceptional value.

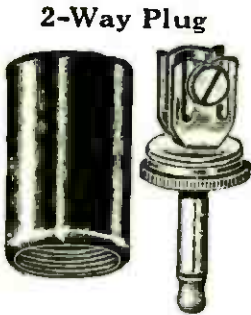

2-Way Plug

CICO 2-WAY PLUG—Two sets of headphones or loudspeaker and one set of phones may be connected simultaneously. Fits all standard jacks. Takes all types of tips. Price 60c.

No. 30—Single circuit open .80
 No. 31—Single circuit closed .85
 No. 32—Double circuit .90
 No. 33—"A" Battery Switch .90

Every CICO PRODUCT is packed in a distinctive GREEN BOX and unqualifiedly guaranteed against all defects.

Consolidated Instrument Co. of America, Inc., 41 East 42nd St., New York

ARROW BATTERY SLASHES Prices

Prices Smashed!

Quality Not Sacrificed

Here is real battery quality, guaranteed to you, at prices that will astound the entire battery-buying public. Order direct from factory. Put the Dealer's Profit in your own pocket. You actually save much more than half, and so that you can be convinced of true quality and performance, we give a

Written Two-Year Guarantee

Here is your protection! No need to take a chance. Our battery is right—and the price is the lowest ever made. Convince yourself. Read the prices!

- Special 2-Volt Radio Storage Battery, \$3.75
- Special 4-Volt Radio Storage Battery, 6.00
- 6-Volt, 60 Amp. Radio Storage Battery, 7.00
- 6-Volt, 80 Amp. Radio Storage Battery, 8.00
- 6-Volt, 100 Amp. Radio Storage Battery, 9.50
- 6-Volt, 120 Amp. Radio Storage Battery, 11.50
- 6-Volt, 140 Amp. Radio Storage Battery, 13.00

We ask for no deposit. Simply send name and address and style wanted. Battery will be shipped the day we receive your order Express C. O. D., subject to your examination on arrival. Our guarantee accompanies each battery. We allow 5% discount for cash in full with order. You cannot lose! Act quick. Send your order today—NOW.

Arrow Battery Co.
 1421 South Wabash Ave.
 Dept. 7 Chicago, Ill.



Why miss Stations? TUNE THEM IN WITH The "EZTOON"

Station wave lengths are so close together that unless you can tune extremely close you lose all of them.

Super Heterodyne owners put one on your heterodyne and oscillator condensers. Tuning will have a new meaning.

On Neutrodyne using three "Ezytones" gives unbelievable results.

No drilling; take off present dial and slip on "Ezytone." Done in a second.

Sold under positive money back guarantee.

Ask your dealer. If he cannot supply we will ship parcel post, prepaid.

Jobbers, Manufacturers, write for discounts.

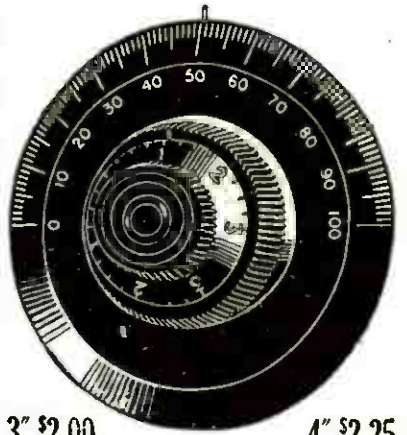

3" \$2.00

4" \$2.25

Two dials in 40 to 1 ratio. Has no cog gears. No back lash and turns as smooth as glass. Gives Vernier adjustment to Variocouplers, Variometers, Condensers, Potentiometers, Rheostats, etc.

BUTLER MANUFACTURING CO.
 3236 W. Washington St., Indianapolis, Ind.



FADA

Transformers and Variable Condensers

FADA
Audio Frequency
Transformer
No. 171-A, \$6.00

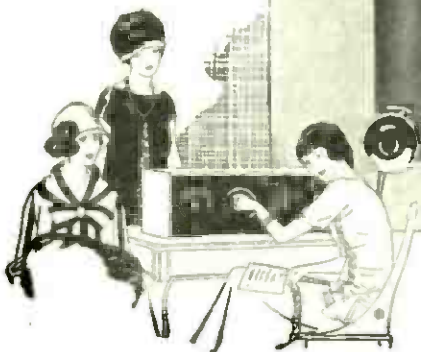

FADA
Variable Condensers
No. 142-A (15
plates .0003 mfd)
\$3.00
No. 144-A (23
plates .0005 mfd)
\$3.50

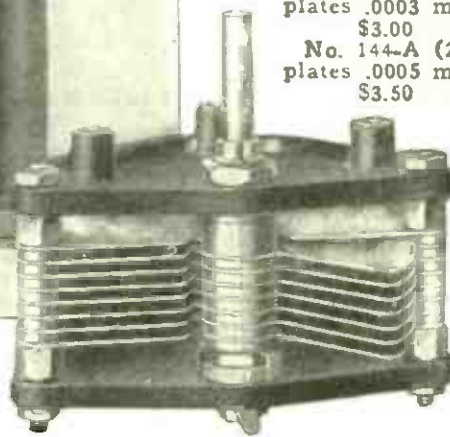

More volume—finer tuning

POOR condensers absorb radio power—that cuts down volume. Poor condensers add resistance—that broadens tuning. You can sharpen your tuning, increase selectivity and get greater volume with the new FADA "low-loss" variable condensers. Use them. The low power factor and low equivalent series resistance prove their superiority. FADA "low-loss" condensers are more efficient than many so-called precision condensers and have a capacity ratio of 40 to 1 as compared with 30 to 1 usually encountered. Two sizes—No. 142-A (15-plate .0003 mfd) at \$3.00 and No. 144-A (23-plate .0005 mfd) at \$3.50.

Performs as well as it looks

The new FADA Audio Frequency Transformer is encased in bakelite with nicked binding posts and soldering lugs. It looks "quality" all over. And it performs up to its appearance. It has a high average amplification over all the broadcasting wave-bands and reproduces voice and music with a volume and tonal fidelity that is surprising. A wonderful addition to the audio frequency stages of Neutrodyne receivers and equally efficient in other types. This new transformer, No. 171-A, is made possible by correct FADA engineering principles and by uniform production methods. Ratio 4 to 1. Price \$6.00.

Ask your dealer for FADA Transformers and Variable Condensers

F. A. D. ANDREA, INC., 1581 Jerome Avenue, New York



BAKELITE

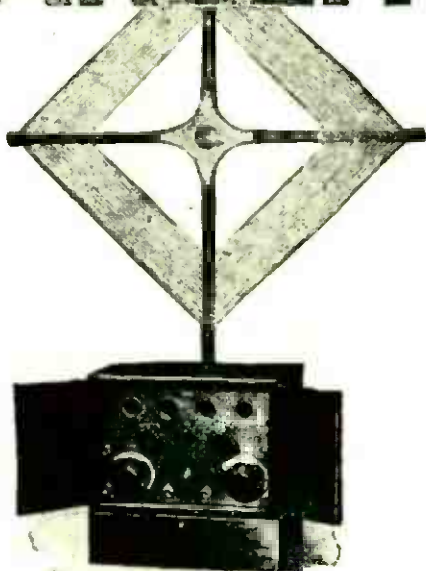

DeForest and Bakelite

Bakelite is standard insulation on all DeForest Radiophones — from panels to transformer covers. The effective protection afforded by Bakelite is a strong factor in the success of these well known radio sets.

Good insulation must have mechanical strength and rigidity, chemical inertness, heat and water as well as electrical resistance and, last but not least, durability. Bakelite possesses all these characteristics in a very high degree.

The fact that practically every radio manufacturer uses Bakelite is an excellent endorsement of its value for radio insulation.

Write for a copy of
our Radio Booklet K

BAKELITE CORPORATION

247 Park Avenue, New York, N. Y.
Chicago Office: 636 West 22d Street



Send for our
Radio Map

Enclose 10c and let us send you the Bakelite Radio Map. It lists the call letters, wave length and location of every broadcasting station in the world. Address Map Department.

THE MATERIAL OF A THOUSAND USES

NOTED EXPERIMENTERS Make This Their Headquarters FOR HARD-TO-GET-PARTS-IN-STOCK

COCKADAY DISTORTIONLESS AMPLIFIER

Bradley ohm No. 25.....	2.00
Amertran transformers 5 to 1 Ratio.....	7.00
Como Push & Pull—1 pr. in kit..... pair	12.50
Quinby Radio Frames—2 in kit..... each	1.00
Celatsite wire 30 inch lengths—5 in kit..... each	.25

Kit consisting of above parts, 21.50

CRAIG NEUTRODYNE

Parts for Craig coupler and radio frequency transformer.....	3.25
Cardwell .0005 mfd. 21-Plate Condensers.....	5.00
Cardwell .001 mfd. 41-Plate Condensers.....	6.00
Cardwell .00025 mfd. 11-Plate Condensers.....	4.25
General Radio transformer 3½ to 1 ratio.....	5.00

Kit consisting of above parts, 20.50

FOUR CIRCUIT IMPROVED TUNER

Complete set genuine Cockaday coils..... each	5.50
Amplex griddensers—2 in kit..... each	1.25
48000 ohm Lavite Resistances—3 in kit, each	1.50
Durham Variable grid leak.....	.75
26-Plate Amesco vernier Condensers with dials—2 in kit..... each	4.50

Kit consisting of above parts, 18.50

NATIONAL CONDENSERS

All parts are exactly as those used by designers in the original hook-ups

Try us on ANY radio parts you have been unable to secure. C. O. D. mail orders will be shipped promptly.

Morison Electrical Supply Company

Wholesale and Retail

15 East 40th Street

New York City

EASTERN COUPLER

and Inductance

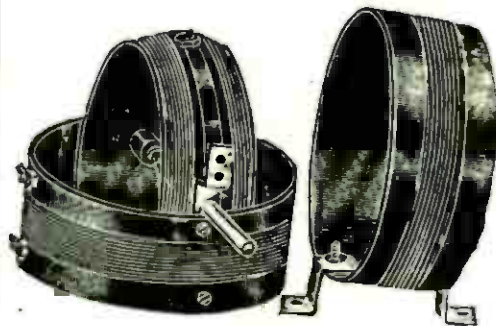

Price
\$6.00

An
Unrivalled
Value

100% EFFICIENT for the

SUPERDYNE CIRCUIT

This circuit, which uses only four tubes, is the ONLY RIVAL of the SUPER-HETERODYNE and surpasses all other circuits for all around efficiency.

Radio engineers all endorse the EASTERN COUPLER for maximum results with the Superdyne Circuit.

Wound with double silk wire on genuine bakelite tubing, with moulded rotor.

This circuit is less expensive to construct than most 3 tube sets.

Picture hook-ups and material list FREE with each coupler.

KIT OF COMPLETE PARTS

For 4 Tube-Set,

With Drilled Panel, Base-Board.

All high-grade parts, \$35.00
and picture hook-up

Mail Orders Filled. Dealers Communicate.

EASTERN COIL CORP.

22 Warren St.

Dept. PR.

New York, N. Y.

"THE MUSICIAN OF THE AIR"

Evenly in every direction—to every corner of the room—Atlas reproduction sends a clear, rounded, faithful tone.

This is true—with Atlas—regardless of what set you use, regardless of what conditions may be, regardless of what type of program you are receiving. For since these things do vary, Atlas reproduction is provided with a simple adjustment to compensate for variation in receiving conditions.

On local or DX stations, on two tubes or eight, on voice or instrumental music, Atlas floods the room with the best that's in your set. Responsible dealers everywhere sell Atlas speakers for \$25.00.

Multiple Electric Products Co., Inc.
36 Spring St., Newark, N. J., Dept B
Boston, Philadelphia, Baltimore, Pittsburgh,
Detroit, Chicago, St. Louis, Denver.
550 Howard St., San Francisco.

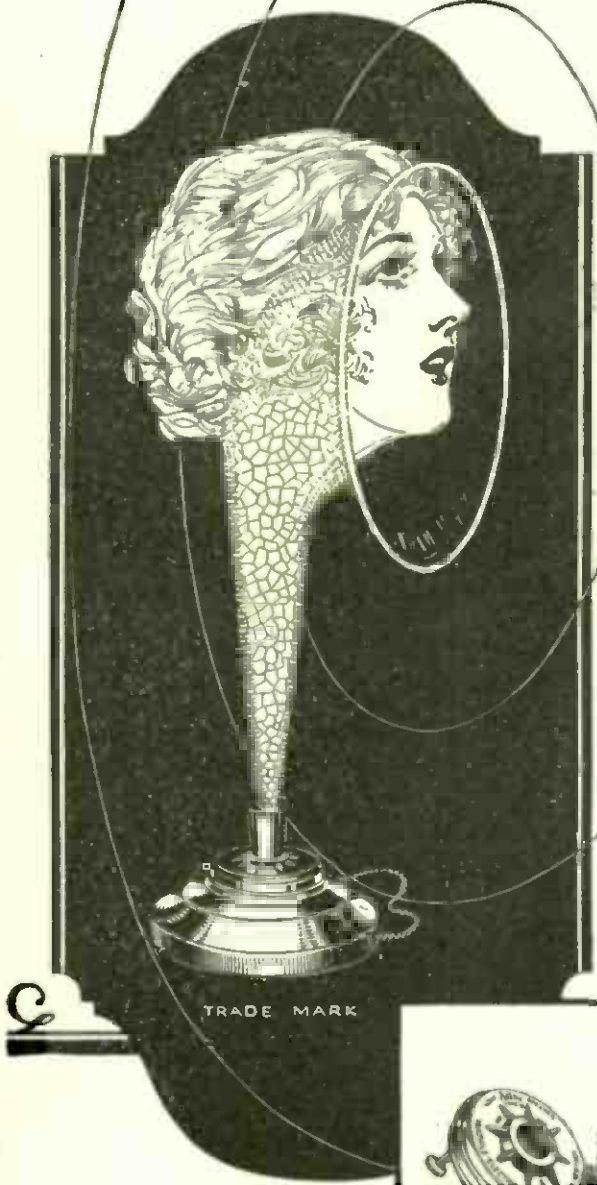

Atlas
TRADE MARK
RADIO REPRODUCTION
Speaker



With the Atlas coupling complete for \$13.50, any standard phonograph may be utilized to produce Atlas reproduction.



More Money For You in **RADIO**

THE amazing expansion of Radio has opened up hundreds of wonderful new positions on land and sea. Big salaries, fascinating, easy work, short hours, and a wonderful future are offered to ambitious men who get into Radio now.

Take advantage of these wonderful opportunities to step into a big paying position in this great new field. Radio offers you an opportunity to travel and see the world, with all expenses paid, and a fine salary besides. Or you can stay at home and work up to a position paying up to \$10,000 a year. One of our recent graduates secured a position one week after graduating, paying a salary of \$300 per month. Hundreds of others report equal success.

Easy to Learn Radio at Home

Hundreds of men are already earning handsome incomes in this wonder science. If you want to get into a profession where opportunities are unlimited make Radio your career—become a Certified Radio-trician.

Thousands of Certified Radio-tricians are wanted to design Radio sets; to make new Radio improvements; to manufacture Radio equipment and to install it; to maintain and operate great broadcasting stations and home Radio sets; to repair and sell Radio apparatus; to go into business for themselves; to operate aboard ship and at land stations.

You can easily and quickly qualify in your spare time at home through the help of the National Radio Institute, first school to teach radio successfully by mail, established 1914. No previous experience or training needed. Prominent Radio experts will help you. FREE, with course—circuits and parts for building latest receiving set also, three instruments are loaned to students, making the work thoroughly practical. The same plan that has already helped hundreds of our graduates to real success and real money in Radio is open to you.

Send for **BIG BOOK**

No other field today offers such great opportunities as Radio. Take your choice of the many wonderful openings everywhere. Prepare now to step into the most interesting and best paid profession today. Read about the opportunities open now—the different kinds of work—the salaries paid. Write today for the 32-page book that tells how America's first and biggest Radio school can teach you to become a Certified Radio-trician in your spare time. Mail the coupon or write a letter NOW. National Radio Institute, Dept. 32GA, Washington, D. C.

National Radio Institute, Dept. 32GA
Washington, D. C.

Without obligation send me your book, "Rich Rewards in Radio," which tells all about the opportunities in Radio, how spare time study at home will qualify me quickly as a Certified Radio-trician so I can get one of the splendid positions, and how your Employment Service helps me to secure a big pay job. Please write plainly.

Name.....Age.....
Street.....Occupation.....
City.....State.....

Around the World!



(1/2 size)

A New Zealand amateur got Alabama (10,000 miles) on one Myers Tube—heard the signals and message perfectly. Reported by Radio News.

This remarkable performance indicates that there is no limit to long-distance reception with Myers Tubes because their design is right.

MYERS TUBES

Practically
Unbreakable

\$5

add to the efficiency of any set by cutting out noise, tube hiss and interference. Two types: Dry Battery and Universal (for storage battery).

Insist on Myers Tubes—at reliable dealers—otherwise send purchase price and be supplied postpaid.

EACH. Complete with clips ready to mount; no other equipment necessary.

E. B. Myers Co., Ltd.
Radio Vacuum Tubes
240 Craig St. W., Montreal, Canada

A C H LONG DISTANCE ONE TUBE SET

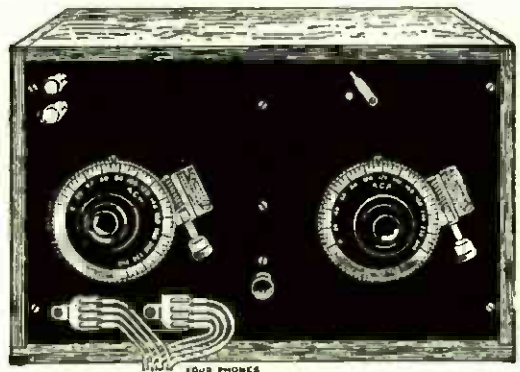

\$17.50 Mail Orders Only

Price includes Case and Parts, all mounted, ready to wire. No Solder. For Dry Cell Tube.

Including

2 A. C. H. Sharp Tuners.....\$5.00
2 A. C. H. 4-Phone Connectors.....25

NOTE—\$2.00 must be sent with
C. O. D. Orders

YES—Use the Wonderful A C H
Sharp Tuners

A. C. Hayden Radio & Research Co.
25 E. Battle St., Brockton, Mass., U. S. A.

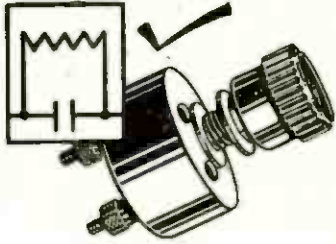

Probably nowhere else in your set, can you accomplish so much for \$1.50, as you can by investing it in the even, step-less, super-critical grid control, supplied by the new MAR-CO variable grid leak. Two types, 1/5 to 5 meg-ohms, and 15,000 to 100,000 ohms

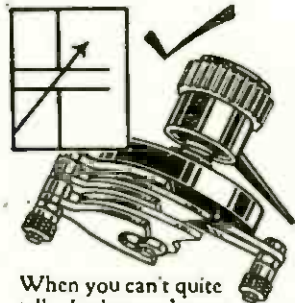

When you can't quite tell whether you've got it or not, the MAR-CO super-vernier condenser lends enough added sharpness to your tuning to make sure! A precision instrument of striking beauty, for \$1.25.

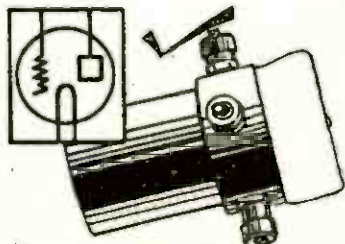

Expensive tubes deserve good sockets! The MAR-CO UV 100 socket costs but one dollar, and its pressure contacts do away with energy losses you might never suspect! Single mounting screw and felt cushion supplied!

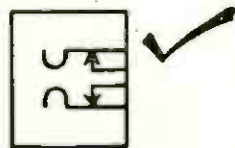

Any MAR-CO plug, with a SHUR-GRIP jack, is ample assurance that all the energy in your set . . . actually gets to your speaker! SHUR-GRIPs are the famous MAR-CO jacks with the hooked terminals for easy, leak-proof, permanent connections!



LOST a DX station

yet a few seconds might have saved it!

HE HAD IT . . . he knew it was a record . . . but he couldn't quite make out the call letters.

The energy reached his set . . . but leaked away before it got to his phones!

"Leaked away"—thru' poor connections, thru' indifferent quality, in some small part he "didn't think was important"!

Yet a few seconds at the dealer's counter might have saved that record. Just a few seconds . . . the time to call for MAR-CO precision in small parts, by name.

It costs no more, frequently less, to say "MAR-CO" when you buy small parts. It may cause the loss of a station you particularly want, to take a chance on unknown quality in even the least important switch!

MAR-CO



✓ in the column at the left, indicates where DX stations may escape . . . and the MAR-CO instrument you can use to plug the leak!

*"Isn't it wonderful that Junior can tune in so nicely.
"Oh, no. There is nothing complicated in it. Anyone can do it.
The one control makes it so easy."*



**Bristol
Single Control
Radio Receiver**

Complicated combinations are eliminated when tuning in with Bristol Single Control Radio Receiver—every station is on the one dial. It gives the joys of radio with technicalities left out.

The well-known Grimes Inverse Duplex System (non reradiating) is utilized in this Receiving Set. Because of the reflex, only four tubes are required to give power equivalent to six. The price, without accessories, \$190.00.

**Audiophone
Loud Speaker**

You forget the radio equipment when listening thru the Audiophone Loud Speaker. The tone is full, clear and pleasing. It gives a true reproduction of the original. Made in three models—Senior \$30.00, Junior \$22.50, and Baby \$12.50.

Ask for Bulletins Nos. 3014 and 3015-L.

Made and sold by

THE BRISTOL COMPANY
Waterbury, Conn.

ENJOY A RADIO SUMMER

RADIO will play a wonderful part in your summer pleasures. At home or vacationing—seashore—north woods or mountain nook, radio will be a friendly, convenient companion.

Broadcasting stations are increasing their sending power. The bugaboo of summer static is no longer feared, and so remarkable has been the improvement and simplification of receiving sets that you will find their cost much lower than you might expect.

Give thought now to summer radio. Replace your worn out batteries with Burgess 'A,' 'B' and 'C's, which are recognized by expert and amateur alike as the best obtainable.

"ASK ANY RADIO ENGINEER"

BURGESS BATTERY COMPANY
 Engineers DRY BATTERIES Manufacturers
 Flashlight - Radio - Ignition - Telephone
 General Sales Office: Harris Trust Bldg.,
 Chicago.
 Laboratories and Works: Madison, Wisc.
 In Canada: General Offices and Works—
 Niagara Falls, Ont.

BURGESS RADIO BATTERIES

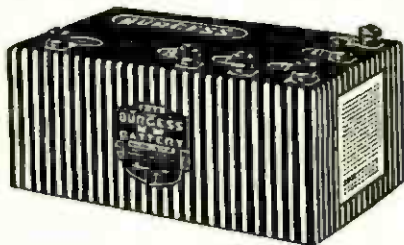

Let HOMMEL'S experience guide you



This organization was one of the pioneer wholesale distributors of radio equipment. They have seen hundreds of retailers come and go—they know from experience "what and when and How" dealers can best sell radio supplies and enjoy a satisfactory margin of profit.

HOMMEL'S Dealer Service Department is maintained for your benefit—their experience and advice will prove helpful to you in many ways, and this service is cheerfully given any time without charge.

Get in touch with us to-day—write for the new HOMMEL encyclopedia 246P—profit by HOMMEL'S experience—it is paying hundreds of other dealers—why not you?

WHOLESALE **LUDWIG HOMMEL & CO** EXCLUSIVELY
 929 PENN AVENUE PITTSBURGH, PA.

A Buffalo Radio Fan Gets London with the help of a **KIC-O**

Mr. E. C. Lewis on March 18th heard Mr. Marconi's voice on a Model 10 Atwater Kent Machine. He said it would have been impossible without a KIC-O Battery. Improve your set with a KIC-O. Our guarantee protects you.

GUARANTEE

Your money back on any KIC-O Battery if not satisfied within 30 days' trial.

Write for full information on "A" and "B" Batteries

Volts	Price, Plain	With Panels
22	\$5.50	
32	7.25	\$11.75
48	9.50	14.00
68	12.50	17.00
100	17.50	22.50
145	23.50	28.50

Kimley Electric Company
 2665 Main St. Buffalo, N. Y.



100 VOLT TYPE

ESTABLISHED!

The MOZART Baby GRAND



NO PIECE of radio apparatus was ever more firmly or more quickly established. From every point of the compass, entirely unsolicited appreciations, testifying to the merit of our product, continue to pour in.

From telegram (April 8th), and letters later.

"Reproducers and units received. Dealers and public enthused. You can expect big results from California.—The real thing was greater than our anticipation."

"(Also) One party stated his wife was so pleased with your Reproducer that if he could not get another one, he would not take \$50.00 for it. It is a pleasure to sell merchandise that brings comments like these."

(Signed) Nelson Rude Co., 16 California St., San Francisco, Calif.

PRICES F. O. B. Factory

Reproducer complete with (gold plated) unit and polarity-indicating cord.....	\$12.00
Unit only with polarity-indicating cord, gold plated.....	5.00
Unit only with polarity-indicating cord, nickel plated.....	4.00
Shipping weight of reproducer, 7 lbs. (approx.)	
Dimensions—diameter of bell 12" Length and height overall, 12½"	

TERMS: C. W. O. or C. O. D. when accompanied by small deposit. Orders shipped direct from the factory or through your dealer.

The MOZART-GRAND CO.

Manufacturers of Fine Instruments

Newark, N. J.

U. S. A.

Please refer to POPULAR RADIO when answering advertisements.



Announcing

The New **MICHIGAN** 4-Tube Set

Bon Voyage \$150.00

Take a trip with a Michigan 4-tube set any place in the U.S.A. A turn of the finger and you jump from Cleveland to Memphis—another turn and you visit New York. A wonderful trip—so simple, so easy, and all with four tubes.

**Less Controls • Less battery consumption
Less tube expense—than ever before**

offered in a set that gives such unusual distance—volume and selectivity and best of all the Michigan 4-tube set is non-radiating—you can enjoy yourself without spoiling your neighbors' pleasure.

The performance of the Michigan 4-tube set is in keeping with its wonderful appearance. Truly—an unusual set from every angle.

Works equally as well with Dry Cell Tubes or standard 6 Volt. wet Battery Tubes.

See your dealer at once—and ask him to give you a demonstration.

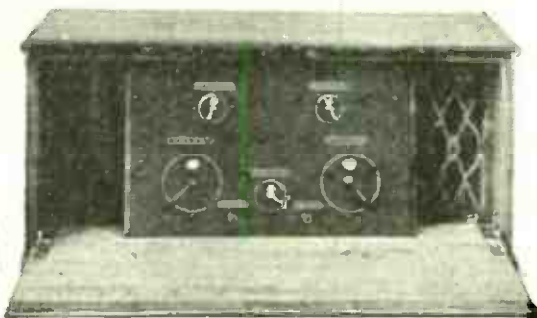

MICHIGAN RADIO CORPORATION

34 OTTAWA STREET, GRAND RAPIDS, MICHIGAN

It's a

Radio Plate Battery

**Proven Best
by Actual
Test!**

**DIAMOND "B"
BATTERIES**

CUT BATTERY
REPLACEMENT
TO A MINIMUM

At All Good Dealers
**DIAMOND ELECTRIC
SPECIALTIES CORP.**
102 So. Orange Ave.,
Newark, N. J.

*Dealers and Jobbers:
Write for Proposition*

FREE!

—a new socket
if it breaks or
fails in any way

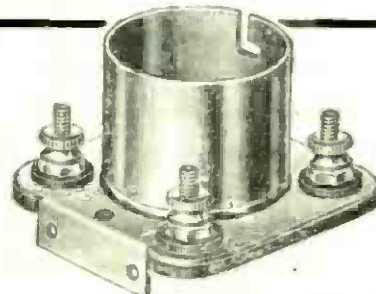

UV 199 or standard
base. List **50c**

Over half a million Walnut Sockets in use—not one broken yet. That's why they're standard on leading sets. Also because dielectric loss is less than bakelite, fibre or composition sockets. Approved by Radio News Laboratories. At dealers.

**WALNART
SENSIBLE SOCKETS**

Bakelite insulation; heavy genuine phosphor bronze contact springs; low resistance; high elasticity (to insure perfect contacts). Nickel or dull black enamel finish. For base or panel mounting. Unconditionally guaranteed by world's largest producer of unbreakable sockets. Trial will convince.

"Makers of good goods only"

WALNART ELECTRIC MFG. CO.
Dept. 1001 Chicago



THE mechanical principles of Magnavox Reproducers are as marvelous as the vocal chords of a great singer.

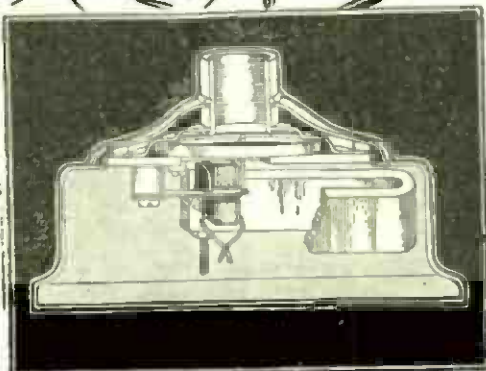

M4

The latest Magnavox Reproducer; beautifully finished. Requires no battery.

\$25.00

The Reproducer Supreme with a Human Throat

The semi-dynamic mechanism of the new Magnavox M4 Reproducer, shown above, insures utmost clearness of tone—a remarkable advance over the ordinary instrument requiring no battery. There is a Magnavox for every type of receiving set.

Magnavox Reproducers—R3 and R2 electro-dynamic with Volume Control; M4 and M1 semi-dynamic, requiring no battery \$25.00 to \$50.00

Magnavox Combination Sets—the only instruments combining electro-dynamic Reproducer and Power Amplifier in one unit \$59.00, \$85.00

Magnavox Power Amplifiers—the most efficient audio-frequency Amplifiers; one, two and three stage \$27.50 to \$60.00

To obtain the fullest usefulness and enjoyment from your receiving set, equip it with Magnavox—for sale at good dealers everywhere.

THE MAGNAVOX CO., OAKLAND, CALIF.

New York Office: 350 West 31st Street

Canadian Distributors:

Perkins Electric Limited, Toronto, Montreal, Winnipeg



R3

New Model with Volume Control

The famous electro-dynamic Reproducer; operates soft, medium or loud as desired.

\$35.00

7R

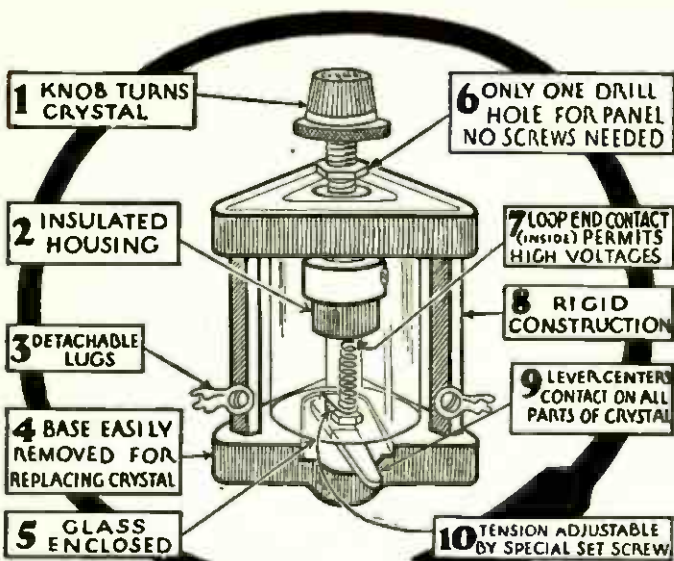

Best Crystal Ever Designed!
FRESHMAN

DOUBLE ADJUSTABLE CRYSTAL DETECTOR

AT LAST the experimenter who has searched for the ideal crystal can now depend upon a perfect detector. The New Freshman Double Adjustable Crystal Detector has met every requirement of the ideal unit. It affords uninterrupted, noiseless, distortionless reception, yielding extraordinary volume with entire absence of squeals and howls often introduced by vacuum tube detectors.

The World's Best for Crystal or reflex sets

Freshman Double Adjustable Crystal Detector for panel or base use complete.

Freshman Super Crystal with Non-Metallic Housing, fits any standard detector unit—\$.50.

\$150

At your dealers or send purchase price and you will be supplied postpaid.

FREE! Write for building plans and hook-ups of Super-Heterodyne, Reflex and other popular circuits. Ask for list L-109.

Chas. Freshman Co. Inc.
Radio Condenser Products

106 SEVENTH AVE. NEW YORK CITY



WORLD BATTERY
Saves You 50%

Famous Guaranteed Quality and Service—Backed by Years of Successful Manufacture and Thousands of Satisfied Users.

Prices That Save and Satisfy

Auto Batteries		Radio Batteries	
6-Volt 11 Plate, \$12.25	6-Volt 60 Amps. \$ 8.50	6-Volt 80 Amps. 10.00	6-Volt 100 Amps. 12.50
6-Volt 13 Plate, 14.25	6-Volt 120 Amps. 14.50	6-Volt 140 Amps. 16.00	
12-Volt 7 Plate, 17.00			

Special 2-Volt Storage Battery for W.D.11 and 12 tubes. Will run 200 hours on one charge. Rechargeable. \$5.00.
Special 4-Volt Storage Battery for U.V.199 tubes. Same features as 2 Volt. \$8.00.
Shipment express C.O.D. subject to examination. 5% Discount for cash in full with order.

2-Yr. Guarantee Bond in Writing With Each World Storage Battery

proves satisfactory World performance. Mail this ad with your name and address and we will ship battery day order is received; and give you a 45-Volt "B" Battery and Hydrometer Free with each battery purchased. Write today.

World Battery Company
Dept. 3, 1219 S. Wabash Ave.
CHICAGO, ILL.

FREE
45 V. B. BATTERY
and
HYDROMETER

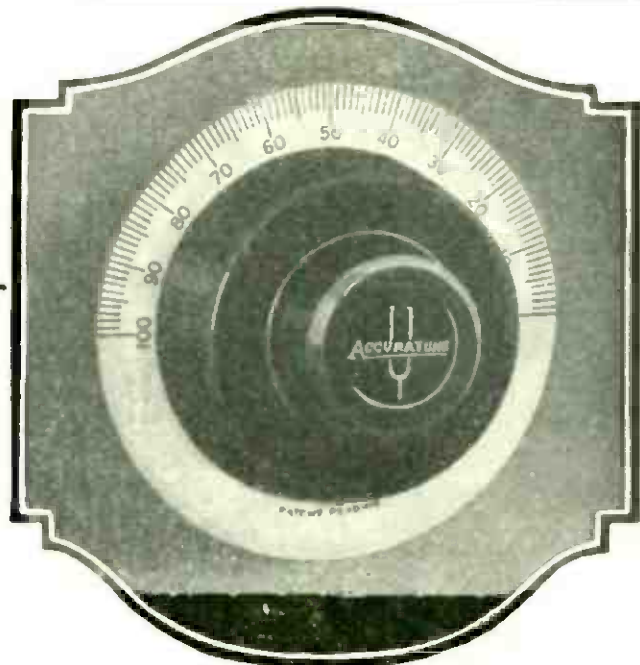

Not a mere dial but an actual micrometer tuning control, ten times more efficient than vernier condensers or any other tuning device. Geared to 80-1 ratio. A necessity for SUPER-HETERODYNE and other receivers where close tuning results are necessary. No drilling of panel. Fits all standard shafts.

PRICE \$3.50

MYDAR RADIO CORP.
9-B Campbell St. Newark, N. J.

ACCURATUNE
MICROMETER CONTROL

ATWATER KENT

Philadelphia

Radio in the Home

IN millions of homes radio is now regarded as almost indispensable—it is daily gaining new enthusiasts. In every section of the country the name "ATWATER KENT" is accepted as the criterion of excellence.

Literature describing
Atwater Kent Receiving
Sets and the Atwater
Kent Loud Speaker sent
on request.

ATWATER KENT MFG. CO.
4933 STENTON AVE.
PHILA., PA.

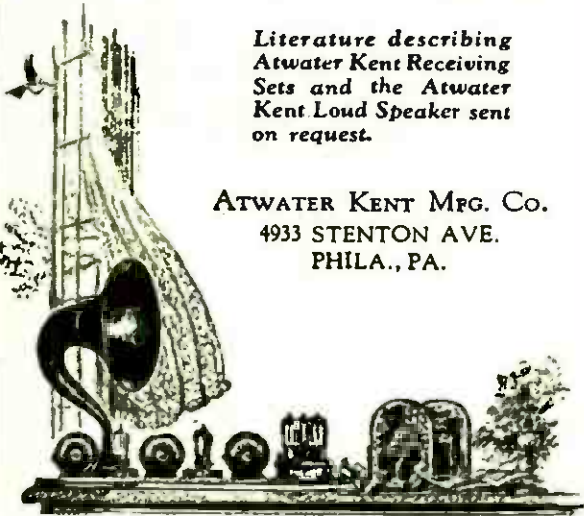

And Now Super Radio Cabinets

Panel size 8 x 40-8 inches deep. Made of solid select mahogany with basswood bottom, varnished and hand rubbed to a piano finish. Built by experienced workmen—experts on cabinet design and construction.

BLANDIN TRIPLE "A" DE LUXE SERIES

Full De Luxe equipment including extra mounting board—inlet flush lid—continuous piano hinge—folding lid supports—rubber feet.

Also Neutrodyne sizes, 7 x 24-7" and 7 x 26-7".
Smaller sizes, 7 x 14-7", 7 x 18-7" and 7 x 21-7".
Write for illustrated price list and name of your nearest jobber or dealer.

Jobbers and dealers, write for discounts

BLANDIN PHONOGRAPH COMPANY, INC.
1500 16th St. :: :: RACINE, WIS.



ACTUAL SIZE

Sterling

R311 MICROCONDENSER

Make it
a Part
of Your
Radio
Frequency
Circuit
Because—

Unusually Wide Range of Capacity—
Perfect Equalization Where Others
Fail—Cures Many Hopeless Sets.
Reflex and Others.

Convenience and Simplicity of
Installation.

Extraordinary Ease of Adjustment—
A Turn Sets it and it Stays Put.

A Turn of the Screw Slot in the
Visible Plate Sets it in the Equalized
Position.

The Equalized Position Then Remains Fixed With-
out Any Further Manipulation.

The Use of a Long, Dry Stick, Sharpened at the End,
Makes Perfect Equalization Possible Without Any
Error Due to Hand or Other Capacity.

Price, Including Connecting Lugs and Screws... \$1.00

THE STERLING MFG. CO.
2843 Prospect Ave. Cleveland, O.

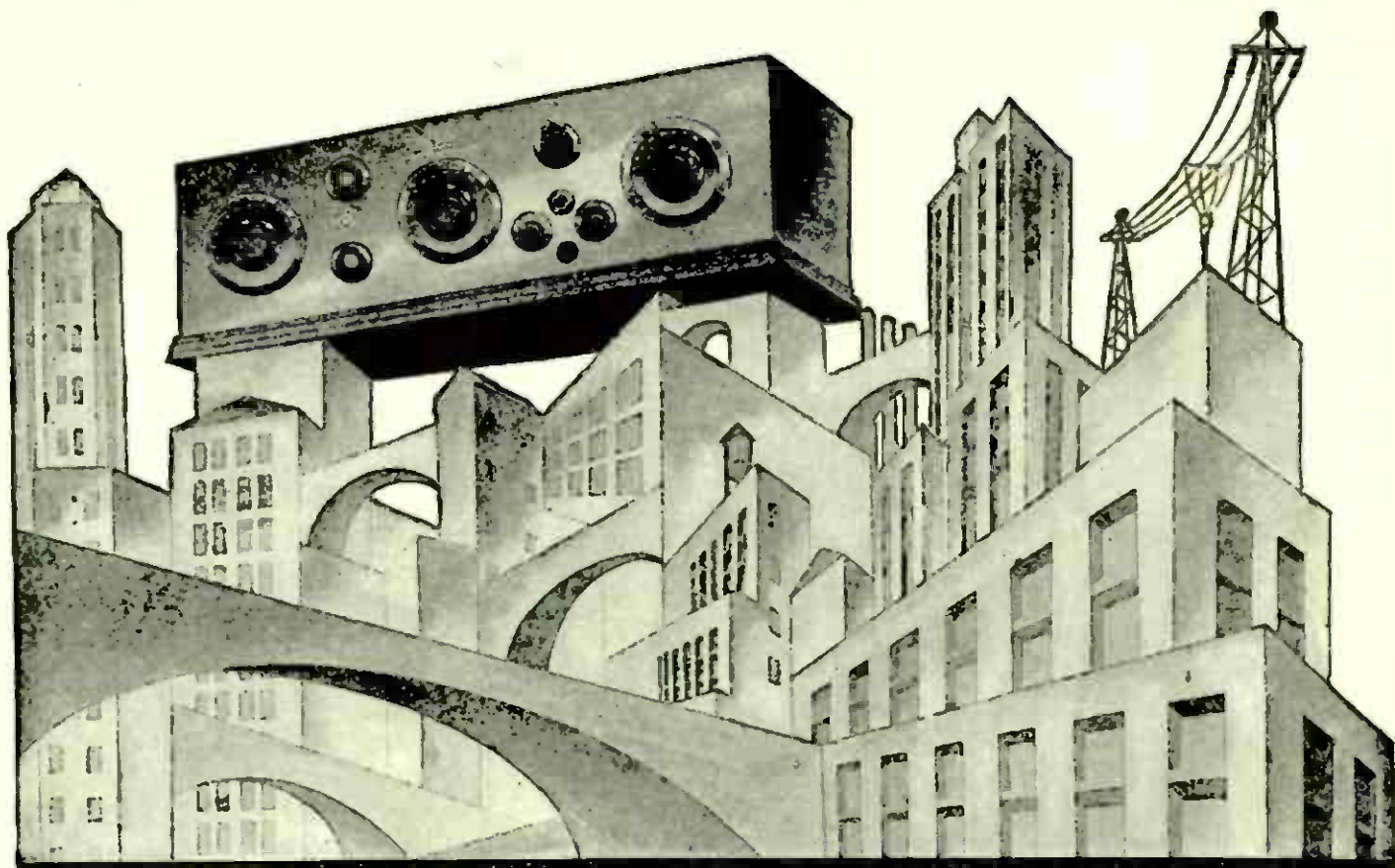

“STEEL IS NO BARRIER!”

SKY-SCRAPERS and thousands of tons of steel may rear themselves to the skies, yet the Melco Supreme Tuned Radio Frequency Receiver, nestled deep among these recognized radio barriers, still retains its marvelous long-distance reception.

Even with high-powered stations broadcasting near-by, the Melco

Supreme will bring in the same long distance without a fractional lowering of the quality or volume of its superb tone.

Marvelous though its performance under such severe conditions, the Melco Supreme has won its greatest host of followers by its extreme selectivity and simplicity of operation.

S A T I S F I E S E V E R Y R A D I O W I S H .



AMSCO PRODUCTS, INC.
Broome and Lafayette Streets, New York, N.Y.



Please refer to POPULAR RADIO when answering advertisements.

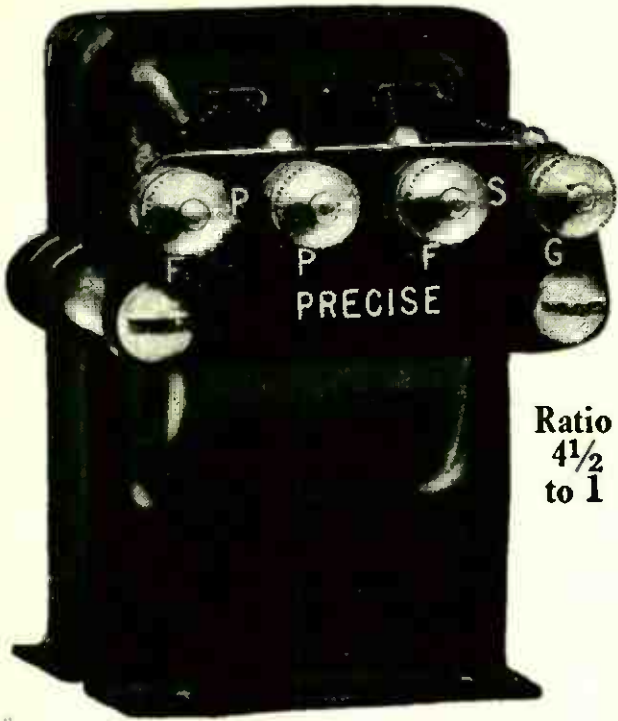

Ratio
4 1/2
to 1

~~PRECISE~~
Transformers
for Best Results

\$5.00

*Guaranteed better than any
other at any price or
money refunded*

IN every test made to date the
Precise has demonstrated its
superiority.

Perfect tonal value and rendition
from the deep vibrant basso
to the high notes of the violin.

30 Days' Trial

Try a Precise Transformer on your
own set. If your dealer cannot
supply you, order one direct. It will
be sent, postpaid, on receipt of price.
If you are not satisfied, return within
thirty days and we will refund your
money.

Precise Manufacturing Corporation
Rochester, N. Y.

Eastern Sales Office: Niagara Sales Corp. 3-5 Waverly
Place, New York City.
Canadian Distributors: Perkins Electric Ltd., Toronto,
Montreal and Winnipeg.
Branches: 53 W. Jackson Blvd., Chicago, Ill., 821 Market
St., San Francisco, Cal.

106 Stations Logged in Two Nights with

B-T Nameless R. F. Circuit

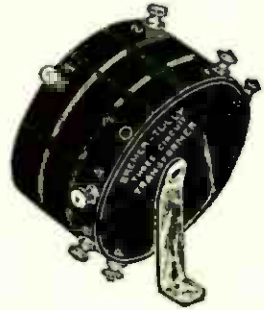

Kit No. 1

1 set of three—3 circuit Transformers, **\$10.50**

Kit No. 3

One set of 3-3-circuit R. F. Transformers.
3—.0005 Vernier Variable Condenser.
2—3-plate control condenser.
1 book of diagrams and instructions.
Price of Kit No. 3, **\$26.50.**

One Chicago Engineer has reported 106 stations
logged in two evenings in the month of May. One Radio
Editor heard Havana on the loudspeaker at Chicago in
mid-afternoon.

The distance selectivity, volume and tone quality of
this set is positively amazing. If built on the now famous
"step-by-step" plan we will absolutely guarantee the
results.

See your dealer at once or write us

BREMER-TULLY MFG. CO.

534 S. Canal St.

Chicago, Ill.

S. HAMMER RADIO CO.

305 Atkins Ave. Brooklyn, New York

FREE!!

Genuine XX Bakelite PANEL drilled and engraved, worth
\$8.00, with all orders received for this kit up to August 1st.

COCKADAY 4-CIRCUIT TUNER

These are GENUINE Complete Parts

	List Price		List Price
1 Bakelite Panel 7x24	\$3.90	2 Pacent Doub. Jacks	\$1.60
1 Cockaday Coil Preci- sion Eastern or Genwin	5.50	1 Pacent Single Jack	.80
2 Amsco 26 Pl. Cond. 4"		2 Amertran Transformers	14.00
Dial	11.00	2 Amsco Switch Levers	.60
5 Meico Tube Sockets	5.00	3 48,000 Ohms Lavite Resistances	3.75
1 Amsco 6 Ohm Rheostat	1.00	1 .00025 Dubilier	.45
3 Amsco 20 Ohm Rheo- stats	3.75	1 .0005 Dubilier	.45
2 Amplex Grid Densers	2.50	1 Pr. Como Dup. P. P. Transformers	12.50
1 Durham Var. Grid Leak	.50	1 Panel 1x12	.40
1 Amsco 400 Ohm Po- tentimeter	1.50	1 Sub Panel 3x2 1/2	
1 Bradley Leak	1.85	11 Switch Points	
		4 Switch Stops, Wire, etc.	

Never Before At This Price \$51.00

List Price \$72.45

NEW COCKADAY DISTORTIONLESS AMPLIFIER

Complete Parts Exactly as Specified by Mr. Cockaday

	List Price		List Price
4 Na-ald Sockets	\$4.00	1 Pr. Como Dup. P. P.	\$12.50
2 Marco Jacks	2.00	1 Amertran. 5 to 1	7.00
2 Amsco 20 Ohm Rheo- stats	2.50	1 Dubilier .00025	.45
1 Bradleyohm No. 25	2.00	6 Dubilier .005 Cond.	3.90
1 Bradley Leak	1.85	10 Eby Binding Posts	2.00
		1 Panel 7x12	2.25

List Price, \$40, for above complete parts. **OUR PRICE \$28.50**

The above parts may be bought separately. Write for our catalogue

Orders over \$5.00 Shipped Prepaid, Money Orders or C. O. D.
One-third must accompany all C. O. D. orders. Not insured
unless insurance charges included.

KELLOGG RADIO

OFFICIAL SCORE BOARD

9 11	CHICAGO	0	0	0	2	1			
17 8	ST. LOUIS	0	1	0	0				
9 10	NEW YORK	0	0	0	0				
11 11	BROOKLYN	0	2	1	1				
11 9	CINCINNATI	0	0	0	0				
8 16	PHILADELPHIA	1	0	0	1				
8 10	BOSTON	0	4	0	0				
9 12	PITTSBURG	0	0						

BASEBALL SCORES BY RADIO

SAY THE RADIO BUGS

BASEBALL fans the country over will be counting on Radio this year more than ever before. Most Radio fans are baseball fans. Every one of them should see that his new set of Kellogg radio parts is ready in time for the baseball scores.

Get the sport records and scores quickest by Radio—build your set of Kellogg radio parts for dependability and economy.

There is a certainty of satisfaction with Kellogg as shown by records of this equipment in use. Kellogg transformers rank among the best. To hear them in operation is to want them. Kellogg tube sockets give the utmost of service, while Kellogg switch arms and knobs are in a class by themselves for quick assembly, low resistance and satisfying operation.

Kellogg variable and fixed condensers, variometers and vario-couplers are all designed and built to give the satisfaction which the word Kellogg expresses in the electrical apparatus field. Kellogg rheostats have but one movable part. They come in six and twenty-five ohm resistances, easily interchangeable. They are simple, yet vary in control on the half turn of the resistance element. Kellogg DX head sets are known wherever radio is in the air. They are built mechanically and electrically for long service, sensitiveness, extreme lightness in wearing, and handling does not affect their tuning. They have Kellogg solid bakelite shells and are furnished with the Kellogg famous receiver cords of which many hundreds of thousands are in use today in the telephone field. Kellogg radio parts are especially suitable in portable sets because of their strength and high class manufacture. They will stand rough handling as will no other radio equipment and yet have the range and afford the selectivity, in the limits of the circuits used, surpassed by none.

If you don't want to bother to pick out the parts for your favorite hook-up buy one of our Radio Kits which include all the necessary and suitable parts including two stages of audio amplification; you can select the tuning units, as you desire.

This summer as never before radio will be heard in every summer resort and camp. See that your set is made of Kellogg radio parts. Specify Kellogg Radio—

Use—Is the Test

KELLOGG SWITCHBOARD & SUPPLY COMPANY

1066 West Adams St., CHICAGO, ILL.

A Boon to D-X Fans!

ELECTRASOTE

REG. U.S. PAT OFF

TRADE

MARK

RADIO PANELS

can be bought at any good
Radio Dealer's Store

At 25 to 50% Less
than any other standard panel

With these panels the surface-leakage and power-loss is reduced to the minimum—hence the *volume* of your set will be *that much greater*.

A good panel deserves proper handling—therefore, to get the best results, use a *sharp* drill with *slight* pressure.

Electrasote is one of the "Sote" products of world-wide fame introduced by
THE PANTASOTE CO., INC.

All Standard Sizes

JOBBERS AND DEALERS:
Write for our interesting proposition.

M. M. FLERON & SON, INC.

*Exclusive Sales Agents for
Electrasote Radio Panels*

Trenton, New Jersey

3-METER STATIONS

WGI
WHN
WMAX

360
METERS

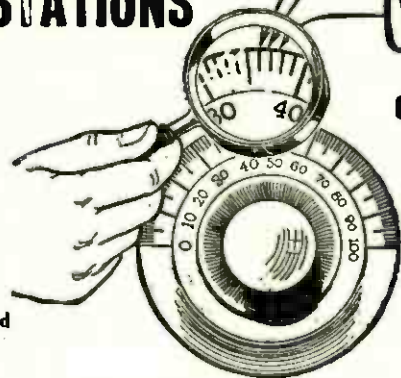

Price
\$5.50

At all good
Dealers

**Broadcasting at once
Tuned In Without Interference**

with the

UNCLE SAM MASTER TUNING COIL

The Red, White and Blue Litz Tuner
Ask your dealer for free diagram, or just send us self-addressed, stamped envelope for circular and panel layout of this wonderful set.

UNCLE SAM ELECTRIC CO.
Plainfield, New Jersey

An Easy Way to
GET DX STATIONS THIS SUMMER

That You Never Got Before

Just order a GOLDENROD AERIAL and your troubles will be over.

Made of 18k. GOLD and PHOSPHOR BRONZE—a discovery solving the reception problems of 95% of the Radio Fans.

Selectivity with volume
Does not corrode
Reduces static
No skin resistance
Perfect results in Summer

—that's why it is used by all Government Stations and Ocean Liners.

Your Dealer or Write

GOLDENROD AERIAL CO.

6 East Lake St. :: :: Chicago, Ill.

Special offer to Dealers

O'NEIL AUDIPHONE

All music and speech re-vivified by "laminated voice-core." Complete with connecting cord **\$30**

O'NEIL MFG. CO.

719 Palisade Avenue West New York, N. J.

ZENITH

TRADE MARK

Radio Companion

A six-tube set completely self-contained!
No need to open case to operate
No exterior loop or antenna required

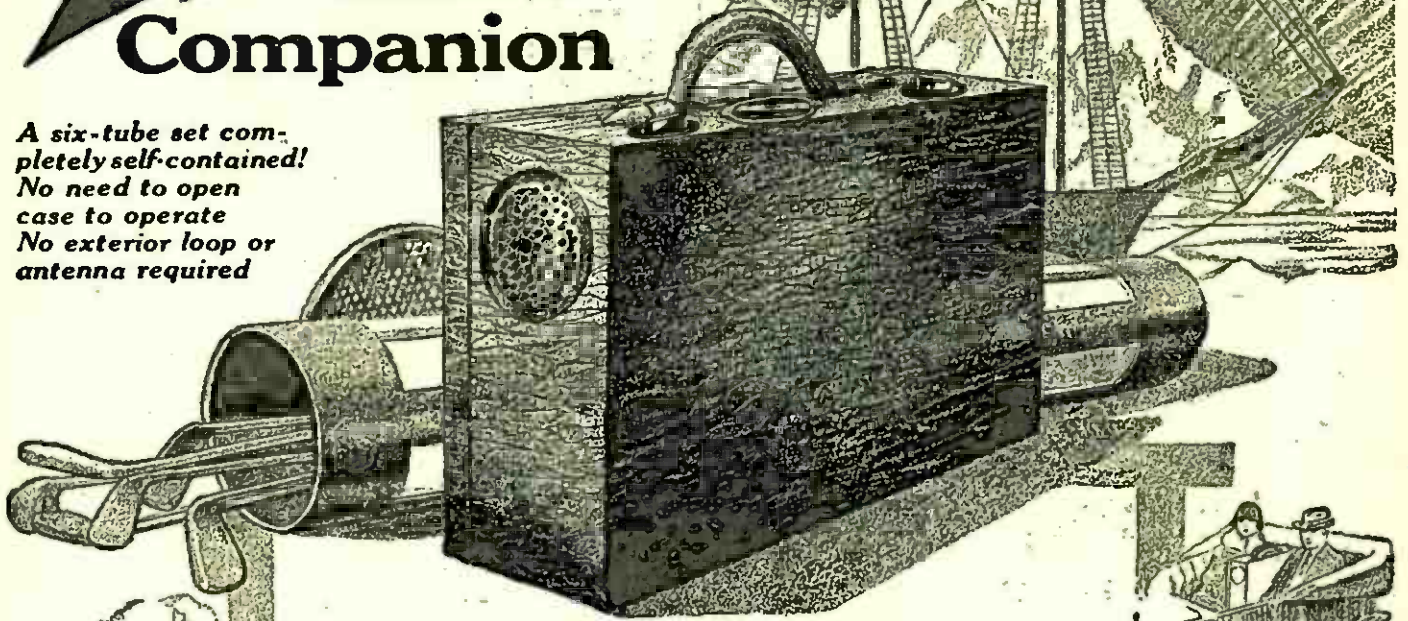

Zenith—MacMillan's Choice Encased in a Light Traveling Bag!

Here's a six-tube radio set that's entirely self-contained—tubes, "A" batteries, "B" batteries, loud speaker and loop antenna complete, and it's a Zenith!

Packed into a small, beautifully finished traveling case—much smaller than the average suitcase—this new Zenith is the most compact set ever made giving clarity, quality, volume and distance.

Do you see those two little buttons close to the handle? Those are the controls. In order to operate the new Zenith Radio Companion you simply turn the controls to bring in the station you want—then for maximum volume you swing the case so that the loop is facing that particular station. You will be astonished at the clearness with which the music and the voices come through—and in what volume!

Think what it would mean to you to be able to take one of these new Zeniths with you on your travels and outings. A real radio set—the exclusive choice of Donald B. MacMillan for his Arctic expedition—yet so compact that it takes up no more space than a light traveling bag!

Think of the fun you could have with this set—the dance music you could listen to on moonlit nights—the orchestras that would play for you as you and your pals gathered round the camp-fire—the companionship it could give you on your motor parties—at the bathing beach. Picture the enjoyment it could bring your guests at the house-party or the week-end gathering.

Again, think how such a set would while away a lonesome evening in that dreary out-of-town hotel—what a godsend it would be to that invalid mother—to that dear relative or friend who must spend weeks and months in the hospital!

You will want to know more of this remarkable set—so light and compact, so easy to operate, so wonderfully convenient. No ear-phones, you understand. No outside antenna. Yet clarity, volume, quality, distance! A real Zenith, packed into a traveling case!

The coupon will bring you full particulars.

Zenith Radio Corporation
McCormick Building
Chicago, Illinois



Listening, with the keenest pleasure, to music and voices in the cities they have left behind!

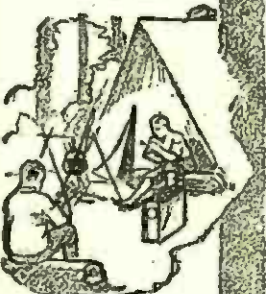

Lively orchestras entertain these boys, miles and miles from civilization.



Receiving the latest market reports, the latest news developments, with the aid of the Zenith Radio Companion.

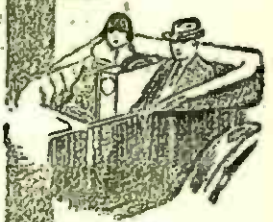

The height of luxury—motoring to music!



When three is company at the bathing beach.



A constant source of entertainment and delight to invalids.

ZENITH RADIO CORPORATION,
Dept. 2 E 328 S. Michigan Ave., Chicago, Ill.
Gentlemen:
Please send me illustrated literature on Zenith Radio, including full particulars of the new Zenith Radio Companion.

Name.....
Address.....



BUELL

E. J. Flewelling

RADIO APPARATUS

It's the Distance That Counts—

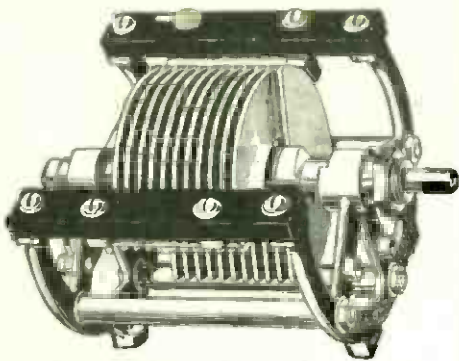

Link your set with the far away stations—CYB, KGW, WDAP, WGY, WMC, WOAI and the many others you have failed to tune in. Miles mean very little to a capably built set. But no

set can be at its best without FLEWELLING CONDENSERS! It is this master constructed condenser that will solve your problem of distance without the sacrifice of selectivity, tone and clarity. Install FLEWELLING CONDENSERS in your set tonight. Or better still—build a new set around FLEWELLING parts. The twenty-three plate size (.0005 mfd.) is now available. Price . . . \$7.00



Many so-called tube noises vanish when FLEWELLING SOCKETS are brought into use. Short, direct contacts of the improved "side-wiping" design, attribute much to the efficiency of performance. Price . . . \$1.00

The FLEWELLING TUNER requires but little cabinet space and produces big results. The coils are free of solid dielectrics and are interchangeable. However, an extremely wide range may be covered with but one set of coils. Price . . . \$8.00

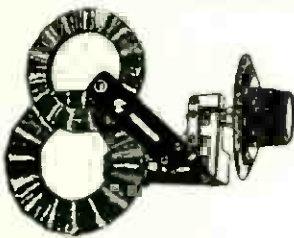

BUELL MANUFACTURING COMPANY

2979 Cottage Grove Avenue
CHICAGO

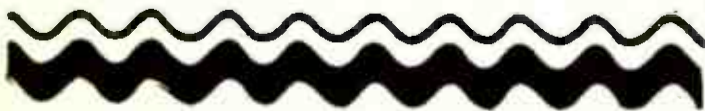

Licensed by Independent Radio Manufacturers, Inc., under Hazeltine Patent No. 1,450,080, dated March 27, 1923, and 1,459,228, dated April 1, 1924. Other patents pending.

The Eagle

Balanced Neutrodyne
"King Of The Air"

The painstaking care maintained provides a balance comparable, figuratively, with the poise of the soaring eagle. Demands upon quantity production are forgotten in the effort to provide the balance of tube capacities that has made the Eagle supreme.

Eagle Neutrodyne cannot reradiate nor regenerate. Its ease of operation makes certain the reception of any station, once logged. As wonderful in simplicity as the phonograph; more wonderful in performance.

We Soar Above

EAGLE RADIO COMPANY

18 Boyden Place

Newark, N. J.

Build Style Into Your Radio

with a
JUNIOR BENCH SAW



Make your radio a handsome piece of living-room furniture by building a cabinet for it. Make money building cabinets for others. Easy to do with the Junior Bench Saw. It does your initering, ripping, rabbeting, tenoning, sanding, grinding with ease and accuracy. Special blades cut bakelite. Saws 1 1/2" wood. Driven by 1/2 h.p. motor attached to any light socket.

Sold on Absolute Money Back Guarantee

Write for descriptive folder

W. & J. BOICE, 1730 Norwood Ave., Dept. 907, Toledo, O.

"Built First - Coto -to Last"

INSIST ON THE SILVER PLATED AIR CONDENSER FOR YOUR RADIO SET.

AMPLION

The World's Standard Loud Speaker



"Simply Divine" — Tamaki Miura

THE golden witchery of Tamaki Miura's internationally famous art finds ideal counterpart in the marvelous purity and tone quality of Erla Duo-Reflex reception.

"Never have I heard anything so beautiful," concludes the eulogy of the Japanese night-ingale upon the supreme flawlessness of Erla reproduction. "The tone is simply divine, so pure, so perfectly natural."

Responsible for this unique excellence are Erla radio and audio transformers, synchronizing perfectly received and reflexed radio, as well as rectified radio and reflexed audio currents, in their simultaneous passage through amplifying tubes, with consequent unprecedented elimination of distortion.

You, too, can enjoy outstanding Erla superiority, at minimum effort and cost. Complete Erla parts are assembled into the most modern and efficient of receivers in a few hours' time. Easily read blueprints guide every step.

Ask your dealer; or write, giving his name.

Electrical Research Laboratories
Dept. R, 2500 Cottage Grove Ave., Chicago



Unequaled ease and accuracy of tuning is gained through Erla Selectoformer. Distant stations are separated from local blasting at will. \$5



Supreme sensitiveness and amplifying power of Erla reflex transformers is the secret of unmatched Erla range and volume. List. \$5



Erla Push-Pull transformers embody numerous scientific advantages over other types. For details, consult Erla Bulletin No. 22. Pair, \$10



Superior accuracy of Erla tested capacity condensers is invaluable for securing utmost efficiency from any receiving unit. 30c to 75c



Indispensable to range and stability in reflex design. Erla fixed crystals create equal improvements in crystal circuits of all types. \$1 ea.

ERLA

Salisbury Radio Table



SOLID OAK

\$7

**FROM THE
FACTORY**

A REMARKABLY substantial, handsomely finished piece of furniture (No. 29), particularly fashioned for holding Radio Sets. Choice of finish: Golden or Fumed Oak or Imitation Mahogany. The top is 18 x 24 in. There is one long drawer, and underneath is a

Handy shelf for batteries

Just check the finish you want in the coupon below. Do not send money. Pay the expressman \$7, plus the small express charge on delivery, and thus have the advantage of buying direct from the makers. Absolute satisfaction guaranteed. Salisbury Bros. Furniture Co., Randolph, Vt.

SEND NO MONEY—Just mail this

SALISBURY BROS. FURNITURE CO.,
Dept. B-3, Randolph, Vermont.
Send the Salisbury Solid Oak "Community"
Radio Table No. 29, finished in (check).....
Golden Oak (check).....Fumed Oak (check)
.....Imitation Mahogany. I will pay the
expressman \$7 and expressage on delivery.
Name.....
Address.....
City.....

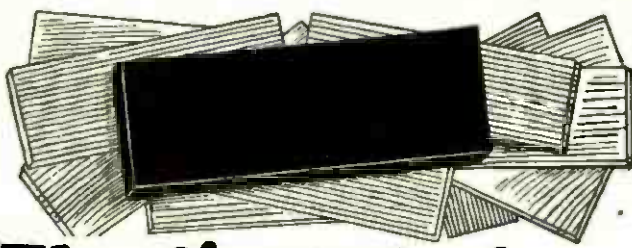

The first choice of those who KNOW

WHEN utter perfection in radio paneling is demanded uncompromisingly, Bakelite-Dilecto is chosen.

bakelite-dilecto

(A Laminated Phenolic Condensation Material)

Finished a handsome sleek, everlasting black. Almost unbelievably hard and tough for a material so readily machined. Will not warp, shrink, crack, swell, check, split or melt. Every fine radio set needs Bakelite-Dilecto panels to achieve highest results. Ask your dealer to get it cut and drilled to size for you. Tell it by its red stripe.

THE CONTINENTAL FIBRE CO.

Factory: Newark, Delaware

Service on Bakelite-Dilecto (also Continental-Bakelite, Conite, Contex and Vulcanized Fibre) from:

New York, Woolworth Bldg. Chicago, Wrigley Bldg.
Pittsburgh, 301 Fifth Ave. San Francisco, 75 Fremont St.
Los Angeles, 307 S. Hill St. Seattle, 1041 Sixth Ave., So.

Offices and Agents Throughout the World

HEATH RADIANT CONDENSERS

No warping or buckling of plates. Stamped to PERMANENT FLATNESS and tempered to STEEL HARDNESS—reasons enough for a guarantee of lasting accuracy.

MICROMETER GEARED VERNIER

Reducing gear gives hair-line adjustment, so essential in the finely tuned circuits. Separate tension adjustments.

Write for Literature!

Jobbers and Dealers: Write Immediately for Proposition.

HEATH RADIO & ELEC. MFG. CO.

204 First Street Newark, N. J.

Canadian Distributor: Marconi Wireless Telegraph Co., Montreal, Canada.

Radio **HARTMAN** Products

HARTMAN ELECTRIC CO.

MANSFIELD, OHIO.

Distance! The Only AUTHORIZED COCKADAY COIL

Gets distant stations easily and clearly. Made in strict accordance with specifications by L. M. Cockaday, inventor of the famous Cockaday Four Circuit Tuner. Greater volume, sharper tuning, maximum selectivity. Guaranteed. At your dealers—otherwise write us direct.

PRECISION COIL COMPANY

209-B Centre Street

New York

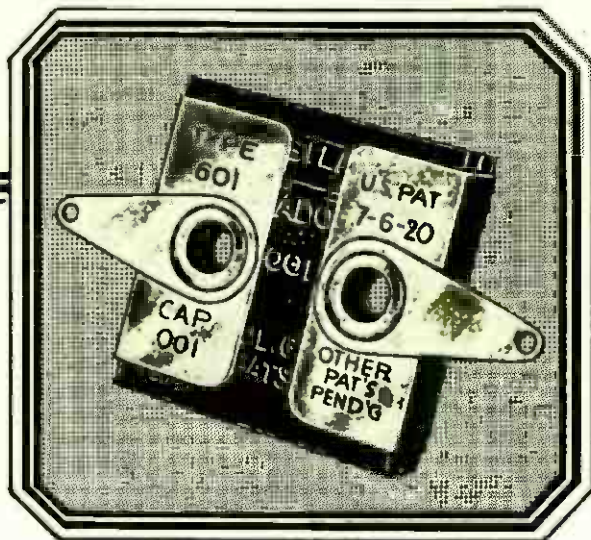

Dubilier Micadon type 601 — standard for straight circuits. Extension tabs facilitate soldering. Price 35 cents up.

DUBILIER MICADONS - are accurate

The name Dubilier is identified with Micadons—fixed condensers which are the most efficient made and which are both *permanent* and *accurate* in capacity.

Over ninety per cent of the sets made by amateurs and manufacturers throughout the world use Micadons because of this efficiency and accuracy.

Accurate Dubilier Micadons cost only a few cents more than inferior condensers—a difference not worth saving at the sacrifice of reception-efficiency.

Look for Dubilier Micadons in the set that you buy. They are always used in *good* sets.

Send for free booklet showing methods of soldering Micadons in radio circuits.

Dubilier Condenser and Radio Corporation
40-50 West 4th Street New York

If its marked Micadon its made by Dubilier-

COCKADAY UNIT

Full Set A, B, C and D Coils

Made strictly in accordance to Mr. Cockaday's Specifications



Range 150 to 600 Meters

For 1, 3 and 5 Tube Set

Price \$5.50

Best quality Radion hard rubber tubing 1/4" wall wound with No. 18 double silk covered wire.

Three Large Blue Prints, Illustrated Instructions, and Material Lists for Building the 1, 3 and 5 Tube Cockaday Sets

Price 50c
(Free with order for unit)

A set is no better than its weakest part. If your Coil is of inferior material or workmanship, you cannot expect to get good results. Thousands of GEN-WIN Coil users write us constantly, telling of the wonderful results they are procuring. If your Coil is unsatisfactory, replace it with a GEN-WIN and see the difference.

Guaranteed mechanically and electrically perfect. The outstanding features: Complete set of A, B, C and D Coils with beautifully knurled binding posts, eliminating loose end wires, insuring perfect contact and easier wiring. Made of the best quality material combined with expert workmanship. Distributed capacity or leakage and dielectric losses practically eliminated. Insures selectivity with maximum sensitivity and volume.

Unconditionally Guaranteed to Give Absolute Satisfaction

At Your Dealer, Otherwise Shipped to You Postpaid

GENERAL RADIO WINDING CO. 214 FULTON ST. NEW YORK, N.Y.



"It may interest you to know that I have the best receiving set in this city. It is a Cockaday four-circuit set as described in your January issue of POPULAR RADIO, and it out performs any set in town, regardless of cost. We have several of them here and they are all giving perfect satisfaction."

—JULIAN M. SCOTT
Hannibal, Missouri

The above appeared on the Editorial page of June, 1924, POPULAR RADIO

RADIO TUBE EXCHANGE

We Repair All Standard Makes of Tubes, Including

W.D. 11 or 12
U. V. 199 or C. 299
C. 11 or 12
U. V. 201A or C. 301A
D. V. 1 or D. V. 2
U. V. 200 or 201
C. 300 or 301

\$2.50



All tubes guaranteed to do the work

RADIO TUBE EXCHANGE
200 BROADWAY, NEW YORK CITY, N. Y.

All Mail Orders Given Prompt Attention
Orders Sent Parcel Post C. O. D.

Production Cuts Costs!

"Push-Pull" Crescent Transformers

Audio transformers 3 1/2 to 1 \$2.95

"Push-Pull" trans-formers, sets of 2. . . \$8.50

Complete wiring diagram and full information free.

Send today. Satisfaction guaranteed



Crescent Mfg. Co., Box 337, Central Sta., Toledo, Ohio

SIMPLEX

Watch for our

Lightning Arrester

SIMPLEX RADIO CO.
Mfns. Philadelphia

DX ANTENNA WIRE

Hard drawn copper—with CORRUGATED surface—gives increased range and clearer signal. Sold in coils of 100, 200, and 500 ft. \$2.00 per 100 ft.

KARDELL CORPORATION
Dept. R. Utica, New York

Haynes-Griffin

RADIO SERVICE, Inc. 41 West 43rd St., N. Y. City

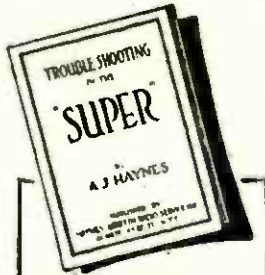

Here is advance information on something really new in radio. It tells all about air core and iron core transformers; what Mr. Haynes has found out about matching transformers; how to match your own transformers; what improved results you can expect.

HAVE YOU MATCHED YOUR TRANSFORMERS?

Here is a tip from the experience and research work of A. J. Haynes, Associate Inst. Radio Engineers, covering years of personal experimentation and trouble shooting for countless numbers of other radio enthusiasts.

It is sound advice that you can well afford to follow. It will save you hours of fruitless tinkering and useless building and rebuilding of your Superheterodyne, ever seeking to find the error that hides the secret of perfect success.

MR. HAYNES SAYS:

"The improper matching of intermediate wave radio frequency transformers used in the Superheterodyne or for long wave amplification is almost invariably the one barrier that stands between the average experimenter and the marvelous accomplishments promised by this best-of-all circuits.

The exact resonant frequency to which any set of transformers is wound, is not, within certain limits, of material importance, but it is of the greatest moment that every transformer in any given set be wound to approximately the same frequency as all the others.

It is now, and I believe always will be, physically impossible in the process of manufacture to wind a large number of transformers to the same resonant frequency."

"Hence they must be matched in sets of four, *after manufacture*, selecting those for each set that bear exactly the correct proportion one to the other.

This matching must be done in careful laboratory tests by experienced radio engineers independent of the manufacturing force. The improved results derived from this plan, which, I believe, is exclusive to ourselves, have surpassed my highest expectations.

I am glad to pass this information along to those experimenters who have the facilities to do this themselves. I am glad also to have devised a plan which makes it easy for others to secure properly matched transformers at the very start."

Every Set of HAYNES-GRIFFIN TRANSFORMERS NOW LABORATORY MATCHED

After the exact resonant frequency of each transformer has been measured, they are grouped in sets of four **ALL IDENTICALLY ALIKE.**

\$20.00 For a Complete Set of four transformers—consisting of one in-put and three inter-stage transformers.

If you are about to build a "Super" or if your present one is not delivering the goods the way you know it should, you owe it to yourself to read Mr. Haynes' treatise on the necessity for matched transformers. Send handy coupon and 4c to cover cost of mailing and it will be mailed to you at once.

MATCHED!

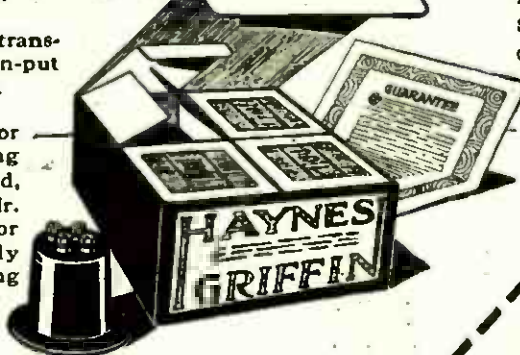

Never furnished individually. Sold only in matched sets of four packed in a single sealed carton.

Mail orders promptly shipped

HAYNES-GRIFFIN
41 W. 43rd St.
New York City

I enclose 4c. in stamps to cover cost of mailing to me a copy of the booklet entitled "Trouble Shooting in the Super," by A. J. Haynes.

Name.....

Address.....

HAYNES-GRIFFIN RADIO SERVICE, Inc.

41 W. 43rd St., N. Y. C.

111 South Clark St., Chicago, Ill.



WHOLESALE RADIO SERVICE COMPANY 9 Church St. N.Y.C.

We Sell Retail at Wholesale Prices!

FOUR TUBE REFLEX SET WITH LOOP

Three Stages Radio Frequency Amplification.
Three Stages Audio Frequency Amplification

Crystal Detector.

LIST OF APPARATUS FOR ABOVE SET

3 Acme A. F. Transformers Type A-1, 2	at	\$5.00
3 Acme R. F. Transformers Type R-2, R-3, R-4	at	5.00
1 Acme Pot. RHEOSTAT	at	3.00
1 Acme low loss condenser .0005 M. F. D.	at	6.50
4 Bakelite Sockets	at	.50
1 .001 M. F. Mica dubilier cond.	at	.40
1 .0005 M. F. Mica dubilier cond.	at	.40
1 .002 M. F. Mica dubilier cond.	at	.40
20 Feet No. solid wire	at	.40
8 Binding posts	at	.05
1 Double circuit Jack	at	.50
2 Feet spaghetti french	at	.15
2 Feet Belden braid shielding	at	.20
1 Loop ritter	at	6.50
1 Freshman crystal detector	at	1.50
KIT PRICE		\$44.50

3-TUBE COCKADAY

1 Cockaday coil. BAKELITE	at	\$4.50
2 Jefferson audio Transformers	at	4.25
2 17 pl. condensers. AMSCO	at	2.30
2 Switch arms	at	.30
1 7x18 panel	at	1.25
2 double circuit jacks	at	.50
1 single circuit jack	at	.40
3 National sockets. BAKELITE	at	.50
3 Rheostats. AMSCO	at	1.00
4 Switch stops	at	.40
1 .00025 mica condenser. DUBILIER	at	.20
1 2 meg. grid leak	at	.20
16 ft. of busbar	at	.15
8 Binding posts	at	.05
1 .001 mica condenser	at	.40
2 3 in. Bakelite dials	at	.50
1 7x18 baseboard	at	.50
Blueprints, instructions, etc.		KIT PRICE \$21.50

THE COMPLETE PARTS FOR SINGLE TUBE COCKADAY RECEIVER \$9.26

COCKADAY

4-CIRCUIT TUNER WITH PUSH-PULL AMPLIFIER

This is the set that Cockaday described as being able to receive over distances of 3,000 miles. You can't build anything better. (Parts are those specified by Cockaday.)

1 Cockaday Improved	List Price	11 Switch Points	\$0.01
Bakelite Coil	\$5.50	2 Switch Stops	.01
2 Amsco 26 Plate	at 4.50	1 Dubilier Cond. .0005	.40
Var. Condensers	at 1.25	1 Dubilier Cond. .00025	.40
2 Amplex Gridensers	at 1.85	1 Durham Var. Leak	.75
1 Bradley leak	at .75	3 Lavite Resistances,	
5 Melco Sockets	at 1.00	48,000	at 1.25
1 Amsco 6 ohm Rheos.	1.00	1 Amsco 400 ohm	
3 Amsco 20 ohm Rheos.	1.25	Potentiometer	1.50
1 Patent Single Jack	.60	1 7x24 drilled Panel	2.50
1 Patent Dble. Jacks	at .80	1 3x2 1/2 Sub-Panel	1.00
1 Amertran Trans.	at 7.00	1 1x12 Panel	.20
1 Como Push-Pull Input	6.25	1 7x24 Baseboard	.75
1 Como Push-Pull Output	6.25	Blue Prints, Wire, etc.,	\$53.50
2 Switch Levers	at .15	with each order.	

NEW COCKADAY

Distortionless Amplifier

Complete parts exactly as specified by Mr. Cockaday.

4 Na-Ald Sockets	List Price	\$4.00
2 Marco Jacks	at	2.00
2 Amsco 20 Ohm Rheostats	at	2.50
1 Bradleyohm No. 25	at	2.00
1 Bradleyleak	at	1.85
1 pr. Como Dup., P. P.	at	12.50
1 Amertran 5 to 1	at	7.00
6 Dubilier .005 Condensers	at	3.60
10 Eby Binding Posts	at	2.00
1 Panel, 7x12	at	2.25

\$29.50

Parts Can Be Bought Separately

Write us as to what you need and let us surprise you with our low prices. Send Money Order, or pay the postman. Money back if not satisfied. Postage paid on all orders over \$5.00.

Send for free catalogue.

VISION AND JEFFERSON TRANSFORMERS

Radio amplification is due in no small degree to Jefferson's vision of Radio possibilities.

Jefferson experiments in amplification predate the public's acceptance of Radio—the time when it was looked upon generally as an impossibility. As a consequence Jefferson Transformers have set a standard in transformer design. Owing to the years of experience back of Jefferson Transformers they give true modulation over the entire vocal and instrumental range.

Install Jefferson's in Your Set

If you are building a set requiring Radio Intermediate or Audio Frequency Amplification, and want to obtain the finest results, install Jefferson's—the quality choice of professional and amateur radioists.

There's a Jefferson Transformer for Every Circuit

An interesting bulletin, "Putting Quality into Radio," will be sent to you upon request.

Jefferson Electric Mfg. Co.
427 So. Green St. Chicago, Ill.

Supremacy Proven by Every Test

FILKO-STAT

THE SCIENTIFICALLY CORRECT RADIO RHEOSTAT

Your Condenser Makes a Difference



Elgin Elraco Precision Condensers

are made by precision tool makers. You will notice the difference the Precision makes in your receiving when you use the Elraco. All sizes.

Ask your dealer or write for full information

ELGIN RADIO CORPORATION
Radio Division of the Elgin Tool Works, Inc.
69 N. State St. Elgin, Ill.

LOUD SPEAKING CRYSTAL SET

Stations brought in from over 1000 miles and music heard all over the room right from your present crystal set with the STEINMETZ AMPLIFYER. Get our complete catalog. STEINMETZ WIRELESS MFG. CO. 5703 Penn Ave., Pittsburg, Pa.

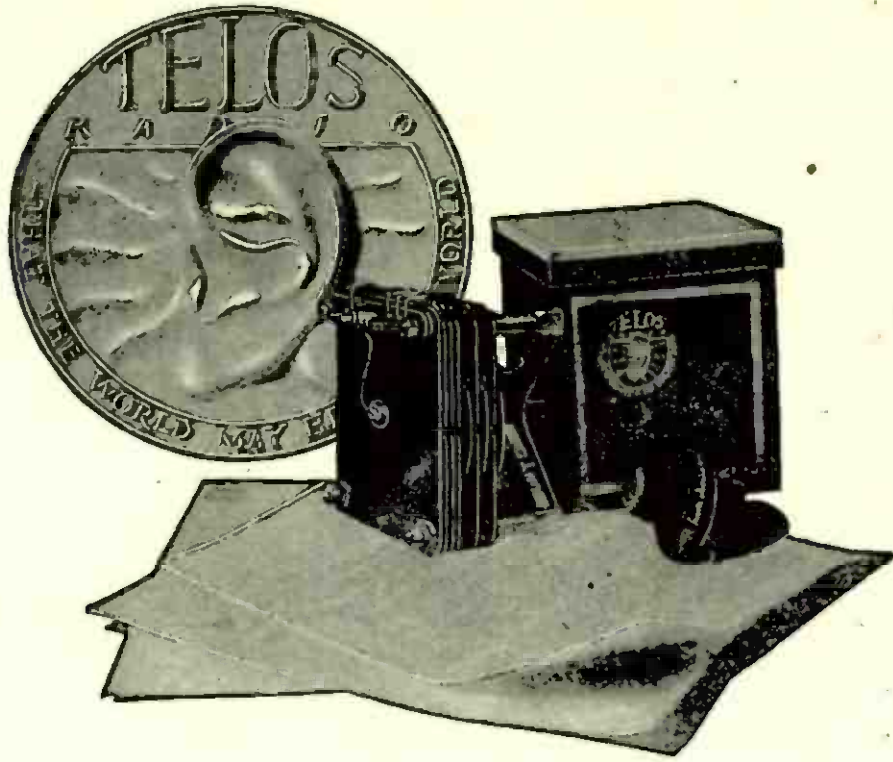

The vario-transformers tune absolutely alike—from 216 to 630 meters

"SINCE building this set, the 'cans' are accumulating dust, as I do practically all of the tuning on the loud speaker. I have had about 50 stations over 500 miles away (from Westfield, N. J.) and many low power stations not listed in the regular call books."

"Of all the circuits I have used—and I have operated most of them from the Colpitts to the Super Het.—I believe the Telos principle is the most sensitive and most perfectly stabilized on the market today."

—So writes Charles L. Pultz, a well-known experimenter of Westport, N. J., 3 weeks after he built a receiver based on the Telos principle of tuned R. F. amplification.

And there is nothing unusual about such results. This is the kind of reception you have a right to expect—from Telos; this is the kind of reception you can easily have—with Telos.

Tuning a Telos set is simply a matter of setting the vario-transformers for the wave length you want, according to the chart supplied. Assembling a Telos set is simply a matter of following the clear, unmistakable instructions in our new brochure, "Success with R. F. Amplification."

Write or use the coupon below to get your FREE copy of this brochure. It will give you an entirely new outlook toward the possibilities of tuned R. F.

Telos Radio

Danziger-Jones, Inc.,
Dept. A, 25 Waverly Place,
New York, N. Y.

Send me a FREE copy of "Success with R. F. Amplification" and complete description of the Telos principle.

Name

Address



TOWER'S Scientific
 WEIGHS ONLY 8OZ
 Perfect Tone Mates
\$2.95
 plus a few cents postage



OUR \$200,000.00 COMPANY STANDS SQUARELY BACK OF EVERY HEADSET **WORLD'S GREATEST HEADSET VALUE**

Formerly \$6.00, now \$2.95, with Notable Improvements
 Longer Cord (full 5 feet). Stronger Magnets, Higher Resistance, Increase of Sensitivity, Perfect Tone Mates
EVERY SET TESTED BY LICENSED RADIO OPERATORS

Send no money - Order on a Post-Card
THE TOWER MFG. CO. : 98J BROOKLINE AVENUE, BOSTON, MASS.



Summer entertaining needs RUBICON Push-Pull System

Music for dancing or to entertain outdoors when the set is inside, needs some form of power amplification. Longer daylight with weaker signals received is another reason. And for the extra building-up of these signals, the RUBICON System of Push-Pull, or Duplex Transformers, at \$12, have won merit based on faithful reproduction. Like RUBICON Audio and Radio Frequency Transformers, RUBICON Duplex are guaranteed without reservation.

*From your dealer or postpaid.
 Postcard brings free folder.*

RUBICON COMPANY
 918 1/2 Victory Bldg.
 Philadelphia

Grewol Fixed Reflex Detector

One less part to tune—Grewol requires no adjustment. Supreme for use with Reflex Circuit. Cannot jar or deteriorate.

NEW LIST PRICE \$1.50

At Your Dealer's Or Direct

GREWOL MFG. CO.
 Newark, N. J.

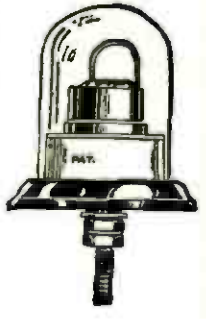

2650 MILES

with ONE TUBE. Broadcasting from Atlantic Coast and Cuba heard in California by users of the CROSS COUNTRY CIRCUIT. This range is due to simplicity of set and operation as only one control is used for tuning. Easily and cheaply built. Dry cell tubes may be used. Complete instructions, with panel layout, assembly views, etc., postpaid for 25c. Or further information for red stamp.
VESCO RADIO CO. Bx. PR-117, Oakland, Calif.



SOLDER WITH INSULATION At Least 1,000 Miles More Distance

is the usual reward if you can solder without impairing the insulation of your set.
 If you are building a radio-frequency amplifier you should read our free booklet:

"HOW TO SOLDER RADIO SETS"

Write for it

THE VALLEY FORGE CHEMICAL CO., Valley Forge, Pa.



“Type ‘P’ Phusiformer Possibilities”

A Special Booklet

56 Pages —filled with successful hook-ups—
with lists of parts and necessary directions. The more important circuits are covered by step-by-step assembling instructions, photos showing all views, panel and baseboard layout—all in clearest detail.

Experimenters and Beginners

The Phusiformer booklet shows you easy construction of circuits from simple crystal hook-ups to the Pathé “Minute Man” 5-tube Receiving Set, so famous for its wonderful clarity of tone. Using Pathé Type “P” Phusiformers throughout, the experimenter can build various circuits without added expense.

Set Owners

—get the booklet and see how adding Pathé Type “P” Phusiformers will give your set greater distance and increased power.

Send the coupon today. The Phusiformer booklet will be sent immediately upon receipt of remittance.

**Pathé Phonograph and
Radio Corp.**

24 Grand Avenue, Brooklyn, N. Y.

**PATHÉ PHONOGRAPH AND
RADIO CORPORATION**

24 Grand Avenue, Brooklyn, N. Y.

I enclose 50¢ (Stamps, Coin or Money Order) for one copy of Pathé “Type ‘P’ Phusiformer Possibilities.”

Name

Street

City.....State.....

RECEPTRAD

Supreme
for the
**SUPER-
HETERODYNE**

With RECEPTRAD Replacement Parts, Super-Heterodyne is at its best. The efficiency and perfect construction of RECEPTRAD Parts combine to produce a Super-Heterodyne set that knows no limits in distance, that enables selectivity in the finest degree, that reduces operation to extreme simplicity and that brings in programs from afar in clear undistorted tones.

FREE Super-Heterodyne Blue Print showing complete hookup of the famous Greiff 8-Tube Super

RECEPTRAD PARTS

for the Super Heterodyne—a complete package

- 1 Oscillo-Coupler, Type SW-21
- 1 Tuned Filter Coupler, Type H-34
- 3 RF-1716 Transformers—Range 5 to 25 M. meters
- 1 Audio Transformer, Type AT3
- 2 1MF By-Pass Condensers, Type G-1000

Price \$53.50

Lieut. Greiff's Super-Heterodyne Manual, \$1.50
Write for complete literature and prices on individual items



Replace all others with
“RECEPTRAD”



RADIO RECEPTOR CO.

59 Bank St.

New York City

R. F. 1716 Transformer for all Long Wave Reception

\$8.00



14" - - - \$12.50

The fact that the Fibertone is used by more Loud Speaker Manufacturers than any other one horn is a significant endorsement to those who want the best reproduction for the least investment. The base is designed to fit the phone from any head set. Use your own unit which you know is good.

If your dealer cannot supply you, write to us direct.

FIBER PRODUCTS COMPANY
34 Orange St. Bloomfield, N. J.

FIBERTONE

RADIO

HORN

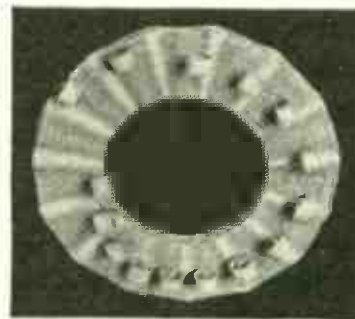

**SICKLES
DIAMOND
WEAVE
INDUCTANCE
COILS**

VARIOMETER and
VARIOCOUPLER

Variometer - - \$4.50
Variocoupler - - \$4.50

Patented Aug. 21, 1923

THE F. W. SICKLES CO.

Successors to
RADIO MANUFACTURING CO.
Dept. B. 337 WORTHINGTON ST., SPRINGFIELD, MASS.

RED-HEAD PHONES

Used and Praised the World Over

3000 Ohm \$6.50. 2000 Ohm \$5.00.

Complete with Cord and Headband

At your dealer's, or sent direct

The Newman-Stern Co., Newman-Stern Bldg., CLEVELAND

CRESCENT LAVITE RESISTANCES

12,000
48,000
50,000
100,000 } Ohms



LIST
\$1.50

Special Sizes to Order

Used in all Circuits. Dealers write for discount.
CRESCENT RADIO SUPPLY CO. 1-3-5 Liberty St., Jamaica, N. Y.



“That’s right, Mike—talk back at him”

THERE are two sides to radio—active and passive. The active radio enthusiast is creative—building, experimenting, improving. To this class belong the boys. The passive radio lover concentrates on enjoyment of the finished creation. As a rule, grown people are radio-passives. Boys build and build—they experiment and improve, each move requiring purchases from radio dealers. Their activity arouses the interests of their elders, swelling the ranks of radio devotees which have been largely recruited by boys. Knowing little of radio, these converts depend on boys for guidance in their purchases and instruction in radio practice. When you consider that 1924 radio sales will probably ex-

ceed 350 million dollars, you realize the tremendous buying control of boys.

THE AMERICAN BOY is the radio oracle of 500,000 boys, averaging 15½ to 16 years old. In it they find thrilling stories of radio adventures—authoritative information on radio development and perfection—helpful suggestions for increasing their radio knowledge and improving their sets. In such an environment, the radio advertisement meets eager, interested readers who are able and anxious to buy.

There’s no more direct route to radio sales than advertising in THE AMERICAN BOY. It augments radio sales and builds up an army of steady buyers. Copy reaching us by July 15th will appear in September.

The **American Boy**
The Biggest, Brightest, Best Magazine for Boys in All the World

Detroit

Michigan

September.

SUPER HETERODYNE PARTS, PRICE \$20.00

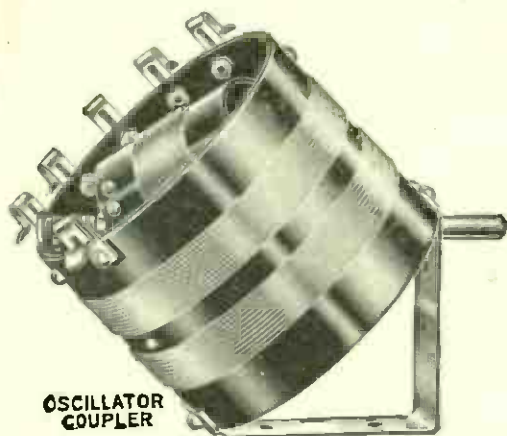

OSCILLATOR COUPLER

OSCILLATOR COUPLER, Large XX Bakelite Black Tubing, Size $3\frac{3}{4} \times 3$ ", using low resistance double silk wire. Rotor, 180 degree type, 6 Fahnestock terminals, metal parts all nicked. Will improve any heterodyne set. Price \$4.00.

NEW YORK COIL, 3,000 Meter R K TYPE, INTERMEDIATE FREQUENCY TRANSFORMERS are marvels of efficiency. Scientific positioning of primary and secondary, together with their extreme low height— $1\frac{1}{4}$ "—allows shorter grid and plate, wire connections than found in any other manufactured.

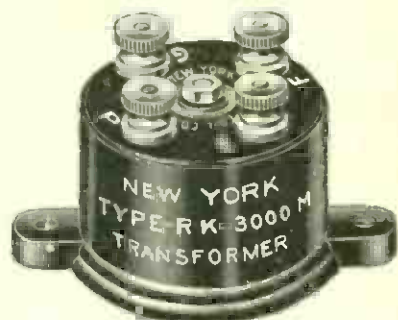

Price \$4.00

NEW YORK Condenser Tuned Radio Frequency Transformers are designed to operate in popular present-day circuits. Electrical losses, such as distributed capacity

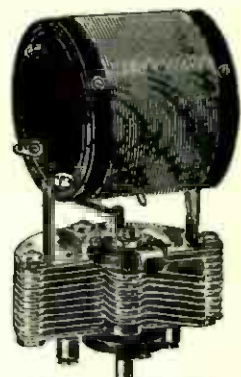

NEW YORK COIL CO.

have been reduced to the minimum.

The transformer is rigidly secured to our universally known New York Variable Condenser of 17 plates, which will tune sharply all wave lengths from 250 to 575 meters. Price, including Condenser, \$4.50.

NEW YORK COIL CO., 338 Pearl Street, New York

Pacific Coast—MARSHANK SALES CO., 1240 S. Main St., Los Angeles, Cal.

"THE BEST BUILT SET IN AMERICA"

A FACT—NOT A SLOGAN

R-212

MATCHED DIAL

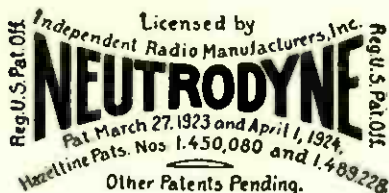

ARTISTRY—QUALITY—WORKMANSHIP AND ENGINEERING

are exemplified in the R-212 Matched DIAL NEUTRODYNE 5-TUBE MODEL

RADIO SERVICE LABORATORIES, 1000-11th Ave., Asbury Park, N. J.

UNITY VERNIER RHEOSTAT



The Highest Type Instrument Made
Any Resistance \$2.00
"Hear a Set That Uses One"

ELIMINATE THE NOISES IN YOUR SET

The book "TUBE CONTROL," written for the amateur, and for the benefit of Radio Reception, by J. Elliott Jenkins, Engineer of Broadcasting Station W. D. A. P. will tell you how to clear up your signals.

Every set owner should have this book.

10c at your dealers, or 14c postage to UNITY MFG. CO., 224 N. Halsted St., Chicago
NEW YORK OFFICE: 50 Church Street

MU-RAD

RECEIVERS

The Ultimate in Radio Reception

DEMAND



Be A Master OF THE Air

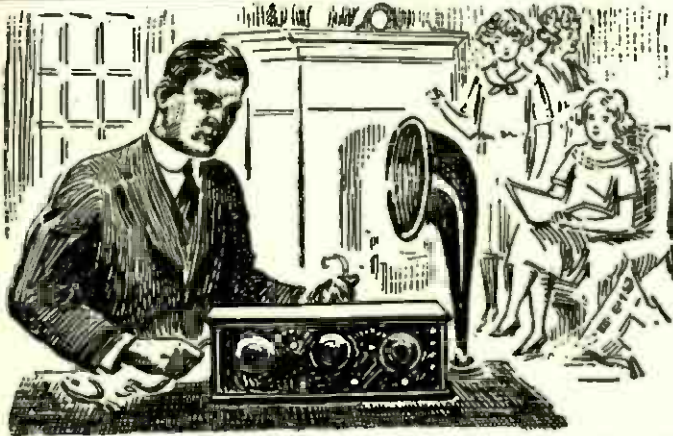

Pleasant Home Study

During the next few months you can, by devoting a few hours each week in pleasant home study, qualify yourself to get into the biggest paying field of all time. My practical, understandable course of instruction enables you to be a Master of the Air. Every problem in radio becomes an open book to you. *Be a Master of the Air and you will be a master of your future.*

\$3,000 to \$10,000
A Year as a Radio Expert

15,000 ships, hundreds and hundreds of Radio stations, with new ones springing up every day, are all keenly competing for the services of the radio-trained man. So enormous is the call for the radio expert that the man who knows his business in this field is in a position to *command* the size of his salary. On land or sea, in Government or private service, there are boundless fine paying opportunities for the man who understands radio problems and how to solve them.

RADIO where Knowledge is Power — And Power is Cash

I show you how to construct, install, operate, repair and sell radio equipment. Instead of being a spectator in this big game with big stakes, you become an active player. I qualify you to handle every branch of radio. There is nothing theoretical or practical that is not presented to you in complete, concise form. You are standing face to face with the greatest money-making chance ever presented to you. Will you turn your back on it or will you decide now, once for all, that you will get your share of the millions being divided among radio-trained men? Right in your own neighborhood you can make easy profits. Neighbors and friends will gladly give orders for sets and pay for advice on radio problems.



A. G. MOHAUPT, B. A., M. S.
Head of the Radio Association of America, Graduate Electrical Engineer, University of Wisconsin, Former Radio Instructor for U. S. Government, Author of "Practice and Theory of Modern Radio."

I give my personal attention to every student taking my course. Your individual problems and questions are answered by myself. I work with you at every stage of the course, guiding you, directing you to your goal to be a Radio Engineer in the big pay class. My course prepares you to successfully pass Gov't examination for Operator's License.

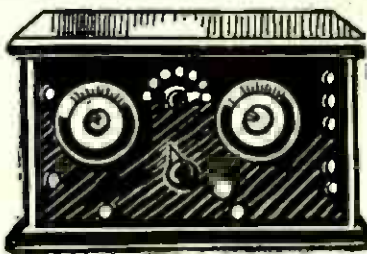

FREE 1000 Mile Radio Outfit

This set, when completed, has a range of over a thousand miles. I give it free with my course. I give you practical training by having you work on this set. The knowledge you gain is not mere book knowledge but is usable, practical experience. When you have finished my course, you can sell this set at a price that will more than pay the cost of the course.

QUICK PRACTICAL TRAINING

Everything in my course is clearly and simply stated so that you can easily understand every point I bring out. No previous experience or education is required. I give you fundamental and practical training in every angle of radio. There is no time to lose. Now is the best time to pass the other fellow by. Mail coupon today and get full information on my course, also details of the thousand mile set that I give free.

A. G. MOHAUPT, Radio Engineer
RADIO ASSOCIATION OF AMERICA
4513 Ravenswood Ave., Dept. 57A, Chicago, Ill.

MAIL COUPON

A. G. MOHAUPT, Radio Engineer,
Radio Association of America,
4513 Ravenswood Ave., Dept. 57A, Chicago

Please send me details of your Home Study Course—also your Free "Radio Facts" and information on how I can get a FREE 1,000 mile Radio Set.

Name

Address

City State

THOROPHONE

TRADE MARK REG. U.S. PAT. OFFICE

Makes Distant Stations
LOUDER

High
Power
Model
S-5
\$45.00



"THE THOROPHONE's capacity to amplify makes it possible to bring in on the loud speaker distant stations that would otherwise have to be received on the head set," says W. D. Leet, Chicago, Ill.

The THOROPHONE uses a powerful solenoid, whose intense force is added to that of the signals, giving maximum volume of tone.

Second only to the THOROPHONE is the new THOROLA, just introduced to meet the demand for an instrument which does not require a storage battery, but which is built with the same precision as the THOROPHONE. Here you have the same controlled mica diaphragm which gives the finest possible shadings of tone.

Due to the exclusive method of adjustment found only on the THOROLA, together with the DOUBLE PUSH and PULL PRINCIPLE of amplification, this instrument will reproduce at highest volumes with the same accurate fidelity as at lowest volumes.

THOROLA THREE, 12 inch bell horn, \$20.00
THOROLA FOUR, 14½ inch bell horn, \$25.00

Ask your dealer about THOROPHONE and THOROLA - each the best of its type - or write for booklet.

WINKLER-REICHMANN CO.
1725 West 74th St., Chicago, Ill.

DUPLEX

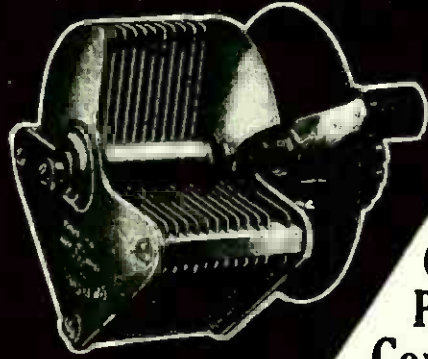

PATS. APPLD FOR

TRADE MARK
NONE OTHER

Compact
Precision
Condensers
Series "DR"

This series has been designed to meet the demand for an excellent commercial reasonably priced condenser. Its compact size makes it desirable for mounting where weight and small size is an important factor.

They are made in all sizes from 3 plate up to 43 plate vernier.

The 23 plate has a maximum to minimum Capacity Ratio of 60/1. We use no washers in our rotor or stator assemblies. The rotor shaft is moulded around the plate.

We have reduced insulating material to the necessary minimum.

Some valuable jobbers' territory still open.

The **DUPLEX ENGINE GOVERNOR CO., Inc.**
50 Flatbush Ave. Extension, Brooklyn, N. Y.



The Traffic Cop of the Air

He arranges in orderly fashion the mass and jumble of Broadcasting Stations that are seeking entrance to your set and brings 'em in, one at a time, so you can enjoy them! Never reduces, but nearly always increases volume. Add a **Ferbend Wave Trap** to your set and "Police" your reception. Regulate the Traffic!

Guaranteed to tune out any interfering station. The price is \$8.50. Shipment is made parcel post C. O. D. plus a few cents postage. If you prefer, send cash in full with order and we will ship postage prepaid. Send us your order today.

FERBEND
Wave Trap

FERBEND
ELECTRIC CO.
21 E. South
Water Street
Chicago, Ill.

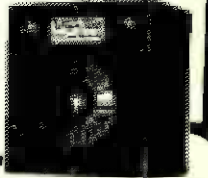

NA-ALD

De Luxe Dials

The artistic qualities of Na-ald De Luxe dials distinguish these dials as truly beautiful. They add to the appearance of any set in which they are used.

Na-ald Dials have a high gloss finish. They are moulded of genuine Bakelite and have patented construction. Dials are matched and made in 2", 3", and 3½" sizes.

Alden Manufacturing Company
Largest makers of Radio sockets and dials in the world
Dept. C 52 Willow St.
Springfield, Mass.

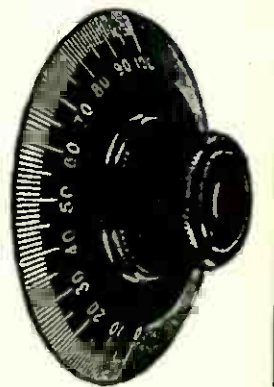

No. 3003-4
3 Inch
35c, 3 for \$1.00

Give Your Loudspeaker to the Ash Man



\$10
Complete with Cord

RHAMSTINE* Needlephone

Transforms the electrical energy of your radio into vibrations which, through the phonograph needle, are transmitted to the reproducer of your phonograph. It makes your phonograph the world's finest loud speaker.

RHAMSTINE* Products

Known throughout the trade for their moderate price as well as their quality.

Audio Transformers in three styles and all ratios, ranging from \$3.50, \$4.00 and \$4.50.

Victophone with Horn. For those not having phonograph desiring easily portable loud speaker, \$12.

Electric Soldering Iron, specially designed for radio and experimental work, complete outfit, \$2.50.

If your dealer hasn't Rhamstine* Products, send for details and prices.

The *Rhamstine* Needlephone* has made the conventional loud speaker as out of date as a single circuit blooper. It sets a new standard, which no radio loud speaker has been able to meet.

It eliminates mechanical noises by removing the cause. It has no diaphragm, so cannot produce metallic sounds. Its limitations are only those of your receiving set.

Twenty-Five Years Work Brought This Perfection

Everyone recognizes the perfection of the present day phonograph as an amplifier. The correctly proportioned tone-arm, the wood tone chamber contribute to this; but the greatest single factor is the mica reproducer.

Only the *Rhamstine* Needlephone* can bring the clarity, mellowness and cello-like beauty of tone of the phonograph to the radio, because it alone uses the phonograph reproducer.

It is not an attachment—not an adapter. There is nothing to change on your phonograph. The illustration shows how it operates. For any phonograph except Edison without Victor attachment.

Think These Strong Claims? Make RHAMSTINE* Prove Them

Don't take anyone's word for it. Try it out. Test it beside the loud speaker you think best. Compare tone, volume, convenience, with any loud speaker at any price. See for yourself how much noise the diaphragm is to blame for.

You take no risk. If it isn't all—and more—than claimed, return it. Your money will be cheerfully refunded. Don't be content with less than *Needlephone* perfection.

J. THOS. RHAMSTINE*

*Radio and Electrical Products

J. THOS. RHAMSTINE*
Woodbridge at Beaubien
Detroit, Michigan

Mail This
Coupon
Today

Send me the *Needlephone*. I'll pay the postman \$10 upon its arrival. It is distinctly understood I may return it if I desire, within 5 days and receive a refund in full.

Name.....

Address.....

SAFE AND SIMPLE

Amplex Kits take the "Guess" out of Radio. Each Kit has a Drilled Panel, Photograph, Blue-Print and complete instructions. No technical skill or knowledge required.

**BUILD YOUR SET
The AMPLEX KIT WAY**

Amplex Instrument Laboratories
57 Dey St., Dept. 7, New York City, N. Y.

SAVE 1/3rd

Amplex Kit costs you about 1/3 less than the price of all the parts bought separately. Every Kit is complete in every detail. No extras to buy.

TOBIAS CIRCUIT

1500 Mile Loud Speaker Range on a short indoor aerial. Described in June issue of POPULAR RADIO. Bids fair to become one of the most popular circuits. Easy to construct and operate. Sharp and Selective.

Just the circuit for places where long outdoor aerials cannot be erected. Ideal for portable sets. Ground connection and 30' wire brings in DX on loud speaker.

Complete parts selected and endorsed by Mr. Tobias for
List Price Kit Price
3 Tube Kit . . . \$44.50 \$33.50
1 Tube Kit . . . 27.00 19.75

TOBIAS TUNER

Wound according to Mr. Tobias' specifications and the only Tuner bearing Mr. Tobias' written endorsement. All molded stator and rotor wound with D.S.C. wire.

Space does not permit illustrations. Amplex guaranteed. Price . . . \$5.50

IMPORTANT

Amplex Kits are NOT a combination of nondescript parts. Every part in every Amplex Kit has been especially selected, tested and guaranteed by our engineers as the most efficient for that particular circuit. Every Kit is Complete in Every Detail

Note! Individual parts may be purchased at List Price.

Courtesy
POPULAR
RADIO



**KGO and 2LO on a LOUD SPEAKER with this
COCKADAY IMPROVED 4-CIRCUIT KIT
HERE IS PROOF**

Dear Sirs: On the night of March 14th, during the Trans-Atlantic Test, I distinctly heard 2LO (London) on the set built with your 5 Tube Kit. At 6:27 P.M. I heard almost the entire selection called "Arcadie" played by a string orchestra. It all came in on a Loud Speaker. I have also frequently heard KGO and KFI. M. Kramer, #100 Davidson Ave. N. Y.

NOTE: Our files are jammed with other such letters of praise.

Parts	List Each	Parts	List Each
1—Panel 7" x 24" Drilled . . .	\$6.00	3—48,000 Ohm Lentites	\$1.25
1—4 Circuit Coll.	5.00	1—Res. Mounting	1.25
2—Amplex 24 Pl. Vern. Cond. . .	5.00	1—.0005 Mica Cond.45
5—Amplex Sockets75	1—.00025 Mica Cond.45
1—6 Ohm Amplex Rheostat.75	2—P. P. Transf. (Como), pr. 12.50	
3—20 Ohm Amplex Rheostat. . . .	1.00	1—Potentiometer	1.00
2—Grid-Densers	1.25	1—Baseboard	1.50
2—Grid Leaks. Var.75	1—Set of plans (blue print) . .	1.50
1—Amplex Improved Jacks S.C. .	.65	12—Binding Posts10
2—Amplex Improved Jacks D.C. .	1.00	Bus bar, etc.50
2—Amplex Transformers	5.00		
2—Switch Levers etc50		

	List Price	Kit Price
5 Tube Cockaday Kit	70.85	56.50
3 Tube Cockaday Kit	54.30	42.50
1 Tube Cockaday Kit	\$31.50	\$24.50

Shipments made within 24 hours from receipt of order.

5-TUBE NEUTRODYNE

This sensational circuit of 1924 can be improved ONLY by building it of the following parts, the "Amplex Kit Way."

- 1 Fada Kit . . . \$25.00
- 1 Panel 7 x 26 drilled. \$8.00
- 2 Amplex Transformers 5.00
- 3 4" Dials. 1.20
- 2 Amplex Rheostats . . . 1.75
- 1 Battery Switch60
- 5 Amplex Sockets75
- 2 .006 Mica Condensers. .65
- 1 .00025 Mica Condenser .45
- 1 Grid Leak50
- 1 Amplex Imp. Jack S.C. .65
- 1 Amplex Imp. Jack D.S. 1.00
- 1 Base Board 7 x 25 . . . 1.50
- 7 Binding Posts10
- Bus Bar, Spaghetti, etc. .50
- Plans, Booklet50
- List Price \$59.70
- Kit Price \$39.75

SUPERDYNE

A 4 Tube circuit that is taking the country by storm employing 1 step tuned R. F. combined with regeneration.

Includes everything from the bus bar to the drilled Panel and an exceptionally efficient special Coil and Coupler.

List, \$45.00—Kit Price, \$33.75

FREE Send for Kit catalog showing how to build your set the "Amplex Kit Way."

"Take No Chances—Use Como"

COMO DUPLEX

The World's Standard Push Pull Transformer



PRICE \$12.50 per pair
For maximum volume without distortion

What Prominent Writers on Radio Subjects say About Como.

Lewis B. Hagerman, Technical Editor, Chicago Post: "Actual Tests show this transformer to be far superior to any others of similar makes."

R. J. Robbins, New York Sun: "After consideration of several well-known makes of push pull transformers which are available "COMO DUPLEX" was selected as most satisfactory."

C. White, Radio World: "COMO DUPLEX" is infinitely superior—most other push pull transformers seem to be ordinary transformers with a center tap brought out as a makeshift."

E. P. Gordon, Open Road: "A system of audio-amplification which is becoming increasingly popular. Its use will give surprising results in both quality and volume, and is thoroughly recommended by this department."

NEED WE SAY MORE?

COMO APPARATUS COMPANY

446 Tremont St. Boston, Mass.
For Sale at Leading Dealers

FREE TO READERS

Many POPULAR RADIO readers have asked how they might secure a copy of "How to Build Your Radio Receiver," described on page 68 of the advertising section. Readers who are not subscribers should take advantage of the present offer and secure it free with an annual subscription at the regular rate of \$3.00. Subscribers whose term expires during 1924 should place a twelve months' renewal at this time and secure the Handbook free.

But until July 20, 1924, we will send anyone a free copy of the Handbook who forwards \$6.00 in payment for two new annual subscriptions for POPULAR RADIO with Handbook free.

Each new subscriber receives "How to Build Your Radio Receiver" with his annual subscription and you get a copy free for sending these two orders.

Dept. 711

POPULAR RADIO

627 West 43d St. New York City



The Greatest Discovery in Radio
Build Your Own Neutrodyne Set
The Aragon Silver Radio Frequency Outfit

- Consisting of
- 3 Supersensitive SILVER Condensers
 - 3 Perfectly Adjusted Coils
 - 2 SILVER Neutralizing Condensers
 - 3 4-in. Dials

With 25 ft.
 Aragon Silver Wire
PRICE \$30.00

Attractive Offer to Dealers
ARAGON RADIO CO. 6 E. Lake St.
 Chicago



WE REPAIR
The Following
RADIO TUBES

WD-11.....\$2.50	DV-6A.....\$2.50
WD-12.....2.50	UV-199.....2.50
UV-200.....2.50	C-299.....2.50
UV-201.....2.50	UV-201A.....2.50
C-300.....2.50	C-301A.....2.50
C-301.....2.50	Marconi.....2.50
DV-6.....2.50	Moorhead.....2.50
DV-1.....2.50	6v.Plain Detector 2.50
DV-2.....2.50	6v.Plain Amplifier.2.50

Mail orders solicited and promptly attended to.
 Dealers and Agents Write for Special Discount.

H. & H. RADIO COMPANY
 Clinton Hill Sta. P. O. Box 22-E. Newark, N. J.

CARTER
"ONE-WAY" Plug

Takes one head set or loud speaker. Easiest, fastest and simplest plug to connect. Heavy phosphor-bronze springs make positive contact entire length of cord tip. Built up to a high standard not down to a low price. *Any dealer can supply.*



50c

Carter Radio Co.
 1807 REPUBLIC BUILDING
 CHICAGO

Salisbury Radio Table

OUR Radio Table No. 82 combines exceptional strength, durability and handsome appearance. The low price is possible only because of economical manufacturing—which enables us to sell direct to you at a substantial saving. The top measures 30 x 20 inches. There is one roomy drawer, and a strong shelf for batteries. May be had in solid oak or imitation mahogany.

Don't send a single cent

CHECK the finish you desire in the coupon below. Do not send any money. Just pay the expressman \$10.50, plus the small express charge, on delivery. We stand behind this table with an absolute guarantee. Send in your order today.

SALISBURY BROS. FURNITURE CO.
 Randolph, Vermont



\$10⁵⁰

Direct to you

Mail coupon and we'll do the rest

SALISBURY BROS. FURNITURE CO.
 Dept. B-2, Randolph, Vermont.

Send the Salisbury Radio Table, No. 82, finished in (check).....solid oak, (check).....imitation mahogany. I will pay the expressman \$10.50 and expressage on delivery.

Name.....

Address.....

City.....

RATHBUN SINGLE-HOLE MOUNTING SUPERIOR CONDENSERS

The famous RATHBUN CONDENSER possesses the STRENGTH and DURABILITY of a BUILT condenser, not an assembled one. Made in our own plant from raw materials to the finished product, stamps this as the best condenser on the market today. With its exclusive Single Hole Mounting, Non-Magnetic Materials, Ground Shafts, Long Brass Bearings, Full Circle Bakelite Discs and Aluminum Plates, the RATHBUN CONDENSER is a MASTERPIECE.

Write for literature and name of nearest RATHBUN dealer.



LIST PRICES		
3 Plate Vernier	.00002	\$1.00
11 " Variable	.00025	3.00
13 " "	.0003	3.00
15 " "	.00035	3.25
23 " "	.0005	3.50
43 " "	.001	4.50

Combination type now available in limited quantities.

Rathbun Mfg. Co., Inc.
Jamestown, N. Y.

The New and Perfect
Variable Grid Leak
65¢

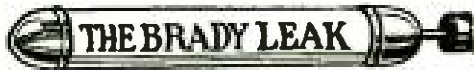

Can be installed in any set in a second! Does not change calibration with age or use! Officially adopted for Ultradyne, Polydyne, etc., circuits.

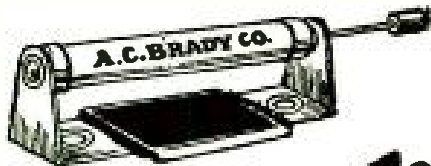

COMPLETE WITH MICA CONDENSER AND PERFECT LEAK MOUNTING \$ **1.00**

At your dealers or direct by mail on receipt of purchase price.

A.C. BRADY CO.
Improved Radio Apparatus
108-SEVENTH AVE. NEW YORK CITY

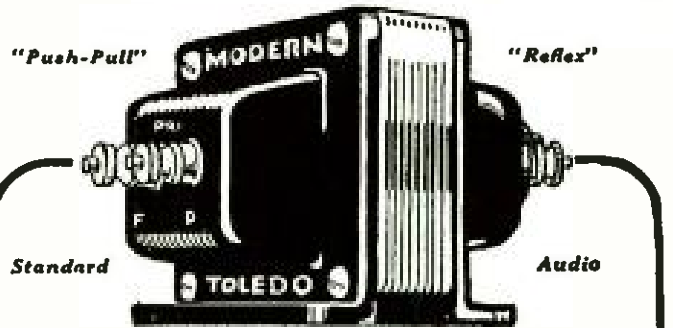

Amplify the MODERN way!

The use of Modern transformers will be a revelation to those not familiar with the fine, clear tones which it is possible to bring out over the entire band of useful audio frequencies.

No note in the musical scale is too high nor too low to escape utmost amplification without the slightest noticeable distortion. Modern transformers are sold by all good dealers.

Send for New Modern Bulletin

The Modern simplified bulletin of hook-ups clearly illustrates and describes the various hook-ups so that anyone can understand without other assistance. Sent free upon request.

The Modern Electric Mfg. Co.
Toledo, Ohio

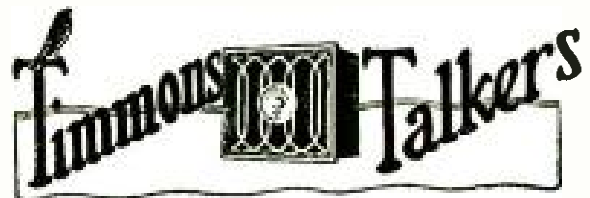

The Most Beautiful Loud Speakers in the World.

Adjustable \$35 Non-adjustable \$25

TIMMONS TALKERS, INC.
339 E. Tulpehocken St., Germantown, Phila., Pa.

Make \$100 Weekly In Spare Time

Sell what the public wants—long distance radio receiving sets. Two sales weekly pays \$100 profit. No big investment, no canvassing. Sharpe of Colorado made \$955 in one month. Representatives wanted at once. This plan is sweeping the country—write today before your county is gone.

OZARKA, 855 Washington Blvd., CHICAGO



Charge Your Battery For A Nickel

The Gold Seal Homcharger charges Radio and Auto Batteries at home overnight for a nickel. Your dealer has it. Write for FREE booklet and list of broadcasting stations.

The Automatic Electrical Devices Co.
132 West Third St., Cincinnati, Ohio



THE reflecting shield of the ancient Roman—Paul Revere's lanterns of revolutionary days—the Town Crier of a generation or more ago—these were some of Radio's historic forerunners.

That Radio has developed to its present perfected state is due to the genius of great scientists and the painstaking experiments of manufacturers of electrical equipment.

The Holtzer-Cabot Electric Company, for 35 years leaders in their electrical field, through their experience and equipment have produced for you three remarkable instruments. With the utmost quality, volume and sensitiveness they transform the electrical energy produced by the receiving set into the original music or spoken word.

It pays to buy Holtzer-Cabot equipment

- | | |
|------------------------------------|---------|
| Holtzer-Cabot Loud Speaker | \$25.00 |
| Loud Speaker Phonograph Attachment | 10.00 |
| No. 2 Universal Headphones | 9.50 |
| No. 4 National Headphones | 6.00 |

Write for booklets explaining how the exclusive features of these instruments enable you to enjoy the wonders of Radio

THE HOLTZER-CABOT ELECTRIC CO.
 125 Amory Street, Boston, Mass.
 6161-65 South State Street, Chicago, Ill.
 Department B-1

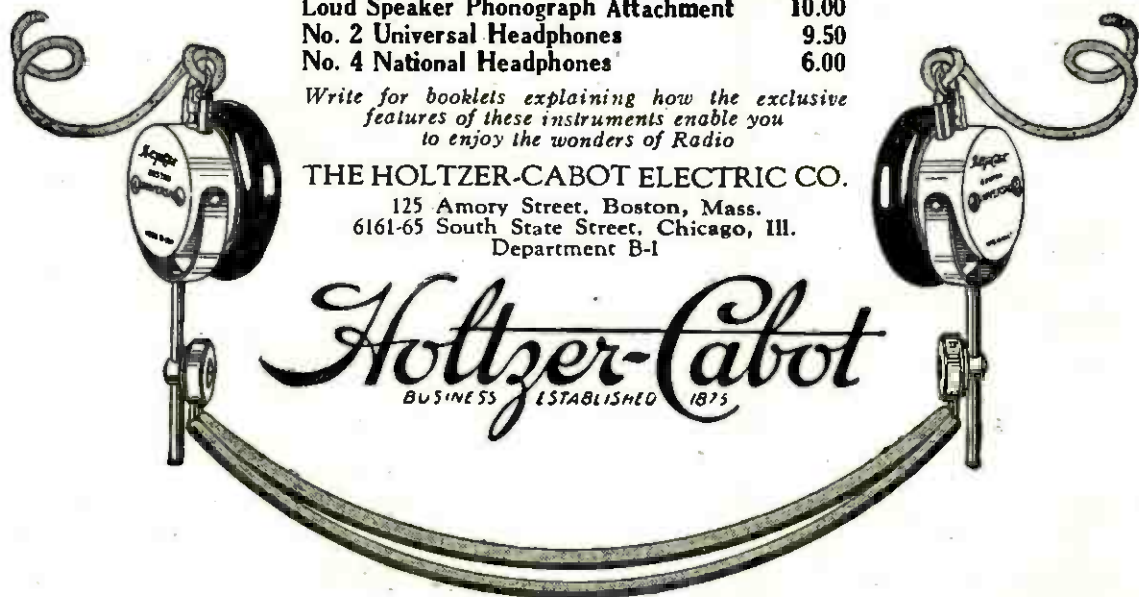

Holtzer-Cabot
 BUSINESS ESTABLISHED 1875

Please refer to POPULAR RADIO when answering advertisements.



The RāBAT Junior \$3⁹⁶
A Rechargeable Wet 'B' Battery. Capacity 800 Mil-Amps.
12 CELLS 24 VOLTS

Your Ultimate "B" Battery
The Rabat (Acid-type)

If a battery is worth having it should be built right. That means proper construction making it trouble-proof. It means ability to give effective continuous service. And it means good appearance as well as quality at a reasonable price. That is the story of the RABAT—known for its long life, its high continuous voltage and the ease with which it can be charged from the ordinary house current. Being built right you can depend upon it. Its reasonable price and its low cost of upkeep makes it an economical battery to buy. Sold at the majority of radio stores. If your dealer cannot supply you give us his name or order direct.

Prices F.O.B. Cleveland, Ohio

The Radio Rabat Company
714 Bangor Building, Cleveland, Ohio



The RāBAT Senior
A Rechargeable Wet 'B' Battery. Capacity 2800 Mil-Amps. 48 VOLTS \$17⁸⁸

12 CELLS 24 VOLTS \$9⁶⁰



U.S. TOOL CONDENSERS
TRADE MARK

It's Capacity that Counts!

Good condensers are designed according to microfarads, not number of plates alone. U. S. Tool Condensers are designed for correct capacity.

100% GUARANTEED
End Plates of CELORON

For Superheterodyne, Superdyne, Inverse Duplex and Four Circuit Tuner Circuits

Condensers of recommended capacity for all known circuits are also carried in stock by leading radio retailers.

Write for Booklet

U. S. TOOL COMPANY, INC.
116 Mechanic St., Newark, N. J.



The Van-Le Reproducer
Fruit Bowl Type

An entirely new and radical departure in the amplification of sound waves.
Big improvement over Horn Type of Loud Speaker.
All throaty tones eliminated.
Sound waves carry equally to every part of room.
Made in three types: Fruit Bowl (as illustrated) Electric lamp and Cabinet.

Ask your dealer or write us
Dealers write for special proposition

VAN-LE CORPORATION
100 Sip Avenue, Jersey City, New Jersey.

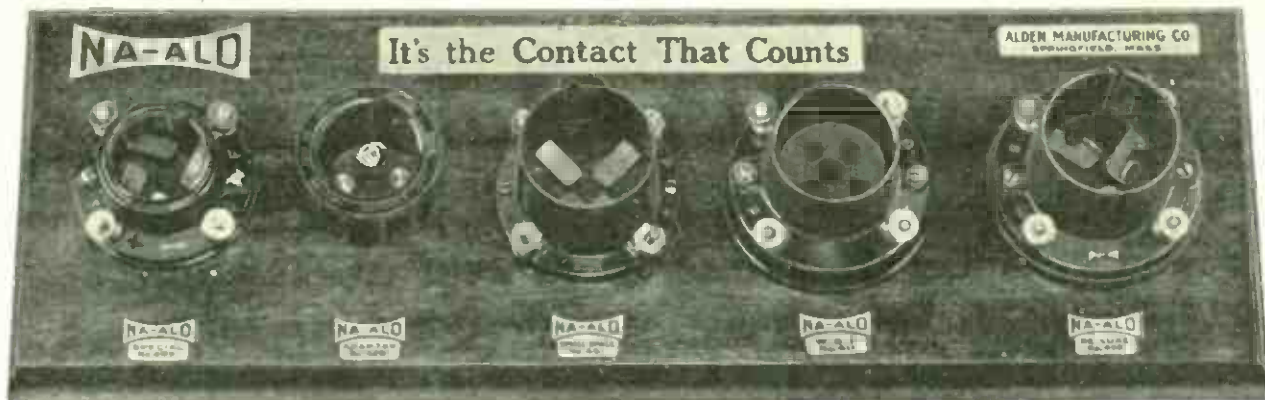

UNIFORM CROSS SECTION OF THE NA-ALD DE LUXE SOCKET



SPECIAL DIPPED BRIGHT PHOSPHOR BRONZE CLIPS, LAMINATED, AND EXERTING DUAL WIPE PRESSURE.

THIS ILLUSTRATION SHOWS HOW THE CONTACT STRIPS CAN BE MADE TO CLEAN TUBE TERMINALS AUTOMATICALLY BY ROTATING TUBE SEVERAL TIMES.

Look for the socket board

In leading radio stores you will find the Na-ald Socket Board, displaying the five standard sockets included in the Na-ald line. These are: for 200 and 201 Tubes, the De Luxe at 75c and the Small Space at 35c; for the UV 199 tubes, No. 499 at 50c and an adapter at 75c; for W. D. 11 tubes, the No. 411 at 75c.

Ask your dealer to show you the self-cleaning arrangement of contacts in Na-ald De Luxe, No. 400. These dual-pressure contact strips cut into the sides of tube terminals, keeping their surface clean and bright, and resulting in perfect contact.

These sockets have the highest dielectric properties, obtained by the thorough cure of the Bakelite used, and made possible by uniform cross-section.

There can be no noisy circuits due to poor contact with these sockets in use.

New rotogravure booklet, "What to Build," now packed with each Na-ald product. Also sent direct for 15c.

ALDEN MANUFACTURING CO. Dept. C Springfield, Mass.





MIRACO
GETS 'EM FROM COAST TO COAST

PRICE ONLY \$29.50

At rock bottom prices you get the efficiency of sets costing three times as much. Users tell us that Miraco Radio frequency receivers pick up stations from coast to coast. Operate either on dry cells or storage battery. Solid mahogany cabinets—finest workmanship throughout. Order direct or send for bulletin.

Two tube outfit.....\$29.50
Four tube outfit.....\$54.50

DEALERS AGENTS—write for proposition quickly—it's a winner

THE MIDWEST RADIO COMPANY
812 Main Street Cincinnati, Ohio.

And now for **ROUND** nuts—**Spintite**



Now you can tighten all the nuts on your set—Spintites for round nuts are ready.

Go over your set with Spintites and make connections as solid as if soldered—then you will get greater distance and volume and cut out noises.

Set of 3 Spintites, for either round or hex nuts, \$1.00.

Set of 9 Spintites, for all Hex nuts, \$3.50.

If not at your dealer's send us your order with his name. Write for Booklet of Special Radio Tools, No. 21.

Stevens & Company

Toolsmiths since 1899

375 Broadway

New York, N. Y.



B-METAL

Quality warrants the 90% discard. Only 10% marketed but it pays us. Your dealer will get you one.

B-METAL REFINING CO.
7th floor
525 Woodward Ave., Detroit, Mich.

FAHNESTOCK CLIPS

"Popular Wherever Radio Is Used"

14 Sizes in Beautiful Display Case.

Dealers write for big money-making proposition.

FAHNESTOCK ELECTRIC CO.

Long Island City, L. I.

Stevens SPEED UP **Tools**

What Parts Can We Give You?

POPULAR RADIO will give you, free of charge, any or all of the parts listed below, as reward for securing a few subscription orders from your friends

HERE is an opportunity for you to secure all or any of the parts needed to build complete either of two very popular receivers or an amplifier—and at no expense. You, surely, are well acquainted with the features of POPULAR RADIO that have given it more subscribers than any other radio publication. Won't it be easy to use your enthusiasm in inducing your friends and their friends to subscribe too?

To make it possible for you to secure an order from everyone we will permit you to make the following offers:

POPULAR RADIO			
24 Months for \$5.00	counts	75 credits	
12	"	3.00	50
8	"	2.00	33
6	"	1.50	25
4	"	1.00	16

You remit the full amount collected with names and

addresses of subscribers and ask for the parts that your total CREDITS entitle you to; or, if you prefer, let us credit them to you and when you have a substantial total, order the parts you want and we will charge against your CREDIT account.

As a further concession, suppose you have sent us 5 annual subscriptions for POPULAR RADIO, and in addition to a set of Approved Cockaday Coils want a 6-ohm Amsco Rheostat. The Coils are 220 CREDITS and the Rheostat, 50 CREDITS. The subscriptions total only 250 CREDITS and you need 20 CREDITS more. We will permit you to buy the additional CREDITS at 3c. apiece—so for 5 annual subscriptions and 60c. in cash we will ship the two parts you want.

Your choice is not limited to the parts listed below. On request we'll gladly quote you the CREDITS required for any radio material of any make you prefer.

CREDITS Needed for Parts Required for the "Improved" Cockaday 4-Circuit Tuner

(Described and illustrated in POPULAR RADIO for January, 1924)

Quantity	Item	Credits
1	set Approved Cockaday Coils	220
2	20-plate Amsco Vernier Variable Condensers @ 180	360
2	Amplex Grid-densers @ 50	100
1	Bradleyleak	74
5	Melco Vacuum tube sockets @ 40	200
1	6-ohm Amsco Rheostat	50
2	Pacent double circuit jacks @ 40	80
1	Pacent single circuit jack	28
2	American Transformers @ 280	560
1	Pair Como push-pull transformers	500
2	Switch levers and knobs @ 12	24
11	Switch points @ 3/5	7
4	Switch stops @ 3/5	2
1	.0005 mica condenser-transformer mounting	18
1	.00025 mica condenser with clips for grid leak	18
3	48,000-ohm Lavite resistances @ 60	180
1	400-ohm Amsco potentiometer	70
12	Hard rubber binding posts @ 4	48
1	7 x 24" panel—hard rubber	120
1	3 x 2 1/4" panel—hard rubber	16
1	12 x 1" panel—hard rubber	16
3	20-ohm Amsco rheostats @ 60	180
1	Durham variable grid lead	30
		2901

CREDITS Needed for Parts Required for the Non-Distorting Audio-Frequency Amplifier

(Described and illustrated in POPULAR RADIO for May, 1924)

Quantity	Item	Credits
1	No. 25 Bradleyohm (25,000 to 250,000 ohms)	80
1	Bradleyleak 1/4 to 10 megohms	74
2	Amsco Rheostats (20 ohms) @ 50	100
4	Naaid Standard Vacuum Tube Sockets No. 400 @ 30	120
1	Amertran Transformer (5 to 1 ratio)	280
1	Como Input Transformer	250
1	Como Output Transformer	250
1	Martin-Copeland Jack double circuit	32
1	Martin-Copeland Jack single circuit	24
1	Dubilier Mica Fixed Condenser, .00025 mfd. with clips for transformer	18
6	Dubilier Mica Fixed Condensers, .005 mfd. plain, @ 24	144
1	7' x 12' Radlon Panel	60
2	Quinby Radio Frames, 7' x 8' @ 40	80
10	Eby Binding Posts @ 8	80
1	Connection Block	14
5	Celatsite Wire @ 10	50
		1656

CREDITS Needed for Parts Required for the Non-Regenerative Tune-1-Radio-Frequency Receiver (simplified neutrodyne)

(Described and illustrated in POPULAR RADIO for April, 1924)

Quantity	Item	Credits	Quantity	Item	Credits
Materials for the construction of the special variocoupler and the radio-frequency transformer:					
1/2	lb. of No. 22 D. S. C. magnet wire	36	1	Daven grid-leak 3 megohms	20
1/4	" diameter brass rod, 7 1/2" long	6	4	Alden-Napier standard sockets (type 400) @ 30	120
1	Bakelite tubing 4" inside diameter, 1/16" wall, 4 1/2" long	24	2	Cutler-Hammer rheostats (6 ohms) @ 40	80
1	Bakelite tubing 3" inside diameter, 1/16" wall, 2" long	10	1	Federal double-circuit jack	32
1	Bakelite tubing 3" inside diameter, 1/16" wall, 1 3/4" long	10	1	Federal single-circuit jack	24
1	One Pacent honeycomb coil, 75 turns	24	1	Amertran transformer 5-1 ratio	280
(These special variocouplers and radio-frequency transformers cannot at the present time be purchased already made in.)					
1	21-plate Cardwell condenser (.0005 mfd.)	200	1	General Radio transformer 3 1/2-1 ratio	200
1	41-plate Cardwell condenser (.001 mfd.)	240	1	Cutler-Hammer filament switch	24
1	11-plate Cardwell condenser (.00025 mfd.)	170	1	Amsco switch lever	12
1	Dubilier mica fixed condenser .00025 mfd. (with grid-leak clips)	18	7	Switch points and 2 stops @ 1 1/5	11
1	Dubilier mica fixed condenser .0025 mfd.	18	1	7' x 26" composition panel	110
1—Special knocked-down solid mahogany cabinet which requires no sub-base					
1—Hard rubber binding post panel, 1' x 10' by 3/16" thick					
1—Strip of brass 24" long, 1/4" wide, 1/8" thick for condenser brackets					
8—Eby binding posts @ 8					
					64
					2157

For only 44 Credits we can supply the famous POPULAR RADIO Blueprints for the Amplifier or either Receiver listed above. Full description of these actual size prints will be found on page 64.

POPULAR RADIO
Department 71
627 West 43d Street, New York City

Cleartone Clear-O-Dyne Model 70

30 Days Old—Already Approved

Beautiful
and
Efficient

\$75.00

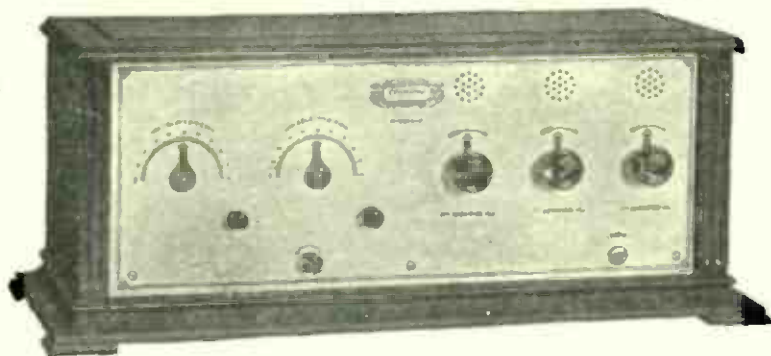

- 4 Tubes
- Selective
- Long Range
- Logable

The new Clear-O-Dyne model 70 has been enthusiastically received and heartily approved by hundreds who say that this wonderful receiver performs better than any four tube set ever tested.

The beautifully etched gold finished panels and the distinctive Cleartone solid mahogany cabinets together with the features of selectivity, log-ability and loud speaker volume means a source of education and a real pleasure for all. Send to us for complete circular matter and our special offer.

DEALERS and JOBBERS: You will want our line of loud speaker receiving sets all of which are guaranteed and are of finest material and workmanship. Our interesting proposition will be sent upon receipt of your request for detailed information.

Model 80 Super Clear-O-Dyne..	\$120.00
Model 60.....	60.00
Model 61.....	75.00
Model 62.....	120.00

Super Clear-O-Dyne Model 82..	\$190.00
Clear-O-Dyne Model 70.....	75.00
Clear-O-Dyne Model 71.....	90.00
Clear-O-Dyne Model 72.....	135.00

The Cleartone Radio Company,

:: ::

Cincinnati, Ohio

VACUUM TUBES REPAIRED

WD-11, WD12, \$2.50
UV-201A, UV-199,
And others for

Quick service. All tubes repaired by us guaranteed to work as good as new. Send your dead tubes. All you pay is \$2.50 plus Postage to Postman.

THOMAS BROWN CO.

511-519 Orange St. Newark, N. J.



The Copper Giant "A" Battery
For UV199 tubes

FIVE TIMES THE LIFE OF A DRY CELL
No deterioration when idle

At your dealer's or postpaid for \$1.35 each. Renewals 50 cents each. Write for circular.

THE COPPER GIANT BATTERY CO., Landsdowne, Pa.

Use — Price 75¢
DURHAM
Variable Grid Leak

At dealers, or postpaid
Durham & Co., 1936 Market St., Phila.

\$25 for \$10
THE FAMOUS

THE ACOUSTICAL AMPLIFIER
BEL-CANTO
TRADE MARK

Loud Speaker

You cannot buy the Bel-Canto through any dealer, only direct from us.

We save you these three profits
—Distributor, Jobber and Dealer.

PRICE \$10

Delivered Free
To Your Door

ADJUSTABLE UNIT FIBRE HORN

GUARANTEE: We guarantee to this publication to refund you your money in full any time within ten days if dissatisfied.

Adjustable Phonograph Loud Speaking Unit **\$3.50** Delivered free

SENT FREE RADIO LOGGING CHART—GET ONE

BEL-CANTO MFG. CO.

BENSEL-BONIS CO., INC.

General Office and Factory Dept. P. R.

417-419-421 E. 34th Street

New York City

Telephone Vanderbilt 8959



Blueprints!

A new idea in drafting—Blueprints, showing all parts exact size, with a wiring diagram so simplified and clear that a knowledge of radio symbols is unnecessary. You will find that POPULAR RADIO Blueprints effect a saving in time, labor and money.

EACH set consists of three prints; (A) Panel Pattern; (B) Instrument Layout; (C) Wiring Diagram.

Panel Pattern.

This blueprint is the exact size of the actual set. So accurate that you need merely lay it on your panel and drill as indicated. You can readily appreciate the convenience of this Blueprint. No scaling to do, no danger of ruining the panel through faulty calculation.

Instrument Layout.

Again you have an actual size print of each instrument and binding post and its exact location both on the panel and within the cabinet. Even the cabinet structure is clearly shown.

Wiring Diagram.

The unusual feature of this Blueprint is that it is a **full size picture diagram** of the finished set. Each instrument or other part appears exact size and the wires are so clearly traced from one contact to another that you can connect all terminals accurately without even knowing how to read a hook-up diagram.

Blueprints Ready.

At the present time three sets of Blueprints are available and have been priced at the very low figure of \$1.10 per set, postpaid. Each set consists of three Blueprints and we cannot break a set to supply single prints.

"Improved" Cockaday 4-Circuit Tuner was described in the January, 1924, issue of POPULAR RADIO. It is a simplified regenerative set that can be built with about \$95.00 worth of parts. It provides for automatic tuning, practically unlimited distance range, maximum volume excellent reproduction and no interference. **Set of three constructional Blueprints \$1.10.**

The Non-Regenerative (Simplified Neutrodyne) Tuned-Radio-Frequency Receiver, described in the April, 1924, issue of POPULAR RADIO, can be built with parts costing about \$70.00. This circuit has remarkable sensitivity and is notable for its ease of control, distance range and clarity of reception. **Set of three constructional Blueprints, \$1.10.**

In the May, 1924, issue of POPULAR RADIO, is a complete description of an **Audio-Frequency Amplifier**. This is a newly developed type of amplifier that is entirely unmarred by distortion. The parts will cost about \$45.00. Blueprints further simplified by showing circuit diagrams in right-to-left sequence—the way you build. **Set of three constructional Blueprints, \$1.10.**

For convenience use the coupon below in ordering sets of Blueprints. If you desire any of the descriptive articles mentioned above, enclose 35c additional for each article wanted. Complete list on page 66.

POPULAR RADIO, INC.

627 West 43rd Street

Dept. 74

New York City

POPULAR RADIO, Inc., Dept. 74	
627 West 43rd St., New York City	
Date.....
Enclosed is my remittance of \$....., for which kindly send me Blueprint Set (s) consisting of Panel Pattern, Instrument Layout and Wiring Diagram as checked below:	
<input type="checkbox"/> "Improved" Cockaday 4-Circuit Tuner.	
<input type="checkbox"/> Non-Regenerative Tuned-Radio-Frequency Receiver.	
<input type="checkbox"/> Audio-Frequency Amplifier.	
Name.....
Address.....
City.....	State.....

Any one set of three Blueprints for \$1.10; any two sets for \$2.20; all three sets for \$3.30

NOTE:

Dealers write for terms

Please refer to POPULAR RADIO when answering advertisements.

PYREX

INSULATOR

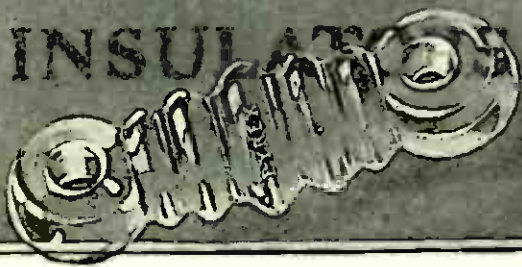

THE Pyrex Antenna Insulator is in demand by all who wish to get the maximum efficiency from their sets.

John L. Reinartz attributes most of his success in receiving European stations to Pyrex. Used by U. S. Bureau of Standards. Great mechanical strength—450 lb. load. Impervious to weather and does not retain surface moisture. Retails at 45¢.

Inquiries from responsible jobbers invited.

CORNING GLASS WORKS
Industrial Division Corning, N. Y.

REGAL
PARTS GUARANTEE DX.

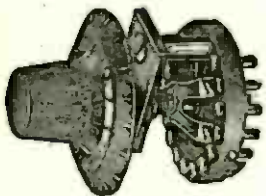

Reform your panel! Make it neat, using REGAL 15 tap switch No. 164, which requires but one drill hole. Sold complete with knob and dial. Price \$1.50.

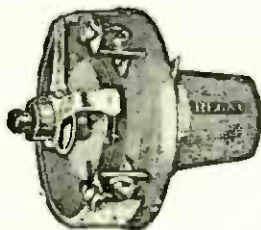

Vernier Rheostats hold filaments at sensitive point. Smooth, firm movement. 6 and 30 ohm Verniers, \$1.25. 6 and 30 ohm non-verniers, \$1.00. 6 and 30 ohm Juniors, 75c. 200 ohm potentiometers, \$1.50.

Ask your dealer or write direct for prices and complete descriptive folder No. 24.

The American Specialty Co.
200 Holland Ave., Bridgeport, Conn.

MADERA DIE-CAST WOOD
"Clearspeakers"

tend to neutralize, rather than amplify, summer static. The dense, homogeneous walls of these artificial wood horns have acoustic properties much like those of a rare old violin.

No. 804, here illustrated, 12 in. high with 10 in. bell, is especially suited to the rough treatment of summer camping—postpaid for \$15.00

Larger sizes are proportionately inexpensive. Send for circulars. Mention dealer you wish to favor.

AMERICAN ART MACHE CO.
351 W. Austin Ave., Chicago, Ill.

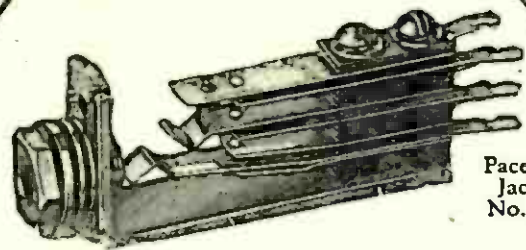
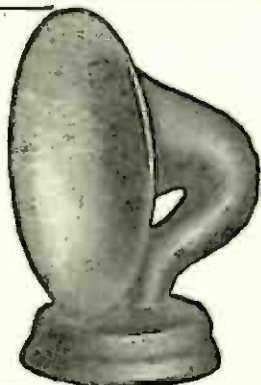

Pacent Jack No. 70

Look to Your JACKS!

When soldering jacks, use only resin. Most soldering flux, running away from the hot iron, into the jack insulation, will cause a leakage, even in a new jack. Leaky jacks cause "frying" noises.

Pacent Jacks, carefully soldered, are noiseless. Look for them in the set you buy. Use them when you build your own. There are ten types from which to choose. At all good radio shops.

Write for Catalog P-7

Pacent Electric Company, Inc.
22 Park Place, New York, N. Y.



Pacent
RADIO ESSENTIALS

What Is Your Problem?

Because some of our Readers may not be aware of POPULAR RADIO'S TECHNICAL SERVICE BUREAU, we are taking this opportunity to explain in detail just what your magazine has to offer in *practical and concrete Service.*

Under Mr. Cockaday's personal supervision is a staff of correspondents who will answer in personal letters any questions you may ask regarding the construction or operation of receiving sets; or any special radio problems that may confront you. It is obvious that this staff cannot be expected to give answers to questions that have already been published in POPULAR RADIO. Below is given a condensed list of contents of the back issues available. Any numbers wanted will be supplied at 35c. each. Nor can you expect to have the Staff

tell you how to construct and maintain a 500 Watt Broadcasting Station. But there are thousands of problems that they can solve for you, and to subscribers the Service is free if you will enclose a stamped addressed return envelope. The same personal service is rendered other readers who are not subscribers for a nominal charge of 50c. Please confine your questions to one general subject and write on one side of the sheet—but write as often as you wish.

May, 1922

- Harnessing waves to wire.
- How to tune a Regenerating Receiver.
- Symbols that help in reading diagrams.
- How to make soldered connections.
- How Radio waves are sent and received.

June, 1922

- Wireless that we can see.
- Can we talk to the dead by Radio?
- How electricity is generated.
- Tones that do and don't broadcast.
- How to make a simple tube Receiving Set.

July, 1922

- Steinmetz on ether waves.
- How to learn the code.
- How to make a two-circuit Receiving Set.
- How high frequency currents are generated.
- Pointers for preventing interference.
- How to make a loose-coupler coil.

August, 1922

- How machines are controlled by Radio.
- How Radio circuits are coupled and tuned.
- What "call letters" mean.
- How to make a variable condenser.

September, 1922

- How to build the Armstrong Circuit Receiver.
- A resonance wave coil for reducing static.
- How to make a rotary plate condenser.
- The simplest receiving antenna.

October, 1922

- How to make a spider-web tuner.
- How to make your own grid condenser.
- Don'ts for Radio fans.
- How to use a Regenerative Set as a transmitter.
- How to restore worn-out crystals.

November, 1922

- Sir Oliver Lodge on ether waves.
- How to add a Vacuum Tube to your crystal set.
- The most popular transmitting aerial.
- How to make a novel varlocoupler.

December, 1922 (Out of stock.)

January, 1923 (Out of stock.)

(A Reprint of Mr. Cockaday's article describing the DX Regenerative Receiver may be had for 25 cents.)

February, 1923 (Out of stock.)

March, 1923 (Out of stock.)

April, 1923 (Out of stock.)

May, 1923 (Out of stock.)

(A full description, however, of Mr. Cockaday's original 4-Circuit Tuner will be found in POPULAR RADIO'S handbook, "How to Build Your Radio Receiver," advertised on pages 56 and 68.)

June, 1923

- How the microphone transmitter works.
- How to build a good single tube receiver.
- How to make a crystal detector stand.

July, 1923

- The ratio in size between your antenna and your coil.
- Useful facts about car-phones.
- How to make a dry-cell tube Regenerative Set.
- How to keep up your storage battery.

August, 1923 (Out of stock.)

(A full description, however, of the Tuned Radio Frequency Receiver will be found in POPULAR RADIO'S handbook, "How to Build Your Radio Receiver," advertised on pages 56 and 68.)

September, 1923

- How to get a radio license.
- How weak signals are regenerated.
- How to make a battery charging rectifier.
- How to build the Haynes DX receiver.

October, 1923

- Practical hints for Coil Calculations.
- How to make a Two-stage Audio-frequency Amplifier.
- Ten good rules for Broadcast Listeners.
- How to make a simple Honeycomb Receiver.

November, 1923

- The 100 Best Hook-ups (Part 1).
- Receiving without Antennas.
- How to build the New Regenerative Super-heterodyne Receiver (Part 1).
- How to build a combination Short and Long-wave Receiver.

December, 1923

- How to Select your Radio Parts.
- The 100 Best Hook-Ups (Part 2).
- How to Read a Diagram (Part 1).

- How to Build an efficient Crystal Receiver
- How to Build the Super-heterodyne Receiver (Part 2).

January, 1924 (Out of stock.)

February, 1924

- How to add "Push and Pull" amplification to the original 3 tube Cockaday 4-Circuit tuner.
- The original 4-Circuit Tuner as a Portable Set with Loop.
- The 100 Best Hook-ups (Part 4).
- How to build a 3-tube Reflex Receiver (Part 1).

March, 1924

- Hoffman Transformer Measurement Chart.
- The 100 Best Hook-ups (Part 5).
- How to Build an Amateur Transmitter.
- A 3-tube Reflex Receiver (Part 2).

April, 1924

- How to Build a Simplified Neutrodyne Receiver.
- The 100 Best Hook-ups (Part 6).
- How NOT to Tune the Single Circuit Receiver.
- A Novel Substitute for "B" Batteries.

May, 1924

- A Compact Radio Kit for a Spring Hike.
- How to Get the Maximum Radio-frequency Amplification.
- Getting Static's Autograph
- 100 Best Hook-ups (Part 6).
- A measurement Chart for Use in Designing a Rheostat.
- Where Interference Comes In.
- How to Make an Audio-frequency Amplifier that Does Not Distort.

June, 1924

- How to Install a Receiver on your Boat.
- The Lightning Bugaboo.
- Why the Broadcast Listener Should Not Be Taxed.
- The 100 Best Hook-ups (Part 7).
- How to Make Your Own Grid Condensers.
- How to Build a Regenerative Receiver for Use with an Indoor Antenna.
- Will We Run the World's Machinery with Radio Power from the Pole?
- How to Make a Two-Slide Tuner.
- How to Calculate the Wiring of Coils.

POPULAR RADIO, INC.

627 West 43d Street

Dept. 78

New York City

Please refer to POPULAR RADIO when answering advertisements.

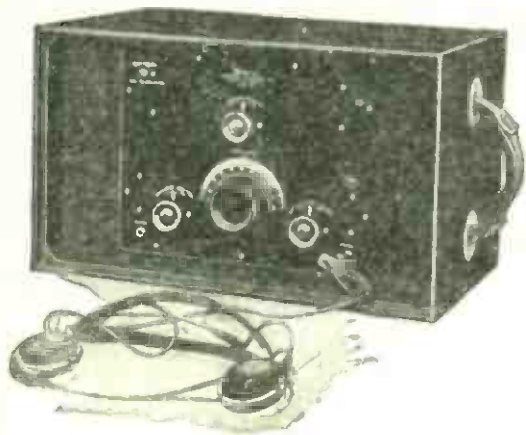

Federal No. 102 Special Set is "CONVERTIBLE"

"Convertible" is the only word that even nearly describes the Federal No. 102 Special Receiver. It is a complete, "portable" set, with dry batteries, head phones, etc., ready for immediate camp or road use—PLUS the capacity for quick and easy changing to wet battery, for city or country "home" use. True to Federal standards, the No. 102 Special incorporates exceptional tone beauty, selectivity and distance range. Federal flexibility pervades throughout—the No. 102 Special will operate perfectly on any tube interchangeably.

Ask any Federal dealer for a demonstration of the Federal No. 102 Special Set

FEDERAL TELEPHONE AND TELEGRAPH CO.
Buffalo, N. Y.

Look for this sign



Federal

Standard RADIO Products

Boston, New York, Philadelphia, Chicago, Pittsburgh, San Francisco, Bridgeburg, Canada, London, England

\$1.50

Anchor Radio Lightning Protector

For removing static charges & discharges from outdoor Radio Receiving Antenna

RADIO RECEPTOR CO. 59 BANK ST. NEW YORK
MAGNUS ELECT. CO., 451 Greenwich St., New York

Don't You Get Tired

of only hearing LOCAL stations on your Crystal Set? There's music on your aerial every night from stations far away. If you want to hear it without buying a tube set. WRITE ME TODAY.

LEON LAMBERT
540 South Volusia Wichita, Kansas

METALECTRIC SOLDERING IRON

"Accepted as the logical solution to radio problems by leading amateurs, manufacturers, and Governmental departments."

Write for descriptive literature.

Post Electric Co. (Inst. Division) 30 E. 42d St., New York

Thinking Radio?

Then Get Our FREE Bulletin No. 92

It shows recent developments and improvements in parts, and the kind you must use if you want the best in Radio. Send for this book today.



SENT FREE

PREMIER PARTS

Quality Unsurpassed—For Every "Hook-up"
All Good Dealers Sell Them

Premier Electric Company

3807 RAVENSWOOD AVE., CHICAGO

FREE

until

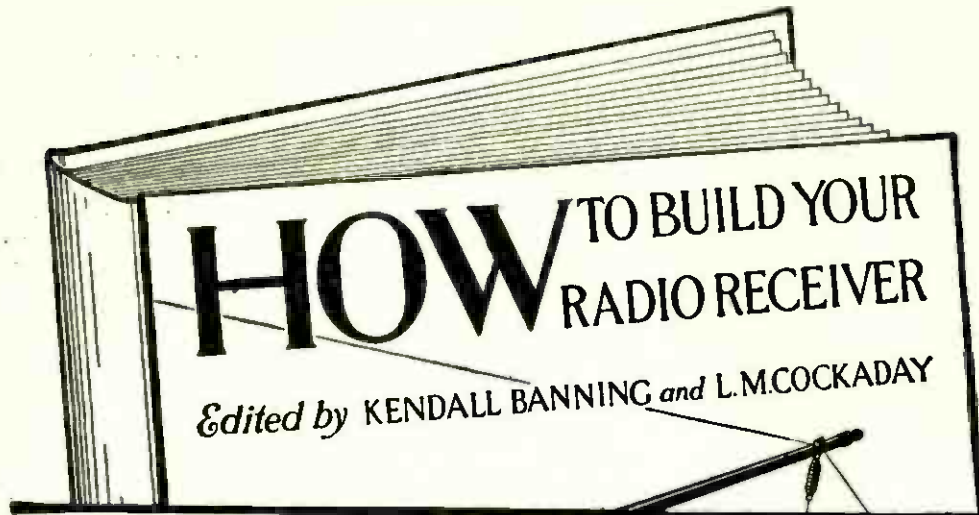
July 20**A Practical Handbook for Beginner or Expert**

"How to Build Your Radio Receiver" is the answer to thousands of questions received by the Editors, Kendall Banning and L. M. Cockaday. Sooner or later everyone interested in radio wants to build a set. So seven representative circuits were selected ranging from the simple crystal set to the extremely sensitive Super-heterodyne. With the descriptive matter are accurate diagrams and illustrations showing exactly how to assemble, mount, wire and operate each set. Even the list of parts needed specifies by manufacturer's name those actually incorporated in the demonstration set built in our laboratories. Follow the simple directions and you will get results beyond your expectations.

There is a wealth of reference matter in addition to the actual constructional data. For beginners is a table showing the forty-four symbols used in radio diagrams, with a description of the function of each part in the completed set. Aerials, grounds and considerable other general information of importance is to be found in this valuable book.

Free for a Limited Time

You would indeed expect that a book of such evident value, consisting of a hundred pages in handsome cloth binding, would be expensive. The fact is that until July 20, 1924, we will give it absolutely free, all postage charges prepaid, with a year's subscription to your favorite radio magazine. Send us \$3.00, the regular annual subscription rate, and we will enter your name on our mailing list to receive POPULAR RADIO for the next twelve months, and "How to Build Your Radio Receiver" will be sent you free.

Dept. 75
Popular Radio
627 West 43d St.
New York City

Enclosed remittance of \$3.00 is payment in full for a 12 months' subscription for POPULAR RADIO. Also send me with your compliments a copy of your 100-page, cloth-bound book, "How to Build Your Radio Receiver," by Kendall Banning and L. M. Cockaday.

Name.....

Address.....

City..... State.....

Offer expires July 20, 1924.

Our unconditional guarantee protects you entirely.

If you are not more than satisfied, notify us within ten days and your remittance will be returned in full.

In "How to Build Your Radio Receiver" you will find complete constructional diagrams, specifications, photographs and instructions for building the following sets. Each has been selected as representative of its circuit because in laboratory tests it proved the best for distance, selectivity, tone volume, simplicity of construction, ease in tuning, reliability and all-around satisfaction.

A \$5 CRYSTAL SET

The simplest up-to-date set for local broadcast reception. Approximate range, 15 miles, though distances up to 400 miles are not extraordinary. Gives clear signals on headset without distortion. No operating cost whatever.

THE HAYNES SINGLE TUBE RECEIVER

An efficient set that may be made by a novice at an approximate cost of only \$15 for parts. Simple to tune, selective, good audibility. Long distance range up to 1,000 miles on earphones. Six-volt storage battery and 22½-volt "B" battery required, or may be adapted for dry cells and dry cell tubes.

A TWO-STAGE AUDIO-FREQUENCY AMPLIFIER

This instrument may be added to any set, crystal or tube, to strengthen the received signals, so that they will operate a loud-speaker. It is easy to construct, efficient and inexpensive, costing only \$15 for parts. Operates on the same "A" battery that is used on the vacuum-tube detector unit.

THE COCKADAY 4-CIRCUIT TUNER

A 3-tube set, famous for its high selectivity and beautiful tone. So neat and compact that it may be kept in a bureau drawer. Cost of parts about \$40. Receiving range approximately 1,500 miles on a loudspeaker. Operates on a 6-volt storage battery and two 45-volt "B" batteries, or may be adapted to dry cells and dry cell tubes.

A 5-TUBE TUNED RADIO-FREQUENCY RECEIVER

Two stages of tuned radio-frequency amplification, detector, and two stages of audio-frequency amplification are here employed so that the possibility of "oscillation and re-radiation" is eliminated. The set can be operated on a loop antenna and may be built at a cost of only \$90 for parts. Six-volt storage battery and two 45-volt "B" batteries required. Range about 1,000 miles on loop or indoor antenna, and 2,500 to 3,000 miles on an outdoor antenna.

THE "IMPROVED" COCKADAY 4-CIRCUIT TUNER

Probably the most important contribution yet made to the equipment of the radio fan. A compact 5-tube set with a receiving range of over 3,000 miles. Cost of parts about \$95. Wavelengths range from 150 to 675 meters. Automatic tuning and power amplification. Maximum volume of sound, excellent reproduction and no interference. Requires a 6-volt "A" battery, three 45-volt "B" batteries, one 22½-volt "B" battery and a 9-volt "C" battery.

THE REGENERATIVE SUPER-HETERODYNE RECEIVER

More sensitive, more selective and more simple to tune than any other 6-tube receiver yet developed. A three-section, 6-tube set employing the Haynes Single Tube Receiver as tuner. May be further extended to a four-section, 8-tube set by the addition of the two-stage audio-frequency amplifier. The cost of parts approximately \$100. Range of 3,000 to 4,000 miles on a loud-speaker. Has been called the "Rolls-Royce" of radio receivers.

POPULAR RADIO

627 West 43d Street :: New York City

Please refer to POPULAR RADIO when answering advertisements.

COAST TO COAST

on the R.C.S Circuit, using
RayCoils



RayCoilS "A" for Reinartz, Ray CoilS "B" for RCS and Ultra Audion Circuits, RayCoilS "C" for RCS, Ultra Audion and Tuned Radio Frequency Circuits. RayCoilS "D" for Tuned Radio Frequency and Neutralizing Circuits of 4, 5 and 6 Tubes.

- A = \$2.50
 - B = 2.00
 - C = 2.00
 - D = 2.00
- Use the RCS Circuit with or without Radio Frequency for Simplicity in operation and results. Not equalled by any set for volume and distance.

Coils in Separate Box With Wiring Diagram

Working Blue Prints of four sheets 12 x 18 of all standard circuits, as Variometer Hookup, Reinartz one and three tube, R.C.S. three and four tube and R.C.S. five tube Tuned Radio Frequency, 50 cents a set.

We also carry a complete line of Carter, Howard, Kellogg, Modern and Trimm parts. If your dealer cannot supply you, we will mail direct.

R. C. SCHOONHOVEN
Major Q. M. R. C.

310 SENECA ST. ELGIN, ILL.

No Matter What You Do This Summer—Take Care of Your Batteries

YOU'LL NEED THIS RELIABLE BATTERY TESTER

Easy to use, easy to clean. Easily read. Float always upright. Acid proof rubber.



THE RELIABLE PARTS MFG. COMPANY
2819 Prospect Ave. Cleveland, Ohio

Perfectone Products

- Loud Speaker \$15.00
- Phonograph Attachment..... 8.75
- Phones..... 5.00

PERFECTONE RADIO CORP.
490-C Broome St. New York

RADIODYNE

NO LOOPS—NO AERIAL

Ready for operation by grounding to a water pipe or radiator, and throwing a few feet of wire on the floor. Uses any standard tubes—dry cell or storage battery. Extremely selective. Simple to operate—only two controls. Wavelength from 200 to 700 meters. Write for Folder describing this (antennaless) receiver.

WESTERN COIL & E. CO.
308 Fifth Street Racine, Wis.

DUPLEX

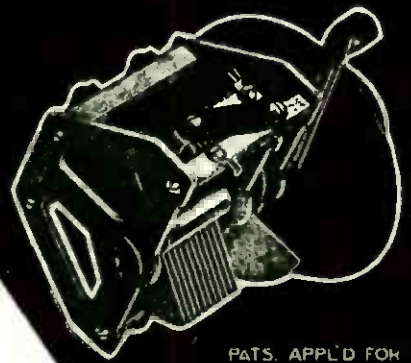

Series "FR"

Precision Condensers

In this series we have met the demand for a condenser in which the rotor can be grounded. Also for a condenser for very short wave reception, particularly in the super-heterodyne and tuned radio frequency circuits.

A CONDENSER IS NO BETTER THAN ITS BEARINGS

"Facts for Fans" goes into more detail on the subject of electrical losses. We will be pleased to mail it to you.

Some valuable jobbers' territory still open.

The DUPLEX ENGINE GOVERNOR CO., Inc.
50 Flatbush Ave. Extension, BROOKLYN, N. Y.

PATS. APPL'D FOR

TRADE MARK
NONE OTHER

AMPLEX GRID-DENSER

Improves ANY Circuit

Replaces FIXED CONDENSERS and Gives

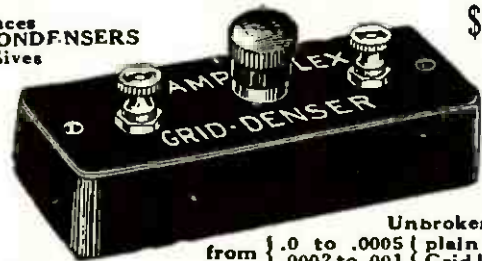

\$1.25

Unbroken Range from { .0 to .0005 } plain or with { .0002 to .001 } Grid leak clips

ABSOLUTELY ESSENTIAL IN Cockaday, Tobias, Super-Heterodyne, Ultradyne, Superdyne, Neutrodyne, Etc.

No two tubes or Circuits are alike. Each requires a different EXACT capacity for maximum efficiency. A slight turn of the GRID-DENSER knob finds the CORRECT capacity for you. Permits operating set at highest point of regeneration, controls oscillations, maintains perfect stability.

SPECIFIED by Haynes, Tobias, Cockaday, Greif, M. B. Sleeper, Loscarbours, Foote, Pfeiffer, in ALL circuits for **GREATER Distance, Louder and Clearer Signals.**

FREE Booklet with hook-ups showing how to double the efficiency of your set.

At your Dealers, or send \$1.25 to
AMPLEX INSTRUMENT LABORATORIES
57 Dey Street, Dept. P. 7A, New York City, N. Y.

Genuine LAVITE Resistance

12,000 } ohms
25,000 }
48,000 }
100,000 }

AMPLEX LAVITE

For the improved Cockaday Circuit and all Resistance Coupled Amplifiers

AMPLEX INSTRUMENT LABORATORIES
57 Dey St., Dept. LA, New York

List \$1.25 each

For Summer Radio

Bradleyleak

THE PERFECT GRID LEAK
 Range— $\frac{1}{2}$ to 10 Megohms.
 A grid condenser of 0.00025
 ml. supplied extra. Endors-
 ed by Cockaday, Amrad,
 Flewelling, Croaley, etc.
 Price . . . \$1.85
 Condenser . . .35



Bradleystat

PERFECT FILAMENT CONTROL
 Noiseless, stepless filament
 current control for ALL
 tubes. Is standard equip-
 ment on many sets, includ-
 ing Amrad Console models.
 Price . . . \$1.85



Bradleyohm

THE PERFECT RESISTOR
 An adjustable resistor for ra-
 dio circuits. Made in three
 ranges:
 10,000 to 100,000 ohms
 25,000 to 250,000 ohms
 40,000 to 500,000 ohms
 Price, any range, \$2.00



The Bradleystat holds first
 place for long distance re-
 ception in many contests.



Bradleyswitch

PERFECT BATTERY SWITCH
 For A- and B-battery circuits.
 Only ONE hole required in
 panel to mount the switch.
 Nickel-plated and totally en-
 closed.
 Price . . . 60c

Bradleyometer

THE PERFECT POTENTIOMETER
 A stepless, non-inductive po-
 tentiometer for all radio cir-
 cuits. Complete range in half
 turn of knob. Made in 200 and
 400 ohm. Price, 200 ohm,
 \$2.00; 400 ohm, \$3.00.

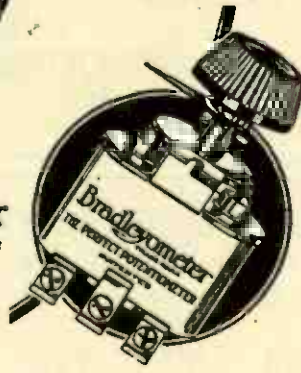

Use Allen-Bradley Products

Summer Radio Sets are portable sets! This means that they must be built for abusive service, and must operate under conditions that are often unfavorable for good reception. Short antenna, loop antenna, and similar receptive devices call for extremely sensitive sets. This, again, means that the parts used must be of high efficiency for maximum signal strength.

Allen-Bradley Radio Products are known the world over for excellence of construction and perfection in operation. They make any good set better, and insure a full measure of enjoyment in summer camps when used in portable sets. Make your set a good set. The above radio parts are the finest obtainable. Follow the advice of radio experts. Use them!

Allen-Bradley Co.,
 276 Greenfield Ave., Milwaukee, Wis.
 Please send me a complete set of your de-
 scriptive circulars on Allen-Bradley radio
 products.
 Name
 Address

Allen-Bradley Co.

Electric Controlling Apparatus

276 Greenfield Ave. Milwaukee, Wis.



The Allen-Bradley Guarantee

Every Allen-Bradley radio product is guaranteed for ONE YEAR against defects in material and workmanship. Any defective material will be repaired or replaced, without charge, within the guarantee period.

This Summer!

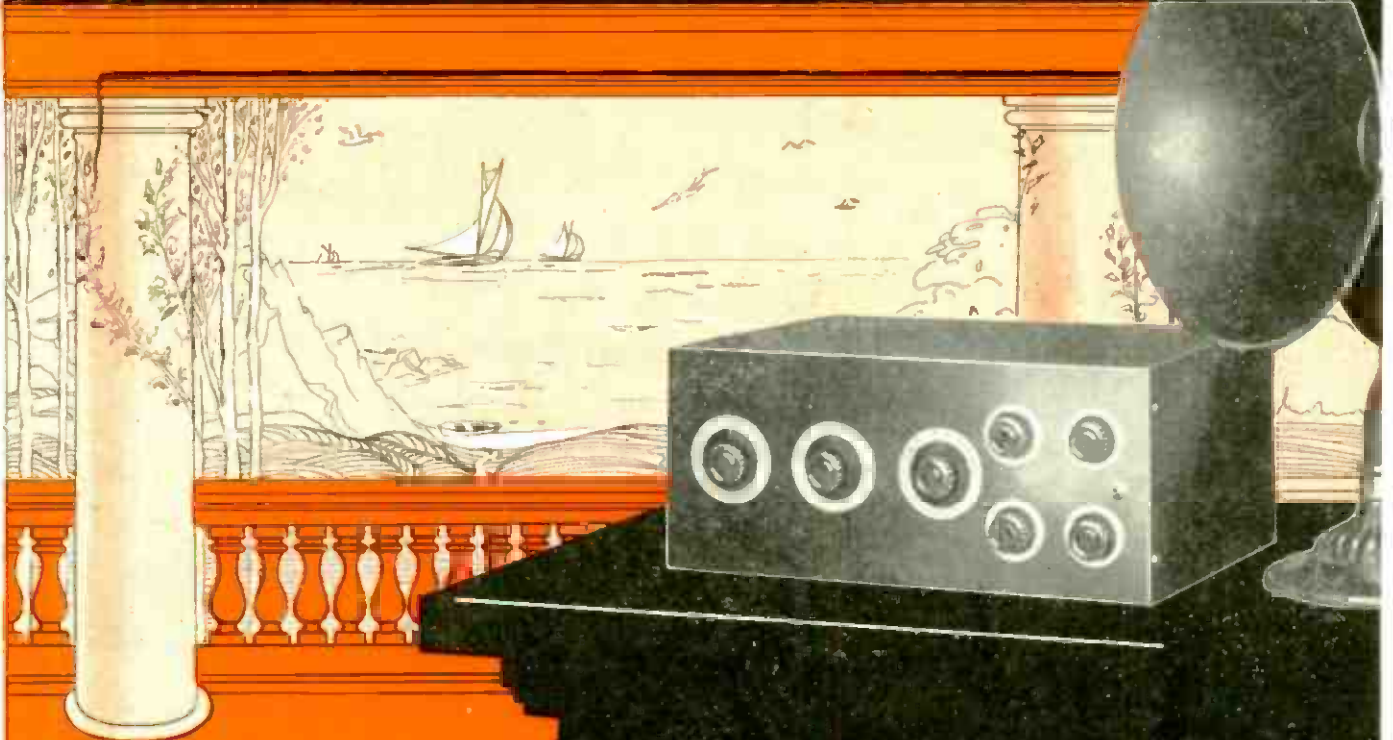

TELEDYNE

On a Ten Foot Antenna

Excellent volume—less interference
—greater selectivity.

What's more, it makes TELEDYNE
an easily portable set. Take it with
you on your vacations.

Inspect TELEDYNE now. You'll
find it the most compact, *practical,*
usable receiver on the radio market.
C&W Dealers everywhere will dem-
onstrate, or write direct to—

The Cutting & Washington Radio Corp.
Kasota Bldg., Minneapolis, Minn.

*Simply attach a 10
ft. wire to the ver-
tical coil post as
shown. Bridge an-
tenna and ground
posts with a .000125
condenser. Make a
ground connection
in usual fashion.
You'll enjoy Sum-
mer broadcasting.*



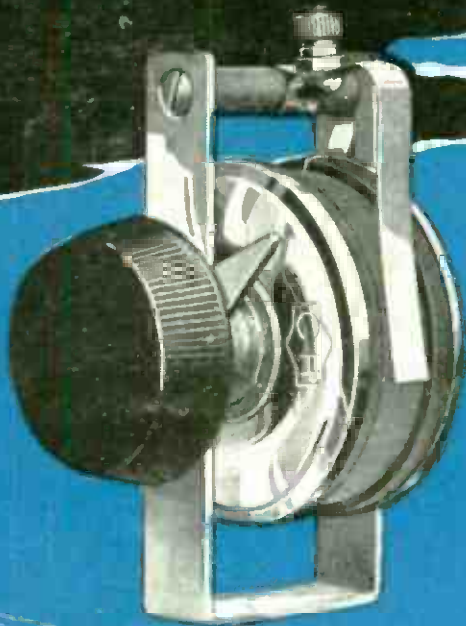
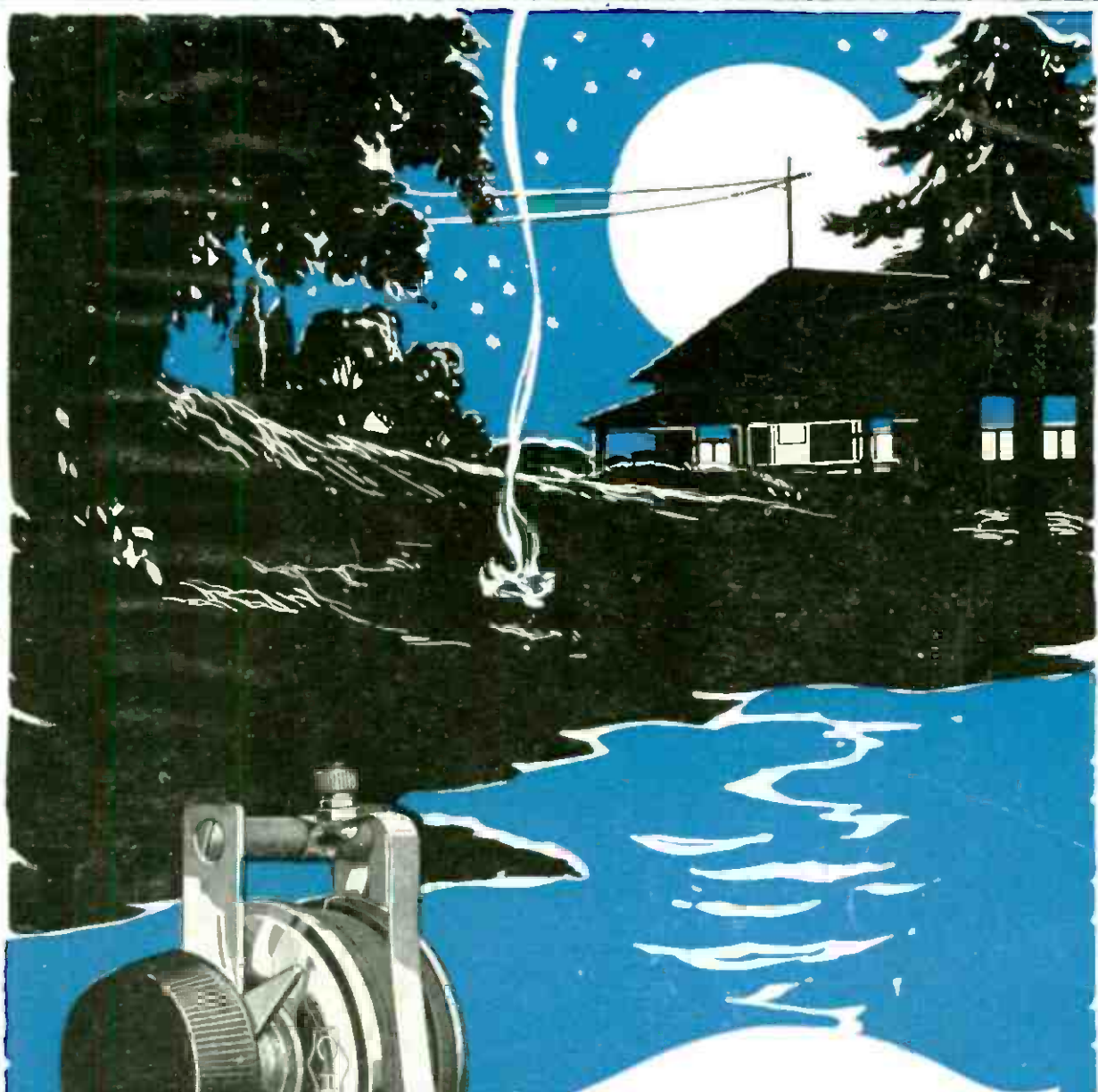

The C-H 30 Ohm Rheostat
The C-H Radio line includes rheo-
stats, potentiometer, switch, and
grid leak—ask for them by name.

The vacationist who has
precise control isn't con-
tinually complaining
about "static." A good set
is a real summer compan-
ion—and easy to build
when you demand the
Mark of the Master Builder.



CUTLER-HAMMER