

Popular Radio

Edited by **KENDALL BANNING**

25¢

**APRIL
1924**



**A SIMPLIFIED
NEUTRODYNE**

**How to Build a
Non-regenerative
Radio-frequency
Receiver—**

TELEDYNE



TELE
means distance
DYNE
means power

5 Vital Improvements in Radio

Dr. Cutting and Mr. Washington have struck at the very heart of the radio problem in the development of the TELEDYNE — 1924's greatest set.

1. TELEDYNE is super-sensitive, catching and developing the weakest signals.
2. Extremely selective — TELEDYNE tunes local stations out.
3. Greater volume — a real LOUD-speaker set.
4. NO radiation — no regeneration howls on the air.
5. Easy to pick up new stations — no need for a "log."

Four tubes do the work of five, saving tubes and batteries.
Price, complete with all tubes and batteries, contained in cabinet \$190

*See the Console Model, complete with Loud-speaker.
Ask a C & W Dealer to demonstrate*

The Cutting and Washington Radio Corp., Kasota Bldg., Minneapolis, Minn.

Cutting and Washington

Standard of Excellence in Radio Since 1914

Brandes

The name to know in Radio



© C. Brandes, Inc., 1924

Table Talker... \$10.00
Navy Type Headset 8.00
Superior Headset... 6.00

All Brandes products are sold under a money back guarantee by reliable dealers everywhere.

Table Talker 50c. additional west of the Rockies.

Please refer to POPULAR RADIO when answering advertisements.

POPULAR RADIO

EDITED by KENDALL BANNING



CONTENTS for APRIL, 1924

(Cover design by Frank B. Masters)

VOLUME V

NUMBER 4

A Foremost Explorer of the Electron Universe (A portrait study of Dr. Niels Bohr)	FRONTISPIECE
Bohr's New Theory of Atoms..... <i>E. E. Free</i>	Page 319
An Electron Pencil for Studying Radio Circuits. <i>Paul Findley</i>	328
How I Built a \$12 Crystal Set, Though 34 Years Old..... <i>Don Herold</i>	335
How the Antenna Is Energized..... <i>Oliver Lodge</i> Article No. 8	340
A Novel Substitute for "B" Batteries..... <i>F. F. Humphreys</i>	345
100 Best Hook-ups..... <i>The Technical Editor</i> Installment No. 6; Transmitting Sets for Amateurs	351
Will Radio Do Our Housework?..... <i>Thomas Elway</i>	356
A Measurement Chart for Determining the Maximum Capacity of a Variable Condenser. <i>Raoul J. Hoffman</i> Article No. 7	362
How NOT to Tune the Single-circuit Receiver. <i>Laurence M. Cockaday</i>	364
How to Build an Experimental Radio Set..... <i>Spencer Boyd</i>	367
Will Radio "Revolutionize" American Educa- tional Methods?..... <i>Harry A. Mount</i>	373
How to Build a Simplified Neutrodyne Receiver. <i>Albert G. Craig</i>	378

DEPARTMENTS

Broadcasts..... <i>David Lay</i>	391
What Readers Ask..... <i>Laurence M. Cockaday</i>	396
Facts You Hunt For..... <i>Richard Lord</i>	402
Hints for Amateurs..... <i>Albert G. Craig</i>	404
In the World's Laboratories..... <i>E. E. Free</i>	406
Listening In..... <i>Kendall Banning</i>	414
"Stations I Have Heard"	419

VOLUME V

APRIL, 1924

NUMBER 4

Published monthly by Popular Radio, Inc., 627 West 43rd St., New York, N. Y., telephone number Chickering 1906; H. B. Emerson, President; Douglas H. Cooke, Vice-President; Kendall Banning, Treasurer. Price, 25 cents a copy; subscription \$3.00 a year in the U. S., Canada and all countries within the domestic postal zone; elsewhere \$3.50 a year, payable in advance. The International News Company, Ltd., No. 5 Bream's Bldg., London, E. C. 4, sole distributors in England. Entered as second class matter April 7, 1922, at the Post Office at New York, N. Y., under the act of March 3, 1879. Copyright, 1924, and title registered as a trade-mark by Popular Radio, Inc. Copyright in Great Britain by Popular Radio, Inc., 6 Henrietta St., Covent Garden, W. C., London, England. Printed in U. S. A.

E. E. FREE, Ph.D., *Contributing Editor* LAURENCE M. COCKADAY, R.E., *Technical Editor*

New York: 9 East 40th St.

For advertising rates address E. R. CROWE & Co.
Chicago: 225 North Michigan Ave.



Dependability!

MORE than ten years of radio manufacturing experience is built into each dependable Grebe Broadcast Receiver.

Made in two easily operated types, in which every detail of craftsmanship is an assurance of trustworthy performance. Ask your dealer or write us for literature.

Licensed Under
Armstrong U. S.
Pat. No. 1,113,149



A. H. GREBE & COMPANY, INC., Richmond Hill, N. Y.
Western Branch—451 East 3rd St., Los Angeles, Cal.

It is only when the cold season comes that we know the pine and cypress to be evergreens.

Confucius —
In the real test of performance

the **GREBE**

Broadcast
Receiver
establishes its true merit.

Doctor My.



Type CR-14 — A 3-tube dry cell Regenerative Receiver \$110⁰⁰
(Accessories extra)

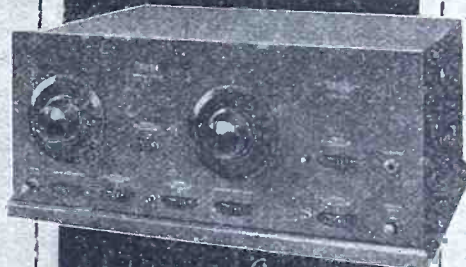

Type CR-12 — 4 tubes. Combines Regeneration and Tuned R.F. . . \$175⁰⁰
(Accessories extra)

Please refer to POPULAR RADIO when answering advertisements.

PAGES WITH THE EDITOR

ONE of the most interesting of our visitors last month was Svend Skov, a good-looking young Dane who was a member of the crew of the ill-fated *Normania*, sunk in a storm off Virginia on January 17, 1924. In fact, Skov was the radio operator whose efforts brought help in the form of the steamers *Henry R. Mallory* and *Charles E. Harwood*, which rescued the entire crew of twenty-six.

* * *

YOUNG Skov (like all the rest of the crew) lost everything he had on board except such of his clothes as he wore and the overcoat which was given to him by the Danish Consul in New York, where all of the penniless castaways were finally landed. But the lost treasure that he mourned most of all was a complete set of POPULAR RADIO!

* * *

"COULD you let me take back with me to Denmark tomorrow a complete file of the magazine?" asked Radioman Skov. "I have no money at all, but I will pay you when I get home."

Needless to say, our Subscription Manager loaded him up with a complete file (with the exception of four numbers that are out of print) with the compliments of POPULAR RADIO.

* * *

FROM now on POPULAR RADIO will undertake to replace without charge all files of the magazine that may be lost at sea by any ship's operator.

* * *

"LAST summer," reports C. G. Isherwood of Old Shirley, Southampton, England, "I

constructed the now famous Cockaday four-circuit tuner from the instructions given by the inventor in your May, 1923 issue, and although I had some difficulty in adapting apparatus of British manufacture to take the place of components specifically advised (unfortunately unobtainable in this country), I was astounded at the remarkable results. On my small antenna, which is only 50 feet long and 20 feet high, I can get WGY and hear every word distinctly as easily as I can get our home stations—not quite so loud, of course!

* * *

"I WAS so enthusiastic over the results that I obtained a dozen copies of the May, 1923 issue and distributed them among my radio friends—seven at least, I know are now regular subscribers. . . . The articles by Sir Oliver Lodge have been of the greatest service to me in my experiments as they contain much data which I have never been able to obtain from any other source.

* * *

"IF the price of POPULAR RADIO were \$1.00 a copy, it would be well worth it and I should still be a regular subscriber!"

* * *

SOMETIMES we wonder why the occasional anonymous letter that is furtively mailed to the Editor is invariably scurrilous and why "the truth is not in them." And then we conclude that the bashful author hides his identity because he also knows that the truth is not in them. And then we file the anonymous letter in the scrap basket.

(Continued on page 6)



Kadel & Herbert

THEY OWE THEIR LIVES TO AN SOS CALL SENT BY A POPULAR RADIO SUBSCRIBER

Nineteen of the crew of twenty-six of the wrecked Danish ship Normania, who were rescued by American vessels when Radioman Skov called for help. A complete file of POPULAR RADIO went down to join the treasures in Davey Jones' locker.

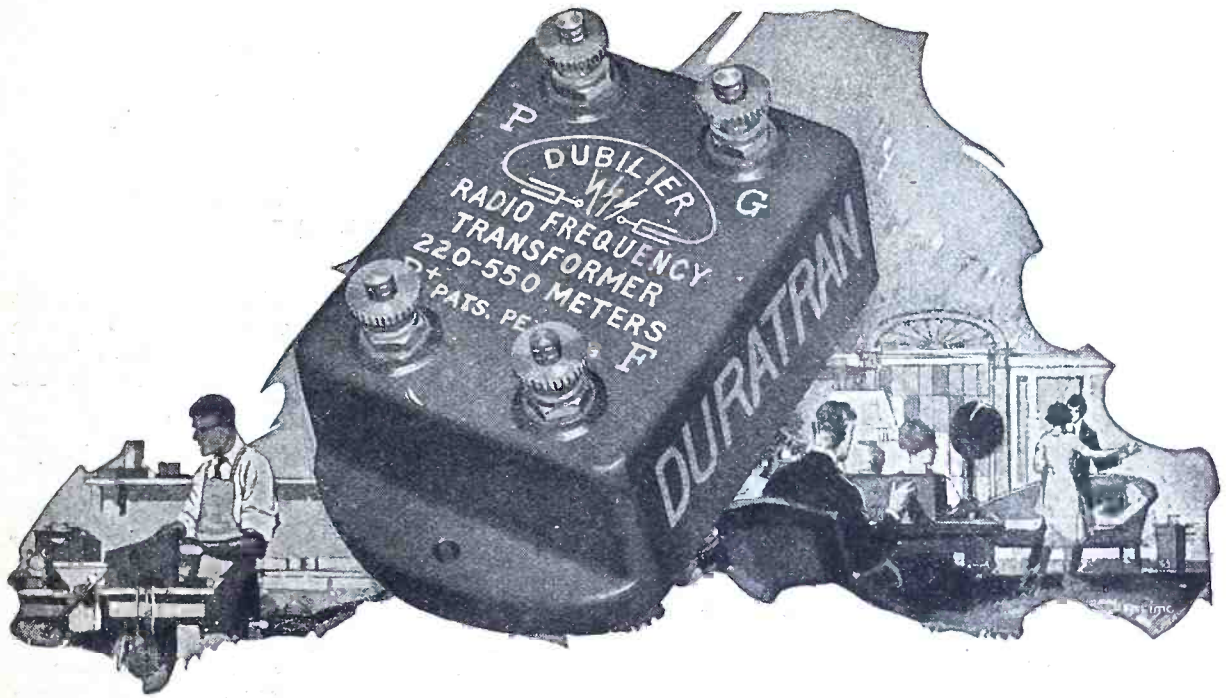

Increase Your Range with the *Dubilier Duratran*

Don't discard your one-tube regenerative set because you can't get the distant stations. The Duratran, the wonderful Dubilier radio-frequency transformer, will bring them in.

Simply add a stage of Duratran radio-frequency amplification to the set. And you will save the ten or fifteen dollars you would spend in buying parts for a new radio-frequency set.

The Duratran will enable you to bring in the distant stations because it amplifies on all broadcasting wave-lengths twenty times. All stations come in with equal clarity because of this unrivalled amplification.

Your dealer sells Dubilier Duratrans. Price \$4.00.

Free Blue Prints of Duratran Hook-ups

Ask your dealer for free blueprints of Duratran hook-ups. They show how a Dubilier Duratran will convert your one-tube set into a sensitive radio-frequency receiver.

Dealers: Your jobber will supply you with blueprints of Duratran hook-ups.

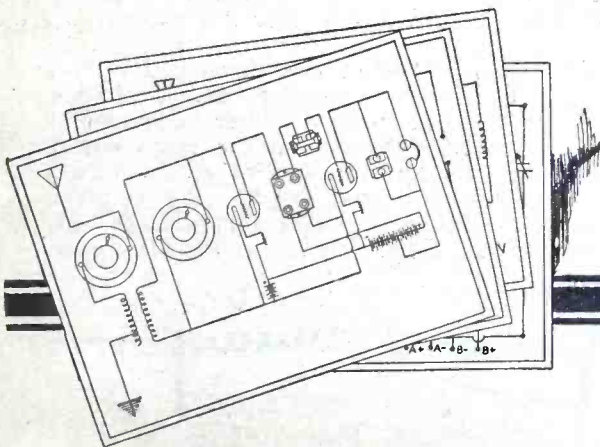

Dubilier Condenser and Radio Corporation
40-50 West Fourth, Street, New York

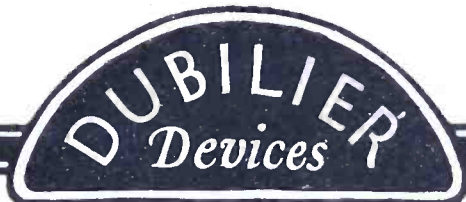

Please refer to POPULAR RADIO when answering advertisements.

PAGES WITH THE EDITOR

(Continued from page 4)



Lieutenant-Commander Fitzhugh Green, U.S.N.

ONE of the foremost radio experts of the U. S. Navy, who is writing an important article for POPULAR RADIO.

WHAT kind of articles do you like best in POPULAR RADIO? What kind of articles do you believe can be dispensed with most readily? Which of the departments do you like best—and the least? What additions or omissions can we make that will increase the value of the magazine to you?

THE Editor welcomes both criticism and commendation. Each is helpful. Indeed, some of the most popular features in POPULAR RADIO have grown out of letters of suggestion from our readers—and some of its faults have been eliminated by the same means.

So many letters from radio operators—amateur and professional—have poured into the editorial sanctum addressed to "The Leader of the Expedition" that will shortly start for a cruise around the world (as announced in the February number) that the Editor has finally persuaded his anonymous friend to come out into the open and reveal his name, his address, his plans and his needs. Here they are:

His name is Barry Buchanan. His address is 16 Gramercy Park, New York. His plans provide for a four-year tour in a 150-foot two-masted schooner with auxiliary engines; he will be accompanied by photographers, scientists and writers—and he needs an experienced operator who will take his pay in adventure and about \$10.00 a week, cash, for pocket money. For further particulars, write Barry Buchanan direct.

IN this number POPULAR RADIO initiates—on page 378—the method of presenting a hook-up diagram from RIGHT-TO-LEFT—which is the order in which the experimenter actually works on it and in which the set appears to him, from the rear.

CONVENTION has heretofore observed a left-to-right diagram—and convention is not to be lightly ignored. On the other hand the right-to-left diagram reading appears to be the logical and more practical form.

Which do the readers prefer?
The Editor will be glad to get opinions.

HERE is a real idea from a fan who finds the advertising pages of POPULAR RADIO so valuable that he is making a radio encyclopedia out of them.

"When I want to buy a new piece of apparatus," he reports, "I am not always able to remember offhand the names of all the makers of that particular thing or the special characteristics of the different makes. So I have begun to put together an encyclopedia of radio apparatus, using the advertising pages of POPULAR RADIO as my material.

THE editorial pages I file separately, to be bound. The advertising pages I cut up; I paste each ad in a scrapbook, indexing each one under the pieces of apparatus that it describes—"condensers," "loudspeakers" or whatever it is. Though I have only been doing this for a few months my collection has already furnished me valuable information. Of course, I have to buy two copies of your magazine, so that I can keep the ads on both sides of the page. But the results make it well worth while."

—T. E. YAWLE.

WITH the next issue—May—POPULAR RADIO will be two years old. In celebration of its birthday POPULAR RADIO will treat its readers, not only to a still further increase in its number of pages, but also to another "How to Build" article that will be of special interest and value to every owner of a receiving set, for it will describe how to make an audio-frequency amplifier that *does not distort*.

THIS new invention was developed by the Technical Editor, Laurence M. Cockaday, whose famous four-circuit tuner is known by millions of fans throughout the radio world. It is not only an amplifier of extraordinary qualities, but an amplifier that the fan can make for himself at a cost for parts of only about \$45.00. *Don't fail to get the May number!*

Kendall Banning
Editor, POPULAR RADIO



The
Thompson
MAGNAPHONE
Reg. U.S. Pat. Office

Your receiving set can be no better, in delivered results, than the loud-speaker you use with it. The THOMPSON MAGNAPHONE is an instrument that brings out the best that is in your set—because it is specifically designed and built as a radio loud speaker, not merely adapted from other purposes.

All that you've been seeking, and haven't found elsewhere in loud-speakers, is yours with the MAGNAPHONE—the volume, the tone quality, the natural reproduction of the original performance unmarred by mechanical distortion. You'll notice the difference instantly, when you plug in a MAGNAPHONE.

Here are a few features that make the MAGNAPHONE different, and better: cone-shaped special composition diaphragm vibrating equally over its whole area; two-to-one driving armature, reducing the permissible air gap 50%; laminated magnetic pole pieces and generously large magnet. These combine in a structure which forms a loud-speaker giving results so incomparably superior that the MAGNAPHONE is the instant choice of those who demand the best.

Price \$35.00—at Good Dealers, Everywhere

Ask your dealer to demonstrate the MAGNAPHONE—compare it with any other loud-speaker, from any standpoint—and you'll admit that Thompson's 14 years' experience in radio manufacture has produced the radio reproducer that satisfies your every requirement.

Manufactured by

R. E. Thompson Manufacturing Co.

Sales Office
150 Nassau St. New York

Factory
Jersey City, N. J.

Manufacturers also of the THOMPSON BALANCED NEUTRODYNE RECEIVER. Licensed under Hazeltine Patents

The Royalty



of Radio

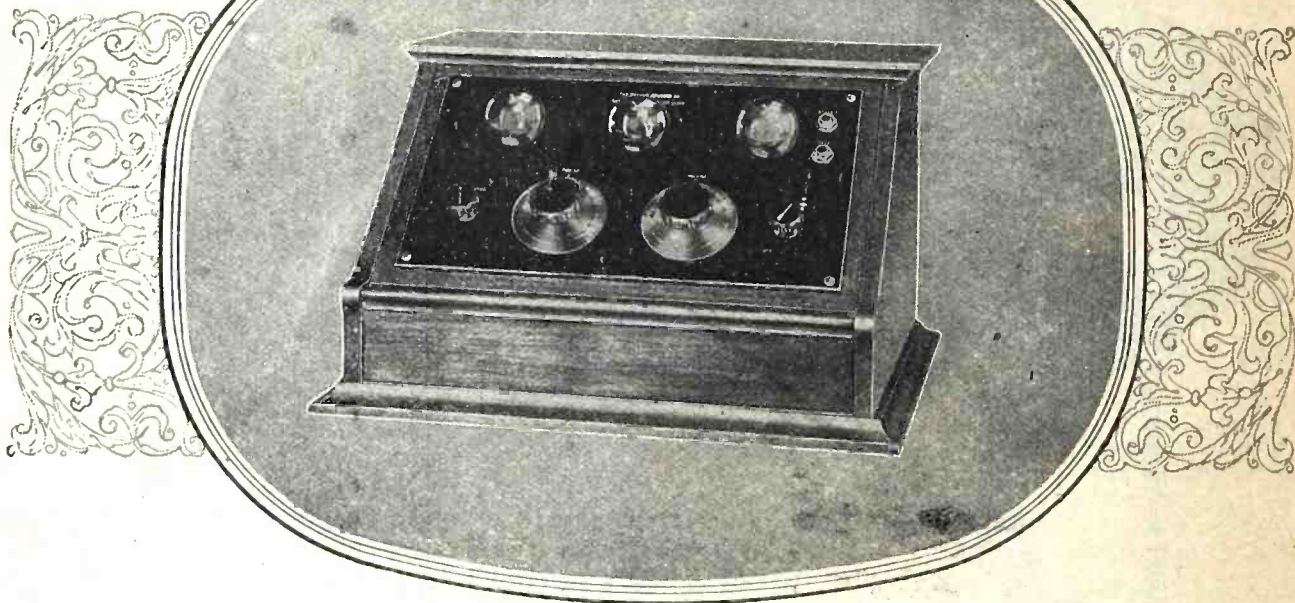

KENNEDY MODEL V

Like the Artist Standing Before You

So pure, sweet and life-like is the tone of the new Kennedy Radio Receiver, Model V, that it really makes you feel the artist's presence—standing at your fireside—performing for you, in your own home!

And, with this new Kennedy, it is astonishingly simple to bring to your own living room the best broadcast entertainment in the country. You, your wife, mother, son or daughter—anyone—can operate Model V with an ease that brings its own form of fascinating pleasure. Only one dial is used to "tune in" a station—a slight regulation of a second dial controls the volume so you can bring in music or voice soft or pronounced as you wish.

Best of all, when once you have determined the dial setting for any station, that station (if it is broadcasting) will "come in" at its own dial setting—any night, anywhere, regardless of the kind of antenna used.

Think of the possibilities here! Many Kennedy owners make up their own station record—showing the dial setting for each station. How wonderfully simple—merely select the station you wish to hear and set the tuning dial to the number of that station.

Another feature about this new Kennedy is one that your neighbors will appreciate. It does not radiate to any appreciable extent—it does not throw

out whining, whistling noises that interfere with listeners living near you.

When you buy your Kennedy Model V, you will add an attractive piece of furniture to your home. The mahogany cabinet is hand-rubbed to a beautiful finish. The polished black Formica panel, in contrast with the mahogany cabinet, creates a pleasing effect. There is no confusing mass of wires dangling from the cabinet and all batteries are completely enclosed.

Model V is really the receiver for you! It is a permanent investment that will bring you years of pleasure. It is sold, completely equipped with all dry battery tubes, dry batteries and Kennedy 3000-ohm phones with plug, for only \$125.00 (\$127.50 west of Rockies). Other models range from \$285.00 to \$825.00 (slightly higher west of Rockies) completely equipped, including built-in loud speaker.

Try this new Model V in your own home—your dealer will gladly arrange this for you. If you cannot locate him, write us direct for fully-illustrated literature covering this and other popular Kennedy models.

All Kennedy Radio Receivers are regenerative.
Licensed under Armstrong U. S. Patent No. 1,113,149.

\$125
fully equipped
(\$127.50 west of Rockies)

THE COLIN B. KENNEDY COMPANY
SAINT LOUIS

KENNEDY



Please refer to POPULAR RADIO when answering advertisements.



International

“Radio Will Make Our Next President”

So state the politicians, who are beginning to realize the enormous audiences that can now be reached through the ether. This picture shows William J. Bryan before a microphone, firing one of the first of the oratorical guns of the campaign.



From a photograph made for POPULAR RADIO

A Foremost Explorer of the Electron Universe

Professor Niels Bohr, of the University of Copenhagen, has done more than any other scientist to lay bare the secrets of the spinning electrons that compose the atoms of matter. This photograph, made during Professor Bohr's recent lectures at Columbia University, shows a few of the mathematical equations which are necessary for the full exposition of his theories of how atoms are built and of how ether waves are produced from them.

Popular Radio

VOLUME V

APRIL, 1924

NUMBER 4



Bohr's New Theory of Atoms

Ether waves start from electrons and end on electrons. *Without electrons there could be no radio.* Atoms, too, are made of electrons. This article tells about the new and revolutionary conceptions of atomic structure that have attracted such profound attention in the world of science.

BY E. E. FREE, PH.D.

THE atoms of matter are so inconceivably tiny that there are more than 2,000,000,000,000,000 of them on the top surface of an ordinary pin-head.

Yet each one of these minute atomic specks contains a wonderful inner universe of its own. It contains, in fact, a whole solar system not unlike that greater system of the sun and the planets on which we ride so comfortably through the emptiness of space.

This knowledge that the atoms are miniature solar systems is new. It results, in the main, from the work of Professor Niels Bohr, a distinguished Danish scientist who has been lecturing recently in the United States.

For the radio engineer this theory has not only the interest which any atomic theory must have for every sci-

entist but a special interest as well. It is the latest word of science about the electrical theory of matter. It is the newest news of the electron. And it is about to give us, so many scientists believe, the key to that great secret of the relation of ether waves (including both light and the waves of radio) to the kinds of electricity with which we are more familiar as electric charges and as electric currents.

The Bohr theories were originally reached, indeed, through the study of the ether waves sent out in the form of light rays from heated atoms; the light rays which make up sunlight or the light from the flame of a fire. But this way of approaching the theory has many difficulties for the student. Explanation will be easier if we consider, first, what the theory has to say about

the make-up of the atoms of matter.

The theory embodies an idea of the atom rather different from that described recently in POPULAR RADIO by Sir Joseph J. Thompson.* The Thompson theory is a static one. It assumes that each atom consists of a central particle around which are grouped a number of electrons which occupy relatively fixed (or "static") positions so long as the atom holds together at all. The arrangement of these electrons in space is determined, Sir Joseph Thompson believes, by the usual electrostatic attractions and repulsions.

The new Bohr theory, on the other hand, is dynamic. It agrees with the Thompson theory in assuming the same ultimate parts for the atom; the central particle or nucleus and the electrons that surround it.

But Bohr does not believe that these

* "New Theories of How the Atom is Put Together," by Sir Joseph J. Thompson. POPULAR RADIO, vol. 4, pages 179-186 (September, 1923).

electrons are stationary. Far from it. He believes them to be in rapid revolution around the central nucleus much as our earth is in revolution around the sun. That is why the model of the atom to which the Bohr theory leads is sometimes called the "solar system" model. It sees the atom as an assemblage of electron "planets" surrounding a nucleus as "sun."

Between these two theories, the static theory favored by Thompson and the dynamic theory proposed by Bohr, the weight of scientific opinion now inclines strongly to the theory of Bohr. There would be general agreement among scientists, presumably, that Bohr's picture of the electrons whirling dizzily around each tiny atomic sun represents the best present idea of science as to what atoms are really like.*

The best introduction to the Bohr

* This picture of the atom was applied to a common material—metallic copper—in an article in POPULAR RADIO for January, 1924, pages 41-48.

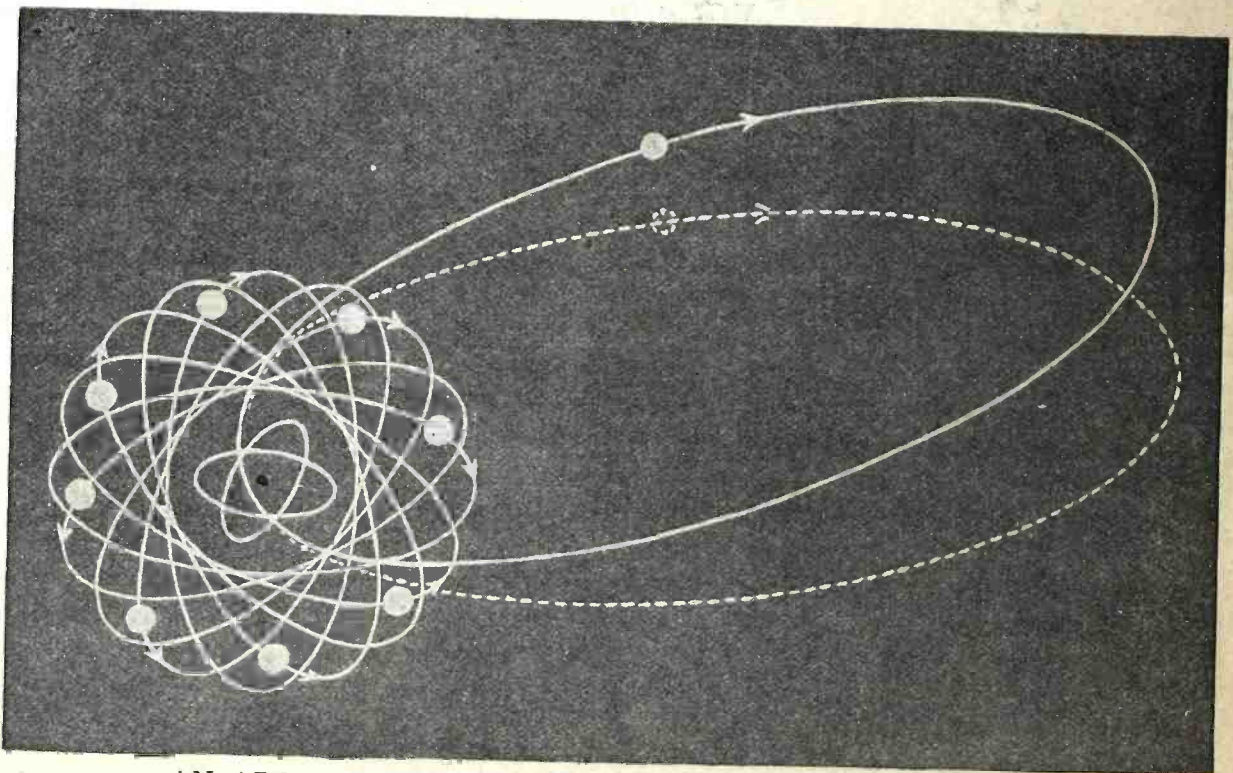

AN ATOM OF SODIUM, AS THE BOHR THEORY SEES IT

Two electrons (not shown in this illustration) occupy the two innermost orbits. Eight more electrons move in orbits of about the same diameter. The eleventh electron has a much larger orbit and this orbit gradually rotates, as shown by the dotted line. It is this outermost electron that is knocked off whenever a sodium ion is produced, as in the sodion vacuum tube.

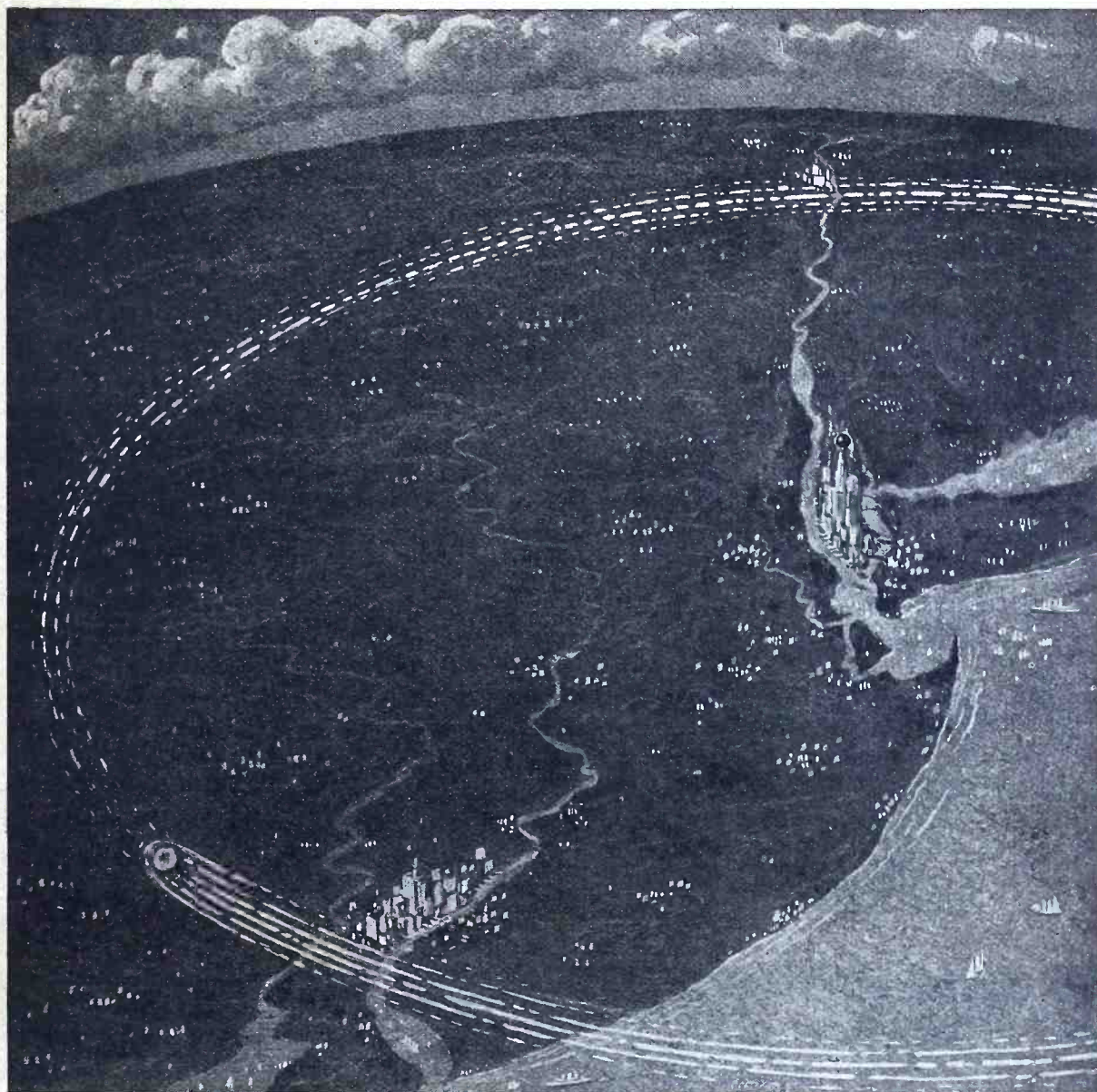

From a drawing by Arthur Merrick for POPULAR RADIO

WHAT A GIGANTIC HYDROGEN ATOM WOULD LOOK LIKE

If a single atom of hydrogen gas were magnified some two billion million times, the central nucleus of it would be represented by a little particle the size of a buckshot on top of the Woolworth Building. Around this would revolve a forty-foot balloon, representing the electron, the orbit of which would reach just beyond Philadelphia. Yet this is the simplest kind of atom; other kinds contain more electrons.

theory is the consideration of its model for the simplest known kind of atom—the atom of hydrogen gas.

This atom contains, everybody agrees, only two particles. At the center is a simple particle that serves as the atomic sun. Around this revolves a single electron. The hydrogen atom is a solar system with only one planet.

This planetary electron is an ordinary

electron, just like those that are familiar to us in the theory of the vacuum tube and of other electric devices. In the vacuum tube the electrons are free and shoot about alone through the space inside the tube. In the hydrogen atom the electron is bound to the atomic nucleus. If it leaves the nucleus the atom no longer exists as an atom.

The central nucleus of this atom is

a particle somewhat less familiar to radio engineers than is the electron. Scientists call this central particle a "proton." Sometimes it is called a "positive particle" or a "positive electron" for it possesses, we discover, a permanent charge of *positive* electricity exactly equal in amount to the charge of *negative* electricity possessed by the ordinary electron.

About the real nature of this positive particle or proton that serves as the atomic sun we know practically nothing. Nor do we know, for that matter, anything about the real nature of the electron. These two particles, the proton and the electron, we must merely take for granted. We know that they exist. We know that they are the building stones of matter. We know that they lie at the root of most (if not all) of the phenomena of electricity. What they really *are* we do not yet know, and it is futile to disguise this ignorance.

But, assuming that these two particles are the universal constituents of all kinds of atoms, let us try to visualize the simplest known combination of them;

that is, the hydrogen atom, which is composed of one particle of each kind.

This atom is far too small, of course, for us to dream of actually seeing it, even with the most powerful imaginable microscopes. But let us imagine that we possess the magical power of enlarging things as much as we wish and let us enlarge a hydrogen atom until we can see it. Or, as we are going to compare it to a solar system, let us enlarge it until the orbit of the electron planet in the atom becomes comparable in size to the orbit of our earth. We can then compare the proton of the atomic system with our sun and the electron with our earth.

Nor will this electron (in the enlarged atom) seem so very different from our earth. It will be a sphere, somewhat flattened at the poles as our earth is, and with a diameter of about 6,500 miles as compared with the 7,900-mile diameter of our earth. It will be moving around the proton in an orbit not unlike the earth's orbit, though the electron moves, as we shall see, very much faster than the earth does.

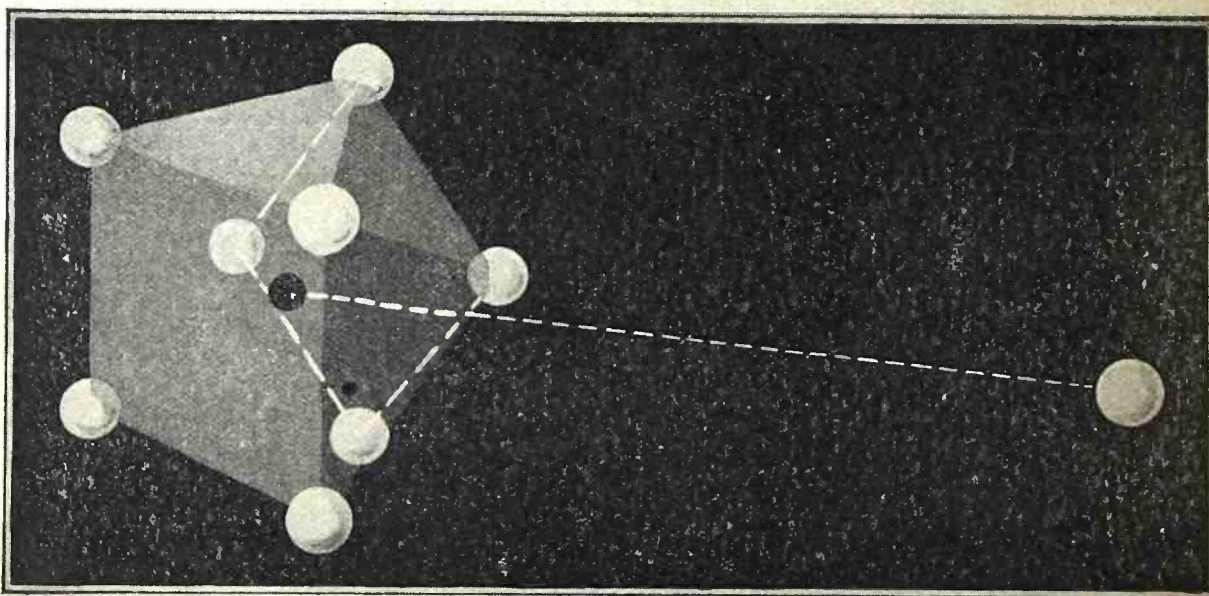

A DIFFERENT MODEL OF THE SODIUM ATOM

This is the "static" model of the same atom the "dynamic" model of which is shown on page 320. The electrons are supposed to occupy relatively fixed positions instead of being in orbital revolution. Most scientists do not favor this static model, but prefer the dynamic, or Bohr, model. Either model will explain the ionization in the sodium tube, as the eleventh electron is far out from the rest of the atom in both models.

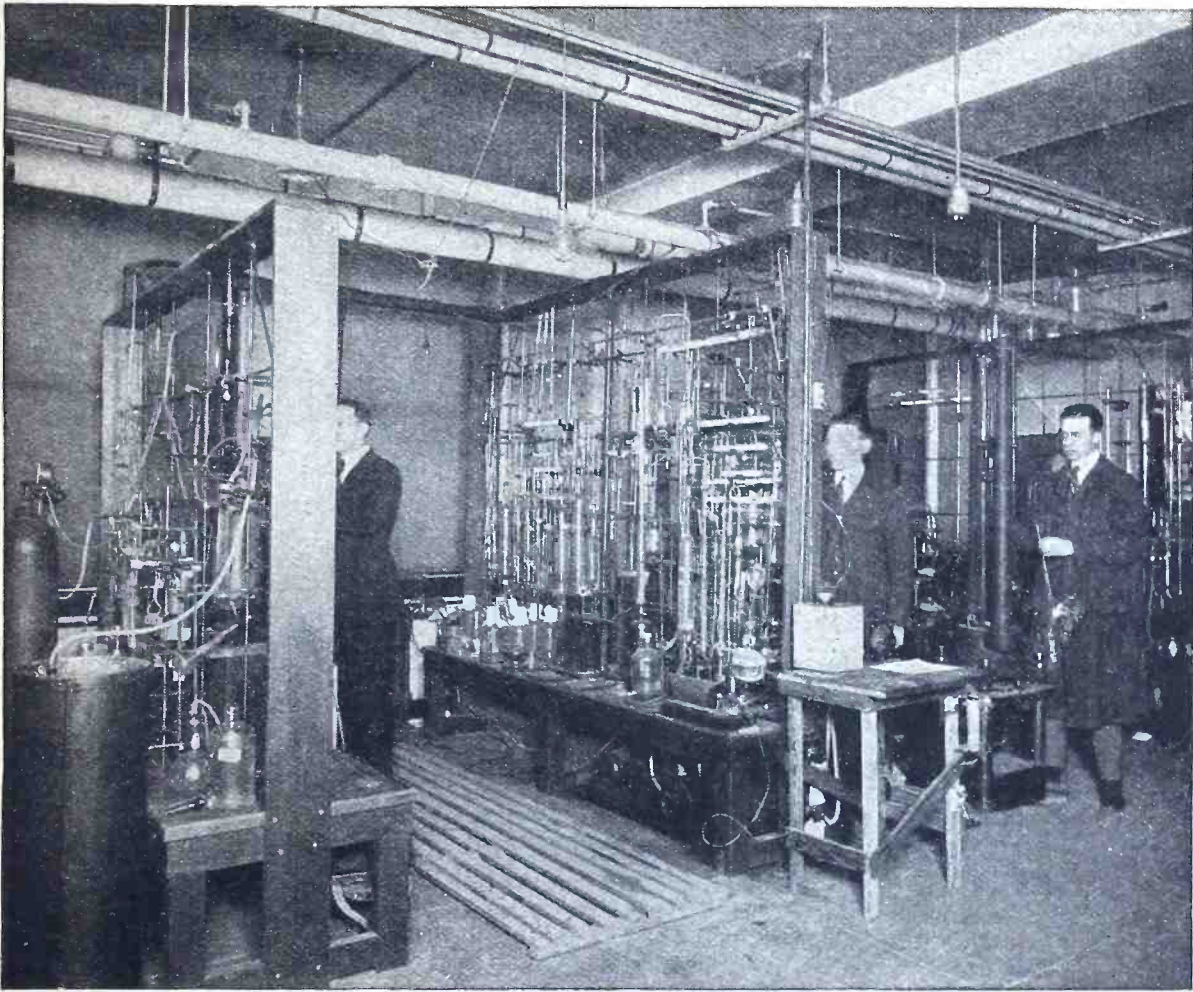

U. S. Bureau of Mines

FREEZING THE ELECTRONS IN ATOMS

The arrangement of the electrons in an atom determines the properties of substances. The two simplest atoms, hydrogen and helium, are the hardest ones to freeze. In this laboratory of the United States Bureau of Mines these two gases are used to produce temperatures hundreds of degrees below zero; at these super-freezing temperatures copper wire has almost no resistance for electric currents.

But it is when we turn to look at the central sun of this enlarged atomic system (that is, at the proton), that we see the greatest difference between the astronomic solar system and the atomic one. In the astronomic system the sun is much larger than the planets. The sun's diameter is, in fact, more than a hundred times the diameter of the earth.

In the atomic system this is not true. The proton is *smaller* than the electron. It has, we believe, only about 1/1850 the diameter of the electron. In our enlarged hydrogen atom where the electron is 6,900 miles in diameter, the central proton will have a diameter of *less than four miles.*

At first sight this is a very surprising fact. How can this tiny proton act as a nucleus to hold the vastly larger electron in its atomic orbit?

There are two reasons for this. One is that the attractions between the electron and the proton are electrical instead of gravitational. They depend, therefore, on the relative *charges* of the bodies, not on their relative weights.

The second reason is that the proton, though exceedingly tiny, is tremendously dense. In common language we would say that it was very "heavy" for its size. It is, in fact, billions of times "heavier" than the densest lead.

For this reason we can find a better

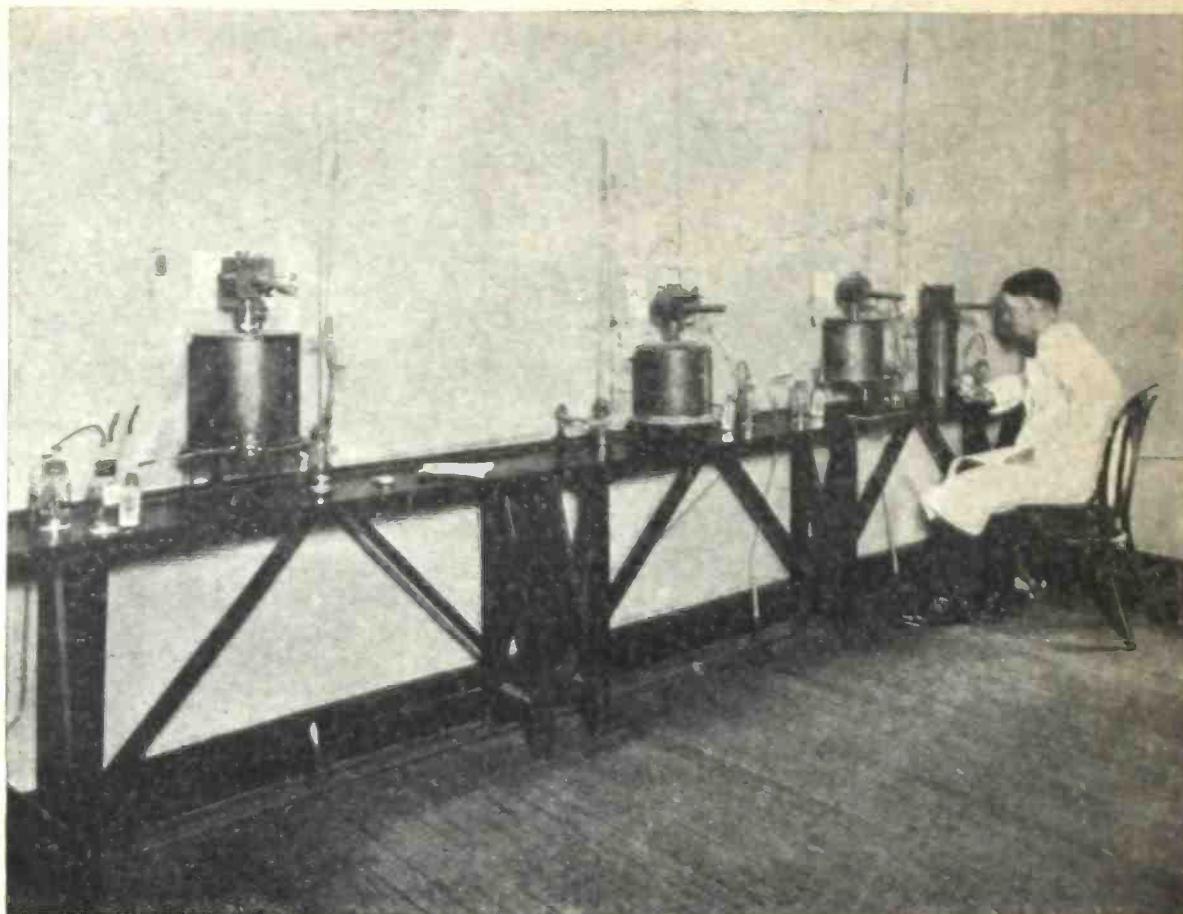

United States Radium Company

MEASURING RADIUM BY THE EXPLOSION OF ITS ATOMS

The atoms of radium are continually blowing up.—Whenever they do so they send out ether waves that are like the waves used in radio, but much shorter. The strength of radium preparations is determined by catching these ether waves (in the apparatus shown here) and measuring their intensity. The exploding radium atom also shoots out some of its contained electrons.

model of the hydrogen atom than is given by our earth and our sun. This better model would consist of a small but very heavy sphere at the center, say a lead buckshot. Around this would revolve a much larger but much lighter sphere, say a gas-filled toy balloon. The buckshot represents the proton; the toy balloon represents the electron.

But we will need a rather unusual toy balloon to represent the electron, for if the proton is the size of a buckshot the electron-balloon will have to be about *forty feet* in diameter. And so inconceivably small is the actual system of the atom that the distance between the buckshot and the forty-foot balloon, if we keep accurately to our scale for the

model, will be *nearly one hundred miles.*

This is the model of the Bohr theory for the hydrogen atom. A small lead buckshot about a quarter of an inch in diameter represents the proton. Let us assume this placed on top of the Woolworth Building in New York City. Around this there sweeps continually in a great circle the forty-foot balloon that represents the electron. On each revolution it passes just beyond Philadelphia on one side, and a little short of Albany on the other.

This represents, as I have said, the simplest known atom. The atoms of the other chemical elements differ from it only in that they are more complex. All of them consist, we believe, of the

same ultimate particles; the protons and the electrons. But the other atoms, beyond hydrogen, contain more than one each of these particles.

The atom which is next in simplicity to hydrogen is the atom of *helium*.

Helium is the newly discovered gas that is now used, you remember, to inflate airships. It is the only non-explosive gas that can be used for this purpose and the proposed North Polar trip of the great navy airship, the *Shenandoah* is expected to be carried out by its aid.

The atom of helium has two electron planets instead of the one possessed by the hydrogen atom. It has, also, an atomic sun that is considerably more complex than the simple one-proton nucleus of the hydrogen atom. The helium nucleus is believed, in fact, to contain four protons. But it contains

something else in addition to the four protons. It contains two electrons.

The atomic sun of the helium atom is, then, a permanent aggregate of *four* protons plus *two* electrons. So far as we know these nuclear electrons are just like any other electrons. They are merely bound, in some fashion which we do not understand, inside the nucleus of the atom. Around the whole of this compound nucleus revolve the two planetary electrons.

The other atoms, still more complicated than helium, are built up in an analogous fashion. More protons and electrons are added. All of the protons go into the nucleus. Some of the electrons do the same; others of the electrons become additional planets.

The third atom, for example, is that of the metal, lithium. It contains *six* protons, all of which are in the nucleus;

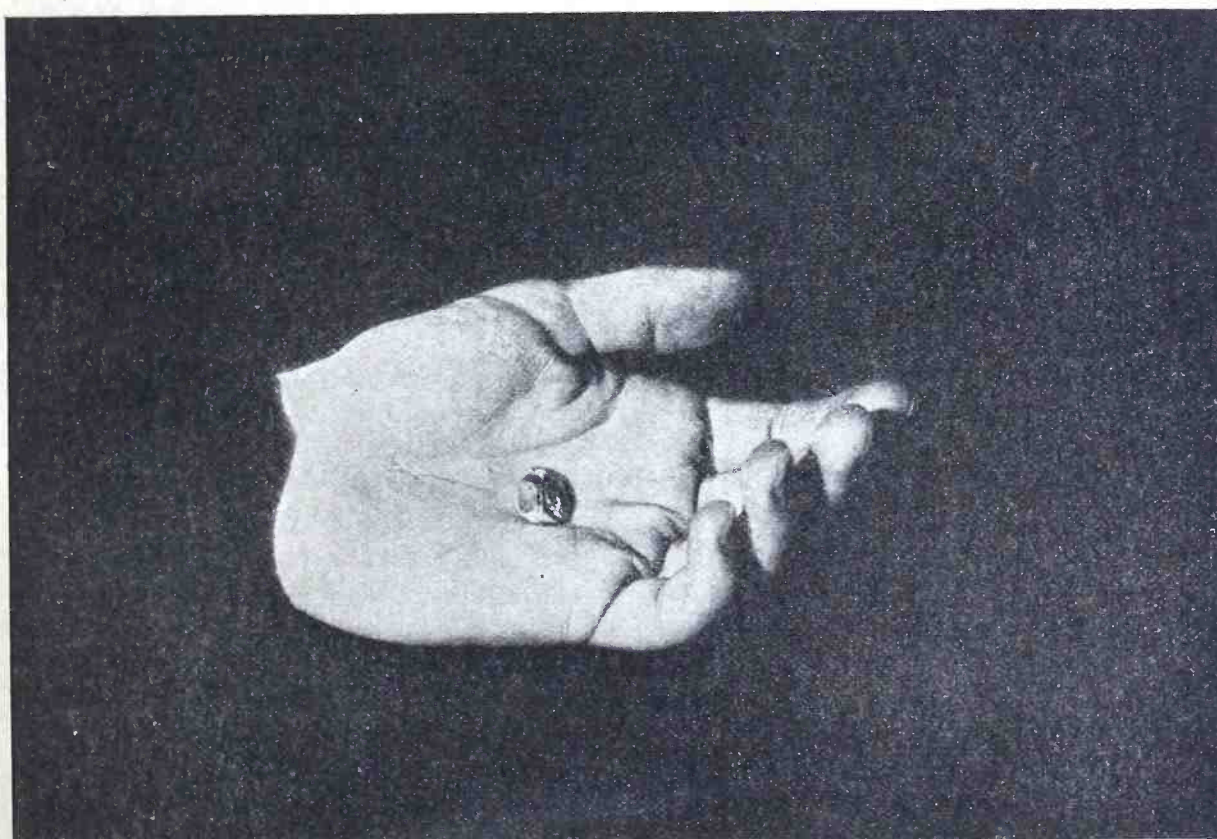

From a photograph made for POPULAR RADIO

A RADIO SET MADE OF THIS METAL MIGHT COST A MILLION DOLLARS

This is the most expensive metal in the world, Iridium. This piece of it is worth over \$300. But its atoms have two valuable properties; the metal is hard and at the same time it resists corrosion. This would make it useful for electric contacts in radio sets—if it were cheaper.

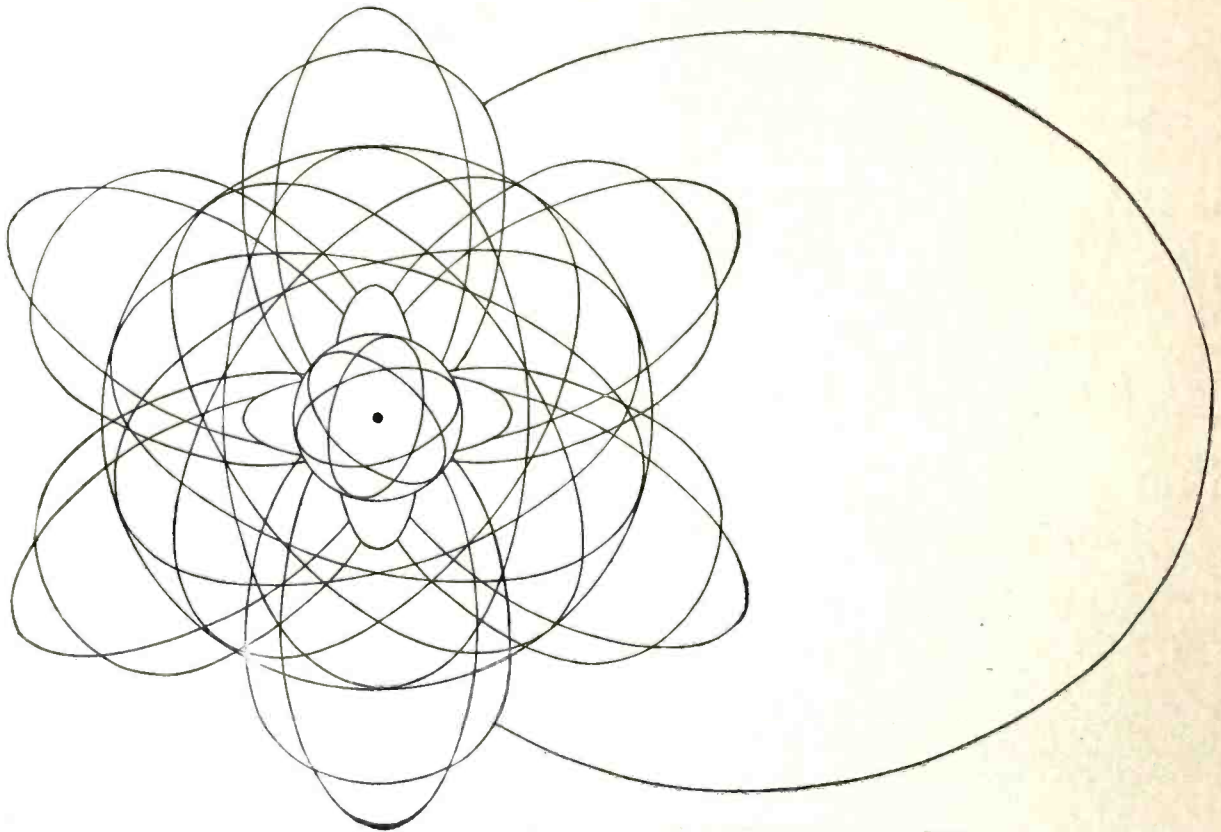

EVERY ATOM OF A COPPER WIRE LOOKS SOMETHING LIKE THIS

This diagram shows a few of the orbits occupied by the 29 electrons in each atom of metallic copper. Each orbit contains an electron that moves with speeds that may exceed 39,000 miles a second. There are billions of these atoms in the smallest visible copper filing that you scrape off a wire when soldering your radio set.

and six electrons, three in the nucleus and three more revolving around it as planets. The fourth atom in the list, that of the rare element beryllium, possesses eight protons and four electrons in the nucleus, with four additional electrons as planets.

And so on through the entire list of the chemical elements until we reach the last and most complicated atom of all, that of the radioactive metal uranium. This atom contains 92 electron planets revolving around a nucleus that consists of about 180 protons combined with about half as many electrons. The atom of radium is almost as complicated, having 88 electron planets and about twice as many nuclear protons. It is probable, in fact, that the tremendous complexity of these last atoms is the reason for their radioactivity. They are so unwieldy that occasionally they

blow up, shooting out the electrons and other particles that produce the radioactive effects.

Throughout the list of atoms it is the *planetary* electrons that determine the ordinary properties of substances. The nucleus is hidden away at the center of the atom and protected. The outer electrons are the atom's contact with other atoms and with the world. It is, for example, the number and arrangement of the planetary electrons that make gold different from lead, that make oxygen the life-giving gas that we breathe while chlorine is a corrosive and poisonous one. It is the continual revolution of these innumerable billions of electrons inside the atoms of matter, each keeping to its own orbit and attending strictly to its own business, that gives to every smallest fragment of the universe the aspect that it has.

Our bodies, for example, consist of some twenty different kinds of atoms. Each atom has its accustomed group of electron planets; one planet each for the atoms of hydrogen (which make up a large part of our body); twenty-six planets each for the atoms of iron, which are, so far as we know, the most complicated kind of atoms really necessary to life.

The human body is really nothing but a maze of flying electrons. Man is motion. If the revolution of the electrons in your bones and muscles and blood corpuscles should stop you would instantly disappear. It is probable, in fact, that you would explode with the most inconceivable violence.

The speed of the electron planets in their orbits is so great that it transcends all human experience. In a copper atom, for example, some of the electrons move with a speed of more than 39,000 miles a second.* Even the slowest of them have, we believe, a speed of nearly 10,000 miles a second. One of these slowest electrons could fly, if it were loose, more than twice around the earth in less time than it took you to read this sentence.

And such speeds mean power. Everyone knows that if the earth hit something and stopped, the energy released would turn every fragment of our globe into white-hot gas. The same kind of

* The structure of the copper atom is described in more detail in the article in POPULAR RADIO for January, to which reference has already been made.

thing would happen if the revolving electrons in the atom were stopped. If the energy of electron motion in your body were suddenly released the explosion would not only dispose of you but it would wreck the neighborhood. There is more energy in the first joint of your thumb than in the explosion of a hundred pounds of dynamite.

Is this energy of any importance in radio?

Undoubtedly. Radio receivers and radio transmitters are alike composed of atoms; the atoms of copper in the antennas, the atoms of air in between the plates of the condensers, the atoms of other substances in the insulating materials out of which the panels and frames and supports are formed.

The radio waves go out from electrons; either free electrons or, perhaps, the electrons of the atoms themselves. The conversion of electricity to radio waves in the transmitter and of radio waves back to electricity in the receiver, both are done by atoms and by electrons.

How, then, can we hope for adequate understanding of the real basis of radio until we have learned about these whirling systems of electron planets that make up the copper of our wires, the plates and filaments of our vacuum tubes and even, we must not forget, the bones and membranes and nerve-cells of the human ears that we must use when we listen to our radio receivers?

THE motions of the electrons in the atom are not only responsible for the nature of matter and for the form of the universe. They control, also, the production of ether waves such as the waves of light. It is electron motions that produce the colors of flames; the red-fire, for example, of political parades. By examining the light that they send us we can study the behavior of electrons off in the most distant stars, millions of millions of miles away. It is electron motions that produce radio waves also. What the Bohr theory has to say about these relations between ether waves and electrons will be told by Dr. Free in a following article in
POPULAR RADIO.

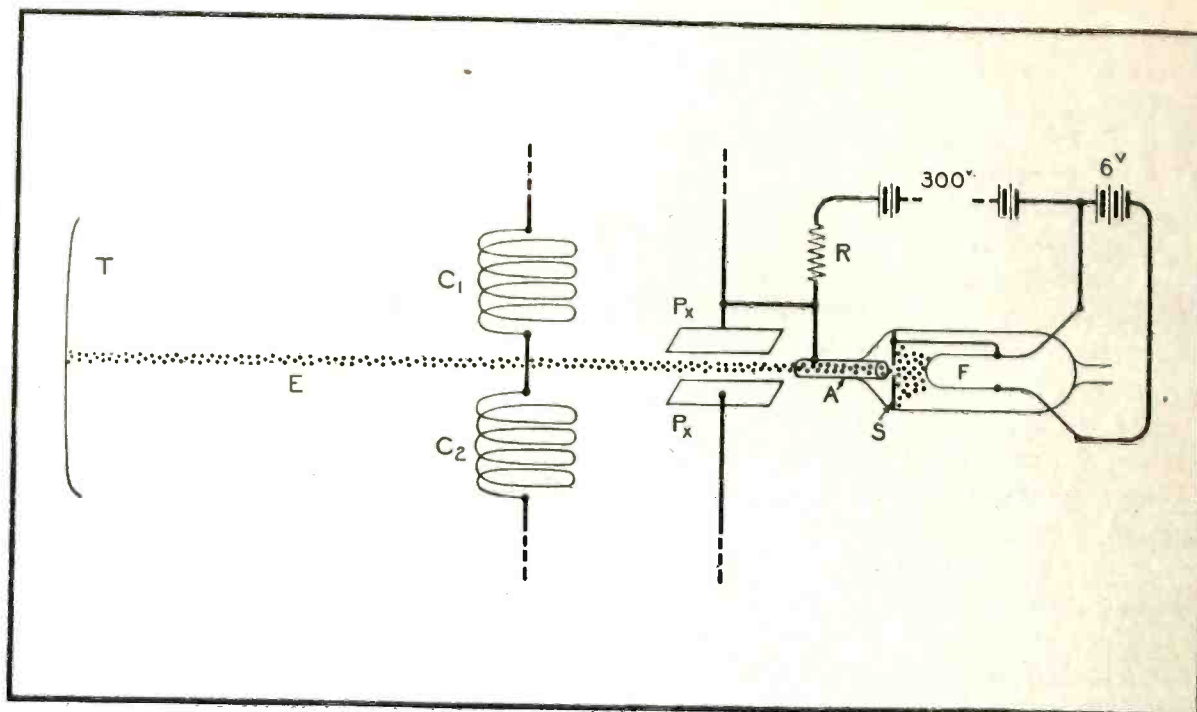

HOW THE OSCILLOGRAPH WORKS

FIGURE 4: *The electrons are produced from the filament F and pass through the charged metal tube A in the form of a thin stream or pencil. Electric deflections are produced by the plates Px and magnetic deflections by the coils C₁ and C₂.*

In addition the tube itself was not stable. The electrical characteristics varied with the amount of gas in the tube and sometimes the electron stream was falsely deflected by negative charges collected on the glass walls of the tube. For these reasons the Braun tube was never used as much as it deserved when its advantages were considered.

The development of the vacuum tube, however, opened up a way to obtain the stream of electrons more easily by the use of the heated filament. In Figure 4 is shown the filament, which is heated by a six-volt battery as in the ordinary vacuum tube. Another battery built up of small radio "B" cells provides 300 volts between the filament and the other electrode A. This electrode is in the shape of a little tube. The voltage at which it is maintained draws off the electrons from the filament. They pass through the hole in the plate S, and down through the tube A. From there they shoot on down between the plates Px, to the end of the vacuum tube where they strike the chemical coating

of the screen T, making a bright dot. To simplify matters only one pair of plates Px, is shown in the diagram. There are really two pairs, the other pair being at right angles to the first and used to swerve the beam at right angles to the motion produced by the first pair of plates.

One plate of the pair Px, has a lead which passes through the glass to a terminal. The other plate is connected to the tubular electrode A, and from there to a terminal outside the tube. In this way when a voltage is put across the two plates the stream of negative electrons will be swerved toward the positive plate.

When it is desired to measure a current instead of a voltage, two small coils of a few turns of wire are placed on opposite sides of the tube. These are shown as C₁ and C₂ in Figure 4. The magnetic effect of a current in these coils deflects the electron stream in a direction parallel to the plane of the coils and the luminous spot will be moved as before.

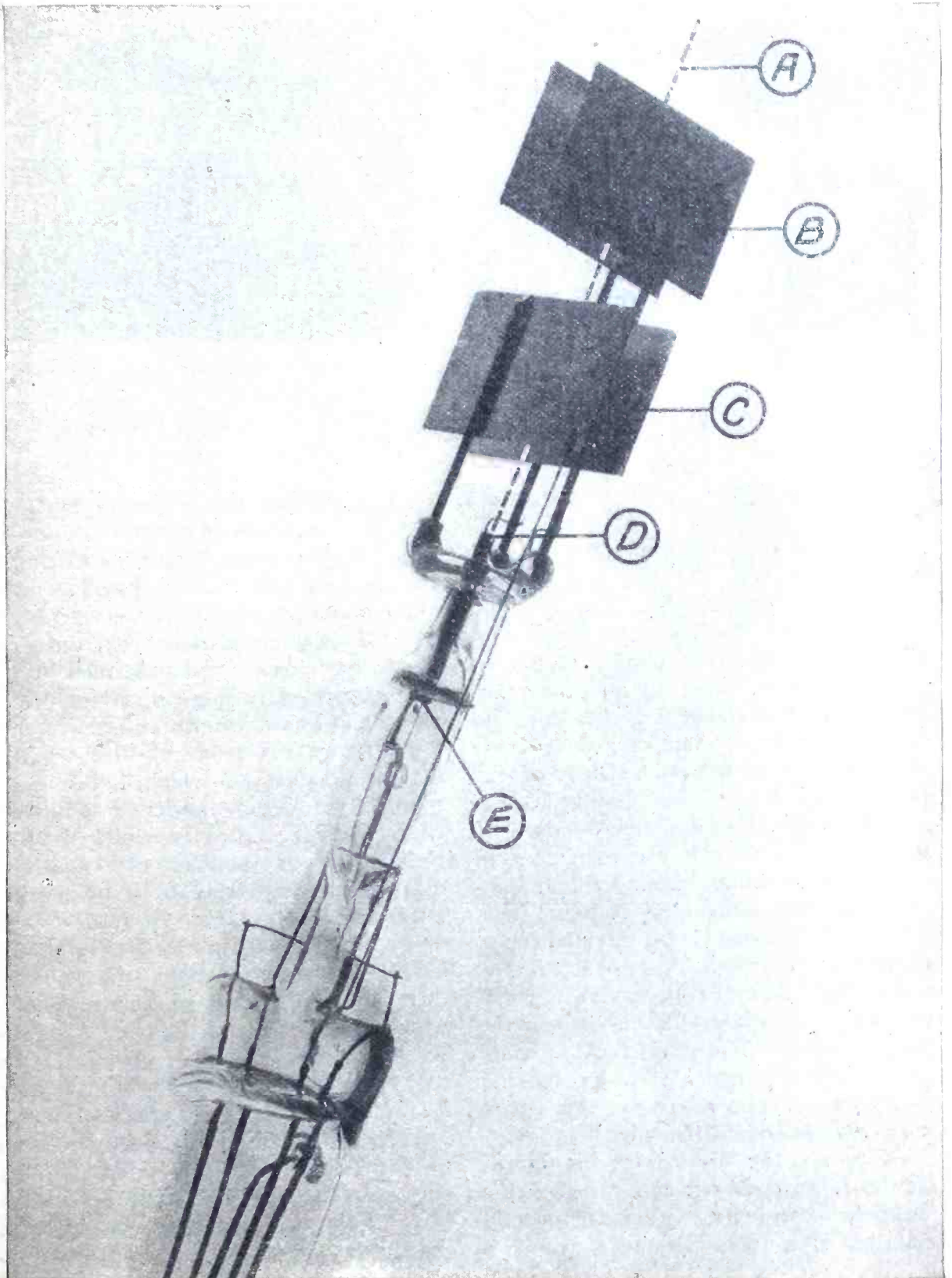

Western Electric Co.

HOW AND WHERE THE ELECTRON PENCIL IS PRODUCED

These are the working parts of the oscillograph. The electrons are produced by the filament E and pass through the tube D, forming the electron pencil A. B and C are the two pairs of charged plates that swerve the stream of electrons to one or the other in correspondence with the forms of the impressed electric wave out

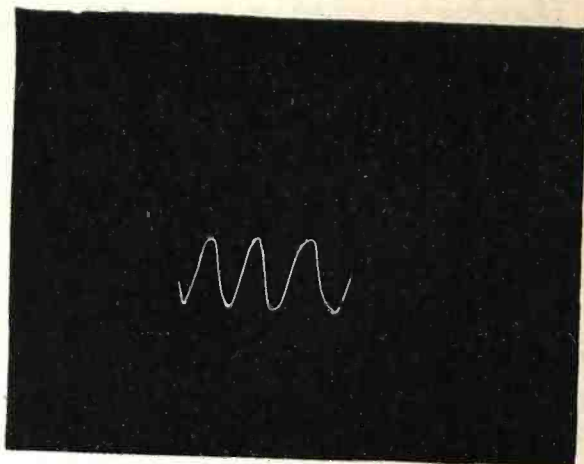
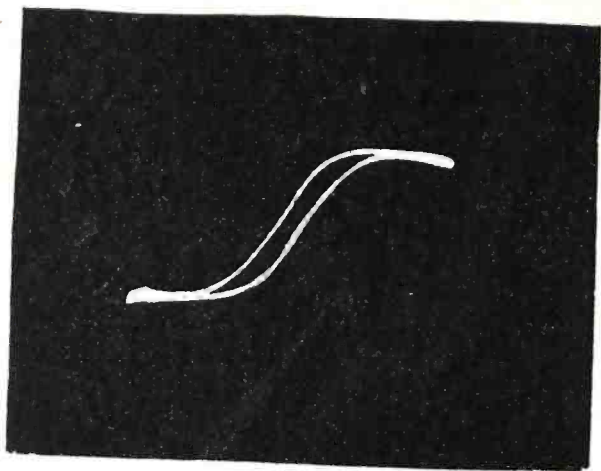

WHAT YOU SEE ON THE SENSITIZED END OF THE OSCILLOGRAPH TUBE

At the left is the appearance of a "hysteresis loop" that is produced by a sample of magnet iron. At the right is the wave form of an ordinary, 60-cycle alternating current.

The cathode-ray oscillograph thus described (as developed by Dr. J. B. Johnson of the Western Electric Company) overcomes the disadvantages of the original Braun tube. The adoption of the heated filament does away with the necessity of maintaining a high voltage between the filament and the other electrode. The elements are so designed that the electrical characteristics of the tube are maintained independent of the pressure of the gas in the tube.

It was found in the development of this tube that when it was exhausted to a very high vacuum the individual electrons of the stream separated. This stream of electrons shooting out through the tubular electrode A, resembles very much the stream of water with which the small boy draws his designs on the board fence. The electrons separate just as do the globules of water, making the electron stream relatively wide where it strikes the end of the tube.

Of course, the boy making his figures on the fence does not care whether the pencil he is drawing with is an inch in diameter or a foot. But when you are intending to calculate the action of an electric current you must use a sharp pointed pencil. So a way had to be found to focus a stream of electrons where a very fine point.

Consequently, the engineers made up a tube containing a small amount of argon, an inert gas. First they exhausted the tube of all the air possible, even baking the glass while it was being exhausted so as to release from the glass all the gas which would be freed by the heat generated during operation. Then the argon gas was introduced.

Every gas is made up of separate molecules, each of which has a comparatively large nucleus positively charged with electricity which is surrounded by a number of negatively charged electrons held to it by electric attraction. The free electrons shoot down the tube at a velocity of some 6,000 miles a second and when one of them hits one of these gas molecules which is moving at the rate of only $\frac{1}{4}$ of a mile a second the force of the collision knocks off one or more electrons from the molecule.

Before the collision the positive charge of the nucleus was neutralized by its ring of negative electrons but when some of these electrons are knocked off, the nucleus, now positive, begins to attract free negative electrons. As these nuclei are heavy in comparison with the flying electrons, they are simply buffeted around by the latter and they stay in the line of the electron stream where

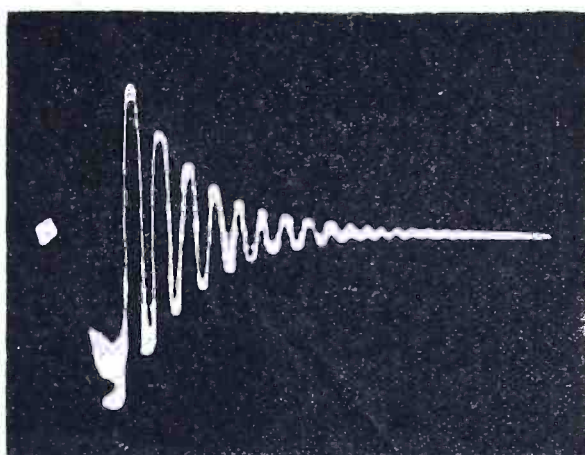
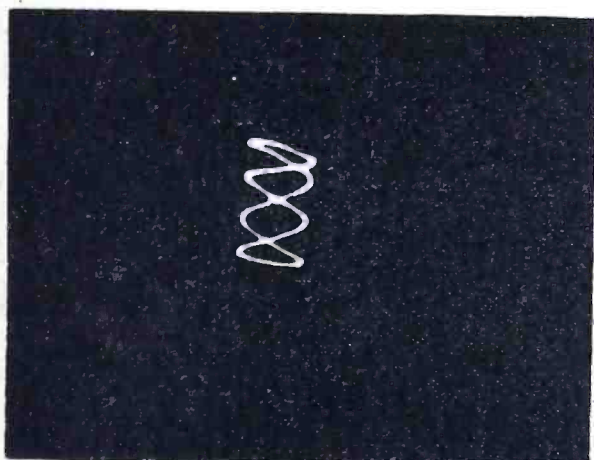

TWO MORE PICTURES FROM THE OSCILLOGRAPH

The figure to the left shows an exact frequency match between 100-cycle current and 400-cycle current. This figure will persist on the tube end so long as neither of the two frequencies is changed. To the right is an oscillograph picture of a damped wave train produced by the discharge of a condenser through an inductance.

they were formed. Therefore, along the whole length of the electron stream, there is a line of positive nuclei which attract the free electrons and hold them in the straight and narrow path in spite of the repulsion between electrons which tempts them to spread out.

Furthermore, the dislodged electrons, shooting off in all directions, soon fill the space outside the stream with negative charges which repel the flying electrons, thus tending, also, to keep them in their own path.

In order to prevent the bombardment of the filament by positive ions, which would destroy its oxide coating and thus render it inactive, the filament is sealed in the glass mounting tube. To prevent the ions from striking the filament when they come through the hole in the plate S, the filament is bent in a circle as shown in the photograph. The filament is made of ribbon instead of wire, which leaves just an edge exposed to these ions.

The great advantage of the cathode-ray oscillograph lies in the fact that the stream of electrons forms a nearly weightless pointer, the movement of which will follow accurately the changing conditions in the circuit to which it is connected. By avoiding mechanical inertia, as it does, it is capable of record-

ing frequencies up to millions of cycles a second.

The instrument can be used in many ways. When only one set of the deflector plates (Px in Figure 4) is used, the electrical potential to be measured causes the luminous spot to become a bright line whose length is proportional to the amplitude of the voltage wave. If now another voltage varying with time is applied to the other pair of plates the beam will be swept across the field and its wave form can be seen. Thus, by speaking into a telephone transmitter one can "see himself talk."

The familiar hysteresis loop of magnetized iron can be shown vividly with this oscillograph. The magnetizing current moves the spot from side to side and the resultant magnetism in the sample moves it up and down. In the Western Electric laboratories of the Bell System, such a set-up has been made by winding the magnetizing coil on a fiber tube, into which is slipped a thin strip of the material to be tested for its magnetic properties. The fiber tube is so placed that the end of the sample is near the oscillograph tube, where its magnetism can swerve the flying electrons.

By connecting each pair of deflecting plates to alternating currents of different frequencies, the spot will trace out

curious patterns. If the frequencies are steady, and one is an exact multiple of the other, the pattern will be stationary, otherwise it will change as the phase relation of the current changes. One of the figures shows a comparison of 100 and 400 cycles, but the ratio between the two may be much greater.

For two currents differing widely in frequency, the pattern may be too long for its ends to appear on the coated end of the tube but the fact that it is steady shows that one frequency is an exact multiple of another. Thus the carrier wave of a broadcasting station may be amplified and impressed on one set of deflector plates, while a locally generated frequency impressed on the other set of plates is adjusted to match with it. The local wave is then matched with another local frequency at say, 1/100 its

frequency and this in turn is "stepped down" to a frequency which can be measured easily, thus using the oscillograph as a wavemeter.

The chief value of this cathode-ray oscillograph is to get quick visible indications of what is going on in an electric circuit. It can be used to explore a situation and to ascertain, roughly, what is going on as a first step to devising measurements which will be more accurate. For example, after the apparatus is set up, hysteresis loops can be taken very rapidly on one sample of iron after another, as against a half-day each by the more accurate "point-by-point" method. Also for demonstrations before students, this device shows what is happening in any oscillating circuit with a clearness and vividness that are most convincing.



Pacific & Atlantic

ANOTHER "MATCHBOX" RECEIVER

Edmund Campbell of Washington, D. C. used, for the coil of this tiny set, the magnet winding from an ordinary bell buzzer, with the iron core removed. The coil, the simple crystal detector and the four binding posts are all mounted on the inner half of the box.



From a photograph made for POPULAR RADIO

DON TUNES IN ON THE RADIO GAME—WITH A TUNING FORK

"My neighbor Jim Brunner let me turn a few knobs myself and look at a lot of pretty electric lights inside," admits the author. "I was a hopeless idiot from that evening on." This picture was made at that stage in Don's career as a fan.

How I Built a \$12 Crystal Set THOUGH 34 YEARS OLD

The Editor asked Don Herold to build a simple crystal receiving set, following the instructions prepared by the Bureau of Standards at Washington and published in POPULAR RADIO, and then to write his experiences. Here they are.

By DON HEROLD

WHEN the radioptimistic editor of this incomprehensible magazine asked me to build a simple crystal receiving set he said: "A twelve-year-old boy can do it with \$12 worth of materials, simply by following the instructions set down by the Bureau of Standards at Washington. The Bureau wrote the instructions so they could be understood by twelve-year-old boys."

After reading the instructions, I decided I would like to see the twelve-year-old boy they keep at the Bureau

of Standards as an example of a standard twelve-year-old boy. He is a whole lot smarter than I used to be when I was twelve years old, or have ever been since.

"If you are handy with tools—" started the instructions.

I am not.

However, I resolved to read on, and, if humanly possible for an old man of thirty-four, to go ahead and build the little crystal set.

I made this resolution in spite of the

fact that I was not the least bit interested in radio and knew that I would not want a radio receiving set in my house even after I got it built. I had heard a static recital at a friend's house in Brooklyn one night and, though this friend had insisted that his set was not "working very well" that night, I had made up my mind then and there what I thought about radio.

The first thing I did, on starting to build my set, was to skim through the instructions hurriedly to get a general idea of what I was up against. I saw immediately that my main problems were going to be:

1. How to get up in a tree to hang the other end of the antenna.
2. How to get a hole bored through the window sill through which to bring the lead-in wire.
3. Where to find a round oatmeal box with which to make a tuner.



I DRIVE THE PIPE EXACTLY
14 INCHES INTO THE GROUND

—and at exactly that point I strike solid rock
fully 150,000 feet thick. That was not in the
book of rules!

4. Where to find a piece of iron pipe for an outside ground.

The first problem was practically insurmountable. It has been at least fifteen years since I have been up a tree. I looked over all the trees in our yard and there wasn't one of them that I could possibly climb, not even with the aid of a ladder, and even if I had had a ladder I would not have known how to get it up against a tree. After considering this tree problem carefully, I gave up the idea of building a receiving set, gave it up entirely. Then it occurred to me that our trees needed trimming and treating and that if I had some expert tree surgeons come over and do this work, they could hang my antenna for me while up one of the trees.

My antenna thus cost me \$78.

The problem of getting a hole through the window sill or frame was solved by getting a carpenter to come over and fix up a lot of screens which did not exactly need fixing.

This hole cost me \$37.50.

I canvassed the neighborhood for a round oatmeal box, but everybody on our street eats oatmeal that comes in square boxes, so it looked as if I were not going to have a tuner. Finally I said to my wife, "We will have to change oatmeal. You will have to subscribe to round oatmeal for a while."

I thought the piece of water pipe for the ground would be fairly easy to find. I was sure there must be a piece under our back porch. Three years ago when we remodeled our house, we tore out \$1,000 worth of old plumbing and put in \$2,000 worth of new plumbing just like it, and I recall walking over long pieces of water pipes, piles of them, for months. Finally, they had hauled this old pipe away and I was sure that I could find it somewhere on the outskirts of town, providing that piece was not under the back porch, which it was not. After a week or so of looking under the back porch, I stayed at home from

the office one afternoon and drove all over the outskirts of town looking for a piece of pipe on all the dump heaps in the city directory. There were plenty of old furnaces and some fine old bathtubs, but not a foot of water pipe. Late in the afternoon I went to the plumber who had hauled away at least \$1,000 worth of old pipe from my house, and said:

"Have you an old piece of second-hand pipe that I can use for an outside ground for a radio set that I am building? Just any kind of old pipe will do, from six to eight feet long."

"No, we haven't a single piece of old pipe on the place, but a piece of new pipe that long won't cost you very much."

"How much?" I said.

"About ninety cents," was the answer.

"Well, the Bureau of Standards at Washington and the editor of POPULAR RADIO haven't allowed me anything for old pipe, so I can't take it. I have got to keep the cost of my set within \$12." I started to walk out.

"Wait a minute," said the kind-hearted plumber. "I believe there is one piece of old pipe out in the back yard. You can have it if it is still there."

We found the piece, and I took it home, intending to drive it three to six feet in the ground, more probably three.

Counting my time at \$100 a day, whether I always get it or not, that hunk o' pipe cost me \$50, to say nothing of wear on my automobile, driving over piles of old tin cans, ash heaps and the like.

I got up on a stepladder with an axe and had Mrs. Herold hold the iron pipe while I drove it from three to six feet into the ground.

I had driven it exactly 14 inches when I struck a stratum of solid rock fully 150,000 feet thick. I tried the pipe in several different places, but the deepest I could get it was 14 inches. Here was something that was not in the book of rules!

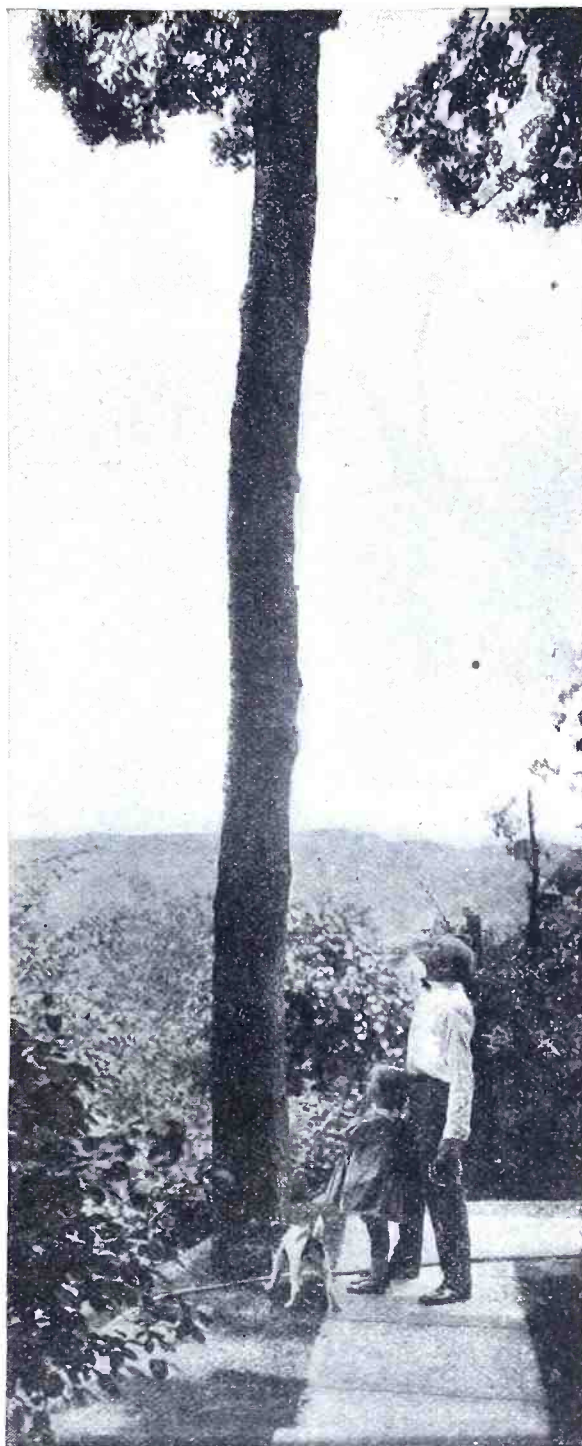

From a photograph made for POPULAR RADIO

HOW COULD I GET UP THAT TREE TO HANG UP THE ANTENNA WIRE?

That, I saw immediately, was to be the first of my main problems.

I had heard that Jim Brunner, one of my neighbors, had a radio set, and that evening I went over to ask him if 14 inches was deep enough for an outside ground pipe.

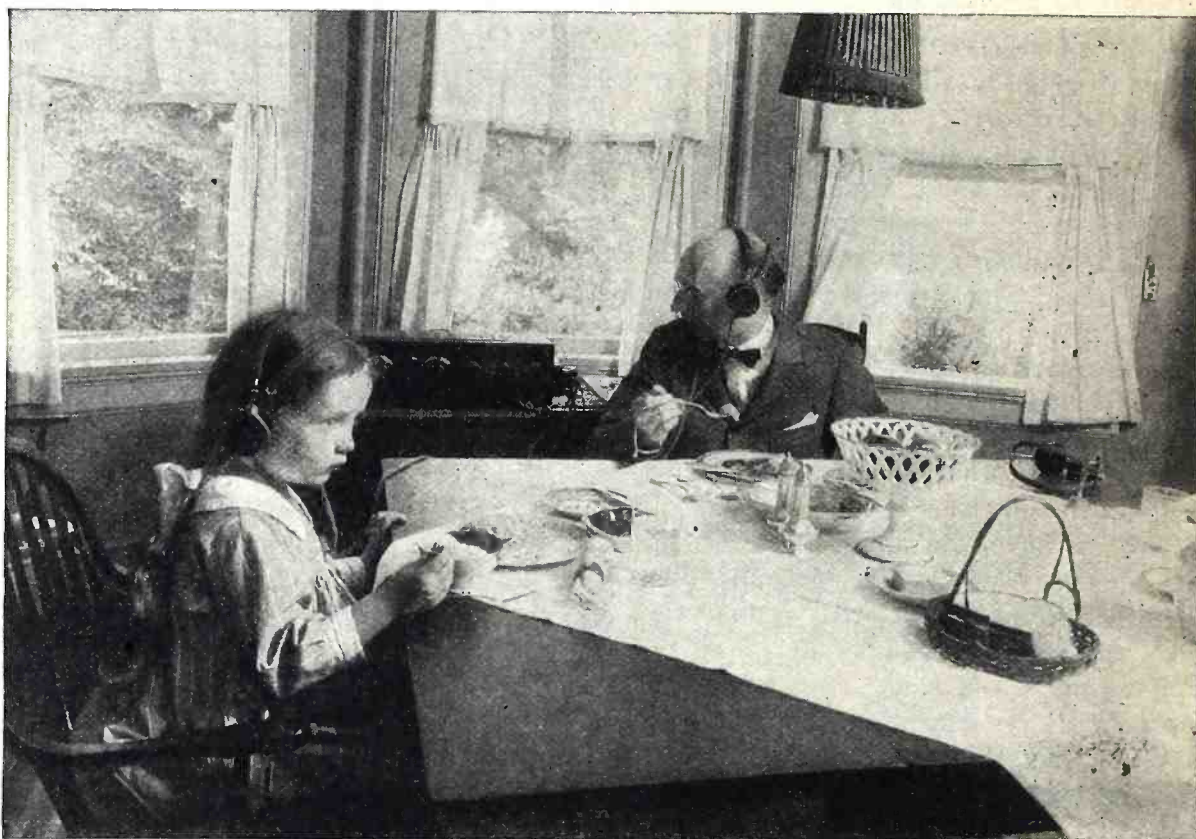

From a photograph made for POPULAR RADIO

THE FAMILY NOW HAS CAULIFLOWER EARS FROM
USING THE HEADPHONES OVERTIME

I am now "collecting cities" with more zeal than I have put into anything since I used to collect stamps.

"Oh, I think so," said Jim. "Are you putting in a set?"

"Yes," I replied. "Doing it all myself. I'm going to write an article about it."

"Fine," he said. "Come in and listen to my set. We are getting some good stuff tonight."

"Naw, I don't want to hear it," I replied. "I'm not interested in radio."

"Well, come on in and hear this set of mine."

"I suppose it isn't working very well tonight."

"No, not very. Still, you can hear a little. Come on in."

I followed him into the house reluctantly and he jammed a set of headphones on my head.

It wasn't bad at all. Really, it was pretty good.

There was good singing and a couple

of fine orchestras, and a lecture on gladioli which we listened to until we discovered it was on gladioli and then switched to a violin recital somewhere or other. I stayed a couple of hours, without having to.

When I reached home, I re-read the instructions for making that crystal set. I was quite enthusiastic about the headphones and other parts that could be bought ready to work, and I made a list of the ingredients of the outfit and resolved to push the set to completion the following evening.

The next night I slipped over to ask Jim Brunner a few questions, and the first thing I knew it was nearly twelve o'clock and we were trying to get long distance broadcasting stations, and getting a few. Jim let me turn a few knobs myself. There were a lot of pretty electric lights inside.

I was a gonner. I was a hopeless radio idiot from that evening on.

Need I tell you how I *didn't build the crystal set at all? Need I tell you how I got Laurence M. Cockaday, the technical editor of POPULAR RADIO, to come out with a car full of contraptions, and put me in an outfit of his own designing, and how thrilled I was to have a great radio engineer running around my house in his shirt sleeves while I sat and smoked?

"What do you like best about radio, Mr. Cockaday?" I asked, hoping to get something of technical interest to put into my article for the readers of POPULAR RADIO.

"The bedtime stories," he replied.

As the installation neared completion we were as interested in guessing what we would first hear on it as we used to be in guessing what the baby's first word would be.

"I hope it isn't 'The Land of the Sky-Blue Water,'" I said.

"Here is something now," said Mr. Cockaday.

I listened.

It was "The Land of the Sky-Blue Water," just as I feared.

"Don't worry," said Mr. Cockaday. "You may not hear that again for a month."

We have now had the set for a month. The house has never been struck by lightning, so I don't know whether 14 inches is deep enough for a ground or not. But it probably is. I don't know the idea of all those electric lights and thingamajings inside the box on my dining room table, but I expect to learn, as I now read POPULAR RADIO instead of using it under the short leg of a chair, and when I get Zion City, Ill., I feel as if I had invented radio myself. I am "collecting cities" with more zeal than I have put into anything since I used to collect stamps. The whole family stays at home evenings now and remains up late, afraid to miss something by going to bed.

We all have cauliflower ears from wearing headphones overtime.

If anybody knows anybody who wants to buy \$12 worth of parts for a crystal receiver set, I will sell them for 50 cents on the dollar. I figure my radio enthusiasm is going to cost me thousands before I die, so what is \$6?

It has been a long time since I was 12 years old, but I will soon be there again, with a radio set in the house.

Mrs. Herold is yelling that she has tuned in on an exceptionally good concert in Philadelphia.

D. H. signing off.



Foto Topics, Inc.

AN AMERICAN BOY PICKS UP FRENCH STATIONS

Dave Tyneberg, a 17-year old fan of New York, recently listened in on two stations in France (F8AI and F8BP) within six minutes of each other. He used a Reinartz circuit.

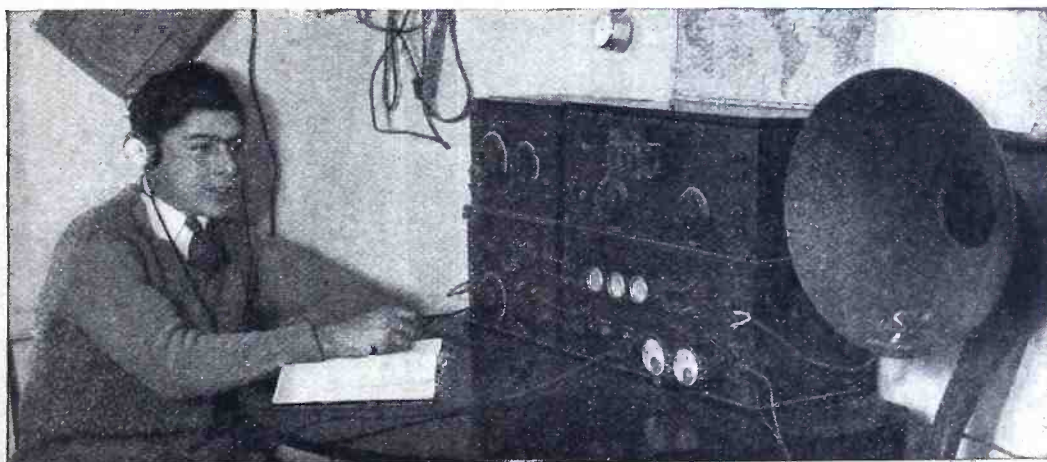
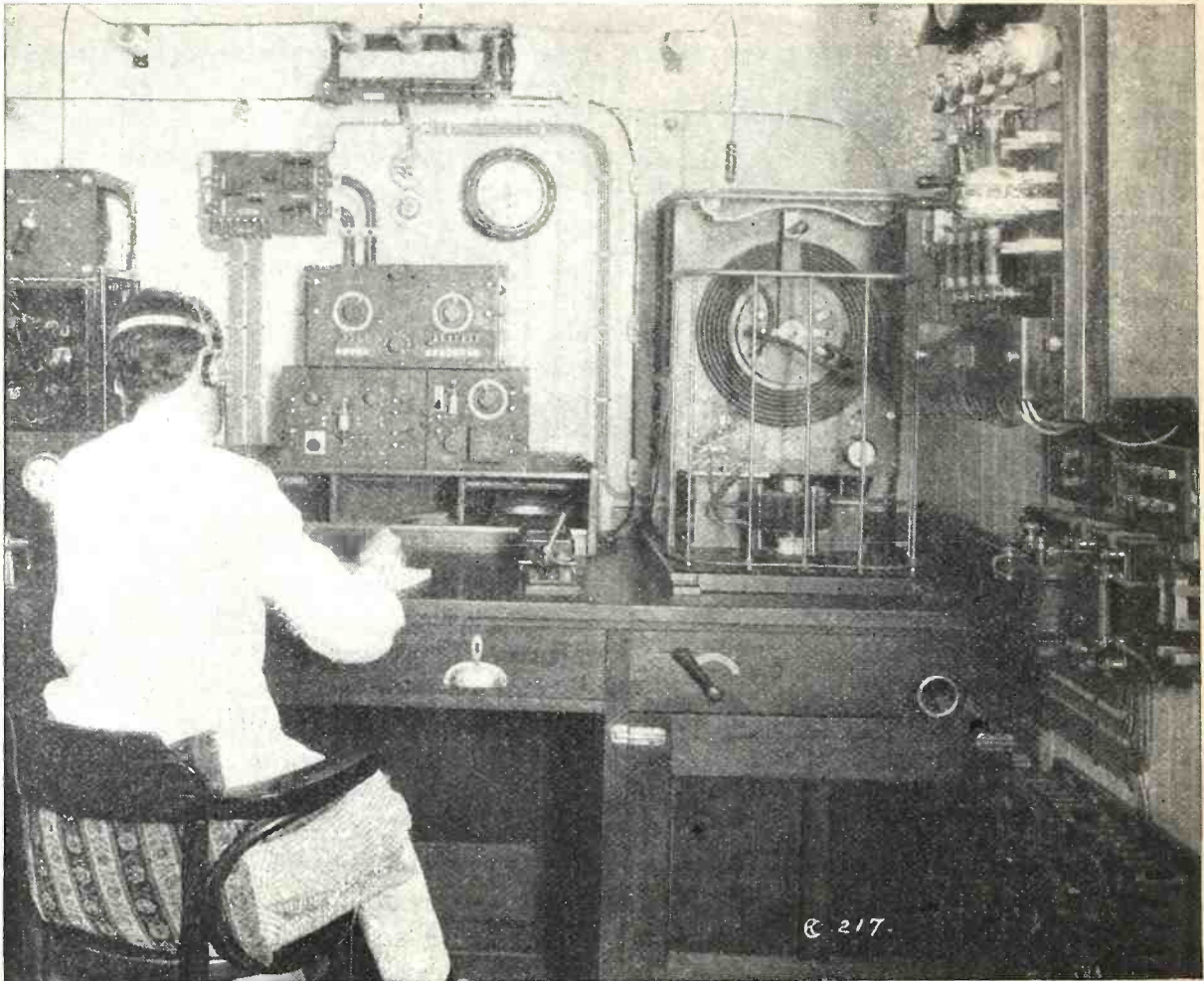

Radio Corporation of America

A QUENCHED-SPARK TRANSMITTER

This is the type used generally aboard ship for commercial traffic. In this transmitter the antenna is excited inductively and both the antenna circuit and the closed oscillatory circuit are tuned to the same wavelength.

How the Antenna Is Energized

Article No. 8

This article tells of some of the different methods that have been used, since transmitting by radio was first accomplished, to excite the antenna with the necessary high-frequency currents to produce radiation of energy into space

By SIR OLIVER LODGE, F.R.S., D.S.C., LL.D.

I WILL introduce this subject by an analogy.

There are two types of model or toy locomotives on the market; one type driven by potential energy, the other by kinetic energy.

The first is energized by twisting a

rubber band, or by tightening a coiled steel spring. This is an example of *static energy*, stored in the shape of material strain.

The other type is energized by spinning a fly-wheel, much as a top is spun by a piece of string. The energy thus imparted

is *kinetic*; and by resting the axle of the fly-wheel on a larger wheel, the whole thing progresses slowly like a steam-roller, till the energy is exhausted.

The above is an example of two different types of mechanism. But a smaller difference can exist between the modes of excitation of a single type. Thus, take a violin string, for instance. There are two ways of making it sound; one by gently bowing it, or by blowing on it, or, in some other way working up the oscillations gradually to a sufficient intensity. That is one way. The other is by plucking it; that is to say, by pulling it forcibly aside till it has acquired a certain amount of potential energy, and then liberating it, so that it may oscillate freely until all the stored-up energy is exhausted.

A string struck by a hammer, as in a piano, belongs to the kinetic type; for the energy is imparted in the form of motion; but it is imparted suddenly, and it virtually amounts to shock excitation.

Thus we have three different methods of exciting a string: a prearranged strain, or static method, illustrated by plucking; a gradual working up of the oscillations, as illustrated by some form of friction, or bowing; and the shock excitation method, illustrated by striking, as in a pianoforte. A harpist, presumably, is able to utilize the plucking method, but most wind instruments depend on the gradual working-up method. Whereas drums and triangles, and other such devices—the *batterie de cuisine*, as a musician has jocularly called it—are obvious examples of percussion.

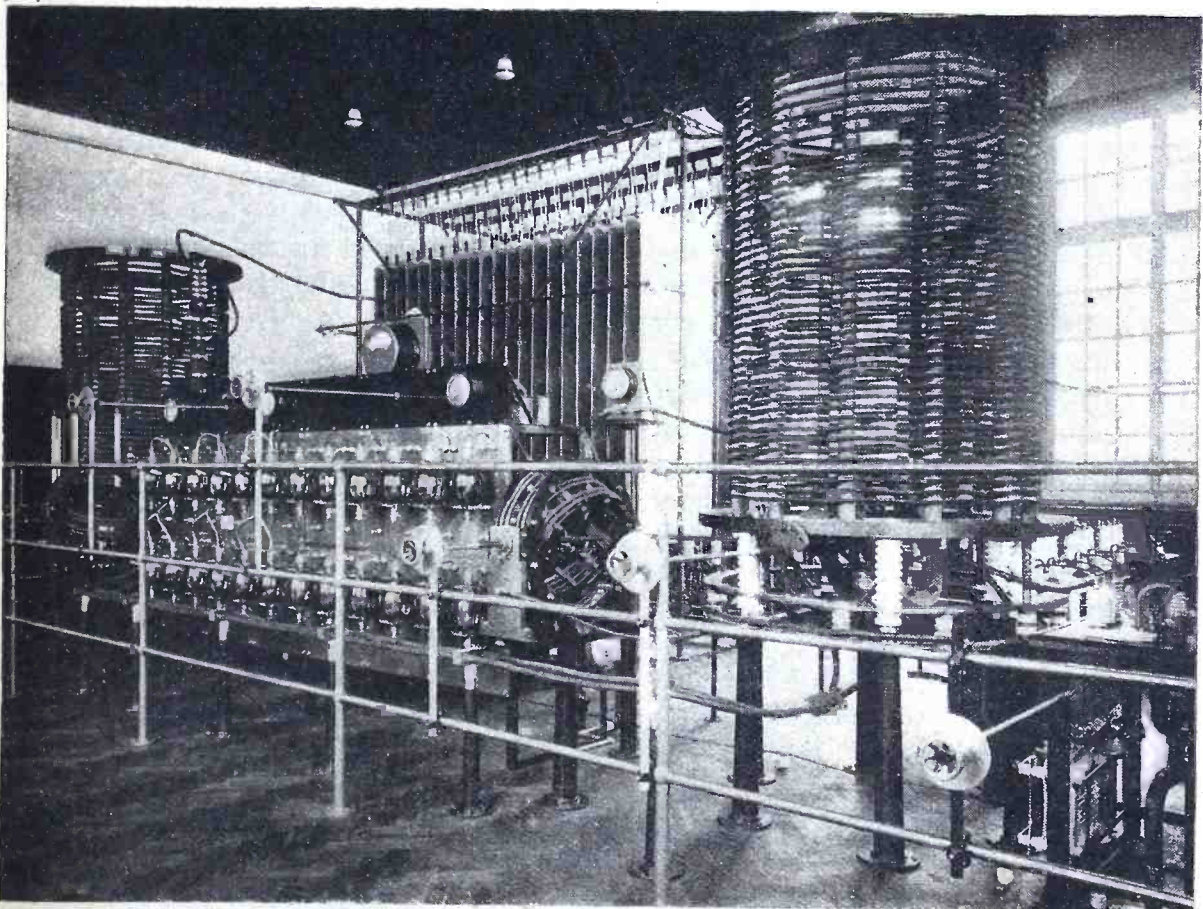

Marcou Wireless Telegraph Co., Ltd., London

A VACUUM-TUBE TRANSMITTER

This type of oscillator employs the continuous-wave method of energizing the antenna. The antenna is being continuously vibrated electrically as in the case of the pipe organ, where a steady blast of compressed air is fed to the pipes to produce a sustained vibration of the air column.

AN EARLY METHOD OF EXCITING THE ANTENNA

FIGURE 1: *A spark gap was introduced in series with the antenna circuit and this gap was charged and broken down with a spark which caused the antenna to oscillate at the frequency to which it was tuned. This method causes broad tuning.*

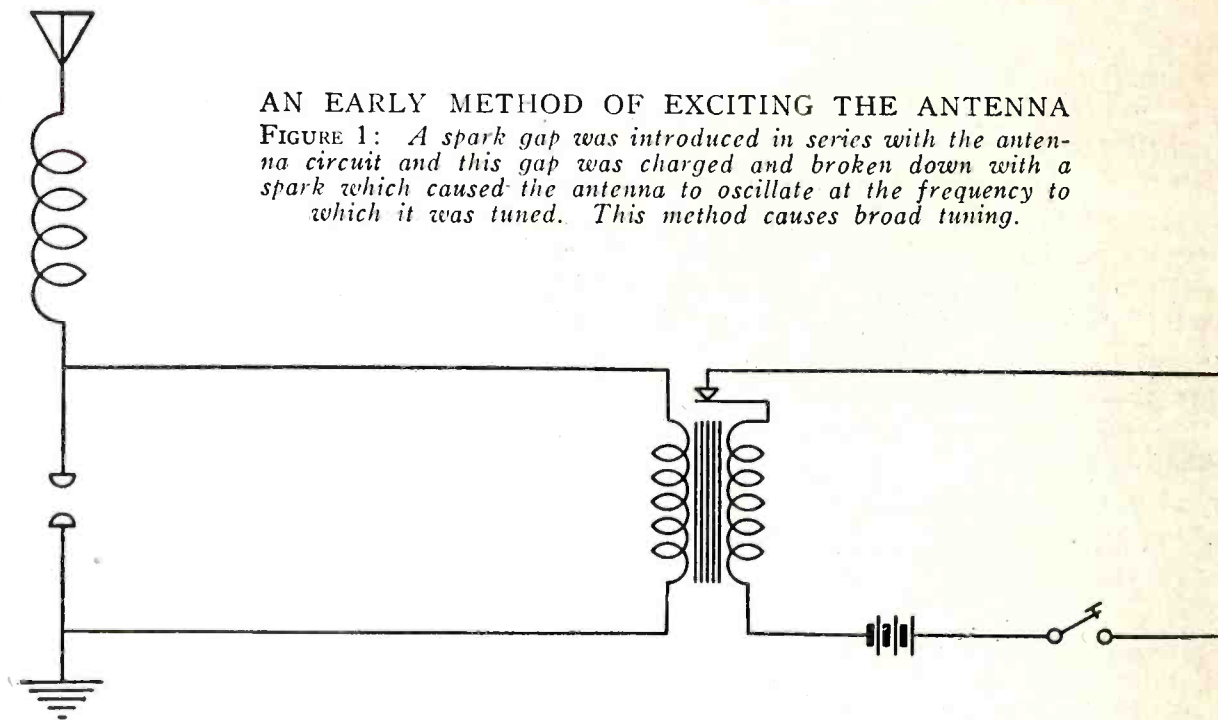

In exciting a radio antenna for transmitting, all three methods have been employed.

In the early days, working on the lines of Hertz, a spark gap was introduced directly into the antenna circuit; the antenna was charged positively, and the ground negatively, setting up a strain between them, until the air between the spark electrodes broke down or gave way electrically, and a spark or rush of current occurred between them, and oscillations began. That is the steady strain or prearranged method—by static electrification. And on this principle many Lodge-Muirhead stations were worked. It is a powerful method, but very difficult to tune out, since the initial jerk is rather violent. For some purposes this is a defect; for others it is an advantage. It was found to be a defect when arranged on the Great Eastern Railway line of steamers between Harwich and Antwerp; for though efficient, it was rather too efficient, and the government forts in the neighborhood found they could not always tune us out. With better tuning devices and, without a ground connection it could be done; but it was admittedly not easy.

The advantage of this mode of excitation is felt when tuning-out is *not* wanted; that is, when you desire every station within range to hear, to whatever wavelength it may be tuned. This is the case with an S. O. S. signal. And accordingly, for distress purposes, this method of excitation used to be employed on board ship, and possibly is still employed. It should be.

Then came the percussion method of excitation, utilizing what I used to call a "B spark"; that is the rush between the outer coatings of two Leyden jars whenever a spark takes place between their inner coatings. In that case the antenna was not pre-charged at all, but was charged with a rush or a blow, by the impact of the liberated induced charges in the outer coats of the jar or condensers employed. This method of shock excitation has been used a good deal; and the quenched-spark system is a modification of it, since the system is left to oscillate freely after receiving a blow, like a bell.

The third method of excitation, that by gradual working up, is now largely employed in various forms at continuous-wave stations. But so far as I know it was introduced at spark stations by Mar-

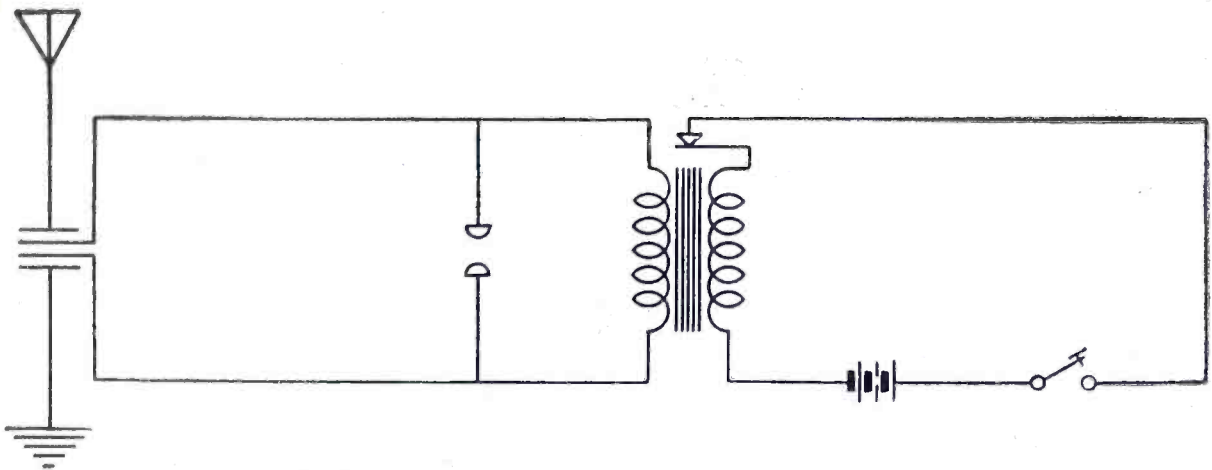

ANOTHER METHOD OF EXCITING THE ANTENNA

FIGURE 2: *By this method the antenna is energized electrostatically by means of a specified condenser, or what is really two condensers. This method found considerable use in the early days of "wireless."*

coni in his famous 7777 Patent, the antenna being excited inductively by an oscillating discharge in a closed circuit, to which it was coupled. Inductive connection at the receiving end had been patented before, *viz*, in my patent of 1897, but not at the sending end. For, though shock excitation is in that patent specification clearly foreshadowed, the continuous working-up method remained for future development, and when introduced was regarded as a decided improvement. For the oscillations do not in this case begin with any suddenness. They are gradually worked up from zero to a max-

imum, just as you may bow a tuning fork or a bell, instead of striking it; and thus excite a purer tone, more satisfactory to deal with, and easier to tune out when not wanted.

In this inductive method of excitation there is, in one sense, a prearranged static charge, at least at a spark station; but it is not a charge in the antenna itself. The potential energy is all in a closed local circuit. It is in the spark gap of this circuit that the strain is suddenly relieved, by fracture; and the oscillations which then begin are employed to stimulate oscillations in the inductively coupled

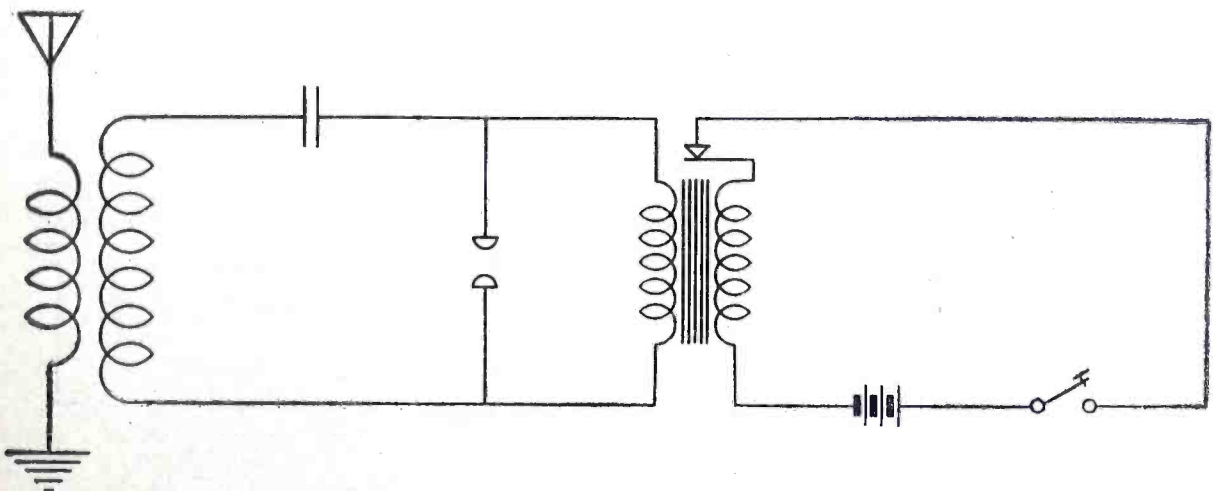

THE INDUCTIVE METHOD OF EXCITING THE ANTENNA

FIGURE 3: *Here the antenna is tuned by a coil which is coupled inductively to another coil in a closed oscillating circuit. If the coupling between the two coils is made loose enough, a much sharper wave will be radiated than is possible with either of the two previous methods.*

The Preceding Articles of This Series by Sir Oliver Lodge—

1. *How to Get the Greatest Efficiency out of Your Radio Circuits*..... March, 1923
2. *How to Get the Maximum Inductance in Your Coils*..... May, 1923
3. *The Ratio in Size Between Your Antenna and Your Coil*..... July, 1923
4. *Helpful Formulas for Designing Your Coil*..... September, 1923
5. *Practical Hints for Coil Calculation*..... October, 1923
6. *How to Calculate the Inductance of Your Coils*..... November, 1923
7. *Capacity Calculations—and Their Application to the Antenna*..... February, 1924

antenna. The spark in the primary may be quenched as soon as it has achieved its function, so that the antenna is left free to oscillate, without being hampered by anything like tight coupling to a closed circuit, which, as is well known, is liable to give waves of double periodicity; that is to say, a double kind of wave instead of a single one, a wave with two peaks, both of which it is difficult to tune out simultaneously.

The vacuum-tube and arc methods of excitation are representative of the continuous-wave system, like an organ pipe steadily blown from a bellows, and in these cases the oscillations are varied artificially by the operator, who makes them respond to the movements of his signalling key, the key being arranged sometimes so as to give variations in pitch instead of in amplitude, as in a flute or other keyed wind instrument.

The inductive method of excitation,

whereby the energy is communicated to the antenna kinetically instead of by static strain, bears some analogy to the fly-wheel kind of model spoken of at the beginning of this article, as contrasted with the static energy of a wound-up spring. There is initial strain in the latter, or potential-energy case; there is none in the kinetic mode of excitation. The act of throwing a ball is an example of a kinetic method. The liberation of an arrow from a bow, or a stone from a catapult, is an illustration of stored potential energy suddenly liberated. So is the projection of a bullet by the chemically stored energy of gunpowder. But a magnetic gun, if such a thing is ever made, is more kinetic in its action. The two necessarily shade into one another, because suddenness is a relative term: but a pre-charged antenna, charged electrically until it reaches its bursting point, is a definite fact.

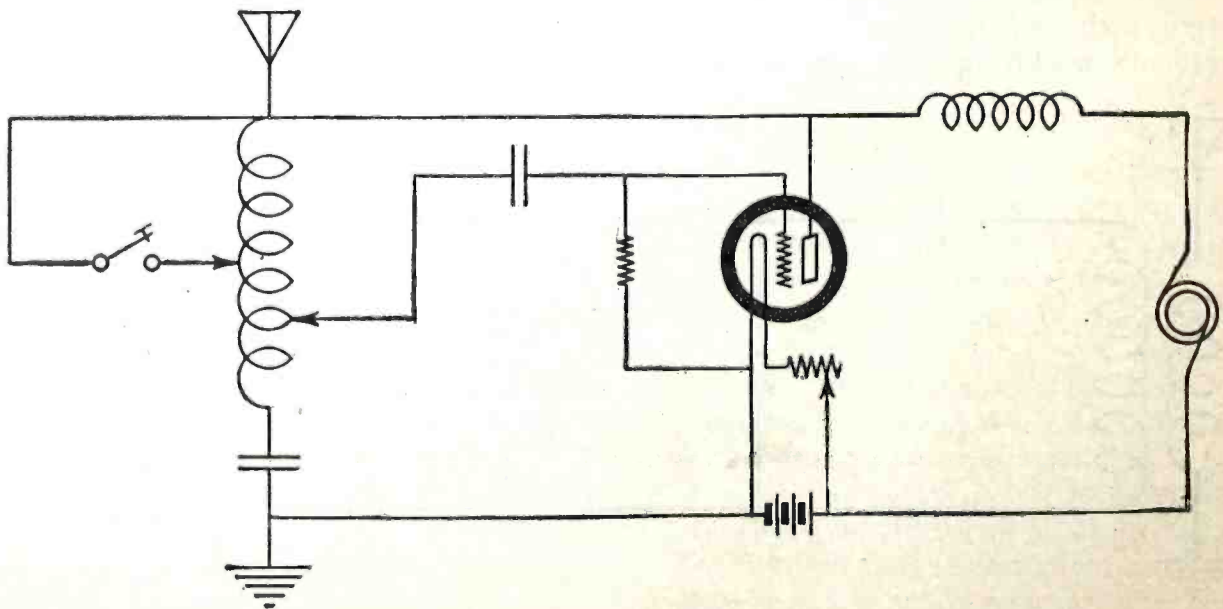

THE CONTINUOUS METHOD OF EXCITATION

FIGURE 4: This is one of the circuits which are used with vacuum-tube transmitters such as pictured on page 341 which send out an extremely sharp wave. Where interference would be a serious disadvantage this is the best method to use.

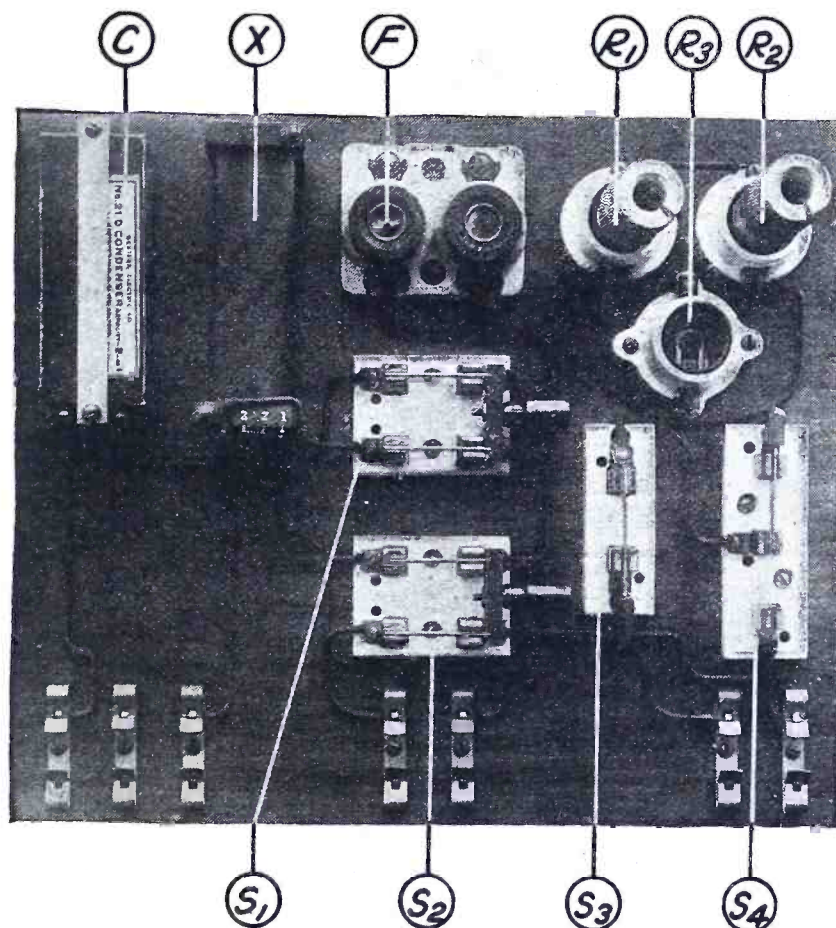

HOW THE COMPLETED PANEL APPEARS

FIGURE 1: *The wooden panel upon which are mounted the instruments for filtering the direct current and for charging the storage battery. All the apparatus is designated by letters which are also used in the text.*

A Novel Substitute for "B" Batteries

By F. F. HUMPHREYS

The radio fan whose home is equipped with a direct-current lighting service is fortunate, for he may eliminate the expensive short-lived "B" battery from his amplifier circuit and charge his storage battery at will. The scheme herewith presented for accomplishing this is entirely practicable, and will add considerably to the owner's enjoyment of his broadcast receiver.

HERE ARE THE ITEMS YOU WILL NEED—

- | | |
|--|---|
| 1 wooden panel, 12 inches by 14 inches by $\frac{3}{4}$ inches; | 2 double-pole single-throw knife switches, 15-amperes, porcelain base; |
| 1 piece of asbestos paper, 14 inches by 16 inches; | 2 Western Electric A-6-116 telephone induction coils; |
| 1 fuse block (double), porcelain; | 1 Western Electric 21-D telephone condenser, 2 mfd., with mounting strip; |
| 2 10-ampere fuses; | 6 Fahnestock binding posts, double connectors; |
| 3 lamp sockets, exposed terminals, porcelain; | 6 feet No. 18 gauge fixture wire; |
| 1 single-pole double-throw knife switch, 15-amperes, porcelain base; | necessary screws for mounting parts. |
| 1 single-pole single-throw knife switch, 15-amperes, porcelain base; | |

FOLKS who dwell in the suburban towns and who subscribe to an electric lighting and power service, are almost invariably supplied with alternating current. But those who live in the large industrial and business centers are supplied with either alternating or direct current.

The facility with which alternating current may be transmitted from the power station to the remote subscriber through the agency of booster and distribution transformers, makes this service especially popular in the rural districts.

Direct current, on the other hand, is used extensively in some large cities for operating variable-speed machinery and where the distances of transmission are not too great. A very substantial percentage of the homes in New York, for example, are wired for direct current.

No doubt the safest if not the most convenient way to determine whether one's home is supplied with alternating current or direct current is to inspect the meter. This device measures the quantity of electricity used by the consumer and is usually located in the basement of his home.

The *alternating-current* meter is generally small, and enclosed in glass; the

number plate on the face of the instrument gives not only its proper voltage and amperage but also the frequency of the current on which it has been designed to operate.

The *direct-current* meter is (in most cases) larger than the former type and somewhat resembles a common gas meter in appearance and proportions. Its mechanism is protected by a metal housing and the number plate bears the voltage and amperage capacities of the meter.

In case a Thompson watt-hour meter has been installed in the home, little or nothing may be learned from an inspection of it, as this instrument measures *both* alternating and direct currents. Should the radio fan be unsuccessful in determining the nature of the current with which he is being supplied from his observations, he may learn what he wants to know by getting in touch with his electric company.

But a simple electrical means of solving the problem is at the disposal of the fan. He may resort to the "salt-water" test. To make this test, it is merely necessary to immerse the exposed ends of two wires, brought from a lamp socket, in a glass of water in which a half teaspoonful of table salt has been dissolved. If, when the current is turned

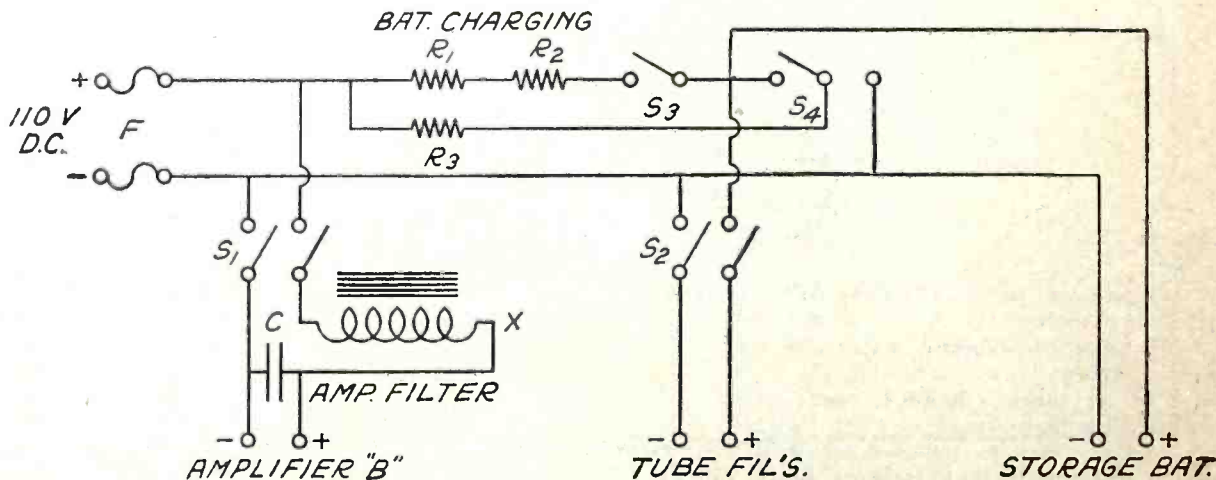

THE WIRING DIAGRAM FOR THE PANEL

FIGURE 2: The symbols on this diagram correspond with the letters on the photograph in Figure 1, so that the builder should have no trouble in making the proper connections.

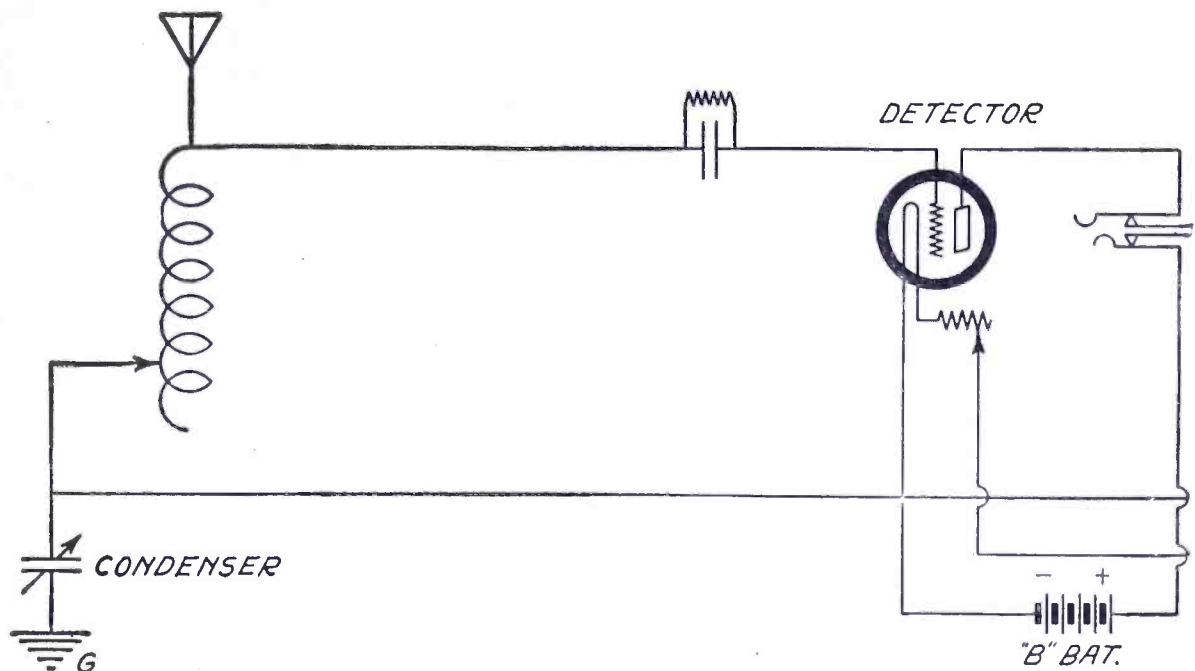

HOW TO CONNECT THE PANEL WITH A SIMPLE RECEIVING SET

FIGURE 3: Of course, any receiving set may be substituted in place of this one with good results.

on, bubbles form on both wires, an alternating current is passing between them. The appearance of bubbles on one or the other of the immersed wires indicates direct current. When performing this test care should be taken to keep the ends of the wires well apart at all times, as, if they should accidentally come together, a short circuit would result. Such an occurrence would require the replacement of a burned-out fuse in the switch or fuse box and might cause the observer serious misfortune. When connecting the test wires to the lamp socket, it is advisable to make use of an attachment plug similar to that employed in conjunction with portable reading lamps or vacuum cleaners.

The Difference Between Direct Current and Alternating Current

For the benefit of those fans who are not familiar with the essential differences between direct and alternating current, a few words here may be helpful.

Direct current differs from alternating current primarily in that the former flows con-

tinually in one direction, whereas the alternating reverses its direction of flow periodically. Direct currents are obtained from batteries and D.C. generators, while alternating currents are produced by A.C. generators or "alternators," as they are frequently called. The expressions A.C. and D.C. are contractions of *alternating current* and *direct current*, respectively.

In the course of his experience, the radio fan has doubtless been impressed with the importance of connecting the "B" battery in the plate circuit of his amplifier or detector tube in the proper manner. That is, he has learned that the *positive* terminal of the battery must be connected toward the *plate* element of the tube and that the *negative* terminal of the battery should be wired to the tube *filament*.

If these connections are reversed, the tube becomes inoperative.

This being the case, it is obvious that only a positive voltage or potential can be applied to the plate of the tube effectively (for receiving). As the alternating current supplied to homes reverses its direction of flow at a frequency of approximately 120 times a second (60 cycles a second) and as the introduction of such a current into the plate circuit of a vacuum tube would produce the same effect as reversing the "B" battery connections to the tube at an equal frequency, alternating current *cannot* be used to supplant the plate battery.

We may, however, replace the battery with a direct-current generator successfully.

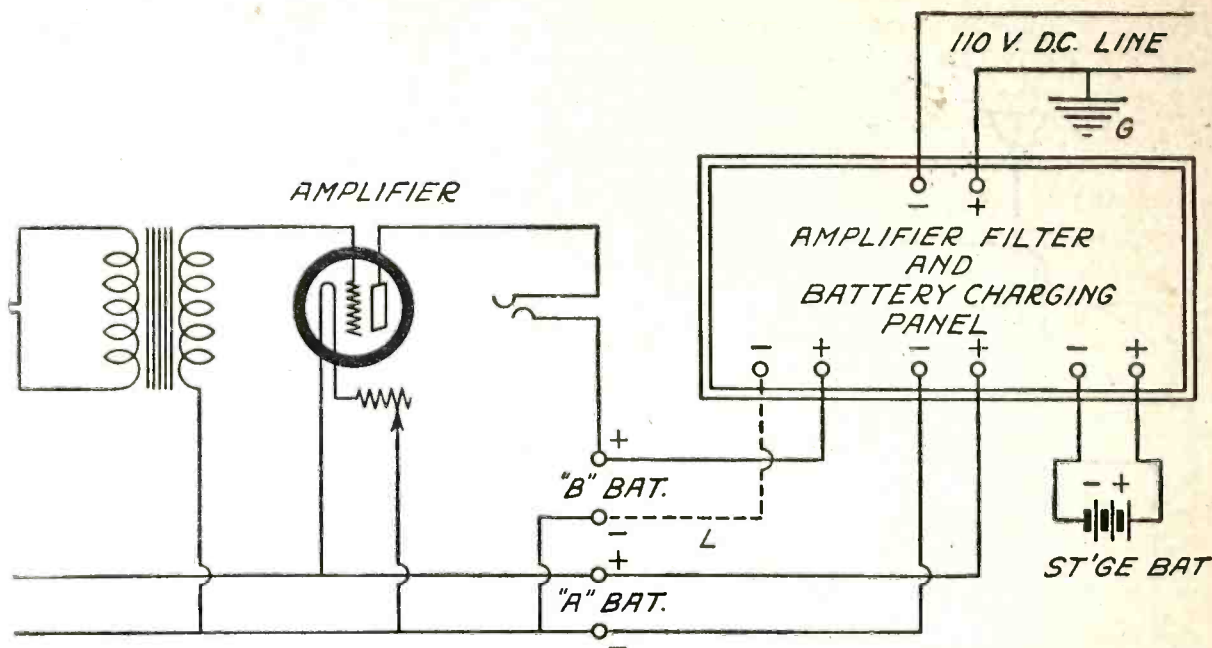

How Direct Current Is Generated

Although the direct current led into the home from the street mains is practically free from fluctuations, it is not nearly as smooth as that developed by a battery of any type. This is due to the fact that the generator at the power station which produces the current, feeds it to the mains through a mechanical agency known as a "commutator."

Batteries depend on chemical action for current production and the currents developed by them are therefore devoid of noticeable irregularities.

As an explanation of commutation, it may be said that the power produced by the generator is delivered by its rotor or armature to the mains through a commutator by means of brushes brought into contact with the latter. The commutator is composed of many small metal segments arranged in cylindrical fashion about one end of the rotor shaft and to these the current-generating coils of the armature are directly connected. As the rotor revolves, the energy generated in its armature coils is drawn off at the proper moment by the brushes which are fastened to the stationary frame of the machine. This process gives rise to a series of uni-directional audio-frequency current pulsations which are blended into each other in a manner such as to produce an almost even direct current.

Now, if generator current is supplied directly to the plate circuit of a receiving tube, a strong "commutator hum" will be perceptible in the headphones. This is due to the passing of the generator commutator segments beneath the brushes and may be sufficiently loud by a receiver. Therefore, before the direct-current lighting system can be successfully used to supplant the "B" battery, the commutator hum must be eliminated from it. This is accomplished by "filtering" the plate current fed to the tube.

What the "Filter" Does to the Current

The effect of inserting a filter between the plate circuit of a vacuum tube and the line, is to smooth out the irregularities in the current supplied to the tube, just as adding a flywheel to a combustion engine serves to steady its operation. Because of *electrical inertia* the filter gives the circuit to which it is added a sort of stability and, therefore, any slight tendency toward a variation (of current) in the circuit is overcome. In order that the filter be effective, it must possess a certain amount of capacitance and reactance.

The filter and charging panel illustrated in Figure 1, was constructed by the writer about one year ago. It was used in conjunction with a tuned-plate regenerative receiver and a two-stage audio-frequency amplifier. The panel was used instead of "B" batteries with the set over a period of eleven months and during that time gave highly satisfactory service. The original intention was to replace also the detector "B" batteries with filtered D.C., but it was found that better results were obtained by applying this scheme to the amplifier only. It is probable that losses were introduced into the plate circuit of the detector tube by associating it with the lighting system of the house. A 6-volt storage battery was used to light the filaments of the tubes and this was recharged from the direct-current supply whenever necessary. The panel was hung at the side of the operating table by means of two iron brackets.

The various instruments on the panel shown in Figure 1, have been similarly arranged in symbolical form with their connections in Figure 2. The 110-volt line connections are made fast to the input terminals of the fuses, F. Current is admitted to the amplifier filter through the double-pole single-throw knife switch S1. The filter consists of a Western Electric No. 21-D telephone condenser C, of 2 mfd. and two No. A-6-116 telephone in-

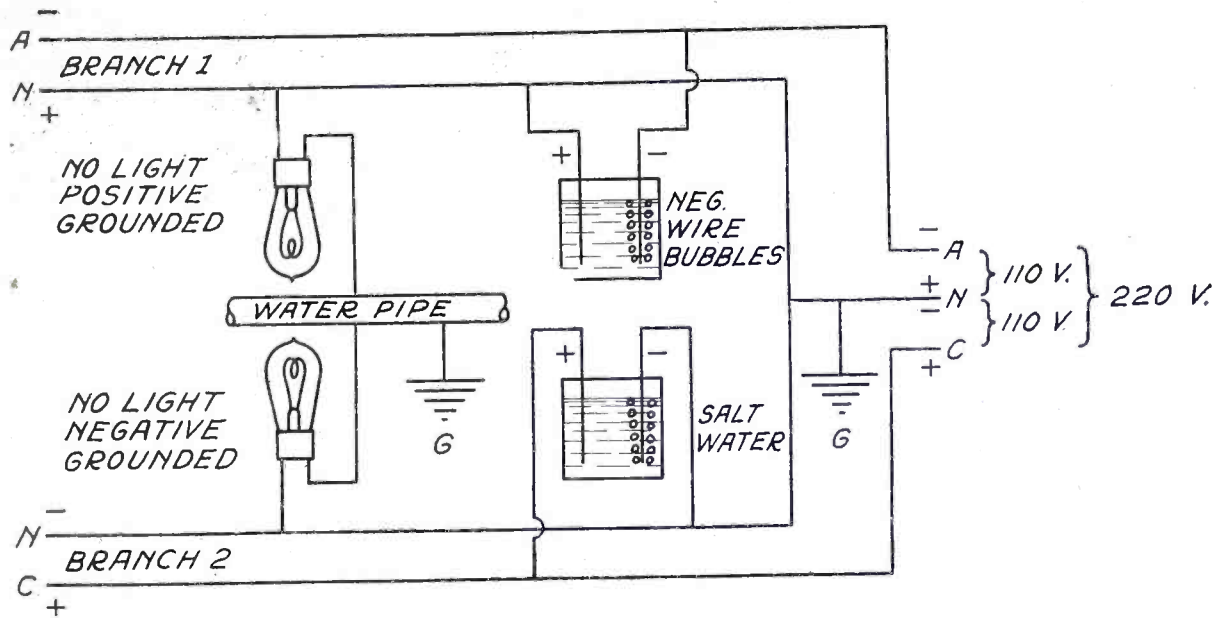

HOW TO DETERMINE THE PROPER SIDE OF THE LIGHTING LINE THAT YOU WANT TO USE

FIGURE 4: The article tells just what to do to make this test with the aid of the diagram.

duction coils X, of the same manufacture. These coils are not used as induction coils, but as choke coils. Their individual primary and secondary windings are so connected with respect to each other that the reactance of each coil is a maximum. This is accomplished by connecting the windings of a coil in series so that the magnetic fields established by the flow of current through them will aid each other.

The method of connecting the coils may be better understood by the novice perhaps, by referring to the numbers of the coil terminals. The primary terminals are numbered 3 and 4, while those of the secondary are designated as 1 and 2. Terminals 2 and 3 of each coil are connected together, and another connection is made from terminal 1 of one coil to terminal 1 of the other. The No. 4 terminals of both coils are wired to the condenser and the switch S1, as indicated in Figure 2.

It will be observed that the condenser and coils are connected in series with the line, through the switch, and that the amplifier "B" terminals are wired to those of the condenser. Arranging the condenser in shunt to the line, with respect to the amplifier plate circuit, restricts the path taken by amplified signal currents in the latter to its immediate limits. This results in efficient amplification. It should be emphasized that the condenser does not serve merely as a bypass condenser, but is an important part of the filter as well.

How the Charging Circuit Works

For charging the storage battery, the resistances R1, R2 and R3 are used. The first and second of these are shown in the upper right-hand corner of Figure 2, and have a resistance of approximately 22 ohms each. They are

550-watt, 110-volt heating elements such as are seen in the popular portable copper reflector heaters for sale in electrical shops, etc. One of these elements will pass a current of about 5 amperes at the rated voltage. As the storage battery used by the writer for lighting the tube filaments of his receiver was of low ampere-hour capacity and had a normal charging rate of 4 amperes, the two heating elements were connected in series for charging. This permitted the battery to be charged at a rate of about 2.5 amperes, which is preferable to employing a rate in excess of the normal one.

For the purpose of replacing the current lost from the battery through surface leakage and other causes, a trickle charging circuit embracing the resistance R3, was found useful. The resistance took the form of a reading lamp of 60-watt size and had a resistance of about 200 ohms. By manipulation of the single-pole double-throw switch S4, the lamp could be operated either directly from the line, or indirectly through the battery. When connected in the latter manner, the battery charged slowly at a rate close to 0.5 ampere. When it was desired to charge the battery at the high rate, the single-pole single-throw switch S3 was closed. The battery connects to the panel at the terminals indicated. Current is supplied to the tube filaments of the set by closing the double-pole single-throw switch S2.

In the event that charging rates of 5 or 7 amperes are required for a battery, the necessary current may be obtained by substituting a third 500-watt heating element for the 60-watt incandescent lamp used as R3. To charge a battery at 5 amperes, the switch S4 is thrown to the down position, while switch S3 is left open. The 7-ampere rate is obtained by clos-

ing switch S3 in addition to switch S4. Throwing switch S4 to the up position places resistance R3 directly across the line. Obviously, this position of the switch should be used only when R3 is a lamp employed for illuminating as well as for trickle charging.

It may be of interest to the reader to learn that the tube filaments may be operated while the battery is on charge. When this convenience is made use of, however, the battery-charging rate is reduced to the extent of the current drawn by the tube filaments, and the battery will, therefore, require a greater time to be restored. The leads to the battery should not be removed under any consideration while it is being charged in the above manner, as this would cause the tube filaments to be burned out instantly due to the high charging voltage which would be impressed directly upon them.

How to Connect the Filter and Panel to the Receiver Circuit

In connecting the filter and charging panel to a receiver circuit, as illustrated in Figure 3, certain precautions should be observed.

First of all, the fuses inserted in the fuse block on the panels should be of sufficiently low current-carrying capacity to fully protect the house fuses and the circuits of the receiver against the effects of a possible short circuit. At the same time, they should be heavy enough to pass adequate current for charging the storage battery. It will be found that 10-ampere fuses will fulfill both these requirements.

Another point of prime importance is that in all cases where the filament or amplifier plate circuits of a receiver equipped with this panel are conductively associated with the earth or ground connection, as in Figure 3, the antenna tuning condenser *be placed in the ground lead* below these circuits, as shown. Either this or a 1-mfd. paper condenser should be inserted in the ground lead. One side or the other of the D.C. line connected with the panel, is grounded by the power company. This may cause the enthusiast considerable trouble unless he is on his guard.

The connection L, Figure 3, need not be made, as the negative terminal of the amplifier "B" source on the panel is also made through the internal circuits of the latter with the negative terminal of the "A" or filament battery. An inspection of Figure 2 will make this clear. It is highly necessary that the negative sides of both the "A" and amplifier "B" sources be connected together to avoid short circuiting the battery, which would result were their "B" minus and "A" plus terminals to be joined, as is the usual practice. Connecting the sources in the prescribed way does not noticeably decrease the amplification of signals as against that obtained with their more usual relation. In connecting the filter and charging panel to a receiver, the internal battery connections of the latter should be altered to meet the necessary requirements. That is, provision should be made for inserting a "B" battery in the detector-tube plate circuit, and for connecting the amplifier "B" terminals independ-

ently to those of the panel. In the event that a connection exists between the "B" minus and "A" plus terminals of the amplifier, this should be removed and the proper connection made.

The Edison three-wire lighting and power system is installed in most homes equipped with direct current. One of these wires is grounded and this is called the neutral wire, which has been designated as N in Figure 4. The remaining wires are negative and positive with respect to the neutral wire and have been indicated as A and C, respectively, for convenience. By means of suitable connections to the wires of the system, the voltages indicated are obtained. Branch 1 consists of wires A and N, while branch 2 comprises wires N and C. The radio fan may determine which of these branches is at his disposal by means of two simple electrical methods.

The positive and negative sides of the line are first ascertained by an application of the salt-water test referred to in the beginning of this article.

For determining which of the leads of the system is grounded, a lamp socket, a 110-volt incandescent lamp, and a piece of insulated wire long enough to reach from the attachment plug to the nearest water pipe, will be required. Having made one of the attachment-plug wires, say the positive, fast to one of the socket terminals, and connected the remaining socket terminal to the water pipe through the piece of wire just mentioned, the lamp is inserted in the socket. If the lamp lights, the negative side of the line is grounded, indicating branch 2. This may be verified by connecting the negative lead from the attachment plug to the socket. Failure of the lamp to light in this instance indicates the negative side of the line to be grounded. Opposite results of the above ground tests will indicate the positive side of the line to be earthed, in which case the enthusiast will be on branch 1 of his lighting system. When using an attachment plug of the plug-in type, the smaller member of which is separable from the larger and is equipped with two prongs which engage the latter, care should be taken not to reverse the insertion of these prongs in the screw part of the plug during tests, or after the line has been connected to the panel.

A list of the materials required for the construction of the filter and charging panel is given at the head of this article. The wooden panel is first covered with asbestos paper to protect it from the effects of an accidental short circuit and the heat of the charging resistances. A neat way to do this is to tack the 1-inch margin of the paper down around the edges of the panel. The various units are then mounted in their relative positions, as suggested in Fig. 1, and are wired in accordance with the panel wiring diagram, Fig. 2. Consistent arrangement of the panel terminals with regard to their polarities will facilitate the installation of the unit later. When the panel has been completed, all circuits should be traced for accuracy before it is connected to the line and the receiver.

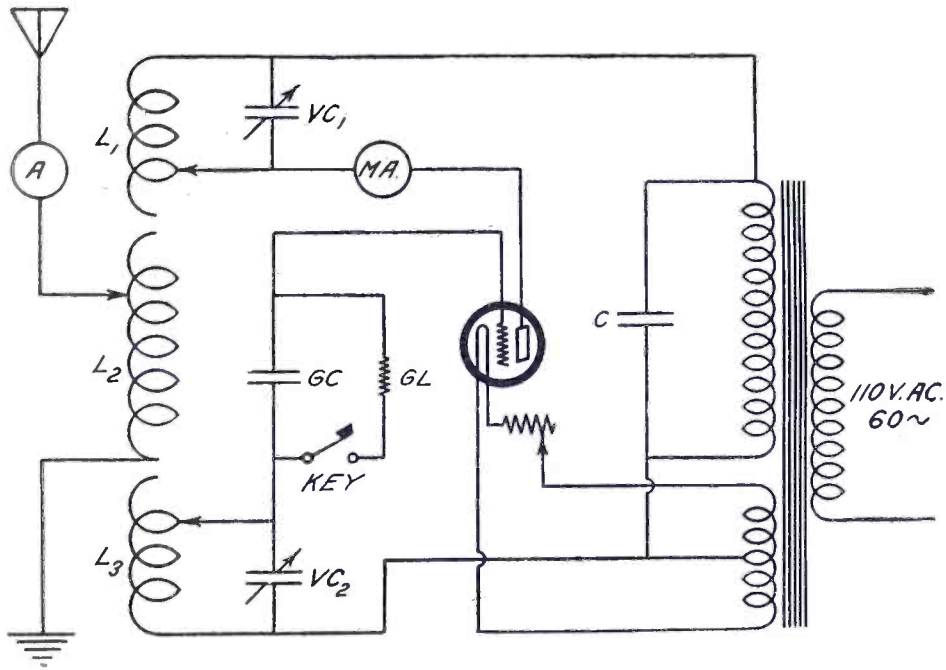

MODIFIED MEISNER CIRCUIT WITH A.C. POWER SUPPLY

Cost of parts: Not more than \$40.00. (Note: The costs of tubes and batteries are considered "extras" and are not included in the costs given in these descriptions.)

Emitted wave: Fairly broad. Using straight A.C. on the plate of the oscillator tube causes a 30-cycle note to be transmitted (as the modulator frequency) which spreads out the frequency to a band instead of a single, pure wave. This will cause interference in nearby receivers which do not tune sharply.

Operation: Easy to get working and inexpensive to keep up. The first cost is the last cost except for tube replacements. It

will work on any type of antenna.

Construction: Nothing difficult about making this set, probably as simple as a single-tube receiving set.*

Approximate transmitting range: 500 miles.

Outstanding features: Simple to make and get into operation. Set functions without any moving parts to wear out, is applicable to a large band of wavelengths with any type of antenna, and requires no batteries. It may cause interference to nearby broadcast listeners, however, if they use single-circuit tuners or other simple sets that are deficient in tuning qualities for reception.

*(See POPULAR RADIO, April, 1923, page 312, for constructional details.)

100 BEST HOOK-UPS

INSTALLMENT NO. 6

Transmitting Sets for Amateurs

The preceding installments of this series of hook-ups gave our readers a condensed review of receiving circuits, ranging from the most simple and inexpensive of crystal sets to some of the most highly developed sets for long-distance work. This present installment gives the novice a little survey of amateur sending sets, ranging in cost from \$15.00 to \$175.00 and with a transmitting range of anywhere from 5 miles to 2,500 miles. And the real joy of radio—as any "radio ham" will tell you—begins when the listener turns his hand to sending!

SHORT-RANGE TELEPHONIC TRANSMITTER WITH BATTERY POWER SUPPLY

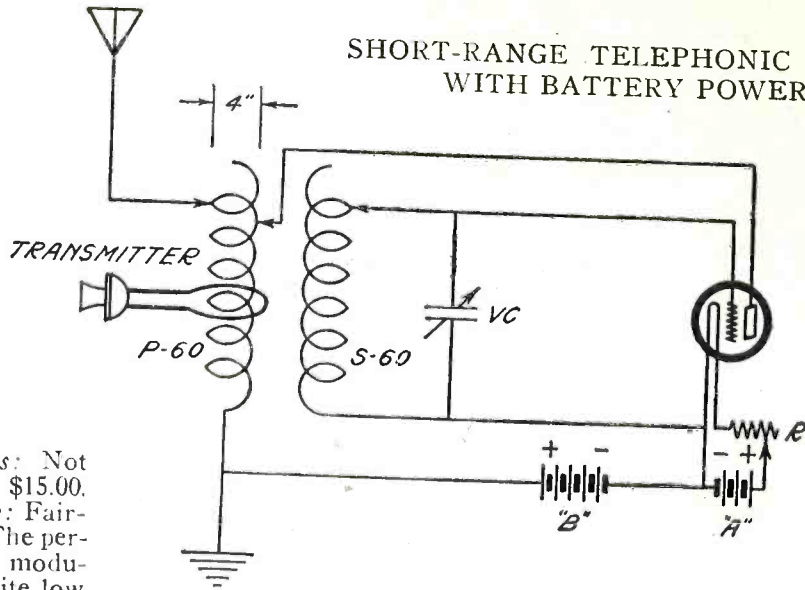

Cost of parts: Not more than \$15.00.

Emitted wave: Fairly sharp. The percentage of modulation is quite low and the wave does not spread much in frequency.

Operation: Just as simple as a single-circuit receiving set. The UV-201-A tube may be used with about 100 volts of "B" battery

for the plate supply.

Construction: Simplicity itself.*

Approximate transmitting range: 5 miles.

Outstanding features: Simple to make and operate.

* (See POPULAR RADIO, April, 1923, page 309, for constructional details.)

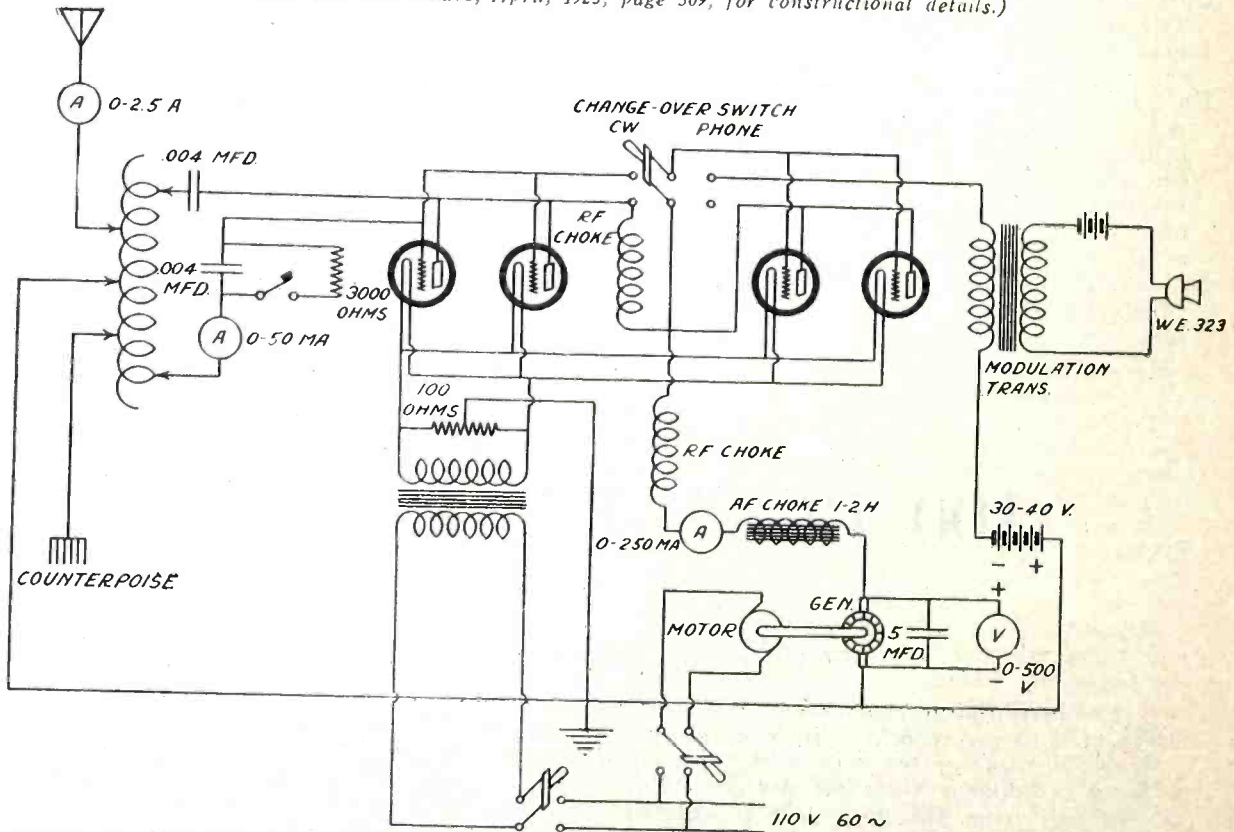

THE HARTLEY CIRCUIT USING HEISING MODULATION FOR TELEPHONY

Cost of parts: Not more than \$175.00.

Emitted wave: Extremely sharp for CW and good on telephony.

Operation: Complicated. A thorough understanding of the principles of modulation is necessary to get the set operating efficiently on telephony.

Construction: Difficult.*

Approximate range: 2,500 miles (on CW), and 1,000 miles (on telephony).

Outstanding features: This circuit is noted for its efficiency and perfection of modulation. This type of modulation is used at most of the broadcasting stations.

* (See POPULAR RADIO, December, 1922, page 256, for constructional details.)

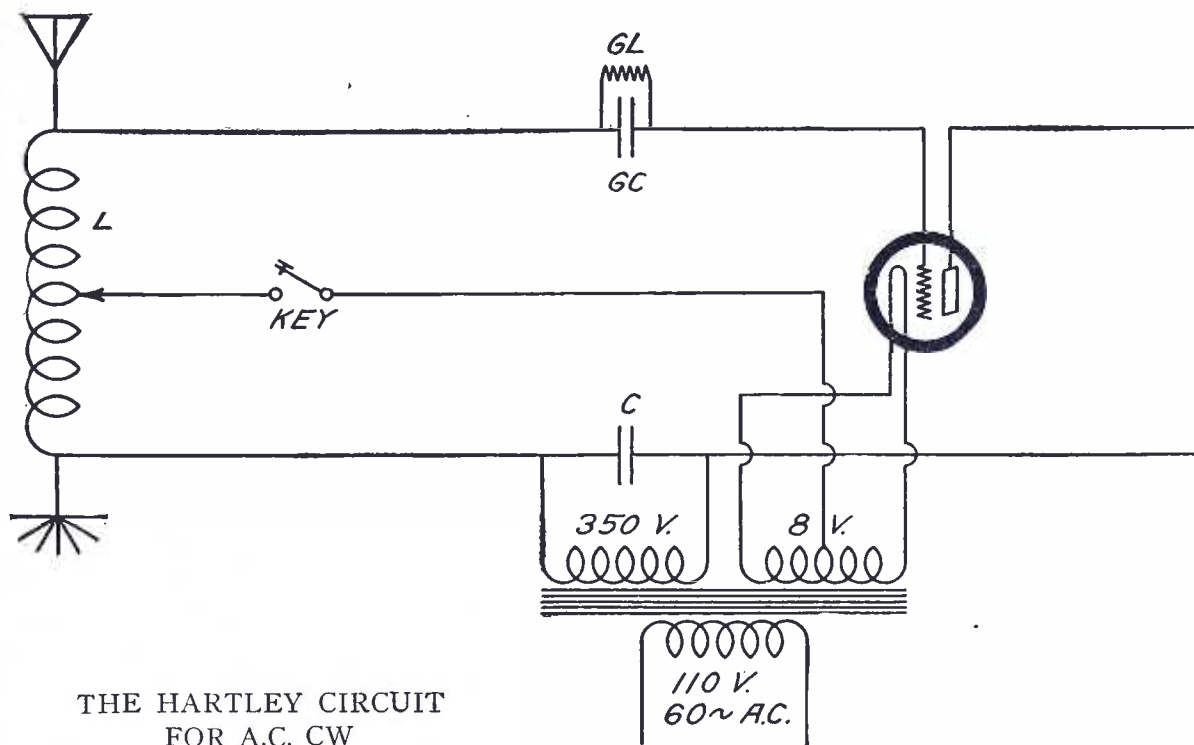

**THE HARTLEY CIRCUIT
FOR A.C. CW**

Cost of parts: Not more than \$30.00.

Emitted wave: Fairly broad.

Operation: Easy to get working and very inexpensive. It will work on any type of antenna. A counterpoise is advisable.

Construction: Simplicity itself.*

Approximate range: 500 miles.

Outstanding features: Simple to make and easy to get into operation. It is also most economical to set up.

*(See POPULAR RADIO, December, 1923, page 513, for constructional details.)

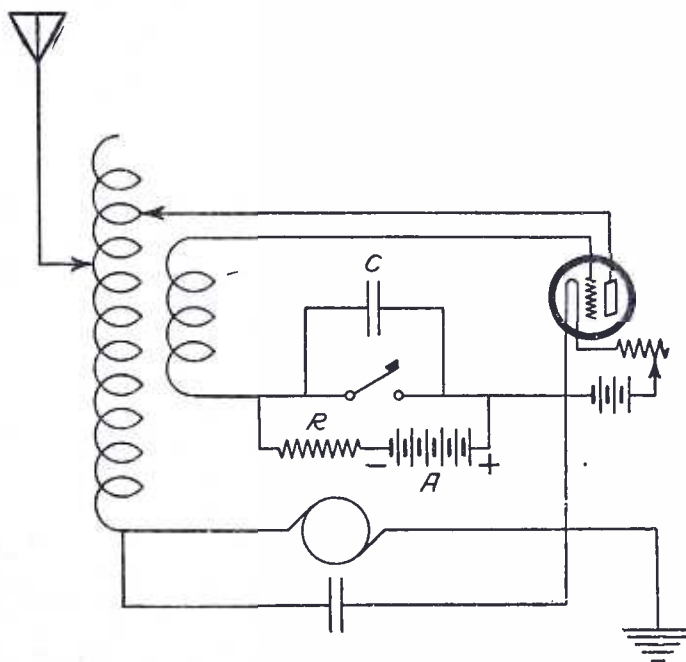

GRID-TICKLER CIRCUIT FOR PURE CW TELEPHONY

Cost of parts: Not more than \$125.00.

Emitted wave: Extremely sharp.

Operation: Not difficult.

Construction: Nothing especially complicated in the arrangement of this set, but the builder should have had some experience in

putting together receiving sets, wiring, soldering and the like before he attempts to make a transmitter.*

Approximate range: 1,000 miles.

Outstanding features: A sharp wave, and a pure "whistle" note for telephony.

*(See POPULAR RADIO, September, 1922, page 39, for constructional details.)

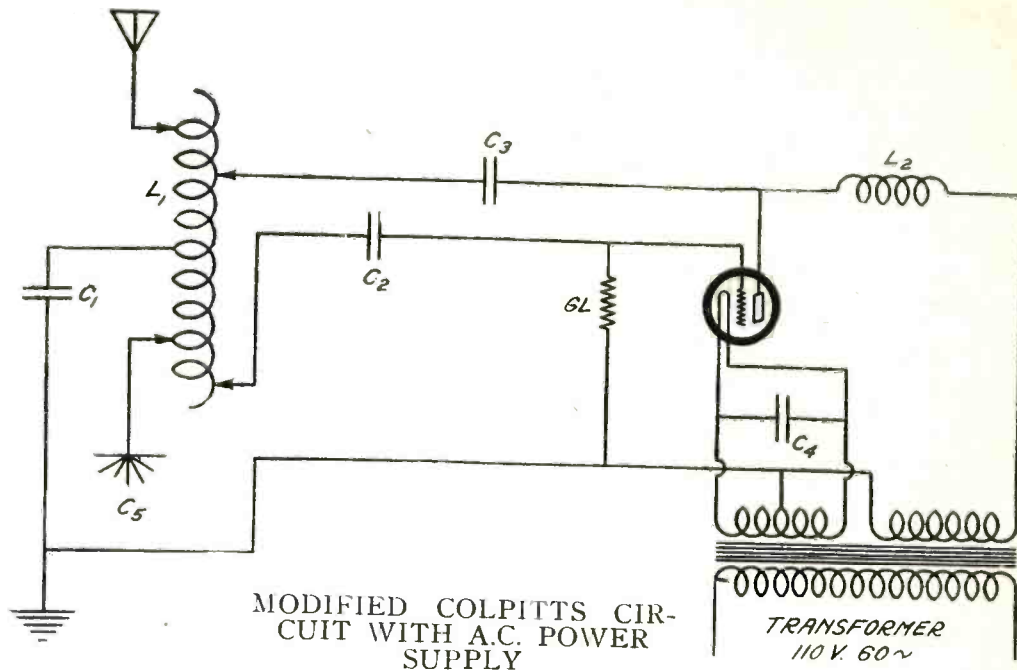

Cost of parts: Not more than \$35.00.
Emitted wave: Fairly broad. (This is due to the A.C. power supply and not to the type of circuit used.)
Operation: Simple to get into successful operation (if a counterpoise is used).

Construction: Not complicated.*
Approximate range: 500 miles.
Outstanding features: A persistent oscillator and efficient. This set employs no batteries of any kind. It is run wholly from the 110-volt, 60-cycle, A.C. lighting mains.

*(See POPULAR RADIO, September, 1923, page 249, for constructional details.)

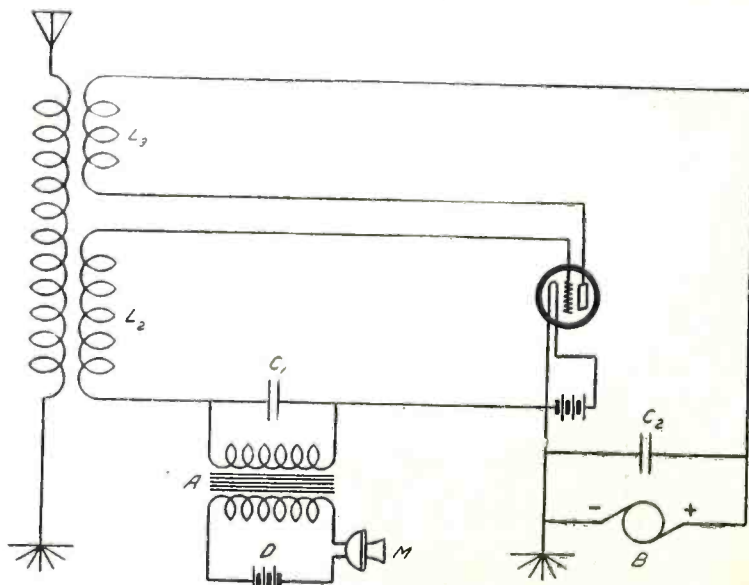

THE MEISSNER CIRCUIT FOR TELEPHONY, WITH GRID MODULATION

Cost of parts: Not more than \$120.00.
Emitted wave: Fairly sharp.
Operation: It is quite difficult to get a large percentage of modulation and still keep the transmitted speech clear.
Construction: The most important parts in this circuit are the coils; they should be wound on high-grade composition tubing with no shellac on the windings. A regular

modulation transformer should be used at A.*
Approximate range: 50 to 100 miles (on telephony).
Outstanding features: This is a good single-tube telephone outfit for the amateur. It will give him a lot of information and allow him to try a lot of experimenting to get better modulation.

*(See POPULAR RADIO, July, 1923, page 42, for constructional details.)

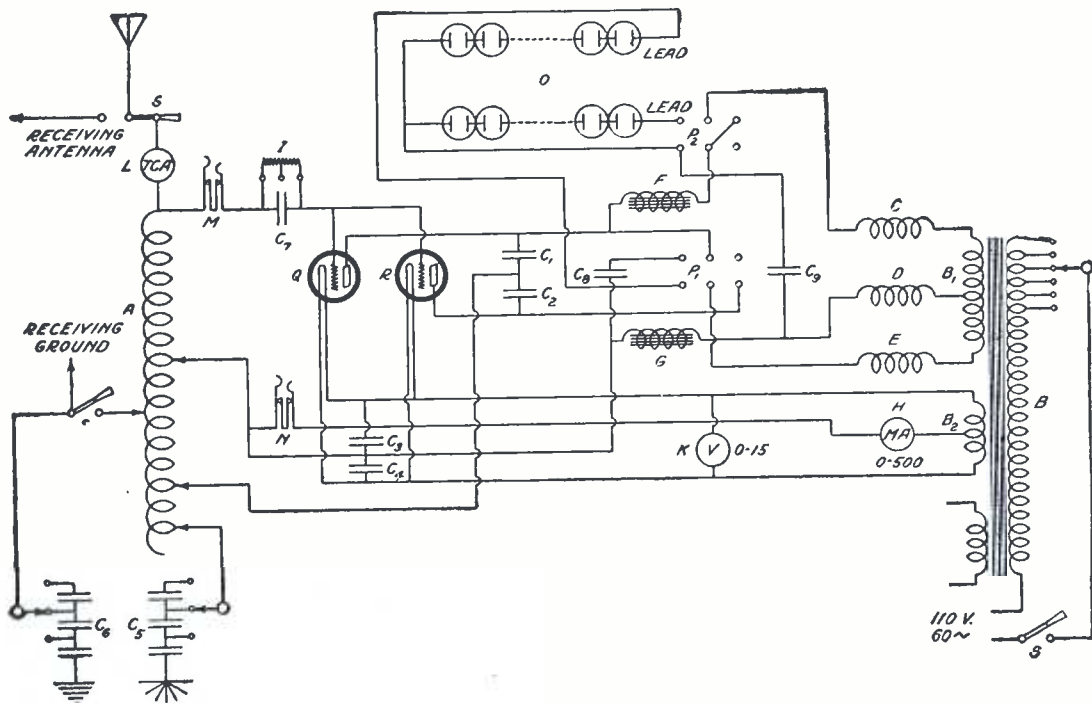

A COMBINATION HARTLEY CIRCUIT FOR USING A CHEMICAL RECTIFIER FOR RECTIFYING THE PLATE CURRENT, OR FOR USING STRAIGHT A.C. ON THE PLATES OF THE TUBES

Cost of parts: Not more than \$125.00 (for use with 50-watt tubes).
Emitted wave: Broad (with self-rectified A.C.). Somewhat sharper (with chemically-rectified A. C. It depends upon how good the filter is).
Operation: Complicated.

Construction: None but the experienced amateur had better try to build this set alone.*
Approximate range: 2,500 to 3,000 miles (on telephony).
Outstanding feature: A powerful set which can be used without batteries for CW telegraphy.

*(See POPULAR RADIO, April, 1923, page 298, for constructional details.)

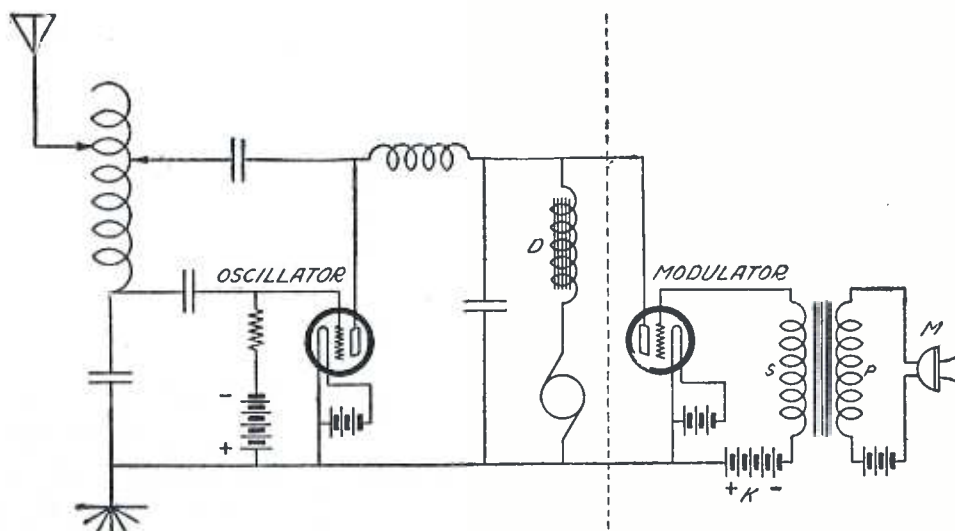

THE COLPITTS CIRCUIT WITH HEISING MODULATION

Cost of parts: Not more than \$130.00.
Emitted wave: Fairly sharp. The modulation is (if the set is properly adjusted) of a very high order and also of a high percentage. This may cause the wave to be broadened out so that the set may interfere locally.

Operation: Simple and efficient.
Construction: Rather complicated.*
Approximate range: 500 to 1,000 miles (on telephony).
Outstanding features: The best modulating system and the one most used for broadcasting.

*(See POPULAR RADIO, July, 1923, page 46, for constructional details.)

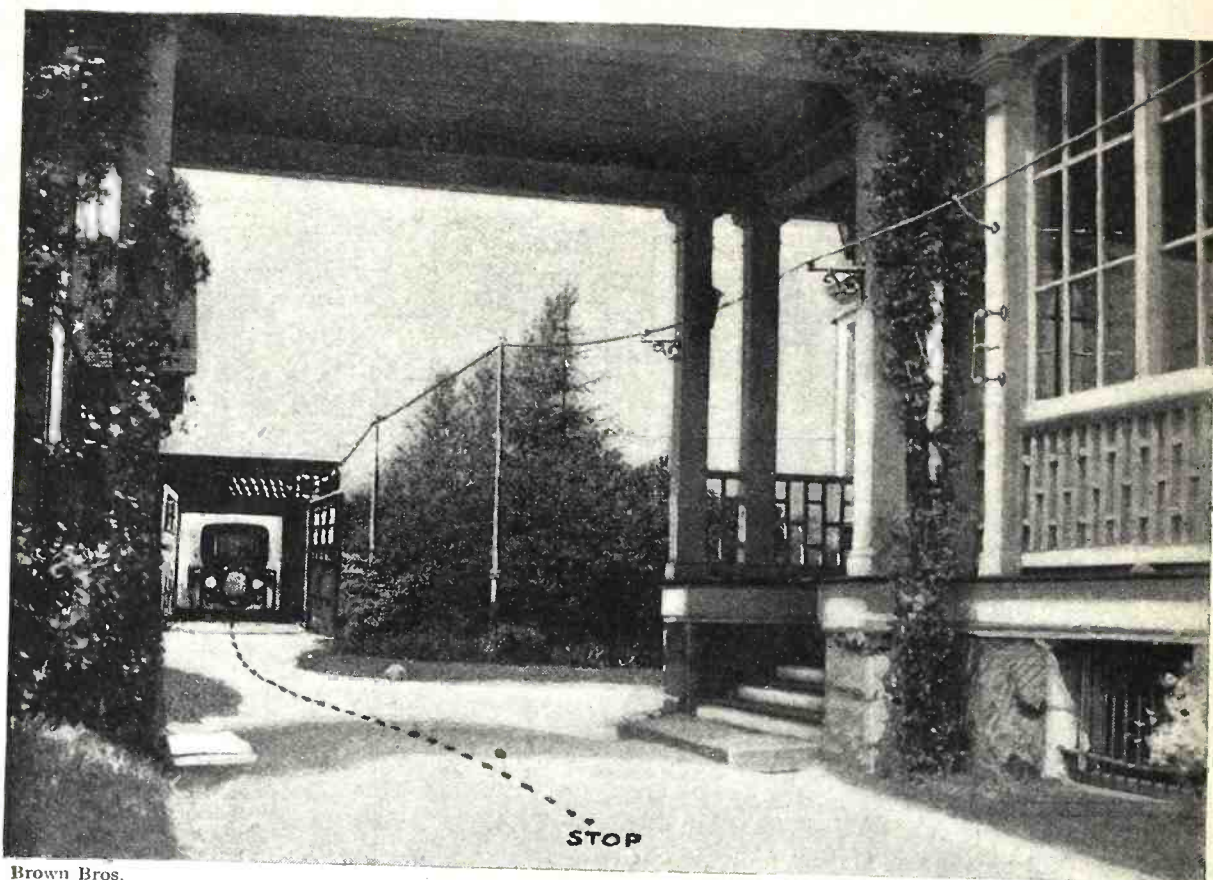

Brown Bros.

A RADIO CHAUFFEUR THAT BRINGS YOUR AUTO TO THE DOOR

The conductor strung between the house and the garage serves as a path for the radio waves that automatically start the car and open the doors. Other waves in this same conductor guide the driverless car up to the step, where the smaller conductor, fixed to the doorpost, stops it.

Will Radio Do Our Housework?

Only forty years ago the layman laughed at the possibility that electricity could be used for even so simple a task as lighting our homes. Yet since then electricity has developed into an indispensable domestic servant. That radio may demonstrate even more startling possibilities in the home is pointed out in this article—which is written by a well-known scientist under the *nom de plume* of—

THOMAS ELWAY

IF you should fall asleep some day, like the heroes in the fairy stories, and not wake up for a hundred years or even for fifty years, you would wake into a very different world from that which we enjoy today.

Just what kind of a world you would find might be, of course, a matter of opinion. But there is one thing about it of which we can be quite sure; it will be a radio world, a world in

which the ether waves will play an astoundingly larger part than they do in the world of today.

Remember the changes in every condition of life that have been accomplished in less than a century by the discovery of how to use electricity. The ether waves that we know about now are incomparably more powerful and pervasive than mere electricity led around in wires. And as these marvel-

ous waves come more and more into daily use we may expect them to work an even greater revolution in almost every feature of our daily life.

Your radio house of 1975 or 2024 will be a very different kind of place from your house of today. It will have few servants or none—for all the disagreeable tasks of housekeeping will be done by radio or by machinery that radio controls. Communication from room to room or between different houses will be as much more convenient than it is today as our present telephone devices are better than the bell-cords and speaking tubes of even forty years ago.

When you want your automobile (if, indeed, they still use automobiles in 1975) it will come from its garage all by itself and will stand waiting in front of the door. Radio will bring it. Your bath will be drawn and warmed, and perhaps electrified, for you by radio. Your breakfast egg will be cooked by radio, your beefsteak will be kept warm for you while you eat, your coffee will be percolated in just the way you like it, all by these wonder-working ether waves that we are just beginning to understand and put to work.

Do these things seem too marvelous? They are not. Everything that is predicted in these paragraphs *could be done now* if anybody wanted to spend the money to do it. Within five years many of these things will have been done. The development of the radio house of the future will be well on its way.

The future of radio entertainment, for example, is already visible. The linkage of the broadcasting stations to each other has been accomplished by land wires in a dozen instances and by radio-relay systems in at least three, including one that spanned the Atlantic. This means that within a year or two the entire country will be listening to the speeches of the President in Washington, to the Metropolitan Opera in

New York or to the Hawaiian entertainers in Honolulu. Great music, inspiring addresses, successful plays will be no longer the exclusive property of those who live in large cities. The smallest hamlet will listen to the greatest of the symphony orchestras or go to school under famous professors.

Nor will this wide availability of entertainment and of opportunity for self culture be confined merely to sounds. It is safe to say that within a year or two the broadcasting of scenes as well as sounds will be done experimentally. Most of us that are now alive will live to see it as common as the present broadcasting of music and speech. The apparatus for this has already been invented.* It is not perfect yet, but neither were the telephone or the moving picture perfect in the first years after their invention. We will see before we die the radio play, visible as well as audible in our own homes, as common as the present day phonograph or motion picture or radio concert.

There is a sure promise, too, of what we might call "canned radio." Perhaps a special event like the President's speech or a recital by some great artist, occurs at an hour when it is impossible or inconvenient for you to be listening. Must you therefore miss it? Not in the least. There is already in existence more than one form of apparatus that can be attached to a radio receiver and that will record for you anything that comes in during the hours for which you set it. You can leave home in the morning, having adjusted your set for the programs that you want to receive, and come back at night to find the record all made for you. Play off the concert, listen to the President's words at your leisure, and, if you feel like it, listen to this over and over again. Store the record away. Let your great-grandchildren listen to it, too, if they want to.

* See the article, "The New Radio Movies," in *POPULAR RADIO* for December, 1923.



Brown Bros.

HOW RADIO CAN COOK YOUR BREAKFAST

A coil of wire supplied with high-frequency current surrounds the egg cup; radio waves from this coil penetrate the egg and cook it. Meanwhile other coils serve as sources of radio waves to cook the chops inside the covered dish and to keep warm the coffee pot and the food on the plate. All this, is a present-day possibility.

All this is possible now. Indeed it is being done every day in at least one experimental laboratory. It belongs, really, to the possible radio house of the present, not that of 1975.

Equally possible, though less successfully done at present are the marvels of radio control. The little toy called "Radio Rex" is familiar to everybody. The toy dog that comes out of his little kennel when you speak to him does not really work by radio, but he does exemplify a prophecy of radio. Anyone who feels like it can build into his house, tomorrow, a radio device, for example, that will open a door if you speak to it. Set this device for the words "open sesame" and you can emulate the master of the forty

thieves. Speak these words to the door as you approach and it will swing open, to close after you as you pass through. Any competent radio engineer can build such a device for you. It might cost two or three hundred dollars, but what did the first telephone cost? Before long we will be buying radio door openers like this perhaps for ten or twenty dollars, possibly for two or three.

And about the automobile. Anyone can equip his garage and his automobile with radio devices so that a set phrase such as "automobile come out" spoken at some fixed place in the house will start off a train of automatic operations and bring the automobile, unoccupied by any human operator, to the door.

How to do this? It is very simple. The spoken words actuate a radio transmitter fixed to respond only to these words, that is, to a special succession of sounds. This transmitter sends out waves that operate a radio relay under the hood of the automobile. This relay starts the engine of the car. When the engine has reached a proper speed a small transmitter under the hood sends out another special signal that operates a relay on the garage door so that the doors swing open. The act of swinging open starts a third transmitter and this gives to the relay in the car the signal that meshes the gears and starts the car in motion. As soon as the car has left the garage door it comes under the direction of a radio wave from a suspended wire along the driveway and this wave, acting through the radio relay system under the hood, steers the car up to the door and stops it at the step. You can even equip the car with an automatic anti-collision device that will stop it instantly if any visible obstacles, such as another car or a playing child, happens to be in the road in front of it.

All this, mind you, *we could do now*. Any time that you want a radio garage you can have one by hiring a good radio engineer or by becoming, yourself, an expert in radio control. The sequence of automatic operations that I have described for the automobile is far less complicated and difficult than the operations necessary to steer an unoccupied battleship or airplane. Both of these tasks have been accomplished with entire success.

But to get back to the house. The calling of the automobile is by no means the chief duty performable by radio control. Much of the house service, like stoking the furnace or carrying out the ashes, can be done in the same way. There need never be any winding or setting of clocks, for all kinds of time-keeping devices will soon be automatic, actuated by the time signals sent out

from the great broadcasting stations. Even a pocket watch that thus regulates itself is possible and at least one such has been built.

Table service may be similarly automatic. When the soup is finished you say merely, "bring in the fish," and the fish comes in from the kitchen by himself; slides in perhaps on some sort of track or runway, or rolls in on a little automatic cart like a tea wagon.

But perhaps, in fact, there will be no such thing as table service. It may not be necessary at all for it may be replaced by applications of radio heat.

Radio heat is not really heat; it is a way of making heat exactly when and where you want it. There is a familiar experiment that illustrates what radio heat is. Inside a wooden box of some kind you put a coil of insulated wire with the turns of the coil horizontal. On top of the box you place an ordinary iron stove-plate. Then you pass a powerful high-frequency current through the coil of wire. The plate gets hot. You can easily fry an egg on it. Indeed, if you have power enough in your high-frequency coil the plate may get red hot or even melt.

This experiment is always astonishing to the uninitiated. The wooden box hides the high-frequency coil. The plate, quite obviously, is not connected with any electric wires or anything else. Where does the heat come from?

It comes, of course, by radio. The ether waves going out from the coil enter the iron plate and make eddying currents of electricity in the iron. These currents heat the plate.

It is possible to heat anything in this way, even non-conducting things like glass or rubber. The only difference is that you need more power. With enough power and with other arrangements that are quite possible in theory you could have, for example, an egg-cup that would cook your egg just to the right point if you merely place the egg in the cup.



Brown Bros.

A MODERN "OPEN SESAME"

A radio device can be arranged to open doors on the signal of a spoken word. The microphone and other radio apparatus in the box over the door are adjusted to operate an opener built like an ordinary door check.

Suppose you have a table equipped with these devices and you sit down to breakfast. From a little cooler at one side you lift out the orange juice (which has been prepared a few minutes before by an automatic squeezer) and an egg. You place the egg, unbroken, in a little hollow on the radio egg-cooker. Before you have finished the orange juice the egg is cooked. Meanwhile you have selected, we will say, a lamb chop. You have laid the chop on a plate and set the plate on a certain spot on the table. Radio waves from underneath cook the chop. Other radio waves,

slightly less intense, keep it warm for you while you eat.

This sounds like the marvels of a motion-picture comedy but it is not. We can do it all now except for one thing. It is difficult to keep these heat-producing radio waves in their place. Sometimes they spread too widely and melt a soup spoon or set fire to the sugar in the sugar bowl. Before we can really have radio breakfasts that are both safe and comfortable we must learn better how to control these unusually powerful waves. That we will learn how to do this no one doubts. Radio breakfasts, and dinners and suppers, too, and midnight welsh rarebits, are coming just as surely as are the "canning" of radio programs and the radio movies.

Radio heat will help us, too, in the matter of hot water. It seems startling to remember, nowadays, that running hot water in houses, even those of the very rich, is an astonishingly recent invention. Thirty years ago automatic hot water was a marvel that people went miles to see as they now go to see the new navy airship or the talking movies.

We can improve it still more. A radio device fitted to the bathtub or to the faucet will give you, instantly, hot water of any temperature that you want and will save one-half the piping in the house to say nothing of a lot of fuel.

We might go on to think of radio hot-water bottles, of radio milk-warmers for the baby, of radio warmers for the baby itself on cold nights. There are thousands of probable applications for radio heat. But there is another possible development of radio that promises, to me at least, a still greater boon than easy heating.

This is the elimination of noise. The curse of civilization is its clatter. Nobody knows how much the noise of cities costs the people who have to live in them in shattered nerves and ruined health. It is no mere accident that

"peace and quiet" are linked together so often in common speech.

Of course, a lot of the city noise is inevitable. Automobile engines are bound to make some noise, though this lessens from year to year. Rapid transit must make some noise, though not a fraction of what it inflicts on us now. Even the feet of people on the pavement cannot be kept absolutely silent.

But there is one great element of noise that we probably can avoid, an element that radio may help us to eliminate. This is the noise of warning signals; the bell of the street-car, the shrill call of the telephone, the whistle of the traffic policeman, the automobile driver who thinks that his horn is something on which to play a tune.

How can these be displaced? No one can be sure. But here is an idea. It is an idea of replacing sound-signals with touch-signals. If you want to attract the attention of a man in front of you in church you do not shout at him,

you touch him on the shoulder. Nobody is disturbed except the man who must be disturbed.

Can we do this generally? Possibly. There is one way in which it might be done by radio. It is comparatively easy to make a small radio device that you can carry in your pocket and that will attract your attention by a slight touch or tingle whenever it is operated by a received radio wave. Perhaps automobile drivers could be required to wear such devices and traffic policemen could be equipped with transmitters to actuate them instead of with whistles. Perhaps some similar device will replace the door-bell and the telephone bell.

Such things are farther ahead, I imagine, than the useful household applications of radio control and of radio heat. But in fifty years a lot can happen. The radio house of 1975 may be not only soundless but still more marvelous in a hundred ways that we cannot even guess.

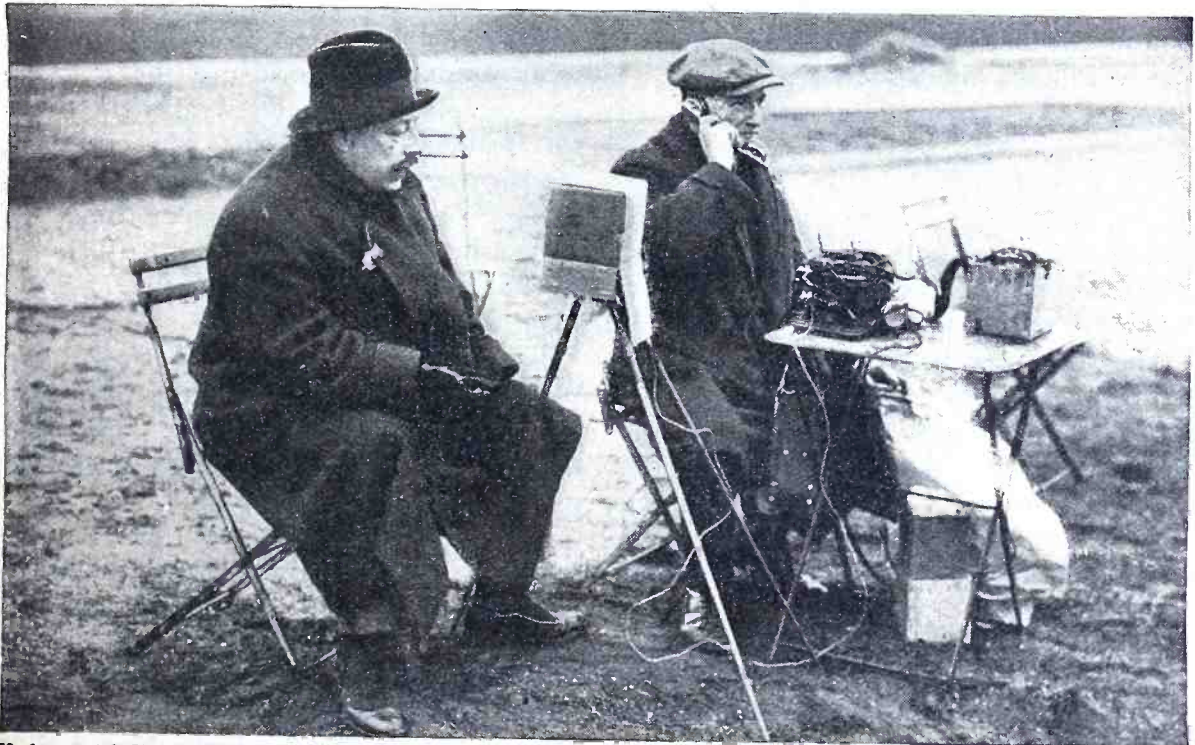

Underwood & Underwood

BROADCASTING SIDE-LINE REPORTS OF A RUGBY GAME

French sport writers are stealing a leaf from the American book of journalistic practice; here is a picture made in the Pershing Stadium in Paris during the France-Scotland rugby contest.

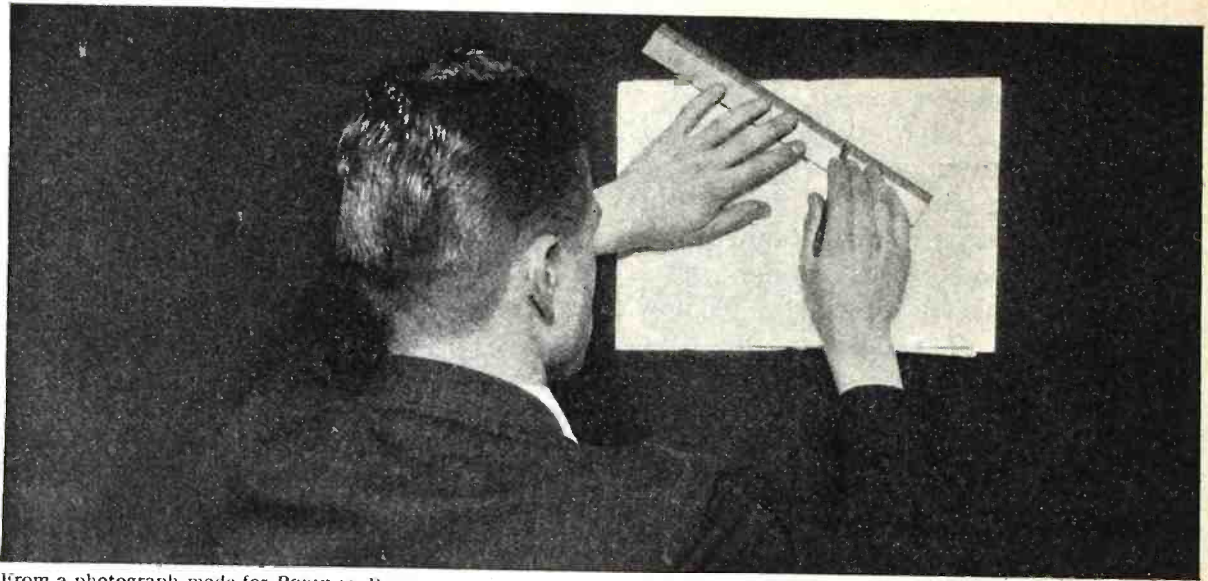

From a photograph made for POPULAR RADIO

Q Lay your ruler across the alignment chart, as described in this article—and read off at a glance the answer to your problems in calculations.

A MEASUREMENT CHART

FOR DETERMINING THE MAXIMUM CAPACITY OF A VARIABLE CONDENSER

ARTICLE NO. 7

By RAOUL J. HOFFMAN, A.M.E.

IN a previous article we have given the calculation of a fixed condenser which follows the equation:

$$C = .0000002248 A K/d$$

where C is the capacity in microfarads, A the area of the effective plates in square inches, D the distance between the plates and K the dielectric constant, which in our case—for air—will be 1.

The area of the plates will be very closely figured by taking the area of one rotor plate and multiplying by the number of the plates *less one*, as the capacity effect is accomplished *between* adjacent plates. From an economical standpoint mostly, an odd number of plates is used.

The thickness of the plates is measured with a sheet-metal gauge, the space between the plates may be measured by using various thicknesses of blank wire; the heaviest wire which could be placed between the plates will be taken as to be

equal to the distance between the plates.

Another close method could be used with simplicity to measure the distance between plates by cutting small strips from the middle page of this magazine and placing them between the plates, multiplying the maximum number thus obtained by .003" (which is the thickness of the paper), resulting in the distance in inches.

Knowing the distance between the plates and the diameter of the rotor will be sufficient to calculate the maximum capacity of the condenser with the aid of the accompanying chart.

For example: a condenser has a rotor diameter of 2½ inches, 21 plates and a distance of No. 18 gauge wire between the plates. Connect 2½ on scale No. 1 with 21 on scale No. 2, intersecting at the reference line; then connect the intersection with 14 on scale No. 3 and read the maximum capacity of .00017 microfarads on scale No. 4.

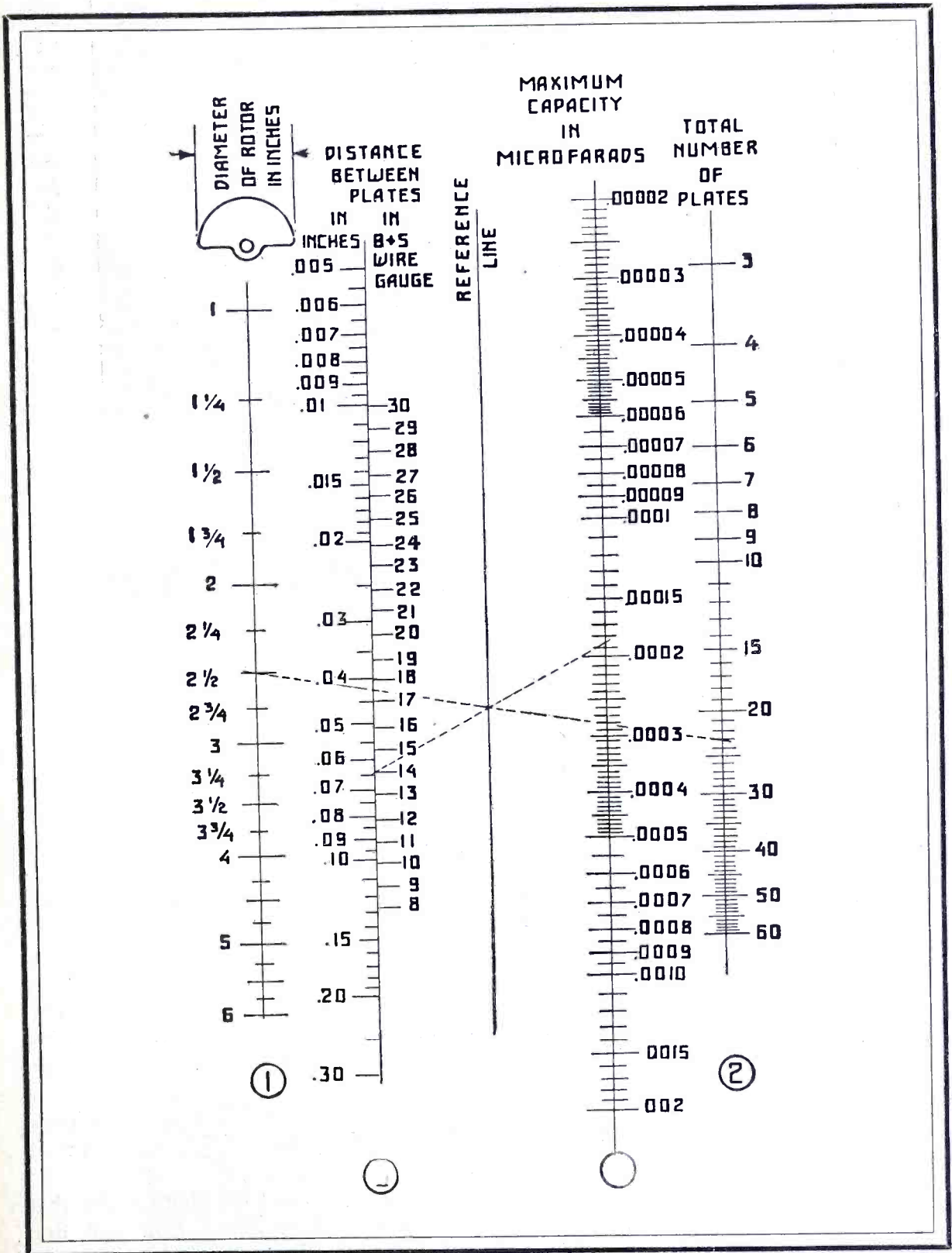

THIS CHART WILL HELP SOLVE YOUR CONDENSER PROBLEMS

This diagrammatic drawing will give you, at a moment's notice, the maximum capacity of any make of variable condenser, whether it contains 11, 17, 23, 26, or 43 plates. It does not matter whether the condenser has a spacing between plates of anywhere between .005 to .3 inch, the chart will tell you the capacity. This is important in buying a new condenser for a given circuit where a given capacity is necessary. The article tells in detail how to use the chart.

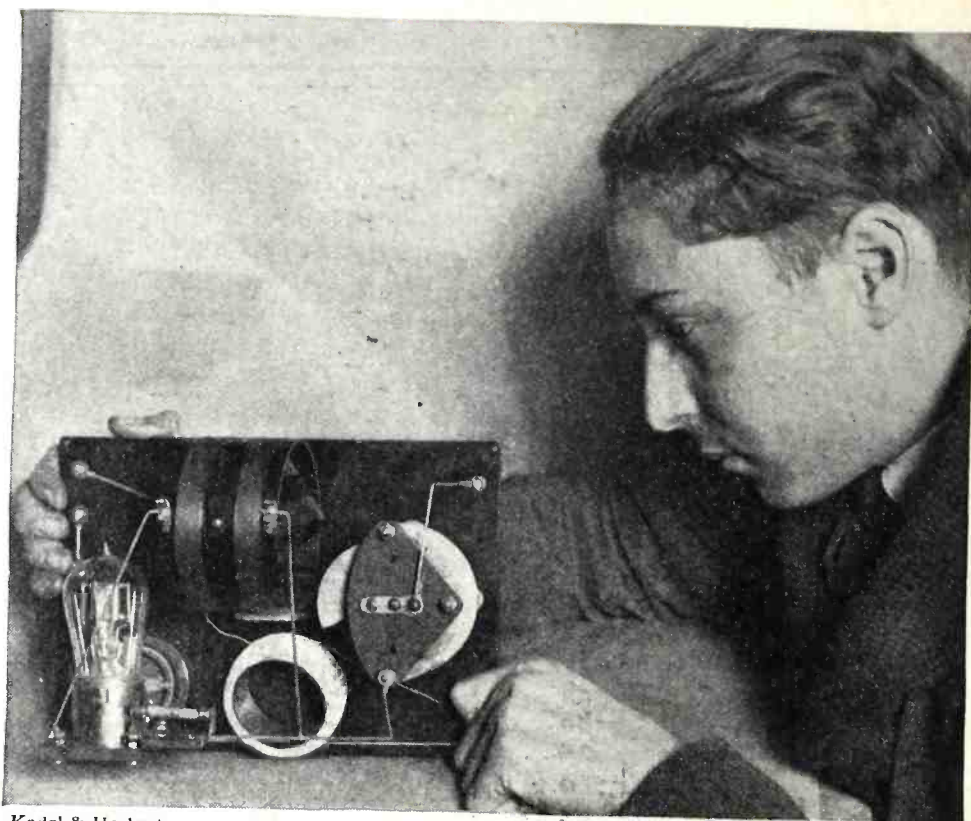

Kadel & Herbert

HERE IS THE TYPE OF SET THAT CAUSES ALL THE TROUBLE
 FIGURE 1: *It is the improper use of the kind of set shown above that makes all the squeaks, whistles and howling, known as "re-radiation," that disturbs you and your neighbors.*

How NOT to Tune the Single-circuit Receiver

By LAURENCE M. COCKADAY, R.E.

ALMOST all of the listeners to radio broadcasting are familiar with the single-circuit tuner. At least all listeners have either operated one of these sets or have *listened in while it is being operated.*

And this does not mean that we have to be at the owner's receiving station to listen to it, either!

In the hands of a novice this type of receiver becomes a fine transmitter. There is no use of going into the details again of how this occurs; we have all read of "re-radiation" and its interference, and we all have heard the whistling, shrieking noises that re-radiation produces. Nevertheless, re-radiation interference is becoming terrifically acute, especially in these days of listening-in

with ultra-sensitive receivers for DX. A little single-circuit set operated within a mile or so of such a DX listener's station will play havoc with his reception. It is discouraging to be compelled to turn off your expensive receiver in disgust just because some neighbor is using his simple little set—but *using it incorrectly.*

There is no need for re-radiation—even if the single-circuit receiver is used.

Just turn to the four photographs that accompany this article. You will find out in these pictures how *not* to tune your single-circuit regenerative set.

This information will give you better results and it will eliminate the trouble you have always been causing your

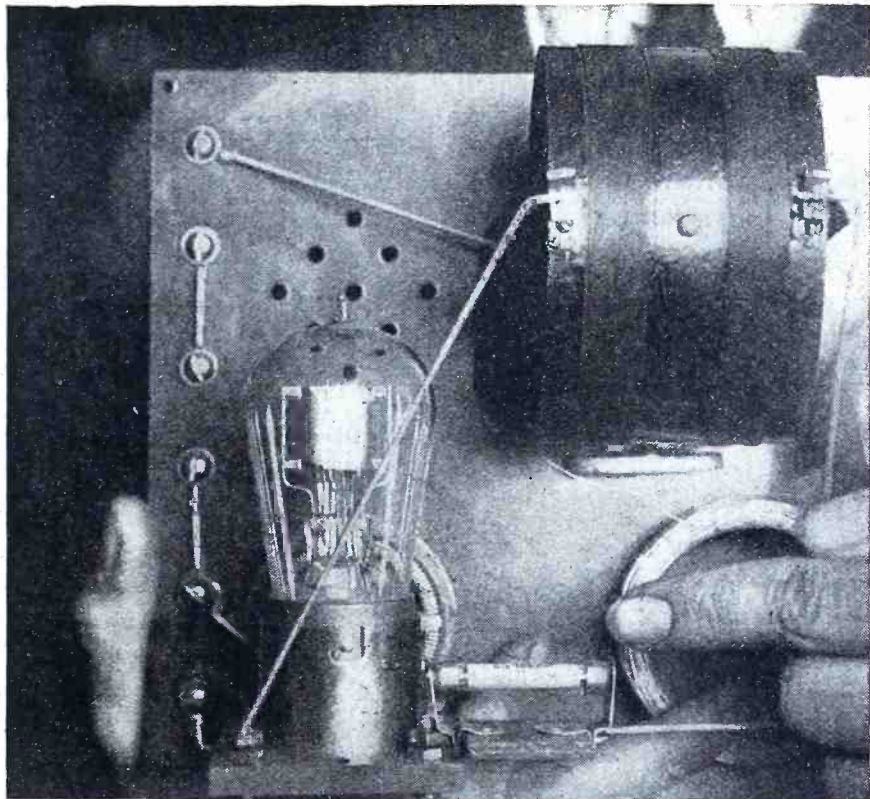

Kadel & Herbert

FIGURE 2: DON'T use a grid-leak of too high a resistance; 2 megohms is plenty. And DON'T use a grid condenser of more than .00025 mfd. capacity.

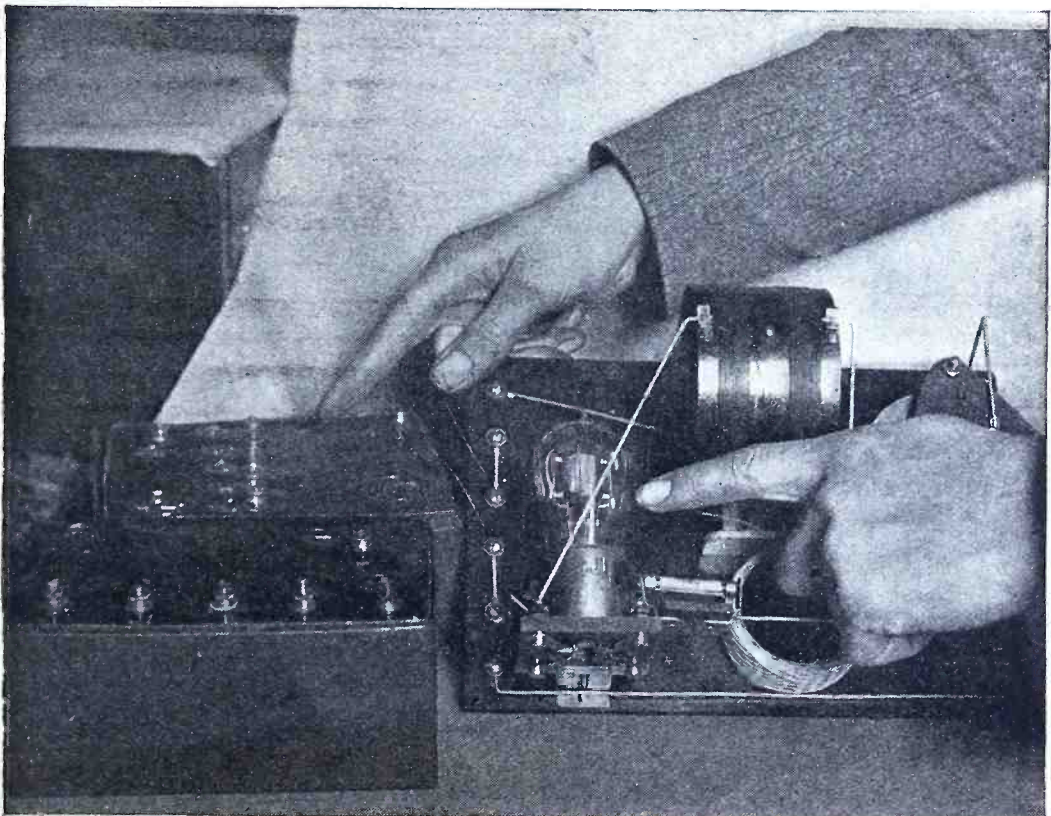

Kadel & Herbert

FIGURE 3: DON'T put too much "B" battery on the plate of your tube; a voltage of between 16½ and 18 volts is plenty for a soft tube. Higher plate voltages will tend to make the set oscillate too much and it will surely re-radiate.

neighbors in the way of whistling interference.

In Figure 1 we have a rear view of a regular single-circuit set with a variable condenser, a variocoupler, a honey-comb loading coil, a rheostat, a socket, a tube, a grid condenser and a grid-leak.

Be sure that you are *not* using too large a grid condenser. The capacity of this condenser should not be more than .00025 mfd. (See Figure 2.)

Be sure that you are *not* using too much plate voltage on your detector tube. This will also cause the set to have a tendency to oscillate too much. Use not more than 18 volts of "B" battery on the plate of the detector tube. (See Figure 3.)

Do *not* turn the knob on the variocoupler around too far when trying to pick up a station. If you do, you will hear a whistle when you pass over a station. Here lies the trouble, when you

hear the whistle, *all your neighbors* hear it too, and it completely spoils their enjoyment.

Keep the tickler knob set only as high as necessary to bring in the signals *without* any suspicion of a whistle.

Do *not* turn up the filament rheostat too high. This will also cause the set to oscillate and produce the same disturbance in your neighbor's set as occurs when the tickler is turned around too far. (See Figure 4). Turn the filament up only far enough so that the signals come in clear without any whistling noises when you tune from one wavelength to another.

Just remember this; *don't* let your set whistle!

You would not whistle out loud at the opera or at the theater. Remember, that for radio the whole of space is the theater, and that you are not the only one in the audience!

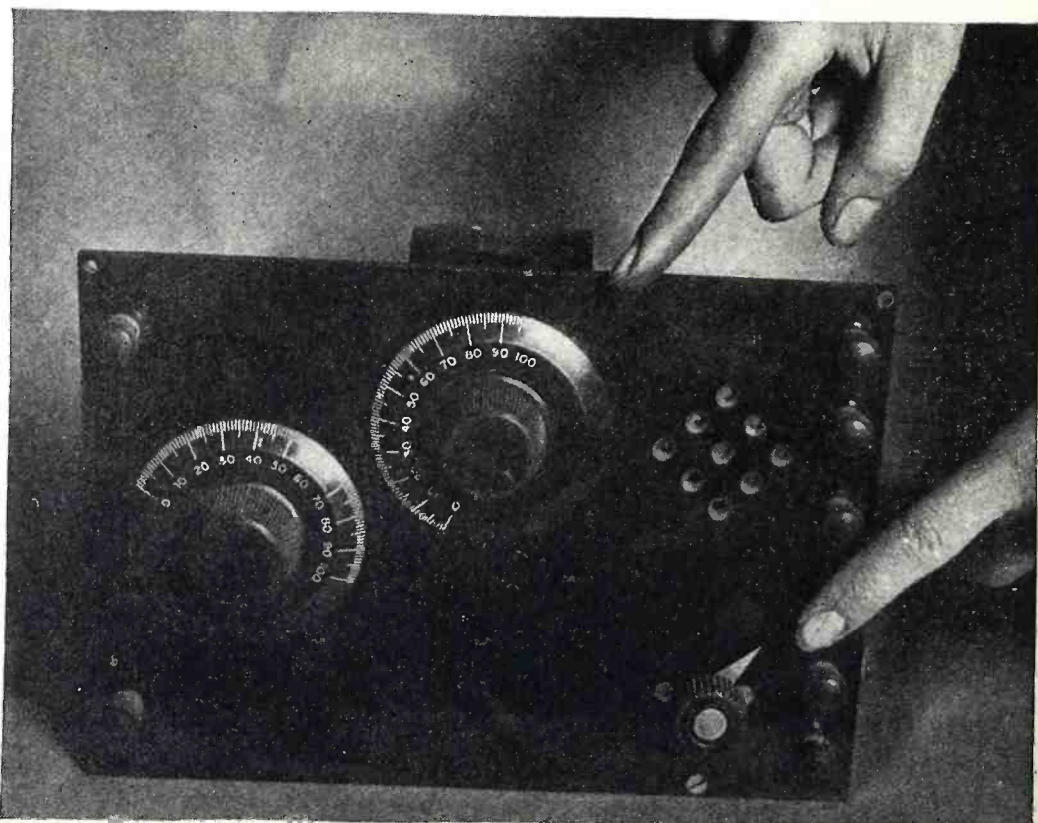

Kadel & Herbert

FIGURE 4: DON'T turn the tickler dial around to too high a number, and DON'T turn up the rheostat too high. These two points are the most important ones to remember if you wish to join in the movement for better reception with less interference.

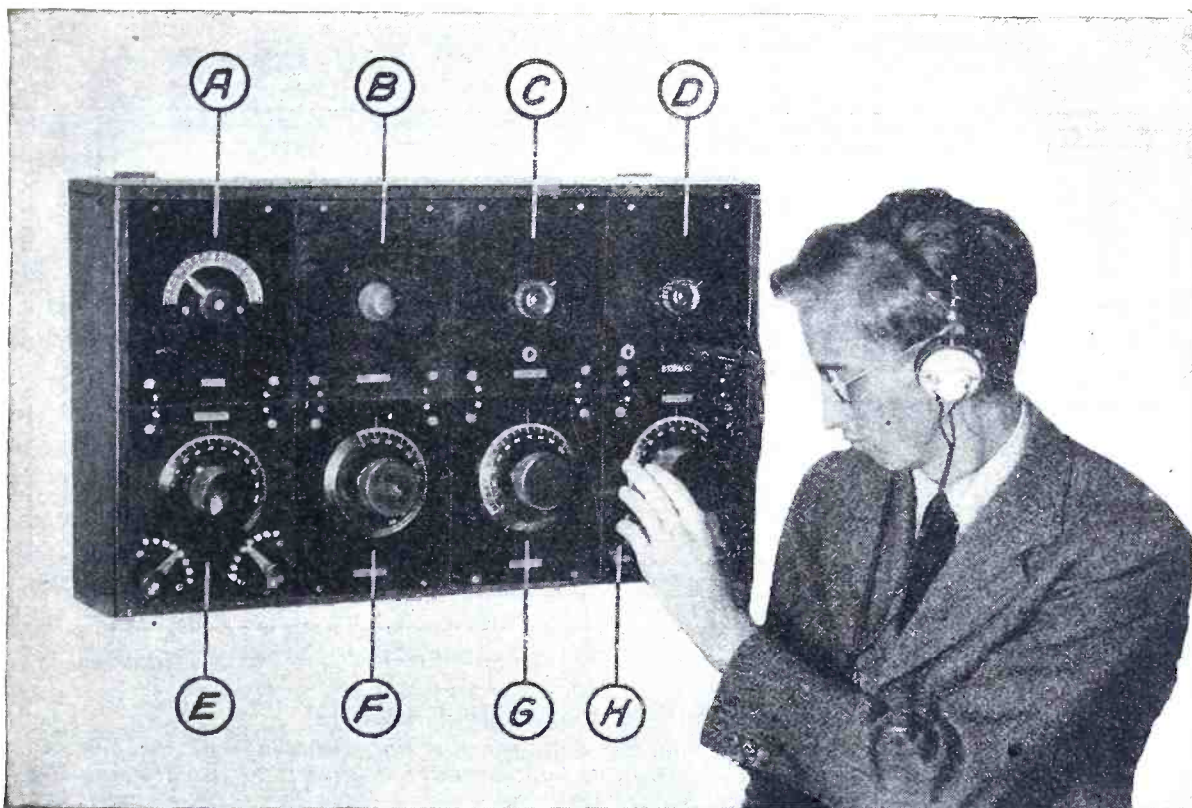

From a photograph made for POPULAR RADIO

THE UNITS OF THE SET

A is the variable condenser, .0005 mfd.; B is the detector unit; C and D are the amplifier units; E is the variometer and tapped inductor; F is the variable condenser and coil; G is the variometer and H is a variocoupler.

HOW TO BUILD AN EXPERIMENTAL RADIO SET

By SPENCER BOYD

This article is written for the special benefit of the many fans who are more interested in actual experimental work—in trying out new hook-ups—than in merely listening in, and who enjoy comparing the results obtained on one circuit with the results from another circuit. This article tells how to make a set that will enable such fans to test out a number of circuits by merely rearranging the wiring.

COST OF PARTS: *About \$65.00.*

HERE ARE THE ITEMS YOU WILL NEED—

- | | |
|--|--|
| 1 Signal variable condenser, .0005 mfd.; | 2 audio-frequency amplifying transformers; |
| 1 Fada vernier variable condenser, .0015 mfd.; | 1 UV-200 and 2 UV-201-a tubes; (or) |
| 3 Chelsea vacuum-tube sockets; | 3 WD-12 tubes; (or) |
| 1 CRL variable grid-leak; | 3 UV-199 tubes; (or) |
| 2 Frost jacks, double-circuit; | 3 DV-6-a tubes; |
| 1 Frost jack, single-circuit; | Fahnestock clips; |
| 1 mica fixed condenser, .00025 mfd.; | 1 pound of No. 22 DCC copper wire; |
| 2 Amrad basket-weave variometers; | connecting wire; |
| 1 Hilco variocoupler; | cabinet; |
| | composition tubing. |

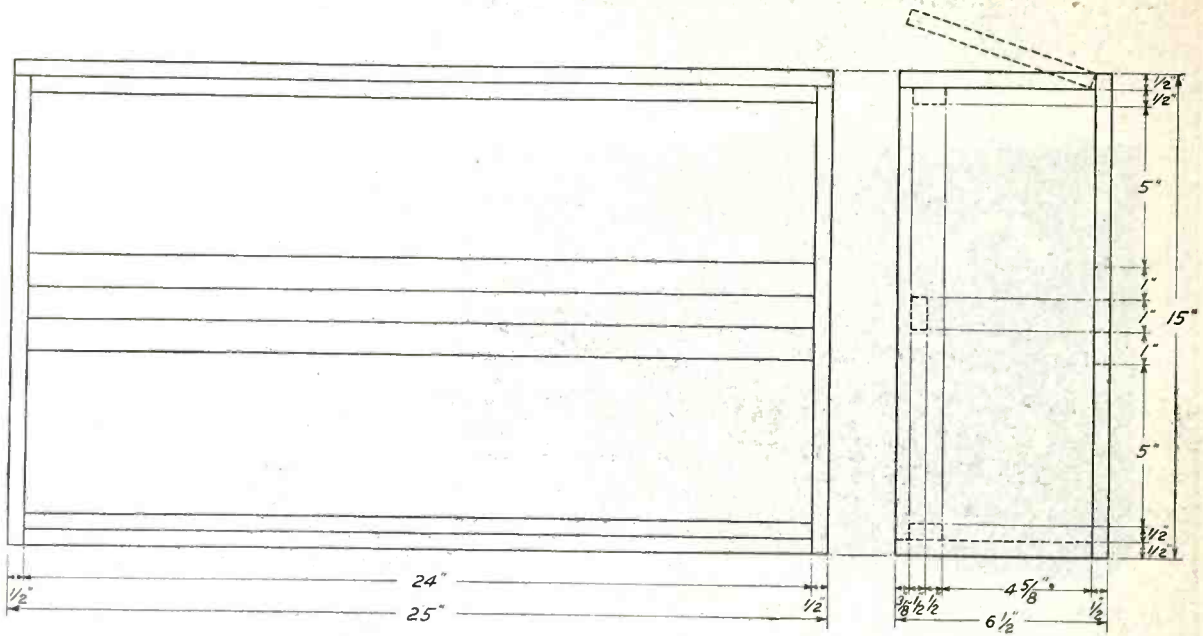

THE DIMENSIONS FOR THE CABINET

FIGURE 1: Here are given the complete data for the size and shape of the box for holding the various units. This may be built by the fan himself or the drawing may be turned over to a cabinet maker who can build it from the instructions it contains.

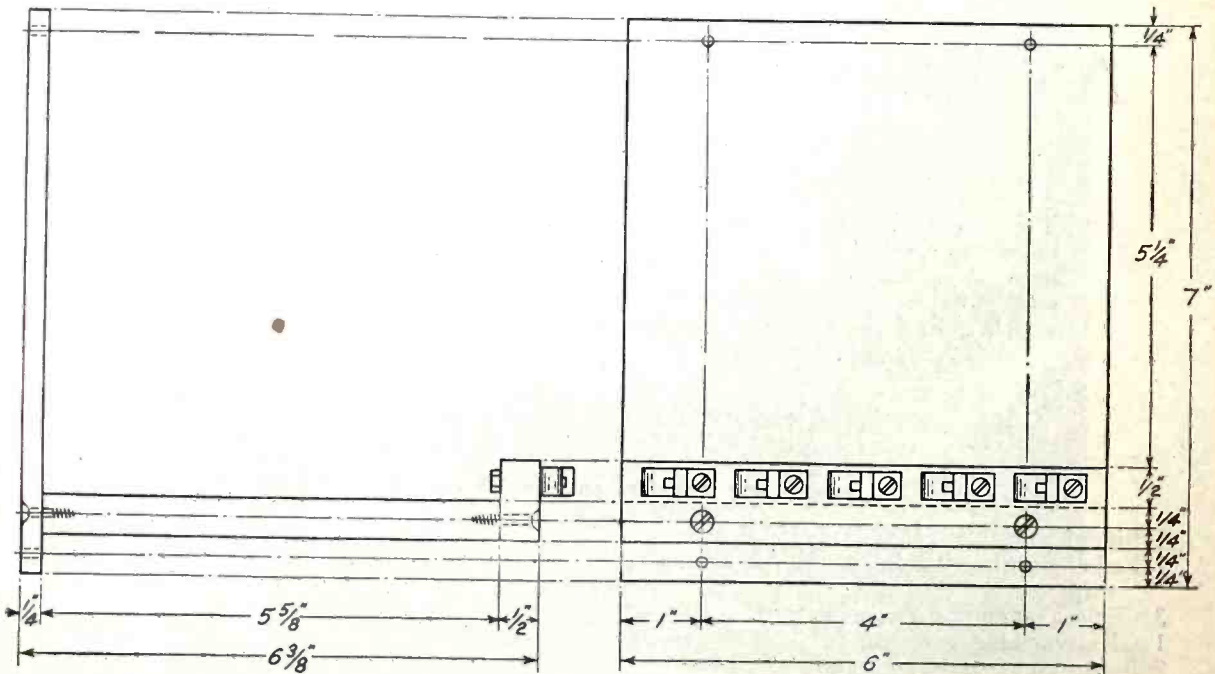

THE FRAME FOR THE UNITS

FIGURE 2: At the left is given a side view of one of the frames and at the right is shown the rear view. The sizes for all of the sections are printed directly upon the drawing.

THE main features of the experimental receiving set discussed in this article may be summarized as follows:

(1) *Unit structure.* The set is composed of a cabinet and a certain number of interchangeable units, any of which may be inserted, taken out or changed without disturbing the others.

(2) *Appearance.* As all of the units are inclosed in one cabinet, this set does not present an unsightly appearance.

(3) *Facility with which the instruments may be connected so as to use any kind of receiving hook-up.* All the connections for the instruments in each unit are made by means of Fahnestock spring clips which are located at the rear of each unit. These clips may be connected in any desired combination and afford a quick and easy way to change from one hook-up to another.

(4) *Efficiency.* The cabinet and units are so designed that the leads from unit to unit will be as short as possible.

This article gives instructions for the construction of a set consisting of eight units. Should the builder desire a greater or smaller number of units, the only change necessary is in the length of the cabinet. The unit make-up of this set permits the use of a large cabinet with only a few units—to which more may be added later without disturbing the original units in any way. It is, therefore, advisable to make the cabinet too large rather than too small—the extra space may be used for storing batteries.

The Parts Used in Building the Set

In all the diagrams in this article each part bears a designating letter. In this way the prospective builder of a receiver may easily determine how to mount the instruments in the correct places and connect them properly in the electric circuit. The same designating letters are used in the text and the list of parts at the beginning of the article.

The list of parts there given includes the exact instruments used in the set from which these specifications were made up; however, there are many other reliable makes of instruments which may be used in the set with equally good results.

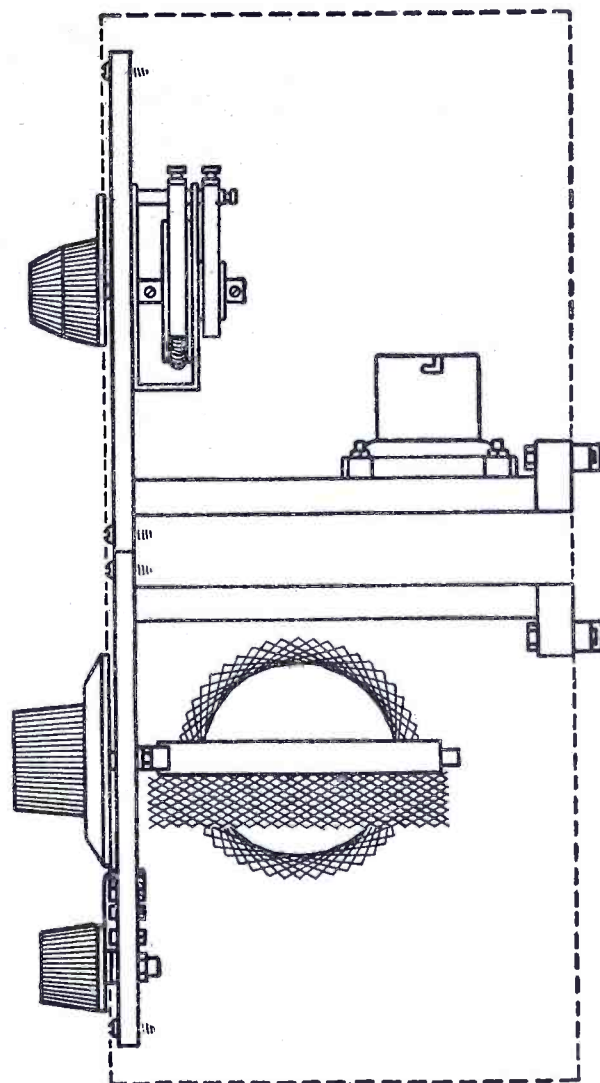

HOW THE UNITS FIT IN THE CABINET

FIGURE 3: This drawing shows how the units fit in the cabinet with the upper units "right-side-up" and the lower ones "up-side-down." This makes for shorter connections when wiring a hook-up.

If instruments other than the ones listed are used it will necessitate only the use of different spacing of the holes drilled in the panel and shelf for mounting them.

How to Construct the Set

Figure 1 gives the specifications for the cabinet. This is made of some hardwood $\frac{1}{2}$ -inch thick and measures (outside dimensions) 25 inches wide by 15 inches high by $6\frac{1}{2}$ inches deep. The top is hinged so as to permit access to the vacuum tubes. The front is open except for three horizontal strips, placed $\frac{3}{8}$ -inch in back of the front edge of the cabinet, to which the units can be screwed. The back is solid except for two horizontal slots, near the middle of the back and extending the length of the cabinet, in which fit the strips on which the spring clips are mounted. When the cabinet

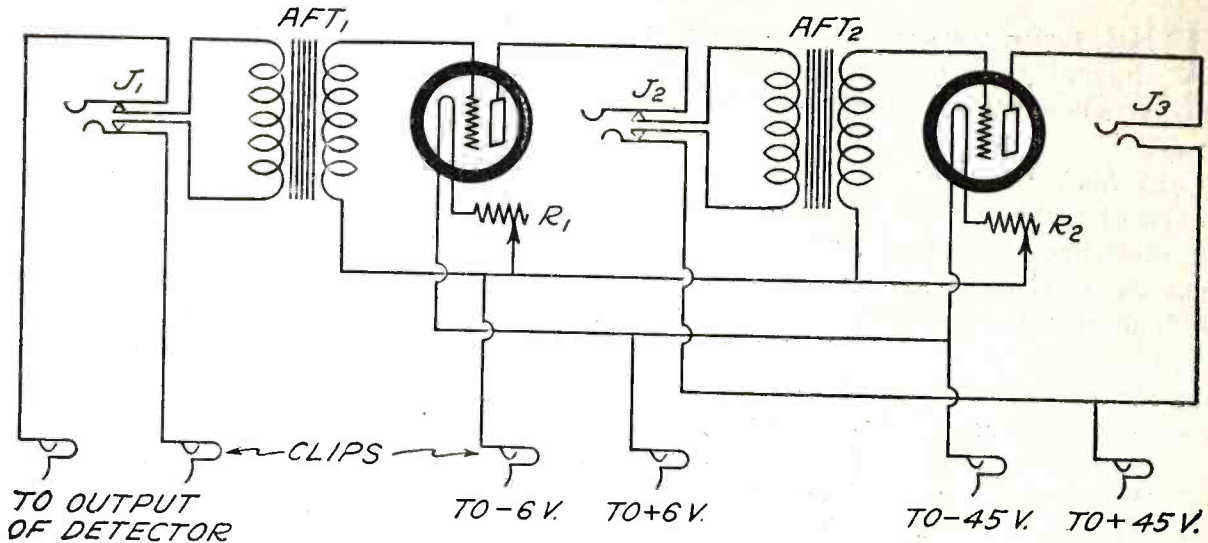

THE WIRING DIAGRAM FOR THE AMPLIFIERS

FIGURE 4: A standard hook-up for the amplifiers is given in this diagram which shows the most efficient way to connect the instruments in the electrical circuit.

has been assembled it should be stained and then shellacked or waxed.

Each unit consists of an instrument and a frame, which is identical for all units. The frame (see Figure 2) is made up of a panel 6 inches by 7 inches, a piece of 1/2-inch wood 5 7/8 inches wide and 5 5/8 inches deep that serves as a base and a piece of 1/2-inch wood, 1 inch by 6 inches, that is mounted at the rear of the base and to which the spring clips are bolted. Well dried quarter-inch, 3-ply wood, may be used for the panel but a composition or hard-rubber panel is better. Three-sixteenth inch composition may also be used for the connection strip; if this is done the base of the unit should be made 5 7/8 inches deep instead of 5 5/8 inches. Two screws, passing through

the panel, fasten it to the base; the connection strip is fastened to the base in the same manner.

The placing of the panel holes, used in mounting the instruments, is left to the builder, as the position and size of the holes vary with the type of instruments used. Exterior connections to the units are made by means of the spring clips which are mounted on the connection strips and are electrically connected to the instruments in each unit. The connection strips should be marked in some manner so as to indicate the proper connections for the different clips, the number of which varies with the units.

In the front-view photograph the units are, from left to right, top row—variable condenser, .0005 mfd., detector, first stage of audio-fre-

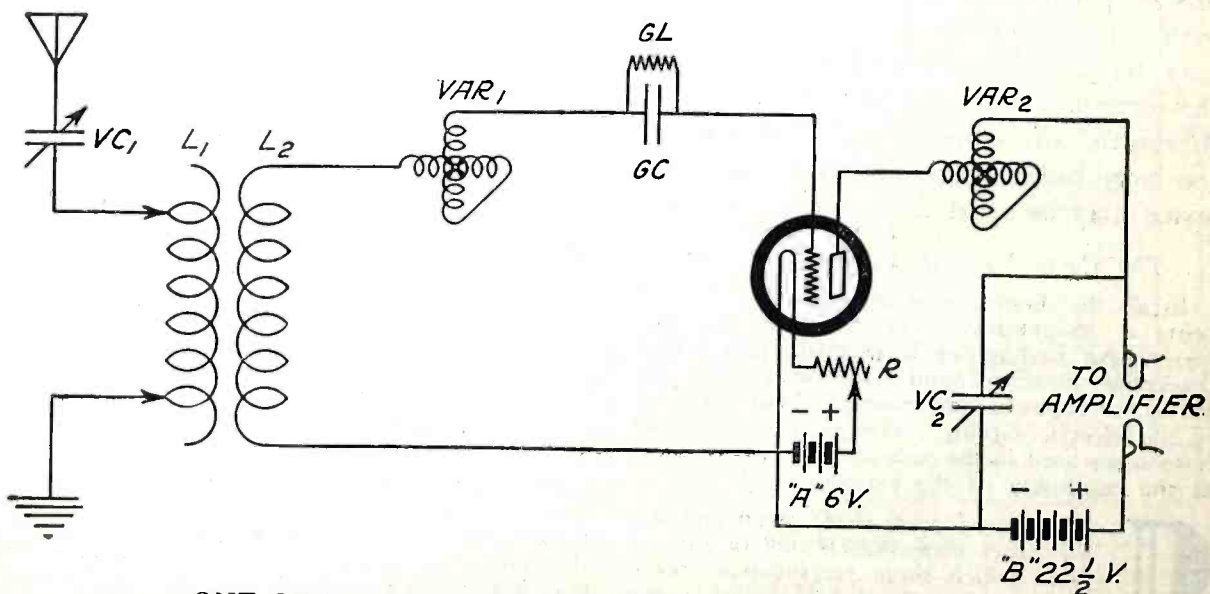

ONE OF THE TUNING CIRCUITS THAT MAY BE USED

FIGURE 5: This hook-up employs all the instruments in the set except the extra inductances contained in sections E and F.

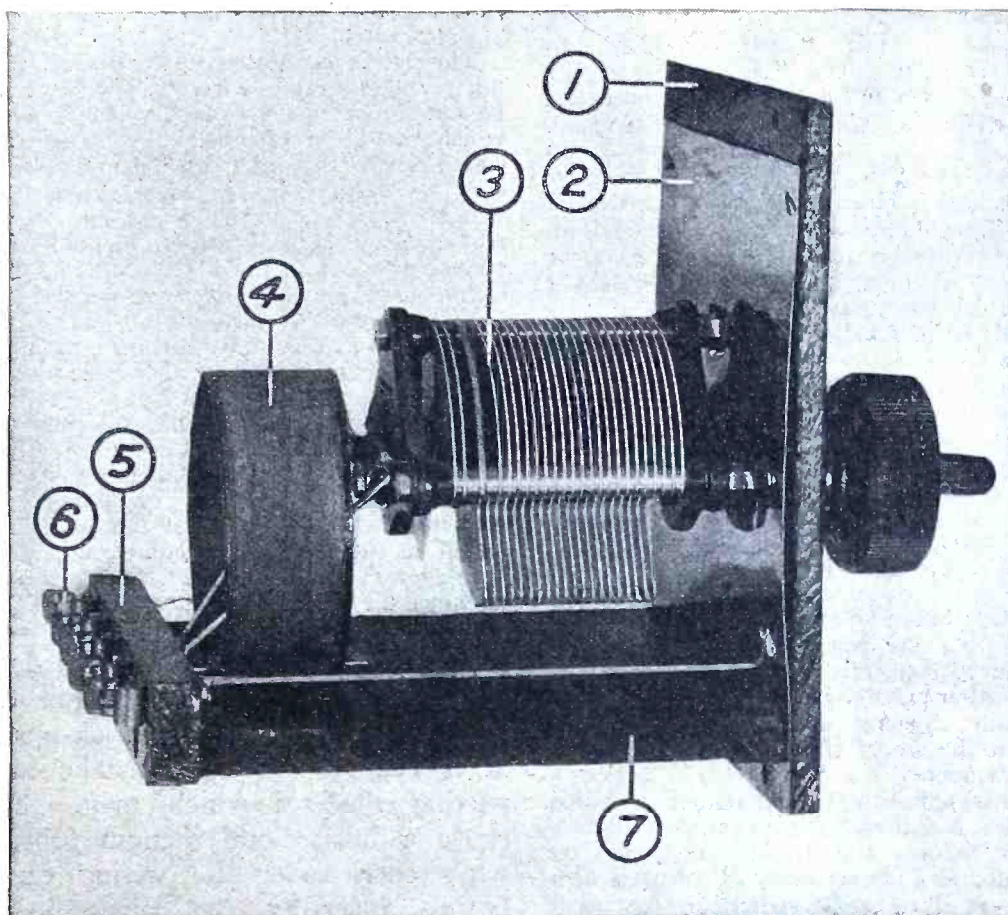

AN INTERIOR VIEW OF ONE OF THE UNITS

FIGURE 6: This is unit F which contains a fixed coil and the .0015-mfd. variable condenser. 1 is the panel, carrying the shield, 2, 3 and 4 are the condenser and the coil. The frame 5 and 7 carries the clips 6.

quency amplification, second stage of audio-frequency amplification; bottom row—variometer, variable condenser, .0015 mfd., variometer and variocoupler.

The builder may select his own instruments; the makes mentioned are those used in the original set, and give good results.

The .0005-mfd. condenser unit contains one Signal variable condenser, equipped with scale and pointer.

The detector unit contains one Cutler-Hammer vernier rheostat, one Chelsea standard vacuum-tube socket and one CRL variable grid-leak with a .00025 mfd. grid condenser. Both the tube socket and the grid-leak are mounted as far back on the unit base as possible, so as to make the connections short. This unit, as well as the amplifier units, need not be shielded.

The amplifier units are constructed differently from the other units. The panels are standard, but one piece of wood forms a base for both units, thus joining them. It is, therefore, possible to put all of the necessary apparatus for both stages of amplification in one standard unit. In the amplifier unit, jacks are provided, not only for one and two stages of amplification, but also for the detector. Two double-circuit and one single-circuit Frost

jacks, two rheostats, two tube sockets and two Jefferson audio-frequency amplifying transformers are used. The internal wiring diagram for these units is shown in Figure 4. Place the tube sockets well to the rear of the base and run the connecting wires in as short paths as possible.

If the builder desires to use vacuum tubes other than those having standard bases he should, of course, use tube sockets that will fit them, instead of using standard sockets. In the original set a UV-200 was used as a detector and two UV-201-a tubes as amplifiers, but either WD-11 tubes or UV-199 tubes give excellent results. Both WD-11 and UV-199 tubes operate with dry-cell "A" batteries, thus obviating the necessity for a storage battery. If UV-199 tubes are used, 30-ohm rheostats should be substituted for the ordinary 5-ohm rheostats, as the latter will not control tubes having such a low filament consumption.

Amrad basket-wound variometers are used in both of the variometer units. One of the units contains only the variometer and shield and is equipped with a 4-inch dial. The other unit contains, beside the variometer, dial and shield, an inductive winding placed at one side of the variometer. This inductance consists of 64 turns of No. 22 DCC wire triple-bank-

wound on a 4-inch tube in the same direction as the stator winding of the variometer, to which it is inductively (not conductively) coupled. This winding is tapped and controlled by means of two switches located on the panel. A second inductive winding consisting of 15 turns of wire may be placed next to the first one, if desired. This will permit the use of the "DX" regenerative circuit published in POPULAR RADIO for January, 1923. Even if this winding is not added, the first inductance will admit of many uses.

The .0015-mfd. condenser is a Fada vernier condenser. This unit is shielded and is equipped with a 4-inch dial, the knob of which has been drilled to permit the vernier rod to pass through it. An inductance consisting of 25 turns of No. 22 DCC wire on a 4-inch tube is also mounted in this unit. This inductance is *not* connected to the condenser—its ends are connected to two spring clips—but it finds use in some hook-ups as a loading coil or, in connection with a condenser, as a wavetrap. A piece of shim brass or sheet copper is fastened to the back of the panel and connected to a clip. This is connected to the ground when the set is in operation and serves as a shield against body capacity when the set is being tuned. Cut the shield clear of all "live" parts of the instrument.

The variocoupler unit consists of a Hilco variocoupler, a dial and the necessary switches. A 150-turn loading coil, triple-bank-wound on a 4-inch tube and tapped every 50 turns is also provided. A third small switch on the panel is used to cut this coil out or insert it in series with the primary of the variocoupler in 50-turn steps. This unit should also be shielded.

Figure 3 shows the manner in which the units fit in the cabinet. The upper row of units is placed in the cabinet "right side up" and the lower row "upside down." Thus the spring clips, which project from the back of the cabinet, are placed close together and the connections are short.

How to Wire the Set

The set is connected up by means of ordinary single-strand wire. This wire should be cut into strips of varying lengths, each of which should be "skinned" for ½-inch at each end. When connecting up the units these bare ends are secured by means of the spring clips which are thus connected together in such a manner as to secure the desired hook-up. The connections within the units are made of 1/16-inch square tinned-copper bus-wire.

When the set has been finished it will be found to be very easy to connect the clips together in such a manner as to use any one of a great number of hook-ups. After a little experience it will be possible to change from one hook-up to another in one or two minutes, and practically any desired hook-up may be tried out. A spiderweb or honeycomb-coil unit may be constructed and new units may be added as new hook-ups come out; thus the set never grows old. Figure 5 shows one that employs all of the instruments.

It is manifestly impossible to describe the tuning of this set, as the tuning operations differ with the hook-ups used. It is easy to make a mistake in connecting the set which may, perhaps, cause a burned-out vacuum tube. Always check over the wiring carefully before inserting the tubes in their sockets. An advisable precaution is to disconnect the positive "B" battery, insert the tubes in their sockets, and then see if the filaments light properly. If all seems in good working order the chances are slight that the re-connection of the "B" battery will burn out a tube.

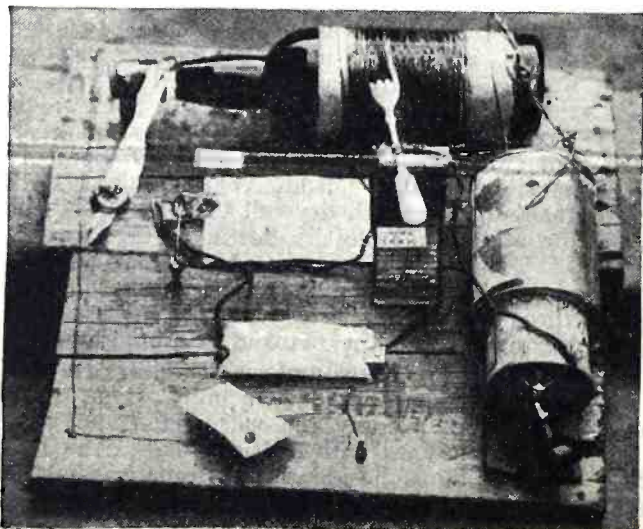

International

A "JUNK" RECEIVER BUILT BY A MODERN CRUSOE

Here is a workable receiving set made from nothing but beachcombers' materials that are washed up on the seashore. The coil is wound on a bottle, the variable condenser comprises two tin cans, the base is a piece of driftwood, the tuning slider is an ordinary fork with a few teeth removed, and the fixed condenser is made of dried paper and tinfoil. If you were ever shipwrecked on a desert isle, this would be a practical set to build.



THE MAN BEHIND "THE MOST INTERESTING EXPERIMENT IN EDUCATION IN THIS COUNTRY"

Arthur E. Morgan, the progressive president of Antioch College in Ohio, who has undertaken to "broadcast education" with the aid of the station maintained by his institution.

Will Radio "Revolutionize" American Educational Methods?

Some people think that it will—particularly the faculty of Antioch College, which is undertaking to demonstrate how broadcast programs can be made both entertaining and informative, and that the first requisite of an educational course is that it be interesting.

By HARRY A. MOUNT

ARTHUR E. MORGAN revolutionized flood-prevention engineering. When he laid his plans for the \$35,000,000 Miami Conservancy project, to protect the city of Dayton and other cities of the Miami Valley from a repetition of the disastrous flood of 1913, he found engineering opinion of the country almost unanimously against him. The thing had never been done that way before. Even

the people of Dayton began to be doubtful and the whole project might have been wrecked. But—

Morgan invited not only his critics, but many hydraulic engineers of note to come to Dayton at his expense and spend as much time as they liked going over his plans. That was all he asked. They came—one of the newspapers said they came in droves—and almost to a man

they went away satisfied that Arthur Morgan had found a simple, logical way to prevent floods. One eminent engineer, who had been one of the severest critics, actually spent several months in Mr. Morgan's office and monopolized a good part of the office force during that time but he went away a warm supporter of the plan.

"And it was his approval," said Mr. Morgan later, "which did more than anything else toward putting the plan across."

Now Mr. Morgan (who has become president of Antioch College) has undertaken an even more difficult task. This time he has undertaken nothing short of a revolution of American educational methods and some of the best minds of this country believe he will succeed.

Dr. Charles W. Eliot has called Mr. Morgan's new project "the most interesting experiment in education going on in this country." Again there is a hard fight to build up interest in and knowledge of a new project, among people already surfeited with "interests." In this new fight Mr. Morgan has found a new ally. Between the quaint old towers of the main college hall one can make out the strands of a radio antenna and in one of the upper rooms of the building is a modern broadcasting station.

The new ally is radio!

We may find, when Mr. Morgan has finished this job, that he has not only revolutionized higher education, but that he has revolutionized the use of radio for educational purposes as well. There are going to be no tiresome speeches on educational methods from station WRAV (those are the call letters). Nor will there be any courses broadcast for volunteer students.

Why?

"Because," said Mr. Morgan, "nobody would listen to them. My son is a radio enthusiast and we have a receiving set at home. I know that no one in our family listens to long talks by radio, unless they are of extraordinary interest. As a rule,

when a talk is announced we immediately begin hunting for another station that offers some lighter entertainment.

"We have a serious subject to present to an audience which will walk out on us if we broach a serious subject. How can we do it? Well, if we are to have an audience at all, we shall have to give them what they want. The body of our programs will be made up of music furnished largely of course by students and student organizations. Occasionally we will have a short talk by one of the teaching staff—and we will make it plain in the announcement that the talk will not be longer than five minutes—on some current topic in the day's news; not just a summary of the news, but an interpretation of the news.

"For instance, there is an earthquake in Japan. That very evening our Professor of Geology delivers a short talk on the cause of earthquakes and the probable cause of this one. And then in a few sentences he will tell why every well educated person should know the rudiments of that science. In a similar way we would like to demonstrate that no man is educated unless he knows how to handle his personal finances so as to remain solvent, or until he can temper the theory of his text-books with the fire of practical experience.

"We are planning no courses of study for broadcasting. I do not believe it is at present possible to obtain an education in that way. Education is not merely accumulated knowledge; it is *coordinated* knowledge. That can best be obtained at school. Let me illustrate:

"The usual course in obtaining an education is first to study the cultural subjects—literature, sociology, languages and the like—with perhaps a smattering of chemistry and physics. The student next takes a technical course, in which he becomes proficient in his chosen profession. Finally he enters professional life, and no one will deny, I think, that his education is not complete until he has developed practical judgment.

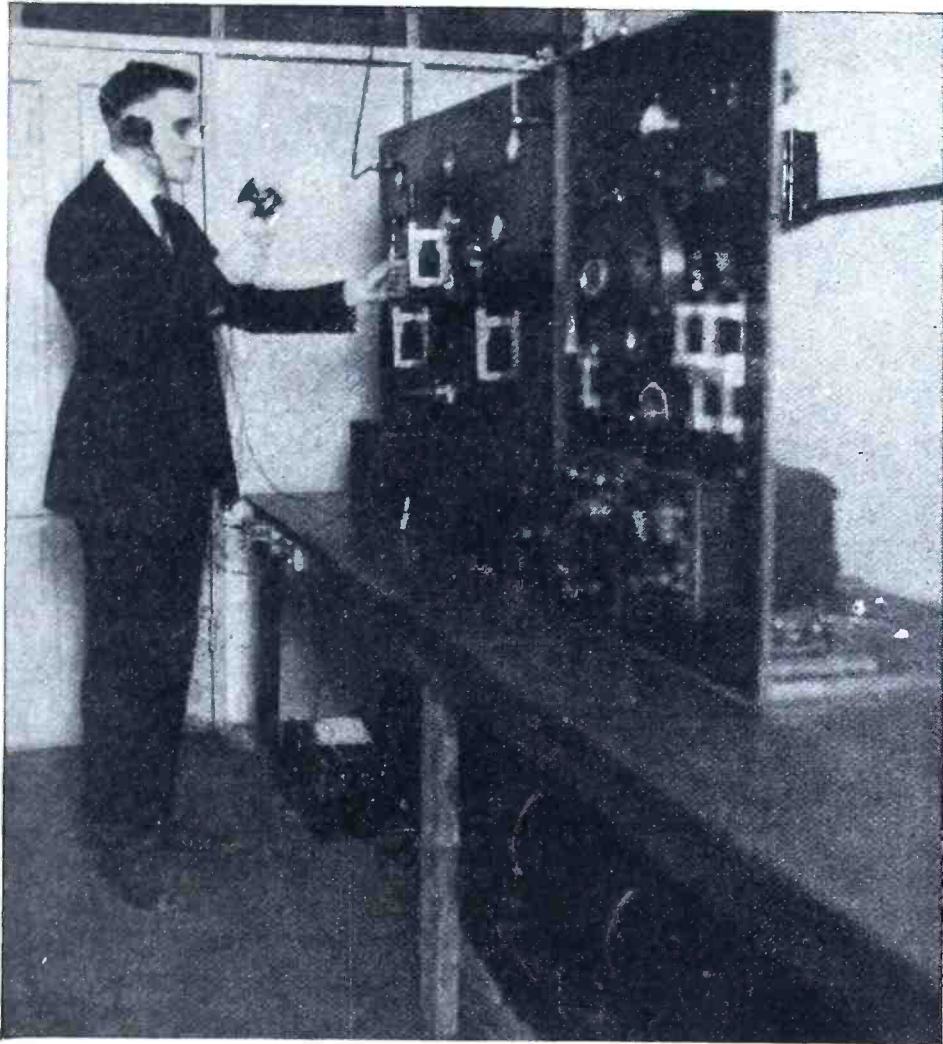

THE TRANSMITTING SET OF THE COLLEGE

Unless the "educational programs" that are broadcast are made interesting, fans will not listen in. To meet this condition may upset many old theories of what "education" really is.

"Now, one might as well decide to exercise the arms for a year to develop them, and then exercise the legs for a year. Mental development as well as physical goes on *all over* at the same time. If we exercise one mental function and neglect the others the result is as grotesque as a physical body with well developed arms and dwarfed legs. I know a college president who has six servants in his home, yet he cannot pay his grocery bill. I know professional men who are fine technicians but who are flat failures in their relations with other men and women. Such men are the natural products of our tandem system of edu-

cation, and they are not educated. Education is coordinated knowledge and that is impossible by radio. We are not going to try to educate people by radio, but we are going to try to create a desire for education, and we are going to try to 'sell' the public our idea of what an education is. And we are going to do it a sentence at a time."

Antioch College is located at Yellow Springs, Ohio. Mr. Morgan found it not far from one of the big dams above Dayton. It was a little struggling institution, scarcely known beyond a twenty-five mile radius. It was founded some three-quarters of a century ago by the great educator, Horace Mann, who, thwarted



ONE OF THE MOST SIGNIFICANT RADIO STATIONS IN THE COUNTRY
The main building of Antioch College, which operates station WRAV for the purpose of extending the institution's influence among the people of Ohio. (The antenna masts and wires have been retouched on this picture.)

by sectarian interference, died there with his dream of an ideal American college unfulfilled. The buildings were mellowed, ivy covered their walls; the paint inside was faded and the rooms were even more bare, but otherwise the old school had changed not one whit from the days of Horace Mann.

It is a little over three years now since Arthur Morgan gave up an engineering practise with a satisfactory income to become head of Antioch. Already there is abundant evidence of a physical rejuvenation, and the eyes of the whole educational world have been turned expectantly to the experiment in education being carried out there.

At Antioch the student spends half of his time working for wages at the profession which he expects to enter. Mr. Morgan's son, who expects to follow in the footsteps of his father, is working with a pick and shovel at laborer's pay on

a dam above Columbus. He worked in a cement mill and carried about five tons of cement a day on his back as part of the process of obtaining an education.

The students are divided into two shifts, which work and go to school in alternate periods of five weeks. About a hundred and twenty industries, located within twenty-five miles of the school are cooperating in this program. Two students are assigned to each job and they work at it alternately; one goes to school while the other works. The school period, in turn, is divided about equally between cultural and technical subjects. Many of the students expect to start life as proprietors of small businesses and these, in their later school days, are expected to conduct small business enterprises upon their own initiative and responsibility, but under the supervision of their instructors. The college finances such undertakings and shares in the

profits. Already under this plan students have purchased the town newspaper office and are conducting a publishing and printing business. Another group has opened a clothing store, others run the college book store, others a tea room, and others a tooled-leather business. It is planned to erect on the campus a modern industrial building, with a power plant, to furnish space to a number of selected industries, which in turn will give employment and experience to students.

Not only do students keep in touch with practical affairs by working at them, but the faculty follows a similar plan so far as is practicable. For instance, the Professor of Accounting is head of the Dayton office of a large accounting firm and he divides his time between Dayton and Antioch. Not only does this keep him in practical touch with his subject, but part of what he earns at Dayton applies on his salary as instructor, and his office furnishes employment for some of his advanced pupils.

The primary object of the scheme is to obtain such a balance between theory and experience that the graduate can take up his full responsibilities in daily life

without paying the usual penalty for inexperience. Secondary objects are to enable students to earn part or all of their expenses while at college, to secure better instructors at less expense to the school, and finally to make the college independent of donations and foundations.

And that is what Antioch has to "sell" by radio.

The transmitting set now at the school is not a powerful one, as broadcasting stations go. Most of the well-known broadcasting stations employ a power of 500 watts, while the Antioch station has a power of 150 watts. This is sufficient, however, to reach the near-by communities where their constant listeners are.

The apparatus is under the supervision of the Professor of Physics, John G. Frayne, who is a practical communication engineer. The broadcasting equipment was given to the college by a Dayton department store and has since been almost entirely rebuilt at the school. The quality of transmission has been brought up to excellence, although the station is still in need of a super-sensitive microphone and other minor pieces of equipment.



Weetinghouse

RADIO'S BLIND CRITIC

A unique figure in the radio world is Miss Marjory Stewart, a blind graduate of the University of Pittsburgh, who is the "radio program literary critic" of a broadcasting station—said to be the only position of its kind in the world. Her daily reviews of the features on the KDKA schedules is an important factor in determining that station's policies.

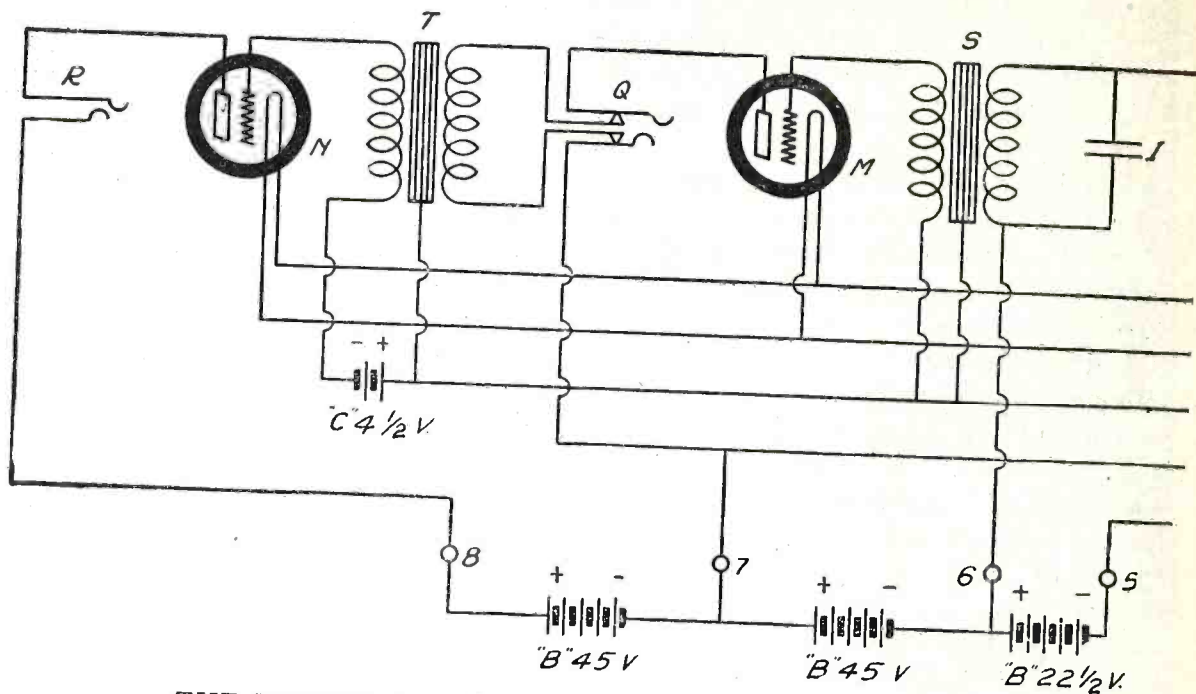

THE WIRING DIAGRAM OF THE ELECTRICAL CIRCUIT
 FIGURE 1: Notice that this diagram reads FROM RIGHT TO LEFT instead of from left to right, which is exactly like the set as looked at from the rear, in wiring.

HOW TO BUILD A NON-REGENERATIVE TUNED-RADIO-FREQUENCY RECEIVER

By ALBERT G. CRAIG

Here is a plate-tuned radio-frequency receiver that embodies the neutrodyne principle by means of a real Wheatstone bridge arrangement. Eliminating the tuning from the grid circuit of the detector tube reduces the losses in that circuit and makes for added sensitivity. This circuit is notable for its ease of control, distance range, and clarity of reception.

COST OF PARTS: *About \$70.00*

RECEIVING RANGE: *Up to 3,000 Miles*

HERE ARE THE ITEMS YOU WILL NEED—

- A and B—special variocoupler;
- C and D—radio-frequency transformer;
- E—Cardwell .0005 mfd. (21-plate) condenser;
- F—Cardwell .001 mfd. (41-plate) condenser;
- G—Cardwell .00025 mfd. (11-plate) condenser;
- H—Dubilier mica fixed condenser .00025 mfd. (with grid-leak clips);
- I—Dubilier mica fixed condenser .0025 mfd.;
- J—Daven grid-leak 3 megohms;
- K, L, M and N—Alden-Napier standard sockets (type 400);
- O and P—Cutler-Hammer rheostats (6 ohms);
- Q—Federal double-circuit jack;
- R—Federal single-circuit jack;
- S—Amertran transformer 5 to 1 ratio;

- T—General Radio transformer $3\frac{1}{2}$ to 1 ratio;
- U—Cutler-Hammer filament switch;
- V—Amsco switch lever;
- W—switch points and stops;
- X, Y and Z—composition panel, hardwood sub-base and cabinet;
- A1—binding-post panel (1 inch by 10 inches by $\frac{3}{16}$ inch);
- AK—condenser brackets;
- 8 Eby binding posts;
- machine screws; wood screws; bus-wire;
- 1 UV-200 or C-300 and 3 UV-201-a or C-301-a vacuum tubes;
- "A" battery (6-volt storage);
- "B" batteries (total $112\frac{1}{2}$ volts);
- "C" battery, Eveready $4\frac{1}{2}$ -volt, No. 751.

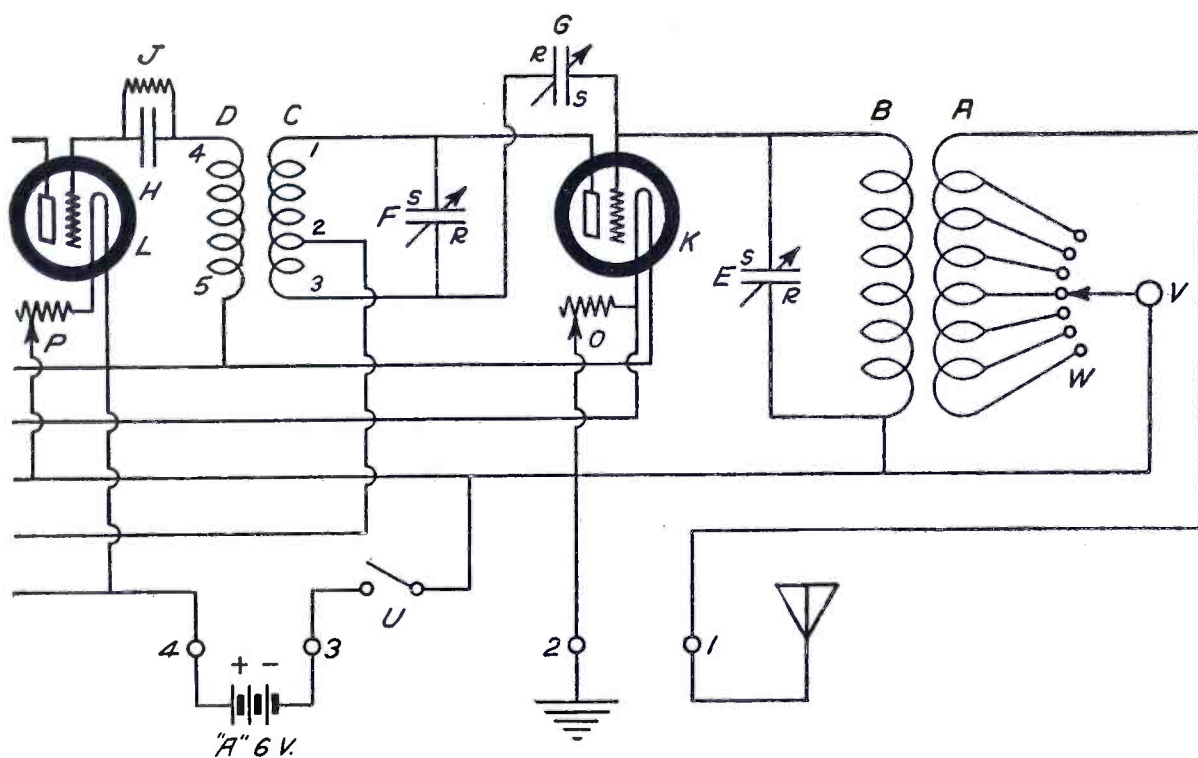

THE editors of POPULAR RADIO have been literally deluged with persistent demands for a radio circuit that employs one stage of radio-frequency amplification; often the reader wants to add one stage of radio-frequency amplification to his regenerative set.

This has been generally discouraged because of the fact that the circuit would become complicated in operation and only in rare cases would louder signals be obtained; indeed, the latter is especially true if an attempt is made to add only a single stage of transformer-coupled radio-frequency amplification, in which the oscillation of the radio-frequency tube is controlled by means of a potentiometer.

The potentiometer method of control is inherently wrong, as it applies an increasing *positive* potential to the grid with respect to the filament, while the grid should be *negative* for best amplification. Also, as the plate circuit of the radio-frequency tube is being tuned, the tendency towards oscillation increases.

On the other hand, the control of oscillation by neutralizing the grid-plate capacity of the radio-frequency tube offers a solution for both of the above

difficulties. The grid of the radio-frequency tube can be operated at a negative potential for obtaining maximum amplification and the plate circuit of the radio-frequency tube can be tuned exactly to the wavelength of the incoming signal. The capacity of the tube is neutralized in this case by means of a Wheatstone bridge arrangement. The tube capacity and the plate inductance constitute one side of the bridge, while an extra inductance and extra capacity form the other arm of the bridge. The two inductances tend to send the radio-frequency current in opposite directions at the same time and the net result is zero current through the tube capacity.

The circuit of the receiver described in this article consists of one stage of tuned radio-frequency (using the principle of neutralization of tube capacity mentioned above), detector, and two stages of transformer-coupled, audio-frequency amplification. It will give considerably stronger signals than the three-tube standard regenerative receiver.

The two notable advantages of this circuit are:

First; it will not re-radiate and;

Second; it always gives clear reception.

The first advantage means that the experimenter cannot disturb his neighbor, with one squeal after another, as he tunes in the various stations. One must be an expert operator to use some of the closely coupled regenerative receivers, and it may even be suspected that experts are inclined to tune in distant stations by the whistle method. There are, in fact, many campaigns on, at the present time, against just this form of interference.

The second advantage means that the experimenter cannot make the music or speech signals from a station sound badly even if he tries. All he has to do is to adjust the tuning controls for maximum signal strength—the quality of signal remains the same always. With most regenerative receivers the adjustment is usually a compromise between clarity and strength of signal.

The number of controls in this receiver is the same as for the regenerative receiver of the loosely coupled type. The condenser of the single stage of radio

frequency replaces the regeneration control while the other controls—the primary and the secondary wavelength and the coupling—are the same in both instances. While some sets use a fixed primary and employ fixed coupling, it was decided to make both of these *variable* for those who desire the highest refinements. If one is satisfied with either fixed primary or fixed coupling, or both, the best values may be determined by experiment and the controls may be left in that position. For any given coupling a tuning chart may be made up for the other controls. (This will be explained later in this article.)

The wiring diagram of the circuit is shown in Figure 1.

The Parts Used in Building the Set

In all the diagrams in this article each part bears a designating letter. In this way the prospective builder of a receiver may easily determine how to mount the instruments in the correct places and connect them properly in the electric circuit. The same designating letters are used in the text and the list of parts at the beginning of the article.

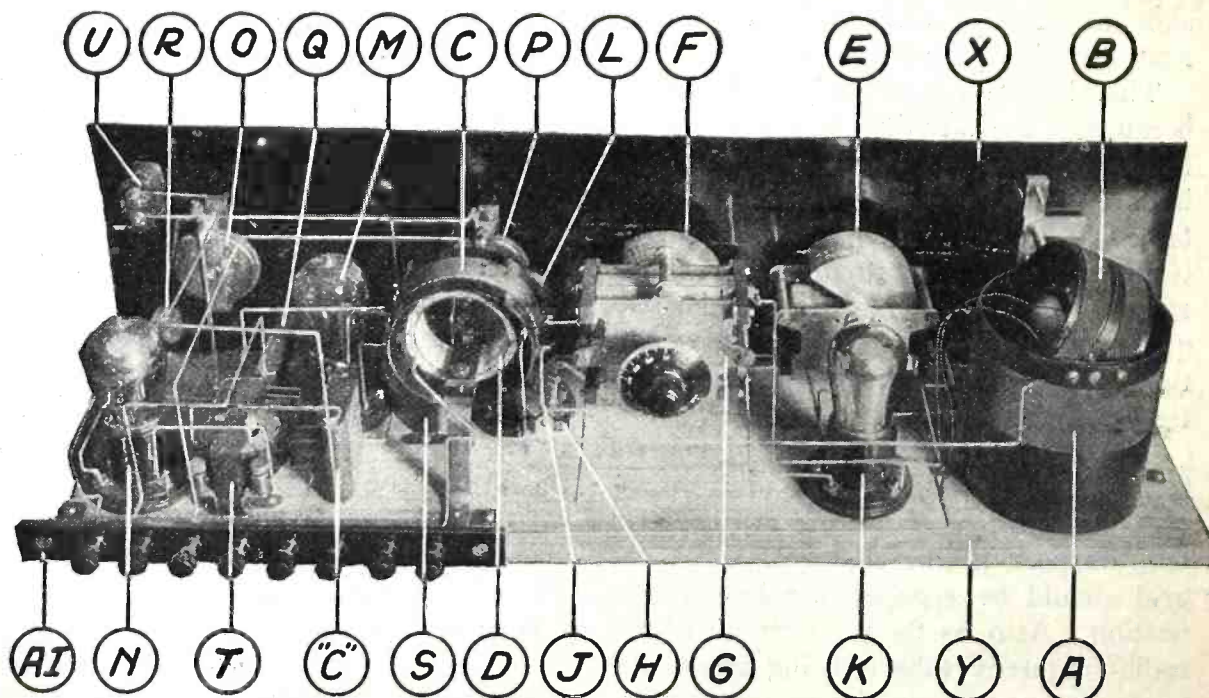

INTERIOR VIEW OF THE RECEIVER, FROM THE REAR

FIGURE 2: This picture shows how the instruments are mounted on the base and the panel. Notice that the neutralizing condenser G, is supported by the tuning condenser F.

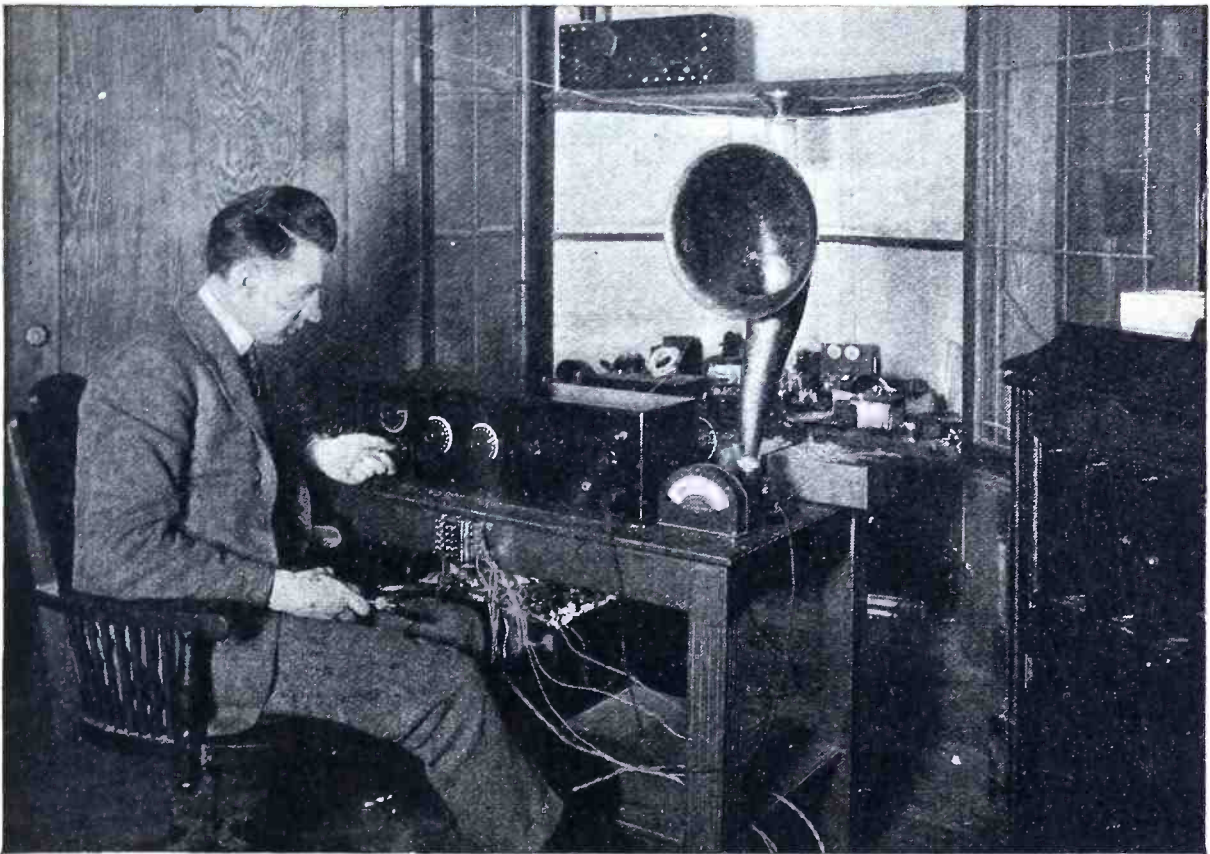

From a photograph made for POPULAR RADIO

THE COMPLETED SET INSTALLED IN THE LABORATORY

The author, Mr. Craig, and the Technical Editor tested out the receiver on distant signals on antennas of various lengths, from 25 feet to 150 feet. The results were remarkable for clarity and truthful reproduction, from all signals both local and distant.

Q *The list of parts there given includes the exact instruments used in the set from which these specifications were made up; however, there are many other reliable makes of instruments which may be used in the set with equally good results.*

If instruments other than the ones listed are used it will necessitate only the use of different spacing of the holes drilled in the panel for mounting them.

How to Construct the Set

After procuring all the instruments and materials for building the set, the amateur should prepare the panel X, (shown in Figures 2, 3, 4, 5 and 6).

First of all, cut the panel to the correct size, 7 by 26 inches.

Then, square up the edges smoothly with a file. The centers for boring the holes (which are necessary for mounting the instruments) should be laid out on the panel as shown in Figure 6. A convenient method of doing this is to lay out all center holes on a piece of paper the same size as the panel; then the piece of paper should be pasted on the panel and the centers marked directly on the panel by punching through the paper.

The holes outlined here with a double circle should be countersunk so that the flat-head machine screws used for fastening the instruments will be flush with the panel. All the rest of the holes in the panel are straight drill holes. Sizes for the diameter of these holes have not been given, but the builder will readily decide what size hole is necessary by measuring the size of the screws and shafts of instruments that must go through the holes.

When the panel is drilled, it may be given a dull finish by rubbing lengthwise with fine sandpaper until the surface is smooth; then the same process should be repeated, except that light machine oil should be applied during the rubbing. The panel should then be rubbed dry with a piece of cheese-cloth; a dull permanent finish will be the result. Or the panel may be left with its original shiny-black finish, if care is exercised so that it is not scratched during the drilling.

The sub-base Y (see Figures 2, 3, 4 and 5), should be cut to size, 7 by 25 inches. If a piece of $\frac{1}{2}$ -inch hardwood, surfaced on both sides, can be obtained the work of squaring up and finishing the edges will be a minimum.

The special coupler, composed of the coils A and B, can now be constructed as shown in detail in Figure 8.

Cut the composition tube, for the primary

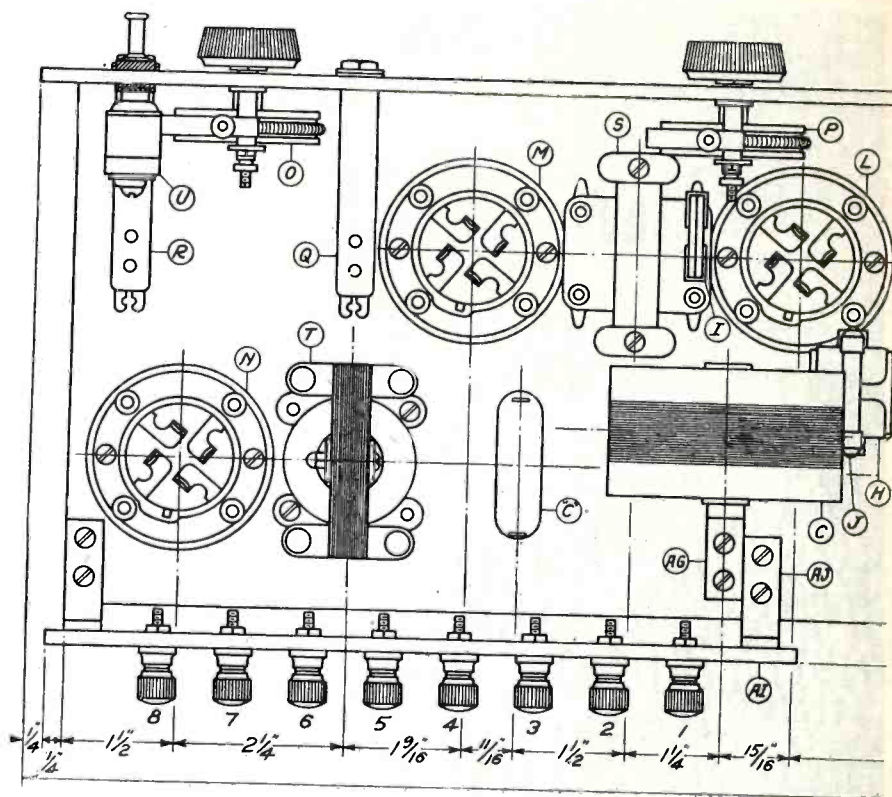

THE WORKING DRAWING FOR CONSTRUCTION

FIGURE 3: Here are shown the correct positions for the various instruments. The positions are given on the diagram, center to center, for all instruments.

coil A, to size and drill the holes for the rear bearing of the coupler AA, the two angle brackets AB and one hole for the shaft in the front of the tube. Cut away the material above this latter hole so that the shaft can be slipped down into place later on. Wind the coil with No. 22 DSC wire, beginning $\frac{1}{2}$ inch from the top of the tube. Taps are taken off at the 3rd, 7th, 12th, 19th, 28th, 40th and 56th turns.

Cut the composition tube, for the secondary coil B, to size and drill the holes for the shaft and the two machine screws shown. Wind 21 turns of No. 22 DSC wire on one side of the shaft hole, beginning $\frac{3}{16}$ inch from the edge of the tube. Then bring the wire over and wind 21 more turns on the other side of the shaft hole. Make the rear bearing AA, the front bearing AE, the arm AF, which strikes the stops, the two pieces AC, for connecting the rotor and shaft, the two angle brackets AB, all out of $\frac{1}{8}$ by $\frac{1}{2}$ -inch strip brass. The shaft AD consists of a piece of $\frac{1}{4}$ -inch brass rod $7\frac{1}{2}$ inches long (see Figure 8).

To assemble the coupler fasten the rear bearing AA and the two angle brackets AB to the primary tube A with 6-32 brass machine screws. Fasten the two lugs AC to the rotor or secondary tube B with machine screws, then pass the shaft AD through the holes in the rotor and solder it to the lugs AC. The remainder of the assembly will be taken care of later when the instruments are mounted.

Next, construct the radio-frequency transformer C and D as shown in Figure 9.

Cut the composition tube for the primary coil C to size, and drill two holes for the mounting bracket AG. Wind 28 turns, of No. 22 DSC wire, centrally on the tube, taking off a tap on the opposite side of the tube half way between the 25th and 26th turn. The width of the winding will be about $\frac{3}{4}$ of an inch. The secondary coil D is a 75-turn Pacont duolateral coil. Make the mounting bracket AG out of $\frac{1}{8}$ by $\frac{1}{2}$ -inch brass strip.

Cut two small clamping strips AH out of composition sheet. Assemble the transformer by passing two brass machine screws first through the tube C, then through the bracket AG and one of the clamping strips AH. Place the duolateral coil in position and fasten the other clamping strip AH down with nuts on the machine screws.

Now, cut the binding-post panel AI out of composition sheet and drill as shown in Figure 10. Then make the two angle brackets AJ for mounting the binding-post panel out of $\frac{1}{8}$ by $\frac{1}{2}$ -inch strip brass, and fasten them to the panel. The brackets AK, for mounting condenser G on the back of condenser E are also shown in Figure 10. Make them also out of $\frac{1}{8}$ by $\frac{1}{2}$ -inch strip brass.

Complete specifications for constructing the cabinet Z, are shown in Figure 7. It may be constructed out of $\frac{1}{2}$ -inch hardwood such as mahogany, walnut or oak, and finished to suit

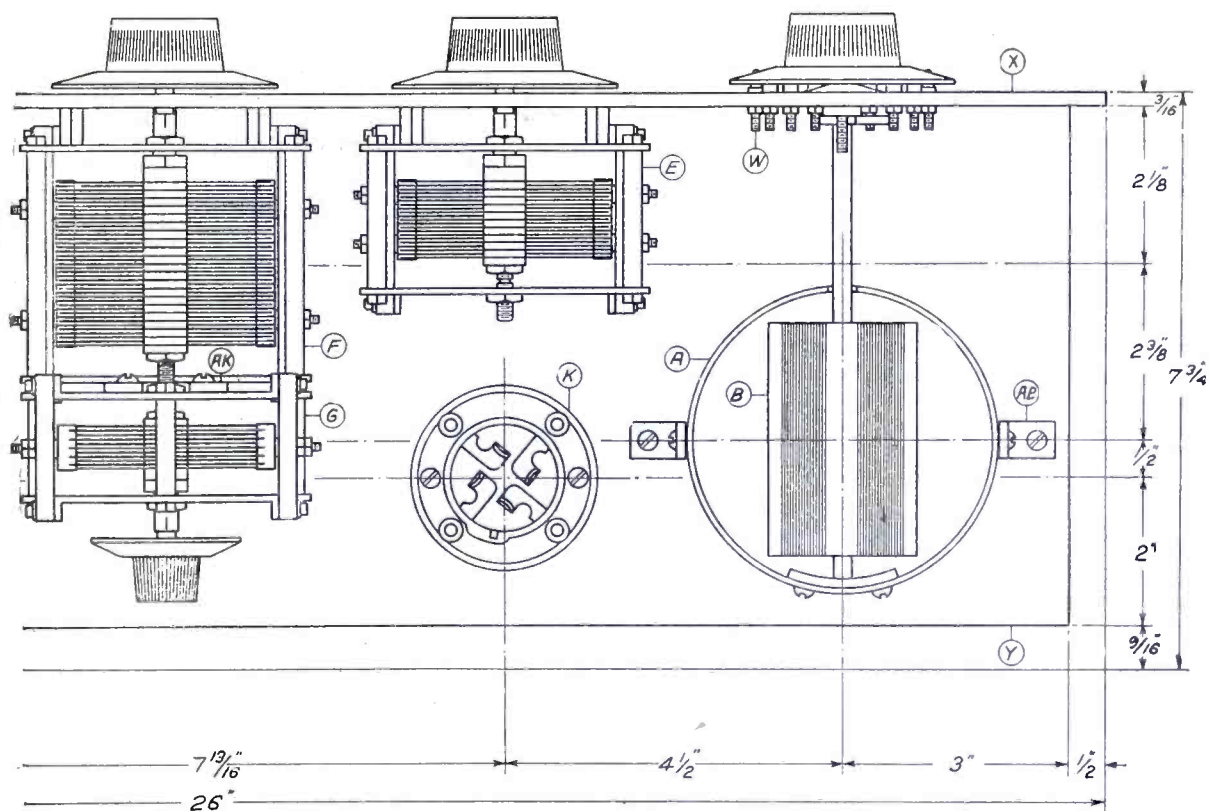

the taste of the builder. Or the cabinet may be purchased complete from your radio dealer, as it is a standard size. In the latter case it will only be necessary to cut the slot in the back of the cabinet for the binding-post panel.

How to Mount the Apparatus

Preliminary to mounting the parts of the set, fasten the panel X to the sub-base Y, (see Figures 2, 3, 4 and 5). Make sure these two are fastened exactly at right angles.

Fasten the sockets K, L, M and N to the sub-base with wood screws in the positions shown in Figure 3. Note that the slot in the socket is towards the rear in each case.

Mount the transformer S with the primary towards the socket L and the secondary towards socket M, and mount the transformer T with the secondary towards the rear of the set. The exact location for each is shown in Figure 3.

Secure the radio-frequency transformer C and D to the sub-base with two wood screws inserted through the mounting bracket as shown in Figures 2 and 3.

The remainder of the coupler assembly can now be carried out.

Fasten the primary coil A in the position shown in Figures 2, 3 and 4. Then place the stop arm AF and the front bearing AE on the shaft of the rotor. Pass the rotor shaft through panel X, drop the rotor into position and insert the shaft in the rear bearing AA. Secure the front bearing AE to the panel with machine screws which project about 1/4 inch beyond the bearing to act as stops. Move the stop arm AF up against the front bearing and

solder it to the shaft in such a position that it strikes one of the stops at zero coupling, that is, with the rotor at right angles to the primary coil. Before soldering see that the direction of rotation from the zero point corresponds with an increase in coupling as indicated on the dial to be used. A spring washer should be inserted between the dial and the panel to take care of any end play.

Mount the jacks Q and R on the panel as shown in Figures 3 and 5. The frames of the jacks are turned up.

Fasten the two rheostats O and P to the panel in the position indicated in Figures 2, 3 and 5. The terminals are towards the top.

Now, mount the two variable condensers E and F on the panel. The correct positions are shown in Figures 2 and 3.

By means of the small mounting brackets AK (shown in Figure 10) mount the condenser G on the back of the condenser F as indicated in Figures 2 and 3. The holes for these brackets are already drilled in the condensers and are tapped with a 6-32 thread, one being found on each side of the bearing.

Next, mount the battery switch U in position as shown in Figures 2, 3 and 5. The construction work on the set is now complete.

How to Wire the Set

When wiring, it should be remembered that all connections from the high-voltage side of the transformers or coils (that is to say the side next to the vacuum tubes) should be kept about 1/2 inch away from other wiring and should not run parallel to it for any considerable distance. This also includes the wir-

ing from the radio-frequency transformer to the condenser G.

Use tinned-copper bus-wire throughout. All connections should be bent into the proper shape and then soldered in place.

Start wiring the filament-lighting circuit as shown in Figure 1. The filament circuit passes along the front of the set towards the bottom of the panel and it includes the positive and negative terminals of sockets K, L, M and N, the rheostats O and P, the filament switch U, the negative "A" battery binding post (No. 3), switch arm to ground binding post, (No. 2).

Now, wire up the antenna and ground circuit. The antenna binding post No. 1 connects to the top of the primary coil A, (the end with few turns between taps). Connect the remaining seven taps to the switch points and the switch arm to the ground binding post, (No. 2).

Connect up the grid circuit of the radio-frequency tube which comprises secondary coil B, condenser E, the grid terminal of vacuum-tube socket K and the negative "A" battery. The stationary and revolving plates of all the condensers are marked S and R respectively in the wiring diagram. The connections to the secondary coil B

should be made with flexible silk-covered wire.

Then, wire the plate circuit of the radio-frequency tube. This embraces the plate terminal of vacuum-tube socket K, the primary coil of the radio-frequency transformer C, condensers F and G, and the positive 67½-volt binding post, (No. 7).

Connect up the secondary of the radio-frequency transformer D, the grid-leak J, the grid condenser H, the grid terminal of socket L and the positive "A" battery to form the grid circuit of the detector tube. Note that the grid condenser J is supported by the two bus-wires used to connect it in the circuit.

Wire up the plate circuit of the detector tube which comprises the plate terminal of socket L, the primary of transformer S, the condenser I, and the positive 22½-volt binding post, (No. 6).

Next, connect the grid circuit of the first audio-frequency amplifier tube. This consists of the secondary of transformer S, the grid terminal of socket M and the negative "A" battery.

Now, wire the plate circuit of the first amplifier tube, embracing the primary of transformer T, the jack Q and the positive 67½-volt binding post, (No. 7).

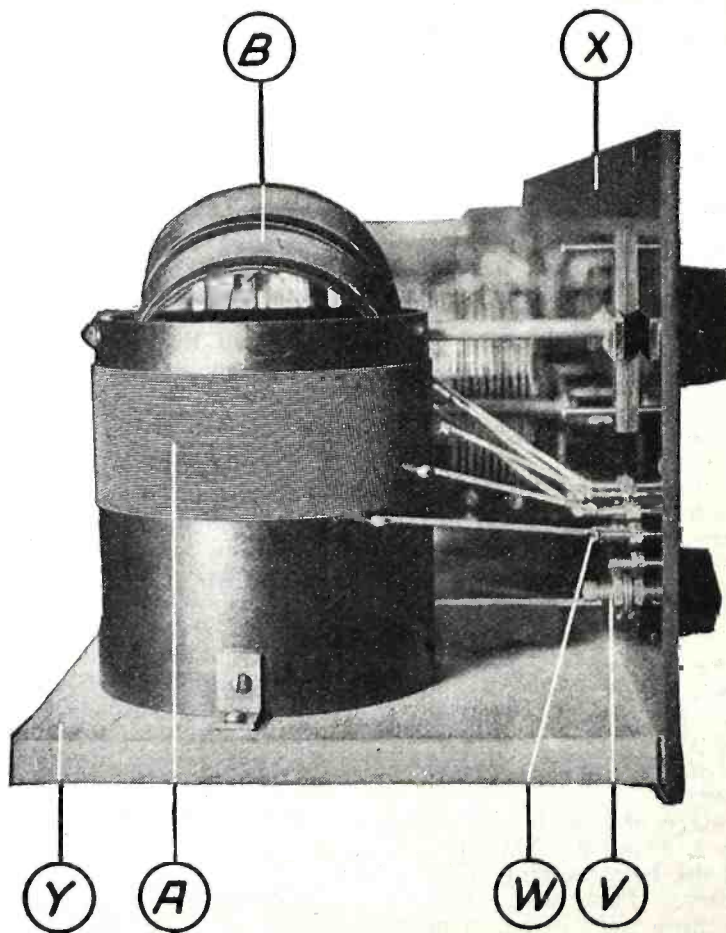

VIEW OF THE SET, FROM THE LEFT

FIGURE 4: Here is shown the manner of mounting the primary coil A and the secondary coil B, with the taps running to the switch points on the panel X.

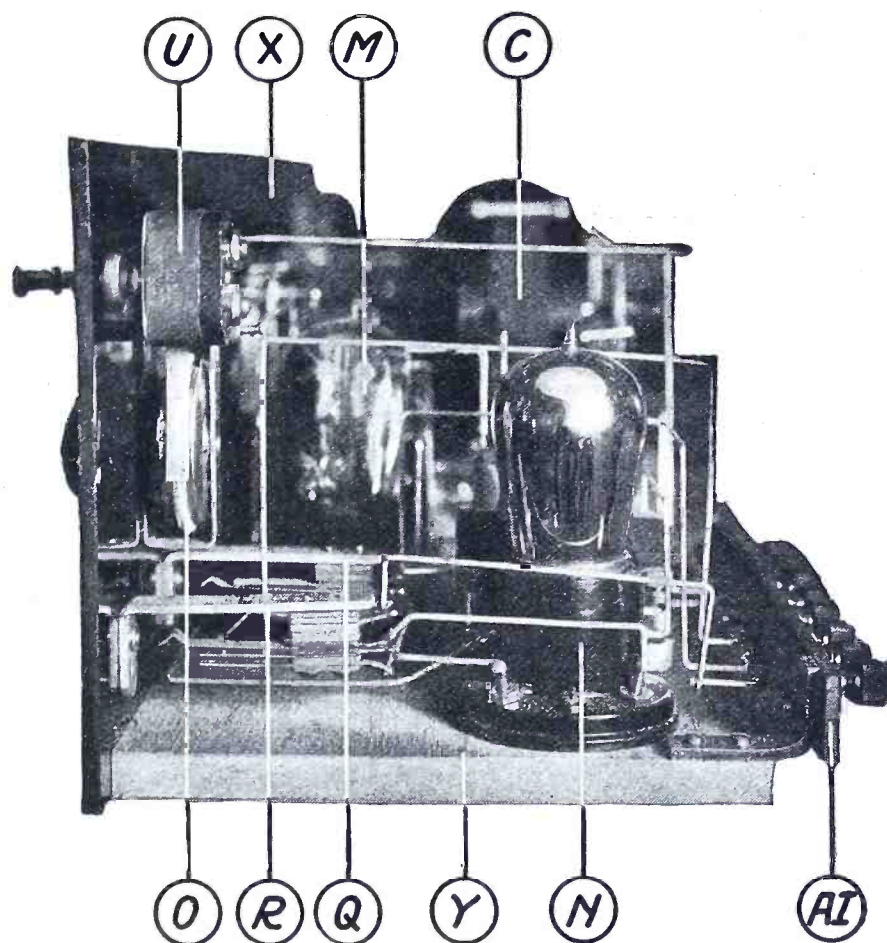

VIEW OF THE SET AS SEEN FROM THE RIGHT END

FIGURE 5: This picture shows the way to mount the jacks, the tube sockets, the connection block, and the filament switch. The base is secured to the main panel with wood screws running through the panel into the edge of the wood.

Wire the grid circuit of the second amplifier tube. This includes the secondary of transformer T, the grid terminal of socket N, the "C" battery and the negative "A" battery binding post (No. 3). The "C" battery terminals are soldered to the wires connecting it in the circuit in order to hold the battery in place.

Connect up the plate circuit of the last tube, consisting of the plate terminal of socket N, the jack R and the 112½-volt binding post, (No. 8).

Lastly, ground the negative filament lead and also the cores of the transformers S and T by putting a wire under the screws used to fasten the transformers down on the base.

How to Install the Set

After the set has been completely wired, place it in the cabinet and fasten it to the cabinet with wood screws through the panel.

The binding-post panel will now fit into the slot in the back of the cabinet and will come approximately flush with the back of the cabinet.

Attach the antenna to the first binding post at the right (looking at the rear of the set).

Connect the ground wire to the second binding post.

Connect the negative "A" battery wire to the third binding post.

Connect the positive "A" battery wire to the fourth binding post.

Preliminary to further connections, the "B" batteries should be connected in series to give a total of 112½ volts and with taps available at 22½ volts and 67½ volts. This combination may be conveniently made up of one 22½-volt and two 45-volt "B" batteries.

Connect the negative "B" battery terminal to the fifth binding post.

Connect the positive 22½-volt "B" battery tap to the sixth binding post.

Connect the positive 67½-volt "B" battery tap to the seventh binding post.

Connect the positive 112½-volt terminal of the "B" battery to the eighth binding post.

Insert one UV-200 or one C-300 vacuum tube in the detector socket L, and insert one UV-201-a or C-301-a tube in each of the remaining sockets K, M and N.

Plug in either the loudspeaker in jack R, or the telephones in jack Q.

Make certain the rheostats are turned off

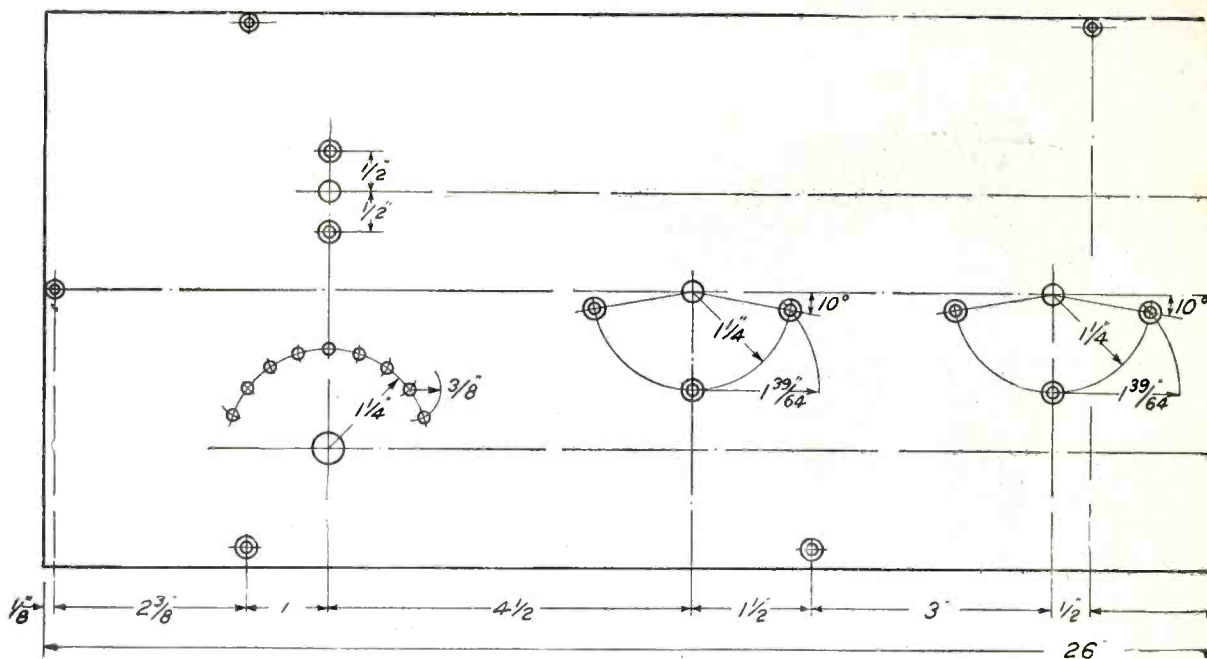

THE DRILLING PLAN FOR THE PANEL

FIGURE 6: This drawing gives the correct dimensions for drilling the holes for mounting the instruments and also for the shaft holes. The holes outlined with a double circle should be countersunk.

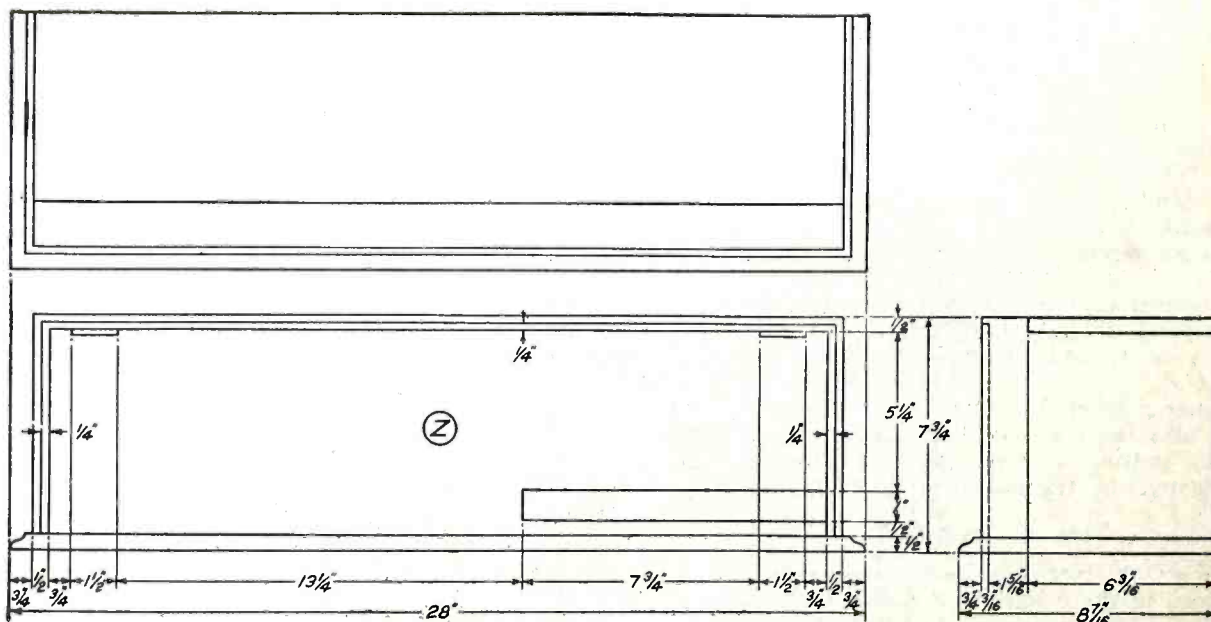

THE DIMENSIONS FOR THE CABINET

FIGURE 7: This drawing, which shows the top, front and side measurements for the hardwood cabinet, may be turned over to a competent cabinet maker or the cabinet may be obtained direct from a manufacturer; it is a standard size.

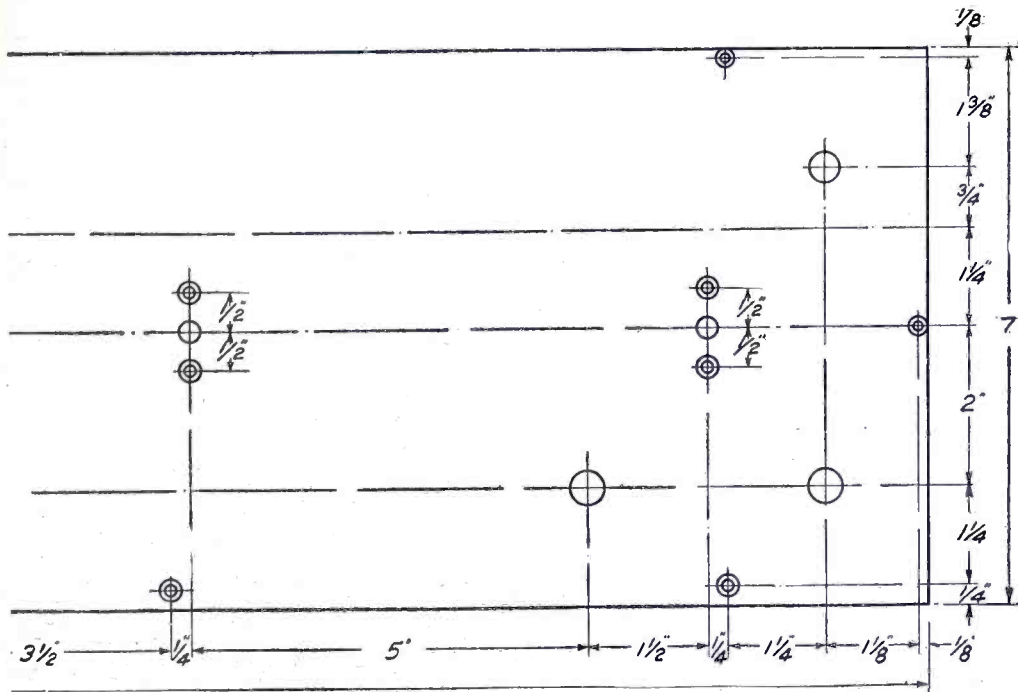

(to the counter-clockwise stop position), and then turn on the battery switch U by pulling the switch button out.

Gradually turn the rheostat P clockwise until the detector tube is burning with almost the same brilliancy as an ordinary tungsten electric light. Light the remaining bulbs by turning up rheostat O until they are burning with considerably less brilliancy than the old carbon style of electric light.

The condenser G can be set with about one-third of the set of rotor plates meshing between the stator plates for testing.

Set the tap switch V for a maximum number of turns in the antenna circuit, and set the coupling with the rotor coil about half way between the vertical and horizontal position.

Now, gradually rotate condensers E and F (keeping them at approximately equal settings) until a station is picked up. Remember that the tuning of condenser E is the sharpest and adjust it more carefully when searching for a station. After tuning in the signal to best advantage with condensers E and F, adjust tap switch V to the best point. This is the point with the smallest number of turns in the antenna circuit, consistent with loud reception. If too many turns are used in the antenna circuit the tuning of condenser E will be very broad. It will usually be found that, with any given antenna, there will be three or four switch points on which most of the tuning can be done.

After tuning in the loudest local station, the neutralizing condenser G may be adjusted permanently, and need be changed only when the radio-frequency amplifying tube in socket K is changed. To do this, remove the vacuum tube from socket K and wrap a piece of paper around one of the filament terminals; then replace the tube in its socket. The tube will

not light now, and does not act as a radio-frequency amplifier. Any signals now audible are merely passing through the grid-to-plate capacity of the tube.

To reduce this signal strength to a minimum, start with the condenser G at zero capacity, (that is, with the rotary plates not meshed at all with the stationary) and gradually increase the capacity of condenser G, at the same time, adjusting condenser E for maximum signal strength with each change of condenser G. The signal strength will gradually decrease as the capacity of condenser G is increased, and the point at which the signal becomes inaudible or a minimum should be carefully noted.

Now, start with the condenser G at maximum capacity and gradually decrease the capacity, at the same time, adjusting condenser E for maximum signal strength as before. The signal strength will again gradually decrease as the capacity of the condenser G is decreased, and the point of zero or minimum signal strength should be again noted. With the aid of a good strong initial signal, these two points of zero signal strength may be made to approach each other within a very few degrees.

Set the neutralizing condenser permanently half way between the two zero points. If a louder signal is available later on, the neutralizing process may then be repeated more accurately, but generally one good test on a loud local station is sufficient.

Now remove the piece of paper from the filament terminal of the tube in socket K and replace the tube in its socket.

The set is now ready for permanent operation.

After tuning in a few stations in the manner described, the experimenter will become familiar with the degree of coupling to ob-

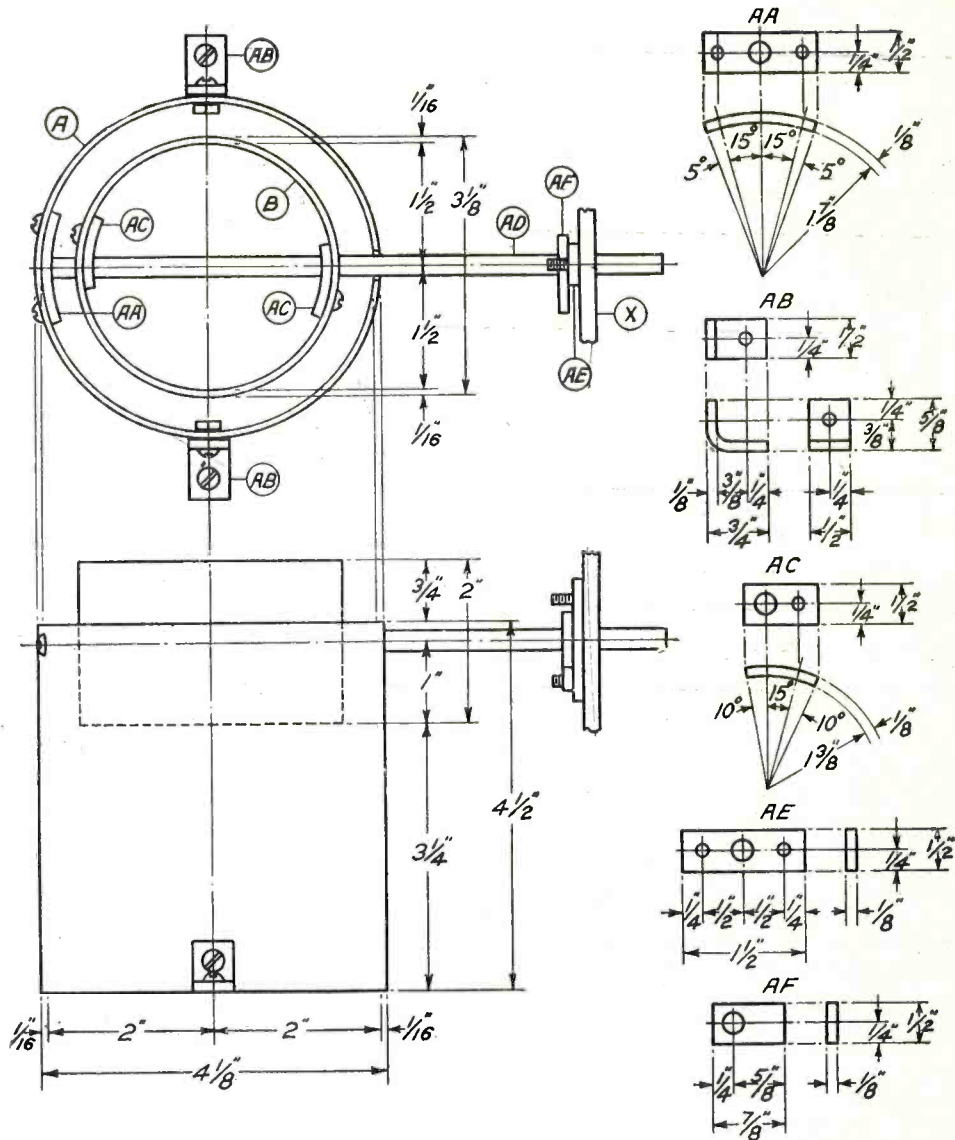

CONSTRUCTIONAL DATA FOR THE CRAIG COUPLER

FIGURE 8: This drawing gives the specific details for the special coupler. The dimensions for all of the small brass parts are clearly shown, as well as the dimensions for the composition tubes.

tain satisfactory selectivity, and also with which one of the switch points the tap switch V should be set on for a given wavelength range. The tuning will thereby be simplified and the sequence will probably be as follows:

Set the coupling as loose as you can, conveniently, for tuning.

Set primary-wavelength switch V on the correct tap for the wavelength you wish to receive.

Move condensers E and F (keeping each on approximately the same dial setting) until a signal is tuned in. Then adjust each of the two condensers until the signal strength is maximum.

The detector rheostat P should be operated below that point where a persistent hissing occurs. The amplifier rheostat O should

be operated at the lowest point consistent with loud reception, that is, where turning the rheostat up higher does not give a noticeable increase in signal strength.

How to Make a Tuning Chart

First, make tests of several stations on different wavelengths and find the coupling value that you like best—taking into account both selectivity and signal strength. The chart will be made up for this one particular value of coupling and will not apply exactly to other coupling values.

Now, tune in as many stations as possible on different wavelengths and record the dial settings of condensers E and F, the setting of primary tap switch V and also the known wavelength of the station. Plot the dial set-

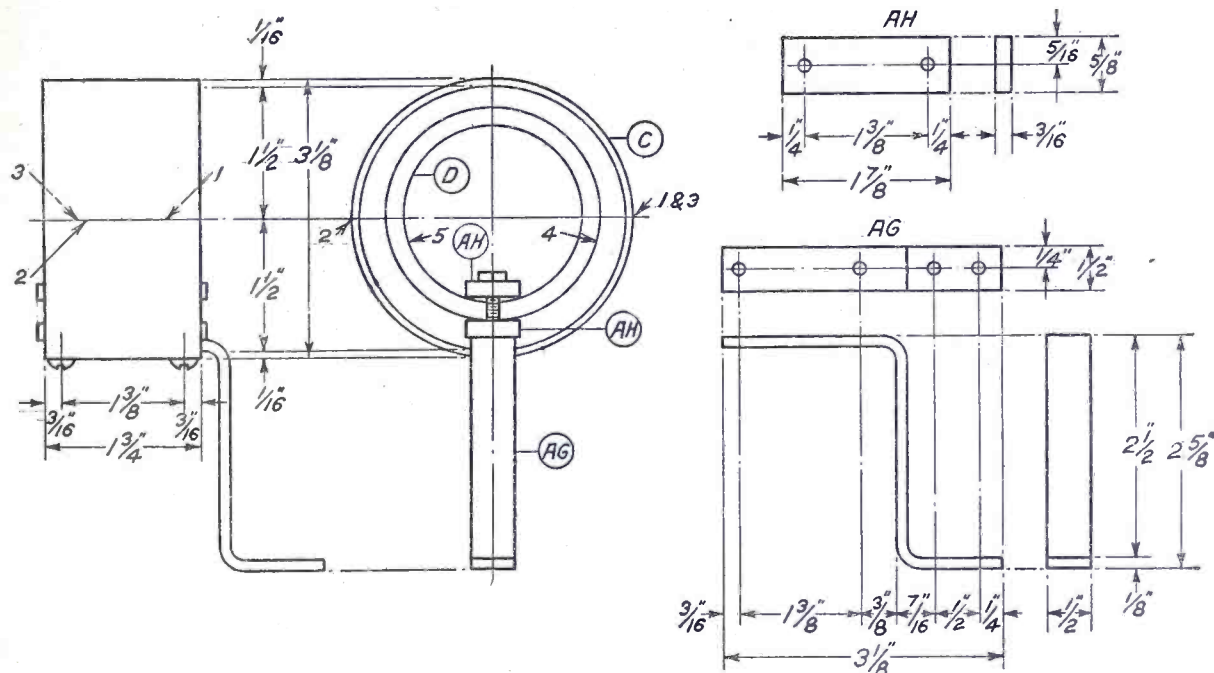

CONSTRUCTIONAL DATA FOR THE RADIO-FREQUENCY TRANSFORMER

FIGURE 9: Here are given the dimensions of the tube for the primary winding, the brass supporting bracket and the small fastening blocks for the secondary coil. The arrows 1, 2, 3, 4 and 5 correspond with the numbers on the radio-frequency transformer in the wiring diagram (see Figure 1) and thus indicate the proper location for each connection to the transformer.

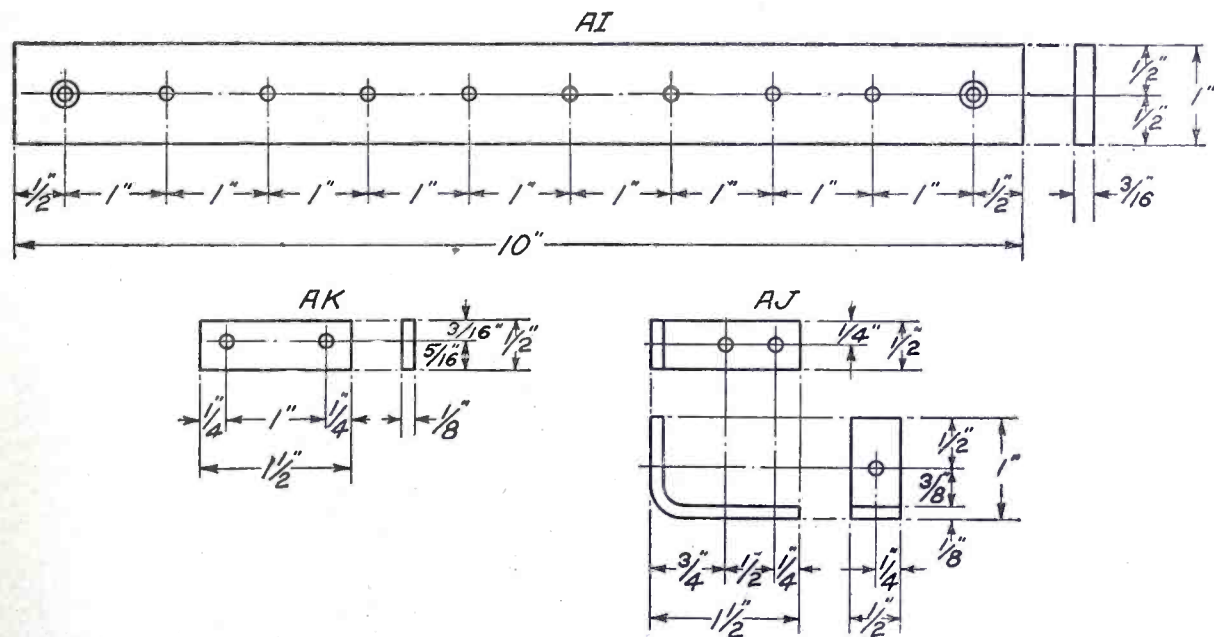

THE CONNECTING BLOCK AND SMALL BRASS BRACKETS

FIGURE 10: The block should be made as shown at AI. The brackets for mounting the block are shown at AJ, and the small pieces for mounting the neutralizing condenser are shown at AK.

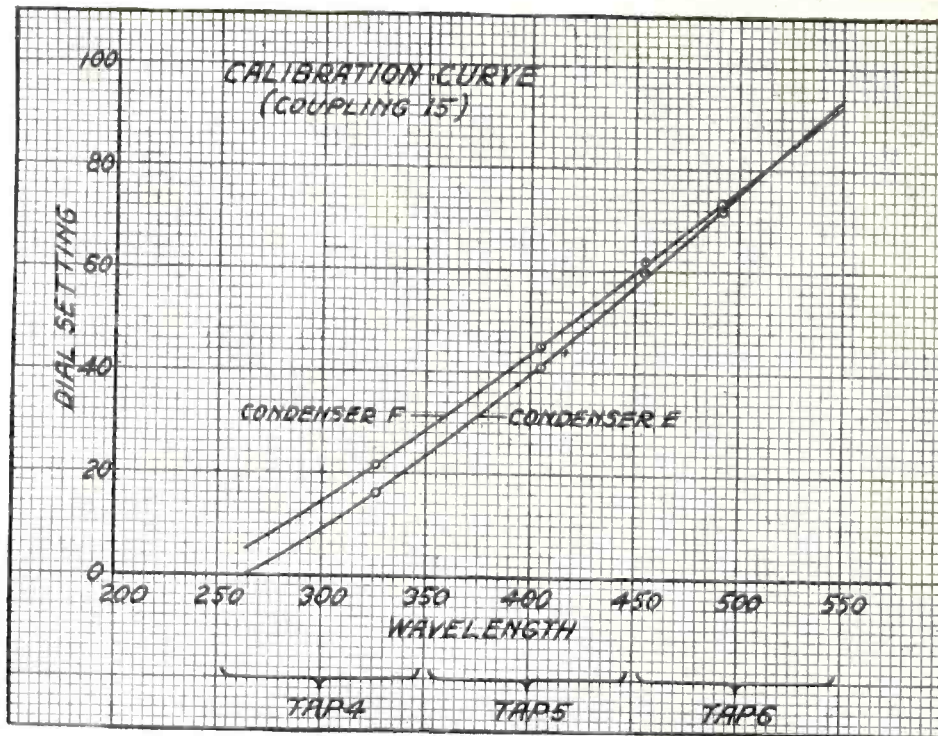

A SAMPLE TUNING CHART

FIGURE 11: This chart was made by the author for use with a set coupling of 15 on the dial. Anyone can make a similar chart for his own set by recording both dial settings and the wavelength of several transmitting stations of various wavelengths. After these points have been plotted on cross section paper (as shown here), the points may be connected by a line which will give the settings for wavelengths that lie between the plotted points.

ting of condenser E against the wavelength of the station, also plot the dial setting of condenser F against the wavelength of the station. Repeat the process for a number of stations and you will get sufficient points to enable you to draw a smooth curve for each condenser. A sample curve is shown in Figure 11. This chart shows how the experimental set tuned for four given stations. By inspecting your list of stations you can bracket the approximate wavelength range which each

point on the primary tap switch V will cover. With the aid of the chart just plotted you can now find the exact setting for the wavelength of any given station and can set all the tuning controls at the correct values to receive the station to best advantage. Of course, this chart assumes that the coupling remains fixed, at a predetermined value, but so do all other tuning charts. They are usually made up for receivers having fixed coupling.

Working Blueprints of This Receiver

IN order to accommodate readers who may desire actual-size diagrams of this simplified neotrodyne receiver, a set of three blueprints has been prepared, consisting of—

- One panel pattern (actual size);
- One instrument layout;
- One picture diagram of all parts, showing the wiring.

This set of three prints will be forwarded, postage prepaid, upon receipt of \$1.10.



BROADCASTS

CONDUCTED BY DAVID LAY

ITEMS of general interest that you ought to know; bits of useful information that every radio fan ought to know.

A Record for Distance with Low Power

ACCORDING to an announcement by the American Radio Relay League, Mr. C. D. Maclurcan of Sidney, Australia, has succeeded in transmitting signals to New Zealand, a distance of 1,400 miles, with an antenna input of only .004 watt, which is far less than the power produced by a burning match. The power expended by an average man in getting up out of a chair would be enough to maintain radio communication at this rate, for about five minutes.

Air Police to Have Radio

THE seven airplanes belonging to the Police Department of New York City are being equipped with radio. The members of the aviation reserve attached to the Department are also receiving radio instruction.

Every State Now Has Broadcasting Stations

MISSISSIPPI was recently the only state in the Union that was without at least one broadcasting station. This distinction has now been relinquished, as a station has been installed at Coldwater, under the call letters KFNG. The wavelength is 254 meters. The station has already been heard in several states under its experimental call 5RK. One number sent out under this testing call was a series of negro spirituals sung by six negro farmhands. This was heard in forty-two states and in several provinces of Canada.

Exploring the Amazon by Radio

ANOTHER exploring expedition about to depart for an extensive investigation in the unknown lands and among the dangerous natives of the headwaters of the Amazon River, is to be equipped with a comprehensive radio outfit, not only for local communication between separate parties of explorers, but for continual

communication with the outside world. The call assigned, temporarily, to the mobile station of the expedition is WJS. Arrangements will be made later for the assignment of calls by the Brazilian authorities. One of the subjects to be studied by the expedition is the nature and cause of the static so commonly reported from the forest-covered region through which the Amazon flows.

Will Radio "Kill" the Theatre?

WILLIAM A. BRADY, who knows the commercial side of the American theatre better, in all probability, than any other living man, is worried about radio. He thinks that it will make the theatre unnecessary—or, at least, that it will cut seriously into the theatrical receipts. Mr. Brady ought to know, but it is to be feared that he has been looking, for once, through bluer glasses than are necessary; the theatre has been threatened with death many times before.

Radio Communication for Railway Men

A new industrial use for radio has been announced by Sir Henry Thornton, president of the Canadian National Railways. It is proposed to install a company broadcasting station and to provide each employee with a radio receiving set, the company acting as purchasing agent to supply these sets at the lowest possible price. Then matters of interest to employees will be broadcast over the company station. It is hoped, says Sir Henry, that one result will be an increased solidarity of the entire company personnel.

Broadcasting Begins in China

ACCORDING to a report from the United States Consul, there are now two broadcasting stations on regular schedule in Hongkong, China. One has a 10-watt power, the other 100 watts. Who will be the first American listener to hear one of these stations?

Radio Starts a Fire in Wet Wood

DURING some repairs recently at the great Leafield radio-telegraph station in England, a wooden partition about twelve feet from the tuning coil got wet. It promptly caught fire. The radio waves from the powerful transmitter were so strong that as soon as the dampness of the wood permitted their absorption by the partition, the heat produced was sufficient to ignite the wood. When powerful radio is around it is water that starts fires. Fortunately, no amateur transmitters are powerful enough.

* * *

Lightning Is Still Mysterious

WHEN he delivered, recently, the presidential address before the Institution of Electrical Engineers, Dr. Alexander Russell urged all scientific men to observe thunderstorms and record any peculiar appearances. This used to be done, he pointed out, before electricity was understood at all. The volumes of Transactions of the Royal Society of London a hundred or a hundred and fifty years ago contain many such records. When the laboratory forms of electricity came to be understood a little better, people lost interest in lightning. Really, however, we know very little about lightning, and the miscellaneous observations by people everywhere might prove very useful. Dr. Russell mentioned, especially, the appearance known as ball lightning or globe lightning. Few good

observations of this have been recorded in scientific literature. If any of the readers of POPULAR RADIO have observed phenomena of interest in this connection the editor of this department will be glad to forward reports to Dr. Russell.

* * *

Radio Runs a Race Track

AT the race track at Grünwald, near Berlin, one of the most famous race tracks in Europe, radio sets have been installed recently for communication between the judges' stand and other parts of the track. The transmitters and receivers are adjustable to any wavelength between 200 and 1,000 meters. Some of the outfits are portable so that temporary stations can be set up anywhere in a short time.

* * *

Telegraphy of Pictures Is Now on a Commercial Basis

THE French government has announced that pictures will be received for transmission by telegraph over the French governmental wires between Paris and the cities of Lyons and Strassbourg. The fee charged figures out about seventy-five cents on the present rate of exchange. The process used is the familiar one of Belin. It ought to be worth while for some agency to offer a similar service in the United States, either by wire or by radio.

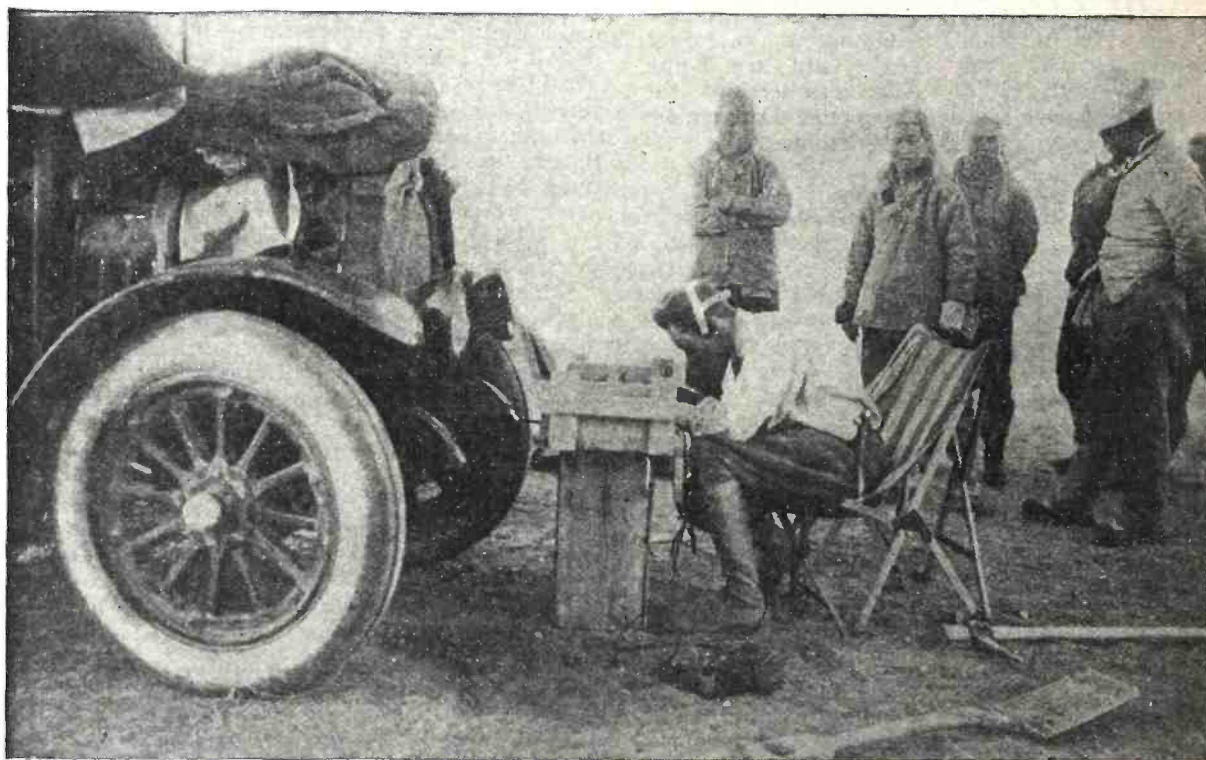

International News Reel

RADIO AIDS HUNT FOR DINOSAUR EGGS

On the recent geological expedition to Central Asia radio was used to get the exact time and thus to determine the exact position of the party from day to day. This expedition discovered the eggs of the great extinct reptile, the dinosaur—eggs believed to be more than 10,000,000 years old.



Underwood & Underwood

A SOLEMN MOMENT IN THE ANNALS OF RADIO

So profound was the impression upon broadcast listeners of being actually present at the funeral services of ex-President Woodrow Wilson on February 6 that many knelt before the receiver during the prayer for the dead. This picture was made in a factory in New York.

Teaching Farming by Radio

IN order to reach that part of the farm population which is unable to attend the courses at the university, the Kansas State Agricultural College is broadcasting, during the present winter, a complete course in scientific agriculture. Persons who take the course will be given certificates of graduation.

* * *

Cable Improvements Help Meet Radio Competition

ONE great difficulty of communication by submarine cables has always been the slow speed of the cable. Capacity effects between the conductor and the water outside, together with other electric difficulties, have limited the available speed to some twenty-five or thirty words a minute. So long as there was no competition, this was not so serious, but now, with transoceanic radio a more and more important factor, an increase of cable speed is desirable. It is announced now that it has been attained. The new metal, "permalloy," which is remarkable for its high magnetic permeability,

has been applied to the construction of a cable which is said to have a possible speed of two hundred words a minute or even more. The details of the construction of the cable have not been made public.

* * *

A Broadcasting Station on Wheels

STATION WTAT, owned by the company that supplies Boston with electric power and light, is built, complete, on a motor truck. The wavelength is 244 meters. The entire station may be moved about at a moment's notice so that broadcast programs can be sent out from any point without relaying the material.

* * *

A Radio Engineer Must Be Musician Too

AT the Manchester (England) broadcasting station the control engineer at the modulation board has an orchestra score, just like the score that is before the conductor. The engineer can thus see what is coming in the music and get ready to increase or decrease the amplification, as may be necessary.



Kadel & Herbert

RADIO ON A PERILOUS TRIP

Thousands of people in New York gasped with horror when they saw Bird Millman walk a tightrope strung between two cornices atop the 25th story of the Municipal Building. She carried a miniature receiver with her.

Radio in the Comic Strips

THERE are two ultimate awards of fame; one is to have a cigar named after you and the other is to break into the comic-strip cartoons of the daily papers. This last has come to radio in full measure in the past two months. A radio set is now as common a companion of Little Jeff, of Cicero Sapp and of all the others as the mislaid banana peel used to be.

* * *

Radio Dance Music in the Yukon

At parties nowadays in the Yukon, says a newspaper dispatch from Dawson, men and women in evening clothes dance under pink-shaded lights to the music of famous orchestras from Chicago to San Francisco. Even the dance music from New York is occasionally received, all by radio.

Radio Fights the "White Plague"

"A RADIO set will do more to cure tuberculosis than any other apparatus yet devised." So says Dr. Walter K. Foley, of the Veterans' Hospital at Minneapolis, as quoted in a newspaper interview. The greatest obstacle to a cure, in tuberculosis cases, Dr. Foley says, is a worried and harassed state of mind on the part of the patient. A radio set gives the patient something to think about and takes his mind off his troubles. Then Nature completes the cure.

* * *

The Phonograph Industry Comes Around to Radio

Not so long ago the phonograph industry was fighting radio, tooth and nail. It is different now. A recent issue of a prominent trade paper in the phonograph field contained, by actual count, as many radio items as all other items put together. One talking machine company is installing a broadcasting station and will soon use it to announce and advertise new records. Thus one of radio's erstwhile enemies becomes a friend.

* * *

A Scientist Who Speaks with His Hands

ONE of the modern scientists who has been studying the physics of speech, an investigation which has been of enormous value in the design of radio telephones and loudspeakers, is Sir Richard Paget. At a recent meeting of the Physical Society of London he demonstrated the skill he has acquired. Arranging his two hands in a box-like form to represent the resonance cavities of the mouth and throat, he blew into this hand-box the noise of a penny squeaker to represent the vocal cords. By manipulation of his hands he was able to pronounce several sentences clearly enough to be recognizable.

* * *

Radio Speech Over European Power Lines

ACCORDING to a recent note in the *Journal Télégraphique* (Berne, Switzerland) the principle of carrier-current telegraphy or "wired wireless" has been applied to communication by voice over power lines aggregating a length of 664 kilometers (413 miles) and with voltages ranging between 50,000 and 110,000 volts.

* * *

3,200 Radio Receivers in Denmark

A RECENT census of radio receivers in Denmark lists a total of 3,200. Nearly a fifth of these belong to students and as many more appear as in the hands of members of the engineering professions. Apparently radio has not yet spread to the Danish public, though regular broadcast concerts are available from the great Danish station at Lyngby as well as from the British, French and German stations.

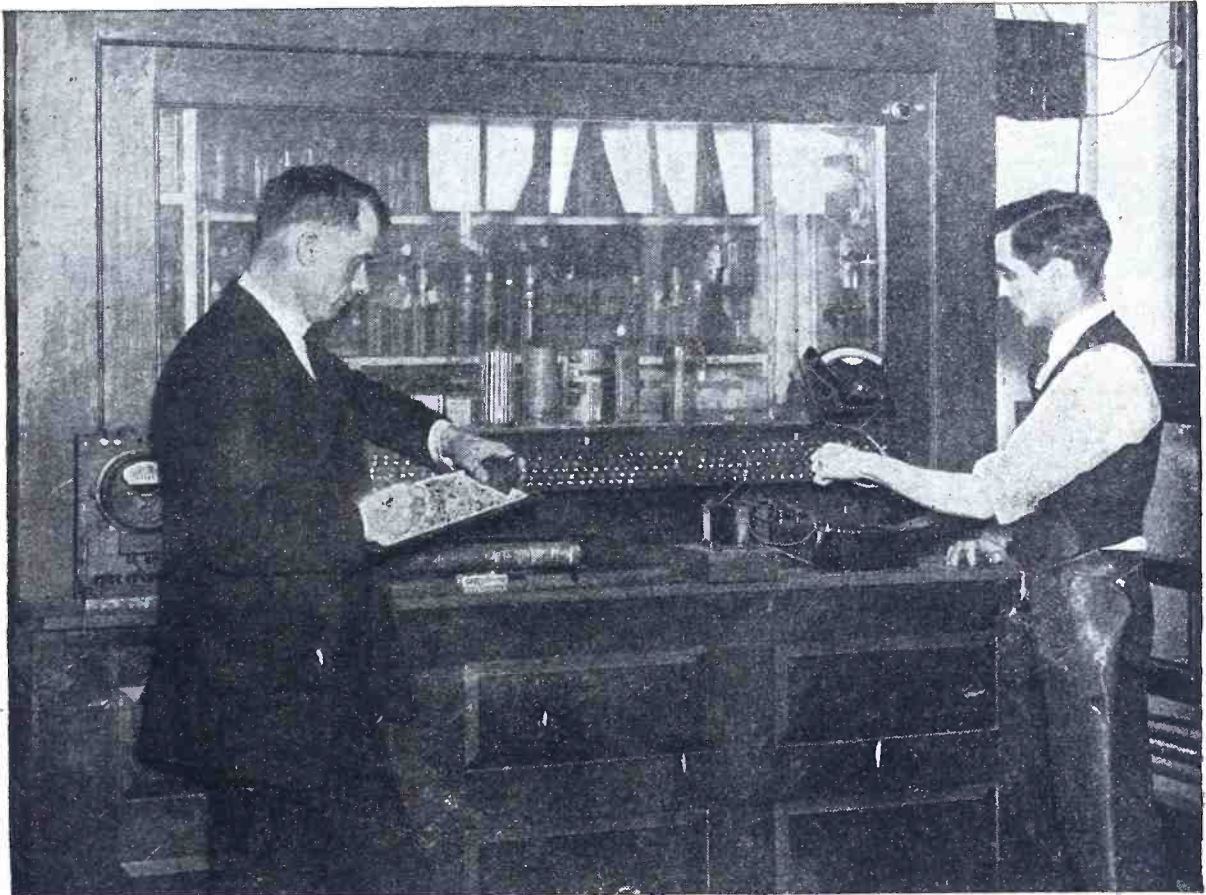

Atlantic and Pacific

HOW UNCLE SAM CHECKS UP ON RADIO BATTERIES

In this laboratory of the Bureau of Standards in Washington the commercial types of dry batteries for radio use are tested periodically for their voltage, amperage and hours of endurance under use. During the test the batteries are kept at constant temperature inside the glass-fronted case.

To Eliminate Interference

RADIO fans at Miami, Arizona, as well as at several other copper towns, have had much interference from the high-tension Cottrell apparatus used to collect dust and acid from the smoke of the smelters. The owners of the Miami installation, realizing the annoyance thus produced, have begun to rebuild the high-tension equipment so that as much of the static as possible will be grounded.

* * *

The Largest Hydro-electric Dynamo in the World

THERE has just been installed at Niagara Falls a new turbo-generator rated at 70,000 horsepower. This would be enough power to provide an amateur radio transmitter for every house in the United States.

* * *

Radio Supplants a Ship's Orchestra

THE steamship *Kroonland* of the International Mercantile Marine, now in passenger service between New York and California

through the Panama Canal, has been equipped with loudspeakers so that broadcast concerts from American stations can be received during the entire trip. During pleasant evenings in the tropic waters, dancing on deck is possible to strains that originate in Chicago or Washington or New York.

* * *

A New Name for Radio Listeners

A PRIZE offered by *Popular Wireless* (London) for the best name to replace the English designation "Listener-in" has been awarded to the word "cohearer." Perhaps this is a delicate suggestion that all listeners ought to stick together.

* * *

Airplane Saved by Radio

THE value of radio installations on all passenger airplanes was demonstrated once more by a recent incident in Paris. An airplane had already left the Paris flying field bound for Geneva, Switzerland, when word was received at Paris that a violent storm was raging in the Swiss mountains. The radio operator at Paris immediately called the airplane pilot and instructed him to return to Paris, which he did.

WHAT READERS ASK

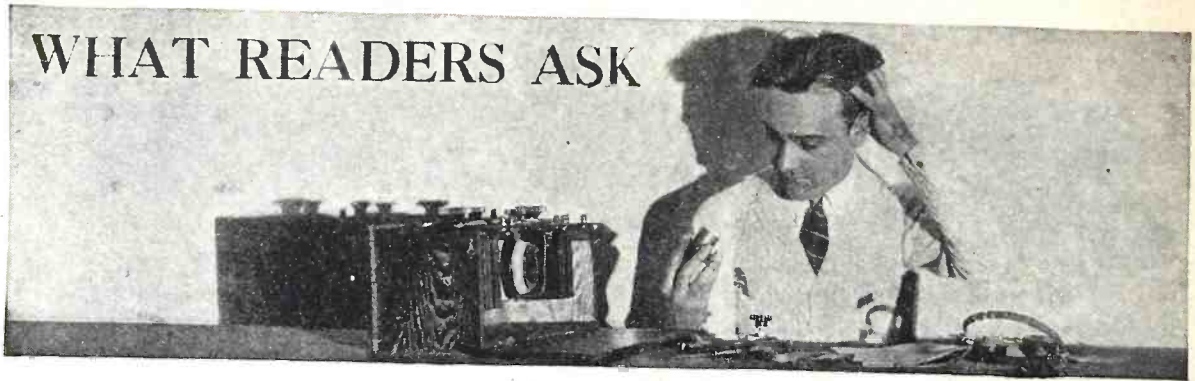

CONDUCTED BY LAURENCE M. COCKADAY

How to Use the Hartley Circuit for Reception

QUESTION: I would like to know if the Hartley circuit could be modified or arranged so that it could be used for reception? I am already using it for transmitting and I find that it reaches out so far that it makes me wonder what results could be obtained if its efficiency were to be the same for reception.

Can you give me a hook-up for such a receiver? I need just a single-tube circuit, as I have a separate two-stage, audio-frequency amplifier.

K. SMITH

ANSWER: The circuit you require is shown in Figure 1. This is not a special arrangement; it has been used considerably, and

should give you fine results for reception. The parts and instruments you will need are the following:

- L1—primary winding of coupler;
- L2—secondary winding of coupler;
- VC1—variable condenser, .0005 mfd.;
- VC2—variable condenser, .0005 mfd.;
- GL—grid-leak, variable;
- GC—mica fixed condenser, .00025 mfd.;
- R—filament rheostat, 6 ohms;
- Tel—telephones.

To make the coupler, wind (for the coil L1) 43 turns of No. 18 DSC wire on a composition tube $3\frac{1}{2}$ inches in diameter. This coil should be tapped at the 3rd, 7th, 13th, 21st, 31st and 43rd turn.

Right next to this, wind the secondary coil L2. This is composed of 70 turns of the same kind of wire tapped at the 10th, 20th, 30th, 50th, 55th, 60th, 65th and 70th turn, starting from the top and looking at the coil as in the diagram.

The two sets of four taps each are hooked up as shown, with the ground wire connected to the 50th turn on the secondary winding.

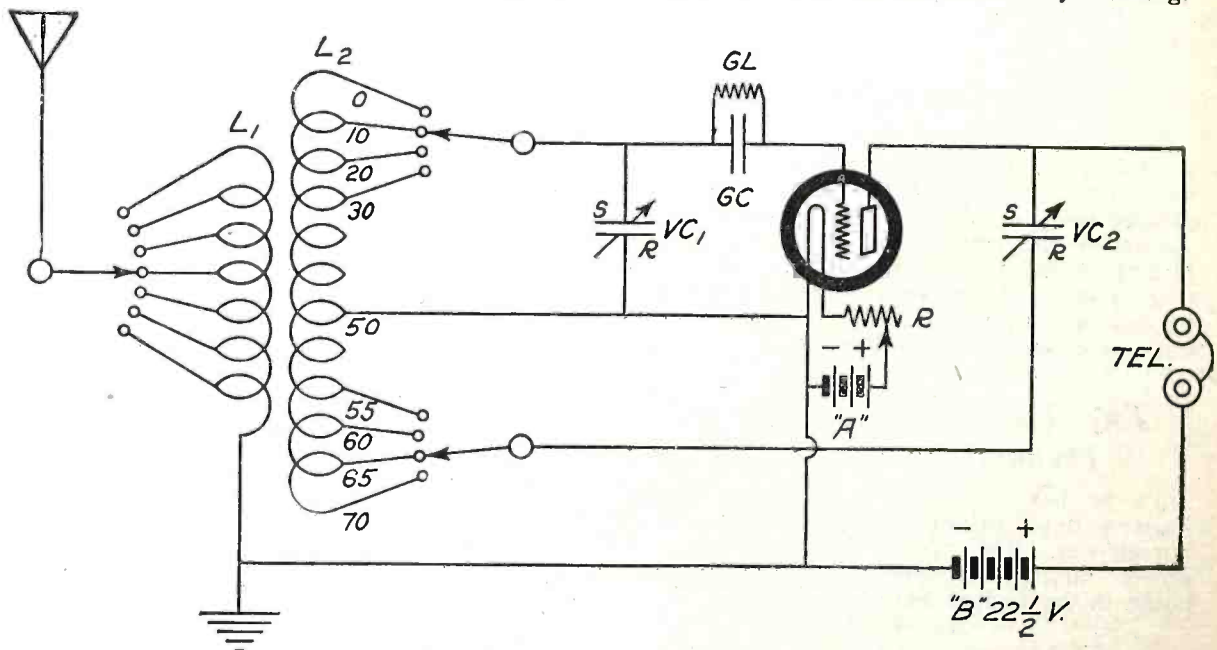

FIGURE 1: A simple one-tube regenerative circuit that gives good results for the DX fan. The circuit is a modification of the Hartley oscillator.

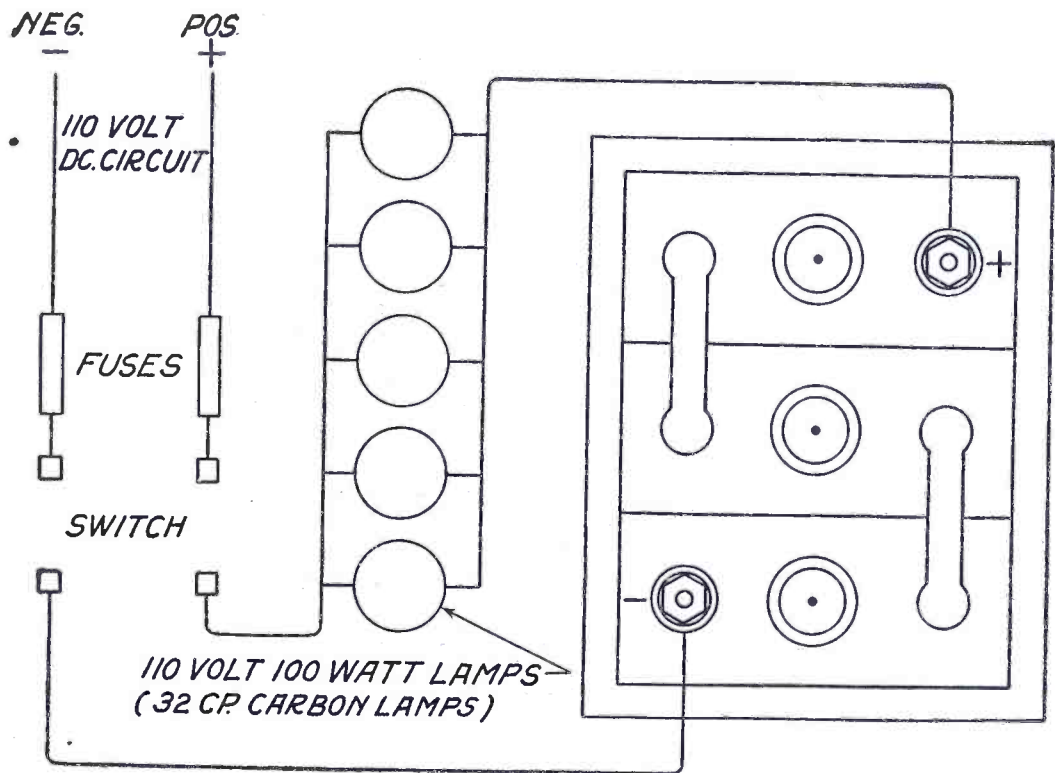

FIGURE 2: This diagram illustrates the connections that should be used with a 110-volt D.C. lighting circuit through a bank of lamps. Be sure that the positive terminal of the lighting main is connected to the positive terminal of your battery.

A Direct-current Battery Charger

QUESTION: I live in a vicinity where the lighting current is D.C., so that I am unable to use a regular battery charger. Will you please show me how to hook up some resistance lamps in series with the line so that it will be suitable for charging my battery? The battery is a 6-volt, 80 ampere-hour battery, and I have to take it to the garage about once in every three weeks for charging, and then I am out of commission for two or three days.

The lighting line that lights our house has a voltage of approximately 120 volts.
HARRY E. RODNEY

ANSWER: The wiring diagram of the lamps and the battery circuit for charging is shown in Figure 2. By throwing the switch you charge the battery. You may use five 100-watt carbon lamps in parallel for the resistance bank. The whole lamp bank is connected in series with the line and the battery.

How to Run the Antenna Wires

QUESTION: I am situated alongside of

a twenty-four-story building and I want to put up a radio receiving set. Would it be better for me to run a wire to the top of this building or out in some other direction? I have talked this over with some of my amateur friends and they seem to agree that it would work better if I keep it away from the tall building and run it to another lower building about 150 feet away across the courtyards.

I had always heard that it was better to get the antenna as high as possible.

So, I still think that the tall building would be the best to attach my wire to.

GEORGE H. MOORE

ANSWER: The single wire stretched across the court to the lower building would be our choice especially if the space directly underneath where the antenna wire would hang, were relatively clear of large objects.

The main objection to stretching a long vertical wire up the side of a tall building is that the building absorbs most of the antenna energy, and it never gets down to the receiving apparatus.

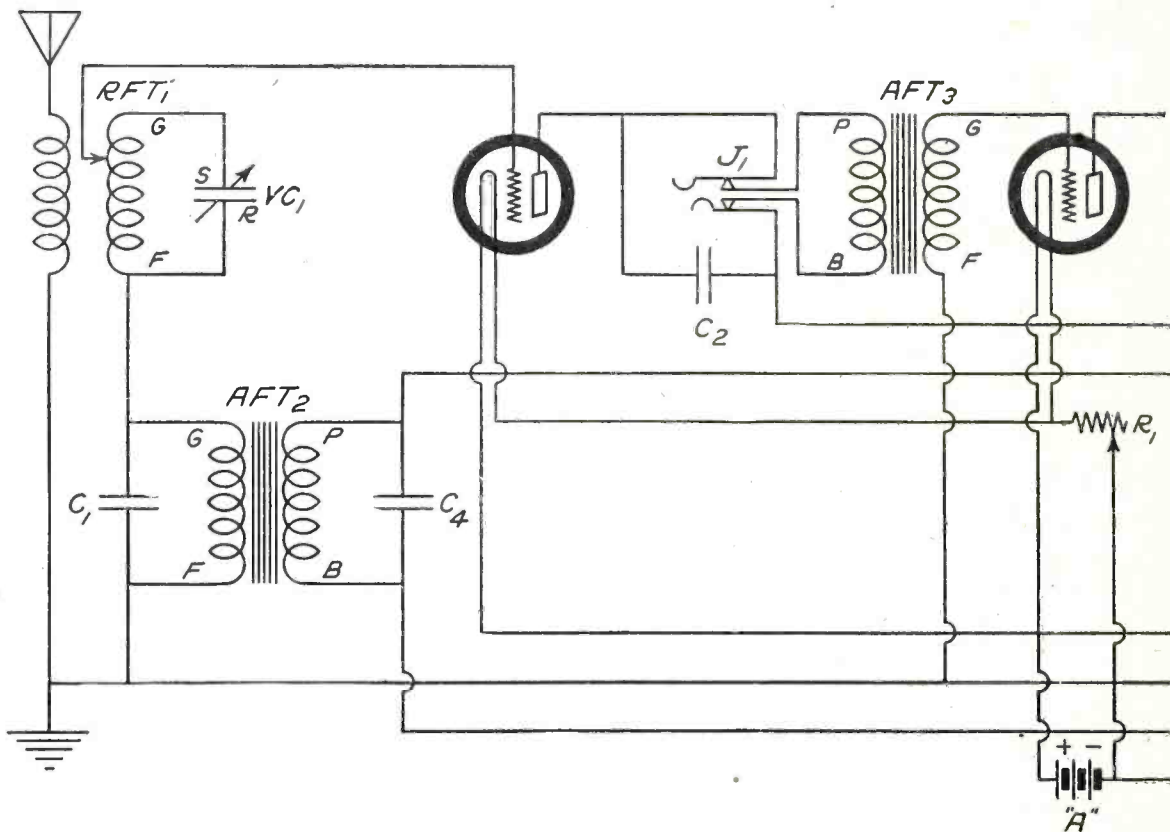

A New Reflex Circuit

QUESTION: Will you please let me know if there is any circuit that will allow me to use two stages of tuned-radio-frequency amplification, detector, and three stages of audio-frequency amplification, using vacuum tubes throughout?

I would like to use not more than five tubes if this is possible. Will you also give me the constants to use in the set and the parts that will be necessary to complete the set.

ALFRED JENNINGS

ANSWER: We recommend that you try the new reflex circuit that gives two stages of tuned-radio-frequency amplification, detector and three stages of audio-frequency amplification, with only four tubes.

We have drawn up the wiring diagram for this circuit in Figure 3.

The instruments and parts you will need for this hook-up are the following:

- RFT1—neutroformer;
- RFT2—neutroformer;
- RFT3—straight radio-frequency transformer;
- AFT1, AFT2 and AFT3—audio-frequency transformers;
- VC1 and VC2—variable condensers, .0005 mfd.;

- C1—mica fixed condenser, .0025 mfd.;
- C2—mica fixed condenser, .001 mfd.;
- C3—mica fixed condenser, .001 mfd.;
- C4—mica fixed condenser, .001 mfd.;
- C5—mica fixed condenser, .001 mfd.;
- R1 and R2—filament rheostats, 20 ohms;
- R3—filament rheostat, 6 ohm;
- GC—mica fixed condenser, .00025 mfd.;
- GL—grid-leak, 2 megohms;
- J1—telephone jack, double circuit;
- J2—telephone jack, single circuit.

The first two and the last tubes may be either C-301-a tubes or UV-201-a tubes and the third tube may be either a C-300 tube or a UV-200 tube.

What Set Should I Build?

QUESTION: Which set would you advise me to build. I don't want to go over 5 or 6 tubes, but I want to get clarity, volume, distance and simplicity of tuning *with* selectivity. Is this possible to date? I want to make the set myself. Which one of the descriptions in your magazine should I follow to most nearly satisfy all of the conditions that I have outlined above?

ROBERT ECKHARDT

ANSWER: We advise you to build the improved 4-circuit tuner described in the January, 1924, issue of POPULAR RADIO. This will give you the results you want to get.

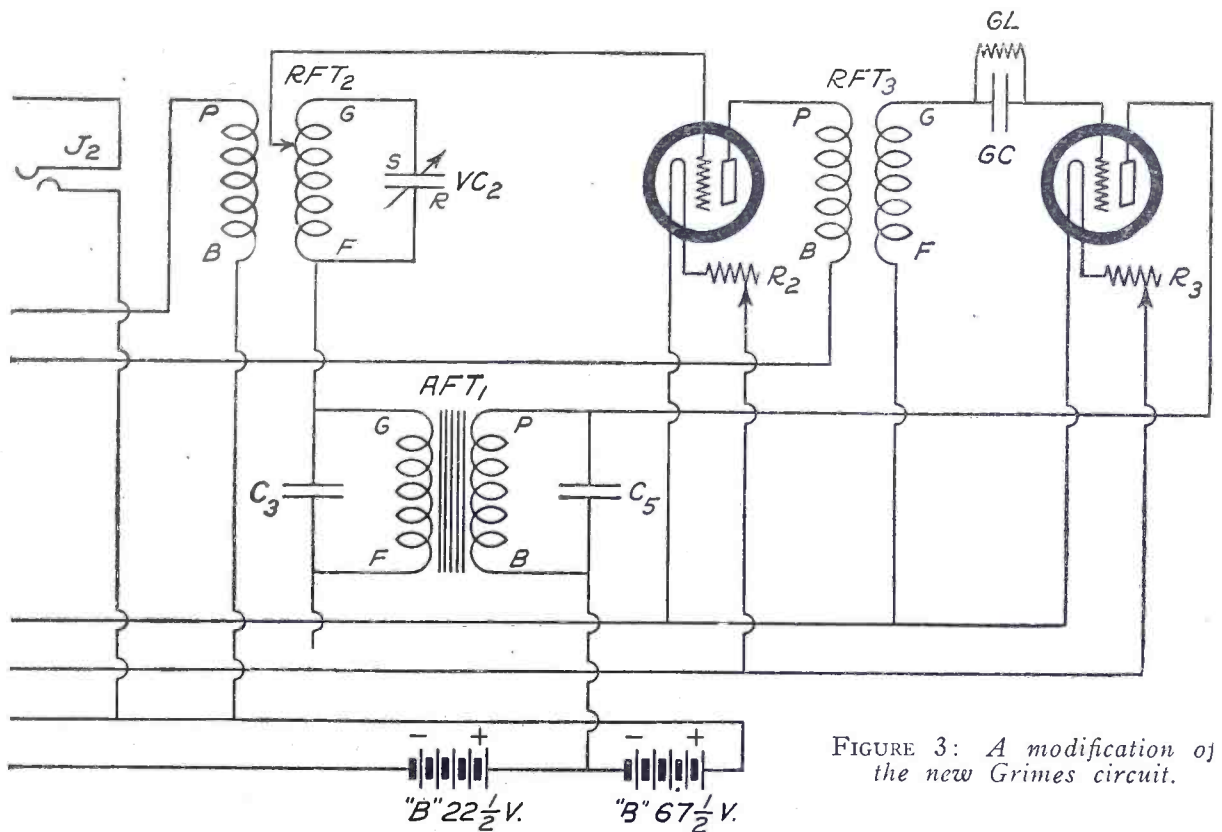

FIGURE 3: A modification of the new Grimes circuit.

Volume Control on a Power Amplifier

QUESTION: I have built the power amplifier described in the February issue of POPULAR RADIO, and I find that it allows me to get much better reception of distant signals on the loudspeaker, than I was able to get before on the headphones.

However, I find that the resistance control of volume does not allow me to cut down the signal strength of local signals sufficiently to make the music low enough for best enjoyment. Will you please tell me if there is any way to accomplish this by any other means?

JOS. ACKERMAN

ANSWER: You may make this control cover a greater range in volume by disconnecting the three resistances and the switch lever, and reconnecting them in the same manner across the two outside terminals of the secondary of the input push-and-pull transformer. This amounts to placing them across the secondary of the transformer instead of across the primary.

This change will allow you to reduce the strength of signal to a much lower value and will still give the same maximum on DX.

Where Can 50,000-ohm Resistances Be Obtained?

QUESTION: Can I use any other kind of resistances in place of the Lavite 48,000-ohm resistances? I find that it is next to impossible to get the Lavites in this part of the country. The dealers do not seem to have any knowledge of this accessory and are not sure what I ought to use instead of it.

K. F.

ANSWER: Any resistance unit of a value of approximately 50,000 ohms will be suitable for the volume control specified in the improved four-circuit tuner described in the January 1924 issue.

What is a Megohm?

QUESTION: What is meant by a 2-megohm grid-leak?

S. D.

ANSWER: A megohm is a unit of resistance. It is equal to one million (1,000,000) ohms. A 2-megohm grid-leak is a resistance of 2,000,000 ohms which is placed between the filament and the grid to allow excessive negative charges to leak off the grid so that the tube will not become inoperative.

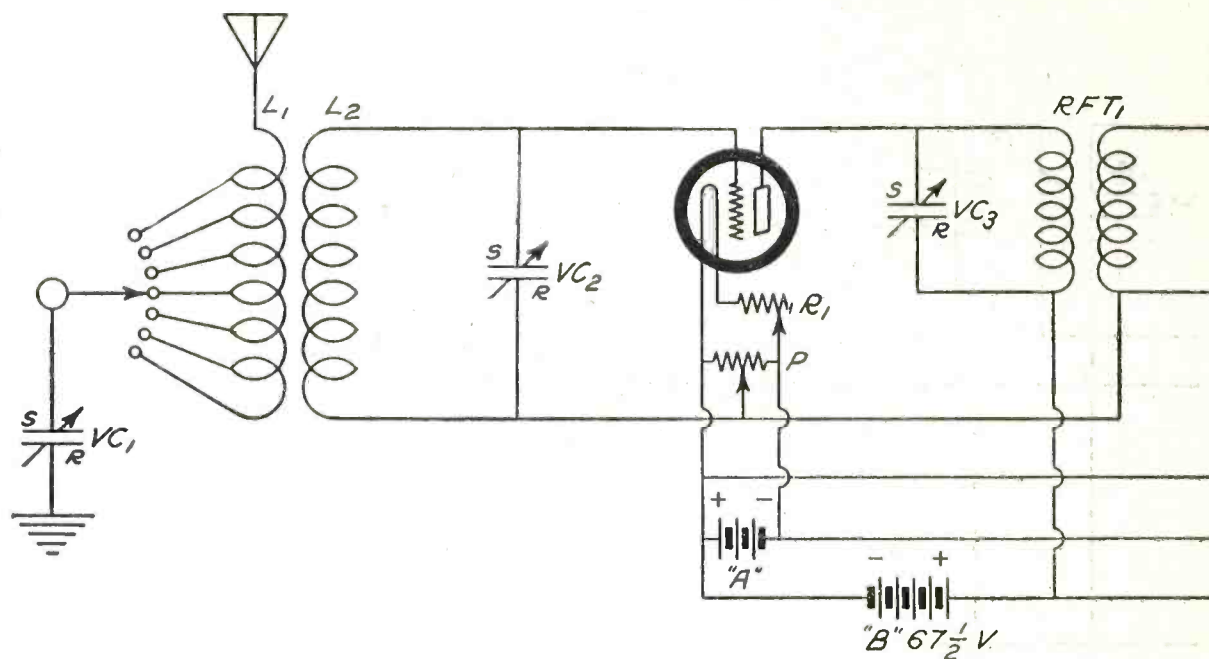

Radio-frequency Amplification with a Crystal

QUESTION: Please give me a diagram showing how to wire up two stages of radio-frequency amplification with a crystal detector. I have only two hard tubes and have been using them with the ordinary single-circuit regenerative tuner with one stage of audio-frequency amplification.

I am dissatisfied with the set, however, not because it could not reach out, but for two other reasons; it cannot tune sharply and I get a lot of interference. And also, as I have a number of other radio fans located in this same apartment house who are always complaining that my set "squeaks in their ears," I have determined to junk it and make another hook-up that will be good on distance but which will not re-radiate.

So, will you please help me out in my resolve and let me have a circuit that will give good distance on the headphones and yet will not require too much expensive apparatus. I haven't much to spend, that is why I started out with the single-circuit set; it was so reasonable in price.

CHAS. J. FINCH

ANSWER: You are doing a very wise thing and it will be to the benefit of all radio lis-

teners in your vicinity, as well as, eventually, to yourself.

The circuit diagram you require will give you splendid results on distance and will cause no re-radiation. You find it in Figure 4.

The parts required are the following:

- L1 and L2—primary and secondary coils of variocoupler;
- VC1—variable condenser, .001 mfd.;
- VC2, VC3, VC4, VC5, and VC6—variable condensers, .0005 mfd.;
- P—potentiometer, 400 ohms;
- R1 and R2—filament rheostats (to suit tubes used);
- C—mica fixed condenser, .0005 mfd.;
- Det—crystal detector;
- Tel—telephones;
- RFT1 and RFT2—two sets of two honeycomb coils mounted in double-coil mountings (four coils in all), two tube sockets.

This circuit met with great success in England in picking up American broadcasting during the tests of transoceanic reception that were held recently.

Cause of Fading

QUESTION: Why is it that stations from 200 to 300 miles away fade in and out regularly, and the same stations when heard from a greater distance do not fade to any extent.

I formerly lived in Clinton, Iowa, and experienced quite severe fading from the Chicago stations, while the eastern stations in Pittsburgh and Schenectady were exceptionally steady and regular.

I recently moved to New York and now I find that I get the Chicago sta-

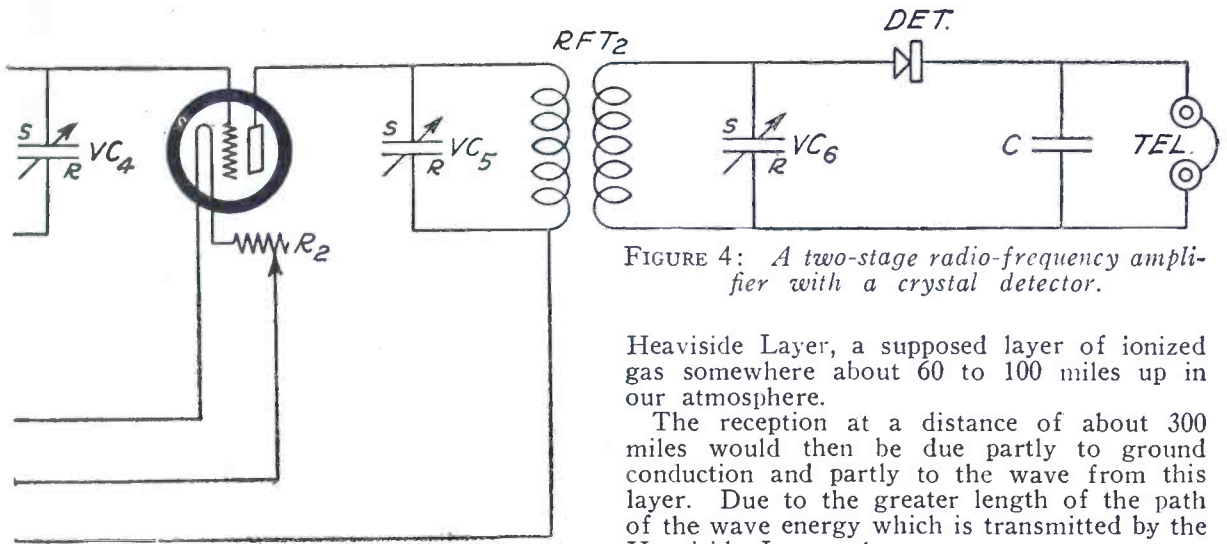

FIGURE 4: A two-stage radio-frequency amplifier with a crystal detector.

tions somewhat weaker but they are absolutely steady, whereas the stations of Pittsburgh and Schenectady seem to have become the worst "faders" that I now get.

This is not some particular freak of my location for I have asked other fans nearby and they tell me that KDKA and WGY always were the worst faders. Out in Clinton they are considered as the most regular and persistent stations in the east.

EDWARD AUSTIN

ANSWER: What you have recorded has been often brought to our attention before. It is a phenomenon which has only lately strengthened the theories of ground conduction of radio waves and the wave-carrying property of the Heaviside Layer.

These two theories have but lately been considered at loggerheads, some authorities claiming that one was correct and the other a fallacy and *vice-versa*.

The multitude of data on fading which have been collected through the aid of the broadcast listener have shed considerable light on the subject, and it seems to offer a substantiation of both theories.

By the new theory, which is a combination of the other two, the wave energy is conducted a short distance, say up to 500 miles, by ground conduction.

Local reception, then, would be due entirely to ground conduction. This may explain why local programs can be tuned in so readily by using a ground connection alone.

The reception from distant points is explained, under the new theory, as being largely due to passage of the radio wave along the

Heaviside Layer, a supposed layer of ionized gas somewhere about 60 to 100 miles up in our atmosphere.

The reception at a distance of about 300 miles would then be due partly to ground conduction and partly to the wave from this layer. Due to the greater length of the path of the wave energy which is transmitted by the Heaviside Layer, the two waves may not arrive at the same instant. Now, if the Heaviside Layer is at all irregular, the path of the wave along it may vary in length. This would shift the time interval of arrival of the wave. The arrival of the wave energy from ground conduction would be constant as far as time is concerned.

Now, the theory goes on to state, if the arrival of a particular impulse by both paths is synchronous, the two would be added together in the receiver and for a short period the signals would be loud.

But if the formation of the Heaviside Layer should shift, so that the energy of a particular impulse arrived out of phase with the ground impulse, the two impulses would be subtracted in the receiver and the remainder would be all that is left to actuate the set. The received signals would then be weaker. The changes of the Heaviside Layer, then, explain fading at short distances because of a phase displacement of the wave along the layer as compared with the ground wave.

At greater distances where ground conduction has little or no part in the transmission it would not matter much whether the signal was slightly shifted in time arrival, for nearly the total energy would be received from the Heaviside Layer. The frequency would be so great that the difference in time arrival could not be noted.

Of What Metal is Bus-bar Wire Made?

QUESTION: What size square wire should I get to wire up my set in the "bus-bar" fashion? What kind of metal is it made of? I have seen some of it and it is silver colored.

WALTER D. GREEN

ANSWER: The wire you refer to is tinned-copper bus-wire, $\frac{1}{8}$ -inch square.

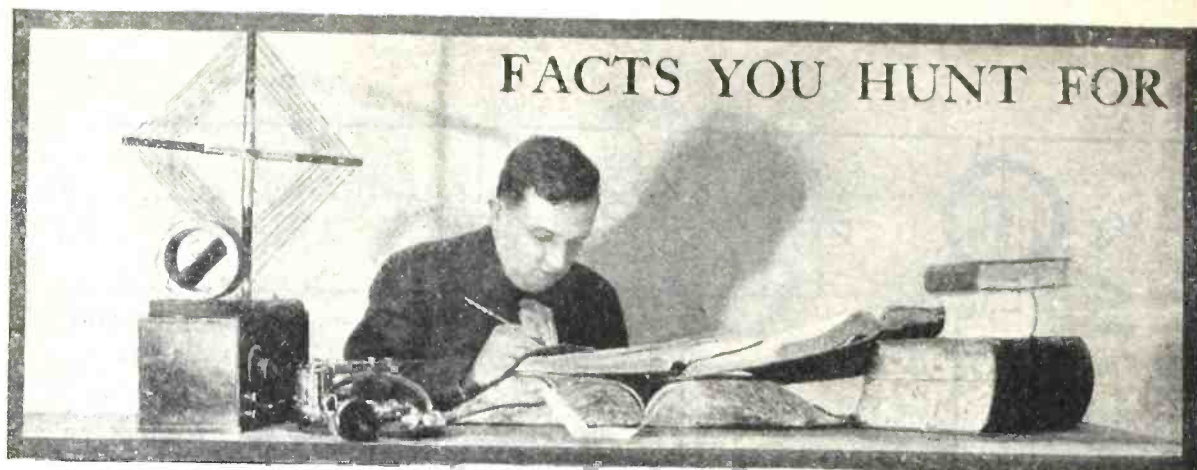

CONDUCTED BY RICHARD LORD

A limited number of questions of general scientific interest will be answered each month in this department. Readers are invited to send in questions that have puzzled them—but the selection of questions for answer cannot be guaranteed nor can questions outside the radio field be answered by mail.

Why are radio signals fainter just at sunrise and sunset than at other times?

THE only answer we can give is, that nobody really knows. This is still one of the many mysteries of radio. It is supposed to be related in some way to the fact that sunlight falling on the air improves its electrical conductivity so that the speed of radio waves is increased slightly. Just why this should affect transmission so greatly just at the beginning or end of the sunlight period we do not know.

What has happened when you "paralyze" a vacuum tube?

IN the normal operation of a vacuum tube the electrons from the filament accumulate to some extent on the grid, as well as on the plate. If the filament is burning very brightly, so that many electrons are being produced from it, the number of electrons hitting the grid may be so great that the grid wires acquire a considerable negative charge. This repels other electrons so that they cannot get through the grid to reach the plate. The tube stops working altogether. This is why a grid-leak is used. It lets the surplus electrons get away.

What are alpha, beta and gamma rays? Are they used in radio?

THEY are rays given out by radium and similar chemical elements the atoms of which are explosive. The names alpha, beta and gamma are merely the three first letters of the Greek alphabet. Alpha rays are really helium atoms shot out from the exploding atom of radium. Beta rays are electrons similarly shot out. Gamma rays are ether waves like X rays, but of shorter wavelength. None of these rays

are used directly in radio, though the use of beta rays as a source of electrons in vacuum tubes has been proposed.

In making an ink line on paper for a grid-leak or other high resistance, why is it necessary to use India ink instead of ordinary ink?

BECAUSE the India ink consists really of very fine particles of carbon suspended in the liquid. The carbon is, of course, a conductor and permits a little current to pass. Ordinary ink does not contain carbon. It is a solution, usually, of aniline dyes. A line drawn with such aniline ink has no conducting properties.

Why does storage-battery fluid stain things so easily?

THE fluid in the ordinary lead-plate storage battery is dilute sulphuric acid. If you get this fluid on your clothes or on any other dyed article the acid will usually decompose the dye and change its color. On wooden articles the acid decomposes the wood and sets free carbon, which blackens it.

What is meant by "super-conductivity"?

WHEN some metals are cooled to extremely low temperatures, as, for example, by dipping them into liquid hydrogen, their conductivity for electricity increases very greatly. For example, at about 445 degrees below zero (Fahrenheit) lead has practically no resistance at all to the passage of an electric current. This is what is called super-conductivity.

What is meant by "distortion" in a telephone or a loudspeaker?

ANY sound is really a vibration in the air or some other material and most sounds consist of a number of different vibrations going on at the same time. Each one of these vibrations has, of course, its own "frequency" or period of vibration. The human voice, for example, contains thousands of separate frequencies from the very low-pitched tones of the broad vowels to the very high pitches of such sounds as the hiss of the letter "S." A telephone (or other sound reproducer) is perfect only if it reproduces *all* of these thousands of frequencies. If any of the frequencies are suppressed or filtered out of the sound the emitted sound seems unnatural and is said to be "distorted."

What is the polarization of light? Is there any such thing in the case of radio waves also?

ORDINARY light consists of ether vibrations that move in every direction. If you think of the ether as having little particles in it, some of these particles would move up and down, some to the right and left, some in every possible direction in between. Polarized light differs from this. In it all the ether particles (if there were such things) would move in a single direction, say all of them up and down. Our eye cannot distinguish the difference between polarized and ordinary light, but there are various scientific instruments which can distinguish this difference easily. It is probable that something like polarization occurs in radio waves also, but it has not yet been detected.

Does the green color that forms on copper wires exposed to the weather decrease their electrical conductivity?

If a green discoloration forms on copper wire it means that the wire is becoming corroded. The green material is copper carbonate or oxychloride. There is probably some acid or sea salt in the air. In itself, the green coating does not greatly affect the electrical properties of a continuous copper wire. But if the wire is joined as, for example, the wiring of a radio set or the connections of an antenna, the presence of green corrosion is a danger signal. The corrosion may penetrate the joints and destroy the electrical contact between the joined wires.

Is it possible to repair a storage battery that has been damaged by being "sulphated"?

It is wiser, if possible, to return the battery to the maker for repairs, being careful, of course, to remove the acid before shipping the battery. If this is impossible, try the following procedure. First wash out the remaining acid with distilled water. Then add a

solution of caustic soda in distilled water (about 4 or 5 percent of the soda) and charge the battery slowly until the positive plate has a pronounced chocolate color. Then wash out the soda solution, add acid as usual, and go ahead as if the battery were new. But do not be much disappointed if this procedure fails to work.

Why is it necessary to place an antenna at right angles to electric power wires that happen to be near it?

STRICTLY speaking it is not *necessary* to do this. It will merely give you less interference from the power wires. All power wires act, really, as a sort of transmitting antenna. Radio waves go out from them constantly, just as they do from a station that is broadcasting. If your antenna is parallel to the wires the waves from them will be picked up strongly and may make a disagreeable hum in your set. If your antenna is at right angles to the wires the waves from them will be picked up much less strongly and will probably not bother you.

Why do crystals "wear out" after a few weeks use so that you can no longer find a sensitive spot on them?

No one knows for a certainty but it is probably because a thin film of dirt or grease accumulates on the surface of the crystal. It is known, for example, that touching the surface of the crystal with the finger may destroy its activity, doubtless because of the tiny smudge of grease which the finger leaves behind. It is known, also, that an occasional washing of a crystal with pure ether or pure alcohol will frequently improve its activity. Most kinds of crystals should *not* be washed with water.

I notice on tracing out the wiring of my set that the circuit which includes the antenna and the ground does not seem to communicate at all with the other circuit in the set. Nevertheless the electricity seems to pass into the rest of the set somehow, for it works all right. How can this be?

THIS often puzzles beginners in radio. The circuits are *not* connected by actual wire, as door-bell or electric-light circuits are. The connection is through the ether. The electric impulses in the antenna-ground circuit set up ether waves around the wires and coils of that circuit. These ether waves pass across to the wiring of the other circuit of your set and produce corresponding electric impulses in it. It is a good deal the same thing, on a much smaller scale, as the fact that ether waves sent out from the broadcasting station affect your set at a distance, the only connection between them being through the ether.

HINTS FOR

AMATEURS



CONDUCTED BY ALBERT G. CRAIG

When Your Batteries Run Dry

WHEN your dry batteries have run down so far as to be useless, unscrew the small nuts that are used to fasten the wires to the terminals, before throwing the batteries away. These nuts or thumb-screws often come in handy just when you are looking for a nut and cannot find one: sometimes you lose a binding-post top and one of these meet the emergency.

Also when your "B" batteries go dead, take off the Fahnestock clips, they will come in handy when you least expect it.

A Short Cut in Wiring

THERE is a new accessory, just recently brought out, which should help the experimenter considerably in making a neat and efficient wiring job in a receiving set. This is a new combination of connection wire and insulation which is similar to a wire over which has been slipped a piece of "spaghetti." To wire up a set with this sort of wire all that is necessary is to cut the wire (with the insulation already upon it), bend it into shape and solder the ends.

This eliminates many of the operations necessary in using ordinary bus-wire and the varnished-cambric tubing.

Why Try for DX Reception?

THE most fascinating part of radio, for a while, is the reaching out for distance, the "DX bug" it is called.

But, for real enjoyment, sitting back

in a comfortable chair and listening to a good local program, is the thing.

Where Haste Means Waste

DON'T get overenthusiastic, in laying out a new set, so that you rush some particular phase of the work or are tempted to put in some kind of make-shift part instead of waiting until you can obtain the correct one.

Go ahead thoroughly and build the set exactly as specified, carefully checking and rechecking your work and being sure of each step as you proceed. In this way you will be sure of success.

Beware of Power Lines!

DON'T run your antenna either over or under a power line. Either of them may break and fall across the other and cause you serious harm from electric shock, if you happen to be listening in at the time with the telephones on your ears. Keep the antenna wires well away from any power lines in your vicinity. This will also help you in obtaining clearer and louder reception.

Where the Whistling Comes From

DISCARD your single-circuit receiver and use one that will give you better tuning and greater sensitivity, to say nothing of elimination of re-radiation. The single-circuit receiver is the worst offender in producing those interfering whistles.

A First-aid Kit for Your Receiver

A "FIRST-AID" kit for radio is pictured on this page. It is in use at the operating room at station WEAJ. This is probably one of the reasons that this station is always on the job, with no serious "shutdowns."

The kit contains fuses of all descriptions and sizes, a screw-driver, pliers, wrenches, a circuit-testing outfit, etc.; all kept in a specific place.

The radio fan would not need exactly this kind of equipment but there is a helpful suggestion contained in the picture. It says: "If the fan would keep all his construction tools and materials on a kit-panel similar to the one shown, he would always know where to find his tools; they would always be accessible and in plain sight."

Most of the time spent in making a set, goes to looking for the tools: "Where is that screw-driver? Where did I put that drill? I can't find those 8-32 screws?"

Did you ever say anything similar to this?

A Tip on Antennas

AN outdoor antenna picks up many more times the energy than is picked up on an indoor antenna, a loop, or on a ground wire. Almost any kind of receiver will work on an outdoor antenna, several kinds of sets will operate on a short indoor antenna but few sets will work satisfactorily on a loop antenna.

A regenerative receiver sometimes works very satisfactorily on an indoor antenna or on the ground alone. It does not generally give the proper results on a loop.

A radio-frequency set will work on almost any kind of antenna if there are enough stages used and the same is true of the super-heterodyne.

For all general purposes an outdoor antenna is desirable, especially where

the reception of distant signals is a requisite.

Use the Tube That Is Specified

USE the tubes specified by the manufacturer or the designer of the receiver you are using. Don't expect to get as good results if you substitute some other kind of tubes.

Radio sets should be used with the proper tubes, just as automobiles should be used with the proper fuels and lubricants. You would not expect to get as good results with a gasoline car if you used kerosene in it. Of course, you might redesign the carburetor to take care of the change in fuel, and again, the radio set might be redesigned to work with another type of tube, but, do you *know* enough about the subject to do it?

This is the question you should ask yourself before you make any rash changes.

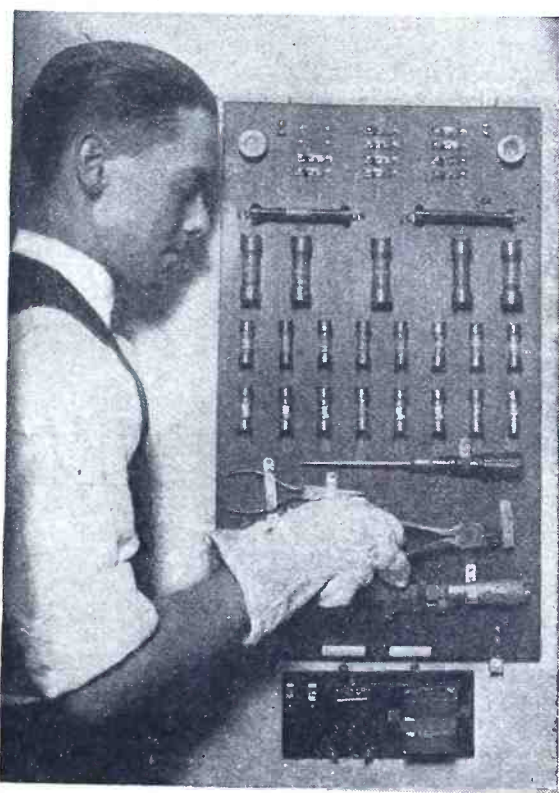

A first-aid panel that contains replacement fuses, screw-drivers, pliers and other necessary tools for repair work on a broadcasting transmitter.



IN THE WORLD'S LABORATORIES

CONDUCTED BY DR. E. E. FREE

Getting a Sample of the Heaviside Layer by Rocket

ONE of the most interesting things that happened at the last meeting of the American Association for the Advancement of Science was a suggestion that came out in the course of the discussion of Professor R. H. Goddard's plan for a rocket powerful enough to escape from the earth's attraction and go off alone into space; the suggestion is that a rocket of this sort might be used to get real information about the Heaviside Layer.

In the last number of *POPULAR RADIO* were mentioned the recent theories of Dr. Vegard and of Professor Lindemann concerning the composition of this Layer.* Dr. Vegard believes that it is composed of solid particles of frozen nitrogen, a kind of nitrogen dust. Professor Lindemann prefers the idea that the Layer consists mainly of ozone. Other scientists incline to helium or hydrogen as the probable constituents of these uppermost levels of our atmosphere.

The best way to settle this argument, so important to the theory of radio, would be to get a sample of the Heaviside Layer and analyze the sample. This has always been considered impossible. The Heaviside Layer is supposed to be at least 50 miles above the earth's surface; some estimates place it as high as 200 miles. No balloon or airplane could hope to get as high as this; the present record, even for the small instrument-carrying balloons used by the Weather Bureau, being about 20 miles.

But the Goddard rocket has no such limitation. When loaded with a high explosive like smokeless powder, the rocket may be made to attain almost any speed, even, Professor Goddard believes, the speed of about six miles a second which the astronomers calculate to be sufficient for a body to escape altogether from the earth's attraction and never return. Certainly a speed sufficient to reach an altitude of 100 or 200 miles offers no insurmountable difficulty.

* "Dust in the Earth's Attic," *POPULAR RADIO*, vol. 5, page 299 (March, 1924).

Public interest in this rocket scheme seems to have centered principally around the idea of sending a rocket to the moon. This would be spectacular but useless, as the rocket could not come back. We would never even know that it had arrived. How much more useful to send up a rocket to bring back the much-desired sample of the Heaviside Layer!

A rocket could be built, Professor Goddard claims, to carry recording apparatus that would give a continuous record of the air pressure, of the electrical constants of the air, of the degree of ionization, even of the amounts of radiation of different kinds received from the sun at each mile of elevation. There could be, also, an apparatus which would automatically seal in and bring down to us a sample of the material; nitrogen dust or ozone or helium gas or whatever it really is, that constitutes the atmosphere at the highest point reached.

A telescope trained on the rocket as it rose would give us the constants of its flight and enable the prediction of its probable place of return. A parachute would bring it down safely and some kind of automatic signal would announce its return and enable the waiting scientists to find it immediately and to recover for laboratory examination the precious freight of scientific records and samples that it would bring back to us. It might be possible, even, to have the rocket report by radio each second during its flight.

Professor Goddard is a scientist of distinction. His plans are said to have the approval of the American Association, of the Smithsonian Institution and of the National Research Council. The proposition is no cracked-brained scheme of a fanatic, but is a serious and practicable scientific project. It is said that the only difficulty is funds; the sum of \$5,000 has been mentioned. This seems small to stand in the way of so important a research but it must be remembered that scientific institutions are never rich.

Any radio fan who can afford to spend a few thousands for the benefit of radio science cannot do better than write to Clark University and get in touch with Professor Goddard.

Everything You Need to Know About Vacuum Tubes

THE vacuum tube has become of so much importance in all kinds of scientific investigations as well as in radio that the National Research Council arranged some time ago for the preparation of a treatise on the properties and uses of this extraordinarily useful new device. The result, from the pen of Mr. Robert W. King,* has now appeared as a separate publication, in advance of the complete manual contemplated by the Council and which is to include accounts of other research instruments and methods as well as of the vacuum tube.

The report is a comprehensive and clear summary of all the important properties and uses of vacuum tubes. The characteristics of tubes are discussed, with examples; as are also the use of the tubes as amplifiers, modulators and detectors; the construction and properties of vacuum-tube oscillator circuits, and a number of minor uses of tubes, such, for example, as their employment in safety devices for power

*"Thermionic Vacuum Tubes and Their Applications," by Robert W. King. *The Bell System Technical Journal*, vol. 2, pages 31-100 (Oct., 1923).

circuits and in the ionization manometer for the measurement of very small gas pressures.

The paper is itself a summary and is adequately condensed. It is useless, therefore, to attempt to summarize it further. Every radio engineer should own a copy of it, and both Mr. King and the National Research Council are to be congratulated on making it available to the radio public.

Does Bad Iron Inside the Earth Help to Cause Fading?

EVERY radio amateur knows that bad iron in the cores of his transformers will make trouble. If the magnetic properties of the cores are uneven or variable the transformers will not behave properly.

Possibly something of the same sort is going on inside the earth. The suggestion is made by Mr. F. Kiebitz, an engineer of the German Governmental Telegraph Service, in a recent article on the transmission of waves used for radio telegraphy.*

*"Propagation Phenomena and Disturbances of Reception in Spark Telegraphy," by F. Kiebitz, *Jahrbuch der drahtlosen Telegraphie und Telephonie* (Berlin), vol. 22, pages 196-203 (November, 1923).

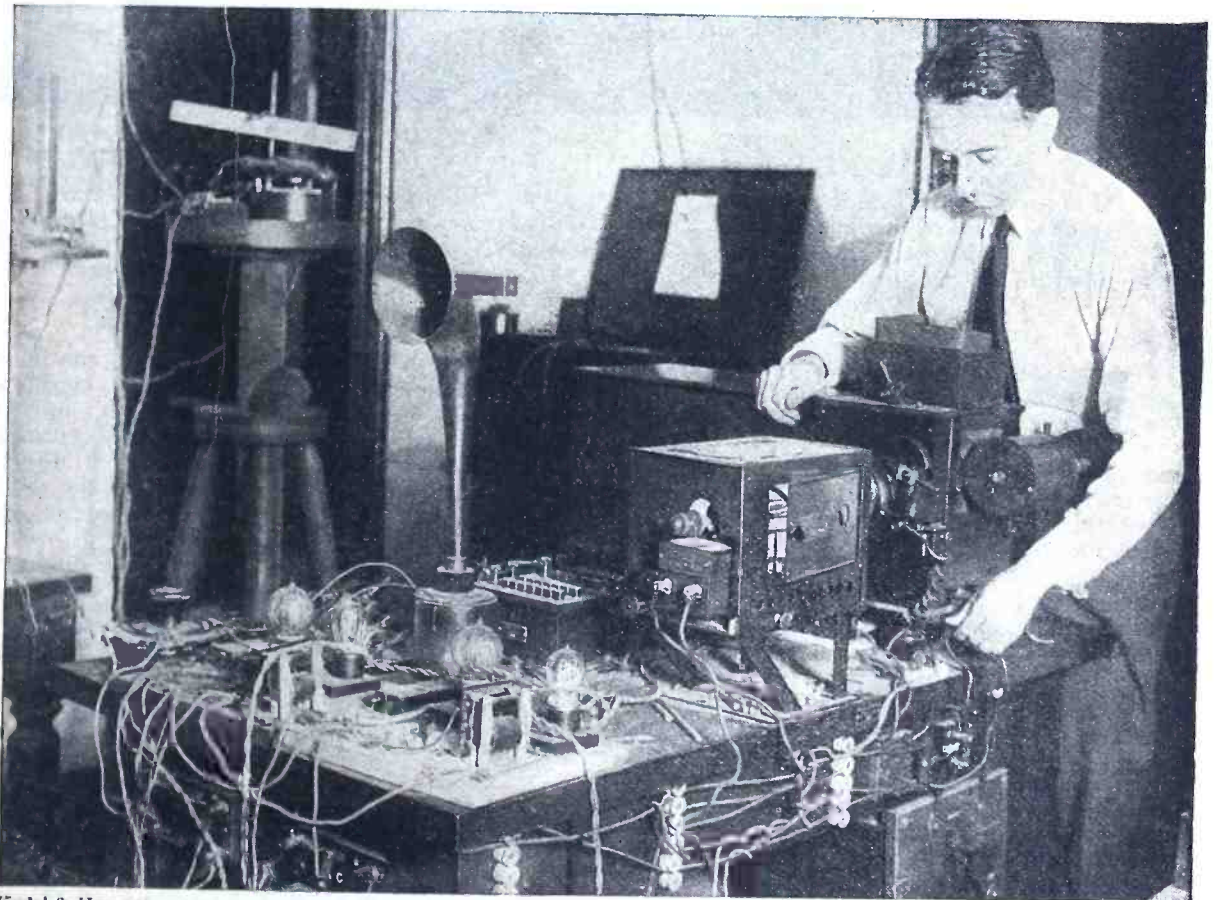

Kadel & Heroert

TAKING THE BERTILLON MEASUREMENTS OF A VACUUM TUBE
Each type of vacuum tube has its own special characteristics, as definitely its own as are the measurements of a criminal. To determine these characteristics the oscillograph is used; this instrument is here shown in operation in the hands of Mr. J. C. Aceves of Columbia University.

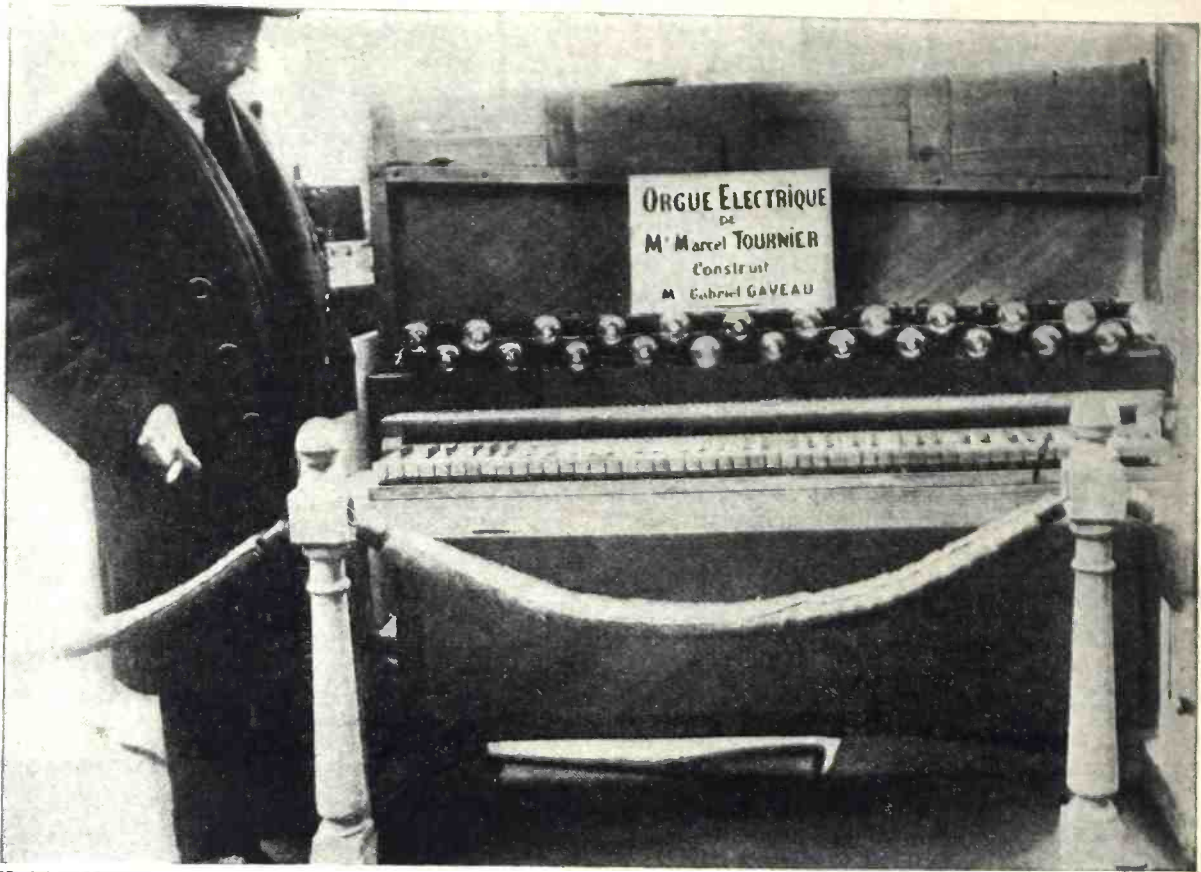

Kadel & Herbert

THE NEW ORGAN BUILT OF VACUUM TUBES

This novel musical instrument, exhibited recently at a radio exposition in Paris, produces music from vacuum tubes, after the manner described by Dr. Lee De Forest in POPULAR RADIO back in November, 1922. Each tube is tuned to give a definite musical note. The keyboard operates these tubes just as an organ keyboard operates the reeds or pipes of the organ.

It is known, says Mr. Kiebitz, that the earth has an iron core. Electric currents and electric charges exist in the atmosphere and in the part of the earth that we call the crust, which surrounds the iron core. We live on the surface of a globe that may be considered, from the electrical standpoint, as a vast iron-core transformer the core of which has been made, not of carefully selected iron as the cores of radio transformers are, but of any old iron that happened to be about. We do not even know what kind of iron it is.

From his own studies as well as from the numerous investigations of other engineers, Mr. Kiebitz concludes that many of the disturbances shown by long-distance radio waves must originate in some world-wide cause; presumably some disturbance in the atmosphere, in cosmic spaces outside the earth, or, he adds, in the earth's interior. This third possibility does not seem to have been considered sufficiently by radio engineers. It is known that many varieties of iron, when placed in a variable magnetic field, do not respond to the field in accordance with any simple law. Both the magnetization of the iron by the field and the reverse action of the iron in modifying the field are quite complicated.

"The earth possesses," Mr. Kiebitz continues, "a magnetic field which experiences continual changes. Masses of iron in the earth's interior or in the crust will suffer, therefore, continual alterations of their magnetism. We do not know much about the iron masses of the earth, but by a study of those electromagnetic disturbances which occur simultaneously over a large part of the earth's surface, we ought to be able to discover whether or not these disturbances may be due to magnetic reactions in, or from, the iron parts of the earth's interior."

Measuring Starlight with a Radio Amplifier

THE latest achievement of General Ferrié, the distinguished head of the Communication Service of the French Army, in his experiments on the scientific uses of radio is the measurement of the light that comes to us from a single star.* Faint as is this tiny ray it will

*"The Amplification of the Current from Photoelectric Cells and Its Applications," by G. Ferrié, R. Jouaust and R. Mesny. *Comptes Rendus de la Académie des Sciences (Paris)*, vol. 177, pages 847-849 (Nov. 5, 1923).

affect very feebly the emission of electrons from a tiny plate of metallic potassium in a vacuum. Such a plate constitutes the most delicate kind of photo-electric cell. When the ray of star-light enters such a cell it causes a tiny electric current.

General Ferrié's apparatus for the amplification of this feeble current involves a special design of vacuum tube the grid of which has a very low capacity, and also an arrangement by which a rotating split-disk alternately cuts off and lets through the light from the star. These interruptions of the light produce an audio-frequency note in the photo-electric cell circuit. The impulses are then fed into a train consisting of an audio-frequency transformer, three amplifier tubes, a modulator tube and a final amplifier tube. The result is an amplification (in terms of energy) of more than a million times.

A Gas Flame as an Amplifier

THE fact that flames contain free electrons is well known to all radio experimenters. According to the familiar story, it was this fact that led De Forest to the invention of the three-element vacuum tube.

The fact has now been applied by Dr. E. V. Appleton to the construction of an amplifier which is novel and which will appeal to many amateurs whose minds have an experimental twist.* The usual three electrodes of a vacuum tube are inserted in the flame of a gas burner of the type used by chemists and called a Bunsen burner.

The electrode corresponding to the plate is

* "A Novel Amplifier," by E. V. Appleton, *Popular Wireless*, vol. 4, page 559 (December 8, 1923).

a straight wire of platinum or other refractory metal inserted in the lower part of the flame. The filament electrode is another wire, the tip of which is bent vertically upward. The grid is a small wire spiral surrounding the filament electrode. A little sealing wax applied to the tip of the filament wire and allowed to burn off increases the number of electrons in the flame and betters the operation of the device.

This arrangement behaves, says Dr. Appleton, much as does an ordinary amplifying tube except that the electrons in the flame are fewer and accordingly the maximum filament-to-plate current is less. The number of electrons can be increased, however, by feeding certain materials, for example sodium, into the flame. The device is not a present rival of the vacuum tube but experimentation with it has interesting possibilities.

Will We Have the Radio Phonograph?

A POSSIBLE new application of radio has been suggested by a French radio engineer, Mr. E. Pepinster, in the form of a revival of the well-known but commercially unsuccessful invention of the telegraphone.* This instrument, invented years ago by the famous Danish engineer Poulsen, was a device for recording speech or other sounds by means of a magnetic record made on a wire of steel or iron running between two spools. It proved in practice to be less satisfactory than the familiar mechanical phonographs in which the record of the sound is made in the form of minute indentations in

* "The Phonograph of the Future," by E. Pepinster, *Radio-Électricité* (Paris), vol. 4, pages 475-476 (Nov. 1, 1923).

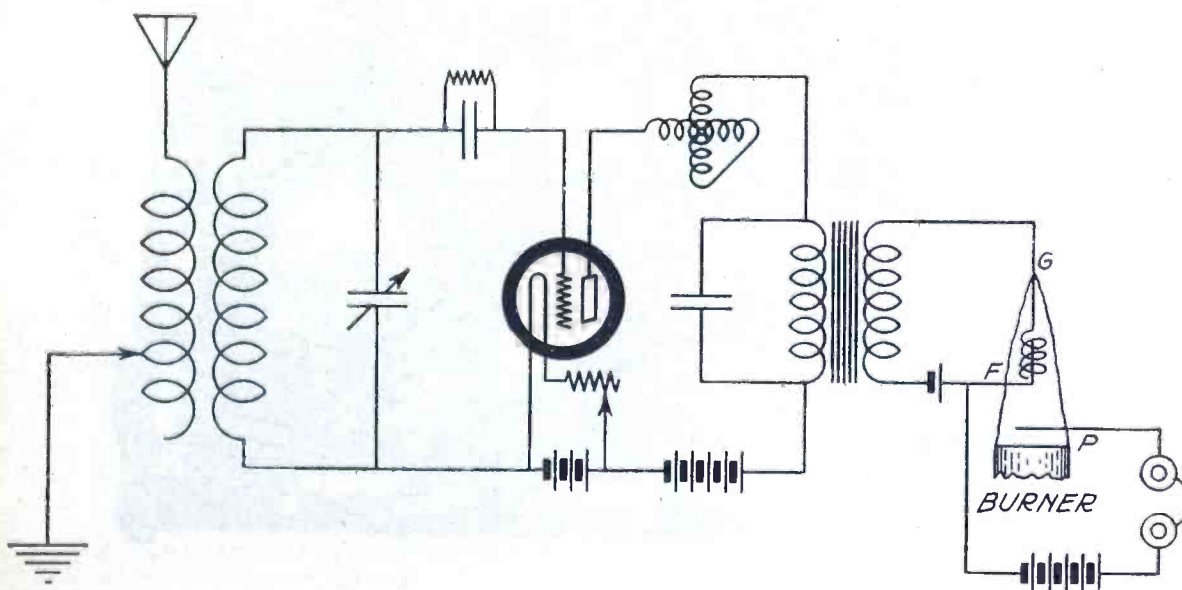

THE HOOK-UP FOR THE GAS-FLAME AMPLIFIER

This shows how the flame of a Bunsen burner may be connected to a standard radio circuit. The flame is shown at the right. The platinum spiral G operates as the grid. The bent wire F is the filament and the straight wire P takes the place of the plate.

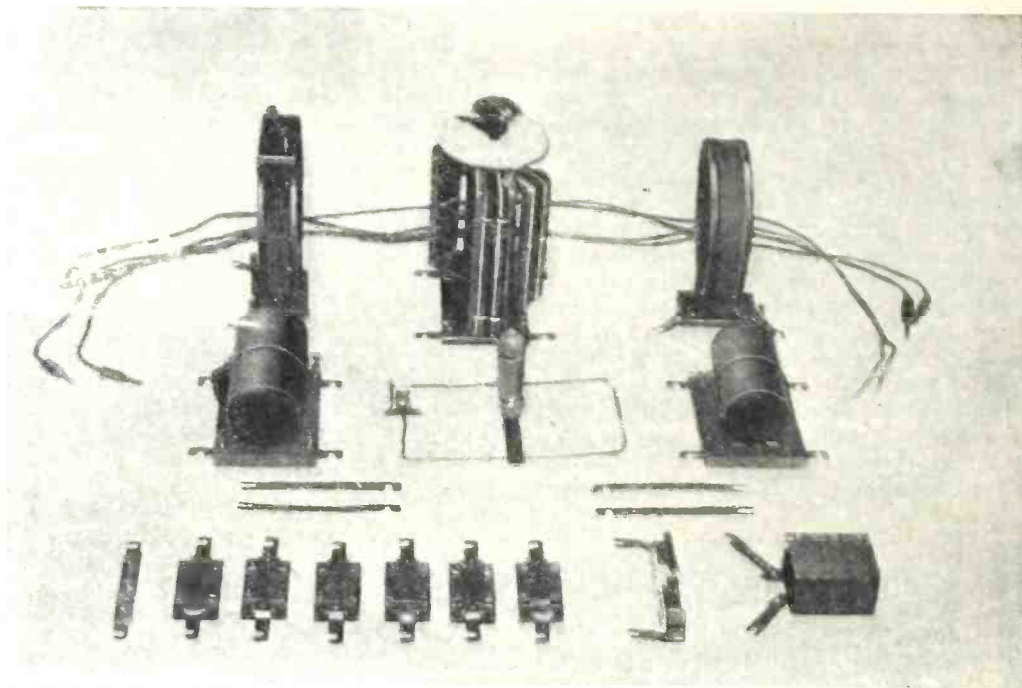

Der Radio Amateur, Berlin

A GERMAN DESIGN FOR A UNIVERSAL RADIO TESTING BOARD

These coils, variometer, transformers and condensers are equipped with metal lugs that fit the gaps between binding posts on the board shown below. It is easy to hook these lugs under the posts and thus insert into the circuits on the board whatever coil or other instrument you want to use.

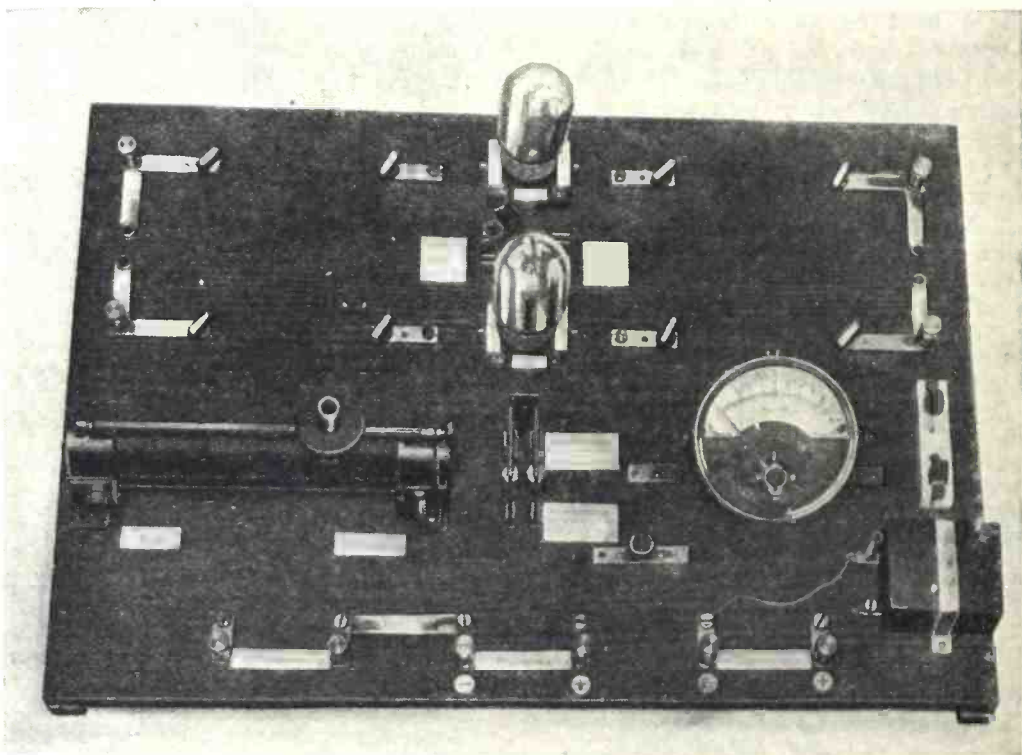

Der Radio Amateur, Berlin

THE FIXED PART OF THE GERMAN TESTING BOARD

The two tube sockets, the sliding resistance and the milli-ammeter are fixed permanently to the board, together with the binding posts for attachment of the interchangeable instruments shown above. The binding posts at the bottom of the board are for the attachment of the battery leads.

the bottom of a groove on a disk or cylinder.

When the telegraphone was new and on trial there was no such thing as a vacuum-tube amplifier. If there had been, says Mr. Pepinster, the Poulsen device might have proved more successful than it did. He suggests that the telegraphone principle, combined with modern amplifiers both for recording and for reproducing, deserves a new trial.

That American inventors are working along a somewhat similar line is evidenced by the patents of Carlson and Hanson noted in the "With the Inventors" Department in POPULAR RADIO for March. But these patents do not contemplate, apparently, the use of the telegraphone as a substitute for the phonograph. That is just what Mr. Pepinster does contemplate. It may be, he thinks, that the helping hand of radio will enable this old invention to do just what its inventor hoped, that is to displace the disk phonograph from popular favor.

Catching Salt Molecules with a Vacuum Tube

THE vacuum tube is invading the chemical laboratory. Scientists at the Worcester Polytechnic Institute had need recently of a very delicate method for measuring the exact amount of common salt in very weak solutions, solutions containing only about one part of salt in some 40,000 parts of the solution. The ordinary chemical methods were not sufficiently precise for this. The molecules were too few to be caught.

It occurred to someone to use a vacuum-tube amplifier. It was tried. It worked, and added to the resources of the analytical chemist one of the most accurate and delicate tools yet discovered in this field.* The tube is used to amplify and thus to indicate on a galvanometer the very slight change of electro-chemical condition in the solution that occurs as the small trace of salt in it combines with a known solution of silver chloride added drop by drop.

It is predicted that this way of following the progress of a chemical reaction is likely to prove useful in many chemical processes, not only in laboratory work but in the larger-scale operations of chemical plants. The wonder-working tube will soon be, we predict, as common in industry as the thermometer and the pressure gauge are now.

A Universal Radio Set for Trying Out New Hook-ups

So many new circuits and modifications of old circuits are proposed each month that the experimenter who wishes to try all of them finds it increasingly convenient to provide himself with a universal receiver mounting that can

be re-connected quickly and easily to fit almost any possible combination of circuits.

One mounting of this kind that seems more convenient than most is described in a recent article by Paul Oard*. It consists of one variocoupler, two variometers, two variable condensers, one three-honeycomb-coil mounting, three tube sockets, one potentiometer, one rheostat and one unit consisting of a detector and two stages of audio-frequency amplification. All these instruments are mounted firmly on a base-board, sufficient space being left between the instruments to permit wires to be run from one to the other in any desired way. There is sufficient space, also, to permit the insertion of fixed condensers, grid-leaks, and other small accessories, wherever desired.

To test out a new circuit with this board all that is necessary is to run bus-wire or flexible connectors between the proper terminals. There is no need to hunt up apparatus, figure out how to place it and then mount it on a panel, only to tear it all down again as soon as the test has been made.

While other experimenters may desire to add additional instruments to the ones used by Mr. Oard, or to modify his selection in other ways, the general idea of a universal test board flexible enough to permit the quick and convenient assembly of almost any radio circuit is one that will appeal to every amateur who likes to try out things for himself.

Broadcasting Lengthens Its Ear

THE ear of the broadcasting station is its microphone. The transmitter can send out only what the microphone can hear. That is why so large a proportion of the programs that are broadcast originate right in the studio of the station, where "mike" is most perfectly at home.

But there has arisen, more and more, a demand for a microphone that can leave home occasionally and go off on short notice to any theatre or concert hall or church where some material worth broadcasting is to be picked up. This demand has now been met by the portable radio-relay equipment devised and used at station WGY at Schenectady, New York. A small portable transmitter has been mounted on an automobile. This can be sent anywhere quickly and the microphone attached to it can pick up any available material. Then, the portable transmitter sends this material, on a short wavelength, the necessary two or three miles to the main station of WGY. There it is picked up by a receiver, translated to the regular WGY wavelength and re-broadcast to the station's listeners.

The advantages of this system are that it does away with the necessity of telephone wires between the broadcasting station and the outside locations of its microphones. Such wires are not always to be had conveniently and they introduce, also, some well-known electrical

*D. F. Calhane and R. E. Cushing, "An Application of the Vacuum Tube to Chemistry," *Industrial and Engineering Chemistry*, Vol. 15, pages 1118-1120 (November, 1923).

*"A Radio-circuit Testing Board," by Paul Oard, *Radio* (San Francisco), vol. 6, page 18 (January, 1924).

troubles in the way of distortion. Eighteen months ago when POPULAR RADIO arranged the first broadcasting of the Lewisohn Stadium Concerts in New York one of the chief difficulties was that of obtaining a satisfactory telephone line from the Stadium in upper New York City to station WJZ, then located in Newark, New Jersey.

The new system does away with all this wire trouble and we may be sure that it will spread. Indeed a similar experiment is reported in London, where programs from the Old Vic Theatre are now being sent by a short-wave transmitter installed at the theatre to a receiver at 2LO, from which station they are re-broadcast to the country.

Pulling Electrons Out of Metal with 200,000 Volts

THE escape of electrons from a heated filament, which constitutes the source of electrons in all vacuum-tube devices, is something which ought to take place, in some degree, even at lower temperatures. The heating of the filament merely facilitates the escape of the electrons.

This idea has been confirmed by experiments by Dr. R. A. Millikan (the man who first isolated the electron) and Mr. C. F. Eyring, at

the California Institute of Technology.* By exposing ordinary metal surfaces to electric fields as high as 200,000 volts they found it possible to pull a measurable number of electrons out of the cold metal.

It would be possible, no doubt, to construct a radio detector that would operate thus without a heated filament, using a plate-to-filament potential of 200,000 volts or more. The practical difficulties of such high voltages would far outweigh, of course, the advantage of dispensing with the hot filament, but the experiment is interesting because it confirms the idea that electrons *can* escape from filaments even in the cold. As the scientists come to understand more and more completely the way in which the electrons are held in metals and discharged from them there is promise, we believe, of securing cold filaments which will operate at voltages within the practicable range.

The Mysterious Effects of Light on Crystals

A NOTE in POPULAR RADIO several months ago mentioned the fact that strong light, especially sunlight, alters the behavior of crystal

*A paper before the American Physical Society, September 8, 1923; abstracted in the *Physical Review*, vol. 22, page 525 (November, 1923).

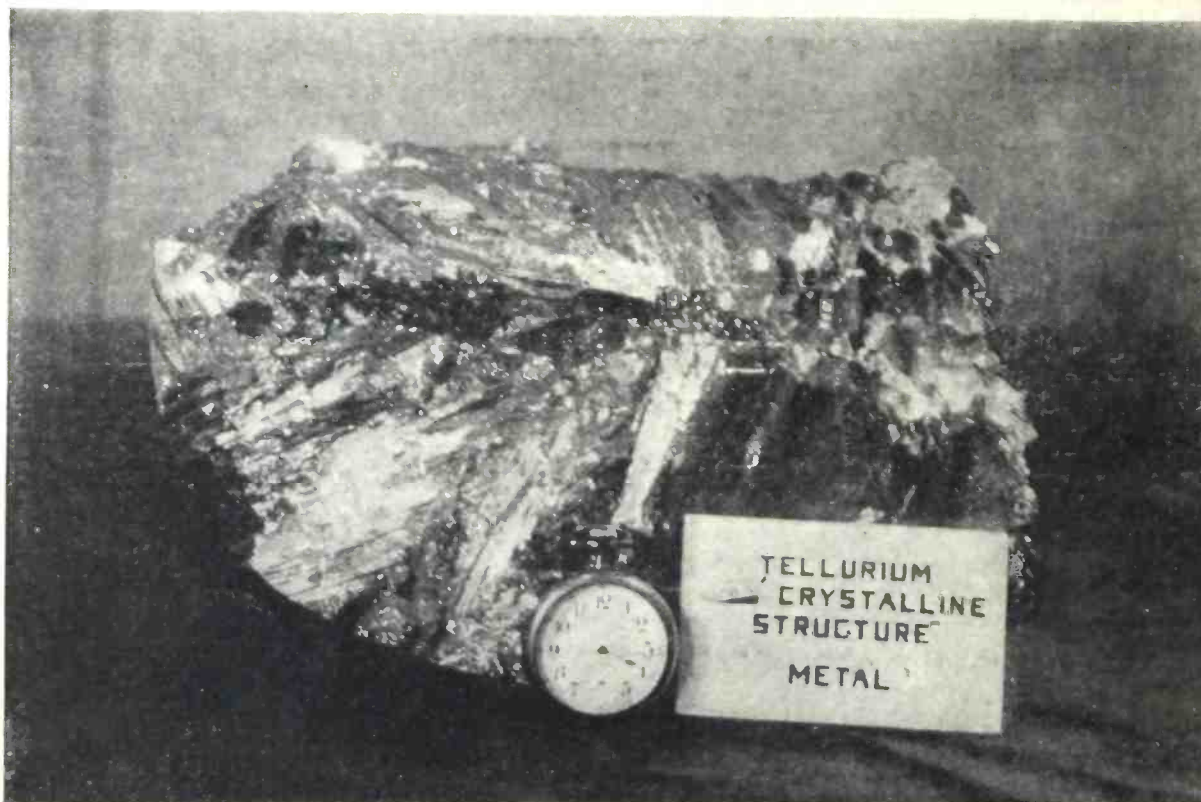

From a photograph made for POPULAR RADIO

THERE ARE MORE ELECTRONS IN THIS CRYSTAL THAN THERE ARE BRICKS IN NEW YORK CITY

When we know how all these electrons move about inside such crystals we may be able to solve the many mysteries in the behavior of tellurium as well as of the other substances used for radio crystals.

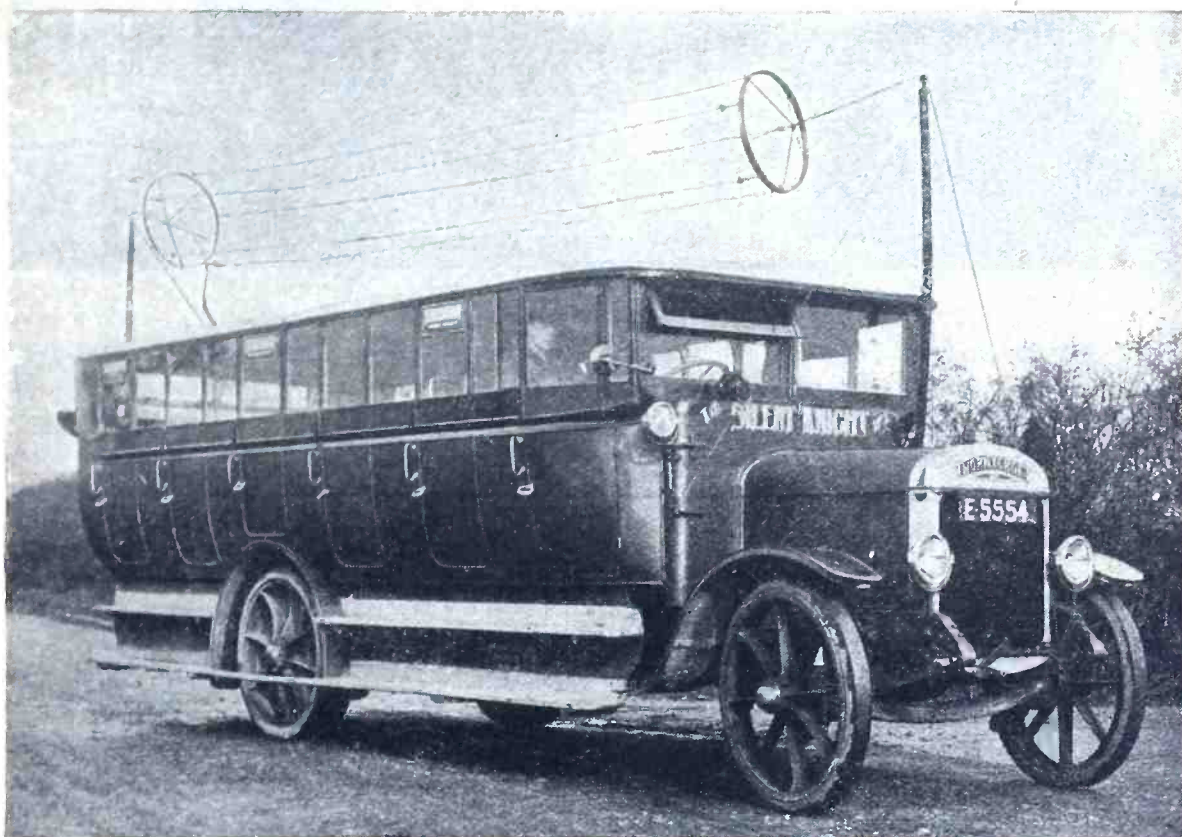

John I. Thornycroft & Co., Ltd., London

AN UNUSUAL ANTENNA FOR AUTOMOBILE RADIO

This motor omnibus, recently constructed in England, makes use of a cage antenna which is said to give more reliable reception than the single-wire or loop antennas that are commoner in the United States. Busses like this did good service in England during the recent railway strike.

detectors whenever the light is focussed on the surface of the crystal during the reception of signals.* The cause of this curious fact is entirely unknown, as are so many other causes that underlie the operation of our familiar combination of a galena fragment and cat-whisker.

Now comes Mr. Paul H. Geiger, of the Physics Department of the University of Michigan, with still another effect of light on the electric properties of crystals; another mystery for the crystal theorist to puzzle over.†

It has been known for some time that the electrical conductivity of a crystal was altered (under some conditions) whenever a strong light is allowed to fall on the crystal. Mr. Geiger set out to investigate this effect with crystals of the mineral argentite, which is a sulphide of silver analogous to galena, the latter being the corresponding sulphide of lead.

Mr. Geiger found, as he expected, that the conductivity of the argentite crystals was affected by light. But he found something else; something entirely new and unexpected. This was the production, inside the illuminated crystal, of an actual electromotive force. In

some manner the crystal, or something in it, acts to convert a part of the energy of the light into electricity, just as a dynamo converts mechanical power into electricity. With a light of 600 candle power at a distance of 1 meter from the crystal the electromotive force produced was as much as .013 volt.

It is improbable, of course, that an effect so small as this (in volts) can ever be employed for the useful conversion of light energy into electric energy. That is not its promise of importance. The real promise lies in the chance of better insight into what really goes on electrically inside a crystal.

All of these electric and photo-electric properties of crystals—the light-detecting property of selenium, the emission of electrons when light falls on a metallic surface, the pressure effects which are responsible for the “talking crystals,” even the familiar but mysterious behavior of the crystal as a radio detector—all these are related, we cannot doubt, to the properties of the electrons in the crystal.

It is these electrons which are sensitive, in some way, to the ether waves, both to the ether waves of radio and to the much shorter waves of light.

No field in all physics offers a greater promise of important discoveries, both in theory and in commercial practice, than does this one.

* POPULAR RADIO for January, 1924, page 83.

† “Spectro-photoelectrical Effects in Argentite,” by Paul H. Geiger, *Physical Review*, vol. 22, pages 461-469 (November, 1923).



CONDUCTED BY KENDALL BANNING

HELP your neighbor. If you have discovered any little Kink that helps to eliminate trouble in your radio apparatus, or if while experimenting with the connections of your set you should run across some interesting phenomenon, or if you should discover some new hook-up that gives better results—send it to the "Listening In" page.

A Tip for Saving Your Vacuum Tubes

HERE is a practical hint from a fan in Sumner, Illinois, who reports that it is being observed to advantage by the listeners of his town:

Many radio users wire their sets so that a single battery switch cuts off both the loudspeaker field current and the tube filament current. When this switch is opened the filaments are left connected across the field terminals of the loudspeaker, and the discharge from this field throws a strong surge of current through the tubes—which is harmful. This is particularly harmful with the new low-filament-current tubes.

Look at your tubes when properly lighted, snap off your switch, and you will see that they flash up brightly for an instant. This is dangerous. You can avoid it by using separate switches to the loudspeaker field and to the filaments. The filament switch should be opened first.

—C. C. SCHUDER

Are Clouds a Source of Static?

THE recent discussion in POPULAR RADIO about the especial prevalence of static in the neighborhood of the mountains of Mexico brings this letter from a sea-going operator who thinks that the cloud banks over these hills may have something to do with it. He writes:

I am aboard a ship about 850 miles south of San Diego and am, therefore, in a position to give some dope about this problem. The static is a good deal stronger on the higher frequencies (600 meters) than it is around 15,000 meters. I do not know how to explain this. Of course, it is heaviest at night but it is fairly strong in the daytime also.

At this time of the year (winter) it is not

so objectionable as during the summer months. I was here in April and in October, and it was so strong during the latter period that the tubes on the receiver actually choked. At times small sparks could be seen jumping around on the antenna switch. The mountains on the Mexican coast are not exceptionally high, but neither are they exactly mole-hills. In some places they are visible sixty and seventy miles at sea.

As to the point that the locality is not especially afflicted with thunderstorms I beg to differ. Of course, these disturbances are not so prevalent during the winter months, and they are not encountered so much fifty miles off the coast. But on a summer's night the lightning can be seen playing continuously over the mountains, and you may be sure this works considerable havoc with the radio.

It seems to me that this static has some relation to the clouds that are common in the vicinity of the Mexican mountains. On a clear day a thick bank of cloud will be visible above their tops and in no other place. According to the theory of electrical discharges between clouds and from clouds to the earth, it seems that we are approaching the solution of the mystery.

If this is really the solution of the mystery the next thing to do is to invent something to disperse those clouds. How would it do to warm up the sides of those mountains with artificial heat? Has anyone a suggestion of how this might be accomplished?

—FRED ROSEBURY

How Mountains Affect Radio Reception

HERE is a radio operator who is an officer in the U. S. Navy; he has some ideas along the same lines as those of Mr. Rosebury, but he has observed the same relation between static and clouds in other parts of the world as well:

From personal observation I believe that I have a possible solution of the Mexican static problem. The static that becomes bothersome along in the middle of the afternoon, especially during the summer months in the temperate zones, is nearly always directional and comes from the direction of the coastal ranges. For ships off the east coast the direction is westward; off the west coast the direction is the eastward. This comes up in the middle of the afternoon and dies down about midnight or shortly before.

I have also observed, while off the coast of the Philippine Islands, that the same kind of static invariably became noticeable at approximately the same time when the sea breeze springs up in the middle of the afternoon. At the same time banner clouds appeared on the higher peaks of the coastal ranges.

For a number of months during 1917-18, I was an operator on a United States warship doing patrol duty just outside of Manila Bay and I took particular notice of these facts:

1. There usually was no static when there was no sea breeze.
2. The regular afternoon static did not occur until shortly after the sea breeze started to blow.
3. The direction of this static was always from the high peaks of the coastal range.

These facts will easily account for the afternoon and evening static that occurs regularly during the summer months. It is caused by the condensation of the moisture in the warm breeze when this breeze strikes the colder peaks. This forms a mist and a steady static discharge from the particles of moisture in the mist to the peaks and to the banner clouds in contact with them.

Another instance of the relation of winds to static is the Kona, a well-known wind in the Hawaiian Islands. This wind blows for several days at a time and causes static so strong that stations near the Islands can receive only with great difficulty while these Kona storms prevail.

—R. J. OSTRANDER



Kadel & Herbert

"THE CHEERFUL LUNGER" RECEIVES 42 STATIONS IN A DAY

Mr. H. R. Thompson, during the past six months of a serious illness, at Lake Placid, N. Y., has developed into an ardent radio fan, who has become known to the announcers of the principal broadcasting stations through his letters in which he signs himself "The Cheerful Lunger"; many of the replies that he receives, indeed, are addressed with that title! He spends his time collecting DX records, and claims that the mental encouragement resulting from his interest in radio has been largely responsible for his rapid improvement in health.

How to Cure the "Radio Ear"

A NEW affection of the ear is being reported by some radio fans, who sit for long periods at their receiving sets. It is called the "radio ear"; it is accompanied by noticeable pains in the auditory appendages even when not listening in. What it is and how to cure it is told as follows:

Sometimes the "radio ear" takes the form of sharp, shooting pains in the head near the ears; this causes fears of possible abscesses or other serious afflictions. Upon consultation, ear specialists usually say that the remedy is easy and fairly sure.

"You are a radio fan?" they ask. "You spend a good portion of your time with your headphones on?"

Upon receiving replies in the affirmative, the doctors say: "When you go home loosen up on your headphones; the spring is too tight and presses on some of the nerves of your ear." "Just like some forms of spectacles," they will tell you. "Your head set is undoubtedly causing the pains; relieve the excessive pressure and it will disappear."



International

A HANDFUL OF BROADCASTINGS

A crystal set in a tack barrel is one of the novelties that were exhibited at a recent radio show. The set was made by the young students of a public school.

One assurance is given of a benefit from radio head sets, however; youths of this generation are not so likely to have as protruding ears as some of their older brothers. All youngsters who sit for as much as three hours a day with their headphones clamped over their ears will grow up with close-fitting ears—at least so some experts believe. Mothers who formerly tied back their offspring's ears to prevent protruding will be saved that worry if they provide their children with radio receiving sets and headphones.

A Receiver That Eavesdrops on a Party Line

A FAN in Bondhead, Ontario, has discovered that his radio receiver gives him everything that passes over the telephone wires near his house. Doubtless the low capacity and high inductance that characterize a circuit when tuned to short waves give him an inductive coupling with some nearby telephone wire. He writes:

While testing a single-circuit regenerative set with two stages of audio-frequency amplification, I happened to try the lowest wavelength of which the set was capable, when I heard voices engaged in neighborly gossip and discovered that I had tuned in conversation from the local telephone party line. Further tests brought in conversations from still other party lines, and what sounded like the operation of a large telephone exchange, with the ringing-in and plugging-in of calls. I find that I can consistently get anything on our own line, and sometimes on other lines. When my telephone bell rings I can hear it in the phones.

I am about seven miles away from the small party-line telephone exchanges and forty miles from the large Toronto exchanges, such as I believe I can hear at work. My radio set is about twenty feet away from the telephone and in another room. The telephone ground is some fifty feet from the radio ground. One party line from which I picked up conversation has no connection with ours, belonging to another company. It runs past the house across the street. My antenna is fifty or sixty feet from the nearest telephone line.

I have an umbrella type antenna on the roof, also an inside antenna strung just under the roof upon the rafters in the attic. The inside antenna gives the telephone conversation much better than the outside antenna. My explanation for that is that the inside antenna is strung parallel with the telephone wires which run past the house outside.

I had a local telephone man in listening to the radio demonstration of party-line telephone conversation, and he gave it as his opinion that the telephone system was grounded somewhere, and that I was getting it through the ground. This will not hold, however, as I detached the ground wire and still the telephone

Will We Have An "American Radio Time" Standard?

SO many fans have trouble in interpreting the times of radio schedules for stations located in distant time zones that this suggestion of a La Plata, New Mexico, enthusiast is interesting because it points out a possible solution:

At present three different "times" need to be taken into account by the majority of radio receivers in the United States—the times of three of the "standard time zones" into which the country is divided. The times of different stations differ and any error in the identity of a station causes misunderstanding as to the time of future announcements.

After railway consolidation had extended the operations of the single railway units there was a similar difficulty which was relieved by the system of standard time zones now in use. One standard time would be still better for radio use. The following seem to be reasonable suggestions:

1. Let Central Standard Time (the time of Chicago and the middle west) be known hereafter as "American Radio Time." If all radio stations use this time it would soon extend to both American continents and to adjacent waters.

2. All radio announcements should be made in this time, thus: "President Coolidge will speak on April sixteenth at 8:30 P.M., American Radio Time, wavelength 360 meters."

If this plan were adopted, a wide use of radio time would probably follow in general business for telephone appointments and the like between distant cities. Another natural extension of the idea would be "Pacific Radio Time," which would be the time of the International Date Line, 180 degrees Longitude from Greenwich. Perhaps, finally, we would have "India Radio Time" for the time of 90 degrees East Longitude. This would have the same clock reading as American time, but would be A.M. when the American time was P.M., and *vice versa*.

Throughout the world there would be, then, only two clock readings for a given instant in radio time. The hour hands would be six hours apart. The minutes and seconds would be the same everywhere.

—HARRISON H. BROWN

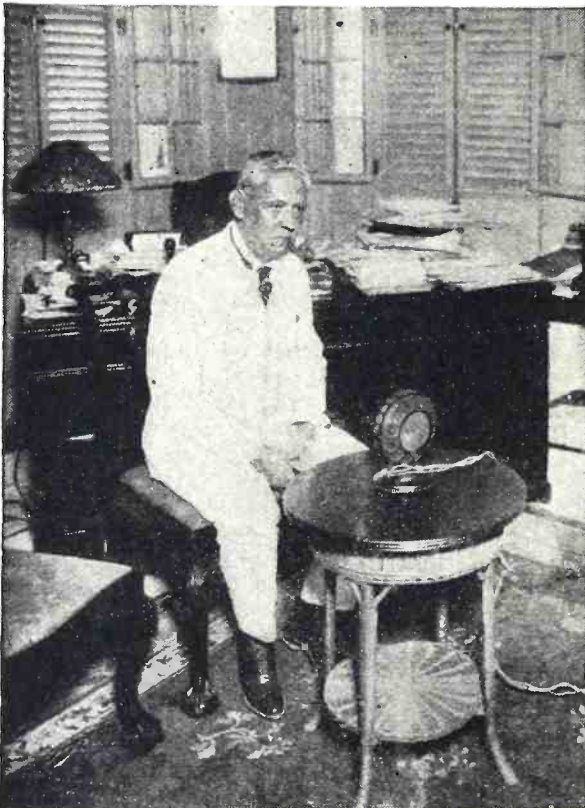

Underwood & Underwood

THE CUBAN PRESIDENT ADDRESSES HIS PEOPLE

When Alfredo Zayas, the head of the Republic of Cuba, talks into the microphone installed in his office by the Cuban Telephone Company of Havana, his voice is broadcast over his entire country—and laps over onto several other countries as well.

Wiring a House for Radio

SO many fans are arranging to provide radio concerts all over the house that the suggestions of this Long Beach, California, amateur will strike a popular chord:

As I wanted to have radio in the different rooms of my house, I ran insulated wires under the floor of the house, attaching them to insulators wherever necessary, and providing outlets in my den, in one bedroom, and in our living room.

For each outlet I ran the wires to a regular two-prong jack, fastening the jack to a piece of bakelite about two inches square. I inserted this jack in the floor, the receiving end upward. Thus, the wires could be attached conveniently to the points of the jack underneath the floor. From each jack, a pair of wires run to my radio table to which they are attached by a plug with a surplus of about 3 feet of wire.

When I want to receive in any particular room, I tune the set properly and then plug in, at the set, the wires for the room that I want to connect. Then I take my loudspeaker into that particular room and plug it in. The line loss is so slight that you cannot notice it, even in one of the rooms the distance to which is over forty feet.

This gives you radio where wanted with no long wires to trip over when walking about. During sickness in our home last winter we had programs right in the sickroom and it was great.

—HORACE G. HAMILTON



"STATIONS I HAVE HEARD"

If you are getting good results with your receiving set, tell your fellow-readers of **POPULAR RADIO** how you get them. Give the call letters of the stations you hear, the locations of them, the type of apparatus that you are using and **HOW YOU ARE USING IT.**

HAYNES CIRCUIT IS PRAISED

"I HAVE been using a single-circuit tuner, but I tried the Haynes circuit which you published in September and find that it is everything you claimed that it was," writes A. J. Thompson of Memphis, Tenn. "I find the set more sensitive than the single-circuit tuner and absolutely free from body capacity.

"One night last week I listened to sixteen stations. I get WGY of Schenectady, N. Y., on the loudspeaker so that it can be heard all over three rooms."

Other stations he hears, using dry-cell tubes and two stages of audio-frequency amplification, are PWX of Havana, Cuba; WEAJ, New York City; KDKA, Pittsburgh, Pa.; WWJ, Detroit, Mich.; WDAP, Fort Worth, Tex., and KYW, Chicago. He listened to KHJ, Los Angeles, Calif., on three consecutive nights.

* * *

FIFTY STATIONS ON A CRYSTAL

ARTHUR HALL of Oakland, Calif., reports hearing a total of 50 stations on a home-made crystal receiving set, 21 of them more than 300 miles away. He uses a two-slide tuning coil and an antenna 135 feet long. His best results were obtained in summer.

"When I first made the set, I could hear only the local stations," he says, "but in a month, after learning more about the instruments, I finally heard a station 70 miles away. From then on I heard farther and farther, and still hope to hear over greater distances. My records were made in the direction of north and south, because my antenna points that way. I am going to change it and add some eastern stations to my list."

Stations up to 700 miles distant he can pick up almost any night, he maintains. The crystal he uses is galena, and he believes he has tried them all.

VISITS ALL PARTS OF THE COUNTRY

"THE minute I turned on my new Cockaday four-circuit tuner I got WGY, Schenectady, 1,200 miles away," writes John C. Holland of Little Rock, Ark. "Then I got more, just as fast as I could tune them in."

He says he hears everything from San Francisco to Newark, N. J., and from Calgary, Canada, to Havana. His set is located in the heart of the business district, with tall buildings, power lines, telephone cables and tin roofs surrounding it.

* * *

A SPEAKER ON ONE TUBE

LOCAL stations operate a loudspeaker for A. W. Thomson of Orange, N. J., with a dry-cell tube and the DX circuit published in **POPULAR RADIO** for January, 1923. It consists of two fixed coils, a variometer and two variable condensers.

He hears two stations in Chicago with his little 1½-volt tube, as well as WSB of Atlanta, Ga., WOC of Davenport, Ia., and WGY of Schenectady. The clarity and sharpness with which these and other stations come in lead him to think he will hear from Denver and Ft. Worth on clear winter nights. His antenna is 80 feet long and 38 feet high.

* * *

WITH A POWER-LINE ANTENNA

"I BUILT the Haynes set described in **POPULAR RADIO**," writes J. W. T. Patton of Truro, Nova Scotia, "and with WD-12 tubes, dry batteries and a plug in my light socket for an antenna, I hear:

"WGY, Schenectady, N. Y.; WMAF, South Dartmouth, Mass.; WHAZ, Troy, N. Y.; WJAR, Providence, R. I.; WOR, Newark, N. J.; WWJ, Detroit, Mich.; KSD, St. Louis, Mo., and WOAW, Omaha, Nebr. WWJ was as clear as if the speaker were in the room with me."

HIS SET NEEDED A BATH

A GOOD bath refreshed the set of H. C. Torreyson of Geneseo, Ill., and changed it from an ordinary receiver into what he now calls a marvel.

"I built the Cockaday four-circuit tuner described in the May issue of POPULAR RADIO," he states, "but at first was unable to hear for more than 200 or 300 miles, due, I think, to the fact that I used acid flux in soldering.

"One day I washed the set in alcohol and dried it thoroughly in an oven. That night I tuned in Regina, Sask, and Los Angeles, Calif. Since then I have been able to reach the Pacific Coast almost any night after eleven o'clock."

Following is a sample of one night's "travel":

5:56 KYW, Chicago, Ill.
 6:11 WOC, Davenport, Ia.
 6:20 WDAP, Chicago, Ill.
 6:25 WGR, Buffalo, N. Y.
 6:47 WSAI, Cincinnati, O.
 6:50 WGY, Schenectady, N. Y.
 6:54 WMAG, Chicago, Ill.
 7:05 WJAX, Cleveland, O.
 7:17 WPAD, Chicago, Ill.
 7:21 KDKA, Pittsburgh, Pa.
 7:46 WHAS, Louisville, Ky.
 7:57 WCAE, Pittsburgh, Pa.
 8:00 WCAP, Washington, D. C.
 8:11 WSB, Atlanta, Ga.
 8:13 KSD, St. Louis, Mo.
 8:16 WHB, Kansas City, Mo.
 8:23 WLAG, Minneapolis, Minn.
 8:39 WTAS, Elgin, Ill.
 8:42 WFAA, Dallas, Tex.
 9:01 WMC, Memphis, Tenn.
 9:05 WPAW, Omaha, Nebr.
 9:30 WJAZ, Chicago, Ill.
 9:43 WLW, Cincinnati, O.
 9:49 WOAL, San Antonio, Tex.
 9:55 WFI, Philadelphia, Pa.
 10:00 CKCK, Regina, Sask.
 10:08 WBAP, Ft. Worth, Tex.
 10:25 WRAL, St. Croix Falls, Wis.
 11:13 WBAK, Harrisburg, Pa.
 11:15 KHJ, Los Angeles, Calif.
 11:46 WDAF, Kansas City, Mo.
 12:06 KFZ, Los Angeles, Calif.
 12:15 9XN, Chicago, Ill.

This total of 33 stations represents a journey of 17,275 miles in one evening. The antenna used was a single wire, 125 feet long, one end 40 feet high and the other end temporarily fastened to a bush two and a half feet above the ground.

* * *

THE OLD HONEYCOMB AGAIN

ONE tube and three honeycomb coils will make one famous in England, according to W. Poynter of London, if they are used properly. He has heard both WEAJ and WGY on his detector tube alone.

The coils are connected in the usual double-circuit, regenerative hook-up, with vernier condensers.

"To my mind," he explains, "reception was possible partly by use of a double circuit and vernier condensers, plus a little patience."

* * *

IT'S ALWAYS FAIR WEATHER

IN spite of heavy rain, thunder, lightning, static, code interference and heavy wind, stations WEAJ of New York and WGY of Schenectady, N. Y., were heard in Loughborough, England, on three tubes by R. G. Burder.

"The reception was very good," he writes, "and the announcer at WGY particularly distinct. I heard one other station, but was unable to ascertain its call letters."

His set contains one stage of radio-frequency amplification, detector and three stages of audio-frequency. For the test he used only one stage of audio frequency. His antenna is a single wire of the seven-strand variety, 100 feet long and 50 feet high, and his ground connection is made to a water pipe.

* * *

CRYSTAL SET ADDS TO CAMP EQUIPMENT

A RADIO set is going to be an essential part of all camp equipment hereafter when John A. Simmons takes to the woods in the summer, for his little crystal set, using a single-tapped coil, picked up Station WEAJ of New York when he was more than 100 miles away in the New Jersey woods.

The queer part of it was, according to Simmons, that his antenna was hastily thrown into a tall tree. He tossed the antenna, a single wire, into the tree after he had pitched camp late in the evening, thinking that if it did not work he would change it in the morning.

"It worked so well that I was afraid to change it," he says, "and I left it there for five days."

The antenna was number 14 wire, insulated, about 75 feet long. A ground connection was made to a tin can dropped into a small stream.

* * *

IN SPITE OF THE LANDLORD

"I MUST use an indoor antenna in a room eleven by eleven feet," writes James Bolton of Richmond, Va., "but I have successfully picked up Chicago, Davenport, Cleveland, Schenectady, Havana and a number of intermediate stations.

"My present set, the best one I have made, is designed from the British tuned-anode, published in the October issue of POPULAR RADIO. A forty-three plate condenser is used in series in the antenna circuit, and WD-11 tubes are employed throughout. I use 22½ volts on the detector and 45 on the amplifiers. Last night I heard KDKA, Pittsburgh, Pa., and WGY, Schenectady, N. Y., with my phones held at arm's length."

* * *

THE FEED-BACK CIRCUIT IS SIMPLE

"WITH only one dial to turn, I hear Chicago, Cincinnati, Pittsburgh and Springfield, Mass.," writes A. F. Hendren of Passaic, N. J. These stations he hears with but one dry-cell tube. With two more dry-cell tubes in an audio-frequency amplifier, he hears the stations fairly well on a loudspeaker. Local stations have unusual volume, he says.

His secret is a fixed condenser of .002 mfd. which feeds back the plate current into his antenna circuit. His primary and secondary coils are fixed and he tunes with a variable condenser. The antenna used is about 69 feet long.

"Wait till Mac sees this panel"

THE finished radio panel is a beautiful job. It's a better-looking panel than the one in Mac's set next door. And Mac has the finest set in the neighborhood.

Hundreds of radio fans are giving their home-built sets the same snappy, professional appearance by mounting their instruments on Celoron Radio Panels. Some like the glossy black Celoron panels. Others get the mahogany or oak finish. They all find they can drill clean holes anywhere in Celoron panels without chipping the smooth, hard surface.

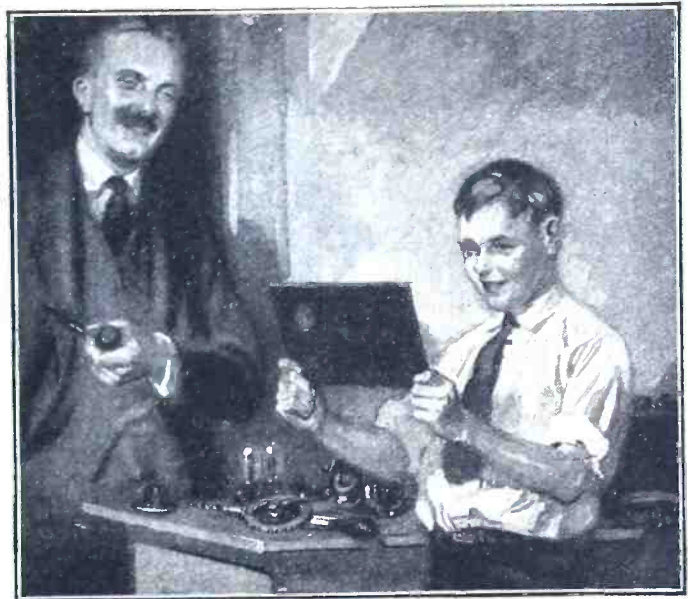

"Doesn't she look great, Dad? Every hole is as clean as a whistle."

Celoron as insulating material

Good looks aren't all a Celoron panel gives your set. This panel's high dielec-

turers mount their parts on Celoron bases.

Ask your dealer for a Celoron panel. You can identify it by the Celoron label that is on every panel. These panels come already cut in nine standard sizes ready for working. A dust-proof glassine wrapper protects each panel surface. Full instructions for working are on every envelope.

Celoron Radio Panels were the first to be cut in standard sizes and sold in separately wrapped packages. They come in the following standard sizes:

1—6 x 7 x 1/8	5—7 x 18 x 3/16
2—7 x 9 x 1/8	6—7 x 21 x 3/16
3—7 x 12 x 1/8	7—7 x 24 x 3/16
4—7 x 14 x 3/16	8—12 x 18 x 3/16
9—7 x 26 x 3/16	

Other sizes can be cut to your order from sheet stock. See your dealer.

tric strength increases the volume of your set and helps you get results from your instruments that you wouldn't get with a cheap panel.

Celoron, a bakelite product, is one of the best insulating materials known. It is approved by the U. S. Navy and U. S. Signal Corps. Leading radio manufac-

Send for our free booklet, "Getting the Right Hook-Up with Celoron." It contains diagrams, list of broadcasting stations, and radio information every set-builder should have.

To radio dealers: Send for special dealer price list showing standard assortments.

DIAMOND STATE FIBRE COMPANY

Bridgeport, Pennsylvania
(near Philadelphia)

Branches in Principal Cities—Toronto, Canada London, England

CELORON

STANDARD RADIO PANEL

Please refer to POPULAR RADIO when answering advertisements.

“THE AIR IS FULL OF THINGS YOU SHOULDN'T MISS”

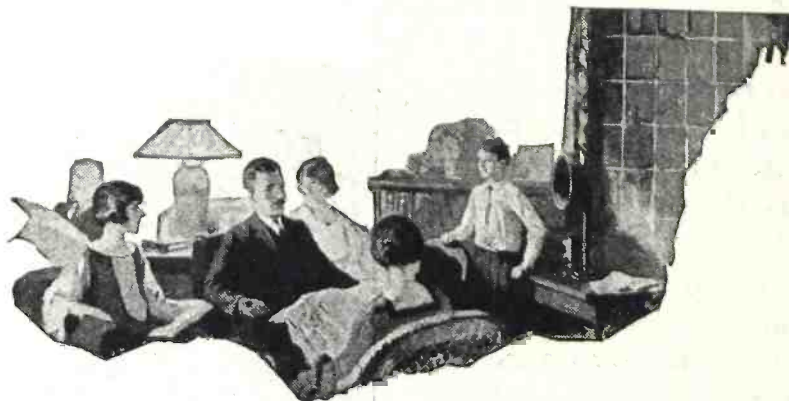

Why big cells count in Radio “B” Batteries

THIS handsome metal case Eveready “B” Battery No. 766 costs only two-thirds more than the smallest Eveready “B” Battery, but it contains seven times the electricity! This makes the No. 766 over four times as economical as its baby brother. That is why most people buy it.

Its fifteen large cells give 22½ volts of strong, steady, energy day after day. Cells that pour out power the moment you turn on your tubes. Cells that rest well when idle, renewing their vigor for your next demands.

No cells have a bluer-blooded ancestry than these. They are the product of thirty years of dry battery research and development of the world's foremost electro-chemical laboratories.

Eveready 6-volt
Storage Battery

No. 764
The Space
Saver
Vertical
22½-volt
“B” Battery



No. 767
“B” Battery, 45 volts
Variable taps, Fahnestock Clips

Eveready Radio “A”
Dry Cell
Specially manufactured
for use with dry
cell tubes

No. 771
“C” Battery
Clarifies tone and
increases “B”
Battery life

Please refer to POPULAR RADIO when answering advertisements.

“THE AIR IS FULL OF THINGS YOU SHOULDN'T MISS”



Eveready "B" Battery No. 766. 22½ volts. Six Fahnestock Spring Clip Terminals, giving variable voltage from 16½ to 22½ volts, in 1½-volt steps. Length, 6¾ ins.; width, 4¾ ins.; height, 3 3/16 ins. Weight, 5 lbs.

WE THINK that No. 766 is the handsomest battery ever made. But that is a matter of opinion. It is a matter of engineering record, however, that this great standard "B" Battery has proved itself as perfect in performance as we are convinced it is super-fine in appearance.

The 45-volt Eveready No. 767 contains the same large powerful cells as the No. 766. For maximum "B" Battery economy, therefore, buy the 22½ volt Eveready No. 766 or the 45-volt Eveready No. 767, as you prefer.

NATIONAL CARBON COMPANY, INC.

Headquarters for Radio Battery Information

New York

San Francisco

Canadian National Carbon Co., Limited
Factory and Offices: Toronto, Ontario

If you have any radio battery problem, write to G. C. Furness, Manager, Radio Division, National Carbon Company, Inc., 128 Thompson Ave., Long Island City, N. Y. Informative and money-saving booklets on "A," "B" and "C" Batteries sent free on request.

EVEREADY
Radio Batteries
-they last longer

Please refer to POPULAR RADIO when answering advertisements.

"Cash In" On These Amazing

You readers of POPULAR RADIO—you who are interested in Radio, and also interested in unusual money-making opportunities—let me send you, without the slightest cost or obligation, my new, interesting Free Book, "Rich Rewards in Radio"—a book which contains **positive proof** of the astounding opportunities in this great new industry and tells exactly how you can get your share of big money from it.

The pictures on this page give only the smallest indication of the scope of Radio today. Mail the coupon on the next page for my Free Book which gives full facts on Radio and what it can mean to you.

Earn \$75 to Over \$200 a week

You're interested in Radio—why not turn your interest into profit? Why not make big money in work you enjoy? No field today is growing so rapidly. No business offers such a rare variety of opportunities. Radio is a new, billion dollar industry in which thousands have already made far more money than they ever dreamed possible.

Radio can take you out of the rut of bare existence—into an enviable field of high salaried specialists. It can offer you unlimited opportunities for honor, wealth, power and satisfaction. It means a future filled with boundless promise!

Recognized Radio Experts In Urgent Demand

Readers of POPULAR RADIO know in part the story of how Radio has jumped forward with leaps and bounds. You know there are broadcasting stations all over the country—that radio is used on every ship—that it is used by newspapers, government departments, business houses, banks, railroads, factories and stores. Every day, some new use for Radio is announced. And this wonderful expansion of Radio has opened up hundreds of splendid positions on land and sea—positions which you can qualify for within a few months!



Please refer to POPULAR RADIO when answering advertisements.

New Opportunities in RADIO!

There's big money in this wonderful new field for you. No matter what you are doing—no matter what experience you've had, you can step in and get your share of the astonishing rewards of Radio. Big salaries, fascinating, easy work, short hours, and a wonderful future—no other field of endeavor can offer anything to compare with what Radio can mean to the men who get into this work now.

Make Radio your career. Become a radio expert now!



E. R. Haas,
Director,
NATIONAL
RADIO
INSTITUTE
(Founded 1913)

How We Place Graduates In Fine Radio Positions

Not a week goes by without our receiving urgent calls for our graduates. "We need the services of a competent Radio Engineer," writes a prominent radio firm. "Would appreciate your recommending any person who could fill position." "We want men with executive ability as well as radio knowledge to become our local managers," writes another firm. "We will require the services of several resident demonstrators," writes still another—and these are just a few small indications of the great variety of splendid opportunities open to our graduates!

Easy Now to Learn at Home

No previous training in electricity or radio is necessary. During your spare time at home, within an amazingly short time, you can get your National Radio Institute diploma, which is government recognized and accepted as part credit on your government license. To make the training more practical, circuits and parts for building latest receiving sets are now included FREE with the course.

Send for FREE BOOK

You have nothing to lose—and everything to gain. No matter what your plans for the future are—mail the coupon now for this new Free Book which tells all about the wonderful opportunities in Radio. Let it point the way to success and happiness for you. Don't delay. Mail the coupon now.

National Radio Institute, Dept. 32DA, Washington, D. C.

I Can Qualify You as a Radio Expert in a Few Months

If you want to earn far more money than you are earning now—if you want to be your own boss—if you want a profitable business of your own—if you want to travel the world over—if you want a field of endeavor where the opportunities are unlimited—Make RADIO your profession.

Hundreds of my students write enthusiastically of my training—and tell how it has helped them. Merle Wetzel now is making three times what he did before taking my training. Emmett Welch started at \$300 a month after graduating. Scores of others tell similar stories. Send for my Free Book which tells of the great opening in Radio, what my students are doing—what you can do. No obligation. Mail the coupon **nw**.

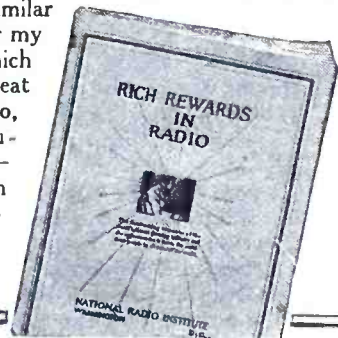

E. R. Haas, Director
National Radio Institute,
Dept. 32DA, Washington, D. C.

Without any obligation on my part, please send me a FREE copy of your book, "Rich Rewards in Radio." Also tell me how your Free Employment Service will help me secure a position, and send me details of your special short time offer. (Please write plainly.)

Name..... Age.....

Address.....

City..... State.....

(Copyright of Photo)

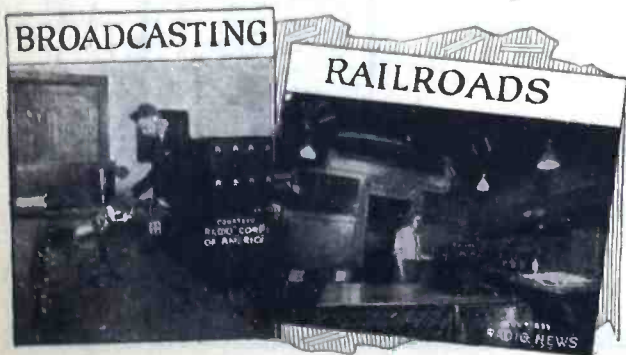

Please refer to POPULAR RADIO when answering advertisements.

MALONE-LEMMON CONTROL-O-METER

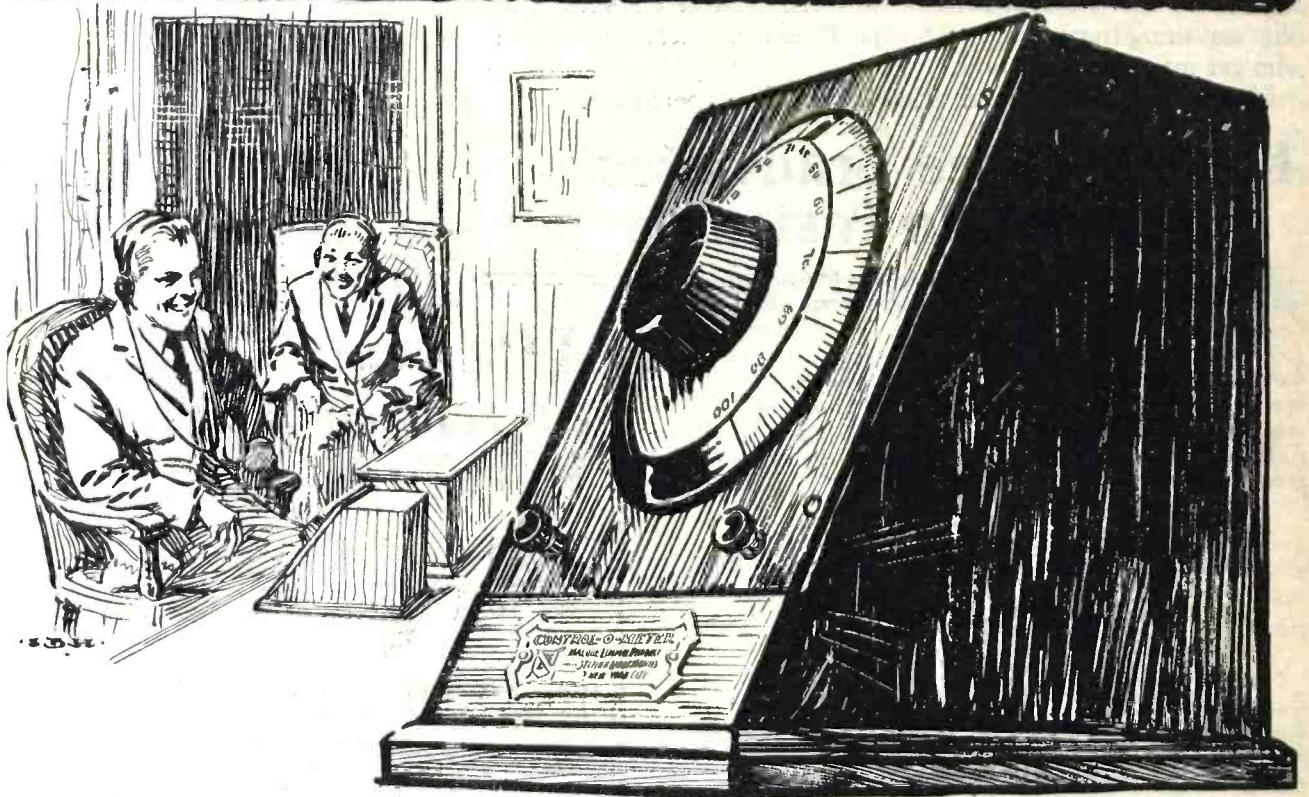

Adding a Malone-Lemmon Control-o-meter to your set means adding the power of selectivity — selectivity which will

1. Allow you to separate two local stations and hear either without interference from the other.
2. Allow you to hear distant programs while local stations are "on the air."
3. Allow you to separate two overlapping distant stations. This feature is of particular value to Neutrodyne owners.

The Malone-Lemmon Control-o-meter will do these things at a turn of the dial — do them consistently, regardless of your location, type of set or antenna. Price complete \$12.50.

Send for Literature

We have prepared a series of folders describing in detail the Control-o-meter and other Malone-Lemmon Products. We will be glad to send you the complete series.

MALONE-LEMMON PRODUCTS

Made by **STEPHENSON LABORATORIES**
342 MADISON AVENUE
NEW YORK CITY

The Chart Makes It Easy

Each Control-o-meter is individually calibrated in our laboratory and a chart is supplied with each instrument showing the "vanishing points" for various wavelengths.

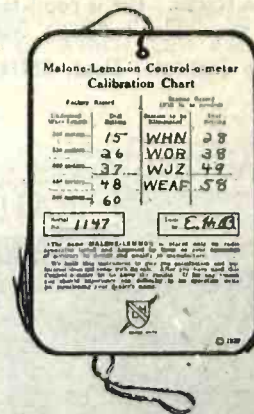

Please refer to POPULAR RADIO when answering advertisements.

"THE STANDARD OF COMPARISON"

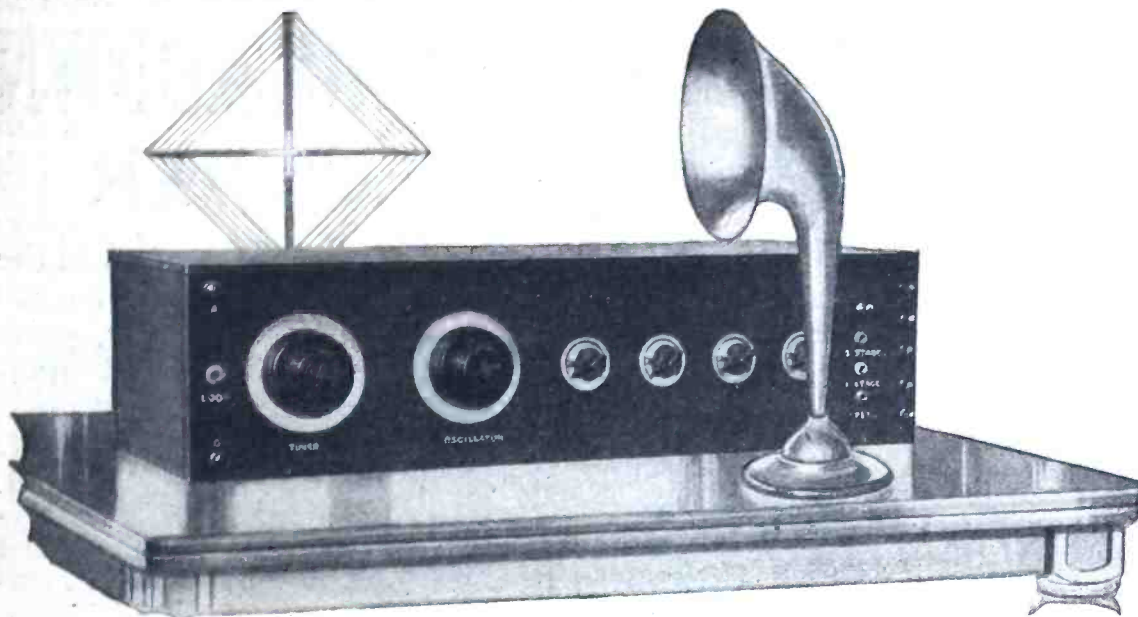

Most Selective Receiver Known

Ultradyne Kit includes tuning coil, oscillator coil, one Ultraformer type "A," three Ultraformers type "B"

\$24.50



Send for the 32 page illustrated book giving latest authentic information on drilling, wiring, assembling and tuning 6 and 8 tube Ultradyne receivers.

50c

ULTRADYNE
The Improved
SUPER-HETERODYNE

Employs "Modulation System," an entirely new principle of radio reception just developed and perfected by R. E. Lacault, A. M. I. R. E., technical editor of *Radio News* and formerly Radio Research Engineer with the French Signal Corps Research Laboratories.

This principle is of such a basic character that the sensitiveness is increased over that of any known receiver. Weakest signals are made to operate the loud speaker. Results secured by the Ultradyne exceed by far those obtained with reflex, super-regenerative, Neutrodyne and even the well-known Super-Heterodyne. This is true in regard to selectivity, range, signal audibility, simplicity and general efficiency.

The "Modulation System" is employed exclusively in the Ultradyne, the improved and simplified Super-Heterodyne.

Write for descriptive circular

PHENIX RADIO CORP.
3-9 Beekman Street New York City

A *Freed-Eisemann* KNOCKDOWN NEUTRODYNE RECEIVER

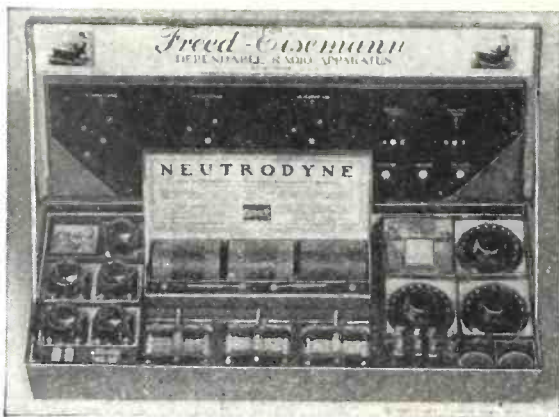

Unassembled Model KD-50
Freed-Eisemann Neutrodyne Receiver

NOW the opportunity is presented to obtain a complete set of parts, recommended by the manufacturer, to work with each other in building your Neutrodyne set. An illustrated 32-page book on how to build the Neutrodyne with full-sized diagrams and templates included.

Complete
With full Instructions

\$80

Dealers Write for Name of
Nearest Distributor

NEUTRODYNE has taken the country by storm. It is *the* remarkable distance getting, powerful, non-oscillating and non-whistling receiver.

A 32-page book answers every question. The panel is accurately drilled. A baseboard is furnished; in fact, everything down to the very last screw and nut, including all necessary parts excepting the cabinet.

Besides the book there is furnished schematic blueprints and template for drilling the baseboard, also full-size pictorial perspective wiring diagram, so that it will hardly be possible for the amateur with ordinary care and skill to make an error.

Remember that here are licensed parts—not a collection of apparatus trusting to luck that they will assemble properly. Each part is *designed* and fitted to work with each other part in this particular set. The instructions are so complete and the parts so accurately matched that you will be grateful for the manner in which we have eliminated guess work in the amateur construction of this receiver.

For sale by dealers of the better class throughout the country, for amateur and experimental building. Builders are cautioned against attempting to build a Neutrodyne Set with parts which are not recommended and designed by the manufacturer to work with each other.



Front View KD-50
Neutrodyne Being Assembled



32-page illustrated book of instructions on "How to Build the Neutrodyne" with full size pictorial wiring diagram and full size panel and baseboard templates, \$1. At your Radio Dealers.

Freed-Eisemann Radio Corporation

SPERRY BUILDING

MANHATTAN BRIDGE PLAZA

BROOKLYN, N. Y.



“*M*y friends all
tell me that my
Manhattan is the
best Loud Speaker
they have ever heard”

Mitzi

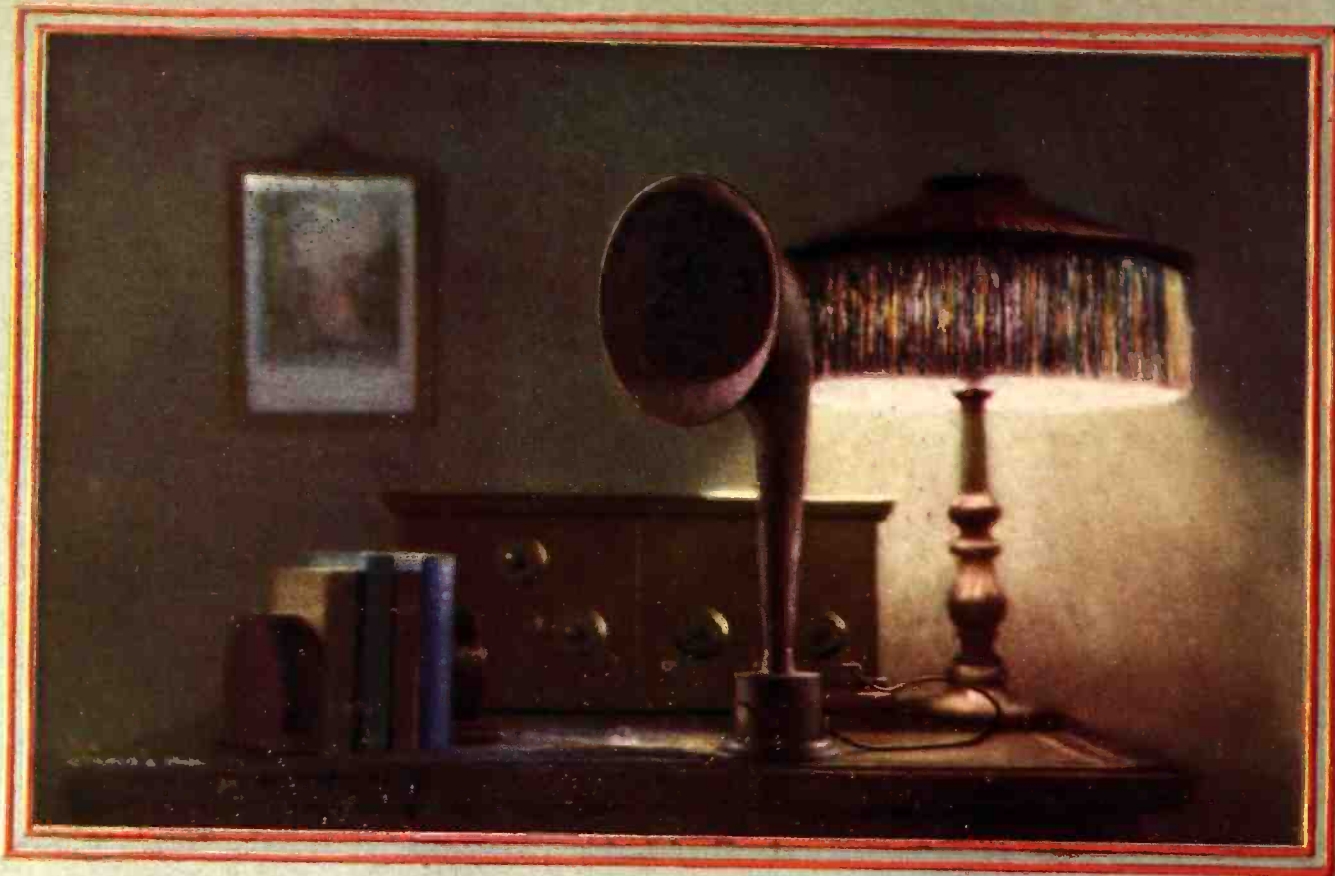

“Anyone who appreciates fine music will want a Manhattan”—writes Mitzi

“In my opinion” runs a recent letter from Mitzi, “the Manhattan Loud Speaker is a real musical instrument. It reproduces difficult programs with a quality and feeling that is nothing short of remarkable. Moreover the Manhattan Concert Modulator eliminates distortion and chattering in a way that makes Radio reception unusually enjoyable.”

Once you have heard the Manhattan, you, too, will agree with Mitzi that it re-creates the work of the broadcasting artists in a most faithful

and natural manner. It produces a full rounded tone extremely mellow in quality. And its attractive finish and pleasing design will harmonize with the furnishings of any home.

Go to your nearest dealer and insist upon a Manhattan, the Loud Speaker with the concert modulator. Or write us for an interesting descriptive booklet.

Manhattan Electrical Supply Co., Inc.
17 Park Place, New York

Makers of the famous Red Seal Dry Battery

New York Chicago St. Louis San Francisco

 **MANHATTAN**
*“The Loud Speaker with
the Concert Modulator”*

Crosley Again Astounds *the* Radio World

*Greatly increased production allows lowered prices
New Two Tube Regenerative Set at \$18⁵⁰*



CROSLEY MODEL 51
New Two-Tube Arm-
strong Regenerative
Price Only . . \$18.50



CROSLEY MODEL VI
Former Price . . . \$30
Present Price . . \$24



CROSLEY TYPE 3-B
Former Price . . . \$50
Present Price . . \$42

That our fixed policy to offer to the public the best possible receivers at the lowest possible cost has been appreciated is proven by the fact that a shortage of Crosley radio apparatus has existed at all times, although The Crosley Radio Corporation has been producing more radio receiving sets than any other organization in the world. Heretofore constantly added improvements have forced us to maintain steady prices, but so great has been the response of the public for Crosley instruments that greatly increased production allows us to lower the price of the entire line and still maintain our constant research for improvements.

As an astounding example of the results of this research, we now offer a new and wonderful two tube receiver consisting of Armstrong regenerative detector and one stage of audio frequency amplification, giving loud speaker volume on local stations at all times and on distant stations under fair receiving conditions. Otherwise head phones should be used for distant reception. This instrument, known as the Crosley Model 51, sells at the remarkably low price of \$18.50.

Other Crosley instruments are well known. Their exceptional performances have given pleasure to hundreds of thousands of people everywhere.

For Sale by the Best Dealers and Jobbers Everywhere



CROSLEY TYPE V
Former Price . . . \$20
Present Price . . \$16



CROSLEY TYPE 3-C
Formerly . . . \$125
Now . . . \$110
CROSLEY MODEL XL
Formerly . . . \$140
Now . . . \$120



CROSLEY MODEL X-J
Former Price . . . \$65
Present Price . . \$55

The Crosley Radio Corporation

POWEL CROSLEY, Jr., President

Formerly Called

**The Precision Equipment Company
and Crosley Manufacturing Company**

416 ALFRED ST., CINCINNATI

*Crosley Regenerative Receivers are manufactured
under Armstrong U. S. Patent Number 1,113,149*

CROSLEY

**Better-Cost Less
Radio Products**

Please refer to POPULAR RADIO when answering advertisements.

The Transformer Sensation of Modern Radio

Model 285A

\$5.75



Ratio
4½ to 1

An Audio Frequency Transformer

Built to the exacting needs of present day broadcasting reception, producing volume with pure realistic tone qualities.

Highly recommended by radio engineers for use in **American Super Sets** and **Neutrodyne Circuits**.

Ask your dealer or write direct for test chart #1094 and electrical characteristics.

Every instrument is sold with the **guarantee of satisfactory performance**. Our attractive sales proposition is of interest to **DEALERS** and **JOBBERS**.

PRECISE MANUFACTURING CORPORATION

53 W. Jackson Blvd.
Chicago, Illinois

Rochester, New York

821 Market Street
San Francisco, Cal.

Canadian Distributors:

PERKINS ELECTRIC, LTD.

Toronto

Montreal

Winnipeg

Please refer to POPULAR RADIO when answering advertisements.

Introducing The MOZART Baby GRAND

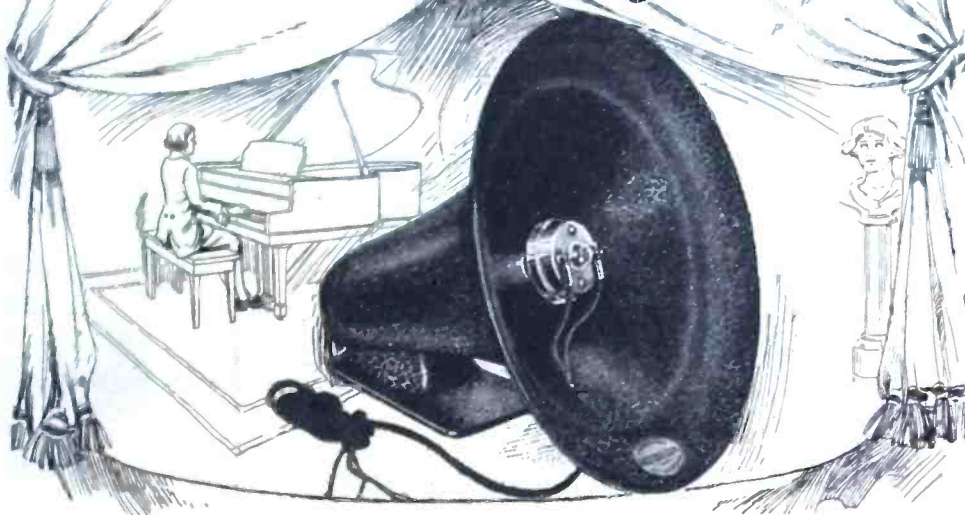

WE announce with pleasure entering the radio equipment field with our complete line of Mozart *Baby Grand*, Mozart-Grand and Mozart *Concert Grand* "reproducers." Shipments have commenced on the *Baby Grand* with a special request to every individual purchaser that they make a minute comparison of their purchase from every aspect, not with other instruments of a similar price, but with the largest and most expensive on the market today. We are, with the utmost confidence, staking the whole of our resources on the result.

While instruments of the reflex type, broadly speaking, are not new, our design is entirely original and has been developed with a technical and practical care, probably never previously bestowed on this class of merchandise. Its extraordinary reproducing qualities, its extremely low center of gravity, with resultant steadiness and its general beauty of outline guarantee it a worthy place among all

that is superlative in radio necessities today.

The color scheme is black and gold. The unit and other fittings are heavily gold plated, the combination resulting in a charming effect which will harmonize perfectly with any furnishings from the simplest to the most pretentious.

The dimensions, etc., of the Mozart *Baby Grand* are: diameter of bell, 12"; height overall, 12½"; length overall, 12½".

Price complete with unit and cord, ready for attaching . . .	\$10.00
West of the Rockies	10.60
Price of unit only, with cord, ready for attaching	4.00

Applications to market our products invited from radio houses of repute.

Communications by mail only. Address Radio Department.

MOZART-GRAND CO.

Manufacturers of fine Instruments.

NEWARK, N. J.

U. S. A.

Please refer to POPULAR RADIO when answering advertisements.

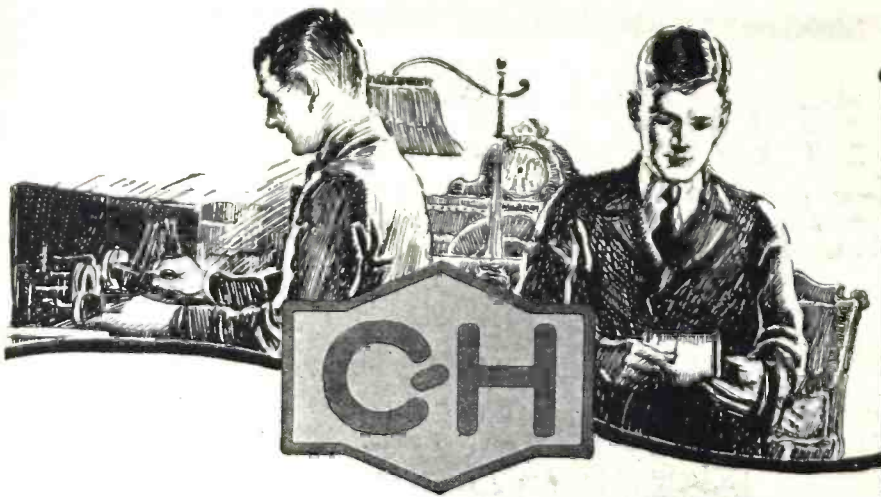

You Can Build With Confidence When You Demand This Trade Mark

Radio men of experience agree that more sets are ruined by careless buying than by careless construction. Most people take pains to see that diagrams are followed faithfully—that connections are tight—and instruments are properly placed. But this alone cannot assure results—the poor design of one single part can destroy the efficiency of the most elaborate set. Radio parts must be purchased with a knowledge of their maker—it is the only measure of their quality of which the average buyer can be certain.

A Complete Line of Radio Current Control Apparatus by the Most Famous Electrical Control Engineers

For more than a quarter of a century the name Cutler-Hammer has been demanded by engineers throughout the world in their specifications on current control. Gliding under the sea on the delicate apparatus of submarines; shooting skyward on the operator's handle of the modern office building elevator; keeping day and night watch over thousands of automatic industrial machines—in every branch of industry and in every country in the world you will find this famous trade mark justifying the confidence with which it was demanded. In radio it affords an easy way to be sure of quality in the parts you buy, demand it and build with satisfaction.

THE CUTLER-HAMMER MFG. CO

Member Radio Section, Associated Manufacturers of Electrical Supplies

MILWAUKEE, WISCONSIN

"BUILT BY THE MASTER BUILDER"

CUTLER-HAMMER

Please refer to POPULAR RADIO when answering advertisements.

CH

*Instruments of Guaranteed
Quality Assure Success in Radio*

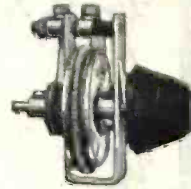

The C-H 4 Ohm Vernier Rheostat—Perfect detector tube control. Also furnished without vernier for amplifier tube control.



The C-H 30 Ohm Radio Rheostat—For control of the $\frac{1}{2}$ ampere, "UV201A-C301A" type receiving tubes and the "UV199-C299" type.

The C-H 125 Ohm Radio Rheostat—The rheostat that makes it possible to use a 6V storage cell with the UV199 or C299 tubes.

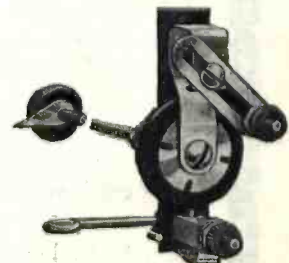

The C-H Variable Grid Leak—Mounted on the tube socket—panel controlled. Adjustable for all grid condensers.



The C-H Radio Potentiometer—The potentiometer with the resistance unit that does not wear and cannot be displaced under constant usage.



Just like being there yourself

JUST like being in the same room—when your favorite violinist plays. You miss none of the wizardry of his art, if you listen-in with Murdock Radio Phones. You get it all—the rich resonance of the high and low notes and the subtle shading of the softer tones. Everything is reproduced clearly and with wonderful volume.

Perfect construction and diaphragm adjustment the reasons

The powerful magnets in the Murdock build up volume signals—and the sensitive, perfectly adjusted diaphragms turn these into clear, natural tones.

The seating and clamping of the diaphragms is an outstanding feature of the Murdock. This adjustment prevents distortion due to vibration.

May be worn for hours without discomfort

The Murdock may be worn through a whole evening without fatigue. Ear caps are moulded to fit the ears and exclude outside noises. The improved flat headband is feather-weight and does not bind the head; and there are no screws to entangle the hair.

SEND FOR FREE BOOKLET. Mail coupon to us and we will send you our helpful booklet, "The Ears Of Radio." It explains in detail the importance of radio phones to efficient radio reception.

MURDOCK MULTIPLE PLUG JACK. This effective plug jack permits the use of one to four 'phones at the same time. Get one.

Announcing the Murdock five tube Neutrodyne Set. (Illustrated above). See this new type at your dealer's. Wm. J. Murdock Company, 372 Washington Ave., Chelsea Mass., Branch Offices: Chicago and San Francisco.



Built, not assembled

Murdocks are made in a single unit, of superior moulded insulation. Each part is fitted by one process into its proper place. They are moulded together—assuring firmness, strength and durability. And they can't get out of adjustment.

For 20 years Murdock has been making radio phones of high efficiency. Over 1,000,000 users have accepted the Murdock standard of quality and price as the best measure of radio phone value. Buy a Murdock today and test it out—if you want to get the best results from your receiving set. They are fully guaranteed.

MURDOCK RADIO PHONES

Standard since 1904

WM. J. MURDOCK CO.
372 Washington Avenue,
Chelsea, Mass.

Gentlemen: Please send me, without obligation, your free booklet, "The Ears Of Radio."

Name

City

State

Please refer to POPULAR RADIO when answering advertisements.

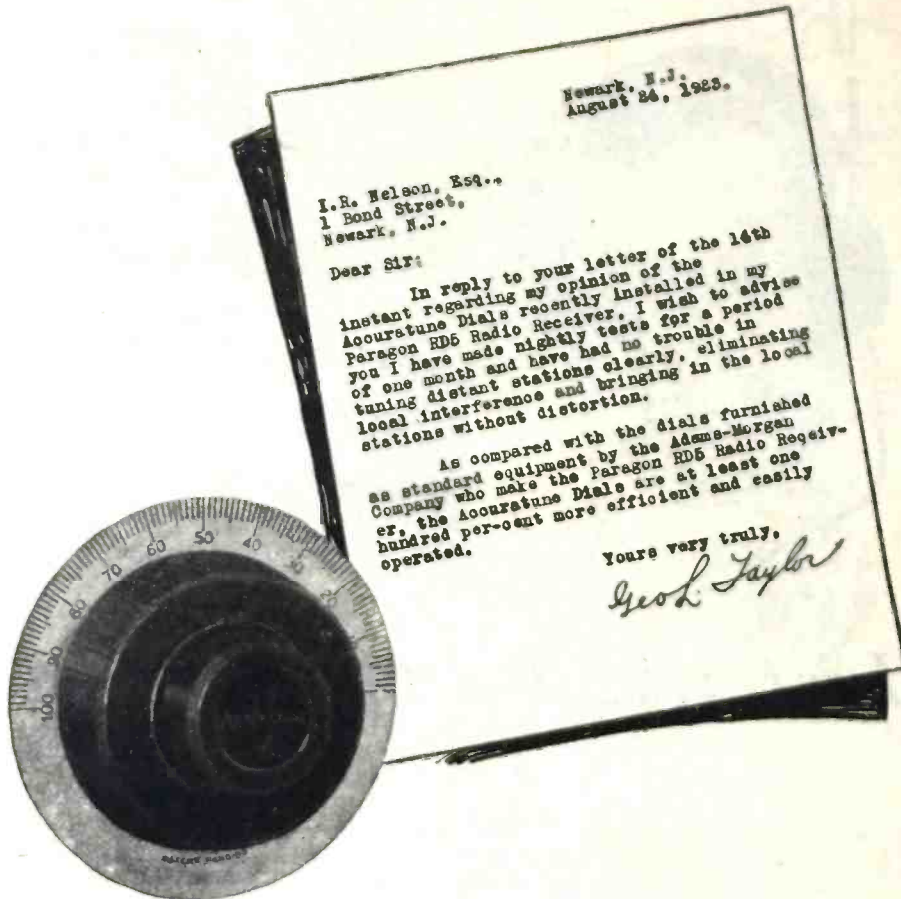

-- from one who uses them

Mr. Taylor says, "I have no trouble tuning distant stations! Accuratune dials are at least one hundred per cent efficient."

ACCURATUNE
Phonograph Attachment



Attaches instantly to the reproducing arm and converts your phonograph into a loud speaker. Permits the whole family to enjoy broadcast music.

\$10⁰⁰

It is no little stunt to bring in a distant station, with all local and other disturbances in the air. But with an Accuratune fine adjustments are easy and the slightest turn of the micrometer knob will throw interferences out of the way and bring in the station you want CLEARLY.

The Accuratune is not a mere dial but an actual Micrometer Control more efficient than vernier condensers or any tuning device and far more simple to operate.

Designed for both coarse and precise tuning. Fits all standard condenser shafts. Price, \$3.50.

MYDAR RADIO COMPANY
9-B Campbell Street Newark, N. J.

ACCURATUNE
MICROMETER CONTROLS

Please refer to POPULAR RADIO when answering advertisements.

Haynes-Griffin

RADIO SERVICE, Inc. 41 West 43rd St., N. Y. City



A. J. HAYNES
Assoc. Institute of Radio Engineers

NEW AND IMPROVED RADIO APPARATUS

Designed by A. J. Haynes

Mr. Haynes has made many valuable contributions to Radio. Featured in this advertisement are four pieces of apparatus designed and perfected by Mr. Haynes after extended research. Each of these items represents an invaluable contribution to the art of Radio.

The Haynes Condenser

\$3.50

Meets every requirement — extreme low minimum capacity and maximum capacity of exactly .00023 mfd. No other condenser is exactly like it—no other achieves exactly the right balance between perfect selectivity and over-critical adjustment.



The Haynes Bank Wound Vario-Coupler

\$4.35

Furnished with only the taps you actually use and just the right number of turns on the secondary. Bank winding provides 100% efficiency on higher broadcasting wave lengths.



Haynes-Griffin Socket

\$1.00

Takes any standard base tube.

Dielectric losses have been reduced to a minimum in this new socket. Metal shell. Reinforced bakelite base.

Can be used for either base or panel mounting.

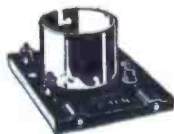

Haynes-Griffin Transformer

\$4.25

An efficient intermediate wave radio frequency transformer giving a minimum of audio frequency amplification. Uniformly tuned to a limited wavelength range, and providing a degree of quietness and stability heretofore unknown in transformers of this type. Haynes-Griffin Input Transformer also, \$4.25.



Special Oscillator Coupler

\$3.50

An indispensable adjunct for those who want the best results from the most advanced circuits.

Supplied with necessary leads already attached.



ASK FOR PRICE LIST OF NEUTRODYNE PARTS

Now available—price list of parts for a simplified and remarkably efficient neutrodyne receiver. This receiver embodies exceptional sensitivity, remarkable clarity of reproduction, and great ease of operation.

Mailed free to interested experimenters.

SEND FOR COMPLETE PRICE LIST

Located in New York City, the headquarters of the radio industry, Haynes-Griffin is always first in marketing new and improved apparatus.

Our new price list—just off the press—brings you up-to-date in radio. Everything that's new in radio included. Mailed anywhere upon receipt of 4c in stamps. Use the handy coupon.

Parcel Post Prepaid in U. S. anywhere east of the Mississippi River.

*New York's
Largest Radio Store*

Haynes-Griffin

145 W. 45th St.,
New York City

Send me at once complete price list of new and improved radio apparatus. I enclose 4c in stamps for same.

HAYNES-GRIFFIN RADIO SERVICE, Inc.

Mail Order Dept.—145 W. 45th ST., N. Y. City

Retail Store—41 W. 43rd ST., N. Y. City



R-90—Oscillator Coupler, complete, with mounting brackets, bank wound inductances and adjustable coupling coil with locking device. It covers a band of wave lengths from 150 to 800 meters and generates the maximum amount of current . . . **\$5.00**

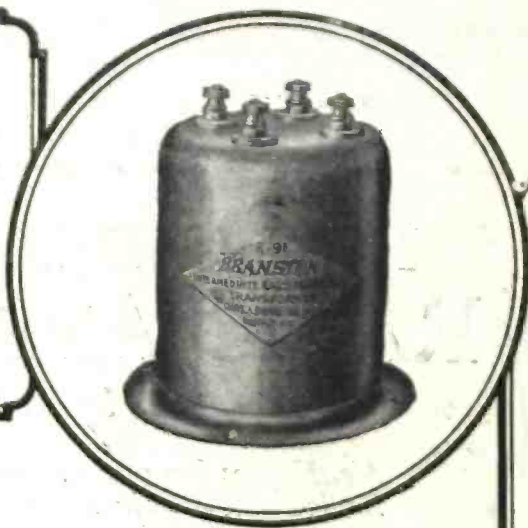

R-91—Intermediate Radio Frequency Transformer. Very sharply tuned and completely shielded **\$6.50**

R-92—Special Transfer Coupler for Last Stage of Intermediate Frequency. Very sharply tuned and completely shielded. **\$7.50**

R-93—Specially Designed Coupler for Using Antenna. **\$4.50**



AT LAST! Intermediate Radio Frequency Transformers

YOU can construct a Super Heterodyne Receiver with the assurance that you will possess the "last word" in Radio Reception. You can log each station and later single it out again with the same dial setting. List your stations in phone book style. Musical reception of crystal clarity, loud speaker volume and minimum interference.

The Branston Special Transformer is not an adaption, it was specially designed for this specific purpose. Rigorous tests prove it greatly superior to anything available prior to this announcement.

Our publication "SUPER HETERODYNE CONSTRUCTION," makes it possible for the amateur to construct a complete and efficient Super Heterodyne Receiver.

PROMPT DELIVERY AT YOUR DEALER'S OR WRITE FOR DETAILED INFORMATION

CHAS. A. BRANSTON, Inc.
811 Main Street, Buffalo, N. Y.

MANUFACTURERS OF
Branston Violet Ray High Frequency Generators

In Canada Chas. A. Branston, Ltd. Toronto, Ont.



Add Miles and Smiles with Branston Standard Radio Parts

Please refer to POPULAR RADIO when answering advertisements.

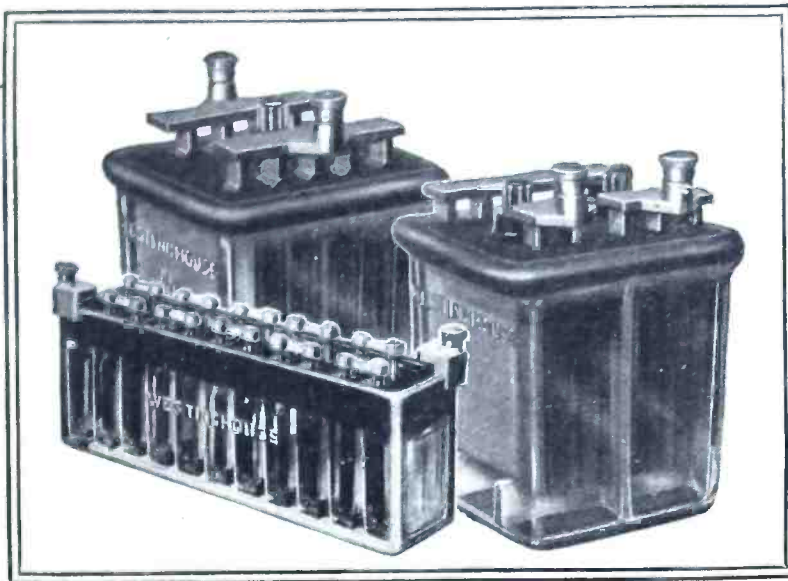

MAIL COUPON
for interesting facts
about batteries

WHEN Westinghouse places an article on the market you can depend on it for highest efficiency. Westinghouse Radio Batteries are made with the most careful consideration of every factor that enters radio broadcast transmission and reception. Built for full-powered and even-powered current delivery; for long sustained voltage; for ample capacity; for utmost quiet; for long life; for economy. Nothing but the very best is good enough in the construction or equipment of an instrument so sensitive as a radio set. Don't be satisfied with anything less than Westinghouse Radio Batteries.

Westinghouse **CRYSTAL CASE** Radio Batteries have one-piece clear glass cases. Solid glass cell partitions and high glass plate rests. Thoroughly insulated against current leakage. They hold their charge long. Last indefinitely and can be easily recharged innumerable times. "A" Batteries in 2, 4 and 6-volt sizes. "B" Batteries in 22-volt units. Regular type 22-MG-2; quadruple capacity 22-LG-2. "C" Batteries in 6-volt units.

WESTINGHOUSE UNION BATTERY CO.
Swissvale, Pa.

WESTINGHOUSE

RADIO "A," "B" and "C" BATTERIES

Westinghouse Union Battery Co.
Swissvale, Pa.
Send me Westinghouse Radio Battery
Folder A-3-C.

.....
.....
.....

Please refer to POPULAR RADIO when answering advertisements.



"Products of Proven Merit"



Type 247-H Condenser
Price \$5.00

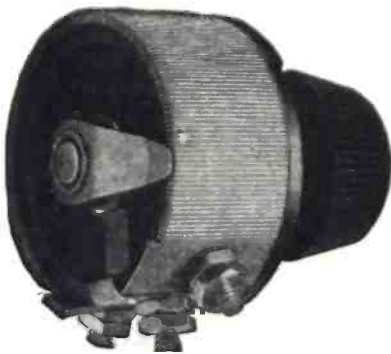

Type 301 Rheostat
Price \$1.25

Amplification—undistorted

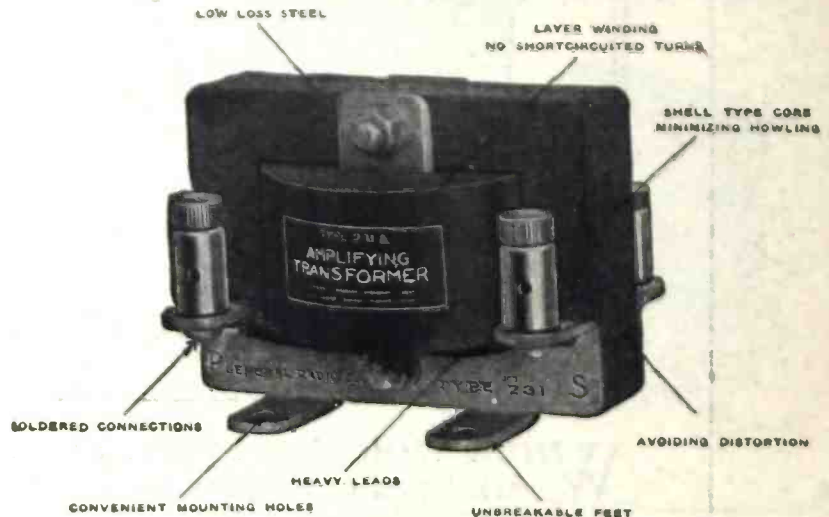

Type 231-A Audio F A Transformer

The efficiency of a broadcast receiver is often destroyed by poor amplification—due to inferior transformers.

In buying transformers be sure to look well into the electrical and mechanical features, as well as appearance and price.

The features which have gained the GENERAL RADIO CO. Type 231-A Transformer its enviable position as a leader among Transformers are:

Low loss steel used in its core construction.

Layer winding prevents short circuiting of turns.

Air gaps in core avoid distortion.

Unbreakable feet with convenient mounting holes, make installation easier.

Soldered connections eliminate losses from poor contacts.

Not only has this Transformer a high amplification factor but the amplification is nearly uniform throughout the entire audio range—making it *best for all stages*.

Turns Ratio 3.7 to 1 — Impedance Ratio 10 to 1

PRICE - - - - - \$5.00

Carried in stock by all good radio dealers.

Write **TODAY** for Instructive Folder—"Quality Amplification" and Bulletin 917U.

General Radio Co.

Manufacturers of
ELECTRICAL AND RADIO LABORATORY APPARATUS

Massachusetts Ave. and Windsor St., Cambridge, Massachusetts



“The Loveliest Thing I’ve Ever Heard Over the Radio”—Mary Garden

Only the most flawless reproduction, free from distortion and parasitic noises, could earn a tribute so unreserved from America’s queen of song. The exquisite tone quality and purity of Erla Duo-Reflex reception that appealed so irresistibly to Miss Garden is finding equally enthusiastic appreciation in the homes of super-critical radio lovers everywhere.

Not only in sheer tonal perfection, but in range and volume, have Erla Duo-Reflex receivers demonstrated decisive superiority. Tube for tube, they are the most powerful receivers known.

Complete Erla parts, including celebrated synchronizing radio and audio transformers that enable vacuum tubes to do triple duty, guarantee success to the amateur who “rolls his own.” Easily understood blue prints guide every step. Ask your dealer for free Erla Bulletin No. 20, giving latest Erla one, two and three-tube diagrams; or write direct, mentioning your dealer’s name.

Electrical Research Laboratories, Dept R, Chicago



Increased range and volume, as well as elimination of distortion, follow installation of Erla transformers. Reflex and Cascade types, \$5



Erla sockets embody every improvement, with nicked shell cast into Bakelite base, and tilted double contact springs. List \$1



Exclusive ability of Erla audio transformers to amplify three stages without distortion assures improvement in any receiving set. List \$5



Erla two-way phone plugs hold phone tips securely without use of tools or cutting or changing phone tips in any way. List, 75c

ERLA

Please refer to POPULAR RADIO when answering advertisements.

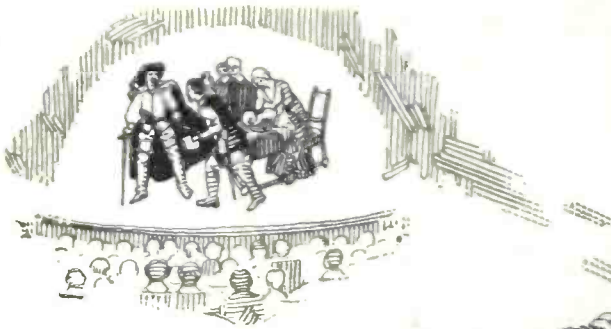

Selected Wood Produces Faithful Tones

LISTEN! The Sextette from Lucia. The living voices of the great artists—as if floating in through the window on wings of magic.

MUSIC MASTER,[®] Radio's musical instrument, catches the softest tones, the most delicate shadings, the personality of each artist's voice—and the illusion of their presence in your home is perfect.

The wood amplifying bell of MUSIC MASTER eliminates blast, rattle and thin nasal tones and substitutes in their stead, full, clear, resonant tones—faithful and lifelike, a delight to the ear.

There is a scientific reason for the material, size and design of every part of MUSIC MASTER—developed and perfected by men who have spent more than a score of years in the study of sound reproduction.

Go to your dealer and let MUSIC MASTER speak for itself; or, better still, have one sent to your home to test and prove on your own set.

MUSIC MASTER CORPORATION

Formerly General Radio Corporation

Makers and Distributors of High Grade Radio Apparatus
S. W. Corner 10th and Cherry Streets, Philadelphia
CHICAGO PITTSBURGH



Dealers
Everywhere

Connect in
place of
headphones.
No batteries
required. No
adjustments.

14-inch Model, for the home	\$30
21-inch Model, for Concerts and Dancing	\$35

Music Master

RADIO REPRODUCER

Please refer to POPULAR RADIO when answering advertisements.

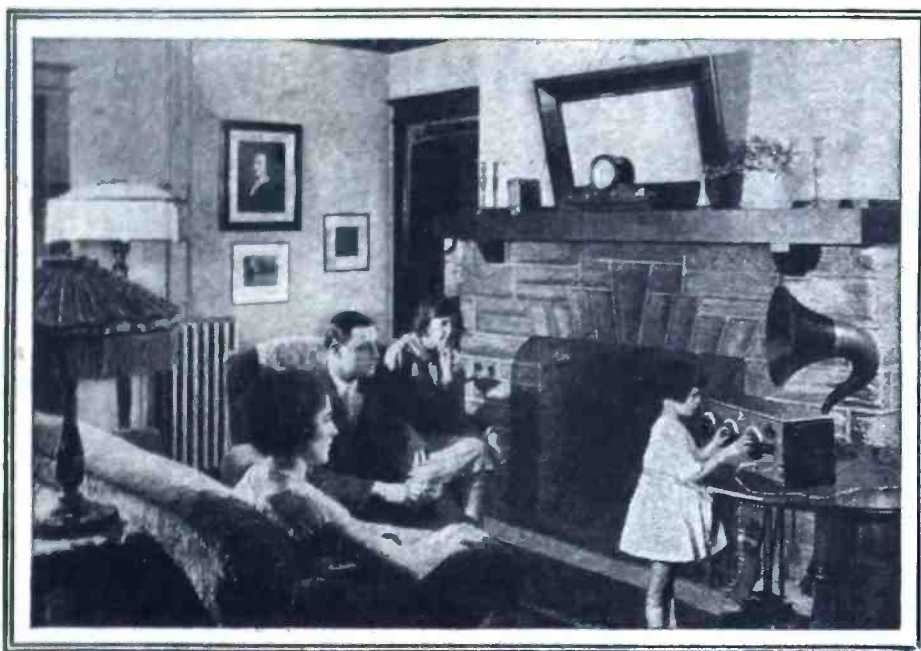

FADA "ONE SIXTY" NEUTRODYNE RADIO RECEIVER

Simplicity

When a radio receiver is so simple that a little child can operate it as well as a grown person, then radio has reached a stage of development little short of perfection.

The Neutrodyne principle as applied to the FADA "One Sixty" has produced a radio receiver that is simplicity itself. Once the notations have been made of the dial settings of any stations, *anyone* can reset the dials in the given positions and listen to that station at will.

F. A. D. ANDREA, INC., 1581

The FADA "One Sixty" four-tube Neutrodyne receiver is as selective, brings in distance and produces as great volume as any five-tube set. And, best of all, the FADA "One Sixty" can be depended upon to bring in most of the programs—local and far distant—on the loud speaker.

The pleasing design of the cabinet and its beautiful finish make it an ornament to any home. Price, exclusive of tubes, batteries and phones, \$120.

Jerome Avenue, New York City

FADA

Radio



Please refer to POPULAR RADIO when answering advertisements.

RADIO FREQUENCY AMPLIFICATION with the BALLANTINE VARIOTRANSFORMER

*Get distance
that everyone
can enjoy*



LET the whole family hear the announcer's "This is station ZYX, The Voice From 'Way off Yonder!" They can—by adding BALLANTINE Radio Frequency to your present outfit. Providing, of course, that you have a loud speaker. The voice or music will be clear and strong. And you'll find it easier to separate the various stations. Furthermore, squealing and distortions may be entirely eliminated.

Any standard set

One or more BALLANTINE units may be hooked in between any standard receiver and its audio amplifier—as shown above. Easy changes in wiring adapt it to regenerative, non-regenera-

tive and even crystal sets. Besides, to reflex circuits the BALLANTINE brings the advantage of tuning each stage. Notable results have been obtained in the One-, Two-, and Three-Tube Reflexes as described in *Radio Broadcast*.

All wavelengths

Pure tones at maximum volume for the number of tubes employed are assured by the *continuously variable* feature of the BALLANTINE transformer. For, by turning only one knob, this instrument tunes sharply throughout the range of 200 to 600 meters. Pigtail connections and full shieldings prevent stray noises. Theory and details of construction will be furnished to those interested in our 25-page booklet, *Radio Frequency Amplification*.

A special service

Every user of BALLANTINE VARIOTRANSFORMERS is entitled to the experience and advice of the engineering staff of the Boonton Rubber Mfg. Co. Try the instrument first. Then, if there's anything you don't understand, write, giving full details of your complete outfit.

BOONTON RUBBER MFG. CO.
Pioneers in Bakelite Moulding

324 Fanny Road, Boonton, N. J.



Complete radio frequency amplifier unit with socket \$15.00 and rheostat .

Transformer only for panel or base \$9.60

At dealers or postpaid



RADIO FREQUENCY AMPLIFICATION with the BALLANTINE VARIOTRANSFORMER

Please refer to POPULAR RADIO when answering advertisements.



YOUR SET WILL BE A MUSICAL INSTRUMENT

WHEN YOU USE

THE THORDARSON SUPER AUDIO FREQUENCY AMPLIFYING TRANSFORMER

Heretofore, amplifying transformer manufacturers have given too much attention to volume of amplification and have sacrificed the most important function of their transformers,—that of perfectly reproducing the broadcasted programs. Consequently many listeners in have complained about the musical qualities of radio reception.

No matter how good your phonograph, you could not expect to obtain good music from a poor record. Likewise, although your loud speaker be the best, you cannot expect to enjoy radio reception if the signals you put into it have been distorted in the process of amplification.

The new THORDARSON SUPER Audio Frequency Transformer was designed to correct the shortcomings of amplifying transformers of the past and embraces the following cardinal features:

- (1) **Perfect reproduction of voice and instrument**
- (2) **Even amplification over the entire musical range. (You will be surprised to hear the amazing reproduction of the bass notes.)**
- (3) **Increase in volume to the extent that tonal purity will permit.**

This SUPER TRANSFORMER is the result of several months research work in the thoroughly equipped Thordarson laboratory and represents the culmination of twenty-eight years experience in manufacturing small transformers.

Such leading set manufacturers as the Colin B. Kennedy Company, Chicago Radio Laboratories Company (Zenith) and the Western Coil and Electric Company (Radiolyne) along with many others proclaim the merits of the THORDARSON SUPER TRANSFORMERS.

Install a pair of Thordarson Super Transformers now and your receiving set will be converted into a real musical instrument.

Even Amplification over the entire musical range

THORDARSON

ELECTRIC MFG. CO.

CHICAGO, ILLINOIS

The CLEAR Loud Speaker!



HOW near the music sounds when it comes through the clear Herald! Just as if you were dining in a famous restaurant, and its orchestra were playing beside you.

That's the effect the Herald always gives. *Absolute clearness.* Because it is free from all blast and blur. Whether the number be music, lecture or news, the clear Herald is faithful to the performer.

THE Herald, like other good musical instruments, improves with age because of its laminated core, mica diaphragm and permanent magnet. It stands up under power without rattling. The adjustable diaphragm makes it possible to get the most out of a weak set. Height 30 inches. 6-foot cord. Price \$30. Slightly more on Pacific Coast and in Canada. Write for folder and enclose your dealer's name.

Herald Electric Co., Inc., 113 Fourth Avenue, New York

Please refer to POPULAR RADIO when answering advertisements.

Now Links Two Continents!



MELCO-SUPREME

Tuned Radio-Frequency RECEIVER

Satisfies Every Radio Wish

TO Consistently copy far west and coast stations is an achievement which only the *Melco-Supreme* can claim. Any set can occasionally get distance, but it remained for the *Melco* engineers to develop the now famous inductively tuned radio frequency receiver with neutralizing compensators, which duplicates its performances daily at the same dial readings.

Extreme Selectivity Exceptional Clarity
Simplicity of Operation Perfect Control

Each instrument is fully guaranteed

Write for complete descriptive literature



Compensating Condenser

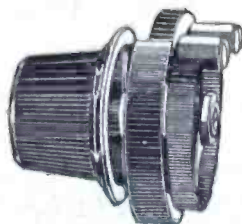

Rheostats and Potentiometers



Bakelite "Vernigrip" Dial

AMSCO PRODUCTS, Inc.
FAIRBANKS BUILDING
BROOME & LAFAYETTE STS. NEW YORK CITY



Please refer to POPULAR RADIO when answering advertisements.

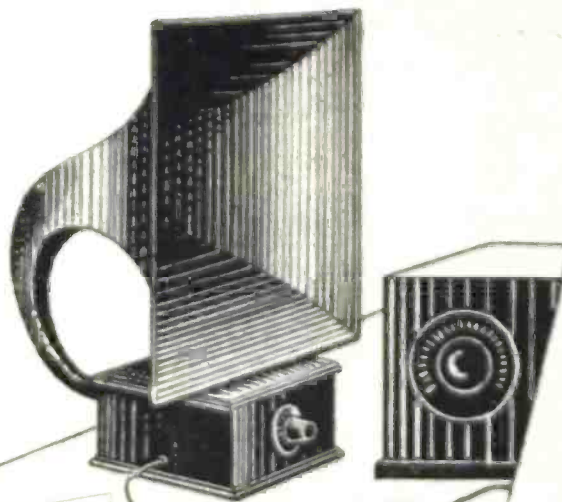

CALLOPHONE

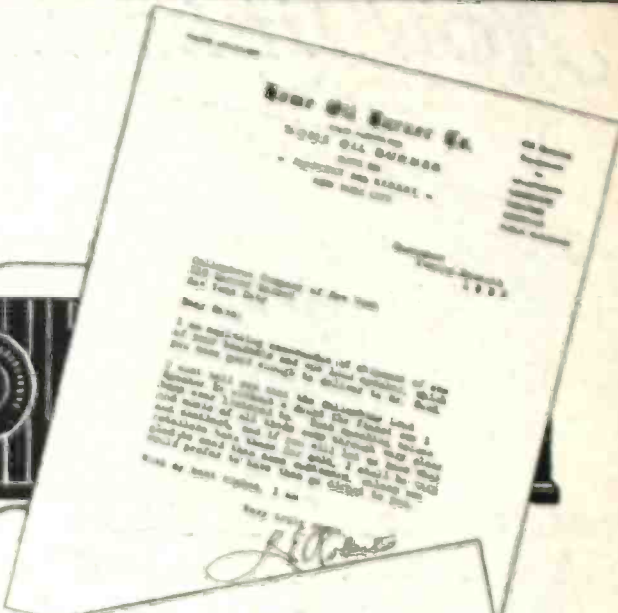

Read These Letters!

—the most critical find perfection in the CALLOPHONE

These people were "from Missouri" until they heard the Callophone. Its clear, natural tones convinced them and will convince you of the superiority of the Callophone over every other type of loud speaker on the market today—regardless of cost.

The Callophone is priced at \$35.00—and worth it.

We ask you to try out the Callophone—if you are not entirely satisfied with its performance—return it, and your money will be refunded immediately.

Every Callophone owner is a "booster"—order yours now, and add your letter to the hundreds we now have. If your dealer doesn't stock the Callophone—send direct to:

**THE CALLOPHONE COMPANY
OF NEW YORK**

216 Mercer Street New York

"Makers of Callophone Loud Talking Commercial Apparatus"

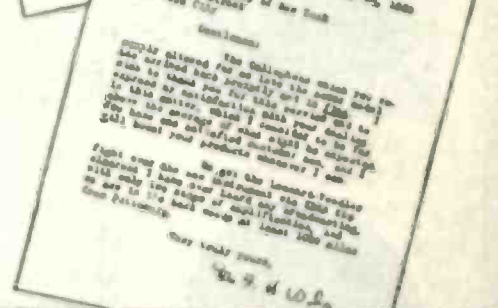
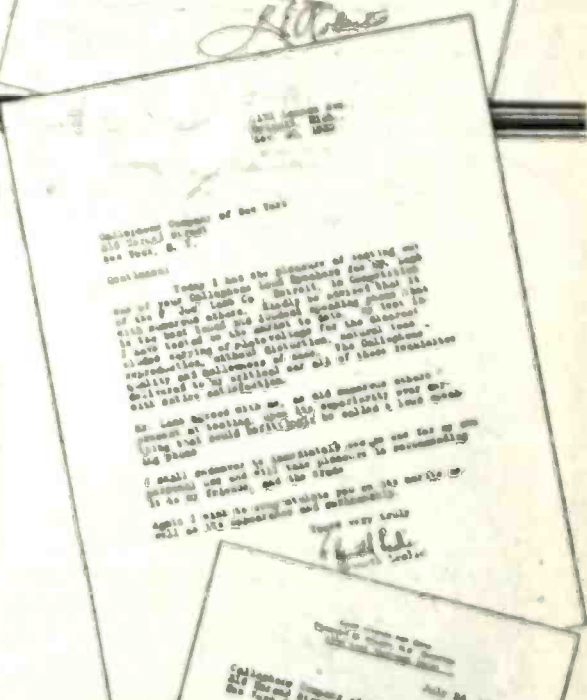

OUR GUARANTEE

The Callophone is tested under actual operating conditions and sealed before shipment. We will keep it in adjustment and repair free of charge, as long as this seal remains intact.

Establishing a New Horizon for Radio!



MU-RAD RECEIVER

MA-15

TILL FURTHER beyond the accepted bounds of radio reception, this long-range MU-RAD Receiver MA-15 has extended the domain of radio entertainment. To the easy operation and high selectivity of the MU-RAD design, is added a still greater mastery of illimitable spaces together with pure, clear loud speaker volume. All this with only a handy 2 foot loop! The standard MU-RAD circuit of proven performance—two stages of audio and three stages of radio frequency amplification with detector. Adam Brown, hand-rubbed finished mahogany cabinet with voltmeter for quick reading of “A” and “B” battery conditions.

**Guaranteed range with
2 foot loop~1000 miles**

Write for Literature

MU-RAD LABORATORIES INC.
809 FIFTH AVE. ASBURY PARK, NEW JERSEY

Please refer to POPULAR RADIO when answering advertisements.

5,000,000 Owners of Single Circuit Sets are waiting to Buy this Copp Vario-Selector



Copp Vario-selector
Patent Applied For

BECAUSE:

I. It will **CHANGE** any Single Circuit Set to a Double Circuit Set without re-wiring and without re-building. Simply connects to Antenna and ground and it is done.

II. **ELIMINATES RE-RADIATION.** This will be a great boon to Broadcast Stations and to all Owners of Broadcast Receiving Sets.

III. **GIVES SELECTIVITY** to a Single Circuit Set equal to any three circuit tuner, preserving the Single Circuit simplicity of tuning.

NOTE: The Copp Vario-Selector is **NOT** a Wave-Trap.

It is known that every Single Circuit Receiver re-radiates energy and causes interference in reception to every Receiving Set within a radius of several miles. Since there are so many Single Circuit Sets this has become a great hindrance to clear reception. A number of communities are trying to solve this situation by agreement and rules. It is certain that eventually The Supervision of the Radio Department will have to lay down the law for its solution.

With Copp Vario-Selector attached to Single Circuit Sets the problem is solved.

Think what a benefit this will be to ALL radio owners.

Think also what great benefit comes to the owner of the Single Circuit Set. No necessity to destroy the set and buy a new one. With Copp Vario-Selector he converts his set to a Double Circuit Tuner, he gets selectivity, he eliminates interference. He has benefited himself and all users of Radio Sets.

Copp Vario-Selector is sold in a Sealed Cabinet, beautifully finished, with engraved Bakelite Panel, and is guaranteed by us absolutely. Signed guarantee with every instrument.

Jobbers and Dealers write us immediately for discounts. We can make quick deliveries now.

Price, \$11.50

A-C ELECTRICAL MFG. CO.

Dayton, Ohio

Makers of Electrical Devices for over 20 years

TUNED WAVE TRAP RADIO FREQUENCY RECEIVER

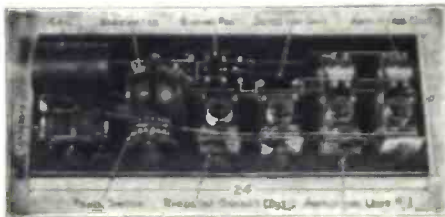

Built on famous Copp Circuit No. IV.

Efficient for all wave lengths from 200 to 700 meters.

Range up to 2000 miles.

Any person can build this set with A-C Dayton complete units.

\$43.35

Units packed complete in one carton with wiring diagrams, photographs, instructions, etc., for complete installation.

See your dealer or write us direct. Circular on request.

THE A-C ELECTRICAL MFG. COMPANY, Dayton, Ohio

Makers of Electrical Devices for over 20 Years

Please refer to POPULAR RADIO when answering advertisements.

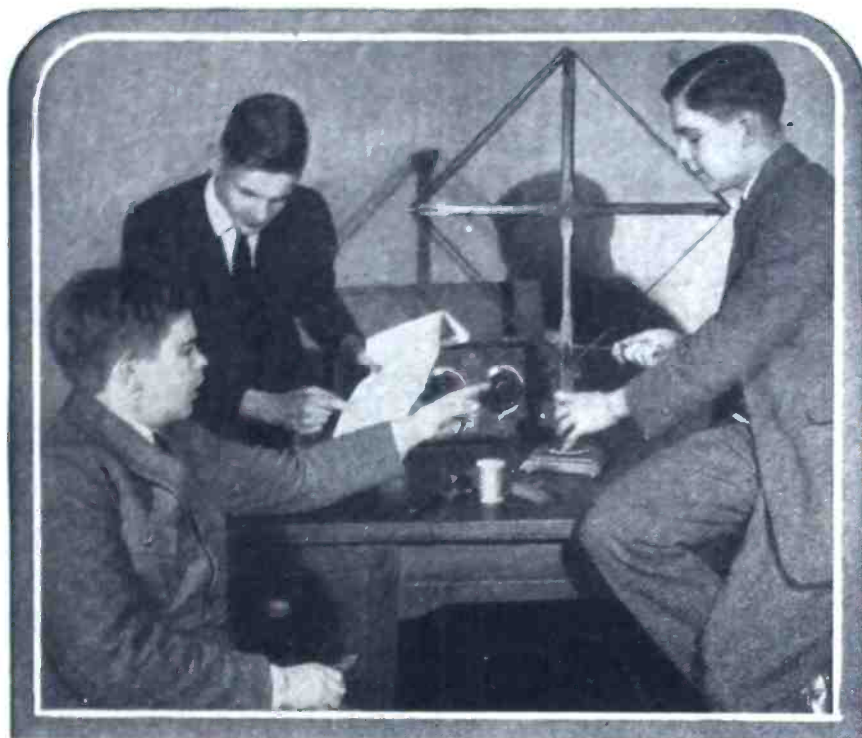

“WHY?”

THE childish persistency that keeps parents answering innumerable questions, does not cease with babyhood. Boys always want to know. But as they grow older they prefer to find out for themselves. And this very boy trait is largely responsible for the marvelous improvement in radio. From Armstrong down to the present day, the boyish desire to know “why” has led to new discoveries and inventions.

Call it curiosity, call it interest, or whatever you will—this universal boy characteristic is one of the greatest factors in the radio business. Not only does it keep manufacturers on their toes, keeping up with or ahead of the pack, but it keeps their plants running to supply the necessary radio equipment to satisfy boy wants. The radio pulse beats strong, because boys’ dollars provide the impulse.

**THE
AMERICAN BOY**
“The Biggest, Brightest, Best Magazine
for Boys in All the World”

is radio guide and instructor to 500,000 live-wire boys, averaging 15½ to 16 years old. Its stories, replete with thrilling radio adventures, fire their already active interest. Its articles deal with radio scientifically and authoritatively. Interest quickened, needs suggested, what more natural than to turn to the advertising columns for information on radio equipment?

Start this force working for you. Tell this army of boys about your product. Win their trade—more, win their loyalty. They’ll boost your goods to the gang—to every “radiophan” of their acquaintance. Advertise where boys are sure to look—in their own respected magazine—**THE AMERICAN BOY.**

Copy reaching us by April 15th will appear in June.

THE SPRAGUE PUBLISHING COMPANY

(Member A. B. C.)

548 Lafayette Boulevard

Detroit, Michigan

Please refer to POPULAR RADIO when answering advertisements.

CHELSEA

SHARPER TUNING AND MORE VOLUME

with CHELSEA parts

Insist on getting a Chelsea

LOW LOSS Condenser

Genuine bakelite insulation
Pigtail connection to rotor



10—23 plate with Vernier, \$4.50

ABSOLUTELY GUARANTEED

All prices include 3" dial

- # 8—43 plate with vernier \$5.00
- # 10—23 " " " \$4.50
- # 12—11 " " " \$4.25

Without Vernier

- # 3—43 plate with dial \$3.25
- # 4—23 " " " \$3.00
- # 5—11 " " " \$2.75

Chelsea offers a complete line of parts and sets
At your dealers or write direct

CHELSEA RADIO COMPANY

183 SPRUCE STREET

Chelsea, Mass.

Supremacy Proven
by Every Test!

FIL-KO-STAT

The SCIENTIFICALLY CORRECT
RADIO RHEOSTAT
for All Tubes!!

Can You "TUNE IN" With Your Rheostat?

THE Satisfaction of hearing DX stations you never heard before and of silent vacuum tube operation is yours when you install a FIL-KO-STAT in any hook-up, using any type of tube.

It means an additional and important tuning unit—for FIL-KO-STAT is more than a rheostat. Its critical control, spread over four turns of the knob, enables you to "tune in" DX stations that no other control on your set will get. And what's more it eliminates tube reradiation through micrometer vernier adjustment of filament heat (electronic flow.)

RADIO STORES CORPORATION

Sole International Distributors
HOME OFFICE, Dept. P. R. 4.

220 West 34th St., N. Y.

Full
resistance
30 ohms



MADE BY
DX INSTRUMENT CO.
BOSTON, MASS.

Unconditionally Guaranteed

ATWATER KENT

Philadelphia

Selectivity — Distance — Volume
and Ease of Operation



ANYONE can tune in a distant station without interference and obtain clear reception with an ATWATER KENT Receiving Set.

Selectivity — range — volume and simplicity of operation have made it the choice of families everywhere. •

The clearness with which the ATWATER KENT Loud Speaker re-creates will give you a new conception of tonal fidelity.

Literature sent on request

ATWATER KENT MFG. CO.
4933 STENTON AVE., PHILA., PA.

Please refer to POPULAR RADIO when answering advertisements.

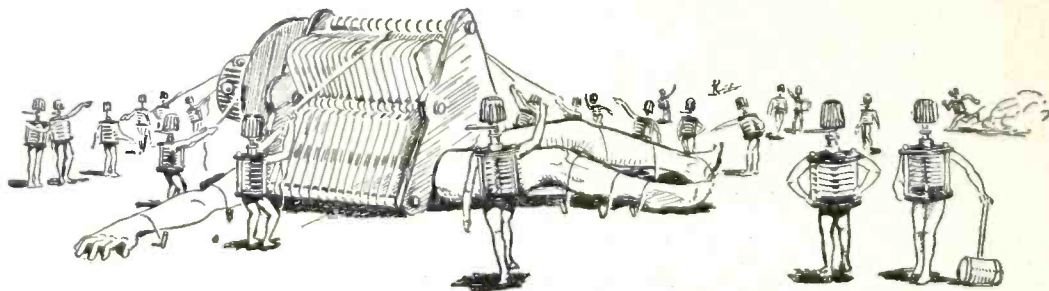

A Modern Gulliver and the Chelten Midgets

Like Gulliver of old—the Variable Condenser is kept within bounds by the tiny Chelten Midgets. These little Verniers with their 13 tiny plates can control the wanderings of your Condenser over this great land, causing it to bring to your listening ears either music—speech—bedtime stories—or other broadcasts.

A turn of its tiny knob and a new station comes in clear and strong to entertain you. It gives that delicate adjustment so often necessary to change disagreeable sound into clear, distinct speech or beautiful music.

If you cannot get the Chelten Midget from your dealer, we will send you one upon receipt of money order for \$1.50 and name of your distributor

CHELTEN ELECTRIC COMPANY
4863 STENTON AVENUE PHILADELPHIA

RHAMSTINE* VICTOPHONE

\$12 Complete
Postpaid

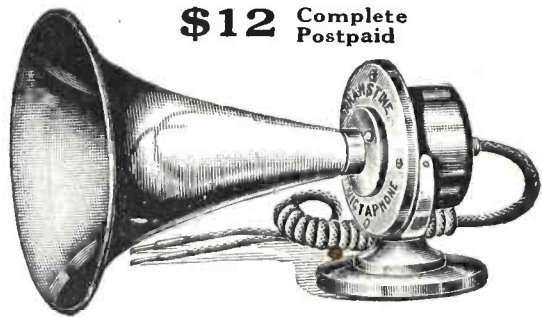

WITH HORN AND BASE

This is a new Rhamstine* Product—combining the popular Victophone with an attractive horn and swivel base. It is a unit which is original in design, neat in appearance, and in connection with the adjustable Victophone, gives remarkable volume.

All parts are nickel plated and polished.

You will be satisfied with a Victophone and Horn. Order yours today.

RHAMSTINE* VICTOPHONE

For All Phonographs and Loud Speaking Horns

In addition to the large diaphragm used in the Victophone, every other detail has been given the closest attention. When incorporated with your phonograph or horn, it will reproduce with the utmost volume and purest tone. No battery required to operate it. Your money back if not satisfied.

It can be furnished to fit all phonographs—the Standard Type fits the Victrola, Columbia, Jewett or Sonora. Specify make of phonograph when ordering.

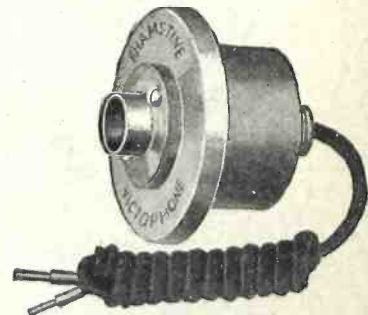

\$7.50 Postpaid
Complete with Cord

Order the New Victophone and test it before buying any other loud speaker

Manufactured by
J. THOS. RHAMSTINE*
Woodbridge at Beaubien Detroit, Mich.
*Maker of Radio and Electrical Products

Please refer to POPULAR RADIO when answering advertisements.



A Metal Arrow Dial Pointer



VERY worth while refinement for your set. These raised metal arrow-pointers simplify dial setting and add a great deal to the workmanlike, "professional" appearance of your set. Easily attached to panels of any thickness—just drill a small hole, insert, and tighten screw in rear of panel. Does not in any way affect the efficiency of your set but makes its operation much easier. A lot of advantages for a very small amount.

Nickel plated raised arrow threaded for a No. 2-56 machine screw. Fits panels of any thickness.



At Your Dealer's

Marle Engineering Co.

Orange, New Jersey

Dealers:

Write for details of our counter display card proposition. A real money-maker.

Please refer to POPULAR RADIO when answering advertisements.



COCKADAY UNIT

Full Set A, B, C and D Coils

Made strictly in accordance to Mr. Cockaday's Specifications



Range 150 to 600 Meters

For 1 and 3 Tube Set
Price **\$4.50**

Genuine XX Bakelite tubing wound with No. 18 single cotton covered wire.

For 5 Tube Set
Price **\$5.50**

Best quality Radion hard rubber tubing 1/4" wall wound with No. 18 double silk covered wire.

Guaranteed mechanically and electrically perfect. The outstanding features: Complete set of A, B, C and D Coils with beautifully knurled binding posts, eliminating loose end wires, insuring perfect contact and easier wiring. Made of the best quality material combined with expert workmanship. Distributed capacity or leakage and dielectric losses practically eliminated. Insures selectivity with maximum sensitivity and volume.

Two large blue prints and illustrated instructions together with list of parts necessary for building Cockaday Tuners furnished with each unit

Unconditionally Guaranteed to Give Absolute Satisfaction

At Your Dealer, Otherwise Shipped to You Postpaid

Dealers and Jobbers Write for Attractive Proposition

GENERAL RADIO WINDING CO. 214 FULTON ST. NEW YORK, N.Y.

91 1/2% OF ALL RADIO TUBES ARE NEEDLESSLY DESTROYED



Accurate estimates show that less than 9 out of every 100 tubes give their full normal service and 91 are destroyed—usually burnt out from excess current.

The chances are 10 to 1 against you unless you use

RADECO SAFETY FUSES

These tube savers are now saving thousands of tubes. They are endorsed by the leading Radio Publications.

They slip on the filament terminals of the tube and in no way interfere with the operation of the set.

Price \$0.50 each

(The cheapest insurance)

Install Radeco Safety Fuses now and whenever you buy a new tube insist on a Radeco Fuse to protect it.

Jobbers: We want a few live distributors to whom we can offer a very attractive proposition.

RADIO EQUIPMENT COMPANY

New England's Oldest Exclusive Radio House

20 STUART STREET

BOSTON, MASS.

Please refer to POPULAR RADIO when answering advertisements.

Published for Every SUPERHETERODYNE Experimenter

In the service of hundreds of experimenters who are constructing or plan to build Superheterodynes, we have published a text book treating every problem involved in this remarkable circuit:

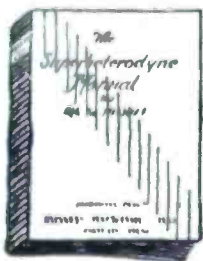

64 pages of valuable data collected after exhaustive investigations. Copiously illustrated. Shows how to build a Superheterodyne successfully. Gives full sized layouts, circuit blue prints, panel templates, etc.

The Superheterodyne Manual

Written by Victor Greiff, Member of the Institute of Radio Engineers, who has been associated in much of the radio development of the United States Navy, the Manual offers the only complete treatise on the subject. At the same time it is written so simply and clearly that any one who has a rudimentary knowledge of radio can easily comprehend every theory and application.

Order At Once! The Edition is Limited

Our First Edition of the Superheterodyne Manual is rapidly being sold out. Hundreds of copies are now being distributed with Receptrad Superheterodyne parts for the convenience of Receptrad builders. If you order promptly, however, you can secure the Manual—through your dealer, or by mail, postpaid. Price \$1.50

Published by The Receptrad Press



That Receptrad has developed the finest Superheterodyne transformer built, is sufficient indication that its engineering personnel are properly qualified to prepare an authoritative Manual. Type 1716 transformers, range, 5,000 — 25,000 meters. Price \$8.50

RADIO RECEPTOR CO.

INCORPORATED

57 BANK STREET

NEW YORK CITY

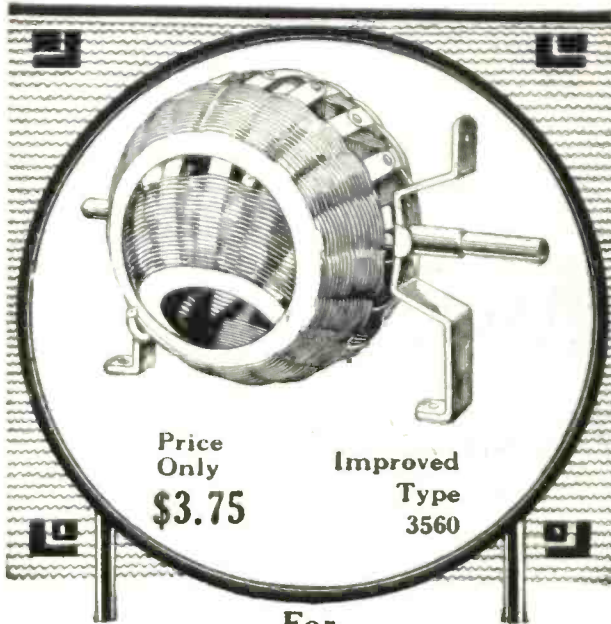

Price
Only
\$3.75

Improved
Type
3560

For
INDUCTANCE TUNING
the

AMRAD

Basketball

Receiving circuits inductively tuned with BASKETBALL Variometers absolutely insure—

1. Greater receiving range
2. Perfect tone
3. Greater volume
4. Extreme selectivity, i. e. ability to "tune out" local broadcasting and get distant stations if desired.

Write today for Bulletin V describing the famous AMRAD Basketball

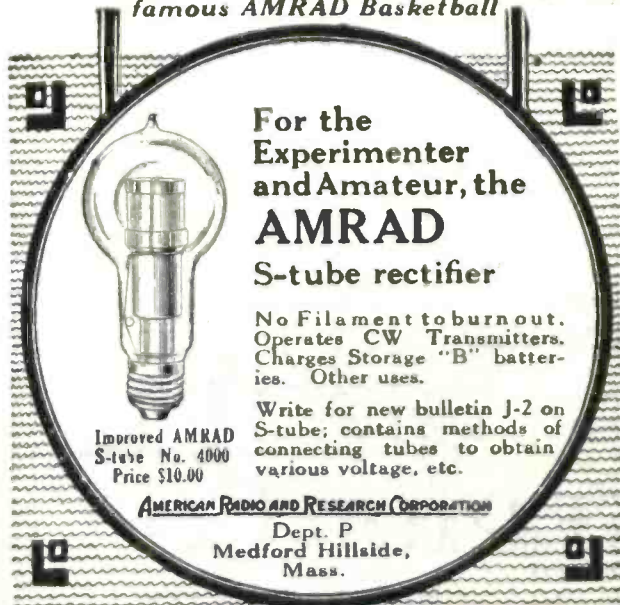

For the
Experimenter
and Amateur, the
AMRAD
S-tube rectifier

No Filament to burn out.
Operates CW Transmitters.
Charges Storage "B" batteries.
Other uses.

Write for new bulletin J-2 on
S-tube; contains methods of
connecting tubes to obtain
various voltage, etc.

Improved AMRAD
S-tube No. 4000
Price \$10.00

AMERICAN RADIO AND RESEARCH CORPORATION

Dept. P
Medford Hillside,
Mass.

AMRAD



Speed Every Nut- Tight-with **Spintite Wrenches**

DON'T let any hard hook-up discourage you. Spintites enable you to work serenely and prevent leaky connections. Spintite's hexagon socket grips the nut solidly—the ebonized handle spins it up tightly—the hollow stem goes over projecting screws—and it's so easy to reach into cramped corners. What you'll save in time and grief on one hook-up will more than pay for Spintites. All sizes, from $\frac{1}{16}$ " to $\frac{9}{16}$ ". Order a set today.

Send \$1.00 for Set No. 71 with 3 most popular radio sizes

Stevens & Company
Toolsmiths since 1899
375 Broadway, N. Y.

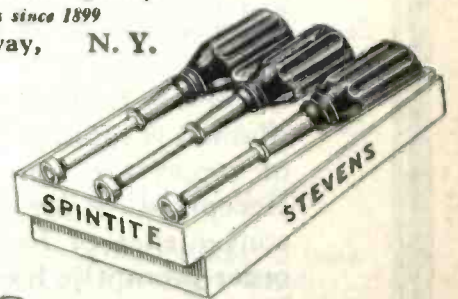

Trade
Name
Registered



Send \$3.50 for Professional Set No. 73—7 sizes, $\frac{1}{8}$ " to $\frac{1}{2}$ ", in beautifully finished metal base

Stevens **SPEED UP** Tools

Please refer to POPULAR RADIO when answering advertisements.

"The Best That Money Can Buy"

"GOLD SEAL" HEADSETS



2200 Ohms
\$6.00

3200 Ohms
\$8.00

"GOLD SEAL" HEAD SETS are electrically and mechanically,—as well as from a radio standpoint,—as perfect as the highest-priced Head Set on the market,—yet, with all their perfection, they retail at only \$6.00 for 2200 Ohm and \$8.00 for 3200 Ohm.

The trade mark "DEVEAU" has stood for the highest quality in telephone apparatus for thirty years,—a guarantee that every known advantage in design and manufacturing has been taken into careful consideration.

Magnets are extra-heavy one-piece units; cups are of aluminum to keep down the weight but unlike other Head Sets, every exposed metal part of the set is finished in genuine 24-karat gold,—under a protective lacquer so that the finish will last for years; the terminals of each unit are concealed,—no contact possible with users' hands.

"DEVEAU GOLD SEAL" HEAD SETS are like a piece of fine jewelry in appearance, but with all the radio niceties that the most advanced radio enthusiast can desire. DEVEAU Units exactly match each other in tone,—each has maximum sensitivity and perfection of tone quality.

"DEVEAU GOLD SEAL" HEAD SETS are guaranteed to be electrically and mechanically perfect,—our Guarantee protects every purchaser.

STANLEY & PATTERSON

27 WARREN STREET
23 MURRAY STREET

NEW YORK CITY, U. S. A.

Please refer to POPULAR RADIO when answering advertisements.

BRISTOL SINGLE CONTROL RADIO RECEIVER



Most Simple to Operate

The set for those who want results with little effort. Anyone in the family can quickly learn to operate it because technicalities and guesswork are eliminated—One Control Dial does it all.

Does Not Interfere With Your Neighbor

Other close by reception is not disturbed when you tune in with this non-reradiating Receiving Set. It gives you a comfortable sensation of freedom to be able to change from one station to another knowing that you will not interfere with your neighbor's receiving.

Choice of Aerial or Loop

Where conditions make it difficult to install an outside aerial, as in congested sections of cities, good results can usually be had by using inside Loop. In fact, the directional feature of the Loop often brings in stations not possible with a stationary aerial.

Mounted in solid mahogany case with walnut finish, the Bristol Single Control Radio Receiver is handsome in appearance. The price is \$190.00. Bulletin 3013-L describing this set will be mailed on request.

BRISTOL

TRADE MARK

AUDIOPHONE

REG. U. S. PAT. OFFICE

LOUD SPEAKER



This is known everywhere as the Loud Speaker with the quality tone. Not only is the tone natural and without mechanical distortion, but is sufficiently big in volume to be easily heard in a large room or all through the house. Comes to you ready to use—no auxiliary batteries are required.

Made in three models:

- Audiophone Senior Price \$32.50
- Audiophone Junior Price 22.50
- Baby Audiophone Price 12.50

THE BRISTOL COMPANY

WATERBURY, CONN., U. S. A.

Please refer to POPULAR RADIO when answering advertisements.

Genuine-
E. J. Flewelling
 Radio Apparatus
 De Luxe

Flewelling Sockets

are made for better reception. Wide spacing of contacts assures no capacity losses. Positive side "wiping" contacts mean positive connection with tubes. Made of extra high test bakelite in two sizes—Standard and 199. Price, **\$1.00.**



Flewelling Condensers

are ruggedly built. Made to give a world of service and stand up under more than ordinary abuse. Heavy 1-16 inch brass plates eliminate misalignment. Large ball bearings assure freedom of rotor. Electrical and mechanical efficiency exceptionally high. Made in two sizes—.005 mfd. 23 plate—**\$7.00**; .0025 mfd. 11 plate—**\$6.00.**

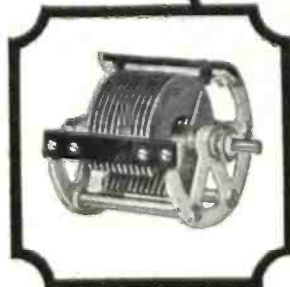

Flewelling Tuners make use of the most efficient basket weave coil windings with a micrometer coupling control. Dielectrics are eliminated from the coil field. Coils are interchangeable. However a wide wave band can be covered with one set of coils. Tuner complete with bakelite dial, **\$8.00.**

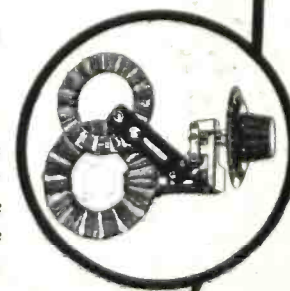

**At Your Dealers
 or Direct**

Genuine E. T. Flewelling parts are manufactured exclusively by

BUELL MANUFACTURING COMPANY

2979 Cottage Grove Avenue
 CHICAGO



**HERE IS A
 WINNER**

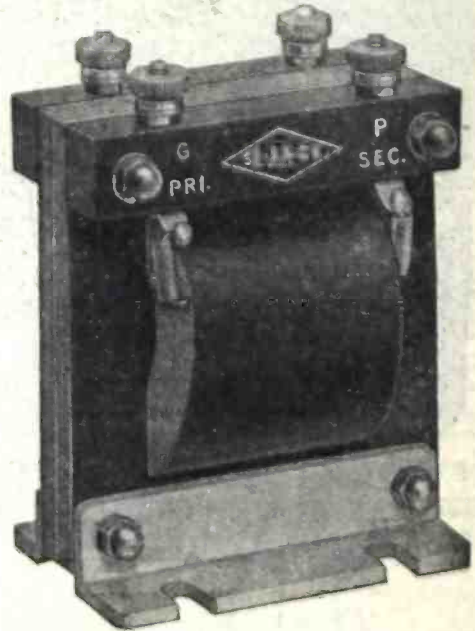

SE-AR-DE
 Amplifying Transformer

Turn Ratio 4-1

20% louder signals with less distortion than any transformer on the market. Large! But oh boy, you should send for copy of the amplification curve,

Price \$5.00

R. MITCHELL CO.

255 Atlantic Ave. Boston, Mass.

EXPORT OFFICE

44 Whitehall Street

New York

PACIFIC COAST OFFICE

Mission Street

San Francisco, Cal.

Please refer to POPULAR RADIO when answering advertisements.

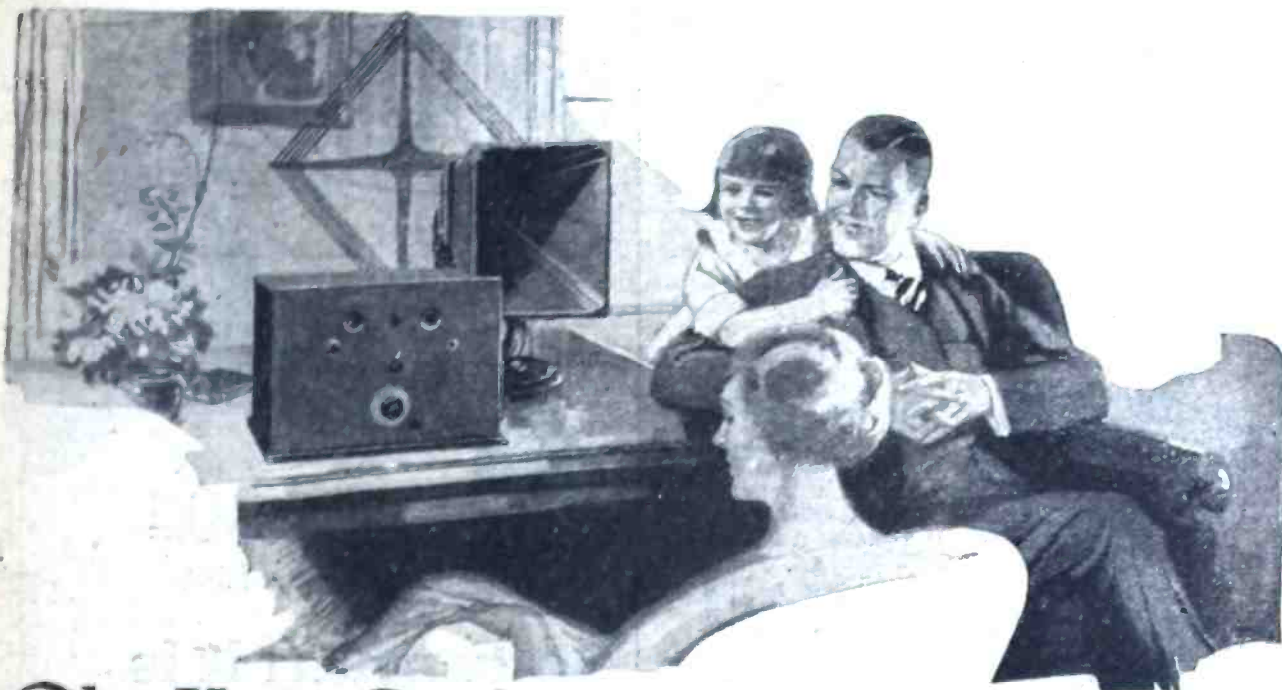

The Key to Radio is — Amplification without Distortion

THE key that unlocks the door to radio, with all its mysterious thrills and pleasures, is Amplification. Amplification builds up the tiny sound waves that come in to your receiving set, making them loud enough for you to hear and enjoy. Sounds that would otherwise be faint and unintelligible are transformed by amplification into—a concert in a far away city or a bedtime story, or the latest news.

The danger of distortion

BUT in amplifying these sounds they must not be distorted. Distortion blurs the quality of the sound and makes squeals and howls out of broadcasting that should be clear and distinct. It is of utmost importance to use amplifying transformers that will amplify without distorting the sound.

How to get amplification without distortion

THE Acme Apparatus Co., specialists in the manufacture of transformers, have

perfected two transformers which are famous among radio owners for giving the greatest amplification without distortion.

The Acme R-2 (also R-3 and R-4) Radio Frequency Amplifying Transformer builds up the incoming radio energy so that your detector will act. This gives added distance.

The Acme A-2 Audio Frequency Amplifying Transformer builds up the audio energy which comes from the detector. This gives greater volume of sound without distortion. To be sure of getting the greatest possible range and getting it "loud and clear" use these Acme Transformers.

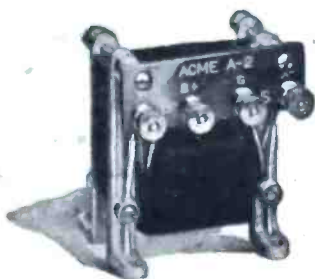

THE Acme A-2 Transformer (shown above) and Acme R-2, R-3, and R-4 Radio Frequency Transformers sell for \$5 each at radio and electrical stores. Your dealer will be glad to help you.

Send for booklet

IN ORDER to get the best results, send for "Amplification Without Distortion"—an instructive and helpful book which not only explains exactly how to get the best results by proper amplification, but also contains a number of reliable wiring diagrams. It will help you build a set. Mail the coupon with 10 cents for your copy.

ACME APPARATUS COMPANY
Dept. 42, Cambridge, Mass., U. S. A.

ACME

for amplification

ACME APPARATUS COMPANY,
Dept. 42, Cambridge, Mass., U. S. A.
Gentlemen: I am enclosing 10 cents (U. S. stamps or coin) for a copy of your book, "Amplification Without Distortion."

Name

Street

City State

Please refer to POPULAR RADIO when answering advertisements.

Now you can UNDERSTAND RADIO!

Know all about it—build and repair sets—explain the vacuum tube—operate a transmitter—be a radio expert!

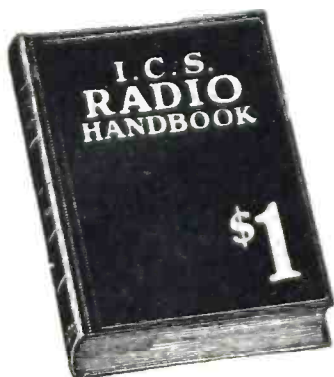

**1 VOLUME
514 PAGES**

Compiled by
**HARRY F. DART
E.E.**

Formerly with the
Western Electric
Co., and U. S.
Army Instructor
of Radio.

Technically Edited by F. H. Doane
30,000 ALREADY SOLD

Every question you can think of is answered in this remarkable book, the biggest dollar's worth in radio to-day. Over 30,000 homes rely on the I. C. S. Radio Handbook to take the mystery out of radio. Why experiment in the dark when you can quickly learn the things that insure success? Hundreds of illustrations and diagrams explain everything so you can get the most out of whatever receiver you build or buy.

It contains: Electrical terms and circuits, antennas, batteries, generators and motors, electron (vacuum) tubes, every receiving hook-up, radio and audio frequency amplification, broadcast and commercial transmitters and receivers, wave meters, super-regeneration, codes, license rules. Many other features.

A practical book. Written and edited by experienced engineers, in plain language. Something useful on every one of its 514 pages. The authority that covers every phase of radio, all under one cover in one book for one dollar. Don't spend another cent for parts, turn a dial or touch a tool until you have mailed \$1 for this I. C. S. Radio Handbook.

Send \$1 at once and get this 514-page I.C.S. Radio Handbook—the biggest value in radio to-day. Money back if not satisfied.

TEAR OUT HERE

INTERNATIONAL CORRESPONDENCE SCHOOLS
Box 8250-C, Scranton, Penna.

I enclose One Dollar. Please send me—post-paid—the 514-page I. C. S. Radio Handbook. It is understood that if I am not entirely satisfied I may return this book within five days and you will refund my money.

Name.....

Address.....



**Junior
DeLuxe**



\$30⁰⁰
List

So human it is almost "uncanny!"

You doubt your ears when you first hear The Amplion.

It is so distinct and natural in its reproductions of voice and music, that it is often described as "almost uncanny."

The reason is that The Amplion, instead of being a head receiver fitted with a horn, is the adaptation for radio of an electro-magnetic and acoustic instrument which for thirty years has been the standard loud-speaking device of the world's leading navies.

Requires no power amplifier, no battery. Attaches to regular phone connections.

Rubber bushings insulate the non-vibrating wooden horn and the reproducer from the metal sound conduit.

The special alloy diaphragm is adjustable to meet all conditions of receiving sets.

The Amplion comes in a variety of models, including portables and phonograph units.

In all the world there is nothing to equal The Amplion—*The World's Standard Loud Speaker.*



Ask your dealer for a demonstration

Patentees: **ALFRED GRAHAM & CO.**
SIGNAL ELECTRIC MFG. COMPANY
Sole United States Distributors Menominee, Michigan
BURNDEPT OF CANADA, LTD.
Canadian Distributors — 172 King Street W., Toronto

Please refer to POPULAR RADIO when answering advertisements.

For Better Radio Reception—

Freshman Products

GUARANTEED to be mechanically perfect, scientifically accurate and built for unusual durability. Used by discriminating manufacturers and amateurs all over the world, who realize that a radio set is only as good as each individual part.

The Standard Unit for Every Tube Set
FRESHMAN
 VARIABLE GRID LEAK and
 CONDENSER COMBINED



Permits you to adjust your circuit to any resistance you wish from zero to 10 megohms, in an unbroken range of 180 degrees. It takes the place of a grid condenser, grid leak mounting and grid leak, and, in addition permits an adjustment to the correct amount of resistance.

It is the most compact, the most efficient, the most adaptable to all grid circuits, and the only one which is entirely sealed and always remains unaffected by any climatic conditions.

Base or Panel Type complete with .00025 or .0005 Freshman Condenser, \$1.00. Either Type without condenser, .75

"FRESHMAN SELECTIVE"
 Variable
 Condenser
 For
 Transmission
 or Reception

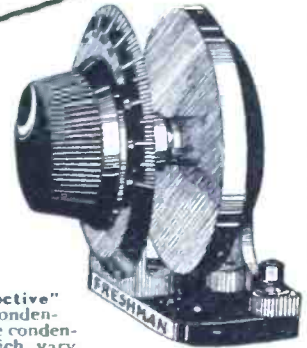

The "Freshman Selective" Mercury Variable Condenser is the only variable condenser the plates of which vary in area, an engineering feat never accomplished before.

The "Freshman Selective" is attractively compact, quiet in operation and will withstand 8,000 volts without leakage or danger of short-circuiting.

.0003 MF (Equiv. to 17 pl.) } \$5
 .0005 MF (Equiv. to 23 pl.) } Each
 .001 MF (Equiv. to 43 pl.) }

All moulded parts and dial of finest Bakelite.



Double Adjustable Freshman
Crystal Detector

for base or panel mounting. When mounted on panel only the knob shows on the front. No more searching for the sensitive spot. Merely turn the knob as you would a dial, thus adjusting the crystal instead of the cat-whisker. Best for both Reflex and Crystal sets. Price.....\$1.50

Guaranteed Capacities



STYLE 100

Capacity	Each
.00005	\$.35
.0001	.35
.00015	.35
.0002	.35
.00025	.35
.0003	.35

The Condenser Sensation of Modern Radio
FRESHMAN NOISELESS TESTED MICA CONDENSER

Every Condenser is individually tested on high voltage for capacity, break-down and leakage. Every piece of Mica embodied in the Condenser is individually tested and examined. The new Style No. 101 is equipped with Freshman Soldering Terminals which allow 3 distinct connections with a very small amount of solder.



STYLE 101

Capacity	Each	Capacity	Each
.00035	\$.35	.002	\$.40
.0005	.35	.0025	.50
.0006	.40	.003	.60
.0008	.40	.0035	.70
.001	.40	.004	.75
.0015	.40	.005	.75

Capacity	Each
.006	\$.75
.007	1.00
.008	1.00
.009	1.00
.01	1.00
.015	1.50



Freshman
Vernier
Dial

A Bakelite dial with Vernier adjustment. A small rubber tire wheel through the slot in the dial permits you to set the dial to the exact point and obtain the same dial setting every time. Just the thing for Neutrodyne and Heterodyne.

Price, 3 in., \$1.00
 Price, 4 in., \$1.50

At your dealer's. Other-wise send purchase price and you will be supplied postpaid.

ANTENELLA

attached to any lighting socket eliminates the inconveniences in radio such as unsightly outdoor aerials, insulators, lightning arresters, lead-in, etc.

ANTENELLA

It is not only a real distance getter but also overcomes static annoyances. The complete and efficient aerial.

NO OUTSIDE WIRES NEEDED



ANTENELLA Price only \$1.25

FRESHMAN FIX-O

A fixed Grid Leak Combination, 4 in 1



Freshman Condenser Leak Mounting
 Freshman Grid Leak
 Safe-T Handle } Price 65c

All megohms from 1/20 to 10 megohms.

Write for free diagrams of Neutrodyne, Tri Flex and Super Heterodyne Circuits.

Chas. Freshman Co. Inc.
Radio Condenser Products
 106 SEVENTH AVENUE
 NEW YORK CITY

Please refer to POPULAR RADIO when answering advertisements.

BAKELITE

TRADE MARK REG. U. S. PAT. OFF.

"We hereby guarantee Federal Standard Radio Products to be free from all mechanical and electrical defects . . . and agree to replace at our expense, any unit or part which may prove defective."

This Federal guarantee is typical of the confidence reposed in Bakelite by the manufacturers of radio parts. For they have found in Bakelite a material which successfully meets all of the requirements for Radio insulation.

They have also found in Bakelite a combination of properties

not possessed by any other material—properties which permit its adaptation to a wide range of manufactured articles in the radio industry. Mechanical strength, permanence of color, indifference to climatic or weather conditions and its durability under all conditions are only a few of the many valuable properties of this unique "Material of a Thousand Uses."

Write for a copy of our Radio Booklet K.



BAKELITE Condensite REDMANOL

are the registered Trade Marks for the Phenol Resin Products manufactured under patents owned by
BAKELITE CORPORATION

Send for our Radio Map

Enclose 10c to cover mailing cost and we will send you a large Radio Map which lists the call letters, wave length and location of every broadcasting station in the world.

BAKELITE CORPORATION
247 Park Avenue, New York, N. Y.
Chicago Office: 636 West 22nd Street

THE MATERIAL OF A THOUSAND USES

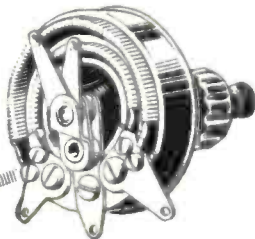

\$3.00
All Types

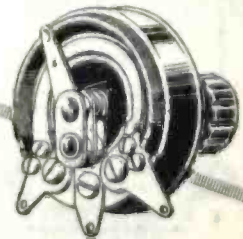

\$2.50

Standardize
Now on These
Quality Radio Parts

PREMIER

"DUOSTAT"

(TRADE MARK)

Two Rheostats in One

Windings independent of one another. Each operates one tube. Simplifies wiring. Base Bakelite molded, silver etched Dial, "NICHROME" wire windings. Made for all types of tubes. No. 12, two windings, each 7 ohms; No. 13, two windings, each 25 ohms; No. 14, two windings, each 40 ohms.

Price all types

\$3.00

DOUBLE DISCONNECT "POTENTIOMETER"

(TRADE MARK)

One outstanding feature is the double circuit breaker, which automatically disconnects A and B battery circuits, thus positively eliminating A battery drain (as heretofore present in all Potentiometers) and at the same time absolutely preventing accidental burning out tubes with B battery voltage. Genuine Nichrome wire wound; Bakelite base; Silver etched dial.

Price

250 ohm \$2.50 500 ohm \$3.00

SPECIAL ANNOUNCEMENT!

Do you know about the other quality Radio Parts made by Premier? Micrometer-Vario-Coupler, Jacks, Jiffy Switches, and "The Little Wonder" "Hegehog" Audio transformer.

Write for Free Bulletin No. 92, giving complete list of Premier Radio Parts, including the famous "MICROSTAT"

Ask for and insist on
"Premier" Parts at
Your Dealer

Premier Electric Company
3807 Ravenswood Ave., Chicago

19 years making
Quality Electrical
Apparatus

Please refer to POPULAR RADIO when answering advertisements.

PARAGON

Reg. U.S. Pat. Off.

3-CIRCUIT RECEIVER

"HEAR THOSE SAXOPHONES!"

Every tone, every note clear and sweet. You can almost see the musicians swaying in time to the music. It's just as if the orchestra was right in the room with you. Why pay money to go dance when the best in the land can be had right at home over the radio?

The Paragon 3-Circuit Receiver here illustrated is the last word in sensitivity, selectivity and simplicity. You need only to switch on the tubes and set the dials for the station you want. The cabinet is of highest finish mahogany or walnut and includes compartment for dry batteries. The Paragon is the ideal Radio Receiver for the home.

Write for illustrated Bulletins of Paragon Radio Receivers

ADAMS-MORGAN CO.

20 Alvin Avenue, Upper Montclair, N. J.

PARAGON MODEL

RB-2

PRICE \$135.00

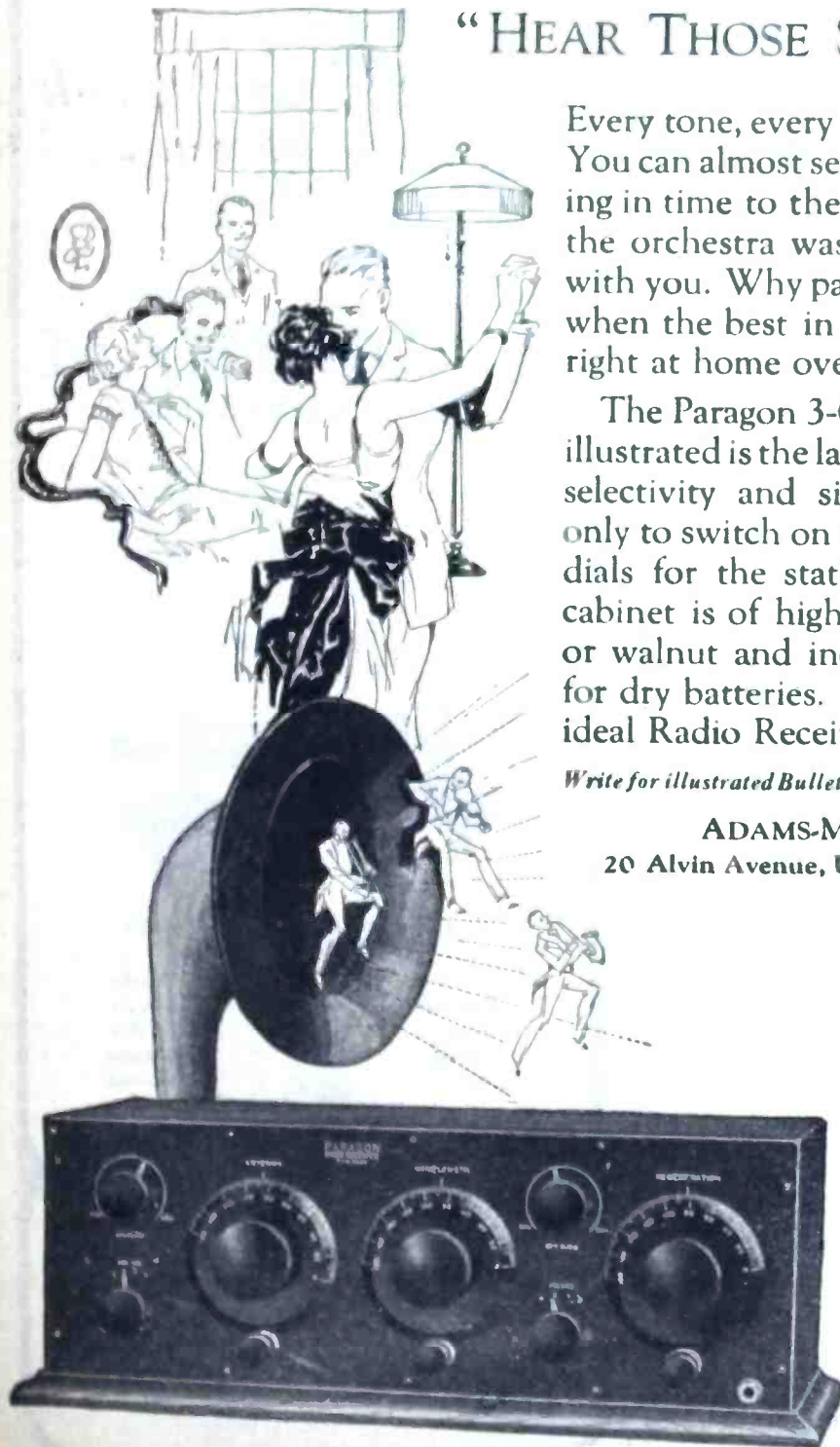

Please refer to POPULAR RADIO when answering advertisements.

Morrison

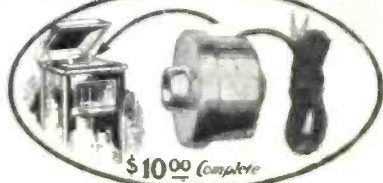

Loud Speaker

Morrison

is a name identified with all that is fine in a loud speaking unit—for phonographs and horns.

Everywhere, those who appreciate really good radio, know they can depend on Morrison to bring out, consistently, the very best in radio reception.

These are the Reasons

Morrison Loud Speakers are manufactured by skilled radio workers in a laboratory ideally equipped.

Quality is never sacrificed—either in material or workmanship.

Every unit is triply tested before shipment.

Thus Morrison Loud Speaker maintains its front rank in the field of radio.

Nickel Plated Model

\$10.00

Complete with a five foot cord.
Send for an illustrated descriptive catalog.

Distributors

There are several territories still available. We are interested in securing proper representation.

Jobbers—Dealers

Our plan of merchandising has been profitable to many jobbers and dealers—if you are interested write or wire for details.

Morrison Laboratories Inc.

345 Jefferson Ave., E., Detroit, Mich.

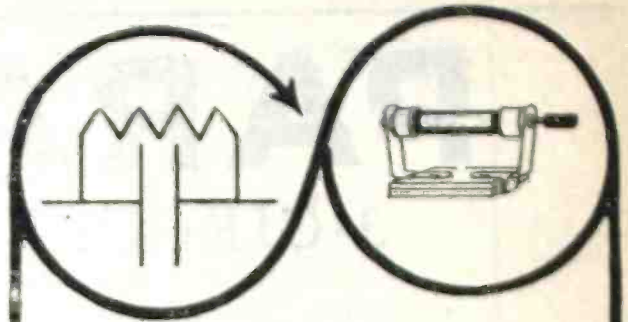

Only
Variable Grid Leak
to fit all sets

Accurate control for every detector tube in the land now possible with

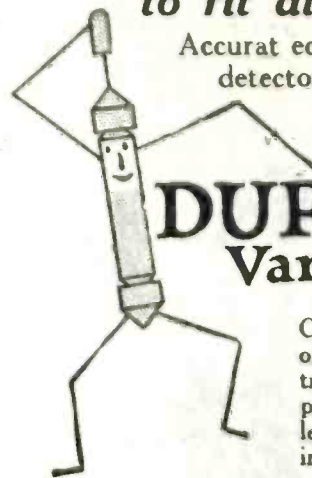

DURHAM
Variables

Cartridge style, having one-finger plunger control, snaps into the place of present fixed leak. No panel-drilling or wire-change.

No. 101 for storage batt. tubes
No. 201A for dry cell tubes



Typical sets improved with
DURHAM Variables

- | | |
|--------------|---------|
| Radiolas | Grebe |
| Westinghouse | Kennedy |
| Crosley | Ace |
| Federal | Paragon |
| Eagle | Mu-rad |

and all Neutrodynes

Only 75c at dealers; or 80c postpaid

Free folder "C" gives details.
Get yours from dealer or write

Satisfaction Guaranteed

DURHAM & CO., Inc.
1930 Market St., Philadelphia

Dealers: Every detector tube needs a DURHAM—the easiest to install, use—and sell.

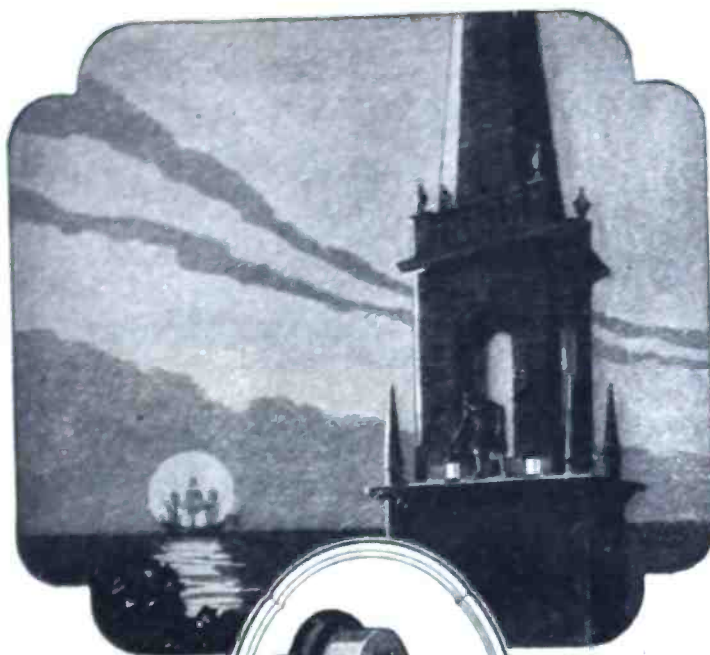

PAUL

REVERE

ON the eighteenth of April in 1775 two lanterns were hung in the tower of the Old North Church in Boston signaling to Paul Revere in Charlestown the movement of the hostile troops. Thus began the famous ride which will always live in our history.

Paul Revere's broadcasting, although romantic and spectacular, seems crude to us today. The death of a president, an earthquake in far-off Japan, and many other instances which history may

deem fully as important are now flashed almost instantaneously to millions of homes.

Only one key is necessary to gain access to this wonder land of Radio. The key is satisfactory receiving apparatus.

HOLTZER-CABOT Headphones and Loud Speakers enable your receiving set to give its utmost in sensitivity, volume and quality.

The fullest enjoyment of Radio is yours if you own HOLTZER-CABOT equipment.

Holtzer-Cabot Loud Speaker	\$25.00
Loud Speaker Phonograph Attachment	10.00
No. 2 Universal Headphones	9.50
No. 4 National Headphones	6.00

Write for booklets explaining how the exclusive features of these instruments enable you to enjoy the wonders of Radio

THE HOLTZER-CABOT ELECTRIC CO.
125 Amory Street, Boston, Mass.
6161-65 South State Street, Chicago, Ill.
Department B-1

Holtzer-Cabot
BUSINESS ESTABLISHED 1875

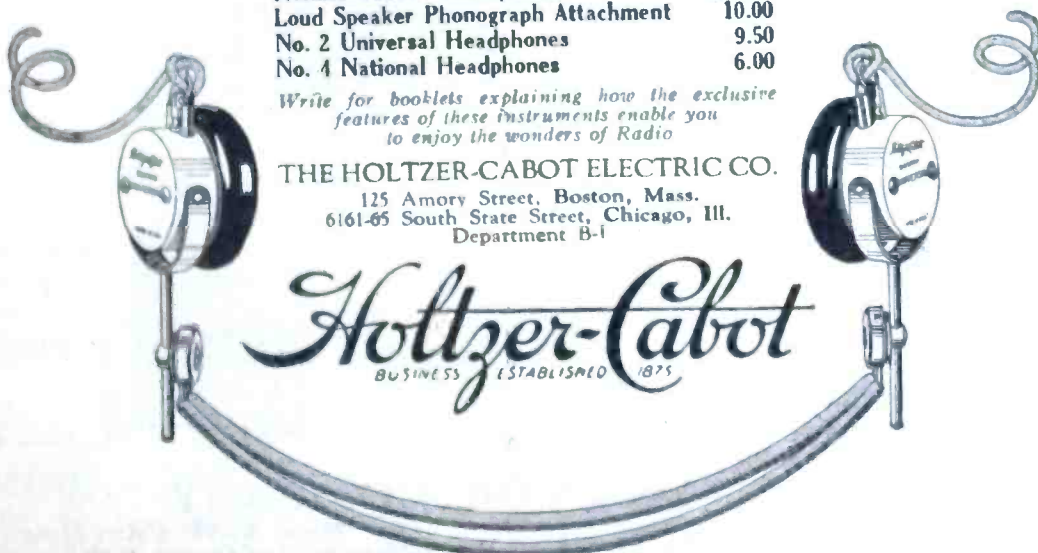

Please refer to POPULAR RADIO when answering advertisements.

Como Duplex Transformers

(Push-pull System)

The best and biggest selling transformer in the field. Merit alone has done it! The "Como Duplex" was first and we are being copied continually by those who lack the skill and knowledge to create. Imitation is the sincerest form of flattery and lots of manufacturers are flattering us. Mr. Laurence M. Cockaday, famous designer of radio circuits, having the world's best transformers to choose from has specified "Como Duplex" in his new 4 circuit tuner. This should be a sufficient guarantee for anyone.



Price \$12.50 per matched pair

"Como Duplex" system of amplification gives a maximum volume without distortion and tube noises.

May be added to your present amplifier giving you power amplification on the weak signals that more of the ordinary amplification would kill.

A copy of "How to Make a Power Amplifier" is yours for the asking

COMO APPARATUS COMPANY, 446 Tremont St., Boston, Mass.

INSIST ON NEW YORK COIL COMPANY'S PROVEN RADIO PRODUCTS

New York Variable Condenser with Vernier, 23 plate, \$3.50, and 43 plate \$4.50. Price includes dial and knob.

- 11 Plate \$1.50
- 23 Plate 2.00
- 43 Plate 3.00

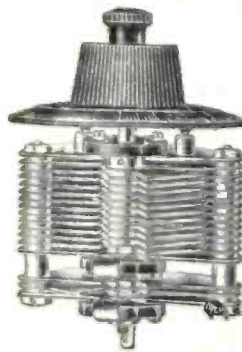

Amplifying Distortionless Transformers

Correct for any tubes.

Price \$4.00



The New York Variable Grid Leak

Easily tops the field in precision, permanency and efficiency.

Price \$1.50

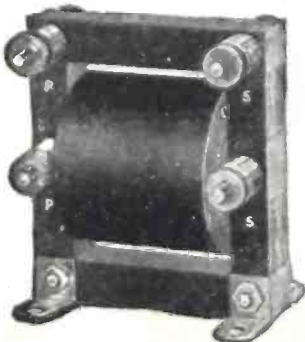

Mica Fixed Condensers

Of tested and permanent capacity, ranging

.00025 with Leak Mountings, 45c



from .0001 to .006, 35 cents to 75 cents, of superior quality.

NEW YORK COIL COMPANY

338 Pearl Street

Pacific Coast—MARSHANK SALES CO., 1240 S. Main St., Los Angeles, Calif.

New York City, New York

Please refer to POPULAR RADIO when answering advertisements.

Introducing — A new Broadcast Receiver

Type RF-2, a receiving set of surpassing excellence is offered to the radio public.

Radio frequency amplification at its best is employed—a transformer-coupled tuned radio frequency circuit, with two stages of audio frequency amplification.

There are but two controls and tuning is extremely simple. Extraordinary sensitivity is combined with a high order of selectivity. Broadcast programs from far distant points are received with marked clarity and volume.

The assembly of instruments is encased in solid mahogany.

SEE IT! HEAR IT! COMPARE IT!

Ask your dealer

EISEMANN MAGNETO CORP.

William N. Shaw, President

46 Thirty-Third Street, Brooklyn, N. Y.

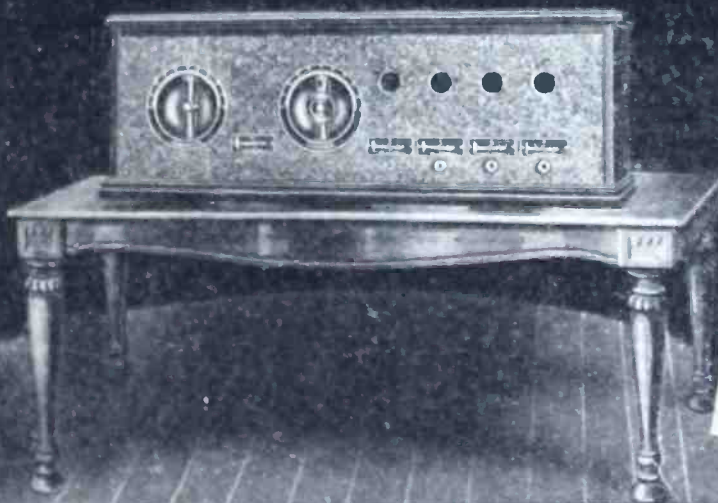

EISEMANN

Please refer to POPULAR RADIO when answering advertisements.

Coto

"Built First to Last"

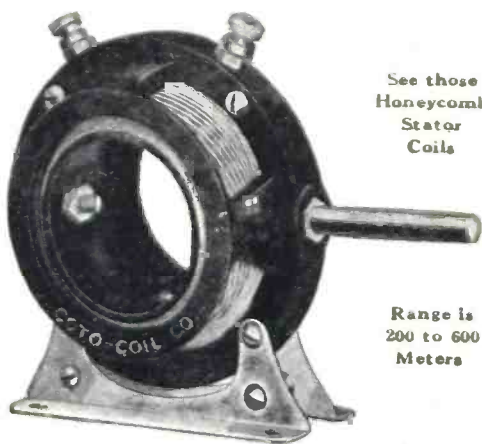

See those
Honeycomb
Stator
Coils

Range is
200 to 600
Meters

Every User More than Pleased!

Nation wide welcome by radio enthusiasts has proved that there is just one mistake you can make while buying this remarkable variometer. You can allow a dealer to switch you to one he wants to sell rather than let you have the popular Coto that is hard to get. Don't let him. Pound the counter if you must. **INSIST!**

Coto Moulded Variometer, Type 80C0, \$5.

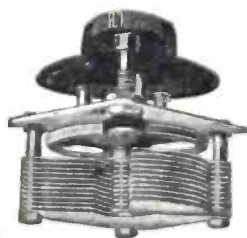

The Silver Plated Air Condenser

Copper plates soldered firmly in place and SILVER PLATED. Losses of antenna energy are very low because of improved design and best rubber insulation. .001 Mfd. \$6. .0005 Mfd. \$5. .00025 Mfd. \$4.50.



Where Loud Speaker Tones are Rich—

look for a really fine 5 to 1 turn ratio Audio Amplifying Transformer. Coto type 4000 has stood every test of wide use and can be depended upon for amplification that it's a treat to hear. \$5.

COTO COIL CO., 87 WILLARD AVE., PROVIDENCE, R. I.

Los Angeles, 329 Union League Bldg.
Minneapolis, Geo. F. Darling, 705 Plymouth Bldg.
Atlanta, C. P. Atkinson, Atlanta Trust Co. Bldg.
Canada, Perkins Electric Co., Ltd.

Montreal Toronto Winnipeg



Your Money's Worth In Peppy Voltage



RADIO PLATE "B BATTERIES"

No slackers. DIAMOND Batteries do a full night's work every night. Don't faint under the load, but come up fresh night after night. You get more out of DIAMONDS because so much more goes into them. The products of a responsible, well known electrical manufacturer. Guaranteed to satisfy. Get a DIAMOND Battery today. Each one in a separate carton stamped with the DIAMOND trade-mark.

If your dealer cannot supply you, order direct, C. O. D., naming your dealer

LIST PRICES

- No. B-1, 22½ volts, \$3.00, 5 binding posts in steps of 1½ volts.
- No. B-2, 45 volts, \$5.50, a longer life 45 volt battery, 5 positive taps.
- No. B-16, 45 volts, \$4.50, 5 taps from 16¼ to 22½ volts.
- No. B-4, 22½ volts, \$1.75, for portable sets. 5 taps. No. 3, Type C, 4½ volts, 70c, 3 taps.

DIAMOND ELECTRIC SPECIALTIES CORP.

102 SO. ORANGE AVE., NEWARK, N. J.

Dealers—Jobbers, Write for Proposition

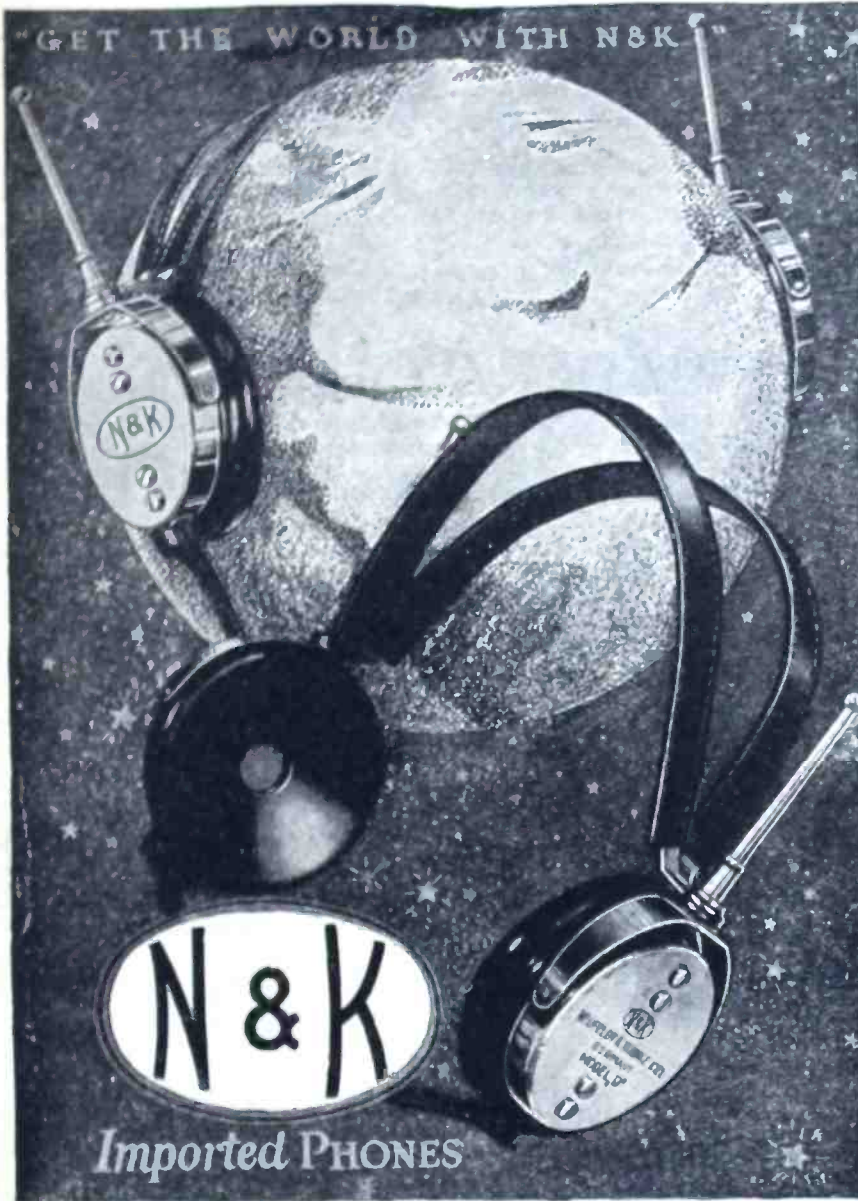

You shall be Sole Judge A Most Unusual Offer

TEST N & K Phones on your radio set alongside *any other phones made*. If the N & K Phones do not reproduce both high and low tones more perfectly, if they do not give a clearer, more mellow tone, if they do not fit more comfortably on the head, send them back to the store within three days, and your money will be promptly refunded. No obligation whatsoever will be incurred. *You shall be the sole judge.* The N & K Head Set, Model D, 4000 ohms, is the imported head set that the radio "fans" are all talking about. Larger diaphragms. Nickeled brass sound chamber. Leather covered bands. \$8.50 at leading stores. Ask for descriptive folder.

THE GOLDSCHMIDT CORP., 15 WILLIAM STREET, DEPT. P4, NEW YORK

Any of the stores listed below or any other store displaying this advertisement will send you an N & K Head Set to make this trial.

- | | |
|--------------------|---------------------------|
| Arhol, Mass. | M. Steinert & Sons Co. |
| Atlanta | M. Rich & Bros. Co. |
| Baltimore | Hochschild, Kohn & Co. |
| | Little Joe Wissenfeld Co. |
| | Joel Gurman & Co. |
| | Jones Electric Radio Co. |
| Bangor, Me. | M. Steinert & Sons Co. |
| Bloomfield, N. J. | United Cigar Store |
| Boston | Shepard Stores |
| | M. Steinert & Sons Co. |
| | A. P. Merchant Co. |
| | Iver Johnson Sporting |
| | Goods Co. |
| Bridgerport | M. Steinert & Sons Co. |
| Brooklyn | Abraham & Straus |
| | Fredrick Loeser & Co. |
| | A. L. Namm & Son |
| | Royal Eastern Elec. |
| | Sup. Co. |
| | 20th Century Radio |
| | Corp. |
| Chicago | United Cigar Store |
| | Marshall Field & Co. |
| | Radio Instruments Co. |
| | of Chicago |
| Cleveland | The May Company |
| | H. Lester & Co. |
| Colorado Springs | Kaufman & Co., Inc. |
| | Teason Bros. |
| Dayton | The Anderson Piano Co. |
| Denver | Daniel & Fisher |
| | Stores Co. |
| Des Moines | Yunker Brothers |
| Detroit | J. L. Hudson Co. |
| | Crowley, Milner Co. |
| | Detroit Electric Co. |
| | United Cigar Store |
| East Orange, N. J. | Barker, Rose & |
| Elmira | Clinton Co. |
| Fall River | M. Steinert & Sons Co. |
| Freshburg | M. Steinert & Sons Co. |
| Harrisburg | Pomeroy's Inc. |
| Hartford | Sage, Allen & Co. |
| Houston | W. C. Munn Co. |
| Indianapolis | Alamo Sales Corp. |
| Jamaica, L. I. | Bangert Electric Co. |
| | Royal Eastern Electric |
| | Supply Co. |
| | United Cigar Store |
| Johnstown | Penn Traffic Co. |
| Kansas City | The Schmeller Co. |
| | Western Radio Corp. |
| | J. W. Jenkins Sons |
| | Music Co. |
| Long Island City | Royal Eastern Electric |
| | Supply Co. |
| Los Angeles | Hamburger's |
| Lowell | M. Steinert & Sons Co. |
| | Bon Marche D. G. Co. |
| | Bry Block Mercantile Co. |
| Memphis | J. Goldsmith & Sons |
| | Gimbel Brothers |
| Milwaukee | L. S. Donaldson Co. |
| Minneapolis | L. Bamberger & Co. |
| Newark, N. J. | Edward Malley Co. |
| New Haven | M. Steinert & Sons Co. |
| New Orleans | D. H. Holmes Co. |
| New York City | Davega (11 stores) |
| | Gimbel Brothers |
| | John Wansmaker |
| | Herbert & Huessen Co. |
| | United Cigar Stores |
| | (10 stores) |
| | David Kilbuck Co. |
| | Royal Eastern Elec. |
| | Supply Co. |
| | J. L. Lewis, Inc. |
| | Hanes-Zener Co. |
| | Haynes-Griffin Radio |
| | Service, Inc. |
| Oklahoma City | J. W. Jenkins Sons |
| | Music Co. |
| Omaha | Oakford Music Co. |
| | Richard M. Shaker |
| Paterson, N. J. | Paterson Radio Co. |
| Pawtucket | M. Steinert & Sons Co. |
| Peoria | Block & Kuhl Co. |
| Philadelphia | Gimbel Brothers |
| | John Wansmaker |
| | Lit Brothers |
| Pittsburgh | N. Snellenburg & Co. |
| | Boggs & Buhl |
| | Kaufmann & Beer Co. |
| | Ludwig Hommel & Co. |
| | Holden & Stone Co. |
| Pittsfield, Mass. | M. Steinert & Sons Co. |
| Portland, Me. | Meier & Frank Company |
| Portland, Ore. | The Outlet Co. |
| Providence | M. Steinert & Sons Co. |
| | Kelman Electric Co. |
| Rochester | The Emporium |
| San Francisco | Leopold Adler |
| Savannah | Fredrick & Nelson, Inc. |
| Seattle | Davidson Bros. Co. |
| Sioux City | Radio Exchange |
| Springfield, Mass. | M. Steinert & Sons Co. |
| St. Louis | Famous & Barr Co. |
| | Van-Althe Radio Co. |
| St. Paul | Pioneer Electric Co. |
| Syracuse | Alexander Grant's Sons |
| Tulsa | J. W. Jenkins Sons |
| | Music Co. |
| Washington | Woodward & Lothrop |
| Waterbury | M. Steinert & Sons Co. |
| Worcester | M. Steinert & Sons Co. |

Dealers: We authorize you to refund the price of any N & K Head Set returned under the conditions named in this ad. We will exchange or replace any sets that come back to you.

No. 805
Height 17½ in.
Bell 6½ x 9½ in.

\$20⁰⁰

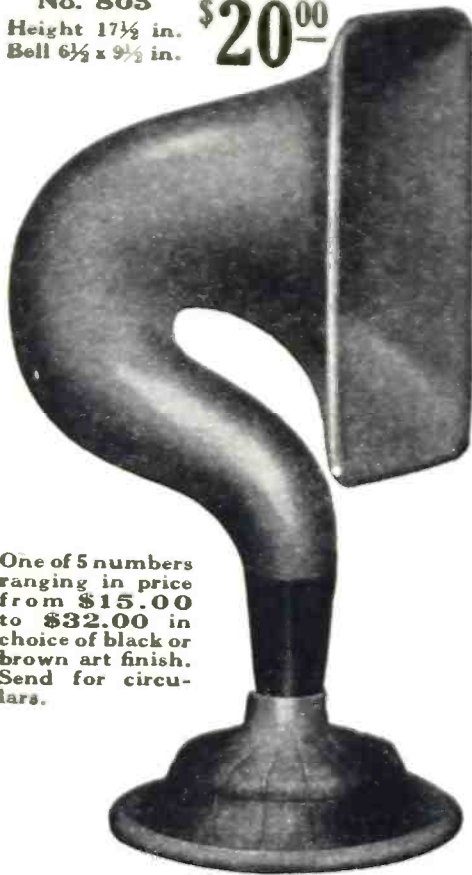

One of 5 numbers ranging in price from \$15.00 to \$32.00 in choice of black or brown art finish. Send for circulars.

“MADERA” Die Cast WOOD Gives Radio a New Voice

Did you ever stop to think that it is not the bow or the strings that give a violin its voice but the harmonious vibration of the wood body of the instrument? Imagine a violin made with a metal body! Then realize what an injury metal horns are doing to radio—just as metal horns held back the talking machine until wise men replaced them with wooden cabinets.

“MADERA Clearspeakers”

are made from artificial wood, cast from the original hardwood fiber, in steel dies, under a pressure of 12 tons to the sq. in. and 800 degrees of heat. This material is twice as dense as natural wood. Its acoustic properties are wonderful—resembling those of a rare old violin.

Madera Clearspeakers are fitted with a special Baldwin loudspeaker unit of great power and clearness. They are all ready to attach to any radio set adapted to loudspeaker service and are being used on many types of sets which could never use loudspeakers—even some of the better of the crystal outfits.

Order from Your Dealer If he does not carry the line write us, giving his name and address.

Circulars Free. Write right away so as not to lose an unnecessary day's delight with your radio.

AMERICAN ART MACHE CO.
351 W. Austin Avenue Chicago

FLERON RADIO SPECIALTIES

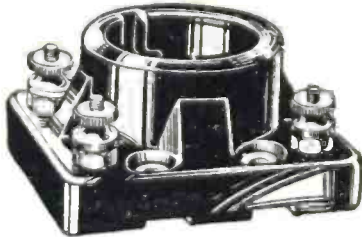

The Porcelain Sockets

Very carefully made. Brass parts nicked. Black Glaze. Two sizes. Standard Bulbs and U. V. 199.

Each socket in a carton. 35c. each.

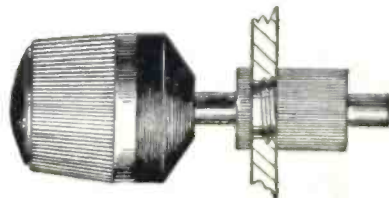

The Vernier Adjuster

The best adjuster on the market. Spring holds head away from dial when not in use. With slight adjustment spring can be made to hold head against dial if desired. Patented. 65c.

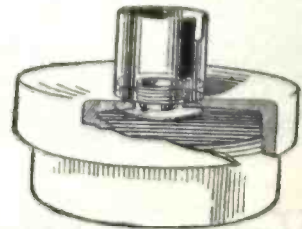

The Phono Adapter

Fits through the hole of the receiver cap and then slides on the phonograph tone arm. Fits Victor, Columbia, and others. Works perfectly. Only 35c. ea.



The Porcelain Insulators

Lowest power losses in the antenna. Dielectric absorption reduced to minimum because of very low phase difference of Fleron Porcelain. Very tough body. Solid Black Glaze. Seven sizes, 20c to \$1.00. Each insulator in a separate carton.



The Stand-Off Insulator

Fills the much-needed requirement for a good strong looking and practical stand off insulator. Meets every requirement of the Board of Fire Underwriters. \$1.25 each.

For Sale by all Good Jobbers and Dealers

M. M. FLERON & SON, Inc., 112 No. Broad St., Trenton, N. J.

Please refer to POPULAR RADIO when answering advertisements.

An Easy Way to Cut Out Interference

Add a Ferbend Wave Trap to Your Set

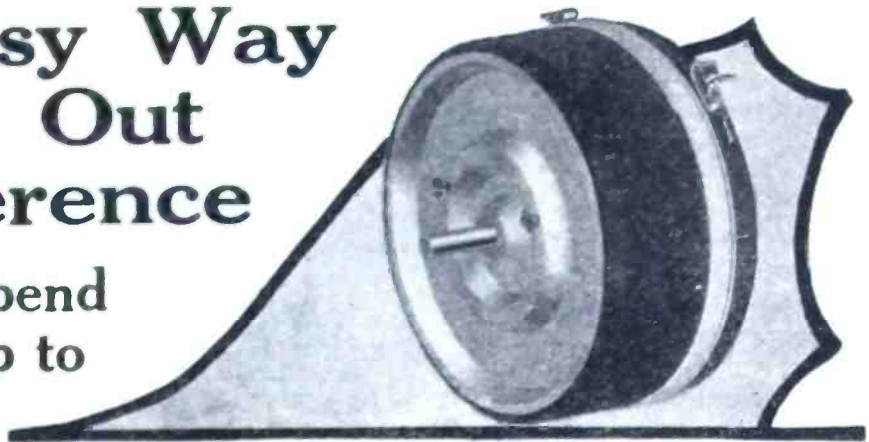

Why Listen to Three Stations at a Time?

Why rebuild and enlarge your set to the last pitch of refinement just to get better selectivity, when you can get a WAVE TRAP which, connected by two wires to your old set, will TRAP OUT the powerful waves from the interfering station, and leave the voice you want to hear just as "clear as a bell?"

The FERBEND is the original WAVE TRAP, designed and manufactured complete by us, after years of careful experimenting. Do not confuse it with imitations, hastily assembled from ordinary radio parts.

This Man Takes His Choice—Why Don't You?

Ferbend Electric Co.,
21 E. South Water St., Chicago.

I have installed the WAVE TRAP I purchased from you some time ago and given it a thorough try-out. There are five broadcasting stations in this city, four of them I can trap out by moving dial ten points, the other KFI, the most powerful one, I can silence by changing the dial twenty points. This station is heard on the Atlantic coast and Hawaiian Islands.

John F. Parsons,
109 N. Avenue 19,
Los Angeles, Calif.

FERBEND

TRADE MARK

Wave Trap

PATENT APPLIED FOR

The Original Wave Filter



GUARANTEE

Every FERBEND WAVE TRAP is warranted to be of best materials, designed and manufactured complete by the Ferbend Electric Co. (not assembled from stock radio parts). When connected to any workable radio receiving set, and properly adjusted, according to directions, we guarantee that any interfering broadcasting station can be tuned out, while the station desired continues to be heard as before.

USE THIS COUPON — to double the pleasure from your RADIO SET

FERBEND ELECTRIC CO., 21 E. South Water St., Chicago, U. S. A.

You may send me a FERBEND WAVE TRAP, subject to your definite guarantee as printed at the left. I will pay the price which I have marked to the postman when he delivers the Wave Trap to me, and will also pay him the postage. (If remittance is sent with the coupon, then the Wave Trap comes post-paid.) **THE POSITIVE GUARANTEE APPLIES JUST THE SAME EITHER WAY.**

Check here for Ferbend Wave Trap UNMOUNTED. \$6.00
 Check here for Ferbend Wave Trap MOUNTED. \$8.50

Name.....
Street.....
City.....
State.....

Send me full information.....

Please refer to POPULAR RADIO when answering advertisements.

A
True-tone
Non-Directional
Ornamental
Solid Mahogany
Loud Speaker

Ask Your Dealer
or
Write Us Direct



TYPE B FRUIT BOWL

The
VAN-LE
REPRODUCER

(Pat. App. for)

Mfd. by
VAN-LE CORP'N
100 Slip Ave., Jersey City
N. J.

AN
INTERESTING
AND
ATTRACTIVE
PROPOSITION
FOR
DEALERS

WRITE FOR DETAILS

SUPERTRAN

Reg. U. S. Patent Office

CERTIFIED!

Supertran Audio Transformers have been approved by the largest testing laboratory in the United States. They are "certified" by scientific measurements to be unequalled for volume, quality, and electrical efficiency.

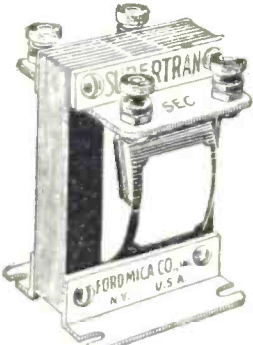

Price \$6.00

These Transformers are especially designed for the Neutrodyne and Reflex circuits.

Can be used with any amplifying tube on the market with excellent results.
At your dealer—or direct by mail on receipt of purchase price

FORD MICA COMPANY, Inc.
33 East 8th St. New York



100 Volt Panel type

"I've found KIC-O 'B' batteries
the most satisfactory"

A prominent New York engineer said the above. KIC-O batteries made good with professionals and novices. Alkaline type; won't sulphate or buckle. Life unlimited. Not harmed by short-circuiting, over charging, idleness. Panel switches give single cell variations. Recharge from any 110-volt A.C. line with small home rectifier. Charge lasts 3 to 6 months in detector or plate circuit.

Volts	Price, plain	With panels
22	\$5.50	
32	7.25	\$11.75
48	9.50	14.00
68	12.50	17.00
100	17.50	22.50
145	23.50	28.50

Unmounted Rectifier . . . \$1.00
Mounted Rectifier . . . \$2.50

KIMLEY ELECTRIC COMPANY, Inc.
2667 MAIN STREET, BUFFALO, N. Y.

KIC-O Storage "B" Batteries—
long service, low cost

"The
Best Built
Set in
America"

R-212



Licensed by I. R. M., Inc.,
under Hazeltine Patents

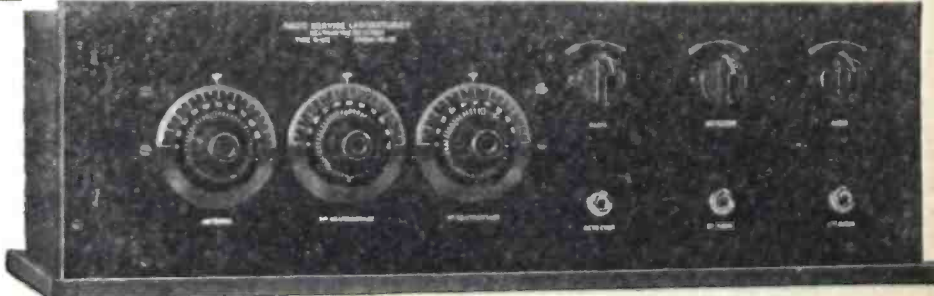

Embodying the Hazeltine Neutrodyne circuit in an improved form as to neutralization, workmanship, quality, appearance and efficiency of operation.

Radio Service Laboratories, 1000 11th Ave.
Asbury Park, N. J.

Please refer to POPULAR RADIO when answering advertisements.



"A" Battery for
six-volt tubes

When is a battery cheap?

A BATTERY that allows your soloist to be accompanied by a noise like a thunderstorm is never a cheap battery; because it's certain that you will be dissatisfied and soon supplant it with a good battery.

Obviously, a battery that does not last long is not a cheap battery.

The battery that is really cheap is the one that gives perfect service and gives it a long time; one that does not have to be recharged too frequently—a silent, long-lasting battery, steady and dependable.

Because they give such good service and such long service, you will find Exide Radio Batteries cheap in the true sense of the word. They may cost you more than some to start with, but long life and freedom from repairs make the last cost low. And the added enjoyment you get from your set, through clarity and lack of needless bother, will be priceless.

In replacing a worn-out battery or when buying a new set, be good to yourself and get an Exide.

Complete line of Exides for radio

There is a complete line of Exide Radio Batteries—batteries that give uniform filament current over a long period of discharge.

Apart from the 12-cell "B" battery there are three "A" batteries for whatever type tube you use. The Exide for 6-volt tubes

gives full-powered, ungrudging service. It has extra-heavy plates and requires only occasional recharging. It comes in four sizes, of 25, 50, 100 and 150 ampere hours capacity.

The Exides for low-voltage tubes are midgets in size but giants in power. The 2-volt battery weighs only five pounds, has a single cell, and will heat the filament of WD-11 or other quarter-ampere tube for approximately 96 hours. The 4-volt "A" battery has 2 cells and will light the filament of UV-199 tube for 200 hours.

The dominant battery

On sea and on land the Exide plays an important role in the industrial life of the nation. In marine radio, Exide Batteries provide an indispensable store of emergency current. A majority of all government and commercial radio plants are equipped with Exides.

Exide Radio Batteries are sold by radio dealers and Exide Service Stations everywhere. Ask your dealer for booklets describing in detail the complete line of Exide Radio Batteries. Or write direct to us.

Exide

RADIO BATTERIES

THE ELECTRIC STORAGE BATTERY COMPANY, PHILADELPHIA

In Canada, Exide Batteries of Canada, Limited, 133-157 Dufferin Street, Toronto

Please refer to POPULAR RADIO when answering advertisements.

GOLDCREST RADIO RECEIVERS

Model 60
\$60

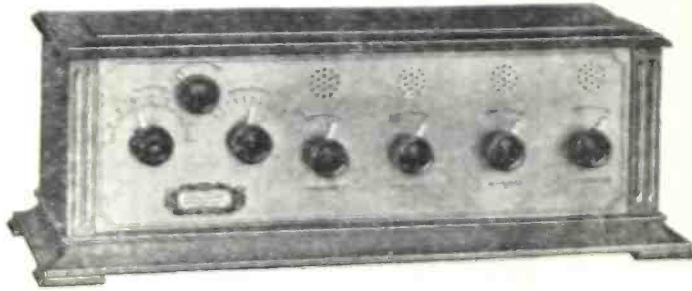

With Gold
Finished
Panel

GOLDCREST Receivers have a distinctive, beautifully etched gold finished panel in a substantial mahogany cabinet. A set beautiful enough to be a valuable addition to the drawing room of the most fastidious.

GOLDCREST MODEL 60 is a four tube receiver consisting of one stage radio frequency, one detector and two stages audio frequency.

This will assure consistent reception from 1000 to 1500 miles, loud speaker volume.

OUR PRICES are placed especially low because all parts are made within our own plant.

Model 60 . . . \$60

Model 61 . . . \$75

Solid Mahogany Console Model 62 . . . \$120

A SPECIAL OFFER

WE WANT YOU TO SEE, TRY AND BE CONVINCED. WRITE TODAY FOR FREE ILLUSTRATED CIRCULAR AND SPECIAL OFFER. IMMEDIATE SHIPMENT MADE ON ALL ORDERS

Dealers and Jobbers: Write and have your name placed on our mailing list. A new and interesting proposition for the asking.

THE CLEARSTONE RADIO CO., Cincinnati, Ohio

WEIGHS
ONLY
8 OZ



A \$200,000.00 COMPANY stands squarely back of the guarantee on every Scientific headset

SEND NO MONEY!

20,000 TURNS
EQUIVALENT TO
3,000 OHMS

Order TODAY
by Postcard
and Pay
Postman
on arrival

\$2.95
POST-PAID

**LOUD
SPEAKER
UNIT \$1.95**

THE
PHONE
IT
TOOK
A SOLID YEAR
TO DESIGN

We Guarantee The Scientific Headset to be the greatest value on the market. Try it for five days. If not satisfactory send it back and your money will be refunded immediately. Circular on request. Dealers wanted.

THE SCIENTIFIC ELECTRIC WORKS
98 Brookline Ave. DEPT. J BOSTON, MASS.

Please refer to POPULAR RADIO when answering advertisements.



THE name Magnavox on a Radio Reproducer stands for the most careful workmanship, highest quality of material and also for a fundamental operating principle utterly distinct from that of ordinary "loud speakers."



The base of the new model Magnavox Reproducer R3, showing tone control

Important features now offered in Magnavox Radio—the Reproducer Supreme

THE Magnavox electro-dynamic principle obviates the need of any mechanical adjustment to regulate the air-gap or change the position of moving parts. This famous principle of operation permits the use of an electrical tone control.

This control directly affects the character of the electrical circuit which creates the sound, controlling the sensitivity of the instrument and also its volume of reproduction.

Moreover, this electrical control produces a great saving of current

(already reduced in the new R3 and R2 to a maximum of .6 ampere) for, by its action, the current value can be reduced to a minimum of .1 ampere.

The new Magnavox electro-dynamic Radio Reproducers R3 and R2, in fact, are equipped with the first true sound controlling device ever designed. See them at your dealers and write us for catalog.

THE MAGNAVOX COMPANY
OAKLAND, CALIF.

New York Office: 370 Seventh Ave.
Perkins Electric Limited, Toronto,
Montreal, Winnipeg, Canadian Distributors

THREE Regal

MASTERPIECES!

Perfect Contact Vernier Rheostat

For fine filament control of tubes and superfine tuning, the Regal Vernier stands alone. Nothing just like it on the market.

Complete with Knob

6-Ohms. . . . \$1.25
30-Ohms. . . . 1.25



Fifteen Taps—But Only One Drill Hole Required!

A 15 Point Switch complete in one unit. No more messy soldering. No more drilling of holes. No more chipped panels. Complete with hard rubber Knob and Dial.
Type No. 162. . . . \$1.50



Broadcast Tested, High Quality Audio Transformer

For clearness of tone, amplification of voice and music from nearby and distant broadcasting stations, Regals are unequaled by any Transformers on the market.

3½ to 1 Ratio. . . \$4.25
5 to 1 Ratio. . . 4.50



At all good dealers—otherwise write direct for complete descriptive folder No. 24, sending dealer's name.

AMERICAN SPECIALTY CO.
Bridgeport, Connecticut, U. S. A.

No Two Receivers Are Alike

Connect In Multiple and One Will Get Most Current

AJAX—MULTI—RADIO

Phone Plugs and Connectors Allow One to Four Head Sets or Loud Speakers

ALWAYS IN SERIES

No. 18—For Jacks
No. 18A—For B Posts

Gives Equal Results to All. No Others Like AJAX—\$1.75 Each.—Dealers or Direct.

Liberal Discounts on Complete Line to Dealers and Distributors

AJAX ELECTRIC SPECIALTY CO.
1926 Chestnut St. St. Louis



FAHNESTOCK'S RADIO PRODUCTS

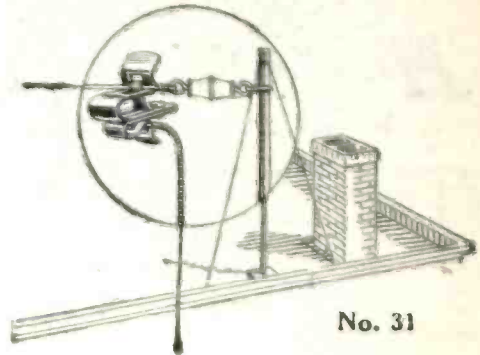

No. 31

The Antenna Connector

Snap larger connector over Antenna Wire; insert Lead-in Wire into smaller clip and a perfect connection is the result.



Improved Ground Clamp

Equipped with Fahnestock Patent Wire Connectors Easily Attached.

No Soldering—For Radio Use Only.

Our name is stamped on all our products. None genuine without it

At Your Dealers

FAHNESTOCK ELEC. CO.
Long Island City, New York

Amplify the MODERN way!

Modern

“Push-Pull”

Power Amplifying Transformers



More volume—less distortion—perfect reproduction of music or speech.

New bulletin of amplifier hook-ups and circuits using “Push-Pull” amplification, at your dealer's or sent free on request to us.

Modern “Reflex” Audio Transformers for all reflex circuits using crystal detectors. Will work satisfactorily with any standard Radio Frequency Transformer.

Modern standard Audio Transformers 4 to 1 ratio for all 2-step amplifiers and specially designed for use with Modern “Push-Pull” Transformers.

If your dealer can't supply you, write us giving his name



The Modern Elec. Mfg. Co.
Dept. 704, Toledo, Ohio

Please refer to POPULAR RADIO when answering advertisements.



Eagle Neutrodyne Balanced! RADIO RECEIVER



*Tube Capacities
BALANCED*

*Just as the Electric
Crane Arm is
Balanced*

ALL the uttermost resources of radio are yours to command with the remarkable *Eagle Neutrodyne Receiver*. Former difficulties with tuning, capacity effects, reradiation, and regeneration are gone. Far-distant stations are brought in clear and loud, as easily as a phonograph is operated. Tube capacities are balanced just as the power crane is balanced by its counterweight. Each Eagle Receiver is individually balanced and tested by a prominent radio expert. Backed by an excellent reputation. Guaranteed without reservation.

Licensed by Independent Radio Manufacturers, Inc., under Hazeltine Patent No. 1,450,080, dated March 27th, 1923, and other patents pending.

Write for Illustrated Leaflet



18 Boyden Place

Please refer to POPULAR RADIO when answering advertisements.

Blueprints

"Improved" Cockaday 4-Circuit Tuner and Tuned-Radio-Frequency Receiver

SO great has been the demand for POPULAR RADIO's Blueprints of the "Improved" Cockaday 4-Circuit Tuner, that we have now prepared similar actual size Blueprints of the Non-Regenerative Tuned Radio-Frequency (neutrodyne) Receiver described in this issue.

EACH of these sets of Blueprints has been drafted by our own staff under Mr. Cockaday's personal supervision. They are full size, accurate, authoritative—and so simple to follow in all details that a novice can work from them without difficulty.

The two complete sets of three prints each, covering all constructional requirements for these two highly-efficient receivers, include an exact panel pattern, an actual size instrument layout, and a picture diagram of all parts showing every wiring connection.

With these actual size Blueprints you can drill your panel without taking a single measurement; you can arrange your instruments and parts in exactly their correct places without guess or hesitation—and you can connect all terminals without even knowing how to read a hook-up diagram.

To make these Blueprints available to all, they have been priced at the very low figure

of only \$1.10 postpaid for each complete set of three prints. The complete set of three prints on the "Improved" Cockaday 4-Circuit Tuner may be had at \$1.10 postpaid. The complete set of three prints on the Non-Regenerative Tuned Radio-Frequency (neutrodyne) Receiver may also be had at the same price, \$1.10 postpaid. Single prints (one sheet only) are not available, as the complete sets cannot be broken.

For your convenience two handy coupons are printed below—one for the Blueprints of the "Improved" Cockaday 4-Circuit Tuner, and one for the Blueprints of the Non-Regenerative Tuned Radio-Frequency (neutrodyne) Receiver. Simply fill out the coupon which calls for the set of Blueprints you want. Attach your remittance for \$1.10, and the Blueprints will come to you by return mail.

If you wish both sets, fill out and mail both coupons with your check or money order for \$2.20.

POPULAR RADIO, INC.

9 East 40th Street

Dept. 44

New York City

POPULAR RADIO, Inc., Dept. 44
9 East 40th Street, New York City

Enclosed is \$1.10 in full payment for a complete set of three Blueprints for the "Improved" Cockaday 4-Circuit Tuner, consisting of the following:

- Exact panel pattern.
- Actual size instrument layout.
- Picture diagram of all parts (actual size) showing complete wiring.

Name.....

Address.....

POPULAR RADIO, Inc., Dept. 44
9 East 40th Street, New York City

Enclosed is \$1.10 in full payment for a complete set of three Blueprints for the Non-Regenerative Tuned Radio-Frequency (neutrodyne) Receiver, consisting of the following:

- Exact panel pattern.
- Actual size instrument layout.
- Picture diagram of all parts (actual size) showing complete wiring.

Name.....

Address.....

Please refer to POPULAR RADIO when answering advertisements.

PULLING POWER

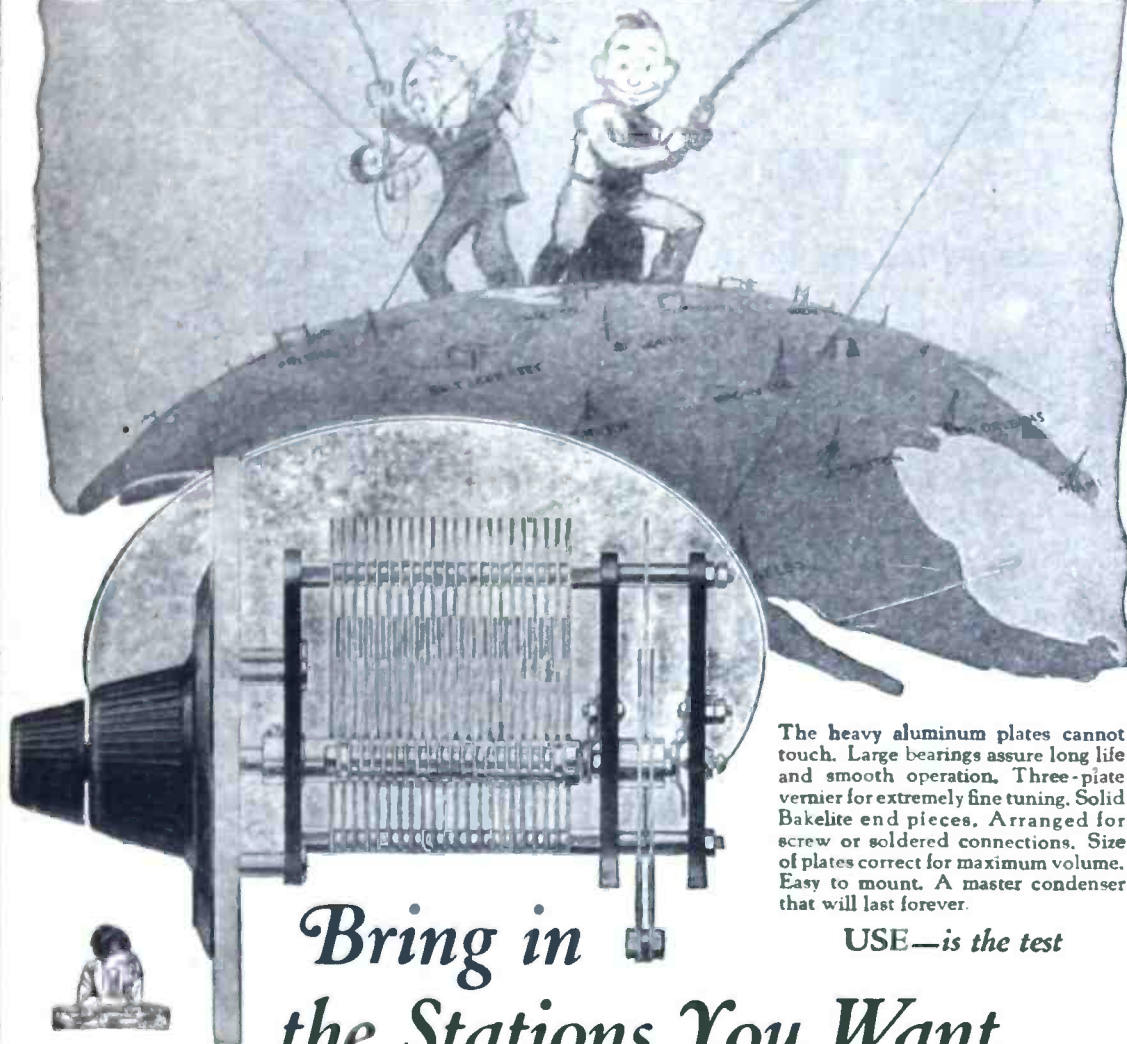

The heavy aluminum plates cannot touch. Large bearings assure long life and smooth operation. Three-plate vernier for extremely fine tuning. Solid Bakelite end pieces. Arranged for screw or soldered connections. Size of plates correct for maximum volume. Easy to mount. A master condenser that will last forever.

USE—*is the test*

*Bring in
the Stations You Want*

THE decremeter type plates of the Kellogg variable condensers furnish the widest tuning range possible, as the increase or decrease in capacity is constant; dials calibrated in wave lengths can be used. This gives the fine tuning necessary where the greatest selectivity is desired.

In constructing a selective set the variable condensers play an important part in the degree of its selectivity. That is why we recommend using Kellogg.

Select Kellogg radio equipment and know you have the best. If your dealer does not handle Kellogg, communicate direct with us.

KELLOGG SWITCHBOARD & SUPPLY CO.

1066 West Adams Street, Chicago



\$ 1⁵⁰

Everybody's Pleased With a

Sterling

12 Point Rotary Switch

No more fumbling around with elusive wires and varicooper taps. This 12 point switch adds to the appearance of the front of board contact points and makes it easy for you to solder varicooper taps to its various terminals. May also be used with a voltmeter for reading voltage on individual tube filaments.

THE STERLING MFG. COMPANY
2843 Prospect Avenue Cleveland, Ohio

Your Condenser Makes a Difference



Pick up those distant stations louder and clearer. Eliminate noise and interference. Get more pleasure out of your receiving with

Elgin Precision Condensers

Fully Guaranteed

Size	Capacity	Plain	Vernier
3 Plate	.000063 M. F.	\$1.75	
11 Plate	.00025 M. F.	2.40	\$4.00
17 Plate	.00035 M. F.	2.75	
23 Plate	.0005 M. F.	3.00	4.50
43 Plate	.001 M. F.	4.00	5.50

3" diameter composition dials, 50c extra

See your local dealer. If he cannot supply you send his name with your order to

Elgin Radio Corporation

Radio Division of The Elgin Tool Works, Inc.
69 No. State St. Elgin, Illinois

THE REFLEX

"VARIOTECTOR"

Fits Cup or Panel \$1.50 Crystal "Refills" 50c

"FIXEDETECTOR"



Like above, but permanently adjusted

\$1.25

GIANT CRYSTALS

TRIPLE SIZE—TRIPLE LIFE—TRIPLE POWER—

Single Pyrite or Galena, 75c
Twins, 90c; Triplets, \$1.00
"Vario-tenser" Gold-Brush Contact, 50c
Guaranteed by Dealers Everywhere



FOOTE

Mineral Co.,

Mfrs. & Distrs.
102 N. 19th St. Phila.
Mineral Pioneers for Nearly 50 Years



Take This Loop on Trial

Ten days to test out this remarkable loop right in your own home.

The only loop aerial of its kind. Flat as an atlas, extremely compact and all enclosed in polished Bakelite, with binding posts for various wave meter lengths.

Select the type for your set, and send C. O. D. order now.

Your money promptly refunded if you decide to return it.



Type A-737 (300-700 meters)	6 inches square—non-directional	\$10
Type A-7236 (176-1000 meters)	6 inches square—non-directional	\$12
Type B-2537 (300-700 meters)	18 inches square—directional	\$20
Type BL-2520 (200-18,000 meters)	with honeycomb coil mounting, 18 inches square—directional	\$25

Send for Bulletin I-102

V-DE-CO RADIO MFG. CO., Dept. F, Asbury Park, N. J.

Please refer to POPULAR RADIO when answering advertisements.



Dance to the world's finest music!

Hear the wonderful orchestras of all the big cities, as clearly as if they were in your home. Merely by the addition of "Push-Pull" power amplification to your present audio frequency amplifier—using any good loud speaker and All-American Power Amplifying Transformers—you can "bring in" distant stations with amazing volume (wholly undistorted) and a roundness, richness, depth and purity of tone positively delightful! Your dealer will gladly explain.

Standard on the better sets



ALL-AMERICAN AMPLIFYING TRANSFORMERS

Largest Selling Transformers in the World

Because they bring in voices and music as loudly and distinctly as you wish—without annoying distortion—All-American Amplifying Transformers enjoy the widest use and are the best-liked of all transformers.

"Old-timers," leading dealers, makers of the better sets, radio engineers—all these critics regard All-American as peerless.

Enormous production makes it possible to price them low, in the face of their superiority. There is nothing gained by paying more. At all the stores.

RAULAND MFG. CO., 2650 Coyne St., Chicago
(Pioneers in the Industry)

SUITABLE FOR ALL SETS AND CIRCUITS

All-American Audio Frequency Transformers. 3:1, \$4.50; 5:1, 10:1, \$4.75.

All-American Radio Frequency Transformers. For wave lengths 150 to 550 meters. \$4.50.

All-American Power Amplifying Transformers. Input and Output types. Each \$6.

SPECIAL OFFER!
We will send the All-American diagram-circular on Power Amplification—also Book of 22 Tested Hook-ups—on receipt of 4c in stamps.

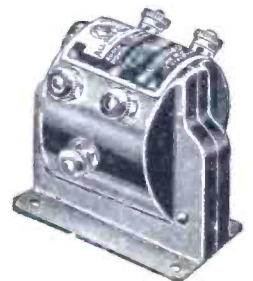

Watch for the new All-American Long Wave Radio Frequency Transformers suitable for Super-Heterodyne Circuits

Please refer to POPULAR RADIO when answering advertisements.

\$5.50

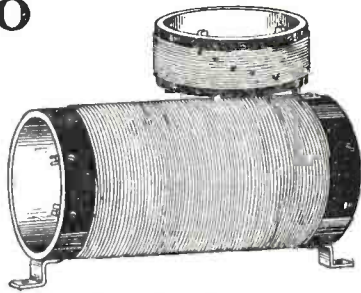

The Only Authorized Cockaday Coil

Capacity effects, high dielectric losses, leakage, broad tuning and howling caused by coils made of cardboard tubes, shellac, and cotton covered wire must be eliminated to get efficient results from Cockaday sets and other circuits.

Replace your old coils with the only Authorized Cockaday Coil, built exactly in accordance with latest specifications of Laurence M. Cockaday, inventor of the famous Cockaday Four Circuit Tuner.

Built on 1/8" hard rubber tubes, threaded—no shellac, and wound with double silk covered wire. Gives maximum selectivity, greater volume, sharp tuning, maximum sensitivity and tonal quality when properly hooked up. Guaranteed.

At your dealers, otherwise shipped to you postpaid.

PRECISION COIL CO., Inc.
209-B Centre Street New York

SHARP TUNING

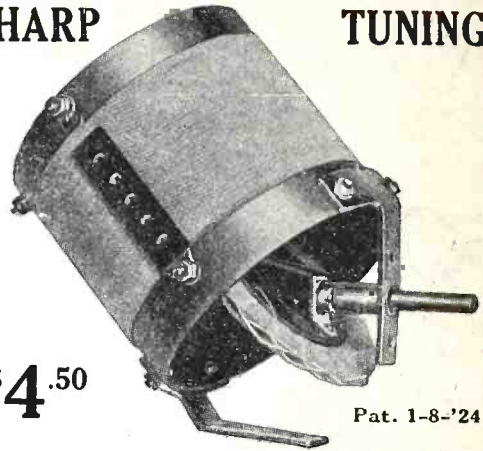

\$4.50

Pat. 1-8-'24

The New Hartman Variocoupler with Spider Web Wound Rotor

Its small size saves panel space. Clearer reception and maximum efficiency insured. Dead shaft has no capacity effect in tuning. Pig Tail contacts; no live brackets. If your dealer can't supply you, write us.

The Hartman Electrical Mfg. Co.
33 East 5th Street, Mansfield, Ohio

Radio **HARTMAN** Products

Acoustically Correct



The Trimm extra large Loud Speaker unit with its wonderful ADJUSTO instantly regulating loud speaker to signal strength insures greatest volume without flaws or distortion. At three prices:

TRIMM STANDARD MODEL

With non-metallic horn 21 1/2" high; bell 10" diam. \$22.50

TRIMM GRAND

With solid Cast Aluminum Horn; the world's finest loud speaker \$35.00

TRIMM

Phonograph Attachment \$10.00

TRIMM High Grade HEADSETS

"Professional" model-3000 ohm. . \$7.65 "Dependable" model-2400 ohms. . \$5.00

Any Trimm product shipped and sold on approval and Guaranteed FOR LIFE. Write for descriptive folders. Mention your dealer's name.

TRIMM RADIO MFG. CO.
Dept. 51
59 S. Clinton St. Chicago, Ill.

HEATH'S Radiant Condensers

A condenser short-circuited will create no end of trouble. Better to think of the plates first, and buy a Heath Radiant Condenser, with the PERMANENTLY F-L-A-T Plates. Compressed and hardened like the plates of a dreadnaught. Guaranteed Non-warping.

Micrometer Vernier

LIST PRICES

Vernier Type
All including 2 7/8" dial and knob.

13 Plate, \$5.00; 25 Plate, \$5.50; 45 Plate, \$6.50

PLAIN TYPE

Mfd. Cap.
11 Plate approx. 0.00025 \$2.30
17 " " 0.00035 2.55
23 " " 0.0005 2.90
43 " " 0.001 3.30

Genuine Condensite Dials 65c Extra

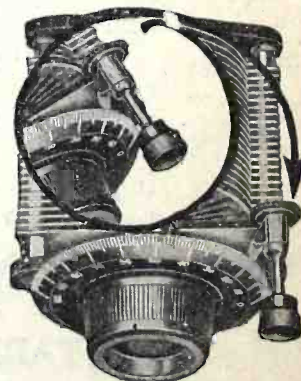

Jobbers and Dealers: Write Immediately for Proposition.

HEATH RADIO & ELEC. MFG. CO.
204 First Street Newark, N. J.

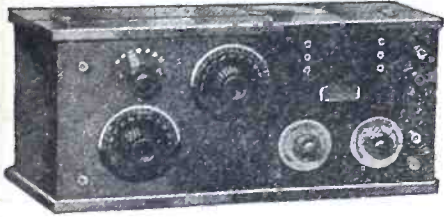

E·D·Elliott of Milford, N.Y. establishes a record

Think of getting London, England, Fairbanks, Alaska, and La Palma, Panama, when you live in New York! Yet this is the experience of Mr. Elliott, one of the hundreds of enthusiastic users of MIRACO sets. With the inexpensive outfit shown here, priced at **only \$29.50**, he received the following list of stations—*results that would do credit to a set costing three or four times as much.*

- | | | | |
|------|---------------------|-------|--------------------|
| WLAV | London, England | WHAY | Wilmington |
| NNW | Fairbanks, Alaska | WRAY | Scranton, Pa. |
| PWY | La Palma, Panama | WOAY | Birmingham |
| CFAC | Havana, Cuba | WSB | Atlanta, Ga. |
| CJCY | Calgary, Can. | WMTU | Washington |
| KFBC | San Diego, Cal. | WCAT | Rapid City |
| KSL | San Francisco, Cal. | WRC | Washington |
| KHQ | Seattle, Wash. | KYWB | Chicago |
| WJAR | Providence, R. I. | KFCB | Phoenix |
| KFRU | Lorine, Wyo. | WHAS | Buffalo, N. Y. |
| WEV | Houston, Tex. | WCAY | Louisville, Ky. |
| WMAT | Duluth, Minn. | WLW | Milwaukee, Wis. |
| WPM | Washington | WDAW | Cincinnati, O. |
| WRAA | Houston, Tex. | WOO | Omaha, Neb. |
| WHB | Kansas, Neb. | WPAW | Kansas City |
| KFHB | Hood River, Ore. | WCE | Wilmington |
| CFCA | Toronto, Can. | WCK | Minneapolis |
| CKCE | Toronto, Can. | WLZ | Detroit, Mich. |
| CJCI | St. John, Can. | WAAS | Warren, O. |
| WRP | Dallas, Tex. | WTAM | Cleveland, Ga. |
| NGE | Miami, Fla. | WWJ | Cleveland, O. |
| KGA | Oakland, Cal. | WJAZ | Detroit, Mich. |
| KFEL | Denver, Colo. | WDPAP | Chicago, Ill. |
| WIAZ | Miami, Fla. | WGY | Chicago, Ill. |
| WKY | Oklahoma City | WJZ | Schenectady, N. Y. |
| WDAE | Tampa, Fla. | WJZ | New York City |
| WEB | St. Louis | WEAF | New York City |
| WRK | Hamilton | WOR | Newark, N. J. |
| WHAB | Galveston, Tex. | WHAS | Louisville, Ky. |
| 6ZV | Salt Lake City | WEAB | Dodge, La. |
| NAA | Arlington Va. | WKD | Gainville, Ga. |
| WJAX | Cleveland, O. | WUO | Washington, D. C. |
| WBZ | Springfield | KMO | Tacoma, Wash. |
| WOO | Philadelphia, Pa. | KOB | New Mexico |
| WOS | Jefferson City, Mo. | WDAR | Philadelphia, Pa. |
| WOK | Pine Bluff, Ark. | WFI | Philadelphia, Pa. |
| WLAG | Minneapolis | WIP | Philadelphia, Pa. |
| WFAZ | Charleston | KDKA | Pittsburg, Pa. |
| WJAB | Lincoln, Neb. | WCNE | Pittsburg, Pa. |
| WCT | Chicago | KMN | Butte, Mont. |
| WMC | Memphis | KOP | Hood River, Ore. |
| WBAK | Harrisburg | WHAZ | Troy, N. Y. |
| WLAK | Bellow Falls, Vt. | WGR | Buffalo, N. Y. |
| WBAN | Paterson, N. J. | WMAV | Auburn, Ala. |
| WOC | Davenport | KFDD | Boise, Ida. |
| WPAP | Winchester, Ky. | WNAL | Omaha, Neb. |
| WMAM | Beaumont, Tex. | WCAP | Washington, D. C. |
| WWZ | New York | WOAB | Springfield, Mo. |
| WBAY | New York | WFB | St. Louis, Mo. |
| WGL | Philadelphia, Pa. | WDR | Detroit, Mich. |
| WMAF | Dartmouth, Mass. | WNAC | Boston, Mass. |
| WBAG | Bridgeport | WBAZ | Columbus, O. |
| WCAP | Decatur | CFZC | Montreal, Que. |
| WHN | Ridgewood | WMAK | Lockport, N. Y. |
| WIAR | Paducah | WGF | Des Moines, Ia. |
| WRP | Camden, N. Y. | WIAM | Rochester, N. Y. |
| WGAR | Fort Smith, Ark. | WCAM | Villa Nova, Pa. |
| WDAK | Hartford, Mass. | WGAY | Madison, Wis. |
| WCAG | New Orleans | WWI | Dearborn, Mich. |
| WWAJ | Columbus, O. | WGAM | Orangeburg, S. C. |



Radio's finest low-priced receivers

Here, in the improved MIRACOS, you'll find the same thrill of getting long distances, generally obtainable with only the most expensive and elaborate sets. To the whole family it will furnish entertainment, **unfailingly**, the whole year round—and at an initial price most every family can afford.

It isn't necessary, either, to be an expert at tuning in with the MIRACO. The operation is extremely simple. Scores of users everywhere tell us of the long-distance records they're making—Cincinnati hears 'Frisco, Denver hears Schenectady, New York hears Havana!

Such range as this is made possible through MIRACO'S many new refinements. Improved rheostats with multiple resistance windings enable you to use any type of tube, and a new aluminum shield prevents annoying body capacity effects. Shock absorbing pads prevent tube noises. Fully **GUARANTEED** against defects in material or workmanship. Price for 4-tube outfit shown above only **\$54.50**.

Other details of MIRACO receivers are explained more fully in our new bulletin. Write today for a copy.

THE MIDWEST RADIO COMPANY
812 Main Street, Cincinnati, Ohio

The Improved MIRACO

Please refer to POPULAR RADIO when answering advertisements.



No More Grief Drilling Panels

No more spoilage! No filing and fussing to correct drill holes that failed to fit.

The Church UNIVERSAL TEMPLATE



This precision instrument adapts itself to every conceivable angle, and makes it possible to transfer to your panel or baseboard the exact position of the correct drill holes for mounting any size radio instrument.

Sent postpaid \$1.25
Jobbers and Dealers correspondence invited

RADIO INSTRUMENTS CO.
17 N. WABASH AVE. CHICAGO - U. S. A.

For Sturdiness and Accuracy Use Lombardi Condensers

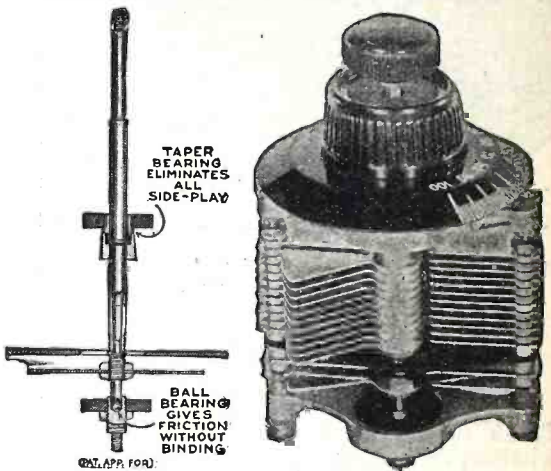

TAPER BEARING ELIMINATES ALL SIDE-PLAY

BALL BEARING GIVES FRICTION WITHOUT BINDING

MADE IN THE MOST POPULAR SIZES, with aluminum plates, aluminum end brackets, with a 1" diameter insulating bushing therein. (A perfect insulator, high in dielectric strength.)

The tension as well as adjusting is accomplished by tightening end thrust plug, which has a spring plunger, causing a thrust of proper tension between a hardened steel ball and a 45 degree tapered brass bushing, this insures smooth running and a contact equal to a soldered joint; also a take up for wear in years to come.

Also makers of coils and sockets
Literature and prices furnished upon request

Lombardi Radio Mfg. Co.
67 MINERVA ST. DERBY, CONN.

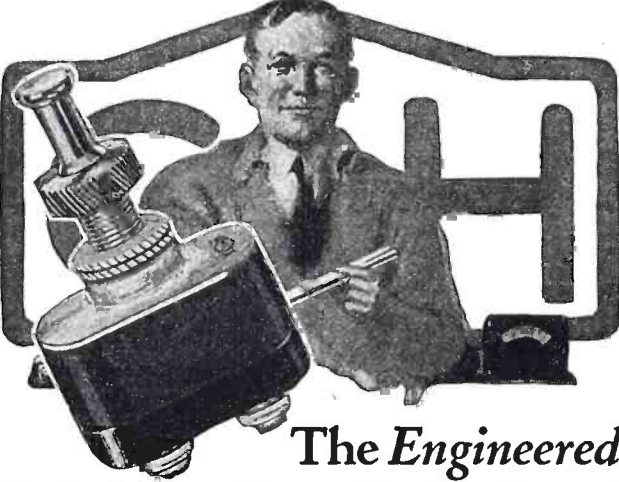

The Engineered Switch for Your Radio Panel

Within the dustproof fibre case of the radio switch by Cutler-Hammer, master builders of all control apparatus, is a mechanism that you can safely insert in your most delicate circuit without introducing microphonic noises. Its floating contactor is independent of the button—touching it or jarring the table will not produce noise in your phones. Sold by radio dealers everywhere. Insist on the genuine in the orange and blue box—the C-H trademark is your assurance of satisfaction.

THE CUTLER-HAMMER MFG. CO.
Member Radio Section, Associated Mfrs. of Electrical Supplies
MILWAUKEE, WISCONSIN

RADIO SWITCH



Better Tone for Your Radio!

FRANK D. PEARNE, famous Radio engineer, says TRANSCONTINENTAL RIBBON Aerials aid reception by combining maximum surface with minimum resistance. FORREST, eminent inventor, says, "I get best results by twisting Ribbon Aerial, 2 twists per 50 feet." Complete with snap hooks soldered to ends for instant attachment to insulators.

Transcontinental RIBBON COPPER AERIAL	50-Foot \$1.50
	75-Ft. \$2.25
	100-Ft. \$3.00
	150-Ft. \$4.50

Clearer tone, greater volume, increased distance and selectivity guaranteed or your money refunded! Improves any set, tube or crystal. A laboratory product, with capacity, resistance and strength calculated to give better results.

Try It Without Risk! If your dealers cannot supply you, order direct from manufacturer, enclosing price. 100-foot length most generally used. Money-back guarantee protects you.

Acorn Radio Mfg. Co. 1806 S. Racine Ave. Dept. 208 CHICAGO

TRANSCONTINENTAL RIBBON AERIAL

DEALERS! Write for Special Offer!

Please refer to POPULAR RADIO when answering advertisements.

Atlas

TRADE MARK

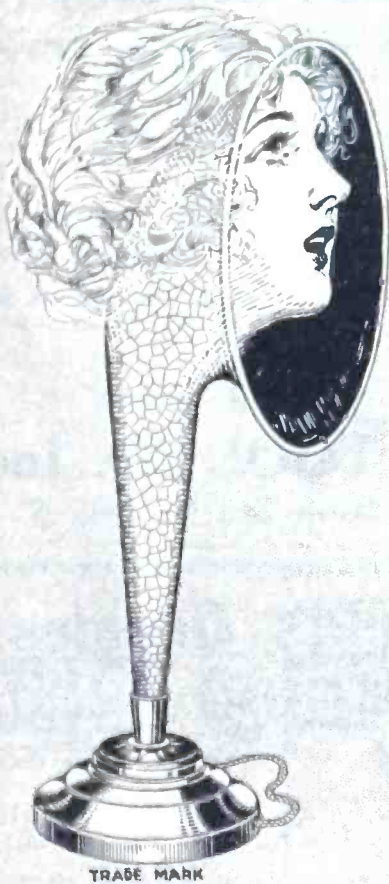

TRADE MARK

RADIO-REPRODUCTION LOUD SPEAKER

THE Atlas Radio
RE-PRODUC-
TION of the
artist's per-
formance brings the
studio into your home.

Complete \$25

WRITE FOR BOOKLET "B"

Atlas Loud Speaker Unit

With Phonograph Coupling \$13.50

Without Phonograph Coupling \$12.50

Sole Canadian Distributors
Marconi Wireless Telegraph Co. of Canada, Ltd.
Montreal, Canada

Multiple Electric Products Co. Inc.

Makers of MONO—TIME-LAG FUSES—MULTIPLE
2 ORANGE STREET DISTRICT OFFICES AT **NEWARK, N. J.**
NEW YORK, CHICAGO, BALTIMORE, PHILADELPHIA, BOSTON, PITTSBURG, DETROIT,
SAN FRANCISCO, KANSAS CITY, ST. LOUIS, LOUISVILLE, DENVER

Please refer to POPULAR RADIO when answering advertisements.



STANDARD OF EXCELLENCE
for audio amplification
With all tubes
In all stages

AMERTRAN
TRADE MARK REG. U.S. PAT. OFF.

Improve your set with an AmerTran
Its flat-top, distortionless amplification curves assures a pure tone rendering of the full musical scale.
Type AF-6: Turn ratio 5:1. Price \$7. Ask your Electrical Dealer or sent carriage charges collect.
Send for Circular 1005
American Transformer Company
Designers and builders of radio transformers for over 22 years
175 Emmet Street, Newark, N. J.



U.S. TOOL CONDENSERS for the
4-Tube Superdyne
A precision condenser of national reputation
100% GUARANTEED
U. S. Tool Type CS 114—23 Plate; Capacity .00055 Mfd. or Type CV 123—24 Plate, Vernier Cap. .00057 Mfd.
Insulated and shielded by end plates of **CELORON—Low Dielectric Losses**
Condensers of recommended plates and capacities for all known circuits are stocked by leading radio retailers.
Write for Literature
U. S. TOOL CO., Inc.
116 Mechanic St., Newark, N. J.

\$8



A phone plus a **FIBERTONE** makes a beautiful musical instrument

The highest tonal quality undisturbed by either metallic noises or distortion is best obtainable with a fiber horn. This one factor is the reason for Fibertone's popularity. And the low price for such fineness is a sensation of the radio world. The beautiful crystalline finish of the Fibertone fits it for any place where the finer things of the home are seen.
If your dealer cannot supply you write direct.
FIBER PRODUCTS COMPANY
34 Orange St. Bloomfield, N. J.
FIBERTONE
RADIO HORN

World's Greatest BATTERY BARGAIN
FREE
Hydrometer and "B" Battery

Written 2 Year Guarantee Your Proof of Satisfaction

SAVE 50%

Thousands of POPULAR RADIO Readers will profit by this amazing offer. They will buy the famous 2-year guaranteed, World battery at the lowest price ever quoted—They will get a hydrometer and a "B" Battery FREE. And they get the best battery built. It is "World" quality that makes possible our 2-year ironclad guarantee. It is "World" quality that makes "World" owners "tell their friends"—that's the best proof of performance any product can have.

Compare These Prices:

Special 200 Hour Rechargeable Storage Batteries	6 Volt 60 Amp...	\$8.50
2 Volt for W.D. 11 and 12 tubes	6 Volt 80 Amp...	10.00
4 Volt for U.V. 199 tubes	6 Volt 100 Amp...	12.50
	6 Volt 120 Amp...	14.50
	6 Volt 140 Amp...	16.00

Send No Money
You need not send a penny. Just clip this ad and attach your name and address. The battery will be shipped to you the day your order is received. When the battery arrives, inspect it—read our 2-year guarantee before you pay one penny. Convince yourself you are protected from every angle—that the World battery price saves you 50%. Get the "B" Battery and hydrometer FREE. Order today.

Special Offer
Clip and mail this ad with your World battery order and get this hydrometer and "B" battery free. 5% disc. for cash in full with order.
WORLD BATTERY CO.
Dept. 3, 1219 So. Wabash Ave., Chicago, Ill.

World

Please refer to POPULAR RADIO when answering advertisements.

Barkeley Four-Phone Plug

PATENTS PENDING

Connects four phones or less in series to
any Radio Set employing standard
telephone jacks

□ □ □

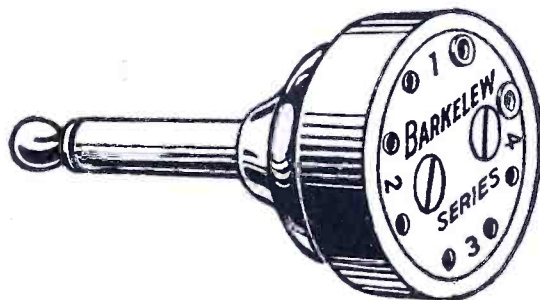

Cat. No. 616
Price \$1.50

It adds to the appearance of any set.
With all phone tips adjusted, the
diameter is but $1\frac{1}{4}$ inches

CHICAGO, ILL.
15 S. CLINTON ST.

BARKELEY

SAN FRANCISCO.
75 FREMONT ST.

ELECTRIC MANUFACTURING CO.
MIDDLETOWN, OHIO.

Please refer to POPULAR RADIO when answering advertisements.

Distance & Volume are found in

RayCoils



RayCoils "A" for Reinartz, Ray Coils "B" for RCS and Ultra Audion Circuits, RayCoils "C" for RCS, Ultra Audion and Tuned Radio Frequency for All Circuits. RayCoils "D" for Neutralizing Circuits 4 & 5 Tubes.

- A = \$2.50 Use the RCS Circuit with or without Radio Frequency for Simplicity in operation and results. Not equalled by any set for volume and distance.
- B = 2.00
- C = 2.00
- D = 2.00 Coast to Coast stations on loud speaker

Coils in Separate Box With Wiring Diagram

Working Blue Prints of four sheets 12 x 18 of all standard circuits, such as The Variometer, Reinartz, RCS one and three tube sets and five tube Neutralizing Circuit 50 cents a set.

We also carry a complete line of Carter, Howard, Kellogg, All American and Trimm parts.

If your dealer cannot supply you, we will mail direct.

R. C. SCHOONHOVEN
Major Q. M. R. C.
FLGIN, ILL.

Montreal-California (More than 2500 Miles) on one Myers Tube



(1/2 size)

Mr. W. E. Gerrard, 73 Pine Avenue, St. Lambert, Montreal, Canada, using only one MYERS TUBE, hears KDZB, Bakersfield, California.

Get distance with clarity. MYERS are the only tubes correctly designed for radio without bunched leads. Two types—for dry or storage battery. Insist on MYERS at your dealers—otherwise send purchase price and be supplied postpaid. Write for free circuit diagrams,

\$5 EACH complete with mounting clips ready to mount on your set; no sockets or extra equipment necessary.

E. B. Myers Co. Ltd.
Radio Vacuum Tubes
240 Craig St. W. Montreal, Canada

"All the difference in the world--"

That's what a well-known scientist engaged in research work for one of America's great universities said after comparing our rheostat with many others. The



PRICE
\$2.00

For most tubes you need
a 6 Ohm Rheostat

25 OHMS

for 201-A and 301-A

40 OHMS

for 199 and 299 Tubes

UNITY Vernier Rheostat

gave him the most satisfactory results of any rheostat used. It will give you the same satisfaction. We guarantee it. The exclusive construction of the UNITY permits the most infinitesimal variation in resistance. You'll appreciate the cut-out switch feature.

*Don't be satisfied
with a substitute*

Ask your dealer for UNITY rheostats

UNITY MANUFACTURING CO.

224 N. Halsted St., Chicago

DX-10-POINT

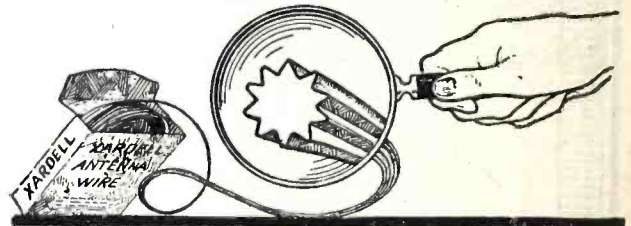

ANTENNA WIRE

\$2.00

PER
HUNDRED
FEET

Designed for long distance reception and is different and better than the usual make-shifts, being hard drawn from the finest copper, having a corrugated surface with ten collecting points on the circumference. This gives a greater collective surface to the high frequency radio currents. The result is extreme sensitiveness and increase in range and clearness of any set from the simplest Crystal to the finest multiple tube receiver.

Use this antenna wire and enjoy the full possibilities of your set.

Sold in coils 100 feet, 200 feet and 500 feet. Order direct or from your nearest dealer.

Dept. R





"MINUTE MAN" Radio Receiving Set

incorporating
Pathé Type "P" Phusiformers

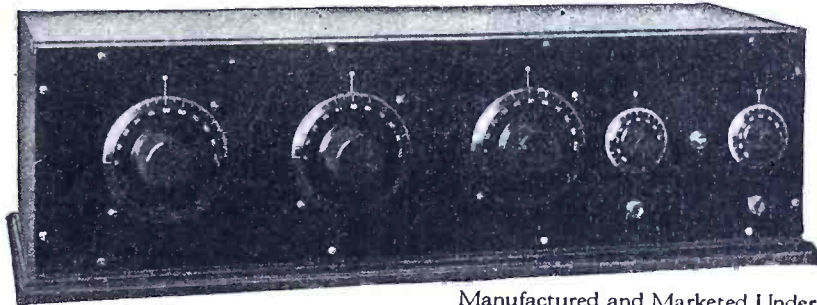

Manufactured and Marketed Under
License Agreement, Patent Pending

Price \$125.00
(tubes, batteries extra)

A 5-tube de luxe set combining all the desirable features
of the best receiving sets:

- Does not oscillate.*
- Does not re-radiate*
- Highly selective.*
- Sensitive to distant stations.*
- Free from hand capacity.*
- Simple to operate.*

The Pathé "Minute Man" is housed in a genuine mahogany cabinet equipped with beautiful mahogany panel and gold engraved dials, making a handsome as well as efficient instrument.

FREE

A most complete and detailed instruction book showing how to construct a "Minute Man" Receiving Set will be sent you absolutely free of charge. Address Dept. 194.

Jobbers and Dealers

Write Dept. 194
for catalogs and
prices of Pathé
line.

PATHÉ PHONOGRAPH & RADIO CORP.
20 GRAND AVENUE :: BROOKLYN, N. Y.

Please refer to POPULAR RADIO when answering advertisements.

Is Your Set a Piece of Furniture?

Your
set here

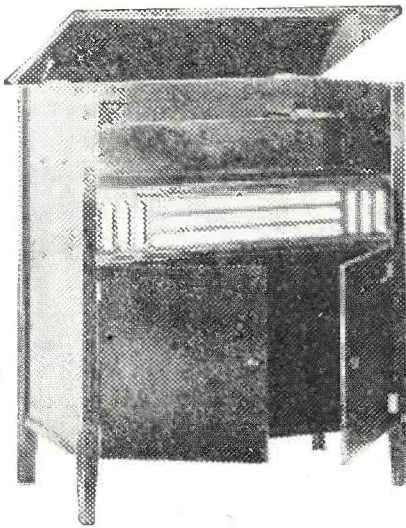

Groove
for
Panel

Built-in
horn

Gold-
Plated
Screen

Charger
A & B
Batteries
here

Large
Spacious
Cabinet

Your radio set deserves a place in the best room of your house. It is impossible to give it this place if it is necessary to have unsightly wires running from part to part and ugly batteries, chargers, and speaker-horns, etc., in close proximity to it.

There is a place for each part of the set. There are grooves for various sizes of panels. The horn is built in and there is a convenient place to fasten the speaker unit. A spacious cabinet in the lower part will conceal the charger and all batteries.

PRICES \$35.00 and up

Whaling Wood Products Co.
Dealers Write 3101 Orange Ave. Dealers Write
CLEVELAND

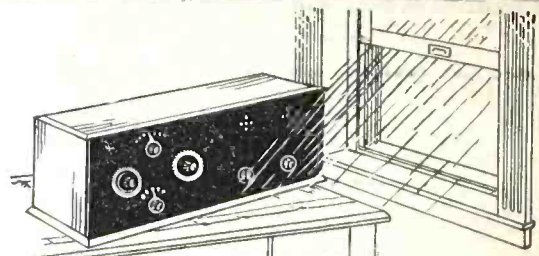

Water wont hurt it!

Bakelite-Dilecto Panels will not warp, split, swell, check, crack, shrink or change their color or brilliant lustre under the severest weather conditions. Water does not hurt them. Neither do steam, oil, solvents, heat and cold.

bakelite-dilecto

(A Laminated Phenolic Condensation Material)

Foremost radio experts have found that Bakelite-Dilecto has every radio-advantage. The U. S. Navy and Signal Corps have used it for over ten years. Finished a beautiful, sleek black. Astonishingly tough, yet machines readily. Have your dealer get genuine Bakelite-Dilecto panels cut and drilled for you.

THE CONTINENTAL FIBRE CO.
Factory: Newark, Delaware

Service on Bakelite-Dilecto (also Continental-Bakelite, Conite, Contex and Vulcanized Fibre) from:

NEW YORK, Woolworth Bldg.
PITTSBURGH, 801 Fifth Ave.
LOS ANGELES, 307 S. Hill St.

CHICAGO, Wrigley Bldg.
SAN FRANCISCO, 75 Fremont St.
SEATTLE, 1041 Sixth Ave., So.

Offices and Agents Throughout the World

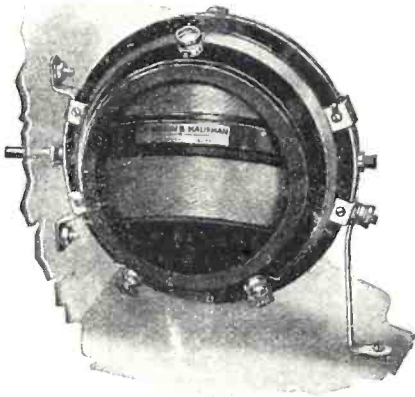

Variotransformer

A variable radio frequency transformer

Only one of eight standard HARD RUBBER moulded tuners.

Send for Literature and Diagrams

THE HOME OF MOULDED TUNER
SPECIALTIES

LANGBEIN & KAUFMAN

654 Grand Ave.

New Haven, Conn.

AMPL-TONE PHONES



A THREE DOLLAR
LOUD SPEAKER
UNIT FOR
HOME MADE SPEAKER
FREE

With Pair of Phones

Money Back Guarantee

Dealers Wanted

C. M. FRENCH MFG. CO.
SEYMOUR, CONN.

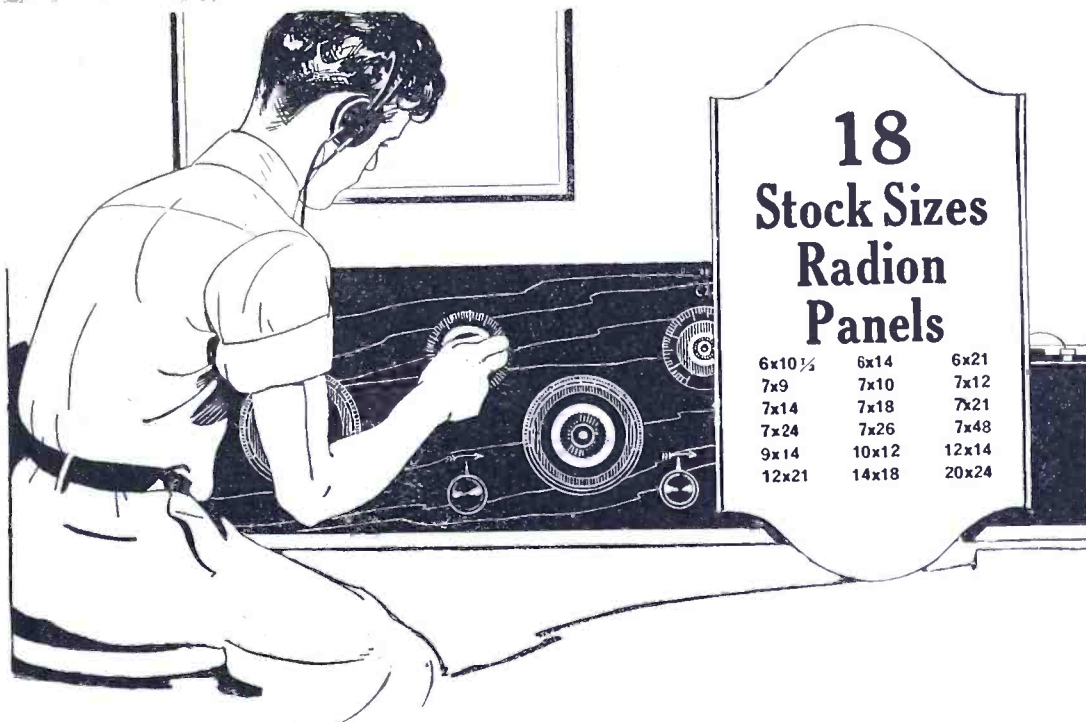

**18
Stock Sizes
Radion
Panels**

6x10½	6x14	6x21
7x9	7x10	7x12
7x14	7x18	7x21
7x24	7x26	7x48
9x14	10x12	12x14
12x21	14x18	20x24

***Eliminate short circuits
and distortion***

Any panel material which will absorb moisture is apt to cause short circuits and distortion. Radion Panels are impervious to moisture. They eliminate most of the leaks of radio frequency currents where other materials fail.

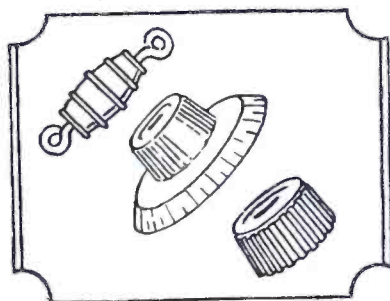

Your dealer carries a stock of Mahoganite or black Radion Panels, Dials and Knobs. Experienced amateurs and professionals, too, demand genuine RADION. Try it and you will notice the difference.



Look for this stamp on every genuine RADION Panel. Beware of substitutes and imitations.

RADION
The Supreme Insulation
PANELS

AMERICAN HARD RUBBER CO., 11 Mercer St., N. Y.

Please refer to POPULAR RADIO when answering advertisements.

Free Parts for Your Radio Sets!

Your choice of these valuable premiums, free to you as a reward for securing only a few subscriptions to POPULAR RADIO

A FEW moments of your spare time spent in bringing POPULAR RADIO to the attention of your friends and acquaintances will yield you big rewards. Never before have we been able to offer such attractive and liberal premium values as these.

Glance over this broad list of radio parts and equipment that you can secure FREE, merely by introducing POPULAR RADIO to some of your friends

and acquaintances who will appreciate the opportunity of subscribing to this most interesting and helpful magazine.

Show this copy of POPULAR RADIO to other radio fans. The pages of the magazine will speak for itself. Then send us the names of your friends, with \$3 for each yearly subscription, and take your choice of any of the following premiums. They'll come to you *absolutely free*.

Any One of These for 2 Subscriptions:

Dubilier Ducon, and choice of any three Dubilier Micadon Grid Condensers of the following capacities: .00025; .0005; .001 or .002.

Pudlin Tubular Grid Leak (2 megs.); Dubilier Micadon Grid Condenser .00025; Cutler Hammer 6 ohm Rheostat, and one Alden Napier Socket, choice of either 201A or WD-11.

Three Pacent Jacks (one single circuit and two double circuit).

Bakelite Panel, size 7 x 18 inches.

22½ volt B Battery, large, choice of Burgess or Eveready.

One copy of Ballantine's "Radio Telephony."

Cutler Hammer 30 ohm Rheostat and choice of one Alden Napier Socket: 201A, 199 or WD-11.

Your Choice for Only 3 Subscriptions:

Bakelite Panel, size 7 x 24 inches.

Set of Mounted De Forest Coils; 35, 50, 75.

Amsco Compensating Condenser and choice of any one Alden Napier Socket: 201A, 199 or WD-11.

"Scientific" Headset.

Two Cutler Hammer 6 ohm Rheostats and one Cutler Hammer Potentiometer.

Diode Dry Cell Tube and Cutler Hammer 6 ohm Rheostat.

Big Value for 4 Subscriptions Each:

Lefax Loose Leaf Radio Handbook with full year's free supplement service.

Sleeper Variocoupler with switch lever and points.

Cardwell 21 Plate Condenser or General Radio 23 Plate Condenser.

Cardwell or Se-Ar-De 17 Plate Condenser.

Cardwell 11 Plate Condenser and Pacent Jack.

U. V. 200 or C. 200 Vacuum Tube.

"Ampl Tone" Phones.

Free With 5 Subscriptions Each:

Cardwell 43 Plate Condenser.

Spiderweb Coil and Mounting.

Brandes or Holtzer. Cabot No. 4 National Phones.

Amertran Transformer.

Atwater Kent or Sleeper Variometer.

U. V. 201A or C. 201A Vacuum Tube.

U. V. 199 or C. 199 Vacuum Tube.

WD-12 or C. 12 Vacuum Tube.

WD-11 or C. 11 Vacuum Tube.

ALL premiums will be sent prepaid, immediately on receipt of your orders. If you want some particular part that is not listed here, write us and we'll tell you how many subscriptions you'll need to get it *free*. Or if you prefer *cash commissions*, just drop us a postcard asking for full particulars.

Renewals of old subscriptions or extensions

of present subscriptions count the same for you as new subscriptions. In other words, any subscription you receive entitles you to your reward in cash or in premiums. Simply send us \$3 to cover each subscription you take and we will send you your premiums.

Start today, and you'll have your required number of subscriptions in a jiffy!

POPULAR RADIO

Dept. 41

9 East 40th Street

New York City

Please refer to POPULAR RADIO when answering advertisements.

"Tune in" on Success

Learn at Home To be a Radio Expert

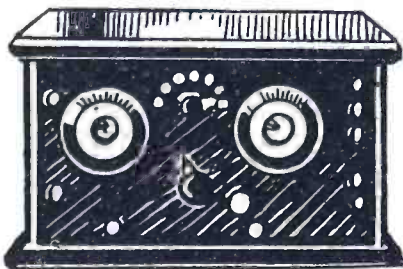

Radio Pays Big

Free 1000 Mile Radio Outfit

This set, when erected, has a range of over 1,000 miles. The cabinet is elegantly finished in a beautiful, lustrous mahogany. You can sell it at a handsome profit if you care to, after you have completed my course. Remember, you do not pay a single penny for it.

Membership Is Valuable!

Upon completion of my course, you receive a membership in the Radio Association of America. This designates that you are a thoroughly trained Radio man. It gives you prestige and a standing in your community not otherwise possible.

Thousands of Big Pay Opportunities

My course enables you to construct, install, operate, repair and sell Radio equipment. As my representative, you can, using either your full time or spare time, take orders from your friends and neighbors. You can easily earn from \$35.00 to \$125.00 a week installing Radio sets in your locality. It is being done every day by my students. What others have done, you can do.

PROOF

Dear Mr. Mohaupt:
Your lessons are very easily digestible. To say that I enjoy them would be putting it very mildly—indeed, I crave them.
And, about the job at the Operadio Corporation; yes, I got it, thanks to you. I am learning to be an inspector at present, but I'll not stop there.
Please send me additional lessons as soon as possible.
GEO. A. GRAESLE.

On this very day there is someone in your neighborhood who is buying a Radio Set from someone else and is having Radio work done by others. On this very day there are big pay Radio positions that are going begging. This will be repeated tomorrow and for a long time to come. Time is precious. Begin at once to get the training that will fit you to cash in on this great chance. At least investigate. Mail the coupon to get the interesting bulletin "Radio Facts."

Radio Experts Earn \$3,000 to \$10,000 a Year

New Radio Stations are being erected every day. Thousands of corporations are putting in private stations. Every large vessel requires its Radio Staff. From everywhere comes the urgent call for Radio Trained Men. There is almost no limit to the pay. Will you step forward and grasp this brilliant money-making chance or are you going to let days drift by and let others take in the cash?

"Learn by Doing" Method

My course is not "high-brow." It is written in plain, everyday language that can be understood by any man. You need have no previous training or experience. I give you a receiving set so that I can take you thru the various steps of Radio work in a practical way. You will be delightfully astonished in having made clear to you the wonderful forces of Radio that appear so mysterious to the untrained person.

FREE I have ready for you a copy of "Radio Facts" which tells you of the latest opportunities that exist in the great field of Radio. I want you to note my "Money Back" guarantee that protects you absolutely. I also want to tell you about the big free 1,000 mile Radio Tube Set that I give away free with my course. I urge you to act at once. Fill in your name and address on the coupon and mail it to me immediately.

A. G. Mohaupt, Radio Engineer
RADIO ASSOCIATION OF AMERICA
Dept. 55 Chicago, Ill.

MAIL COUPON

A. G. Mohaupt, Radio Engr., Radio Assn. of America,
Dept. 55, Chicago, Ill.

Please send me details of your Home Study Course—also your Free "Radio Facts" and information on how I can get a FREE 1,000 mile Radio Set.

NAME
ADDRESS
CITY STATE

A.G. Mohaupt Radio Engineer Radio Association of America Dept 55 Chicago, Ill.

Please refer to POPULAR RADIO when answering advertisements.

**THE NEW
METALECTRIC
SOLDERING IRON**

Operates with the Simplicity—
Ease and Efficiency of a
Pencil on any Electric Current

ACCEPTED

As the logical Solution
to Radio Soldering
Problems
Ample Heating Capacity
Handle Always Cool

Now
\$3.75

"Worth it"

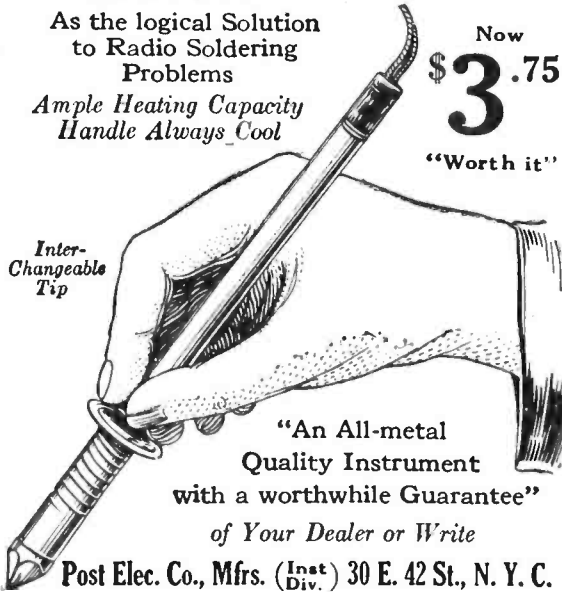

"An All-metal
Quality Instrument
with a worthwhile Guarantee"

of Your Dealer or Write

Post Elec. Co., Mfrs. (Invt. Div.) 30 E. 42 St., N. Y. C.

The
"EZTOON"
(Easy Tune)

Radio Dial

is two dials in
one with a 40 to
1 ratio.

"EZTOON" dials
make possible vernier
adjustment of
vario-coupler, vario-
meter rheostat,
potentiometer, or tickler, as
well as saving the expense of
a second set of adjustable
plates on condensers.

The "EZTOON" gives unusual
close tuning so essential in
Heterodyne, Acmedyne, Neu-
trodyne and tuned radio fre-
quency circuits.

No panel holes to drill. Just
take off old dial, slip on
"EZTOON" dial and tighten
set screw.

Sold under positive money-back
guarantee.

Ask your dealer. If he cannot
supply you, we ship parcel
post 3" dial, \$2.00; 4" dial, \$2.25.
Jobbers—Dealers—Manufactur-
ers: Write for discounts.

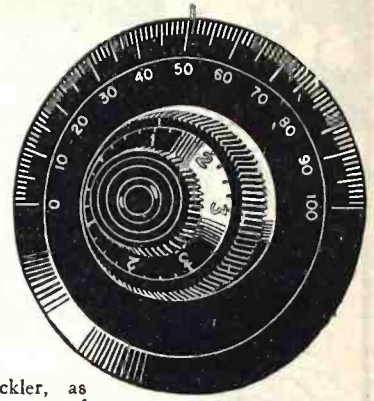

With
"EZTOON"
(Easy Tune)
RADIO DIAL

You Can
bring in stations that heretofore you have passed up as impossible.
Get and hold stations.
Use it on any and all types of receiving sets to obtain vernier adjustment unobtainable before.
Tune in DX stations you never heard before.
Obtain vernier adjustment of all tuning instruments within your set.

BUTLER MANUFACTURING CO.
3236 W. Washington St., Indianapolis, Ind.



\$3.50
2200 OHMS

"You get every
tone with a
Pacent Phone"

"EVERYTONE"
guaranteed
RADIO HEADSET

The "EVERYTONE" is low
in price. But it is extremely
high in all the qualities you
expect to enjoy in the headset
you buy—clear reception,
without distortion—comfort
and long life.

Everytone Headset,
3000 Ohms—\$3.75

At all good Radio Dealers
Write for bulletin P-4

PACENT ELECTRIC CO. Inc.
22 Park Place New York



With
Plug
50c.
Extra

Pacent
RADIO ESSENTIALS

FOUR CIRCUIT COIL SET

\$2.50



"A" Coil
covered
square
wire

"D" Coil
bank
wound

Full set A, B, C and D coils made exactly according
to Cockaday's specifications. Full size blue prints and
illustrated instructions with each set.

Materials for standard Four Circuit Tuner—panels, coils,
condensers, verniers, grid leak, vernier rheostat, socket,
jack, dials, switch, contacts, posts, busbar wire, spaghetti,
etc. (no tubes or phones).

Complete for \$11.65

IMPROVED TYPE COILS

Double silk covered wire on Bakelite tubing \$4.00
per set.
Complete materials for 5 tube improved \$58.75
Cockaday set

All parts in stock. Get our price list.

Postage additional on all orders.

Send no money. Order by post card, pay the postman.
RADIO SURPLUS STORES
HELENA, MONTANA

The "RICO" Grand Opera Loud Speaker Unit

You have no doubt read or heard that every loud-speaker is positively the best one ever manufactured. We could with very little effort make similar claims—on paper—and perhaps go other "ad" writers one better. Modesty, however, forbids. We therefore make the following statement:

\$7.50

Patented Dec. 25, '23

Get a "RICO" GRAND OPERA LOUD-SPEAKER UNIT from your dealer or direct from us. Compare it with any loud-speaker you have now or you have ever heard. Consider the money you have paid is on deposit with your dealer or with us. If after 5 days you find the "RICO" GRAND OPERA LOUD-SPEAKER UNIT does not give you greater volume—does not give you greater clarity of sound—does not give you greater satisfaction than any other loud-speaker unit—then our dealers or we will gladly refund the purchase price.

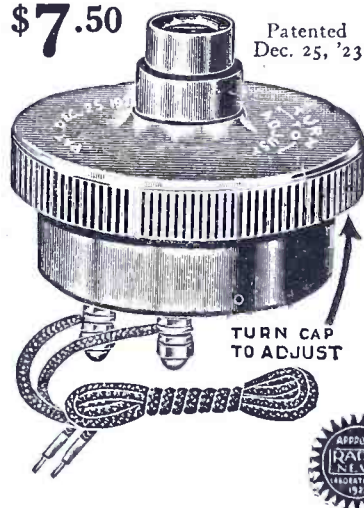

TURN CAP TO ADJUST



DESCRIPTION: This loud-speaker unit is ideal for phonographs. With it, you can turn your phonograph into a loud-speaker. Any good horn, however, can be attached to it. (Speaker does not work with crystal sets, only on vacuum tubes.)

No Metal Can Touch Diaphragm

This feature is not found in any loud-speaker except the "RICO" GRAND OPERA LOUD-SPEAKER UNIT. Diaphragm cannot rattle. Metallic, harsh sounds are entirely eliminated

The "RICO" GRAND OPERA LOUD-SPEAKER

UNIT is fully adjustable. For light or soft tones, simply turn the milled rim for best results. With this arrangement you can get either tremendous volume or soft tones, as you desire. Aluminum shell and cap highly nickel-plated and polished. Five-foot green cord furnished. No. 75 "RICO" GRAND OPERA LOUD-SPEAKER UNIT as described. Price \$7.50.

The "RICO" Straight Line Condenser

This condenser marks a revolution in condenser building. It is the simplest and most practical type yet developed for broadcast and amateur work. This condenser has been developed by our engineers after considerable research work and has been pronounced perfect by experts.



THREE STYLES
.001 mfd. (=43 Plate)
.0005 mfd. (=23 Plate)
.00025 mfd. (=11 Plate)



NEW TYPE

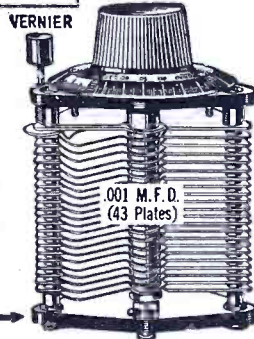

OLD TYPE

This Replaces This

Both Instruments Drawn to Scale

This →

Manufactured in three types, to replace 43 plates, 23 plates and 11 plates.

No. 450 "Rico" Condenser .001 mfd. (=43 plate capacity) . . . \$1.75

No. 423 "Rico" Condenser .0005 mfd. (=23 plate capacity) . . . \$1.75

No. 411 "Rico" Condenser .00025 mfd. (=11 plate capacity) . . . \$1.75

All above types without dial . . . \$1.50

The "Rico" condenser weighs 6 oz. The old style weighs 15 oz. "Rico" vernier type has only one dial. Old style requires difficult mechanism.

Here are Some of the Outstanding Points:

- 1—Large capacity.
 - 2—Replaces all standard condensers.
 - 3—Uses a minimum of space size, 3 1/2" x 2 1/2" x 1 1/4".
 - 4—For panel mounting or for table mounting—universal in its scope.
 - 5—Complete revolution of dial from minimum to maximum.
 - 6—Vernier effect.
 - 7—Absolute straight line curve.
 - 8—Accumulates no dust between plates as is the case with air condensers.
 - 9—Light weight. Condenser only weighs 3 oz.
 - 10—Less than 1-10th amount of parts as used in old style mesh plate condenser.
 - 11—Can never get out of order.
 - 12—Impossible to short circuit.
 - 13—Works in any position, vertical or horizontal. No counterweights needed.
 - 14—Lowest in prices for high class condenser.
- The "Rico" Straight Line Condenser must be seen to be appreciated. Made of the best materials money can buy. In a class by itself. All metal parts finished in nickel plate. We will refund your money if this condenser is not all we claim for it.

Dealers and Jobbers Write or Wire for Territory that is Still Open for Proposition

RADIO INDUSTRIES CORPORATION
131 Duane Street, New York City
Cable Address: Ricotrade, New York

SEND NO MONEY P.R.4
Radio Industries Corp.,
131 Duane St., New York City
Gentlemen:—Please send me by
Parcel Post
for which I will pay the postman
the amount of
Name
Street
City State

Please refer to POPULAR RADIO when answering advertisements.

Listen to the Difference!

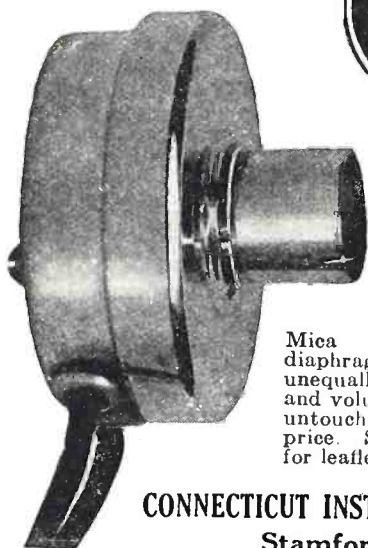

PHONOGRAPH ATTACHMENT

\$6.50

Mica diaphragm—unequalled quality and volume—untouchable price. Send for leaflet.

CONNECTICUT INSTRUMENT COMPANY
Stamford, Conn.



HOWARD

HOWARD



No. 1001

No. 1002

6 1/2 Ohm Rheostat . . . \$1.10
25 Ohm Rheostat . . . 1.10
40 Ohm Rheostat . . . 1.10
Patd. 870,042

6 1/2 Ohm Micro-meter Rheostat . . . \$1.50
25 Ohm Micro-meter Rheostat . . . 1.50
40 Ohm Micro-meter Rheostat . . . 1.50
Patd. July 10, 1923

Ask the man behind the counter to show you the Howard line of quality Radio Merchandise. Every piece is sold with the guarantee of satisfactory performance.

HOWARD

HOWARD



No. 1003

200 Ohm Potentiometer . \$1.50
400 Ohm Potentiometer . 2.00
Patd. 870,042

No. 1004 Multi Terminal Receiver Plug, instantaneous connection for as many as six pairs of standard receiver tips . . . \$2.00
Patd. Aug. 28, 1923

Jobbers write for discounts.

Send two cents for folder.

HOWARD RADIO CO., Inc.
4248 North Western Ave., Chicago, U. S. A.

FROST-RADIO

Ask Your Neighbor



\$4.00

\$5.00

\$6.00

FROST-FONES

No. 161 **FROST-FONES.** Drawn aluminum shells and composition caps. 2,000 ohm, Special head band . . . **\$4.00**

No. 171 **FROST-FONES.** Same as No. 161, aluminum shell type, but 3,000 ohm . . . **\$5.00**

No. 162 **FROST-FONES.** Composition shells and caps, improved design with reinforced terminal and cord. 2,000 ohm . . . **\$5.00**

No. 172 **FROST-FONES.** Genuine maroon moulded BAKELITE shells and caps with moulded in terminal block and special improved design. 3,200 ohm . . . **\$6.00**

Your neighborhood dealer handles **FROST-RADIO**

HERBERT H. FROST, Inc.
154 West Lake Street
CHICAGO

New York

Kansas City, Mo.

A Pleasant Surprise Awaits the User of the A. C. H. Sharp Tuner Dials

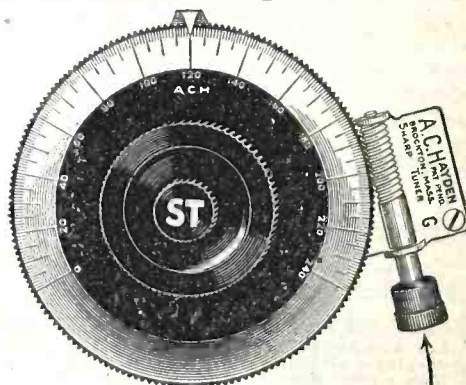

Why the A.C.H. is different

3 in. DIAL ➔ A.C.H. ➔ 156-T0-1

4 in. DIAL ➔ A.C.H. ➔ 215-T0-1

Will improve any receiving set, making difficult tuning easy
Money Back Guarantee

Price 3-inch size . . . \$2.50 Price 4-inch size . . . \$5.00
Regular fitting 5/16 shaft 1/4 and 3/16 5c each extra

Extra Advantage of the A.C.H.

1. Can be attached or removed from any instrument.
2. Rough tuning same as any dial.
3. Movement so fine that the eye cannot detect but the ear can.
4. Automatically locks instrument so no jar can disturb it.
5. Dial grounded reducing the body capacity to a minimum.
6. Special dial 2 graduations where ordinarily one.

MAIL ORDERS SENT PREPAID IN U. S. A.

A. C. HAYDEN RADIO & RESEARCH CO.
25 E. Battle St., BROCKTON, MASS., U. S. A.

Please refer to POPULAR RADIO when answering advertisements.

\$25 for \$10

The Famous BEL-CANTO Acoustical Amplifier

Direct from
Manufacturer
to you

You cannot buy the
BEL-CANTO from
any dealer

Only direct from us. We
save you these three profits
**DISTRIBUTOR, JOBBER
and DEALER**

Call at our factory, send us your
check, money order, or pay the
postman \$10.00. Prepaid to any
part of U. S. and possessions.

Tel. Vanderbilt 8959

C. O. D. Delivered to your door

Price \$10

BEL-CANTO MFG. CO.,

BENSEL-BONIS Co., Inc.

General Office and Factory, Dept. P. R. 417-419-421 East 34th St., N.Y.C.

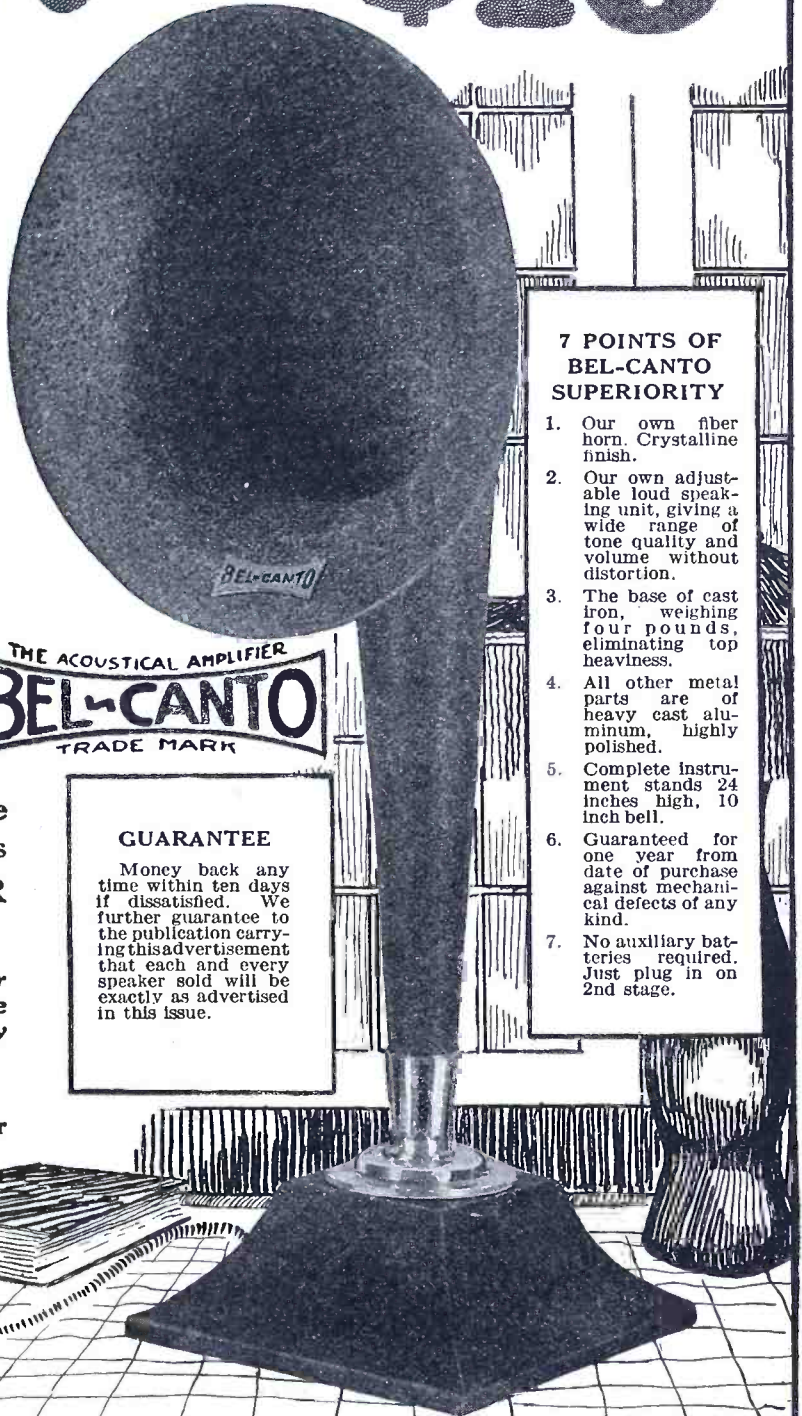

THE ACOUSTICAL AMPLIFIER
BEL-CANTO
TRADE MARK

GUARANTEE

Money back any
time within ten days
if dissatisfied. We
further guarantee to
the publication carry-
ing this advertisement
that each and every
speaker sold will be
exactly as advertised
in this issue.

7 POINTS OF BEL-CANTO SUPERIORITY

1. Our own fiber horn. Crystalline finish.
2. Our own adjustable loud speaking unit, giving a wide range of tone quality and volume without distortion.
3. The base of cast iron, weighing four pounds, eliminating top heaviness.
4. All other metal parts are of heavy cast aluminum, highly polished.
5. Complete instrument stands 24 inches high, 10 inch bell.
6. Guaranteed for one year from date of purchase against mechanical defects of any kind.
7. No auxiliary batteries required. Just plug in on 2nd stage.

Please refer to POPULAR RADIO when answering advertisements.

Your Choice!

—for Only 35 Cents in Stamps!

Hundreds of reliable hook-ups and circuit diagrams—practical hints and handy knacks—money-saving tips and pointers on how to make and improve your own sets. Take your pick of all this authoritative information on radio!

PERHAPS you haven't realized what a tremendous amount of information is available in the back issues of POPULAR RADIO. Since the first number was published, May, 1922, literally hundreds of requests have come to us for these valuable back issues of POPULAR RADIO which contain so many practical hints and worth-while suggestions.

There are still a few copies left of many of these back issues. *While they last* you can take your pick

of them at only 35 cents each, to cover cost and mailing. Here's your opportunity to complete your files of POPULAR RADIO and to add to your store of information on just the subjects which interest you.

Glance over this partial list of contents of each issue. Then tell us which ones you want, enclosing stamps, check or money order to cover your requirements. Our stock is getting very low, so don't delay taking advantage of this offer!

May, 1922

- Harnessing waves to wire.
- How to tune a Regenerative Receiver.
- Symbols that help in reading diagrams.
- How to make soldered connections.
- How Radio waves are sent and received.

June, 1922

- Wireless that we can see.
- Can we talk to the dead by Radio?
- How electricity is generated.
- Tones that do and don't broadcast.
- How to make a simple tube Receiving Set.

July, 1922

- Steinmetz on ether waves.
- How to learn the code.
- How to make a two-circuit Receiving Set.
- How high frequency currents are generated.
- Pointers for preventing interference.
- How to make a loose-coupler coil.

August, 1922

- How machines are controlled by Radio.
- How Radio circuits are coupled and tuned.
- What "call letters" mean.
- How to make a variable condenser.

September, 1922

- How to build the Armstrong Circuit Receiver.
- A resonance wave coil for reducing static.
- How to make a rotary plate condenser.
- The simplest receiving antenna.

October, 1922

- How to make a spider-web tuner.
- How to make your own grid condenser.
- Don'ts for Radio fans.
- How to use a Regenerative Set as a transmitter.
- How to restore worn-out crystals.

November, 1922

- Sir Oliver Lodge on ether waves.
- How to add a Vacuum Tube to your crystal set.
- The most popular transmitting aerial.
- How to make a novel varlocoupler.

December, 1922

- How to select the best coil for your set.
- How to make and use a loading coil.
- A Receiving Set that takes notes.
- How to make a series-antenna condenser.

January, 1923

(Out of stock. A Reprint of Mr. Cockaday's article describing the DX Regenerative Receiver may be had for 22 cents.)

February, 1923 (Out of stock)

March, 1923 (Out of stock)

April, 1923

- Regeneration without Radiation.
- How to make a simple single tube Receiving Set.
- Circuit diagram of the Cockaday DX-3 Circuit Tuner, with instructions on how to add three stages of radio frequency.

May, 1923

(Out of stock. A full description, however, of Mr. Cockaday's original 4-Circuit Tuner will be found in POPULAR RADIO'S handbook, "How to Build Your Radio Receiver," advertised on page 00.)

June, 1923

- How the microphone transmitter works.
- How to build a good single tube receiver.
- How to make a crystal detector stand.

July, 1923

- The ratio in size between your antenna and your coil.
- Useful facts about ear-phones.
- How to make a dry-cell tube Regenerative Set.
- How to keep up your storage battery.

August, 1923

(Out of stock. A full description, however, of the Tuned Radio Frequency Receiver will be found in POPULAR RADIO'S handbook, "How to Build Your Radio Receiver," advertised on page 110.)

September, 1923

- How to get a radio license.
- How weak signals are regenerated.
- How to make a battery charging rectifier.
- How to build the Haynes DX receiver.

October, 1923

- Practical hints for Coil Calculations.
- How to make a Two-stage Audio frequency Amplifier.
- Ten good rules for Broadcast Listeners.
- How to make a simple Honeycomb Receiver.

November, 1923

- The 100 Best Hook-ups (Part 1)
- Receiving without Antennas.
- How to build the New Regenerative Super-heterodyne Receiver (Part 1.)
- How to build a combination Short and Long-wave Receiver.

December, 1923

- How to Select your Radio Parts.
- The 100 Best Hook-Ups (Part 2).
- How to Read a Diagram (Part 1).
- How to Build an efficient Crystal Receiver.
- How to Build the Super-heterodyne Receiver (Part 2).

January, 1924

- How to build the "Improved" Cockaday 4-Circuit Tuner.
- The 100 Best Hook-ups (Part 3.)
- How to Read a Diagram (Part 2.)
- List of U. S. Broadcasting Stations.
- How to build the coupler, oscillator coupler and r. f. transformers for the Super-heterodyne.

February, 1924

- How to add "Push and Pull" amplification to the original 3 tube Cockaday 4-circuit tuner.
- The original 4-Circuit Tuner as a Portable Set with Loop.
- The 100 Best Hook-ups (Part 4.)
- How to build a 3-tube Reflex Receiver (Part 1.)

March, 1924

- Hoffman Transformer Measurement Chart.
- The 100 Best Hook-ups (Part 5)
- How to Build an Amateur Transmitter.
- A 3-tube Reflex Receiver (Part 2).

POPULAR RADIO, INC.

9 East 40th Street

Dept. 48

New York City

Please refer to POPULAR RADIO when answering advertisements.

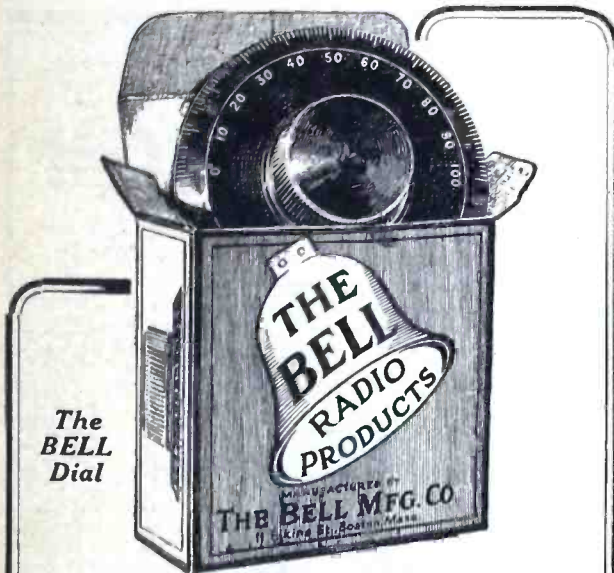

For Best Results

you will want to use BELL sockets and dials in your new hook-up. The blue box guarantees the genuine BELL.

Bell Dials

Highly polished molded Bakelite, with clean sharp engraving. Brass bushings; out-of-sight set screws. 2, 3, 3½ and 4 inch sizes. A handsome dial that adds to the looks as well as to the efficiency of any set.

Bell Sockets

An unusual VT socket. Polished molded Bakelite, for base or panel mounting. Unique spring construction gives double wipe contact, ensuring perfect connection. No leakage or current losses. Ask for the BELL, the efficiency socket.

Dealers: If your jobber does not carry BELL Radio Products, write us for circular on molded sockets and dials.

Bell Manufacturing Co.

12 Elkins St. Boston 27, Mass.

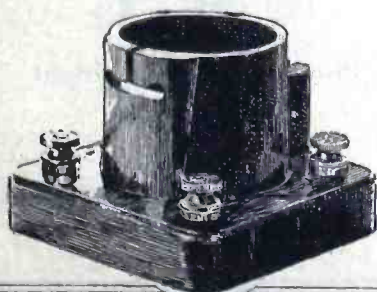

The BELL Square Socket

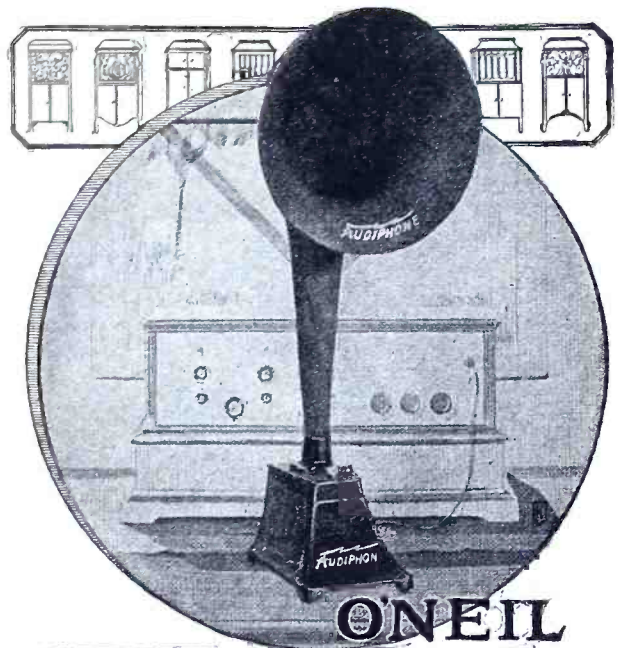

AUDIPHONE

GENUINE Loud Speaker construction—not a magnified headset: a superior instrument conceived by phonograph craftsmen and radio acoustic engineers. Music and speech actually reproduced. A "laminated voice core" produces all of the original music. Exterior adjustment. Will not blast on most powerful circuits. Guaranteed to satisfy or full purchase price promptly refunded. Your dealer has the Audiphone or order direct, mentioning his name. Descriptive booklet on request.

ART MODEL

Beautiful Antique Bronze Finish. No extra batteries needed. Complete, with connecting cord.

\$30

14 Inch Horn
\$5 additional

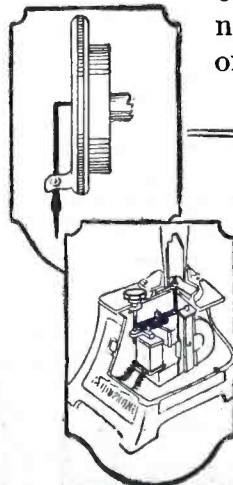

Write for Literature

Note the similarity of construction between the phonograph reproducer (illustrated in the upper panel) and the reproducer of the O'Neil AUDIPHONE (below): both have a mica diaphragm set in a sound-box chamber actuated by an elbow stylus bar.

O'Neil Mfg. Co.

714 Palisade Avenue
West New York, New Jersey

Please refer to POPULAR RADIO when answering advertisements.

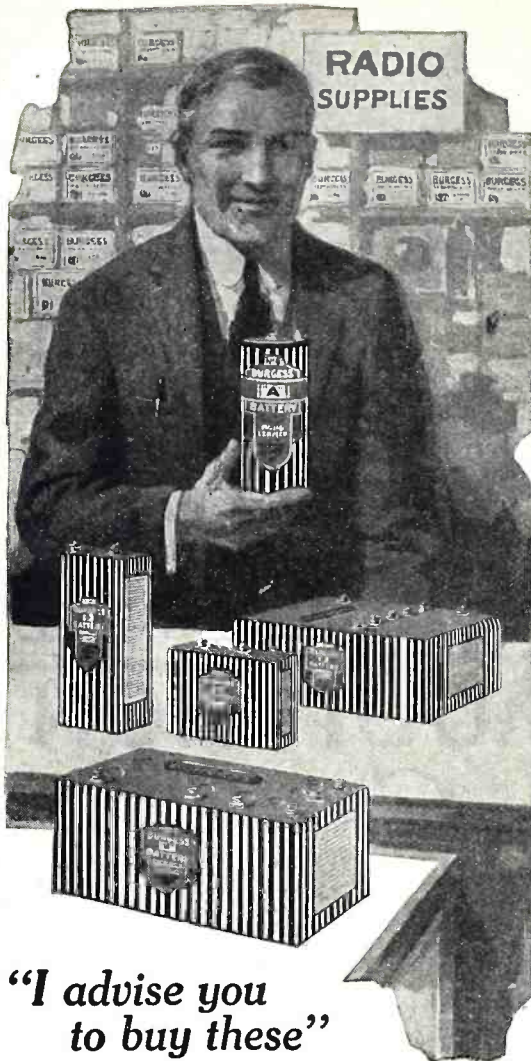

"I advise you to buy these"

BURGESS RADIO BATTERIES

Long life, noiselessness, high capacity and smooth, uniform current discharge are qualities vitally necessary to clear reception and economical service. We believe Burgess Batteries offer an unequalled combination of these qualities. "Ask Any Radio Engineer."

Send for "The 'A' 'B' 'C' of Radio Dry Batteries." If you are a user of dry batteries in radio service you will find this book of instructions crowded with authoritative information and suggestions. As a handy reference and buying guide, it is well worth the few moments spent in sending for it.

BURGESS BATTERY COMPANY
106 Washington St., Madison, Wisconsin
Please send me free of charge a copy of the booklet, "The 'A' 'B' 'C' of Radio Dry Batteries."

Name _____
Street _____
City _____ State _____

Perfectone

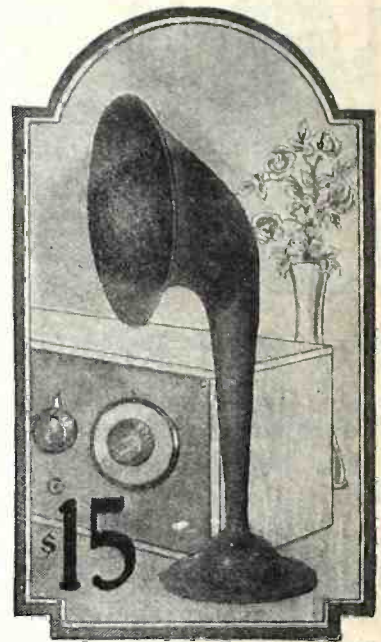

FAMOUS for Performance
ATTRACTIVE in Appearance
POPULAR in Price

It is refreshing to hear a Perfectone as its tone convinces you of its superiority.

Before you purchase a loud speaker or phonograph attachment at any price, see and hear the Perfectone.

At your dealers, otherwise send purchase price and we will supply you postpaid.



Phonograph Attachment
\$8.75

Perfectone Radio Corporation
490-C Broome St., New York

Please refer to POPULAR RADIO when answering advertisements.

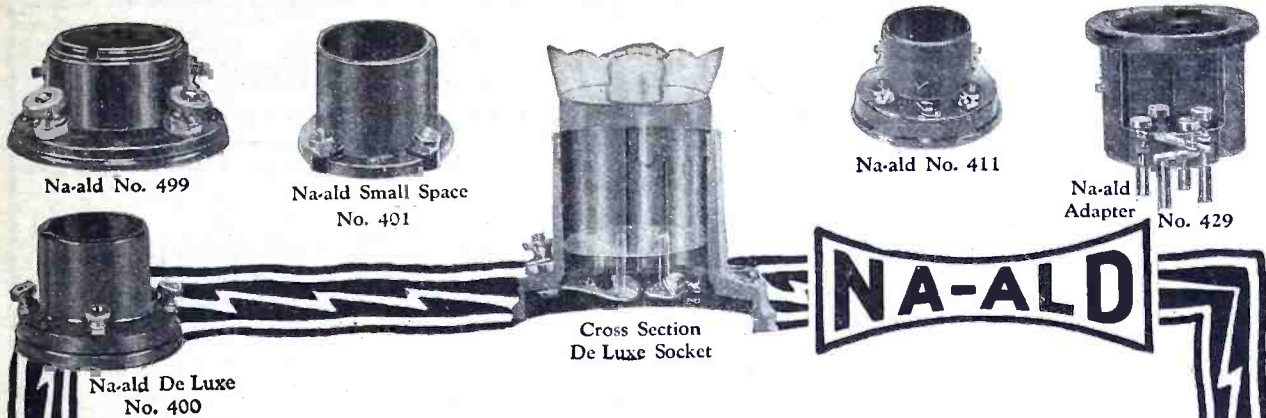

IT'S THE CONTACT THAT COUNTS

Na-ald Sockets

- Na-ald De Luxe No. 400 Price 75c
- Na-ald Socket, No. 499 Price 50c
- Na-ald Adapter, No. 429 Price 75c
- Na-ald W D 11 Socket No. 411 Price 75c
- Na-ald Small Space No. 401 Price 35c, 3 for \$1.00

Na-ald sockets embody features which make for thoroughly dependable contact under all conditions. This fact has won for them the place of leadership among radio sockets.

Each contact strip in Na-ald sockets is of a wiping nature, maintaining contact over a broad surface, and so designed that strong, permanent tension is assured.

All Na-ald sockets are moulded of Bakelite, with uniform cross-section and cure. These, with other engineering features, avoid plate to grid losses and insure the development of full efficiency in tubes.

Write for "Why a Bakelite Socket" and other descriptive literature

ALDEN MANUFACTURING CO.

Dept. C. 52 Willow St., Springfield, Mass.

Bakelite Jack



- No. 30—Single circuit open \$.80
- No. 31—Single circuit closed .85
- No. 32—Double Circuit .90
- No. 33—"A" Battery Switch .90

Approved and Used by Experts and Amateurs

CICO Jacks moulded from Bakelite—no metal in frame construction. Connections made to Binding Posts—no soldering necessary. Phosphor Bronze Springs—will last a lifetime without adjustment. Direct connections to springs—insure perfect contacts. Sterling Silver Contact Points.



2-Way Plug

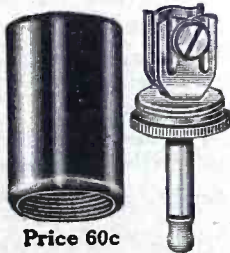

Price 60c

CICO 2-Way Plugs constructed so that loud speaker and headphones can be connected simultaneously or individually whichever you desire. Fit all standard jacks. Take all types of tips, forked, straight, and plain wire.

Every CICO PRODUCT is packed in a distinctive GREEN BOX and unqualifiedly guaranteed against all defects.

Consolidated Instrument Co. of America, Inc.

41 East 42nd Street, New York

Please refer to POPULAR RADIO when answering advertisements.

RAJAH SOLDERLESS SNAP TERMINALS

For Aerial, Ground and Battery Connections

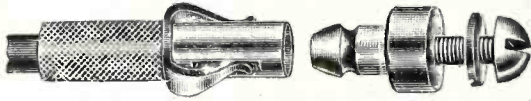

Patent Pending

Instantaneous in Operation—Positive Contact



Patent Pending

SOLDERLESS
ATTACHMENT
TO WIRE

Just push removable part, attached to wire, on the base stud and it snaps into place making a positive electrical connection.

To remove, just pull it off; no screws to bother with; no springs to bruise the fingers.

A positive electrical connection in ten seconds, without solder or rools, that cannot pull out or shake loose and is as easy to remove as it is to assemble to the cable.

Base studs secured by No. 8-32 screws and will fit all "B" batteries with screw posts.

Rajah Snap Terminals allow instantaneous change in place voltage with a secure connection, better than any switch.

No owner of a radio set who has seen or used a Rajah Snap Terminal will ever use any other style of binding post.

Price, Snap Terminal and Base Stud, complete as illustrated, each 20c.

Base studs are sold separately as they can be used wherever a change of connection is desired, thus permitting a quick change of lead in and battery wires from one set to another.

Base studs with screw and washer, each 5c.

Special Introductory Offer: 1 Dozen Snap Terminals and Base Studs complete by mail prepaid, \$2.00.

Dealers get in line at once for the best-selling radio device you ever saw.

**RAJAH AUTO SUPPLY CO. BLOOMFIELD
NEW JERSEY**

Parts

for all POPULAR
RADIO Circuits

WE SPECIALIZE in supplying parts for hook-ups described in this magazine. All orders sent to us will be filled promptly, with all parts exactly as specified.

Mail orders will be filled at the right prices and C. O. D. shipments gladly handled.

This is your opportunity to establish a reliable purchasing connection in New York where all radio supplies can be quickly secured for you.

**Morison Electrical
Supply Company**

15 East 40th Street

New York City

The New B-T Synchrondyne

is "The Hook-up
you Hoped for"

We confidently believe
it surpasses any 4 or 5
tube R. F. Circuit yet
developed—

Ask your dealer or
send 2c for folder

BREMER-TULLY MFG. CO.

534 S. Canal St., Chicago

\$4⁵⁰

List

\$4⁵⁰

List

"ROYALFONE"
KING OF ALL



Tune in those distant stations with
a pair of "Royalphones."

JACK BINNS, says, "They will give
an audible sound with a weaker signal
than the average phone."

That is why you will get distance
where you don't with your present pair.

If your dealer can't supply you,
write direct.

Royal Electrical Laboratories

Dept P. R., Newark, N. J.

Royalfone
KING OF ALL

Please refer to POPULAR RADIO when answering advertisements.



Type A9 Shelltype
Ratio 5 to 1
\$6.00



Radio & Audio Frequency TRANSFORMERS

*"The Heart of a
Good Receiver"*

EQUAL to the widest range of reception requirements. **Marle Transformers** amplify the weakest broadcasting, over frequencies all the way up to 3500 cycles without variation. Perfect tone quality. Utter absence of howling or distortion. To get the most out of radio—use **Marle Transformers**.

Specially adapted to the latest circuits, the **SUPERDYNE, SUPERHETERODYNE, FOUR-CIRCUIT TUNER, NEUTRODYNE, INVERSE DUPLEX** and any circuit that makes high requirements of a transformer.

Type A4
Ratio $3\frac{3}{4}$ to 1
\$3.75

Type A6 Audio F
Ratio 5 to 1
\$4.25

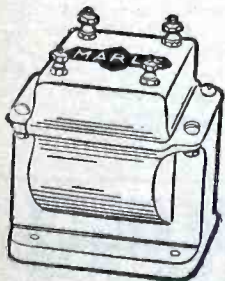

MARLE Engineering Company

Orange
New Jersey

Audio F
Shelltype
Type A7

Ratio
 $3\frac{3}{4}$ to 1
\$4.50



Radio F
Types
R1
and R2
\$4.00

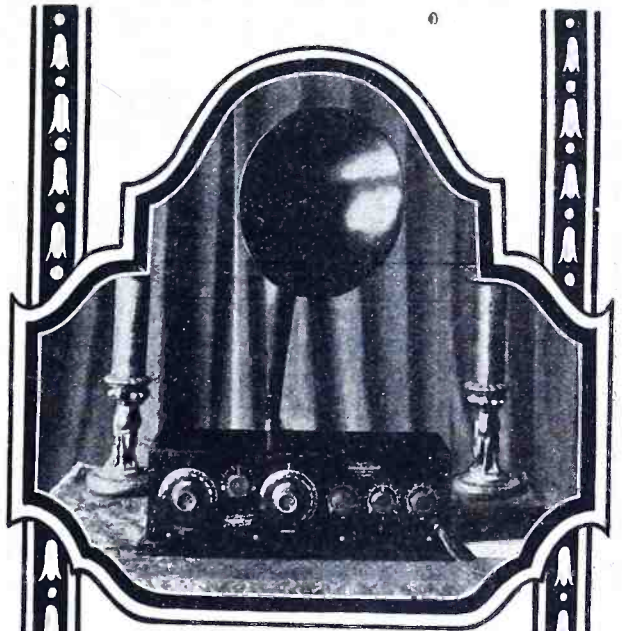

Radiodyne

"The Voice of the Nation"
NO LOOPS — NO ANTENNA

The air is your theatre, college, church and newspaper if you own a Radiodyne. New York, Cuba, San Francisco and Honolulu can be picked up clear and distinct without interference from nearby stations.

The Radiodyne is ready for operation by simply grounding to a water pipe or radiator, and throwing a few feet of wire on the floor. Uses any standard tubes—dry cell or storage battery. Extremely selective. Simple to operate—**Only two controls**—you can tune in on any program you select—any wave length from 200 to 700 meters.

For use in apartments, boats, automobiles, railroad trains, etc., the **RADIODYNE** is enjoyable where other receiving sets would not be practical.

Price, \$150.00

Write for illustrated folder which describes the RADIODYNE in detail. Every radio fan will be interested in this new type (antennaless) receiving set

WESTERN COIL & ELECTRICAL CO.
308 5th St., :: Racine, Wisconsin

Please refer to **POPULAR RADIO** when answering advertisements.

EASTERN COIL SETS

for the **COCKADAY** CIRCUIT

are the Standard, and in Universal Use due to their Proved Efficiency in this wonder circuit

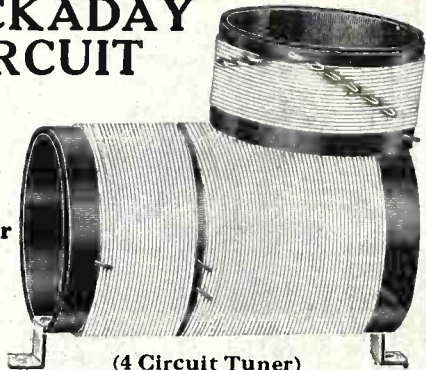

(4 Circuit Tuner)

Made as per specifications of Mr. Cockaday, "D" Coil bank-wound.

Complete assembled Set of B, C and D Coils on GENUINE BAKELITE TUBING, wound with #18 double silk \$4.25 covered wire.

Original and new improved hook-ups with material lists FREE with each set of coils.

GENUINE LAVITE RESISTANCES, 48000 **\$1.50** ohm, each.

These resistances control the tone of the Cockaday Circuit and eliminate all transformer distortion; modulating the tone after the fashion of the best of phonographs.

Mail Orders Filled. Dealers Communicate.

EASTERN RADIO MFG. CO.

22 Warren Street, Dept. P. R. NEW YORK, N. Y.



TYPE AI
\$25.00
21" Fibre
Horn

The TRINITY LOUD SPEAKER

The Trinity Loud Speaker is an instrument that combines the best qualities of a phonograph reproducer in combination with electro-magnetic principles best fitted for radio amplification.

Perfect reproduction of all music and speech without distortion. No storage batteries required. The instrument is of a heavy duty type and is guaranteed fully by the manufacturers.

For sale by good dealers
Literature upon request

TRINITY RADIO CORPORATION
446 1/2 Tremont Street, Boston, Mass.

"Push-Pull" Crescent Transformers

Experts admit "Push-Pull" amplification gives greatest satisfaction. The Crescent is a high grade Transformer. Specially designed to give maximum amplification on the new and improved circuits. Perfectly balanced. Gives clearer tones, reducing distortion to a minimum. Crescent "Push-Pull" Transformers are sold in matched pairs at \$8.50 per pair. Complete diagram, hook-up, list of necessary parts, all sent free with each pair. Crescent Audio Transformers, 3/4 to 1 ratio, specially designed for 2-step amplifier to match above "Push-Pull" at \$2.95 each. At your dealer's or sent postpaid on receipt of price. Satisfaction guaranteed.



CRESCENT MANUFACTURING CO.
P. O. Box 337 Cent. Sta. Toledo, Ohio

Pity the Bug Who Has None!

THE fellow who tinkers and fools around all kinds of adjustments in order to eliminate back alley discord will appreciate this tip regarding Reliable condensers for all tuned radio circuits. You get smooth sounding messages and concerts without difficulty and numerous other advantages with this little device.

The Reliable Parts Mfg. Co.
7306 Madison Ave. Cleveland, O.

75c

Reliable



neutralizing condensers



Edson

TONE TESTED
Radio Headsets

\$3
POST PAID

2000
OR
3000
OHMS

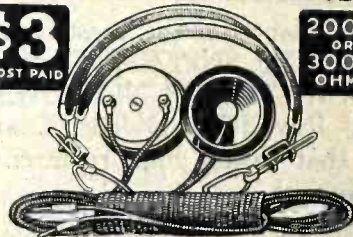

YOU can afford to have several at this price. Our guarantee protects you. Equal to any headset on the market in perfect reception of broadcasting. Send \$3.00 by registered mail or money-order. We will ship C.O.D., if you prefer. Prompt shipment—we pay postage. Ask for our

Free Catalog of Radio Parts
EDSON RADIO SALES CO.
2 Elmwood, Providence, R. I.

RADIO TUBE EXCHANGE

We Repair All Standard Makes of Tubes, Including

- W. D. 11 or 12
- U. V. 199 or C. 299
- C. 11 or 12
- U. V. 201A or C. 301A
- D. V. 1 or D. V. 2
- U. V. 200 or 201
- C. 300 or 301

\$2.50



All tubes guaranteed to do the work
RADIO TUBE EXCHANGE
200 BROADWAY, NEW YORK

All Mail Orders Given Prompt Attention
Orders Sent Parcel Post C. O. D.

Please refer to POPULAR RADIO when answering advertisements.

As You Gaze at the Stars—

The gentle calm of a bright starry night fills us with mystery. Little did we dream a while back that today, far and wide in the unknown, thousands of voices, hurled by electrical energy, are rushing at unheard of speed through space to all points of the compass.

A person here, a group there—in fact, in a million or more homes people are anxiously tuning in on their radios, groping in the air, hoping to catch the sound of a far-away station. Scarcely a sound, a slight turn, a faint noise,

another adjustment and then clear and clearer comes voices, a quartet is singing; so clear and distinct comes the soft gentle melody that the listeners close their eyes, the singers seem to be in the very room with them.

If you desire clearer reception, greater volume and the elimination of howling and distortions, install Jefferson transformers in your set.

There's a Jefferson Transformer for every circuit

Write for amplification data and interesting descriptive literature.

Jefferson Electric Mfg. Co.
427 So. Green St., Chicago, Ill.

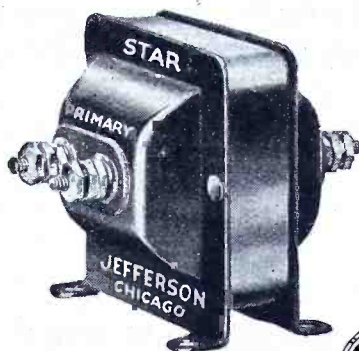

An Absolute Guarantee
with every instrument
made them famous!

SHAMROCK
FOR SELECTIVE TUNING

180°

Vario-Coupler

List price,
\$3⁵⁰
each



**DOUBLE
DUTY
PIG-TAIL**

Variometer



SHAMROCK MFG. CO.
314 E. Market St. — Newark N. J.

Please refer to POPULAR RADIO when answering advertisements.

USE ONLY
AMPERITE
 THE SELF ADJUSTING RHEOSTAT
 FOR AMPLIFYING TUBES
 \$ 1.00 WITH MOUNTING



ELIMINATES
HAND RHEOSTATS
SAVES YOUR
TUBES

ASK
YOUR
DEALER

GIVES LOUDER
AND CLEARER
MUSIC
SIMPLIFIES
WIRING
GREATER
DISTANCE

RADIALL CO. 320 WEST 42ND STREET
NEW YORK

RADIO PIN-MAP
 of United States, Canada and West Indies with indexed
 booklet Broadcasting guide.

Spot Stations You Hear with Colored Map Pins

Map size, 22x14 in., mounted on map-pin board. Shows all
 broadcasting cities, distance scale, relay and time divisions.
 Guide gives all call signals, locations, stations, wave lengths,
 etc. Price complete, 85c. Map-plus, 10c per doz. Any color.
 Above booklet with folded paper map, 35c. At your dealer or
 direct.

AMERICAN MAP CO.
 MAP MAKERS PUBLISHERS
 7 WEST 42ND ST. Dept. L. NEW YORK
 Maps of Every Description
 Representatives wanted.

**RADIO
 FREE SET**

**WONDERFUL
 RECEIVING SET!**
 Complete, including head phones
 aerial, ground wire, insulators, etc.
 Just hook up and listen in on Con-
 certs, Sport Returns, Lectures, etc.
 No batteries needed.

**COMPLETE
 WITH HEAD
 PHONES
 ETC.**

ABSOLUTELY FREE
 Rush name and address for Free
 Radio Plan

RELIABLE SALES CORPORATION
 434 Broadway, N.Y.C. Dept. 5

READY TO LISTEN IN



**BURNT OUT
 RADIO TUBES**

Repaired by us guaranteed to be
 equal to new. We have convinced
 hundreds, why not you? All
 Tubes \$2.75 with the following
 exceptions: 201A—301A—199
 299, which are \$3.00.

P. T. SUPPLY CO.
 79 West 45th St. New York City
 Mail orders promptly filled

GOLDWHISKER

Improves any crystal. Gets greater distance.
 PURE GOLD makes the best contact known. We
 guarantee a GOLDWHISKER to get greater range
 and louder signals out of any crystal. 50c pre-
 paid—send coin or stamps, or we'll send C. O. D.

REP RADIO CO.
 Dept. N-1 3231 Nebraska Ave., St. Louis, Mo.

Free to You!

**--Your Choice of a
 set of Blueprints**

POPULAR RADIO makes a special 30-day
 offer of a set of three full size Blueprints
free. You may take your choice of the set
 covering the "Improved" Cockaday 4-Circuit
 Tuner, or the set covering the Non-Regenerative
 Tuned Radio-Frequency (Neutrodyne) Receiver.

Either of these sets of Blueprints will come to
 you postpaid, absolutely free of charge, if you
 take advantage of this short-term offer.

Each set of three prints includes an actual size
 panel pattern, an instrument layout, actual size,
 and a *picture diagram showing all wiring con-
 nections*. These Blueprints are announced on
 another page of this issue of POPULAR RADIO
 at their retail price of \$1.10 per set.

But by availing yourself of this special offer
 now, you get your choice of either set *free* with
 your yearly subscription to POPULAR RADIO at
 \$3—the price of the magazine alone.

You know how helpful and interesting POPU-
 LAR RADIO is. A year's subscription will bring
 you a multitude of hints and practical pointers
 that will make a world of difference in your en-
 joyment of radio. And with either set of these
 Blueprints—offered to you free—you can con-
 struct one of the most highly-efficient radio
 receivers that can be had.

Fill out the handy coupon today. Your sub-
 scription will be entered to start with the May
 issue, and your set of Blueprints will come to
 you by return mail.

POPULAR RADIO, Inc.
 9 East 40th Street, New York City

POPULAR RADIO, INC., Dept. 43,
 9 East 40th Street, New York City

I enclose \$3 in full payment of a year's subscription
 to POPULAR RADIO starting with the May number.
 Please send me absolutely free of charge, postpaid, a
 complete set of three actual-size Blueprints for the
 Receiver checked below:

- "Improved" Cockaday 4-Circuit Tuner.
- Non-Regenerative Tuned Radio-Frequency
 (Neutrodyne) Receiver.

Name.....

Address.....

(No extra for Canada. Foreign countries 50c magazine post-
 age extra.)

REMEMBER THIS ABOUT RADIO LOUD SPEAKERS—

that no matter what type of loud speaker you have bought or intend to buy eventually you will come to a cabinet type—

FOR

—Loud Speakers will follow the phonograph in developing into beautiful furniture.

—And Timmons Talkers are the most beautiful loud speakers in the world.

For tone, volume and clarity we ask you to hear either type A (adjustable) \$35, or N (non-adjustable) \$25 at your dealers, or in your own home.

We, or any of our representatives, will send a 17 x 22 inch folder showing what is inside and your dealer will give you a "Volume without Noise" folder.

J. S. TIMMONS
339 E. Tulpehocken St.
Germantown, Philadelphia, Pa.

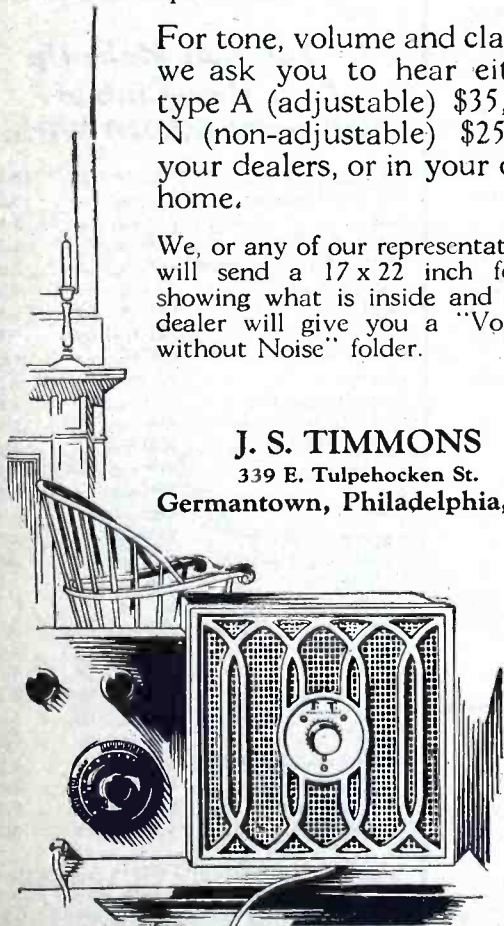

Timmons Talkers

In any circuit where a Variable Condenser is specified, select the one condenser that insures absolutely faultless reception.

THE DUPLEX COMPACT PRECISION

TRADE  MARK

NONE OTHER
CONDENSER

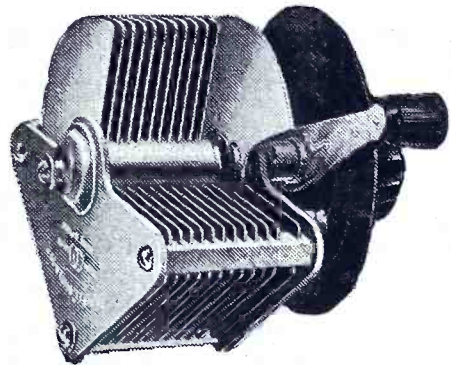

Built as nearly as is commercially possible to specifications of U. S. Bureau of Standards.

Knob and Lever Vernier Control.

Maximum-Minimum ratio of 23 Plate Vernier 60 to 1.

Die-cast Rotor—Milled Stator.

Awarded approval by "Radio Broadcast."

SPECIFICATIONS OF ALL MODELS

Model	Total No. of Plates	Max. Cap. Mfds.	Min. Cap. Mfds.	Ratio Max./Min.	List Price
DR-3	3	.00005	.00001	5/1	\$1.00
DR-11	11	.00024	.00001	24/1	2.00
DR-11V (Vernier)	14	.00029	.00001	29/1	2.50
DR-13	13	.00029	.00001	29/1	2.25
DR-13V (Vernier)	16	.00034	.00001	34/1	3.00
DR-17	17	.00040	.00001	40/1	2.35
DR-17V (Vernier)	20	.00044	.00001	44/1	3.25
DR-23	23	.00055	.00001	55/1	2.50
DR-23V (Vernier)	26	.00060	.00001	60/1	3.50
DR-43	43	.00103	.00002	51.5/1	3.50
DR-43V (Vernier)	46	.00115	.00002	57.5/1	4.00

Prices on vernier including knob and lever but not the dial.

Send us the name of your dealer and jobber.

Write for pamphlet "Taking the CON" out of condensers. It contains facts you should know.

JOBBERS send for distributor's proposition.

The Duplex Engine Governor Co., Inc.
50 Flatbush Ave. Extension, Brooklyn, N. Y.

POPULAR RADIO with Your Other Favorites — at Special Club Prices!

Save money on these magazine bargains
They are figured at rock bottom prices

GLANCE over this big list of magazine bargains that have been arranged for your benefit. Here is your chance to get almost any magazine you want—and by ordering *now* with a year's subscription to POPULAR RADIO you get *both* magazines at special low prices.

If you are already a subscriber to POPULAR RADIO or to any of these other magazines, these special club offers allow you the privilege of renewing or extending your present subscription for an additional year *at a considerable saving of money.*

Fill your magazine requirements *now* for the coming year and save money. Simply check the offer you want and mail the coupon below, with your remittance, without delay.

All subscription prices quoted are for one full year, and may be sent to *one* or to *separate addresses* unless otherwise noted. (Club prices for Canada and foreign countries will be quoted on request.)

McCall's Popular Radio \$4.00 Reg. For.....	\$3.25	Modern Priscilla Popular Radio \$5.00 Reg. For.....	\$4.00
Youth's Companion (52 issues) Popular Radio \$5.50 Reg. For.....	\$4.50	Scientific American Popular Radio \$7.00 Reg. For.....	\$6.00
American Magazine Woman's Home Companion (both to one address) Popular Radio \$7.00 Reg. For.....	\$5.75	Pictorial Review Modern Priscilla Popular Radio \$6.50 Reg. For.....	\$5.35

Or You Can Make Up Your Own Club of POPULAR RADIO With:

American Boy	\$5.00 reg., for ...	\$4.50
American Magazine.....	5.50 reg., for ...	5.00
Asia	6.50 reg., for ...	5.50
Boy's Life	5.00 reg., for ...	4.25
Christian Herald (52 issues)	5.00 reg., for ...	3.90
Collier's (52 issues)	5.50 reg., for ...	4.50
Cosmopolitan	6.00 reg., for ...	5.50
Country Life	8.00 reg., for ...	7.00
Delineator	5.00 reg., for ...	4.25
Designer	4.50 reg., for ...	3.75
Good Housekeeping.....	6.00 reg., for ...	5.50
Heart's International.....	6.00 reg., for ...	5.50
House & Garden	6.50 reg., for ...	5.50
McClure's	6.00 reg., for ...	5.00
Mentor	7.00 reg., for ...	6.00
Movie Weekly	8.00 reg., for ...	7.00
National Geographic.....	6.50 reg., for ...	6.00
People's Home Journal	4.25 reg., for ...	3.50
Photoplay	5.50 reg., for ...	4.75
Physical Culture	6.00 reg., for ...	5.00
Popular Science Monthly.	5.50 reg., for ...	5.00
QST	5.00 reg., for ...	4.35
Radio	5.50 reg., for ...	4.75
Radio Broadcast.....	6.00 reg., for ...	5.00
Radio Digest (52 issues) ..	8.00 reg., for ...	7.00
Radio News	5.50 reg., for ...	4.75
Radio World (52 issues) ..	9.00 reg., for ...	8.00
Today's Housewife	4.00 reg., for ...	3.25
Vogue (26 issues)	8.00 reg., for ...	7.00
Wireless Age	5.50 reg., for ...	4.75

Note: If you wish any TWO or more of these magazines with POPULAR RADIO, simply deduct \$2.50 from the bargain club price quoted, then add POPULAR RADIO at \$2.50. For example:

McCall's	\$3.25 less \$2.50 =	\$0.75
Radio	4.75 less 2.50 =	2.25
POPULAR RADIO, added at only.....		2.50

Remit this amount **\$5.50**

POPULAR RADIO, Dept. 42,
9 East 40th Street, New York City.

Enclosed is \$..... Please see that yearly subscriptions are at once entered in my name for each of the magazines I have checked in the special bargain club list at the right.

Name.....

Street and Number.....

City..... State.....

(If not a NEW subscription, please mark R after the name of the magazine, to indicate RENEWAL.)

Prices for Canada and foreign countries will be quoted on request.

Please refer to POPULAR RADIO when answering advertisements.

The New Genuine Guaranteed "SHEPCO" "ALL WAVE" JR. TRADE MARK-PATENTS GRANTED AND PENDING NON-RADIATING DX COUPLER

Combination Flat and Bank Wound



150 to 1000 Meters
Guaranteed Wave Length

Set of six efficient hook-ups packed with every "All Wave" Coupler or mailed on receipt of 10c in stamps to cover cost of mailing.

All the SELECTIVITY of TUNED RADIO FREQUENCY at a SMALL FRACTION OF ITS COST. Like its companion the 3000 meter Capitol "All Wave" Coupler, Sr., it may be used in a single circuit with the added feature that it may be used in a double or triple circuit.

Used in the "All Wave" triple circuit, the "All Wave" Jr. is guaranteed not to radiate and to bring in distant stations clear and loud on one tube. Log your stations and get them at the same setting every time. Only one dial to tune.

"SHEPCO" "ALL WAVE" JR.

Eliminates use of all variometers, vario couplers and loading coils. Permits building most efficient, sharp tuning, loud long distance receiver at lowest cost.

ON SALE AT ALL DEALERS IN STANDARD RADIO PARTS OR SENT DIRECT ON RECEIPT OF PRICE. ABSOLUTE MONEY BACK GUARANTEE **\$6.00**

SHEPARD-POTTER CO., Inc.

Plattsburgh, N. Y.

Let HOMMEL'S experience guide you

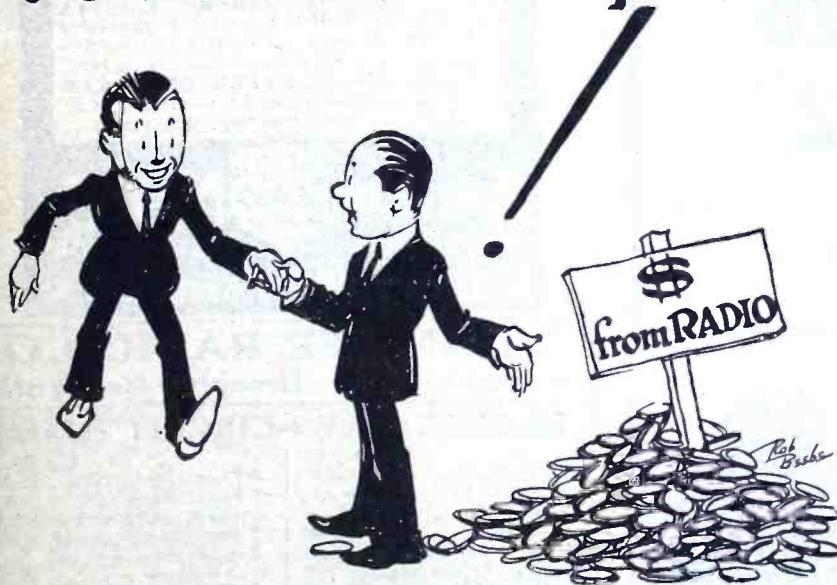

THIS organization was one of the pioneer wholesale distributors of radio equipment. They have seen hundreds of retailers come and go—they know from experience "what and when and how" dealers can best sell radio supplies and enjoy a satisfactory margin of profit.

HOMMEL distributes only recognized nationally advertised apparatus that is guaranteed by the manufacturer—their dealer discounts are very liberal—their stocks are always ample to take care of any requirement—they wholesale exclusively and do not compete with dealers by retailing.

HOMMEL'S Dealer Service Department is maintained for your benefit—their experience and advice will prove helpful to you in many ways, and this service is cheerfully given any time without charge.

Get in touch with us today, write for the new HOMMEL ENCYCLOPEDIA, 248-P—profit by Hommel's experience—it is paying hundreds of other dealers—why not you?

LUDWIG HOMMEL & CO

530-534 FERNANDO ST.



PITTSBURGH, PENNA

Please refer to POPULAR RADIO when answering advertisements.

"3000 mile"



**RADIO "B" BATTERIES
AT FACTORY PRICES**

Greatest radio "B" battery on market. Full number voltage taps; **QUALITY GUARANTEED; LOWEST PRICES;** brings in concerts **LOUDER AND STRONGER;** will work on any tube or loud speaker. Order by number **TO-DAY** with check, money order or pay postman C. O. D.

No. 122B 22½ volt variable, regularly \$2.25 ... **\$1.52**
 No. 122A 22½ volt variable, regularly 3.00 ... **1.85**
 No. 145A 45 volt, 8 taps, regularly 5.50 ... **3.25**

AYRES BATTERY CORPORATION, Cincinnati, Ohio

IF YOU WANT THE BEST
Use
EBY ENGRAVED Posts



A complete set at a special price.
 And they're EBY posts, so the tops don't come off.
 Your dealer will have them and will show you other popular markings.
\$1.50 per set

THE H. H. EBY MFG. CO., PHILA., PA.

Grewol Fixed Reflex Detector

Most sensitive spot found and fixed at the factory. Glass enclosure protects crystal from dust, moisture and vibration.



At your dealer's or sent direct **\$2**

RANDEL WIRELESS CO.
 4 Central Ave., Newark, N. J.

THE NEW SIMPLEX

180° Vario-Coupler
 With a Special Woven Rotor



will bring in those distant stations you are trying for. An exceedingly efficient and neat coupling device combining all of the best features that have been developed in the past year and which will cover all broadcast wave lengths up to 600 meters.

Price - - **\$3.50**

SIMPLEX RADIO CO.
 1015 Ridge Ave. Phila., Pa.

VACUUM TUBES REPAIRED

WD-11, WD12, \$2.50
 UV-201A, UV-199, **2**
 And others for **2**

Quick service. All tubes repaired by us guaranteed to work as good as new. Send your dead tubes. All you pay is \$2.50 plus Postage to Postman.

THOMAS BROWN CO.
 511-519 Orange St. Newark, N. J.

CATALOG L-25-148 PAGES FREE!

Latest Reflex Neurodyne and Super-Heterodyne Circuits. 40 Diagrams, latest Hook-ups. Largest Complete Stock.

EVERY SPOT HOT **SPECIAL American Reflex Super - Sensitive**
 Crystal, 35c ea. Hot as Hot, Every Spot. Hear stations clearly. **GUARANTEED ONE YEAR**
 Jobbers and Dealers write for Quantity Discounts.

AMERICAN RADIO MFG. CO.
 WHOLESALE DISTRIBUTORS
 Dept. P 6 WEST 14TH ST. KANSAS CITY, MO.

NA-ALD De Luxe Dials



The artistic qualities of Na-ald De Luxe dials distinguish these dials as truly beautiful. They add to the appearance of any set in which they are used.
 Na-ald Dials have a high gloss finish. They are moulded of genuine Bakelite and have patented construction. Dials are matched and made in 2", 3", and 3½" sizes.

Alden Manufacturing Company
 Largest makers of Radio sockets and dials in the world
 Dept. C 52 Willow St. Springfield, Mass.

No. 3003-4
 3 Inch
 35c, 3 for \$1.00

S. HAMMER RADIO CO.
 303 Atkins Ave. Brooklyn, New York

The COCKADAY 4-CIRCUIT TUNER

List Price	List Price
1 Bakelite Panel 7x24 ... \$3.90	2 Patent Doub. Jacks ... \$1.60
1 Precision Cockaday Coil .50	1 Patent Single Jack60
2 Amsco 26 Pl. Cond. 4" Dial ... 11.00	2 Amertran Transformers 14.00
5 Melco Tube Sockets ... 5.00	2 Amsco Switch Lavers60
1 Amsco 6 Ohm Rheostat 1.00	3 48,000 Ohms Lavite Resistances ... 3.75
3 Amsco 20 Ohm Rheostats 3.75	1 .00025 Dubilier45
2 Amplex Grid Densers .250	1 .0005 Dubilier45
1 Durham Var. Grid Leak .50	1 Pr. Como Dup. P. P. Transformers ... 12.50
1 Amsco 400 Ohm Potentiometer ... 1.50	1 Panel 1x12 ... 40

GENUINE COMPLETE PARTS as listed above for the Improved Cockaday 4-Circuit Tuner. Exactly as specified by Mr. Cockaday List price \$69.00. **SPECIAL KIT PRICE \$55.00**

The above parts may be bought separately. Write for our catalogue

Orders over \$5.00 Shipped Prepaid, Money Orders or C. O. D. One-third must accompany all C. O. D. orders. Not insured unless insurance charges included.

Please refer to POPULAR RADIO when answering advertisements.

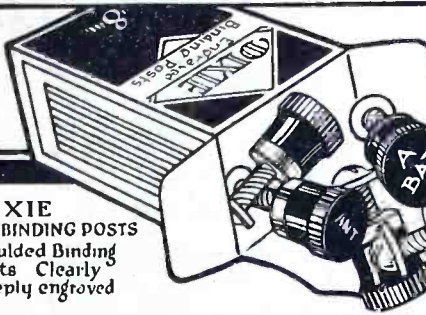

DIXIE
ENGRAVED BINDING POSTS
8 Moulded Binding Posts Clearly and deeply engraved

DIXIE

You Need These!

If you're building a set these two DIXIE products will make things immeasurably easier for you. No more hunting for screws! No need of using inferior binding posts!

The DIXIE Junior Screw Assortment contains 100 pieces of essential radio hardware—screws, nuts and lugs. The DIXIE Engraved Binding Posts are a set of 8, moulded and beautifully engraved.

The price of each is only 50c per box!
SEND FOR BOTH TODAY

DEALERS ~
Write about these attractive display cartons.



DIXIE
JUNIOR SCREW ASSORTMENT
100 Screws, Nuts and Lugs ~
Solid brass heavily nickel plated

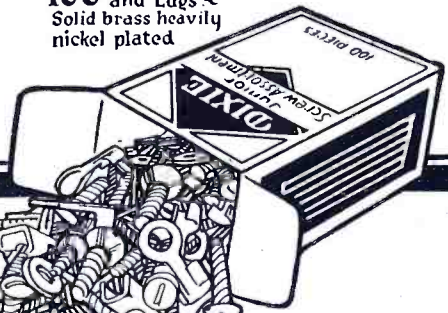

DIXIE SUPPLY CO.
91 Seventh Ave. N.Y.C.

New Model "B" HAMMARLUND

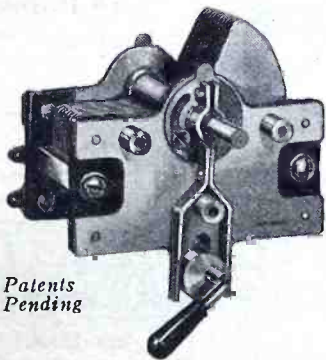

Patents Pending

Vernier Variable Condenser
SHARPEST TUNING—MINIMUM LOSSES
Will Increase Your Range and Volume—
Eliminates Interference

Grounded Panel—Brass Plates

PRICES FOR PANEL MOUNTING

43 Plate 001 Mfd. . . \$7.00 17 Plate 00037 Mfd. . . \$5.75
23 Plate 0005 Mfd. . . \$6.00 13 Plate 00025 Mfd. . . \$5.50

3 1/2" pure Bakelite Dial \$1.00
4" pure Bakelite Dial \$1.00

At your dealers—otherwise send purchase price and you will be supplied postpaid.

Write for New and Interesting Folder

HAMMARLUND MFG. CO.
144-146 W. 18th St. New York City

RATHBUN SINGLE-HOLE MOUNTING SUPERIOR CONDENSERS

Special—13 Plate

NEUTRODYNE CONDENSERS

Every requirement which the Hazeltine Neutrodyne circuit makes of a condenser is perfectly met in this special Rathbun Condenser. *Single hole mounting and full Bakelite disc end-plates*, reduces capacity to insignificant minimum. No iron or steel parts. So much of the success of your Neutrodyne receiver depends on accurate condensers that you should insist upon the name RATHBUN.

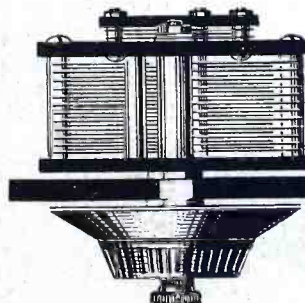

Capacity
.0003 MFD
LIST
\$3.00

Write TODAY for the name of the nearest Rathbun dealer and for illustrated literature

RATHBUN MFG. CO.
Jamestown, N. Y.

Please refer to POPULAR RADIO when answering advertisements.

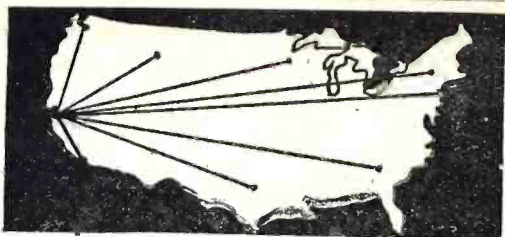

ON ONE TUBE

Broadcasting from Atlantic Coast, Canada, Mexico, Cuba & Hawaii heard in Calif. by users of the CROSS COUNTRY CIRCUIT. Range due to simplicity. One tuning control. ANY NOVICE can build easily and cheaply. Dry cell tubes used. No soldering. Complete instructions, Blue print panel layout, Assembly Photo, etc., postpaid 25 cents. Stamps accepted. VESCO RADIO SHOP, Box PR-117, OAKLAND, CALIF.

2 Transformers for the price of 1 NEUTRODYNE

No Distortion
Greater Volume
Half-Price

For \$6 we will send postpaid TWO of the famous Globe Audio Transformers made especially for Neutrodyne sets.

MONEY BACK GUARANTEE

If you are not fully satisfied with the transformers, return them within 5 days and your money will be refunded.

COYNE RADIO SERVICE
Suite 603

507 Fifth Avenue, New York City

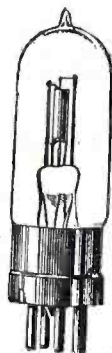

WE REPAIR The Following RADIO TUBES

WD-11.....\$3.00	DV-6A.....\$3.00
WD-12.....3.00	UV-199.....3.00
UV-200.....2.75	C-299.....3.00
UV-201.....3.00	UV-201A.....3.00
C-300.....2.75	C-301A.....3.00
C-301.....3.00	Marconi.....3.00
DV-6.....3.00	Moorhead.....3.00
DV-1.....3.00	6v. Plain Detector 2.75
DV-2.....3.00	6v. Plain Amplifier 3.00

Mail orders solicited and promptly attended to.
Dealers and Agents Write for Special Discount.

H. & H. RADIO COMPANY
Clinton Hill Sta. P. O. Box 22-E. Newark, N. J.



Charge Your Battery For A Nickel

The Gold Seal Homcharger charges Radio and Auto Batteries at home overnight for a nickel. Your dealer has it. Write for FREE booklet and list of broadcasting stations.

The Automatic Electrical Devices Co.
132 West Third St., Cincinnati, Ohio

The **Sodion** Tube

Type S-12 "THOROBRED" Socket



Radio fans call this standard tube socket "the most beautiful socket on the market." Thick nickel-plated and hand-polished tube, tube fits snug, genuine Bakelite molded base, leakage cut to a minimum. Contact springs of finest phosphor bronze set at correct angles. \$1.00.

If your dealer can't supply you with "Thorobred" Socket, send money order direct to us. Ask about "Read'em" Binding Posts and "Minute Man" Switch Levers.

The MARSHALL-GERKEN Co.
Dept. J. 27 No. Ontario St. Toledo, Ohio



"The Crystal With a Soul"
(Reg. U. S. Patent Office)

Functions with any condutor.
No special Cat-Whisker necessary.
Will not burn out.

Reception
Louder
Clearer
More
Natural

50c

Celerundum "DE-TEX-IT"

A perfect fixed detector
Needs no adjustment

\$1.25

Celerundum Products carry a
MONEY BACK GUARANTEE

Celerundum Radio Products Co.
170 Summer Street, Boston

CARTER Inductance Switch

(1-15 Points)

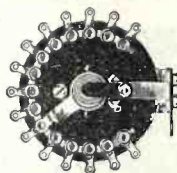

Original design. Solder terminal and contact one piece. Numbered Knob dial. Pig tail connection. Positive contact. Only one hole to drill. Carter quality throughout.

\$2.00

Send for catalog

Carter Radio Co.
1807 REPUBLIC BUILDING
CHICAGO

Write for free booklet:

"HOW TO SOLDER RADIO SETS"

For radio-frequency results use
SOLDER-BOTTLE FLUX and
PROFESSIONAL BRAND ROSIN-CORE SOLDER
as therein described.



THE VALLEY FORGE CHEMICAL CO.
Valley Forge, Pa.

MONEY

"I Earn \$50 to \$83 Weekly!
At work nicer than Movies!
\$5 to \$10 made daily while taking
Lowest-cost, Simple-to-learn, Fun-
giving, Personal Radio Instruction.
First 4 jobs pay instruction cost. Be
an expert by MARVELOUS NEW METHOD.
Pay by installment. Write for details

JAMES A. DOWIE, RE.
D-584 RADIO, VA.

Please refer to POPULAR RADIO when answering advertisements.

RESISTRON Precision Variable \$2.00 Grid Leak

Its the *MERCURY* that does the *TRICK*

everywhere

Refinement—that's the keynote of perfect reception. You use vernier condensers and 180° couplers. But how about your grid leak? Does it have a 340° range like RESISTRON? Can you go back and repeat a dial setting and be sure of the same results? Does it do its work properly?

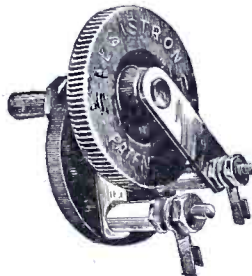

Rear view—showing panel mounting and supports for grid condenser

RESISTRON is built to give you a refinement of grid control suited to the extremely sensitive detector tube. For the adjustable contact with the high resistance elements, mercury is used—combining accuracy of setting with quiet operation. Reliability for all time is assured by sealing the active parts in an air-tight case.

Put on RESISTRON—and go to the COAST

Each instrument tested. Look for inspector's serial number on label—it's your guarantee of perfect satisfaction.

RESISTRON positively will adjust your detector grid to greatest sensitivity. Back your set to go its limit.

If your dealer cannot supply you, we will ship parcel post, C. O. D.

TEMPLE INSTRUMENT CO. Camden, N. J.

3000 MILES

on a

Loud Speaker

(By Courtesy "Popular Radio")

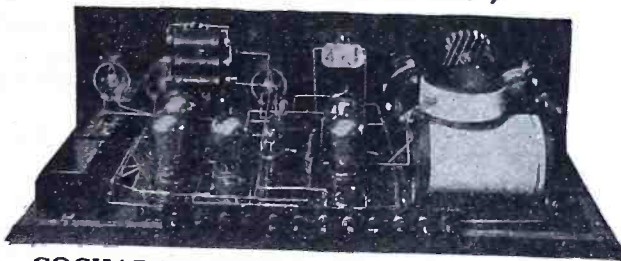

with COCKADAY IMPROVED 4-CIRCUIT KIT

Build Your Set

The Amplex Kit Way

SAVE 1/3



For Greater Distance

Clearer Signals

"GRID-DENSER"

(Variable condenser, 0 to .0005 mfd.)

Specified by Cockaday. Absolutely essential to control oscillations. Will improve any circuit. With Kit, or separately, \$1.25.

48,000 Ohm Genuine "Lavit" Resistances, each, \$1.25

FREE Our engineers will answer any Radio questions, or help you with any wiring or assembling problems. This service is absolutely FREE to our patrons. Just write to Service Dept.

HERE IS PROOF

Gentlemen: Let me congratulate you on your Cockaday Kit. A set constructed from your parts during the course of the first evening picked up 34 stations including KHJ (Los Angeles) all on the Loud Speaker. It sure is easy to construct a set from your "KIT." L. Newman, Harrison, N. J.

Dear Sirs: I have made exhaustive tests of the Improved Cockaday Four Circuit Tuner, and the outstanding improvement to my mind is the AMPLEX "GRID-DENSER."

Using a set constructed from your "KIT" I logged over 45 stations including KFI (Los Angeles) and PWX (Havana.) I only logged those heard on a Loud Speaker. H. Jawetz, E. E., Consulting Engineer, New York.

Parts	List Price Each	Kit Price	Parts	List Price Each
1—Panel 7" x 24" Drilled	\$6.00		3—48,000 Ohm Res.	\$1.25
1—4 Circuit Coil	5.00		1—Res. Mounting	1.25
2—Amplex 24 Pl. Vari. Cond.	5.00		1—.0005 Mica Cond.	.45
5—Amplex Sockets	.75		1—.00025 Mica Cond.	.45
1—6 Ohm Amplex Rheostat	.75		2—P. P. Transformers, pr.	12.50
3—20 Ohm Amplex Rheostat	1.00		1—Potentiometer	1.00
2—Grid-Densers	1.25		1—Baseboard	1.50
2—Grid Leaks, Var.	.75		1—Set of plans (blue print)	1.50
1—Amplex Improved Jacks S.C.	.65		12—Binding Posts	.10
2—Amplex Improved Jacks D.C.	1.00		Bus bar, etc.	.50
2—Amplex Transformers	5.00			
2—Switch Levers, etc	50			

AMPLEX INSTRUMENT LABORATORIES
Desk P.R. :: 57 Dey Street, New York, N. Y.



4 CIRCUIT COIL

Built strictly according to Cockaday's specifications. Bakelite tubing, No. 18 DSC wire. \$5.00

DRILLED PANEL AND COMPLETE BLUE PRINT INSTRUCTIONS

for wiring and assembling with each Kit. No special skill or technical knowledge required. Safe and Simple.

Every part in every Kit is tested, guaranteed. Individual parts may be purchased separately at list price.

Please refer to POPULAR RADIO when answering advertisements.

POPULAR RADIO Invites You to a Birthday Party

ON April twentieth, POPULAR RADIO will celebrate its birthday. On that date the magazine will be *two years old*.

Probably few magazines in the history of publishing have *so rapidly* attained pre-eminence in their fields, as has POPULAR RADIO.

Those of our readers who remember the first issue of POPULAR RADIO, published in May, 1922, will recall that the magazine at that time was barely more than pamphlet size.

Since then, POPULAR RADIO has grown steadily and rapidly to its present size and importance. Today POPULAR RADIO has *more subscribers than any other radio magazine whose net paid circulation figures have been reported to us*.

From the day of its first publication, POPULAR RADIO has maintained strictly and consistently the open policy of giving its readers *accurate and authoritative* facts and information. No expense has been spared to make sure that the hook-ups printed are *practical and will work*. POPULAR RADIO'S "how to build" articles have become famous. Our exclusive articles by leading scientists of world-wide reputation, telling "how radio works," have been quoted in technical journals and in scientific circles both here and abroad. The scores of practical hints published in every issue of POPULAR RADIO on "how to get the best results" have enabled millions of radio novices and amateurs to attain greater enjoyment and satisfaction from their equipment.

Yet with all of its phenomenal growth, there are still many radio enthusiasts who have yet to appreciate the pleasure and value that can be derived from POPULAR RADIO. And in order

that this magazine may be brought to *their* attention we are now making a special 30-day Birthday Offer.

Here is our offer—in a nutshell.

If you, who are a reader of POPULAR RADIO, will secure the subscription of some friend or acquaintance who is *not* a regular subscriber, we will reward you by entering or extending *your own subscription* for a period of six months absolutely free of charge. In other words, you get a six-months' subscription to POPULAR RADIO *free*—merely by inducing someone else to subscribe.

Or if you secure two subscriptions, you get a year's subscription for yourself, free of cost.

You have only to show this copy of POPULAR RADIO to friends who you know would be interested. Demonstrate to your friends the many valuable features of the magazine. They will be glad to subscribe. Then simply send to us the \$3 you receive for each subscription you take, and *your own* subscription will be entered, renewed or extended, free of charge.

Will you help to make POPULAR RADIO'S Birthday Party a success?

Simply return to us the little coupon below, with the necessary remittance to cover all subscriptions you send. We will do the rest—putting you down on the list for the free term of subscription to which you are entitled as a reward for your efforts, and entering all subscriptions you send us, to start with the May Anniversary Number.

POPULAR RADIO, Inc., Dept. 49
9 East 40th Street, New York City

I am glad to help make POPULAR RADIO'S second birthday a pleasurable one. Enclosed is \$ covering new yearly subscriptions to POPULAR RADIO (at \$3 each) which I have taken from friends and acquaintances. As a reward to me, you are to enter (renew or extend) my own subscription for months free of charge (6 months for each subscription I have sent). The names and addresses of the new subscribers are listed on a sheet of paper attached to this coupon.

MY NAME

MY ADDRESS

(No extra for Canada. Foreign countries, 50 cents postage extra.)

Please refer to POPULAR RADIO when answering advertisements.

D. V. 2 Storage Battery
 D. V. 3 Dry Cell
 \$6.50 Each



**A Set is only as
 Good as its Tubes**

**DeForest Audions
 are the Finest
 Tubes made**

**DeForest
 Audions**

"Made by the Man Who Invented Broadcasting"

DeForest Radio Tel. and Tel. Co.
 Dept. P. R. 8 Jersey City, N. J.

**Improve
 Your
 Set**

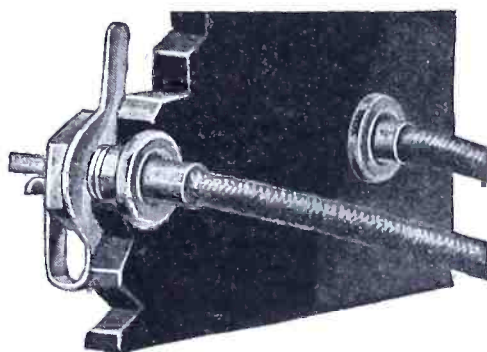

Union Radio Tip Jacks
(Patent Pending)
Only 25c a Pair

No more trouble with binding posts, no more noises from poor connections. Use these tip jacks for all antenna, ground and battery connections and contacts. They give you quickly made, positive connections, and improve the appearance of your set. Now being used by leading set manufacturers.

Two sizes for all mountings. STANDARD TYPE A for panels up to 1/4" thick. SPECIAL TYPE B for panels, cabinet walls and partitions from 1/8" to 1/2" thick. Will firmly grip all wires from No. 11 to No. 24 B. & S. gauge and can be reamed to hold antenna wire.

No parts to chip, lose or deteriorate. All parts heavily nickel plated.

25c a Pair in U. S. 35c in Canada.

**Other Guaranteed
 Union Radio Parts**

DIAL ADJUSTERS for minute variations in capacities of variable condensers. Price 60c.

TUBE SOCKETS of molded condensite highly polished. Phosphor Bronze contact springs. Reinforced bayonet slot prevents breakage. Accommodates all standard tubes. Price 70c.

Should your favorite Radio Store not carry Union Radio Tip Jacks and other guaranteed Parts send your order direct to us; also write for your copy of "The Union Radio Catalogue A."

Retailers and Wholesalers

Samples of our guaranteed reasonably priced "Quality Products" sent on request. Our terms and trade discounts are liberal. Write for our proposition. Also write for your copy of the Union Radio Catalog "A."

UNION RADIO CORPORATION
 200-MT. PLEASANT AVENUE, NEWARK, N.J.
 NEW YORK OFFICE 116-WEST 32ND-STREET.

Please refer to POPULAR RADIO when answering advertisements.

Sexton Condensers

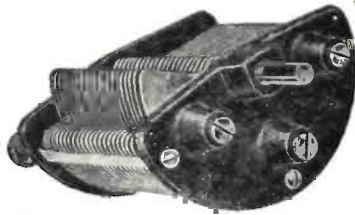

High grade instruments made of most expensive materials and finest workmanship.
Pigtails Connections—Genuine Bakelite End-plates—Accurate Spacing of Plates—Smooth Action.

Write for descriptive circular and name of nearest jobber

THE HARTFORD INSTRUMENT CO.
308 Pearl Street Hartford, Conn.

CRESCENT LAVITE RESISTANCES

12,000
48,000
50,000
100,000 } Ohms.



LIST
\$1.50

Used in the New Cockaday Circuit. Dealers write for discount.
CRESCENT RADIO SUPPLY CO. 1-3-5 Liberty St., Jamaica, N. Y.

YOU to hear programs from stations 400 to 1000 Miles Away. I can show you how to get them on **YOUR CRYSTAL SET.** Changes often cost Less Than One Dollar. Send self-addressed envelope for picture of my set.

LEON LAMBERT
540 So. Volusia, Wichita, Kansas



THE EXCLUSIVE CHOICE OF DR. MAC MILLAN for his ARCTIC EXPEDITION

Zenith Radio Corporation
328 South Michigan Avenue, Chicago, Ill.

SUPER-HETERODYNE TRANSFORMERS

Write for details and prices

RIEGER-BAILEY CO. of America
820 Real Estate Trust Bldg.
Philadelphia, Pa.

Make \$100 Weekly In Spare Time

Sell what the public wants—long distance radio receiving sets. Two sales weekly pays \$120 profit. No big investment, no canvassing. Sharpe of Colorado made \$955 in one month. Representatives wanted at once. This plan is sweeping the country—write today before your county is gone.

OZARKA, 855 Washington Blvd., CHICAGO



USED ALL OVER THE WORLD
Guaranteed. Price Mounted 50c
RUSONITE CATWHISKER 14K. GOLD, 25c
Rusonite Products Corporation
15 Park Row, New York, N. Y.

Please refer to POPULAR RADIO when answering advertisements.

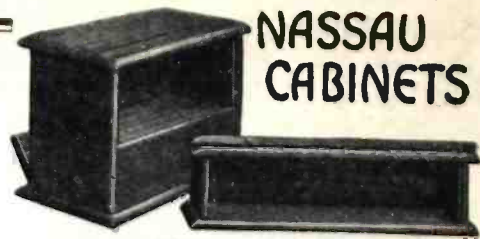

NASSAU CABINETS

SOLID MAHOGANY

Assembled Routed and Finished.	Knockdown with Screws and Hinges.
14x7x7 \$6.00	14x7x7 \$2.50
21x7x7 7.50	21x7x7 3.50
26x7x7 8.50	26x7x7 4.50
36x7x7 10.00	36x7x7 5.50

All other sizes, any length, height and depth at corresponding prices. Sent C.O.D.
NASSAU CABINET CO.
20 NASSAU STREET, NEW YORK



The Copper Giant "A" Battery

A small size for 199 type tubes. 1000 hours, 1/4 cent per tube per hour. No deterioration when idle. Can also be used for WD11 and WD12 at a cost of less than 1/2 cent per tube per hour. Write for circular.

THE COPPER GIANT BATTERY CO., Lansdowne, Pa.



FOR BEST RECEPTION you need

The Goodman

The niftiest short wave tuner on the market. Great for present broadcasts, local and DX. Used in all parts of the world. Certificates of merit from testing laboratories. Pamphlet on request.

L. W. GOODMAN, Mfr., Drexel Hill, Pa.

LOUD SPEAKING CRYSTAL SET

Stations brought in from over 1000 miles and music heard all over the room right from your present crystal set with the **STEINMETZ AMPLIFIER.** Get our complete catalog.
STEINMETZ WIRELESS MFG. CO.
5703 Penn Ave., Pittsburg, Pa.

PATENTS Domestic and Foreign, Trade Marks and Copyrights. Infringement Suits and Interference Cases.

Booklet "More Light on Patents" Sent Free
MAX D. ORDMANN, Reg. Pat. Lawyer,
Mech. and Elect. Engineer,
Specializing in Radio

1503 Woolworth Bldg., N. Y. City Tel. Whitehall 7040-1

Insist on the new 1924 model!

"4-Way" Switch Plug

Now vastly improved — with new positive spring locking terminals which never work loose. Only \$1.50 at your dealer's.

Four Way Co., Springfield, Mass.

RADIO WORLD

The Great Illustrated Weekly. All dealers. 100 copy. Yearly (52 nos.), \$6. Six Months, \$3. Three Months, \$1.50. Full of latest technical and news developments in radio. Special: \$1.00 for trial subscription of 10 issues. Send 15c. for big Anniversary Number.

RADIO WORLD, 1493 Broadway, New York

HANES-ZENER

1480 Broadway, Corner 42nd St., New York City

IN STOCK ALL PARTS FOR THE
NEW AND IMPROVED

Cockaday Four Circuit Receiver

As described by Mr. Cockaday in January Popular Radio

Original and Genuine P-L Resistances	100,000 Ohms	} List Price
	80,000 Ohms	
	50,000 Ohms	
	48,000 Ohms	

\$1.00

DEALERS
Write for Our
Discounts

Send for Our Complete Catalogue G and Price List

"Just Off The Press"

Mailed anywhere upon receipt of 2 cent stamp

KEEPS THE RADIO SET ALIVE

HANDY CHARGER

A Battery Charger that gives a quick charge economically. No Sticking Contacts. No bulbs nor Liquids. Fully enclosed — beautiful.

SIMPLEX MODEL — For 6 volt Batteries only. The Most Practical, Most Complete Battery Charger, for only **\$16.00**

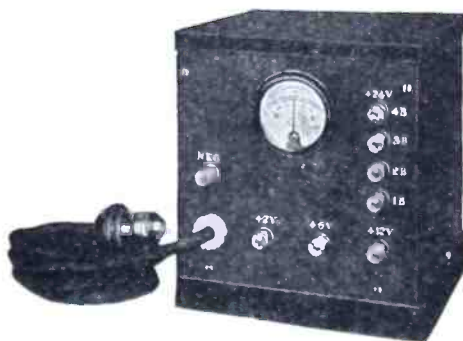

ULTRA MODEL — Charges Them All. Charges 2 volt, 4 volt, 6 volt, 8 volt, 10 volt, 12 volt and 1 to 4 "B" Storage Batteries, with WESTON AMMETER, **\$18.00**

All prices f. o. b. St. Louis

INTERSTATE ELECTRIC COMPANY of St. Louis, Mo. 4015 Laclede Avenue

Please refer to POPULAR RADIO when answering advertisements.



The RāBAT Junior \$3.96

A Rechargeable Wet 'B' Battery. Capacity 800 Mil-Amps.
12 CELLS 24 VOLTS

Here are two acid type wet "B" radio batteries that are entirely free from internal current leakage. All elements visible through clear glass cells. RABATS have longer life with higher and more continuous voltage. Noiseless and compactly constructed—The Rabat Junior with a capacity of 800 mil-amps at \$3.96 and the Rabat Senior with a capacity of 2800 mil-amps at \$9.60 represent more actual battery value at a lower cost. More economical to buy—more economical to maintain. Easily recharged from ordinary house current. If your dealer cannot supply you send direct.

Prices F.O.B. Cleveland, Ohio

The Radio Rabat Company
714 Bangor Building, Cleveland, Ohio



The RāBAT Senior

A Rechargeable Wet 'B' Battery. Capacity 2800 Mil-Amps. 48 VOLTS \$17.88

24 \$9.60
12 CELLS VOLTS

Announcement to the Radio Trade

POPULAR RADIO has a message of interest to radio jobbers and dealers who are eager to increase their sales and their profits.

We have recently published a large 100-page book: "How to Build Your Radio Receiver," edited by Kendall Banning and L. M. Cockaday. This book is described on pages 110 and 111 of this issue of POPULAR RADIO.

Also, we have published two sets of Blueprints covering all constructional details for the "Improved" Cockaday 4-Circuit Tuner and for the Non-Regenerative Tuned Radio-Frequency (Neutrodyne) Receiver. (These Blueprints are described on page 68 of this issue.)

Although this book and these Blueprints have been published primarily to supply the needs of POPULAR RADIO readers, we are willing that recognized radio jobbers and dealers be furnished a limited supply of these books and Blueprints for sale to their customers.

By carrying in your stock a reasonable supply of these books and Blueprints, you will render a valuable service to your radio customers.

For full information regarding prices and terms, simply mail the attached coupon to POPULAR RADIO, Department 47, 9 East 40th Street, New York City.

POPULAR RADIO, Inc., Dept. 47
9 East 40th Street, New York City

Please send me full information regarding your prices to the radio trade on POPULAR RADIO's handbook, "How to Build Your Radio Receiver," and on your Blueprints. I enclose my business letterhead pinned to this coupon.

NAME..... POSITION.....

ADDRESS..... FIRM.....

.....

Please refer to POPULAR RADIO when answering advertisements.

At Last! ^{a real} SILENT — Super BATTERY CHARGER

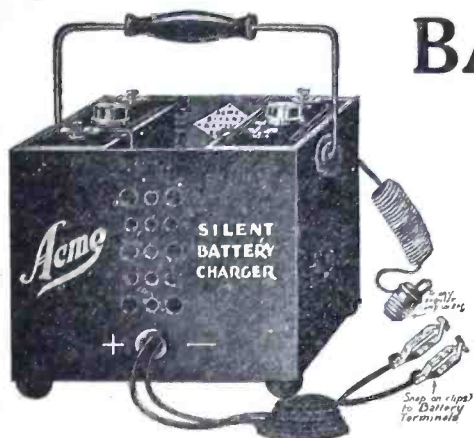

at a price every fan can afford, only

\$10.50 AT YOUR DEALER'S
or postpaid on receipt of this price

The Acme Battery Charger contains no bulbs, no glass, no contacts, no moving parts. It never needs adjustment, is fool proof, silent and practically indestructible. Charges both "A" and "B" Batteries properly without overheating or overcharging. Stops charging automatically when your battery reaches full strength. Simple and efficient—absolutely the last word in battery charging.

Charges BOTH "A" and "B"
STORAGE BATTERIES
FULLY GUARANTEED

The ACME ENGINEERING CO., Dept. 7,
Louisville, Ky.

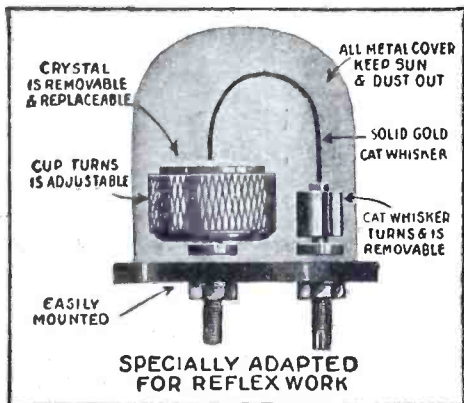

The "Lincoln" Enclosed Fixed Adjustable Detector

New. Wonderful. Fans wildly enthusiastic. Kills your reflex troubles. Brings in distant stations loud and clear. Price only \$2.00. Absolutely guaranteed for one year. Ask your dealer or write—today. Jobbers and dealers: wire or write. Mention this ad. Address Dept J.

Lincoln Mfg. Co.
Los Angeles, Calif.

Guaranteed Head-Sets

"RED-HEADS" are guaranteed radiophones. You run no risk when you buy them. Money back if, after 7 days' trial, you're not satisfied that they're the best receivers on the market at the price. Why not act right now and get a pair? It'll mean getting the maximum from broadcasting from the day you put them into use.



RED-HEAD
RADIO
RECEIVERS

NOW READY

The new 1924 Model F | The new "Red-Head" Jr.
\$6.50 Per Pair | \$5.00 Per Pair
Complete Complete

"Red-Heads" sent prepaid on receipt of price if you are unable to get them at your dealer's.

The NEWMAN-STERN COMPANY
Dept. PR Newman-Stern Bldg. Cleveland

Campbell XX RADIO CABINETS (set up or knocked down) "from the lumber to you"



Campbell XX Radio Cabinets, designed by expert Cabinet Makers, are made absolutely accurate in size, and will fit standard panels perfectly.

Made of extra dry high-grade lumber, in solid Mahogany or Walnut, also, Mahogany or Walnut high piano rubbed or bright finishes.

WILL NOT WARP OR CRACK

PRICES

Cash with order, prepaid east of Missouri River, west add 15 cents to quoted price.

Send Post Office Money or Express Order or Bank Draft.

Panel Sizes	Walnut or Mahogany Finish	Genuine Walnut or Mahogany
7 x 7	\$2.94	\$5.52
7 x 10 1/2	3.54	6.28
7 x 12	3.68	6.38
7 x 14	3.84	7.12
7 x 18	4.24	7.30
7 x 21	5.50	10.06
7 x 24	6.52	11.48
7 x 26	8.78	14.50
7 x 28	9.00	15.00

SPECIAL SIZES TO ORDER
We make a specialty of cabinets for Cockaday "hook-ups." Price of cabinet for new 1924 circuit \$8.89.

Manufacturers' and Distributors' inquiries solicited

THE PERKINS-CAMPBELL CO. (Established 1879)
410-440 New St., Cincinnati, O. Reference Dun or Bradstreet's

Please refer to POPULAR RADIO when answering advertisements.

Still Time to Get This Big Book FREE

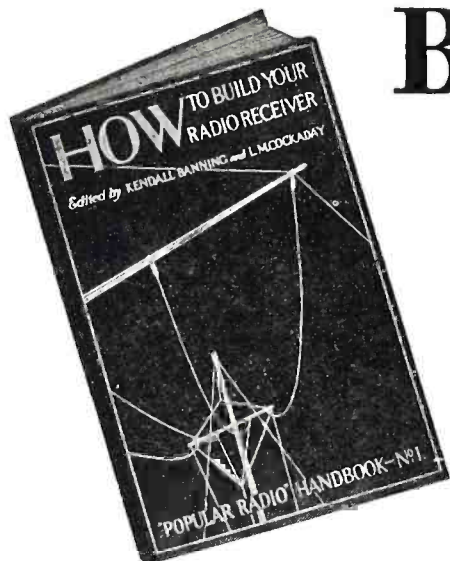

—but you must act at once, before this amazing offer is withdrawn!

THE first edition of POPULAR RADIO's new 100-page handbook, edited by Kendall Banning and Laurence M. Cockaday, is fast becoming exhausted. It can be given away free, for only a limited time longer.

So great has been the demand for this new handbook, "How to Build Your Radio Receiver," since its publication was first announced, that now after only 90 days it is necessary to plan for a second printing.

Therefore it is very doubtful how long this most liberal introductory offer can be held open.

This book is the most comprehensive and valuable contribution of its kind ever published for the radio enthusiast who, *with or without previous technical knowledge or training*, wishes to construct a radio receiving set of his own that will meet his every requirement.

"How to Build Your Radio Receiver" gives complete specifications for the construction of *seven* separate and distinct receiving sets—covering the most remarkable range and variety of circuits, from the most modern simple crystal set to the famous Super-heterodyne.

All working details are given—the list of parts required and their approximate cost; complete hook-ups and circuit diagrams and *how to read them*; illustrations making all points clear, and simple instructions on how to assemble, mount, wire and operate each set.

Scores of Helpful Hints

In this new book edited by Mr. Banning and Mr. Cockaday, you will also find scores of valuable suggestions about aerials, how to select your parts, how to install your set, tips on tuning and how to learn the code.

In all, a book you will not want to be without—one that will be worth many dollars to you. Yet, if you act at once, it will cost you not a penny. We will send you a copy of this valuable handbook absolutely free with a year's subscription to POPULAR RADIO.

The Coupon printed at the bottom of the opposite page provides a convenient means for you to secure this big cloth-bound handbook free. But you must act quickly!

100 PAGES
Size 7 $\frac{3}{4}$ x 11 $\frac{1}{4}$
inches

Edited by

**Kendall Banning and
L. M. Cockaday**

- How to build a Crystal Set.
- How to build the Haynes Single Tube Receiver.
- How to build a Two-Stage Audio-Frequency Amplifier.
- How to build the Original Cockaday 4-Circuit Tuner.
- How to build a 5-Tube Tuned Radio-Frequency Receiver.
- How to build the 5-Tube "Improved" Cockaday 4-Circuit Tuner.
- How to build the Regenerative Super-heterodyne Receiver.
- How to add "Push and Pull" Amplification to the Original Cockaday 4-Circuit Tuner.
- How to read a Diagram.
- How to put up an Outdoor Receiving Antenna.
- List of U. S. Broadcasting Stations of 50-watt Power and up.
- Ten good Rules for Broadcast Listeners.
- Practical Pointers for Getting Best Results.

Please refer to POPULAR RADIO when answering advertisements.

"Far Superior to anything thus far attempted"—says Waldemar Kaempffert

EACH of the sets described in POPULAR RADIO'S new handbook has been selected as the most *ideal* of its kind—for distance, selectivity, tone, volume, simplicity of construction, ease in tuning, reliability and general all-around satisfaction.

sets employing both crystal and vacuum tube with regenerative amplification, audio-frequency, "push and pull" power amplification, compensated radio-frequency and intermediate frequency amplification. Choice of crystal, one-tube, three-tube, five-tube sets—as broad a selection as could be fully illustrated, diagrammed and described in simple terms. If you act quickly, this remarkable handbook FREE with your year's subscription to POPULAR RADIO at the mere price of the magazine alone—

Money Back Guarantee

If you are not *more than satisfied* with this great bargain, simply notify us within 10 days and your money will be refunded without question. Just fill out the handy coupon below. A FREE copy of "How to Build Your Radio Receiver" will be sent you, postage prepaid, at once. Your yearly subscription to POPULAR RADIO will also be entered at once.

POPULAR RADIO, Inc.
9 East 40th Street :: New York City

What Readers Say

"'How to Build Your Radio Receiver,' is one of the most complete books of its kind I have ever seen. I wish that all the books that come to my notice were as worthy of commendation as this one."
ROBERT S. WOOD, Radio Editor,
New York Evening World.

"Mr. Banning and Mr. Cockaday have compiled a book which deserves to rank high in the estimation of amateur set builders. The typography is excellent, the diagrams clear and easily read, and the whole manner of presentation far superior to anything that has thus far been attempted by a radio publisher."
WALDEMAR KAEMPFERT,
Formerly Editor of "Scientific American" and "Popular Science Monthly."

"Any radio bookshelf has a decided place for your new contribution of HOW articles in book form."
PAUL MCGINNIS, Radio Editor,
New York Evening Journal.

"To say I am surprised and delighted puts it too mildly. I knew that any book that POPULAR RADIO put out would be good; but I had no idea that I would receive such a big and truly valuable book as 'How to Build Your Radio Receiver.' A whole year of POPULAR RADIO, with this wonderful book free, is the biggest \$3 value I've ever had."
CUSTOMER NO. 7347.

"In one evening I built a set following the easy instructions in your book, and my friends are all jealous of me now."
CUSTOMER NO. 4260.

Mail this Coupon Today for a Free Copy

POPULAR RADIO, Dept. 45,
9 East 40th Street, New York City.
Please send me, postage prepaid, a FREE copy of POPULAR RADIO'S new handbook, "How to Build Your Radio Receiver," edited by Kendall Banning and L. M. Cockaday. I enclose \$3 for a year's subscription to POPULAR RADIO which entitles me to this big cloth-bound book (size 7 3/4 x 11 1/4 inches) absolutely free of charge. If not fully satisfied I will return the book within 10 days and you will cancel my subscription, refunding my \$3 without question.

NAME.....

STREET & NO.....

CITY & STATE.....

(No extra for Canada. Foreign countries 50 cents postage extra).

Please mark here

Indicate by a circle whether your subscription is new (N), renewal (R), or an extension of your present subscription (E).

N R E

Please refer to POPULAR RADIO when answering advertisements.

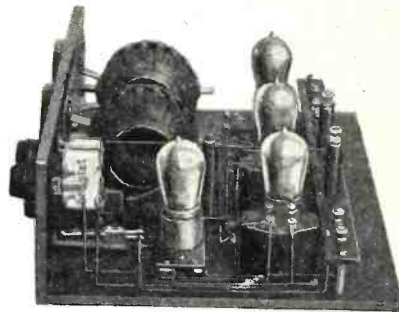
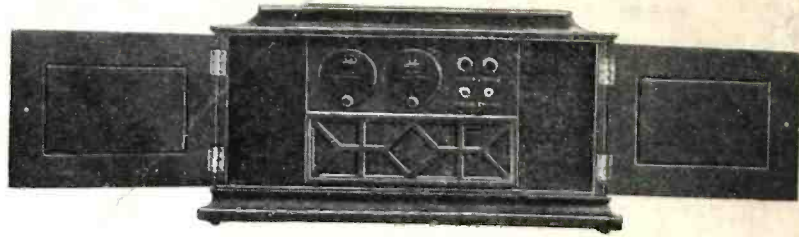

Amrad Radio Unit, removed from Console Cabinet, to show Bradleystat and Bradleyleak mounted in front of detector tube



It at
maz-
rawn!

100-page hand-
book by Laurence M.
It can be given

Handbook, "How
to use it was first
necessary to plan

most liberal

Amrad Adopts Both Bradleystat and Bradleyleak!

The Amrad Jewel—Italian Renaissance Period Art Model
Is Now Equipped With Ultra-Fine Tuning Control

ALL of the more expensive Amrad receiving sets, including the beautiful Jewel Console models, are now equipped with Bradleystats and Bradleyleaks! The noisy wire rheostats have given way to the noiseless Bradleystat. The old type of grid leak is replaced by the stepless Bradleyleak. The perfect filament control of the Bradleystat means greater range and louder reception. The stepless grid leak adjustment of the Bradleyleak, from $\frac{1}{4}$ to 10 megohms, means higher tube efficiency.

The Console models, with self-contained loud speaker, battery compartment, and highly perfected tuner, are made more selective with the ultra-fine filament and grid control, so essential for long range reception.

YOUR radio receiving set will afford new possibilities and new thrills if equipped with Bradleystats and Bradleyleaks. Many radio dealers replace the wire rheostats of ready-built sets with Bradleystats, and they invariably recommend them to set builders who seek the best in radio.

The Bradleyleak has the endorsement of Amrad, Flewelling, Kennedy, Crosley, Clarkson, Cockaday, and other radio engineers. It is pronounced "the perfect grid leak" by all users.

Get the benefit of the graphite disc design by avoiding all substitutes. Carbon or metallic powder was abandoned, years ago, as impractical and unreliable. Insist that your dealer supply you with the genuine Bradleystat and Bradleyleak.

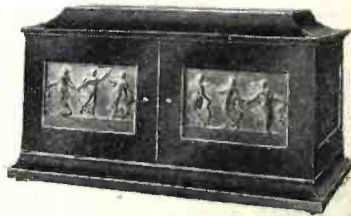

Send for the latest bulletins
on closer tuning and per-
fect grid leak control

Allen-Bradley Co.
Electric Controlling Apparatus

276 Greenfield
Ave.



Milwaukee,
Wis.

There is no substitute for
the scientifically-treated
graphite discs

THE ALLEN-BRADLEY CO. HAS BUILT GRAPHITE DISC RHEOSTATS FOR OVER TWENTY YEARS

Please refer to POPULAR RADIO when answering advertisements.

New

"Town and Country" Set

By Dr. Fulton Cutting and Mr. Bowden Washington

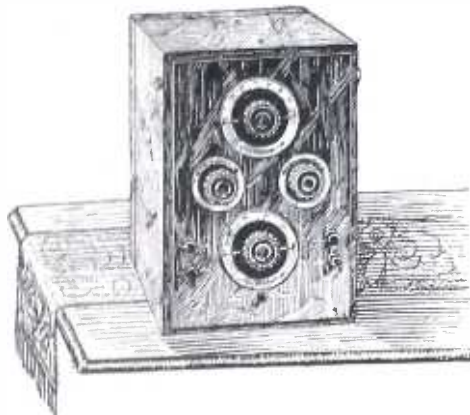

For more than 10 years Dr. Fulton Cutting and Mr. Bowden Washington have been designing the highest type of professional radio equipment—U. S. and Foreign Naval Apparatus, Radio for the U. S. Merchant Marine, U. S. and foreign land stations. And now, they have turned their attention to *Radio for the Home*—you can own a genuine C & W Receiver—know the simplicity, ease of operation, sharp selectivity and clear reception that characterize the best professional equipment.

At last, a successful all-purpose receiver. Out of the years of experience of Dr. Cutting and Mr. Washington has come this "Town and Country" model—a portable that you can carry with you when and where you wish—yet the perfect set for your home.

In your home, without the carrying handle, "Town and Country" is a handsome 2-tube, *double circuit* cabinet set, highly selective, range up to 1200 miles, capable of operating a loud speaker for local or near-by stations.

*and then, at a turn
of a switch—*

it becomes a 2-tube, *single circuit* portable set—ready to operate on any sort of *temporary antenna*—a wire around the top of your car—stretched along a tent top—or across the room in the home of a friend.

It's the complete all-purpose set—no compromise. Self-contained—uses dry batteries—LARGE dry batteries that last. It's complete with Brandes Head-set—ready for antennae and ground wires when you get it—ready to give you "what's in the air." Price, \$97.50. See it at a C & W Dealer's—or write for literature.

Cutting & Washington Radio Corp.
Minneapolis Minn.
Operating Station WLAG

Cutting and Washington

Standard of Excellence in Radio Since 1914

The COURT JESTER of TODAY

"No wit to flatter left of all his store,
No fool to laugh at, which he valued more."
—Pope

SINCE the earliest days laughter and gaiety have been the most sought after things in life. In ancient times stately rulers unbent, courtly knights forgot seriousness; beautiful ladies became more alluring as the clever quips and merry pranks of the court jester brought a sparkle to their eyes and drove dull care away. But they were limited to the clownish antics and slap stick comedy of the jester.

Moderns have unlimited sources of amusement. Every broadcasting station has its Jester; its humorous stories; amusing songs and clever comedies. Each night the air is filled with merriment.

With a Crosley Model X-J radio receiver, amusement may be brought clearly and distinctly to your fireside. Sitting comfortably in an easy chair you forget dull care. The magic wand of the radio sends worry scurrying.

The very moderate prices of all Crosley instruments bring radio within the reach of all. No matter which Crosley Model you may select you can be assured of the maximum results at the lowest cost.

Let a Crosley Radio Receiver bring fun, laughter and good humor into your home.

CROSLLEY
Better • Cost Less
Radio Products

See the Crosley Line at Good Dealers Everywhere

Write for Free Catalog. This fully describes the Crosley line of Radio receivers which range in price from the Model VI, a 2 tube set at \$30, to the graceful Consolette Model X-L at \$140. It also shows the complete line of Crosley parts.

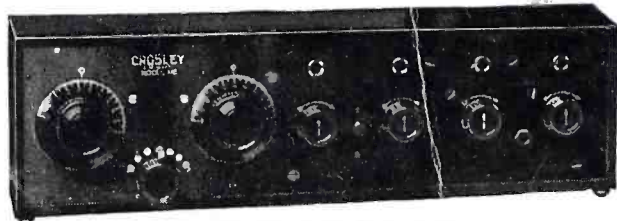

Crosley Model X-J—Price \$65

For tuning out local interference and bringing in distant stations this receiver is unexcelled. It is a 4 tube set combining one stage of tuned radio frequency amplification, detector and two stages of audio frequency amplification.

Nowhere can a better set be purchased at any price.
Cost of necessary accessories \$40.00 and up.

CROSLLEY MANUFACTURING COMPANY
Powel Crosley, Jr., President
116 Alfred Street Cincinnati, Ohio



CROSLLEY \$
Model X-J **65**

The broadcasting station WLW is maintained by the
CROSLLEY MANUFACTURING COMPANY

MAIL THIS COUPON TODAY

Crosley Manufacturing Co.,
116 Alfred St., Cincinnati, O.

Gentlemen: Please mail me free of charge your complete catalog of Crosley instruments and parts together with booklet entitled "The Simplicity of Radio."

Name.....

Address.....