

# Popular Radio

Edited by **KENDALL BANNING**

**DECEMBER · 1923**

**25¢**

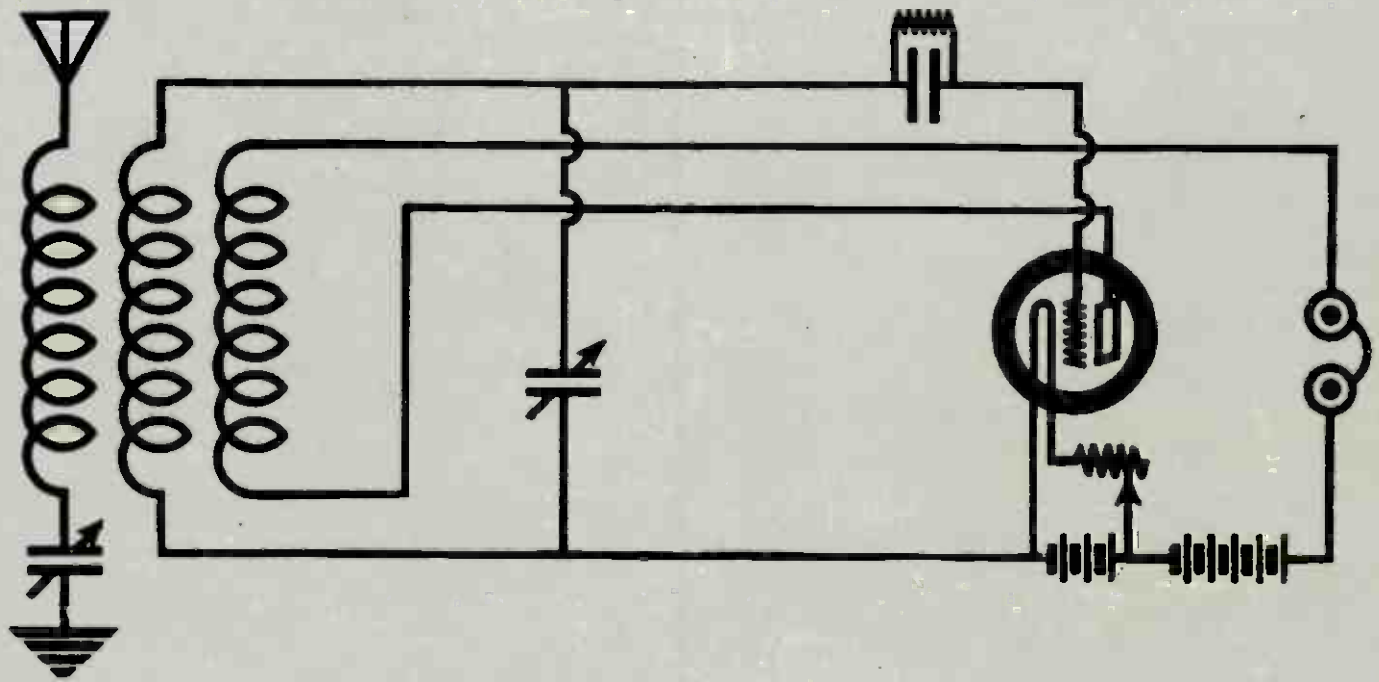

*In this Number*

**How to Read a Diagram—**

**How to Build a Simple Crystal Set—**

**How to Build the Super-Heterodyne-Receiver**

# Get Your Station

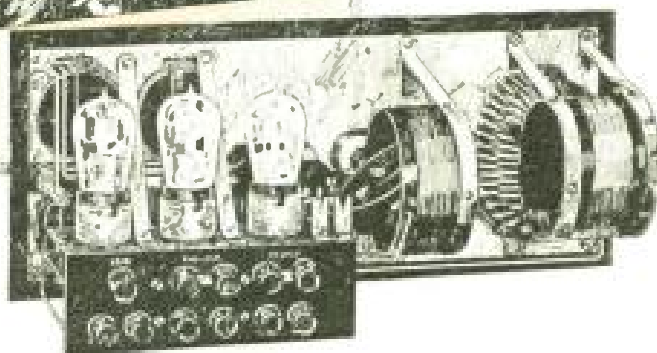
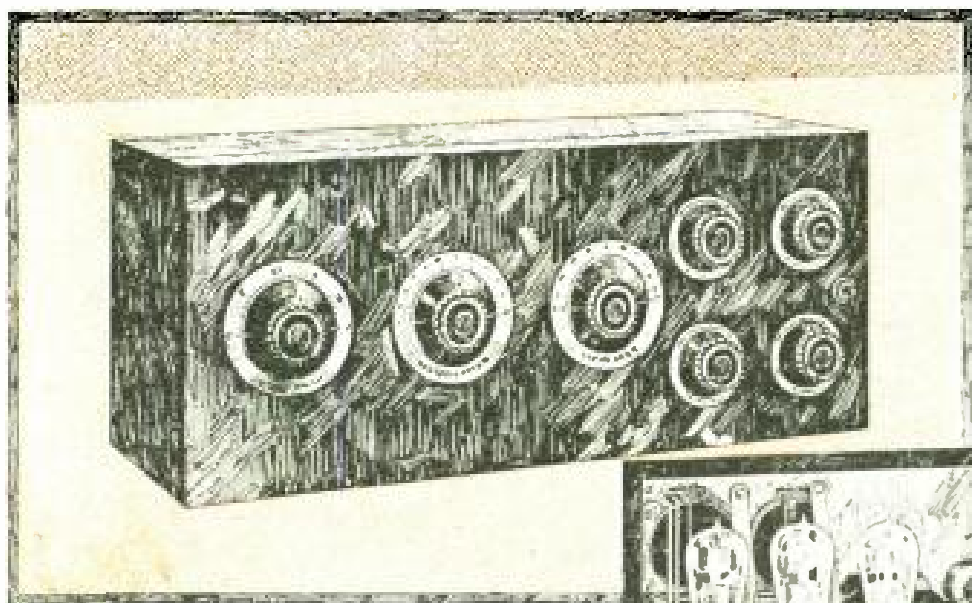

## With a C & W Receiver

Once you know the real thrill of Radio—once a slight turn of the dial gives you New York—Atlanta—San Francisco—you'll never be content to possess any but the most highly selective receiver—the set that will **GET YOUR STATION** if the station is to be had.

This is why you will sooner or later choose a genuine C & W Receiver—built by two of America's foremost radio engineers—designers of U. S. Naval and Marine Equipment—men who have been building the highest type of commercial apparatus for more than 10 years.

Actual tests have proved C & W Sets more highly selective than any others in their class. Choose the best set *first*—why experiment?

C & W Receiver 11A—(Armstrong Patent). A 3-tube, special double circuit set. Note the simplicity of parts. Easily operated—remarkably long range and clear reception—the set used in the famous C & W selectivity tests. Uses 6-volt storage battery. All wires back connected. Price (without batteries or tubes) . . \$135

**The Cutting & Washington Radio Corp.**  
Minneapolis, Minn.

**DEALERS**—write for complete details of the C & W Merchandising Plan, including your own magazine, **FREE**, to mail to prospects

# Cutting and Washington

*Standard of Excellence in Radio Since 1914*

Please mention POPULAR RADIO when answering advertisements.

# THORDARSON KENNEDY

*The Royalty*



*of Radio*

The Colin B. Kennedy Co., internationally renowned for their **QUALITY RECEIVING SETS**, are equipping all their sets with Thordarson super-transformers.

**BE**

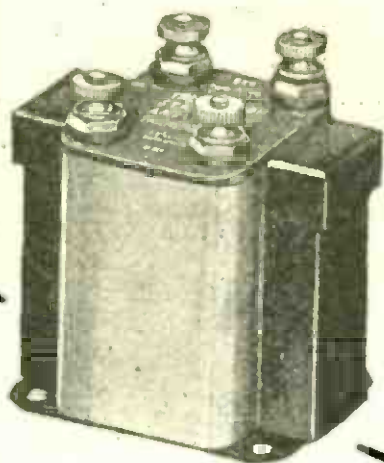

**CONVINCED**



The Zenith Radio Corporation, manufacturers of **LONG DISTANCE RADIO RECEIVERS**, famous for the Berengaria record and their accomplishments on the S. S. Bowdoin at the North Pole, also have adopted Thordarson super-transformers as standard equipment.

## SUPER TRANSFORMER



# POPULAR RADIO

EDITED by KENDALL BANNING



## CONTENTS for DECEMBER, 1923

(Cover design by Frank B. Masters)

VOLUME IV	NUMBER 6
The First Man to See by Radio . . . . . A Portrait Study of C. Francis Jenkins	Page 436
The New "Radio Movies" . . . . . <i>Watson Davis</i>	437
How Radio Is Making the American Boy a "Citizen of the World" . . . . . <i>Forrest Crissey</i>	444
How to Select Your Radio Parts . . . . . <i>S. Gordon Taylor</i>	450
Learning the Code While Asleep . . . . . <i>Kenneth Swezey</i>	459
The 100 Best Hook-ups . . . . . Installment No. 2	463
Do Ether Waves Cause Gravitation? . . . . . <i>E. E. Free</i>	468
How to Read a Diagram . . . . . Part I <i>Albert G. Craig</i>	478
How to Build an Efficient Crystal Receiver . . . . . <i>Morris S. Strock</i>	486
How to Build the Super-heterodyne Receiver . . . . . Part II <i>Laurence M. Cockaday</i>	496
How to Increase the Selectivity of Your Receiver . . . . . <i>John V. L. Hogan</i>	504

### DEPARTMENTS

What Readers Ask . . . . .	512
In the Works Laboratories . . . . .	518
Hints for Amateurs . . . . .	526
Broadcasts . . . . .	528
Listening In . . . . .	531
Facts You Hunt For . . . . .	537

---

VOLUME IV DECEMBER, 1923 NUMBER 6  
Published monthly by Popular Radio, Inc., 9 East 40th Street, New York, N. Y., telephone number  
Vanderbilt 9985; H. B. Emerson, President; Paul O. Batch, Secretary; F. C. Hemberger,  
Treasurer. Price, 25 cents a copy; subscription \$2.00 a year (prior to Dec. 15, 1923) in the U. S.,  
Canada and all countries within the domestic postal zone; after Dec. 15, \$3.00 a year; elsewhere  
\$3.50 a year, payable in advance. The International News Company, Ltd., No. 5 Bream's Bldg.,  
London, E. C. 4, sole distributors in England. Entered as second class matter April 7, 1922, at  
the Post Office at New York, N. Y., under the act of March 3, 1879. Copyright, 1923, and title  
registered as a trade-mark by Popular Radio, Inc. Copyright in Great Britain by Popular  
Radio, Inc., 6 Henrietta St., Covent Garden, W. C., London, England. Printed in U. S. A.  
E. E. FREE, Ph.D., *Contributing Editor* LAURENCE M. COCKADAY, R.E., *Technical Editor*

---

For advertising rates address E. R. CROWE & Co.  
New York: 9 East 40th St. Chicago: 645 North Michigan Ave.



Please mention POPULAR RADIO when answering advertisements.



"For the ear to desire  
pleasant sounds is natural."

Mencius-

There are no sounds more  
pleasant than the music brought  
by the

**GREBE**

Broadcast Receiver-

*Doctor Mm.*

REGENERATION and Tuned Radio Frequency  
Amplification find their first successful com-  
bination in this Receiver. The 20-foot silk-cov-  
ered wire, readily concealed behind the picture  
moulding, is the only antenna required.

The attractively finished walnut cabinet has  
compartments for all necessary batteries.

Write for "GREBE Radio in the Well-Appointed Home"

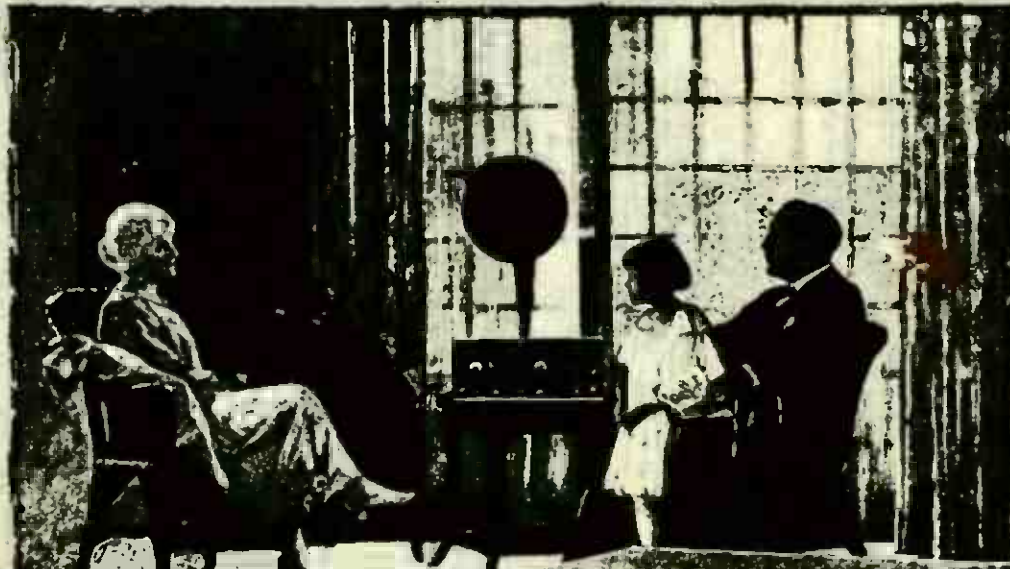

A. H. GREBE & COMPANY, Inc.  
Richmond Hill, N.Y.

Western Branch, 451 East 3rd St., Los Angeles, Cal.



Licensed under Armstrong  
U. S. Pat. No. 1,113,149

Type CR-12

# PAGES WITH THE EDITOR

OUT of the wilds of Canada comes a letter from an Irate Reader who peremptorily orders his subscription cancelled because of "the tacit approval of hootlegging and contempt of the law expressed in an article by "a writer called Williams" in our September number.

\* \* \*

So far as the Editor knows, this cancellation is the first one ever received from an Irate Subscriber by POPULAR RADIO. It is at least a gratification to know that the irritation was not occasioned by a technical error in our pages or by a misstatement of a fact!

\* \* \*

CANCELLATIONS due to a subscriber's disagreement with a point of view expressed by a contributor are so rare—particularly in scientific magazines which appeal primarily to open-minded seekers of the truth—as to attract comment. The Editor does not and obviously cannot commit either himself or the magazine to the opinions of the contributors. If any considerable portion of our readers shared our Canadian reader's censorious mental attitude, what in the world would have happened to our large and growing subscription list following the famous controversy in our pages between Sir Oliver Lodge and Dr. Charles P. Steinmetz on the Ether Hypothesis? Or between Dr. Elihu Thomson, Sir Oliver Lodge, General Squier and Dr. Reginald A. Fessenden on the Gliding Wave Theory?

\* \* \*

As a matter of fact, "a writer named Williams" merely made the parenthetical observation (in his article descriptive of the broadcasting of his play) that "fortunately" Mr. Volstead's efforts to suppress cocktails were unsuccessful. This point of view is reported to be held by several million pretty good Americans and apparently too by a good many Canadians, who are presumably just as sincere in their convictions as is the Irate Subscriber. POPULAR RADIO neither disapproves nor endorses these opinions. Furthermore, the Editor expects to publish other opinions, provided that the contributors are persons of standing whose views command consideration.

\* \* \*

"A WRITER called Williams." in this case happens to be the internationally known novelist, Jesse Lynch Williams, Doctor of Letters, president of the Authors' League of America, member of the National Institute of Arts and Letters, a writer and publicist who has been honored by institutions of learning and a dramatist who is known here and abroad for his keen understanding of present-day people and present-day problems.

\* \* \*

ONCE, when the Editor was on the staff of another magazine, he lost an Irate Subscriber

who bore a personal grudge against a certain author who had inconsiderately married the Irate Subscriber's sweetheart. And once he lost an Irate Subscriber because an illustration in the magazine showed a man firing a revolver—and the Irate Subscriber, being an avowed pacifist, disapproved even of pictures of guns! And once he lost an Irate Subscriber who was a Catholic and didn't believe that the magazine should employ a Jew as subscription agent—or perhaps it was the other way around.

\* \* \*

BUT no amount of cancellations of subscriptions or advertising—and, contrariwise, no amount of promises of contracts for either—will divert the editorial policy of POPULAR RADIO or lead the Editor to publish or to suppress an honest opinion.

\* \* \*

THE editorial pages of POPULAR RADIO are not for sale—to subscribers or to advertisers.

\* \* \*

As this paragraph is being written, the cash price of POPULAR RADIO is 250,000,000 marks—although, of course, that trifling sum is no criterion of its value. "I wouldn't sell my May number for \$10.00," writes an enthusiastic reader from Bethel, Conn. . . . Um! let's see, that's about 10,000,000,000 marks, isn't it?

\* \* \*

THE author of the article on page 504 of this issue of POPULAR RADIO, John V. L. Hogan, is not only one of the most capable and widely experienced of radio experts in the world, but is adding to his scientific laurels an occasional sprig or two from the world of literature. His latest book, "The Outline of Radio," is perhaps the most understandable yet authoritative volume on the subject that the Editor has yet seen—comparable only to "Radio for Everyone" by our own Laurence M. Cockaday. And no praise could be fairer than that!

\* \* \*

OUR enterprising subscription manager tells the Editor that he has arranged with numerous publishers for filling orders for POPULAR RADIO, in combination with other magazines, at special club rates.

"Our readers will profit well by taking advantage of some of these clubbing offers and filling the magazine requirements of their whole family for the coming year" he reports. "These special units, as announced in our advertisement in the current number, are priced lower than they can ever be priced again, and the offers are for a very limited time only. Why not tell our readers about them in *Pages with the Editor*?"

\* \* \*

WHY not, indeed?

(Continued on page 8)



Please mention POPULAR RADIO when answering advertisements.



Natural re-PRODUCTION

# Atlas Loud Speaker



TRADE MARK

### Letters from Users Requested

The remarkable re-PRODUCTION of Atlas Loud Speakers makes every owner enthusiastic. "Musical experts," writes a man in St. Paul, "have pronounced it the clearest reproduction they have ever heard." What results have you accomplished with your Atlas Loud Speaker? Write us about them—TODAY.

FOR Christmas give the radio enthusiast his fondest expectation—a perfect radio re-PRODUCER, the Atlas Loud Speaker. Natural re-PRODUCTION, identical with the original in the broadcasting studio. The patented "double diaphragm" responds uniformly to the full range of sound intensities. Adjustable to each individual set and receiving conditions. The Atlas Loud Speaker is a gift to an entire home.

Hear the Atlas Loud Speaker at your dealer's.

WARNING. Be sure you get the genuine Atlas Loud Speaker with our red tag factory guarantee! LIST PRICE **\$25**

Write for Booklet "B"

Contains much helpful information

Sole Canadian Distributors

The Marconi Wireless Telegraph Company of Canada, Ltd.  
Montreal, Canada

MANUFACTURED BY  
**Multiple Electric Products Co. Inc.**  
ORANGE, N.J. RADIO DIVISION, NEWARK, N.J.



PAGES WITH THE EDITOR

(Continued from page 6)



From a photograph made for POPULAR RADIO

A CORNER OF THE EXPERIMENTAL LABORATORY OF POPULAR RADIO

*Before the Technical Editor's article on the super-heterodyne receiver was written, the set was designed, built and put into successful operation. Then the Technical Editor told in detail how it was done.*

You will find above a snapshot of a corner of the experimental laboratory conducted by our Technical Editor. This particular picture was made while the staff was actually working on the super-heterodyne set that is described in this issue.

\* \* \*

EVERY set and every circuit that is described in this magazine is built and tested before it appears in our pages.

\* \* \*

EVERY one of our "How-to-Build" articles is so carefully written and checked up that the possibility of error is remote. In order to insure successful results to the builder, the articles contain all the specific information that is necessary, ranging from the exact instruments that should be used to detailed and minute instructions as to where to drill the holes for the screws.

\* \* \*

THERE are some radio parts, however, that POPULAR RADIO recommends its readers to buy outright rather than to try to make himself.

The amateur—even the most experienced—has neither the experience nor the facilities for making his own vacuum tubes, for example. Nor has he the facilities for making such apparatus as audio-frequency transformers or couplers. It would be as unwise for the radio fan to try to make them as it would be for POPULAR RADIO to advise him to do so.

\* \* \*

If you fail to find in our "How-to-Build" series construction details for certain instruments, you may properly conclude that, in the opinion of POPULAR RADIO at least, the amateur should not attempt to construct them himself.

*Kendall Banning*  
Editor, POPULAR RADIO

Please mention POPULAR RADIO when answering advertisements.



## Charges Radio and Auto Batteries at Home Over Night - For a Nickel!

For a friend who owns a radio set or automobile, what could be more appropriate than a gift which would eliminate the inconvenience and expense of taking his battery to a service station every time it requires recharging? The

### GOLD SEAL **HOMCHARGER** *The World's Most Popular & Battery Charger*

is such a gift, appropriately dressed up in a beautiful Christmas package, too. It charges any AUTO, RADIO or "B" storage battery in the simplest, quickest and most efficient manner possible. Connects to any lamp socket—operates silently—requires no watching. Fully automatic in operation—absolutely safe.

#### HOMCHARGER'S TEN POINTS OF SUPERIORITY

1. **Simple**—Only one moving and wearing part, replaceable after thousands of hours use for \$1.00. Will last a lifetime.
2. **Efficient**—Uses less than one-half the current of any bulb or liquid type rectifier. Will charge any radio or automobile battery for a nickel.
3. **Quick**—Its high charging rate of 7 amperes eliminates long waiting for battery to become charged. Will charge any "A" or "B" battery over night, or three times as fast as a 2-ampere machine.
4. **Clean**—No expensive bulbs to break or acids to spill or replace. No acid fumes. Charges without fuss or bother.
5. **Dependable**—Tungsten contacts insure continuous operation—prevent sticking and stopping.
6. **Fool-Proof**—Can be operated by anyone. Attach to lamp socket and connect battery either way, it will always charge. High-grade ammeter eliminates guess work.
7. **Safe**—No danger or shock or fire. Tested and approved by Fire Insurance Underwriters everywhere. Gives tapering charge—will not overheat or injure battery.
8. **Beautiful**—Mahogany and Gold Finish.
9. **Unqualifiedly Guaranteed.**
10. **Popularly Priced**—Retail at \$18.50 complete (\$25.00 Canada). No extras to buy. Sold by all dealers.

**FREE BROADCASTING LIST.** Ask your dealer or write direct for Free Homcharger List of Broadcasting Stations, and Circular Describing the Gold Seal Homcharger.

#### DEALERS! JOBBERS!

GOLD SEAL HOMCHARGERS in their attractive Xmas packages are going to be "best sellers" to the holiday trade. Write for our elaborate merchandising plans and then prepare to get your share of this big "Homcharger Xmas business."

#### Insist on the GOLD SEAL

ACCEPT NO SUBSTITUTE. Like all good products, the HOMCHARGER has been widely imitated. No other charger is just as good. INSIST on seeing our registered trade-mark, the "GOLD SEAL," on nameplate and carton before purchasing.



**The Automatic Electrical Devices Co., 132 West Third St., Cincinnati, O.**  
*Largest Manufacturers of Vibrating Rectifiers in the World*



Please mention POPULAR RADIO when answering advertisements.

## The Outstanding Value in New Kennedy Radio Sets

The new Kennedy Radio Model V is everywhere acknowledged as the one outstanding value in the radio field today.

The receiving unit in Model V is a distinct advance in radio engineering. It is a special development of extensive research in the Kennedy Laboratories and was produced in response to an insistent, popular demand for more simplified apparatus. After initial settings are made, all tuning is controlled by a single dial. Yet, with this extreme simplicity of operation the selectivity of the earlier Kennedy models has been retained. The new unit responds to all broadcast wave-lengths and operates on any ordinary antenna.

The cabinet is of solid mahogany and follows a pleasing design that adapts itself to home surroundings. Equipment includes all tubes, dry batteries, Kennedy phones and plug—batteries are fully enclosed. Price, complete, \$125.00.

More elaborate Kennedy furniture models range from \$285.00 to \$825.00, completely equipped, including built-in loud speaker.

*See the new Kennedy furniture models at your dealer or write us for fully illustrated particulars.*

THE COLIN B. KENNEDY COMPANY

SAINT LOUIS

SAN FRANCISCO

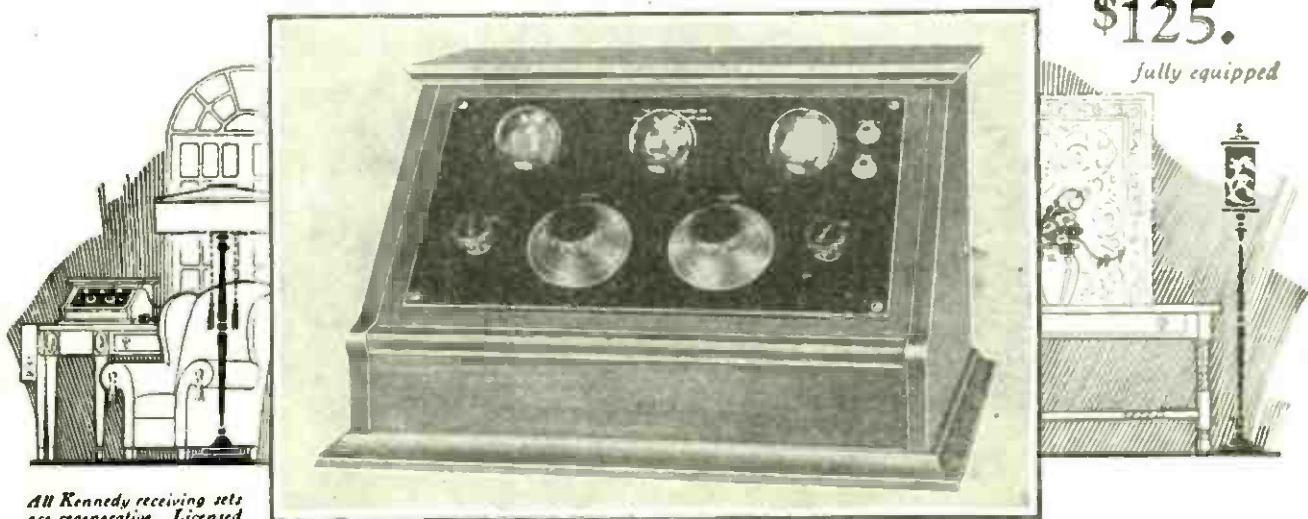

*All Kennedy receiving sets are regenerative. Licensed under Armstrong U. S. Patent No. 1,113,149.*

# K E N N E D Y

The Royalty  of Radio





From a photograph made for POPULAR RADIO

### The Inventor of the Radio Furnace

*AMONG the first American experiments with radio were those made at the University of Texas in 1896 by Dr. E. F. Northrup. Dr. Northrup's most recent achievement is the invention of a furnace that melts the most refractory metals by means of radio waves. He will describe this in an early number of POPULAR RADIO.*

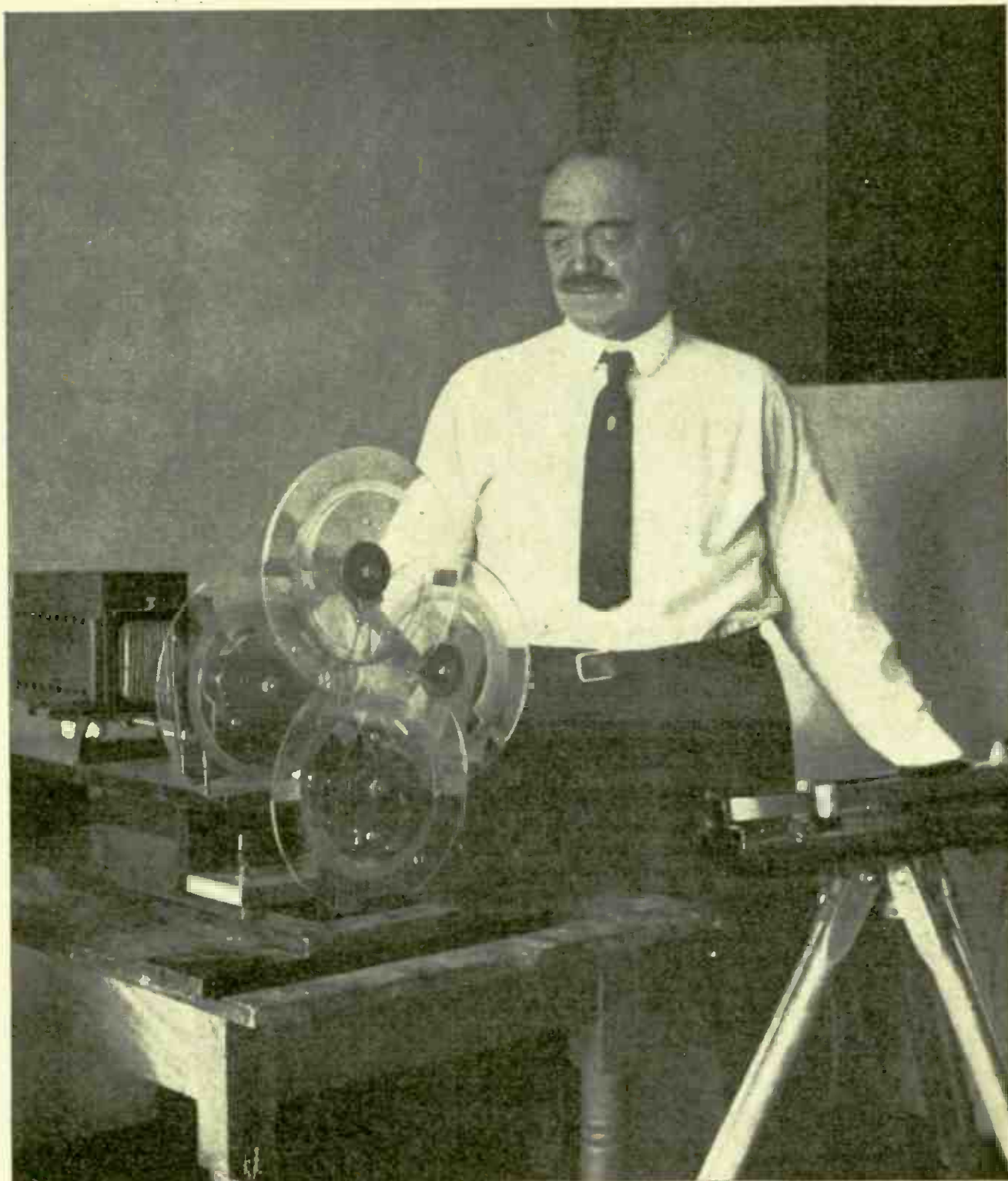

From a photograph made for POPULAR RADIO

### The First Man to See by Radio

*This modest genius, Mr. C. Francis Jenkins, of Washington, D. C., believes in letting his inventions make their way in the world on merit alone. Although he is less known to newspaper readers than many other inventors of far less accomplishment, Mr. Jenkins already has to his credit several important contributions to the production of motion pictures as well as to radio. His most recent invention combines these fields in the "radio movies," described in the article that starts on the page opposite.*

# Popular Radio

VOLUME IV

DECEMBER, 1923

NUMBER 6



## THE NEW RADIO MOVIES

In this authoritative article Mr. Davis describes for the first time an invention that some scientists believe to be one of the most important ever made in the whole science of radio. It is not too much to say that it may result in permitting you to actually *see* any part of the world—its people, its street scenes, its great events and spectacles—without leaving your own fireside.

By WATSON DAVIS

WHEN I talked to C. Francis Jenkins over the telephone and he asked me to come up to his laboratory, I was not surprised and startled that he and I could talk over a copper wire. Telephoning is a common performance. Even the nightly radio voices in the ether are no longer the marvel they were a mere two years ago.

But, when Mr. Jenkins asked me to watch a screen in his laboratory which was shut off from the rest of the room and when I *saw* him wave his hand to me, although my back was turned to him, it was unusual.

*I was seeing by radio!*

But Mr. Jenkins has done unusual and unprecedented things before. Every ordinary motion picture projector contains a vital principle invented by him. Readers of POPULAR RADIO know also that he has within the last year made it possible to send diagrams, messages

written in Chinese characters, and even photographs by wire and radio.\*

Sending and receiving sets for transmitting still pictures by radio were in his laboratory, and it was plain that this apparatus for radio vision, a new assembly of disks, motors, lenses and lights, was related to the more finished and mature equipment that has been successful in sending pictures and diagrams through thin air.

In reply to my hardly pronounced "How?" Mr. Jenkins showed how he had made the movement of his fingers and hand visible by radio. The apparatus seemed extremely simple, certainly no more complex than the telephone when Bell first operated it. A magic lantern, the same as thousands in ordinary use, was projecting its shaft of light through a disk that revolved at

\*The Jenkins method of sending pictures by radio was described in "Seeing by Radio" by Watson Davis, POPULAR RADIO, April, 1923.



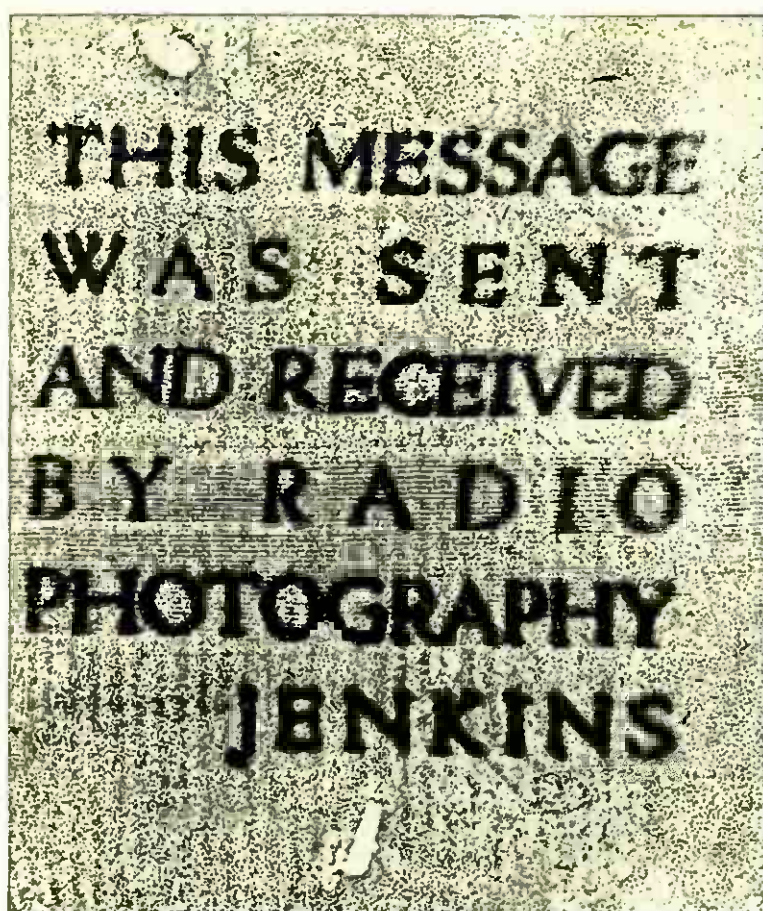

AN EXAMPLE OF FACSIMILE REPRODUCTION OF READING  
MATTER (OR PICTURE) BY THE JENKINS MACHINE

*The transmission of a "still picture" by radio was the first step in the transmission of motion pictures—which are but a series of still pictures. Now the inventor is transmitting actual scenes directly from the moving objects.*

high speed. The light fell on an opening in a rectangular box, supported, much like a small camera, on a heavy tripod placed half way across the room. From the black box on the tripod wires ran to a radio transmitting set that was heavily screened to keep stray and troublesome electric currents from getting in the way. When a wave of the hand was to be transmitted, Mr. Jenkins simply inserted his fingers into the space where the lantern slide holder of the ordinary stereopticon is placed.

The object of the whirling disk and stereopticon, Mr. Jenkins told me, was to impress the shadow of the moving fingers and hand, portion by portion, upon the light-sensitive cell that was contained in the camera-like black box on the tripod. How this is done will be explained later. But the result is that the variations in light that this cell

receives are translated into variations in electric current, just as the variations in sound that enter the telephone transmitter exit upon the wires as variations in electric current. The shadow of the moving fingers, now in the form of varying electric current, was fed into the radio transmitting set and handled in exactly the same way as hundreds of jazz concerts are broadcast every night.

The receiving antenna in the case of this demonstration was only a few feet away from the sending antenna on the roof of the Jenkins laboratory, but for a short distance that wave of a hand went through the ether in the form of radio waves. After being picked up by the receiving radio set, these impulses were changed back into an electric current and sent to the radio-vision receiving set.

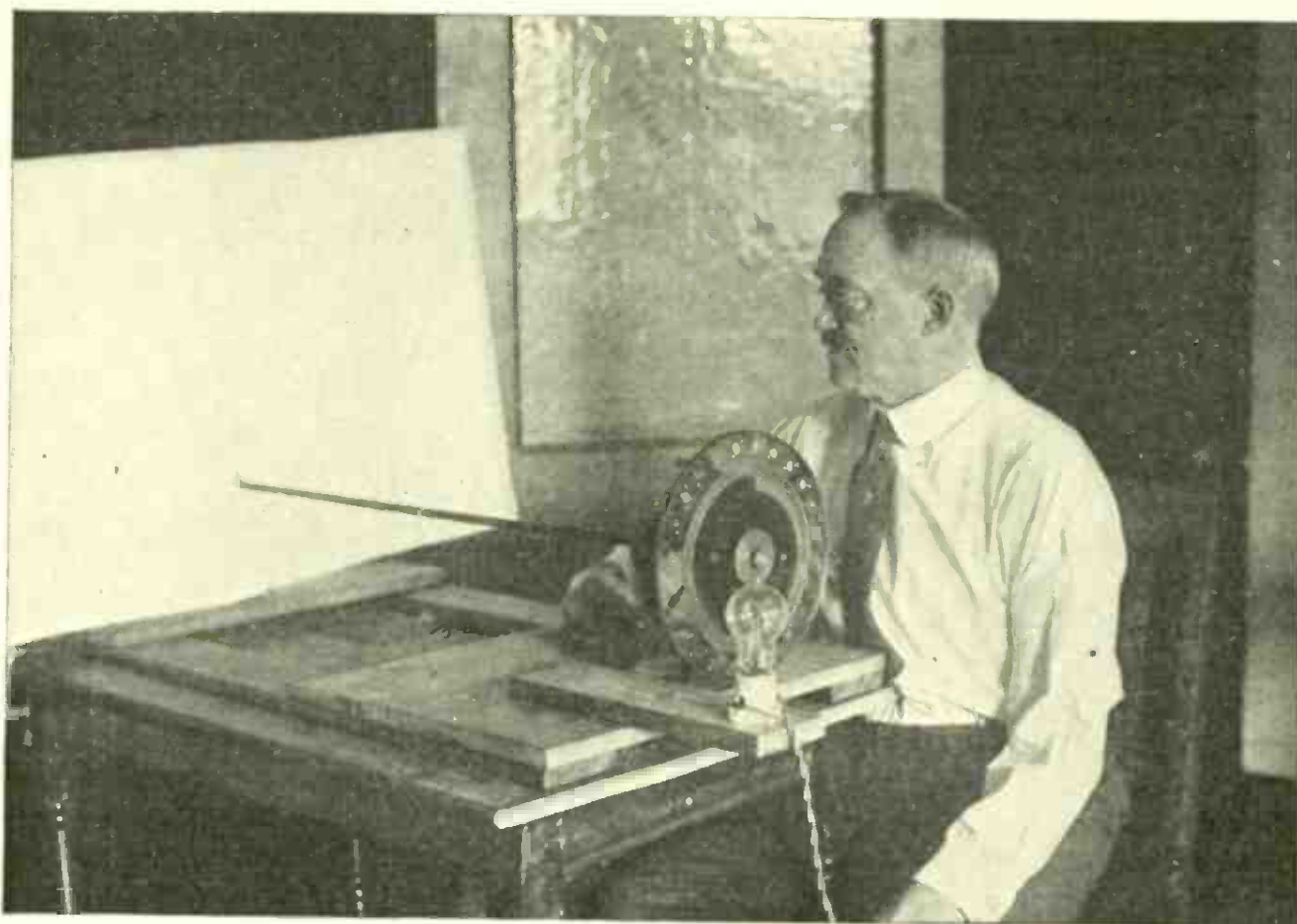

From a photograph made for POPULAR RADIO

#### THE ESSENTIALS OF THE RECEIVING SET FOR RADIO VISION

*The lamp shown in the picture receives a varying electric current and transforms it into variations in light, which are taken by the multiple-lens disk and thrown onto the screen in the background in the form of a picture. The motor driving the disk is located behind the screen.*

This receiving apparatus consisted of just four essentials: a lamp that changed electric-current variations into light variations, a whirling disk similar to the one in the transmitter, a lens, and a picture-receiving screen.

Radio vision is as much a matter of optics as electricity, and since light and electricity are both members of the big family of ether waves, differing only in length, there is no reason why they should not work amicably.

Yet there is no question but that the radio part of radio vision plays second fiddle to the whirling disk. These rings of lenses make radio vision possible. They take the wave of the hand and impress it portion by portion on the light-sensitive cell; they take the rapidly fluctuating light and change it into a moving picture.

The human eye is easily pleased and slurs over minute imperfections. All of the halftone illustrations in our newspapers are nothing but areas of coarse dots, sixty to the inch, that our eyes obligingly turn into pleasing pictures. That is a very useful optical trick and it is used by Mr. Jenkins in sending still pictures by radio and also in his process of radio vision.

Again, speed can be used to fool the eye. Getting fooled is not always unpleasant, because it allows us to enjoy motion pictures. In the theaters, sixteen photographs appear on the screen each second, and that is speedy enough to make it seem to our eyes that the motion is in the objects in the pictures, not in the pictures themselves. And this optical illusion is used by Mr. Jenkins in radio vision.



Lines, not dots as in the halftone, very close together, are the structure of both pictures and vision by radio. These lines of light are swept across the progressing picture by the whirling disks. Light is the paint and the whirling disk is the brush in radio pictures and vision.

In the Jenkins apparatus for transmitting still pictures, the whirling disk has a prism curled around its circumference. Prismatic lenses, as almost all of us have observed, have a way of persuading light to deviate from its straight path. The disks used in transmitting still pictures by radio are made entirely of glass, and the prismatic lens is ground on the circumference. This is, however, the equivalent of many lenses since it is of varying thickness. And this causes a beam of light, projected through it while it revolves, to be swept from one side to the other or up and down.

Two of these disks are used to project the photograph upon the transmitting light-sensitive cell in Jenkins' pictures

by radio apparatus. One disk covers the picture in one direction while the other covers it at right angles to the first, and one of these disks operates many times faster than the other so that the effect, in both sending and receiving, is the drawing of lines across the picture very close to each other. In sending still pictures, this operation takes about a minute.

To transmit motion, the sending must be speeded up so that at least sixteen pictures are transmitted each second instead of one picture in several minutes. Compared with this, ordinary motion pictures such as we see in theaters, are comparatively simple. At the movies whole photographs are projected on the screen all at once, and they are thrown on and taken off so rapidly that the eye can not detect the separate projections but blends them together into continuous motion of the objects in the picture. In radio vision the picture is projected on the screen portion by portion, but to produce the effect of motion or actual vision a complete picture must be built

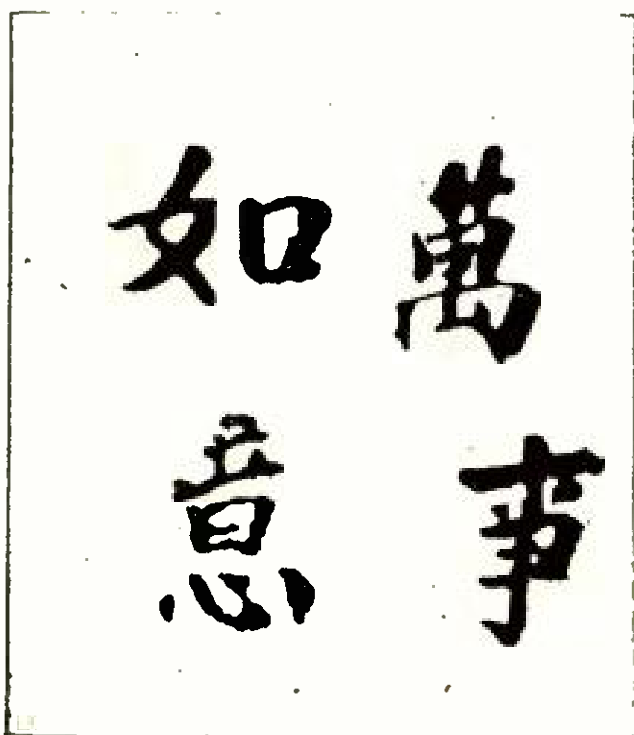

AS IT WAS SENT—

*This is the original Chinese message that was handed to the radio operator for transmission at the sending station. Its Chinese significance is "Ten thousand joys on your journey."*

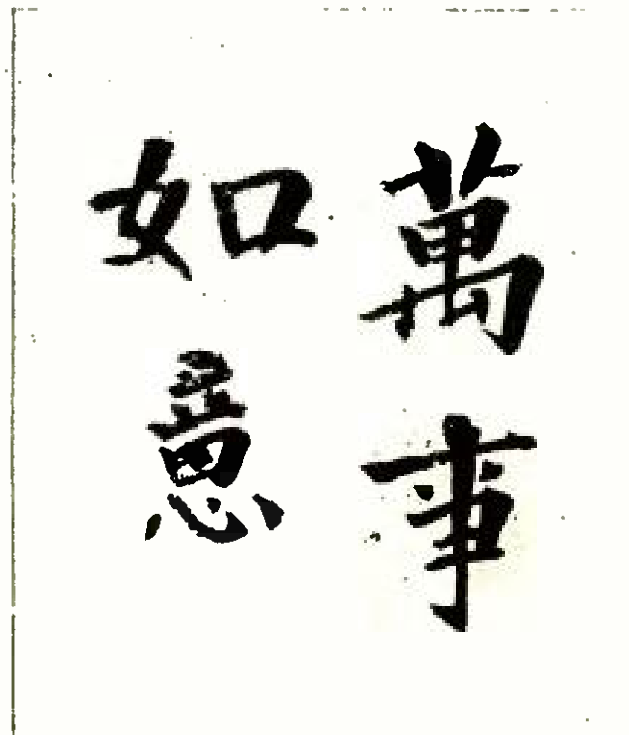

—AND AS IT WAS RECEIVED

*This is the message as it was received by the radio operator and handed to its Chinese addressee; it is practically a perfect reproduction in somewhat grayer tone.*

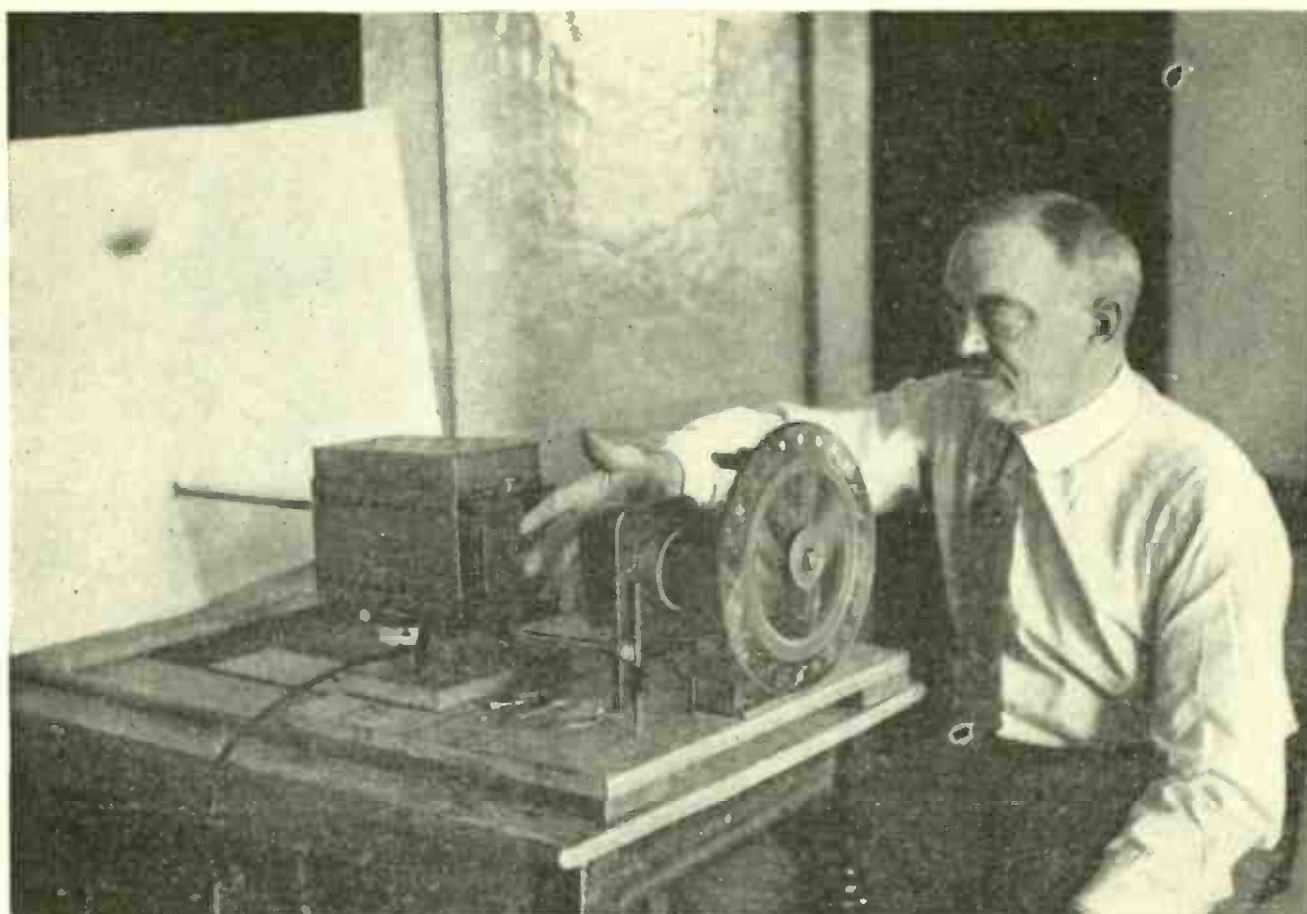

From a photograph made for POPULAR RADIO

#### THE SIMPLE APPARATUS THAT SENDS A WAVE OF THE HAND BY RADIO

*The inventor, C. Francis Jenkins, is placing his hand in the stereopticon which throws a beam of light on the multiple-lens disk. This disk impresses a picture of his hand upon the light-sensitive cell (which is across the room and not shown in the photograph) and this cell translates variations in light to variations in electricity.*

up every sixteenth of a second. Prismatic disks that produce only one picture a minute are obviously too slow.

So Mr. Jenkins has devised a new form or disk, that contains lenses that combine the function of covering the picture vertically and horizontally. In the apparatus that he demonstrated, the disk was so made as to produce one complete picture with each revolution. It contained forty-eight lenses in all. Each of these was, in effect, a combination of a rather flat convex lens and a prismatic lens. The lenses varied by having the prismatic part thick on one edge for the first lens and then gradually changing their angles until the thickness was on the other edge for the last or forty-eighth lens. For all lenses the convex portion was the same. Thus in this compound lens both horizontal

and vertical motion of the light was obtained. The forty-eight lenses forming a prism of varying angles shifted the scene once horizontally, while each convex lens by its vertical motion swept the scene over the light-sensitive cell in one-forty-eighth the time of the horizontal shift. Thus each scene was impressed on the cell as forty-eight horizontal lines spaced close together. The speed necessary for the production of continuous motion in the radio-vision receiving apparatus was sixteen revolutions a second or 960 r.p.m.

Exactly the reverse process takes place in the radio-vision receiver. The dismembered scene enters the lamp of the receiver as a fluctuating current, strong where the light of the transmitted scene was strong, weak where it was weak. Faithfully the lamp repro-



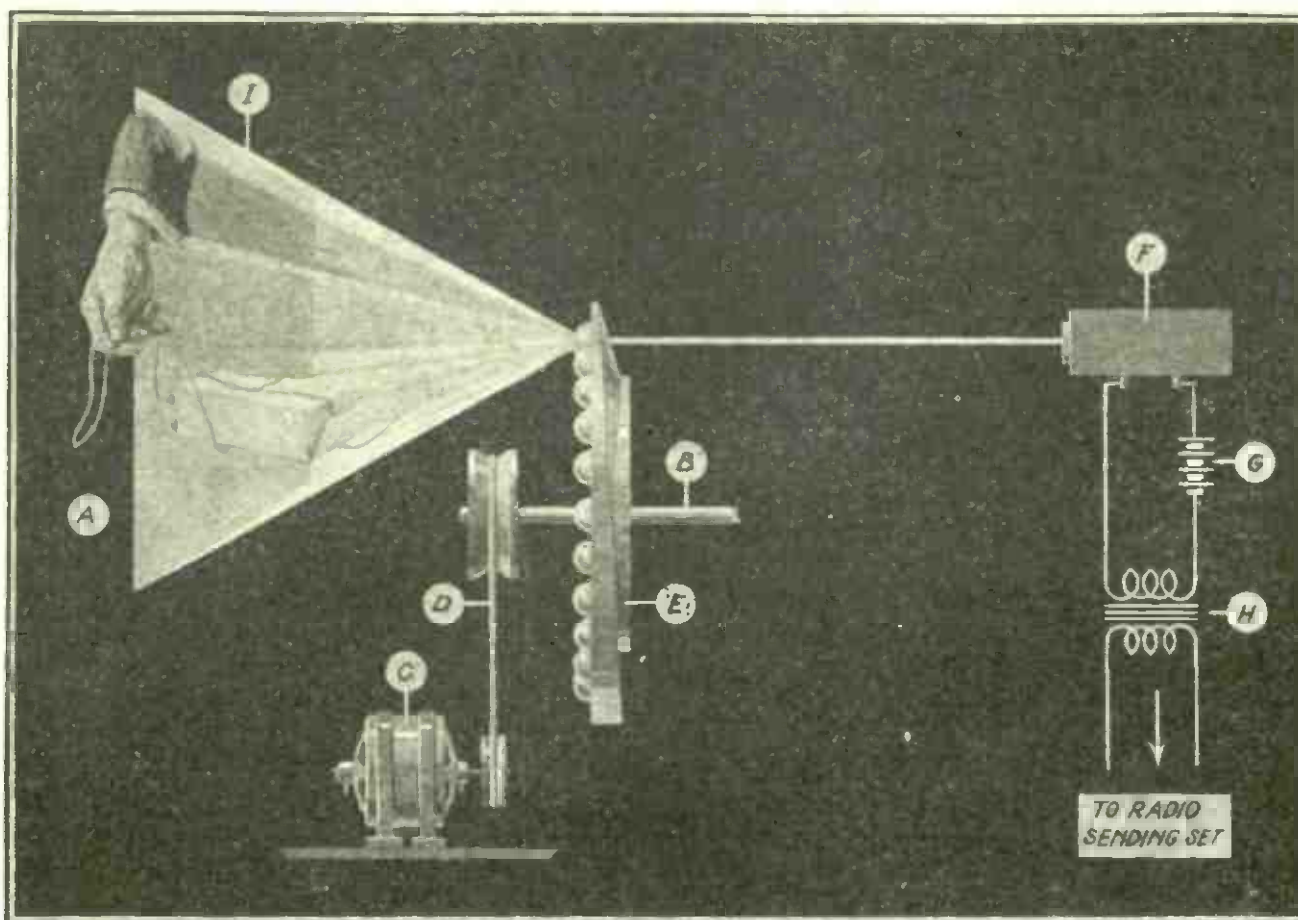

From a drawing by J. H. Picken for POPULAR RADIO

### THE RADIO TRANSMITTER FOR MOTION PICTURES

*The light I, from an object A, is focussed one strip at a time, through lenses on the rotating disk E, onto the light-sensitive cell F. Electric current from the battery G, is modulated by the light and sent out by radio in the usual way.*

duces light, and the whirling disk with its dual-purpose lenses sweeps the scene on the screen just as its twin in the transmitter swept it on the light-sensitive cell.

It is a shadowy wave of the hand or movement of the fingers that is produced. A picture composed of only a few horizontal lines, varying in light intensity along their lengths, can not be expected to be very distinct or detailed.

But even shadowy motion such as was produced was a demonstration of the important possibilities that the method holds. Increase the number of lenses that produce each picture to several hundred and the detail will come.

In another important way, the radio-vision apparatus differs from the radio-pictures outfit. The light source in the

receiver must vary quickly with variations in the incoming current. The ordinary lamp that is speedy enough for still pictures by radio can not make the pace necessary for radio vision. Mr. Jenkins is using a corona glow lamp, in which the gas around the internal electrodes gives off the light. The lamps are filled with neon, one of the rare inert gases. With this kind of lamp the lag is sufficiently small but the intensity of light is not great and efforts are being made to obtain lamps of the same principle that are more suitable.

The question of synchronism, of keeping the disks of the transmitting and receiving sets running exactly together, Mr. Jenkins says, is a simpler problem in radio vision than in radio transmission of pictures. The pulleys used are conical and the speed of the

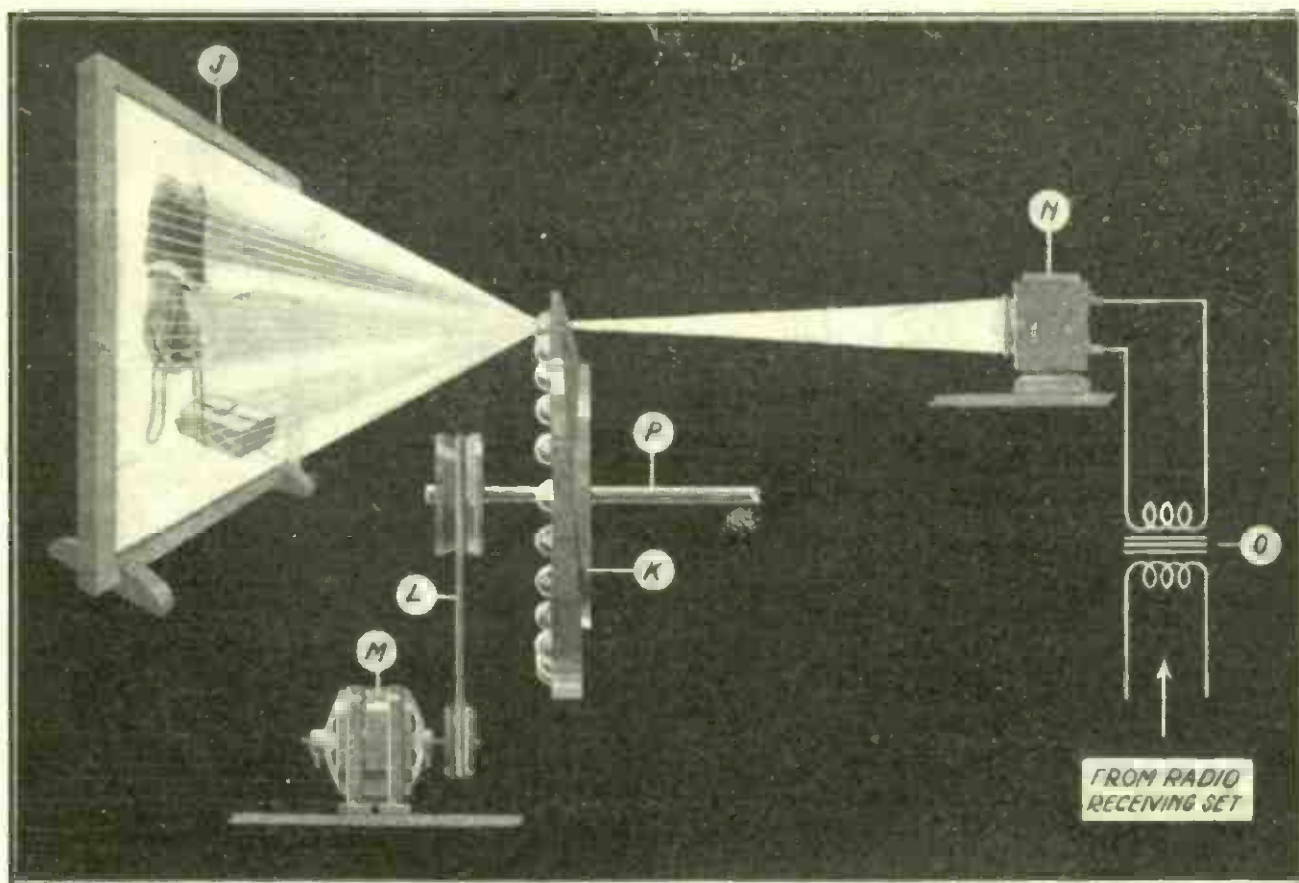

From a drawing by J. H. Picken for POPULAR RADIO

#### HOW THE RADIO MOVIES ARE RECEIVED

*Radio impulses are communicated through the transformer O, to the device N, which reconverts them into pulses of light. These pulses, passing through the lenses on the rotating disk K, produce an image of the original object on the screen J.*

disks can be regulated by sliding the belt slightly to such a degree that synchronism can be obtained more easily than the picture is framed in ordinary motion-picture projection today. In the experimental set that was demonstrated, disks of both the transmitting and receiving sets were driven from the same motor for the sake of simplicity in operation.

The transmission of pantomime by radio has been accomplished. There is no reason why the receiver should not have been in New York rather than in Washington next to the radio-vision transmitting set.

The perfection of the invention has not yet reached the point where actual scenes in all their lights and shadows can be reproduced or motion pictures distributed to the hearth and home. But the experimental apparatus devised by Mr. Jenkins gives promise eventually of

our being able to see in New York at nine o'clock in the morning what "will occur" the same afternoon at two o'clock in London.

Mr. Jenkins simply moved his hand and fingers when he made his demonstration. With those moving shadows radioed on the screen, I could hardly refrain from hoping that he would form a shadowy rabbit or bird with a long neck or some other strange animal such as all of us have made or seen for the amusement of children. Tony Sarg and his marionettes might well produce pantomime by radio vision when the process is slightly perfected.

In fact, it is a hope of Mr. Jenkins that he will be able to devise a low-priced piece of apparatus that will take pantomime entertainment into the home just as bedtime radio stories now are received with so much glee by eager childish ears.



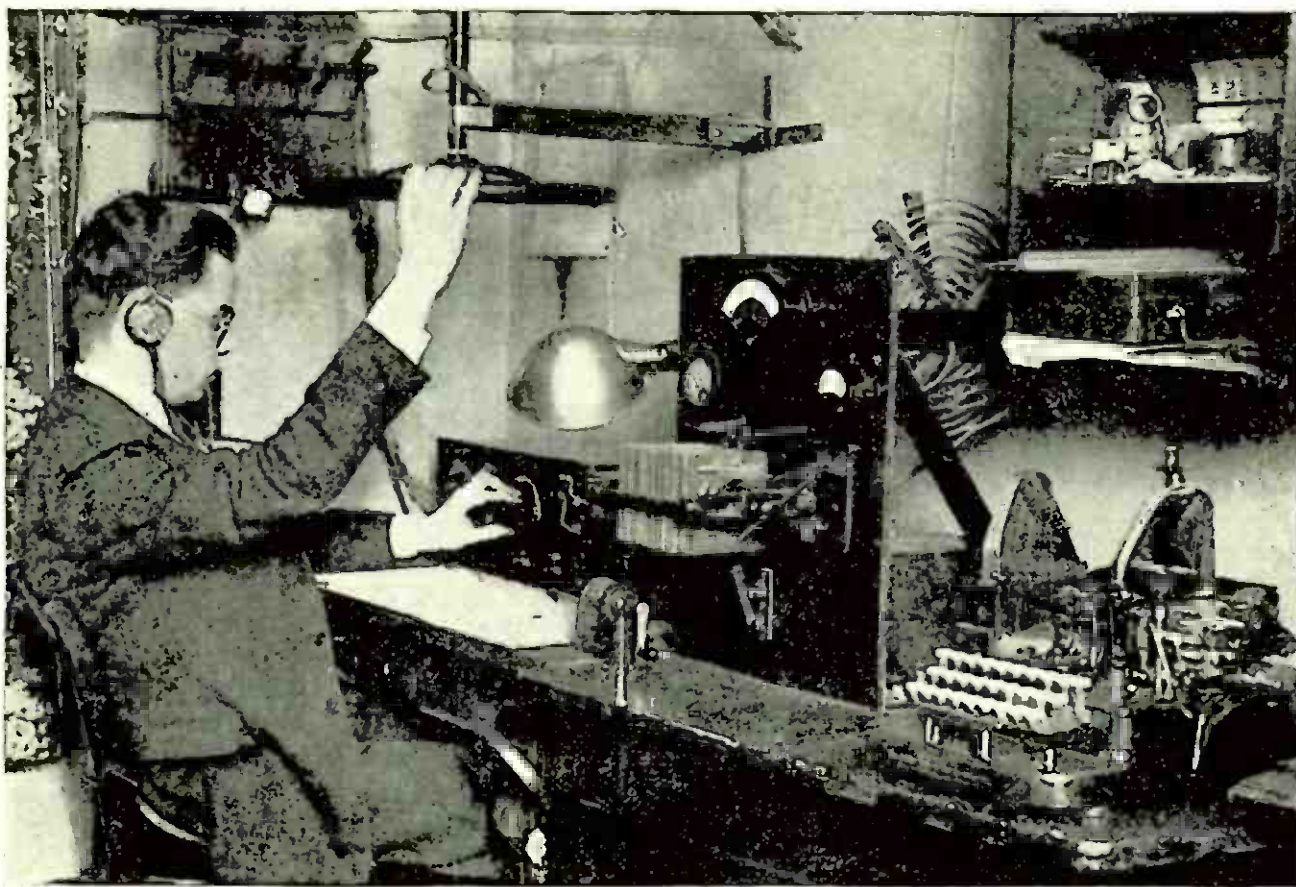

Kadel & Herbert

### A YOUTHFUL RADIO AMATEUR WHO SERVED HIS COUNTRY IN WARTIME

*Wendell Kilmer, whose station 2KX is known to amateurs in the east, rode his hobby to such good effect while the German-owned station at Sayville, Long Island, New York, was in operation that he was given special permission to operate during the war period.*

## HOW RADIO IS MAKING THE AMERICAN BOY “A Citizen of the World”

During a recent conversation, Forrest Crissey, the well-known author, told the incident that first awoke him to a realization of the tremendous effect that radio is having upon civilization. The incident was so interesting—and so significant—that the Editor asked Mr. Crissey to tell the story to the readers of POPULAR RADIO. This is it.

ALTHOUGH I am not of those who find themselves and their own thoughts intolerable company—for a day or even an hour—I suffered a sense of well-nigh sickening loneliness as I climbed a series of richly wooded hills in “Old Chautauqua” County to spend a night with a boyhood friend.

“What a desolate place,” was my inward exclamation, “in which to rear a family of children!” The wood-colored house stood on a side hill and was al-

most encircled by dense woods of hard maple, beech, birch and hemlock—huge and towering trees typical of New York State.

Before I followed the lane leading from the main road to my destination my thoughts went back to my own boyhood in that same county—but on a farm far more open and friendly, and much less remote from neighbors—and I recalled, as distinctly as I smelled the moist, woodsey odor of the forest

through which the lane wound, the feeling of complete isolation which often assailed me as a child on the little farm in the snug and verdant Bear Creek Valley. How easy it had been, then, to imagine myself a Robinson Crusoe cut off from all contact or communication with the great world of busy, happy human beings who did not know solitude, isolation, loneliness.

This recollection was so vivid, so compelling, that I sat on a moss-grown boulder to give a few minutes of pity to the small boy who had felt so much alone, so wholly separated from the great world outside Bear Creek Valley, in the years of my country childhood. Instantly I was drawn into a survey, an inventory, of my contacts with "the world without." Of a truth they were pitifully meager: the regular Sabbath pilgrimage to the little white church in the village of Stockton. If a returned missionary, intent on drawing a few dollars from the congregation, was permitted to occupy the pulpit and relate harrowing experiences among benighted and bloodthirsty savages of remote and heathen lands—the occasion was never to be forgotten.

Then there were the visits to our home of a friend of my father's from Ohio, who told thrilling experiences of his life in the south after the Civil War—and smoked fragrant cigars in the sacred "front parlor" as he related his "Carpet Bagger" narratives. Here was a Man Among Men, a Citizen of the World! From my slippery perch on the haircloth stool beside the marble-topped center table I hung on his words with avid and thirsty delight.

Then there were the annual visits of the itinerant craftsmen and peddlers—a hunched old "infidel" tinker who carried his tools in a tin box slung from a shoulder strap; a swarthy essence vender, reputed to be "part Indian" who carried his aromatic distillations in brown jugs and applied his art of salesmanship by touching

the tip of my tongue with the small end of each cork; a sleek, perfumed "watch peddler" who carried cases of marvelous pocket timepieces, pillowed against dainty satin; and a glib and merry Irish vender of linens and laces. These exciting visits were, in the main, my world contacts.

As I sat on the moss-grown rock taking stock of the limitations of my



Keystone

#### A HOME-MADE SET AND ITS BUILDER

*A representative of the great army of young American radio fans—in this specific instance Master Joseph S. Frelinghuysen, Jr., the son of Senator Frelinghuysen of New Jersey.*



boyhood—before pushing on to the end of the land to pay my old friend a surprise visit—I felt a wave of pity for the loneliness of his boy, more completely shut away from companions and a wholesome and cheering contact with the world of affairs than I had ever been down in the valley where neighbors were nearer. Yes; if opportunity opened, I would point out to Tom the injustice which he was doing his alert young lad by isolating him on this remote, timber-walled hill farm. There was a message for that father—and he would get it if he gave me half a chance!

The boy didn't appear until dinner was on the table. My eyes instantly searched his face for tell-tale signs of his loneliness. They were not in evidence. Instead he seemed strangely at ease, wholesome, natural, happy. The shy wistfulness of the isolated and the lonely was utterly lacking in his eyes. Instead they seemed to carry the hint of an eager surprise held in abeyance with some difficulty. Occasionally he exchanged glances with his mother which seemed to say:

"Aren't we going to show this friend of father's a thing or two? We'll open his eyes!"

Then the solution of the mystery came to me: After supper he was going to bring out the family checker-board and "stump" the visiting stranger to a game. This inspiration brought back to me the marvelous relief to evening monotony which came with the first checker-board that had cheered our home. And how I hated checkers now! But I would have to make the best of the ordeal for the sake of good-fellowship to the lonely and isolated young son of my host.

As we arose from the table the boy winked at his mother and, with rather well-suppressed eagerness asked:

"Like music?"

Being morally certain, from casual inspection of the family living room

and the parlor, that the roof did not cover a talking machine or piano, I recalled my own boyish experiments with the harmonica—and feared for the worst! What an instrument of family torture that shining rectangle of cells had been in my lips!

I think the boy must have sensed something of my fears for a half-amused grin overspread his face as he opened the door into the traditional "downstairs bedroom" and invited me to be seated in the Boston rocker which I recalled as my favorite resting place in his grandmother's sitting room.

As he drew a dark cover from a wall table and revealed a radio set of impressive proportions I was stunned into silence.

The boy's tongue was loosened and he became an easy, well-poised master-of-ceremonies, remarking:

"I put all the money I earned in grapes, over Brockton way, into this set. Cost quite a lot, but it's worth it. I can pick up Los Angeles, when conditions are good—had Chicago last night clear as a bell. Well; I'll tune up and see what we can get."

As his deft hands flashed from one tuning device to another his mother whispered:

"He'd rather stay at home and work that thing than go to a party or a picture show in town. Can't drag him away. And before he had his first little set he was wild to go out—said it was as lonesome as a graveyard up here away from everybody and everything." She hesitated a moment and then confessed: "He was getting to be rather a problem and we were anxious. But that's all past now. He's changed a lot, too, since he took hold of radio—developed! I can see that he's getting an education in ways and things that would have been beyond him if he hadn't become so carried away with this. I don't mean in electricity or mechanics or whatever it is that he's forever studying into in the



Keystone

#### YOUNG AMERICA LISTENS IN ON THE WORLD

*No longer are the affairs of men as a closed book to the American boy; they are matters that are brought close to him by the magic of radio. And their personalities and their problems are becoming known to the younger generation in a way that was never before possible.*

magazine which he takes and the books which he buys; I mean in the things which he hears over the radio.

"Why, the other day we heard President Harding speak just as plainly as if he'd been in this house. The next day Junior talked about what Mr. Harding had said in a way that showed me how the President's message had sunk in. He wouldn't have read it in a newspaper—but he took it in over

the wireless. It's the same way with music, he—"

"Here's KDKA," interrupted the boy. "Generally have good concerts at Pittsburgh—real artists, not the jazz stuff. Like a little jazz now'n then, but—"

A clear soprano cut in—for the boy's set boasted an excellent amplifier—and not a word was spoken in the room until the last silver note trailed into silence.





Harris &amp; Ewing

**A BOY'S TRANSMITTER THAT WAS HEARD IN SWITZERLAND**  
*Station 3ZH, located in Washington, D. C., is operated by the youthful Herbert Hoover, Jr., who is making a name for himself quite independently of his famous father.*

"Now," eagerly exclaimed the lad, "I'm going to try for Los Angeles. Like t' show you what this set 'll do. If it was a clear, still winter night I'd be almost certain of tuning in on any station in the east—but you never can tell in other seasons."

We waited with a breathless expectancy that amounted almost to suspended animation while the boy deftly adjusted his instrument. One moment he shook his head as if in despair, then suddenly thrilled with recovered hope—reaching out across the old Western Reserve, the Mississippi Valley, the Great American Desert, the Rockies and the plains and valleys of California for the sound of a voice in the City of the Angels which the old missionaries had established so many, many years ago! And the boy turned a face shining with triumph upon us as the strains of Chopin's *Moonlight Sonata* became audible—distinct, silvery and yet carrying in its delicate attenuation a hint of the far sweeps of mountains, plains, deserts and fertile lands between the player

and her four auditors in the remote, isolated hillside farm house in Old Chautauqua.

Isolated? The boy's eyes lighted with faith and prophesy and he forgot his youth and our maturity as he exclaimed:

"Some day I'll pick up London and Paris just as we have Los Angeles—and that's coming soon, too. Just think of our hearing the Premier of Great Britain speaking to a London audience or a grand opera star singing in Berlin—hearing it right here in our own farmhouse a few miles from the shores of Lake Erie! I'm going to have the outfit that'll do it, no matter what it costs. It's so, so—well, gee! I've just got to, that's all!"

"Yes," I responded, "I think you're right!"

Then I laughed and related my reflections as I had sat on the big stone half way up the lane—my memories of the isolation and loneliness of my own childhood, in the little valley a few miles below, my pity for young Tom.

"And," I added "you and your radio have opened my eyes to the fact that you are a Citizen of the World compared with the boy I remember. You are ages older, wiser and more alive than that Crusoe-like youngster. Theoretically I have known that the radio is a marvelous thing, a great, vibrant, vital and distance-annihilating thing. But its reach into the realm of boyhood never occurred to me until tonight. I shall always count this as one of the most revealing experiences of my life. It has given me a new definition of radio. The voice that can reach and dispel the isolation of the boys in the remote homes of American farms and ranches is certainly the voice of a new

Evangel that can not be stilled."

"You bet," was the boy's enthusiastic response. "Why; it makes me interested in almost everything, everywhere. I read up a lot about what I hear by the radio. Just do it because I want to—not because anyone tells me to. I get interested in a lot of things and follow 'em up in my reading. If I had to choose between going to college and giving up my radio—pushing ahead with it as fast as it's developed by the big men who are working in it—I think I'd stick with the radio."

And my reply to his unaffected fervor was:

"I'm not so sure but that you are right."

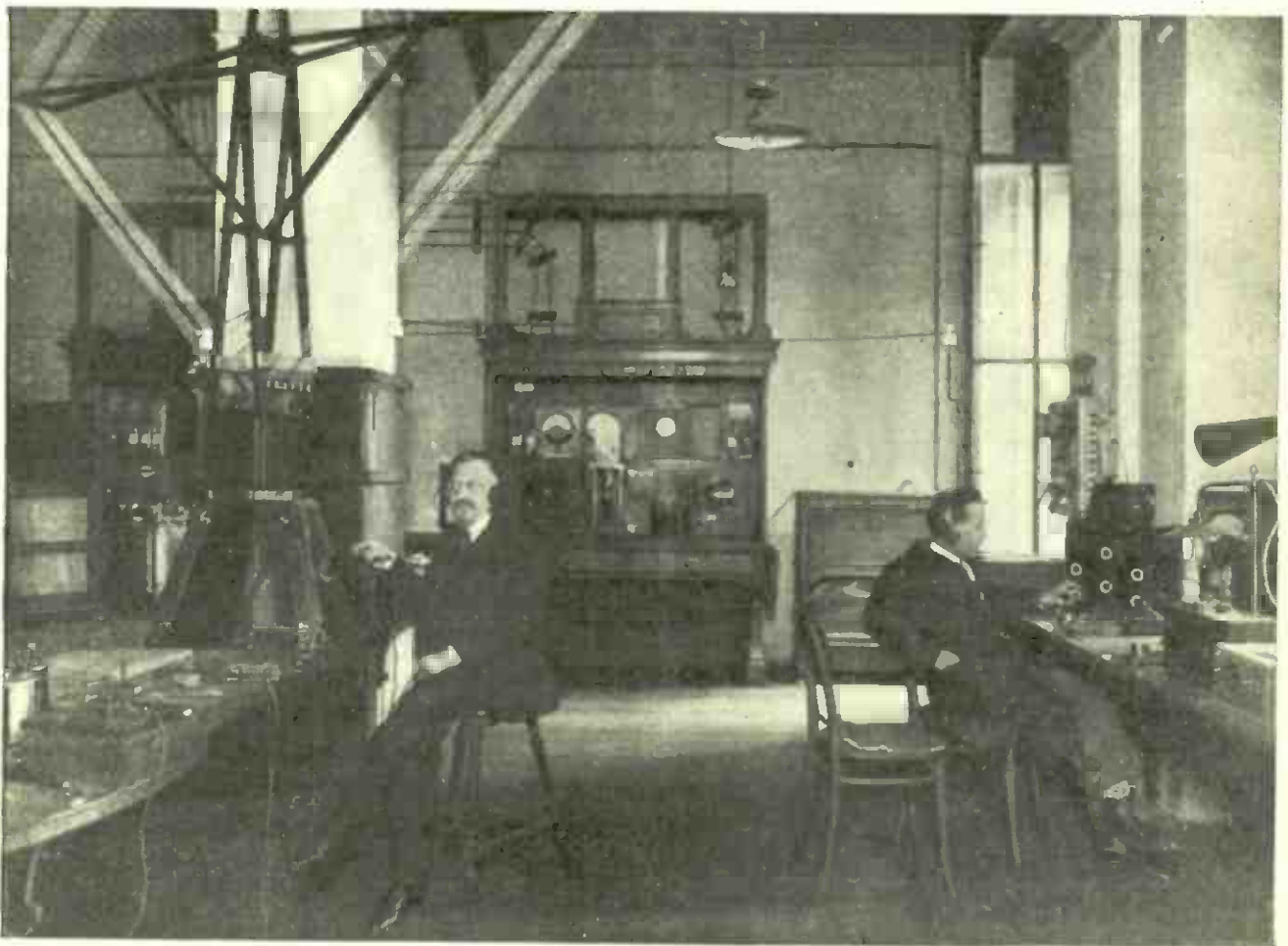

From a photograph loaned by Armstrong Perry

#### THE EXPERIMENTAL LABORATORY IN AUSTRIA'S RADIO SCHOOL

*The loop aerial (at the left) was built under the direction of Dr. Max Reithoffer, who appears in the picture. The loop has a tuning range of 7,500-15,000 meters. At the right is an assistant who is bringing in radiophone stock-market reports from Berlin, with the aid of an outside aerial, four stages of radio-frequency amplification, detector, two stages of audio frequency and a loudspeaker.*





From a photograph made for POPULAR RADIO

## How to Select YOUR RADIO PARTS

Have you ever been undecided whether to buy an instrument for your set at \$2.50 or \$5.00? Have you ever bought a condenser because it "didn't cost as much" and have the plates loosen up so that you could not make a proper adjustment? Have you ever bought paper condensers when you should have bought mica ones, or vice-versa? In other words, do you REALLY know how to choose the parts for your radio set? This article tells you how.

By S. GORDON TAYLOR

**I** HAPPENED to be at a friend's house the other day when his fourteen-year-old youngster came in with a big package of parts that he had just purchased in a downtown radio store. He had been hoarding his money for months until he had saved enough to purchase parts to build a set that would enable him to "pick up Pittsburgh and Chicago." At last he had accumulated the required sum and here he was, all ready to start assembling the receiving set of his dreams.

He spread out his purchases on the table with the air of a world conqueror, but the exhibition was pathetic. The collection of junk he had brought home was almost valueless to a radio circuit. He would probably develop gray hair long before he succeeded in

getting his set into working order.

He had figured on paying a reasonable price for his parts but when he looked around in the stores he found many parts could be obtained for prices considerably lower than he had figured. He immediately began to picture his set with one stage of amplification and in order to make his money cover this added list of parts he had purchased the cheapest of everything.

Had this beginner gone ahead to make his set of these parts it is doubtful whether he would have obtained even fair results. His father came to the rescue, however, and saved the day by supplying enough cash to enable the boy to exchange his junk for some really usable parts.

Usually, however, the novice who

gets "stuck" does not get off so easily. The moral is plain. Anyone who buys radio parts or sets will do well to call on a friend who really knows something about the points to look for in selecting instruments.

Unfortunately every beginner does not have among his friends an experienced fan who can help him. For them the following suggestions will prove helpful:

In the first place, all cheap instruments are not bad nor are all expensive ones good.

As a general rule it pays to buy the best one can afford. The very cheap articles should be avoided by all means. It is usually a safe rule to make a practice of paying a little more than the medium price. For instance, an article may run anywhere from \$1.00 to \$5.00 in price, according to the make. In such a case a price of \$3.00 to \$4.00 will usually assure good quality.

When selecting a part see that all contacts on the apparatus are well made and positive in their operation. In some variable condensers and variometers, for instance, electric contact is made by means of a shaft rubbing against the bearings. Frequently such a contact is *not* positive. A direct flexible wire connection is to be preferred. This is called a "pigtail" connection and is made by connecting a wire or coil-spring between the shaft and bearing in such a way that the shaft can turn freely but still maintain a positive path for the current whether or not there is a good contact between the shaft and bearing.

Here are some points to watch out for in purchasing individual instruments. For the sake of convenience the items have been arranged in alphabetical order:

**ANTENNA WIRE**—For the average antenna the regular seven-strand copper antenna wire is excellent. Single-strand copper wire will give good results, but it is not quite as strong as the seven-

### STIFF CONNECTION

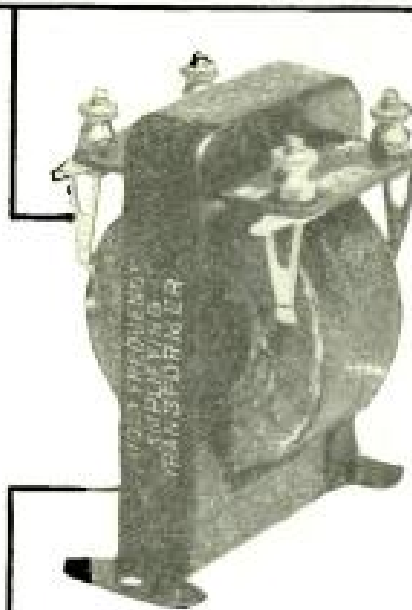

### CORE CLAMPED TIGHT

**AUDIO-FREQUENCY TRANSFORMER**  
Be sure that the wires running to the terminals are protected. The core laminations should be clamped tightly together to prevent vibration on loud signals.

### ROTATABLE 180°

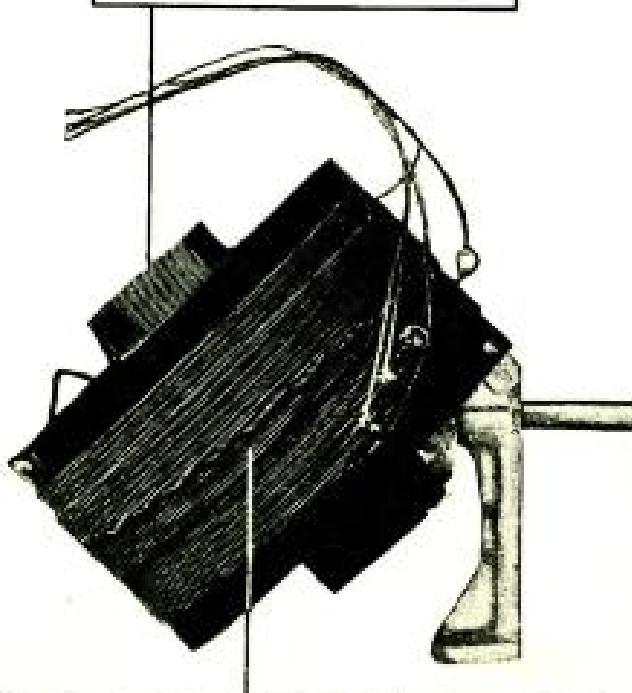

### NO SHELLAC ON WINDINGS

#### VARIOCOUPLER

A finer tuning is assured with a variocoupler which is rotatable throughout 180 degrees. The windings should be wound dry.



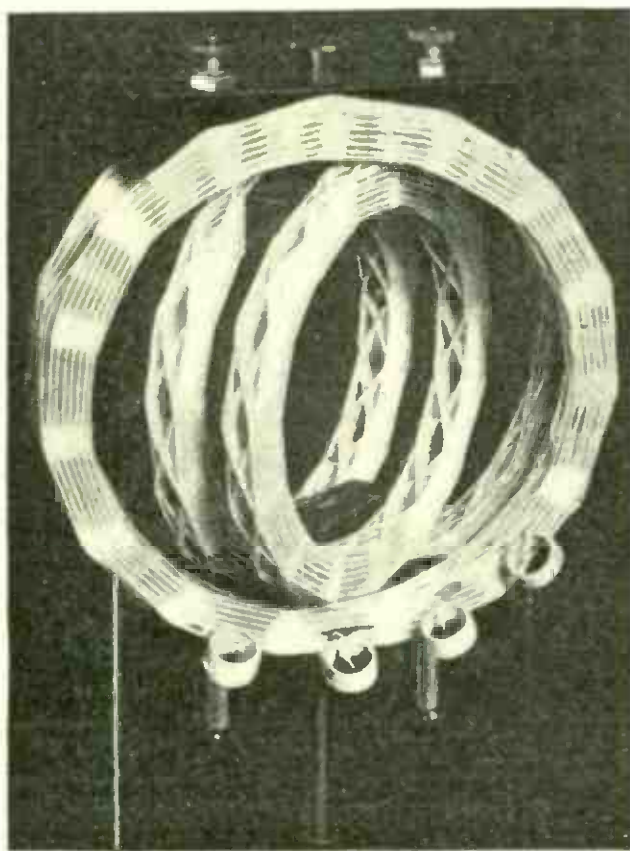

### LOW DISTRIBUTED CAPACITY

#### VARIOCOUPLER

*A new type of winding which reduces distributed capacity to a minimum.*

strand wire nor does it give quite as loud a signal, although this latter point is almost negligible.

**ANTENNA INSULATOR**—Regular porcelain cleats are inexpensive and serve the purpose as well as anything for receiving. If composition insulators are used, buy the best, because some of the cheaper ones have a tendency to allow the end rings, through which the wire is passed, to pull out, thus causing the antenna to fall—a most exasperating occurrence, to say the least. If porcelain cleats are used be sure that they are glazed, otherwise their insulating qualities are affected by the absorption of moisture.

**BATTERIES**—When buying batteries the safest guide is the price. In almost every case the battery will be sealed or so inclosed that the inside cannot be seen, whether it be storage, dry-cell or

“B” battery. Everyone is too familiar with the ordinary dry cells (such as are used to operate the WD-11 tube) to need any instruction on this point. In the case of storage batteries it is well to stick to recognized makes. They may cost more but they have “quality”; that is why they are well known. Storage batteries such as are used for the lighting systems on automobiles are good for radio work. Most manufacturers of storage batteries make a special type for radio and those are the best to buy. The size of the storage battery is an important consideration, as one will realize after he has carried one two or three blocks to have it charged. If one must depend on a charging station to charge his battery then a small one rated at 40 to 60 ampere-hours is best. It will be necessary to have it recharged more often than the larger batteries but it is light enough in weight to be carried conveniently. If more than one vacuum tube is to be used, however, a larger battery of from 60 to 120-ampere hours is to be preferred. In such a case a battery charger will be needed so that the charging can be done at home from the electric light circuit.

Most of the “B” batteries on the market are good, with the exception of the very cheapest. Here again those recognized as best for radio work are those manufactured by well-known companies. Batteries of 22½ volts come in two sizes: small, and large. So do the 45-volt batteries. In either case it is best to buy the large size as they will last much longer than the small size, and in the end will be found cheaper. For use with detector tubes buy 22½-volt batteries. For amplifier tubes two or more 22½-volt batteries, connected in series, may be used, but the 45-volt battery is to be preferred as a matter of convenience.

**CONDENSERS (FIXED)**—Buy the best. Avoid the paper-covered variety. Often

the contacts are poor and they are loosely assembled as a rule. The better kind are assembled under heavy pressure and this pressure is maintained by means of a metal case or by impregnating with wax so that a solid block is formed. Condensers are rated in microfarads and one should be sure to obtain the proper capacity for the particular use to which the condenser is to be put. In most circuit diagrams the capacities of the condensers used are specified. In cases where they are not, the phone condenser is usually .001 microfarads and the grid condenser either .00025 or .0005 mfd. If a tubular grid leak is to be used in shunt with the grid condenser, a special condenser may be obtained with clips all ready to mount the grid leak. The better grade condensers, mentioned above, have a mica dielectric which is much better than the oiled paper used in the cheaper grades.

**CONDENSERS (VARIABLE)**—These condensers are a vital part of any radio set; it may truly be said that a set is only as good as the condensers that are used in it. Do not buy a cheap one because it will cause no end of trouble. First of all see that the moving plates do not touch the stationary ones as they revolve. The moving and fixed plates should remain equally spaced throughout the complete revolution. One glance is usually sufficient to enable even the beginner to tell a good condenser when he sees it because its mechanical perfection will be at once noticeable. It almost always follows that if a manufacturer makes a mechanically good condenser it will be good from the electrical standpoint also. Pig-tail connection between shaft and bearings, as previously described, are not essential but are an advantage. Large plates of very thin metal are considered less desirable than thicker plates of smaller diameter and the smaller condenser takes up less panel space. End plates of bakelite are suitable or hard

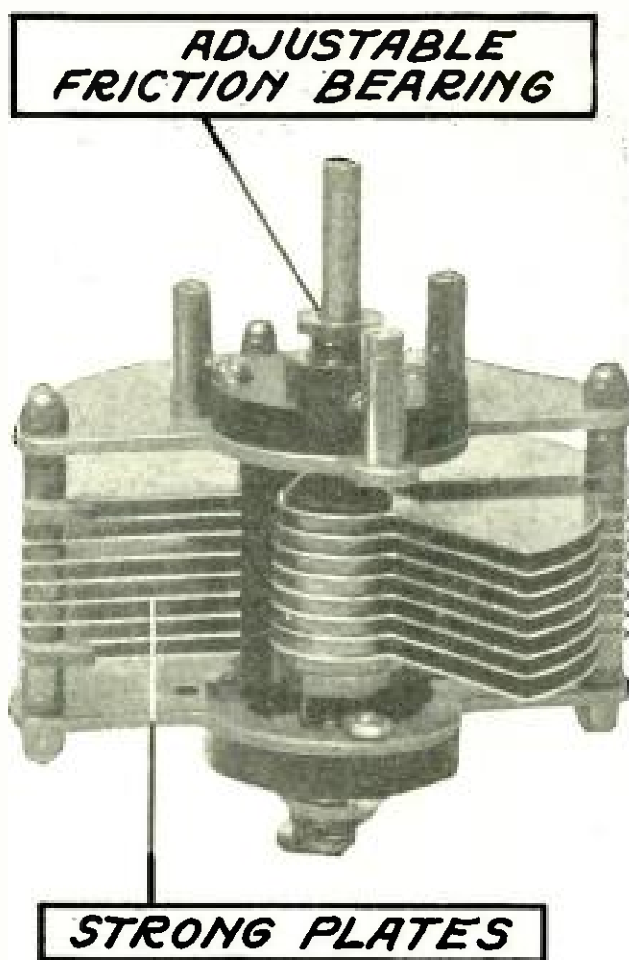

**VARIABLE CONDENSER**

*The plates should be cut out of heavy, flat, rigid material to prevent warping. One good point is an adjustable split-collar friction bearing.*

rubber plates are equally good, provided they are not less than  $\frac{1}{4}$ -inch thick so they will not bend under the pressure to which they are subjected by the tension of contact between shaft and bearing. Some condensers have end plates of cast aluminum. These are good and have the advantage of rigidity and lightness. Iron ends should be avoided. These will be found on some of the cheaper makes. 43-plate condensers have a capacity of approximately .001 mfd. and the 23-plate variety are of about .0005 mfd. For condensers which are used in a circuit that is critical in adjustment, as the average secondary circuit, or the primary condenser in a single-circuit set, a condenser with a vernier attachment is useful. The vernier may take several forms but the type I have found most satisfactory is the one consisting of





#### FILAMENT RHEOSTAT

*No matter what type of rheostat is used, the terminals should be accessible to facilitate connection.*

three extra plates mounted on the end of a regular condenser. This is really another variable condenser mounted right on the large one but it gives much finer tuning than the larger one.

**GRID LEAKS**—A grid leak may easily be made in a few minutes with a piece of fiber, two binding posts and a few pencil lines. The one objection to this type is that it may be affected by dampness or weather conditions or even by dust. On the other hand it has the advantage of being adjustable, the adjustment being made by simply adding or erasing some of the pencil marks. For ordinary use, however, the grid leak value is not critical, so this feature is not really important. In purchasing grid leaks the glass-tube variety is probably best. Usually a leak of about two megohms is the proper size but good results are often obtained with 1 or 1½ megohms.

**HONEYCOMB OR DUOLATERAL COILS**—There are few brands on the market

and these are practically standardized, both in price and quality. Care should be exercised in selecting a mounting. One which has calibrated coupling dials is to be preferred because then a notation can be made of the setting at which a certain broadcasting station can be best received and when it is desired to tune in the same station again the setting can be duplicated by referring to the notations. A useful refinement is the mounting which has extension handles. These make extremely fine tuning possible.

**JACKS**—Buy good ones and inspect them closely as even the best seem to have a tendency to be imperfect. First, look at the contacts carefully in the case of double-circuit jacks, to see that there is a good contact between the arms of the different circuits when the plug is or is not inserted. Make sure that the jack will fit the plug you intend using. Next, see that the screw which is used for mounting the jack on the panel will screw far enough into the frame of the jack to grip the panel tightly. If a 3/16-inch panel is used it will be found that most jacks will require an extra washer which the dealer will usually furnish. A jack that is imperfect can cause a great deal of trouble and one cannot be too careful.

**LIGHTNING ARRESTERS**—Insurance regulations require lightning arresters on every outdoor antenna and they further specify that only those approved by the Board of Fire Underwriters are acceptable. Therefore, purchase an approved type which bears the approval stamp of the board. There are two general types—those for outside mounting and the indoor type. It is advisable to use the outdoor type because in some suburban communities the insurance companies will not accept those mounted indoors, even though of a type approved by the underwriters.

**PANELS**—Many kinds of compositions are used in making panels. It is best to stick to well-known, standard materials, however, for then you will know what you are getting. Resinous compounds or hard rubber are perhaps the most commonly used. Hard rubber serves very well if it is screwed on the front of a cabinet to keep it from warping. If a cabinet is not used it may be reinforced with metal strips. Quarter-inch hard rubber will not usually warp unless very large panels are used. If a resinous compound is used the thickness need not be greater than 3/16 of an inch. Wood may be used for panels provided it is well seasoned. A three-ply veneer which has been given three coats of good white shellac makes a good panel and is somewhat cheaper than hard rubber and considerably cheaper than good grade compositions. Hard rubber is very easy to drill but in the case of compositions more care must be exercised to keep them from chipping where the drill passes through the back. Ordinary red or black fiber should be avoided because it warps badly unless strongly reinforced, and will absorb moisture.

**PHONES**—Headphones are an article that cannot be judged by appearance. Nor can they be judged by price entirely. *The rating in ohms means little*, as practically all phones used for radio work are rated at from 2,000 to 3,000 ohms a pair, whether they be good, bad or indifferent. A good pair may be purchased at present day prices for five or six dollars. They may not be the best but they will serve admirably for ordinary use. If phones are to be used on a horn with one or two stages of amplification, then a better grade phone with mica diaphragms should be used because the metal diaphragms in cheaper phones sometimes rattle against the magnets causing a "tinny" noise which is unpleasant especially if there is a large volume of sound. In

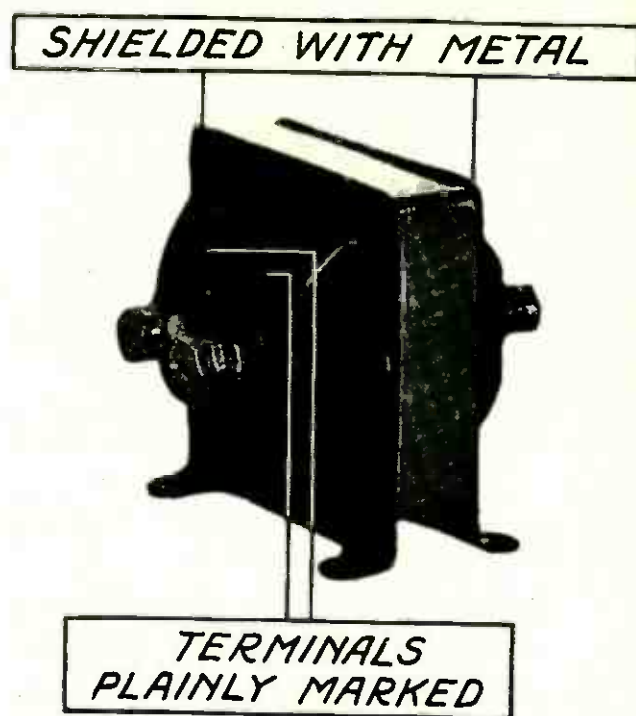

#### AUDIO-FREQUENCY TRANSFORMER

*A metal shield around the windings protects them mechanically and electrically. The terminals should be clearly marked for identification in connecting up.*

buying phones pick out a time when the dealer is not very busy and have him try out the different kinds on a receiving set and compare their volume and clearness. When you decide on a pair be sure that the two phones are well matched as to tone and volume—*test them both out on the same ear!*

**PLUGS**—Most of the plugs on the market are good; the difference in price is largely dependent on quality of workmanship. Selection is, therefore, a matter of personal preference as to shape and other details. Be sure that the means of gripping the receiver tips is secure and that the plug fits the jack in which it is to be used. I prefer the round type myself, because they may be changed from one pair of phones to another without the necessity of removing screws to take the plug apart.

**RHEOSTATS**—Many of the cheaper grades work very well. The contact arm should slide easily over the coil



**PLATES ARE LOCKED**

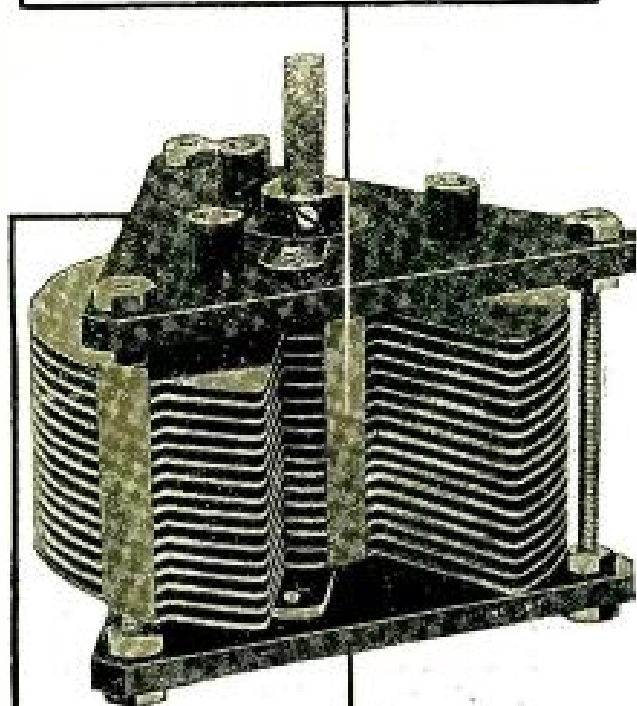

**INSULATED END PLATES**

#### VARIABLE CONDENSER

*A new method is to lock the plates together in a slotted strip of metal to prevent shifting. Wide spacing is obtained by using insulated end plates.*

of resistance wire but should at the same time make good contact. Some rheostats make good contact at some points but poor at others. In buying one, turn the arm, and see that the pressure is equal in all positions. A vernier rheostat is not necessary with amplifier tubes. With the UV-200 and other detector tubes a vernier is needed. For such tubes a good rheostat is the type which functions by increasing or decreasing pressure on carbon disks. In this type no resistance wire is used and extremely fine regulation of current is possible.

**SOCKETS**—All sockets are alike, the main differences being in the material used in the contact springs and the insulating material used in the base. Test the contact springs to see that they are springy, but fairly stiff, so that they will press tightly against the prongs on

the tube when it is inserted. It is difficult to judge the material in the base but a polished socket is always more dependable because where cheap composition is used in the base either it will not take a polish or else the manufacturers do not bother to polish it. This does not mean, of course, that all unpolished sockets are not good but one will be safer in buying one he is sure of. Make sure that nuts are furnished for all the binding posts. This may seem like an unnecessary suggestion but one can slip up on little things like this—and dealers are careless in this respect. Dry-cell tubes do not fit the ordinary socket. Special sockets may be purchased for these, but many prefer to use regular sockets with adapters so that either the WD-11, UV-199, or regular 6-volt tubes may be used without the necessity for replacing the sockets. Some WD-11-tube sockets are simply a flat piece of insulating material with four holes to fit the prongs of the tube and with springs underneath to make contact with the prongs. There is another type which is to be preferred, however. It is shaped exactly like a regular socket except that it has no slot in the top part such as is necessary with a standard six-volt tube. One socket of this type has the contact springs bent in such a way that they press on the side of the tube prongs rather than on the ends. This is an advantage because each time a tube is inserted these springs scrape the prongs clean so that a perfect contact is made.

**PANEL SWITCHES; SERIES-PARALLEL**—In general, switches are all alike except for workmanship. However, there is one point in which they vary—in the way in which the switch arm is held against the switch points. They have a bushing which is inserted through the hole in the panel and a nut is screwed on the back end to hold it tight to the panel. This is the bearing for the

shaft of the switch arm and the shaft is slipped through the hole in this bearing. Now there must be a means of holding the arm in this bearing and it is in this that switches vary. By far the best type is that in which another metal bushing, in which there is a set-screw, is slipped over the back end of the shaft. The set-screw is tightened up so that the switch arm can revolve freely at the same time maintaining a fair pressure of the switch arm on the points. Other types use two nuts for this purpose but the objection to this type is that the nuts frequently work loose, and when a switch is mounted on a panel it is not always easy to get at these nuts to tighten them. Switch points should have heads not less than  $\frac{3}{16}$  of an inch in diameter so that the holes through which they are inserted in the panel need not be too close together.

**TRANSFORMERS; AUDIO-FREQUENCY—**  
The beginner is up against an obstacle here. To the novice all transformers look alike—and to the more seasoned fan as well. However, there are good ones and bad ones. Don't be misled by advertisers' claims because a comparison of manufacturers' claims will show that most of them say the same things about their products. By all means obtain the advice of a friend who has tried out the different makes, if that is at all possible. Generally speaking, the higher-priced transformers are superior to the cheaper kinds. One cannot judge them from appearance because I have in mind one of the best that doesn't look as good as many of the cheapest. It is difficult to give detailed suggestions on this instrument. Your friend can advise you best because he can recommend certain makes that he has found to be good. A vacuum tube of low impedance requires a low-impedance transformer for best results. Do not believe everything you hear about certain transformers being

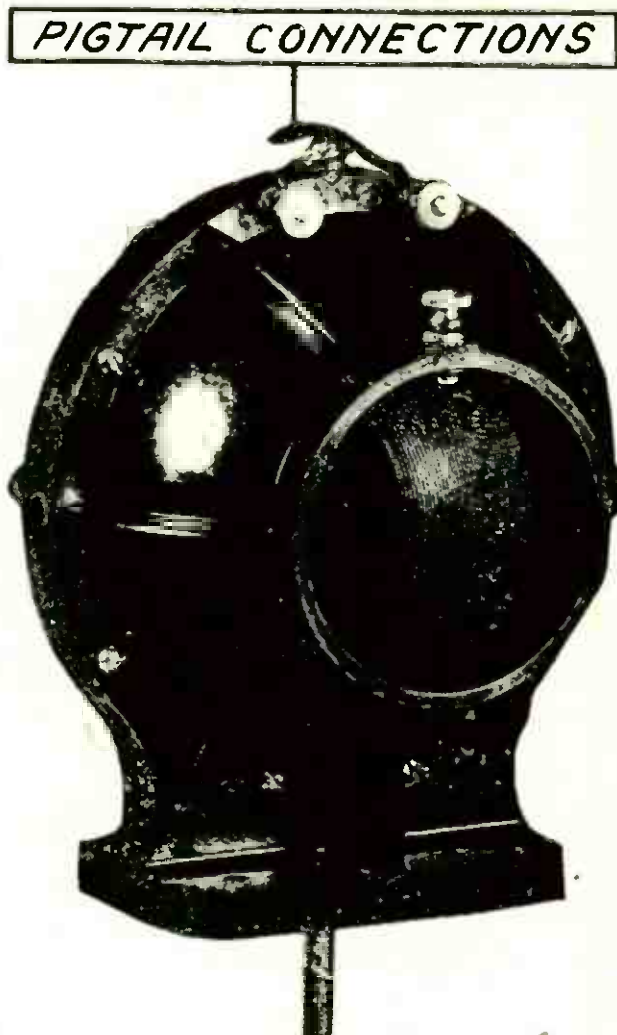

VARIOMETER

*The frame should be rigid and the rotation should be smooth. Pigtail connections to the rotor are advisable. If pigtails are used the instrument should be equipped with "stops" to prevent twisting off the pigtails.*

designed especially for use with the WD-11 tube. I have found that while some of these are fairly good they are no better with this tube than any other standard transformers.

**VARIOCOUPERS—**The most efficient variocoupler has two ball-shaped windings for the primary and secondary. In other words the secondary is wound on a wood or composition ball and the primary is wound on the *inside* of the stator or stationary form. This is not essential but is an advantage as far as efficiency is concerned. There are few made in this way and it may not be possible for the reader to obtain this type in his locality. If not the next



best is to obtain one which has two ball-shaped windings but which has the primary on the outside of the stator. Slightly less efficient than this is a third type which has the primary wound on a bakelite or other composition tube and the secondary on a ball just small enough to rotate snugly within the primary tube. Composition tubing is to be preferred to cardboard. Pigtail connections should be used to connect the secondary winding to its binding posts. Taps taken off the primary should be so arranged that in connecting them to the switch points the coil winding will not become loosened. If the coupler is to be used in a single-circuit outfit with the secondary acting as a tickler, the 180-degree coupler gives finer tuning and is to be preferred.

**VARIOMETERS**—It is essential that the two windings be ball shaped and that the stator winding be on the inside of the stator form with a minimum clearance between the two windings. Variometers with excessive glue, shellac or cement on the windings are not recommended. Wood is suitable for the rotor and stator blocks provided it is thoroughly seasoned. It is not an easy matter to tell by the appearance whether the wood is well seasoned or not, however, for that reason many prefer vario-

meters which are wound on composition forms. Pigtail connections are an additional assurance of proper operation. A last and obvious suggestion is that the purchaser make sure that the rotor does not scrape against the stator in revolving. If it does the insulation will soon become worn through and cause the two windings to short-circuit.

A last word of caution to the builder of a radio set; it may not be directly connected with the selection of parts but it is nevertheless relevant. When building a set do not try to plunge right in by making a five-tube outfit, or even one with three tubes. Start with the necessary tuning unit and a single detector tube and mount these instruments temporarily on a small board or panel. Then experiment with them until you know them thoroughly and have them working at highest efficiency. Then if you intend to add other tubes do so one at a time and become familiar with each part as you go along. When you finally have everything that is going into the finished set and all the parts are working properly, then go ahead and mount them on a regular panel.

If you follow this suggestion you will be well satisfied with your set and you will get the most enjoyment out of it.

---

### The New and Improved Four-circuit Tuner

*SINCE the publication, in the May, 1923 issue, of the Cockaday four-circuit tuner, there have been made and are now in use somewhere between 200,000 and probably twice this number of these sets. Since the article was published there have been so many improvements and changes in the circuit that the inventor has written another article, explaining how to build the set with these new and important developments incorporated in it. The four-circuit tuner de luxe with one stage of power amplification will be described in the January issue of POPULAR RADIO. This set will get anything in the United States on a loudspeaker, consistently, through the local stations, without interference.*

---



From a photograph made for POPULAR RADIO

THE SUBCONSCIOUS MIND MAY BE REACHED BY SOUNDS  
WHILE THE STUDENT LOSES CONSCIOUSNESS

*In all cases sleep-listening to the code will help to master it; in some cases the results will be phenomenal.*

## Learning the Code While Asleep

How the progress of students may be increased as much as 100 percent by an appeal to the subconscious mind

By KENNETH M. SWEZEY

THE young aviators of the Naval Air Station at Pensacola have been successful in their attempt to become more proficient in the code by listening-in while they were asleep.

At first thought, such a proposition seems so revolutionary as to be almost foolish, but it seems so only because the principles involved are not generally clearly understood. The underlying theory is perfectly sound, and the practical application is not difficult, if the problem is approached properly. Furthermore, a knowledge of the why and wherefore and the how of these phenomena is of value to every individual operator who is willing to give it a trial.

The first observation of anything of this sort in the radio world was made, so far as I know, by Mr. Laurence M.

Cockaday in 1918 while he was instructing in radio theory and operation on the U. S. Training Ship *Granite State*. Mr. Cockaday found that code students made about 100 percent better progress in learning code when messages, sent with a buzzer and received on a pair of headphones, were received in the evening just before retiring, than when the code classes were held early in the morning. In fact, code classes held just before "taps" were found to be at least 100 percent more efficient than those held at any other time during the day; that is, the evening classes ultimately learned the code in about one-half the time needed by the classes that got their practice at other times during the day.

In a report to the commanding officer



made at that time Mr. Cockaday suggested that these experiences were probably explained by the fact that the students were able to sleep with the code firmly fixed in their minds without any other thoughts intruding for a considerable period of time. It was recommended that the students practice the code shortly before hammock-time, so that they could "sleep on it."

These observations do not seem to have attracted much attention at the time, and the matter remained unnoticed until the recent tests at Pensacola. Several experienced operators have assured me, however, that if one falls asleep with the phones on his ears, or if one is reading a book and not paying particular attention to what is coming in, code messages may be received unconsciously. On waking or on coming out of his "brown study," the operator is likely to find fixed in his brain the meaning or even the exact words of

messages that were received while he was inattentive.

The following paragraphs attempt to give an explanation of these phenomena in the light of modern psychology, and also to describe a fairly positive method of carrying out this learning-while-asleep procedure most satisfactorily.

First let us consider the mind.

This complex something is not a unified whole, as is generally supposed. It is divided into two main divisions, the *conscious* mind and the *subconscious* mind.

The conscious mind is our reasoning mind; our volitional mind. With it we make our decisions, solve our problems, cause our arms and our hands to move, talk, become conscious of what we hear and what we see, and perform all other duties and functions that are under the direct control of our will.

The subconscious mind, in our present stage of development, is quite dis-

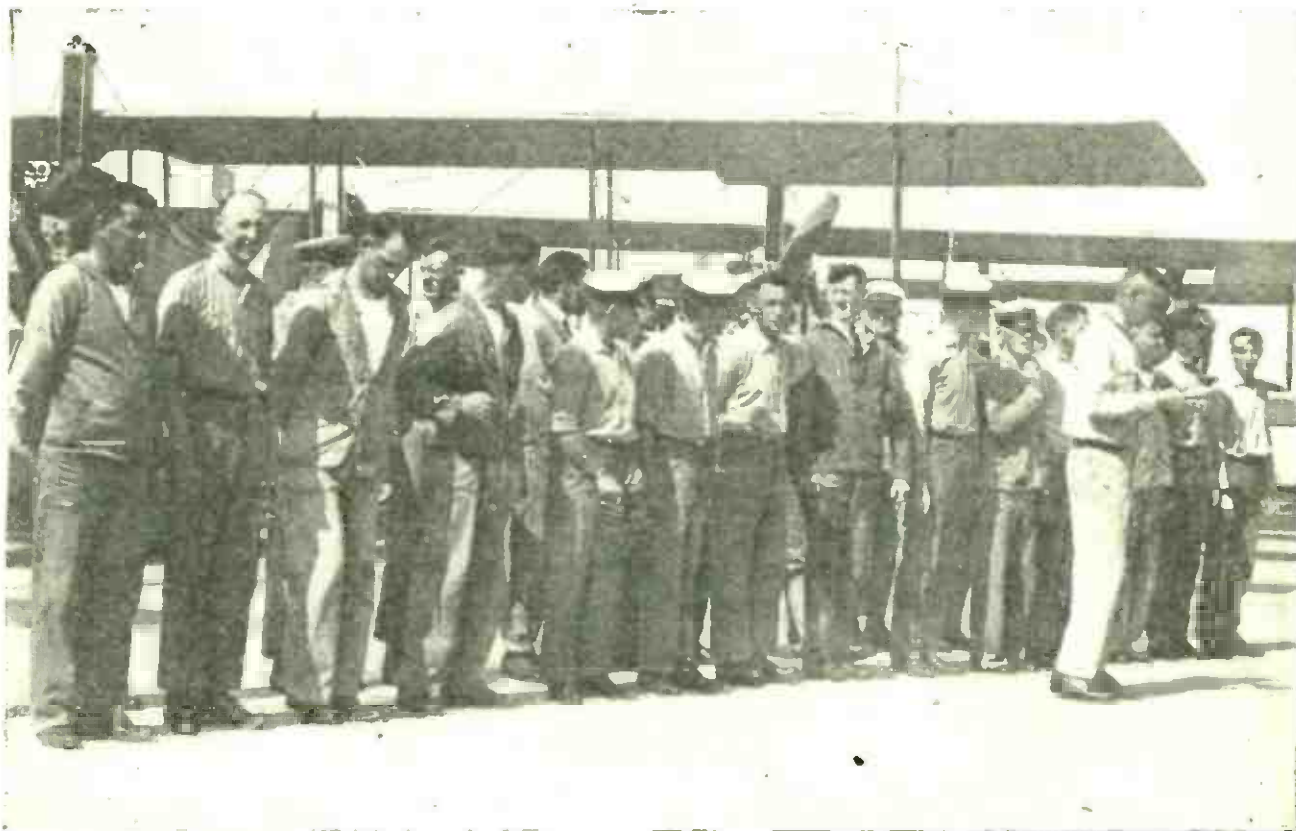

Official photograph U. S. Navy

**HERE ARE THE MEN WHO ARE LEARNING THE RADIO  
CODE WHILE THEY SLEEP**

*Upon this group of students at the Naval Air Station at Pensacola, Florida, the Navy Department is conducting a novel and apparently successful experiment.*

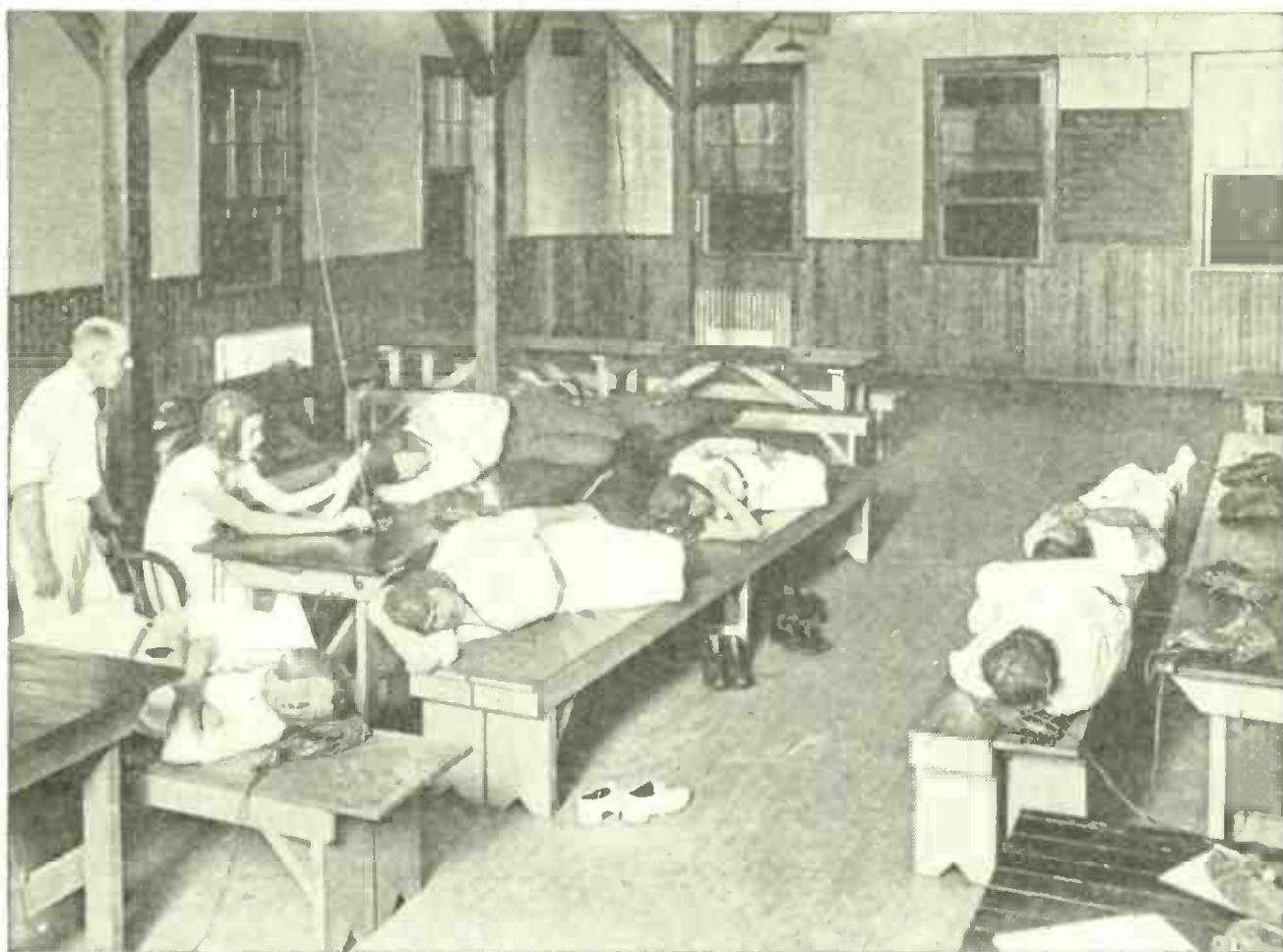

International

### THE ONLY CLASSROOM IN WHICH SLEEP IS PRESCRIBED

*While the students of this remarkable school for naval aviators at Pensacola are dozing off with headphones over their ears, the operator sends a continuous flow of code messages.*

tinct from this conscious mind. It is an automatic, rather than a reasoning mind. It cannot make decisions of its own but must take the decisions that are handed down to it by the conscious mind, and carry them out. It is this subconscious mind that controls all the automatic functions of our bodies; such as the beating of the heart, the production and the repression of the gland secretions and the other body functions over which we do not have any direct control. The subconscious mind has an almost perfect memory of things impressed upon it. It is the photographic plate upon which our life's experiences are recorded. Its makeup determines our personality.

We are more subconscious than we might think; scientists tell us we are fully ninety percent so. Yet the vast

resources of this mind remain untapped by most of us for the reason that we have been living for so many centuries in the conscious, or superficial, aspect of our minds that we have forgotten how to go back.

Let us take an example:

We want to recall some incident of a week ago. I have said that the memory of the subconscious is almost perfect. How is it, therefore, that the particular incident we want has "slipped our mind?"

We may rest assured that the information we want is still with us, that it has not really slipped out. It has merely passed from the surface of our mind to the depths. If the incident had made any great impression at the time of its occurrence we would be able to recall it instantly. But evidently it did



not, so it has drifted to its permanent filing place. It is the same as putting our money in the safe and forgetting the combination.

The only thing to do in such a case is to let our mind rest for a few moments in a passive state or else to go about our work until the forgotten incident rises up from our subconscious mind and, as we say, "it comes to us."

Did you ever notice how difficult it is to concentrate on one subject for more than a very short time? Suppose you are studying code. Every few minutes some irrelevant thought floats into your consciousness and throws you off the track.

These are thoughts of the conscious mind. They interfere with reaching the subconscious and making a deep impression on it. When you are asleep you do not have them. The subconscious mind is reached more directly and is more deeply impressed.

This is especially true of things that enter your mind while you are in a partly unconscious, very suggestible state just before you go to sleep. These are the things you dream about.

In the same way thoughts you have just after awaking, when your subconscious mind is more easily accessible, are likely to be the ones that carry their impressions all day long.

Such was Coué's theory when he suggested that you say to yourself twenty times before retiring each night, "day by day in every way I am getting better and better."

When a person sleeps, he loses his consciousness—but that is all. The subconscious is as active as usual; otherwise life would be extinguished from the body. The subconscious may be reached from external sources, for example, by sounds.

Now we come to the application of the principles outlined to the studying of the radio code. Can it be done successfully, and if so, what is the best method to follow? In answer, it may

be said that in all cases sleep-listening will help; in many cases the results will be remarkable, and in a few cases phenomenal. The writer does not know exactly how the experiments were carried on at the Pensacola station, but if the following directions are adhered to, you are quite sure to get positive results.

Let us first mention the rules for doing the best work at ordinary daytime operating. Old-time expert operators might consider these externals all a lot of bosh; but you will find in all cases good operators follow them, even though they may not realize that they do so.

Select a seat that is comfortable, and in which you may relax as much as possible. Try to relieve every physical tension, by just "letting go" at the spot. Then try to make your mind a blank and to become passive. Throw out all the fool thoughts that fit up. Concentrate on the subject at hand—that of reception; and *perfect* reception. The relaxation and passivity as preliminaries will make the concentration easier.

Listen in for about fifteen minutes or more each night, just before going to bed—to code, of course. And from the time you get into bed until you go to sleep, keep your mind on nothing but dots and dashes. If you can stand keeping the phones on your ears, try that; if you can't, move a loudspeaker close to your head, but it is not necessary to have it going too loud. Sincerely try to believe that the signals will continue to impress themselves on your subconscious mind after you have passed the borderland of consciousness.

If you are earnest in your endeavor this will really happen. And the next morning you will wake up with a greater ability at receiving code than ever before. It is a psychological law, and must work if properly applied. And ability thus gained will stick by you permanently.

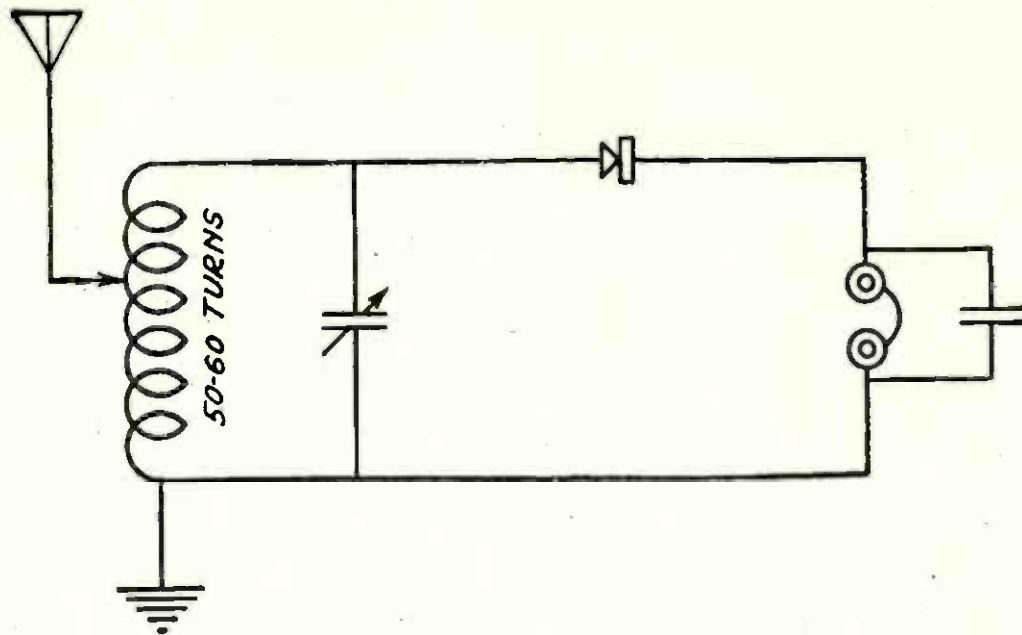

THE CAPACITY-TUNED CRYSTAL CIRCUIT

*Cost of parts:* Not more than \$12.00.

*Selectivity:* Good.

*Operation:* Simple. Only two controls; a primary slider and a secondary variable condenser.

*Ease of construction:* Nothing complicated.

*Approximate range:* 15 miles.

*Outstanding features:* The circuit is more selective than the ordinary conductively-coupled tuner and the variable condenser gives smoother wavelength control.

## 100 BEST HOOK-UPS

INSTALLMENT NO. 2

**I**N this series of hook-ups will be published—for the special benefit of the radio novice who is undecided as to just what circuit he wants—100 of the best radio receiving circuits, each thoroughly tested. The approximate ranges given here are averages based on actual records made with receiving sets throughout the country. During the summer the actual ranges may fall to 50 percent of the value given, while in the winter, in the best of conditions, the actual ranges may exceed the values given by as much as 500 percent.

In the November number the following hookups were published:

The Conductively-coupled Crystal Circuit; range 15 miles; cost, \$10.00.

The Inductively-tuned Crystal Circuit; range 15 miles; cost, \$15.00.

The Combination Tuned-plate, Ultra-audion Circuit; range 500 miles; cost, \$25.00.

The Man-Day Single-control Regenerative Circuit; range 500 miles; cost, \$12.00.

The Reinartz Circuit, with Two Stages of Audio Amplification; range 1,500 miles; cost, \$35.00.

Tuned Radio-frequency and Regenerative-detector Circuit; range 500 miles; cost, \$28.00.

The Squire Reflex Circuit; range 500 miles; cost, \$50.00.

Triple-coil Honeycomb Regenerative Circuit with Two Stages of Amplification; range 100 miles; cost, \$35.00.

The Grimes Reflex Circuit; range 500 miles; cost, \$40.00.



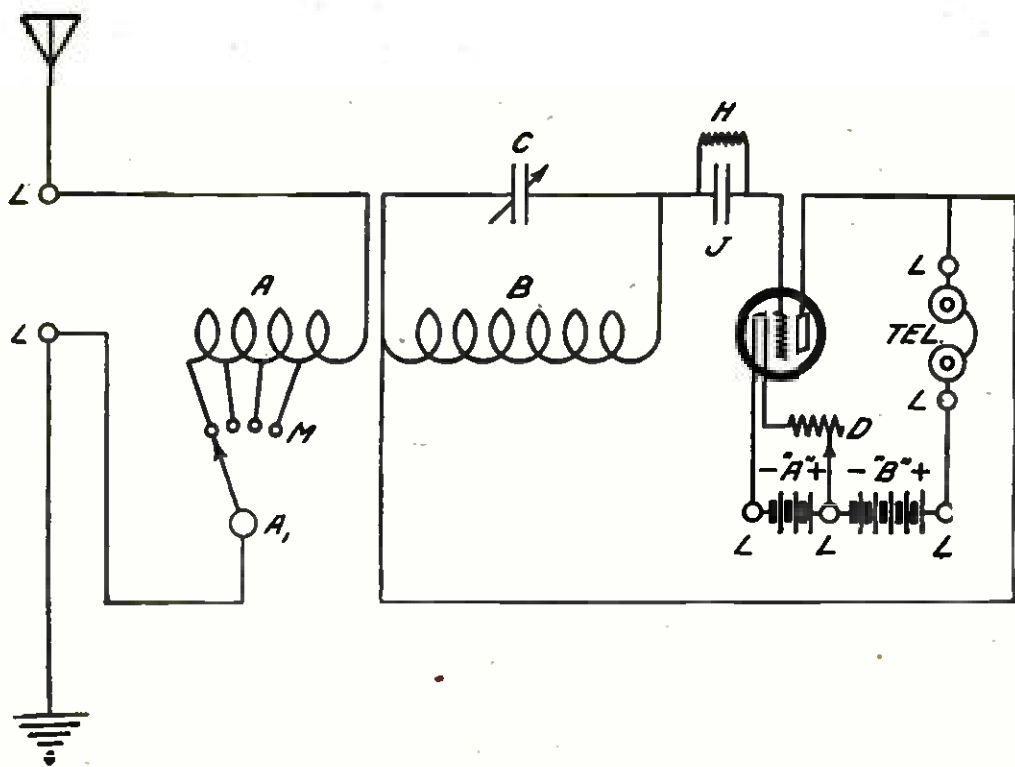

SPECIAL ULTRA-AUDION CIRCUIT

*Cost of parts:* Not more than \$12.00 (Note: The costs of tubes and batteries are considered "extras" and are not included in the costs given in these descriptions).

*Selectivity:* Excellent.

*Operation:* Very easy. When the switchpoint A1 is adjusted for the antenna, there is only one control for wavelength. The re-

generation is controlled by the filament rheostat.

*Ease of construction:* Simple.

*Approximate range:* 500 miles.

*Outstanding features:* This circuit shares first place with the Man-Day circuit in simplicity of operation. It is very selective, and costs but little.

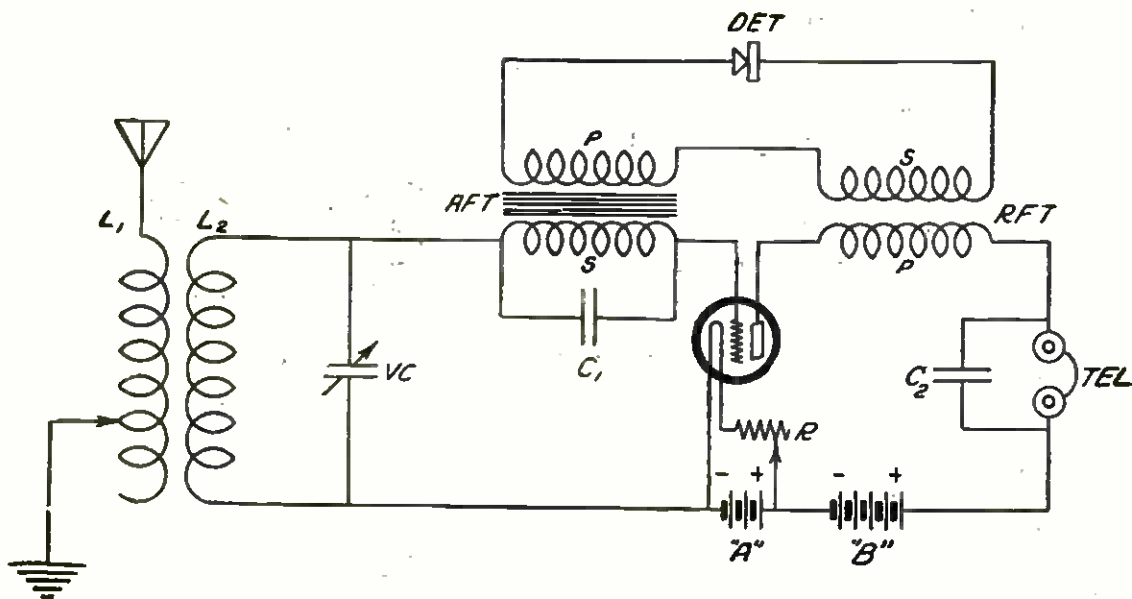

SINGLE-TUBE AND CRYSTAL REFLEX CIRCUIT

*Cost of parts:* Not more than \$28.00.

*Selectivity:* Very good.

*Operation:* Fairly simple. Two controls for wavelength and one coupling control are used. The crystal adjustment must be changed for any considerable change in wavelength in order to prevent the circuit from oscillating and still have it

retain its maximum signal strength.

*Ease of construction:* More complicated than the straight regenerative circuits but not beyond the ordinary radio fan's ability.

*Approximate range:* 1,000 miles.

*Outstanding feature:* Circuit combines radio-frequency, and audio-frequency amplification and regeneration in one tube.

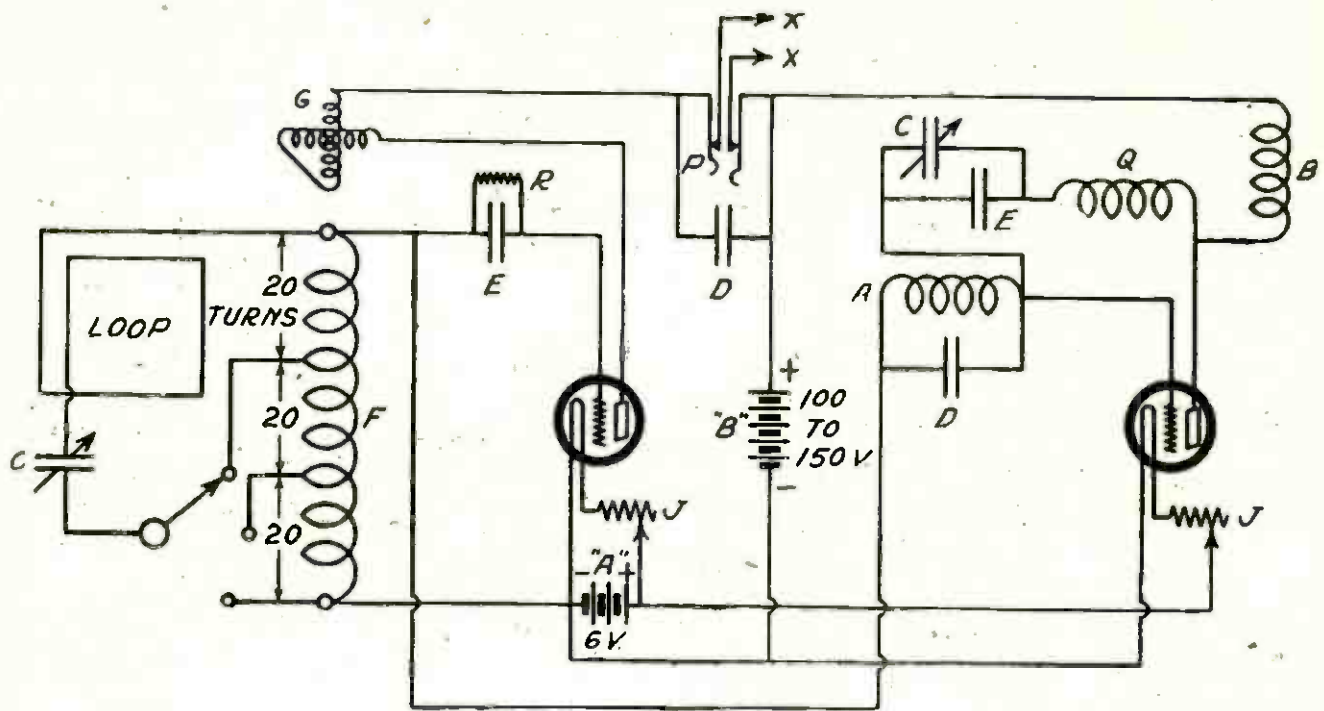

TWO-TUBE SUPER-REGENERATIVE CIRCUIT

*Cost of parts:* Not more than \$45.00.

*Selectivity:* Good.

*Operation:* Difficult. It is a real engineering feat to get the oscillator circuit to function with the correct frequency and amplitude to cause the proper "super" action and at the same time filter out the high-pitched whistle in the detector circuit.

*Ease of construction:* Difficult. Every part of the circuit must be just right before the

set will function as it should.

*Approximate range:* Variable: from local reception on the higher broadcasting wavelengths up to 1,000 miles on lower wavelengths (with a loop).

*Outstanding features:* The best method for unlimited amplification of the extremely short wavelengths. Especially suitable for local reception with great volume for a minimum number of tubes.

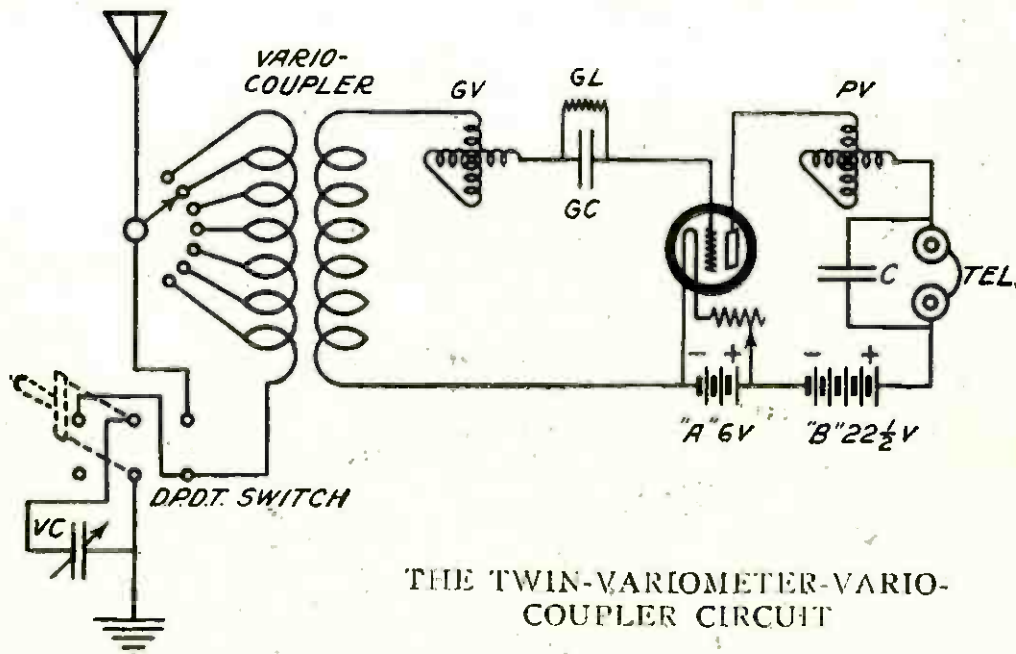

THE TWIN-VARIOMETER-VARIO-COUPLER CIRCUIT

*Cost of parts:* Not more than \$30.00.

*Selectivity:* Good.

*Operation:* Requires considerable skill which can be acquired in a couple of months of experimenting with the tuning.

*Ease of construction:* Just an ordinary acquaintance with tools—but some electrical

ability in wiring up the circuit is necessary.

*Approximate range:* 500 miles.

*Outstanding features:* This was the first well-known short-wave regenerative receiver and it has been found reliable and probably has been more used than any other type of receiver in the past.



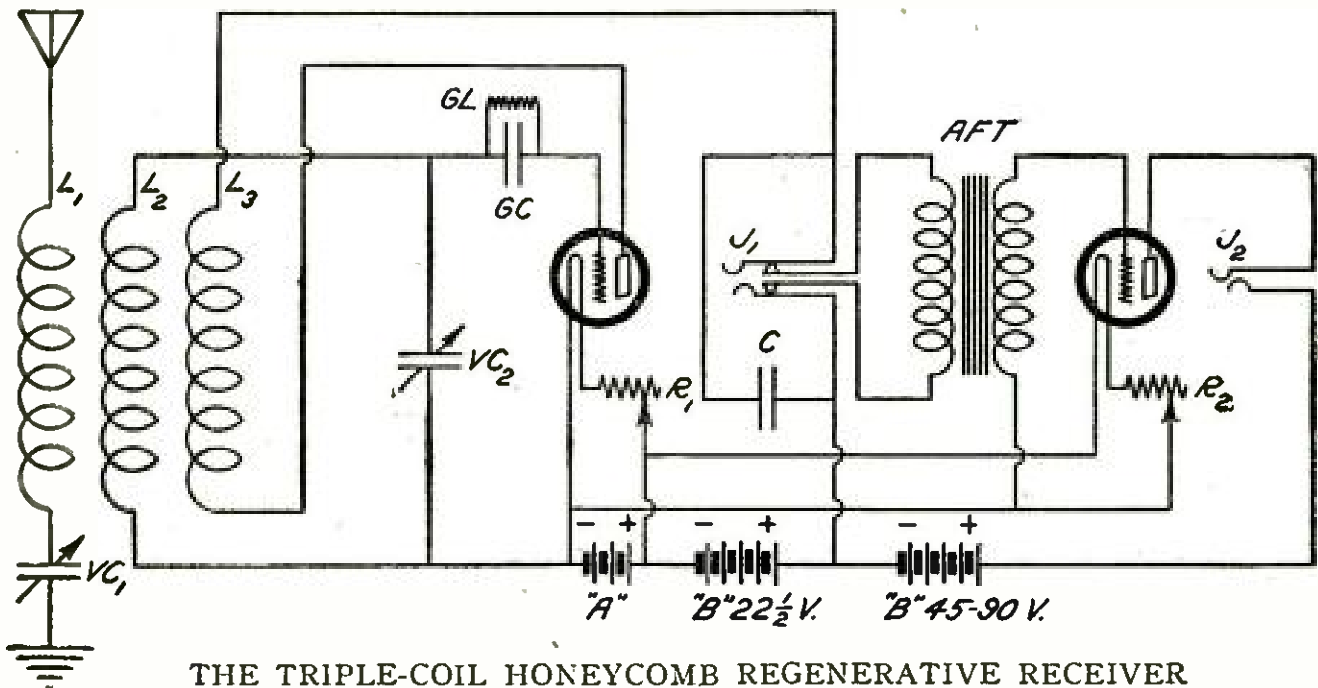

THE TRIPLE-COIL HONEYCOMB REGENERATIVE RECEIVER WITH ONE STAGE OF AUDIO-FREQUENCY AMPLIFICATION

*Cost of parts:* Between \$25.00 and \$30.00 (depending on the wavelength).  
*Selectivity:* Very good.  
*Operation:* Rather complicated for a beginner.  
*Ease of construction:* Fairly simple.  
*Approximate range:* 800 miles.

*Outstanding features:* Can be used on any wavelength. By merely changing the three coils, using large or small, for the long or short waves, the set can be used for commercial reception, broadcast reception or amateur reception.

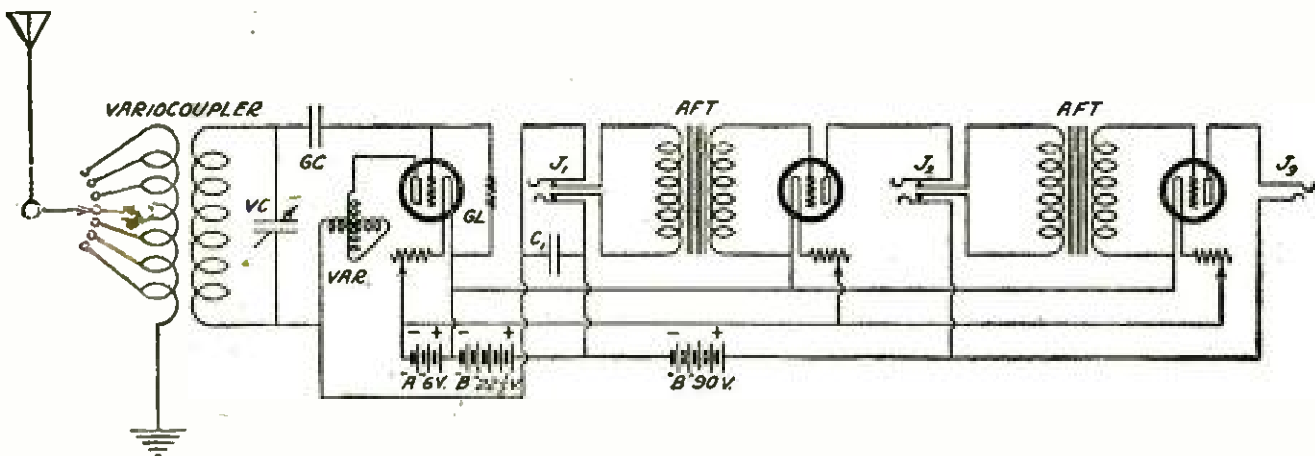

MODIFIED DX THREE-CIRCUIT REGENERATIVE RECEIVER, WITH TWO STAGES OF AUDIO-FREQUENCY AMPLIFICATION

*Cost of parts:* Not more than \$35.00.  
*Selectivity:* Excellent.  
*Operation:* Fairly simple.  
*Ease of construction:* Fairly easy to build.

*Approximate range:* 1,500 miles.  
*Outstanding features:* Noted for DX amateur and broadcast reception and for its exceptionally sharp tuning.

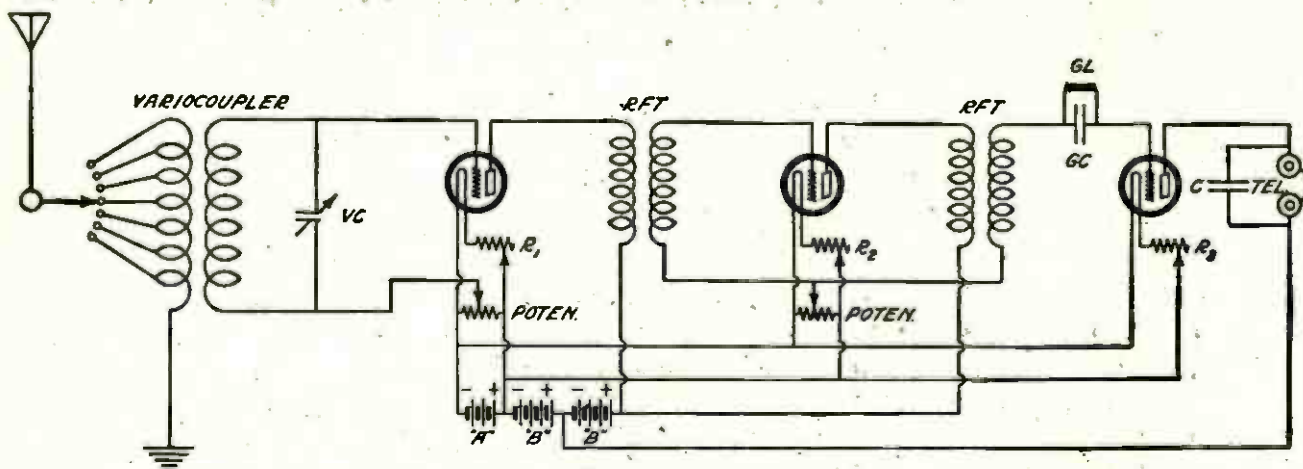

**TRANSFORMER-COUPLED RADIO-FREQUENCY CIRCUIT WITH VACUUM-TUBE DETECTOR**

*Cost of parts:* Not more than \$35.00.

*Selectivity:* Good.

*Operation:* Simple. Two controls for wavelength, one for coupling and one for regeneration (the potentiometer).

*Ease of construction:* Not easy for the experimenter to get working right but a little

patience and experimenting will soon get results.

*Approximate range:* 1,000 miles.

*Outstanding feature:* Although the amplification with this type is not as great (per stage), as with tuned-radio-frequency amplification, the tuning control is simplified.

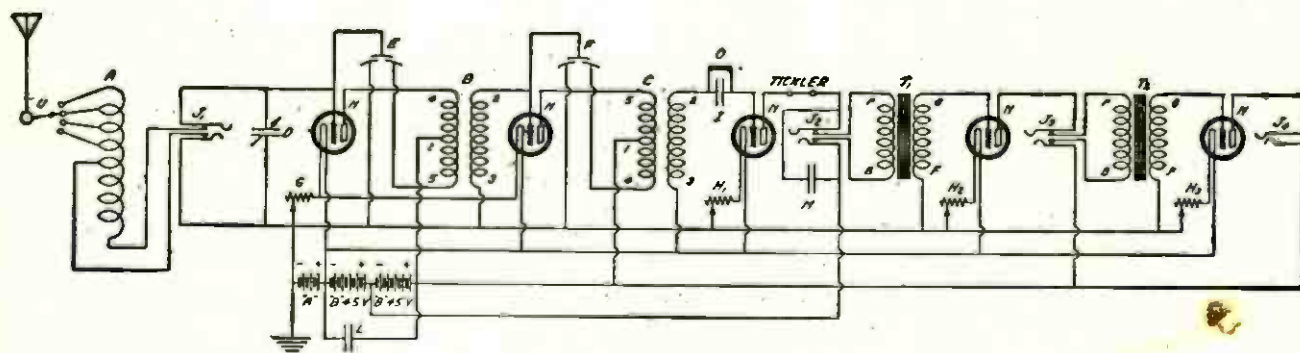

**MODIFIED ACMEDYNE CIRCUIT WITH TWO STAGES OF COMPENSATED RADIO-FREQUENCY AMPLIFICATION AND TWO STAGES OF AUDIO-FREQUENCY AMPLIFICATION**

*Cost of parts:* Not more than \$60.00.

*Selectivity:* Wonderful.

*Operation:* Rather complicated for the beginner, but the correct method can be acquired in a month's practice in tuning.

*Ease of construction:* This, of course, is a complicated circuit to follow out and to get going properly, but it can be done and the set is well worth while.

*Approximate range:* 2,500 miles.

*Outstanding features:* Extremely sharp tuning, DX reception and clarity of signals. The trouble encountered in most radio-frequency-amplification circuits, that of properly controlling or eliminating oscillation, is definitely taken out of this circuit by an ingenious device called a compensating condenser which has three plates attached respectively to the grid, filament, and plate circuits of the vacuum tubes.



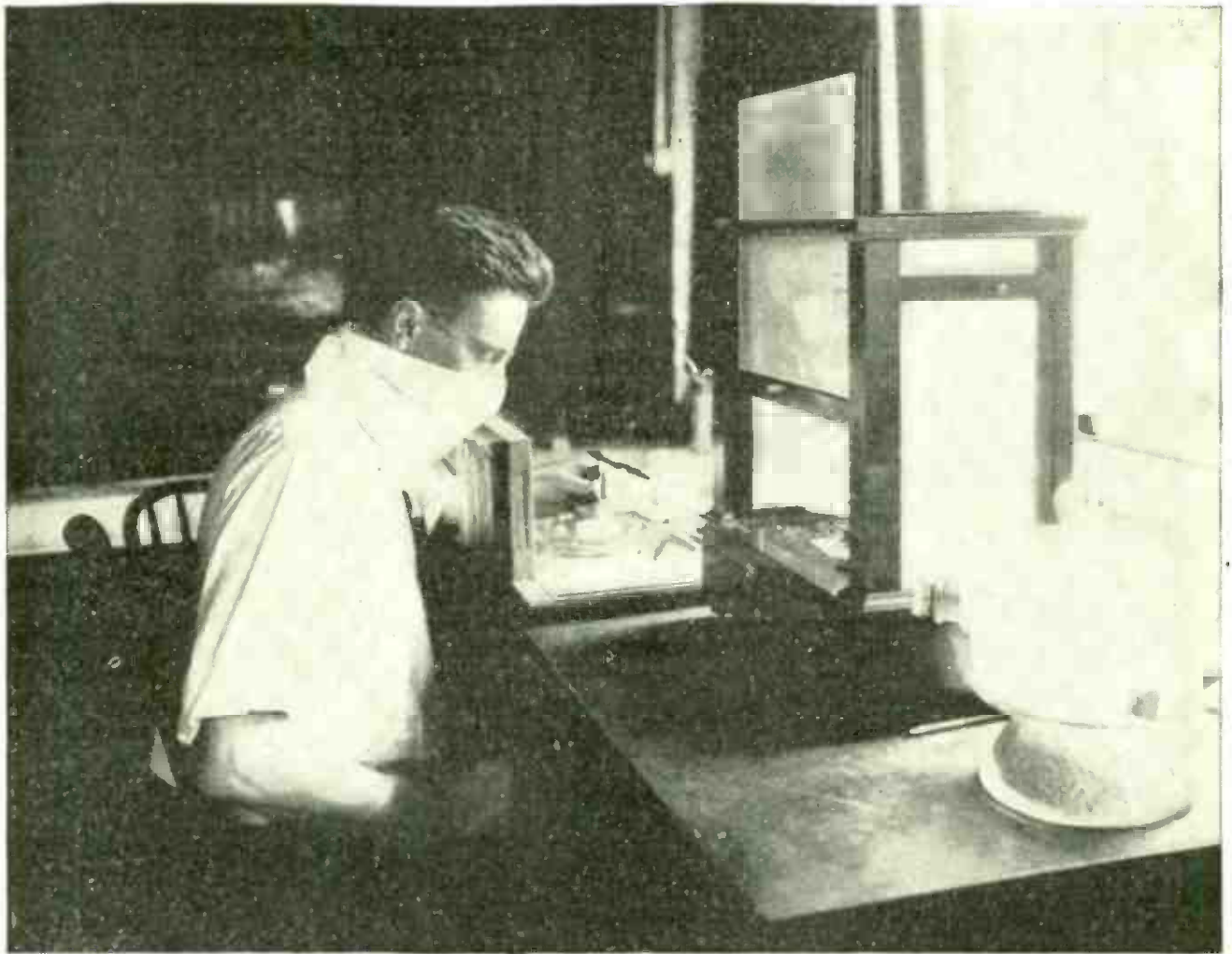

Courtesy United States Radium Company

#### WHERE A SNEEZE MIGHT COST \$1,000.00

*This shows how radium preparations worth thousands of dollars a grain are weighed and handled. The lead plate in front of the operator protects him from the very short ether waves given off by radium.*

## Do Ether Waves Cause Gravitation?

Scientists are coming to believe in the existence of a new kind of ether waves, the ultra-X rays. Knowledge of these remarkable rays may solve for us some of the most fundamental scientific mysteries. This article describes the latest developments in this up-to-the-minute field of research and speculation.

By E. E. FREE, Ph.D.

**T**HE real nature of the universe has always been a mystery. The distant suns that we call stars are composed, we know, of matter like the matter here on earth—but what is matter?

Light comes to us from these stars through the ether—but what is ether?

The planets hold their paths around the sun because of gravitation—but what is gravitation?

For more than six thousand years philosophers have been seeking to unlock these fundamental mysteries. Now, at last, it seems as though we may have found a key.

It is radio.

The family of ether waves, some of them the nightly companions nowadays of the possessor of a radio set, may turn out (some scientists believe) to contain a member that is not only the key to the great mystery of gravitation but perhaps to still deeper mysteries; the mystery of energy, the mystery of the sun's heat, the mystery, even, of life itself.

The story of these new ideas begins with the suspicion that there may exist in the universe a new kind of ether waves, hitherto unsuspected, which are characterized by extremely short wavelength. They are much shorter, even, than the X rays. That is why they have been named the ultra-X rays, just as the waves next shorter than those of violet light have been called the ultra-violet.

The whole family of known ether waves stretches, you remember, from the very long waves of radio, thousands of meters long, down through heat waves, light waves, the ultra-violet and the X rays to the shortest known waves, those given off by radium.\* The shortest waves yet detected come from a variety of the radioactive element called thorium and have a wavelength of about one million-millionth of a meter.

This is a very short wave according to ordinary standards. If you laid a piece of this kind of thorium on your hand, with a sheet of tissue paper in between so that the rays from it had to penetrate the paper before they could reach your hand, there would be room for about ten million separate waves in the thickness of the paper. There is quite a contrast, you see, between these shortest known waves and the great waves used in radio telegraphy, some three or four hundred of which will span the Atlantic.

But tiny as these shortest waves are,

millions of them inside the smallest speck of dust that you could see, science knows some things that are still smaller. The electron, for example, is some three hundred times smaller. There would be room for nearly three hundred electrons along a single one of these shortest waves, and for some three thousand million electrons, therefore, in the thickness of a sheet of tissue paper.

Now these very short waves are merely the shortest *known* waves. There is no reason to believe that they are the shortest that exist. The ultimate structure of the universe, whatever it may be, is obviously much finer-grained than this. The electron, which is quite definitely known, is smaller and there are almost certainly a number of perfectly real and separate things, for example, the central nucleus of the hydrogen atom, that are smaller even than the electron. There is plenty of opportunity, then, for waves a hundred times or a thousand times shorter than these shortest known ones without exceeding the smallest dimensions that we know to be possible.

The question has been, of course, whether any such very short, unknown waves actually do exist.

Scientists are coming to believe that they do, though because they penetrate all kinds of matter so readily they are extremely difficult to detect. Even the X rays, which are some thousands of times longer, penetrate our bodies, for example, with the greatest ease. These ultra-X rays, if they exist, would go through us (probably) as though we were not there at all. They would also go right through our physical instruments and our photographic plates and all the other material things that we are accustomed to use in detecting various kinds of ether waves.

We can stop light rays with a mirror or bend them with a lens, and that enables us to study the nature of light. The ordinary X rays, being so much shorter than light waves, go right

\*Details of this ether wave family were described in POPULAR RADIO for November, 1923, page 407.



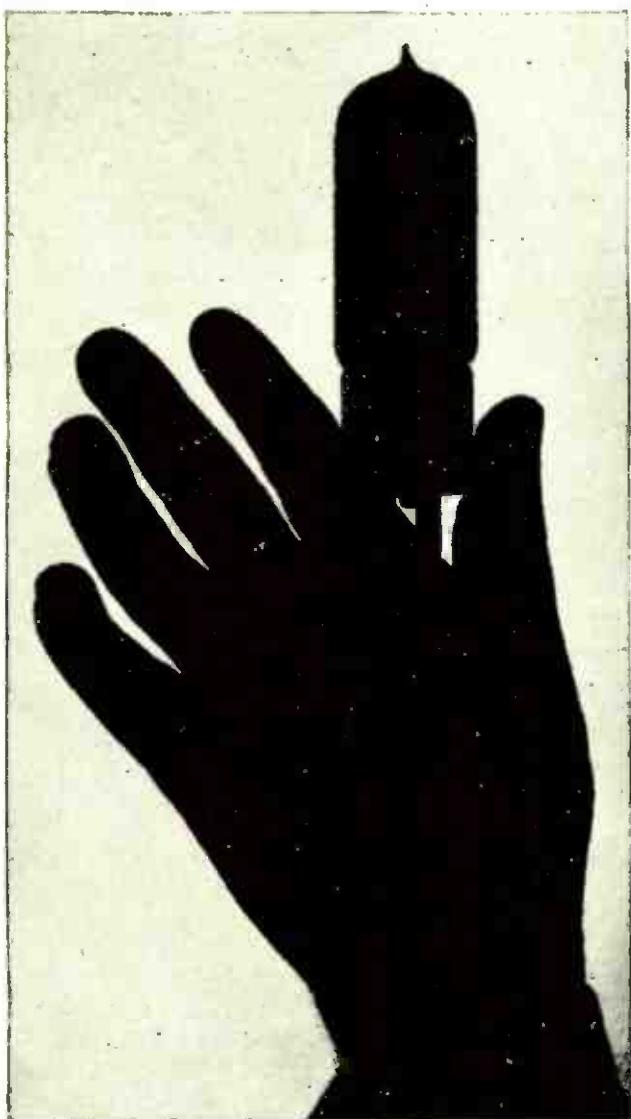

From photographs made for POPULAR RADIO

#### BY INFRA-RED RAYS

The following pictures show the different transparencies of things for different kinds of waves. This view corresponds to rays, like the infra-red rays, to which both the hand and the glass globe are perfectly opaque—all waves being absorbed.

through lenses or mirrors as though they were not there. So we cannot study X rays with such ordinary instruments. But a sheet of lead will catch the X rays and some kinds of crystals will catch them in part and bend them, and so we have been able to study these ordinary X rays by using metal sheets and crystals and similar devices instead of lenses and mirrors.

The ultra-X rays, however, may go right through lead sheets just as ordinary X rays go through a mirror. They probably do, in fact, go right through

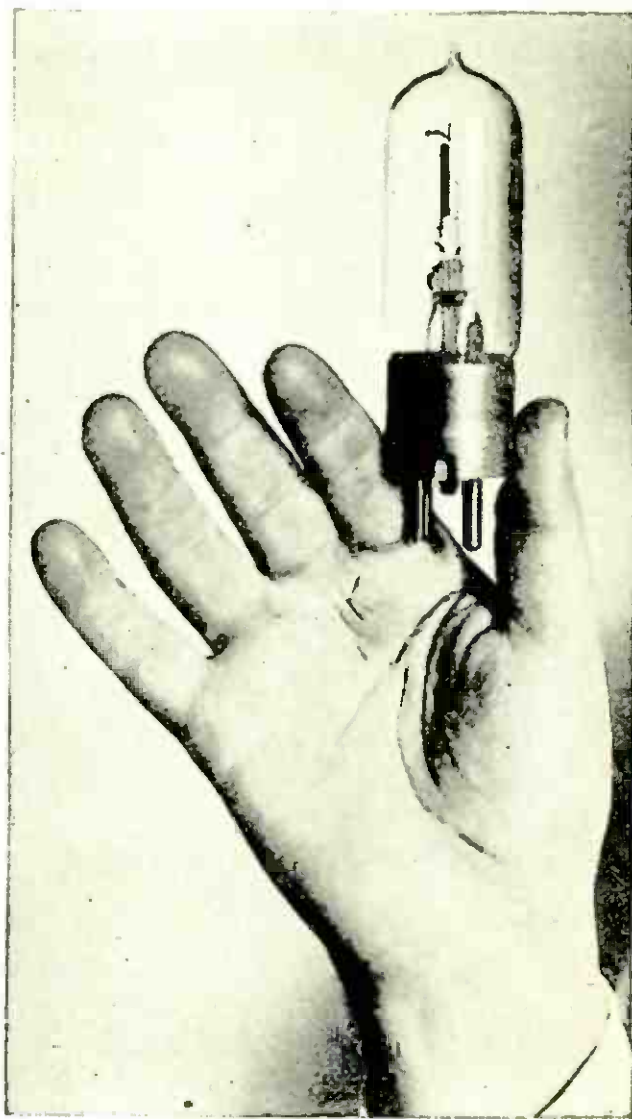

#### BY VISIBLE LIGHT

This is a similar photograph taken with ordinary light, the waves of which are shorter than those of the infra-red. The hand is opaque but the glass globe is transparent to these waves, so that the metal parts inside may be clearly seen.

everything. We are left, then, with nothing in the way of apparatus that will catch these exceedingly elusive, mightily penetrating rays so that we can study them. This explains how these rays have escaped discovery for so long in spite of the fact (if we are right in thinking that it is a fact) that these rays exist and are vastly important in the world.

But is it a fact? What makes the scientists believe that some very short ether waves like this are a physical actuality and not merely something that is possible theoretically?



From an X ray photograph made for POPULAR RADIO by Dr. George Palmer Ratner, N. Y.

#### BY X RAYS

*This is the same hand and globe photographed by X rays. Being shorter than the waves of light, these X rays penetrate the flesh so that the bones may be seen. The metal parts of the tube are perfectly black, showing complete absorption of the waves.*

The first suspicion to this effect arose in connection with an effort to explain the peculiar behavior of radium. The atoms of radium, you remember, are in the habit of exploding. In a little piece of radium, containing, of course, billions of billions of individual atoms, a certain number of the atoms blow up every second and keep on doing so, one by one, until all the radium is gone. There are so many atoms in even the smallest speck of radium that the disappearance of the material is extremely slow; only half of it will be gone, in fact, after two thousand years. But it

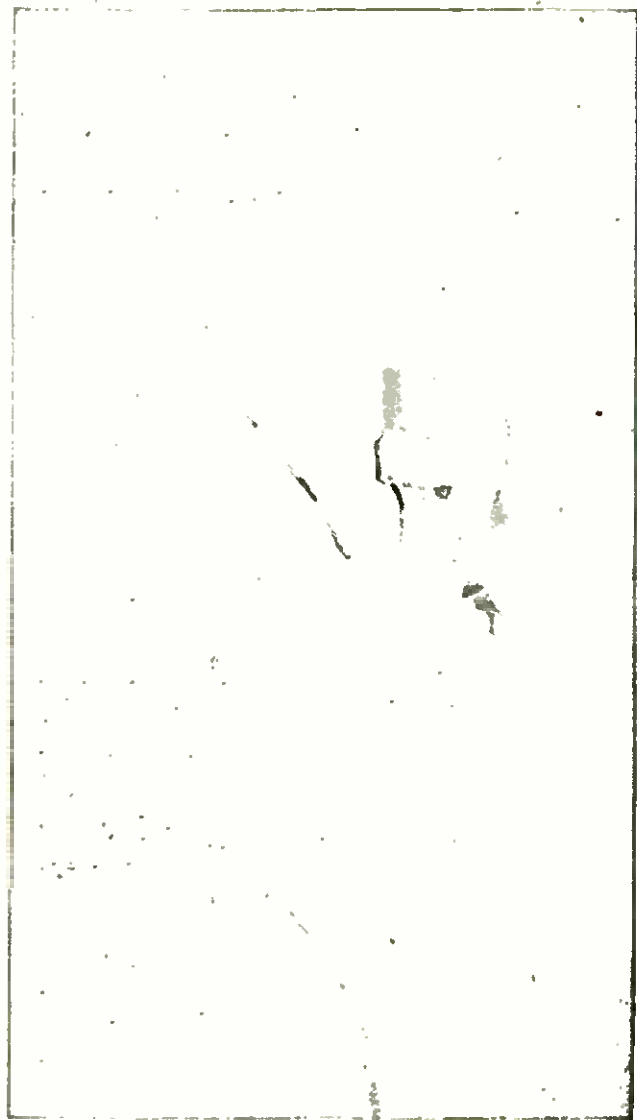

#### BY ULTRA-X RAYS

*This is how a hand might look if it could be photographed by the supposed ultra-X rays. These rays, the shortest waves of all, would penetrate flesh, bones and glass globe with almost complete perfection, showing only the faintest possible shadow.*

does disappear, however slowly, and this is what causes the continual production of heat and the discharge of tiny particles and of other rays, all of which taken together constitute the phenomena of radioactivity.

The cause of this has always been a puzzle. Why should the radium atoms blow up? It is possible, of course, that they do so spontaneously, just as badly-made dynamite goes off occasionally all by itself. But this has never seemed very likely. Scientists have always believed that there probably was something that touched off the indi-



vidual radium atoms once in a while, just as we use an exploder cap to touch off a stick of dynamite. Only we have never been able to find out what this radium exploder was.

About four years ago the distinguished French physicist, Dr. Jean Perrin, the same who had discovered, some years earlier, the first direct proof of the real existence of molecules, suggested that the radium exploder might be a kind of ultra-X rays. The radium atoms might have, he pointed out, the power of absorbing these very short waves just as a black wall will absorb light or a lead plate will absorb X rays. And as a strong light absorbed by a black wall will heat up the wall a little and a beam of X rays, if it be strong enough, will heat up a lead plate, so the absorption of ultra-X rays by the atoms of radium ought to add energy of some sort to the atom; so much energy, perhaps, that after a while the atom would explode.

Suppose you take a tightly closed can of gasoline and put it in the hot sun. Or suppose that you get a large burning glass and focus it on the can of gasoline so that the sunlight that strikes it will be much stronger. The can will explode. It absorbs more and more energy from the sunlight. It gets hotter and hotter. Finally there is so much heat energy in it that the can cannot stand it any longer and it blows up.

Something of this same sort may be happening, Dr. Perrin suggested, to the atoms of radium. They may be absorbing all the time a little of the energy of the ultra-X rays. This energy accumulates inside the atoms just as the energy of sunlight accumulates inside the can of gasoline. Every once in a while an atom gets so much of this extra energy that it blows up.

The atoms of the other elements, the ones that are not radioactive, might be, Dr. Perrin thought, totally transparent to the ultra-X rays so that they caught

no energy from them and were not affected. Just so the sunlight passing through the transparent pane of a window will warm any dark-colored (and therefore absorbing) object inside, leaving the non-absorbing pane unaffected and cool. According to the Perrin theory the only kinds of atoms that had the property of absorbing the ultra-X rays at all were the atoms of the radioactive elements. These were the only elements, therefore, that could accumulate the ultra-X-ray energy and explode.

This, of course, was only theory. It was a way of explaining the behavior, otherwise so mysterious, of the radium atoms in exploding every once in a while without having anything to touch them off. Dr. Perrin did not catch or measure any ultra-X rays or produce any direct experimental evidence that they existed.

This step was left for an American scientist, Dr. R. A. Millikan of the California Institute of Technology. By ingenious experiments which he described recently before the American Institute of Electrical Engineers but which he has not yet published in detail, some rays similar to the supposed ultra-X rays seem actually to have been detected. Experiments on top of California mountains and in airplanes high above the earth indicate that these new rays come from space outside the earth. They do not come from the sun, for they are observed at night as well as during the day.

Dr. Millikan has established, also, a probability that radium atoms are not the only ones that sometimes explode. All kinds of atoms explode occasionally, but the ordinary kinds, like the atoms that compose our bodies, do so only once in a long time. All substances, says Dr. Millikan, are probably radioactive just as radium is but much more faintly, so faintly that the fact had hitherto escaped observation.

Dr. Millikan is not ready (if I correctly understand his position) to give

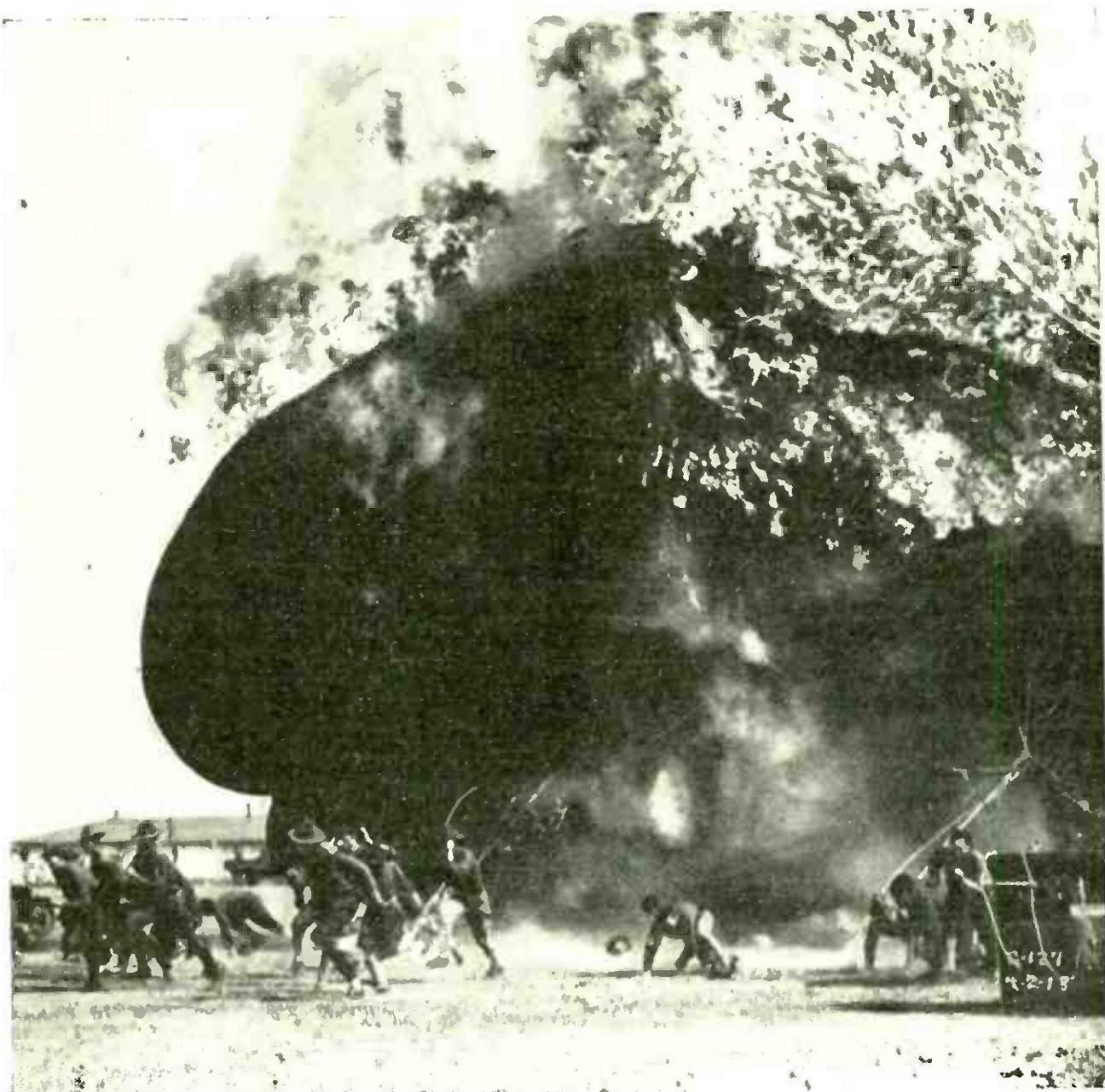

Signal Corps, U. S. A.

#### A VERY MILD EXPLOSION—FROM THE ATOM'S VIEWPOINT

*This explosion of a hydrogen-filled army balloon, Goodrich Type R72, is among the most violent explosions ever photographed, according to human standards. Yet the explosions of the radium atoms, perhaps induced by the ultra-X rays, are millions of times more violent, bulk for bulk, than this one is. This remarkable snapshot was taken April 2, 1918, at Fort Sill, Oklahoma, by Captain Roger B. Whitman.*

full agreement to Dr. Perrin's idea that the ultra-X rays produce all these atomic explosions, both of radium and of other kinds of matter. But he is willing to grant the fact that these ultra-X rays, or something very like them actually exist. We can conclude, then, that the family of ether waves is reasonably certain to have a shorter brother; a tiniest one of all who is so small that science has not previously seen him.

The problem arises, then, whether

this newly discovered member of the family may not have some rather important jobs. None of the other kinds of ether waves are loafers. Light and heat rays and the X rays are all doing rather significant jobs in the universe; for example, helping to keep us alive and to keep the world habitable. Perhaps the smallest brother has something to keep busy on too.

This problem had been attacked even before Dr. Millikan's experiments by



a compatriot of Dr. Perrin, Dr. Felix Michaud, a well-known physicist and distinguished member of the Faculty of the University of Paris. These ultra-X rays may be, Dr. Michaud thinks, the most important ether waves of all. The littlest brother may be the most powerful. He may be, in fact, the cause of that age-old mystery that we call gravitation.

Let us imagine, says Dr. Michaud, that the entire universe is filled with a vast assemblage of ultra-X rays, moving in all possible directions at the same time, just as a mirror-walled and brilliantly lighted room is filled with a multitude of light rays, crossing and interlacing and filling every tiniest cranny of the space inside the room. We do not perceive this vast flood of ultra-X rays that comes from every direction and bathes everything because the rays go right through us. Just so a perfectly transparent object in the lighted room, if there were such a thing as a *perfectly* transparent object, would

be utterly invisible. Nor, if this object had a consciousness, would it perceive the light that was passing all around and through it. To it the brilliant room would seem dark.

Just so the universe, brilliantly "illuminated," so to speak, with the ultra-X rays, appears to us to have none of them because we are transparent to them and cannot perceive them at all.

But just as there is no known object, even the clearest glass or the most brilliant crystal, that is *perfectly* transparent to light rays, so there is no substance that is *perfectly* transparent to the ultra-X rays. We ourselves, the earth under our feet, every kind of matter everywhere in the universe, absorbs a tiny fraction of the rays, just as a "transparent" glass really absorbs a tiny fraction of the light.

But if we do absorb even the tiniest fraction of the ultra-X rays it ought to have *some* effect on us; we ought, in some way, to be able to perceive it. It has, says Dr. Michaud, an effect on us;

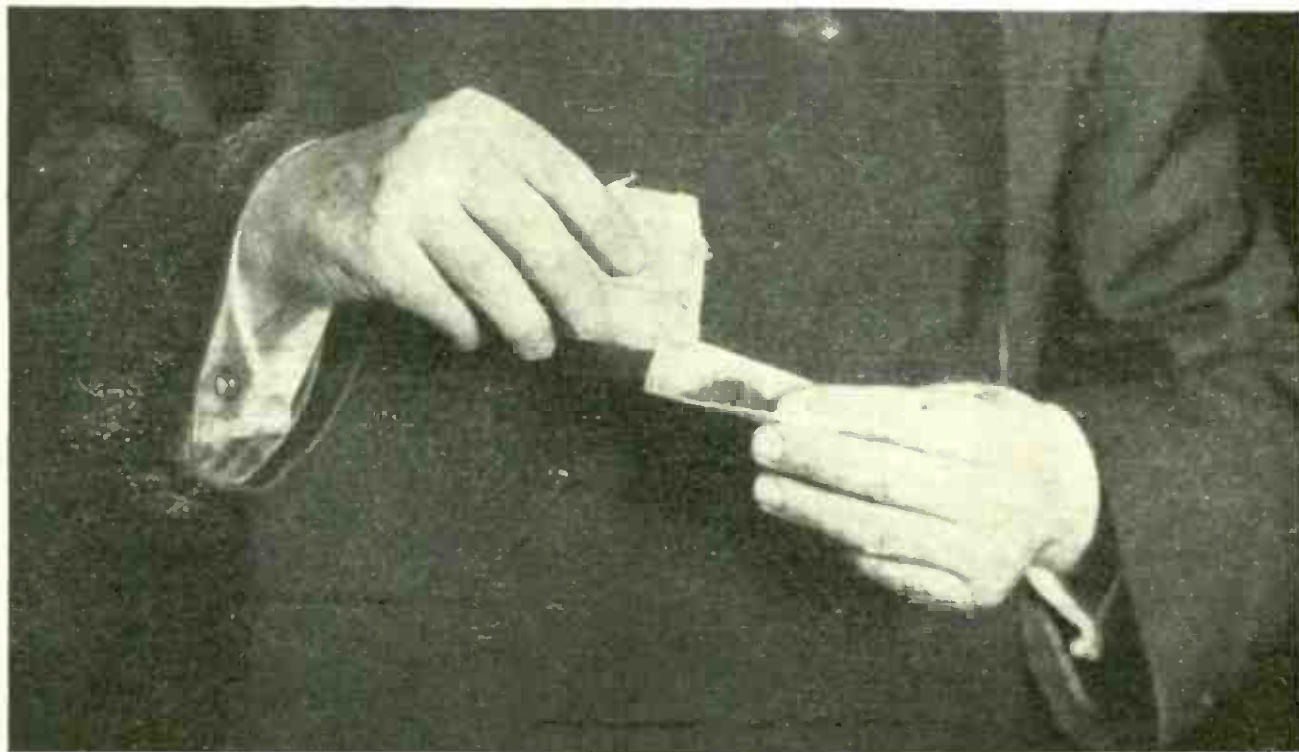

From a photograph made for POPULAR RADIO

#### THIS CIGARETTE PAPER IS TWENTY MILLION WAVES THICK

*It is so thick in comparison with the wavelength of the gamma rays given off by radium that there would be room for nearly 20,000,000 single waves in one thickness of the paper. The ultra-X rays are believed to be even shorter than this.*



we do perceive it, but we do not recognize it as a radiation.

What it really does, this tiny absorbed fraction of the pervasive flood of ultra-X rays, is to cause gravitation.

Consider, says Dr. Michaud, two almost transparent objects, like two glass balls, inside our mirror-lined, brilliantly-lighted room. Each ball absorbs a little light. If the balls are fairly close together each will shade the other just a trifle. Delicate light-measuring instruments would show that the side of each ball that faced toward the other ball would be receiving all the time a little less light than the other sides of the balls freely exposed to the flood of light in the room.

This is what is happening to two material bodies, like the sun and the earth, floating in space. Space, you remember, is considered to be full of a flood of ultra-X rays just as our room is full of a flood of light. The sun and the earth each allow most of these ultra-X rays to pass right through them just as most of the light passes through the glass balls. But the matter of the sun and the earth absorbs a tiny fraction of the rays and so the two great globes shade each other a trifle from the pervasive ultra-X rays, just as the two glass balls in the room shaded each other a little from the pervasive light.

But how, you say, does this explain gravitation?

Because all kinds of rays, when they are absorbed, create a pressure on the thing that absorbs them. This was proved years ago for light by two American physicists, Dr. Ernest F. Nichols and Dr. Gordon F. Hull. Light exerts a pressure and this is why, for example, the tails of comets point away from the sun. The little particles of dust in the tail are driven backward by the pressure of sunlight.\*

The ultra-X rays, like light and all other kinds of ether waves, may be ex-



#### HE ORIGINATED THE ETHER-WAVE THEORY OF GRAVITATION

*Dr. Felix Michaud, distinguished physicist of the University of Paris, whose theory that ether waves cause gravitation is explained in this article.*

pected to exert a pressure also. If the earth were floating alone in empty space the pressure would be the same on all sides of it, for the amount of the ultra-X rays arriving from any selected direction would be exactly the same as the amount arriving from every other direction. But the earth is not alone in space. It is accompanied, for example, by the sun. Therefore, the sun shades it partly and the earth partly shades the sun. The pressure of the ultra-X rays is slightly less on the near sides of the sun-earth combination, or, what is the

\*See POPULAR RADIO for August, 1922, pages 249-255.

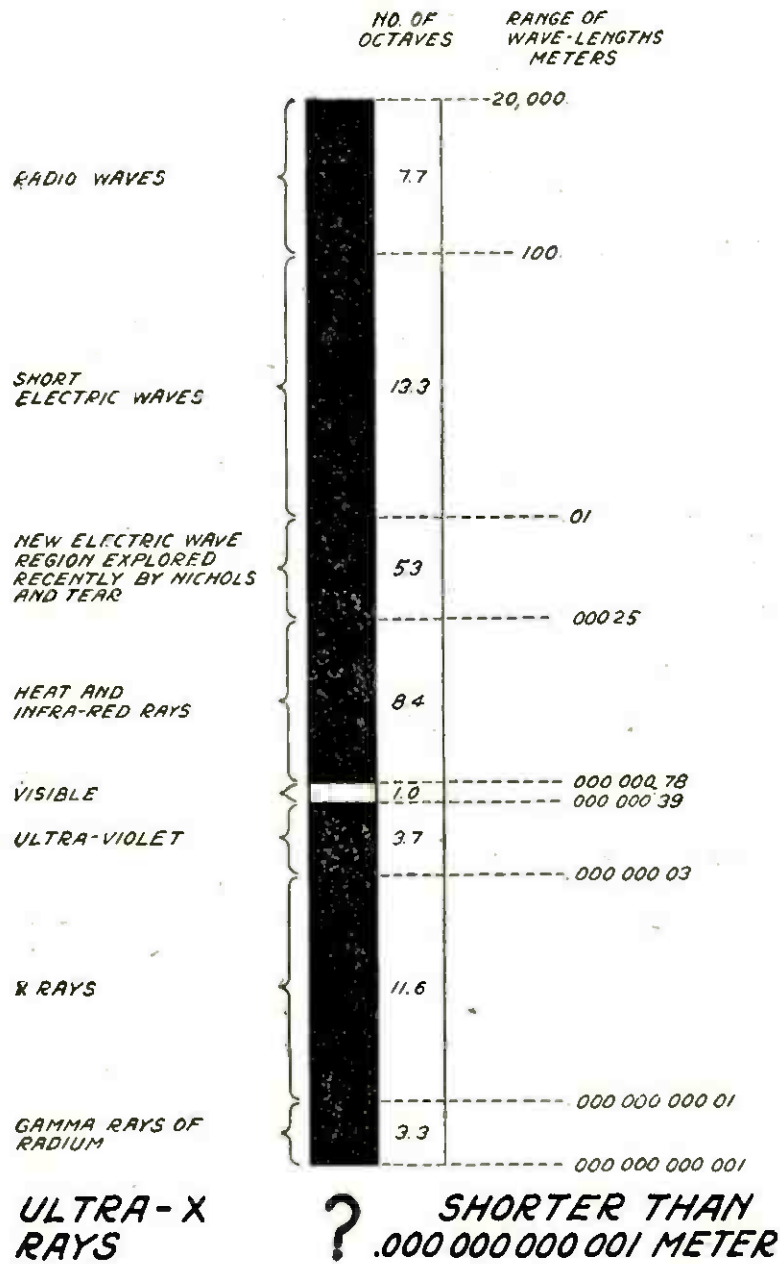

THE COMPLETE ETHER-WAVE SERIES

This chart shows the supposed ultra-X rays as the shortest ether waves of all.

same thing, it is greater on the far sides. There is a force tending to drive the sun and the earth together. That is what we observe and call gravitation. Extend this same reasoning to all the other bodies in the universe, work out the detailed relations of the amount of ultra-X ray absorption to the masses of bodies, to the distances, to relative motions and the like (all of which Dr. Michaud has done) and you come out with the well-known laws of gravitation.

You come out also with a possible explanation for that very puzzling mys-

tery of where the sun gets the energy to keep up its heat. The sun, geologists tell us, is at least six or eight billion years old. No kind of burning would supply its heat for even a thousandth of this time. What does give it its heat?

Perhaps, says Dr. Michaud, it is the great flood of ultra-X-ray energy that fills all space. The part of this that the sun absorbs and which is manifested, as we have seen, in gravitation is very tiny with relation to the total amount of such energy that space contains. But



it may be very large with relation to the sun; ample, perhaps, to keep the sun going indefinitely.

This same unsuspected source of energy, if it really exists, may have important significance for the problems of life, especially of life on other planets. The surface of Mars, for example, has been found, by measurement of its radiation, to be considerably warmer than the usual theories would indicate as possible. It seems warm enough, in fact, to support life quite like the life on earth. Where does this warmth come from? Not from the sun, we are sure, unless the atmosphere of Mars is of some peculiar composition and is able to trap and retain the sun's heat much more efficiently than the astronomers suppose. Perhaps the extra heat comes from ultra-X rays absorbed from space by the matter of the planet, just as does (so the theory says) the heat of the sun.

If this be true some heat like this must be arriving all the time on the earth. Very likely it is. It has long been known, for example, that all rocks, soils and natural waters are slightly radioactive. The heat thus produced has been ascribed by most scientists to traces of radium in the rocks. It has been calculated to be sufficient to make the earth grow slowly warmer instead of cooling off as the older theorists used to believe. Perhaps this, too, may be an ultra-X-ray effect. Even our own life may depend in ways that we do not yet understand, upon the properties of this new and remarkable kind of ether waves.

There are many other implications of this ultra-X-ray theory. Some affect the theories of astronomy. Others have

to do, as Dr. Perrin foresaw, with radioactivity. Still others concern the cause of light or of those mysterious effects that we call electricity and magnetism. I cannot describe here the details of all these conclusions and suggestions and possibilities. Perhaps, indeed, it is profitless to describe them at all until the exact facts about these ultra-X rays have been ascertained and fully proved. That, we may be sure, will not be a matter of many years.

But there is one thing, even at present, that I must not leave unsaid. It is that in these experiments of Dr. Millikan and in the theories of Dr. Michaud we seem to have caught a glimpse of a whole new universe that we have been living in without knowing it. Like a blind man who begins, as they remove the bandage from his eyes, to catch his first glimmer of light, to perceive a dim and distorted vision of unknown realities all around him, so we stand, it seems, on the very verge of new and enormously important discoveries; discoveries that will change, it may well be, every supposed fact and every present idea and every condition of life in the world.

#### REFERENCES

Readers desirous of studying the details of the theories here described will find Dr. Perrin's ideas set forth in his monograph "Matière et Lumière" in the *Annales de Physique*, vol. 11, pages 5-108 (January, 1919), especially on pages 78 to 95. Dr. Michaud's theory of the cause of gravitation, as well as many other implications of the ultra-X-ray idea for which I have not had space in this article, was published in his pamphlet entitled "Rayonnement et Gravitation," 61 pages, Gautier-Villars et Cie., Paris, 1922. There is a brief review by Dr. Michaud himself in the *Revue générale des Sciences* for January 15, 1923. Dr. Millikan's experiments have not been published. They will be noted in POPULAR RADIO as soon as they appear. For information about X rays and gamma rays—a necessary starting point, of course, for study of the possible shorter waves—the best book is *X Rays* by G. W. C. Kaye, fourth edition, 320 pages, Longmans Green and Co., New York, 1923.

—The Author

---

### Where Fortunes Await Radio Inventors

Unlimited opportunities lie before the radio fan—before the novice as well as the scientist—for solving some of the mysteries of radio phenomena. In the next issue of POPULAR RADIO Henry Woodhouse will point out just where these opportunities are.

---

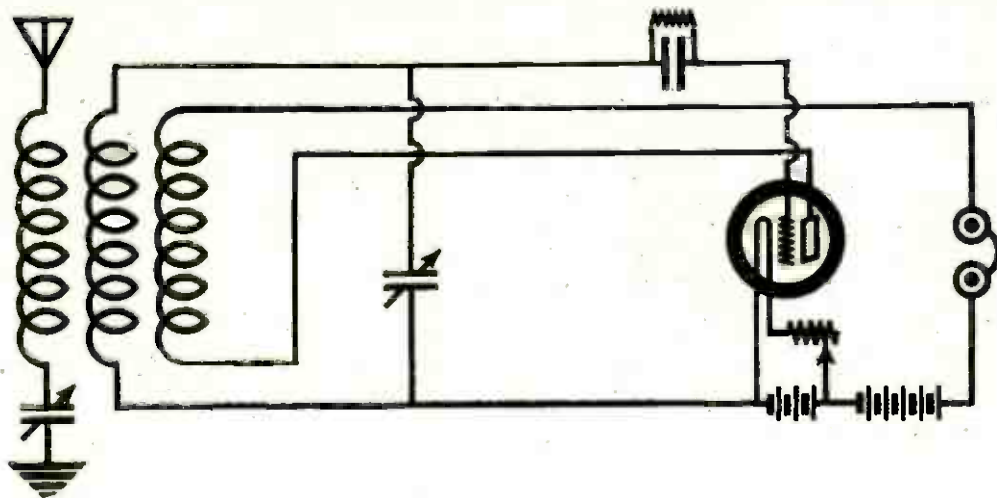

DO YOU KNOW WHAT THE ABOVE SYMBOLS MEAN?  
*Unless you do, you cannot understand the practical and useful hook-up drawings that constitute such a valuable part of this magazine. Read this article and learn how simple to understand these diagrams really are!*

## HOW TO READ A DIAGRAM

### PART I

*THIS article is written—and illustrated—for the very particular benefit of the radio fan who is unfamiliar with the common symbols used in the technical diagrams that explain radio circuits. A knowledge of these symbols is necessary to the understanding of "hook-up" drawings. In this two-part article this information is presented in the most simple and comprehensive form. KEEP THIS ARTICLE FOR REFERENCE.*

By ALBERT G. CRAIG

"**W**HERE may I obtain a 'picture-diagram' of the four-circuit tuner? I do not know how to read the regular diagrams."

This is one of the most frequent questions received by The Technical Service Bureau of this magazine.

It is evident that a large percentage of radio fans are unable to interpret the conventional, electric-circuit diagram. Rather than use the inferior picture method to bring home a circuit to the uninitiated, POPULAR RADIO has decided to show the radio fan how to master the standard diagram.

First of all, the student who wants to learn how to read a diagram must make himself familiar with the conventional symbols which are used in all hook-ups. Therefore, let us first consider the instruments that are most familiar in radio.

The following pages show pictures of the instrument, together with the standard symbol that represents it; also short descriptions of the instruments and their uses. These symbols should be memorized before the beginner undertakes to read a diagram.

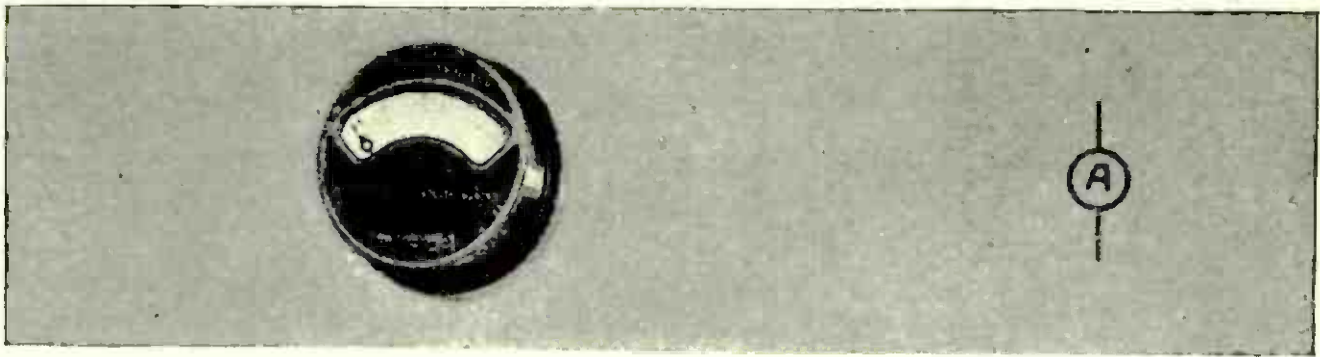

**AMMETER**—The ammeter is a device for measuring the current flowing in some particular circuit; for instance, it could be placed in the filament circuit of a vacuum tube to see how many amperes were being drawn from the storage battery. An instrument for smaller current values (the milliammeter) could be connected in the plate circuit of the vacuum tube to see how many thousandths of an ampere were being drawn from the "B" battery.

An ammeter never measures how many amperes there are in the battery, but it does measure the number of amperes that some other instrument is drawing from the battery or whatever source of power we may have. The ammeter has two terminals and is always connected in series in the circuit; that is, one of the wires of the circuit is broken and the two resultant ends are connected to the two terminals of the ammeter.

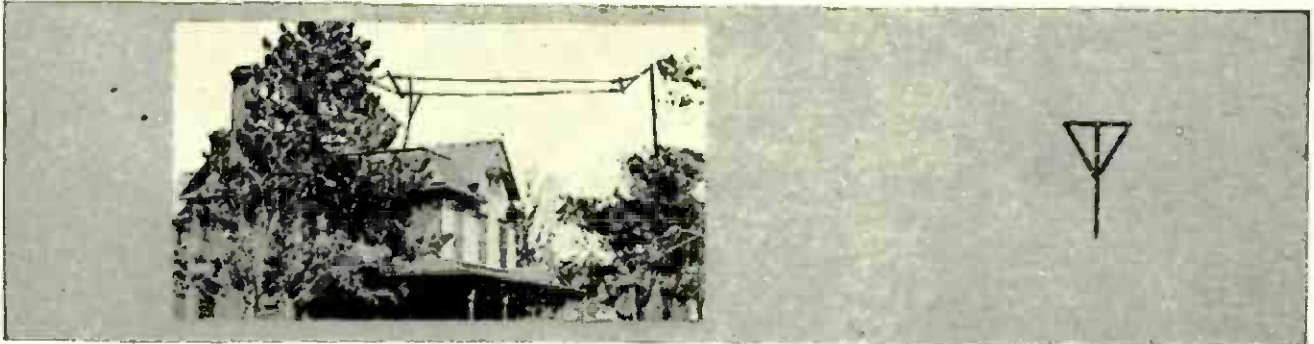

**ANTENNA**—The most common type of antenna (and one that gives universal satisfaction for receiving) is the single-wire "L" type, approximately 100 feet long. It is insulated at each end, preferably with a glazed-porcelain antenna insulator, and the lead-in to the receiving set is taken off at one end. Number 14 seven-strand bare copper wire is most suitable for antenna wire because of its larger

surface and greater strength than the solid wire of the same gauge. For transmitting, four parallel wires are often used to give greater radiating area; a wire joined to each of these is in turn connected to the single lead-in. As the multiple lead-ins always are joined to one common wire we may regard the antenna as having a single connection and thus it is shown in the diagrams.

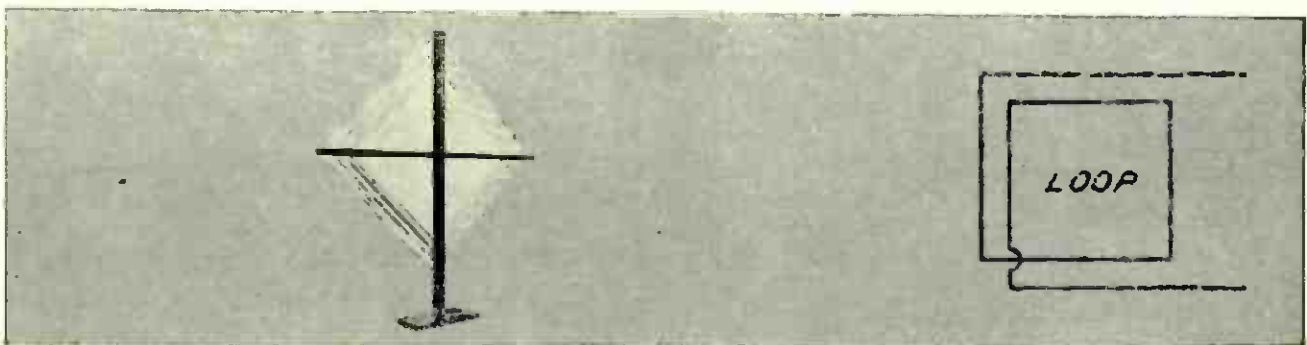

**LOOP ANTENNA**—The regulation outdoor antenna always gives reception over greater distances and also louder signals than the loop on the same receiving set. However, circumstances may make the use of a loop necessary; in this case the amplification will have to be increased considerably over what would be necessary with the outdoor antenna. Two or three stages of radio-frequency amplification will be required in addition to the customary

detector and two stages of audio-frequency amplification. Do not attempt to use a loop on the ordinary three-bulb regenerative set. For broadcast reception the loop antenna may consist of twelve turns of No. 18 wire wound in a square, two feet on a side, the turns being separated one-half inch. The loop antenna has two connections, although one of these may be arranged so that it can be cut in on different turns.



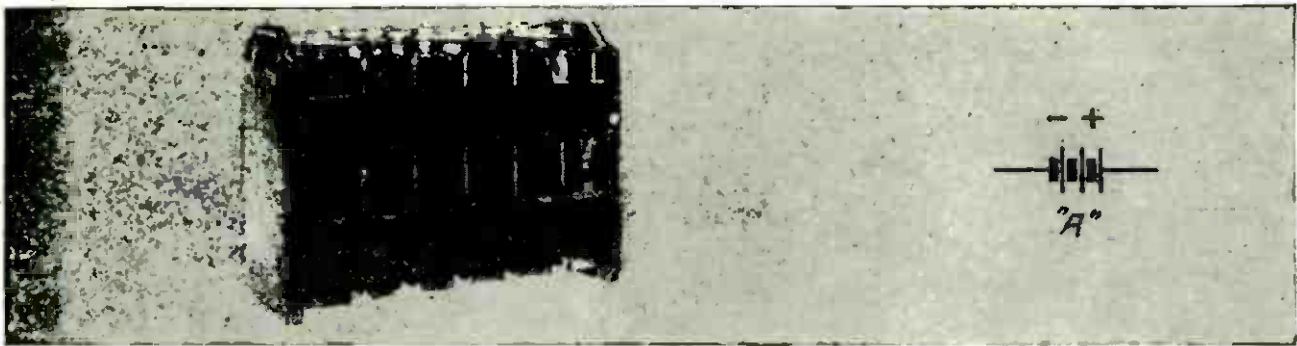

**"A" BATTERY**—Until recently the "A" or filament-lighting battery was almost universally of the storage type. It may be well to note here that the UV-201-a tube is primarily a storage-battery tube, and that it is not economical to operate more than one of these tubes on dry cells. However, the use of tubes, such as the UV-199 and WD-11, which operate on an "A" battery made up of dry cells, has increased materially in the last year or two. Although made up of several cells, the "A" battery has two main terminals which connect

to the filament of the tube; one of these is positive and the other negative. Make sure that the voltage at these terminals is correct for the tubes you are using, and also that the "A" battery is capable of furnishing current for the number of tubes which you intend to use. Three WD-11 tubes should have three dry cells connected in parallel, for instance. One dry cell would have the same voltage but it could not furnish current for three tubes economically. By using three cells in parallel the current is divided between the three.



**"B" BATTERY**—The "B" battery is made up of a number of "flashlight" cells connected in series and sealed together in a convenient container, there being fifteen of the cells in the 22½-volt size and a correspondingly larger number in the higher-voltage batteries. The large-type "B" battery will prove more economical for a permanent set, while the smaller sizes have their points of advantage for portable sets. The detector battery is usually a 22½-

volt, tapped type which gives any voltage in steps of 1½ volts from 16½ to 22½ volts for soft detector tubes which are critical to plate voltage. The amplifier "B" battery can be conveniently made up of 22½ or 45-volt blocks connected up in series to give the required voltage. The battery made up in this manner will have two outside or unconnected terminals, one positive and one negative, and these will form the connections to the set.

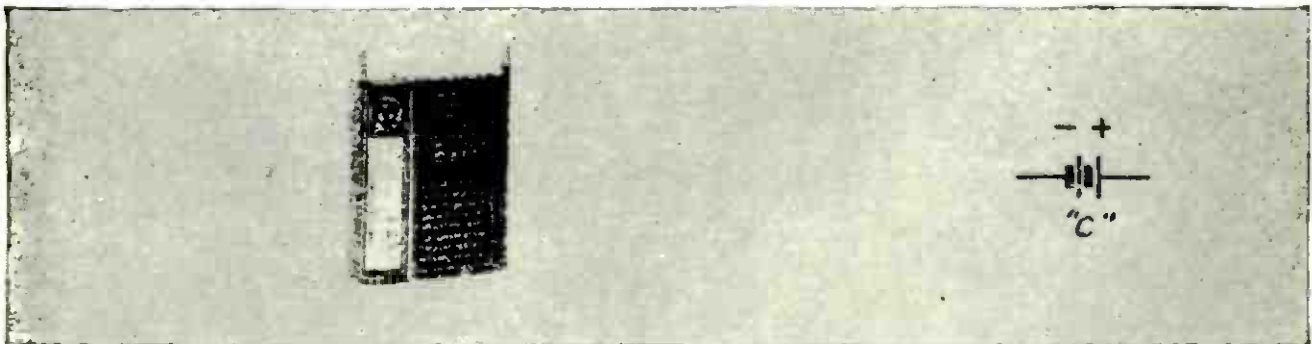

**"C" BATTERY**—With more than 67½ volts on the plate of the average tube it is advisable to connect a "C" battery in the grid circuit to bring the potential of the grid to the correct negative point with respect to the filament. Small flashlight cells of 3 to 4½ volts make good "C" batteries and are easy to obtain. To connect a "C" battery in an amplifying cir-

cuit, break the grid lead between the amplifying transformer and the filament, and connect the ends to the two terminals of the "C" battery, the negative side of the latter should be toward the transformer and grid. Another advantage of the "C" battery is that it cuts down the average plate current greatly and makes the "B" battery last much longer.

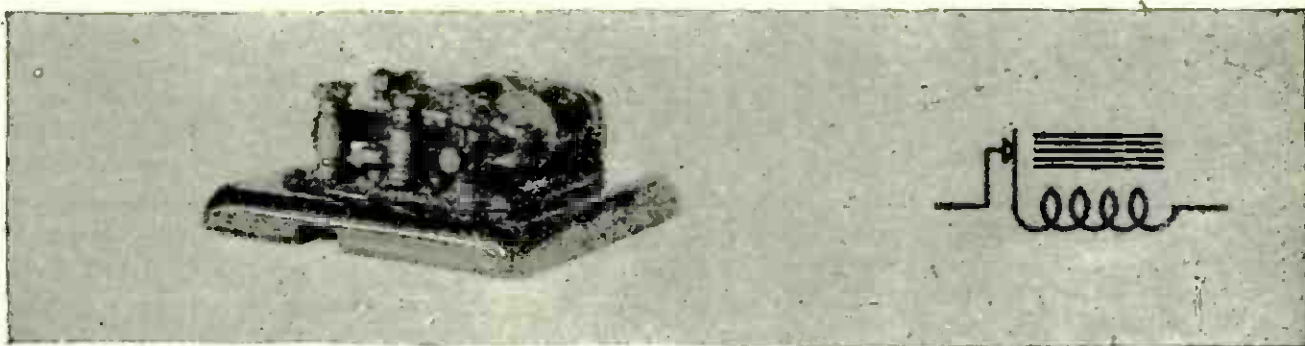

**BUZZER**—The chief uses of the buzzer in radio are for code practice and for testing out crystal detectors to find a sensitive spot. The buzzer for either of these purposes should (preferably) be one of the special high-frequency type. The note of an ordinary call buzzer is much too low. For code practice a

buzzer, battery (dry cell) and a key are simply connected in series. For testing crystal-detector adjustment, a buzzer, battery, and a key or push button are connected as above, and in addition a wire is connected, from the binding post nearest the buzzer interrupter, to the ground lead of the receiving set.

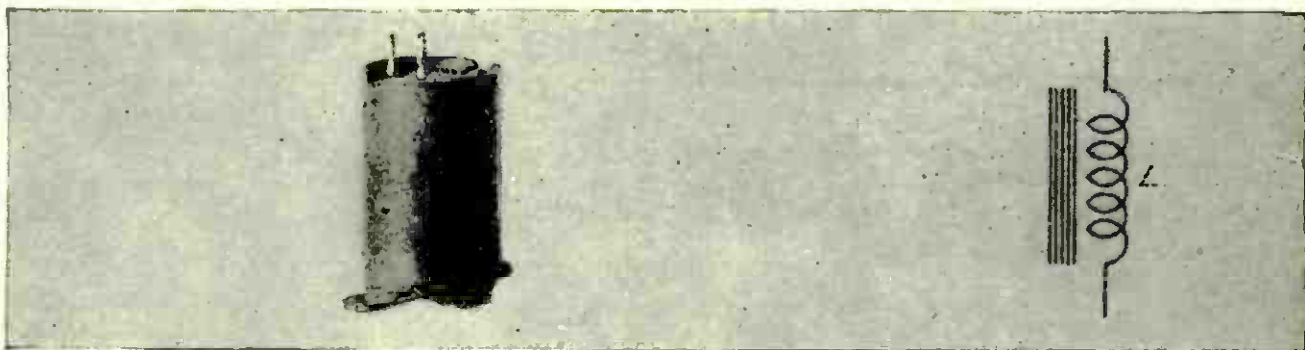

**AUDIO-FREQUENCY CHOKE COIL**—The audio-frequency choke coil consists of an iron core with a continuous winding, and has two connections, one to each end of the winding. The choke coil has a tendency to smooth out variations in current as its magnetic field opposes all changes in the current. An example of this use is to steady the plate current of a trans-

mitting tube by connecting one or more choke coils in series with the rectified supply. There is always a drop in voltage across a choke coil and this is used in choke-coil-coupled amplifiers. The choke coil is connected in the plate circuit of one tube and the drop across it used to operate the succeeding tube in the next stage of amplification.

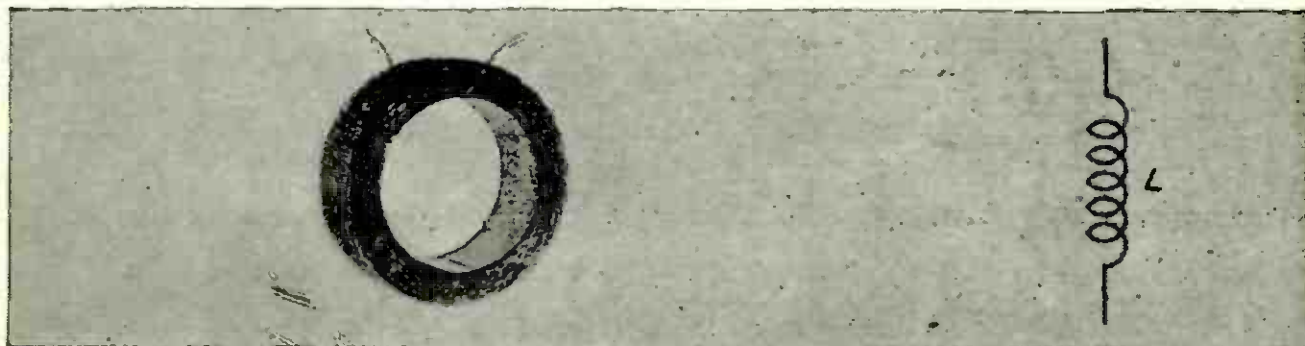

**RADIO-FREQUENCY CHOKE COIL**—The uses of the radio-frequency choke coil are very similar to the audio-frequency choke coil except that it is constructed to operate at much higher frequencies and is therefore generally made with an air core. The coil shown in the illustration is an ordinary honeycomb coil, which type is usually satisfactory for radio-frequency

choke-coil purposes. The radio-frequency choke consists of a single winding and has one connection at each end. Such a coil may be used in a low-power vacuum-tube transmitting set as a radio-frequency choke in the grid-leak circuit or in the plate circuit to keep the high-frequency energy from getting back into the power supply.



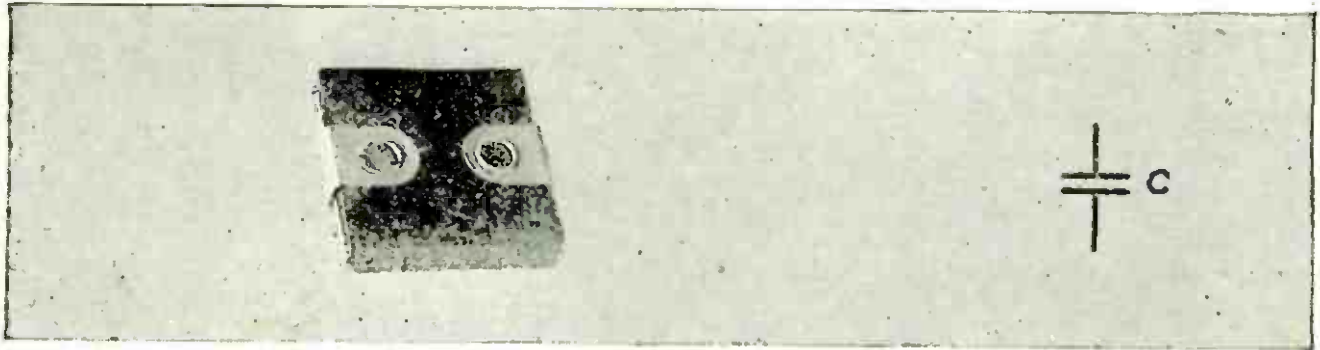

**FIXED CONDENSER**—The most satisfactory type of fixed condenser for receiving sets, and one that is comparatively inexpensive, is the small mica condenser of reliable make. As the amount of energy handled is extremely small, it is not advisable to use home-made condensers of doubtful quality. One of these small condensers of .00025 or .0005 mfd. capacity can often be connected in series with the antenna to cut down the wavelength if neces-

sary. In places where some loss does not matter and where the cost of a mica condenser of such large size would be prohibitive, such as the filter condensers for transmitting sets, paper condensers are often used. The fixed condenser has fundamentally two metal surfaces which are separated by an insulating sheet, although the metal surfaces may be made up of a large number of sheets. There are two connections, one to each of the metal surfaces.

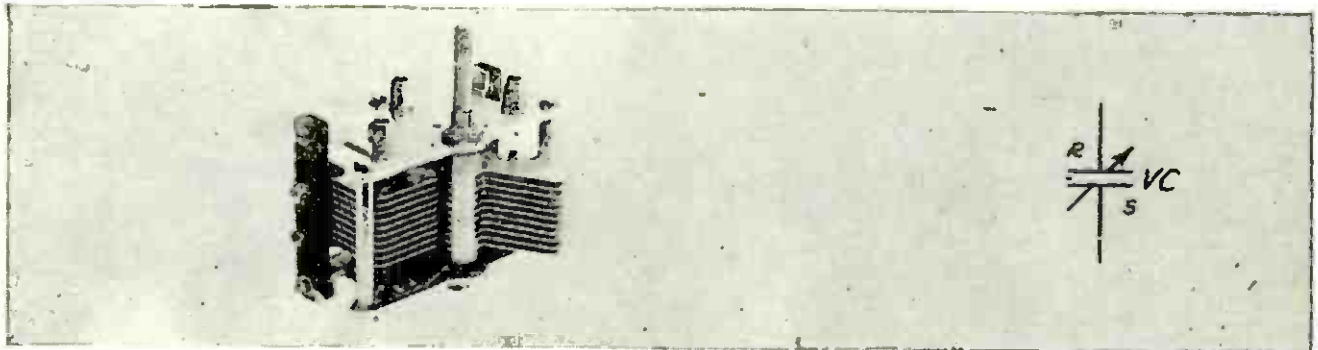

**VARIABLE CONDENSER**—The variable air condenser has become fairly well standardized in form; it consists of a number of stationary plates, closely spaced and connected together, and approximately the same number of rotary plates which are also connected together and which mesh between but do not touch the stationary plates. The condenser has two connections, one to the stationary plates and one

to the rotary plates. Always connect the rotary plates to the part of the circuit which is nearest the ground potential to avoid "body-capacity" effects. The condenser should be well made *mechanically* and *electrically*; the bearings should fit well and preferably be of metal; and the stator and rotor should be separated by a good insulating material to avoid excessive dielectric loss.

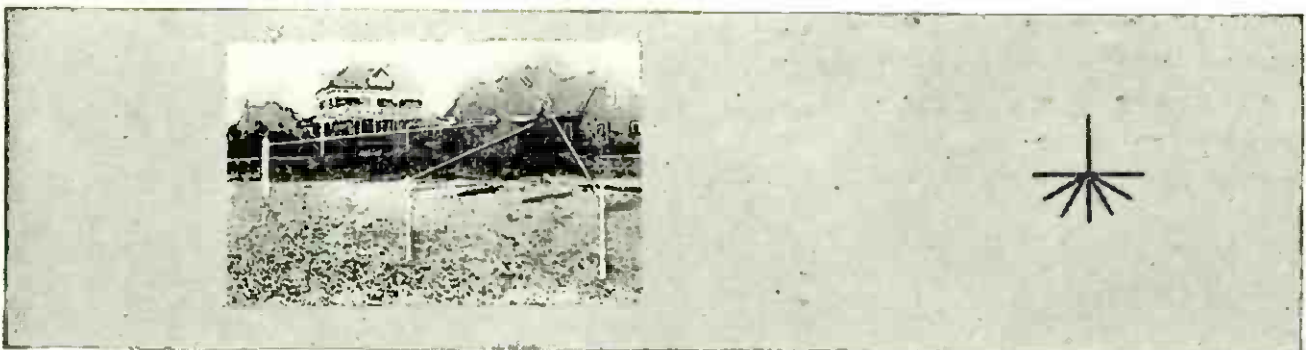

**COUNTERPOISE**—When a ground connection is impossible or when a natural ground gives too high a wavelength on our transmitting set, we fall back on the counterpoise; this is placed below the antenna and far enough above ground to clear obstructions. The counterpoise may take the form of the antenna or it may be spread out fan shape. At any rate it should be well insulated just the same as an

antenna; otherwise, if it should be grounded (even poorly) at some point, we defeat the purpose of the counterpoise which is to give a uniform electric stress over its entire area much the same as the stress between condenser plates. The wires of the counterpoise should be all connected and soldered together to form a single lead-in to the transmitting or receiving set.



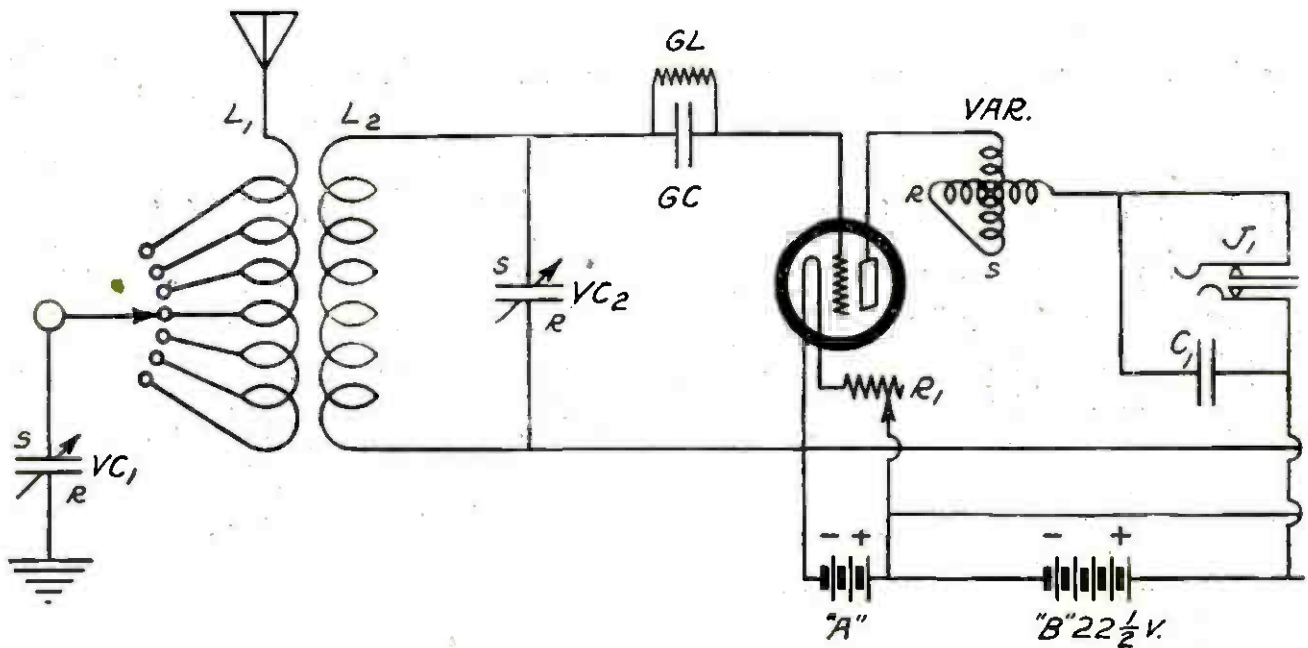

QUESTION: I have the following parts connected as shown in my sketch of the hook-up, which I am enclosing in my letter:

- 2 Malone-Lemon variable condensers, .0005 mfd.;
- 1 Cardwell variocoupler;
- 1 Mitchell variometer;
- 1 Dubilier combination grid leak and grid condenser;
- 1 rheostat;
- 1 UV-200 vacuum tube and socket.

Will you kindly give me a hook-up showing how to use this same circuit I am now using, with two stages of audio-frequency amplification added to it?

I have just bought one of the best loudspeakers to go with my set and when I tried it I did not get enough volume. I could just hear the music if I put my head right into the mouth of the loudspeaker. So I guess I must need an amplifier. Will you also tell me what extra parts I will need to go with my present apparatus.

D. J. WATROUSE

ANSWER: In Figure 2 you will find the circuit you require. The extra parts you will need are:

- C1—mica fixed condenser, .0005 mfd.;
  - J1 and J2—double-circuit jacks;
  - J3—single-circuit jack;
  - R2 and R3—filament rheostats, 20 ohms;
  - AFT1 and AFT2—audio-frequency amplifying transformers;
  - additional "B" batteries, 67½ volts.
- If you use phones you will find that insert-

ing the telephone plug in jack J2 will give you more distance than in your original set. The loudspeaker will give the best results if inserted in jack J3. You will need a separate plug for the phones and one for the loudspeaker.

\* \* \*

QUESTION: In using the new type of vacuum tubes, what side of the filament battery should the rheostats be connected in for an amplifying circuit? I have them in the positive side of the filament at present and the amplifier seems to work best when I use only 22½ volts on the plates of the amplifiers as well as the detector.

I have 90 volts of "B" batteries, and it seems a shame that I am unable to use only one 22½-volt section. The others will go to waste.

Someone told me I might have the rheostats connected in the wrong way and that I should follow the "dope" on the sheet which came with the tubes. I have not been able to find the sheet that I got with the tubes so I guess I am out of luck, as far as that is concerned.

I thought that you might perhaps help me out. Do I need "C" batteries?

WARD GIFFORD

ANSWER: For use as an amplifier the new UV-199 and UV-201a or C-299 or C-301a tubes should have the filament rheostat connected in the negative side of the "A" battery leads. You have them reversed and that is the reason

**QUESTION:** Please send me a circuit for a small 5-watt CW transmitter. I am getting the transmitting bug; caught it from watching a fellow amateur who has helped me with my set when I had trouble.

Now I am able to fix my junk all by myself and feel that I would like to try to steal some of his stuff and surprise him with a set in full operation.

ADRIAN ROSCH

**ANSWER:** The wiring diagram for the transmitter is given in Figure 1. It is a simple Hartley oscillator.

The parts you will need are the following:  
 L—transmitting inductance;  
 GL—grid leak, 5,000 ohms;  
 GC—grid condenser, .002 mfd.;  
 key—well insulated transmitting key;  
 C—mica fixed condenser, .002 mfd.;  
 vacuum tube, UV-202 and socket;  
 power transformer, for lighting the filament and supplying the plate voltage.

You may make the transmitting inductance L yourself by winding 25 turns of No. 14 copper wire on a grooved composition tube, 3½ inches in diameter.

This circuit has been giving satisfaction at 7UD's station for over a year. He radiates 1.4 amperes and has worked 1,100 miles and was reported QSA (strong) at this distance.

The only adjustment to make with the set after the proper wavelength has been obtained is the grid-plate coupling which is adjusted by the sliding contact on the coil L.

**QUESTION:** Is it really necessary that antenna wires should be soldered? I have an indoor antenna, and I am afraid that if I try to solder the joints (there are three) I may damage the carpet.

I remember that when we lived in our other house I had an outdoor antenna which I soldered. In soldering it I also remember that the soldering paste melted down and fell on the roof. As the paste contains acid I know what it would do to the carpet. And if it did that to the carpet I know what would happen to my set. And I want to keep my radio set even if it does make me stay up late at night, and cause me to get scolded.

So again I ask, is there any way to do without soldering?

PERCY DICKINSON

**ANSWER:** Under the circumstances, you are safe! For an indoor antenna requires no soldering at the joints. You will find that the copper wire keeps reasonably clean and bright indoors.

However, in an outdoor antenna the copper wire will soon become oxidized or corroded and will make poor contact if not soldered. The soldering is only to make the joint a permanent affair so that its resistance will not increase with age.

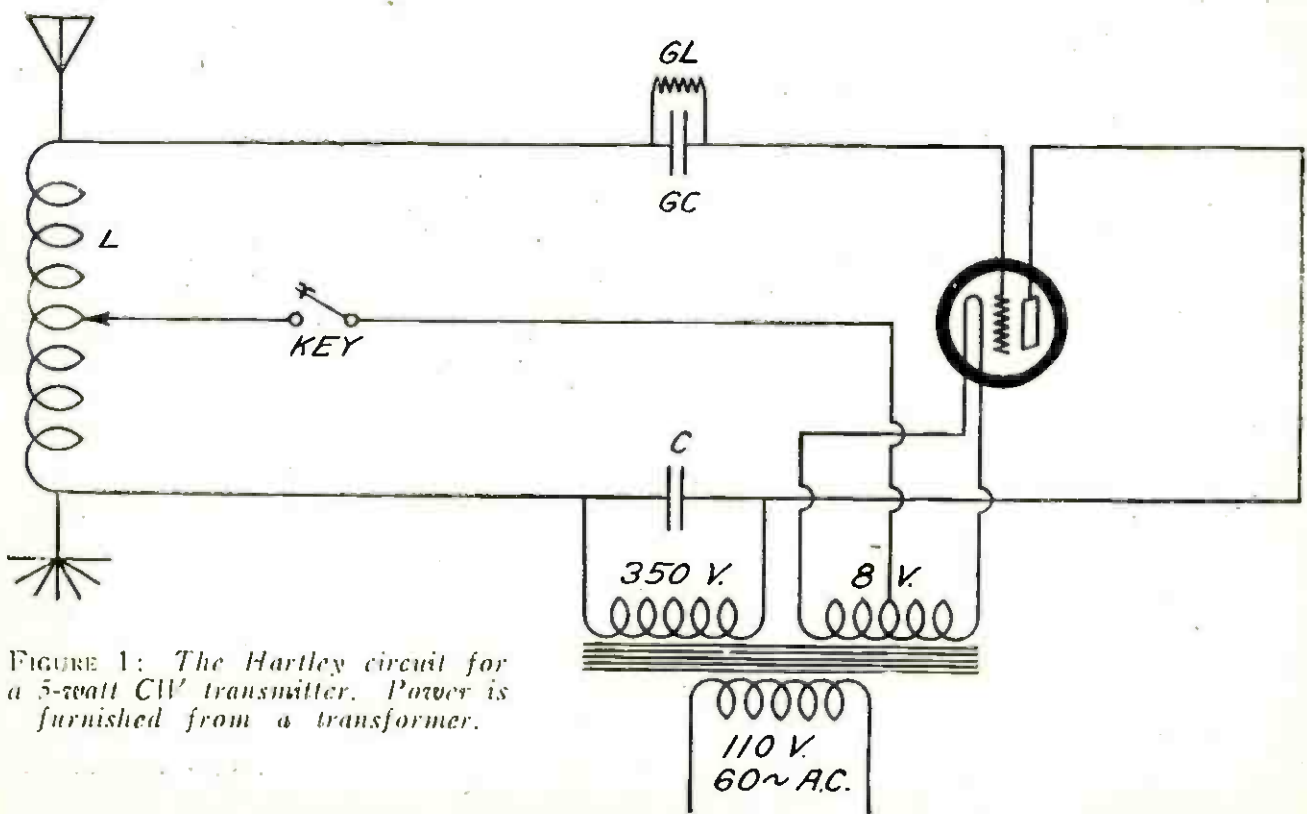

FIGURE 1: The Hartley circuit for a 5-watt CW transmitter. Power is furnished from a transformer.

## WHAT READERS ASK



THIS department is conducted for the benefit of our readers who want expert help in unravelling the innumerable kinks that puzzle the amateur who installs and operates his own radio apparatus. If the mechanism of your equipment bothers you—if you believe that you are not getting the best results from it—ask the SERVICE BUREAU.

THE flood of inquiries that has poured in upon the Service Bureau has not only furnished evidence of the need of this department, it has also necessitated a system of handling the correspondence that will insure the selection of and answer to only those questions that are of the widest application and that are, consequently, of the greatest value to the greatest number of our readers. Our correspondents are, accordingly, asked to co-oper-

ate with us by observing the following requests:

1. Confine each letter of inquiry to one specific subject.
2. Enclose a stamped and self-addressed envelope with your inquiry.
3. Do not ask how far your radio set should receive. To answer this inquiry properly involves a far more intimate knowledge of conditions than it is possible to incorporate in your letter.

**Q** In justice to our regular subscribers, the Service Bureau is compelled to restrict this special service to those whose names appear on our subscription list. A nominal fee of 50 cents is charged to non-subscribers to cover the costs of this service and this sum must be enclosed with the letter of inquiry. No inquiries can be answered personally or by telephone.

**QUESTION:** Please tell me which of the three modulation methods is the best: Heising, grid modulation or absorption modulation?

JULIUS MORRISON

**ANSWER:** The Heising scheme is the best in quality, and best in efficiency, though high in cost. It requires two tubes of equal power. The grid method is second in quality and efficiency, but is more economical in first cost. It requires but one tube. With two tubes it can not be as efficient as the Heising method.

The absorption method is efficient and the quality is good on extremely low power (say one 5-watt tube). But on higher powers the microphone heats up and introduces losses and distortion into the circuit. It is the most economical radio-telephone circuit for low power with one tube, for it needs no batteries for modulation—only a loop of wire and a suitable microphone.

\* \* \*

**QUESTION:** Do I have to obtain a license for receiving in America? I had one when I lived in London and want to put up my set over here. If I need

a license please let me know how to go about getting one.

KNOWLTON BAIRD

**ANSWER:** You do not need a license to own and operate a receiving set in the United States.

\* \* \*

**QUESTION:** What is the speed of radio waves? Has this ever been ascertained?

EDWARD HORNE

**ANSWER:** Yes. The speed of these waves is 3,000,000,000 meters a second (in round figures). This is equivalent to about 186,000 miles a second.

\* \* \*

**QUESTION:** What is a telephone repeater?

L. J. C.

**ANSWER:** A telephone repeater is one or a number of stages of audio-frequency amplification added to a telephone line to magnify or strengthen weakened voice currents that have traveled long distances across the country.



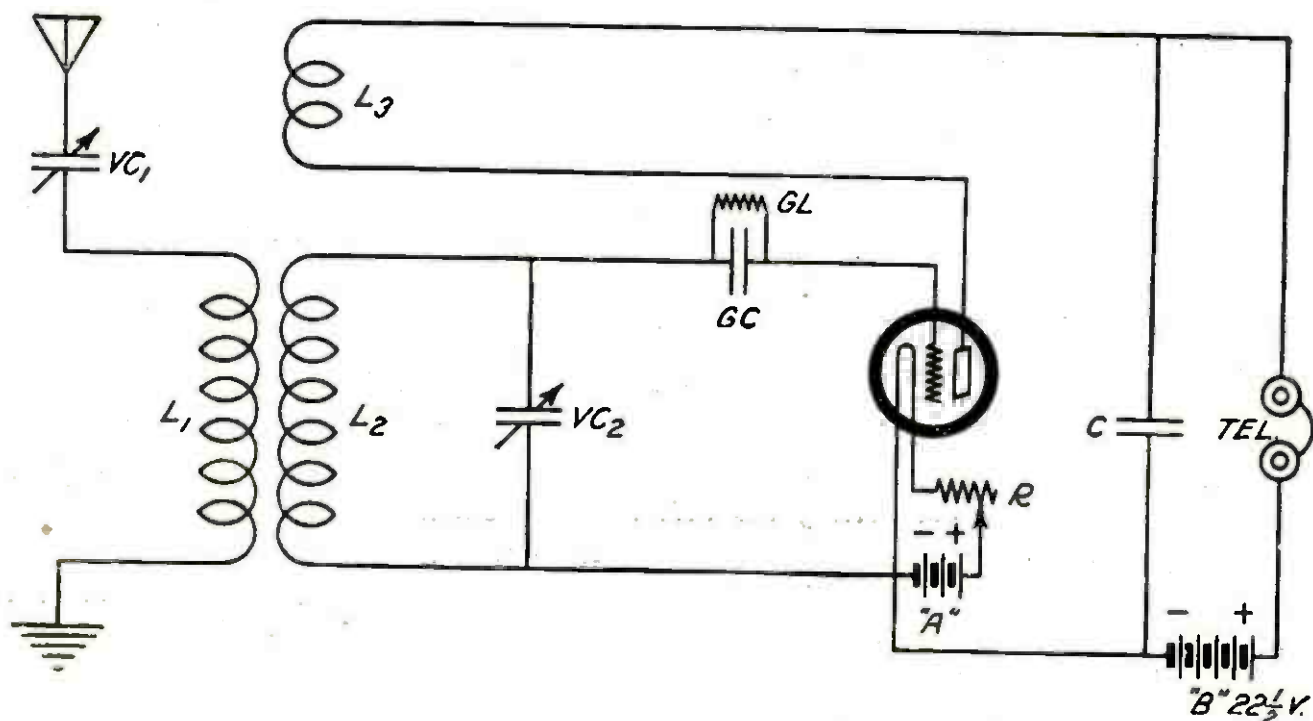

### THE TRIPLE-CIRCUIT, VACUUM-TUBE, REGENERATIVE CIRCUIT

FIGURE 6: By adding one more coil to your present single-circuit tuner you may greatly increase the selectivity and at the same time cut down re-radiation which is the most objectionable feature of the single-circuit hook-up.

highly selective tuner as to drive a car through the heavy traffic encountered in a big city.

Don't expect to become expert in handling the tuner any sooner than the car. It is easy to pick up and enjoy programs from the local stations—as easy as it is to run a phonograph—but practice and patience are required to learn to hear all the available distant points through the local interference. But don't let that fact discourage you; you can do what others are doing, with

a little perseverance, in really learning the facts about tuning.

If your object (or one of your objects) in radio receiving is to "get distance," get the most highly selective tuner and the most sensitive detecting and amplifying system that you can handle effectively, and work with it until you learn the tricks of manipulation. Your effort will be well repaid, and you will find that the new schedule of wavelengths makes these great results possible.

### Radio Telephones on Trains

It is now possible to carry on conversation between trains in motion and distant radio stations. What recent experiments in this field have developed in this country, France and Germany will be told by Robert G. Skerrett in POPULAR RADIO for January.

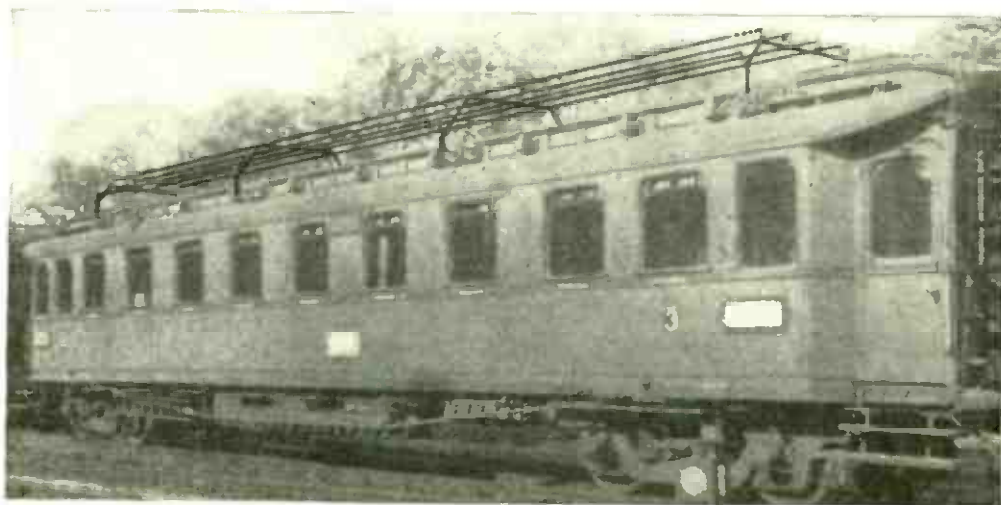

Dr. Albert Neuberger, Berlin

intensity 60 and Philadelphia (WIP) with intensity 20. If your tuner has the selectivity characteristic of curve XX in Figure 2, can you expect to hear Philadelphia without even the faintest interfering signals from either New York station?

To find out the answer we need only note that Philadelphia's wave-frequency is 590 kc. and those of the New York stations 610 kc. for WEAJ and 660 kc. for WJZ. The differences are 20 kc. and 70 kc.; if the receiver is tuned to WIP, the desired signals will be received at full 100-percent intensity or 20; WEAJ's signals, being 70 kc. removed, would not be heard. But WJZ's signals, only 20 kc. away from WIP's would come in at 25 percent of their full strength of 60, or at 15 which is three-quarters as loud as WIP. Consequently WJZ would interfere with WIP under these conditions, and a more highly selective tuner would be required to receive signals from this particular Philadelphia station without interference.

What can one do to increase selectivity so that such interference can

be prevented? The details of all the answers to that question would be enough to fill the space of several articles such as this, but we can at least set down some of the high spots:

1. If you are using a crystal detector with single-circuit receiver (the ordinary form of which is shown in Figure 3), change over to the double-circuit receiver of Figure 4. If you cannot do this, at least tap the detector circuit across only a *part* of the inductance coil as in Figure 5.

2. If you are using an ordinary vacuum-tube detector, in a non-regenerative circuit, change to a good regenerative circuit and preferably one which is coupled inductively to the antenna (as in Figure 6).

3. If your interference conditions are too severe to be overcome by a circuit of the type represented by Figure 6 (a very unusual state of affairs), use a loop antenna with *tuned* radio-frequency amplifiers and regeneration, or, perhaps still better, with a super-heterodyne receiver.

Above all things, bear in mind that as much skill is required to operate a

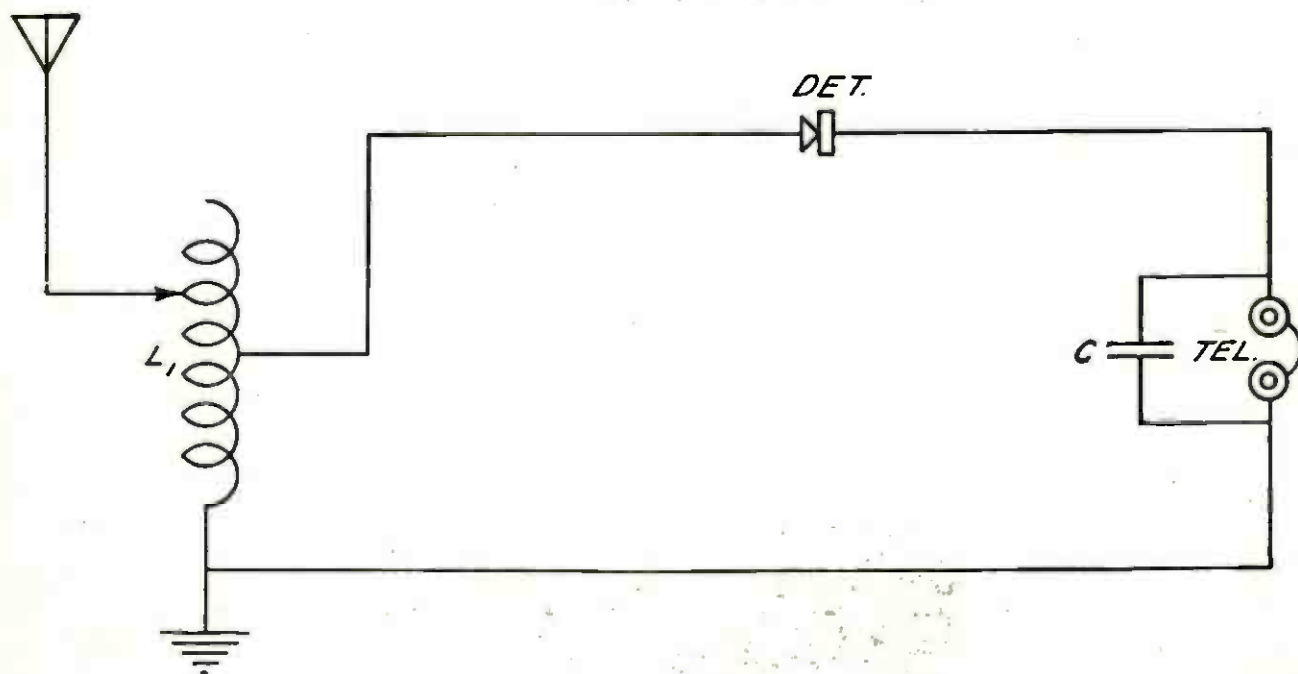

A DOUBLE-CIRCUIT CONDUCTIVELY COUPLED CRYSTAL SET

FIGURE 5: By using only a small part of the coil  $L_1$  for the secondary circuit which contains the detector and the telephones, the selectivity is increased to a considerable extent over that obtained by the circuit in Figure 3.

receiver. When set to give a maximum response to 660 kc. (line Q, as shown) signals on carrier frequency 690 kc. (line R) would give only about 15 percent full response, while other signals of 590 kc. (line P) would produce practically no sound in the telephones.

We might make a table showing the percentage of normal or best signal strength that would be received by such a tuner for various differences of wave-frequency, using this resonance curve as a basis, like the following:

Difference from Resonant Frequency	Percentage of Resonant Signal
0	100
10	80
20	25
30	15
40	10
50	5
60	3
70	0

From such a table we can see just what to expect in the way of freedom from interference. For instance, if instead of tuning to 660 kc. as shown, you adjusted to New York (WEAF) at 610 kc., the energies of signals from other stations would be as follows (New York being rated 100 percent because tuned to its maximum):

Memphis and Davenport—80 percent of their maxima.  
 Dallas and Philadelphia—25 percent of their maxima.  
 Washington and Detroit—15 percent of their maxima.  
 Pittsburgh and Omaha—10 percent of their maxima.  
 New York (WJZ) and San Diego—5 percent of their maxima.  
 Chicago and St. Louis—3 percent of their maxima.  
 Jefferson City and others—0.

Note that these relative signal strengths are given as percentages of the loudest possible signal your set could receive from any particular station, and that each percentage refers to the signal from the station in question and that only. In other words, this above table will not show the relative signal strengths in comparison with the signal from some one station, such as the one to which the set is tuned. To get this information we must combine with the above figures another tabulation giving the *relative* signal strengths of the station in question. One or two examples will show how this can easily be learned, however.

Suppose that with your receiver, under some particular condition, you can hear New York (WEAF) with intensity 100, New York (WJZ) with

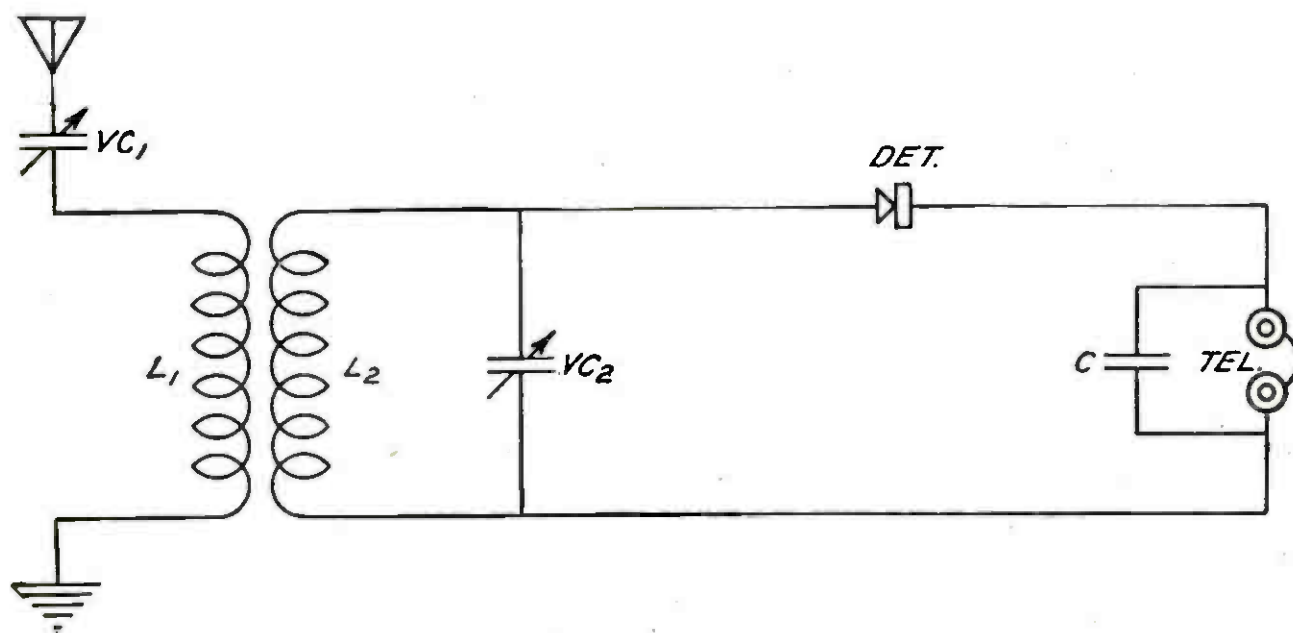

THE INDUCTIVELY COUPLED CRYSTAL CIRCUIT.

FIGURE 4: This is the best crystal circuit to use from a standpoint of selectivity. It is even better than the hook-up shown in Figure 5.



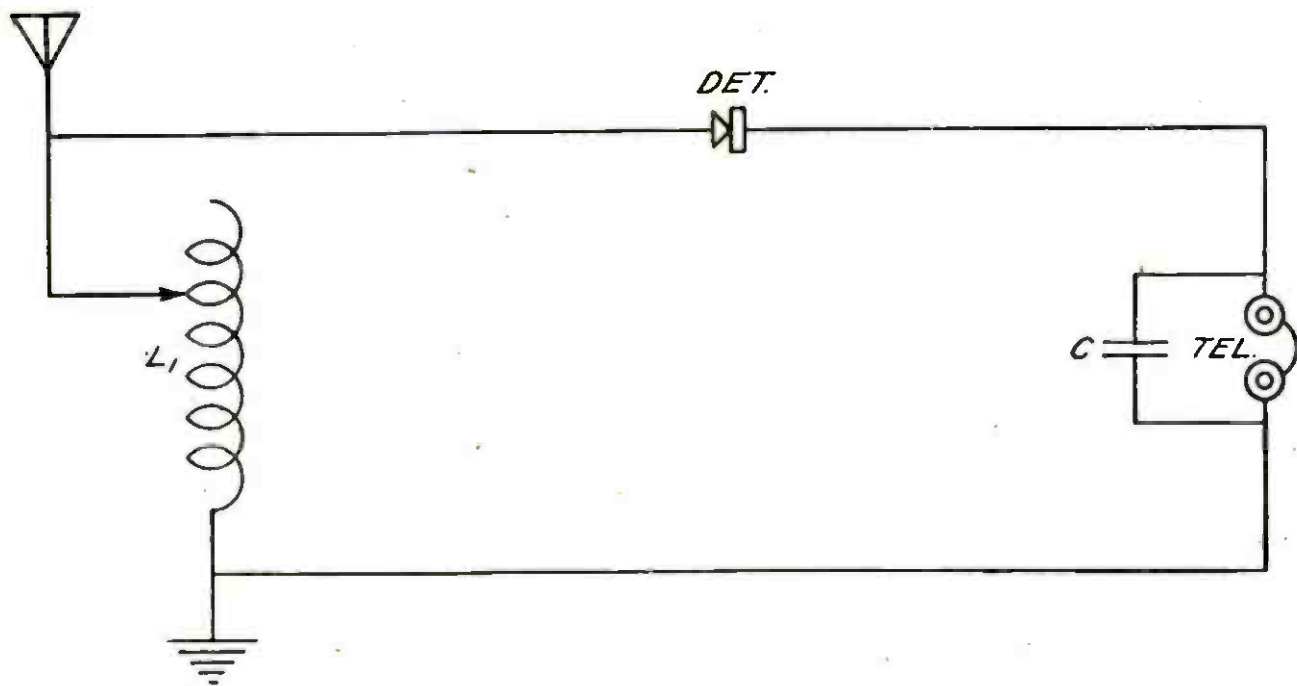

#### THE CONVENTIONAL SINGLE-CIRCUIT CRYSTAL RECEIVER

FIGURE 3: Many beginners who have this type of simple set are experiencing trouble with interference. The author tells us that the trouble may be lessened if not eliminated by changing over this circuit to the circuit shown in Figure 5.

bringing in interference, because the selectivity of the tuner has been much increased. With a tuner that would exclude all but 10 kc. at a time, one might use a sufficiently sensitive amplifying system to pick up any of the broadcasting stations in the United States without experiencing interference from any of the others. It is feasible to build receivers having even more than this extreme degree of selectivity.

The chart of Figure 1 is based on the assumption that the receiving tuner will admit freely, and with equal facility, energy received on any of the wave-frequencies that fall opposite the opening in the line AA (or BB) but that at the end frequencies of this admitted band the tuner will cut off sharply so as not to admit any energy from waves outside the frequency limits marked by the opening. It is possible to build receivers that have practically this sharp cut-off characteristic, but the ordinary tuners that depend upon simple circuit resonance for their selectivity have a gradual or tapered cut-off on each side of a single frequency that they receive best.

Figure 2 compares these two characteristics; here the frequency scale is drawn horizontally and the vertical scale represents the percentage response that the receiver would give to a signal of some definite intensity at all of the wave-frequencies illustrated.

In Figure 2 the square-shaped line marked AA corresponds to the barrier line and opening similarly designated in Figure 1, and represents a receiver that admits a 100-kc. wave-band with sharp cut-off at each end. It is easy to see that, at the setting illustrated, a wave of frequency 590 kc. (as used by some of the Philadelphia stations and indicated by the vertical dash line P) will produce 100-percent signals. A wave of frequency less than 585 would produce no response on account of the sharp lower cut-off. A wave of 660 kc. (used by WJZ in New York and shown at line Q) would give 100-percent response, but 690 kc. (Washington; line R) would be above the upper cut-off and give no signals.

Now look at the curve XX in Figure 2, which shows the selection characteristic of an ordinary but reasonably good

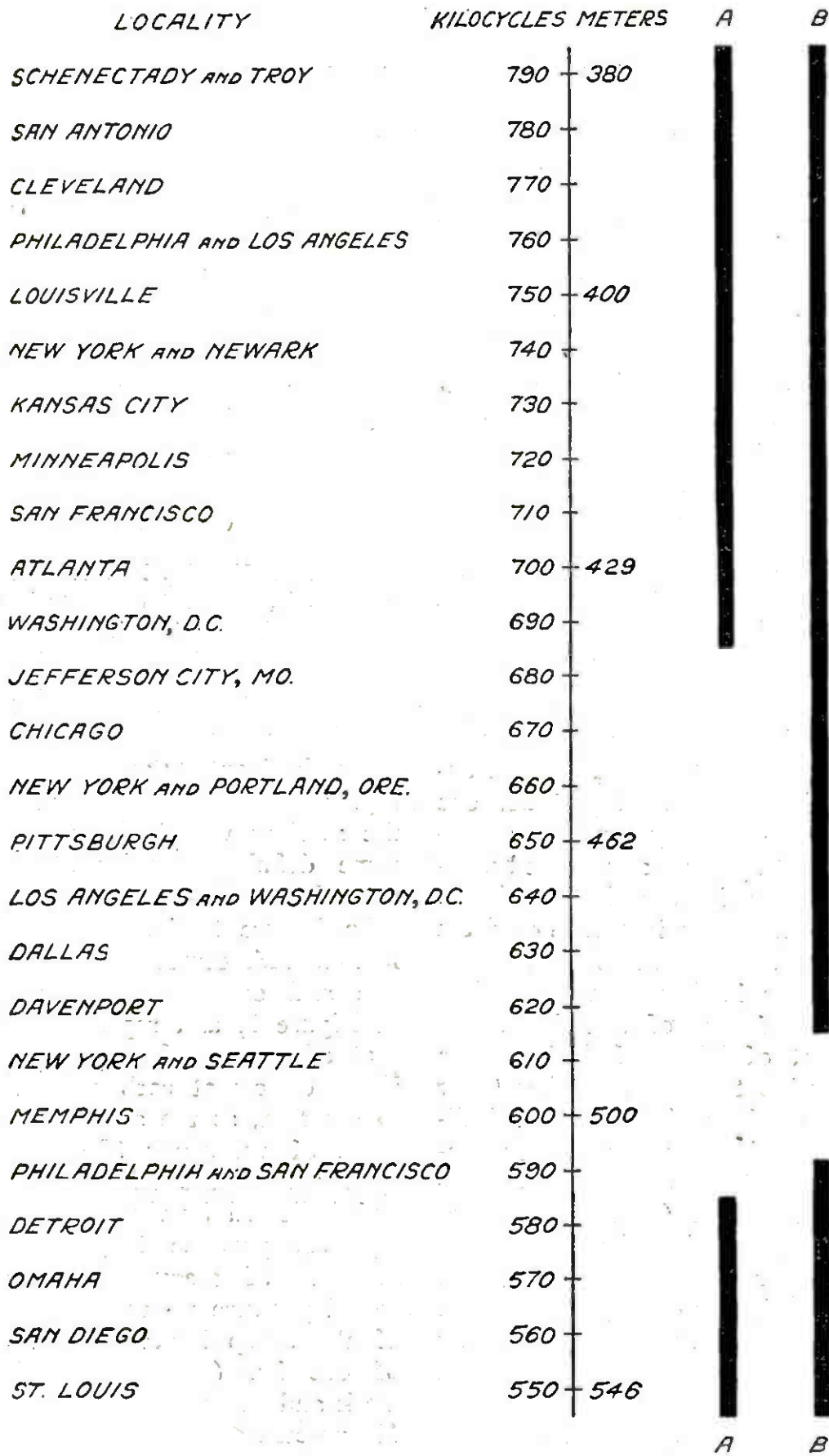

FIGURE 2: This chart shows how a broad-tuning set would include the signals of a number of stations at one time while the sharp-tuning set would get only one or two. The small gap in the dark heavy line at the extreme right of the chart would include only New York, Memphis and Seattle. This line is for a sharp tuner. The large gap in the second heavy line includes everything from Jefferson City to Philadelphia and San Francisco; this line is for a broad tuner and considerable interference would be experienced.

on your receiver. Make it as highly selective as you can and enjoy the choice of programs that you will be able to get in that way.

Some of your neighbors (and probably a good many of them) have found that by sharp tuning they can hear any one of twenty or more stations at a time on "good nights" this season; last winter they were lucky to be able to choose more than five or six.

Let us look more closely into this matter of receiver selectivity.

The term is almost self-explanatory, it means the ability of a radio receiving outfit to select signals transmitted on one frequency of carrier wave from other signals that are simultaneously being sent out on waves of other frequencies.

Suppose we made a chart of some of the broadcasting wave-frequencies as in Figure 1, where the different values are arranged along a vertical scale. In this figure, the localities to which the various wave-frequencies have been assigned are indicated, as well as the corresponding wavelengths in meters.

Toward the right-hand side of Figure 1 is drawn a heavy vertical line, marked AA, with an opening equivalent in width to 100 kilocycles. Imagine that this line represents the barrier set up by your receiving tuner; that no wave energy can get through at the frequencies opposite the line, but that the wave-frequencies opposite the opening can get through to operate your telephones. From the diagram it is quite clear that a receiving set which admits a 100-kc. band (or continuous group) of wave-frequencies could simultaneously pick up signals from two of the New York stations, from Philadelphia, from Washington at 640 kc. and (if the signals were strong enough) from Pittsburgh, Chicago and a few others. This assumes that the particular set be located in the east; if it were on the west coast, it would

simultaneously admit signals from San Francisco, Los Angeles and Portland.

Following the diagram's teachings a little farther we see that even a receiver so non-selective as this could choose between the three New York stations at 610, 660 and 740 kc. Although in the position shown it admits both 610 and 660 kc. by turning the tuner controls to give resonance to the lower frequencies (which would have the effect of lowering the opening in the line AA) the 660-kc. wave could be cut out. By raising the admitted frequencies 40 kc. above the illustrated values, 610 kc. would be cut out but 740 kc. not yet admitted. On the other hand, so broad a tuner could not be effectively used with a very sensitive detector and amplifier, for the increased responsiveness of the receiver would bring in interference from the more distant stations.

Here we have the crux of the whole tuning situation. Your receiving tuner *must be more and more selective the more sensitive your detector and amplifiers, or the farther you desire to receive.*

If you are in the vicinity of two or three broadcasting stations that use well separated wavelengths, and if you are satisfied to limit your reception to those stations, a relatively dull detector (such as a crystal) and a tuner with 100 kc. selectivity may be all you need. If, however, you want to reach out with amplifiers so as to hear Omaha, Detroit, Philadelphia or other stations whose wave-frequencies are not very different from each other, you will have to match your sensitive detecting system with a highly selective tuner.

You can see at once that the narrowness of the opening in the line AA (Figure 1) is a measure of the receiver's selectivity. If this opening is made more narrow, say to a width admitting only a 20-kc. range at one time, as in BB, the receiver sensitivity may be greatly increased without





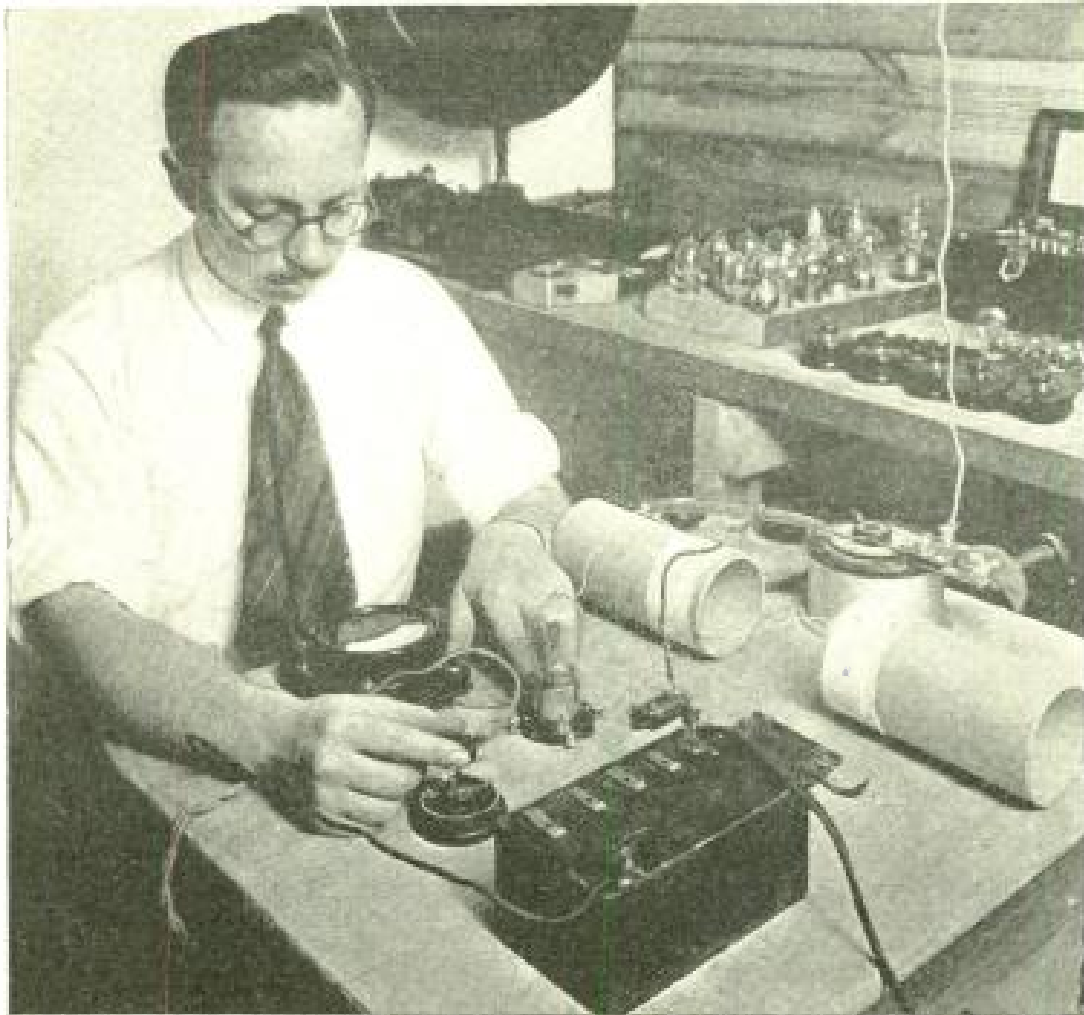

From a photograph made for POPULAR RADIO

*"If you are now using an ordinary vacuum-tube detector, in a non-regenerative circuit, change to a good regenerative circuit and preferably one that is coupled inductively to the antenna."—JOHN V. L. HOGAN.*

## How to Increase the Selectivity OF YOUR RECEIVER

Do you have trouble in tuning out interference now that the broadcasting stations are using the re-allotted wavelengths? This article by one of the best radio engineers in the world tells how to overcome your difficulty.

By JOHN V. L. HOGAN

**S**INCE the adoption of the new wave-frequency (or, in the old phrase, wavelength) allocations for broadcasting, the number of transmitters that can be heard by any receiving station has been substantially increased.

Under the former plan the transmitters were licensed to work at only two wave-frequencies—833 and 750 kilocycles a second (corresponding to

360 and 400 meters wavelength). If the broadcasters had lived up to the regulations no one would have been able to receive from more than two stations, one on each wave, at any one time. As a matter of fact it was found that so much interference developed when only the two waves were used that the station managements gradually tuned their transmitters to

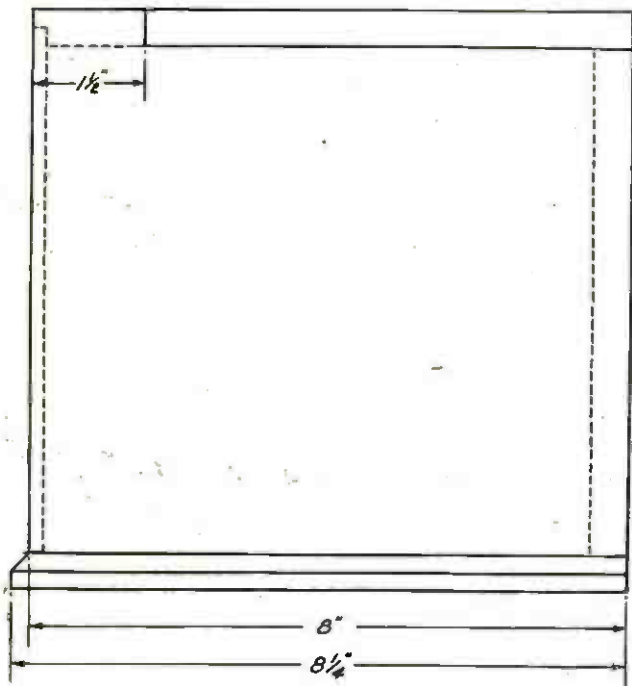

THE DIMENSIONS FOR THE CABINET  
 FIGURE 5: This diagram (which contains the front and side measurements for the hard-wood cabinet) may be turned over for construction to the cabinet maker or a cabinet of this size may be obtained from almost any radio supply store.

All the other units will then be automatically connected to the batteries and to each other.

Next, place in the sockets six UV-201-a vacuum tubes, making sure before doing so that the rheostats in all the units are turned off.

Put the receivers on your head, but not too near your ears, and turn up the tubes to the correct brilliancy.

Then start with the initial adjustment. Place the regenerative control knob A1 on the tuner at a low value (say at 10). Place the oscillator-coupler knob K1 at a high value (near 100). Place the antenna switch F1 on the second tap from the left. Set the wavelength knob B1 at 40. Place the heterodyne control knob L1 at about 40. Then adjust the potentiometer knob on the amplifier, by turning in a clockwise motion until a loud rushing noise is heard in the telephones. Turn the potentiometer just a little further on beyond this point.

The initial adjustment is finished, now to tune in a station.

Turn the heterodyne adjusting knob L1 slowly in one direction or the other until you hear a signal. Then bring in the signal louder by adjusting with the wavelength knob A1. (These are the two knobs that you will use altogether for tuning; A1 to tune to wavelength and L1 to heterodyne the signals).

When you have these two adjustments made the best you can get them, start and go over all the other adjustments you have already made and thus get the set working, once and for all, at the highest efficiency.

When this is *once* done, you need not bother with the other adjustments again; they are only necessary to get the set working properly.

To get other stations, you may change the setting of A1 and find the corresponding setting for L1 to bring in this wavelength. You will find that for a given setting on A1 there will be a given setting on L1.

The regenerative control should only be used on extremely distant stations where it will be found a great help in making the signals audible.

When you have mastered the tuning method, you will find that you can tune in anything, no matter what the distance, if the wavelength is within the range of the tuner (180 to 550 meters) and if the static is not too strong.

You will find little interference and great sensitivity in such a set and the reception will be extraordinarily clear.

←AT LEFT: A VIEW OF THE AMPLIFIER FROM THE RIGHT-HAND SIDE

FIGURE 6: This view gives a better idea of the grouping of the transformers, rheostats, condensers, sockets and binding posts, when considered from a "depth" standpoint. It should be noticed that the condenser X1 is mounted directly on the terminals of the input transformer T1.



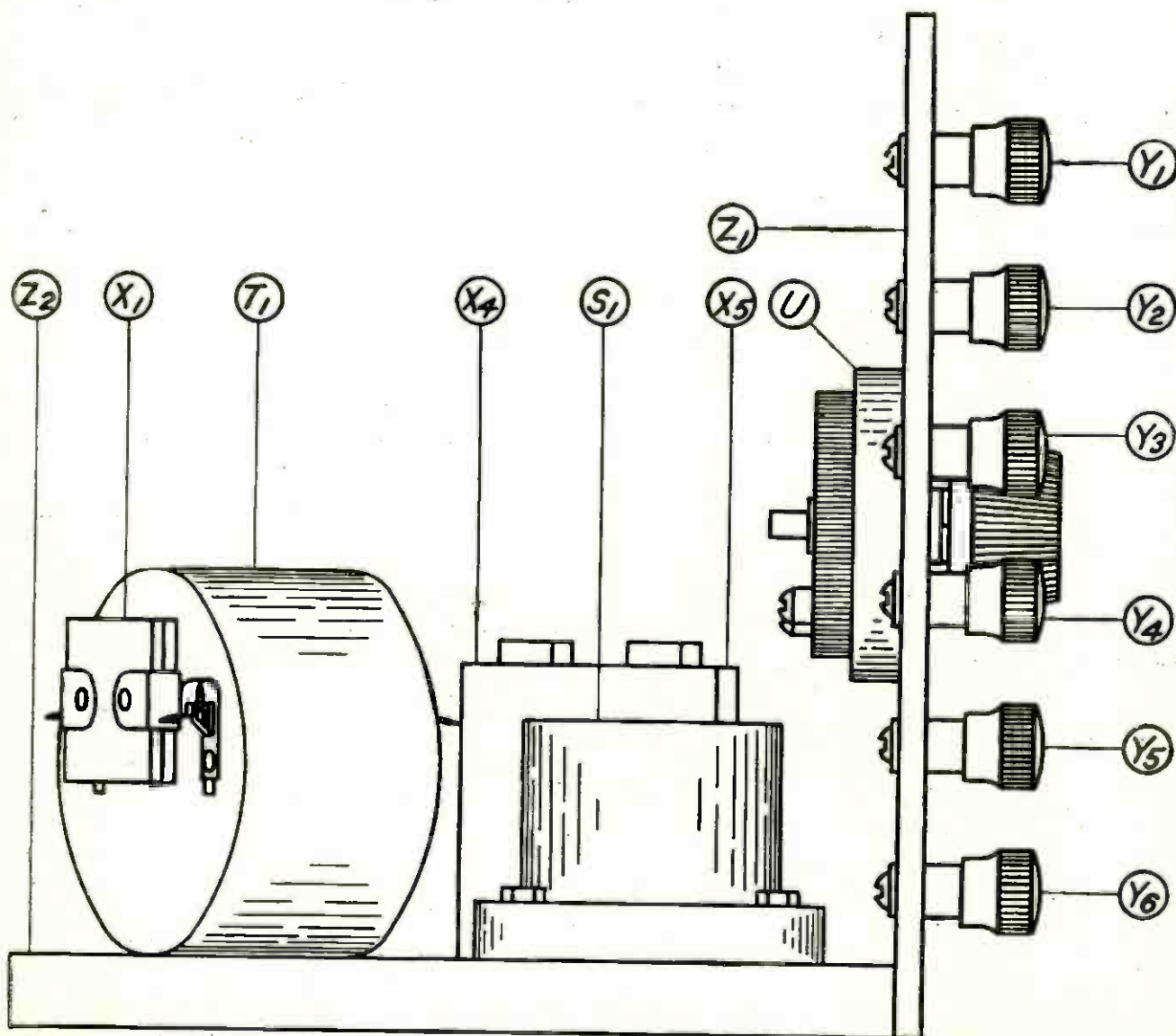
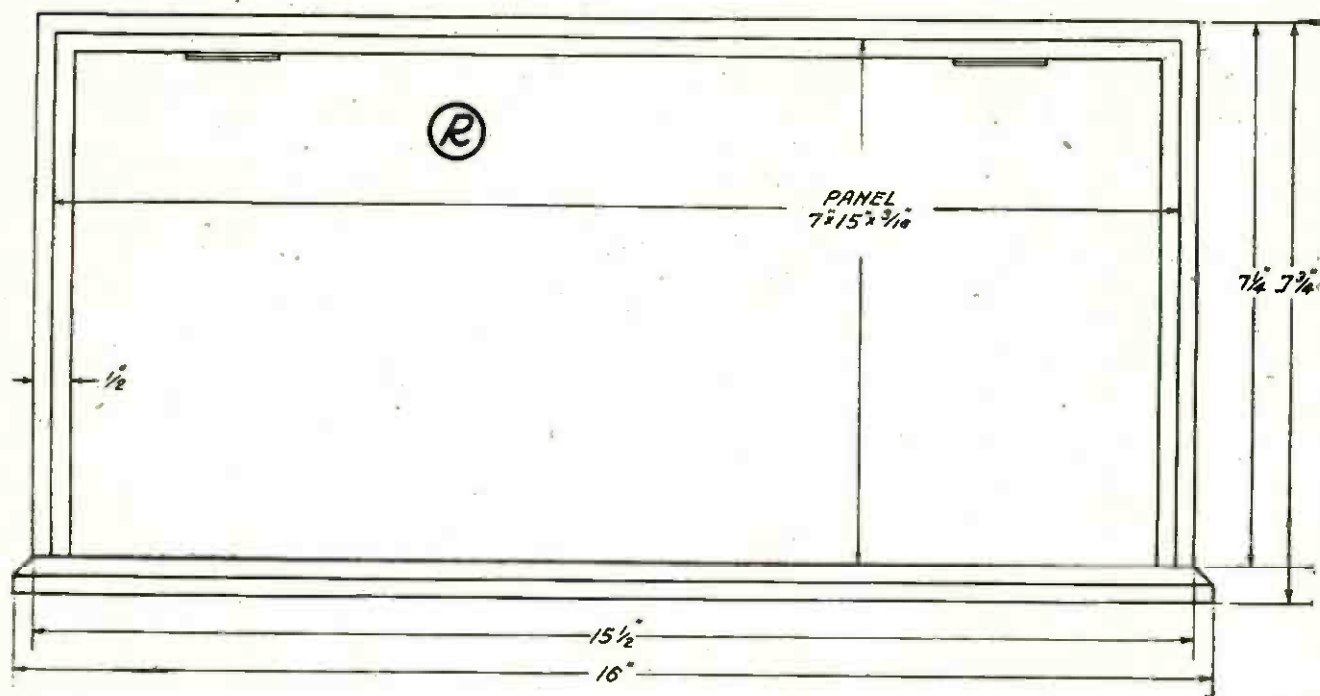

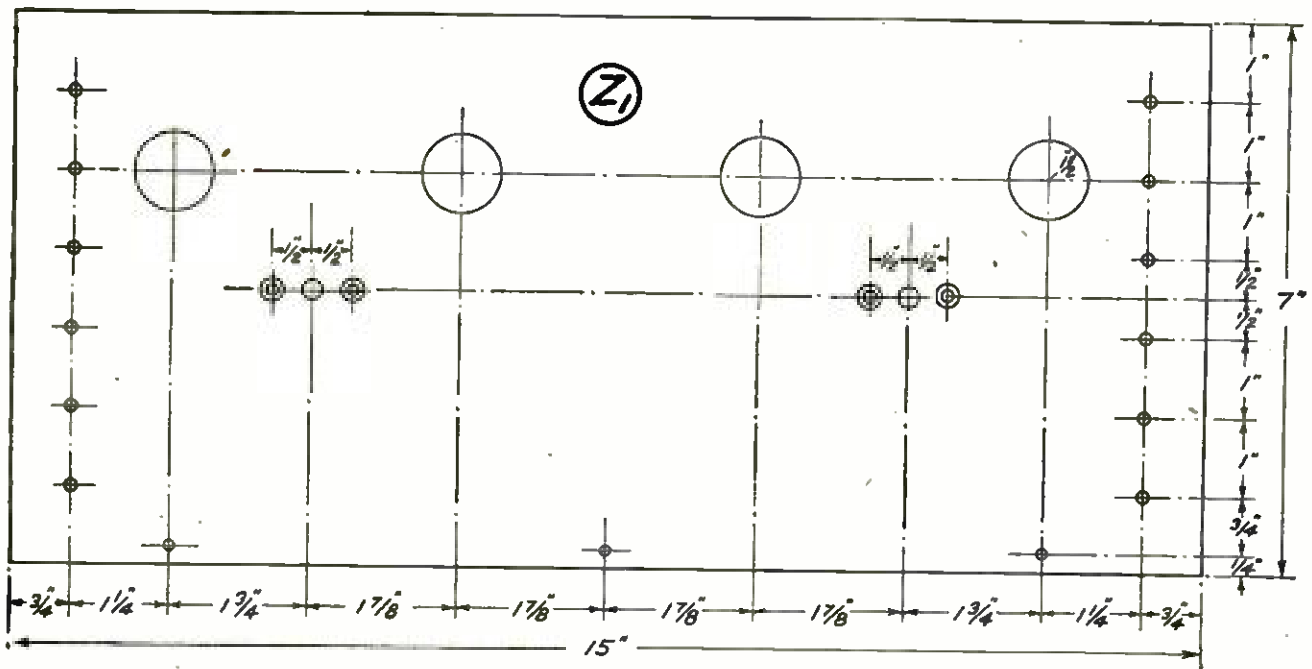

#### THE DIMENSIONS FOR THE MAIN PANEL

FIGURE 4: By following this diagram, the correct size of the panel will be assured together with the correct spacing for the holes for the screws which hold the parts, and the shafts of the instruments which protrude through the face of the panel.

connected to the grid terminals of sockets S2 and S3, respectively.

Now connect the remaining side of condenser X4 to the bottom wire attached to post Y6.

Then connect the condenser X5 across Y3 and Y6 binding posts, anywhere suitable along the two long wires connecting these two posts to posts Y9 and Y12, respectively.

Now connect condenser X3 across post Y7 and Y12.

Run a wire from Y12 to the pointer on the rheostat V. The other end of the rheostat should be connected to one of the filament terminals on each of the sockets S4, S3, S2 and S1. The remaining filament terminals on these four sockets should all be connected to the long wire connecting posts Y5 and Y11. From this same wire run another wire to one end of the secondary winding of the transformer T4. The other end of this winding should be connected direct to one side of the condenser X2 and the grid leak W. The other side of these two instruments should be connected to the grid terminal of the socket S4.

Connect the plate terminal of the socket S1 to one end of the primary winding of transformer T2. The other end of the primary T2 should be connected to the long wire connecting posts Y3 and Y9.

Do the same thing with the plate terminal of socket S2 and the primary winding of transformer T3.

Do the same thing with the plate terminal of socket S3 and the primary winding of transformer T4.

The last wiring job will be to connect the plate terminal of socket S4 to post Y7 and the hook-up will be complete.

#### Operating Data

To set up the various units after they have been completed and put in their cabinets is a simple matter.

First, place the Haynes tuning unit at the left-hand side of the table and next to it, on the right, place the oscillator. Then, at the right of the oscillator, place the amplifier unit that you have just completed. You may also place the two-stage audio-frequency amplifying unit at the right of the radio-frequency unit if a terrific signal is required—but this is not recommended by the author.

As all the cabinets are of the same size and finish they make a neat business-like appearance.

Now, just bridge across from one binding post on one unit to the binding post opposite it on the next unit as they stand together. This will give you six connections between the tuner unit and the oscillator unit, six between the oscillator unit and the radio-frequency amplifier unit, and so on.

Now, to connect the batteries and phones, do the following:

Connect the positive "A" battery to the post Y12 on the amplifier unit.

Connect the negative "A" battery to the post Y11 on the amplifier unit.

Connect the negative "B" battery to the post Y10 on the amplifier unit.

Connect the positive "B" battery to the post Y9 on the amplifier unit.

Connect one terminal of the telephones to the post Y8 on the amplifier unit.

Connect the remaining terminal of the telephones to post Y7.

Connect the antenna and ground to the two left-hand posts on the tuner.

correct size,  $6\frac{1}{4}$  by 14 inches, and painted with a dark *insulating* paint, and fastened to the main panel Z1, with wood screws running through the face of the main panel and into the edge of the sub-panel. (See Figures 4 and 6).

Now mount the potentiometer U on the main panel with two screws, and likewise the filament rheostat V, as shown in Figures 2 and 6.

Next, screw the four sockets S1, S2, S3, and S4 to the sub-panel Z2 by means of two brass screws to each socket. Secure the two paper condensers in a similar manner, X4 between the sockets S1 and S2 and X5 between the sockets S3 and S4. (See Figures 2, 3 and 6.)

Mount the input transformer T1, as shown in Figures 2 and 6, by a single brass wood-screw, and do the same thing similarly with the radio-frequency transformers T2, T3, and T4.

As the three condensers X1, X2 and X3 are supported by the wiring they may be left until the set is connected up. The condenser X2 should be of the type of micadon that has two clips for mounting the grid leak directly upon it.

Now mount and fasten, with screws on the rear of the panel, the twelve binding posts Y1 to Y12, in two vertical lines of six each, one line at one end of the panel and one line at the other. These binding posts should be fastened in the proper holes drilled for them in the main panel Z1.

A standard cabinet may be obtained for the amplifier; just ask for a 7 x 15-inch cabinet.

The dimensions for this cabinet are shown in Figure 5.

The construction work is now completed.

#### How to Wire the Amplifier

The amplifier should be connected up with bus wire in the following manner:

Connect one end of the primary coil of the transformer T1 with binding post Y1. (Posts Y1 to Y6 are located on the left-hand end of the panel, looking from the *front* and posts Y7 to Y12 are located at the right-hand end of the panel, also looking from the *front*. The wiring diagram in Figure 1 should be reversed if you figure out the connections from the *back* of the panel.)

The other end of the primary coil should be connected to post Y2 and the condenser X1 should be connected directly across the primary wires of the transformer.

Next connect three separate wires straight across from post Y3 to Y9, from Y5 to Y11 and from Y6 to Y12. Then connect posts Y4 and Y5 together and connect posts Y10 and Y11 together, with short bits of the bus wire.

The next job will be to connect potentiometer U across the two wires connecting Y5 to Y11 and Y6 to Y12. The mid-connection on the potentiometer should be connected to one side of the condenser X4 and one end of the secondary of T1, T2 and T3. The remaining end of T1 secondary winding should be connected to the grid terminal of the socket S1. Likewise with the remaining end of the secondary windings of T2 and T3; they should be

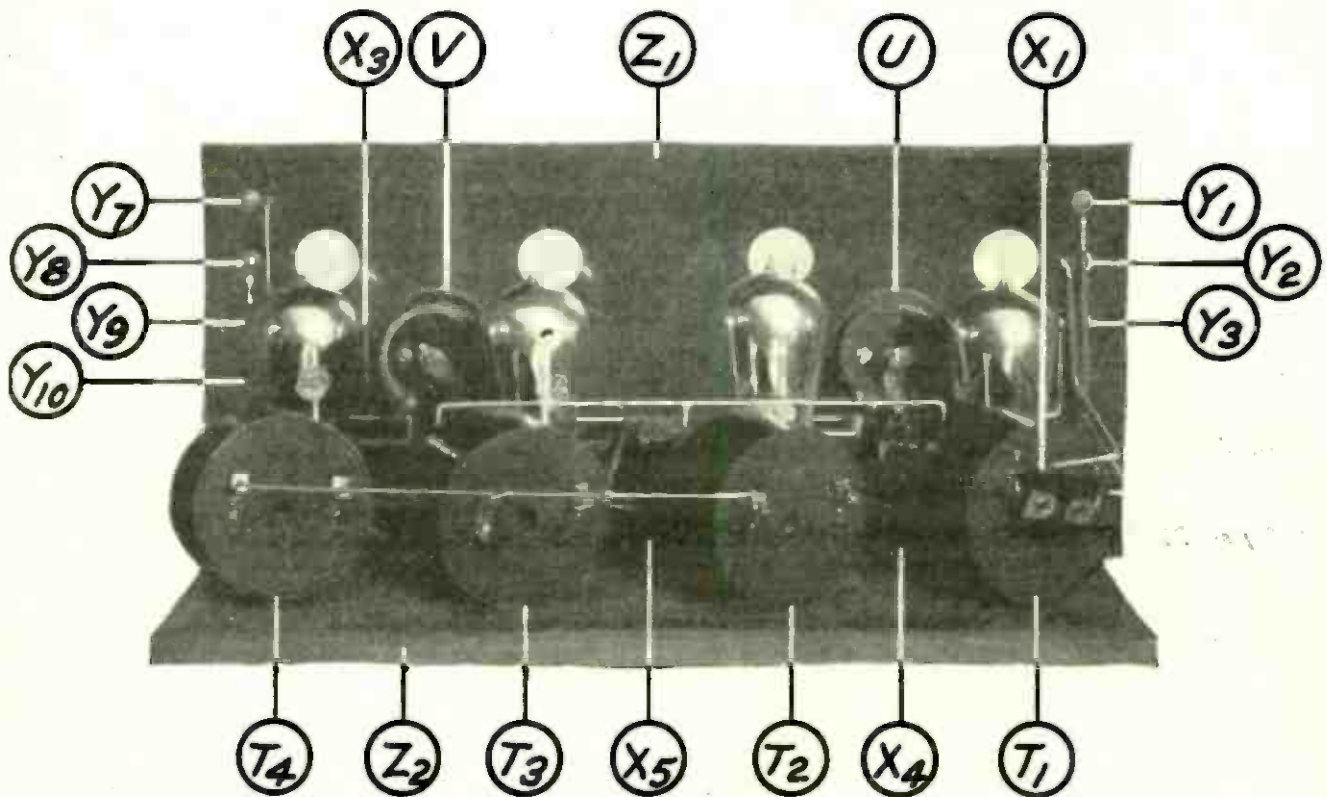

A VIEW OF THE AMPLIFIER FROM THE REAR

FIGURE 3: Here is shown the general arrangement of the apparatus which is mounted partly on the main panel and partly on the sub-panel or base-board.



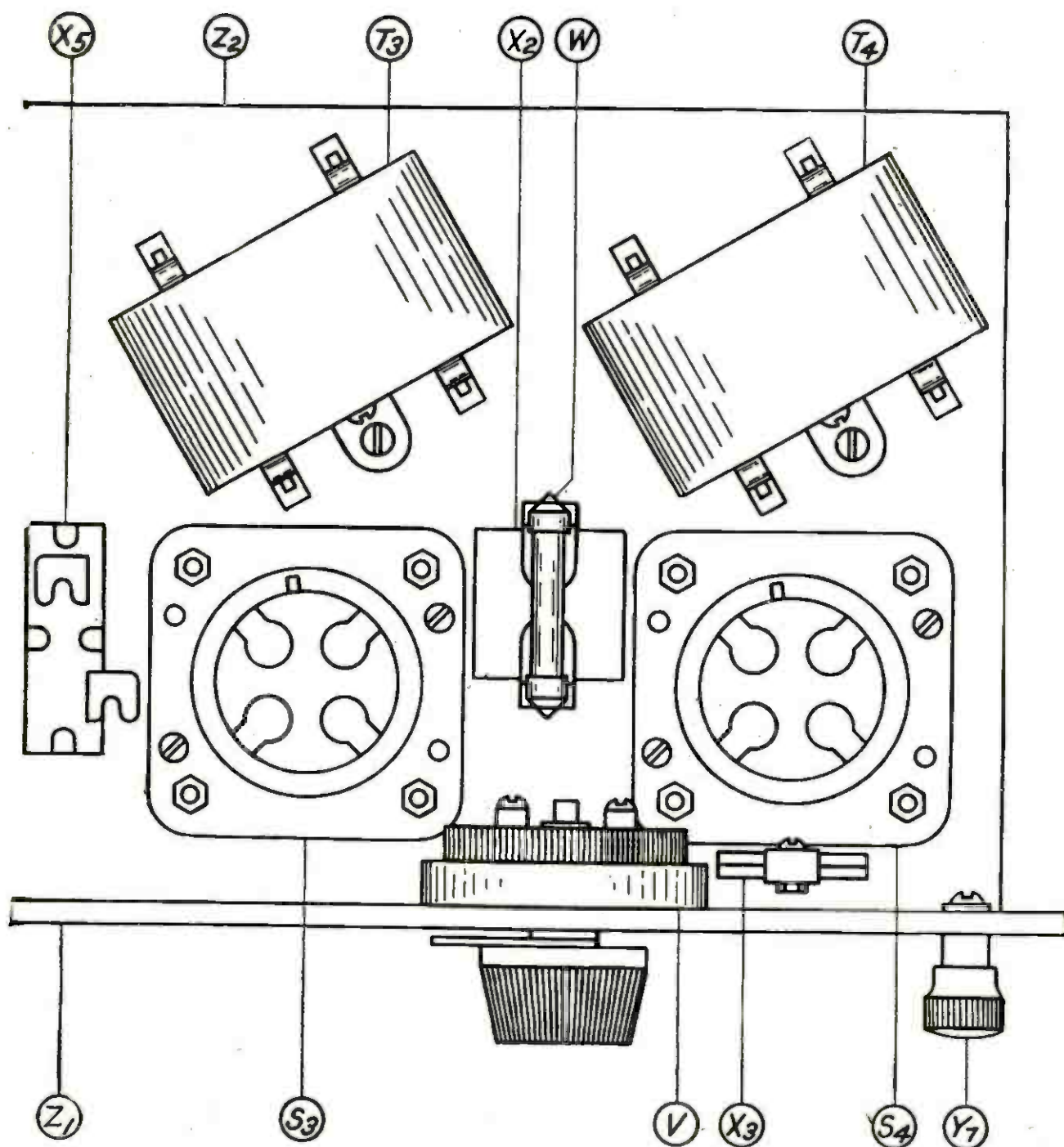

X4—Dubilier paper condenser, .5 mfd.;  
 X5—Dubilier paper condenser, .5 mfd.;  
 Y1 to Y12—binding posts;  
 Z1—composition panel;  
 Z2—wooden sub-panel,  $6\frac{1}{4} \times 14 \times \frac{1}{2}$  inches.

#### How to Construct the Set

After procuring all the instruments and materials for building the set, the amateur should set about preparing the panel Z1, (shown in Figures 2, 3, 4 and 6).

First of all the panel should be cut to the correct size, 7 by 15 inches.

Then the edges should be squared up smoothly with a file. The centers for boring the holes (which are necessary for mounting the instruments) should be laid out on the panel as shown in Figure 4.

The holes outlined here with a double circle should be countersunk so that the flat-head ma-

chine screws used for fastening the instruments will be flush with the panel. All the rest of the holes in this panel are straight drill holes. Sizes for the diameter of these holes have not been given, but the builder will readily decide what size hole is necessary by measuring the size of the screws and shafts of instruments that have to go through the holes.

When the panel is drilled, it may be given a dull finish by rubbing lengthwise with smooth sandpaper until the surface is smooth, then the same process should be repeated except that light machine oil should be applied during the rubbing. The panel should then be rubbed dry with a piece of cheese-cloth, and a dull permanent finish will be the result. Or the panel may be left with its original shiny-black finish, if care is exercised so that it is not scratched during drilling.

Next the sub-panel Z2, should be cut to the

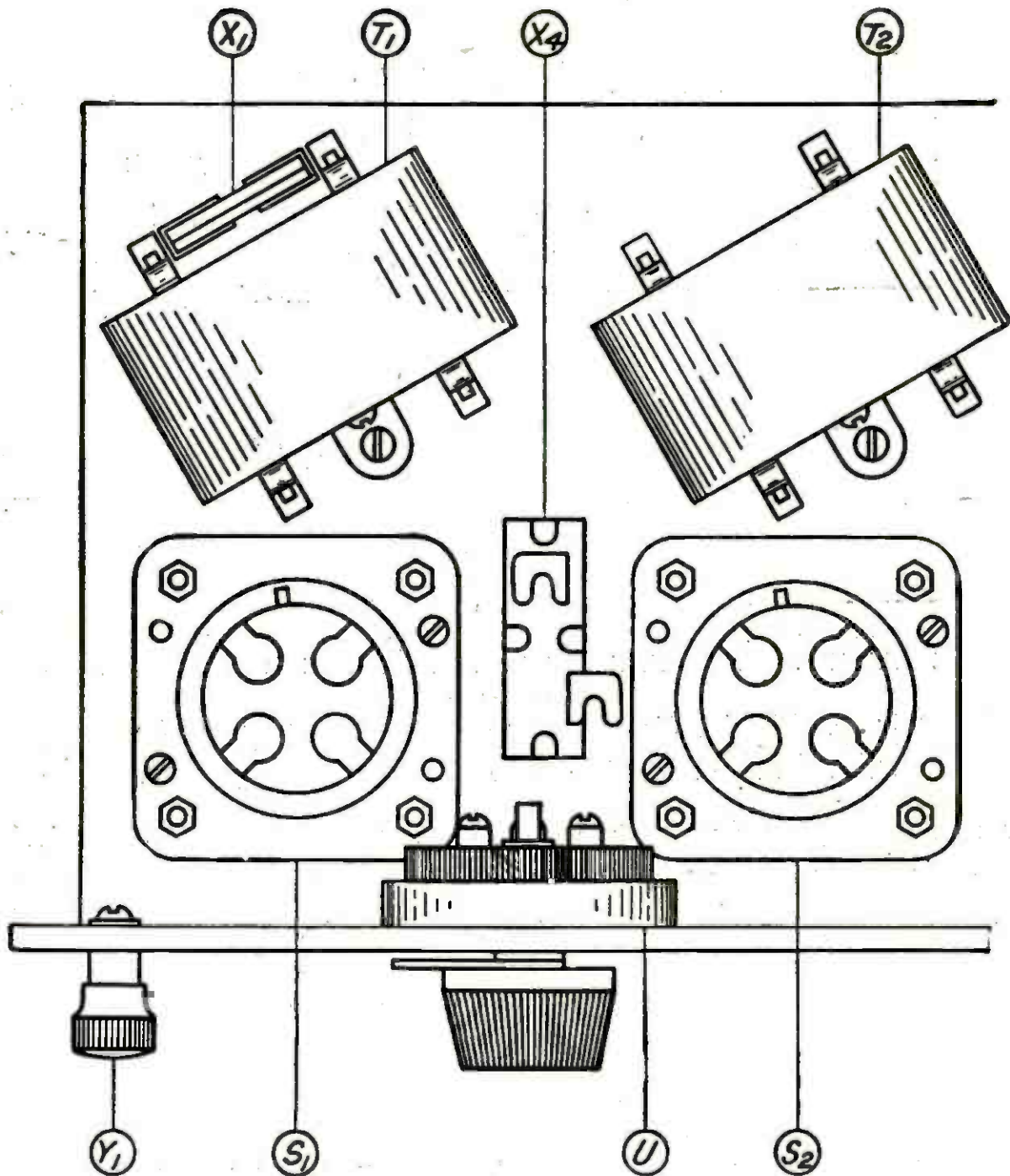

THE WORKING DRAWING FOR ASSEMBLING THE AMPLIFIER UNIT

FIGURE 2: This layout shows the spacings for the instruments, the transformers, the sockets, rheostats, condensers, potentiometer, and the two rows of binding posts.

#### The Parts Used in Building the Set

In all the diagrams in this article each part bears a designating letter. In this way the prospective builder of a receiver may easily determine how to mount the instruments in the correct places and connect them properly in the electric circuit. The same designating letters are used in the text and the list of parts below.

**T**he list of parts here given includes the exact instruments used in the particular set from which these specifications were made up; however, there are many other reliable makes of instruments which

may be used with equally good results

If instruments other than the ones listed are used it will necessitate only the use of different spacing of the holes drilled in the panel and shelf for mounting them.

- S1 to S4—vacuum-tube sockets;
- T1 to T4—four Haynes-Griffin transformers, one input and three radio-frequency transformers, 3,000 meters;
- U—Fada potentiometer, 200 ohms;
- V—Fada filament rheostat, 6 ohms;
- W—tubular grid leak, 2 megohms;
- X1—Dubilier mica condenser, .0005 mfd.;
- X2—Dubilier mica condenser, .00025 mfd.;
- X3—Dubilier mica condenser, .002 mfd.;

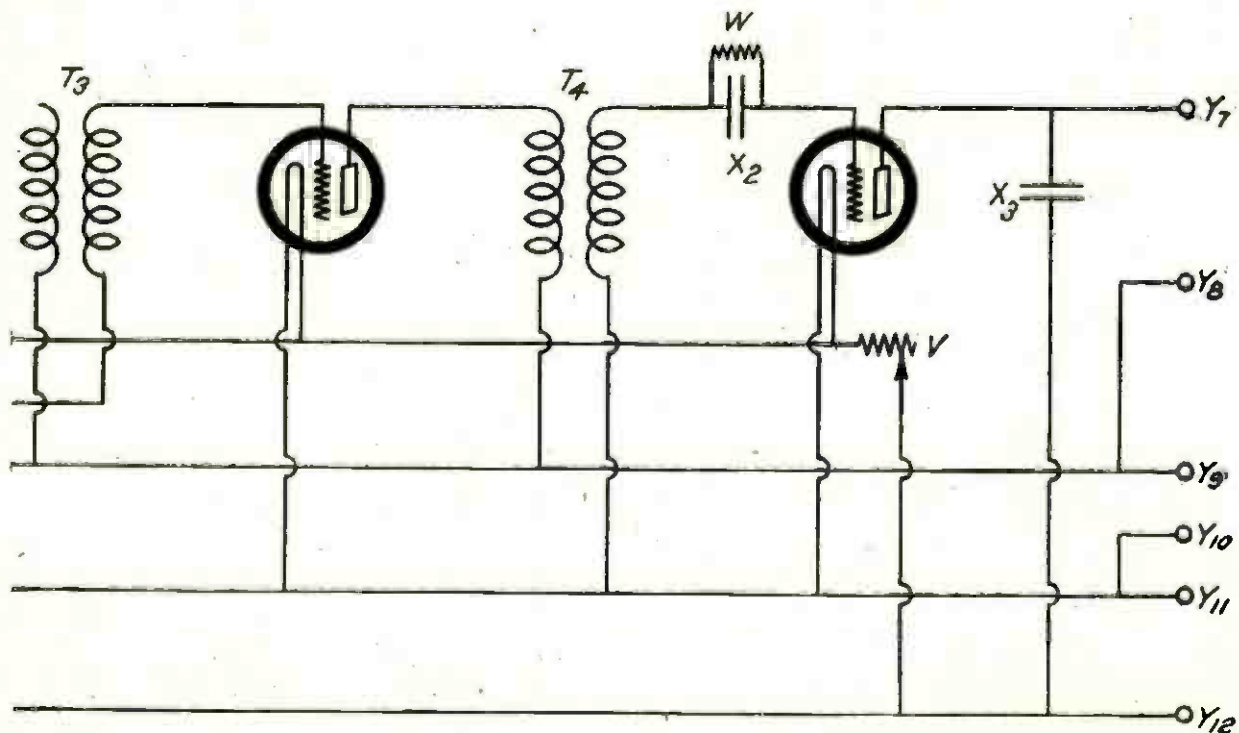

THE ELECTRICAL WIRING DIAGRAM FOR THE AMPLIFIER AND DETECTOR

FIGURE 1: By following this circuit, the amateur experimenter may be sure of obtaining the proper connections for the instruments. The parts are designated by the same letters that appear in the other diagrams and the text.

parts of radio apparatus which it considers beyond the scope of the amateur experimenter's handiwork. It is much better that he should buy the parts and be sure of satisfaction in his experiments than that he should waste a lot of time and energy and finally get unsatisfactory results.)

Then there was the consideration of a suitable means for coupling the output circuits of the tuner\* and the oscillator† to the radio-frequency amplifier. In most amplifiers which are broadly tuned, the input circuits are usually tuned fairly sharply by means of two honeycomb coils placed in inductive relation and shunted by two variable condensers. In adjusting such a set the proper coupling had to be found by experiment; then the two condensers had to be adjusted to the best resonance point of the radio-frequency transformers. This of course helped in sharpening up the operation of the set, but it added the

adjustments of coupling and double-circuit tuning to the set.

In the amplifier described in this article the input transformer is designed with a high step-up voltage ratio; at the same time, by shunting the primary coil with a fixed condenser of the proper capacity, the correct wavelength (corresponding to the wavelength of the other transformers) is automatically adjusted, thus eliminating all the adjustments that have heretofore been regarded as necessary.

The amplifier contains three steps of tuned-radio-frequency amplification which is fixed in wavelength and also the detector (vacuum tube). It is a simple matter to build the unit and it is also a simple matter to operate it. There are only two knobs on the set; a regeneration control (potentiometer) which has to be adjusted only once, and one rheostat which controls the filament of all four tubes.

The exact electrical wiring diagram is shown in Figure 1.

\*See POPULAR RADIO for September, 1923.

†See POPULAR RADIO for November, 1923.



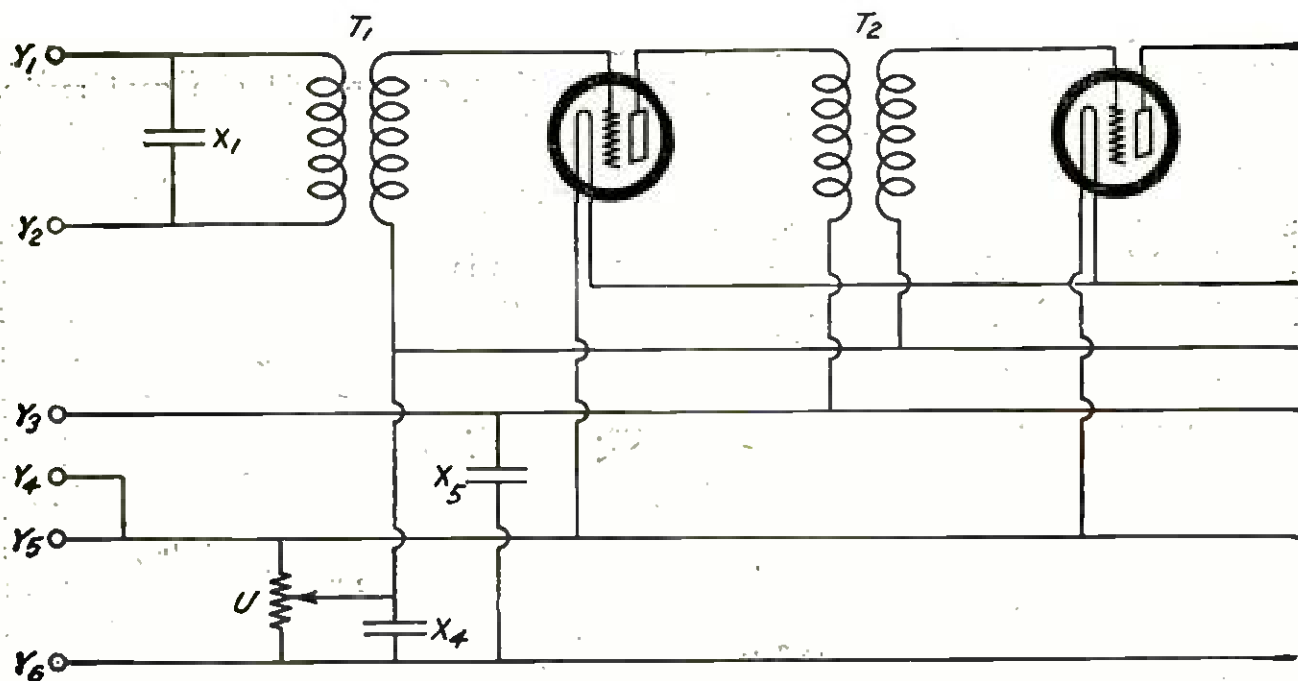

## HOW TO BUILD THE NEW REGENERATIVE Super-heterodyne Receiver

### PART II

Part 1 of this article told how to make the oscillator for the super-heterodyne; it also gave an outline of the salient points of this type of receiver and described what it was and what it would do. Some of the new points involved in the amplifier unit are described in detail in the following article.

By LAURENCE M. COCKADAY, R. E.

**F**IRST of all, when they started work on this set, the designers tested out the various makes of transformers for radio frequencies between 2,000 and 6,000 meters. After long experimentation, they decided that there would be a distinct advantage in a transformer which would not involve the use of an iron core. It was decided that they needed a transformer that would be *sharply* tuned to *one particular wavelength* to which all incoming signals could be heterodyned.

This, of course, would insure much sharper tuning, in the set as a whole, than would be possible with a radio-frequency transformer which responded to signals over a relatively wide band of wavelengths.

After still more experimentation with

air-core transformers which were built up with variations in the turn ratios variations in the fundamental wavelengths, variations in the magnetic coupling, and variations in the resistance of coils (this involved many trials with windings of different sizes of wire) it was decided to use a transformer that was extremely sharply tuned on 3,000 meters. This was found better than the somewhat higher wavelengths more generally used in super-heterodyne amplifiers in that the possibility of cutting out some of the side bands due to critical tuning was less than at the higher wavelengths. This wavelength also was found to be relatively free from interference. (The reader will note that POPULAR RADIO does not describe how to make these transformers or any other

whisker and replacing lightly in various positions.

As the switch blades are moved *up* the wavelength of the set is increased. When the left switch advances one point the tuning inductance turns are increased by two. When this switch reaches point 6 the turns are increased somewhat less than two by advancing the right switch one point and returning the left switch to point 1. Thus, in tuning, as the successive turns are cut in, that part of the process which requires shifting both switches, will give a smaller wavelength increase.

The antenna may be a single wire 80 feet long (or two wires 50 feet long) and about 30 feet high. If the antenna is too large the number of inductance turns required to receive the shorter broadcast wavelengths will be so reduced that the signal strength will also be decreased. In this connection, most effective results will be obtained by keeping the antenna clear of obstructions and adjusting its length until signals from the longest wave broadcast station are heard with the switches near the upper points. With this set the writer obtained good reception from a Class B station two and a half miles distant, using a small indoor antenna, but such an antenna is not recommended for a crystal set.

A telephone head-set having a resistance of

2,000 ohms or more will give good results. Reception from a considerable distance will be more satisfactory if phones priced above the conventional standard be used.

As the crystal is the life of the set, emphasis is laid upon the importance of securing a good one, which should not only be sensitive to weak signals, but which should give response from local stations at most random positions of the catwhisker. The crystal may be kept covered when the set is not in use, but after a time its surface may become insensitive. It may be cleaned with alcohol or soap and water and a clean brush.

The input terminals of a two-step, audio-frequency amplifier may be connected to the phone binding posts of this set and good volume of sound will be obtained from local stations. The use of the crystal detector gives signals of maximum clearness.

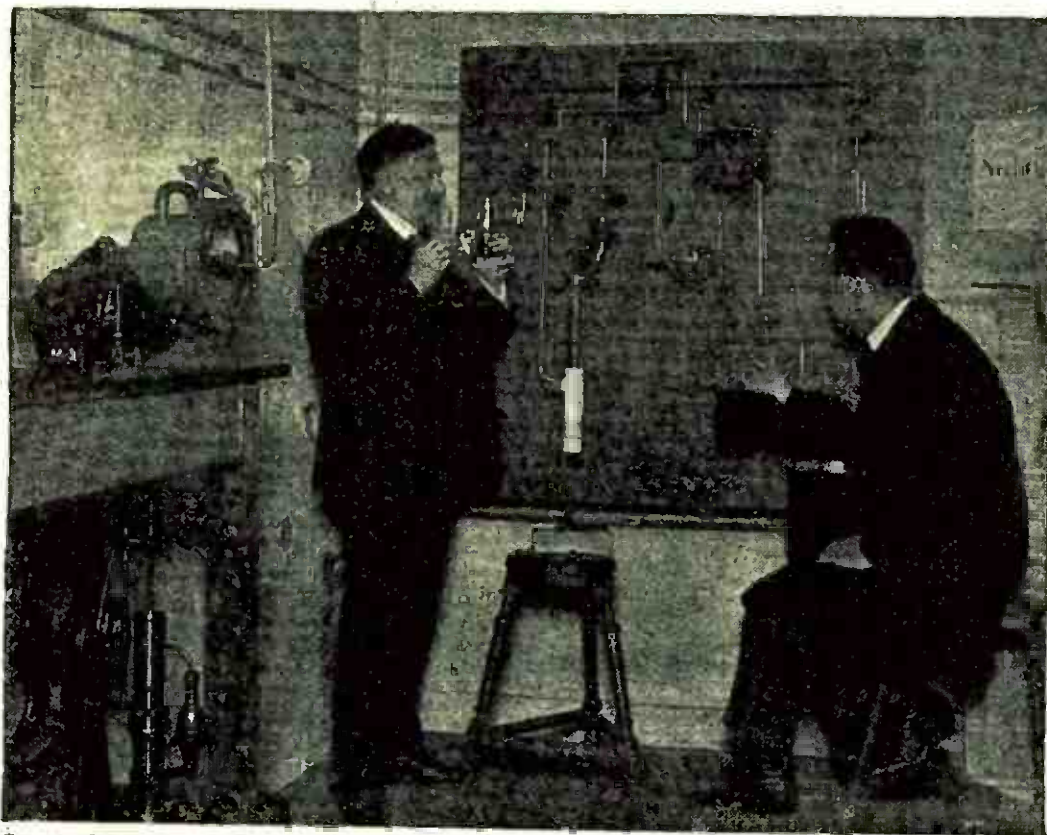

Courtesy of Armstrong Perry

#### VACUUM TUBES THAT SELL FOR 50 CENTS

*Dr. Max Reithoffer of the government Electrotechnical Institute of Vienna is holding two of the Austrian vacuum tubes which are efficient detectors and amplifiers and which sell in that country for an equivalent of about 50 cents in American money. The apparatus in the lower left-hand part of the picture are the mechanical pumps used in the evacuating system for making these foreign tubes.*

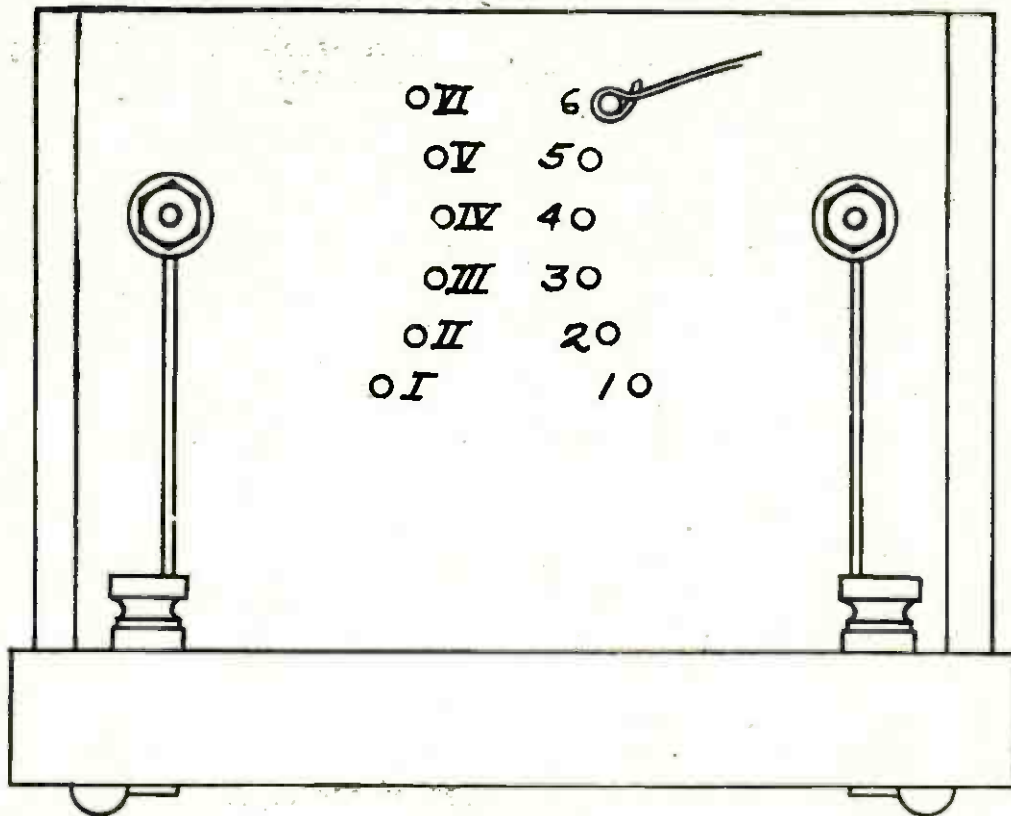

FIGURE 12

*Assembling the panels and the switch points and binding posts. This is a view from the rear and shows how the switch points are forced into the holes drilled for them in the upright panel, and how the wire taps are connected one to each switch point. The two switch blades are connected by a wire to the two binding posts on the base.*

g and p (Figures 3 and 8) back down through the base and thence connected to the left phone binding post and the screw securing the rod holder in place. One short length of wire connects the remaining phone binding post and the crystal. The wire ends are secured by looping around between the washers on the bottom of the base; the screws are then tightened until the nuts on top of the base become rigid. Before the crystal clip and rod holder are permanently secured in place a burr is formed on the edges which come in contact with the wood by bending down these edges slightly.

Twelve short lengths of No. 20 bare copper wire should be soldered to the switch points where they project through the rear of the panel as shown in Figure 12.

The cover of the tuning inductance is tacked to the base equally distant from the edges and one-half inch from the rear of the panel. The inductance is fitted into the cover and secured by glue or varnish. The location for the taps will be determined by referring to Figure 3. Tap 1 (Figures 3, 7, and 12), will be directly below switch point 1 (Figure 12). The twelve wires from the switch points (Figures 3 and 12) are formed into neat curves, cut off to the proper length so that they may just be inserted in the inductance taps, and soldered in place using a very small soldering iron and a small amount of solder. Switch points in Figure 12 are numbered to correspond to taps in Figure 7. Point 1, being most inaccessible is first soldered to tap 1.

The parts of the cover, shown in Figure 6, are fastened together with glue and brads (or small screws) forming the completed cover which gives the set the finished appearance shown in Figure 1.

#### *How to Operate the Set*

The antenna is connected to the right-hand rear binding post. The ground wire is connected to the left-hand rear binding post, thus bringing the phones near ground potential. The antenna wire is shown in Figure 1. An inspection is made of the mounted crystal to see that it is held firmly by the clip; the extreme end of the catwhisker should then be given a sharp diagonal cut with a pair of scissors.

Adjusting the set involves two operations:

(1) Securing a sensitive contact of the catwhisker;

(2) Tuning.

By means of the knob the point of the catwhisker is brought down lightly upon the crystal. The right switch blade is rotated slowly over its points and at each new position the left switch blade is rotated two or three times over its points. This operation explores all the inductance turns, two at a time. If there is no response in the phones, operations (1) and (2) are repeated and local stations should now be heard. Finally, when the switches are set at the most advantageous position, a more sensitive adjustment of the detector may be obtained by lifting the cat-



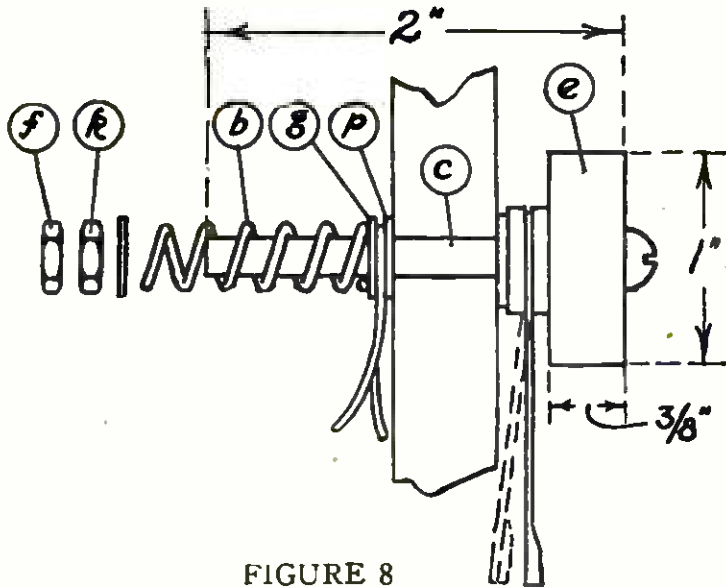

FIGURE 8

Details of the tap switch for wavelength control.

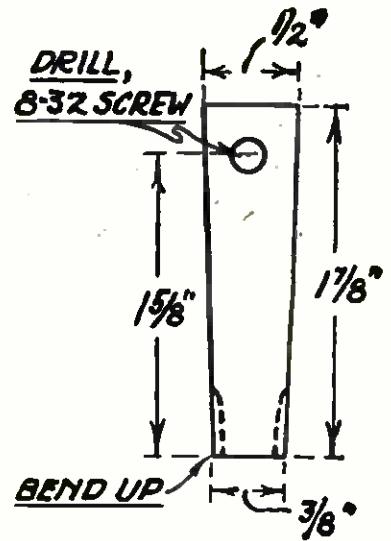

FIGURE 8A

How to cut out, drill and bend the switch blades.

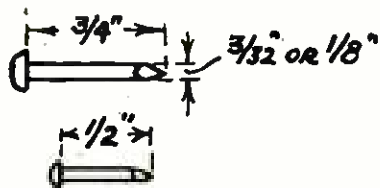

FIGURE 9

The dimensions for the switch points and stops.

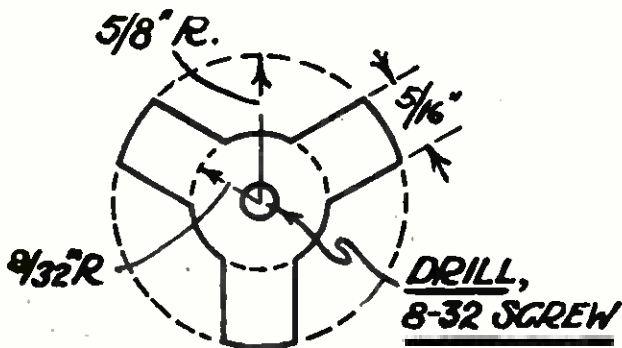

FIGURE 10A

How to drill and bend the clip for holding the crystal.

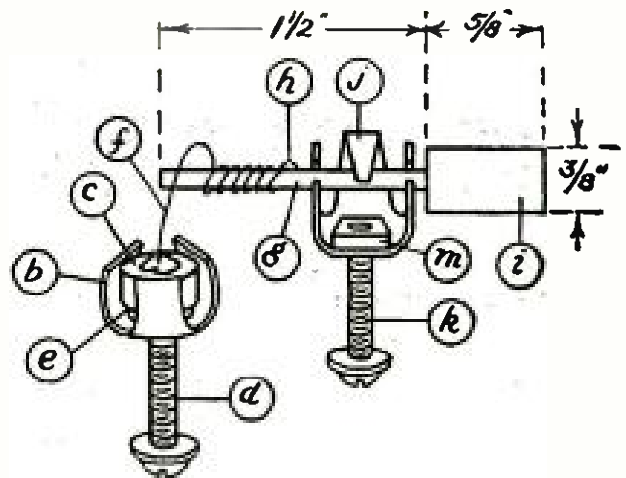

FIGURE 10

The complete detector assembly, showing the general arrangement of all the parts used.

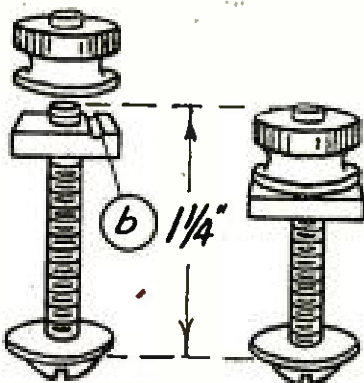

FIGURE 11

Sizes for the binding posts.

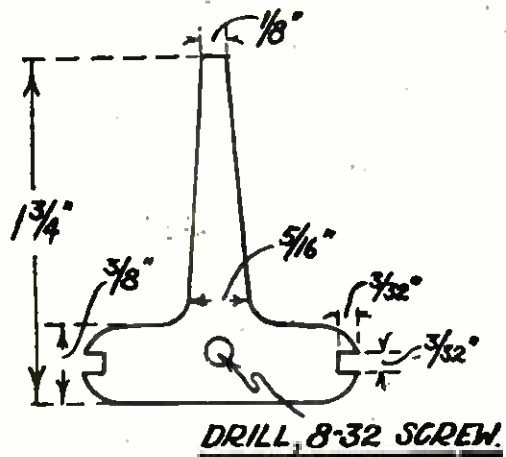

FIGURE 10B

The way to make the rod holder is shown here with the dimensions for drilling and shaping.

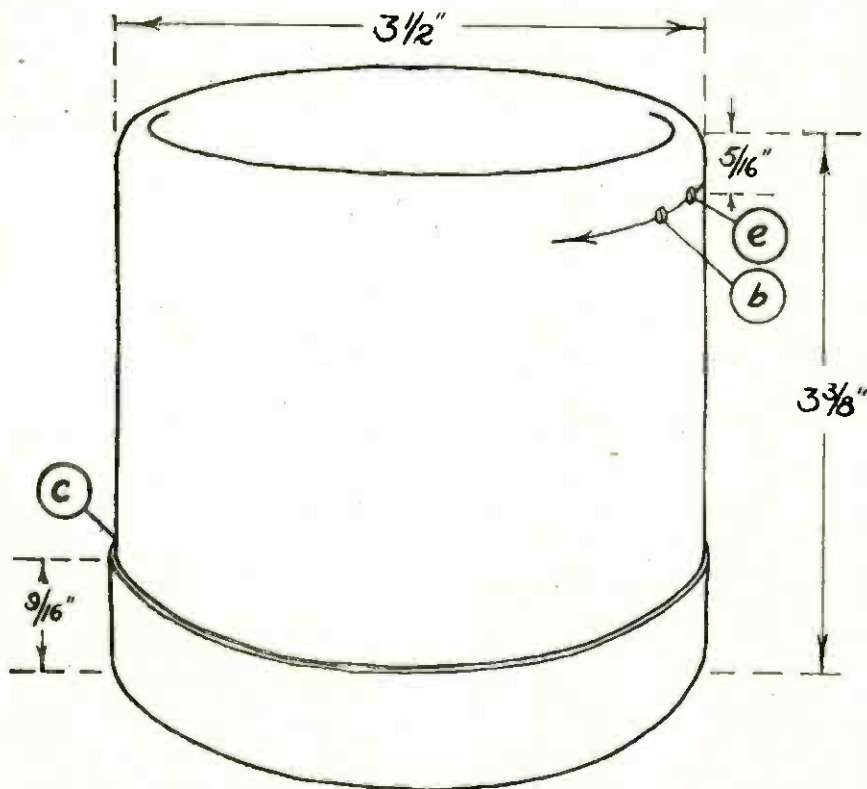

FIGURE 7A

*How the container should be shortened by cutting off the end. This sketch gives the dimensions to which the tube should be cut down before starting the actual winding of the coil.*

ping 10 turns of No. 20 piano wire around a 3/16-inch rod clamped in a vise. The switch is assembled upon an 8-32 brass machine screw c, shown in Figure 8.

**F. SWITCH POINTS AND STOPS (Figure 9).** The switch points are made from 12 brass pins with heads surfaced off with a file or in a lathe. This work requires accuracy to insure smooth operation of switch blades. The switch stops are made from four small brass pins.

**G. CRYSTAL DETECTOR (Figure 10).** In Figure 10 are shown the assembled parts of the detector. These are: a clip b, holding a mounted crystal c; an 8-32 screw d, and nut e; a fine wire (catwhisker) f, wrapped around a rod g, and secured by a drop of solder h; a knob i; a rod-holder j; an 8-32 screw k, and a nut m.

The clip is cut and filed from No. 24 spring brass sheet as shown in Figure 10a, and bent into the shape shown in Figure 10. All brass sheet must be bent with caution, the bends being made slowly and kept well rounded.

The catwhisker is an 8-inch length of fine springy wire wrapped 20 times evenly around the rod g, and secured by a drop of solder h, so positioned that when the rod is placed in the holder the lateral movement will be equal to the diameter of the crystal. The fiber knob i, is forced on the other end of the rod.

In Figure 10b are shown the dimensions of the rod holder, cut and filed from spring brass sheet, so that the grain of the metal runs with the narrow tongue. When bent carefully into shape it appears as shown at j, Figure 10.

**H. BINDING POSTS (Figure 11).** Each binding post is made up of an 8-32 brass screw, two washers, square brass nut and a thumb nut taken from a dry cell. A groove b, is filed in two of the nuts to facilitate connections of telephone-receiver terminals.

#### *How to Assemble the Set*

Four rubber-headed tacks are driven into the corners of the bottom of the base as indicated in Figure 4. The panel (Figure 5) is laid face up on two supporting strips and the 12 switch points are forced into the holes, caution being observed to have the surfaces of all the points in the same plane.

The tap switches are placed in position as shown in Figures 3 and 8. The switch blades are bent as shown by the dotted lines, and when forced down upon the switch points by the spring b, final adjustments are made to secure smoothness of operation. The nuts f and k, are then locked.

The panel (Figure 5) is mounted by three wood screws passing through the base and into the holes d, e, and f. It then appears as shown in Figure 3.

The detector parts (shown in Figure 10) are loosely mounted—in the positions shown in Figure 3—the screw d, being cut off so that it will not project through the nuts. The four binding posts—shown in Figure 11—are then loosely inserted in the base (Figure 3). Connecting wires—shown in Figure 3—of No. 20 wire are run from the two rear binding posts up through two holes b (Figure 4) in the base, looped around and forced between the washers

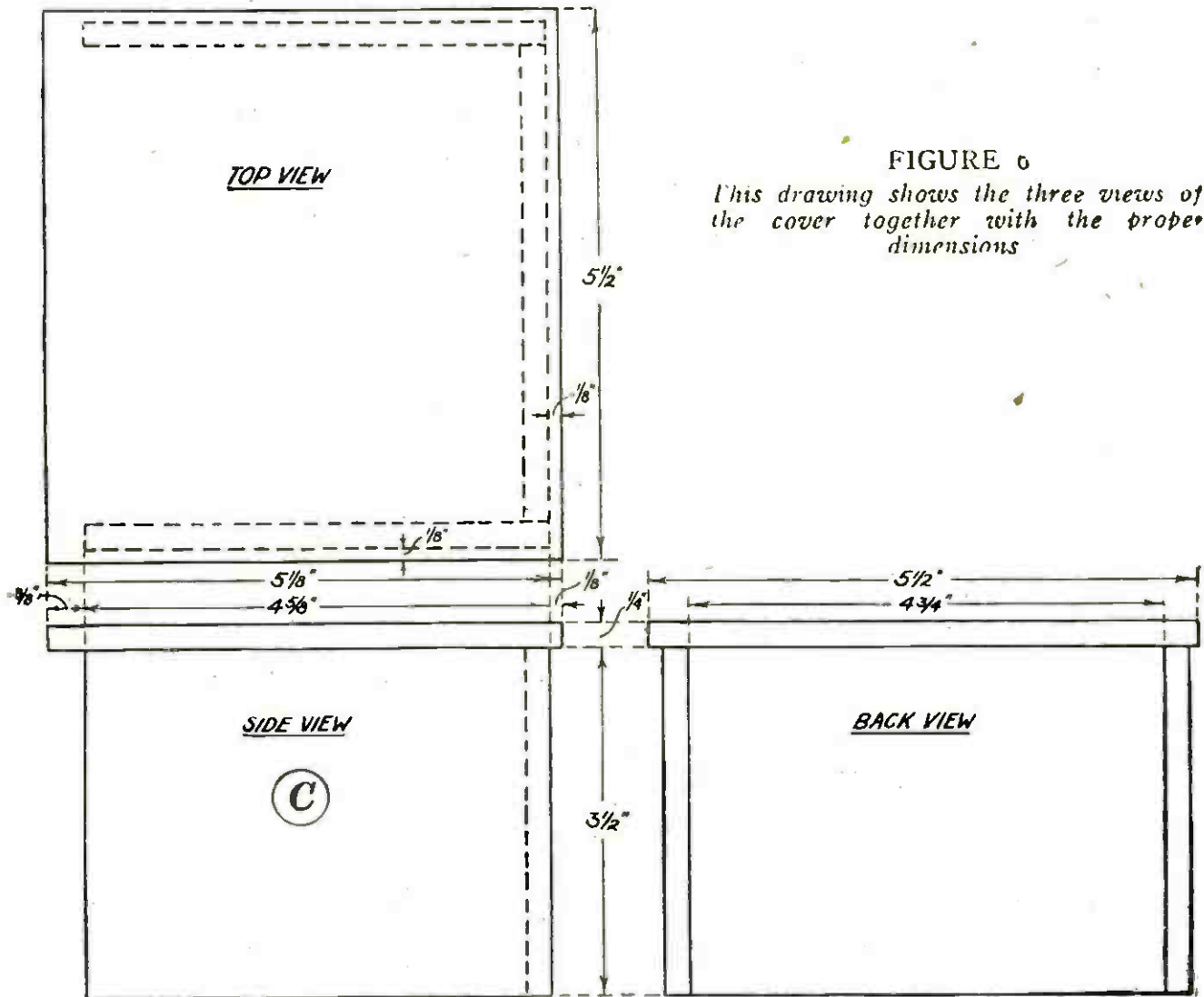

**FIGURE 6**  
 This drawing shows the three views of the cover together with the proper dimensions

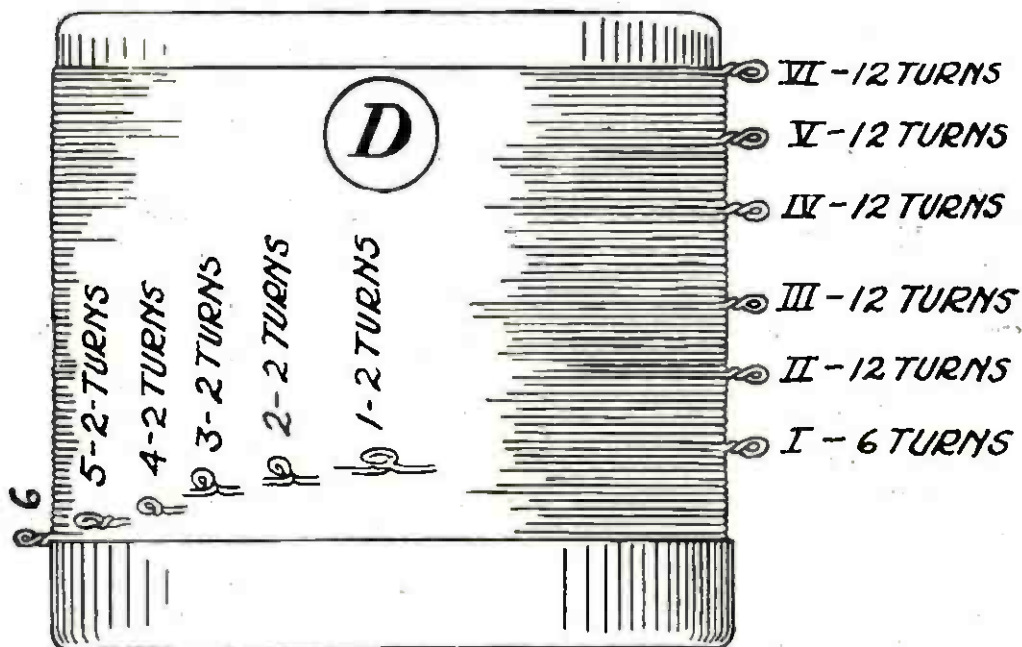

**FIGURE 7**

The completed inductance coil made on a pint-size container. This drawing shows the correct way to make the taps with the spacing between the taps indicated.





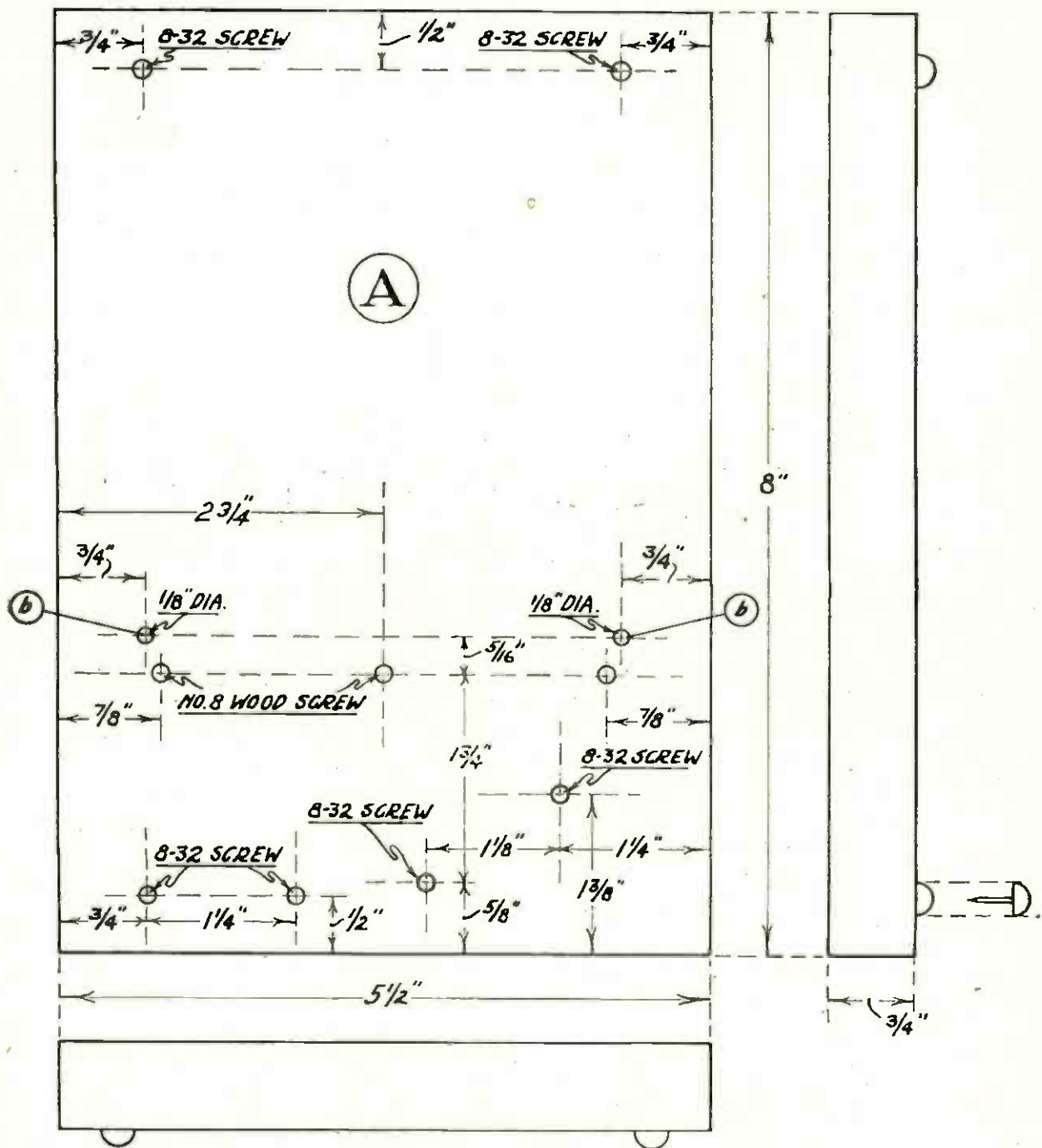

FIGURE 4

The dimensions of the base and the drilling plan. This drawing gives the front, side and top views of the base, together with the drilling data for the holes for the screws that are used to mount the instruments and binding posts.

eight 8-32 brass washers;  
four 8-32 square brass nuts;  
four 8-32 brass hexagon nuts.

#### F. SWITCH POINTS AND STOPS.

Required:

12 brass pins  $\frac{1}{8}$  to  $\frac{3}{32}$  of an inch in diameter and  $\frac{3}{4}$ -inch long;  
four small brass pins,  $\frac{1}{2}$ -inch long.

#### G. CRYSTAL DETECTOR.

Required:

One galena crystal mounted in a block of Wood's metal  $\frac{1}{2}$ -inch in diameter and  $\frac{1}{4}$ -inch thick;  
No. 24 (B. and S.) gauge spring brass sheet 2 by  $2\frac{1}{4}$  inches;

eight inches of fine springy wire;  
one  $\frac{3}{32}$ -inch brass rod two inches long;

one  $\frac{3}{8}$ -inch fiber rod  $\frac{5}{8}$ -inch long;  
two 8-32 brass machine screws one-inch long;  
four 8-32 brass washers;  
two 8-32 square brass nuts.

#### H. BINDING POSTS.

Required:

Four 8-32 brass machine screws,  $1\frac{1}{4}$  inches long;  
four 8-32 square brass nuts;  
four 8-32 thumb nuts from dry cells;  
eight 8-32 brass washers.

## B. SWITCH PANEL.

Required:

One piece of seasoned wood,  $5\frac{1}{4}$  by  $3\frac{1}{2}$  by  $\frac{1}{2}$  inches; three No. 8 wood screws,  $1\frac{1}{2}$  inches long.

## C. COVER (top removed).

Required:

Four pieces of seasoned wood,  $\frac{1}{4}$ -inch thick;  
 one piece,  $5\frac{1}{2}$  by  $5\frac{1}{8}$  inches;  
 two pieces,  $4\frac{5}{8}$  by  $3\frac{1}{2}$  inches;  
 one piece,  $4\frac{3}{4}$  by  $3\frac{1}{2}$  inches;  
 brads or small screws.

## D. TUNING INDUCTANCE.

Required:

One one-pint cardboard carton;  
 two ounces No. 24 dcc copper wire.

## E. TAP SWITCHES.

Required:

No. 24 (B. and S.) gauge spring brass sheet, 1 by 2 inches;  
 two knobs cut from one-inch fiber rod;  
 18 inches No. 20 (B. and S.) gauge piano wire;  
 two 8-32 brass machine screws 2 inches long;

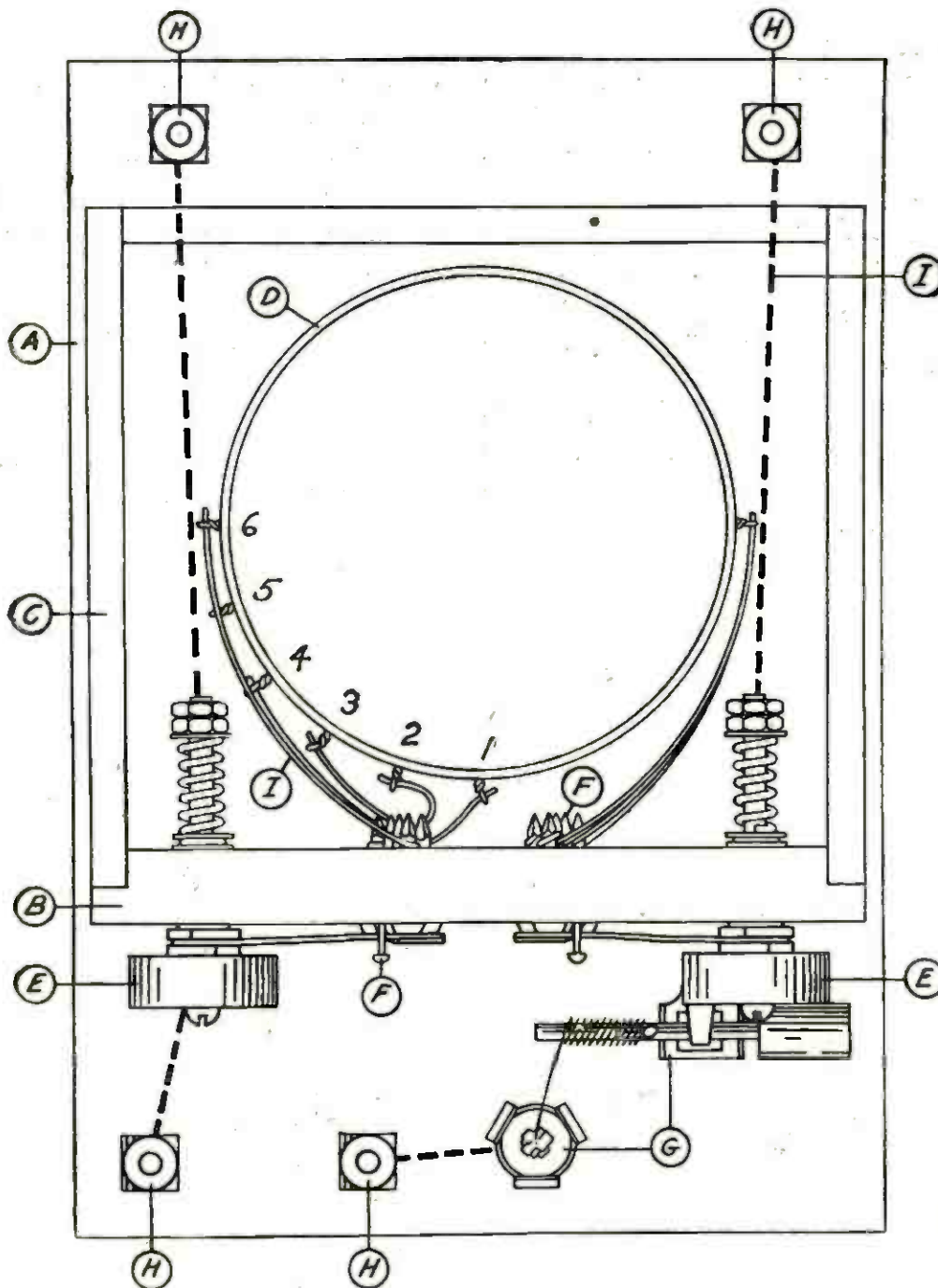

FIGURE 3

The working drawing of the set. This layout diagram shows the relative positions for all the instruments, as seen from above. The parts are designated by letters which reappear in the text and list of parts.



elaborate construction or it may be very simple without reducing its efficiency. Its cost is then much less than a set equipped with a low-voltage tube. Other points, often overlooked, are clearness of signal, absence of distortion, and no operating cost. Although the crystal is a relatively insensitive device, there is no justification in statements frequently made in radio articles, which give the impression that there is a definite limit to its receiving range. From a low-power broadcast station the reliable receiving range of a crystal set is, say five miles; in winter the same set may receive high-power stations from a distance of three or four hundred miles.

This article describes a crystal set of satisfactory performance. All structural details are given so that one need not be in doubt as to dimensions. Attention is called to the importance of good mechanical design. This requirement includes convenience of adjustment, rigid connections, permanent contacts, light, stable contact of the fine wire on the crystal, elimination of jar-

ring and vibration from the tuning controls, and protection of parts from injury.

The parts of the set are arranged so that the connecting wires will be short and direct, and losses from unused turns on the tuning inductor have been reduced by cutting down the total number of turns. A variable condenser or phone condenser is not used. The former sometimes gives a little better selectivity but at the expense of signal strength; the latter is not necessary for broadcast reception. There is no objection to the use of wood for a switch panel. Tests show that there is less power loss in dry wood at radio frequencies than in the average insulating material used in radio panels.

#### *Parts and Material*

The completed set is shown in operation in Figure 1. Figure 2 is a photograph of the set with cover removed. Figure 3 is a plan drawing and shows the parts and wiring. The list below names the parts used and gives the material required to make them.

#### A. BASE.

##### *Required:*

- One piece of seasoned wood, 8 by 5½ by ¾ inches;
- four rubber-headed tacks.

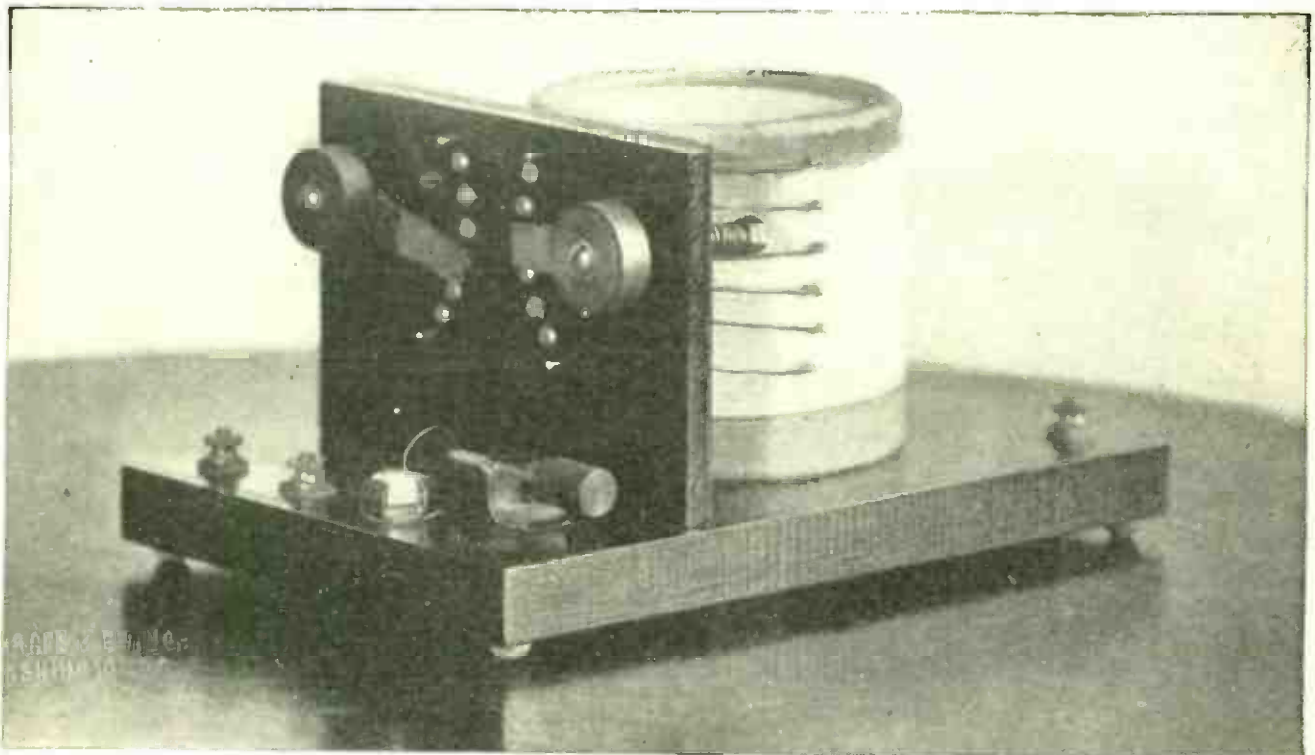

**THE COMPLETED SET WITH THE COVER REMOVED**

**FIGURE 2:** This shows what a neat-looking job can be made of the set if the experimenter takes the trouble to make every part as specified in this article.



From a photograph made for POPULAR RADIO

#### THE COMPLETED SET

FIGURE 1: *The author shows how to adjust the crystal detector while rotating the switch that controls the tuning.*

## HOW TO BUILD AN EFFICIENT CRYSTAL RECEIVER

For local reception, the crystal set is still the simplest that will produce satisfactory results. Here is a re-creation of the famous Bureau of Standards receiver, brought up to date with a suitable wavelength range. The parts cost about \$5.00 (exclusive of the phones) and the approximate reception range is 15 miles.

By MORRIS S. STROCK

**I**N recent months the radio broadcasting services have been greatly improved. This development has been marked by a reduction of interference through the new assignment of wavelengths, a more uniform distribution of stations transmitting good musical programs (this includes the relaying of programs by wire before broadcasting)

\*Published by permission of the Director of the Bureau of Standards of the U. S. Department of Commerce.

and a tendency for mediocre stations to discontinue transmission.

In the large communities there are now many thousands of people within a few miles of the Class B stations; from them comes a demand for simple receiving apparatus that requires a small monetary outlay. For this purpose a crystal set will give practically perfect reception.

A crystal set may be of rather



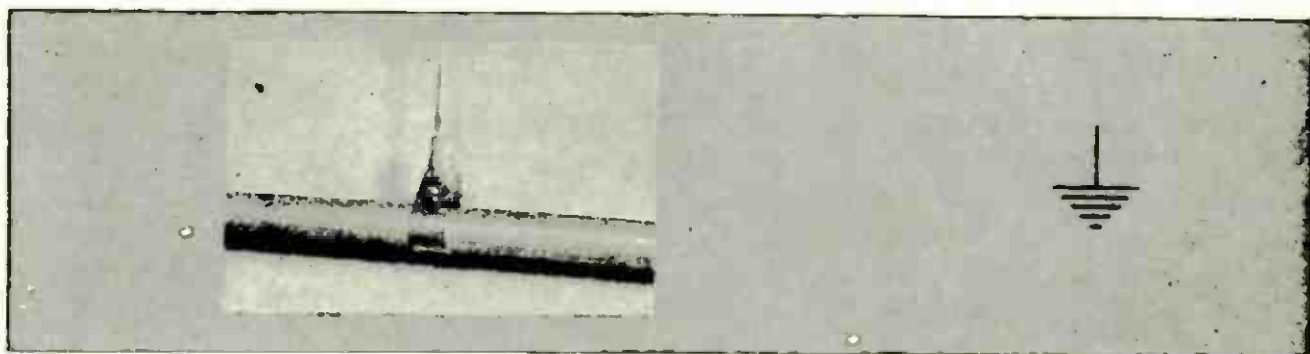

**GROUND**—Fortunately a good ground is available to most of us; the solution of this important problem is the ordinary water-piping system of the house. The ground wire may be soldered to a brass fitting, or one of the faucets, or it may be connected directly to the pipe itself by means of a ground clamp. The

pipe should be brightened up with a file before connecting the ground clamp. If a ready-made ground is not at hand, a galvanized pipe driven in moist earth or a buried copper sheet is the best substitute. There is a single lead to the ground connection and the size of this should not be smaller than No. 14 copper wire

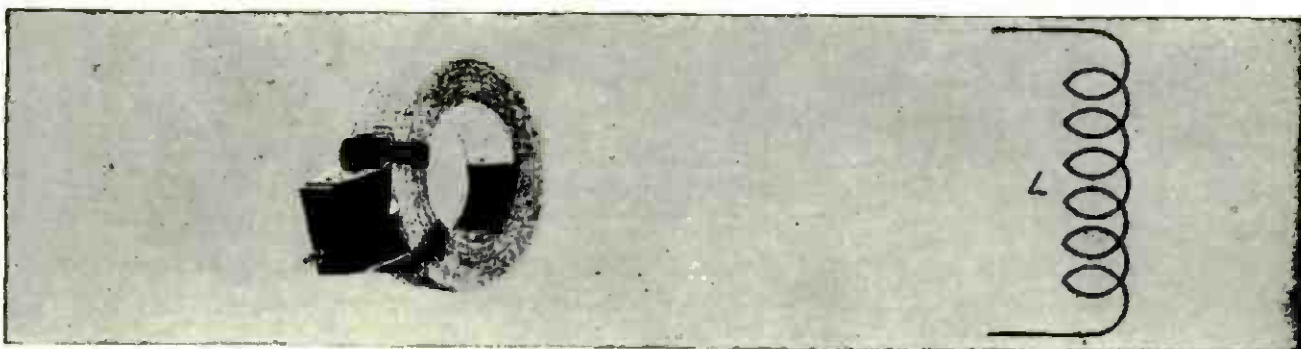

**FIXED INDUCTANCE**—The fixed inductance or coil is a continuous winding with two connections, one at the beginning and one at the end. It may take the form of the single-layer coil, bank-wound coil, spiderweb coil, honeycomb coil, etc. The purpose of the various forms of winding is to decrease the distributed capacity of the coil; such inherent capacity acts much the same as a fixed con-

denser across the coil and this gives the system a natural wavelength, which is an undesirable condition since we usually wish to control the wavelength by means of a variable condenser connected across the coil. The honeycomb coil is especially useful for receiving the long wavelengths, while the other forms of winding are more widely employed on the short and medium wavelengths.



**VARIABLE INDUCTANCE**—The variable inductance is merely a coil with provisions for using a part or the whole of it. There are two fundamental connections; one usually goes to the end of the coil and the other to a slider, clip, or inductance switch. If an inductance switch is used, taps are taken off the coil five to ten turns apart and connected to switch points. A switch arm makes contact with any one of these points, thus cutting in

more or less of the coil. Sometimes two switches are provided at opposite ends of the coil, one for *tens of turns* and one for *single turns*. Then the two fundamental connections are to the two switch arms. The old two-slide tuning coil was a little different, in that it had one fixed connection at the end, and *also* two sliders, one for the primary circuit and one for varying the inductance included in the secondary circuit.



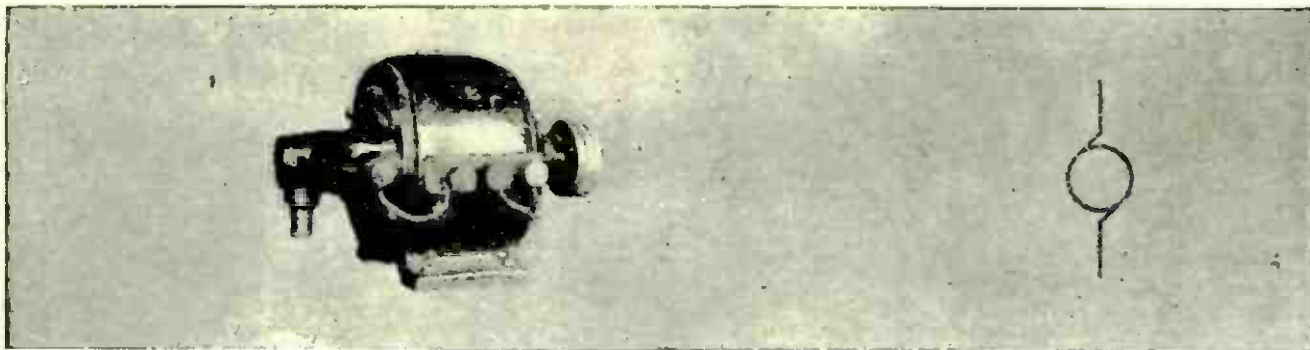

**D.C. GENERATOR OR MOTOR**—The D.C. generator is used in radio work to produce the high-voltage plate supply for the better class of transmitters. It also finds a use in stepping the voltage down for battery charging. The D.C. motor is used for power in the motor-generator set, for driving spark gaps, etc., when the local electric supply is direct cur-

rent. There will usually be two connections for the generator and also two connections for the motor unless the latter is so powerful that it requires some sort of starting mechanism. The local electric company will have its own regulations about the sizes of motors requiring starters. The motor itself will have two external connections or terminals.



**GRID CONDENSER**—For the purpose of detection we must operate the tube at the knee of the "characteristic curve" by the use of a "C" battery or resort to the grid condenser, which isolates the grid and allows the negative charge on it to build up through several cycles instead of changing to positive at each half cycle as it would normally do. The grid-

condenser method of detection is used in most receiving sets and the common value of the grid condenser is .00025 mfd. One of the small mica fixed condensers is just as good as something more expensive. However, do not try to economize by using a paper condenser at this point. The grid condenser has two leads.

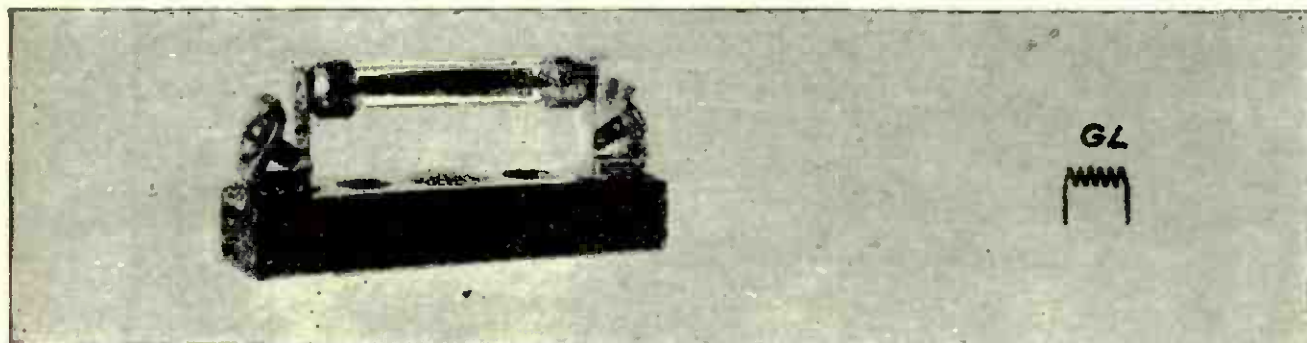

**GRID LEAK**—With the grid-condenser method of detection some means must be provided to allow the negative charge on the grid of the tube to *leak off gradually*; otherwise the charge would build up until the tube was paralyzed. For this purpose a high-resistance path called the grid leak is connected between the grid and the filament; the value of the

grid leak runs into the millions of ohms, 2 megohms (2,000,000 ohms) being a common value. While there may be some advantage in a variable grid leak, it is so difficult to find a good one, that the tubular type is perhaps the safest one to use. There are two connections to the grid leak, one to each end of the resistance unit.

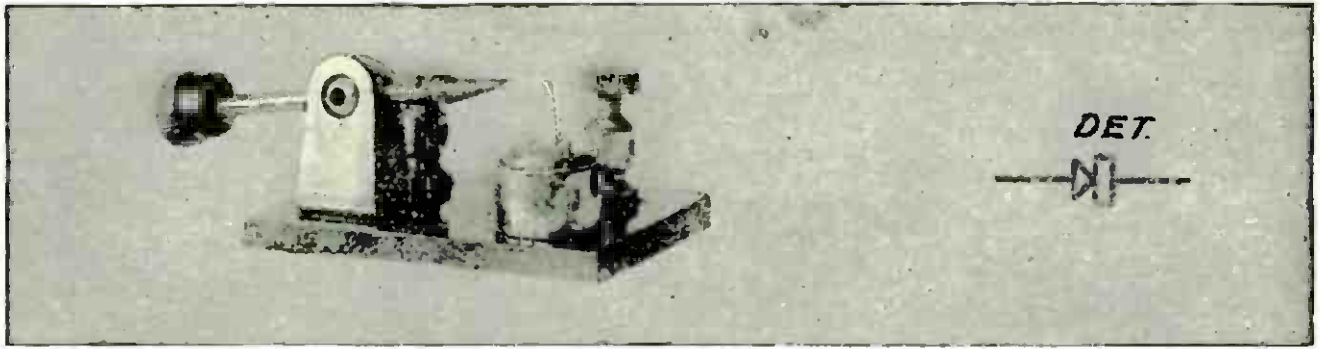

**CRYSTAL DETECTOR**—The crystal detector generally takes the form of a fine wire or “catwhisker” pressing lightly on some kind of mineral crystal; the common minerals are galena, silicon, pyrites, carborundum or one of the synthetic crystals. Within 15 to 25 miles of the large broadcasting stations the crystal set will give good, clear reception on the tele-

phones; a loudspeaker cannot be used with a crystal set. In selecting a crystal detector see that it is so constructed mechanically that the entire surface of the crystal can be easily explored with the “catwhisker.” There are two connections to the crystal detector, one to the “catwhisker” and one to the cup which holds the mineral.

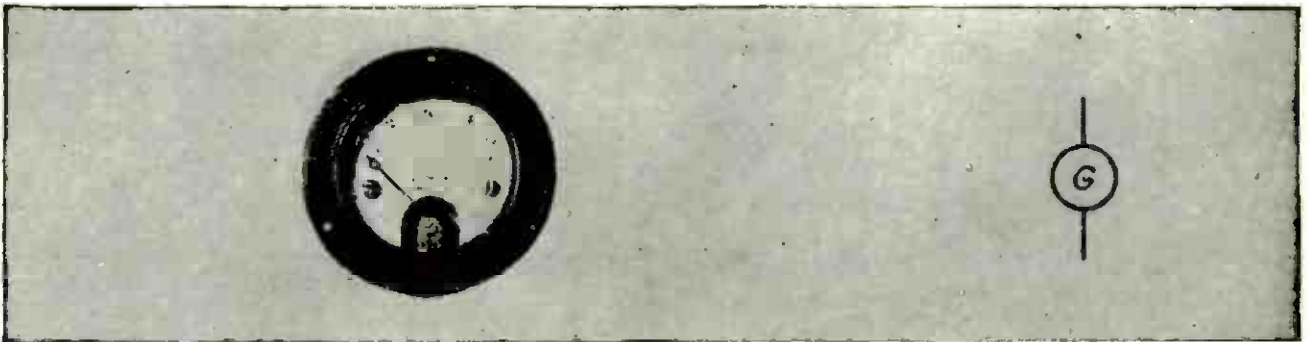

**GALVANOMETER**—The galvanometer is a delicate instrument for indicating a small electric current, but is not used for measuring current. That is, it may be used to show when the current is minimum or maximum, but not the exact value of it. The galvanometer is useful in bridge-measurement work where it is neces-

sary to compare unknown values of resistance, inductance or capacity with standards of the same. It can also be used for wavemeter work in radio. The galvanometer has two connecting terminals and there will always be shown two wires running to it in any circuit diagram.

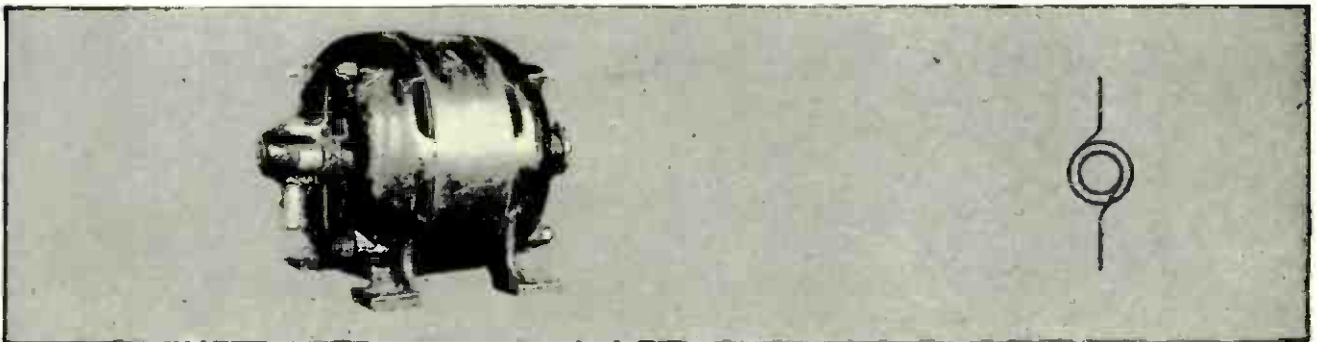

**A.C. GENERATOR OR MOTOR**—The A.C. generator finds little use in radio work except in spark transmitters but the motor is often used as a source of power for motor-generator sets when the local electric supply is alternating current. The A.C. generator or motor frequently has three terminals in the larger sizes as three-phase distribution of power is more

satisfactory than single phase. The single-phase motor is not inherently a self-starting device, and must have some sort of starting mechanism incorporated within it; on the other hand the three-phase motor is self-starting and is much more rugged. The single-phase motor has two terminals brought out to binding posts.

FIGURE 2: A simple tuned-plate regenerative circuit that includes two stages of audio-frequency amplification. This circuit is easy to operate and tunes sharply.

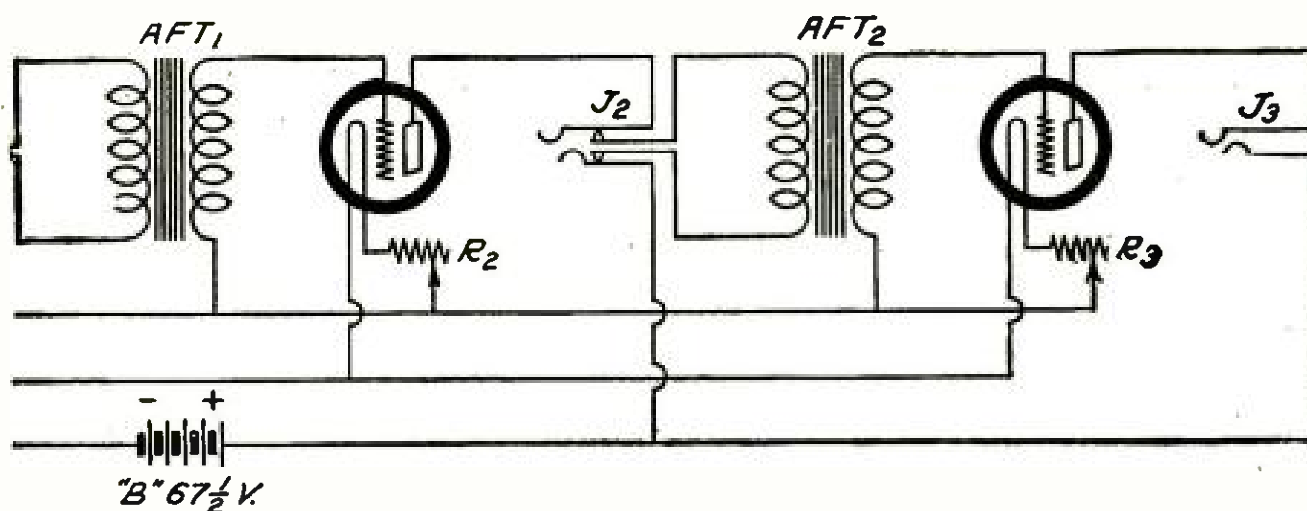

that you cannot use more than  $22\frac{1}{2}$  volts on the plates of the tubes and still get good results. The grid return wire should also be connected to the negative end of the "A" battery for best results.

At the same time it would be a saving in "B" batteries for you to use a "C" battery included in the grid return wires from your amplifying transformers. These batteries should be connected in the circuit with their positive terminals connected toward the filament and their negative terminals connected toward the grid. For a "B" battery potential of 45 volts you need no "C" battery, the negative drop across the filaments will be enough. For a potential of 90 volts you should use a "C" battery of 4.5 volts and for a plate potential up to 135 volts you will require a "C" battery of 9 volts.

\* \* \*

QUESTION: Sometimes while I am listening in for long distance, I hear a station which seems to be enveloped by a kind of wailing whistle. I listen to this station for awhile and the whistle seems to fade in and out.

The other night I heard this same kind of noise on WHN near by, and I kept on listening, and soon I could hear a sort of tattoo like someone beating a drum. I stuck to it to find out what it was and after about half an hour the tattoo noise developed quite strongly and finally I made out that it was an orchestra playing "jazz." A little later I heard the announcer during a quiet spell at WHN, announce that it was station WDAP at the Drake Hotel in Chicago. This is the greatest

distance I have heard so far, and I am wondering if I was hearing it direct or through the power of station WHN?

Can you shed any light on this phenomena? I am curious to know if the one station was being carried by the other or just what was happening.

I have heard something about earth currents which flowed from the earth up into the atmosphere and have also been wondering if these earth currents may not be responsible for some of our distance records.

ROY SHIELDON

ANSWER: When two stations are broadcasting on nearly the same wavelength, with vacuum-tube generators, they will produce a beat note that will be audible when tuned in with an ordinary receiver. The note you will hear will be the difference in frequency between the two transmitted waves.

If there were a difference in frequency of 500 cycles you would hear a whistle equal to about a tone of B-flat, two octaves above middle C on the piano. The strength of the note you would hear would depend upon the ratio of their signal strengths. Hence if either one were to die out or "fade," as it is more commonly known, the whistle would also die out and you would hear the other station which would then come in clearly. This is often experienced in DX reception. You may be listening to a far-off station and suddenly there will be a whistling noise heard in the receivers. A few minutes may elapse and you find the whistling sound diminishing until you are listening to a totally different DX station—and you haven't touched your tuning!

In your case you were picking up WDAP direct.



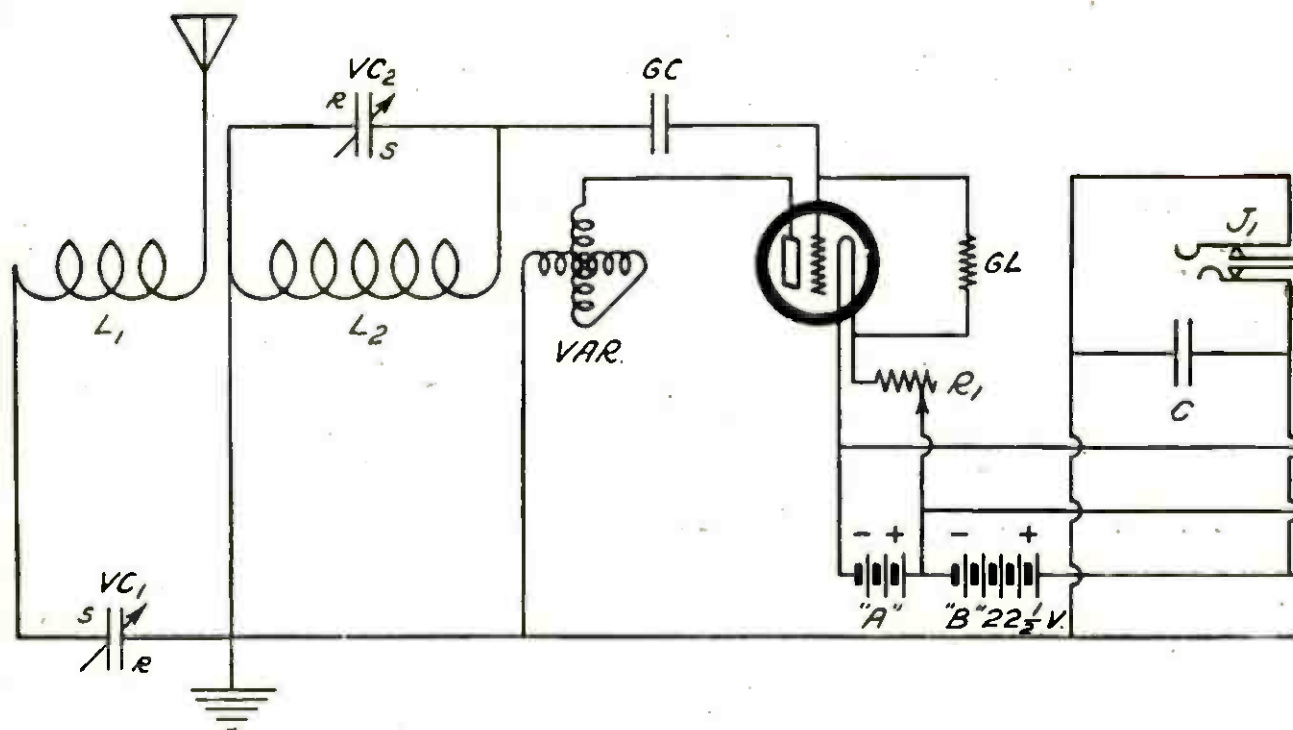

QUESTION: A number of the boys who live around here have been having such wonderful results with the DX receiver, described in your January issue, that I have at last decided that I would have to build one of them. However, when I sent for a copy of that issue I was told that it was all sold out. So I am writing you to request that you republish the wiring diagram with any useful information or improvements that you may have made. Also show me how to hook on the two stages of audio-frequency amplification so that I may use a loudspeaker.

E. MOORE SEVERANCE

ANSWER: In Figure 3 you will find the circuit for the DX regenerative receiver, otherwise known as the DX "bringer-in." In the improved set the coils L1 and L2 are wound on a composition tube  $3\frac{1}{2}$  inches in diameter. Coil L1, consists of 22 turns of No. 18 DSC. (double-silk-covered) wire and coil L2, consists of 50 turns of the same kind of wire wound  $\frac{1}{8}$ -inch away from the coil L1. VAR is a variometer which is placed in inductive relation with coil L2. The distance between the edge of the stator winding of the variometer and the edge of the coil L2 winding should be  $\frac{3}{4}$  of an inch.

The condenser VC1 is a .001 mfd. condenser with the rotor and stator plates connected as indicated by "S" and "R." Condenser VC2 is a .0005 mfd. vernier variable condenser.

The other parts are:

GC—mica fixed condenser, .00025 mfd.;

GL—grid leak, 2 megohms;

C—mica fixed condenser, .0005 mfd.;  
R1, R2, and R3—filament rheostats, 6 ohms;  
J1 and J2—double-circuit jacks;  
J3—single-circuit jack;  
AFT1 and AFT2—audio-frequency amplifying transformers (for first-stage, high ratio; second-stage, low ratio);  
suitable "A" and "B" batteries.

Be sure that you use no shellac or any kind of insulating paint on the coil windings, and be sure that the windings are not shorted between turns.

In trying out the set for the first time, reverse the connections to the variometer, after a signal is tuned in, and leave it connected in the way it produces the loudest signals.

\* \* \*

QUESTION: Why is it that I seldom hear any more player pianos from the larger broadcasting stations? I surely did enjoy some of their dance music. I think the piano was about the best sounding music that they ever sent out and now they have no more of it. Can you tell me why?

S. F.

ANSWER: This was prohibited for the larger broadcasting stations by the Secretary of Commerce; in fact only the stations operating on a wavelength of 360 meters or below were allowed to continue sending out player piano selections or phonograph music. The larger transmitting stations working on wavelengths above 360 meters must have real artists and no "canned" music is allowed.

You have probably been listening more to the larger stations than to the smaller ones, and this is why you have missed the type of music referred to.

FIGURE 3: The improved DX regenerative circuit as it has been revised to take care of the change in wavelengths of the broadcasting stations.

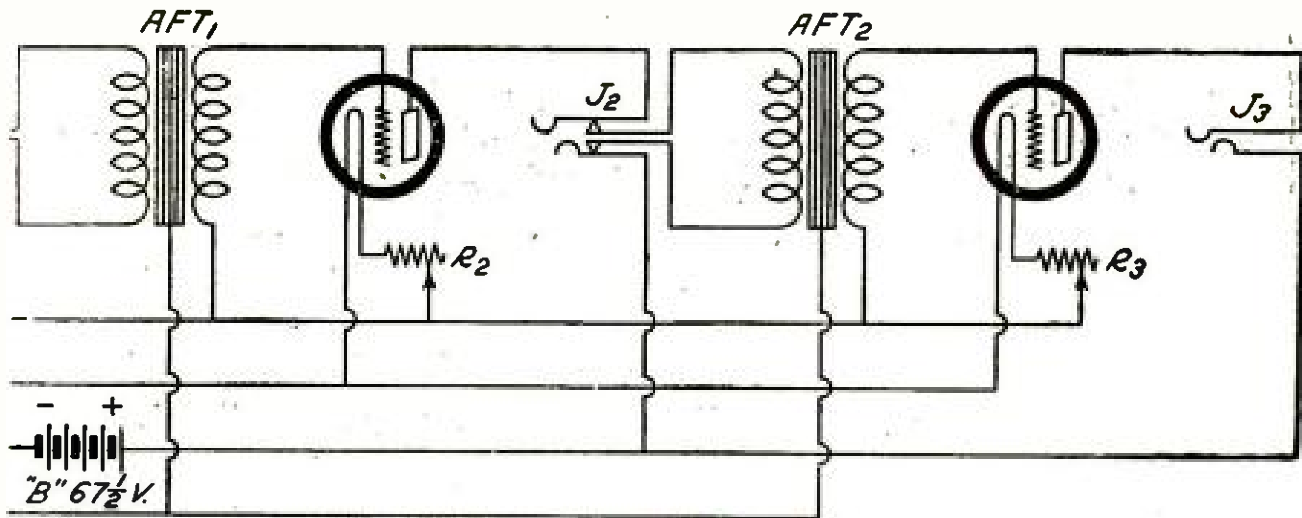

QUESTION: What can I do to eliminate the squeaking in my set that occurs when the man upstairs tunes his set. I saw recently in POPULAR RADIO that this nuisance was caused by the single-circuit regenerative receiver, and until then I never knew what the squeaking was; I thought it was one of those peculiar things that go with radio. However, after reading the item in your magazine, I went up to visit him as a neighbor and verified your statements; he was using one of these sets and it *made the same kind of noise in his set* as I heard in mine.

I showed him the article in the magazine, and he was much surprised and really disappointed, for until that time he had thought his was a good set. He has asked me to write to you and find out how to tune it or what to do to help him eliminate the trouble. He is a good fellow, and really didn't know what an awful racket he was setting up until I brought him downstairs and let him listen to it for himself.

HAROLD H. BRECKENRIDGE

ANSWER: There are three ways in which the trouble could be eliminated. The surest way would be to get another set of the loosely coupled type, one employing two or more circuits.

Another way would be to add a single stage of radio-frequency amplification to the present set.

The third way would be to learn how to

tune the set without ever allowing it to go into oscillation, and it is doubtful if this could be accomplished because while listening to distant stations the tube will oscillate extremely easily. This is because the regeneration is increased to such an extent in order to hear these stations, that the circuits are in a critical condition and will burst into oscillation at a slight change in wavelength of the tuning dials.

\* \* \*

QUESTION: Why is it that my 5-watt transmitting tubes work all right for about a minute and then they seem to choke up? I was using them on a 350-volt DC. generator, but then I was using "voice"; now I am using ACCW. with 750 volts on the plate for telegraphy.

All of a sudden the antenna hot-wire meter drops to zero, the plates get white hot, and there is a blue fuzz in between the filament and the plate. I know I am using a higher voltage than the tubes are supposed to operate with, but I am wondering if you cannot tell me how I might use it and still keep the tubes from overheating.

SAMUEL BROWN

ANSWER: Although you are using the tubes at an overrated voltage you can keep them at the correct temperature by slightly changing the plate and grid adjustments of the set so that the plate current is reduced. It is evident that your set is only slightly overloaded because the tubes *do* stand up for a time. If you cut down the plate current (say about 25 milliamperes) you will undoubtedly prevent the tubes from slowly developing too high a plate temperature which finally ionizes the tubes.

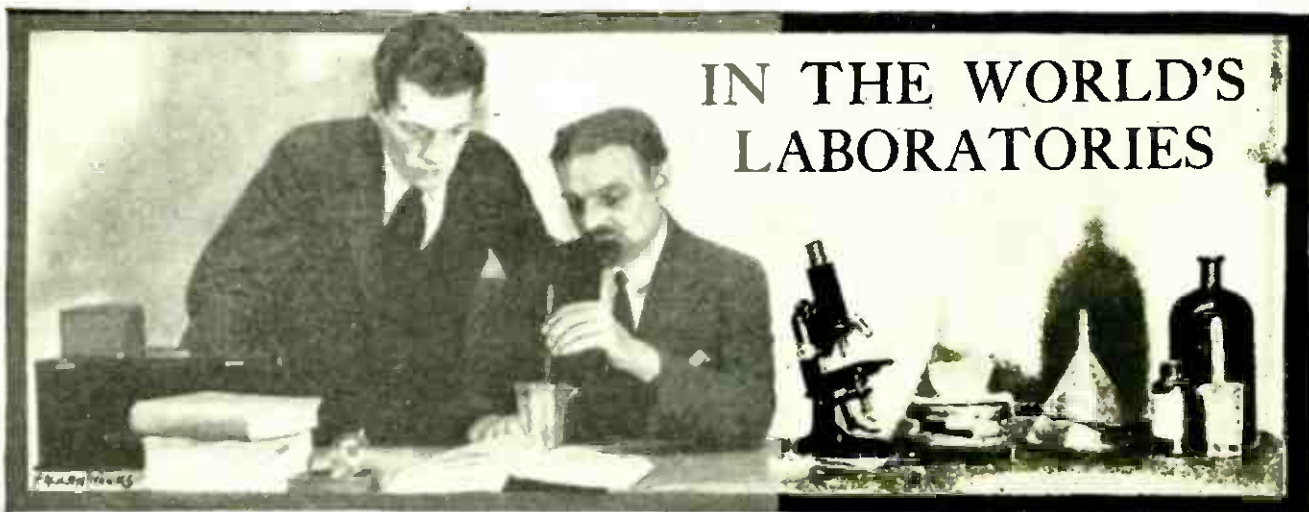

## Will We Run Our Automobiles with Power Obtained by Radio?

THE newest suggestion of how to meet the prospective shortage of automobile fuel comes from France. It is that we might equip our roads with high-frequency power cables and run our autos by radio.

The process is suggested by Maurice Leblanc as a development of his plan for supplying radio power to railway trains. According to *La Science et la Vie* (Paris), the suggested system for railways consists of a pair of conductors suspended above the right of way and supplied with current at a frequency of 20,000 cycles a second. On top of the locomotives (or coaches) are two similar conductors, mounted so that they are parallel to the line conductors and at a distance from them, when the train is on the rails, of about sixteen inches.

These conductors on the train pick up the high-frequency waves from the fixed conductors by electromagnetic induction, just as a receiving station picks up radio waves sent out from a transmitting station. The high-frequency impulses thus produced are converted, on the train, into three-phase current at 15 to 25 cycles and this is used to drive the motors in the usual fashion. The conversion is made in the standard manner by means of vacuum-tube rectifiers and a rotating commutator.

The application of this system to the

propulsion of automobiles is obvious. Cables carrying the high-frequency current would be suspended along the main roads and cars would be provided with reception conductors, converting equipment and three-phase motors, just as are the trains. There would be an obvious disadvantage in that the automobile could not operate at any great distance from the driving cable and would be confined, therefore, to the roads that were so equipped. But this might be avoided by supplementary storage batteries on the car.

It would seem that the most obvious opening for a system of this kind would be on motor-bus lines operated by what are now known as trackless trolleys. It is to be hoped that an actual trial of this kind will be made.

As an incidental to his system of train propulsion Mr. Leblanc has designed a high-frequency generator consisting of a vacuum tube operated by the vapor of mercury and provided with a fourth electrode for the purpose of maintaining the mercury arc. Several novel features of design are indicated by the sketch on page 519.

## Does Static Come from Outside the Earth?

THIS is an implication that cannot help suggesting itself when one examines the results of static studies by Dr. Max Räumler, reported in a recent number of the *Jahrbuch für drahtlosen*



*Telegraphie und Telephonie.* By means of automatic recording apparatus Dr. Bäumlér has compared carefully the records of single static disturbances received at four widely separated stations, three of them in Germany and the fourth the station of the Radio Corporation at Riverhead, Long Island. He finds, surprisingly, that a large proportion of the static disturbances, the individual clicks or roars, are simultaneous and of about the same strength, not only at the German stations but at the distant Long Island station as well.

If static is due, as is frequently supposed, to local thunderstorms it is difficult to imagine how the waves originating on one continent can reach another continent with their strength so little impaired. Dr. Bäumlér does not discuss this problem. He would object,

no doubt, to deducing from his results any conclusions not directly warranted by his data. But those of us who are inclined at all to speculation cannot help wondering whether these new facts about static may not mean that some, at least, of the disturbances originate in the Heaviside Layer or even above it, this layer functioning as a sort of great transmitting network high above the earth and from which the disturbing impulse is sent downward to the ground from all parts of the layer at almost the same instant all over the earth.

It has been suggested, for example, that static is due to meteors. This seems improbable in the light of the opinion of astronomers that the average meteor is a tiny particle even smaller, probably, than a grain of wheat. But there is another sort of cosmic visitors



#### WILL OUR MOTOR CARS RUN BY RADIO POWER?

*If we equip our roads with high-frequency conductors radio power can be supplied to automobiles, says Mr. Leblanc, especially in mountain country where water power is usually cheap and where gasoline is dear.*

that may be more important. These are the clouds of charged gas or tiny dust particles that are supposed to be shot out frequently from the sun, especially from the great centers of solar disturbance that we know as sun-spots. One of these clouds hitting the Heavyside Layer would give it, probably, a sudden increase of charge. This might start a wave downward from the layer just as a sudden charge added to an antenna will start a sharp single wave outward from it.

Each click that you hear when static is bad *may* be the signal that another solar messenger has knocked at the outside door of the earth.

### Are There Unsuspected Sources of Power?

THE problem of what the world is going to do for power when all the coal

and oil have been used up is one that has agitated economists and scientific men for a number of years. It has been raised again by Dr. E. E. Slosson, distinguished American chemist and now Director of Science Service. We have enough coal, of course, for this year and for quite a few years in the future, but ultimate exhaustion of it is inevitable, and each increased use of power brings that fatal day a little nearer.

The confidence so often expressed that science will find some way for us to escape this threat of a power-less world is, Dr. Slosson says, "flattering—but unfounded." Many sources of power are known, but we do not know, in most cases, how to get the power out usefully. The scientific and engineering professions should make an immediate effort, Dr. Slosson urges, to

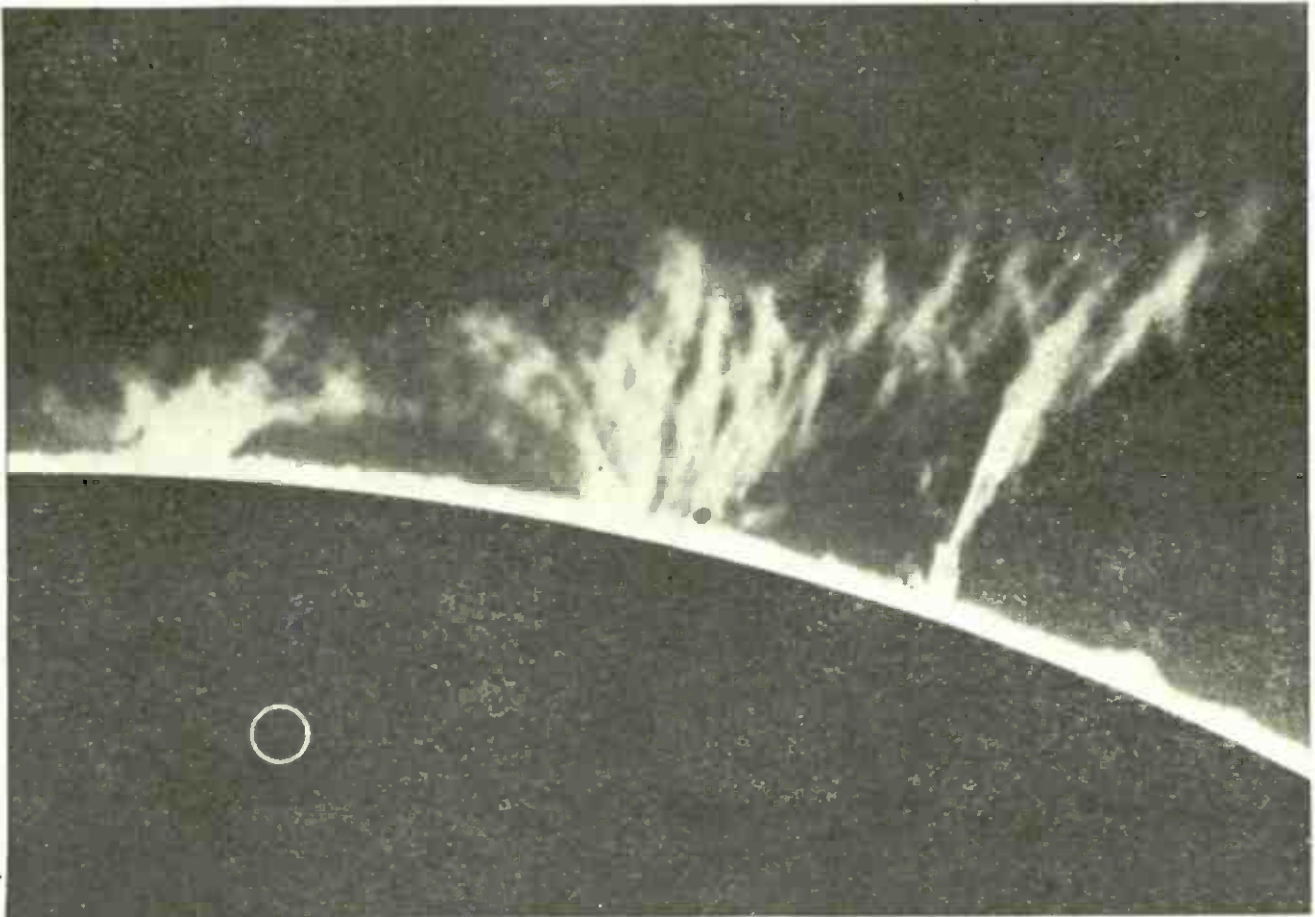

Science Service

#### A SOLAR FIRE-FOUNTAIN 80,000 MILES HIGH

*This remarkable photograph made at Mount Wilson Observatory shows one of the great solar storms that shoot out clouds of charged particles toward the earth. These particles may be one cause of static. The white circle is the size of the earth on the same scale.*





U. S. Bureau of Standards

#### THE STANDARD KILOGRAM AND METER BAR

*The fundamental standards of weight and measure for the United States are the standard kilogram, under the glass case in the center, and the standard meter bar on the shelf just below. All units, even the electric ones like the volt or the watt, depend on these two fundamental units and on a third, the second of time.*

inventory all possible or probable sources of power so that intensive study of the more promising ones can be begun.

All our present power, with negligible exceptions, comes from the sun. Coal and oil are derived from ancient sunlight by which the plants that produced these fuels grew in former geologic ages. Water power is really the power of the sun, translated into water raised from the sea and fallen as rain on the land. Winds, wood used for fuel, alcohol produced from vegetation; all are manifestations of this same solar power.

Much of the solar power that falls on the earth's surface is not used. Perhaps engines can be devised to catch and use this. Then there are a few known power sources that are not related to the sun. The tides constitute

one of them, these being due to the attraction of the moon and drawing their energy, really, from the rotation of the earth. Another source to which Dr. Slosson refers is the internal heat of the earth, now being used in a very small way by steam plants located near volcanoes and hot springs. Still another is the power known to be held inside the atoms of matter but which cannot be got out except in the quite special instance of radium and the analogous elements.

All these power sources, Dr. Slosson insists, must be studied and evaluated if the world is to escape ultimate disaster. Still other sources must be thought of and studied too.

Radio engineers ought to join this procession. Are there any unsuspected radio sources of power? How about,



for example, radio impulses which may be received from time to time from the sun or other heavenly bodies? These have been little studied. It may seem a long step to the idea that power might be got in this way, but stranger things have already happened in the brief history of radio.

### Better Crystals for Detectors -

It is probable, suggests a writer in the *Mining Journal* (London), that the resources of mineralogy have still much to offer to the radio engineer. Out of some thousands of minerals which the mineralogists have identified only a very few appear to have been tested as crystal detectors. Most of the crystals commonly used are metallic sulphides like pyrite, which is a sulphide of iron, or galena which is a sulphide of lead.

But there exist, says this writer, many other minerals that ought to be even

more valuable. Examples are pitchblende and the similar radioactive minerals. The conductivity of these minerals is good and they have the further property (because of their radioactivity) that they emit electrons spontaneously. Other "prospects" are tantalite and columbite which contain the rare metals tantalum and columbium, monazite which contains thorium and other unusual elements, samarskite which contains uranium, and others.

It would probably be worth while for some radio enthusiast who has access to a good mineral collection to make systematic tests of all the known metallic minerals, not forgetting that different fragments of the same mineral often vary greatly in detecting power and that, accordingly, a number of pieces of each one should be tested, both alone and with a biasing potential such as has to be used with carborundum.

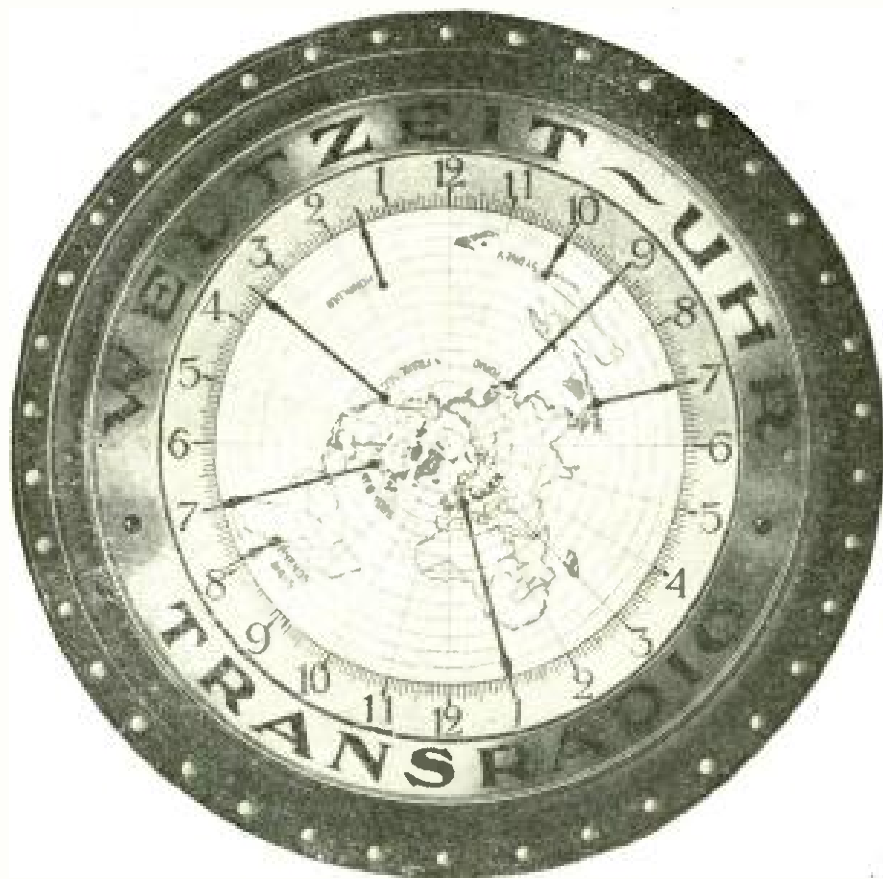

### A UNIQUE CLOCK FOR RADIO OPERATORS

*This timepiece, which was designed in Germany, shows the time in all parts of the world simultaneously. When the radio amateurs begin to listen regularly to European broadcasting, clocks like these will be useful to check up the schedules of the foreign stations.*

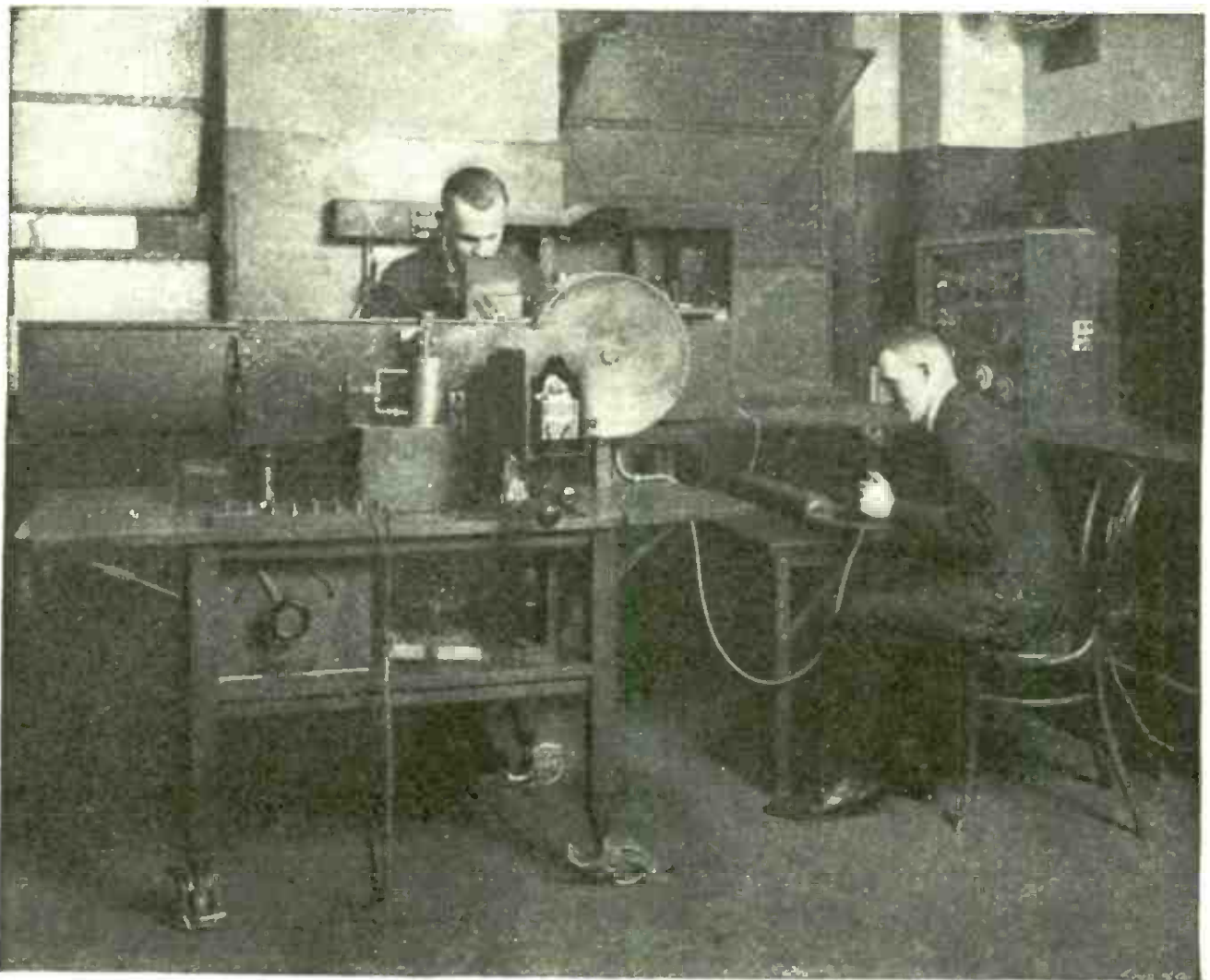

Western Electric

#### AN INSTRUMENT USED FOR DESIGNING LOUDSPEAKERS

*This special oscillograph was devised for the study of the vibration frequencies in speech sounds. The voice of the operator at the telephone is magnified and made visible on a screen so that the other operator may see exactly what frequencies and wave forms are associated with each vowel and consonant sound and what happens to each frequency when it passes through electric or magnetic apparatus.*

#### The Earth as an Electric Generator

THE surface of the earth in northern latitudes is usually charged negatively with respect to the atmosphere. There is accordingly a small electric current flowing all the time through the air, or rather between the air and the soil. It is small on any square foot, but for the whole earth it may equal, scientists calculate, as much as 2,000,000 amperes—enough to keep about four million electric lamps burning all the time. The electric and magnetic properties of the earth, of which this surface current is one, are probably of great importance in radio communication.

#### Why It Is Difficult to Produce a Really Good Loudspeaker

THE search for a better loudspeaker continues to absorb the attention of radio engineers all over the world. Yet it is safe to predict that not one of these will prove to be fully satisfactory. The perfect loudspeaker remains to be invented.

The extraordinary difficulty of this effort is not hard to understand when one sets down the number of different scientific problems which demand solution before this invention is possible. A cursory look through recent loudspeaker literature discloses at least six or eight of these problems.

The most important and well known one is that of electric distortion in the circuits. This is really a name for the habit of any electric speech-transmitting apparatus to absorb and remove from the sound some of the frequencies that ought to be in it. The human voice, for example, sounds sharp and nasal when it loses its lower frequen-

cies (say below 1,500 cycles a second) and hoarse and throaty when it lacks the normal higher frequencies. All of the frequencies from about 200 cycles to 4,000 or over must be present and must come satisfactorily through the apparatus if the reproduction is to be reasonably normal.

Then in addition to the electric distortion (determined, of course, by the combined capacities, inductances and resistances of the circuits) there is a magnetic distortion due to the fact that the magnetic properties of iron are not perfect, that any electromagnetic system which one can devise will always respond more readily to some frequencies than it does to others.

And when one has solved these two troubles there are the peculiarities of the diaphragm to reckon with; its persistent tendency to seize hold of one particular frequency that it happens to like and sing it out at one to the practical exclusion of all the other tones that ought to come out too. The horn or other sound-magnifying device adds still other peculiarities. Like the diaphragm it has its preferences, and it insists that the listener shall hear them.

Then a loudspeaker must be heard, usually, in a room, and the room, too, has its acoustic properties and preferences. There are echoes and rattles and the absorption of sound by hangings, all to be reckoned with. A person speaking in a room or anywhere else adjusts unthinkingly the loudness and quality of his voice to the needs of the circumstances; such as the size of the room and the number of auditors. No one has yet invented a brain for the loudspeaker that will enable it to do this.

Finally there are a couple of difficulties that are in the auditor instead of in the apparatus. The human ear is one of them. Gallileo is reported to have said that if any optician had sent him an instrument so imperfect as the human eye he would have returned it

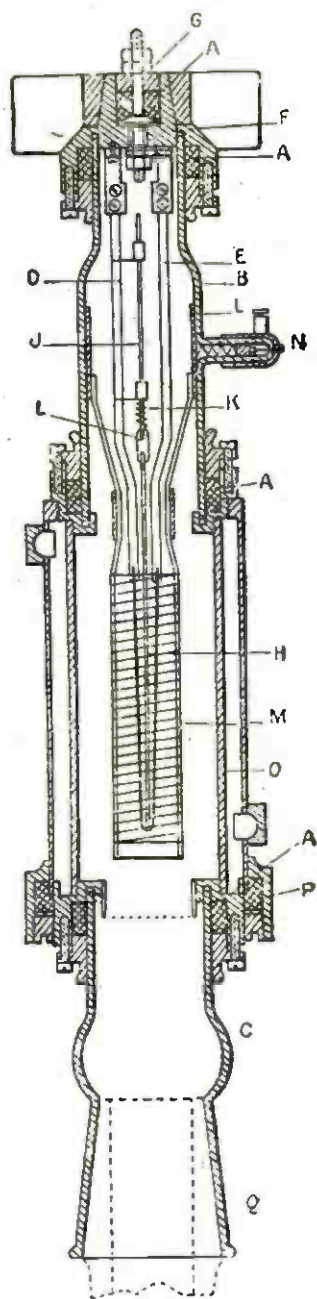

THE NEW DEMOUNTABLE  
VACUUM TUBE

The parts B and C are of glass, joined to the other parts of the tube by the four rubber gaskets indicated by A. M is the grid of molybdenum wire, the electric connection for it being at N. The plate is the copper cylinder O, cooled by the circulation of water in the space outside it. The vacuum is produced and maintained by a pump attached inside the cone Q by means of a ground-glass joint.



in disgust. If he proposed to get as mad as this about an eye, which is, after all, a fairly effective light detector, what *would* Gallileo have done about an ear? No two human ears are alike in the tones they hear nor in how they hear them. A person's hearing varies, even with the time of day or with what he had for dinner!

This is one of the imperfections of the auditor that the loudspeaker inventor has to take into account. He must realize that his instrument will have to be so clear in tone, so perfect in reproduction, that *anyone* can understand it, even people who have really only about half an ear to hear with.

The other personal imperfection of hearers is psychological. It is due to inattention. Many people get interested in something else and miss whole sentences of a lecture or a stage performance. They do not seem to mind this but let the same thing happen for the same reason with a radio apparatus and soon letters will be written to the manufacturer. These psychological and physiological peculiarities of us humans have not had from the radio designer as much attention as they deserve.

Note how many problems in what we used to call "pure science" are opened up by this one device of the loudspeaker. One is the problem of what is magnetism, for if we knew all about the magnetic behavior of iron we could avoid, probably, the various varieties of magnetic distortion. Others are the problems of the interference and resonance of sound waves in material bodies like horns, problems that were investigated so brilliantly by the late Professor Sabine of Harvard. Still another is the problem of cohesion and of what controls elasticity, for this it is that determines the vibratory properties of diaphragms. And then there are the problems of human physiology and psychology, those that concern the mechanism of hearing both in the ear and in the brain.

## A Vacuum Tube That Comes Apart for Repairs

THE accidental circumstance that the vacuum tube was developed out of the electric lamp has given to the form of this useful instrument some characteristics that are from the engineering viewpoint, a serious handicap. The glass bulb is one of them. When the filament burns out or the grid connections come loose the glass bulb must be destroyed and remade (or resealed), which makes the repairing nearly as costly as a new tube.

So long as tubes were of small power and used only for reception this was not, perhaps, a matter of much importance. But as tubes advance more and more into the class of engineering equipment this impossibility of easy repairs must be escaped in some fashion. Imagine an electric motor that had to be thrown away whenever the armature burned out!

Hence the demand, growing more and more insistent, for a demountable and easily repairable form of tube. The development of such a tube is, we believe, inevitable. Indeed one form that has been constructed and is on trial in the Eiffel Tower station at Paris is illustrated in the diagram on page 524, which we take from *La Nature* (Paris). The tube is completely demountable; all joints are held gas-tight by gaskets of special rubber free of volatile matters and of excess sulphur. The rating is 10 kilowatts. the antenna input, at a plate potential of 5,000 volts, being about 8 kilowatts. The necessary vacuum is maintained by a pump of special design to which the tube is attached.

It is natural that the development of a demountable tube should begin with high-power units of this kind but it may be expected to extend to smaller tubes as well. Even the tubes used for everyday reception will probably take on before long new designs leading in this same direction.

## HINTS FOR

## AMATEURS



Most instructions for erecting single-wire antennas provide for cutting the wire at the insulator nearest the house, and then urge precautions against a bad connection between antenna and lead-in. Often this difficulty can be obviated by purchasing enough wire, in one piece, to reach from the far support to the set, or at least inside the house, so that no joints are exposed to the weather. Attach the far end of the wire first, then put the other end through the house insulator, draw the wire taut, and give it a few turns around itself before it is continued as the lead-in.

Inasmuch as the lead-in should be kept several inches from the side of the house, and insulated where it enters the building, a bare wire serves just as well as one that is covered. When, for the sake of appearance, an insulated wire inside the house is desirable, the junction between bare and insulated wire can easily be soldered, or kept clean if joined otherwise.

A small single-pole, single-throw knife switch, costing about 25 cents, makes this connection conveniently, and affords additional protection against lightning when an automatic arrester is used outside.

\* \* \*

WHEN loading up the old DX receiver (described in the January issue of POPULAR RADIO) for reception at the higher wavelengths (lower frequencies) that are now used by some of the broadcasting stations, the following suggestions will be found of value:

1. Remove the secondary condenser from its place and connect it in parallel with the antenna coil.

2. Remove the antenna condenser and place it where the secondary condenser was first connected.

3. Join the two wires together which were first connected to the antenna condenser.

4. Place a .00025 mfd. mica fixed condenser across the terminals of the variometer in the plate circuit.

The effect of No. 1 is to replace the .001 mfd. series condenser in the antenna circuit with a .0005 mfd. shunt condenser. This materially increases the antenna wavelength range *upwards*.

The effect of No. 2 is to increase the secondary capacity from .0005 mfd. to .001 mfd. This boosts up the secondary wavelength range.

No. 3 closes the gap in the antenna circuit made by taking out the primary series condenser.

No. 4 raises the wavelength of the plate circuit.

You will find that these hints will bring in the "higher" stations with the same robustness that you used to get the "lower" stations before the wavelength changes went into effect.

\* \* \*

IF a regenerative receiver refuses to oscillate properly, when completed, it would probably help if the builder were to try a .00025 mfd. fixed condenser connected across the telephones (if a single tube is used) or across the primary of the first amplifying trans-

former (if more tubes are used).

\* \* \*

THE wide use and great popularity of the UV-199 radiotron have led to numerous attempts on the part of unscrupulous manufacturers to counterfeit this tube. In external appearance some of the imitations bear such a close resemblance to the genuine tube that it is difficult to detect the difference; even the carton markings, the instruction sheets and the trade-marks are copied.

However, in spite of the resemblance in appearance, the electric characteristics of the counterfeit tubes are very different from those of the genuine UV-199. So far, none of the manufacturers of the illegal tube has been able to duplicate the 60-milliampere filament of the UV-199 and most of the counterfeits require as much as one-fourth of an ampere. Since the voltage of this filament can easily be made 3.0 volts or less, the user of such a tube is often misled by the apparently satisfactory operation when the tube is first lighted, but he soon finds that his dry battery is quickly exhausted and often the tube itself fails in a few hours.

Of course, the easiest way of determining the current required by the filament is to use a milliammeter and a voltmeter, but as such instruments are not in common use among radio experimenters another simple method described below may be used which

gives a rough approximation of the filament current.

Connect three new six-inch dry cells in series with the tube to be tested and an ordinary 50-watt, 110-120-volt mazda electric lamp. Figure 1 shows the proper connections. If the filament of the tube that is being tested does not take more than 60 milliamperes, it will light up almost to normal temperature. But, if the tube is not a genuine UV-199 and the filament requires appreciably more than 60 milliamperes, the resistance of the mazda lamp will rise due to the higher current flowing through it, and the voltage on the tube will be so low that its filament will not light. In making the test, be sure that the tube is left in the socket for about 30 seconds to allow the mazda lamp filament to heat up to constant temperature.

When the proper electric instruments are available, an even better test is to use a voltmeter and milliammeter connected exactly as shown in Figure 2. At three volts the current through the filament of a genuine UV-199 radiotron lies between 55 and 65 milliamperes. For this test high-quality instruments *must be used* as otherwise this test is worthless.

A voltmeter that has a full scale reading of 5 is recommended. For the milliammeter use an instrument having a full scale reading somewhere between 100 and 250 milliamperes.

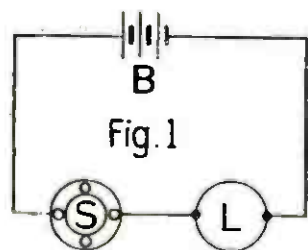

B -- Three New 6" Dry Cells  
connected in series  
S -- UV 199 Socket  
L -- 50 Watt 110-120 Volt Mazda Lamp

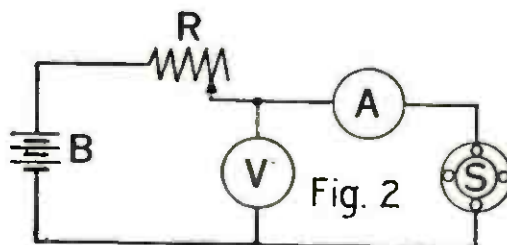

R -- 30 Ohm Rheostat  
A -- Milliammeter  
V -- Voltmeter  
S -- UV 199 Socket  
B -- Three 6" Dry Cells

The two diagrams shown above in Figure 1 and Figure 2 illustrate the two simple methods for detecting counterfeit vacuum tubes. Figure 1 gives the circuit for the lamp method and Figure 2 gives the circuit for the voltmeter-ammeter method.





## BROADCASTS

ITEMS of general interest that you ought to know; bits of useful information that every radio fan ought to know.

### *The Great Mexican Static Mystery*

WHY is it that the special home and playground of the static-making forces is in the mountains of Northern Mexico? All ships' operators agree that the neighborhood of the Mexican coast is saturated almost continuously with squeaks, clicks, roars and scratches. At land stations within Mexican range whenever the direction of static is determined most of it is found to be coming from the direction of these trouble-making hills just south of the border of the United States. There is no obvious reason for this. The Mexican mountains are not especially high nor especially afflicted with thunderstorms. With a few extinct exceptions, they are not volcanic. Whoever can solve the mystery of why this particular part of the earth is so cursed with atmospheric disturbances may go a long way toward solving the other problems of the origin and nature of all static problems which are still so entirely mysterious. Have our readers who live near the Mexican border any suggestions?

\* \* \*

### *Advance Seat Sale for Radio Concerts*

IN a family that owns only one receiving set, it has been necessary to reduce the receiving schedule to a system of advance reservations. A schedule sheet is kept for each evening hour for a week or two ahead. When Mother reads in the paper that a song she especially wants to hear is to be sent out by a certain station at nine o'clock Tuesday evening she reserves that hour on the sheet. That holds the hour for that station and for her against claims of other members of the family. Sister may reserve Thursday evening for jazz from her favorite band and invite in her friends, secure in the knowledge that no one else will have pre-empted the set that evening for a missionary lecture or the report of a prize fight.

\* \* \*

### *Yes, Radio Will Help Us Get Bananas*

THE United Fruit Company, which supplies most of the bananas to the United States is installing six new radio stations in Central America and at Gulf ports. This will bring the cost of this company's radio system to over

\$4,000,000, all of it being used to direct the movement of the company's fleet of steamships and thus to control the shipment of bananas and other fruits to the United States.

\* \* \*

### *Longest One-way Radio Circuit in the World*

ONE-way traffic is being handled regularly twice each day from the United States Navy station at Cavite near Manila to San Francisco, a distance of 6,221 miles. This is believed to be the longest regular radio circuit in the world.

\* \* \*

### *Language Study by Radio*

THE broadcasting station at Manchester, England, is reported to be supplying its patrons with short programs in French, Spanish, German and Italian, in addition to the regular English program. It is usually admitted that the chief difficulty in mastering any foreign language is lack of opportunity for hearing it spoken regularly. This radio innovation ought to provide an easy means for this without the expense of foreign travel. Many prophets have predicted that radio is to give us a universal language. Perhaps it will, but there is another possibility. When listening becomes regularly international, which it will soon if the improvement of apparatus continues, it may be that radio listeners will learn *all* the languages. Many travelers have remarked that most of the natives of Switzerland, because of constant contact with many languages, speak French, English, German and Italian equally well. There is no reason why this should not be general all over the world. Perhaps it will be when a generation of boys and girls has grown up under the nightly influence of international broadcasting.

\* \* \*

### *Advertising Towns by Radio*

THE first municipality that has attempted to spread its fame by means of its own broadcasting station is Union Hill, New Jersey. A broadcasting transmitter is to be installed in the rooms of the local hook-and-ladder company and the beauties and commercial advantages of Union Hill will be sung nightly over the ether.

*Radio for the Land of Ancient Babylon*

A NETWORK of radio stations for local communication as well as for contact with the outside world is to be one of the first developments, it is announced, of the great Cl. ester Concession covering large parts of Asiatic Turkey and Mesopotamia, a concession that was recently confirmed by the new Turkish Government. Thus the oldest civilized country in the world, the land of ancient Babylon, will receive the benefits of the newest invention. Roads that were built by Chaldean kings more than six thousand years ago and that were traversed each day by the king's messengers in the first of all postal systems can still be traced on the desert and along the rivers. But now the messages will move over them in a hundredth of a second instead of in many days.

\* \* \*

*Running Your Radio with Wind-power*

ACCORDING to the *Scientific American* Mr. A. I. Root, of Florida, has connected his windmill to a battery-charging dynamo and secures thereby enough electricity to run his automobile. Why would not this be a good idea for the radio fan who lives in the country where battery-charging service is difficult to obtain? A small generator could be connected to the family windmill and the batteries charged automatically whenever the radio set was not itself in use.

\* \* \*

*A Forecast in Fiction of Radio Broadcasting*

LITERARY students have called attention recently to the fact that "Looking Backward," a novel of the future written by Edward Bellamy and one of the best sellers in the early nineties, contains a good description of today's broadcasting. The hero is supposed to have been transported to the year 2000 and in the houses of that period he finds "music rooms" containing nothing but some electrical apparatus and a few switches. By turning a knob or two the householder of that period can have any selection he desires out of a number that are on tap for each hour of the day. Science has anticipated Mr. Bellamy by 77 years. What will radio have led to when the year 2000 really does arrive?

\* \* \*

*Successful Radio Navigation of an Airplane*

THE air service of the French Government carried out recently an interesting experiment with radio navigation. An airplane flew from Sainte Assise to Tours and back again without any guide beyond the radio compass bearing of the radio station at the former town. The pilot did not look at the ground nor make use of his maps. The bearing of the radio signals was reported to him moment by moment by an assistant and the course was steered by this means alone.

\* \* \*

*Looping the Library*

A FRENCH amateur, lacking available materials for a revolving loop aerial, solved the problem recently by winding some turns of wire around his revolving bookcase. Entertainment

by ear or from the printed page became equally available by turning this radio library to the book or the wave that one happened to desire.

\* \* \*

*Radio Batteries Made from Old Automobile Batteries*

AUTOMOBILE batteries usually contain three cells connected in series. It frequently happens that an auto battery is discarded because one of the three cells in it has gone bad, the other two being perfectly good. By removing the two good cells, or merely by short-circuiting the one bad one, the radio fan has a perfectly good two-cell battery for use experimentally or on his radio set.

\* \* \*



Atlantic Photo Service

**A RADIO PLAYWRIGHT**

Clyde Agnew Criswell has the distinction of being among the first, if not the very first author to write a play especially for radio broadcasting—which is developing a technique of its own. Several of his plays have been broadcast from Station WDAR.



*The Natural Wavelength of the Earth*

THE size of the earth is such, says Dr. Fournier d'Albe, that it has a natural vibration period of 15 cycles a second, corresponding to a wavelength of 20,000,000 meters. If we could produce a wave of this length we might set the whole earth into electromagnetic vibration just as an organ note will shake the walls and floors of a room. What would happen? It is an interesting problem for the radio theorists to solve.

\* \* \*

*Relay Broadcasting to Reach All the World*

A SIGNIFICANT experiment has been tried recently both in England and in America; this is the connecting of two or more broadcasting stations by land lines so that the same program can be broadcast simultaneously from all stations. In the United States, WEAJ in New York and WCAP in Washington have been linked several times in this way. As many as four stations have been linked on special occasions. In England, three stations of the British Broadcasting Company have been linked experimentally. There is no reason why this cannot be extended. Linkage can be accomplished not only by land lines but by powerful radio waves on a longer wavelength. It is not impossible that before long we may have special programs on the air

simultaneously, not only in all parts of the United States but over all parts of the civilized world.

\* \* \*

*Radio Fog Signals That Give Both Distance and Direction*

THE familiar radio compass that informs a fog-bound ship of the direction of selected shore stations has been supplemented on the Maas lightship off the coast of Holland by a sound-transmitting device which gives the ship captain his air-line distance from the lightship as well as his direction. A radio wave through the ether and a special sound wave through the water are sent out simultaneously from the lightship. The ships off shore can pick up both. The radio signal gives the direction in the usual manner and the length of time that the sound signal lags behind the radio signal gives the distance. The radio signal is, of course, practically instantaneous while the sound wave requires a little over a second to travel each mile.

\* \* \*

*Naming the Radio Baby*

A RECENT arrival, Master Wallace Gordon Yaden, has been named for WGY. Now is the time for some Hottentot or other gentleman possessed of a clicky, stick-breaking language to name his baby after static.



From a photograph made for POPULAR RADIO

**RINGSIDE SEATS AT THE RECEIVING SET**

The next-best-thing to a ticket to the famous Dempsey-Firpo boxing contest for the world's championship was an invitation from a radio fan to listen-in on Major J. Andrew White's thrilling blow-by-blow report of the encounter. The Technical Editor of POPULAR RADIO entertained a whole neighborhood by means of his loud-speaker; this picture shows the crowd beginning to gather.





HELP your neighbor. If you have discovered any little Kink that helps to eliminate trouble in your radio apparatus, or if while experimenting with the connections of your set you should run across some interesting phenomenon, or if you should discover some new hook-up that gives better results—send it to the "Listening In" page.

## European Broadcasting Stations that You May Hear

THE receipt of American broadcasting in Europe having become a frequent occurrence, American enthusiasts are attempting more and more actively to return the compliment and receive the European stations here. There is one serious difficulty, that of time. London time, for example, is five hours faster than New York time.

This means that the broadcasting wave from Europe must cross a broad belt of sunlight, with consequent transmission troubles. It means, also, that the hours when European concerts have to be listened for are either the hours of the American working day or are those early in the morning when even the most enthusiastic fans are apt to have exchanged their earphones for the pillow.

Here are some of the main stations that now broadcast more or less regular material, with their wavelengths and brief notes of the usual program hours:

The times given are Eastern Standard Time (New York time). For Central Time (Chicago) subtract one hour; for Mountain Time (Denver) subtract two hours; for Pacific Time (San Francisco) subtract three hours. To compare the time in Europe, the time of transmission of the programs, add five hours to these figures for stations in England, France, Belgium, Holland and Spain. This gives Greenwich Standard Time, which is official in these countries. The time in Germany,

Denmark, Switzerland, Czeko-Slovakia and Italy is an hour earlier still; for stations in these countries add six hours.

553 meters, Cardiff, Wales, 5WA. This has the shortest wave of any of the European stations. It is one of six stations conducted in the British Isles by the British Broadcasting Company, which has a monopoly of broadcasting in that country. The other British stations follow. All of them give programs at the same hours: week-days from 10:30 to 11:30 A.M. and from 12:00 noon to 5:30 P.M. (New York time); Sundays from 3:30 to 5:30 P.M. The programs are separate for each station.

369 meters, London, England, 2LO. The main one of the British stations (see above). In addition to the same program hours as the other stations, 2LO gives a program at 6:30 to 7:30 A.M. on week-days and at 10:00 A.M. on Sundays.

385 meters, Manchester, England, 2ZY. A British station.

400 meters, Newcastle, England, 5NO. A British station.

415 meters, Glasgow, Scotland, 5SC. A British station.

420 meters, Birmingham, England, 5IT. A British station.

450 meters, Station of the Telegraph School at Paris, France. (*École supérieure des Postes et Télégraphes*). Concerts at 2:30 P.M. Tuesdays and Thursdays and from 8:30 A.M. to about 1:00 P.M. on Saturdays. Announcements in French. (Paris is pronounced "pah-rec.")

460 meters, Station "Radiola-Riviera" at Nice, France (pronounced "neece"). News (in French) and concerts at somewhat irregular times, usually about 7:00 A.M., 12:00 noon and 4:00 P.M.

900 meters, Geneva, Switzerland (pronounced "Zhen-ayve"), HB1. Daily concert, announcements in French, 12:00 noon to 2:30 P.M. A 900-meter wave is also used for the radiophone system of most of the European lines of passenger airplanes, and listeners may hear this occasionally.

1,000 meters, Kbel, near Prague, Czeko-Slovakia (pronounced "kbail"). Weather report, news and concert, daily, 1:20 P.M. In German and Czech.

1,050 meters. This is the wavelength used by all the stations in Holland. Material is mostly in Dutch sometimes in French or English. Following are the stations: The Hague, Velthuyzen station (pronounced "felt-high-sen"). PCKK, concert, Fridays, 2:40 to 3:40 P.M. The Hague, Heussen station (pronounced "hoy-sen"). PCUU, concerts, Tuesdays, 1:45 to 4:00 P.M. and Sundays, 3:40 to 4:40 P.M. The Hague station PCGG, concerts Sundays, 9:00 to 11:00 A.M. and Mondays and Thursdays, 2:40 to 3:40 P.M. Amsterdam, station PA5, concert and news, Wednesday 2:10 to 3:10 P.M. and irregularly on other days. Ijmuden (pronounced "yim-mee-den"), station PCMM, concerts Saturdays, 2:40 to 3:40 P.M.

1,100 meters, Brussels, Belgium, BAV. (pronounced "brew-sell"). Daily weather report (in French), 7:00 A.M. and 11:00 A.M. Concerts Tuesdays and Thursdays at 4:00 P.M. and Sundays at 1:00 P.M.

1,300 meters, Haren, Belgium, O.P.O. The same weather report as from the Brussels station at same hours.

1,350 meters, Lausanne, Switzerland. (pronounced "law-sahn"). Daily concerts at somewhat variable hours, usually beginning about 12:00 noon.

1,780 meters, Paris, France, "Radiola" Station, S.F.R. The most popular station in France. Concerts and general programs (in French), week-days 6:00 A.M., 11:15 A.M., 3:00 to 4:00 P.M.; Sundays 8:00 to 10:00 A.M. and 3:00 to 4:30 P.M. Special dance music 4:00 to 5:00 P.M., Thursdays and Sundays. News, 2:45 P.M. week-days. Stock exchange quotations, 11:00 A.M. week-days.

1,800 meters, Prague, Czeko-Slovakia, (pronounced "prah-g"), PRG. Weather and news somewhat irregularly, usually about 2:00 A.M., 5:00 A.M. and 10:00 A.M. This station also broadcasts on 4,500 meters. (See below.)

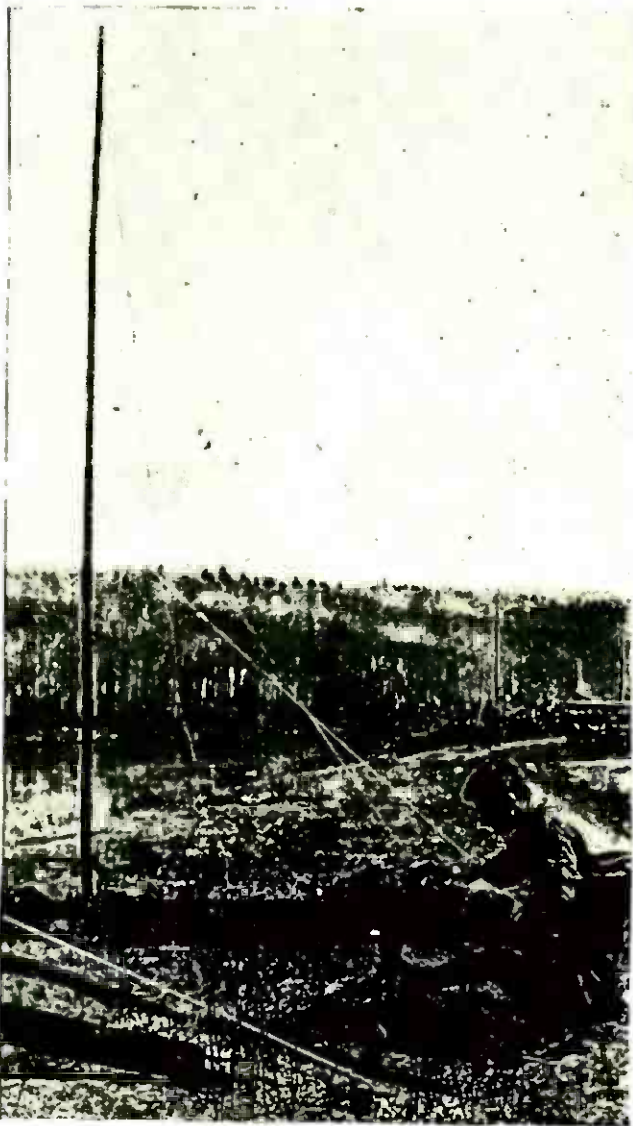

Francis Dickle

#### A PORTABLE SET 800 MILES FROM CIVILIZATION

Until last summer surveyors who are mapping the sub-Arctic regions were completely cut off from civilization. Now, however, they are equipped with portable radio sets; the one shown above was photographed on the north shore of Great Slave Lake, British Columbia—800 miles in airline from the nearest city.

2,200 meters, Madrid, Spain, (pronounced "mah-dreed.") The word for Spain in Spanish is "es-pahnya"), EGC. News and notices, in Spanish, week-days, 6:00 to 8:00 A.M.

2,400 meters, Lyngby, Denmark (pronounced "leeng-bee"), OXE. Weather reports and news, in Danish (occasionally in English), 3:30 A.M., 9:40 A.M. and 2:45 P.M. daily. Concerts, 1:30 to 2:45 P.M. week-days.

2,600 meters, Paris, France, Eiffel Tower station, FL. Weather reports, 1:40 A.M., 6:15 A.M., 1:20 P.M. and 5:15 P.M. daily. Stock exchange quotations at 9:30 A.M. week-days. Concert, 12:10 P.M. daily and frequently also in the evening, 3:00 to 7:00 P.M., New York time.

2,700 meters, Berlin, Germany (pronounced "hear-leen"), I.P. Daily program, in German, 6:00 to 7:00 A.M. This station also broadcasts on 4,000 meters. (See below.)

2,930 meters, Eberswalde, Germany (pronounced "a-bears-valld-eh"). Daily programs in German, 7:00 to 8:00 A.M., 2:00 to 3:00 P.M. Special concerts Tuesdays and Saturdays, 12:30 to 1:30 P.M.

3,000 meters, Budapest, Hungary, HB. News, in Hungarian and German, week-days, 6:30 to 7:30 A.M.

3,100 meters, Lyons, France (pronounced "lee-ong"), YN. News (in French) and phonograph selections, week-days, 4:45 to 10:00 A.M.

3,200 meters, Rome, Italy (pronounced "roam-ah"). Concert daily, 4:00 to 5:30 A.M.

4,000 meters, Berlin, Germany. (See under 2,700 meters above.) On 4,000 meters news (in German) is broadcast daily 1:00 A.M. to 2:00 A.M., 6:00 to 7:30 A.M. and 10:00 A.M. to 12:30 P.M. Music is broadcast Sundays between 5:00 and 6:00 A.M.

4,500 meters, Prague, Czeko-Slovakia. (See under 1,800 meters above.) On 4,500 meters concerts are broadcast at 4:00 A.M., 9:00 A.M. and 4:00 P.M.

For American listeners the first station available in the morning is Berlin, with news on 4,000 meters; this comes in about 1:00 A.M. At 1:40 A.M. comes the first weather report from the Eiffel tower at Paris on 2,600 meters. The Prague weather report is due about 2:00 on 1,800 meters and is followed by the Danish one from Lyngby at 3:30 on 2,400 meters. The first music is due from Prague about 4:00 A.M. on 4,500 meters. Lyons, on 3,100 meters, comes in about 4:45 A.M. and Rome, on 3,200 meters, about 4:00 A.M.

The programs on waves below 1,000 meters begin at 6:30 A.M. with the early London program on 369 meters. The two short-wave French stations, the Radiola Riviera at Nice and the Telegraph School at Paris, come in at 7:00 and at 8:30, respectively. The best programs available below 1,000 meters are those of the British stations, due at 10:30 A.M., 12:00 noon and 3:30 P.M.

After you get home in the evening you have a chance at the late concerts from the Eiffel tower on 2,600 meters. Sometimes these last until 7:00 P.M. but they are not broadcast every day. The British programs, on 353 to 420 meters, last until 5:30 P.M.

On Sundays there is a long list of stations; notably the British programs from 3:30 to 5:30 P.M.; the concert from the Eiffel tower (2,600 meters) at 12:10 P.M.; the Paris "Radiola" concerts on 1,780 meters from 8:00 to 10:00 A.M. and from 3:00 to 4:30 P.M.; the Berlin concert on 4,000 meters from 5:00 to 6:00 A.M. and on 2,700 meters from 6:00 to 7:00 A.M.; two concerts from The Hague, PCGG at 9:00 A.M. and PCUU at 3:40 P.M., both on 1,050 meters; Geneva at 12:00 noon on 900 meters and Brussels at 1:00 P.M. on 1,100 meters.





International

### A Real Portable Receiving Set

*During the period of the Leipzig Fair this distinctly modernized "sandwich man" paraded the main streets of the town, with a four-tube radio set hanging on his breast and a loop antenna and loudspeaker on his back. Presumably the local broadcasting station transmitted entertainment that was designed to attract visitors to the displays of 13,000 exhibitors.*



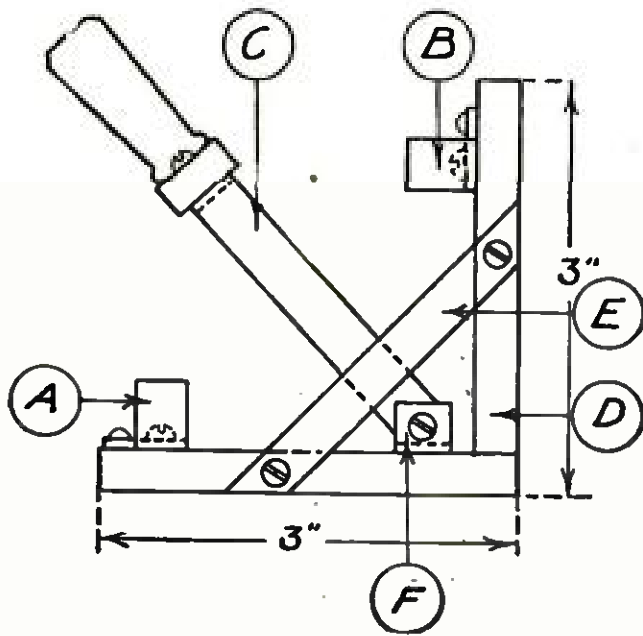

A rebuilt antenna switch that is made of A and B, the "send and receive" contacts, respectively; C the switch blades; F the hinge contacts and E the brass strips to hold the wooden base D rigid.

### A Home-made Switch

**H**ERE is a clever little labor-saving stunt that was devised by an amateur who submits it to the readers of POPULAR RADIO:

I found that the blades of the ready-made D.P.D.T. switch I was using were too far apart for convenience in operating. So I took the switch apart and rebuilt it with the blades only two inches from each other, as shown in the diagram. I no longer had to operate from an awkward position.

—DOUG TREMPER

### Unexplained Phenomena of Transmission at Sunrise and Sunset

**F**ROM a thoroughly experienced and exceptionally observant operator who is in charge of the U. S. Air Mail Radio Station at Salt Lake City, Utah, come these pertinent observations that have a bearing upon the Heaviside Layer Theory; they were prompted by an article "Why We Cannot Send So Well by Day" that appeared in the September issue, which contained the statement:

"We have it on the authority of Marconi that transmission is at its worst 'When the line of the sunrise or the sunset is between the two stations.'"

If I may be pardoned for challenging a statement by so eminent an authority, I would like to state that I have found this to be only partly true. In fact, for a short period at sunrise and at sunset, I have found it possible to do better radio work than at any other time of day. These short periods, however, are invariably preceded by periods during which east-and-west communication is practically impossible. From this, it appears to me that Marconi's statement, while not incorrect, is not complete.

During more than two years past, I have communicated daily with east-and-west stations of the U. S. Air Mail Service; this communication starts before sunrise and ends after sunset, and I have noticed on numerous occasions that the so-called sunrise and sunset fading periods are affected differently on different wavelengths at the same instant, and also that stations at various distances—even though in the same direction—are not affected simultaneously, as would be supposed.

The signals from stations to the east of us are affected more by the sunrise fading period than at sunset, whereas stations west of us show the greatest effect during sunset.

Furthermore, stations which may be receiving my station and reporting that my signals are extremely weak due to sunset fading, can be copied here at the same instant with usual ease, and when signals from that station are weak here, they receive my signals O.K.

A most peculiar phenomenon has been noticed with the Reno station during the evening fading period. Signals from that station are generally very good all day long here in Salt Lake City, especially during winter time. At the fading period, however, Reno's signals become weaker and weaker until they become absolutely inaudible. Ten minutes is generally the time required from the time signal-fading is first noticed until the lowest ebb is reached. Immediately the signals then become extremely loud and clear—louder than at any other time of day, gradually dropping again to their normal strength.

This seems to me to partially confirm that phase of the "Heaviside Theory" that has to do with the so-called "blanket of ionization" which travels westward with the sun; however, the fact that the increased signal strength is not noticed directly before the sunrise fading period, leaves an additional explanation necessary, for in the evenings when the "blanket" has passed a station to the west of us, or in the mornings, when the "blanket" has not quite reached a station to the east of us, it should act as a reflector, directing the signals to us with added strength such as is actually noticed in the case of stations west of us in the evenings.

My observations were all taken on wavelengths of from 2,500 to 4,000 meters. During the coming winter, however, I will also work on wavelengths from 150 to 600 meters, and I will watch, with anticipation, any change in the fading characteristics on these waves which may vary from the longer ones.

—PHILIP L. COUPLAND

## Wire Antennas Better Than Copper Ribbons

FROM a Philadelphia reader comes this pertinent bit of information, prompted by the constantly recurring suggestion that the standard copper-wire antenna may be improved by copper in other forms:

While many of the writers on radio recommend the use of a copper ribbon for an antenna, especially for use on crystal sets, because of its greater "skin effect," the Bureau of Standards at Washington considers the disadvantages of such an antenna to be greater than its benefits. In a letter to a Philadelphian, William T. Innes, in response to a request by him for information concerning the copper-ribbon antenna, the Bureau wrote that it did not recommend such an antenna for receiving purposes, as little advantage would be gained by its use. Such an antenna is subject to excessive stresses in sleet and wind storms and would, therefore, not be as permanent as the ordinary single-wire antenna.

—BERNARD KLIMAN

## Practical Experiments with Coils

THE stimulating effect of our articles is aptly illustrated by the following observations that are not only of interest but of value to amateurs:

The very interesting as well as valuable article which appeared in the May, 1923, issue of this magazine written by no less an authority than Sir Oliver Lodge, excited my curiosity; it made me anxious to learn just what the difference was between coils having the same number of turns of the same sized wire but of different shapes. I therefore constructed a coil having the following specifications:

25 turns No. 25 S.C. enamel wire  
4 inches diameter.

The coil was then treated with an insulating solution so that it would be possible to bend the

coil into any shape desired. It was connected to a .001-mfd. condenser and a crystal detector and a pair of telephone receivers.

A Kolster wavemeter was used as the "driver."

Readings were taken on five different settings namely, 170, 210, 275, 365 and 450 meters. The results are shown in the table below. The round coil gave the maximum inductance (self-induction), the D-shaped coil slightly less, while the figure eight coil had considerably less inductance.

The star-shaped coil had less than any of those tested.

Unfortunately the capacity sheet was not furnished with the wavemeter and therefore it was not possible to take distributed capacity readings.

The following is a list of the wavelengths for each coil together with the condenser settings:

Coil	Wavelength	Condenser setting in degrees
O-shape	170 meters	13
D-shape	" "	16
8-shape	" "	20
Star-shape	" "	22
O-shape	210 meters	22
D-shape	" "	26
8-shape	" "	35
Star-shape	" "	38
O-shape	275 meters	44
D-shape	" "	47
8-shape	" "	56
Star-shape	" "	64
O-shape	365 meters	73
D-shape	" "	76
8-shape	" "	92
Star-shape	" "	100
O-shape	450 meters	115
D-shape	" "	118
8-shape	" "	140
Star-shape	" "	160

This data will permit the readers of this magazine to make a mental picture of what that eminent authority had to say in the May, 1923, issue, on pages 354 to 357 inclusive.

—EDWARD T. JONES

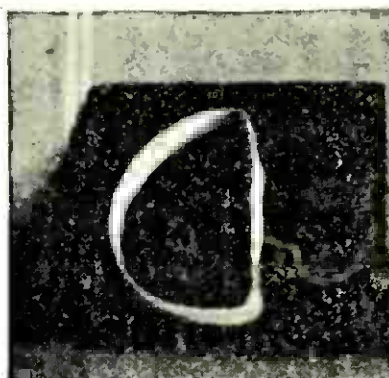
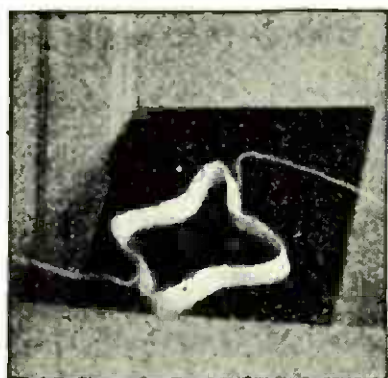

### WHAT SHAPE OF COIL WILL GIVE THE MAXIMUM INDUCTANCE?

Here are three pictures of a coil which was bent into a star shape (shown at the left), a D shape (in the center) and a figure-8 shape (at the right). The coil was found to have the greater inductance when it was left round, less in the D shape, still less in the figure-8 shape, and least of all in the star shape.



## "Secret" Radiophone Messages

"SECRET communication" by radio is already an established fact, as was described in the May number of POPULAR RADIO which included a description of M. Edouard Belin's remarkable apparatus that literally "scrambles" radio code messages on the transmitting device and re-assembles them on the receiver. Now comes an invention that does somewhat the same thing for radio telephone communication.

The radio telephone link between Los Angeles and Catalina Island, 30 miles off the coast of California, has set a new record in the history of communication; it is the scene of the first trial on a commercial basis of a private radio telephone system insuring secrecy to its users.

This radio "talk bridge" across the 30-mile gap of water separating Catalina from the California coast is unique in many respects. It was designed and installed in 1920 to give two-way talk between the mainland and an island 30 miles at sea, and has "proved in" on a commercial basis, giving satisfactory transmission throughout the year.

The wireless link connects Catalina Island not only with Los Angeles but also, through the trunk lines of the telephone system, it connects the island residents with every commercial center in the United States. After the laying of the telephone cable between Key

West and Havana, the longest telephone circuit on record was that set up between Catalina Island in the Pacific and the island of Cuba in the Atlantic. This circuit was remarkable for its character as well as for its length.

Heretofore talks over the Catalina Island link while clear and understandable to those using the service, have also been picked up by amateur radio receiving stations in the neighborhood, but the privacy system which was designed by the American Telephone and Telegraph Company has remedied this situation. It is not claimed that the new system is *absolutely* secret, but at least privacy has been obtained, so that no one will inadvertently overhear the conversations.

While any one familiar with this system, and possibly an ingenious person not familiar with it, might devise a set which *could* listen to the system, such a set would be much more complicated than the ordinary set, and the added complication would be of no value except for picking up transmission over this system. It is, therefore, not likely that many people will undertake this work.

Such a privacy system may be compared to a lock and key. A person relies upon a lock to secure his house and other property and is not much troubled by the possibility of a thief breaking in to steal. However, this is always a possibility. The privacy system presents an analogous case. For all practical cases it insures the requisite privacy to a radio telephone conversation, but it does not make impossible the designing of a special set near enough like the receiving sets used in the system itself, to transform the messages into more or less intelligible form.

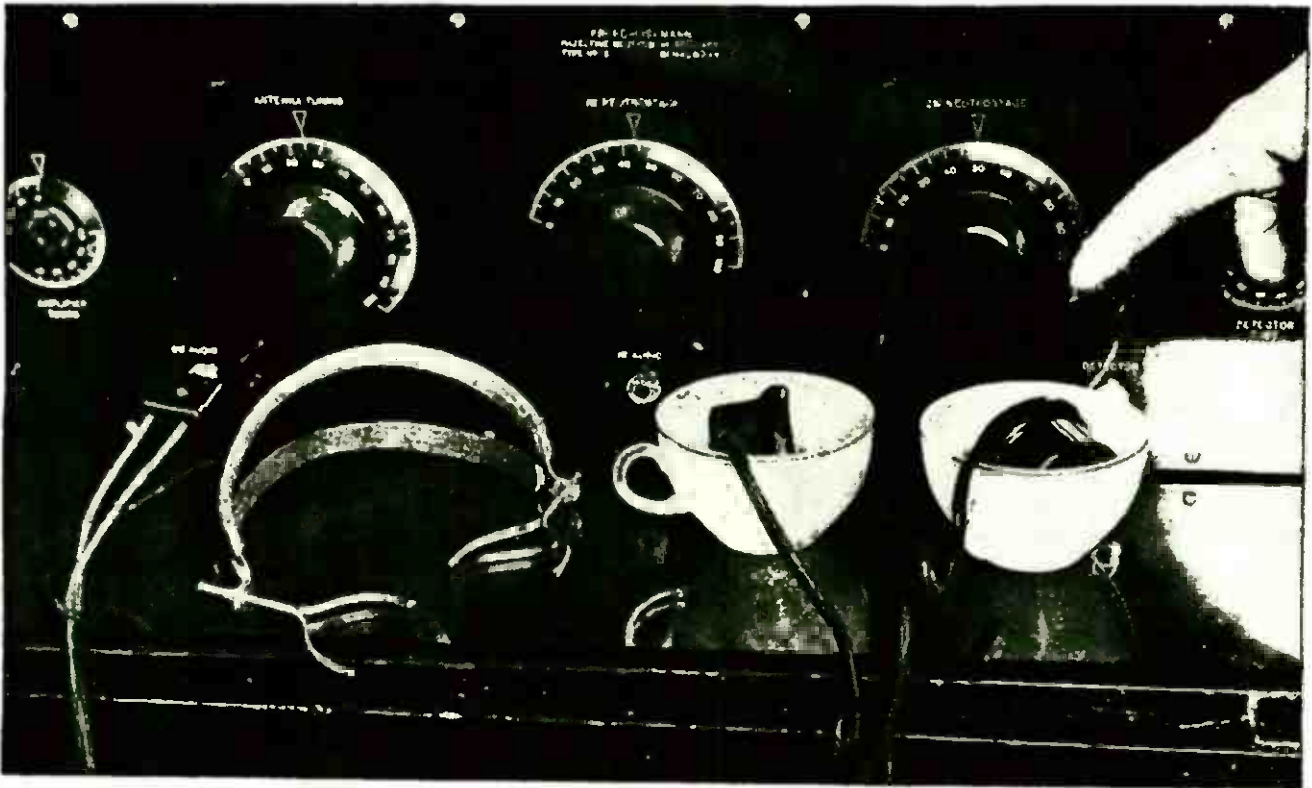

*By placing each of your telephone ear-pieces in a teacup, you can make a satisfactory loudspeaker—if there is an audio frequency amplifier included in your set.*



## FACTS YOU HUNT FOR

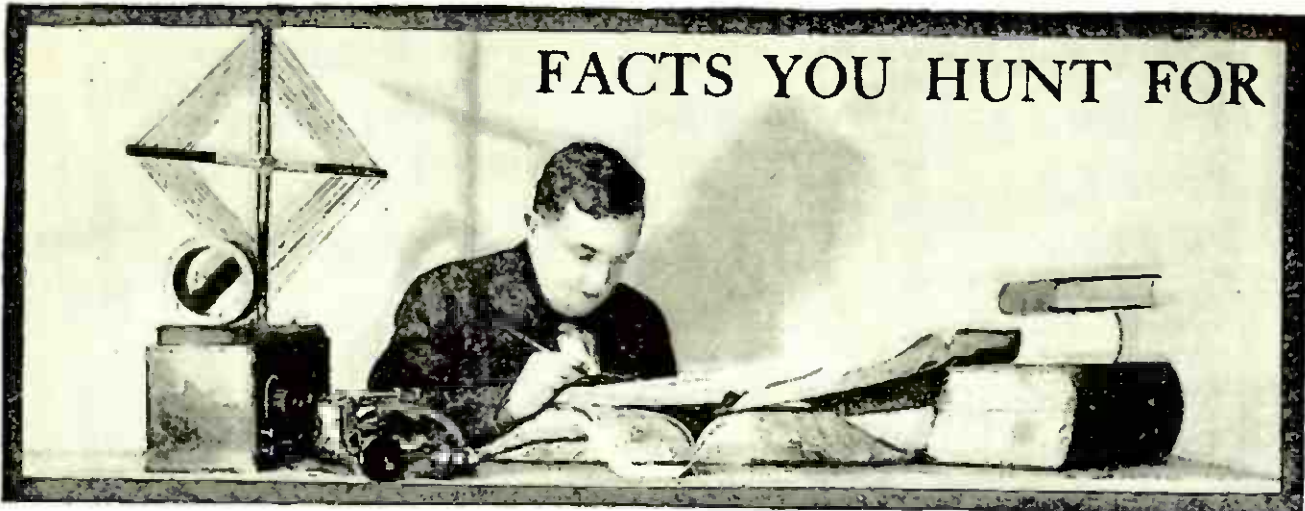

*A limited number of questions of general scientific interest will be answered each month in this department. Readers are invited to send in questions that have puzzled them—but the selection of questions for answer cannot be guaranteed nor can questions outside the radio field be answered by mail.*

*Is radio transmission affected by the phases of the moon?*

So far as known it is not. Sunlight has a well known effect on radio conditions and it has been claimed that moonlight has a similar influence, though a smaller one. This may be true, but if so the effect is presumably so small that in ordinary cases it is masked altogether by the accidental variations of transmission that come under the heads of fading, atmospherics, and the like.

*Why will a nail driven into a live tree make a good ground while one in a dead tree is useless?*

BECAUSE the live tree has sap in it. The sap is not pure water but contains various salts in solution. This solution is a fairly good conductor of electricity. The dead tree, having no sap in it, is a very poor conductor and will not serve as a ground.

*I have seen a mention of something called a "Diode Valve." Is this the same thing as an ordinary vacuum tube?*

No. The British name for vacuum tube is "triode valve." The diode valve is a vacuum tube with only two electrodes, the filament and the plate only, without the grid. These two-electrode vacuum tubes or "valves" were invented by Dr. J. A. Fleming before the three-electrode tube was discovered, and were used for a while both as radio detectors and as rectifiers for alternating currents. They still have some scientific uses but are not much used in radio, the three-electrode tube being much more efficient.

*Is it true that some flashes of lightning move from the ground upward to the clouds instead of downward from the clouds to the ground?*

As a matter of fact nearly every flash of lightning, if not absolutely every one, moves in *both* directions. The flash is an oscillating discharge. If the first discharge is downward there is an immediate surge back in the opposite direction. The charge may oscillate in this way many times during what seems to be the single flash. The net movement of electrons is, of course, from the negatively charged area to the positive one. The cloud, we believe, is usually positive, so the *net* discharge of electrons after all the back and forth oscillations are over, is usually upward rather than downward.

*How is it that radio waves have proved the inside of the earth to be solid instead of molten?*

THIS has been proved by *earthquake* waves, not by radio waves. An earthquake wave is the shock set up in the earth's crust by a quake. It travels through the earth just as the vibration caused by a hammer blow will travel through a steel girder and may be felt at the other end. The speed of these earthquake waves in traversing the earth shows, the scientists say, that the inside of the earth is more rigid than steel. *Radio* waves are now being used experimentally to explore the inside of the earth but so far as we know, no conclusions have been reached in this way.

*Why is an electric shock sometimes fatal and sometimes not?*

THE difference is due, probably, to variations in the path of the current through the

body and in the length of time it flows. The main damage caused by a current is to the nerves, which are themselves electric in nature and are disorganized, in some way which we do not understand, by strong currents. If the current due to an electric shock does not happen to pass through the nerves or if it flows along them only for a very brief instant the damage done to them is not severe enough to cause death.

*Is it possible to break a wine glass by singing at it?*

WE have never seen it done, in spite of many trials. The idea that it is possible arises from the fact that if you sound near a wine glass the particular musical note to which that glass happens, by virtue of its material and shape, to be tuned, the glass will vibrate, just as two tuning forks of the same note or two radio circuits of the same frequency will do. These vibrations induced in the glass *might* break it but only, we imagine, if it was very fragile and tuned with great exactness.

*How has the speed of ether waves been measured?*

THE most exact measurements have been made with light waves. A beam of light is sent past the edge of a revolving gear wheel so that each tooth of the wheel, as it passes, makes a little shadow. Then this intermittent light beam is sent off to a distant station, where a mirror reflects it back again. By measuring just how far one tooth of the wheel has moved while the light was on its way to the other station and back the speed of the light is calculated. The speed of radio waves cannot be measured in this way but comparisons of the time signals from American and European stations prove that the speed of radio is the same, approximately at least, as the speed of light, that is, 186,326 miles a second.

*Why do different substances differ in specific gravity?*

FOR one of two reasons; either because the atoms themselves are heavier or because they are closer together. The heaviest atoms known are those of uranium, but there are several substances that are heavier in bulk. The heaviest known substance is the metal called osmium. A cubic inch of this will weigh nearly twice as much as the same volume of lead.

*What is meant by "the C. G. S. units?"*

THIS is scientific shorthand for the system of units of length, weight, electricity and everything else based on the three fundamental units of the centimeter for length, the gram for weight and the second for time. The foot-pound, for example, is not a C.G.S. unit, since it involves the foot instead of the centimeter

as a unit of length. The corresponding C.G.S. unit is the kilogram-meter. The customary electric units do not belong to the C.G.S. system. The C.G.S. ones are much used in scientific research work but seldom elsewhere.

*How can a storage battery store up electricity without accumulating so high a charge as to be dangerous?*

A STORAGE battery does not really store electricity as such. If it did the voltage would rise to very high values, just as when electricity accumulates on a condenser. What happens in a storage battery is that the charging current deposits a chemical on one of the plates of the battery. When you stop the charging current and connect the wires to the circuit through which you want current to flow, some of this chemical dissolves again in the battery acid and produces some electricity. What is stored in the battery is really this chemical, not electricity itself.

*Is it possible to measure the voltage of an electric charge by the distance that a spark will jump?*

IT is possible to do so with fair accuracy if the sparks are between balls or other rounded objects, not pointed or sharp-cornered ones. For the best results the balls should be as large or larger than the gap between them. The following table gives the approximate voltages for sparks of different lengths between four-inch balls.

one-tenth inch.....	8,000 volts
one-quarter inch.....	20,000 volts
one-half inch.....	40,000 volts
one inch.....	70,000 volts
two inches.....	125,000 volts
three inches.....	165,000 volts
four inches.....	200,000 volts

Above about 200,000 volts the readings by this method are not sufficiently reliable.

*Some electrical apparatus is referred to as having a power of so many "kva." Does this mean the same as kilowatts?*

NOR exactly. If you are dealing with direct current the power of a dynamo or motor is measured by the product of the current (in amperes) and the voltage (in volts). This gives you watts, thousandths of a kilowatt. This is a simple calculation. But with alternating current the calculation of the power in watts or kilowatts is less simple. The product of volts and amperes is not always exactly equal to the watts of power. So this product, which remains a convenient way to describe the apparatus, is given a symbol of its own, "kva." This means "kilo-volt-amperes," one thousand times the product of volts and amperes. 1,000 kva means a machine that is delivering (or using) 1,000 amperes at 1,000 volts, or 10,000 amperes at 100 volts, and so on.



Please mention POPULAR RADIO when answering advertisements.



## The size you want— the insulation you need

**Y**OU don't need to wait while your panel is cut to order when you get ready to build your radio set. Just go to your dealer and ask for a Celoron Radio Panel. He will give you, without a moment's delay, the exact size you want. And—what is more important—you get the proper insulation for successful results in radio receiving.

Celoron is recognized by radio experts as the best material for insulation purposes. Its high dielectric strength makes it the ideal panel material.

### *Used by leading manufacturers*

Many of the leading manufacturers of radio equipment use Celoron in making their standard parts. It is approved by the U. S. Navy Department Bureau of Engineering and the U. S. Signal Corps.

Celoron Radio Panels come ready-cut in eight standard sizes, selected to meet the needs of the set-builder. Each panel is neatly wrapped in glassine paper to protect the handsome surface.

Celoron panels are readily worked with

ordinary tools at home. They are easy to machine, saw, drill, and tap.

Ask a radio dealer for one of the following standard sizes:

1—6 x 7 x $\frac{1}{8}$	5—7 x 18 x $\frac{3}{16}$
2—7 x 9 x $\frac{1}{8}$	6—7 x 21 x $\frac{3}{16}$
3—7 x 12 x $\frac{1}{8}$	7—7 x 24 x $\frac{3}{16}$
4—7 x 14 x $\frac{3}{16}$	8—12 x 18 x $\frac{3}{16}$

We also furnish Celoron in full sized sheets and in tubes, and can cut panels in special sizes when desired. If your dealer hasn't yet stocked Celoron panels, ask him to order for you, or write direct to us, indicating by number the size you want.

### *Send for free booklet*

"Tuning in on a New World" is the title of a booklet we have prepared especially for the radio fan. It contains a list of the leading broadcasting stations in the United States and Canada, an explanation of symbols used in radio diagrams, and several popular radio hook-ups. This booklet will be sent without charge, on request.

*To radio dealers: Write for special dealer price list showing standard assortments*

## Diamond State Fibre Company

BRIDGEPORT

(near Philadelphia)

PENNSYLVANIA

BRANCH FACTORIES AND WAREHOUSES

BOSTON

CHICAGO

SAN FRANCISCO

Offices in Principal Cities

In Canada: Diamond State Fibre Company of Canada, Limited, 245 Carlaw Ave., Toronto

# CONDENSITE CELORON STANDARD RADIO PANEL



Please mention POPULAR RADIO when answering advertisements.

# Brandes



SUPERIOR  
\$6<sup>00</sup>  
NAVY TYPE  
\$8<sup>00</sup>

*Matched Tone*  
TRADE MARK REG. U.S. PAT. OFF.  
Radio Headsets

Please mention POPULAR RADIO when answering advertisements.

# Brandes

## New - the Table-Talker!

New! New in the quality of its performance. New in the beauty of its appearance. New in the moderation of its price.

Another Brandes achievement—worthy to stand beside the now famous *Matched Tone Headset*. Brandes engineers have worked more than two years to make its tone strong, mellow, true.

Attractive—because an expert decorator suggested its simple lines and neutral brown finish.

The perfect gift for every radio fan. The easiest way to transform a one-man set into a joy for all the family!

*All Brandes products  
are sold under a  
money-back guarantee.*

C. BRANDES, Inc. New York

## Table-Talker

TRADEMARK REG. U.S. PAT. OFF.

© C. Brandes, Inc.

\$10



Please mention POPULAR RADIO when answering advertisements.

# DUBILIER

## Radio-Frequency Amplification over all wave lengths

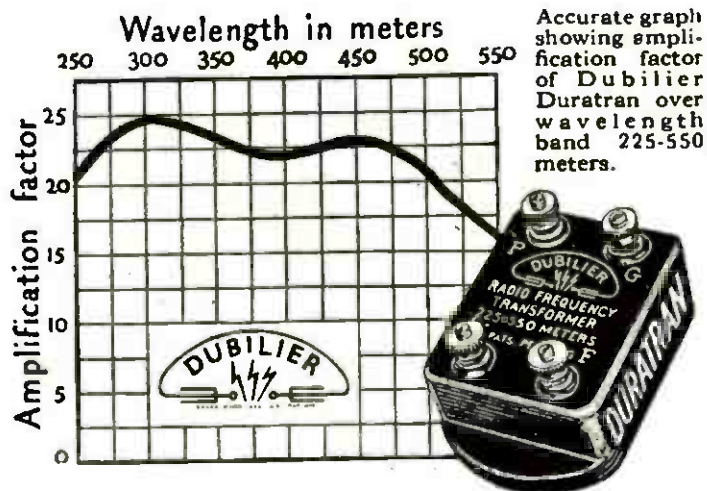

The Dubilier Duratran is the supreme radio frequency transformer.

It amplifies twenty times over the wave-length band 220-550 meters and is therefore adapted for receiving on all the broadcasting stations *equally well*.

The curve shows you exactly how uniform is a Duratran amplification over the standard broadcasting wavelength band.

Price \$5.00.

## The Biggest Little Thing in Radio

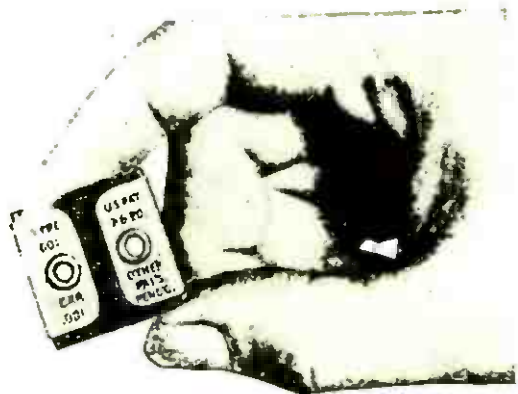

Dubilier Micadons are fixed mica condensers, permanent in capacity.

They have been adopted by the leading radio manufacturers and by discriminating amateurs.

Dubilier Micadons are made in many styles and capacities to meet any circuit requirement.

See if your set is equipped with Micadons. If it isn't, your tubes are probably oscillating too much. Your set is not receiving at its best.

Price 35 cents to \$1.50, depending on style and capacity.



# DEVICES

## The Ducon in a Light-Socket

*takes the place of  
the antenna or loop*

The Dubilier Ducon is the standard socket-plug. Four hundred thousand are in successful use.

Simply screw the Ducon in any convenient lamp-socket, and the broadcasting station comes in strong and clear.

No lightning arresters or switches are needed.

Tuning is sharper than with the usual antenna.

If unsatisfactory, your money will be refunded after five days' trial.

Price \$1.50.

*Bulletin PR, a simply worded, accurate description of radio-frequency amplification, with valuable hook-ups, will be sent you on request.*

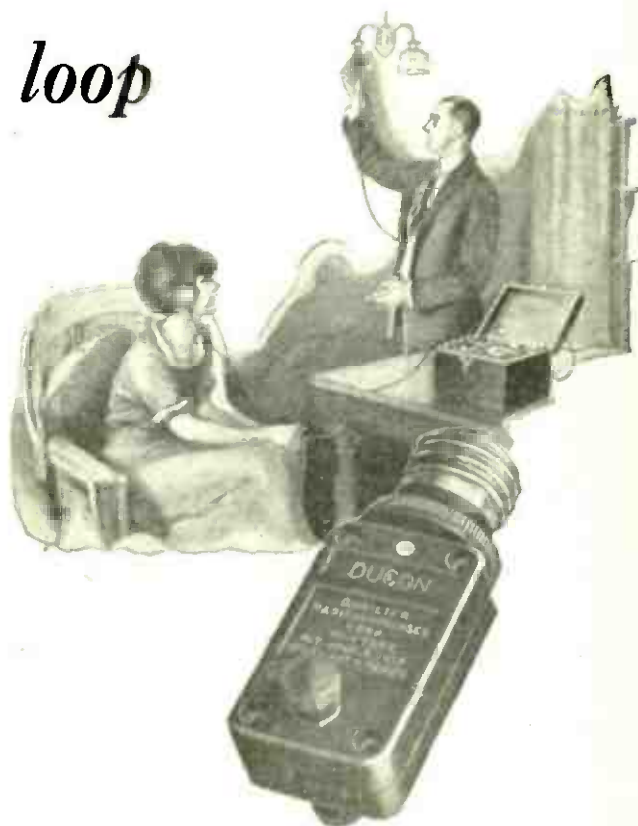

## Dubilier Condenser & Radio Corporation

48-50 West Fourth Street, New York

### BRANCH OFFICES

Huntington, W. Va., Atlanta, Ga., Pittsburgh, Pa., Chicago, Ill., St. Louis Mo.,  
Los Angeles, Cal., Washington, D. C.

Please mention POPULAR RADIO when answering advertisements.

# Quality Amplification

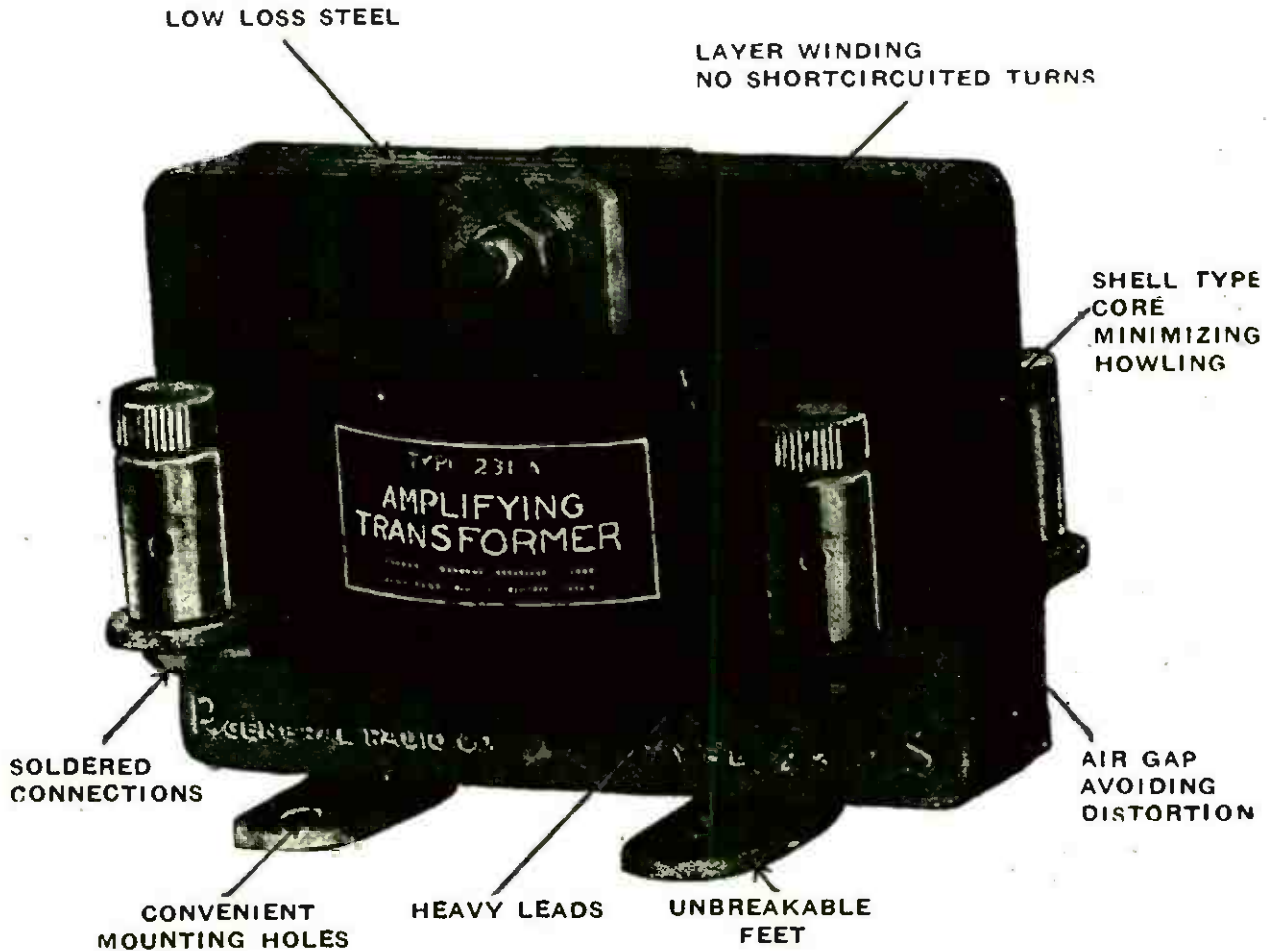

High mu or low mu, when you amplify you must be sure that you do not distort because maximum amplification by itself does not necessarily mean satisfaction. You should seek maximum amplification with minimum distortion over the entire audio frequency range.

This problem has been studied for nearly a decade in our laboratory. Its result is expressed in our Type 231A amplifying transformer. Not only has this transformer a high amplification factor but the amplification is nearly uniform throughout the audio range. This flat curve makes it unnecessary to employ the cumbersome method of using different makes of transformers for 2 stage amplification. Use an engineering designed transformer. It costs no more

Turns ratio . . . . .	3.7 to 1
Impedance ratio . . . . .	10 to 1

**PRICE, COMPLETELY MOUNTED....\$5.00**

Send for free educational folder—"Quality Amplification," and Radio Bulletin No. 9161

## General Radio Company

Manufacturers of Electrical and Laboratory Apparatus  
Massachusetts Avenue and Windsor Street

CAMBRIDGE

∴

∴

MASSACHUSETTS

5878

## GUARANTEED RADIO

Results can only be relied on with standard make instruments that are guaranteed by a reputable manufacturer. The General Radio Company has been guaranteeing its instruments for nearly a decade. When you are adding to your set consider these guaranteed instruments.

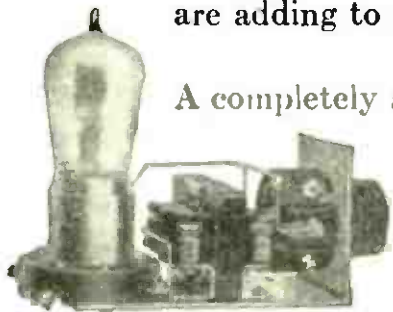

TYPE 300

A completely assembled and wired audio frequency amplifying unit for very little more than the price of the parts. This unit is ready for external connection, and is adapted to table or back of panel mounting.

Type 300A Unit for WD-11 Tubes . . . . . \$7.50  
 Type 300C Unit for UV 199 Tubes . . . . . 7.75  
 Type 300D Unit for Standard Base Tubes . . . . . 8.25



TYPE 156

A vacuum tube socket with positive contact springs. Base of real bakelite. Wall of heavy brass with high polished nickel finish. Will carry current of 5 watts without arcing.

Type 156, Vacuum Tube Socket, . . . . . \$1.00



TYPE 299

A socket for UV-199 Tubes. Of moulded bakelite with stiff phosphor bronze springs.

Type 299, Vacuum Tube Socket . . . . . \$0.75

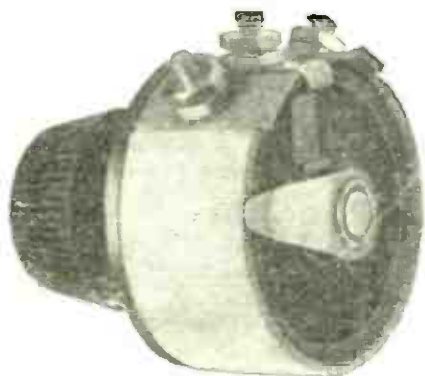

TYPE 301

A wire wound rheostat of real quality. Base of bakelite. Resistance wire finely wound on specially treated fibre strip.

Type 301 Rheostat—Resistance 30 ohms. \$1.25  
 Type 301 Potentiometer—Resistance 200 ohms . . . . . \$1.25

## General Radio Company

Manufacturers of Electrical and Laboratory Apparatus  
 Massachusetts Avenue and Windsor Street

CAMBRIDGE

∴

∴

MASSACHUSETTS

5878



Please mention POPULAR RADIO when answering advertisements.

# Teleradio

**\$4.50**

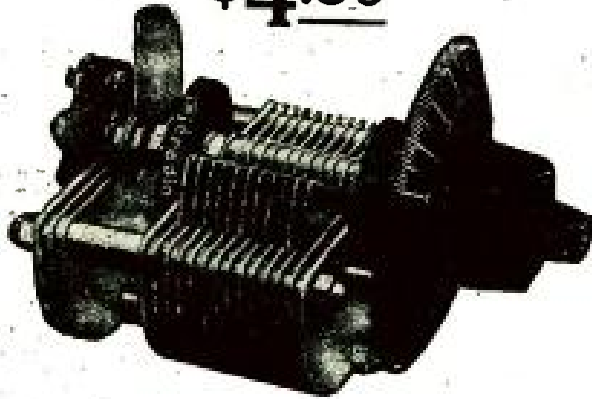

## Reliability in Your Condenser

The principle factors that brand reliability in condensers are sturdiness and accuracy.

Teleradio Vernier Condensers are well worthy of these qualities. The plates are extra heavy polished hard aluminum that will not warp. Rigid construction throughout insures perfect plate alignment. Special locking feature prevents short circuiting of vernier and provides permanent and perfect contact. Capacity is accurate and constant. All metal parts nickel plated. Built for base or panel mounting. Guaranteed electrically and mechanically perfect.

Truly, tuning is a pleasure with Teleradio Condensers.

At your dealers or send direct.

**TELERADIO ENGINEERING CORP.**  
488-490 Broome Street New York



### SUPER-SENSITIVE

Teleradio head phones accurately reproduce the faintest signals on either crystal or tube sets, and bring in voice or music with wonderful tonal quality. Equally successful for local or long distance work. Built on sound engineering principles and are so sturdy they will stand up under unusual usage.

2000 ohm..... \$5.50  
2200 ohm..... \$6.00  
3000 ohm..... \$7.00

VERNIER CONDENSERS 23 plate \$4.50. 43 plate \$5.50  
VARIABLE CONDENSERS 3 plate \$2.00. 11 plate \$2.50. 23 plate \$3.00. 43 plate \$4.00  
RHEOSTATS (6 and 30 ohms) \$1.00 LIGHTNING ARRESTER \$1.00

# TELERADIO PRODUCTS

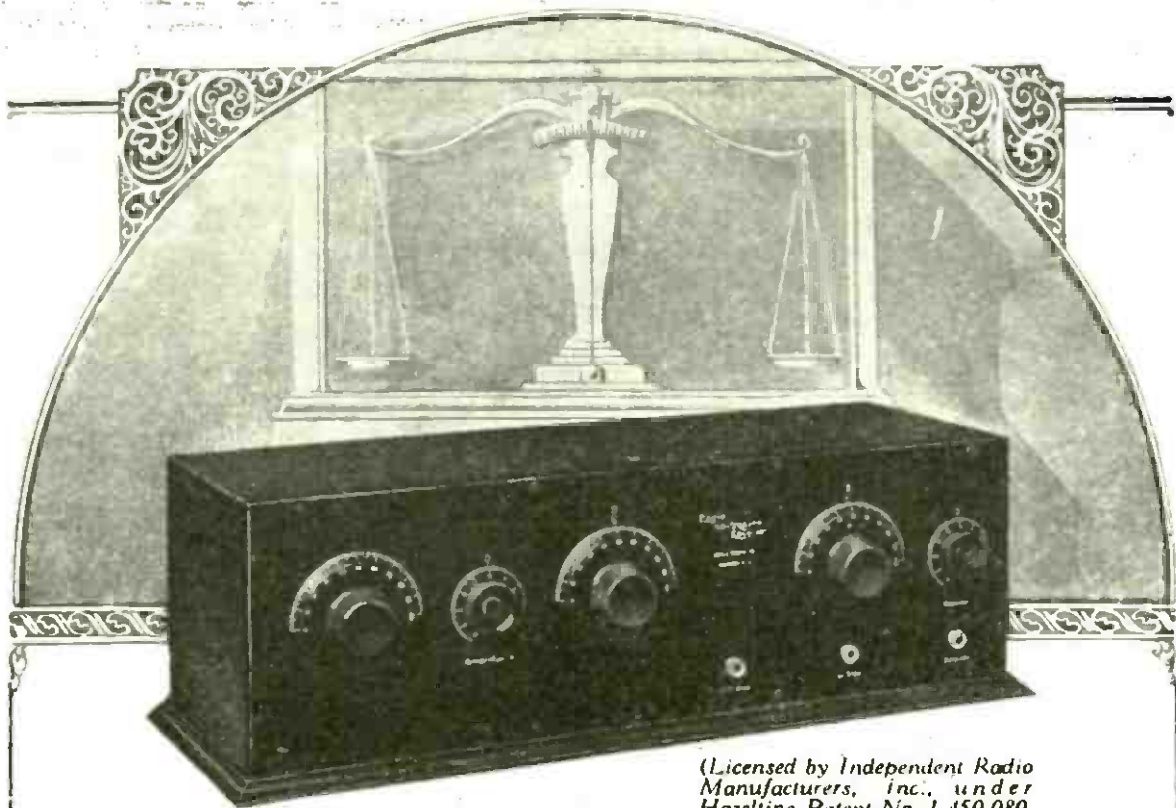

(Licensed by Independent Radio Manufacturers, Inc., under Hazeltine Patent No. 1,450,080, dated March 27, 1923, and other patents pending.)

THE cherished ideal of radio scientists—reception without limitations, yet simple to use as a telephone—crystalized in this amazing receiver.

# The Eagle

## Balanced-Neutrodyne

### RADIO RECEIVER

Balanced tube capacities, as infinitely scrupulous as the balance of a jeweler's scale, makes impossible regeneration, reradiation, static disturbance and all body capacity effects. Therefore, the *Eagle Balanced Neutrodyne Receiver* has greater range, crystal-clear reception and easy, positive operation. As fine reception for

the novice, as for the most adept, with the *Eagle Balanced Neutrodyne Receiver*. All tuned circuits. Each receiver individually tested and inspected from beginning to completion. Quality, not quantity, production in order to sustain a well-respected reputation. Guaranteed without reservations.

Write for  
Booklet Today!



18 Boyden Place  
Newark, N. J.

Please mention POPULAR RADIO when answering advertisements.

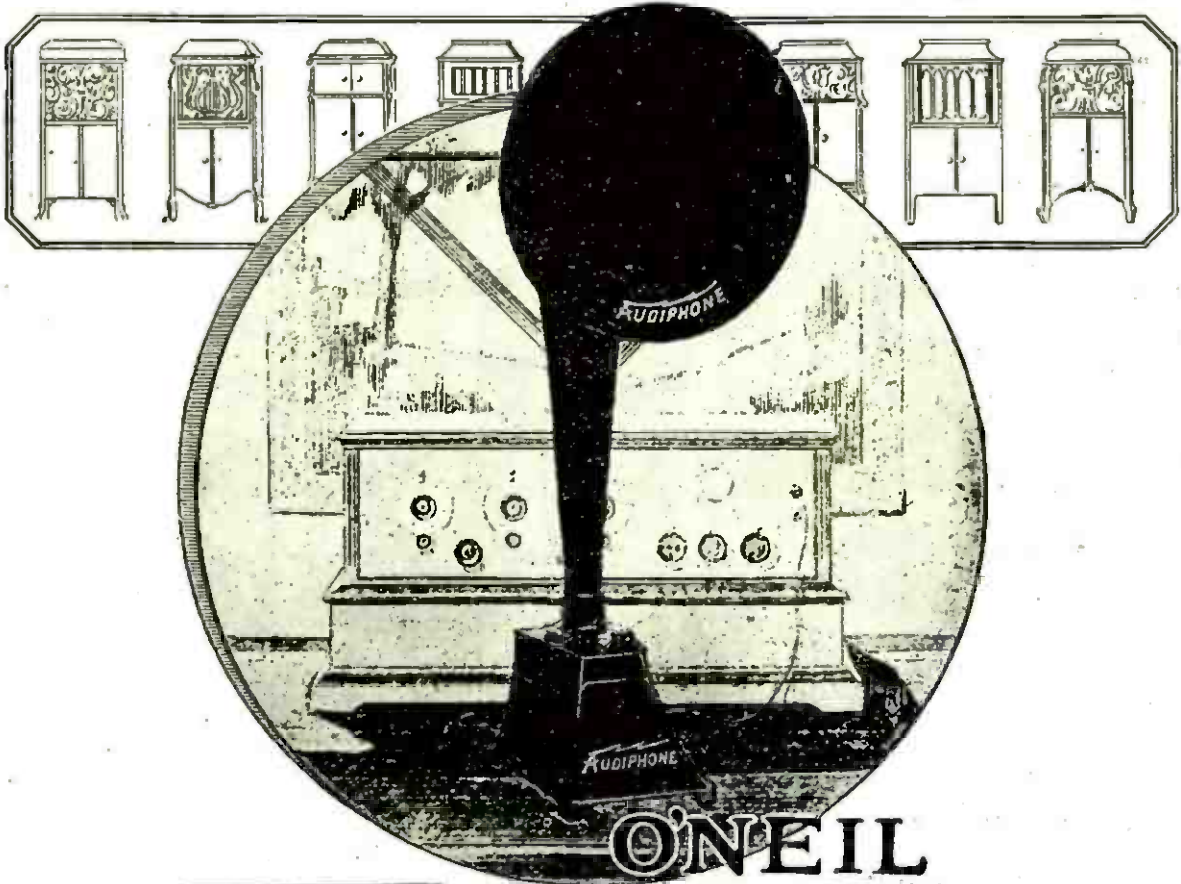

# O'NEIL AUDIPHONE

Knowledge stored up during many years of phonograph reproduction and electro acoustic experience now released to the radio world thru the AUDIPHONE.

**N**O radio receiver is better than its reproducer—the loud speaker. The AUDIPHONE puts the human touch into the electrical elements of your receiver. Sturdy loud speaker construction with strong magnetic field absolutely eliminates blast and distortion so prevalent in car-phone types of loud speakers. Programs created anew in your home

exactly as broadcasted from the radio studios. The patented, "External Adjusting" feature enables you to regulate the AUDIPHONE to your individual receiving conditions. Startlingly real amplification without extra batteries, transformer or induction coil. Write for illustrated booklet and send us the name of your dealer.

*Dealers, Jobbers and Distributors;  
write for attractive proposition*

Complete with 5  
foot phone cord.

PRICE  
**\$25<sup>00</sup>**

No extra batteries required.

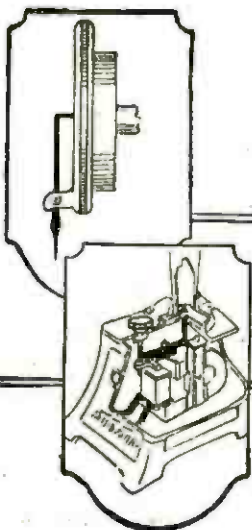

Note the similarity of construction between the phonograph reproducer (illustrated in the upper panel) and the reproducer of the O'Neil AUDIPHONE (below): both have a mica diaphragm set in a sound-box chamber and actuated by an elbow stylus bar—the principle of sound production is the same, resulting in perfect reproduction.

## O'Neil Mfg. Co.

714 Palisade Avenue

West New York, N. J.



# Haynes-Griffin

RADIO SERVICE, Inc. 41 West 43rd St., N. Y. City



A. J. HAYNES

Assoc. Institute of Radio Engineers

Designer of the Haynes Circuit described by Mr. Cockaday as the ideal tuning element of the super-heterodyne.

## Haynes-Griffin Transformer

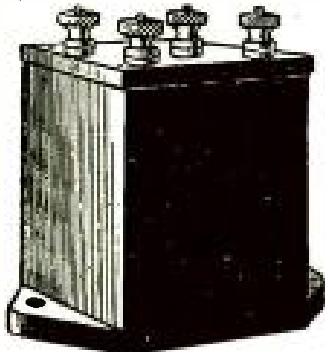

**\$4.25**

A new air-core radio frequency transformer, sharply tuned to 3,000 meters. Upon the use of this transformer depends much of the success of the super-heterodyne model described. Haynes-Griffin Input Transformer also \$4.25.

Haynes-Griffin Condenser .00023 mfd. ....	\$3.50
Haynes-Griffin Bank Wound Coupler ..	4.35
Haynes-Griffin Oscillator Coupler ..	2.75
F & K .0002 Microtune Vernier Condenser .....	5.80
Fada Socket .....	1.00
.5 mfd. fixed Condenser .....	.90
.0005 fixed Condenser .....	.35
.00025 mfd. fixed Condenser with Leak mounting .....	.45
¼ Meg. Leak .....	.50
.005 fixed Condenser .....	.60
Haynes-Griffin 20 ohm Rheostat ...	.85

The above list covers only certain of the most essential and special apparatus required by those building one or all of the units described. Send coupon for complete list of absolutely everything needed, including drilled panels.

## The Haynes Circuit and the Super-Heterodyne

We have on hand a supply of reprints of the three articles by Laurence M. Cockaday on the Haynes Circuit, exactly as published in the September page (222) October (page 288) and November page (392) issues of POPULAR RADIO. These will be mailed to interested experimenters upon receipt of a 2c stamp for each article desired.

### SEPTEMBER

In this first article (published in the September issue of *Popular Radio*). Mr. Cockaday describes how to make the Haynes Circuit—the finest one-tube receiver that can be built. Combines wonderful selectivity and extreme long distance range with a simplicity of construction never before equalled. 1,000 miles for \$15.00

### OCTOBER

In the October article, Mr. Cockaday explains the first addition that the ambitious experimenter can make to his original Haynes Circuit. He describes the Haynes two-stage audio frequency amplifier, which converts the Haynes Circuit to a three-tube receiver, permitting the use of a Loud Speaker.

### NOVEMBER

The November article is regarded by many as the most important contribution to radio in the last year. Mr. Cockaday describes the construction of a separate oscillator—the first step necessary to the construction of a simplified super-heterodyne circuit, using the Haynes Circuit as the tuning element.

## Why you should read these articles

The beginner in radio will find in the September article on the Haynes Circuit itself a conclusive answer to all his radio problems. Mr. Cockaday shows how, at a maximum expense of \$15, the average man can obtain a selectivity, long distance range, and volume of clear reception heretofore impossible at a cost of many times this amount.

As the series of articles progresses, the user of the Haynes Circuit will find that the development and possible additions to the Haynes Circuit more than keeps pace with his own growing interest and experience; until finally we have the super-heterodyne circuit itself—the ultimate of all radio receiving circuits.

## Careful Preparation in Advance

enables us to render an unusually exact and prompt service to radio experimenters. Because many of the remarkable results described by Mr. Cockaday are directly dependent upon the use of new and differently designed material, we are prepared to furnish the identical apparatus recommended by him, without changes or substitutions of any kind. Much of this material was originally designed by A. J. Haynes and cannot be obtained elsewhere.

Parcel Post Prepaid in U. S. anywhere east of the Mississippi River

New York's Largest  
Radio Store

Haynes-Griffin,  
41 West 43rd Street,  
New York City.

Send me at once complete data and prices on all material mentioned by Mr. Cockaday in the four articles on the Haynes Circuit and Super-Heterodyne. I would also like to have a reprint of the articles in the issue of *Popular Radio* as checked:

September  October   
November  December

**HAYNES-GRIFFIN RADIO SERVICE, Inc.**

41 West 43rd Street, New York City

# Three Things To Remember When You "Build Your Own"

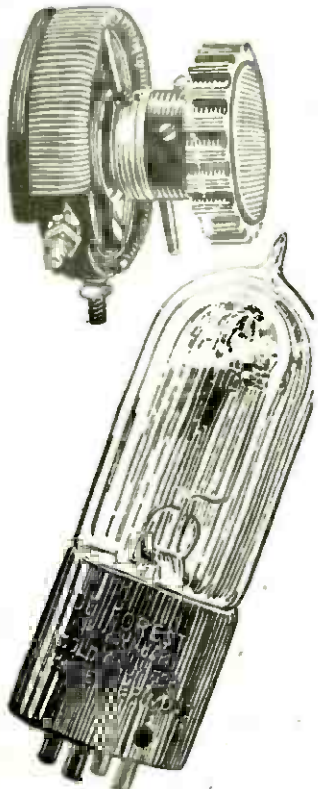

**T**HE success of that Radio Receiver you are going to build depends on just three things—the circuit, your care, and the parts you use.

Select your circuit—do a careful job—and use De Forest parts.

You protect yourself on the first two points—and the De Forest name protects you on the quality of the parts you use.

Remember that De Forest invented the 3-electrode vacuum tube that makes all present day radio possible. So you will naturally want to use De Forest wet or dry cell audions. Remember that the De Forest experience in building radio parts

goes back a quarter of a century—no wonder you can rely on them. Condensers, variometers, tube sockets, potentiometers, grid leaks, switches, honeycomb coils, and coil mountings—let them all be De Forest—and you will get the results.

Or, if you want a short cut to radio enjoyment and listening in on the broadcast of the Continent—if you want to forget the outdoor antenna—if you want ease of operation and brilliantly clear reception without interference—buy a De Forest Reflex Radiophone.

Either way, you rely on De Forest, the greatest name in radio.

## RADIO CATALOG FREE

Send for De Forest new radio catalog with description and prices on sets (including Reflexes), audions or parts.

**DE FOREST RADIO TEL. & TEL. CO.**  
Dept. P. R. 4 Jersey City, N. J.

*If located west of Pennsylvania, address*

**DE FOREST RADIO TEL. & TEL. CO.**

WESTERN SALES DIVISION

Dept. P. R. 4, 5680-12th St.

Detroit, Mich.

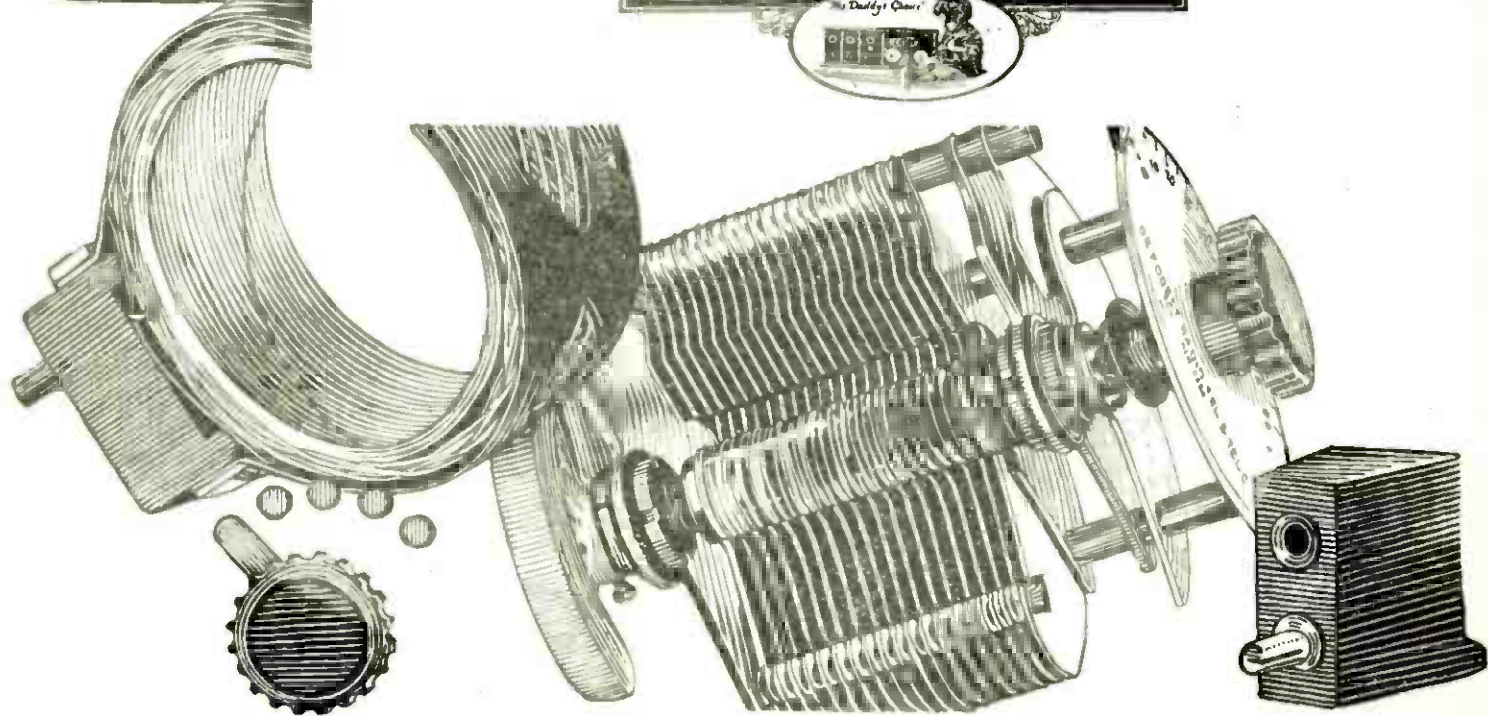
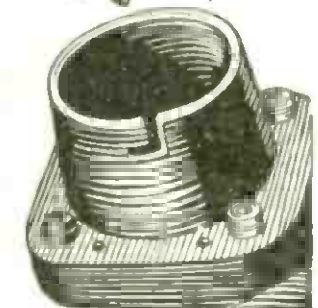



Eveready No. 764 "B" Battery, 22½ volts. 3¼ inches long, 2¾ inches wide, 5⅝ inches high, weight 2½ lbs. Price \$2.25 everywhere



## The skyscraper "B" Battery is here!

*New—this upright Eveready "B" Battery for cabinet or table where space is limited*

Here is a new "B" Battery that stands on practically the same size base as the smallest Eveready "B" Battery, but towers above it in height and capacity.

It is twice as high, and will last you more than twice as long.

And you pay only 50 cents more for the added capacity.

For portable sets, where smallest size and light weight are

essential, the familiar favorite Eveready No. 763 is supreme at \$1.75. But where weight is not so important as space, buy the more than double service of the new upright No. 764 at \$2.25.

Fifteen vigorous cells give 22½ volts. Two Fahnestock Spring Clip terminals.

For compact capacity, buy the new Eveready No. 764.

*Manufactured and guaranteed by*

**NATIONAL CARBON COMPANY, Inc., New York, N. Y.**



Please mention POPULAR RADIO when answering advertisements.

**Turn the knob**  
**Select the station**  
**you want to hear**  
**on indoor antenna or loop**

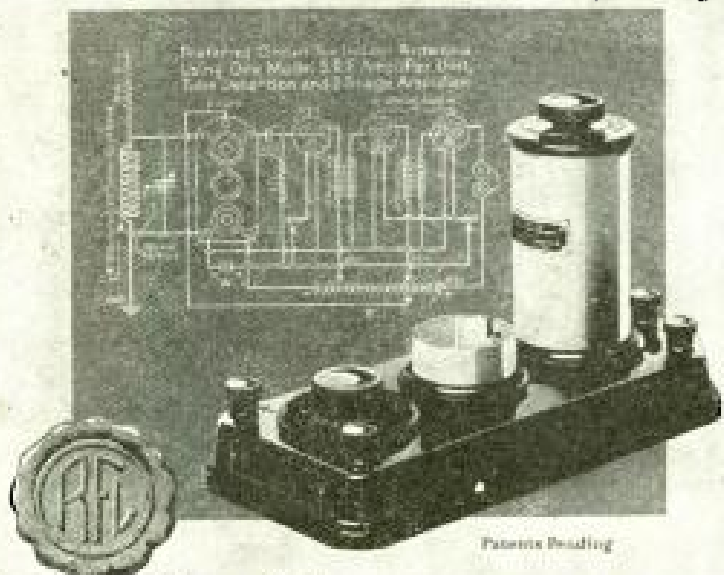

**Radio Frequency**  
**Amplifier Unit**  
*with BALLANTINE*  
**Variotransformer**

*Fits Your Set*

Add one or more stages of R. F. amplification to your present set—be it home-built or manufactured. Complete, with socket, rheostat and variotransformer, \$15.00, at dealers, or postpaid.

*Limited edition of "Radio Frequency Amplification with the Ballantine Variotransformers"—a 25-page booklet—mailed free on request.*

**BOONTON RUBBER MFG. CO.**

*Pioneers in making Radio parts of Bakelite*

324 Fanny Road

Boonton, N. J., U.S.A.

# Careful Selection of Parts *Insures* Satisfaction!

**O**F COURSE the set you build is to be better than any owned by friends—and it can be. Avoid their mistakes—profit by experience—and build a set to be proud of. The difference in cost between a makeshift assembly and a good one is nominal—but the difference in reception results obtained is tremendous. For best results

## Gilfillan Radio Parts

*(Units of Recognized Quality)*

offer the most at least cost. Ask your dealer for these *better* parts. If your dealer does not handle *Gilfillan*, write us for name of nearest dealer, descriptive folder and list.

*Genuine Gilfillan Radio Parts can always be identified by this trade-mark. Look for it.*



### OTHER GILFILLAN PARTS

- |                          |                              |                          |                        |
|--------------------------|------------------------------|--------------------------|------------------------|
| Varicouplers (2 sizes)   | Audio Frequency Transformers | Tube Sockets             | Vernier Air Condensers |
| Varimeters (2 sizes)     | Primary Inductance Switches  | Tube Socket Adapters     | Filament Rheostats     |
| Air Condensers (3 sizes) | Panel Switches               | Detector Amplifier Units | Vernier Rheostats      |
| Potentiometers           |                              | Detector Units           | Moulded Knobs, etc.    |

## GILFILLAN BROS. INC.

1925 McGee St.,  
Kansas City, Mo.

1815 W. 16th St.,  
Los Angeles, Cal.

225 W. 57th St.,  
New York, N. Y.

*Licenseses General Bakelite Co.*

See These New Units  
at Gilfillan Dealers

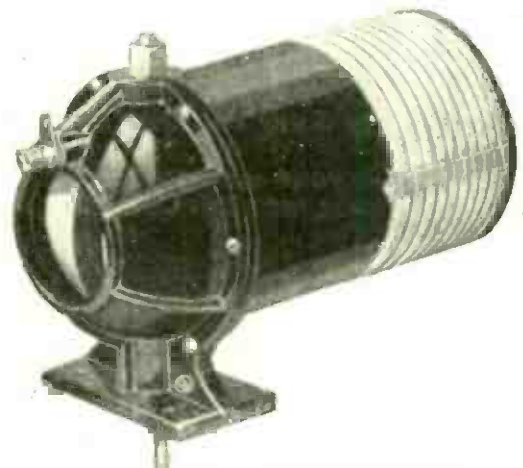

**RADIO FREQUENCY VARIO-COUPLER**

Sharp tuning and extreme selectivity are made possible by this unit. Highly recommended for radio frequency work. Local broadcasting easily tuned out in favor of more distant stations.

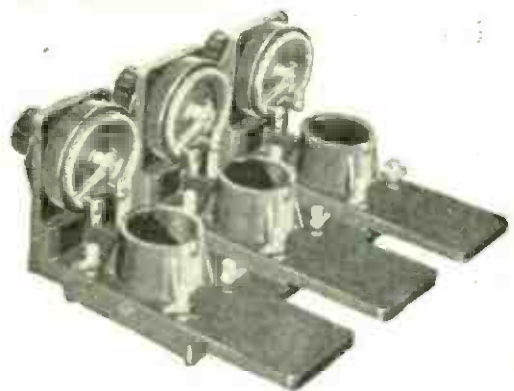

**DETECTOR-AMPLIFIER UNIT**

Admirably adaptable for radio frequency circuits or audio frequency work. Simplicity of wiring and exceptionally short leads. Jacks can be mounted directly to bottom, and transformers on platforms provided. Filament rheostats, tube sockets, binding posts and solder lugs complete in this unit.

**Coto**

"Built First to Last"

## Build Your Radio Set Coto Compact and Portable

Thousands upon thousands of radio listeners have learned the past summer that the static scare is a bugaboo. They listened in and enjoyed radio nearly every summer night.

Build your set now for portability. Make it an all the year set with Coto compact parts.

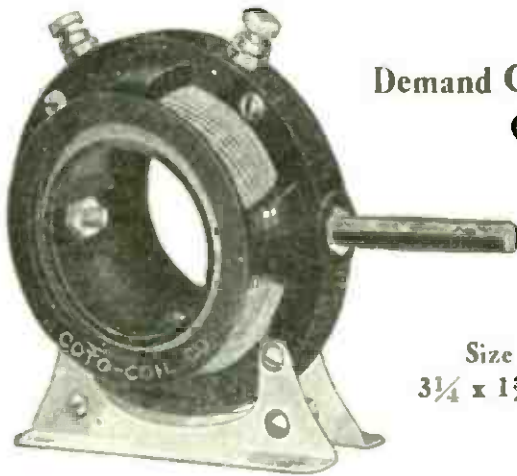

**Demand Coto!  
Get Coto!**

Size only  
 $3\frac{1}{4} \times 1\frac{3}{4} \times 3\frac{3}{4}$

### New Coto Compact Moulded Bakelite Variometer

Notice the Honeycomb wound stator. By this means a range of 200 to 600 meters is obtained in unusually small space. Here is a Variometer positive in action. Pigtail connection to rotor prevents clicking contacts. Mounts either on panel or base. Once you handle it you will take it home. Type 8000..... **\$5.00**

**Jobbers! Dealers!**

The radio parts business is the foundation of your success. Coto offers you salability and reliability. Write for descriptions and prices.

### Coto Coil Co.

87 Willard Avenue  
Providence, Rhode Island

Pacific Coast Branch,  
329 Union League Bldg.,  
Los Angeles, Cal.

Northwestern Branch,  
Geo. F. Darling,  
705 Plymouth Bldg.,  
Minneapolis, Minn.

Southeastern Branch,  
C. P. Atkinson,  
Atlanta Trust Co. Bldg.,  
Atlanta, Ga.

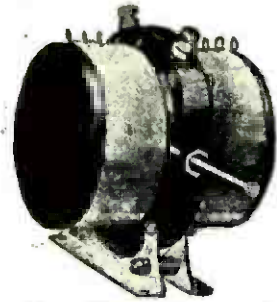

**New Coto Compact  
Moulded Variocoupler**  
Companion piece of the Variometer. Size only  $3\frac{1}{4} \times 3 \times 3\frac{3}{4}$  inches. Range 200 to 600 meters. Base or panel mount. **\$5.50**  
Type 9000.....



**The Original  
Honeycomb Wound Coils**  
Popular low-priced favorites of the amateur and experimenter. Maintained at a standard of excellence second to none. Sold mounted or unmounted.



**Coto Tapped Radio  
Frequency Transformer**  
Efficiently covers the whole broadcasting range because it is TAPPED. Just turn the switch. Type 5000... **\$7.50**

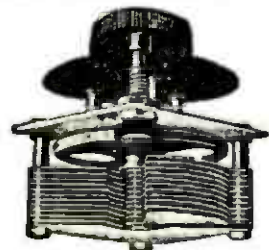

**Coto Compact Air  
Condenser with Vernier**  
Only  $2\frac{7}{8}$  inches square. Rotor plates soldered to shaft. Stator plates soldered at three points. .0005 Mfd. \$5. .001 Mfd. \$6.



Please mention POPULAR RADIO when answering advertisements.

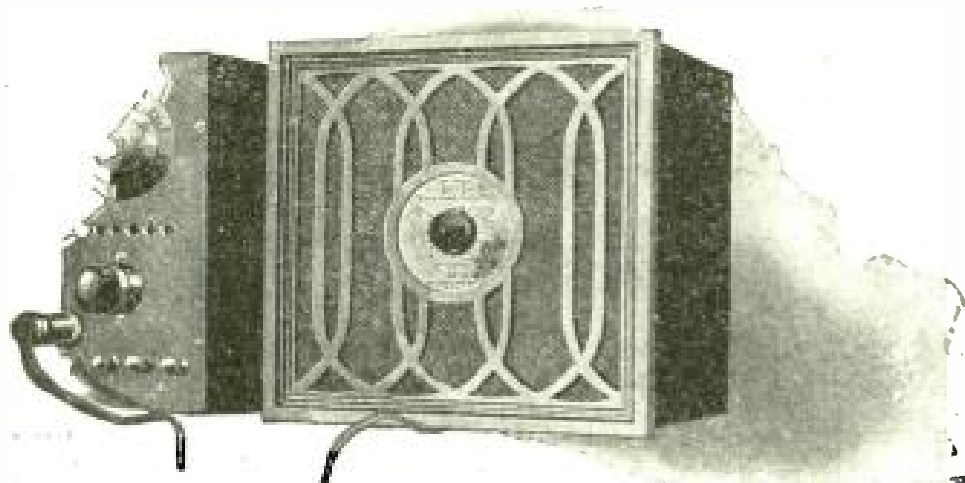

## Its two horns Give volume—*without noise* and without forcing your tubes

These horns in Timmons Talkers are so arranged that the tones, after being amplified in the small horn are re-amplified by being thrown against the especially prepared surface of the larger horn. The surfacing of the large amplifying horn is "acousticoat", a substance developed in the Timmons laboratories.

"Acousticoat" deadens all false tones and distortions and at the same time thousands of small craters in its surface pick-up even the most minute musical note and reproduce it clear, round and full.

But hear Timmons Talkers at your dealer's. Note also what fine pieces of furniture they are, with their screens and rich, hand-rubbed mahogany finish and their graceful Gothic grills.

*Also, your dealer will give you "Volume Without Noise" our new folder, or write us*

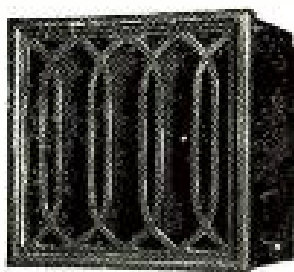

The screen of type A (Adjustable) is rich bronzed gold. Type N (Non-adjustable) has a screen of copper-color mercerized Madras.

### J. S. TIMMONS

339 East Tulpehocken St.  
Germantown, Phila., Pa.

Manufacturers of Radio and Loud Speaking Telephone Apparatus

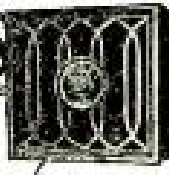
**Timmons**  **Talkers**



## Tame the Wild Waves

with a Service Type 212 Receiver. Will tune through local phone and telegraph interference and get the distant stations. 30 inches loop antenna furnished with set.

Price \$150<sup>00</sup>



Why take our word for what "Service" will do. Ask your dealer.

This is a Teleforce product

Dealers-Jobbers: Write for Terms and complete information



4745 Montgomery Ave.  
Norwood, O.

# Every Question ANSWERED for only \$1

At last you have under one cover  
a Complete Radio Handbook



JUST OUT  
514 PAGES

Compiled by  
HARRY F. DART,  
B.S.E.E.

Formerly with the  
Western Electric  
Co., and U. S.  
Army Instructor  
of Radio.

Technically Edited by F. H. DOANE

NO more need you turn from book to book, hoping to find what you want. It is all here, in 514 pages crammed full of every possible radio detail. Written in plain language, by engineers for laymen. Clears up the mysteries, tells you what you want to know. A complete index puts everything within your reach in a few seconds.

**IT EXPLAINS:** Electrical terms and circuits, antennas, batteries, generators and motors, electron (vacuum) tubes, every receiving hook-up, radio and audio frequency amplification, broadcast and commercial transmitters and receivers, super-regeneration, codes, license rules. Many other features.

**Under one cover.** Yes, it is all in one volume of 514 pages of clear type with hundreds of diagrams and illustrations. Takes the place of eleven or more specialized texts, each costing from two to ten times the dollar you pay for this single book. Belongs in every radio-equipped home, on every amateur's table.

Send \$1 to-day and get this 514-page I. C. S. Radio Handbook—the biggest value in radio to-day. Money back if not satisfied.

TEAR OUT HERE

INTERNATIONAL CORRESPONDENCE SCHOOLS  
Box 8251-B, Scranton, Penna.

I enclose One Dollar. Please send me—post-paid—the 514-page I. C. S. Radio Handbook. It is understood that if I am not entirely satisfied I may return this book within five days and you will refund my money.

Name.....

Address.....



## Boys' Influence on Radio Buying Is Decisive

The growth of the radio business has been sudden, tremendous, and nation-wide. The demand for radio equipment has increased 60,000% in two years. To-day there are more than two and a half million radio sets in this country. And the radio business confidently anticipates even greater growth in the immediate future.

What has happened, and what will happen in radio, is directly attributable to the irresistible enthusiasm and contagious interest of boys. An overwhelming majority of radio sales are made to boys, to parents buying for boys, and to parents guided by boys. Right now, boys are recognized authorities on radio construction, installation and operation.

**THE  
AMERICAN BOY**  
"The Biggest, Brightest, Best Magazine  
for Boys in All the World"

goes to five hundred thousand creators of the radio business. Over half a million dyed-in-the-wool radio fans, averaging 15½ to 16 years old, read it regularly from cover to cover. THE AMERICAN BOY hits them right when their radio interest is all-consuming; when their spending money is considerable, and when their knowledge of radio holds the respect and interest of their elders.

Their own buying power, already large, is ever increasing. Their influence on buying is decisive. The radio manufacturer who is winning their interest and enthusiasm for his product, by advertising to them in their own magazine, is feeling the results in increased sales in every corner of the country.

Copy reaching us by December 15th will catch the February issue.

**THE SPRAGUE PUBLISHING COMPANY**

(Member A.B.C.)

**548 Lafayette Boulevard, Detroit, Michigan**



Please mention POPULAR RADIO when answering advertisements.

# Build This Transcontinental Receiver At Half the Usual Cost!

Ordinarily You  
Would Pay From  
\$125<sup>00</sup> to \$250<sup>00</sup>

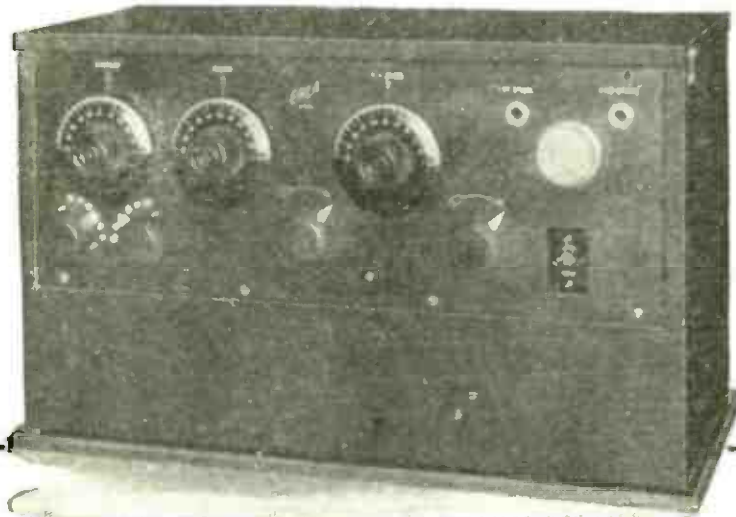

This Way You  
Pay Only \$65<sup>00</sup>



Erla synchronizing radio frequency reflex transformers provide unequalled magnification without distortion. Types, reflex 1, 2. List, \$5



Providing utmost sensitiveness with perfect stability, the Erla fixed crystal rectifier is uniquely adapted for reflex work. List, \$1

Dealers and Jobbers—No day passes that Erla does not increase your opportunities for sales and profits. Write for sample Erla Triplex receiving sets, in beautifully finished solid mahogany cabinets, at manufacturers cost, for demonstration to your trade

So simple and inexpensive to build is the Erla transcontinental Triplex receiver that every home can now enjoy the infinite pleasure and variety of nation-wide loud speaker reception.

Erla parts, complete even to the cabinet and panel, and Erla solderless connectors, make child's play of the work of assembly. Accurate, easily understood drawings guide every step.

Materials are reduced to a minimum through the employment of Erla synchronizing transformers, enabling vacuum tubes to do triple duty. Only three tubes are used, yet costliest multi-stage amplifiers are surpassed in range and volume.

Choice of broadcasting programs is exercised at will, so sharp and selective is the tuning. Yet controls are so few and simple as to be operated by any child. Especially remarkable is the purity and fidelity of reproduction, exceeding the finest phonograph.

For further information regarding Erla Triplex, as well as perfected Erla one and two-tube receivers, consult Erla Bulletin No. 14, obtainable gratis from leading radio dealers, Or write us direct, giving your dealer's name.

Electrical Research Laboratories  
Dept R 2515 Michigan Avenue, Chicago

# ERLA



The unique ability of Erla synchronizing audio transformers to reflex properly enables vacuum tubes to do triple duty. List \$5

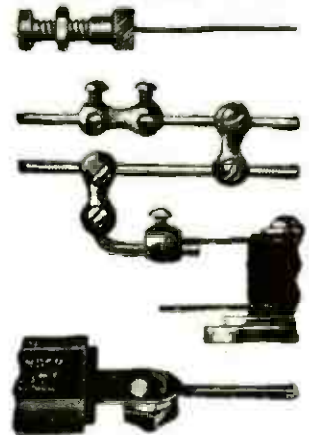

Difficult, dangerous use of soldering irons is eliminated by Erla solderless connectors, saving time, temper and money. List, 5c ea.



## The Copper Giant "A" Battery

For WD11, WD12 and other low voltage tubes. Equal to 20 dry cells. Can stand idle for years without deterioration and requires no attention whatever. Can be furnished mounted in radio cabinets. Write for circular.

THE COPPER GIANT BATTERY CO., Lansdowne, Pa.

FOR EFFICIENCY USE  
**FRAMINGHAM**

DE LUXE PARTS

Ask Your Dealer

# New York Coil Company's Radio Products

Are leaders everywhere due to quality, ease of installing and assurance that your set will bring in the results when finished. Used by leading constructors and handled by the best informed dealers.

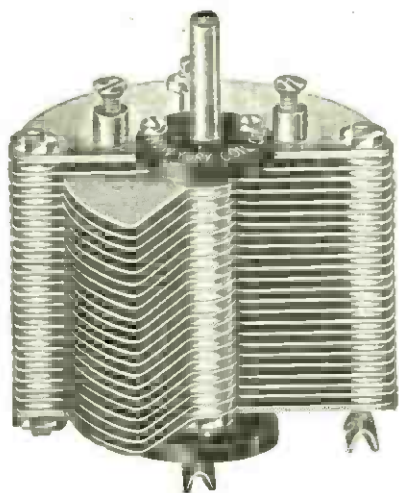

New York Condensers bring in the broadcasting loud and clear, with the true tone, because the construction eliminates all leakage and electrical losses—the standard by which others are judged.

11 Plate	.....	\$1.50
23 "	.....	2.00
43 "	.....	3.00
3 "	.....	1.25



Supplementary  
Vernier Condenser  
\$1.00

Insist on New York Amplifying Transformers. Do not be satisfied with something claimed to be "just as good." They are universally recognized for their marvelous amplification, purity of tone and ability to produce uniformly perfect results with any style of standard tube. Price \$4.00 and worth it.



Our skeleton type tuned Radio Frequency Transformers really give the D X results with loop or indoor aerial that you have long wished for. Totally unlike any other in design or results. Two required, fully guaranteed.

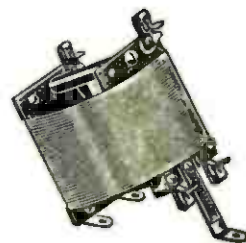

\$4.00 Each

Get literature on *Variometers, Couplers, Mica Condensers, Inductance Tap Switches.*

**NEW YORK COIL CO., 338 Pearl St., N. Y. CITY**



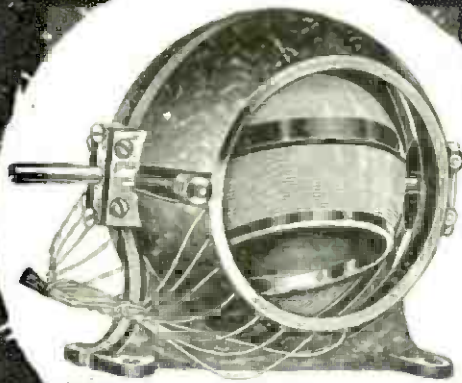

"Pioneer" Variocoupler

\$ 7<sup>00</sup>

# "PIONEER"

**Beauty is Only Skin Deep?**

*—not always*

Might just as well build a good looking set as not.

Build your set with Pioneer Variometers and Variocouplers and you have a set whose instruments are not only the most efficient yet devised but that for sheer beauty have nothing to equal them.

Pioneer Variometers and Variocouplers are made of genuine Bakelite, moulded in our own factory. A rich deep mahogany finish—the wiring is covered with pure green silk. The hardware is heavily nicked. It will stand up. All contacts are positive—both instruments are made for either table or panel mounting.

*Ask your dealer or write us.*

"Pioneer" Variometer

\$ 6<sup>50</sup>

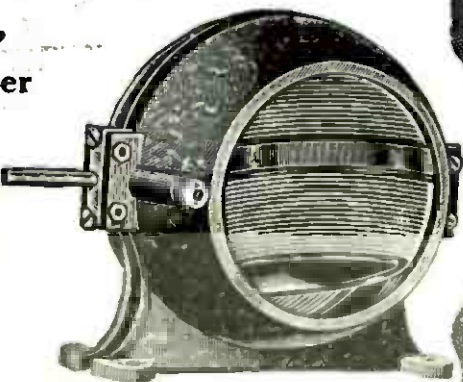

*Sales Agents in All Large Cities*

**PIONEER RADIO CORPORATION**  
100 Pioneer Ave., GALESBURG, ILL.

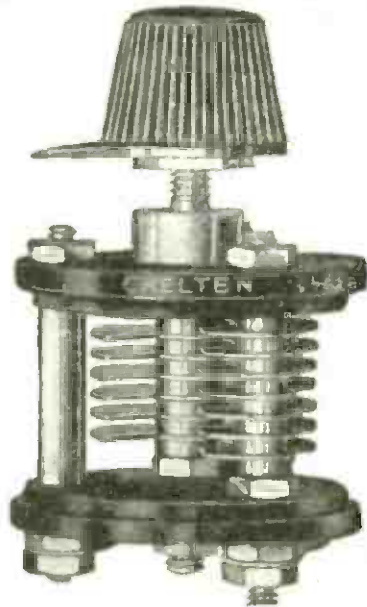

Price

\$1.50

*Actual Size of the Midget Condenser  
Patents Pending*

This is the Low Capacity  
**CHELTEN MIDGET**  
variable condenser for  
Vernier regulation

OTHER NEW TYPE  
CHELTEN CONDENSERS  
ARE

**MICROFARAD JR.**  
**CHELTEN VERNET**  
**RADIOSCOPE**  
**CHELTEN SPECIAL**

*(For Radio Frequency Circuits)*

*Distributing Jobber's Catalogue  
for 1923-1924 now ready*

*Amateur's Catalogue  
mailed on request*

**CHELTEN ELECTRIC CO.**  
**PHILADELPHIA**

*Eastern Sales Agents*

**H. N. SHEBLE CO.**  
4859 Stenton Ave., Philadelphia







# This Certificate Opens the Way to the Best Radio Positions Get It - You Can Earn Big Money With It

No previous experience in electricity or Radio is necessary. In a short time, you can easily win this certificate and qualify for one of the splendid, big money positions in Radio.

Edwin L. Powell is an Expert Radio Aide at the Washington Navy Yard and earns Big Money. Leo Goldblatt is earning a Big Salary and all expenses paid as a radio operator. James F. Nicholls is earning \$150 a month and all expenses paid as a radio instructor at Walter Reed Government Hospital. Harry Runk has made big money manufacturing radio sets. Hundreds of other men are occupying equally attractive positions after winning our Certified Radio-ician certificate.

Read in the panel of the fine salaries paid in all the wonderful radio positions for which you can qualify once you have this certificate.

### Easy Now to Become A Certified Radio-ician

No other work in the world today offers such opportunities, such big money, such rapid advancement, such a promising future as does Radio. And the Expert Radio-ician is the man who is in a position to choose the best of these opportunities—to jump farthest ahead in this newest and fastest growing industry.

Become an Expert Radio-ician. You can—easily and quickly. The National Radio Institute, America's first and largest Radio School, has devised a remarkable method that makes it easy for anyone to qualify right at home during spare time. Prominent radio experts give you personal advice and instruction through the mail. They grade your papers, answer your questions, and in every possible way help you in your work. And you learn the practical, wonderful side of radio by actual practice on patented instruments we send you free. The Certified Radio-ician Certificate awarded

### Pick Out the Job You Want And We Will Help You Get It

This is a brief list of the positions in the Radio field today, and the salaries paid.  
 Radio Mechanic, \$1,600 to \$4,000 a year.  
 Radio Inspector, \$1,800 to \$4,600 a year.  
 Radio Auditor, \$1,200 to \$1,800 a year.  
 Radio Salesman, \$2,000 to \$10,000 a year.  
 Radio Engineers, \$3,500 a year and up.  
 Radio Executive, up to \$15,000 a year.  
 Radio Aide, \$8 to \$10 a day.  
 Radio Draftsman, \$7 to \$15 a day.  
 First Grade Ship Operator, \$105 a month, all expenses paid.  
 Second Grade Ship Operator, \$95 a month, all expenses paid.  
 Third Grade Operator, \$85 a month, all expenses paid.  
 Commercial Land Station Operator, \$150 a month and up.  
 Broadcasting Station Operator, \$125 to \$250 a month.

you on the completion of your course is government recognized, counting for 5 to 10 points on all government license examinations.

### Instruments Loaned to Students

An extraordinary feature of this course is the use of four patented instruments, owned exclusively by us, which give practical training in radio operation, installation, maintenance and repair—all of which you must have to become an Expert Radio-ician.

Among these instruments is the wonderful Natrometer, said by experts to be the perfect device for teaching the Radio Code. All of these instruments are loaned to students.

### Send for Radio Book

Thousands of positions are open to Certified Radio-icians. Find out what your opportunities are in this fascinating profession. Send for interesting book, "Your Opportunity in Radio," which gives complete details on plan by which the National Radio Institute quickly qualifies you at home in spare time as a Certified Radio-ician. Send the coupon or a postcard for free book. NATIONAL RADIO INSTITUTE, Dept. 32-M, Washington, D. C.

NATIONAL RADIO INSTITUTE, Dept. 32-M, Washington, D. C.  
 Send me your book, "Your Opportunity in Radio," with full particulars about the opportunities in radio, and how you will quickly train me in my spare time at home to win a Certified Radio-ician Certificate. Also about your employment service.

Name..... Age.....  
 Street.....  
 City..... State.....



Radio Operator



Radio Mechanic

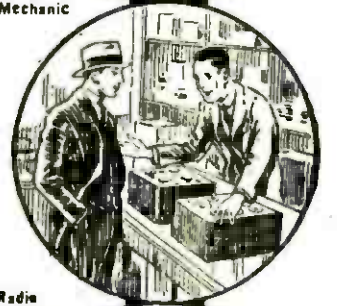

Radio Salesman

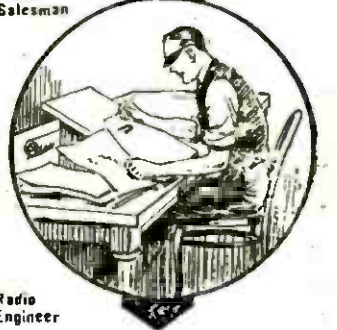

Radio Engineer

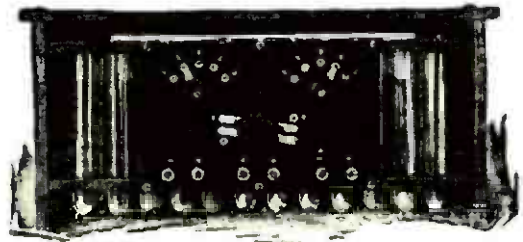
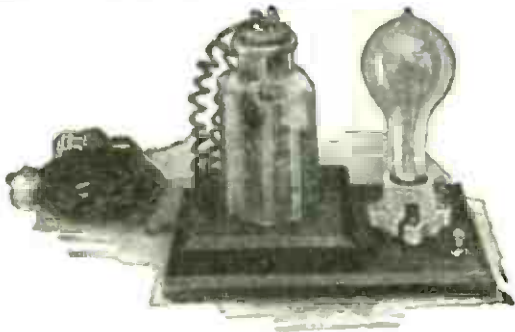

## Trinidad government pleased with KICO efficiency —

"We are ordering this battery on behalf of the Trinidad Government whose wireless officer was impressed with the efficiency of the Kico battery we are using with our receiving set." The above extract is only one of the many endorsements we are receiving of Kico Batteries. Alkaline type, won't sulphate or buckle. Life unlimited. Not harmed by short circuiting, overcharging, idleness. Panel switches give single cell variation. Recharge from any 110-volt A.C. line with small home rectifier. Charge lasts 3 to 6 months in detector plate circuit.

**KIMLEY ELECTRIC COMPANY, Inc.**  
2667 Main Street Buffalo, N. Y.

**KICO** Storage "B" Batteries—  
long service, low cost

## GUARANTEE

Your money back on any KICO Battery if not satisfied within 30 days' trial. Write for full information on "A" and "B" Batteries.

Unmounted Rectifier \$1.00  
Mounted Rectifier \$2.50

Cells	Volts	Price, Plain	With Panels
16	22	\$5.50	
24	32	7.25	\$11.75
36	48	9.50	14.00
50	68	12.50	17.00
78	100	17.50	22.50
108	145	23.50	28.50

An Ideal Christmas Present  
for the Radio Family

## Build yourself a high grade receiving set—at a big saving!

No soldering of joints, no tools necessary. Simple connections made to binding posts. Each RPM instrument is of the highest grade and complete in itself with all wiring concealed and properly insulated to stand exposure. Bakelite mounted—handsome in appearance. *Hook-up circuits in every package.*

Every unit you need to assemble a high grade receiving set at low cost is included in the RPM Line; mounted and unmounted; variometers, variocouplers, variable condensers, coupled circuit tuners. Detector and amplifying units—each the best you can buy, yet surprisingly low in price.



ADD-A-UNIT  
LINE



This is the No. 201 RPM mounted Coupled Circuit Tuner. Bakelite panel. \$12

**RADIO PRODUCTS MFG. CO.**

667 W. 14th St.

Chicago



# ATWATER KENT

## RADIO EQUIPMENT

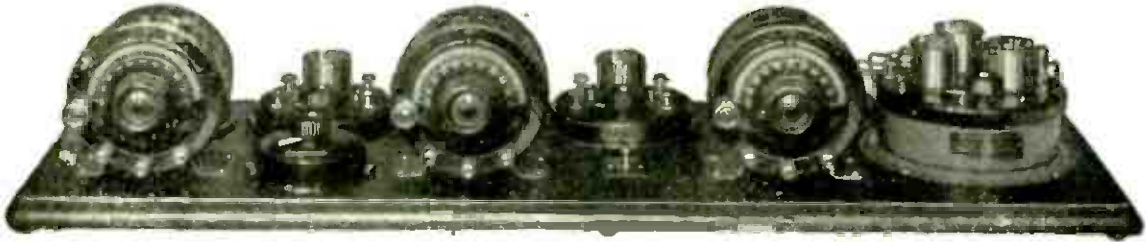

*The Atwater Kent Model 10 Receiving Set*

**T**HIS Receiving Set is the latest achievement of the ATWATER KENT Research Laboratories. With it you will enjoy many surprises due to its remarkable performances in radio reception.

Unusual volume and clearness of tones are easily obtained from distant points. Despite its wide range, this instrument is exceedingly simple to operate.

When the dial positions have once been noted on the Model 10 Receiving Set, the operator can tune in the desired broadcasting station at will.

ATWATER KENT Equipment embraces a variety sufficiently wide to meet the requirements of every user of radio:—it includes complete sets and every instrument necessary for the assembling of sets from tuning unit to loud speaker.

*Literature describing the entire line of Atwater  
Kent Radio Sets and Parts sent on request*

ATWATER KENT MANUFACTURING COMPANY  
4933 STENTON AVENUE, PHILADELPHIA, PA.

*Makers of*  
THE WORLD'S HIGHEST GRADE IGNITION  
STARTING AND LIGHTING



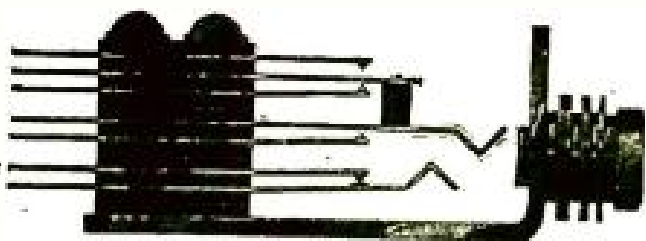

## There's a Pacent Quality Jack for Every Circuit

Right in every detail of their construction, Pacent Jacks can be depended upon to function properly at all times, and to give long satisfactory service.

The complete line, including a number of Jacks not ordinarily available, is illustrated below.

- |    |  |  |               |
|----|--|--|---------------|
| 61 |  | No. 61—Single Open Circuit Jack                  | Price, 60c    |
| 62 |  | No. 62—Single Closed Circuit Jack                | Price, 70c    |
| 63 |  | No. 63—Double Circuit Jack                       | Price, 80c    |
| 64 |  | No. 64—Heavy Duty (Loop) Jack                    | Price, \$1.00 |
| 65 |  | No. 65—Three Spring Automatic Jack               | Price, 85c    |
| 66 |  | No. 66—Five Spring Automatic Jack                | Price, \$1.00 |
| 67 |  | No. 67—Seven Spring Automatic Jack               | Price, \$1.00 |
| 68 |  | No. 68—Four Spring Automatic Triple Circuit Jack | Price, \$1.00 |
| 69 |  | No. 69—Five Spring Special Automatic Jack        | Price, \$1.00 |
| 70 |  | No. 70—Six Spring Automatic Jack                 | Price, \$1.00 |



Write for new Illustrated Catalog (P-12) of Pacent Radio Essentials

Pacent Electric Co., Inc.  
22 Park Place, New York

Sales Offices: Philadelphia, Washington, Minneapolis, Chicago, St. Louis, San Francisco, Jacksonville

# Pacent

## RADIO ESSENTIALS

# Morrison

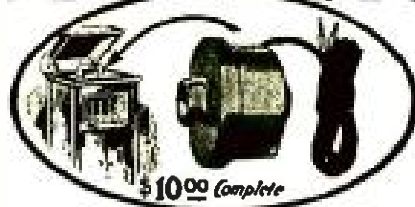

*Loud Speaker*

## If You Are Critical

Ask the man who is proud of his receiving set—who boasts of the wonderful reproduction from long distance stations—ask him what Loud Speaker he uses and he will say "Morrison." Today people want to hear their opera and their dance orchestra in clear, full tones entirely free of harsh noises.

Attach Morrison Loud Speaker to the tone arm of your

**PHONOGRAPH**

or use it with your

**HORN**

and you will be proud to entertain your friends with a real radio concert. Tones adjusted soft or loud by a turn of a little dial—no other adjustment necessary.

Sold under an absolute money-back guarantee. Order from your dealer or send direct to factory.

**\$10.00**

Nickle Plated Model  
Complete with 5 foot cord

**\$15.00**

Gold Plated Model

Illustrated Catalog will be sent free on request.

**DEALERS**

Morrison Loud Speaker is Radio's most popular merchandising unit. We have a plan to help you sell that many of the best dealers in the country are finding quite profitable. Wire us today.

**MORRISON LABORATORIES, Inc.**  
345 Jefferson Ave., East; Detroit, Mich.

Please mention POPULAR RADIO when answering advertisements.

# Here It Is!

## DISTRIBUTORS FOR

Radio Corporation of America  
 Westinghouse  
 General Electric  
 Murdock  
 Fada  
 Remler  
 Frost  
 Brandes  
 Pacent  
 Burgess  
 Hipco  
 Baldwin  
 Signal  
 Acme  
 Rhamstine  
 Kellogg  
 Holtzer-Cabot  
 Connecticut  
 General Radio  
 Radio Service  
 Homecharger  
 Brach  
 Chelsea  
 Arkay  
 Clapp-Eastham

and other leading manufacturers

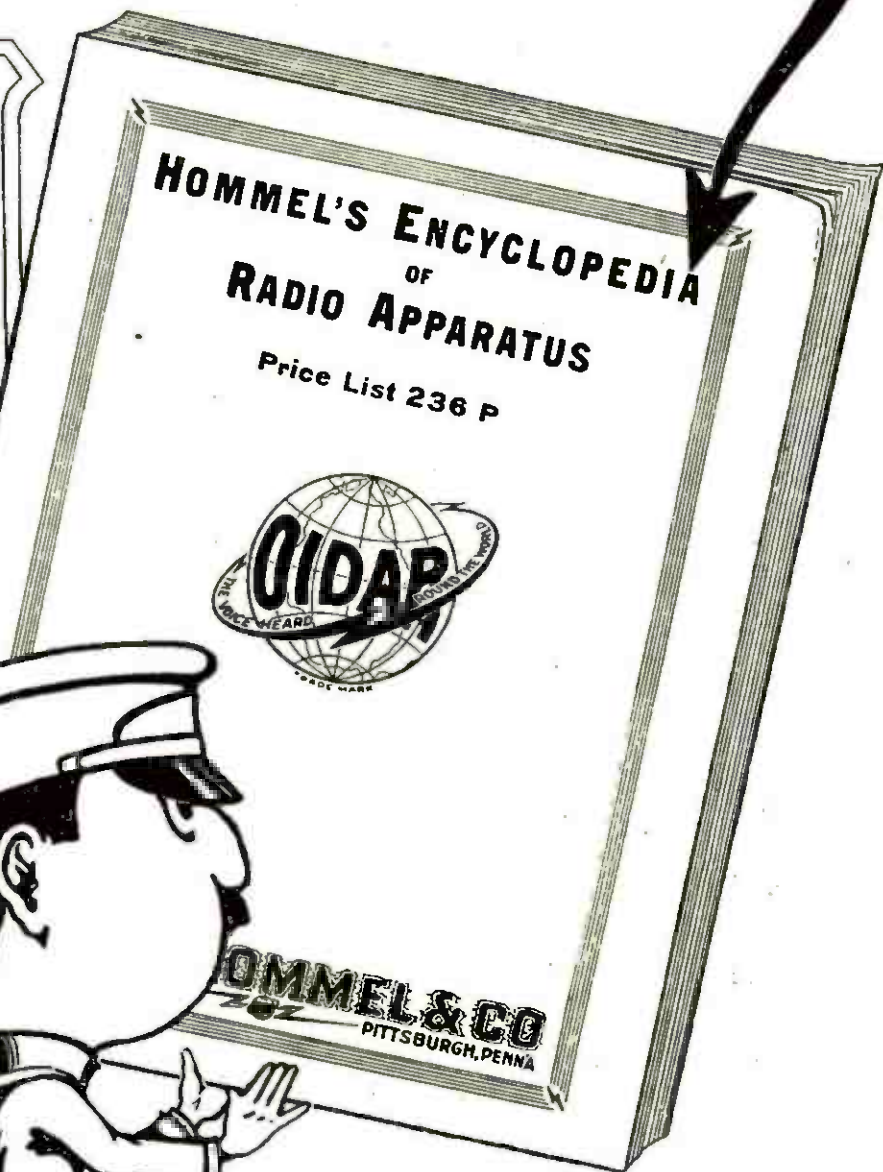

Send for it  
**NOW**

# LUDWIG HOMMEL & CO

530-534 FERNANDO ST.

PITTSBURGH, PENNA



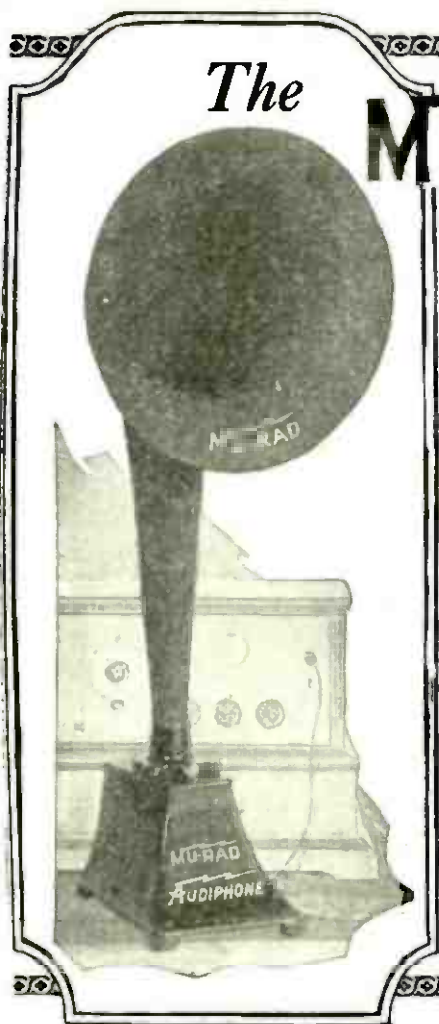

The

# MU-RAD AUDIPHONE

WITH one daring stroke of genius, the MU-RAD AUDIPHONE transcends all previous conceptions of radio sound amplification. Modelled upon the principles of the human vocal organ. The super-sensitive mica diaphragm is actuated by an armature which expands and contracts just like the larynx in the throat. Hence, the MU-RAD AUDIPHONE responds in perfect harmony to all voice and music vibration ranges. Extremely fine, easily operated, exterior adjustment of diaphragm eliminates distortion.

No Extra Battery  
Connections-PRICE

\$ 25

WRITE FOR BOOKLET AND NAME  
OF THE NEAREST MU-RAD DEALER!

**MU-RAD LABORATORIES, INC.**

809 FIFTH AVE ASBURY PARK, NEW JERSEY

Radio  
Frequency  
Unit

\$3<sup>50</sup>



The

# UNITED

Radio  
Frequency  
Transformer

\$2<sup>50</sup>



## Radio Frequency Unit

**The New United Radio Frequency Unit**  
Type RU-1 has nothing to equal it in efficiency, design and amplification.

The very latest design in Radio frequency Amplifier—reduces capacity effect to a minimum—short leads (not necessary to be longer than 1"). Units can be placed close together when two or more stages are used. Handsomely finished in black and polished nickel—2 1/4" square.

**United Radio Frequency Transformer**  
200-600 meters. It has an air core and impregnated windings. Can be used for table panel or socket mounting. It has a highly polished nickel finish—with black ends. Gives excellent results

with any standard radio frequency, Reflex, Inverse Duplex or Neutrodyne Circuits.

**United Audio Frequency Transformer**  
Made in 2 ratio: A1—5 to 1; A2—3.5 to 1. Finished in Black with Nickel trim. For one, two or more stages of Audio Frequency Amplification.

**United Condensers—Both Vernier and Plain**  
Have become the Standard Condensers through their unequalled performance in all circuits.

Write for complete catalog of United Quality Radio-Products, tells how to make a power amplifier out of an audio Transformer.

Audio  
Frequency  
Transformer

\$4<sup>50</sup>



**United Mfg. & Distributing Co.**

9704 Cottage Grove Ave., Chicago, Ill.

N. Y. Office: 50 Church St., New York, N. Y.  
San Francisco Office: 709 Mission St., San Francisco, Cal.



**Condenser  
Vernier and Plain—  
\$2<sup>25</sup> to \$6<sup>50</sup>**



Please mention POPULAR RADIO when answering advertisements.

Travel Across the Country Most  
Any Night With the

**ACE \$20**

**TYPE V** **U** **Armstrong  
Regenerative  
Receiver**

Formerly called  
Crosley Model V



Licensed under Armstrong U. S. Patent No. 1,113,149

The Ace Type V Armstrong Regenerative Radio Receiver is without doubt the most popular of all sets. Its low cost is not indicative of its efficient service because it performs equally as well as any one tube at any price.

The very first evening you enjoy the Ace Type V you'll wonder how you ever did without it.

Under ordinary conditions you can pick up stations from coast to coast one after the other, with this long range regenerative receiver. A loud speaker can be operated in connection with the Ace Type V by simply adding an Ace Type 2B, a new two-step Audio Frequency Amplifier, which sells for \$20.00. This makes it possible to hear a concert all over the house.

This set is so low in cost that everyone can now afford to enjoy radio. Don't be without radio entertainment any longer—listen to the world's best talent—both instrumental and vocal.

Prices do not include batteries, tubes or head phones. Buy these from your dealer.

If your dealer cannot supply you, order direct, mentioning his name. Ask for "Simplicity of Radio." Your copy is FREE.

**DEALERS:** Write on your letterhead for attractive sales proposition.

"List price west of the Rockies 10% higher. In Canada tariff added." Be sure to come to the Grand Annual Radio Exposition, Coliseum, Chicago. Visit our booth on the Collonade, November 20 to 25th.

**The Precision Equipment Company**

*Powel Crosley, Jr., President*

1216 Vandalia Avenue, Cincinnati, Ohio

#### Ace Type 3C Console

This is a new addition to the Ace Family. Has beautiful solid mahogany, wax finished cabinet. Set consists of a regenerative tuner, detector and two stages of Amplification, with built in loud speaker. The tuning circuit is licensed under the Armstrong U. S. Patent No. 1,113,149 and due to the particular method of winding Crosley coils it is exceptionally selective. Has sufficient room inside Cabinet for dry batteries making a complete self contained long range receiving outfit. Phone jack for tuning with head phones; Crosley multistat; filament switch Crosley moulded condenser; beautifully engraved Formica panel. Uses all kinds of tubes. A wonderful set at a remarkable price, \$125.00—without tubes or batteries.

#### The New Ace Type 3B

This set is equal to a combination of the Ace Type V and the Ace two-stage amplifier. Manufactured under Armstrong U. S. Patent No. 1,113,149. A filament switch eliminates necessity of turning out rheostats when set is not in use. You may turn off the set by throwing switch and come back later without retuning. Has telephone jack in between first and second stage. Crosley Multistats. Universal filament control rheostats for all makes of tubes. Price \$50.00.

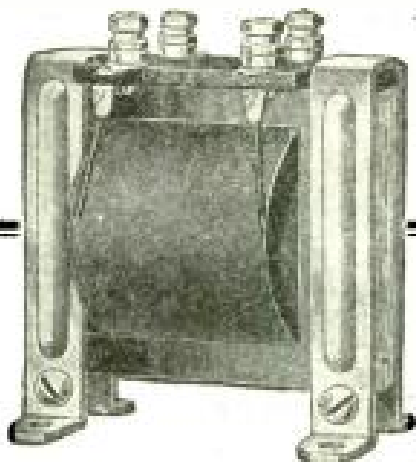

# GENUINE JEFFERSONS

## The Standard Audio Frequency Transformers

No matter what circuit you wish to complete, there is a JEFFERSON Audio Frequency Amplifier which will insure 100% Amplification, the elimination of distortion and the quiet easy tuning so eagerly sought after.

### FIVE JEFFERSON TYPES

to choose from—manufactured by the pioneers in the audio frequency transformer field. Right from the start put Jeffersons in your set—don't experiment—expert Radio Engineers, after careful and exhaustive tests have found them perfect in every detail of construction.

DESCRIPTIVE BULLETIN sent free and our Engineering Department will be glad to make recommendations as to the proper transformer to be used in any circuit

**Jefferson Electric Mfg. Co.**  
427 S. Green Street Chicago

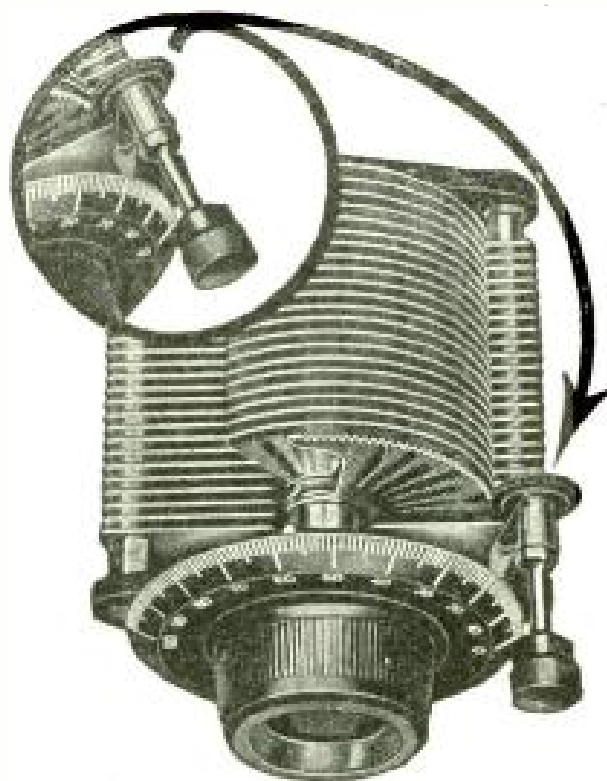

## Heath's Radiant Condensers

Heath Radiant Condensers will tune as perfectly years later as they do the day you install them. The plates, (which in other condensers buckle and get out of alignment) in **Radiant Condensers are made permanently FLAT** by a patented process. They are pressed into **absolute flatness** and then tempered, so that they can **never lose that flatness!** Look for the Radiant trade-mark, impressed on every rotary plate of Heath's Radiant Condensers.

**Vernier, Geared Like a Watch**  
Adjusting knob geared to vernier plate so that an ordinary turn is reduced to micrometer fineness. Positive, accurate, durable. No play. Separate tension adjustment.

*Write for illustrated booklet and name of the nearest Radiant Dealer.*

### PRICES

#### Vernier Type

13 Plate including 2 3/8" dial and knob. . . . .	\$5.00
25 Plate including 2 3/8" dial and knob. . . . .	5.50
45 Plate including 2 3/8" dial and knob. . . . .	6.50

*Jobbers and Dealers Write  
Immediately for Proposition*

## HEATH RADIO & Electric Mfg. Co.

204 First Street  
Newark, N. J. U. S. A.



Please mention POPULAR RADIO when answering advertisements.

# Your Kellogg Radio Christmas

Here is a way to get a wonderful receiver of Kellogg parts that most radio fans will tell you, are the most reliable, durable and efficient on the market. In several million families this year, each of us will be racking our brains to think of some Xmas present to please each member of the family.

Forget all this trouble and work, and plan a radio Christmas. Ask the boy or dad to make up a list of reliable parts for a simple set; then each one buy one part for someone in the family, and you will have a receiving set that will bring Christmas carols, and the world to your fireside, if you have efficient Kellogg parts carefully put together.

Such assembling is an easy matter with Kellogg radio equipment. There are thousands of circuits, some very efficient, both as to distance and selectivity, that require only a condenser, coupler [or variometer], tube socket, fixed condenser, grid leak, tube, dials, and a few other inexpensive parts. You don't need to buy an expensive cabinet to have a good radio set.



Every in-Orbit World With Kellogg Radio Equipment

If your dealer does not handle Kellogg, send us his address. We will send you our helpful and valuable radio hand book. Start today on your Christmas receiving set, and make every member of the household happy.



## KELLOGG SWITCHBOARD & SUPPLY COMPANY

CHICAGO, ILLINOIS



## for Better Receiving

Pick up those distant stations louder and clearer. Eliminate noise and interference. You can do this when you use

### *Elgin* PRECISION CONDENSERS

Permanent accuracy and rigidity are built into Elgin Precision Condensers. Plates are made of specially hard rolled aluminum and are of uniform thickness throughout. Special process spacers assure uniform spacing of plates. Adjustable vernier shaft makes it possible to use the Elgin Vernier Type Condenser on any thickness of panel and with dials of different thicknesses.

**FULLY GUARANTEED**

*See your local dealer. If he cannot supply you send his name with your order to*

**The Elgin Tool Works**

Incorporated  
69 N. State St.  
ELGIN, ILL.

Size	Capacity	Plain	Vernier
3 Plate	.000063 M. F.	\$1.75	\$—
11 Plate	.00025 M. F.	2.40	4.00
17 Plate	.00035 M. F.	2.75	—
23 Plate	.0005 M. F.	3.00	4.50
43 Plate	.001 M. F.	4.00	5.50

3" diameter composition dials, 50c extra

## New- CONTROL-O-METER

You don't have to be annoyed any longer by a jumble of words and music from two broadcasting stations when you want to hear one of them. Through the development of the Control-O-Meter, the simplest set is made as selective as the most complicated and yet the addition of this instrument will not increase the difficulty of tuning. All you have to do is to connect your antenna to one convenient binding post of the Control-O-Meter and your set to another, then turn the Control-O-Meter dial until the interfering station disappears—and the only way you can bring the station back is to change the Control-O-Meter setting.

To assist you in quickly setting the Control-O-Meter, each instrument is individually calibrated in our laboratory and a chart provided showing the setting for each wave length.

The Control-O-Meter, with its piano finished mahogany cabinet, faced with a polished bakelite panel and handsome dial, matches the best of standard sets.

The Control-O-Meter is a perfected instrument that has made good in the most congested radio districts in the United States. You will get results the moment you turn the dial.

**LIST PRICE \$12.50 COMPLETE**

If your dealer cannot supply you, a Control-O-Meter will be sent you direct, postpaid, upon receipt of the above amount.



**MALONE-LEMMON PRODUCTS**

Made by **STEPHENSON LABORATORIES**  
342 MADISON AVENUE  
NEW YORK CITY

Please mention POPULAR RADIO when answering advertisements.

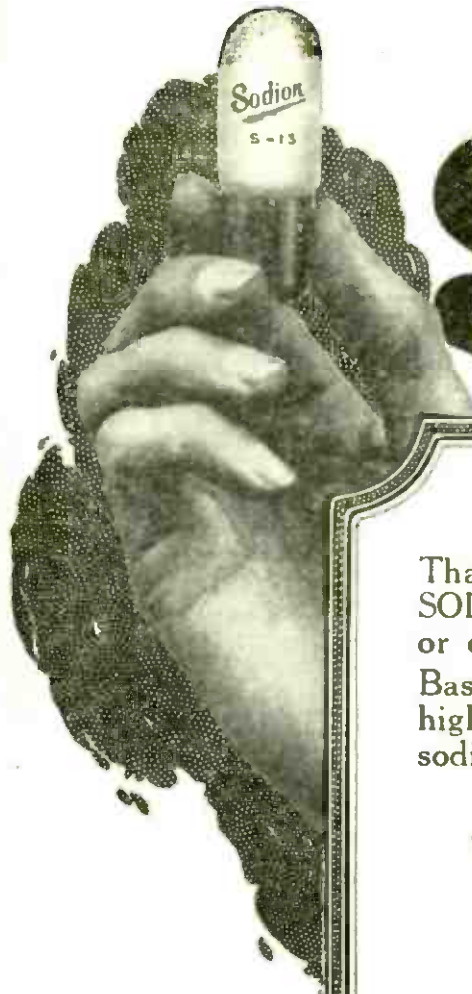

# Sodian

## A New Era in Radio

That, in the fullest sense of the word, is what the SODION TUBE means to everybody who owns or expects to own a receiving set.

Based on an entirely new principle—utilizing the highly valuable and peculiar properties of the sodium ion

## The Sodian Tube

*(Sodium-Ion)*

is many times more sensitive and produces far stronger signals than any detector yet developed.

Due to the fact that it cannot be made to oscillate, it not only eliminates any semblance of whistles or beat-note howls in your own reception, but does not interfere with the reception of others.

At a meeting of the Institute of Radio Engineers where this tube was being demonstrated, a prominent Scientist and Radio Engineer, in contrasting this with the action of the ordinary detector, dubbed it

### “THE GOLDEN RULE TUBE”

Stable and uniform in operation. Runs for hours without adjustment. Has no grid. No grid leak or grid condenser are required. Crystal tone reception.

Unusually sensitive to weak signals.

Operates on dry cells or storage battery.

Bulletin A-100 describing this tube upon request.

**CONNECTICUT TELEPHONE & ELECTRIC COMPANY**  
MERIDEN RADIO DIVISION CONNECTICUT



# BUILD YOUR OWN RADIO OUTFIT

HIGH QUALITY GOODS AT LOW PRICES  
FAST SERVICE—WE PAY TRANSPORTATION CHARGES EAST OF THE ROCKIES

## SUPERIOR VARIOMETER

A525 Each... \$4.45  
Forms moulded of red brown bakelite. A neat handsome instrument. Green silk windings calculated for highest efficiency. 1/4 inch shaft. Noiseless pigtail connections. Table or panel mounting. Produces superior results in any type circuit 180 to 650 meters.

## SUPER 180° VARIOCOUPLER

A521 Each... 98c  
A wonderful value, produces excellent results. Green windings on black fibre tubes. Rigid mounting support for table or panel mounting. Primary tapped for fine tuning. 1/4 inch shaft. Range 200 to 600 meters.

A522 Variometer—same style. Each. 98c

## SUPERIOR VARIOCOUPLER

A523 Each... \$3.15  
A handsome instrument of superior design and construction. Stator tube and rotor ball of moulded red brown bakelite. Large size green silk windings insure highest efficiency. Table or panel mounting. 1/4 inch shaft. Superior results in circuits for 180 to 650 meters. Tapped primary for finest tuning. Noiseless contacts. A526 Special single circuit type... \$3.60

## SUPER MOULDED VARIOMETER

A412 Each \$2.70  
Polished black moulded rotor and stator forms. Maximum inductance with greatest efficiency and minimum distributed capacity. A high grade instrument that will get the best results. Wave length 180 to 600 meters.

## EXCEL MOULDED VARIOMETER

A524 Each... \$3.80  
A wonderful value at our price. Properly designed and constructed. Polished black bakelite rotor and stator forms. Large size green silk wire insures greatest efficiency. 1/4 inch shaft. Noiseless pigtail connection. Table or panel mounting.

## OUR SPECIAL VARIOMETER AND VARIOCOUPLER

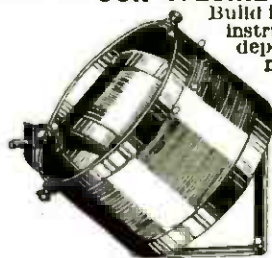

Build into your set reliable instruments. You can depend on this variometer and variocoupler to give you the best results in any circuit working from 180 to 650 meters. In design and construction they are the best. Only the highest grade materials are used. The prices quoted save you 30 to 40 per cent. Why pay more?

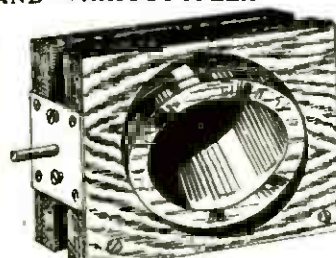

A418 Variocoupler. Each... \$2.45  
The most efficient type of coupler, insures better tuning and louder signals. Primary and secondary wound on natural uncolored genuine bakelite tubes. Handsome green silk windings. Primary tapped for fine tuning. Can be panel or table mounted. 1/4 inch shaft.

A410 Variometer. Each... \$2.10  
Perfect in design and construction. Accurate wood forms thoroughly seasoned. Correct inductive ratios. Solid baked windings. Plenty of large sized wire insures highest efficiency. A strong high grade instrument that will give you lasting service. 1/4 inch shaft.

**This Guarantee Protects You.**  
Examine the goods we ship you. They must suit you in every respect. If you are not satisfied with your purchase return the goods at once and we will refund the price you paid.

## RADIO INDUCTANCE COILS



Carefully made—fine looking coils. Highest efficiency. Low distributed capacity effect, low resistance—high self inductance. Very firm impregnation. Range given is in meters when used with .001 variable condenser. Mounted coils have standard plug mountings.

Turns	Range	Art No.	Not Mntd.	Art No.	Price
25	120-250	A301	\$0.39	A320	\$0.85
35	175-450	A302	.42	A322	.95
50	240-720	A303	.49	A323	1.02
75	390-910	A304	.54	A324	1.08
100	500-1450	A305	.58	A325	1.13
150	600-2000	A306	.63	A326	1.17
200	900-2500	A307	.72	A327	1.26
250	1200-3500	A308	.78	A328	1.35
300	1500-4500	A309	.82	A329	1.36
400	2000-5000	A310	.97	A330	1.57
500	2800-6100	A311	1.12	A331	1.63
600	4000-10000	A312	1.27	A332	1.78
750	5000-12000	A313	1.43	A333	1.93
1000	7900-15000	A314	1.70	A334	2.25
1250	9750-19500	A315	1.92	A335	2.45
1500	14500-26500	A316	2.18	A336	2.60

## INDUCTANCE COIL MOUNTINGS

A340—3 Coll. Ea... \$3.40  
A341—2 Coll. Ea... 2.75  
Sturdy, rigid durable construction. Made of polished black bakelite. Mount on front of panel.  
BACK OF PANEL MOUNTING  
Mounts back of panel, with knobs or dials on front of panel. Helps make a neat efficient set.  
A342—3 coil back of Panel Mounting... \$4.45

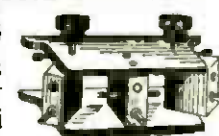

## COIL MOUNTING PLUGS

Made of genuine bakelite.  
A344 Plug for mounting "honeycomb" inductance coils... 39c  
A345 Stationary plug to fasten mounted coil stationary to panel... 42c  
A346 Movable plug to fasten mounted coil to panel so it can be rotated... 89c  
A343 Fibre strip to hold coils for mounting. Two foot piece... 15c



## REINARTZ INDUCTANCE

A296 Each... \$1.15  
Made of green silk covered wire. Spider web wound to produce greatest efficiency and lowest losses. 21 taps so arranged that crossing is avoided. Two fibre strips and wooden rod furnished permit various styles of mounting. With this coil a high grade set can be built at low cost. Diagram included.

SPIDER WEB COILS  
A290—25 turn. 39c A292—50 turn. 47c  
A291—35 turn. 42c A293—75 turn. 54c  
A294—100 turn. Each... 59c  
A new popular type of inductance of highest efficiency. Lowest distributed capacity and lowest high frequency resistance. Firm green silk windings with fibre mounting strips.

ULTRA AUDION COIL  
A295 Each... 85c  
Spider web wound of green silk covered wire. Four taps. Produces wonderful results. Fibre strips and wooden rod for mounting included. Diagram included.

STRANDED ANTENNA WIRE  
Cable of fine copper strands. Very flexible. High tensile strength. Best for aeriads. A248—100 ft. coil 58c. A249—500 ft. coil \$2.75

SOLID BARE COPPER WIRE  
Solid bare copper wire for aeriads, leads or wiring instruments.  
Solid Bare Copper Wire, size 14. A240—100 ft. coil 48c. A242—500 ft. coil \$2.25  
Solid Bare Copper Wire, size 12. A244—100 ft. coil 67c A245—500 ft. coil \$3.05

BRASS ROD  
Supplied only in 8 inch lengths.  
A961 Threaded 6-32, per 8 in. length. 6c  
A963 Threaded 8-32, per 8 in. length. 8c  
A965 Solid 3-16 in., per 8 in. length. 6c  
A967 Solid 1/4 in., per 8 in. length. 9c

## ANTENNA INSULATORS

A260 Size 1x3/4. Composition, metal eyelets. Two for... 17c  
A264 Size 1 1/2 x 4. For medium size aeriads. Two for... 69c  
A266 Size 1 1/2 x 10 1/2. For large aeriads. Two for \$1.28  
A263 Ribbed Porcelain Insulator. 2 1/2 in. long. Each 6c Dozen... 55c



## LEAD-IN INSULATORS

A270 For 4 inch walls or less Ea. 42c  
A271 For 9 inch walls or less. Ea. 69c  
The only practical lead-in insulator for aerial wires. Small, neat, effective, durable. Fits 1/4 inch hole. Securely locked by two adjustable nuts.



## OUTDOOR LIGHTNING ARRESTER

A980 Price... \$1.55  
Protect your instruments with this lightning arrester. Weatherproof porcelain case. Air gap type. Permanent. Durable. Underwriters approved.

High-Grade Lightning Arrester  
A981 Each... 79c  
A dependable protector, always on guard. Small and compact. Weatherproof porcelain case. Easily fastened and connected. Underwriters approved.

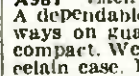

## DETECTOR PARTS

A725 Price set. 27c  
All metal parts for crystal detector. No base included. Easily assembled. Polished nickel finish.



THE BARAWIK CO. 102 S. CANAL STREET CHICAGO, ILL.



# USE BARAWIK STANDARD PARTS

**YOU SAVE MONEY WHEN YOU BUY FROM US**  
**FAST SERVICE—THE PRICES QUOTED DELIVER THE GOODS TO YOUR DOOR**

## "CONSOLIDATED" RADIO PLAN PACKETS

Designed and laid out by the foremost radio engineers. With their help you can build an outfit that will give the finest results. Every packet contains complete instruction for the construction and tells what tools and parts are needed. Detailed directions for drilling, mounting and wiring, also how to handle set after it is built. Thousands of sets have been built from these plans and are in perfect operation. Folder giving detailed description of each packet sent on request.

Price per packet.....42c

Order item wanted by article number.

A640 How to make a Neutrodyne Receiver.

A641 How to make a Reinartz Receiver.

A642 How to make a Regenerative Receiver.

A643 How to make a Cockaday Receiver.

A644 How to make a Reflex Receiver.

A645 How to make Detector and Amplifier Units.

A646 All about aerials and their construction.

A647 Twenty Radio Diagrams of Latest Hook-ups.

A648 14 Radio Formulas and Diagrams.

## ENCLOSED DETECTOR

One of the finest crystal detectors on the market, supersensitive galena crystal enclosed in heavy glass shield. Quick, positive adjustment. Brass parts polished nickel finish.

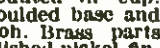

A730 Each.....89c

## GALENA DETECTOR

Easy fine adjustment. Crystal mounted in cup. Moulded base and knob. Brass parts polished nickel finish. An unequalled value.

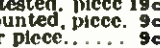

A732 Each.....59c

## DETECTOR CRYSTAL CAREFULLY TESTED

A736 Galena, Arlington tested, piece 19c

A738 Silicon, Arlington tested, piece 19c

A735 Tested, Galena, mounted, piece 9c

A737 Tested, Silicon, per piece.....9c

A739 Genuine million point crystal Ea. 21c

## BAKELITE DIALS

A931—2 in. Diam. for 3-16 in. shaft. Each...35c

A932—2 in. Diam. for 1/4 in. shaft. Each...35c

A933—3 in. Diam. for 3-16 in. shaft. Each...39c

A934—3 in. Diam. for 1/4 in. shaft. Each...39c

A935—4 in. Diam. for 1/4 in. shaft. Ea. 43c

Moulded in one piece of genuine bakelite in polished black finish. Finely engraved scale in contrasting white enamel. Sure grip knob that fits the fingers. Higher grade dials for good sets. Sizes match perfectly.

## THREE INCH DIAL

A923 For 3-16 inch shaft. Each...19c

A924 For 1/4 inch shaft. Each...19c

A handsome neat looking dial moulded in one piece of polished black composition. 180° scale marked 0 to 100 finely engraved in contrasting white enamel. Diameter 3 inches.

## TWO INCH DIAL

A921 For 3-16 inch shaft. Each...16c

A922 For 1/4 inch shaft. Each...16c

A handsome dial moulded in one piece of polished black composition. 270° scale marked 0 to 100 finely engraved in contrasting white enamel. Fine for rheostat or switch control. Diam. 2 in.

## VERNIER DIAL ADJUSTER

A941 Each...19c

Easily installed at edge of dial, gives finest vernier adjustment of condenser or inductance. A great value. Polished black knob.

## Over 30,000 Barawik Radio Sets Are Operated All Over the World

All of these sets were built with Barawik Standard Radio Parts mostly by persons without any previous radio experience. These home-made sets equal in results the best factory made sets—many are even superior and at a cost only a fraction of the cost of the factory made sets. You can easily equal these results by following directions given in the numerous magazine articles on radio. Also directly below you will find listed Blue Prints, Instruction Packs and Books. With the help of these anyone can successfully make a Radio Set.

## RADIO BOOKS

That every Home Builder and Amateur needs. Written in plain simple language everyone can understand.

A631 100 Radio Hookups. Each...25c

Shows hookups from the simple crystal set to the more elaborate and latest tube circuits. Numerous types of Reflex, super-Regenerative, super-Heterodyne, Neutrodyne, Reinartz, Flewelling, Bishop, etc.

A632 How to Tune your Radio Set. Each...25c

A633 How to Build Loud Talkers. Each...25c

A634 How to Make Radio-Phone Receiving Sets. Each...25c

A635 How to Make Radio Frequency Amplifiers. Each...25c

## STANDARD TUBE SOCKET

A140 Each...39c

Moulded of genuine red brown bakelite. Binding post connections. For table or panel mounting. Neat and strong.

## METAL TUBE SOCKET

A146 Each...39c

A strong durable socket for panel or table mounting. Metal tube and base. Plainly marked binding post connections well insulated.

## TWO AND THREE GANG SOCKETS

These sockets make it easy to build detector and amplifier units and make a neat, compact workmanlike job.

Perfectly made of highgrade materials. Quickly mounted on panel or base.

A147 Two-gang socket...95c

A149 Three-gang socket...1.30

## 199 SOCKET

A145 Each...49c

Moulded of high insulating material. Sponge rubber base prevents ringing in tube. Plainly marked binding post connections. Neat and compact.

## FILAMENT CONTROL RHEOSTATS

A132 6 ohm. Each...45c

A129 20 ohm. Each 52c

A131 30 ohm. Each 52c

A135 6 ohm Vernier. 95c

Best grade. Will give real service. Durable and lasting. High heat resisting base. Diam. 2 1/4 in. Tapped polished black knob 1 1/4" diam.

Potentiometers. Match above rheostats. Same high grade construction.

A151 200 ohm. Each...79c

A152 400 ohm. Each...79c

## SUPERIOR RHEOSTATS

A153—6 ohm. Each...69c

A154—20 ohm. Each...76c

A155—30 ohm. Each...83c

The finest rheostat. Smooth, even action. Best design, best workmanship. Supplied with attractive dial and knob. A rheostat for high grade sets.

Potentiometers to match above rheostats with dial and knob.

A156—375 ohm...98c

## QUICK ACTING RHEOSTAT

A124—6 ohm. Ea. 79c

A125—15 ohm. Ea. 88c

A126—30 ohm. Ea. 99c

Vernier adjustment at every degree of resistance. Pushing knob in turns off the filament.

## PRINTS OF POPULAR CIRCUITS

These prints give a full-size panel layout, schematic hookup, hookup showing parts wired and explanatory notes. With them as a guide anyone can build a set that will operate perfectly and bring in the long distance stations.

A621 One Tube Reflex and Amplifier. Each...10c

A622 Single Circuit Tuner. Each...10c

A623 Reinartz Tuner using Spider Web Coil. Each...10c

A624 Radio and Audio Frequency Amplifier. Each...10c

A625 Short Wave Regenerative Set, using two Variocouplers. Each...10c

A626 Honeycomb Coil Circuit and Amplifier. Each...10c

## VACUUM TUBES

Standard Brands—Every one guaranteed new and perfect. We will ship brand in stock unless you specify otherwise.

A 105 Detector UV 200

A 300. Each...\$4.38

A 112 Amplifier, UV201A

A 301A...5.85

A 118 5 Watt Transmitter 7.70

A 107 WD11 C11. Each 5.85

A 101 WD12 C12. Each 5.85

A 102 UV199 C299. Each 5.85

A 104 UV199 Adapter fits 199 tube to standard socket...42

A 108 WD11 Socket. Each...31

A 109 WD11 Adapter. Each...45

## SUPERIOR VARIABLE GRID RESISTANCE

A167 Each...80c

A168 With .00025 Condenser...95c

Eliminates hiss, clarifies signals. Capacity smoothly varied from 0 to 6 megohms by half turn of knob. Easily mounted on any panel.

A171 Panel mounting variable grid leak with .00025 condenser...Each 69c

A172 Variable grid leak with mounting. Each...89c

A173 Variable grid leak. Each...\$1.19

## TUBULAR GRID LEAKS AND CONDENSERS

Very convenient. Permit of quick change of leaks, or condensers of varying capacity. Cut shows leak mounted. Leaks and condensers have same appearance. Each part priced separately.

A849 Grid Leaks. Each...18c

Resistances—1/2, 1, 1 1/2, 2, 3, 5, 7, and 10 megohms. Specify which size is wanted.

A831 Grid and Plate Condensers. Ea. 39c

Capacities—.00025, .0001, .00025, .0005 mfd. Specify which size is wanted.

Mountings. Bakelite base.

A840 Single mounting. Each...29c

A842. Double mounting. Each...49c

A844. Triple mounting. Each...69c

## VARIABLE GRID LEAKS

A160 Standard style...15c

A161 De Luxe style with extra heavy screw top, finely finished...32c

Pencil mark type for panel mounting. Resistance may be varied exactly as needed.

## GRID CONDENSERS

A162 Well insulated. Paper covering. Each...8c

A163 Highest grade. Mira insulated. Polished nickel case. Each...23c

Fit over posts of above leaks. The combination makes an efficient unit. Cap .00025 mfd.

**THE BARAWIK CO. 102 S. CANAL STREET CHICAGO, ILL.**



# BUILD YOUR OWN RADIO OUTFIT

## HIGH QUALITY GOODS AT LOW PRICES

### FAST SERVICE—WE PAY TRANSPORTATION CHARGES EAST OF THE ROCKIES



#### SPECIAL PRICES ON ALL RADIO GOODS

If what you want is not quoted here, write for prices. We can save you money on any Radio set or parts. Our stock is complete, we can ship promptly almost every brand of headset, loud-speaker, tube, variometer, etc.

#### BARAWIK QUALITY HEADSETS

A770 Per Set, 2000 ohms.....\$3.25  
 These headsets have proven on rigid tests to be one of the very best on the market. The tone quality is excellent with an unusual volume. Skilled workmen make them from only the best selected materials. The receiver cases are fine polished finish with polished black ear pieces. Fabric covered head band comfortably and quickly fitted to the head. Supplied with 5-foot cord. These sets were designed to sell for much higher prices than we ask, and at our price are a wonderful bargain. We guarantee that you will be pleased with them and agree that they are the best value by far yet offered. If they don't suit you we will cheerfully return your money.

#### OUR SPECIAL AUDIO FREQUENCY AMPLIFYING TRANSFORMERS

A550 Each.....\$2.25  
 The result of years of research work and experienced engineering. In quality of tone and volume of sound, the things a transformer is built for, we guarantee it to equal or surpass any other transformer. Neat in appearance. Carefully made. Fully mounted with plainly marked binding post connections. 5 to 1 Ratio. Wonderful results on one, two or three steps without distortion or howling. A quality item in every respect. Not to be compared with articles built for price only.



#### OUR SPECIAL SHIELDED TRANSFORMER

A551—3 1/2 to 1 Ratio Each.....\$2.55  
 A552—6 to 1 Ratio. Each.....\$2.75  
 The same high grade style of transformer as above which completely shields it from any outside magnetic influences. Very attractive appearance and sturdy construction. Free from howling and local disturbances.

#### NEUTRODYNE TRANSFORMERS

A571 Per set of three.....\$4.95  
 An air core transformer for use in neutrodyne method of reception. Can also be used for tuned radio frequency or as a fixed coupler with condenser across secondary. Proper design for results and efficiency. Green silk windings on bakelite tubes with adjustable mounting brackets to fit most any condenser.

#### SPECIAL

A573 Neutrodyne Jack. Each.....69c

#### NEUTRALIZING CONDENSERS

A572 Per set of two.....40c  
 Simple, inexpensive, effective precision type. Micrometer adjustment is attainable. Easily mounted in circuit.

#### PORCELAIN BASE SWITCHES

A385 Single Pole Single Throw. Each 20c  
 A383 Single Pole Double Throw. Each 32c  
 A384 Double Pole Double Throw. Each 50c  
 Fine white porcelain bases. Copper contacts and blades. Can be used as antenna switches.



#### ENCLOSED VARIABLE CONDENSERS

One of the best made condensers. Rigid, accurately spaced aluminum plates. Formica ends. Engraved scale. Knob and pointer. Clear transparent case.  
 A805 43 plate .001 mfd. \$2.80  
 A808 21 plate .0005 mfd. 2.45



#### RADIO FREQUENCY AMPLIFYING TRANSFORMER

A560 For 201A or 301A Tubes.....\$1.70  
 A561 For 199 or 11 or 12 Tubes.....\$1.70

Due to its special design this transformer will produce wonderful results in any type of regular or reflex radio frequency circuit. While low in price we believe it equal or superior to higher priced transformers. Perfect for one, two or three stages. Compact, convenient form, easily mounted. Range 175 to 600 meters. Try it. If you are not satisfied return it and get your money back.

#### TINNED COPPER "BUS BAR" WIRE

Size 14 tinned copper wire. For wiring sets. Best size for neat job and easy soldering.

A957 Round. Ten feet for.....12c  
 A958 Square. Ten feet for.....14c

#### SPAGHETTI

For covering connecting wires in sets. For size 12 and 14 wires.

A955 Finest quality braided and saturated with best baked lustrous transparent insulating varnish. 3 feet for.....19c

A956 Best quality braid and covered with black insulating compound. 3 feet for.....9c

A957 Round. Ten feet for.....12c  
 A958 Square. Ten feet for.....14c

#### PANEL MOUNTING VARIABLE CONDENSERS

59c \$2.45  
 These are especially high grade condensers and we guarantee them to be mechanically and electrically perfect. Fine polished end plates of heavy bakelite. Shafts 1/4 inch diameter. Sturdy, heavy aluminum alloy plates perfectly spaced to insure smooth, even, reliable capacity. Our low prices save you money. These condensers are of the very best make and are not to be compared with many inferior, cheap condensers offered. We guarantee them to please you or your money back. The vernier style has one separately controlled plate which permits of the finest tuning.

**REGULAR STYLE**  
 A815—3 plate.....59c  
 A816—5 plate.....97c  
 A814—11 plate .00025 mfd.....\$1.28  
 A813—21 plate .0005 mfd.....1.35  
 A812—43 plate .001 mfd.....1.58

**VERNIER STYLE**  
 Including Dial and Knobs  
 A825—14 plate .00025 mfd.....\$2.45  
 A824—26 plate .0005 mfd.....2.75  
 A826—46 plate .001 mfd.....3.15



#### RADIO SOLDERING IRON



A540 Each.....\$1.50  
 Soldered connections in radio sets produce better results. This guaranteed iron is exactly right for radio work. A neat solid connection quickly and easily made. Operates on any lighting socket 100 to 120 volts. 6ft. cord with attaching plug. Length 13 inches. Heats quickly, will not overheat.

Heavier irons for general repair or manufacturing work. Wonderful values at our prices.

A541 Medium size...\$3.48  
 A542 Larger size.....4.25



#### AUTOMATIC BLOW TORCH

A543 Each.....\$1.19  
 Burns denatured alcohol. Automatically generates pointed flame in a few seconds. Easy to solder joints in hard places. Lights with a match. Burns 20 minutes on one filling. 5 1/2 inches high. 3/4 inch diameter cylinders. Works fine with Tinol listed below.

#### TINOL

A544 Each.....39c  
 Burns denatured alcohol. Vest pocket size. Blowing on tube produces a hot pointed flame. Lights with a match. Works fast. Burns 10 minutes on one filling. Easy to solder joints in hard places. 3 in. high. 1/4 in. cylinder. Long rubber tube. Produces fine joints with Tinol listed above.



#### SUPER BLOW TORCH

A544 Each.....39c  
 Burns denatured alcohol. Vest pocket size. Blowing on tube produces a hot pointed flame. Lights with a match. Works fast. Burns 10 minutes on one filling. Easy to solder joints in hard places. 3 in. high. 1/4 in. cylinder. Long rubber tube. Produces fine joints with Tinol listed above.

#### LONG NOSE PLIERS

A970 Price...95c  
 The handiest pliers for radio work. Made of hardened steel. Length, 5 in.



#### DIAGONAL JAW NIPPERS

A972 Price...\$1.05  
 For fine electrical work, made of hardened steel, length 5 inches.



#### FOUR-IN-ONE Screw-Driver

A974 Each.....55c  
 Especially suitable for radio work. Will handle any size screw used. Smaller drivers nest inside larger one and are held in place with screw cap. Made of steel, nickel finished.

Insulated copper wire. Best quality even drawn wire, one piece to a spool. Prices quoted are for 8 oz. spools unless otherwise stated.

Double Cotton Covered		Enameled Insulation		Green Silk Covered	
No.	A990	No.	A992	No.	A991
Gauge	Price	Gauge	Price	Gauge	Price
18	43c	20	39c	20	\$0.78
20	55c	22	50c	22	.95
22	70c	24	55c	24	1.10
24	80c	26	60c	26	1.38
26	90c	30	65c	30 (4 oz.)	1.25
28	\$1.05	32	70c	32 (4 oz.)	1.65
30	1.45	36	90c	36 (4 oz.)	2.20

# THE BARAWIK CO. 102 S. CANAL STREET CHICAGO, ILL.



# USE BARAWIK STANDARD PARTS

YOU SAVE MONEY WHEN YOU BUY FROM US  
FAST SERVICE—THE PRICES QUOTED DELIVER THE GOODS TO YOUR DOOR

**BINDING POSTS**  
Brass, polished nickel finish. Washer and 6-32 in. screw extending 3/4 in.

A370 Large size—barrel and knob 3/4" long. Dozen.....85c  
A372 Smaller size—barrel and knob 9-16" long. Dozen.....70c

A370-2-4 barrel and knob 9-16" long. Dozen.....70c

A374 Large size with composition knob. Dozen.....45c  
A376 Large size with hole for phone tip or wire. Dozen.....80c  
A378 Small size with hole for phone tip or wire. Dozen.....35c

## GUARANTEED QUALITY GOODS

at money saving prices. You can build the parts purchased from us into your set and feel confident of the best results. If what you want is not shown here write us for prices—we have every part for your set ready for quick shipment and the prices are right.

### SUPERIOR RADIO JACKS

Finest Grade Jacks. Improved design. Best materials. Phosphor bronze springs. Silver contact points. Nickel finish. Mount on panels 1/2 to 3/4 in.

A390 Open circuit. Each.....38c  
A391 Closed circuit. Each.....46c  
A392 Two circuit. Each.....55c  
A393 Single circuit filament control. 59c  
A394 Two circuit filament control. 76c

### COMPETITOR JACKS

A387 Open circuit. Each.....27c  
A388 Two circuit. Each.....35c

Well made, durable, smooth working nickel finished frame. Well insulated.

### SUPERIOR RADIO PLUGS

A395 With set screws for fastening cord. Each.....35c  
A397 Two-way—takes two pair any style cords. Each.....59c

Highest grade plugs. Fit any standard jacks. Polished round barrels.

### SWITCH CONTACT POINTS

Brass polished nickel finish. All have 3/8 in. long size 6-32 screws and two nuts. All prices the same.

Dozen 18c    Hundred \$1.05

Order by Article Number.

A360 Head, 1/4" diam.; 1/2" high  
A362 Head, 3-16" diam.; 3/4" high  
A363 Head, 3-16" diam.; 1-16" high

### Solder Lugs to Fit Contact Points

Also for connecting wires to binding posts, etc.

A365 Dozen 8c    Hundred 30c

### SWITCH LEVER STOP

Brass polished nickel finish.

A386 Dozen 18c    Hundred \$1.05

### SWITCH LEVERS

Very neat polished black composition knob. Exposed metal parts polished nickel finish. Fitted with panel bushing and two set nuts. A high grade switch.

A381 1 1/2 in. Radius. Ea. 15c

### INDUCTANCE SWITCH

A285 Price including knob and dial. \$1.29

Mounts switch points and contact lever behind panel. Only one hole needed to mount. 15 switch points, any number of which may be used. Smooth wiping contacts. Attractive tapered knob.

### SILVERED METAL DIAL

A651 Each.....65c

Same as used on above switch. Polished black knob. Engraved graduations.

### SUPERIOR INDUCTANCE SWITCH

A286 Each.....79c

Quickly and securely mounted by drilling one hole. Only knob and pointer show in front of panel. Connections can be soldered before fastening switch, making assembly much easier. Metal parts nickel-plated. Bakelite knob and supporting base.

### PLATE CIRCUIT "B" BATTERIES

You can make real savings on these batteries. Don't pay more. We guarantee them to equal any on the market regardless of price. Absolutely uniform. Extra long life.

A180 Signal Corps type, small size. 15 cells, 22 1/2 volts. Each.....\$1.10

A182 Large size, 5 taps 16 1/2, 18, 19 1/2, 21 and 22 volts. Each.....\$1.59

A184 Variable Large Navy size, 16 1/2 x 4 x 3 inches 5 taps, giving range from 16 1/2 to 22 1/2 volts in 1 1/2 volt steps. Each.....\$1.95

A188 Combination Tapped 45 volts, 30 cell, 13x4x3 battery. Tapped to give 45, 22 1/2, 21, 19 1/2, 18 and 16 1/2 volts. Handles both detector and amplifier tubes. Ea. \$3.65

### STORAGE "A" BATTERY

A very high grade battery made especially for radio service. Guaranteed for three years. Properly cared for will give many years of service for filament lighting. Made of best new materials. Full capacity. The best battery buy on the market. Try one of these batteries on your set for 10 days. If at the end of that time you are not fully satisfied with the battery return it and we will refund the purchase price.

A194 6 volt, 40 amp. size. Each \$10.75  
A196 6 volt, 80 amp. size. Each 13.25

### STORAGE "B" BATTERY

A790 Each.....\$8.75

The most satisfactory and practical 24 volt storage B Battery. Rubber case carefully sealed to prevent leakage. Connections are brought out at every cell for voltage regulation in 2 volt steps. Shipped fully charged.

### BATTERY CHARGING RECTIFIER

Charge your battery at home over night for a few cents. Simply connect to any 110 volt 60 cycle light socket, turn on current and rectifier does the rest automatically. Will work for years without attention. Simple connections. Gives a tapering charge which batteries should have. You can make it pay a profit charging your friends' auto batteries. Long connecting cords with pair of battery clips.

A201 For 6 volt battery.....\$12.95  
A203 For 12 volt battery.....12.95

### HYDROMETER

A190 Each.....48c

Accurately tells you the condition of your storage battery. Helps you keep your battery in better condition.

### BATTERY CLIPS

A198 Two for.....28c

Clip onto storage battery terminals, lead coated. Make positive non-corrosive contact at all times.

### WIRE CONNECTING CLIPS

A199 Per dozen.....30c

Small connecting clips for quickly fastening leads onto binding posts, etc. Handy and useful. Every radioist should have at least a dozen

### "B" BATTERY METER

A189 Each.....98c

Reads 0 to 50 volts. Accurately tells you the exact condition of your B Battery. Convenient watch size. Polished nickel case with wire lead.

### RADIO "BAKELITE" PANELS

Notice our very low prices on this fine quality material. Others ask as much for hard rubber panels which are worth much less. We supply genuine Bakelite. Condensite Celeron or Formica, all of which are materials with practically identical mechanical, chemical and electrical properties. Machines well without chipping. Won't warp. Waterproof. Highest mechanical and dielectric strength. Attractive natural polished black finish which can be sanded and oiled.

Panel Size Inches	1/4" thick		3-16" thick		1/2" thick	
	Art. No.	Price	Art. No.	Price	Art. No.	Price
6x7	A450	\$0.57	A460	\$0.86	A470	\$1.15
6x10 1/2	A451	.86	A461	1.27	A471	1.73
7x14	A458	1.38	A468	2.07	A478	2.76
7x18	A453	1.78	A463	2.65	A473	3.56
7x21	A457	2.05	A467	3.05	A477	5.10
7x24	A459	2.42	A469	3.56		
9x14	A454	1.85	A464	2.65	A474	3.56
12x14	A455	2.42	A465	3.56	A475	4.78
12x21	A456	3.62	A466	5.35	A476	7.13

### CABINETS

Fine looking cabinets solidly built. Elegant hand rubbed dark mahogany finish. You will be proud of your set mounted in one of these cabinets. Hinged tops. Front rabbeted to take panels. Panels not included. Prices are transportation paid.



Panel Size	Inside High	Dimensions		Art. No.	Price Each
		Wide	Deep		
6x7	5 1/2"	6 1/2"	7"	A420	\$2.15
6x10 1/2	5 1/2"	10"	7"	A422	2.65
7x10	6 1/2"	9 1/2"	7"	A421	2.90
7x12	6 1/2"	11 1/2"	7"	A424	3.05
7x14	6 1/2"	13 1/2"	7"	A423	3.20
7x18	6 1/2"	17 1/2"	7"	A426	3.45
7x21	6 1/2"	20 1/2"	7"	A425	3.85
7x24	6 1/2"	23 1/2"	7"	A429	4.65
9x14	8 1/2"	13 1/2"	10"	A428	3.55
12x14	11 1/2"	13 1/2"	10"	A430	4.65
12x21	11 1/2"	20 1/2"	10"	A432	5.45

### BEZELS

A641 Diameter 3/4 inch—Each.....15c  
A642 Diameter 1 1/4 inch—Each.....15c

Polished nickel finish. Finest quality. Fit any thickness panel. Greatly improve appearance of panel.

### RUBBER COMPOUND PANELS

Made of a special compound having a rubber base. Equal in appearance and in all essential points to any other class of panels. Fine smooth polished finish. Can be drilled or cut without chipping. Guaranteed not to warp and to be a perfect insulator for radio use. Smooth clean edges. Thickness 3/16 inch. Size given is in inches.

A481	7x10.	.88	A484	7x18.	\$1.60
A482	7x12.	1.05	A485	7x21.	1.85
A483	7x14.	1.22	A486	7x24.	2.10

THE BARAWIK CO. 102 S. CANAL STREET CHICAGO, ILL.



# You Don't Need To Be An Expert



## RADIODYNE

"The Voice of a Nation"

The RADIODYNE is operated by simply grounding to a water pipe or radiator and throwing a few feet of wire on the floor. No outside antenna or loops necessary. You don't have to be an expert to install and operate it effectively.

For use in apartments, boats, automobiles, railroad trains, etc., the RADIODYNE is enjoyable where other types of receiving sets would not be practical.

Stations within a radius of 2000 miles can be picked up on the loud speaker; any wavelength from 200 to 700 meters. The RADIODYNE is so sensitive that it picks up Radio telephone speech and music when other types of equipment fail.

Write for illustrated folder which describes the RADIODYNE in detail. Every radio fan will be interested in this new type (antennaless) receiving set.

**WESTERN COIL & ELECTRICAL CO.**  
308 Fifth St. Racine Wisconsin



### DESIGNED ESPECIALLY FOR RADIO RECEIVING

We are Manufacturers of Fine Furniture and we sell direct to you with only a small factory profit.

A handsome hardwood hand-rubbed mahogany or golden oak finished Radio Table. Size of top 20 x 34 inches x 31 inches high.

Conceals A & B batteries. Small drawer holds tools and accessories.  
PRICE, FREIGHT PAID, East of Mississippi River.....\$18.00  
FREIGHT PAID to Rocky Mt. States.. 20.00  
FREIGHT PAID to Pacific States..... 22.50  
Cash with order. Prompt shipment.

### CABINET PRICES REDUCED!

Hardwood, hand-rubbed mahogany finish. Hinged top.

Panel Size	Depth	Price
6 x 7 in.	7 in.	\$2.25
6 x 10½ in.	7 in.	2.50
6 x 14 in.	7 in.	3.00
6 x 21 in.	10 in.	3.75
7 x 18 in.	10 in.	3.50
9 x 14 in.	10 in.	3.50
12 x 14 in.	10 in.	4.00

POSTPAID, East of Mississippi River.

POSTPAID to Rocky Mt. states, add 25 cents.

POSTPAID to Pacific states, add 50 cents.

Cash with order. Prompt shipment.

Send for free catalogue of Radio Furniture.

**THE SOUTHERN TOY CO.**  
HICKORY, NORTH CAROLINA



*Inductance Switch*  
Price \$1.50



*Detector Amplifier Switch*  
Price \$1.50



*Single Pole Double Throw Switch*  
Price \$1.25



*Double Filament Control Jack*  
Price \$1.25



**JOSEPH W. JONES**

One of America's leading inventors, and who has been granted over 300 patents.

Inventor of the method now used for making Disc Phonograph records.

Inventor of the pioneer Speedometer and the Best, The Jones.

Inventor of the Jones Victometer, or Aero-plane Tachometer, used by the U. S. Army and Navy.

Inventor of the Jones Motrola, which eliminates the need of phonograph winding

Inventor of the Jones Electric Drill.

**JOS. W. JONES**  
RADIO  
TRADE MARK

*Invented these*

**IMPROVED**  
ANTI-CAPACITY

**Radio Jacks and Switches To Save Your Time and Money**

HERE is a line of radio jacks and switches radically different in design and construction from any similar product. They are *not* telephone fittings modified for radio use, but are designed especially to meet the exacting requirements of the radio enthusiast who knows what he wants.

They save drilling and soldering—give you better results by eliminating capacity effects—give you a neater set, because they eliminate contact points on front of panel—they save your time, temper and money.

Most radio dealers have these little round jacks and switches with the red button. If yours hasn't, send us his name and ask for folder describing the entire line.

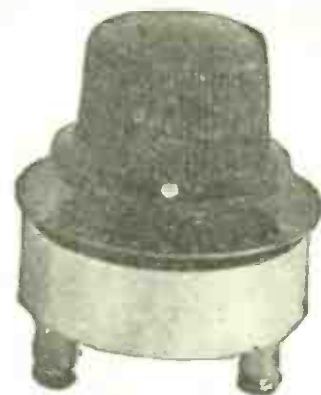

*Grid Leak*  
Price \$1.50

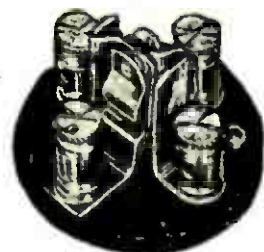

*Double Circuit Jack*  
Price \$1.00

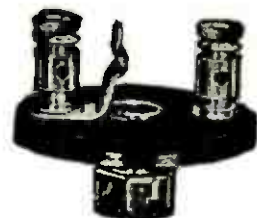

*Open Circuit*  
Price 70 cents



*Single Filament Control Jack*  
Price \$1.00

**RADIO IMPROVEMENT CO., Inc., 25 W. 35th, New York**  
*Agents in 26 Principal Cities*



Price  
\$1.75  
6 ohms  
25 ohms  
40 ohms



## Unity Rheostats are the Best

*Vernier and Non-Vernier*

### The Unity Vernier Rheostat

*The highest type electrical instrument made for controlling resistance.*

*A refinement in tuning adjustment, far surpassing the possibilities of any other instrument, is very easily obtained.*

*The Unity Vernier Rheostat is the only Rheostat with a cut-out switch operating with no change in tuning adjustment.*

— "Hear a set that uses Unity Rheostats" —

### The Unity Non-Vernier Rheostat *or the Cartridge Rheostat*

*Where a non-vernier rheostat is sufficient, the Unity Cartridge Rheostat is the best made.*

In addition, resistance cartridges are interchangeable without removing the bracket from the panel.

Unity Potentiometer Cartridges also fit the Unity Brackets

If your dealer cannot supply you, send your check or money-order to the factory with dealer's name.

**UNITY MFG. CO., 228 North Halsted St., Chicago**  
*Automatic Screw Machine Products, Stampings, General Manufacturing on Contract or Royalty.*

Dealers are offered a free Counter Display Card.

6 ohms  
25 ohms  
40 ohms

*Other resistances if desired*

Complete Rheostats - - \$ .80

Brackets only .45

Cartridges, any resistance - .35

Potentiometers, complete, 200 or 400 ohms 1.45

Potentiometer cartridges only 1.00

Interchangeable Resistance Cartridge

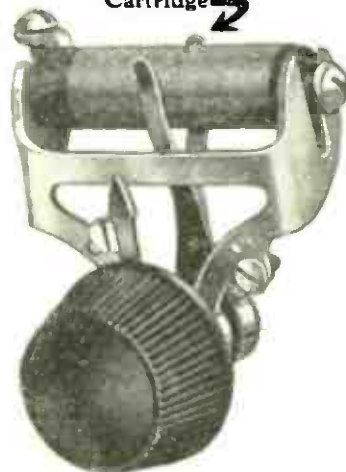

## EACO DUPLEX RECEIVERS

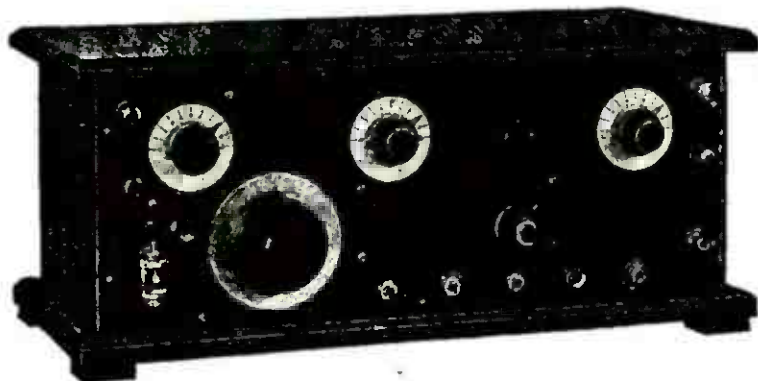

*Excel in—*

**RANGE**

**VOLUME**

**CLARITY**

**EFFICIENCY**

### **A Revelation in Radio Frequency**

A supersensitive Receiver incorporating two stages of Tuned Radio Frequency. Affords the user choice of either crystal or tube detector, with or without amplification. Ideal for use with loud speakers of any type. Delivers great volume from distant Broadcasters. Will operate without an aerial.

Literature and prices furnished upon request.

**ECONOMIC APPLIANCE COMPANY, Irwin, Penna.**

# New Thrills from Radio



## ALL-AMERICAN

### Amplifying Transformers

#### Out-Distance and Out-Class All Your Radio Associates

"All-American" Transformers will enable you to annihilate distance, defeat interference, and abolish extraneous noises. They faithfully amplify the tone-quality of both distance and nearby broadcasting stations with remarkable volume. "All-American" Transformers mean thrills and radio achievements worth talking about.

Equally adapted for use with new and old circuits and all tubes. Approved and officially adopted by leading makers of high class receiving sets. Standard in the industry.

Ask your dealer to supply you with "All-American" Transformers. Every instrument guaranteed to be electrically and mechanically perfect.

**RAULAND MFG. CO.**  
200 N. Jefferson St. Chicago

**FREE**

"All-American" Book of Tested Hook-ups.  
Send 2 cent stamp for postage and give dealer's name and address.



Audio Frequency Transformer

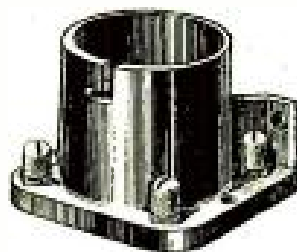

"All-American" Bakelite Tube Socket-base or panel mounting 75c

# ALL-AMERICAN

# The E. J. Flewelling Tuner

Simplifies the building of a Radio set by eliminating loss producing taps and reducing tuning operation to setting of one condenser reading and adjusting tuner to maximum volume.

High efficiency is obtained by practically eliminating solid dielectrics from the coil field. Vernier control. Single hole panel mounting. Wide wave band covered without changing coil units.

This is one of Mr. Flewelling's master designs. It will enable you to build an efficient set at a minimum cost. Requires little room but produces big volume reception. Price includes Tuner complete with dial.

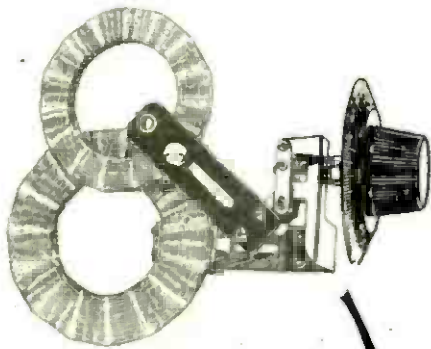

## SOCKETS

E. T. Flewelling Sockets will make your set more efficient. Price \$1.00. At your dealer's or postpaid.

**\$8.00** / At  
Your  
Dealer's  
or Postpaid

**BUELL MANUFACTURING COMPANY**  
2979 Cottage Grove Avenue  
CHICAGO

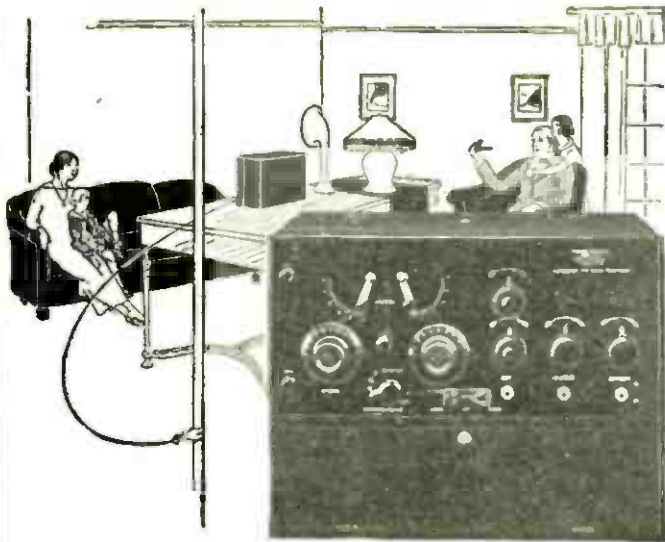

## —hook it to the waterpipe

Moon "Satterlee Antennaless" Radio will produce wonderful results simply connected to a waterpipe. No antenna, loop or indoor wire is necessary.

Stations within a conservative 1000 mile radius are regularly received with a non-power loud speaker on this set.

It is the ideal set for use in apartments, automobiles, yachts or railroad trains where an antenna is not practical. Extremely sensitive, unusually selective, yet simple to operate.

*Write today for our folder  
"California or Newark"*

**MOON RADIO CORPORATION**  
501 Steinway Ave., Long Island City, N. Y.

In Canada: Continental Equipment Co., Ltd., New  
Birks Bldg., Montreal, Quebec

# MOON

Satterlee  
antennaless  
—RADIO—



# Radio Catalogue Free—

**Write us  
a post card—**

**Address Dept. 38-R**

and we will send you free this 52 page catalogue of radio sets and parts. It also contains explanation of radio terms, map and list of broadcasting stations and much radio information, including an explanation of successful hook-ups and circuits.

You will be amazed at the low prices Ward's quote. A complete tube set having a range of 500 miles and more, including tube, head set, batteries, and antenna equipment, as low as \$23.50.

This catalogue contains everything for the expert and amateur. Complete sets and every improved part for building sets, all the most up-to-date devices—at the lowest possible prices.

## **Headquarters for Radio**

Montgomery Ward & Co. is headquarters for Radio, selling everything direct by mail without the usual "Radio-profits." Why pay higher prices? Ward quality is the best and the prices will often save you one-third. Everything sold under our Fifty Year Old Guarantee—Your Money Back if You Are Not Satisfied. Write today for your copy of this complete 52-page Radio Book.

**Write to our house nearest you. Address Dept. 38-R**

**Chicago Kansas City St. Paul Portland, Ore. Ft. Worth**

# Montgomery Ward & Co.

**The Oldest Mail Order House is Today the Most Progressive**





Variometers  
—  
Variocouplers  
—  
Audio Frequency Transformers  
—  
Radio Frequency Transformers

### Balanced Vernier Condensers



Equipped with Bakelite knob and dial.  
Bakelite end plates.  
Separate Vernier control.  
Table or panel mounting.  
Balanced rotor and stator plates.  
Guaranteed not to short circuit.

Detector Units  
—  
Amplifying Units  
—  
Rheostats  
—  
Potentiometers  
—  
Knobs and Dials

Model 5017—23 plate—.0006 Mf.—\$5.00  
 Model 5018—43 plate—.001 Mf.— 5.50  
 Model 5019—13 plate—.0003 Mf.— 4.50

*Write for complete Catalogue*

**The Dayton Fan & Motor Co.**  
*Established 1889*  
 Dayton, Ohio



VARIOMETER



VARIOCOUPLER

## Another Radio Achievement

*“For the Grid of Your Tube”—Use*

# GREWOL VARI-GRID



An exceedingly small enclosed vernier variable condenser, taking up but 1 3/4" on your panel and absolutely replacing all 11 and 23 plate condensers!

**TWO ARTICLES FOR LESS THAN THE PRICE OF ONE**

The Grewol Vari-Grid is especially adapted for use as a variable grid condenser being equipped with a variable grid leak which can be removed if desired.

**EVERY SET NEEDS AT LEAST ONE**

You'll get a 100% improvement in distance and reception by using the Grewol Vari-Grid in your grid circuit. Try one in the aerial circuit too and across the secondary. They work wherever ordinary condensers are used. And they have a vernier adjustment.

You've plenty of room for two on your present set. They take up so little room, only one hole to drill.

**At  
Your  
Dealers**

Or Sent Direct Upon Receipt of

**\$2.25**

*Write for folder*

## RANDEL WIRELESS CO.

4 Central Ave., Newark, N. J.



Please mention POPULAR RADIO when answering advertisements.

# FIL-KO-STAT CONQUERS DISTANCE

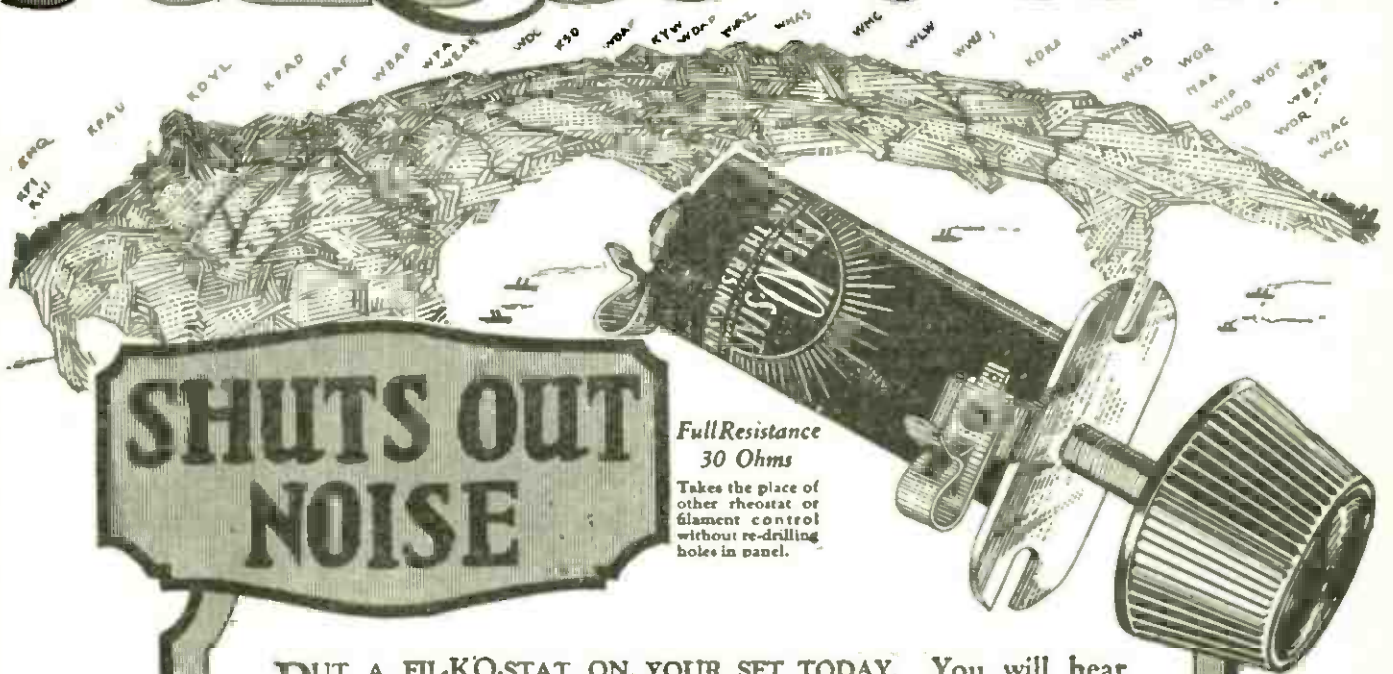

**SHUTS OUT NOISE**

Full Resistance  
30 Ohms  
Takes the place of  
other rheostat or  
filament control  
without re-drilling  
holes in panel.

**P**UT A FIL-KO-STAT ON YOUR SET TODAY. You will hear stations you believed to be far beyond its range. You will get greater distance! Louder signals! Finer adjustment! **NOISELESS OPERATION!** A. S. Allsup, of Kansas City, writes, "Since using my Fil-Ko-Stat I have picked up 5 stations I never heard before."

The FIL-KO-STAT is the filament control of INFINITE adjustment, with a fine adjustment area 18 times greater than a wire rheostat, and several times greater than the next best filament control.

There are no screws to tamper with on the FIL-KO-STAT. No wires! No discs to chip or break! No adjustments to puzzle! Triple tested and adjusted at the factory to the ideal "off" for UV200, 201, 201A, WD11, WD12, UV199, DV6A, W. E. Peanut and all other tubes including 5 watt transmitting tubes. Hailed by amateur and professional radio men as the greatest step forward in the development of the tuning possibilities of the vacuum tube.

*FIL-KO-STAT supremacy is proven by every test.*

Price

**\$2**

In Canada \$2.75

Recommended  
and sold by dealers  
in high quality  
radio supplies.



MADE AND GUARANTEED BY **DX INSTRUMENT CO.**

**RADIO STORES CORPORATION**

SOLE INTERNATIONAL DISTRIBUTORS

Dept. PR 12 218-222 West 34th Street New York

**BEWARE**  
Of Inferior  
Powdered Car-  
bon Rheostats.  
Filko-Stat Resis-  
tance Element  
is 80% Metallic  
Substances.



## ELECTRAD PRODUCTS

**\$2**

socket 50c



Write for FREE  
Cockaday-Diode  
Reflex Circuit.

**The NEW DIODE** A revelation for all reflex work. Replaces the crystal and overcomes all former difficulties of reflex circuits. Requires no adjustments for change of wave lengths. Gives you the clear reproductions of a crystal with the sturdiness and reliability of a tube. No "B" batteries required. Operates on less than 1/2 ampere from single dry cell. Easily adapted to Erla and all other circuits.

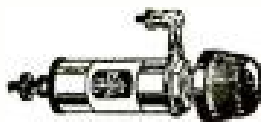

**75c**

**The NEW VARIOHM** The latest invention in variable grid leaks. Each movement gives a definite new resistance. Positively does the work where others fail. A gradual resistance over entire range of 1/4 to 10 megohms. Eliminates circuit noises, is moisture proof and non-microphonic. Ideal for use in Mitoplex and other circuits. Guaranteed.

### The LEAD-IN

Fits right under closed window. Can be bent into any shape to fit ledges. Covered with fire-proof insulating material which prevents grounding of circuits on wet window sills. Takes the place of ungainly porcelain tubes and holes in the window sash. Fitted with Fahnestock clips. Always presents a neat appearance.

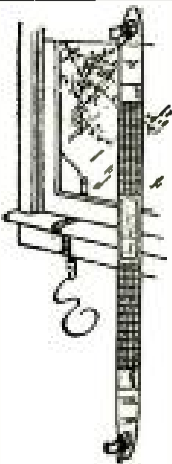

**40c**

All products at your dealers. otherwise send purchase price and you will be supplied postpaid.

**ELECTRAD, Inc.**

428-C Broadway  
New York

*The  
Supreme  
Insulation*

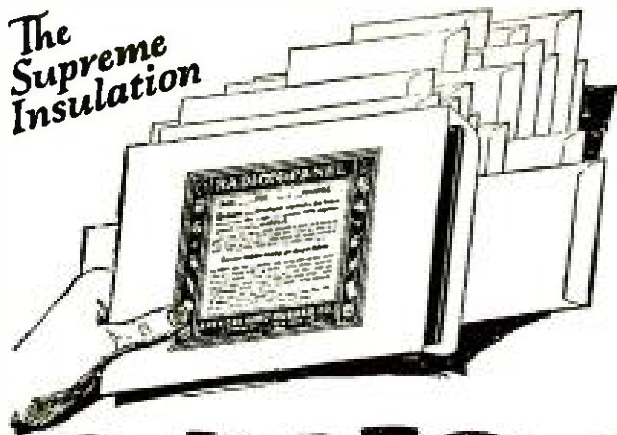

# RADION Panels

are furnished in 18 stock sizes & ~ each packed in heavy envelope to protect beautiful finish. A size for every requirement

Every genuine RADION panel is stamped RADION. Do not accept substitutes.

6 x 7	7 x 12	9 x 14
6 x 10 1/2	7 x 14	10 x 12
6 x 14	7 x 18	12 x 14
6 x 21	7 x 21	12 x 21
7 x 9	7 x 24	14 x 18
7 x 10	7 x 48	20 x 24

Radion being an insulation material especially made for wireless use, has the lowest phase angle difference, lowest dielectric constant, highest resistivity and supreme moisture, gas and acid repelling properties.

Sold by Radio Dealers Everywhere

**American Hard Rubber Co.**  
11 Mercer St., New York

# RADION

*Panels - Dials - Knobs - Sockets - Insulators*

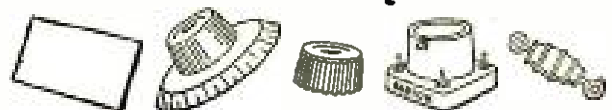



# THE S P 2 RECEIVER—

*Greater in Every Essential Than  
Other Receivers Costing Twice Its Price*

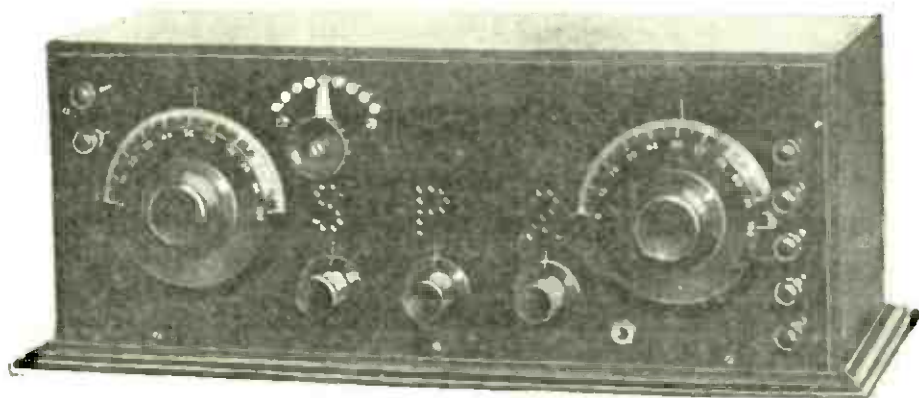

In New York, in Chicago, in Philadelphia—wherever it is demonstrated—the S P 2 RECEIVER scores as the outstanding marvel of the radio world.

Greater in every essential than other Receivers costing two to three times its price. As great as any Receiver at any price.

Radio experts, where comparisons have been made, are as one in the opinion that the S P 2 is a real wonder of radio.

Larger, extremely more expensive Receivers remarkably eclipsed in performance, in every comparison.

**S P 2 EFFICIENCY LEAVES NOTHING TO BE DESIRED.  
ITS REMARKABLY LOW PRICE MAKES IT THE  
GREATEST SELLING PROPOSITION OF THE DAY.**

*Write us today for Catalog IOIA*

**PITTSBURGH RADIO SUPPLY HOUSE**  
963 LIBERTY AVENUE                    ::                    ::                    PITTSBURGH, PA.

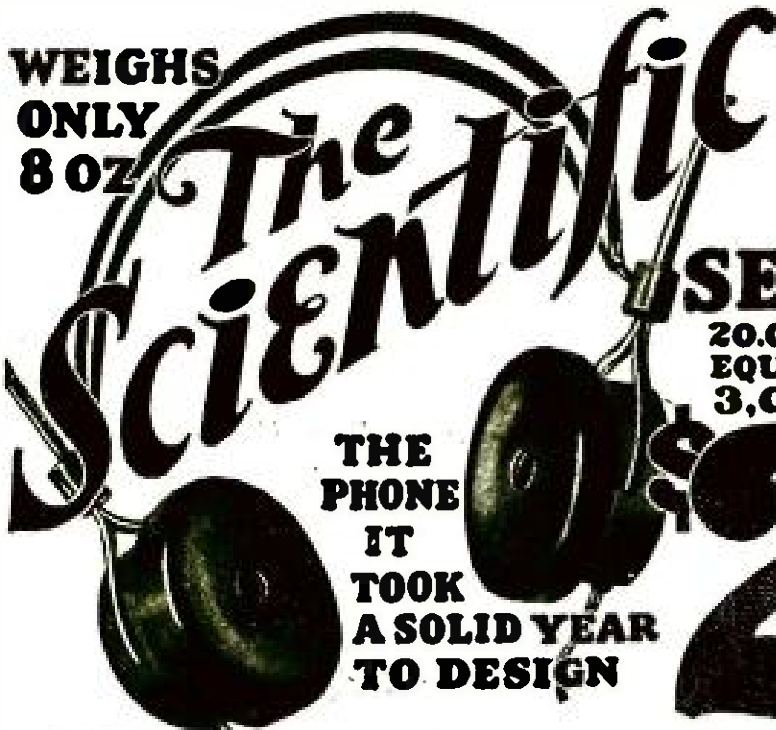

**WEIGHS  
ONLY  
8 OZ.**

**The Scientific**

**THE  
PHONE  
IT  
TOOK  
A SOLID YEAR  
TO DESIGN**

**SEND NO MONEY!**

**20,000 TURNS  
EQUIVALENT TO  
3,000 OHMS**

**\$2.95**

**POST-PAID**

**A \$200,000.00 COMPANY  
stands squarely back  
of the guarantee on  
every Scientific headset**

**Order TODAY  
by Postcard  
and Pay  
Postman  
on arrival**

**LOUD  
SPEAKER  
UNIT \$1.95**

**We Guarantee** The Scientific Headset to be the greatest value on the market. Try it for five days. If not satisfactory send it back and your money will be refunded immediately. Circular on request. Dealers wanted.

**THE SCIENTIFIC ELECTRIC WORKS**  
98 Brookline Ave. DEPT. J BOSTON, MASS.

**The Original** **AUTOMATIC TELEPHONE PLUG!**

**COMSCO BULL DOG GRIP PLUG**

**Eliminates**  **plug troubles**

Saves you from short circuit and battery kicks. No more burned out phones or ruined transformers. No more broken finger nails.

**Simple to operate**  **Bull Dog Grip Plug**

**INSERT**

by a single touch, and the connecting tips of your phone cords accomplish automatically the most perfect electrical contact.



FOR  
ONE PAIR  
PHONES \$1.00  
FOR TWO PAIR  
PHONES \$1.50



**RELEASE**

by pressing the small knob and the tips will slide out easily without pulling the electrical contacts.

For sale at your dealer. Otherwise send purchase price to us and you will be supplied

**GENERAL INSTRUMENT Co., 123 Liberty St., N.Y.C.**



Please mention POPULAR RADIO when answering advertisements.

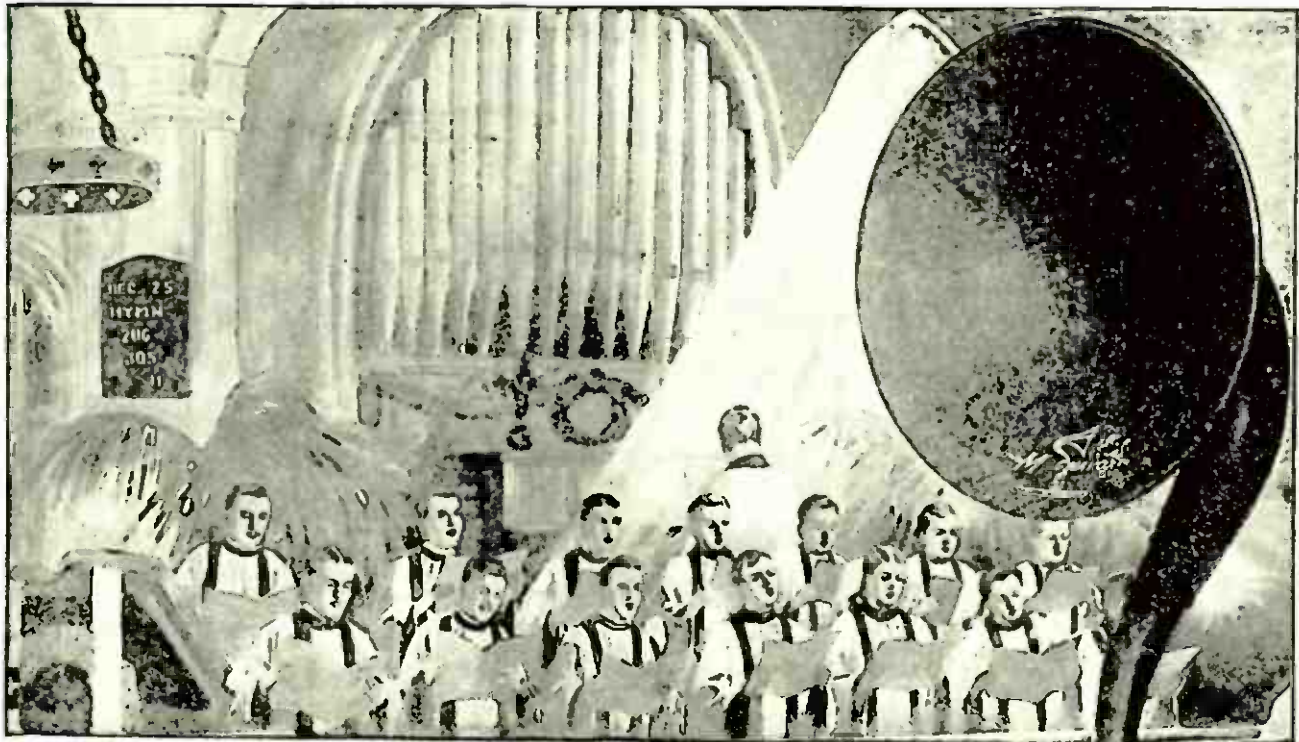

## Magnavox brings you the Voice of all Christmastide

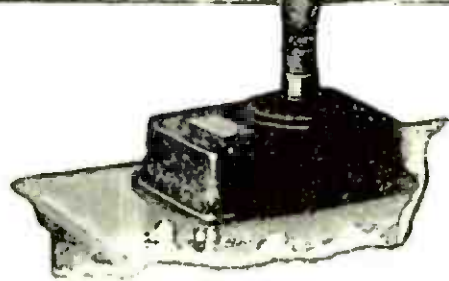

THE Art of Radio Reproduction is enjoyed by every Magnavox owner. Despite the ever-increasing quality and variety of Broadcast Programs, many a receiving set gathers dust unlamented because of insufficient sensitivity or an unsatisfactory "loudspeaker."

Every Magnavox owner is a master of the art of radio reproduction—the results obtained by the use of Magnavox Reproducers and Power Amplifiers cannot be equalled with apparatus constructed in the ordinary way.

The special attention of dry battery receiving set owners is called to the new Magnavox Reproducer M1, illustrated above.

### Magnavox Reproducers

R2 with 18-inch horn . . . . .	\$60.00
R3 with 14-inch horn . . . . .	35.00
M1 for dry battery sets . . . . .	35.00

### Combination Sets

A1-R Reproducer and 1-stage Amplifier . . . . .	\$59.00
A2-R same with 2-stage . . . . .	85.00

### Power Amplifiers

A1-One-stage . . . . .	\$27.50
AC-2-C Two-stage . . . . .	55.00
AC-3-C Three-stage . . . . .	75.00

Magnavox Products can be had of  
good dealers everywhere

**THE MAGNAVOX CO.**  
Oakland, Cal.

New York Office: 370 Seventh Avenue  
Perkins Electric Limited: Toronto, Montreal,  
Winnipeg, Canadian Distributors

# MAGNAVOX PRODUCTS

There is a Magnavox for every receiving set

IMITATED BUT NEVER DUPLICATED

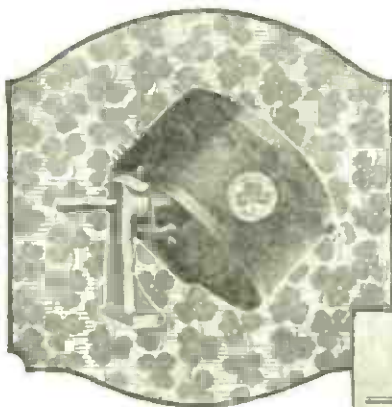

\$3.50  
each



## DEPENDABLE — for all new wave lengths

—Range 150 to 600 meters, tunes in on all new high wave lengths.

—180° type, gives double selectivity of ordinary 90° instrument.

—Tubes of genuine grade XX bakelite wound with single green silk covered wire.

—Angular movement of rotor gives super selective tuning with ease.

—Direct flexible leads to Fahnestock clips eliminate contact noises of spring contacts.

—Aluminum die cast frame reduces body capacity. For bench or panel mounting.

### VARIOMETER

Write for descriptive specifications

Dealers write for trade prices

SHAMROCK MANUFACTURING CO.  
320 Market St., Newark, N. J.

# SHAMROCK

FOR SELECTIVE TUNING

180° VARIO-COUPLER  
VARIOMETER

CONCERNING

# BURGESS BATTERIES

The unique position of esteem and confidence occupied by Burgess Radio Batteries is a natural development of the conservative policy which has characterized the manufacture, advertising and sale of Burgess products.

Of interest, perhaps, to the thinking battery buyer is the fact that no Burgess product is advertised or sold until its merit has been proven, not only by our own rigid tests, but also those of the foremost radio engineers, manufacturers and experimenters in the country.

Through friendly criticism and suggestions, together with extensive research and engineering by the C. F. Burgess Laboratories the efficiency of Burgess Batteries has increased to a degree which we believe is not equalled elsewhere.

*Ask Any Radio Engineer*

## BURGESS BATTERY COMPANY

ENGINEERS • DRY BATTERIES • MANUFACTURERS  
FLASHLIGHT • RADIO • IGNITION • TELEPHONE  
GENERAL SALES OFFICE: HARRIS TRUST BLDG., CHICAGO  
LABORATORIES AND WORKS: MADISON, WISCONSIN

### BRANCHES

NEW YORK      BOSTON      KANSAS CITY      MINNEAPOLIS  
WASHINGTON      PITTSBURGH      ST. LOUIS      NEW ORLEANS

### IN CANADA

PLANTS: NIAGARA FALLS AND WINNIPEG  
BRANCHES: TORONTO • MONTREAL • ST. JOHN





Please mention POPULAR RADIO when answering advertisements.

# TUSKA RADIO



## TUSKA POPULAR No. 225

3-bulb Regenerative Receiving Set. Piano finish mahogany cabinet. Amplifier switch. Concealed binding posts. Armstrong circuit. Licensed under Patent No. 1,113,149. Price, \$75 without bulbs, batteries or loud speaker.

Ask for special circular No. 15-F describing this set.



## Your entertainers are ready

Singers, bands, orchestras, speakers, organists, humorists—an unlimited host of performers are yours to command when you own a Tuska Radio. A simple adjustment of dials, and you can choose between them. Dozens of programs are in the air. Your Tuska will bring in whichever entertainer pleases you best and shut out all others.

Tuska owners are not obliged to tinker incessantly and add devices to correct construction faults. Their pleasure is unmarred by troubles. Every Tuska set is finished with exacting care by painstaking New England workmen—the best that live. Then it is examined and tested on distant signals by inspectors who are keenly

critical. Both manufacturing and testing are under the personal direction of C. D. Tuska, a pioneer radio engineer.

For a dozen years before general radio broadcasting began, Tuska-made instruments were famous among radio experimenters for skillful design, superb workmanship and high efficiency. In the past two years, the demand for Tuska Radio has grown enormously. Each set in this increased production of today is as perfectly built as the finest Tuska instrument ever made—and yet, the prices are remarkably moderate for high-grade radio receivers.

Ask any first-class radio store to show you one of the models of Tuska Radio, priced \$35.00 upward

### The C. D. Tuska Co., Hartford, Conn.

Ogden, Utah, receives Troy, N. Y.

"In one evening, using Tuska 225 with one amplifier only, I received 19 stations, including San Francisco; Calgary, Alberta, and Troy, N. Y. Conditions were not abnormal, and the same stations were received again last night.—W. D. Garner."



Picks up Davenport the first time he tunes

"I never had my hands on a set until my Tuska came Saturday. First evening, I tuned in Pittsburgh, New York, Richmond, Ind., and Davenport, Ia. It certainly was great.—Wm. Parsons, Salisbury, Conn."



only  
\$7.50



Clear from  
the "Moon"

You want a Loud Speaker that will swell the sound volume of what your set brings in—without rasping, growling or harshness—so everybody can hear as agreeably as if all used head-phones. That's what you get with the



the most successful  
non-magnetic instrument

**Dealers:**

Boosts by enthusiastic users give you a fine repeat business on the Moon. Write for our proposition.

Two types, for single or double phone connections, same price. For use with your own phones. Heavy iron sound channels. Horn of heavy aluminum with beautiful black indestructible finish. Fifteen inches high. Hear it at your dealer's—if he isn't demonstrating the MOON, order direct from us on guarantee of satisfaction or refund.

**Wilson Utensil Co.**  
Manufacturers → Dayton, Ohio

*Transformation — from  
Back Alley Discord to  
Metropolitan Symphony*

NOTHING IS WORTH WHILE  
UNLESS IT IS  
"RELIABLE"

SOUNDS like *sympathy* instead of *symphony* often trickle through the air to strike unappreciative ears. Many a classic has been mistaken for back alley discord simply because those sound waves had not been refined—"passed through the strainer" as radio slang puts it.

That's where "old Reliable" lends a helping hand, working in its obscure way. Reliable Transformers not only tend to bring distant stations within ear-range but every sound-wave receives a velvet touch of magic which makes the harshness, distortion and similar evils of radio receiving a thing of the past.

**RELIABLE AUDIO and RADIO TRANSFORMERS**

AUDIO Transformers furnished in three different stages of ratios—6 to 1, 4 to 1, and 2 to 1. Fully enclosed. Shielded type. Price \$4.50 and \$5.00

RADIO Transformers made in adjustable types with range from 150 to 1750 meters. Also fixed types. Price \$2.75

ANOTHER BIG-IMPROVEMENT IN YOUR SET

Ask About Reliable Neutralizing Condensers. Only 75c

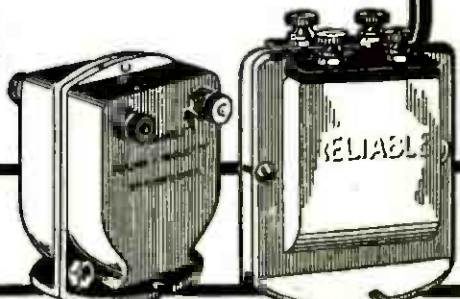

RADIO FREQUENCY  
AMPLIFYING TRANSFORMER

AUDIO FREQUENCY  
AMPLIFYING TRANSFORMER

**The Reliable Parts Mfg. Co.**  
2819 Prospect Ave. Cleveland, O.

# Precise Broadcasting—

## • New Low Prices on Three Great Instruments



Model 285A 5.75

**T**HE PRECISE AUDIO TRANSFORMER is recognized as a supreme achievement by radio engineers. Designed to produce maximum volume, realistic tone qualities and clear rendition of the low tones with the absence of distortion. The instrument is compact in design, neat in construction and appearance, and has a ratio of  $4\frac{1}{2}$  to 1. We will be glad to forward on request a copy of our voltage amplification chart 1094 which accurately records the remarkable performance of this transformer. It is highly recommended for use in neutrodyne circuits.

**T**HE IMPROVED PRECISE VERNIER RHEOSTAT assures smooth, noiseless, and sensitive control of the filament current. It also features single hole mounting, single knob control, zero to thirty ohms resistance, and is universal for all tubes. The Bakelite drum is wound with specially selected resistance wire. Turning the knob in either direction revolves the drum, which is guided by a fine pitched thread on the shaft, thus varying the resistance in the circuit. Select this instrument for your set and enjoy increased range, ease of clearing up or separating broadcasting stations.

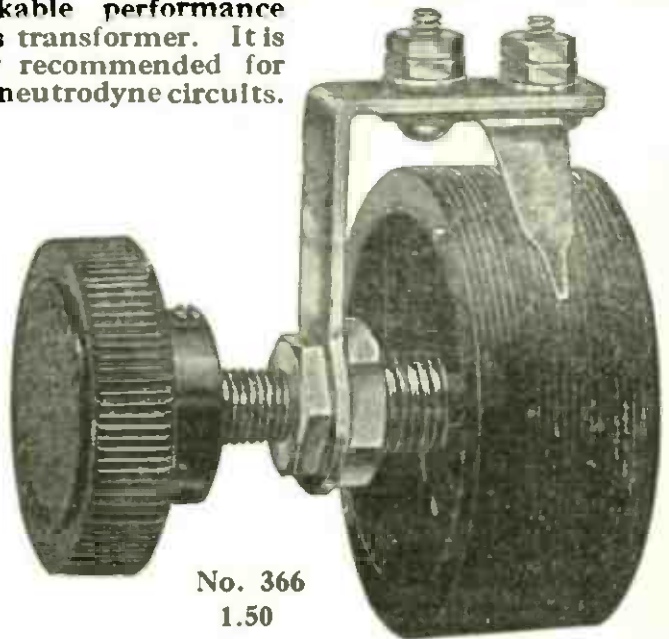

No. 366  
1.50

**I**T is needless to ask why you solder connections on your radio set—for the same reason you should appreciate the importance of using a well built switch lever which will give positive wiping contact on the points and cut down current losses. Our switch lever features a closely fitted shaft bearing, a spring lever of special design to prevent weakening or fracturing under long service. The lever radius is  $1\frac{3}{8}$  inches. A radio set, like a chain, is no better than its weakest member. Install this lever in your set and note the difference.



No. 305  
.35

### TRIAL OFFER

If your dealer cannot furnish these, send us his name or on receipt of price we will forward you any instrument for ten days trial and will refund your money on return if unsatisfactory.

## PRECISE MANUFACTURING CORPORATION

Rochester, :: :: :: New York

53 W. Jackson Blvd. Chicago, Ill. Branches 821 Market Street San Francisco, Cal.  
Distributed in Canada by Perkins Electric, Ltd.  
Toronto Montreal Winnipeg



# Sterling

## 12 POINT ROTARY SWITCH

*The Last Link  
In the Perfection  
of the Radio Set*



**\$1.50**

Do away with unsightly front of board contact-points, and instead provide a complete unit for rear of panel mounting to which variocoupler taps may be soldered easily. The Sterling 12 Point Rotary Switch solves one of the radio builder's most vexing problems. It is the final perfection to assure satisfactory radio receiving.

It is held in place by two mounting screws, the heads of which are covered by the dial. Knob and dial mounted on adjustable shaft held by set screws for any thickness of panel up to  $\frac{1}{8}$  inch. This Switch May Be Used With A Voltmeter For Reading Voltage On Individual Tube Filament.

### *Other Sterling Radio Equipment*

*Portable Rectifiers   Filament Rheostats  
Audio & Radio Frequency Transformers  
Filament Meters   Pocket Voltmeters  
"B" Battery Charging Attachments*

*The*  
**STERLING MFG. CO.**  
2854 Prospect Ave.   Cleveland, O.

## Look For The Green Box

CICO TWO WAY RADIO PLUGS are the largest selling round plugs in America because they are the best.

To eliminate any misunderstanding, CICO PLUGS are now available at reputable dealers' stores in an attractive and individual GREEN BOX with the word CICO on it.

# CICO

### TWO WAY RADIO PLUGS

Be sure you get  
**THE PLUG IN  
THE GREEN  
BOX** and you  
will be sure to  
get the best plug  
on the market  
today.

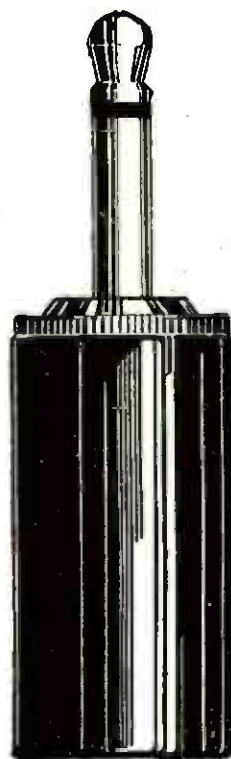

**Price 60c**

**Consolidated Instrument  
Company of America, Inc.**  
41 East 42nd Street, New York



Please mention POPULAR RADIO when answering advertisements.

The  
FERBEND



# Wave Trap

TRADE MARK  
PATENT APPLIED FOR

## STOPS INTERFERENCE

**ANY NIGHT is "SILENT NIGHT" with a FERBEND!**

With each locality operating its broadcasting station on its own wave-frequency, the possibilities for listening in on distant stations are now vastly increased compared with last year. Many owners of long-distance sets are, however, discovering that powerful amplification is of little value so long as local stations are "all over the dials." Here is the secret of the remarkable growth in popularity of the FERBEND WAVE TRAP. For example, a St. Louis user (name on request) brought in Havana on his loud speaker while *three* St. Louis stations were broadcasting. Similar results are uniformly obtained in all parts of the United States, with all makes and types of receiving sets.

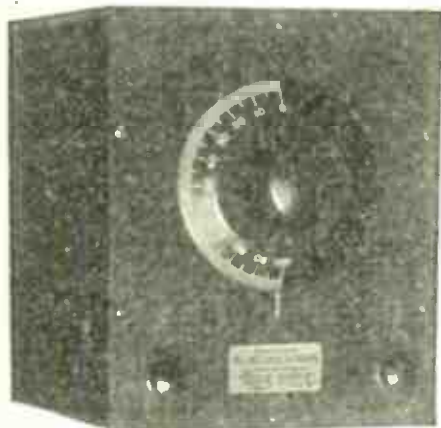

Mounted on Formica panel in Mahogany finished cabinet 6 x 5 x 6  
**\$8.50 Postpaid**



Unmounted ready for panel mounting

**\$6.00 Postpaid**

---

Send in your order now, or write for full information

---

*Do not be misled by imitations. The FERBEND WAVE TRAP is the first inductive as well as the original WAVE TRAP. It is not assembled haphazardly from standard parts, but is made up of special parts designed and manufactured by us for the sole purpose for which they are used.*

**"The Original Wave Filter"**

**Ferbend Electric Company**

**21 E. South Water St. Chicago**

# SAVE MONEY

## Radeco Safety Fuses

"The biggest little thing in radio"

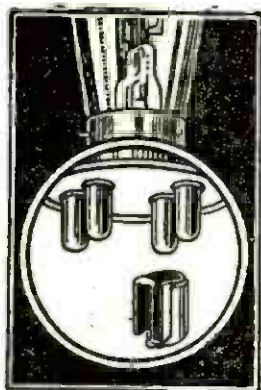

Price 50 cents  
each postpaid

**R**ADIO experts recognize that some means of protecting the delicate filament of vacuum tubes is necessary. Thousands of tubes are needlessly burnt out each year. Radeco Safety Fuses have been developed to prevent this waste. They are endorsed by the leading radio publications. You can now absolutely protect the tubes of your set by slipping a Radeco Fuse on one of the filament terminals of each of your tubes.

Guaranteed not to interfere with the efficiency of your set. Save money by ordering today one fuse for each of your tubes. Mention type of tube.

DEPT. 2

### RADIO EQUIPMENT COMPANY

20 Stuart Street, Boston, Mass.

New England's Oldest Exclusive Radio House  
Distributors of many other successful radio specialties

DEALERS: We are going to appoint live distributors. Write for our proposition and full details.

### READ WHAT ONE MAN SAYS

939 Dunlop Avenue  
Forest Park, Illinois

Radio Equipment Company,

Gentlemen: About last January I purchased some of your Radeco Safety Fuses. I have never had cause to regret this purchase, because I believe it has saved me many dollars. So I am writing to thank you and will recommend them to my Radio friends. The fuses have not interfered in any way with the operation of my set, and you are entirely at liberty to use this letter as an "ad" for your product, if you should so desire. Wishing you success in your present enterprise, I am,

Yours truly,  
Mr. Harvey F. Reese.

9/26/23

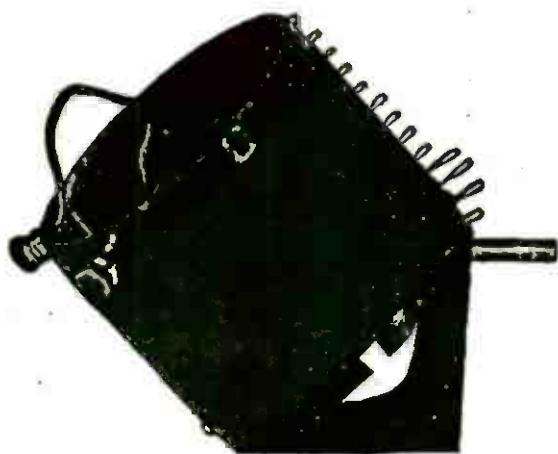

Raven Super 180 Degree Coupler  
Catalogue No. B-104

# RAVEN RADIO

We are now making a 180 degree coupler which is the last word in coupler construction. This instrument is made of Red Moulded Bakelite thruout, including the Bracket. The only metal used is in the two binding posts and the shaft to hold the rotor. These are made of Nickled Brass.

This instrument will not only measure up to all "RAVEN PRODUCTS" but it will stand out on the market as the Best 180 Degree Coupler of the day.

## EVERY RAVEN INSTRUMENT IS UNCONDITIONALLY GUARANTEED

All Instruments are thoroughly inspected before leaving our factory and any purchase made by a Jobber, Retailer or User found defective in any way, will be replaced by us with a new instrument free of charge to the purchaser.

Radio jobbers and dealers should write for our prices and descriptive literature on our complete line.

**RAVEN RADIO, Inc.** 8 Learned Street,  
ALBANY, N. Y.

- Bakelite Variometer . . . . . B-101
- Bakelite Vario-coupler . . . B-102
- Bakelite Tickler Coil . . . . B-103
- Bakelite 180° Coupler . . . . B-104
- Bakelite Rheostat . . . . . B-106
- Wooden Variometer . . . . . C-101
- Wooden Tickler Coil . . . . . C-103



"Listen  
to the Difference!"

**T**HIS Christmas, you can give the C.I.C. loud speaker as a treasured gift. Its cost is low—only \$14.50—and its efficiency is greater than many loud speakers at twice the price.

It is distinguished by small size, grace of line, beauty of tone equal to the famous C.I.C. head set—and it is unconditionally guaranteed. Send for booklet—or "Listen to the Difference" at your dealers.

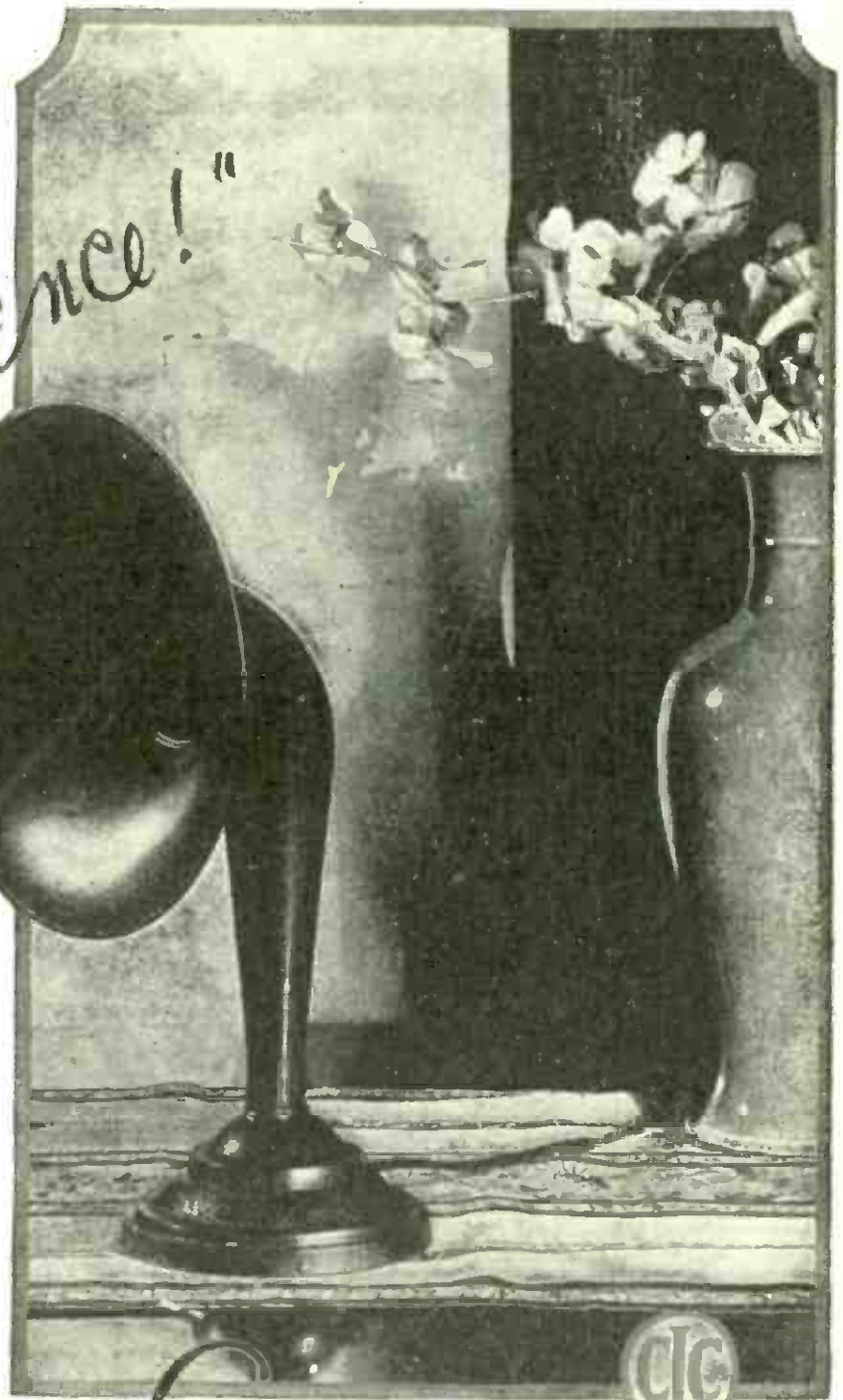

# Loud Speaker Facts

*A booklet will be  
sent on request.*

**CONNECTICUT INSTRUMENT CO.**  
STAMFORD, CONN.

*Distributed in Canada by Perkins Electric Ltd., Toronto, MONTREAL, Winnipeg*





## Send 50c for this FADA NEUTRODYNE BOOK

It tells in simple language how to construct a Neutrodyne circuit receiver using FADA parts. Nothing is left in doubt. Both four and five tube Neutrodyne wiring diagrams are included. In addition, in the rear of the book there are both four and five tube full size paper panel drilling templates.

This 32-page book and the use of FADA Neutrodyne and standard parts will insure successful Neutrodyne circuit receiver construction.

**F. A. D. ANDREA, INC.**  
1581-D JEROME AVE., N. Y. C.



The special FADA Neutrodyne parts including three Neutroformers, two Neutrodons and the HOW-TO-BUILD-IT book sell for \$25.00.

# SPECIAL OFFER!

Good for 30 days only

Two new subs.  
to POPULAR RADIO for only . . . . . **\$3.**

**T**AKE advantage of this Special Offer! It means a big saving to you.

You and a friend of yours may have POPULAR RADIO for a whole year, provided you are both *new* subscribers.

Just wrap your check for \$3 around the double coupon and mail it to-day before the price goes up.

Soon a subscription for *one* year will cost as much as you need now pay for these *two* subscriptions. But you must act at once!

(Coupon good only until December 15th, 1923)

POPULAR RADIO, Dept. 122  
9 East 40th Street, New York City

Please send POPULAR RADIO for one year to:

NAME.....

ADDRESS.....

CITY.....STATE.....

And also to this other new subscriber. Here's my cash remittance— (or a check or money order for \$3.00).

NAME.....

ADDRESS.....

CITY.....STATE.....

(No extra for Canada. Foreign countries 25 cents extra per subscription.)

# A PLEASANT SURPRISE

Awaits the User of the

# A. C. H. SHARP TUNER DIALS

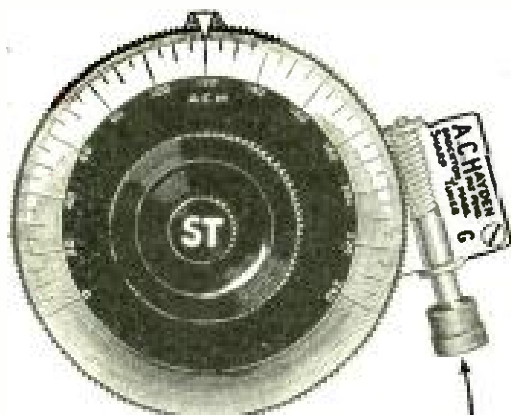

Why the A.C.H. is different  
3 in. DIAL → ACH → 156-10-1  
4 in. DIAL → ACH → 215-10-1

ROUGH TUNING OR 1,000 OF AN INCH IN EITHER DIRECTION

CAN BE INSTALLED AND WILL IMPROVE ANY RECEIVING SET MAKING DIFFICULT TUNING EASY

Price 3 inch size.....\$2.50 complete

Price 4 inch size.....\$5.00 complete

Regular fitting 5/16 shaft 1/4 and 3/16, 5 cts. each, extra

### Money Back Guarantee

The principal of the A. C. H. Sharp Tuner has only been embodied on very expensive instruments where the most delicate adjustment is necessary and then as a permanent part.

### Extra Advantage of the A. C. H.

1. Can be attached or removed from any instrument.
2. Rough tuning same as any dial.
3. Movement so fine that the eye cannot detect but the ear can.
4. Automatically locks instrument so no jar can disturb it.
5. Dial grounded reducing body capacity to a minimum.
6. Special dial 2 graduations where ordinarily one.

Mail orders sent prepaid in U. S. A.

## A. C. HAYDEN RADIO & RESEARCH CO.

BROCKTON, MASS., U. S. A.

SOLD BY RADIO LTD., MONTREAL, CANADA



Make Your  
Reflex Set  
100% Efficient  
By Using

**MPM**  
Million Point Mineral  
**CRYSTAL**

and  
**MPM**  
Reflex Radio  
Frequency  
**TRANSFORMER**



Price  
\$4.50



Prices  
Mounted  
35c  
Unmounted  
25c

M. P. M.  
Reflex Radio Frequency  
**TRANSFORMER**  
Absolute precision in  
the assembling of these  
transformers assures re-  
markable range and vol-  
ume with positive elim-  
ination of distortion.

M. P. M.  
Million Point Mineral  
**CRYSTAL**

Super-sensitive—reproducing  
from every point on its sur-  
face. Greatly increases both  
audibility and radius. Will  
not burn out or corrode.  
M. P. M. Crystal is unsur-  
passed for reception both  
with or without amplification.

**SPECIAL FREE OFFER**

Detailed working diagram of a successful re-  
flex circuit will be sent free with all orders  
for either crystals or transformers.

**M. P. M. SALES CO.**

Dept. P

247 S. Central Ave., Los Angeles, Cal.

**SOMETHING  
NEW!**

**IN RADIO**  
**COAST TO COAST**  
AND  
**HAVANA, CUBA**  
WITH A

**VOISOMETER**  
PRICE \$5.50

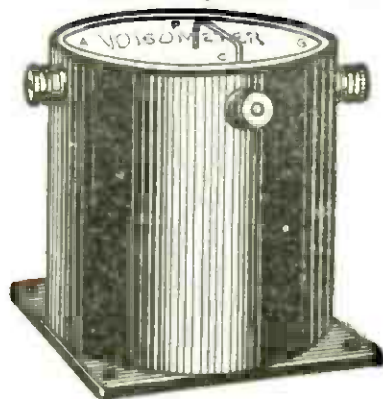

**ELIMINATES  
THE  
VARIOMOTOR  
VARIOCOUPLER  
AND OTHER PARTS**

The Voisometer is extremely Simple in  
Appearance and Operation. You save two  
or more parts of a tube set a saving of 70  
per cent for the Radio Fan.

The only parts used in the Voisometer  
Sets are as follows.

**VOISOMETER  
VERNIER RHEOSTAT  
GRID LEAD  
TUBE SOCKET  
VERNIER VARIABLE  
CONDENSER  
WITH A COMPLETE WIRING  
DIAGRAM**

*Every Voisometer Tested and guaranteed*

**CO-OPERATIVE  
SALES CO.**

**SOLE DISTRIBUTORS**

112 NORTH 7th STREET, ROOM 401  
ST. LOUIS, MO.

**LIVE DISTRIBUTORS & DEALERS WRITE**



Na-ald Special Socket No. 499 for UV-199 and C-299 Tubes. Price 50c



Na-ald Adapter No. 429 For UV-199 and C-299 Tubes. Price 75c



De Luxe No. 400 Price 75c



Small Space No. 401 35c, 3 for \$1.00

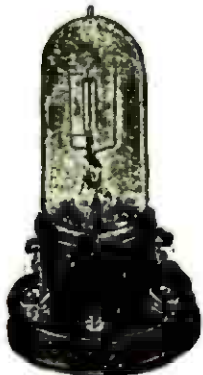

Na-ald W.D. 11 No. 411 Price 75c

# It's the contact that counts

A CAREFUL examination will show that each contact in Na-ald sockets and adapters is of a wiping nature on a broad surface, and so designed that strong tension is permanent, no matter how often the bulbs may be removed or how much the connecting prongs in the tubes vary. Na-ald Sockets are moulded of Bakelite with uniform cross-section, cure and other engineering features incorporated, to avoid plate to grid losses and to insure that each tube develops its fullest efficiency.

The new Na-ald dials combine rare beauty of design with highest efficiency in use. These dials are moulded from genuine Condensite in such a way that absorption losses are reduced to a minimum. Knobs are so shaped that fingers do not conceal clear numerals and graduation on the bevel of Na-ald dials.

*Na-ald Circuit Booklet packed with each Na-ald product*

Write for "Why a Bakelite Socket?" and other descriptive literature

## Alden Manufacturing Company

Manufacturers of sockets and dials for every radio requirement

Dept. C 52 Willow Street

Springfield, Mass.

Cable Address, Aldenco

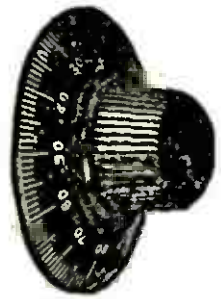

No. 3023-4 2 Inch 35c, 3 for \$1.00

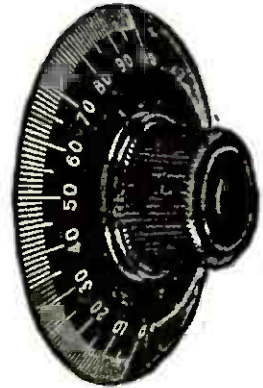

No. 3003-4 3 Inch 35c, 3 for \$1.00

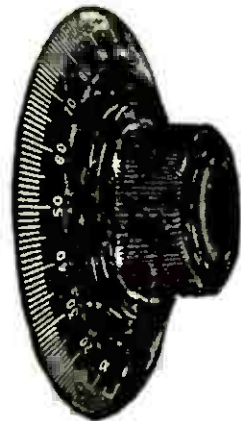

No. 3783-4 3 1/2 Inch Price 75c



Na-ald Knob No. 3153-4 Price 50c

# NA-ALD

## extreme selectivity—

A single tuning adjustment—assuring the greatest degree of program selectivity—enabling one to tune in desired stations and enjoy their broadcasting without the slightest sign of interference by other stations, is one of the features of



### Melco-Supreme

The Tuned Radio Frequency Amplifying Receiver that also

PRICE ONLY **\$140**

Complete knock-down parts for Melco-Supreme including drilled engraved Bakelite panel and solid mahogany cabinet

PRICE \$90

1. Operates with merely a 10 FT. WIRE—not even a ground necessary.
2. Offers exceptional CLARITY without the slightest loss of tone quality.
3. Affords real LONG DISTANCE by covering all Broadcasting ranges from 180 to 610 meters.

We also manufacture a complete line of standard parts under the Amaco Brand. Write for our complete descriptive literature.

**AMSCO PRODUCTS, Inc.**

Broome and Lafayette Streets

Dept. P.R.

New York City

# RHAMSTINE\*

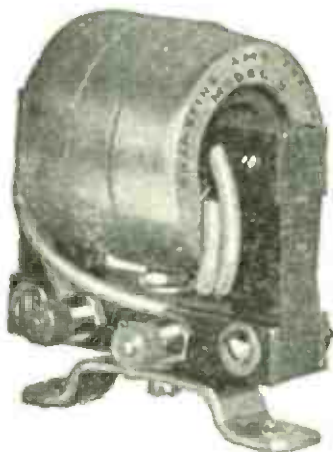

Model B Amplifying Transformer

**\$4.00** Postpaid

For UV 199

use the Model B

### Amplifying Transformer

to secure the greatest efficiency. Each transformer is guaranteed to give satisfaction. Order yours today.

### The Victophone

for your Victrola or Columbia at \$7.50 is the equal of some loud speakers costing much more. Special fittings can be provided for other makes of phonographs, or the unit can be used with a loud-speaking horn. A Victophone is the solution to your loud-speaker problem. Immediate deliveries.



**\$7.50** Postpaid

Manufactured by

**J. THOS. RHAMSTINE,\* Woodbridge at Beaubien Detroit, Mich.**

\* Maker of Radio and Electrical Products





## SIGNALING

**C**ONSIDER the vast difference between the methods of the savage and the marvellous broadcasting of today. This difference can be stated in one word — instruments.

Modern broadcasting employs delicate instruments to transform messages into electricity. Satisfactory reception requires equally fine apparatus to translate this current into the original music or spoken word.

Upon your loud speaker or head phones falls the task of transforming the electric current that flows through your set into sound. Poorly designed or carelessly constructed instruments cannot do this with satisfaction to you.

Holtzer-Cabot Phones and Loud Speakers are the perfected results of 25 years' specialization in the manufacture of sensitive electric apparatus.

- |                              |         |
|------------------------------|---------|
| Holtzer-Cabot Loud Speaker,  | \$25.00 |
| No. 2 Universal Head Phones, | 9.50    |
| No. 4 National Head Phones,  | 6.00    |

Write for booklets, "What you should know about Radio Reception" and "A better Loud Speaker."

THE HOLTZER-CABOT ELECTRIC CO.

125 Amory Street, Boston, Mass.  
6161-65 South State Street, Chicago, Ill.  
Department B

*Holtzer-Cabot*  
BUSINESS ESTABLISHED 1875

HEAD SETS

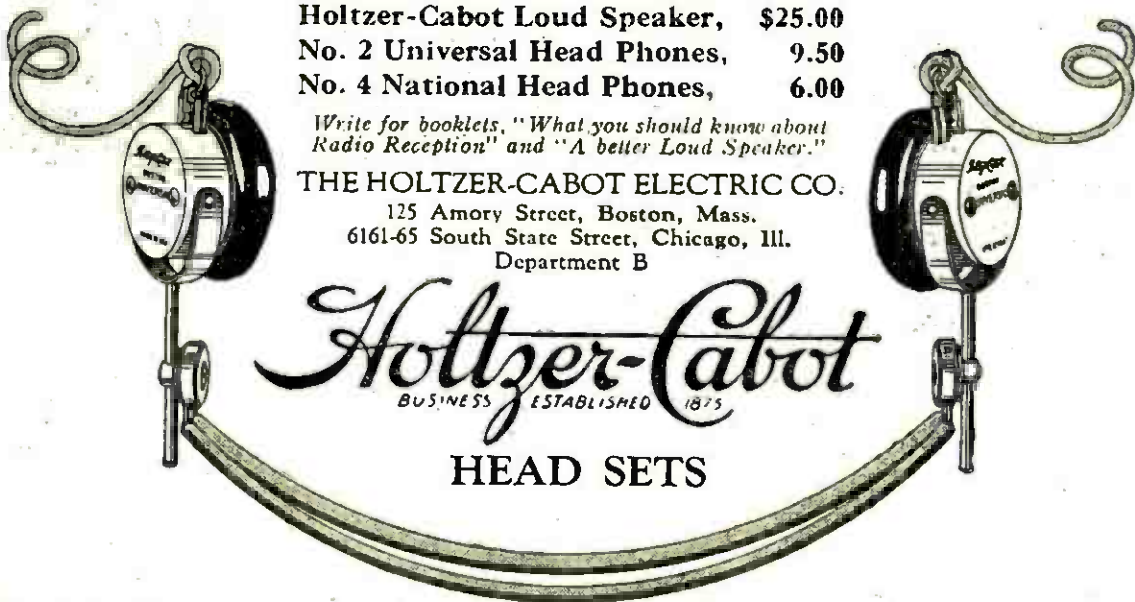

Please mention POPULAR RADIO when answering advertisements.

## The New "Penn C" Receiver. Type GT 2.

A "COAST TO COAST SET" THAT ANY NOVICE CAN OPERATE

Plenty of volume to operate any good loud speaker

List Price  
**\$78.50**  
Without  
Accessories



Efficient  
Selective  
Regenerative  
Easy to Tune

A Three Tube Set That Stays Sold

Licensed under Armstrong Patent  
No. 1,113,149



Established 1910

Three Other Models  
Dealers, Write Us

**PENNSYLVANIA WIRELESS MFG. COMPANY**  
NEW CASTLE, PENNA.

## "Regal" Radio Products—Fit for a King

New "REGAL" Items for the 1923-1924 Season

New "Regal" No. 162  
Double Arm Inductance  
Switch



A 15 Point Switch complete in one unit. No more messy soldering. No more drilling of hole. No more chipped panels. Complete with hard rubber Knob and Dial  
**\$1.50**

New "Regal" No. 200  
Audio Frequency Amplifying  
Transformer



For clearness of tone, amplification of voice and music from nearby and distant broadcasting stations, is unequaled by any Transformer on the market

3/4 to 1 Ratio. . . . \$4.50  
5 to 1 Ratio. . . . 4.75

New "Regal" No. 120  
Vernier  
Rheostat



For fine filament control of tubes and superfine tuning, the Regal Vernier stands alone. Nothing just like it on the market. Complete with Knob:

6-Ohms. . . . \$1.25  
30-Ohms. . . . 1.25

If your dealer does not carry "REGAL" Products, write us direct

*(Send for Catalog No. 24, showing 30 Big "REGAL" Items)*

**THE AMERICAN SPECIALTY COMPANY - Bridgeport, Conn.**

# Precision Adjustment of Coupling Brings in Distant Stations

With CURKOID Couplers elusive distant stations can be tuned in easily and to full volume.

CURKOID Couplers give you *eight times* more accurate control over regeneration than the average variometer and variocoupler. You can take full advantage of regeneration when receiving distant stations without risk of having your set oscillate at the very point of maximum volume.

Coils mounted on CURKOID Couplers move *but one four hundredth of an inch* for each graduation of the dial. The accurately made and finely finished worm drive moves the coils over a range of four inches. This gives you looser coupling than you can obtain with any existing form of mounting. Yet when the coils are as close together as the mounting permits, it is practically equivalent to conductive coupling.

CURKOID interchangeable inductances, which slip into these mountings without fuss or fumble, are the most efficient inductances yet devised. They are wound in the form of the curtate epitrochoid—a circle with a constantly progressing center. Adjacent turns are widely separated yet the winding is concentrated over a limited area, giving minimum distributive capacity and an intense magnetic field. Every CURKOID inductance, no matter how many turns, has the same inside and outside diameter. Minimum resistance, minimum distributive capacity and maximum inductance give the greatest efficiency and selectivity.

CURKOID Dual and Triple Couplers are adapted for use with any circuit.

Send ten cents for booklet showing how to make single and coupled circuit sets, tuned and untuned radio frequency, neutrodyne, regenerative, super-regenerative, the Cockaday, Reinartz and other sets.

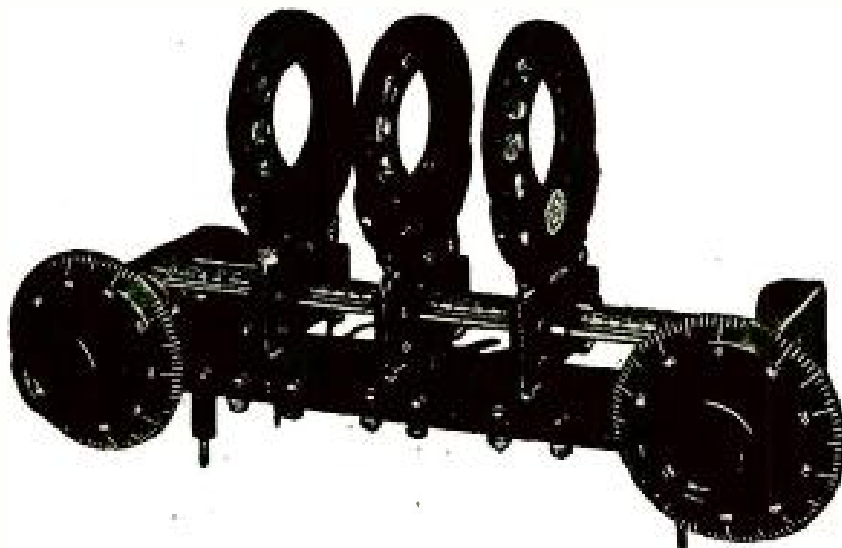

The CURKOID Radio Frequency Unit solves the radio frequency problem. It is the only radio frequency unit which has adjustable coupling and is adapted to any make of tube and wavelength by means of CURKOID Interchangeable Coils. Ideal for tuned and untuned radio frequency. CURKOID Coils give maximum transformation of energy without the usual capacity and resistance losses. Enjoy real efficiency and absolute control of your radio frequency amplifier by using a CURKOID worm driven adjustable coupler with CURKOID inductances.

## RIEGER RESEARCH CORPORATION

114 WEST 44th STREET  
NEW YORK

### CURKOID PRICES

Radio Frequency Mounting.....	\$2.75		
Triple coupler.....	7.50		
Dual coupler.....	4.50		
20K inductance	\$1.40	50K inductance	1.60
25K     "     "	1.50	75K     "     "	1.65
35K     "     "	1.50	100K   "     "	1.70

(Made up to 1500K)



## Reliable RADIO Goods

### Distributors for

Radio Corporation of America	Western Coil
Grebe	Magnavox
Atwater Kent	Burgess
Brandes	Gould
Murdock	Eveready
Nath. Baldwin	Frost
Western Electric	Carter
Acme	Dubilier
All American	Howard
Signal	Eby
Chelsea	Bradley
Cutler-Hammer	
Jewell	

and other standard manufacturers

We carry a comprehensive stock of the latest receiving sets, parts and supplies of the leading manufacturers, and ship from stock promptly.

**FREE** Illustrated,  
**CATALOG** sent  
on request

DEALERS: Buy reliable equipment from a house of established reputation. Send for catalog of tested and approved apparatus, and our discount sheet.

**JULIUS ANDRAE & SONS CO.**  
127 Michigan St., Milwaukee, Wis.

**ANDRAE** In Business Since 1860

## AMPL-TONE PHONES

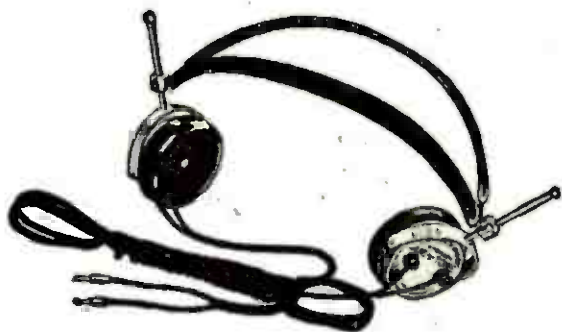

ALWAYS FRESH  
Sample to dealers \$3.20

This is our only  
ADVERTISEMENT

It sells our entire product  
Merit does the rest for us

**C. M. FRENCH MFG. CO.**  
SEYMOUR, CONN.



## For All Batteries

The one charger which re-charges all radio storage batteries—2-volt peanut tube batteries, 6-volt A Batteries, 6 and 12 volt Automobile Batteries, and 1 to 4 B Batteries. It's the new Valley Type A B C Battery charger.

Plugs into regular electric light sockets. Takes about a dime's worth of current for an average charge.

A lot of people were disappointed last year because we could not make enough Valley Chargers. We are making more this year, but with the improvements, they will be in greater demand. Don't miss out. At all good radio dealers.

**VALLEY ELECTRIC CO.**  
3157 S. Kingshighway - St. Louis, Mo.

## Valley Battery Charger

## FREE RADIO VACUUM TUBE SET

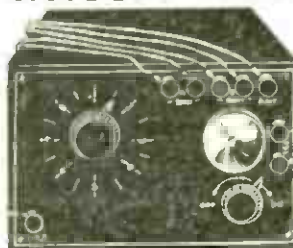

Receives  
100 Miles or More  
Send name and address.  
Learn HOW you can get  
a Vacuum Tube Radio Set  
**ABSOLUTELY FREE**  
Write today for Free Radio Plan.  
**RELIABLE SALES CORP.**  
434 Broadway, N.Y. City Dept. 582

FOR BETTER RESULTS  
**FRAMINGHAM**  
DE LUXE PARTS

Ask Your Dealer

# SOLID COMFORT Comes With The Use Of The

TRADE MARK  
**AUDIOPHONE**  
REG. U. S. PAT. OFFICE

**because nothing is lost from  
the original broadcasting**

Not only is it easily possible to distinguish the words of the speaker, but also the minute graduations in pitch, timbre and quality of overtones which distinguish individual voices.

The Audiophone is complete and self-contained—needs no separate battery or other accessories—goes to you ready for use on connecting to your receiving set. It will prove a source of lasting pride and pleasure.

Audiophone Sr.....Price \$32.50  
Audiophone Jr.....Price 22.50

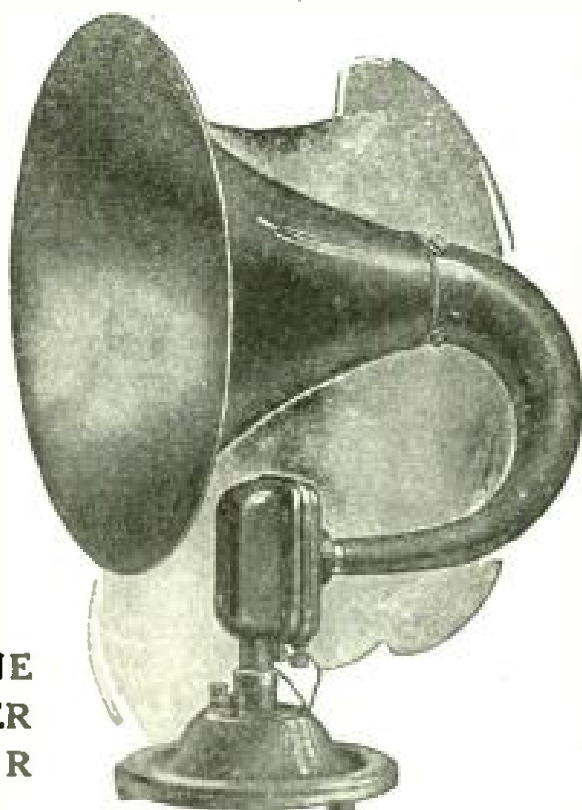

**BRISTOL ONE  
STAGE POWER  
AMPLIFIER**

If greater volume is desired, over what you already obtain, use the Bristol One Stage Power Amplifier. No C Battery required  
Price \$25.00

**THE BRISTOL COMPANY**  
WATERBURY, CONN.

**THE BRISTOL COMPANY**  
Waterbury, Conn.

Please send me without cost or obligation to myself, Bulletins Nos. 3006 and 3011-L on Bristol Audiophone and One Stage Power Amplifier.

Name.....  
Street and No.....  
City.....State.....

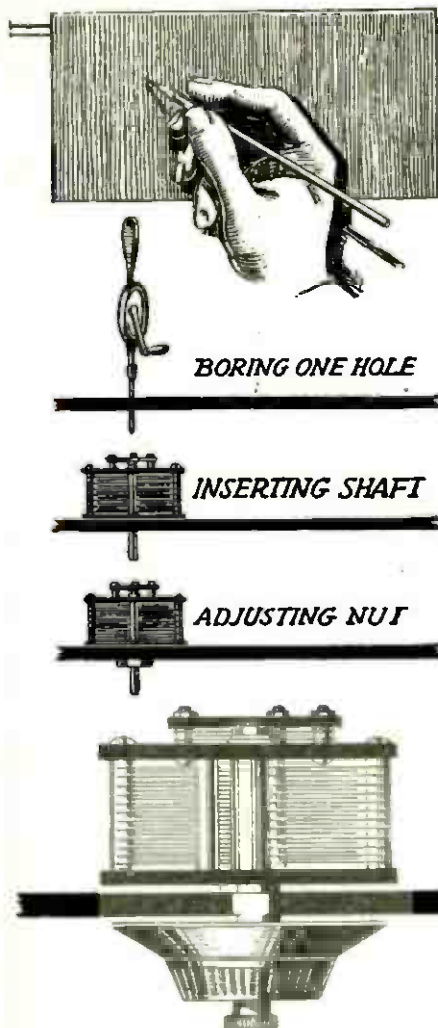

BORING ONE HOLE

INSERTING SHAFT

ADJUSTING NUT

# RATHBUN

SINGLE-HOLE MOUNTING

## SUPERIOR CONDENSERS

TURN the dial of a Rathbun Condenser and notice the absolute lack of side or end play, and the perfect alignment of plates at every point. Yet it turns easily and smoothly because of the extra long brass bearings. Such bearings wear longer so that Rathbun Condensers retain their positive alignment indefinitely. Send for the name of the nearest Rathbun dealer and folder that explains all the points of Rathbun Superiority.

### LIST PRICES—RATHBUN CONDENSERS

PLAIN TYPE			VERNIER TYPE	
5 Plate	.000125	\$3.00	3 Plate	.000075 \$1.00
11 "	.00025	3.00	COMBINATION	
23 "	.0005	3.50	VERNIER TYPE	
43 "	.001	4.50	3-11 Vernier Variable	\$4.50
			3-23 "	5.00
			3-43 "	6.00

RATHBUN MANUFACTURING CO.  
Jamestown, New York

## "RESIST-O-METER" MEANS PERFECT RESISTANCE CONTROL



TYPE-2A

### Ideal Filament Control Over All Receiving Tubes

(Also 5 Watt Power Tubes)

RANGE 0—60 OHMS

Complete vernier action over entire range.

Non-packing fibrous cushion type of resistance variation.

Positively silent in operation.

Size back of panel, 2<sup>3</sup>/<sub>8</sub>" , diameter 1<sup>1</sup>/<sub>8</sub>".

PRICE \$1.80



SCHOLES RADIO & MFG. CORP., 32 W. 18th St., N.Y.



Please mention POPULAR RADIO when answering advertisements.



## The Most Practical Set For Low Wave Specialists

Are you having trouble getting short wave signals? The WC-5-SW shown above picks up signals on wave lengths from 90 to 380 meters sharp and clear. It is built by and for short wave specialists. The price is \$85.00.

# WC-5-SW

Built especially for Transmitting Amateurs

The WC-5-SW is a 4 tube set. One stage of tuned Radio Frequency amplification is employed ahead of the detector to make it super-sensitive. Two stages of audio frequency are used to bring up the signal strength. Uses any type of tubes. Gives perfect control of audibility. Detector rectifies only. Uses antenna compensating condenser. Only two control adjustments. Pure negative biasing on all tubes, thus marked saving on B Battery

current. Tuned Radio Frequency sharpest known and most selective principle ever adopted. Plate potential non-critical. Mono-block tube socket. No grid plate leads on audio amplifiers. Audio amplification absolutely necessary when using low efficiency receiving antenna, i.e., underground or indoor. Mahogany cabinet, piano rub finish. Rabbited-in panel. Split lid cover.

Write for complete description and illustrated folder on this practical set for low wave specialists. All transmitting amateurs will be interested in this literature.

**OTT RADIO, Inc.**  
222 Main St. La Crosse, Wis.

## A New Discovery!

EXTREME SUPER-REGENERATION  
is obtained without noises through

### FRESHMAN

*Variable Resistance Leaks*

by connecting between plate and Grid of the tube as disclosed by the sensational

*New Kaufman Circuit No. 2*



PANEL TYPE

Only the Knob  
Shows on  
the Panel



BASE TYPE

**Absolutely No  
Pencil Markings**

Freshman Resistance Leaks are especially built for use as tuning instruments. Construction is such that they will withstand unusual usage. Freshman Leaks give an unbroken range of 180 degrees from 0 to 5 megohms. Absolutely guaranteed. Enables you to get stations you've never heard before.

*Either Type*

Complete with either .00025 or .0005 mfd. Mica Condenser. \$1.00  
Without Condenser. .75c

At your dealers—otherwise send purchase price  
and you will be supplied without further charge.

Ask your dealer or write direct for free diagram  
showing how you can convert your single tube cir-  
cuit into the new sensational Kaufman Circuit No. 2.

**Chas. Freshman Co. Inc.**  
*Radio Condenser Products*

106 SEVENTH AVENUE,

NEW YORK

## EDSON

Tone Tested  
Radio Headsets

**\$3**  
POST PAID

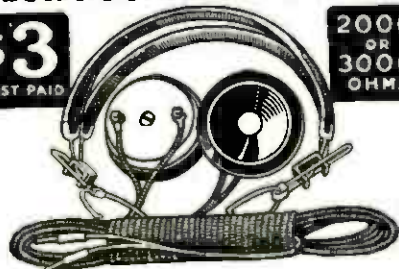

THE lowest-priced first quality headset on the market today.  
Compare with headsets costing twice our price. Return  
ours if not satisfied. Our written guarantee protects you.  
Send \$3.00 by registered mail or money order. Buy  
direct of us and save the difference. We ship, postage pre-  
paid, same day order is received. Ask for our

*Free Catalog of Radio Parts*

**EDSON RADIO SALES CO.**

2 Elmwood

Providence, R. I.

## It charges them all!



## HANDY CHARGER

A Battery Charger that em-  
ploys no contacts that stick and  
give trouble, no liquids nor bulbs  
—yet charges 6 volt batteries at  
5 to 7 amperes and also charges  
12 volt batteries and from 1 to 4  
"B" batteries at a time. Beauti-  
ful metal case—panel with con-  
venient terminals for each size  
battery and Weston Ammeter.

If it doesn't charge 'em all, it  
isn't a

**Handy Charger**  
List \$18.00

**Interstate Electric  
Company**  
*of St. Louis, Mo.*  
4015 Laclede Avenue

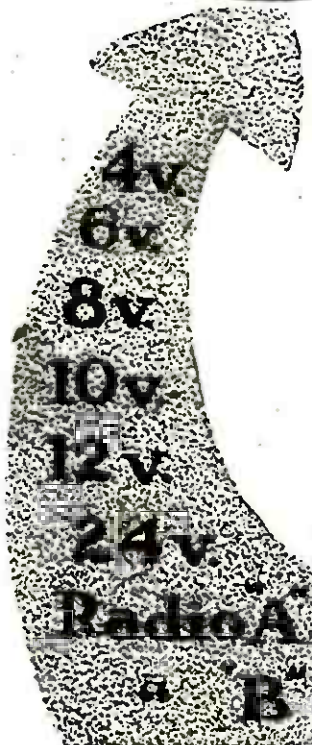

## EASTERN COIL SETS

for the  
**COCKADAY  
CIRCUIT**

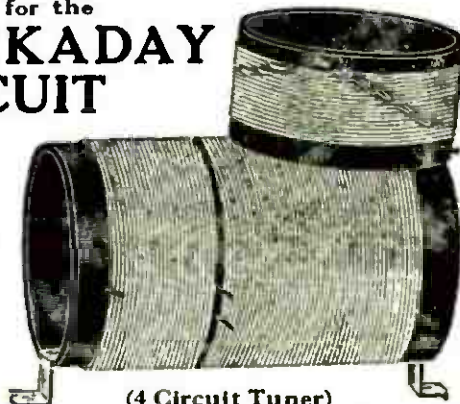

(4 Circuit Tuner)

are now a standard, and in universal use, due to  
their efficiency in this wonder circuit.

Made as per specifications of Mr. Cockaday, using No. 18 wire  
with D coil bank-wound.

**COMPLETE ASSEMBLED  
SET OF B, C AND D COILS. \$2.75**

Hook-up, directions and material list furnished FREE with  
each set of coils.

Mail Orders Filled. Dealers Communicate.

**EASTERN RADIO MFG. CO.**

22 Warren Street, Dept. P. R. NEW YORK, N. Y.



# Will your battery stay for the concert?

**T**HERE is nothing more exasperating than a battery that "signs off" just when you are enjoying a splendid radio concert.

A good A battery should supply uniform filament current during a long period of discharge. Frequent recharging and replacements take all the fun out of radio receiving.

When you hook up your set to an Exide A Battery you'll appreciate what ungrudging battery service means. You'll be impressed time and again with the value of its ample capacity-rating and the smooth, unvarying flow of current that it delivers to your tubes.

## Features you will appreciate

From its heavy, well-made plates to its convenient terminal binding posts, every detail of the Exide's construction is designed to help you get better reception. Vent plugs that may be inserted or removed by a single twist of the wrist

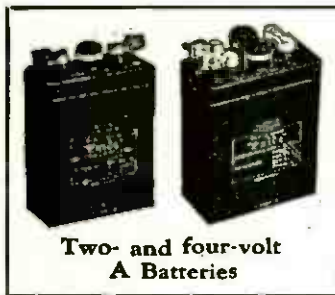

Two- and four-volt A Batteries

make it an easy matter to add water or test the battery. A deep sediment space in the bottom of each cell eliminates danger of internal short circuits or reduced life. Wood separators of the same fine quality that are found in the Exide automobile batteries insulate the plates from one another and also contribute to the battery's long life. A stout detachable handle across the top of the battery makes it extremely easy to carry.

## Two low-voltage A batteries

The Exide line has been extended to include



two low-voltage A batteries, consisting of one and two cells. They are designed specifically for WD-11 and UV-199 vacuum tubes, and are right in line with recent developments in radio receiving.

The two-volt Exide A Battery will heat the filament of a quarter-ampere tube for approximately 96 hours. The

four-volt Exide A Battery will heat the filament of a 60 milli-ampere tube for 200 hours.

## Exide B Battery

Current from the new Exide B Battery is full-powered and noiseless. It is free from fluctuations that cause hissing and crackling sounds in your phones. When you tune in distant stations you know that your satisfaction will not be marred by imitation static that sounds as though a heavy electrical storm were in progress.



Exide B Batteries

You don't have to put up with a battery that discharges quickly. Go to any radio dealer or Exide Service Station and ask for Exide A and B Batteries.

If your dealer cannot supply you with free booklets describing the complete Exide line of radio batteries, write to us.

# Exide

## RADIO BATTERIES

THE ELECTRIC STORAGE BATTERY COMPANY, PHILADELPHIA

Oldest and largest manufacturers in the world of storage batteries for every purpose

Service Stations Everywhere

Branches in Seventeen Cities





**A FISCHER PRODUCT  
EVEN THE EXPERTS LOOK  
NO FURTHER—They Know**

This 180° Multi-Coupler is splendidly built, Bankwound, with a wave length of 800 meters, 5 Soldered Leads, Bankwound Stator on genuine Bakelite Tubing, Kiln Dried Rotor, Fahnestock Spring Clip Connections, Aluminum Mounting Base, Non-conductive Adhesive.

**20 DIAGRAMS \$4.50 FREE WITH EACH**

For sale at your dealer's—otherwise send the \$4.50 directly to the Manufacturer and you will be supplied postpaid.

**G. H. FISCHER & CO.**  
123 Liberty Street New York City

**Fall in Line  
USE RAYCOILS**

for  
Distance  
and  
Volume



RayCoils "A" for Reinartz, Ray Coils "B" for RCS and Ultra Audion Circuits, RayCoils "C" for RCS, Ultra Audion and Tuned Radio Frequency for All Circuits.

A = \$2.50 Use the RCS Circuit with or without  
B = 2.00 Radio Frequency for Simplicity in operation and results. Not equalled by any  
C = 2.00 set for volume and distance.

**Coils in Separate Box  
With Wiring Diagram**

Working Blue Prints of four sheets 12 x 18 of all standard circuits, such as The Variometer, Reinartz and RCS one and three tube sets. 50 cents a set.

If your dealer cannot supply you, send direct to us and we will mail them post paid anywhere in the U. S. A.

**R. C. SCHOONHOVEN**  
Major Q. M. R. C.  
ELGIN, ILL.

**U.S. TOOL CONDENSERS**



**Precisely Lathed Shafts  
Insure Exact Alignment**

The bearings, where continued use first tests the quality of a condenser, in U. S. Tool Condensers are machined as carefully as the parts of the finest precision instruments. The main rotor shafts fits its bearings with just a micrometer determined space between to give smooth, frictionless turning, but without enough space to allow side or end play. Consequently wear is reduced to insignificance. Another reason why all U. S. Tool Condensers are so unconditionally guaranteed.

Write for booklet and the name of your nearest dealer.

**U.S. TOOL COMPANY INC.** 116 Mechanic St.  
Newark, N.J.

**The Three Best  
Radio Bargains**

All good dealers carry Murdock Radio Apparatus because it is standard the world over—made right—priced right. If your dealer cannot supply you, send your order direct.

**MURDOCK HEADPHONES**

Will give you better satisfaction than phones costing more money and will last longer. Now priced at

**\$4.00 and \$4.50**

**MURDOCK LOUDSPEAKER**

Absolutely complete. A clear toned, practical loudspeaker at a very low price. You should have one. (Not suited to crystal sets.)

**\$5.00**

**NEW MURDOCK PLUG JACK**

You need one of these. It enables you to connect four pairs of headphones at once. Low in price, but of best quality. **\$1.00**

**Wm. J. Murdock Co.**  
354 Washington Ave., Chelsea, Mass.  
Sales Offices: Chicago and San Francisco

STANDARD SINCE 1904

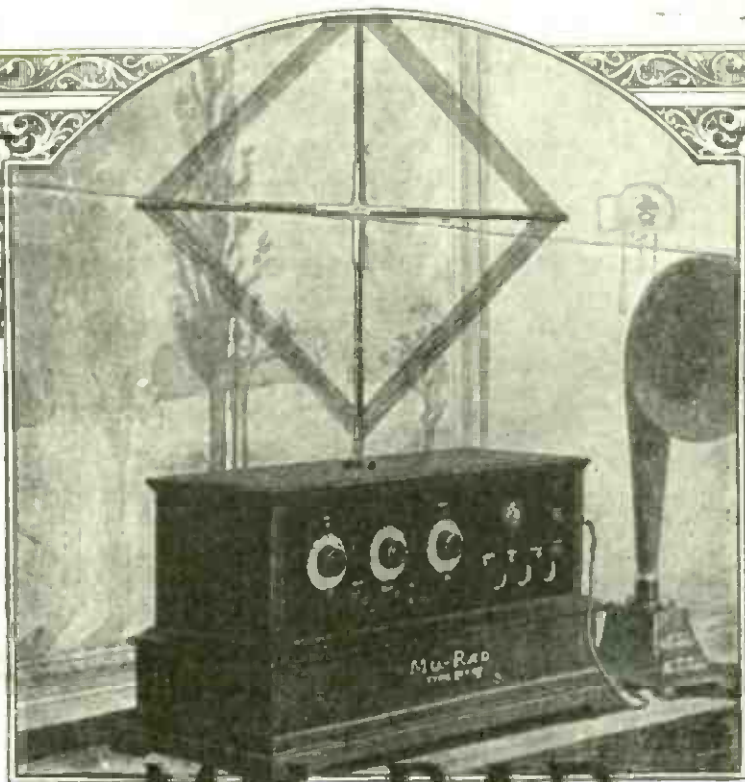

## MU-RAD RECEIVERS

### NEW MU-RAD RECEIVER MA-17

**Y**EARS of scientific achievement anticipated in this *super set*, the MU-RAD MA-17. A new sensitivity, greater distance, fuller volume — with the absolute simplicity and substantial construction of the famous MU-RAD MA-13. Most recently discovered principles are embodied and the future thoughtfully considered in the designing of the MU-RAD MA-17.

Three stages of radio and two of audio frequency amplification and detector. *One* tuning dial and two selecting dials, each independent of the other. Plug-in type r. f. transformers to care for changes of tube type or wave lengths. Panel-mounted volt-meter for quick reading of A and B batteries. Solid mahogany, Adam Brown hand-rubbed finish cabinet with loop fitted into top and compartment in base for "B" batteries. Guaranteed for 1000 miles reception using only a 2-foot loop.

WRITE FOR BOOKLET AND THE NAME OF NEAREST DEALER

**MU-RAD LABORATORIES, INC.**

809 FIFTH AVE ASBURY PARK, NEW JERSEY



# Last Chance to Subscribe to Popular Radio at the Old Price!

*Fill out the coupon below, and save from one to three dollars*

**I**N its improved and enlarged form, POPULAR RADIO now sells for 25 cents on the newsstands. The addition of 56 more pages of reading matter beginning with the November issue, makes POPULAR RADIO the biggest value for the money that can be had in the radio magazine field.

And although the newsstand price has already advanced, the *subscription* price, for a few weeks longer, remains the same. Up to December 15th you can still subscribe to POPULAR RADIO at the old rate—only \$2 for 12 big issues of 192 pages each. After December 15th, the price will be \$3 a year.

### Save Money by Acting Now

A year's subscription to POPULAR RADIO placed now, saves you a dollar over what you would pay later. Or better still, you can now get **TWO YEARS** of POPULAR RADIO for only \$3. This special offer means a saving to you of \$3. In other words, by acting now you may get two years of POPULAR RADIO at exactly **half** the price you would pay after December 15th.

To either **new** subscribers or **present** subscribers this same liberal offer is made. If you are already a subscriber, you may

*extend* your present subscription for one or two years at these low rates, thus insuring yourself of all the helpful hints and practical suggestions, interesting articles, new hook-ups, and the wealth of timely information on all phases of radio which will appear in the pages of POPULAR RADIO during the months to come.

### Mail the Coupon Today

Do not delay filling out and mailing the attached coupon. This offer is good only until December 15th, 1923. After that date all subscriptions to POPULAR RADIO will be at the rate of \$3 a year. By taking advantage of this offer now, you save from one to three dollars.

And in addition, POPULAR RADIO itself—besides keeping you in touch with all the rapid developments in this fascinating field, will save you many times its cost when constructing and improving a set of your own, and will safeguard you against many an hour wasted in costly experiment.

Get only the *best* results with radio by becoming a regular subscriber to POPULAR RADIO. Fill out and mail the handy coupon today. This is absolutely your last chance!

*(This offer holds good only until December 15th, 1923)*

## This Coupon Saves You \$1.00 to \$3.00

POPULAR RADIO, Dept. 125,  
9 East 40th Street, New York City

Please enter (renew, or extend) my subscription to POPULAR RADIO for **ONE YEAR** at the present rate of only \$2.00 a year. This saves me a dollar over what I would pay after December 15th. I enclose \$2.00 (check, money order or registered mail).

Name.....

Address.....

.....

POPULAR RADIO, Dept. 125,  
9 East 40th Street, New York City.

Please enter (renew, or extend) my subscription to POPULAR RADIO for **TWO YEARS** at the special low rate of only \$3.00. This saves me three dollars over what I would pay after December 15th. I enclose \$3.00 (check, money order or registered mail).

Name.....

Address.....

.....

*(No extra for Canada. Foreign, ONE YEAR, \$2.25; TWO YEARS, \$3.50).*



# AMPLION

The World's Standard Loud Speaker

## You Never Tire of the Amplion

THE most striking thing about the Amplion is that its reproduction is never tiring. Its perfect rendition, absence of harshness gives you a thrill that is pleasing and refreshing.

No matter if it's voice or instrument, the charm is there. The message has lost nothing in its flight through space. It holds you and enthalls you just as if you were listening to the original.

The Amplion is made in several sizes to suit all occasions and pocket books from \$18 for the Junior model to \$66 for the Concert type

Ask your dealers to let you hear the Amplion. You owe it to yourself to hear the world's standard loud speaker before you buy.

Folder of styles and prices on request.

Patentees:  
Alfred Graham & Company

### Signal Electric Mfg. Co.

Sole U. S. Distributors Menominee, Mich.

BURNDIPT OF CANADA, Ltd.

Canadian Distributors  
172 King Street, W.,  
Toronto



Amplion  
Beauty  
AR-15  
\$46.00



Phonograph Unit  
AR-35—\$24.00



Amplion  
Dragon  
AR-19  
\$40.00



Amplion Junior  
DeLuxe AR-45  
\$26.00



Amplion Portable  
AR-61—\$50.00



Amplion  
Junior  
AR-39  
\$18.00

The Supremacy of the AMPLION is the Supremacy of Actual Performance



**KEYSTONE**  
RADIO LIGHTNING  
**ARRESTERS**

\$2.00  \$2.00

Should be on every aerial the year 'round. Provides highly efficient lightning and static protection for the home. Fully approved by Fire Underwriters. Can be installed out-doors. Has no vacuum to lose. Install one in your aerial lead now—be safe.

This pioneer radio arrester is backed by 21 years experience in lightning arrester design. For sale by Dealers everywhere, or sent post-paid for \$2.00. Write for circular.

**Electric Service Supplies Co.**  
17 & Cambria Sts.  
Philadelphia

Monadnock Bldg., Chicago  
60 Church St., New York



YOUR SET DESERVES A  
**TURN-IT**  
GRID-LEAK  
"ADJUSTABLE"

75c  75c

THIS IS FULL SIZE—AND SHOWS THE CONTACT PIECES IN POSITION FOR MAXIMUM RESISTANCE WHEN FULLY SUBMERGED IT HAS MINIMUM RESISTANCE. ALL INTERMEDIATE VALUES ARE OBTAINABLE. FITS ALL STANDARD MOUNTS

**Charles E. Bonine**  
20 So. 15th St. Philadelphia

**Long Distance**

That's where!

THE NEW  
**Pathe**  
LOUD SPEAKER

**RULES SUPREME**

Price \$22.00

Pick up the Drake Hotel, Chicago, on any good set. Plug in a Pathe Loud Speaker. You'll get it as clear and loud as a local station. No speaker can compare with a Pathe for distant work. That's why thousands of Neutrodyne owners have bought a Pathe—the best at any price.

*Every Pathe Loud Speaker is Guaranteed*

**PATHE PHONOGRAPH & RADIO CORP.**  
20 Grand Avenue Brooklyn, N. Y.      533 South Wabash Avenue Chicago, Ill.



  
*The Saturn*

**"Above the Ordinary" Radio Products**

**Automatic Plug**  
Terminal tips inserted, or removed in a moment. Perfect electrical connection without taking apart or soldering. Your satisfaction with the Saturn Automatic Plug unreservedly guaranteed. **\$1**



**Perfect Jack**  
A difficult soldering job made easy by crow-foot offset and solder-flex compound on blades. Brass brackets, nickel-plated, with rounded corners. Blades of spring German Silver. Solid silver contact points. Right in every detail.

List Prices

No. 1	Single Circuit, Open	.....	.50c
No. 2	" " closed	.....	.55c
No. 3	Double " "	.....	.70c
No. 4	Single Filament control	.....	.75c
No. 5	Double " "	.....	.80c

Write for Folder

**The SATURN Mfg. & Sales Co.**  
48 Beekman St.  
New York, N. Y.





Please mention POPULAR RADIO when answering advertisements.

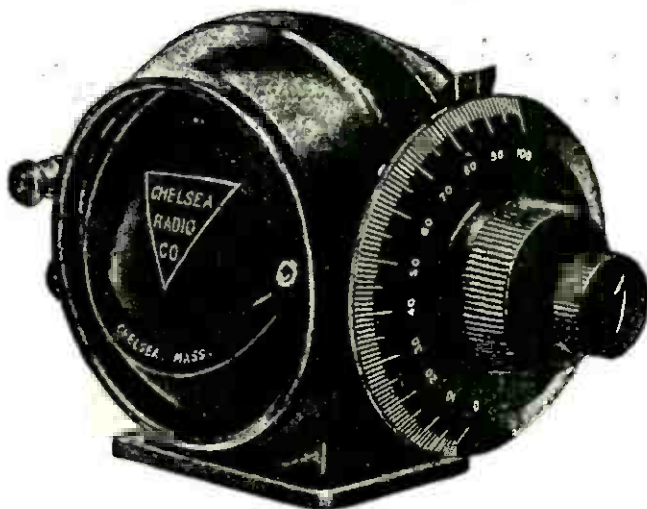

*Get the Maximum Out of  
Your Receiving Set*

Vernier  
Variometer  
No. 80  
\$8.00



Variocoupler  
No. 90  
\$8.00

BY USING  
**CHELSEA VARIOMETERS  
AND VARIOCOUPLERS**

**Y**OUR Set will tune sharper, thereby eliminating troublesome interference and will bring in stations you have never heard before.

ALL insulation is moulded bakelite. Great wavelength range—100-600 metres. No sliding contacts, therefore no objectionable noises. May be used for table or panel mounting. Variometer contains a *built-in* Vernier, an exclusive Chelsea feature.

Variocoupler contains individual binding posts for all taps.

Complete with Chelsea grade 3¼-inch dials.

*Prices, \$8.00*

**OTHER QUALITY CHELSEA RADIO EQUIPMENT:**

Variable Condensers with Vernier	\$4.25 to \$6.75	Rheostats	\$1.00 and \$1.40
Variable Condensers	2.50 to 5.00	Tube Sockets	.50
Audio Transformers	3.75 and 4.50	Dials	.40, 45, 50

*Write for our large catalogue, No. 3, which illustrates and describes the complete line of Chelsea Receiving Sets and Parts*

**NATIONAL CHELSEA RADIO CORP.**  
739 Boylston St., Boston, Mass.



**\$8**



**A phone plus a  
FIBERTONE  
makes a beautiful  
musical instrument**

The highest tonal quality undisturbed by either metallic noises or distortion is best obtainable with a fiber horn. This one factor is the reason for Fibertone's popularity. And the low price for such fineness is a sensation of the radio world. The beautiful crystalline finish of the Fibertone fits it for any place where the finer things of the home are seen.

If your dealer cannot supply you write direct.

**FIBER PRODUCTS COMPANY**  
24 Orange St. Bloomfield, N. J.

**FIBERTONE**

RADIO HORN

**VERNI-TUNER**  
(Trade Mark)

**3 in 1** Primary, Secondary and Variable Condenser

**NO TAPS - - NO INTERFERENCE**



No. 453 Price \$5.00

**Indispensable for construction of Radio Sets**  
Just add a rheostat and socket and you have a complete regenerative set.

**MOST SELECTIVE TUNER MADE**  
*Saves Labor—Space—Money*

Serves as the main tuning device for all regenerative circuits, reflex circuits and the Horne "Combined Tuned radio frequency and reflex" circuits. Other units for Reinartz, Cockaday, Flewelling and other circuits.

Booklet of 14 circuits free with each device.

At your dealer or postpaid on receipt of purchase price. Write for leaflet.

**HORNE ELECTRIC & MFG. CO.**  
Mercer & Colgate Sts. Jersey City, N. J.

for  
**PURE TONE QUALITY  
and MAXIMUM VOLUME**



Price \$7  
Ask your dealer.

Or, sent carriage charges collect.  
(Wt. 1 lb.)

**The AMERTRAN**  
—REG. U. S. PAT. OFF.—

**AUDIO TRANSFORMER**

—recognized by the Radio Profession as the  
**STANDARD of EXCELLENCE**

Turn ratio, 5:1. Amplification ratio, 30-40 times audibility in the flat part of the curve.

Send for Circular 1005

**American Transformer Company**  
Designers and builders of radio transformers for over 22 years.  
175 Emmet St., Newark, N. J.

**ARMORCLAD FOR  
YOUR PROTECTION**



Here is a tiny efficient instrument for controlling the filament temperature of U. V. 199 or similar tubes. It has a nichrome resistance unit, polished nickel finish, Bakelite knob and pointer, and is arranged for one hole panel mounting in a very small space.

**THE MAR-CO 30 OHM ARMORCLAD RHEOSTAT** can be mounted on any radio frequency set in series with the potentiometer as a vernier adjustment and is worth its weight in gold as a critical control for regeneration.

**LIST PRICE \$1.00**

**MARTIN-COPELAND COMPANY**  
Providence, R. I., U. S. A.

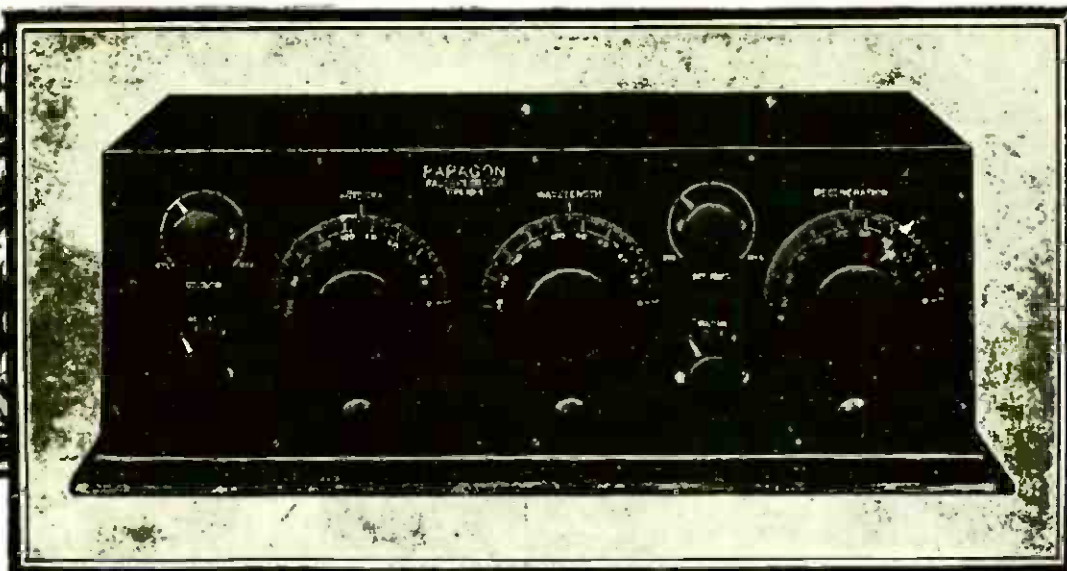

Type RB-2

Price \$135.00

## Announcing a *New Paragon Receiver* —the Ideal Family Christmas Gift

What could be a more wonderful Christmas gift than a radio receiving set that you *know* is the best money can buy? Think of the pleasure it will bring to every member of the family, young and old. Think of the happiness it will mean to you every night of the year.

PARAGON Radio Receivers are famous as the three circuit pioneers which have proved their superiority by eight years of practical operation.

The newest PARAGON, pictured above, is the last word in sensitivity and selectivity. The superiority of this type over all other classes of receiving equipment has been thoroughly proved by the long list of distance records which it holds. Included in these records are the reception of the first transcontinental amateur message, the reception of the first trans-Atlantic message, and the unbroken communication which it has maintained with the McMillan

Expedition frozen in above the Arctic Circle.

The operation of the new PARAGON receiver is so materially simplified that even in the hands of a novice it equals in every way the performance of the older type in the hands of an expert.

All cabinet work is of mahogany with a brown mahogany finish. All metal parts showing, inside as well as outside of the cabinet are nickel plated. 98% of the wiring is invisible. The whole outfit is compact, neat, solidly built, and finely finished. It is the ideal Radio receiver and the ideal holiday gift.

*An illustrated catalog of Paragon Radio Products is yours for the asking*

Dealers: We believe in the proper distribution of Paragon Radio Products. Our Exclusive Distributors are particularly interested in territorially protected dealers, who will concentrate, solicit and serve the consumer in the sale of Paragon Radio Receivers. If interested, write us for details.

ADAMS-MORGAN CO., 20 Alvin Avenue, Upper Montclair, N. J.

# PARAGON

Reg. U. S. Pat. Off.

## RADIO PRODUCTS

A Perfect Christmas Gift **\$7.00**



At Your Dealer's or Direct  
**RADIOCEIVE MFG. CO.**  
NEWARK, N. J.

# YELLOWTIP

MICROMETER ADJUSTING  
**CRYSTAL DETECTOR**

INCREASES THE EFFICIENCY OF YOUR CRYSTAL SET



Any adjustment made in a moment—fixed instantly! Holds indefinitely, until you wish to change, then—"A Twist of the Wrist, It's Set." Ideal for reflex and other circuits. **\$2**

Write for folder and name of your nearest dealer  
Dealers and Jobbers—Write for Attractive Proposition

**Wholesale Radio Equipment Company**  
Exclusive Factory Representatives  
36 William Street Newark, N. J.

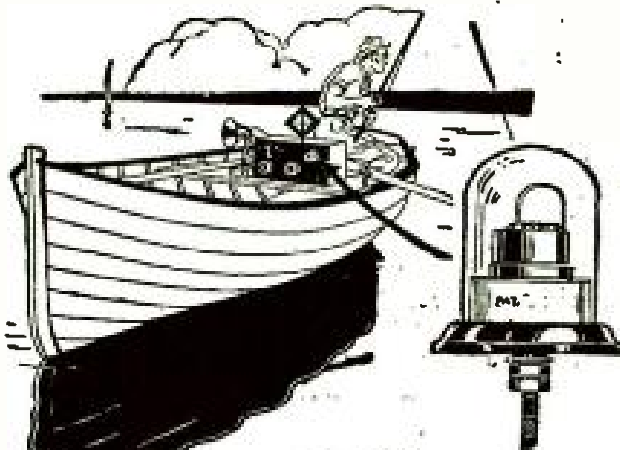

*It's Fun to Fish  
for Fish BUT—*

fishing for a spot on your detector  
is no pleasure at all

## THE GREWOL FIXED DETECTOR

is always set and ready for use. No adjusting or replacements. The most satisfactory, always sensitive, guaranteed detector. **\$2**  
At your dealer's or direct upon receipt of



Write for free booklet with new reflex hook-ups.

**RANDEL WIRELESS COMPANY**  
4 Central Avenue, Newark, N. J.

# HIGHEST QUALITY SILVERTONE Lowest Price TUBES

**O-T**  
SILVERTONE  
DETECTOR  
AND  
AMPLIFIER

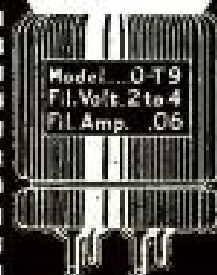

TONE—like a silver bell.  
VOLUME—unexcelled.  
LIFE—2000 to 3000 hours.  
OPERATES—on dry cell  
or storage battery.

THREE MODELS

Voltage 2 3 5

Max. consumption 05 15 25

FULLY GUARANTEED

One Price \$6.00 Everywhere

See also the Silver Tone Detector and Amplifier, which can also operate on dry cell. Literature free on request.

Send no money. Pay the postage. Money back, without question, if not exactly as advertised.

Manufactured by  
DeForest Tel. & Tel. Co.

O. & T. Electric Corporation  
1918 Broadway New York

also other representative dealers



Please mention POPULAR RADIO when answering advertisements.

MEMBER  
RADIO

MANUFACTURERS  
OF



SECTION

ELECTRICAL  
SUPPLIES

# AUTOMATIC SELECTOR SWITCH

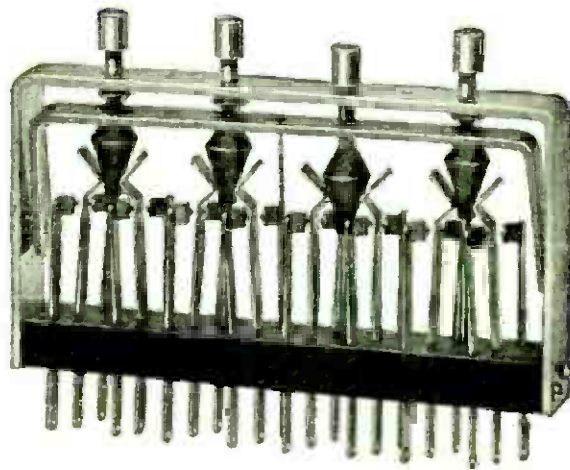

CATALOGUE No. 110 \$6.50

The automatic selector switch is designed to do away with jacks and gives both phone and filament control. The phones or loud speaker remain permanently connected and it is only necessary to push the various buttons to shift from detector to one step or two steps or vice versa.

This switch is entirely automatic in its operation. It is built of first class material throughout, all springs are made from phosphor bronze, all contacts made of sterling silver.

*We can make immediate shipments from stock*

**R. MITCHELL CO.**

**255 Atlantic Ave.**

**Boston, Mass.**

Pacific Coast Office: 709 Mission St., San Francisco

Export Office: 44 Whitehall St., New York



Warren Radio Loop, cut away to show construction

**Keep Your Set Small**

A WARREN Radio Loop the most compact loop aerial, will fit inside your cabinet, under a table in almost any odd space. Remove the unsightly, dangerous, troublesome, old-fashioned outside antenna. A Warren Radio Loop simplifies, increases efficiency, and makes your set more useful.

**WARREN RADIO LOOP**

Type A-737 (300-700 meters) 6 inches square—non-directional.....\$10  
 Type A-7236 (175-1000 meters) 6 inches square—non-directional.....\$12  
 Type B-2537 (300-700 meters) 18 inches square—directional.....\$20  
 Type BL-2520 (200-18,000 meters) with honeycomb coil mounting, 18 inches square—directional.....\$25

Send for Bulletin I-102  
**V-DE-CO RADIO MFG. CO., Dept. F, Asbury Park, N. J.**



**resistant!**

BDXX has higher dielectric strength than is ever required in radio.

Perfect for panels!

**bakelite-dilecto!!**

(A Laminated Phenolic-Condensation Material)

It is the only good insulator having amazing mechanical strength—yet readily machinable like metals.

Tough, durable, super-resistant. Resists water and solvents. Won't warp.

Ask any electrical man to get Bakelite-Dilecto (xx grade) cut to size for you.

**THE CONTINENTAL FIBRE CO.**  
 Factory: Newark, Delaware  
 Dealer Service From:  
 New York, 233 Broadway  
 Pittsburgh, 301 Fifth Ave.  
 Chicago, 332 S. Michigan Ave.  
 San Francisco, 75 Fremont St.  
 Los Angeles, 411 S. Main St.  
 Seattle, 1041 Sixth Ave., S.

**The Ideal Gift For Your Radio Friend**

**\$15.00**

F. O. B. Cleveland



Type 6 charges 6 Volt Storage Battery from any 110 Volt 60 Cycle lamp socket at average rate of 6 amperes, or over if battery needs it.

Scarcely a gift you could think of will bring more genuine appreciation than the satisfaction obtained from an F-F Battery Charger.

Buy from your dealer. If he cannot supply you, write for literature or enclose remittance covering express or postal charges on 9 lbs.

**IT'S FREE—Write for Bulletin No. 44**

**The France Mfg. Co.**  
 10444 Berea Road Cleveland, Ohio  
 Pioneer Manufacturers of Patented Battery Chargers



**For Radio Aerial Installation**

**THE BULL DOG MAST SEAT**

FILLS A LONG FELT WANT by enabling anyone to install a firm and rigid mast, on either a peaked or metal ridge roll type of roof, with ordinary tools found around the home, thereby eliminating customary trouble, labor and expense. Supplying neat, substantial construction throughout the entire aerial.

Seat for 1 1/2" mast, hinged type.....\$3.00  
 Seat for 1 1/2" mast, peaked type, plain.....2.50  
 Seat for 1" mast, peaked type, plain.....2.00  
 Seat for 1 1/2" mast, flat base.....2.50

Jobbers and distributors write for discounts.

**MAST SEAT MFG. CO.**  
 121 5TH ST. S. E.  
**MINNEAPOLIS MINN.**



The little button projects to warn, "I'm ON—don't forget me!" Saves both tubes and batteries.



The C-H Radio Switch can be installed on any panel in only a few minutes. Just one 7-16 inch hole is required. Large, convenient binding posts with cupped washers make wiring easy.

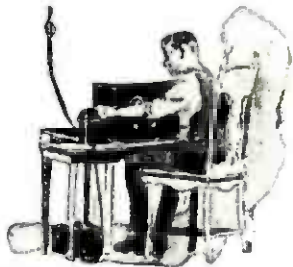

The heavy capacity of the C-H Radio Switch makes it suitable for a great number of radio control applications. Its perfect mechanism is the result of more than fifteen years' development by the famous C-H engineers, specialists in electrical control.

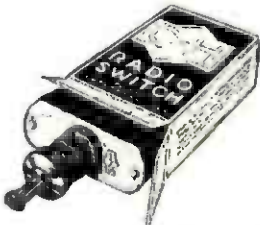

The Genuine Cutler-Hammer Radio Switch is sold only in the orange and blue carton, marked plainly with the C-H Trade mark. There is no substitute—even the Cutler-Hammer engineers could not build a switch to meet radio requirements and sell for less.

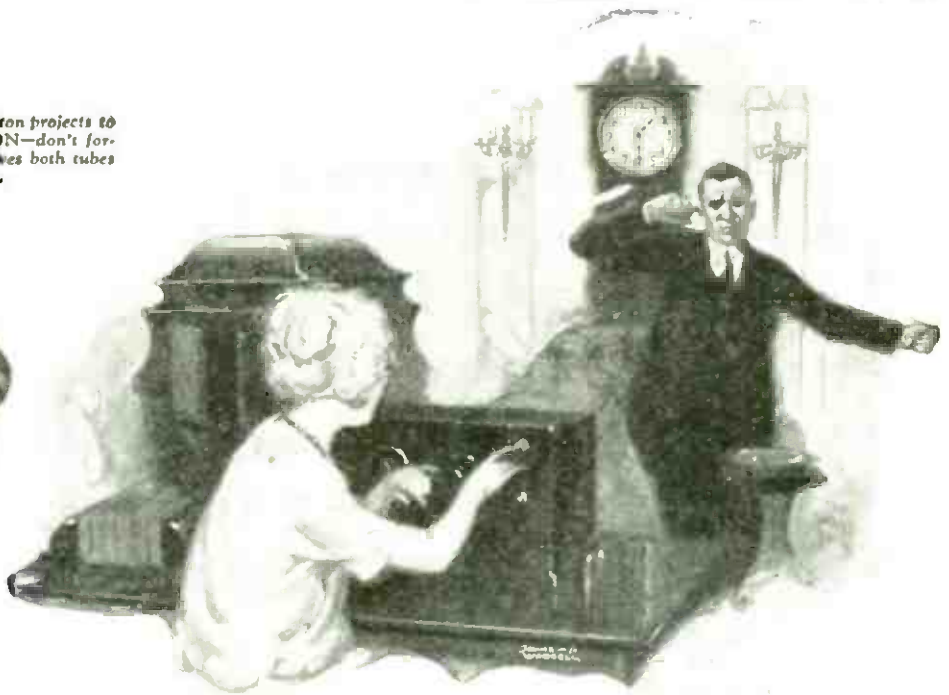

## If You Use the New Tubes You Certainly Need This C-H Switch

*There is No Filament Glare to Remind You When the Current is ON—The Little Nickeled Button Takes Its Place*

There is no easier, safer way to protect *any* tubes than by placing a C-H Radio Switch directly in the "A" battery circuit. Then you can always be certain, when you push in the sparkling nickel button, that the current is *completely off* throughout the set.

But with the new tubes, this little convenience becomes a necessity. There is no filament glare to remind you, and unless a C-H Radio Switch button projects to say, "I'm On, don't forget me," you may easily do so at the cost of tubes and batteries.

See your dealer today. Have him show you the Radio Switch in the orange and blue box—and look for the C-H trade mark. Then you can be sure that it has the famous C-H wiping knife-blade contact that cleans itself and holds a perfect connection so as not to introduce microphonic noises when used in the most delicate circuits. It only takes a few minutes to install on any panel and adds hours of pleasure. If your dealer is not yet stocked, send 60c plus 10c for packing and you will be supplied promptly.

**THE CUTLER-HAMMER MFG. CO.**

Member Radio Section, Associated Manufacturers of Electrical Supplies

MILWAUKEE, WISCONSIN

# CH

# RADIO SWITCH





A  
SUPER  
VERNIER  
RHEOSTAT

**\$3.00**  
AND  
WORTH IT

## 100% Efficiency from Your Tubes

There is no substitute for the Premier "Microstat"—no other instrument that gives such perfect control of the current delivered to the filament of radio tubes. New principle—two windings in parallel—one 6 ohm—other 40 ohm. Absolutely noiseless. Infinite control—handles any tube—Cap. 3 amp. Bakelite moulded—silver etched dial. Do not install a rheostat until you know all about the "Microstat." Our Bulletin No. 97 explains it in detail. Send for it. It's FREE.

**Premier Electric Company**

3807 Ravenswood Ave. Chicago

Ask your Dealer for PREMIER  
**"MICROSTAT"**  
TRADE MARK

# B. T.

## BREMER-TULLY UNIVERSAL-TUNER

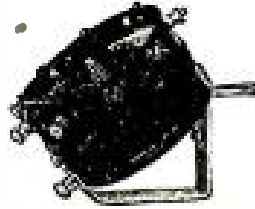

**\$5.00**

## Gives

1. Vernier control hitherto unobtainable.
2. Unequalled results in single circuit regenerative Ultra Audion, etc.

## Replaces

3. Tapped Reinartz Coils.

## Highly

4. Selective and efficient for Reflex and R. F. Hook-ups.

Our new Booklet, "Better Tuning," will help you. It includes valuable information and new photodiagrams. Sent on receipt of 10c—free with each tuner.

**Bremer-Tully Mfg. Company**  
534 S. Canal St., - - Chicago, Ill.

LOUD  
SPEAKER  
\$18.50



HEAD  
SET  
\$4.50

## "ROYALPHONE" KING OF ALL



A complete loud speaker of superior qualities. Will reproduce music or speech with no distortion.

No extra batteries required. Will operate at one or more stages of amplification.

Comes complete with 6 foot cord. 24" high—14" bell—Crystaline Finish.

Loud Speaker Unit with special phonograph attachment

\$8.00. Can be attached to any horn or phonograph arm.

We are the makers of the "Royalphone" King of All headset at \$4.50.

**Royal Electrical Laboratories**  
Dept P. R., Newark, N. J.

*Royalphone*  
KING OF ALL

# DURHAM

## Variables

High  
Resistance

### No. 201 A

Special for UV201-A, C301, and WD12 tubes. Plunger control accurately variable from 2 to 10 megohms. Only 75c at dealers.

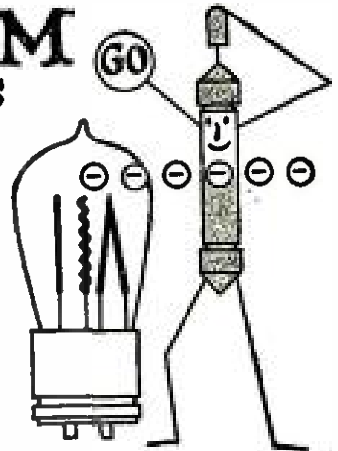

Durham Base, 30c

FREE folder tells how variable grid leaks work. Ask your dealer for copy

**DURHAM & CO., Inc.**  
1930 Market St., Philadelphia

**Dealers:** When what you sell gets better results, the customer comes back — for more DURHAMS

# -JUST PLUG IT IN,

## IT FITS A STANDARD SOCKET



*An Adapter for UV-199 and C-299 Radiotrons which supplies the required resistance*

It is no longer necessary to use an extra resistance coil, in series with low resistance rheostats — and the substitution of a high resistance rheostat is a needless expense.



The change to UV-199 and C-299 tubes may be made by simply connecting to a filament battery of proper voltage and inserting this combination Resistance-Adapter.



### CONSTRUCTION DETAILS

- (1) Contact at tube terminals is positive. Steel spring supplements tension of phosphor bronze contacts.
- (2) Design of Spring and method of mounting contacts gives low distributed capacity.
- (3) First quality insulation, moulded in one piece, reduces leakage to a minimum.
- (4) Resistance element (18

ohms) is counter-sunk in a deep groove, assuring thorough protection from mechanical injury.

(5) Projecting knurled edge simplifies insertion and removal of Adapter.

(6) Like all other Eisemann Products, this unit will be found to be thoroughly efficient and high grade.

*Ask Your Dealer For It*

**Price, \$1.25**



**EISEMANN MAGNETO CORPORATION**

*William N. Shaw, President*

**BROOKLYN, N. Y.**

**Detroit**

**Chicago**

**San Francisco**

## Revolutionary Construction Gives Increased Efficiency In The **BROCKWAY** VARIABLE CONDENSER

There are only two spring bronze plates, separated by mica and scientifically formed to properly control the capacity curve. The result is elimination of high resistance and moving contacts, and reduction of radio frequency and dielectric losses. Beautifully finished genuine bakelite dial and base.



**Easier to Adjust**  
than a vernier. Two complete revolutions of dial (720 degree movement) allow a wide range for fine adjustment, making accurate tuning easy and more stations possible.

**Saves Space**  
Mounts entirely on front of panel, leaving more room behind for other instruments, tubes, B batteries, etc.

**More Efficient**  
in radio frequency, reflex, neutrodyne and other critical circuits. Improves any circuit requiring 11 to 43 plate condenser.

If your dealer has no Brockway Variable Condenser in stock, ask him to order for you; or we'll send postpaid on receipt of price with dealer's name and address.

Price \$3.50

**BROCKWAY LABORATORIES CO.**  
Factories Bldg., TOLEDO, OHIO

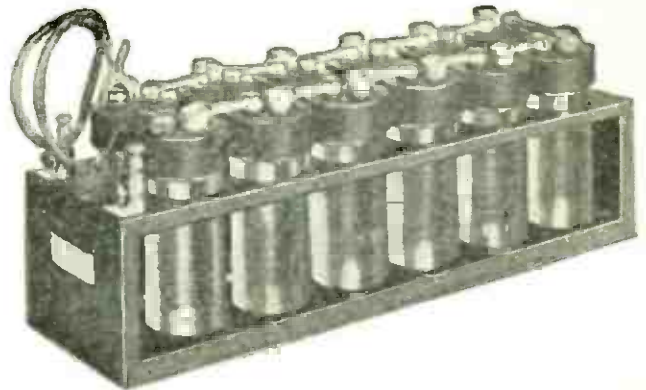

24 V **\$8.25** RADIO "B"  
SENECA **Post Paid** BATTERY

### Absolutely Quiet Dry Charged

The Seneca 24 Volt Radio B Battery is designed and constructed for long life, absolutely quiet and uninterrupted service, its separate cell assembly prevents current leakage common to other types. Seneca Batteries are shipped DRY with FULLY CHARGED PLATES and are ready for service immediately after addition of acid, without initial charging. They guarantee successful RADIO OPERATION. Send for yours today, if not satisfactory, return in 30 Days and money refunded.

For those who wish to build their own B battery we offer Genuine Seneca Battery Parts at 50c each, consisting of one each Pos. and Neg. DRY CHARGED plates, one Separator, one Glass Jar, one Cover with Gasket and Vent. and one Cell Connector. Shipped via P. P. prepaid upon receipt of price.

**SENECA BATTERY CORPORATION**  
1525 Main Street - - Buffalo, N. Y.

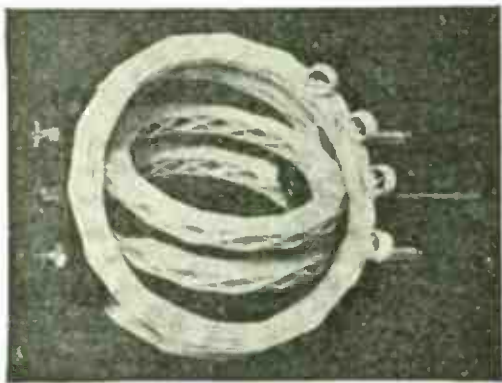

### R. M. C. Diamond Weave Variocoupler and Variometer

Due to diamond weave construction and the fact that 75% of the total area of windings are supported in mid-air, capacity and dielectric losses are reduced to a minimum in R. M. C. Variometers and Variocouplers. The rotor is continuously variable. These products may be used in any circuit where a high grade coupler or variometer is required.

All metal parts are nickel-plated. Panel mounting requires very small space. Screw holes covered by 2" dial.

R. M. C. products are built for the finest sets that can be constructed.

Variocoupler.....\$4.25  
Variometer.....\$4.25

Write for catalog of other diamond weave coils, and Radio Frequency Transformer.

**THE RADIO MANUFACTURING COMPANY**  
of Springfield, Massachusetts  
Dept. B 97 Dwight Street

## TYPE R-B-4

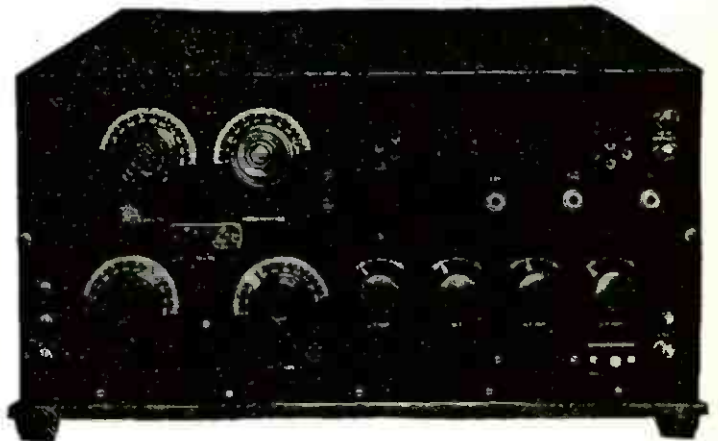

This is the set you have been looking for, and the one that you need.

Having one stage Radio Frequency, Tuned Impedance, Detector and Two Stages of Audio Frequency.

All apparatus mounted on panel 10 inches high, 21 inches long, and set in panel cabinet 10 x 21 x 10 inches deep.

Price \$125.00 without tubes or batteries

**WIRELESS ELECTRIC CO.**  
204 Stanwix St. Pittsburgh, Pa.



# How Lively Is Your "B" Battery?

THIS IS NUMBER THREE OF A SERIES

Some people buy Eveready "B" Batteries oftener than other people. This is because each fan has different tastes and desires in radio receiving. Those that demand maximum volume—and to get it use many tubes, forcing them to the limit with high voltages on the plates—are eager and frequent buyers of these batteries.

Others renew them less often. They are the ones that are content with smaller volume and employ fewer tubes at lower plate voltages.

Furthermore, every radio fan, regardless of the tubes he uses, has his own ideas as to when it is time to strengthen the signals with fresh "B" Batteries. Some will long enjoy concerts that others would not consider loud enough. Just what is "too weak" is purely a matter of personal opinion.

These, then, are the things that determine how long you use your "B" Batteries—

1. *The number and kind of tubes.* The more tubes you use and the greater their power, the more current flows from the "B" Battery and the shorter is its life.
2. *The "B" Battery voltage.* The higher it is, the more current flows from the battery.
3. *The amount of negative grid bias ("C" Battery voltage) on amplifiers.* The greater the bias, the smaller the "B" Battery current.
4. *The life put into the battery in the first place by the manufacturer, and the freshness of the battery when you buy it.*
5. *The signal strength you wish.* The smaller the volume of sound you can enjoy, the longer you can use your "B" Batteries.

The life of any "B" Battery you can buy is affected by the above factors. Subsequent advertisements will set forth each factor in detail.

Eveready "B" Batteries predominate. There is more life in them—they last longer! Blocks of large cells, packed with energy, made especially for radio use, delivered fresh to your dealer, give you the most power for your money—power you can use loudly and swiftly, or softly and slowly, as you wish—Eveready for Everybody.

## "the life of your radio"

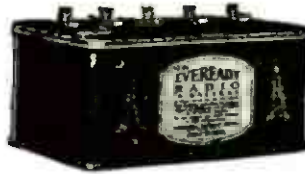

The Metal Case Eveready "B" Battery, No. 766. The popular 22½-volt Eveready Battery in a new handsome, durable, waterproof metal case. At all dealers, \$3.00.



Eveready "B" Battery No. 767. Contains 30 large size cells, as used in the popular No. 766. Voltage, 45. Made especially for sets using detector and one or more stage of amplification. The most economical "B" Battery where 45 volts are required. At all dealers, \$5.50.



Eveready Radio Battery No. 771. The Eveready "Three." The ideal "C" Battery. Voltage, 4½—three terminals permitting the use of 1½, 3, or 4½ volts. The correct use of this battery greatly prolongs the life of the "B" Battery. At all dealers, 70 cents.

Manufactured and guaranteed by

NATIONAL CARBON COMPANY, Inc.

Long Island City, N. Y.

# EVEREADY

## Radio Batteries

—they last longer

Note: This is Number 3 of a series of informative advertisements, printed to enable users to know how to get the most out of their receivers and batteries. If you have any battery problem, write to G. C. Furness, Manager Radio Division, National Carbon Company, Inc., 128 Thompson Avenue, Long Island City, N. Y. Write for special booklets on "A," "B," and "C" Batteries.

## ARMORCLAD FOR YOUR PROTECTION

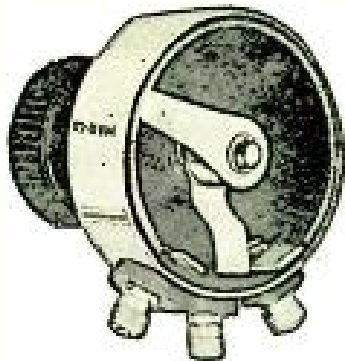

On the regulation of grid and plate circuit voltage depends the operation of a vacuum tube as detector, radio or audio frequency amplifier. This regulation is critical for greatest efficiency and for best results should be obtained while the tube is in operation through the use of a voltage regulator or potentiometer.

### THE MAR-CO 600 OHM ARMORCLAD POTENTIOMETER

is altogether reliable for the purpose. It has a nichrome resistance unit so tightly wound that the turns cannot move under the action of the contact arm. Panel mounting requires only one drilled hole and the instrument is furnished with Bakelite Knob and Pointer and handsome polished nickel finish.

LIST PRICE \$2.00

**MARTIN-COPELAND COMPANY**  
Providence, R. I., U. S. A

INSTRUMENT MAKERS

DEPENDABLE  PRODUCTS  
SINCE 1909

## PRECISION HIGH EFFICIENCY CRYSTAL SETS

Guaranteed to receive local broadcasts with volume and clarity equal to any sets manufactured

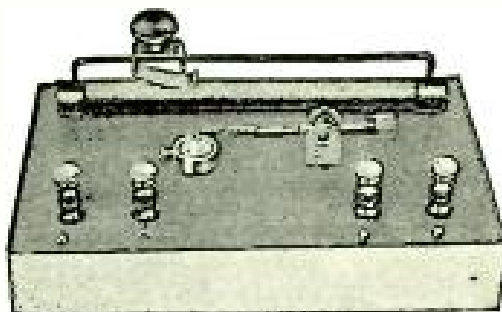

### FREE FAMOUS TESCO RADIO Crystal Set (Shown in Cut)

To introduce the wonderful T-B-H radio headset we will give absolutely free of charge, the most efficient crystal receiver on the market.

#### SEND NO MONEY

Just pay postman \$5.00 plus postage. Money refunded if not absolutely satisfied.

**THE EASTERN SPECIALTY CO.**  
3552 N. Fifth Street, PHILADELPHIA, PA.

# HOWARD

HOWARD



No. 1001

6½ Ohm Rheostat..... \$1.10  
25 Ohm Rheostat..... 1.10  
40 Ohm Rheostat..... 1.10  
Patd. 870,042

HOWARD



No. 1002

6½ Ohm Micro-rheostat.... \$1.50  
25 Ohm Micro-rheostat.... 1.50  
40 Ohm Micro-rheostat.... 1.50  
Patd. July 10, 1923

HOWARD



No. 1003

200 Ohm Potentiometer. \$1.50  
400 Ohm Potentiometer .2.00  
Patd. 870,042

HOWARD



No. 1004

Multi Terminal Receiver Plug, instantaneous connection for as many as six pairs of standard receiver tips..... \$2.00  
Patd. Aug. 28, 1923

Ask the man to show you the Howard line of quality Radio Merchandise. Every piece is sold with the guarantee of satisfactory performance.

Jobbers write for discounts.

**HOWARD RADIO CO., Inc.**  
4248 North Western Ave., Chicago, U. S. A.



MA-13

### 80% of demonstrations result in sales for MU-RAD dealers.

When a complete check on the radio sales of one Chicago store reveals that Mu-Rad Receivers are sold in eight out of ten competitive demonstrations, there must be a reason.

There is! Mu-Rad is easy to operate, uses an inside 2-ft. loop aerial, and is highly selective. Mu-Rad is guaranteed to receive at least 1000 miles.

*Dealers: Write for Mu-Rad proposition.*

Inquiries are solicited from responsible dealers only.

In order to help us weed out curiosity seekers, please use your business stationery in requesting this information.

We also carry a complete stock of  
**WESTERN ELECTRIC CO.**  
**GENERAL RADIO CO.**  
parts. Write for details and discounts.

**Chicago Radio Apparatus Co.**  
Jobbers of Good Radio Merchandise  
General Offices: 407 S. Dearborn Street, Chicago

# THE SONOCHORDE

TRADE MARK

**A comparative demonstration leaves no other Loud Speaker in the thoughts of those with whom performance is paramount.**



Type C. With the 16 exclusive Sonochorde features. Mahogany or walnut cabinet. Complete with phone tip jacks, and swinging doors to vary volume . . . . . \$50.00

Other Sonochorde models  
Type D, (illus.) . . . . \$35.00  
Type B . . . . . 27.50



*If your dealer cannot supply you, order direct*

*Correspondence with established distributors is invited*

**BOUDETTE MANUFACTURING CO., REVERE, MASS.**



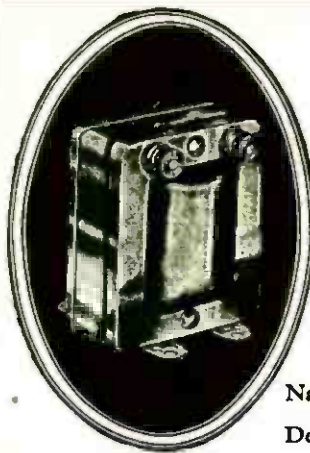

### National Audio Frequency Transformers

The New 6 to 1 Ratio National Transformer is for use on the first stage of amplification. Its greater ratio means increased volume, but the tone qualities that characterize the 3 1/2 to 1 ratio have been fully retained. Price of 6 to 1 ratio \$4.50 postpaid; of the 3 1/2 to 1 ratio, \$4.00 postpaid. Dealers: Write for interesting sales proposition.

National Transformer Mfg. Co.  
154 Whiting Street  
Dept. 1211 Chicago, Ill.

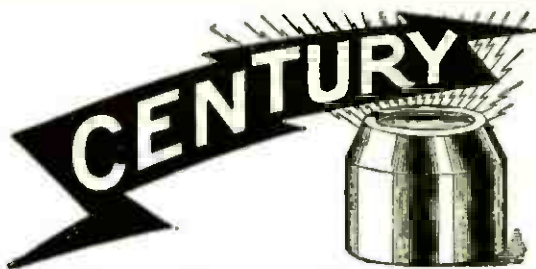

### THAT NEW CRYSTAL THAT GIVES SUCH WONDERFUL RESULTS!

Entirely Different From Any Other Crystal on the Market. Surface Perfectly Smooth, and Supersensitive Everywhere.

**CENTURY "RADIO REFLEX" Price \$1.**

Order from your dealer or direct from  
**CENTURY PRODUCTS COMPANY**

110 So. 13th Street

Allentown, Pa.

## CATALOG E19-100 PAGES FREE

### EVERYTHING IN RADIO

One of the largest complete stocks in the world. 40 diagrams of latest Hookups.

### DEALERS ALL OVER THE U.S.

Making big profits handling our supplies. 24-hour service. Goods shipped same day order received.



WHOLESALE RADIO DISTRIBUTORS

Dept. P 6 West 14th St. Kansas City, Mo.

## LEARN RADIO

Here's your opportunity. Radio needs you. Win success in this fascinating field. Trained men in demand at highest salaries. Learn at home, in your spare time.

### Be a Radio Expert

I will train you, quickly and easily, to design, construct, install, operate, repair, maintain, and sell all forms of Radio apparatus. My new methods are the most successful in existence. Learn to earn

**\$1,800 to \$10,000 a Year**

**FREE** Wonderful, home-construction, tube receiving set, of latest design.

Write for "Radio Facts" free. Engineer Mohaupt.  
**American Electrical Association**  
Dept. 611 4513 Ravenswood Ave., Chicago

# "3000 mile"

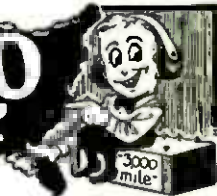

### RADIO "B" BATTERY

DIRECT FROM FACTORY TO YOU SHIPPED PREPAID

Greatest radio B battery on market. Absolutely fresh, full voltage, seamless cells, noiseless—will bring in Concerts **LOUDER** and **STRONGER!** Built correctly—full number of voltage taps—will work any tube or loud speaker. Real service **GUARANTEED.** Sold direct from our factories to you at lowest prices. Shipped prepaid to your door. **ORDER TODAY.** Send money order, check or pay C. O. D. Order By Number

No. 122B—22 1/2 volt variable—regularly \$2.25—our price **\$1.98**  
No. 122A—22 1/2 volt variable—regularly \$3.00—our price **\$2.65**  
No. 145A—45 volt—8 taps—regularly \$6.00—our price **\$4.98**

**AYRES BATTERY CORPORATION.** Cincinnati, Ohio

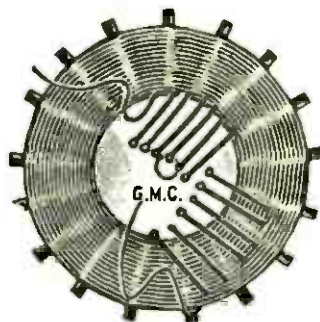

### Order by Mail Reinartz Coil

This coil for standard Reinartz circuit Green silk windings Special this month \$1.75 post free

6 ohm Rheostat .75  
30 ohm Rheostat .75

SEND FOR OUR FREE CATALOGUE NO. 10

**ATWOOD ELECTRIC CO.**

3122 W. Madison St. Dept. R. Chicago, Ill.



### WE REPAIR The Following RADIO TUBES

WD-11.....\$3.50	UV-199.....\$3.50
WD-12.....3.50	C-299.....3.50
UV-200.....2.75	UV-201A.....3.50
UV-201.....3.00	C-301A.....3.50
C-300.....2.75	UV-202.....4.00
C-301.....3.00	C-302.....4.00
DV-6.....3.00	DV-6A.....3.50

Mail orders solicited and promptly attended to.

Dealers and Agents Write for Special Discount.

**H. & H. RADIO COMPANY**  
Clinton Hill Sta. P. O. Box 22-E. Newark, N. J.



### "Read'em" Binding Posts

Simplify the most complicated hook-up

Tell at a glance whether it is Antenna, Ground, Fones, A or B battery, etc. Name neatly engraved for keeps on top of each Post. (See illustration.)

**Knobs Can't Come Off**

The Irremovable knobs save time, trouble and petty annoyances. "Read'em" add to the appearance of any set. Don't be without them. Price 15c each. Set of ten \$1.50. If your dealer can't supply you with "Read'em" order direct.

Look for the name "Read'em" on every post

**The Marshall-Gerken Co.**  
Dept. J. 27 N. Ontario St., Toledo, Ohio



Please mention POPULAR RADIO when answering advertisements.

# "BUILD YOUR OWN" WITH "RASCO" PARTS!

THE Radio Specialty Company—"RASCO" for short—now in its third year, is unquestionably the oldest and most unique radio parts supply house in the United States, if not in the whole world. This Company makes a specialty of small orders. No order is too small to get immediate and prompt attention. The reason is simple: 80% of our orders are small. The reputation of this house was built upon service. Ask any of your radio acquaintances what they think of "RASCO" service. "RASCO" promptness. Though unsolicited testimonials are in our files, to prove that we serve the public as it has never been served in radio merchandise before. Be sure to get our great 84-page catalog, containing over 500 different parts. Catalog contains over 300 illustrations. "WE CAN ONLY DISAPPOINT YOU ONCE." Try us with a 50c. order and make us prove what we say. Prices include delivery to your door.

Order direct from this page. We pay all transportation charges. All goods sent prepaid in 24 hours.

**NOTE BIG PRICE REDUCTIONS THIS MONTH** Money refunded if goods do not satisfy

### LOOP AERIAL

The loop aerial you have been waiting for. Made entirely of well seasoned hard wood. Complete with all parts and base; No. 21 enameled wire used. Total length of loop 36", 2 feet on the side; loop is 10 constructions. Can be put together by anyone in less than 5 minutes. Satisfaction guaranteed.

R-2600. Two foot loop aerial, complete..... \$1.15

### STORAGE BATTERIES

New! New! New! Two volt. 40 ampere hour storage battery for use with W-9111, 12, and U.V. 199 tubes. Don't keep on buying dry cells continuously. This storage battery will last for itself in two months. Only best materials used. Guaranteed for 2 years. You can connect up to 6 dry cell tubes on a single one of these batteries. Can be recharged for a few cents. Hard rubber container engaged in laminated wood case. Due to low price and large weight of batteries, shipped express collect.

R-2400. Two volt. 40 ampere hour storage battery, size 2 1/2 x 8 1/2"..... \$4.25  
 R-640. Six volt. 40 ampere hour storage battery, size 4 3/4 x 7 1/2"..... 8.75  
 R-660. Six volt. 40 ampere hour storage battery, size 6 7/8 x 9 1/2"..... 11.00

### WOOD CABINETS

Highest grade mahogany cabinets made. Best hand rubbed finish. Top is hinged. Front of cabinet rabbetted to fit panel. Price delivered to your door; no panel included in these prices. Entire cabinet made of 1/2" well seasoned stock.

R-714. Wood cabinets, panel size 7 1/2 x 12..... \$3.35  
 R-716. Wood cabinets, panel size 7 1/2 x 18..... 3.60  
 R-724. Wood cabinets, panel size 7 1/2 x 21..... 4.40  
 R-710. Wood cabinets, panel size 7 1/2 x 10..... 2.60  
 R-712. Wood cabinets, panel size 7 1/2 x 12..... 3.30  
 R-721. Wood cabinets, panel size 7 1/2 x 21..... 3.90

### CARDBOARD TUBING

Only seamless tubing made in United States. Perfectly seasoned. Heavy wall. (I.D.—Inside Diameter, O.D.—Outside Diameter, L—Length.)

R-6600. 2" I.D., 3/4" O.D. x 7' L..... \$3.30  
 R-7101. 3 1/4" I.D., 3/4" O.D. x 7' L..... .35  
 R-6602. 3 1/4" I.D., 3/4" O.D. x 5' L..... .25  
 R-6603. 3 1/4" I.D., 3/4" O.D. x 3' L..... .22  
 R-6604. 4" I.D., 3/4" O.D. x 7' L..... .45  
 R-6605. 2 1/4" I.D., 3/4" O.D. x 2 1/2' L..... .18

### "RASCO" BEZELS

The finest bezel on the market. Best brass mesh used. The bezel comes entirely nickel plated. Will improve looks of your panel 100 per cent. Outside diameter 1". Can be used on 1/2" or 3/16" panel.

R-1700. Rasco bezel..... \$1.15  
 R-1701. Bezel 1 1/4" diam..... .20

### FORMICA PANELS

Clearance Sale. This sheeting is positively the best grade on the market. High finish on both sides. Too well known to require much explanation. Due to the fact that we are discontinuing these particular sizes, this material is now offered practically at cost. Prices are about 40 per cent lower than our catalogue list. Note also that we ship these panels prepaid. This alone amounts to a considerable saving.

R-350. 6" x 12" x 3/16" thick, each..... \$1.50  
 R-352. 9" x 12" x 3/16" thick, each..... 1.60  
 R-353. 12" x 18" x 3/16" thick, each..... 4.00  
 R-354. 6" x 18" x 3/16" thick, each..... 1.90  
 R-356. 6" x 14" x 3/16" thick, each..... 1.60  
 R-357. 8" x 14" x 3/16" thick, each..... .65

### RASCO 160° VARIOCOUPLER

This Coupler while extremely low in price will do anything and everything that the more expensive ones accomplish. Still wire wound on bicycle tire. There are six 18 p.p.s. wave length of 150 to 600 meters. Coupler is made for panel mounting, 1/4" shaft. Your money refunded if it does not do all that we claim for it.

R-3100 Variocoupler, prepaid..... \$1.30

### MELOTONE LOUD SPEAKER

The best popular loud speaker on the market. Has tuned feature the same as all "Rico" phones. Fibre horn, heavy metal base, fire proof cord. Nickel gasket. Greatest lured loud talker. Compares favorably with most expensive speakers. Size overall 14 1/2"; horn length 11 1/2"; bell 6"; total height 9".

R-235. Melotone Speaker..... \$4.90

### RICO TUNED RECEIVERS

No better phones made. Super sensitive. Awarded Radio News Laboratory Certificate of Merit. The only tuned phone on the market. Can be tuned for any intensity and sensitivity. Magnetic pole of phone is in mathematical center of diaphragm.

R-2020. 2000 ohms, double head set..... \$4.45  
 R-3030. 3000 ohms, double head set..... \$5.50

### "RASCO" VERNIER

Clearer, variable made. Can be used with any dial. Soft rubber zinc encase dial. Does away with vernier condenser. Wire in best black composition. Nothing to come apart. Highest hit of the season.

R-1450. Vernier..... \$3.30

### "RASCO" POSTS

R-650. Post made entirely of best black composition—3/32" screw—each..... \$1.00  
 R-202. Post has nickel-plated bottom part, each..... .50  
 R-201. Post, each size..... .50

### "RASCO" SWITCH POINTS

Nickel-plated and polished. The following have been found the most popular.

R-301. 1/4" x 1/4", 6/32" thread, doz..... \$1.18  
 R-302. 3/16" x 1/4", 1/4" dia., 6/32" thread 1 doz..... .18  
 R-303. 3/16" x 1/4", 1/4" dia., 6/32" thread 1 doz..... .18  
 R-304. 1/4" dia., 1/4" thick; shank 6/32" doz..... .18  
 R-305. 1/4" dia., 3/16" thick; shank 4/36" doz..... .18  
 R-306. 3/16" dia., 3/16" thick; shank 4/36" doz..... .18  
 R-307. 3/16" dia., 1/4" thick; shank 4/36" doz..... .18  
 R-308. Switch AMP, 1/4" long; 4/36" thread, complete with nut, each..... .18

### "RASCO" SOCKETTES

Substitute for Vacuum Tube Sockets. Four of these take one Vacuum Tube. Great time saver. Best contact possible. Take less room. Are better.

R-1550. Sockettes, nickel-plated, set of 4..... \$2.25  
 R-1551. Sockettes, nickel-plated, set of 4 to take W-11 Tubes..... .25  
 Note: Set of 4 sufficient to hold 1 Tube.

### COPPER FOIL

Thinnest copper foil made. .001" thick. Comes 6" wide.

R-5025. Copper Foil, per ft. x 1 in 10-ft. length..... .80

### PHONEHORN

Fills a new and distinct want. Base consists of 12-110 Phonodapter 4 x 4—scrubed on this base into which fits a fine enameled fibre horn. Size of horn 12", bell 6". Slip Phonodapter end on a single telephone receiver and you have the lowest priced loud talker ever made. Mounted in your set or hung in corner of room it will bring sound all over the room. A most useful article. Welcome by all radio fans.

R-1321 Phonehorn, prepaid..... \$1.45

### AUDIO FREQUENCY TRANSFORMERS

No better Transformer on the market. Highest class materials. Impregnated coils. Silicon steel stampings used. Save 50 per cent by assembling it yourself.

R-1100. A.F. Transformer, ratio 4 to 1..... \$2.00  
 R-1150. A.F. Transformer, ratio 6 to 1..... \$2.00

### RADIO FREQUENCY TRANSFORMERS

The Best Radio Frequency Transformer developed by Mr. R. E. Laxalt, Associate Editor of RADIO NEWS. Air core. Guaranteed to do the work. This Transformer brings in the long distances.

R-2500. Radio Frequency Transformer, size 1 1/2" x 2 1/2"..... \$1.50

### RHEOSTATS AND POTENTIOMETERS

Highest grade Rheostat made. High heat dielectric composition base. Wound with best non-corrosive resistance wire. Comes with tapered, knurled knob. Diameter, 2 1/2". Complete with 45 pointer.

R-4310—0 ohm, each \$1.45  
 R-4311—20 ohms, for 301 and 301a tubes, each..... .65  
 R-4312—Potentiometer, 200 Ohms each..... \$1.85

### SPIDER WEB FORMS

At last! Fine forms to wind your spider web. Made from hard, well seasoned fibre. 1-1/16" thick, center and side holes for wiring. 3200 has 12 slots, 3201, 11 slots. Both \$2.00.

R-3200—Spider web form, each..... \$2.25  
 R-3201—Spider web form, each..... \$2.25

### BRASS RODS

Sold in 6" lengths only

R-6032. Brass Rod, 3/32" thread, per length..... \$1.08  
 R-6032. Brass Rod, 6/32" thread, per length..... .06  
 R-1425. Brass Rod, plain 1/4" round, per length..... .10  
 R-3616. Brass Rod, plain 3/16" round, per length..... .06

### "RASCO" NAME PLATES

The circuit plate is our new binding Post Name Plate. Diameter, 3". These denominations: PHONES, GROUND, OUTPUT, "A" BATTERY, "B" BATTERY, "C" BATTERY, GRID, LOAN, "BATTERY"—AERIAL, "A" INPUT, "A" HAT, TERY, "B" HAT, LOOP, TICKLER, "A" HAT, "B" HAT, "C" HAT, "D" HAT, "E" HAT, "F" HAT, "G" HAT, "H" HAT, "I" HAT, "J" HAT, "K" HAT, "L" HAT, "M" HAT, "N" HAT, "O" HAT, "P" HAT, "Q" HAT, "R" HAT, "S" HAT, "T" HAT, "U" HAT, "V" HAT, "W" HAT, "X" HAT, "Y" HAT, "Z" HAT.

R-6000 to 6019. Binding Post Name Plates, each denomination..... \$1.30  
 Dozen..... \$15.60

### REINARTZ SPIOERWEB COIL

Here is a very fine inductance for Reinartz circuit. 200-600 meters. 19 turns. Size 4 1/2" diameter; 1 1/2" center opening. Can be used in nearly all new circuits. Construction: double-silvered Phonodapter. Unit is firm and will not fall apart as is case with many inferior makes. A few of these coils will work wonders in your set.

R-2650 Spider-web Reinartz coil..... \$1.15

### PHONODAPTER

The Phonodapter will fit any phone. Metal tube fits any standard phonograph. Make your Phonograph a loud talker. Fits Columbia, Victor and Gramophone phonographs. Is made entirely of pure soft rubber with brass tube inserted.

R-1310 Phonodapter..... \$1.50

### DOUBLE PHONODAPTER

The Double Phonodapter will take any standard double head set, thereby making your Phonograph a loud talker. Made of best metal, nickel plated and highly polished. Has three generous soft rubber bushings.

R-1320 Double Phonodapter..... \$1.65

### RASCO Telephone Plug

This is the plug that is sold from 75c to \$1.00 everywhere. Has hard rubber composition shell and patented tin holder. Must be seen to be appreciated. Finest workmanship throughout.

R-1030—Rasco Telephone Plug, each..... \$3.35

### LITZ WIRE

R-323. equals No. 22 I.R.S. per foot..... \$1.02  
 R-390. equals No. 23 I.R.S. per foot..... .01  
 R-391. equals No. 24 I.R.S. per foot..... .03  
 R-392. equals No. 25 I.R.S. per foot..... .04  
 Discounts of 10 percent in 100-ft. lots.

### UNIVERSAL BEARING

Tilt bearing to hold setometer and variocoupler centers. Total length of bearing 3 1/2". Outside shaft, 1 1/4". Length of thread 1". Length of threaded sleeve, 1/2".

R-1375. Bearing..... \$2.25

### PANEL MOUNTING VARIABLE CONDENSERS

This condenser presents the latest type of precision mechanics. Plates, washers, and all other parts are accurately machined. Positively an better condenser on the market. Shafts 1/4". Save from 40% to 60% by assembling condenser yourself. A child can do it in a few minutes spare time. Capacities guaranteed.

R-1111 11 plate condenser, .0025 mfd..... \$1.10  
 R-2121 21 plate condenser, .0005 mfd..... 1.22  
 R-4343 43 plate condenser, .001 mfd..... 1.50

### The "Rasco" Catalog

CONTAINS 75 VACUUM TUBE HOOK-UPS. 350 ILLUSTRATIONS No. 10. 350 ARTICLES. 84 PAGES.

All Armstrong Circuits: These important circuits are explained clearly, all values having been given leaving out nothing that could puzzle you. Just to name a few of the Vacuum Tube Circuits: The V.T. as a detector and one-step amplifier; e.v. Armstrong circuits; one-step audio frequency amplifier and detector; three stage audio frequency amplifier; short wave regenerative circuits; 4-stage radio frequency amplifiers; radio and audio frequency amplifier; inductively coupled amplifier; Armstrong superheterodyne, etc. Catalog mailed only upon receipt of 15 Cents in Stamps or Coin.

**Radio Specialty Co.**  
 96A Park Place - New York City  
 Oldest and Original Exclusive  
 Radio Parts House in U. S.  
 Factories: Brooklyn, N. Y. Elkridge, Md.

**DEALERS**  
 Get Our Special Proposition



This Christmas Greeting Card will reach your friend on Christmas morning.

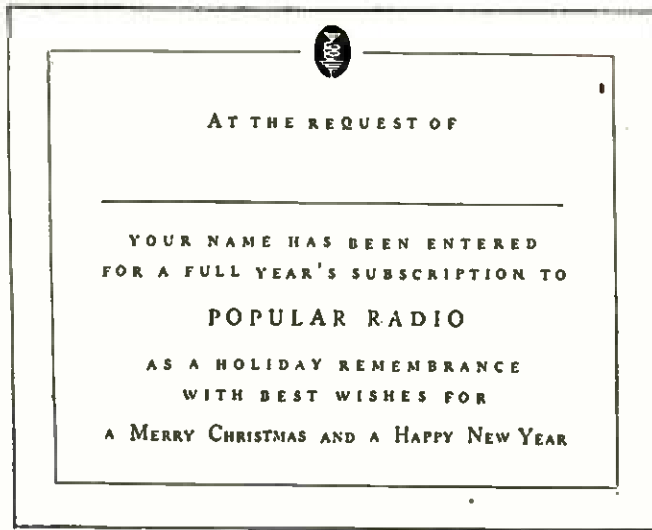

Could any gift be more heartily appreciated than 12 months of POPULAR RADIO?

# Let POPULAR RADIO Solve Your Christmas Problems for You

A GIFT that will be truly appreciated by any radio enthusiast! A year's subscription to POPULAR RADIO. And you need not pay for it until later, unless you prefer.

The illustration shown above is a small facsimile of a beautiful colored Christmas Card which POPULAR RADIO will mail for you to any friend you select. The card will reach your friend on Christmas morning, telling him that you are the generous donor of a year's subscription to POPULAR RADIO.

With this Christmas Greeting Card will go the first copy of POPULAR RADIO applying on this gift subscription. Both the card and magazine will reach your friend on Christmas morning. And every month thereafter for a year your friend will receive his copies of POPULAR RADIO—a twelve-time reminder of you and your Christmas remembrance.

Could any gift be more appropriate for your friends who are interested in radio than a year's subscription to POPULAR RADIO? And if some friend that you would like to remember at Christmas

time already happens to be a subscriber to POPULAR RADIO what gift would be more appreciated by him than a *renewal* or a year's *extension* of his subscription?

All that is necessary for you to do is to fill out the handy coupon below, indicating your own name and address, also the name and address of the friend to whom you wish us to send the Christmas Card and POPULAR RADIO. We will do the rest. Send no money. We will gladly bill you later for the small amount of \$2.

When your friend receives his Christmas gift of a year's subscription to POPULAR RADIO, it will be a \$3 magazine. Your friend receives, therefore, a \$3 Christmas remembrance from you. But you pay only \$2 because up to December 15th you can place this subscription at the old rate. And you do not pay a penny now. We will simply send you a bill for the \$2 later on.

"Do your Christmas shopping early." Send the coupon today, and one or more of your Christmas problems will be solved!

**(This coupon must be mailed before midnight, December 15th)**

<p>POPULAR RADIO, Dept. 127, 9 East 40th Street, New York City</p> <p>I am very glad to avail myself of your special Christmas offer. Please send (so as to arrive on Christmas morning) a copy of January POPULAR RADIO to the address shown on the right. Also send a Christmas Greeting Card, announcing that the gift of a year's subscription is from me. Bill me later for \$2.</p> <p>My Name.....</p> <p>My Address.....</p>	<p>Here is the name and address of my friend whom I wish to remember at Christmas time with a year's subscription to POPULAR RADIO.</p> <p>Friend's Name.....</p> <p>Address.....</p> <p>.....</p> <p><b>NOTE:</b> If you wish to remember several friends in this appropriate way, simply write their names and addresses on a sheet of paper and mail with this coupon to POPULAR RADIO.</p>
--	--



Please mention POPULAR RADIO when answering advertisements.

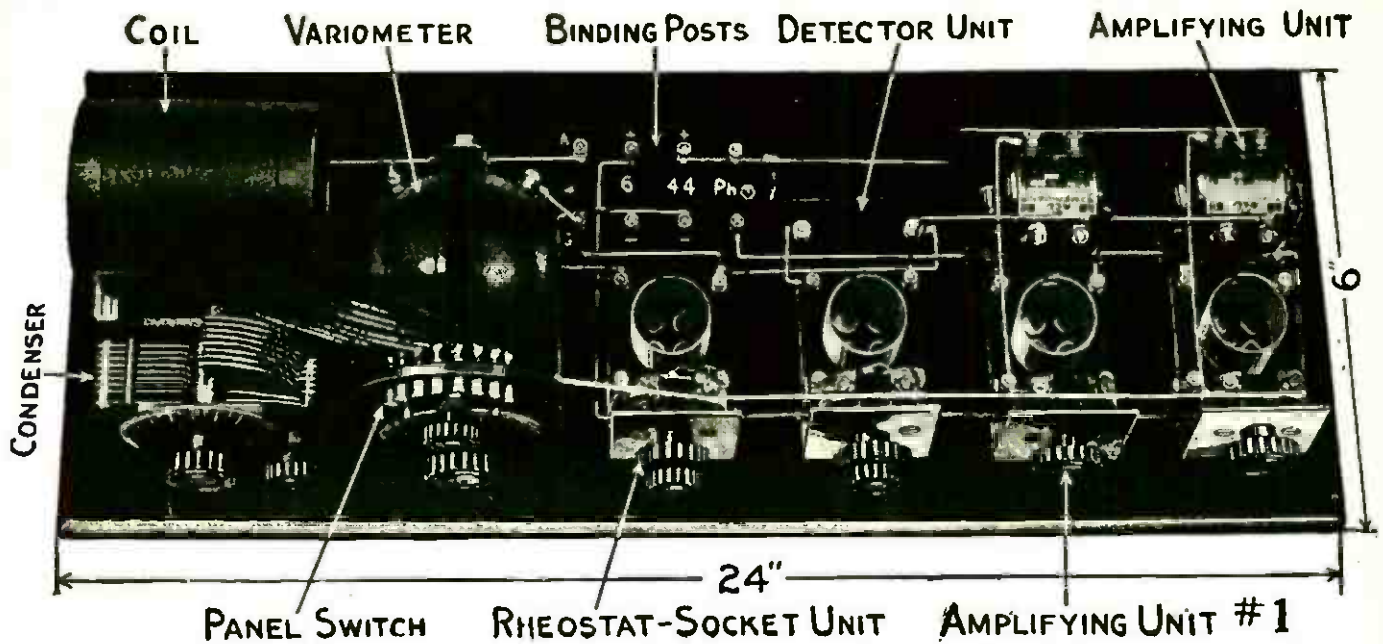

## Tuned Wave Trap Radio Frequency Receiver

1 Stage Radio-frequency—2 Stages Audio-frequency  
Built on Famous Copp Circuit No. 4  
Efficient for all wave-lengths from 200 to 700 meters  
Range up to 2000 miles

Any amateur can build the above set with A-C DAYTON Complete Units

**\$43.35**

*Units packed complete in one carton with wiring diagrams, photographs, instructions, etc., for complete installation.*

SEE YOUR DEALER OR WRITE US DIRECT

**THE A-C ELECTRICAL MFG. CO., Dayton, Ohio**

*Makers of Electrical Devices for over 20 Years.*

## A Socket of Exceptional Merit

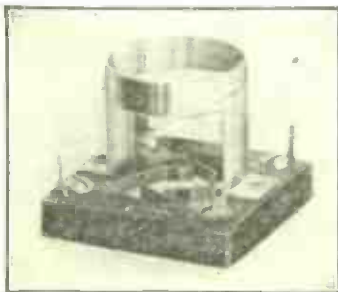

### Specifications

1. Contact springs and wire terminals of one piece heavy phosphor bronze.
2. Convenient screw terminals of large dimensions.
3. Handy soldering terminals.
4. Skeleton sleeve allows for inspection of tube contacts without removal of socket.
5. Base, high grade moulded insulation  $2\frac{1}{8}$  inches square.
6. All metal parts highly polished and heavy nickel plated.

At your Dealer's or by mail on receipt of purchase price

**Price 50c**

**WEIN SALES CORP., 254 Park Ave., Brooklyn, N. Y.**



**A set of  
EBY ENGRAVED  
POSTS**

will make him happy on Christmas morning. Your boy or his pal will appreciate this useful gift because it will give him lasting satisfaction.

For sale by Dealers everywhere

The H. H. Eby Manufacturing Co.  
Philadelphia, Pa.

**THE NEW SIMPLEX**



180° Vario-Coupler with Special Spider Web Rotor will bring in those distant stations you are trying for. An exceedingly efficient and neat coupling device which will cover all broadcast wave lengths up to 600 meters.

Price - - \$3.50

**SIMPLEX RADIO CO.**  
1013-15 Ridge Ave. Phila., Pa.

Announcing **DX-ALENA** Announcing

**The Powerful Long-Distance Crystal**

DX-ALENA is a phenomenal, all-sensitive, synthetic crystal that positively outclasses all others. DX-ALENA is broadcast tested and guaranteed absolutely without an equal for loudspeaking and long-distance reception. Fans report extraordinary success with DX-ALENA. Order one of these wonderful crystals today for your crystal or reflex set. By mail 50 cents. DX-ALENA is made by The Chemical Research Co.

Dealers and Jobbers write for prices.

Distributed by

**EVERETT RADIO CO.**  
Radio Equipment of Quality  
5207 Dorchester Ave. Chicago, Ill.

**\$2.50 Republic Audio Frequency Transformer**  
(FOR ALL TUBES)



Mail Orders Filled Promptly

**FLINT RADIO CO.**  
1770 Wilson Ave. CHICAGO, ILL.

GUARANTEED

**BARKELEW**  
**FOUR-PHONE PLUG**  
for  
STANDARD JACKS



The BARKELEW ELEC. MFG. CO.  
MIDDLETOWN, OHIO.

**MAKE YOUR OWN RADIO RECEIVING SET**



ENJOY the concerts, market reports, latest news, etc., as sent out by large broadcasting stations. This NEW copyright book, "EFFICIENT RADIO SETS," shows how to make INEXPENSIVE set for receiving wireless broadcasts. Sent postpaid for 25c. Address J. C. Dorn, Pub., 725 S. Dearborn St., Dept. 110, Chicago.



**TU-WAY PLUG \$1.00**  
Takes 1-4 head-sets. Does more for a dollar than any other plug, and does it better. Catalogue free.

**Carter Radio Co.**  
1807 Republic Bldg. CHICAGO

**Let Radio Experts Buy for You**

**This Service Is Free**

Why hunt from store to store? Save time, trouble and money—a group of Radio Experts in New York will act as your personal representative, buy for you any standard make of radio equipment you want, from the smallest part to a complete set, either assembled or unassembled, and deliver it to you prepaid—all for less than if you did your own buying. Satisfaction guaranteed. Advice on all radio problems—free to our clients. Write for plan.

**PERSONAL SERVICE PURCHASING BUREAU**  
505 Fifth Ave., Desk 12, New York

**You Don't Need Tubes** to get out of town. If you want new stations on your crystal set **WRITE ME TODAY.** Mine works 400 to 1,000 miles without tubes or batteries! Thousands have bought my plans and now get results like mine. **CHANGES OFTEN COST LESS THAN A DOLLAR.** Send self-addressed envelope for further information. Leon Lambert, 540 South Volutsia, Wichita, Kansas.

**PALL MALL PRODUCTS**

**HOOK UP AND DESCRIPTION of the famous ESSEX ONE TUBE COAST TO COAST CIRCUIT**  
— FREE —

To the first 1000 fans who send in a 2c stamp and the names and addresses of five friends who are interested in Radio.

**ESSEX MFG. CO., 115 Mulberry St., Newark, N. J.**

**FOR EASY MOUNTING FRAMINGHAM DE LUXE PARTS**

**Ask Your Dealer**

**2650 MILES**

with ONE TUBE. Broadcasting from Atlantic Coast and Cuba heard in California by users of the **CROSS COUNTRY CIRCUIT.** This range is due to simplicity of set and operation as only one control is used for tuning. Easily and cheaply built. Dry cell tubes may be used. Complete instructions, with panel layout, assembly views, etc., postpaid for 25c. Or further information for red stamp.

**VESCO RADIO SHOP, Bx. PR-117, Oakland, Cal.**



Please mention POPULAR RADIO when answering advertisements.

**"The  
Best Built  
Set in  
America"  
R-212**



Licensed by I. R. M., Inc.,  
under Hazeltine Patents



Embodying the Hazeltine Neutrodyne circuit in an improved form as to neutralization, workmanship, quality, appearance and efficiency of operation.

Radio Service Laboratories, 1000 11th Ave.

Asbury Park, N. J.

## DEALERS!

We handle only well known and nationally advertised lines. On top of that we give the kind of service you expect.

And—Our discounts are RIGHT.

Drop us a post card for our 36-page catalog just off the press.

**Wholesale Radio  
Distributors**

Address Dept. 10

**WERNES & PATCH**

159 N. STATE ST. CHICAGO, ILL.

IMPROVED RECEPTION

with

## THE PRECISION COIL

This coil is made according to the specifications of Laurence M. Cockaday.

These include

1. Better Wire
2. Better Insulation
3. Better Tubing
4. Better Terminals
5. Better Design

In short, BETTER EFFICIENCY than has heretofore been attainable.

*Write us about these coils*

Mail orders filled promptly.

Special Dealer Proposition

**PRECISION COIL CO., INC.**

Flushing, N. Y.

## SHELTONE LOUD SPEAKER

This NEW Puralin-SHELTONE, made by DUPONT, gives greater volume—better tone and is more beautiful in appearance.

AT ALL DEALERS

Use the SHELTONE with ANY good phones and get wonderful results.

We are distributors for Nath. Baldwin phones and the new Baldwin Loud Speaker.

**THE SHELTONE CO.**

185-189 Clinton Ave., Newark, N. J. *Discount to Dealers*



**\$3.00**



# Sweeping the Nation!

1,000 MILE  
RECEPTION

\$39  
and Up

Electro  
Magnetic  
Loud-speaker  
\$35



The Lytton line of radio masterpieces is now being demonstrated by a number of unsolicited dealers. Mark us! When our broad campaign is announced in a short time, it will start a new era in radio.

Write for catalog. Specify which set interests you.



WALTER LYTTON, INC.  
CHICAGO  
LYTTON BLDG.

ALSO "COAST-TO-COAST" \$112.50  
Loop set with the Lytton  
4-tube "Duplex" circuit

## Cold Winter Nights

Won't find you on the roof fixing the aerial—removing snow and sleet, exposing yourself to sickness, if you use



### ANTENELLA

(No aerial or antenna needed.)

A light socket plug that eliminates all outside wiring, lightning arresters and other inconveniences. Merely plug Antenella in any light socket and you can enjoy the best in radio in any room in the house.

Now Only \$1.25

At your dealers—otherwise send purchase price and you will be supplied without further charge.

Chas. Freshman Co. Inc.  
Radio Condenser Products  
106 Seventh Ave., New York

### E-Z-ON SELECTOR

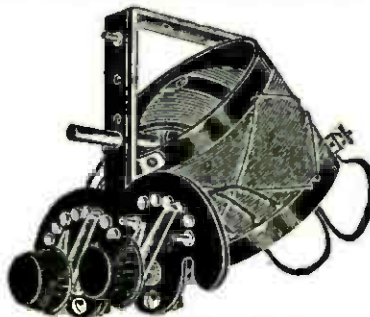

Both rough and Vernier taps already soldered. Only two extra holes to drill. Drill template furnished. Sharpest tuning. Guaranteed, \$8.50

UTILITY ELECTRICAL PRODUCTS CO.  
2738 Van Buren St., Chicago, Ill.



### "TRI-COIL"

The Transformer with the Compensating Coil  
Meets All Requirements

"Tri-Coil" covers all wave lengths and assures perfect amplification.

"Tri-Coil" is excellent in standard radio frequency circuits.

"Tri-Coil" is scientifically designed to conform with the individual characteristics of the various tubes on the market.

"Tri-Coil" Type A is for use with U. V. 201A or C301A tubes.

"Tri-Coil" Type 9 is for use with U. V. 199-C299 W. D. 11 or 12 tubes.

Only \$2.00

At your dealers—otherwise by mail postpaid on receipt of purchase price.

Free illustrated drawing of one tube "Tri-Coil" Reflex Circuit, which will operate loudspeaker, on request.

BROOKLYN METAL STAMPING CO.  
718-28 Atlantic Avenue, Brooklyn, New York

## RADIO TUBE EXCHANGE

We Repair All Standard Makes of Tubes  
Including

W. D. 11 or W. D. 12	\$3.50
U. V. 200 or C. 300	\$2.75
U. V. 201 or C. 301	\$3.00
U. V. 201A or C. 301A	\$3.50
U. V. 199 or C. 299	\$3.50
U. V. 202 or C. 302	\$3.50
New 1 1/4 Volt Tubes	\$4.00

All tubes guaranteed to do the work.

RADIO TUBE EXCHANGE  
200 BROADWAY DEPT. 3 NEW YORK CITY  
All Mail Orders Given Prompt Attention  
Orders sent Parcel Post C. O. D.

FOR CLEARER SIGNALS  
FRAMINGHAM  
DE LUXE PARTS

Ask Your Dealer



## The Improved MIRACO

Gets 'em from Coast to Coast

Clearly and distinctly, too! For our users tell us that Cincinnati hears Frisco, Denver hears Schenectady, New York hears Havana! Scores of long distance records were made on these instruments last year so with the many new refinements incorporated the result obtained now will be far better than ever.

### Highest Quality at Lowest Price

This has always been the MIRACO key-note and the thousands of sets now in use are a fitting tribute to MIRACO'S excellent performance. Many new improvements, such as new sockets resting on shock absorbing pads—a refinement found only in the most expensive sets—rheostats with multiple resistance windings, making it possible to use either dry cell or storage battery tubes, and a new aluminum shield that prevents annoying body capacity effects, are embodied.

Cabinet is of solid mahogany—workmanship the finest—operation extremely simple yet always dependable.

2 tube outfit shown above..... \$29.50  
1 tube outfit..... 18.50  
4 tube outfit shown below..... 54.50

Write for our new bulletin today.

Dealers—Jobbers

Write for our proposition quickly.

Agents

There's still some territory open—write or wire.



THE MIDWEST RADIO COMPANY, 812 Main Street, Cincinnati, Ohio

## IF YOU CAN'T BUY THEM AT YOUR DEALER'S SEND DIRECT TO US

"Red-Heads" are guaranteed radio phones. You run no risk when you buy them. Money back if, after 7 days' trial, you're not satisfied that they're the best receivers on the market at the price. Why not act right now and get a pair? It'll mean getting the maximum from broadcasting from the day you put them into use.



## RED-HEAD RADIO RECEIVERS

These remarkable head-sets are made by The Newman-Stern Co., one of the pioneer radio manufacturing houses in America.

### JUST OUT

The new 1924 Model F

**\$6.50** PER PAIR Complete

The new 1924 "Red-Head" Jr.

**\$5.00** PER PAIR Complete

This is the standard 3,000 ohm "Red-Head." The 1924 Model F has eleven improved features. Sensitive and fine-toned; aluminum case; famous brown-red ear caps; military headband; high-grade cord.

The Junior Model has most of the quality features of the standard Model F here described. The resistance is 2,000 ohms per set instead of 3,000 ohms. A remarkable value.

"Red-Heads" sent prepaid on receipt of price if you are unable to get them at your dealer's.

THE NEWMAN-STERN COMPANY  
Dept. PR Newman-Stern Bldg. Cleveland

## The TRINITY LOUD-SPEAKER

The Trinity Loud Speaker is an instrument that combines the best qualities of a phonograph reproducer in combination with electro-magnetic principles best fitted for radio amplification.

Perfect reproduction of all music and speech without distortion. No storage batteries required. The instrument is of a heavy duty type and is guaranteed fully by the manufacturers.

For sale by good dealers.

Literature upon request.

TYPE AI  
\$25.00  
21" Fibre Horn



TRINITY RADIO CORPORATION  
446 1/2 Tremont Street, Boston, Mass.



## "Push-Pull" Amplifying Transformers

for those who demand more than has heretofore been secured from audio frequency amplification. Supplied in sets of two.

### Modern 10 to 1

has carved its own way to fame by performance in reflex circuits. Also preferred by many on the first stage of standard audio frequency amplifiers.

### Modern 4 to 1

meets with a welcome wherever it goes. The many repeat orders attest to its all around efficiency.

Write today for illustrated circulars and bulletins.

The Modern Electric Mfg. Co.  
Dept. 712  
Toledo, Ohio

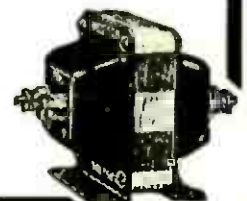



# POPULAR RADIO with Your Other Favorites — at Bargain Club Prices!

But you must act quickly. These offers hold good only up to midnight December 15th, 1923

**G**LANCE over this big list of magazine bargains that have been arranged for your benefit. Here is your chance to get almost any magazine you want—and by ordering *now* with a year's subscription to POPULAR RADIO you get *both* magazines at special low prices.

If you are already a subscriber to POPULAR RADIO or to any of these other magazines, these special club offers allow you the privilege of renewing or extending your subscription *at a considerable saving of money*.

As you know, the subscription price of POPULAR RADIO advances from \$2 to \$3 a year, effective December 15th, 1923. Yet practically all of these magazine combinations are figured at a price for each magazine that is lower than even the present subscription price.

Fill your magazine requirements *now* for the coming year and save money. Simply check the offer you want and mail the coupon below, with your remittance, without delay.

## A Christmas Suggestion

All subscription prices quoted are for one full year, and may be sent to *one* or to *separate addresses* unless otherwise noted. This gives you the opportunity of placing your own subscription for POPULAR RADIO, and having the other magazine sent to some friend as a Christmas gift.

But do not delay. These offers are good only until December 15th, 1923. After that date POPULAR RADIO advances in price and these offers will be withdrawn. Safeguard yourself *now* against POPULAR RADIO's raise in price, and in addition get these other magazines at special bargain club rates!

(This offer expires midnight Dec. 15, 1923.)

POPULAR RADIO, Dept. 121,  
9 East 40th Street, New York City.

Enclosed is \$..... Please see that yearly subscriptions are at once entered in my name for each of the magazines I have checked in the special bargain club list at the right.

Name.....

Street and Number.....

City..... State.....

(If not a NEW subscription, please mark R after the name of the magazine, to indicate RENEWAL.)

Prices for Canada and foreign countries will be quoted on request.

McCall's Popular Radio \$3.00 Reg. For..... <b>\$2.40</b>	Modern Priscilla Popular Radio \$4.00 Reg. For..... <b>\$3.25</b>
Youth's Companion (52 issues) Popular Radio \$4.50 Reg. For..... <b>\$3.75</b>	Scientific American Popular Radio \$6.00 Reg. For..... <b>\$5.25</b>
American Magazine Woman's Home Com- panion (both to one address) Popular Radio \$6.00 Reg. For..... <b>\$5.00</b>	Pictorial Review Modern Priscilla Popular Radio \$5.50 Reg. For..... <b>\$4.50</b>

## Or You Can Make Up Your Own Club of POPULAR RADIO With:

American Boy.....	\$4.00 reg., for...	\$3.75
American Magazine.....	4.50 reg., for...	4.25
Asia.....	5.50 reg., for...	4.75
Boy's Life.....	4.00 reg., for...	3.50
Century.....	7.00 reg., for...	5.75
Christian Herald (52 issues).....	4.00 reg., for...	3.15
Collier's (52 issues).....	4.50 reg., for...	3.75
Country Life.....	7.00 reg., for...	6.25
Delineator.....	4.00 reg., for...	3.25
Designer.....	3.50 reg., for...	2.85
House & Garden.....	5.50 reg., for...	4.75
Judge (52 issues).....	7.00 reg., for...	6.25
Life.....	7.00 reg., for...	6.25
McClure's.....	5.00 reg., for...	3.90
Mentor.....	6.00 reg., for...	5.25
Movie Weekly.....	7.00 reg., for...	6.25
People's Home Journal.....	3.25 reg., for...	2.65
Photoplay.....	4.50 reg., for...	4.00
Physical Culture.....	5.00 reg., for...	4.25
Popular Science Monthly.....	4.50 reg., for...	4.25
QST.....	4.00 reg., for...	3.60
Radio.....	4.50 reg., for...	4.00
Radio Broadcast.....	5.00 reg., for...	4.25
Radio Digest (52 issues).....	7.00 reg., for...	6.25
Radio News.....	4.50 reg., for...	4.00
Radio World (52 issues).....	8.00 reg., for...	7.25
Review of Reviews.....	6.00 reg., for...	4.75
Scribner's.....	6.00 reg., for...	5.25
Sunset.....	4.50 reg., for...	3.75
System.....	6.00 reg., for...	5.25
Today's Housewife.....	3.00 reg., for...	2.40
Vogue (26 issues).....	7.00 reg., for...	6.25
Wireless Age.....	4.50 reg., for...	4.00
World's Work.....	6.00 reg., for...	5.25

**Note:** If you wish any TWO or more of these magazines with POPULAR RADIO, simply deduct \$1.75 from the bargain club price quoted, then add POPULAR RADIO at \$1.75. For example:

Collier's.....	\$3.75 less \$1.75=	\$2.00
Radio News.....	4.00 less 1.75=	2.25
POPULAR RADIO, added at only.....	1.75	

Remit this amount **\$6.00**



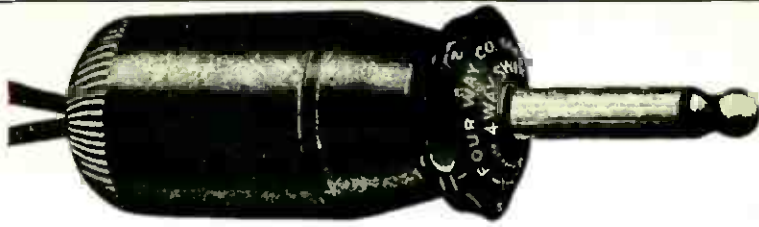

## The New 1924 Model "4-Way" Switch Plug!

Many refinements have been added to make this the best radio plug.



—a switch plug which makes it possible to tune in through head set and switch in loud speaker by turning dial. Two head sets can be readily attached, or one head set and loud speaker. Both can be used at same time or either one alone. **Order yours TODAY.**

# \$1.50

FOUR WAY CO., 29 Worthington St., Springfield, Mass.

## DX-10-POINT

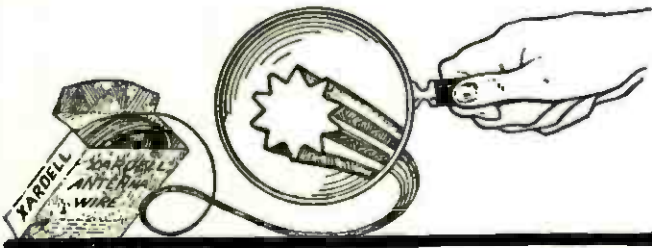

## ANTENNA WIRE

# \$2<sup>00</sup>

PER  
HUNDRED  
FEET

Designed for long distance reception and is different and better than the usual make-shifts, being hard drawn from the finest copper, having a corrugated surface with ten collecting points on the circumference. This gives a greater collective surface to the high frequency radio currents. The result is extreme sensitiveness and increase in range and clearness of any set from the simplest Crystal to the finest multiple tube receiver.

Use this antenna wire and enjoy the full possibilities of your set.

Sold in coils 100 feet, 200 feet and 500 feet. Order direct or from your nearest dealer.

Dept. R



## Critical Circuits

REQUIRE GOOD MICA CONDENSERS



The FRESHMAN is so designed that constant equal pressure is exerted on the condenser plates over the entire area. They are the only condensers that do this and therefore the only condensers that avoid noises, which are due to variable pressure on the plates.

Capacity	Each	Capacity	Each
.0001	\$.35	.0025	\$.50
.00015	.35	.003	.60
.00025	.35	.0035	.70
.0002	.35	.004	.75
.0003	.35	.005	.75
.00035	.35	.006	.75
.0005	.35	.007	1.00
.0006	.40	.008	1.00
.0008	.40	.01	1.00
.001	.40	.015	1.50
.0015	.40	.02	2.00
.002	.40	.025	2.50

Ask your dealer or write for our free diagrams of the Neutrodyne, Sensational New Kaufman No. 2, Flewelling and other circuits.

At your dealers, otherwise send purchase price and you will be supplied postpaid

**Chas. Freshman Co. Inc.**  
Radio Condenser Products  
106 SEVENTH AVE., NEW YORK

## METALECTRIC SOLDERING IRON

(Indestructible All-Metal Quality Instrument—"GUARANTEED")

"Designed to meet the requirements of the discriminating assembler"

Interchangeable  
Tip



\$5.50  
"Worth  
It"

ONE-HALF ACTUAL SIZE

Operates with the Simplicity-Comfort-Ease and Efficiency of a Pen

of your dealer or write

POST ELECTRIC CO., Mfrs. (Instruments Division) 30 East 42nd St., New York



**The BATES EAR CUSHION**

No finer Christmas gift for radio fans. Supreme comfort and keener hearing. Slips over any radio phone.

**POSTPAID ANYWHERE IN U. S. \$1.00**

**DEALERS:** Write for special discounts. Fastest moving radio accessory on the market.

**BATES & COMPANY**

1520 Montana St. Chicago, U. S. A.

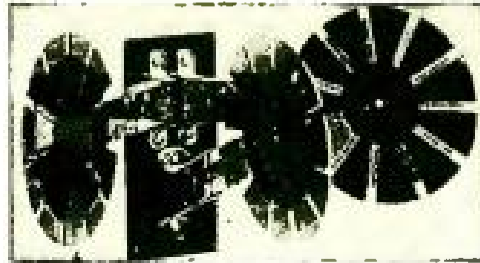

Patent Pending

The **GOODMAN** is the niftiest short wave tuner on the market. Awarded certificates of merit. Our pamphlet tells all about it. Send for one. Price \$6 and PP. on one pound. **L. W. GOODMAN, Mfr., Drexel Hill, Pa.**

**RADIO FANS**

Tune in on station

**W E A F** (New York)

every Thursday at 8:50 P. M. and listen to a story or article selected from

**HEARST'S**

**I N T E R N A T I O N A L**

This is one of the most popular weekly features "on the air"

**FREE**

Write for Free Copy of the Latest Radio Reprint A. It contains a complete story from Hearst's International Magazine.

Address Radio Editor, Hearst's International Magazine, 119 West 40th St., New York City

**Cockaday Coil Set \$2.50**

Including full size blue prints of panel layout, complete picture hookup, and fully illustrated instructions for construction and operation.

Coils are fully assembled, made exactly as specified by Mr. Cockaday, D coil bank wound. Far more efficient than any home made coils.

Standard parts for this sensational circuit—panel, coils, condensers, verniers, variable resistance, vernier rheostat, socket, double jack, dials, switch, contact points, posts, busbar wire, spaghetti, etc. (no tubes or phones).

**Complete for \$11.65**

Postage additional on all shipments

Send No Money. **PAY THE POSTMAN**  
All Goods Shipped Parcel Post C. O. D.

**RADIO SURPLUS STORES**  
HELENA, MONTANA

FOR SALE

**BROADCASTING STATION**

500 Watt Master Oscillator  
Heising Modulation

Now in operation. Public opinion classifies this station as one of the best in the country. No fair offer refused.

ADDRESS, DEPT. S., POPULAR RADIO

**T**O the manufacturer of one or more articles of meritorious radio equipment, this organization, well experienced in the trade of Spanish and Portuguese speaking countries, offers a service of exceptional interest.

We now handle the export business of Dubilier Products, Burgess Batteries, Radio Service Labs., Freed-Eisemann and Scholes Radio and Mfg. Corp., and are equipped to take on one or two additional high grade lines. Full information and statistics on market conditions in these countries will be given confidentially on request.

AD. AURIEMA  
116 BROAD STREET  
NEW YORK CITY

"LET ACMEDYNE IN EVERY HOME"

with



**VARIO-FORMERS**

**DANZIGER-JONES, Inc.**

25A Waverly Place :: New York, N. Y.

**Loud Speaking Crystal Set**

AT LAST

You can add a loud speaker to any crystal set by using the **STEINMETZ** Amplifier costing only \$8.50. Guaranteed to operate on any kind of crystal set regardless of what type it is, or we will refund your money. By using your crystal set with this amplifier music is brought in as clear as a bell and can be heard all over the room. Amplifier uses dry cell tube

Write for our complete catalog and also information on a highly efficient detector and two-stage amplifier at \$22.50

**STEINMETZ WIRELESS MFG. CO.**  
Manufacturers and Engineers

5703 Penn Ave. Pittsburgh, Pa.

**HARTMAN**

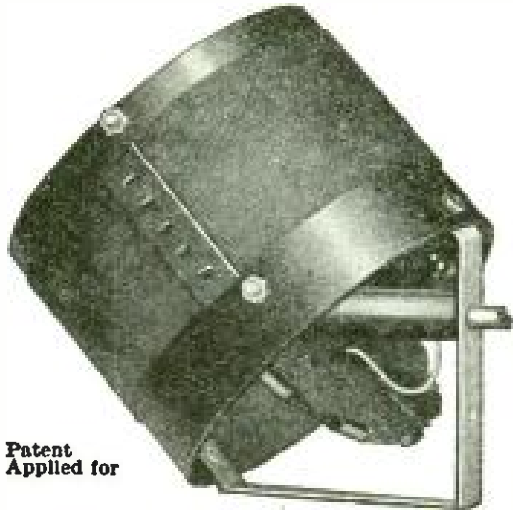

Patent Applied for

**\$4.50 VARIOCOUPLER \$4.50**

Here is a distinctively high grade Variocoupler at an exceptionally low price.

Check the following points and verify this claim.

- (1) Spider web rotor. The only means of obtaining minimum coupling.
- (2) Pig tail contacts.
- (3) Bakelite tube.
- (4) Green silk wire.
- (5) No live brackets.
- (6) Improved taps.
- (7) Dead shaft and no capacity effect in tuning.
- (8) 180° dial adjustment without the rotor being submerged in stator field.

**THE HARTMAN ELECTRICAL MFG. CO.**  
Mansfield, Ohio



**BRANSTON RADIO**

"Standard of the World"

**LOOK FOR THIS TRADE MARK CARD IN YOUR DEALER'S WINDOW OR SALESROOM**

**Leich Radio Products**

**Leich Non-Tune Rectifier**

Needs no attention while in operation. Power interruptions automatically disconnects storage battery. Starts charging again as soon as power is on.

The Non-Tune is furnished in two types, one for charging A batteries, the other B batteries.

No. 16 Non-Tune Radio Rectifier to charge 6 volt battery . . . . . **\$19.00**

No. 10 Non-Tune Radio Rectifier to charge B batteries . . . . . **12.00**



No. 16 Non-Tune Radio Rectifier, Price \$19.00

**Leich Comfortable Headphones**

Leich Headphones bring in broadcast reception in pleasing natural tone like listening to the artists direct. Regardless of how expensive your receiving set, if you do not get a natural tone, if you do not get the overtones, the reception is flat.

Ask your dealer to let you "listen in" with Leich Phones. You will appreciate the difference.

1-B-2000 Leich Radio Headphone . . . . . **\$6.00**  
Ask your dealer for Leich Radio Products—write us for booklet 101-I giving complete list and prices.

**LEICH ELECTRIC CO.**  
GENOA, ILLINOIS

**ACOUSTICOLA**

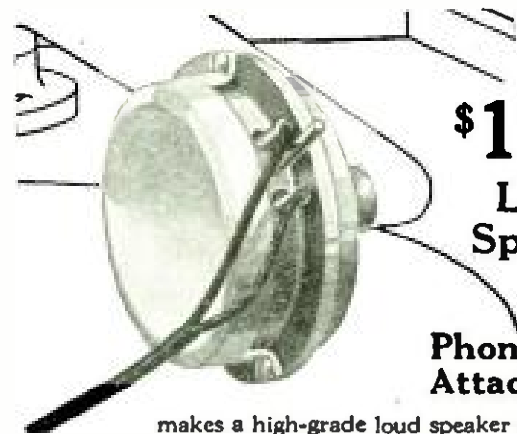

**\$10.00**

**Loud Speaker**

**Phonograph Attachment**

makes a high-grade loud speaker of any phonograph. Extra large size. Wonderful adjustment lever tones down local stations and strengthens and clarifies weak signals from distant stations by instantly increasing or decreasing distance between poles and diaphragm. Just like focusing a camera.

**ACOUSTICOLA STANDARD MODEL \$22.50**

Same lever equipped, giant size unit with non-metallic horn, 21 1/2" high; bell 10" wide

**ACOUSTICOLA GRAND \$35.00**

With Cast Aluminum VIBRATIONLESS Horn—the world's finest loud speaker. . . . .

**TRIMM HEADPHONES**

"Professional" \$7.65 "Dependable" \$5.00

With every Trimm product we give a LIFETIME Guarantee. Write for folder.

**TRIMM RADIO MFG. CO.**  
Dept. 59 24 S. Clinton St., Chicago



# Xmas Buying Is Here Dealers! Profit!

Let Us Help You Get the  
Most Out of this Radio  
Season

Prompt Shipment—Efficient Service

We carry complete stock of all fast moving nationally advertised Radio Supplies. Orders filled same day received. This means money to you.

SEND TODAY: for complete catalog Radio Supplies priced to make you a profit. We list over a thousand items.

We are the largest exclusive radio jobbers in the middle west

**HUDSON-ROSS**  
123 W. Madison St. Chicago

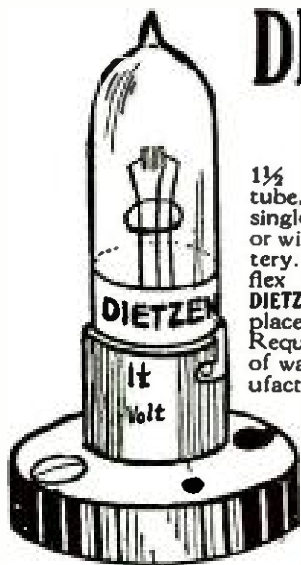

## DIETZEN MIDGET TUBE

The Little Tube  
for Big Results

1½ Volt Vacuum tube, operates on single dry cell, with or without "B" battery. Great for reflex work. The DIETZEN MIDGET replaces the crystal. Requires no adjustment or change of wave lengths. Order from manufacturer direct. Send for your tube today, enclosing currency or money order. (No stamps.)

**\$1.00**  
Special Socket 40c

**DIETZEN, Inc.**  
71 Cortlandt Street  
Dept. P New York

# RUSONITE

CRYSTAL RECTIFIER

(Patent pending)  
THE PERFECT SYNTHETIC CRYSTAL DETECTOR  
SENSITIVE OVER ENTIRE SURFACE  
No Hunting for "Spots." Loud and Clear. Endorsed by Thousands of Satisfied Users

Sensitiveness Guaranteed	Price Mounted	<b>50c</b>
--------------------------	---------------	------------

14 K. Gold Supersensitive RUSONITE CATWHISKER, Price Permanent. Will not Oxidize	<b>25c</b>
---	------------

RUSONITE REFLEX CRYSTAL Manufactured Expressly for Reflex Circuits. Will Stand Up Under Heavy Plate Voltage	Price Mounted	<b>\$1.00</b>
--	---------------	---------------

WATCH FOR OUR NEW FIXED CONDENSER  
Order from your dealer or direct from  
**RUSONITE PRODUCTS CORP.**  
16 Park Row New York, N. Y.

# Hear them all clearly

With a Premier

## "HEGEHOG"

Trade Mark

Audio Transformer

Little but mighty—a wizard for volume and tone quality. Look at the cut. It shows the "HEGEHOG" one half actual size. "Small," you say. Yes, but inside this "Little Wonder" you will find more efficiency, more reproduction volume, and less distortion than found in any other Transformer, regardless of size, price or design. The secret is in its patented construction. It is shielded 100% against foreign noises. Fully guaranteed. You'll want them in your next "hook-up," so get all the facts NOW. Our Free Bulletin No. 97 gives them fully. Send for it.

**Premier Electric Company**

3807 Ravenswood Ave. :: Chicago

Price, \$3<sup>50</sup>



Cut one-half actual size

Ask for and  
insist on "HEGEHOG"  
at your dealer's

STATEMENT OF THE OWNERSHIP, MANAGEMENT, CIRCULATION, ETC., REQUIRED BY THE ACT OF CONGRESS OF AUGUST 24, 1912, OF POPULAR RADIO Published monthly at New York, N. Y., for October 1, 1923.

STATE OF NEW YORK }  
COUNTY OF NEW YORK } ss.

Before me, a Notary Public in and for the State and county aforesaid, personally appeared Kendall Banning, who, having been duly sworn according to law, deposes and says that he is the Editor of POPULAR RADIO, and that the following is, to the best of his knowledge and belief, a true statement of the ownership, management, etc., of the aforesaid publication for the date shown in the above caption, required by the Act of August 24, 1912, embodied in section 443, Postal Laws and Regulations, to wit: 1. That the names and addresses of the publisher, editor, managing editor, and business managers are: Publisher, POPULAR RADIO, Inc., 9 East 40th St., New York City; Editor, Kendall Banning, 9 East 40th St., New York City; Managing Editor, None; Business Managers, none. 2. That the owner is: POPULAR RADIO, Inc., whose stockholders are: New Fiction Pub. Corp., 9 E. 40th St., New York City, whose stockholders are: Abel I. Smith, 120 Broadway, New York City; Marjorie L. Sargent, Premium Point, New Rochelle, N. Y.; H. B. Emerson, 9 East 40th St., New York City; Metropolitan Finance Corporation, 9 East 40th St., New York City; whose stockholder is Harvey Fisk & Sons, Inc., 34 Pine St., New York City, whose stockholders are: Frank B. Ansted, Connorsville, Ind.; William G. Audenreid, Jr., 34 Pine St., New York City; Harvey Fisk, 34 Pine St., New York City; Pliny Fisk, 34 Pine St., New York City; Lorin L. Homer, 34 Pine St., New York City; Henry K. Hooker, 40 State St., Boston, Mass.; Wilfred Jessup, 34 Pine St., New York City; James Magill, Land Title Bldg., Philadelphia, Pa.; F. O. Marsh, 52 Wall St., New York City; Joseph R. Paul, Westinghouse Bldg., Pittsburgh, Pa.; Carlton W. Rich, 60 State St., Boston, Mass.; Richard U. Sherman, 246 Genesee St., Utica, N. Y. 3. That the known bondholders, mortgages, and other security holders owning or holding 1 per cent. or more of total amount of bonds, mortgages, or other securities are: None. 4. That the two paragraphs next above, giving the names of the owners, stockholders, and security holders, if any, contain not only the list of stockholders and security holders as they appear upon the books of the company but also, in cases where the stockholder or security holder appears upon the books of the company as trustee or in any other fiduciary relation, the name of the person or corporation for whom such trustee is acting, is given; also that the said two paragraphs contain statements embracing affiant's full knowledge and belief as to the circumstances and conditions under which stockholders and security holders who do not appear upon the books of the company as trustees, hold stock and securities in a capacity other than that of a bona fide owner; and this affiant has no reason to believe that any other person, association, or corporation has any interest direct or indirect in the said stock, bonds, or other securities than as so stated by him.

(Signed) KENDALL BANNING, Editor.

Sworn to and subscribed before me this 1st day of October, 1923.  
[SEAL] J. E. AHLQUIST, Notary Public.



*Fine Lenses  
without close adjustment  
are worthless!*

## Why cripple your radio set with poor filament control?

EVERY seaman knows that a binocular cannot bring in distance clearly unless focused with extreme care. It is the last fractional turn of the adjusting screw, perhaps the width of a hair, that brings the distant object within the range of clear vision. The slightest turn, either way, makes a blurred, distorted image.

The same is true of radio sets. The finest detector tube cannot bring in distance clearly without ultra-fine filament control. The Universal Bradleystat performs this delicate operation with utmost precision. The gradual adjustment of the Bradleystat knob brings in distant stations without noise or distortion. Every fine radio set deserves a Bradleystat. Are you getting the best out of your set, today? Try a Universal Bradleystat.

# Bradleystat

REGISTERED U.S. PAT. OFF.  
PERFECT FILAMENT CONTROL

Retail Price, \$1.85  
In Canada, \$2.50  
Postage 10c



Perfect Control  
For ALL Tubes

If you want to extend the range of your radio set, improve reception and get louder signals, learn about Bradleystat by mailing the coupon below.

Allen-Bradley Co.,  
276 Greenfield Ave., Milwaukee, Wis.

I would like to know more about the Bradleystat and why it improves radio reception.

Name \_\_\_\_\_

Address \_\_\_\_\_



**Allen-Bradley Co.**  
Electric Controlling Apparatus  
276 Greenfield Ave. Milwaukee, Wis.



Manufacturers of graphite disc rheostats for over 20 years.



# Bradleyleak

## THE PERFECT GRID LEAK



Retail Price 185  
Condenser (00025ME) 35¢

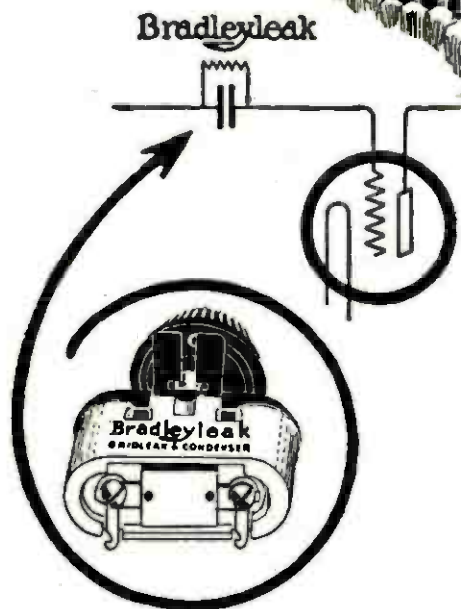

## The Dawn of Better Radio

Long distance records in radio reception depend upon the precise adjustment of several elements in the radio set. Too often, the correct adjustment of grid leak resistance is considered of minor importance and frequently it is much too high or too low for the best operation of the detector tube.

The new Bradleyleak adds the final touch of perfection to the radio set. When substituted for the ordinary grid leak, it enables you to get the precise value of grid leak resistance which your detector tube requires. Any resistance between  $\frac{1}{4}$  and 10 megohms is obtained without noise, steps or jumps by merely turning the Bradleyleak knob.

The volume of the detector increases gradually as the proper amount of grid leak resistance is approached, and if the Bradleyleak knob is turned too far, the volume again diminishes. Nothing could be simpler. Try it on your radio set, tonight.

### The Grid Leak Is Important!

The following table gives the approximate values of grid leak resistance recommended by vacuum tube manufacturers:

Audion (DeForest) DV-6	2 Megohms
C-200	2 Megohms
C-299	2 to 5 Megohms
C-301-A	2 Megohms
UV-199	2 to 5 Megohms
UV-200	2 Megohms
UV-201-A	2 Megohms
WD-11	3 Megohms, or more
WD-12	3 Megohms, or more

Install the Bradleyleak and work your tubes at highest efficiency



**Allen-Bradley Co.**  
Electric Controlling Apparatus  
276 Greenfield Avenue • Milwaukee, Wis.



The Allen-Bradley Co. has built graphite disc rheostats for over twenty years



# The TOWN CRIER of TODAY



In the quaint old villages and towns of long ago, when each community was a world unto itself, the Town Crier played an important part in the affairs of the day. With clanging bell and stentorian voice, he broadcast the news, perhaps weeks old, that occasionally drifted in from outside places.

Today news from all parts is immediately available right at your fireside. No matter how isolated your abode, Radio binds you to civilization. By a turn of the dial, the happenings, entertainments and amusements of the world are yours to command.

The Crosley Manufacturing Co. has done much toward bringing this new wonder within the reach of all and has made Radio a living, tangible thing—something to use in daily life, in business or pleasure.

Popularly priced, these famous receivers give perfect performance. Unsolicited letters are received daily from owners telling of satisfaction and new distance records.

Everyday tests prove to us that Crosley instruments are the most simple and efficient Radio receivers ever offered to the public, regardless of cost.

*For Sale by Good Dealers Everywhere*

Write for complete catalog. This fully describes the Crosley line of Radio parts and receivers which range in price from a 2 tube set at \$30 to the new beautiful Model X-L at \$140.



**CROSLEY**  
Better - Cost Less  
Radio Products

*The Broadcasting Station  
WLW is maintained by the  
Crosley Manufacturing Co.*

**Crosley Manufacturing Co.**

POWEL CROSLEY, JR., President

1216 Alfred St.

Cincinnati, O.

**CROSLEY**

Model X-J

\$65



Crosley Model X-J \$65

A 4 tube radio frequency set combining one stage of Tuned Radio Frequency Amplification, a Detector, and two stages of Audio Frequency Amplification. A Jack to Plug in on three tubes for head phones, the four tubes being otherwise connected to loud speaker, new Crosley Multistat, universal rheostats for all makes of tubes for dry cells or storage batteries, new condenser with molded plates, filament switch and other refinements add to its performance and beauty.

*Nowhere can a better receiver  
be purchased at any price.*

Cost of necessary accessories from \$40 up.

List prices on our equipment west of the Rockies 10% higher. In Canada add duty.

MAIL THIS COUPON

**Crosley Manufacturing Co.**  
1216 Alfred St., Cincinnati, O.

Gentlemen: Please mail me free of charge your complete catalog of Crosley instruments and parts together with booklet entitled "The Simplicity of Radio."

Name.....

Address.....

# CLEAR~for the Crowd!

**M**MUSIC for the crowd as clear as one man gets it on the headphones! Sit back and listen. Tune in—shut your eyes—it's real! Every word clear—every musical note true—every instrument with its full rich tone. With a RADIOLA LOUDSPEAKER.

With the ordinary loudspeaker, there is something lost—and something added. The lost tones are the overtones and partials that give music or voice its richness, color, and personality. The added sounds are the independent vibrations of the horn itself—metallic—hard—and grating.

To erase these faults was the problem. Not to make another loudspeaker with the limitations of the old one—but to create a new one without those limitations. And we have it in the RADIOLA LOUDSPEAKER.

#### *First—we have greater tone range*

To get the deep tones of the organ—the full range of the piano—the highest notes of the violin—all with full color and richness.

#### *Then—adjustable volume*

Volume enough for a large room, yet with means to soften the tone when a near station comes in too loud. On the RADIOLA LOUDSPEAKER you control the volume with a turn of the thumb.

#### *And the horn*

This was a problem for acoustical experts. The mere shape of a horn can make it or ruin it. Each curve of the RADIOLA LOUDSPEAKER horn has been developed for pure tone reproduction. And it is made of a composition with no audible vibration of its own—amplifying without adding.



Radiola Loudspeaker  
Model U. Z.-1320  
Price  
\$36.50

Radio Corporation of America

Sales Offices: Dept. 2057

233 Broadway, New York    10 So. La Salle St., Chicago, Ill.    433 California St., San Francisco, Cal.



This symbol  
of quality  
is your pro-  
tection

# Radiola

REG. U. S. PAT. OFF.

## LOUD SPEAKER



This symbol  
of quality  
is your pro-  
tection.