

Epoch-Making Electrical Inventions In This Issue

POPULAR ELECTRICITY

MAGAZINE

IN PLAIN ENGLISH
(NON TECHNICAL)

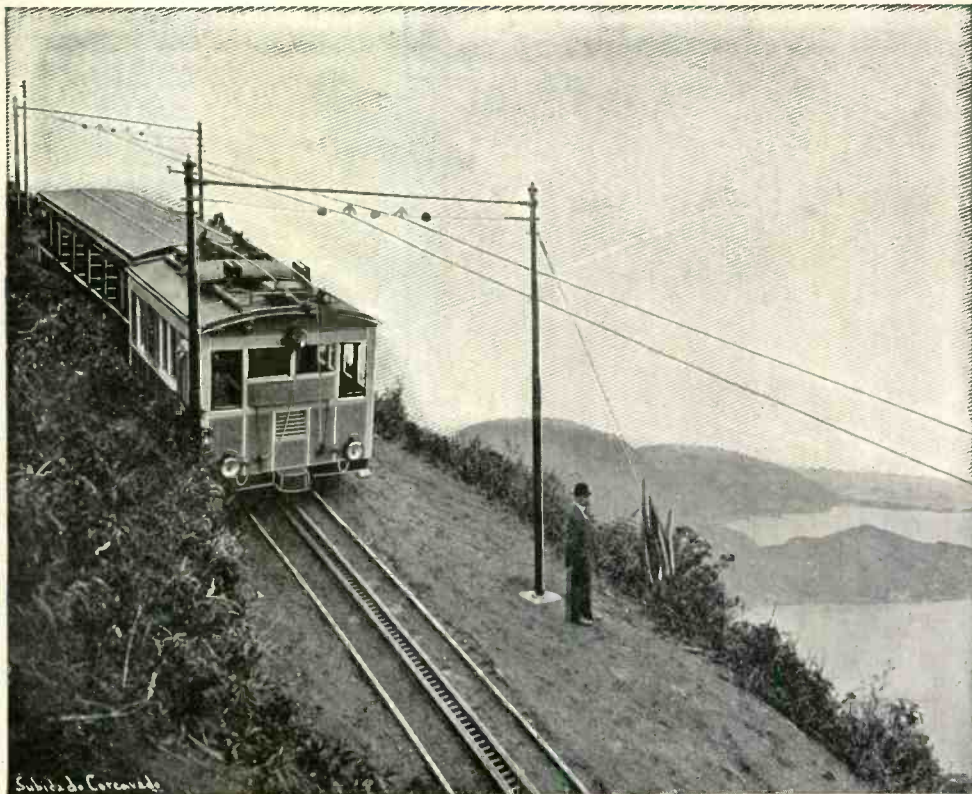

Subida do Corcovado

SCENIC RAILWAY OVERLOOKING THE BEAUTIFUL BAY OF RIO JANEIRO

See page 1085

Vol. III

APRIL, 1911

No. 12

A MAGAZINE FOR EVERYBODY

10 Cents



Dirt taken out of one rug after being broom swept

THE SIMPLEX IS JUST AS EFFECTIVE AND MORE SERVICEABLE THAN ANY OTHER VACUUM CLEANER as—

IT IS NOT COMPLICATED
IT IS SELF-CONTAINED

IT HAS NO WHEELS
IT HAS NO GEARS

IT HAS NO MOTOR
IT HAS NO BELTS

It has no long rubber hose to rot, wear out and tangle

It takes up no more space than the old-fashioned broom

It weighs but five pounds (complete)
A child can use it as it requires so little exertion.

Send For Our FREE Book:

“CLEANLINESS Is Next To GODLINESS”

RESPONSIBLE

AGENTS
WANTED

SIMPLEX CLEANER CO.

1741-1749 Berwin Ave.

CHICAGO

SENT TO YOU BY
PREPAID EXPRESS

GUARANTEED FOR
TWO YEARS

FULLY PAID FOR

A SIMPLEX VACUUM CLEANER

FOR ONLY

Five Dollars

CLEANS carpets, rugs, cushions, draperies, clothing and all fabrics CLEAN, and just as good as ANY high-priced Electric Outfit.

IT'S SANITARY, makes no dust, as it draws ALL of the dirt and dust UP AND OUT of the carpets and rugs by a POWERFUL SUCTION and RETAINS it in an AIR TIGHT dust chamber, where it can be easily removed and emptied out of doors.

THE SIMPLEX VACUUM CLEANER does exactly THE SAME WORK and is used in exactly the same manner as all of the high-priced Electric Cleaners, namely, the cleaner is moved back and forth over the carpets, rugs or articles to be cleaned, without any of the many disadvantages of the higher priced cleaners.

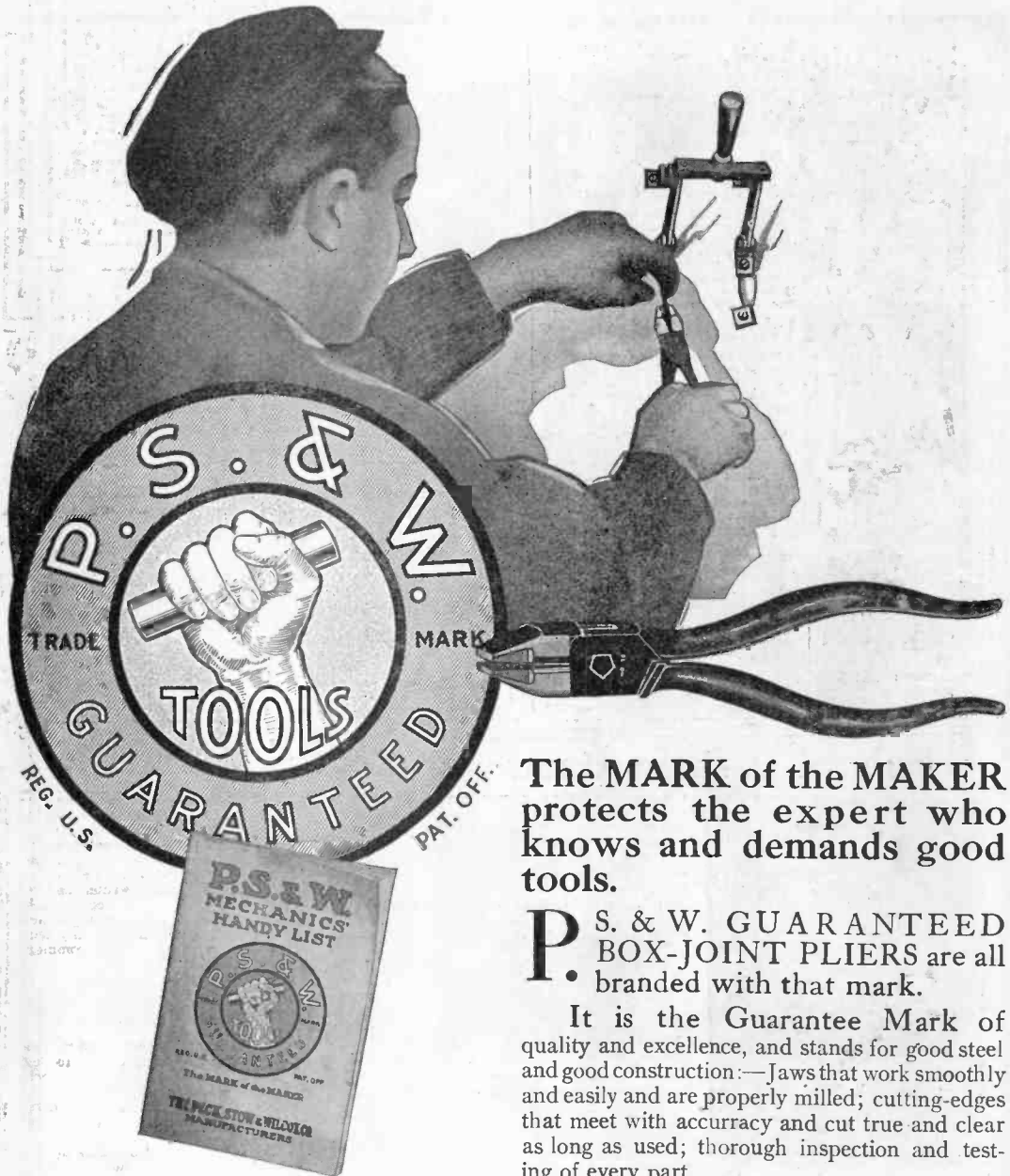

The MARK of the MAKER protects the expert who knows and demands good tools.

P. S. & W. GUARANTEED BOX-JOINT PLIERS are all branded with that mark.

It is the Guarantee Mark of quality and excellence, and stands for good steel and good construction:—Jaws that work smoothly and easily and are properly milled; cutting-edges that meet with accuracy and cut true and clear as long as used; thorough inspection and testing of every part.

Besides our large Line of Box-joint Pliers we make a full Line of Lap-joint Pliers and Splicing Clamps.

Our four large Lines of Guaranteed Hand Tools for Electricians, Machinists, Tinsmiths and Carpenters are sold by leading dealers in the United States and Canada, or can be ordered by them from any hardware jobber. Insist on The MARK of the MAKER and accept no substitute.

WRITE FOR THIS FREE BOOK

Our 165-page "Mechanics' Handy List," shown above, is a valuable reference book containing 35 pages of shop information and a Catalog of over 200 tools. It is in great demand among practical mechanics and the second large edition is already nearly exhausted. Write for your copy at once.

The Peck, Stow & Wilcox Co.
MANUF'RS of the Largest Line of Mechanics' Hand-Tools offered by Any Maker

Established 1819

Address Correspondence to 30 Murray Street, NEW YORK CITY

Five Large Factories

For our Mutual Advantage mention Popular Electricity when writing to Advertisers.

LEARN TO RUN AND REPAIR AUTOMOBILES YOU CAN

LEARN THE AUTOMOBILE TRADE
The Best Profession in the World



ENGINE MODEL



MAGNETO MODEL



CARBURETTOR MODEL



MANIKIN
OF AN
AUTOMOBILE
TAKE IT APART.

It's Easy WITH DYKE'S NEW SYSTEM

I Will Teach You Right in Your Own Home, during spare time and quicker and more thorough than you could learn in years around a car—Because: in addition to Dyke's New Revised Home Study Course of 29 complete Instructions (or 12 Books) and 120 Charts, we include absolutely free several

Working Models

of parts of the Automobile (see Illustrations) for you to actually see the principle, construction and practice valve setting—timing ignition—setting the magneto, etc. Barney Oldfield says—"A person surely can learn with your system"
If Others Can Learn, You Can—We will send you testimonials from hundreds.
Ten Dollars Covers All—Others charge \$20 to \$30—and not near so complete—We send on approval—everything goes at one time—Diploma when you finish.

FREE: 24 Page Book—"How to get into the Auto Business"
Don't Miss It! Write Today!

DYKE'S CORP. SCHOOL MOTORING,
Box 2 — 3947 Washington, ST. LOUIS

SEE HOW AN AUTO IS CONSTRUCTED.

of an auto driving "Within Six" Days we really teach—Omit to your course "Low Garage, Monclair, N. J."
 "Am opening Garage and Repair Shop about taking your course." "E. J. Eshar, LeVadburg, Ohio. Let us show you many others."

LEARN TO REPAIR AND RUN AUTOMOBILES

You can learn all in a few weeks. Demand for trained men exceeds supply. Work pleasant. Every man wanting to become a chauffeur, expert repairer, salesman, garage manager, agent or desiring to learn any branch of the automobile business should

Write for our interesting free book and learn all about the tremendous opportunities everywhere in this new business and our excellent course of training.

KANSAS CITY AUTOMOBILE SCHOOL
(Largest, Best Equipped Automobile School in America)
2163 E. 15th Street, Kansas City, Mo.

IF YOU STAMMER



attend no school till you hear from me. Largest school in the world, employing the advanced natural method for the cure of stammering, stuttering, etc. No sing-songing or time-beating. If let run, stammering will wreck your life's happiness and handicap your endeavors. I cured myself and thousands of others by my method and can cure you. Beautiful 88 page book and Special Rate sent FREE.

Leo Wells Millard, Pres., North-Western School for Stammerers, Inc., 940 First St., Milwaukee, Wis.

RAILROAD MEN WANTED

\$80 TO \$185 A MONTH

Doesn't this beat following a plow? No matter where you live we can quickly fit you for a big paying position as brakeman or fireman, at home in spare time. Learn from practical railroad men with a

Position Positively Guaranteed

to men between 20 and 35 years, who are mentally and physically O. K. This is the official school endorsed by R. R. managers. Thousands of positions open. Write today, giving age and weight. **OFFICIAL RY. SCHOOL, Gen'l Office, 451, FREEPORT, ILL.**



A School Within Itself

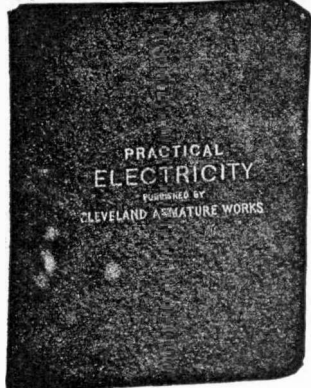

There are XX chapters in all, XIX carrying you from the fundamental principles of electricity on through the various branches to a point where the careful student comprehends the complete designing, care and operation of a dynamo or motor, and I chapter on electric automobiles, outlining their construction, care and operation, and all about storage batteries and how to handle them. Each subject is carefully written and to the point. After a student studies a subject, he is questioned on that subject in such a manner as to bring clearly to his mind the points he needs to know regarding same. A **DICTIONARY** in back of book will enable him to learn the meaning of any electrical word, term or phrase used in this book, as well as hundreds of others in common use. All required tables necessary in the study are in it.

- TABLE OF SUBJECTS:**
- | | |
|---|---|
| <p>Chapter</p> <p>I—Wiring.</p> <p>II—Electric Batteries, Electro Plating.</p> <p>III—Magnetism.</p> <p>IV—The Magnetic Circuit.]</p> <p>V—Magnetic Traction.</p> <p>VI—Magnetic Leakage.</p> <p>VII—Energy in Electric Circuit.</p> <p>VIII—Calculation of Size of Wire for Magnetizing Coils.</p> <p>IX—Calculation of EMF's in Electric Machines.</p> <p>X—Counter EMF.</p> <p>XI—Hysteresis and Eddy Currents.</p> | <p>Chapter</p> <p>XII—Armature Reaction.</p> <p>XIII—Sparking.</p> <p>XIV—Winding of Dynamos and Motors</p> <p>XV—Proper Method of connecting Dynamos and Motors—Self Excitation.</p> <p>XVI—Diseases of Dynamos and Motors, their symptoms and how to Cure Them.</p> <p>XVII—Arc and Incandescent Lamps.</p> <p>XVIII—Measuring Instruments.</p> <p>XIX—Alternating Current.</p> <p>XX—Automobiles.</p> |
|---|---|

A Dictionary of over 1500 Electrical Words, Terms and Phrases, giving a brief meaning of all which are in common use.

\$2.00 PER COPY—FIFTH EDITION—24,000 COPIES SOLD

The offer we make of refunding money if book is not satisfactory upon examination is AN UNUSUAL ONE in connection with the sale of a book. But we have no fear of its return. Your decision will be what thousands of others have been. Money would not buy it if it could not be duplicated. We could print testimonials by the hundreds. It is best to order and be your own judge of its merits.

CLEVELAND ARMATURE WORKS, 4730 St. Clair Ave., Cleveland, Ohio.

Armatures and Fields Wound, Commutators Filled
AMERICA'S GREATEST REPAIR WORKS

Complete Course on Instruments and Meters—By Mail

Our Course covers the design, theory, construction, operation, calibration, care and maintenance of all makes and types of electric Instruments and Meters.

BIG DEMAND FOR COMPETENT METERMEN

A Course in our School will qualify you for a good position where you can demand a splendid salary. Our booklet, Instruments and Meters, explaining the entire Course, with valuable information on Meter Testing, FREE on request. Write for it—TODAY.

FORT WAYNE CORRESPONDENCE SCHOOL, FORT WAYNE, IND.

For our Mutual Advantage mention Popular Electricity when writing to Advertisers.

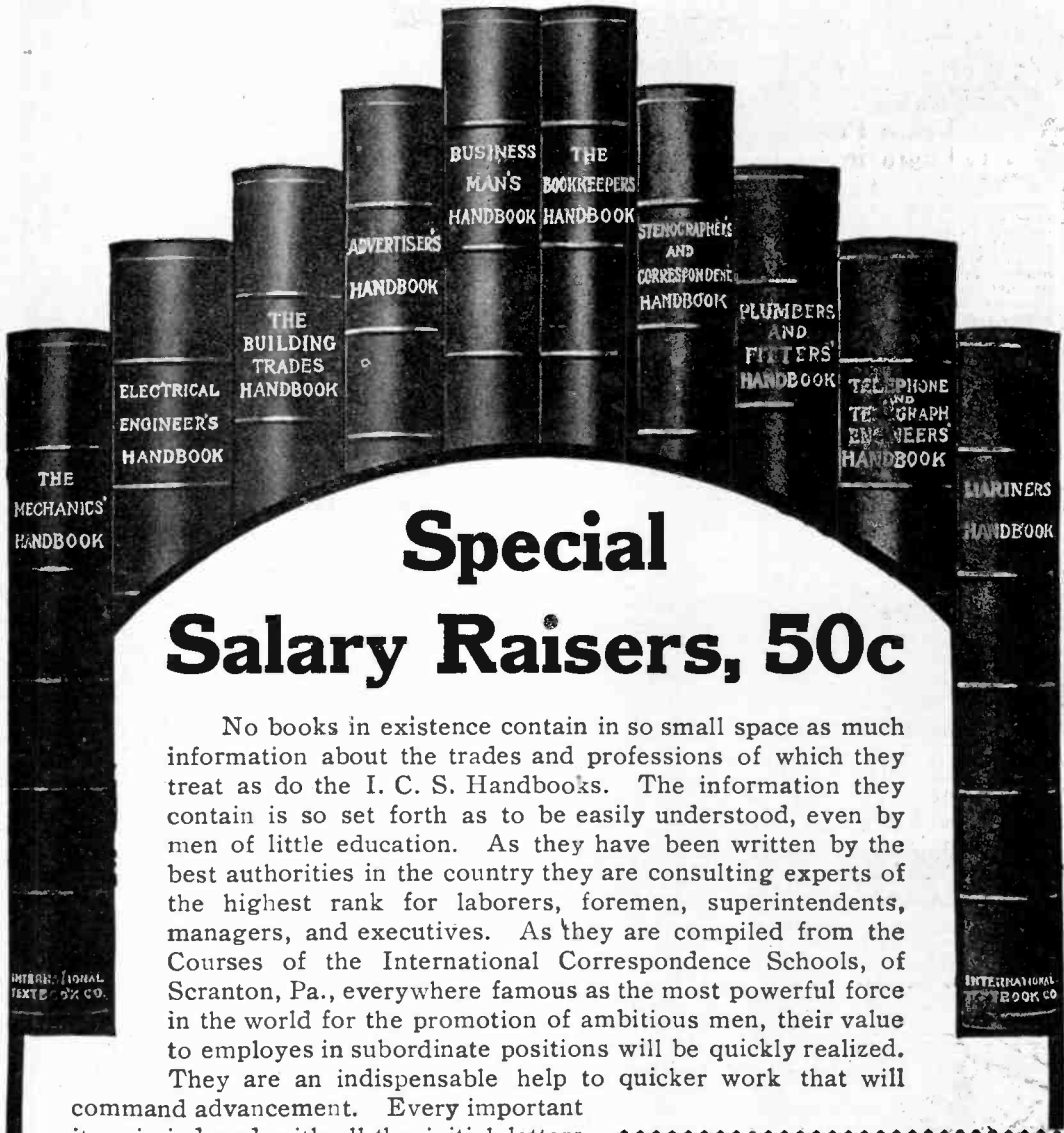

Special Salary Raisers, 50c

No books in existence contain in so small space as much information about the trades and professions of which they treat as do the I. C. S. Handbooks. The information they contain is so set forth as to be easily understood, even by men of little education. As they have been written by the best authorities in the country they are consulting experts of the highest rank for laborers, foremen, superintendents, managers, and executives. As they are compiled from the Courses of the International Correspondence Schools, of Scranton, Pa., everywhere famous as the most powerful force in the world for the promotion of ambitious men, their value to employes in subordinate positions will be quickly realized. They are an indispensable help to quicker work that will

command advancement. Every important item is indexed with all the initial letters under which it is likely to be sought. They are printed on high-grade book paper in clear type, and durably and handsomely bound in cloth with gilt titles. They contain on an average 364 pages and 175 illustrations and are regularly sold for \$1.25.

Special Offer: To better introduce the value of I. C. S. Textbooks and I. C. S. Training we will sell these books for a limited time to those sending to us this coupon and 50 cents.

.....

International Textbook Co.

Box 1102-P, SCRANTON, PA.

I enclose \$_____ for which please send me
the books before which I have marked X.

<input type="checkbox"/> Mechanics' Handbook	<input type="checkbox"/> Advertiser's Handbook
<input type="checkbox"/> Elect. Eng. Handbook	<input type="checkbox"/> Business Handbook
<input type="checkbox"/> Bldg. Trades Handbook	<input type="checkbox"/> Book'per's Handbook
<input type="checkbox"/> Plumb. & Fit. Handbook	<input type="checkbox"/> Sten. & Corr. Handbook
<input type="checkbox"/> Tel. & Tel. Handbook	<input type="checkbox"/> Mariners' Handbook

Name _____

St. and No. _____

City _____ State _____

.....

For our Mutual Advantage mention Popular Electricity when writing to Advertisers.



Learn Photography, Photo-Engraving or 3-Color Work

Photographers and Engravers Earn \$20 to \$50 Per Week. Only college in the world where these paying professions are taught successfully. Established 7 years. Endorsed by International Association of Photo-Engravers and Photographers' Association of Illinois. Terms easy; living inexpensive. Graduates assisted in securing good positions. Write for catalog, and specify course in which you are interested.
 Illinois College of Photography or 945 Wabash Av.
 Bissell College of Photo-Engraving Effingham, Ill.
 L. H. BISSELL, Pres.

LEARN TO BE A WATCHMAKER

Bradley Polytechnic Institute
 Horological Department
 Peoria, Illinois



Largest and Best Watch School in America
 We teach Watch Work, Jewelry, Engraving, Clock Work, Optics. Tuition reasonable. Board and rooms near school at moderate rates. Send for Catalog of Information.
 BRADLEY, H. Peoria, Ill.



LEARN PIANO TUNING AT HOME by the aid of the TUNE-A-PHONE. A Profession that can be converted into money at any time or place in the civilized world at an hour's notice. Earn \$5.00 to \$15.00 per day. Valuable illustrated book FREE. Write HILES BRYANT SCHOOL OF PIANO TUNING, 77 Music Hall, Battle Creek, Mich.

LEARN WATCHMAKING

ENGRAVING AND JEWELRY REPAIRING

Practical specialists in charge of all instruction. Students trained for the best paying positions. Earn while learning. Our school is endorsed and recommended by leading jewelers. A few months will make you an expert. Positions secured for graduates. Demand for watchmakers greater than the supply. Write for free catalog.

CHICAGO SCHOOL OF WATCHMAKING
 Department 30 Bush Temple, CHICAGO



Do You Like to Draw?

That's all we want to know. Now we will not give you any grand prize or alot of free stuff if you answer this ad. Nor do we claim to make you rich in a week. But if you are anxious to develop your talent with a successful cartoonist, so you can make money, send a copy of this picture with 6c. in stamps for portfolio of cartoons and sample lesson plate, and let us explain.
 THE W. L. EVANS SCHOOL OF CARTOONING
 325 Kingmoore Bldg., Cleveland, O.

New York Electrical School

Offers to men and boys a theoretical and practical course in applied electricity without limit as to time.

Instruction individual, day and night school, equipment complete and up-to-date. Students learn by doing, and by practical application are fitted to enter all fields of electrical industry fully qualified. School open all year. Write for free prospectus.

40 West Seventeenth St. NEW YORK

CAN YOU DRAW?

Our Graduates
 Are Filling High Salaried Positions
EARN \$25 TO \$100 PER WEEK

In easy, fascinating work. Practical, Individual Home Instruction. Expert Instructors. Superior equipment. Founded 1899. Twelve years' successful teaching.

Financial Returns Guaranteed.

Complete Courses in Commercial, Fashion, Magazine, Book and Advt. Illustrating; Newspaper, Cartooning, Lettering, Designing, Show Card, Architectural Perspective, Photo Retouching, Normal, Color, General Drawing, etc.

FREE ARTIST'S OUTFIT of fine instruments and supplies to each student.

Write for particulars and handsome Art Book. Our Own Fireproof Bldg.

SCHOOL OF APPLIED ART

E 70 FINE ARTS BLDG.
 Battle Creek, Mich.



Salesmen Wanted

Trained Salesmen earn from \$1,200.00 to \$10,000.00 a year, and expenses. Hundreds of good positions now open. No experience needed to get one of them. We will assist you to secure a position where you can get Practical Experience as a Salesman and earn \$100 a month or more while you are learning. Write to-day for our free book "A Knight of the Grip," list of good openings, and testimonials from hundreds of men recently placed in good positions. Address nearest office, Dept. 133

National Salesmen's Training Association
 Chicago New York Kansas City Seattle New Orleans

ARITHMETIC SELF-TAUGHT

A plain, easily-understood volume for all who have not had the opportunity of learning this subject thoroughly, or who have forgotten what they once learned. 257 Pages. Requires no teacher. This great little book sent postpaid for 60 CENTS. Stamps accepted, leather binding \$1.

GEO. A. ZELLER BOOK CO.
 Est. 1870. 4464 W. Belle Place, ST. LOUIS, MO.

SPANGENBERG'S
 PRACTICAL
 ARITHMETIC
 Self-Taught



Wanted—Men

Brakemen, Firemen, Electric Motor-men, Conductors, Train Porters

Hundreds put to work. \$65 to \$150 per month. 500 more wanted. Experience unnecessary. Application blank and map of new lines free. Give age and position wanted.

J. RAILWAY C. I., No. 47, INDIANAPOLIS, IND.



If YOU Would Be Successful Stop Forgetting

MEMORY
 the BASIS
 of ALL
 KNOWLEDGE

THE KEY TO SUCCESS
 You are no greater intellectually than your memory. Send today for my free book "How to Remember"—Faces, Names, Studies—Develops Will, Concentration, Self-Confidence, Conversation, Public Speaking. Increases income. Sent absolutely free—Address DICKSON MEMORY SCHOOL, 929 AUDITORIUM BLDG., CHICAGO

PRACTICAL ELECTRICAL EDUCATION

¶ We teach by practical work and scientific methods under practical working conditions. All branches of Electrical Science and Engineering.

¶ Students can enter at any time for the full or special courses.

¶ No matter what your education, we start you at the very point you are competent to begin. By our system of Individual Instruction you can complete our course as quick as your ability warrants.

¶ We guarantee positions. Many of our students have started to earning from \$1500 a year and up immediately upon completion of the course.

¶ Full particulars, handsomely illustrated catalog and terms free upon request.

SCHOOL OF ENGINEERING

1025 Winnebago Street MILWAUKEE, WIS.

HOW TO RUN AN AUTO

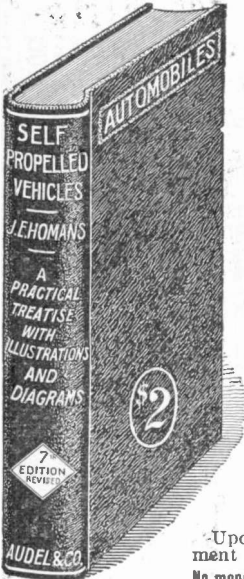

"Homans' Self Propelled Vehicles" gives full details on successful care, handling and how to locate trouble.

Beginning at the first principles necessary to be known, and then forward to the principles used in every part of a Motor Car.

It is a thorough 1911 course in the Science of Automobiles, highly approved by manufacturers, owners, operators and repairmen. Contains over 400 illustrations and diagrams, making every detail clear, written in plain language. Handsomely bound.

PRICE \$2 POSTPAID

APPROVAL OFFER

The only way the practical merit of this MANUAL can be given is by an examination of the book itself, which we will submit for examination, to be paid for or returned, after looking it over.

Upon receipt of the following agreement the book will be forwarded.

No money in advance required, sign and return

Theo. Auel & Co., 63 Fifth Ave., New York

Kindly mail me copy of Homans' Automobiles, and, if found satisfactory, I will immediately remit you \$2.00, or return the book to you.

NAME.....

OCCUPATION.....

ADDRESS..... Pop. Elect.

"HELP WANTED"

—Uncle Sam.

Railway Mail Clerks
Internal Revenue Employees
Clerks in the Departments at Washington, D.C.
City Carriers — Postoffice Clerks
 Over 15,000 positions will be filled during 1911.

\$800⁰⁰ to \$1800⁰⁰ a Year
for LIFE

No "layoffs" without pay, because of strikes, financial flurries or the whims of some petty boss. Excellent opportunities for quick advancement to Higher Government Positions. If you want immediate appointment, send **TODAY** for our schedule showing locations and dates of the Spring examinations. Any delay means the loss of just so much time in preparing yourself for examination.

SEND COUPON BELOW
FRANKLIN INSTITUTE
 Dept. H 119 ROCHESTER, N. Y.

This coupon, filled out as directed, entitles the sender to a free copy of our book, "Government Positions and How to Obtain Them," and to consideration for Free Coaching for the examination here checked.

COUPON

.. Railway Mail Clerk	(\$800 to \$1400)	.. Customs Positions	(\$500 to \$1500)
.. Postoffice Clerk	(\$600 to \$1200)	.. Internal Revenue	\$700 to \$1800
.. Postoffice Carrier	(\$500 to \$1200)	.. Stenographer	\$600 to \$1500
.. Rural Mail Carrier	(\$500 to \$900)	.. Clerk in the Depart-	ments at Washington
.. Bookkeeper	(\$800 to \$1500)		

Name..... H119
 Address.....
 Use this before you loose it. Write plainly

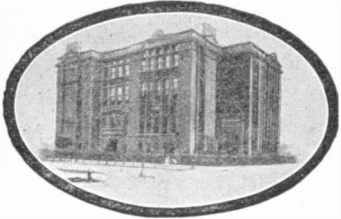

WHY BE A ROUSTABOUT

working at uncertain wages, when you can now learn a fine trade in three to five months, and be a high grade mechanic. Independent for life, earning \$5 to \$8 a day or running a business of your own.

Plumbing, Bricklaying, Electrical Work,
Mechanical Drawing, or Painting
Decorating and Paper Hanging

We occupy this entire building taught at the most successful trade institute in the world. No books, but tools and actual working materials in teaching. Individual instruction. Low expenses. Easy terms. Graduates placed. Your success assured. Write today for large illustrated catalog.

LESLIE L. COOKE, President

COYNE NATIONAL TRADE SCHOOLS, 74 East Illinois Street, CHICAGO, ILL.

Good News

OCCULT FORCES. A Key to Mental and Physical Power. A wonderful, magical power that invests the owner with a sense of perfect confidence in the ability to sway the minds and actions of others. 140 pages, 30c. "The Power of Personal Influence." Your latent forces and how to use them. Make the most of life and its possibilities. Over 100 pgs. 25c. Catalogue of Occult and Scientific Books free. Science Inst. Dept. P.E. 27 Randolph St., Chicago.



Learn Telegraphy

MORSE and WIRELESS
 At My Practical School, Demand for operators greater than supply. We also teach Station Agency Work. Graduates assisted. We occupy our own 2 large modern buildings equipped with R. R. Dispatchers and Western Union Wires and Wireless Station. Endorsed by Railroad, Wireless and Western Union Officials. Exclusive Methods. Teachers are practical experts. Living expenses earned. Easy payments. Correspondence course if desired. Catalogs Free. **GEORGE M. DODGE,** Pres., Dodge's Institute. Established 1874. 21st St., VALPARAISO, IND.

Draws Dandy Pay

Job a cinch

Are you Ambitious?—Want to get Ahead?

IF SO, You can become an Automobile Expert like the man at the wheel above. Such Experts earn \$35 to \$50 per week, and are never out of a job. In a few weeks' time we can train you, and assist you to better your position. Small down payment starts you. Valuable model of automobile free to every student.

Write us for free samples of lessons, etc.

BUFFALO AUTOMOBILE SCHOOL
 (The auto school that comes to you.)
 121 Franklin St. . . BUFFALO, N. Y.



**A Spotless Collar Will Blaze The Way
To A Good Position**

CLEANLINESS is an invaluable asset. It is essential that one be both clean and capable. Where there's dirt, there's usually shirk. Wear a clean, white, smartly shaped collar every day.

**Litholin Waterproofed
Linen Collars**

The same collar you have always worn—*only waterproofed.* Permanently clean.

*At your dealer's, or by mail on receipt of price.
Write for booklet.*

Collars **The Fiberloid Co.** Cuffs
25c each 7 & 9 Waverly Pl., N.Y. 50c a pair

LITHOLIN

Just off the Press—1911 Edition
Standard Wiring
for Electric Light and
Power as Adopted by the

**Fire
Underwriters
of the
United States**

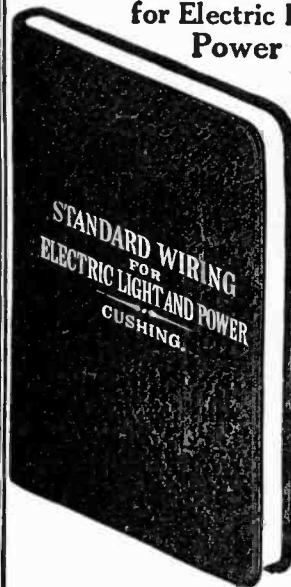

Containing the National Electric Code, explained with numerous illustrations, together with the necessary tables and formulae for outside and inside wiring and construction for all systems. Everything revised right up-to-date. Handy size for the pocket. Black limp leather binding—gilt embossed.

Price prepaid

\$1.00

Free for 2 paid yearly
Subscriptions
to
Popular
Electricity

**POPULAR ELECTRICITY BOOK DEPT.,
100 Lake St., CHICAGO, ILL.**

Send for our illustrated Catalog—FREE

INDEX TO VOL. III

Popular Electricity

The Index to Volume III will be ready about April 1st.

This year the index will be sent only to those who ask for it.

Simply write us that you desire an index to Volume III and enclose one-cent stamp for postage.

**POPULAR ELECTRICITY
MAGAZINE**



**Money
Back If
Books Are
Not
Satisfactory**

Actual size of each volume, $7\frac{1}{8}'' \times 4\frac{7}{8}'' \times 1''$; 300 pages to the volume. Beautifully bound in red buckram, tastefully lettered in gold.

For the first time it is possible to place in your library at a very low cost a complete science Cyclopedia which is comprehensible to everyone. In these ten handy, volumes is the whole story of the universe. They trace the world along the long road of evolution, and man's origin from the earliest unicellular life to the complex and highly specialized creature who rules supreme today, who, with infinite toil, has wrested from nature the secrets told in these books.

This Cyclopedia is offered as a supplement to Technical World Magazine, because it is a record of the scientific facts that are now established, while Technical World records all new discoveries and achievements. So you see these books and a file of Technical World Magazines constitute a complete science history right down to the minute that the current number of Technical World is laid on your library table.

**Here's the Whole
World's Scientific
Knowledge,
Written So
You Can
Under-
stand
It**

What Big Men Say.

centration into a set of ten books in such fascinatingly interesting shape is certainly an exceptionally masterful piece of editorial work. But what strikes one as a yet more puzzling wonder is that you give the complete set of these ten volumes as a premium for a merely nominal additional sum.

HUDSON MAXIM, The Inventor.

"I have received the ten volumes of the Science-History of the Universe and consider it an excellent work. It deals with subjects often treated in a technical way, in a manner that will interest all readers."

ALBERT J. BEVERIDGE,
U. S. Senate, Washington, D. C.

Our Liberal Offer.

We will send you the ten volumes of the Science-History of the Universe, carefully packed, all charges prepaid and Technical World Magazine for one year, twelve numbers, for only \$3.90. Send money in way most convenient. The books and magazines may go to any addresses you choose.

What These Great Books Contain:

- VOL. I. ASTRONOMY—Telescopes, Spectroscopes, Gravitation, Solar System, Stars.
- VOL. II. GEOLOGY—Structure, Eras, Mines, Minerals, Quarries.
- VOL. III. PHYSICS—Matter, Heat, Sound, Light, Magnetism, Electricity.
- VOL. IV. CHEMISTRY—Alchemy, Modern Chemistry, Agricultural, Physiology.
- VOL. V. BIOLOGY—Origin, Nutrition, Descent, Reproduction, Heredity, Evolution.
- VOL. VI. ZOOLOGY—Fossils, Insects, Vertebrates, BOTANY—Structure, Growth, Forestry.
- VOL. VII. ANTHROPOLOGY—Racial Characteristics. MEDICINE—Anatomy, Diagnosis, Surgery.
- VOL. VIII. MATHEMATICS—Arithmetic, Algebra, Geometry, Surveying.
- VOL. IX. ART—Architecture, Music. LITERATURE—Drama, Poets, Prose, Novels.
- VOL. X. PHILOSOPHY—Schools, Development, Political Economy, Ethics.

Science - History of the Universe, ten volumes prepaid, and Technical World Magazine for one full year, only \$3.90

**SEND TODAY
USE THE
COUPON**



NAME.....
ADDRESS.....
CITY.....
STATE.....

P. E.
4-11
**Tech.
World
Magazine**
5758 Drexel Ave.
Chicago, U. S. A.

Gentlemen:—Enclosed please find \$3.90, for which send me the ten volumes of the Science-History of the Universe and Technical World Magazine for one year.

Electrical Talks—Flash No. 10

SWR

A LONG comes Mr. Electrical Advertiser, after reading "Flash No. 9," and he says: "You're talking through your hat. Why should I advertise in Popular Electricity, even if it does go to thousands to whom I have never talked before? What good is such a general circulation going to do me? I know what I am about when I spend my money only in the electrical trade journals—special mediums of my field."

All right, if you're from Missouri, here is an example and the reason.

Magnetite arc lamps have certain qualities which recommend them for street lighting. These qualities have been described in the technical trade journals; the lamps have been advertised in these journals for a considerable time. It is safe to say that there is hardly a technical man or one who reads these journals who does not know who makes the magnetite arc and all about it. To them it is an old story.

In the February issue we printed a brief article describing this lamp. The result was a number of letters of inquiry concerning it. Here is one of them:

Directors
W. G. SCHAMBERGER, Mayor
W. L. OLDHAM, Recorder
W. F. BROWN, Treasurer
J. T. BASKERVILLE, City Attorney



Aldermen
ED. L. ANDERSON
JOHN FRY
J. W. MCCORMACK
J. C. DUBELL
W. W. PARBOE
R. T. RAMSEY
DR. B. A. WILLIAMS

THE HOME AND SCHOOL TOWN

Popular Electricity Pub. Co.,
Chicago, Ill.

Gallatin, Tennessee, Jan. 31st. 1911.

Gentlemen:

In your Feb. number I have read an article on Luminous (Magnetite) Arc Lamp and would like to know who makes this lamp.

Thanking you for your reply, I am,

Yours truly,

This man is in a position to influence the buying of arc lamps. A glance at the letter head will show you that. In all probability he is neither a technical man nor reader of technical journals.

Being a progressive man, he *will*, however, buy a magazine like Popular Electricity and absorb its contents, which are not immersed in technicalities. After the editorial matter, or before, as the case may be, he will get at the advertising pages.

That is the secret of how we are stirring up new electrical business for our present satisfied patrons.

That is how we can stir it up for you just as soon as you are tired of raking the same field over and over.

POPULAR ELECTRICITY.

Get \$1200 OF THIS \$500,000.00 NEXT MONTH

\$500,000.00 to change hands

One cent starts you. Any honest, industrious man or woman can enter

HURRY! HURRY! HURRY!

Thousands of dollars already distributed—going on daily. Listen!

10 people receive over \$40,000

\$2,212 in two weeks went to Korstad (a farmer)

\$1,200 one month **\$1,100** another, to Stone-

\$13,245 in 110 days, credited to Zimmerman (a farmer).

\$3,000 in 30 days to Wilson (a banker).

\$1,685 in 73 days to Rasp (an agent).

\$800 in 11 days **\$4,000** to date, received by and Oviatt (a minister).

\$2,800 to Rogers (a surveyor).

\$6,800 to Juell (a clerk).

\$2,200 to Hoard (a doctor).

\$5,000 to Hart (a farmer).

These are just a few—hundreds sharing similar prosperity. Reads like fiction, yet it's the gospel truth. **Proven by sworn statements—investigation—any proof you want.**

Don't envy these people—join hands—Win a Fortune

Do as they are doing. Let us give you the same high grade opportunity, supplying 8 out of 10 homes with **Allen's Wonderful Bath Apparatus.**

Something new, different, grand

Wonderful but true—**gives every home a bath room for only \$6.50**; excels others costing \$200. Think of it! So energizes water—one gallon ample; cleanses almost automatically; **no plumbing—no water works—self heating.** Could anything be more popular? Agents, it's simply irresistible. **Used by the U. S. Government.** Think of millions who want bath-rooms. No wonder.

Beem writes: I averaged

\$164.25 WEEKLY FOR 3 MONTHS

Wilson sold 102 in 14 days; Hart 16 in 2 hours; Langley \$115 worth the first day; Reese solicited 80 people—sold 55. No wonder Cashman says: "Men who couldn't sell your goods couldn't sell bread in a famine," and Lodewick "Lucky I answered ad; it's great; money coming fast, 17 orders today."

\$500,000.00

worth will be sold easily this season. 75 per cent. profit to you. Experience unnecessary.

Free Sample and Credit to Active Agents

Be first—get exclusive rights—own a rip-roaring business. Investigate for your own use anyhow.

MAKE \$8,000 THIS YEAR

spare time means \$15 daily. One cent starts you—a mere postal, containing your name and address—that's all. Send today for amazing offer—It's free.

ALLEN MFG. CO., 3311 Allen Bldg., Toledo, O.



Sectional View



Rev. C. Miller



R. V. Zimmerman



M. Stoneman



M. Juell



Send for Sample

We will send you by mail, postage paid, 10 collars for 30 cents, or a sample for 6 cents in U. S. Stamps. Cost at the stores 25 cents for box of ten. *State size and style.*

These collars look just like linen and are more comfortable, but cost so little that they may be thrown away when soiled. They may be reversed and worn both sides.

REVERSIBLE COLLAR COMPANY
Department W, Boston, Mass.



To Central Station Managers

As advertising agents for the two largest central stations in the world, we have naturally acquired a fund of experience which might be drawn upon to advantage by other central stations.

And, on the whole problem of interesting the consumer in things electrical, we are qualified by what we have done to give sound advice to the advertiser—small or large.

WM. D. McJUNKIN
Advertising Agency
167 Dearborn Street, Chicago

A COMPLETE Electrical Workers' Library

By HENRY C. HORSTMANN and VICTOR H. TOUSLEY

Positively up-to-date and written
for the men who do the work

We defy any publisher in the world to produce a more practical collection of books for the electrical worker than this series. The immense sale of these popular books since date of publication has been greater than any electrical books ever sold to working electricians.

The Reason?

They are *practical* and do not confuse the worker. They also have the *highest endorsement* of the *International Brotherhood of Electrical Workers*.

To substantiate this claim we offer the sum of *One Hundred Dollars* to any publisher who will produce a sworn statement showing a greater sale of any similar book or books treating on the subject matter than these do, for the length of time they have been on the market.

As to our reputation for keeping business promises, we will refer you to any bank or business house in Chicago.

For the next ninety days we are making a special introductory offer of the complete set of four volumes, neatly cased (regular price \$6.00).

Our special introductory price to electrical workers \$5.00, prepaid to any address upon receipt of price. To all persons ordering this set by return mail, we will present, free of charge, our *Handy Electrical Dictionary* for the Vest Pocket, bound in red Russia Leather, gold edges, indexed, 224 pages, illustrated. If the books ordered are not found entirely satisfactory in every way, they may be returned and your money will be cheerfully refunded. To electrical workers already having any of the below enumerated volumes, we will supply single copies of any one or more books at \$1.50 each, postpaid to any address in the world.

Electrical Wiring and Construction Tables	120 pages 70 diagrams
Modern Electrical Construction	340 pages 173 diagrams
Modern Wiring Diagrams and Descriptions	250 pages 200 diagrams
Practical Armature and Magnet Winding	232 pages 128 diagrams

Each volume is substantially bound in full Persian Seal Grain Morocco Leather, stamped on the outside covers in genuine gold leaf, round corners, red edges, pocket size, printed on super-calendered book paper.

Address all Orders to the Publishers

Frederick J. Drake & Company

222-1325 Michigan Avenue CHICAGO, U. S. A.



Send for descriptive booklet which gives a partial list of contents

A NEW BOOK Dynamo Building

FOR

Amateurs

By A. J. WEED

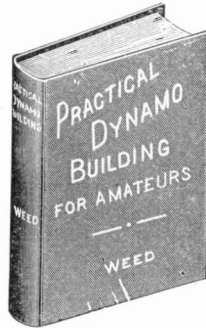

This book is a practical, up-to-date treatise showing in every detail the construction of a small dynamo or motor. Complete working drawings are given for each piece of machine

work which can be done on a small foot lathe.

This machine, when used as a dynamo, has an output of 50 watts; and when used as a motor is powerful enough to drive a small drill press, lathe or sewing machine. 100 pages fully illustrated.

Price { Cloth Binding . . \$1.00
Paper Binding . . .50

Popular Electricity Book Department

100 Lake Street, Chicago, Ill.

Flying Machines

CONSTRUCTION—OPERATION

BY

W. S. JACKMAN
Thos. H. Russell
Octave Chanute

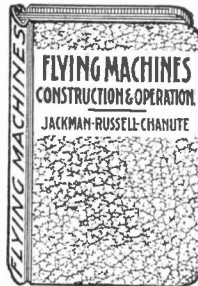

A "Show How" Book

Written for the novice or amateur in aviation, from which he will not only learn how to build, equip and manipulate an aeroplane, but will also gain a thorough knowledge of the principle by which an aeroplane is suspended in the air.

This book should also be of great interest to those who have no intention of constructing or operating a flying machine, as it will enable them to better understand the performances of the men who are now making such startling records in the air.

Also contains detailed directions for the construction of a modern Biplane Glider, complete with working drawings. Pocket size, 220 pages, fully illustrated.

Price: Flexible Leather \$1.50
Cloth Binding \$1.00

POPULAR ELECTRICITY BOOK DEPT.

100 Lake Street, CHICAGO, ILL.

We Recommend to Illinois Investors the following Tax-Exempt Stocks

1. ***Commonwealth Edison Company, of Chicago**—The largest Central Station Company in the world, with an investment of over \$70,000,000, paying dividends at the rate of 6% per annum. This Company has made a phenomenal growth in the past few years and prospects for the future justify us in the belief that the stockholders will be materially benefited thereby. Market price about \$115.00 per share, to net nearly 5½%.

2. **North Shore Electric Company**—This Company supplies electric current for light and power to the prosperous and growing residential and manufacturing districts surrounding Chicago, from the Wisconsin line on the North to the Indiana line on the South and East. This Company is paying dividends at the rate of 4% per annum, which rate will eventually be undoubtedly increased. Market price about \$81.00 per share, to net about 5%.

3. **Illinois Valley Gas & Electric Company**—Recently organized to supply gas and electricity in the thriving cities and towns of the mining and manufacturing districts in the vicinity of Streator and Ottawa. This Company is paying regular dividends at the rate of 6% on its Cumulative Preferred stock, which is selling at about \$85.00 per share, and accrued interest, to net the investor better than 7.06%.

The fact that all three of these companies are controlled by practically the same interests under the presidency of Mr. Samuel Insull, insures their harmonious operation with the most efficient management.

Detailed information regarding these investments will be sent upon request.

* Listed on the Chicago Stock Exchange.

Russell, Brewster & Company

Members:
New York Stock Exchange
Chicago Stock Exchange

137 Adams Street,
Chicago, Ill.

7

FOUR LATEST ELECTRICAL BOOKS BY THE BEST AUTHORITIES

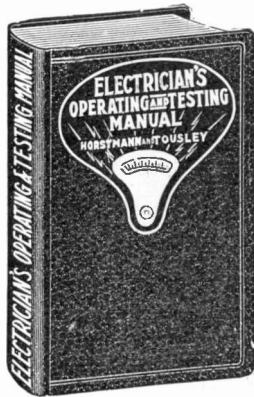

Electricians Operating and Testing Manual

By H. C. Hortsman and V. H. Tousley

This new book was written to instruct the practical electrician in the management, operation and testing of the more important electrical devices now in use, and is of particular value to the man in charge of a plant, as it will tell him how to install and operate all electrical devices, and what is more important, instruct how to readily locate and remedy any trouble that may occur.

The subject is covered thoroughly and it is all entirely practical. 360 Pages Fully illustrated, bound in flexible leather.

PRICE \$1.50 Postpaid.

Mr. Morgan has written a number of articles for POPULAR ELECTRICITY MAGAZINE whose readers should at once recognize the value of his new work.

The illustrations are mostly of apparatus specially made and previously put in operation, so that it is all entirely practical.

PRICE \$1.50 POSTPAID

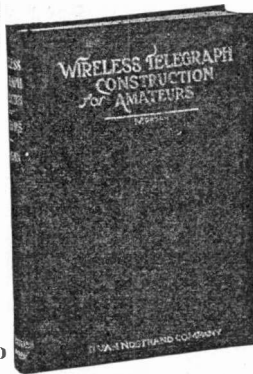

WIRELESS TELEGRAPH CONSTRUCTION FOR AMATEURS

By Alfred P. Morgan

220 pages. 153 illustrations.

Meets the demand for a practical work on the construction of wireless telegraph instruments, and is unusually complete, giving in minute detail full directions, down to the smallest screw, for each part in the construction of various outfits capable of receiving from 100 to 1,500 miles and of transmitting 3 to 100 miles.

The purpose and action of each instrument used in connection with a complete wireless outfit is also clearly explained.

Practical Applied Electricity

By David Penn Moreton, B. S. E. E.

300 Pages. 200 Illustrations.

Just the information that will advance the Electrical worker in place and pay; intended for the practical man as well as the expert and presented in a practical way in plain English. Contains no useless matter, is up to the minute, complete and authentic.

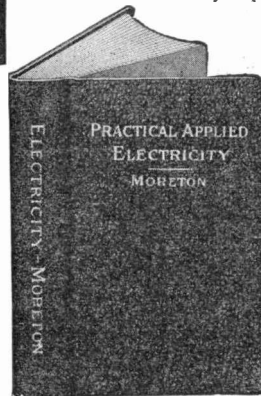

Practical every-day problems and careful detailed line drawings are given to illustrate the theory and their solution is indicated.

PRICE \$1.50
POSTPAID

The Tesla High Frequency Coil Its Construction and Uses

By Haller and Cunningham

Describes numerous uses for such a coil, also a number of interesting and instructive experiments.

The Apparatus described consists of the Step up Transformer, The Condenser, Interrupter and the Oscillation Transformer. The theory and construction of each of these is carefully considered without mathematical explanations.

149 Pages—Fully Illustrated.

PRICE \$1.25 POSTPAID

Fills a long felt want for a practical work on the construction of high frequency apparatus.

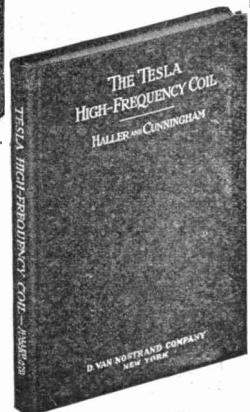

POPULAR ELECTRICITY BOOK DEPT., 100 Lake St., CHICAGO, ILLINOIS

6 Important Books For Electrical Men

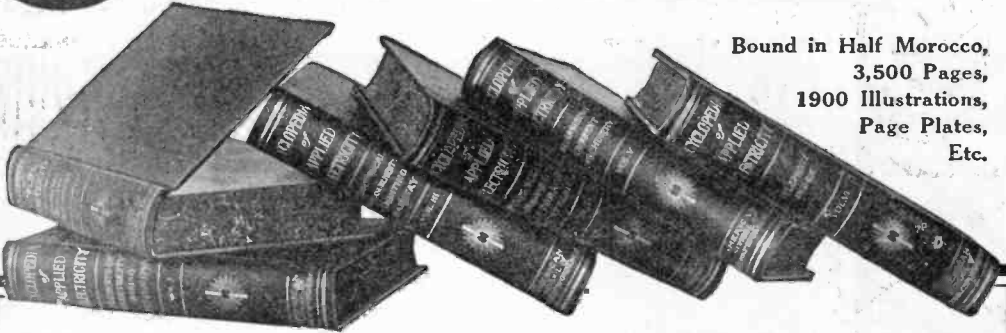

Bound in Half Morocco,
3,500 Pages,
1900 Illustrations,
Page Plates,
Etc.

We Want You to Examine These Books
FREE OF CHARGE

They are just what you want if interested in any branch of electrical engineering. We want you to examine the complete set at our expense.

This Great Cyclopedia of
Applied Electricity

is written by thirty expert electrical engineers—the biggest men in the profession. It is especially designed as a working guide for the student and ready reference for the expert. Their reference value is guaranteed because they are compiled from the regular text books used in the correspondence courses of the American School of Correspondence.

You Take No Risk. Examine the books five days at our expense. So confident are we that the books are just what you want, that we will send them to you by prepaid express. Keep them five days, test them—apply them to your every-day work. If satisfied that they are the most complete and comprehensive work ever published on Electricity, keep them and send us \$2.00, then pay \$2.00 a month until you have paid our special introductory price of \$18.80. The regular price is \$36.00. If the books do not satisfy you and are not just what we claim them to be, notify us and we will have them returned at our expense. Just fill in and send the coupon. *The books will be sent to you free.*

IMPORTANT SUBJECTS TREATED IN DETAIL

Electric Wiring—Electric Telegraph—Wireless Telegraphy—Telautograph—Theory, Calculation, Design and Construction of Generators and Motors—Types of Dynamos and Motors—Elevators—Direct Current Motors—Direct-Driven Machine Shop Tools—Electric Lighting—Electric Railways—Alternating Current Motors—Single Phase Electric Railway—Management of Dynamos and Motors—Power Stations—Central Station Engineering—Storage Batteries—Power Transmission—Alternating Current Machinery—Telephony—Automatic Telephone—Wireless Telephony—Telegraphone, etc.

For a short time we will include, as a monthly supplement, for one year, the TECHNICAL WORLD MAGAZINE. This is a regular \$1.50 monthly, full of Twentieth Century Scientific facts, written in popular form. Also contains the latest discussions on timely topics in invention, discovery, industry, etc.

AMERICAN SCHOOL OF CORRESPONDENCE
CHICAGO, U. S. A.

P. E.
4-11

A. S. of C.

Please send me Cyclopedia of Applied Electricity for five days' free examination. Also T. W. for one year. I will send \$2 within five days and \$2 a month until I have paid \$18.80; otherwise I will notify you and hold the books subject to your order. Title not to pass until fully paid.

FREE EXAMINATION COUPON

NAME

ADDRESS

OCCUPATION

EMPLOYER



CHIEF DRAFTSMAN

Will INSTRUCT PERSONALLY a limited number selected, ambitious men in

Practical Drafting, Detailing, Designing

Draftsmen Drawing \$125-\$150 Monthly

Are NOT MADE in Schoolrooms,
Are NOT MADE by Reading Books,
Are NOT MADE by making Copies,
Are NOT MADE at home drawing pictures
from printed book lesson.

LET ME TELL YOU:

It requires actual, practical, up-to-date
DRAFTING-ROOM WORK to train YOU to
gain the PRACTICAL EXPERIENCE that your
employer will demand of you.



FREE

This \$13.85
DRAWING OUTFIT
and Free Position

As Chief Draftsman of Engineering firm I know exactly the Quality and Quantity of PRACTICAL training, knowledge and actual up-to-date experience (not school knowledge) you must have, in order to obtain a good position and advance to highest salary.

I give INSTRUCTIONS UNTIL COMPETENT and
PLACED in POSITION at above Salary

DON'T waste TIME and MONEY trying to learn from books or printed "STUFF" you can only learn on PRACTICAL WORK which I furnish you.

Address **CHIEF DRAFTSMAN**

Div. 10, Eng's Equip't Co. (Inc.), Chicago



POPULAR ELECTRICITY

IN PLAIN ENGLISH

HENRY WALTER YOUNG, Editor.



Vol. III

April, 1911

No. 12

CONTENTS

	Page		Page
FIVE EPOCH-MAKING ELECTRICAL INVENTIONS. By Elmer E. Burns.....	1047	Speed Regulators for Motors.....	1099
Making Iron of High Purity.....	1051	An Electric Milk Jug.....	1099
Silver Plated Porcelain.....	1051	Sterilizing Liquids by Ultra-Violet Rays. By Dr. Alfred Gradenwitz.....	1100
THE BLIND AT THE KEY. By H. Metti.....	1052	He Overcame the "Impossible".....	1102
ELECTRICITY—THE FARM HAND.....	1056	The World's Greatest Pig Yard.....	1103
Electrical Operation of Bulkhead Doors.....	1061	Lamp and Flasher Combined.....	1103
The Telegraph in the Far East.....	1062	Electric Drink Mixer.....	1104
MAGNETIC DIP. By Brother Potamian.....	1063	Producing a Stage Illusion.....	1104
Scenic Railway in Brazil.....	1065	Cigar Lighter.....	1104
Bridge Wrecked by Electric Current.....	1065	Sewing Up Grain Bags.....	1105
INVENTION BY EFFORT AND STUDY. By Geo. Ethelbert Walsh.....	1066	Making Blue Prints from the Original Drawing.....	1105
ELECTRIC BLOCK SIGNALLING. By Simon Deutsch.....	1068	Monorial for Handling Lumber.....	1106
A Telephone Repeater.....	1071	Automatic Fire Extinguisher and Alarm.....	1106
The Aero-Meter.....	1072	Machine puts Labels on Bottles.....	1107
An Electric Sandwich Man.....	1072	Signboard for Facilitating Ticket Selling. By Theron P. Foote.....	1108
Ripening Bananas by Electric Heat.....	1073	Practical "Don'ts" for the Electrician.....	1109
Getting a Ship's Location During Fog.....	1073	Removing Oil from Water.....	1110
Can the Battery Car "Come Back".....	1074	Spring Clip Cord Adjuster.....	1110
Trackless Snow Plows and Trucks.....	1075	Pressure of a Church Organ Bellows.....	1111
Telephone in the South Pole Quest.....	1075	Hollow Axle with Motor.....	1111
Sunday Telephone Letters.....	1076	ELECTRICAL MEN OF THE TIMES. Elmer E. Sperry.....	1112
Odd Electric Vehicle—'89 Model.....	1076	Alcohol Chafing Dish Changed to Electric.....	1113
Tungsten Production in 1910.....	1077	WHERE ART AND SCIENCE MEET. By T. Vernette Morse.....	1113
A Hook and Ladder Electric.....	1077	No Sweeping, No Dusting.....	1115
Pocket Lamps at the Opera.....	1077	Vacuum Fly Trap.....	1115
Photographing Actors and Actresses.....	1079	Small Color Changing Fountain.....	1115
Why Electric Light Bills Vary.....	1079	Pillars of Glass.....	1116
Most Artistic Display Sign Ever Built.....	1080	CONSTRUCTION OF SMALL MOTORS AND DYNAMOS. By Chas. F. Fraasa, Jr.....	1117
The Story of a Skull. By G. A. Woolon.....	1081	The Vanishing Lady.....	1121
From Coal to the Car.....	1082	The Young Edisons' Club.....	1122
Lifting Wrecks from "Davy Jones' Locker".....	1084	A HIGH-POWER WIRELESS EQUIPMENT. By Alfred P. Morgan.....	1124
Artistic Shadow Dancing.....	1085	Operation of Spark Coils on 110 Volts.....	1127
Playing with a 93-ton Locomotive.....	1087	Wireless Without a Ground.....	1128
The Honey Bee a Live Battery.....	1087	Solder for Detector Crystals.....	1129
Caught in the Act.....	1087	Hints on Increasing Efficiency. By Geo. F. Worts.....	1130
Electric Locomotive the Largest.....	1088	Prescription by Wireless.....	1131
Magnetized Rails Upset Compass.....	1088	Three Slide Tuning Coil. By A. B. Cole.....	1132
Electricity!	1088	Wireless Queries.....	1133
ELECTRICITY IN GERMAN BREWERIES. By Dr. Robert Grimshaw.....	1089	QUESTIONS AND ANSWERS.....	1135
Electricity Wrongly Accused.....	1091	Application and Proceedings for Reissue. By Obed C. Billman.....	1137
Handling and Cutting Ice Sheets.....	1092	New Books.....	1138
TIMING BULLET SPEEDS. By Albert Scheible.....	1093	Index to Volume 3.....	1139
Electricity Saves Fruit.....	1095	Questions and Answers.....	1139
Mining With Magnets.....	1095	SHORT CIRCUITS.....	1140
X-Ray Pictures of the Stomach. By Alfred Gradenwitz.....	1096	COMMON ELECTRICAL TERMS DEFINED.....	1142
The Electric Stevedore.....	1097		
A Startling Gateway.....	1097		
From Out the Leyden Jar.....	1098		

RENEWALS When your subscription expires, you will find a renewal blank enclosed here. You should fill out and return same with remittance at once to avoid missing a number. Positively no copies will be mailed on any subscription after same expires unless renewed, and we cannot agree to begin subscriptions with back numbers. The date on wrapper of your magazine shows the issue with which your subscription ends. The extension of this date to period covered by renewal is sufficient receipt. If any other is desired it should be requested at time of renewal.

CHANGE OF ADDRESS Notify us promptly of any change in your address, giving both the old and new location. Since our mailing list for each issue closes the 5th of the preceding month, (i. e., list for February closes January 5th), changes received after the 5th must necessarily take effect with issue for second month following. Postmaster, as well as Publisher should always be notified of changes in order to forward mail sent to old address.

ISSUED MONTHLY BY POPULAR ELECTRICITY PUBLISHING CO., Commercial Bldg., Chicago, Ill.
 YEARLY SUBSCRIPTION, \$1.00; CANADIAN, \$1.35; FOREIGN, \$1.50; SINGLE COPY, 10 CENTS

No additional copies will be sent after expiration of subscription except upon renewal.

Entered as Second Class Matter April 14, 1908, at the Post Office at Chicago. Under Act of March 3, 1879.

Copyright 1911, by Popular Electricity Publishing Co.

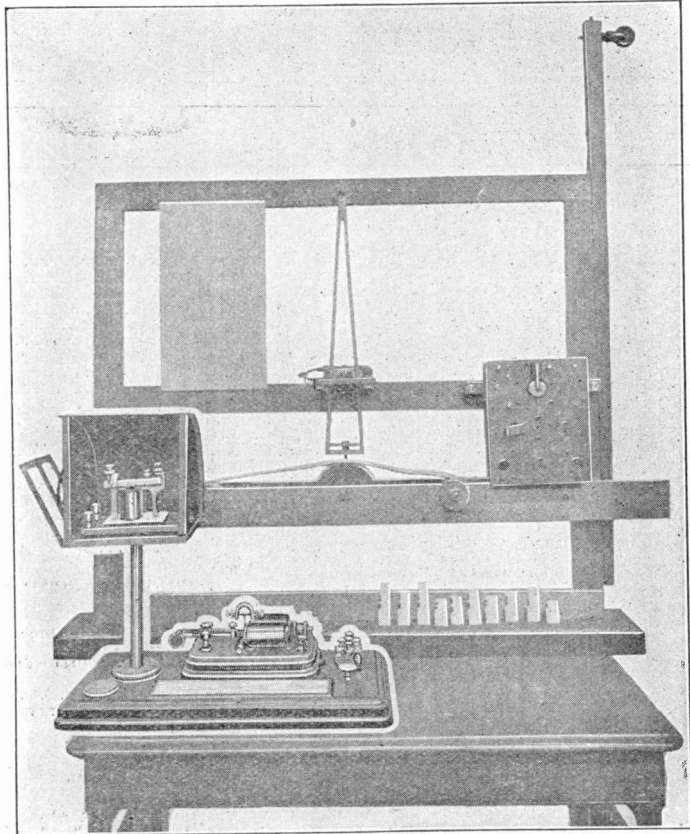

Copyright by Harper & Bros. 1910

MORSE'S EXPERIMENTAL INSTRUMENT (RECEIVING). THE PEN ON THE VERTICAL ARM IS BROUGHT INTO CONTACT WITH THE PAPER STRIP BY ELECTRO-MAGNETS. IN THE FOREGROUND IS A MODERN TELEGRAPH SENDER AND RECEIVER (THE ONE USED IN THE ROUND THE WORLD TEST OF 1896)

Popular Electricity

In Plain English

Vol. III

April, 1911

No. 12

Five Epoch-Making Electrical Inventions

By ELMER E. BURNS

What were the greatest electrical inventions? When this question is asked, and we cast about among the thousands of ways in which electricity is applied, five things stand out from all the rest. First in chronological order comes the telegraph; next the discovery of electric motor and its application to electric traction; then the telephone; the electric incandescent lamp, and, finally, the wireless telegraph. In this series of five articles Mr. Burns will relate the fascinating stories of these five great inventions, all of which are fraught with that element popularly termed "human interest."—Editorial Note.

I. THE TELEGRAPH

If you had mentioned the telegraph in a conversation with any intelligent person in the year 1840, he would have asked at once: "Which telegraph?" The word telegraph would have suggested to his mind not a wire carrying an electric current with sending and receiving instruments at either end, but it would have suggested, among other things, a system of semaphore signals similar to those used in certain forms of the railroad block signal system. France had the most extensive system of telegraphs of this kind in the world, five great lines extending from the capital to the extreme cities of the kingdom, a total distance of nearly 15,000 miles with a semaphore for every three miles. The signals were operated by human hands and caught by human vision. This system of telegraphs was maintained by the government at a cost of over \$200,000 per year.

The need of some method of conveying intelligence to a distance was keenly felt and this clumsy method was the best that was then known. Certain forms of electric telegraph had been invented but these were expensive to install and uncertain in operation. So it happened that when Morse filed his application for a patent on his electro-magnetic telegraph, he did not claim

the telegraph as a new invention but claimed "certain new and useful improvements in the telegraph."

It is true of the telegraph as of many other great inventions that a little knowledge leads us to give undue honor and applause to one fortunate inventor while a deeper knowledge leads us to recognize the contributions of many minds and give honor to whom honor is due.

The Franklin Institute of Philadelphia reported to Congress that the time required to make signals with the Morse telegraph was "at least as short as that of the common telegraphs," referring to the semaphore and other visible signal systems.

Benjamin Franklin was the first to conceive the idea of telegraphing by means of electricity and leave a record of his idea for the benefit of later investigators. He tried the experiment with four miles of wire, but the electric battery was then unknown and the discharge from an electrical machine or a Leyden jar could not be used for a practical telegraph. The invention of the electric battery revived the idea of an electric telegraph. Every known method of producing an electric current or a static electric charge and every known effect of an

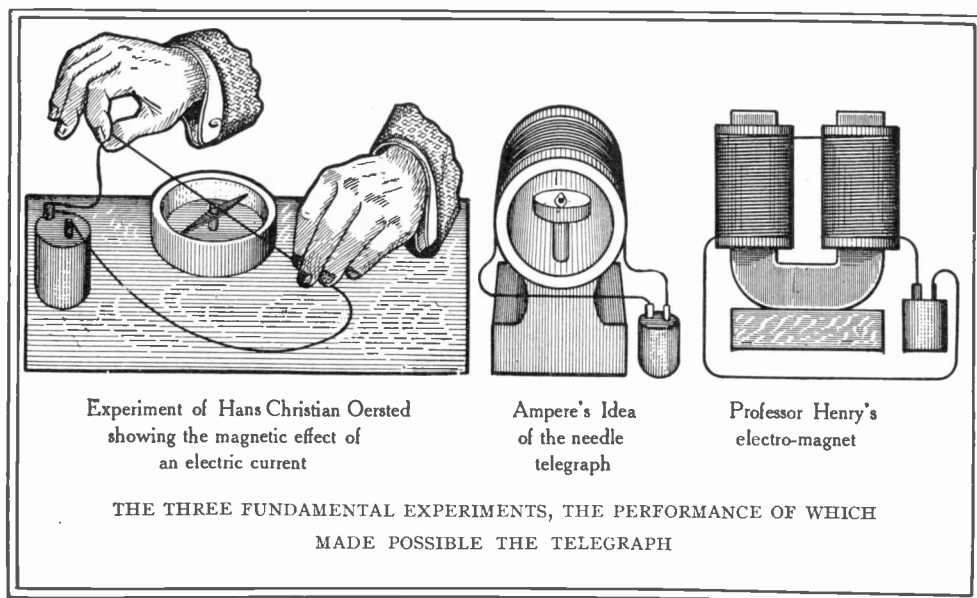

electric current up to the time of Morse's invention had been used in attempts to invent a telegraph. No success was possible, however, until the electro-magnet had been discovered and perfected.

The magnetic action of an electric current was discovered by Hans Christian Oersted, a professor in the University of Copenhagen, Denmark, in the winter of 1819-20. It was known that a stroke of lightning sometimes magnetizes steel knives and other steel objects that are in its path, and it was expected that an electric current would produce some magnetic effect if only the current were used in the right way. Oersted, after seven years of untiring work and many failures, one day while lecturing to his class thought to place the wire carrying the current in a north and south direction over a compass needle. He was surprised to see the needle swing round and point nearly east and west. When he changed the direction of the current still holding the wire north and south the needle swung round in the opposite direction and again pointed nearly east and west.

If the current were flowing toward the north the needle would turn so that the north pole pointed nearly west. If the current were flowing south over the needle the north pole would point nearly east.

In a few months a Frenchman named Ampere learned of Oersted's discovery and it occurred to him that here was the germ of

an electric telegraph. If a long wire could be used and a current passed through this wire and through a coil around a compass needle then the circuit could be made and broken or the direction of the current reversed at the one end of the wire and the needle at the other end would swing to and fro and the movements of the needle might be arranged to indicate the letters of the alphabet and so convey a message.

A number of "needle telegraphs" were invented on the principle suggested by Ampere. Some of these were used commercially. The Cooke and Wheatstone needle telegraph was used in England as late as the year 1870. Inventors found difficulty, however, in making the telegraph work over long distances. Barlow in 1824 claimed to have demonstrated that the telegraph could never be made a commercial success. This prediction would have proven to be correct if no further discoveries in electricity or electromagnetism had been made. With a wire many miles in length the current was so weak that the magnetic effect was almost imperceptible. Two facts were yet to be discovered that would seem extremely simple even to the novice in electrical work today. We can scarcely understand that it should require many years to discover these two simple facts.

The discovery that made long distance telegraphy possible is due to Professor Henry of the Albany Academy, afterward secretary

of the Smithsonian Institution in Washington. Professor Henry was endeavoring to increase the strength of electro-magnets. Sturgeon had devised the horseshoe magnet with a single layer of wire, the iron core being first coated with wax, and the turns of wire not touching, for insulated wire was then unknown. Henry improved the magnet by insulating the wire and winding many turns of wire around the iron core. So successful was he that he produced a magnet weighing only $59\frac{1}{2}$ pounds that would hold up a ton of iron. The great length of wire in the coils of this magnet meant, of course, increased resistance and weaker current, if no change had been made in the battery, but Henry found that what he called a "battery of intensity," that is, a battery of high voltage, would overcome the resistance of the long wire. These were the two things that were needed to prepare the way for the invention of a long distance telegraph, an electro-magnet of considerable strength even with a weak current flowing through its coils and a battery that would overcome the resistance of miles of wire. We should add another discovery, that of a battery that would give a constant current even with the circuit closed for hours. This we have in the cell devised by Professor Daniell of King's College, London, and in the gravity cell or crowfoot battery which is only a modified form of Daniell cell.

The materials for a successful telegraph were at hand when Morse took up the work. There was needed the practical man who should combine these materials and develop a working telegraph. That a man who up to the age of 40 had devoted his life to art, an artist, a dreamer, should become the practical inventor is one of the strange facts in the history of invention. When Samuel F. B. Morse first learned in a conversation on shipboard on his return from Europe in 1832 that an electric current will travel instantaneously through any known length of wire he had a vision of an electric telegraph girdling the earth. He felt that this was his work. He gave up his former vocation to a great extent. At times he faced starvation and in a little room provided for him by his brothers he gave himself up to working out his idea.

It was Morse's idea that the entire operation of sending and receiving a telegraph message must be automatic. He would not trust the human hand to manipulate the

contact key nor the human brain to interpret the intervals denoting dots and dashes. He therefore made an automatic device for opening and closing the circuit at the desired intervals and an automatic recording instrument. The recording instrument was a pendulum carrying a pen at its lower end and a piece of soft iron opposite the poles of an electromagnet. When the current was sent through the coils of the magnet, the pen was drawn across a strip of paper. At first a weight and later a spring was used to pull the armature away from the magnet when the circuit was broken. If the armature was held against the magnet a very short time a dot was made, if for a longer time a dash. The instruments used in the first commercial work were smaller, the pen being carried by a short arm that was pulled away from the magnet by a spring when the current ceased to flow. It was the same cumbersome method of receiving the message, however, with the winding and unwinding of the tape, the whirr of wheels in the winding mechanism, the occasional breaking of the weight cord and the laborious reading and transcribing of the message on the tape.

Although the sound system was secured to Morse in his patent, for years the Morse company vigorously enforced rules against receiving messages by sound. When in 1848, James Leonard, the fastest operator in the country, discarded the tape system and received messages by sound, he became the wonder of the telegraphic world. The famous showman, P. T. Barnum, happened to place a message in the hands of Leonard. He was so surprised at his speed in sending and astonished at seeing him receive by sound that he offered Leonard a large salary to accompany his show and exhibit his skill in taking messages by sound. The offer was rejected.

On the second of September, 1837, Morse gave the first public exhibition of his telegraph system, a message being sent through one-third of a mile of wire and recorded on the tape. In his first experiments Morse used an electro-magnet like the one employed by Sturgeon. He had not then learned Henry's device for increasing the strength of the magnet. The principle of Henry's magnet was given to Morse later by Mr. Vail, who became his partner. Without the assistance of Mr. Vail it is doubtful if Morse would have his telegraph a commercial success.

It was Mr. Vail who worked out the Morse alphabet. It occurred to him that the letters most frequently used should have the simplest signs. The problem of finding which letters are most frequently used had been already solved by the printers. So he chose the simplest signs for the letters that have the largest compartments in the typesetter's case. The most common letter of all, the letter "e," was represented by a single dot.

The Morse instrument was exhibited to the President and a Congressional Committee

of the invention, if successful, is so extensive for good and for evil, that the government alone should possess the right to control and regulate it."

An appropriation of thirty thousand dollars enabled Morse to establish a line between Washington and Baltimore, on May 27, 1844. The first message was sent over this line. This was the famous message, "What hath God wrought?" dictated by Miss Ellsworth. Morse had abandoned all hope of favorable action by Congress, had gone to his hotel, counted his money and found

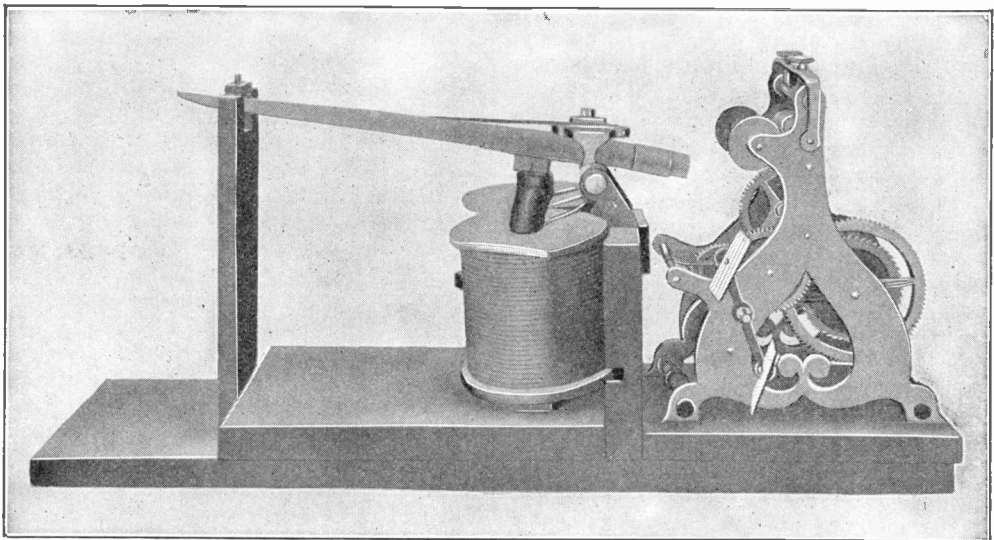

Copyright by Harper & Bros., 1910

THE MORSE INSTRUMENT USED IN RECEIVING THE FIRST COMMERCIAL MESSAGE, FROM A PHOTOGRAPH OF THE ORIGINAL IN THE U. S. PATENT OFFICE. THE ORIGINAL AS FIRST BUILT HAD A PIN ON THE END OF THE ARM WHICH TOUCHED A ROLL OF PAPER OPERATED BY THE CLOCKWORK MECHANISM

in the winter of 1837-8, and then began a long series of committee investigations and reports. Although the Committee on Commerce reported to Congress in April, 1838, that "the influence of this invention over the political, commercial, and social relations of the people of this widely extended country, will, in event of success, of itself amount to a revolution unsurpassed in moral grandeur by any discovery that has ever been made in the arts and sciences," it was not until 1844 that Congress could be induced to make an appropriation for establishing the first telegraph line.

It is significant that this Congressional Committee reported further that "the power

that he could pay his hotel bill and his fare home and have thirty-seven cents left, when Miss Ellsworth had brought him the news that Congress had made the appropriation for his telegraph. He promised her that the first message over the new line should be hers.

Morse made use of Steinheil's discovery that the earth could be used as part of the circuit. Steinheil had made this discovery in 1838 while trying some experiments on the use of the rails of a railroad as part of a telegraphic circuit. He found that the current would pass from one rail to the other through the earth, and the thought occurred to him that he might use the ground

itself and dispense with half of the metallic circuit. This plan had the added advantage that it reduced the resistance of the circuit one-half, for the resistance of the earth is practically zero.

Vail tried the experiment of using an earth battery and found that a copper plate buried in the earth at Washington and a zinc plate buried at Baltimore and connected by a wire was sufficient to transmit a message, though it was found that the current was very weak.

Morse had contracted for lead pipe for the line from Washington to Baltimore, intending to place the insulated wire in the pipe underground. The use of poles was an after-thought. Copper wire was at first used, for it was known that copper would conduct the electric current better than iron. The first telegraph lines erected in the United States were of No. 16 copper wire insulated at the points of support by means of cloth saturated with gum-lac. The copper wires were too easily broken so they were soon replaced by iron wires of a larger diameter. The resistance of iron is about six times that of copper, therefore an iron wire to have the same conductivity must have six times the sectional area or $2\frac{1}{4}$ times the diameter of the copper wire. Such an iron wire has about twelve times the strength of the copper wire which it displaces while its cost is less.

Morse said that if he could make his telegraph work through ten miles of wire he could make it work around the world. Henry's method of winding an electro-magnet combined with the relay made this possible.

The relay was invented by Sir Humphrey Davy in England and afterward adopted by Morse. He was using a needle telegraph and, finding the current very much weakened when passed through a long wire, he thought that the slightest motion of the needle would be sufficient to bring into contact two metallic surfaces, and so close a circuit including a local battery. This second current might close the circuit of a third current and so on without limit.

Though Morse did not live to see the fulfillment of his prediction, a message was sent around the world in 1896. This message did not actually encircle the globe but it did travel across the two continents and the Atlantic Ocean and back to the starting point, a distance of 27,000 miles.

Making Iron of High Purity

Several decades ago the copper industry was partly revolutionized by the introduction of electrical methods, it being shown that an electrolytic process could not only produce copper at low cost from ores which had previously been neglected, but that the copper thus produced was of unusual purity. Now it looks as if similar methods when applied to certain iron ores may also prove commercial. Experiments just reported by Prof. C. F. Burgess (of the University of Wisconsin) show that iron can be deposited in thick layers by passing a current through a solution of sulphate of iron, at a total cost of about one cent per pound for the current, chemicals and labor. What is more, the iron thus obtained is remarkably pure, that obtained at Madison testing as high as 99.97 per cent, which purity might be still further improved by taking unusual precautions. It would therefore seem well suited for competing with the high grade Swedish iron which is at present imported at considerable expense, and the electrical production of such pure iron may mean another step towards making the United States independent of foreign markets.

Silver Plated Porcelain

If the richness of silverware could be combined with the lightness and the heat retaining qualities of porcelain, the combination ought to suit a quite fastidious taste without involving either the cost of heavy silver or the easy denting of lighter metal.

Besides being a poor conductor of heat, porcelain also conducts electricity so poorly that it cannot be covered with a film of metal in an electroplating bath unless the surface could first be coated with a conducting covering. Recent German efforts towards this seem to have been successful, for a line of such ware has recently been put on the European market as "Electro-Porcelain." This consists of tea sets, platters, sauce dishes, water jugs and the like made of china with an outer coating of silver, or in some cases, of nickel. As the interior is of porcelain, it will not stain even when used with eggs and is more easily kept clean than the solid metal ware. Hot foods in it will keep warm longer than in silver ware and the plated porcelain is said to withstand the jars of handling better than fine china.

The Blind at the Key

By H. METTIE

One rainy, November night, as the station agent at Park Junction closed the office safe with a slam, the door of the waiting room opened, and a spectacled man, with a cane in one hand and a nickel-bound black leather case in the other, entered. After a moment's pause, he set the case on a seat near the door and walked straight up to the window.

"How about No. 4," he asked in a pleasant but eager tone.

"Why, hello, Mr. Wells," greeted the agent. "I didn't see you get off the train."

"No; I was in the country, about twelve miles below here, tuning some pianos, and one of my patrons brought me up in his buggy. I'm obliged to catch No. 4. We have to flag her, don't we?"

"Yes," answered the agent, and then he added, "There's a young woman here, too, waiting for that train."

Having completed his arrangements for the night and locked the office, the station official strode across the waiting-room to where the young woman sat.

"This blind man is going your way and knows all about the road and the trains," he explained. "I'll leave the lantern here for you to flag the train with," he added, as he placed it on a seat, "and I guess you'll have no trouble."

Above the lantern, in a socket on the wall, smoked and flickered a single lamp, which, as the agent opened and closed the door, flamed up and went out, leaving the lantern to do double duty." The girl shuddered. Half in pity, half in curious interest, her

glance rested on the blind man who still leaned against the ticket shelf. She waited for him to speak. Finally, turning his sightless eyes upon her, he ventured:

"Miserable night."

"Indeed it is," she rejoined, "and such a dreary place to wait."

"Yes," he agreed, cheerful at the thought of her companionship, "but it might be worse."

Then he took a turn or two about the room in order to get his bearings and relieve himself of the slight embarrassment he felt. "I've waited here a good many times," he added.

"It's my first experience," said the girl. "I missed connection with the accommodation, my train being an hour late, so I had choice between walking in the rain with the agent to a farm house a mile away or waiting. I confess I was dreadfully afraid, and it took all my courage to decide to wait; but"—she hesitated—"but since you are here it will not be so lonely."

"Thank you," said the blind man. Then by way of introduction, "My name is Wells."

"And mine is Helen Duglace," she returned.

The man sat down beside his leather case, feeling for it as he did so.

"Can't you see at all?" inquired the girl, solemnly.

"Not a bit," he replied.

"Isn't it difficult for you to go about alone?" was her next question.

"Oh, no, not now. At first when I undertook to solicit business, I found it trying;



but ten years of hustling have made it easier for me to get around, and now I find pleasure in traveling, coming in contact with people, studying them, and battling with the little obstacles we blind people have to encounter. Yes, I get along about as well as other people do, I presume. I have a good trade, and like my work." With his fingers he tapped nervously on the case beside him.

The girl peered into the darkness beyond the window, and wondered how one who lived in constant gloom could smile and be cheerful. It was this thought which prompted her to say:

"Pardon me, but does it always appear dark to you?"

"Oh, no," he replied. "There can be no realization of darkness without light. It is only a matter of contrast, you know. I once saw, and, of course, I understand what you mean by dark. However, it has been so long since I saw the light that I seem not to be in the dark. When I feel the warm sunshine on my face, the world appears light. The knowledge that there is a lighted lantern there on the bench makes this room appear cheerful to me. Our mental world rotates between night and day almost in concert with the physical world. There is a softness about the atmosphere of a bright day which seems to throw light around me. Likewise the heaviness of a cloudy sky puts me into a semi-gloom. After all," he added, with a contented smile, "we live more in mind than elsewhere."

"Do you form pictures of people when you meet them?" asked the girl, with growing interest.

Wells leaned forward in an attitude of listening and did not at once reply. Suddenly he gave a little start and exclaimed:

"Great heavens! No. 4 is two hours late."

"Why, how do you know?" she asked.

"Just caught it over the wire. You see," he went on, "I used to study telegraphy a little, just for pastime, and it has served me well on several occasions. Station agents are so very economical with their knowledge that some of them find it hard to answer a civil question, so I frequently steal information about late trains."

"How remarkable!" said the girl.

"Not remarkable at all. I take the message just as they do. The operators do it by ear, and so do I. You asked me a

moment ago if I formed pictures of the people I meet. Yes, especially of those who interest me. The voice is my strongest index of human nature. To me it is what the face, the eye, and the general expression are to you. It is the central feature that I remember as something that I liked or disliked. A voice lives in my memory as a face does in yours. Upon that foundation I build all other mental conceptions regarding those whom I care to study."

For some minutes there was a lull in the conversation. The water dripped monotonously in the spout, and the telegraph instrument ticked on industriously. Finally the girl spoke:

"Two hours late! That means nearly morning before the train comes."

"Yes," he answered slowly, as if his attention were divided between what she was saying and something outside. Presently he arose and moved toward her. "I fancied I could hear low voices outside, but it may have been the barking of dogs in the distance. The rain, the telegraph instrument, and the ripple of the creek below here make it difficult to distinguish sounds."

"It must be close to midnight," observed the girl.

Wells drew a watch from his pocket, touched the exposed hands and said:

"Eleven forty."

"Please, may I see your watch?" she asked.

"It is not much to see,"—he replied, extending the hand that held the timepiece—"only an ordinary watch without a crystal," and he proceeded to explain the simple method of telling the time by touch.

Suddenly the girl clutched his arm and whispered, "Listen!"

The wooden platform resounded to heavy footsteps, the waiting room door opened, and a man walked in.

"Which way's the agent?" came in a voice of peculiar smoothness.

"Gone home," answered Wells.

"You folks waiting for the express?" questioned the stranger.

"We are," Wells informed him.

"Well, I don't see as you need this lantern," said the man, as he picked it up, "I do, so I'll borrow it for a while," and with a swish of his gum coat and a rattle of the lantern, he departed as abruptly as he had entered.

Trembling in every fibre of her body, the girl clung to the blind man's arm.

"That fellow means mischief," whispered Wells, "I must see what he's up to." And he gently loosened her hold on his arm.

"Oh, please don't open the door," she entreated. "He has a revolver in his belt."

"Keep right still," said Wells, "I'll not open the door, I'm only going to listen."

A ray of light from the lantern in the hand of the man on the platform sifted through the dirty panes and made it possible for the girl to see the blind man crouch by the window. A lower glass had been broken and replaced with a discarded coat of the agent. Quickly pulling away the coat and listening, Wells' keen ear caught the words:

"A man and a woman—express. Agent home." This from the man who had taken the lantern.

"The cut will be soft," another remarked.

"Anyhow, it's an easy job," said a third.

This was all Wells could hear, but it was enough to make him realize the situation. When the sound of their footsteps had died

away in the distance, he straightened himself and returned to the side of the frightened girl who still stood trembling in the darkness in the middle of the room.

"Don't be alarmed, Miss Duglace," he said, "they're gone and we're safe. I'm sure, though, that they mean harm to the express—in fact," he emphasized, "I'd be willing to bet every dollar I possess that there's going to be a hold-up in the cut south of here tonight."

"What makes you think so?" she asked.

"In the first place," began Wells, "that man is a professional train robber. He was caught once, and served two years in the State penitentiary, but he made his escape. You see, the warden of the prison is a friend of mine. I have frequently been in his home, and was there once while this man—Adams is his name—was a prisoner, and I heard him talk. I could never forget that

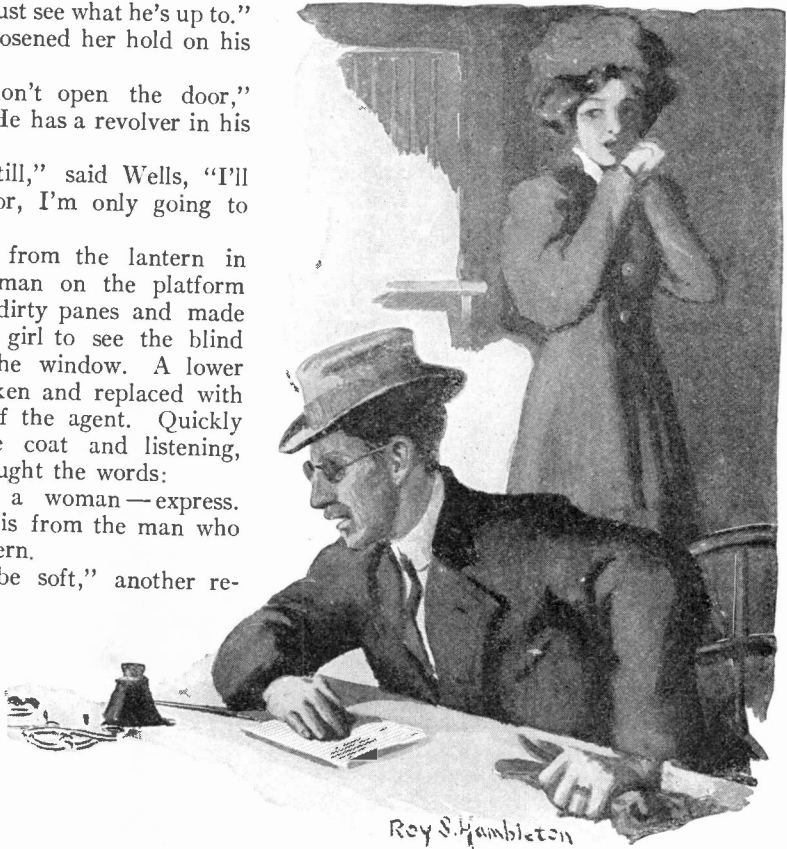

ROY S. HAMBLETON
DROPPING INTO THE CHAIR HE FELT FOR THE KEY

peculiar quality of smoothness in his voice.

"How did it happen, then, that he did not recognize you?"

"He might have, for all I know, but that wouldn't make any difference. He thinks I'm helpless. He'll see, though, whether I'm helpless or not."

"Oh, I wish we could do something," said the girl.

Wells was feeling for his tool case. "We can," he said as he opened it. "I'm going to bore out the lock of the office door and get into that telegraph instrument."

"I'll stir the fire and make a better light," said the girl, anxious to be of some assistance.

In spite of the serious business at hand, Wells laughed softly. "Never mind the light, sister, the less we have the better."

"Of course! I must be crazy," she said, as she trembled in the darkness.

"You stand close to the outside entrance," he commanded, "and warn me if you should hear anyone approaching."

The girl guarded the door and listened, while the blind man's sensitive fingers carefully traced the key-hole and latch. Soon he was boring, and his hands, long trained in the use of fine tools, made rapid progress. So excited was the girl as she watched and waited in the darkness that she could almost hear her own heart beat. The wind whistled dolefully through the telegraph wires; the dull drumming of the water in the spout kept time to the dreary dirge of night. The sightless man worked on. Once, thinking she heard the faraway moan of a locomotive whistle, the girl exclaimed:

"O mercy! Mr. Wells, I believe the train is coming!"

"It can't be," he replied, as his watch closed with a snap.

A few minutes later the girl heard a soft stroke of the little saw; a few more turns of the drill, and then Wells whispered,

"The lock—at last."

"Thank God," murmured the girl.

The office door went back with a creak.

Along the inner wall crept the girl until she stood leaning against the facing of the broken portal. Wells was already inside the small apartment. His hand touched each object that he encountered, first a chair, then the iron safe, and finally the operator's desk. Dropping into the chair, he felt about until his fingers found the key.

"Here we are," he said. "Let's see. I believe H.T. is Hartford's call. I'll try it," and he began ticking off the letters of the call.

There was no answer.

"I may be mistaken," he said to himself, "I'll just spell it in full a few times."

How his heart throbbed when the distant office rattled the answer in quick, sharp clicks. Then he sent an answer to the signal as fast as his lack of practice would admit:

"Hartford, for God's sake hold No. 4. Outlaws in the cut a mile south of Park Junction to hold her up."

"Wait," broke in Hartford, "she is coming."

Trembling with suspense, Wells waited for three minutes. Again the instrument clicked.

"We have stopped No. 4. Who are you?"

As quickly as he could, the blind man sent his story over the wire, and back came the command from Hartford to "Stay at the key."

All this time Miss Duglace stood in the doorway, waiting breathless with excitement.

"We caught the express at Hartford," he informed her.

"Great!" she exclaimed.

Then came another message from Hartford "Have notified sheriff at Williamsfield, and gang will be surrounded. Wait at Junction for No. 4."

With a sigh of relief, the blind operator arose and made his way to where the girl stood.

"You are perfectly wonderful, Mr. Wells," she said. She could not see the smile that illuminated his face, but she could feel the gentle pressure of his hand.

Lest one of the robbers might return to the station, and discover what had been done, Wells replaced the lock and closed the door. Then he revived the dying fire and he and the girl sat down to wait.

Just before daybreak the blast of a whistle brought them to their feet, and a minute later No. 4, with the captured robbers aboard, steamed up to the platform.

No telegraph operator ever received better pay for a night at the key, than that represented by the check which the railroad company sent to Frank Wells. It came to him in a letter while he was spending a week at the home of the Duglace family.



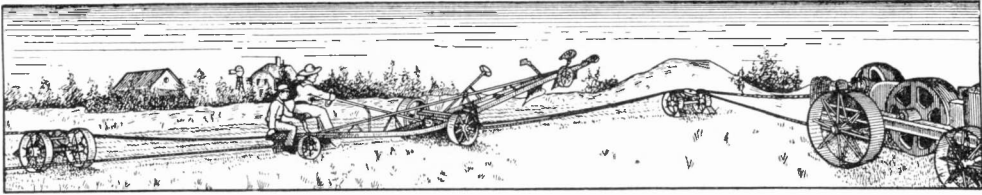

Electricity—The Farm Hand

When the young men of ten years ago left the farm because of its hard labor and long hours, to seek employment in the large cities where shorter hours and more genteel labor is said to be found, they did not realize how close they were on the old homestead to a time when electricity would be the hired man.

The means afforded for obtaining electric current are increasing. Electric transmission lines from centrally located generating stations now run from town to town through many farm districts, furnishing power and light wherever wanted along the line. In other parts of the country the trolley or interurban line is used as a source of current supply, while on some farms are streams, which, when developed, are capable of furnishing waterpower sufficient to generate current for use on one or several farms. When one of these sources is not available a plant consisting of a direct connected gasoline or gas engine and generator set, and is so built as almost to take care of itself, may be had at a moderate cost, and with a storage battery affords an ever ready electric supply.

It is not the purpose of this article to take up the ways of generating or obtaining electric power, for, if the gas-engine method is

decided upon, there are engine and battery manufacturers who stand ready to furnish plans and estimates for an equipment suitable for any particular set of conditions. Similarly with water powers, each of which represents a special problem to be worked out. If there is an electric central station or interurban railway company prepared to furnish current to a rural district, it also has its agents and representatives who are

prepared to give the farmer engineering advice as to the methods to be employed in obtaining and distributing the current. But it is the purpose to show by illustration and a few descriptive paragraphs the ways in which electric power can now be applied to farming operations.

The city man who visits the modern farm will have more trouble to escape being called "green" than has his country cousin in seeing the city.

The tallow candle and oil lamp are disappearing from the clock shelf in the

kitchen and a turn of the switch lights any part of the house, barn or other buildings, and furnishes current to a dozen different labor-saving devices in the home. In the heavy work in the barn, shop, dairy and field, however, electricity is at its best.

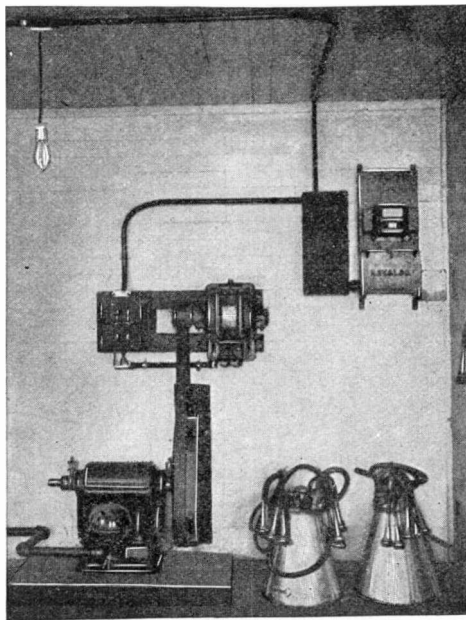

DAIRY VACUUM PUMP AND COW-MILKING MACHINE

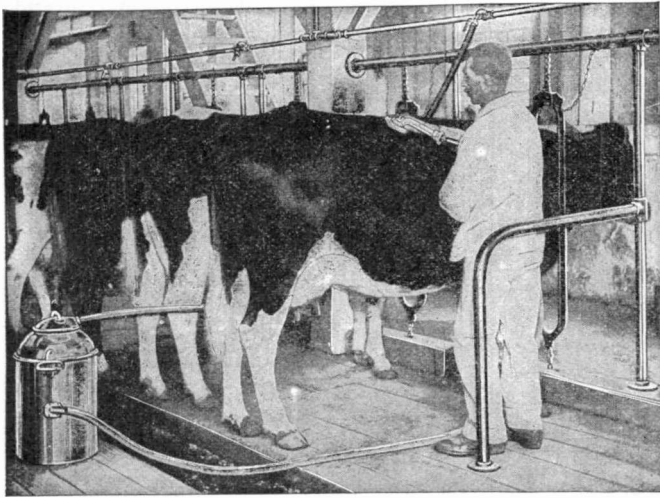

COWS MADE SLEEK WITH A VACUUM CLEANER

These things are said to be true on the modern farm, advisedly, of course, for it is not presumed that even a large minority of the farms of this country are as yet equipped with electrical conveniences. But the movement is growing, and each year the electrical manufacturers are developing new devices specially fitted for this work, and the electrical age is surely dawning for the farmer as it has already dawned for his city brother.

But to get down to specific examples: About the first thing we think of after the word "farm" is mentioned is "milking." Milking the cows by hand on a farm usually means getting up anywhere from four to five o'clock in the morning and is the after-supper job also. Electricity does this work in a quicker, more sanitary way. The outfit consists of a motor, suction pump, milk can and suction cups, these last on the end of a rubber tube. The can may be connected to a suction pump pipe outlet coming from the dairy, by a flexible rubber hose, the pump and motor being stationary in the dairy and utilized for other purposes. By making and breaking the vacuum in the tube suckers the milk is drawn and released into the can, giving no more discomfort to the cow than does her young calf in getting its breakfast.

The dairy pump may be used also to operate a vacuum cleaner, with which, when the proper "tools" are connected, the coats of the horses and cattle may be cleaned after

motor-driven rotary brushes have first "curried" and loosened the dust.

The dairy offers still more work for the motor, in operating the cream separator and driving the churn. We remember how mother used to work the butter in the old-fashioned wooden butter bowl, using a wooden paddle, but a motor-driven butter worker may now be made to displace paddle and bowl.

During the winter season in the country and after weather cold enough to form ice six inches or more thick on the lake or neighboring millpond, the farmers begin the "ice-harvest," helping one another to fill the several ice-houses which are often crudely built wooden affairs roofed over. The ice sawed into blocks is hauled to these houses and covered with sawdust, to be dug out the following summer. The use of ice thus gathered and stored is not altogether

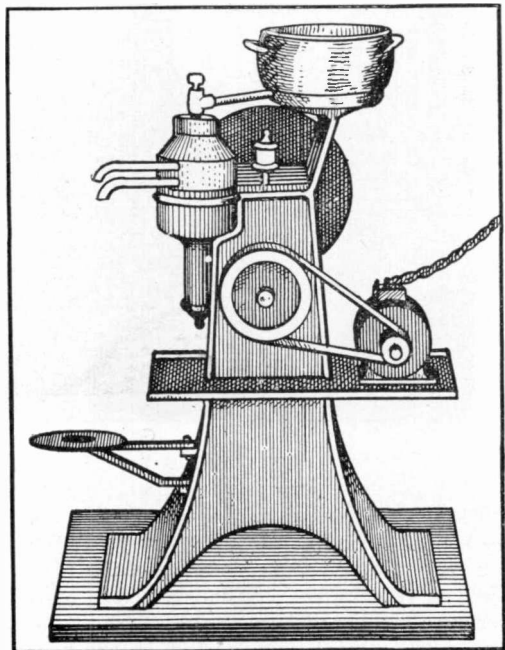
ELECTRICALLY OPERATED MILK.
SEPARATOR

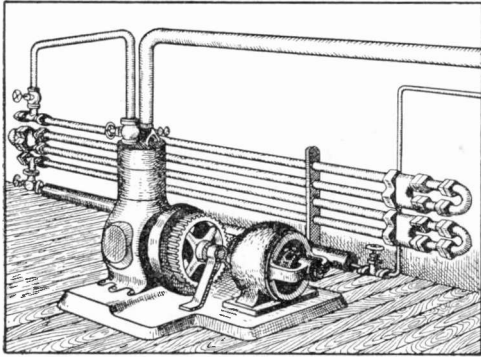

ELECTRICALLY OPERATED REFRIGERATOR

satisfactory and involves considerable labor besides. There is always present a good deal of water, it is not possible to regulate the temperature at which a chill room may be kept, the ice is always wasting away and it may also contain impurities.

large and small are now on the market and the repeated trips to town for fresh meat during the hot weather of harvest and threshing time may be reduced to one or two, the cold dry storage of an electric refrigerator keeping a quarter of beef as long as desired.

The modern farmer aims to utilize the full feed value of his corn and other fodder by cutting it up either by hand or horse-power and packing it in a silo. One of the illustrations shows the silo being filled the "electric way," a motor driving the fodder-cutting machine while a centrifugal fan blows the fodder up into the silo.

Nearly every farm has some sort of a shop where in bad weather odd jobs of repairing may be done on wagons, tools and farm implements. The shop shown is rigged up to run a lathe, a saw or any other needed machine from a single motor and jackshaft. Even the grindstone for the "love" of which many a youngster has lost out on an anti-

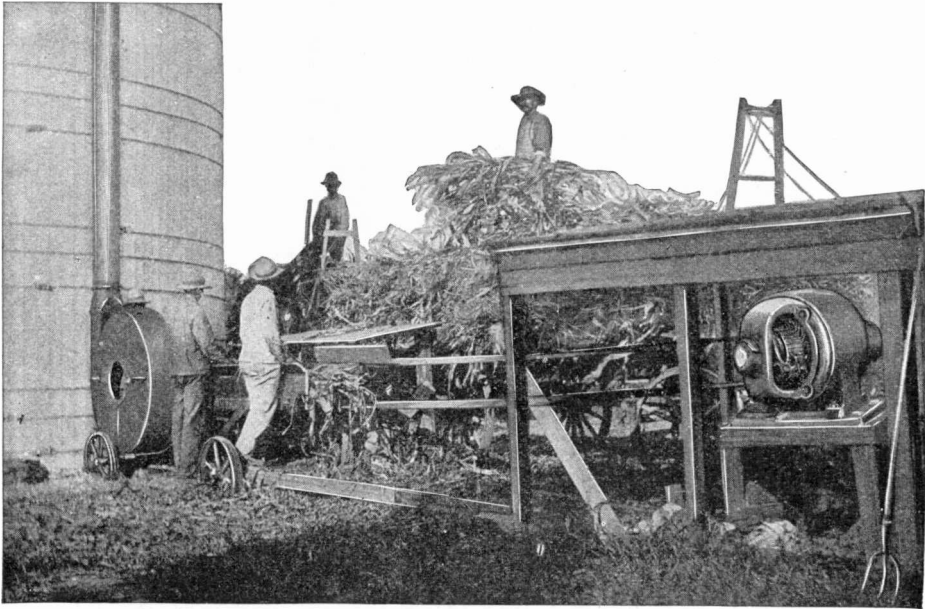

FILLING A SILO THE ELECTRIC WAY

Electric refrigeration does away with the ice-harvest even for the average farm by the use of motor-driven ice-machines which regulate themselves. Whenever the temperature rises or falls in the refrigerator the motor is automatically started or stopped, thus controlling by the pump, the circulation of the freezing fluid in the pipes. Outfits

pated fishing trip, is here connected up, and future inventors, to compensate for past youthful drudgery, may yet produce an electric bait-digger. As but one machine out of several is usually operated at a time, a large motor is not necessary, and the cost of such an installation would not be excessive.

That patch of ground, and every farm has one, which seems to have no bottom to retain moisture after a rain or spell of wet weather is not a source of revenue. Then, too, there are the inevitable droughts that come at just the right time to endanger some crop. A small motor-driven pump set up under shelter as in the illustration is just the thing to use in draining and in modest systems of irrigating.

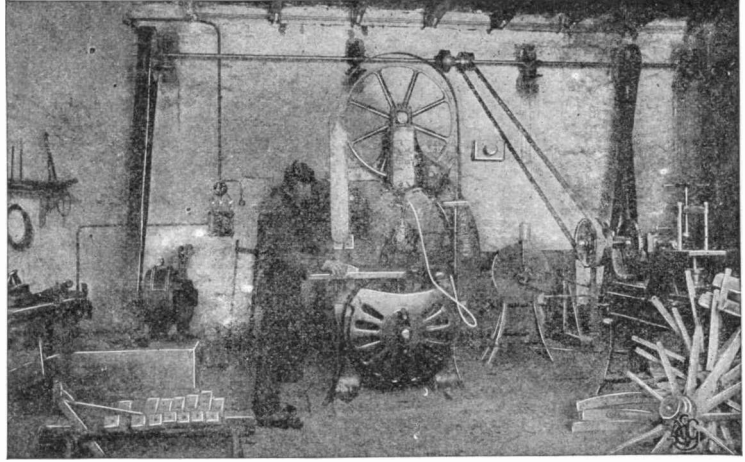

THE FARM WORKSHOP

An interesting equipment in the form of a sprinkler system installed on a truck farm

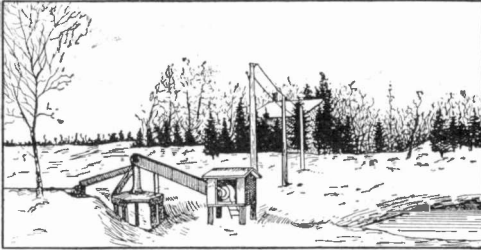

THAT LOW PATCH OF GROUND IS EASILY DRAINED

in New York State is here illustrated, pipes being run from the pump and on supports

over the field. In some cases these pipes have been placed on supports high enough to allow the passage of a wagon under them. It is quite possible to arrange so that the water flow may be controlled from a distance as by the greenhouse electric pumping installation shown in one of the pictures on the next page.

Following the plow handles behind a team of horses is still the most common way of turning the soil except on large farms, where steam plows are frequent. Europe, however, and particularly Germany, has at least a dozen motor-driven equipments and there is but small doubt that the electric plow will some day come close to performing its share of work.

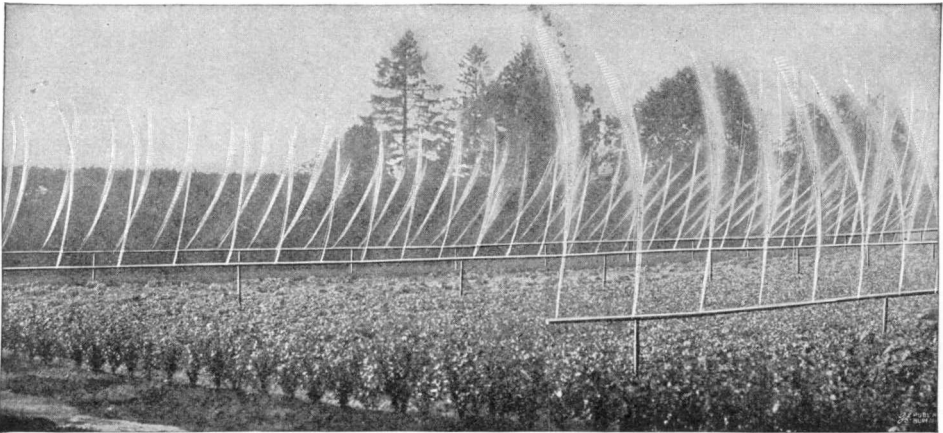

SPRINKLER EQUIPMENT INSTALLED ON A TRUCK FARM

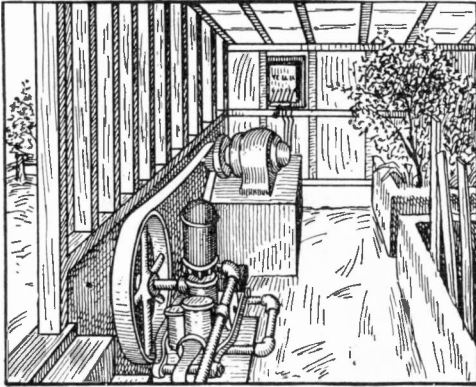

THE PUMPING OUTFIT IN A VACANT
CORNER OF THE GREEN HOUSE

Edison predicts the extensive use of electric plows and rests this assurance upon the lightness, output and adaptability of his new storage battery, plowing thus being done with as simple an equipment as an electric automobile.

In the meantime, however, efforts in this line can only be called experimental and the day is still to come when electrically

turned furrows will be practicable. Still, the pictures here shown of experimental equipments for electrical plowing are interesting as indicating one stage in the development so far attained. In this instance a jack carriage or truck carrying a motor and controller operates an endless cable and reel which, in connection with the anchor carriage and its flanged wheels on the opposite side of the field, drag the plow back and forth. One man at the jack carriage controls the motor, while a second looks after the plow. This is a queer looking implement arranged on the "teeter-board" principle with plows, steering gear and everything complete on each end of the beam, so by lowering one end or the other it will operate in either direction.

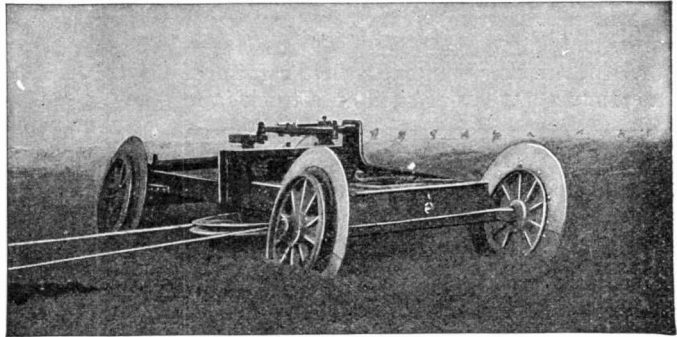

ANCHOR WAGON USED IN ELECTRICAL PLOWING

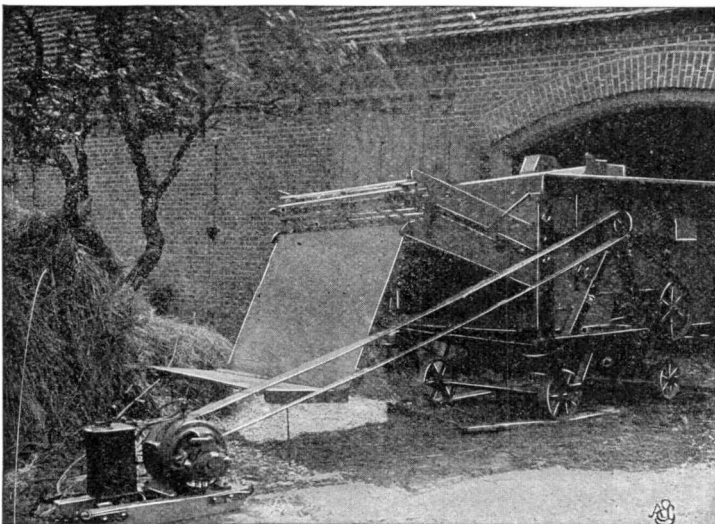

A PORTABLE MOTOR APPLIED TO THE THRESHING MACHINE

A motor which can be shifted from place to place, belted to a machine and readily connected by flexible conductor to a nearby outlet, finds unlimited uses on the farm. Such a one is illustrated in one of the pictures, being mounted, with its controller, on a sled. One horse can pull the sled and load to any location where it can be staked down ready for service, it being presumed, of course, that the premises are wired and provided with suitable

outlets for attachment of the motor cable near such places as the motor will find employment.

Probably the most practical farmers when they read this over will contend that all the devices enumerated above would cost a small fortune and represent an investment far out of proportion to the value of the farm. In answer to this it must be said that there are farms and farms. Some of the largest, where all operations are carried out on a

big scale might well use all the labor-saving means described and get a commensurate return on the investment. On smaller places again, perhaps for the first beginning only electric lighting and the portable motor for all around work would be advisable. These are matters which each farmer must decide for himself after first having carefully calculated the cost of a certain installation and then set off against this the actual economies and conveniences to be obtained.

ELECTRICAL OPERATION OF BULKHEAD DOORS

As nearly everyone knows the hold of a modern ship is divided into compartments by water-tight partitions extending clear across the hull of the vessel, and having communicating doorways, which may be closed by water-tight sliding doors.

Thus in case of accident permitting water to enter one compartment through the hull of the vessel, the inflowing water may not enter an adjacent compartment. As a rule, lengthwise compartments are avoided, because filling one of them for very long might result in careening of the vessel and throwing one screw out of the water and even capsizing the ship. Or water might get to the furnace room and put out the fires.

So we may assume that the vessel may have from three to 20 water-tight compartments separated by cross partitions, having on several deck levels through-ways which may be closed at once in case of accident or danger.

The demands of the present day are for control of any or all of the water-tight doors from some central station, as well as the

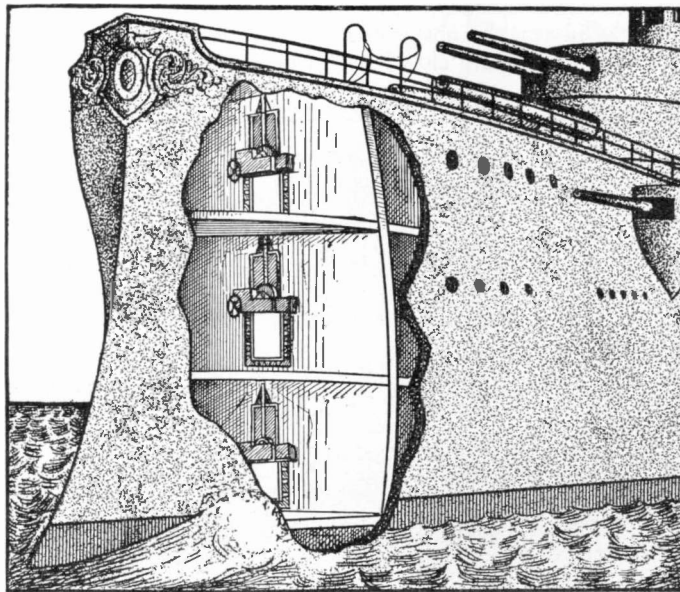

WATER-TIGHT BULK HEADS IN A SHIP, SHOWING ELECTRICALLY OPERATED DOORS

possibility of controlling any one of them not only from this point but also from other points convenient to reach. The principal thing is to render the closing independent of human working of the separate individual doors. It is rather difficult, if not impossible, to have the partitions free from doors

under the water-line. That would result in an inconvenience to passengers which the most strenuous advocates of safety among them would be the first to resent. So all the various water-tight compartments are connected by doorways, the water-tight vertically sliding doors of which may be opened or closed from above the water-line; and the prompt and perfect action of which is tested daily not only at sea but also in port.

The doors are opened and closed either by hydraulic cylinders, receiving pressure

from machinery driven by steam from the main boiler room, or by small electric motors through a worm and worm-wheel. In the latter system, which is the most modern and altogether the most efficient, there is an apparatus, located on the captain's bridge, which automatically connects the various separate motors with an electric circuit, so that the doors are closed in short order.

Besides the device for closing every door from the bridge, there is also a hand-closing apparatus for each one, independent of every other; a small hand lever throwing in the necessary motor for the door in question and opening it. As soon as this lever is let go, the door closes automatically.

Should there be any mechanical obstruction to the closing of the door—or anything in the doorway itself—the motor would be switched out at once automatically, but in such manner that the instant the obstacle is removed the door will be at once closed by

the motor. Such a case might occur by reason of a leaky coal bunker.

The motor in question is a slow running compound which may be quite suddenly overloaded without injury. It is of about one horsepower, but for a short time may be crowded up to three horsepower. The door is furnished with a rack which is driven by a pinion in connection with a worm gear. The wedging action of the door itself is such that it closes tightly, but is readily opened without any great friction. There is force enough in the motor to cut through any ordinary mass of coal which might get in the doorway.

In connection with both the electric or the hydraulic system there is a widely-ramified system of alarm bells, to notify all who are below the water-line; and as a rule there is on the bridge a control system by which lamps show the officer there at once which doors are closed, and which are open.

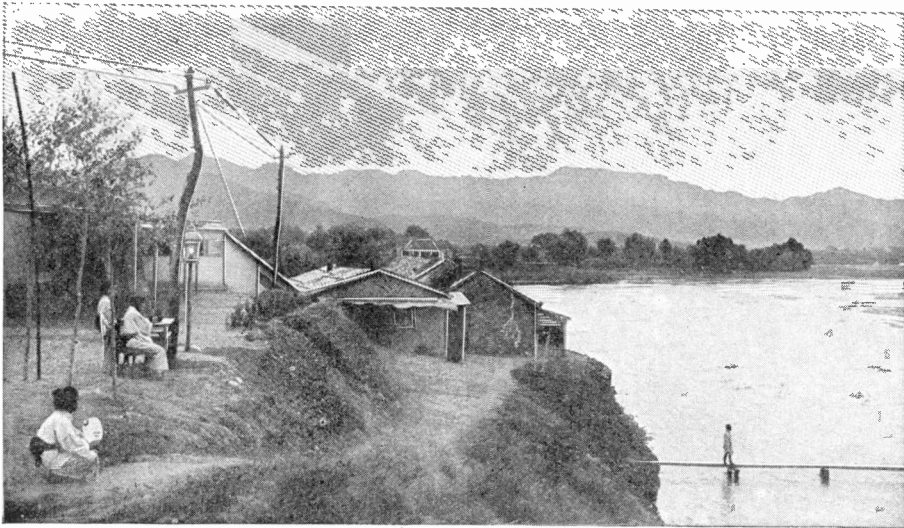

The Telegraph in the Far East

The new Trans-Manchurian Railway, of which the papers have had so much to say lately, is drawing the attention of the traveler to the famous hot springs of Hsiung-yuehcheng, and it is some comfort to the sick, gone there for healing, to know that they are in telegraphic communication with home. The telegraph has penetrated the farthest East. How primitive it is the picture above, showing the telegraph poles, attests. Any old pole will do, whether bulging or not, and underneath these posts my Chinese lady sits, meditating to the whisper of the wires overhead.

Magnetic Dip

By BROTHER POTAMIAN, D. Sc., Lond. Professor of Physics
in Manhattan College, New York

The property of a magnetic needle by which it takes up a definite direction under the influence of the earth's magnetism was used for navigating purposes in European waters in the Thirteenth Century. The other property in virtue of which a needle, free to move in a vertical plane, will not remain in a horizontal position was not discovered until the Sixteenth Century, the fortunate discoverer being Robert Norman, a compass-maker of Limehouse, London. Norman described this peculiar behavior of the needle in his quaint little book *The Newe Attractive* which appeared in 1581, though the discovery itself was made five years earlier, in 1576.

Norman possessed many of the qualities of mind and hand that go to make up the successful investigator of the phenomena of nature; for he was cool, careful, painstaking and resourceful. In pivoting his ships' compasses, he noticed that however carefully he balanced them they did not remain strictly horizontal after magnetization, the north-seeking end invariably dipping downward to some extent. Knowing as he did that the act of magnetizing changed neither the weight of the needle nor its center of gravity, he rightly inferred that this unexpected action of the needle was due, in some way, to the magnetic influence of the earth itself. With the instinct of genius—and Norman was no ordinary man—he bethought him of swinging the needle on a horizontal axis instead of on a pivot so that the magnet might be free to move up and down in a vertical plane; and in this way, he was led to the discovery which is known today as "magnetic dip," a discovery of cardinal importance in the science of terrestrial magnetism.

Fig. 1 is copied from the *Newe Attractive* and shows that the dip in London was $71^{\circ} 50'$ when determined by Norman in the year 1576.

In Fig. 2, we have an apt illustration of magnetic dip devised by the ingenious artificer of Limehouse. Thrusting a steel needle through a piece of cork he pared the latter away until the needle floated horizontally at a certain depth. He next took out the needle and magnetized it. Replacing it very carefully so as not to disturb its position in the cork, he noticed not only that the needle sank to its former depth in the water but that it settled down in an oblique position at an angle of about 72 degrees.

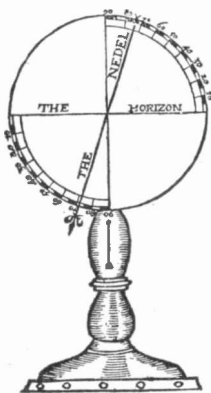

FIG. 1

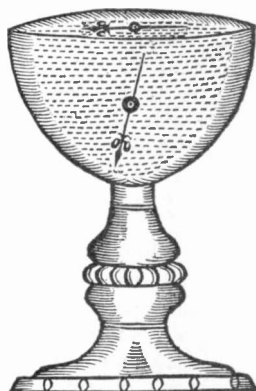

FIG. 2

The magnetic inclination at any place on land or on sea is determined by means of a carefully made dip-circle. Fig. 3 shows a laboratory model. After leveling the instrument, it is slowly turned around until the needle takes up a vertical position which it does when the plane of the circle stands at right angles to the magnetic meridian. The circle is next turned through 90 degrees in order to bring it into the meridian, after which the position of the needle is read at both the upper and the lower end for the purpose of eliminating any error that might arise from the center of suspension not coinciding with the center of graduation. The circle is next swung round through 180 degrees so that the side which faced east at first now faces west; the needle is read at both ends as before in order to eliminate this time any error that might arise from the non-coincidence of the magnetic axis of the needle with its geometric axis, or axis of figure. Finally, the needle is taken out of its bearings and its polarity reversed after

which it is replaced in the instrument and two more readings taken to eliminate any error that might be due to the non-coincidence of the center of gravity and center of suspension. The mean of all these readings will give the true value of the angle of dip.

There are many places on the earth's surface at which the dip is zero; *i. e.*, where the needle remains exactly horizontal. Connect all these places together and you will have the magnetic equator of our planet; it will be found to be a wavy line encircling the globe and nowhere coinciding with the geographical equator, though lying near it. As the inclination of the needle is zero on the magnetic equator, this equator is technically called the *acclinic* line. If we connect together a number of places at which the dip has the same value, the joining line will be an *isoclinic* line.

It is a fact of observation that as we ascend the ladder of latitudes from the equatorial to the arctic regions, the dip of the needle increases until, at a certain spot, it reaches its maximum value of 90 degrees. The needle then stands vertically over the interesting area which we call the magnetic pole of our Northern Hemisphere.

When the sextant tells the fortunate pole-hunter that his latitude is 90 degrees, he knows that he has reached the goal of geographical exploration; so, too, when Ross (Sir James Clark) on the first day of June 1831 found that the compass had lost all directive power and that the inclination of the dip-needle was $89^{\circ} 59.5'$, he concluded that he had finally reached the north magnetic pole of the earth. Swayed by a feeling of gratitude, he christened the newly-discovered land *Boothia Felix* in honor of Sir Felix Booth, the wealthy Englishman who financed the expedition.

Later on, in the year 1841, Ross, in command of the *Erebus*, undertook an expedition to the Southern Hemisphere during which he endeavored to locate the south magnetic pole. The greatest dip observed was $88^{\circ} 35'$, and this was in latitude $76^{\circ} 20' S$, longitude $165^{\circ} 32' E$.

It is germane to the subject to say that, after surmounting great difficulties and enduring untold hardships, Lieut. Shackleton's men finally located the south magnetic pole on Jan. 16th of the year 1909. They found it to be at latitude $72^{\circ} 45' S$, longitude $145^{\circ} E$.

It is interesting to note in passing that Gauss, one of the greatest mathematicians of the Nineteenth Century, determined the position of the same pole from available magnetic data and found it to be in latitude $72^{\circ} 35' S$, longitude $152^{\circ} 30' E$.

Professor David and the other members of the party sent out by Lieut. Shackleton were grievously disappointed at not getting nearer the polar dip of 90° than their $89^{\circ} 48'$; and it was with manifest reluctance that they abandoned all further hunt for the antarctic spot of supreme magnetic interest, being compelled to do so by constant blizzards, icy winds, dangerous crevasses and failing provisions. It has now passed into history that the discovery of the two magnetic poles

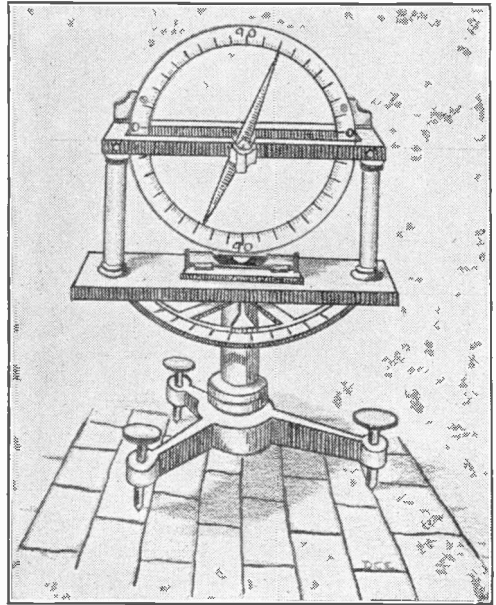

FIG. 3. LABORATORY MODEL OF A DIP CIRCLE AND NEEDLE

of the earth was made by officers of the British navy.

Observations on latitude have shown that the pole of rotation is not fixed and stationary as was universally believed until accurate observations of recent date disclosed its want of absolute steadiness, rhetorically called its "wobbling" propensities. These excursions of the end of our axis of rotation are, however, limited to a score of feet to the right and the left of the true polar point, whereas our magnetic pole indulges in sec-

ular wanderings of much greater amplitude, having shifted on a north-westerly course for a great many years at the rate of a mile and more per annum to return with the same impressive slowness to its original position in Boothia Felix. This we infer from the determinations of Ross in 1831 and those of subsequent arctic explorers including the observations of the Norwegian Captain, Roald Amundsen, in 1903-7.

The dip of the needle is of no service to the traveler whether on land or on sea; but it is of primary importance in the science of terrestrial magnetism as well as the physics of the globe. A study of the two elements—declination and dip—reveals the manner in which the earth's magnetism is distributed and enables us to realize the irregularity and complexity of this distribution.

Scenic Railway in Brazil

(Illustrated on the front cover, this issue)

According to the verdict of unbiased travelers few localities on the whole globe are equal in their charm to the bay of Rio de Janeiro, which has been a favorite theme for poets ever since its discovery 355 years ago. Sixteen miles long and nowhere over seven miles wide, its irregular shore line can easily be scanned from various vantage points on the picturesque hills which border it and particularly so from the Corcovado which rises to a height of nearly 2,200 feet above the bay and from which the capital city of Brazil draws most of its water supply. The view of the bay from different points on this mountain shows a continual variation of coast lines marked by a maze of inlets, of bird's-eye effects as to the city itself which stretches for nearly fifteen miles along the opposite shore, of clustered hilltops and of luxuriant tropical vegetation.

A single trip up this steep but scenic mountain will show even a skeptic why the difficult task of installing a railway reaching to the summit was warranted nearly 30 years ago. The road installed was a rack and pinion railroad operated by steam locomotives which too often belched out the smoke where it obscured the charming view. Now this road has been electrified, the power being supplied by a plant at Rio das Lages, fully 50 miles off. A 44,000 volt transmission circuit, arranged so that it can be increased to 88,000 volts if the demand for current grows, carries the current to substations where it is transformed into a safe

voltage. Owing to the steep climb which ranges from grades of four per cent to some of 30 per cent, the rack and pinion feature of the old steam road has been maintained and a most unusual type of electric locomotive has been developed for this work by two Swiss concerns, the Oerlikon Maschinen-

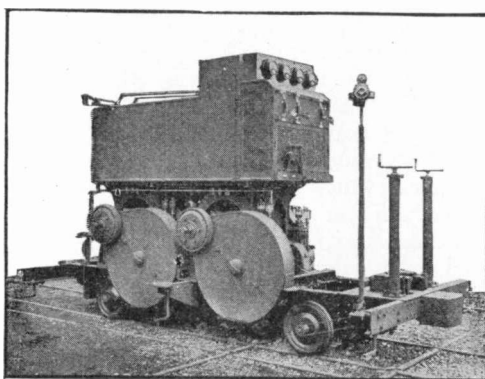

ELECTRIC RACK LOCOMOTIVE WITHOUT HOUSING

fabrik and the locomotive works at Winterthur. This novel type of locomotive has a pair of 155-horsepower motors arranged so that they can serve as dynamos when going down hill so as to light the cars and furnish magnetic brake action on the downward trip while entirely disconnected from the twin trolley wires.

Bridge Wrecked by Electric Current

Recently a large wooden bridge stood over the Wabash River in Indiana. It was purchased by the county authorities to be replaced by a steel structure. The owners agreed to remove it in 30 days, which was a bigger task than was anticipated. They did not wish to destroy the piers or else it would have been blown up with dynamite. Neither did they wish to injure the masonry by burning the structure. Along came an electrician, then, who proposed to burn it apart with electricity.

Twenty-seven sills were to be cut in two simultaneously in each span and this was accomplished by burning them through with loops of iron resistance made red hot by the passage of electricity through the wires. The wires were arranged, the current turned on and in a few hours the last span had dropped into the river.

Invention by Effort and Study

By GEORGE ETHELBERT WALSH

Many of our great inventions appear to have been the result of accident rather than of well-directed and persistent effort, and there has grown up a pretty well defined impression that the inventor like the poet is born and not made. This theory has enough to justify it, in the lives of many of our great inventive geniuses, and we have records of inventions which seem to have sprung, without any previous thought or training, full-fledged and fully developed from minds gifted with unusual inventive faculties. But these accidental discoveries were in a great many instances the result of long study and work, and while the final achievement came suddenly and unexpectedly it was really the culmination of experiments and effort stretching over years.

In modern industrial life invention by accident receives less and less credit. The inventor of today is such by profession, and is equipped with experience and knowledge far more likely to aid in achieving results than the man without accurate training and study.

There is and always will be a certain element of luck, of accident, and of chance in invention, and there will be born men whose inventive faculties are much greater than those of the majority, but outside of a small number of well-known geniuses the greater bulk of our inventions come from unknown men and women toiling daily at their allotted tasks. Some of these are professional inventors who deliberately pursue this calling as a business, while others are working at various odd trades and industries but with an eye to the chances of possible self-improvement through the invention of some labor-saving machine or novelty. There are industrial organizations whose employees, no matter how humble and poor, are encouraged to make inventions, and if any one of them conceives a new idea he is given every opportunity to develop it. More than that, he is helped by experts, and if the idea proves feasible both credit and royalties are given.

In the last 50 years there have been over three and one-half million applications for patents, and over two and one-half million of these applications have been granted letters

patent. A little less than one-half of these, or about one million, were granted in this country.

Sometimes we hear that the day of the inventor is past, and that the great fortunes realized on royalties will not be easily duplicated in the future. This conclusion is hardly warranted. The electrical field alone, although it has yielded vast fortunes to inventors, instead of being exhausted is now being diligently cultivated by companies which employ inventors on salaries, with a further promise of royalties on every successful achievement. Two of the greatest electrical manufacturing companies of the country have each an organized patent department, presided over by men of experience and ability. This board of inventors not only carries on a campaign of careful research, but it is on the lookout for all possible inventions from outside, as well as inside sources. Every employe is encouraged to make suggestions for improvements in his particular department, and if he has an idea of practical value it is developed for him. Some men appear to have the faculty of suggesting improvements, but not the ability to carry them out. Sometimes an ignorant workman can vaguely suggest how a thing ought to be done, but cannot tell exactly how. It is to develop such hazy ideas that boards of inventors are organized in many of our big industries.

Years ago when Niagara Falls was first harnessed, the theory of its organizers was that cheap electrical current would revolutionize lighting and rail transportation. But instead of achieving this result, the harnessing of Niagara gave as its first real benefit a stupendous impetus to invention. It was a great inspiration to inventive minds to have cheap electrical current furnished on a large scale and almost immediately experts began to delve deep down into the mysteries of electrochemistry to discover processes that could be developed and patented.

The Ampere Electrochemical Company was soon formed, consisting of inventors and electrical chemists, and it was more of a patent factory than a manufacturing enterprise. The aim was to discover and perfect

new processes, and then turn the results of their efforts over to manufacturing companies to exploit. They were inventors and discoverers pure and simple, and they no longer found inspiration in their work when their goal was once reached. In this old patent factory were some remarkable and ambitious men; old inventors who understood all the ropes and guides to success; an old college professor who was familiar with all the theoretical knowledge of the age; the practical electrician; the business man; the trained chemist, and young, ambitious men with their laurels yet to win. No hint, no theory, no suggestion was too insignificant for these men to consider and follow out.

From this group of men devoted to invention came such money-making, patented processes as the manufacture of carborundum, the making of nitric acid from nitrogen and oxygen, the production of a low grade of artificial camphor from turpentine, and the manufacture of barium salts and calcium carbide by an electrical process.

One of the greatest inventors of the age, Thomas A. Edison, has often been chosen as a typical illustration of the value of chance or accident in inventing. Yet Mr. Edison's whole life work is a contradiction of this theory. He is one of the hardest and most diligent workers of the age. He spent ten years of intense application to the perfecting of a single one of his inventions, and worked nearly as long on his electrical storage battery. In his own words, in an interview with the writer: "Invention is the hardest kind of work, and requires the intensest application of every faculty. There is nothing haphazard about it. There is no luck in it. You reach your goal by a process of elimination. Every factor must be studied, examined, and then eliminated if it is not what you want, until you have narrowed the whole problem down to two or three points. Then possibly luck or accident may play a minor part. Some day the whole thing will dawn upon the mind, and you see the goal you have been working for."

William Sturgeon invented the electromagnet, and in 1825 he presented to the English Society of Arts his first soft iron electromagnet, for which he was awarded a premium of \$150 and a silver medal. His life was a perpetual struggle against poverty, and finally friends secured for him a grant of \$1,000 and an annuity of \$250. But he only lived a few months to enjoy them.

In more recent times many unpleasant stories could be told of inventors who were robbed of the rewards of their discoveries through failure on their part to protect themselves properly. Discovering some great labor saving device, they have sold their patent outright for a nominal sum or disposed of it to companies who simply "shelved" it for years without utilizing it. The expected royalties did not materialize and the inventors did not reap any profits as a result. This phase of the subject emphasizes the necessity of some business ability as well as inventive gifts. The Patent Department of the Government protects the inventor in the use of his discovery, but it can go no further.

One of the discouraging features of the whole inventing profession is that about one in every three applications must be refused because they infringe upon patents already granted. In the majority of cases the inventors are innocent of any intention of infringing upon the rights of others. They are simply poorly informed. Nearly every day applications for patents are made covering important parts of machinery which have already been protected by patents. In order to work intelligently one must make an exhaustive study of his specialty to see what others have done in this field. An idea new to one may be old to others. Before going to the expense of making models and applications study up on the subject and exhaust the field. It is this hard work and effort which brings success.

The profession of the inventor is one of the best and noblest of his day, and it benefits humanity as well as the individual inventor. But it is becoming more and more a specialized profession. Great minds, and many minds, are at work all the time in the field, and the amateur has little show in outstripping the professionals. The safest way is to make a specialty of one line and stick to it. There may be no reward for years, but if one is possessed of reasonable inventive faculties the results are bound to come. Often the greatest inventions waiting for some one to discover and develop them are lying very close by. It may be in some article of furniture, a tool which we use constantly in our daily work, or an article of dress which we handle every day of the year. It is well to cultivate the home field first and try to improve things with which we are the most familiar and not those of which we have only a vague knowledge.

Electric Block Signaling

By SIMON DEUTSCH, E. E.

PART V

The basic principle of the automatic block signal system, where the signal indications are controlled by the position of a train on the rails, condition of the track, switches, derails, etc., was founded on the track circuit. As has been previously explained, the presence or absence of the wheels of a train or car on the rails included in the track circuit, is indicated by its effect, electrically, on the electro-magnet controlling the signal circuits.

The signal indications are mostly conveyed by the semaphore signal, position indications being apparent to the engineer at daytime, and light indications at night. The semaphore signal generally consists of a blade, pivoted on a high post, and attached to a blade carrying a casting which has openings for glass plates or lenses of different colors, the blade when at right angles to the post, denoting "Danger" or "Stop." This combination of pivoted blade and casting is operated through the medi-

um of a rod connected to an operating mechanism similar to that shown in Fig. 17, the colored glass moving into a position corresponding to the position of the blade, and giving at night, a like indication.

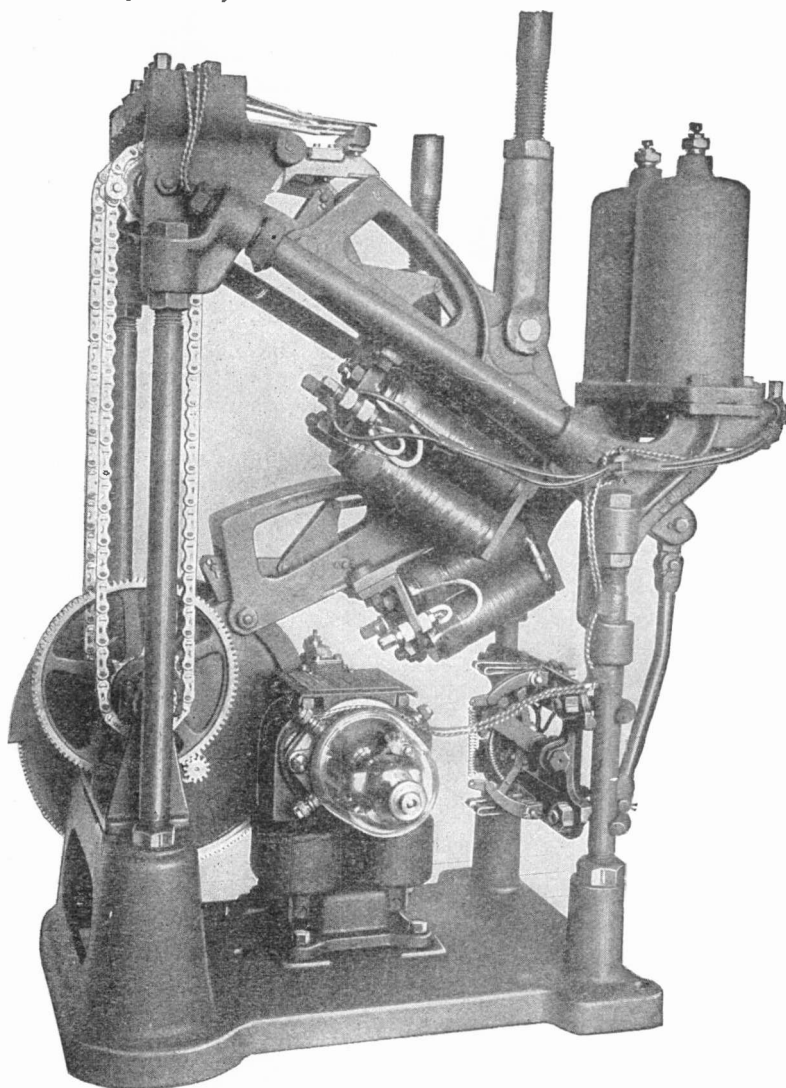

FIG. 17. MECHANISM WHICH OPERATES AN ELECTRIC SEMAPHORE



FIG. 18. THIS TRAIN HAS PROTECTED ITSELF—RIGHT-HAND SEMAPHORE INDICATES "STOP" TO FOLLOWING TRAINS

The means of operation shown by Fig. 17 consists of a motor driven gear and chain transmission, the chain being endless and interconnected at proper times to the blade operating rod through an electro-magnetically

controlled arm, commonly called a slot arm. This slot arm, as will be noted, is permanently fastened to the blade operating rod, and carries with it a linked pawl which will engage with the operating mechanism,



FIG. 19. LOS ANGELES LIMITED NEAR KEARNEY, NEBRASKA, OBEYING A "STOP"

only when the electro-magnet controlling this pawl, is energized.

Part of the current operating the motor is conducted into this electro-magnet, which generally consists of two windings, one of low and one of high resistance, by means of collector switches and flexible wires. As soon as track conditions are such as to cause the "track relay" to close the "signal circuit," the motor begins to operate and the linked

in reducing cost of power, is self-evident. Should any portion of this local signal circuit, or the "track circuit" to which this is secondary, be disturbed or deranged, current supply is immediately cut off from this slot arm "holding coil," and the linked pawl will be pushed from its path of engagement by the weight of the signal blade casting and rod, which are designed sufficiently heavy for this purpose.

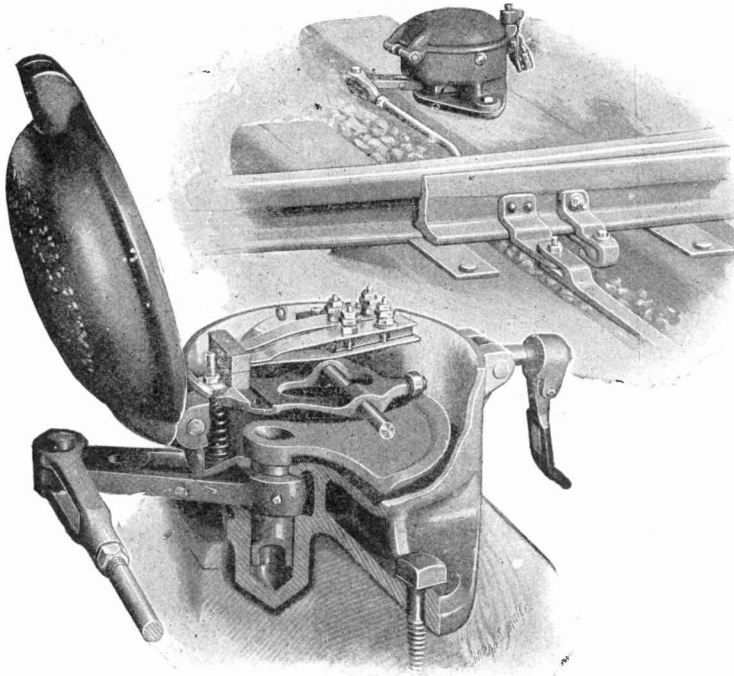

FIG. 20. MECHANICAL CONNECTIONS TO THE SWITCH POINTS

pawl is simultaneously projected into path for engagement with the operating mechanism, due to the low winding of the controlling electro-magnet being in series with the motor. Thus the blade is carried from its original horizontal position, to a position corresponding with the indication which is to be given and at this point the motor circuit is automatically opened and the current switched into the high resistance winding of the electro-magnet, which uses but a small percentage of the original current, yet, is sufficient to hold the signal blade in the position to which it was carried. Inasmuch as the signal blade is in the "Clear" position the greatest part of the time, the function of the high resistance holding coil

opening of a switch will set signals on both sides of the switch to "Stop."

In order that trains on a siding desiring to take the main line, may know whether or not other trains are approaching, a miniature signal, or switch indicator is placed at the switch stand, same being so connected electrically as to correspond with the position of the signals protecting that portion of the trackway within which the switch is located. In Fig. 21 is shown a common type of switch indicator.

Automatic block signals although primarily are thought of in the sense of protection, as a matter of fact hold an equally important position in increasing the ordinary traffic capacity over certain stretches of track. It is

The operation of these signals in actual practice on the Union Pacific Railroad is clearly shown by Figs. 18 and 19. For protection against trains going into or coming from sidings, circuit controllers or "switch boxes," as they are commonly termed, are generally connected mechanically to the switch point, as shown by Fig. 20, so that a slight movement of the switch operates contacts in the switch box, which open or close the signal circuit. Normally all switches are set for main line trains, and the

without doubt a fact that were it not for the possibilities of automatic block signaling, many of the railroads now satisfactorily operating single track, would under the same traffic conditions be forced to double-track their systems.

In general, the ideal arrangement of automatic block signals, for securing the maximum capacity for train movements over a given piece of track, is to make such spacing as will overlap the maximum distance required to stop any train on the road. This can be decided from air brake tests, and

the control of the signals should be such as not only to warn an engineer when he reaches a block which is occupied, but also to warn him in time to permit him to stop his train before reaching the entrance of the occupied block.

With this arrangement and control of signals, it would be possible to start two trains from one end of the line, two blocks apart, run them the entire length of the protected road at the same speed.

(To be Continued.)

A Telephone Repeater

Chicago talks every day by telephone with New York, and those who have given these accomplishments little attention often wonder why it is not possible to talk over still greater distances just as easily as we telegraph. The reason lies in the fact that the minute fluctuations in the talking current are damped out and lost if voltage and current of sufficient power to travel over longer stretches of wire be used.

"Why not have a repeater, as in the telegraph system?" is asked.

That is just where the rub comes in. A telephone repeater—for years the dream of inventors—is what is needed, but also, alas, what nobody has ever been able to make work on a commercial basis, unless the repeater of Charles Adams Randall, latest comer in this particular field of invention, should prove to be a practical business proposition.

Mr. Randall exhibited his telephone repeater at the recent Independent Telephone Convention in Chicago, and, although full particulars concerning its construction were not divulged, it apparently did the work over a dummy line equivalent to an actual line a thousand miles long. It has also been demonstrated on a series of short telephone lines in Iowa connected up to aggregate 4,460 miles.

The principle on which this repeater is based embodies the use of a special transmitter which will permit of the passage of heavier currents at higher voltage than ever before used for telephony, and that without any frying or sizzling and fusing of contacts. Furthermore, when a transmission is made, as far as is practicable a receiver at the distant end of the line talks into another of these high power transmitters and on your voice goes, from coast to coast if need be. This latter feature constitutes the repeater proper.

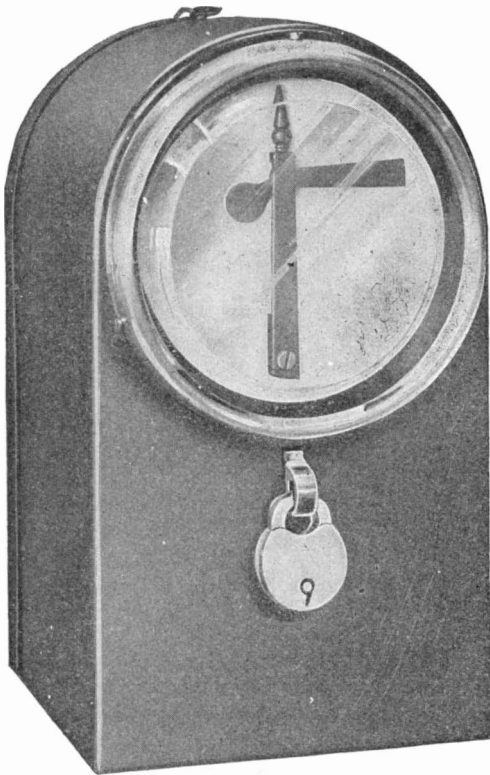

FIG. 21. SWITCH INDICATOR AT THE SWITCH STAND

this distance would naturally be the maximum length of the block.

Since it is more difficult to stop on a descending grade than on an ascending grade, the blocks would gradually be lengthened out on the descending grade, and gradually shortened on the ascending grade. As large terminals are approached, the blocks would gradually be shortened on account of the limited speed and congestion of traffic at such places. Having fixed the locations,

Correction

By one of those exasperating typographical errors which will sometimes occur in the printing of a magazine, it is made to appear in the March issue that Mr. Edward Schildhauer wrote his own biography under "Electrical Men of the Times." The biography was not written "by" Mr. Schildhauer. It was prepared in this office. Mr. Schildhauer is a modest man and it is a shame to have that one little word put him in an embarrassing position.—Editor.

The Aero-meter

No legislative speed laws control the aeronaut's flight, nor are likely to; but other laws, old as Time, immutable as the Polar Star, he must observe, for the penalty of violation is Death. Can inventive genius supply this need and reduce the dizzy pace to miles per hour?

The lifting and supporting power of the planes depends on the speed at which they are driven through the air; and all evolutions depend on the supporting power. It therefore becomes of the utmost importance to

As a consequence we now have the aero-meter, one of the first aeroplane "accessories," its inventor being Mr. A. P. Warner of Beloit, Wis. On the front of the aeroplane are mounted four little cup-shaped devices on the ends of two arms placed at right angles to each other. These are similar to the ordinary wind velocity indicator. These rapidly revolving arms turn a very small dynamo which generates electric current. The faster the arms rotate the higher the voltage or electrical pressure developed. In fact the voltage is exactly proportional to the speed, so that it is possible to measure this voltage on a little meter right in front of the aviator's eyes and have the face of this meter calibrated to read in miles per hour instead of volts.

An Electric Sandwich Man

A retailer who believes in advertising through the medium of "sandwich men" recently employed one to walk the sidewalks after dark each night in the neighborhood of the store. The man was decked out in evening dress, with silk hat and open shirt

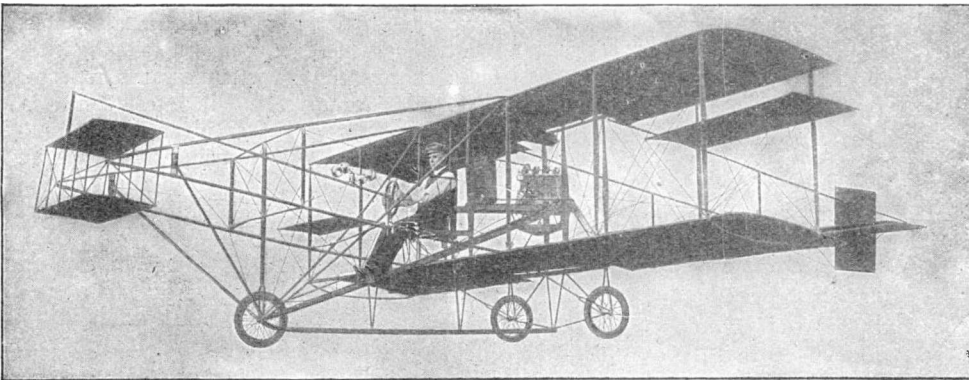

AEROPLANE EQUIPPED WITH AERO-METER

the aeronaut to know at what speed he is moving through the air. A breeze may be retarding him, so far as the earth is concerned, or it may be blowing him onward; but his flight, his ability to sustain his weight and that of his machine, is governed by his speed through the air that carries him, and by nothing else. It would not help him to observe speed indications based on his movement over the earth. He must measure his speed with reference to the air that carries him.

front. Upon the bosom of the laundered shirt the trade-mark and name of some article on sale at the store that employed the walker was formed by small battery lamps—a miniature electric sign. The man flashed the lights at intervals and when persons about him least expected it. In time the walker became known by the name which he flashed across his shirt front. A battery secreted in his clothes and a push button to press completes the outfit.

Ripening Bananas by Electric Heat

Among the many uses to which electricity is put there is none more novel than that of ripening bananas. A dry heat is necessary because of the steam arising from the sweat

of the fruit during the ripening process. Also, a temperature of about 75° F. must be maintained in the room at all times. These conditions are best maintained by placing a small electric radiator in the room.

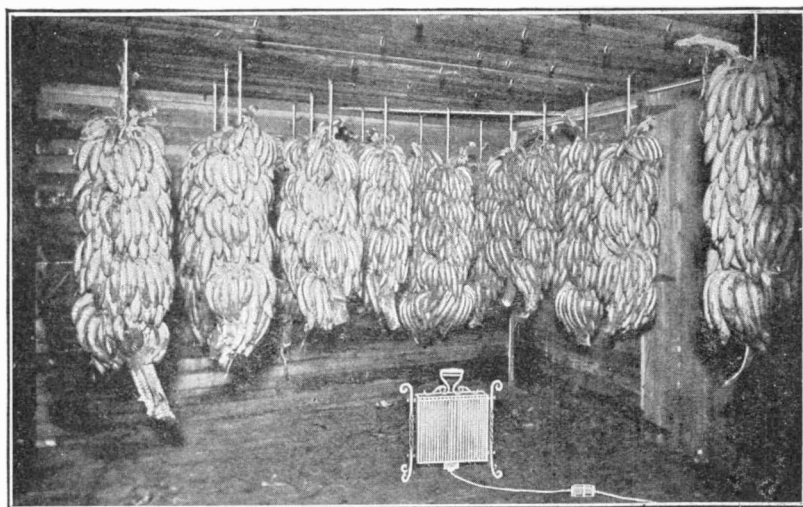

Courtesy of "Chained Lightning"

RIPENING BANANAS ELECTRICALLY

of the fruit during the ripening process. Also, a temperature of about 75° F. must be maintained in the room at all times. These conditions are best maintained by placing a small electric radiator in the room.

Getting a Ship's Location During Fogs

When a vessel is near enough to land so that it can receive ordinary sound signals sent out from some point on the shore, these will be much longer in reaching the ship than a wireless message sent out at the same time from the same place. In fact, the time consumed in transit by the wireless signal will be too small to be measured by ordinary methods, since the wireless wave travels at the rate of over 186,000 miles per second. For any distance within hearing, such as five or ten miles, this time interval will be negligible so that we can assume that the message is received on board the vessel at the same instant that it is sent from the shore.

But if an audible signal (like the firing of a gun or the tapping of a gong) is sent at

the same moment, this will travel through the air at the rate of only 1,123 feet per second, assuming the temperature to be at about the usual average of 60° F. Therefore if both signals are sent simultaneously and the mariner notes the difference in time of their receipt, multiplying this by 1,123 will give the distance in feet between him and the source of the signals. Then since there are 6,080 feet in a nautical mile, there will be 11,230 divided by 6080 or 1.85 sea miles for every ten seconds of intervening time.

Knowing this, the mariner who is groping round in the fog somewhere near land can call the nearest wireless station and ask the operator to tell him its location and to send out simultaneous sound and wireless signals, from which he can easily figure his distance from this wireless station.

Suppose the interval between receiving the wireless message and hearing the sound to be 27 seconds, that would mean a distance of just five miles, hence he will know that his vessel is somewhere on the outer edge of a circle drawn on his map about the location of the wireless station with a radius of five miles. Now suppose the vessel travels in a fixed direction (as shown by its compass) for say four miles (as shown by its log) before getting another pair of signals which show that it is now seven miles from the same point on the shore. Then if the pilot were to cut out a triangle having 5, 4 and 7 mile sides to correspond to the scale of his map, laying this triangle on the map so that the four-mile side is in the direction just traveled by his ship while the opposite point is at the wireless station, the end of the four-mile side will show the present location of his vessel.

To avoid the cutting out of paper triangles, Capt. W. J. Smith of the Seattle Nautical School has invented a folding rule with a third part sliding on one of the two jointed ones. By using this rule on his chart he can find his location in the above manner almost instantly.

If the simultaneous wireless and audible signals were sent out regularly say every half hour during fogs by certain stations, the mariner would not even need to call for such signals, but could always get his bearings in this way when near enough to the shore to catch the sound waves. Hence Capt. Smith predicts that in the near future such an issuing of simultaneous signals at stated intervals during foggy weather will become a regular practice as an aid to navigation.

Can the Battery Car "Come Back?"

Among the very first attempts at electric railroading the experiment was tried of operating cars by means of storage batteries. This scheme was abandoned at a very early

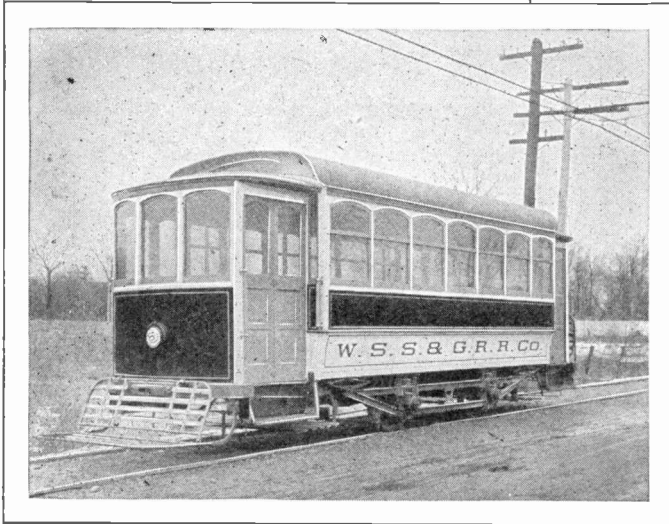

CAR OPERATED BY STORAGE BATTERY

stage in the development and the overhead trolley and the third rail were considered to be the only practicable methods of supplying power to a car. In those days storage batteries were too inefficient and would not "stand the racket." There is a tendency, however, in almost all lines of development to revert, at some time or other, to earlier

types. The question now is: Can the storage battery car "come back?" Since the new Edison battery has been perfected and tried out on a working basis for the operation of street cars many are inclined to think it can.

Some mention has already been made in these pages of the new "Beach Car," as it is called after its designer, Ralph Beach, which has for some time been operated on two of the crosstown lines in New York City. These cars are equipped with Edison batteries and possess certain economical advantages which may lead to an extensive adoption. Just now the most interesting equipment of this sort is being operated in Washington, D. C., by the Wash. Spa. Spr. and Gretna Railroad. Aside from the fact that this line, now a trolley line, will have its wires taken down altogether, the point of greatest interest is that this road, four miles in length, consists entirely of grades, with the exception of about 800 feet, the length of two sidings which are at level. The grades range from one per cent to eight per cent, and some of them are very long. The car is said to operate over the Washington grades beautifully. It makes the schedule speed of four miles in fifteen minutes, which includes all stops, and which is barely possible to maintain with trolley cars.

The Beach car is able to take full advantage of its coasting qualities. Once it reaches the peak of a long grade, the men "turn it loose," and with its chain gear, roller bearings, and independent wheel action it coasts down the hills faster even than automobiles alongside on the country turnpike. The ordinary trolley car cannot be allowed to coast very much because of the inadequate spring arrangement—at an unusual speed it oscillates at the first rail joint, and the brakes have to be applied constantly—whereas the battery car does not "rock at all," even crossing switch frogs.

This coasting feature and the small savings here and there in the weight of the car, the independent wheel action, in the gear-

ing, etc., altogether result in a very considerable saving in power per car mile, according to tests which have been made.

What effect the Beach car may have in the ultimate elimination of the overhead trolley, which, after all, does seem somewhat unsightly and cumbersome, it is impossible at this time to foretell. But undoubtedly it is doing its full share of the "pioneer work."

Trackless Snow Plows and Trucks

Encouraged by the success of the trackless omnibuses in Italy, Austria, Switzerland and California, several manufacturers have been experimenting with trolleyed vehicles for other than passenger purposes. In Austria the Daimler Motor Society has lately been using trackless trolleys for heavy hauling, two of its new types being shown in the illustrations. One of these is a hooded truck with a carrying capacity of four tons, the vehicle itself weighing about half as much.

The other is a trackless snow plow which has a big advantage over the usual plows of the traction companies in that it can be shifted from one part of the road to the other. The plow as shown has a wagon box



TRACKLESS TROLLEY TRUCK

for hauling the snow and proves surprisingly effective.

Three men with this trolleyed plow were able to remove as much snow in one day as six men with two teams formerly moved in two whole days.

Telephone in the South Pole Quest

A telephone system is to be installed at the south pole, or as near to it as explorers can get. Captain Scott, who recently started on a search for the earth's lower extremity, took with him a complete telephone equipment, consisting of five sending and receiving



TRACKLESS TROLLEY SNOW PLOW

ing instruments, a number of light poles and six drums, each containing thirteen miles of aluminum insulated wire. The drums are so made that they can be attached to the rear of a sleigh and the wire laid on the snow as fast as the sleigh moves forward.

Uninsulated wire was selected because of its lightness. It is believed that the extreme dryness of the atmosphere will make insulated wire unnecessary, and the increased conductivity due to the extremely low temperature will more than compensate for any leakage of current.

The telephoner receivers and transmitters are made of wood because it is feared that ebonite would crack under the effects of the extreme cold.

It is planned to run several lines from a central station, one to an observatory a mile away, another to a post in the open air five miles distant and another to the explorer's headquarters 26 miles distant from the central station.

This telephone system will be of great assistance in enabling simultaneous photographs to be taken.

Sunday Telephone Letters

Not to be outdone by the American system of lettergrams under which a telegraph message sent at night is mailed by the operator at the receiving station so as to reach the addressee in the morning mail, the English are introducing a novelty in the form of Sunday telephone letters. Here the idea is to get the message to the person addressed without the need of carriers such as the special delivery messengers to which we resort in this country when we want letters delivered on Sunday. The Englishman writes on his envelope: "To be telephoned on Sunday," and adds an extra half cent of postage for every 30 words or fraction thereof. Then the postal clerk at the receiving office calls up the person addressed by telephone and conveys the message without leaving the post office. If enough postage is included, the same message may be delivered by telephone to a number of different parties in the same city.

mitted its power to the foot pedal shaft by means of a sprocket pinion, gear and sprocket chain. From the foot pedal shaft, power was transmitted to the driving wheels by

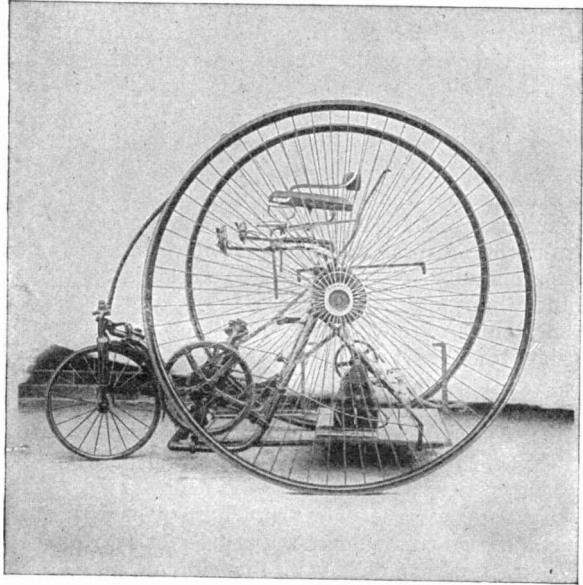

QUEER ELECTRIC VEHICLE OF '89

Odd Electric Vehicle—'89 Model

In the September, 1910, issue of POPULAR ELECTRICITY there was presented a picture of the first electric automobile. That is, it was the first electric road vehicle approaching the lines of present-day construction. If we include under this category any kind of vehicle for road work driven by batteries the odd machine shown herewith antedates the one above mentioned by two years. The machine is best described in a letter from Mr. Fred M. Kimball of Boston to Mr. Day Baker, manager of the New England office of the General Vehicle Company. To quote from this letter:

"Agreeable to your request, I hand you herewith negative of the tricycle to which my firm, Fred M. Kimball & Co., adapted the electric drive for Mr. P. W. Pratt of this city about the year 1889.

"The switches on the extended arms in front of the seat were used, respectively, for ringing an alarm bell and governing the supply of current furnished the motor.

"The motor, as you will observe, was a two-pole, back-gearred machine and trans-

mitted its power to the foot pedal shaft by means of a sprocket pinion, gear and sprocket chain.

"The vehicle was equipped with six cells of storage battery, and the crate in which the batteries were assembled was supported by spiral springs from the crane arms, seen projecting fore and aft, respectively, just above the axle. A mechanical band brake, the operating lever of which is seen rising just behind the seat, was an important factor of the outfit, which weighed, all together and ready to operate, about 300 pounds.

"The flexible leads which connected the motor to the battery can be seen coiled up through the spokes of one of the driving wheels. They are identified by one U-shaped terminal, which is plainly discernible.

"This machine was first tested in Winthrop Square, Boston, just after the first concrete pavement was laid therein; subsequently, it was run for several weeks on Columbus Avenue, which, at that time, had just been repaved with concrete."

"The original owner, Mr. Pratt, used the machine two or three years in Boston after which it was taken to Atlantic City and was one of the attractions of the Board Walk.

Tungsten Production in 1910

According to the *Electrical World* the production during 1910 of 1,824 short tons of tungsten concentrates is believed to be the largest annual output made by this or any other country up to date, although the total value of the product falls below the figure of 1907. The value of last year's output was \$832,992, while that of three years ago was \$890,048.

Nearly all the tungsten is produced from fields in Colorado and California, and in the former state the Boulder field, which is the greatest producer, is situated. The second largest field is the Atolia field in California. Arizona, Washington and Nevada also contribute to the output.

A Hook and Ladder Electric

The first electric hook and ladder truck ever built has just been turned over to the Springfield, Mass., fire department. Like the electric fire engine and hose reel the electric motors propelling the truck are located in the wheels themselves and the

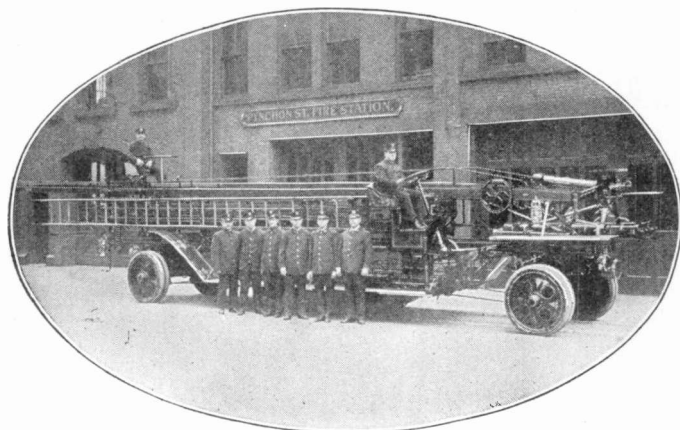

A HOOK AND LADDER ELECTRIC

armatures turn as one unit with the wheel hubs.

The building of such a long, ungainly vehicle was somewhat of a problem and the vehicle as a whole was the product of no less than four firms. The battery being made by one firm, the trucks and running gear by another, the wheels by a third and the body by a fourth.

The four motors located in the wheels impart a maximum speed of 20 miles an

hour, and 80 cells of the new Edison batteries are utilized to furnish power. An automatic arrangement in the engine house provides for the charging of the batteries at all times that the hook and ladder is in the house, thus the batteries are always fully charged and ready for use. An electric search light provides light at night and plenty of it, giving about twice as much light as two ordinary automobile headlights combined.

Pocket Lamps at the Opera

The average play-goer glances over his program before the curtain rises and remembers the names of the actors well enough so that he does not need light at his seat while the curtain is up. But with music lovers it is often different, for the true connoisseur likes to bring his score with him and to watch it during the course of the concert or opera. Then the serious problem arises: Shall the house be darkened sufficiently to make the stage stand out by its brilliancy, or shall there still be light enough so that patrons of the opera can read their librettos or scores?

That this is still a live question, was shown by some discussions overheard during the recent Grand Opera season at Chicago, where some advocated a moderate illumination of the auditorium all through the evening, with a correspondingly more intense lighting of the stage. Others suggested that as the light for reading librettos and music scores was only needed at the listener's lap, this should be supplied by a miniature lamp fastened to the seat in front of him and placed

too low to shine into the eyes of anyone. While this hardly seems practical, it recalls the experience of the Convent Garden Opera House in London some years ago during the Wagner festivals. There so many of the regular attendants brought pocket electric lamps with them that the scattered flashing gave a sort of firefly effect which was so distracting to others that the management had to prohibit the use of such portable lamps.

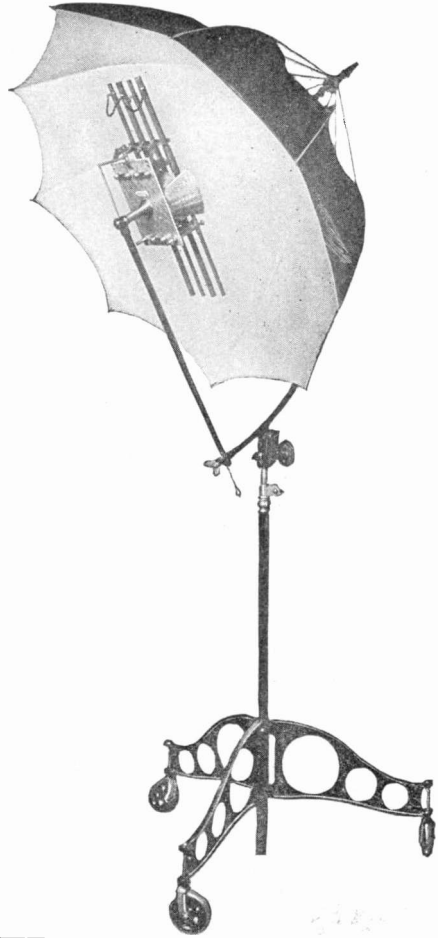

LAMP AND REFLECTOR USED
BY A LONDON PHOTOGRAPHER
TO BRING OUT THE DETAILS
OF FEATURE AND COSTUME

Photographing Actors and Actresses

No people, as a class, pose more frequently before the camera than those of the stage; and certainly no one can be more particular about the perfection of the resulting pictures than the modern actors and actresses. It is not merely artistic pictures and faithful portraits that they want, but photos that will truly portray their individuality and that will show the richness of their garb to the minutest detail. For this purpose any direct sunlight is inadequate, as it leads to "flat" effects. To make the latter stand out, requires a diffused light which can be obtained during the day through windows facing northward by a proper manipulation of screens and curtains. Whenever there are clouds, or when the sun is low, even a fine north exposure of the studio will not give good results.

With the electric light, the available intensity (and therefore shortness of exposure) is easily under the photographer's control. And yet many users of arc lamps have fallen short of their artistic possibilities by exposing the sitter to the direct rays of the lamp instead of diffusing the light; consequently, some have concluded that the electric light could not equal the diffused daylight for the richness of its effects and the wealth of detail reproduced by its use. That this impression is far from true, is proven by the photograph of an English stage favorite reproduced herewith. This was taken in a fraction of a second by the intense light of an arc lamp having four pairs of carbons, the light being reflected and diffused from the interior of a dome-shaped reflector which is collapsible like an umbrella, being made of black gingham lined with a special twill.

This odd-looking lamp and reflector outfit as perfected by Marion & Co., Ltd., of London, is easily adjusted to throw the light just where it is wanted, the top of the reflector being usually about eight feet above the floor.

Mr. Thomas A. Edison celebrated the sixty-fourth anniversary of his birth on February 11 by a particularly busy day at his laboratory in Llewellyn Park, Orange, N. J. He received telegrams of congratulation from a number of the leaders in the electric lighting industry and other scientific fields.

Why Electric Light Bills Vary

The farmer has his busy season in the summer months. It is different with the electric light companies. They make hay when the sun does not shine.

The change in the seasons takes place so gradually that most people do not realize

CHART SHOWING AVERAGE NUMBER OF DARK HOURS IN EACH MONTH
Between 6 o'clock Morning and 10 o'clock Night

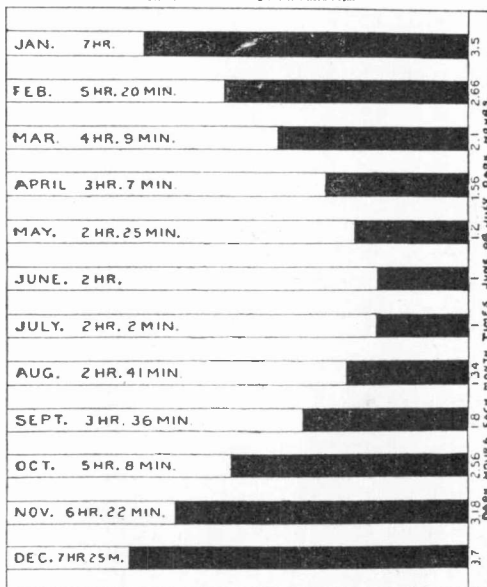

DIAGRAM SHOWING WHY LIGHT BILLS VARY

that the hours of darkness, that is the working hours of darkness, are nearly three times as long in December as they are in June. The exact relation between these hours is shown in the chart, which gives the hours of darkness between 6 o'clock in the morning and 10 o'clock at night.

Naturally the amount of light used is not necessarily in exact proportion to the hours of darkness, but if people go to bed earlier in the winter they also stay out doors in the summer, which evens matters, so the light bills follow the chart fairly closely. This particular chart is true of the Great Lake latitudes. It was prepared by an electric lighting company to give its patrons ocular demonstration of why their light bills vary. Of course the moral is: "Do not rail at the lighting company if your bills increase as winter comes on." Instead, take your bills for a year back and see if their relation is not pretty nearly shown by the chart.

Most Artistic Display Sign Ever Built

In this day of striking electrical display signs, it is unusual for signs of extraordinary size to combine as many unique and original effects as are shown in this mammoth display sign at Louisville, Ky., erected in Federal Park, where by actual count 20,000 people pass every night, between the hours of 5 and 11 o'clock.

The huge steel frame work of this sign, which is built by R. H. Frazier of the Federal

the beautifully colored art glass balls which are lighted from the interior. The word "Louisville" and the strip lighting separating the panels are outlined in white light.

One of the display signs shows a pianist playing a grand piano, operated by a flasher which causes the player's hands apparently to move up and down the key-board of the piano and her body to assume different positions.

The street car is the most realistic moving effect on the sign and rivals in cleverness the famous chariot race sign in New York.



LOUISVILLE'S ARTISTIC SIGN

Sign System, is 100 feet long and towers 60 feet into the air above the surrounding buildings. At each end is a massive Corinthian pillar forty feet in height, surmounted by a huge ball of wrought iron and art glass four feet in diameter. The sign is divided into six rectangular display spaces, each measuring 20 by 30 feet, upon which are built the various advertising displays. Over the sign the word "Louisville" is shown in huge letters.

The illumination is accomplished by means of 5,503 lamps and the color effects are startling in their beauty and effectiveness. Except for a few red lamps at the base and in the scroll in the capital, the two pillars are a blaze of white light, supporting

The wheels of the car, outlined in blue lamps, revolve forward, and the track, outlined in white, apparently moves backward. Apparently the car is rushing forward at full speed, and its headlight (a 100-watt tungsten lamp) and the sparking trolley wheel adding to the realism of the effect. Suddenly a gong rings twice, the trolley stops sparking, the wheels cease revolving and the car stops.

A firm of electric contractors in London, England, has installed, as an advertisement, an electrically driven time ball which drops every hour. This is said to be the most reliable public time-piece in London.

The Story of a Skull

By G. A. WOOLSON

"Studying anatomy?" asked the insurance agent as he gazed at the skull and cross-bones on the ebonized panel over the desk.

"No," drawled Smyth, "I sometimes have commercial visitors or insurance agents that bore me and need a little help."

Smyth touched an unobtrusive button and the hideous bullet-pierced skull turned from side to side, the jaws opened and shut, and the eyes glared in fiendish glee.

The insurance gentleman took out the cigars and said, "Good afternoon."

"Are you disturbed by gruesome things?" asked mine host as he displayed the afore-said ebonized panel with its

weight of horror over his desk. The ghastly skull flanked by smaller composites thrown out in high relief by the somber background and velvet drapery which filled the open space black above, was a trifle startling. An electric button was again pressed and the illuminated skull gnashed its teeth and turned from side to side, and the little skulls followed suit. Lighted or otherwise, no thief or safe-breaker would linger long in the above presence.

The history of the skull is briefly told:

Away back in the seventies, two New England men—Brown and Jones—had charge of ranches in New Mexico for several years. One season a couple of desperate-looking men attached themselves to their camp. One night Jones, who was appar-

ently sleeping rolled up in his blanket, overheard a conversation between their uninvited guests.

"We have got to shoot Jones," said the giant of the pair, "he is getting suspicious of us."

"Hate to kill a man in cold blood," replied the other.

"Can't be helped. I am sure he is on our track. You watch your chance tomorrow and I'll watch mine; which ever gets the first 'll pop him over."

Jones waited until his would-be executioners were snoring like more worthy men, stepped between them with a revolver in each hand,

and shot them both. One of the men proved to be Tom Taylor, a noted highwayman, for whom a large bounty was offered. The dead men were buried after the manner of the Wild West.

A few years later, when Brown and Jones were ready to quit the ranches for good, typical souvenirs of the rough life about to close were in order; consequently the skeletons were unearthed. Brown appropriated the skull and thigh-bones of Tom Taylor. The former is remarkable for size and extraordinary development of all but intellectual propensities. The unusual length of the latter bones indicates a height of nearly seven feet, a formidable brigand, as his record proved.

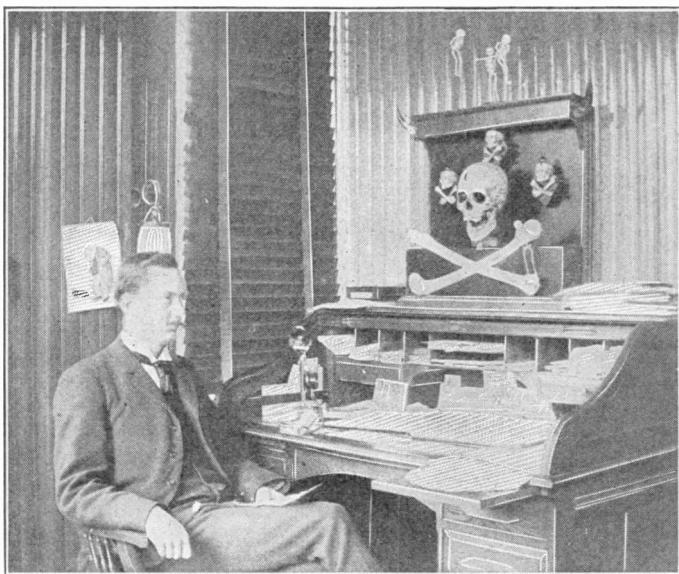

THE GHOSTLY SKULL FLANKED BY SMALLER COMPOSITES

Later on, these important factors in the anatomy of the once powerful Taylor came into the hands of an eccentric genius, who, although lacking perhaps in reverence for "the dead past," is sufficiently optimistic and practical enough to re-animate the deceased Taylor in the following manner:

In the cabinet was mounted a small motor easily controlled from the chair in front of the desk. This motor operated a train of gears and an eccentric that turned

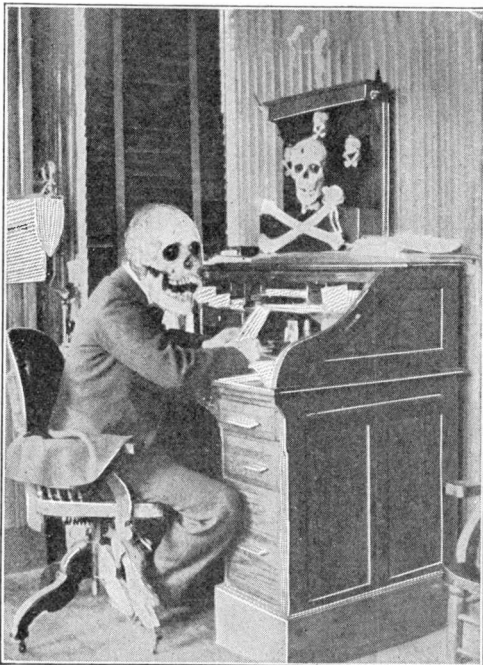

A LITTLE TRICK OF THE PHOTOGRAPHER

a rod on which the skull was mounted; so as to make it face in different directions as a human head would be capable of doing. Another cam operated a crank that caused the jaws to open and shut with rapidity. A circuit-breaker interrupted the current that went to the red lamps in the eye sockets, thus giving the appearance of winking. This breaking was irregular so as to make the uncanny object at times wink rapidly and again stare for a moment. At the same time the little skeletons were operated by strings with due effect.

If the ghost of Tom Taylor should come "riding adown the gale," the temerity of the unscrupulous gentleman would probably be duly punished and what penalty could

be more fitting than a transposition of skulls as shown in the second picture—a little trick of the photographer. It is a curious fact that even facial expression of inanimate subjects is influenced by pose of body. "To see ourselves as others" may "see us," even by an odd trick of photography, is no doubt good for the soul.

From Coal to the Car

A small town in the middle west had enjoyed the benefits of a tiny central station for some years. The station consisted of one single cylinder engine and an old-fashioned dynamo. The position of chief engineer, which embraced a variety of duties, had been held by one man from the start. He was an Irishman, one Mike Flaherty. A small boy in the town developed some curiosity on the subject of electricity, and finally decided to ask the chief engineer for information.

"Mr. Flaherty," he said, "what makes electricity?"

Mr. Flaherty surveyed the youngster with calm scorn.

"And don't ye know that, even. Phwat for do ye go to school at all?"

"But what makes it?" persisted the boy.

"Well, 'tis little time I've got to waste on the likes of ye, but out av pure goodness av heart I'll tell ye. If ye rub the side av a cat what do ye get? Sparks. Electricity. 'Tis the same with this masheen here. Them little sticks av carbon rubs on the copper armyture, and what do they get? Electricity. Fr-r-iction, I belave they call it. Yes, me boy, 'tis friction makes electricity."

And the boy went away inflated with wisdom.

Most people, or at least most readers of this magazine, know better than that, but there may well be a good many who do not understand exactly how electricity is transmitted from power houses to electric cars. In fact the pictures accompanying this article were prepared by Mr. George Westinghouse to illustrate a talk he delivered last summer before one of the greatest electrical societies in the world—the American Institute of Electrical Engineers.

The first diagram shows the essential parts of a direct current railway system. The electricity is generated at the power station at the left. It is what we call three-

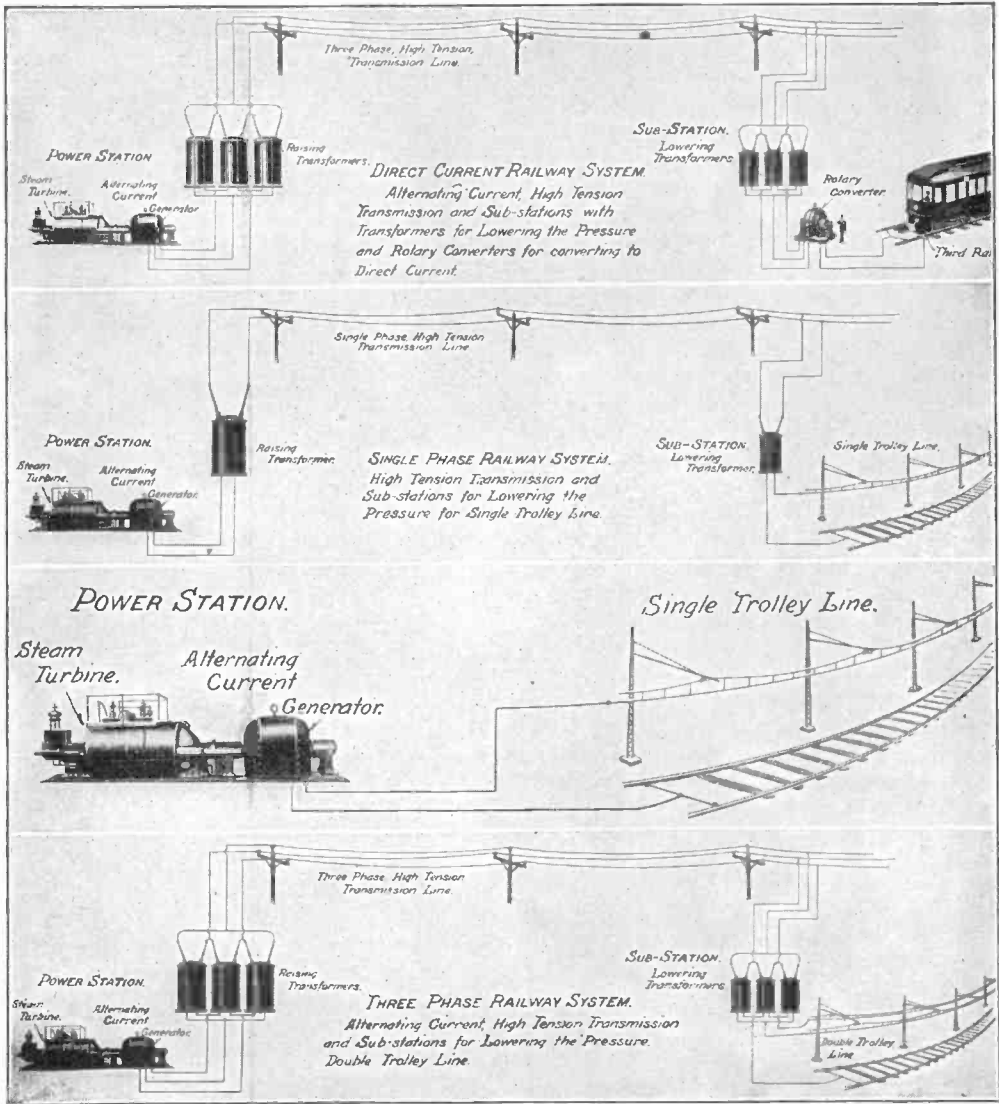

HOW ELECTRIC CARS SECURE THEIR POWER

phase alternating current. Yet the car is using direct current. Why, then, is alternating current generated at the power station? Because we can use transformers with it. Why do we want to use transformers? To change the voltage. Why do we want to change the voltage? Because the same amount of power can be transmitted with much smaller copper wires when high voltage is used. And copper is expensive. Also, since the current gets smaller as the voltage gets larger, and since the "line loss" varies with the square of the current, we do

not lose so much power on the way when we transmit it at high voltage.

Because it is easier to build low voltage generators, we generate our electricity at say 440 volts, "step it up" to 6,600 for transmission, and "step it down" again where we want to use it. This is at the substation, shown to the right on the diagram. Then we change it to direct current by means of a rotary converter, and send it out into the third rail or trolley, as the case may be, usually at a pressure of either 600 or 1,200 volts. The current goes from the third rail

through the motors and back over the other two rails.

The second diagram shows a single-phase alternating current system. It is a good deal like the direct current system we have just seen, except that we make single-phase alternating current at the generators in the power plant, instead of three-phase. We raise its voltage at the power house and lower it again at the sub-station. Then we feed it direct into the trolley wires, and it comes back through the rails.

If the distance between the power house and the cars is not great we can get along without transformers and feed the current from the generator directly into the trolley wire as shown in the third diagram.

The last diagram shows a three-phase railway system. It is exactly the same as the direct current system until we get to the sub-station. There we have transformers for lowering the voltage, but instead of having one trolley, we have two, for three-phase current has to have three paths to travel.

The direct current system is by far the most commonly used in this country. Next comes the single-phase, and after that the three-phase, of which the Cascade Tunnel electrification on the Great Northern Railroad is the only American example.

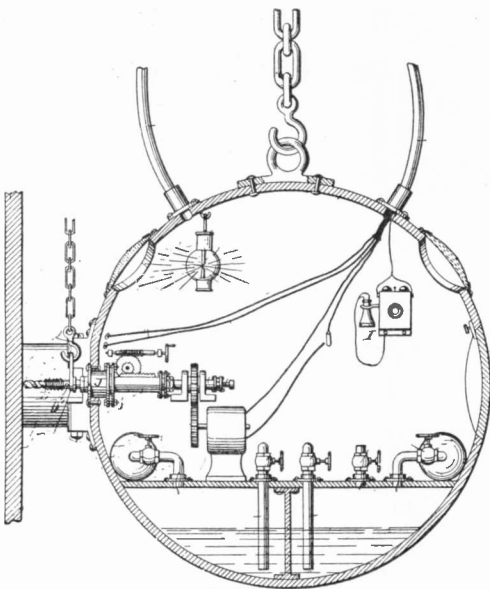

ELECTRICALLY EQUIPPED DIVING BELL.

Lifting Wrecks From "Davy Jones' Locker"

When disaster sends a vessel to the bottom there is always the question of whether the cargo and ship will pay for the expense of raising. At present one means used in raising a vessel is to attach cables to the sides by hooks in portholes, or on projections, or to pass the cables beneath and lift the ship bodily. But difficulty is met in attaching cables, especially if the vessel is at a depth greater than that at which divers can work. Then ordinary methods fail and the vessel is considered lost.

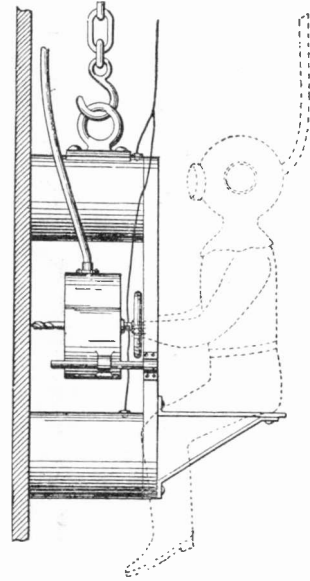

MOTOR DRIVEN DRILL
WORKING UNDER
WATER

A patent granted to Robert O. King, Buffalo, New York, provides means for attaching lifting cables to a vessel even when sunk in water too deep for a diver in his helmet. The equipment consists of a strong metal spherical diving bell or ball into the side of which is built a drilling machine operated by a motor inside. The bell is large enough to allow one or two men to work. Air is supplied through piping from above, the operators not suffering in consequence from high air pressure. Water in a lower compartment regulated by tanks of compressed air is used for ballast. An electric cable runs the drill motor and energizes electromagnets on the side of the bell holding it firmly against the armor plate of the vessel when necessary. Powerful lights may be directed through the windows of the bell and a telephone line enables the divers to communicate with their helpers.

The second illustration shows the device built for operation by a diver in helmet when the wreck is not in too deep water.

Artistic Shadow Dancing

In reviving shadow pictures, the Palace Theatre at London has departed widely from the crude farce effects and the "horse play" that have characterized the shadow performances with which we are all familiar. Instead of presenting burlesque pantomines, the new shadow effects are catering to the same high taste which appreciates the best that sculptors have produced in ancient as well as modern times—lines of beauty, gracefulness of movement and rhythm of action. To attain the artistic in shadow effects has proven far more difficult than in the ordinary stage dancing, as the lack



which many of us took part as amateurs when we were younger. Instead of a vast, uniformly bright screen the picture now stands out against a bright background gradually shading off to a dark border, giving the artistic blended effect as of a vignette in a photograph. Nor is it entirely void of color, as the use of colored slides before the spot lights make the shadow figure stand out in the complementary color: dark green against a pink background, brown against a greenish screen, and so on. In some cases it has even seemed appropriate to have another lamp project a suitable picture on the screen as



ELECTRICITY MAKES POSSIBLE ARTISTIC SHADOW DANCING

of color schemes and of a second dimension to give a depth and setting to the picture impose rather severe limitations. Indeed, some of the popular stage diversions, such as clog dancing, skirt dancing and even the ballet for this reason lose much of their artistic effect when presented in the shadow form.

Thanks to the ease with which electric lighting lends itself to all sorts of stage effects, the setting is no longer as bare or as colorless as it was with the shadow pantomine in

a background for the dance; as for example, a temple scene for some of the Greek dances. Indeed, so many different effects are obtainable by a judicious use of electric lights that it should be easy to satisfy a wide range of tastes; and if the artistic shadow dances which have already charmed London audiences also set a new standard for stage grace in America, this may be due in no small measure to the lighting effects without which the shadow pictures of earlier days were limited to hurly-burly presentations.

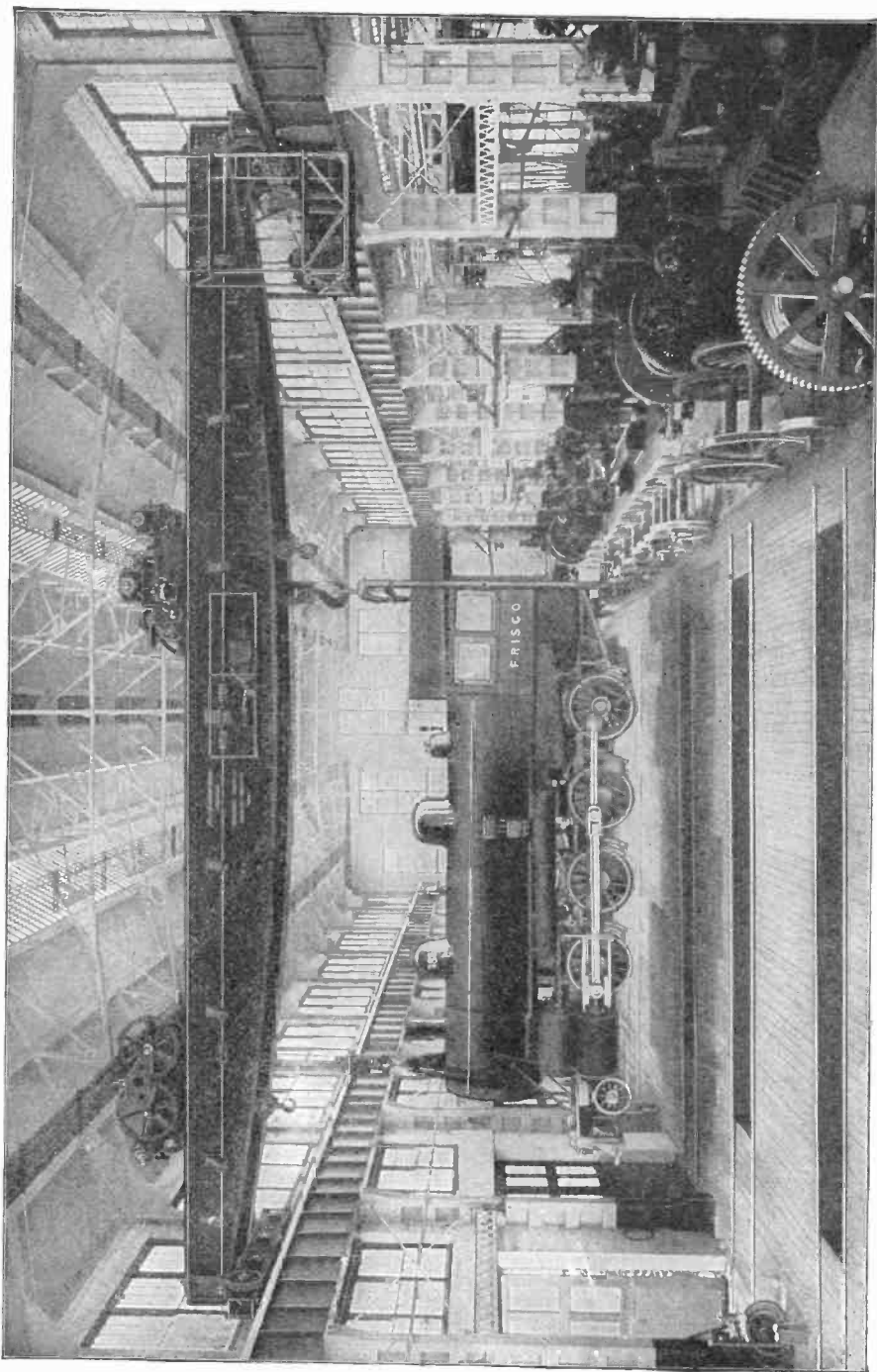

ELECTRIC CRANE CARRYING 187,000-POUND LOCOMOTIVE

Playing With a 93-Ton Locomotive

On the opposite page is a picture showing how a modern electric crane is able to pick up and carry about a locomotive weighing 187,000 pounds. The span of this great traveling crane is 74 feet and the vertical lift 29 feet. The entire weight is carried by a pair of massive steel girders which run on wheels on two girders at the sides of the erecting room. The lifting hooks are raised and lowered by motors mounted on the carriages on top of the crane. These motors are all controlled to a nicety by the man in the cage at the right end of the crane. There he stands in his majesty and by the manipulation of a few levers and switches he lowers away the hooks, picks up the 93-ton mogul and moves quickly and silently down the long room.

The Honey Bee a Live Battery

In the following letter from Mr. L. K. Smith, of Grant, Fla., there is the germ of an idea for "electro-naturalists" to investigate. He writes:

"GENTLEMEN: Your magazine is a live wire. The article 'Live Batteries,' page 376, by W. H. Miller, is of special interest to me in the description of these fishes' storage batteries, for it solves the problem of the honey bees stinging without injecting any of the contents of the venom sac. After handling bees eighteen years I note the similarity in the shock imparted by the ignition system of gasoline motors and that of the impact of an angry bee, and I ask myself this question: Has the honey bee a battery in the flakes of wax which it secretes along the sides of its abdomen in thin narrow flakes separated by the telescope-like sections of the abdomen? And at this moment I am convinced that the honey bee is a live battery although not able to prove it by an experiment with electrical apparatus."

Most of us are aware, from experience, that when an angry bee, coming full tilt, hits us in the face, something more than a tickling sensation is felt, even though the bee does not pause long enough to do any real stinging. Whether the feelings so excited are the result of "nerves" on the part of the person being bombarded or are in reality caused by an electric shock no one, to our knowledge, has ever explained. It is conceivable, however, that the busy bee, whose

wings beat the air with tremendous rapidity, may constitute within himself a little machine for the generation of static electricity, after the manner of clouds, which generate great quantities of such electricity through friction with the air. Then, given a little leyden jar of telescopic wax flakes, as suggested by Mr. Smith, he might be ready to do business.

Caught in the Act

This unusual photograph was taken at the Thetford Mines in Quebec. It shows very graphically the methods employed in disposing of asbestos chats, a waste material

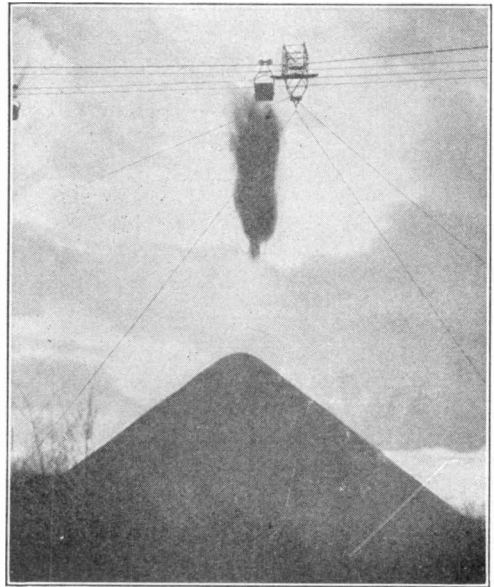

CAUGHT IN THE ACT

produced at the mines. Ninety tons of this waste are handled in an hour by the buckets of the electrically operated aerial tramway.

Two cables on which the carriers travel are supported by towers 100 feet high. Below the carriers are the endless traction ropes, operated by motors at the loading station, which drag the carriers with their buckets out over the line at the rate of 250 feet a minute. Each bucket holds 1,500 pounds of chats, which, at the proper moment, is automatically tripped and dumped on the waste pile as shown in the illustration.

Electric Locomotive the Largest

One of the great Westinghouse electric locomotives, of which nine more have just been added to the equipment of the Pennsylvania railroad, is shown just leaving the tunnel in New York City. These locomotives

are lifted by huge horseshoe-shaped electro-magnets and sufficient magnetism had remained in them from this momentary magnetization to deflect the compass more than a point when stacked end to end in the hold all in the same direction. The trouble might be averted, of course, by reversing

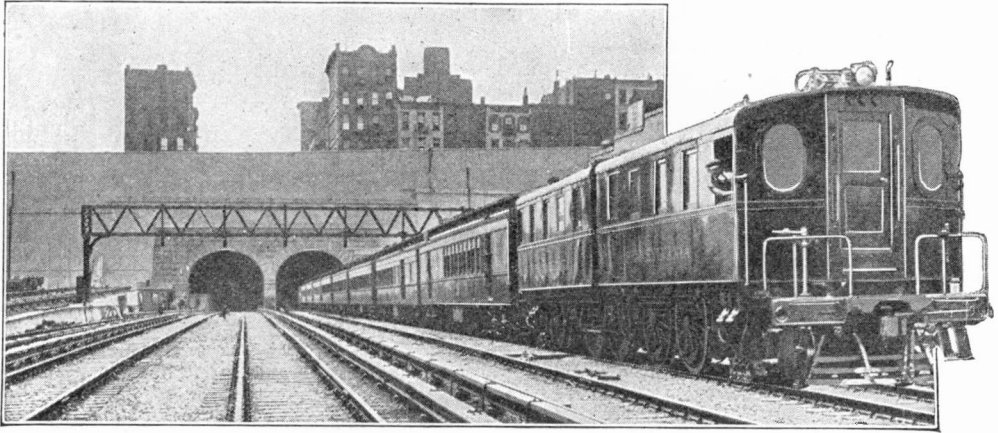

ELECTRIC LOCOMOTIVE WHICH WEIGHS 312,000 POUNDS

are by far the largest ever built. They weigh 312,000 pounds or 156 tons. Each driving axle weighs 50,000 pounds. They are of the articulated, double-cabin type with a total wheel base length of 55 feet, eleven inches. The maximum draw bar pull (recorded test) is 79,200 pounds; normal speed with full train, 60 miles per hour. The two motors on each locomotive, aggregating about 4,500 horsepower, turn the drive wheels by means of cranks and connecting rods.

Magnetized Rails Upset Compass

Leaving Gary, Ind., with a cargo of steel rails, bound up Lake Michigan, the captain of a lake vessel was recently surprised to find after steering for twelve hours steadily by his compass and the chart that his ship had approached within a mile or two of the west shore when by his reckoning he should have been almost in mid-lake. After correcting his course and steering carefully by landmarks and stellar observations during the remainder of the voyage, he reported the peculiar behavior of his compass and found that this load of rails had been loaded by electro-magnets from the rail mill to the flat cars used to run onto the docks. The

alternate cars as the rails are loaded into the vessel.—*Electrical World.*

Electricity

I my destiny fulfill,
 Servant to the human will;
 I am yet the fleetest courser,
 I am first in speed and skill.

Everywhere my track is free—
 Over mountains, under sea;
 Through the world's remote dominion
 South and north are one to me.

All that sundered lives require,
 All they proffer and desire,—
 Swift as light I waft their message,
 Speed their thoughts along the wire.

From the ship by danger pressed,
 O'er the ocean's heaving breast
 I, its hope in hour of peril,
 Flash the tidings east and west.

On through time the earth will roll,
 Yet am I its life and soul;

Over it my thought pulsations
 Knit all lands, from pole to pole.

EUGENE C. DOLSON.

Electricity in German Breweries

By DR. ROBERT GRIMSHAW

The brewing industry has reached the high stage of perfection which now characterizes it by the fact that it has not confined itself to utilizing the results of experience and researches in malting and brewing alone,

of the simplicity which it brings with it, as well as on account of the saving thereby achieved. Figs. 2 to 4 inclusive show electric drive in several parts of a brewery, the motors being of a special type, designed with

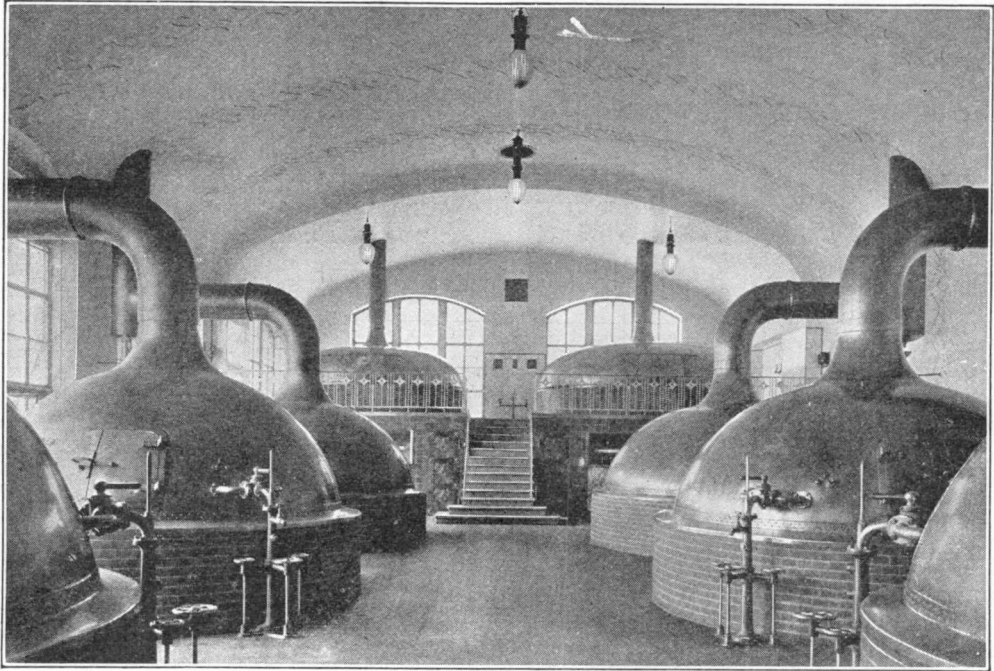

FIG. 1. THE "MASH ROOM" IN A GERMAN BREWERY—ILLUMINATION BY ENCLOSED ARC LAMPS

but has drawn on many other industries for improvements' all along the line—technically and commercially. In this connection, electricity in the arts has not been forgotten; and the illustrations here given (by the courtesy of the Siemens-Schuckert Works) show this progress in various branches of the business.

In the first place, illumination, which is of great importance in brewing, has received due consideration. In Fig. 1 we see the "mash room" of the Thomas Brewery in Muenchen, lighted by arc lamps, and Fig. 2 the corresponding machinery-room immediately below it with incandescent lighting.

The introduction of electric drive for the machinery has found great favor by reason

due regard to the particular conditions under which they work. For instance, the winding of such motors as run in damp rooms must be protected by a special device against dampness. Where the motor requires protection from mechanical injury or from dripping or spraying water, or where for any cause the touching of a current-carrying part is to be prevented, it is covered with a protecting casing as seen in Fig. 2. Where there is a great deal of water about, the motors are fully enclosed, as seen in Figs. 3 and 4.

In the same way, such electric apparatus as switchboards, safety appliances, starting devices, etc., are protected by a hood or

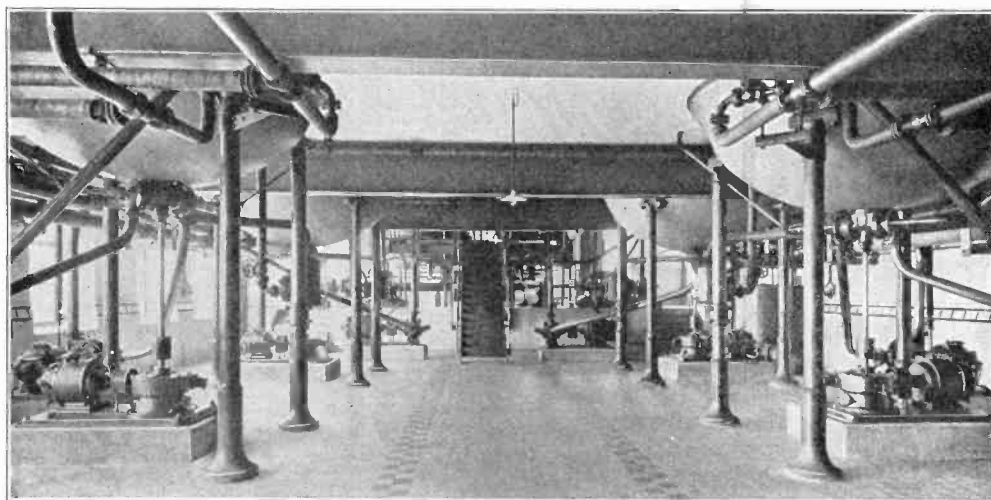

FIG. 2. SHOWING THE ELECTRICALLY DRIVEN PUMPS DIRECTLY BENEATH THE GREAT RETORTS IN THE "MASH ROOM"

casing, to exclude moisture and also prevent injury to the attendants.

Among the examples of electric drive may be mentioned that of the mashing pans and the mash pumps. Fig. 2 shows for instance, the employment of motors for this purpose in the mash department of the brewery above mentioned. To drive the stirring device there are necessary motors of from four

to eight horsepower, with rotation speeds which are regulatable within very wide extremes. The machinery is started from the mash-tub house by hand-wheel, shaft and gear-wheels. In the back-ground in Fig. 2 there can be seen the motor for driving the cloudy mash pump, spent malt machinery, etc.

Other machines which are electrically

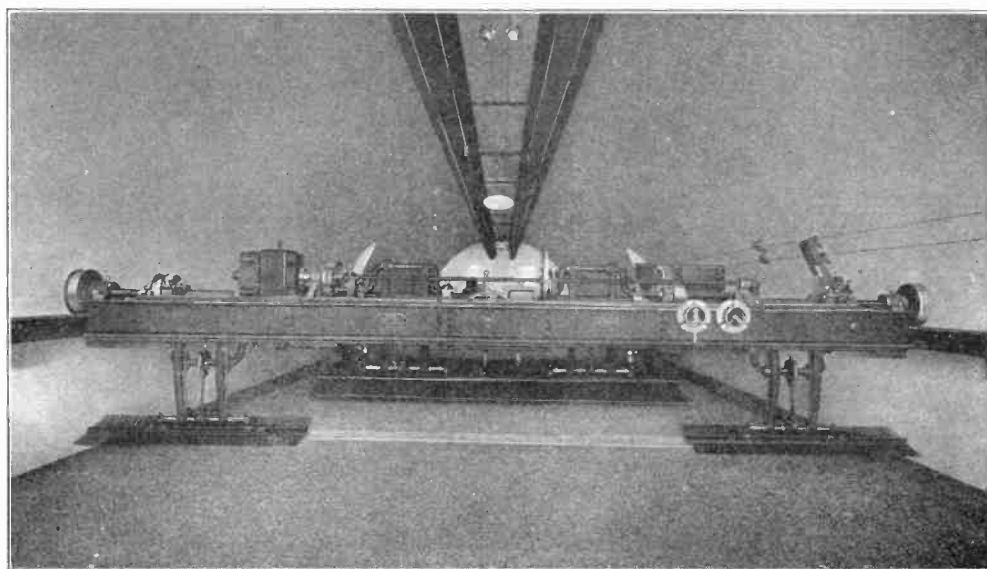

FIG. 3. MOTOR DRIVEN DEVICE LIKE AN OLD-FASHIONED HAY RAKE FOR TURNING AND SPREADING MALT



ELECTRICALLY DRIVEN MACHINE WHICH WASHES KEGS AND BARRELS

driven are those for mixing, washing and ventilating, removing the germs and polishing the grain, the grinding mills, and the apparatus for the spent malt.

A very important application of electricity is in the mechanical malting rooms, where the material is spread and the green malt turned by a sort of electric traveling crane from which are suspended devices something like old-fashioned hay rakes. Also the washing of the malting-floors, the leveling and turning of the malt heaps, as well as the transportation of the cars to the malt-turners, is electric, effecting a very great saving of labor. Fig. 3 shows a malt turner driven by motors.

Among other electrically driven machinery may be named the vacuum pumps, that for handling the spent grains, etc., and in all the various processes connected with storing and shipping, electricity is used as far as possible to save hand labor. Fig. 4 shows, for instance, the electrical drive of a barrel-washing machine in the Paulaner brewery, Muenchen. This machine is driven through a countershaft by a 2.8 horsepower enclosed electric motor, standing on a bracket. The barrels are washed outside and in without any attention on the part of the workmen; so that the thoroughness of washing is not dependent on the workmen's attention or conscientiousness. The machine for pitch-

ing the interior of the kegs, washing out the bottles and pasting on the labels are electrically driven.

It is therefore evident that there is hardly in the brewery a single machine for driving which electricity may not be used to simplify and cheapen the application of the power from the prime mover.

Electricity Wrongly Accused

The hue and cry that electricity is a great fire hazard has no foundation, in fact, as is so often proven by the fire reports of large cities where electricity is extensively used.

According to the report of the New York Board of Fire Underwriters electrical fire losses were extremely small for the year 1910. But 24 fires out of the large number investigated were caused by electricity, the property loss being only \$27,530. Five fires were due to short circuits; nine to grounds on gas or other piping; two to sparks thrown from operating switches; three to overloaded circuits; one to defective joints; one to loose contacts and one to the heat from an incandescent lamp placed on inflammable material. Of two causes under this head resulting in no damage, one was due to an explosion of an incandescent lamp in gasoline, the other to the igniting of a moving picture film.

Handling and Cutting Ice Sheets

In a plant where artificial ice is made it is interesting to study the methods of handling the product, now done principally by the power of electric motors. In the first place the ice is frozen in huge sheets as large as the size of a good-sized room. To facilitate handling eye-bolts are frozen into each sheet by means of which the latter is picked up by an electric crane as shown in the first picture. Then it is easily transported to a tilting table, also operated by a motor as

shown in the second picture. By means of this table the ice sheet is lowered and slid on to the cutting floor without breaking or cracking.

Over the cutting floor a buzz-saw, carried by a movable bridge, is arranged to travel back and forth along the bridge, cutting through the ice as it goes. The motor just above the saw not only turns the latter but furnishes the power for propelling it across the bridge.

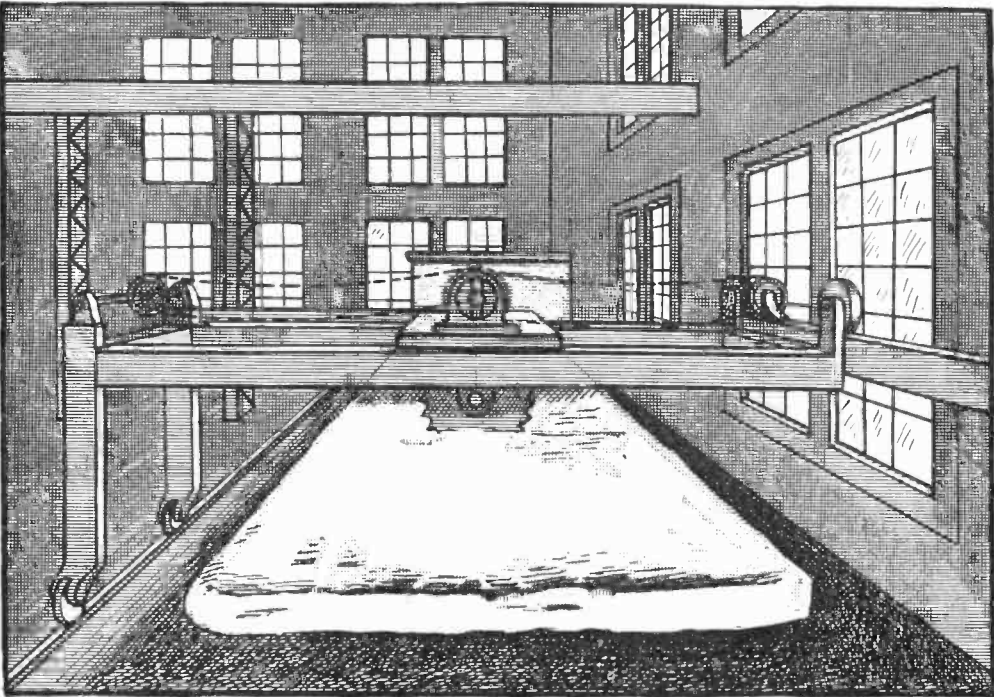
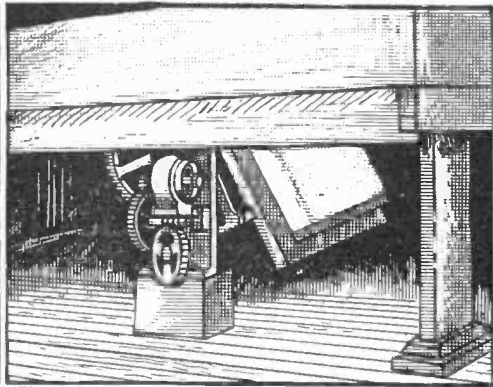
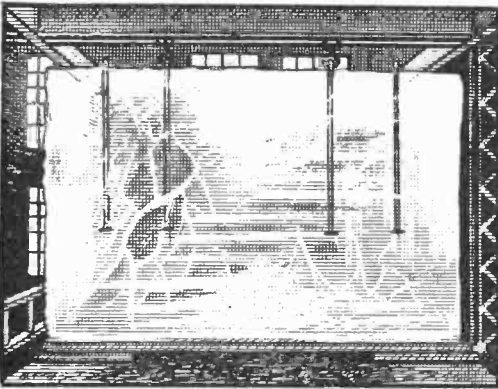

ICE SHEETS ARE HANDLED AND SAWED BY MOTORS

Timing Bullet Speeds

By ALBERT SCHEIBLE

The simplest method of testing the efficiency of different powders for propelling firearm projectiles consists in comparing their initial velocities when forced from the same bore by these different explosives. In other words, if we set a screen or target at a fixed distance from the muzzle (say 100 feet or 100 yards) and find the exact time which it takes the projectiles to reach

pierce the screen at (B). The vertical distance between (A) and (B) would depend upon the time spent by the screen in falling, which was equal to the time spent by the bullet on its way, assuming that the breaking of the contact took just as much time as the stroke of the hammer and the exploding of the cartridge. The time that the screen was falling is easily determined by the dis

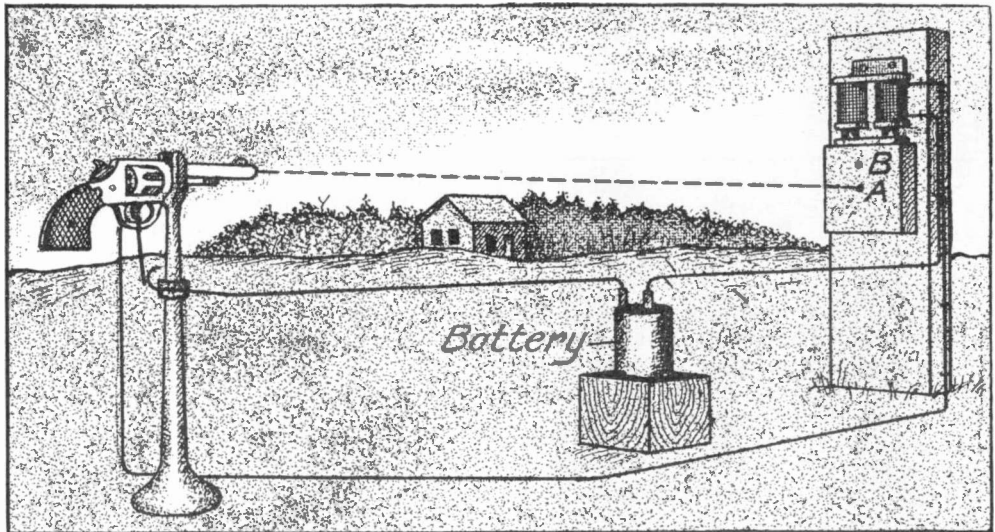

FIG. 1. ONE WAY OF TIMING BULLET SPEED—BY FALLING TARGET

this target, we will have a comparison of the initial velocities from which we can judge the effectiveness of different powders.

In making such comparisons, electricity has long played an important part, being used in widely varying ways. For instance, one of the methods used in the 70's employed as a target a screen supported by an electromagnet and released at the moment of firing so that the bullet would strike higher on the screen than if this had been stationary. To make sure that the release of the screen would be simultaneous with the firing, the trigger of the pistol or gun was extended to make a contact through which the current passed to the magnet (Fig. 1). When the trigger was pulled, the circuit was opened and the magnet let the screen drop so that the bullet instead of striking at (A) would

tance through which it fell before it was struck by the bullet (from the law of falling bodies). However, any variation in the interval of time necessary for the hammer to act and the cartridge to fire, might change the results materially, as the time intervals involved were all quite small. So this method was improved by having the magnet circuit broken, not by a contact on the trigger (which might act before the shot was actually fired) but by a fine wire or gauze which the bullet pierced immediately after leaving the muzzle.

In more recent years various other methods of timing the speed of projectiles have involved the same principle of measuring the time over long distance, so that these tests usually had to be made out of doors. The long ranges were used because they

made the time interval longer so that any errors in recording the time would be much smaller in proportion to the elapsed time than they would be for the short ranges. If smaller lapses of time could be measured with equal accuracy, the testing might be done at short range and much more conveniently. This has lately been made possible by a new bullet-velocity meter brought out by one of the most prominent European

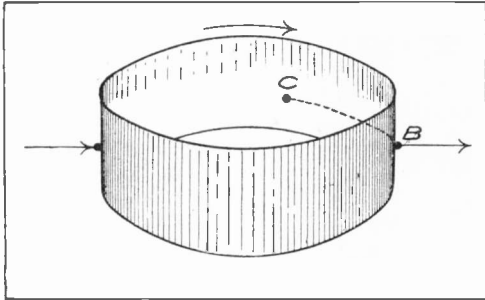

FIG. 2. PRINCIPLE OF THE HARTMANN-BRAUN BULLET TIMER

makers of electrical measuring instruments, Hartmann & Braun, Frankfort, A. M., Germany. The new device works on the principle that if you shoot a bullet diametrically through a thin paper drum or cylinder (as in Fig. 2) the point (B) at which the bullet leaves the cylinder will be diametrically opposite the point at which it entered. Now if this cylinder was rapidly rotating in the direction indicated by the arrow, the point (B) would no longer be opposite the entering point by the time the bullet reached the other side of the cylinder, so that the bullet would pierce the latter at a point (C). Then the distance around the circumference between (B) and (C) would depend on the time it took the cylinder to rotate that distance, this being equal to the time spent by the bullet in passing diametrically across the drum. By having the cylinder rotated at a fixed speed (say 2,000 revolutions per minute) it is easy to calculate this time and thus determine the speed of bullets without resorting to long ranges and cumbersome apparatus.

Of course the reliability of this method depends on getting an accurate record of the speed at which the drum rotates.

For this purpose the simpler types of speed indicators are not as accurate as many other laboratory devices, as for instance those used for telling the rate at which an alternating current changes its direction. The makers of this device therefore adopted the ingenious plan of letting the shaft of the drum produce an alternating current whose pulsations will be equal in number to the rotations of the drum. This is done by a simple commutating device on the shaft of the drum, from which wires run to the "frequency indicator" pictured just to the right of the pistol in the cut. A knob on the base of this indicator adjusts a resistance so as to vary the speed of the motor.

All the operator has to do, after starting the motor is to adjust the speed till he gets the desired reading on the frequency indicator and then fire the shot.

In practice, the shots do not always pass exactly over the center of the drum and allowances have to be made for any deviations from the proper firing line. For this purpose flat

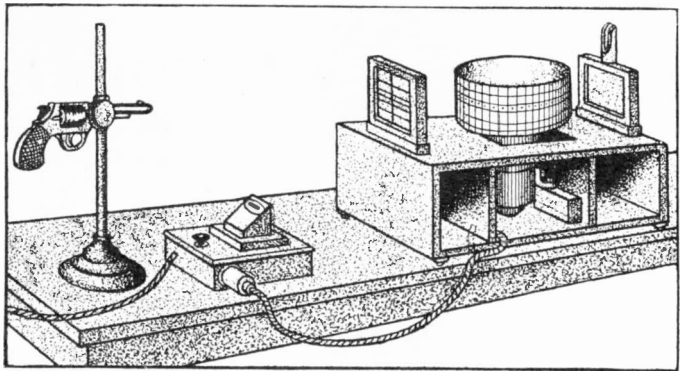

HARTMANN-BRAUN BULLET TIMER READY FOR A TRIAL

screens of thin, ruled paper are placed on either side of the drum and the bullet holes in these show the actual course followed by the bullet. Then it is easy to determine the angle of rotation through which the drum has traveled by applying a straight-edge between the holes in the two screens.

Electricity Saves Fruit

Fruit growers will welcome the electric frost alarm, which by its timely warning will save thousands of dollars' worth of fruit from freezing, and yet allow the orchardists to sleep nights instead of sitting up to watch a thermometer. The device is small and compact, having a certain resemblance to a clock in a square case, and it is equipped like a clock with two hands. One of these registers the degrees of temperature, while the other is set at the danger mark, which differs for the various fruits. When the thermometer hand reaches the point at which the alarm hand is set, a bell rings and continues ringing until the sleepers are aroused and shut it off. The electric thermometer is

ranch foreman or whoever is responsible for the frost protection.

This device is operated in connection with the oil-burning smudge pot, extensively used by fruit growers in California and Florida.

These pots are placed between the rows, about one hundred of them to an acre, and as they are kept filled and in readiness the laborers merely apply a torch to each, and the resulting heat and movement of the air prevents the frost from settling.

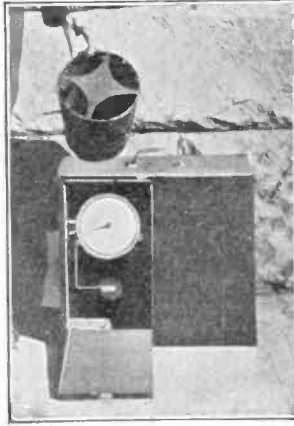

ELECTRIC ALARM AND
SMUDGE POT

At the Moose Mountain workings in Ontario, Canada, an electro-magnet has taken the place of a steam shovel for loading iron ore. The ore is first broken up by blasting, and then picked up by the magnet, 800 pounds at a time, and loaded into cars.



ORCHARD PROTECTED FROM FROST BY SMUDGE POTS

placed in the orchard and connected by wires with the sleeping quarters of the

This saves the expense of new buckets formerly worn away by the hard ore.

X-Ray Pictures of the Stomach

By DR. ALFRED GRADENWITZ

Considerable difficulty has been so far experienced in obtaining X-ray pictures of the stomach, on account of the characteristic ("peristaltic") motions of that organ. Unless therefore the duration of exposure be reduced to a minimum, the outlines of the X-ray picture are liable to become blurred, thus wiping out any finer details. Another necessity difficult to comply with is to provide for a visual X-ray examination being made previous to the taking of an X-ray picture, so as to get an adequate idea as to any constrictions and expansions in the walls of the stomach.

Again, as the X-ray picture should be taken immediately after radioscopic observation, the outfit should contain a simple switch allowing it to be made ready at a moment's notice for either operation.

The outfit constructed by a Berlin company effectually eliminates all these difficulties and is equally suitable for radioscopic and radiographic work (flash-light, instantaneous and long-exposure views) as well as for therapeutical radiation.

The outfit merely comprises a high-intensity induction coil mounted on two brackets, a quick-break switch, a Rotax interrupter and a distributing board con-

nected with a switching desk. A special universal stop allows the intensity of X-ray radiation to be readily adapted to any special conditions. When experimenting on per-

sons in an upright position there is used a vertical support comprising a universal slide against which the subject is placed. The apparatus is operated as follows:

After having taken a "bismuth meal" (diaphanite or bismuth) required for any X-ray photography of the stomach, the subject is examined radioscopically immediately after which an X-ray picture is taken.

After adjusting the switch to instantaneous working, the time of exposure is adjusted for on the scale and the apparatus is thrown into circuit.

Since the first of the year the National Bureau of Standards has adopted a new value for the standard volt in this country to correspond with that in England, France and Germany. The change, while numerically very slight, will be felt in the incandescent lamp industries. The change is based on the value of the Weston cell at 20 deg. C. Heretofore we have rated the cell at 1.091 volts; now the rating is 1.0183 volts.

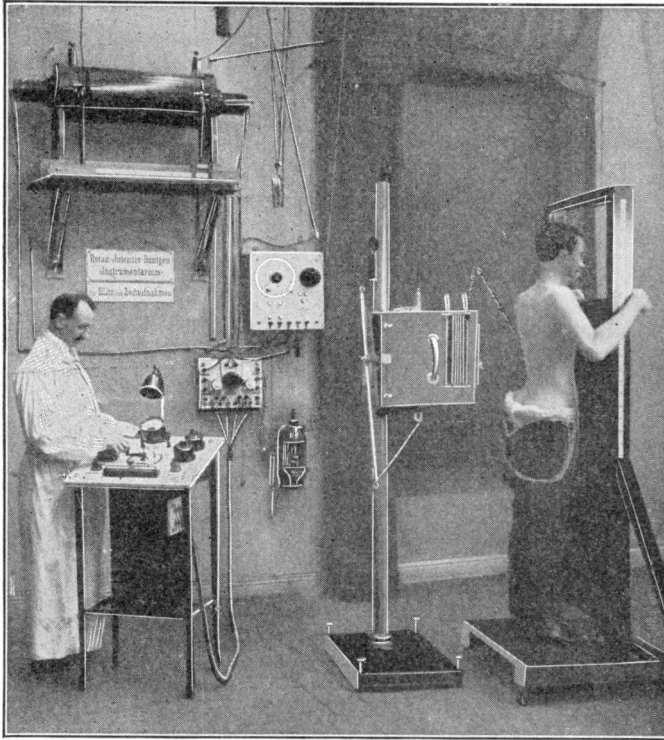

TAKING AN X-RAY PICTURE OF THE STOMACH

The Electric Stevedore

The big stevedore who pushes trucks around the freight houses, and whose chief strength is physical rather than mental, will have to look for another job if other companies follow the lead of those along the New York docks, where the electric freight truck is being used in his place.

This truck carries its own power in storage batteries. It is hinged in the center and can get over almost any inequality or scoot around a corner like a big caterpillar. It will run eighteen miles on a single charge at a maximum speed of $4\frac{1}{2}$ miles per hour. Two tons of freight makes a nice comfortable load for it but it can carry four tons at a pinch. It has solid rubber tires and can be steered from either end. The operating cost with current at six cents per kilowatt-hour is about ten cents per mile.

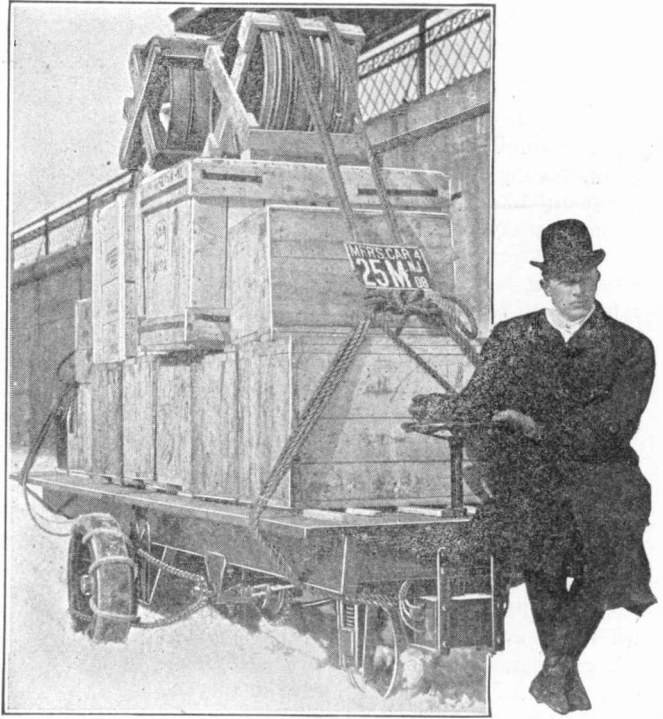

THE ELECTRIC STEVEDORE

A Startling Gateway

A remarkable specimen of grotesque art is the dragon gate at Venice, California, which stands before the Oriental pavilion of that resort. It has a height of about 20 feet and is in the type of Japanese portal made familiar by "tea gardens," but the startling feature of it is the pair of huge gilt dragons coiled around the upright posts and apparently hanging on by their murderous looking claws. These dragons are brightly gilded and with their menacing fangs and bristles form the substantial theme for a nightmare. As they are brilliantly lighted by incandescent lamps that follow their sinuous course around the posts, they are as spectacular by night as by day.

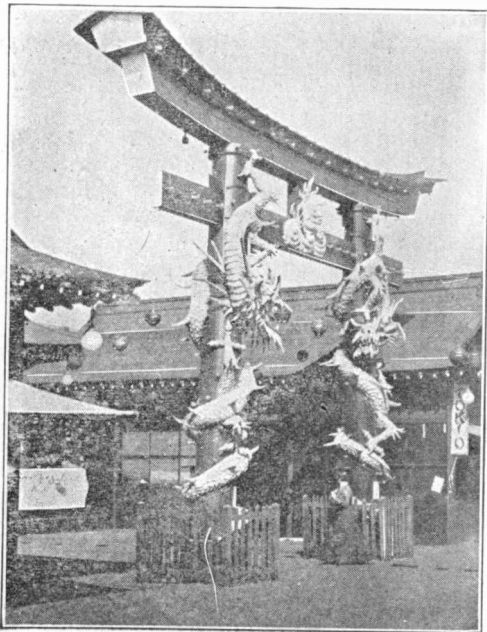

A STARTLING GATEWAY

The Indianapolis & Louisville Traction Company has taken a novel method of advertising, with the intention of reducing the number of accidents. In carrying out the plan, blotters bearing a list of the most common causes of accidents have been distributed among the school children in the vicinity of the company's lines.

From Out the Leyden Jar

The Vandalia Railroad recently conducted an interesting experiment with the telephone as an aid to freight-train operation. On a freight train of 123 cars, one and a half miles long, drawn by two engines, a telephone wire was strung along over the tops of the cars, connecting telephone instruments in the caboose and engine cab. The movement of the train was directed by the conductor who, sitting in the caboose, telephoned his orders up to the enginemen.

* * *

The Colonial Sugar Co. is about to establish a system of wireless telegraphy at its mills in the Fiji Islands. The mills are situated on different islands, and some of them are hundreds of miles apart. Their steamer "Fiona" is also to be fitted with wireless apparatus. When the installations are completed at all the mills communication will be maintained between all the company's properties, and will enable the "Fiona" to be advised by wireless at which island she is required to call.

* * *

Two new telephone lines between London and Paris are being opened for public service and two more are promised in the spring. With the new lines in operation around 400 conversations per day can be transmitted between the two capitals.

* * *

An electrical teleprinting apparatus enables the Berlin police to print notices in 200 stations in the city and its suburbs simultaneously.

* * *

One million electric lights glow in Los Angeles every night, as shown by the connection records in the city electrician's office.

* * *

The experiment made by the Canadian Pacific Railway in train dispatching by telephone has proved so satisfactory that a further 2,000 miles of track is to be fitted with telephones for this purpose, making a total of 4,254 miles in operation.

* * *

A platinum mine was recently opened between Pecos and San Antonio, Tex., and a shipment of the ore has already been made to Boston.

The principal forms of tungsten ore are tungstates of iron, manganese and calcium; more rarely of lead. Tungsten trioxide is a bright yellow powder, which is almost insoluble in hydrochloric or nitric acids; hence by boiling the suspected mineral with hydrochloric acid, the presence of tungsten may be detected by the appearance of the bright yellow precipitate. With the addition of metallic tin or zinc the trioxide is further reduced, the lower oxides showing successive colors of blue to brown.

* * *

Canada purchased from the United States in the eight months ended November 30, 1910, electric insulators and batteries and telephone and telegraph instruments valued at \$2,417,569 and only \$53,209 from all other countries.

* * *

The Navy department is planning to establish a wireless system along the Aleutian islands, according to advices from Washington. The system, when established, will naturally work in harmony with the present wireless system operated in Alaska by the Signal Corps of the Army in connection with the cable which places Alaska in communication with the outside world.

* * *

The Illinois Traction System is preparing large excavations made in the ground at Riverton and Mackinaw which will be filled with coal, and afterward covered with water to shut out the air. Each reservoir will hold about 12,000 tons of coal and will be lined with cement.

* * *

The largest telephone exchange building in the world is to be erected soon at a cost of about \$1,500,000, by the New York Telephone Company.

* * *

The wire guessing contest at the Chicago Electrical Show which waged fiercely about the pillar built of spools of wire was won by Prof. John D. Nies of the Lewis Institute, Chicago. His guess was 19,415 feet, while the measured length of the wire was 19,416.1 feet. Prof. Nies now travels about in a new "electric."

ELECTRIC CURRENT AT WORK

NEW DEVICES FOR APPLYING ELECTRICITY

An Electric Milk Jug

The British fondness for hot milk is reflected by the electric milk jugs now offered on the English market in one, two and three



ELECTRIC MILK JUG

pint sizes. They have the heating element in a separable base which can also be used for warming or heating other dishes.

Electric Branding Iron

Electricity is even used to stamp the United States imprint on ham and other meat prod-

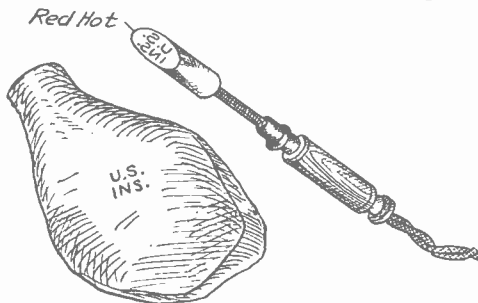

ELECTRIC BRANDING IRON

ucts, designating that they have been approved by the pure food inspector. The Vulcan branding iron by which this is done is made on the principle of an electric soldering iron. It is connected to a convenient lamp socket with a flexible cord. The conductors pass down through the wood handle and terminate in a heating element inside the die. When the current is turned on the die is heated to a red heat,

Speed-Regulators for Small Motors

A great many people now operate sewing machines, buffers, small blowers, washing machines, jewellers' and dentists' lathes, coffee mills, adding and copying machines, etc., by small electric motors of from one-twentieth to one-sixth horsepower. To use these machines to the best advantage a regulator should be used in connection with the motor so that the speed may be varied.

To meet these requirements a very small but at the same time trustworthy regulator of the Cutler-Hammer type has been developed. It is only six inches in diameter and weighs only 2½ pounds. The operation is by means of a simple sliding lever. Seven contacts are provided giving seven running positions, or these contacts can be arranged to provide one "off" point and six running positions.

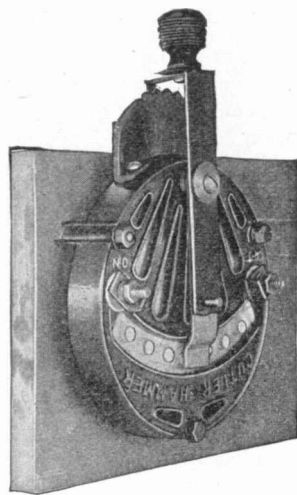

REGULATOR FOR SMALL MOTORS

The picture shows one of these regulators provided with a projecting lever or handle which carries a pointer to indicate the position of the contact arm on the buttons below. So arranged it can be mounted underneath a table top, carrying a copying machine for instance, with only the handle and indicator projecting. Then, although the regulator is out of sight and out of the way, the operator, in varying the speed of the machine, can tell by the indicator on what speed the motor is operating.

Sterilizing Liquids by Ultra-Violet Rays

By DR. ALFRED GRADENWITZ

Those rays which in the scale of the prism lie beyond the range of visible light waves are detected only by their chemical effects, especially by the action they exert on photographic plates. Investigations have shown these radiations (termed ultra-violet, that is, beyond violet) to exert harmful effects on living tissues, and especially, to destroy all kinds of minute organisms, such as the microbes.

In view of this behavior it occurred to a French physician, Dr. Billon-Daguerre, that ultra-violet rays could be utilized for the sterilization of liquids, and the experiments conducted by him actually confirmed this prevision.

The first apparatus used by the doctor consisted merely of an exhausted quartz tube (A) Fig. 1, filled with mercury vapor in the interior of which an electric arc could generate those useful radiations. The tube was surrounded by a protective quartz sleeve (B) and an outside brass cover (C). It may be said in this connection that the use of quartz instead of glass is quite imperative, as glass absorbs most of those precious rays. Even air is impervious to them and this is why the vacuum tube arrangement (similar to the well-known mercury lamp) is adopted.

After passing into the apparatus the liquid to be sterilized flows in the annular space between the protective sleeve and the brass cover in an extremely thin layer, thus undergoing the sterilizing effects of the ultra-violet rays given off from the lamp.

The next apparatus designed by Dr. Billon-Daguerre, as represented in Fig. 2, consisted of a cylindrical quartz bulb (A) traversed by the current; this likewise formed

a mercury lamp. A quartz sleeve (B) soldered to the ends of the lamp insulated the latter from the contact of the liquid to be sterilized, the intermediary space (V) being exhausted. This apparatus was completely immersed into the liquid to be sterilized, and this underwent the action of the lamp without becoming heated, the vacuum (V) constituting an efficient insulation.

In order now to produce a perfect sterilization of the liquid, the latter had to be brought in all its parts into direct contact with the lamp. This is achieved in the apparatus represented in Fig. 3.

A siphon system consisting of a set of bent silver tubes collects the liquid from the outside sleeve (B). The ends of these siphons are so cut as to adapt themselves as far as possible to the curvature of the sleeve, thus allowing the liquid to be collected from the immediate neighborhood of the lamp.

For the sterilization of milk, which is impervious to ultra-violet light, the tubes (T) are given a considerable thickness, Fig. 4, thus causing the liquid to pass in a thin layer between the lamp and the discharging tubes. By increasing the number of these tubes, the volume of the liquid discharged from the apparatus can be increased in proportion.

According to the inventor this lamp (which is located in a relatively small glass case) is able to sterilize, with an electrical consumption of only two amperes and 110 volts, 3,600 litres of liquid (wine, beer, milk, etc.) per hour, while in the case of clear water the output may even be raised to 10,000 litres, a litre being about .26 of a gallon,

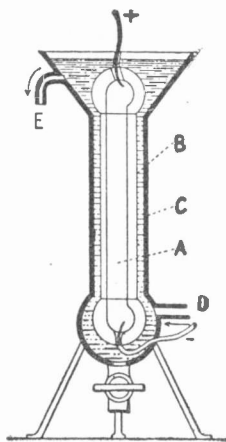

FIG. 1. FIRST APPARATUS OF DR. BILLON-DAGUERRE

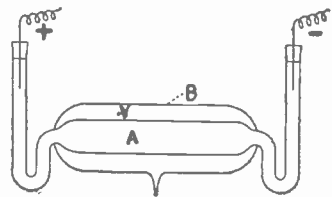

FIG. 2. CYLINDRICAL QUARTZ BULB

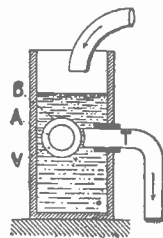

FIG. 3. SIPHON TYPE OF STERILIZER

In spite of these satisfactory results, Dr. Billon-Daguerre unceasingly endeavored to improve his apparatus. The drawback so far experienced was that the effective rays were accompanied by other radiations belonging to the visible part of the spectrum, and which were practically devoid of chemical properties, and accordingly, of any

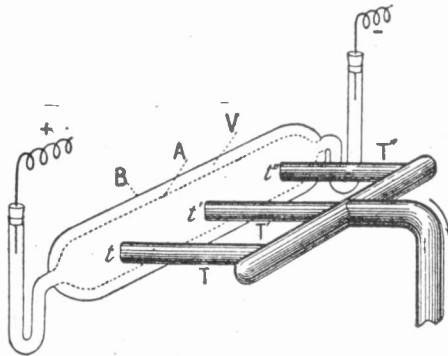

FIG. 4. APPARATUS FOR STERILIZING MILK

sterilizing effects, serving only to dilute the rays and to reduce the efficiency of the apparatus.

This is why the Doctor proceeded to design a lamp able to produce only chemical radiations. Now, by investigating the familiar Crookes and Geissler tubes, containing carbonic acid, hydrogen, sulphide, or other gases, he found the photo-chemical effects exerted by their radiations to be about 25 times more energetic than those obtained with ordinary ultra-violet rays. In fact, the spectrum of those gases showed evidence of radiations of extremely short wave-length (far shorter even than the ultra-violet rays generally used) and which, in view of their situation beyond the ultra-violet, he termed "hyper-ultra-violet" rays.

These radiations were found to possess so extraordinary a microbe-destroying power as to allow of an instantaneous sterilization of the liquids.

It will therefore readily be understood that by substituting for the mercury lamp in the apparatus described above, a Crookes tube of variable shape, the output of the apparatus can be considerably increased, the same effects as above stated being

obtained with an incomparably lower electric consumption (two amperes and five to six volts).

It may be said that the sterilizing effects are due exclusively to the radiations, and not to the ozone and oxygenized water generated by their action. In fact sterilization is absolutely instantaneous.

The latest apparatus recently submitted to the French Academy of Sciences (Fig. 5) consists of a quartz tube, 9.8 inches in length, and .79 inch in diameter, containing extremely diluted hydrogen which is traversed by the induced current of a small induction coil, giving sparks .6 inch in length with two amperes and six volts. This minute amount of electrical energy is transformed nearly entirely into invisible rays of extraordinarily short wave-lengths, the chemical action of which is at least 20 times as great as that of mercury vapor lamps.

As the water sterilized by this process is not heated, it remains perfectly fresh, and its taste is not altered in any way. On account of its small dimension and easy handling it can even be used in private houses while on the other hand, its remarkable efficiency makes it quite suitable for use in the very largest installations. In the case of municipal water distribution plants the water is sterilized immediately in the mains, and in order to avoid any breakage, the lamps are located outside of the water conduits, the ultra-violet rays penetrating into the water through two quartz windows.

Another sterilizing apparatus based on the action of ultra-violet rays has been designed by the Westinghouse Company (limited) and comprises a mercury vapor lamp of the Cooper-Hewitt type, suspended above the surface of the liquid, and which exerts on the micro-organisms in the latter immediate destructive effects without the intermediary of any ozone or oxygenized water.

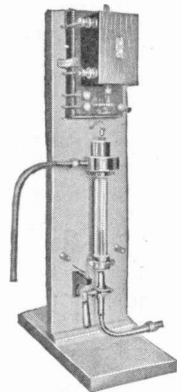

FIG. 5. LATEST FORM OF STERILIZER



He Overcame the "Impossible"

Some fifteen years ago a real estate man in looking over a building which came under his care out on Chicago's West Side found in charge a young lad who performed the numerous duties of elevator boy, engineer, etc. The boy's knowledge of things, his confidence in himself and his great desire to know something of electricity led the real estate man to install a private lighting plant in the building. Entrusted to the lad's care, it never wanted for attention, and it was a friendship thus begun between Perkins B. Bass and Austin Kimble that helped lead to the invention and manufacture of a motor that, to those who have made a study of electricity, does seemingly impossible things.

But the story of the man who thought it out is full of interest. Upon the advice of his friend he took up a correspondence course in electricity and it was not long before he was told as a result of his investigating turn of mind that an alternating current variable speed motor was an impossibility without using a wasteful resistance, controller or rheostat with it.

"Well, I'll build one then," he replied, for it was always the seemingly impossible things that Kimble thought worth trying out, his queries in this line often causing his electrical associates to smile. As the first step to change the meaning of these smiles, a shop not more than fourteen feet square was set up in a barn, with his wife as first assistant, and an old automobile engine to furnish power to a lathe. His first motor armature was mounted on a broom stick for a shaft, but demonstrated that he was on the right track. Fitted with a steel shaft, it was sold, but for less than it cost. Another motor was built and sold, and then others followed.

Mrs. Kimble advanced from helper to armature winder, then bookkeeper. Business grew. The lad of yesterday was coming on, but by hard work. He had accomplished one thing thought "impossible." He frequently slept on a cot in the shop during these years for two reasons: To save time going to an from work and to work out new problems that came to his mind whether during night or day; for Austin Kimble thought best at night and often would get up at two or three o'clock in the morning to try out in the shop some new idea that came to his mind.

Finally the little shop was abandoned for a larger place, and then for a second time business forced expansion and yet the third and fourth time, to the present factory location which the visitor can see will not long provide sufficient room.

Kimble's single phase alternating current motor operates off single, or any phase of two or three-phase circuits. Without a controller or resistance the motor starts, runs at any speed from 300 up to 3,000 revolutions per minute, may be reversed while at full speed by throwing a single lever from one

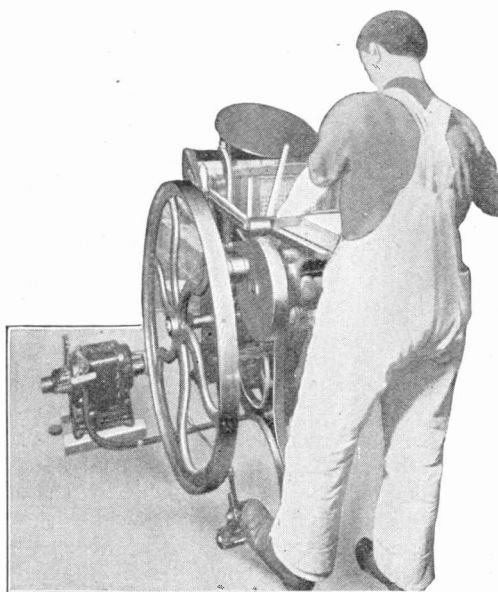

VARIABLE SPEED ALTERNATING CURRENT
MOTOR DRIVING A PRINTING PRESS

extreme point to the other, or stopped by placing at mid-position this lever which merely shifts the brushes.

Electrical engineers and professors are incredulous until they see the motor doing these things. Further and unlike other motors the current, speed and power all increase or decrease together. There is no surge of current to blow fuses when starting the motor.

Built in sizes of from $\frac{1}{4}$ to ten horsepower the motor has solved the problem of economy and variable speed regulation where alternating current is available. The illustration shows a motor operating a printing press, the operator having complete control by a foot lever.

The World's Greatest Pig Yard

Where is the world's largest pig yard? Most men will answer Chicago, Omaha, or Kansas City, thinking of the immense stock yards at each place. But by actual count the larger stocks of pigs are found far from the packing industries, for in certain indus-

Lamp and Flasher Combined

An incandescent lamp having two different candle-power filaments and with a make and break thermostat for flashing them contained in the neck or screw shell of the lamp is described in a patent issued to William J. Phelps, Detroit, Michigan. A bent bar

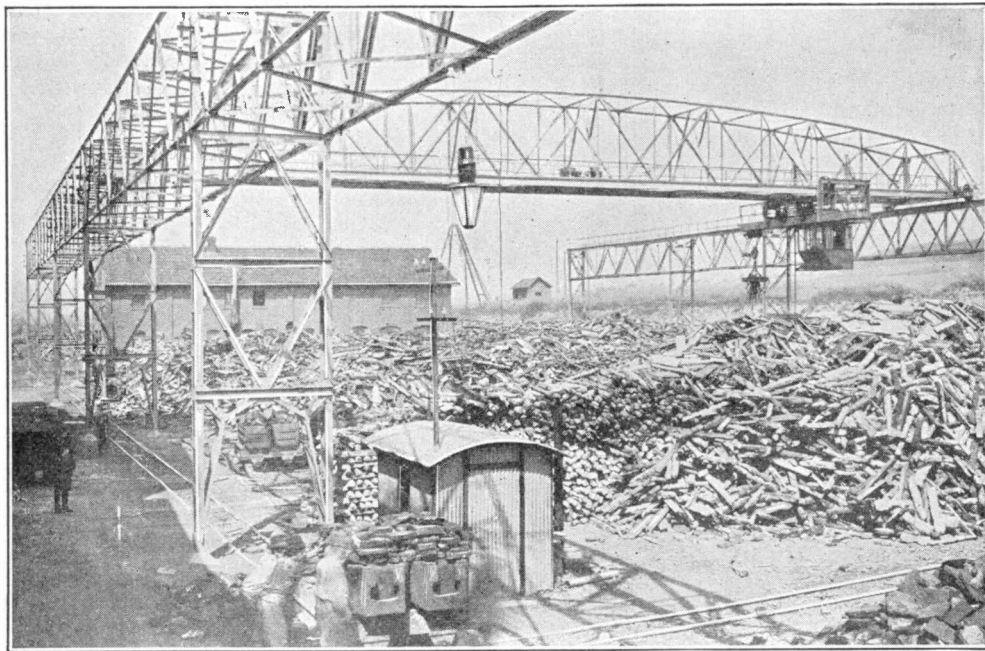

ELECTRO-MAGNET HANDLING PIG IRON

tries the word pig means something quite different from the porker of our barnyards or the guinea among our household pets. In the iron and steel trades the word pig denotes the slab or stick form into which iron is first poured when it comes from the blast furnace. To avoid being caught short of their supply of such raw material in case of railroad troubles, most users like to carry a huge stock of these pigs on hand. Formerly they were handicapped in this by the long time it took the laborers to unload and afterwards to cart the heavy bars. Now this work is made easy by an electro-magnet on a traveling crane which picks up ten to 20 of the pigs at a time and holds them until the current is turned off. With the handling of the pigs thus simplified, the yards used for storing them have grown to immense proportions, like the one of which our cut shows only a part, this being a German pig yard,

thermostat of two metals such as brass or steel closes the circuit through the high power filament. The current heating the thermostat opens the circuit as the bent metals expand, placing the long filament as a resistance in series with the low power short filament. As the latter has a greater resistance per unit length than the long filament the short filament lights up. The thermostat now carrying no current, cools and again closes the circuit through the high power filament.

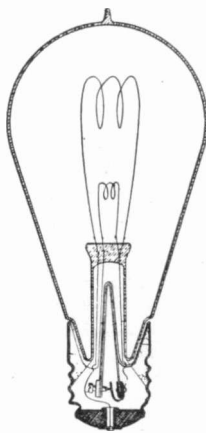

LAMP AND FLASHER
COMBINED

Electric Drink Mixer

Ever quaff an "electric milk shake?" It's delicious, and in this age of things electrical will surely become popular. The "O-See-Us" drink mixer runs by electricity and consists of a little motor mounted on a suitable stand. Direct connected to the motor is a vertical shaft on the lower end of which is a large thick button. Running at high speed the button will mix thoroughly any drink that you now shake or stir. All flavors are perfectly blended and the customer gets a more satisfying drink in less time than by the old "arm-strong" method.

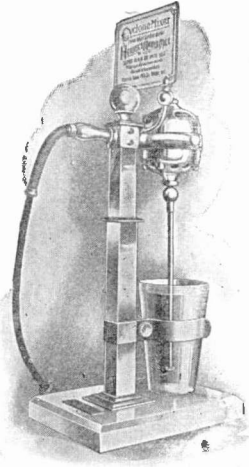

ELECTRIC DRINK MIXER

Producing a Stage Illusion

To cover an invention for producing illusory effects on the stage, a patent has been granted to Timothy R. Barrett, Bordentown, New Jersey. The arrangement provides means for showing a person vainly endeavoring to catch a train, boat or other conveyance. In the back ground is an endless curtain upon which is painted a panoramic view of scenes along the route of the conveyance. At the front of the stage is a narrow endless curtain painted to represent the ties and rails of the railroad track as in the illustration, the wheel of the coach being turned by contact with the edge of this curtain. Between the two curtains a moving sidewalk operates fast enough to

enable the actor to produce a good imitation of a frantic attempt to catch a departing train. Both curtains move at the same rate of speed operated by an electric motor.

Cigar Lighter

This device is not a telephone but a cigar lighter. The cross-wire within the transmitter-like opening is a resistance wire bent back and forth to afford plenty of hot wire against which to place a cigar to be lighted.

Platinum wire which is often used in lighters is expensive and breakable. It is the object of this invention to so construct a cigar lighter that the current can be transformed or stepped down to a lower voltage and increased amperage, enabling the use of a much coarser and stronger wire, of a much less expensive material which will offer a greater heating surface, and will come to the glowing point in the shortest possible space of time. A small step-down transformer is therefore enclosed in the body, the current being turned on by pressing the push button. A patent on the device has been

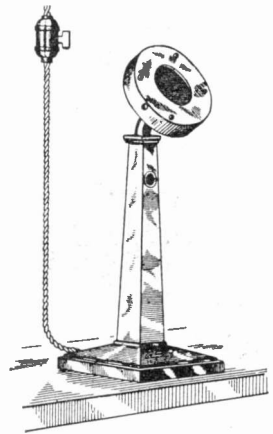

CIGAR LIGHTER

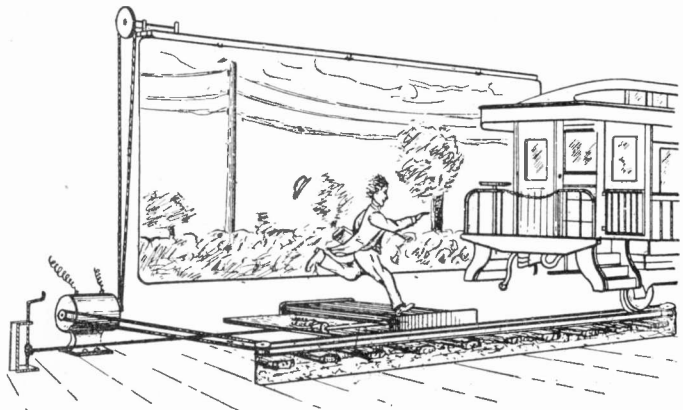

STAGE ILLUSION

issued to Victor E. Extrom and Thomas G. Boardman of Tomahawk, Wisconsin.

Sewing Up Grain Bags

A bag stitching machine invented in Germany by A. von Hasperg, actually sews up the mouth of a filled bag. The bag itself is placed on a little wheeled cart which is automatically moved past the needle after each stitch, the sewing mechanism being easily moved up or down to match the height of each bag. The machine sews a peculiar seam of interlocking stitches which it tangles at the end of its run so that no hand knotting is required, but which can be quickly unraveled after cutting one of the thread loops at the right end.

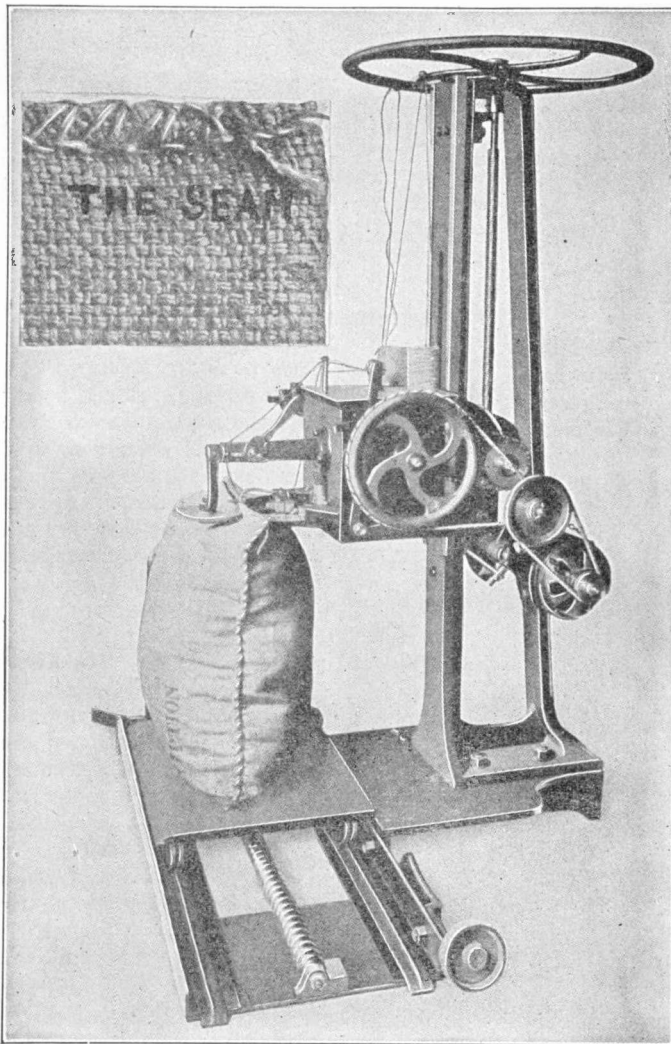

GRAIN BAG STITCHER AND SOME OF ITS WORK

A quarter horsepower electric motor does the work.

The peculiar stitch produced by this machine cannot readily be duplicated by hand, hence bags closed in this way will show at a glance if there has been any tampering with their contents in transit.

Making Blue Prints From the Original Drawing

In making blue prints it is necessary that the drawing be made on transparent material. As ordinary drawing paper is practically opaque, a tracing must be made from the original on transparent tracing cloth. Obviously, therefore, if the original drawing could be made transparent by some process, so as to be used in blue printing, one time-consuming step would be saved. This might be done with inflammable liquids, such as gasoline, but there would be great danger of burning up the drawing, especially if an arc light were used in printing.

If the sheet could be drawn through some safely handled liquid which would make it transparent and then dried, we could get the needed transparency in less time than it takes to tell about it.

Carrying out this principle, a New York firm has brought out a "Mechanigraph" in which the drawing is passed between rollers into an electrically heated liquid and then carried by moving tapes over the drying rollers which are also heated by the same current. All the operator has to do is to start the paper between the rolls and to turn a crank just as if he were using a clothes wringer. The liquid used is said to be non-inflammable and

to cost only a third of a cent per square yard of the paper treated; and as the current is used only for short periods, its cost would be more than covered by the saving in tracing cloth. The space occupied by the apparatus is less than would be needed by a single draftsman, though a single such device may replace scores of tracers, thus increasing the capacity of the draughting room.

Monorail for Handling Lumber

Not very far back the lumber as it was produced in the mill was handled and stored by hand labor and with teams to cart it from one shed to another. Now, in many instances an electric monorail system whisks the lumber about with incredible rapidity and at a great saving in labor expense.

The tracks of the system are steel I-beams hung high above the floor level. Suspended therefrom on wheeled carriages are a cage for the operator, a winding drum for lifting a sheaf of lumber and the motor for doing the lifting and propelling. The lumber is piled, to begin with, on cross bars. The monorail car is then run over the lumber and a set of tongs lowered away until they can be hooked under the ends of the cross pieces. Then the load is raised and carried away over the track to the particular tier on which it is to be placed, all these operations being controlled to a nicety by the man in the cage.

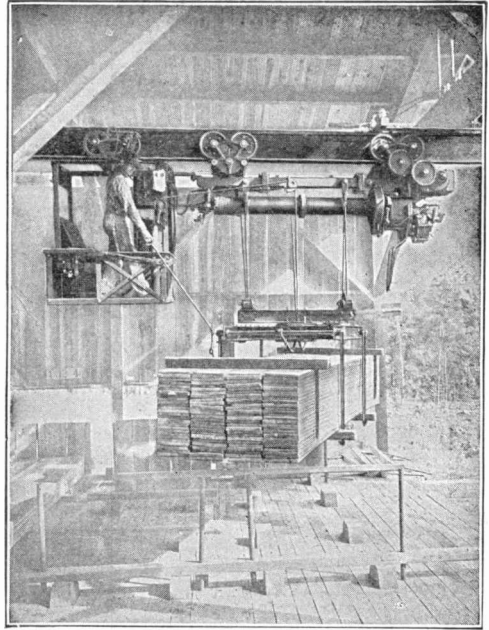

RAISING A LOAD AND GETTING READY TO NEGOTIATE A TURN

Automatic Fire Extinguisher and Alarm

A German inventor has developed a new device which is at once a fire alarm and fire extinguisher. It consists of a carbonic acid generator to be placed in the room to be protected. It operates in connection with a thermostat which closes the circuit to the alarm and generator when the temperature of the room gets above the danger point.

When the thermostat makes electrical contact, by an excessive temperature a pawl is disengaged by the armature of an electro-magnet in a small chamber on the outside of a fire extinguisher. This releases a lever which causes a small tank containing sulphuric acid within the extinguisher, to tilt by its overweight, the acid flowing out through small holes into a solution of potash contained in the outer vessel,

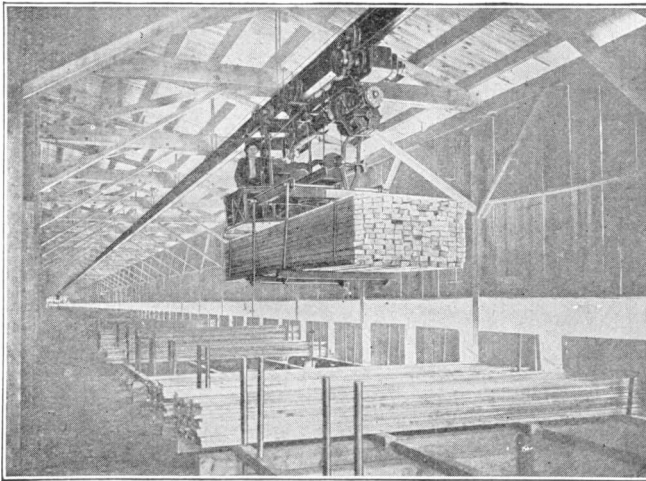

A LOAD UNDER WAY IN THE SORTER SHED

Instantly large volumes of carbonic acid gas are produced by the mixture of the acid and potash solution, from 5,000 to 15,000 liters of this gas being produced within 30 seconds, according to the size of the extinguisher, and thrown into the room by a surplus pressure varying up to one atmosphere. As is well known combustion cannot take place in an atmosphere of carbonic acid gas, so the fire is extinguished.

At the same time an electric fire alarm circuit is closed giving the alarm at any dis-

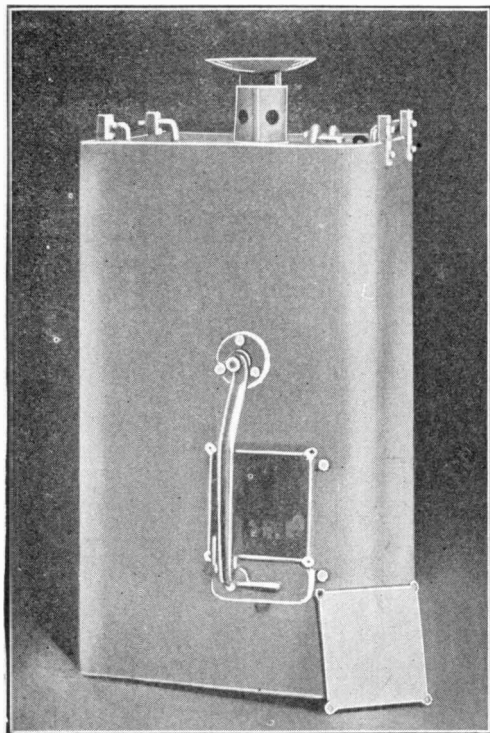

AUTOMATIC FIRE EXTINGUISHER AND ALARM

tant point desired. Then, if the carbonic acid gas has not completed its work other means may be employed to put out the fire.

Machine Puts Labels on Bottles

The next time you pick up a bottle containing wine, a vegetable sauce or something else, just notice the paper labels on it. There is probably one around the body and another on the neck of the bottle, and although these labels are in many cases put on by hand yet a machine which will do all this automatically

in one operation is here shown. The Economic Labeler does what might seem impossible to the casual observer for it will handle round, square, hexagon, oval or flat bottles, gluing the entire surface of the label to the bottle, or simply the edges of the label as desired. Cams, rolls and prongs all acting as if alive take the labels from a

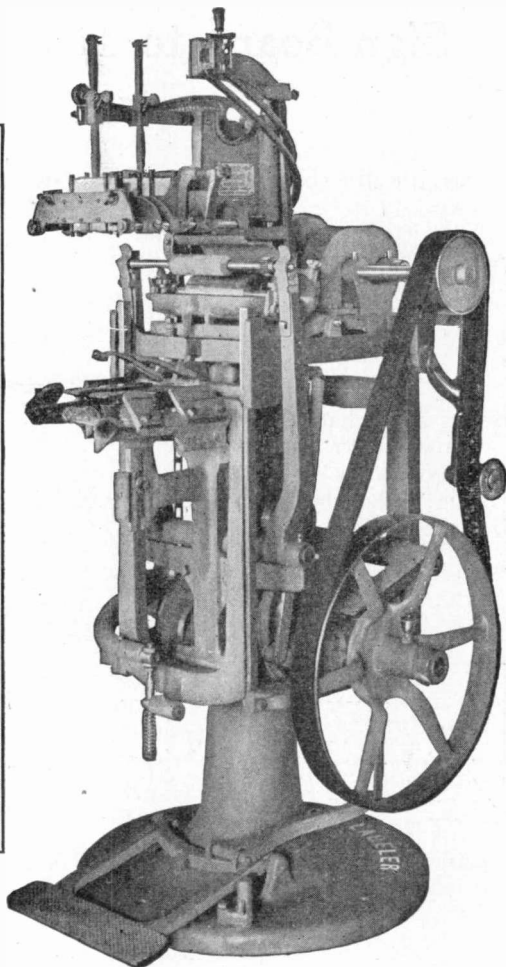

MACHINE FOR PUTTING LABELS ON BOTTLES

holder on the machine in which 1,000 may be placed, put on the glue and finish the job with accuracy and speed. An electric motor furnishes the power.

Edward C. Pond of Petersburg, Va., has patented a device for photographing the dials of electric meters, thus giving the meter reader an infallible record of his work.

FOR PRACTICAL ELECTRICAL WORKERS

HOW TO MAKE AND OPERATE ELECTRICAL DEVICES

Sign Board to Facilitate Ticket Selling

By THERON P. FOOTE

The theatre box-office man has his troubles.

"Two tickets near the front, please," calls a patron. The box-office man hands him E-5 and 6.

"Oh, No!" objects the buyer, "I want something near the front." E-5 and 6 are put back and B-2 and 3 offered.

"Are those on the aisle?" Again the tickets are exchanged for B-4 and 5.

"How much?"

"Two dollars."

"Oh! I thought they were 75 cents each," is the response.

theatre-goer to know at a glance what seats are not sold, take his choice and put down his money with "Give me B-4 and 5."

The general arrangement for the equipment is as follows: In the vestibule of the theatre may be placed a board (A) about $\frac{1}{2}$ inch thick and large enough to contain a full chart of the seats in the theatre, allowing a $\frac{1}{2}$ -inch square for each seat. After locating the seats by squares, $\frac{1}{4}$ -candlepower lamps are set in the board by drilling a $\frac{3}{8}$ -inch hole in each square to a depth of $\frac{3}{8}$ inch, and then a $\frac{1}{4}$ -inch hole the rest of the way through. Miniature sign receptacles may be set in

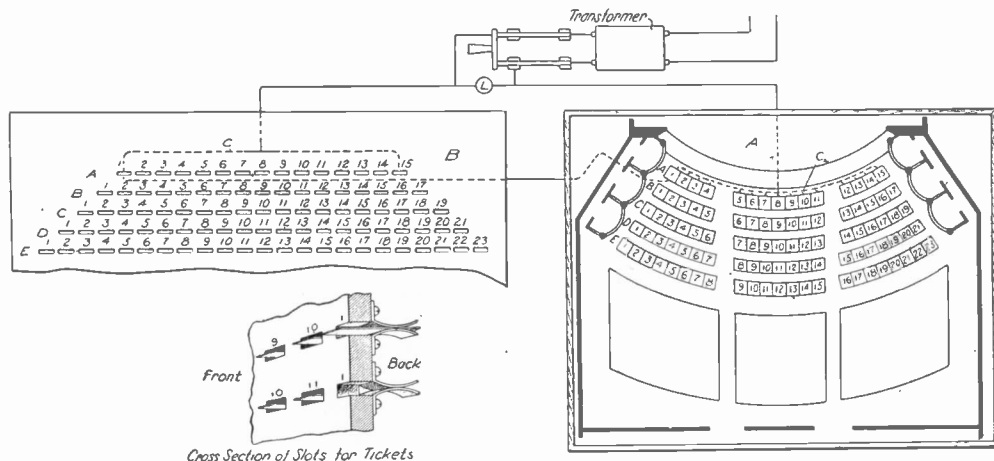

SIGN BOARD TO FACILITATE TICKET SELLING

"No, rows A to E are one dollar, E to N, 75 cents."

"Well, then give me two seats in E on the aisle if possible," and during all this time others are waiting perhaps to hear the same thing by the next in line.

The device here illustrated would do away with the annoyances noted, enabling a

these holes. A common wire (C₂) is now connected to one side of all of these receptacles in which small lamps are placed, this common wire being connected to one side of the transformer as shown. From the other side of each lamp a wire is run into the ticket office and connected to the lower of two brass spring clips shown in the detail

drawing which is a cross-section through (B).

In the board (B) which may be about $\frac{1}{4}$ inch in thickness are cut slots 1-16 inch wide and 1-16 inch longer than a ticket is wide each slot representing a seat on the chart in the vestibule. On the back of board (B) which may be mounted out from the wall on brackets the spring clips are mounted as shown in the detail, one above the slot, the other below. The brass pieces make contact when in position but when a ticket is inserted from the front they are sprung apart and thus serve as a switch. Each upper clip is connected to a common wire (C), as at A-1, and this common wire runs to the transformer.

After low voltage lamps have been placed in the receptacles of the vestibule board a frame containing glass frosted on the inside is mounted in front of the lamps and with

black oil paint a chart of the seats drawn on the glass and numbered as in the theatre and on the ticket board of the box office.

When the tickets are all in the slots of the board (B) the lights are all out, but as soon as a seat is sold the ticket is pulled from the slot, allowing the brass clips to make contact and light the lamp under that seat in the vestibule chart.

From the seats over the unlighted lamps the purchaser makes his selection, before he gets to the window. He then tells the location by number, pays the price, and makes way for the next. The glass may also contain the scale of prices for seats in different parts of the house, thus enabling the patron to know this when making his choice.

A step-down transformer which lowers the voltage to ten volts will simplify the wiring requirements and reduce the cost of current by using low-voltage low candlepower lamps.

Practical Don'ts for the Electrician

Don't wire a building and leave the wires sagging.

Don't use fuses that are not enclosed.

Don't put a pulling strain on a lamp cord.

Don't use the edge of a knife to clean a wire.

Don't allow the switchboard to get out of repair.

Don't leave the conduit pipe ungrounded.

Don't use an unnecessary amount of wire and tape to do the job.

Don't place the fuse plugs in such position that water can get to them.

Don't use emery paper on a commutator; it will soon ruin it.

Don't leave a joint without soldering it.

Don't throw a switch lever in and out too slowly.

Don't forget that mica is one of the best insulators.

Don't put up rosettes without their proper fuses.

Don't use dry cells where a constant current is desired and expect to get the best of results.

Don't allow dirt and grease to come in contact with the switchboard or rheostat.

Don't attempt to switch the brushes while the motor is running at full speed.

Don't place the hands about the generator when it is not necessary.

Don't forget that electricity is an unseen force and keep your mind on your work.

Don't use a screw-driver or pliers unless the handles are well insulated. Many a life has been hurled into Eternity because of this.

Don't put in a new brush without first fitting it to the commutator.

Don't start a new motor without first making a close examination of it.

Don't put wires crossways without first putting bushings between them.

Don't leave a key in a socket and expect no one to tamper with it.

Don't overload a circuit beyond the carrying capacity of the conductors used.

Don't use anything but fuses that are authorized by authority.

Don't work around the generator with your pockets crammed full of steel tools, as it is dangerous.

Don't sweep the floor and clean while the generator is running, as the dust that settles on the generator will be very injurious to it.

Don't solder a joint close up to the wall or woodwork, without first placing next to it a sheet of asbestos.

Don't forget that a generator should have a good blowing out with a strong blast of air occasionally.

Don't wind a large wad of tape over a joint after splicing, for a splice should be covered with just enough tape to make the splice the same size as the original insulated wire.

Don't forget that pure coin silver makes a very good emergency contact point.

Don't throw a rheostat lever too quickly but give a little time.

Don't put two solid carbons, or two cored carbons in an alternating arc lamp.

Don't throw a switch before you know a connection has been made.

Don't splice a small line and a large one together.

Don't enclose a generator in a place where it cannot get air.

Don't try to make a splice without first cleaning the wires.

Don't use acid in soldering a wire.

Don't fail to place the switches in places that will be handy to get at in case of fire.

Don't put a generator or a motor on a shaky foundation.

Don't disconnect a number of wires without tagging them, as some one else may have trouble in finding the proper connection.

Don't attempt to trim an arc lamp while the current is on, turn it off.

Don't overload the motor or generator for a very long time, as it will be very injurious to the machine.

Don't leave loose bolts, nuts, tools, etc., around the generator, for they are liable to get into the machine and something serious might happen.

Don't allow visitors to wander about among the belts and machines. They are not aware of what could or might happen to them.

Removing Oil From Water

One of the most persistent problems confronting the steam engineer has been that of removing the oil from the condensed steam which is obtained when using steam engines. This condensed steam, in the form of very hot water, is economical to use over again in the boilers if the oil can be taken out of it. The engines must have the oil to lubricate them, hence it is partly diffused through the steam and unless it is separated from the latter after this is con-

densed into water, the oil may be troublesome in the boiler. Mechanical devices, as used to effect this separation, have so far succeeded only in removing about three quarters of the oil, but a new electrolytic method is much more efficient. This works on the principle of forming a basic salt in the water through the action of an electric current and when this salt sinks to the bottom of the electrolytic tank, it carries most of the oil with it. Tests recently made with this new Davis-Perrett process are said to have shown that 98.5 per cent of the oil was thus separated from the water, and that at the remarkably low cost of only three cents per 100,000 gallons of water.

Spring Clip Cord Adjuster

A convenient lamp cord adjuster has been patented by John Maitland of Lynn, Mass. The drawing explains the principle, which is very simple. Two spring clips, working

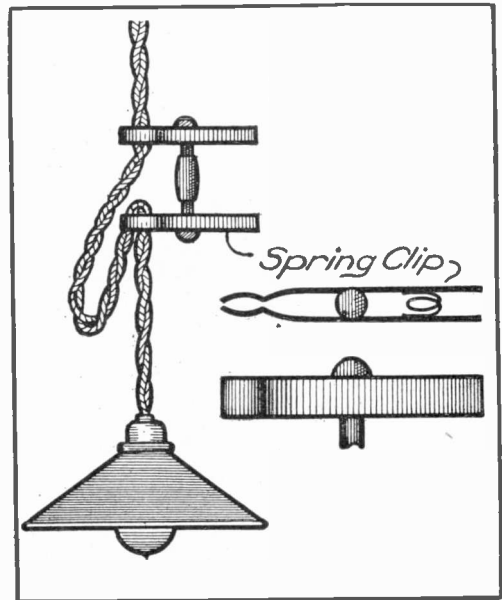

SPRING CLIP CORD ADJUSTER

somewhat on the plan of a spring clothes-pin, grip the cord at two points and are held together by a short connecting member. As much or as little slack as desired may be included between the two clips in order to adjust the position of the lamp to the particular height desired.

Pressure of a Church-organ Bellows

In the side view, Fig. 1, is shown a one-half horsepower, single phase, back-gearred electric motor pumping an old church-organ bellows of the reciprocating type. As an automatic speed regulator cannot well be used in connection with this current the homemade mechanism as described below was devised to govern the air pressure. Being fixed at the proper distance above the bellows it is operated by the action of the bellows itself.

The slide, (shown in detail at (S) Fig. 2) made of $\frac{1}{4}$ inch hard fibre, is readily adjusted to break the motor circuit at any desired fullness of the bellows. Any convenient number of holes for the removable pins may be used in both parts.

In Fig. 2 (A) is a knife blade switch terminal with spring washer under screw-head

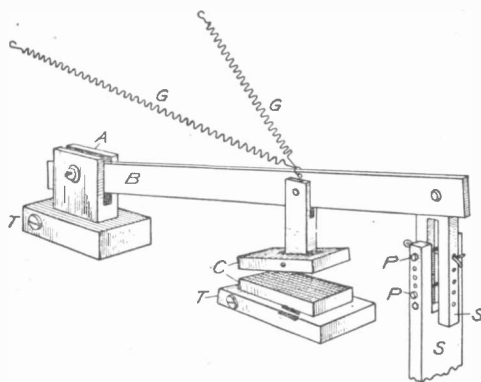

FIG. 2. DEVICE FOR MAKING AND BREAKING MOTOR CIRCUIT

and carries the copper blade (B) which may be of any required length.

As the current is interrupted quite frequently when the motor is in operation, carbon blocks (C C) are used to insure a continued smooth surface and good contact.

The iron ball from an old two-ball cord adjuster answers admirably for a weight (D). The spiral springs (G) are of sufficient tension and so situated as to make a quick break before the upward pressure of the bellows separates the carbons. It will be noted

that the upper carbon is not quite centrally pivoted, thus keeping one end in contact until springs (G) operate. The pull of these springs is nearly parallel with blade (B), when the circuit is closed and cannot act until the blade is slightly raised.

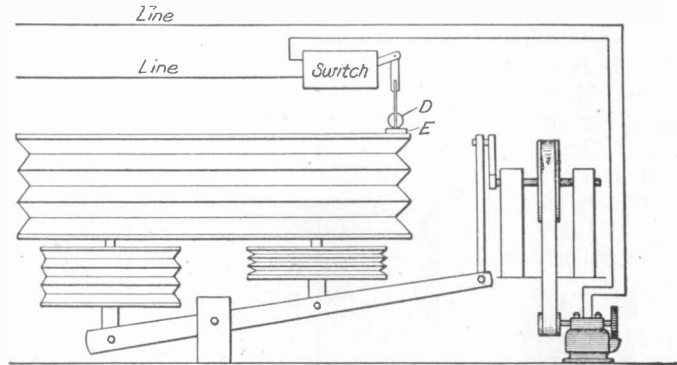
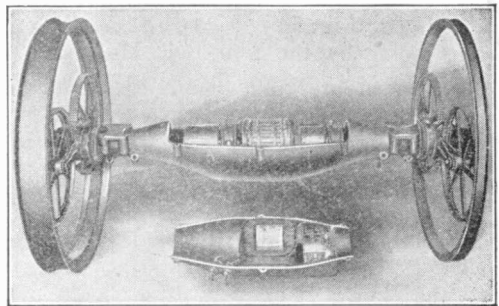

FIG. 1. MOTOR DRIVING CHURCH ORGAN BELLWS

The play between pins (PP) allows the bellows to rise until the lower pin (P), with the later assistance of springs (G), trip the switch and stop the motor. Due, now, to the fall of the bellows the weight (D) finally closes the circuit again, the upper pin (P) coming into play.

Hollow Axle with Motor

An unusual form of gearing for driving an automobile is represented by the Walker



MOTOR ENCLOSED IN THE AXLE

balance drive. The armature of the electric motor is mounted directly on the axle of the vehicle. As the armature turns the axle must turn with it. Then, on each end of the axle is a small pinion driving two larger gear wheels which in turn transmit the power to an annular gear on the inside of the wheel rim. The entire axle and motor are enclosed.

Electrical Men of the Times

ELMER A. SPERRY

One of the pioneers in modern electrical development is Mr. Elmer A. Sperry, now of New York City. He was born at Cortland, New York, on the 12th of October, 1860. After eleven years at the State Normal and Training School, Cortland, he studied at Cornell, beginning with a special course of lectures in 1879 under Dr. William A. Anthony, Professor John E. Sweet, Professor Moler and others of this period. This was the first electrical course of study in America.

On graduation he started a manufacturing concern of his own in Chicago, in the latter part of 1880, namely, the Sperry Electric Company, which made arc light dynamos, lamps and motors. He also became later engineer of the Standard Electric Company, the Sperry Electric Mining Machine Company, the Link-Belt Machinery Company of Chicago, the Sperry Engineering Company and the Sperry Electric Railway Company of Cleveland, Ohio.

In 1883 he started, and for some years operated the first central station for electrical supply in Chicago; lighted the Chicago Tribune Building, Marshall Field's, etc. This was later consolidated with the Arc Light and Power Company and finally absorbed by the Chicago Edison Company.

In the early '80s Mr. Sperry began constructing electric mining machinery, the concern becoming the Sperry Electric Mining Machine Company. This was the pioneer in this line of work, which is now being carried on by its successor, the Goodman Manufacturing Company of Chicago. About this time he also perfected a system of electric traction in which field much pioneer work was done. He has also done much

research work in connection with internal combustion engines, especially of the compound type, one of these engines reaching the thermal efficiency of over 40 per cent as measured at the brake.

Mr. Sperry was one of the founders of the

American Institute of Electrical Engineers, before which body he has presented a number of papers. He also was one of the founders and organizers of the National Electric Light Association, being active in the early years of the history of this institution, and having been chairman of the Committee of Call of the first convention. He has read papers and presented discussions before this body and at the twenty-fifth anniversary at St. Louis, in May, 1910, read an interesting account of the creation of the Association

in 1885. In addition to this, he was one of the founders of the American Electro-Chemical Society and has presented papers before that body.

Among other things, Mr. Sperry developed the Townsend electrolytic cell which now forms the basis of the largest producer of alkaline and bleach in this country; the factory is located at Niagara Falls. He has for many years been engaged on original research work in connection with practical applications of the gyroscope; and has delivered a number of illustrated lectures on this subject. He has been working with the United States Navy in the development of the larger engineering type of gyroscopic apparatus for steadying ships and also for battle and marine compasses, and "gyros" for steadying aeroplanes. Mr. Sperry is now engaged as a general consulting engineer in New York.



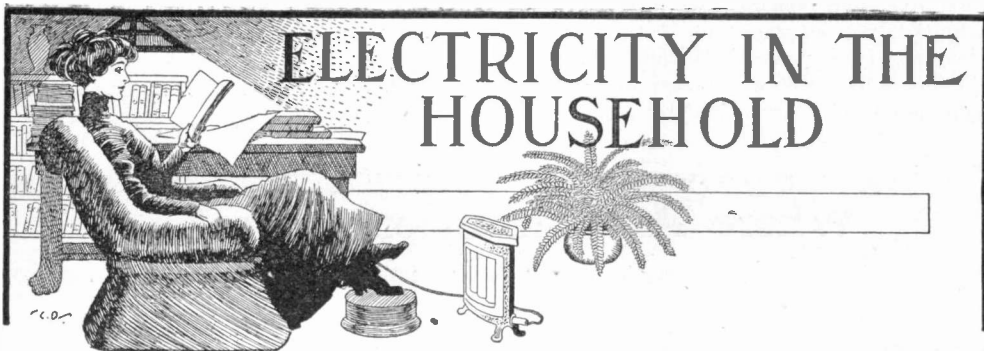

Alcohol Chafing Dish Changed to Electric

In accordance with a law well known to electrical engineers the efficiency of the heating element which is a part of your electric chafing dish, coffee percolator or any other electrically heated device of similar nature cannot be increased. As far as actually turning the energy of the current into heat is concerned one is as efficient as another.

The problem, then, is to apply the heat from this element in such a manner that none of it will be lost.

In a new type of Westinghouse chafing dish the manufacturer claims certain advantages in the above respect. The new chafing dish, the parts of which are shown in the "exploded view,"

consists of an ordinary chafing dish to which is added a disk type heater and a spacing ring to provide for its admission. This heater somewhat resembles a stove lid with handle permanently attached. The electrical conductors to the heating element are carried up through the handle, called the lead arm.

A glance at the sectional view shows how the parts go together. You first place the necessary amount of water in the water pan

and then suspend the heater in the water. Next put on the food pan. The whole outfit may be bought complete, or, if you have an old chafing dish of the alcohol type, having an outside diameter of water pan of $8\frac{3}{4}$ to $9\frac{3}{8}$ inches, it may be converted into an electric by the use of the spacing ring

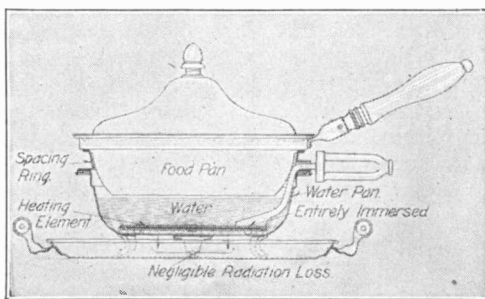

CROSS SECTION OF NEW CHAFING DISH

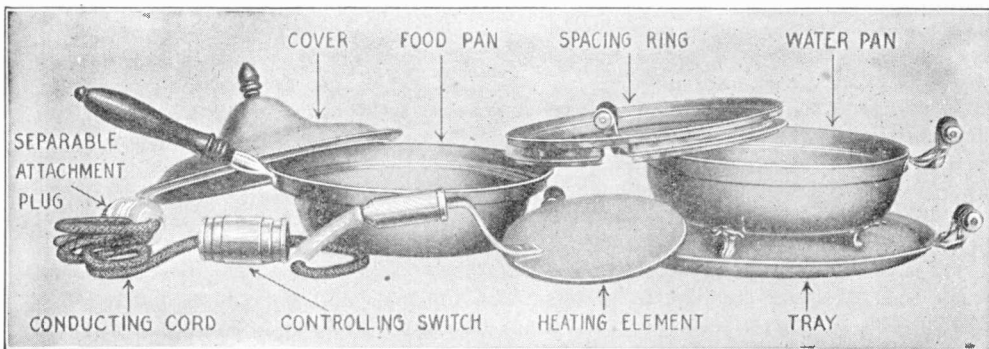

"EXPLODED" VIEW OF NEW CHAFING DISH

alluded to. The spacing ring and heater may be obtained separately for this purpose.

The claim for increased efficiency is based on the fact that, as you will notice, the heater element is entirely surrounded by water in-

stead of the under side being exposed to the air at the bottom of the dish, as in some other types. Therefore all the heat from the heating element must enter the water, which does the cooking.

Where Art and Science Meet

By T. VERNETTE MORSE

There are two classes of women who entertain. The one, who, with plenty of servants at her command, gives her orders, calls in the extra "help" that is necessary, invites the guests that belong to her "set," provides plenty of amusement, and is in every respect a queen among the social leaders.

Frequently she is the envy of her near-by neighbors, whose means do not admit of such expenditures, although they instinctively long for the same privileges under the same conditions.

For some reason the woman who entertains in this conventional manner does not, as a rule, give her guest half as much pleasure as the resourceful woman, who never lacks for ideas that are at once novel and interesting.

Friends of the latter soon learn that she has the ability to give them pleasure, and her invitations are looked forward to with delight.

The rooms may be small and plainly furnished, but they are always comfortable and homelike, only a few friends are invited at a time, consequently there is no crowding. Every hostess is, or should be, a law unto herself, giving of her hospitality for friendship's sake.

With electricity in the house, many novel results may be obtained. For a company luncheon why not bring into use the electrical percolator, chafing dish and toaster? Invite some friends to assist and let each one of them prepare a favorite dish. There is always good cheer where every one is busy, and the general air of preparation finds an interesting echo in the hearts of the guests, who will no doubt catch the spirit of the occasion and thereafter combine in groups for the purpose of entertaining. At such a gathering there is a feeling of good fellowship that is often lacking in more formal

occasions, and all will go so merrily that the hostess and her friends actually forget the cares and anxiety of life in the enjoyment of gracious hospitality.

The housewife who understands the artistic arrangement of the table will make a simple repast appear like a banquet. Snowy white linen, fresh flowers and bright silver properly arranged are the first requisites.

For the conventional or formal luncheon the polished table with individual embroidered doilies is generally used, although a luncheon cloth covering the table is always in good taste. The menus for use in serving from the electrical appliances may be varied, as there is plenty of heat for the cooking, and by the use of a side table the extra dishes may be removed without confusion. For hot water there is nothing to equal the convenient glass globe electric heater which is ornamental as well as useful.

Excellent company luncheons may be served from the following attractive menus which may be varied and enlarged to suit the occasion:

MENU NUMBER ONE

Cream of tomato soup	
Creamed chicken in patty shells	Jelly
Rice croquettes	Celery salad
Ice cream	Cake
Coffee demi tasse	

Cream of Tomato Soup.—Place one can of tomatoes in the stew pan and cook slowly for half an hour, add one-fourth teaspoon soda, rub through strainer. Make a white sauce of one quart milk, one teaspoon butter, $\frac{1}{3}$ cup flour, $\frac{1}{2}$ teaspoon pepper, salt to taste. When sauce is thoroughly cooked add tomatoes and serve immediately.

Creamed Chicken.—Two cups cold diced chicken, $\frac{1}{3}$ teaspoon celery salt, a few drops of onion juice. Make a cream sauce of two

tablespoons of butter heated in the chafing dish. Add two tablespoons of flour, salt, pepper, add one cup of thin cream. When the sauce is cooked add chicken and heat through. Serve in patty shells.

Celery Salad.—Cut the celery into fine pieces; add half as much chopped apple as celery. Serve on lettuce leaf with mayonnaise dressing.

MENU NUMBER TWO

Consomme soup
Creamed sweetbreads with mushrooms
served on toast
Saratoga potatoes
Fruit salad
Orange ice
Chocolate
Lady fingers

MENU NUMBER THREE

Clear soup with salted wafers
Chicken croquets with creamed peas
Medley salad
Toasted crackers
Charlotte russe
Bananas in jelly
Coffee with whipped cream

MENU NUMBER FOUR

Beef tea
Escalloped oysters
Nutlet sandwiches
Waldorf salad
Chocolate cream
Mixed cakes
Coffee with cream

A little practice in arranging a neat family luncheon will soon enable one to extend the courtesy to a small company without the slightest confusion.

Electric lights hidden in the foliage of plants is an attractive feature in decoration.

The woman who is able to overcome her inclination to follow "style" blindly, who cultivates her good taste through the proper application of her life to the conditions by which she is surrounded, who is kind and gracious to the faults as well as the good qualities of others, need have no fear as to the result of her entertainments, for they will reflect her own character and receive the grateful acknowledgement of her friends.

No Sweeping, No Dusting

There is no more reason why a woman should have to sweep and dust than there is why she should have to cook over a fireplace. Sweeping and dusting are signs of a time that should be past. Such methods of cleaning were all right when better methods were unknown. Vacuum cleaning is a better method. A vacuum cleaner gets all the dust and makes none—so there is no

dusting and electricity does most of the work. The little work that a woman does is not burdensome. The air she breathes while cleaning is clean. No dust settles in her hair. When her task is finished, she is not in need of a bath. And, if she has been running the cleaner for an hour the cost of the electricity consumed is less than three cents.

Vacuum Fly Trap

A great campaign is now on, fostered by the United States Government and the health departments of various cities, against flies as carriers of disease germs. In line with this movement a Colorado housekeeper has made novel use of an electric vacuum as a fly trap. As shown in the drawing, a series of funnels are hung at the windows, over tables, or wherever flies are apt to buzz

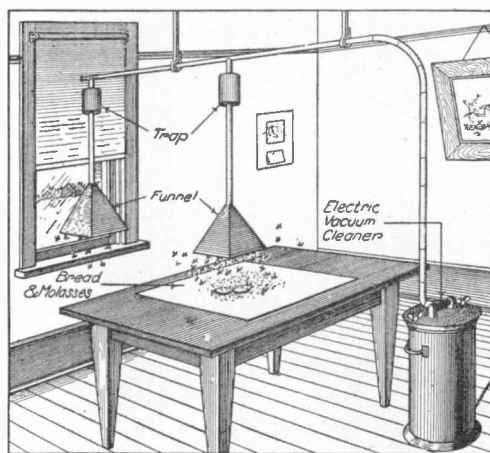

CURIOUS VACUUM FLY TRAP

about. The moment a fly gets close to a funnel the suction overcomes its wing power and it is drawn up into the fly trap, never to return. This trap has a valve which closes the suction tube when the vacuum motor is shut down, otherwise the flies might trace their way back to freedom. At convenient times the trap portion is taken off and immersed in hot water to kill the flies. If preferred the flies may be chloroformed. An interesting line of investigation would be to ascertain how many flies per kilowatt-hour of electric energy can be handled in this manner.

Small! Color Changing Fountain

An artistic electric fountain of small size, so as to be suitable for the home, is the product of a Boston firm. Unlike most of the larger fountains, this type has the jets for the water arranged around the rim of the basin, letting the spray fall inward upon a glass plate through which the light of an incandescent lamp penetrates the finely divided particles of water. In running off this glass plate the water turns a little water-wheel of the old-fashioned bucket type, which is geared to a glass cylinder surrounding the lamp. The cylinder is colored in sections, so that the spray changes from blue through green to yellow, from orange to red

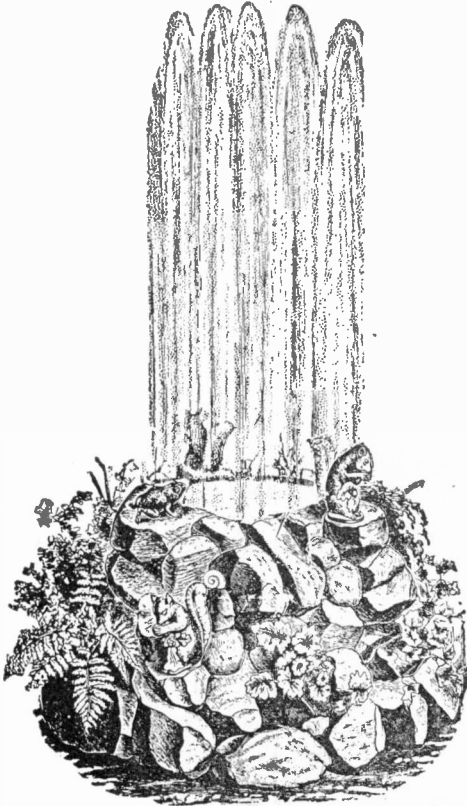

COLOR CHANGING FOUNTAIN

and then through purple back to blue. A single 32 candle-power lamp is used, thus requiring very little current, and as the waste water works the color changes, no motor is needed for this. Hence the cost of operation is very small, although the effect is a charming one

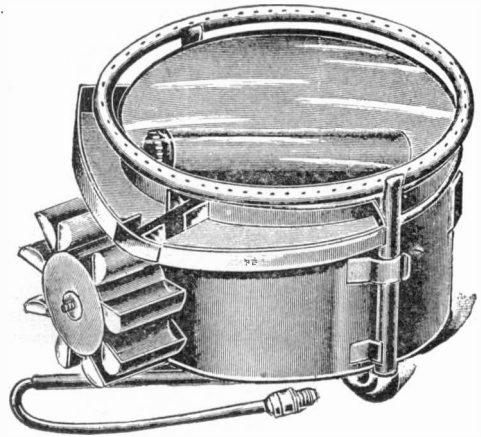

A LITTLE WATER WHEEL CHANGES THE FOUNTAIN COLORS

Pillars of Glass

Little beyond mere mention is needed to recall to the memory of Chicago Electrical Show visitors the beautiful marble like pillars of Alba glass surmounted by globes of the same material in the Macbeth-Evans exhibit.

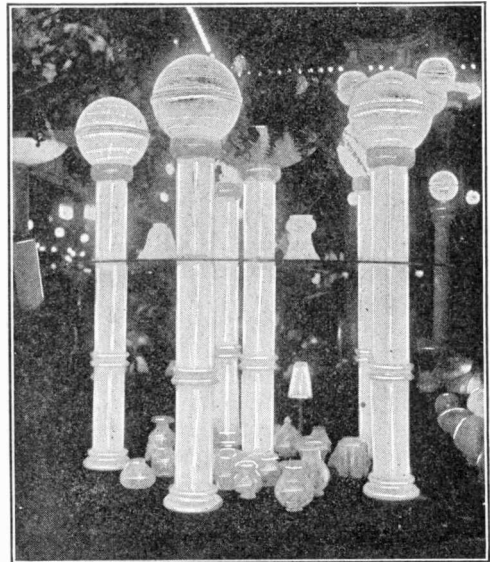

PILLARS OF GLASS

Illuminated from within, these pillars afford a most strikingly beautiful decorative effect which can be compared only to alabaster marble. Reflectors and globes made from this material have high diffusing power.

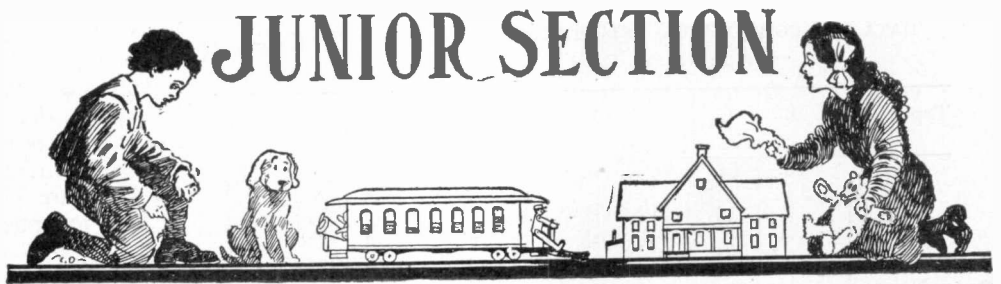

JUNIOR SECTION

Construction of Small Motors and Dynamos

By CHAS. F. FRAASA, JR.

CHAPTER IV.—BEARINGS, SHAFTS, COMMUTATORS, BRUSHES AND BRUSH HOLDERS

The bearings for the models are shown in Figs. 13 to 15 of this chapter, and the dimensions are given in tables III and IV. Fig. 13 shows the method of shaping the bearings. There are three successive stages shown in this illustration: first, the strip of metal of which the bearing is made is cut in from both

ends; second, the ends are bent apart after heating, and third, in the final shape the arms are bent so as to be perpendicular to each other.

When the bearing is of the proper shape, place on the boring machine and drill a 13-16-inch hole in the centre, and through this hole place a piece of 1/2-inch (internal diameter) brass pipe, 1 1/2 inches long. In

the smaller sizes this brass pipe should be driven in at a tight fit, but in the larger sizes must be held in place by small set screws. The holes for the bolts of the field magnets which hold the bearings in place

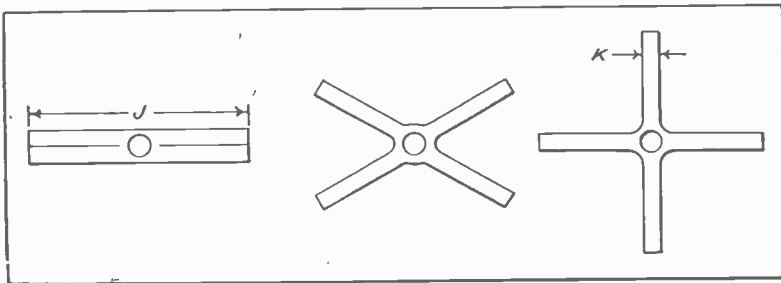

FIG. 13. METHOD OF SHAPING THE BEARINGS

ends; second, the ends are bent apart after heating, and third, in the final shape the arms are bent so as to be perpendicular to each other.

For the 50-watt size, the material is 1/4 inch thick, and for this purpose procure from the blacksmith, a strip of soft steel 1/4 inch thick by two inches wide, and about fifteen inches long, and either have the blacksmith finish it, or do it yourself. Saw a line down the centre of each end

should now be drilled. Reference to Figs. 14 and 15 will make this plain.

A grease cup, shown in Fig. 16, is a valuable addition to the bearing. To make this, drill a one-inch diameter hole in a piece of

TABLE III
DATA FOR PULLEY END BEARINGS, REFERRED TO FIG. 14
(K EQUALS 1 INCH FOR ALL TYPES)

Type	A Curve Radius	B	C	D	E	F	G	H	I	J	L
A	3 1/2	1 1/2	5	1	7	1 1/2	2 1/2	1 1/2	5-32	12	1 1/2
B	3 1/2	1 1/2	5 1/2	1 1/2	7 1/2	1 1/2	2 1/2	1 1/2	5-32	14	1 1/2
C	4 1/2	2 1/2	6	1 1/2	9	1	3 1/2	1	5-32	16	1 1/2
D	4 1/2	2 1/2	7	2	11 1/2	1	4	1	5-32	18	2

TABLE IV
DATA FOR COMMUTATOR END BEARINGS, REFERRED TO FIG. 15
(K EQUALS I INCH FOR ALL TYPES)

Type	A Curve Radius	B	C	D	E	G	H	I	J	L
A	in. $3\frac{1}{2}$	in. $1\frac{1}{4}$	in. 5	in. 1	in. 7	in. $3\frac{3}{8}$	in. $1\frac{1}{2}$	in. 5-32	in. 14	in. $1\frac{1}{2}$
B	in. $3\frac{1}{2}$	in. $1\frac{1}{4}$	in. $5\frac{1}{2}$	in. $1\frac{1}{4}$	in. $7\frac{5}{8}$	in. 4	in. $1\frac{1}{2}$	in. 5-32	in. 15	in. $1\frac{1}{2}$
C	in. 6	in. $1\frac{1}{2}$	in. 6	in. $1\frac{3}{8}$	in. $9\frac{1}{4}$	in. $5\frac{1}{4}$	in. $1\frac{1}{2}$	in. 5-32	in. 16	in. $1\frac{1}{2}$
D	in. 7	in. $1\frac{3}{4}$	in. 7	in. 2	in. $11\frac{3}{8}$	in. $6\frac{1}{4}$	in. 1	in. 5-32	in. 18	in. 2

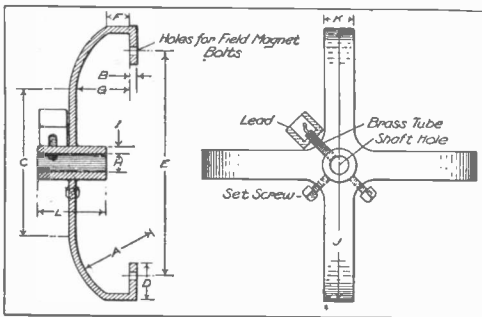

FIG. 14. PULLEY END BEARINGS

one-inch wood, and fasten by means of tacks a thin piece of wood on each side of it covering the hole. Drill holes through the two thin cover-boards, their centres coinciding with the centre of the one-inch hole, and put a piece of $\frac{1}{4}$ -inch (internal diameter) brass pipe through one side till it extends into the large hole about one-fourth inch. Then put a wooden plug in the end of the pipe in the block, and pour molten lead into the other hole, (A) Fig. 16. The casting should now be removed from the mould, and a $\frac{1}{2}$ or $\frac{3}{4}$ -inch diameter hole drilled in the top, down to the tube. Remove the plug in the tube, and put a wick in it. This makes a very good grease cup.

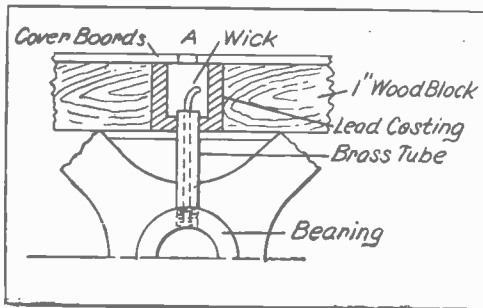

FIG. 16. GREASE CUP

The end of the brass tube should not be threaded, and should be screwed into a threaded hole in the brass bearing.

The dimensions of the shaft are shown in Fig. 17, referred to table V. The shaft may be cut from material similar

to that of the shaft of the boring machine and may be turned to shape, but must not be cut off until all the machine work is done. The shaft is turned in the same manner as the armature core (see Chapter III), and with the same tool holder. The tool holder is fastened at the proper place by the same method as was employed in turning the armature—inserted through a hole in the bed of the boring machine and clamped by lock nuts. At the position which the armature and commutator will occupy, cut a slot or

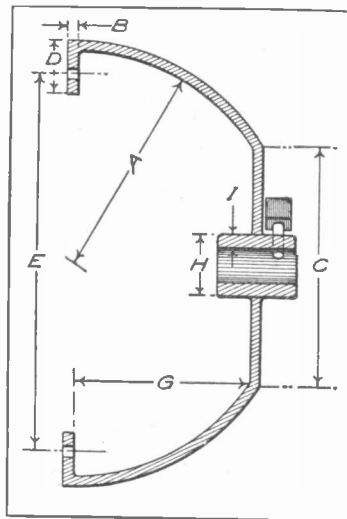

FIG. 15. COMMUTATOR END BEARINGS

keyway in one side of the shaft with a small cape chisel. This slot or keyway should be $\frac{1}{4}$ inch wide by about $\frac{1}{8}$ inch deep, so that a key of the above size will fit into it tightly. One of these keys is shown in the illustration of the commutator, Fig. 18.

The commutators of these small machines are very simple in construction, being composed of a hardwood core on which are fastened the segments, cut from a short piece of brass tubing. The commutator is

shown in Fig. 18, and is dimensioned in table VI. It is fastened to the shaft by means of a key, as shown.

To construct a commutator for the 50-watt machine, mount on the boring machine shaft a piece of oak about $\frac{3}{4}$ inch long, and of sufficient diameter for turning a cylinder $2\frac{1}{2}$ inches in diameter. Turn down as

Now loosen up the screws on the segments, and raise one segment at a time, and by means of shellac, fasten enough mica in the saw slots to completely fill them. Then screw the segments down tightly, and on the boring machine, turn down the face of the commutator and the flat-headed screws with a light cut. The armature leads are to

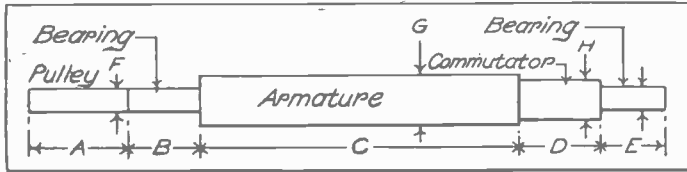

FIG. 17. SHAFT

smooth as possible and shellac its surface. Obtain a $\frac{3}{4}$ -inch piece of $2\frac{1}{2}$ -inch (internal diameter) seamless drawn brass tubing and drive onto the cylinder. If making a commutator for the two-pole field, divide its perimeter into eleven parts by eleven equally spaced lines drawn parallel to the shaft; if for the four-pole field, divide it into 33 parts. The 100-watt commutator with a two-pole field should be divided into eleven equal parts; the 300-watt, thirteen, and the 800-watt, fifteen. On the four-pole types: 100-watt, 33 parts; 300-watt, 39; on the 800-watt, 45.

Between the lines drawn on the commutator, and near the ends of the tube, drill one pair of holes to each segment marked off. Use flat-headed screws in the hole on one end and round-headed screws on the other. The flat-headed screws should be countersunk. When this is done cut the commutator tube into segments, by cutting the metal out along the lines with a hacksaw, cutting entirely through into the wood. Be careful that the segments are separated, and brush out all small saw cuttings from the saw cuts.

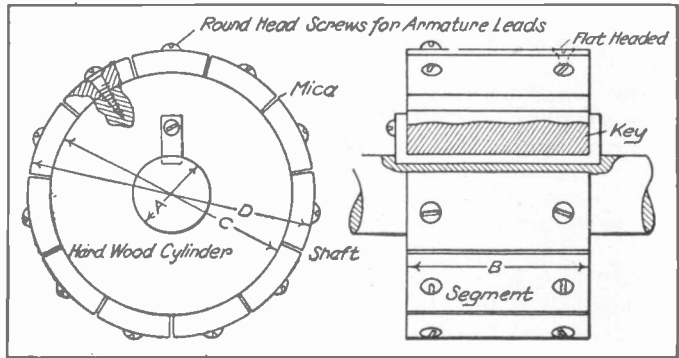

FIG. 18. COMMUTATOR

be connected under the round-headed brass screws.

The brush holders Fig. 19 of these machines are all designed for carbon brushes. These brushes may be cut down from larger sizes

TABLE VI
DATA FOR COMMUTATOR DIMENSIONS, REFERRED TO FIG. 18

Type	A	B	C	D
A	in. $\frac{3}{4}$ or 1	in. $\frac{3}{4}$	in. $2\frac{1}{2}$	in. 2 13-16
B	$\frac{3}{4}$ or 1	1	$2\frac{1}{2}$	2 13-16
C	1	$1\frac{1}{2}$	3	$3\frac{1}{2}$
D	1	$2\frac{1}{2}$	3	$3\frac{1}{2}$

TABLE V
DATA FOR SHAFT DIMENSIONS, REFERRED TO FIG. 17

Type	A	B	C	D	E	F	G	H	I
A	in. 2	in. $1\frac{1}{2}$	in. $6\frac{3}{4}$	in. $1\frac{1}{2}$	in. $1\frac{1}{2}$	in. $\frac{1}{2}$	in. 1	in. $\frac{3}{4}$	in. $\frac{1}{2}$
B	2	$1\frac{1}{2}$	$6\frac{3}{4}$	$1\frac{1}{2}$	$1\frac{1}{2}$	$\frac{3}{4}$	1	$\frac{3}{4}$	$\frac{3}{4}$
C	2	$1\frac{1}{2}$	$9\frac{1}{2}$	2	$1\frac{1}{2}$	$\frac{3}{4}$	1	$\frac{3}{4}$	$\frac{3}{4}$
D	3	2	$11\frac{1}{4}$	3	2	1	1	1	1

if the proper sizes are not at hand. The dimensions of the brushes are given in table VII under (A) and (F). The brush holders are made of a strip and a block of copper or brass. The strip, cut to the dimensions shown, should be bent to shape, and the block, $\frac{1}{4}$ by $\frac{1}{2}$ by $\frac{3}{8}$ inch fastened in place by screws. Drill and tap a hole in

it so that it will bear down on the brush as illustrated. Washers and nuts should be placed on both ends, and the brush holder fastened to the rocker brush support, Fig. 20. The rod (R) should be insulated from the support by an insulating bushing and

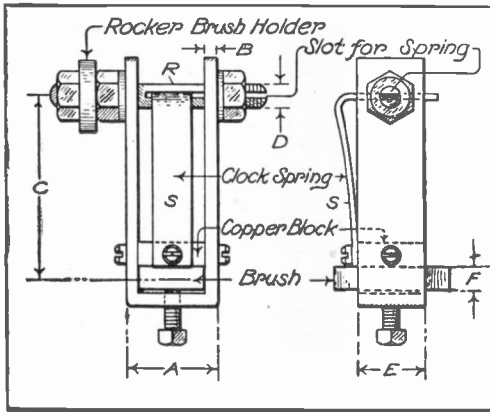

FIG. 19. BRUSH AND HOLDER

the top of the $\frac{1}{4}$ by $\frac{1}{2}$ by $\frac{3}{8}$ inch block for a screw which is used as a connector for flexible brush leads. Drill the holes for supporting

TABLE VII
BRUSH HOLDER DIMENSIONS REFERRED TO
FIG. 19

Type	TWO POLE AND FOUR POLE						Two Pole		Four Pole	
	A	B	C	D	E	F	A	B	C	D
A	in.	in.	in.	in.	in.	in.	5-16	in.	in.	in.
B	5-16	$1\frac{1}{8}$	$1\frac{3}{8}$	$1\frac{3}{8}$	$1\frac{1}{2}$	5-16	$\frac{1}{2}$	$\frac{1}{2}$	$\frac{1}{2}$	$\frac{1}{2}$
C	$1\frac{1}{2}$	$1\frac{1}{8}$	2	$2\frac{1}{2}$	$2\frac{1}{2}$	$1\frac{1}{2}$	$\frac{1}{2}$	$\frac{1}{2}$	$\frac{1}{2}$	$\frac{1}{2}$
D	$1\frac{1}{2}$	$1\frac{1}{8}$	$2\frac{1}{2}$	$2\frac{1}{2}$	$2\frac{1}{2}$	$1\frac{1}{2}$	$\frac{1}{2}$	$\frac{1}{2}$	$\frac{1}{2}$	$\frac{1}{2}$

the holder on the rod (R), in the end of the holder. Then drill and tap the hole of the screw (T) which clamps the brush in place. Cut the rod (R) to the proper length; thread the two ends, and cut a slot down one end with a hacksaw for the spring. Insert a piece of clock-spring in this slot, and bend

TABLE VIII
ROCKER ARM BRUSH HOLDER DIMENSIONS,
REFERRED TO FIG. 20

Type	A	B	C	D	E	F
A	in.	in.	in.	in.	in.	in.
B	13-16	$1\frac{3}{8}$	$2\frac{1}{4}$	$2\frac{1}{4}$	$2\frac{1}{4}$	$2\frac{1}{4}$
C	1 1-16	$2\frac{1}{4}$	$2\frac{1}{4}$	$2\frac{1}{4}$	$2\frac{1}{4}$	$2\frac{1}{4}$
D	1 5-16	$2\frac{1}{4}$	$3\frac{1}{8}$	$3\frac{1}{8}$	$3\frac{1}{8}$	$3\frac{1}{8}$

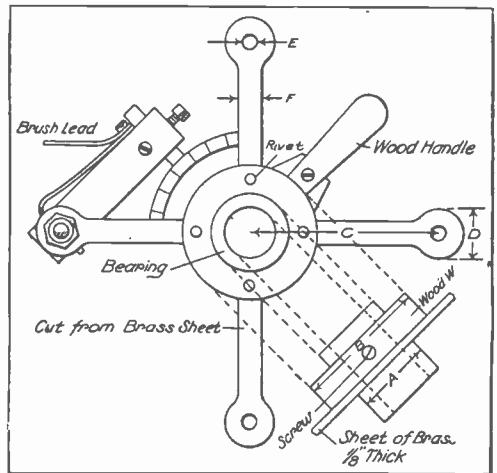

FIG. 20. ROCKER ARM BRUSH HOLDER

washers. For the two pole machine, two brushes will be required; for the four-pole, four.

The rocker arm brush holder, Fig. 20, should be cut to shape and dimensions given in table VIII, and should have fastened to it a block of wood (W) with a hole through the centre the size of the brass bearing tube. This is to support it upon the bearing, and contains a wood screw for tightening it in position.

(To be Continued.)



The Vanishing Lady

Almost as real as if of flesh and blood instead of wax, this little bright-eyed Oriental magician clad in silk gown and turban and enclosed in a glass case, entertains both the children and grownups as he shows in pantomime that he is about to do something mysterious.

Upon each side of him is a metal cabinet, one oblong, the other a cube, each with hinged doors.

To begin his mysterious act, at his first gesture both doors open, the lamps on the platform light up and the cabinets are seen to be empty. The doors then close as with a nod of cunning the wax wizard turns to his right and strikes a gong suspended at the corner of the table. Immediately the cabinet door opens disclosing a lady seated within clad in a silk kimono, and holding a fan in her right hand. The door closes, then both cabinet doors open, the lamps light, and my lady has vanished. At a wave of his fan toward the oblong cabinet the door opens and there she is found standing up with the fan still in her hand. The door closes and again both doors open. The lady has disappeared and the cabinets are found unoccupied as at first. The scene is made more weird by the light from

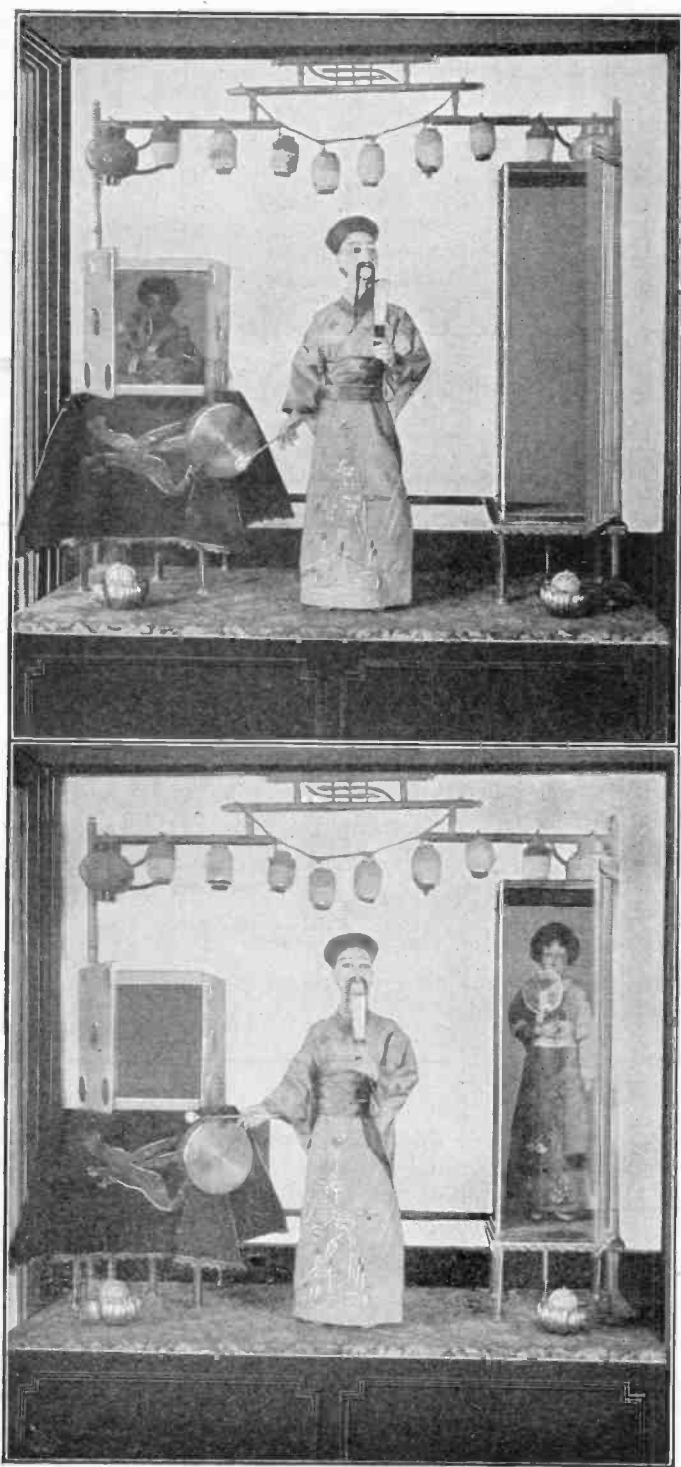

THE STRANGE DELUSION OF THE VANISHING LADY

eight small lamps within Chinese lanterns suspended over the magician's head and the little folks exclaim in wonderment, "How does he do it?"

A little electric motor and small flasher are located under the platform. The lady in the cabinet at the magician's right eludes the eye by being lowered floor and all into the table which, of course, is covered by a beautiful table cloth, and a false floor above her head comes down, too, covering her up

You might also arrange to have the water from the overflow pipe move a lever arm and taking the place of the floor she sits on. Her twin sister who stands up all the time is fastened to a velvet-covered revolving board which the motor by means of wheels and belts quickly turns half round while the door is closed.

This interesting device may be seen in the children's play room on the eighth floor of Marshall Field's, Chicago.

THE YOUNG EDISONS' CLUB

Under this heading will be published letters from readers of the Junior Department. These letters should describe briefly and accurately your experiences in the making and operation of electrical devices and in the performing of electrical experiments. See how good an "engineering report" you can make of your investigations.

The Young Edisons' Club:

Here is a description of a high water alarm designed to be used in a place where you have to pump water from the cellar up into a tank in the attic. It saves you the trouble

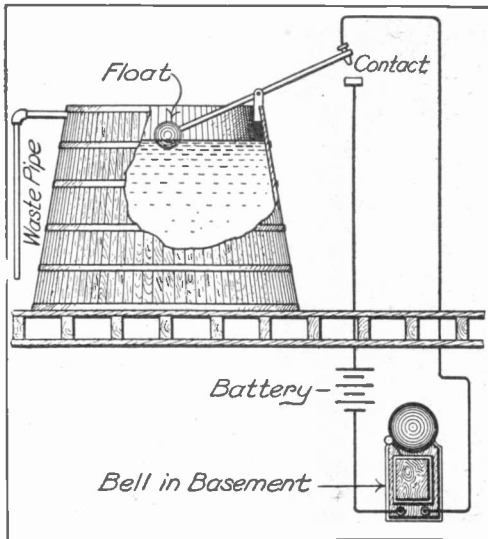

FIG. 1

of climbing up stairs every little while to see if the tank is full.

Pivot a lever arm on the edge of the tank so that one end will tip down into the tank. Arrange a float on the end of the lever so that it will be lifted when the tank is nearly full. Arrange a bell circuit so that the circuit will be closed when the water reaches a certain height (Fig. 1).

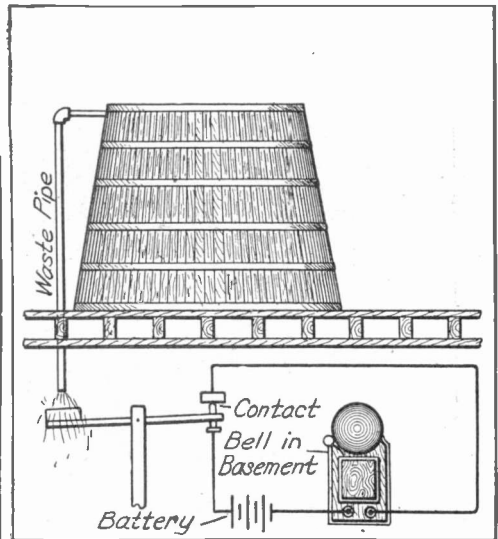

FIG. 2

during shopping hours a crowd of the curious of all ages may be found in front of it. Close the circuit when the water begins to flow from the pipe outside the house (Fig. 2).

HAROLD H. LEWIS.

617 N. Fayette St.,
Saginaw, Mich.

The Young Edisons' Club:

My shop is built of scraps and boxing lumber and is 8 by 10 feet 6 inches. The roof is shingled and I have it whitewashed inside to make it lighter.

My equipment, which I bought outright, consists first of a dynamo (20 volts, 4 am-

peres, 80 watts at 2000 revolutions per minute). This I drive with my $2\frac{1}{2}$ horsepower Shaw motorcycle engine. I put a sewing machine fly wheel on the dynamo to steady it. Besides this I have twelve Edison key sockets, twelve Edison base 14-candle-power lamps, 300 feet No. 14 R. C. wire, 30 feet No. 16 lamp cord, switchboard (soft wood, 24 by 30 inches), one voltmeter 0 to 25, one field rheostat, two switch and fuse blocks, eight four-ampere fuses, one single pole switch and one double pole switch.

For tools I have two screw drivers, one compass saw, one hand saw, one hack saw, four bits ($\frac{1}{4}$, $\frac{3}{8}$, $\frac{1}{2}$, $\cdot 1$), three drills (3-32, $\frac{1}{4}$, 5-32), one brace, one cold chisel, one punch, one hammer, one rivet set, one soldering copper, one pair tin snips, two awls and two planes.

My library consists of one "Physics," one "Easy Experiments in Electricity," one "Amateur Mechanics," POPULAR ELECTRICITY and *Popular Mechanics*.

When I get my wireless I will have a nearly complete shop. I have already made two telephones, I have one in the shop and one in the house. These were made from so-called worthless parts. But I found only a little labor would make them as good as new.

F. R. STERLING.

Box 772,
Hartington, Nebr.

The Young Edisons' Club:

My experience with electricity is of course only as an amateur, but I will first tell you how I first became interested in electrical matters. When I was attending High School, I boarded with a fellow student who studied physics. He became interested in making an electric bell and of course I was anxious to learn what kind of a thing an electric bell was and to help him. After a good deal of experimenting and studying we made a contrivance which would buzz, but not ring, as we did not have the facilities for putting the bell part on. The magnet was about three and one-half inches long and two inches wide across the poles. We had wound the magnet with No. 28 magnet wire, which as you know is too fine for an electric bell to be operated by batteries. It worked fairly well, however, on three cells. It was an awkward looking affair, with a wooden base about ten inches in length and

seven in width. We didn't even have a then cover for it to keep the dust out.

Our success with the electric bell of course made us more anxious to make some more apparatus; so we decided to make a spark coil, but our lack of finances would not then allow it.

About two months later I purchased a half pound of No. 16 magnet wire and a quarter of a pound of No. 29. I used the No. 16 for the primary and the No. 29 for the secondary and constructed an induction coil which would give a good shock when run on two or three dry cells. I used to have lots of fun with my induction coil with my friends as I could give them good smart shocks when they were least expecting it. I also made a good shocking coil out of an ordinary telephone induction coil, by simply winding more wire onto the secondary.

I have never bought any new batteries. Instead I would get the worn-out batteries from the telephone office and renew them. This I would do by cutting the zinc open on one side and removing it, being careful not to break the paper or pasteboard on the inside. Then I would scrape the zinc clean and sandpaper the outside, then place it carefully on the carbon element again, tying it in place with a cord. Then I take a quart fruit jar or bottle and remove the top in the following manner: Wrap four or five thicknesses of string around the top just above where you intend to take it off, saturate it with kerosene, light it and it will usually break off just above the string; if it does not, dash it into cold water, top first, which will generally take it off. Now place the cell in the jar and fill the latter with rain water and add enough sal ammoniac to make a good strong solution. After the cell stands for a few minutes it is ready for use. I have two of these cells in operation now and they do fine work on my "Little Hustler" motor and doorbell. Of course more cells could be "fixed up" in this way, but I think I would connect them series-multiple so as to get more current. One of these cells has been in operation more than two weeks and I can't see that the zinc is consumed a bit yet.

Do not pay any attention to anyone who tries to make fun of you for "monkeying" with "electrical things."

ORLO MUTCHLER.

202 Herkimer Ave.,
Allegan, Mich.

POPULAR ELECTRICITY WIRELESS CLUB

Membership in Popular Electricity Wireless Club is made up of readers of this magazine who have constructed or are operating wireless apparatus or systems. Membership blanks will be sent upon request. This department of the magazine will be devoted to the interests of the Club, and members are invited to assist in making it as valuable and interesting as possible, by sending in descriptions and photographs of their equipments.

A High-Power Wireless Equipment

By ALFRED P. MORGAN

PART XII.—POTENTIOMETER; FIXED CONDENSER

The action of the electrolytic detector has already been explained in detail, but in order more fully to understand the purpose and usefulness of a potentiometer it may be well to recall that when the positive half of the wave is passing, the voltage of the high frequency currents is sufficient to break down the film of gas on the Wollaston wire point and permit the battery current to flow.

The purpose of the potentiometer is to lower the voltage of the battery to such a point that it is insufficient of itself to break down the film of gas but still is strong enough to quickly reform the film of gas after it has been broken by the high frequency currents and the latter have ceased to pass.

In order to understand this action, which is the principle of the Wheatstone bridge, the fall of potential along a wire must first be explained. If any electrical circuit connected with a source of current supply is carefully examined, it will be found that the

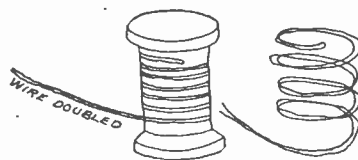

FIG. 134. NON-INDUCTIVE WINDING

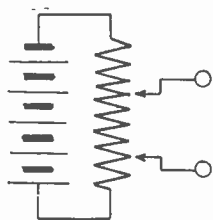

FIG. 132. RESISTANCE IN PARALLEL

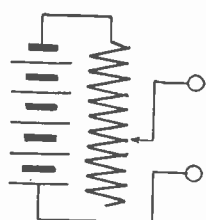

FIG. 133. RESISTANCE IN SERIES

In construction, a potentiometer is merely a variable resistance shunted across the terminals of the battery as in Fig. 132. If placed in series with the battery as in Fig. 133, it would serve merely to regulate the current strength in the circuit. When connected in parallel with the source of current it is the voltage which is varied.

potential falls off as the distance away from the source of current becomes greater. In other words, the voltage drop between two points in a circuit is proportional to the resistance between the points.

Potentiometers are made in two forms, the first employed usually by makers of amateur wireless telegraph instruments, wherein the resistance is in the form of a graphite rod or a hard rubber rod wound with German silver wire and having a ball bearing slider or wheel rubbing over it. The second is more often used in connection with commercial apparatus and the resistance consists of a number of coils of wire variable by means of a multi-pointed switch.

I have chosen this latter type to describe because it is not only more satisfactory but also because it is more in keeping with the remainder of the apparatus.

The resistance units consist of coils of German-silver wire wound carefully in the non-inductive manner shown in Fig. 134. The wire forming each coil is doubled back on itself before being wound in order to avoid self-induction and not unbalance the detector circuit whenever the adjustment of the potentiometer is changed.

The coils number 22 all told. Eleven coils have a resistance of 35 ohms apiece and the other eleven 33 ohms together or three ohms apiece.

The table given below shows the length of wire for several sizes required to form each coil. The proper lengths should be measured off and cut and then rolled up in the manner stated.

GERMAN SILVER WIRE—18 PER CENT

NO. B.&S.	LENGTH OF WIRE IN 35 OHM COILS	LENGTH OF WIRE IN 3 OHM COILS
30	18.5 feet	1.6 feet
32	11.9 "	1.0 "
34	7.3 "	0.6 "
36	4.5 "	0.4 "

The case of the instrument is $\frac{3}{8}$ -inch mahogany, built so as to form a box whose outside dimensions are 6 by $4\frac{1}{2}$ by $2\frac{3}{4}$ inches. The top and bottom of the case project slightly beyond the sides so as to improve its appearance.

The details of the contacts and the switches are shown in Fig. 135. The contacts are

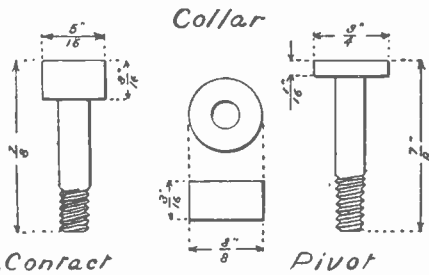

FIG. 135. DETAILS OF CONTACTS AND SWITCHES

turned out of 5-16 inch brass rod and are threaded with an 8-32 die at the lower end. They are $\frac{7}{8}$ inch long over all and $\frac{3}{16}$ inch high above the top of the case. They are set equidistantly around the circumference of two circles each $1\frac{1}{8}$ inches in diameter.

A hexagonal brass nut having an 8-32 thread is screwed on the lower end of the

contact so as to hold it firmly in place. After all the contacts are in place the resistance units are fastened in the bottom part of the case by gluing around the sides. Connections are established to the lower ends of the contacts by soldering.

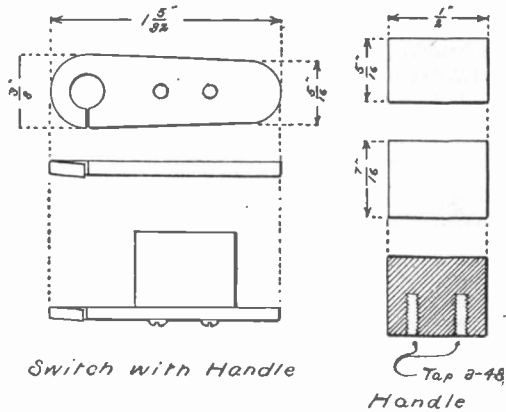

FIG. 136. DETAILS OF SWITCH ARMS AND HANDLE

All of the 35-ohm coils are connected in one group and all of the three-ohm coils in the other.

The switch arms are cut out of 1-16-inch hard sheet brass as shown in Fig. 136. The pivoted end of the switch is cut and bent down so as to form good contact with the pivot at all times. A brass collar $\frac{3}{8}$ inch in

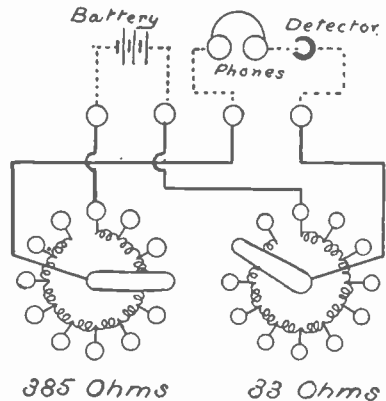

FIG. 137. CIRCUIT DIAGRAM

diameter and 3-16 inch thick is placed under the switch so as to bring it level with the tops of the contacts.

The handles are formed of two small hard rubber blocks $\frac{1}{2}$ inch long, 7-16 inch high and 5-16 inch thick. They are polished in a

buffing wheel charged with wet pumice stone or tripoli powder. Two 3-48 brass screws passing through the switch from the under side into each block hold them in position.

The connections are shown by the diagram in Fig. 137. The heavy wires leading from the resistance units lead to two binding posts which are connected to the battery. The two switch arms connect to two other

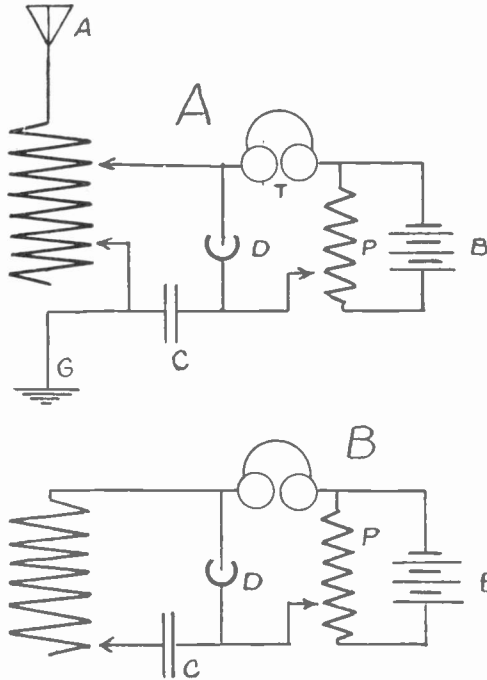

FIG. 138. RECEIVING CIRCUITS WITH FIXED CONDENSERS

binding posts which in turn are connected to the detector and to the telephone receivers.

FIXED CONDENSER

Condensers for use in the receiving circuit of a wireless telegraph installations may be divided into two types, those which are adjustable or variable and "fixed" condensers whose capacities may only be altered in steps. To the former class belong the rotary plate, sliding plate and sliding tube types which have air as a dielectric. Those are used exclusively for tuning purposes and therefore may be dismissed from our attention at the present.

Fixed condensers usually employ paper, mica or thin glass as a dielectric. They are

necessary in the receiving circuit in order to prevent the turns of the tuning coil which are included in the closed circuit from forming a short-circuit around the battery and the telephone receivers. This will be readily understood from the two circuits shown in Fig. 138.

The first one (A), represents the arrangement of an ordinary "close" coupled double slide tuning coil while the second (B) illustrates the secondary circuit of a "loose" coupled system.

The proper capacity for a fixed condenser is dependent upon conditions peculiar to each receiving set. It is something which if the best results are desired it is impossible to predetermine. I always prefer to build several condensers of varying capacity and pick out the best one by experiment. If the capacity is too small it will weaken the sig-

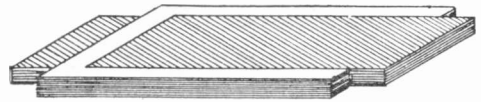

FIG. 139. FIXED CONDENSER, "BUILT UP" TYPE

nals while if too large the signals will sound "mushy". The proper capacity will render the signals sharp and clear.

The most desirable fixed condenser for receiving purposes is that type known as a "built-up" condenser and which consists of a large number of small sheets alternately paper and tinfoil laid one on top of the other as opposed to the roll condenser which consists of a smaller number of large sheets rolled up so as to occupy a smaller space. It has been found that a roll condenser cannot charge and discharge as rapidly as a "built-up" condenser.

In making a condenser for this purpose it is sometimes a good plan to divide it into several units and then by connecting the units in various ways several values of capacity may be obtained. Two condensers of equal capacity connected in parallel have twice the capacity of one, while in series they will have only one-half the capacity of either.

The condenser described below will be found to be as nearly suited to the average receptor as it is possible to obtain without experiment.

It is composed of sixteen sheets of tinfoil $1\frac{1}{4}$ inches wide and three inches long. The

paper is a good grade of linen .005 inch thick carefully prepared by dripping in a molten bath of clean paraffin until all bubbles cease to rise. It is hung up to dry and then cut into strips, $1\frac{1}{2}$ inches wide and three inches long. The paper and tinfoil strips are piled up alternately allowing about 5-16 inch on each tinfoil strip to project beyond the paper as shown in Fig. 139, alternately, first on one side and then the other.

Place the condenser between two flat boards which may be squeezed together with

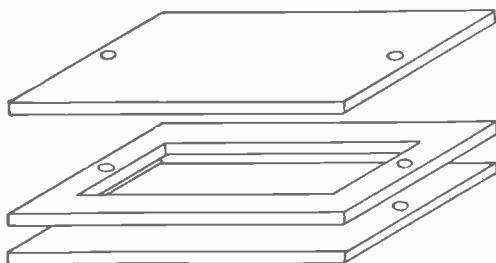

FIG. 140. CONDENSER CASE

a clamp and put them in an oven which is hot enough to melt the paraffin. As soon as the paraffin on the paper has thoroughly softened, tighten up the clamps and set the condenser away to cool.

As soon as cool it may be removed from the clamps. It should be firm and hard enough to hold together.

The tinfoil strips are bunched together at each end and soldered to a stranded copper wire.

If desired the condenser may be placed in the base of the detector or mounted in a case of its own. If the latter, the scheme shown in Fig. 140 will be found to be very effective. A rectangular hole $3\frac{1}{2}$ inches long and $1\frac{3}{4}$ inches wide is cut and is the centre of a piece of hard rubber 3-16 inch thick, $4\frac{3}{4}$ inches long and $2\frac{3}{4}$ inches wide. The corners are rounded so as to give a finished appearance to the case.

The sections may now be fastened together by two brass machine screws which pass through at both ends as shown in the illustration. The condenser is placed in the case and connections established to the screws. These may be passed through the sides of the potentiometer box or the detector case and secured on the under side with a hexagonal unit, making a neat and compact unit.

(To be Continued.)

Operation of Spark Coils on 110 Volts

Many letters have been received of late requesting information as to how spark coils may be run on 110-volt electric light circuits. Most coils used by experimenters are designed to operate on from six to twelve volts, and a well designed coil should not consume more than eighteen watts per inch of rated spark length.

The use of an electrolytic interrupter in series with a battery spark coil on 110 volts is often the cause of the insulation of the secondary winding breaking down. The prime reason for this is that there is no electrolytic interrupter on the market at a low price which will operate satisfactorily unless a current of 20 amperes or more is passing through it. If this combination is used in connection with a circuit of 110 volts pressure, 2,000 watts or more are being used in the coil, depending upon the resistance of the electrolyte used in the interrupter and the amount of surface exposed at the "point." Since the coil was made to consume from eighteen to 75 watts, depending upon its size, the use of an electrolytic interrupter as described

greatly overloads the coil and causes considerable heating of the windings. Moreover, the voltage produced in the secondary of a coil connected in this way is many times higher at the moment the current is broken by the interrupter than that for which the coil was designed, and consequently many break-downs occur.

One of the most satisfactory ways to operate a battery spark coil on 110 volts, D. C. is illustrated. The battery (B) may be a set of dry cells connected in series, or a storage battery of the proper voltage for the coil. As many 32-candle-power lamps should be connected as shown² as will give the number of amperes the coil consumes. The battery acts as a voltage reducer and will last almost indefinitely if switch (S) is "on" while the

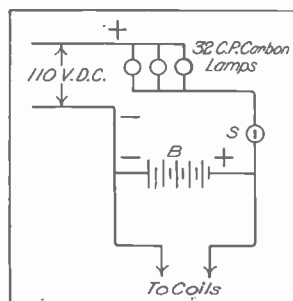

SPARK COIL ON 110 VOLTS

coil is being used, and "off" at all other times. This method does not cause flickering of the lights in the house when the key is depressed and the coil cannot possibly be damaged. In connecting be sure that the positive (carbon, in the case of a dry battery) is connected to the positive wire of the electric light circuit.

One of the most satisfactory and safe ways to operate a battery spark coil on a 110-volt A. C. circuit is to revolve the adjusting screw of the vibrator until it cannot

operate, and to connect the coil in series with two ten-inch gas lighting spark coils. These coils consist of one winding of wire. The spark coil then acts as an open core transformer, and the gas lighting coils act as a reactance. The spark produced by the coil with this method is short and thick, like that of a transformer, and large spark gap terminals should be used to prevent their overheating. It will also be found that a larger condenser connected in the secondary circuit will be needed. A. B. COLE.

Wireless Without a Ground

The sending of wireless messages through space without a ground at either station has been demonstrated by the inventors, Messrs. Jonesick Bros. of Cambridge, Mass., and I. Wolff of Roxbury, Mass. The experiment was made by means of a complete sending and receiving set of apparatus mounted on bicycles

including the aerial, as seen in the photographs. No ground wire was used, as the rubber tires prevented any con-

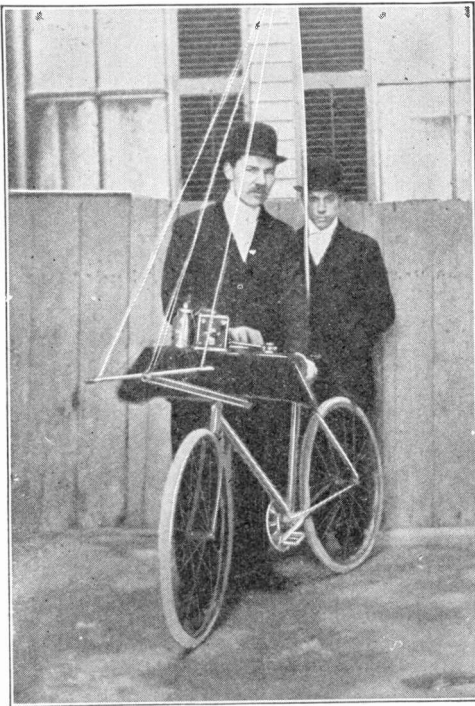

SENDING SET

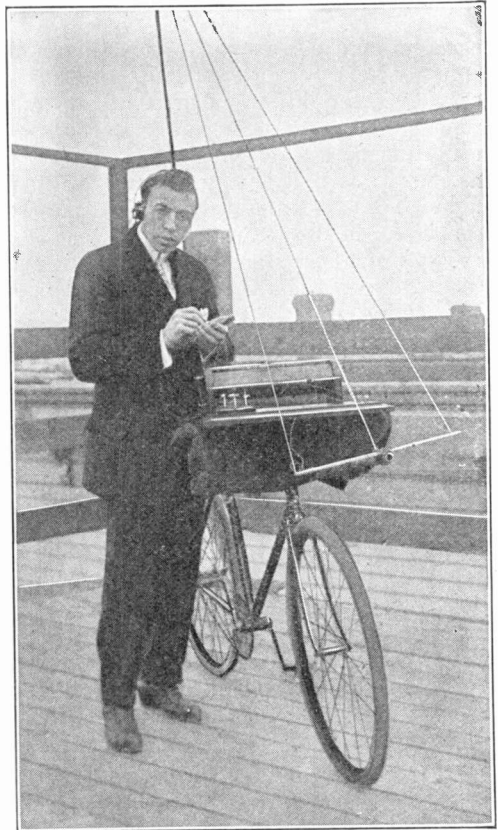

RECEIVING SET

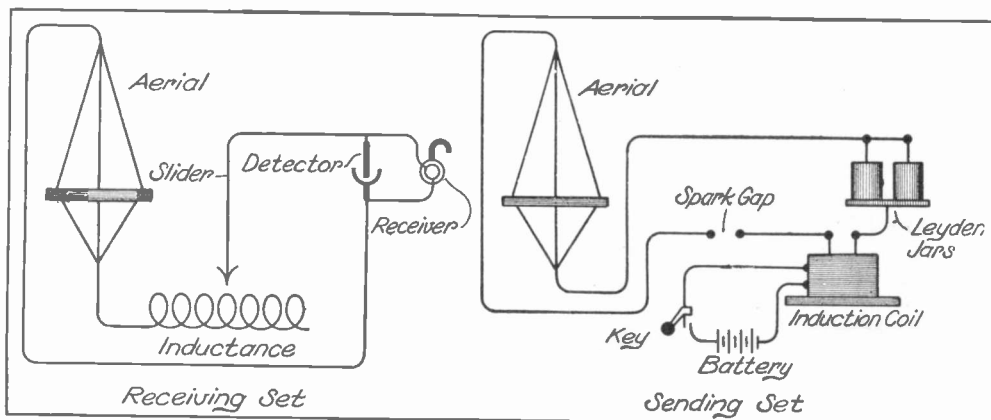

CONNECTIONS OF BICYCLE WIRELESS OUTFIT

nection or leak of the high frequency oscillating currents to escape through the frame and wheels.

The sending apparatus of the set consisted of a three-inch spark coil, two high tension leyden jar condensers connected in multiple, a spark gap, and an operator's key. The entire set was mounted rigidly on a board $8\frac{1}{2}$ by eighteen inches. A set of six dry cells which operated the coil was placed underneath the board, and the complete station fastened to the handle bar of the bicycle. The operator would guide the bicycle with one hand and operate the set with the other.

The receiving apparatus of the set, which was operated by Mr. Wolff, consisted of a large inductance coil equipped with a sliding contact so as to provide accurate tuning when necessary, a sensitive piece of silicon used in a high tension adjustable mineral detector holder, a switch and one 2,000-ohm double pole laminated core magnet receiver, wound with copper wire, held on the head by means of a head band. The entire set was mounted on a board and fastened to the handle bar of the bicycle as seen in the photograph, and operated in the same manner as described in the sending set.

The aerials of the two sets were equivalent. Each was made up of a ten-foot pole (a bamboo fishing rod ten feet long) fastened to the back of the seat on the bicycle, and three wires each $12\frac{1}{2}$ feet long of phosphor bronze. These were constructed in the shape of a cage, connected at top and looped in one at the bottom, which was suspended on a cross bar as shown in the photographs. All connections were permanent and rigidly

clamped so as to prevent trouble.

The lack of space for a helix in the sending circuit compelled the construction of a double wire spread in the aerial used by Mr. Jonesick in his sending set.

Where both sets were to be used as one, the clear space on the board, as shown to the right of the photograph representing the receiving set, was left for placing the sending apparatus.

A distance of about $2\frac{1}{2}$ miles was covered with great success, on the evening of February 4, 1911, at 10:30 p. m., and the distance of about $3\frac{1}{2}$ miles on the morning following at 2 a. m. When covering the last distance one of the operators was situated at the foot of the N. Harvard St. Bridge and the other at the foot of the Cambridge Bridge along the banks of the Charles River, Boston, Mass.

H. FRANK.

Solder for Detector Crystals

Most of the articles published on detectors recommend ordinary solder for holding the crystals in the cups. For one who is willing to take the trouble to get the bismuth, the alloy here described is better. Its convenience lies in its low melting point, which is very near the temperature of boiling water. The composition of the alloy is as follows: Bismuth two parts (by weight); lead one part; tin one part. The lead is first melted and the tin added, then the bismuth put in and stirred, the temperature being kept only high enough to keep the alloy melted, otherwise the tin becomes oxidized and forms a scum.

J. H. STEWART.

Hints on Increasing Efficiency

By GEORGE F. WORTS

There is hardly any portion of the amateur's transmitting set that is not susceptible to improvement of some kind. Leakage and incorrect capacity are about the commonest faults. In insulating wireless sets, it should be borne in mind that though rubber and glass rank high as dielectrics their surface leakage is extremely high. Where a great difference of potential exists across a small area, such as in a helix or spark gap, fibre, though ranking low as a dielectric, should be used as its surface leakage is low as contrasted with rubber and glass. Slate will nearly always be found to contain metallic veins that are conducting paths for high voltage currents and therefore undesirable for all but low voltage insulation. Wood may be used on most all high voltage insulation as it appears to hold up very well under most conditions.

Connecting wires should lead in as straight a line as possible to the instruments as sharp corners incur leakage, while numerous turns introduce extra inductance and will possibly unbalance an otherwise well synchronised circuit.

The induction coil has been gradually superseded by the closed core transformer, which is much more efficient, cheaper to build and costs less to run. Experiment has proven that the type of closed core transformer in which the primary is wound upon one side or "leg" and the secondary upon the other side, is practically as efficient as the type in which part of the primary and secondary are wound upon each leg and is cheaper to build.

Of late, amateurs have awakened to the fact that high voltage transformers will send considerably farther than those of low voltage. The commercial companies have realized this for several years and consequently use transformers producing 25,000 to 50,000 volts. It is impossible to use this high voltage on low power, amateur wireless sets, as the amperage of a 250-watt transformer is so low if over 15,000 volts is used, that it will not charge condensers satisfactorily. However, the amperage at 15,000 volts of a properly designed, 250-watt transformer will, with condensers, produce a fat spark about

$\frac{3}{8}$ of an inch in length, that has marvelous powers for sending. Without condensers a worm-like flame will jump between points about $\frac{1}{2}$ inch apart. It may be easily drawn out to $1\frac{1}{2}$ inches.

A $\frac{1}{2}$ K. W. transformer wound to give 20,000 volts on the high side will charge condensers rapidly enough to give a working spark of over one inch, see illustration.

The use of the high voltage transformer makes possible the use of the high speed rotating gap, the advantage of which lies in the sharp and even spark that results from its use. A high pitched tone may be also produced by a series gap. A satisfactory experimental series gap can be made by driving a row of copper tacks in a well

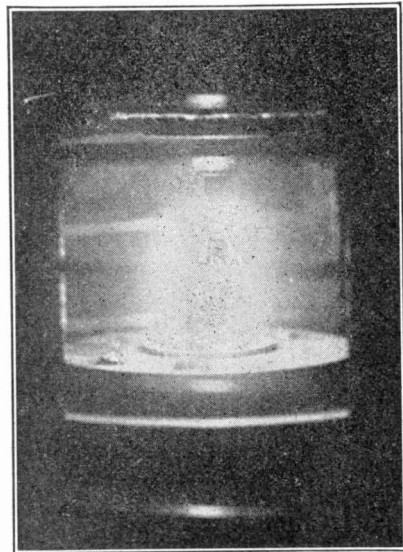

SPARK FROM A $\frac{1}{2}$ K. W. TRANSFORMER

seasoned board. Their heads should protrude $\frac{1}{8}$ inch and be separated 1-32 inch. The number will depend, of course, on the voltage. The tone at the receiving end is clear and almost musical. Tests have proven that the sensitiveness of high resistance wireless receivers increases with the increase in the height of the pitch of the tone. Fessenden and Stone, observing this, have brought out their well known singing spark

apparatus that has about revolutionized wireless commercially. The cost of high frequency generators which are necessary in this type of transmitter, prohibit its use by amateurs. However, by the use of a series or revolving gap with a high voltage transformer and condenser, a fairly high pitched tone may be produced that is suitable for most amateurs' requirements.

In designing high voltage transformers, the insulation enters as a prime factor. Primaries should be well insulated between consecutive layers and all secondary windings should be subjected to an impregnating process in slowly boiling refined paraffin for a long period. If the secondaries are wound pancake style, which is a much more efficient though difficult method of construction than that entailed in the block secondary type, each section, after impregnation, should be well taped with oiled linen or muslin tape $\frac{3}{4}$ inch in width. This tape should be cut diagonally from large sheets of the material. If it is cut or torn lengthwise, it will break easily. Varnished muslin cloth, owing to its stiffness, is not well adapted for sharp turns or small diameters.

Oiled muslin has a greater flexibility and longer life under heat conditions, its insulating base being the best quality of linseed oil in which no varnish or drier is used. If bias tape is desired the raw material should be first prepared before going through the insulating process and then cleanly and evenly cut to the width desired, thus eliminating any rupture on the oiled insulating films. This tape may be purchased in the yellow color of oil, although black varnished tape is sometimes used. The average puncture test of oiled muslin is one thousand volts per mil.

Windings should be insulated from the iron to withstand a direct puncture test of 100,000 volts. This can be obtained with ten layers of ten mil cloth. If transformers are to be immersed in oil, it should be pure linseed oil, as inferior oils will do much more harm than good to transformers.

The condensers used in converting the secondary current into a live, effective discharge will differ materially from those used on low voltage sets. The usual descriptions of sending condensers depict a lug of tin foil fastened by shellac between photographic plates. A condenser of this type will actually "burn up" when connected across the secondary of a transformer of over 15,000 volts.

Even two sheets of the aforementioned dielectric are insufficient. It is advisable to construct the condenser in units with two plates between each lug and the group of units connected in series multiple. For a one K. W. transformer 200 eight by ten photographic plates, connected in this manner, will suffice.

In using a high voltage transformer, if an ordinary gap is used, it may be of silver, copper, brass, zinc, aluminum or steel, though zinc will be found to give results a trifle superior to the others. The electrodes should be about the size of pencils and rounded at the ends. These electrodes will do for any transformer under five K. W. capacity.

Transmitting loose couplers (oscillation transformers) are not efficient on small aeriels. If a helix is used, its diameter should be no less than twelve inches as a smaller diameter will cause the tuning to be too sharp at the receiving end. Commercial companies wind their helices, on sets as low as one K. W., fourteen inches in diameter. This causes the tuning to be coarse even at a great distance which is an important consideration in commercial work. The usual ineffectiveness of amateurs' aeriels calls for some counterbalance which is found at least partially in the use of a helix of large diameter. The turns should be spaced over one inch apart and should be well insulated from the wood helix frame by heavy fibre strips.

An efficient set with a good aerial *under all conditions* should cover one mile for every ten watts of energy expended. A $\frac{1}{2}$ kilowatt set should cover 50 miles; a two kilowatt set, 200 miles, etc. Actual tests have proven that most stations will send considerably farther than this under good operating conditions.

Prescription by Wireless

The captain of a tramp steamer in the Gulf of Mexico was taken ill with ptomaine poisoning. With death staring him in the face on account of inadequate medical aid he decided to call, by wireless, for assistance from the physicians at a naval station 100 miles distant. A liner 700 miles farther away heard the wireless call and the ship's surgeon made haste to reply with the necessary prescription which was then filled from the tramp steamer's medicine chest.

Three Slide Tuning Coil

BY A. B. COLE

The three slide tuning coil is preferred to the loose coupled tuner by many experimenters for several reasons. A first-class loose coupled tuner is expensive as compared to the ordinary straight tuner, but is much more selective, enabling the operator to pick out one station from a number, provided that their wave lengths are quite different.

This very selectivity is, however, a disadvantage at times, for if the tuner is set for any one wave length, it is highly probable that signals from a distant station of a different wave length will not affect the detector sufficiently to attract the attention of the receiving operator, and the distant station will have difficulty in making itself heard.

The well known double slide tuner is not nearly so selective as the loose coupled type, and while better adapted to all around work for the reason stated above, is not satisfactory where there is much interference.

The three slide tuning coil combines the advantages of both the above mentioned types, and it can readily be made by the experimenter. It may be well to show how this tuner operates.

In both the double slide tuning coil and the loose coupled variety we have a number of turns of wire in series with the aerial and the ground, and variation of the inductance of this circuit is accomplished by cutting in or out more or less of the turns of wire, generally by means of a sliding contact.

In both these tuning coils we also have a circuit of variable inductance containing turns of wire on the tuner, the detector, and a condenser. In the case of the double slide tuner, this circuit generally contains turns of wire on the tuner which are common to the aerial, tuning-coil ground circuit, whereas in the loose coupled tuner the detector, tuning-coil condenser circuit includes turns of the secondary winding, which are separated from the primary turns by an air gap.

In both types of tuning coils the inductance of the aerial, tuning-coil ground circuit and that of the detector, tuning-coil, condenser circuit may be varied independently of each other, but in the loose coupled tuner we can also vary the distance between the primary and secondary windings, and thereby effect a greater selectivity.

Referring to the figure, it will be seen that the three-slide tuner acts as both a straight tuner and a loose coupled tuner. The aerial-tuning-coil ground circuit is (A-3-G). The detector, tuning-coil, condenser circuit is (D-1-2-C). The inductance of these circuits can be varied by moving sliding contacts (3), and (2) and (1) respectively. So far we have the general characteristics of the straight tuner.

Beyond the above variation we have another,—that of changing the distance between the two circuits. By leaving slider (3) fixed, and the distance between (1) and

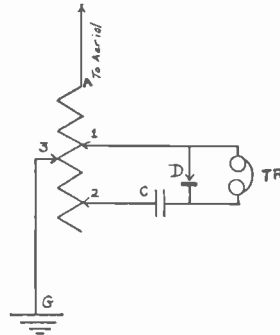

CONNECTIONS OF THREE SLIDE TUNING COIL

(2) constant, it will be observed that the distance between active turns (A-3) and active turns (1-2) can also be varied by moving sliders (1) and (2) down. Thus we combine the actions of the double slide and loose coupled tuning coils and increase efficiency for all around working, for while the three slide tuner is not quite so selective as the loose coupled tuner, it is generally sufficiently so, especially if condenser (C) is variable and of large maximum capacity.

It will be found that there is a general position for the sliders, where nearly all stations can be heard, and after a little practice the experimenter will be able to find this without difficulty.

The general position may be found more readily than in the loose coupled tuner because the three slide type is not so selective, as we have stated above, due to the fact that the two circuits are common to the same wire, and not separated by an air gap.

The writer has used this type of tuner for about a year in a location where there is considerable interference, and the results have been very satisfactory.

WIRELESS QUERIES

Answered by A. B. Cole

Questions sent in to this department must comply with the same requirements that are specified in the case of the questions and answers on general electrical subjects. See "Questions and Answers" department.

Location of Aerial; Effect of High Mountain

Questions.—(A) For a station located in a valley, would an aerial 65 or 70 feet high be satisfactory? (B) When electric waves from a wireless telegraph station meet a high mountain, will they pass over it, or will they die out? (C) If my aerial were on the farther side of the mountain could I receive messages from the above transmitting station?—R. J., Vancouver, Can.

Answers.—(A) Yes.

(B) Part of the waves will pass over the mountain and down the other side, and part will be reflected in the same way as would a beam of light thrown against the mountain.

(C) You could receive from the transmitting station, but more sensitive instruments would be needed than if your aerial were located on the nearer side of the mountain, since the reflected energy is lost, as far as your station is concerned.

Lightning Rings Telephone Bell; Aerial and Wireless Waves

Questions.—(A) Why do the bells of a country telephone line ring during a thunderstorm, even if it is at a distance? (B) Are the waves in wireless telegraphy similar (but on a larger scale) to the magnetic lines of force about a conductor or magnet? (C) Explain how an aerial catches or receives these waves. (D) In what way will an aerial assist in sending the waves?—B. C., Fairview, Mo.

Answers.—(A) Because at some point the line is near a place where there is a lightning discharge. If the line is not struck, the ringing of the bells is probably due to its potential being increased, on account of its capacity as a condenser.

(B) Yes, there are two component parts of electro-magnetic waves, the electric and the magnetic. These latter act very much like magnetic lines of force.

(C) The cutting of the electro-magnetic waves by the aerial sets up a current, or oscillations, in the aerial, in the same way as lines of force cutting a conductor set up an electromotive force in it.

(D) The aerial has at least two distinct properties, that of capacity, and that of height. The first allows it to store up a

large amount of energy and to radiate it, and the second allows the waves sent out to pass over most obstructions.

Spark Muffler; Use of Ammeter; Anchor Gap

Questions.—(A) What is a "spark muffler"? (B) What is an ammeter used for in tuning, and how is it connected? (C) What is an anchor gap used for?—E. S. W., Plainfield, N. J.

Answers.—(A) A spark muffler consists of a tube of glass or some other insulating material, surrounding the spark gap. The only advantage of having a muffler is that it diminishes the sound of the spark. The spark gap terminals should be cooled as much as possible, and when a muffler is used, it is well to arrange for a circulation of air around the gap terminals, as otherwise they will be heated considerably, and the efficiency of the station will be lowered.

(B) A hot wire ammeter is used to determine when the maximum amount of radiation by the aerial is being obtained, and consequently to show when the transmitting instruments are properly tuned. The meter is connected in series with the helix and aerial, and when a helix is not used, is connected in series with the spark gap and the aerial.

When the instruments are in tune, the reading on the scale of the meter is the highest.

(C) An anchor gap is used wherever it is not desirable to run the high tension currents through the aerial switch. It is used with the loop and umbrella aeriels, and prevents the oscillations from passing through the transmitting instruments while receiving.

Wireless and Telephone

Question.—We have a telephone line which is grounded on the same water pipe as our wireless station. When we call up on the telephone and press the key of the wireless set, we can hear the signals in the telephone receiver. What is the trouble?—W. C. A., Chicago, Ill.

Answers.—The telephone line acts as an aerial, and the water pipe is the ground. The carbon grains in the telephone transmitter act as the filings in a coherer. You have, therefore, a wireless outfit in the telephone instrument. There is no way to prevent the disturbance of the telephone line by the wireless set.

Enameled Wire on Tuning Coils

Question.—What is the effect of enameled wire in tuning coils?—H. S. B., Lansing, Ont., Can.

Answer.—A greater number of turns, per inch length of core, can be placed on a coil using enameled wire than when cotton-covered wire is used. Considering two consecutive turns of wire separated by enamel insulation on each wire, we have a condenser effect, the two copper wires acting as conductors, the enamel as an insulator. This condenser or capacity effect acts so as to give a greater wave length per turn of wire on the coil, and since the number of turns per inch of enameled wire is greater than with cotton covered wire, tuning is far less accurate. However, enameled wire has its advantages. The coil needs no further finishing after the wire is in place, the copper wire is hard drawn and so does not wear away so readily under the slider as does the cotton covered soft copper. Lastly, the slider makes a better path for itself through the enamel than through the copper. By reducing the diameter of the coil the capacity effect is somewhat decreased and closer tuning is possible.

Behavior of Wehnelt Interrupter

Question.—I made a Wehnelt interrupter to use in series with a ½-inch spark coil on 110 volts. As soon as I turned the current on I heard a pop and saw a flash, accompanied by a loud buzzing. When I examined the interrupter the platinum wire had disappeared along with the sealing wax which I had used to fasten it in the glass. Can you account for this?—G. B., Washington, D. C.

Answer.—Either there was too much of the platinum wire immersed in the solution, or the percentage of acid in the solution was too great. It may be well to note that German silver wire will give almost as good results as platinum for this purpose. The percentage of acid should be about ten, that is, one part of acid (sulphuric) and nine parts of water.

See article on page 1127.

Aerial Insulation Test; Receiving Current

Questions.—(A) How is a galvanometer used in testing the aerial and lead-in wire insulation? (B) When receiving two miles, how much current is coming through the aerial? When receiving fifty miles?—H. H. K., Wheaton, Ill.

Answers.—(A) Connect the galvanometer in series with two or three batteries, the aerial, and ground, previously disconnecting all instruments from the aerial. The galvanometer should show only a slight deflection. The higher the insulation, the less the deflection.

(B) The amount depends on the power of the transmitting station, the height of both aerials, the methods of connection, and several other factors. In any event, only a small fraction of an ampere is received.

Buzzer Test

Question.—Of what does a buzzer test consist?—F. A. U., Brooklyn, N. Y.

Answers.—This test consists in making use of the electro-magnetic waves set up at the contact points of a buzzer to determine whether the detector is in adjustment or not. The diagram shows the connections. By completing the buzzer circuit by pressing the push button the buzzer is set in operation, and a buzz will be heard in the receivers

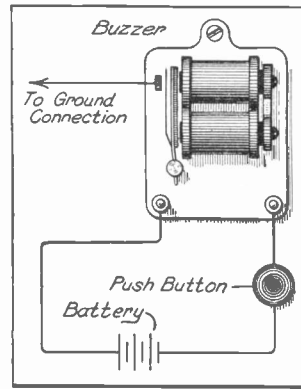

CONNECTIONS FOR BUZZER TEST

if the detector is properly adjusted. The more sensitive the detector, the louder the sound.

Sensitiveness of Loose Coupled Tuner

Question.—Is a loose coupled tuner with the primary wound over the secondary, the secondary divided into sections, with a slide on the primary, as sensitive as one in which the secondary is drawn out from the primary?—H. F. D., Saratoga Springs, N. Y.

Answer.—No, because one of the essential advantages of the loose coupled tuner is that the primary and secondary can be separated. In an ordinary tuning coil of the single or double slide types, the detector circuit and the aerial-ground circuit are dependent upon each other, that is, if the inductance of one is increased, the inductance of the other is also increased. In the loose coupled tuner, the inductance of these circuits can be varied independently, but for best results, it should also be possible to vary the distance between the windings, thereby varying their mutual inductance.

QUESTIONS AND ANSWERS

Use of this department is free to readers of Popular Electricity, but attention will not be given to questions which do not comply with the following rules: All questions must be written in the form of a letter addressed to the Questions and Answers Department and containing nothing for the other departments of the magazine; two-cent stamp must be enclosed for answer by mail, for space will not permit of printing all answers; the full name and address of the writer must be given.

Intensity of Illumination; Mercury Arc Rectifier

Questions.—(A) A surface 60 feet from a source of light will receive how intense an illumination as compared with the light on a surface 20 feet from the source of light? (B) State briefly the principle of the action of the Mercury Arc Rectifier—F. H. S., Los Angeles, Cal.

Answers.—(A) The intensity of light on a surface varies inversely as the square of the distance of that surface from the source of light. The drawing will help to understand this law. Suppose the distance from a light source (C) to a given surface (P) is r . Then assume another surface (Q) at a distance $2r$ from (P). As light travels in straight lines a glance at the drawing, even without a knowledge of geometry, will show that the area (Q) is four times the area (P). If the surface (P) were removed, surface (Q) would receive the same amount of light as (P) received, but this light being distributed over four times the area would be only $\frac{1}{4}$ as intense as on (P). If the surface (Q) were three times as far from (C)

to the intensity on the surface 20 feet distance as 20^2 is to 60^2 . Or in other words is one-ninth as great.

(B) If current is made to flow in one direction between two points through mercury vapor in a glass tube exhausted of air, and the direction of flow be suddenly changed, making what was the negative electrode, positive, the

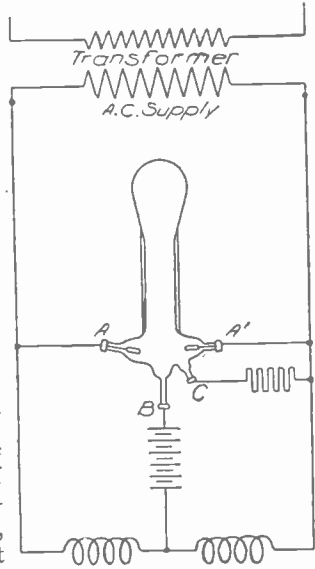

SHOWING THE PRINCIPLE OF THE MERCURY RECTIFIER

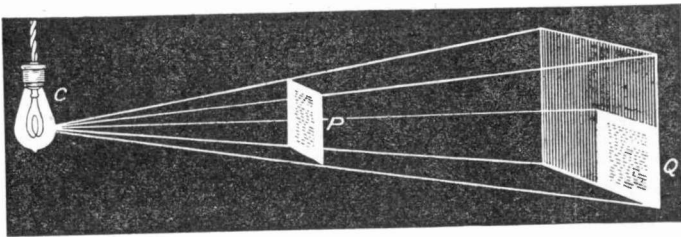

ILLUSTRATING THE LAW OF INVERSE SQUARES

as (P) the light would be distributed over an area at (Q) nine times as great. The intensity of illumination would then be only one-ninth as great, and so on, hence the law of inverse squares. Applying the law to the given case in hand, the intensity of light on a surface 60 feet from the source is

current will cease to flow because mercury displays the characteristic of opposing the change in direction and the formation of a new negative electrode. Using this phenomenon as a basis the mercury vapor rectifier is built on the principle shown in the drawing.

There are two electrodes (A) and (A') entering the tube as shown. Below is a third electrode (B). (C) is simply an arrangement for vaporizing the mercury in starting and is automatically cut out as soon as the tube is in operation. Now the current in the alternating supply wires is constantly

reversing. Therefore it tends to enter at (A) and leave at (A') and to enter at (A') and leave at (A) many times per second. But this it cannot do because of the fact that the current will flow in one direction only through a single electrode as above stated. Therefore the only action which can take place is for one impulse to enter at (A') and pass down and out at (B). The next impulse, of opposite sign, can not enter at (A') but does enter at (A), going out also at (B). Therefore we have current flowing out at (B) always in the same direction, or direct current, which is capable of charging a storage battery, as shown, or performing any other work requiring direct current. The two coils down at the bottom of the diagram are choke coils. These choke coils stop alternating current but allow direct current to flow through them. If it were not for these coils a wave coming down and entering (A'), we will say, could also divide and part pass on down and up into the tube at (B), meeting the other part of the divided wave and neutralizing it.

Lamp Circuits

Questions.—(A) How can I wire up a circuit to turn off lights from two points by a switch at each

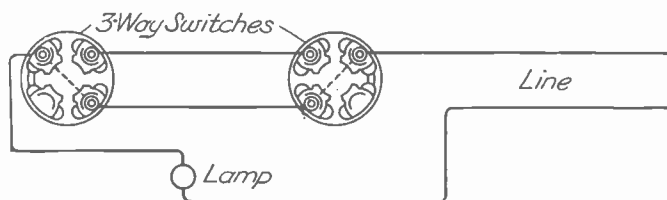

FIG. 1

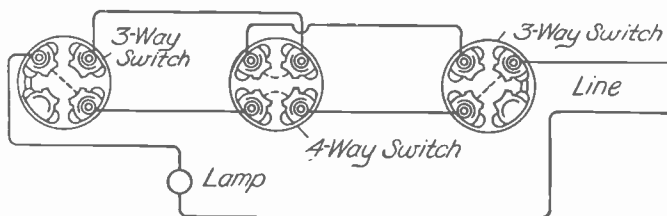

FIG. 2

place? For example, I want to turn on a light located at the top of the stairs while I am at the bottom and turn it out again when I reach the top. (B) How many lights be turned on or off from any one of three points?—N. B. K., Erie, Pa.

Answers.—(A) See diagram No. 1.

(B) See diagram No. 2.

Transformer Windings; Alternator and Ampere Turns Defined

Questions.—(A) When winding transformers, must the primary and secondary coils be wound in the same direction? (B) What is an alternator? (C) What is meant by "ampere-turns"?—F. J. S., Etna, Pa.

Answers.—(A) It makes no difference as to their direction with reference to each other. However on a closed core transformer the two parts of the same coil on each leg must be connected so that flux produced by one coil will not oppose the flux produced by the other.

(B) An alternator is a dynamo constructed to generate alternating current.

(C) A term applied to magnet coils and specifying the product of the number of turns of wire multiplied by the number of amperes flowing in the coil. Thus, a magnet wound with a coil of ten turns of wire carrying two amperes would be regarded as affected by twenty ampere-turns.

Underwriters' Rules

Questions.—(A) How many sixteen-candle-power 110-volt carbon filament lamps do the underwriters' rules allow on a branch circuit? (B) On cleat work, how far apart should the cleats be placed? (C) What size fuse plugs should be used on a circuit carrying eleven sixteen-candle-power lamps?

Answers.—(A) The rule reads, "Automatic cut-outs (fuses) must be so placed that no set of incandescent lamps requiring more than 660 watts, whether grouped on one fixture or on several fixtures or pendants, will be dependent upon one cut-out." This rule allows, then, practically twelve sixteen-candle-power, 110-volt, carbon filament lamps upon a branch circuit.

(B) Rigid supporting requires under ordinary conditions, where wiring along flat surfaces, supports at least every $4\frac{1}{2}$ feet. If the wires are liable to be disturbed, the distance between supports must be

shortened. In buildings of mill construction, wires of not less than No. 8 B. & S. gauge, where not liable to be disturbed, may be separated about six inches, and run from timber to timber, not breaking around.

(C) Use six ampere fuses.

Application and Proceedings for Reissue

By OBED C. BILLMAN, L. L. B., M. P. L.

APPLICATION AND PROCEEDINGS THEREON.—*In General.*—The proceedings to obtain a reissue are governed by the rules of the patent office. The application must set forth the facts upon which the right to a reissue is based, and must be accompanied by an oath in conformity to the rules of the patent office. Evidence is admissible in support of the averments of the application. The original patent must be surrendered. In a proper case, the granting of a reissue is a matter of right, the commissioner having no discretion. Where a reissue is improperly refused the applicant has a remedy by bill in equity.

TIME OF APPLICATION.—*In General.*—As a general rule, a patent may be surrendered and reissued at any time during the life of the patent, though the right to a reissue may be lost by unreasonable delay or laches, and the reissue if granted may then be held void.

DELAY IN APPLYING FOR ENLARGEMENT OF CLAIMS.—A reissue with enlarged claims will not be allowed where there has been unreasonable delay or laches in making the application, especially where in the meanwhile other devices have gone into use which will be affected by such a reissue. Where the error is apparent on the face of the patent, delay in applying for a reissue is especially apt to prove fatal. A delay of more than two years in reissuing in analogy to use prior to the application, requires special circumstances to excuse it, or it will be deemed an abandonment of the new matter to the public. The rule of laches should be strictly applied. Such lapse of time as indicates, under the circumstances, a want of due diligence is fatal, and the reissue if granted is void.

DELAY WHERE CLAIM NOT ENLARGED.—The correction of a patent by a reissue, where it is involved or inoperative for want of a full and clear description of the invention, is not attended with such injurious results to the public as follows from the enlargement of the claim, and hence a reissue may be proper though a longer period has elapsed since the issue of the original patent. But though a greater degree of diligence is required where the claims are expanded than

where they are narrowed or simply made more specific and certain, due diligence is required in all cases.

REISSUE IN DIVISIONS.—The commissioner may, in his discretion, cause several patents to be issued for distinct and separate parts of the thing patented on demand of the applicant. Thus a patent may be reissued in division for a process and its product. Such divisional reissues are treated as a single patent with several claims.

IDENTITY OF INVENTION IN ORIGINAL AND REISSUED PATENTS—NECESSITY OF IDENTITY.—The statute only authorizes a reissue for the same invention as the original patent. Accordingly, a reissued patent for a different invention is void.

NEW MATTER IN SPECIFICATION—AMENDMENT.—By express provision of the statute no new matter may be introduced into the specification of the reissued patent. Nor, in the case of a machine patent, may the model or drawing be amended, except by each other. But when there is neither model nor drawing, amendments may be made upon proof satisfactory to the commissioner that such new matter or amendment was a part of the original invention, and was omitted from the specification by inadvertence, accident, or mistake. The power to surrender and reissue patents implies that the specification may be corrected to cure the defect and supply the deficiency.

WHAT CONSTITUTES IDENTITY.—Questions for Court and Jury.—Whether or not the reissued patent is for the same invention as the original patent is ordinarily a question of fact for the jury. But whenever the question can be determined solely from the face of the patents by mere comparison, without the aid of extrinsic evidence to explain terms of art or to apply the description to the subject-matter, it is one of law for the court.

In an equity case the question may always be determined by the court.

Inclusion of Disclaimed, Rejected, or Abandoned Matter.—A reissued patent cannot be sustained where it contains claims that have once been formally disclaimed by the patentee, or have been rejected and he has acquiesced in such rejection in order to

obtain his patent. Claims for matter clearly included in the original application and subsequently abandoned cannot be included in a reissue. But if a disclaimer, withdrawal, or abandonment of a feature of the original invention was caused by mistake or error of the patent office, such features may be included in a reissue.

Enlargement of Claims.—It is well settled that upon reissue the specification cannot be substantially changed so as to enlarge the invention as intended to be originally claimed. But, as has been seen, this does not prevent the reissue of a patent with claims broader than the claims of the original patent, where such original claims were too narrow to cover the actual invention made and intended to be claimed. But what is dedicated to the public by description and failure to claim in the original cannot be claimed in a reissue. Where a claim has been limited by amendments in the patent office it cannot be afterward broadened by reissue of the patent.

Narrowing Claims.—The inventor is always at liberty in a reissued patent to omit a part of his original invention, thereby dedicating it to the public.

Substitution of Equivalents.—The substitution of equivalents will not be permitted in a reissue, except, perhaps, in such a clear case that the court could decide as a matter of law that the ingredient substituted is an equivalent for the one withdrawn, and was well known as such at the date of the original patent. In any case, however, it is held that the substituted device should be alleged to be an equivalent of the one stricken out.

Combinations.—An original combination claim reissued for a greater or less number of parts is void because not for the same invention. So a reissue claiming the elements separately and not as a combination is void, as is a combination of different or new elements. But sub-combinations may be claimed on reissue.

Machine, Process and Product.—A patent for the invention of a machine cannot be reissued for the purpose of claiming a process or a product, or *vice versa*, because not for the same invention. But if one is the result of the other, and they are so related that the invention of one involves the invention of the other, it seems that a failure to claim all may be cured by reissue.

NEW BOOKS

STORAGE BATTERIES. By A. E. Watson. Lynn, Mass.: Bubier Publishing Company. 1911. 160 pages with 63 illustrations. Price \$1.50.

In this work the author has aimed to cover the theory, construction and use of storage batteries in a brief but clear way so that the man who is not acquainted with the subject is able to find out what he wants to know without assistance. The lead cell is the basis of the treatise, modern cells of various makes being described. A chapter is devoted to "How to Make," and one to "Switchboard Arrangements," while all the essential facts which the practical man looks for have been given consideration.

MANAGEMENT OF DYNAMOS. By G. W. Lumis-Patterson. New York: Norman W. Henley Publishing Company. 1909. 285 pages with 117 illustrations. Price, \$2.00.

This book was first published thirteen years ago. The present (fourth edition) has been brought up to date by eliminating descriptions and illustrations of obsolete types of apparatus. Present day machinery is illustrated and described. The volume is prepared with a view to meet the wants of mechanics, engineers, students and others who may have to know about or care for dynamos. After explaining the principles of electricity and magnetism the book sets forth their application in the dynamo, helping the dynamo tender by giving space to such subjects as: "Shutting Down Dynamo," "Freeing Commutator," "Failure to Excite," "Erecting Dynamos," etc.

WINDMILLS AND WIND MOTORS. HOW TO BUILD AND RUN THEM. By F. E. Powell. New York: Spon and Chamberlain. 1910. 78 pages with 76 illustrations. Price, 25 cents.

The author has endeavored to interest all classes of readers in his subject. The book treats on the construction of small windmills for pumping water, generating electricity, or driving small machines. An American type windmill, diameter of sails three feet, is described; also a small working windmill large enough to drive a 30-watt dynamo, and later a 10-foot mill rated by the author to develop $\frac{1}{4}$ horsepower in a 16-mile breeze. The final chapter treats on "Production of Electricity by Wind-power."

ON POLYPHASE SUBJECTS

A great many of the regular subscribers to POPULAR ELECTRICITY keep all the numbers and bind them up in a

Index to Volume III volume at the end of the year. To them a comprehensive index of the contents of the twelve numbers is of great value in using the magazines for reference. It has been our custom in the past to print such an index and one will be printed this year for Volume III. Previously, every subscriber received an index with the last number of each volume (April issue). But our mailing list has become so large, and the index this year being more voluminous than ever, it seems a pity to send out so many thousands when a certain percentage will be wasted on those who do not make a practice of keeping back copies

Therefore we are going to ask those who desire an index this year to write and ask for it, inclosing a one-cent stamp to pay the postage. A sufficient supply will be printed to meet the requests. The index will be ready about April 1st.

From the very beginning it has been our policy to answer the questions on electricity which our readers may ask.

On Questions and Answers The Question and Answer Department we believe to be one of our most important aids in making friends for the magazine. But the business of answering questions is not altogether holiday work and we cannot refrain from unbosoming to those who make use of the service some of the troubles which it brings to us.

As we have explained before, the number of questions answered in the magazine is small in comparison to the number we answer by mail. Every day brings scores of letters of this sort, all of which are taken care of if they comply with the regulations printed at the head of the Question and Answer Department. This is done at a heavy expense. We ask in return that those who ask questions make our work as easy as possible. State your questions as concisely as possible

and try to limit the number to a reasonable extent. Some go so far as to ask a dozen to fifteen questions in a string, carelessly written with a lead pencil on both sides of several sheets of paper. Try to bear in mind that it is hardly fair to us to sit down and dash off a lot of questions that we have repeatedly answered in the magazine or the answers to which you could easily obtain from some elementary book to which, likely as not, you have access.

Do not ask foolish questions. The other day we received a letter in which the writer calmly asked us to tell him how to build a submarine. If he had expended one-tenth of the energy in thinking that he did in writing the letter he would have realized that our Question and Answer Department could not be expected to furnish plans for submarines, warships, skyscrapers and kindred objects—especially for the price of a two-cent stamp.

Still others send letters asking for an immediate answer but forget to give their name and address. These letters are referred to "no address" file. Shortly we receive an inquiry sometimes quite emphatic asking why we do not answer. Relieved from embarrassment we reply after consulting the "file of mystery." Don't fail to let us know who you are and where you live.

It is our desire to do all in our power to assist our readers who are interested in and making a study of electricity. We want them to feel free to come to us when they are really "up against it," to use a slang expression which seems to fit the case. In return we feel that it is only fair that they should take the pains to try and dig out the information for themselves first and only come to us as a last resort. When it is really necessary to write, the questions should be as few as possible to cover the point, they should be clearly stated, they should be neatly and legibly written on one side of the sheet and this sheet should be mailed, care of the Question and Answer Department without containing anything for other departments, and with a two-cent stamp included.

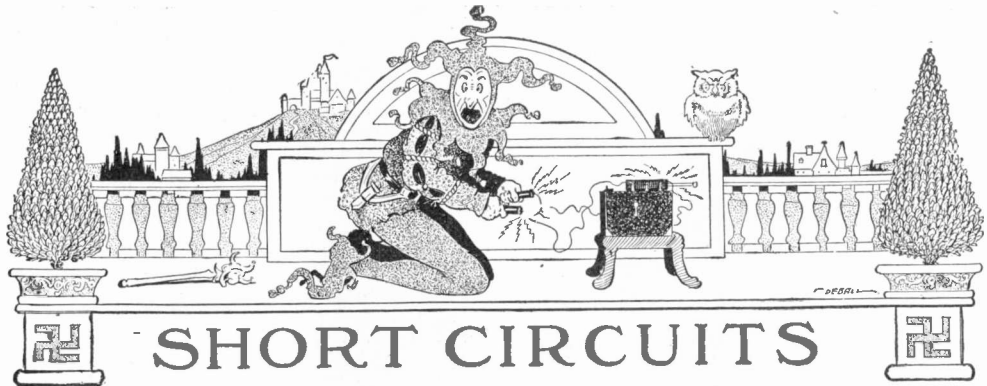

SHORT CIRCUITS

Just before the boat left on its return trip, a big, rosy German came straggling down the pier to the ticket gate.

"Ticket, please," said the keeper.
 "I don't got a teckit—I'm der drummer mit der band," replied the German.
 "But you must have a ticket."
 "Veil, I hat one but I loose him."
 "You must have it, I tell you," persisted the gate-keeper; "you couldn't lose it."
 "Vat!" shouted the bandman. "I couldn't loose dat little teckit? Mein Gott! I haf loose my bass-drum!"

* * *

She was a beautiful statuesque blonde who had changed her residence from New York to Philadelphia and secured a position as stenographer in the office of a staid, dignified citizen of good old Quaker descent. On the morning of her first appearance she went straight to the desk of the boss.
 "I presume," she remarked, "that you begin the day over here the same as they do in New York."
 "Oh, yes," replied the boss, without glancing from the letter he was reading.
 "Well, hurry up and kiss me, then," was the startling rejoinder. "I want to get to work."

* * *

A young person of Tomahawk Bluff
 Carried pistols to make him look tough.
 When they asked "Do you chew?" he replied,
 "Yes, I do,
 I'm a wogular wetch of a wough."

* * *

"Now, Johnny," said the Sunday-school superintendent, "can you tell me what it was that caused the prophet Elijah to go up?"
 "Yeth, thir," said Johnny, "it wath the Payne tariff bill."

* * *

Two Peoria women boarded a street car the other day and sat opposite each other in perfect silence. Both wore the wastebasket style of hat. They rode downtown oblivious of each other's presence and got off at the same corner. The first looked up as she descended and gave a start of surprise.
 "Why, is that you dear?" she exclaimed. "I wondered who is was, but I didn't recognize your feet."

* * *

"Why does a dog hang his tongue out of his mouth?" asked the teacher.
 "Yes, my boy," he said to a bright looking lad who held up his hand, while the light of genius was in his eye.
 "To balance his tail!" shouted the bright boy.

* * *

"That nephew of yours is a little wild, I'll admit," said Uncle Jerry's neighbor, trying to comfort him, "but he'll reform as he grows older. Leave him to time and nature."
 "Time and nature!" snapped Uncle Jerry. "It's time and nature that make Limburger cheese what it is."

Artist—"Madam, it is not faces alone that I paint it is souls."
 Madam—"Oh, you do interiors, then?"

* * *

Rastus: "For the love of heben, Sambo, what fer you got you 'alls pants turned wrong side befores?"
 Sambo: "Sh! Don't talk so loud. You see, I's invited to a swell reception to-night and I's gettin' de bulge out'n de knees."

* * *

Opie Read, the novelist, appeared as entertainer for a switchman's convention in Peoria.
 "It was a very enthusiastic audience," said Mr. Read. "They laughed heartily, but they didn't applaud much. You see there were so many one-armed men there, that they had to applaud in pairs."

* * *

In the first act he tied the beautiful heroine to a railroad track just as the limited was due. In the second, he lured her into an old house, locked her in an upper room and set the place on fire. In the third, he strapped her under a buzz saw and set the machinery in motion.

In the fourth act he started to make love to her. She shrank from him.

"Why do you fear me, Nellie?" he asked.

* * *

A man looking for a position was walking along the banks of a river when he heard cries for help. He stopped, and found it to be a friend of his who was employed in a nearby factory. The man was about to save his friend, when a quick thought came to him, and he said:

"No, I'll get his job." So he went to the factory and said to the manager, "I came to apply for the position of the man if just saw drowning." "You are just five minutes too late," said the manager; "the man that pushed him in was here first."

* * *

Stubbs was feeling his way to the kitchen range in the dark, when he fell over the coal scuttle.

"Oh, John," called Mrs. Stubbs, sweetly, "I know what you need. You should get what they have on battleships."

"What's that?" growled Stubbs, as he rubbed his shins.

"Why, a range finder."
 And what Stubbs said about woman's wit was plenty.

* * *

"Say, Waiter, that lobster is without one claw. How's that?"

"You see, sir, they're so fresh, those lobsters, they fight with each other in the pantry."
 "Well, take that one away and bring me the winner."

* * *

"It was Satan," said a mother to one of her children, "who put it into your head to pull Elsie's hair."
 "Perhaps it was," replied the little girl, "but kicking her shins was my own idea."

* * *

A girl who was wearing a hobble,
 While carefully treading the "cobble,"
 Dropped her new diamond brooch,
 But she just couldn't "scrooch."
 And a gutter snipe captured the bauble.

The Magnetic Burglar



COMMON ELECTRICAL TERMS DEFINED

In this age of electricity everyone should be versed in its phraseology. By studying this page from month to month a working knowledge of the most commonly employed electrical terms may be obtained.

CONTROLLER.—A device operated by the motor-man of an electric car by means of which the motor is controlled, resistance being cut in or out of the circuit. In the Thomson-Houston system of automatic regulation of current, a magnet controlled by the main circuit current, thus operating with every change of strength of current and so keeping this current practically constant.

CONVERTER.—A term sometimes used instead of transformer.

CO-PHASAL ALTERNATIONS.—If two alternate current generators are "in step" their alternations are co-phasal.

CORED CARBONS.—An arc lamp electrode having a center of charcoal or soft carbon around which is moulded hard carbon.

COULOMB.—The quantity of current that would pass in one second through a circuit of one ohm resistance and under a pressure of one volt. Called after the scientist of that name.

C²R LOSS.—An expression for the loss of energy of a current passing through a conductor, this loss being due to the fact that the conductor offers a resistance. The expression is derived as follows: The number of watts flowing in a circuit equals the current times the volts or $W = C \times E$. But from Ohm's law $E = C \times R$. Substituting for E , $W = C \times C \times R = C^2R$, watts lost.

COUNTER ELECTROMOTIVE FORCE.—A voltage or pressure opposed to the main voltage in a circuit. A motor develops counter electromotive force which opposes to a certain extent the voltage impressed upon the motor. In the electrolysis of water, one electrode becomes covered with bubbles of hydrogen, the other with bubbles of oxygen; this creates a counter E. M. F. of polarization. In the carbon arc the heating differentially of the two carbons develops counter E. M. F.

COUNTER INDUCTIVE EFFECT.—A current produced in a second circuit by induction from the first, this second current opposing the regular flow of current in the first.

COUPLE.—Used in electricity to designate a galvanic or voltaic cell consisting of two electrodes and one or two liquids. The Daniell cell is an example.

C. P.—An abbreviation for candle-power. Also applied instead of the words "chemically pure" with reference to chemicals used in electric batteries.

CRATER.—The hollow in what is usually the upper or positive carbon in the arc lamp. This crater emits most of the light and averages .04 inch deep by .2 inch across. This is the hottest part of the arc and attains a temperature of approximately 3500° C.

CREEPING.—The solution in a battery jar will always rise a little above the level of the liquid, evaporation takes place and the salt dries on and affords a path for more of the solution to "creep" through it. This action, termed "creeping," continues until a layer of the salt is formed up over the edge of the vessel. To prevent creeping paraf-

fine may be applied to the edges of the jar or oil may be poured over the battery solution.

CRITICAL CURRENT.—The current produced by a dynamo at what is called its critical speed which if varied slightly causes a great difference in the voltage.

CRITICAL RESISTANCE.—That resistance of the external circuit of a series wound machine which if raised beyond a certain point will cause the machine to refuse to excite itself.

CRITICAL VOLTAGE.—Used in wireless telegraphy to denote the voltage at which a detector commences its action. In an electrolytic detector it is the voltage at which the thin film of gas that collects on the "bare point" breaks down.

CROOKES' DARK SPACE.—If an electric current is caused to pass through an exhausted tube provided with electrodes, the space about the negative electrode is dark, this darkness going farther into the tube as the vacuum is increased. If the vacuum be made very high the dark space will extend almost the entire length of the tube.

CROSS ARM.—A cross piece of wood or iron fastened horizontally to a telegraph, telephone, or light and power pole to support insulators and wires.

CROSS-MAGNETIZING EFFECT.—The current flowing in the armature of a dynamo or motor develops lines of force approximately perpendicular to those from the field poles. The resultant of these two sets of lines is a somewhat distorted field between the poles.

CROSS-OVER.—A device used where two trolley car lines cross each other to prevent the trolley from jumping off the wire and from arcing.

CROSS TALK.—A transfer of current between two or more telephone circuits by induction or crossed wires so that conversation intended for one line is heard upon another line or lines.

CROWFOOT BATTERY.—See Battery. Gravity,

CRUCIBLE, ELECTRIC.—A crucible in which the heat produced by an electric arc is used to obtain high temperatures in reducing ores, forming alloys and performing difficult fusions.

CRYSTAL DETECTOR.—A device used in wireless telegraphy for rectifying the electrical oscillations or Hertzian waves that the aerial gathers, enabling them to pass as an electric current through a telephone receiver in which they produce sound. The detector consists of two crystals so held as just to touch each other, or of one crystal and a metallic point lightly adjusted to its surface. The crystals used belong principally to the carbon and sulphur groups and have the peculiar property of passing current better in one direction than in the other. Some of the more common crystals are: Carborundum, fused silicon and iron pyrites.

CURRENT.—A term used to designate the transference of electrical energy from one point to another over or through a conductor. A rough analogy is to liken it to the flow of water through a pipe connecting two tanks of different level.

Instruction Book and Wood Finishing Samples FREE

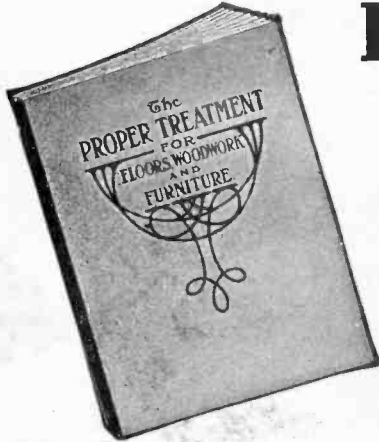

HERE'S the best book ever published on artistic wood finishing, the work of famous experts, illustrated in five colors. For a limited time, we will mail it FREE, postage paid, together with samples of

Johnson's Wood Finishes

Yes! You—yourself—can beautifully finish or refinish all furniture, woodwork or floors in the latest and most artistic shades—in little time—at small expense—with

Johnson's Wood Dye and Prepared Wax

If you are interested in craftsmanship—if you want the correct finish on a new piece of furniture—if you are *building or remodeling*—if you want to brighten up or change the color of any piece of furniture or of woodwork or floors—either hard or soft wood—if you are interested in basketry—get this expert Instruction Book and the FREE SAMPLES at your leading paint dealers.



Johnson's Wood Dye is made in many beautiful greens, browns, reds, etc. It is not a mere stain but a penetrating dye which colors the wood so deeply that if it becomes scratched or marred the natural color is not disclosed. It brings out the beauty of the grain without raising it, giving a soft, rich, permanent color. A coat of Johnson's Prepared Wax over the dye gives that beautiful, dull, artistic finish so much admired today. If you prefer a higher gloss than the wax gives apply a coat of UNDER-LAC over the dye and then one coat of Prepared Wax.

Under-Lac is a thin, elastic spirit finish very much superior to shellac or varnish. It dries hard in less than an hour. Under-Lac is just what you want for your linoleum and oilcloth; it brings out the pattern making it bright and glossy like new, protects it from wear and makes cleaning easy. It dries so the floors may be walked on in an hour.

We want you to try Johnson's Wood Finishes so we are supplying all leading paint dealers with samples for their customers' use. If your dealers haven't samples of our Wood Dye, Under-Lac and Prepared Wax and the Instruction Book—we will send them to you postpaid for the name of your dealer in paints. In writing us mention the shade of dye you prefer and Instruction Booklet, edition P. E.-4

S. C. Johnson & Son, "The Wood Finishing Authorities" Racine, Wis.

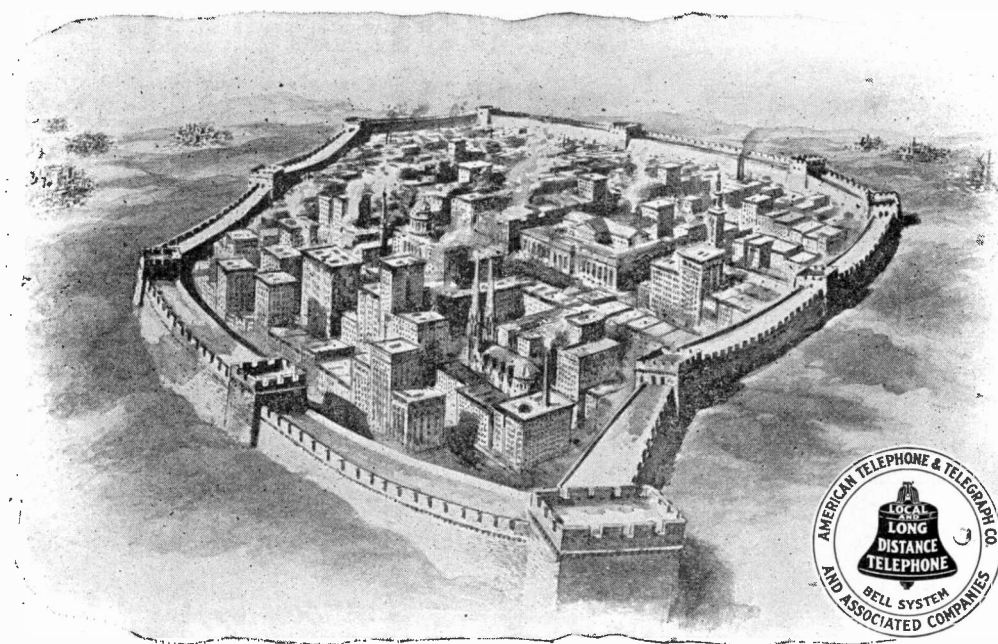

A MEDIAEVAL CONDITION

Telephone Service— Universal or Limited?

TELEPHONE users make more local than long distance calls yet to each user comes the vital demand for distant communication.

No individual can escape this necessity. It comes to all and cannot be foreseen.

No community can afford to surround itself with a sound-proof Chinese Wall and risk telephone isolation.

No American State would be willing to make its boundary line

an impenetrable barrier, to prevent telephone communication with the world outside.

Each telephone subscriber, each community, each State demands to be the center of a talking circle which shall be large enough to include all possible needs of inter-communication.

In response to this universal demand the Bell Telephone System is clearing the way for universal service.

Every Bell Telephone is the Center of the System

**AMERICAN TELEPHONE AND TELEGRAPH COMPANY
AND ASSOCIATED COMPANIES**

For our Mutual Advantage mention Popular Electricity when writing to Advertisers.



This is a reduced reproduction to show detail. The actual height of the machine is 12 inches.

One Dollar

Puts the

"RICHMOND" Suction Cleaner in Your Home

ONE Dollar forever frees you from brooms, mops and dusters—and the backaches and drudgery they bring.

One Dollar forever stops the expense and the nuisance of Spring and Fall housecleaning.

One Dollar enables you to do, *easily*, by electricity, the *worst work* a woman has to do.

And One Dollar is the only cash outlay.

It will bring you the "RICHMOND" Suction Cleaner complete—ready for instant use.

The balance you pay for month by month out of the actual money you save.

For Vacuum Cleaning is the greatest of all household economies.

You are paying the price of a suction cleaner, *right now*—whether you have one or not.

You are paying its price out in twice-a-year house cleaning alone—for a "RICHMOND" makes housecleaning needless.

You are paying its price out—many times over—in the hard labor of sweeping and dusting which the "RICHMOND" makes unnecessary.

You are paying its price out again and again in the damage which dust does to your furniture, to your carpets, to your hangings, to your clothing—to YOU.

You are paying the price of a "RICHMOND" when a single dollar would save the waste.

YOU see here the lightest and simplest suction cleaner ever designed.

1.—Is the motor—not a "stock" motor, but one built expressly to operate the powerful suction fan to which it is directly connected, under

2.—a suction fan which embodies the best of all that was learned in two years of steady, scientific experiment.

3.—Is the suction nozzle which is pushed over the surfaces to be cleaned—or to which can be attached a twelve-foot hose for high wall, drapery and upholstery cleaning.

The "RICHMOND" Suction Cleaner enables you, now for the first time, to clean by electricity without lugging a 60 to 80 pound machine from room to room—upstairs and down.

It represents as great an advance over heavy weight vacuum cleaners as these cleaners represented over brooms and carpet sweepers.

But light weight and easy operation are but two of the "RICHMOND'S" exclusive superiorities. There are many more.

The vibrating brush, which taps the caked dirt out of otherwise uncleanable rugs and carpets—the hair-drying and pillow-renovating attachments—the seven special tools which make the "RICHMOND" the most complete cleaner ever offered.

Manufactured exclusively for the RICHMOND SALES CO. by
THE M^cCRUM-HOWELL Co.
 103 Park Ave. and 41st St., New York

Five Factories: Two at Uniontown, Pa.—One at Norwich, Conn.
 One at Racine, Wis.—One at Chicago, Ill.

MANUFACTURERS OF "RICHMOND" Boilers and Radiators,
 "RICHMOND" Enamelled Ware, Bath Tubs, Sinks, Lavatories,
 "RICHMOND" Suds Makers, "RICHMOND" Concealed Transom
 Lifts, and "RICHMOND" Stationary Vacuum Cleaning Systems

Inquiries regarding built-in-the-house Vacuum Cleaning systems should be addressed to The McCrum-Howell Co., New York and Chicago.

Limited Offer

The Dollar Offer is limited. It is made to show our unbounded confidence in the "RICHMOND"

But by its very liberality, it is bound to swamp the factory. And when the limit of factory output is reached, the offer must be withdrawn.

So send the coupon today while the opportunity is still yours! Don't wait. Do it NOW.

THE RICHMOND SALES CO.
 Dept. 74, 103 Park Ave. New York

DOLLAR COUPON

THE RICHMOND SALES CO., Dept. 74, 103 Park Ave., N. Y. City

I hereby order one "RICHMOND" Suction Cleaner, complete with the following attachments:

- | | | |
|-------------------------------|-------------------------|-----------------------------------|
| I Hose Attachment Shoe | I 10-in. Drapery Tool | I 30-ft. Electrical Cord |
| I 12-ft. covered Suction Hose | I 3-in. Suction Tool | I Complete Hair Drying Attachment |
| I Book and Wall Brush | I Felt-Faced Floor Tool | I Adjustable Wall Brush |

—for which I agree to pay to your order, \$1.00 herewith, and \$6.00 on the first day of each of the next 12 consecutive months. Title to be given me when full amount is paid.

Name.....
 Address.....

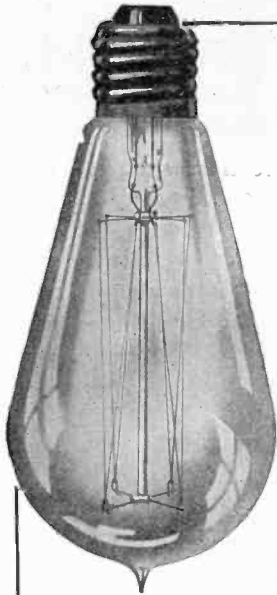

The *Mazda Lamp* may be substituted for any electric bulb which you are now using, with these results:—

*Saving in Electric Current
Increasing Beauty and
Value of Light*

These lamps will fit any socket and burns at any angle; they produce $2\frac{1}{2}$ times the light of an ordinary electric lamp.

Electric light is now cheaper than any other practical illuminant. Cleanliness and healthfulness, beauty and safety are four characteristics possessed by electric light in greater measure than any other illuminant. Electric light is most desirable; *it is least expensive* now that the Mazda Lamp cut the cost of electric light to less than half its former prices. Electric lighting will increase the value and comfort of your home.

Use Mazda Lamps and have all the light you want at no increased expense. Your lighting company or the nearest electrical dealer can supply you with these lamps. Stop in and discuss the lamp and its performance with them and try one lamp in your home.

National Electric Lamp Association
CLEVELAND



Wire your house with the *money YOU SAVE* by using electric lights. You may save money by using electric light because the Mazda lamp has reduced the cost of electric light by producing three rays of light where only one was produced before with the old style lamp.

Your lighting company will make you a wiring proposition and will demonstrate just how and why the Mazda lamp is most economical and efficient.

The Member Companies of the National Electric Lamp Association listed below, each manufacture Mazda lamps and maintain the highest standard of lamp quality set by the Engineering Department of that Association.

- | | |
|--|---|
| THE BANNER ELECTRIC CO.,
Youngstown, O. | THE GENERAL INC. LAMP CO.,
Cleveland, O. |
| THE BRILLIANT ELECTRIC CO.,
Cleveland, O. | THE MONARCH INC. LAMP CO.,
Chicago, Ill. |
| THE BRYAN-MARSH COMPANY,
Central Falls, R. I. | NEW YORK & OHIO COMPANY,
Warren, O. |
| THE BRYAN-MARSH COMPANY,
Chicago, Ill. | THE SHELBY ELECTRIC CO.,
Shelby, O. |
| THE BUCKEYE ELECTRIC CO.
Cleveland, O. | THE STANDARD ELECTRICAL
MFG. CO.,
Warren, O. |
| THE BUCKEYE ELECTRIC
LAMP CO.,
Mexico City, Mexico | SUNBEAM INC. LAMP CO.,
Chicago, Ill. |
| THE CLEVELAND MINIA.
LAMP CO.,
Cleveland, O. | SUNBEAM INC. LAMP CO.,
New York City |
| THE COLONIAL ELECTRIC CO.,
Warren, O. | THE SUNBEAM INC. LAMP CO.,
of Canada,
Toronto, Ont., Can. |
| THE COLUMBIA INC. LAMP CO.
St. Louis, Mo. | THE WARREN ELECTRIC &
SPECIALTY CO.,
Warren, O. |
| THE FOSTORIA INC. LAMP CO.,
Fostoria, O. | |

National Electric Lamp Association
CLEVELAND

CLASSIFIED ADVERTISING

¶ Advertisements in this section of Popular Electricity will cost 5 cents per word with 5% off for 3 times, 10% off for 6 times, 15% off for 9 times and 20% off for 12 times, cash with order.

¶ In order to secure the proper classification, advertisements must be in this office the first of each month preceding date of issue.

AERONAUTICS

BLERIOT MONOPLANE — GUARANTEED Flyer 25c. Antoinette Two-foot; three wheels, thrust bearing; Rubbers, Mailed K. D. 50c. Reberts, 344 Cumberland, Brooklyn, N. Y.

BLUEPRINTS OF MODEL CURTISS, Wright, Bleriot, and Antoinette Aeroplanes; or twenty-foot gliders. One Dollar. Chicago Aeroplane Mfg. Co., Dept. E, Chicago.

"BOY AVIATORS' SERIES," SIX THRILLING airship books for young Americans. New, exciting and absorbing. Send for Vol. 1, and you will quickly want the others. Postpaid 50c. At all bookstores. Our immense catalogue free. Hurst & Co., 395 Broadway, New York.

IT PAYS TO GO UP IN THE AIR! SPECIAL course to out-of-town students. We have our own aviation field, factory, and classroom, also exhibit department. Positions secured competent aviators. Write for booklet. Chicago School of Aviation, Dept. E, Chicago.

MODEL BALLOONS AND FLYING MACHINES. How to Make Them. By J. H. Alexander. Contains complete directions for constructing models with five folding plates of working drawings, also an account of the progress of aviation. \$1.50 postpaid. Popular Electricity Book Dept.

THE AVIATION DIRECTORY. AVIATORS, Aeroplane Builders!! The Directory contains the information you want. Conveniently classified addresses of manufacturers and dealers in Aeroplanes, Motors, Propellers, Magnetos, Radiators, Carburetors, Fabric, Wheels, Tires, Blueprints, Models, Castings, Woodwork, Tubing, Bamboo, Wire, Turnbuckles, Sockets, Steering and Alighting Gears, Ribs, Struts, Knockdown Frames, etc. Everything of use to Aviator and Aeroplane Constructor. Also addresses of Aviation Schools, Consulting Engineers, Patent Attorneys, Aero Clubs, Clipping Bureaus, Magazine and Book Publishers; and other information. Price 50 cents per copy. Classified advertisements inserted free. The Aviation Directory, Lawrence, Kansas.

AGENTS WANTED

2-TICKLE-U, 3c. STIX, STOCKTON, CAL.

See what I say under "Typewriters." ATCHISON

"PERFECTION POCKET ADDING MACHINE—Lightning seller. Agents wanted. Cincinnati Specialty Mfg. Co., Dept. E, Cincinnati, Ohio.

PINLESS CLOTHES LINE AGENTS COIN money, sample prepaid, 25c. 501 Lumber Exchange, Portland, Oregon.

DON'T ACCEPT AN AGENCY UNTIL YOU get my samples and particulars. Money-makers. Address SAYMAN, 706 Sayman Bldg., St. Louis, Mo.

AGENTS WANTED

AGENTS—SALARY OR COMMISSION—Portable fountain bathing apparatus, plain or electric, for every home, only \$6.00. State right for sale. Electric Bath Co., Findlay, Ohio.

PICTURE AGENTS! PORTRAITS, 25c, Frames 14c, Pillow-tops 35c. Photographic China Plates, 65c. Our new "Negro Angel" and Jack Johnson pictures get the coin. Samples and catalogues FREE. Berlin Art Association, Dept. 301, Chicago.

AGENTS MAKE BIG MONEY—BIG PAY, NO experience, no capital required. 5,000 new art specialties, photo pillow tops 25c, portraits 30c, bromides 25c. New 1911 catalog and samples free. Write. Daniel H. Ritter Co., Madison St., Chicago, Ill.

AGENTS MAKE BIG MONEY SELLING OUR new gold letters for office windows, store fronts and glass signs. Any one can put them on. Write today for a free sample and full particulars. Metallic Sign Letter Co., 400 N. Clark St., Chicago, Ill.

AGENTS EASILY MAKE \$25 TO \$100 PER week, with Greatest Labor Saving Invention. If you are out for the money, send dime for three samples, wholesale prices, and unique selling plan which is a winner and money getter. Eagle Rubber Company, 207 East Tenth St., New York.

AGENTS—WE HAVE PERFECTED AN incandescent Mantle Lamp. As represented or money refunded. Burns with or without a mantle, 16 hours on 1 quart common kerosene oil. Gives 100 candle-power. Write at once. American Light Co., Birmingham, Ala.

BULLY! GREAT! IMMENSE!—THAT'S WHAT all our agents say after selling our attractive 1911 combination packages of soap and toilet articles with valuable premiums. 100 to 300 per cent profit. One Michigan agent made \$65 in 47 hours; another \$21 in 8 hours; another \$22.50 in 10 hours; ACT NOW—NOT TOMORROW. Davis Soap Co., 27 Union Park Court, Chicago.

I WANT A GOOD MAN TO ACT AS GENERAL agent and District Manager, and appoint sub-agents for the sale of my Florida land. No experience necessary. I pay the general agent \$50.00 spot cash on every sale. My terms of \$5.00 a month for a 10-acre farm (no interest, no taxes) makes it possible to sell nearly everybody. \$200.00 IN GOLD free every month to my best men. Also one Grand Prize of \$1,000 in GOLD COIN. No capital required, but man must have a standing in his community and be willing to work. If you think you can fill the bill, send for my "Confidential Circular to General Agents," and "Selling Manual." Both free if you are the first to apply from your locality. E. C. HOWE, 31 Hartford Building, Chicago, Ill.

AGENTS WANTED

AGENTS—BIGGEST MONEY-MAKER known. The new Canchester Incandescent Kerosene Lamp revolutionizes old lighting methods. Burns air, not money. Six times brighter than electricity, gas or acetylene at 1-10th cost. Burns with or without mantle. Burner fits any lamp. Saves 75 per cent oil. No trimming wicks. Showing means selling. Territory going fast. Write today. Handsome outfit furnished. Canchester Light Co., Dept. P. E., 4, Chicago.

WANTED—ENERGETIC MEMBER IN EVERY shop—town—country community. To join and work for grandest fraternal order known. Pays sick, injury, accident, death benefits, 50c a month and up will carry full membership. Make money too—get new members. Give whole or spare time. Be first from your locality. Send 10c for Official Journal—membership particulars—great money-making plan. **THE I-L-U OF THE WORLD**, 443 First National Bank Bldg., Covington, Ky.

AUTOMOBILES

AUTOMOBILES—OVER FOUR HUNDRED bargains, \$95.00 upward. All guaranteed! Freight prepaid! Write now for latest illustrated bulletin. **MOTOR CAR EXCHANGE**, Dept. A, 217 West 125th St., New York City.

BOOKS

STIX, STOCKTON, CAL.—MENDER 3c.

BREEZY BOOKS! CATALOGUE FOR STAMP. Duff Company, E-2713 Mozart St., Chicago.

VENTRILQUIST'S INTERESTING BOOK-let Free. Send stamp. Prof Baily, 771 Iglehart, St. Paul, Minn.

NEW BOOK, "HOW TO OBTAIN A POSI-tion," any line, success sure, postpaid 25c. Wm. Paul, 640 E. Indiana Ave., Philadelphia, Pa.

OUR 368-PAGE VOLUME CONTAINING 3,000 formulas \$1.00. Smaller volume containing 500 formulas, 25 single formulas 25 each. Breuel Company, 117 Bloomfield St., Hoboken, N. J.

"THREE LITTLE BOOKS FOR LADIES," postpaid in plain cover, 25c. (They tell what you want to know). O. K. Pub. Co., Clerk 191, Decatur, Ill.

READ MY NEW BOOK—ON CEMENT, Stone, iron, and wood-fibre concrete. The poor man's gold mine. Price fifty cents. Peter De Linde, Zion City, Ill.

FOXY FLORENCE—A TALE OF A WAYWARD girl. One long laugh from cover to cover. 10c silver. E. G. Treichler, Sanborn, N. Y.

"YOUR LATENT FORCES"—HOW TO USE them. 120 pages, 25c. "Personal Magnetism," 146 pages of valuable advice, insuring success in life, 20c. Catalogues and "Hypnotic Wonders" free. Popular-elec Institute, 29 Randolph, Chicago.

"HOW TO BECOME A STAGE ELECTRI-cian." Long guarded stage secrets revealed. \$5.00 book for \$1.00. Profusely illustrated. Non-technical. Only book of its kind ever published. Copyrighted. Address Shuberts-Expert Stage Electrician, Box 1043, Denver, Colo.

BOOKS

THE GREATEST WORK ON THE FUTURE Life. Swedenborg's "Heaven and Hell." Four hundred pages. Fifteen cents, postpaid. Pastor Landenberger, Windsor Place, St. Louis, Mo., Department 7.

TELEPHONE TROUBLES AND HOW TO Find Them, new 14th edition, price 25c, Hyde Pub. Co., Telephone Building, 183 Fifth St., Milwaukee, Wis.

"WIRING A HOUSE," BY H. PRATT. SHOWS a house already built; tells you just how to start about wiring it; where to begin; what wire to use; how to run it according to insurance rates, in fact, all the information necessary for wiring a house and shop. Postpaid, 25c. Popular Electricity Book Dept.

LEARN AT HOME, IN A FEW EVENINGS, how to construct, operate and repair Automobiles, Commercial Trucks, Flying Machines, Motorcycles, Motor Boats, Gasoline Engines, Electric Motors. Big demand, with good pay for competent men. Thousands of positions open. Let us help you in place and pay. A postal card will do. Address, **EXTENSION DEPARTMENT**, The Charles C. Thompson Co., 549 Wabash Ave., Chicago.

"LOVERS' SECRETS," AN INVALUABLE book on Love, Courtship and Marriage. Contains 210 large pages of winning advice, 50c. "Occult Forces," Key to Personal Magnetism, 146 pages, 30c. "How to Win Success," 362 pages (illustrated), \$2. "The Power of Personal Influence," Your Latent Forces and How to Use Them, 128 pages, 25c. All for \$3. Catalog free. A. W. Martens, Pub., P. E. E., Burlington, Iowa.

BUSINESS OPPORTUNITIES

See what I say under "Typewriters." **ATCHISON.**

SEE ADVERTISEMENT UNDER AGENTS—Eagle Rubber Company.

BARGAIN, PAYING MAIL ORDER BUSI-ness. Successful plan and samples 30c. Popular-elec. Institute, Fairbank's Bldg., Chicago.

I MADE OVER \$15,000 IN TWO YEARS in mail-order business. Free booklet tells how. Haynes, Marion, Ky.

MAIL ORDER DEALERS—SELL MONEY-making plans; big profits; circulars furnished; write. Walters Printery, Brooklyn, N. Y.

FORM A CORPORATION—CONGRESS LAW for D. C. and all States; cheap. Raise money easily; advice free. U. S. Legal Corporation, Washington, D. C. Representing \$1,225,000,000.

CONDUCT A "CANDY KITCHEN." CLEAR \$20 daily. Small capital required. Send for particulars. Kennon and Co., 148 West Ontario St., Dept. C, Chicago.

\$100 MONTHLY AND EXPENSES TO TRUST-worthy men and women to travel and distribute samples; big manufacturer. Steady work. S. Scheffer, Treas., MO 174. Chicago.

MOTION PICTURE MACHINES, FILM Views, Magic Lanterns, Slides, and similar Wonders For Sale. Catalogue Free. We also buy Magic Machines, Films, Slides, etc. Harbach & Co., 809 Filbert St., Philadelphia, Pa.

BUSINESS OPPORTUNITIES

MAKE \$20 DAILY OPERATING OUR MINUTE Picture Machines. Experience unnecessary. Small investment; large profits. Free book, testimonials, etc. Write: American Minute Photo Co., Dept. 37, Chicago, Ill.

FASCINATING. MONEY MAKING MAIL Order Business at home. Anyone Anywhere can conduct it. New plans. Everything furnished. Free Booklet tells how. Write today. W. E. Foote, Box 254, Muskegon, Mich.

\$100 WILL BUY A CLEAN STOCK OF MAIL order goods that will retail for over \$1,000; on account of leaving United States, will sell all for only \$100; circulars describing goods free. James Orr, 214 Kasota Bldg., Minneapolis, Minn.

EXTRAORDINARY MYSTERY—PEOPLE, ARTICLES, living heads, made to appear on stage, absolutely without using mirrors, trap-doors, or wires. It's simple, but a great money-getter at shows. You can do it. Complete instructions, 25 cents. Jack Howe, 6 Dwight Block, Binghamton, N. Y.

START A NEW BUSINESS—THE AMERICAN Razor Honing and Safety Blade Sharpening Machine earns \$5 to \$10 a day. We teach you how. No previous experience required. Illinois Cutlery Co., Dept. 4, 171 Washington St., Chicago.

WE START YOU IN A PERMANENT BUSINESS with us and furnish everything. We have new easy-selling plans and seasonable leaders in the Mail Order line to keep our factories busy. No canvassing. Small capital. You pay us out of the business. Large profits. Spare time only required. Personal assistance. Write today for plans, positive proof and sworn statements. J. M. Pease Mfg. Co., 1185 Pease Building, Buffalo, N. Y.

MAKE MIRRORS AT HOME. BIG PROFITS with little outlay. One 18x36 in. mirror, costs \$2.00 to \$5.00. You can silver a glass this size for 20c. Send \$1.00 in stamps or money order and we will send you **EXPLICIT DIRECTIONS** how to do it; also how to emboss, grind, foil, gold leaf, frost chip, and make imitation stained glass. How to transfer photos on glass, bore holes in glass and cut skylights. George L. Patterson & Co., Dept. 4, Brooksville, Ky.

FOR GENTLEMEN—SUSPENDERS, GARTERS, Socks. Guyot Suspenders are better known and better liked than any other. Better liked because of their surpassing quality and durability, better known because always made with the same excellence, since 1848—and every wearer is always a talking advertiser. Made in France, direct to you, 50 cents. Garters, Socks, these are the best 25-cent value ever offered. They are our leaders. Mail \$1.00 for these three attractive articles. Grasp this advantage. It will delight you or money refunded. In silk \$2.00. T. S. Todd & Co., 40 Broadway, New York.

COINS AND STAMPS

\$7.75 PAID FOR RARE DATE 1853 QUARTERS. \$20.00 for a Half-Dollar. We pay a cash premium on hundreds of old coins. Keep all money dated before 1884, and send 10 cents at once for our New Illustrated Coin Value Book, 4x7. It may mean your fortune. Clarke & Co., Coin Dealers, Dept. 83, Le Roy, N. Y.

COINS AND STAMPS

WATERMARK DETECTOR, 10c. STAMP Microscope, 25c. Guaranteed. Beaver Book Co., Chemawa, Ore.

500 MIXED FOREIGN, CHILI, AFRICA, Russia, Japan, etc., 12 cents. 1,000 mixed old United States, 25 cents. Stamps bought, list 4 cents. Kleinman Stamp Co., 3643 N. Marshall St., Philadelphia, Pa.

ANNUAL COIN CLEARANCE SALE—THREE-dollar gold pieces, \$4.25. Gold dollars, \$2.20. Columbian 1892 ½-dollars, 65 cents. Early ½-dollars, Liberty head, 65 cents. Liberty head ¼-dollars, 34 cents. Isabella ¼-dollars, 55 cents; 20-cent pieces 28 cents. Ten different small war cents, 45 cents. 10 different large war cents 45 cents. All in good shape, new January 50-page selling catalogue just out, free. William Hesslein, 674 Elm St., New Haven, Conn.

ELECTRICAL MATERIAL

500 GUARANTEED \$2 AMMETERS FOR testing batteries, beautifully nicked in chamois leather case, 25c postpaid. Stamps taken. Automobile Repair Company, 521-23 West 144th St., N. Y.

RENEW OLD DRY CELL BATTERIES AT very small cost. Send 25c for complete formula and instructions. Will make them good as new. E. G. Mayer, 3642 N. Seeley Ave., Chicago.

"HI-LIFE" STORAGE BATTERIES. BEST for Automobile sparking and lighting. These are high grade batteries at a remarkably low price. Guaranteed. Give us a trial or write for particulars. Discounts to the trade. NORTHWEST MFG. CO., 1247 Wells St., Chicago.

FOR SALE

FOR SALE—MOVING PICTURE FILM, 1-cent foot. H. Davis, Watertown, Wis.

FOR SALE—RAMBLER, 2-CYLINDER AUTO-mobile, \$300. Pope Toledo, 4-cylinder automobile, \$600. Longest Bros., Louisville, Ky.

LATHES—SEND FOR FREE CIRCULAR showing bargains on small Screw Cutting Engine Lathes. S. B. Tool Co., Dept. O, South Bend, Ind.

IRON TURNING LATHE, FOOT POWER \$30.00. Hand Vacuum Cleaner, \$7.00. Photos. Butts, Oxford, New York.

HALF PRICE—25c POSTPAID, PAIR TEM-pered tool steel pliers. Catalog for stamp. Woodside Electrical Shop, Bryant St., Newark, N. J.

LATEST REVISED COURSE I. C. S. COM-plete Electrical Engineering, \$20. Contractor, 1022 Bannock, Denver, Colorado.

FOR SALE—BRAND NEW \$13.00 DRAFTING Outfit complete. Price \$7.00. Complete motion picture outfit at bargain. Cecil Hurlbut, Bangor, Mich.

FOR SALE—COMPLETE SET OF CASTINGS, with blueprints of 3-4 h. p. gasoline stationary engine; includes governor and timer, screws, etc. \$10. Comet Motor Works, 512 W. Monroe St., Chicago, Ill.

LUBRICANTS, ASBESTOS, GRAPHITE AND mica candles for loose pulleys and shaftings; no drip; no dirt; economical. Swain Lubricator Co., 250 E. Lake St., Chicago.

FOR SALE

FOR SALE—PAT. NO. 798,833 TOY. BEACH Novelty, Copper plate, Dies and Material included. Address Cornish Electric Co., No. 42 Bradt St., Schenectady, N. Y.

ELECTRIC ALARM MAIL BOXES, READILY connected with doorbell, intermittent alarm, positive in action, simple and durable. Agents wanted. Send stamp for particulars. Hodgson & Co., 29 Cortland St., Springfield, Mass.

FOR SALE—A BARGAIN AT HALF PRICE—One bench lathe, 7-inch swing with variable speed motor and counter shafting. Chuck slide rest complete with tools. One 75-watt dynamo, steel, one 50-watt dynamo, steel, one laminated field complete with bearings, commutator and armature. One enclosed dynamo field ready wound, capacity about 50 watts. Two small electric locomotives, 2-inch gauge. One drawing set complete. One drawing table with board. Two water motors for 75- and 50-watt dynamos. All of the above machines are nearly new. For further information address William Adler, 219 Cardwell Ave., Wilmerding, Pa.

GAMES AND AMUSEMENTS

THEATRICAL WIGS—CATALOGUE FREE. Percy Ewing, Decatur, Ill.

THREE CARD TRICKS—10 CENTS. BAMBERG, 1193 Broadway, New York.

MOVING PICTURE MACHINE, 35c PREPAID. Turns with crank. Extra pictures 5c. B. K. Bunch, Marshall, Mo.

EWING'S CABINET OF MAGICAL TRICKS, contains apparatus to perform 7 good tricks including the Wonderful Magic Coiner, 25c, postpaid. Ewing's, 191 Thatcher Pl., Decatur, Ill.

PLAYS, VAUDEVILLE SKETCHES, MONOLOGUES, Dialogues, Speakers' Minstrel Material, Jokes, Recitations, Tableaux, Drills, Musical Pieces, Entertainments, Make Up Goods. Large Catalog Free. T. S. Denison and Company, Dept. 26, Chicago.

INSTRUCTIONS

THE BEST CUT AND ENGRAVING COURSE for 25c, regular price \$5.00. Herman Becker, 32 7th St., New York.

USE OF LOGARITHMS, AND HOW TO figure any electrical formula. \$3.00. Cpt. C. Nielsen, Box, L 448, Willits, Cal.

MAKE YOUR OWN DRY BATTERIES—Instructions with Blueprint, 25c. Renew dry batteries, 20c. Stamps taken. Heco Electric Co., Box. 988, Dallas, Texas.

LEARN TO CARVE BEAUTIFUL FLOWERS, etc., on cardboard. A money-making home employment. Information free. A. W. Dakin, Syracuse, N. Y.

FREE—"INVESTING FOR PROFIT" MAGAZINE. Send me your name and I will mail you this magazine absolutely FREE. Before you invest a dollar anywhere, get this magazine—it is worth \$10 a copy to any man who intends to invest \$5 or more per month. Tells you how \$1,000 can grow to \$22,000—how to judge different classes of investments, the REAL EARNING POWER of your money. This magazine six months FREE if you write today. H. L. Barber, Publisher, 423, 77 Jackson Blvd., Chicago.

INSTRUCTIONS

MODEL ELECTRIC ELEVATOR—BOYS, build one with controller. Blueprints and directions, 20 cents (coin). Cheaply made. Motor suitable for model locomotive, etc. L. King, Tomah, Wis.

INVESTMENTS

CRIPPLE CREEK GOLD—\$10.00 BUYS 1,000 shares Isabella and Victor Leasing Stock, producing and shipping gold ore continually; dividends assured. Write FRANK SMOKEY, 1723 Vine St., Denver, Colo.

POLK COUNTY, FLORIDA, FOR HEALTH, Wealth and Prosperity. Openings in citrus groves, farming, trucking, phosphate mining. For general information write, Secretary, Polk County Board of Trade, Bartow, Florida.

HAVE YOU FIVE DOLLARS PER MONTH to invest for 14 months in a Mexican plantation for the growing of a very profitable FIBER PRODUCT, that ought to pay you 20 per cent within two years? If so, write UNITED STATES & MEXICAN TRUST CO., Mexico City, Mexico, assets, \$2,000,000.

MISCELLANEOUS

See what I say under "Typewriters." ATCHISON SEE ADVERTISEMENT UNDER AGENTS—Eagle Rubber Company.

CORRECT FORMULAS FOR ANYTHING 50 cents each. Malalane Company, 1411 Longfellow Ave., New York.

MAGIC GHOST HEAD—SHINES IN DARK—10 cents. Bamberg, 1193 Broadway, N. Y.

"KEEN KNOWLEDGE" ANNUAL SUBSCRIPTION 25c, three months, 10c. Palmland, Floral Park, N. Y.

RAISE GINSENG—\$1 PER SQUARE FOOT OF ground. \$25,000 on 1/2 acre. Grows anywhere; 1/2 city lot a bonanza. 10c brings booklet. Sheboygan Ginseng Gardens, Sheboygan, Wis.

ELECTRICIANS' TROUBLES IN MOTORS and generators cleared up. Send me your name and address on a postal for full information to Lock Box 520, West Des Moines, Iowa.

IRON, BRASS, AND ALUMINUM CASTINGS. Metal Specialties. Patterns, Models, Polishing, Plating and Japanning. North Chicago Tool Works, North Chicago, Ill., 3 Broadway.

CYCLONE DISH AND VEGETABLE WASHER. Labor saver for women. Washes dishes clean. Absolutely guaranteed. Particulars free. One Minute Washer Co., El Reno, Okla.

BROTHER—ACCIDENTALLY DISCOVERED Root will cure both tobacco habit and indigestion. Gladly send particulars. F. F. STOKES, Mohawk, Fla.

CACHOO (IT MAKES PEOPLE SNEEZE) a harmless joke. Sample 12c, dozen 80c, hundred \$5.00, postpaid. Ewing's, 191 Thatcher Pl., Decatur, Ill.

GET "THOUGHT FORCE FOR HEALTH" BY Julia Seton Sears, M. D. I will send it with a copy of Ella Wheeler Wilcox's New Thought booklet and a three months' trial subscription to THE NAUTILUS, magazine of self-help, for 10c. Address: Elizabeth Towne, Dept. 176, Holyoke, Mass.

MISCELLANEOUS

I WILL START YOU EARNING \$4 DAILY at home in spare time, silvering mirrors; no capital; send for free instructive Booklet, giving plans of operation. G. F. Redmond, Dept. H, Boston, Mass.

SELL A HIGH GRADE MAIL ORDER Article in constant demand for \$1.00. Cost you 5c. Send 25c coin for instructions. Cœur d'Alene Supply Co., Box 1641, Spokane, Wash.

AN ADDING MACHINE COSTS \$300. JUST think—we will mail a sample of our Lightning Multiplier, with special terms to agents, for 10c. Simplicity Co., 421 Ashton, Grand Rapids, Mich.

SHEET MUSIC—ALL THE LATEST SONGS 15c each. 7 for \$1. Write for circular showing latest hits. Jersey Music Co., 2903 Westfield Ave., Camden, N. J.

TEN ORE SPECIMENS—GOLD, SILVER, copper, iron, lead, zinc, tin, nickel, graphite, sulphur; also mineral booklet, 25 cents. MacLaughlin, Sharpsville, Pa.

WANTED—PARTIES IN THE MAIL ORDER business to send 10 cents for sample of one of the best money-making novelties there is. F. C. Knepfel, 4118 Calumet Ave., Chicago, Ill.

ANYBODY CAN MAKE GOOD CUTS WITH my simple zinc etching process; price, \$1; specimens and particulars for stamp. T. M. Day, Box E., Windfall, Ind.

WOOD TURNED SPECIALTIES.—IF YOU desire estimate on large quantities of small accurate wood work, please send us samples for prices. The Olida Co., 414 W. Indiana St., Chicago, Ill.

I BUY, SELL AND EXCHANGE, GASOLINE Engines, Motors, Generators, Typewriters, Telephone and Switchboard Equipment, what have you for sale, or what are you in market for? M. C. Suttle, McLeansboro, Ill.

"HOW TO JUDGE A PATENT" CONTAINS the Patent claim of Selden Automobile, Morse Telegraph, and Bell Telephone. 10c., prepaid, Obed Billman, Cleveland, Ohio. Author of "Notes on Patent Law," Popular Electricity.

STOP LOSING FLESH! EVERY MAN DEplores losing flesh by means of his razor. Safeguard your appearance and razor. Our Adjustable Razor Guard is the remedy. 35c postpaid. Agents wanted. Walter Distributing Co., 103 East Philadelphia St., York, Pa.

RADIUM-YTE—THE GREATEST KNOWN piano polish for finger marks, scratches. Best factories endorse. \$1.00, 50c., refunded if unsatisfactory. Splendid agents' proposition. Montana Piano Hospital, 107 N. Mont. St., Butte, Mont.

WE MANUFACTURE GLASS PAPER. PLAIN glass windows made to look like real stained glass. Easily applied and beautifies the home. Something new for agents. Two sheets of this glass paper sent as a sample with catalogue in colors and complete instructions on receipt of 10 cents. S. H. Parrish & Co., 216 Clark St., Chicago.

A NEW STYLE TRUST SCHEME IN WHICH there are no losses. A new bright idea which any man or woman can work by mail. Unlimited possibilities. Send 25c coin for complete plan and if you fail to make good we will return your money. Cœur d'Alene Supply Co., Box 1641, Spokane, Wash.

MOTORCYCLES

MOTORCYCLES, NEW AND SECOND-HAND; motors, castings and accessories. Our Attachable Motor Outfit converts any bicycle into a motorcycle at small cost. Write for catalogue and bargain list. Shaw Mfg. Co., Dept. 31, Galesburg, Kan.

MOTORCYCLES—ENORMOUS VARIETY OF American and imported makes—Indians, Marsh's \$35.00—hundreds of other bargains! Shipped freight prepaid! Write now! Large illustrated bulletin-free! MOTORCYCLE EXCHANGE, Dept. B, 217 West 125th St., New York City.

PATENTS

See what I say under "Typewriters." ATCHISON MODELS MADE FOR INVENTORS. LOW prices. S. H. Merryman, Towson, Md.

INVENTORS—LET US SELL YOUR PATENTS We are manufacturers' agents. Write for plan. Atlantic Supply Co., Long Branch, N. J.

PATENT—ADVICE AND BOOKS FREE. Highest references. Best results. I procure patents that protect. Watson E. Coleman, Patent Lawyer, 612 F. St., N. W., Washington, D. C.

C. L. PARKER, PATENT ATTORNEY, EX-Examiner U. S. Patent Office, 912 G St., Washington, D. C., Inventors' handbook, "Protecting, Exploiting and Selling Inventions" sent free upon request.

HERBERT JENNER, PATENT ATTORNEY and Mechanical Expert, 608 F Street, Washington, D. C. Established 1883. I make a free examination and report if a patent can be had and the exact cost. Send for circular.

\$15 FILES YOUR IDEA IN THE PATENT Office under my "No-fee-in-advance" Plan, and you make and sell under "Patent Applied For." Send sketch for free report. Obed C. Billman, Main Office, Cleveland, Ohio.

PICTURES AND POST CARDS

JUST GIRLS—20 POSTCARDS 25c POSTPAID. No trash or landscapes. O. K. Pub. Co., Decatur, Ill.

SAMPLE PACKAGE BEAUTIFUL EASTER Cards, 10c. White Elephant Co., 2058 Coral, Phila.

"PARISIAN BATHING GIRLS" GENUINE photographs. Hand colored. 3 for 25c, 10c each. Colonial Co., 981-A Main St., Hartford, Conn.

12 BEAUTIFUL NEW YORK VIEWS FOR 10c and addresses of five friends. Order now. H. Borsch Co., 224 North 52d St., Philadelphia.

DECORATE YOUR "DEN" WITH "STAGE Beauty" Posters. Send stamp for profusely illustrated sheets and our free "Salome Nymphs" offer. Gordon Art Co., Dept. P 2, New York City.

YOU'LL GET CARDS FROM EVERYWHERE, Membership 10c. Idaho Card Exchange, Dept. O. Box 906 Boise, Idaho.

IF YOU REALLY WANT TO EXCHANGE post cards, try our splendid club. Lists circulate in many countries Membership ten cents. Halcyon Exchange, Box 133, Erie, Pa.

JOIN THE CURTIS CORRESPONDENCE Club and receive post-cards from members everywhere. Largest in existence. Membership 10c. C. C. Club, 3935 N. Tracy Ave., Kansas City, Mo.

PICTURES AND POST CARDS

REAL PHOTOS—PRETTY GIRLS, RARE beauties from life. 6 for 25c. Larger and better ones 15c each, 5 for 50c. 132-page book for men. Only \$1.00. "A Powerful Influence," 25c. Curtis Co., 7149 Union Ave., Chicago.

RUBBER AND STEEL STAMPS

FREE—A 25c BOX STUART'S HERB TABLETS with your name on 12 rubber-tipped pencils, 50c. W. M. Stuart, Marshall, Mich.

RUBBER STAMPS AND SPECIALTIES—BEST prices—prompt delivery—Most complete line. Don't buy till you see my big catalog. Free. Theo. Helbling, 607 Marquette Bldg., Chicago.

STAMPS, STENCILS, SEALS, CHECKS, Punches and Dies. Presswork. Dickey-Grabler Co., Cleveland, Ohio.

SCHOOLS

See what I say under "Typewriters." ATCHISON

\$200 TO \$600 MONTHLY EASILY MADE FITTING eye glasses. Short, easy mail course. Reduced tuition. Big demand for opticians. Write today for free "Booklet O," National Optical College, St. Louis.

PLUMBING, ELECTRICITY, BRICKLAYING and Mechanical Draughting, taught by expert workmen. Short time and small cost. Positions always open. Catalogue free. Write today. Coyne National Trade Schools, 79 E. Illinois St., Chicago.

TELEGRAPHY, BOTH MORSE AND WIRELESS, taught quickly, also Station Agency Work. R. R. Dispatcher's and Western Union wires, and complete wireless station in school. Big demand for operators. Living expenses earned. Correspondence courses if desired. Catalogs free. DODGE'S INSTITUTE, 16th St., Valparaiso, Ind. Est. 1874.

YOUNG MAN—BIG DEMAND FOR AUTOMOBILE experts. A few weeks' study in your own home qualifies you. Earn \$35 to \$50 a week—job a cinch. Models free to every student. Small down payment starts you. Write today for our free prospectus with sample lessons, also plan to earn cost of course. Automobile School, 49 Centaur Bldg., Buffalo, N. Y.

BOYS AND YOUNG MEN—WE CONDUCT the best telegraph school on the Atlantic Coast for learning Wireless Telegraphy. Our students have the advantage of using the latest type Perikon and Pyron Detectors in receiving long distance wireless messages. These Detectors are now the standard in our Navy. Write for Catalogue. BOSTON SCHOOL OF TELEGRAPHY, Boylston Building, 18 Boylston St., Boston, Mass.

LEARN TO BE A TELEGRAPH OPERATOR—Telegraphy without doubt offers more inducements than any other field. A School conducted by practical telegraph operators. No charge for typewriting or supplies. Only School in Chicago giving main line practice. Look us up. Jones' School of Telegraphy, Suite 20, 260 Clark St., Chicago.

LEARN TO BE A PRACTICAL ELECTRICIAN. We teach you in eight weeks how to be a first-class Electrician. Pupils have no difficulty in finding good jobs because we teach them from the ground up. Don't delay—write me NOW for details. Wilcox & Cote, Electrical Engineers, 432 Columbus Ave., Boston, Mass.

SCHOOLS

AUTOMOBILE SCHOOL—LEARN THE AUTOMOBILE business, repairing and driving, in which you can earn good wages and have healthful and pleasant work. We give a thorough and practical course in road work and repairing. For full particulars address Academy of Automobile Engineering, 1420 Michigan Ave., Dept. "C," Chicago, Ill.

TYPEWRITERS

\$10.00 FOR A REAL REMINGTON TYPEWRITER. 5 per cent discount for cash with order. Also have large stock of all other makes of typewriters. Donald Price, 40 Dearborn St., Chicago, Ill.

REMINGTON \$18.75. THIS IS YOUR OPPORTUNITY. Write at once for the most interesting proposition ever made. We are the final word. Standard Typewriter Exchange, 23 Park Row, New York.

GENUINE TYPEWRITER BARGAINS—NO matter what make, will quote you lower prices and easiest terms. Write for big bargain list and illustrated catalogue. L. J. Peabody, 364 Minot Bldg., Boston, Mass.

I WANT TO CORRESPOND WITH PERSONS who are about to buy a high-grade typewriter, and object to paying the high prices generally asked by manufacturers and dealers. Any make on approval. Catalogue, bargain list and valuable information sent free. A. E. Atchison, 4125 West 21st St., Chicago.

TYPEWRITERS: CALIGRAPH, \$6.00; HAMMOND, Yost, Densmore, Williams, \$10.00; Remington, \$12.00; Smith Premier, \$15.00; Oliver, \$24.00; Underwood, \$30.00; all makes on hand; fifteen days' trial allowed, and a year's guarantee. Send for catalogue. Harlem Typewriter Exchange, Dept. 89, 217 West 125th St., New York City.

WIRELESS

FREE—SEND AT ONCE FOR OUR CODE Card No. 2 and Blue Book which has space for local call letters, etc. Minneapolis Electric Motor Company, 9 South 5th St., Minneapolis, Minn.

ENAMELED AND STRANDED COPPER ANTENNAE wire at a big discount. Send for list prices and discounts. I can save you money. B. Kendig, 7th Ave., Mt. Vernon, N. Y.

SPECIAL PRICES—1,000-OHM WIRELESS receiver, double pole, special thin diaphragm, hard rubber case, wound with copper wire, \$1.75. Leather covered head-band, double, \$1.00, single, 60c. "National" receiving condenser, 30c. Waterhouse Bros., Bourne, Mass.

COMPLETE LONG DISTANCE WIRELESS Receiving Set \$5.95, consisting of double-slide tuning coil, condenser, readily adjusted mineral detector, 1,000-ohm double-pole receiver and cord, all mounted on polished base. Complete two-mile sending sets \$7.95. 1,000-ohm double-pole receivers, \$1.75. Sensitive mineral detector \$1.00. Square slider rod, \$0.10 a foot. Sliders \$1.12, with hard rubber handles \$1.23. Tuning coil cores, twelve inches long, wound with bare wire, machine spaced, \$1.35 each. Reliable apparatus of all kinds. Send stamp for circulars. Alden Wireless Co., Dept. D., Campello, Mass.

WIRELESS

WIRELESS CODES 10c, Standard circuits, 5c. Formula for wave length calculation 20c. Two thousand-ohm wireless receivers, genuine Marconi type, \$6. Enamel wire 20 per cent off list. Austin & Secor, 25 P E. 14th St., New York.

ARC LAMPS—JUST THE DEVICE FOR YOUR wireless station, giving thousand candle-power on 110 volts direct and alternating current, including carbons, \$3.50. Magnet wire at fabulous low prices. Cosmos Electric Company, 136 Liberty St., New York.

HELP WANTED

SEE ADVERTISEMENT UNDER AGENTS—Eagle Rubber Company.

\$25 WEEKLY AND EXPENSES TO MEN AND women to collect names, distribute samples and advertise. Steady work. C. H. Emery, M J 302, Chicago, Ill.

LEARN TO FLY. \$1,000,000 IN PRIZES. Greatest new industry. Correspondence course in aviation. Apply immediately. UNIVERSITY EXTENSION BUREAU, Aviation Dept., Chicago.

DO YOU WANT A \$1,200 GOVERNMENT position? We tell you how to get it, and send you a free trial examination. Write today. Ozment, Dept. 72, St. Louis, Mo.

MOTION PICTURE PLAYS WANTED—YOU can write them. We teach you by mail. No experience necessary. Writers earn \$50 a week. Demand increasing. For particulars address Ass'd M. P. Schools, 112 Clark St., Chicago, Ill.

WANTED—A MAN OR WOMAN TO ACT AS our information reporter. All or spare time. No experience necessary. \$50 to \$300 per month. Nothing to sell. Send stamp for particulars. Sales Association, 611 Association Building, Indianapolis, Ind.

WANTED—MEN BY LARGE CONTRACTING company. Can learn trade of plumbing, electricity, bricklaying, automobiles, in few months. No apprentice or helper's work and no expense. \$20,000.00 contract work going. Catalogue free. United Trade School Contracting Co., Los Angeles.

CIVIL SERVICE GOVERNMENT POSITIONS are very desirable for young people. Full information and questions recently used by the Civil Service Commission free. Columbian Correspondence College, Washington, D. C.

YOU ARE WANTED FOR GOVERNMENT positions, \$80.00 a month. Annual vacations, short hours, no "lay-offs." Common education sufficient. Over 12,000 appointments coming this year. Influence unnecessary. Send postal immediately for list of positions open. Franklin Institute, Dept. H 53, Rochester, N. Y.

FREE ILLUSTRATED BOOK TELLS ABOUT over 360,000 protected positions in U. S. service. More than 40,000 vacancies every year. There is a big chance here for you, sure and generous pay, lifetime employment. Easy to get. Just ask for booklet A 50. No obligation. Earl Hopkins, Washington, D. C.

MANUFACTURERS: WE DESIRE EXCLUSIVE agency for California or Southern California. Can handle one or two more good lines, either staples or specialties, not necessarily electric. Willing to "show you." Pacific Sales Co., 218 Grant Bldg., Los Angeles, Cal.

HELP WANTED

MEN WANTED—EVERY RAILROAD COMPANY wants signal engineers. We absolutely guarantee every graduate enrolled with us before August 1st, 1911, a well paid position at the start. Send for free catalog No. 60 for full particulars. The School of Railway Signaling, Utica, N. Y., U. S. A.

WANTED—ONE GOOD MAN IN EACH town to take orders for made-to-measure clothes. Up-to-date styles, very low prices; orders come easy. High-class permanent business; fine profits, \$5.00 a day and up. No money or experience needed. We ship on approval express prepaid, and guarantee perfect fit. Write for free sample outfit and inside price on suit for yourself. Banner Tailoring Co., Dept. 664, Chicago.

IF YOU CAN READ AND WRITE AND ARE willing to try, we will teach, train and equip you to be a top-notch, scientific salesman, a splendid position with us is then yours; no previous experience necessary. We want "I CAN" and "I WILL" men for our permanent sales force. This is an opening for the man who wants to be a REAL salesman, with exceptional money-making opportunities. If you believe in doing business on a "100 per cent honesty basis," if you want "success," if your wishbone is not where your backbone ought to be, write us today for particulars. Stace, Burroughs & Co., (manufacturers' representatives), 310 Michigan Ave., Offices 748, Chicago.

MAGIC POCKET TRICK FREE
Catalog included, send 6c stamp
Dept. 17 270 W. 39th St., NEW YORK



YOUNG MEN WANTED

For Chauffeurs AUTOMOBILE

Salesmen, Demonstrators, and Repairmen

EARN \$25 TO \$50 WEEKLY

Demand for these trained men can't be supplied. The work is pleasant and instructive, out-of-doors, and the hours short. You can prepare yourself for one of these positions in 10 weeks by a few hours' study each week. We teach you the entire subject by our simple course of instruction by mail. It is very interesting, practical and thoroughly efficient because it is personal. Free model of automobile to every student. Ask our graduates who are earning \$25 weekly or more in positions we obtained for them.

FIRST LESSON IS FREE

Write for it today. Let us prove our claims.

Empire Auto. Institute, 473 Empire Bldg.
The Original Automobile School Rochester, N. Y.
Chauffeurs and competent men furnished owners and garages.

Let me send you a Free Book on Florida



Dan Riley
President Orlando Florida
Farms Company.

This Book Tells You of an Opportunity to Secure a Small Farm in the Proven Protected Grapefruit, Orange and Truck Farm Section of Florida

I want you to send to-day for "A NEW DOMINION."

This is the name of a book on Florida which I consider the most enlightening of any ever issued from the press.

"A NEW DOMINION" will tell you all about my new Florida project. It tells all about what is probably the most magnificent tract of Florida land ever opened up to the public.

This tract starts within about three miles of Orlando — the busiest, prettiest and fastest growing city in Florida. It is in the very heart of Florida's greatest producing section.

This land has never before been sold in small tracts. For the first time I am in position to offer this land in 5, 10, 20 and 40 acre allotments. Here is land located in the proven, protected orange and grapefruit section of Florida; here is land also that is in the soil belt which produces the greatest returns in the growing of vegetables for the winter markets of the North.

Orlando is a city of over seven thousand people, and is the county seat of Orange County. Orange County may be truthfully called the real banner county of the State of Florida.

In the production of citrus fruits, such as oranges, grapefruit, tangerines, etc.; this county leads the State; in the production of celery, lettuce, cabbage and other trucking crops it is not approached by any other section of Florida.

The truck growers of Orange County are realizing right now anywhere from \$250.00 to \$1,000.00 per acre clear profit each year. The owners of grapefruit and orange groves are taking off crops that realize from \$600.00 to \$1,200.00 per acre.

The tract of land which I am offering in 5, 10, 20 and 40 acre farms extends from the towns of Gabriella and Golden Rod on the north, to some few miles south of Orlando.

Right through the center of it flows the Econtockhatchee River, a stream that is navigable for quite a distance for boats and launches. This land lies about one hundred feet above sea level, and the climate, both summer and winter, in this section is incomparable.

I am going to sell this land at \$25.00 per acre, and on terms of \$1.00 per acre per month.



Send for this Great Free Book To-Day! Fill out the Information Blank Below and it will be sent to you Postage Paid Without any Expense or Obligation.

I AM GOING TO GIVE YOU A FULL HALF YEAR FOR EX- AMINATION AND INVESTI- GATION!

I have confidence in this land and know that any one who once sees it will be satisfied and delighted. This is the reason that I can offer to give you plenty of time to go down there and look over your purchase. All that I want you to do is to send for my new book, "A New Dominion." This book tells you how on five or ten acres men can achieve independence for life in Florida.

It is handsomely illustrated from actual photographs showing you orange and grapefruit groves and truck farms right in the heart of this land. This book may be the stepping stone to a glorious future for you and your loved ones. It costs you nothing. I am going to send it to you free along with maps and other literature showing the exact location of these magnificent farms.

Fill out the information blank below and it will be sent you by return mail without any cost or obligation whatsoever.

DAN RILEY, President
Orlando Florida Farms Company.

FREE INFORMATION BLANK

Orlando Florida Farms Company,
Fisher Building, Chicago, Ill.

Please send me, postage paid, and without any obligation on my part whatsoever, your free book on Florida entitled "A NEW DOMINION," map showing location of the Orlando Florida Farms, and all information concerning this land.

Name

Town

State

R. F. D.

(No letter necessary with this blank.)

Address your envelope this way:

ORLANDO FLORIDA FARMS COMPANY,
305 Fisher Building, Chicago, Ill. P. E.

For our Mutual Advantage mention Popular Electricity when writing to Advertisers.

THE WORLD'S LATEST INVENTION

DARCHE UTILITY HOUSEHOLD ELECTRIC CLOCK AND MEDICAL BATTERY

(PATENTED)

Absolutely necessary in every household

*To see
the time*

*Electric
Alarm
Clock*

*Electric
Night
Light
by
pressing
the button*

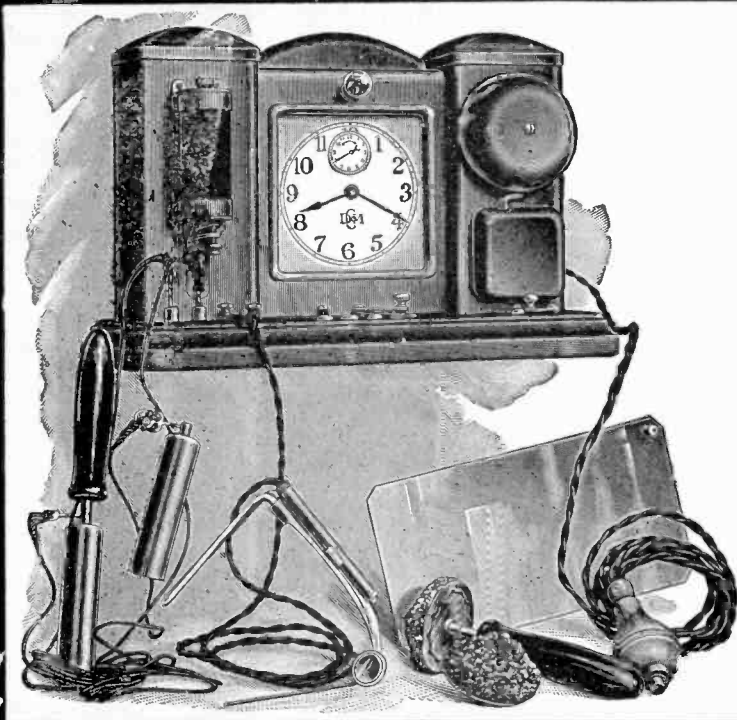

*Electric
Call Bell*

*Electric
Bell
Alarm*

*Electric
Lamp
to examine
the throat
teeth and
mouth*

Electric Medical Battery and all attachments

ALL IN ONE

READY FOR USE. OPERATED BY DRY BATTERIES

Send for illustrated booklet showing uses with full directions. General Agents wanted everywhere. Address all communications to

DARCHE MFG. CO.

(ESTABLISHED 1882)

2117 S. HALSTED ST.

**BRANCH
NEW YORK**

CHICAGO

**FACTORY
DETROIT**

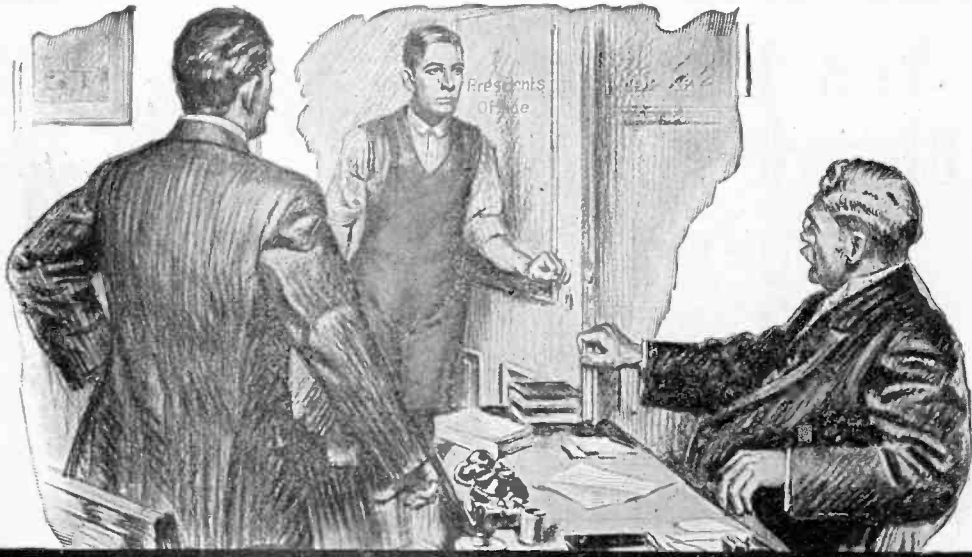

Will YOU Be Ready When YOUR Chance Comes?

Will YOU be chosen as the right man when the big opportunity comes? Are YOU better prepared to rise from the ranks than the men beside you?

Could you fill satisfactorily a position requiring knowledge of "hows" and "whys"? Could you direct the work of others so as to get the best results? Would any employer be safe to trust your planning and figuring and doing?

To make it short, have you any special equipment? Is there anything in you to command big pay?

Through the study of I. C. S. Courses, shop hands have become draftsmen, foremen, and superintendents; carpenters and masons have made themselves contractors, architects, or structural engineers; clerks have advanced to high-salaried places as advertising men, window trimmers, show-card writers, or chemists; farmers' sons have mastered electrical or civil engineering; miners have qualified for positions as inspectors, superintendents, or mining engineers; young men have prepared for Civil Service positions, or studied successfully surveying and mapping, illustrating and designing, automobile running, sanitary plumbing, textile work, navigation, or some other occupation covered by one of the 214 Courses of the I. C. S.

It will cost you nothing but postage to learn all about the salary-raising plan of the I. C. S.

Mark and Mail the Coupon NOW

**International Correspondence Schools
Box 1102, Scranton, Pa.**

Please explain, without further obligation on my part, how I can qualify for a larger salary and advancement to the position, trade, or profession before which I have marked X.

Electrical Engineering
 Electric Lighting
 Electric Railways
 Electrician
 Electric Car Running
 Dynamo Foreman
 Dynamo Tender
 Wireman
 Mining Engineer
 Telephone Expert
 Civil Engineer
 Automobile Running

Mechanical Engineer
 Mechanical Draftsman
 R. R. Constructing
 Concrete Construction
 Architect
 Contracting and Building
 Architectural Draftsman
 Plumbing & Heating
 Chemist
 Bookkeeper
 Advertising Man
 Civil Service Exams.

Name _____

St. & No. _____

City _____ State _____

Present Occupation _____

**You Turn on
Electric Power
Simply as
You Turn on
Electric Light
With This Motor**

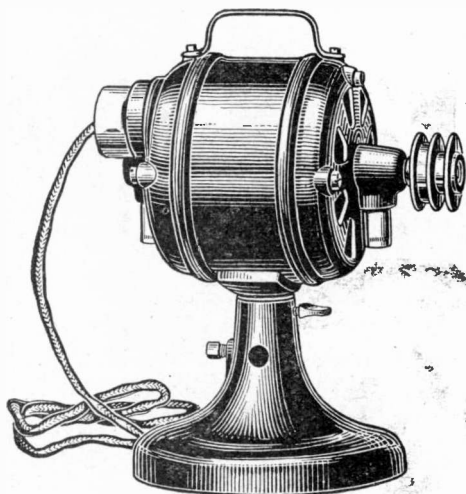

JUST enough power to put an edge on tools—to run a lathe, a jig-saw, a sign-flasher, any light machine—to do ordinary buffing—to run a direct connected blower which will exhaust when reversed—to operate a sewing machine. All these things and more with one single motor

The Westinghouse General Utility Motor

Offices homes and small shops that are wired for electric current are installing them for many duties requiring moderate power. Different inexpensive attachments are used to do the various kinds of work. You only need invest in the motor and the attachment you require.

Costs very little to operate and so well built that it lasts and does its work a lifetime. May be attached to any electrical connection. No trouble and no care. Price \$18.25 upward according to attachments.

Go see it work. Call on your lighting company or a dealer in your neighborhood and ask for a demonstration. If he is unable to show it write us and we will send you full description and tell you a dealer to go to. Address Westinghouse Dept. of Publicity, Pittsburg.

Westinghouse Electric & Manufacturing Company
PITTSBURG

Sales Offices in 40 American Cities

Representatives All Over the World

A Child Can
Operate It



As Safe as
Electric Light

The Right Kind of Heat for Chilly Spring Days is Electric Heat

Altho many spring days are bright and cheery, the mornings and evenings are usually too chilly for comfort. Just enough heat is needed, *at the right time*, to drive away dampness and cold.

For centuries the Orientals and Europeans have used charcoal braziers for this purpose. But Americans need be content with nothing less than an electric portable radiator.

A Portable Luminous Electric Radiator

For bathroom, nursery, library, dining-room, office—anywhere there is an electric light socket—a turn of a switch will produce instantly a cheerful warm glow from a radiator that requires no watching.

The bright luminous rays of heat are like summer sunshine.

With *electric* radiators there are no dirt, gases or odors; no oxygen consuming flames; no fires to build; no ashes to remove; above all, *no danger*.

This electric radiator can be seen in the show rooms of your lighting company or electrical supply dealer. Prices are reasonable.

General Electric Company

Largest Electrical Manufacturers in the World

Dept. 30, Schenectady, N. Y.

Sales Offices in all Large Cities

2992

FREIGHT PREPAID
30 Days Free Trial
\$1 a Week
 FOR THE ARTISTIC
Meister Piano

SOLD DIRECT FROM FACTORY TO YOU



NO CASH DOWN NO INTEREST
 NO EXTRAS

Price **\$175.00**

STOOL AND SCARF FREE

A guaranteed saving of \$100 at least
 on each instrument

We believe the correct way to buy a piano is to try it in your own home first. We don't want the trial to cause you any expense, hence we pay the freight—also the return freight if the piano is not entirely satisfactory.

Notwithstanding our easy terms of payments, and our extremely low prices, the Meister is a high-class instrument of standard construction and quality, fully guaranteed for 10 years. Ask your local banker to investigate our standing. Rothschild & Co's. resources exceed \$3,000,000.00.

We sell more pianos direct from factory to home than any other concern in the world

SEND A POSTAL FOR THE PIANO BOOK
 It is FREE, and illustrates in the colors of the wood eight styles of the Meister.

THE MEISTER PIANO CO.

Rothschild & Co., sole owners
 State, Van Buren and Dept. 20E
 Wabash Ave. CHICAGO, ILL.



\$11.50 FOR THIS

Lowdown Washdown Combination

The best and most sanitary closet on the market. Deep seal syphon action washdown vitreous china bowl, solid oak, copper lined tank, seat attached to bowl with nickel-plated hinges, brass nickel-plated supply pipe and two inch flush connection.

35 to 70% Saved on Everything in Plumbing and Heating

- Iron enameled kitchen sink, sink and back cast in one piece \$9.00
- Porcelain-enameled lavatory, complete with nickel-plated faucets, and nickel-plated trap \$7.00
- Complete three-piece porcelain enameled Bath Room outfits \$24.95

Complete Water System for Country Homes

Write for Catalogue No. 11 today—It's a money saver.



John HARDIN Co.
 Established 1876
 4533 Cottage Grove Ave., Chicago.

HESS MEDICINE SANITARY LOCKER



The Only Modern, Sanitary STEEL Medicine Cabinet

or locker finished in snow-white, baked everlasting enamel, inside and out. Beautiful beveled mirror door. Nickel plate brass trimmings. Steel or glass shelves.

Costs Less Than Wood

Never warps, shrinks, nor swells. Dust and vermin proof, easily cleaned.

Should Be In Every Bath Room

Four styles—four sizes. To recess in wall or to hang outside. Send for illustrated circular.

The Recessed Steel Medicine Cabinet **HESS, 912 L Tacoma Bldg., Chicago**
 Makers of Steel Furnaces. Free Booklet.



Body and Brain Perfection

DR. MORAS has written a Commonsense Book on Autology, and by so doing placed the Standard of the

Creed of Health Farther to the Front than any man who has lived for a thousand years—**Elbert Hubbard**. So you may see for yourself. Send for FREE "Guide to Autology." Address **E. R. MORAS, M. D., Dept. 12, Highland Park, Ill.**

A MAGAZINE OF THE POCKET-BOOK

Everyone now interested in real estate, or about to become interested in it, should send at once for a free copy (or 25 cents postage for yearly subscription), for the best magazine in that field.

REALTY PROFITS MAGAZINE

Room 428, 1316 Broadway New York

DIAMONDS ON CREDIT WATCHES

EASTER PRESENTS

WRITE FOR CATALOG

Write for our handsome 100-page Catalog. Over 2,000 illustrations of Diamonds, Watches, Artistic Jewelry, Silverware, Novelties. Every article priced 10 to 20 per cent lower than others charge for equal value. Let us send you a fine Diamond or Watch on approval, all charges prepaid. If satisfactory, keep it and send us one-fifth of the price, balance in eight equal monthly amounts. Great bargains in ladies' and men's Watches. Our new booklet, "Historic Diamonds," sent free on request.

LOFTIS
BROS & CO. 1722

THE OLD RELIABLE ORIGINAL DIAMOND AND WATCH CREDIT HOUSE

Dept. D865, 92 to 98 State St., Chicago, Ill.

Branches: Pittsburg, Pa. and St. Louis, Mo. | Write for Catalog today.

We Want YOU to be a USER-AGENT



In your neighborhood for the New York Vacuum Cleaner

"The Cleaner That Cleans"

We want men and women to use, exhibit and demonstrate in their own homes this remarkable cleaning device—who will show their friends, acquaintances and neighbors the lightest, most powerful, durable and economical Suction Cleaner made; who will explain how it lightens housework, improves the sanitary condition of the home, how it pays for itself many times in the course of a year.

Factory Prices We furnish you your cleaner at lowest wholesale price and give you big profit on your sales. Exclusive territory and all needful advertising matter. We help you in many ways to make sales.

Now, at House Cleaning Time, is one of the best seasons. Write to-day for catalogue, booklet and full information, and secure this money-making opportunity for yourself.

NEW YORK VACUUM CLEANER CO.
505 Marbridge Building
34th Street and Broadway New York City

Such an Opportunity may not come your way again

Many of our agents are making from \$30 to \$60 a week.

Our New Jersey factory is one of the largest and most complete of its kind in the world. We can manufacture cheaper and better. Our agents get the benefit.

Everybody is interested in Vacuum Cleaning—glad to see our agents.

Many storekeepers are making big profits from handling our Cleaners. Hand Power Cleaners retail at \$15.00.

We make the best hand power cleaners—the best electric cleaners.

Remember—There will be but one agent in your neighborhood, so you should write now, to-day.

HESS FURNACE



We will deliver a complete heating equipment at your station at factory prices and wait for our pay while you test it during 60 days of winter weather.

The entire outfit must satisfy you or you pay nothing. Isn't this worth looking into? Could we offer such liberal terms if we didn't know that the Hess Furnace excels in service, simplicity, efficiency, economy?

We are makers—not dealers—and will save you all middlemen's profits. No room for more details here. Write today for free 48-page booklet which tells all about it.

Your name and address on a post card is sufficient.

HESS, 912 Tacoma Bldg., Chicago

No. 45
"Leader" Hess
Steel Furnace
Price \$49
Delivered East of Omaha and
North of Ohio River
Tires and Registers Extra

IRONING MADE EASY



Your bed and table linen, plain clothes, flat pieces, 80 per cent of family wash, can be ironed Easier (no backache or tired feet), Quicker (in 1-5 the time), Better, with finish far superior to hand work, by using the

SIMPLEX IRONER

"THE BEST IRONER"

1 1/2 ct. per hour to heat by gas or gasoline. Price within reach of all. Sizes for small homes and large; operate by hand, or small washing machine motor. Illustrated booklet sent free on request.

Write for our 30 day free trial offer and nearest dealer.
American Ironing Machine Co., 25 E. Lake St., Chicago

5000 COPIES SOLD BEFORE OFF THE PRESS

Practical Applied Electricity

By DAVID PENN MORETON, B.S., E.E.
Associate Professor of Electrical Engineering at Armour Institute of Technology.

Over 300 pages, 200 detailed line drawings, diagrams and descriptions. Bound in Black Seal Flexible Leather. Front and Back stamped in Gold. Round Corners. Red Edges. Just fits the Pocket. If unable to secure a copy from your Bookseller or Electrical Supply House, we will fill your order, postpaid on receipt of price.

A book written especially for home study for the practical man, in a plain, simple, everyday language. Every illustration was especially drawn to show the reader just how and why—no other book on the market just like this one—new from cover to cover—a school within itself.

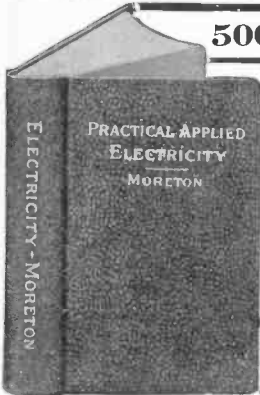

THE CHARLES C. THOMPSON CO.,

545-549 WABASH AVE.

Publishers

CHICAGO

For our Mutual Advantage mention Popular Electricity when writing to Advertisers.

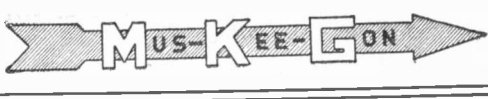

BARGAINS IN Spark Coils

A Rare Opportunity to get
a Remarkably Good Coil at
a Ridiculously Low Price

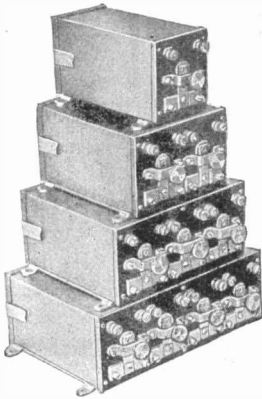

We had on hand a large assortment of odd windings, vibrators, cases, etc., and quite a number of completed spark coils, which have been slightly used in shop experimental work. We have made up the parts into coils and have put the whole lot into good shape, tested them out, and now offer them at from 50% to 75% reduction. They are perfectly good—every one of them—but they're not new and we don't care to sell them as regular stock. **THEY WON'T LAST LONG.** Order at once. **CASH MUST ACCOMPANY ORDER.**

Quantity	IGNITION COILS	Sale Price
396	1-cyl. Box Coils, oak and birch finishes Regular price, ea. \$4.45.....ea.	\$1.50
84	Same as above with covers on vibrators Regular price, ea. \$4.95.....ea.	1.75
44	2-cyl. Box Coils Regular Price, ea. \$8.25.....ea.	3.00
63	2-cyl. Box Coils with covers Regular Price, ea. \$8.75.....ea.	3.50
10	3-cyl. Box Coils Regular Price, ea. \$12.60.....ea.	4.50
60	4-cyl. Box Coils with covers Regular Price, ea. \$17.50.....ea.	5.95
35	Cylindrical Metal Case Coils Regular Price, ea. \$4.45.....ea.	1.95

WIRELESS COILS

165	Good Wireless Coils. Spark length on factory tests, 3-8 inch to 1 inch. Well finished oak cases. Regularly sold at \$3.00 to \$6.00 all go at ea.	1.95
-----	---	------

Send your order at once to Dept. B
MUSKEGON COIL CO.
MUSKEGON, MICHIGAN



Wireless Receivers

Our long experience in manufacturing all kinds of receivers for telephone use, has made us specialists in **WIRELESS RECEIVER** work. Our special magnet steel, sensitiveness of operation, durable construction, places our wireless receiver set far ahead of anything manufactured in the country
Most Popular Electricity when writing.

THE HOLTZER-CABOT ELECTRIC CO.
Chicago, Ill. Brookline, Mass.

FRENCH WOLLASTON WIRE

We have discovered a new Wollaston wire, made in France, which is far more sensitive and superior to the ordinary wire. This is not the only point in its favor; it will last longer and is far less expensive.

Price: Two Inches, 25 Cents; One Foot, 51.00.

WIRELESS DEALERS WRITE.

Send 3c. in stamps for large illustrated catalogue of Electrical and Wireless apparatus.

FRANKLIN ELECTRIC NOVELTY & MFG. CO.

Branch, Biloxi, Miss. 846 Ninth Ave., New York, N. Y.
LEVY ELECTRIC CO., San Francisco, Cal., Western Agents.

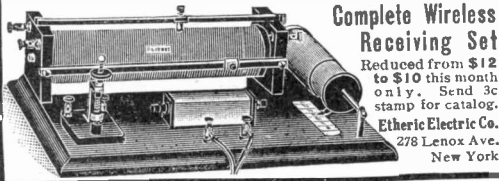

Complete Wireless Receiving Set

Reduced from \$12 to \$10 this month only. Send 3c stamp for catalog.

Etheric Electric Co.
278 Lenox Ave. New York

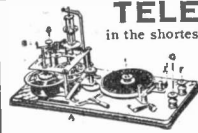

TELEGRAPHY TAUGHT

in the shortest possible time. The Omnigraph Automatic Transmitter combined with standard key and sounder. Sends you telegraph messages at any speed just as an expert operator would. Five styles, \$2 up; circular free.

OMNIGRAPH MFG. CO.

89 H Cortland Street New York

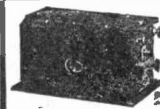

WIRELESS COILS

No. 1— 1-4 in. to 3-4 in. spark \$3.50
No. 2— 3-4 in. to 1 1-4 in. spark 4.50
No. 3— 1-2 in. to 2 1-2 in. spark 9.00

These high-grade guaranteed coils are not over-rated.

Send your money and coil will be shipped to you same day. Thousands of them in use.

LEMKE ELECTRIC CO., Dept. P. E., Milwaukee, Wis.



ATTENTION!!

On account of error made in using wrong electrolyte in our ad. of March issue, we herewith repeat same, with correct illustration.

CAN YOU BEAT THIS?

2000 Ohm Leather Headband Set... **\$4.50**

I SAY YOU CAN'T.

Better than anything on the market at this, and even at a higher price. Let us prove it.

Receiver only, 1000 ohms \$1.50
Postage,10

C. BRANDES

111 Broadway, New York

Brooklyn Wireless "Mark of Quality" Be Wise

No. 8-14 Aluminum Aerial or Helix, or No. 14-22 Enameled Wires per pound	\$0.50
No. 14-22 Bare Copper Wire per pound	.40
Stranded Galvanized Guy Wire per 100 feet, \$0.35, Turn Buckles Each	.10
"Bwaenco" Universal Mineral Detectors Adjustable (for any Mineral)	1.00
"Bwaenco" Spark-Gap Adjustable, \$0.35, Geissler-Tubes-3-inch Liquid	.20
"Bwaenco" Non-Inductive-Potentiometer, \$0.75, Potentiometer-Rods	.15
"Bwaenco" Tuning Coils, Double Slide, \$1.50, Single Slide	1.25
"Bwaenco" 410-Fixed-Condenser (Box-Shape-outside dimensions, 6 $\frac{1}{2}$ x4 $\frac{1}{2}$ x1 $\frac{1}{2}$)	.65
"Bwaenco" 409-A-Variable "Tubular-Type-Seamless Brass Tubing"	2.00
"Bwaenco" $\frac{1}{2}$ -K. W. Transformer with Fine Vibrator, \$9.00; without Vibrator	6.50

BROOKLYN WIRELESS CO., 766 Broadway, Brooklyn, N. Y.

MURDOCK Wireless Apparatus

The WM. J. MURDOCK CO. is prepared to furnish complete installations of the wireless telegraph for experimental or commercial purposes.

The correspondence of individuals or corporations contemplating either application of this mode of communication is solicited, and will receive careful and immediate attention.

Catalog No. 8 will be sent upon request

WM. J. MURDOCK CO.
50 Carter St., Chelsea, Mass.

162 Minna Street
San Francisco

221 S. Clinton Street
Chicago

WIRELESS TRANSFORMERS

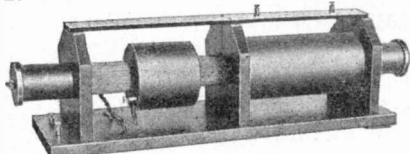

1-2 K. W.
\$30.00

Send for
Catalogue

E. S. RITCHIE & SON, 117 Cypress St., BROOKLINE, MASS.

SECONDARY "UNITS"

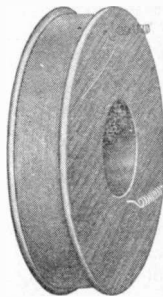

Been having trouble winding your Secondary for your Induction Coil or Transformer? Why not put your worries on our shoulders? The winding is not a WORKY to us, as we have the equipment, and winding coils is a part of our BUSINESS.

Our Secondary "UNITS" are wood spool sections wound, parafined, etc., and all ready to connect up. You can buy a spool at a time or as many as you want, and they will cost you but little more than the wire alone.

Send 2-cent stamp for our large catalogue which tells all about it and many other things "WIRELESS" besides.

Dawson & Winger Electric Co.
429 Dearborn Street: Chicago, Ill.

ENAMEL
INSULATED



MAGNET
WIRE

ENAMEL WIRE is supplanting silk and cotton covered because the insulation is better, because it requires less space, because it is cheaper.

FEVAL WIRE has a dielectric strength in excess of 75 volts per .0001 inch of insulation. The evenly distributed enamel covering adheres tenaciously yet is resistant and elastic, never cracking. No change at 400° to 500° F. All sizes, Nos. 16 to 40.

MANUFACTURERS: We have an attractive contract proposal to offer covering your requirements for 12 months.

INDIVIDUALS: We will furnish small quantities for spark coils and magnets.

FEVAL ENAMEL INSULATED WIRE CO.
129 N. Curtis Street CHICAGO

EVERYBODY CAN OWN A WIRELESS

We are this month offering an exceptional bargain in our new Wireless Receiving Set, consisting of combination Electrolyte and Mineral Detector, Ohm Nickelized Receiver, 3 feet Milk Cord, 65 feet Aluminum Wire, and 8 Wiring Diagrams. 300 to 500 miles guaranteed. 2 inches of finest Wollaston Wire furnished. Price \$1.40; postage 16c. extra. Send 3c. in stamps for large illustrated catalogue of Wireless and Electrical Specialties.

FRANKLIN ELECTRIC NOVELTY & MFG. CO.
Branch, Biloxi, Miss. 846 Ninth Ave., New York, N. Y.
LEYEY ELECTRIC CO., San Francisco, Cal., Western Agents.

High-Power Transmission Set, 1 K.W. to 25 K.W.

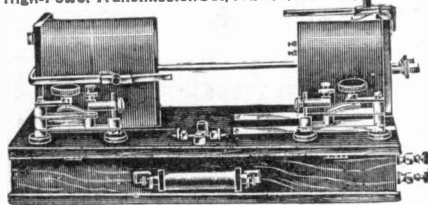

No. 6040, price - - \$45.00
Complete Set, unmounted 32.00

BIG 200 Page Electrical Catalog

The Greatest Line of Wireless and Electrical Goods Extant

Send 4c stamp (to cover postage only) for this catalog, deducting same, if desired, from first order.

One of our patrons from California voluntarily writes as follows: "I think that it is only right for me to express my appreciation to you for the receiving set No. 6040 that you supplied me with some two weeks ago. I have never seen anything that can be compared to it. I have received messages from stations sixteen hundred miles distant,—on three occasions I picked up Honolulu in the Hawaiian Islands and heard signals very clearly," etc.

J. J. DUCK, 428 St. Clair Street **TOLEDO, OHIO**

For our Mutual Advantage mention Popular Electricity when writing to Advertisers.



SEBCO
SCREW ANCHOR

**To Fasten
Electrical Fixtures**

Push buttons, switches, lamp sockets, bells, switch boxes, and in fact all kinds of fixtures can be fastened more securely and with greater economy by the use of the **Sebco Screw Anchors**. To prove to you that they are best for fastening fixtures in brick, stone, tile or concrete, we will send you our free sample set, together with seventy page catalogue, No. 10.

STAR EXPANSION BOLT CO.
Catalogue Dept. 10
147 Cedar Street New York



Here's a Beauty
THE NEW
"YANKEE"
HAND DRILL No. 1530

**A Tool for Every
Mechanic**

Has the same unique ratchet movement used in our popular Breast Drills, the little slide between the gears changing it instantly from a plain drill to a right and left hand ratchet; or a double ratchet where any movement of the crank forward or backward causes the drill to cut continually. A great convenience when working at close quarters where a full revolution of crank cannot be obtained. Takes round shank drills 3-16" and smaller. Drill Points carried in the handle.

Send for Tool Book (Free)
TELLS ABOUT 35 STYLES 75 SIZES
Your dealer sells the "YANKEE."

NORTH BROS. MFG. CO.
Dept. C PHILADELPHIA, PA.



Every Tool
in this Kit a first necessity to Mechanic Inspector, Lineman. In sight, in place, ready for action. Write for descriptive folder on Kit No. 403H.

Mathias Klein & Sons
Station U-3, Chicago



Star Hack Saw Blades

are highest in quality and lowest in price. These two features work well together. The blades which we are now turning out are the best we have ever made. You can satisfy yourself that this statement is no exaggeration by remitting to us 34c. for a sample dozen of 8-inch, or 42c. for 10-inch, or 50c. for 12-inch. Postage free.

MILLERS FALLS COMPANY
26 Warren St., New York, N. Y.

Schug Electrical Specialties

Spark Coils, Spark Plugs, Storage Batteries, Electric Lighting outfits.

BEST BY EVERY TEST
Send 4c postage for our illustrated catalog direct to dealers. Write us today.

SCHUG ELECTRIC MFG. CO.
Detroit, Mich. Dept. W.

Genuine "Red Devil" Self Feeding Chain Drill

Will drill Iron, Steel or Rock with bit brace.

SPECIAL OFFER:—Cut this out and send to us with \$1.50. We will deliver this drill to your nearest Express Office.

Smith & Hemenway Co.
New York City 150 Chambers Street

"Runs Like A Scared Rabbit"

Writes Cleburne Grady, Montgomery, Ala., who while yet a green hand at motors averaged 12.92 miles per hour on a 8.62 mile river trip.

Perfection Marine Motor

The "Perfection" is so worthy of the name it needs little attention. Just a regular flow of gasoline and a good spark will keep it working on hard towing and a good pleasure jaunts—and it will last as long as ferrying or pleasure jaunts—and it will last as long as

the boat. We build 2, 2½, 3½, 4, 6 and 8 H. P. in the single cylinder and 8 to 30 H. P. in the two, three and four-cylinder engines. Prices range from \$40 to \$450 according to type and horse power.

CO., 106 Caille St., Detroit, Mich.
Send for our Stationary Kerosene Engine Catalog if interested

Write for catalog. **CAILLE PERFECTION MOTOR**

For our Mutual Advantage mention Popular Electricity when writing to Advertisers.



10 DAYS FREE TRIAL We will ship you a "RANGER" BICYCLE on approval, freight prepaid, to any place in the United States without a cent deposit in advance, and allow ten days free trial from the day you receive it. If it does not suit you in every way and is not all or more than we claim for it and a better bicycle than you can get anywhere else regardless of price, or if for any reason whatever you do not wish to keep it, ship it back to us at our expense for freight and you will not be out one cent.

LOW FACTORY PRICES We sell the highest grade bicycles direct from factory to rider at lower prices than any other house. We save you \$10 to \$25 middlemen's profit on every bicycle. Highest grade models with Puncture-Proof tires, Imported Roller chains, pedals, etc., at prices no higher than cheap mail order bicycles; also reliable medium grade models at unheard of low prices.

RIDER AGENTS WANTED in each town and district to ride and exhibit a sample 1911 "Ranger" Bicycle furnished by us. You will be astonished at the wonderfully low prices and the liberal propositions and special offer we will give on the first 1911 sample going to your town. Write at once for our special offer. **DO NOT BUY** a bicycle or a pair of tires from anyone at any price until you receive our catalogue and learn our low prices and liberal terms. **BICYCLE DEALERS**, you can sell our bicycles under your own name plate at double our prices. Orders filled the day received. **SECOND HAND BICYCLES**—a limited number taken in trade by our Chicago retail stores will be closed out at once, at \$3 to \$8 each. Descriptive bargain list mailed free.

TIRES, COASTER-BRAKE rear wheels, inner tubes, lamps, cyclometers, parts, repairs and everything in the bicycle line at half usual prices. **DO NOT WAIT**, but write today for our *Large Catalogue* beautifully illustrated and containing a great fund of interesting matter and useful information. It only costs a postal to get everything.

MEAD CYCLE CO. Dept. S-019 CHICAGO, ILL.

Logue Write It Now.



Every Ride
A Joy Ride

There is no limitation to the pleasure of motorcycling when you ride an

R. S. Motorcycle

"Built and Tested in the Mountains"

You can leave the zone of machine shops with a feeling of safety. You can climb hills that defy the ordinary motorcycle. A twist of the wrist and the **R. S.** immediately responds with any speed you dare ride. The **R. S.** is the only motorcycle in this country with a coaster brake and a foot brake. Make safety doubly sure. The **R. S.** has the simplest, coolest, surest, most powerful little motor ever produced. Most economical, silent and simple. Most comfortable. Most efficient spring seat post and shock absorber, and other exclusive and valuable features. Write for catalog. Agents wanted.

READING STANDARD COMPANY
Makers Renowned Reading Standard Bicycles
491 Water St., Reading, Pa.



PUNCTURES REPAIRED
BICYCLE TIRES

FREE

CLOVERLEAF BRAND FIXITFREE TIRES, are nearly perfect or we could not afford this guarantee; 99 per cent of the value in a tire cannot be seen, you cannot judge a tire by the looks; all look alike except the tread design, which has no value nor merit; only fancy. Wearing and puncture resisting qualities are what count. This is the service we are willing to pay for; **TROUBLE SAVING**; this is what we offer you. On usual guaranty you receive nothing in this direction, but unkept promises and "Hot Air".

Our Guaranty covers the unseen, the unknown parts; guarantees you the year's tire service WITHOUT EXTRA COST to you. All punctures and other repairs **MADE FREE**, or replaced with new tires, without charge, regardless of what or who is at fault. No questions, we simply do it. Local Dealers handling this brand of tires can do the same. **INSURANCE TAG ATTACHED TO EACH TIRE**. This special introductory price now, Order early; give size wanted; Catalog Free. Agents Wanted. Chicago, Ill., Des Moines, Iowa, Minneapolis, Minn.

THE VIM
CLOVERLEAF BRAND WE PAY EXPRESS
\$5.85 PER PAIR **FIXIT FREE**

Mention Popular Electricity

TELEPHONE CONSTRUCTION
INSTALLATION
WIRING, OPERATION
AND MAINTENANCE

By Radcliffe & Cushing

A practical reference book and guide for amateurs, electricians, wiremen and contractors, showing the principles of construction and operation of telephone instruments and improved methods of installing and wiring them.

Line wiring and the wiring of special telephone systems is also covered.

100 Pages 125 Illustrations
PRICE \$1.00—POSTPAID

POPULAR ELECTRICITY BOOK DEPT.

30 Days' Free Trial

and if we haven't an agent in your city, we will sell you at Wholesale Agents' Price one

American Motorcycle or Bicycle

and prepay the freight. Hundreds of people will snap up this introducing proposition. The number of machines we sell on this liberal basis is limited—first come, first served. Here is our plan—You ride the motorcycle or bicycle for 30 days. If it is not satisfactory, you may return it. If you like it, it's yours at the wholesale agents' price. The American Motorcycles are highest grade made, easy to start, simple to handle and powerful. You do not have to be a mechanic to run one. The American won the 1910 F. A. M. Western Endurance Contest, scoring 1000 per cent perfect. The American Bicycles are the best on the market. We give a Life Guarantee.

We have a money making proposition for live agents. Our enormous advertising campaign makes it easy to sell American machines. Don't delay a moment. Our catalog and introducing offer will interest you; it's free. Write us which you want, motorcycle or bicycle. Do it now.

AMERICAN MOTOR CYCLE CO., 114 American Bldg., Chicago, Ill.



For our Mutual Advantage mention Popular Electricity when writing to Advertisers.

STOP THIS SMOKE

You might just as well shovel **money** into your furnaces as to turn part of your fuel into **black smoke**, which is simply **soot**—the product of imperfect combustion.

A smoking stack is a **double waste** and a **double expense**. It shows **waste of fuel** from incomplete combustion and a **waste of heat** from soot-deadened flues or tubes. It means both **greater expense** in cleaning boilers and usually **more expensive fuel** than would otherwise be efficient.

In short, whenever your chimneys smoke,

You are Burning Money

We absolutely guarantee **The Scharf System** to cut out ninety per cent of your smoke and to effect a saving in fuel cost. The Brookside Mills, of Knoxville, Tenn., writes:—"We have **five** 125 h. p. boilers equipped with **five** Scharf Smoke consumers and **we know** we are saving fuel and have reduced our smoke 90%."

The Scharf System

The Only Automatic Smoke Preventing and Fuel Saving Device

Simple, reliable, safe and needs no attention. Gives perfect results while firing and all the time. Your engineer can install it, and without altering a single part of your boilers or shutting down the plant. Weighs but 100 lbs. complete. We sell it on an absolute guarantee. If you have several boilers, try it on one first. "Ten years ago we installed **two** Scharf Smoke Consumers," says the Marble & Shattuck Chair Co., of Cleveland, O., "and in 1907 a third one. With 300 h. p. capacity, our stack is **free from smoke**." There are in all two thousand of our machines in use to-day.

WRITE US for our proposition and new catalog. Tell us (without obligation) how many tons of coal you burn each day, at what cost, how many boilers and what h. p. each. We will tell you what we can save you.

THE G. H. SCHARF COMPANY
68 Huron St., Ypsilanti, Mich.

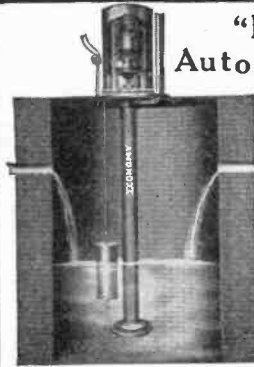

"ECONOMY" Automatic Electric Protected Type Bilge Pumps

are especially designed for automatically pumping all seepage, drainage and sewage water out of basements, keeping them dry, useful and sanitary.

Are designed to work automatically and require no care aside from an occasional oiling.

The Automatic Switch which starts and stops the motor is of simple construction, having no weights, air valves, fulcrums or other apparatus easy to get out of order, and is controlled by a position float. The motor is of standard make especially adapted for this peculiar service.

The pump is the centrifugal type, having no gears, cams, belts or valves to get out of order.

The pump is always below the water level.

The motor and switch are protected by a heat radiating hood, which eliminates any danger of the motor being damaged by moisture and which allows for a forced circulation of air.

We also manufacture: Automatic Water Systems, Sewerage Ejectors, Condensation Pumps and Receiver, Cellar Drainers, Centrifugal and Plunger Pumps, Hot Air Engines, Vacuum Cleaning Apparatus, Air Washers, Purifiers and Cooling Apparatus. Watch for our ads. telling you all about them.

THOMAS & SMITH, Inc. 116-118 N. Carpenter St., CHICAGO
416 Broadway, NEW YORK

Thank You, Gentlemen

You **DID** respond to our full page ad in the last issue—**splendidly**.

Now, let me tell you something:

Kimble Motors

Are the only **A. C. Motors** that give you a large variation in speed on single phase. **One Lever** on the motor stops, starts, reverses and controls speed up or down, and no resistance, starting, compensating or any other outside controlling device is necessary.

This single phase Motor also operates on 2 phase or 3 phase circuits.

It puts **all the current** you pay for to useful use—consuming none in reducers or other wasteful devices, and it requires no more current to start a Kimble Motor than it does for full load running.

The **Kimble A. C. Motors** are the best of all motors for any machinery that calls for an approximately even, continuous load—like printing presses, pipe organs, ice cream freezers, sewing and washing machines, etc.; but are not adapted to variable intermittent loads, like lathes, drills, etc.

Kimble Single Phase Variable Speed reversible A. C. Motors are made in 1/6, 1/4, 1/3 1/2, 3/4, 1, 1 1/2 and 2 H. P. sizes—110 and 220 volts, 25 to 60 cycles.

Send for price list and guarantee on our Single Phase, as well as our Polyphase Constant and Variable Speed Motors made up to 10 H. P.

JAS. K. BASS, General Manager

KIMBLE ELECTRIC COMPANY

1119 Washington Blvd.

Chicago, Ills.

For our Mutual Advantage mention Popular Electricity when writing to Advertisers.

This Kerosene Engine Cuts Your Expenses 75%

YOU should not even consider engines that operate on gasoline only. The rapidly rising price of gasoline, now 6 to 16 cents higher than kerosene, absolutely makes operation on this fuel too expensive. The Perfection Kerosene Engine operates on any engine fuel. When you purchase it you are on the safe side—proof against all fluctuations of the market. You can always run this engine at a great fuel saving and get the greatest amount of work done. The Perfection vaporizes its own kerosene and so makes it as efficient as gasoline—something other engines cannot do.

The Perfection is very light, portable, has only three moving parts, runs everything about the place, is lower in price than any other engine of its capacity on the market.

PERFECTION Kerosene Engine

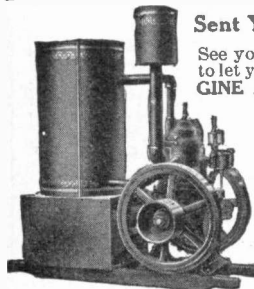

Sent You on 15 Days Free Trial

See your dealer at once and ask him to let you have a copy of our Free ENGINE BOOK, which shows the sizes and styles of the "Perfection" and explains this very attractive offer. Your dealer will send any "perfection" engine to your farm for 15 days and let you return it if you are not satisfied. Ask him about it. If he does not carry the "Perfection" write to us and we will send you our Free Engine Book direct.

CAILLE PERFECTION MOTOR CO.
202 Second Ave., Detroit, Mich.

You Can Have Electric Lights

in your home, no matter where you live, at the small cost of generating the current. Our complete outfits are easy to install and to care for. They furnish a light of great brilliancy—the most convenient and healthful light known. Same engine can be used for operating a water supply system or other machinery. The outfit can be used to run electric motors for driving pumps, fans, sewing machines, etc. Outfit will last for years at a very small maintenance cost. We also make larger electric light plants up to 500 H. P. in single units.

Write Today for Catalog No. CH1163

50-Light, 30-Volt
Outfit Complete
for \$500

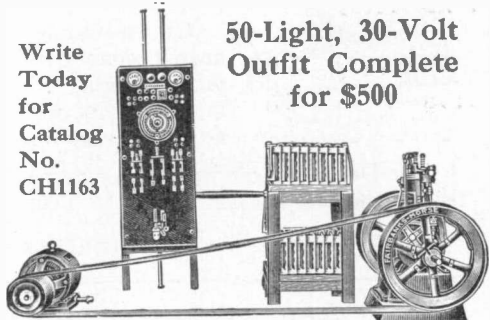

Fairbanks, Morse & Co.

481 Wabash Avenue

Chicago, Ill.

1/12 AND 1/8 Direct and Alternating
Current Motors
VARIABLE SPEED - SINGLE PHASE

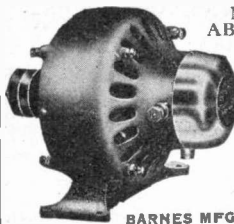

MOTORS THAT WILL
ABSOLUTELY NOT HEAT

"The Barnes Motors" are especially adapted for Washing Machines, Vacuum Cleaners, Air Purifiers, Ventilating Devices, Coffee Mills, Meat Choppers, Printing Presses, etc., etc.—Dental and Medical work a specialty. Positively the best motor for use where motor driven work is necessary—greatest power, highest efficiency. We want Reliable Agents everywhere—write at once for prices and catalog. Let us figure on your requirements.

BARNES MFG. CO., SUSQUEHANNA, PA.

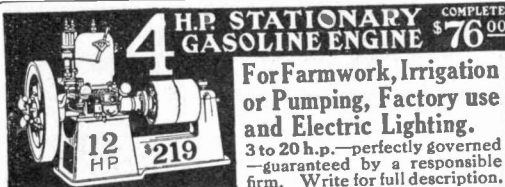

COMPLETE \$76.00
4 H.P. STATIONARY GASOLINE ENGINE \$76.00
For Farmwork, Irrigation or Pumping, Factory use and Electric Lighting.
12 HP \$219
3 to 20 h.p.—perfectly governed—guaranteed by a responsible firm. Write for full description.
GRAY MOTOR CO., 128 Leib St., DETROIT, MICH.

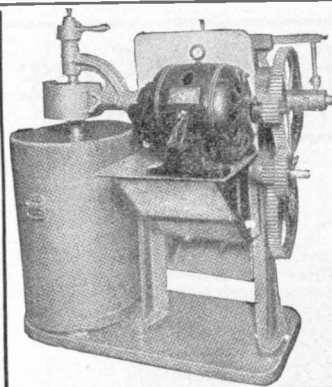

The Dewsberry
ELECTRIC
Power Freezer

Will enable you to produce a better grade of ice cream at a lower price and in less time than by any other method. These machines are built unusually substantial, and are guaranteed to give satisfaction. Made in 20 and 40 quart sizes. The 40 quart size runs both fast and slow on A.C. current. Write to-day for circular.

R. A. Dewsberry
216 N. Morgan St.
CHICAGO.

2 H.P. Gasoline Engine \$36.00
With Complete Equipment

4 H. P. Water Cooled..... \$64.00
3 H. P. Air Cooled..... 78.50

A full line of Portable and Marine Engines in all sizes, at the same extremely low prices. Brand new and guaranteed strictly high grade. 30 days free trial, or money back if not satisfactory. Enormous stock of Electrical supplies, Shating, Hangers, Pulleys, Belting, everything in the line of machinery at a saving to you from 30 to 75 per cent. Write us your wants.
Chicago House Wrecking Co., Chicago

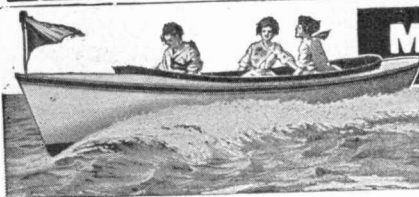

Magnificent Steel Launch \$96
Complete With Engine, Ready to Run

18-20-22 and 27 ft. boats at proportionate prices. All launches tested and fitted with Detroit two-cycle reversible engines with speed controlling lever—simplest engine made—starts without cranking—has only 3 moving parts—anyone can run it. The Safe Launch—absolutely non-sinkable—needs no boathouse. All boats fitted with air-tight compartments—cannot sink, leak or rust. We are sole owners of the patents for the manufacture of rolled steel, lock-seamed steel boats. Orders filled the day they are received. Boats shipped to every part of the world. Free Catalog. Steel Rowboats, \$20.
MICHIGAN STEEL BOAT CO., 1366 Jefferson Avenue, Detroit, Mich., U. S. A. (83)

For our Mutual Advantage mention Popular Electricity when writing to Advertisers.

CUTLER-HAMMER

ELECTRIC HEATING DEVICES

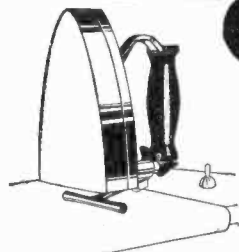

Household Iron—5, 6, 7 lbs.
No separate stand required

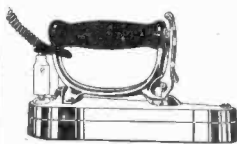

Sleeve Iron—3 lb.
Detachable Handle
Convenient for travelers

Turn on the switch of a Cutler-Hammer Portable Water Heater and in 45 seconds you will have steaming hot water for tea, malted milk, lemonade, a hot "toddie" or for medicinal or other purposes.

Cutler-Hammer Electric Irons have uniformly heated ironing surfaces and unusual heat retaining qualities. The small sleeve iron is 2 1/4 inches at its widest part. It is especially adapted for ironing fancy laces, dollies, etc.



Portable Water Heater
3-qt. size—Hot water, 45 sec.



Disc Stove
Has quickly heated 7-in. surface

The Disc Stove can be used for numerous uses in the kitchen, dining room and bed room. It is finished in polished nickel.

Our entire line is illustrated and described in a 32-page booklet. Copy sent free on request.

**The Cutler-Hammer
Mfg. Co. Milwaukee, Wis.**

NEW YORK: 50 Church St.

BOSTON: 176 Federal St.

CLEVELAND: 1320 Schofield Bldg.

CHICAGO: Monadnock Block

PITTSBURG: Farmers' Bank Bldg.

PHILADELPHIA: 1201 Chestnut St.

PACIFIC COAST AGENTS: OTIS & SQUIRES

155 New Montgomery St., San Francisco

COMET ELECTRIC STOVE A REAL FIRELESS COOKER

ASK ABOUT IT

That is PRACTICAL and REASONABLE

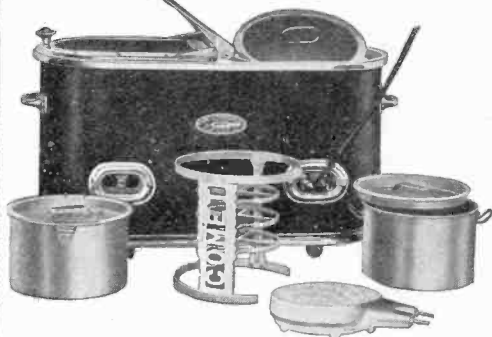

The Comet Electric Stove is designed to save fuel. Cheaper than gas, coal or wood, no odor, dust or smoke.

Reasonable to buy—convenient to use—economical for the Home, Camp, Motor Boat, or Automobile. You don't have to depend on electricity alone—it's a fireless cooker as well.

Ask us more about it now—today. Special prices to Central Stations and Dealers.

COMET ELECTRIC STOVE CO.

280-284 Eighteenth Street

DETROIT, MICH.

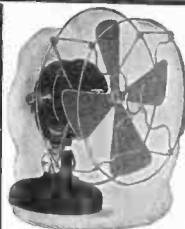

A PERFECT
110 VOLT
FAN FOR
\$6.50



Electrically,
Mechanically and Aesthetically Perfect.

Finish, black enamel and nickel. For home and office, telephone booth, picture show, or in any place where a ceiling fan is not needed. As good as any fan at any price. Desk or bracket. Noiseless and sparkless. Strong breeze—6 in. blades. Say whether for alternating or direct current, and give dealer's name. We PREPAY EXPRESS and guarantee satisfaction.

The Carleton Company

Seven volt battery fan at same price.
178 Summer St., Boston, Mass.

"Domestic" Electric Washer and Wringer

Oscillating, Self Cleaning, All Metal Tub, Reversible, Metal Frame Wringer, Positive Drive, Automatic Belt Tightener, Inclosed Working Parts. No Springs to Break.

SEND FOR BOOKLET

Domestic Equipment Co.

53 State St., Chicago

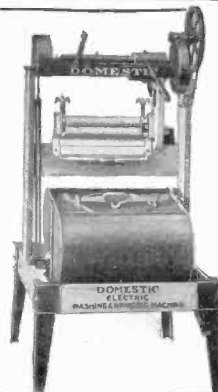

Let Electricity Make Pure Air for You

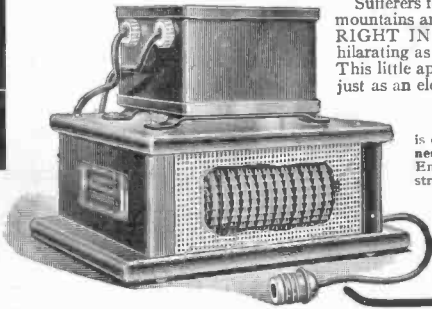

Sufferers from many ailments travel thousands of miles to breathe the OZONE of the mountains and pine forests. Yet a recent scientific invention enables everyone to have—**RIGHT IN THEIR OWN BEDROOM**—air constantly as pure, refreshing and exhilarating as the purest oxygen-filled atmosphere of the piny woods and mountain peaks. This little apparatus is operated by electricity and "ozonizes" the air of the closest room just as an electric storm purifies the out-door air. The

OZONE PURE AIRIFIER

is of greatest benefit in the treatment of Asthma, Hay Fever, Catarrh, Insomnia, Nervousness, Pneumonia, Typhoid and Scarlet Fevers, Diphtheria, Bronchitis, Tuberculosis, etc. Endorsed by highest medical and scientific authorities thoroughly tested and demonstrated success.

Central Station, Electric Jobber and Dealer, this is the latest Electrical Appliance on the market. Write now for illustrated catalogue, price list and descriptive matter and plan of placing for liberal trial.

We want distribution throughout the United States in Every Place Where Electrical Appliances are Sold.

OZONE PURE AIRIFIER COMPANY

307-314 Rand McNally Bldg.

CHICAGO, ILL.



Every Hostess

appreciates the dainty convenience of the Simplex Electric Percolator—those who have made coffee with a Simplex percolator know that such delicious coffee cannot be made as readily and easily on the table by any other method. Catalog of other styles as well as other Simplex Household Helps sent on request—or ask to see Simplex devices at your lighting Company's or dealers.

Simplex Electric Heating Co.
CAMBRIDGE, MASS.

CHICAGO
Monadnock Block

SAN FRANCISCO
612 Howard St.

Back Gears Save Power Enough to Pay For It

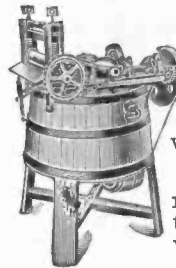

The back gear drive of the Elmo Power Washer enables it to do a big washing with the same amount of power that ordinarily does a small washing.

It is like the muscular man who does twice or three times the work of a weak man.

The Elmo

has also a positive action wringer, an easy-opening lid, a protected motor. It is noiseless, strongly built, has cypress tub good for fifty years use, and will do a week's wash at an average cost of 1c. for power.

Write for booklet that tells the whole story of Elmo supremacy.

Grinnell Washing Machine Co.
Grinnell, Ia.

Canadian Trade Supplied by the Gem Motor Co.,
419 Portage Ave., Winnipeg, Man.



TO BE CLEAN YOU NEED The "BEE" Suction Cleaner

IT

costs only \$65.00 with complete equipment.
weighs only 20 lbs. No Jar or Vibration.
equals the highest priced machines in efficiency.
does the best work with the least effort.
has NEW and EXCLUSIVE FEATURES.

SOLD ONLY BY RELIABLE AGENTS.
BIRTMAN ELECTRIC CO., CHICAGO, U. S. A.

For our Mutual Advantage mention Popular Electricity when writing to Advertisers.

Our new catalog

supplemented by specific information regarding the work of the Edison in various fields,* such as electric commercial and pleasure vehicle propulsion, ignition of gasoline cars and motor boats, and electric lighting of motor cars, motor boats, yachts, houseboats and country homes, covers the entire subject of construction, performance and use of

The Edison Storage Battery

No matter for what use you require storage batteries, you should have the definite information regarding the Edison as compared with other storage batteries, which this new Edison Catalog contains—together with the specialized data for your particular field of work.

No matter how disappointing your previous experience with storage batteries has been—for whatever purpose—your appreciation of the Edison will be all the greater.

The Edison is not merely an improvement on other storage batteries. It is an absolutely new departure—radically different in every respect. The result is a battery of about double the capacity of a lead battery of equal weight; a battery that is not subject to any of the ills of the lead battery, that will stand the roughest treatment, that requires only a fraction of the care and attention of the lead battery and that lasts many times as long.

In writing for the new catalog, state the field in which you are interested and additional information will be sent to you with it.

Edison Storage Battery Company
117 Lakeside Ave., Orange, N. Y.

At Last

It is possible to secure comfortable, even light throughout a room without a brilliant light in range of vision.

The Eye Comfort System of Indirect Illumination is the notable succession in the lighting field.

Installations are being made in all sections of the country.

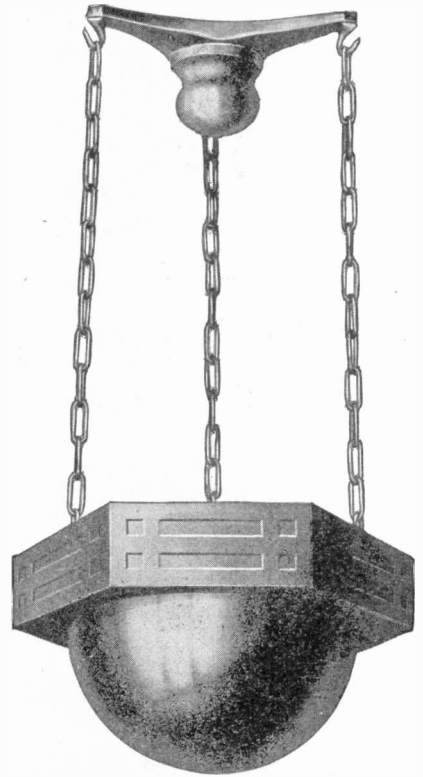

- | | |
|---------------|--------------|
| ☐ Residences | ☐ Churches |
| ☐ Offices | ☐ Theatres |
| ☐ Clubs | ☐ Banks |
| ☐ Hotels | ☐ Hospitals |
| ☐ Restaurants | ☐ Etc., etc. |

☐ While we sell through the electrical trade only, our Engineering Department solves free of charge your lighting problem if you will but send details of interior.

☐ Originators and sole producers of the first and only scientifically designed reflectors and appliances which make indirect illumination possible.

☐ Write today for full particulars.

National X-Ray Reflector Co.
257 Jackson Boulevard Chicago, Illinois

The THOR Electric Home Laundry Machine

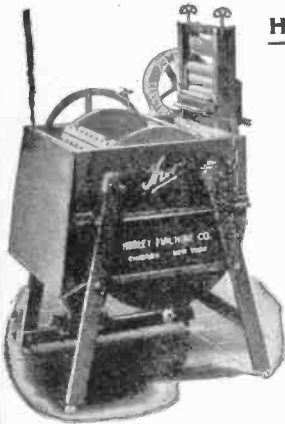

HAS NO EQUAL

for
Efficiency
Durability
Simplicity
and
Low Cost
of operation

Made in different sizes and materials adapted for any house or apartment.

Not to know all about the THOR Electric means a direct loss to you.

Sold for Cash or on Monthly Payments
Send for Free Booklet 50

HURLEY MACHINE COMPANY

1010 Flat Iron Bldg.
New York

37 S. Clinton Street
Chicago

Let Us Send You This

EUREKA Electric Cleaner

On Free Trial

Then if you like it the price is only **\$35** delivered

—If not, the Trial Costs You Nothing



Any broom, brush, cloth or other dry cleaner that does not suck in every particle of dust it raises is not only unclean, but unhealthful. No other indoor dry method of cleaning than suction can make your house **really clean**. The **EUREKA** cleans floors, rugs, carpets, etc., and our extra attachments clean portiers, walls, furniture—everything. **Quickly pays for itself**. Electricity used costs less than one cent per hour. So light a child can use it, yet we guarantee it to clean faster, better and with less effort than any other cleaner, regardless of cost.

Will you let us prove this broad claim at our own expense? If you have electric lights, write today for booklet and full particulars of our **FREE TRIAL OFFER**.

EUREKA VACUUM CLEANER CO.
1233 MAJESTIC BLDG. DETROIT, MICH.
REAL AGENTS WANTED

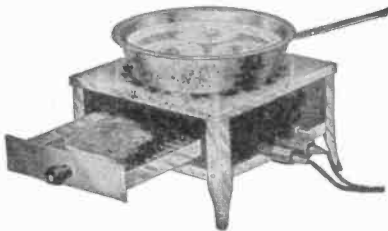

Cadillac Combination Electric Stove and Toaster

Prepares Eggs, Coffee or Chops and at the Same Time Toasts in the Drawer Below

Three different degrees of heat are instantly available—high, medium and low—for fast cooking, slow cooking or simply keeping things warm. No special wiring is required as it operates from the ordinary light socket. Guaranteed against burn-outs for one year and can be instantly repaired by an inexperienced child.

The *Cadillac Combination Stove and Toaster* may be had from the better class of electrical dealers for *Seven Dollars and Fifty Cents*.

MADE BY THE
CADILLAC ELECTRIC MANUFACTURING CO.
16 MITCHELL STREET CADILLAC, MICHIGAN

For our Mutual Advantage mention Popular Electricity when writing to Advertisers.

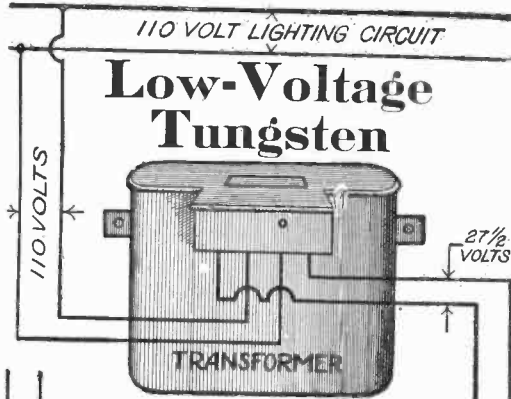

Low-Voltage Tungsten

Agent's Make Big Money

Selling Warner Low Voltage Tungsten Lighting Outfits

As applied to the use of the Tungsten lamp, Low Voltage stands for LONG LIFE as well as efficiency. The lower the voltage the safer it becomes, both to life and property.

The insulation of the extra transformer is quite an added factor of SAFETY—Safety from danger of fires and short-circuits, from lightning, from electric shocks.

27 1/2 volts, (the standard voltage adopted by us) is absolutely harmless, even the most sensitive person can scarcely feel the current at this voltage.

Low Voltage Tungsten Lamps have a SHORT-Heavy filament, which withstand shocks and vibration very much the same as the carbon lamp, and yet they make three times as much light as the carbon lamp on the same current.

Our bulletin 600-P tells more about this wonderful "money-saving-system." It is yours for the asking.

Warner Arc Lamp Co.
Davenport, Ia.

Lamps

Volt

27 1/2

Lamps

Volt

27 1/2

The Electro Copper Plating Outfit

This little outfit will copper plate not only metal articles, but is also used for **metalizing beetles, insects, nuts, fruits, flowers, etc.**, all of which can be turned out to perfection. There is a large demand for such goods.

This outfit needs no batteries, but supplies its own current, something which no other outfit can do. Size over all, 13 x 5 1/2 inches, weight complete, 3 1/2 pounds; comes with copper plating salts ready for use. **Price complete, \$1.25.** Send 4c postage at once for our great 19c-page Electrical Encyclopedia containing 400 illustrations.

THE ELECTRO IMPORTING CO.
233B Fulton St., New York
Everything for the Experimenter

Wireless Transformers

Closed, Laminated Core, High Efficiency

PRICE
1-2 K. W. \$16.00
1 K. W. 30.00

Stamp for Leaflet, Write at Once

Worts McKissen Mfg. Co.
DEPT. A TOLEDO, OHIO

ELECTRIC GOODS FOR EVERYBODY.

World's headquarters for Dynamos, Motors, Fans, Toys, Railways, Batteries, Belts, Bells, Pocket Lamps, Telephones, House Lighting Plants, Books. If it's electric we have it. *Undersell all.* Fortune for agents. Big Catalogue 4 cents. **OHIO ELECTRIC WORKS, CLEVELAND, OHIO.**

WIRELESS APPARATUS

Our Wireless Goods are the best on the market, and are guaranteed to work. Our instruments are made of the finest materials, and are sold at a price within the reach of every experimenter. Send 2c stamp for our large catalogue which contains a full list of Wireless Instruments, Novelties and Electrical Goods, and also a great deal of Wireless information for the Wireless experimenter.

The I. W. T. Wireless Co., 726 1/2 Broadway, Brooklyn, N. Y.

ELECTRIC LIGHT AND POWER

DAY AND NIGHT SERVICE
The Junior No. 1 Equipment

Direct Connected Dynamo, Gasoline Engine Set, Complete Switchboard, 16-Cell "American" Storage Battery } \$265

The most complete, reliable equipment ever offered at this price. We want a representative in every county.

AMERICAN BATTERY COMPANY
Est. 1889 1143 Fulton St., CHICAGO

KEEP THE FACTORY RUNNING BUT IF YOU HAVE A BREAKDOWN I HAVE MOTORS TO RENT

FOR IMMEDIATE SHIPMENT. MACHINES SHIPPED ANYWHERE IN THIS COUNTRY ALL SIZES, from one horse-power up IMMEDIATELY FROM STOCK. State voltage and whether direct current or alternating current, single phase, two phase, or three phase is desired.

Sales Manager **Gregory Electric Company** Chicago

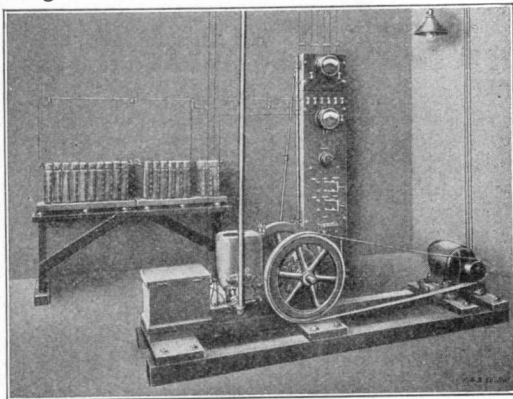

The Cost of Electric Lighting Reduced

The introduction of the low voltage Tungsten lamp has so reduced the cost of electric lighting apparatus that complete electric lighting plants can now be purchased for \$350 and upwards.

A complete plant consists of a gas engine, dynamo, switchboard and storage battery. These plants give a full 24-hour service by only an occasional running of the gas engine, so that the engine can be utilized for other work.

The "Chloride Accumulator" used with these plants is the same type of battery used by the large Central Stations in New York, Chicago, Philadelphia and nearly all of the large cities as well as by the leading Electric Railways, Western Union and Postal Telegraph Companies, Bell Telephone Companies, etc.

If your home, factory or mill is not near a public electric lighting station, write to our nearest Sales Office to-day for a copy of our book entitled "How to Have Your Own Electric Lighting Plant." It will give you interesting and valuable information.

THE ELECTRIC STORAGE BATTERY CO.

1888 PHILADELPHIA, PA. 1911

New York Boston Chicago St. Louis Cleveland Atlanta Denver
 Detroit San Francisco Portland Seattle Los Angeles Toronto

The "Exide" Sparking Battery is best for ignition service



No More "Battery Trouble"

Cease sending for the electrician to "fix that bell." Let the electric light current ring your annunciators, burglar alarms, etc. Our

"Junior" Transformer

will do it more cheaply than any other way. It uses scarcely any current, and can't be damaged by short circuits. Fireproof and durable. Price \$3, at dealers or direct from us.

THORDARSON ELECTRIC MFG. CO.
 214 Jefferson Street CHICAGO

Pelouze Electric Iron

THE ECONOMICAL IRON

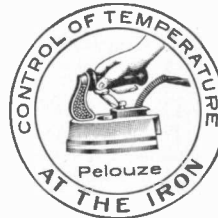

Consumes less current than other irons

The only Electric Iron in which the current and temperature can be controlled at the iron.

Heats in half the time usually required.

No extra stand, saves constant lifting

Every Iron Guaranteed

4lb.	6½ lb.	9 lb.	20 lb.
\$5.00	\$5.00	\$7.00	\$12.00

For Sale by Leading Dealers. Send for circular "Heating Devices."

PELOUZE ELECTRIC HEATER CO.

232 East Ohio St., CHICAGO, ILL.

TESTED APPARATUS Means the Elimination of Faults in Your Product.

Electrical and photometrical tests of every description.
 Checking electrical instruments of all kinds and classes.
 Inspecting and testing new electrical machinery, apparatus and material at factories and after installation.
 Tests on any electrical machinery and apparatus made anywhere.
 Arc and incandescent lamp tests, either electric, gas, acetylene or oil.
 Illumination tests made anywhere.
 Secondary standards of candle-power furnished.
 Facilities furnished to experimenters and investigators.

We have recently added to the above, coal testing, and are now prepared to make proximate analyses and calorific determinations on samples of coal, promptly and accurately.

ELECTRICAL TESTING LABORATORIES
 80th Street and East End Avenue NEW YORK, N. Y.

For our Mutual Advantage mention Popular Electricity when writing to Advertisers.

Two 4-ply
Collars
with
every
Signal
Shirt

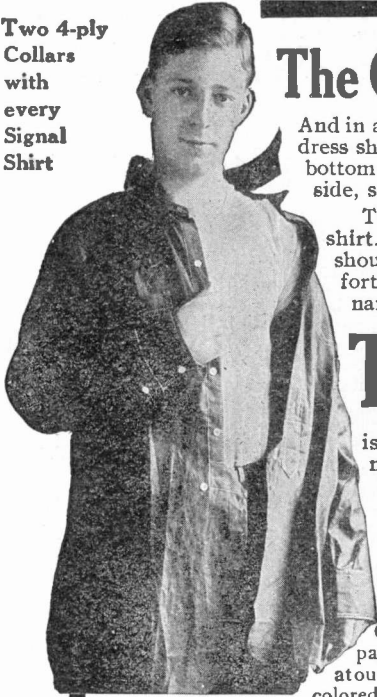

The One Work Shirt Cut Coat Style

And in addition, furnished with advantages that even the high priced dress shirts don't have—exclusive comfort features, like extra button at bottom of breast plait, to improve fit; extra full skirts, sleeve-slit in side, so it keeps out dirt—can't gap.

Two 4-ply double band collars and two handy pockets in every shirt. Also made with soft collar attached, if this style garment should be desired. Besides, all the care in finishing, all the comfort in cut, all the excellence in materials, that have made the name "Signal" famous on work clothes.

The Signal Coat Shirt

is made of fast indigo blue percale, stitched by double needle machine, every one inspected rigidly for flaws before it leaves our light, sanitary shops.

You'll be pleased with this shirt in every detail—*better* pleased than with any other make you ever had.

Send For a Couple Price \$1.00

If your dealer hasn't the Signal Coat Shirt, tell us his name and your size and we will supply you by express, C. O. D. West of Missouri River, \$1.25. If you like them, pay Express Company. If not entirely satisfied, return at our expense. Write for folder showing styles in neat colored patterns with collars to match, at \$1.00 and \$1.50.



Hilker-Wiechers Mfg. Co. 1248 Mound Avenue
Racine Wisconsin

OWN A BUSINESS

WE WILL HELP YOU



"I made \$88.16 first three days, writes Mr. Reed, of Ohio. Mr. Woodward earns \$170 a month. Mr. M. L. Smith turned out \$301 in two weeks. Rev. Crawford made \$7.00 first day. See what they have done, judge what you can do.

LET US START YOU

in Gold, Silver, Nickel and metal plating. Prof. Gray's new electro machine plates on watches, jewelry, tableware and metal goods. Prof. Gray's New Royal Immersion Process

latest methods. Goods come out instantly with fine, brilliant, beautiful thick plate, guaranteed 3 to 10 yrs. No polishing or grinding. Every family, hotel and restaurant wants goods plated.

PLATERS HAVE ALL THEY CAN DO

People bring it. You can hire boys to do the plating as we do. Men and women gather work for small per cent. Work is fine—no way to do it better. No experience required, we teach you, Recipes, Formulas, Trade Secrets Free. Outfits ready for work when received. Materials cost about ten cents to do \$1.00 worth of plating.

Our new plan, testimonials, circulars and Sample Free. Don't wait. Send us your address anyway. **GRAY & CO. PLATING WORKS**, 289 Gray Bldg., Cincinnati, Ohio

WHEN desirous of information inquire at the information Dept. of Popular Electricity Pub. Co.

JUST PUBLISHED

SWITCHBOARDS

By WILLIAM BAXTER, Jr.

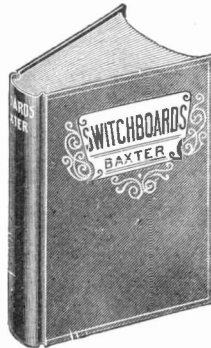

Price \$1.50
Postpaid

Appeals to every engineer and electrician who wants to know the practical side of things. All kinds and conditions of dynamos, connections and circuits are shown by diagram and illustrate just how the switch-board should be connected.

Includes direct and alternating current boards, also those for arc and incandescent lighting and power circuits.

Special treatment on high voltage boards for power transmission.

Also contains a description of modern switches and their operation.

190 Pages—Fully Illustrated

Popular Electricity Book Dept.

100 Lake Street, CHICAGO, ILL.

Let Us Put This Piano in Your Parlor
Not a Dollar To Pay Us.

SEND NO MONEY

Enjoy This Piano—Take Your
Own Time—Sent to You
on 30 Days' Free Trial

Write right now and let us put this piano
in your parlor — not a dollar to pay us.

Let us send you our big, free, actual photograph, color-illustrated, handsome book, and offers to trust you absolutely with any celebrated and artistic Reed & Sons Piano on as long time as you want, even three years or more, if you are satisfied after 30 Days' Free Trial. Not a cent to pay down— not a dollar for any of our beautiful styles you select from the book we send you on



REED & SONS PIANOS

Established 1842. Given Highest Award
at World's Columbian Exposition, 1893

Now Sold Direct to
You From Factory

We've sold through dealers, jobbers and agents—for over 68 years—but now we have cut out their big profits and are giving the savings to our customers. We have made our direct-to-you wholesale factory prices so low that you can have a celebrated Reed & Sons Piano, for lifelong service, at a price as low as the price of many "cheap" made pianos—and get the highest artistic quality. Our 25-year guarantee bond goes with every Reed & Sons instrument. Hundreds have had generations of enjoyment from our pianos. So can you on our plan and prove it positively at our risk.

Saves you from \$128.00 to \$222.00 on price. No Security — No Interest to Pay—No Collectors.

Also Self-Playing Pianos



Reed & Sons Self-Playing Pianos now sold on the most liberal plan. Thousands who "never knew a note" are now enjoying our Self-Players. See our offers and prices all explained in handsomest color-illustrated catalog sent Free.

Take Your Own Time
—On Trying and Paying— We Pay Freight Both Ways.



Take 30 Days' Free Trial in your home with your family and friends to judge the beautiful tone quality—handsome exclusive design and finish—easy action and splendid satisfaction. After a full year's enjoyment send our Reed & Sons Piano or Self-Playing Piano back and we'll pay the freight if not exactly as represented. That's the fairest offer ever made. It means 365 Days' Approval Test, besides 30 Days' Free Trial and 3 years' time to pay if satisfied. When absolutely satisfied you can pay \$1.00 a week, or by the month, or 3 months, or twice a year. We don't care how. Suit your own time. We want you to be happy with one of our pianos or self-playing pianos—prove it at our risk—right now. Write right now—a Postal Today—or the Coupon—For Our Big Book.

REED & SONS PIANO MFG. CO., 265 Wabash Ave., CHICAGO, ILL.
Capital and Resources, \$1,750,000.—Largest Factory-to-Home Piano Manufacturers in the World.

Big Book Free

Reed & Sons Piano Mfg. Co.,
265 Wabash Ave., Chicago, Ill.

Please send me your Big Color Illustrated Piano Book and offer FREE. Everything at your risk.

Name _____

Address _____

Town _____ State _____

365 Days Approval Test

For our Mutual Advantage mention Popular Electricity when writing to Advertisers.

Wayne Bell Transformers



Take the place of unreliable, troublesome batteries and use practically no current. Can be connected to any alternating current lamp socket and will

Operate Door Bells, Buzzers, Toys, Burglar Alarm Systems, Gongs, Annunciators, Etc.

Made in three types and sizes for different classes of work and so neat in appearance that they can be installed anywhere in homes, hotels, offices, schools, hospitals, etc.

Built to run for hours on dead short circuit without danger of burning out.

If your dealer does not have them write us and we will send our illustrated leaflet 4511.

Fort Wayne Electric Works

"Wood" Systems

1603 Broadway Fort Wayne, Ind.

Branch Offices: Most Large Cities

MESCO MESCO MESCO

Electric Signal Horn

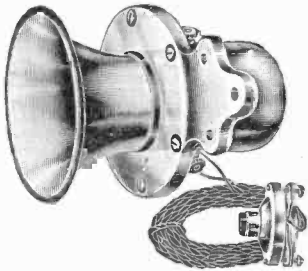

Approved for Motor Boat Use

Has strong note. Clear resonant tone. Made of heavy cast and wrought brass, highly finished. Will stand rough usage. Equipment includes Push Button, 10-foot Flexible Cable and necessary screws for installing.

Price, for Auto, \$15.00; for Motor Boat, \$15.50.
Ask for Catalogue 24N.

Wireless manual sent on receipt of request.

Manhattan Electrical Supply Co.

17 Park Place, NEW YORK
186, 188 Fifth Ave., CHICAGO

MESCO MESCO

THE 1900 DRY CELL

IS THE BATTERY OF KNOWN QUALITY



Which can only be proven by its use, at which time you will agree that the high electro-motive-force and great efficiency make it the best battery on the market.

This cell is made with the view of obtaining the longest possible life under the most exacting requirements.

Recommended especially for Experimenters, Small Wireless Outfit, Gas Engine Ignition, Telephones and all open circuit work.

Write today and secure our catalog, which gives full particulars regarding sizes and prices.

The Nungesser Electric Battery Co.
CLEVELAND, OHIO

GENERAL SALES OFFICE
627 W. Jackson Blvd. CHICAGO

I'll Make You a STYLISH SUIT

—to your order—from any cloth-pattern you select from the FREE SAMPLES I send you—tailored to your exact measurements—cut and trimmed exactly as you want it in every particular—



Perfect Fit Guaranteed— \$12

and suit delivered to you, express prepaid—\$12 to \$20. Where else can you duplicate this offer? Why pay your neighborhood tailor \$30 to \$40 for no better suit? Why wear shoddy, ill-fitting "store clothes" that cost as much or more than I charge you for a genuine tailored suit that will fit and set perfectly, and mark you as a tasty and modish dresser? Write to me to-day for FREE SAMPLES of suit fabrics, perfected system of self-measurement (whereby you are assured an exact fit) and my magnificent 24-page STYLE BOOK showing latest New York and Chicago styles. Then if you don't care to order a suit, you're under no obligations to do so. But remember, I guarantee to fit you and please you—and if you don't think my guarantee is good, write to the Illinois Trust & Savings Bank, Chicago. I have been making honest tailored clothes at bed-rock prices, for fifteen years. Why can't I make them for you? If you want the FREE SAMPLES of new stylish fabrics, self-measurement blank and the superb STYLE BOOK—write to me to-day—you'll receive them all by return mail—FREE.



McGRAW ELZ
(Mgr. Madison Tailors)
DESK W CHICAGO, ILLINOIS

YOU CAN BE A SALESMAN
EARN WHILE YOU LEARN
We have Salesman's Positions open in which you can secure Practical Training and earn good money while studying our course. Men equipped with our system of Practical Training earn from \$1,200 to \$5,000 a year. Positions now open. Address: C. J. Brown, President, THE PRACTICAL SCHOOLS OF SALESMANSHIP, Box A-11 Cleveland, D., Box A-11 Ft. Worth, Tex., or Box A-11 N.Y. City

WHEN desirous of information inquire at the information Dept. of Popular Electricity Pub. Co.

Handy Electrical Dictionary
"Just Fits The Vest Pocket"
Designed to meet the needs of the beginner, and at the same time furnish a compact, reliable reference for the electrical worker and expert.
224 pages—"Plain English" definitions of over 4,800 electrical terms and phrases—7 pages of diagrams
Everyone Interested in Electricity Needs it
Price, Cloth, 25c
Full leather, full gilt, 50c
POPULAR ELECTRICITY PUBLISHING CO.
Book Department CHICAGO, ILL.

\$3.50 FOR THIS High Grade MOTOR

Runs on a. c. and d. c. current, 110 volts. Includes complete set of blue prints showing how to assemble. Has laminated field and armature, mica insulated commutator, 3-16 carbon brushes, bronze bearings, brass grease cups, pulley and terminals.

Type M
1-15
H.P.

Any bright boy can get valuable experience and at the same time STUDY MOTOR CONSTRUCTION WITH PRACTICAL WORKING MODEL. Many interesting experiments can also be performed such as winding so that IT WILL RUN AS A DYNAMO AND ON BATTERY CURRENT. Hundreds of these motors sold to ambitious Electrical Students during the last sixty days.

The complete set of blue prints showing this motor in detail sent for 12 cents in stamps; illustrated catalogue for 4 cents in stamps.

Send today for the blue prints, tomorrow we are sure you will send for the motor.

This motor assembled complete ready to attach to any 110-volt lamp socket, \$5.50.

Send Express or P. O. money order.

JOSEPH WEIDENHOFF
Manufacturer Electrical Specialties
1215 S. Ashland Ave. CHICAGO, ILL.

WIRELESS SUPPLIES
ELECTRICAL NOVELTIES
POCKET CIGAR LIGHTER
Agents Wanted

Combination Pocket Light and Cigar Lighter. The best metallic friction spark lighter on the market. Will last a lifetime. Press the button, the lid springs up, and the sparks from the "Ceric-Iron" pill ignite the wick. Unscrew valve and fill with 40 drops benzine, gasoline or alcohol, which will last 8 days. Benzine preferred. Regular price \$1.50.

OUR PRICE, POSTPAID

Style A1—Vest-pocket	75c
Style A—like cut (nickel plated)	95c
Extra "Ceric-Iron" refill pill	10c

Nickel Tungsten Flashlight, with (new process) Merchor Battery, and enameled Tungsten Bulb.

Price by mail, postpaid	95c
In silver finish	\$1.35
In gold finish	1.50
Extra Battery (Merchor)	25c
Extra Tungsten Bulb (Bat)	35c

LATEST QUICK ACTION CIGAR LIGHTER
Sample by mail, postpaid, 50c

Turn the wheel—that's all—and the sparks from the pyrophorer under wheel ignites the benzine saturated wick. Extra pyrophorer (lasts 6 months) 10c. We carry a complete stock of Wireless Goods, Flash Lights and Batteries, Tungsten and Carbon Battery Lamps, Telegraph Outfits, Motors, Engines, Trains, Toys, and Pocket Cigar Lighters.

Send 4c stamp for our Wireless Booklet and General Catalog of Electrical Novelties. PRICES: Wireless Booklet, Net; Large Catalog, 20 per cent Discount.

Anderson Light & Specialty Co.
Known as LA SALLE LIGHT STORE
70A LA SALLE STREET (Opposite the New City Hall) CHICAGO

For our Mutual Advantage mention Popular Electricity when writing to Advertisers.

FREE FUEL

Most Wonderful Stove Ever Invented

BURNS AIR

Fuel Drawn Principally From Atmosphere

COOKING OR HEATING

Air now burned in this wonderful stove is free to rich and poor alike. No trust in control.

**This Valveless
Wickless Automatic
Oil-Gas and
Air-Burner
Stove**

automatically generates gas from kerosene oil, mixing it with air.

Scientific test proves it uses 395 barrels of air to one gallon common kerosene oil.

CHEAPEST FUEL—SUMMER COMFORT. Intense heat but concentrated under cooking vessels and absorbed by articles being cooked—not thrown out to overheat your kitchen.

To operate—turn knob—oil runs into burner—touch a match; it generates gas, which passes through air mixer, drawing in about a barrel of air to every large spoonful of oil consumed. That's all. It is self-regulating, no more attention. Same heat all day or all night. For more or less heat, simply turn knob. There it remains until you come again. To put fire out, turn knob, raising burner—oil runs back into can, fire's out. As near perfection as anything in this world. **Ideal for summer use.** Not dangerous like gasoline. No dirt, soot or ashes. No leaks—nothing to clog or close up. No wick—not even a valve, yet heat is under perfect control—kitchen always cool. **D. CARN, IND.,** writes: "It costs me only 4 1-2 cents a day for fuel." **L. NORRIS, VT.,** writes: "The Harrison Oil-Gas

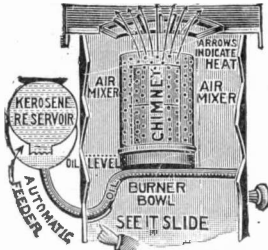

Sectional Cut of Generator

Generators are wonderful savers of fuel, at least 50 to 75 per cent over wood and coal." **E. ARNOLD, NEB.,** writes: "Saved \$4.25 a month for fuel by using the Harrison Oil-gas stove. My range costs me \$5.50 per month, the Harrison \$1.25 per month." **THOS. VINCENT, WIS.,** "My wife never had anything she enjoyed so much as her stove. It is very quick, no heated room or dirt. Surpasses anything we ever saw."

NOT LIKE THOSE SOLD IN STORES. Ideal for roasting, cooking, baking, ironing, canning



ALL SIZES

fruit, picnics, cottages, camping. In Winter use Radiator for heating houses, stores, rooms, etc. No more carrying coal, kindling, ashes, soot and dirt. **No hot firey kitchens.** Absolutely safe from explosion. Not dangerous like gasoline. Simple, durable—last for years. Saves expense, drudgery and fuel bills.

ALL SIZES, PRICES LOW—\$3.25 AND UP. Sent to any address. Give this stove a trial. Send no money—only send your name and address. Write today for full description, thousands of testimonials. Our 1911 Proposition, Circulars FREE.

EXCITING BUSINESS FOR AGENTS

SALESMEN—MANAGERS—Men or Women at home or traveling, all or part time—showing—taking orders—appointing agents, etc. **MESSRS. HEAD & FRAZER, TEXAS,** writes: "Enclose order for \$81.00. RUSH. Sell like hot cakes. Sold 50 stoves in our town." **B. L. HEUSTED, MICH.,** writes: "Been out one day and sold 11 stoves." This patent new. Nothing like it. Demand enormous. Agents reaping great harvest. Where operated, people stop, look, get interested, want to buy at once. Show dozen, sell ten. Write today for special agents' new plan. Send no money. World unsupplied. Get in early for territory. **THE WORLD MANUFACTURING CO.,** 350 World Building, CINCINNATI, O.

For our Mutual Advantage mention Popular Electricity when writing to Advertisers.

Furniture Bargain Book

Picturing 3,000 Things
Mostly Bought from
98 Hard-Up Makers

Cash or Credit

Our whole business is to buy and sell bargains in house-furnishings. We buy surplus stocks on which makers dare not cut prices to dealers.

Hard-up makers unload on us, and we sell direct to the user at savings up to 50 per cent.

Our latest Bargain Book pictures 3,000 articles at almost unbelievable prices.

Furniture	Rugs	Graphophones
Carpets	Stoves	Refrigerators
Draperies	Ranges	Kitchen Cabinets
Silverware	Pianos	Sewing Machines
Chinaware	Lamps	Baby Cabs, etc.

Most of these things were bought in midwinter, when makers had to sell.

Pay as Convenient

We sell for cash or credit at an equal price. We have charge accounts with 600,000 homes. They take, on the average, a year to pay—a little each month.

You are welcome to such an account if you wish it. There is no interest, no security, no red tape or publicity—just an open charge account. We gladly trust people who buy things for the home.

Everything is sent on 30 days' approval. Use it a month before deciding to keep it. If it isn't such a bargain as you expect, return it at our expense for freight both ways.

On these fair lines we have built up here the largest trade in our line in the world.

Bargain Book Free

This mammoth book of 3,000 bargains—size 12x24 inches—will be mailed you free. It pictures more articles and quotes lower prices than any book of its kind ever issued. Every home should have it.

Simply send us your name and address—a postal will do. Write it now, before you forget it, and the book will be mailed you free.

Spiegel, May, Stern Co.

1481 35th Street

(98)

CHICAGO

DR. FOOTE'S WONDER BOOK 10

ON HEALTH—DISEASES—FREAKS—MARRIAGE—PARENTAGE—HUMAN NATURE

A peep into the Mysteries of the INNER-MAN. This remarkable book is a thought-awakener, and is as intensely interesting as a novel. It contains more truths, common-sense, vital facts, valuable advice and information than your doctor would give you for \$10. In two sections—240 pages and 40 illustrations. Sent by mail postpaid on receipt of Price—10c. Write TO-DAY.

Murray Hill Book Co., 106 East 28th St., N. Y.

TURN your spare time into cash. No matter where you are employed, you can make easy money and lots of it working for **POPULAR ELECTRICITY**. Our salary plan is the most liberal ever offered. Send stamp for particulars.

POPULAR ELECTRICITY PUB. CO.

Circulation Department

100 Lake Street

CHICAGO, ILL.



G. H. BRINKLER
Food Expert
WASHINGTON, D. C.

DO YOU KNOW how to combine your daily foods to produce HEALTH?

DO YOU REALIZE the striking difference in the properties of foods? For instance, eggs and flour may be used to make paste, firm enough to fasten up your wall paper, and their adhesive properties are powerful for nourishing the system when they are properly combined with other foods. When wrongly combined they clog the human machinery. But meat, green vegetables and fruit cannot do this.

I Have No Foods To Sell

I CAN TELL YOU, without technical terms, the best combinations and proportions of the different foods for your condition.

THE NEW BRAINY DIET CURE of ordinary foods in daily use, first taught by S. Leppel in England, is an exact science based on experiments published in Dr. Bellow's Standard work, "The Philosophy of Eating."

Striking Effects of Different Combinations and Quantities of Foods

An excess of starchy and fatty combinations of food will make you sluggish; it will give you dull, splitting headaches, lack of memory and concentration, drowsiness and inertia. A complete change to "digestible" brainy foods, suitable meat, game, fish and dairy foods, combined with suitable vegetables and fruits according to the new brainy diet plan, will produce the most marked improvements in a few weeks.

One dropsical consultant lost 18 pounds of over-weight in the first week, and returned to business.

Another, a thin man, after being out of work nearly a year through weakness, was restored in three weeks to hard work as a carpenter at full pay. In such cases the change from a clogging, death-producing diet to energizing foods, caused a literal transformation.

Another patient, deaf in the right ear, owing to a discharge caused by an excess of mucus-making foods, (cream, butter, cheese, etc.), was completely cured of deafness and catarrh by taking correct combinations of foods.

A case of kidney and bladder trouble of ten years' standing was saved from a surgical operation, and the objectionable discharge cured within ten days, because the loss of control was due entirely to the constant irritation from certain irritating foods and drinks.

A chronic sufferer, weighing 415 pounds, reduced over 150 pounds (in public life under many witnesses), gained strength, and firmer flesh, and lost rheumatism. Many well-known diseased persons have been taught how to cure themselves by brainy foods during 23 years, by S. Leppel in England. (See the Leppel "Bulletin") and during 9 years by the writer in America.

Eat for Health, Energy, Brain Power, Good Looks and Success

Here are a few curative principles: suitable meats, dairy foods, etc., generate vitality and nourish the brain and nerves; starchy foods feed the muscles, and furnish staying power, etc.; tomatoes and lemons are solvents for impurities, foreign elements and waste matter—the cause of disease; green vegetables purify the blood, dislodge, disperse and carry off the waste products, and keep one comfortable in hot weather, provided all other foods are properly selected and combined for individual requirements.

Indigestible, irritating foods and the retention of their waste matter are the cause of homeliness (double chin, dull eyes, bad skin, fagged face, etc.), dullness and disease. **The foods which cause expectoration, catarrh, cough, constipation, tumors, etc., are specified in the free booklets.** Wrongly combined foods either ferment, cause gas, poison or kill. They produce such complaints as gastritis, appendicitis, tonsillitis, apoplexy, etc.

No Manufactured Foods, nor Fasting, Privations, Exercises nor Drugs

During thirteen years of personal experience in co-operation with S. Leppel, and others, I have learned to produce in myself various diseases, each by eating certain wrong foods for a few days or weeks. They are: Rheumatism, catarrh, sore throat, tonsillitis, constipation, double chin, swollen glands, kidney troubles, shortness of breath, rough scaly skin, dandruff, sores, boils, pimples with white pus, blackheads, rash, dry hair and numerous other symptoms, **AND I CAN CURE THESE SYMPTOMS OF ILL HEALTH IN A FEW DAYS BY CORRECT FOODS.** I am willing to give public demonstrations to show the rapidly with which different sets of foods operate throughout the whole body for good or bad. As far as I know, I am the only man who can produce these changes in a short time methodically. My experiments were begun when a student at Cambridge University, England, with the idea of increasing mental endurance. I advise all ambitious students to investigate the **BRAINY DIET SYSTEM.** They will find a correct application of its principles to be the foundation of health, energy, good looks and success.

Brainy Diet



A chronic sufferer, weighing 415 pounds, unable to exercise, took correct combinations of ordinary daily foods and reduced over 150 pounds (in public life under many witnesses) gained strength with firmer flesh, and lost rheumatism.

Remarks about the four booklets:—

"A suggestion from your booklet relieved my catarrh in two weeks and gave me confidence in your methods."

"The government should investigate and teach the Brainy Diet System for the good of the nation."

"My brain power and general efficiency have been about doubled this year by taking brainy foods. I have made a fortune in real estate and the credit is honestly yours."

"The hints in booklet No. III, on foods for curing congested liver, nourishing the brain, etc., are worth untold dollars, although the books are free."

(1) TESTS OF BRAINY DIET (3) EFFECTS OF FOODS
(2) DIET VERSUS DRUGS (4) KEY TO LONGEVITY

Send 10 Cents for Postage, etc.

Send the addresses of your sick friends to

G. H. BRINKLER

Food Expert Dept. E. Washington, D. C.

For our Mutual Advantage mention Popular Electricity when writing to Advertisers.

Special Reduction Price WHILE THEY LAST

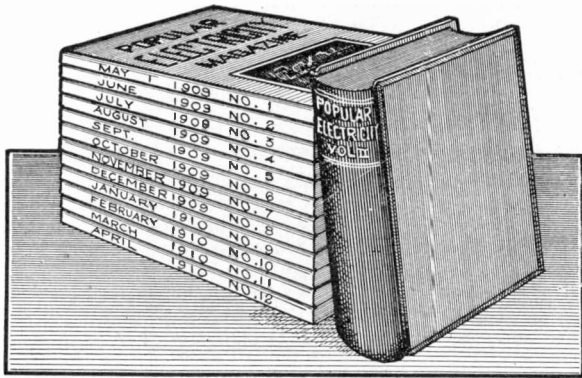

Popular Electricity Bound Volume II

\$1.50 POSTPAID

Don't overlook this opportunity to
secure this

**Great Reference Book
At a Greatly Reduced Price**

A summary of the year's progress in electrical science, containing authentic, interesting information on a thousand and one electrical subjects.

Also complete detailed directions for doing Electroplating, Electric Welding, Charging Batteries, Bell Wiring; Constructing Motors, Electric Heaters, Spark Coils, Burglar Alarms, Rheostats, Speaking Arc, Battery Motor Controller, "Pericon" Detector, Electric Alarm Clock, Transformers, Direct Current Ammeter, Electric Static Machine, Hot Wire Ammeter, Wireless Transformers, Direct Current Dynamo, Shocking Coil, Simple Wireless Telephone Set, Instantaneous Water Heater, Electrolytic Detector, Variable Coupling Tuning Coil, and numerous other electrical apparatus.

A complete index serves to locate any desired subject instantly.

Complete serials in this volume are:—

Electric Light and Power for Country Homes. By Louis A. Pratt.

A series of articles describing the uses and convenience of electricity in country homes or farms.

Construction and Operation of Spark Coils. By Victor H. Laughter.

Detailed directions for the construction of different sized coils and their uses.

How to Do Electroplating. By J. R. Wilson.

Contains full directions for electroplating with nickel, copper, silver and other alloys, showing how to prepare the work, tools to be used, etc.

Also:—Elementary Electricity, Chapters 13-24. By Prof. E. J. Houston.

Explains in a simple way with illustrations the basic principles necessary for every one to know who is taking up the study of Electricity.

Where Electricity Stands in the Practice of Medicine—Parts 1-4. By Dr. Noble M. Eberhart. Showing just where electricity is used in the practice of medicine told in a manner that is interesting to all.

An Electrical Laboratory for Twenty five Dollars—Parts 1-4. By David P. Morrison.

To anyone desiring an electrical laboratory for experimental use this series is invaluable as it gives directions for the construction of inexpensive instruments which can be made with ordinary tools.

In the Department of Questions and Answers, are solved a great many problems that arise in electrical work.

Numerous Electrical stories furnish both interesting and instructive reading.

900 Pages with over 1000 illustrations, well bound in handsome blue silk covers.

A complete description of this book will be sent on request. Also an illustrated catalog.

POPULAR ELECTRICITY

Book Department

100 Lake Street

CHICAGO, ILL.



Everything About an Auto

No matter how fine the car you own, or drive, or manufacture; no matter how thoroughly it is equipped, your outfit is not *complete* unless you own the new

Cyclopedia of Automobile Engineering

Four large, handsome volumes bound in half morocco, 1,200 illustrations, full-page plates, diagrams, etc., 1,500 pages, 7 x 10 inches, crammed with interesting and very necessary information concerning automobiles, aeroplanes, and motor boats; knowledge that you've got to get some way or other before you can thoroughly understand or enjoy the automobile "game."

CONDENSED TABLE OF CONTENTS

<p>VOL. I GASOLINE AUTOMOBILES: Running Gear — Power — Operation — Repair. AUTOMOBILE MECHANISMS: Carbureters — Starting Devices — Clutches — Gears — Brakes.</p>	<p>VOL. III ELECTRIC AUTOMOBILES: Battery—Motor—Transmission — Control — Tires — Driving. ELEMENTS OF ELECTRICITY; ELECTRIC CURRENT; AUTOMOBILE DRIVING: Starting and Stopping — Gear Changing — Use of Spark and Throttle — Care of Car — Road Repairs.</p>
<p>VOL. II STEAM AUTOMOBILES: Flash Boiler—Engines — Operation and Repair. COMMERCIAL VEHICLES: Selection—Delivery Trucks—Upkeep—Mileage—Capacity. TYPES: Selection — Price — Demonstration — Speed.</p>	<p>VOL. IV AERIAL NAVIGATION: Dirigible Balloons—Aeroplanes — Airship Motors. GAS AND OIL ENGINES: Ignition—Testing. MOTORCYCLES: Construction—Operation. MOTOR BOATS: Types—Engines—Installation.</p>

READ THIS FREE EXAMINATION OFFER

You can examine these books for five days in your own home or office, free of all cost. Don't risk missing this offer by stopping to think it over. Order now and do your careful thinking with the books before you. That costs nothing. Here's the coupon.

HERE'S OUR LIBERAL SELLING PLAN

If you like the books after examination, send us \$2.00; then \$2.00 a month until the special price of \$12.80 is paid. If they are not satisfactory, advise us and we will have the books returned at our expense.

Order promptly and we will include for one year, as a monthly supplement, the **TECHNICAL WORLD MAGAZINE**, a regular \$1.50 monthly, full of interesting scientific topics written in popular form.

AMERICAN SCHOOL OF CORRESPONDENCE
 CHICAGO, U. S. A.

FREE EXAMINATION COUPON

NAME

ADDRESS

OCCUPATION

EMPLOYER

P. E.
4-'11
A. S. of C.

Please send set Cyclopedia of Automobile Engineering for five days' free examination; also Tech. World for one year. I will send \$2 within five days and \$2 a month until I have paid \$12.80 for books and magazine or notify you and hold the books subject to your order. Title not to pass until fully paid.

Increase Your Knowledge of Electricity

SELECT YOUR BOOKS FROM THIS LIST

ELEMENTARY

PRICE POSTPAID

Handy Electrical Dictionary. By W. L. Weber. 224 pages, cloth 25 cents, leather.	\$0.50
Practical Compend of Electricity. By Jas. A. Beaton. 272 pages, cloth 25 cents, leather.50
First Steps in Electricity. By J. Harrison. 283 pages, illustrated.	1.00
Electricity Made Simple. By Clark Caryl Haskins. 232 pages, illustrated.	1.00
Elementary Electricity up to Date. By Sidney A. Smnll. 443 pages, illustrated.	1.25
Easy Experiments in Electricity. By L. P. Dickenson. 204 pages. Illustrated.	1.00
Electric Toy Making. By T. O'Connor Sloane. 185 pages, illustrated.	1.00
Electricity Simplified. By T. O'Connor Sloane. 172 pages, illustrated.	1.00
Conversations on Electricity. By J. G. Branch. 282 pages, illustrated.	2.00
Practical Lessons in Electricity. 250 pages, illustrated.	1.50
The Wonder Book of Magnetism. By E. J. Houston. 325 pages, illustrated.	1.50
The Boy Electrician. By E. J. Houston. 326 pages illustrated.	1.50
Harper's Electricity Book for Boys. By J. H. Adams. 407 pages. Illustrated.	1.75

WIRING

Standard Wiring for Electric Light and Power. By H. C. Cushing. 157 pages. Leather.	1.00
Modern Electrical Construction. By Hortsman & Tousley. 250 pages. Leather.	1.50
Modern Wiring Diagrams and Descriptions. By Hortsman & Tousley. 240 pages. Leather.	1.50
Electric Wiring and Construction Tables. By Hortsman & Tousley. 119 pages. Leather.	1.50
Practical Armature and Magnet Winding. By Hortsman & Tousley. 231 pages. Leather.	1.50
Electrician's Operating Testing Manual. By Hortsman & Tousley. 400 pages. Leather.	1.50

TELEGRAPHY AND TELEPHONY

Telegraphy Self Taught. By Theodore A. Edison. 175 pages. Illustrated.	1.00
The Telegraph Instructor. By G. M. Dodge. 375 pages. Illustrated.	1.00
A. B. C. of the Telephone. By James E. Homan. New Edition. 349 pages. Illustrated.	1.00
Telephone Construction, Installation, Wiring, Operation and Maintenance. By H. C. Cushing.	1.00
Practical Telephone Handbook and Guide to Telephone Exchanges. 179 pages.	1.00

WIRELESS TELEGRAPHY AND TELEPHONY

Wireless Telephones and How They Work. By Jas. Erskine Murray. 68 pages. Illustrated.	1.00
Operators' Wireless Telegraph and Telephone Handbook. By V. H. Laughter. 180 pages.	1.00
Wireless Telegraph Construction for Amateurs. By A. P. Morgan. 200 pages. Illustrated.	1.50
The Story of Wireless Telegraphy. By A. T. Story. 210 pages. Illustrated.	1.00

ELECTRIC RAILROADING

Electric Railway Troubles and How to Find Them. By P. E. Lowe. 367 pages. Illustrated.	1.50
How to Become a Successful Motorman. By S. Aylmer Small. 312 pages. Illustrated.	1.50
Electric Railway Power Stations. By Calvin F. Swingle. 718 pages. Illustrated.	2.00
Electrical Railroading as Applied to Steam Railways. By S. A. Small. 924 pages. Illustrated.	3.50

AUTOMOBILES AND MISCELLANEOUS

Self Propelled Vehicles. By J. E. Homan. Latest Revised Edition. 600 pages.	2.00
Auto Troubles and How to Remedy Them. By Chas. P. Root. 225 pages. Illustrated. Cloth, \$1.00.	1.50
Leather.	1.50
Flying Machines Construction and Operation. By Jackman & Russell. 250 pages. Cloth, \$1.00 Leather.	1.50
Practical Applied Electricity. By David Penn Moreton. 256 pages.	1.50
Dynamo Building for Amateurs. By A. J. Weed. 110 pages. Paper, 50 cents. Cloth.	1.00
Dynamo Tending for Engineers. By Hortsman & Tousley. 210 pages.	1.50
Up-to-date Electroplating Handbook. James H. Weston. 178 pages. Illustrated. Cloth, \$1.00. Leather	1.50
How to Become a Successful Electrician. T. O'Connor Sloane. 202 pages. Illustrated.	1.00
Electricians' Handy Book. By T. O'Connor Sloane. 768 pages. Illustrated.	3.50
Standard Electrical Dictionary. 682 pages. Illustrated.	3.00
Switchboards, Complete and Up to Date. By Wm. Baxter. 190 pages. Illustrated.	1.50
Electricity in Factories and Workshops, Cost and Convenience. By Haslem. 312 pages.	2.50
Harper's How to Understand Electrical Work. W. H. Onken & J. B. Baker. 359 pages.	1.75
Stationary Transformers, Theory, Connection and Operation. By Taylor. 169 pages.	1.50
The Tesla High-Frequency Coils, By Haller & Cunningham, . 120 pages. Illustrated.	1.25

This list contains the most practical and up to date books on the subject and by the best authorities on Electrical work. If we have failed to list books on any particular subject that you are interested in write us, we can furnish any electrical or mechanical book published and may also be of assistance to you in their selection.

SPECIAL OFFER—On orders for the above books amounting to \$1.50 we will give you a "Handy Electrical Dictionary" or "Practical Compend of Electricity." On \$3.00 orders you can have both books and on \$6.00 orders you can select any \$1.00 book in the list.

For a complete description of these books send for our Illustrated Catalog. It's Free.

POPULAR ELECTRICITY BOOK DEPT., 100 Lake Street, Chicago, Ill.

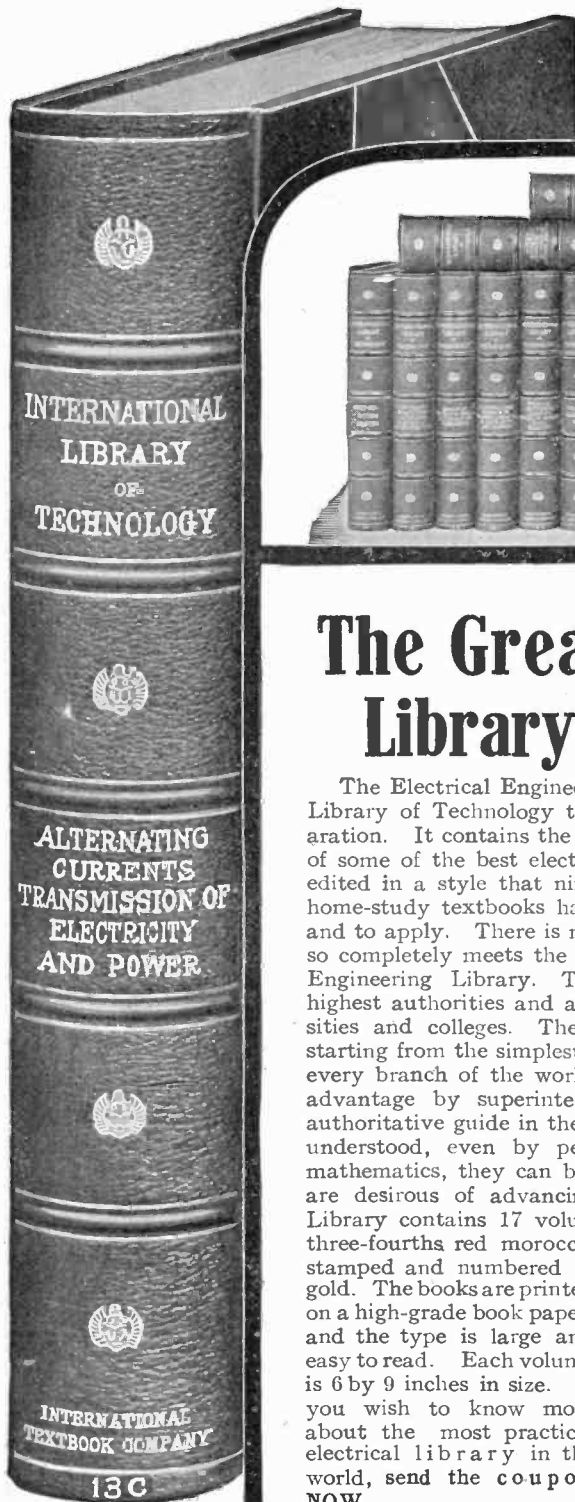

The Greatest Electrical Library in the World

The Electrical Engineering Library is part of the International Library of Technology that cost \$1,500,000 in its original preparation. It contains the knowledge given from the life experience of some of the best electrical engineering experts in the country, edited in a style that nineteen years of experience in publishing home-study textbooks has proved easiest to learn, to remember, and to apply. There is no other reference work in the world that so completely meets the needs of the electrician as the Electrical Engineering Library. The volumes are recommended by the highest authorities and are used in nearly all the leading universities and colleges. They treat of practical electrical methods, starting from the simplest problems and comprehensively covering every branch of the work. Not only can they be used to great advantage by superintendents, foremen, and engineers as an authoritative guide in their work, but since they can be so clearly understood, even by persons having no knowledge of higher mathematics, they can be used by all classes of electricians that are desirous of advancing to higher positions. The Electrical Library contains 17 volumes durably and handsomely bound in three-fourths red morocco, stamped and numbered in gold. The books are printed on a high-grade book paper, and the type is large and easy to read. Each volume is 6 by 9 inches in size. If you wish to know more about the most practical electrical library in the world, send the coupon NOW.

International Textbook Co.
Box 1102, Scranton, Pa.

Please send, without further obligation to me, full particulars in regard to your Library of Technology, with special reference to the Electrical Library.

Name _____

St. & No. _____

City _____ State _____

ELECTRICITY

VOLTAMP

The most wonderful and fascinating scientific study of the age. Every Boy, Girl and Grown-up should know about it. The new "VOLTAMP ELECTRICAL PRODUCTS" our 112 Page Catalog now ready, the most complete and interesting book ever issued—is full of illustrations and descriptions of the latest VOLTAMP Electrical Novelties—Motors, Dynamos, Toys, Machine Models, Telegraph and "Wireless" Instruments, Ruhmkorff Coils, Spark Coils, Gelsler Tubes, Switches, Meters, Lamps, Flashlights, Transformers, Tools, etc. The greatest line of Miniature Electric Railways ever shown. Anything Electrical for Anybody. Prices consistently low.

Send for this Catalog—6 cents in stamps or coin, which will be refunded on first order of 50 cents or over. No postals answered.

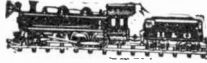

VOLTAMP ELECTRIC MFG. CO., Park Bldg., Baltimore, Md.

Own a Model AEROPLANE



Be up-to-date. Learn how to fly with our Flying Bat 8 in. model. It flies 30 ft. by its own power. Very instructive and amusing. Sent complete, postpaid, on receipt of 20c in coin. Satisfaction guaranteed.

GOFFAEROPLANE CO., Station M, CHICAGO

P. S.—We have one of the best equipped shops for model work in the west. Let us build your machine. City Office, 225 Dearborn St. Suite 414-415

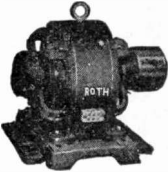

ROTH

ELECTRIC MOTORS
POLISHING LATHES
FORGE BLOWERS
SPECIAL MACHINERY

ROTH BROS. & CO.

1358 W. Adams St.
Chicago, Ill.

136 Liberty St.
New York City



Big Mail FREE

Your NAME PRINTED in our Mailing Directory and sent to 10,000 firms all over the world so they can send you FREE Samples, Catalogs, Books, Papers, Magazines, etc., etc. Send 20c to cover cost of printing your name and you will receive a big mail free.

Ingram, Va., Jan. 7, 1910. Mr. Anderson, I have already received more than 2,000 parcels of mail, and still they come, scores of papers, samples, magazines, etc., for which I had often paid 10 to 25c each. R. T. James, Send to ANDERSON, The Mail Man, 5856, Jamestown, N. Y.



WHITE VALLEY GEMS

IMPORTED from FRANCE

SEE THEM BEFORE PAYING! These Gems are chemical white sapphires. Can't be told from diamonds except by an expert. Stand acid and fire diamond tests.

So hard they scratch a file, will cut glass. Brilliance guaranteed 25 years. All mounted in 14K solid gold diamond mountings. Will send you any style ring, pin or stud on approval—all charges prepaid—no money in advance. Write for Free illustrated booklet, special prices and ring measure WHITE VALLEY GEM CO., 742 Saks Bldg., Indianapolis, Ind.



SEND FOR THIS FLASHER TODAY

The greatest bargain in Electrical Pocket Flashers known. Mo her of Pe ri—fine nickled finish, size 2 1-2 x 3 1-2 inches, absolutely guaranteed for longer life and greater brilliancy than all others. Genuinely imported.

This is only one of many electrical novelty bargains. Keep in touch with us each month. We will have some of the greatest and most wonderful bargains in electrical novelties ever known. All warranted and absolutely imported.

FOREIGN ELECTRICAL EXCHANGE

90 Wabash Avenue

Chicago, Ill.

Aviation Directory

Aviators, Aeroplane Builders!—The Directory contains the information you want.

Aeroplanes, Motors, Supplies

Every concern in the industry listed

50 CENTS PER COPY

Advertisers: Classified Adv. printed free. Display rate, \$20 per page, 8 1/2 x 12.

The Aviation Directory, Lawrence, Kans.

ELECTRIC SHAVING MIRROR

The best light for shaving. Special reflector throws the light on lower part of the face only. No glare in the eyes or on the mirror. The 6 in. x 9 in. French plate mirror is mounted on a heavily nickelled frame. Both mirror and reflector are adjustable to any angle. Can be packed in suit case for traveling. Sent complete with lamp and silk attachment cord to any address on receipt of price. Write for our booklet "Federalites."

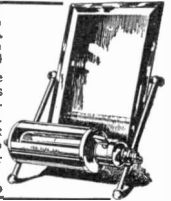

Federal Electric Co., Lake & Desplaines St., Chicago

Now is the Time

to reserve space if you intend exhibiting at the Eighth Annual Electric Show 1912

Electrical Trades Exposition Co.

150 Michigan Avenue,

Homer E. Niesz, Mgr. CHICAGO, ILL.



Do Your Own Printing

Cards, circulars, book, newspaper. Press \$5, Larger \$18, Rotary \$60. Save money. Big profit printing for others. All easy, rules sent. Write factory for press catalog TYPE, cards, paper. THE PRESS CO., Meriden, Conn.

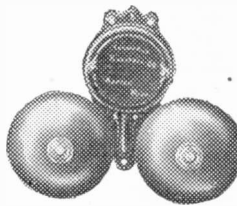

MAKE EASY MONEY INSTALLING SCHWARZE ELECTRIC BELLS

They cure all Bell troubles and save their cost. For any current. Send \$1.50 today for sample silver-toned house bell, all charges prepaid anywhere in the United States.

SCHWARZE ELECTRIC CO., 5 Main St., ADRIAN, MICH.

ELECTRIC TURKISH BATHS RIGHT AT HOME FOR 2 CENTS



Electric Vapor and Electric Heat Bath made possible by using any of your Electric Heating Appliances such as an Electric Iron, Toaster, Hot Plate. Attach it to your lamp socket, place it in the Robinson Bath Cabinet, and you can get the greatest Electric Vapor or Heat Bath you ever had.

Every Benefit, Every Luxury of Vapor Bathing within reach of all. The "Robinson" Thermal Bath Cabinet Going into Countless Homes.

You no longer need to go to an expensive hotel or public Turkish Bath when you want to get a fine hot vapor bath, rid the pores of accumulated waste and feel fresh and fit instead of dull and "stale." Just get a "Robinson" Thermal Bath Cabinet. Pursued systematically, this home cabinet bath will accomplish wonders in the treatment of La Grippe, Fever, Hard Colds and Rheumatism. Beware of imitations. OUR \$2.00 BOOK SENT FREE for a limited period only. Send today. ROBINSON MFG. COMPANY, 218 Snowflake Bldg., Toledo, O.

PATENTS THAT PROTECT and PAY

Advice free. Terms reasonable. Highest references. Best results.

Send sketch or model for FREE examination and opinion.

Recommended Patent Lawyer in the Bankers' Register and SPECIAL LIST OF SELECTED LAWYERS. Also in Martindale's Law Directory, Sharp and Alleman's Directory of Lawyers, The Gast-Paul Directory of Lawyers, and Kime's International Law Directory.

ALL BUSINESS GIVEN PROMPT AND PROPER ATTENTION

A large list of strong recommendations furnished free

WATSON E. COLEMAN, Patent Lawyer, 622 F St., N. W., Washington, D. C.

PATENTS

C. L. PARKER
Ex-Examiner U. S. Patent Office
PATENT LAWYER
12 MCGILL BLDG.
WASHINGTON, D. C.

Patents, Trade Marks, Copyrights, Patent Litigation
Handbook for inventors, "Protecting, Exploiting and Selling Inventions" sent free upon request.

PATENTS AND PROFIT.

"A Talk to the Inventor"

FREE BOOK explains WHAT YOU SHOULD KNOW before applying for a Patent; WHAT TO INVENT; HOW TO SELL YOUR PATENT; WHAT NOT TO INVENT. Write for it today. Send sketch for advice.

H. L. WOODWARD, 726 9th ST., WASHINGTON, D. C. BY PATENT OFFICE

LANGDON MOORE

Counselor-at-Law and Patent Attorney

Patents, Trade-Marks, Designs and Copyrights

520 9th Street WASHINGTON, D. C.

Formerly Examiner U. S. Patent Office

SEND FOR BOOKLET C

PATENTS

secured or fee returned. Free expert search of official records. Send for free handbook.

MILO B. STEVENS & CO., Attys.
ESTABLISHED 1884

800 14th St., WASHINGTON, D. C. 351 Monadnock Block, CHICAGO

Guaranteed and recommended by the Bankers' Register. Highest rating by Martindale's American Law Directory.

WANTED—IDEAS

The demand for good patentable ideas is greater than ever before. Am constantly in receipt of letters from parties desiring to buy patents procured through me. Electrical devices, tools of all kinds, advertising novelties, agents' supplies, mail order articles, and many other inventions are sought after. Protect your ideal Write for "Stepping Stones" (containing over 200 inventions wanted) and new guide book "Successful Patents." Clients' patents sold free. My personal services. Highest references.

RICHARD B. OWEN

Dept. 6.

WASHINGTON, D. C.

CAPITALIZE YOUR BRAINS

For our Mutual Advantage mention Popular Electricity when writing to Advertisers.

PATENTS

TRADE MARKS AND COPYRIGHTS

SECURED OR FEE RETURNED

Send model or sketch and description of your invention for free search of the U. S. Patent Office Records.

Our Four Books mailed free to any address. Send for these books; the finest publications ever issued for free distribution.

HOW TO OBTAIN A PATENT

Our Illustrated 80 page Guide Book is an invaluable book of reference for inventors and contains 100 mechanical movements, illustrated and described.

FORTUNES IN PATENTS

Tells how to invent for profit and gives history of successful inventions.

WHAT TO INVENT

Contains a valuable list of inventions wanted and suggestions concerning profitable fields of invention. Also information regarding prizes offered for inventions, among which is a

PRIZE OF ONE MILLION DOLLARS

offered for one invention and \$10,000 for others.

PATENTS THAT PAY

Contains fac-similes of unsolicited letters from our clients who have built up profitable enterprises founded upon patents procured by us. Also endorsements from prominent inventors, manufacturers, Senators, Congressmen, Governors, etc.

WE ADVERTISE OUR CLIENTS' INVENTIONS FREE

in a list of Sunday newspapers with two million circulation and in the *World's Progress*. Sample copy free.

ELECTRICAL CASES A SPECIALTY

We have secured many important Electrical patents.

VICTOR J. EVANS & CO.

(Formerly Evans, Wilkins & Co)

Victor Bldg., 724 9th St. E

Washington, D. C.

PATENTS: For facts about Prize and Reward offers and Inventions that will bring from \$5000 to 10 Million Dollars; and for books of Intense Interest to Inventors, send 8c postage to Pubs. Patent Sense, Dept. 52, Barrister Bldg., Washington, D. C.



PATENT YOUR IDEAS

\$8,500 for one invention. Book, "How to Obtain a Patent" and "What to Invent" sent free. Send rough sketch for free report as to patentability. Patents advertised for sale at our expense in fourteen Manufacturers' Journals. Patent Obtained or Fee Returned

CHANDLEE & CHANDLEE, Patent Attorneys

Established 16 Years

974 F. Street, Washington, D. C.



The only Solution: **Get a better job**

Are you "trying to make both ends meet" on a small, unsatisfactory salary? Are you one of the thousands of energetic, capable men whose days are spent in work not suited to their natural talents?

Then read this wonderful offer. We mean it and there is a fine chance for you if you improve it.

If you lack the time and the means to stop work and take a course of training, the American School will lend you the cost of the training you need and let you make your own terms for repaying us.

This is the greatest offer ever made to men who have "got it in them to rise," and we are prepared to help everyone who comes to us in earnest.

Check the coupon, mail it to us, and we will explain fully our "Deferred Tuition" plan, how we will lend you the cost of the tuition, and allow you to pay us back when the increase in your yearly income equals the amount of the loan.

No Promotion—No Pay— that's what our "Deferred Tuition" Scholarship means. Send the coupon today and prepare for a better job.

AMERICAN SCHOOL OF CORRESPONDENCE
CHICAGO, U. S. A.

Opportunity Coupon

American School of Correspondence, Chicago, U. S. A.

Please send me your Bulletin and advise me how I can qualify for the position marked "X." Pop. Elect. 4-11.

- | | |
|-----------------------------|---------------------------|
|Book-keeper |Draftsman |
|Stenographer |Architect |
|Accountant |Civil Engineer |
|Cost Accountant |Automobile Operator |
|Systematizer |Electrical Engineer |
|Certified Public Acc't |Mechanical Engineer |
|Auditor |Moving Picture Op'r |
|Business Manager |Steam Engineer |
|Commercial Law |Fire Insurance Eng'r |
|Reclamation Engineer |College Preparatory |

NAME

ADDRESS

For our Mutual Advantage mention Popular Electricity when writing to Advertisers.

FREE TRIAL for 6 Months

We want you to grind your tools on this perfected carborundum grinder for six months so you can find out its great value in your work. If after six months' trial you decide not to keep it, return it to us—no hard feelings, just send it back. The six months' use will have cost you nothing.



Mechanic's Special with Twist Drill Grinding Attachment

Luther Diamond Tool Grinder The Perfected Carborundum Sharpener

25 times faster than grindstones
6 times faster than emery

25 Times Faster Than Grindstones

This Luther Grinder — the standard of the world — with its wheels of the wonderful abrasive carborundum, is 25 times faster than grindstones. It cuts the hardest steel as emery does copper. One man with the Luther does the work of 20 men with any other sharpening device. Does not draw temper. No need of hard pressing — just a light touch — the hard, sharp carborundum crystals of the wheels peel off steel in tiny shavings. No water needed.

Return This Coupon and get our 6 months Free Trial Offer

Send for our 6 months' free trial offer — we will also send you free a booklet telling the interesting story of the discovery of carborundum — how a scientist, attempting to make artificial diamonds, and fusing the elements of diamonds in an electric furnace, hot beyond the measurements of science, discovered, not the diamond, but carborundum — the wonderful abrasive that will scratch the diamond itself and cut steel as emery does copper.

Send coupon for our 6 months' free trial offer today.

Sending this coupon puts you under no obligations. Fill in your name at once and return coupon now while it is on your mind.

LUTHER GRINDER MFG. CO.
62 Madison Street
MILWAUKEE, WIS.

Foot and Hand Power Equipped with Sharpening Attachments

The special sharpening attachments enable anyone to do the most difficult sharpening, such as sharpening twist drills, chisels, plane bits, etc.

Luther Diamond Tool Grinders are the standard grinders of the world. In addition to their wonderful carborundum wheels, that never need dressing, they are mechanically perfect machines — machine cut spur gears — dust proof and bronze bearings — machined parts run in bath of oil.

In short, a Luther Diamond Tool Grinder will please you by its solid construction, and because it makes it easy to have keen edged tools without drudgery.

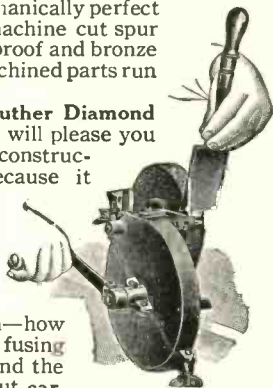

Hand Power Mechanic's Special with Attachment

LUTHER GRINDER MFG. CO.
62 Madison St., MILWAUKEE, WIS.

Please send me free and prepaid your free carborundum booklets and your six months free trial offer on the Luther Diamond Tool Grinder Mechanics' Special.

Name..... Address.....
Dealer's Name..... Dealer's Address.....



An Ideal Lamp for the Office Desk

This is a very popular lamp because it combines, at a moderate price, the utmost practicality with a very pleasing appearance. The standard is in Statuary Bronze, with green relief. Its base, 7 x 9 1-2 in., contains two ink-wells. A pen-rack and a watch (a good time keeper) are attached to standard. The shade is of green plated-glass outside, with white opal glass inside. The lamp lights an area 48 in. wide by 36 in. in front of base. Complete with 6 foot silk connecting cord and plug, price \$18, f. o. b. Chicago.

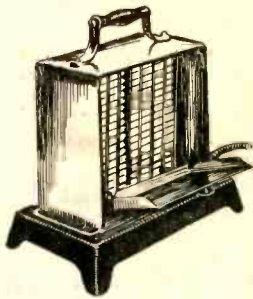
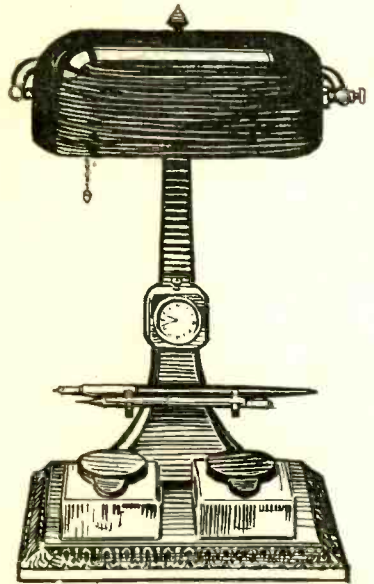

To Make Delicious Toast At the Table

The Electric Toaster is intended for use on the dining table. It toasts bread, two slices at a time, as fast as required for three or four persons. The toast comes out piping hot, crisp and brown outside, tender inside. The cost for electricity is about one cent per dozen slices. Price complete with connecting cord, \$4.80 f. o. b. Chicago. (See foot-note below.)

An Electric Flat Iron Saves Time and Strength

There is no changing of cold irons for hot. No walking back and forth between the range and ironing-board. An Electric iron stays hot; uniformly so from point to heel. Always bright and clean, it does better work than stove heated irons. Can be used in any room, or on the back porch in summer by extending the connecting cord. Price \$4.25, f. o. b. Chicago. (See foot-note below).



Note:—In ordering the Toaster or Flat Iron, ask your Central Station what voltage you should specify.

ELECTRIC SHOP

Michigan and
Jackson Blvds.

CHICAGO